

October 26, 1970

\$1.00 A McGraw-Hill Publication

Signal processing with digital filters 78

Ten ways to use d-a converters 91

Coping with feedthrough in emitter-coupled logic 98

LIBRARY
STATE TECHNICAL INSTITUTE
AT MEMPHIS

Electronics®

**VIETNAM:
THE FIRST
DIGITAL
WAR**

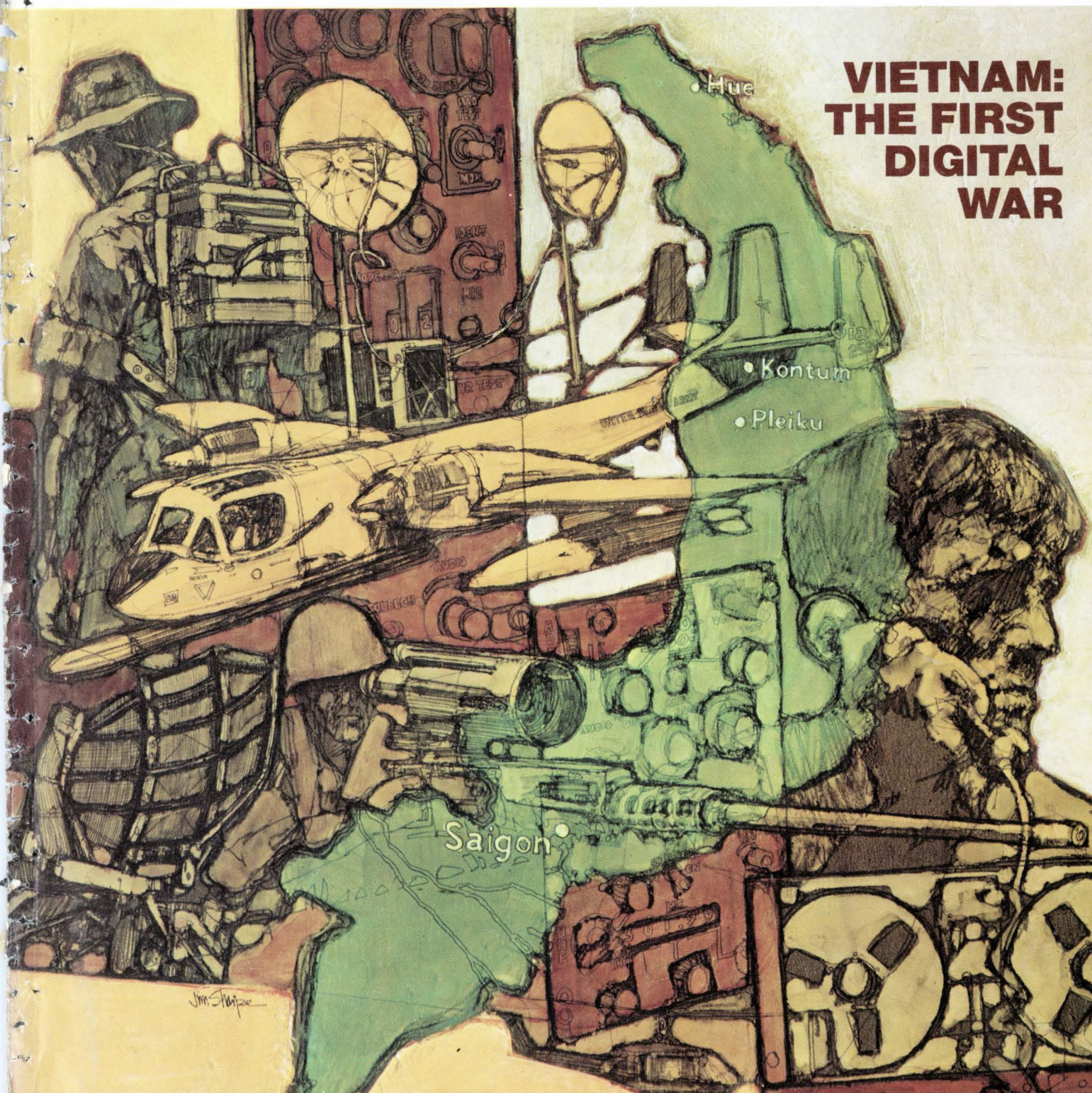

Jim Stimpze

1-MHz CAPACITANCE TESTING now there's a better way

Remember the old RX-meter, Q-meter, and nulling methods of measuring capacitance? What a headache they were to work with! You just couldn't get the speed you needed at 1 MHz!

Now there's a better way: GR's 1682 Automatic Capacitance Bridge — 1-MHz test frequency, 0.1% basic accuracy, and a balance time better than 50 ms — all in one package.

And the 1682 doesn't stop there! The 0.001-pF to 20,000-pF range exceeds the 1-MHz testing requirements of any MIL specs to which you might be obligated. The test fixture doesn't affect accuracy because 0.1% is the basic accuracy at the remote test fixture. Five-digit resolution eliminates uncertainty in the least significant digit. The low voltage on the unknown makes the 1682 ideal for semiconductor junction capacitance and resist-

ance measurements. The 1682 comes with a built-in 0- to 100-V bias supply (or you can use external sources up to 200 V). Plus, 1682 prices start at only \$4200 in the U.S.

With the 1682, you can choose from a variety of test fixtures for axial leads or many common connectors. If you're interested in 100% testing and data logging, add the optional BCD output and remote programmability.

If you're considering an automatic system, ask for our booklet *Automatic Systems for High-Speed Component and Network Measurements* for additional information on the speed, functioning, control, and data-handling capabilities of the 1682 in automated handling and measuring configurations.

Get all the details about the 1682 Automatic Capacitance Bridge at your nearest GR District Office or at 300 Baker Avenue, Concord, Mass. 01742. In Europe write Postfach 124, CH 8034, Zürich, Switzerland.



General Radio

ATLANTA 404 633-8183 / BOSTON 617 646-0850 / CHICAGO 312 992-0806 / CLEVELAND 216 886-0180
DALLAS 214 637-2240 / LOS ANGELES 714 540-9830 / NEW YORK (N.Y.) 212 964-2722 (N.J.) 201 943-3140
PHILADELPHIA 215 646-8030 / SAN FRANCISCO 415 948-8233 / SEATTLE 206 747-9190 / SYRACUSE 315 454-9323
WASHINGTON, D.C. 301 881-5333 / TORONTO 416 262-3396 / ZÜRICH (051) 47 70 20

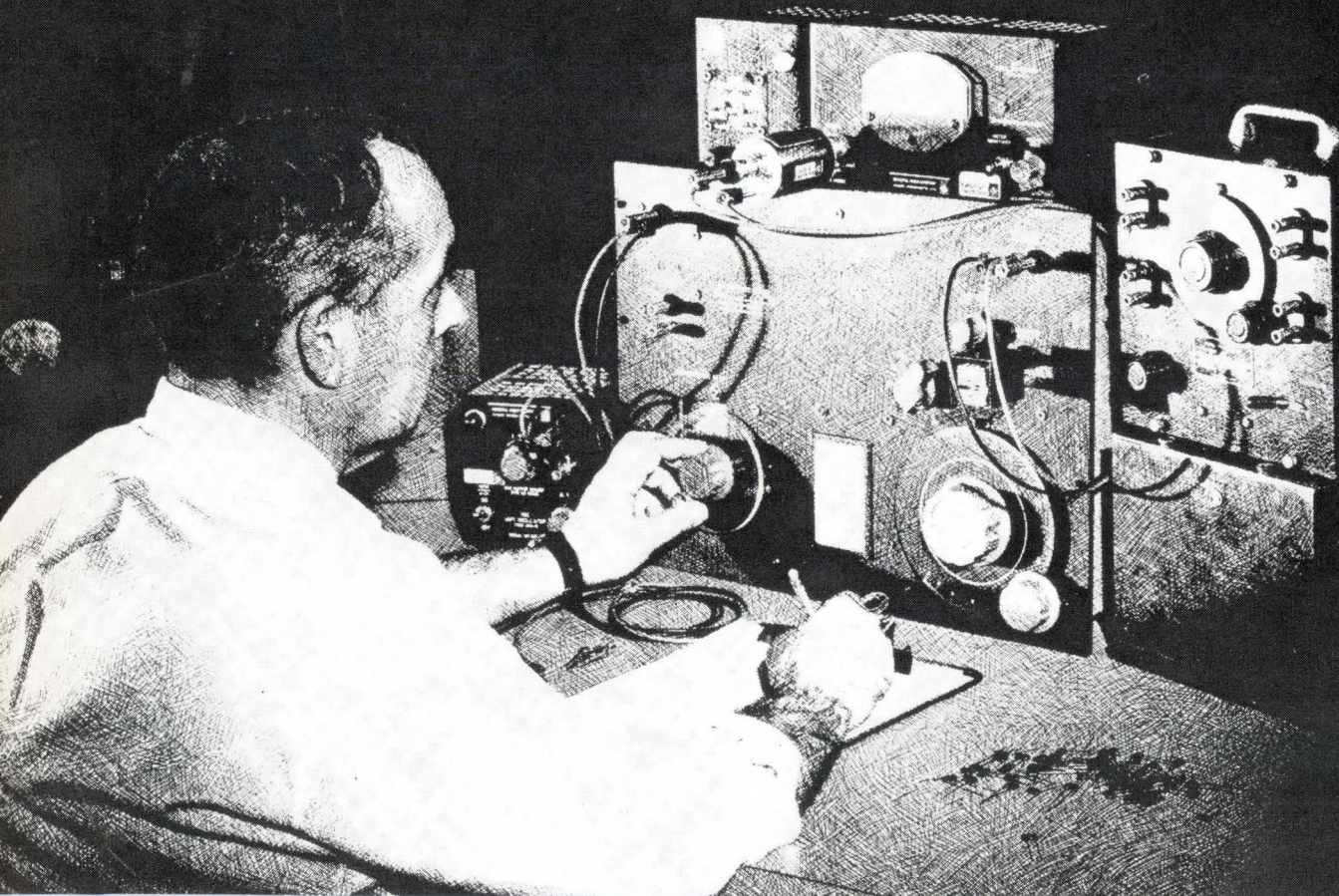

The sweeper with the "think ahead" design



It's here right now. HP's new multiband solid-state sweeper.

Take a look at the front panel and see how unique it really is. Functions are divided up the way you use them: frequency functions around the dial, sweep functions below. You can select frequency band simply by pressing a lever that rotates the dial. This gives multi-octave output from a single RF connector. The plug-in drawer holds the thin-film micro-circuit RF modules.

HP's new 8620A Microwave Sweep

Oscillator gives you exceptional tuning linearity, low noise, low residual FM and high power output along with multiband performance, compact size, programmability, and HP instrument compatibility. In fact, all the performance features you expect in a sweeper are built into this new instrument.

Not only is the 8620A an economical bench sweeper, but its "think ahead" design lets it grow into a sophisticated

multi-octave sweeper system for far less money than you'd expect. A demonstration? Just call your local HP field engineer. Or write to Hewlett-Packard, Palo Alto, California 94304; Europe: 1217 Meyrin-Geneva, Switzerland.

04022

HEWLETT  PACKARD

SWEEP OSCILLATORS



Now your calculator can control your instruments.

You don't have to hand feed data to your calculator any more. Nor control instrument test conditions. Our new HP 2570A Coupler/Controller gives you an inexpensive way to transfer data, automatically, from your instruments to your HP 9100 Calculator. It lets the calculator control your instruments and test stimuli. And record results on a teletypewriter or high-speed punch, as well as the calculator printer and plotter. There's no programming language

to learn—just use the calculator keyboard. Program all instrument functions simply by hitting the "format" key. You get the problem solving conditional programming and system control capabilities of a computer—without computer cost.

Price of this 2570A is only \$1625. Interfaces cost \$450-\$1500 per device. Now your calculator can be the base of a simple, real-time data acquisition and automatic test system. If you don't own an HP calculator all the more reason to

get one. For some revealing cost comparisons, contact your local HP field engineer. Or write Hewlett-Packard, Palo Alto, California 94304; Europe: 1217 Meyrin-Geneva, Switzerland.

06005

HEWLETT  PACKARD
DATA ACQUISITION SYSTEMS

Features

Probing the News

- 109 **Government electronics:** DOD computer waste: \$500 million
- 115 **Computers:** Interface pact gains momentum
- 119 **Solid state:** LSI starts to go standard
- 121 **Military electronics:** Radar of the future?
- 122 **Communications:** Banks moving on paperless payments

Electronics Review

- 39 **Advanced technology:** Ebird has virtues of semiconductor, tube
- 39 **Integrated electronics:** Thin-film cermet solves resistor woes
- 40 **Integrated electronics:** C/MOS, silicon gate combined
- 41 **Commercial electronics:** Photocathode matrix for office copier
- 42 **Commercial electronics:** Bridging the technology gap for students
- 42 **Materials:** GaP ready to compete with cold cathode readouts
- 44 **Solid state:** Spreading resistance probe has light touch
- 44 **Memories:** MNOS for bipolar
- 46 **Lasers:** Cw CO₂ system for radar
- 46 **Employment:** Bay State woes
- 48 **Communications:** Time and frequency phone multiplexing
- 48 **Instrumentation:** IC wafers probed at 2 GHz

Electronics International

- 159 **Japan:** Anti-skid control modulates braking force
- 160 **France:** Atomic clock takes wing
- 160 **Japan:** More MAOs FETs
- 161 **Great Britain:** On pcm converters
- 162 **West Germany:** Solid state radio frequency display

New Products

- 127 **In the spotlight**
- 127 Reed relays swing to DIP
- 130 **Microwave review**
- 130 Transistors are job-specified
- 135 Analog phase shifters fit pc cards
- 137 **Instruments review**
- 137 Digital panel meters are versatile
- 141 **Data handling review**
- 141 Shift register is programmable
- 145 **Semiconductor review**
- 145 IC regulator offers dual polarity
- 146 Single chip holds LED circuits
- 148 Off-the-shelf MSI multiplexer

Title R registered U.S. Patent Office; © copyright 1970 by McGraw-Hill Inc. All rights reserved, including the right to reproduce the contents of this publication in whole or in part.

Articles

- Military electronics** 70 **Air Force plans with computers, Army sees by starlight**
In the first digital war, computerized command and control system directs bombing missions and night vision gear guides firepower for Army's air armada

- Communications** 78 **Programmable digital filter performs multiple functions**
Software changes enable a sampled-data filter to meet highpass, lowpass, bandpass or other requirements with high accuracy

- Circuit design** 86 **Designer's casebook**
 - Pulse generator uses digital ICs
 - Voltage monitor is easy on both battery and budget
 - Optical biasing maintains phototransistor sensitivity
 - Thermistor stabilizes Gunn oscillator

- Components** 91 **Putting d-a converters to work: 10 examples show versatility**
Devices provide interface for systems with analog inputs and outputs, permitting simple and accurate digital processing suitable for broad range of operations and functions

- Solid state** 98 **Coping with feedthrough in ECL ICs**
Certain unwanted capacitances in high-speed logic circuits are liable to produce spurious signals; the engineer must know how to design around them

- Departments**
 - 4 About the issue
 - 6 Readers Comment
 - 14 Meetings
 - 22 Who's who in electronics
 - 33 Electronics Newsletter
 - 59 Washington Newsletter
 - 152 Technical Abstracts
 - 154 New Literature
 - 157 International Newsletter

EDITOR-IN-CHIEF: Kemp Anderson

EXECUTIVE EDITOR: Samuel Weber

MANAGING EDITORS: Robert Henkel, News;
Arthur Erikson, International

SENIOR EDITORS: H. Thomas Maguire,
Stephen E. Scrupski

ASSOCIATE EDITORS: William Bucci, Richard
Gundlach, John Johnsrud, Howard Wolf

DEPARTMENT EDITORS

Communications & Microwave: Leon M. Magill;
Components: George F. Watson; *Computers:*
Wallace B. Riley; *Consumer:* Gerald M. Walker;
Industrial Electronics: Alfred Rosenblatt;
Instrumentation: Owen Doyle; *Military/*
Aerospace: Herman Lowenhar; *New*
Products: H. Thomas Maguire (Mgr.),
William P. O'Brien, George Weiss; *Packaging*
& Production: Stephen E. Scrupski;
Solid State: Laurence Altman

COPY EDITORS: William S. Weiss, Chief;
Margaret Eastman

ART: Fred Sklenar, Director
Charles D. Ciatto, Assistant Director

PRODUCTION EDITORS: Susan Hurlburt,
Arthur C. Miller

EDITORIAL SECRETARIES: Claire Goodlin,
Vickie Green, Terri O'Neil,
Bernice Pawlak, Patricia Ritter

FIELD EDITORS

Boston: James Brinton (Mgr.), Gail Farrell;
Los Angeles: Lawrence Curran (Mgr.);
New York: Peter Schuyten (Mgr.); *San*
Francisco: Stephen Wm. Fields (Mgr.),
Marilyn Howey; *Washington:* Ray Connolly
(Mgr.), Jim Hardcastle, Lois Vermillion;
Frankfurt: John Gosch; *London:* Michael
Payne; *Paris:* Arthur Erikson; *Tokyo:*
Charles Cohen

McGraw-Hill WORLD NEWS

Director: Walter A. Stanbury; *Atlanta:* Stan
Fisher; *Chicago:* Robert E. Lee; *Cleveland:*
Arthur Zimmerman; *Dallas:* Marvin Reid;
Detroit: James Wargo; *Los Angeles:* Michael
Murphy; *San Francisco:* Margaret Drossel,
Tyler Marshall; *Seattle:* Ray Bloomberg;
Washington: Charles Gardner, James Canan,
Herbert W. Cheshire, Seth Payne, Warren
Burkett, William D. Hickman; *Bonn:* Robert F.
Ingersoll; *Brussels:* James Smith; *London:*
Marvin Petal; *Milan:* Jack Star; *Moscow:*
Axel Krause; *Paris:* Robert E. Farrell, Stewart
Toy; *Tokyo:* Mike Mealey

PUBLISHER: Dan McMillan

ASSISTANT TO THE PUBLISHER: Wallace C.
Carmichael

PLANNING & DEVELOPMENT MANAGER:
Donald Christiansen

ADVERTISING SALES MANAGER: Pierre Braudé

CIRCULATION MANAGER: George F. Werner

RESEARCH MANAGER: David Strassler

PROMOTION MANAGER: Tomlinson Howland

ADVERTISING SALES SERVICE MANAGER:
Wallis Clarke



All the pitched battles were in Cambodia when Arthur Erikson, managing editor, international, was making his reporting rounds in Saigon and Da Nang for the Vietnam report [page 70]. But the Viet Cong managed to demonstrate for Erikson that it can still deliver isolated wallops anywhere in South Vietnam, even at big U.S. bases.

"The first time," Erikson writes, "it was mildly diverting. I was at Da Nang talking old times with a Los Angeles Timesman I'd known in Europe. Suddenly we heard a far-off tat-tat-tat of machine-guns, and the pulump of artillery.

"He'd been at Da Nang several days and the change of background noise didn't seem to faze him. But I went outside to see if there was anything to see. There was. Salvos of star shells lit up a spit of land across the bay, where the Viet Cong apparently had probed somebody's perimeter.

"It was a bizarre scene, a vignette of the bizarre war in Vietnam. The press compound is right on the

bay and the Army shows a movie outdoors there. The star shells kept blossoming in the sky for about an hour, but the press people paid no attention while the show was on. A half-mile away, people were getting shot at.

"The second time, they were much less blase. Later that evening the half-dozen reporters there had drifted into the quarters of the resident Marine Corps combat artist, where a party was under way. A Marine lieutenant had launched into an emotional account of how his platoon had lost several men in ambushes. Then a solid whump shook the compound. I hit the deck a millisecond after the Marine lieutenant, but after all he's had more training at that sort of thing.

"The next day we learned the Viet Cong had fired a salvo of rockets, presumably at the air base about a mile-and-a-half away. None had come close to the target, the Army insisted, but one of the strays had smacked in about 200 yards from the compound."

October 26, 1970 Volume No. 43, Number 22—89,245 copies of this issue printed

Published every other Monday by McGraw-Hill, Inc. Founder: James H. McGraw 1860-1948. Publication office 330 West 42nd N.Y., N.Y. 10036; second class postage paid at New York, N.Y. and additional mailing offices.

Executive, editorial, circulation and advertising addresses: Electronics, McGraw-Hill Building, 330 W. 42nd Street, New York, N.Y. 10036. Telephone (212) 971-3333. Teletype TWX N. Y. 710-581-4235. Cable address: MCGRAWHILLN.Y.

Subscriptions limited to persons with active, professional, functional responsibility in electronics technology. Publisher reserves the right to reject non-qualified requests. No subscriptions accepted without complete identification of subscriber name, title or job function, company or organization, including product manufactured or services performed. Subscription rates: qualified subscribers in the United States and possessions and Canada, \$8.00 one year, \$12.00 two years, \$16.00 three years; all other countries \$25.00 one year. Limited quota of subscriptions available at higher-than-basic rate for persons outside of field served, as follows: U.S. and possessions and Canada, \$25.00 one year; all other countries \$50.00. Air freight service to Japan \$60.00 one year, including prepaid postage. Single copies: United States and possessions and Canada, \$1.00; all other countries, \$1.75.

Officers of McGraw-Hill Publications Company: Joseph H. Allen, President; John R. Emery, J. Elton

Tuohig, Senior Vice Presidents; Donald B. Gridley, Group Vice President; Vice Presidents: Ralph Blackburn, Circulation; John R. Callahan, Editorial; William P. Giglio, Administration; David G. Jensen, Manufacturing; Jerome D. Luntz, Planning & Development; Joseph C. Page, Marketing; Robert M. Wilhelm, Finance.

Officers of the Corporation: Shelton Fisher, President and Chief Executive Officer; John J. Cooke, Senior Vice President and Secretary; Gordon W. McKinley, Vice President and Treasurer.

Title registered in U.S. Patent Office. © Copyright 1970 by McGraw-Hill, Inc. All rights reserved. The contents of this publication may not be reproduced either in whole or in part without the consent of copyright owner.

Subscribers: The publisher, upon written request to our New York office from any subscriber, agrees to refund that part of the subscription price applying to copies not yet mailed. Please send change of address notices or complaints to Fulfillment Manager; subscription orders to Circulation Manager. Electronics at address below. Change of address notices should provide old as well as new addresses, including postal zip code number. If possible, attach address label from recent issue. Allow one month for change to become effective. Postmaster: Please send form 3579 to Fulfillment Manager, Electronics, P.O. Box 430, Hightstown, N.J. 08520.

Best for Hybrid Circuits...

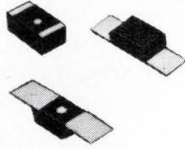

PIPS OF CHIPS

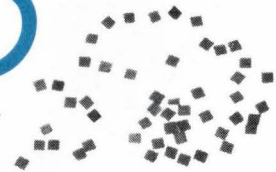

DOMINO[®] Molded

Solid-electrolyte Tantalum Capacitors

Designed for hybrid circuit and low-profile flatpak printed circuit board applications. Fully-molded construction for superior mechanical and humidity protection. Excellent stability. Compatible with automatic insertion equipment. Available with and without extended tab terminals.

Write for Engineering Bulletin 3532.

Circle 517 on reader service card

Technical Literature Service
Sprague Electric Company
35 Marshall Street
North Adams, Mass. 01247

MONOLYTHIC[®]

Chip Ceramic Capacitors

Offer a unique combination of high volumetric efficiency, wide selection of capacitance ranges and body formulations, and moderate cost. Excellent adherence of metallized terminations eliminates problems often encountered with other chip ceramic capacitors. Available in four EIA-preferred chip sizes.

Write for Engineering Bulletin 6200.

Circle 518 on reader service card

45-0148

SPRAGUE[®]
THE MARK OF RELIABILITY

THE BROAD-LINE PRODUCER OF ELECTRONIC PARTS

The ideal way to handle low frequency, high voltage capacitor requirements.

These Lapp Capacitors are precision-built to give years of accurate, trouble-free service. They are offered in both fixed and variable models and all are external safety-gap equipped to protect against internal flashover.

Skillful Lapp design has made our capacitors small in size and low in cost. High current and high capacitance applications are also easily handled. Available with water cooling for extra high current.

Current ratings are available up to 400 amps at 1 MHz, capacitance up to 30,000 picofarads and safety gap settings to 85 Kv peak. Let us send you complete information.

Lapp Insulator Division,
INTERPACE Corporation,
LeRoy, N.Y. 14482.

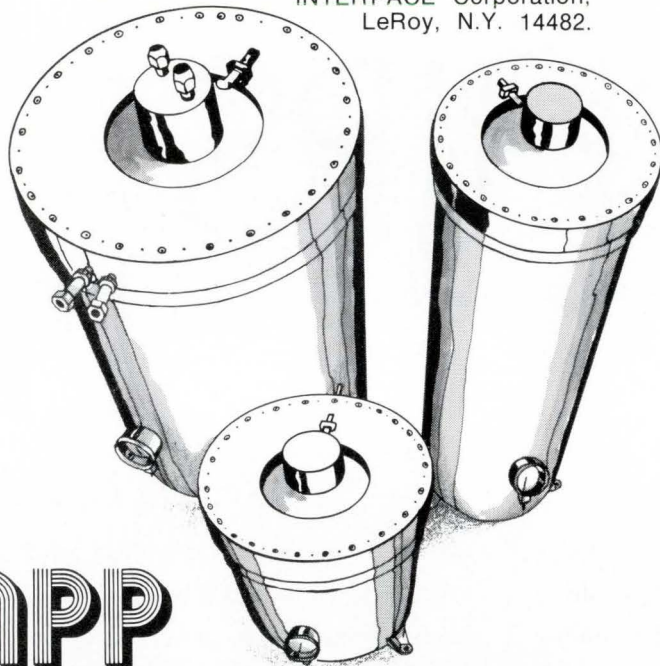

LAPP GAS-FILLED CAPACITORS

Lapp

INTERPACE
CORPORATION

Readers comment

Making contact

To the Editor: I read with interest the August 31 edition which carried Stephen Scrupski's article "Point-to-point wiring gains new popularity among DIP users" [p. 56]. I agree that wire-wrapped DIP sockets have much to be gained in prototype and one-shot applications, but the article belabors the technical advantage of wire-wrap as an interconnection media. There are few doubts concerning the reliability of wire-wrap; a look at the ratings applied to wrapped vs. soldered connections for MTBF calculations establishes that. The real reliability question concerns the 14 or more-DIP leads making contact with the socket. These are almost always dissimilar metals, the socket usually gold plated, the DIP a variety depending upon manufacturer, type, time, and a host of other variables. This is the area that concerns us in the use of DIPs in sockets, and is the key to their use. Perhaps it's difficult to get data on and it was deleted.

Roger C. Cady
PDP-11 engineering manager
Digital Equipment Corp.
Maynard, Mass.

Automatic answering

To the Editor: In the article on the Bell System's data sets ["Modem race," Aug. 31, p. 42], the following statement is made: "[The 113B] is designed to replace the 103E station for the user who doesn't require features such as call-out and automatic answering."

While it is true that call originating capability is not presently included, automatic answering is a built-in feature of the 113B.

Lewis H. Mammel
Bell Laboratories

Wrong side

To the Editor: In the Designer's Casebook I authored [Sept. 28, p. 78] I noted that in the circuit diagram, the connection of the -15 V to resistor R_1 was put on the wrong side of R_1 .

Robert P. Patterson
University of Minnesota

Which 5-digit multimeter is your best buy?



The new S-D 7005 offers five-digit resolution and accuracy. Designed for top performance in actual laboratory use.

Price: \$1,295.

S-D just introduced it.

Prove it to yourself. Ask these questions in evaluating any competitive DVM:

Does the basic DVM include **four dc ranges** from 1 V full scale to 1,000 V full scale?

Can all **optional functions** be added by means of individual cards at any time? (Auto-ranging, AC volts, DC millivolts, ohms, DC current and digital outputs?)

Is the **input impedance** greater than 10,000 megohms on 1 V and 10 V ranges? Is **feedback noise** at the input terminals less than 1 mV? Is full scale **response time** less than 400 millisecs?

Does the unit use **dual slope integration** for max noise immunity at line frequencies? Are **plug-in cards** used for easy maintainability of all measurement circuitry?

Does it have an **annunciator** to remind you what measurement you're making? Are its **digital outputs** compatible with both IC logic and discrete component logic?

The S-D 7005 offers all these features and more for just \$1,295. Request technical data or a demonstration from your local Scientific Devices office or contact: Concord Instruments Division, 888 Galindo St., Concord, California 94520. Phone: (415) 682-6161. TWX: 910-481-9478.

SYSTRON  **DONNER**

Another S-D instrument first! Electronic counters/Digital voltmeters/Pulse generators/Data generators/Time code generators/Sweep generators/Spectrum analyzers/Digital panel meters/Digital clocks/Signal generators/Oscillators/Laboratory magnets/Precision power supplies/Analog & analog-hybrid computers/Data acquisition systems.

A top-down view of numerous microprocessors scattered across a white surface. The chips are dark grey or black, with white markings and gold-plated pins. They are arranged in a somewhat circular pattern around the central text.

THE

END

**CORES LOSE
PRICE WAR
TO NEW CHIP**

ASK INTEL FOR

 **PROOF** 

Intel introduces Type 1103, a history-making 1024-bit RAM made by our silicon-gate MOS process at such high yields that the cost dips below cores.

Just tell us what core memories cost you, and we'll tell you how to build operational Type 1103 memories for less cost in any size from 50,000 bits to 10,000,000 bits.

The Intel 1103 makes a fully assembled memory system that has a maximum access of 300 nanoseconds and a total cycle time of 600 nanoseconds. The chip is fully decoded and dissipates only 100 microwatts per bit, permitting dense packing in compact configurations.

For proof of the cost advantage, phone your Intel representative or call us collect at (415) 961-8080. For immediate delivery phone your local Intel distributor, Cramer Electronics or Hamilton Electro Sales. If your distributor isn't stocked, call Intel collect for immediate same-day shipment.

Intel Corporation is in high-volume production at 365 Middlefield Road, Mountain View, California 94040.

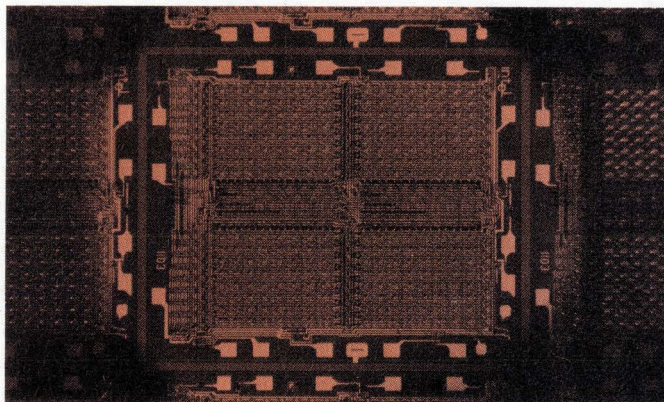

intelTM
delivers.

Circle 9 on reader service card

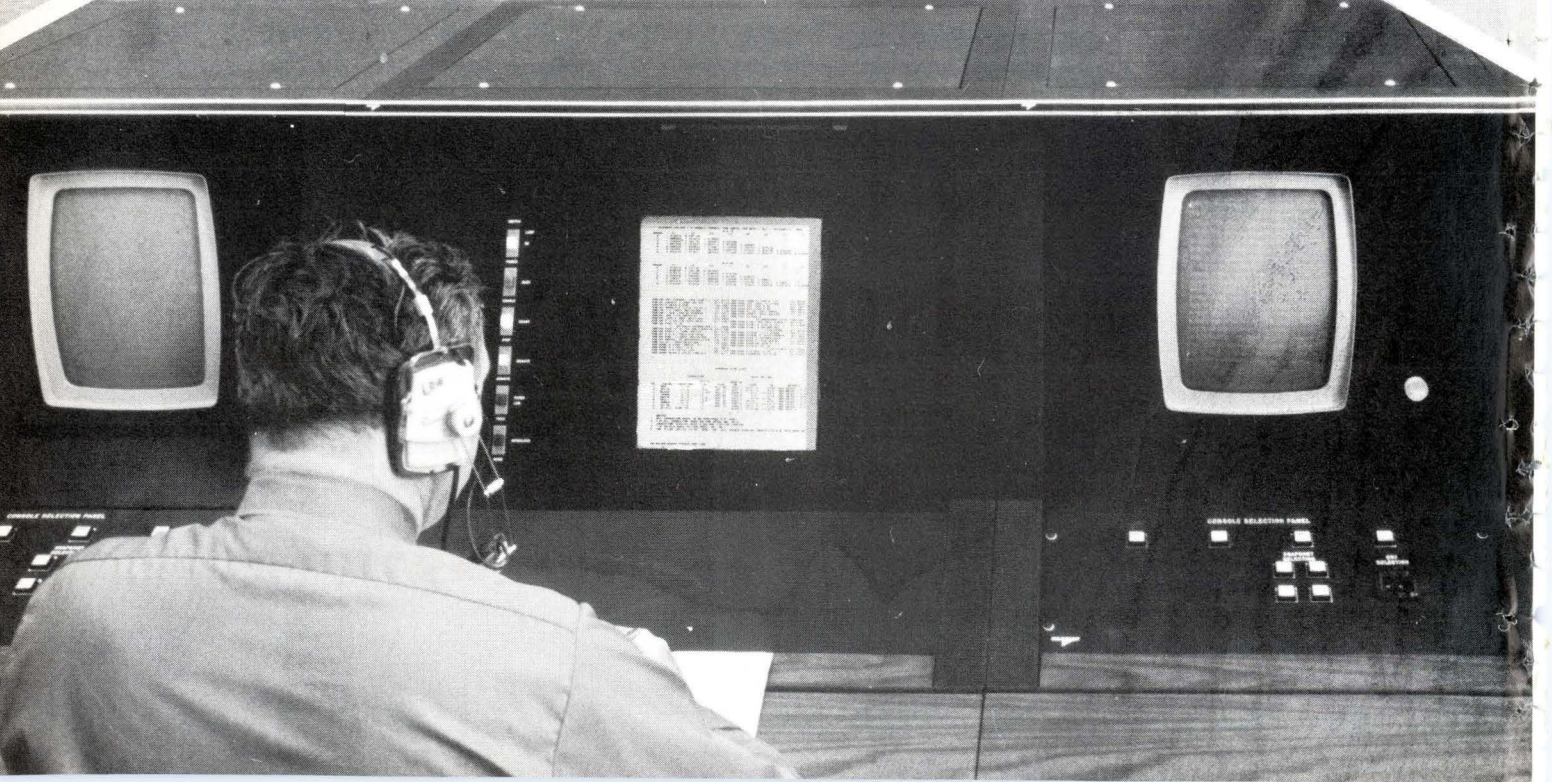
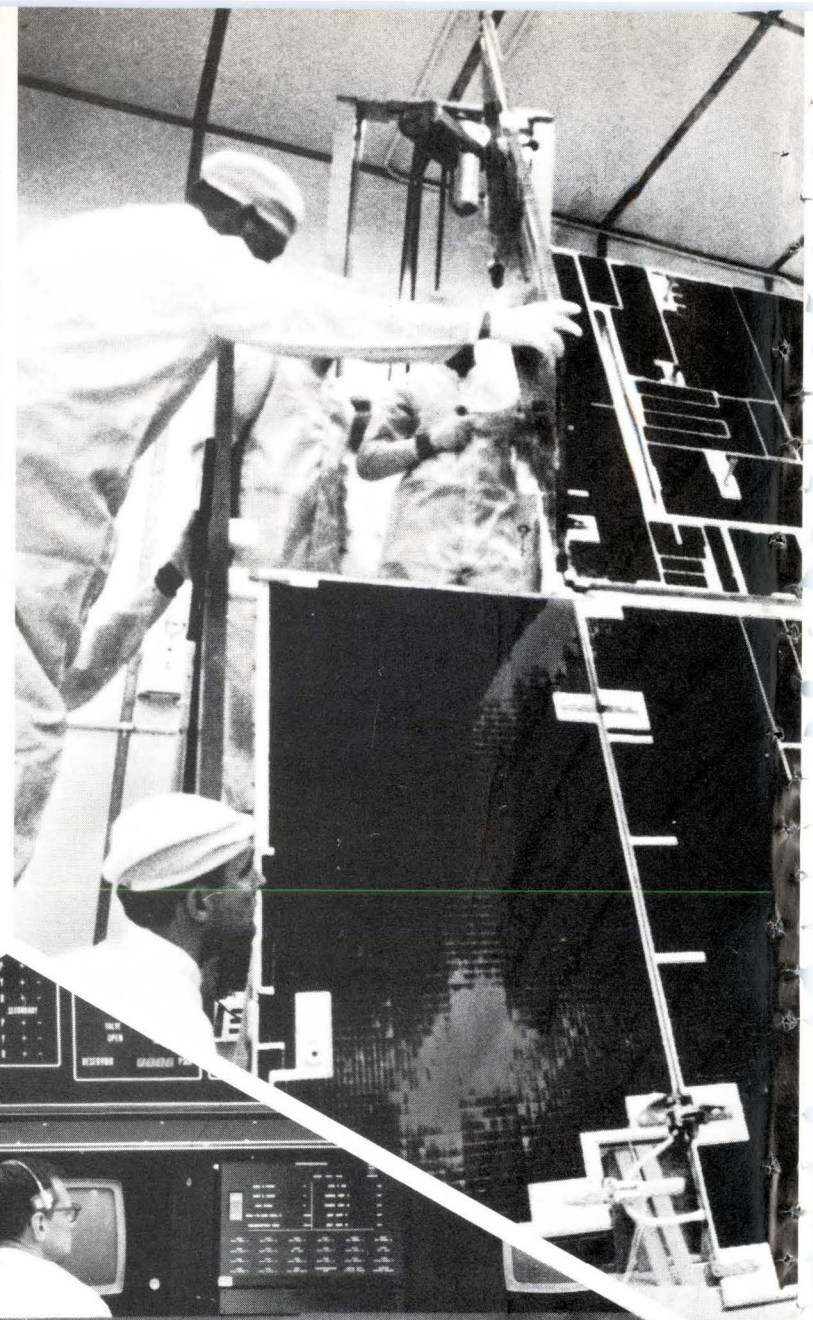
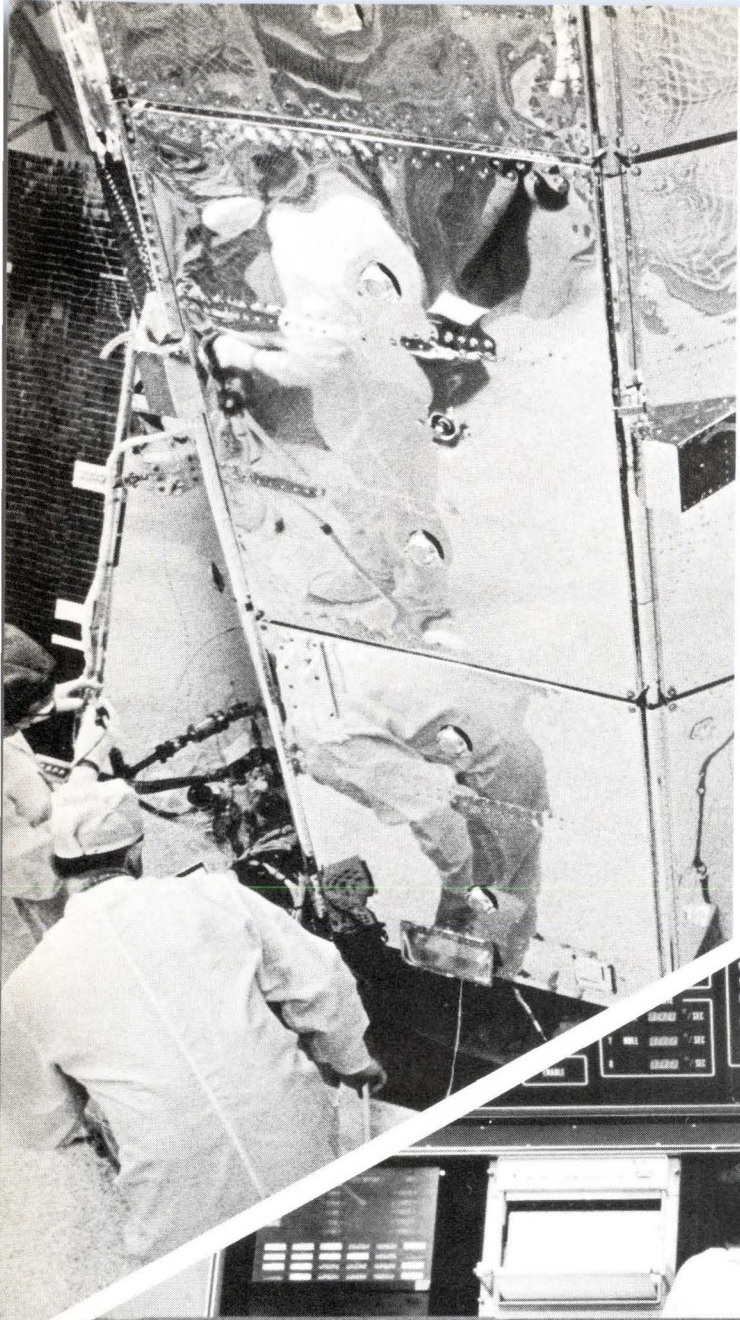

When the Goddard Space Flight Center wrote their specs for a hardcopy printer, they wound up with a choice of one.

They didn't mean to. It just turned out that way.

Because of all the printers around, the Gould 4800 was the only printer which could give the Goddard people all they asked for.

Speed Goddard asked for 1000 lines per minute. The 4800 will whip out 4800.

Silence Goddard planned to put their printer right in their on-line control room. And weren't about to put up with a noisy impact printer. With the Gould 4800, they don't have to. It's electrostatic. And very quiet.

Printout Width Goddard wanted a full 80 columns wide. The Gould 4800 provides it.

On convenient 8½" wide paper.

The Goddard people also were impressed by several other important factors:

alphanumerics and graphics — the Gould 4800 delivers words and pictures,

simultaneously, direct from computer output; *permanent paper* — special,

high-contrast, won't curl, get yellow or brittle . . . you can write on

it with anything; *reliability* — smooth, quiet, impact-free operation means less wear and tear on parts, less maintenance, little downtime; *versatility* — Gould 4800 generates wide variety of fonts, from smallest matrix on up, in many weights, sizes and faces. It can be integrated into a console set-up (see Goddard installation photo on opposite page) or used independently as shown below. One more thing: The Gould 4800 is priced at or below printers that can't come close to the performance. So the Goddard people not only got quite a lot more than they bargained for. They also got quite a bargain.

Talk to your computer people about the Gould 4800. Then talk to us about a demonstration.

We're ready whenever you are.

Gould Inc., Graphics Division, 3631 Perkins Avenue, Cleveland, Ohio 44114.

 **GOULD**

Gould 4800. The next generation of high-speed printers.

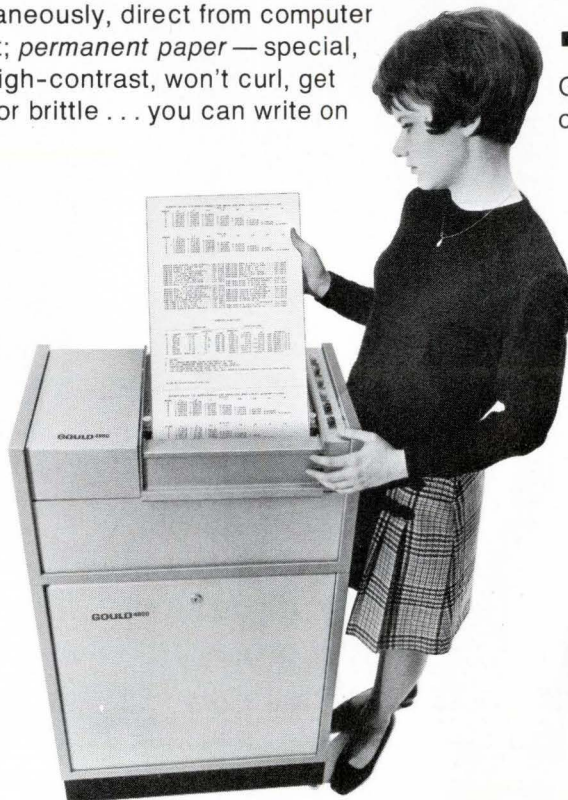

National m popular devi Signetics and put together.

What do we mean by popular? We mean popular: National makes all the bipolar digitals, linears, hybrids, transistors and J-FETS most companies use most of the time. And we make them in all the popular packages.

Who determines our line? Our customers. Primarily systems designers. Guys with common needs and custom needs. We fill the common needs with the devices we all know and love. And, we find a way to turn custom problems

into more common solutions. Which means we wind up with most of the devices you're most likely to put on your own parts list.

Which makes us the logical first stop when you've got a new list of parts to buy.

Or, if you already have a good first source, give us a shot at seconds.

When you use National **National.** as a second source, you don't have to shop around for a third source.

akes more ces than TI, Fairchild

Bipolar Digital Circuits			Linear			Hybrids	Discrete Devices
TTL	MSI	DTL	Amplifiers	Comparators & Sense Amps	Regulators		
54N (T.I.)	Popular 7400 (T.I.)	830 (Mot)	703 (FSC)	710 (FSC)	723 (FSC)	SH2001 (FSC)	Jan TX types
74N (T.I.)	Popular 9300 (FSC)	930 (FSC)	709 (FSC)	711 (FSC)		SH2002 (FSC)	Industrial (T.I.)
54LN (T.I.)	Popular 8200 (Sig.)		741 (FSC)	SN5520 Series (T.I.)		SH2200 (FSC)	Consumer (Mot)
74LN (T.I.)			747 (FSC)	SN7520 Series (T.I.)			J-Fets (Mot)
74H (T.I.)			748 (FSC)				
54J (T.I.)			CA3028 (RCA)				
54L (T.I.)							

**To be a good second source, you
have to be a good first source.**

RCL SWITCH INFORMATION CENTER

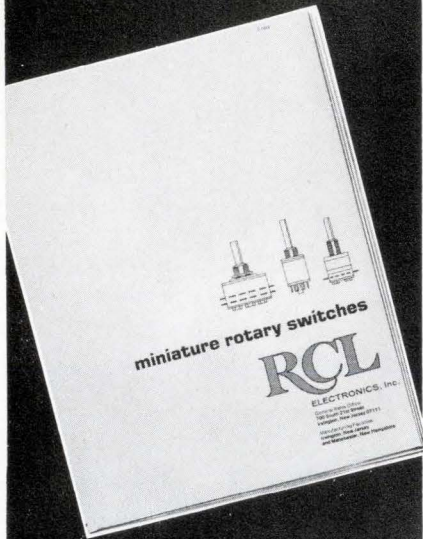

AN EASY-TO-READ
NEWLY EXPANDED
TECHNICAL CATALOG OF
INDUSTRY'S MOST
COMPLETE SELECTION
OF

MINIATURE ROTARY SWITCHES

WRITE FOR YOUR FREE COPY

RCL

General Sales Office
RCL ELECTRONICS, INC.
700 South 21st Street
Irvington, New Jersey 07111

Bright picture

The gamut of display device technology—from the workhorse cathode ray tube to the latest in photochromics—will be run through at the IEEE Conference on Display Devices to be held Dec. 2 and 3 at the United Engineering Center in New York. Two invited speakers will present their views on general interest subjects. Stephen W. Miller of Stanford Research Institute will gaze into the crystal ball to predict "Display Requirements for Future Man/Machine Systems," and Sydney Feinlieb of Arthur D. Little Inc. will examine the present and future market potential for display devices in a talk called "The Business of Displays."

Rapidly developing—and to some extent, competing—display devices will be surveyed in two other invited papers. D.G. Thomas of Bell Laboratories, in "Light-Emitting Diodes," will evaluate and compare the various approaches (such as GaAsP, GaP, and GaAs with phosphor coating) to fabricating these semiconductor devices. H.G. Slottow of Owens-Illinois Inc. will speak on a controversial glow-discharge display technique in "The Plasma Display Panel—Principles and Prospects." In another invited paper, "The Cathode Ray Tube—a Review of Current Technology and Future Trends," Peter Seats of Thomas Electronics Inc. will show that the familiar device is far from obsolescent.

Others papers will delve into subjects ranging from materials for display devices ("Phosphors for Current-Sensitive Single-Gun Polychromatic Cathode Ray Tubes," by F.J. Avella of General Telephone & Electronics Laboratories, and "Orientation and Thickness Dependence of Contrast and Brightness in $Gd_2(MoO_4)_3$ Light Valves," by A.R. Kmetz of Texas Instruments), through theoretical considerations ("Energy Transfer in a Fiber-Optic Ultraviolet Cathode Ray Tube," by J.J. Pucilowski and E.B. Schlam of the U.S. Army Electronics Command).

For further information contact Thomas Henion, Palisades Institute, 201 Varick Street, New York, N.Y. 10014.

Calendar

Society of Engineering Science Meeting, George Washington University; Washington, **Nov. 9-11.**

International Congress on Microelectronics, International Electronics Group; Munich Fairgrounds, Germany, **Nov. 9-11.**

Symposium on Man-Machine Systems, IEEE; Langford Hotel, Winter Park, Fla., **Nov. 12-13.**

Symposium on Communications, IEEE; Queen Elizabeth Hotel, Montreal, Canada, **Nov. 12-13.**

Magnetism and Magnetic Materials Conference, IEEE; Diplomat Hotel, Hollywood Beach, Fla., **Nov. 15-19.**

Fall Joint Computer Conference, IEEE; Astro Hall, Houston, **Nov. 17-19.**

Short courses

Electronic Methods of Precision Positioning at Sea, University of California at Los Angeles, University Extension; Boelter Hall, Room 2444, **Nov. 9-13**; \$310 fee.

Metal and Ceramic Matrix Composites, University of California at Los Angeles, University Extension; Boelter Hall, Room 4442, **Nov. 9-13**; \$310 fee.

Active Filter Design, George Washington University; Washington, **Dec. 14-16**; \$215 fee.

Call for papers

Conference on Computers for Analysis and Control in Medical and Biological Research, IEE; University of Sheffield, England, Sept. 7-9, 1971. **Nov. 5** is deadline for submission of synopses to IEE Conference Dept., Manager, Savoy Place, London WC2R OBL.

International Symposium on Electromagnetic Compatibility, IEEE; Bellevue Stratford Hotel, Philadelphia, July 13-15, 1971. **Dec. 14** is deadline for submission of summaries to F. Haber, chairman, Technical Papers Committee, Moore School of Electrical Engineering, University of Pennsylvania, Philadelphia, Pa. 19104.

International Symposium on Remote Sensing of Environment, University of Michigan; Ann Arbor, May 17-21, 1971. **Dec. 15** is deadline for submission of summaries to The Center for Remote Sensing Information and Analysis, Willow Run Laboratories, P.O. Box 618, Ann Arbor, Mich. 48107, Attn: Jerald J. Cook.

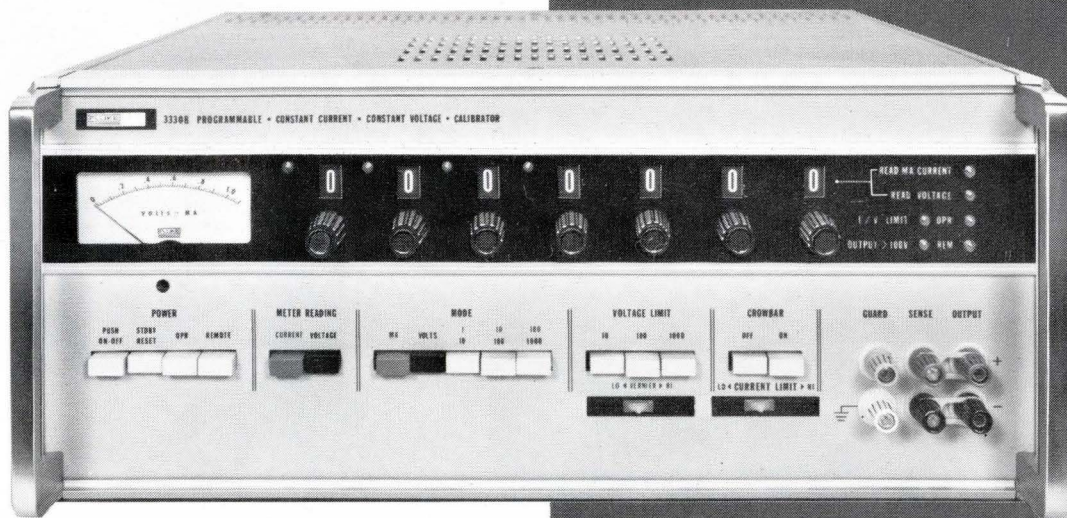

For the engineer whose responsibility is checking out incoming precision components, the new Fluke 3330B Programmable Constant Current/Voltage Calibrator will shorten your day and heighten your nights. For the first time, computer programmed checkout over a wide range of voltages and currents is available with an off-the-shelf low priced quality instrument.

The Fluke 3330B is unique. It can be operated in either a constant current or constant voltage mode. Modes can be changed without turning the unit off. Voltage range is 0 to 1000 volts in three ranges with 10% overranging. Voltage accuracy is $\pm 0.003\%$. Resolution is 0.1 ppm. Stability is 15 ppm per month. Line and load regulation are 2 ppm of range. Ripple and noise are less than 60 μV . Voltage trip is adjustable from 1 v to 1000 v. Output current is 100 ma in the 10 and 100 v ranges and 50 ma in the 1000 v range.

In the constant current mode, ranges are 0 to 100 ma in three ranges with 10% overranging. Accuracy is $\pm 0.006\%$. Resolution is 1 ppm. Stability is 30 ppm/month. Line and load are 2 ppm of range. Compliance voltage is 1000 volts on the 1 and 10 ma ranges and 500 volts on the 100 ma range.

Crowbar effect through a programmable relay shorts output to limit voltage while changing loads.

Programmable functions are output range, mode, level and polarity, voltage and current limit, crowbar, and standby/operate. Programming time is tens of milliseconds. Price is \$3,495.

For full details write or call us today.

Fluke, Box 7428, Seattle, Washington 98133.
Phone: (206) 774-2211. TWX: 910-449-2850.

In Europe, address Fluke Nederland (N.V.), P.O. Box 5053,
Tilburg, Holland. Phone: (04250) 70130. Telex: 884-50237.
In the U.K., address Fluke International Corp., Garnett Close,
Watford, WD2 4TT. Phone: Watford 27769. Telex: 934583.

PRECISION TESTING AND CALIBRATION MADE EASY...

or how the new Fluke
programmable constant
current, constant
voltage calibrator goes
to work calibrating
and testing precision
instruments, semi-
conductors, resistors
and
sub-assemblies.

Enroll now in the Magnetics Technology Center

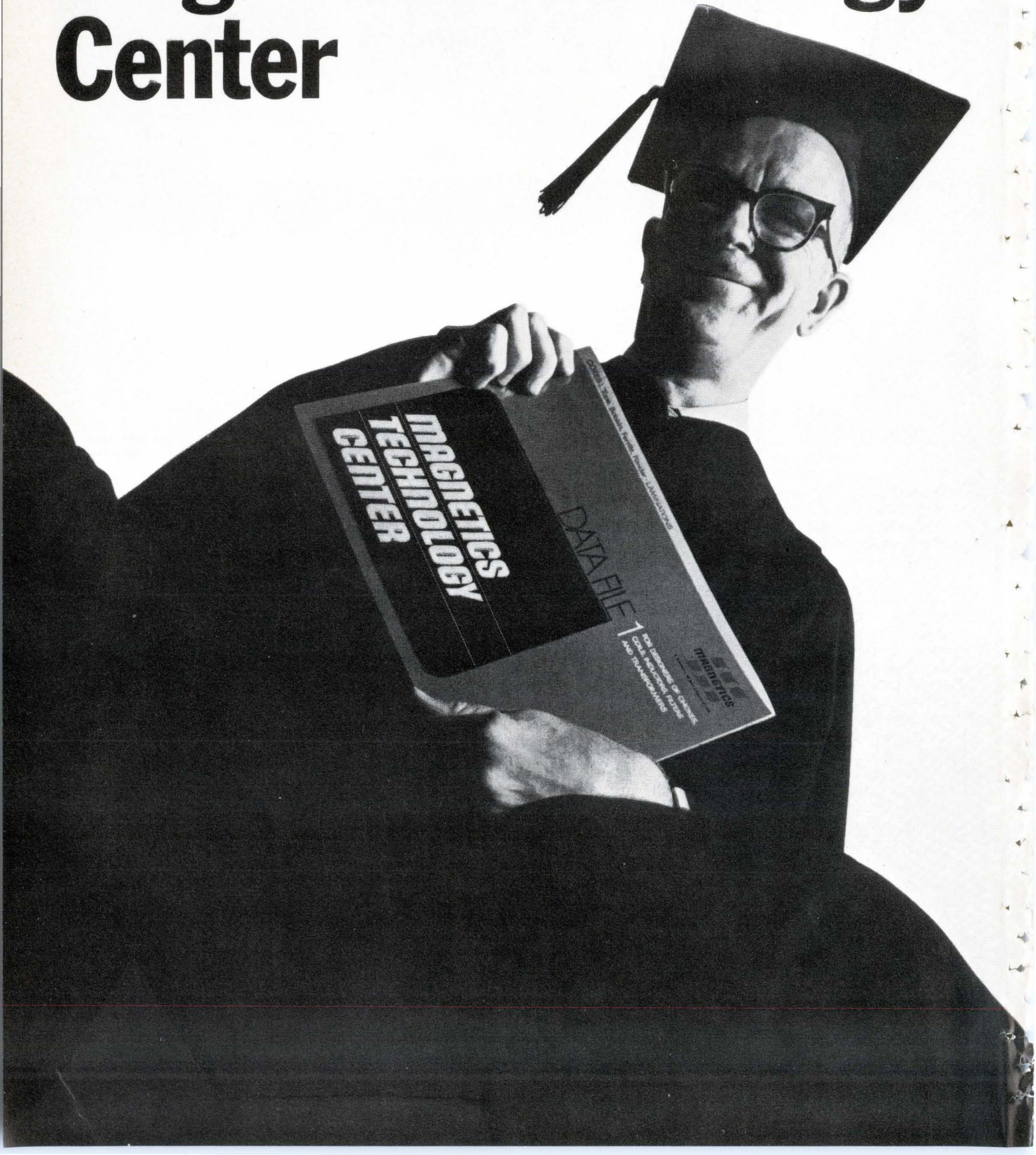

Magnetics introduces a post-grad center that keeps you up to date on the state of the art in magnetic materials. No campus; no fee; texts free. You learn on your own time.

We don't pretend to be scholars behind ivy-covered walls. We are a group of inquisitive specialists with interests in electronics, electrical engineering, physics, metallurgy and related fields. We work with low and high permeability magnetics, ferrites and photo-chemically machined metals. Some of us have spent over 20 years here at Magnetics developing theories and putting them to practical use.

Now we'd like to share with you what we've learned—through a curriculum that no undergraduate school to our knowledge now offers. (Sure, we have another purpose. We believe that as people learn what our products can do, the more these products will be used in future commercial applications. If today we give you the kind of information that will help you do a better job, it seems reasonable to assume you may give us an order someday.)

So we invite you to enroll now in our newly created Magnetics Technology Center. It exists as a repository of what is known about magnetic materials. It intends to spread this knowledge freely—and broadly. It seeks engineers interested in learning more about this field. It welcomes both recent graduates and those who have been involved in design and application for some time. We intend to gear

our programs to your needs.

As an enrollee in the Magnetics Technology Center you will receive without obligation a continuing flow of printed material. You may have received some of this in previous years, but the bulk will be new material developed especially for our Center. Among the items:

1) Magnetics Technology Center Study Courses on such subjects as:

- Ferrites versus magnetic materials
- Photo-chemically machined parts
- Reducing magnetic circuit size and response time
- Ferrites in transformer design
- Proper selection of cores for saturating transformers

2) Magnetics Technology Center Data Bank Files for designers of chokes, coils, inductors, filters, magnetic amplifiers, converter-inverter transformers and electronic transformers

3) Magnetics Technology Center news, at regular intervals, on advances in magnetic materials, applications, etc.

4) Magnetics Technology Center Annual Bibliography of important papers and articles on magnetic science technology

Enroll now. No tuition. No tests.

No campus. Merely fill out and mail the coupon.

MAGNETICS, Magnetics Technology Center, Dept. EL-106, Box 391, Butler, Pennsylvania 16001

How do we qualify to institute this Center?

- We developed the 550 Mu Flake Core, an industry first, that allows miniaturization without excessive circuit losses
- We tightened up industry inductance tolerances for powder cores. Twelve years ago the accepted tolerance was as high as $\pm 22\%$. We went to $\pm 8\%$ and others followed
- We established ourselves as the only approved source of bobbin cores for the Apollo program
- We patented a one-piece powder core die to increase production and help make a more uniform product
- We developed linear inductance-temperature characteristics in powder cores
- We stabilized miniature cores for inductance changes with temperature
- We developed a guaranteed voltage breakdown finish for tape and bobbin cores, eliminating the need for taping
- We developed our own powder metallurgy techniques and producing facilities to gain stricter control of magnetic core properties
- We tightened limits or standards on tape wound cores and set limits on other cores where no industrial standards were in place

To enroll, clip this and mail today.

MAGNETICS, Magnetics Technology Center, Dept. EL-106, Box 391, Butler, Pennsylvania 16001

Please enroll me in the Magnetics Technology Center and forward all curriculum materials, free of charge, to:

Name _____

Title or Function _____

Field of Interest and/or Product Now Working On _____

Specific Subjects You Would Like Us to Include in the Curriculum _____

Degree _____ School _____ Year _____

Firm Name _____

Address _____

City _____ State _____ Zip _____

Your associates may wish to enroll also. Have them furnish the above information on their company letterhead and send it to us. We need this data to assist us in selecting your curriculum.



**Reliability is 756 little dents
and one big one.**



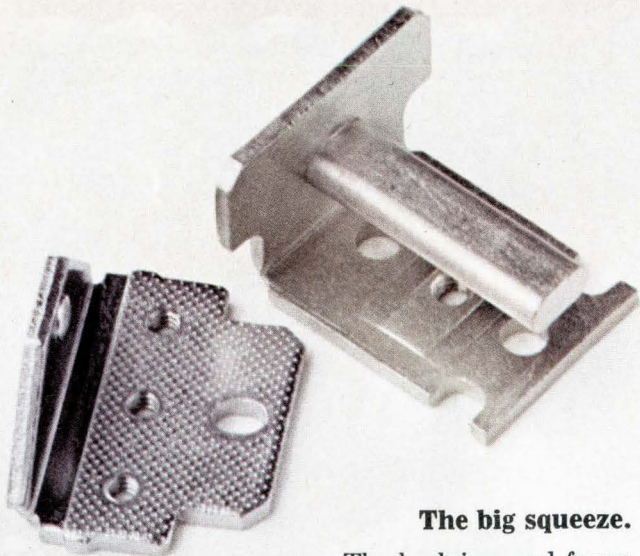

The big squeeze.

The heelpiece and frame are the backbone of our Class H relay. The slightest squiggle or shimmy out of either and the whole relay is out of whack.

756 tiny dents on the heelpiece, plus one big one on the frame, make sure this'll never happen.

They're the result of planishing, a big squeeze. Planishing is an extra step we go through in forming the pieces to add strength and stability by relieving surface strain. It also makes the parts extra flat.

This takes the biggest press in the industry and the biggest squeeze. Both exclusively ours.

A different kind of coil.

The heart of a relay is the coil. If ours looks different, it's because we build it around a glass-filled nylon bobbin. It costs us more, but you know how most plastic tends to chip and crack.

Also, moisture and humidity have no effect on glass-filled nylon. No effect means no malfunctions for you to worry about. No current leakage, either.

The coil is wound on the bobbin automatically. No chance of human error here.

We didn't forget the solder.

We use a solderless splice. That's because solderless splice connections are sure-fire protection against the coil going open under temperature changes, stress, or electrolysis.

A solderless splice is more expensive to produce, so it's usually found only on the most reliable relays. AE is the only manufacturer to use this method on all of its relays.

Finally, we wrap the whole assembly with extra-tough, mylar-laminated material. A cover is not really necessary here; but why take chances?

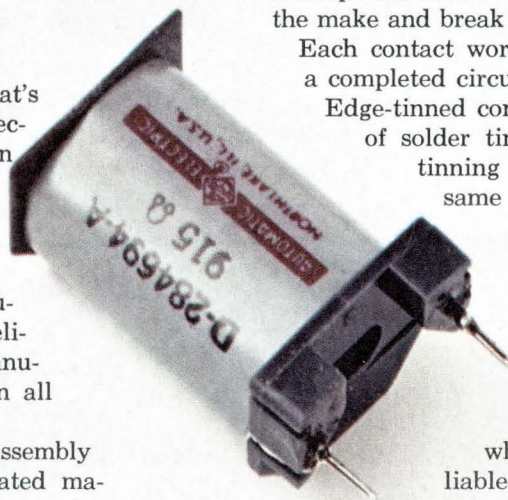

Springs and other things.

We don't take any chances with our contact assembly, either. Even things like the pileup insulators (those little black rectangles) get special attention. We precision mold them. Other manufacturers just punch them out.

It makes a lot of difference. They're stronger, for one thing; and because they're molded, there's no chance of the insulators absorbing even a droplet of harmful moisture. Finally, they'll withstand the high temperatures that knock out punched insulators.

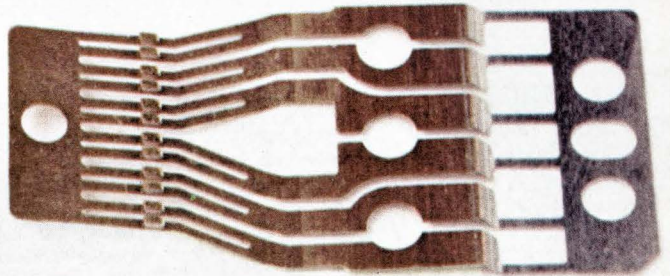

Then there are the contact springs.

Ours are phosphor-bronze. Others use nickel-silver. Our lab gave this stuff a thorough check, but found nickel-silver too prone to stress-corrosion. Atmospheric conditions which cause tarnish and ultimately stress corrosion have almost no effect on phosphor-bronze.



Two are better than one.

Our next step was to make sure our contacts give a completed circuit every time. So we bifurcate both the make and break springs.

Each contact works independently to give you a completed circuit every time.

Edge-tinned contact springs save you the job of solder tinning them later. Also, edge-tinning enables you to safely use the same relay with sockets or mounted directly to a printed circuit board. A simple thing, but it takes a big chunk out of the inventory you have to stock.

Etc. Etc. Etc.

There's a lot more to tell about what makes our Class H relay reliable. Now we're waiting to hear from you. Automatic Electric Company, Northlake, Ill. 60164.

AUTOMATIC ELECTRIC

SUBSIDIARY OF GENERAL TELEPHONE & ELECTRONICS

Circle 19 on reader service card

Get nosy

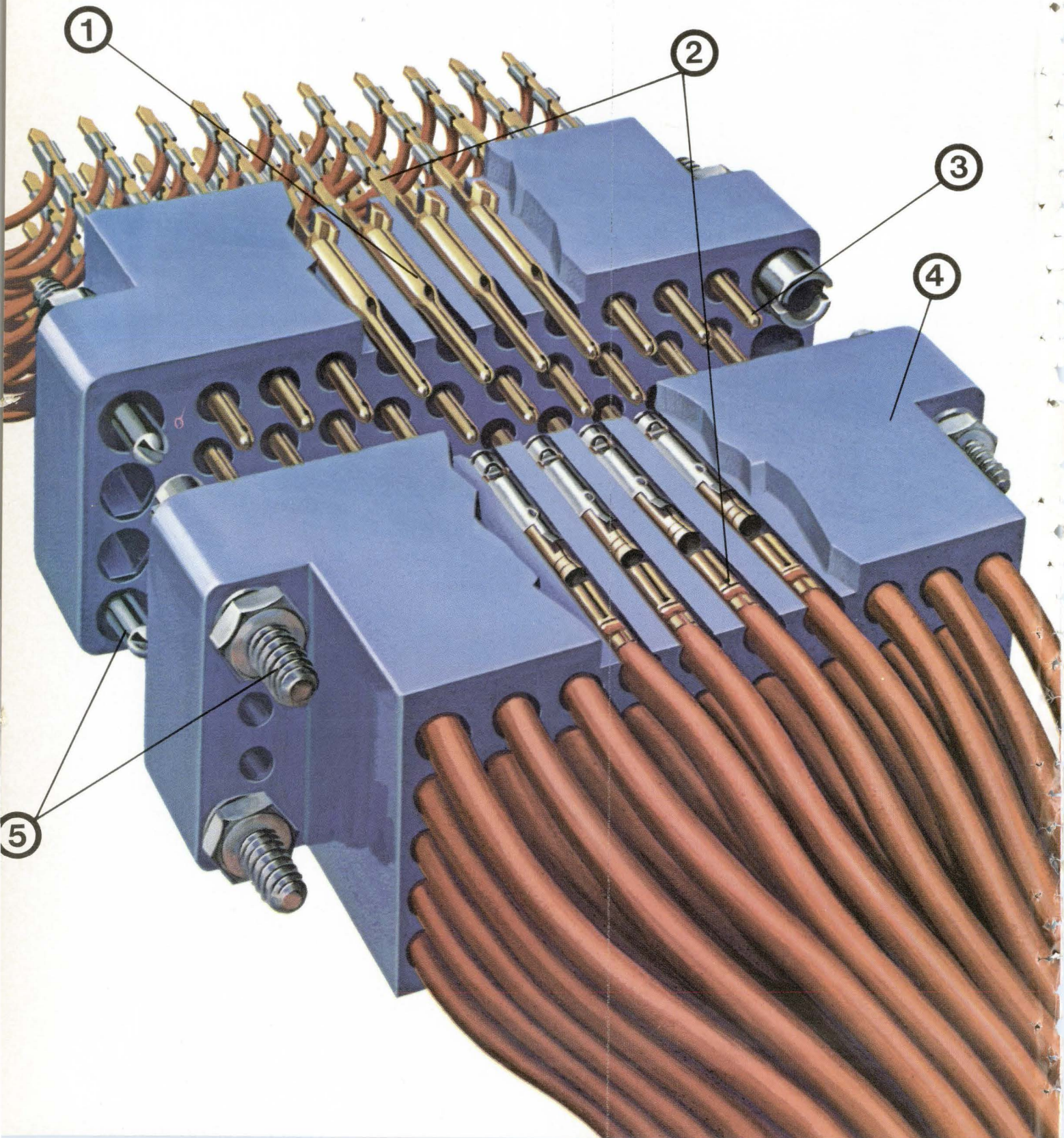

...it pays.

Take a close look at the broad line of AMP "M" Series Connectors. You'll see how everything is designed and made better to give you better performance and higher reliability, at the lowest *installed* cost . . . this is what we call Economation.

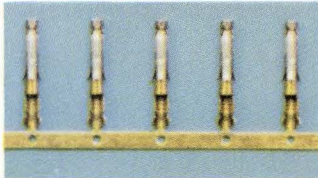

① The right pin and socket contacts for the job. Formed contacts with special socket spring design to make stronger and more uniform electrical contact—an AMP mated connector exhibits less resistance per contact than equal length of wire. Formed pins and sockets available in contact sizes 20, 18 and 16 accommodating wire ranges #14 to #30 AWG. Solid, screw-machined contacts available for military or aerospace requirements down to #32 AWG wire.

② AMP contacts are designed to be manually or automatically crimped on wire, or for soldering or welding techniques. Special contacts are designed for back-bay wiring, with either AMP TERMI-POINT★ point-to-point wiring or wrap type methods.

Single crimp coaxial contacts. AMP COAXICON★ Sub-miniature Coaxial Contacts cover a range from RG174U to RG196U including some twisted pairs. These contacts are terminated with one quick crimping action . . . inner conductor, outer braid and cable support, all simultaneously. VSWR and noise levels are kept at minimum. The finished termination is inspectable via a see-thru port. Coaxicon subminiature contacts fit all "M" Series blocks to allow complete freedom of mixing with standard contacts.

③ The right contact plating—the right thickness. With AMP, you can select from various platings engineered to do a specific job best. Available in gold, silver, tin and special alloys. Proper thickness during AMP manufacture is assured by exclusive X-ray emission analysis techniques.

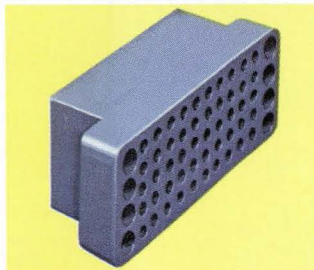

④ Largest selection of connector blocks. AMP offers more variety of contact configurations and a choice of quality molded plastics—"M" Series blocks are made from phenolics for all around service, or diallyl phthalates for stability under extreme conditions. They also meet Mil Spec requirements. Available in 6 to 160 positions for standard or coaxial contacts. Mix or match for your particular circuit needs.

★Trademark of AMP Incorporated

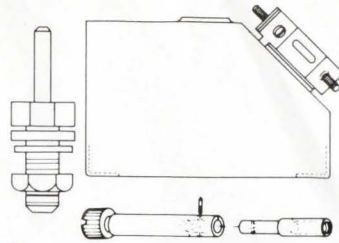

⑤ Pick from the broadest selection of hardware. Choose from a complete line of guide pins, sockets, strain-relief clamps. And two piece shields, with either lock-spring, quick-release or jackscrews, and cable clamps up to 1¼" diameter. Internal and external pin hoods are available for pin protection. Jackscrews of all types . . . fixed, turnable, short-short to long-long.

Everything about our "M" Series Connector design permits mating with almost any similar connector available today. So you can use them to retrofit, modify or interface . . . at a cost savings.

⑥ High-speed crimping or point-to-point wiring machines. AMP offers the most complete line of automatic application machines for use in your plant that give you capacities of 1,000 to 12,000 terminations per hour. Human error is cut to the absolute minimum. And operator skills are quickly and easily learned—we even train your production personnel.

The unique semi-automatic AMP Stripper / Crimper★ simultaneously strips and terminates unstripped leads or wire harnesses at speeds up to 1,200 pins or sockets per hour.

Our fully-automated AMP-O-MATOR★ Machine does everything . . . cuts wire to exact length, strips, terminates one or both ends. And with the same or two different contacts. Maximum capacity . . . 12,000 terminations per hour.

⑥

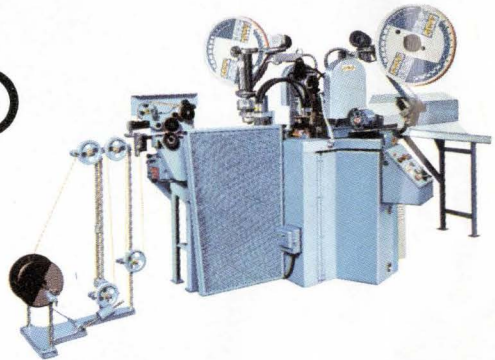

The AMP line is thoroughly tested. Tests cover all areas of electrical and mechanical performance and adverse environments—contact resistance, millivolt drop, shock, vibration, heat stability and corrosion resistance. Data covering these and other criteria is available.

Get nosy. Get all the information you need and learn how our "M" Series line pays off in reliability and improved productivity through AMP Economation. Write: **Industrial Division, AMP Incorporated, Harrisburg, Pa. 17105.**

AMP
INCORPORATED

Circle 21 on reader service card

NOW HIGH-PERFORMANCE SCRs TO MEET THE CRITICAL NEEDS OF...

- Power Inverters
- A.C. Motor Variable Speed Drives
- Induction Heaters
- Pulse Width Modulators

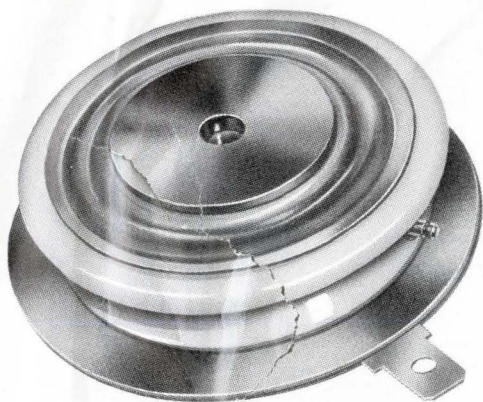

NATIONAL®
DISC PACKAGED
REGENERATIVE GATE* SCRs
provide these plus factors...

- + Voltages to 1000 V
- + dv/dt to 500 V/ μ sec.
- + Turn-off time to 15 μ sec.
- + di/dt to 800 A/ μ sec.
- + Low power gate drive
- + Operation to 20 KHz, with low switching losses
- + 175 and 380 amperes RMS
- + Also available in stud packages to 470 amperes RMS

* A NATIONAL® exclusive.
Patent No. 3,486,088

We welcome requests for detailed data and application assistance. Contact...

NATIONAL ELECTRONICS, INC.
a varian subsidiary

Geneva, Ill. 60134, phone 312-232-4300

Who's who in electronics



David

"When I came to this job," says Presidential Science Adviser Edward E. David, "people said I'd make it a low-profile operation. Well, all I can say is that I expect to make it high profile." But to most scientists and engineers outside the computer and electronics fields, David himself presents no profile at all—he's virtually a complete unknown.

The word went around, especially through the academic community, that President Nixon was further undercutting basic research by hiring a man who was first an engineer and second an industrial researcher. The university basic research budget may not rise in such classical fields as physics and chemistry, but David makes it clear that he expects to push for strong research and development programs on campus.

That may sound like political sidestepping, but basic science is only one thing on the short, slender science adviser's mind. His job is to make science practical and steer technology on a more problem-directed course.

At Bell Labs, David was known for constantly pushing new ideas into the experimental stage, always with an eye toward applications. He spearheaded Bell's use of computers for designing communications systems. Until his departure

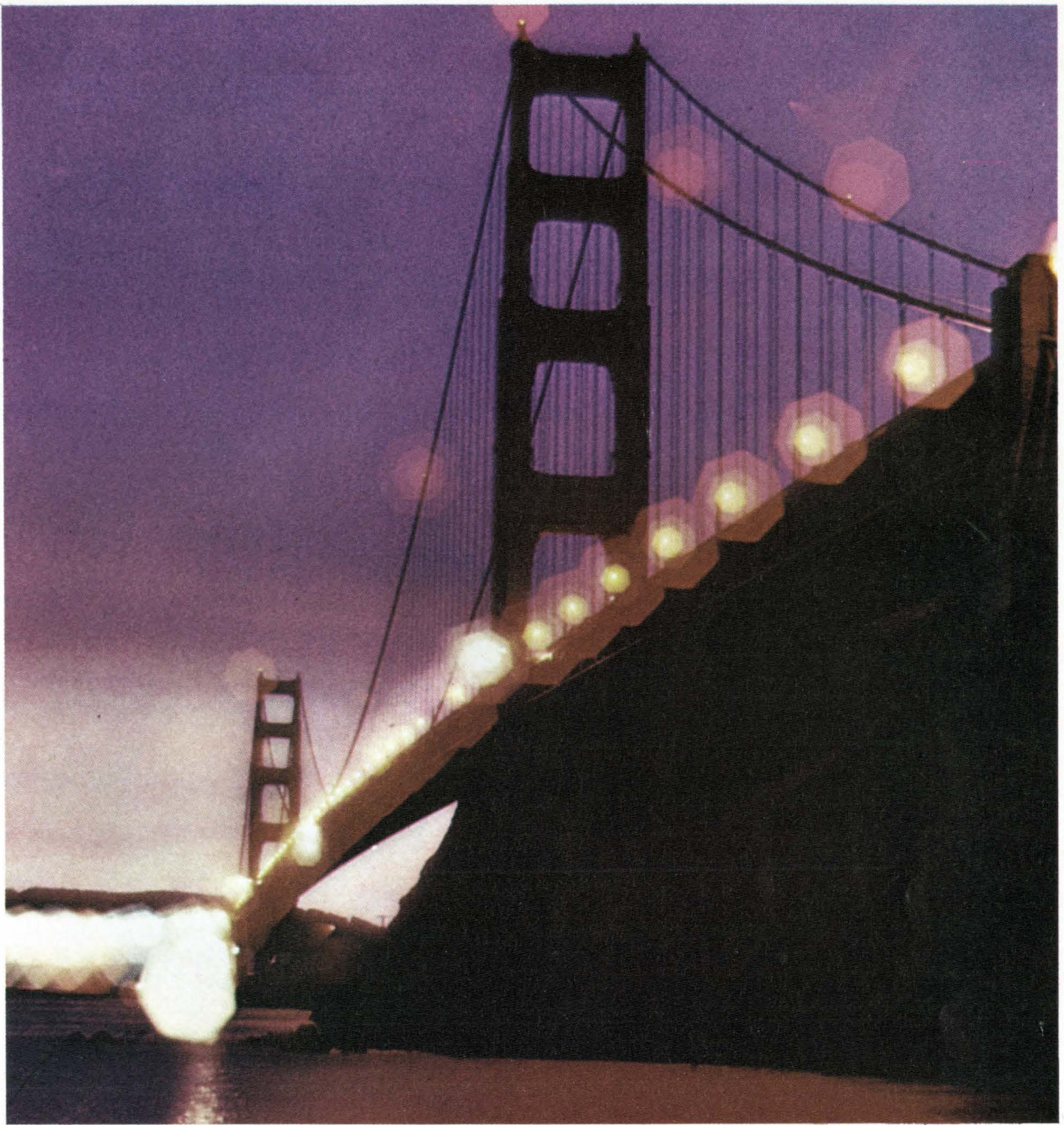

Strong, Unique and Outstanding

AMI is strong, unique and outstanding in MOS — Metal Oxide Semiconductor technology — the “new” technology that is producing startling results for our customers in profitable new products such as calculators, computers, peripherals and other electronic items. Our strength and unique MOS

expertise can also be put to work for you — to strengthen your company’s product line. If your company manufactures anything with electronic parts, hop a jet and visit our Santa Clara headquarters to see for yourself what we are doing with microscopic chips of silicon. Afterwards, you could visit the

Golden Gate Bridge in nearby San Francisco.

American Micro-systems, Inc.
3800 Homestead Road, Santa Clara,
Calif. 95051 Phone: (408) 246-0330



THE LEADING
MOS COMPANY,
WITH FACILITIES IN
CALIFORNIA, MEXICO,
IDAHO & KOREA

There Is a Difference In Quartz Crystals

Space age communication equipment demands a crystal that meets all standards of technical advancement. Crystals that were acceptable some years ago do not meet present day specifications. As a general rule, your crystal must be selected from the best quartz . . . (no throw off cuts). Tight tolerances demand selected angles of cut. The x-ray is important in making this selection. The crystal should be preaged with stress cycling. It should be checked for frequency change vs temperature change. It must be checked for optimum spurious response. It should be calibrated to frequency with the correct oscillator. International Crystals are manufactured to meet today's high accuracy requirements. That's why **we guarantee all** International crystals against defective materials and workmanship for an unlimited time when used in equipment for which they were specifically made.

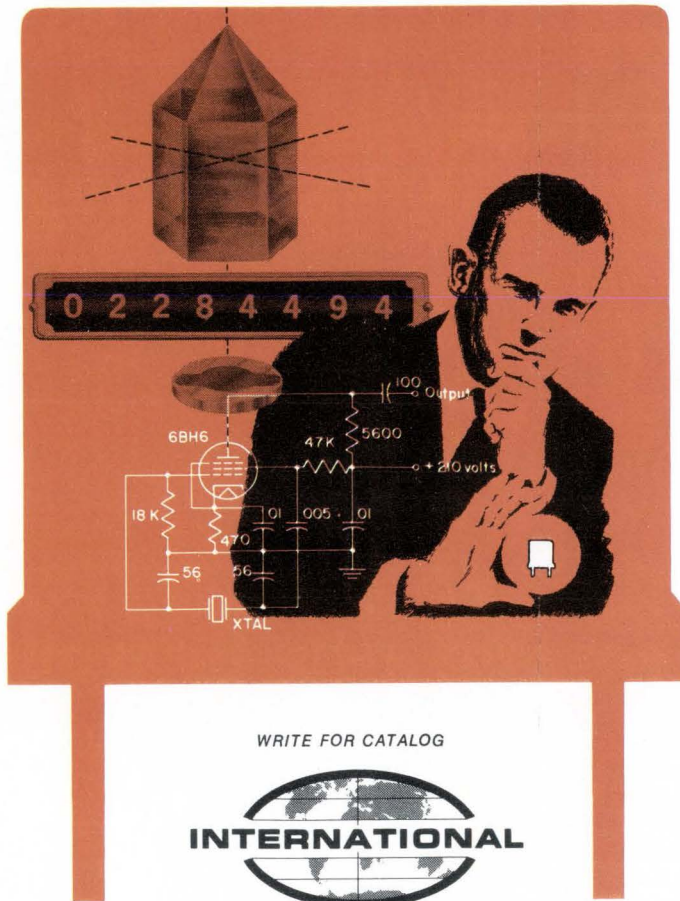

WRITE FOR CATALOG



CRYSTAL MFG. CO., INC.
10 NO. LEE • OKLA. CITY, OKLA. 73102

Who's who in electronics

in late August he worked to improve the man-computer interface. His working style was to go directly to the scientists under him rather than through the investigator's immediate superior—a habit some section heads found disconcerting. Some felt that at times he was slow to make decisions until all options were examined. At the Office of Science and Technology, David will have less time to ruminate, but at least he'll have a staff that's used to giving instant, considered responses to White House signals. At the moment the OST staff numbers about 20 professionals. It is expected to expand.

What kind of a science adviser will David be? At Bell Labs, where he headed the division of communications principles, he was known as a quick-witted managerial innovator, a sparkler of ideas who pushed his colleagues well beyond the most obvious implications.

"Ed grew in every way during his 20 years at Bell," says W.O. Baker, research chief at Bell. "He recognized the balance of judgments that had to be brought into human subsystems. He saw engineering in all its social and economic sides. With those features you don't look for a discoverer of new atomic principles or someone Edisonian, but instead for someone with the skills of synthesis. He represents the new scientist—a bridge between generations."

It was almost as though Baker did the choosing himself, for David's job will be to synthesize the social and economic goals of the country with science and technology. Book after book is being written today about the threat to human life posed by technology. But institutions, including the White House staff, haven't yet learned to cope with change generated by technology. Indeed, they have hardly learned to think about technology as a social force. That will be David's job, whether he thinks about new missile systems or figures a way to coordinate Federal R&D on new housing concepts and medical care delivery.

In fact, while at Bell, David took

Room for improvement.

Until now, most rack and panel and I/O connectors came with contacts spaced at .150". Or wider.

Which meant that your dense forest of .100" center connections had to spread out whenever it came to an R/P connector.

Or your standard .125" center automatic-wire-wrapping grid had to lengthen stride to accommodate an I/O connector.

No more.

Our new crimp-and-insert mini-Varilok™ contact fits easily, with no sacrifice of electrical or mechanical integrity, into .100" or .125" center plugs and receptacles.

R/P connectors with mini-Varilok contacts on .100" centers (Series 8026) are less than half the size of their .150" counterparts. They're suitable either for the rigors of military service or the air-conditioned comfort of a computer room. And they have all the options you'll need: 33-contact connectors with plastic covers; 75- or 117-contact connectors with metal covers;

cable clamps; jackscrews; polarizing hardware.

For I/O applications you can use the same connectors, mating them with modular receptacles (Series 5540). The receptacles—a keyed connector-center module, contact modules, and polarizing hardware modules—have Varicon™ contacts, ready for wire-wrapping. Your choice of 33, 75, or 117 contacts on .100" centers, 55 or 79 contacts on .125" centers.

When you're ready, you'll find all these connectors, all ready, at your Elco distributor. In the meantime, call, write, wire, or TWX us for your copy of our new 1971 R/P and I/O connector guide. For special assistance, call Joe Roos—Product Manager, Elco Corporation, Willow Grove, Pa. 19090. (215) 659-7000. TWX 510-665-5573.



Improvements.

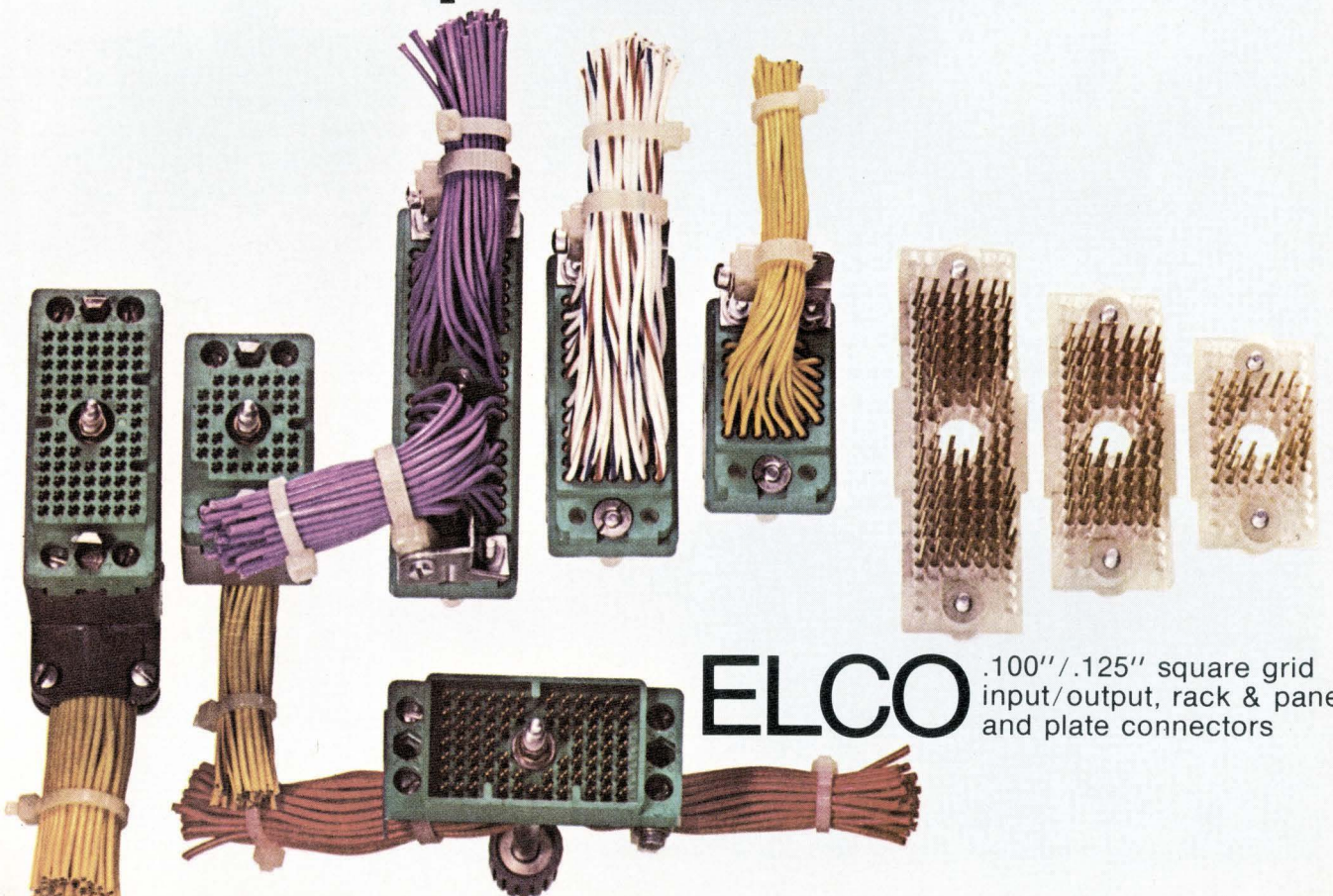

ELCO .100"/.125" square grid
input/output, rack & panel
and plate connectors

serve at room temp.

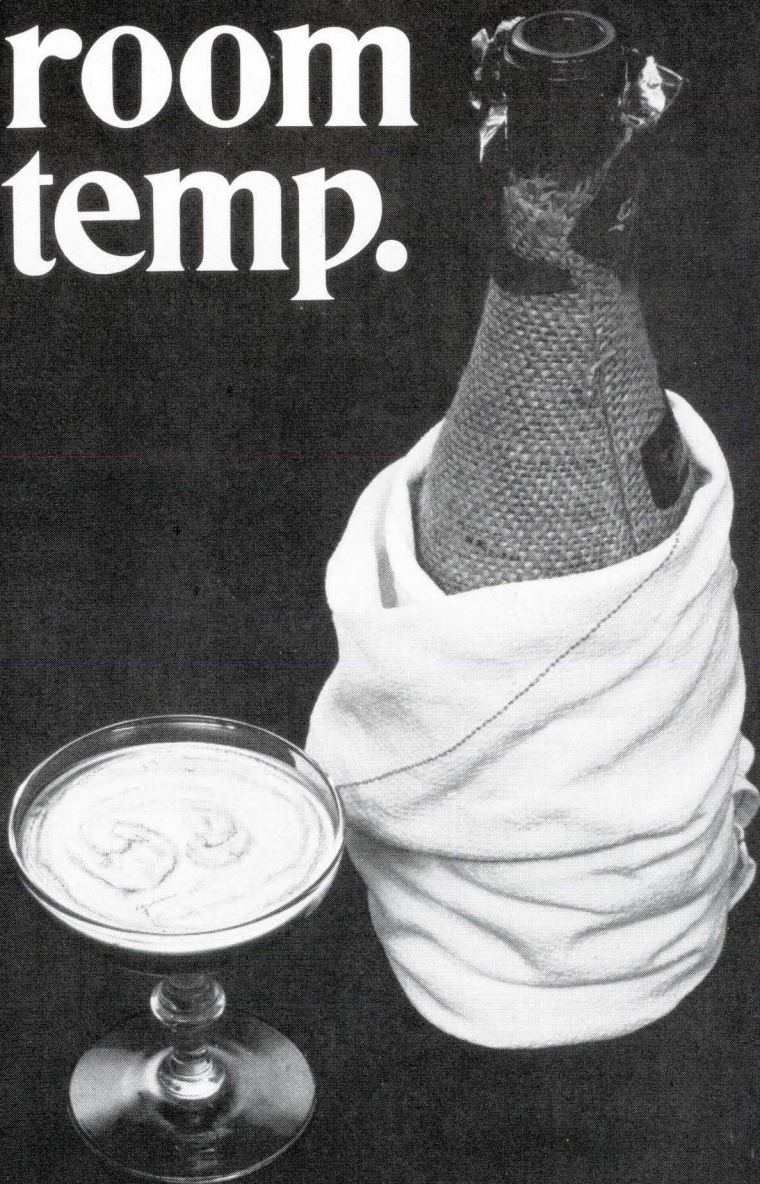

Some of our solders *are* liquid at room temperature.

Alloys and solders from The Indium Corporation of America are available at melting temperatures from 50° to 545°F. And at purities up to 99.9999%. Some of our solders are Indium-base. Others are primarily lead, tin, silver, cadmium, gallium, bismuth, copper, aluminum, nickel or germanium. All are available in ingot, rod, wire, foil, ribbon, tube, powder, shot and PREFORMS TO YOUR SPECIFICATIONS. And we *deliver* this metals "menu" when you want it. So, call on The Indium Corporation.

We're your low-melting metals gourmet.



INDIUM CORPORATION OF AMERICA

1676 LINCOLN AVE. • UTICA, N.Y. 13503
TELEPHONE 315/797-1630 • TWX 510-242-0288

Who's who in electronics

part in a project, "Man-Made World," designed to teach high-school seniors to cope with constant technological change. A coordinated textbook and machine course, "Man-Made World" is published by McGraw-Hill and is commercially available.

Universities and the government are the main buyers of Boston-based Adage Inc.'s graphics terminals; they use them for modeling, molecular structuring, intelligence work, and other tasks. But with the recent appointment of Robert M. Beckett as president and director, Adage will be expanding into industrial markets.

Beckett, who held several marketing positions at IBM and was most recently systems manager for its information display systems, approaches his new job from a marketing viewpoint, and says his first goal is "to broaden our base and get into other areas, to uncover applications not existing today."

"Adage should be getting a better piece of the action," he says, and thinks the way to get it is by moving new applications from the exploratory stage to practical use. While universities and the government use terminals for research and nonmanufacturing purposes, Beckett knows that in industry "if the terminal is product oriented, it is of more specific dollar value to the user."

New industrial markets, however, mean "we will have to approach sales differently." The capabilities of Adage's graphics terminals are not yet fully exploited. "The difficulty is in recognizing the match between capability and the customer's problem," says Beckett, and this is a task for Adage's sales force. He plans to give salesmen more support and applications exposure so they can learn to relate problems presented to them to the systems' capabilities.

Although he thinks it's "premature to sound off" about possible future markets, some aerospace and manufacturing firms are beginning to use sophisticated graphics terminals, and Adage will prob-



THAT SPOT IS NOT JUST A BEAUTY MARK

**It's a complete 16 bit
digital monitoring, control,
and communications system...**



This tiny, 9 oz. DATA COMMUNICATOR™ module outperforms an entire rack of equipment.

A major breakthrough, it is the only data communications system for process and supervisory control that takes advantage of MOS/LSI technology. Each unit measures 3.2" x 7.5" x 1".

The SEN™ module consists of a 16-bit Scanner, ENcoder, and modem. The REDE™ module is a REceiver, DEcoder and 16-bit demultiplexer, also including a modem. They'll communicate in FSK, AM or line switch.

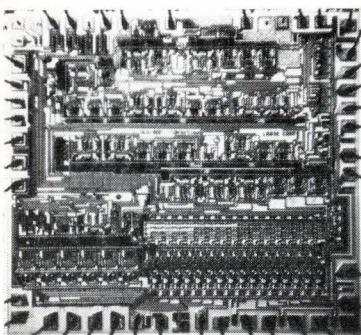

The "beauty spot" really does have beauty... one per module... (x15)

Thanks to LSI technology, DATA COMMUNICATOR reads like a page out of Ripley's "Believe It Or Not" when compared to the most widely used equipment now in service:

- 98% less power required**
- 1,661 times smaller in volume**
- 93% fewer parts used**
- 75% greater temperature range**
- 2 to 1 less power supply regulation required**
- 98% fewer internal connections**
- The price is about half that of your present rack of equipment.**
- They're about \$600 each, less quantity and significant OEM discounts.**
- The reliability is so good we back it with a 5 year warranty.**

And there is a whole list of options you're used to paying extra for — included free if you specify them — and these include flashing and double scan.

We don't know a *single reason* for specifying anything other than a DATA COMMUNICATOR module... unless you

just want to be uncompetitive or unnecessarily spend company money. Can you afford to? Especially if you're an OEM.

Get your copy of the brochure on DATA COMMUNICATOR modules. Call or write Larse Corporation, 1070 E. Meadow Circle, Palo Alto, California 94303. (415) 493-0700.

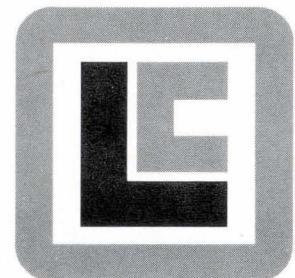

LARSE CORPORATION

See us at  INTERNATIONAL SHOW Booth 365/464

Who's who in electronics

ably try to get a share of this market. Beckett also thinks Adage terminals can replace other types of displays in existing applications like ticket reservation systems. "Performance at the lower end of a system can be improved by upgrading the device attached to the computer," he says.

In assessing his new job as national sales manager for Philco-Ford's Microelectronics division, Edward A. Youch is more than realistic about the competition he's facing. "For starters," he notes, "my sales force is outnumbered 10 to 1." Not that it scares him: "I've seen those odds overcome before," he asserts. Youch, who has a BSEE as well as a master's in business administration, practically cut his teeth on semiconductor sales and marketing. He spent three years at Fairchild Semiconductor, three at Sprague, and then most recently four at Texas Instruments as marketing manager for the Optoelectronics department.

While the challenges at Philco admittedly are large, the 40-year-old Youch, whose other accomplishments include a brown-belt rating in judo, seems more than equal to the task. High on his priority list is upgrading his sales force and sales reps. This entails "knocking out the lowest guys and bringing in better ones. I'm telling my guys that whatever happens from now on, it's the sales force's responsibility."

If Philco, as claimed, has solved its MOS production problems to the point where wafer yields are up to 65%, then it's truly up to Youch and his staff to make the division a power in MOS, not to mention holding its own in the bipolar market. Youch feels that the era of "sales engineering" has returned—the salesman can no longer just go out and sell a product, he's also got to work with the customer as he had to during the early days of the integrated circuit. "Technological leadership, of course, is vital to success, but only if you help the customer solve his own particular problems," explains Youch.

If you're looking for a state that caters to corporations...

Forget Minnesota!

We cater to individuals—the ones who manage corporations, work for corporations and locate corporations. We demand the best education, the cleanest environment and the highest quality of life possible for our people. Which makes them among the most highly-trained, healthy, reliable and happy people you can find—anywhere. That may be why they're more productive than other workers and lose less time from the job. And that may be why corporations locate here.

Write for facts about the state that doesn't cater to corporations.

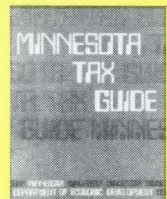
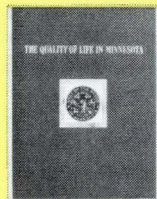

Minnesota

Department of Economic Development
Industrial Development Division Suite: L-10
57 West Seventh St., St. Paul, Minn. 55102

Please send your free literature on:

- Quality of Life*—Why Minnesota ranks second among the 50 states.
- Towns Alive*—What Minnesota towns are doing to attract industry.
- Minnesota's Instant Manpower*—How Minnesota's 26 Vo-Tech schools provide trained labor for your needs.
- Minnesota Tax Guide*—How Minnesota collects and allocates the tax dollar.

NAME _____

FIRM _____

POSITION _____

ADDRESS _____

CITY _____

STATE _____

ZIP _____



Start	Stop	1	2	3
Cancel	Recall	4	5	6
Store	Edit	7	8	9

By 1979, your wife will be computer-aided.

Running a household is getting as complicated as running a business. So, by the end of this decade, your household will have something business couldn't do without — the computer.

Although no larger than a personal TV, your home computer will help your wife plan and cook meals. It'll automatically activate the laundry cycle, balance the checkbook and do the shopping. In addition, your computer will be able to check your child's homework or take you on in a game of chess.

Best of all, your computer will be able to converse with other computers. So you can order tickets to the theatre or Sunday's double header from your kitchen table. Even make airplane and hotel reservations for an entire vacation.

But a home computer will be just one of the home-electronic breakthroughs you'll see in the decade ahead.

The fact is, products of electronics technology will be doing more in our lives tomorrow than electricity does for us today.

Our daily newspapers will be automatically printed in our living rooms. Home diagnostic centers will keep watch on our health. Automated highways will do the driving.

Who are the master minds masterminding these changes?

Our readers.

Among them the engineers who'll be adapting more and more electronic innovations for home use.

Every two weeks, Electronics presents its readers with a complete up-to-the-minute picture of the state of the technology. Plus all the fast-changing developments in their particular fields of interest. Industry-wide and world-wide.

Whether you're a reader or an advertiser, Electronics can help make you part of the future.

Electronics, a McGraw-Hill market directed publication.

Our readers are changing the world.

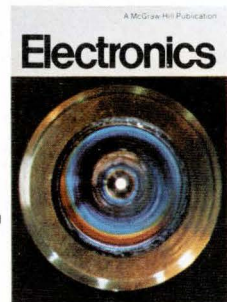

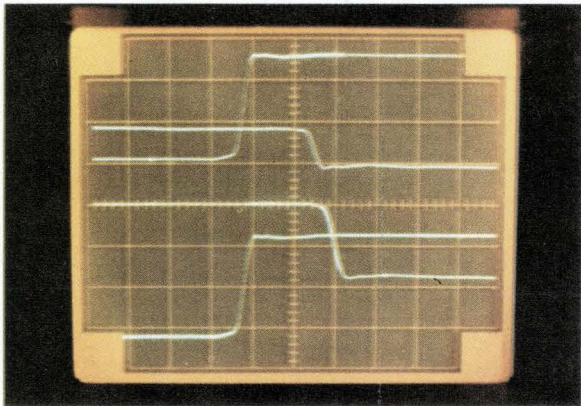
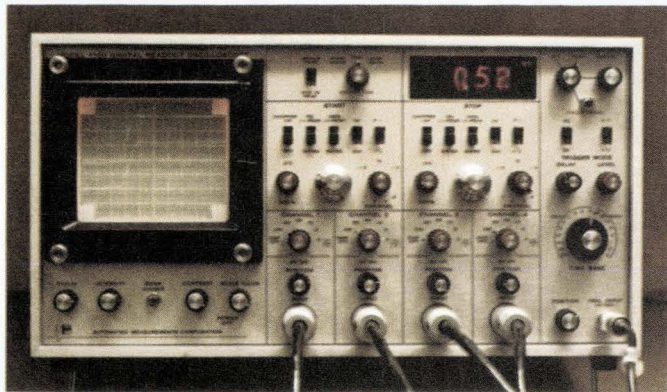
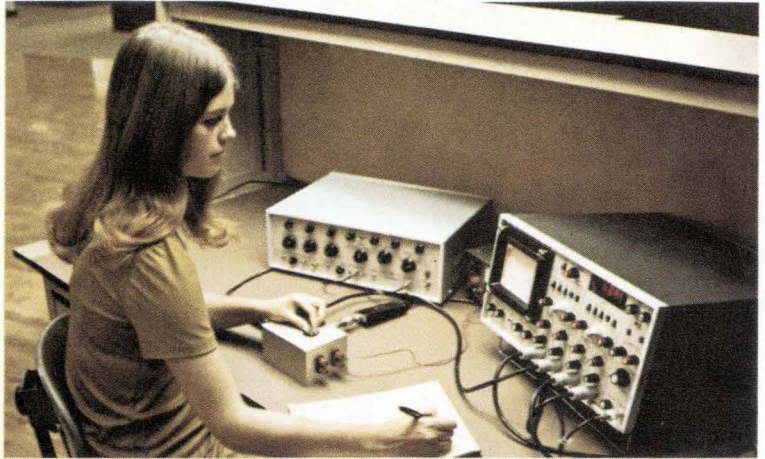
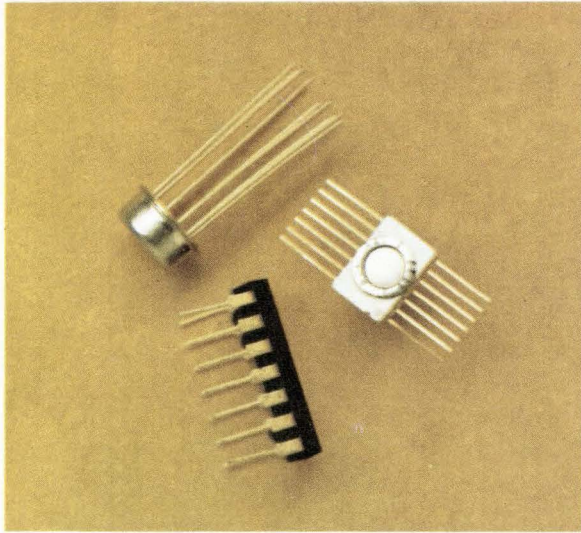

E-H the simple solution

If you want to simplify your testing operations to the point where a relatively untrained technician can make sophisticated tests with complete confidence and accuracy, E-H Research Laboratories, Inc., and its subsidiary, Automated Measurements Corporation, offer the simple solution.

First, take a look at the **AMC Model 1100 Digital Readout Oscilloscope**. It's the only four-channel, four-trace digital readout oscilloscope on the market. It was developed for the most versatile laboratory and benchtop applications, using remote sampling units to give you greater freedom in your testing operations. It has the capability for simultaneous viewing of four waveforms. And the digital display can show time accuracy to 1% f.s. and voltage accuracy to 1% f.s.

The ideal companion for the AMC Model 1100 is the **E-H 135 Pulse Generator**. It's fondly called the Universal Pulser because of its great versatility and capability of handling just about any pulser requirement you might have today and for some time to come. The E-H 135 is the only 50 MHz pulser available that has unattenuated baseline offset to $\pm 5V$ into 50 ohms. It also features rise and fall times of from 3 ns to greater than 8 ms.

The two instruments mentioned above are just a sample of a complete line of E-H and AMC equipment available. So no matter how complex your testing problems are, get to the simple solution fast. Contact your E-H representative today.



E-H RESEARCH LABORATORIES, INC.

515 Eleventh Street • Box 1289, Oakland, California 94604 • Phone: (415) 834-3030 • TWX 910-366-7258

In Europe: E-H Research Laboratories (Ned) N.V., Box 1018, Eindhoven, The Netherlands, Telex 51116

In Japan: Iwatsu Electric Company, Ltd., 7-41, 1-Chome Kugayama Suginami-Ku, Tokyo 167, Japan

Electronics Newsletter

October 26, 1970

MOS-bipolar memory due in '71

Sprague Electric Co. and Mostek may announce an MOS-bipolar hybrid memory early in 1971. Both the MOS storage and bipolar decoding chips would be optimized for speed. Cycle time would be about 100 nanoseconds with TTL decoding. What's more, even faster versions with ECL decoding chips are being considered.

Sprague spokesmen say their goal is to combine the speed of bipolar devices with the high packing density and low cost of MOS. They hope to enter the market with a memory midway in speed between the ultrafast monolithic ECL units and less-costly, multihundred-nanosecond film or wire assemblies.

N-channel MOS to be twice as fast as p-channel units

Systems designers soon may be working with faster MOS circuits. Intersil Memory Corp. of Cupertino, Calif., is planning a family of n-channel silicon gate MOS devices that will run at 10 megahertz with about 0.6 milliwatt-per-bit power dissipation, about twice as good as the 5-MHz rates of p-channel MOS. According to a company official, the family, to be introduced in the first half of 1971, will include static and dynamic random access memories, dynamic shift registers, and read only memories.

The n-channel family will be truly TTL compatible and will require only one 5-volt supply and a 5-V clock, instead of the 15 or 20 volts needed by other MOS circuits.

TI developing new MOS process

Texas Instruments is said to be working on a simplified MOS manufacturing technique that promises to ease design and production problems, resulting in higher yields. Called Mark 1, the process would be threshold compatible with TTL. However, unlike Intersil's new line of n-channel MOS, a separate power supply voltage would be needed.

The process uses a dielectric structure during oxidation to prevent oxide contamination of its gate structure. Industry insiders expect TI's first Mark 1 product will be a 1,024-bit random access memory.

Conductive ceramic compensates for temperature changes

A conductive ceramic which can greatly improve the performance of almost any semiconductor device has been developed by the Sprague Electric Co. Called PTCR, for positive temperature coefficient resistance, it would be layered between a semiconductor and its header. When dc is passed through it, PTCR rises to a controlled temperature—its current-voltage characteristic changes with, and compensates for, changes in temperature. Thus, says Sprague, it acts as an oven to eliminate temperature-induced drift—something never before available to monolithic IC designers.

Applications of PTCR soon will include a high-accuracy monolithic voltage reference—drift as low as 10 millivolts over a full Mil-Spec temperature range—and operational amplifiers. With a capacitor deposited on top, PTCR would form half of a nearly drift-free RC network. Sprague notes that PTCR should not only improve performance but cut costs as well—less chip real estate would be needed for temperature control.

Electronics Newsletter

IBM to bring out successor to 1800

Watch for IBM's announcement of a successor to its 1800 middle-sized process control computer, perhaps early in 1971. The new machine would use a combination of technologies already introduced in IBM's System 3 and 370 lines. Selling price could be as low as \$30,000—putting the machine into direct competition with middle-sized systems using Digital Equipment Corp.'s PDP-11 and Data General's Nova line.

At least one potential competitor views the move as more evidence that "IBM is definitely extending its line downward into the faster-growing end of the computer market—minicomputers."

Price to be halved on built-in EVR

As the consumer electronics woods become thicker with home video playback gear, CBS is predicting that built-in versions of its EVR will add \$125 to \$150 to the cost of a color television set. On the other hand, a separate player module that attaches externally to the antenna poles will sell for about \$300 by 1972, according to latest CBS estimates. The reason: when built in, EVR will share TV set circuits.

As of now, Motorola is the only set manufacturer licensed to produce and market the player. However, the firm's consumer division has not yet announced when it will incorporate EVR into its products.

Process computer controls variables

An analog computer that anticipates changes in process control variables will be announced at the Instrument Society of America convention (Oct. 26-28) by Anacon Inc. of Ashland, Mass. The model 11 Probability Computer compares real-time values of temperature, pressure, and other variables with their values over the preceding several seconds and with preset limits. Through a series of integrations, the model 11 computes the probability that the variable will exceed the desired limit.

Fairchild ready with antiskid system

Fairchild Camera and Instrument Co.'s Microwave and Optoelectronics division is entering the automotive electronics field with an antiskid control system. The system employs a small, solid state doppler radar as a fifth wheel to provide true ground speed. Other antiskid systems use one of the car's four wheels for a speed reference, and under certain conditions this could provide false information.

A division spokesman says the system has been tested, "and it works under all road conditions." He adds: "It's economical and it can be done now." In fact, representatives from a Japanese auto manufacturer were investigating the system last week. Once again, the Japanese may be the catalyst needed to get things going in a consumer area.

IBM, CDC in line for Safeguard computer

If the White House gains Congressional approval for more Safeguard missile sites next year, their command and control computers will be built by IBM or Control Data Corp. rather than Western Electric. The Safeguard Systems Command has decided that the custom-built Western Electric computers developed prior to the availability of IBM and CDC supercomputers are too expensive for a role in a broad antimissile defense system. As a result, the command plans to issue requests for proposals for IBM 360/195 or CDC 7600 series machines. The Safeguard sites at Malmstrom Air Force Base, Mont., and Grand Forks Air Force Base, N.D., will continue to use the Western Electric machines.



states of the art

Come to where the action is... when you've got a capacitor requirement. We've got five manufacturing facilities with over one million square feet of manufacturing capability, almost 30,000 square feet of "clean room" facilities, and over two thousand employees who take particular pride in turning out the finest capacitors you can buy... anywhere. From design to production, we're geared to turning out new ideas, better products and making significant contributions to

the state-of-the-capacitor art.

Whatever your requirements . . . from run-of-the-mill capacitors for routine commercial applications to HI-REL units for your most critical computer or military program, we can not only solve your problems but translate those answers into production and deliveries. So, if you're looking for action on your capacitor requirements come to Aerovox... that's where the action is!

AVOX Aerovox®

AEROVOX CORPORATION, NEW BEDFORD, MASSACHUSETTS 02741 • TEL. 617-994-9661
PLANTS IN: NEW BEDFORD, MA., OLEAN & FRANKLINVILLE, N.Y., MYRTLE BEACH, S.C. AND HAMILTON, ONT., CANADA

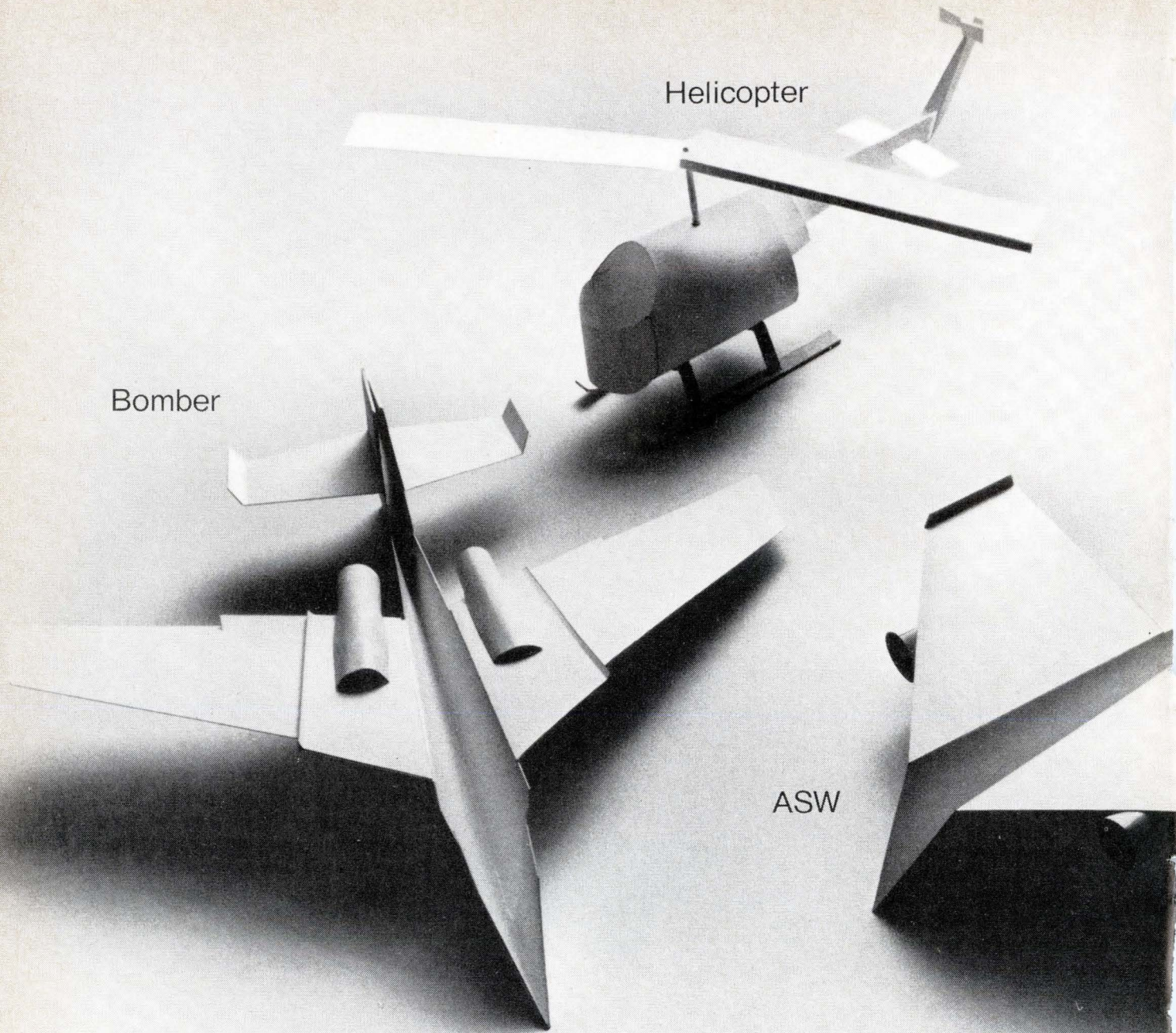

Helicopter

Bomber

ASW

Name any new aircraft of this decade. Our AGE can test its avionics.

Till now, when you delivered a new type of aircraft, you also delivered new Aerospace Ground Equipment for it.

Which, with each new generation of aircraft, caused a lot of the same old problems:

Less than optimum standardization, repetitive research and development costs, variable quality and reliability, and very often, a wide gap between delivery of the airplanes and arrival of their support equipment.

Granted each new aircraft has to be different for different needs. But does it make sense to have all of their support equipment different, too? We think not.

So we designed and developed an AGE concept to solve these problems. Our AGE is the first automatic test equipment applicable to not just a single aircraft, but to an entire generation of future aircraft.

The reason for AGE's flexibility: the system is made up of integrated test stations in highly flexible building block configurations. The system can be adapted to all advanced aircraft planned through the end of this decade.

Our AGE is currently in use at bases

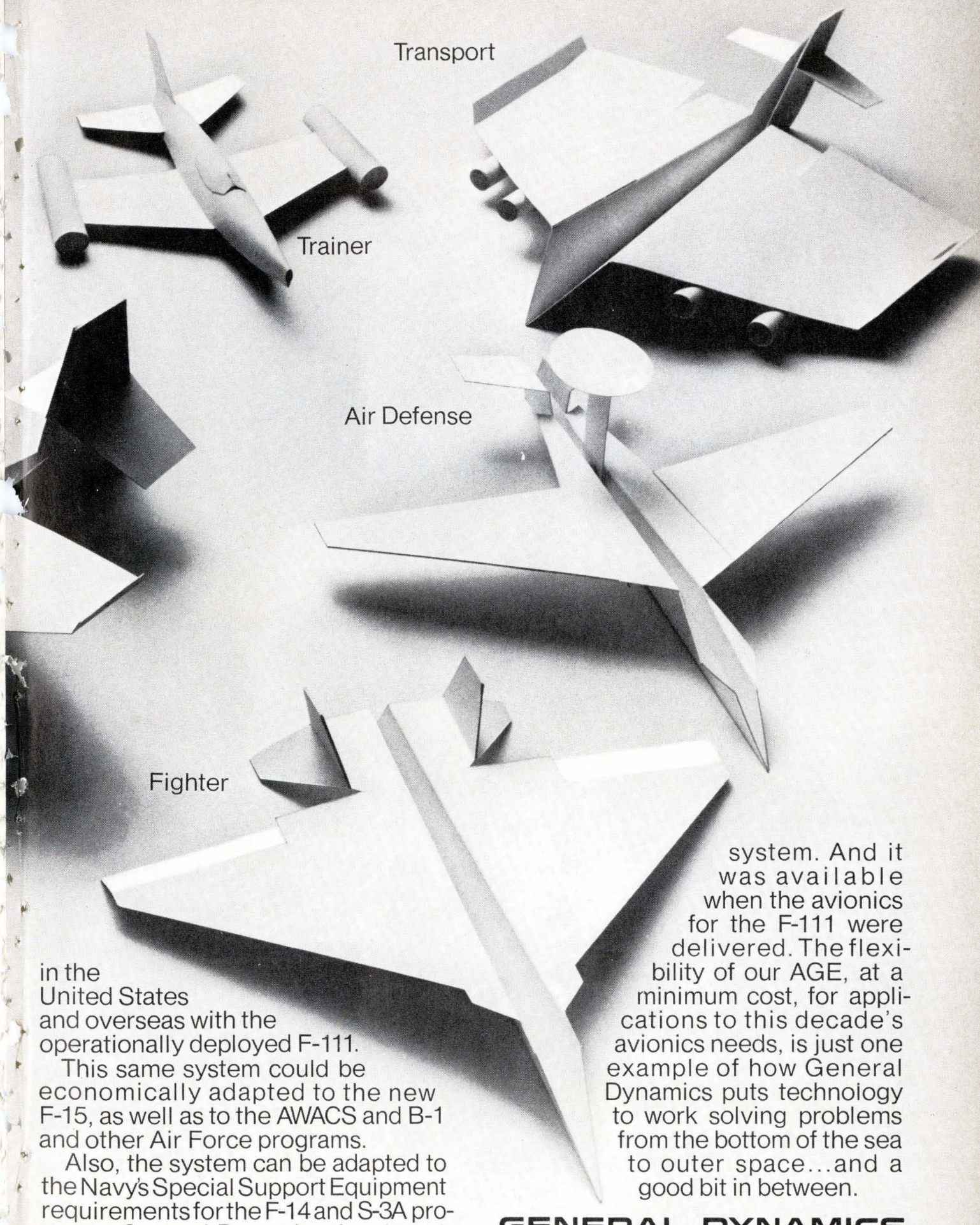

Transport

Trainer

Air Defense

Fighter

in the United States and overseas with the operationally deployed F-111.

This same system could be economically adapted to the new F-15, as well as to the AWACS and B-1 and other Air Force programs.

Also, the system can be adapted to the Navy's Special Support Equipment requirements for the F-14 and S-3A programs. General Dynamics developed and delivered the first integrated AGE

system. And it was available when the avionics for the F-111 were delivered. The flexibility of our AGE, at a minimum cost, for applications to this decade's avionics needs, is just one example of how General Dynamics puts technology to work solving problems from the bottom of the sea to outer space...and a good bit in between.

GENERAL DYNAMICS

1 Rockefeller Plaza, New York, N.Y. 10020

Circle 37 on reader service card

CENTIGRID*

The Low Profile .100 Grid Relay

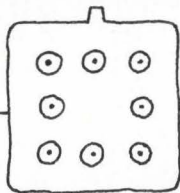

Packaging and Production Engineers please note:

CENTIGRID* Series 112 Relay's 8 leads, spaced on 0.100 centers — all on the periphery of the header — permit direct plug-in convenience on all PC boards. This relay won't be the highest component on the board. It's only .225 high, thereby minimizing board spacing. It's only .370 per side.

Design and Circuit Engineers please note: The CENTIGRID* has the same performance as our TO-5 relays. Coil voltages, in 6 choices, range from 5 to 26.5 VDC.

Using CENTIGRID* Series 112 relays permits compliance to Mil Std. 275B and Mil-P-55110A circuit board specifications without complicated lead spreading.

Space-wise Engineers please note: Ease of installation and inspection makes CENTIGRID* the perfect answer to any packaging density problem.

We're not complacent. We're relay innovators.

- First with the TO-5 Relay.
- First with an internal coil diode.
- First with an internal transistor driver.
- First with an internal op-amp.

And now: CENTIGRID* . . . another big breakthrough from the "little relay people." All the problem-solving low-down is yours for the asking. Simply write or call:



*TM App.



TELEDYNE RELAYS

3155 West El Segundo Boulevard, Hawthorne, California 90250 • Telephone (213) 679-2205

Electron beam semiconductor set for market

Devices for rf amplification will offer rise times below 1 ns, large bandwidth, and microwave operation

A new electron device that offers the long life of a semiconductor plus the high power amplification of an electron tube is preparing for a market debut. The device, called Ebird (for electron beam ionization of a semiconductor device), has been the subject of work by at least four companies, including RCA. But the Watkins-Johnson Co. of Palo Alto, Calif., is the closest to a product. In fact, says David J. Bates, head of the medium-power tube R&D section, the company will be selling a device by the first of the year.

The new item's electron source is biased negatively with respect to the semiconductor target so that the beam electrons will strike the diode with an energy of 10 kilo-electron-volts. The diode is reversed biased below its avalanche threshold. Without an electron beam, there is almost no target leakage current, but with a beam illuminating the target, target current is proportional to beam current and the device acts as a linear amplifier.

The amplification mechanism is based on formation of multiple electron-hole pairs by a single incident high-energy electron. With pair creation energy of the typical silicon semiconductor lattice at

approximately 3.6 eV, each 10-keV incident beam electron will produce thousands of carrier pairs in the diode, yielding a current amplification factor of 2,000 or more.

In essence, the device consists of two metallic electrodes separated by a region of semiconductor material (silicon in the W-J device). It's structured with a very shallow pn junction under the top contact so that all of the semiconductor material between the two electrodes is fully depleted. Thus, no low field regions impede the flow of carriers or add serious parasitic resistances.

Carriers are injected in the beam diode by bombarding the top metal contact with the electron beam. The electrons in the beam penetrate the thin metal contact and enter the semiconductor with considerable energy. This energy is dissipated when electron-hole pairs are formed; this occurs in a region near the edge of the semiconductor region. These carrier pairs are separated by a high electrical field in the semiconductor. One type of carrier moves through the drift region and is collected at the far contact. The other returns very quickly to the bombarded contact.

All Ebird rf amplifiers being developed at Watkins-Johnson utilize deflection modulation of the electron beam and a balanced twin target configuration. Without an rf input signal, the electron beam is deflected from one target to the other, and a positive portion of a sine wave generated is in one diode, the negative portion in the other.

This technique allows true class B operation, and maximizes output power capability.

The basic frequency response characteristic of a lumped target Ebird amplifier is that of a low-pass amplifier. Limitations are imposed by the transit time for charge carriers through the diode, and by the diode's time constant. Rise times less than 1 nanosecond are predicted for practical diode geometrics, leading to upper-frequency limits well into the microwave range. With the rf amplifier's low-pass frequency response, a rise time of 1 ns implies an rf bandwidth from 0 to about 350 megahertz.

Integrated electronics

Thin-film cermet solves resistor problems

Diffused silicon resistors leave a lot to be desired. In precision divider networks their ratio tolerances can be as high as 200 parts per million per degree C while temperature coefficients might reach 2,000 or more ppm/°C. These are problems engineers at TRW systems group's microelectronics center have solved in developing a 64-bit large-scale integrated parallel correlator. The device will be used to measure the correlation between two digital words.

TRW engineers have been working on thin-film cermet resistors for about five years. By evaporating chromium silicon monoxide thin

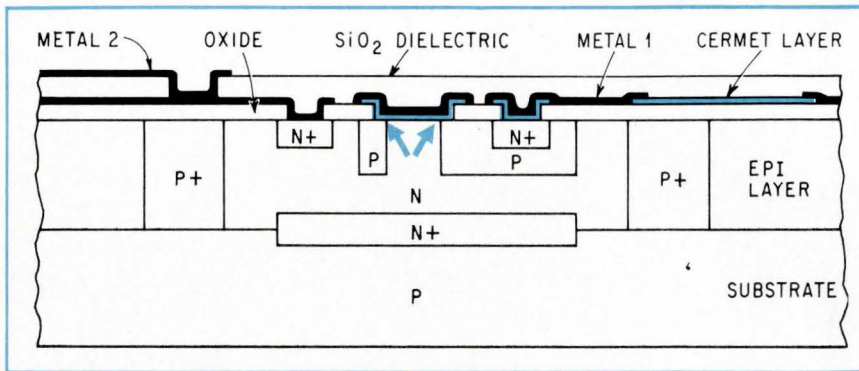

Built in. In cross section of TRW correlator, ohmic contact is to the left of cermet resistor stripe where cermet meets n+ emitter region. Arrows indicate Schottky barrier diodes where cermet meets p region.

films on a monolithic circuit they obtain not only precision resistors, but also Schottky-barrier contacts to the collector region and nonpenetrating ohmic contacts to the emitter region all in one manufacturing step.

This technique produces resistors with ratio tolerances of 5 ppm/°C and an absolute temperature coefficient of 100 ppm/°C. David Breuer, section head in the applications section of the microelectronics center, says the type of contact—whether Schottky-barrier or ohmic—is determined by the impurity level of the silicon under the contact.

TRW's overall goal is to deliver to the Navy by next June a 256-bit correlator using 12,000 devices for a classified communications application. The 3,200-device, 64-bit correlator already has been built. It consists of two shift registers in which each bit position is compared by an exclusive OR circuit, whose output, in turn, controls a digital-to-analog converter for each bit.

In the 256-bit correlator, devices will operate in both a digital and an analog mode. The contract calls for digital propagation delays of less than 10 microseconds and analog accuracies of less than 5% over the full military temperature range.

TRW uses a standard epitaxial collector with a buried layer isolated from the top. The correlator's

high-speed requirements dictate shallow transistor diffusions—typically 1 micron deep for the base and 3 microns deep for the emitter—to yield transistors operating at 2 to 3 gigahertz. Before the first metalization layer is applied, TRW evaporates a 300-to-400-angstrom-thick layer of chromium silicon monoxide over the wafer. Etching leaves a cermet resistor stripe pattern and a cermet region over the Schottky-barrier diode areas and over the emitter contacts.

Ohmic contacts between the cermet and silicon are established in those regions that previously received an emitter diffusion. "We want to put the Schottky-barrier diodes in direct parallel to base-collector junction," Breuer explains, "and we do this simply by leaving holes in the base region. We don't put an emitter in that region. The cermet goes directly onto the collector."

The diode is used to prevent the collector from approaching saturation—it would be slowed if it had to be brought out of saturation. The collector potential comes down only far enough to turn on the Schottky-barrier diode. When it does, the base current is shunted out of the active base into the Schottky diode, preventing saturation.

Cermet ohmic contacts also bar the metal penetration into the silicon emitters that occurs with aluminum.

Silicon gate joins C/MOS for wristwatch

Complementary MOS devices offer low power dissipation and low leakage currents, while silicon gate technology yields high-frequency operation and low threshold voltages. What happens if you combine them? Engineers in the central research laboratory at Motorola's Semiconductor Products division have found out by marrying the two technologies in a monolithic circuit. The results aren't laboratory curiosities; they've produced preproduction prototypes of a toggle flip-flop that's designed to function as the frequency divider or counter portion of the circuitry in a \$50 electronic wristwatch.

Power consumption in an electronic watch must be low to allow operation on a 1.35-volt mercury battery or a 1.5-V silver oxide "button" for a year or more. Likewise, threshold voltage must be kept below 1.5 V. Ronald Burgess, section manager for process development in the laboratory, says Motorola is aiming at thresholds in the 0.50-to-0.75-V region on both the p- and n-channel transistors in its integrated circuits.

But some other characteristics of the flip-flops in the IC counters are more remarkable. R. Gary Daniels, project electronics engineer, points out that the really unique feature of Motorola's silicon-gate C/MOS flip-flops is operation at 1.5 megahertz from a 1.5-V supply. Moreover, they'll deliver 25 MHz if a 10-volt battery is available. Standby power dissipation at the lower frequency is only 6 nanowatts; power-frequency ratio is 23 nW per kilohertz. Minimum operating supply voltage is 0.9 V.

Daniels says metal-gate C/MOS flip-flops wouldn't provide the high-frequency micropower counter required in an electronic watch. "Without the silicon gate," he notes, "it would take 2 to 3 volts to operate this kind of device." He also points out that the self-alignment feature of silicon gate technology allows high-frequency op-

eration. In conventional metal-gate MOS devices overly large gates assure that the gate will overlap the source and drain. This leads to gate-to-drain capacitance, which, multiplied by the Miller feedback effect typical of these devices, slows the device considerably. The self-aligned silicon gate, however, minimizes capacitance.

Burgess and Daniels believe the most reliable circuit design for such a counter is a cascade of binary flip-flops.

At least 13 of the toggle flip-flops would be required for the counter portion of an electronic watch operating at a crystal frequency of 8,192 hertz; at 131 kHz, 17 flip-flops would be needed.

Cascaded IC flip-flops have been completed, they report, adding that they're processing a 70-mil-square LSI chip that includes not only the cascaded counter but also the oscillator and output buffer for an electronic watch.

The central research laboratory has put together working models of electronic wristwatches (not including the motor drive) using silicon-gate C/MOS devices for the oscillator. A 65.536 kHz quartz crystal has been used with a cascade of 16 flip-flops, each dividing the frequency by 2. Power consumption for the oscillator and counter with a 1.5-V battery is just 4 microwatts; with a 1.35-V battery, it's 3 μ W, allowing either battery to operate the system for a year or more.

Burgess and Daniels will detail their work at the International Electron Devices meeting in Washington starting Oct. 28.

Commercial electronics

Photocathode matrix puts copier in new light

A new breed of office copier promising improved speed and simplicity may be possible with the development of a multiphotocathode device by CBS Laboratories.

In its primitive state, the device contains a 1-square-inch photocathode matrix mounted in a vacuum inside a glass envelope which also contains an anode ring. Sealed in the matrix are 62,500 tungsten pins, 0.001 inch in diameter and spaced 0.004 inch apart. Each pin is a photocathode, produced by a technique that selectively deposits photo-emitting material on each pin top.

Fast image conversion is the device's strong point. For example, latent image formation rate with a pin illumination of 100 foot-candles and a sensitivity of 100 microamperes/lumen is 0.01 second. But CBS Labs researchers admit that plenty of follow-up will be required before this technique seriously challenges the photoconductive approach in both resolution and cost areas.

To function inside an office copier the matrix will have to be larger, at least 8.5 x 0.5 inch with 265,525 pins, Robert J. Doyle of CBS will note at the International Electron Devices Conference in Washington beginning Oct. 28. A negatively charged dielectric mounted on a backplate would be located under the pin matrix and anode vacuum device. The image to be copied is projected past the anode to the photosensitive pins with a lens system. Then a 1,000-volt charge is applied—positive pole to the anode, negative to the backplate. At this point photoelectrons from the pins excited by the image bombard the anode, positively charging the dielectric below in the projected pattern. This forms the latent image of positive and negative fields on the dielectric.

The remainder of the copying procedure is similar to present techniques. Negatively charged toner is spread over the latent image, adhering only to the positive sections. The copy, now visible, can be fixed chemically. Finally, the fixed image may be transferred to standard paper. Treated paper also can be used as the dielectric to omit the transfer step.

One advantage of the photocathode technique, says Doyle, is its ability to get continuous halftones by the pin screen, similar to the dot pattern that makes up photoengravings for newspapers. In addition, because the pins don't directly contact the dielectric, there is no wear. Only one voltage source is necessary, and there's no need to clear the neutral charge on the matrix. Finally, the image converter's light spectrum response depends on the photoemitter deposited on the pins, so it is possible to produce a matrix capable of converting infrared and ultraviolet light as well as the visual spectrum.

On the other hand, production presents a reliability problem. Every pin must be completely sealed in the glass body, a difficult manufacturing task. Moreover, the pins are more efficient if a fraction of the glass is etched away before the optical transmission is applied. This etch step increases the possibility of breaking the seal around the pins. And all of this adds up to high cost.

The 1-square-inch matrix assembly used in the initial experiments cost about \$500. A similar device for a copier will measure 4.25

Copy mat. Pin matrix of photocathodes in new image converter is key to fast copying of images focused into glass envelope vacuum past anode ring.

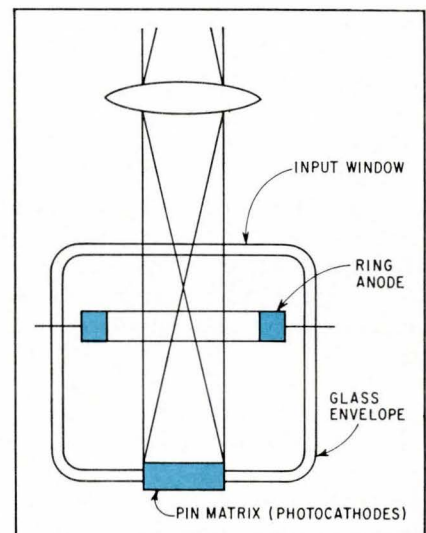

square inches, thus increasing the likelihood of failure. To improve resolution, twin matrices probably will be necessary and three matrices will be required for a color copier. Despite the reliability problem, however, Doyle projects a full-scale production price of just \$75.

Technology enters the science class

While most faculties are meeting student demands for curricular relevance by redesigning existing courses, one interdisciplinary group is taking a more radical approach. By teaching high-school students how to use some electronic equipment, the group's curriculum project brings them face to face with modern technology.

The project, which is called "The Man-Made World," hinges on a small analog computer made by AMF. Other equipment includes a specially developed logic circuit board, a card reader and switch demonstrator for the board, a resonant circuit board, a relay demonstrator, and a torque amplifier. The text and lab manual will be published by McGraw-Hill's Webster Division, Manchester, Mo., in April. Total minimum course cost for tests and materials is about \$2,400.

An important part of "The Man-Made World" is the study of decision-making. Using modeling, algorithms, and optimization, the student examines the problems of today's social systems to which there are no obvious solutions. An example is the urban housing crisis, created by an economic situation that simultaneously discourages the construction of new houses and causes abandonment of buildings. The student works out systems for solving such problems, and finally is taught the principle around which the whole solution method is built.

The course also helps the student make valid predictions for models, and to communicate with machines effectively. Its emphasis is not so much on how to write programs, however, as on how the

computer works and what kind of problems it can solve.

Moreover, in contrast to contemporary science teaching, with its emphasis on conceptual material, "The Man-Made World" presents problems of personal interest to the student, such as pollution, population, health services, computers, and traffic control.

John Truxal, academic vice president of the Polytechnic Institute of Brooklyn and director of the project with Edward E. David [see p. 22], says he hopes the course will educate a generation not to be afraid of technology and its implications. "People exhibit a terrible antipathy to, and distrust of, electronics technology, for example," Truxal said. "They need to understand that a computer is limited by the imagination and creativity of its master."

Materials

GaP enters ballgame against cold cathodes

Gallium phosphide always has been considered a highly efficient—but expensive—light emitter with possible application as a numeric indicator. But now a year-old New Jersey company, Opcoa Inc., says it can produce the crystals in quantity, and will sell a GaP indicator at a price almost as low as that of cold cathode tubes.

Opcoa is using a technique

developed at Bell Laboratories to produce GaP crystals in sufficient quantity to make displays economically possible. Opcoa's seven-segment bar indicator will sell for \$8 in 1,000-unit quantities, and "for less than half of that in very large quantities," says company president Aaron Kestenbaum. Gas-discharge display tubes, by comparison, are priced in the \$3-to-\$4 range.

Gallium arsenide phosphide (GaAsP) diodes have been the exclusive source for solid state displays. In the two years GaAsP displays have been available, their price has fallen dramatically, but the per-digit price is still in the \$12 area in 1,000-unit lots.

GaP displays are less expensive because the material has a much higher quantum efficiency than GaAsP. Even though the eye is more sensitive to GaAsP's 6,600-angstrom radiation than to GaP's 6,900-Å light, overall ratio of visible light out to power in is still three times higher for GaP, says Richard Ahrons, Opcoa's vice president and engineering chief. As a result, less material is needed for a given job. The raw materials for GaAsP and for GaP cost about the same. Opcoa, under a general licensing agreement with Western Electric, uses Bell's technique for making its GaP diodes. The method demands some relatively expensive equipment, some of which isn't even available—Opcoa had to build its own ovens for the two liquid-phase

Growing GaP

Opcoa follows a process developed at Bell Laboratories to make gallium phosphide diodes. The material is grown by the Czochralski method. For GaP the rotating and pulling process takes place at approximately 1,500°C in a nitrogen atmosphere at 1,000 psi.

The resulting crystal is cone shaped, about 1 inch in diameter, and from 2 to 3 inches high. While growing, the crystal is doped with an n-type material, such as tellurium or sulfur. This doped crystal

then is sliced into wafers 15 mils thick which are lapped and polished to a 10-mil thickness.

Next, a 2-mil-thick layer of GaP, also doped with an n-type material, is grown on the wafers by a liquid-phase epitaxial process. Then a second 2-mil layer of GaP is grown by the same technique. However, this layer is doped with zinc and oxygen so that a pn junction is formed between the two epitaxial layers. Each wafer is diced into 1,000 diodes 15 mils on a side.

50-MHz dual-beam oscilloscope



556

delayed sweep

7-ns risetime

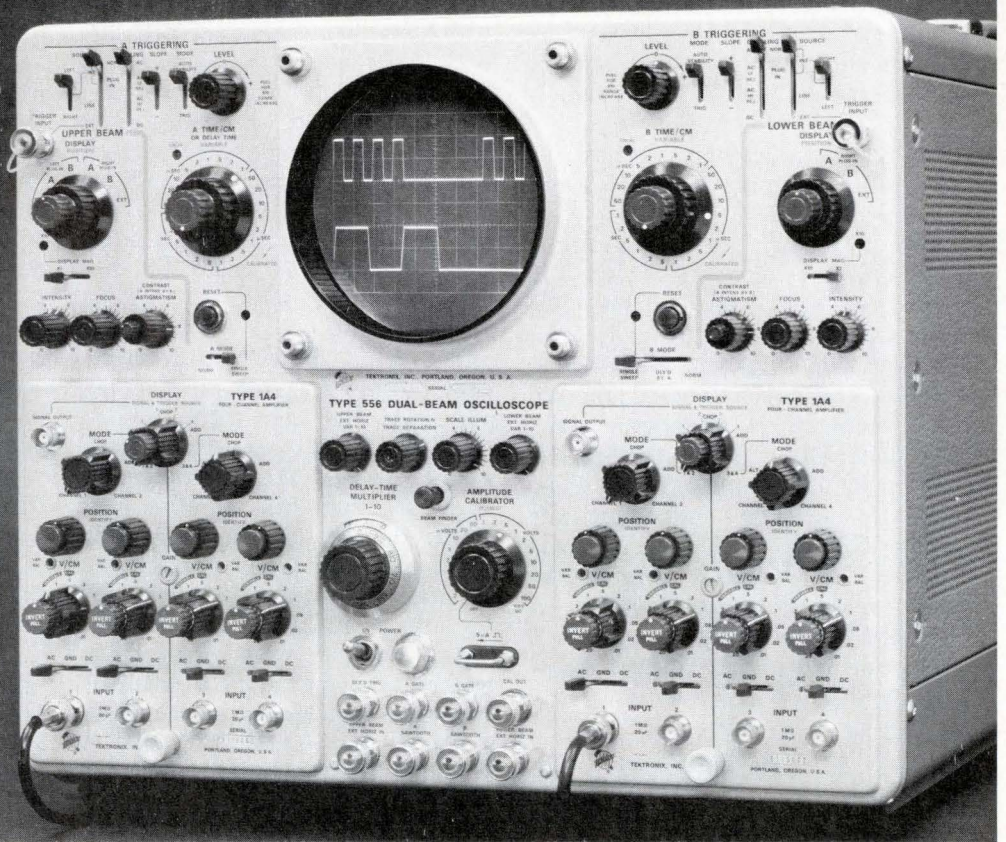

Multi-Trace

The six waveforms are time related digital pulses. The upper four displays are A Sweep ($2 \mu\text{s}/\text{cm}$) with the Type 1A4 Four-Channel Plug-In. The lower two displays are B Sweep Delayed ($100 \text{ ns}/\text{cm}$) with the Type 1A2 Dual-Trace Plug-In.

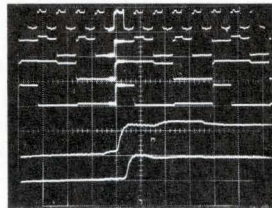

Sampling and Real-Time

The upper beam shows a square wave at $2 \mu\text{s}/\text{cm}$ as applied to a Type 1A2 Dual-Trace Plug-In. The lower beam shows the risetime of the same pulse with the Type 1S1 Sampling Plug-In at $1 \text{ ns}/\text{cm}$.

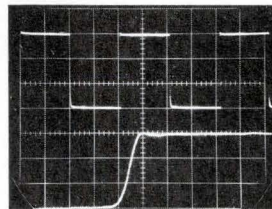

Frequency and Time

The upper beam shows the spectral output of a 200 MHz gated oscillator applied to the Type 1L20 Spectrum Analyzer; calibrated dispersion is $1 \text{ MHz}/\text{cm}$. The lower beam shows a real-time display of the $2.5 \mu\text{s}$ gating pulse.

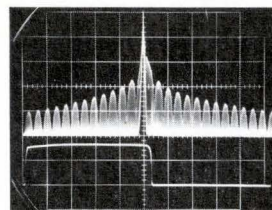

The Tektronix 556 Dual-Beam Oscilloscope features 50-MHz bandwidth, calibrated sweep delay, $6 \times 10 \text{ cm}$ scan per beam and dual plug-in flexibility. Using two plug-ins at a time, the 556 offers many display combinations, including: **dual-beam single-shot**; multiple-trace; sampling and real-time; frequency and time; delaying and delayed sweep.

The two independent horizontal deflection systems provide full bandwidth triggering and calibrated sweep speeds from $5 \text{ s}/\text{cm}$ to $100 \text{ ns}/\text{cm}$, extending to $10 \text{ ns}/\text{cm}$ with the X10 magnifier. The calibrated sweep delay range is from 100 ns to 50 seconds.

The CRT shows two simultaneous single-shot pulse sequences displayed at two different sweep speeds, a measurement that is possible only with a truly dual-beam oscilloscope. The two 1A4 Four-Channel Plug-Ins provide eight channels, each with 7-ns risetime and DC to 50 MHz bandwidth. You can also select from differential plug-ins with bandwidths to 50 MHz, TDR and sampling plug-ins with 90-ps risetime, and spectrum analyzer plug-ins that cover the spectrum from 50 Hz to 40 GHz. The 556 is also available in a rackmount model.

For a demonstration, contact your nearby Tektronix field engineer or write: Tektronix, Inc., P. O. Box 500, Beaverton, Oregon 97005.

556 Dual-Beam Oscilloscope	\$3700
1A4 Four-Channel Plug-In	\$ 895

U.S. Sales Prices FOB Beaverton, Oregon

Available in U.S. through the Tektronix lease plan.



TEKTRONIX®

committed to progress
in waveform measurement

Electronics review

epitaxial growth steps. There are no diffusion steps involved. The epitaxial steps, says Ahrons, are relatively easy to control and he characterizes yields as "extremely high."

Opcoa's indicator resembles the GaAsP indicators sold by Hewlett-Packard and Monsanto. However, each segment in the Opcoa device has only one diode, 15 mils by 15 mils, not two. And at 0.334 inch, the Opcoa character itself is a bit higher than those in GaAsP displays. The seven diodes required are mounted on a ceramic base, capped with a faceplate that has seven long rectangular holes. Plastic fills each hole, and reflects the light coming from an energized diode. The reflection spreads the light over the entire segment. A lighted segment appears not as a uniform light source, but as a row of about four or five sources.

Solid state

Resistance probe has gentle touch

The pressure exerted by standard four-point testing probes used on semiconductor fabrication lines isn't uniform, but if it were, it would come to around 1.5 million pounds per square inch—quite a jolt for a silicon wafer. And that, says Solid State Measurements, a new company in Murrysville, Pa., is one of the reasons it expects to find a more than willing market for its automatic spreading resistance probe.

The company itself has been set up by two ex-Westingshouse Electric Corp. employees, Harold F. John, who is president, and Robert G. Mazur, vice president. Their spreading resistance probe was developed at Westingshouse, which has just licensed Solid State Measurements. The first two \$17,750 systems will be delivered this month to Bell Laboratories and Canadian Westingshouse, and John and Mazur promise two-month delivery.

The pressure problem is solved, says Mazur, with a pneumatic control. This means that the pressure is reproducible. What's more, the control provides resiliency so that the probes' load is transferred to the surface of the sample gradually—in a couple of hundred milliseconds. Mazur agrees that other probe testers in use today are doing basically the same thing, but his, he says, is the only one available commercially.

But Solid State Measurements isn't basing its pitch on pressure alone. Another key feature of its test system, says president John, is the probes' smaller radius of curvature than that of other versions. He says that his spreading resistance probe has a radius of 1.2 mils compared to "5 mils or so" for others. And he adds that his tester can do what capacitance testers do plus examine as many as 19 layers with no limit to high or low resistivity or thickness of layers—and that includes integrated circuits.

The system, as it's used at Westingshouse's Semiconductor division, gives a printed diffusion profile that can dramatically increase yields and cut costs when taken early in the fabrication process, before

wafers go through their many steps. In fact, at Westingshouse its use has led to the establishment of a so-called diffusion bank in which wafers are stored according to characteristics, enabling the company to promise 54-hour delivery on certain devices.

The tester works by applying a 10 millivolt bias to its probes. Current is measured and plotted on an x-y point plotter. At the same time, a digital voltmeter gives a visual reading. After analog to digital conversion, a digital interface converts the DVM output to ASCII code for punched tape. The data then is fed to a computer for analysis and instructions.

Memories

MNOS in bipolar device could increase speed

MNOS (metal nitride oxide silicon) structures, which are common enough in field-effect memory circuits, may also be usable in bipolar devices, suggests a Fairchild R&D engineer, B.A. McDonald. He says the surface potential dependence on the base and collector currents in a bipolar transistor can be com-

And it comes out here. Diffusion profile taken by automatic spreading resistance probe shows thyristor profile.

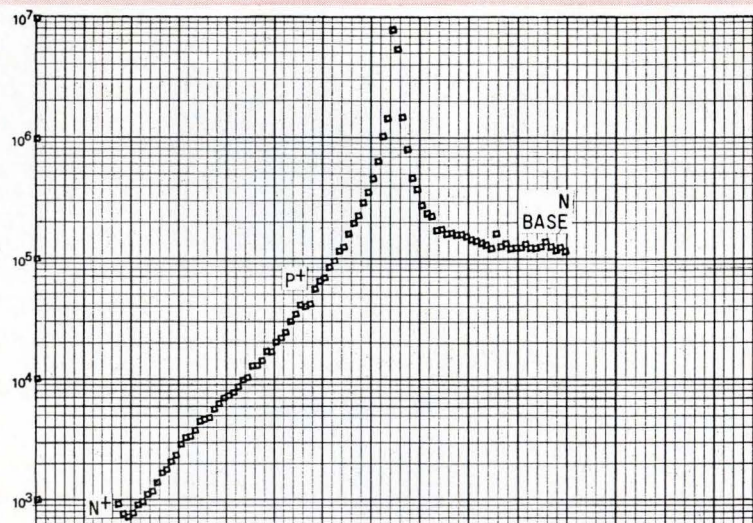

SHARP FIGURES WITH MOS/LSI.

You're looking at a good customer's good product. The remarkable Sharp Micro Compet desk-top calculator that weighs just a little over 3 pounds. The world's best seller.

Our company, North American Rockwell Microelectronics, is producing more than 250,000 advanced MOS/LSI circuits a month. Five are employed in each machine, mounted on a 4" x 5" circuit board, as its calculating system.

Largest MOS/LSI order in history.

North American Rockwell became the world's largest producer of advanced MOS/LSI circuits when the Sharp Corporation (formerly Hayakawa Electric Company of

Japan) signed a \$30-million contract for these components.

Sharp now makes more than 30,000 of these calculators a month. Simple arithmetic shows we're well ahead of our

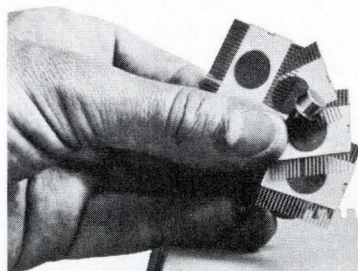
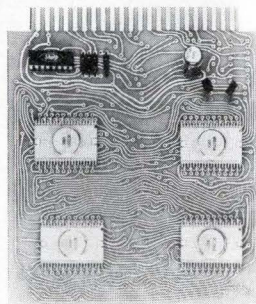

OURS.

ing MOS/LSI systems or circuits for calculators, mini-computers, computer terminals and data transmission multiplexing systems, both airborne and ground.

Prices guaranteed, product guaranteed.

NR - Microelectronics has developed innovations for making custom MOS logic and memory devices at the lowest prices in the industry.

Cost effectiveness is just one of many customer appeals.

We're ready to protect our customers with guaranteed prices for the number of years required. And if we design the custom circuits you use, we're prepared to assure that they'll be yours exclusively.

Our telephone number is (714) 632-2231. Our zip code in Anaheim, California, is 92803.

customer's needs.

Since the initial contract, Sharp has signed an even larger follow-on contract.

The only house where everything's in-house.

Today, NR-Microelectronics is the only company with total capability to transfer a multiplicity of circuit functions into a single MOS/LSI device and then mass-produce them. With our versatile computer equipment, we've designed more logic capability into a given circuit on a larger chip than other semiconductor manufacturers. Presently we're supplying or design-



**North American Rockwell
Microelectronics Company**

bined with charge storage effects of the MNOS gate to create a programmable bipolar transistor. The result may be faster memories.

The idea is that, if an MNOS gate is put over the emitter/base junction of a bipolar transistor, the base surface beneath the gate can be shifted from accumulation to inversion because of the stored charge in the MNOS gate. The inversion layer beneath the gate acts as an efficient emitter, according to McDonald, which results in a "designable increase in collector current at fixed forward emitter base bias." And the technique applies to both npn and pnp devices.

In the case of npn devices, McDonald says that the normal positive interface charge results in the inversion of the base surface. "Under this condition, the base current consists principally of recombination within the field-induced junction. Collector current at fixed V_{be} is at maximum, since the inversion layer, which is electrically tied to the diffused emitter, results in additional minority carrier injection," he explains. Since the diffused emitters in the devices are very shallow, the base q beneath the inversion layer is essentially equal to that beneath the diffused emitter.

Under a positive gate pulse of 25 volts, enough negative charge is stored within the MNOS structure to accumulate at the base surface. This results in minimum base and collector currents since the base current now consists of recombination within the metallurgical junction only, and minority carrier injection takes place from the diffused emitter only.

A negative gate pulse of 25 V returns the device to the inverted mode. The ratio of collector currents between modes was found to be equal to the ratio of the summed areas of both the inversion layer and diffused emitter to the area of the diffused emitter alone.

With pnp devices, the normal positive interface charge results in base surface accumulation. Hence pnp devices require positive gate voltage to invert the base surface.

The principal advantage that this

type of device has over conventional MNOS devices is its inherently higher transconductance. While both types of devices rely upon the conductance of the inversion layer for charge transport, the inversion layer in the case of the MNOS bipolar injects over its entire length. This reduces the effective channel resistance for a given read current, so decreasing the read access time.

Lasers

MIT radar uses cw carbon dioxide system

Laser ranging systems have bounced light pulses off the moon for years, but laser radar is still in its infancy. The effort now is to develop continuous-wave laser systems capable of doppler tracking along with a crude imaging capability. The military wants these systems for warhead discrimination and satellite tracking.

Perhaps the most powerful cw laser radar has been running for about 18 months at MIT's Lincoln Laboratory in experiments performed by research scientists T.J. Gilmartin, H.A. Bostick, and L.J. Sullivan. The system uses mixer and master oscillator carbon dioxide lasers. Close tolerances on cavity dimensions result in output frequencies that vary by less than 1 kilohertz over several seconds. And since these signals are mixed to give the doppler output of the radar system during tracking, that subkilohertz figure translates into a velocity measurement error of only 0.012 miles per hour.

The transmitter boosts the master oscillator's 10.6-micron output first in a 100-watt preamplifier, then in a 1,400-W final stage. Mirrors are used to move the beam through azimuth and elevation readings. Transmitter aperture is 48 centimeters and the beam is nearly diffraction limited, its shape is as well controlled as system optics will allow.

The team has tried about six tracking methods, ranging from

hand wheels to computer control. One technique scans the beam through a small conical angle, establishing a null in the center of the cone and allowing automatic tracking somewhat like that of monopulse radars. Using this system, the Lincoln Lab team has been able to track an airborne 2.5-centimeter-diameter corner reflector as far away as 30 kilometers with a tracking error of only two inches rms.

Good as that is, the team feels it can be bettered and is experimenting with new conical scan frequencies and detectors to improve the system's signal-to-noise ratio. Gains here should allow the system's mechanical components to respond to faster-moving targets—the laser system alone can register targets moving at radial velocities of about 15,000 mph with the latest available detectors, but the relative speed with which nearby targets could cross the radar's field of view would be too fast for the present beam steering system.

Pulsed experiments are coming up. The final stage CO₂ laser amplifier is capable of 15-kilowatt pulses at 10,000 per second. These experiments will have the incoming and outgoing beams duplexed through a larger 50-centimeter aperture, and with the five-microsecond-long high-power pulses, the lab team is looking for a 20-decibel signal-to-noise ratio improvement with a true monopulse detector array of four copper-doped germanium photo diodes. This not only should increase the system's range capability, but help shave its tracking error to mark nearer the potential of the laser system in general.

Employment

Sinking feeling in the Bay State

While the nation broods over an unemployment rate of 5% to 6%, electronics engineers in Massachusetts may face a job shortage three times as severe. Harold S. Gold-

The only UHF tetrodes that will deliver up to 2 KW CW at 1000 MHz with a guaranteed -52 db intermodulation*

The outstanding linearity of our tetrodes allows the engineer to design TV translators with visual and sound carriers amplified through the same tube—exceeding FCC and CCIR specifications.

All ceramic-and-metal construction assures long-life and reliability under severe environmental conditions. Hundreds are in field use today at low operational cost. These tetrodes are part of the

most comprehensive line of UHF tubes available. They can be driven by our 20 dB gain triodes thereby permitting use of a solid state exciter.

A family of coaxial cavities has also been specially designed to assure optimum performance of our tubes in UHF operation. For specific information, please circle the appropriate number on the Reader Service Card or contact us directly.

Tube Type	Typical Plate Voltage (volts)	Typical Plate Current (amps)	Drive Power (watts)	Output** Power (watts)
TH 327	2800	0.6	6.5	250
TH 331	3500	1.8	50	1000
TH 290	3500	3.0	100	2000

*THREE-TONE TEST **peak sync level in class A operation.

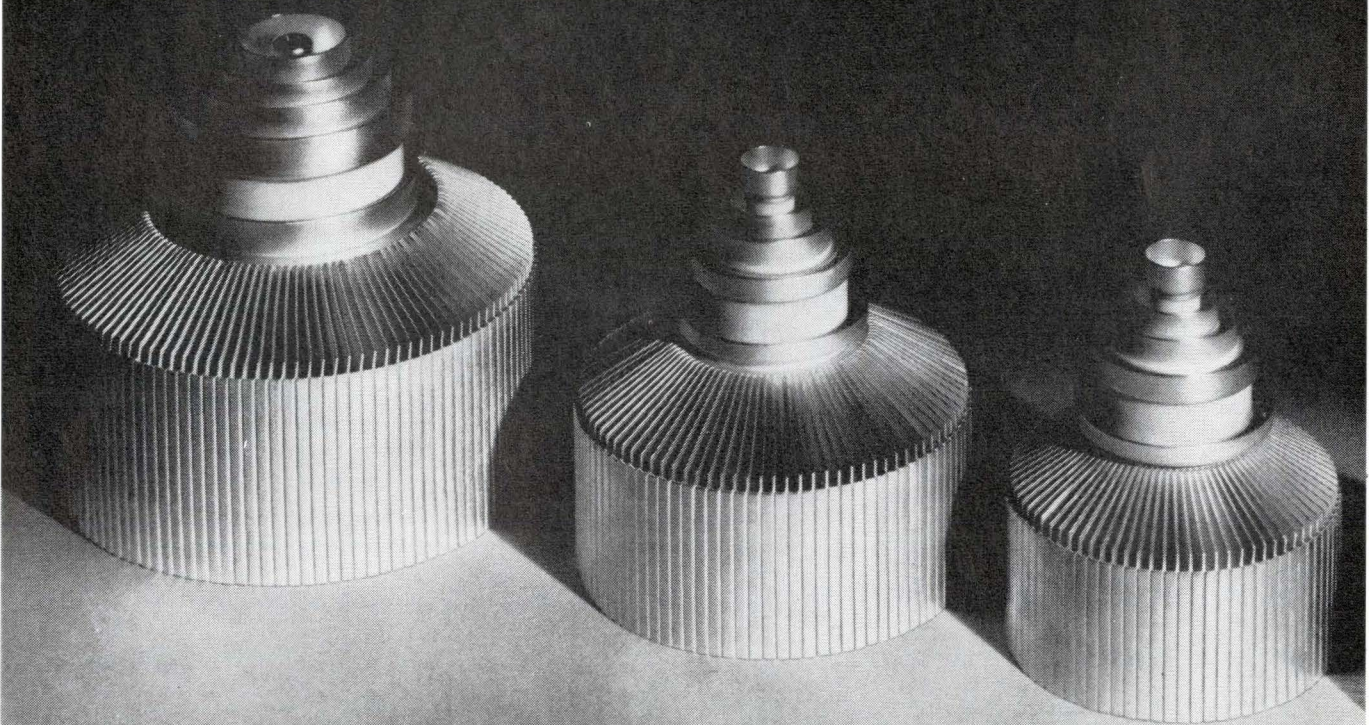

THOMSON-CSF

Thomson-CSF Electron Tubes, Inc./50 Rockefeller Plaza/New York, N.Y. 10020/(212) 489-0400

Electronics review

berg, chairman of the IEEE Boston section and applications vice president at the Applicon Corp., says this estimate may be conservative. "We started with the idea of a 10% unemployment rate, but every added bit of information pushes the figure upward."

One employment agency official scoffed at the suggestion that there were only 2,000 unemployed electronics engineers out of 18,000 in the Boston area. "There are a hell of a lot more than that," he says, adding, "Any day you want only 2,000, I can put them on your doorstep."

Goldberg notes that precise figures are hard to nail down. "The firms in this area making layoffs have been successful in keeping them quiet. They've laid off many people, but a few at a time."

Raytheon is a prime example. Reorganization of its communications and data processing organization, its Equipment division, and particularly its Missile Systems division has proceeded quietly over the past 12 months. But total cuts for the firm, which used to be known as a safe haven for electronics engineers, are estimated to exceed 4,500. No one can guess how many of those laid off were EEs.

Other firms have been more obvious: Itek now employs 1,400 instead of 1,600; Texas Instruments has laid off more than 200 of its 5,000-man staff; Teradyne has released 15% of its employees (about 100 men) and imposed graduated salary cuts as test gear sales slowed; Sprague Electric in North Adams has closed two of four plants and cut salaries by 7% to 12%. What's more, North Adams has made the Department of Labor's list of regions of "substantial unemployment." It's also the first major town in the state to go over the 6% overall unemployment rate.

Most recently, about 1,200 jobs were eliminated with the closing of Sylvania's Semiconductor division [*Electronics*, Oct. 12, p. 46].

A report from a panel headed by Albert J. Kelley, dean of Boston College's School of Management,

is filled with gloom. Kelley's state-sponsored study found that almost all defense-oriented companies in the state have had "significant" layoffs over the past six months.

The report notes that these and other layoffs have broken up talented research and development teams. Furthermore, "many of the scientists and engineers in the defense-oriented firms never have been involved with commercial products and markets." Thus, it concludes, such men may be doubly unemployable, because not only do most aerospace firms in the Boston area depend on government R&D funds that are shrinking, but they also seem disinclined to diversify into commercial markets.

Things could get worse in Massachusetts. According to a new study by Arthur D. Little Inc., 25,000 to 30,000 defense-related jobs could be lost by the end of 1972 if spending cuts continue at present rates.

Communications

Time or frequency: that's multiplex question

It's agreed that time division multiplex is best for large key systems with about 50 stations. But when it comes to smaller systems, opinions diverge: Bell Laboratories sticks to time division while the General Telephone and Electronics Labs prefers frequency division.

The newer of the two systems—both of which are still prototypes—is GT&E's. It reduces the number of wires for a six-button set to four; two extra wires are required for each additional six buttons, with the limit at 14 wires and 36 buttons. (Present key systems require 50 wires for six-button sets and 120 wires for 18-button units.) The wires run from the telephone stations to a centrally located Electronic Key Service Unit (EKSU).

One pair of the wires linking the basic key telephone set to the EKSU carries voice and user commands when a button is depressed. The

other pair carries these control signals from the EKSU back to each telephone station.

Independent control of the different functions required at the key set is accomplished by frequency division multiplexing of the supervisory signals. Six out-of-band (18 to 28 kilohertz) carriers, one for each key in the set, are transmitted to the station, and serve for both line pickup and local supervision. When a key is depressed, one of the six carriers is coupled to the voice pair and relayed to the EKSU, which picks it up and identifies which key was depressed and what the associated command is. Decisions are made by the circuit logic, which allows the EKSU to respond to the user's commands by actuating a space division crosspoint switch. In response to the signals generated by the line circuit and station logic, a status signal is generated for each line. These status signals indirectly modulate the amplitude of the associated carriers transmitted to each station. And as the amplitude changes, lights on the phone go on and off.

The Bell system, called the Modular Electronic Key Telephone System (MEKTS), is organized on a circuit-per-function basis where each circuit is semi-autonomous. It uses a small fixed sequencer, and employs modular distributed processor facilities as the system size increases. This system requires only six wires per station, no matter how many buttons are required; the limit is 60 buttons and is a function of power. Two wires are used for voice, two transmit data from the station, and two receive data from the station.

Instrumentation

IC wafers probed at 2 GHz and beyond

One thing led to another at the Hewlett-Packard Corp. in Palo Alto, Calif., where a new line of high-frequency counters required development of a new technique

Performance pacers! RCA's new GaAs lasers

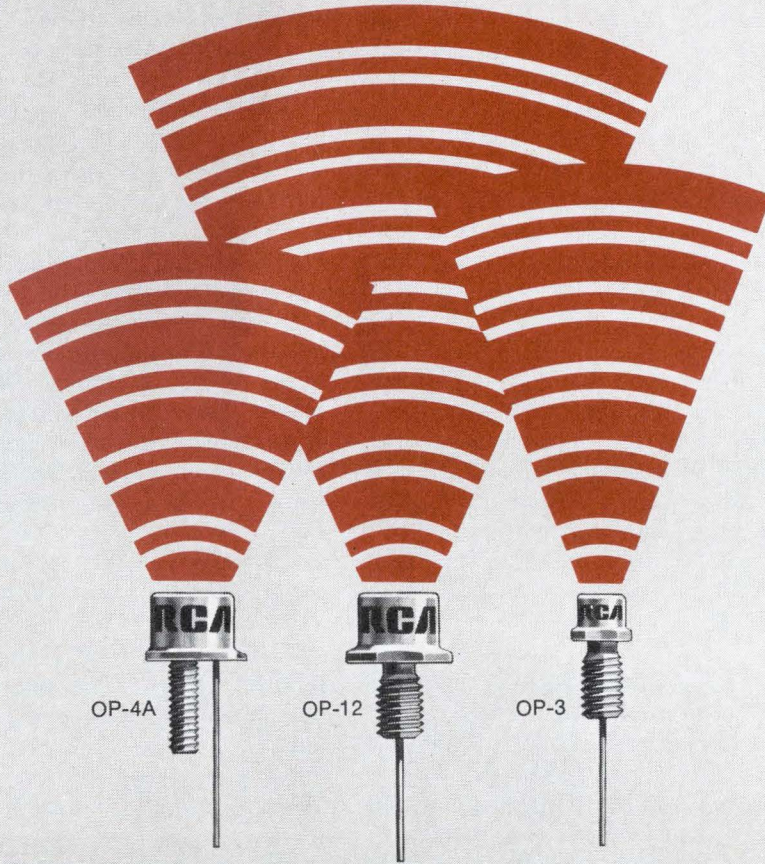

Now, improved device efficiency and a new concept of stacking diodes enables RCA to extend its "Close Confinement" gallium arsenide laser line. In so doing, RCA assures you of the right device for your system application.

Available as diodes, stacks and arrays, RCA's GaAs lasing devices feature high peak and average power outputs at low drive currents. What's more, the exceptionally low drive current requirements of these devices enhance even further their proven reliability and high temperature performance.

You'll find that RCA GaAs lasers belong in data-link communications, fuzing devices, intrusion alarms, ranging equipment, target-designation equipment, night-vision systems, and many other infrared systems. So if you've had trouble finding the right GaAs laser for your application, better check RCA.

For further information and free copy of laser brochure OPT-100, see your local RCA Representative or your RCA Distributor. Or write: RCA Commercial Engineering, Section 70J-28 /US6, Harrison, N. J. 07029. International: RCA, 2-4 rue du Lievre, 1227 Geneva, Switzerland, or P.O. Box 112, Hong Kong.

RCA
Optoelectronics

Single-diode lasers ● efficiency—4% ● pulse duration—0.2 μ s (max.)*
● wavelength—905 nanometers ● case polarity—negative
● V_f at max. drive—9 V typ.

Type	Pkg.	Power Output (W)		$I_{FM}(A)$	No. of Diodes	Source Size (mil)	Duty Factor (%)	(Typ.)
		Min.	Typ.					Threshold Current A
TA7606	OP-3	1	2	10	—	3 x 0.08	0.1	4
TA7607	OP-3	5	6	20	—	6 x 0.08	0.1	7
TA7608	OP-3	5	6	25	—	6 x 0.08	0.1	7
TA7609	OP-3	10	13	30	—	9 x 0.08	0.1	10
TA7610	OP-3	10	13	40	—	9 x 0.08	0.1	10
TA7925	OP-3	15	21	60	—	16 x 0.08	0.02	20
TA7699	OP-3	15	23	75	—	16 x 0.08	0.02	20
TA7864	OP-12	25	30	75	—	24 x 0.08	0.02	24
TA7763	OP-12	25	30	100	—	24 x 0.08	0.02	30
TA7705	OP-12	40	50	250	—	55 x 0.08	0.005	75
TA7787	OP-12	60	65	250	—	55 x 0.08	0.005	75

*0.1 μ s max. for TA7705 and TA7787

Laser Arrays ● wavelength—905 nanometers ● drive current—25 A
● series wired ● case polarity—negative

Type	Pkg.	Power Output (W)		$I_{FM}(A)$	No. of Diodes	Source Size (mil)	Duty Factor (%)	(Typ.)
		Min.	Typ.					Threshold Current A
TA7687	OP-4A	25	50	25	10	100 x 0.08	0.02	8
TA7688	OP-4A	35	75	25	15	150 x 0.08	0.02	8
TA7689	OP-4A	50	100	25	20	110 x 40	0.02	8
TA7690	OP-4A	75	150	25	30	160 x 40	0.02	8
TA7691	OP-4A	100	200	25	40	110 x 60	0.02	8
TA7692	OP-4A	150	300	25	60	160 x 60	0.02	8

Laser stacks ● wavelength—905 nanometers ● pulse duration—0.2 μ s (max.)
● series wired

TA7764	OP-12	25	30	40	3	10 x 10	0.01	14
TA7765	OP-12	50	60	100	2	25 x 4	0.01	23

Note: new types are shown in bold face.

for testing such monolithic integrated circuits, at frequencies in excess of 2 gigahertz while still at the wafer stage. Crucial to the technique, which will be described in detail at the International Electron Devices Meeting, Oct. 28 in Washington, D.C., is a test transistor that's placed on each chip on a wafer.

H-P engineers wanted a monolithic IC counter capable of 500-megahertz operation as part of the new line that the company plans to introduce in December. No such device was available, so they had to design one. And once it was designed and built, it had to be tested.

The combination of a special high-frequency probe, a sophisticated software package, and an H-P network analyzer measures both large and small signal parameters and accumulates enough data to give a complete picture of the wafer. According to Merrill Brooksby, manager of h-f counter development at H-P's Santa Clara division, the transistor can be completely characterized at frequencies from 100 MHz through 2 GHz while still part of a wafer.

"This allows the process engineer to know immediately whether the wafer is good," says Brooksby, "and also how good it is." All the information is stored on cassettes for future analysis.

The system is programmed to step the frequency, current, and voltage applied to the device and to measure a complete set of s-parameters at each point. Processed information is put out on a bar graph plotter in the form of a probability density function and the distribution function of the wafer for any specified parameter. The mean and standard deviation are also indicated on each plot.

Brooksby says that the probing system is also used for checking complete circuits for large signal dynamic characteristics and functional operation. "Digital ICs have been tested at frequencies greater than 700 MHz," he says, "and the results are better than those obtained from the packaged circuits."

For the record

H-P pushing components. Instrument-maker Hewlett-Packard is reaching for the high-volume components business. Having recently developed its version of the high-performance microwave transistor, HP21, [*Electronics*, March 30, p. 33], H-P's going full blast to market—and at prices that should give pause to the big transistor makers. H-P's small-quantity price tag for its F_{max} —15-gigahertz transistor: \$15 for the chip, \$19 in the stripline package.

Price aside, the HP21's performance is up to its competitors' specs. For example, at a frequency as high as 8 GHz it offers 3-dB gain with a power output of approximately 4 milliwatts, whereas 4-GHz output is 100 mW. Typical noise figures: 3 dB at 1 GHz, 5.5 dB at 8 GHz.

Standard package. In an effort to standardize MOS packaging, nine manufacturers in committee are considering a 22-pin package as a compromise. The configuration, to be presented at the committee's next meeting, consists of a large-cavity, 22-lead ceramic package with 0.400-inch lead spacing.

"The 22-pin package is a give-and-take situation," Ken Moyle of Intersil Memory Corp., chairman of the committee, says. "But if we can settle on a single package, it will be cheaper for all of us. And the package makers, too, can tool up for high-volume production." Other companies represented are Advanced Memory Systems, American Micro Systems, Electronic Arrays, Fairchild Semiconductor, Intel, National Semiconductor, Signetics, and Motorola Semiconductor.

GaAs, glass in sea. Researchers have started to promote gallium arsenide and electronic conducting glass as resistive sea materials. The resistive sea, in vidicon tubes, is the thin film covering the silicon diode array. It prevents current

leakage from diode to diode while permitting leakage outward.

The material currently used for this purpose is antimony trisulfide but both GaAs and electronic glass permit vacuum processing at higher temperatures, yielding better outgassing of the tubes as well as improved performance and longer life.

When GaAs is used, beam acceptance by the target is two to three times better, tube aging is improved, lag (smearing on the screen) is reduced by a third to a half, and picture resolution is improved, according to Bell Laboratories' Hatsuaki Fukui and F.J. Morris. Reduced lag and improved performance are also claimed by R.H. Wilson of General Electric, whose group is advocating a resistive sea of glass that's made electronically conductive by being combined with other substances.

TI computer coming on. Texas Instruments' big computer project (Advanced Scientific Computer, or ASC) is on schedule, according to a source connected with the project. TI has built and purchased enough read/write magnetic heads to assemble one machine at its Austin, Tex., plant. Reports indicate that some minor speed problems have been encountered.

Sale. Sylvania Electric Products has agreed to sell its microwave department to Alpha Industries of Newton, Mass.

Cheerless Yule. Tektronix employees can expect a payless two-week Christmas vacation. The reason, says the company, is that inventory is piling up too fast. At the same time, two Maryland rental firms—Rental Electronics and Rentronix—are trying to sign instrument makers to a trade-in deal. Rental Electronics says it's close to a deal with Monsanto under which that firm will accept Tektronix scopes in trade toward any of its instrument line. Rental adds that it is negotiating a similar deal with Singer-General Precision.

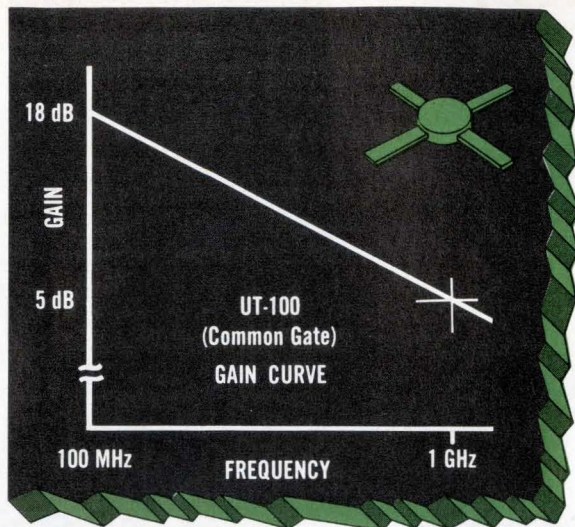

GHZ FETS FROM SILICONIX

Siliconix?*

Here are two new FETs, specifically designed for GHz performance. The UT-100 is for common gate service, the UT-101 for common source. We give you complete S-parameter characterizations for simplified circuit design.

Typical Application: Stable Oscillator

You can design a simple L-band oscillator with either of these new microwave FETs. Stability is better than ± 5 ppm/day, and you're done with crystals and multipliers.

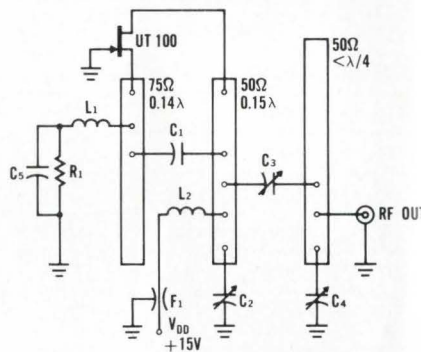

You can also use these GHz FETs for RF switching
Voltage controlled oscillators Amplifiers Mixers
Impedance transformers Etc.

Data sheets are waiting for you. Just write or call any of the offices below...or send in the bingo card.

*Two more additions to the growing family of microwave devices from

New York: Sy Levine (516) 796-4680
New England: Al La Croix (617) 769-3780
Ft. Worth/Dallas: Charlie Williams (214) 231-8151
St. Louis: Jim Spicer (314) 291-3616
Minneapolis: Ed Koelfgen (612) 920-4483
Southern California: Dave Ferran (213) 420-1307
Northern California: Chuck Brush (408) 246-8000



Siliconix incorporated

2201 Laurelwood Road • Santa Clara • California 95054
Telephone (408) 246-8000 Extension 201 • TWX: 910-338-0227
In Europe: Siliconix Limited, Saunders Way, Sketty, Swansea, Great Britain

High energy silicon for the 70's

The new tough breed from the Kokomoans

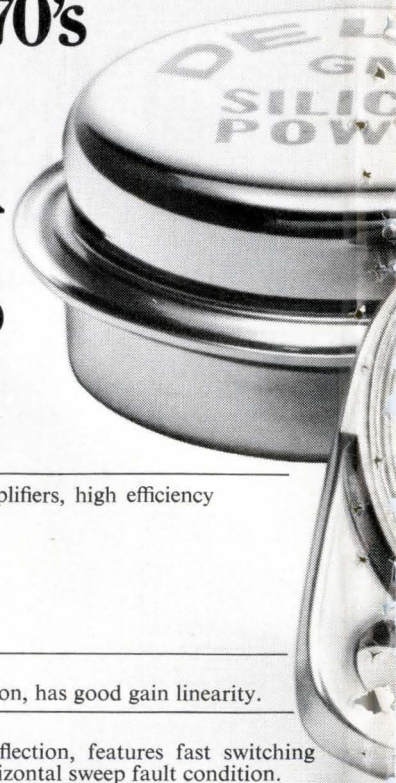

* Circle no.	Transistor	V _{CEX} Voltage	Con- tinuous I _C	V _{CEO} (sus)	Maximum Power Dissipation	Typical Applications
310	DTS 103	80V	15A	60V	125W	Voltage regulators, power amplifiers, high efficiency switching circuits.
311	DTS 104	80V	15A	60V	125W	
312	DTS 105	100V	15A	75V	125W	
313	DTS 106	110V	15A	80V	125W	
314	DTS 107	120V	15A	85V	125W	*I _C Peak = 5A Vertical magnetic CRT deflection, has good gain linearity.
315	DTS 401	400V	2A*	300V		
316	DTS 402	700V	3.5A*	325V		*I _C Peak = 10A Horizontal magnetic CRT deflection, features fast switching time, high reliability under horizontal sweep fault condition.
317	DTS 410	200V	3.5A	200V	80W	
318	DTS 411	300V	3.5A	300V	100W	Voltage regulator, switching regulator, DC to DC converter, class A audio amplifiers.
319	DTS 413	400V	2.0A	325V	75W	
320	DTS 423	400V	3.5A*	325V	100W	*I _C Peak = 10A High V _{CB0} and V _{CEO} ratings make it practical to operate directly from rectifier 117V or 220V AC line.
321	DTS 424	700V	3.5A*	350V	100W	
322	DTS 425	700V	3.5A	400V	100W	*I _C Peak = 10A High V _{CB0} , V _{CEO} (sus) ratings make them ideal for use in deflection circuits, switching regulators and line operating amplifiers.
323	DTS 430	400V	5A	300V	125W	
324	DTS 431	400V	5A	325V	125W	Voltage regulators, power amplifiers, high voltage switching.
325	DTS 701	800V	1A	600V	50W	Vertical magnetic CRT deflection circuits.
326	DTS 702	1200V	3A	750V	50W	Horizontal magnetic CRT deflection circuits operating off-line.
327	DTS 704	1400V	3A	800V	50W	
328	DTS 721	1000V	3A	800V	50W	High voltage DC regulators.
329	DTS 723	1200V	3A	750V	50W	Very high voltage industrial and commercial switching.
330	DTS 801	1000V	2A	700V	100W	Color vertical magnetic CRT deflection circuits.
331	DTS 802	1200V	5A	750V	100W	Color horizontal magnetic CRT deflection circuits.
332	DTS 804	1400V	5A	800V	100W	
333	2N3902†	700V	3.5A*	325V	100W	*I _C Peak = 10A Ideal for switching applications. Can be operated from rectified 117 or 220 volt AC line.
334	2N5157	700V	3.5A*	400V	100W	
335	2N5241	400V	5A	325V	125W	
336	2N2580	400V	10A	325V	150W	For general use in electrical and electronic circuits such as converters, inverters, regulators, etc.
337	2N2581	400V	10A	325V	150W	
271	2N2582	500V	10A	325V	150W	
272	2N2583	500V	10A	325V	150W	
273	2N3079	200V	10A	200V		
274	2N3080	300V	10A	300V		

†Mil. qualified units available.

Transistors are NPN triple diffused.

*Use reader service cards for further information.

Now available from these distributors in production quantities.

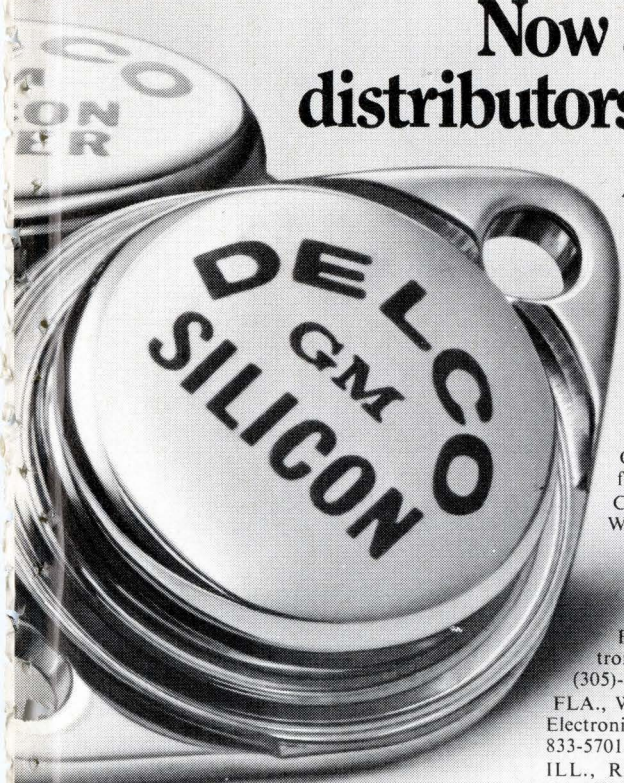

- ALA., BIRMINGHAM • Forbes Distributing Co., Inc. (205)-251-4104
- ARIZ., PHOENIX • Cramer/Arizona (602)-263-1112 • Sterling Electronics (602)-258-4531
- CAL., LOS ANGELES • Kierulff Electronics, Inc. (213)-685-5511 • Radio Products Sales, Inc. (213)-748-1271
- CAL., PALO ALTO • Kierulff Electronics, Inc. (415)-968-6292
- CAL., SAN DIEGO • Milo of California, Inc. (714)-232-8951
- COLO., COLORADO SPRINGS • Walker Electronics (303)-636-1661
- COLO., DENVER • Cramer/Denver (303)-758-2100 • Denver Walker Electronics (303)-935-2406
- FLA., MIAMI • Mountain Electronics, Subsidiary of Avnet, Inc., (305)-634-4556
- FLA., WEST PALM BEACH • Mountain Electronics, Subsidiary of Avnet, Inc., (305)-833-5701
- ILL., ROSEMONT (Chicago) • F-J-R/Kierulff (312)-678-8560
- ILL., SKOKIE (Chicago) • Merquip Electronics (312)-282-5400
- IND., INDIANAPOLIS • Graham Electronics Supply, Inc., (317)-634-8486
- MD., BALTIMORE • Radio Electric Service Co. (301)-823-0070
- MASS., NEWTON • The Greene-Shaw Co., Inc. (617)-969-8900
- MICH., ROMULUS • Harvey/Detroit (313)-729-5500
- MINN., MINNEAPOLIS • Stark Electronics Supply Co. (612)-332-1325
- MO., KANSAS CITY • Walters Radio Supply, Inc. (816)-531-7015
- MO., NO. KANSAS CITY • ECI Semiconductors, Inc. (816)-221-2400
- MO., ST. LOUIS • Electronic Components for Industry Co. (314)-647-5505
- N.J., CLIFTON • Eastern Radio Corporation (201)-471-6600
- N.M., ALBUQUERQUE • Cramer/New Mexico (505)-265-5767 • Sterling Electronics (505)-247-2486
- N.Y., BINGHAMTON • Harvey/Federal (607)-748-8211
- N.Y., NEW YORK • Harvey/New York (212)-582-2590
- N.Y., WOODBURY • Harvey/New York (516)-921-8700
- OHIO, CLEVELAND • Pattison Supply (216)-441-3000
- OHIO, DAYTON • F-J-R/Kierulff (513)-278-9411
- OKLA., OKLAHOMA CITY • Radio, Inc. (405)-235-1551
- OKLA., TULSA • Radio, Inc. (918)-587-9123
- PENN., PHILADELPHIA • Almo Electronics (215)-676-6000
- PENN., PITTSBURGH • RPC Electronics (412)-782-3770
- S.C., COLUMBIA • Dixie Radio Supply Co., Inc. (803)-253-5333
- TEXAS, DALLAS • Adleta Electronics Company (214)-742-8257
- TEXAS, FORT WORTH • Adleta Electronics Co. (817)-336-7446
- TEXAS, HOUSTON • Harrison Equipment Co., Inc. (713)-224-9131
- UTAH, SALT LAKE CITY • Cramer/Utah (801)-487-3681
- VA., RICHMOND • Meridian Electronics, Inc., a Sterling Electronics Company (703)-353-6648
- WASH., SEATTLE • Kierulff Electronics, Inc. (206)-763-1550
- WASH., TACOMA • C & G Electronics Co. (206)-272-3181
- CANADA., ONT., SCARBOROUGH • Lake Engineering Co., Ltd. (416)-751-5980
- All Overseas Inquiries:
General Motors Overseas Operations
Power and Industrial Products Dept.
767 Fifth Avenue, New York, N.Y.
10022. Phone: (212)-486-3723.

Best for Your Systems of the 70's. Here's Why: Delco silicon power transistors have earned a reputation for survival in the most rugged applications. Their proved performance in solid state deflection circuits for the new large screen color TV sets is but one example. This new breed of silicon power is built to handle the high energy found in inductive switching or in circuits normally subject to fault conditions or transients.

Their high voltage capability permits the design of simpler circuits, eliminating the extra weight, bulk, and complexity associated with low voltage, higher current systems. Their energy capability is backed by the surest rating in the business—Peak Energy Testing. Solid copper TO-3 and TO-36 packages assure maximum thermal conductivity. All in all this is the silicon power for the equipment of the 70's.

When you specify Delco you can count on consistent quality and on-time delivery, too. These are assured because our semiconductor production and quality controls are geared to our own high volume output of automobile radios and electronic systems.

Call the Kokomoans or your Delco distributor for more information on the New Tough Breed.



THE KOKOMOANS ARE IN POWER
DELCO RADIO
DIVISION OF GENERAL MOTORS
KOKOMO, INDIANA

Kokomoan's Regional Headquarters. Union, New Jersey* 07083, Box 1018 Chestnut Station, (201)-687-3770 ■ Chicago, Illinois* 60656, 5151 N. Harlem Avenue, (312)-775-5411 ■ Kokomo, Ind. 46901, 700 E. Firmin, (317)-459-2175 Home Office ■ *Office includes field lab and resident engineer for application assistance.



MARK OF EXCELLENCE

The industry's chameleon.



The adaptable V3 snap-action switch. So versatile it offers more than 500 working variations in circuitry, electrical capacity, actuators and terminals. In addition, the V3 offers options like extended overtravel, extra long life, and low operating force. This, plus a wide temperature tolerance (-100° F to specials of +600° F), make it the "standard" throughout industry. It also reduces costly downtime. Even better, it's inexpensive and readily available. For more information on the adaptability of the V3 contact your MICRO SWITCH Branch Office or Authorized Distributor. Or write for Catalog 50.

MICRO SWITCH
FREEPORT, ILLINOIS 61032
A DIVISION OF HONEYWELL

HONEYWELL INTERNATIONAL: Sales and service offices in all principal cities of the world.

We've upped the line to 7 pin spacings without upping the price.

CTS cermet industrial trimmers
still 50¢ each.*

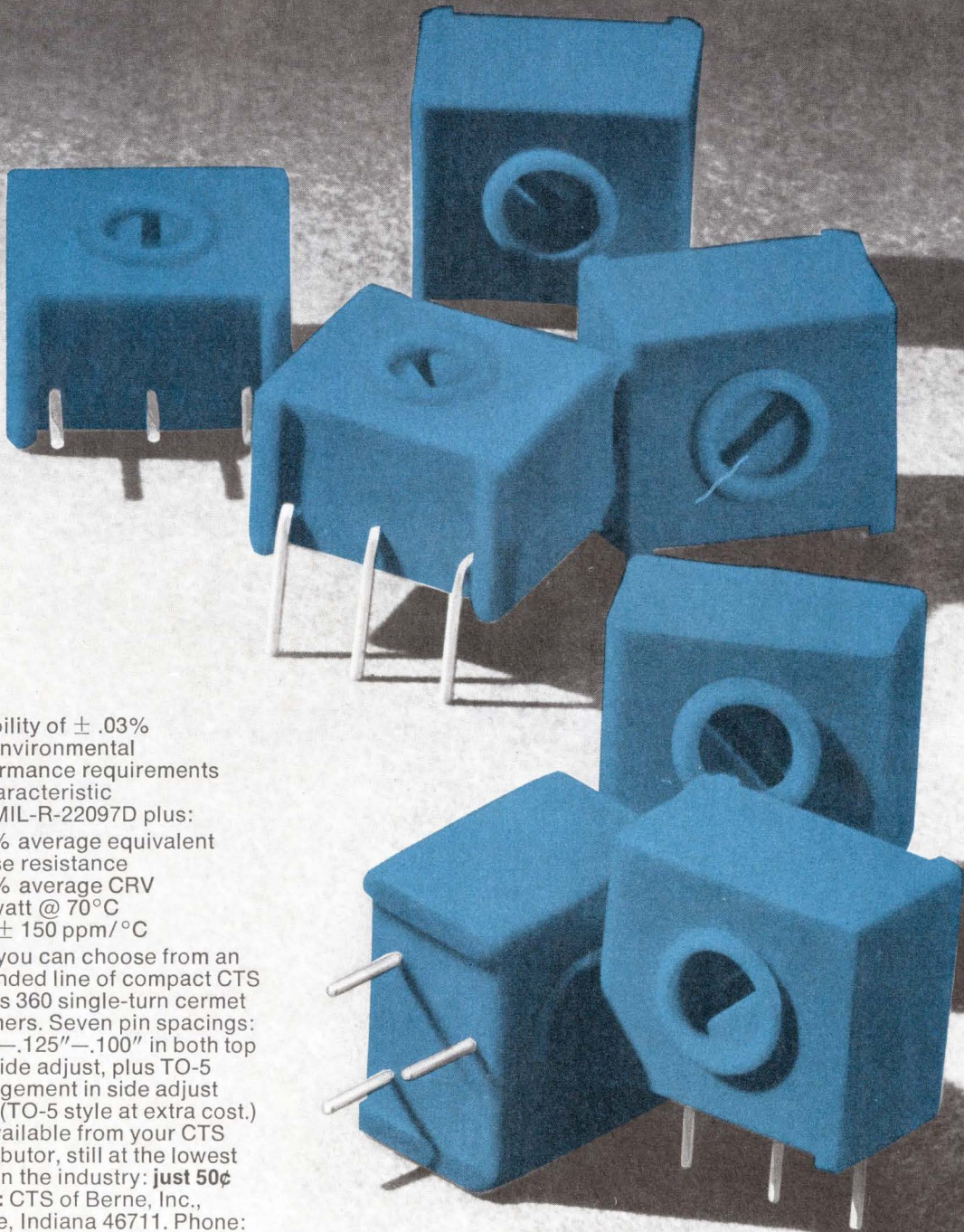

Stability of $\pm .03\%$
and environmental
performance requirements
of characteristic
C of MIL-R-22097D plus:

- 1.5% average equivalent noise resistance
- 0.5% average CRV
- $\frac{1}{2}$ watt @ 70°C
- TC ± 150 ppm/°C

Now you can choose from an expanded line of compact CTS Series 360 single-turn cermet trimmers. Seven pin spacings: .150"-.125"-.100" in both top and side adjust, plus TO-5 arrangement in side adjust only. (TO-5 style at extra cost.) All available from your CTS Distributor, still at the lowest cost in the industry: **just 50¢ each**: CTS of Berne, Inc., Berne, Indiana 46711. Phone: (219) 589-3111.

*in 50,000 quantity for $\pm 20\%$ tolerance. Add 4¢ for 10% tolerance. Comparably low prices for smaller quantities.

CTS CORPORATION
Elkhart, Indiana



Your CTS Answer Man stands ready to fit our expanded trimmer line into your application.



This cleaning agent is boiling at 118° F.

It's Du Pont FREON® TF solvent.

FREON fluorocarbon solvents are ideal for low-temperature vapor degreasing. Cooling time is eliminated for post-cleaning processing and testing. There's no damage to heat-sensitive parts. And low heat passage to the work environment.

If your product has to be cleaned thoroughly, safely and economically, there are five more reasons why you should be using FREON solvents:

1. Complete Wetting and Penetration. High density com-

bined with low surface tension lifts soils and floats away trapped contaminants.

2. Compatibility. No damage to widely used materials of construction.

3. Chemically Pure and Stable. No need for acid acceptance and scratch tests. No inhibitors needed. Parts dry residue-free.

4. Lower Overall Cleaning Costs. FREON is recoverable for reuse indefinitely. Power requirements are low in vapor

degreasing. Fewer production rejects. Save labor by cleaning complete assembly instead of separate parts.

5. Safe. Nonflammable and non-explosive. Low in toxicity, though prolonged skin contact will remove natural oils and should be avoided.

If you have a cleaning problem or are looking for an improved cleaning system, write today to Du Pont Company, Room 8789-J, Wilmington, Delaware 19898.



FREON
Cleaning Agents

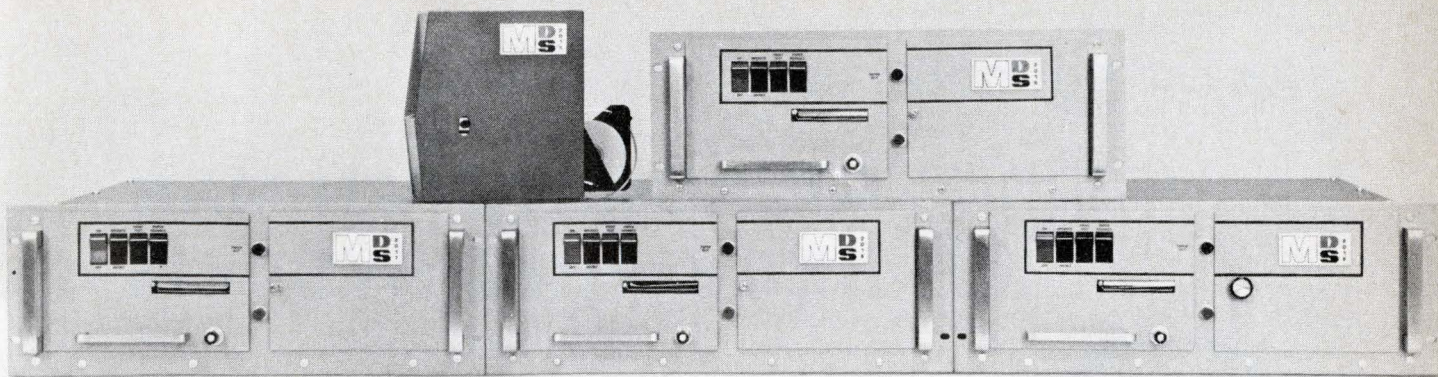

Five new printers from Mohawk.

These 5 new printers plus the 6 original Franklin printers give MDS a product line of strip and lister printers that can fill any requirement.

Our five new printers are the 2015 through the 2019. They're all fully buffered, asynchronous, have ultra-reliable TTL integrated circuits, and can operate on either 50 or 60 cycles. The lister printers range from 8 columns to 20 columns with printing rates from 10 to 20 lines per second. While the 2016 and the 2018 are numeric, the 2017 and 2019 are alpha-numeric. All four have programmable zero suppress and format control. And two of them, the 2018 and 2019, are character-serial. The 2015 strip printer features first character readability and a full 96 character ASCII font.

Our six original Franklin printers, the 800, 1200, 1600, 2200,

and 3200, add more capabilities to our line. Such as speeds up to 40 lines per second, a range of positive and negative interfaces, synchronous operation, and capacities up to 32 columns.

And, of course, all these printers are in production and are available for immediate delivery.

For more information about these MDS/Franklin digital printers, or about special printers like airline ticket printers, boarding pass printers, and card serial printers, call your nearest MDS salesman.

Mohawk Data Sciences Corp.
King of Prussia, Pa.



An Introduction to—

THE MICROWAVE PAN-MAN RECEIVING SYSTEM

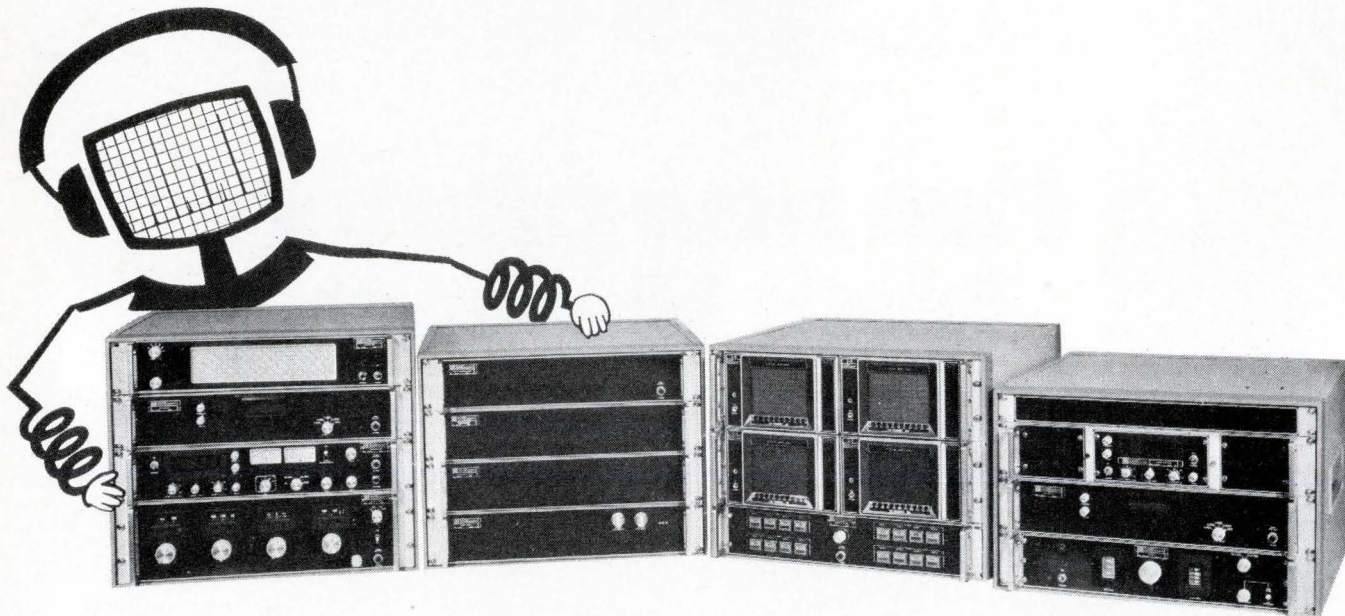

THE RS-112 Microwave Receiving System introduces a new concept in scanning and receiving microwave signals. The scanning portion automatically sweeps the RF spectrum from 1 to 12 GHz simultaneously in four octave bands. Manual receivers, which are a part of the system, permit receiving and demodulation of any selected signal. The RS-112 system provides maximum flexibility by separating scanning and receiver functions to component parts which are optimized for their particular function.

Advantages gained by this approach are:

- Simultaneous sweeping of the four bands provides a greater intercept probability
- The independent manual receiver capability permits a high degree of versatility
- Pan function is not interrupted while analysis and monitoring of specific signals takes place
- Building-block concept permits easy expansion or reconfiguration to meet new requirements
- Manually-operated components of the system can be used independently of the pan system

World's Largest Selection of Receiving Equipment for Surveillance, Direction-Finding and Countermeasures

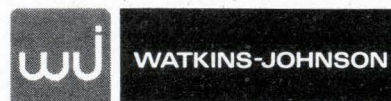

6006 EXECUTIVE BOULEVARD, ROCKVILLE, MARYLAND 20852 • (301) 881-3300

Washington Newsletter

October 26, 1970

USAF scrambling to counter EMP threat

An accelerated Air Force program is under way to harden strategic weapons against pulses of electromagnetic energy from nuclear explosions outside the atmosphere. Since one or two well-placed bursts could create broadband rf fields that could knock out most Minuteman missile electronics, the Air Force is pouring funds into simulators that will test missile systems' resistance to electromagnetic pulses (EMP). One such simulator, called Ares, has just been completed at the Air Force Weapons Laboratory, Kirtland Air Force Base, N.M. It uses capacitative generators to pulse extra-high-voltage currents through wires suspended by four towers over a concrete pad. To test electronics buried in silos, the laboratory is asking industry for bids on lighter-than-air or glider-like simulators thousands of feet long that could be towed over silos by helicopters.

Industry expects no WWMCCS money after House cuts

Even though a final defense appropriation bill will not emerge until Congress reconvenes after the elections, at least two major computer makers have given up hopes of any funding for the controversial World-Wide Military Command and Control System (WWMCCS). Their expectations were dashed by a preadjournment House cut of \$6.4 million in Defense Communications Agency procurement money, coupled with the admonition to the Pentagon that it "should not allow the services any funds to implement the system." Though the Pentagon wants the \$6.4 million restored in a Senate-approved bill, current betting is that the House will prevail and the best that can be done is to get half back. Congress, still awaiting a General Accounting Office report on WWMCCS, is disturbed at reports that the final cost is likely to run over \$500 million. "At this point, we're not counting on anything for this year," says one competitor, suggesting that "fiscal 1972 will be the big funding year," if it can be salvaged at all.

Navy spells out specs, pricetags for AADC system

Specifications for the Navy's Advanced Airborne Digital Computer are being nailed down. The Naval Air Systems Command says it will first ask industry to build a simplex processor using three memories: a 10,000 word-by-32-bit random access module using closed-flux thin film and costing between \$3,200 and \$16,000 depending on size of procurement; a 70,000-word ferroacoustic bulk storage module costing between \$2,240 and \$5,400; and a 2,000-word semiconductor or thin film task memory costing between \$2,700 and \$3,000. The Navy also is seeking a 2-million-operation-per-second processor module with fixed- and floating-point arithmetic for \$1,800 to \$3,000. The largest of the four modules will be the bulk storage unit, which Navair says can weigh no more than 10 pounds and be no larger than 448 cubic inches.

FAA, NASA to define Aerosat roles

Top officials of the Federal Aviation Administration and the National Aeronautics and Space Administration will be closeted for several weeks to iron out conflicts over the roles that the two agencies will play in developing aeronautical services satellites [*Electronics*, Sept. 28, p. 52]. The FAA holds the upper hand, since the Office of Management and

Washington Newsletter

Budget is expected to say no to the NASA and European Space Research Organization plan to develop a two-satellite L-band system. According to FAA officials, the most likely solution will be for NASA to research antenna design and a means of decreasing carrier noise for future aeronautical satellites, while the FAA lays plans for a hybrid satellite to be lofted over the Pacific in 1973. Chances are that three satellites will be orbited, with one moved over the Atlantic in the mid-1970's.

Remotely piloted vehicles studied by Mitre, Aerospace

Contract-hungry avionics companies are watching to see whether the Air Force Systems Command can generate DOD interest in Mitre Corp. and Aerospace Corp. studies of remotely piloted vehicles. The RPV concept, originated by AFSC and the Rand Corp., is being studied for feasibility by Mitre and Aerospace, as well as by NASA and the Naval Weapons Center. One use for RPVs would be as air superiority fighters, with one concept calling for launching from a radar-carrying mother ship similar to the one used in the Airborne Warning and Control System. Unlike the comparatively austere aircraft such as the F-15 now being sought by USAF, the RPV would be loaded with avionics. However, "the end of the tunnel leading to RPVs is still probably a decade away for industry," says one program source. Nevertheless, the Air Force is looking to the program as a major post-Vietnam effort.

ULMS cleared; MIT lab gets guidance package

The Navy has funded Massachusetts Institute of Technology's Draper Laboratory to proceed with development of a guidance package for its new Undersea Long-range Missile System. The Navy will get the full \$44 million requested for ULMS research and development in fiscal 1971. Though the missile effort has been approved, there is still a question about whether top-level DOD approval can be obtained for the new class of large submarines that will be required to carry the long-range intercontinental missiles [*Electronics*, Sept. 14, p. 67].

Though the Navy wants the new submarine class for ULMS, some high-ups in DOD management are arguing for a surface ship to launch the missiles, which are seen as an addition to and eventually successor to the USAF Minuteman vehicles. What's more, the fact that the new subs would not have to leave the protection of the continental shelf—where detection is more difficult—to launch ULMS missiles is being used as argument for holding costs down by limiting their range and depth.

Second U.S. system planned by Comsat

The Communications Satellite Corp. plans to seek Federal Communications Commission approval to launch a second domestic satellite system for smaller carriers in addition to its agreement to operate a \$210 million, two-satellite system for the American Telephone & Telegraph Co. Culmination of the Comsat-AT&T agreement comes after more than eight months of negotiations [*Electronics*, Mar. 2, p. 77]. AT&T will be sole user of the all-digital Comsat system, using 24-transponder models that probably will be built by Hughes Aircraft.

Comsat engineers say they have developed a technique for doubling the capacity of the 4-to-6-gigahertz band, thus avoiding the need to go to bandwidths above 10 GHz, where weather can affect performance. Each synchronous satellite would be able to handle 10,800 voice channels, 24 color TV channels, or combinations of these.

We've coined a
\$332,000,000
new word.

Ak·zo·na (ăk zō'nă) **1.** A new American corporation made up of four member companies with combined 1969 sales of \$332 million: American Enka Company (fibers), International Salt Company, Brand-Rex Company (wire and cable), Organon Incorporated (ethical drugs). *These four operating units will keep their separate identities.* **2.** A new American corporation affiliated with a worldwide industrial complex which has over 5,000 people in research and development. And, as part of that complex, is in an excellent position to benefit from a vast reservoir of technology in man-made fibers, specialty chemicals, plastics, pharmaceuticals and other areas. **3.** A new American corporation that will serve as a vehicle for growth and diversification. **4.** A new American corporation named Akzona, replacing American Enka and International Salt on the New York Stock Exchange. Symbol: AXO.

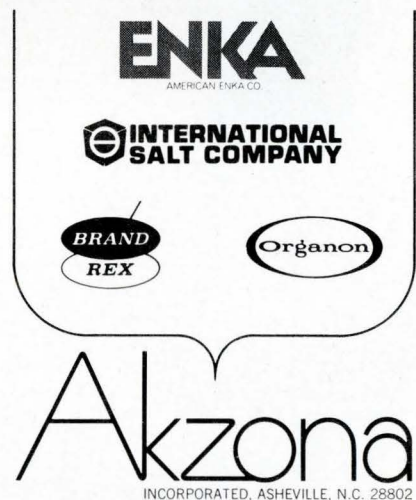

by the time
you find out
we're in
electronics...

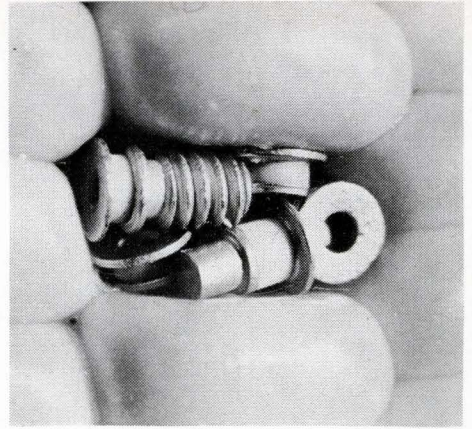

From Ceramics International, varactor diodes, five the size of a kernel of corn, are critical elements in microwave systems.

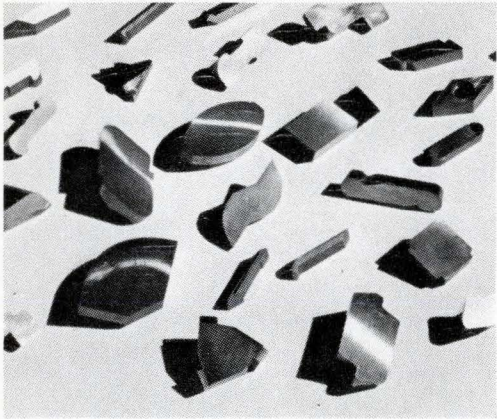

Special Mill-All indexable, replaceable carbide inserts with a wide variety of configurations for grooving, forming and turning metal.

and metalworking...

we'll be in
something new!

■ Special materials technology is our business. And it takes us almost everywhere. Into established industries and newly emerging ones. To the borderline of man's imagination. Wherever environmental stress is a factor, Fansteel is important.

Our solutions come in many forms. To name a few: Precision forgings. Investment castings. Carbide cutting tools. Special metals. Electrical contacts. Composite structures.

We make more products than you imagine. And we're ready to put one (or more) to work for you now.



© 1970, Fansteel Inc.



Number One Tantalum Place
North Chicago, Illinois 60064
Phone: (312) 689-4900

DIVISIONS: ADVANCED STRUCTURES • ELECTRONIC PRODUCTS • MECH-TRONICS • METALS • VR/WESSON

FROM THE WAVE MAKERS:

FUNCTION GENERATORS FOR SQUARES...AND MUCH ELSE

And much less expensive, to boot. Krohn-Hite's new line of function generators give you solid versatility, performance, and operating convenience. Two brand new models covering the frequency range of 0.002 Hz to 5 MHz. Each gives you wavemaking capability for sine, square, triangle, plus and minus ramps, and additional simultaneous square wave outputs. Ultra-fast risetimes. Provision for external V.C. of 1000:1 over the full range. D-C offset control. Adjustable symmetry on square wave for pulse operation. Best of all, we do everything with fewer components.

NEW MODEL 5100 FUNCTION GENERATOR, 0.002 Hz, to 3 MHz



Simultaneous auxiliary square wave
VCO 1000:1 sweep capability
Price: \$375.00.

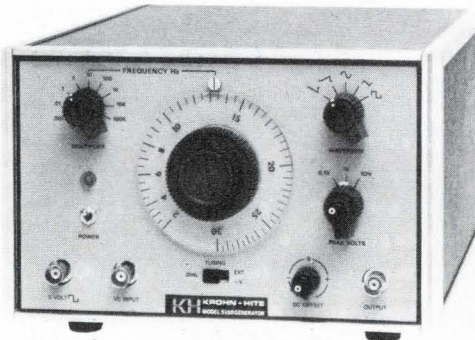

NEW MODEL 5400 FUNCTION GENERATOR, 0.002 to 5 MHz



Symmetry offset provides pulse and
sawtooth
VCO 1000:1 sweep capability
Price: \$550.00



If you would like to know much more about much else, drop us a line: The Wavemakers, Krohn-Hite Corporation, 580 Massachusetts Avenue, Cambridge, Mass. 02139

KH **KROHN-HITE**
CORPORATION

OSCILLATORS / FILTERS / AC SOURCES / FUNCTION GENERATORS / AMPLIFIERS

OVERSEAS SALES OFFICES: BELGIUM, C. N. Rood s. a.; DENMARK, SC Metric A/S; FRANCE, Antares; GERMANY, Nucletron Vertriebs-GMBH; HOLLAND, C. N. Rood n. v.; ITALY Dott. Ing. Mario Vianello; SWEDEN, Teleinstrument; ISRAEL, R. D. T. Elect. Eng. Ltd.; JAPAN, Shoshin Shoji Kaisha, Ltd.; AUSTRALIA, Sample Electronics (Vic.) Pty., Ltd.; G. B., B & K Inst. Ltd.

Circle 63 on reader service card

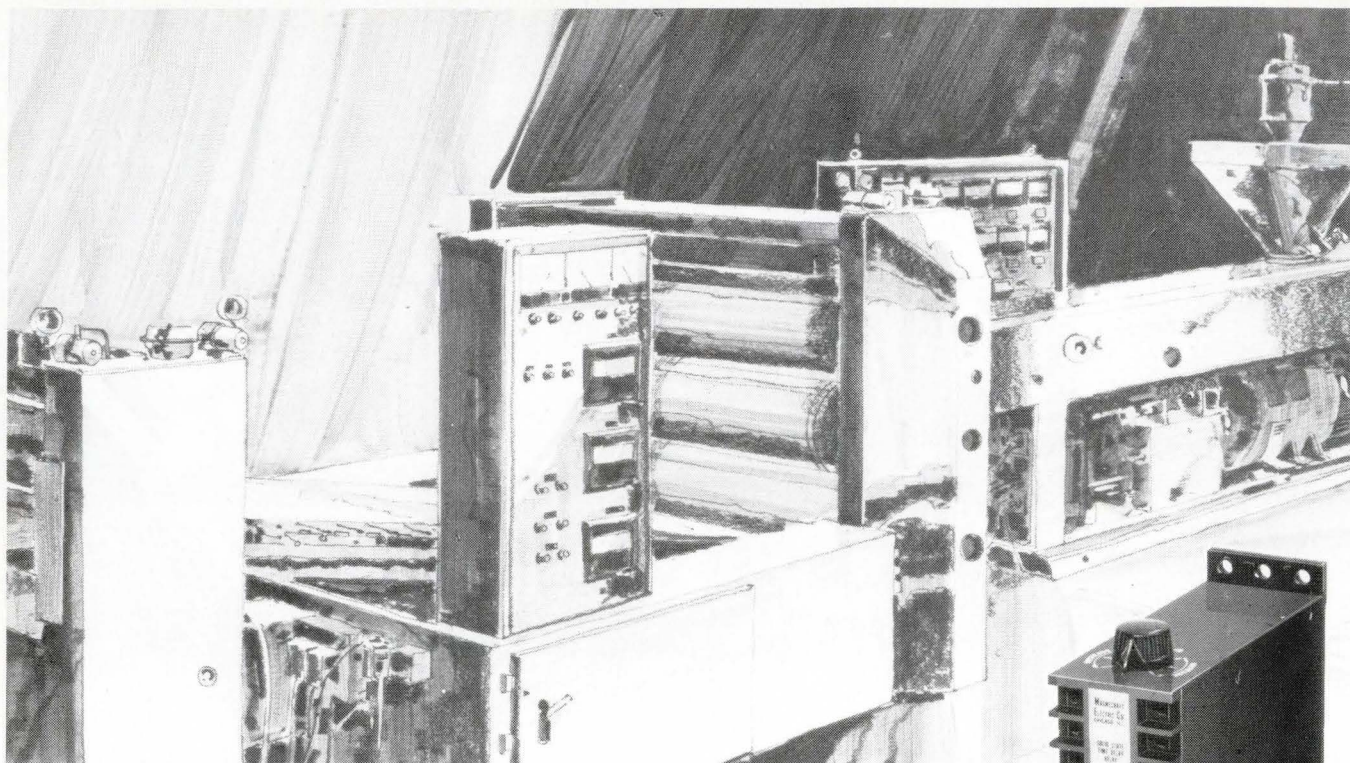

MAGNECRAFT THE CONTROLLER

**Heavy duty time delay and power relays
for rugged industrial applications**

The Solid State (hybrid) Class 211M time delay relay is designed for heavy duty service requiring accurate time delay control with $\pm 5\%$ repeatability. This time delay relay makes use of hybrid technology combining solid state circuitry for the timing function with an electromechanical relay for DPDT 10 ampere output switching. This highly reliable relay operates on AC or DC, has an adjustable delay for either operate time or release time. The surface mounted molded plastic enclosure incorporates screw terminals. In stock for immediate delivery, this new relay costs less than \$29.00 in single quantities.

The Electromechanical Class 112M time delay relay comes in a package similar to the 211M. However, it utilizes a highly reliable precision air dashpot for the timing function, and an electromechanical relay for the 10 amp DPDT output switch. The designer will quickly recognize the inherent quality and simplicity in the design. Also in stock for immediate delivery, this time delay relay costs less than \$29.00 in single quantities.

The Class 99 is ideal for heavy duty industrial power relay applications. Occupies less than $2\frac{1}{2}'' \times 2\frac{1}{2}'' \times 2\frac{1}{8}''$ of space. Yet, it's capable of switching 115 volts at up to 50 amps. Available with a "Magnetic-Blowout" for greater arc suppression and increased DC switching. Class 99 power relays can be supplied with contact combinations from SPST to DPDT at ratings up to 50 amps and in Underwriters Laboratories Listings. In stock for immediate delivery and priced as low as \$5.66 in single quantities.

For your source of 512 different stock relays, write for Magnecraft's Catalog No. 271.

See our product data in EEM

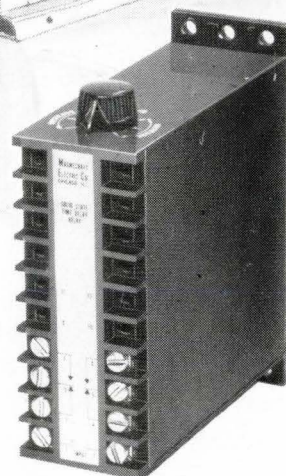

Class 211M
Class 112M
Time Delay
Relay

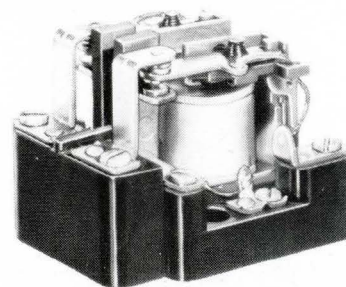

Class 99 Heavy
Duty Power Relay

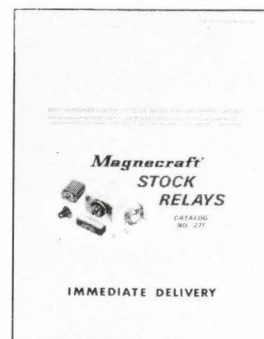

Magnecraft[®] ELECTRIC CO.

5575 NORTH LYNCH AVENUE • CHICAGO, ILLINOIS 60630 • 312 282-5500 • TWX-910-221-5221

A new way to water your plant.

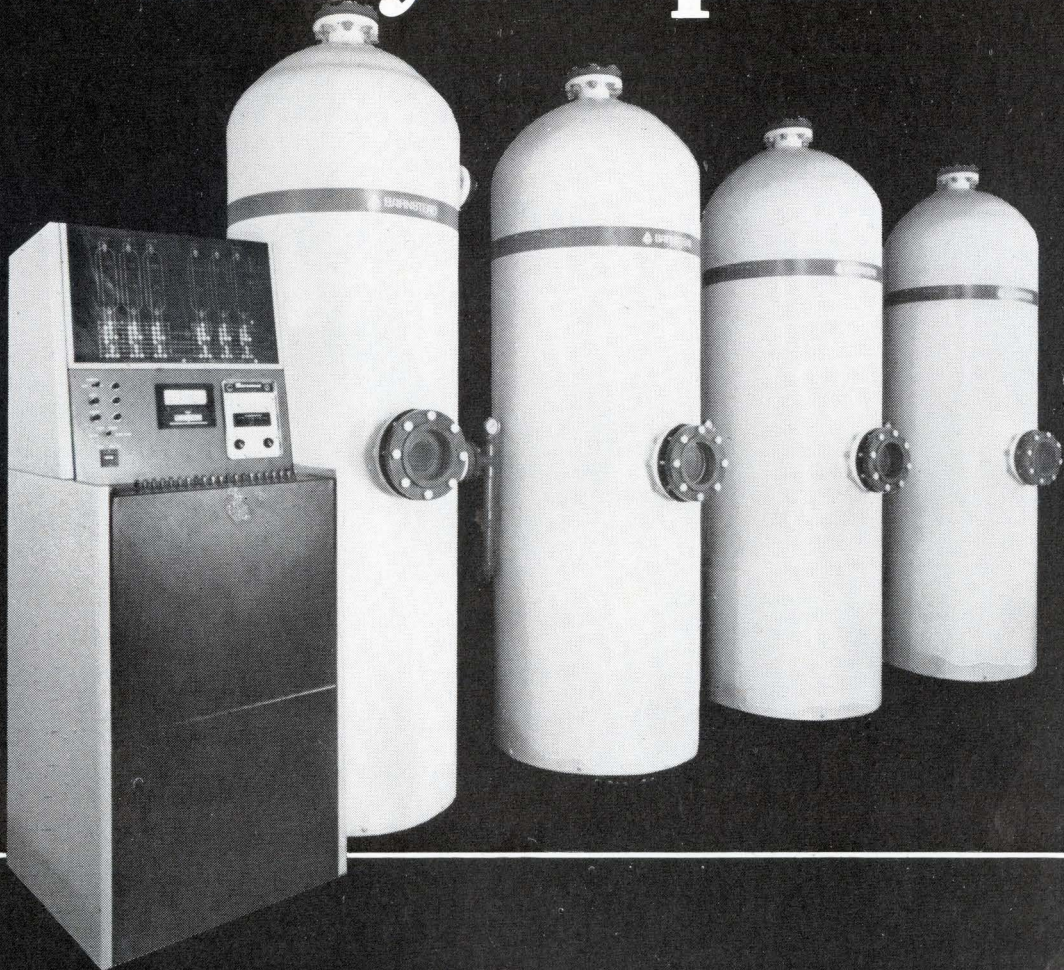

Meet the Ultra-Flow Water Treatment System. Designed for the firm that requires good water to operate efficiently. Water in volumes between 25 and 2000 gallons each minute.

The whole idea of the system makes sense. It's big, but made in a modular way that allows us to mass produce the design. Cost is reduced. Reliability increased. Delivery is practically off the shelf. When you want to grow the system will grow. Economically.

It removes those things that shouldn't be in a water supply in the first place. Ionic salts. Gases. Dissolved organics. Micro-organisms and more. What harm these items won't cause your

equipment, they will cause the product you sell.

So we designed our system to provide the water treatment you need. Single or alternate columns. Progressive deionization. Progressive regeneration. Two bed or four bed with integral pre-treatment – including reverse osmosis where needed.

We also designed unique controls to handle those various functions. Flow, regeneration, complete water treatment, can all be guided from a single console. With the simple flick of a switch. Or automatically, if you desire, with a special pre-programmed tape drive.

And before we sell a system,

we diagnose your water supply. We consider the work you have to do and just how fast you must do it. Then we design the precise way to start a water treatment program, including estimates of capital costs and operating costs, as well.

You should learn more about this new way to water your plant inexpensively. The Ultra-Flow Water Treatment System. Write or call for our literature. Barnstead Company, 225 Rivermoor Street, Boston, Massachusetts 02132. (617) 327-1600.

 **BARNSTEAD**
SYBRON CORPORATION

Circle 65 on reader service card



Sue, from the harnessing department says:
"Spot ties... cut lengths
of tape... new knot...
harnessing's a breeze!"

(She's really talking about
GUDEBROD'S
SYSTEM "S")

Sue's department had tried all kinds of harness tying materials and methods but they recently switched to Gudebrod's System "S". This uses cut lengths of lacing tape (in a size and coating to suit the cabling) . . . with an easily learned knot that takes only seconds to make a spot tie. To bring every section of the harness within easy arm reach, harness boards are on Gudebrod Swivel-Tilt-Mounts. That's all there is to it!

Except, of course, the satisfaction from the swiftly made, firm neat harnesses that hold up under handling—and the money saving per harness. For details, talk to our Technical Representative.

*Naturally, Gudebrod
has a System "C" for
continuous lacing.*



GUDEBROD BROS. SILK CO., INC.

FOUNDED IN 1870

Electronics Division

12 SOUTH 12TH STREET, PHILADELPHIA, PENNSYLVANIA 19107

Area Code 215. WA 2-1122

A lot of people didn't believe it was possible for even Wang to make a calculator the size of the new 700 that would perform so many functions.

Once somebody begins using the 700 their doubts quickly turn to admiration. They find that features like the 16 special function keys actually turn the 700 into their own specially programmed personal calculator. And the 120 register calculating capacity will take care of all their side calculations and then some.

Then they discover how easy it is to program the 700 and store the program on a tape cassette for later use. Now there's no stopping them because the 700 is theirs.

Something else they quickly learn about

the 700 is that it is a real calculating system with a complete program library and two optional output devices.

Skeptical? For a convincing demonstration, call any one of our factory sales/service offices from coast to coast. Wang Laboratories, Inc., Dept. E-10, 836 North Street, Tewksbury, Mass. 01876. Tel. (617) 851-7311.

Tested by skeptics.



WANG

Clairex standard photocells meet 98% of all requirements...

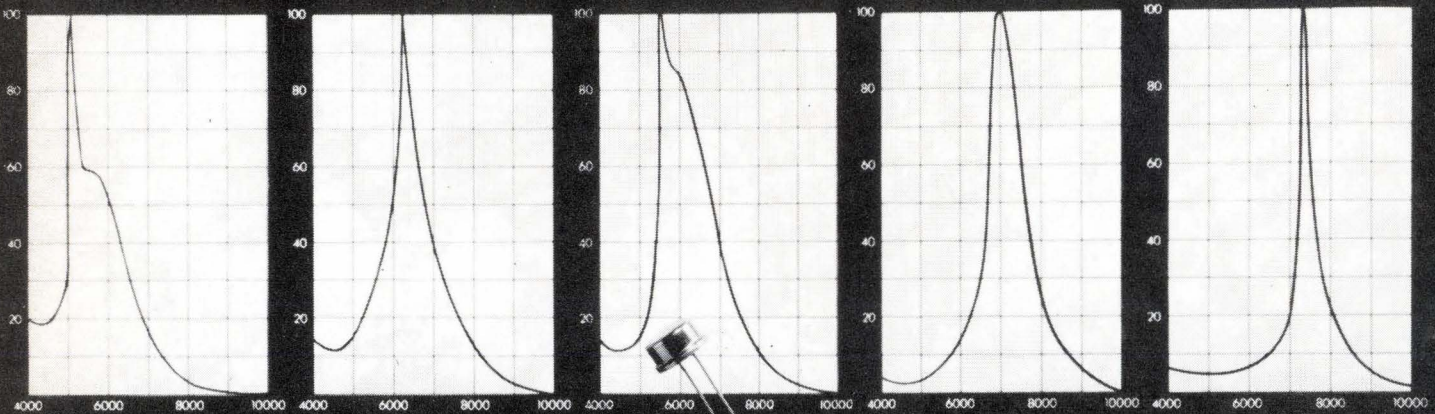

but if you really
need a special...
we'll design it for you.

Clairex has the widest line of standard cells available. Light control has been our business since 1953.

For complete information on our stock photocells or for special assistance with your problems call (914) 664-6602 or write Clairex® 560 South Third Avenue, Mount Vernon, New York 10550.

CLAIREX ELECTRONICS

A DIVISION OF CLAIREX CORPORATION

Article Highlights

**Air Force plans
with computers, Army
sees by starlight**
page 70

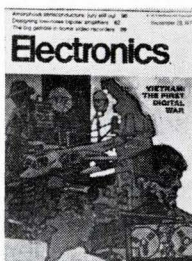

In the first of a two-part series on electronics in Vietnam, *Electronics* focuses on the use of computers and night vision gear for military operations. In what will be known as the first digital war, the Air Force is relying extensively on computerized command and control systems to direct bombing missions. The Army isn't neglecting the air, either: sophisticated night vision gear helps to direct firepower for its helicopter armada. And on the ground, soldiers use the equipment to spot enemy troops, while personnel radars guard their perimeters.

**Programmable digital
filter performs
multiple functions**
page 78

The programmable digital filter is capable of processing signals with an accuracy that's tough to achieve in analog devices. The digital units are untroubled by temperature instability, allowing them to deal effectively with long time delays. And with the availability of inexpensive digital components, the filters are now a commercial proposition.

**10 examples
show versatility
of d-a converters**
page 91

The digital-to-analog converter forms the vital interface that allows digital techniques to be applied to a variety of operations in systems with analog inputs and outputs. Ten examples show how the d-a units can be used for a variety of functions, including CRT character and sweep generation; positioning resolvers; programable power supplies; and automatic gain measurement on an amplifier.

**Coping with
feedthrough in
ECL circuits**
page 98

Capacitive feedthrough is a source of instability in emitter-coupled logic integrated circuits, and can cause spurious outputs in gates or flip-flops. The feedthrough appears in various forms, some of which can be controlled by the designer of the IC chip, and others by the ECL system designer.

Coming

LSI in minicomputers

Shrewd design, anticipating advances in integrated circuit technology, was the key factor enabling engineers behind the new Nova series of computers to accommodate large-scale ICs and achieve high performance without a big cost premium.

Air Force plans with computers, Army sees by starlight

In the first digital war, computerized command and control system directs bombing missions; night vision gear guides firepower for Army's air armada; personnel radar secures ground perimeters

By Arthur Erikson, *managing editor, international*



1. **Combat veterans.** Army radios that get out to where the action is most often are the AN/PRC-77 manpack and the jeep-mounted AN/GRC-163. Both can operate in a voice-secure mode, using an AN/KY-28 digital scrambler.

□ Slogging their way through Communist-infested Vietnamese jungle, U.S. infantrymen—grunts they call themselves—seldom get far from electronic gear that theoretically could link them directly to Washington (Fig. 1). Since the Vietnam war has become a massive counterinsurgency operation, action can pop up almost anywhere, and communications, as well as fire power, must be at the scene.

The military communications network in Vietnam—built at a cost of about \$333 million—is so extensive and so effective that the top brass in the Pentagon could fire off an order directly to a squad of grunts on patrol. Though this capability isn't used, the network does put the Pentagon effectively into the field. In fact, tactical decisions on targeting made at the Pentagon spew out of printers at U.S. 7th Air Force Headquarters at the Tan Son Nhut air field on the edge of Saigon.

There's much more to electronics in Vietnam. In the history of military technology, Vietnam likely will be known as the first digital war. Unlocking a filing cabinet marked "Confidential," a general officer at the headquarters for the Military Assistance Command-Vietnam (MACV) pulls out a bulky computer printout. "That's the real impact of electronics in this war," he explains. "We've been fighting with computers." And the digital war doesn't stop at MACV's sprawling Tan Son Nhut headquarters. Field commanders have hardware tied into the Autodin (for automatic digital network) system. The Air Force even has jeep-mounted input terminals so that reports can be filed back by the numbers from the most rudimentary airstrip, reports that computers digest to tell the Air Force what targets to strike and how to do it. Infantry squads often use digital-based voice-secure transmission gear. Digital frequency synthesizers are widely used in troposcatter communications gear. General purpose avionics computers have been tested by the Army to calculate and store the geographic coordinates of targets picked up by overflying infrared sensors. Digital techniques have found their way even into personnel-detection radars. All told, the bit-streams that criss-cross Vietnam, carrying data, messages, tactical decisions and detailed orders, detecting, processing and analyzing, have delivered far more wallop than the firepower directed at an elusive enemy.

Because guerrilla groups can strike swiftly almost anywhere, deploying troops by convoy or on foot often is inadequate. So to fight its peculiar war in Vietnam, the U.S. Army has acquired its own air armada—some 5,000 aircraft, mostly helicopters. The ensuing proliferation of Army avionics has led to a whole new complement of lightweight airborne radios on the combat scene during the past 15 months. Sophisticated stability controls are used in choppers converted into gunships and though helicopter pilots like to fly by the seat of their pants, they may be getting direction finders.

Direction finding of another sort—the bearing and range of Communist troops—has always been a high-priority item for Army ground elements. Night-vision aids rate high on the list of battlefield-spurred elec-

tronic advances, says Maj. Gen. Thomas M. Rienzi, who recently completed 22 months as commander of Vietnam's top electronics organization, the 1st Signal Brigade. Initially, the push was on infrared equipment, but the emphasis has shifted to low-light-level equipment. And along with it has come a new batch of personnel-detection radars, from manpacks on up to large surveillance radars.

All told, there's a bewildering mix of electronics equipment in Vietnam, some brand new, some of Korean War and even earlier vintage. Says an Air Force technical sergeant at the Da Nang air base, "I've got kids repairing Loran equipment that was built before they were born." To keep the sophisticated electronics gear working, the military has built up an army in mufti, a corps of contract civilian engineers and technicians.

There's much that can be faulted in some combat-zone hardware, even though the services deploy on-the-spot research and development teams. Tubes and transistors blow in the Vietnamese heat. Dust is a plague. Anything that protrudes on a piece of field equipment is a candidate for breakage.

In the air—and on the ground

U.S. air operations in Vietnam have much about them that's bemusing. Although President Lyndon Johnson called a halt to the strategic bombing of North Vietnam 24 months ago, Air Force B-52 strategic bombers still carry out sorties over South Vietnam. Like elephants stomping out anthills they can't see in the underbrush, the B-52s streak in from bases outside the country to clobber enemy concentrations in the jungle.

Marine and Air Force fighter pilots, too, essentially have become ordnance delivery men since there's no airborne opposition south of the demilitarized zone. The closest thing to a dogfight these days is when an Army helicopter shoots it out with a Viet Cong patrol on a hillside.

And while its glamour boys pour bombs, missiles, and bullets onto targets they often can't see, the Air Force's transport pilots move so much cargo and so many men that the Vietnam airborne logistics effort, in the words of an Air Force colonel, "dwarfs the Berlin airlift."

Impressive as these air exploits are, in one sense the Air Force has scored highest on the ground. At a closely guarded, bunkered-in computer center at Tan Son Nhut (and a companion installation in Washington) Air Force commanders are making military history with an automated command and control system that covers an entire combat theatre.

The Air Force realized that computers would be a tremendous help in planning missions back when it was devastating North Vietnam. Particularly when attacking heavily defended key targets in the North, strikes had to be carefully planned to get the right planes to the right targets at the right times with the right bomb load.

Designating secondary targets for aircraft that couldn't get through to their primary targets because of weather or overpowering defense was particularly difficult. Reconnaissance results of an early-morning strike's effectiveness, essential for sensible retargeting, generally didn't get back to headquarters before late in the afternoon. That meant that manually elaborated "frag" orders weren't ready for the 3 a.m. briefing that preceeded the next day's strikes. So the frag orders—the often-long fragments of an overall operations order that tells each flight wing where and when to strike—had to be based on day-old information.

To slash this delay, the Air Force set up a program called Seek Data II. And by early 1968 a computer-aided combat reporting system (CREST) was operating at 7th Air Force headquarters. Since then, the system has been expanded. This spring, for example, Crest stepped up from its initial IBM 1410 to an IBM 360/50. This fall, a sister, airlift management system (ALMS), will start operating.

The speedup in frag order generation has been dramatic. For strike missions, the time has been dropped from 10 hours to 10 minutes in some cases. And automated order preparation for airlift operations will take four hours instead of 14. Along with developing the frag orders, the automated systems transmit them to the operating units.

Crest data also is transmitted to Commander-in-Chief Pacific (Cincpac) headquarters in Hawaii and to the National Military Command Center at the Pentagon. Both have IBM 360/50s and operations analysts who scrutinize the data to develop more effective strike tactics. The Pentagon-Tan Son Nhut computer tie, through transpacific cable or by satellite into the Integrated Communications System (ICS) that blankets Vietnam, in effect puts the top brass up in the front line. "Washington even picks our targets," says a general officer at Tan Son Nhut.

The hardware for Crest, reports Lt. Col. Patrick Coleman of the 7th Air Force's directorate for automated systems, "has been standing up beautifully." Along with the 360/50 computer, which is tied into the worldwide Autodin network, the system has an IBM 7740 linked to a dedicated communications network and a pair of IBM 1130s to handle inputs and outputs. The computers are leased from IBM but the software was developed by Control Data Corp., with a 200-man team under an initial \$10 million contract. CDC will continue to upgrade the software with a 30-man team under a \$1.5 million annual contract.

So far, the system requires manual compilation of mission reports, but the Air Force is examining hardware that would let squadron commanders feed reports straight into the computer.

Alongside the Crest 360/50 computer at Tan Son Nhut sits a second 360/50, this one for the ALMS that is going into operation now. This 360/50 has three IBM 1130 satellites tied to it, each driving an IBM 2250 cathode ray tube display unit.

ALMS does for C-7 Caribous, C-123 Providers, and C-130 Hercules transports what Crest does for bombers and fighters: it puts out up-to-date frag orders in

a hurry for a supply effort that requires some 1,200 sorties a day handled by 200 aircraft working through 134 airbases. Before ALMS, frag order preparation for transport squadrons started at 2 each morning and went on until 4 p.m. ALMS reduces the cycle to four hours. At the same time, the frag orders are more detailed; they include, for example, identification of preloaded pallets, selected after a daily inventory.

Like Crest, ALMS isn't fully automated: the main 360/50 computer is linked through the Autodin network to 16 airlift control units spotted throughout Vietnam that feed in reports from transport wings in their areas. However, the system "extends all the way out to dirt strips," says Lt. Col. Oswald D. Tolley, who heads the ALMS development team.

ALMS gets out in the field via its AN/UYA-7 digital terminals (Fig. 2), made by the Garland division of LTV Electrosystems Inc. Twenty-three of these terminals, in jeep-borne portable versions and in transportable air-lift control centers, are planned for use with ALMS. They'll transmit airlift data to three master stations, for manual reformatting and Autodin transmission to the 360/50 computer.

Airborne command and control

Although campaigning by computer ranks as the Air Force's most noteworthy technological effort in Vietnam, there are other notable advances too. One that proved invaluable, during the siege of Khe Sanh, was the airborne command and control center developed by LTV Electrosystems.

The airborne command and control center (ABCC) used at Khe Sanh was a trailer-sized module that fitted into the cargo bay of a C-130 Hercules. The center had working slots for a 14-man control crew and heavy communications facilities but no radar or identification, friend or foe equipment. Also, there was a large grease-pencil-and-plexiglass display board to keep track of incoming friendly aircraft and match their payloads to targets on the ground.

During the 77-day battle, Gen. William Momyer, now chief of the Air Force's Tactical Air Command but at the time in charge of air operations in Vietnam, often personally manned this post. It controlled about 450 sorties a day: 375 for aircraft in close support; 30 for C-130 airlifts (each plane moved as much material in a day as an 80-truck convoy), and 45 for B-52 bombers, each raining 120 500-pound bombs on enemy positions. Fighters and bombers entering the strike zone went into holding patterns until the ABCC either vectored them out onto targets or handed them off to a forward air controller for target instructions.

Still to get its first real workout in combat is another piece of Vietnam-sired gear, the Talar-IV (for tactical landing radar), built by Singer-General Precision Inc. Talar, which transmits a microwave glide slope for instrument landings, can be set up in 15 minutes by two men who only have to level it, set the glide slope, and turn it on. Few would differ with Air Force Tech. Sgt. Ervin Baumgarten, an

2. Calling in. U.S. Air Force combat control teams now have jeep-mounted AN/UYA-7 data terminals to feed airlift information back to control centers, where it's passed on to the airlift control computer at Tan Son Nhut.

3. Looking in. Electronics Command technician checks out SLAE (standard lightweight avionics equipment) on Lockheed YO-3A, a special night-reconnaissance plane fitted with classified night sensors. SLAE radios are at bottom of control console.

4. Medium range. AN/TVS-4 night observation device offers 1,200-meter range in starlight, 2,000-meter range in moonlight.

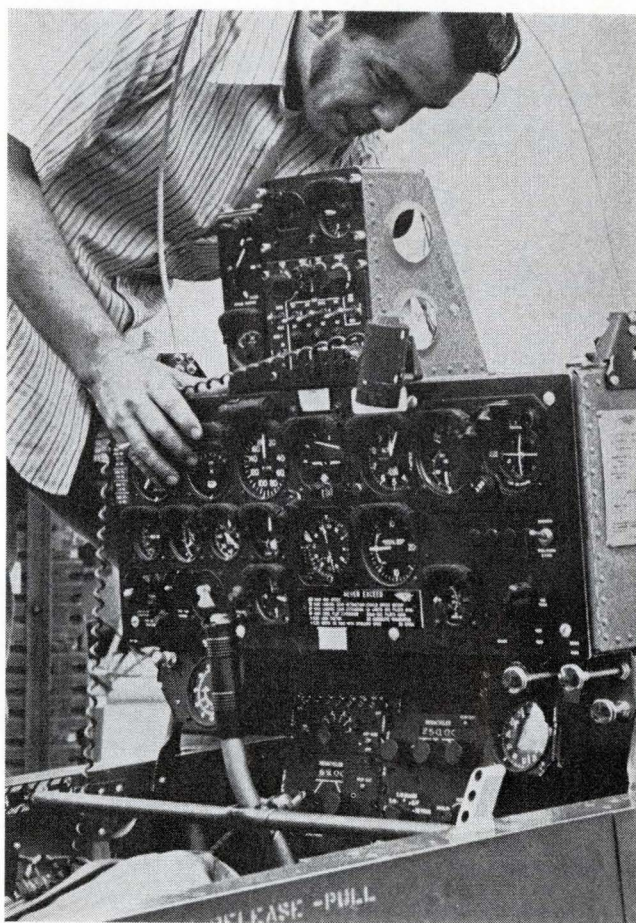

instruments expert at Tan Son Nhut, who asserts, "We should have had this 15 years ago." Yet the first Talar equipment hadn't reached Vietnam at midyear.

As with much of the new hardware the Air Force uses or will use in Vietnam, Talar got its start as a Seacor (Southeast Asia operational requirement). As of mid-1970, 350 Seacors had been initiated covering items as diverse as base defense gear to high-flying (and highly secret) countermeasures equipment.

Equipment added to planes because of Seacors, and because a lot of electronics gear tends to go aboard aircraft only after a need for it has been shown in combat, has caused some trouble in Vietnam. Particularly in the F-4 Phantom, there's been a problem of overheating in compartments crammed with add-on gear. Regulated power supply busses, too, don't work as they should when there's too much added load. In some instances, says an Air Force officer on the scene, the mean time before failure is lower than the average mission time. His suggested remedy: an independent power supply for critical avionics gear.

One rational hardware collection, widely used in Army helicopters, has been on the scene since mid-1969. Called SLAE (for standard lightweight avionics equipment) (Fig. 3) it's a set of radio equipment that includes an fm tactical radio, a vhf command set, an intercom control, and a direction finder. This five-set package weighs 40.4 pounds and replaces a radio complement that totaled 103.7 pounds.



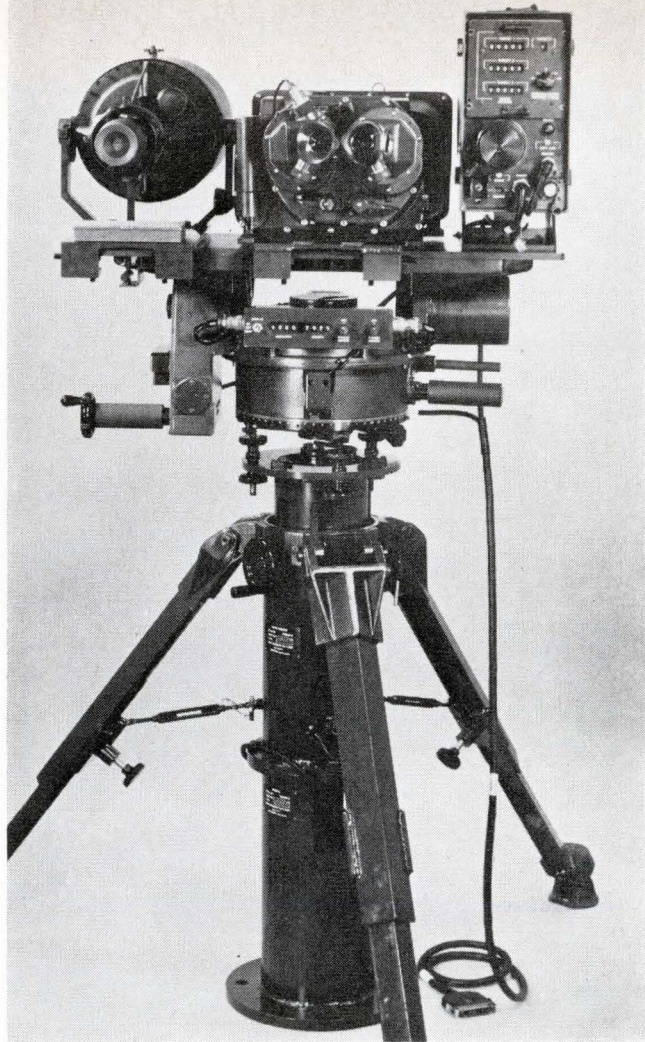

5. All together now. RCA's AN/GVQ-10 Integrated Observation System combines an AN/TVS-4 night observation device, an AN/SU-63 target acquisition binocular and an AN/UVS-2 laser rangefinder. The latter provides range readout for three targets simultaneously; the pedestal gives bearing and elevation.

6. On guard. An AN/PPS-5 doing its thing for the infantry. The lightweight radar can spot a walking man at 5,000 meters.



Like other avionics equipment in Vietnam, SLAE has its pluses and minuses. SLAE's reliability goal is a 1,000-hour MTBF. So far, the world-wide average is 700 hours except for Vietnam, where the figure is 180 hours. Elmer Goetsch who heads up the Army Electronics Command's civilian avionics team at Tan Son Nhut trots out a lot of reasons for this. For one thing, the equipment is subject to very rough treatment.

Helicopters often are simply hose-cleaned inside after a mission, and since the Army's air missions have a 13,500-foot ceiling (higher air space is exclusively for the Air Force and Navy) equipment isn't sealed against pressure and consequently isn't hose proof. Then, too, there's the all-pervasive dust. "Just before the monsoon season," says Goetsch, "we have a rash of tuning capacitor failures. Then the rains come and knock the dust out of the air and the failures stop." Goetsch thinks sealed equipment is the answer.

Teeth for the choppers

For its chopper armada, the Army has developed some highly specialized fire-control gear to hit the Viet Cong at night. One of the latest systems in action is the Iroquois Night Fighter and Night Tracker (Infant), (*Electronics*, Sept. 1, 1969, p. 69).

Infant, in effect, is a closed-circuit tv system tied to the fast-firing Gatling miniguns on the "killer"

partner of a helicopter hunter-killer pair. An OH-6 observation chopper flies slow and low over suspect terrain, a fat target for enemy riflemen. When they expose themselves, down swoops the Iroquois killer, which can spew out 6,000 rounds per minute.

The Gatling miniguns on Iroquois and Huey Cobra killer copters have been around for some time. One reason for their effectiveness in helicopters is a set of hardware called SCAS (for stability control augmentation system), which has been in the Vietnam theater for nearly two years. The system stabilizes the chopper's yaw, roll, and pitch, picking up its control inputs from three rate gyros. Response time is 0.1 millisecond at the most. With SCAS, the miniguns spray an area about 75 yards wide; without it, the helicopter bucks and the ordnance disperses over a zone about a quarter-mile wide.

Flying low and slow enough to attract ground fire obviously is not the safest way to search out the enemy. So the Army has developed hardware to mitigate that occupational hazard of helicopter pilots. Some observation choppers carry a pair of pole-like projecting 18-foot booms. The booms have sniffers that spot the scent—condensation nuclei of compounds like urea and ammonia—of troop concentrations. Originally, the detector head was to be mounted on a rifle—where it most often spotted the presence of nearby well-fed, heavily-sweating grunts.

Even more effective, is the Army's AN/ADR-6 radiological monitoring system. It spots radioactive dust

stirred up when people or vehicles pass through a preseeded area.

Of course, there's a whopping inventory of more conventional surveillance equipment—photographic, infrared, and radar. It's flown mainly from the Grumman OV-1 twin-turboprop Mohawk, the Army air armada's fixed-wing mainstay.

The first Mohawks went into Vietnam service late in 1962 and were originally designed for photoreconnaissance. Since, the hardware complement has been upgraded to include an infrared capability and side-looking radar. The latest Mohawk, the OV-1D, can fly photo, infrared, radiological monitoring, or radar reconnaissance missions. Changeover from an IR module to a SLAR pod takes about a half hour.

Flying radar surveillance missions at altitudes between 8,000 and 10,000 feet, the Mohawk's search area runs from 24 to 30 miles on either side of the ground track. Interestingly, the Mohawk's side-looking radar, the AN/APS-94 does not use synthetic aperture techniques. Instead, a 17-foot-long antenna is used to achieve high angular resolution. Developed by Motorola, the radar is intended to detect moving targets and can spot a single walking man. With synthetic-aperture processing this would be impossible since doppler-shifted signals are interpreted as returns from fixed targets at some angle other than broadside to the line of flight.

Along with the usual line-by-line printout of a side looker, SLAR-equipped Mohawks have a CRT display. There's also an in-flight data transmission system, the AN/AKT-18, built by Motorola. The system relays the imagery to a ground terminal in real-time so field commanders can scrutinize it as the target areas are overflown. The terminal also has hard copy, film printout of the imagery.

Mohawk's camera complement includes downlookers with side-to-side scan, exposing 5-inch roll film a line at a time. Also on board are forward-looking panoramic cameras that view the entire horizon with 70 mm film. Printed on the film strips are the plane's heading, the time, and coordinates fed in from a navigation system. Early Mohawks used doppler navigation. The OV-1D's will have a more accurate inertial navigator, Litton Industries' AN/ASN-86.

Mohawk's IR surveillance systems too, have been improved. Closed-cycle cryogenic coolers long ago replaced the liquid-nitrogen dewars which could cool the detector heads for only 2 hours. The latest system, the AN/AAS-24, has a slightly wider field of view and quadruple the spatial resolution of its predecessor, the AN/AAS-14, though at the cost of reduced thermal resolution, one degree Centigrade compared to the AAS-14's 0.5 degrees. Other improvements include an 8.5-inch by 10.5-inch moving-map bright-screen display and an image-freeze mode, which holds and refreshes an image that warrants close examination.

Night vision aids is what first comes to mind when Lt. Col. Don Fague, a resident expert of the Electronics Command at Long Binh, is asked about the impact of the Vietnam War on battlefield electronics. "We've got a bookful of them now" he asserts, a reference to the Army's catalog night vision aids.

Seeing in the dark

People like Fague who are close to the fighting will tell you the most significant night-sight advance has been drastic weight reduction—from about 8 pounds for early infantrymen's see-in-the-dark devices to 3 pounds for the latest ones. Back at Fort Belvoir, the Washington, D.C. area base that houses the night-vision project office, they see things in a different light. There, the shift from an emphasis on IR sensing to low-light-level viewing is considered most significant.

From a grunt's standpoint, though, the marvels of mechanics sometimes surpass electronics advances in night-vision gear. The sights now come fitted with a secure eyeshield, a molded-rubber eyepiece with an integral shutter that remains closed until actuated by eye-socket pressure. The shutter also closes before the observer's face is fully drawn away. This feature was included after sniper counterfire had taken a heavy toll of U.S. soldiers whose faces were briefly illuminated by the viewing screen as they turned from the eyepiece of the rifle-mounted night sights.

Most of the night-vision devices in use are built around an image intensifier, typically the Type 8586. It has three-stage intensification, a 25-millimeter aperture, S-20 photocathodes, P-20 phosphor screens, a peak sensitivity at 4,000 angstroms, and a resolution of about 600 lines. The dynamic range: from 10^{-5} foot-candles (starlight) to 10^{-1} foot-candles (dusk).

So-called first-generation devices use three image-intensifiers in cascade, coupled through contacting fiber-optics faceplates. Each tube provides a gain of about 40, so that the trio's total gain is about 60,000. Now, second-generation image intensifier tubes provide the same gain in one-third the length. They top the phosphor with a microchannel plate, a thick wafer comprising a bundle matrix of glass tubes with an internal diameter of perhaps 0.002 inch, whose inner walls are coated with a conductive, electron-multiplying surface. Electrons emitted from the photon-illuminated photocathode are accelerated to the microchannel plate where each produces on the order of 60,000 secondary electrons. This adds to the normal image-intensifier gain, so the device is about 40 times as sensitive as the earlier cascaded intensifiers.

The simplest and sveltest member of the night-vision family is a riflescope, the AN/PVS-3. It weighs 3 pounds and its intensifier tube has an 18-mm aperture. A rifleman can pick up a target 250 meters away under moon light and in open country. The range drops to 150 meters in foliage, where contrast is poor. Both figures are cut by about 40% in starlight.

Both Electro-Optical Systems and Varo Inc. produce the AN/PVS-3, which costs some \$1,000 each. Its principal predecessor, the AN/PVS-2A weighs twice as much but has considerably more range—400 meters in moonlight and 300 meters in starlight—with the same 10.4° field of view, thanks to its 25-mm image-tube aperture and its large light-collecting optics. Although it can be mounted on rifles, the 6-pound scope turns up more often on machine guns, grenade

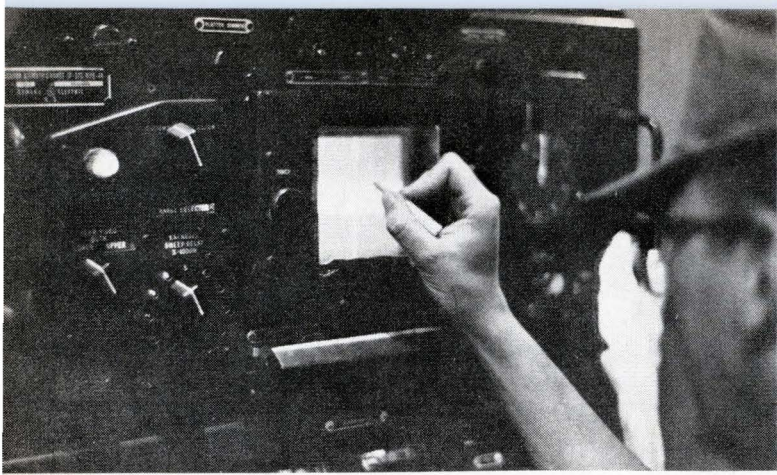

7. "X" marks the spot. By marking in two pips, operator of AN/MPQ-4 radar can spot mortar launch point.

launchers, and rocket launchers.

For tank guns and heavy machine guns, there's Varo's \$3,500, 15-pound, 2-foot-long AN/TVS-2. Although the basic image tube is the same as the larger riflescope's, the TVS-2 has considerably larger light-collecting optics and a narrower field of view, 6°. With this combination, range jumps to 1,000 meters in moonlight and 800 meters in starlight.

Further up the performance, weight, and cost scale, there's a \$5,000 set that the soldiers call "NOD," (from Night Observation Device) actually the AN/TVS-4 (Fig. 4). It uses a combination of reflective and refractive optics and a 40-mm image intensifier tube to obtain a range of 2,000 meters in moonlight and 1,200 meters in starlight. The viewer alone weighs 34 pounds; its tripod, carrying case, and accessories bring total weight to 70 pounds. This is too much for grunts on patrol, so the TVS-4, made by Electro-Optical Systems, is mainly used for perimeter defense.

The heaviest—and most versatile—piece of gear is RCA's AN/GVQ-10, Integrated Observation System (Fig. 5). This combines low-light viewing with a laser range finder and a pair of spotting binoculars. The Army has bought 11, ordered 17 more and uses them for base defense.

At the lightweight end, there's a new low-light-level binocular under development to replace the widely used AN/PAS-5 near-infrared binocular. The new unit, the SU-50 is intended for close-up work like reading maps and driving slowly at night. The PAS-5 has a close-up attachment for these and similar tasks, but the active IR illumination requirement presents a potential beacon for the enemy.

Seeing red

Despite the shift in emphasis to the visible spectrum considerable work is continuing on IR equipment. But the effort now is on passive techniques, detecting targets by their own IR radiation rather than illuminating them with an IR searchlight. The advantage is twofold: you don't become a well-lit target for an enemy unit that's managed to acquire IR binoculars; and because of temperature differentials you can pick up camouflaged targets.

One new development is a far-IR night observation set whose range tops 2000 meters. It is scheduled for deployment in 1974.

Also under development is a passive IR binocular with an integral low-light-level viewer and a range of 400 meters. Then there's the AN/VAS-1 far-IR hardware designed for the M60 tank. Still in advanced development, the VAS-1 marks a new generation of IR gear. Instead of vacuum-tube imaging, it uses a silicon photomosaic array. And for broad sector coverage while maintaining the narrow field of view essential for high sensitivity, the mosaic is scanned. Range on tank targets, which are considerably hotter than their surroundings, will top 3,000 meters.

Until this equipment becomes operational, though, tank units will depend on the AN/VSS-3 IR-white-light searchlight, which has been deployed in Vietnam for several months. It packs 75 million candlepower into a 1° or 7° beam. Its Xenon lamp draws 100 amps from a 28-volt dc power source. Although it's mainly used on Sheridan tanks, the VSS-3 also finds its way onto armored personnel carriers and "killer" helicopters.

Doppler delivers

The Army, by and large, has also been forced to come up with the most striking new radar equipment. The Army already is well into the second generation of man-and-vehicle detecting radars with the AN/PPS-5. And it has successfully tested the AN/PPS-9, a modified version of which will be procured under the nomenclature AN/PPS-15.

In all models, audio is either the prime or auxiliary display medium. A trained operator can reliably pick up moving targets by the doppler burbling of their echoes as they move through relatively stationary backgrounds. Vehicles actually whine as they accelerate; human targets are identified by the whoosh-whoosh of their arms, swinging as they walk and moving faster than the body as a whole. Rather unnerving though, is the background return, a mixture of moans and sighs as vegetation flutters and sways.

The first of these radars to see service in Vietnam was the AN/PPS-4, now largely phased out. Built by Sperry the PPS-4 is a lightweight x-band radar that uses noncoherent moving target indicator processing. It can spot a walking man at up to 1,500 meters; the range doubles for a small vehicle. The 0.2-microsecond transmitted pulse is range-gated on reception by a gate that's manually cranked out to the suspect range. This technique limits the clutter-to-signal ratio. The received signal includes returns from both targets and background; a simple mixing process extracts and makes directly audible the doppler terms.

The PPS-4 can be scanned manually, but is most often used to view a fixed sector. But that limitation doesn't apply to the AN/PPS-5 (Fig. 13), designed by Airborne Instruments Lab. division of Cutler-Hammer. Deployed for nearly two years in Vietnam, it automatically scans a 30°, 60°, 90°, or 110° sector. What's

more, its remotely controlled "orange peel" antenna can keep the operator from becoming a target.

Along with these advantages, the PPS-5 has better range—5,000 meters on people and up to 10,000 meters for vehicles.

Three major improvements account for the PPS-5's performance. One is a 50-channel range-gate filter that permits display of MTI video over a full 5,000-meter range. Second is the A-scope, which lets the operator position the 40-meter range gate accurately. Third is the narrow beam width of the radar—1.1° in azimuth and 3.5° in elevation—which limits the clutter backscatter in each resolution cell.

The PPS-5, too, has its drawbacks. Chief among them is an MTBF on the order of 100 hours. A modified version, the PPS-5A, has a demonstrated MTBF of at least 250 hours.

However, size and weight remain problems. The largest battery available is good for only 8 hours of operation and it takes two men to backpack the set to a fire base. But the 500-odd sets in the field have worked so well that the Army plans to buy about 1,200 more PPS-5As for the South Vietnam Army.

Good as the PPS-5 is for medium-range detection, the Army wants something better for short-range work. RCA has supplied a candidate, a 15-pound set called the AN/PPS-9. It uses a correlation processing technique to extract target range for subsequent doppler-audio scrutiny. The technique yields the same 1,500 meter detection range as the PPS-4 with far lower average power, only 10 milliwatts.

The PPS-9's X-band cw signal is derived from a Gunn oscillator and phase shift modulated in a pseudo-random manner. The modulation comes from a ten-step shift register with two feedback taps; it provides 1,000 different phase positions before repeating a sequence. Phase shifting rate is 6 megahertz; when a received signal is correlated with a time-stepped replica of the transmitted signal, resolution is 25 meters. Time stepping is done manually as a range gate is cranked out. Gearing limits the crankout rate to less than the minimum time interval required for correlation. Four operating modes are available: all-range search, with a resolution of 3,000 meters; acquisition, with simultaneous 3,000-meter and 25-meter resolution; fine range, with 25-meter resolution alone; coarse range, with a 250-meter automatic-alarm zone set to any range to act as an electronic fence.

The receiver uses a homodyne mixer for which the transmitter acts as a local oscillator, directly converting received signals to audio. Doppler return becomes audible and a lamp lights when the range gate brackets a target.

Much of the PPS-9's virtue lies in its antenna, basically an array of planar diodes on a pc board assembly that measures 12 inches by 8 inches by ½ inch. Including its automatic scanning drive, the antenna unit weighs about 2.5 pounds. Because little power is needed to drive this lightweight head and thanks to the 10-mw output power, the set runs up to 16 hours on its magnesium dioxide battery.

The Army has field tested about 20 PPS-9 sets in



8. Losing its cool. U.S. and Vietnamese technicians ponder antenna and circuits of AN/MPQ-4, frequent victim of the hot season.

the U.S. and in Vietnam. Demonstrated MTBF is 1,000 hours and the mean time to repair is one hour. But one drawback was found when this set was evaluated under combat conditions: the battery is hard to change. Reports Lt. Col. Jack D. McClary, an electronics evaluation officer at Long Binh, "You have to take the transmitter off to, get at the battery and that's hard to do silently at night."

Two offshoots of the PPS-9 have also been put through field tests. USAF has brought two dozen AN/PPS-11s, a rifle-mounted version that weighs just 9 pounds. This radar provides a 500-meter range for a walking man and twice that for a small vehicle. In tests, it's had a remarkable 2,000-hour MTBF. Another Air Force version is designated AN/PPS-12. It can be set to scan sectors from 10° on up to 240°.

Further down the procurement pike is a set designated the AN/PPS-15, an 18-pound version of the PPS-9. A remote-control capability will account for the three additional pounds and the radar will emphasize improved, automatic visual alarm so the operator won't always have to wear headphones.

One veteran artillery radar still kicking around is the AN/MPQ-4 (Figs. 7 and 8), which locates the source of enemy mortar rounds and also shows how close retaliatory fire is landing. The set—when working—locates a mortar within four seconds after a round is fired. However, only a 25° sector is covered; that's far short of the 360° often needed in Vietnam.

Among grunts, the MPQ-4 is a favorite piece of hardware—most are convinced enemy units avoid mortar attacks on fire bases that have an MPQ-4. Maintenance men, though, say it's hard to keep the set on the air. The high-voltage tubes burn out in epidemics; the waveguides tend to develop leaks during the rainy season. The MPQ-4 first went into production back in 1956, but the Army still has not come up with a successor—although the latest models are modified to allow them to pick up low trajectories. However, there are three candidates under test (and under security wraps). The prime candidate seems to be Gilfillan's AN/TPQ-28. Others are Raytheon's AN/TPQ-31 and AN/TPQ-33. The latter has an anti-rocket capability.

In the Nov. 9 issue, Electronics will explore communications systems in Vietnam, as well as radar-bombing equipment and rescue and para-drop beacons.

Programmable digital filter performs multiple functions

Software changes enable a sampled-data filter to meet highpass, lowpass, bandpass or other requirements —and with greater accuracy than analog counterparts

By A. T. Anderson, *Electronic Communications Inc.*

□ Digital filters can process signals with an accuracy that's difficult to achieve with an analog device. Free of temperature instabilities, they can deal competently with long time delays, a tough task for an analog unit. Still better, with the rapid advances in integrated circuit technology, versatile, programmable digital filters have become a possibility.

Actually, a programmable filter is just a real-time special-purpose computer. Thanks to the availability of small, inexpensive digital components, it's now a commercial proposition, as the newly developed ECI model 999 proves.

This programmable filter is capable of bandpass, bandstop, comb, nonlinear phase, matched, and still other kinds of filtering. Filter coefficients for each of these functions are entered by means of a paper-tape reader located on its front panel. Its memory—a 200 tap shift register—can store 200 12-bit words, and operates from either an external clock, whose sampling rates can vary from 50 to 10,000 hertz, or an internal clock, which samples at 10,000 Hz.

These rates allow the specification of 200 sample impulse responses lasting from 20 milliseconds to 4 seconds, or alternatively permit the user to specify the magnitude and phase of 100 frequency samples at intervals of from dc to half the sampling rate (the remaining 100 samples are complex conjugates of the first 100 if the impulse response is real).

Since such a filter contains an analog-to-digital converter at its input and a digital-to-analog converter at its output, it can act directly on analog signals. A lowpass preprocessing filter limits the input signal bandwidth to about half the sampling frequency to prevent aliasing distortion which results if a signal is sampled too slowly. A postprocessing filter then reconstructs the baseband components of the sampled output waveform.

The concepts employed to describe, analyze, and synthesize digital systems, such as impulse and frequency response, are the same as those used with analog systems.

A linear analog network is completely described

1. Programmable filter. ECI model 999 is a 12-bit, 200-tap transversal filter. Filter coefficients corresponding to the desired function are entered into the coefficient memory by paper tape. To prevent aliasing distortion during sampling, the preprocessing filter limits the input signal bandwidth to half the sampling frequency. The postprocessing filter reconstructs the baseband component of the sampled-data waveform.

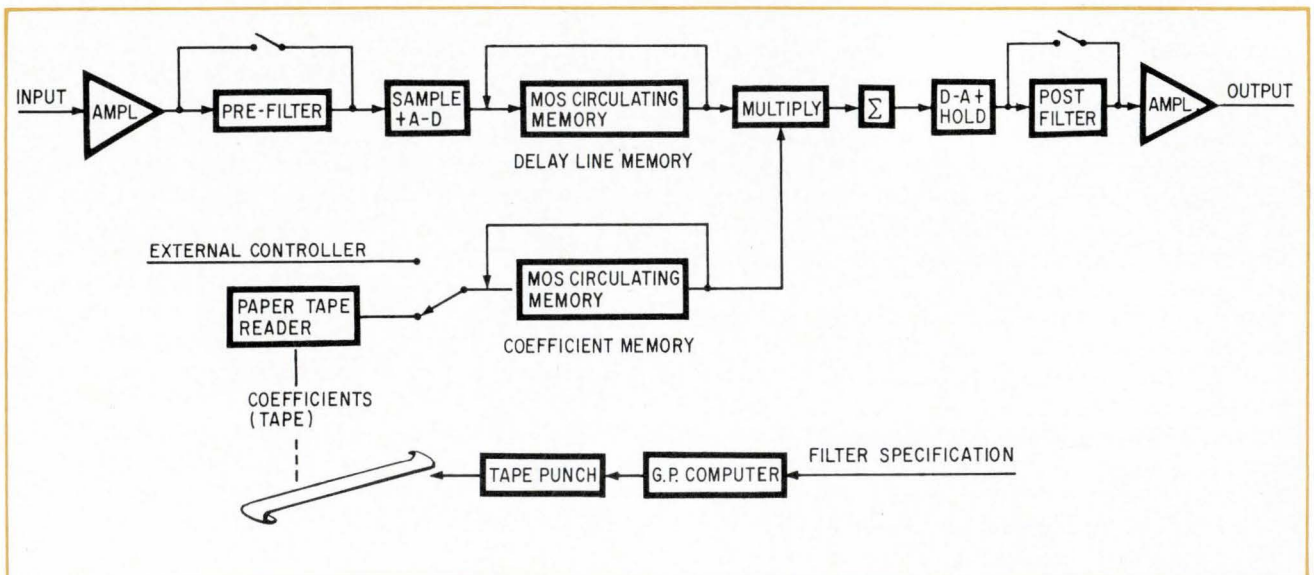

either by its impulse response, $h(t)$, or by its frequency response, $H(\omega)$. If a signal, $x(t)$, is impressed on the system input, the resulting output, $y(t)$, can be found from the convolution of $x(t)$ and $h(t)$. Alternatively, the frequency spectrum of the output signal, $Y(\omega)$, can be expressed as the product of the spectrum of the input signal, $X(\omega)$, and $H(\omega)$. Conversely, if a particular output spectrum is desired in response to a given input, the filter response, $H(\omega)$, can be found from

$$H(\omega) = \frac{Y(\omega)}{X(\omega)}$$

and synthesized from analog components, such as resistors, capacitors, inductors, and operational amplifiers.

The filter can also be designed by finding $h(t)$ as the inverse transform of $H(\omega)$ and then building a network characterized by that $h(t)$. But frequency domain synthesis is generally more useful.

In a sampled-data filter—a filter which accepts inputs and produces outputs only at specific instants of time called sample points—the convolution equation relating the discrete output to the discrete impulse response and discrete input is a summation:

$$y(n) = \sum_{k=-\infty}^{\infty} h(k) x(n - k)$$

If the input spectrum, $X^*(\omega)$, and the desired output spectrum, $Y^*(\omega)$, are known, the frequency response of the sampled-data filter is

$$H^*(\omega) = \frac{Y^*(\omega)}{X^*(\omega)}$$

where the asterisks indicate a sampled signal. $H^*(\omega)$

can be found and synthesized by means of differential equations, as in the continuous case. However, an approach based on difference equations is usually simpler. The best method depends upon the way the desired system is described or specified, and upon the network configuration used to synthesize it.

For example if the continuous impulse response, $h(t)$, of a filter to be synthesized digitally is specified, impulse invariance¹ is the technique to use. Impulse invariance results in a sampled-data filter whose impulse response, $h(k)$, is a sampled version of $h(t)$. The most direct way to implement this is to set the impulse response samples, $h(k)$, equal to the scaling coefficients, a_k , of the transversal filter. A transversal or nonrecursive filter lacks feedback, and directly implements the convolution summation with the feedback coefficients, b_k , set equal to zero (see "Filtering Digitally," p. 82). But recursive filters—those with feedback—can also sometimes be designed by the impulse-invariant technique if the transformed impulse response can be written in closed form in terms of z^{-1} , a Fourier transform of one-sample delay.

Or suppose the desired filter is specified by its frequency response. In this case, the frequency response could also be transformed into an impulse response by means of either a Fourier transform or a discrete Fourier transform, and the same technique then used to synthesize it²⁻⁴. But alternatively, the designer could use the frequency sampling method⁵ and, in effect, build the desired frequency response by scaling and summing the responses of a number of narrow-band filters.

A third technique consists of first designing an analog counterpart filter, $H(s)$, using analog synthesis techniques.²⁻⁴ A bilinear transform expression

$$\frac{2}{T} \left[\frac{1 - z^{-1}}{1 + z^{-1}} \right]$$

2. Digital filters. General recursive digital filters take one of two forms: direct or canonical. Canonical form is usually preferred since it contains half as many delays and therefore produces less noise. But the same difference equation describes both. Higher order filters of either form are sensitive to coefficient inaccuracy caused by limited word length.

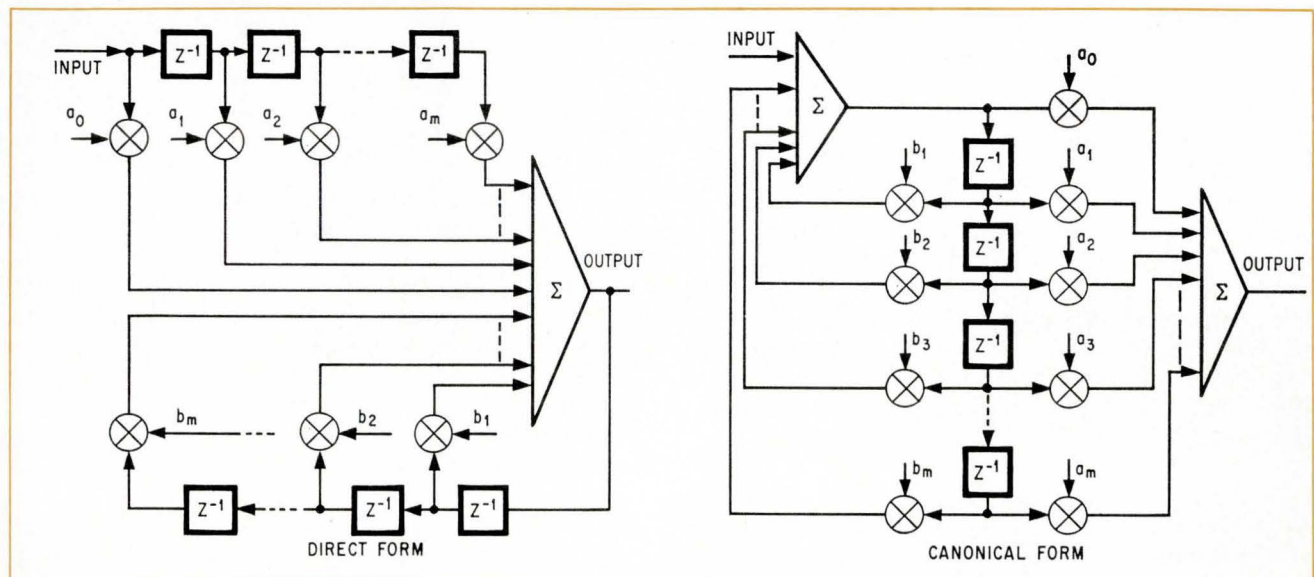

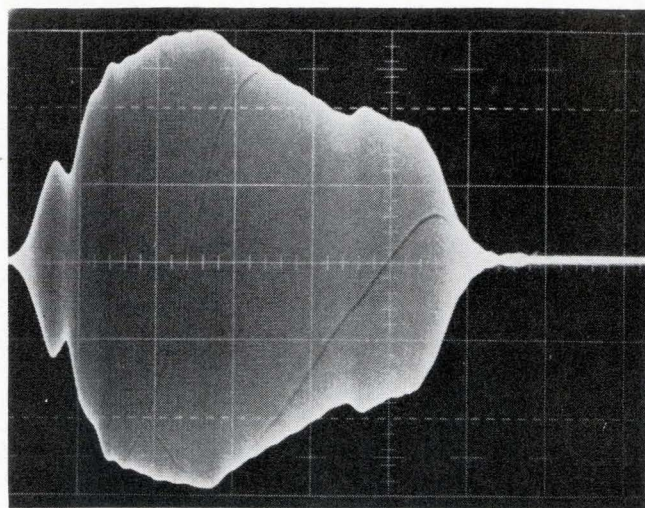
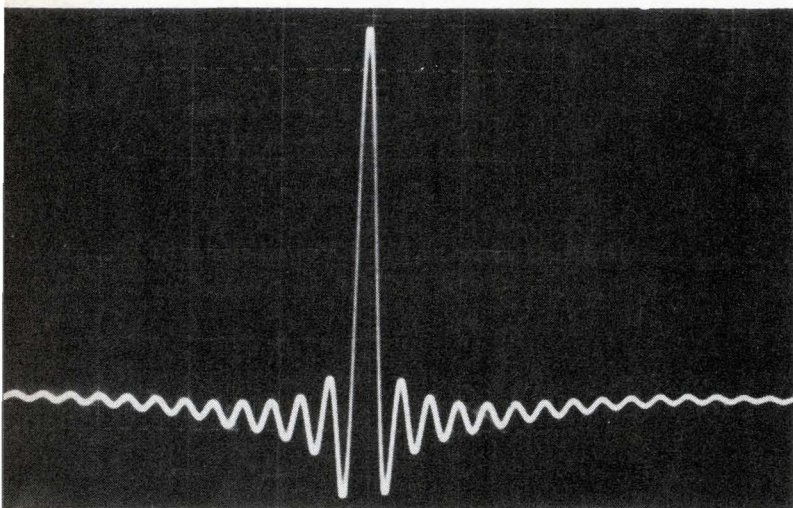

3. Output waveforms. Impulse response (left) demonstrates linear phase characteristics of recursive bandpass filter. Response (right) is that of filter designed to simulate both phase and magnitude of typical voice-grade telephone line in the switched network; filter was specifically designed for nonlinear phase characteristics. Phone line simulation is particularly effective for modern testing, and with model 999, variety of characteristics can be simulated by reading in different filter coefficients.

replaces s , thereby transforming $H(s)$ into a difference equation (see "Filtering digitally," p. 82). The resulting $H^*(z)$ can then be synthesized in a general recursive form, as shown in Fig. 2, or separated into sums and products of basic factors—usually 2-pole, 2-zero—and synthesized as a serial/parallel combination of basic building blocks. The serial/parallel combination is preferred because third-order or higher filters of general form are often very sensitive to coefficient inaccuracies.

To illustrate the variety of functions which digital filters can provide and the flexibility which can be programmed into a single piece of equipment, several types were designed, and the appropriate coefficients punched on tape with the aid of the associated Fortran support software and a general purpose digital computer.

The support software includes several options to aid the filter designer in synthesizing transversal filters. One routine automatically constructs linear phase bandpass and bandstop filters from given upper and lower cut-off frequencies. There are also available several analysis routines, which compute the total response resulting from a given filter design, including effects due to analog filters, coefficient quantization, and data reconstruction.

The model 999, as shown in Fig. 1, appears to be an analog device at the input and output terminals. The d-a converter, holding circuit, and postprocessing filter reconstruct the baseband component of the sampled-data waveform for delivery to the output. The a-d converter and preprocessing filter prevent distortion during the sampling operation. In this way, a programmable filter may approximate many types of low frequency analog filters.

An important feature of the model 999 is its ability to produce a variety of frequency responses while still maintaining a completely linear phase response.

Though a small amount of nonlinear delay distortion is introduced by the pre- and postprocessing filters, it occurs only at the upper end of the band, and most of it can be eliminated by modifying the digital filter coefficients. The only other phase shift aside from this is the one due to constant time delay through the filter.

Linear phase filters are easily designed in digital form. For example, a low pass filter can have an extremely fast roll-off—say 60 decibels in 200 hertz—which can be made even steeper at the expense of higher sidelobes. Bandpass filters can be designed with equal roll-off at the high and low ends of the band. Bandstop filters can be designed with either narrow or wide stopbands, and introduce no nonlinear phase shift in the passband.

Another type that can take digital form is the harmonic or comb filter, which is particularly useful for isolating repetitive signals of known frequency, like sonar signals, from noise or other unwanted signals. The comb "teeth" are designed to coincide with the spectral components of the signal. Moreover, if the frequency of the input signal is known, the filter clock can be driven synchronously so that the filter comb "teeth" will follow variations in the input signal's repetition rate. And, since the comb filter introduces only linear phase shifts with frequency, the input signal is not distorted as it passes through.

Linear phase shift, however, is not always desirable. For instance, a telephone-line simulator has to have a nonlinear phase response since it has to simulate both the magnitude and the phase characteristics of a typical voice-grade line in the switched telephone network. This filter's response is usually specified on the basis of measurements taken on an actual phone line.

The principal advantage of simulating the effects of telephone lines in this way is that different line

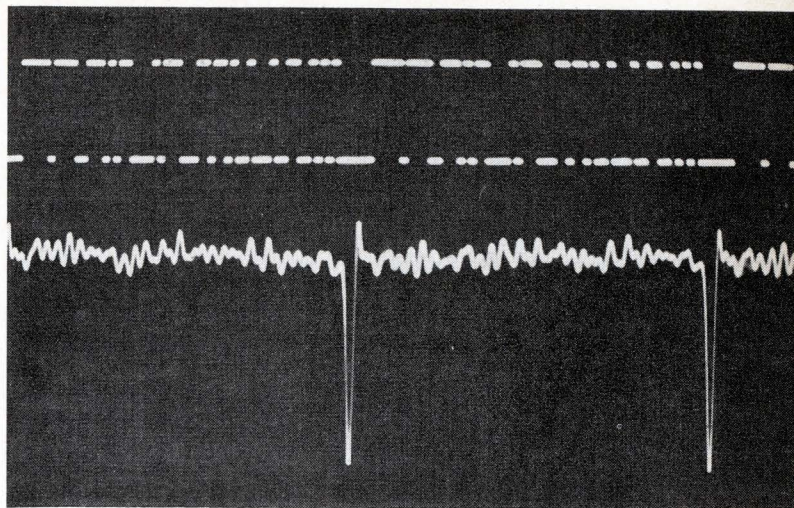
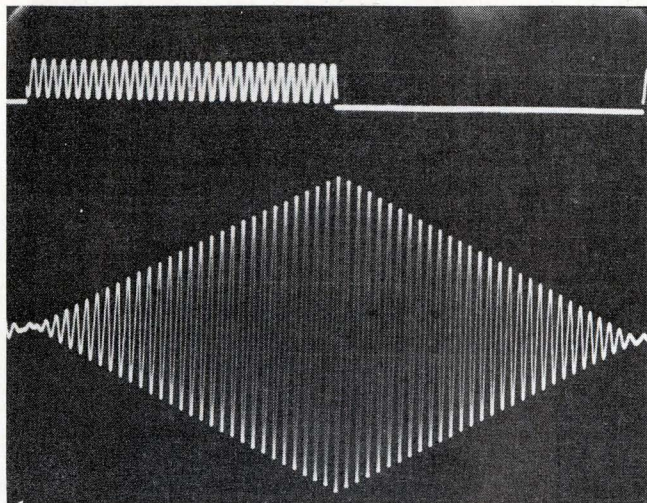

4. **Matched filters.** Sinusoidal burst (upper left) is typical modem waveform. When passed through matched filter, response is triangular waveform (lower left). 63-bit binary pseudo-random sequence (upper right) is passed through code-word detector, also a matched filter. Filter's output (lower right) reacts at beginning of each new input sequence. Code word detector is a digital filter designed to have an impulse response that is the time-reversed sequence of a particular bit sequence in the bit stream.

characteristics can be affected simply by reading in different filter coefficients—a particularly effective technique in line-modem testing. It also makes it simple to simulate the effects of multipath or echos for a given line. This is done by determining the line impulse response, delaying samples of this response in the filter's delay line memory, scaling the delay samples by the relative amplitude of the echo, and finally summing them to form the composite impulse response which includes the effects of multipath.

All the filters mentioned so far have been specified in terms of their desired frequency domain characteristics. But sometimes it is more appropriate to specify the time response. Probably the most common example of this is a matched filter, where the impulse response of the filter is a mirror image in the time domain of the waveform to be filtered. Such a filter may be matched to a sinusoidal burst, a widely used modem signal waveform shown in Fig. 4; the response is a triangular waveform. Or it may be a code word detector. In this case, if its job is to detect a particular bit sequence in a bit stream, it can be designed with an impulse response that is an exactly reverse sequence, and its output reaches a peak in amplitude when the desired sequence appears. The case of a 63-bit binary pseudo-random sequence is shown in Fig. 4.

The digital filter version of a waveform generator may be quite useful when complex waveforms are desired. One arbitrary waveform is a frequency-modulated sinusoid with a frequency that increases linearly with time—but the variety of possible waveforms is virtually limitless. However, a system consisting of a digital filter, a unit pulse generator, frequency divider, and external clock (Fig. 5) is capable of generating almost any periodic waveform, within the constraints of the pre- and postprocessing filters. If one cycle of the waveform goes to zero before the next cycle begins, it is not necessary to drive the filter

clock from the pulse train, since in this application timing is not critical.

Another use for the digital filter is to generate single sideband signals by means of the phase-shift method, shown in Fig. 6. This system requires the use of a network, often called a Hilbert transformer, which provides a 90° phase shift at all frequencies of the input modulating signal. A modification of this method generates a hybrid waveform, called compatible ssb, which has the same bandwidth as a conventional ssb network but which can be detected with a conventional a-m square-law detector⁶ (Fig. 6). Although this system requires a square-law detector for distortionless detection, a linear envelope detector will produce no serious loss of speech intelligibility. The result in some cases is that compatibility with standard a-m receivers is achieved.

The generation of ssb signals requires a linear phase, wideband, phase-splitting network, and can be achieved by sampling the modulating signal and using a tapped delay-line filter to produce the necessary 90° phase shift. Such a tapped delay-line approach is the analog equivalent of a non-recursive sampled-data filter and is easily implemented in digital form with the 200-tap model 999. Since the delay-line filter introduces delay as well as the 90° phase shift, a compensating delay in the non-shifted signal is introduced by adding another digital-to-analog converter and filter.

These particular digital filter applications were used to process baseband signals. As already noted, sample-data filters have frequency responses that recur periodically at multiples of the sampling frequency. Similarly, the input signal, if it were impulse sampled, would have an aliased spectrum repeating at multiples of the sampling frequency. Consequently, the digital filter can be used to process signals above baseband.

Filtering digitally

A sampled-data system accepts inputs and produces outputs only at specific instants of time, called sample points. One type is a digital filter. In this, the input and output are quantized and the system function is realized numerically, as with a computer or logic circuitry. If the filter is implemented with electrical circuits, binary numbers are often used.

Essentially, a digital filter is a difference equation which derives an output from the present input and from previous values of the input and output. Its basic elements are delays, constant multipliers, and summers. The relationship may be expressed as:

$$y(n) = \sum_{k=0}^{\infty} a_k x(n-k) + \sum_{k=1}^{\infty} b_k y(n-k)$$

which states that the present output, $y(n)$, is found by scaling, then adding the present input, $x(n)$, and previous inputs, $x(n-k)$, and outputs, $y(n-k)$.

When a filter's output is a function only of the inputs, and not the previous outputs ($b_k = 0$), the filter is known as a transversal or nonrecursive filter.

However, if the output of a digital filter is a function of at least one previous output, the filter is called recursive. An example is a trapezoidal rule integrator, which approximates the integral of the input signal by a sum of trapezoids whose width is equal to the sampling interval.

The integral is formed by adding the area under the trapezoid being sampled to the integral value at the last sample:

$$y(n) = \frac{T}{2} [x(n) + x(n-1)] + y(n-1)$$

The frequency response of a digital filter is easy to determine from its difference equation by means of the Fourier transform of a unit delay of T seconds:

$$\mathcal{F}[D] = \mathcal{F}[\delta(t - T)] = e^{-j\omega T}$$

where T is the time spacing between samples, δ is an impulse function, and ω is the frequency in radians per second.

Using the general difference equation that describes a digital filter and the transform of a unit delay, the frequency response is found directly from

$$Y^*(\omega) = \left[\sum_{k=0}^{\infty} a_k e^{-jk\omega T} \right] X^*(\omega) + \left[\sum_{k=1}^{\infty} b_k e^{-jk\omega T} \right] Y^*(\omega)$$

where the asterisks indicate a sampled-data signal. This equation can be rearranged to give

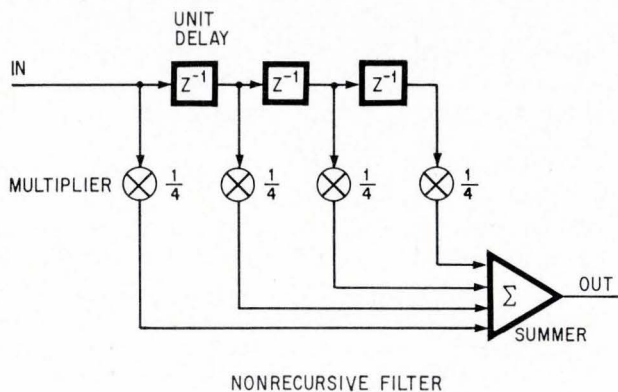

$$H^*(\omega) = \frac{Y^*(\omega)}{X^*(\omega)} = \frac{\sum_{k=0}^{\infty} a_k e^{-jk\omega T}}{1 - \sum_{k=1}^{\infty} b_k e^{-jk\omega T}}$$

where $H^*(\omega)$ is the frequency response since

$$e^{-jk\omega T} = e^{-jk(\omega T + 2n\pi)}$$

It can be seen that the frequency response of a digital filter, $H^*(\omega)$, repeats at intervals of the sampling frequency, $\omega_s = 2\pi/T$

For convenience, $e^{-j\omega T}$ is written as z^{-1} , and Fourier transforms of digital filters are written in terms of z^{-1} rather than ω , and hence are called Z-transforms. Using this notation, the frequency response of a filter becomes

$$H^*(z) = \frac{\sum_{k=0}^{\infty} a_k z^{-k}}{1 - \sum_{k=1}^{\infty} b_k z^{-k}}$$

To illustrate the Z-transform approach, consider the trapezoidal rule integrator where

$$Y^*(\omega) = \frac{T}{2} X^*(\omega) + \frac{T}{2} X^*(\omega) e^{-j\omega T} + Y^*(\omega) e^{-j\omega T}$$

The frequency response is written

$$H^*(\omega) = \frac{Y^*(\omega)}{X^*(\omega)} = \frac{\frac{T}{2} + \frac{T}{2} e^{-j\omega T}}{1 - e^{-j\omega T}}$$

The transfer function can also be written in terms of z :

$$H^*(z) = \frac{Y^*(z)}{X^*(z)} = \frac{T}{2} \left[\frac{1 + z^{-1}}{1 - z^{-1}} \right]$$

Since this expression is a good approximation of an integrator, $1/j\omega$ or $1/s$, it would appear that

$$\frac{1}{H^*(z)} = \frac{2}{T} \left[\frac{1 - z^{-1}}{1 + z^{-1}} \right]$$

might be a good approximation for s or $j\omega$. This is often the case, and substitution of $1/H^*(z)$ for s is a common way of transforming an analog transfer function into a difference equation; it is called a bilinear Z-transform.

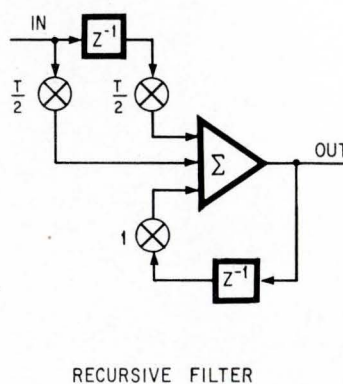

Feedback or not.

Nonrecursive filter (left) computes a running average of four consecutive points; its output is a function of the inputs only. Recursive filter (right) is a trapezoidal rule integrator which approximates the integral of the input signal by a sum of trapezoids.

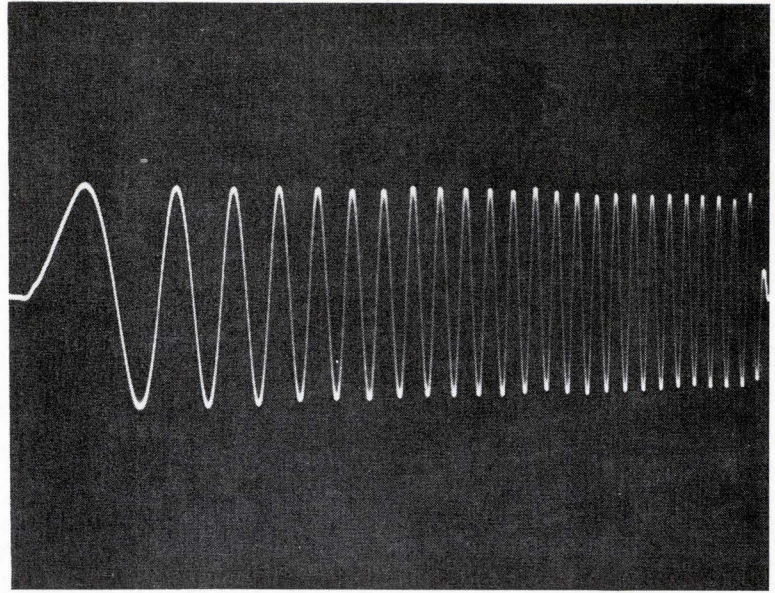
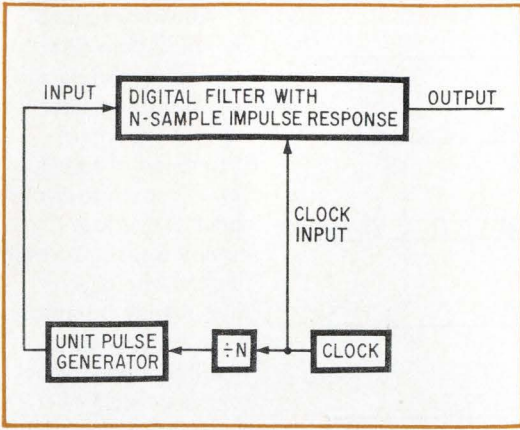

5. **Waveform generator.** Arrangement for producing complex periodic waveforms (left) uses digital filter plus other equipment. Example of output is fm sinusoid, the frequency of which increases linearly with time (right).

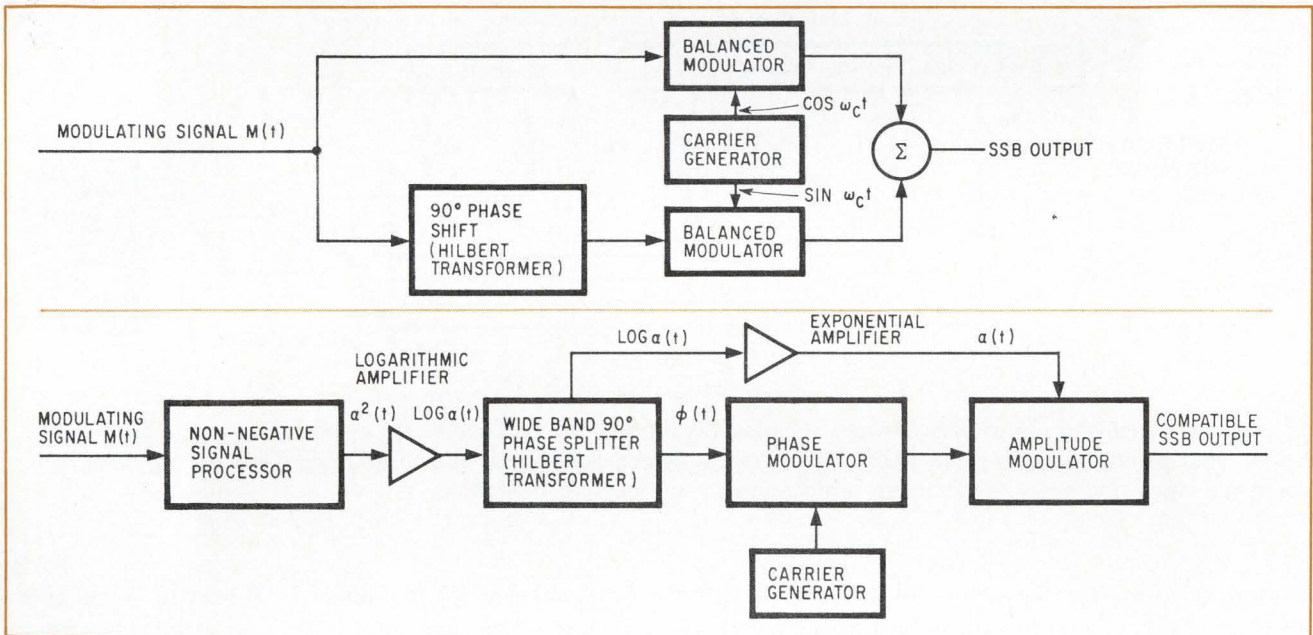

6. **Single sideband.** Phase shift method of ssb generation (top) uses Hilbert transformer to provide 90° phase shift at all frequencies of input signal. A method of compatible ssb generation (bottom) uses tapped delay line filter to produce required 90° phase shift and a-m square-law detector for distortionless detection. Tapped delay line approach is analog equivalent of nonrecursive sampled-data filter, and is sometimes compatible with standard a-m receivers.

Just how this can happen is seen in Fig. 7, which shows a technique for using a sampled-data filter, above baseband, as a bandpass filter, to achieve extremely sharp, linear phase bandpass response. If the input signal is sampled at the rate F_s , and if F_s is carefully chosen, the sampled spectrum

$$X^*(f) = \sum_n X(f - nF_s)$$

has no spectral overlap and may be filtered with a digital filter that has a bandpass transfer function. The resulting output spectrum is the product of the

filter transfer function and the input spectrum. Finally, the desired component of the sampled output spectrum is selected by a relatively broad bandpass smoothing filter, $H_s(f)$, leaving the filtered version of the original input function.

However, there is really no constraint to select the component of the output spectrum at the center frequency f_0 . If the bandpass filter function, $H_s(f)$, is shifted by nF_s so as to select one of the other components, the combination becomes a frequency translator as well as a filter, in effect using the sampler

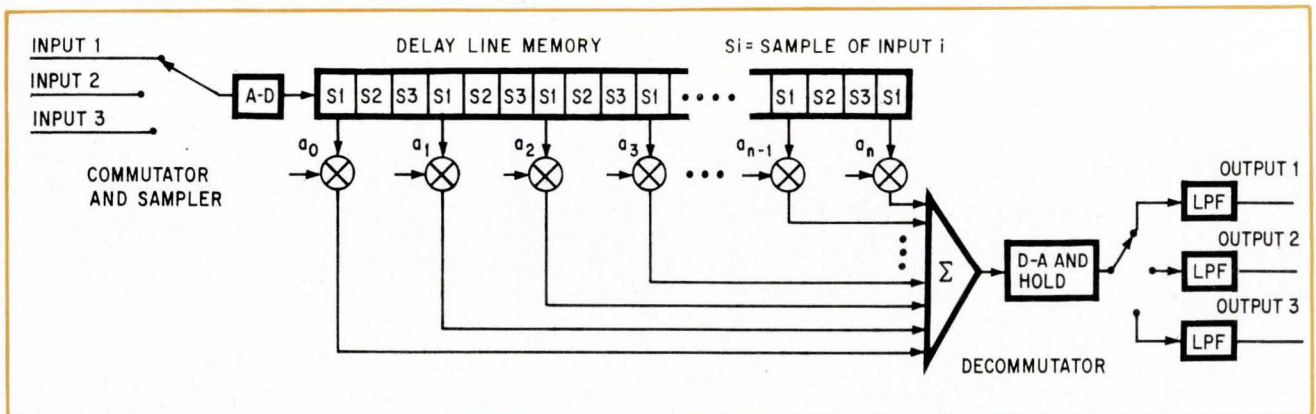
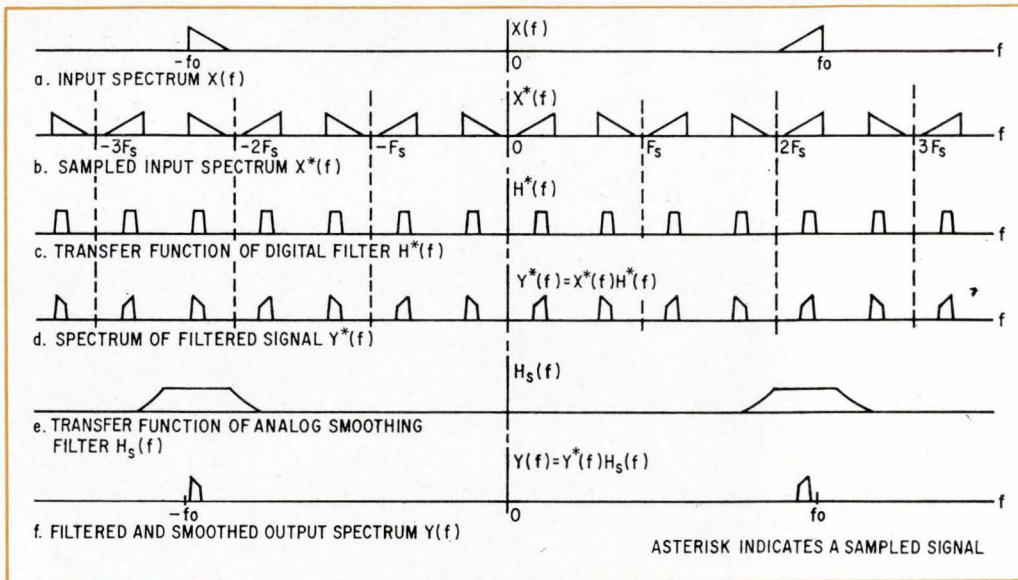

as a mixer with many harmonics. Or if $H_s(f)$ is shifted by $(n + \frac{1}{2})F_s$, the resulting output spectrum is not only translated but also inverted.

If the bandpass signal at f_0 is a baseband spectrum that has been modulated—am or ssb—the spectrum can be demodulated (translated back to baseband) by an appropriate choice of F_s , and smoothed with a lowpass instead of a bandpass filter.

Sampled-data systems, by operating on time-sampled waveforms, also open up the possibility of time sharing. For they use the time between samples to perform operations required to generate the next output, and, if enough time exists between samples for the system logic to repeat these operations, the filter hardware can be time-shared among several input signals.

Consider using one filter to process three inputs (Fig. 8). The delay line containing signal samples would be three times the length of the delay line for a single input, and every third sample would

be processed by the filter. In this way, each of the computations involves samples from only one of the inputs. Time-shared filters of this type are finding application in low frequency multi-input systems such as processors of seismic data from arrays of sensors. □

References

1. C.M. Rader and B. Gold, "Digital Processing of Signals," McGraw-Hill, pp. 51-58, 1969.
2. I.M. Langenthal, "Digital Filtering Techniques," Final Technical Report, RADCR-69-27, Rome Air Development Center, Griffiss Air Force Base, N.Y. March 1969.
3. R.E. Sonderegger, W.L. Betts, J.W. Elliott, "Digital Filter Realization of High Quality Bandpass Filters," IEEE Computers and Communications Conference, Rome, N.Y., 1969.
4. J.R. Stitt and R.E. Sonderegger, "Development and Application of a Programmable Real-Time 200 Coefficient Non-Recursive Digital Filter," IEEE UMR-M.J. Kelly Communications Conference, Rolla, Missouri, 1970.
5. C.M. Rader and B. Gold, op. cit., pp. 81-86.
6. K.H. Powers, "The Compatibility Problems in Single Sideband Transmission," Proceedings of the IRE, Vol. 28, No. 2, pp. 1,431-1,435, August 1960.

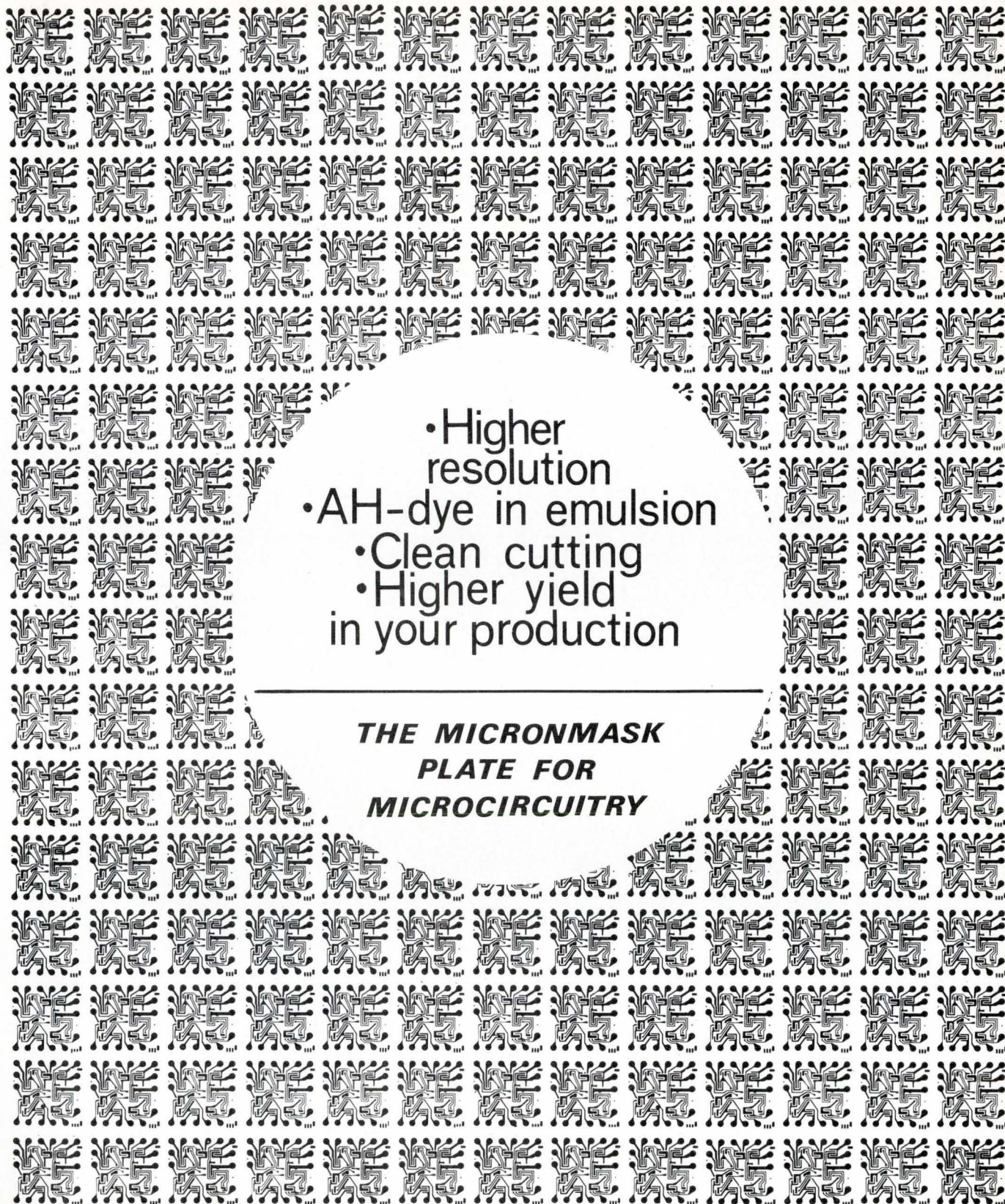

- Higher resolution
- AH-dye in emulsion
- Clean cutting
- Higher yield in your production

**THE MICRONMASK
PLATE FOR
MICROCIRCUITRY**

Write for full information to :

AGFA-GEVAERT INC. - 275 NORTH STREET - TETERBORO - NEW JERSEY

GEVAERT-AGFA N.V. - MORTSEL - BELGIUM

MICRONMASK



AGFA-GEVAERT

Designer's casebook

Pulse generator uses digital ICs

By Edmund Lafko
Tampa, Fla.

A wide variety of pulse waveforms can be produced with just a few integrated circuits. Such circuits should prove more economical than buying a complete function generator, particularly if the user doesn't require the full capability of the generator. And, if he's in a hurry, putting together a simple pulse generator from available ICs insures prompt delivery.

The circuit comprises five IC flatpacks. Two RD221s are used as a four-bit counter that's driven from an astable multivibrator. The free-running multivibrator uses a single flatpack, an RD209 dual line driver; capacitively coupling the output back to the input provides the feedback path required for oscillation. The four stages of the counter are gated by two RD209 ICs, one of which also provides the inverted

output. The switch setting and the output terminal used determine the duty cycle and pulse width of the output waveform.

For the example shown, the dual line driver was connected so that the repetition rate was 100 kilohertz. This produces a symmetrical square wave of 10 microseconds at the first stage of the counter. Further processing of the square wave provides a waveform with different duty cycles and a 10 μ s pulse width; varying duty cycles with pulse widths of 10 μ s, 30 μ s, 70 μ s, and 150 μ s.

By changing the repetition rate of the counter and gating the counter stages, waveforms of various pulse widths and duty cycles, as well as groups of pulses, can be obtained.

This circuitry also could be used as a trigger delay. The delayed trigger pulse would be gated where required within a cycle of the counter.

If the power output isn't sufficient, the circuit can be used to drive additional ICs. Or, if still more power is required, a transistor could be switched by the IC circuit. The voltage, impedance, and rise and fall times of the output can be tailored to meet the individual's specification.

User's choice. An astable multivibrator drives a four-bit counter, which is triggered by the three gates. Numerous waveforms of different duty cycles and pulse widths are obtained simply by selecting the proper switch setting and output terminal. The various combinations obtained with this circuit are detailed.

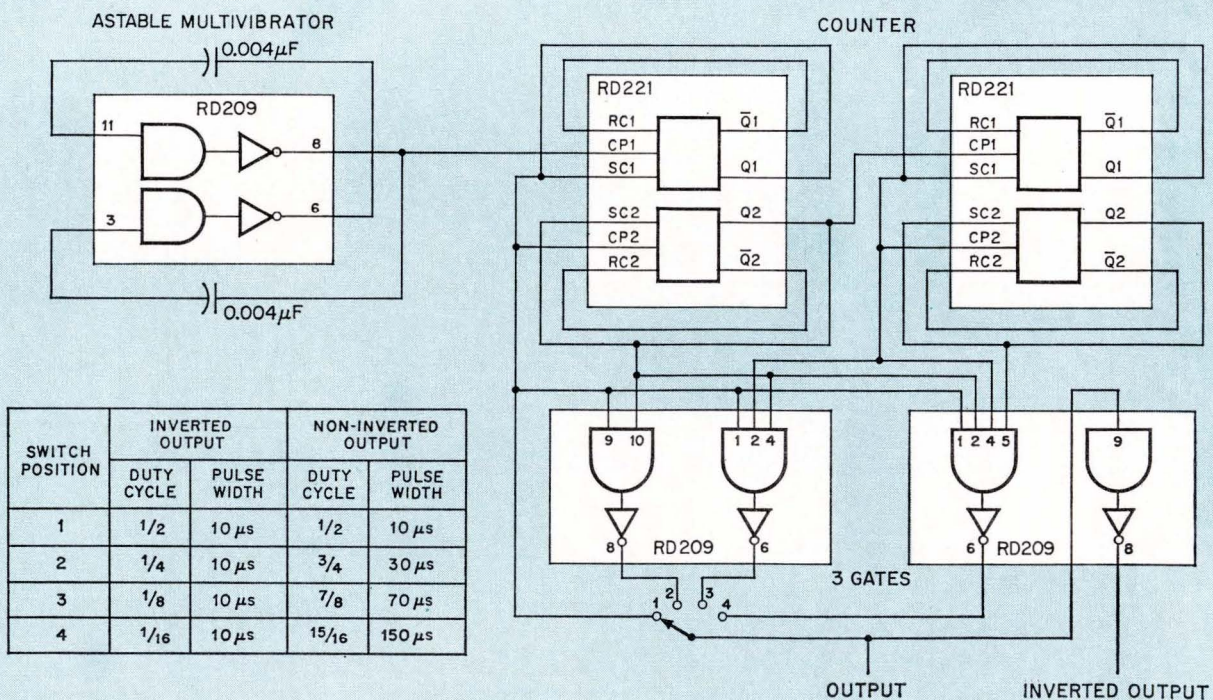

Voltage monitor is easy on both battery and budget

By William G.S. Brown and Victor K.L. Huang
University of Virginia, Charlottesville

At less than \$6, even the most tightly budgeted researchers can afford to build this voltage monitor. It is valuable for monitoring critical battery levels during experiments.

The lamp, of course, also goes on when the battery needs replacing or recharging. The voltage across the capacitor triggers the programmable unijunction transistor, PUT, at a threshold voltage, which is preset with the variable resistor. The PUT, in turn, fires the silicon controlled rectifier. The PUT consumes very little current and probably good flexibility in threshold voltage adjustment.

If the battery is in good condition, current flows only through the variable resistor and zener diode, plus whatever small leakage currents are present. A low-current zener keeps total current drain within 300 microamperes. Until the PUT fires to start the SCR, neither consume any current.

Battery saver. Voltage monitor drains little battery current. At a preset threshold the transistor turns on the SCR and the lamp. General Electric or equivalent devices can be used.

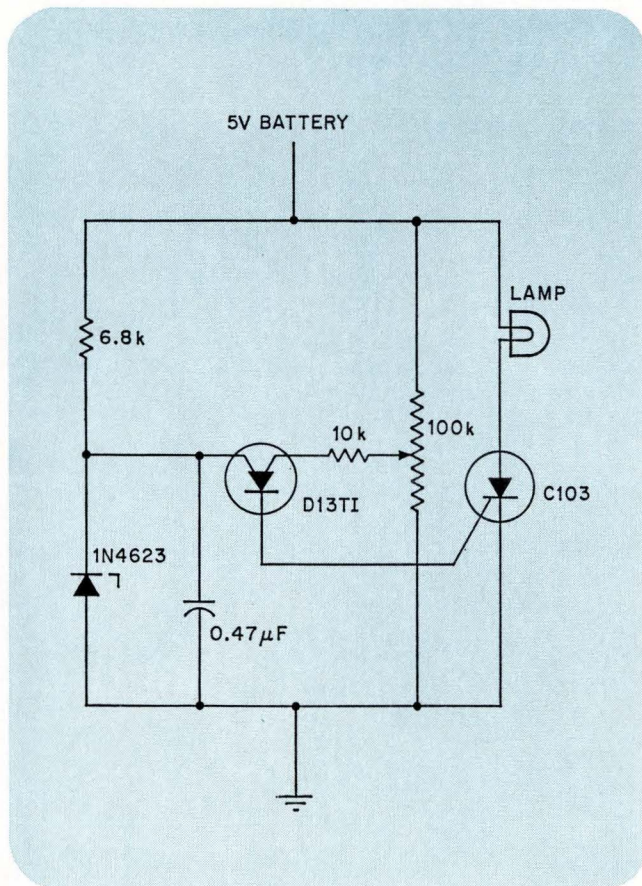

Optical biasing maintains phototransistor sensitivity

By Dennis Knowlton
University of Wyoming, Laramie

Light-biasing a phototransistor permits it to measure changes in low light levels at high speed. The extra light improves response time by boosting the collector current so that the device operates in a more favorable region. And, unlike in an electrical bias connection to the base, the transistor's sensitivity is not degraded.

The biasing circuit is an electro-optical feedback loop controlling the collector current in phototransistor Q_1 . A reference current determined by R_1 and R_2 is compared in differential amplifier Q_2 - Q_3 with Q_1 's collector current. The amplifier output drives emitter-follower Q_4 to regulate the lamp. The light from the lamp controls the phototransistor's collector current, closing the current control feedback loop.

Bypass capacitor C_1 on the collector resistor prevents feedback to the base of Q_3 (common-collector connection). And the lamp is located where it won't shadow Q_1 's active sensitivity cone.

No connection. Leaving Q_1 's base unconnected gives it maximum sensitivity to light changes. Collector current is raised by the lamp to improve the response time.

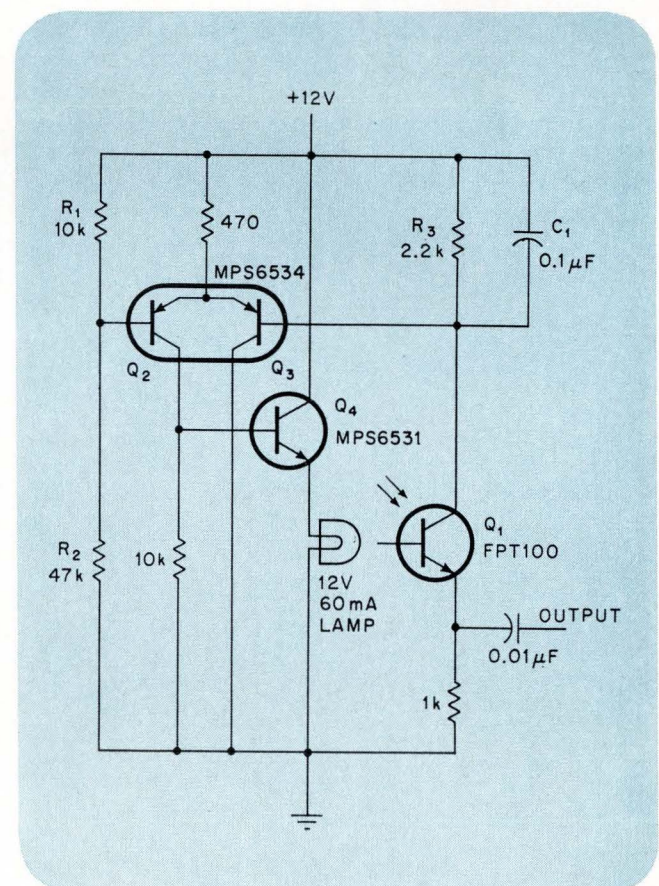

Thermistor stabilizes Gunn oscillator

By T.V. Seling

University of Michigan, Ann Arbor

Gunn-diode oscillators usually take 30 to 40 minutes to warm up and become temperature stable. During this time, a thermistor in the voltage-biasing network that tunes the diode will compensate for resonant cavity changes and quickly stabilize the frequency. In addition, it will reduce frequency drift due to changes in ambient temperature.

The biasing circuit at the left, below, stabilizes an 8-gigahertz oscillator to better than 4 ppm/°C after only a 4-minute warmup. Two general purpose versions of the circuit are shown at the right. The component values and direction of changes in the bias voltage with temperature will depend on the particular oscillator.

Normally, the oscillation frequency decreases as temperature increases because the cavity expands and lowers the resonance frequency. Eventually, the heat from the diode brings the cavity's larger thermal mass to a fairly stable temperature. During warmup, the bias circuit should be compensated for this.

The circuit at the left has a negative temperature

coefficient. Measurement of the uncompensated oscillator showed an approximately linear change of -9 megahertz/volt over the biasing range of 8.6 to 10.0 V. The uncompensated circuit drifted -0.8 MHz/°C, had a maximum variation in power output of 0.2 decibel, and took 40 minutes to stabilize.

The oscillator is a Monsanto Electronics DC1414A diode in a coaxial cavity 2.5 inches long. An X-band waveguide forms the outer cavity wall, and the center conductor that holds the diode is brass.

The combination of the resistor R_1 and the thermistor R_2 in the first circuit provides a bias voltage with the negative temperature coefficient.

A Darlington-connected emitter follower furnishes the power gain to drive the diode. The emitter follower was used rather than a directly connected bias network to reduce the amount of heat dissipated in the bias network.

Stabilities of the compensated oscillator are plotted in the graph. After a 4-minute warmup, drift drops to -0.03 MHz/°C. Power output still varies 0.2 dB but becomes stable after the full warmup.

Other oscillators with different temperature coefficients may require padding by a variable resistor to reduce the bias variation. If a greater variation is desired, it can be obtained by using the connection in the third circuit to amplify the bias voltage.

Designer's casebook is a regular feature in Electronics. Readers are invited to submit novel circuit ideas and solutions to design problems. Descriptions should be brief. We'll pay \$50 for each item published.

Gunn stabilizer. Thermistor reduces bias voltage when temperature rises, stabilizing diode oscillation frequency. Circuit (A) for an 8-GHz oscillator yields the temperature characteristics charted in (B). Circuit (C) is a version that reduces the bias variation, while the additional gain of (D) provides larger bias swings with temperature.

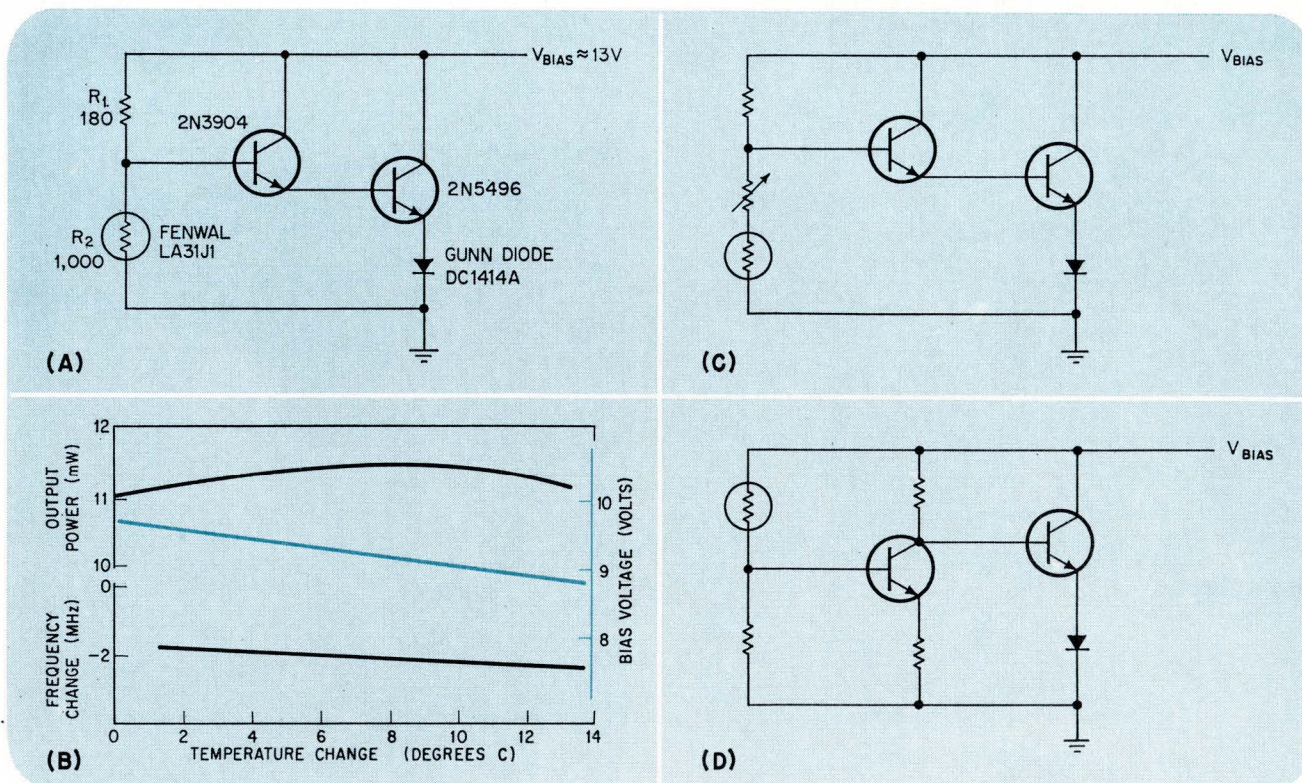

Philips dual beam 3231 at Teradyne...

"Its simplicity simplifies our work."

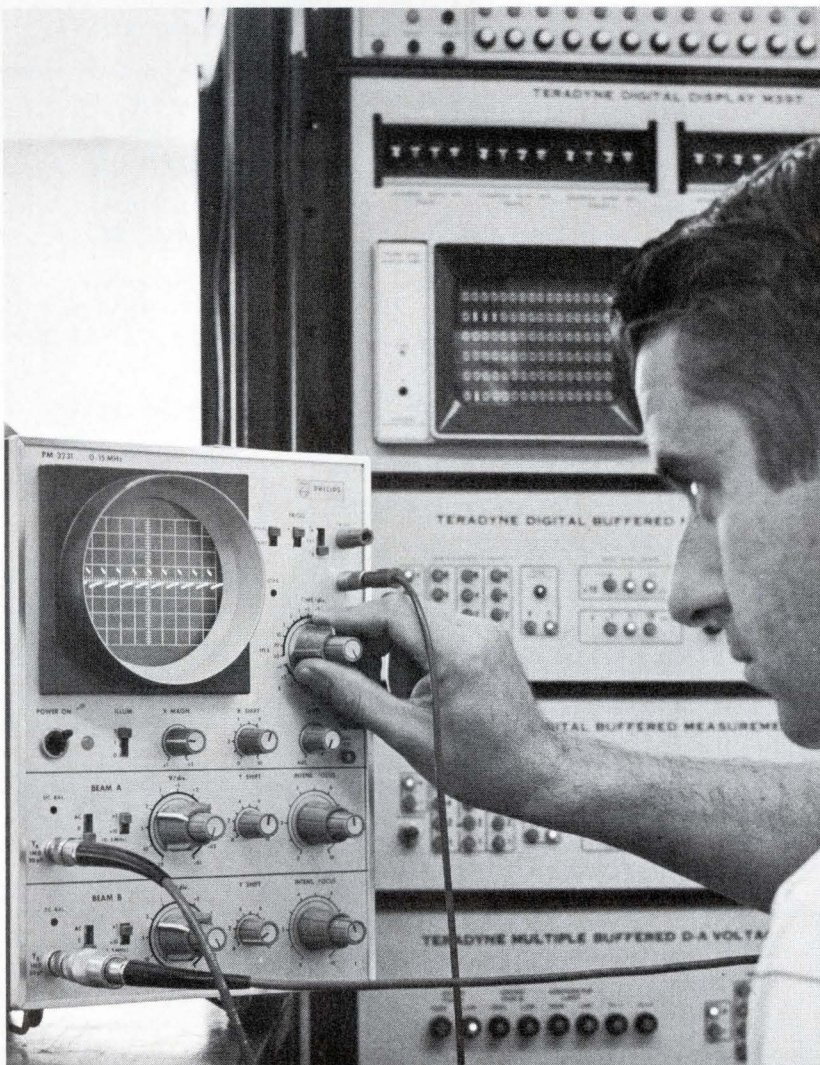

International Search for Scope for The SLOT Machine

Teradyne's international scope search for an *industrial* scope to final check The SLOT Machine proved the Philips 3231 15 MHz/10mV (5MHz/1mV) dual beam scope the "easiest to own, the easiest to work, and with the best rise-time per dollar."

Teradyne's SLOT Machine's one week test

Teradyne's systems for sequential logic testing see a week or more of stringent checkout before shipping to manufacturers who use them for high-speed production-line tests of complex IC's. Teradyne has to assure that leading edges of logic pulses are fast and straight but not so fast as to cause crosstalk and oscillations in the system.

T1... T2, T3

Because its high speed response (together with simple delay line to catch a leading edge) spots overshoots and crosstalk, and because the dual beam function makes logic chain comparisons a cinch, Philips PM 3231 does daily engineering duty for every SLOT Machine that Teradyne ships. What can Philips do for you in logic testing — in pre-shipment test, research or in production? Teradyne liked our industrial no-tricky-business approach. Perhaps you will too — give us a call and see: 914-664-4500. Ask for Dick Rude, National Sales Manager, Test & Measuring Equipment.

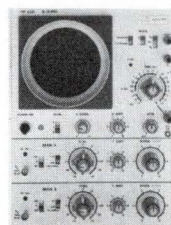

PM 3231
15 MHz/10mV
Two gun crt

\$1050

**PHILIPS
ELECTRONIC
INSTRUMENTS**

750 S. FULTON AVE., MT. VERNON, N.Y. 10550
A DIVISION OF PEPI, INC.

COMPARE CALCULATORS!

If you're looking for a scientific calculator, ask yourself these questions.

YES NO

- Press $2 \times 3 + 4 \times 5 =$. Do you get the correct result (26) instead of 50?
- Are there a sufficient number of stored constants (26 or 100) that are separate and independent from the number of program steps used?
- Enter $6378.388125 \times 10^{-13}$. Does the data appear correctly? ($6378.388125 \times 10^{-13}$, instead of $6.378388125 \times 10^{-13}$.)
- Can you write equations directly on the keyboard in mathematical form, bypassing computer "languages"?
- Does it have individual left and right parentheses keys that allow you to solve directly expressions such as:
 $((a + b) - c \div d) \times (f - g) = ?$
- Is every function and program uniquely and unambiguously defined by the keying sequence (without modification by toggle or rotary switches)?

YES NO

- Does it have a true equals key to display partial sums or total results immediately?
- Will it solve complicated problems and still be easy enough for your secretary to operate?
- After a questionable procedure, does operation continue using the best available data? (With an unmistakable indicator showing an assumption was made?)
- Does it have hard-wired xy , $\sqrt{x^2 + y^2 + z^2 + \dots}$, trigonometric, and hyperbolic functions?
- Is 10 significant figure accuracy maintained after repetitive sequences such as $\ln x - e^x - \ln x - e^x \dots$?
- Does it have simple keyboard access to a wide range of peripherals (including a 25,600-step programmer, printer, x-y plotter, etc.)?

YES NO

- Can you write and store constants and equalities through direct and indirect addressing?
- Is the longest calculation time less than 75 milliseconds through the use of reliable MOS/LSI and IC circuitry?
- Will the same calculator serve as the heart of a data acquisition system or minicomputer for on-line data processing?
- Is correct algebraic hierarchy automatically observed in performing all operations?
- Can you get prompt, reliable service from the same company that designed and built the instrument?
- Is the basic calculator portable and priced under \$3,800?
- Is it still a money-saver if you add on the "cost of learning" for the people who will operate it?

Every answer should be "yes". If it isn't, keep looking.

The Cintra Scientist



P. S. If you haven't already guessed, every answer is "yes" for the Cintra Scientist.



1089 Morse Avenue / Sunnyvale, California 94086 / Phone (408) 734-3630
Cintra Incorporated—a subsidiary of Physics International Co.

Putting d-a converters to work: 10 examples show versatility

Devices provide interface for systems with inputs and outputs, permitting simple and accurate digital processing suitable for a broad range of operations and functions

By W. R. Spofford Jr., *Analog Devices Inc., Pastoriza division, Newton Upper Falls, Mass.*

□ Digital methods for processing signals no longer are restricted to computers. Many engineers, although they may be designing systems with inputs and outputs in analog form, are adopting digital methods to do almost everything in between. They find that these methods yield more accurate answers, are easier to apply with the new integrated circuit logic and memories, and, in many cases, allow operations that just couldn't be done any other way.

Besides the growing variety of digital ICs, another component pacing this shift to digital techniques is the digital-to-analog converter. In fact, it's the d-a and analog-to-digital converters that make it possible to get into the digital mode and present an output that's usable in analog form.

The basic component in most of the 10 examples in this article is the d-a converter. The a-d converter is often an extension of the d-a converter, using a d-a in a feedback loop to convert the digital word to analog. By making comparisons with the analog input, the feedback loop adjusts the digital value until the two values are the same.

There are two basic types of d-a converters: the fixed reference and the multiplying types. Each converts a digital input number, D , to a corresponding analog voltage or current ($V_{\text{analog}} = kD$). In the first type, the proportionality constant, k , is fixed, often with a zener diode; while in the multiplying converters, k may vary. The multiplying d-a converter thus is often used to change the value of varying signals according to digital input information. Fixed reference converters, on the other hand, are used where simple d-a conversion (digital input produces proportional dc voltage output) is needed.

In general, fixed reference converters are more accurate because the reference is included in the package. A manufacturer thus can compensate the reference directly for temperature drift and match the reference's offset to the circuit's. By contrast, the multiplying d-a converter accepts an external, varying reference, which limits the converter's ability to match the circuit to the source.

The multiplying d-a converter is useful in such systems as resolver positioning circuits, where 400-hertz signals are adjusted with digital inputs. However, where high dc accuracy is needed, such as for cathode-ray tube character generation, the fixed

reference converters are particularly useful.

CRT character generation requires two steps: one to fix the character's position on the screen, and the other to form the character. In circuit 1, two high-speed d-a converters, DAC-1 and DAC-4, hold the 10-bit x and y addresses of the character location on the CRT. The outputs of these converters are added to the outputs of the respective eight-bit d-a converters, DAC-2 and DAC-3, that provide information about character shape. This is one application where there's no analog counterpart.

Each character's shape is described by 16 eight-bit words, in both the x and y directions, stored in the two read-only memories. This group of 16 words is selected by a six-bit address for the location in the ROMs. The four-bit counter, driven by the clock, steps the ROMs through the selected 16 words, and DAC-2 and DAC-3 produce the necessary x and y deflection voltages, which ride on the coarse positioning voltages set by DAC-1 and DAC-4. The beam is thus displaced

The 10 applications

- 1 CRT character generation
- 2 CRT sweep generation
- 3 Programmable power supplies
- 4 Resolver positioning
- 5 Shaft angle conversion
- 6 Radar PPI display
- 7 Radar moving target indicator
- 8 Low-noise communications
- 9 Aircraft music distribution
- 10 Automatic gain measurement

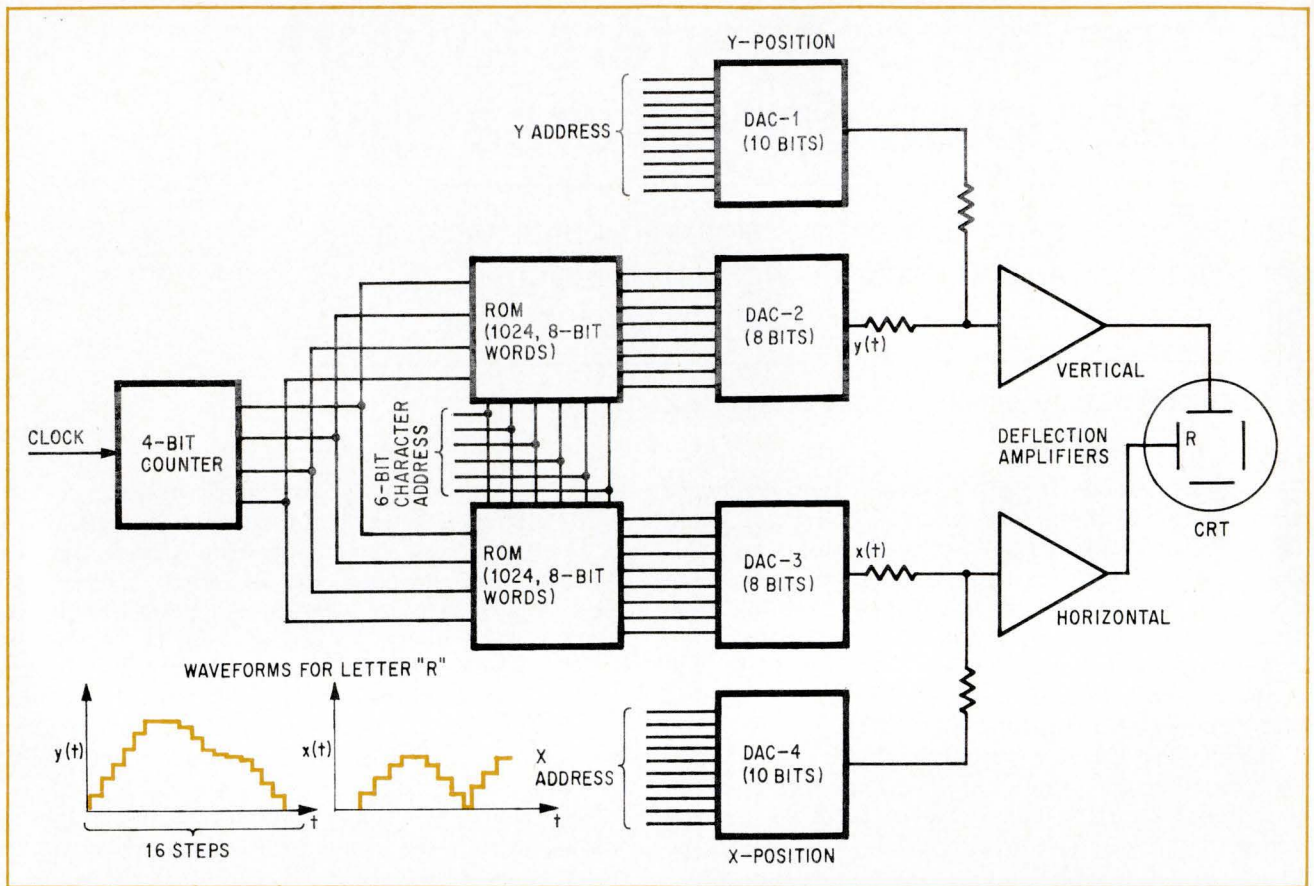

1. **CRT character generation.** The 10-bit d-a converters set the character location on the screen while the eight-bit d-a converters generate the character shape, based on the information stored in the read-only memories. The four-bit counter steps the two ROMs through 16 words of eight bits each. The characters are thus formed in 16 x and y steps, each quantized with eight-bit accuracy.

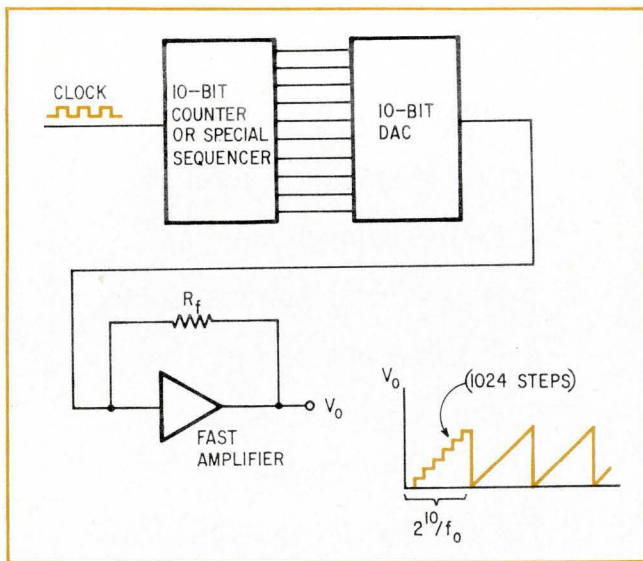

2. **CRT sweep generation.** Linear sweeps for an oscilloscope are generated by converting a counter's output to a series of steps. With 10 bits, 1024 steps are generated per sweep, resulting in linearity in the 0.05% range. The time base can be derived from a crystal oscillator for stable operation.

from its coarse position to form the character, with the two character-forming waveforms, $y(t)$ and $x(t)$, thus being quantized with eight-bit (256 levels) accuracy.

Generating the letter R, for example, would begin with the coarse voltage setting the beam at the character's lower left hand corner, and stepping it in the y-direction with zero x deflection to form the first upstroke. The beam then moves horizontally (constant y voltage), and then begins to curve down in steps toward the right as the y voltage decreases and the x voltage reaches a peak and then decreases. When the x voltage reaches zero—the beam has completed the D-shaped upper portion of the R—it steps a small amount to move the beam about halfway over, beginning the final diagonal downstroke as the $y(t)$ voltage also steps down. The 16 words thus create 16 x and 16 y steps.

With a 1024-word ROM, 64 characters can be stored. Any character shape can be stored in the ROMs, simply by describing it with 16 dots having almost arbitrary placement (256-level quantization). The locations of each of these 16 dots then are converted to eight-bit digital words representing the voltages required to place the beam at that spot.

For this application, the d-a converters must have

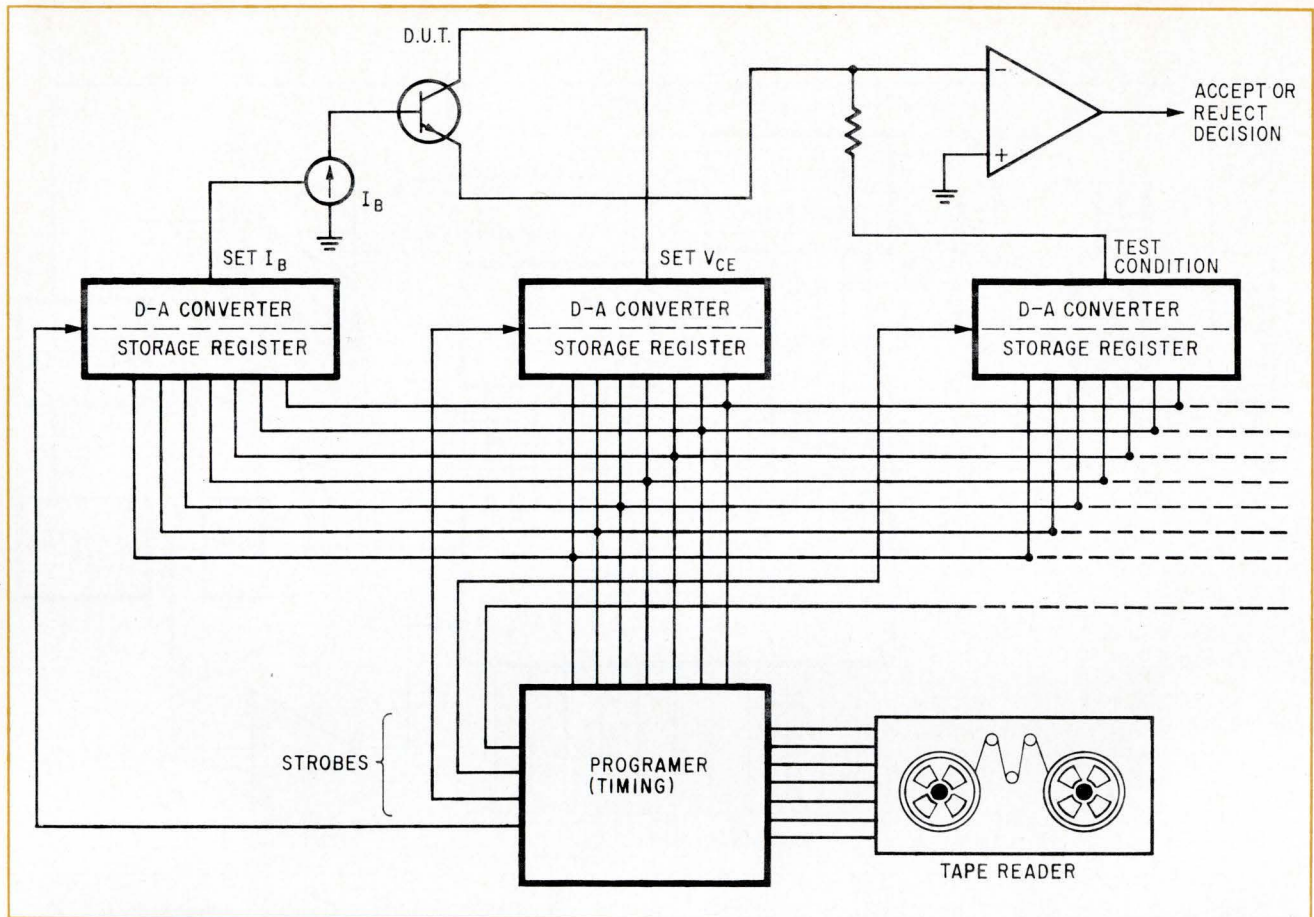

3. Programmable power supplies. Automated test equipment uses programmable power supplies to set up test voltages and currents under control from digital information on magnetic tape. The data for each parameter test point is applied to all d-a converters in parallel, but is entered only into converter that's strobed. The final d-a converter sets up the parameter level for go/no-go decision.

fast settling time—about 200 to 300 nanoseconds—for each character segment and should not generate transients when switching. Another amplifier can be added at the d-a converter output to correct for deflection nonlinearity in the CRT.

Ultralinear sweep generation is often required for precision instrumentation. Standard linear sawtooth generators are often not accurate enough or are subject to drift.

A d-a converter driven by a simple counter will generate a series of voltage steps, which, if there are enough of them, will appear as a continuous ramp function. For example, a 10-bit d-a converter will generate 1024 steps in its upward rise as the counter goes from zero to full scale, and will recover quickly as the counter recycles. The time base is controlled by the clock pulses, which can be derived from a crystal oscillator, operating, say, at 20 megahertz.

With this step-wise approximation to the ramp, the most the waveform can deviate from a straight line is half a step. With 10 bits, there will be 1024 steps, keeping the deviation to 1 part in about 2048, or about 0.05%. This is far better than the linearity attained with any other method. Settling time for these converters should be about 50 ns.

This type of sweep generator can also be used for

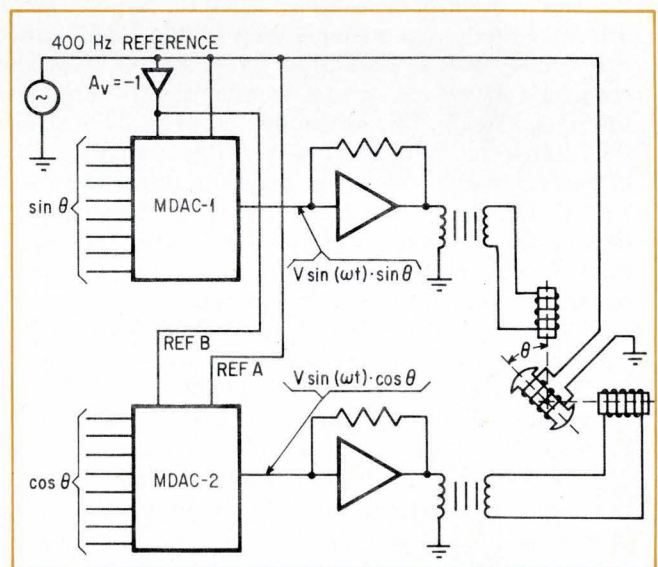

4. Resolver positioning. Digital data for sine and cosine of the angle to which the resolver is to be set are converted to sinusoidal signals with magnitudes proportional to sine and cosine of desired angle. When applied to resolver, the resolver moves to corresponding position.

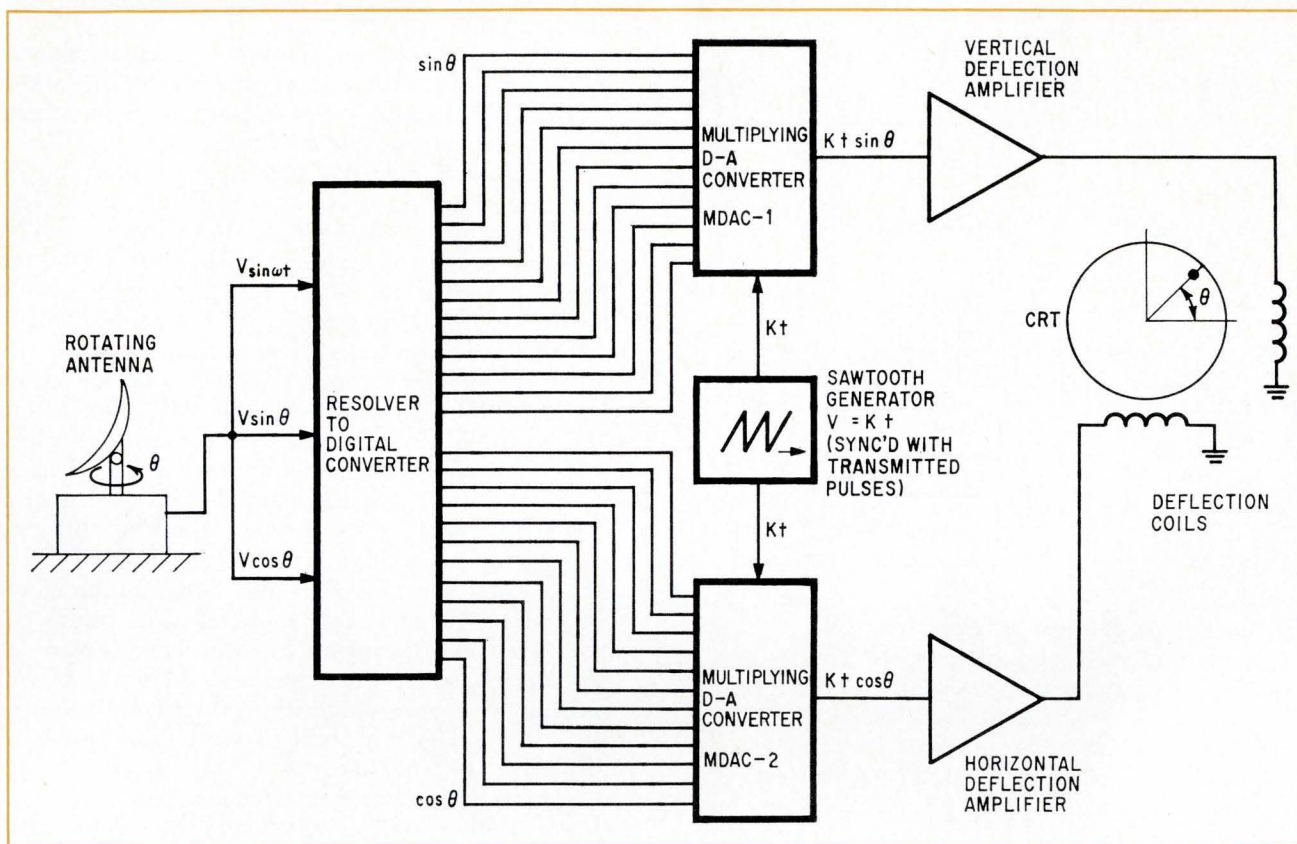

6. Radar PPI display. Resolver-to-digital converter generates digital signals proportional to sine and cosine of the radar antenna angle. Multiplying d-a converters use this data to set voltage of the sawtooth signals applied to horizontal and vertical deflection coils. CRT beam then scans outward from screen center at an angle corresponding to antenna angle. Logarithmic drive amplifiers could help give a large dynamic range with high resolution for close targets.

stator windings proportional to the sine and the cosine of the shaft angle. Conversely, if the voltages applied to the stator windings are proportional to the sine and cosine of some angle, the rotor will position itself at the corresponding angle.

In circuit 4, two multiplying d-a converters, MDAC-1 and MDAC-2, are used to position a resolver. The 400-Hz reference wave is applied directly to the rotor and also to the two converters. Each converter takes both the reference wave and its inverse—the reference shifted by 180°—allowing operation in all four quadrants of the shaft angle.

Digital numbers corresponding to the sine and cosine of the desired angle are loaded into the digital-to-analog converters. The outputs of the converters thus are 400-Hz voltages having amplitudes proportional to the sine and cosine of the angle. These voltages then are applied through power amplifiers to the stator windings, and the rotor moves to the desired angle.

The same function, performed in analog fashion, would require two analog multipliers, each multiplying the 400-Hz reference by dc voltages proportional to the sine or cosine of the desired angle. However, analog multiplier accuracy is only about 0.5%, even when trimmed externally, whereas 12-bit multiplying d-a converters provide 0.01% accuracy. And the analog's 0.5% is percent-of-full-scale accuracy, while

the d-a converter's accuracy is percent-of-reading accuracy, giving better results at small values.

Shaft-angle-to-digital conversion can be accomplished with multiplying d-a converters, as in circuit 5. The resolver, when positioned at a particular angle, generates two voltages proportional to the sine and cosine of the angle. A digital word proportional to the angle is generated by allowing a voltage-controlled oscillator (VCO) to drive an up-down counter. The counter has sine-cosine conversion logic that develops two digital outputs, each proportional to the sine and cosine of the angle represented by the digital number at the third output. The sine and cosine digital information is converted to analog form in multiplying d-a converters, MDAC-1 and MDAC-2, and the two outputs are summed in a difference amplifier.

An analog multiplier multiplies this difference by the original reference, generating a dc term proportional to the sine of the difference between the digital angle and the actual angle; this can be shown with simple trigonometric identities. A low-pass filter singles out this dc error term and applies it to the VCO to reduce the error to zero. When the error is zero, the VCO then stops oscillating, and the counter's final count represents the angle.

This method provides much more accurate conversions than are possible with encoders. It's used

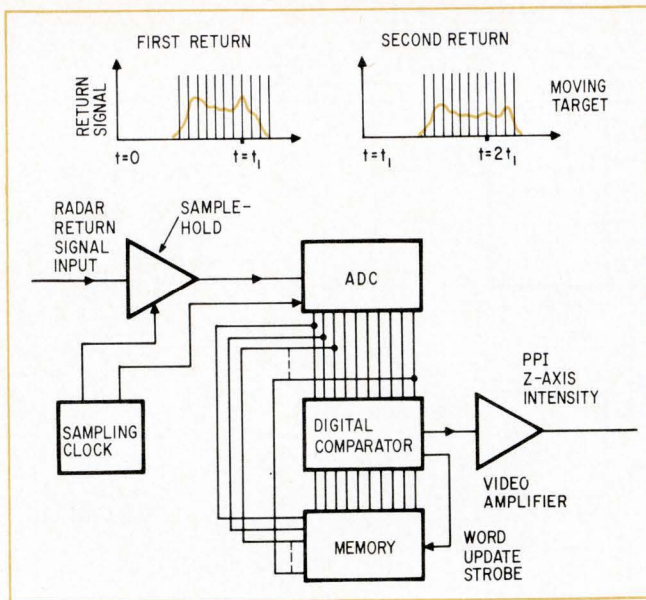

7. Radar moving target indicator. Returns from two successive pulses are compared after sampling and analog-to-digital conversion. When difference is significant, signal is applied to z-axis for intensity modulation of CRT display. Thus, signals from stationary objects can be blanked out.

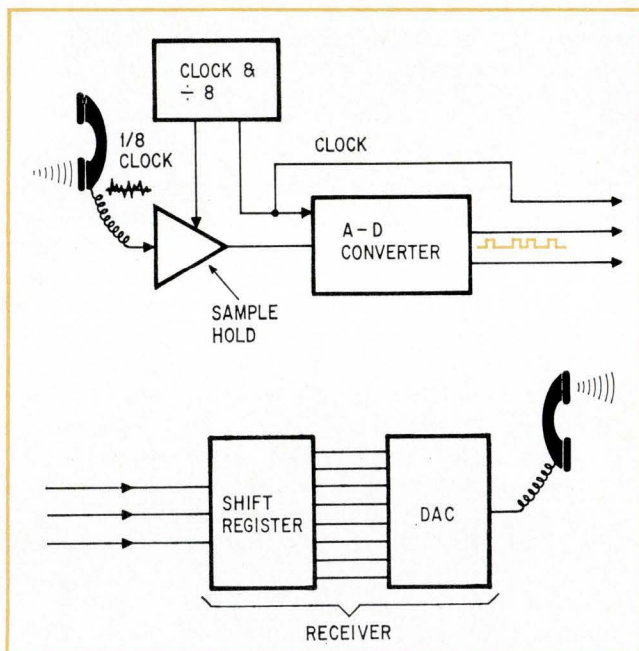

8. Low-noise communications. In this basic form of pulse-code modulation, voice signal is sampled, converted to digital form in step with a clock and transmitted over the lines. At receiving end, each eight-bit word is assembled in the shift register and reconverted to its original analog form by the d-a converter. Use of digital signals avoids signal-to-noise degradation problems inherent in analog transmission since pulses can be regenerated between transmitter and receiver.

often in displaying and processing data related to radar antenna position.

Radar pulse position display—a circular sweep of the beam on the CRT corresponding to the rotating antenna—can gain an order of magnitude in accuracy with the conversion scheme of circuit 5.

The resolver converts the antenna shaft position angle to corresponding sine and cosine voltages, which are converted to digital form by the resolver-to-digital converter of circuit 5. Then the digital numbers are multiplied, as in circuit 6, by a sawtooth applied to the analog input of the multiplying d-a converter. The outputs of the converters are sawtooth waveforms having maximum values proportional to the sine and cosine of the antenna angle. When amplified and converted to sawtooth current waveforms, the signals are applied to the deflection coils of the CRT (sine sawtooth to the vertical, and cosine sawtooth to the horizontal). The CRT beam sweeps from the center of the tube toward the rim along a line that is at the same angle as the antenna with respect to some zero reference. The return pulse then intensifies the beam as it sweeps outward, giving an indication of range and azimuth. It's also possible to include a logarithmic function to compress the scale and give a large dynamic range with high resolution for close targets.

In conventional analog schemes, the amplitude of the respective resolver sinewaves was detected and multiplied in an analog multiplier with the sawtooth waveform. This was less accurate than the digital scheme because of the multiplier's inaccuracy.

Radar moving target indicators compare sequentially received returns and pick out those whose position has changed with respect to the previous return. In this way, stationary objects may be ignored. With an a-d converter, a digital comparator, and memory, the job is easily implemented, as in circuit 7.

Each return is sampled at $2\text{-}\mu\text{s}$ intervals. The output of the sample and hold circuit is converted to digital form by the a-d converter and compared to the previous output stored in the memory. If the two words are nearly equal, no z-axis intensification is developed. Only when two sequential words are significantly different will the beam be intensified for display on the PPI scope.

Low-noise communication is possible when a voice signal is converted to digital form before transmission. Analog signals pick up much noise when amplified along the way, but if digital transmission is used, the effects of amplification noise can be minimized by regenerating the pulses at points along the transmission. At the receiving end, a d-a converter reconstructs the original voice signal.

A simplified diagram of such a system is shown in circuit 8. The analog signal is sampled at regular intervals, converted to digital form in the a-d converter and transmitted serially along with the clock pulses. At the receiving end, the signals are assembled in a shift register, kept in step by the clock pulses, and converted back to the original sound with the d-a converter.

The clock is divided by eight before being applied

to the sample and hold. The a-d converter thus sends one serial eight-bit word for each time the sample and hold circuit is strobed. The shift register at the receiving end assembles the words of eight bits each.

The sampling rate should be at least twice the bandwidth; thus for a 10-kilohertz bandwidth, a 20-kHz sampling rate is required. The converters thus should operate on 50- μ s cycle times.

Music distribution systems in commercial aircraft, as in the 747, utilize digital techniques to conserve wiring and economize on weight. As an alternative to piping eight channels to each seat, the music channels are multiplexed on one pair of wires and decoded at the seat.

In circuit 9, the analog music channels are multiplexed into the sample and hold circuit. The a-d converter sends out serial words corresponding to samples of each of the eight channels in sequence. A three-bit address code is added to the eight bits of analog information and the complete word is wired to every seat in the plane. At each seat, an address decoder is linked with the channel selection switch, and the d-a converter operates on only the digital words corresponding to the selected channel.

Note that in this and the previous scheme, absolute accuracy in the d-a converters is unimportant—all that counts is linearity for good sound reproduction. It's also interesting to note that only six bits are required for satisfactory music reproduction.

Automatic gain measurement, vital in any telephone system with repeater amplifiers, can be accomplished with a multiplying d-a converter. An input voltage, in circuit 9, is used as a reference in the multiplying d-a converter and also as one input to the null detector. The multiplying d-a converter takes its digital input from an up-down counter that counts the pulses generated by a VCO under up-down control from the null detector.

The null detector compares the input reference voltage with the output of the amplifier under test. When the two are equal, the multiplying d-a converter has a digital input proportional to the reciprocal of the amplifier gain. The multiplying d-a converter thus is applying a 1/G term to the amplifier input and the amplifier is amplifying it G times to restore it to its original value.

The digital word then can be applied to a second multiplying d-a converter to produce a voltage proportional to the amplifier gain itself. The second circuit acts as a divider: it divides 1/G into some constant term to result in a constant multiplying the amplifier gain G.

The second circuit alone may also be used as a divider to perform the function $Y=Z/X$. Here the divisor, X, is applied to the digital inputs of the multiplying d-a converter. The quotient, Y, appears at the reference input to the d-a converter. The closed loop output, V_o , produces a current $i=-V_o/R_1$, equal and opposite to the current in R_2 , Z/R_2 , insuring that the amplifier input is at virtual ground. The output V_o of the multiplier is XY . Since $(V_o R_1) = (XY/R_1) = Z/R_2$ then $Y = (-Z/X) (R_1/R_2)$. The R_1/R_2 ratio is thus a scale factor for the quotient. □

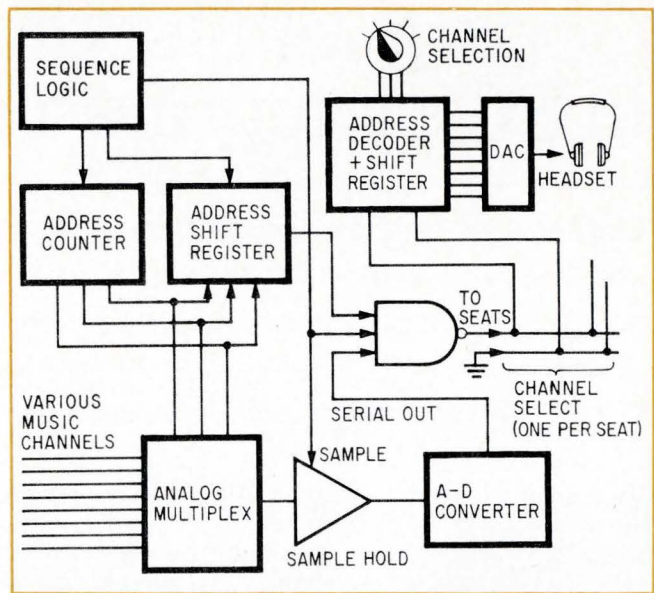

9. Aircraft music distribution. To save weight in interconnecting cables, music channels are multiplexed into a sample and hold circuit and then converted to digital form for transmission on a single pair of wires. Selector at the seat sets up an address decoder which allows selected channel to reach the headset.

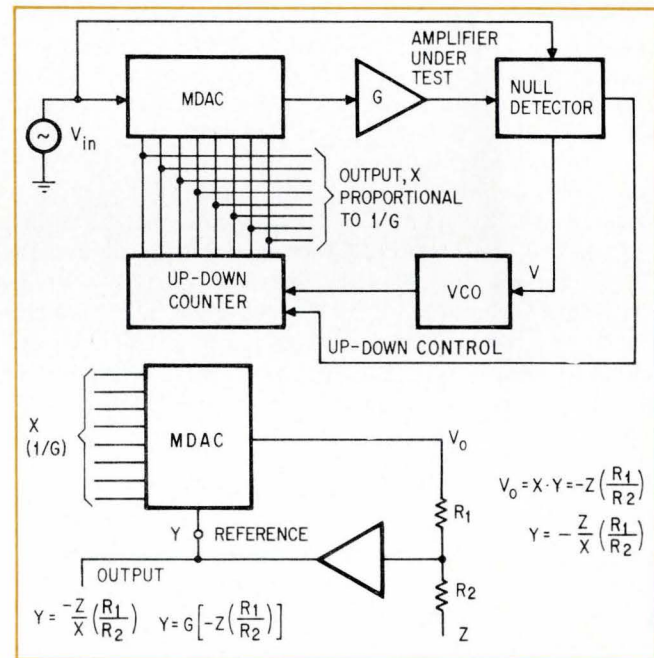

10. Automatic gain measurement. Upper circuit shows how a multiplying d-a converter effectively acts as an attenuator to cut input signal by 1/G. When amplifier output equals the reference, the voltage-controlled oscillator stops. Corresponding digital word developed by the counter is proportional to 1/G. A signal proportional to G is produced by the divider circuit, below. Here output Y is proportional to reciprocal of the X input, or quotient $(-Z/X)$. Lower circuit may function as a divider in any other system.

Coping with feedthrough in ECL integrated circuits

Certain unwanted capacitances in high-speed logic circuits are liable to produce spurious signals; the engineer must know how to design around them

By Fred U. Rosenberger, *Computer Systems Laboratory, Washington University, St. Louis*

□ A big advantage of emitter-coupled logic, next to great speed, is relative immunity to many noise sources. In particular, noise caused by crosstalk between connecting lines affects ECL much less than it does saturating logic like TTL and DTL.

However, ECL is particularly susceptible to feedthrough. Feedthrough coupling occurs when logic level transitions of input signals to an ECL integrated circuit produce short pulses on the IC output, even though the logical description of the circuit indicates no such coupling. In some cases, the amplitude of these feedthrough pulses approaches the normal logic swing.

This circumstance only causes difficulties when a stable, transient-free output from a logic circuit must be insured despite changes in some of the inputs—and while such stability is not required for all the logic circuits in a system, it will almost certainly be needed in some, particularly sequential circuits.

When feedthrough is a problem, it can be eliminated or minimized by limiting the number of inputs to the circuit, by using only the noninverting outputs of OR-NOR gates (which are less seriously affected by input transitions than the inverted outputs), or by avoiding certain circuit types altogether. The IC manufacturer also can eliminate one form of feedthrough almost entirely by designing in an extra transistor or diode to bleed off parasitic capacitance charge.

For the same propagation delay, ECL circuits can be expected to produce less crosstalk coupling than saturating logic circuits since the ratio of rise and fall time to propagation delay is less than for saturating logic. In addition, less noise is coupled into the power supply line with ECL than with most saturating logic types—particularly TTL with totem pole outputs—because ECL draws nearly constant current from the power supply. Yet another advantage is that two or three levels of current steering can be used to construct functions such as AND or exclusive-OR with a propagation delay approximately equal to that of a single gate. Nevertheless, feedthrough is a recurrent difficulty with ECL.

Two examples of how feedthrough may disturb the operation of an ECL gated flip-flop are shown in Fig. 1. In the top circuit, data are available from two sources and the select line determines which is gated into the flip-flop. If the AND gates suffer from

feedthrough, changes in data applied to the unselected AND gate may set the flip-flop incorrectly. (Only feedthrough from the AND gate input labeled D has any effect; the flip-flop clock is off when the AND gate's C input changes.) In the bottom circuit in Fig. 1, the flip-flop output should not change when the clock changes and the input level is the same as the flip-flop state. Such a circuit may be used to store transition logic signals temporarily (that is, to generate a conditional pause). In this application, feedthrough from the clock input could generate two transition signals at the flip-flop output for each clock pulse, even though the data input level does not change.

There are several different causes of feedthrough:

- Coupling via the collector-to-base capacitance, C_{cb} , of the transistors.
- Coupling through the base-to-emitter capacitance, C_{be} .
- Coupling by the capacitance between internal current source and ground.
- Coupling caused by stray capacitances.

The equipment designer, however, can calculate the amplitude of the spurious signals generated and then, if necessary, take steps to minimize them. To do so, he may make certain simplifying assumptions: he may ignore the switching time of the transistors, and assume a constant base-to-emitter voltage drop V_{be} of 0.7 in the conducting state. In the following examples, junction capacitances will also be assumed to be independent of reverse bias, and their values will be assumed to be: $C_{cb} = 1.5$ picofarads, $C_{be} = 1.5$ pF, and collector-to-substrate capacitance $C_{cs} = 2$ pF. These values are typical of many ECL circuits.

To start with the first of the causes of feedthrough listed above, consider the C_{cb} coupling of the input transistors of an ECL gate, Fig. 2. If one input is at a high level, holding the NOR output low, the equivalent gate circuit when transitions are applied to the other inputs is in the state shown at the bottom of Fig. 2. From the equivalent circuit, the amplitude of the spurious output voltage of the gate for an input ramp is:

$$V_o = C_1 A R_{c1} \{ 1 - \exp[-t/R_{c1}(C_1 + C_2)] u(t) \} - C_1 A R_{c1} \{ 1 - \exp[-(t-B)/R_{c1}(C_1 + C_2)] u(t-B) \}$$

where $C_1 = M C_{cb}$ and M is the number of inputs switched from low to high, $C_2 = N C_{cs} + (N - M$

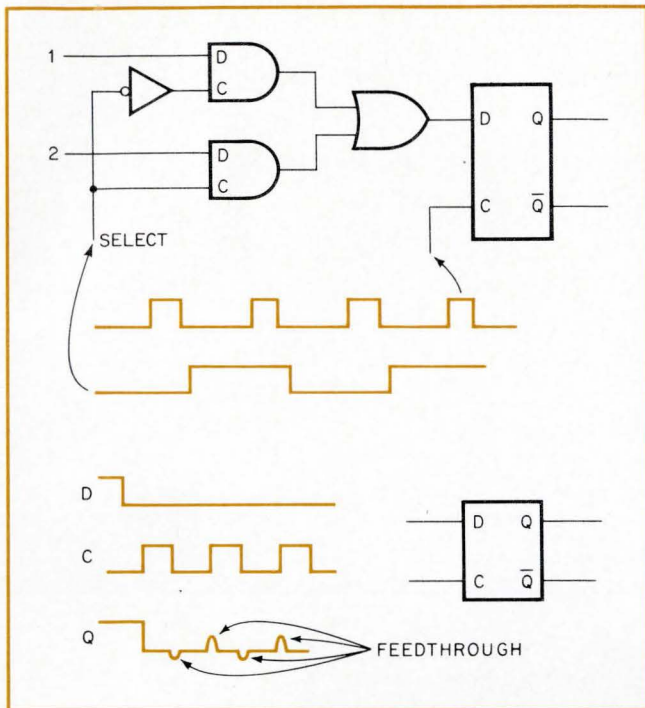

1. **Examples.** Feedthrough in ECL AND gate can incorrectly set flip-flop (top), or in ECL flip-flop can produce erroneous output signals (bottom). These effects arise from internal capacitances in the integrated circuit.

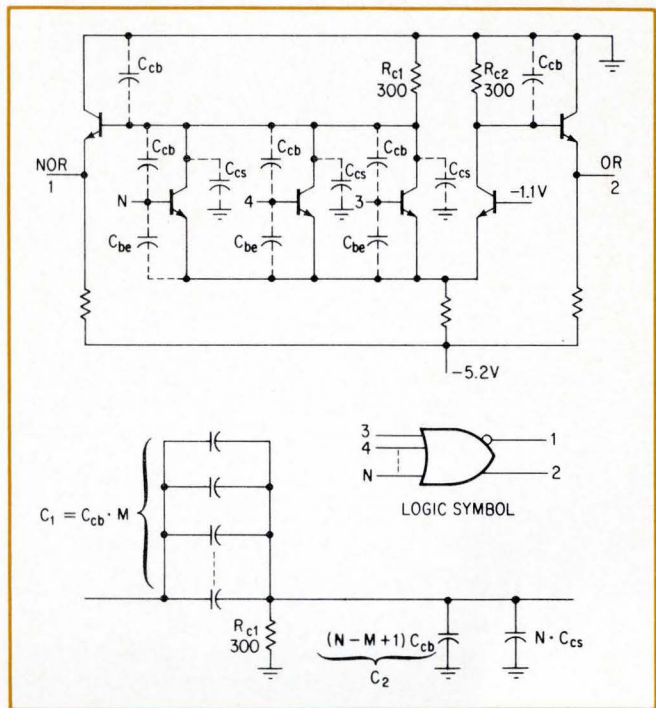

2. **Junction capacitance.** Capacitance in input transistors of ECL OR-NOR gate (top) cause feedthrough when one input is at high level, and holds the NOR output low, as the equivalent circuit (bottom) shows.

+ 1) C_{cb} and N is the total number of inputs, A is the rate of rise of the input ramp in volts per second, B is the duration of the input ramp in seconds, and $u(t)$ is a unit step function. The other terms represent circuit values shown in the diagram.

Solving the equation of a four-input gate ($N = 4$), three of which are switched ($M = 3$) from low to high with a 1 volt transition in 5 ns ($A = 2 \times 10^8$ volts/s and $B = 5 \times 10^{-9}$), reveals that the peak spurious output, V_o , occurs at $t = 5$ ns and has a magnitude of 154 millivolts. In a gate having a greater fan-in, $-M > 3$ —an even larger spurious signal would be coupled to the output.

The second mode of coupling results from the emitter-base capacitance: the input transistor whose base is held high acts as a common-base amplifier, so that it couples signals through the C_{be} capacitance of the other input transistors to the collector resistor R_{c1} .

To determine the effect of C_{be} coupling, it's assumed usually that the common-base amplifier has zero input impedance and a current gain of 1. If so, the output collector current from the common base stage can be expressed as:

$$I_c = AC_3 [u(t) - u(t - B)]$$

where C_3 is the total base-to-emitter capacitance of the input transistors. This current, I_c , applied to R_{c1} and the associated capacitances, $C_1 + C_2$, at that point causes the following output voltage:

$$V_o = AC_3 R_{c1} \{1 - \exp[-t/R_{c1} (C_1 + C_2)]\} u(t) - AC_3 R_{c1} \{1 - \exp[-(t-B)/R_{c1} (C_1 + C_2)]\} u(t-B)$$

Using the same example as before, a gate with four inputs, three of which are switched from low to high with a 1-volt transition in 5 ns, the maximum amplitude of the output pulse due to C_{be} coupling is also 154 mV.

With this C_{be} coupling added to the C_{cb} coupling, the total peak V_o would be 308 mV—considerably larger than the worst-case noise margin of 200 mV usually specified for ECL circuits. The oscilloscope waveform in Fig. 3 shows the combined effects of C_{be} and C_{cb} feedthrough on a four-input ECL gate operated under the conditions described in this example. The pulse amplitude is close to the predicted value, and its waveform also resembles the one predicted, except for being rather rounded because both the output emitter follower and the oscilloscope have bandwidth limitations.

The third source of feedthrough is the capacitance that exists from the current source to ground in two-level circuits such as the AND gate shown in Fig. 4. In this circuit, the output is high only when both inputs are high, and therefore steers the current through R_{c2} . Also, Q_1 is used in the circuit instead of just the resistor used in the OR-NOR gate, to develop a constant current. The reason: the percentage change in voltage across the current source is rather high—much greater than for the single level of current steering in an OR-NOR gate.

To understand the effect of the current source-to-ground-capacitance, consider the circuit shown in Fig. 4. If the D input is held low, the output level should remain low despite any changes in the level

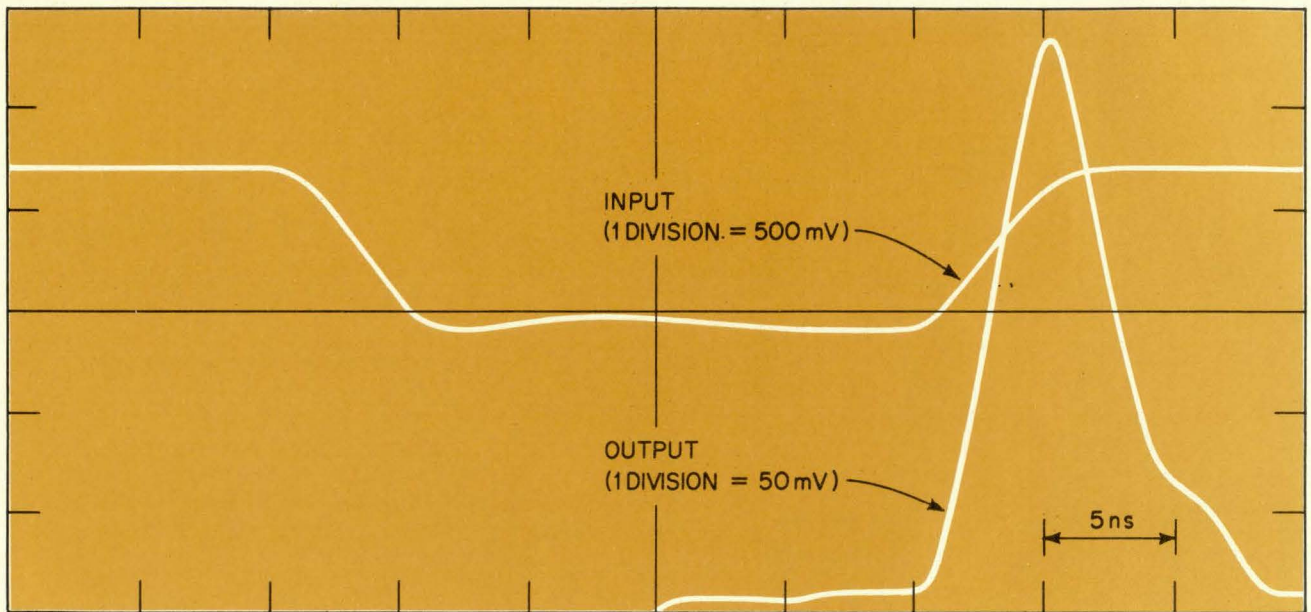

3. Excessive. Combined effects of junction capacitance feedthrough may far exceed noise margin of ECL OR-NOR gate. The input signal is applied to each of three inputs.

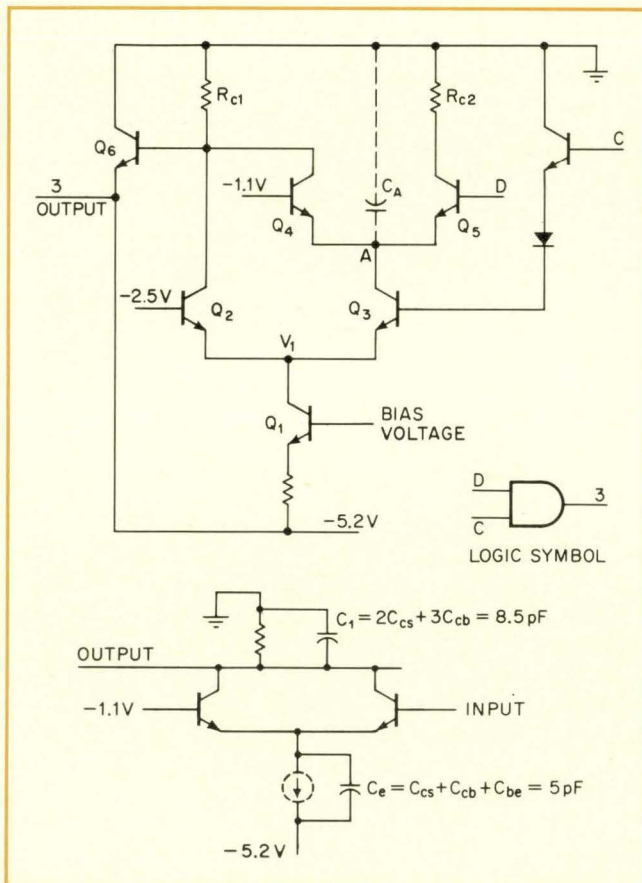

4. Two level. Major sources of feedthrough in ECL circuits with two (or more) input levels such as this AND gate (top) are capacitance between current source and ground and parasitic capacitance at node labeled A. Equivalent circuit (bottom) is used for analysis of feedthrough caused by current source.

of C. However, as the input C changes from high to low, V_1 , the voltage at the collector of Q_1 , changes by about half the logic swing. If the internal current source were ideal, there would be no change at the output due to the change in V_1 . However, the internal current source, although essentially constant at d-c, is shunted by capacitance that affects the high frequency performance. It acts as an emitter-peaking capacitor for Q_3 and causes a transition on input C to be coupled to the output.

From the simplified equivalent circuit also shown in Fig. 4, the output voltage of the AND gate for a negative-going input ramp is:

$$V_o = AC_e R_{c1} \{1 - \exp[-(t - B)/R_{c1} C_1]\} u(t - B) - AC_e R_{c1} \{1 - \exp[-(t - B/2)/R_{c1} C_1]\} u(t - B/2)$$

For the values used in the previous examples, the calculated peak output pulse amplitude is about 243 mV—a large output transient to result from switching only one input.

Feedthrough due to capacitance shunting the current source differs from C_{be} and C_{cb} feedthrough in several interesting respects. There is no direct capacitance coupling to the output. The output pulse is in the opposite direction to the input transition.

The fourth feedthrough effect occurs in two-level ECL circuits; this is the discharge of stray capacitance C_A from the node labeled A in Fig. 4. If both inputs to the AND gate are low, then transistors Q_3 , Q_4 , and Q_5 are all OFF and conduct only leakage currents. The capacitance from node A to ground will be charged to a voltage determined by these leakage currents.

This charge at node A can produce feedthrough in the following manner: if input C of the AND gate (Fig. 4) is changed from low to high, transistor Q_3 will begin conducting instead of Q_2 —but transistor Q_4

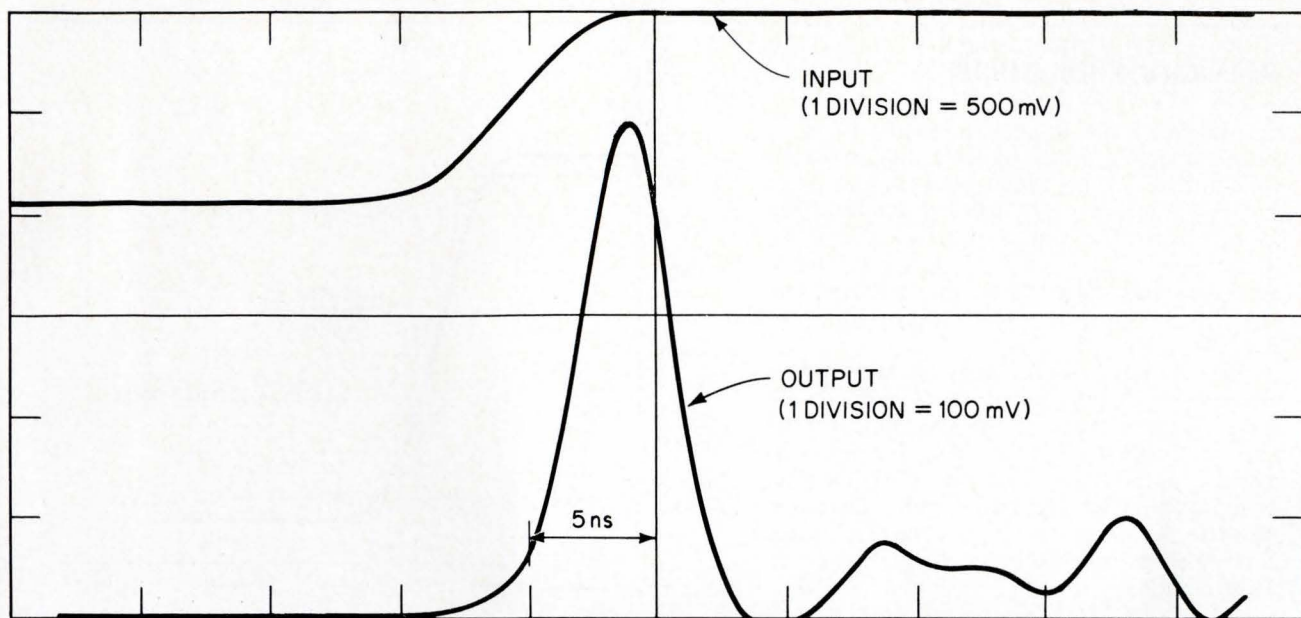

5. **Worst case.** In this particularly bad instance of C_A feedthrough, upper trace represents input at C terminal of AND gate and lower trace represents the output.

cannot conduct until the capacitance from node A to ground, C_A , is discharged to -1.8 volts. The current for the current source will therefore be supplied meanwhile by C_A instead of by R_{c1} , and a positive-going pulse will appear at the output.

The amplitude of this C_A -generated pulse depends on the relative values of the leakage currents of the transistors, and can vary widely from circuit to circuit. In fact, variations of two to one in output pulse amplitude have been observed in circuits within the same package.

To estimate the voltage output caused by C_A , consider the case when both gate inputs are initially low and the C input is then switched from low to high. Q_4 will not conduct until C_A is discharged, and the time required for this to occur is $t_0 = (C_A \Delta V)/I_E$ seconds where ΔV is the voltage, -1.8 volt, to which C_A is charged and I_E is the current-source value. With assumed values of 5 pF for C_A , 400 mV for ΔV , and 3.33 mA for I_E , the time for Q_4 to turn ON is $t_0 = 0.6$ ns.

The output pulse, from the equivalent circuit, is

$$V_o = I_E R_{c1} [1 - \exp(-t/R_{c1} C_1)] u(t) - I_E R_{c1} \{1 - \exp[-(t - t_0)/R_{c1} C_1]\} u(t - t_0)$$

This gives a peak amplitude for V_o of -330 mV.

A more complete analysis—one taking into account the switching time of the transistors—would indicate a slightly smaller peak amplitude (although the area under the pulse would remain the same). Nevertheless, it's still possible that in some cases C_A would be charged to more than 400 mV and produce an even larger output pulse on discharge.

The oscilloscope trace in Fig. 5 shows an extremely bad case of C_A -induced feedthrough, with the spurious output peaking at almost 500 mV. In the small number of gates investigated at the Computer Sys-

tems Laboratory at Washington University, some 3% of the approximately 200 units tested showed this large an output. Almost all other gates exhibited an output about half that large. (The investigation was supported by the Advanced Research Projects Agency and the National Institutes of Health.)

Unlike the capacitive coupling caused by C_{be} and C_{cb} and the emitter-peaking feedthrough caused by capacitance shunting the current source, output pulse amplitude and shape that are not dependent on the rise time or amplitude of the input signal. (There is actually a small dependence on the input transition time, but this is not significant with typical signals.) This is because of the stage of gain between the input signal and node A.

There are two other distinct differences between C_A feedthrough and the other types. First, C_A only occurs when the input transition is positive, whereas the other forms of feedthrough occur with either positive or negative transitions. Second, the peak output pulse amplitude may be much larger for C_A feedthrough than for any other with a single-switched input. Only changes in the C input affect the gate in this example. If the C input is held low and the D input changed, there is no feedthrough to the output due to C_{cb} coupling, C_{be} coupling, emitter peaking, or C_A discharge because there is no current through R_{c1} and because C_{be} and C_{cb} of Q_5 do not couple to the output.

Experiments in which a variable voltage source was attached through a 100 kilohm resistor to the ECL gate at node A confirmed that discharge of stray capacitance C_A was indeed the culprit in causing the large feedthrough signals with positive transitions at the C input. In these experiments, the charge at A could be varied, and it was found that the magnitude of the feedthrough decreased with the charge. The

Allowance for noise

ECL Logic ICs are usually specified with a dc noise margin V_N , which indicates the maximum voltage that can be added between two gates and still insure a valid logic output from the second gate. The way to test a circuit's V_N is to apply $V_{IH(min)}$ and $V_{IL(max)}$, as shown at right, and check that the outputs are, respectively, greater than $V_{OL(max)}$ and less than $V_{OH(min)}$.

The ac noise margin may be specified as a plot of input pulse widths versus the amplitudes required to cause the output to exceed the worst-case level. In general, the ac noise margin approaches the dc noise margin asymptotically as the pulse width increases. Ac noise margin is usually not specified, since it is much more difficult to measure than dc noise margin.

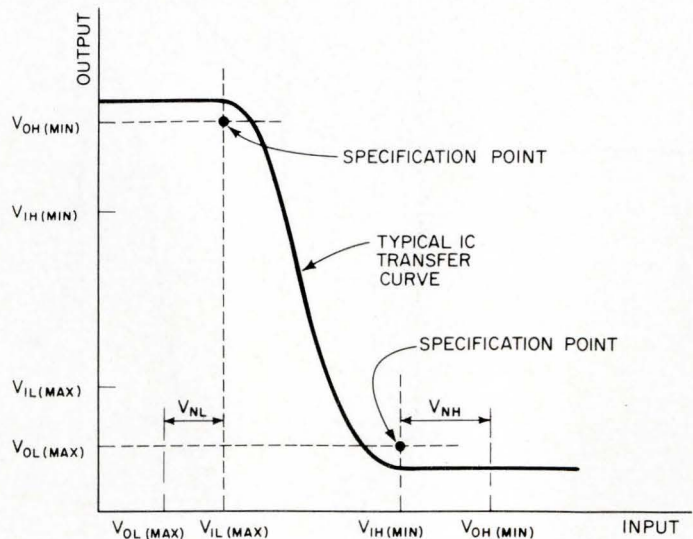

experiments also indicated a cure for the problem: if an extra transistor or diode with sufficient leakage were designed into the IC chip, connecting node A to the -5.2 volt supply, C_A discharge would be eliminated as a cause of feedthrough.

There is yet another kind of feedthrough, which, fortunately, is insignificant when compared to the other forms. Some coupling between circuits on the same chip results from the use of a common bias voltage source or sources, common ground and power leads, and capacitance between circuit elements on the chip. The worst case occurred when three sections of a quad exclusive-OR gate were switched while the output of the fourth section was monitored. The signal induced in the output had a peak amplitude of about 75 mV, well within the noise tolerance of ECL circuitry.

Having identified the sources of feedthrough and their magnitude, how can the ECL circuit user minimize or eliminate them? The things that can be done depend on the type of circuit and its relation to other circuits in the system.

Thus, although OR-NOR logic gates with a single level of current steering are affected by C_{cb} and C_{be} coupling, feedthrough is troublesome only when the NOR input is low—when it is high, a change on any input will change the output. Moreover, negative transitions on the input do not cause problems since they can only make the output more negative. Therefore, the only harmful condition is when the NOR output is low and some inputs change from low to high. The options available to the user of an ECL OR-NOR gate family are to reduce the number of inputs that can change simultaneously or to use a noninverting gate output.

As an example of what he can do to minimize the effects of C_{cb} and C_{be} , consider a three-bit synchronous counter that is decoded by four input gates, where the

fourth input is used to hold the decoder output off while the input values are changing. If all the bits of the counter change from low to high simultaneously, the pulse coupled to the NOR output may be large enough to propagate through the succeeding stages. This large a pulse can be avoided by using a three-input gate for decoding followed by a two-input gate for control, or by using the OR output of the four-input gate.

Unlike the OR-NOR gate, circuits with two or more levels of current steering (such as the two-input AND gate) suffer primarily from current-source capacitance and parasitic capacitance C_A . Feedthrough due to current-source capacitance can be controlled by slowing the input transitions, at the expense of circuit speed; but this is of little help for C_A feedthrough, since C_A discharge is not particularly sensitive to input transition time. If the C input of the AND gate is held low, changes on the D input aren't coupled to the output, so that the gate can be used if feedthrough from the C input is not a problem.

Many other ECL circuits in addition to the AND gate—flip-flops, decoders, full adders, multiplexers, for example—may use two or three levels of current steering and the same comments apply to them. In many such circuits feedthrough due to current source capacitance and C_A will exist, and careful analysis is necessary to assure that it doesn't exceed tolerable levels or does not occur where it may cause malfunctions. Also, if a two-level gate has multiple inputs, C_{cb} and C_{be} may present a problem. In all cases of emitter-peaking or C_A feedthrough, feedthrough is a matter of concern only when the output is low: feedthrough increases the output voltage at a low level by decreasing the effective value of the current source but does not affect a high level, since there is no current through the collector resistor when the output is high. □

Save-a-can.

And clean up.

You do it with OPEN COLLECTOR MSI. Ours. That cost you less than the plain-Jane jobs from the other guys.

We've got twelve of these bonus babies on the shelf. Put 'em on the boards and cut your can-count. With elimination of gates, system speed jumps about 10ns—power requirements drop significantly.

Obvious results: lower total system costs.

Write for our open collector MSI specs pack. Or call if you just can't wait. (408) 739-7700.

Signetics Corporation, 811 E. Arques Avenue, Sunnyvale, California 94086 / A subsidiary of Corning Glass Works.

- 8220 Content Addressable Memory
- 8222 Content Addressable Memory
- 8224 256-Bit Read Only Memory
- 8231 8-Input Digital Multiplexer
- 8234 4-Bit 2-Input Digital Multiplexer
- 8235 4-Bit 2-Input Digital Multiplexer
- 8242 Exclusive NOR
- 8243 Scaler
- 8264 4-Bit 3-Input Digital Multiplexer
- 8267 4-Bit 2-Input Digital Multiplexer
- 8T80 High Voltage Quad 2-Input NAND
- 8T90 High Voltage HEX Inverter

Signetics 

“We came to fish, and got hooked.”

“Eight years ago, I decided to combine business and pleasure. I was seeking a site for a new manufacturing facility for our electronic instruments company. So, on a trip to Colorado I brought Louise and the boys along to do some fishing and sight seeing as well as site seeking.

“Our whole family was fascinated by western Colorado.

“Well, one year later, we located our new plant in a city of about 40,000 people, nestled in a scenic valley of the Colorado River. It's strategically located on an excellent

air, rail and all-weather highway transportation network which provides efficient distribution to all our national markets.

“Now we employ over 300. And, the people here are great. Our local employees are reliable, stable and trainable. Our local college organized a vocational training program for our new employees and provides a continuing educational service for industry throughout the area.

“It's a great place for a family and a business to grow. And incidentally, the fishing *is* great.”

For further details on Colorado site seeking, write William C. Hacker, 1115 State Capitol Annex, Denver, Colorado 80203.

Mr. Bruce Dixon,
President of Dixson, Inc.,
Grand Junction, with son.

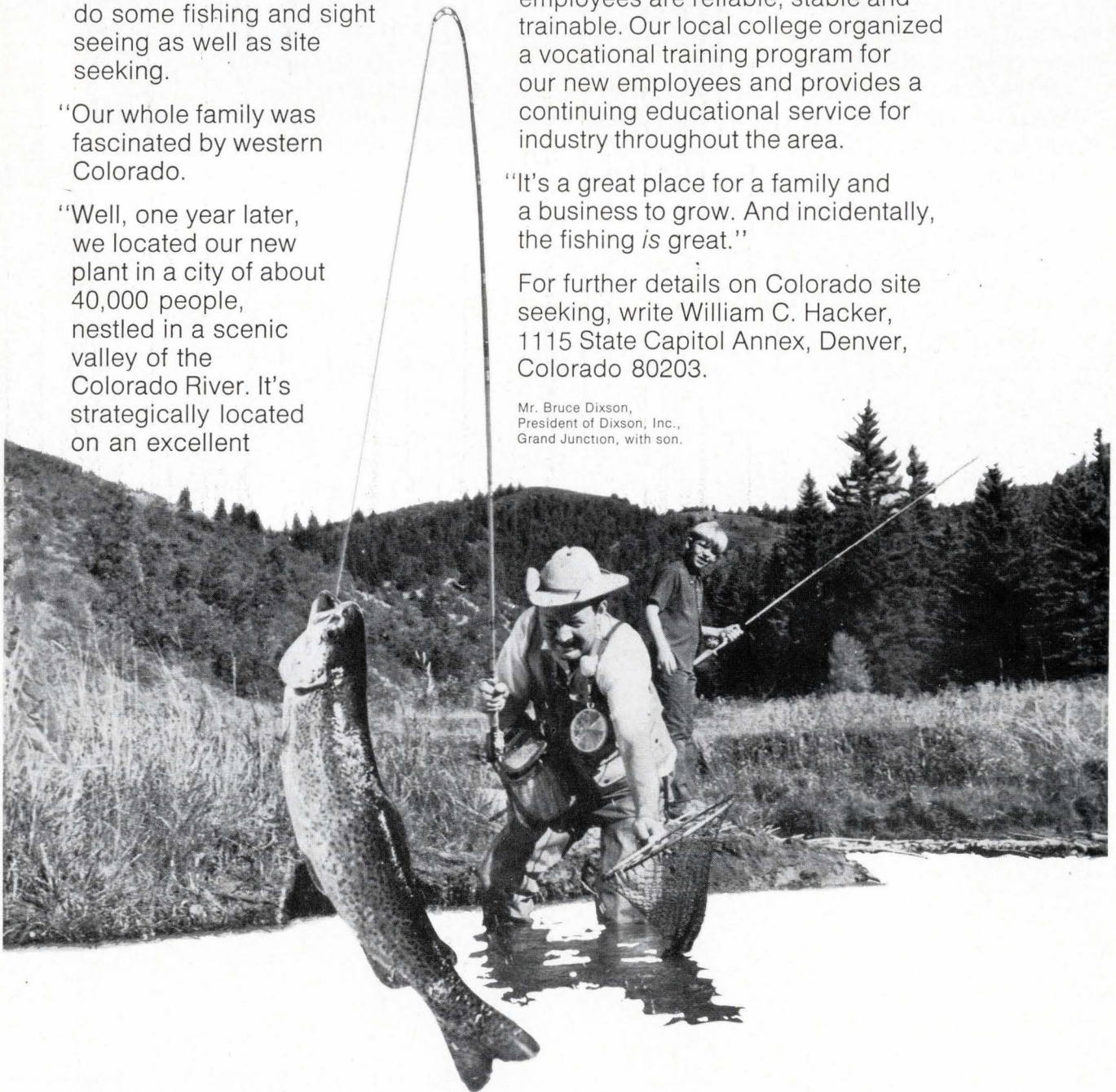

COLORADO... *where there's room to live and breathe.*

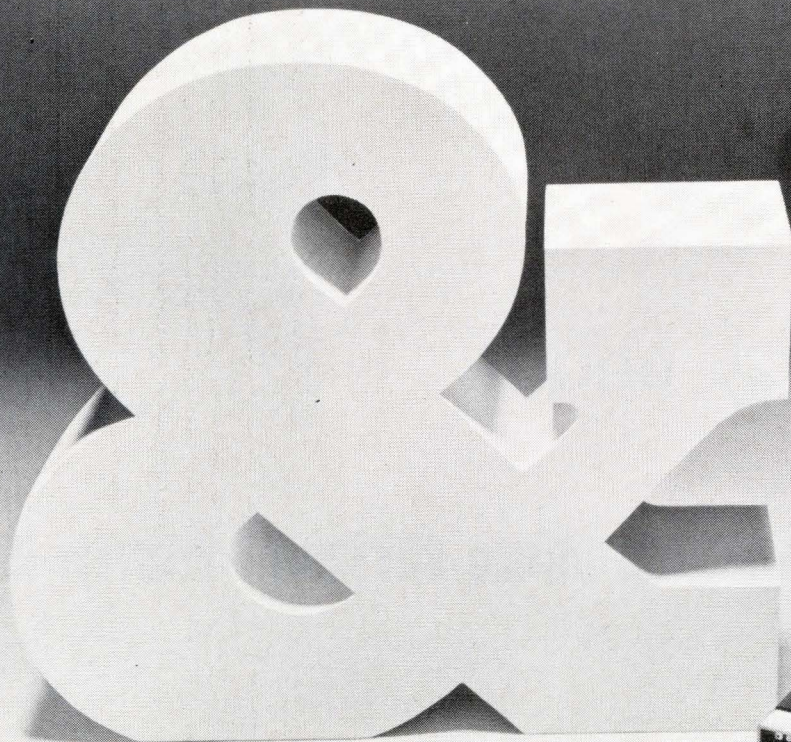

Bell & Howell & Recording & How

It's done with oscillographs. We have a bunch, but let's talk about these two. They can handle on-line or off-line test and measurement of any physical happening you might have in mind. From pulse flutters during surgery to whether or not you're refining that crude the same way today as last year.

The one on the bottom is the 5-134. It does everything but talk. It writes to 25,000 Hz. (But with all that speed, it has a data accuracy to $\pm 1/2\%$.) And can flip into any one of 10 different servo-controlled speeds.

It's modular, of course, with special refinements. Like the timer, servo control board and galvo all plug in. Individual input connectors as standard. An extremely quiet operation. That type of thing.

Here's a couple more exclusives. You don't have to write out timing line rates. With us, that's taken care of automatically. With a timing ID marked on the edge of the paper. Not only that, the rate can be manually selected or can be automatically synced with paper speed.

And it's got a "jog" feature that allows you to move the paper short distances for initial set up—one hold-down button for on/off.

The smaller box is the 5-135. It weighs in at 35 pounds (a real portable) as compared to the other's 50 pounds. Both boxes share pretty much the same components. It's just that the 5-135 has broader application by more industries across the board because it's not quite so fancy (9 channels versus the 5-134's 18, for instance). Even though it's smaller, it doesn't skimp on performance. It has the largest range of input power options of anybody going. And all that at a lot less money. Not bad, huh?

And one more thing. Just in case you're building a system, we've got a range of other new goodies to complement these graphs: 1-172 amplifier, 8-114 bridge excitation/signal conditioner and the 23-111 paper processor.

If anything here piques your curiosity, you can get the full package of specs by writing Bell & Howell, Instruments Division, 360 Sierra Madre Villa, Pasadena, California 91109.

INSTRUMENTS DIVISION

 BELL & HOWELL

You can really know what geometry lurks beyond the linear profile. You can record spatial relationships based on length, breadth, height and depth scanning of surfaces, even on soft materials. No longer is there a need to rely on arithmetical averages or linear cross sectional profiles. Surfaces up to 2" square can be examined for profile, roughness, arithmetical average and waviness. A precision diamond stylus repetitively scans the sur-

face to be measured and transmits signals for hard copy print out in 3-D macro topograph. Magnification can be stepped from 5X to 200X on the X-Y plane, and from 10X to 100,000X in the Z axis.

Gould, Inc.
Gaging & Control Division, 4601
Arden Drive, El Monte, California
91731 (213) 442-7755

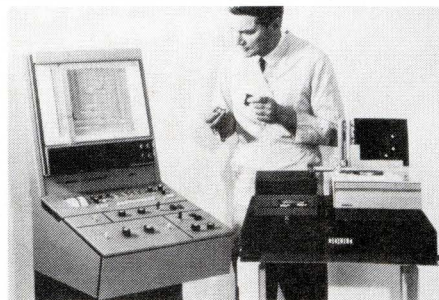

The Gould Micro-Topographer™ 200 recording (below) of a micro electronic circuit illustrates the potential of this analytical tool for micro surface geometry.

Now you can study hidden micro surface patterns in 3-D

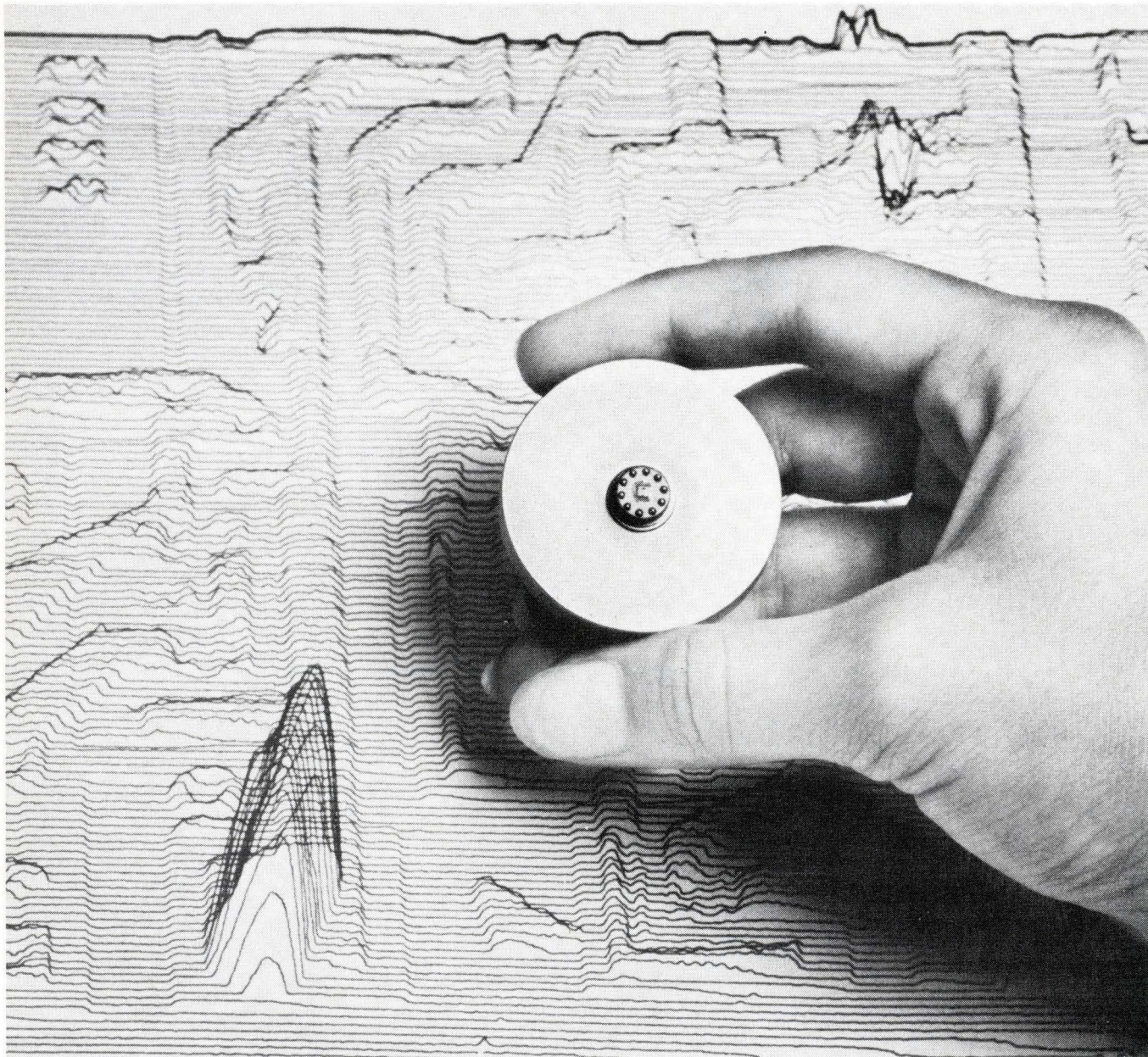

If the new PDP-8/e is so great, how come it's so cheap?



We've got the price down under \$5000 for the basic 4K computer. (With teletype, under \$6500.) And our new modular design means that you don't have to pay for anything you won't use. The peripherals, the options, even the CPU, all plug into the OMNIBUS™. In any order. Buy only what you need for your application. Expand later if you want.

And you don't have to spend any time or money to debug the

software. 7500 other PDP-8 family computers have done it for you. The PDP-8/e is completely compatible with all the lovely software that's working right now in laboratories and factories, steel mills and power plants.

The PDP-8/e is made by the most experienced company in the small computer field. That's why it's such a great mini-computer. And that's why it costs so little.

digital
COMPUTERS · MODULES

Digital Equipment Corporation
Maynard, Mass. 01754 (617) 897-5111

the world's most widely traveled oscilloscopes!

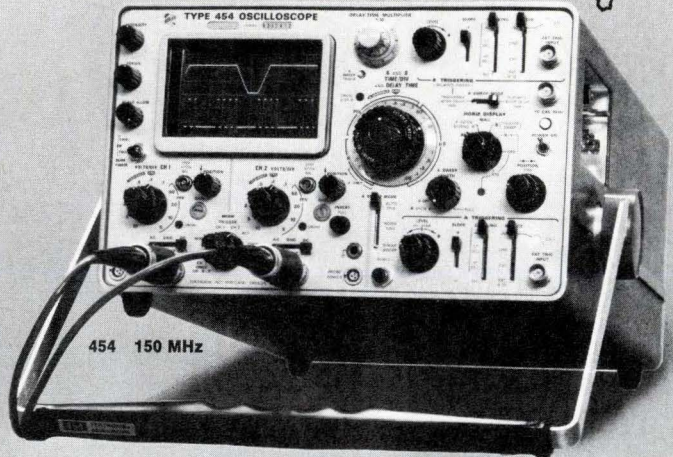
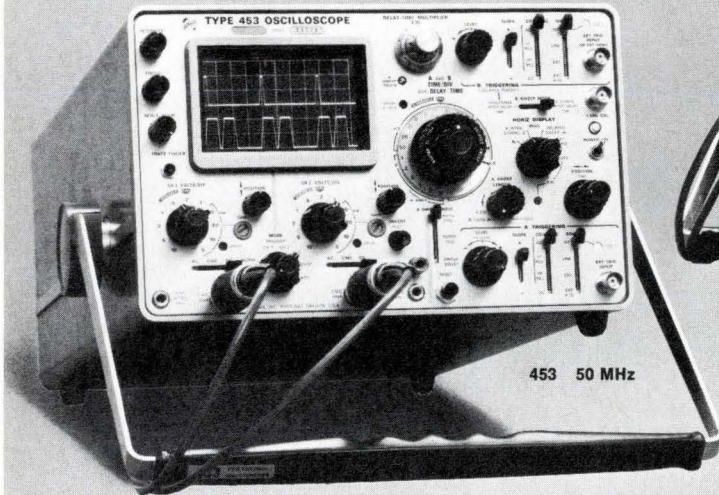

TEKTRONIX®

committed to progress
in waveform measurement

Customer preference has made the Tektronix 453 and 454 the world's most widely traveled oscilloscopes. The reasons are many. Here are just a few!

PORTABILITY: Features which make the going easy include—storage for accessories in a convenient front-panel protective cover; a cover to keep out rain and dust; a vertical handle position makes the carrying easy. The 453 and 454 take rugged trips in stride and arrive ready to work.

PERFORMANCE: With dual channel $1\text{ M}\Omega$ inputs, delayed sweep, 5 mV/div , plus many other built-in performance features, you solve problems quickly in the field or in the lab.

OPERATOR EASE: The controls are human engineered to take the guesswork out of triggering, delayed sweep, and other functions—less guesswork means faster measurements.

RUGGEDIZED: Some oscilloscopes are temperamental about severe environments. Not the 453 and 454. Both meet essentially all of the important military environmental specs, without the associated extra cost.

When you make field trips, take along a field-proven oscilloscope designed to travel. Between trips, use the 453 and 454 in the lab. These ruggedized, portable oscilloscopes are designed to solve a vast range of measurement problems with *laboratory precision*. Wherever you are!

For a demonstration in your application, call your local Tektronix Field Engineer or write Tektronix, Inc., P.O. Box 500, Beaverton, Oregon 97005.

453 Oscilloscope \$2050
454 Oscilloscope \$2925

U.S. Sales Prices FOB Beaverton, Oregon

Available in U.S. through the Tektronix lease plan

DOD computer waste: \$500 million

Special study finds inefficiency costs the Pentagon one-quarter of its annual EDP outlay; urges strong controls under new assistant secretary

By Ray Connolly, *Washington bureau manager*

Short on technical capability and qualified personnel, the Defense Department spends "at least \$500 million per year more for computers and automatic data processing support than is necessary," wasting about a quarter of its \$2 billion annual outlay in this area. What's more, some 36% of the military's 2,800 unclassified machines "are considered obsolete." This assessment of the low state of DOD's computer art appears in an unreleased 55-page report prepared for Defense Secretary Melvin Laird's Blue Ribbon Defense Panel [*Electronics*, Aug. 17, p. 109]. The special study—one of 14 appendices to the massive overview of total Defense Department operations made public this summer—was written by John P. Malbrain, director of advanced systems at North American Rockwell, and David B. Breedon, Westinghouse Electric Corp.'s manager of management systems.

To counter escalating inefficiency, the Pentagon should move first to consolidate data processing responsibility under a new assistant secretary of defense for computer systems and services, say Malbrain and Breedon. Then, after an ADP industrial fund is established to pay for all general-purpose hardware, software, maintenance, and related telecommunications, the Pentagon can begin to acquire the expertise needed to pull together and streamline an operation now flawed by "poorly applied, fragmented, underutilized, and obsolete computer equipment."

A major recommendation calls for creation of a huge computer systems network in which several

major regional centers would serve military users in the same area via telecommunications links. To be located at bases with major workloads, the centers would operate all DOD general-purpose machines in both time-shared and batch modes, billing each user monthly. Still to be resolved is whether the new organization becomes a separate entity or is incorporated into an expanded version of the recently formed telecommunications group headed by Louis de Rosa, an assistant to Laird. Implementation of the network, say Malbrain and Breedon, "might require three to five years."

Malbrain, who estimates he and

Breedon devoted "about 90% of our time" for more than four months to completing the report, sees a variety of situations crying for correction. Among the most serious is the lack of any developed and coordinated policy for general-purpose computer acquisition and usage. A related and equally serious weakness, say Malbrain and Breedon, is the fact that DOD "does not have sufficient technical capability to make decisions that are in the best interest of the department."

The study further determines that:

► Justification procedures for system purchase and leasing "are too

Consolidation. DOD general purpose computers and services should be under an assistant secretary of defense, says the Blue Ribbon Defense Panel. The key operations and user support group would operate a vast computer network.

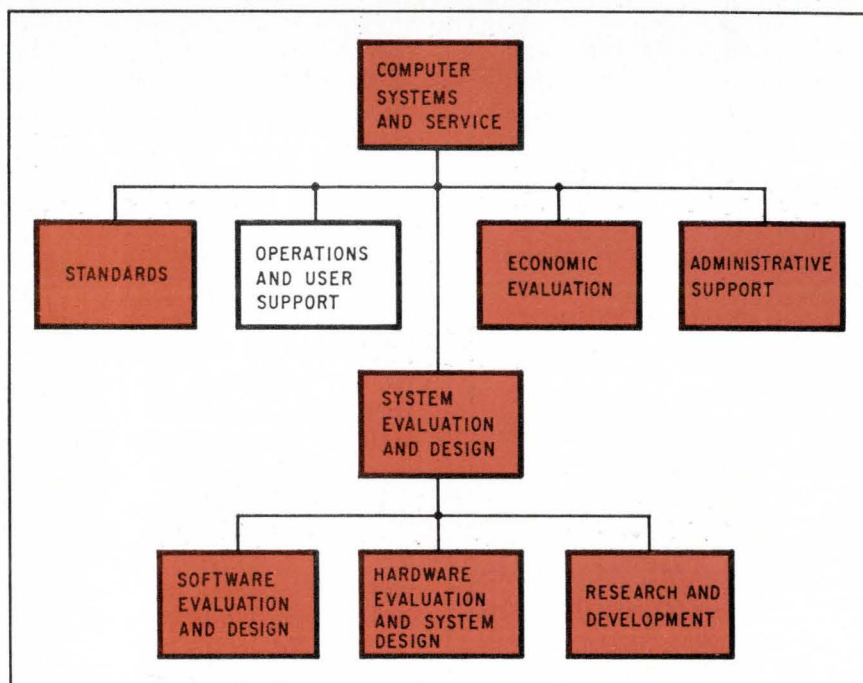

Reliability

EXCEEDS 100 MILLION CYCLES

Simplicity

EASY TO USE

Performance

VALUE ENGINEERED

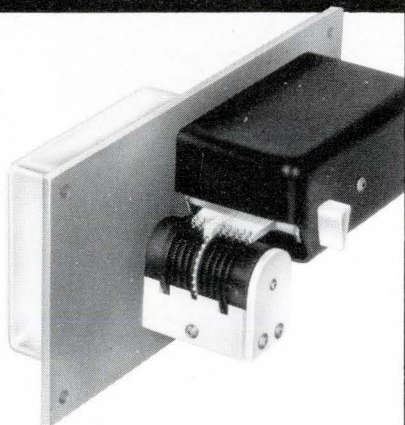

CMC MODEL 18 Tape Reader

This simple unit reads tape uni-directionally... at 30 characters per second. **Starwheels sense holes;** output is in the form of contact closures.

Model 18 Tape Reader provides control equivalent to that of far more costly units **without complex circuitry or timing.** As easy to use as a relay.

Other models also available for special applications (call or write for more information).

CMC

COMPUTER
MECHANISMS
CORPORATION

493 WASHINGTON AVE. • CARLSTADT, N.J. 07072
(201) 438-1770 U.S.A.

TWX 710-989-0111 Cable: COMPUTERMECH

Probing the news

involved and require too much time and resources." The elapsed time between the first description of a computer requirement and actual installation "varies between a minimum of two years and a maximum of at least six years." What's more, this time lapse "has often resulted in equipment which did not meet requirements when it was installed."

▶DOD has "no criteria for replacing computers." If a system becomes saturated, it is often augmented by another identical machine. As Malbrain pointed out in an interview, some DOD installations use as many as nine early RCA 301 models together. DOD could have achieved significant economies if it had acquired the later RCA 3301 systems, whose capacity is approximately triple that of the 301s, instead of adding more earlier machines.

▶Data storage and retrieval is DOD's major software problem. "Millions of dollars have been spent, and many more millions will be required, before a suitable system is developed," the study concludes. In general, DOD's uncoordinated computer operations have severely handicapped its software development program. The department "is one of the few computer users which has sufficient resources to become independent of software supplied by the manufacturer," report Malbrain and Breedon, "but to date it has not made any real effort to achieve this independence."

Rapid advances in electronics technology make a strong Pentagon software capability imperative, the report suggests. In the next decade, says the study, computer electronics costs will fall "by a factor approaching 10." On-line storage capability will grow to "billions of characters by 1980," permitting systems with up to 100 times the capacity of the largest now available. Thus, the authors conclude, "the medium-scale computer which has been the backbone of the department's system will disappear," and cheaper hardware costs create the possibility that DOD "could spend millions of dollars program-

ing a computer which would cost less than \$100."

Apart from technological advances, the computer industry will see further unbundling of hardware and software; most 1980 computers will be required to have on-line teleprocessing capabilities.

"By 1980," they report, "each part of the ADP system will be obtained separately. Mainframes, memories, tapes, discs, printers, card equipment, terminals, maintenance, software, etc. will be purchased separately. Large users will require substantial systems staffs to convert these individual items into an integrated operating ADP system."

DOD's heavyweights

The Defense Department's computer inventory contains 113 large scale machines—those which generally have the lowest "cost per job," according to the blue ribbon panel's economic analysis. In view of the panel's suggestion that large scale systems will be a major element in rebuilding DOD's capability as "the recognized leader" in effective computer usage, the number and kinds of large computers now in use is worth reviewing.

DOD's large computers are: Control Data 6000 series-7; General Electric 600 series-5; IBM 360/65 and larger-27; IBM 7080/90/94 models-64; Univac 1108-10, for a total of 113.

A massive organization of interconnected centers forming a Computer Service Network for the Defense Department is the major recommendation most likely to affect industry. Using common software—codes, formats and programs—the centers would serve military installations in a particular geographic region via telecommunications links. If a military installation would require its own computer—Malbrain and Breedon believe the centers will be large enough to make such instances rare—the CSN would operate and maintain the system, billing the users monthly for work performed plus a surcharge to cover the dedicated system's cost and overhead.

The Blue Ribbon panel study as-

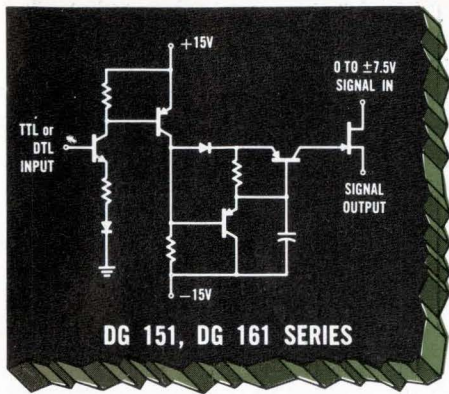

SWITCH 1 MHz ANALOG SIGNALS WITH JFETS

- $R_{on} < 15\Omega$ independent of signal frequency to 1 MHz.
- Operate from $\pm 15V$ power supplies.
- Settling time limited only by external circuitry.
- No bleed current from signal source.

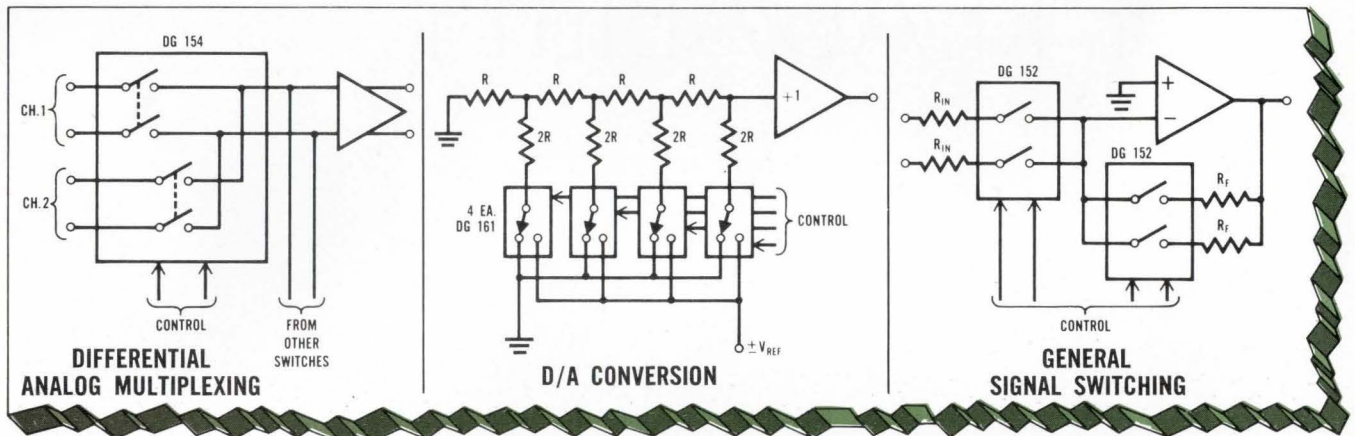

These unique JFET driver-switches offer all of the listed advantages over other driver circuits and are ideal for any JFET switching application. A full range of configurations is available. SPST, DPST, SPDT and DPDT, in MIL or industrial ratings. Maximum R_{on} is from 15 to 100 Ω .

For complete data on the DG 151 and 161 series, write or call any of these offices. *Prices from \$5.25/channel 100 pc. quantities.

New York: Sy Levine (516) 796-4680
New England: Al La Croix (617) 769-3780
Ft. Worth/Dallas: Charlie Williams (214) 231-8151
St. Louis: Jim Spicer (314) 291-3616
Minneapolis: Ed Koelfgen (612) 920-4483
Southern California: Dave Ferran (213) 420-1307
Northern California: Chuck Brush (408) 246-8000



Siliconix incorporated

2201 Laurelwood Road • Santa Clara • California 95054
 Telephone (408) 246-8000 Extension 201 • TWX: 910-338-0227
 In Europe: Siliconix Limited, Saunders Way, Sketty, Swansea, Great Britain

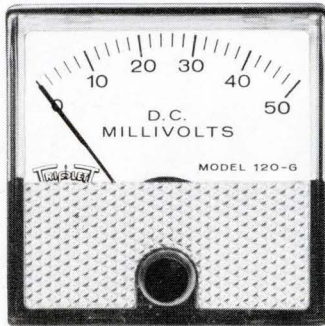

YOU CAN'T HAVE REAL ACCURACY WITHOUT THIS KIND OF READABILITY.

Recognizing that the overall accuracy of a metering system can be limited by the legibility of the meter scale, Triplet maintains a continuing study of type styles, colors, printing methods and the other factors which affect that legibility. The current state-of-the-art in legibility is exemplified by Triplet's G-Series panel meter line.

Counting the several sizes and types and the many ranges in which the G-Series meters are available,

Triplet offers more than 1,000 different meters featuring this superior legibility. With 1½, 2½, 3½, 4½ and 5½" models, the G-Series includes AC, DC and RF ammeters and milliammeters; AC and DC voltmeters and DC millivoltmeters and microammeters in addition to null meters and VU and dB meters. Knowing that with such dial legibility the accuracy of the meter movement becomes the limit to overall system accuracy, Triplet furnishes the AC iron vane, DC and

RF movements with 2% accuracy ... 3% for the AC rectifier-type meters.

The entire Triplet G-Series meter line is available right now at your local Triplet distributor or sales/service/modification center. For more information, including the availability of special ranges, scales or trim, contact one of them or your Triplet sales representative. Triplet Corporation, Bluffton, Ohio 45817.

TRIPLETT

Manufacturers of the World's most
complete line of V-O-Ms

Probing the news

sumes the centers would be operated "on an around-the-clock, seven-day-week schedule, and the charges for different priorities will even the work load over the week." Implementation would be "on a progressive basis," the study explains, "beginning with an evaluation of the status of computer support in each geographical area." Areas with the most critical need would have first priority. While the centers would be the responsibility of the Operations and User Support group under the new assistant secretary, design and evaluation of systems would go to a separate office and its branches that would deal with hardware, software, and research and development.

The in-house R&D function, says Breedon, would be largely devoted to conceptual studies for systems, leaving the nitty-gritty of new hardware developments, such as memories, compilers and input-output terminals, to commercial contractors. Responsibility for Directorate of Defense Research and Engineering hardware and software development contracts would be shifted to this office, too, Breedon says.

Both men see other distinct dollars-and-cents advantages in the new organization. Consolidation of computer operations should ease professional staff recruitment by offering significant promotion opportunities within the group as well as salary schedules competitive with industry scales. And the ADP industrial fund that buys and leases hardware and software should cut the cycle time between a system's conception and its implementation. Further, the fund would permit "a direct comparison of operating cost with other alternatives, principally commercial service, on a logically similar basis," Malbrain and Breedon point out.

"If another alternative showed lower cost," the study explains, "then that alternative could be used, or management action could be taken to bring international costs into line." Says Breedon, "The fund provides a kind of profit-and-loss statement that will show DOD how it's doing."

The CHAMP'S profile



Bausch & Lomb's StereoZoom 7 Microscope.

Overwhelming choice for cost reduction, increased production in microelectronics, quality control/assurance, manufacture and assembly.

- Greatest range of 100% USABLE magnification, from 2.5X through 280X.
- Infinitely variable zoom and accessory lenses let you select the power best for you and your work.
- Large field of view, optimum for visual scanning.
- All the working distance you need for widely diversified applications.
- Convenient photomicrography with integral and interchangeable cameras.
- Highest eyepoint eyepieces, comfortable for eyeglass wearers.
- Power pods interchangeable with any models from 1959 to 1970, and 180° reversible.

That's the world's Champ.

Bausch & Lomb's StereoZoom 7 Microscope.

There's a new catalog that tells all about The Champ. Write today for No. 31-15 and our free demonstration plan.

StereoZoom, Reg. T. M. Bausch & Lomb.

BAUSCH & LOMB 
SCIENTIFIC INSTRUMENT DIVISION

61434 Bausch Street, Rochester, New York 14602

For a limited time only!

Special Trial Offer on a New Low-Cost State-of-the-Art Counter--the Model 904!

Compare these main-frame features with those of any other counter. Compare the price tags. Then choose!

- 8-decade readout
- Direct counting to 200 MHz
- Universal functions in main-frame — TIM, Period, Multiple Period Average, Signal Scaling, Frequency Ratio, Multiple Frequency Ratio, Totalizing

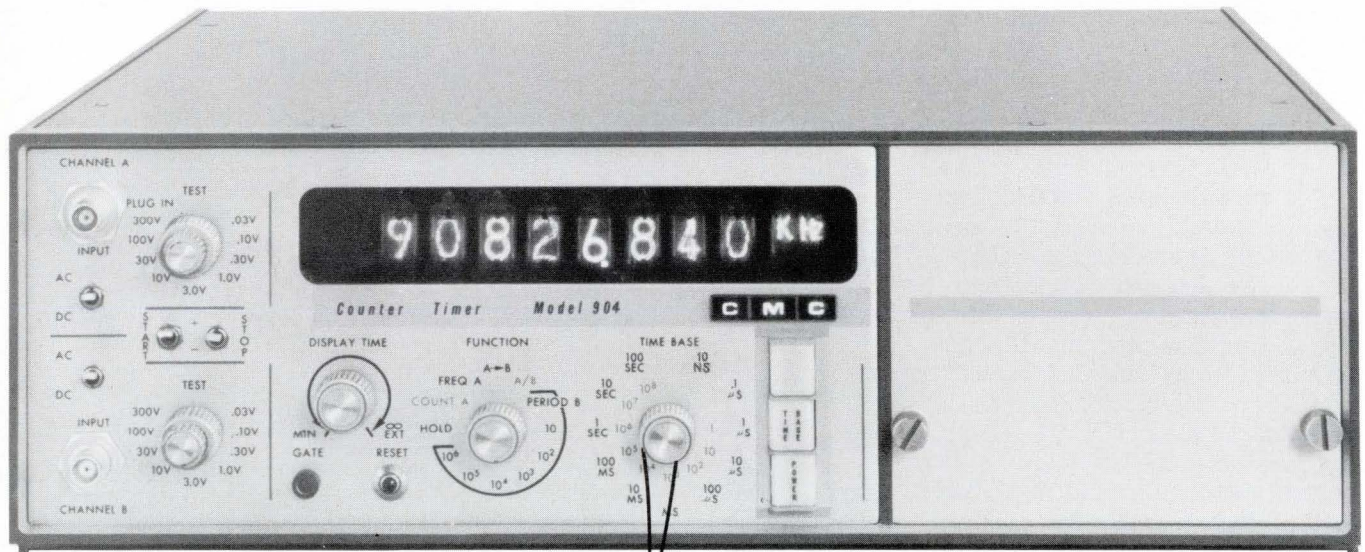

- Accepts all 901 plug-ins — heterodyning to 3 GHz

\$1975

For a limited time only!

CMC's 200-MHz Model 901 is still the best universal counter-timer available for only \$2475. But now—for a limited time only—we are market testing our brand new Model 904 Universal Counter-timer which boasts many of the same features as the Model 901 and sells for \$500 less! Compare it with competitive units that sell for \$1000 more, and you will see what a bargain the 904 truly is.

But, to take advantage of the special trial price, you must act now. Since we are market testing this low-cost high-quality instrument—we will not be able to hold the price at \$1975 for very long unless there is a high-volume response to our trial offer. So get yours now while the price is right. Why wait and pay more?

For more information, use the reader service card. And for immediate action at the price quoted, take advantage of our Special Trial Offer by mailing the coupon now.

COMPUTER MEASUREMENTS COMPANY



12970 Bradley / San Fernando, Calif. 91342 / (213) 367-2161

SPECIAL TRIAL OFFER New CMC Model 904 Universal Counter-Timer

If it's as good as you say, send me a Model 904 for the Special Trial Offer price of \$1975. (Purchase order is enclosed, but I reserve the right to return the instrument within 10 days—without obligation—if not fully satisfied.)

Reserve a Model 904 for me at the Special Trial Offer price of \$1975, but I want to see a demonstration before I buy.

Name _____ Title _____
Company _____
Address _____
City _____ State _____ Zip _____

Computers

Interface pact gains momentum

International group accepts outline of standard interface requirements that could lead to major cost savings in every computer installation

By Wallace B. Riley, *Computers editor*

Computer users will find life much easier if the movement toward an interface standard bears fruit. Now, installation of input-output devices costs more than it should because no interface standard exists. Without it manufacturers can't work with a single logic configuration for generating or receiving signals, programmers must write different instruction routines for many types of equipment, and users can't shop as competitively for their computer peripherals.

But there is hope. Last month, a working group of the International Standards Organization meeting in Turin, Italy, took several positive steps toward outlining general requirements for an interface standard. And other groups in the U.S. and abroad are showing strong interest.

In the U.S., James P. Nigro, acting director of the National Bureau of Standards' Center for Computer Sciences and Technology, says he has four logic designers and engineers studying the most widely used computers to determine commonalities in their interfaces. On the basis of their findings, Nigro will decide whether or not to design such an interface. "I might do it," he says cautiously. "That's all I can say now."

If his decision is to go ahead with a standard, and if it becomes official, it would apply to all Government-purchased EDP gear. Since the Government owns about 10% of the nation's computers, this would effectively force an industry-wide standard in the U.S.

There's big money involved. The General Accounting Office reported two years ago that a

standard interface would save \$100 million or more a year. With it, the Government could buy peripheral equipment from the cheapest source instead of from the main-frame manufacturers.

One type of unofficial U.S. standard already exists. International Business Machines Corp. has used its own standard for interfacing input-output equipment to its System 360 computers since 1964, and used an earlier and simpler version on some of the 360's ancestors. IBM accounts for about 70% of the domestic computer markets, and so, the many smaller companies

that build peripheral equipment specifically to replace IBM gear must use its interface if they are to be compatible.

On the other hand, many other U.S. manufacturers use their own interfaces—and they aren't compatible with IBM's. National Cash Register Co., for example, has one that's completely different, and RCA, whose computers are program-compatible with IBM's, has an input-output interface that is electrically incompatible and uses a few signal definitions that are different, too.

None of these companies was

The channel's the choice

All computer installations have interfaces between the processor and its channel, between the channel and the input-output control unit, and between the control unit and the input-output device. Standardizing the interface at the processor level would be difficult and would tie the interface directly to the processor's basic characteristics. Likewise, a standard at the device level would necessarily depend on the nature of the device. So the principal interest is in an interface at the channel level.

An interface independent of device characteristics would allow any device to be plugged into any connector on any computer, and any program requiring data transfer across the interface could be written the same way regardless of the kind of I/O device.

Capability of both multiplex and nonmultiplex operation modes allows the interface to handle both single and multiple devices on an individual cable.

Bus mode, in which many input-output devices are connected on a single cable for either multiplex or nonmultiplex operation, represents the simplest hardware configuration in the processor. However, it imposes severe restraints on device operation—only one at a time can transmit or receive data. Multiplex mode permits some flexibility for slow devices in data transmission, but fast units can't be multiplexed. Another difficulty is that if a device close to the processor fails, it effectively renders useless all the devices beyond it on the cable.

In the star mode, many cables radiate from the central processor like the points of a star, but only one device is connected on a cable. It offers maximum flexibility in simultaneous operation of several devices, but also requires complex processor hardware design.

Send us your precious metal scrap...



we'll squeeze out every last bit of Au, Ag, Pd, Pt.

From the moment we receive it, your scrap gets handled with care. Witness our careful sampling methods: we mix your *entire* shipment, fire assay two or more separate samples (and stash away yet another—sealed—in our vault for your future reference), and chemically separate out each precious metal. Then we send you the good news.

Handy & Harman has been refining its own precious metal scrap for a hundred years—as prime refiners we know how to squeeze out the last bit of gold, silver, palladium, and platinum. We refine our own scrap, we refine Government scrap, and we'd like to extract full value from yours. We have a booklet that covers the subject; please write for it. After all, your scrap may be worth its weight in gold.

Please send your booklet about precious metal scrap.

Name _____

Title _____

Company _____

Address _____

City _____

State _____ Zip _____

HANDY & HARMAN
850 Third Avenue, Dept. EL-14,
New York, N.Y. 10022



Probing the news

represented as such at the Turin meeting, although the U.S. delegation did include some of their employees.

Establishing an interface standard is extremely complicated. The signals must control many functions in many kinds of devices and are themselves subject to strict electrical specifications. And any standard would have a strong impact on existing software.

Reaching agreement on a proposal that must accommodate these complications is a glacially slow process. The Turin meeting's biggest accomplishment was acceptance of an outline of the general interface standard requirements, submitted by the American National Standards Institute. The conference also agreed on a timetable for contributing to or commenting on these general requirements—comments to be received by May 1971, another meeting to discuss them in September 1971, a selection of a specific proposal in meeting in September 1972, and finally, in September 1973, a meeting to accept the proposal, with amendments and corrections, as a full-fledged standard.

Slow as it is, this schedule was described by one of the delegates as "very elastic." Another observer commented, "Considering the amount of work to be done, the agreed schedule seems rather accelerated."

Japanese delegates proposed a standard at the ISO meeting based on work that has been in progress in their country. Far in advance of anything offered anywhere else, the Japanese plan wasn't seriously considered because it is at an advanced level that the official timetable says won't be considered until 1972.

The Japanese proposal, ANSI's requirements, IBM's standard, and most other schemes resemble each other in many respects. Their differences, the major bones of contention, lie in the small but important details. For example, IBM's current standard calls for a set of nine data lines, carrying one eight-bit byte plus a parity bit, from the

processor to the input-output device, and nine more coming back. These lines carry all data, address, control, and status information back and forth; additional tag lines carry signals that identify the information on the bus lines at any given time. But some proposals call for separate lines for data and addresses; their proponents argue that the selection sequence for a subsequent operation can be initiated during a previous operation if a separate address bus is available. And IBM's standard calls for a single set of data lines in each direction, whereas one of ANSI's proposed requirements is for a modular path width capable of transferring one, two, four or eight eight-bit bytes at a time, depending on the device it connects to the processor. A two-byte-wide path is available with some of IBM's largest, fastest computer systems.

ANSI also suggests that the interface be at a channel level, instead of a device or processor level; that it not have characteristics unique to any particular control unit or device, and that it support both multiplex and nonmultiplex operation. Other ANSI-suggested interface capabilities include operating only in bus mode, in star mode, or in a hybrid combination of both; detection of transmission errors, and addition of new units.

Like ANSI, the National Bureau of Standards favors a standard channel interface. But its more immediate concern is the establishing of a device interface, at least for some types of equipment. The bureau hopes to set up such a standard for magnetic tape and drum units to be purchased by the government. There are probably more of these units in use than any other single type of equipment.

Another requirement of most interface proposals is pure asynchronous operation. Here neither the processor nor the I/O device must time signals that cross the interface. This asynchronous operation is usually defined in terms of "handshaking"—every signal generated either by the processor or by the device is maintained as a dc level until a definite acknowledgment is received from the other end of the cable.

Clad metal parts reduce production costs.

Can you save on silver...or labor?

There are still ways to cut the costs of fabrication.

The technology of cladding is expanding rapidly, saving money where two or more metals must work closely together.

Handy & Harman has adapted the technology to producing clad metals which reduce the amount of precious metal needed in many components. Our Bimets put the precious metal only where it's needed—base metal supplies the beef.

Now, thanks to the addition of American Clad Metals, Inc., Pawtucket, Rhode Island, to the Handy and Harman group, we are able to provide a greater variety of clad metals that reduce costs by reducing labor.

We have attacked the costs of making a connection. Fabrication of a finished assembly often calls for soldering. This involves placing of the solder, or a preform. This expensive operation can be eliminated by using a clad metal that consists of the part to be soldered, clad with

the solder.

We are manufacturing a variety of these solder-clad bimets, cladding solder (of various tin/lead ratios) to such base metals as steel, copper, copper-clad aluminum and nickel-clad moly.

This may sound like small potatoes. But we prepared solder-clad metals for a company that makes electrical components, and the elimination of solder preforms will save them \$150,000 per year in the production of just one of their components. The company is now working with us in investigating clad metals of various materials for five other assemblies.

You may be using more silver or gold than necessary. You may be using too much labor for joining functions.

Handy & Harman would like to discuss the possibilities of our rolling a clad metal strip or drawing a Bimet wire, to reduce your manufacturing costs. Just ask us.

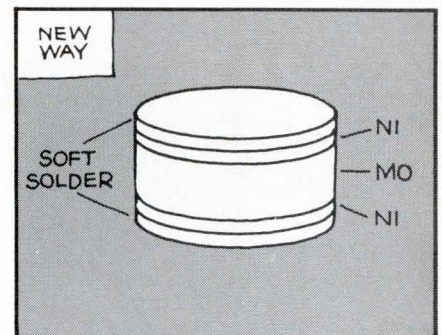
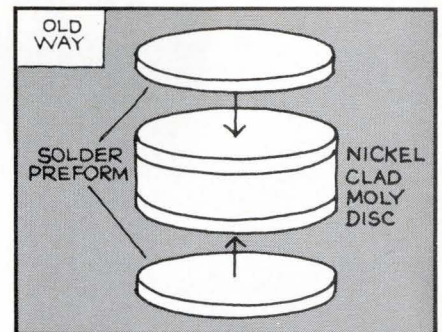

Naturally, you'll ask Handy & Harman

how Bimets could be used for

Application: _____
Name _____ Title _____
Company _____
Address _____
City _____
State _____ Zip _____

Send to: Handy & Harman, 850 Third Avenue, Dept. EL60, New York, New York 10022



What a way to **GROW!**

**STRAIGHT OUT OF TOMORROW
TO FILL YOUR NEEDS TODAY**

Now. At last. You can pull crystals up to 4 inch diameter with Veeco's new 10Kg silicon production Crystalline Growers!

Veeco's series of Crystalline Silicon Growers is a complete break with the past. A dynamic departure from the traditional 15-year-old machine design concept. Veeco's unique approach offers an unmatched degree of flexibility that results in:

- Replaceable and interchangeable modules to accommodate advances in technology and minimize obsolescence.
- Availability of many options including diameter control, dope injector, furnace recharge/reseed.

Veeco can also supply your needs for the following crystal growing techniques:

TECHNIQUE	HEATING METHOD	MODIFICATION	MAXIMUM TEMP. (°C)	PRESSURE	
				MIN. (TORR)	MAX. (ATMOS)
FLUX (SOLUTION) GROWTH CZOCHEKRALSKI	RESISTANCE	STANDARD	1600	—	1
	RESISTANCE	STANDARD	1650	10 ⁻³	1
	RF	STANDARD	3000	10 ⁻³	1
	RF	HIGH PRESS.	2800	—	100
	RF	VACUUM	4000	10 ⁻⁴	—
VERNEUIL (FLAME FUSION)	RESISTANCE	VACUUM	2200	10 ⁻⁷	—
	RESISTANCE	H ₂ FLAME, PLASMA	4000	—	1
	RF	STANDARD	3000	—	1
FLOATING ZONE (HORIZ. AND VERTICAL) AND "STRANGLER" FLOATING ZONE	RF	VACUUM	4000	10 ⁻⁴	—
	RF	HIGH PRESS.	2000	—	200
	RF	STANDARD	1600	10 ⁻²	1
PEDESTAL FLOAT ZONE BRIDGEMAN	RESISTANCE	PRESS. OR VAC.	2000	10 ⁻⁴	200
	RF	STANDARD	3000	10 ⁻³	1

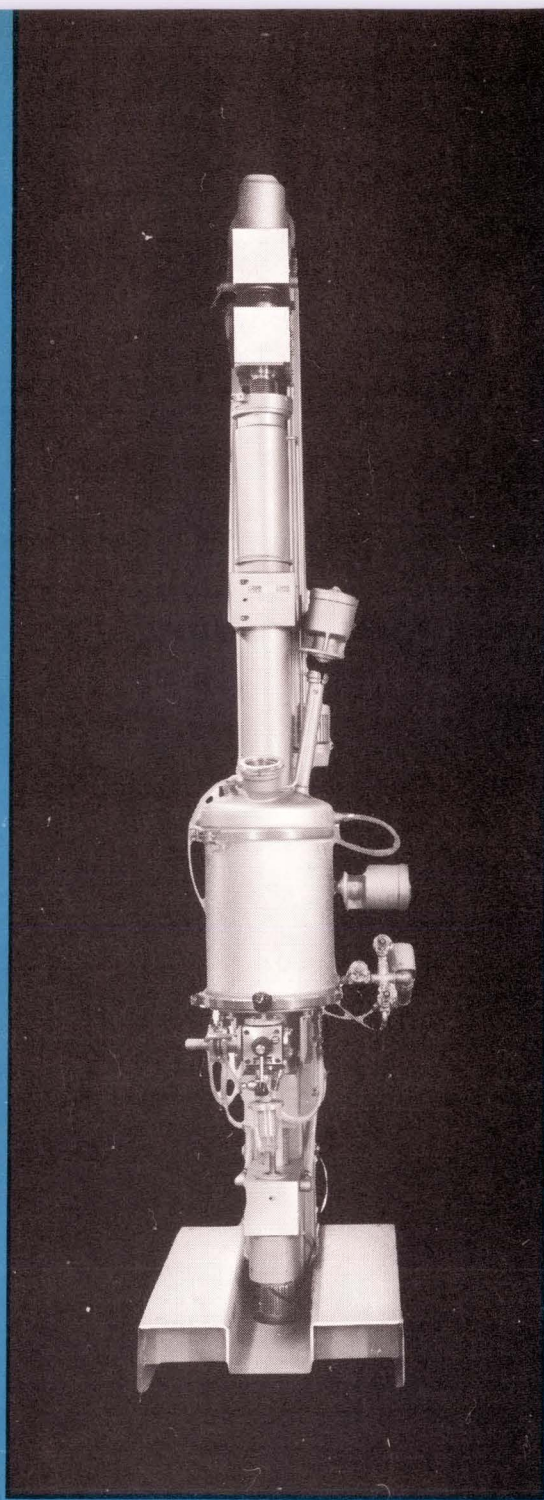

*Veeco's
Crystalline
Growers*

Yes; Veeco's got a lot growing for you. Write and find out why nothing else but Crystalline Growers will do. Or call 516/681-8300.

VEECO INSTRUMENTS INC.
Terminal Drive / Plainview, New York 11803

Go Modern . . . Grow with Veeco!

Solid state

LSI starts to go standard

As peripheral equipment circuitry grows more complex, semiconductor manufacturers are pushing ahead with more and more catalog LSI items

By Lawrence Curran, *Los Angeles bureau manager*

Standardization is catching on in bipolar large-scale integrated logic functions, despite some earlier assertions that LSI would always be a custom market. The push comes from the manufacturers of peripheral equipment and instruments, who find LSI the most economical way of building their increasingly complex circuitry and whose LSI needs are similar enough to hold out hope of volume production.

At Motorola's Semiconductor Products Division in Phoenix, Roger Helmick, who's in charge of product plans and strategies in computer device marketing, foresees standard devices taking over 30% of the market in three years' time, as opposed to today's 10%. Fairchild Semiconductor also senses such a trend. And even at the originally skeptical Texas Instruments, the manager of development and technology, Dean Toombs, agrees that "an evolutionary trend . . . is happening now and will continue to happen in the next two to three years."

Motorola, which has established a program for building standard bipolar LSI logic arrays, is also most specific about the changeover.

Helmick believes it will take 12 to 18 months before today's standard parts get designed into equipment and reach volume production.

His company has designed three such parts, all based on a 112 gate LSI array on a 133- by 142-mil die, and all of which will be introduced in the next six months. The three are an 8-bit look-ahead/carry adder made with approximately 108 gates, a dual 6-bit shift register with approximately 100 gates, and a 5-stage Johnson counter made with some 100 gates. Each uses three metal layers.

Another Motorola effort, which began as a custom job, will soon lead to standard time-division multiplexers with complexities of about 108 gates and 3 layers of metal, for use in modems and computer time-sharing applications.

At Fairchild Semiconductor, however, there is more emphasis on the evolutionary aspect of the trend. Hank Smith, TTL market planning manager, for instance, maintains, "There won't be a family of LSI devices—our 9300 MSI line will just grow."

This growth is to occur in two basic areas—in functional blocks, such as adders, multipliers and

parity generators, and in special functions that have wide application for a large market in a small area. Possible applications in the last category include tape transports and other computer peripheral equipment, in which special complex circuits offer a definite advantage.

Like Motorola, though, Fairchild is going with three-layer metalization, because such multilayering permits a reduction in chip area. Three parts slated for introduction in the next six months, all with three metal layers, are: a 110-gate, 4-by-2 multiplier; an adder with a shift register/accumulator; and a quad 4-bit register with 85 to 90 gates. The multiplier will probably be introduced first.

TI's original contention that the LSI market was going to be almost exclusively a custom market, Toombs believes, was related to the firm's discretionary wiring technology. "But over the past four years at TI," he says, "there's been an evolution to higher-complexity fixed-pattern standard bipolar parts."

But the company doesn't like to talk about specific standard LSI logic functions coming soon. The TTL random-access memory component that TI introduced in August has the equivalent of 98 gates on a 90- by 110-mil chip; yet Toombs doesn't consider it a "significant" part. Jack C. Carsten, digital circuits marketing manager in Houston, adds there will be five complex memory elements introduced in the near future, and expects TI's catalog parts to remain at about the 100-gate complexity for some time. "While we've identified

LSI parts. Motorola has designed three standard bipolar LSI devices, all based on this 112-gate array, shown here without metalization.

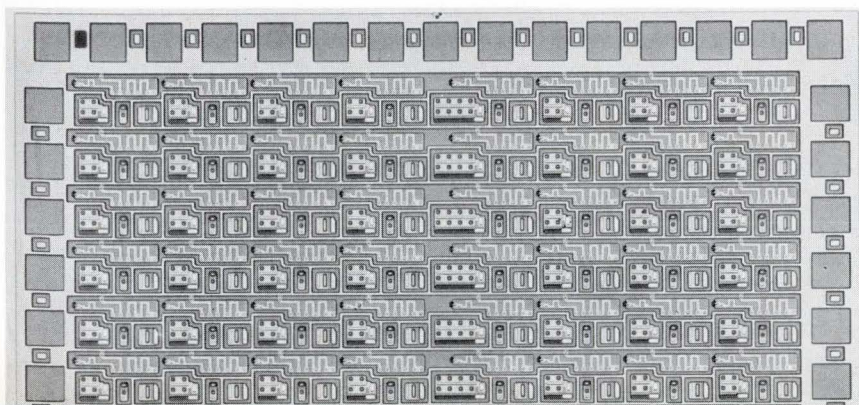

DIGITAL TV

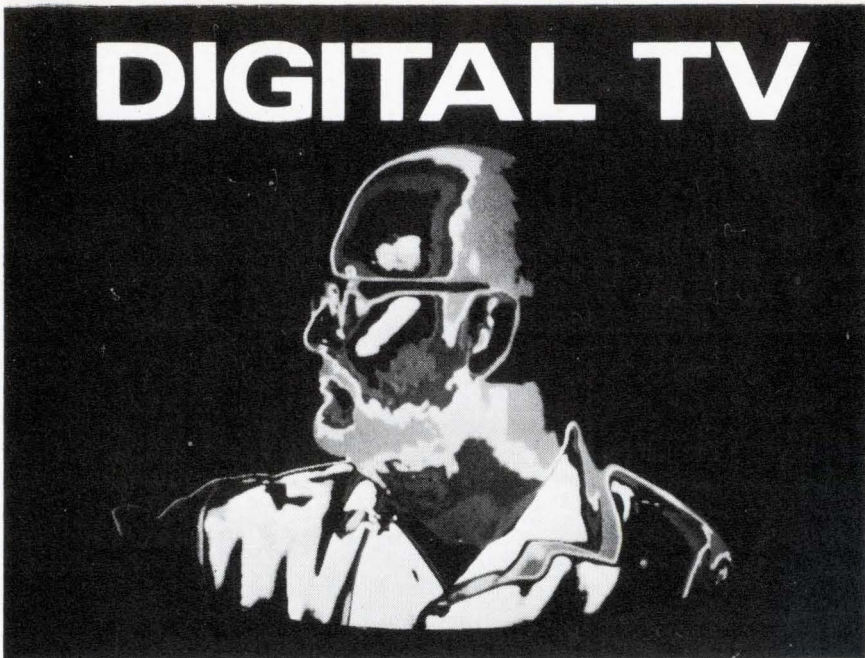

CVI video sampling instruments allow your computer to "look" at practically anything. High accuracy bandwidth compression of conventional television signals opens new doors to data processing in research and industrial applications. Let us tell you about some of our unique video devices.

COLORADO VIDEO, INCORPORATED
P.O. Box 928 • Boulder, Colo. 80302 • Phone (303) 444-3972

cv*i*

Video Data Acquisition • Processing • Display • Transmission

Circle 169 on reader service card

Where reliability really counts!

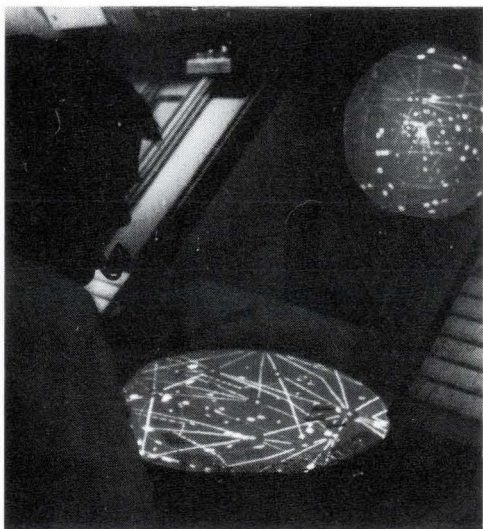

The reliability of Zenith Flat-Face Metal CRTs is demonstrated by their extensive use in enroute air traffic control centers and airports. When safety depends on reliability, Zenith is specified! Shouldn't you take advantage of Zenith CRT quality in your application? Write for details.



ZENITH RADIO CORPORATION

THE RAULAND DIVISION

5614 W. JARVIS AVE. • CHICAGO, ILL. 60648 • 312-647-8000

a few standard parts," Toombs notes, "it's difficult to identify those with high-volume potential when you apply all the constraints, such as chip size and pin count." On chip size, he feels, "it's generally preferable to stay below 100 square mils."

Unlike the other two companies, TI is not counting heavily on multi-layer metal in its LSI plans. "We've been able to design standard MSI parts with single-layer metal," Toombs says. "We're not now producing multilayer TTL parts, and TI won't do so until it's needed."

Motorola, in short, is the most heavily committed to the trend. And, in fact, its whole system for manufacturing the 112-gate array offers standard/custom flexibility. Wafers are stored containing only diffused components and no metallization. Motorola can then make a mask set for a customized array or apply a mask set for a catalog part.

"We've tried to make custom parts look like standard parts by the time they reach the factory," Helmick explains. "The operator doesn't know whether they're custom or standard; she just slaps the masks on."

Now that the 112-gate design has been mastered, Motorola is expanding its repertoire by adding 80-, 60-, and 40-gate arrays that can be turned into custom or standard parts from wafers in stock. All of the arrays have been, or are being, designed with computer aids. The 80-gate array will use three metal layers; the 60- and 40-gate units will have two.

In Motorola's three-layer metal scheme for the 112-gate array, first-layer metal is reserved for cell makeup, and for running power and ground between the cell rows. Signal wiring on that first layer may connect only the output of a cell to the input of the next cell in the same row, or the output of the last cell in a row to the adjacent pad. All other signal wiring must be done on the second and third layers, with eight vertical and five horizontal wiring channels available per cell. Some of the third-layer channels are used for power and ground straps that connect to the power and ground busses on first-layer metal.

Military electronics

Radar of the future?

Rassr aims to upgrade radars built in Air Force's MERA program through extensive use of large-scale integrated circuits

By Herman Lowenhar, *Military/aerospace editor*

Enough information has penetrated the veil of Air Force secrecy to suggest that the Reliable Advanced Solid State Phased Array Radar (Rassr) may prove to be the technological pacesetter for all new tactical radars in the 1970s. Scheduled for delivery early in 1972, the multifunction radar is being developed by Texas Instruments under a \$7 million contract from Wright-Patterson Air Force Base's avionics laboratory.

Rassr is an upgraded and miniaturized version of the radar developed under the Air Force's Molecular Electronics for Radar Applications (MERA) program. But whereas that radar was just a laboratory demonstration model, Rassr is essentially Mil Spec equipment that could actually operate in a severe airborne environment. Its main differences from MERA are the use of large-scale integrated circuits, which will improve reliability, and the substitution of ridge waveguides for dipoles, which along with LSI will contribute to greater compactness.

The LSI circuits will be used throughout the radar, but especially in the computer that controls operational modes and steers the phased array beam. Yield and reliability are expected to benefit from TI's discretionary wiring techniques. And the Air Force appears confident that a smooth transition can be made from MERA's ICs to the LSI circuits. Though not designed to have the air-to-air acquisition, tracking, and missile guidance modes required in a tactical airborne radar, Rassr could acquire these capabilities through modest hardware and software changes.

The ridge-waveguide radiators can be flush mounted, and their size also allows almost three times as many elements—1,650—as were used in the MERA radar to be packed in an antenna of identical dimensions.

By spacing the antenna elements 0.534 wavelength apart, Rassr keeps the first grating lobe to 70° off bore-sight—well removed from the maximum scan angle of 60°.

The radar is coherent, essential for its synthetic aperture, ground-mapping mode. Frequency hopping is used to break up extended clutter as well as to improve detection of targets that don't have background interference. And pulse compression yields high resolution. While these techniques are intended to meet Air Force requirements, they also are applicable to such Navy objectives as periscope detection.

Sidelobes are controlled by uniformly illuminating each antenna element during transmission and by modified Taylor weighting during reception. Transmitted first sidelobes are 17 decibels down from the main lobe, and received sidelobes are about 30 dB down, for a total two-way level of -47 dB.

Antenna beamwidth, about 3° at a 30° angle off boresight, can be narrowed by 90% through synthetic aperture processing, a technique that achieves the resolution of a large antenna by coherent summation of signals received over many interpulse periods. By doing so, Rassr will be able to resolve a 300-foot patch at a range of 10 miles, a good match to the resolution afforded by the 0.66-microsecond compressed pulse width.

The spread in the doppler-shifted signal returned from such a 300-ft patch at 10 miles and at a typical scan angle of 30° from the line of flight will be about 150 Hertz. Each filter of the receiver's doppler bank, therefore, must have that narrow bandwidth. This, in turn, places stringent requirements on the system's spectral purity and stability—both the local oscillator and transmitter must have very low incidental am and fm components, and spurious signals must be suppressed. The linear frequency sweep—1.5 megahertz for pulse lengths up to 100 μsec—must be essentially free of nonlinearities and must be accurately repeatable.

Schottky diodes are used to down-convert the received X-band signals, first to 500 MHz and then to 60 MHz. Then they are compressed to 0.66 μsec in a surface wave acoustic device. Overall system noise figure, including 0.5-dB strip-line losses, is 10 dB.

Since peak output power to each waveguide radiator is 1 watt, a total of 1,650 W is transmitted. Maximum pulse repetition frequency (PRF) is four kilohertz, so that the highest duty factor with a 100-μsec pulse is 0.4, and average transmitted power is 640 W.

To get around the problem of "blind speeds"—at which moving targets can't be detected by a radar with a constant PRF—Rassr's PRF is continually changed. Moving target indicator processing is entirely digital and therefore inherently more stable than analog methods. Rassr will be able to detect moving targets in clutter backgrounds that return signals 50 dB stronger than those of the targets.

Communications

Banks moving on paperless payments

Federal Reserve installs computer gear in wire transfer network;
plans for electronic payments gain as checking volume mushrooms

By Jim Hardcastle, *Washington bureau*

With a flood of paper threatening to break down the checking system, the nation's traditionally conservative bankers are under severe pressure to develop a paperless payments system. And once they do so, a huge new market will open up for the electronics industry, which will be called upon to provide the computers, communications gear and expertise needed to make the systems work.

Some of the equipment needed for a "checkless society"—or at least a "less-check" society is already in use. A case in point is the Federal Reserve Systems' 48-year-old Teletype network, which is used on a limited scale to transfer funds between bankers and their big corporate clients. The Fed, the principal Federal regulatory agency for the nation's money and banking system, recently replaced a torn-tape switch for the Teletype system with a state-of-the-art computer-controlled device. And it's already drawing up plans to dramatically upgrade its communications network.

About 60% of the traffic carried by the network, which serves the 12 Fed regional banks and their branches, is represented by "wire transfers" in which banks with cash needs borrow uncommitted reserve funds from other banks and transfer large sums for corporations. The sums transferred are huge, and traffic is growing as more banks use the wire to make sure their money is constantly at work.

As a result, says John Rand, who directs the Fed's Culpeper, Va., switching center, the old Richmond, Va., switch was so overloaded that "perforated tape was

backing up on the floor for two hours."

With the banks paying huge interest rates on these very short-term loans, the two-hour queues were negating the reason for transferring funds by wire, so the Fed's Board of Governors decided to replace the switch. And recognizing that the trend was toward more computers and less paper, the board asked Arinc Research Corp. to design a system using the most advanced store and forward switch.

Arinc's choice was four Control Data Corp. M-100 communications processors, put together to perform store-and-forward and point-to-point message communications. Each processor uses its 60,000-byte core as an input/output buffer and maintains its queue on part of its 12-megabit, fast-access disk pack. Queue overflow is directed to a 5.5-million-byte disk pack. Journal tapes of all message traffic are maintained on five magnetic tape drive units.

The system initially will be used to switch traffic between 150-baud M-37 Teletypes being installed at all Federal Reserve member banks.

Before the year-end, however, the Culpeper system will be switching 2,400-baud circuits that at first will carry traffic between IBM 2968 magnetic tape terminals and eventually will be used for direct computer-to-computer communications. Even that load won't strain the switch's 9,600-baud capacity, which Rand says can be increased to 50,000 baud with more core and up to four additional processors.

One computer expert turned banker, Chicago Fed senior vice president Bruce Smyth, predicts that as more bandwidth becomes available and each bit becomes cheaper, more and more payments transfers will take place between computers using Fed wire. Currently, he says, "our office people paw over the financial documents before they put them into our own computer systems." Once the traditionally conservative banking industry gains confidence in electronic systems, he says, "all we'll have to do is shake out the people components."

Meanwhile, the 12 Federal Reserve Banks are planning similar networks to serve member commer-

Paper costs

The number of bottlenecks in the nation's payments complex is providing the strongest push toward an electronic payments system. Today's check makes four to eight trips between banks and clearing houses before it gets back to the person who wrote it. Even with much of the work being done by computers aided by magnetic ink and optical character readers, the mounds of paper are growing, and their handling costs are increasing—an estimated \$4 billion a year, averaging 13.5¢ a check.

Such costs are unacceptable to bankers, who see annual volume of paper transactions doubling in this decade to 40 billion—a volume that some predict will cause the system to collapse of its own weight.

OCTOBER 1970

Health

What every middle-age man should know

Fashion & Sports

Stadium fashions

Insurance

Safeguarding income
"High-risk" coverage

Healthy, Wealthy and Wise

Detroit's Mini Cars Challenge the Imports

The first of a new breed of cars is starting to show up on the road. These new autos have the grille work and long hood associated with cars made in Detroit but the size and style of foreign cars. They are Detroit's answer to imported car sales which have risen so high that one of every seven cars sold in the U.S. is now imported. But while the new cars offer the economy in price and ease of maintenance of the foreign cars, their luxury and power is strictly American.

If you're in the market for a new car, the new minis merit a good looking over. American Motors started the mini wave last April with its impish wedge-shaped Gremlin, a reduced version of the compact Hornet.

Ford and Chevrolet joined the small car rush last month when their new minis, the Pinto and Vega 2300, went on sale around the country.

You'll have to wait for Chrysler Corp.'s small cars until January, 1972. In the meantime, Dodge dealers will sell the small Mitsubishi Colt from Japan, and Plymouth dealers will offer the British Avenger under the name The Cricket, starting next January.

There is a plethora of new models to look at. Ford offers one four passenger sedan to start—company insiders say to look for more in six months; and American Motors has two and four passenger models. Chevy, however, has a four passenger sedan, a sporty coupe with a hatch back rear door that opens the full height of the car,

and a station wagon with square-back lines reminiscent of the Volkswagen. A one-seater panel van is also in the Vega line—a model Chevy people think will sell well as a utility vehicle or delivery truck for small businesses like pizzerias.

Under the hood, Detroit has it all over the imports. The Vega, for example, sports a totally new, four cylinder aluminum engine in two horsepower sizes—90 and 110. The Ford Pinto offers a choice of two four cylinder engines. The standard is an 85 horsepower engine used successfully here and abroad in the British-made Ford Cortina.

The other is a brand new engine built in Germany; it has a 95 horsepower rating. It will also be used in the new German Ford, the "T.C.," soon. American Motors' Gremlin is powered by a much heavier six cylinder engine, with 135 horsepower. An optional engine has 150 horsepower



ESCAPE!

Had all you can take today?
Worried about tomorrow?

Escape to yesterday—in the pages of *AMERICAN HERITAGE*, the world's leading magazine of history. Great, masculine reading and fine on-scene pictures let you fly with Lindbergh, fight with Vinegar Joe Stilwell, explore with Lewis and Clark, paint with Maxfield Parrish. Your new subscription will begin with the October issue, which features fascinating articles by noted historians Barbara W. Tuchman and Richard Hofstadter.

Read *AMERICAN HERITAGE*, and you'll come back to today reassured and ready for tomorrow. Things look terrible in the U.S.A.? They almost always did—but they're wonderful in retrospect.

AMERICAN HERITAGE. Hard covers, no ads, six times a year.

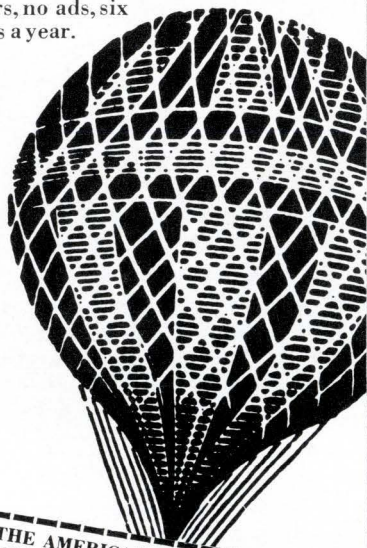

THE AMERICAN HERITAGE SOCIETY
383 West Center Street, Marion, Ohio 43302

Send me a one-year (6 issues) *AMERICAN HERITAGE* subscription, and bill me for \$13.95. (Reg. price, \$5 a copy, \$20 a year.) Also send me **FREE** copy of *The Civil War* book, when I confirm order with payment.

Name _____
Street _____
City _____ State _____ Zip _____

Bill me \$13.95 enclosed. Send book at once.
MO909

SPECIAL BONUS OFFER

Subscribe now and receive, without additional charge, *The American Heritage Picture History of The Civil War*, the famous illustrated book by Bruce Catton. A 630-page volume, it usually retails at \$19.95—now yours free with your new subscription.

output. The Volkswagen Beetle, by comparison, has 60 horsepower.

For you this means faster acceleration and generally a top speed of 10-20 miles above most imports. Still you can expect an import-like 25 miles per gallon with the Vega and Pinto, a little less with the Gremlin.

Detroit is cutting costs to sell its small cars at a favorable price. Chevy hopes to crank out 100 Vegas an hour at Lordstown, Ohio, on a highly automated assembly line using mechanical robots to do the welding. Travel damage will be



cut down because the Vegas will be shipped to the West Coast on their noses in enclosed railroad cars. Ford will build Pintos (picture) with Mustangs and Mavericks at the usual assembly line rate of 55-60 an hour at three sites across the country. Ford will use some robots of its own.

Don't be misled by the advertised base price for the small car. By the time you add dealer preparation charges and taxes, even the VW Beetle is usually over \$2,000. And optional equipment such as bigger engines, larger tires, plush interiors, air conditioning, radios and other appliances—even cigarette lighters are optional on the Vega and Pinto—jacks up the cost measurably. The average Gremlin with a base price of \$1,879 for the two passenger model and \$1,959 for the four passenger version actually was selling for \$2,500 this summer.

If you are handy with tools, the new minis may be even less expensive. Both Pinto and Vega come with simple manuals that describe how to make minor repairs such as headlight and grille replacements, or major adjustments to carburetors and brakes. The cars are designed to make maintenance easy.

Warning: Read your warranty carefully to be sure you do not jeopardize your coverage with

homemade repairs.

In the Vega and Pinto you'll be able to get three or four speed manual transmissions as well as typically American automatic transmissions. All the shift levers are on the floor—where they are in European cars. Plastic is used heavily but effectively in the interiors of both cars for door panels and dashboards. And the Vega sports a one piece injection molded plastic roof lining that has fine acoustical qualities. The back seats offer a little more room than most imports but small car rear seats

are never very big anyway.

Your best bet before buying is to take a spin in the new Detroit minis and compare them to the foreign makes.

Some domestic car dealers are still importing foreign makes from the overseas subsidiaries of Detroit auto makers: The Opel at Buick dealers, the Capri at Lincoln-Mercury dealers, French Simca and English Sunbeam cars at Chrysler Corp. dealers. Ford division dealers, who have added the Pinto to their stable, have discontinued selling the English-built Cortina.

The battle between domestic small cars and foreign imports will be fierce. Detroit's sheer marketing muscle and vast dealer outlets are sure to harass foreign car makers such as Volkswagen, Toyota and Datsun, Fiat, Renault and British Leyland.

Half of U.S. car sales by 1980 are likely to be in the compact, import, and mini car category which starts at about 111-inch wheelbase, on down.

You may be the eventual winner in the resulting sales battle. Pricing may get to be a bitter battle. But don't count on big price concessions to start. It's usually well into the model year before car dealers are willing to cut prices when supply outpaces demand.

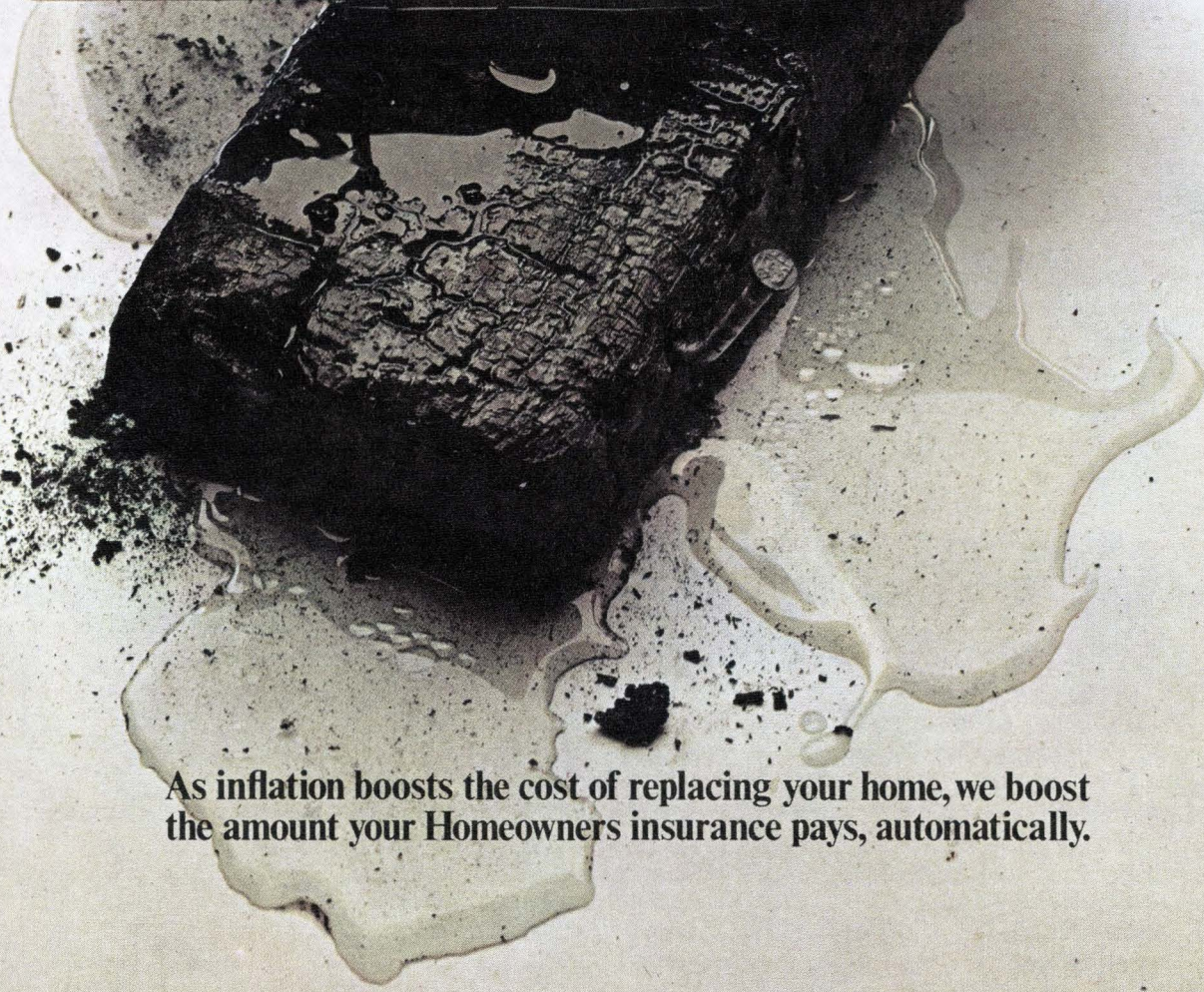
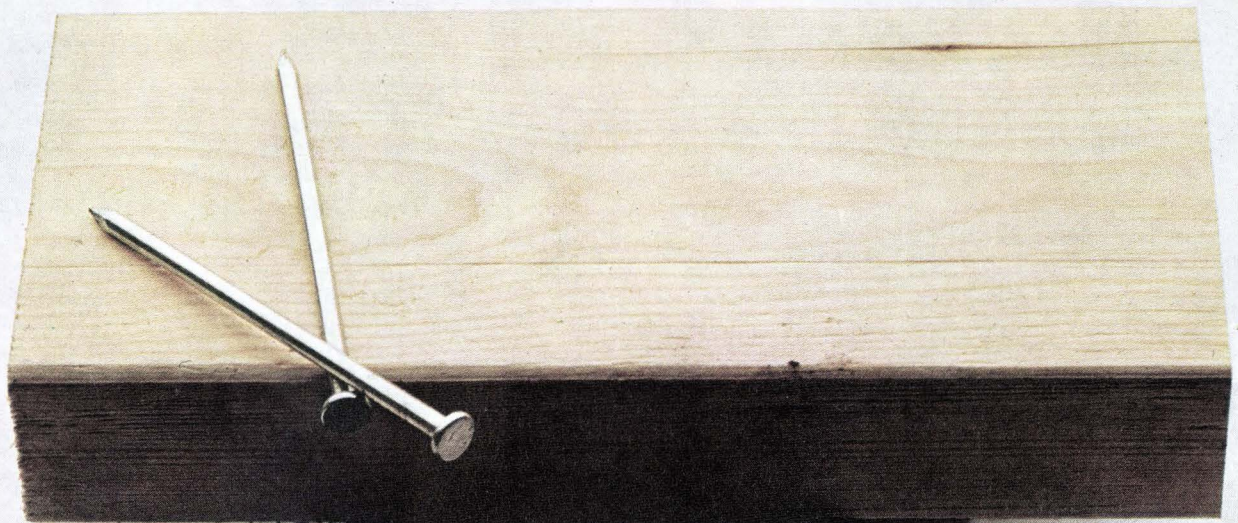

As inflation boosts the cost of replacing your home, we boost the amount your Homeowners insurance pays, automatically.

In just a few years, inflation can increase the cost of replacing your home and its possessions by thousands of dollars. If it does, we automatically increase the amount your Homeowners insurance will pay. It's one less thing for you to worry about. We protect you from loss by fire, tornado, burglary, vandalism and more, at low rates. We're the world's largest home insurer, for some very good reasons. (Current policyholders: if your coverage hasn't been updated with this new feature, call your State Farm agent.) **State Farm is all you need to know about insurance.**



automatic reverse record/playback
plus automatic repeat playback



**KENWOOD
KW-8077**

6-HEAD STEREO TAPE DECK

Features Remote Control (as optional equipment), smooth solenoid-action controls, built-in search system, and mixing for both "line" and "mic" inputs. Just a few of the many refinements that rank the KW-8077 among the great tape recorders of the world.

For complete specifications write...

KENWOOD

15711 South Broadway,
Gardena, California 90247

Interested in a

Get-Rich-Slowly
franchise investment?

Buckaroo Steak Ranch franchises are what we're selling. The concept was started in 1966; 23 units exist today and 10 more are on the way. All are making money.

Investors are not required to be active in the franchise operation. Day to day operation of franchises will be handled by The Downtowner Corporation through management contracts. This unique franchising concept provides a maximum return on investment as well as an attractive tax shelter. All with a minimum of involvement on behalf of the investor. The number of units within a franchise will be determined by market size. Regardless of the number of franchises, there will be only one franchise holder per market.

Buckaroo Steak Ranches are one of The Downtowner Corporation Companies dedicated to the growing food and lodging service industry.

For detailed information without obligation, send for The Buckaroo Franchise concept brochure. Write to:

BUCKAROO
STEAK RANCHES

Franchise Sales Dept. PB-1
The Downtowner Corporation
202 Union Ave.
Memphis, Tenn. 38103

HEALTH

What Every Middle-Age Man Should Know

As the fall season gains momentum with its faster tempo plus more and varied demands on your time and energy, how do you feel about the main currents of life—career, family responsibilities, marriage?

Particularly, how do you feel about the role that sex plays?

For a man of say 45 to 55, clear-cut answers to these questions are often difficult. Says a leading New York psychiatrist: "The trouble is, too many men push this type of inventory-taking out of their minds."

The man in this middle age bracket—under pressure in his work and at home—may begin to experience something new: He finds himself tired, listless, too hemmed in by responsibility. He feels run down, and sometimes he notices with alarm that his interest in sex has run down, too. This point he finds dreadfully hard to admit to himself.

He may even put on blinders, and use pure physical fatigue as the excuse for his weaker sex drive. He's kidding himself.

His prime problem is not physical, but emotional. A man in this spot must take stock of more than his muscle tone and waistline. First—and most important—there's the wearing thin under the burden of stepped-up pressure.

Day to day living —
and the pressure builds

At his office he's likely geared up more than ever before in his career. And on the home front he's pressured by a mix of problems ranging from his teenager's attitude about smoking pot to his frighteningly thin savings in relation to income. His round of social affairs is even getting to be a bore.

Many experts note a second possible cause of his problem: the male climacteric which, to some degree, happens to every man.

It most often occurs between 45 and 55, they say, and is a biological-psychological process of aging.

The climacteric in some men produces no symptoms at all, but in others, it can produce emotions ranging from feelings of futility to dark depression. It may last a few weeks, or as long as a year or so.

In any case, the danger is that the victim of all these heavy emotional strains and pressures may react quite childishly. Feeling depressed and with a fear of losing libido, he may flirt with real trouble.

In rashness he might decide on a quick divorce and remarriage to a woman who better "understands him." This may fail miserably.

Or an otherwise sensible man may put a deep dent in his career by impulsive, even irrational fits of anger and conflict at his office. Or he may put himself under impossible added burdens. Thus in trying to prove his worth and shore sagging confidence, he may push himself deeper into his own miseries.

Shoring up a man's morale — a battle looms

How does a man win out in this battle of the middle years? If he's smart, he does it largely by learning to understand his own emotions. The first step is some thoughtful self-analysis. If the going gets too rough, the search for understanding needs the aid of a trained person—internist, psychiatrist, or psychologist. A few sessions—or a short series—may well do the job.

The middle-age man should understand that a decline in sexual interest is commonplace—and temporary. But the more worry, the worse it gets. He will snap back on a new but still satisfying level of sex activity, if he gives himself a fair chance.

He must know too, that he's far from alone. His friends in the same age group have similar woes and regrets—even if they won't admit it.

Pitfalls: A man shouldn't be fooled into thinking that drugs or health foods or vitamins will put him where he was sexually at age 40—they won't. Also, he shouldn't play mathematics with sex. Once a week is about average at age 50.



In
exquisite
sterling —
The "Silver Imperial"
by
Sheaffer

SHEAFFER 
still the proud craftsmen

W. A. SHEAFFER PEN COMPANY, A  COMPANY, FORT MADISON, IOWA 52627

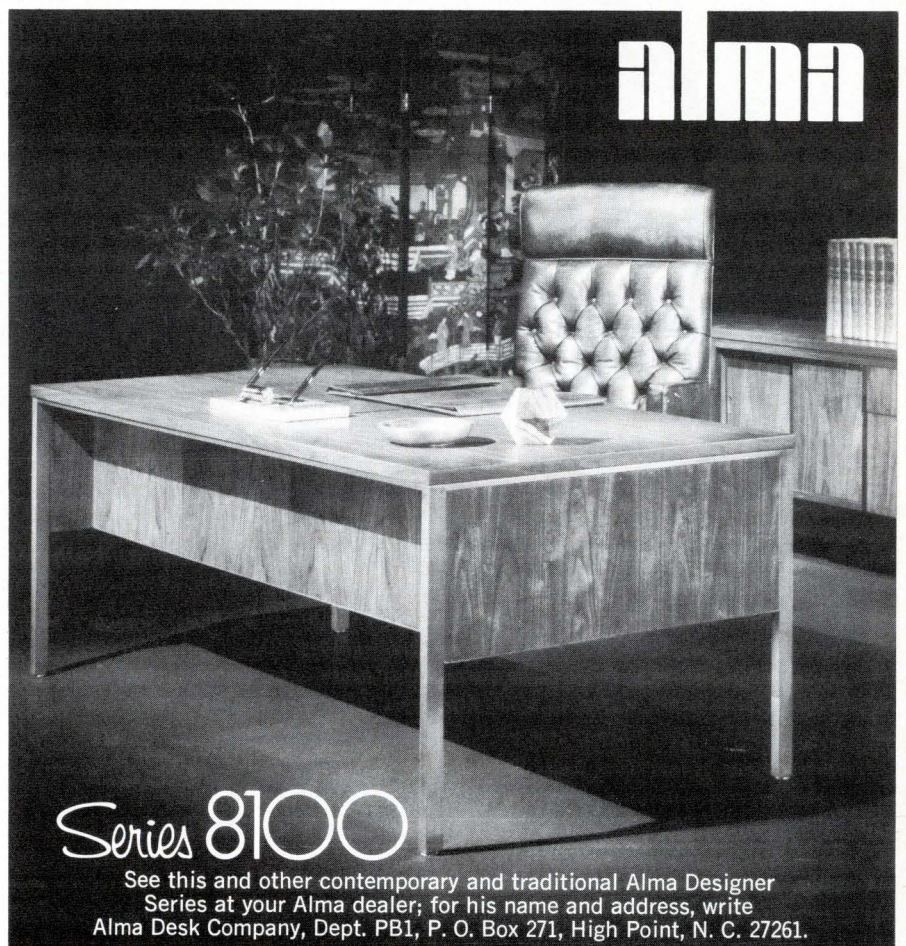

alma

Series 8100

See this and other contemporary and traditional Alma Designer Series at your Alma dealer; for his name and address, write Alma Desk Company, Dept. PB1, P. O. Box 271, High Point, N. C. 27261.

Fashions on the Fifty Yard Line

If you haven't checked, here is a fast look at fall and winter football fashions featured in top men's shops:

In sports jackets, the blazer look stays big. Double and single-breasted, the jackets this season have wide lapels, a flared body, and deep center vent in the rear. Gray, navy and brown are the prime colors, with burgundy, plum, and off-white the runners-up. In wool and polyester knit, at the best stores (\$80 to \$180).

Sports slacks are slightly flared, with western pockets and belt loops; many are without cuffs. Checks, plaids, and geometric patterns are in vogue (\$25 to \$50). [Note: Wool knits are out for late fall and winter. They're not warm enough, and create static electricity in the cold.]



Stanley Blacker, Inc.

Long-sleeved turtleneck shirts are back again, this year with the turtle a bit higher; in wool (\$17), cotton (\$11). Sports shirts with wide collars come in patterns and prints; red and green tartan wool plaids (\$22). The "layered look" in sweater-shirts is in fashion (\$20).

Longer, belted outer coats are being shown for late fall and winter football games. Water-repellent leather is big this year, and more stylish than you might imagine (\$125 and up). So are suede and sheepskin coats with pile linings, ¾-length style (\$140-\$180).

For icy cold sessions in the stadium, you'll see mouton fur coats, sold by such shops as Abercrombie & Fitch (\$350).

Viewing the action: You may need new binoculars. If you want to step up to finest quality, Zeiss has a new lifetime model: it's 8" by 20", magnifies eight times, has a field of vision over 100 yds. at stadium distances (\$115).

INSURANCE

Safeguarding Your Income

A new disability insurance contract points up a trend that's worth checking out with your agent.

The policy, introduced by Aetna Life & Casualty, pays you up to \$1,500 a month in replacement income if you are sick or injured and unable to work. If the disability begins before age 45 and continues the rest of your life, you receive benefits for life. If it begins after 45, benefits run until age 65.

The policy guarantees a total refund of premiums at age 65 if no benefits have been paid in the meantime.

For \$1,500 a month in disability income, the premium is roughly \$1,150 a year; with a 180-day wait, it comes to \$1,050. Note: The age-65 refund provision accounts partly for the high premium.

The trend has been to higher and higher coverage in the field of disability income protection. Now another move in the business makes these policies more attractive to the man under 35.

The innovation is an option in the policy that lets you jump your coverage freely. For example, a man under 35 can now boost his protection from, say, \$500 to \$1,000 a month via an option clause. The point is that if higher income justifies the added coverage, you can exercise the jump-up option for up to 10 years after you buy the policy.

For income protection, besides Aetna Life & Casualty, check with Continental Assurance, Guardian Life, Monarch Life, Mutual of Omaha, Paul Revere Life, and Provident Life & Accident, among others.

More Coverage for the "High Risk" Man

If you were turned down for life insurance in the past as a health or occupational risk, you may well find that you can get a policy today.

Many top companies have been easing their rules and going in heavily for what the trade calls substandard business. You pay an extra premium, and sometimes it's high. But often it will be just a couple of dollars more per \$1,000.

Even a man who has had cancer can get a life insurance policy if he has had no recurrence of the disease in five years or more. The added premium he'll have to pay is about \$15 per thousand a year. Thus, a man of 50 will pay about \$50 per thousand instead of \$35.

If more than 10 years have passed since the cancer illness, the cost will be fairly close to normal.

You can get insurance today even if you have a bad case of high blood pressure, partly because of new drug therapy. A person 35 years old with a severe case will pay about double the standard premium of \$18 per thousand; at age 50, the normal \$35 premium jumps to \$85. But the younger man gets close to the standard premium when his case is moderate and under control, and the 50-year-old pays only \$40.

The 50-year-old has to pay \$8 to \$16 per thousand extra if he has diabetes; \$2.50 to \$5 if he has a duodenal ulcer.

A coronary poses the hardest case. The extra premium during the first year of recovery can be triple the standard rate. But this drops to less than double at five years, and gets substantially lower as more time passes.

Health insurers are getting more lenient too. You can buy coverage — despite a poor medical history — from many top companies.

The history can include everything from ulcers to emotional disorders. Again you'll usually pay a higher premium. But some companies, such as Mutual of Omaha, will take you on at standard rates, with a waiting period before benefits begin.

Where there's a premium boost, the extra rate can vary a good deal.

	Atlanta	New Orleans	San Francisco	
A Day A Mile	\$ 9 9¢	\$10 8¢	\$ 8 8¢	*Econo Car
A Day A Mile	\$14 14¢	\$13 13¢	\$14 14¢	HERTZ
A Day A Mile	\$14 14¢	\$13 13¢	\$14 14¢	AVIS

*(Based on current published daily rates for a standard size air conditioned sedan. Econo-Car rates do not include gas, you pay only for the gas you use.)



Pick a city. Any city.

Econo-Car costs less than Hertz, Avis or National.

We're not as big as the other guys, but we do rent the same new, clean Chevrolets and Pontiacs and other fine cars.

We *serve* almost every major airport in the country. Call us when you arrive and we'll be there before your baggage.

Compare your present car rental costs in any city with Econo-Car. You'll find in many cases you could be saving almost half.

For advance reservations nationwide, and in Canada, Puerto Rico, the Virgin Islands, and Hawaii, call this toll free number:

1-800-874-5000
(in Florida dial 1-800-342-5628)

Call Econo-Car for reservations, or further information.

Go ahead, pick a city.

ECONO-CAR[®]
INTERNATIONAL

The "Phone" Company

**Save a dollar here—
a dollar there**

On the tax side, medical deduction rules continue to get easier. The Tax Court has now allowed deducting the cost of auto driving prescribed by an M.D. as therapy for an accident victim.... If you use your car to get medical care, Internal Revenue now says you can deduct 5¢ a mile and tolls and parking fees. IRS also has eased its rules on deducting for schooling for handicapped children.... Cash gifts to churches get liberal tax treatment, too. Two cases: Taxpayers lacked records and were limited by IRS to deductions in the \$50 to \$100 range; but the Tax Court raised these figures to around \$500. The taxpayers were steady churchgoers.

Arcane arts of Wall Street: People persist in taking a fast financial bath in commodities; the psychology often is do-or-drown, and the knowledge intended to keep the investor afloat far too shallow. *The Commodity Futures Trading Guide*, by Teweles, Harlow and Stone, is the kind of aid that should be employed; it realistically views these markets (McGraw-Hill, \$12.50).

Now credit card loss is eased, with some refinements added to the usual insurance package. You pay \$10 a year to the American Credit Card Assn. of Milwaukee and get \$5,000 in insurance covering lost or stolen cards. Family members are covered, and the insurer arranges issue of new cards. And you can do temporary charging (ACCA, 2901 West Forest Home Ave., Milwaukee).

**Travel
and sports
department**

October classic: Jim Bouton's *Ball Four—My Life and Hard Times Throwing the Knuckle Ball in the Big Leagues* is the best baseball book in years; it kicks up some dust about managers, team owners, and prima donna players. It's funny, human—and right in step with the October series (World, \$6.95).... *Medical Advice for the Traveler*, by Kevin M. Cahill, M.D., is sensible stuff if you're off to the Caribbean or other hot climes (Holt, \$3.95).

Executive chef

When you feel in the mood for a plate of hot soup, try corn-pea bisque, a personal recipe of Henry J. Heinz II, of H.J. Heinz Co.: Put in a blender 1 pack frozen peas in butter, 1 pack frozen corn in butter, $\frac{3}{4}$ cup milk, $\frac{3}{4}$ cup light cream, onion salt. Blend and heat; add $\frac{1}{4}$ cup dry sherry.... From the fine kitchen at Cantina D'Italia on Connecticut Ave., Washington, try the Roman favorite, spaghetti alla carbonara: Cook 1 lb. spaghetti al dente (8 min.); for sauce, heat in butter and olive oil $\frac{1}{2}$ lb. diced bacon that has been fried and drained, add $\frac{1}{2}$ finely diced onion, and 3 eggs; mix sauce and spaghetti while still piping hot, season with fresh black pepper and sprinkle with parmesan. Serve with a bottle of Frascati (white).

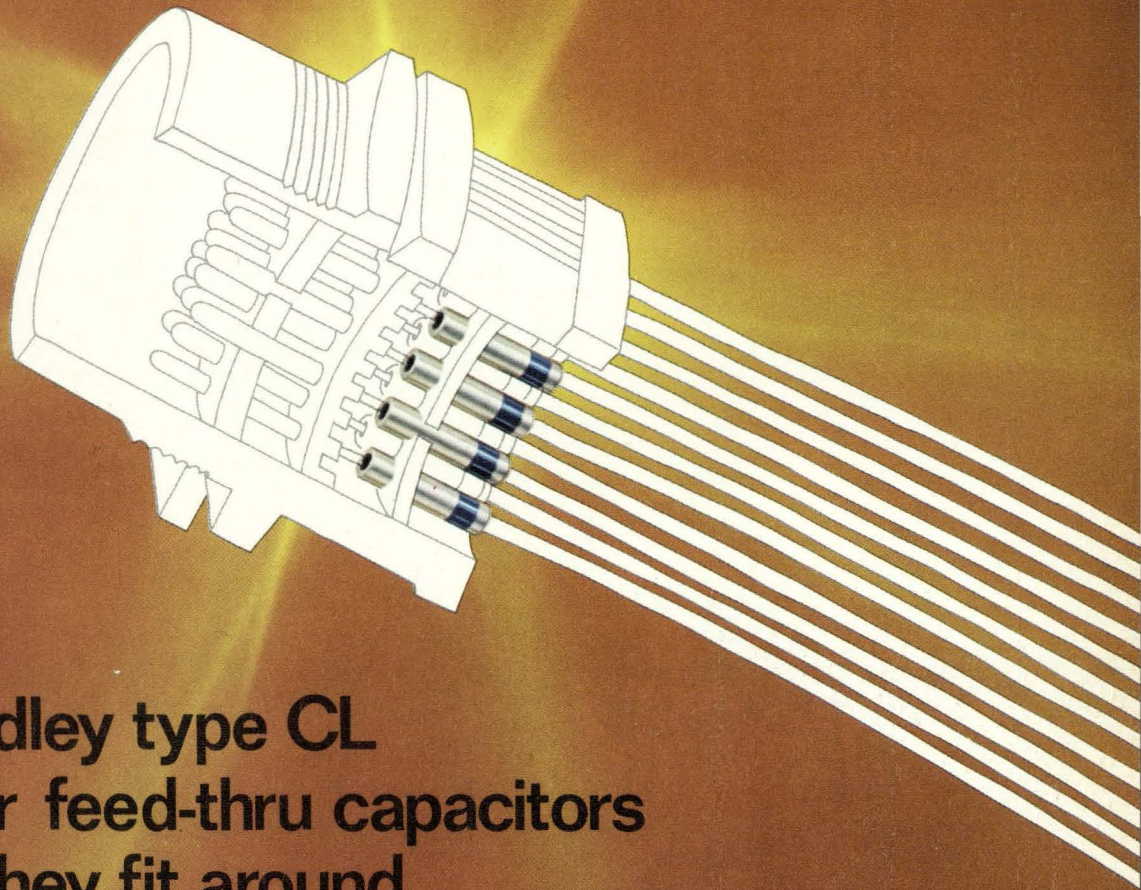

Allen-Bradley type CL multi-layer feed-thru capacitors so small they fit around the head of a pin.

VOLUMETRIC EFFICIENCY. Big words that explain why Allen-Bradley type CL feed-thru capacitors are so small. Our unique multi-layer concept shaves size to a minimum, without affecting performance. It took Allen-Bradley to get filter capacitors down to their fighting weight. Now rolled capacitors are no longer a design alternative.

Concentric layers of proprietary Allen-Bradley ceramic and noble metal electrodes are fired together for unmatched protection against moisture and contamination. Rugged. Non-polar. With lower inductance and far less noise.

Voltages to 200 WVDC. Temperatures to 125°C. Capacities to 1.0 μ F. High dielectric strength and reliability.

Several styles and sizes are available through your appointed A-B industrial electronic distributors. For further information write: Marketing Department, Electronics Division, Allen-Bradley Co., 1201 South Second Street, Milwaukee,

Wisconsin 53204. Export office: 1293 Broad Street, Bloomfield, N.J. 07003 U.S.A. In Canada: Allen-Bradley Canada Ltd., 135 Dundas St., Galt, Ontario.

ALLEN-BRADLEY

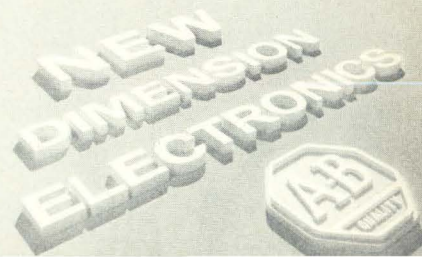

A computerized coin return for your corporate telephone.

You can cut way back on your communications costs with data communications systems using Honeywell Series 16, Series 32, and H112 computers.

For a time-sharing service bureau, Honeywell message concentration systems are slashing telephone line lease costs.

For a huge airline's reservation system, Honeywell computers are cutting terminal response time by 30%.

Many other businesses are using Honeywell computers for communications economy, efficiency, and control.

An inventory control organization, for example. And a credit verification business. And an on-line business management service.

Maybe your company could reduce communications costs, too. With Honeywell data concentration systems. Store and forward message switching systems. Terminal control systems. Or time-sharing systems.

There's one sure way to find out. Write for our new communications capabilities brochure. So you can consider the alternative: Honeywell, Computer Control Division, Framingham, Massachusetts 01701.

The Other Computer Company:
Honeywell

Circle 126 on reader service card

HONEYWELL INTERNATIONAL—Sales and Service offices in all principal cities of the world. Manufacturing in Australia, Canada, Finland, France, Germany, Japan, Mexico, Netherlands, Spain, Taiwan, U.K. and U.S.A.

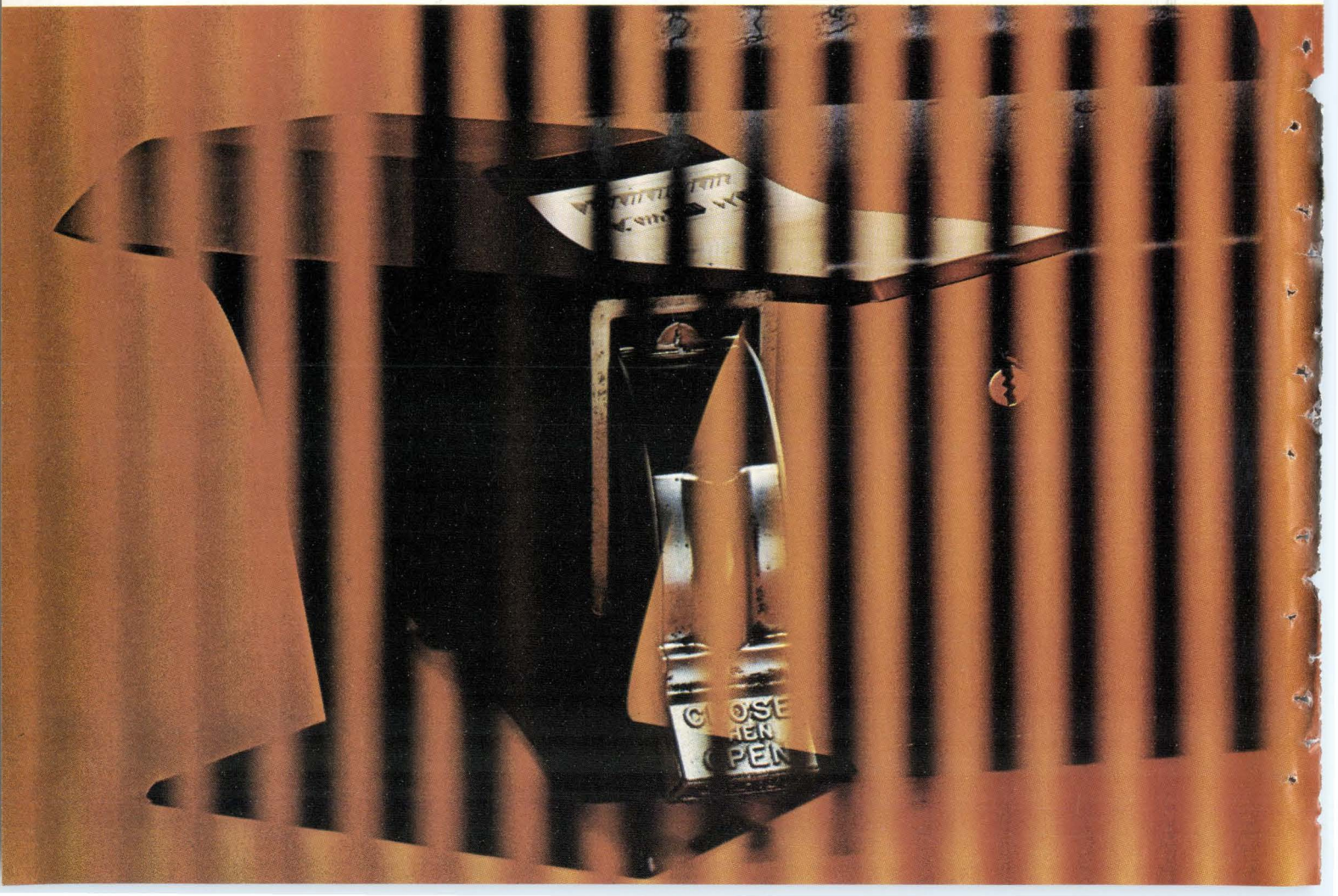

Reed relay makers swing to dual in-line

By George Weiss, *New Products editor*

Low-profile package increases attractiveness of device for computerized control; price, manufacturing hurdles remain

Industrial equipment designers like the reed relay as a switching link for computer control. It provides better isolation than does solid state logic, it's faster and more reliable than electromechanical switches, and its hermetically sealed contacts provide protection against dust and corrosion.

A group at General Electric Co. decided about a year ago to incorporate the reed device as a dual in-line package in a computer system. They asked Grigsby-Barton Inc. to put the reed relay in a DIP so it would fit integrated-circuit sockets, offer a low profile that contributes to higher component density, and lend itself to rapid insertion and to automatic testing

on the printed circuit board.

After making design changes in the reed switch and coil as well as the encapsulation process, Grigsby-Barton produced eight- and 14-pin DIPs. At about the same time, Elec-Trol Inc. also developed a DIP line. Now, a year later, at least a dozen reed relay makers have fallen in line or plan to.

The pioneers are optimistic. At Elec-Trol in Saugus, Calif., vice president Kenneth Doriot says the DIP relays already represent a significant sales volume and notes that acceptance is growing. Forbes Barton, vice president of Grigsby-Barton, says the Arlington Heights, Ill., firm has started a product line of 16-pin DIPs to complement its eight- and 14-pin types. The new line will include the entire range of miniature reeds, including large power ratings and mercury-wetted devices.

Others, however, aren't so optimistic. Prices of DIP units, they point out, tend to run about double

those for standard miniature relays; mechanical difficulties are encountered in squeezing the glass envelope and coil into the low-profile package, and the injection molding process exerts considerable stress on the reed switch's glass envelope, therefore reducing production yields.

One sales manager admits that his firm's DIP devices will not compare favorably in price-performance ratio with its standard sub-miniature relays. A marketing director who feels it is too early to determine how significant the trend to DIPs will become, adds that his company cannot afford not to get into the business. Still another major manufacturer cautions the user that the industry "is rife with garage-shop operations."

There has been some progress in easing the packaging problem. Two companies, Hamlin Inc. of Lake Mills, Wis., and Gordos Corp. of Bloomfield, N.J., say they have simplified it by reducing the size

Building a relay. Construction of a 14-pin dual in-line reed relay begins with two reed switches, a miniature coil, and a gold-plated lead frame. The switches and coil are welded to the frame, and the assembly is molded. Trim and form operations complete the process.

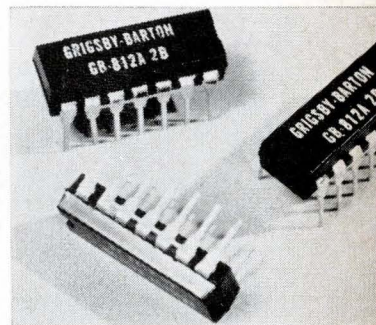
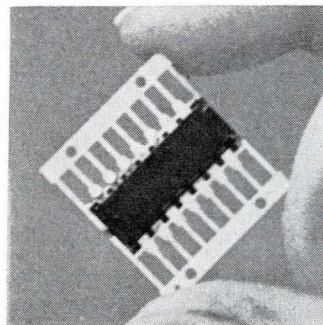
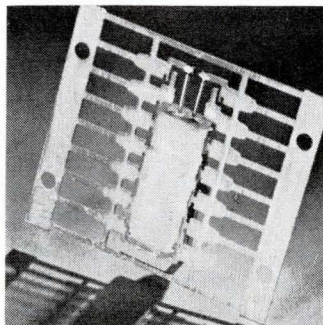
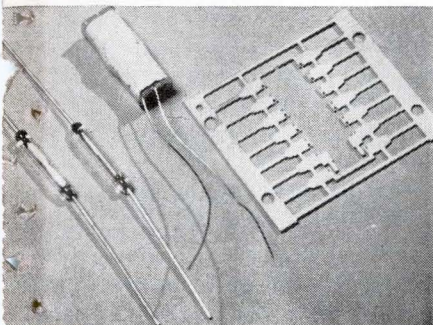

There is a difference in Heath Dynamics' Quartz Crystal Filters!

Heath Dynamics specializes in the design and manufacture of the highest quality Quartz Crystal Filters and Discriminators for the Communications Industry.

Our facility is completely new, inside and out, fully staffed and equipped with the most modern mechanical and electronic test measuring devices.

We employ the assistance of one of the largest time sharing computers available.

Heath Dynamics' area of specialization includes the manufacture of miniature and sub-miniature filters in the range of 10 thru 32 Mhz. Bandwidths may be from .025% thru .35% in the smallest packages and may range up to 2.0% in the larger ones.

We manufacture direct replacement filters for all the current monolithic designs using our half lattice configuration which yield lower insertion loss, lower ripple and greater ultimate rejection. Yet our filters cost less and faster delivery is guaranteed!

All Heath Dynamics' crystal filters designed and manufactured to your particular specifications meet Mil F. 18327.

In short, we want your business and we'll act like it. Do us both a favor and send us your print or specification for a quote. If you have any questions just write or call us... we're here to serve you.

 **heath
dynamics, inc.**

6050 n. 52nd avenue
glendale, arizona 85301
(602) 934-5234

subsidiary of
Heath International, Inc., Richmond, Mich.

New products

of the glass envelope. In earlier devices, the glass was 0.090 inch in diameter and about 0.560 long. The newer switches are less than 0.500 in. long and have a diameter of 0.070 in.

Stuart Wilson, Hamlin's sales manager, finds that the smaller switch size allows the coil to be placed much closer to the reed, for better coupling. And while conventional reed units need from 17 to 50 ampere-turns of coil winding to activate the switch, "the specially designed ones can work with 7 to 22, reducing coil-winding space and power consumption," he notes.

Wilson adds that the smaller size permits faster switching speeds—200 microseconds instead of 500. The faster speed is due to more efficient coupling and to thinner blades.

Angelo Ghio, Gordos' sales manager, does not see any immediate rush to DIP reeds. Manufacturers are ordering the special reeds for DIPs in quantities of about a thousand, against 50,000 or more for other types, he says. But Ghio feels that as semiconductor technology progresses, there will be more demand for standardization and integration of components, especially in computers and terminals. This eventually should make reed DIPs a very popular item.

Some manufacturers are accommodating the tight space problem by slightly enlarging the package. Triridge Corp. of Pittsburgh recently introduced a 14-pin package that fits standard DIP grid spacing but is slightly wider and higher.

Michael Minich, president of Triridge, at first was put off by the standard tight packaging scheme and so decided to compromise the regular package height of 0.187 in. for 0.281 in. off the board to accommodate a more powerful switch. "We would have had to settle for a 3-watt switch available only in a form A (single pole, single throw)," he says. "In our package we can insert a 10-watt Form A or 3-watt Form C (single pole, double throw)."

The greater height, however, makes racking pc cards on $\frac{3}{8}$ -in.

centers barely possible. But Minich believes the sacrifice of card spacing was necessary to accommodate larger power capability—a tradeoff that is paying off because "we're replacing a lot of packages from users who need more than the 3 watts they're now getting."

An arc suppression diode is the only other component that relay manufacturers have been able to add in the DIP package. But now Astro Space Labs in Huntsville, Ala., is incorporating the driver circuitry as well. This reed-relay DIP can be driven directly from TTL or DTL gates. Another model employs the same concept of integration; it also has an internal current-sinking load for TTL/DTL gates.

Bob Mapes, vice president, says he got the idea from Teledyne's integrated TO-5 electromechanical relay and driver, and decided to use Astro's thick film facilities to produce a hybrid drive for reed relays. "We print the resistor, interconnect, and lead configuration on a ceramic substrate and mount the drive transistor and arc suppression diode in chip form. The reed relay and coil are then added, the lead frame is attached, and the whole unit is encapsulated by injection molding."

The chief advantage of the integrated package design, says Mapes, is price. "We can sell the relay and driver circuitry together for less than you would ordinarily pay for the driver and relay separately." The units will sell for about \$5 in quantities of 1,000—a price that usually covers relay drivers alone, he says.

Struthers-Dunn of Pitman, N.J., has six versions of a 1 Form A contact and recently introduced a 2 Form A and a 1 Form C. C.P. Clare will have DIP reed relays available this month. Potter and Brumfield, Princeton, Ind., will introduce its first DIPs early next year, as will Wheelock Signals Inc., of Long Branch, N.J. Sigma Instruments Inc., of Braintree, Mass., and Self-Organizing Systems Inc. of Dallas, have recently introduced the new packages and several others have similar plans.



What you hear about our new dry test bath is true.

The tape recorder is operating in a dry bath of Fluorinert® Brand Electronic Liquids. Just as your electronic and microelectronic units will.

Fluorinert Liquids give you an accurate method of temperature testing or testing for gross leaks. They keep their efficiency over a wide range of temperatures. They

do not react with even the most sensitive of materials. They won't deteriorate with use.

And you can ship or use parts directly out of the test bath without cleaning because Fluorinert Liquids evaporate, leaving no residue.

If you've been listening, you know that Fluorinert Electronic

Liquids are specified for Mil-Standard 883 and Mil-Standard 750A gross leak tests for microcircuits.

The coupon will bring you copies of both Mil-Standards and a lot of good solid information about test baths. Send it or call your local 3M man.

Fluorinert® Electronic Liquids 3M_{COMPANY}

3M Company, Chemical Division, 3M Center
St. Paul, Minn. 55101

KAX-10-70

Send me all the details about Fluorinert Brand Electronic Liquids.

Name _____

Company _____ Title _____

Address _____

City _____ State _____ Zip _____

New products

Microwave

Transistors are job-specified

1-GHz oscillators have common emitters; amplifiers put in common-base package

A transistor that makes a good 1-gigahertz power amplifier doesn't necessarily make a good power oscillator, and vice-versa, even

though microwave equipment designers often try to use the same device for both jobs. Engineers at Microwave Semiconductor Corp. believe that a common-base transistor makes a superior class-C power amplifier, whereas the common-emitter configuration is best for oscillators. The company's new family of 1-GHz transistors is characterized accordingly as either amplifiers or oscillators: the amplifier devices, MSC 1020 (20 watts output power at 1 GHz, 8.2 decibel gain), MSC 1016 (10 watts, 8.2 dB), and the MSC 1005 (5 watts, 10dB), are in a common-base, grounded heat-sink stud package; and the oscillator devices, MSC 80081 (10

watts minimum output power at 1 GHz), MSC 80080 (5 watts), MSC 80069 (3 watts) are in a common-emitter package with an isolated heat-sink stud.

In both the amplifier and the oscillator, the stud conforms to the standard 2N4431 transistor stud outline.

Most 1-GHz power devices on the market have a common emitter, the company claims, and when used as amplifiers, their high input Q and reduced gain make broadband operation difficult. However, the common-base 1020, 1010, and 1005 have Q values one-third those of comparable conventional 1-GHz devices, and can therefore operate

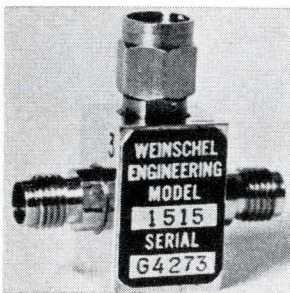

Miniature power divider model 1515 is a 50-ohm coaxial device for accurate division of power from matched ports over a broad frequency range. It covers the dc to 18 GHz range, and provides a nearly constant power division of 6 dB across its broadband. Its input power rating is 1 watt cw. Unit is for system and lab use. Weinschel Engineering, Gaithersburg, Md. [401]

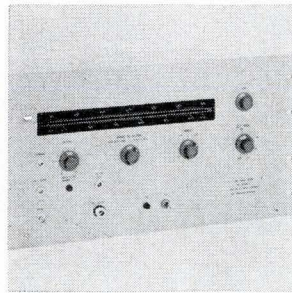

Common carrier sweep generator model 610 WE has frequency ranges of 3.6 to 4.3 GHz and 5.9 to 6.5 GHz. The rf output of 1 V rms is externally leveled to a flatness of ± 0.02 dB per 20 MHz over the two bands. Calibrated rf sweep from 0 to 160 MHz is provided. Effective rf filtering keeps spurious signals more than 40 dB down. Wiltron Co., Palo Alto, Calif. [402]

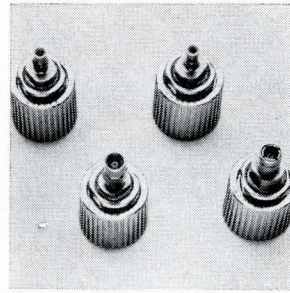

Precision coaxial adapters, models 71250 and 71200 are APC-7 to SMB devices covering the frequency range of dc to 4 GHz. VSWR is 1.05 ± 0.005 times frequency in GHz. Models 81250 and 81260 are APC-7 to SMC, covering the frequency range of dc to 12.4 GHz. VSWR is 1.015 ± 0.004 times frequency in GHz. Omni Spectra Inc., Hallwood Ct., Farmington, Mich. [403]

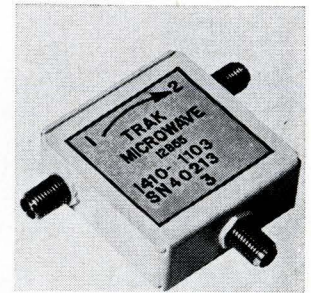

L-band circulator is designed to operate between 0.960 and 1.215 GHz. Isolation is 18 dB minimum with an insertion loss of only 0.5 dB maximum. Unit has a VSWR of 1.3:1 maximum and is stable over a temperature range of -54° to $+95^\circ$ C. Dimensions are $1\frac{1}{2} \times 9/16$ in. excluding connectors. Trak Microwave Corp., 4726 Eisenhower Blvd., Tampa, Fla. 33614 [404]

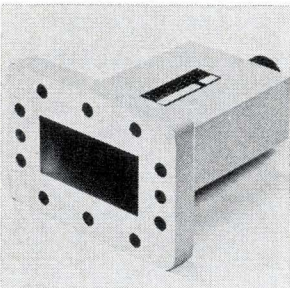

End launch WR430 adapters provide extremely low VSWR of 1.10 maximum over the band of 2.1 to 2.4 GHz. They can be obtained for adapting to a variety of coaxial connectors, including precision N connectors (male and female), APC7 and GR900 connectors, and large line size connectors. Maury Microwave Corp., 8610 Helms Ave., Cucamonga, Calif. 91730 [405]

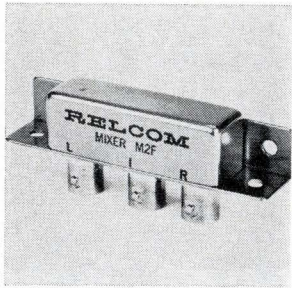

Balanced mixer model M2F features high isolation and a low noise figure over a 1,000-MHz to 2,500-MHz frequency band. At midband, the noise figure is typically less than 5.5 dB. Isolation is specified at greater than 20 dB; the output bandwidth is dc to 500 MHz; and a set of built-in filters isolates the R port. Relcom, 2329 Charleston Rd., Mountain View, Calif. 94040 [406]

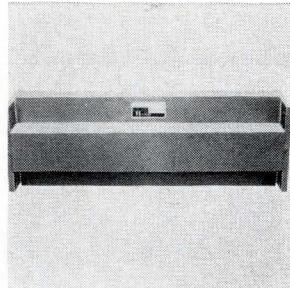

Harmonic absorption filters are offered for frequencies from uhf through Ku band. A typical unit, model 91141, is a C-band device that operates from 4.4 to 5 GHz with an average power of 2 kW and a peak of 1 MW. Pass band VSWR is 1.15:1 with insertion loss limited to 0.25 dB. Unit measures $1\frac{1}{2} \times 5\frac{1}{4} \times 4\frac{1}{4}$ in. Solitron Microwave, 37-11 47th Ave., L.I.C., N.Y. [407]

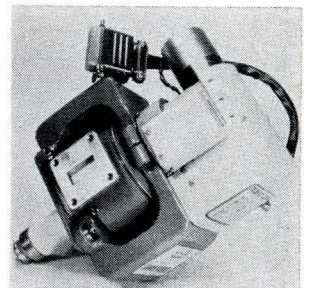

Two pulsed coaxial magnetrons, which deliver 75 kW of peak power at X band, are available for use in airborne and ground-based radar systems. The SFD-370 operates at a fixed frequency between 9.205 and 9.285 GHz. The SFD-380, which is mechanically tunable, operates from 9.1 to 9.5 GHz. Varian Eastern Tube Division, 800 Rahway Ave., Union, N.J. [408]

BRAND-REX PRESENTS
**BUCK
 ROGERS**
 IN THE 25th CENTURY



THIS USED TO BE WILLIMANTIC, CONN. NOW IT'S CALLED REXOPOLIS, BUCK. THE CITY **BRAND-REX** WIRE AND CABLE HELPED BUILD. IT'S BECOME THE MOST ADVANCED IN THE UNIVERSE, LARGELY BECAUSE THE ENGINEERS WHO DESIGNED IT WERE SMART ENOUGH TO SPECIFY **BRAND-REX** WIRE AND CABLE. IT'S PAID OFF BY ALLOWING THEM TO EXPAND RAPIDLY AS THEIR SOPHISTICATED TECHNOLOGY PROGRESSED.

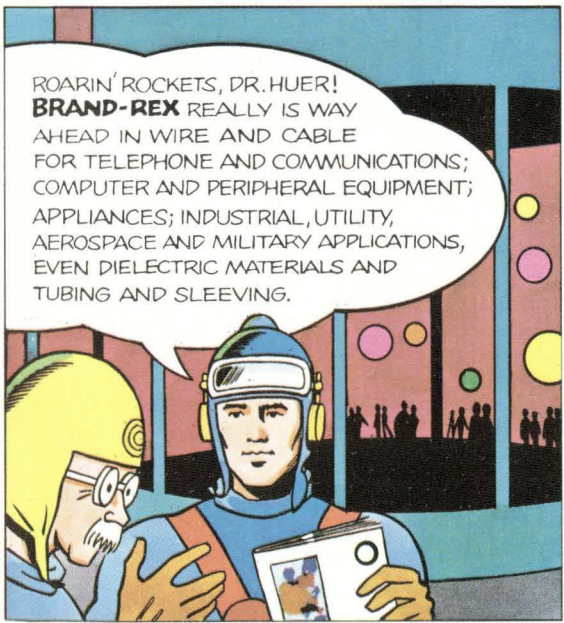
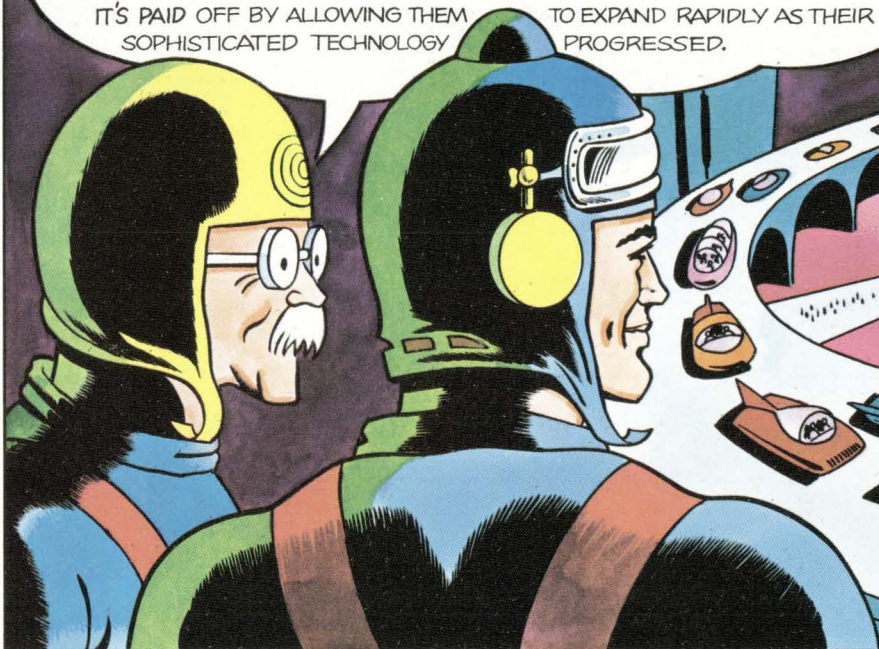

ROARIN' ROCKETS, DR. HUER! **BRAND-REX** REALLY IS WAY AHEAD IN WIRE AND CABLE FOR TELEPHONE AND COMMUNICATIONS; COMPUTER AND PERIPHERAL EQUIPMENT; APPLIANCES; INDUSTRIAL, UTILITY, AEROSPACE AND MILITARY APPLICATIONS, EVEN DIELECTRIC MATERIALS AND TUBING AND SLEEVING.

ATTENTION, EARTHFOLKS... BE THE FIRST ON YOUR PLANET TO GET THE FANTASTIC NEW **BRAND-REX** ALL PRODUCTS BROCHURE. JUST MAIL THIS COUPON TO:

BRAND-REX DIVISION
 AMERICAN ENKA CORPORATION
 WILLIMANTIC, CONN. 06226. OR
 PHONE (203) 423-7771.

BRAND-REX, WAY AHEAD IN WIRE AND CABLE

NAME _____ TITLE _____
 COMPANY _____
 ADDRESS _____
 CITY _____ ZIP _____ PLANET _____



Liquid RIVET

One drop bonds almost anything to almost anything for almost forever. We call it Eastman 910[®] Adhesive. It works with metals. With plastics. With rubber. With glass. With bonds that are often stronger than the materials being bonded. It works without heat. Without solvents. Without pressure. Without catalysts. And without a lot of waiting. Philco-Ford uses Eastman 910 to bond aluminum to aluminum. Cessna uses it to bond rubber to acrylic plastic. Bendix uses it to bond steel to brass. For more information, call your Eastman representative. Or write Eastman Chemical Products, Inc., Kingsport, Tennessee. You may find that Eastman 910 bonding is a lot easier than what you're doing now. More economical. Maybe even quieter.

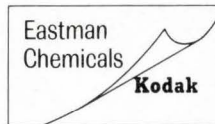

Circle 170 on reader service card

New products

broadband, down through 500 MHz. Prices of the amplifier devices in lots of 100 are \$150, \$75, and \$50, in order of decreasing power.

The common-emitter, isolated-stud design of the new oscillator permits use of a single dc supply circuit with either positive or negative ground. They will oscillate either with external feedback or with the package parasitic elements as part of the feedback loop. Though external feedback produces highest output power and efficiency, internal feedback is more effective for voltage controlled oscillator applications. The 80069, for example, was voltage tuned over a range of more than 150 MHz, centered on 900 MHz, with output power greater than 2 watts. The oscillators can also be operated in pulsed mode—the 80080 can generate more than 10 watts peak power at 1 GHz.

All devices have efficiencies in the range of 40 to 45%. Microwave Semiconductor engineers report that it makes little difference in power output or efficiency whether power is removed through the base (with dc and rf grounding of the collector) or through the collector (with rf grounding of the base).

Prices, in quantities of 100, are \$150 for the 80081, \$75 for the 80080, and \$50 for the 80069.

The new transistors, both amplifiers and oscillators, were designed to withstand the mismatched loading conditions that often cause devices to burn out in L-band power circuits. Even under forward bias conditions, which oscillators need for starting, the 80081, 80080, and 80069 will withstand severe mistuning. The 1010 and 1005 amplifiers are the highest power 1-GHz transistors with an output mismatch rating, according to the manufacturer; the 1010 will withstand a voltage standing-wave ratio of at least 5 to 1 at 10 watts and 28 volts, and the 1005 will withstand an infinite VSWR at 5 watts and 28 volts.

All the devices are in stock.

Microwave Semiconductor Corp., 100 School House Road, Somerset, N.J. 08873 [409]

This announcement is under no circumstances to be construed as an offer to sell or as a solicitation of an offer to buy any of these securities. The offering is made only by the Prospectus.

NEW ISSUE

September 30, 1970

\$150,000,000

Western Electric Company, Incorporated

8³/₈% Sinking Fund Debentures, due October 1, 1995

Price 99³/₄%

(Plus accrued interest from October 1, 1970 to the date of delivery)

Copies of the Prospectus may be obtained in any State in which this announcement is circulated from only such of the undersigned or other dealers or brokers as may lawfully offer these securities in such State.

Merrill Lynch, Pierce, Fenner & Smith
Incorporated

Salomon Brothers

Dillon, Read & Co. Inc. The First Boston Corporation Goldman, Sachs & Co. Kuhn, Loeb & Co.

Blyth & Co., Inc.

Drexel Harriman Ripley
Incorporated

duPont Glore Forgan
Incorporated

Eastman Dillon, Union Securities & Co.

Halsey, Stuart & Co. Inc.

Hornblower & Weeks-Hemphill, Noyes

Kidder, Peabody & Co.
Incorporated

Lazard Frères & Co.

Lehman Brothers

Loeb, Rhoades & Co.

Paine, Webber, Jackson & Curtis

Smith, Barney & Co.
Incorporated

Stone & Webster Securities Corporation

Wertheim & Co.

White, Weld & Co.

Dean Witter & Co.
Incorporated

Bache & Co.
Incorporated

Paribas Corporation



we goofed.



This Howard Cyclohm Fan was engineered to run 10 years. So far it's been running 12 years, 6 months, 21 days.

Our modest 5-year guarantee on Cyclohm Fans and Blowers is based on an engineered lifespan of 10 years. So, what do we tell our customers when they report the fans are still blowing strong 12 or even 14 years after installation? We tell them we goofed—and they benefit.

There's more to the Howard Cyclohm Fans and

Blowers success story than just long life. There's the high reliability of Howard's unit bearing motor that never needs maintenance or re-lubrication. And all metal construction. Indestructible nylon blades. Standard mounting on 4-1/8" centers. UL yellow card listing. All units are off-the-shelf . . . available for immediate delivery from Standard Motor Product Sales. All the facts are in the newly-published, 14-page Cyclohm Fans and Blowers Catalog EL107 From Howard.



HOWARD

HOWARD INDUSTRIES
MSL INDUSTRIES, INC./MOTOR GROUP
2420 18th STREET, RACINE, WISCONSIN 53403
414-632-2731 TWX 910-271-2387

OUR ANGLE: Fast and Accurate Digital-to-Synchro Converters

Isn't
There
Another
Angle to Your
Conversion
Problem?

Now you can have both speed and accuracy in digital conversion. Without compromise. North Atlantic's Series 538 provides a precision interface between your digital computer or tape programmer and analog servo system. With 1-minute accuracy, resolving 14, 15, or 16 bits. For both 400Hz synchro and resolver outputs at 11.8, 26, or 90 Volts, Series 538 accepts digital input data in binary angle form whenever a $4\mu\text{s}$ pulse appears on the strobe line. The strobe design prevents misidentification of noise as a valid word. It can also be addressed in hard-wire applications where several converters are shared by a central processor. Featuring solid-state design with precision trigonometric transformers,

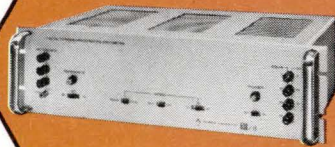

MODEL 538/10



MODEL 538/20

the units have introduced improved control and speed to the entire spectrum of commercial and military applications: automatic test equipment, production testing, numerical control, celestial scene simulation, etc.

Priced from \$1000 to \$4000, all units in the series are completely protected against power line transients, power line frequency changes or an improperly connected reference frequency, overload and short circuit of the output terminals.

Numerous options available for local/remote selection, special reference frequencies, logic levels, etc. For more about these fantastic multi-function converters, contact your North Atlantic sales engineering representative today. He'll show you another angle.

NA

NORTH ATLANTIC
industries, inc.

200 TERMINAL DRIVE, PLAINVIEW, NEW YORK 11803
cable: noatlantic / twx: 510-221-1879 / phone: (516) 681-8600

New products

Tiny analog phase shifters fit onto circuit board

The bulky line-stretcher may become a thing of the past for equipment that requires an analog phase shifter. Subminiature phase shifters built by Merrimac Research and Development Inc. are so small and light that they can be mounted on printed circuit boards. They're designed for applications in space, airborne, and backpack equipment.

The phase shifters are available in electronically and manually controlled models. The electronically controlled unit, the PSES-3, can provide closed-loop control of a system, with typical applications in phased array equipment. The manual unit, the PSS-2, is primarily intended for phase trimming and adjusting. Both units are designed to Mil-E-5400.

The PSES-3 series operates over 10% bandwidths at center frequencies from 30 to 225 megahertz and exhibits phase shifts from 0 to -180° . The device uses a variable capacitance diode controlled by 0 to 48 volts. Control slope is $3^\circ/\text{volt}$. Maximum rf input power is -10 decibels, while worst case voltage standing wave ratio is 1.5:1. Maximum insertion loss is 0.8 dB.

The manually controlled model, PSS-2, is screw-tuned to provide a maximum phase shift to 90° over 10% bandwidths from 21 to 225 MHz. The entire phase shift is achieved in 14 screw revolutions. This unit can operate at 0.5 W average and 10 W peak power. Maximum VSWR is 1.6:1, while insertion loss is 1.1 dB maximum.

Both units are bilaterally constructed—input and output terminals can be reversed—and have solder-pin terminals for pc board use. The PSES-3 measures $\frac{1}{2}$ by $\frac{3}{4}$ by 1 inch and weighs 0.5 ounce. The PSS-2 measures $\frac{1}{2}$ by $\frac{3}{4}$ by $1\frac{1}{8}$ inches and weighs 1 ounce.

The PSES-3 is priced at \$95 in small quantities; the PSS-2 costs \$75. Delivery time is four weeks.

Merrimac Research and Development Inc., 41 Fairfield Place, West Caldwell, N.J. 07006 [410]

TIGHT-WAD BREADBOARD DESIGNER

*The ELite 2 is stingy with your money - with your time
When it comes to advanced circuit design*

This dynamic lab in a box will enable you to design, layout, test and construct (and re-use) all IC and discrete components circuitry (LIS, MSI, MOS) **WITHOUT SOLDERING, SPECIAL TOOLS, PLUGS OR PATCH CORDS.**

PLUS THESE BUILT-IN FEATURES:

- Wide range function generator — sine, square, triangle
- Wide range pulse generator—bi-polar outputs
- 3 monitored power supplies — floating, stable, short circuit proof
- 12 data display lamps — high input impedance \pm turn-on thresholds
- All breadboard interconnections with solid #22 gauge hook up wire
- Desk top convenience: 6 inches high, $17\frac{1}{2}$ inches wide, 12 inches deep.
- **ORDER ONE TODAY**

Write or call for complete specifications catalog

PRICE
\$1,300
COMPLETE

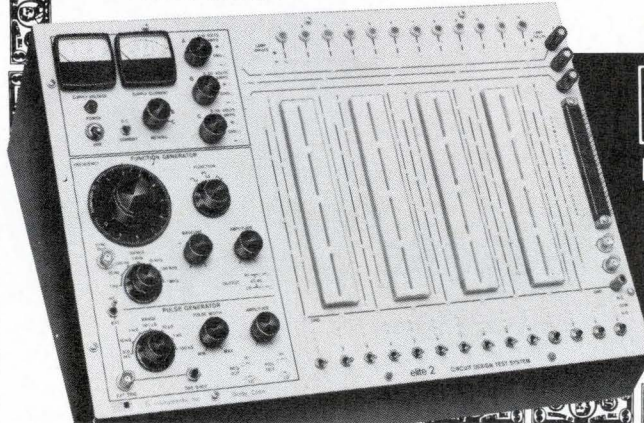

ELI
EL Instruments
Incorporated
61 First Street
Derby, Conn. 06418
Phone:
203/735-8774

Circle 171 on reader service card

aer·o·ne·tics (â'r'ə-nê'tiks)n.

1. Having to do with electronic metering and measuring. 2. The design and manufacture of metering and measuring devices to equal or exceed all known industrial, scientific or military requirements. 3. The ability to adapt principles proven by the aviation/aerospace industry to satisfy similar electronic instrumentation requirements.

AERONETICS Division has the engineering creativity and manufacturing flexibility to satisfy your electronic metering and measuring needs. Send us your requirements and specifications.

Aeronetics 
a division of AAR CORP.

2100 Touhy Avenue
Elk Grove Village, Illinois 60007
PHONE: (312) 593-6700
TELEX: 253594 / CABLE: AIRNAVCOM

**Open up
closed-circuit
markets...**

**...with this new
one-inch-diameter
Plumbicon***

*Registered trade-mark of
N.V. Philips' Gloeilampenfabrieken
Eindhoven, the Netherlands

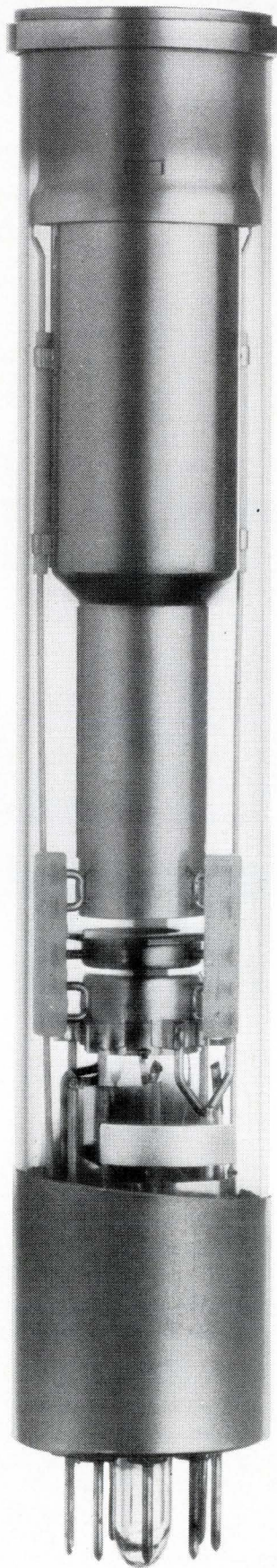

What a boost the entire CCTV industry would enjoy if existing cameras could operate well at significantly lower light levels and higher response speeds. That's exactly what this new Philips **Plumbicon** camera tube has to offer. Its one-inch-diameter makes it **retrofitable into existing cameras now using vidicons**. Developed originally to meet the exacting needs of live broadcast television, the **Plumbicon** won the industry's "Emmy" in 1967, as the year's most significant technological advance. Since then it has dominated its field - today it's in 9 out of 10 colour cameras in use throughout the world. When used in CCTV applications - in medicine, industry, education or commerce - this superb tube makes practical many applications hitherto only theoretical. The very high sensitivity, low dark current and fast response mean greatly improved picture quality - even when the subject is poorly illuminated or moving rapidly. All of which means the **Plumbicon** can make existing CCTV equipment work better, can make **CCTV colour** a practical proposition... can open up vast new markets, not only for cameras, but for related equipment as well! Let's help you open up new opportunities!

**Philips Electronic Components
and Materials Division,
Eindhoven, the Netherlands.**

Manufactured, distributed and sold
in the U.S. by
Amperex Electronic Corporation,
Electro-Optical Devices Division,
Slatersville R.I.

PHILIPS

New products

Instruments

Digital meter is versatile

Input/output slope adjustable to suit application; units are expandable for special jobs

One way not to make a name is to sell strictly to original equipment manufacturers. Once an OEM gets his hands on a product, off goes the

original nameplate and on goes his. That's why Gralex Industries, which has made digital panel meters since 1967 but only on a custom basis, decided to introduce two off-the-shelf instruments.

Both are 3½-digit types. The Model 1 is unipolar, the Model 2 is bipolar. "Mechanically, we think we have a package with a high degree of reliability," says Bernard Grand, executive vice president of Gralex, a division of General Microwave Corp. Each meter is in an extruded aluminum case measuring 4½ by 3½ by 5¼ inches and can be mounted from the front or back. Two boards hold all the basic circuitry, and there's room to add

100 boards for special functions.

"We can easily add appendages to the basic meter," says Grand, "by simply lengthening the case or adding circuit boards inside the enclosure. Sometimes you might want to drive different levels out, or handle different input signals; or you might want to convert it to a ratimeter, or use it to shape analog inputs, or multiplex. We can do these things within the basic package design."

There are nine versions for each model, depending on full-scale input: 100 millivolts, 1 volt, 10 V, 100 V, 1,000 V, 1 milliamp, 10 mA, 100 mA, and 1 A.

To avoid display ambiguity, the

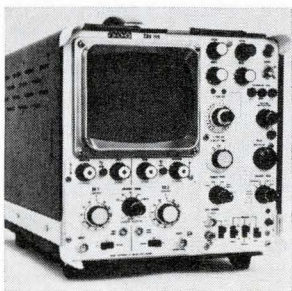

Low-cost, general purpose oscilloscope CDU150 is a dual-trace unit that features dc to 35 MHz bandwidth and is particularly suitable for field computer applications. The CRT has an 8 x 10 cm viewing area. Scope sensitivity is 5 mV/cm at full bandwidth in 12 steps with 1-2-5 sequence for both channels. Price is \$1,695. Raytheon Co., 141 Spring St., Lexington, Mass. 02173 [361]

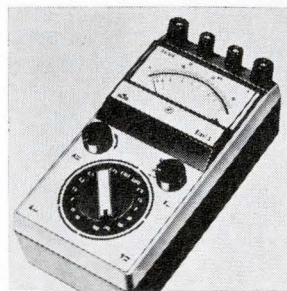

Multirange ac-dc portable meter has 30 measuring ranges for current and voltage and one resistance measuring range up to 1 kilohm. The internal resistance is 3,333 ohms per volt for all voltage ranges. The resistance range is protected by a fuse cut-out. Accuracy is within ±1.5%. Test voltage is 2 kV. Dimensions are 9 x 4½ x 3½ in. Epic Inc., 150 Nassau St., New York [362]

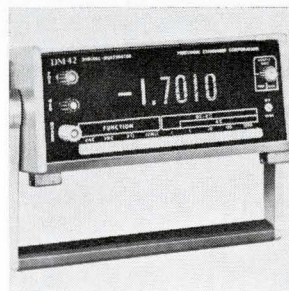

Multimeter DM42 is a full 4½-digit unit that offers 0.02% dc accuracy with 10 µV resolution, 0.05% accuracy with 0.01 ohm resolution and 0.2% ac accuracy with 100 µV resolution. Features include 100% overranging, variable sample rate, 5 full readings per second, small size and computer styling. Price is \$690. Precision Standards Corp., 1701 Reynolds, Santa Ana, Calif. [363]

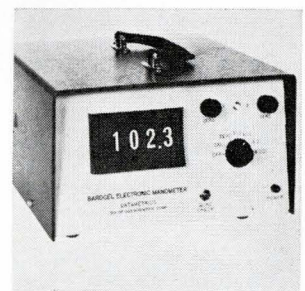

Electronic manometer type 1083 is a high-accuracy measuring and transducing system for differential pressure or vacuum from 10⁻⁵ mmHg to 5,000 mmHg. Pressure is indicated by an automatic, three and one-half Nixie tube display as well as by an optional BCD digital output and a high level 0 to 1 V dc, analog output. CGS/Datametrics, 127 Coolidge Hill Rd., Watertown, Mass. [364]

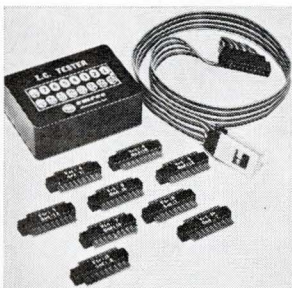

IC tester features a clip probe and a flexible cable for in-system testing of both 14- and 16-pin dual in-line TTL or DTL ICs. It displays the logic states of all pins simultaneously. Tester lamps are "on" for logic highs and "off" for lows. The unit, complete with cable and nine adaptor plugs, is priced at \$120. Emcee Electronics Inc., Old Churchman Rd., New Castle, Del. [365]

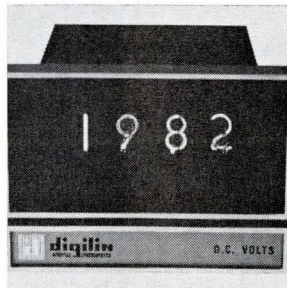

Digital panel meter type 330A will function over a range of input power frequencies varying from 50 Hz to 400 Hz at either 115 V or 230 V. The 3½-digit meter also features automatic zero adjustment and constant high input impedance. Maximum sensitivity is 1 mV, 100 nA, 1 ohm. Accuracy is 0.1% full scale. Digilin Inc., 6533 San Fernando Rd., Glendale, Calif. [366]

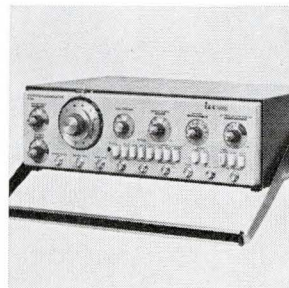

Function generators F51 through F55 operate as multipurpose, universal signal sources. Operating over a ten-decade spectrum of 0.0005 Hz to 10 MHz, they produce outputs of variable width pulse, sine, square, triangle, ramp, and fixed duty cycle pulse waveforms. Units feature calibrated attenuators with 70-dB range. Interstate Electronics Corp., Anaheim, Calif. [367]



Direct-reading peak wattmeter CTS-1 covers the range from 1 mW to 10 W peak with a resolution of 0.5 dB, handles PRFs from 1 kHz to 20 MHz, is accurate to 5% from 350 MHz to 2 GHz, and exhibits a maximum VSWR of 1.3 over the same range. With external pad the unit will handle up to several hundred watts peak. Cartwright Engineering Inc., 1020 E. Elm Ave., Fullerton, Calif. [368]

What Memory-System Maker Is Speeding Up the Cycle Time— But Holding Down the Price?

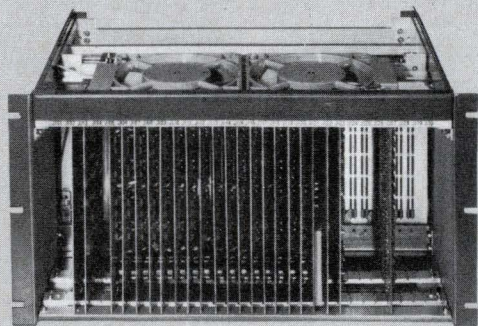

HS500R

Toko. Of course!

Beef up your technology with Toko's 500 nanoseconds Memory System without raising your costs.

Now rolling off the production line, Toko's HS500R Memory System offers the following key features:

- * Access time of 250ns. * Memory capacity of 4K words by 18 bits expandable to 16K words by 18 bits, rearrangeable to multiples of 36 and 72 bits.
- * Compact, space-saving advantages—measuring 10" x 19" x 13-1/3".

Toko's advanced electronic technology also enables it to provide computer components, such as memory stacks. Contact Toko today for details.



TOKO, INC.

Head Office: 1-17, 2-chome, Higashi-Yukigaya, Ohta-ku, Tokyo, Japan
TOKO N.Y., INC. 350 Fifth Avenue, New York, New York 10001 Tel: 212-565-3767

Circle 172 on reader service card

MICO

NEW MODEL 885 SEVEN RATIO WIDE-RANGE ENGRAVER

NO. 885

FOR LONG AND
MULTI-LINE WORK

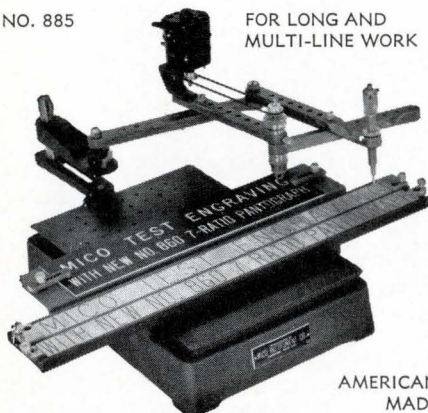

AMERICAN
MADE

- A time-saver for large plate work
- Engravers letters 1/32" to 3" high using standard masters.
- Seven pantograph ratios—from 1:5:1 to 6:1.
- Choice of 3-ball-bearing spindle assemblies for 1/8", 3/16" or taper-shank cutters.
- HSS, COBALT and Solid Carbide Cutters.
- Single and multi-line copy carriers for holding blanks 3/4" to 3 1/2" high.
- Accommodates Mico standard accessories.

Send for bulletins and prices

MICO INSTRUMENT CO.

77 Trowbridge St. Cambridge, Mass. 02138

Your Heart Fund Fights

**HEART ATTACK
STROKE
HIGH BLOOD
PRESSURE
INBORN HEART
DEFECTS**



New products

bipolar model shows a minus sign for negative inputs and a plus sign—not a blank space—for positive inputs. With the unipolar meter, a minus sign flashes when the input is negative.

The meters' OEM heritage shows up in the adjustment capability of the straight-line input/output characteristic slope. This is useful when voltage can come from any of several types of transducers. Thus the meters can be made to directly read out pressure, strain, torque and weight, for example. Grand says customized meters from Gralex have shown up in such diverse applications as analyzing blood and monitoring nuclear experiments.

Gralex concentrates its panel-meter efforts in the OEM area because that's where most of the business is, says Grand. "It (a dpm) doesn't meet the need as a general bench instrument," he points out. "It's really very dedicated applications that people have for them. And they don't buy one. We see the market as being in the multiple orders involving 25, 50, and up."

Basically, the new Gralex meters are dual-slope instruments with high input impedances to permit differential operation.

Input impedance varies from version to version, but is 10 megohms in most cases. Response time is 7 milliseconds, and the meters make up to five measurements a second. The actual display rate, though, is specified by the customer.

The standard output is in digital format—3.5 V or above for a 1 and 0.4 V or lower for a 0. Binary-coded-decimal outputs are optional.

Accuracy is \pm (0.1% of reading \pm 1 count). Stability is 0.005% per degree centigrade for all but the 100 mV scale, where it's 0.05%/°C.

The meters have a minimum over-range capability of 50%, except for the 1,000-V models where the figure is 10%. To hold a reading, the user shorts a designated pair of pins in the back panel connector.

Gralex Industries, 155 Marine St., Farmingdale, N.Y. 11735 [369]

Would you believe a 50 MHz pulser from E-H for only \$395?

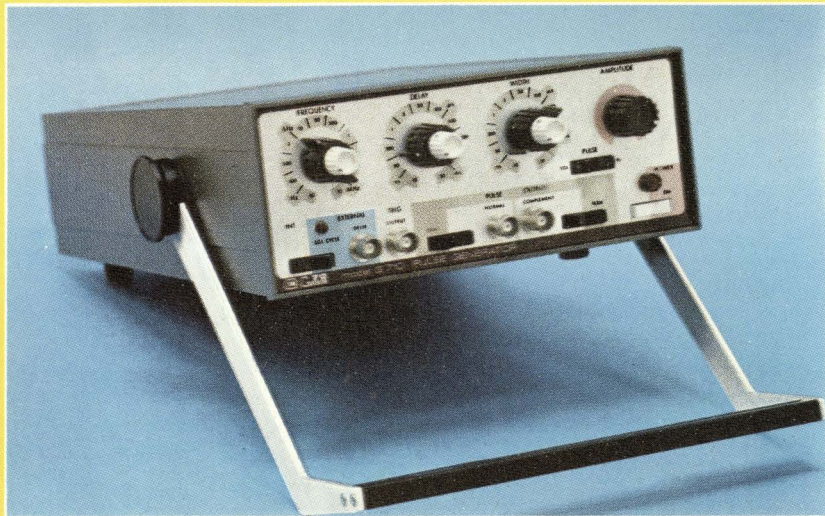

Here are the facts about GENERATION 70™, a revolutionary new series of test instruments from E-H Research Laboratories, which will offer maximum performance at minimum cost to the user.

The first instrument in the Generation 70 Series is E-H Model G710, a 50 MHz pulse generator for only \$395! That boils down to \$7.90 per MHz! Where else could you get such high performance at such a price? Other features of the Model G710 include dual outputs with amplitudes to 5V into 50 ohms, rise and fall times of 5 ns, duty factor greater than 50%, external triggering and waveform distortion less than

5% peak-to-peak. It weighs 7 lbs. and measures only 3½" x 8½" x 12" in size.

Like all other Generation 70 instruments to come, the Model G710 will also feature no internal adjustments, no special parts (which means replacement parts are available from shelves of local distributors), and no recalibration procedures. Add to all this a One-Year Guarantee of Performance, One-Year Free Service and a price tag of \$395. Unbelievable? E-H believes their new Generation 70 instruments to be so superior that they're offering you a 5-Day Free Trial. So what can you lose? Clip out the coupon below or call your E-H Representative today and order one—or three or four.

Try us!



515 11th Street • Box 1289, Oakland, California 94604 • (415) 834-3030

Dear Sir:

- Here is a purchase order. Please ship me _____ \$395 Model G710 pulsers for a 5-day free trial.
- Sounds interesting. Please have an E-H Representative contact me.
- I'm still not convinced. Please mail me more information.

Name _____ Title _____

Company _____

Address _____ Telephone _____

City _____ State _____ Zip _____



When you're adding a new "twist" to tornado tracking...

Symbolic representation of global weather as plotted by Burroughs ILLIAC IV computer.

bring ERIE in early.

Cyclone off Ceylon. 17-inch snow at Salem. Tropical storm in Trinidad. World-wide weather reports? No, forecasts! Made four days in advance... with the same accuracy as present one-day predictions. That's just one of the superscale jobs possible with the incredible new ILLIAC IV computer designed by the University of Illinois and built by Burroughs Corporation. Unlike conventional computers that process serially, ILLIAC IV utilizes parallel processing... crunching numbers on many matrix problems or differential equations simultaneously, and at super speeds. From the start, ERIE engineers have worked closely with Burroughs to develop the highly-sophisticated resistor/capacitor and resistor modules at the heart of ILLIAC IV. Proof, once again, that it pays to bring ERIE in early.

ERIE TECHNOLOGICAL PRODUCTS, INC.
644 West 12th Street, Erie, Pennsylvania 16512
(814) 453-5611

Circle 140 on reader service card

New products

Data handling

Shift register is programable

Dynamic MOS unit accommodates any length from 233 to 512 bits

Because bit lengths for shift registers vary with applications, demands for custom-built circuits abound. But custom shift register

ICs cost anywhere from \$15,000 to \$40,000 per design and require several months lead time. To make it easier—as well as faster and cheaper—for customers to obtain nonstandard shift registers, Texas Instruments has introduced a “programable” two-phase dynamic MOS shift register, the TMS3401, that can accommodate any bit length from 233 to 512. Price per bit is less than 1 cent when the circuit is purchased in large quantities, and normal delivery time is six to eight weeks. Programming the bit length is accomplished by changing a single photomask during the manufacturing process.

To minimize cost, says Daniel

Baudouin, program manager for new MOS standard products, TI engineers selected 512 bits as the register's maximum length; a longer configuration, such as 1,024 bits, “was tempting, but the price was too high,” Baudouin explains, because the larger chip size would decrease yield. To further reduce chip size—and to make the circuit faster at the same time—TI selected a ratioless two-phase circuit design. The resulting chip is small for a circuit of such complexity, 117 by 113 mils, and is about two-thirds the size of the equivalent ratio circuit. Moreover, with a maximum shift rate of 5 megahertz, the circuit is one of the fastest

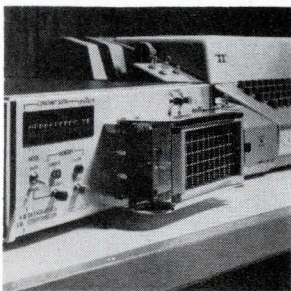

Time-sharing/instrument data transfer system DGC-301 couples various instruments to a remote computer via a time-sharing terminal. It accepts BCD data from various digital measuring instruments, stores the data in memory, decodes the data and presents it to the time-sharing terminal. The memory is loaded within 1 μ s. Data Graphics Corp., Speedway Dr., San Antonio, Texas [341]

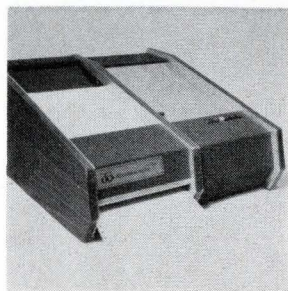

Remote terminal printer designated Typeliner model III is available with 80 columns of upper and lower case alphabetic and standard ASCII 64 character set. It may be used with CRT terminals with plug-to-plug compatibility and with any modem. Print speed is 100 lines per minute. Printout is on pinfeed, fanfold paper. Data Computing Inc., W. Shangri-La Rd., Phoenix [342]

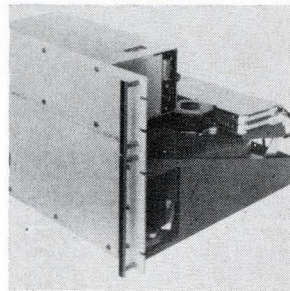

Disk memory 7207 is a head-per-track unit that has 128 heads with an average access time of 16.4 milliseconds. It maintains the plug-compatible feature of all the company's memories, which allows field expansion of the memory without danger of data loss. Unit price is \$17,000 and OEM quantity prices are as low as \$11,000. Data Disc Inc., 1275 California Ave., Palo Alto, Calif. [343]

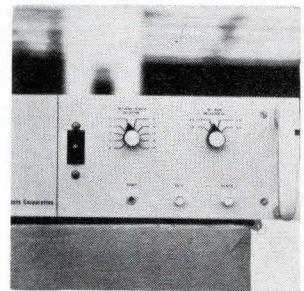

Pseudo-random pattern generator model 112 is for testing digital transmission equipment typically used for telephone line communication or telemetry. It provides selectable bit rates of 1.2, 2.4, 4.8, and 9.6 kHz. The pseudo-random pattern length is programmable by switch selection in binary steps from 1,024 to 524,688 bits. Digital Products Corp., Ft. Lauderdale, Fla. [344]

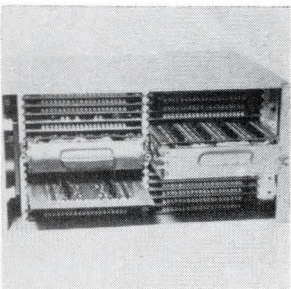

Random access computer mainframe memory system, the Comrac 1010, features 900 nanosecond full cycle time, 350 ns access time and field expandability from 8K x 36 to 32K x 36. The memory system uses 3D selection and fast switching 22-mil cores for high speed and density. Operating temperature is 0° to 50°C. Information Control Corp., 9610 Bellanca Ave., Los Angeles [345]

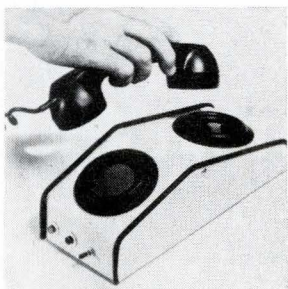

Acoustic/magnetic data coupler IT-332A operates at a maximum of 300 baud for both transmit and receive mode, full on half duplex. It can interface Bell System 103 Series modems through the telephone system. It comes with an interconnection cable for the model 33 Teletype by pre-wired plug connections. ITI Electronics Inc., 369 Lexington Ave., Clifton, N.J. [346]

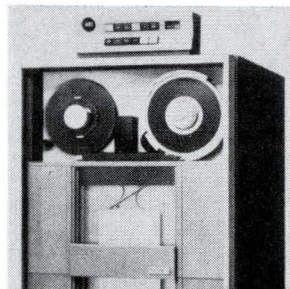

Magnetic tape systems 20291 and 20292 are automatic loading, high-speed drives that operate at speeds of from 75-120 in./s and 120-200 in./s, respectively. They are available with read/write electronics for 800 b/in. non-return-to-zero-inverted, 1600 b/in. phase-encoded, and dual (800/1600 b/in.) density recording. Bucode Inc., 175 Engineers Rd., Hauppauge, N.Y. [347]

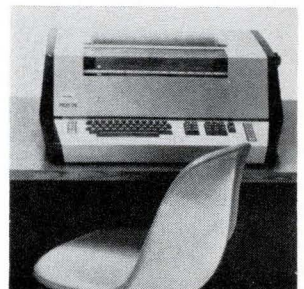

Programmable data terminal model 711 is a remote batch intelligent terminal with an integral 1200 baud modem and universal input/output, computer-type printer, and a standard 4 K (512 bytes) core memory expandable to 32 K. It is capable of operating attended or unattended. Single unit price is \$12,500. Daedalus Computer Products Inc., P. O. Box 248, North Syracuse, N.Y. [348]

New products

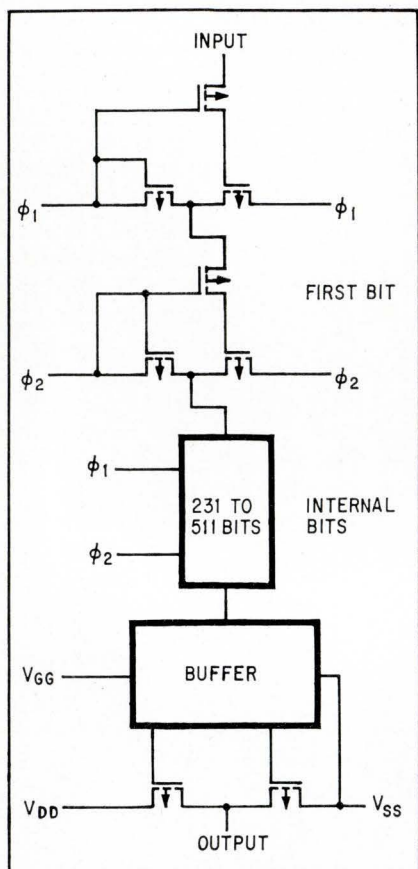

Adaptable. Programming of bit length is controlled by a single photomask.

large-bit-length shift registers.

Low-threshold silicon nitride technology is used, so that the device can interface directly with TTL circuitry; no external resistors on input or output are needed. The chip contains two internal diffused resistors, one 6 kilohms and the other 1.5 kΩ. Either can be connected to the input, if desired, to increase noise margin. Power supplies of +5 and -12 volts are required. Dissipation is 0.1 milliwatt per bit at a 1-MHz shift rate.

The TMS3401 also is available as a standard 512-bit device at a unit price of \$5 in 100 to 249 quantities; units can be delivered from stock in evaluation quantities. In the non-standard bit lengths from 233 to 512 bits, there is a \$2,000 mask charge; minimum-quantity order is 1,000.

Texas Instruments Inc., Inquiry Answering Service, P.O. Box 5012, M.S. 308, Dallas, Texas 75222 [349]

Get four FREE transistors from your authorized GE semiconductor distributor

ALABAMA	MARYLAND	OHIO
Birmingham Forbes Distributing Co. (205) 251-4104	Baltimore Kann-Ellert Electronics, Inc. (301) 889-4242	Akron Sun Radio Co., Inc. (216) 434-2171
Huntsville Cramer/Huntsville, Inc. (205) 536-4493	Hanover Hamilton/Avnet Electronics (301) 796-5000	Cincinnati Hughes-Peters, Inc. (513) 351-2000
Electronic Wholesalers, Inc. (205) 534-2461	Rockville Cramer/Washington, Inc. (301) 424-2700	Cleveland Pioneer-Standard Electronics, Inc. (216) 432-0010
PHOENIX	Salisbury Schweber Electronics (301) 427-4977	Columbus Pioneer-Standard Electronics, Inc. (614) 299-4161
Hamilton/Avnet Electronics (602) 272-2601	Almo Industrial Electronics (301) 742-1393	Hughes-Peters, Inc. (614) 294-5351
Kierulff Electronics, Inc. (602) 273-7331	MASSACHUSETTS	Dayton Pioneer-Dayton (513) 236-9900
ARIZONA	Dedham Gerber Electronics (617) 329-2400	Toledo Warren Radio Co. (419) 248-3364
Little Rock Carlton-Bates Co. (501) 375-5375	Newton Cramer Electronics, Inc. (617) 969-7700	OKLAHOMA
CALIFORNIA	Springfield T. F. Cushing, Inc. (413) 788-7341	Oklahoma City Trice Wholesale Electronics (405) 524-4415
Culver City Hamilton Electro Sales (213) 870-3301	Walworth Schweber Electronics (617) 891-8484	Tulsa Oil Capitol Electronics Corp. (918) 836-2541
El Monte G. S. Marshall Company (213) 686-1500	MICHIGAN	PENNSYLVANIA
Los Angeles Kierulff Electronics, Inc. (213) 685-5511	Detroit Radio Specialties Co. (313) 491-1012	Philadelphia Almo Electronics Corp. (215) 676-6000
Mountain View Brill Electronics (415) 961-1500	Grand Rapids Newark-Industrial Electronics (616) 452-1411	Pittsburgh R.P.C. Electronics (412) 782-3770
Elmer Electronics (415) 961-3611	Redford Semiconductor Specialists, Inc. (313) 255-0300	Semiconductor Specialists, Inc. (412) 781-8120
Hamilton/Avnet Electronics (415) 961-7000	MINNESOTA	York Rosen Electronics Co. (717) 843-3875
Oakland Brill Electronics (415) 834-5888	Edina Lev Bonn Company (612) 941-2770	RHODE ISLAND
Palo Alto Kierulff Electronics, Inc. (415) 968-6292	Minneapolis Semiconductor Specialists, Inc. (612) 866-3434	Providence W. H. Edwards Co. (401) 781-8000
Riverside Electronic Supply (714) 682-8110	St. Paul Gopher Electronics Co. (612) 645-0241	SOUTH CAROLINA
San Diego Hamilton/Avnet Electronics (714) 279-2421	JACKSON	Columbia Radio Radio Supply Co., Inc. (803) 253-5333
Kierulff Electronics, Inc. (714) 278-2112	Ellington Electronic Supply, Inc. (601) 355-0561	Greenville Dixie Radio Supply Co., Inc. (803) 239-1328
G. S. Marshall Company (213) 686-1500	MISSOURI	TENNESSEE
Western Radio & TV Supply (714) 239-0361	Hazelwood Hamilton/Avnet (314) 731-1144	Chattanooga Harpe Electronics Distributors, Inc. (615) 267-2381
COLORADO	Kansas City Radio Lab, Inc. (816) 421-0171	Kingsport Radio Electric Supply Co. (615) 247-8111
Denver Electronic Parts Co. (303) 266-3755	North Kansas City ESI Semiconductors, Inc. (816) 421-8400	Memphis Bluff City Distributing Co. (901) 276-4501
Hamilton/Avnet Electronics (303) 443-8551	St. Louis Olive Industrial Electronics (314) 863-7800	Nashville Electra Distributing Co. (615) 255-8444
L. B. Walker Radio Co. (303) 935-2401	NEBRASKA	TEXAS
CONNECTICUT	Lincoln Scott Electronic Supply Corp. (402) 434-8308	Arco Electronics (214) 239-9122
North Haven Cramer/Connecticut (203) 239-5641	Omaha Radio Equipment Co. (402) 341-7700	Hamilton/Avnet Electronics (214) 638-0900
Norwalk Arrow Electronics (203) 838-4851	NEW JERSEY	Sterling Electronics (214) 357-9131
Waterbury Bond Radio Electronics, Inc. (203) 753-1184	Camden General Radio Supply Co., Inc. (609) 964-8560	El Paso McNicol, Inc. (915) 566-2936
DELAWARE	Cedar Grove Hamilton/Avnet Electronics (201) 239-0800	Midland Specialty Co. (915) 533-9555
Wilmington Almo Industrial Electronics (302) 656-9467	Cherry Hill Hamilton/Avnet Electronics (609) 662-9337	Houston Hamilton/Avnet Electronics (713) 526-4661
FLORIDA	Mt. Ephraim Almo Industrial Electronics (609) 933-3800	Sterling Electronics (713) 623-6600
Ft. Lauderdale Cramer/Florida, Inc. (305) 566-7511	Pennsauken Cramer/Pennsylvania, Inc. (215) 923-5950	DALLAS
Hollywood Electronic Wholesalers, Inc. (305) 923-8181	Totowa Arrow Electronics, Inc. (201) 256-7331	Arco Electronics (214) 239-9122
Schweber Electronics (305) 927-0511	NEW MEXICO	Hamilton/Avnet Electronics (214) 638-0900
Orlando Electronic Wholesalers, Inc. (305) 841-1550	Albuquerque Kierulff Electronics, Inc. (505) 268-3901	Sterling Electronics (214) 357-9131
Hammond Electronics (305) 241-6601	Sterling Electronics, Inc. (505) 247-2486	EL PASO
GEORGIA	NEW YORK	McNicol, Inc. (915) 566-2936
Atlanta Jackson Electronics Co. (404) 355-2223	Buffalo Standard Electronics, Inc. (716) 685-4320	Midland Specialty Co. (915) 533-9555
ILLINOIS	Endicott Standard Electronics, Inc. (607) 754-3102	Sterling Electronics (713) 623-6600
Chicago Electronic Distributors, Inc. (312) 283-4800	Farmingdale, L. I. Arrow Electronics, Inc. (516) 694-6800	DALLAS
Newark Electronics Corp. (312) 638-4411	Hauppauge Cramer/Long Island (516) 231-5600	Arco Electronics (214) 239-9122
Semiconductor Specialists, Inc. (312) 279-1000	Rochester Cramer/Rochester (716) 275-0300	Hamilton/Avnet Electronics (214) 638-0900
Schiller Park Hamilton/Avnet Electronics (312) 678-6310	Syracuse Rochester Radio Supply Co. (716) 454-7800	Sterling Electronics (214) 357-9131
INDIANA	Rome Rome Electronics, Inc. (315) 337-5400	Houston Hamilton/Avnet Electronics (713) 526-4661
Evansville Ohio Valley Sound (812) 425-6173	Syracuse Cramer/Syracuse (315) 437-6671	Sterling Electronics (713) 623-6600
Indianapolis Graham Electronics, Inc. (317) 634-8486	Westbury, L. I. Schweber Electronics (516) 334-7474	DALLAS
Graham Electronics, Inc. (317) 634-8486	Yorville Valley Industrial Electronics, Inc. (315) 736-3393	Arco Electronics (214) 239-9122
Semiconductor Specialists, Inc. (317) 243-8271	NORTH CAROLINA	Hamilton/Avnet Electronics (214) 638-0900
IOWA	Charlotte Dixie Radio Supply Co. (704) 377-5413	Sterling Electronics (214) 357-9131
Cedar Rapids Deeco, Inc. (319) 365-7551	Raleigh Southeastern Radio Supply Co., Inc. (919) 828-2311	Sterling Electronics (214) 357-9131
KANSAS	Winston-Salem Electronic Wholesalers, Inc. (919) 725-8711	EL PASO
Wichita Interstate Electronics Supply Corp. (316) 264-6318	LOUISIANA	Arco Electronics (214) 239-9122
KENTUCKY	Lafayette Ralph's of Lafayette (318) 234-4507	Hamilton/Avnet Electronics (214) 638-0900
Louisville P. I. Burks Co. (502) 583-2871	New Orleans EPCOR (504) 486-7441	Sterling Electronics (214) 357-9131
LOUISIANA	Sterling Electronics, Inc. (504) 522-8726	EL PASO
Lafayette Ralph's of Lafayette (318) 234-4507	MAINE	Arco Electronics (214) 239-9122
New Orleans EPCOR (504) 486-7441	Portland Holmes Distributors, Inc. (207) 774-5901	Hamilton/Avnet Electronics (214) 638-0900
Sterling Electronics, Inc. (504) 522-8726		Sterling Electronics (214) 357-9131

GENERAL ELECTRIC

221-31

FREE EPOXY TO-18 TRANSISTORS

Present or mail this coupon to your authorized GE semiconductor distributor for up to four free transistors. Just enter the quantities opposite the type numbers below (maximum of four).

Type No.	Qty.	Type No.	Qty.	Type No.	Qty.	Type No.	Qty.	Type No.	Qty.	Type No.	Qty.	Type No.	Qty.	
2N6000		2N6004		2N6010		2N6014		GET706		GET930		GET2222A		GET3014
2N6001		2N6005		2N6011		2N6015		GET708		GET22221		GET2369		GET3638
2N6002		2N6006		2N6012		2N6016		GET914		GET2221A		GET2484		GET3638A
2N6003		2N6007		2N6013		2N6017		GET929		GET2222		GET3013		GET3646

Name _____ Firm _____

Position _____ Street _____ City _____

State _____ Zip _____ Distributor's Name _____

Offer expires November 31, 1970

C

General Electric's new epoxy TO-18 transistors run hot and cold

**FREE
SAMPLES**

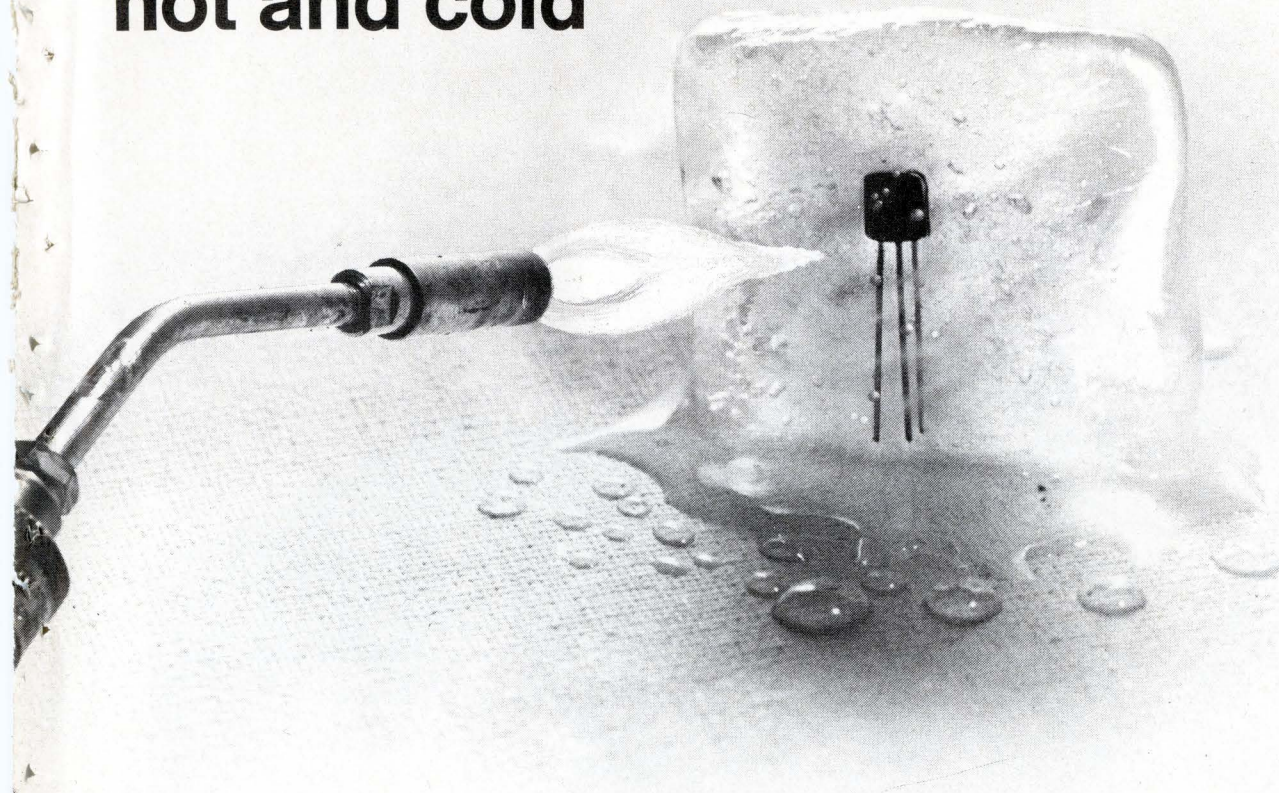

✓ **PASSED**
85C @ 85% R.H.

✓ **PASSED**
-65 to +150C
temperature cycling
MIL TEST

General Electric has just introduced 32 new TO-18 based epoxy transistors. And we know they're good. We've tested them over and over again. Tests like temperature cycling from -65C to +150C. Not just a few times . . . but 300 times. That's 30-times the normal MIL requirement for reliability.

We've subjected these new epoxy transistors to other tests, too, such as 85C at 85% relative humidity for up to 8000 hours just to find out how reliable they really are.

GE's epoxy TO-18 transistors can take the bumps, too. No need to worry about shock or vibration damage. Their solid epoxy encapsulant provides rigid mechanical stability . . . seals trouble out and performance in.

We've got 16 new JEDEC types and many new GET replacement devices that will substitute for common 2N types with no redesign at all. We're adding more new types every month. They're available in NPN's, PNP's, matched pairs and Darlington amps with breakdown ratings up to 60V and dissipation as high as 500 mw.

We've tested these transistors in every way possible. See the results for yourself in our new reliability brochure (Pub. #95.28). We'll send

the brochure along with four free samples for testing in your circuits. Prove to yourself that GE's new epoxy TO-18 transistors meet all your transistor requirements.

To get your four free samples, specification sheets and reliability brochure, fill out the coupon on the opposite page and mail it to your authorized GE Semiconductor distributor shown on the list. We think you'll find that GE's new epoxy TO-18 transistors meet your reliability standards with ease. 221-30

Pd mW	Ic mA	NPN				PNP					
		JEDEC Type	hFE			Noise fig. dB (max)	JEDEC Type	hFE			
			Ic=1 Vce=1V	Ic=300 Vce=2V	Ic=800 Vce=5V			Ic=1 Vce=-1V	Ic=300 Vce=-2V	Ic=800 Vce=-5V	
400†	500	2N6000	50	40		3.0	2N6001	90	35		3.0
400††	500	2N6002	130	80		2.0	2N6003	210	50		1.5
400†††	500	2N6004	50	40		3.0	2N6005	90	35		3.0
400†††	500	2N6006	130	80		2.0	2N6007	210	50		1.5
500†††	800	2N6010	45	85	45	5.0	2N6011	70	65	45	3.0
500†††	800	2N6012	90	160	50	3.0	2N6013	180	135	70	2.0
500††††	800	2N6014	45	65	15	5.0	2N6015	70	60	35	3.0
500†††††	800	2N6016	90	60	15	3.0	2N6017	180	125	55	2.0

† BVcEo=25V; †† BVcEo=40V; ††† BVcEo=60V

GE Type	Replaces	GE Type	Replaces	GE Type	Replaces
GET706	2N706	GET2221A	2N2221A	GET3013	2N3013
GET708	2N708	GET2222	2N2222	GET3014	2N3014
GET914	2N914	GET2222A	2N2222A	GET3638	2N3638
GET929	2N929	GET2369	2N2369	GET3638A	2N3638A
GET930	2N930	GET2484	2N2484	GET3646	2N3646
GET2221	2N2221				

GENERAL ELECTRIC



**You'll get
the direct print paper
on the right faster.**

There's no need for "hurry" stamps on Astroprint oscillographic papers. Easy ordering and direct delivery are part of the package.

You also get a direct print, orthochromatic paper unsurpassed for

trace density, instant pop-up (less than 1 second), excellent image stability and sharp contrast. On mercury vapor, Xenon, and cathode ray light sources.

Astroprint DP 90 (for open magazine applications) and DP 80 (for closed magazines).

As a starter, test us for delivery and cost. Just call your local Xerox Product Specialist or write to Xerox Corporation, Dept. HL, Rochester, New York 14603.

The paper will prove itself.

XEROX

Xerox and Astroprint are registered trademarks of Xerox Corporation.

New products

Semiconductors

Dual-polarity IC regulator

Monolithic unit provides ± 15 V at up to 100 mA; zener diode is reference

Almost every circuit design that contains operational amplifiers requires dual-polarity voltage regulation. Silicon General Inc. in West-

minster, Calif., has introduced what it says is the first monolithic tracking voltage regulator on the market to feature dual polarity. Its output voltage is internally preset, but a single external potentiometer can be adjusted to change both outputs simultaneously over a range of 8-25 volts.

Three versions of the device, which will provide plus and minus outputs of 15 V at currents up to 100 milliamperes, are available. The SG1501 operates over the full military temperature range of -55 to $+125^\circ$ C; the SG2501 and SG3501 are intended for commercial applications at 0 to 70° C.

In designing the regulator, Ro-

bert Mammano, vice president for engineering, set out to correct some of the problems that beset previous monolithic units. For example, says Mammano, a lot of outboard components are usually required but the SG1501 only needs an external current-limiting resistor and two stabilizing capacitors for each side of the dual regulator—a total of two external resistors and four capacitors.

Another problem with other monolithic regulators has been thermal gradients on the chip. These cause shifts in output that affect various circuit components, each of which has a different temperature coefficient. According to Mammano, the

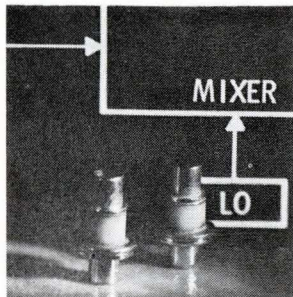

Single-sideband, Schottky-barrier mixer diodes designated MD0189-191 and MD0219-221 feature noise figures ranging from 6 to 8 decibels. They use silicon as the basic material with the wafers encased in a double-ended microwave pill prong package. Capacitance is 0.18 pF. Inductance is 0.40 nH. Price ranges from \$20 to \$50. Texas Instruments Inc., Box 5012, Dallas [436]

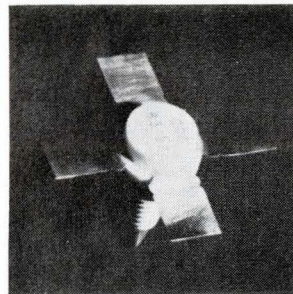

Three compatible 12-V vhf communications transistors withstand infinite VSWR through all phase angles. Aimed at the land mobile communications markets, they are designated B3-12 (3 W with 10 dB gain), B12-12 (12 W with 0.8 dB gain) and B25-12 (25 W with 6.2 dB gain). Price (100 up) is \$37.82. Communications Transistor Corp., 301 Industrial Way, San Carlos, Calif. [440]

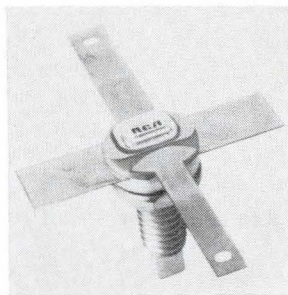

Silicon npn, rf power transistor type 2N5918 is an emitter-balanced overlay type for vhf/uhf communications equipment. It features 10 W output at 400 MHz (8 dB minimum gain). Collector-to-emitter voltage with base open is 30 V; collector-to-base voltage 60 V; emitter-to-base voltage 4 V; continuous collector current, 0.75A. RCA, Solid State Division, Somerville, N.J. 08876 [437]



Pnp, diffused alloy power germanium transistors feature high current capabilities and fast switching times. Series 2N2294-95-96 come in a lugged TO-41 case; the 2N1073-A-B and 2N2288-93, in a TO-3 case. Collector current is 20 A maximum with high gain. Collector-emitter saturation voltage is as low as 0.4 V. Solitron Devices Inc., 1177 Blue Heron Blvd., Riviera Beach, Fla. [441]

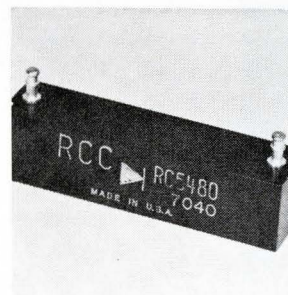

High-voltage rectifiers series RC-5477-RC5481 feature a forward rectifier current rating of 1 ampere at 55° C case temperature with voltage types from 5,000 to 10,000 volts. They differ only in surge current rating from the JEDEC registered types (50 amperes peak for the RC series rather than 80 amperes peak). Rectifier Components Corp., 124 Albany Ave., Freeport, N.Y. [438]

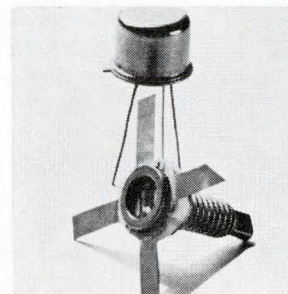

Microwave power transistors are available in TO-39 packages or hermetically sealed stripline stud packages. Operating range is from 175 MHz in the vhf band through the L and S bands to 2 GHz. Units can produce up to 10 watts of output power with a minimum of 6 dB gain at 1 GHz. Prices in lots of 100 to 999 range from \$3.18 to \$48. Raytheon Co., Mountain View, Calif. [442]

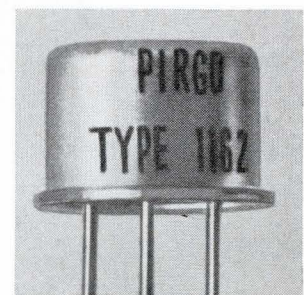

Monolithic Darlington power transistor type 1162 will dissipate 5 W. Peak collector current is 10 A with a continuous collector current of 7 A. Minimum gain is 2500. Typical applications include driving transducers from ICs in displays, thermal printers, chain printers, and relays. Price is \$22.50 each in 1-99 lots. Pirgo Electronics Inc., 130 Central Ave., Farmingdale, N.Y. [439]

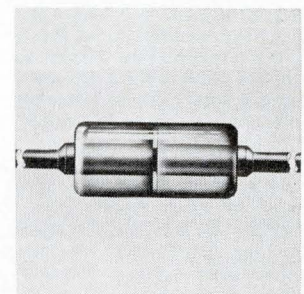

Varactor tuning diode 6702A combines the best features of a low-inductance package with varactor diode performance in glass for use up to 2.5 GHz. It is a 10% tolerance device rated at 2.2 pF at -4 V with a Q of 700. It has a breakdown rating of 25V at 1 μ A dc. Price in 100 to 999 lots is \$6.72 each. MSI Electronics Inc., 34-32 57th St., Woodside, N.Y. [443]

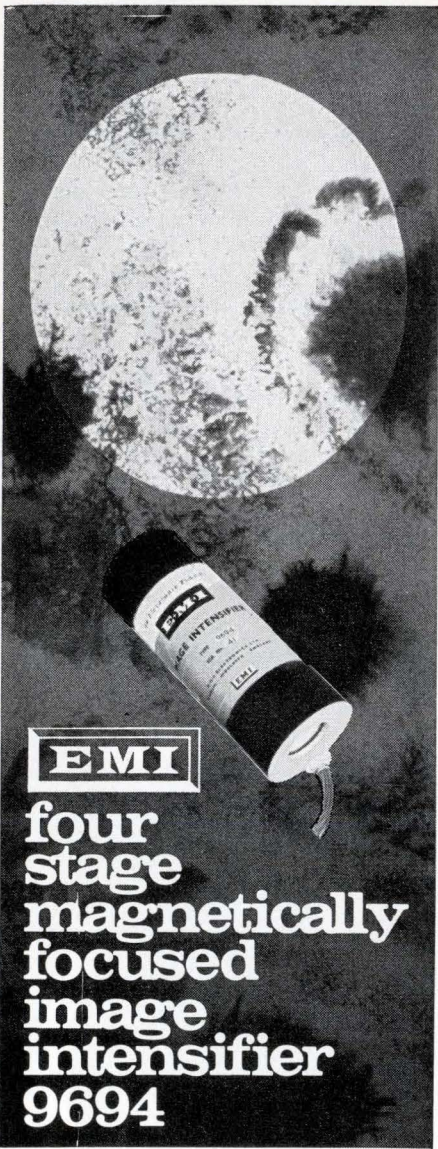

... offers an overall light gain of 10^6 with a typical background of 10^{-10} lumens/cm². (light equivalent input.)

Typical operating voltage for these conditions is 40kV. The background indicated is for a tube having bialkali photocathodes.—tubes are also available with a range of S-20 cathodes for use out to 8,000 Angstroms. Input and output windows are flat Zinc crown glass, 50 mm diameter. Type 9693 is available with sapphire input window for use in the UV. Developmental types are now being made with fibre optic windows. All present types are furnished with P-11 phosphors throughout although other types of phosphors are under investigation □ Tubes are normally supplied potted in silicon rubber and a number of variations are available. A complete package, including electromagnet, divider chain, high voltage power supply and magnet supply is offered. A permanent magnet is also available □ An extensive technical manual, as well as useful application notes, are available on request. Write on your company letter-head to:

GENCOM DIVISION
varian/EMI

80 EXPRESS STREET, PLAINVIEW, N. Y. 11803
TELEPHONE: (516) 433-5900

New products

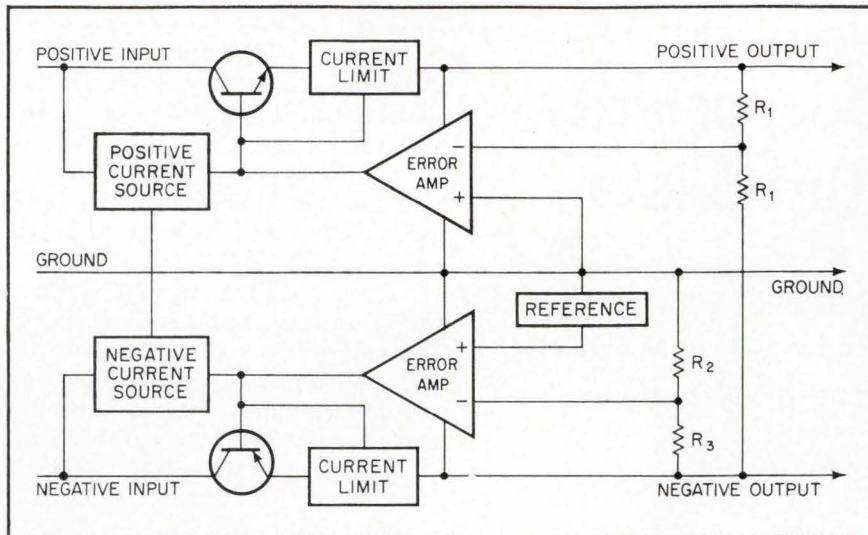

Balanced. Dual-polarity regulating circuit provides plus and minus outputs at up to 100 mA. Design has provision for adjustable current limiting.

voltage reference was partly responsible. "It's been a question of how to get zero-temperature-coefficient reference voltage when the reference element included several components that had to compensate for each other's temperatures," he says. Silicon General's solution is a double-anode, 6.3 V zener diode with zero temperature coefficient. This assures compatibility with standard processing and makes the reference voltage independent of chip temperature.

Mammano also points out that in earlier monolithic devices the resistors that set the exact output voltage were left outside because their positive temperature coefficients caused output voltage shifts when heat unbalanced them in use. The company managed, however, to use internal resistors by regulating the negative voltage output against the reference, and by setting the positive voltage output equal to the negative output to provide good tracking.

Further, the error sensors—the differential amplifiers—on both sides of the regulator are far enough away from the power transistors to heat up uniformly and at the same time as the chip temperature rises in use. This also helps prevent output voltage shifts.

The output voltage is balanced to within 1%, allowing only 150 mV

of differential between the positive and negative sides. Minimum input-output differential is 2 V. Line and load regulation of 0.01% is offered and the maximum temperature variation is 1%. Standby current drain is less than 3 mA.

The SG1501 will sell for \$9.80 each in quantities of 100; the 2501 price for 100-unit quantities is \$6.75, and the 3501 will sell for \$4.80. Delivery is from stock. TO-100 or 14-lead dual in-line packages are available.

Silicon General Inc., 7382 Bolsa Ave., Westminster, Calif., 92683 [444]

Single chip for LED displays
holds counter, latch, decoder

One goal before the manufacturers of components for solid state numeric displays is to integrate the addressing circuits on a single chip, so that the circuit area can be shrunk and at the same time, cost-effective power sharing can be made available.

A big step in this direction has been taken by the Motorola Semiconductor Products division with its MC4050, a transistor-transistor-logic circuit that integrates the functions of a decade counter, a 4-bit latch, and a 7-segment decoder/driver in a 54-gate

The mind easer...



- You never worry about what it's doing to the circuit
- You forget about zero adjusting forever

The Digilin Type 340 Digital Multimeter eliminates the two major causes of multimeter fretting in one low-cost, high-performance meter. First, the exclusive new Digilin Input Amplifier Technique (patent pending) does away with circuit loading *throughout* the test function. Forget about transient noise creeping in when impedance drops during the measurement cycle—a worry that always nags you when such input techniques as dual slope integration and chopper-stabilized ampli-

fiers are used. The 340 never disturbs the circuit ever. And with a 340, you'll never short another lead and adjust for zero again. Before every measurement cycle, the 340 does it for you—automatically, precisely, leaving no doubt about whether it was done right.

Only with Digilin do you get these features, and the 3½-digit, 0.1%-accuracy Digilin 340 gives you lots more: Award winning design (1969 WESCON Industrial Design Competition) • Automatic

polarity • Pushbutton ranging • High visibility, no-blink display • only 3 pounds • Assured reliability by Digilin 100-hour burn-in and factory test. \$375 complete in single units. Need battery-powered flexibility? Digilin 341 with same features plus battery supply at \$445. Digilin Type 340. The mind easer. It's an eye pleaser, too.

Get more information—or no-obligation demonstration. Call or write Digilin today. Digilin Inc., 6533 San Fernando Rd., Glendale, California 91201. Tel. 213-246-8161.

digilin
DIGITAL INSTRUMENTS



If you can't stand the heat ...

stay out of the kitchen!



Here are components that stand the heat ... and the cold (-55°C to $+125^{\circ}\text{C}$) without voltage de-rating. The dissipation curve is as flat as a pancake ... and the other specs are out of this world. Maybe your recipe calls for

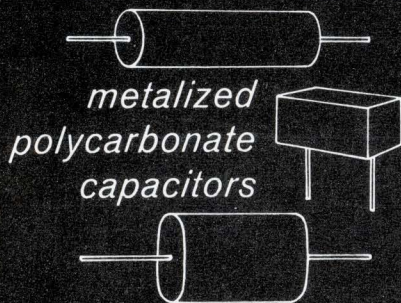

Try Standard's PC2-E (Rectangular Epoxy) and PC2-W (Wrap and Fill).

Send for Catalog and complete details.

Standard

CONDENSER CORPORATION

Dept. E-10

1065 West Addison Street
Chicago, Illinois 60613 • (312) 327-5440

New products

unit. In the plastic-packaged version, the unit will sell for \$9 in quantities of 100, whereas the three devices in the company's TTL 7400 series that together do the same job cost a total of \$14.09 in lots of 100.

Ron Treadway, design section head for new product development at Motorola's IC center in Mesa, Ariz., says the counter design is the most unusual part of the circuit. Conventional counter designs, he says, start with four flip-flops, with serial or parallel counters between them. Motorola, however, employs a parallel counter scheme, for which it uses four latches and the associated steering, instead of four flip-flops and associated steering. The result is to eliminate eight gates from the parallel counter design.

The latch and decoder/driver portions of the circuit are fairly conventional. First, data is fed into an AND/OR circuit in the counter, then fed into the 4-bit latch by a positive-going clock. At the same time, the latch input is disabled by a negative-going clock. Treadway says the latch "is essentially a 4-bit storage device that locks the data from the counter for the duration of the clock pulse in which the counter was disabled."

One of the counter's features is that, when the display is reset, any zeros that occur in front of the first significant digit in a multi-digit display are blanked out. This makes it easier to read the display accurately. There's also a lamp test input in the decoder/driver section to check the condition of the display, and a lamp-blanking input is offered for intensity modulation.

Die size was kept down to 94 square mils by the use of two-layer metalization—and without this process, Motorola engineers say, the device couldn't have been built economically. They foresee a substantial market for unpackaged MC4050 chips that the user can put into the same hybrid package as the light emitters (one MC4050 is required for each digit in a display).

The decoder/driver provides up to 40 mA of drive for displays that require current sinking in the low or "0" state, which is 0.4 volts. (Motorola officials say the 40 mA figure compares with the 3 milli-ampere limit of MOS devices that also integrate the counter/latch/decoder function on one chip.) Total power dissipation is typically 450 milliwatts and maximum toggle frequency is 35 megahertz.

The medium-scale integrated unit is available from stock in either a 16-pin dual in-line ceramic (MC4050L) or plastic (MC4050P) package, and is designed to operate over the $0-75^{\circ}\text{C}$ temperature range. It will be followed by the MC4350, intended for the full military temperature range of -55°C to $+125^{\circ}\text{C}$.

Motorola Semiconductor Products Inc.,
Box 955, Phoenix, Ariz. 85001 [445]

MSI multiplexer added to standard product line

Semiconductor manufacturers are starting to produce as standard products devices that used to be considered part of the custom market. The latest example is a medium-scale integrated device from Signetics Corp.

Signetics has developed a digital integrated circuit gating array which functions like a four-pole three-position switch, says Jerry Markus, digital product marketing manager. The array is a three-input, four-bit multiplexer, the newest addition to the company's DCL (designer's choice logic) line.

"Four bits of digital data are selected from one of three inputs," says Markus, "and the input to be active is determined by a two-bit channel selection code." The "data complement" input can invert data or allow straight data flow by controlling a complement circuit at the multiplexer's output.

The multiplexer comes in two versions: the 8263 employs active pullup output structures to effect minimum delays, and the 8264 utilizes bare collector outputs for



Improving the leader...Split-Field Optics

A new high-accuracy alignment system on the Tempress Model D Automatic Scribing Machine dramatically increases scribing efficiency. The unique Tempress split-field alignment microscope reduces set-up time by 90%. Fast, repeatable alignment, to 50 millionths of an inch accuracy, allows narrower scribe streets, resulting in more devices per wafer. This superb instrument, although compact in size, incorporates the finest advanced optical design features. It provides 75 \times magnification, built-in high-intensity illumination, built-in focusing mechanism, built-in movable reticle, and wide-field high-eyepoint binocular viewing. Adjustable objective

spacing permits optimum accuracy, regardless of wafer size. The MODEL D Automatic Scribing Machine with split-field optics reflects the world renowned Tempress Standard of Excellence in the manufacture of miniature assembly tools and production machines for the semiconductor and microelectronics industries.



TEMPRESS

TEMPRESS INDUSTRIES INC. 990 UNIVERSITY AVENUE,
LOS GATOS, CALIFORNIA 95030, USA TEL: 408 356 8151



Leave my power supply system alone! You can get your own in only 9 days from Acopian.

"I tried struggling through that old power supply system catalog. It was like a jigsaw puzzle, hunting for the pieces I needed for my new power system. There had to be a better way.

"Then I remembered the Acopian hotline. I called it. I told them the DC voltages and currents I wanted. Discussed panel size. Meters. Switches. And other accessories.

"They gave me a firm price. Right on the phone. It was a lot less than I expected. I had our buyer phone in the P.O. And Acopian designed,

built, tested and shipped it in nine days. Completely wired.

"So go order your own Acopian power system . . . It's easy!"

HOW TO ORDER ACOPIAN POWER SYSTEMS

- Call Acopian collect
- Tell us the outputs and accessories you need
- Get a firm price
- Shipment of completely wired system will be made in 9 days.

For immediate service, call the Acopian hotline: (215) 258-5441. For literature, write Acopian Corp., Easton, Pa. 18042. And remember, Acopian also offers 82,000 different DC power modules, every one shipped with this tag . . .



New products

expansion of input terms.

According to Markus, one application for the 8263 multiplexer is as a variable modulus counter where the multiplexer is combined with the Signetics 8281 four-bit binary counter and the Signetics 8270 four-bit shift register. "Here," says Markus, "the shift register acts as a three-register memory; the register's outputs are fed to the corresponding multiplexer inputs. Three different presettable four-bit words can be chosen by the multiplexer, and when the channel select codes are alternated, the binary counter is preset with one of three words. The counter produces an output which has a repetition rate dependent on the inputs from the multiplexer."

Recommended operating voltage for both units is 5 volts $\pm 5\%$. The 8263's binary 1 output voltage is 2.6 V; the 1 output leakage current in the 8264 is no more than 200 microamperes. Maximum 0-output voltage for both units is 0.4 V; the 0 input current is 1.6 milliamperes maximum for data input and output enable channels. Maximum 1 input current for data inputs and output enable channels is 40 μA and 80 μA for "channel select."

The 8263's propagation delay typically is 17 nanoseconds for all functions except channel select, where it's 25 ns. For the 8264, propagation delay typically is 25 ns from data input to output, and 20 ns from "output enable" to the data outputs.

The 8263 consumes no more than 420 milliwatts; maximum power consumption of the 8264 is 475 mW. Output short-circuit current ranges from 20 to 70 mA.

Both versions of the digital multiplexer are available in a 24-pin flatpack or in a 24-pin dual in-line ceramic or silicone package. The ceramic unit operates over the -55 to $+125^\circ\text{C}$ range; the silicone, from 0 to 75°C .

Price for the 8263 and 8264 is \$15.95 in the 24-pin flat package, with a 0° to 75°C temperature range, in quantities of 100.

Signetics Corp., 811 East Arques Ave., Sunnyvale, Calif. 94086 [350]



EMPLOYMENT OPPORTUNITIES

Project Manager

A Texas based electronics company which is a division of a NYSE corporation has immediate openings for individuals with the following qualifications:

REQUIRES BSEE (MSEE preferred) and minimum of 8 or more years experience in technical positions of increasing responsibility involving conceptual systems design, technical proposal preparation, detailed systems design and management of projects involving implementation of systems design.

Experience must have involved military non-airborne computer based monitor and control systems (such as NTDS) or industrial control systems (direct digital preferred).

Submit full resume including salary history in complete confidence to:

P-2630, Electronics, Class. Adv. Dept., 645 N. Mich. Ave., Chicago, Ill. 60611

An Equal Opportunity Employer

CLASSIFIED ADVERTISING
 **SEARCHLIGHT SECTION**
 BUSINESS OPPORTUNITIES
 USED OR SURPLUS EQUIPMENT

RADAR SYSTEMS GROUND AND AIRBORNE, AUTOMATIC TRACKING ANTENNA SYSTEMS, NIKE AJAX, NIKE HERCULES, M-33, MSQ-1A, MPS-19, MPS-9, SCR 584, TPS-1D, TPS-28, FAA-ASR-2, AIRBORNE SYSTEMS, APN-84, APN-102, APS-20, APS-27, APS-45, DPN-19, DIGITAL COMPUTERS, IBM 650, IBM 704.

 LARGEST INVENTORY OF RADAR AND MICROWAVE EQUIPMENT IN THE WORLD.
RADIO RESEARCH INSTRUMENT CO.
 45 WEST 45TH ST. N. Y. 10036 212-JU 6-4691

CIRCLE 966 ON READER SERVICE CARD

free catalog
POTTING APPLICATORS
 MANUAL AND DISPOSABLE
 6cc 12cc 30cc
 FOR POTTING, ENCAPSULATING, AND SEALING OF MINIATURE COMPONENTS
 PHILIP FISHMAN COMPANY
 7 CAMERON ST., WELLESLEY 81, MASSACHUSETTS

CIRCLE 967 ON READER SERVICE CARD

"SEARCHLIGHT" IS Opportunity Advertising

—to help you get what you want—to help you sell what you no longer need.

Take Advantage Of It
 "THINK SEARCHLIGHT FIRST"
 For Every Business Want

ADDRESS BOX NO. REPLIES TO: Box No. Classified Adv. Dept. of this publication. Send to office nearest you.
 NEW YORK, N. Y. 10036; P. O. Box 12
 CHICAGO, ILL. 60611; 645 N. Michigan Ave.
 SAN FRANCISCO, CAL. 94111; 255 California St.

SELLING OPPORTUNITY WANTED

Distributors—Manufacturers of Electronic Instruments seeking service representation in Ontario, premises located in Toronto, please contact RA-2693, Electronics.

LEGAL NOTICE

STATEMENT OF OWNERSHIP, MANAGEMENT AND CIRCULATION
 (Act of October 23, 1962, Section 4369, Title 39, United States Code)

- Date of filing: October 1, 1970.
- Title of publication: ELECTRONICS.
- Frequency of issue: Biweekly.
- Location of known office of publication: 330 West 42nd St., City, County and State of New York—10036.
- Location of the headquarters or general business offices of the publishers: 330 West 42nd St., City, County and State of New York—10036.
- Names and addresses of publisher, associate publisher, editor, and managing editor: Publisher, Daniel A. McMillan, 111—330 West 42nd St., New York, N. Y. —10036; Editor, Kemp Anderson—330 West 42nd St., N. Y.—10036; Executive Editor, Samuel Weber—330 West 42nd St., New York, N. Y.—10036.
- The owner is McGraw-Hill, Inc., 330 West 42nd St., New York, N. Y., 10036. Stockholders holding 1% or more of stock are: Paul T. Babson, 330 Beacon St., Boston, Mass. 02116; Barnett & Co., c/o Bankers Trust Company, 16 Wall St., New York, N. Y. 10015; Maxwell M. Geffen, 1271 Avenue of Americas, New York, N. Y. 10020; Donald C. McGraw, Elizabeth McGraw Webster, Donald C. McGraw, Jr. & Harold W. McGraw, Jr., Trustees under Indenture of Trust m/b James H. McGraw, dated 1/14/21 as modified; Donald C. McGraw, Trustee under an Indenture of Trust m/b James H. McGraw, dated 7/1/37 as amended; Donald C. McGraw, individually; Donald C. McGraw & Catharine McGraw Rock, as Trustees of the Estate of Mildred W. McGraw, all of 330 West 42nd St., New York, N. Y. 10036; Stanford E. Taylor, Hawk Dr., Lloyd Harbor, Huntington, N. Y. 11742.
- Known bondholders, mortgagees, and other security holders owning or holding 1 percent or more of total amount of bonds, mortgages or other securities: None.
- Not applicable.
- Extent and nature of circulation:

	Average No. Copies Each Issue During Preceding 12 Months	Actual No. Copies Of Single Issue Published Nearest To Filing Date
A. Total No. Copies Printed.....	86,855	89,998
B. Paid Circulation		
1. Sales through dealers and carriers, street vendors and counter sales.....		83,558
2. Mail subscriptions.....	80,707	83,558
C. Total Paid Circulation.....	80,707	83,558
D. Free distribution by mail, carrier or other means.....	4,512	5,415
E. Total Distribution.....	85,219	88,973
F. Office use, left-over, unaccounted, spoiled after printing.....	1,636	1,025
G. Total.....	86,855	89,998

I certify that the statements made by me above are correct and complete.

McGraw-Hill, Inc.
 By JOHN J. COOKE,
 Senior Vice President & Secretary

START

WITH A LENS-END LAMP

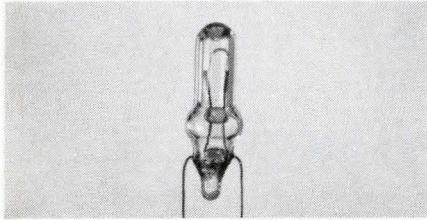

TEST

FOR SPOT SIZE AND
CANDLEPOWER

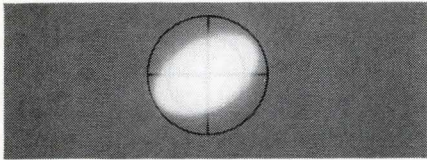

WELD

PINS TO END OF LEAD
WIRES

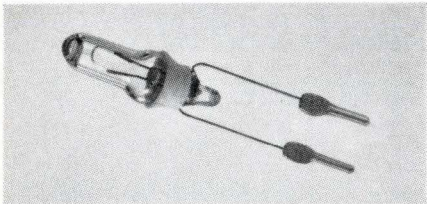

MOLD

TO MAKE A PLUG-IN LIGHT
MODULE THAT WILL ACTIVATE
PHOTO ELECTRIC SENSOR IN
A HIGH SPEED CHECK SORTER

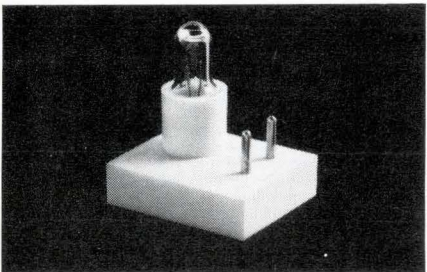

We specialize in finding practical solutions to small applications where cataloged items won't do. Write, describing your requirement. Tung-Sol Division, Wagner Electric Corporation, 630 W. Mt. Pleasant Avenue, Livingston, N.J. 07039. TWX: 710-994-4865. Phone: (201) 992-1100.

TUNG-SOL®

WHERE BIG THINGS ARE
DONE WITH SMALL LAMPS

© Reg. T.M. Wagner Electric Corporation

Technical Abstracts

Cash in the chips

Multichip hybrid microcircuits for low cost reliability
Dewitt A. Graybill
General Dynamics Electronics Division
San Diego, Calif.

Where quantities are below 100 pieces per type, multichip hybrid circuits can offer low cost and high reliability, as well as design flexibility. Such circuits use a fixed metalization pattern, resistor chips, and semiconductor device chips. The circuit is laid out so that interconnections are made with wire bonds to common paths on the universal metalization pattern.

The designers chose a 14-lead glass-Kovar package measuring $\frac{3}{8}$ by $\frac{3}{8}$ inch. Gold-silicon eutectic chip bonding was required, but since vapor-deposited or sputtered films tend to degrade with temperature, the gold pad was formed by electroplating the gold over screened-and-fired molybdenum.

Only seven different semiconductor types were used, all available from a single supplier. Waffle trays with individual dice compartments helped minimize physical damage during shipping and handling. Multitap Nichrome silicon chip resistors were bonded at the same time as the semiconductor devices. Each resistor chip, 35 mils square, had a serpentine resistive film tapped with aluminum wire bonding pads.

Gold wire thermocompression bonding was used rather than ultrasonic bonding because of the variations in die size and metalization, which complicate the frictional energy transfer mechanism in the ultrasonic bonding process. Temperatures were held to below 200°C to avoid purple plague problems with gold-aluminum bonds.

This circuit fabrication method should be more adaptable in the future as more components and equipment appear. Chip resistors now are available with values from 10 ohms to 4 megohms rated at 250 milliwatts at 125°C; many semiconductor devices are available in chip form from distributor stock, and wider ranges of packages are becoming available.

Presented at Eastern Electronics Packaging Conference, MIT, June 8-9.

Control at the interface

A versatile interface control station
Nico H. Roos
Motorola Instrumentation and Control
Inc., Phoenix, Ariz.

A fall-back or computer-control station is a complex interface that allows a digital computer to control continuous analog processes. The station converts digital information to an analog control signal; stores information pulses to maintain the control signal constant, and allows the operator to override the computer and intervene in the process control.

Two operational modes are possible when in a computer-controlled process. One mode is supervisory and the computer signals are used as the setpoints for analog controllers. The other mode uses the digital signals to directly manipulate the control valves. In either mode, the control signal is maintained by one of three circuits: a sample-and-hold unit which produces an absolute position signal; an integrator that integrates a variable input signal to produce an incremental signal to the control valve, and an integrator that's pulsed on and off to integrate a fixed internal reference signal.

A variety of backup capabilities, ranging from complete manual backup to various combinations of manual local-automatic and full computer control, also may be applied. If the computer fails, the stations could hold output currents at the last values before the failure or switch to automatic analog control with setpoints held at either the last values or changed slowly toward safe internal setpoints.

Modular design allows different types of control modes to be added whenever desired, as in the Veritrac Computer Control Station developed by Motorola. The station offers both direct digital or supervisory control as well as four different types of analog control units which can be used for automatic (though noncomputer) control, and more than a half-dozen setpoint and output memories which can take over if the computer fails.

Presented at Wescon, Los Angeles, Aug. 25-28.

MAGNET REED MINIATURES

Super miniature proximity switch & magnet assembly includes an encased Alnico-5 magnet that actuates the reed switch within .39". Rating @ 50 VDC: 150ma break, 500-ma carry.

NORMALLY OPEN or



NORMALLY CLOSED

ALCOSWITCH®

DIV. OF ALCO ELECTRONIC PRODUCTS, INC., LAWRENCE, MASS.

Circle 173 on reader service card

DESIGN YOUR OWN KEYBOARD

A reliable reed switch is actuated by a permanent magnet. Close tolerance is maintained in operating pressure; and operating points are standard. Optional keytops similar to electric typewriters.

STEP-UP FORMATION

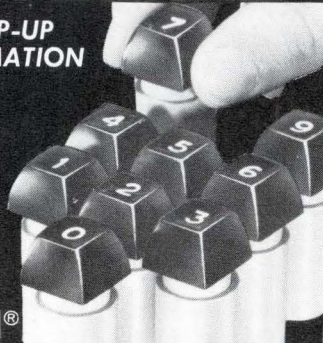

ALCOSWITCH®

DIV. OF ALCO ELECTRONIC PRODUCTS, INC., LAWRENCE, MASS.

Circle 174 on reader service card



we're plugging our patching potential

For instance, our brand-new .040" pin patch cord kit is perfect for breadboarding, IC patching or test point work. It contains 100 straight-pin and piggyback style cords in 2-, 4-, 6-, and 8-inch lengths. Packaged by size in neatly labeled poly bags, the cords are red, blue and black to simplify coding. Other colors and lengths are available in the piggyback style, .040" pin. Write or call us today for details.

Cambridge Thermionic Corporation, 445 Concord Avenue, Cambridge, Mass. 02138. Phone: (617) 491-5400. In Los Angeles, 8703 La Tijera Boulevard 90045. Phone: (213) 776-0472.

Standardize on

CAMBION®

The Guaranteed Electronic Components

Circle 175 on reader service card

This is the multiplex coupler.

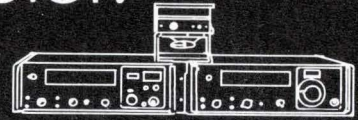

It'll put your data acquisition

- Low Cost Data Acquisition
- Eliminate Manual Monitoring of Data
- Interface Up To 4 Instruments
- 10 Digit Data Field (plus sign)
- Simultaneous Parallel ASCII Output

altogether for just \$995.00

MULTIPLEX/COUPLER Model BAC



1 Adler Dr., East Syracuse, New York 13057
TWX 710-541-0406 Tel. (315) 437-9951

Send for complete information on any of your data acquisition requirements.

Circle 153 on reader service card

153

Synchron[®] motors help money make money



In the vending business, a would-be customer with dollar bills and no coins might just as well be flat broke. Unless there's a bill changer around. Like this one made by Rowe International.

Feed it a dollar bill and, presto! Instant alchemy. That useless paper is turned into spendable change.

The acceptance of the bill provides a signal which is transformed into multiple pulses in a Hansen-actuated electromechanical pulse chopper. Impulses are then sent to a memory unit and the payoff is actuated. The major reason why Hansen motors are specified:

"Dependability." Contact your Hansen man and find out how Hansen dependability can help you.



HANSEN

Manufacturing Company, Inc.
Princeton, Indiana 47570



HANSEN REPRESENTATIVES: CAREY & ASSOCIATES, Houston and Dallas, Texas; R. S. HOPKINS CO., Sherman Oaks, Calif.; MELCHIOR ASSOCIATES, INC., San Carlos, Calif.; THE FROMM CO., River Forest, Ill.; JOHN ORR ASSOCIATES, Grand Rapids, Mich.; H. C. JOHNSON AGENCY, INC., Rochester, N.Y.; WINSLOW ELECTRIC CO., Essex, Conn.; Villanova, Pa., and Teaneck, N.J.
EXPORT DEPARTMENT: 2200 Shames Drive, Westbury, N.Y. 11590

New Literature

IC sockets. Connector Corp., 6025 N. Keystone Ave., Chicago 60646. Technical publication 49A describes type 561 14-pin dual in-line IC sockets. Also, the pc layout recommended is shown with associated drawing.
Circle **446** on reader service card.

I-f amplifiers. Siemens Corp., 186 Wood Ave. South, Iselin, N.J. 08830. A four-page data sheet describes and illustrates a line of a-m/fm i-f amplifiers.
[447]

Electronics parts. Shigoto Industries Ltd., 350 Fifth Ave., New York 10001, has issued a comprehensive 32-page illustrated catalog of economy priced electronics parts for OEM applications.
[448]

Digital panel meters. Electro-Numerics Corp., 2961 Corvin Dr., Santa Clara, Calif. 95051. A four-page brochure covers the complete electronic and physical characteristics of the 3300 series of digital panel meters.
[449]

Fixed composition resistors. Stackpole Carbon Co., Kane, Pa. 16735. An eight-page bulletin (80-100) on fixed composition resistors contains comprehensive technical data with illustrated charts, component features, application guidelines and packaging specifications.
[450]

Magnetic measurements. O.S. Walker Co., Rockdale St., Worcester, Mass. 01606, has made available an eight-page review of equipments and techniques for a wide variety of magnetic measurements.
[451]

Layer short tester. U.S. Asiatic Co., 13-12, Shimbashi-I-Chome, Manato-ku, 105 Tokyo. A single-sheet bulletin describes a layer short tester designed for high accuracy and detection of virtually every type of coil.
[452]

Plastics bonding. Eastman Chemical Products Inc., Kingsport, Tenn. 37662. Publication R-190 presents a variety of successful plastics bonding applications based on Eastman 910 cyanoacrylate adhesive.
[453]

Stepper motors, controllers. Clifton Division of Litton Industries, Clifton Heights, Pa. 19018, has issued a newly revised and updated four-page bulletin covering an expanded line of stepper motors and controllers.
[454]

Ultrasonic cleaners. Esterline Angus, division of Esterline Corp., P.O. Box 24000, Indianapolis 46224. A two-color catalog sheet describes four ultrasonic cleaners with cleaning power ranging from 25 to 150 watts.
[455]

Foam folder. Emerson & Cuming Inc., Canton, Mass. 02021. A new Eccofoam folder contains descriptions of four

foam-in-place types, three types of foam sheet stock, three types of syntactic foams, and six types of foams especially suitable for microwave applications.
[456]

Trace moisture analyzer. Beckman Instruments Inc., 2500 Harbor Blvd., Fullerton, Calif. 92634, has issued a bulletin on a solid state trace moisture analyzer that incorporates a phosphorus pentoxide detector cell and plug-in circuit boards.
[457]

Miniature connectors. Continental Connector Corp., 34-63 56th St., Woodside, N.Y. 11377, has available a 48-page catalog covering a line of miniature rectangular and hexagonal plug and socket connectors.
[458]

Air movers. Rotron Inc., Woodstock, N.Y. 12498. A 32-page quick-reference catalog describes seven lines of air movers and includes helpful selection aids.
[459]

Tap switches. Ohmite Mfg. Co., 3601 Howard St., Skokie, Ill. 60076. A comprehensive line of rotary tap switches is described in a 12-page catalog.
[460]

Phosphors and chemicals. General Electric Co., Lamp Metals and Components Dept., 21800 Tungsten Rd., Cleveland 44117, has published a descriptive brochure on electronic phosphors and chemicals.
[461]

Power supplies. CEA, a division of Berkleonics Inc., 1221 S. Shamrock Ave., Monrovia, Calif. 91016, has available a 32-page catalog of modular dc power supplies and precision voltage references.
[462]

Circuit test system. Teradyne Inc., 183 Essex St., Boston 02111, offers a brochure on the J283 circuit test system, known as the SLOT machine because of its application in Sequential Logic Testing.
[463]

Digital-to-analog converter. Analog Devices Inc., Pastoriza Division, 221 Fifth St., Cambridge, Mass. 02142. A data sheet presents comprehensive specifications of the model DAC-12Q digital-to-analog converter.
[464]

Circuit modules. Computer Products Inc., 1400 Gateway Dr., Fort Lauderdale, Fla. 33307, has published a folder containing a complete description of the series CL800 CompuLogic circuit modules.
[465]

Special purpose core memory. Dataram Corp., Route 206, Princeton, N.J. 08540. A technical bulletin covers the model PDM-8, a new addition to a line of Point Designed Memories, which are designed to provide optimum performance/cost at a specific memory capacity and speed.
[466]

PUSH BUTTON MINIATURES

MSPN SERIES

Lighted snap-action DPDT models handle 6A @ 125 VAC & features separate connections to T-1½ lamp. ½", ⅝", ¾" round or square buttons; transparent or translucent colors. P.C. side terminals.

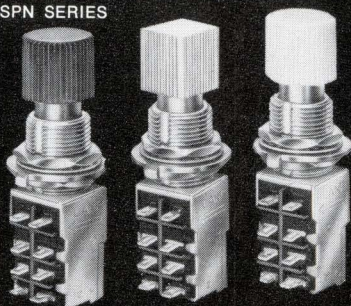

ALCOSWITCH®

ILLUMINATED

DIV. OF ALCO ELECTRONIC PRODUCTS, INC., LAWRENCE, MASS.

Circle 176 on reader service card

TOGGLE SWITCH MINIATURES

Accident-proof mini switches have toggles locking in position to guard against human errors. Interchangeable colored toggles. 1-2-3-4 poles in many configurations. 6A @ 125 VAC.

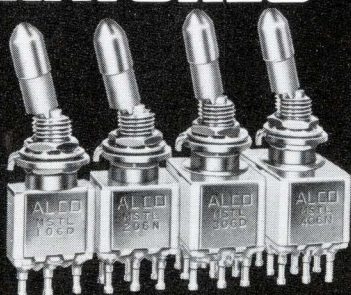

ALCOSWITCH®

DIV. OF ALCO ELECTRONIC PRODUCTS, INC., LAWRENCE, MASS.

Circle 177 on reader service card

E=2(C+EDP)X

Last year, Electronics magazine contained twice as much information on computers and electronic data processing as the next leading electronic publication.

If the cover of this magazine has your name and address on it, there is no better formula for keeping yourself abreast of the industry's technology.

You say you want a

low-profile snap-in-mounting push button switch or matching indicator that is interchangeable with most 4-lamp displays... available in a full range of cap colors... with a choice of bezels with or without barriers in black, gray, dark gray or white.

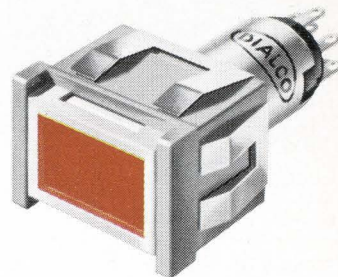

and a

legend presentation that's positive (like this one) or negative (like the one below) or just plain (like the one above)... one that's white when "off" and red, green, yellow (amber), blue or light yellow when "on"... or colored both "on" and "off."



and a

highly reliable switch proven in thousands of installations... available in momentary or alternate action... N.O., N.C. or two circuit (one N.O., one N.C.)... that accommodates a T-1½ bulb with midget flanged base, incandescent, in a range of voltages from 6-28V.

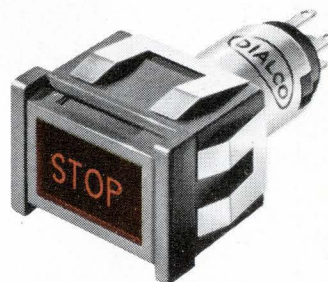

*etc.
etc.
etc.*

Now, for the first time Dialight gives you custom panel designing with a standard line of push-button switches and matching indicators

Dialight offers a broader range of switch and indicator possibilities than you'll find anywhere in a standard single-lamp line. Sizes: ¾" x 1", ⅝" square and round. Send today for our new full-color catalog L-209.

DIALIGHT

Dialight Corporation, 60 Stewart Ave., Brooklyn, N.Y. 11237

DT-125

Circle 155 on reader service card

155

TRY TO MATCH THIS

for size and reliability

you can't!

For their size, Type BB resistors pack a tremendous power dissipating ability. Rated 1/8 watt at 70°C in a 0.0004375 cu. in. volume.

And miniaturization has not reduced reliability. Tests prove it. They satisfy the highest level—the S level—of the latest MIL-R-39008 Established Reliability Specifications in all resistance values.

The key is hot molding—the Allen-Bradley way. A-B developed and built the machines. Only A-B uses them. They're fully automatic. Built-in precision control. A high degree of uniformity. Predictable performance from resistor to resistor—year after year.

For immediate delivery at factory prices call your authorized A-B industrial electronics distributor. Or write Marketing Dept., Electronics Division, Allen-Bradley Co., 1201 South Second St., Milwaukee, Wis. 53204. Export Office: 1293 Broad St., Bloomfield, N.J., U.S.A. 07003. In Canada: Allen-Bradley Canada Limited.

© Allen-Bradley Company 1969



Exclusive

Only A-B Type BB
RCR05 meets MIL-R-39008
ER (established reliability)
for 1/8-watt resistors
at the S level.
Shown actual size.



ALLEN - BRADLEY
QUALITY ELECTRONIC COMPONENTS

EC69-80

International Newsletter

October 26, 1970

Japanese develop flyback transformer cooled by silicone

In a new approach to preventing color tv fire hazards, Matsushita Electric Industrial Co. has immersed a specially designed flyback transformer and a silicon rectifier stack in a sealed can filled with silicone oil. With a much higher breakdown voltage than air, silicone oil eliminates corona-caused deterioration of insulation and allows a dramatic reduction in size—volume is only one-fifth that of former designs. What's more, the sealed transformer-rectifier unit is only marginally more expensive than the standard components it replaces, says Matsushita. While it costs more than early flybacks, nonflammable material requirements in the latest conventional flybacks make prices almost equal. The silicone oil's evaporation point is above 300°C and when the temperature inside the can reaches 200°C, a solder seal on the can's bathtub-shaped top melts, allowing oil to expand into the top before pressure can build up.

Russia eyes German consumer electronic parts

The Russians are giving a lot more thought to consumer products. Some sort of an agreement involving semiconductor components soon may be reached between the Soviet Union and Intermetall GmbH, the German subsidiary of ITT. A six-man Russian delegation, representing the Soviet radio and communications industry, visited Intermetall earlier this month. During their two-day visit, the Russians showed interest not only in the delivery of components but also in a knowhow exchange.

The delegation's prime interest at Intermetall's Freiburg plant in the Black Forest centered on semiconductor components for entertainment applications, such as variable capacity diodes for television tuners. An Intermetall official says that "although there's no big market for such products presently discernible in the Soviet Union, it is likely that one could spring up suddenly." In any knowhow exchange agreement the Russians probably will insist on delivery of semi-finished products and the equipment required for further processing. The talks started in Freiburg will be continued in Leningrad, probably next spring.

Swedish government promotes SAAB tie with ITT subsidiary

A new Swedish electronics company has entered the computer-based systems fray. Standard Radio AB, a subsidiary of ITT; SAAB-Scania AB, the aircraft-auto-electronics firm; and the state-owned Swedish Development Co. have set up Stansaab Elektronik AB. The new company will aim primarily at computer-based ground and air traffic control, medical, and educational systems. The state, through the development company, served as the catalyst in bringing the other companies together in Stansaab, with the aim of strengthening Sweden's electronics industry and rationalizing development and production.

British OCR machines use photodiode arrays

Launching into optical character recognition, Plessey Co. is marketing two machines built around silicon photodiode arrays integrated along with MOS amplifiers and scanning circuitry on a single chip. The characters have a 72-high, five-wide diode matrix which is scanned vertically at 5 megahertz. Charge decay in each diode proportionate to the light incident on it provides analog output patterns which are analyzed by TTL circuitry to identify characters. The A-font reader depends on identifying horizontal and vertical stroke patterns; the B-font reader

International Newsletter

on identifying more detailed character features. Plessey claims that integrated arrays are new in production OCR equipment and that they so increase sensitivity that its new systems can read badly printed and dirty documents. Sales will be aimed at utilities and organizations which process large quantities of turn-around documents like bills, and also at computer makers as original equipment. **Maximum reading speed is 3,000 characters per second. Price will be "low by current standards."**

Public outcry over computers and privacy hits Sweden

A census form sent out to all Swedes by the Central Bureau of Statistics has touched off a debate over data banks and computer secrecy that many in the industry have feared would happen [*Electronics*, Aug. 17, p. 115]. Stockholm newspapers not only attacked the census form—aimed mainly at getting information for urban planning and housing schemes—but detailed how the data supplied can be misused. One enterprising newspaper obtained the so-called "personal number" of the census bureau official handling the survey and then "retrieved" much personal information about him just by calling the proper offices with computer terminals. At the same time, two men were indicted for "stealing" information from computer tapes owned by an addressing service.

Industry officials have long feared that a public outcry over computer privacy might force delays in systems installations. The Swedish Federation of Industry is so concerned that it set up a special office to investigate the affair, and hired Per-Gunnar Vinge, former head of Sweden's counter-espionage security police division, to head it. Referring to the daily barrage of newspaper stories on data banks and computer abuse, he said: "This is not really the kind of discussion we had hoped for."

British Gunn diodes handle 400 mW

By next spring Mullard Ltd. expects to offer Gunn diodes putting out 300 to 400 milliwatts continuous wave in X band. This compares with peaks of about 100 mW presently available from European companies, though in the U.S. Monsanto has circulated data sheets on a 300 mW device. The big jump in power output was obtained by bonding the copper heat sink to the active epitaxial layer instead of to the GaAs substrate as is usual, thus allowing the device to accept higher currents without overheating. Key to the new device is the bonding technique: layers of evaporated silver-tin alloy and plated gold separate the GaAs and the copper. GaAs technology, operating voltages of 8 to 15 volts, and efficiencies of 3 to 5% have not changed. The higher power level, says Mullard engineers, will make Gunn oscillators practicable as local oscillators in professional radar equipment and as transmitters in secondary radar transponders and low-power microwave links.

Addenda

A laser communications link capable of simultaneous transmission of 100 telephone channels will be shown for the first time in Europe by the Russians at Electronica, the big German electronics show to be held in Munich Nov. 5 to 11. The laser link, at the booths of the German import agent Transelectronic KG, already is being used in Moscow to take some of the load off the city's regular phone lines during peak traffic hours . . . To cope with the rising demand for semiconductor products in Europe, Valvo GmbH, a Philips subsidiary, is investing some \$12 million in a 20,000-square-foot manufacturing plant in Lubeck.

IC firm makes solid state brake control

Japanese company uses sensors and modulator to provide continuous anti-skid control for vehicle braking

Preventing automobiles from changing direction during emergency braking represents a change of direction for a small Japanese semiconductor manufacturer. Kyodo Electronics Laboratories Ltd., set up primarily to make ICs [*Electronics*, June 27, 1966, p. 195], now is concentrating on hybrid circuits and discrete semiconductors. It did not make a go of standard monolithic digital units because the firm is too small to crank out the large numbers needed to be price-competitive. Kyodo's antiskid braking control is the company's first try at making not just the hybrid ICs but an entire control unit.

The control's operation is based on sensing wheel deceleration. Sensors for tire speed indication are mounted on both rear wheels, as opposed to the single sensor at the transmission used in earlier systems, such as developed by Toyota and Nippon Denso. In another departure, the new system uses a modulator to provide continuous control of braking pressure, rather than an on-off control—Kyodo engineers feel modulated braking is much smoother. Solenoids driven by power transistors operate valves in the modulator, but vacuum from the engine intake manifold provides the power needed to modulate braking force.

Kyodo's control consists of a small box with two printed circuit boards which contain hybrid ICs and discrete components, and a heat sink with power transistors. Also added to the vehicle are a single modulator to handle hydraulic pressure to the two rear brakes, and the rear-wheel speed sensors.

For most applications a single modulator is sufficient, with the same hydraulic pressure fed to the two rear brakes. But individual sensors are needed because the vehicle's differential allows the two rear tires to turn at different speeds, and one may start to lock before the other. Thus, outputs from the two sensors pass through individual frequency-to-voltage converters, and then the two are fed to a circuit that selects the lower of the two speeds, indicating the tire closer to locking. Output of the speed comparator circuit is differentiated to give deceleration. The deceleration signal rises sharply as tire slip increases and

the wheel speed rapidly decreases.

With the deceleration signal as a basic input, logic circuits develop drive signals for the power transistors that drive the solenoids that operate the valves. Also applied to the logic circuits is a reference signal. Inputs determining reference are vehicle speed and an optional road condition unit, which comes from an accelerometer that determines whether the road has a high or low friction surface. Among the differences between this control and others is a provision in the logic for different control conditions for the first operation cycle and subsequent control cycles.

Kyodo engineers say there is an optimum value of wheel slip for maximum braking for low friction surfaces generally running in the range between 10 and 20%—vehicle speed is about 15% greater than wheel speed. The decrease in tire speed as well as the increase in tire deceleration is somewhat greater on the first cycle than on

Applying the brakes. System developed by Kyodo Electronics Laboratories provides continuous modulation of braking force rather than on-off control.

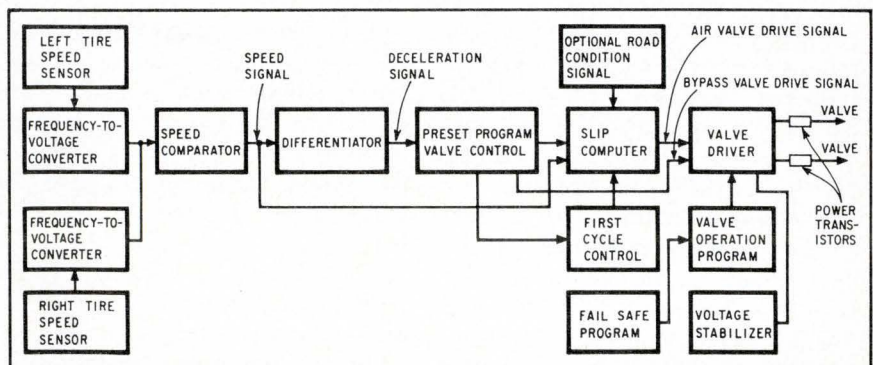

the second and subsequent cycles.

As with any antiskid system, this one is designed for fail-safe operation. These functions include ignoring fast-moving signals caused by wheel bounce on rough roads, cutting out the electronic unit for normal control during low speed when unit isn't needed, or when no pressure is applied to brakes. Automatic cutout is applied for such conditions as low power-supply voltage, low control voltage, no vacuum, and when a valve control wire is cut or a valve inoperative.

New functions made possible by the control include a speed warning alarm, which produces different audio outputs for each 10 kilometers per hour above a preset maximum speed. Another is an indication of brake shoe wear. A third is warning when the brake fluid level is low.

Kyodo designed and is building the controls for Akebono Brake Industry Co., an independent manufacturer of automotive brakes.

France

Atomic clock takes wing

Telling the time with hair-splitting accuracy is an essential requirement in the aircraft collision-avoidance systems being developed on both sides of the Atlantic. France's Thomson-CSF has come up with a new atomic clock which it feels is the perfect timekeeper for the job—it's highly precise, as well as light, compact, and sturdy enough to keep its accuracy in the air.

The new clock, which the company calls the third generation of atomic timepieces, uses an optically pumped rubidium-gas frequency standard. The principle of such clocks was discovered years ago by France's Nobel prize winning physicist, Alfred Kastler.

The higher accuracy of cesium clocks has kept rubidium in the background until recently. But cesium clocks are sensitive and difficult to adapt to tough environmental situations. So Hewlett-

Packard and Tracor in the U.S. and Thomson-CSF in France, among other companies, have turned to rubidium for aerospace uses.

Thomson-CSF's new clock weighs only 26.5 pounds and takes up only 0.35 cubic feet. It is so insensitive to shock that vibrations of 15 g and continuous acceleration of 30 g—such as found in rockets—don't faze it. In fact, at a French airport test ground, the \$13,000 instrument accidentally fell off a moving truck and tumbled along the asphalt apron. But it went on ticking with no loss of accuracy.

The French clock can stand temperatures from -20°C to $+70^{\circ}\text{C}$. Its American competitors can take heat of only 45°C , say Thomson-CSF engineers—who also claim their clock's precision is an order of magnitude better than the 10^{-10} per year of the American units.

Like all rubidium clocks, the French unit uses a quartz pilot to produce a primary frequency. A resonance cell containing vaporized rubidium metal and an absorption stripe of a second frequency absorbs the first frequency. Detecting the absorption through an optical pumping system produces an error signal that can regulate the pilot frequency via a servomechanism. The resonance cell's design is the key to clock accuracy—and Thomson-CSF's design is a company secret.

The clock's electronic circuitry is standard, but components and soldering techniques are said to be of the highest reliability. Outside of power circuitry, everything possible has been integrated, says Henri Brun, a member of the engineering team that designed the clock.

The clock consumes only 20 watts. It runs on 27-volt dc current, but optionally can be had to run on 110 or 220 V ac or on internal batteries, which keep it ticking for two hours. Output frequencies are 5 megahertz, 1 MHz and 100 kilohertz.

The French Government's Direction des Recherches et Moyens d'Essai funded the clock's development and has given a contract to

Societe Crouzet of Valence to design a civil aircraft anti-collision system around it. McDonnell Douglas is developing a similar system in the U.S. using a Hewlett-Packard clock.

Though Thomson-CSF doubts that its clock will be able to penetrate the U.S. market, sales officials see a big market on the Continent, in the U.K., and in Russia. The company is aiming to sell "at least 100" clocks in coming years.

Aside from air navigation use, the clock should find scientific and space applications, according to Thomson-CSF. The proposed U.S.-European space shuttle, with its complex time problems connected with navigation, could be an early customer. And France's state television network may order some of the clocks as synchronization generators for mobile tv networks.

Japan

Adding alumina gives 2,048-bit ROM chip

Further developing its MAOS FET technique, Hitachi's Central Research Laboratory has fabricated a prototype 2,048-bit read-only memory chip. The n-channel enhancement-type driver FETs [*Electronics*, Oct. 13, 1969, p. 208] have gate insulation of alumina overlying silicon dioxide. They feature low values of threshold voltage for bipolar compatibility, high speed, and low power consumption.

Depletion type FETs are not often used in ICs because they require isolation from each other, while enhancement FETs do not. Also, when the same gate insulation is used for enhancement and depletion devices, it may be tricky to obtain the required values of channel resistivity for both types on the same chip. In Hitachi's approach, alumina directly overlies the surface around the depletion FETs, with no oxide under the alumina at this point. The alumina thus provides isolation without requiring an isolation diffusion or other difficult and area consuming

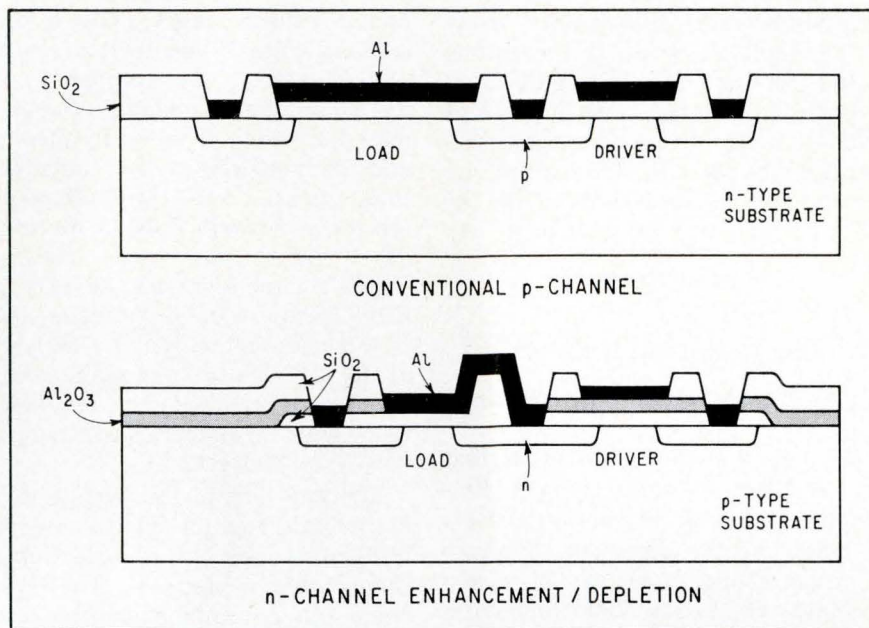

Alumina insulation. Researchers at Hitachi's Central Research Laboratory use alumina for gate insulation in n-channel enhancement-type FETs.

processes. Thus, overlying the surface of the silicon at the gates of enhancement FETs are silicon dioxide and alumina. Overlying the gates of the depletion FETs is silicon dioxide only, while alumina overlies the surface around them. One important consideration is that, unlike diffusion isolation, alumina does not spread and increase in area.

In Hitachi's memory, the alumina layer is omitted under the gates of the load FETs, and inversion of the surface layer of the p-type substrates gives n-channel depletion-mode operation. Depletion-type FETs used as loads give faster circuit operation than either resistors or the commonly used enhancement-type devices. Furthermore, since the gates of depletion-type load FETs are connected to their own source rather than to a clock signal bus, there is a significant saving in chip real estate because the bus can be eliminated.

Suitable fabrication of oxide and alumina layers give transistor-transistor logic compatible memories with a threshold voltage of 1 volt. Access time of the experimental memories is about 300 nanoseconds, including address decoder, dissipation is 50 microwatts

per bit, and the power supply is 5 V for compatibility with TTL.

A Hitachi worker says that while more depositions are needed than in conventional MOS, development of selective etching processes allows the overlying layer to be used as a mask, resulting in the same number of fabrication steps as for standard MOS. Depending on the temperature at which the alumina is deposited, the ease with which it can be etched varies. By selecting the right temperatures technicians can produce an alumina that either will or will not be etched by silicon dioxide etchants.

Great Britain

On some research into pcm converters

If all goes well on development work, it's likely that within a decade Britain will have a skeleton network of transmission links capable of 100 megabits per second or more. Capacities of this order offer the possibility of transmitting 625-line color television pictures in pulse code modulated form.

The British Broadcasting Corp., which is interested primarily in

program generation, and GEC-AEI Telecommunications Research Laboratory, which is interested primarily in transmission equipment, are building and experimenting with coding and conversion equipment with the aim of establishing the technical parameters for operational coders and decoders.

The BBC's gear was completed only this summer, and is built entirely from ICs except for the analog sections. GEC-AEI's equipment, which was built first, consists mainly of discrete components. But since GEC-AEI also has in mind conversion of signals for frequency division multiplex telephony, where the linearity and quantizing requirements are stricter than for TV, its equipment is capable of greater accuracy: it can code to nine bits, whereas the BBC can code to only eight.

The main parameter to be determined is the number of bits per word. Both companies, therefore, code the samples of the video wave into words of different bit length on demand so that the effects can be studied. Using ordinary color program material carried on short lengths of test waveguide, both systems indicate that eight bits at a sample rate of around 13 megahertz—2.33 times the 5.5 MHz standard video bandwidth—produces no perceptible degradation. But operational program links may well contain a number of analog-digital-analog conversion stages that would progressively degrade signal quality, and Vic Devereux, designer of BBC's converter, acknowledges that nine bits may prove necessary.

Besides being around the minimum theoretical acceptable sampling rate, 13 MHz is also slightly below three times the color sub-carrier frequency. In both systems it's possible to take advantage of this by locking one frequency to the other, giving a 13.3-MHz sampling rate. But, Devereux points out it may not be possible to use the coincidence because it may not fit in with the effective line bit rate, which will have to accommodate other data forms besides TV signals. One reason the BBC is building

conversion equipment now, while the transmission link technology is still in its infancy, is so that it can work out what bit rate it would prefer to see adopted as the international standard.

Devereux's design carries out the analog to eight-bit digital conversion in two stages, the first providing the four most significant and the second the four least significant bits. Output of the first four bits is delayed slightly to time it properly in relation to the last four. By using two stages, Devereux needs only 30 level comparators compared to 255 in simultaneous parallel conversion, and he claims there is no real disadvantage.

The sampled video signal is fed to the 15 parallel-connected comparators, which are supplied with reference voltages equally spaced over the conversion range. According to Devereux, the extra clarity obtained by using the optimum non-linear quantizing law is not worth the extra complications. The comparator output signal has two stable states, one for when the video sample is above the reference, the other for when it's below the reference. A logic network following the comparators is able to distinguish 16 levels which it converts into a four-digit binary number. To obtain the four least significant bits, this four bit number is decoded into a quantized voltage and subtracted from a delayed portion of the original video sample. The difference signal is fed to 15 further level comparators and a logic network that operates in the same way as the first stage. A digit synchronizer retimes the completed number.

The sample-and-hold circuit which supplies the video sample is basically a four-diode gate and storage capacitor. The wave is sampled for 25 nanoseconds and its value at cutoff is held for 50 ns. These two period together provide the 13.3-MHz frequency. All the digital logic is built from readily available TTL integrated circuits.

Devereux says that theoretically the BBC's equipment is capable of providing a video signal-to-quantiz-

ing-noise ratio of 50 decibels, using the eight-bit word and encoding the full signal, including the sync pulse. In fact, he claims, it provides 58 dB rms. Video analog main links presently provide a signal-to-noise ratio approaching 50 dB, so that the unit equals present standards.

West Germany

Pulley-replacing frequency display shown at Electronica

Though a sickly infant in its first year, Electronica, the biennial Munich fair, has grown in the past six years into an important showcase of electronics progress. This year's show will house 750 companies, display wares from 24 countries, and host 40,000 visitors. No wonder more and more companies are planning to show off their latest developments—even if not finished products—at the show. Texas Instruments GmbH, for example, plans to exhibit a new approach for indicating the frequency to which a radio is tuned. The system uses an optoelectronic display and completely replaces the pulleys and strings now used with radio tuners.

As most radio owners know, it's tough to get an accurate indication of received frequencies with the usual pulley-based indicators. In the medium-wave band the difference is usually several kilohertz, and in the short-wave range it's several tens of kilohertz even on expanded scales. These deviations make accurate station identification difficult, if not impossible.

These deficiencies are about to be remedied, says Eilhard Haseloff, an engineer with the German subsidiary of the Dallas firm. Using microelectronics and optoelectronic devices Haseloff and his coworker Erich Ellbogen have designed a digital frequency-indicating system. The system, built into an ordinary Grundig type RTV 650 receiver, will be one of the star attractions at TI's stands during Electronica.

The frequency to be indicated is measured at the receiver's heterodyning oscillator, instead of di-

rectly at the rf stages, because the antenna voltages are far too small.

If, however, the frequency of the heterodyne oscillator is determined, addition of the i-f frequency accurately identifies the transmitting station. And the indication always is reproducible. In the medium- and short-wave ranges, where channels are spaced several kilohertz apart, the input frequency is indicated to within 1 kHz, and in the ultra-short-wave range, with a channel separation of 100 kHz, the frequency indication is accurate to within 100 kHz too.

The key unit in the system is a five-decade counter whose content is displayed by the optoelectronic semiconductor devices. The system's other component parts are pulse shaping and control logic circuits, several frequency dividers, and a 100-kHz quartz oscillator, which serves as a time standard.

The signals coming from the receiver's a-m or fm oscillator first are amplified and then shaped into pulses suitable for processing by the digital circuitry. Next, in the case of fm, the signal frequencies are reduced in a 20-to-1 dividing network. In a-m operation, frequency division takes place at a 2-to-1 ratio. Depending on the position of the receiver's range switch, either the a-m or f-m pulses are sent to a 5-to-1 divider.

The time standard's output frequency is cut down by a 10,000-to-1 divider and then is applied to the control logic circuit. Every 100 milliseconds this circuit delivers a 10-ms gate pulse to the 5-to-1 divider, allowing the signals to enter the decade counter. Initiating the counting process in the five-decade counter is a 30-nanosecond pulse coming from the control logic circuit. To prevent the frequency indication from flickering during the counting operation, a 10-ms blanking pulse, also coming from the control logic circuit, keeps the indication cut off. At the end of the counting process the counter's content is decoded and finally displayed by the optoelectronic devices. These are TI type DIS10 seven-segment numerical displays.



NEW PHASE METER

- 0.1° Resolution
- 5 Hz to 2.0 MHz
- 0.0025V to 5.0 volts (66dB)
- Accepts AC Waves and DC Pulses
- Voltmeter from 0.000 to 9.999 volts

COMBINED PHASE METER AND DC DIGITAL VOLT METER

The VIC 933A Phase Meter measures the phase displacement between two signals over the range of 5 Hz to 2 MHz with a resolution of 0.1 degree and an accuracy of 0.5°. The phase is indicated on a digital display unit which also includes BCD logic printer output capability.

A separate dc analog of phase (10 mV/degree) is provided on a BNC output jack. Both 0 to 360.0° and 0 to ±180.0° are provided.

This unit can be either ac or dc coupled with an offset dc adjustment to facilitate operation with pulse type inputs. A unique feature of this unit allows, for example, a sine wave to be measured against a digital pulse signal, and either the leading edge or trailing edge of the pulse can be used as the phase reference point.

A special feature is its capability of being used directly as a dc digital volt meter with 0.05% full scale accuracy.

The VIC 933A makes use of the latest IC circuitry and requires no adjustments, warm-up time, or calibration.



VIBRATION INSTRUMENTS CO.
1614 Orangethorpe Way, Anaheim, California 92801
(714) 879-6085

NOISY SIGNALS? If the signals to be measured are noisy, a VIC 235DS Dual Channel Tracking Filter (Analyzer) with phase matched filters may be used to filter the signals. It can also be used for Transmissibility measurements, and Mechanical Impedance measurements.



Circle 178 on reader service card

SANKEN Packs 50 Watts into A Hybrid Audio Amplifier!



SI-1020A (25W)



SI-1050A (50W)

SI-1000 Series Hybrid Power Amplifiers are designed and manufactured for a high power Hi-Fi stereophonic system. With the simple addition of power supply and a coupling capacitor to a speaker one has an IC audio amplifier of the highest quality.

OUTSTANDING FEATURES:

- *Single-ended push-pull circuit
- *Provided with temperature compensating element
- *Can withstand a 5-second short-circuit in the output terminals due to special single-diffused power transistors
- *Harmonic distortion of less than 0.5% at full power level

	SI-1020A	SI-1050A
Power supply voltage	48V	62V
Max. continuous output power (distortion < 0.5%)	25W	50W
Voltage gain	30dB typ.	
Frequency range (output 1W)	20Hz~100kHz	
Input impedance	70kΩ typ.	
Output impedance	0.2Ω typ.	
S/N ratio	90dB typ.	
Idling current	30mA typ.	



Write for further information to:

SANKEN ELECTRIC CO., LTD.

1-22-8, Nishi-Ikebukuro, Toshima-ku, Tokyo
Cable: SANKELE TOKYO Phone: 986-6151
Telex: 0272-2323 SANKELE TOK

<input type="checkbox"/> General Electric Company Robert S. Cragin Inc. General Electric Company, Semiconductor Products Division Robert S. Cragin Inc.	15E 142, 143	Kenwood Electronics Albert Frank Guenther Law Inc. Krohn-Hite Corporation Ingalls Associates Inc.	PB4 63	North American Rockwell Microelectronics Company Campbell Ewald Company North Atlantic Industries Inc. Helme Associates Inc.	45 134
<input type="checkbox"/> General Instrument Microelectronics Michael Lawler & Borradaile Ltd. General Radio Company GRAD Associates Gould Inc., Gaging & Control Division Swain, Mealer & Emerson Inc. Gould Inc. Graphics Carr Liggett Advertising	39E 2nd Cover 106 10, 11	<input type="checkbox"/> Lambda Electronics Corp. Michel Cather Inc. <input type="checkbox"/> Lapp Radio Specialty Div. of Interpace Corp. Wolf Associates Inc. Larse Corporation Hal Lawrence Incorporated <input type="checkbox"/> LTT Publibel	3rd Cover 6 27, 28 30E, 31E	Philips Eindhoven Nederland Philips GAD ELCOMA Media International <input type="checkbox"/> Philips ElectroLogica Office Machine Division Media International Philips Electronics Instruments Marsteller Inc. <input type="checkbox"/> Philips N. V. Pit/Tmi Division Marsteller International S. A. <input type="checkbox"/> Plessey Components Rumrill Hoyt Inc. <input type="checkbox"/> Polymotor S. A. George Hynes & Partners Ltd.	89 136 37E 89 2E 24E 20E
Handy & Harman J.J. Lane Inc. Hansen Manufacturing Company Keller-Crescent Company <input type="checkbox"/> Heath Dynamics Inc. Ira Morton Advertising <input type="checkbox"/> Hewlett Packard Company Lennen & Newell Inc. <input type="checkbox"/> Hewlett Packard Palo Alto Division Lennen & Newell Inc. Honeywell Computer Control Division Creamer, Trowbridge, Case & Basford Inc. <input type="checkbox"/> Howard Industries Inc. K & A Inc. Advertising	116, 117 154 128 1 2 126 133	Magnecraft Electric Company Mills, Fife and MacDonald Inc. Magnetics Inc. Lando Advertising Agency Inc. Merrill Lynch, Pierce, Fenner & Smith Inc. Foote Cone & Belding Inc. Mico Instrument Company <input type="checkbox"/> Micro Switch Division of Honeywell N. W. Ayer & Son Inc. 3M Company, Industrial Chemical Division Young & Rubicam Inc. Mohawk Data Sciences Corporation The Lampert Agency Inc.	64 16, 17 132 138 54 129 57	RCA Electronic Components Al Paul Lefton Company <input type="checkbox"/> RCL Electronics Inc. Morvay Advertising Agency <input type="checkbox"/> Rohde & Schwarz <input type="checkbox"/> RTC La Radiotechnique Agence Giorgi	4th Cover, 49 14 41E 22E, 23E
<input type="checkbox"/> I. E. R. PEMA Indium Corporation of America Evans Garber Ligas & Paige Intel Corporation Bonfield Associates <input type="checkbox"/> International Crystal Mfg. Co. Robert V. Freeland & Associates	16E 26 8, 9 24	<input type="checkbox"/> National Electronics Inc. Subsidiary Varian Associates Connor-Sager Associates Inc. National Semiconductor Corp. Chiat/Day Inc. Advertising	22 12, 13	Sanken Electric Co. Ltd. Seikosha Adv. Inc. <input type="checkbox"/> Schlumberger Ltd. EMD T. B. Browne Ltd. <input type="checkbox"/> Schlumberger SIS T. B. Browne Ltd.	D1 5E 6E

when ordering pots.

Weston Components, a Schlumberger company
Archibald, Pennsylvania 18403

Gentlemen:

- Please send me a copy of your new catalog of
Weston trimming potentiometers.
 Please have a salesman call to discuss samples and
prices.

Name

Title

Company Name

Mail Station

Street Address

City

State

Zip

10

11

12

13

14

15

16

17

18

WESTON®

Electronics in Medicine Conference

April 13-15, 1971
Boston

CALL FOR PAPERS

Prospective speakers are invited to submit 100 word abstracts of papers to be considered for the Third Annual Conference and Exposition on Electronics in Medicine.

Five copies of the abstract, along with biographical information and a list of illustrations, should be submitted by October 31, 1970. Submission date for full manuscripts from invited speakers is January 31, 1971.

Presentations should be specific and follow a case history format if possible. Suggested topics are: information processing and small computers in the hospital, laboratory automation, patient monitoring, automated history taking, design of prosthetics, and buying and evaluating medical electronics equipment.

Send all material to: **Dr. John Truxal**
Polytechnic Institute of Brooklyn
333 Jay Street
Brooklyn, New York 11201

Conference sponsors are four McGraw-Hill, Inc., publications: Electronics, Medical World News, Modern Hospital and Postgraduate Medicine.

□ Schneider R. T. Noirclerc Publicite	14E
□ SGS Scuola Di Design Di Novara	21E
W. A. Sheaffer Pen Company, A Textron Company	PB5
Sperry-Boom Inc.	
Signetics Corp. Sub of Corning Glass Works	103
Hall Butler Blatherwick Inc.	
Silliconix Inc.	51, 111
Robertson West Inc.	
□ Sogle Etudes et Creations Publicitaire	8E
□ Solartron Electronics Group Ltd. T. B. Browne Ltd.	7E
□ S. P. Elettronica Studio Sergio Rosata	13E
Sprague Electric Company The Harry P. Bridge Company	5
□ Sprague Electric Company Harry P. Bridge Company	17E
Standard Condenser Corporation	148
R. N. Johnson Advertising	
State Farm Insurance Co. Needham, Harper & Steers Inc.	PB3
State of Minnesota Industrial Development	29
The Erle Savage Company	
■ Systron Donner Corporation Bonfield Associates Inc.	7
■ Tektronix Inc. Dawson Inc.	43, 108
Teledyne Relays Company S. Michelson Advertising	38
Tempress Industries Inc. Hal Lawrence Inc.	149
Thompson CSF Electron Tubes Inc. Mohr & Company Inc.	47
Toko Inc. Hakuho Inc.	138
Triplett Electrical Instrument Company Byer and Bowman Advertising	112
■ Tung-Sol Division, Wagner Electric Corp. Winius-Brandon Company	152
Veeco Instruments Inc. Lehigh Advertising	118
Vibration Instruments Company Communication Trends Inc.	D1
Wang Laboratories Chirurg & Cairns Inc. Advertising	67
Watkins Johnson Company Williams C. Estler Pub. Rel.	58
□ Westinghouse Electric International Van Brant & Company	26E, 27E
Weston Instruments Inc. Archabald Division Michel Cather Inc.	D2, D3
□ Weston Schlumberger	35E
Xerox Corporation Hutchins Advertising Company Inc.	144
Zenith Radio Corporation Mills, Fife & Mac Donald Inc.	120

Classified & Employment Advertising

F.J. Eberle, Manager 212-971-2557	
EMPLOYMENT OPPORTUNITIES	151
EQUIPMENT (Used or Surplus New) For Sale	
Philip Fishman Co.	151
Radio Research Instrument Co.	151

■ For more information on complete product line see advertisement in the latest Electronics Buyer's Guide
□ Advertisers in Electronics International

Advertising Sales Staff

Pierre J. Braudé [212] 971-3485
Advertising Sales Manager

Atlanta, Ga. 30309: Charlton H. Calhoun, III
1375 Peachtree St., N.E.
[404] 892-2868

Boston, Mass. 02116: William S. Hodgkinson
607 Boylston St.
[617] 262-1160

Chicago, Ill. 60611: Ralph Hanning,
Kenneth E. Nicklas, 645 North Michigan
Avenue, [312] MO 4-5800

Cleveland, Ohio 44113: William J. Boyle,
[716] 586-5040

Dallas, Texas 75201: Richard P. Poole,
1800 Republic National Bank Tower,
[214] RI 7-9721

Detroit, Michigan 48226: Ralph Hanning,
2600 Penobscot Building
[313] 962-1793

Houston, Texas 77002: Richard P. Poole,
2270 Humble Bldg. [713] CA 4-8381

Minneapolis, Minn. 55402: Kenneth E. Nicklas,
1104 Northstar Center [612] 332-7425

New York, N.Y. 10036
500 Fifth Avenue
James R. Pierce [212] 971-3615
Warren H. Gardner [212] 971-3617
Michael J. Stoller [212] 971-3616

Philadelphia, Pa. 19103:
Jeffrey M. Preston
6 Penn Center Plaza,
[215] LO 8-6161

Pittsburgh, Pa. 15222: Jeffrey M. Preston,
4 Gateway Center, [412] 391-1314

Rochester, N.Y. 14534: William J. Boyle,
9 Greylock Ridge, Pittsford, N.Y.
[716] 586-5040

St. Louis, Mo. 63105: Kenneth E. Nicklas,
The Clayton Tower, 7751 Carondelet Ave.
[314] PA 5-7285

James T. Hauptli [415] DO 2-4600
Western Advertising Sales Manager

Denver, Colo. 80202: Richard W. Carpenter
Tower Bldg., 1700 Broadway
[303] 266-3863

Los Angeles, Calif. 90017: Robert J. Rielly,
Bradley K. Jones, 1125 W. 6th St.,
[213] HU 2-5450

San Francisco, Calif. 94111: Don Farris,
James T. Hauptli, 255 California Street,
[415] DO 2-4600

Paris: Denis Jacob
17 Rue-Georges Bizet, 75 Paris 16, France
Tel 727 33 42, 727 33 60

Geneva: Denis Jacob
1 rue du Temple

United Kingdom and Scandinavia
London: Keith Mantle, Tel: Hyde Park 1451
34 Dover Street, London W1

Milan: Robert Saidel, Roberto Laurer Jr.
1 via Baracchini Phone 86-90-656

Brussels: Denis Jacob
22 Chaussee de Wavre
Brussels 1040, Belgium

Frankfurt/Main: Fritz Krusebecker
Elsa-Brandstroem Str. 2
Phone 72 01 81

Tokyo: Masaru Wakeshima, McGraw-Hill
Publications Overseas Corporation,
Kasumigaseki Building 2-5, 3-chome,
Kasumigaseki, Chiyoda-Ku, Tokyo, Japan
[581] 9811

Osaka: Akihiko Kamesaka, McGraw-Hill
Publications Overseas Corporation, Kondo
Bldg., 163, Umegae-cho Kita-ku [362] 8771

Australasia: Warren E. Ball, IPO Box 5106,
Tokyo, Japan

Business Department
Stephen R. Weiss, Manager
[212] 971-2044

Thomas M. Egan,
Production Manager [212] 971-3140

Dorothy Carmesin, Contracts and Billings
[212] 971-2908

Frances Vallone, Reader Service Manager
[212] 971-6057

Electronics Buyers' Guide
George F. Werner, Associate Publisher
[212] 971-3139

Regina Hera, Directory Manager
[212] 971-2544