

March 15, 1971

\$1.00 A McGraw-Hill Publication

Jumbo read-only memory simplifies microprogramming 64

How to choose the right test system for pc boards 68

MOSFETs find a home in CATV 72

LIBRARY
THE TECHNICAL INSTITUTE
AT MEMPHIS

Electronics®



**FINK
AND
MULLIGAN:
CAN THEY
MAKE IEEE
RELEVANT?**



Hunting in the Electronic Jungle?

Hunting for MOS arrays in the teeming electronic jungle may be exciting — but is it profitable? To take the danger out of the hunt, come to AMI. Then you're dealing with the company that has produced more reliable MOS arrays and devices, and more MOS transistors, than the next several competitors combined.

We know more about designing and manufacturing MOS memory and logic circuits than anyone else

— that's why we're the world leader. Our four plants in California, Idaho, Mexico and Korea produce thousands of MOS LSI every day. Our satisfied customers include many leading manufacturers of computers, computer terminals, data communication systems and dozens of other products running the gamut from electronic calculators to coin-operated record players and vending machines to solid-state timers.

Don't gamble your company's future on unproven MOS LSI or on suppliers without a proven record of performance and on-time delivery. Call us today — and we'll show you how our mastery of MOS can give you the competitive edge.

American Micro-systems, Inc.



® 3800 Homestead Road,
Santa Clara, Calif. 95051
Phone: (408) 246-0330

'Masters of MOS'



If anyone else had built this microwave sweeper, it would cost at least \$1000 more.

That's with just one octave of RF coverage! As you add RF modules, you save even more. This is how you do it:

You buy the 8620B mainframe for just \$975. It gives you all the functions you normally need—highly linear sweeps (wide and narrow), stable CW and versatile modulation. Then, with a single-band RF plug-in, you get a complete sweeper for as little as \$2475.

The same mainframe will also accept a drawer which, in turn, holds two RF modules and a heterodyne unit. This gives you multiband operation up to 12.4 GHz. And these RF modules cost much less than anyone else's. For example, the 3.2-6.5 GHz module goes for \$1650; the

8-12.4 GHz unit is just \$1950.

So you're really saving a bundle, while still enjoying the performance and reliability you expect of an HP product.

How can it do so much for so little? It's really very simple. We design and manufacture our own high-frequency microcircuits in volume. So we can cut production costs to the bone. And pass the savings on to you.

So when we talk about low-cost sweepers, we're still talking about high quality. Why not call your HP field engineer and see for yourself. Or write to Hewlett-Packard, Palo Alto, California 94304; Europe: 1217 Meyrin-Geneva, Switzerland.

04105A

HEWLETT  PACKARD
SWEEP OSCILLATORS

Circle 1 on reader service card

The Incredible Dodecameter...

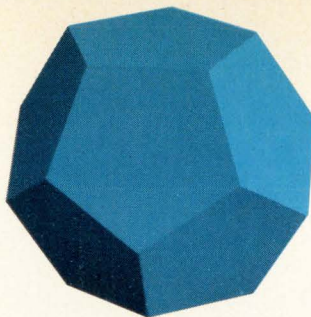

Adds twelve programmable measurement functions to your system. You start with the basic dc unit and add options to fit your systems needs. You can use the new HP 3450A Multi-Function Meter for dc, ac and ohms measurements — ratio, limit tests, and ratio limit tests. The 3450A has autoranging on all functions—and all functions are fully programmable. This broad capability is contained in a 3½" high rack mount — ideal for systems.

The basic dc unit is integrating and fully guarded for excellent noise immunity. You can make 15 readings per second with a sensitivity of 1 μ V. Add the AC Voltage and AC Ratio Option to your basic dc unit and you can make true RMS ac measure-

ments from 45 Hz to 1 MHz—without the errors due to harmonic distortion.

Add the Ohms and Ohms Ratio Option for ohms measurements with 1 m Ω sensitivity. The four-wire ohms input provides sense and signal leads to reduce errors due to lead resistance.

Put in the Limit Test Option and you can preset two four-digit limits. Your system then can make simple comparisons without using a computer or digital comparator. Use the Digital Output Option with the Limit Test Option for nine columns of information including HI, GO, LO limit test decisions.

The Rear Input Terminal Option provides a set of guarded rear input terminals and a FRONT/REAR INPUT selector switch on the front panel.

If your requirements change, any of the options are field-installable (except rear input terminals). Call your nearest HP field engineer to learn how easily "the incredible dodecameter" adapts to your measurement system. For full specifications, write to Hewlett-Packard, Palo Alto, California 94304. Europe: 1217 Meyrin-Geneva, Switzerland.

Prices: Basic 3450A, \$3300; AC Option 001, \$1250; Ohms Option 002, \$425; Limit Test Option 003, \$375; Digital Output Option 004, \$225; Remote Control Option 005, \$260; Rear Input Terminal Option 006, \$70.

099/4A

HEWLETT  PACKARD

DIGITAL VOLTMETERS

Circle 2 on reader service card

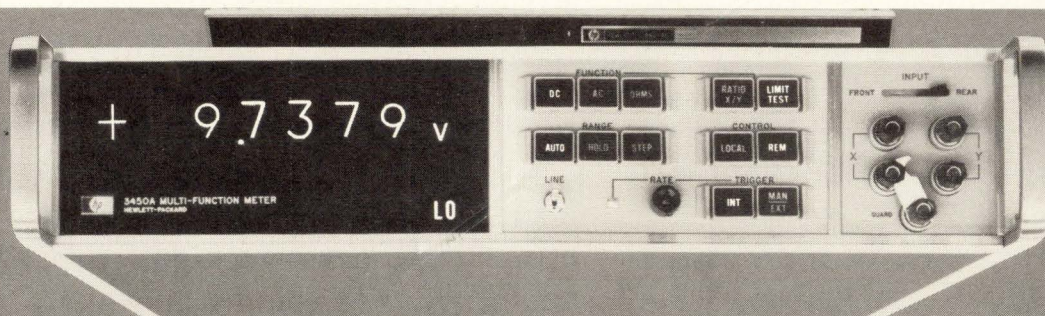

31 Electronics Review

ADVANCED TECHNOLOGY: Charge-coupled technology used in memory, 31
DISPLAYS: Color finds way into plasma panels, 31
MICROWAVES: Repeaters threaten traveling wave tubes, 32
ELECTRONICS INDEX OF ACTIVITY, 34
COMMERCIAL ELECTRONICS: IBM terminal enters credit checking race, 34
COMMUNICATIONS: Competition quickens for domestic satellite, 36
INTEGRATED ELECTRONICS: Standard calculator chip can be customized, 39
COMPUTERS: Stripped minis sharpen price competition, 40; IBM and the MOS-bipolar option, 42
DEFENSE ELECTRONICS: Profit study sees it both ways, 42
FOR THE RECORD, 44

63 Technical Articles

SOLID STATE: Microprogramming made easy—with a 4,096-bit bipolar ROM, 64
PACKAGING & PRODUCTION: Proving out large pc boards: which system is best for you? 68
COMMUNICATIONS: MOSFETs rejuvenate old design for CATV broadband amplifiers, 72
CIRCUIT DESIGN: Designer's casebook, 76
AVIONICS: Digital ICs + VOR = simpler navigation, 80
SPECIAL REPORT: IEEE—Dissension spurs a search for relevance, 88
SPECIAL REPORT: IEEE—Changing times bring a changing show, 93

103 Probing the News

YOU & YOUR JOB: EEs find self-help groups help little, 103
INDUSTRIAL ELECTRONICS: Programable controls hit the line, 107
COMPUTERS: IBM guns failing to sink independents, 110
MILITARY ELECTRONICS: Intrusion detectors score in Laos, 114

119 New Products

IN THE SPOTLIGHT: MOS/LSI tester is versatile and flexible, 119
COMPONENTS: Four-output power supply, 123; Diode display in a DIP, 124; Memory drivers are ICs, 126
INSTRUMENTS: Synthesizer sweeps, too, 129; Frequency response analyzer, 133; Bridge offers BCD output, 134
DATA HANDLING: Wire memory on a card, 137; Analog-to-teletypewriter coupler, 140; Low-cost display, 143
SEMICONDUCTORS: Hammer driver handles 6.5 A, 145; Off-the-shelf military-type memories, 146

157 Electronics International

FRANCE: Portable DVM bows for less than \$350, 157
GREAT BRITAIN: Electronic aids invade Scotland Yard's sanctums, 158
JAPAN: 200 megahertz under the sea, 158
WEST GERMANY: Programable ceramic matrix, 159; Time division for satellite links, 160

Departments

Publisher's letter, 4
Readers comment, 6
People, 14
Meetings, 21
Electronics Newsletter, 25
Washington Newsletter, 53
New Literature, 150
International Newsletter, 155

Title R registered U.S. Patent Office; © copyright 1971 by McGraw-Hill Inc.
All rights reserved, including the right to reproduce the contents of this publication in whole or in part.

EDITOR-IN-CHIEF: Kemp Anderson

EXECUTIVE EDITOR: Samuel Weber

MANAGING EDITORS: Robert Henkel, *News*;
Arthur Erikson, *International*

SENIOR EDITORS: John Johnsrud, H. Thomas
Maguire, Stephen E. Scrupski

ASSOCIATE EDITORS: William Bucci, Richard
Gundlach, Howard Wolff

DEPARTMENT EDITORS

Communications & Microwave: Leon M. Magill;
Computers: Wallace B. Riley; *Consumer*:
Gerald M. Walker; *Industrial Electronics*:
Alfred Rosenblatt; *Instrumentation*: Owen Doyle;
Military/Aerospace: Herman Lowenhar;
New Products: H. Thomas Maguire (Mgr.),
William P. O'Brien; *Packaging*
& *Production*: Stephen E. Scrupski;
Solid State: Laurence Altman

COPY EDITORS: William S. Weiss,
Margaret Eastman

ART: Fred Sklenar, *Director*
Charles D. Ciatto, *Associate Director*

PRODUCTION EDITORS: Susan Hurlburt,
Arthur C. Miller

EDITORIAL SECRETARIES: Claire Goodlin,
Vickie Green, Terri O'Neil,
Bernice Pawlak

FIELD EDITORS

Boston: James Brinton (Mgr.), Gail Farrell;
Dallas: Paul Franson (Mgr.);
Los Angeles: Lawrence Curran (Mgr.);
San Francisco: Stephen Wm. Fields (Mgr.),
Marilyn Howey; *Washington*: Ray Connolly
(Mgr.), Jim Hardcastle, Larry Armstrong;
Frankfurt: John Gosch; *London*: Michael
Payne; *Paris*: Arthur Erikson; *Tokyo*:
Charles Cohen

McGRAW-HILL WORLD NEWS

Director: Walter A. Stanbury; *Atlanta*: Stan
Fisher; *Chicago*: Mike Sheldrick; *Cleveland*:
Arthur Zimmerman; *Dallas*: Marvin Reid;
Detroit: James Wargo; *Los Angeles*: Michael
Murphy; *San Francisco*: Margaret Drossel,
Tyler Marshall; *Seattle*: Ray Bloomberg;
Washington: Charles Gardner, James Canan,
Herbert W. Cheshire, Seth Payne, Warren
Burkett, William D. Hickman; *Bonn*: Robert F.
Ingersoll; *Brussels*: James Smith; *London*:
Marvin Petal; *Milan*: Jack Star; *Moscow*:
Axel Krause; *Paris*: Robert E. Farrell, Stewart
Toy; *Tokyo*: Mike Mealey

PUBLISHER: Dan McMillan

ASSISTANT TO THE PUBLISHER: Wallace C.
Carmichael

PLANNING & DEVELOPMENT MANAGER:
Donald Christiansen

ADVERTISING SALES MANAGER: Pierre Braudé

CIRCULATION MANAGER: George F. Werner

RESEARCH MANAGER: David Strassler

PROMOTION MANAGER: Tomlinson Howland

ADVERTISING SALES SERVICE MANAGER:
Wallis Clarke

The IEEE show gets off and running next week at the New York Coliseum, and the New York Hilton, which is, happily for the staff here, right across the street. But the fact is we've already gone far afield to gather the inputs for our two-part IEEE report (see p. 88).

For the first part, about the IEEE in changing times, came reporting, from as far away from New York as the West Coast, about the dissidents and militants who are pushing the IEEE to get involved in the engineer's economic and social concerns, not just his professional interests. From Washington came interview comments from this year's president, James H. Mulligan Jr., who points out that the institute is very much aware of the engineer's plight and is already responding to the winds of change.

For the second part, about the IEEE show itself, the staff gathered information from all over the country to give you background on the more unusual technical sessions, to detail why there are fewer exhibitors this year, to relate how the IEEE has worked to make the show more "relevant" and attractive to both the engineer and the exhibitor, and to preview some of this year's new products.

And although the show is a stone's throw away, we're still a long way from being done with our coverage. Next week, our veteran news and technical editors will be fanning out to cover the show like a glove, sniffing out the trends, spotting the hot news items, seeking out the top-level people

who shape and shake the industry.

Indeed, as has happened for years past, many of these top-level people will be seeking us out, since they look to *Electronics* as a valuable source of up-to-the-minute reports, a clearinghouse for the latest industry news. That's when we really open up a window on the insider's view of industry happenings. But we gain no benefit from the insider's information unless you do, too. You can be sure that anything of significance we spot at the show will be passed on to you as fast as possible in our news or technical pages.

It's not every day you run into the world's biggest monolithic bipolar ROM. And it's not every day you get the chance to read about one. This issue we're printing the first technical run-down (see p. 64) of how Signetics put together the biggest bipolar-ROM-on-a-chip that you can buy, a 4,096-bit beauty that promises, among other things, a big step forward in the micro-programming of complex digital systems. Representing the technical and marketing side of the development, Signetics' team of authors—Sam Sirkin, Orville Baker, Bill Davidow, and Dave Allison—worked hard on bringing out the ROM and worked hard, too, with us in bringing the details to *Electronics*' readers.

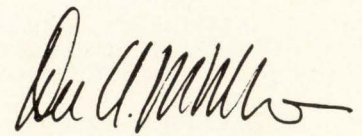

March 15, 1971 Volume 44, Number 6
91,266 copies of this issue printed

Published every other Monday by McGraw-Hill, Inc. Founder: James H. McGraw 1860-1948. Publication office 330 West 42nd, N.Y., N.Y. 10036; second class postage paid at New York, N.Y., and additional mailing offices. Executive, editorial, circulation and advertising addresses: Electronics, McGraw-Hill Building, 330 W. 42nd Street, New York, N.Y. 10036. Telephone (212) 971-3333. Teletype TWX N.Y. 710-581-4235. Cable address: MCGRAWHILLN.Y.

Subscriptions limited to persons with active, professional, functional responsibility in electronics technology. Publisher reserves the right to reject non-qualified requests. No subscriptions accepted without complete identification of subscriber name, title, or job function, company or organization, including product manufactured or services performed. Subscription rates: qualified subscribers in the United States and possessions and Canada, \$8.00 one year, \$12.00 two years, \$16.00 three years; all other countries \$25.00 one year. Limited quota of subscriptions available at higher-than-basic rate for persons outside of field served, as follows: U.S. and possessions and Canada, \$25.00 one year; all other countries \$50.00. Air freight service to Japan \$60.00 one year, including prepaid postage. Single copies: United States and possessions and Canada, \$1.00; all other countries, \$1.75

Officers of the McGraw-Hill Publications Company: John R. Emery, President; J. Elton Tuohig, Senior Vice President—Services; Donald B. Gridley, Group Vice President; Vice Presidents: Ralph Blackburn, Circulation; John R. Callahan, Editorial; William P. Giglio, Administration; David G. Jensen, Manufacturing; Jerome D. Luntz, Planning & Development; Joseph C. Page, Marketing; Robert M. Wilhelmy, Finance.

Officers of the Corporation: Shelton Fisher, President; Joseph H. Allen, Group Vice President—Publications and Business Services; John J. Cooke, Senior Vice President and Secretary; Ralph J. Webb, Treasurer.

Title © registered in U.S. Patent Office; © Copyright 1971 by McGraw-Hill, Inc. All rights reserved. The contents of this publication may not be reproduced either in whole or in part without the consent of copyright owner. Subscribers: The publisher, upon written request to our New York office from any subscriber, agrees to refund that part of the subscription price applying to copies not yet mailed. Please send change of address notices or complaints to Fulfillment Manager; subscription orders to Circulation Manager, Electronics at address below. Change of address notices should provide old as well as new address, including postal zip code number. If possible, attach address label from recent issue. Allow one month for change to become effective.

Postmaster: Please send form 3579 to Fulfillment Manager, Electronics, P.O. Box 430, Hightstown, N.J. 08520.

URGENTLY NEEDED: RELIABILITY

Accidental Electrocutions Claim 1200 Patients a Year

Fairchild News Service
At least three patients in United States hospitals are accidentally electrocuted each day.

The total number of electrocutions annually is about 1200.

According to Dr. Paul W. Wight, a surgeon at Kettering Memorial Hospital, Dayton, Ohio, who supplied the figures, most of the patients

condition but were undergoing "routine diagnostic tests," or "routine treatment."

Dr. Wight's figure on accidental electrocutions quoted last week at a Symposium held in conjunction with a session of the Medical Instrumentation Society.

search Council, Canada, said:

"Internal electric shock is a subtle hazard that has often escaped recognition. As a result, many deaths were attributed to natural causes."

patients a year are electrocuted during hospital treatment in the U.S.A."

In a telephone interview last week, Dr. Wight said he received the figures from an actuary for a national United States insurance company's computer study.

NEWS

The tiny flaws in medical design can kill

Errant currents from faulty electronic equipment are reported imperiling patients in certain cases

Ronald Gechman
West Coast Editor

aware that small electrical currents applied to the body can be fatal.

Reproduced from: *Electronic News*

Reproduced from: *Electronic Design*

FROM SPRAGUE: RELIABLE CAPACITORS

Sprague Electric has long been aware of the crucial importance of reliability . . . particularly in medical electronics, where failure can be fatal. The capacitors shown on this page are designed for utmost reliability . . . not merely to meet existing standards, but to be as failure-free as the present state of the art will permit.

HYREL® Capacitors



Manufactured under climate- and dust-controlled conditions in factory space used solely for high reliability production. 100% tested for optimum quality control. Exceed military and industrial standards for shock, vibration, moisture resistance, life. Reliability documented by extensive test data. Applications now include cardiac pacers and coronary care units. One 4-year user reports no failures. Available in following types:

- Type 350D HYREL® ST Solid Tantalum
6 to 75 WVDC, .0047 to 330 μ F
- Type 351D Non-Polar HYREL® ST Solid Tantalum
6 to 50 WVDC, .0023 to 160 μ F
- Type 309D HYREL® GT Sintered-Anode Tantalum
6 to 150 WVDC, 1.7 to 1200 μ F
- Type 330D HYREL® GT Sintered-Anode Tantalum
4 to 100 WVDC, 1.7 to 1200 μ F
- Type 195P HYREL® Q Subminiature Paper
200 to 600 WVDC, .001 to 1.0 μ F
- Type 168P HYREL® PQ Subminiature Paper
50 WVDC, .001 to 1.0 μ F

Type 118P Subminiature DIFILM® Metallized Capacitors

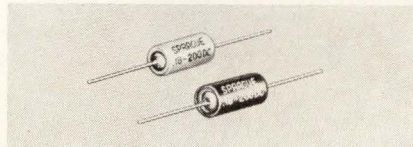

Unmatched for reliability at 125C by any other metallized paper capacitor. Higher insulation resistance than that of any other metallized paper design. Unique dielectric combines metallized paper and polyester film impregnated with special high temperature mineral wax. Hermetically sealed.

200 to 1000 WVDC, .001 to 12.0 μ F

Heart Defibrillator Capacitors

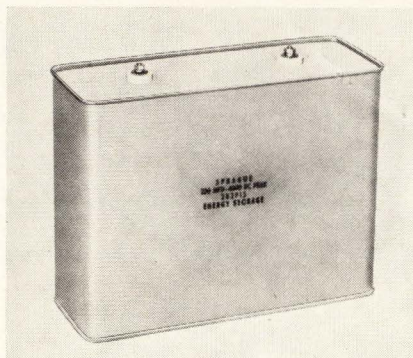

True energy-storage capacitors expressly developed for heart defibrillators. Charged in milliseconds and discharged in a fraction of a millisecond.

Three case sizes available.

Each rated 16 μ F, 7500 WVDC.

Type 260P METFILM® 'K' Film Capacitors



Exceptional versatility and superior electrical characteristics in small physical size. Metallized polycarbonate-film dielectric provides high insulation resistance, high capacitance stability, low dielectric absorption, low dissipation factor. Hermetically sealed.

200 to 600 WVDC, .01 to 10.0 μ F

COMPULYTIC® Aluminum Electrolytic Capacitors

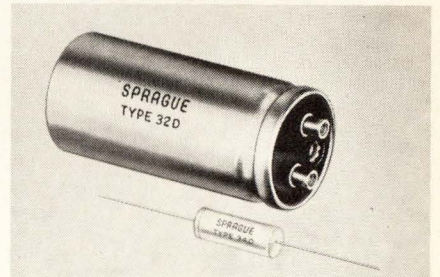

Power supply filter capacitors with low leakage currents, low ESR, long shelf life. Feature the most reliable seal yet developed for aluminum electrolytics.

Type 32D—Cylindrical with tapped terminal inserts or solder lug terminals

2.5 to 450 WVDC, 35 to 200,000 μ F

Type 34D—Tubular with axial leads

2.5 to 450 WVDC, 1 to 13,000 μ F

4SC-0119

For technical literature on any of these capacitors, or engineering assistance without obligation, write or call Mr. John Moynihan, Sprague Electric Company, 35 Marshall Street, North Adams, Mass. 01247. Telephone (413) 664-4411

THE BROAD-LINE PRODUCER OF ELECTRONIC PARTS



Sprague and 'S' are registered trademarks of the Sprague Electric Co.

A Smart Way to Beat Your Power Supply Size Problem

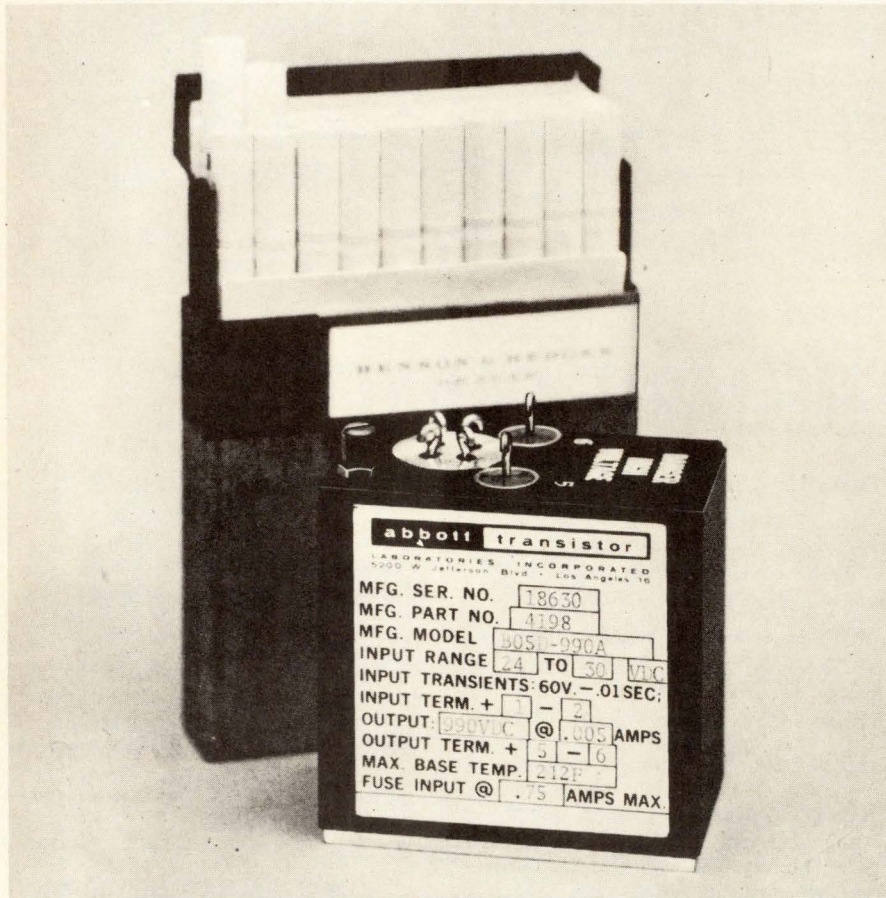

1½" thin, 2¾" narrow, 2¾" short

yet this converter produces 1000 volts DC, regulated, from a battery input of 28 VDC! It weighs less than 15 ounces. This is only one of our wide variety of many small light weight converters, inverters and power supplies — there are over 3000 models listed in our newest catalog, including size, weight and prices. If you have a size problem, why not send for an Abbott catalog?

MIL SPEC ENVIRONMENT — All of the power modules listed in our new catalog have been designed to meet the severe environmental conditions required by modern aerospace systems, including MIL-E-5272C and MIL-E-5400K. They are hermetically sealed and encapsulated in heavy steel containers. New all silicon units will operate at 100°C.

Please see pages 930 to 949 of your 1970-71 EEM (ELECTRONIC ENGINEERS MASTER Catalog) for complete information on Abbott modules.

Send for our new 68 page FREE catalog.

abbott transistor

LABORATORIES, INCORPORATED

5200 W. Jefferson Blvd./Los Angeles 90016
(213) 936-8185 Cable ABTLABS

1224 Anderson Ave./Fort Lee, N.J. 07024
(201) 224-6900

Readers comment

Tempest over testers

To the Editor: Michael A. Robin-ton's article on MOS/LSI testers [Feb. 1, p. 62] renders an extreme disservice to the realistic character of the entire engineering community. If Mr. Robin-ton would pause and reflect that the test equipment manufacturers exist in a competitive business environment ruled largely by the laws of supply and demand, the prices dictated by these laws, and the costs that establish a lower bound to prices in both the short and long term, most of his machinations would fall into perspective.

We are releasing our study of the automated test equipment market, which reveals considerable indecision among equipment users and builders on several fundamental aspects of highly expensive MOS testing. For example, these questions require precise, definitive answers:

- What minimum tests are really required to validate a given MOS subsystem or system—parametric, functional and/or dynamic?
- How should these tests be implemented—sampling, random, one-shot, repetitive, environmental, exhaustive, etc.?
- Would an equal effort in increased process control at the wafer and chip level be more practical and profitable?

The confluence of these questions has reached a zenith and finds itself centered on the heretofore inadequately defined requirements of dynamic MOS testing. Successful filling of this need in the marketplace is not a simple, deterministic linear function of technology and economics.

The required equipment is state of the art. The R&D expenditures necessary to participate in this market are high in terms of dollars and skill. The basic technology of devices being tested still is evolving. Unit prices of testers can be between \$200,000 and \$1 million. Investment in in-process inventories is high; the typical tester manufacturer can command such sizable financing only on the basis

ADLAKE DRY REED RELAYS

of unusually firm planning. Market size and equipment configurations demand a clearer, more insistent definition for and by all MOS manufacturers.

Mr. Robinton is correct when pointing out the exaggerated capability claims of the suppliers and their marginal equipment adaptations. However, these are normal strategies employed when neither the entrepreneurial buyer or seller is properly prepared to assume the risks necessary to achieve an order or two of magnitude change in capability.

Our study confirms the existence and definition of an attractive market, but it will not be met or satisfied simply by establishing a few specification objectives by an individual.

E. Paul Moschella
Research director
Theta Technology Corp.
Wethersfield, Conn.

To the Editor: We fully agree with Mr. Robinton's article as far as it went. However, it appears that either he did not fully survey the systems available on the market or he specifically chose to review only those test systems which justify his own in-house development.

We manufacture and sell test systems for MOS/LSI that will meet all of the requirements outlined by Mr. Robinton. Price of a 40-pin system, with full 5-megahertz test capability, functional speeds up to 5 MHz, and dc parametric capability is approximately \$250,000—less than two-thirds the amount which Mr. Robinton is reported to have spent on his "in-house" system. This particular system, our model 4630, can be expanded up to 80 pins for less than \$2,000 per pin additional.

We must agree with Mr. Robinton that the cost of systems that fully test MOS/LSI is substantial. However, a careful review of the actual cost of testing, based on a typical five-year useful life for a well-designed test system, will show that operating labor and maintenance costs will exceed the original system's price by an order

Quality and reliability are key design parameters built into Adlake's complete line of DRY REED RELAYS. Advanced electrical, mechanical and packaging features qualify these *standard, intermediate, and miniature* size devices for an extremely wide range of commercial, industrial, and military switching applications, such as control panels, machine process control instrumentation, and telephone and communications apparatus, to mention just a few.

ELECTRICAL DETAILS:

- Contact Arrangements:
Up to 4-A or 2-B
- Contact Current Ratings:
Switch 0.5 A; carry 3 A
(Miniature & Intermediate)
Switch 1.5 A; carry 6 A (Standard)
- Contact Resistance:
Initial—50 milliohms, max.;
end-of-life—2 ohms max.
(Standard)
Initial—200 milliohms max.;
end-of-life—2 ohms max.
(Intermediate & Miniature)
- Contact Life:
Rated Loads—20 x 10⁶ operations
Dry Circuit—500 x 10⁶ operations
- Contact Voltage Ratings:
100 VDC or 150 VAC
(Miniature or Intermediate)
150 VDC or 250 VAC (Standard)
- Insulation Resistance:
10¹² ohms (min.)
- Operating Speed:
1 to 2.5 ms
(Miniature & Intermediate)
2.5 to 4.5 ms (Standard)
(Varies with sensitivity and number of poles; including contact bounce and coil time)

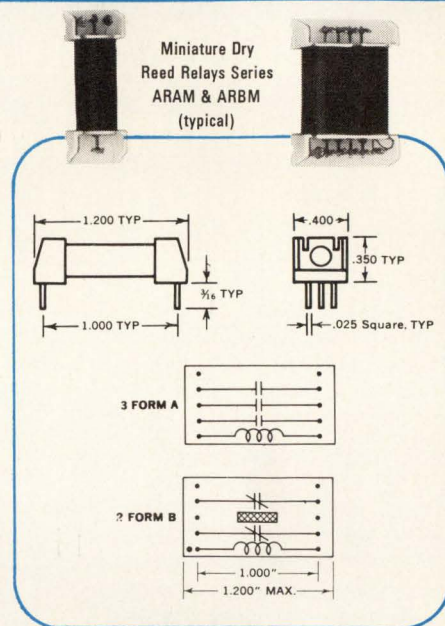

PACKAGING DETAILS:

- Environmental Protection:
Hermetically sealed contacts. Rhodium plating on contacts for higher loads and longer life characteristics.
 - Shielding:
Magnetic shielding layer
 - Shock:
200G max. 11 ± 1 ms
(Miniature & Intermediate)
100G max. 11 ± 1 ms (Standard)
 - Vibration:
30 G max. 0-1700 cps
(Miniature & Intermediate)
0-600 cps (Standard)
 - Temperature Range:
—55 to 105°C
- Choose from 123 cataloged items. Dry Reed Relays with special features are available on special order with surprisingly short delivery times.

MERCURY WETTED CONTACT RELAYS

Low, stable contact resistance and "1-billion-operation" life qualify Sensitive Mercury Wetted Contact Relays for a wide array of switching applications, such as digital and analog computers, telecommunications system, multiplex, industrial control equipment, power control devices. New Series MWK and AWK Sensitive Relays offer contact form K (SPDT, center off)—ideal for multiple channel switching.

MERCURY DISPLACEMENT RELAYS

Time delay and load relays meet the toughest, most demanding switching applications. Non-adjustable time delay relays offer contact forms A and B with delays up to 1 hour, current ratings to 15 amps. Load relays switch from 30 to 100 amps with contact forms A and B.

USE READER SERVICE NUMBER FOR COMPLETE INFORMATION



THE ADAMS & WESTLAKE COMPANY

A SUBSIDIARY OF  **ALLIED PRODUCTS CORPORATION**

ELKHART, INDIANA 46514 • 219 • 264-1141 • TWX 219-522-3102 • TELEX 25-8458 • CABLE ADLAKE

Some day these tests may save your life...

because DCS VCO's and FM Demodulators are on the job today!

Whether your application is gathering test data from advanced automotive safety testing systems or from any transducer input . . . GOM-5 Series Voltage Controlled Oscillators will faithfully FM-encode your data for recording and future analysis. DCS FM Demodulators will reduce the recorded data to original format for accurate analysis and evaluation.

GOM-5 Series VCO's feature highest input sensitivities available. Our GFD-15 Demodulators interface with your computer or stand alone as the finest unit available.

**Circle Reader Service Number
for Free Application Data**

Data Control Systems, Inc.
Commerce Drive
Danbury, Conn. 06810
Tel: (203) 743-9241
TWX: 710-456-0376



DATA-CONTROL SYSTEMS, INC



Readers comment

of magnitude. Since these costs are relatively independent of the original price of the system, the real criterion is the product of the throughput multiplied by the usage factor (total number of devices tested), not the original cost of the system.

We agree that many of the companies that claim to be offering low-priced test systems are really offering systems inadequate to fully test MOS/LSI. However, a very few companies, including ours, have been able to fight their way through the tangle of conflicting requirements voiced by the semiconductor manufacturers and actually do offer systems that will adequately test a wide range of semiconductor products at a price that is more than competitive with in-house systems.

William F. Boggs
Systems sales manager
E-H Research Laboratories Inc.
Oakland, Calif.

"Good sense"

To the Editor: In the article on retail point-of-sale terminals [Nov. 23, 1970, p. 52], Irving I. Solomon's remarks about the National Retail Merchants Association's work on specifications for equipment and tag identification had the clear ring of good sense.

We have found from practical experience that installing such a data capture system is a difficult task. Making the system give the retailer the information he wants, when he wants it, in a form he can use, is difficult enough without adding the complications of a totally new merchandise marking system and computer technology that retail merchants may never have heard of.

It's easy to get so caught up in the machinery that one forgets the point: to furnish the retailer with data he never had before. We think this is where J.C. Penney and the General Electric Co. went wrong with the Tradar system.

Bernard Edelman
President
Information Machines Corp.
Santee, Calif.

**WE PUT
OUR MONEY
WHERE OUR
MOS IS.**

INTRODUCING MOS MACHIN

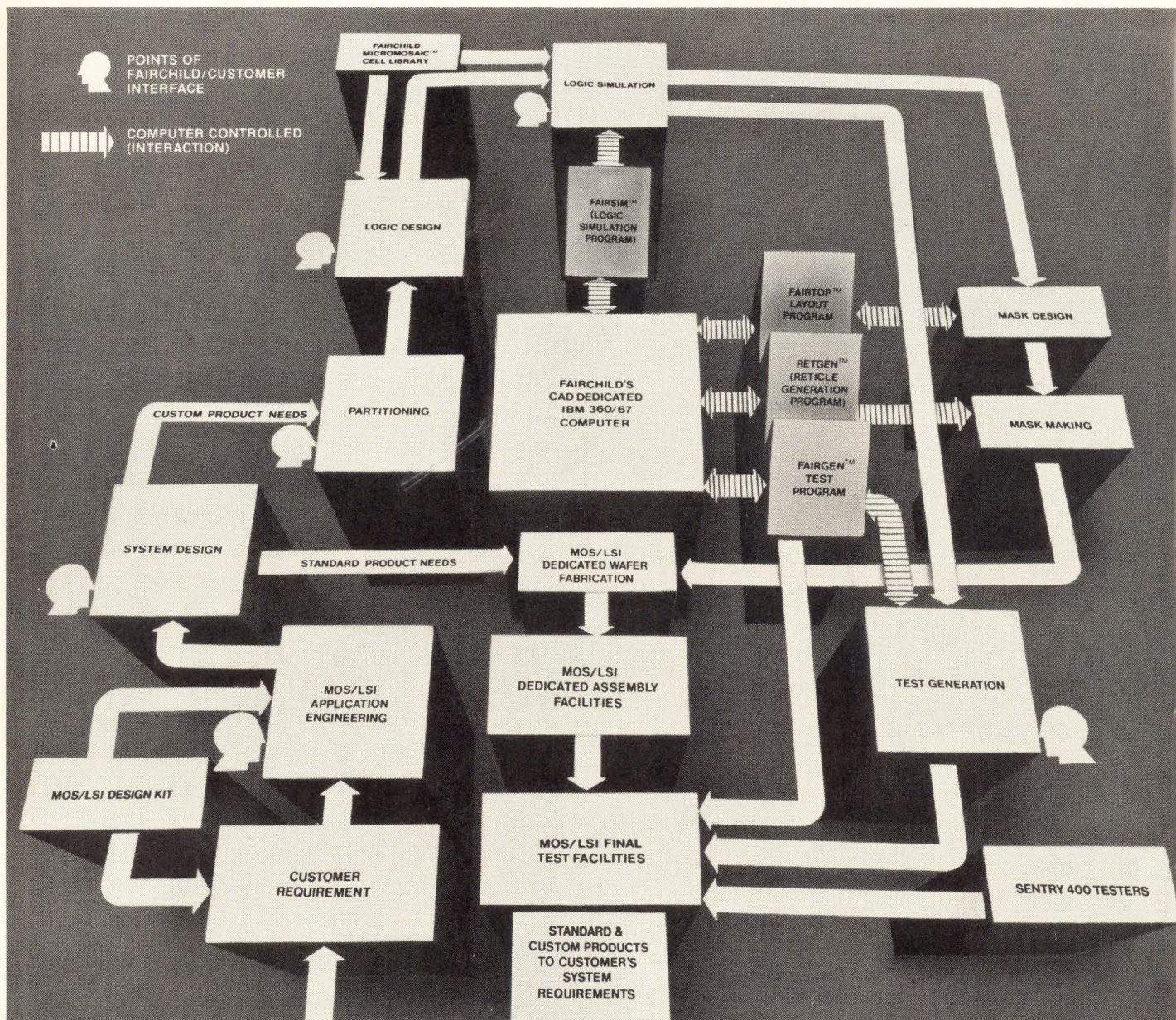

THE MIGHTY E.

We built a mighty MOS Machine capable of delivering total MOS systems. A complex of talent and experience, design and production capabilities, facilities and equipment, hardware and software. Fully operational now.

Our machine makes us the first of the Big Guys with a massive commitment to MOS. We've invested \$15 million to make it mighty: new MOS-dedicated wafer fabrication equipment for both silicon gate and metal gate devices, new mask shop, new test equipment, CAD systems using a 360/67 computer and over \$3,000,000 worth of software (including our unique Micromosaic™ technique). Some Machine.

The Mighty MOS Machine Delivers the Goods.

In the last year we designed and delivered over 100 custom LSI arrays for terminals, desk calculators, minicomputers, modems, digital voltmeters, process controllers, scientific calculators, and security systems. 1-chip to 23-chip systems. Up to 500 gates per chip.

That's a lot of MOS.

But there's even more to come. Right now, our Mighty Machine is purring along at the rate of over 15 new product designs a month. It will crank out close to 200 new circuits in 1971. Mighty MOS.

The Machine has been doing custom work almost exclusively. But now the Mighty MOS Capability also includes standards with 2 dozen TTL-compatible silicon gate devices scheduled for 1971: shift registers, ROMs, RAMs, display drivers, keyboard encoders, standard calculator sets.

For greater insight into our MOS capability, contact us c/o MOS Product Marketing. We'll send you applications information and/or a User Design Kit. Better yet, ask to have one of our Applications Engineering teams call on you for on-the-spot MOS systems assistance.

Either way, you can bring all your MOS problems to one place for a total solution: Fairchild's Mighty MOS Machine.

Fairchild Semiconductor.
A division of Fairchild Camera
and Instrument Corporation,
Mountain View, California.
(415) 962-5011
TWX: 910-379-6435

FAIRCHILD
SEMICONDUCTOR

If we make them fail safe, you can forget about us.

Are you thinking about your line drivers and line receivers more than you want to?

Do you worry about accidental grounding or shorting; random data, errors you can't detect, oscillation?

Then you might want to think about us.

We have a single ended quad line driver that saves you three wires every time you use one. (It works beautifully with pairs of our dual fail-safe receivers.)

How many companies make a single ended quad line driver?

One. Us.

We have lots of them. And so does Hamilton/Avnet.

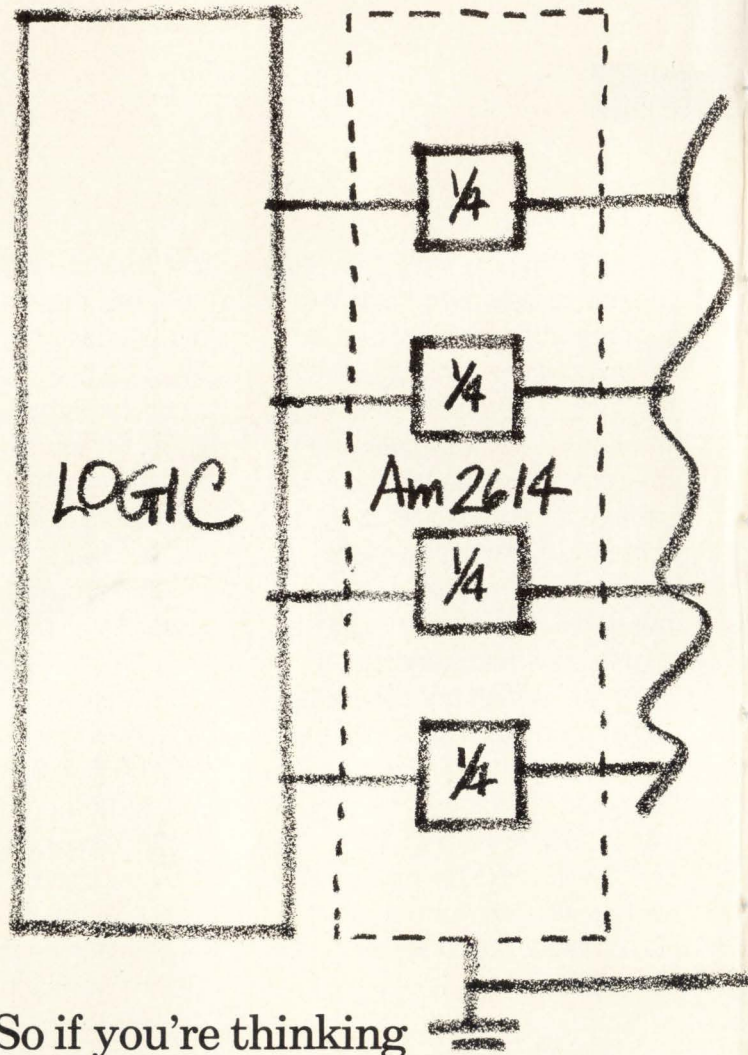

So if you're thinking about your line drivers and line receivers more than you want to, think about us.

Just once.



SINGLE ENDED DATA TRANSMISSION

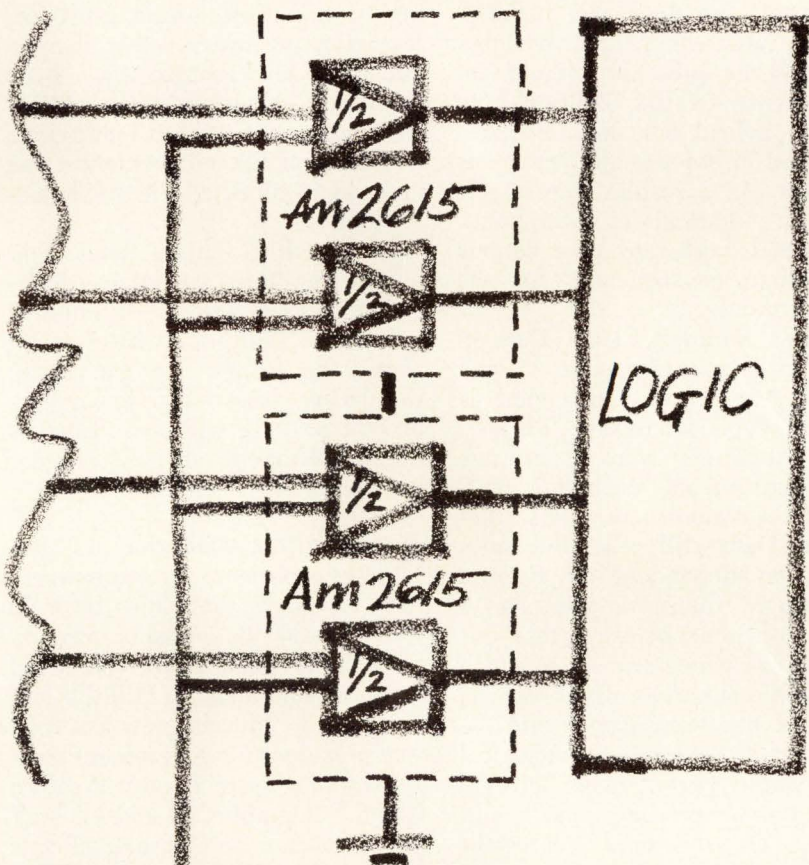

The Am 2614: It takes all kinds. TTL, DTL & MOS. Mix or match.
Each Am2614 quad driver needs only one wire per channel, plus
one ground once for the whole system!

Our line drivers & receivers.

Meet the whole family, Ours and
Theirs. All work off a single 5 volt
power supply. All are available
in Hermetic DIP, Flat Pak and
Silicone DIP. All are available in
both military (-55°C to $+125^{\circ}\text{C}$)
and commercial (0°C to $+75^{\circ}\text{C}$)
temperature ranges.

Am2614

Single Ended Quad Line Driver

Am2615

Single Ended Dual Fail Safe Line
Receiver (with high common
mode voltage range $\pm 15\text{ V}$)

Am9614

Dual Line Driver

Am9615

Dual Differential Line Receiver

Am7830/8830

Dual Line Driver

Circle Bingo card #303.

Advanced Micro Devices, Inc.

Telephone 800-538-7904 toll free, and ask for Shel Schumaker. In California, call 408-732-2400. In Los Angeles, call Steve Zelencik at 213-360-2102.
In Chicago, call George Flynn at 312-825-1144. In the eastern United States, call Steve Marks at 212-343-2220.
901 Thompson Place, Sunnyvale, California 94086/TWX 910-339-9280/TLX 346306

FREE Engineering Handbook on Electromagnetic Delay Lines

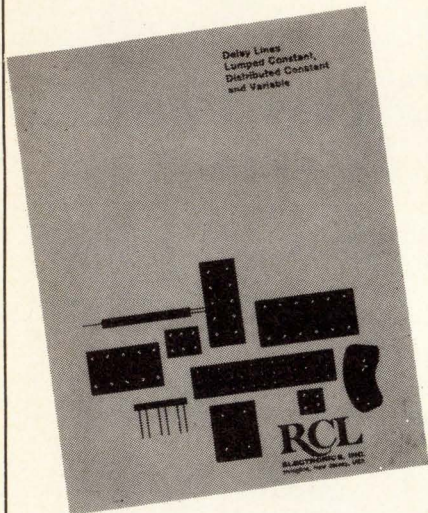

**We've reserved
a copy
for your desk . . .**

Terms . . . engineering definitions . . . how to specify delay lines . . . characteristics of various types . . . specifications . . . they're all included in this concise, easy-to-read handbook . . . yours for the asking.

**LUMPED CONSTANT . . .
DISTRIBUTED CONSTANT
. . . VARIABLE**
all three types are covered
in this reference
handbook.

RCL

RCL ELECTRONICS, Inc.,

General Sales Office:

Seven Hundred
South Twenty First Street
Irvington, New Jersey 07111

People

The refrain is heard again and again: electronics companies must move away from the comfortable warmth of military and aerospace and out into the cruel, cold reality of the commercial world. Many are agonizing over the move, others are having some success. One of the successful ones is Electro-Data Inc. of Garland, Texas. While it did 75% of its business with the Government in 1967, Electro-Data expects to do 15% in 1972, with its all-electronic watch leading the way.

But George Thiess, president, points to a significant fact: his company's new commercial business wouldn't be possible without developments—C/MOS, light-emitting diodes, hybrid ICs, and the like—spawned in defense and aerospace projects. As a result, Thiess feels that the reductions in government-sponsored work may have serious long-range consequences for the U.S. economy.

Thiess founded Electro-Data in 1967 after experience at TI and Sperry Microwave and a stint as president of Microwave Physics. Early products were microwave test instruments, including YIG-tuned panoramic receivers that Electro-Data still sells. But sales were too dependent on Federal spending. "About two years ago, I came to the conclusion that our sales were concentrated too much in government areas. And I realized that if I put some money into the commercial field, our technological base would permit us to develop some unique products that would give us an advantage over established companies," says Thiess.

His first venture into commercial business was the futuristic Orbits clock, which sold for \$125 through fashionable stores such as Neiman-Marcus in Dallas. Electro-Data did not attempt to market the clock itself, but left this to an established company, an approach that Thiess feels permits his firm to compete effectively in new markets.

Next came what is considered the first all-electronic watch—the Pulsar—with C/MOS dividers and LED display. The Hamilton Watch

Co. is selling the Pulsar for \$1,500 as a prestige timepiece. Thiess expects half of his company's sales this year to be from the Pulsar.

In another foray into commercial sales, Thiess acquired American Time Co., which makes and leases time and temperature signs for banks. This provided Electro-Data with another good way to gain marketing experience, and Electro-Data is making a technical contribution by replacing the 500-lb electromechanical controller with a 25-lb IC and Triac assembly.

Now Thiess' engineers are reading a miniature ground-fault detector/circuit breaker that can be added at low cost to any house to prevent accidental electrocution. Here again, the work is being done with an experienced partner, in this case an established electrical distributor.

In all this, Thiess feels that unique products are vital; "diversification as a 'me-too' is doomed to failure." But he worries a bit about the future. He can't help wondering where the technology he is exploiting will come from as the Government sharply reduces its spending for research.

Armed with a smattering of Greek plus experience in communications networks that dates back 25 years, Harold R. Johnson, formerly a brigadier general, has launched a major campaign. Before the end of the year, Johnson, new assistant vice president for government communications systems with Western Union Telegraph Co., and his staff plan to present seminars to officials in 50 states. Their message: "Rho data, not crematics."

Johnson's mission is to sell state officials on the need for dedicated data communications systems, which Western Union feels it is uniquely qualified to provide. This he does by comparing what he calls RhoData systems, or networks that transfer data by moving electrons, and RhoCrematic systems, which move data by transporting piles of paper. In the final analysis, he says, "They're going to learn sooner or later they can do a better

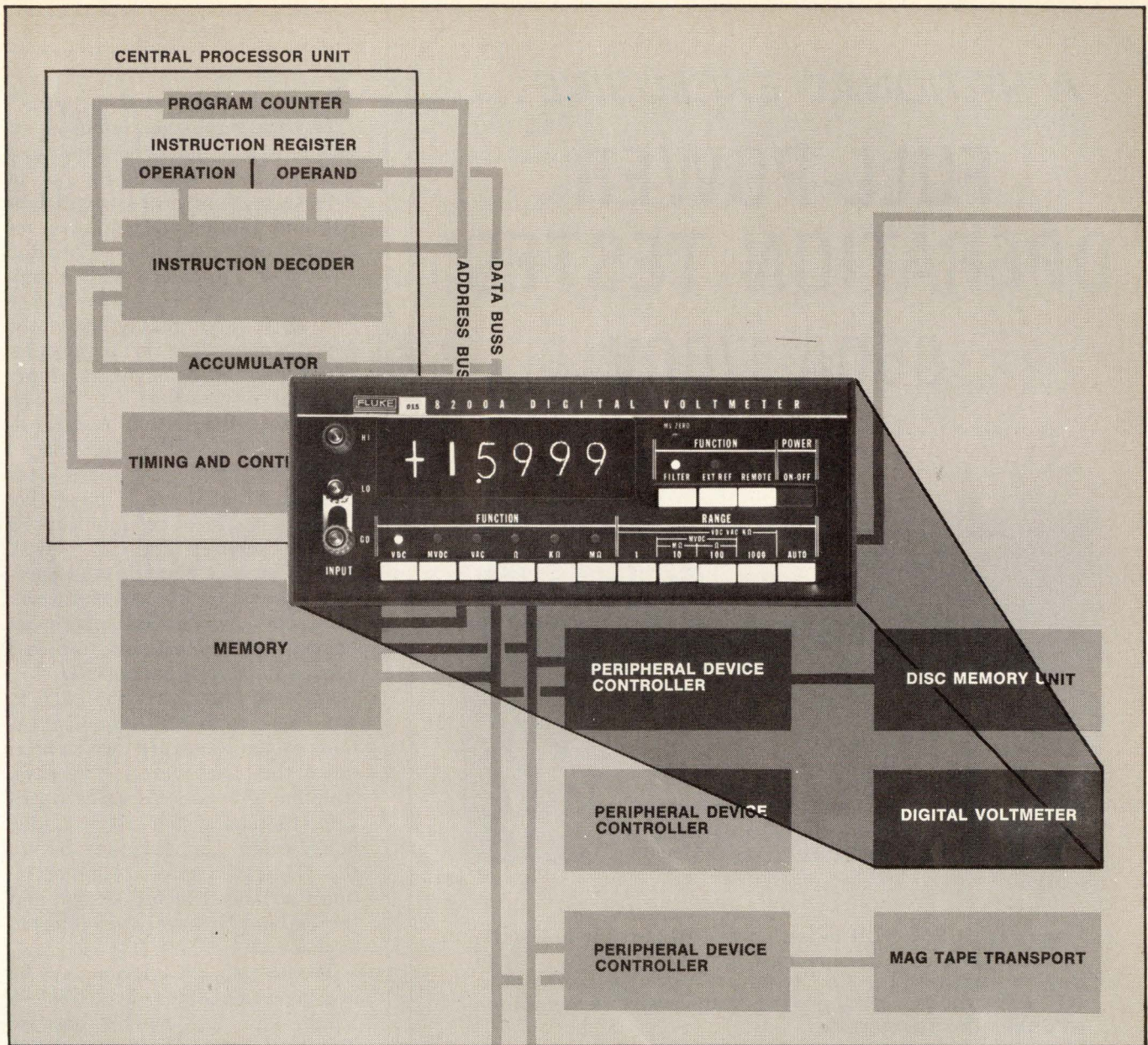

The only fast new systems DVM

(400 samples per second, 60% overranging, autoranging and remote programming with memory).

The new Fluke 8200A DVM will give you years of topflight performance in either systems use or on the bench. A fast four digit instrument with an accuracy of 0.01%, the Fluke 8200A is small and lightweight.

We designed it to give you maximum flexibility. All the options can be added in the field so that it's easy to satisfy your changing requirements.

The Fluke 8200A gives you high accuracy, overranging, and **high sampling**

speed. Standard features include autoranging (**millivolts through volts and ohms through megohms**), 1 millisecond sample and hold, half-rack width of 3½" high, modular construction with vertical plug-in boards, switched four pole filter in volts and **millivolts**, dc capability from 100 microvolts to 1100 volts, full guarding for 140 db common mode rejection dc to 60 Hz, 2 millisecond response time, and overload proof design.

The basic instrument goes for \$995. Many options are available: two ranges of millivolts for **1 microvolt resolution**, six ranges for measurements from 10 milliohms to 16 megohms, four ranges of ac, true 4 wire ratio, isolated digital or printer output, and isolated remote control **with memory** for direct computer interface. A full bore Fluke 8200A with all options goes for \$2,395.

For the full story, see your Fluke sales engineer or contact us directly.



® Fluke, Box 7428, Seattle, Washington 98133. Phone: (206) 774-2211. TWX: 910-449-2850
 In Europe, address Fluke Nederland (N.V.) P.O. Box 5053, Tilburg, Holland.
 Phone: (04250) 70130. Telex: 884-50237/In the U.K., address Fluke International Corp.,
 Garnett Close, Watford, WD2 4TT. Phone: Watford 27769. Telex: 934583.

See it at the 1971 IEEE, New York Coliseum, March 21-25.

A NATIONAL® EXCLUSIVE...

FULL-POWER OPERATION TESTED*

850A-1700V

SCRs

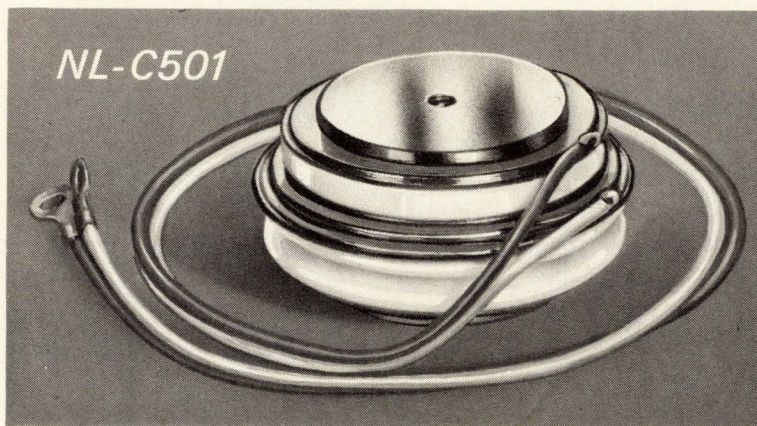

*Every NL-C501 SCR is tested at full current and voltage ratings under a reactive load to validate the critical device parameters. No "cheater" circuits are used in testing. Only National provides this positive assurance of device performance.

NL-C501 PLUS FACTORS

- ⊕ Voltage range up to 1700 V.
- ⊕ Double diffused construction to assure repeatable performance
- ⊕ Shorted emitter for minimum dv/dt of 100 V/ μ sec.
- ⊕ Disc construction for either reverse polarity or parallel assembly
- ⊕ Also available in factory assembled back-to-back heat sink

We welcome requests for detailed data and application assistance. Contact...

NATIONAL ELECTRONICS, INC.
a varian subsidiary

Geneva, Ill. 60134, phone 312-232-4300

job moving electrons than paper."

Most governments, Johnson explains, spend much of their time building large data bases. But in most cases, punch-card-oriented input and limited output have restricted their usefulness. With the advent of computers with strong communications capabilities and of low cost, high-quality networks governments "are in a position where they can begin to apply some real cost saving."

Johnson, the former commanding general for the Air Force's Pacific communications area, concedes that the growth of the market for state and local communications will be "uneven and not rapid." But because of the size and enormous growth of this area of government, he says, Western Union must begin the educational process needed to develop this market.

Western Union has the edge in building leased-line communications systems because "we've been down this road before," he says. Autodin, the nation's largest private-line data system, for example, is a Western Union service. So are the General Services Administration's advanced record system and the Federal Reserve wire, Johnson explains.

The 48-year-old Johnson says he is a good candidate to lead Western Union into this market because "I have spent my life learning this business and I know it pretty well." Most of the first big data-communication-system planning was done by the military in Autodin and the National Military Command System. Johnson played a strong role in both, first as chief of the Air Force Communications Directorate's plans branch, then as associate director of the Directorate of Defense Research and Engineering's National Military Command System office.

Finally, he says that his three-year tour as assistant director of the White House Office of Telecommunications Management from 1965 through 1968 offered unparalleled experience. "I don't think there's anything in this country comparable to working that job."

New third generation op amps.



Exotic, but never neurotic.

No more paying a premium for sticky performance problems. Signetics' new third generation linear offers optimum performance without the usual penalties.

New 537 precision op amp. At last, a "super" op amp that's finally practical. Permits a full range of input signals without blowing up. Standard pinout like 748, 101, etc. Drives 2K load as any op amp should.

New 536 FET input op amp. Very high input impedance — now much easier to apply. Combines high gain and large signal AC performance with extremely low input offset voltage and bias current. Can be provided with 7.5mV offset voltage.

New 533 micro power op amp. The bonus: the 533 fits existing designs (pinouts, voltage swings, compensation). Operates from supplies as low as $\pm 1V$.

Delivery now from your Signetics distributor or salesman. Along with our 528 sense amp and 531 high slew rate op amp. All true third generation linear devices that let you perform — and expand — existing functions without neurotic hang-ups. 

Signetics

Signetics-Linear
811 E. Arques Avenue
Sunnyvale, Calif. 94086

Show me Signetics counts
in linear.

Rush me third generation
information package
on 533, 536, 537, 528 and 531.

Name

Title

Company

Address

City

State

Zip

Telephone

SIGNETICS CORPORATION—A SUBSIDIARY OF CORNING GLASS WORKS

We give you more
of what you need;
quality.



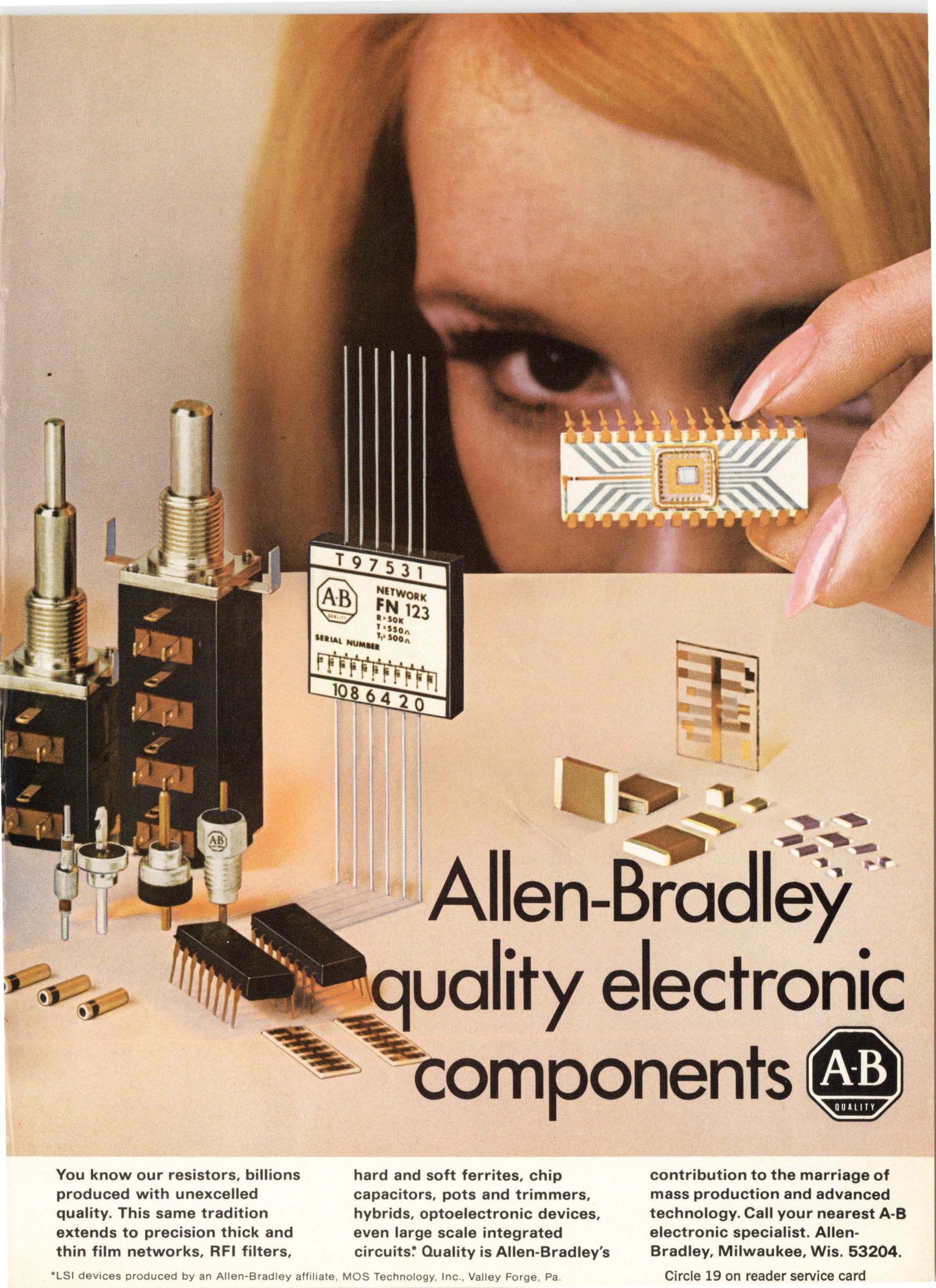

T 97531
 AB NETWORK
 FN 123
 R = 50K
 T = 550Ω
 T₁ = 500Ω
 SERIAL NUMBER
 1086420

Allen-Bradley quality electronic components



You know our resistors, billions produced with unexcelled quality. This same tradition extends to precision thick and thin film networks, RFI filters,

hard and soft ferrites, chip capacitors, pots and trimmers, hybrids, optoelectronic devices, even large scale integrated circuits.* Quality is Allen-Bradley's

contribution to the marriage of mass production and advanced technology. Call your nearest A-B electronic specialist. Allen-Bradley, Milwaukee, Wis. 53204.

*LSI devices produced by an Allen-Bradley affiliate, MOS Technology, Inc., Valley Forge, Pa.

Circle 19 on reader service card

Large jet aircraft equipped with RCA 400 Hz triacs are making aviation history

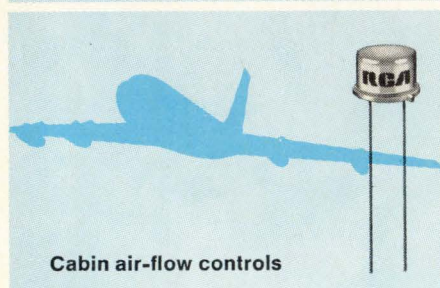
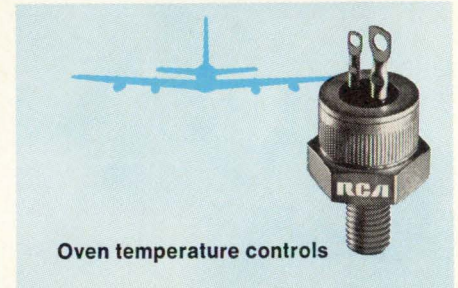
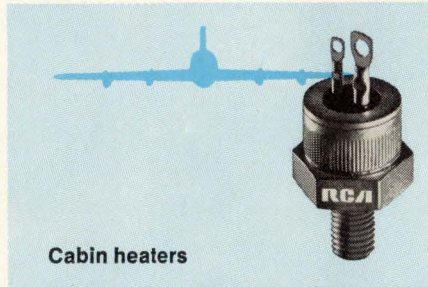
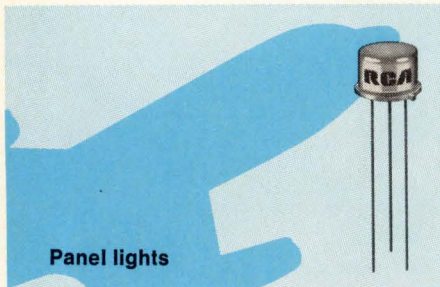

Today, in the jet age of aviation, strong demands are placed on "super" new designs. Now, more than ever, systems designers of aircraft controls recognize the need for these designs which must feature reduced weight and increased reliability. To achieve this, designers are relying on RCA 400 Hz triacs for aircraft control applications. You will find RCA 400 Hz triacs in some of the newest and biggest aircraft — operating windshield and instrument heaters, and controlling panel lights, cabin air flow, lamp intensity, cabin heaters, and landing-gear systems.

Examine your circuit designs against the following table, to see where the superior quality, reliability and high performance of RCA 400 Hz triacs can help you. Then call your local RCA Representative or your RCA Distributor for further details. For technical data, write: RCA, Commercial Engineering, Section 70C-15/UR7, Harrison, N.J. 07029. International: RCA, 2-4 rue du Lièvre, 1227 Geneva, Switzerland, or P.O. Box 112, Hong Kong.

Type Number	Rating I _r (RMS) (A)	Package	Voltage* V _{DRM} (V)	Gate Trigger Current I _{GT} (max.) (mA)	Modes
40769	0.5	3-lead modified TO-5	200	10	all
40771	0.5	3-lead modified TO-5	200	25 40	I ⁺ , III ⁻ I ⁻ , III ⁺
40773	2.5	2-lead modified TO-5	200	25 40	I ⁺ , III ⁻ I ⁻ , III ⁺
40775/ 40777	6.0	press-fit/ stud**	200	80	all
40779/ 40781	10.0	press-fit/ stud**	200	80	all
40783/ 40785	15.0	press-fit/ stud**	200	80	all
TA 7646/ TA 7648	25.0	press-fit/ stud**	200	80	all
TA 7650/ TA 7652	40.0	press-fit/ stud**	200	30	all

*All above devices are also available in 400-V versions.
**On special request, these units are available in Isolated stud.

RCA Thyristors

Meetings

Calendar

International Convention & Exhibition, IEEE; Coliseum and New York Hilton Hotel, New York, **March 22-25.**

European Semiconductor Device Research Conference, IEEE, DPG (German physical society), NTG (German communications society); Munich, **March 30-April 2.**

Reliability Physics Symposium, IEEE; Stardust Hotel, Las Vegas, **March 31-April 2.**

USNC/URSI IEEE Spring Meeting, Statler Hilton Hotel, Washington, **April 8-10.**

National Telemetry Conference, IEEE; Washington Hilton Hotel, **April 12-15.**

International Magnetics Conference (Intermag), IEEE; Denver Hilton, Denver, Colo., **April 13-16.**

Conference & Exposition on Electronics in Medicine, Electronics, Medical World News, Modern Hospital, Postgraduate Medicine; Sheraton-Boston Hotel and the John B. Hynes Civic Auditorium, **April 13-15.**

Offshore Technology Conference, IEEE, Houston, **April 18-21.**

International Geoscience Electronics Symposium, IEEE; Marriott Twin Bridges Motor Hotel, Washington, **April 18-23.**

Frequency Control Symposium, U.S. Army Electronics Command; Shelburne Hotel, Atlantic City, N.J., **April 26-28.**

Relay Conference, College of Engineering, Oklahoma State University Extension, National Association of Relay Manufacturers; Stillwater, Okla., **April 27-28.**

Southwestern IEEE Conference and Exhibition, Houston, Texas, April 25-May 2.

Symposium on Theory of Computing, Association for Computing Machinery; Shaker Heights, Ohio, **May 3-5.**

Electronic Components Conference, IEEE; Statler-Hilton Hotel, Washington, **May 10-12.**

Spring Joint Computer Conference, IEEE; Convention Center, Atlantic City, N.J., **May 18-20.**

Electric & Electronic Measurement & Test Instrument Conference, IEEE; Skyline Hotel, Ottawa, Ontario, Canada, **June 1-3.**

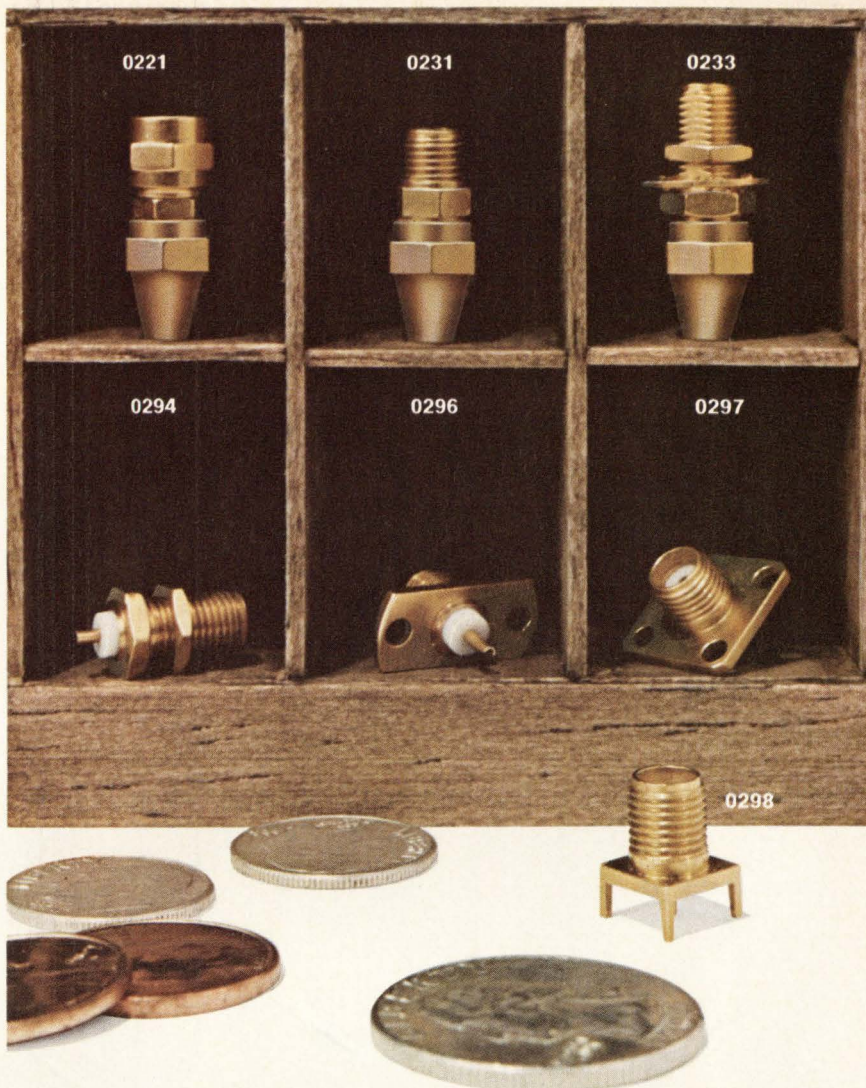

Would you believe they'll do the job for a fraction of SMA prices?

Until now you've had to buy SMA connectors built to MIL specification. And pay the price. There just wasn't any other kind.

Johnson has changed that. With this new series of JCM miniature RF coaxial connectors. Up to 3 GHz you get the same electrical performance as with the expensive SMA types. Only we don't over-build them. That way we don't have to charge as much for them.

We make 7 types—for panel and PC mounting and for flexible cable assemblies. All are interchangeable and intermateable with the standard, expensive SMA connectors. So you can use them without making any changes . . . and without compromising required performance. And JCM connectors accept virtually any size cable, so you don't have to stock a big variety. It's worth looking into, isn't it? All it costs is a stamp.

E. F. JOHNSON COMPANY / Waseca, Minnesota 56093

Please send technical information and test samples of your new low-cost series 142-0200-001 JCM connectors. Specify model #: _____.

NAME _____

FIRM _____ TITLE _____

ADDRESS _____

CITY _____ STATE _____ ZIP _____



E. F. JOHNSON COMPANY

Visit our booth at IEEE: #2506 & 2508

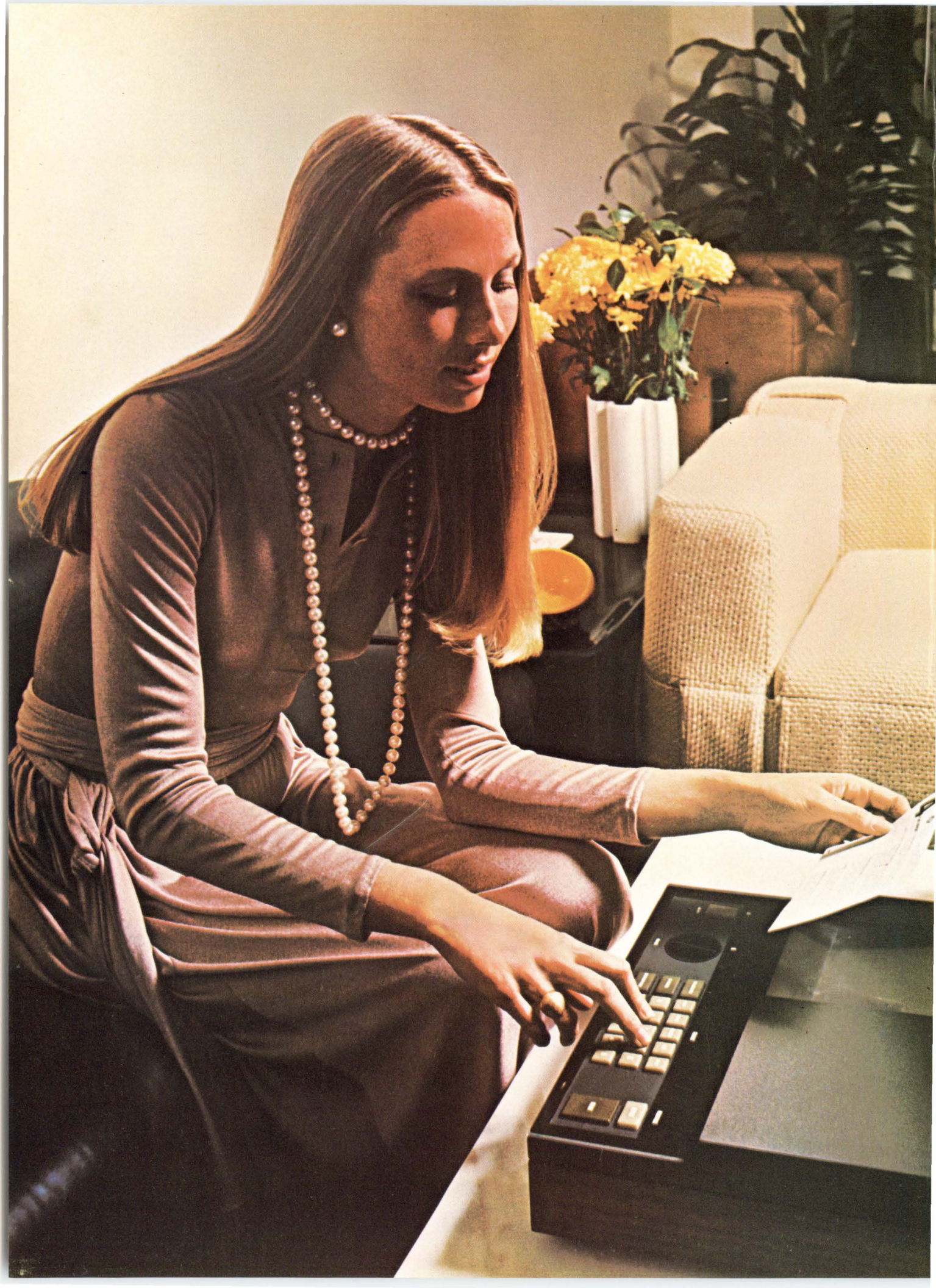

By 1979, newspapers will be printed in your living room.

You won't have to roll up the carpet. Or even cover up the furniture.

Because all it will take is a compact print-out unit attached to an ordinary tv set.

When you're ready for the stock market closings, ball game scores or movies listings, you'll simply push a button.

Instant newspaper. And you'll be able to get any part of it, or all of it, any hour of the day or night.

The fact is, the products of electronics technology will be doing more for our lives tomorrow than electricity does for us today.

Automated highways will drive our cars. Home computers will cook the food and wash the clothes. Electronic health maintenance programs will even help us avoid illness.

Who are the master minds masterminding these changes?

Our readers. Engineers and technical managers who must keep abreast of all fast-changing developments. Industry-wide and world-wide. Which is why they come to us.

Every two weeks, Electronics magazine presents them with a complete, up-to-the-minute picture of the state of the technology.

Last year alone, Electronics presented six times as much information on consumer electronics as any other publication in the field. And twice as much on communications.

If you expect to be part of the future, speak to the men who are working on it today.

Electronics, a McGraw-Hill market-directed publication.

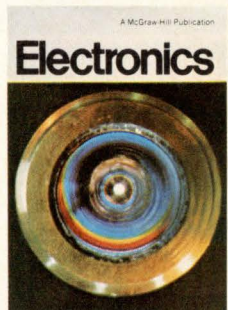

Our readers are changing the world.

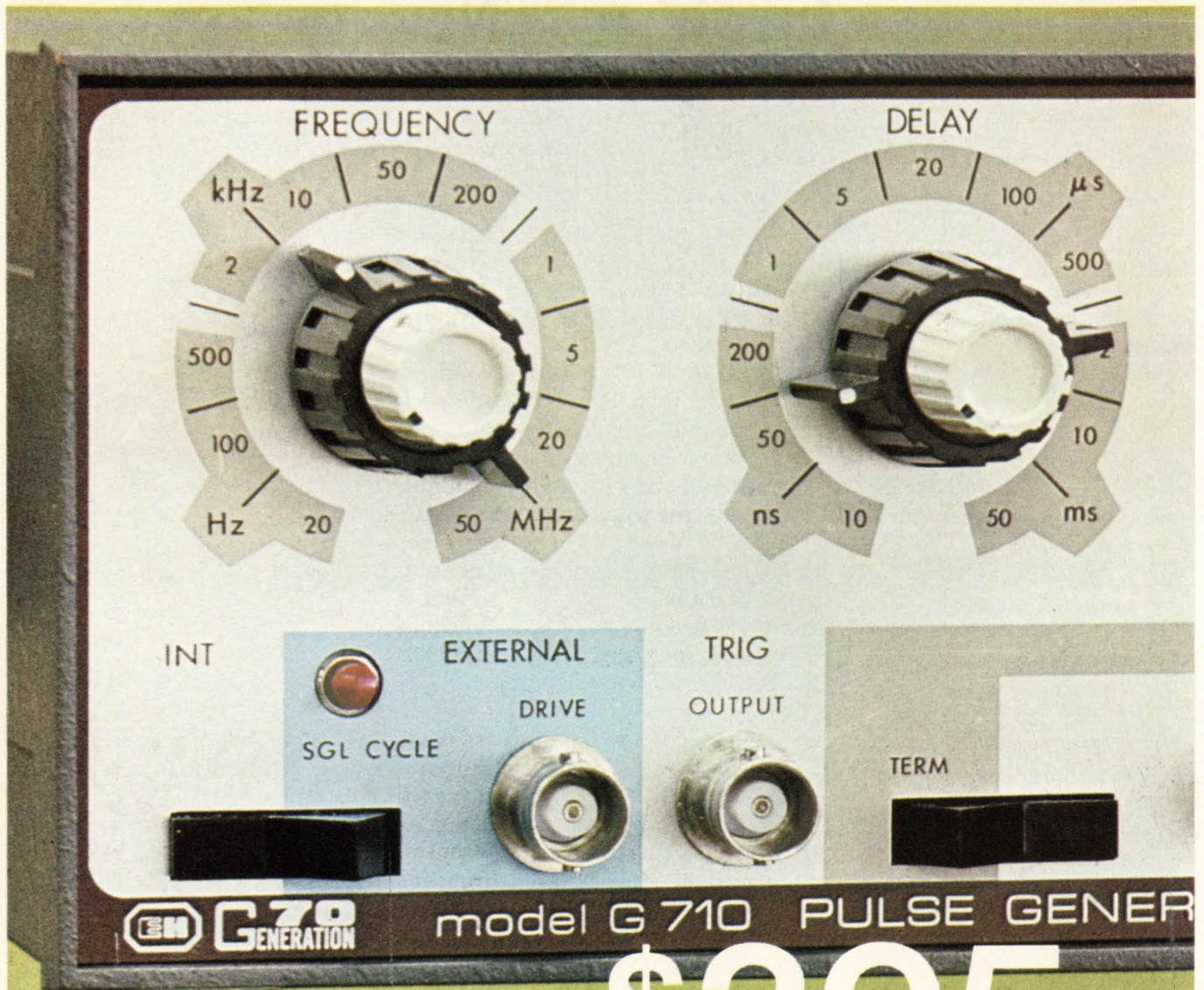

\$395

Dear Sir:

You boys from E-H Research Laboratories talk big. Now, prove it. Here is my purchase order. Please ship me _____ Model G710 50 MHz pulsers for only \$395 each. I understand the E-H Model G710 pulser from your new GENERATION 70™ line offers dual outputs with amplitude to 5V into 50 ohms, rise and fall times of 5ns, duty factor greater than 50%, external triggering and waveform distortion less than 5% peak-to-peak. I want a 5-Day Free Trial and a One-Year Guarantee.

Name _____	Title _____
Company _____	
Address _____	Telephone _____
City _____	State _____ Zip _____

515 11th Street • Box 1289, Oakland, California 94604 • (415) 834-3030

If you don't want to cut up your magazine, just a purchase order to E-H or to an E-H Representative will do.



Electronics Newsletter

March 15, 1971

Surface waves used in logic devices

Surface wave acoustic technology—usually reserved for delay line applications—has broken into the logic sector. Autonetics researchers have made inverters, OR gates, and NAND gates with surface wave devices. In the NAND gate, for example, a 120-megahertz signal is launched into the quartz substrate from an interdigital transducer, with a second transducer supplied for logic inputs, also at 120 MHz. Centered between them is an output transducer. With clock and so-called bit inputs out of phase, the team observed 25-decibel cancellations below input levels; in-phase inputs add and a signal appears at the output. The Autonetics team made simple gates and series-connected logic assemblies, and demonstrated signal-leveling techniques.

Not only should the acoustic logic show high resistance to nuclear radiation, it also could challenge electronic logic speeds. Lithium niobate, which has a high coupling constant, could be substituted for quartz and increase bit rate from its present 2 MHz to perhaps 20 MHz. Autonetics also figures that better transducers and higher frequency sources could boost speed beyond the expected 20 MHz.

Amorphous devices switch uhf signals

Amorphous semiconductors, glass devices limited up to now to dc, have successfully switched ultrahigh-frequency signals. Experimenters at Texas A&M University, using a silicon-germanium-arsenic-tellurium glass supplied by Texas Instruments, used 100-microsecond, 250-to-300-volt pulses to change the glass from the on to the off state. The switch was placed in series on strip transmission line, thus acting more like an attenuator than a switch; still, the ratio of transmitted power between the on and off states of the switch was about 10:1 at 300 megahertz.

The University team noted three other effects that are sure to interest communications and radar engineers. First, switching action was more or less independent of pulse length. Second, the higher the pulse repetition rate the sooner switching began to occur—indicating that the amorphous material might act as a modulator for an ultrahigh-repetition-rate radar or as a fast pulse-coding modem without degrading pulse shape. Third, switching was too rapid for the researchers to measure but took far less than a microsecond.

GPO may enter computer output microfilm market

Public Printer A. N. Spence's proposal to put his Government Printing Office into the computer-generated microfilm business using a new 48-to-1 reduction ratio has both users and hardware makers in an uproar. The new ratio would permit reproduction of 90% of all GPO documents on single, 4-by-6-inch microfiches.

However, the proposal would require major changes in computer hardware of the 21 manufacturers whose 37 models capable of producing microfiches direct from taped data all use a 42:1 ratio.

Computer controls wafer fabrication

In a step toward complete automation of semiconductor production, Applied Materials Technology Inc. of Sunnyvale, Calif., has developed a computer-controlled epitaxial-reactor system for wafer making. It uses a Digital Equipment Corp. PDP-8 in a closed loop and will be marketed. All the operator need do is insert a punched card in a slot.

Electronics Newsletter

The computer controls both impurity flow rate and temperature. An optional magnetic disk offers programed storage and voice response.

Reflective array boasts 500% bandwidth

An antenna that seems to combine a little of the best of all current designs—it corrects for coma, spherical, and chromatic aberrations, which degrade the performance of other reflective antennas—has been developed at the University of Illinois, Urbana. **Unlike phased arrays, the new antenna has an extremely broad bandwidth—at least 500%.** The trick lies in the design of the reflector. It is corrugated at different depths across its aperture to provide broadband phase-delay compensation. Further, the beam can be scanned simply by moving the feed; the ultra-high level of correction allows a tight beam almost without sidelobes.

The new design is going to attract interest for several reasons. **First, its broad bandwidth could allow use of very narrow radar pulses, which would result in very high resolution.** Second, the system could be steered electrically by putting phase shifters in the corrugations to change their electronic depth. Finally, amplifiers could be installed there, too, to amplify the beam while it is being steered.

Tester takes on instrument package

PRD Electronics of Syosset, N.Y., is readying what it calls a commercial automatic system tester that may be exhibited for the first time in June at the Armed Forces Communications and Electronics Association conference in Washington. Reluctant to disclose details because the tester is still in development, **PRD asserts the new unit is not merely a component or printed circuit board tester but will accommodate “an entire instrumentation package.”**

Addenda

Sprague Electric Co. is about to sign a second-sourcing and exchange-of-technology contract with a West Coast company that will move it into the bipolar IC memory field. **The giant components company already has a big stake in the MOS memory field** through its affiliate, Mostek Corp. of Carrollton, Texas. . . . American Micro-systems, a 1970 leader in MOS sales and one of the staunchest advocates of the standard, p-channel MOS process, **is entering the realm of ion implantation.** The company has developed an 11,848-bit read-only memory on a chip that measures less than 150 mils on a side. The biggest ROM yet announced is a demonstration vehicle. **The first ion-implanted product will be a 448-word-by-five-bit, 2-megahertz video display character generator.** . . . Signetics has developed a process that might hasten the advent of ECL MSI. Most complex ECL circuits require two layers of metal interconnect that, with present processes, cause reliability problems. **Signetics employs anodized aluminum as an insulator between the two conductor paths.** This eliminates the oxide steps (if oxide was used as in the older processes), so greatly reduces metal cracking, the most common failure mode for two layer devices. . . . Prime candidates for Congressional defense budget cutters are cost increases on the Army's XM-803 main battle tank whose “austere version,” it is hoped, can be built at a unit cost of “about \$600,000 in fiscal 1970 dollars,” says Secretary of Defense Laird, and the Navy F-14 fighter with a fiscal 1972 request of \$228 million for R&D and \$806 million for 48 planes. Unlikely to be hurt, however, are the electronics-laden E-2C and EA-6B aircraft.

**"Bigger and better...this
engineer's bible..."**

—Electronics Magazine

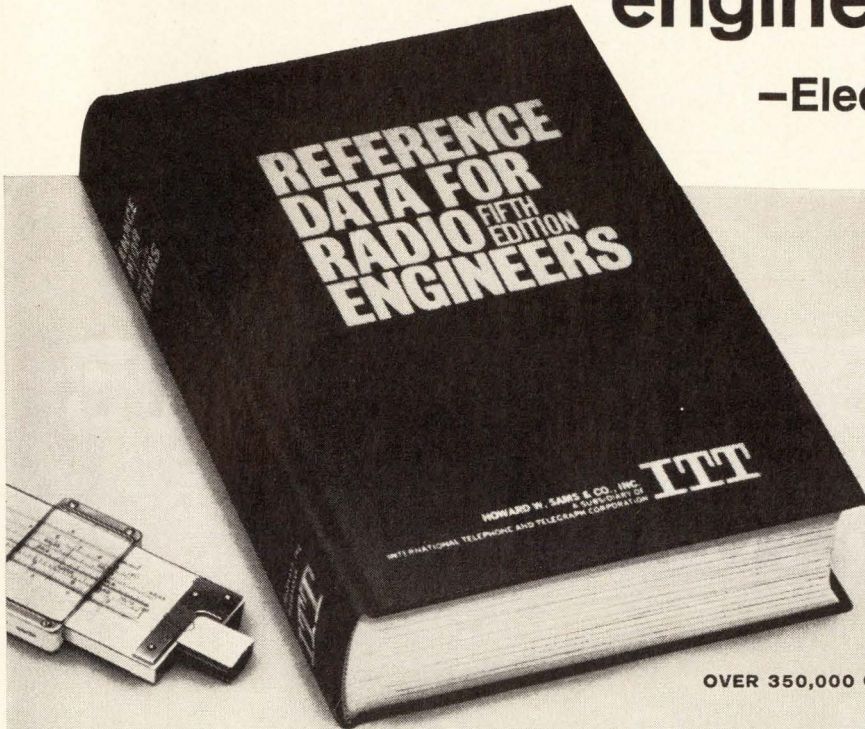

**5th EDITION of a
world-famous reference**

Now contains 50% MORE DATA to include major information developed over the past 12 years. Prepared by an outstanding group of practicing engineers, professors, and industry and government experts, under the direction of the International Telephone and Telegraph Corporation staff.

OVER 350,000 COPIES SOLD IN PRIOR EDITIONS

Reference Data for Radio Engineers

CHAPTER CONTENTS

Frequency Data	Transmission Lines
*International Telecommunication Recommendations	Waveguides and Resonators
Units, Constants, and Conversion Factors	Scattering Matrices
Properties of Materials	Antennas
Components or Parts	Electromagnetic-Wave Propagation
Fundamentals of Networks	Radio Noise and Interference
Filters, Image-Parameter Design	Broadcasting and Recording
Filters, Modern-Network-Theory Design	Radar Fundamentals
Filters, Simple Bandpass Design	Wire Transmission
Attenuators	*Switching Networks and Traffic Concepts
Bridges and Impedance Measurements	Digital Computers
Magnetic-Core Transformers and Reactors	*Navigation Aids
Rectifiers and Filters	*Space Communications
Magnetic Amplifiers	Electroacoustics
Feedback Control Systems	Nuclear Physics
Electron Tubes	*Quantum Electronics
Electron-Tube Circuits	Information Theory
Semiconductors and Transistors	Probability and Statistics
Transistor Circuits	*Reliability and Life Testing
*Microminiature Electronics Modulation	Miscellaneous Data
	Fourier Waveform Analysis
	Maxwell's Equations
	Mathematical Equations
	Mathematical Tables

*New chapters on subjects not covered in 4th Edition

1196 PAGES • 1350 ILLUSTRATIONS
plus 41 page index

The FIFTH EDITION of this widely used reference work has been completely revised and updated. It provides in a single volume comprehensive data on all basic phases of electronics, including tables, formulas, standards, and circuit information—PLUS—all-new data on microminiature electronics, space communications, navigation aids, reliability and life testing, international telecommunication recommendations, switching networks and traffic concepts, and quantum electronics. Includes over 1300 charts, nomographs, diagrams, tables, and illustrations. 45 data-packed chapters. 1196 pages of invaluable information for practicing radio and electronics engineers.

10-Day Free Examination

HOWARD W. SAMS & CO., INC., Dept. EL-031
A Subsidiary of International Telephone & Telegraph Corporation
4300 West 62nd Street, Indianapolis, Ind. 46268

- Send me REFERENCE DATA FOR RADIO ENGINEERS for 10-day examination, without cost or obligation. If I decide to keep the volume, I will send \$20.00 (plus postage) in 10 days; otherwise, I will return the book within 10 days.
- \$20 payment enclosed. Send my copy postpaid with full 10-day refund privilege. (Include sales tax where applicable.)

Name _____

Company _____

Address _____

City _____ State _____ Zip _____

**TELEDYNE RELAYS
REPRESENTATIVE
LIST**

AUSTRALIA Austronic Engineering Labs., 452 Victoria Street, Brunswick, 3056, 387-1477
AUSTRIA Omni Ray AG, Mollargasse 54, Vienna VI
BELGIUM Uni-Office, Inter'l Centrum, 5E Verdieping, Kamer 522, Rogierplein, Brussels
ENGLAND Souriau Lectropon, Ltd., Shirley Avenue, Vale Rd., Windsor, Berks, Slough 27629, Telex 85184456
FRANCE Technique et Produits, Cite des Bruyeres, Rue Carle Vernet, 92 - Sevres, 626-02-35, 626-24-38, Telex 84225997
GERMANY Omni Ray GMBH, Nymphenburgerstr. 164, 8 Munich 19, Telex 841524385, Telephone # 0811-513-2059,
HISPANO ELECTRONICA, S.A., Comandante Zorita, 8-Madrid 20, Spain
HOLLAND, LUXEMBURG, Uni-Office, N.V., P.O. Box 1122, Rotterdam, Holland, 13 22 20 Telex 84421484
ISRAEL, STG International, Ltd., 52 Nachlat Benyamin St., P.O. Box 1276, Tel Aviv, 53459
ITALY Tekelec Airtronic, Viale Romagna 14, 20133 Milano, 73-85-674
NORWAY Nordisk Elektronik (NORGE) A/S, Elkehuset, Middelthunsgate 27, Oslo 3
SO. AFRICA Impetron, P.O. Box 10262, Vogas House, 123 Pritchard St., Johannesburg
SWEDEN Nordisk Elektronik AB, Postfack, Stureplan 3, Stockholm 7, 08/24 83 40, Telex 85410547
SWITZERLAND Omni Ray AG, 8008 Zurich, Dufourstrasse 56, Telex 84553239

NEW

LOW-COST, SOLID STATE AC RELAYS

To Turn on:

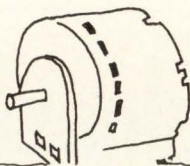

MOTORS



SOLENOIDS



LIGHTS



HEATERS

etc.

ETC.

Choose from 70 new SPST Solid State Relays

SERIES 601 FEATURES:

- Amazingly low cost
- 1 - 10 AMPS at 140 V RMS or 280 V RMS
- Drive directly from TTL logic
- Total isolation between control and load circuits (4-Terminal Network)
- All solid state (NO REEDS)
- Zero voltage switching available to minimize RFI
- Transient protected on input and output
- PC board or screw terminal mounted

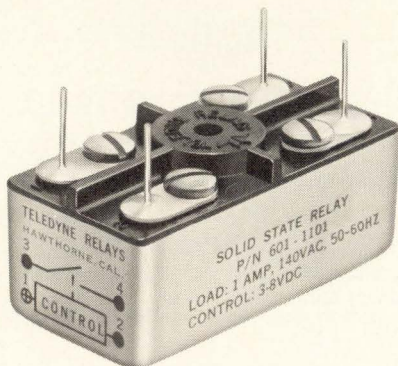

PART NUMBERING (Economy Line)

INPUT (CONTROL) VOLTAGE RANGE	OUTPUT VOLTAGE RATING	OUTPUT (LOAD) CURRENT RATING & PART NUMBERS				
		1 AMP	3 AMP	5 AMP	7 AMP	10 AMP
3-10 VDC	140 VAC	601-1001	601-1002	601-1003	601-1004	601-1005
	280 VAC	601-1006	601-1007	601-1008	601-1009	601-1010
6-32 VDC	140 VAC	601-1011	601-1012	601-1013	601-1014	601-1015
	280 VAC	601-1016	601-1017	601-1018	601-1019	601-1020
15-45 VDC	140 VAC	601-1021	601-1022	601-1023	601-1024	601-1025
	280 VAC	601-1026	601-1027	601-1028	601-1029	601-1030
20-75 VDC	140 VAC	601-1031	601-1032	601-1033	601-1034	601-1035
	280 VAC	601-1036	60-1037	601-1038	601-1039	601-1040

NOTE: Add "P" to P/N for printed circuit (pin) mounting only.

ECONOMY LINE PRICE / QUANTITY (Typical)

LOAD	QUANTITY		
Amps @ 140 VAC	10 - 24	100 - 249	1000 - 2499
1	\$12.20	\$ 8.75	\$ 6.65
3	13.50	9.70	7.35
5	15.30	10.60	8.10
7	16.60	11.55	8.80
10	18.45	12.80	9.75

PART NUMBERING (Zero Voltage Turn-On)

INPUT (CONTROL) VOLTAGE RANGE	OUTPUT VOLTAGE RATING	OUTPUT (LOAD) CURRENT RATING & PART NUMBERS				
		1 AMP	3 AMP	5 AMP	7 AMP	10 AMP
3-8 VDC	140 VAC	601-1101	601-1102	601-1103	601-1104	601-1105
	280 VAC	601-1106	601-1107	601-1108	601-1109	601-1110
7-85 VDC	140 VAC	601-1111	601-1112	601-1113	601-1114	601-1115
	280 VAC	601-1116	601-1117	601-1118	601-1119	601-1120
90-280 VAC	140 VAC	601-1121	601-1122	601-1123	601-1124	601-1125
	280 VAC	601-1126	601-1127	601-1128	601-1129	601-1130

ZERO VOLTAGE TURN-ON LINE PRICE / QUANTITY (Typical)

LOAD	QUANTITY		
Amps @ 140 VAC	10 - 24	100 - 249	1000 - 2499
1	\$21.60	\$15.00	\$11.40
3	22.95	15.94	12.11
5	24.30	16.88	12.83
7	25.65	17.81	13.55
10	27.45	19.06	14.50

All prices shown are F.O.B., Hawthorne, California, U.S.A.



TELEDYNE RELAYS

3155 West El Segundo Boulevard, Hawthorne, California 90250 • Telephone (213) 679-2205

Circle 30 on reader service card

CCD makes it into memory denser than MOS

GE's 14-bit development has 0.24-mil storage unit, can be made on same chip as conventional FETs

One of the fastest moving technologies in solid state is the charge-coupled device. As introduced by Bell Laboratories less than a year ago, CCDs were thought of as basically shift registers for imaging devices. Now they have become candidates for large-scale random access and read only memories as well. In fact, the CCD mechanism, in which charge is transported across an insulator-semiconductor interface, is under intensive development at more than half a dozen major labs. Among them are Hughes, Fairchild, General Electric, RCA, Philips, and Bell itself.

A darkhorse in the race is GE—fast to show the feasibility of dynamic shift registers [*Electronics*, Nov. 9, 1970, p. 33]. But GE is in it for more than just shift registers, and now feels ready to demonstrate CCD capability in large-scale memories as well. In this case it's a 14-bit device whose basic storage element is only 0.24 mil, the size of the storage gate of, say, Intel's popular 1103. Better yet, the GE element works into a basic cell size of about 2 mil² when refresh circuits plus busses are included, and this compares with 30 to 40 mil² for most dynamic MOS devices.

Jerome J. Tiemann, one of the developers in the GE program, points out that this translates to

somewhat less than five-times improvement in bit density because both X and Y lines are required; but in any event it's clear that conventional MOS can't hold a candle to CCDs on the density front. More important, Tiemann says that only GE's CCDs use a refractory (molybdenum) MOS fabricating process that's compatible with GE's other MOS refractory devices. Thus, conventional low-threshold voltage, self-aligning field-effect transistors can be simultaneously fabricated on the same chip, a key feature for refresh circuits and input and output logic implementation.

Perhaps most significant of all, because of the refractory MOS compatibility, LSI/MOS logic circuits can be designed with imbedded CCD subsystems doing the shift register or random-access-memory functions and conventional MOS doing the rest. This approach combines high-density memory with other logic functions.

And while GE is still in the early development stage, it is going to continue an extensive R&D effort.

Trinity. GE's basic CCD element, called a surface charge transistor, has third electrode (gate) between two MOS capacitors. Exclusive to CCD construction, GE's concept allows charge transfer to flow either way.

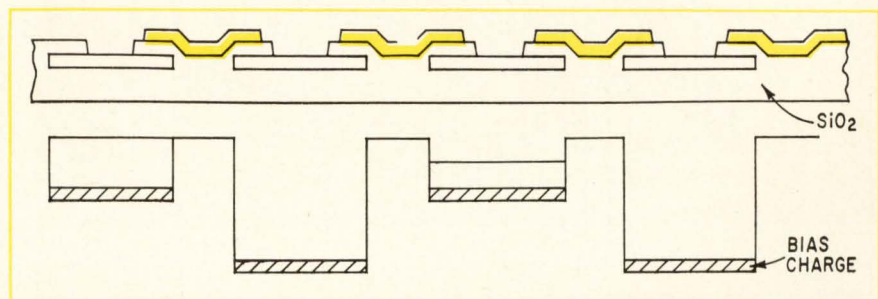

Displays

Color in plasma opens new doors

Plasma display panels are getting a new look—color. With such a capability, the panels may find applications in aircraft instrumentation, data terminals, point-of-sale recorders, and so on. In fact, many monochrome panels already are being evaluated for these tasks.

At least two color plasma displays are in the works. One is in breadboard form at the Electronic Components division of the Burroughs Corp., Plainfield, N.J.; it's based on Burroughs' Self-Scan display [*Electronics*, March 2, 1970, p. 121]. The other is a refinement of the Digivue panel [*Electronics*, March 31, 1969, p. 133] developed at Owens-Illinois Inc., Toledo, Ohio, under a contract from the Pentagon's Advanced Research Projects Agency.

The Burroughs display presents

a row of up to 18 alphanumeric characters in a 5-by-7 dot matrix for each character. Each dot, a cell containing a mixture of neon and other gases, is divided into two parts with a tiny connecting hole. A three-phase scanning signal in the rear creates an ionic discharge, sweeping the seven-cell columns from left to right. Some of the ions in each discharging cell lead through the small hole into the front part of the cell, in a priming action. The priming alone is insufficient to initiate a discharge in the front cell. But with an anode signal at the front of the display synchronized with the scanning signal, it causes selected cells to discharge and emit a bright orange-red glow.

This visible light discharge also emits a substantial amount of ultraviolet light, which excites a phosphor coating on the walls of the front discharge cells, making the phosphor glow. Radiation wavelength is about 700 angstroms.

Furthermore, this ultraviolet ra-

diation occurs at very low current levels supplied to the scanning and display signals—levels too low to generate a noticeable light. Thus, only the light from the phosphor is visible; it can be any of several colors depending on the phosphor used. As current increases, visible light from the gas discharge is added to that of the phosphor. It becomes stronger and stronger until at high current levels the discharge light overwhelms the phosphor light. This way a continuously variable color range is obtained.

Owens-Illinois is taking a different approach. Its Digivue panel doesn't scan; individual cells are selected and a discharge is initiated and maintained by the peripheral circuits. The basic Digivue panel, like the Self-Scan, emits a reddish glow from the discharging cells, because neon is its principal gas. But by using a xenon-based mixture instead of neon, most of the discharge radiation is in the ultraviolet region instead of the visible spectrum.

With no holes in the inner sur-

faces there is no place to put the phosphor; the panel consists only of two glass plates with a narrow gas-filled space between them and with transparent electrodes deposited on the inner surfaces. One set of electrodes is horizontal and the other vertical; their intersection defines a discharge point in the otherwise unconfined space between the plates. Phosphor dots on the inner surface of the front plate, one per discharge point, glow when bombarded with ultraviolet radiation.

By using three kinds of phosphor and arranging the dots in triads, three colors can be obtained; by combining these in various ways, up to seven mixtures are possible. But because one dot corresponds to one cell, color display resolution is somewhat degraded, though Owens-Illinois is working on high-resolution Digivue panels.

Microwave

Repeater series to take on TWT

New microwave repeaters coming out of Microwave Associates Inc., Burlington, Mass., give other solid state repeaters a run for their money and eventually, company spokesmen feel, they will even challenge traveling wave tubes. The challenge is likely to be strongest in the 6- to 7-gigahertz and 12-GHz carrier bands.

The first device to hit the market is the MA2H, not the TWT killer its successors may turn out to be, but a trailblazer in lower-frequency carrier applications. Eric A. Stromsted, sales manager for broadcast and CATV equipment, claims that the closest competitive solid state equipment yields about 2 watts at 2 GHz, while 10 or even 20-W outputs are possible with the new repeater.

The MA2H also deletes one of the

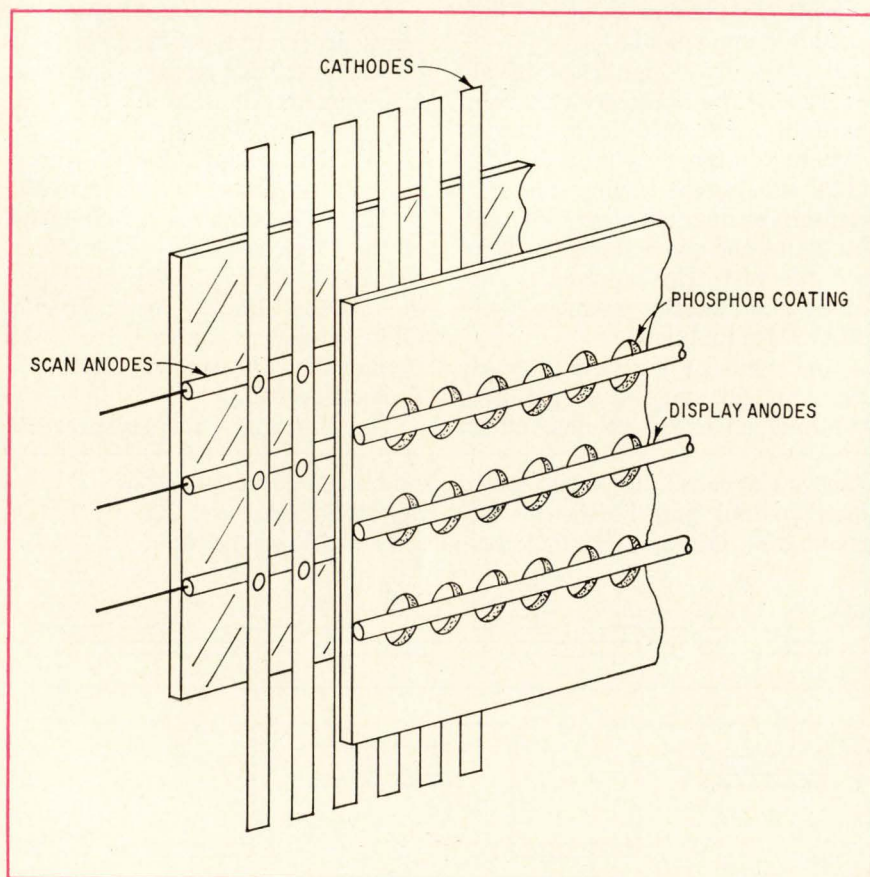

Dots. Burroughs plasma display uses phosphor-coated holes. Owens-Illinois display has phosphor dots.

usual two down-conversion stages found in most such devices. "Instead of going all the way down to the baseband signal [0 to 4.5 megahertz] and using this to modulate the output of our repeater, we down-convert only once, to an intermediate frequency of 70 MHz," he says.

Dividends are reduced noise and distortion over multiple hop links, he claims. By the same token, the high power that can be achieved now may make fewer repeaters necessary in a given link.

To get high power, the company first mixes the 70 MHz i-f with a 2-GHz pump signal to get an upper sideband output. Lower sidebands are filtered out and the 5-milliwatt mixer signal passes to an amplifier that boosts it to 200 mW. Another stage raises this to 2 W—the industry's repeater standard.

Beyond the 2-W point, until now, traveling wave tubes, with their weight, power supply, and unreliability problems—had to be used. Microwave Associates stays solid state, however, splitting the signal into two 1-W signals using a 90° terminated hybrid made on strip-line. Each output port feeds an amplifier, each capable of about 5-W output so that when their outputs are summed in another hybrid coupler, the total is 10 W.

The FCC clamps on the legal lid above 10 W at these frequencies, but in special cases gives waivers. Airborne police communications is one example. To get 20 W, Microwave Associates adds hybrids and amp modules to get a summed output of 20 W—it's that simple.

As Stromsted says, "The power dissipation problems of hybrids on alumina substrates are a lot less troublesome than finding semiconductors capable of 20 W continuous output at 2 GHz."

The MA2H is only the first of a line of amplifiers and relay gear based on the same principle. Coming up is the PA-220, a 20-W, 2-GHz amplifier. A prototype already has seen action during the California earthquake, when it maintained communications between police helicopters and the ground.

Stromsted hopes most to cut into TWT sales in the 5.9 to 7.125 GHz area with the upcoming MA7H. "Reliability will be the largest single selling point here. Because the amplification load is divided among several individual modules, one or more could fail before repair work is needed—a big plus when relays are located in hard-to-reach areas, and many are. Also, he adds, "the power supply requirements of an all-semiconductor system are very small compared to the high-wattage, high-voltage power supplies needed for TWTs. And amp modules should cost a lot less on a unit basis than a TWT."

Memories

MOS device accesses in 120 nanoseconds

Though manufacturers of MOS and bipolar memories are poaching in each others' domain in the laboratory, the line is still well defined in the market: bipolar devices are fast and MOS memories are dense. Thus, if a system requires 1,024 bits on one chip, MOS is the choice; if 100-nanosecond access time is needed, then it has to be a bipolar memory. Attempts are being made to increase the density of bipolar circuits but there is still no 1,024-bit bipolar random access memory available. And various new MOS techniques—ion implantation, silicon gate, and n-channel, for example—have been implemented to increase the speed of MOS RAMs, but the limit seems to be around 300 nanoseconds access time.

However, by employing a novel circuit technique, engineers at Advanced Memory Systems Inc., Sunnyvale, Calif., have developed a 1,024-bit random access MOS memory that has a typical access time of 120 nanoseconds and a cycle time of 200 nanoseconds. It employs a standard p-channel aluminum-gate MOS process whose reliability has been proven.

"Most people thought you'd have to go to n-channel or to some multi-chip technique to get speed with

MOS," says Jerold Larkin, marketing vice president, "but we've done it with one chip and a standard process." He says that the problem in using a multichip package is cost and the problem with n-channel is reliability. "Surface inversion problems with n-channel devices may affect leakage currents in the memory, and since dynamic MOS RAMs rely on charge leakage (or storage) for their operation, their reliability is questionable." There are static n-channel memories, such as those used by IBM, that don't rely on leakage, but they're slower and require more chip area.

The AMS memory brings confidence to the system designer—he can design around a high-speed RAM and know it will work. "Some designers feel that they are sticking their necks out in using MOS in the first place," says Larkin, "and so they certainly won't go to something like n-channel—it doesn't have the hours behind it."

The key to the AMS memory is the cell design. In other MOS dynamic RAMs the basic cell layout is three transistors, and is a dynamic structure that has to be recharged periodically. To do this, data has to be read out of the cell, amplified, and then read back in—and this takes time. In the AMS cell, four transistors are used and the cell structure is quasi-stable—under address conditions, it is dc stable and acts as a static cell; data doesn't have to be read out and read back in again in order to be refreshed.

In the read mode, for example, the CLOCK and CHIP SELECT lines are held low while the bit location is being addressed. This sets the data. "In effect," says Larkin, "the three-transistor cell in the other RAMs in analogous to a core memory—you have to read before you can write. Our four-transistor cell is like a bipolar flip-flop—it sets the data."

Larkin also feels he's ahead on power dissipation and cost. Memory output is a differential pair that is sensed by a differential amplifier. And since this is a low-power process, total power dissipation is

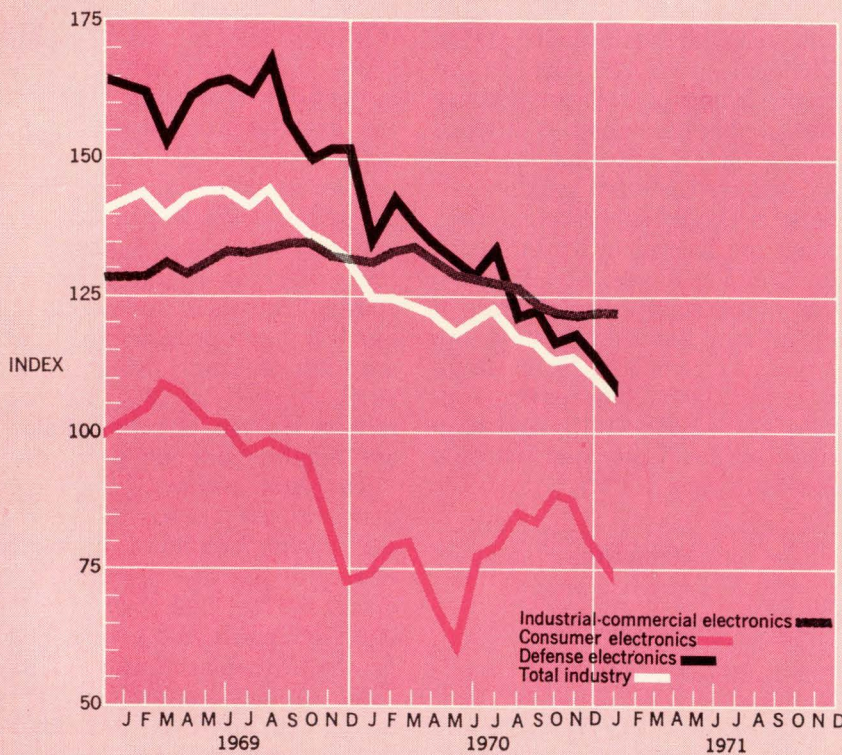

Segment of Industry	Jan. '71	Dec. '70*	Jan. '70
Consumer electronics	75.0	80.6	74.9
Defense electronics	109.7	114.7	147.1
Industrial-commercial electronics	123.2	123.2	131.1
Total industry	107.5	111.2	125.2

Electronics Index of Activity

March 15, 1971

The year started dismally for electronics companies. The January index of activity fell 3.3% to 107.5 from December's revised 111.2. The decline was 14.1% from January 1970.

The only component that didn't skid was industrial-commercial. It stayed even with the previous month's upward-revised 123.2. However, consumer and defense fell off considerably. Consumer's drop for the month was 6.9%; defense's 4.4%. Compared to the year-ago figures, consumer was up 0.1%, but defense was down 25.4%.

Indexes chart pace of production volume for total industry and each segment. The base period, equal to 100, is the average of 1965 monthly output for each of the three parts of the industry. Index numbers are expressed as a percentage of the base period. Data is seasonally adjusted. * Revised.

about 200 milliwatts in a systems application.

Cost at the 10,000-piece level are about 1.8 cents per bit compared to 1.3 cents for the much slower (500-nanosecond access) MOS RAMs now available.

Commercial electronics

IBM enters terminal in credit checking race

Manufacturers of credit authorization terminals are nervously making room for IBM as the computer giant prepares to market its 2730 Transaction Validation Terminal for reading and transmitting magnetic stripe codes.

Primarily aimed at banks with card plans, such as UniCard, Master Charge, and BankAmericard, the first terminals will be delivered in the second quarter of

1972. In a related move, IBM is getting into the card coding market by setting up a service center run by its Information Records division, Dayton, N.J. The Magnetic Credit Card Service Center, starting in the fourth quarter of this year, will emboss and magnetically encode cards from source material submitted by the customer, verify data, mount the card on a carrier, and address it for mailing.

As an IBM spokesman puts it, "We're into bank credit systems lock, stock, and barrel." But the field is crowded. For instance, before the American Bankers Association endorsed a magnetic stripe encoding approach that puts the stripe on the back of the card, it had to poll 103 U.S. and foreign manufacturers thought to be able to build and market credit authorization terminals.

Of the 52 companies responding, 44 indicated that they could pro-

vide terminals meeting the general considerations outlined by the ABA. Based on recommendations in the responses, the ABA decided the magnetic stripe has the edge in availability, cost, capacity, security, and terminal availability.

Comments from some of the larger competitors among the responders indicated that IBM's move may cause some spinout of the smaller manufacturers or else their acquisition by larger conglomerates able to finance a five-year-plus marketing effort. The chief engineer of a small firm admitted it's a new ball game with IBM's entry.

IBM's 2730 will sell for \$515 to banks. They, in turn, will install the terminals for merchants participating in their credit card plans. To authorize a credit card purchase with the 2730, a sales clerk places the customer's magnetic stripe card in the terminal and dials an IBM computer from a con-

Tektronix presents ... a totally different low-frequency oscilloscope

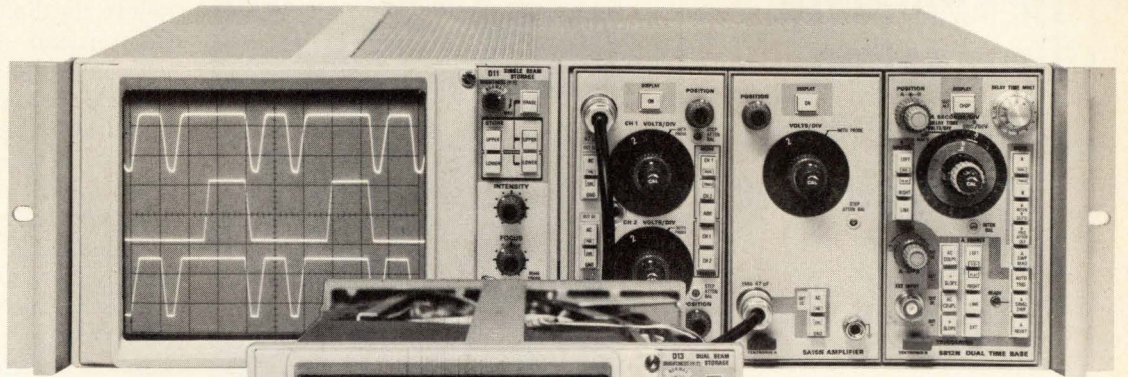

- unmatched low prices
- laboratory performance
- plug-ins
- 6-1/2-inch CRT's
- interchangeable display units
- cabinet-to-rackmount conversion
- solid state stability
- Y-T or X-Y operation
- new improved storage
- one to four trace displays
- lighted knob skirts for scale factor readout

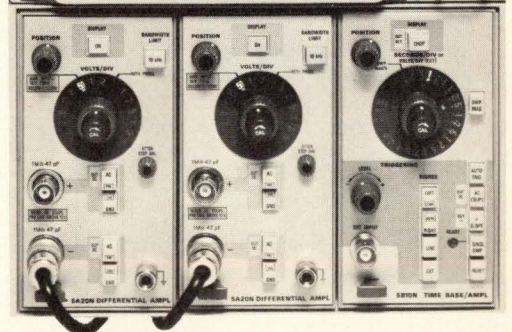
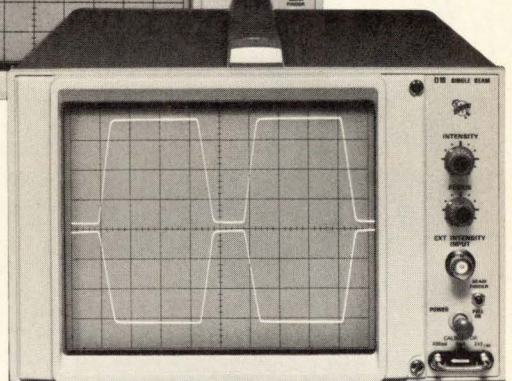
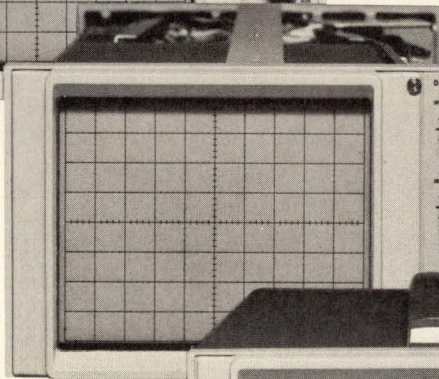
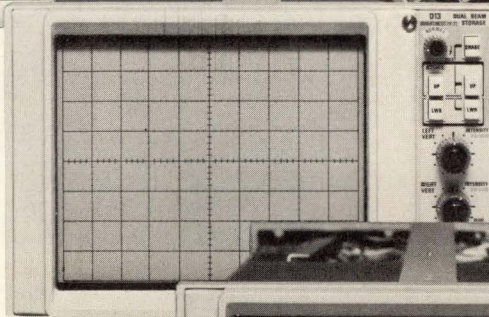

The low-priced 5103N Oscilloscope System offers cost-saving innovations never before available in any oscilloscope. Today, this series consists of six vertical amplifiers, three time bases and a three-plug-in mainframe compatible with four interchangeable display modules. Bandwidth is DC-to-2 MHz, depending upon the amplifier plug-ins.

Select a low-cost oscilloscope with a single-beam, dual-beam, single-beam storage or a dual-beam storage display module. When your applications change simply choose another low-cost display module and save the cost of buying a complete oscilloscope.

The unique modular design of the 5103N Oscilloscope System lets you convert between cabinet and 5 1/4-inch rackmount configurations at your convenience. It's easy. A few minutes of your time and a conversion kit (available for a few dollars) is all that's needed. When your application calls for a new configuration, convert! Save the cost of a new oscilloscope.

Here is just one example of the low-cost performance and unmatched versatility of the 5103N Oscilloscope System. Pictured at the right is a 5103N/D10 cabinet oscilloscope with a single-beam display module, two 5A20N 50- μ V/div DC-to-1 MHz high-gain differential amplifiers and a 5B10N 100-ns/div time base. The complete cost is only \$1045 in cabinet or 5 1/4-inch rackmount (includes slide assemblies). U.S. Sales Prices FOB Beaverton, Oregon.



TEKTRONIX®

committed to
technical excellence

For complete information contact your field engineer or write Tektronix, Inc., P.O. Box 500, Beaverton, Oregon 97005.

See these new oscilloscopes at IEEE Booths 3520-3527

Circle 35 on reader service card

Kahle — leaders in Automatic Production Machinery for the Electronics Industry.

"Call Kahle" when a production process and assembly problem requires 'specialists' in the custom designing and building of automatic machinery for the electronics industry.

Over the last 40 years, "calling Kahle" has solved the high speed process and assembly problems of hundreds of leading electronics firms. The wide range of products for which automatic equipment has been designed and built includes electronic components and assemblies, diodes, resistors, capacitors, lamp components and assemblies, encapsulated glass assemblies, and evacuated assemblies — to name a few.

If you have a process and assembly operation or are simply looking to reduce costs, give Kahle a call. We'll be pleased to discuss the matter with you. No obligation, of course. The number is 201-867-6500. Or, if you'd prefer, write for free literature. Also inquire about Kahle's complete line of Index Drives and Chassis.

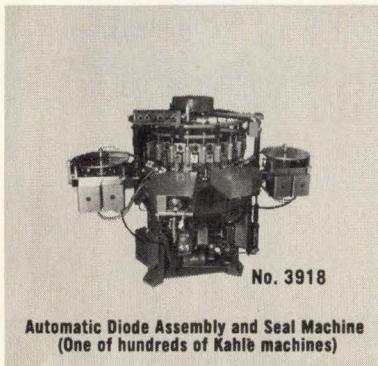

Automatic Diode Assembly and Seal Machine
(One of hundreds of Kahle machines)

KAHLE

Kahle Engineering
3320 Hudson Ave., Union City, N.J. 07087
Designers and Builders of Automatic
Production Machines and Machine Systems

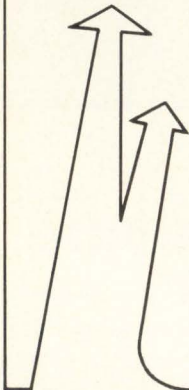

Electronics review



Cash call. IBM's credit authorization terminal uses acoustic coupler attached to telephone's mouthpiece.

ventional telephone. After the purchase amount is entered, the terminal reads and transmits the data by acoustic coupler attached to the telephone mouthpiece. The computer checks the account, records the purchase, and replies to the clerk by prerecorded words. Each credit card plan will determine the computer-generated voice response and other procedures it wants.

For added security, the keyboard and card reader communicate with the computer center by different code so that the card number cannot be faked from a keyboard, and the keyboard and the keyboard input cannot be faked by a push-button telephone. Though the terminal is designed for IBM computers, the company will work out interfaces with other machines.

Communications

Competition for Comsat in domestic satellites

If the Communication Satellite Corp.'s plan is to secure an effective monopoly in domestic satellite communications as the Bell System holds on the ground, it will have to overcome some stiff competition

before the Federal Communication Commission. And that competition will have the White House Office of Telecommunications Policy behind it: OTP has come down strongly for free enterprise in space communications.

Nevertheless, as predicted, Comsat filed early in March for a second synchronous system to service network television broadcasters [*Electronics*, Jan. 4, p. 33]. It proposes a package virtually identical to the first it plans to use with American Telephone & Telegraph Co. [*Electronics*, Nov. 9, 1970, p. 112]. If approved, the two systems, each with three satellites, will occupy all of the six orbital positions capable of serving Alaska and Hawaii as well as the continental United States. When the FCC's recommendation of 5° longitudinal separation between satellites is applied, at least seven other orbital slots for continental U.S. service can be identified.

But some communications heavyweights also have applications pending before the FCC. These include RCA, Western Union, General Telephone & Electronics (which wants to use a Hughes Aircraft satellite equivalent to its Intelsat 4), plus a fast-moving new combine called MCI-Lockheed Satellite Corp., jointly owned by Microwave Communications of America Inc. and Lockheed Missiles & Space Co., builder of more than 300 military satellites [*Electronics*, Feb. 1, p. 17]. Also in the competition is Fairchild-Hiller Corp.

Unlike GT&E, AT&T, and Western Union, Comsat's second system and that of MCI-Lockheed do not plan to use satellite circuits to link far-flung voice and data nets. Instead, they propose to supply long-haul, leased-line communications for business, industry, and broadcasters—a market that has grown at an annual rate of 22.4% since 1965. Observers are waiting for the comments that each of the companies will file on the others' applications by the end of April. These could answer numerous secondary questions raised by the

Bell & Howell & The Light Fantastic

It tips the scale at around seventy pounds. So you can take it anywhere. That's the light part.

Now the fantastic. It's a high performance, seven speed, seven channel recorder/reproducer that comes in for a bit over \$1k a channel.

It's the CPR-4000. Designed by the boys in the back to placate the sales engineers. "Give us a mag tape system with practically everything, for practically nothing," they begged. And the boys in the back did pretty well.

From the top, the seven speeds are electrically selectable (15/16 through 60 ips). It takes 1/2" tape on 8" reels.

The heads have an edge track voice channel and don't require a touch worth of alignment or adjustment after first installation. In fact, those heads are so darn good, we'll guarantee you 1,000 hours of head life.

Dual capstans keep the tape away from any motion disturbances, give minimum flutter, constant tape tension and a uniform head to tape contact. It doesn't have any solenoid actuated pinch rollers like you normally find around. So that cuts down power consumption and gives you more precise tape guidance and better short wavelength recording.

But probably the best feature is an automatic load, automatic feed option. Not only is that faster, it cuts out the mess ups and wipe outs.

And of course, the CPR-4000 has the latest in IC circuitry, is all modular, has solid state plug-in record/reproduce amplifiers, comes direct or FM and is just the nice new ticket for over a hundred lab, mobile or remote facility applications.

The light fantastic. You can get one now. (The specs don't take that long, though.) Just write Bell & Howell, Instruments Division, 360 Sierra Madre Villa, Pasadena, California 91109.

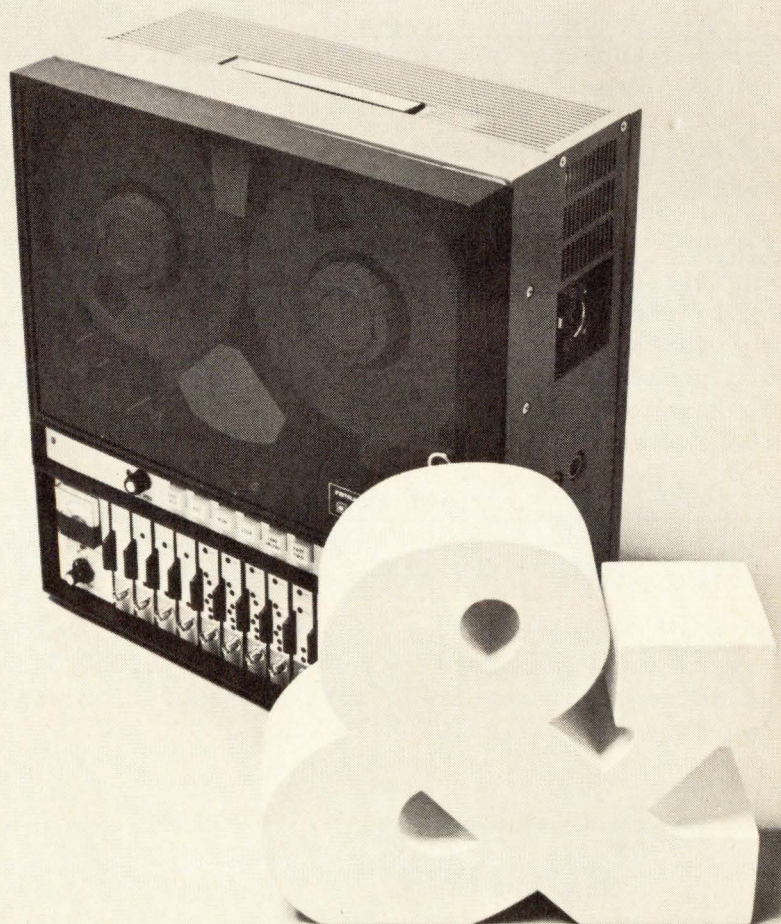

INSTRUMENTS DIVISION

 **BELL & HOWELL**

SCIENCE/SCOPE

The successful launch of the Intelsat IV spacecraft will greatly expand the capacity and flexibility of the present Intelsat global system. Built by Hughes under the direction of Comsat for the International Telecommunications Satellite Consortium, the satellite has a communications capacity more than seven times as large as the presently operational Intelsat III satellites and more than 35 times as great as Early Bird, world's first commercial satellite, launched six years ago.

Two steerable dish antennas on the satellite are unique features which can focus power into "spotlight" beams to provide heavy traffic areas on both sides of the Atlantic with stronger signals and more channels. Intelsat IV has a capacity of approximately 9,000 telephone circuits, or 12 simultaneous color television programs, or tens of thousands of teletype circuits, or any combination of these.

The Law Enforcement Assistance Administration, Department of Justice, has contracted with Hughes for a 13-month research study of police problems in handling crowds and demonstrations. Systems engineers are reviewing the causes and results of past disturbances to gain a better understanding of patterns and responses. Purpose is to recommend tactics, equipment, and training for future command-and-control systems adapted to the specific requirements of civilian police departments.

A new type of IMPATT diode marks the entry of Hughes into the microwave semiconductor business. The diodes cover X-band, Ku-band, and KA-band. A unique packaging concept makes applications in commercial products and phased-array radars economically feasible for the first time.

U.S. Air Force B-52 crews will be able to fly "blind" night or day with the FLIR (Forward-Looking Infrared) system Hughes is developing under contract with Boeing's Wichita, Kans. division. FLIR produces a TV-like image on a cockpit display from thermal radiation of ground objects. It is one of the sensors that will be installed in the B-52 G and H series under the EVS (Electro-Optical Visual Sensors) program. Hughes' contract could lead to production of more than 300 FLIR systems.

Airborne radar transmitter design engineers are needed now at Hughes. Must have specific fire-control-system, doppler, pulse-compression, microwave, and power-supply experience. Also: solid state microwave engineers with experience ranging from UHF to millimeter frequencies, and in the design and use of related circuits. Both positions require accredited degree, 3 years of specific experience, and U.S. citizenship. Write: Mr. Robert A. Martin, Hughes Aerospace Engineering Divisions, 11940 W. Jefferson Blvd., Culver City, CA 90230. An equal opportunity M/F employer.

The mission of the three Orbiting Solar Observatory satellites Hughes will build for NASA's Goddard Space Flight Center is to gain a better understanding of how energy is transported from the sun's photosphere into its corona. Key task is to learn the secrets of the chromosphere, where the unexplained solar flares erupt. It is an irregular layer of gases extending outward from 3,000 to 10,000 miles and varying in temperature from less than 10,000°C to more than 100,000°C. The new satellites will require a spatial resolution capability nearly 20 times greater than that of earlier OSOs.

Creating a new world with electronics

HUGHES

HUGHES AIRCRAFT COMPANY

Electronics review

many filings. Among them: would the National Broadcasting Co. buy circuits on Comsat's second system if these were available through a satellite owned by parent company RCA?

Comsat president Joseph Charyk concedes, however, that the system's feasibility depends on obtaining a significant share of the \$70 million a year in traffic. AT&T now carries for the three broadcasting networks. He says the satellite system would permit Comsat to carry video traffic at about half the rate paid by the networks.

The Comsat system would use spin-stabilized satellites similar to the Intelsat 4 series manufactured by Hughes. It would differ in that it would use a cross-polarization technique that would provide room for 24 40-megahertz channels in the 500-MHz bandwidth. Intelsat 4 provides only 12 channels in the same bandwidth using 4-to-6-gigahertz bands. The space portion of the Comsat system would cost \$142.5 million. The firm would pay an additional \$106 million for the initial ground network of 132 earth stations.

Meanwhile, MCI-Lockheed is betting that it can sweeten its application with a heavy dose of advanced military technology. By far the largest system proposed to date, the MCI-Lockheed network would use two 48-transponder spacecraft; each transponder would have a transmission bandwidth of 36 MHz.

Besides large capacity, the system would use Lockheed's three-axis momentum wheel stabilization used in many of the 300 military satellites built by Lockheed. This feature will permit erection of a giant 106-foot-long solar array that generates 4.4 kilowatts or six times as much as can be generated by the Comsat system's spinning arrays. Each spacecraft will fill up both the 4- and 6-GHz and 12- and 13-GHz bands.

William McGowan, Micom's chairman, is convinced that the satellite's size will permit it to offer communications services at lower cost than any other system, since

launch and operational costs will be spread over many more channels. Because of its enormous power supply and use of the uncongested 12- to 13-GHz band, he says, MCI-Lockheed will be able to offer rooftop service.

Integrated electronics

Standard chip offers custom options

A semiconductor maker may have found the way to compromise between the electronic calculator manufacturers who insist on custom MOS/LSI circuits and the semiconductor houses that are pressing for standardized designs. Each may have its own way if a concept of programable standards developed by National Semiconductor Inc. of Santa Clara, Calif., catches on.

The concept is based on a set of chips customized to a user's needs—a read-only memory is programmed to a particular bit pattern, and the interface parameters are designed so that a given chip can function in almost any system. The keyboard interface chip is one example.

Says Floyd Kvamme, director of marketing at National, "The keyboard interface chip is intended to interface almost any type of keyboard to almost any type of system. This includes computer terminals as well as calculators." The chip, in a 24-pin dual in-line package, is designed to work with up to 32 keys and eight static switches. The static switches may remain in one state or another and can be used for any system function. The ROM on the chip contains 64 words of 9 bits each so that both upper case and lower case characters can be accommodated.

If more than 32 are needed, one can be designated the shift key. Up to four interface chips can be connected to handle 128 (upper and lower case) characters.

Besides being able to program the contents of the ROM, the user programs the sampling rate and the make-and-break bounce delay.

Hughes is more than just electronic components and equipment.

It's devices too.

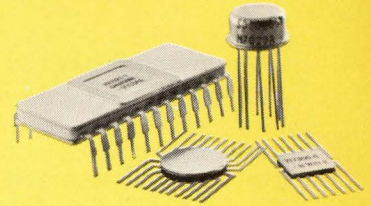

MOS integrated circuits (RS 283)

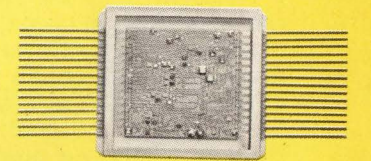

Bipolar and hybrid circuits (RS 284)



Microwave diodes (RS 282)

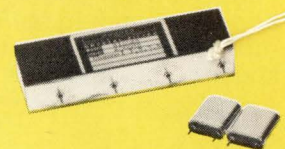

Frequency control devices (RS 285)

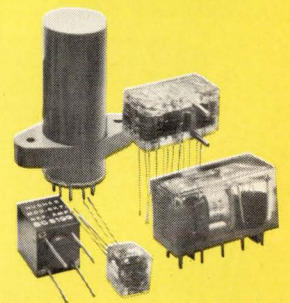

Special assemblies (RS 286)

HUGHES

HUGHES AIRCRAFT COMPANY
INDUSTRIAL ELECTRONICS GROUP
BUILDING 100, MAIL STN. C-512
CULVER CITY, CALIFORNIA 90230

Circle appropriate Reader Service (RS) numbers.

custom mics now

So you won't have to pay later.

The design looks perfect . . . but then, somewhere something goes wrong. A defective part, an improper assembly, or maybe it was the installation in the field. It's impossible to avoid all imperfections.

As experts in the field of reconstituted mica capacitors, our experience shows that the greatest single cause for capacitor failure is a short in the dielectric material. Consequently, we precisely inspect and grade all of our dielectric material **before** production. Because of our meticulous quality control, Custom Mica Capacitors are absolutely the finest quality capacitors of their kind available on the market today.

We pay now so you won't have to pay later.

Another major reason why you should join our client list of Who's Who in high voltage electronics. Write for our Facility Folder and Product Sheets, or call today for our rapid reaction quote to your specific requirements.



CMR, wrap and fill

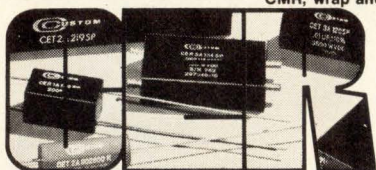

CER, epoxy housed



CEM, epoxy molded



CUSTOM ELECTRONICS, Inc.

Browne St., Oneonta, N. Y. 13820

PH: 607-432-3880 TWX 510-241-8292

Electronics review

"This way," says Kvamme, "any type of keyboard can be employed." For example, one-piece molded keyboards, although they may be the most economical, are seldom used in calculators because contact bounce may permit the keys to register twice. But this bounce delay is programable—it can be set to be long enough so that the impact registers only after the contacts have stopped bouncing.

Another programable feature is the charging delay at the input. If the keyboard is remote from the interface chip, for example, the time delay between key closure and system recognition can be adjusted to compensate for the distance. Other chip outputs include "character ready," "chip busy," and an alarm (if more than three keys of the keyboard are depressed at the same time).

Because of the versatility of the chip, Kvamme speculates that it may find applications outside the calculator and terminal worlds. In alarm systems, for example, one chip could monitor 32 stations, since the chip input is just a contact closure, and its nine-bit output code could provide location information.

Computers

Stripped minis quicken price skirmish

The price leaders in the minicomputer business traditionally have been Digital Equipment Corp. and Data General Corp. and while those firms maintain that they're still the price-performance top dogs, David H. Methvin, president of Computer Automation Inc. in Newport Beach, Calif., believes his firm has jumped right into the thick of it with the leaders.

Computer Automation will have available for November delivery versions of its model 208 and 216 machines that it's calling naked minis. They will include the processor, core memory (4,096 words by eight bits for the naked 208, 4,096 words by 16 bits for the

naked 216), and all the software Computer Automation offers with the fully packaged units. Not included will be power supply, console, and chassis. The eight-bit machine sells for only \$1,700 in quantities of 200. The naked model 216 will carry a \$2,400 price tag. In contrast, the fully packaged model 208 sells for \$5,190 now in single quantities, and one fully packaged model 216 costs \$7,990.

The move may be in response to DEC's rumored pending introduction of a new modular processor series. Little is known about the development other than that the modules would not be those now in the PDP-11 and PDP-8 computers. However, there is speculation that processor word length could be a customer option. And the fact that DEC insiders don't appear impressed with Computer Automation's \$1,700 price may reflect their own pricing attitudes toward the new line.

Computer Automation also will have chassis-mounted versions of both machines. Such a 216 will be priced at \$5,600 for one; the similar version of the model 208 hasn't been priced yet.

Other manufacturers offer the guts of their machines in stripped-down form. Some include power supply, chassis, and console, but the big difference, Methvin maintains, is that his units include the complete core memory that comes with the fully packaged system, with machine language, and a one-year warranty. The three circuit boards in the naked 208 and 216 are connected to a back plane.

Others are skeptical of Computer Automation's move. Alan Z. Kluchman, marketing director at Data General, points out that his firm's Nova 1200, a 16-bit machine with four accumulators, power supply, chassis, and console, sells for \$1,440 in quantities of 200. With 4,096 words of memory, the OEM discount price would be about \$2,500. But Methvin says that in a recent competition for an OEM order from a company with a requirement for 500 to 1,000 minicomputers a year over five years, Computer Automa-

Never before so much Function Generator for \$495!



**The new F34 proves that a
Function Generator doesn't have
to be expensive to be great!**

Read the panel! The Output Limit indicator Light — unique! It guarantees you an unclipped waveform. The Sweep Width control — foolproof and calibrated. Frequency analog output, variable width pulse and manual trigger — they're all there and more. See for yourself! For details on IEC's complete Function Generator line, contact John Norburg today.

**The new SERIES 30 includes 3 other models
costing even less, starting at just \$295!**

See SERIES 50
and the new
SERIES 30 at
IEEE 71
Booth 3212

IEC
**INTERSTATE
ELECTRONICS
CORPORATION**

A Subsidiary Of A-T-O Inc.

Dept. 7000, Box 3117
Anaheim, Calif. 92803
(714) 772-2811,
TWX 714-776-0280
Telex Nos.
655443, 655419

DATAPLEXERS

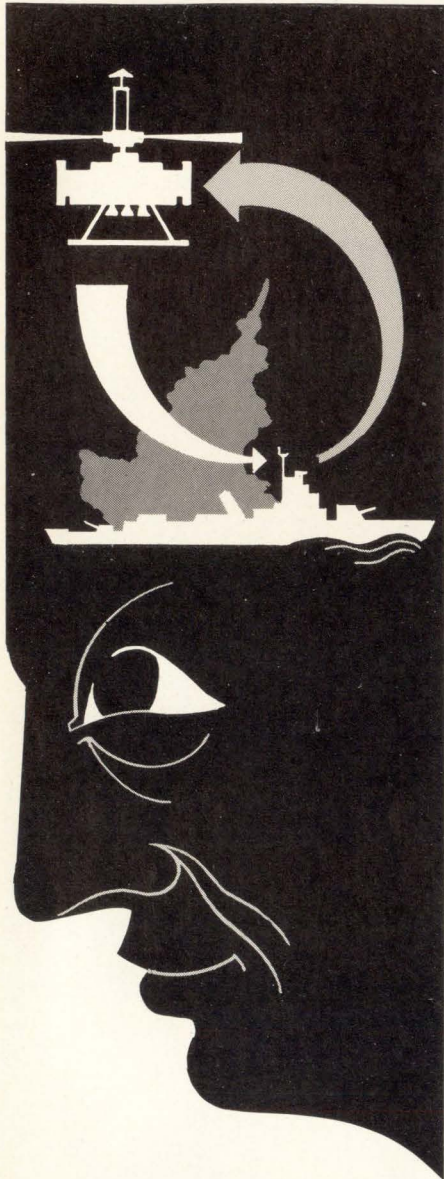

TOTAL ELECTRONIC
SYSTEMS CAPABILITY.
SPECIALISTS IN
TIME/FREQUENCY,
RADAR AND
DATA SYSTEMS
OFFERING RAPID
GROWTH.

SIERRA

RESEARCH CORPORATION
an equal opportunity employer

P. O. BOX 222, BUFFALO, N. Y. 14225

Electronics review

tion's quantity price bidding on one of the naked minis was less than Data General's.

Another source says "Methvin's price better be his single unit price. If that \$1,700 represents his discounted position, he's as good as out of business." Methvin replies that he knows of no company that can market a fully parallel computer with 4,096 words of core memory for \$1,700 in unit quantities, discount from that price, and make a profit. He realizes he'll have to sell far more machines at \$1,700 than at \$7,990 to get the same dollar volume, but he notes "the OEM market is going to thousand-quantity orders regularly now. They're coming thick and fast. We're convinced we'll have more dollar volume with the naked minis or we wouldn't do it."

IBM banks on bipolar with MOS density

Bipolar techniques that attain greater packing density at no sacrifice in speed are probably part of the reason IBM didn't use MOS in the semiconductor main memory of its System 370 model 135 announced last week. The techniques were developed in IBM's West German laboratories [*Electronics*, March 1, p. 103].

Although the West German circuits aren't used in the 135, IBM knows that by sticking with standard bipolars—even though performance levels of the 135 could be met with MOS—it retains the option of boosting memory speed at any time with the denser bipolars while incurring no penalty in size. This couldn't be done with MOS.

If the West German development is any indication, IBM probably will stay with bipolar main memories, at least for some time, while using MOS now and then in low-grade peripheral equipment—as, for example, in its model 129 keypunch.

Another model 135 feature is an integrated communications adapter, expected since the introduction of an integrated file adapter in the

System 370 model 145 last fall [*Electronics*, Oct. 12, 1970, p. 125]. The adapter controls up to eight low- and medium-speed communications lines, through a combination of logic circuits and microcode. The integrated file adapter is also available in the 135. IBM had been putting in stand-alone boxes connected by cable to the central processor.

The model 135 is a replacement for System 360 models 25 and 30. It's considerably faster than either of the older machines and has nearly four times as much memory—up to 240,000 eight-bit bytes. Like the model 145, the new machine has a reloadable control storage that is physically part of the main semiconductor memory but is not accessible to the user; control information is loaded from a small disk cartridge through a special fixture in the operator's console.

Either one or two input/output devices are available on the model 135; they are fast enough to accept the speediest peripheral devices now available, such as the 3330 disk storage unit announced last summer.

Defense electronics

Contractor profits: too large or too small?

How much profit is enough for defense contractors? That question is unlikely to be answered to anyone's satisfaction even though it has been studied and restudied by countless private and public agencies, including the General Accounting Office, economic watchdog for the Congress. A draft of the latest GAO analysis, leaked to the press and set for release at the end of March, suggests the agency is unable to define precisely what is "profit" when it comes to defense contracts.

The GAO study presents two sidely disparate sets of data based on analyses of (1) a survey of defense contractors and (2) figures covering 146 specific contracts valued at \$4.3 billion and completed

**The 5600 magnetic tape recorder:
more performance per dollar than any
other recorder available!**

IT'S A MOVER!

Our 5600 magnetic tape recorder is a 75-pound, lab-quality portable. Which means it goes where you go. Easily.

But the 5600 does more than just go where you want it to. It gives you more value per dollar than any other magnetic tape recorder. Because it does everything you'd expect it to. And more.

The 5600 is the most versatile portable in its price category. It gives you a choice of FM, direct and digital electronics. Recording bandwidths available DC to 40kHz FM, 50Hz to 300kHz direct, and 600 BPI serial digital. It converts between tape widths of 1/4", 1/2" and 1" on all

standard reels up to 10 1/2" diameter. It offers seven electrically switched speeds. And can be powered from virtually any commercial source as well as two different battery voltages: 12 volts and 28 volts.

The 5600 also has features previously found only in laboratory-size systems. Like full 14-channel, 16-track recording capability. And low-mass, high-performance phase lock capstan servo drive which provides a faster response than other drive systems. It also features a complete line of accessory devices, including

differential input wideband amplifiers. The 5600 is available in either horizontal or vertical rack mount configurations.

If you need a lab-quality recorder that flies, rides or even walks along with you, you need the 5600. For additional information, simply complete and mail the coupon, call your local Honeywell office or contact C. S. Corbin, 303-771-4700, X692, Honeywell, Test Instruments Division, P. O. Box 5227, Denver, Colorado 80217.

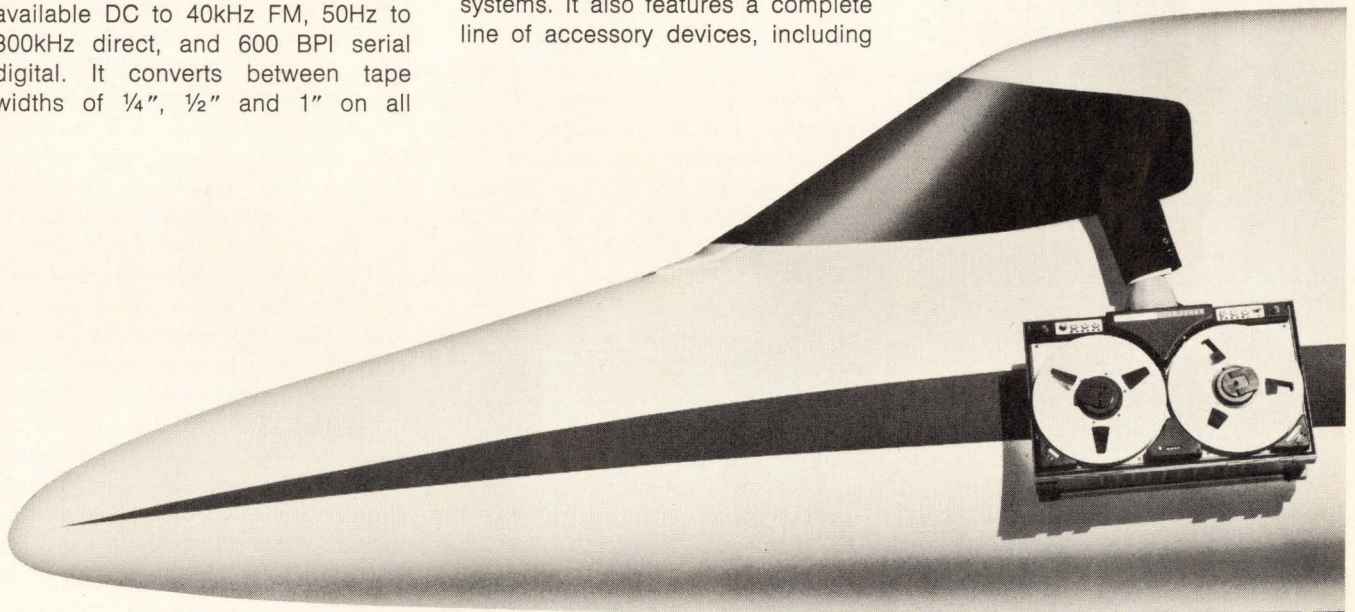

Honeywell
The Automation Company

Yes! Please have someone contact me with more information on the Honeywell 5600 magnetic tape recorder.

NAME _____

FIRM _____ POSITION _____

ADDRESS _____

CITY/STATE/ZIP _____

a new concept in PC Board Relays

Plugs directly into
your PC module
without SOCKETS
or SOLDERING

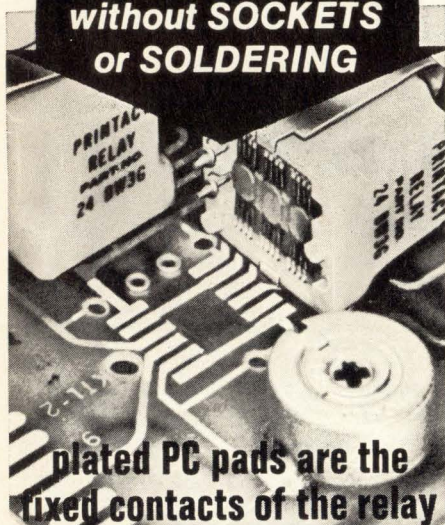

Printact[®]

MAGNETIC LATCHING AND NON-LATCHING RELAYS

The only relay designed to make full use of printed circuit technology. Unlike others adapted with terminal pins or sockets for solder mounting, Printact plugs directly into your module. Precious metal plated PC pads mate with shorting bar contacts on the pivoting armature, which is the single moving part: Held by a permanent magnet, it eliminates return springs, pigtailed, electrical and mechanical connections—assuring reliability for millions of cycles.

Inherent Custom Features include: Low Thermal EMF, Low Contact Bounce, Impedance Matching, 45-60 db Isolation, Bifurcated Contacts, and Encapsulated Coil—all at low cost!

Send for Test Sample and PC Board Preparation Aids to simplify design and production of your module.

For action write or call 212—EX 2-4800.

Executone

PRINTACT RELAY DIVISION
P.O. Box 1430E
LONG ISLAND CITY, N.Y. 11101

Electronics review

by 30 companies. Profits are far lower in the first case than they are in the second, whether they are computed as a percentage of sales, total capital investment (TCI), or equity capital investment (ECI). The percentage breakdown:

Pretax profits	Industry survey	146 specific awards
Sales	3.9-5.4%	6.5%
TCI	10.2-14.7%	28.3%
ECI	19.8-28.4%	56.1%

"It's a perfectly politic little study," giped one Washington-based industry official after reading the report. "It has something for everybody but doesn't reach any definite conclusions." Other sources dispute that, noting that GAO does make the point that its defense contractor survey spanning four years shows that defense contract profits are below those of commercial business of the same companies. Return on commercial business ranged from 7.9% to 11.6% on sales; 11.1% to 17.4% on total capital investment and 17.2% to 28.6% on equity. Industry reaction to that comparison is positive, but it questions most of the GAO's other conclusions.

Electronic Industries Association President V. J. Adduci has cited three fundamental criticisms made by EIA members. Adduci charged that:

- The 146 contracts "are clearly nonrepresentative" of normal return on capital for defense business and that the GAO therefore failed to obey Congress' directive to look at prime and subcontractor profits "on a selective, representative basis." Adduci urges that types of contracts, rather than specific awards, should be looked at.
- Return on investment data has been overemphasized and overlooks contractors' use of "a significantly greater proportion" of its skilled personnel on defense contracts than on commercial business.
- GAO statements that awards based on contractor costs give "no incentive to invest in more modern equipment" and "encourage ineffi-

ciency" are in the EIA's view "unsupported and contrary to good management."

EIA's rebuttal, however, does not specifically treat the GAO assertion that contractors frequently realize additional profits because "the Government generally pays for R&D costs for defense work while a contractor may invest a substantial amount in a commercial product that does not sell," and because contractors realize "substantial benefits" in commercial application of defense-sponsored technology whose overhead costs are often absorbed by Federal contracts.

For the record

Moving up. IBM has announced the availability of Cobol and Fortran IV compilers, faster disk storage units, and larger main storage capacity for its System 3 model 10. Also now available is a fast line printer, which could not be used before on this minicomputer.

With these new software packages and hardware options—and the presence of the smaller System 3 model 6 and System 7 announced last fall—the original System 3 is looking less and less mini and more and more maxi, tending to confirm a report that the System 3 and its new models may become, in effect, the low end of the 370 line. The announcements are in contrast with how it looked when it was first announced [*Electronics*, Aug. 18, 1969, p. 48]. It wasn't long, however, before IBM added data communication capability. Conversion facilities, permitting the little computer to be used on-line with the 360 and 370, have long been rumored.

Dumping aftermath. The U.S. Tariff Commission's decision that Japanese television receivers being dumped on the U.S. market have harmed domestic producers now puts the ball in the Customs Bureau's court. The bureau will have to determine exact dumping margins retroactive to the Treasury Department's withholding of ap-

All Relays Are Not Created Equal!



Magnecraft Creates Better Reed Relays.

Magnecraft relays are not created equal because they are created to be better. Created better than its competitors, created better than the most demanding requirements, created better because reliability is important. We are then in the best position to help solve your switching and control needs, not just sell you a relay.

We have demonstrated our Engineering leadership in reed relays, over the past decade, in many ways. Our break-through in high voltage switching, utilizing a reed relay. The Class 102UHV is capable of switching 20,000 volts at 1 milliamp. Our I. C. compatible reed relays operate directly from TTL or DTL circuits without the use of Buffers, Op Amps, or anything else, as they require only 40 to 50 milliwatts of power at 2.5 VDC or 5.0 VDC. We have also brought you the latest advancements in mercury-wetted reed relays, offering bounce free switching and virtually a limitless lifetime of operations. Magnecraft reed relays are created better because of features such as, hermetically sealed contacts, molded nylon coil bobbins, and contact leads that are soldered stress free to terminal pins. The next time your circuit calls for a reed relay, turn to Magnecraft with confidence.

Your first step is simple. Send today for Stock Catalog #272, listing over 550 different relays stocked by Magnecraft and its nationwide network of distributors.

Magnecraft[®] ELECTRIC COMPANY

5575 NORTH LYNCH AVENUE • CHICAGO, ILLINOIS 60630 • 312 • 282-5500 • TWX-910-221-5221

See You At IEEE, Booth #2146

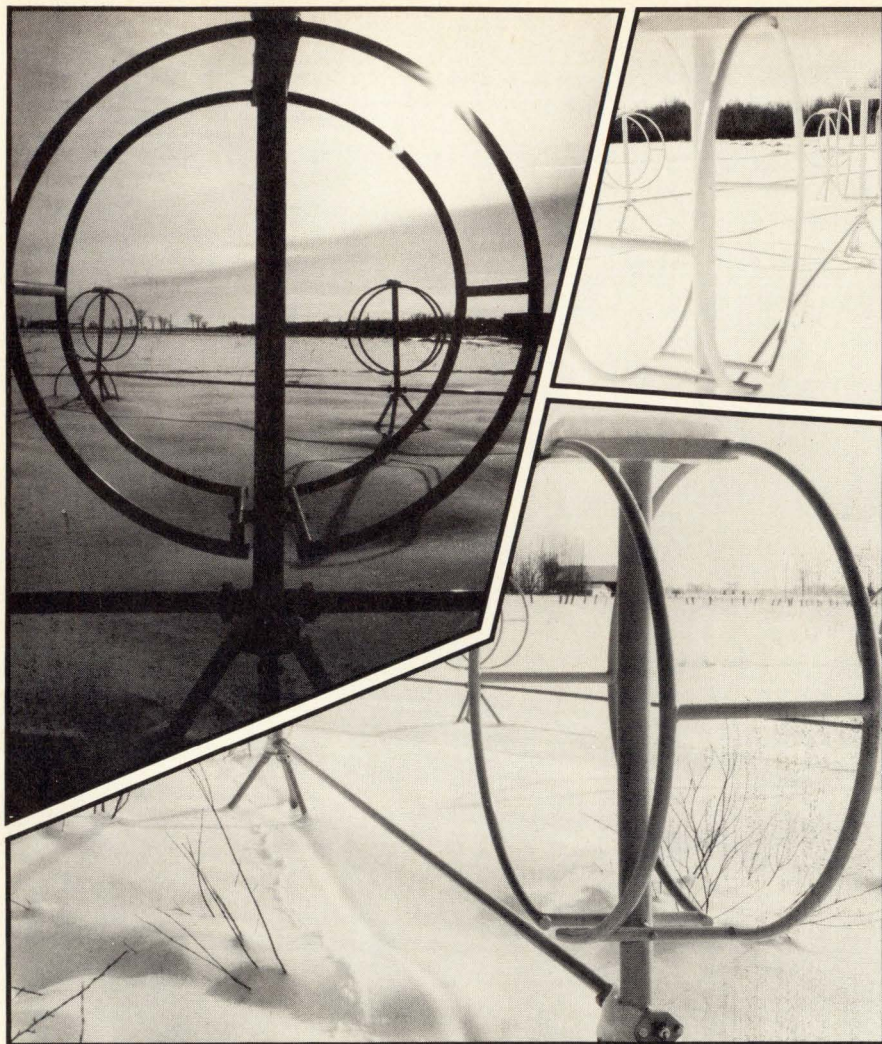

Communications Men Think Big Small

The Canadian Broadcasting Corporation uses aperiodic loop antenna above and that's big and small.

Big ... at Britannia Heights, near the nation's Capital at Ottawa, Canadians listen to the world.

Small ... CBC listens on the aperiodic loop antenna which is only 50 meters in diameter in Rosette array.

Big ... Its omni-directional, point-to-point, broad band, long and short range receive capability is big enough to replace vast rhombic or log-periodic antenna farms.

That's why, whenever communications men think big and small, Hermes Electronics Ltd. supplies the aperiodic loop antenna to government agencies and military forces around the world.

Roof mountable, fast set up, small spaces, big jobs, or just below ground level *it snows a lot at Canada's Britannia Heights.*

ASK US

Hermes Electronics Limited

Suite 315
2020 F Street N.W.
WASHINGTON
D.C., 20006
Telephone 202 296-2978
TWX 710-882-1106

Electronics review

praisment begun last September, and impose antidumping duties against the Japanese sets—mostly small-screen models—on an entry-by-entry basis.

Duties undoubtedly will be collected, but the complicated procedures for calculating less-than-fair-value prices may make any attempt at determining margins for assessing these duties only sporadically successful. Nevertheless, the major impact of the U.S. action against Japanese television imports probably has been felt already.

The Japanese claim that dumping margins have been eliminated since Jan. 1, 1970. If the Customs Bureau confirms this claim, little duty collection will be needed.

Cheaper. Concurring with the recommendations made by the General Accounting Office, NASA has agreed to open up competition in commercial instruments by making sure specs do not limit it to one high-priced vendor.

Leader. Wracked for months by divided opinions within the White House, the Nixon Administration has finally decided to put a man with experience in both technology and management at the helm of NASA. Its choice, James C. Fletcher, is president of the University of Utah and founded what became the Space General division of Aerojet-General Corp.

Tightening. Fairchild Camera & Instrument has consolidated its Semiconductor division's four units into two operating groups—domestic and international. Wilfred J. Corrigan, domestic vice president and general manager, will head MOS and memory work. He replaces Leo E. Dwork, named vice president for technology planning. George M. Scalise will head European and Far Eastern operations. Richard A. Henderson Jr., marketing development vice president on the corporate staff, will replace Andrew A. Procassini as division marketing vice president. Procassini will direct reliability and quality assurance.

We packed even more circuitry into CTS cermet resistor networks.

New 8 and 18-lead styles added to 14 & 16-lead Series 760 Dual In-Line Packages.

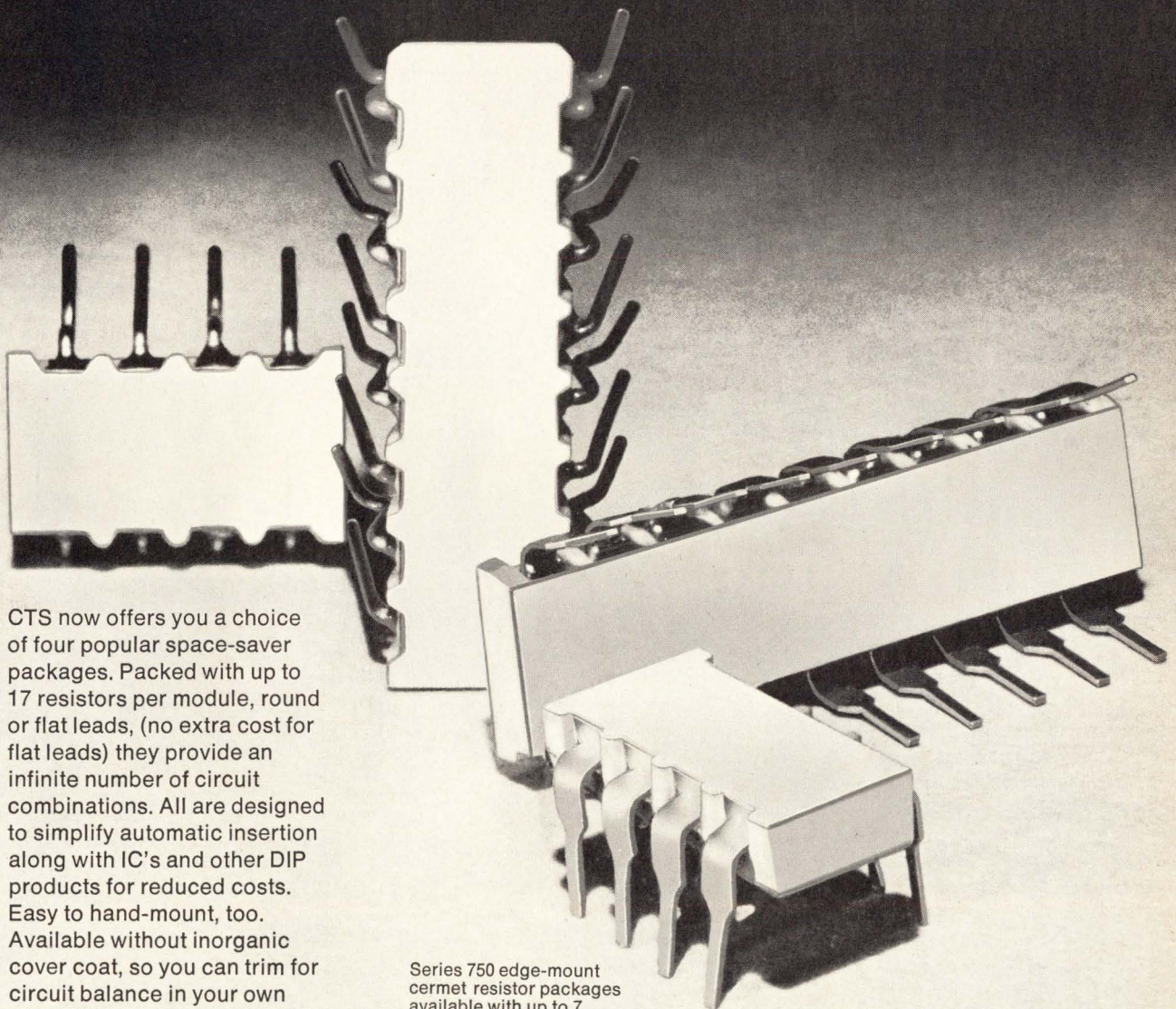

CTS now offers you a choice of four popular space-saver packages. Packed with up to 17 resistors per module, round or flat leads, (no extra cost for flat leads) they provide an infinite number of circuit combinations. All are designed to simplify automatic insertion along with IC's and other DIP products for reduced costs. Easy to hand-mount, too. Available without inorganic cover coat, so you can trim for circuit balance in your own plant. 5 lbs. pull strength on all leads; .100" lead spacing; rated up to 2 watts on 18 lead style.

CTS of Berne, Inc., Berne, Indiana 46711. (219) 589-3111.

Series 750 edge-mount cermet resistor packages available with up to 7 resistors per module in 9 package configurations.

CTS CORPORATION
Elkhart, Indiana



YOUR CTS ANSWER MAN will be glad to work with you to pack maximum circuitry into your compact design with this expanded line of dual in-line packages.

The Magn

HP's got a great new idea in counters: buy one that just fits your specific application—without paying for extras you'll never use. Yet make your choice from a family of six counters with a wide range of unique features, at prices so low you'll wonder how we did it.

You'll get all the things you expect from our 5326 and 5327 family of counters: totalizing, frequency, ratio, period and time interval measurements, in a range of 50 MHz or 550 MHz.

In addition, they let you perform tasks no counters could handle before.

For instance, you can now do IC logic timing testing simply and economically with 15 picosecond resolution. HP's unique time interval averaging mode makes it possible! (Request HP Application Note 129 for the story.) Price is just \$1195 for a 50 MHz unit and \$1795 for the 550 MHz model with this powerful time interval capability.



ificent Six.

For just \$355 more you can get a counter with a DVM built in. So you can do things like measure rise times more rapidly, simply and accurately than with a scope. And you can check external dc voltages with it, too. Add a \$60 HP 11096A Probe if you need rf voltage measurements.

Want programming capability? Our options will permit remote control of all front panel functions, including trigger levels and attenuators.

Computer interface is easy and costs less than ever.

Suppose you just want the basics? Our frill-free models will supply them with trouble-free, simple operation. They'll cost you \$950 for 50 MHz, \$1495 for 550 MHz.

Your HP field engineer has the 5326/27 data sheet that tells the complete story about these precise new counters. Or write to Hewlett-Packard, Palo Alto, California 94304; Europe: 1217 Meyrin-Geneva, Switzerland.

02102



HEWLETT  PACKARD

Counters that promise a lot and deliver it all.

Circle 49 on reader service card

See them in action at IEEE

Learn new applications for electronics in medicine

- Attend technical sessions
- See exhibits and demonstrations
- Participate in workshops

**3rd National Conference & Exposition on Electronics in Medicine
April 13-14-15, 1971, Sheraton-Boston, Boston, Massachusetts**

- What's available in patient-monitoring equipment and what's needed?
- What can computers do in medical record keeping and data analyses that they couldn't do before?
- How safe is medical electronics equipment—from the standpoints of both patient and operator?
- How stringent are major test equipment requirements of the clinical laboratory?
- What are the most effective techniques now in use in multiphasic screening?
- What are the key problems in hospital electronic equipment buying and maintenance?
- How will the Cooper Committee report affect new device control legislation?

These questions will be fully explored at a series of unique workshop sessions during the three-day 3rd National Conference on Electronics in Medicine to be held in Boston next April.

The 1971 meeting will include 50 per cent more topics and speakers than the previous conference. Morning sessions will feature speakers who have been selected for their expertise as well as for the articulate manner in which they convey their knowledge to a professional gathering such as this.

The enthusiasm of the '70 conferees for the afternoon panel/workshops has won a repeat performance—this time with topical discussions and specialists who will lead the workshops. They'll attack problems from all sides, then invite attendees to become active participants in the sessions. Conferees will have a chance to join at least two of the six workshop sessions.

An important adjunct to the technical program will be an exposition of new hardware (and software) in the medical electronics field.

SPEAKERS:

Dr. John Knowles, General Director
The Massachusetts General Hospital
Boston, Mass.: Feature address

Dr. Donald M. MacArthur, former
Deputy Director (Research & Technology)
Department of Defense
Topic: Hospital of the future

Dr. H. Fernandez-Moran
The University of Chicago
Topic: Information storage

Dr. Charles Edwards, Commissioner
Food and Drug Administration
Topic: FDA's role in medical device legislation

William Goodrich, General Counsel, FDA
Topic: Evaluating present and proposed regulatory practices

Professor Oliver Schroeder, Director
Law-Medicine Center
Case Western Reserve University
Topic: Medicolegal aspects of electronics in medicine

John T. Kimbell, Exec. Vice President
Baxter Laboratories
Topic: How industry views device legislation

Dr. Arthur C. Beall, Jr.
Baylor University, College of Medicine
Topic: Device legislation: Another look

Dr. Cesar A. Caceres
Professor and Chairman
Department of Clinical Engineering
The George Washington University Medical Center
Topic: Cardiac screening

Dr. Octo Barnett
Director, Laboratory of Computer Science
The Massachusetts General Hospital
Topic: Hospital automation

Dr. John B. Henry, Professor and Director,
Dept. of Pathology
State University of New York
Upstate Medical Center
Topic: Multiphasic screening

Dr. Julius Korein
Dept. of Neurology
New York University Medical Center
Topic: The computer and the medical record

Dr. Max Harry Weil
Associate Professor of Medicine
Presbyterian Hospital, Los Angeles
Topic: Patient monitoring

Dr. Joel Nobel, Director of Research
Emergency Care Research Institute
Philadelphia
Topic: Evaluating equipment

Dr. Dwight E. Harken
Chief, Thoracic Surgery
Peter Bent Brigham Hospital
Topic: Periontogenic diseases

Dr. William A. Spencer, Director
Texas Institute for Rehabilitation and Research
Topic: Electronic prosthetic devices

Dr. Allen Wolfe
Barnes Engineering Company
Stamford, Conn.
Topic: Thermography

Dr. Aida S. Khalafalla
Senior Principal Research Scientist
Honeywell
Topic: Plethysmography

Mr. Roger S. Powell
National Heart & Lung Institute, NIH
Topic: Electrical energy systems for
artificial hearts

EXHIBITS:

Exhibits will provide an important opportunity for attendees to see first hand (and in some cases even

operate) the latest equipment and instrumentation designed specifically for medical applications.

Among those companies which plan to display their most advanced equipment are American Telephone and Telegraph Co., Bio-Optronics, Biotronics, DeVilbiss, Eastman Kodak, Elcor, Goodman Brothers, Graphic Controls, Honeywell, Inc., Humetrics, Hytec Electronics, Intec, Isotopes (Teledyne), Mediquip Corp., Meditran, Motorola, Mousseau Scientific Instruments, Raytheon, Sloan Technology Corp., T & T Technology, Technicon, Vertel, Westinghouse and Whittaker Corp. The Department of Health, Education and Welfare (Office of Equipment and Consultation) will also present an exhibit.

WORK SESSIONS:

Patient monitoring: Leader, Dr. Howard Hochberg; Roche Medical Electronics; A discussion of routine and critical problems in patient monitoring, including available instrumentation and equipment needed to provide improved monitoring.

Computers in medicine: Leader, Dr. William E. Chapman, Palo Alto Medical Research Foundation. What the computer can and can't do in medical record-keeping, data analysis, and medical history taking.

Safety clinic: Leader, Allan F. Pacela, chief research scientist, Beckman Instruments. A forum at which doctors and engineers will be able to exchange views on what is available and what is needed to improve the safety of medical electronic equipment from the standpoint of both patients and operators.

Laboratory automation: Leader, Dr. Hugo C. Pribor, Director, Institute of Laboratory Medicine, Perth Amboy. A discussion of the major test equipment requirements of the clinical laboratory, with a critical evaluation of present and future needs.

Multiphasic screening: Leader, Dr. Allen Pryor, Latter Day Saints Hospital. What are the most efficient techniques now in use and how can they be improved? This session will probe the question.

Impact of electronics instrumentation in hospitals: Leader, John Foster, Associate Director, Tufts-New England Medical Center. Key problems center on selecting and organizing electronics equipment in the hospital to get maximum immediate benefit.

Presented by McGraw-Hill Publications

Electronics • Medical World News • Modern Hospital • Postgraduate Medicine

REGISTER NOW—SAVE \$35!

Advance registration fee: \$165
Registration at conference: \$200
(includes all sessions, exhibits, luncheons, reception and a digest of technical papers when published).
Mail this registration form along with your check payable to:
Donald Christiansen
Conference Chairman
Electronics in Medicine P-30
330 West 42nd St.,
New York, New York 10036
A block of rooms is being held at the Sheraton-Boston Hotel for registrants. Make your reservations directly with the hotel, identifying yourself as a Conference attendee.



Advance Registration Form
3rd National Conference & Exposition
on Electronics in Medicine
April 13-14-15, 1971

EL-2-71

- Please pre-register me for meetings, work sessions, and exhibits. My check for \$165 is enclosed.
- I cannot attend the full conference but plan to visit the exhibits. Fee: none for qualified registrants. Please pre-register me for
- first day third day
second day all three days

Name _____ Title _____

Company or Hospital _____

Address _____

City _____ State _____ Zip _____

Want to see them do it again?

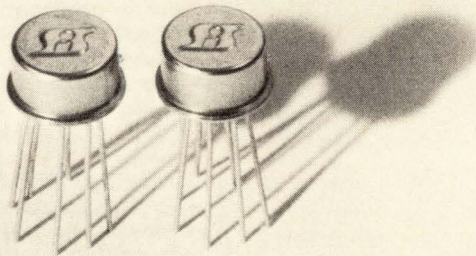

Analog switch/drivers so fast, you'd think they would cost a fortune.

They might have six months ago. If you could get them at all. But now you can choose from a complete line of both JFET and MOS analog switch/drivers that switch three times faster than previous designs (≈ 200 ns). And they'll run as low as \$3 to \$4 per switch function (100 quantity).

The secret of the Siliconix high speed switch: Schottky diodes. Their advantage: To prevent saturation of the output-drive transistors. Result: Extremely fast switching.

What's more, the R_{on} is independent of signal

frequency. And there's no load on the signal source in the OFF condition. These Siliconix devices are especially suited for high speed RF-IF or video

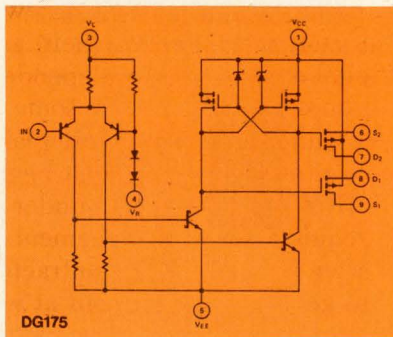

switching applications because of 70 dB OFF isolation at 1 MHz.

All devices are off-the-shelf, specified to MIL-883, Class B, Notice 2; or industrial grade over -20 to $+85^\circ\text{C}$ range.

See how the new Siliconix switching circuits can improve your system and better your application while saving you money. For more information on the JFET and MOS analog switch/drivers, call your Siliconix representative and ask for specs and prices on the JFET DG150 and 160 series, or the MOS DG171, 175 and 176.

You'll be glad you did.



Siliconix incorporated

2201 Laurelwood Road • Santa Clara • Calif. 95054
Phone (408) 246-8000 Ext. 201 • TWX: 910-338-0227

New York: Sy Levine (516) 796-4680 **New England:** Al La Croix (617) 769-3780 **St. Louis:** Jim Spicer (314) 291-3616 **Minneapolis:** Ed Koelfgen (612) 920-4483 **Southern California:** Dave Ferran (213) 420-1307 **Northern California:** Chuck Brush (408) 246-8000 **In Europe:** Siliconix Limited, Saunders Way, Sketty, Swansea, Great Britain. Siliconix GmbH, 7024 Bernhausen, Postfach 1340, W. Germany. Siliconix 9, Ave d'Arromanches, 94-Saint-Maur, France.

Washington Newsletter

March 15, 1971

**Laird will ask
Congress for
second deputy . . .**

Defense Secretary Melvin Laird will soon ask Congress to create a post for a second deputy secretary to complement David Packard. The proposal is a compromise with the recommendation of the Blue Ribbon Defense Panel which last year advised having three deputy secretaries with responsibilities for operations, resource management, and evaluation [*Electronics*, Aug. 17, 1970, p. 109]. Laird says he prefers two deputies so as to limit the expansion of the bureaucracy.

The Defense Secretary says he wants the new deputy to have "a full delegation of authority," but does not want the specific responsibilities of each deputy spelled out. Instead, he envisions "an agreement between the secretary and the two deputies on their respective areas of responsibility" based on the secretary's wishes and the expertise of the individuals involved. Further, he wishes to name two additional assistant secretaries, and not the five extra recommended by the panel. This would raise the number of the assistants from seven to nine.

**. . . and will shift
research and weapons
management groups**

Rather than break up John Foster's Directorate of Defense Research and Engineering, as recommended by the Blue Ribbon Panel, and divide the job among three new assistant secretaries—for research and technology, engineering development, and test and evaluation—Laird will name three new deputies with these functions within DDR&E. And, rather than make the Advanced Research Projects Agency a separate entity, it will remain in DDR&E "for the time being," he says. The Defense Communications Planning Group, which got high marks for handling Southeast Asian sensor programs on a crash basis, will not be phased out, but will be renamed the Defense Special Projects Group and "expand its role to encompass a wide range of new projects," mostly classified electronics. Another change that will impact electronics is the relocation closer to the Pentagon of the Defense Weapons System Management Center, from Wright-Patterson Air Force Base to Fort Belvoir, Va., on July 1.

**Slack DOD firms
risk loss of IR&D
costs under law**

Through failure to comply with a new Federal regulation, some defense electronics contractors, who in their last fiscal year received \$2 million or more in reimbursements for independent research and development plus bid and proposal costs, may lose some or all of those funds this year.

"They're either ignorant or just plain careless," says one Government official of contractors who haven't begun negotiating the advance agreements for IR&D and B&P costs under Section 203 of Public Law 91-441. The law requires advance agreements for reimbursement of such costs incurred after Dec. 31, 1970. Contractors who fail to negotiate an agreement could get no reimbursement at worst, and 75% at best.

**Industry sees good
and bad in cutback
of patent awards**

Electronics companies with patents pending have both positive and negative reactions to the forced 50% cutback in U.S. patent awards that began the second week in March. Though Patent Office officials say they will give publication priority to those who request it, some companies with patents pending won't make that request since a delay in disclosure will extend the 17-year lifetime of a patent. But the same delay will upset other companies anxious to get patents recognized and publicized.

Washington Newsletter

Issuance of a patent, as well as trademark recognition, is simultaneous with its publication in the Official Gazette.

Charges by the Government Printing Office, plus the cost of storing patents on magnetic computer tape preparatory to the automation of patent search procedures, have put pressure on the Patent Office budget. **The office has therefore reduced awards to 900 a week while it pushes for a \$3-million supplemental appropriation.**

Postal service takes closer look at electronic mail

Encouraged by findings that electronic mail systems could take more than a third of the load off present creaking methods and also provide faster service, the U.S. Postal Service is turning to industry to study the technical feasibility and cost of such a system. Postal officials say they are now evaluating proposals by a number of firms and plan to award a contract for the conceptual design of such a system within five weeks. They cite postal regulations in declining to name the bidders for the contract.

The three most important questions to be answered by the study are: what electronic mail's security, quality and speed of delivery will be, what new services the system will provide for the patron, and what its operation will cost over the long term.

Incorporated in the electronic system would probably be optical character recognition, facsimile input or keyboard-to-tape input, electronic circuit and message switching, and transmission by cable, microwave or satellite circuits. Output devices would probably be high-speed printers or microfilm units. **The winning contractor will also be asked to build a computer model to simulate its operation.**

Jobless engineers get little hope from Nixon

A grim picture is emerging from White House proposals to accelerate work and retraining programs that would affect jobless engineers. Early in March Administration science adviser Edward David hosted a Washington conference where most officials present merely summarized on-going Federal programs (see p. 103). **And the Nixon manpower training programs that would spend \$2 billion by substituting \$4 for every \$3 now spent is viewed by industry sources as just about enough to cover costs on inflation.**

Moreover, the fact that the Nixon plan is part of his controversial revenue-sharing plan to turn back money to states, counties, and cities, makes it unlikely that Congress will act quickly. If passed, however, the legislation would give local governments 85% of the funds for use in programs tailored to local unemployment conditions. It also contains a "trigger" that could make an extra 10% available for areas with substantial, persistent joblessness.

Army adopts laser guidance for tactical missiles

The Army Missile Command is ordering at least four live firings at White Sands Missile Range of laser guidance and control systems aboard tactical missiles. **The decision follows this winter's successful tests of a Texas Instruments system on board obsolete Little John missiles, which were launched about 10 miles from plywood targets and guided by nose fins on the laser seeker kits.**

The Army also plans to buy and test a second laser-aided rocket system, which Martin Marietta Corp.'s Orlando, Fla., division will design.

Think of it as a six pack...

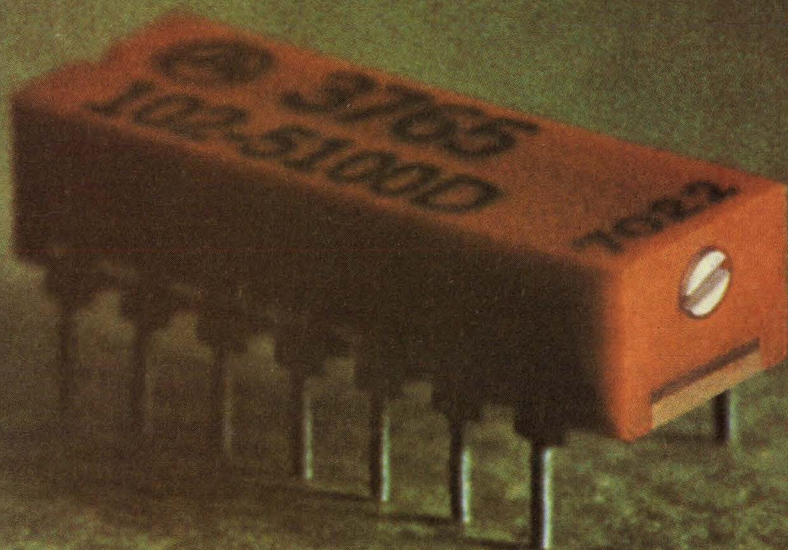

one trimmer, five resistors, in one package. That's TRN.

Our new Trimming Resistive Network will cut resistor insertion and preparation cost by at least a 6:1 ratio. In addition it satisfies engineering requirements better than anything on the market. For instance, the TRN provides cermet TCR performance values of 50 or 100 ppm/°C. The one-paste, one-step deposition method that we use allows for uniform, predictable TCR drift within the range of ± 2 ppm/°C of each other for each resistor in the circuit. In addition, the unit features a ratio accuracy with respect to the variable re-

sistor available as low as $\pm 1\%$.

All componentry is housed in a single shell, which means that ambient temperature for each resistor in the circuit is the same for all others. Plus, you get versatility of applications, reliable long life and dimensions that are perfect for automatic insertion machines.

Like to know more? Write Bill Dunn. He's at Amphenol Controls Division, 120 S. Main Street, Janesville, Wisconsin 53545.

Circle 55 on reader service card



AMPHENOL
THE BUNKER-RAMO CORPORATION

High energy silicon for the 70's.

Switching Regulator

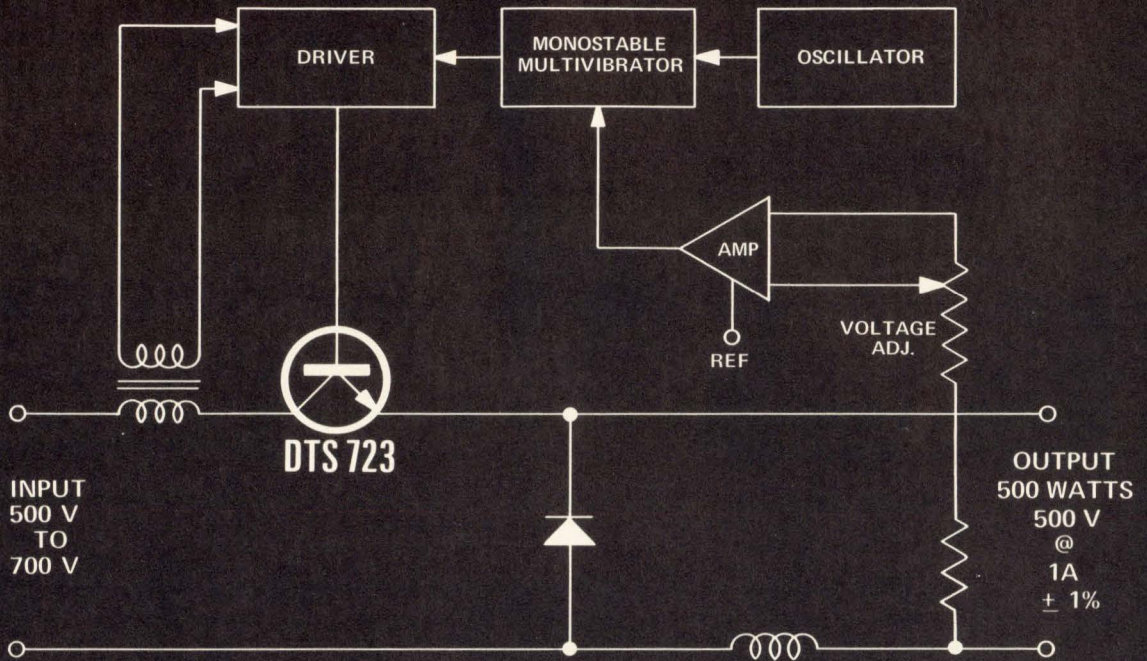

DC Regulator

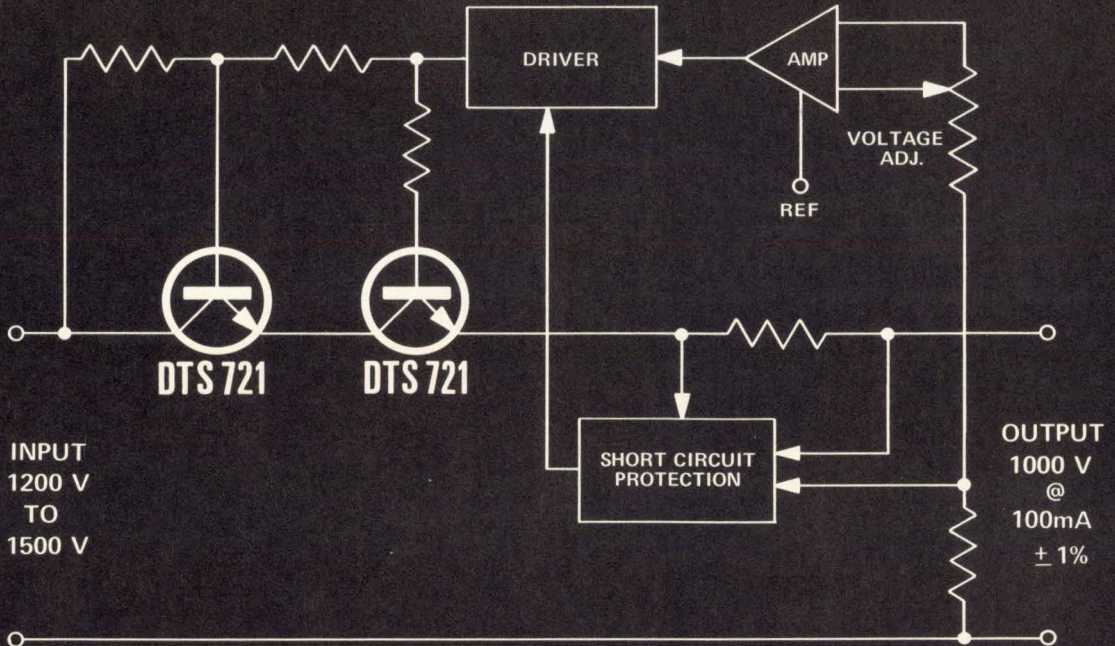

	V _{CEX}	V _{CEO}	V _{CEO} (sus)	I _C (cont)	h _{FE} @I _C min/max V _{CE} =5.0V	P _T
DTS-721	1000V	1000V	800	3A	20/60 @ 150 mA	50W
DTS-723	1200V	1000V	750	3A	2 min @ 2.5 A	50W

Delco announces two new 1000-volt transistors for high power regulators in small packages.



Our new DTS-721 and DTS-723 1000-volt silicon transistors permit you to design solid state circuits for industrial applications with capabilities previously reserved for tubes. Now you can think small.

These two new silicon devices were developed specially for instrumentation and power supply builders, as well as for computer and military applications. They can operate from DC inputs of 1200 volts to 1500 volts. With 1% regulation at full load.

In a switching regulator, they can operate directly from a 220-volt line or from rectified 440-volt single or polyphase sources.

Both devices are NPN triple diffused, packaged in Delco's solid copper TO-3 cases. They are mounted to withstand mechanical and thermal shock because of special bonding of the emitter and base contacts.

The DTS-721 and DTS-723 have been proven by

application tests from production lots by prospective users with stringent reliability requirements.

And their energy handling capability is verified by Delco Pulse Energy Testing.

These new high voltage silicon transistors make it possible for you to take advantage of reduced size, weight and component costs in designing circuits—and get far greater reliability.

The circuits shown are explained in detail in our application notes nos. 45 and 46.

Call the Kokomoans or your Delco Distributor for more information.



Delco Electronics

DIVISION OF GENERAL MOTORS CORPORATION, KOKOMO, INDIANA

Available from these Delco distributors:

ALA., BIRMINGHAM • Forbes Distributing Co., Inc. (205)-251-4104
ARIZ., PHOENIX • Cramer/Arizona (602)-263-1112 • Sterling Electronics (602)-258-4531
CAL., LOS ANGELES • Kierulff Electronics, Inc. (213)-685-5511 • Radio Products Sales, Inc. (213)-748-1271
CAL., PALO ALTO • Kierulff Electronics, Inc. (415)-968-6292
CAL., SAN DIEGO • Milo of California, Inc. (714)-232-8951
COLO., COLORADO SPRINGS • Walker Electronics (303)-636-1661
COLO., DENVER • Cramer/Denver (303)-758-2100 • Denver Walker Electronics (305)-935-2406
FLA., MIAMI • Mountain Electronics Subsidiary of Avnet, Inc. (305)-634-4556
FLA., WEST PALM BEACH • Mountain Electronics, Subsidiary of Avnet, Inc. (305)-833-5701
ILL., ROSEMONT (Chicago) • F-J-R/Kierulff (312)-678-8560
ILL., SKOKIE (Chicago) • Merquip Electronics (312)-282-5400
IND., INDIANAPOLIS • Graham Electronics Supply, Inc. (317)-634-8486
MD., BALTIMORE • Radio Electric Service Co. (301)-823-0070
MASS., NEWTON • The Greene-Shaw Co., Inc. (617)-969-8900
MICH., ROMULUS • Harvey/Detroit (313)-729-5500

MINN., MINNEAPOLIS • Stark Electronics Supply Co. (612)-332-1325
MO., KANSAS CITY • Walters Radio Supply, Inc. (816)-531-7015
MO., NO. KANSAS CITY • ECI Semiconductors, Inc. (816)-221-2400
MO., ST. LOUIS • Electronic Components for Industry Co. (314)-647-5505
N.J., CLIFTON • Eastern Radio Corporation (201)-471-6600
N.M., ALBUQUERQUE • Cramer/New Mexico (505)-265-5767 • Sterling Electronics (505)-247-2486
N.Y., BINGHAMTON • Harvey/Federal (607)-748-8211
N.Y., NEW YORK • Harvey/New York (212)-582-2590
N.Y., WOODBURY • Harvey/New York (516)-921-8700
OHIO, DAYTON • F-J-R/Kierulff (513)-278-9411
OHIO, CLEVELAND • Pattison Supply (216)-441-3000
OKLA., OKLAHOMA CITY • Radio, Inc. (405)-235-1551
OKLA., TULSA • Radio, Inc. (918)-587-9123
PENN., PHILADELPHIA • Almo Electronics (215)-676-6000
PENN., PITTSBURGH • RPC Electronics (412)-782-3770
S.C., COLUMBIA • Dixie Radio Supply Co., Inc. (803)-253-5333

TEXAS, DALLAS • Adleta Electronics Company (214)-742-8257
TEXAS, FORT WORTH • Adleta Electronics Co. (817)-336-7446
TEXAS, HOUSTON • Harrison Equipment Co., Inc. (713)-224-9131
UTAH, SALT LAKE CITY • Cramer/Utah (801)-487-3681
VA., RICHMOND • Meridian Electronics, Inc., a Sterling Electronics Company (703)-353-6648
WASH., SEATTLE • Kierulff Electronics, Inc. (206)-763-1550
WASH., TACOMA • C & G Electronics Co. (206)-272-3181
CANADA, ONT., SCARBOROUGH • Lake Engineering Co., Ltd. (416)-751-5980
ALL OVERSEAS INQUIRIES:
General Motors Overseas Operations
Power and Industrial Products Dept.,
767 Fifth Avenue, New York, N.Y.
10022. Phone: (212)-486-3723.

Regional Headquarters, Union, New Jersey*
07083, Box 1018 Chestnut Station, (201)-687-3770 ■ El Segundo, Calif. 90245, 354 Coral Circle, (213)-772-5181
■ Chicago, Illinois* 60656, 5151 N. Harlem Avenue, (312)-775-5411 ■ Kokomo, Ind. 46901, 700 E. Firmin, (317)-459-2175 Home Office
■ Office includes field lab and resident engineer for application assistance.



707 SPECTRUM ANALYZER

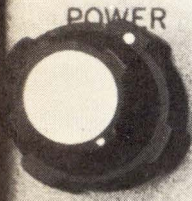

POWER

SCALE



FOCUS

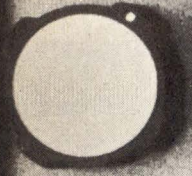

INTENSITY



VERT POS



HOR POS

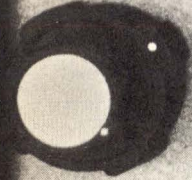

BASELINE
CONTRAST

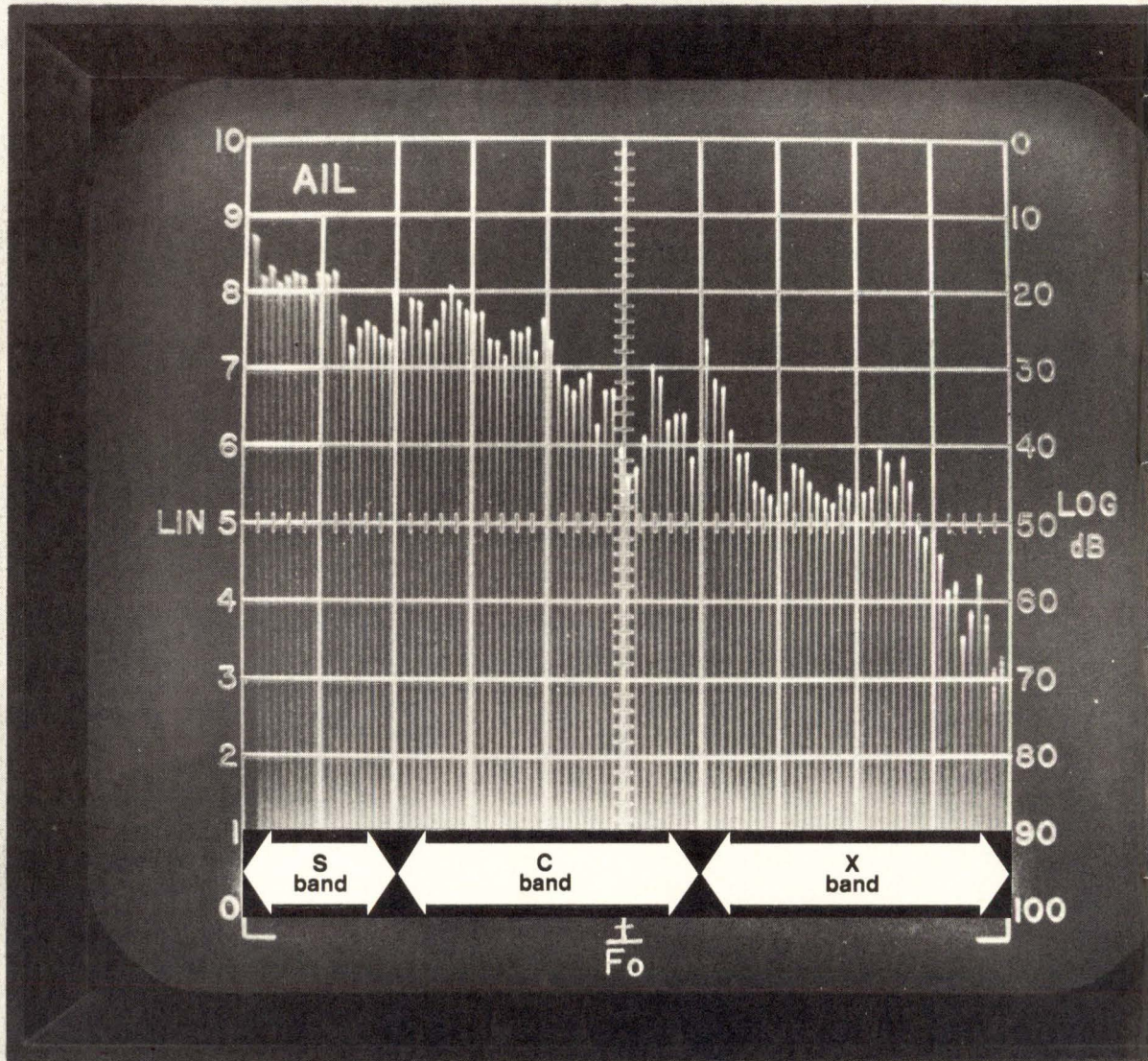

AIL a division of **CUTLER-HAMMER** 

SCAN MODE

EXT TRIG VIDEO

SINGLE
EXT SWEEP

LINE
AUTO

SCAN WIDTH/cm

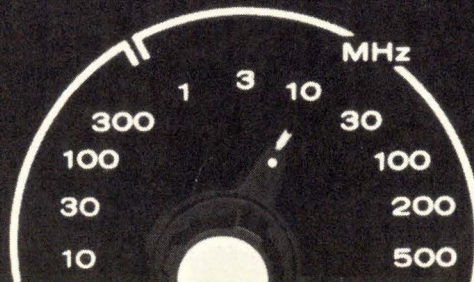

SCAN TIME /

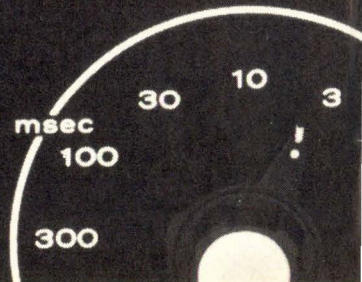

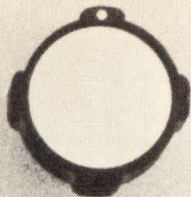

SIGNAL
CENTER

First time on any screen.

Introducing the only 100dB display with 10GHz scan width.

AIL's State-of-the-Art 707 Spectrum Analyzer gives you 10 MHz to 12.4 GHz coverage in just two bands with 150 dB dynamic range (a full 100 dB on screen) and -115 dBm sensitivity.

Error-free analysis is improved because spurious responses—in-band and out-of-band—are down typically 80 dB for -20 dBm inputs. A 5:1 filter shape factor significantly improves display resolution.

Simplicity of operation is apparent: minimum number of operator controls, an automatic phase-lock system, and a highly accurate digital frequency readout.

100% solid-state design does away with expensive BWO replacements and practically eliminates analyzer maintenance problems. Also the 707 has 100 times the built-in protection against accidental mixer burn-out.

Here is a true state-of-the-art contribution. Delivering more function and precision in an instrument whose ease of use **saves you money** on every measurement.

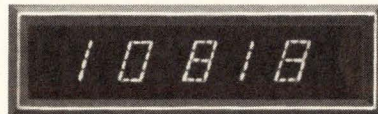

Frequency readout is accurate to $\pm 0.2\%$.

Priced at \$10,900, it is far and away today's best value in spectrum analyzers. For

convincing proof, write for more information. Or call 516-595-6471 to schedule a demonstration.



100 dB range is displayed on big 7" screen.

BANDWIDTHS (kHz)

I. F.

10

100

1000

1

AUT

AIL a division of

CUTLER-HAMMER



FARMINGDALE, LONG ISLAND, NEW YORK 11735

See the 707 and other AIL instruments in action at the IEEE Show. Booth 3612.

Circle 59 on reader service card

here's
two unbeatable
ICs
from Plessey

*550 MHz \div 2 ECL High Speed Divider SP 602
for instrumentation.*

The SP.602 is one of a series of devices produced by Plessey Microelectronics. The device toggles at very high frequencies with low power consumption — 550 MHz with 60 mW dissipation. It operates with 400 to 800 mV input levels (single drive) and provides a 500 mV output swing. The SP 600 series has a temperature range of -55°C to $+125^{\circ}\text{C}$ and is available in 8 lead TO5 or 10 lead flat pack encapsulations.

*Logarithmic wideband amplifier SL 521
for radar.*

The SL 521 provides a typical voltage gain of 12db, cut off frequency of 170 MHz with maximum rectified output of 1.0 mA. This wideband amplifier is primarily intended for use in successive detection logarithmic IF strips operating at centre frequencies between 10 and 100 MHz.

A full range of linear and wideband ICs is also available for SSB and other major communications applications.

Ask for full specifications of these
unbeatable ICs and many others
on Booth 2341 & 2343 at the IEEE.



PLESSEY microelectronics

Plessey Electronics Corporation
170 Finn Court, Farmingdale, LI, NY 11735. Tel: 516 694-7377. Telex: 961457.

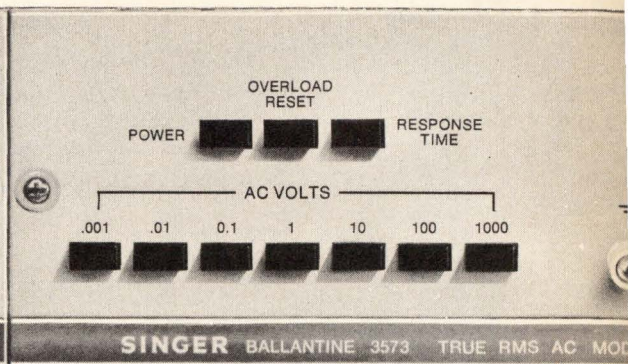
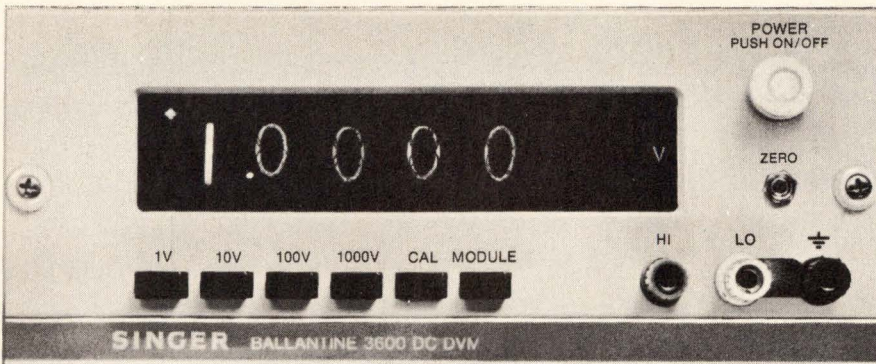



if you didn't buy SINGER'S New True RMS DVM...

And were measuring signals like this ...

Your present average responding DVM would give you errors like this ...

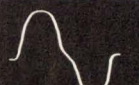
But with Singer's 3573 you get accuracy like this!

	10%	0.05%
	3%	0.05%
	4%	0.05%
	10%	0.05%

Only a True RMS DVM can accurately measure non-sinusoidal waveforms, and only the Singer Model 3573 is true from 10 Hz to 11 MHz. It's true from an astonishing 1 mV full scale (and that means 100 nanovolt resolution) to 1000 volts full scale. It's also true to an accuracy of $\pm 0.05\%$ of reading, $\pm 0.05\%$ of full scale at mid band.

And coupled to this great AC capability you can also make DC measurements with an accuracy of $\pm 0.01\%$ of reading and $\pm 0.01\%$ of full scale. using the Model 3600.

We have prepared a paper explaining the significance of True RMS, Average, and Peak Responses which we will send to you upon request.

The Singer Company
Electronic Products Division
250 Crossways Park Drive
Woodbury, New York 11797
Telephone: (516) 921-9400
Telex: 961-468

SINGER INSTRUMENTATION

The perfect part to fit
your buffer memory needs
...fully stocked on distributors' shelves!

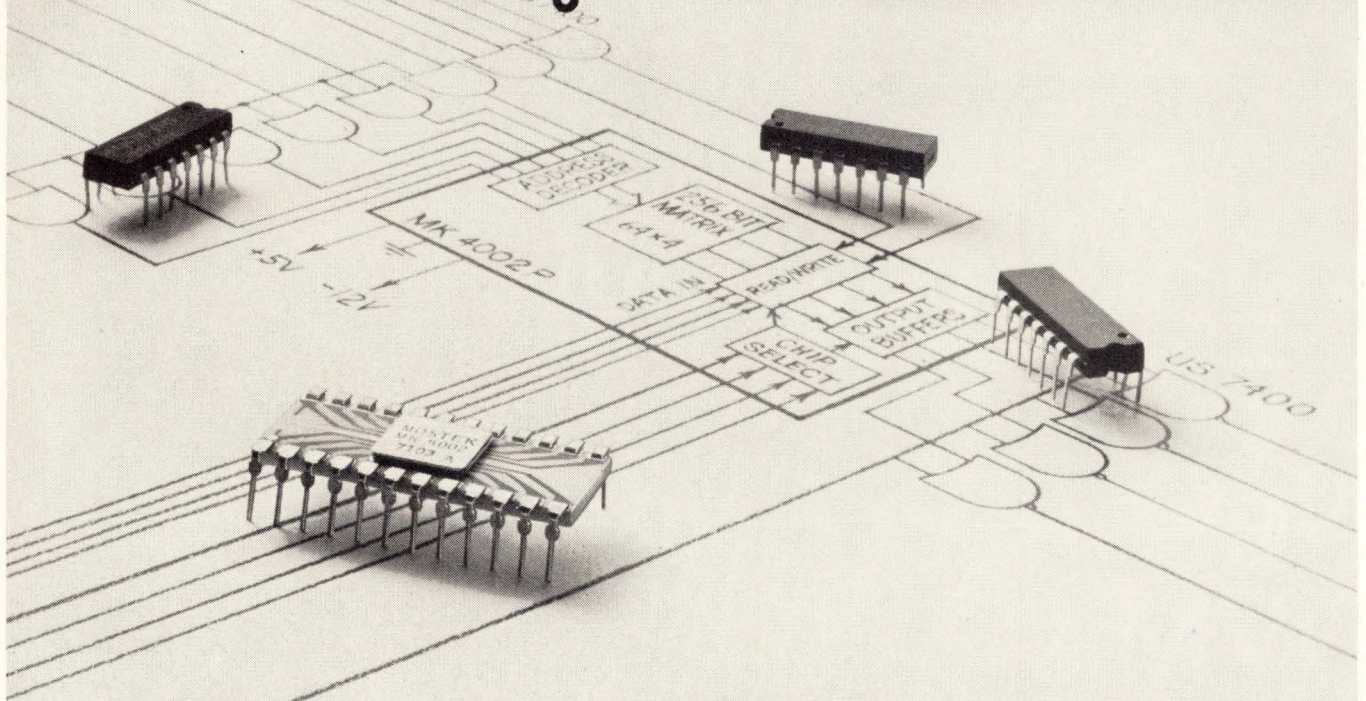

MOSTEK'S 64x4-bit MOS static RAM

Don't buy more bits than you need for those small buffer memory applications. MOSTEK's MK 4002 P 256-bit static RAM is organized as 64,4-bit words. Perfect for such requirements as data acquisition; key-to-tape and tape-to-printer buffers; in short, any application where you need temporary storage of data.

Don't get the idea that the 4002 is any slouch in performance, though. Access time is less than one microsecond . . . even up to +75°C. Memory operation is static so no refresh clocks are required. And power dissipation is low, typically less than 200mW.

Plus, MOSTEK's exclusive low-threshold ion-implantation process gives you full TTL/DTL compatibility . . . no need for external components or interface circuitry. We even put pull-up resistors on the chip for driving from TTL gates . . . and all four out-

puts have a TTL fan-out of 1. If your system requirements grow, additional packages are easily wire-OR'd thanks to the four chip-select inputs.

Got the message? MOSTEK makes it easy for you to use MOS. Call today for information and fast delivery of all the MOS components you need to Gordon Hoffman at our home office (214) 242-1494, or contact your nearest Sprague Electric Company office or representative.



An affiliate of Sprague Electric Company
1400 Uptfield Drive
Carrollton, Texas 75006

Technical articles

Big bipolar ROM expedites microprogramming: page 64

Microprogramming with semiconductor read-only memories could go a long way toward reducing the cost of controlling a computer's main memory—if only a ROM fast enough and dense enough were available. Now such a device is possible, say the four authors from Signetics Corp. Their answer is a 4,096-bit ROM that achieves its speed and remarkable density through the latest processing advances.

Choose the right test system for large pc boards: page 68

You've got two choices: the comparison tester, in which a test board is proven out against a known good unit, and the programmed method, where a computer controls a series of tests. To decide which one is best you have to know your tradeoffs.

MOSFETs fit into CATV picture: page 72

CATV applications require broadband amplifiers that can achieve reliable, distortionless performance at low cost. A logical choice, says author Don Lee, is to use MOSFETs in a distributed-amplifier configuration, where they offer longer life and lower power consumption than vacuum tubes and less distortion than bipolar transistors.

ICs in airborne indicators show the way to simpler navigation: page 80

With the number of light aircraft in the U.S. growing, there's a clear need for better navigation hardware. One approach to the converter-indicator for the standard international navigation system relies heavily on digital ICs; the result is a light-emitting diode readout system that's small, light, reliable, and inexpensive.

IEEE show opens under storm of controversy: page 88 (cover)

Hard times are forging a new militance among electrical engineers—and the fundamental character of the IEEE may change, too. The institute is under pressure to shift its stance from a strictly professional and educational organization. The militants want it to get involved in the bread-and-butter issues relevant to engineers—job security and pension rights—and assume a lobbying role in legislation affecting EEs.

Meanwhile, the show itself will reflect the changing times. An expanded technical program will spotlight practical applications; technical sessions will number 83, up from 69 last year. Yet the number of exhibitors will be down and fewer new products will make their debut. See page 93.

And in the next issue . . .

Electronics firms cash in on cashless society . . . can defense-oriented engineers make it in a commercial environment? . . . connecting mini-computers in networks . . . interactive CAD program simulates logic . . . a low-power analog-to-digital converter.

Microprogramming made easy— with a 4,096-bit bipolar ROM

Complex digital systems need complex, expensive control systems; but the latest bipolar processing techniques have produced a fast ROM that's large enough for the job and can save about \$100 per device used

by Sam Sirkin, Orville Baker, William Davidow, and David Allison, *Signetics Corp., Sunnyvale, Calif.*

□ Microprogramming costs can be substantially cut by using semiconductor read-only memories—and the denser the ROM, the greater the savings. Analysis of digital systems indicates that by using microprogramming for complex control functions, a designer could save over 300 gates with each 4,096-bit ROM. This results in a reduction of system size by 100 cubic inches and a reduction of system cost by around \$80 to \$120 per 4,096-bit device used.

However, up until now this density has only been achieved with MOS devices, which are not fast enough for microprogramming. But by combining the latest bipolar processing advances, it has proved possible to build a 4,096-bit ROM that serves the purpose.

As Table 1 shows, it has four times the capacity of other bipolar ROMs, dissipates about a quarter of their power—actually about 125 microwatts per bit—and is fractionally faster. Compared to current MOS ROMs, it is about equal in capacity, dissipates twice as much power per bit, and is 10 times faster.

Microprogramming is a technique for designing digital systems devised by the British scientist, M. V. Wilkes. His aim was “a systematic alternative to the usual somewhat ad hoc procedure used for designing the control system for a digital computer.”

Figure 1 compares the cost of control by microprogramming and random logic methods, and shows that a certain base cost is associated with microprogrammed control. But the advantage of such control, as Fig. 1 also shows, is that its cost increases very slowly with the number of sequencing cycles—or system complexity—because each cycle requires the addition, not of an entire new logic circuit, but of only one more word of memory. Because of this it has been chosen for many models of the IBM 360 and 370 series and is employed by other manufacturers of large computer systems, as well as minicomputer and terminal manufacturers.

Microprogramming with nonsemiconductor techniques, however, requires expensive external sensing and decoding circuitry. Therefore, it is important to note that such circuitry is built into a semiconductor ROM like the SMS 8228 and is capable of cutting microprogramming costs.

The new ROM is organized into 1,024 four-bit words, with a configuration that permits pin-for-pin replacement of currently available 1,024-bit ROMs. The 1,024-

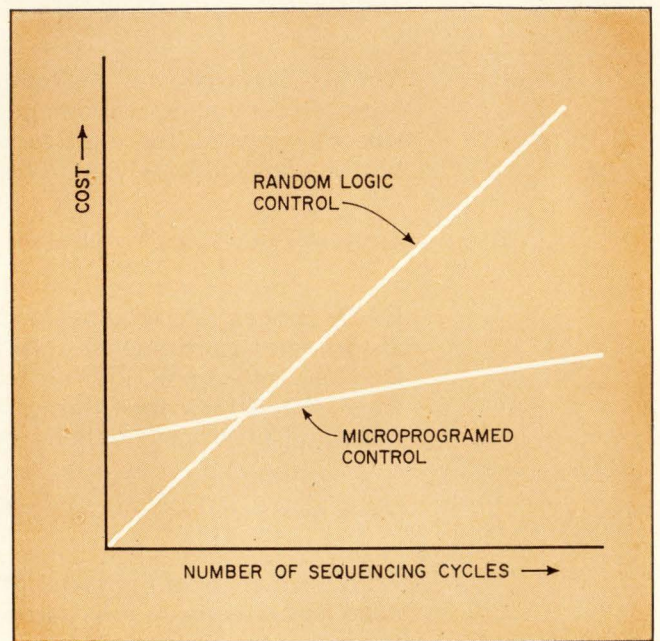

1. **Cost effective.** Since only one additional word of memory is required for each additional sequencing cycle, costs of microprogrammed control stay low even as complexity goes up. Crossover points for microprogram advantage over random logic control is about 150 control cycles, or 100 ICs per control device.

TABLE 1
Comparison of available bipolar and MOS ROMs
with SMS 4,096-bit device.

	SMS 4,096-bit bipolar	1,024-bit bipolar	2,048-bit MOS	4,096-bit MOS
Maximum access time	80ns	90ns	750ns	1,500ns
Typical access time	50ns	60ns	550ns	1,200ns
Typical power dissipation per bit	125 μ w	500 μ w	82 μ w	70 μ w

by-4 organization was also chosen because many machines use less than 1,024 words of ROM and therefore, by using readily available multiplexers, the memory can be expanded in the word direction at the expense of adding only a minor delay. Moreover, active outputs for floating low impedances are employed, since the chip cannot be disabled.

The system implications of using bipolar ROM in microprogramed control can be seen from the following example. Suppose a device has an 8,192-bit control memory and the basic microcontrol with memory occupies one pc card. Adding two 4,096-bit ROMs would double the amount of control storage, in effect doubling the control complexity. Thus if the control portion of a small minicomputer contained about 50 ICs, two of which were ROMs, only a 4% increase in the number of circuits would double the complexity of the control portion of the system. The basic instruction set of such a device might contain all the simple arithmetic, logic, branch, and input-output instructions. And by adding still another 8,192 bits, such instructions as variable length adds, search and move instructions, and floating point arithmetic could be easily made available.

A 4,096-bit ROM also opens the way to, say, a \$5,000 minicomputer with floating-point arithmetic, and to highly sophisticated remote terminals. It should be pointed out that this same type of control could be implemented with MOS/LSI circuitry, but it would only be practicable if it were to be built in very high volume. In lower volume, microprogramming using ROMs is more economical.

The cost advantage of microprogramming with a 4,096-bit ROM can be seen by comparing it with conventional methods. Table 2 shows the direct cost of putting a conventional 16-pin dual in-line package into a system. (Actual numbers from large-scale system manufacturers, including all manufacturing overheads, control panels and cabinetry, frequently exceeds \$2.00 per IC.) Assuming three gates per IC, the cost per gate indicated by Table 2 averages 35¢. It is interesting to note that even reducing the cost of the ICs to zero does not produce a lower cost than 25¢ per gate.

Table 3 shows the cost of placing a 4,096-bit ROM

in a microprogramed system. The point here is that while the manufacturing cost of supporting a ROM in a system is about \$1.70 per circuit as opposed to 75¢ for a single IC, the ROM can replace numerous ICs.

Figure 2 indicates the dollars saved for each 4,096-bit ROM employed. The plot, which uses the data in Tables 2 and 3, shows that if eight bits of ROM can replace one gate, then a 4,096-bit ROM, which will then replace 512 gates, will save about \$160 per ROM. The lines labeled optimistic, pessimistic, and realistic summarize discussion with system designers concerning their estimates of how many bits replace a gate. From a practical point of view the breakeven points (where gates and ROM control cost are equal) are about 36, 68, and 124 bits in order of decreasing cost per bit, or well above designers' estimates.

And while cost savings are important, microprogramed control with a ROM provides the user with some other advantages—namely, as shown in Table 4, savings in volume and power, which are of interest to terminal and military systems designers.

These advantages were gained by combining a number of the latest improvements in bipolar processing techniques. Included are the use of Schottky barrier diodes without the usual gold-diffused impurities, very thin epitaxial layer (3 microns), (100) crystal orientation, high-frequency npn transistors with f_T in excess of 800 MHz, lateral and vertical pnp transistors, and 3-inch wafers for fabrication.

The use of low-barrier Schottky diodes across the transistor base-collector junction can reduce the effective storage time of the transistor to less than 1 ns. If used on the multiple emitter input transistors of T²L structures, the inverse h_{FE} (static forward-current transfer ratio) is reduced to an insignificant level. And the usual disadvantage of the Schottky arrangement—a somewhat larger area requirement, which normally could amount to approximately 10% to 20% of the transistor area in high-power transistors—is obviated because the memory portion of the array, which takes up the largest area of the die, operates at low power and low current. The required area for such low-power Schottky-clamped devices are only 5% to 10% greater than for a transistor alone.

With Schottky barrier diodes, the use of gold dif-

TABLE 2
Direct system cost of 16-pin DIP

IC	.30
Incoming inspection	.05
PC board (88-pin, 60-IC capacity)	.25
Component insertion and fabrication	.03
Board checkout	.05
Connector	.05
Capacitors	.03
Wiring	.07
Power supply (\$1/watt)	.10
Cabinetry/card guides/fans, etc.	.10
	<u>\$1.05</u>

TABLE 3
Cost of ROM in microprogramed system

	1¢/bit	0.5¢/bit	0.25¢/bit
4,096-bit ROM	40.00	20.00	10.00
Incoming inspection	.50	.50	.50
PC card	.25	.25	.25
Component insertion and fabrication	.03	.03	.03
Board checkout	.15	.15	.15
Connector	.05	.05	.05
Wiring	.12	.12	.12
Power supply (\$1/watt)	.50	.50	.50
Cabinetry/card guides/fans, etc.	.10	.10	.10
	<u>\$41.70</u>	<u>\$21.70</u>	<u>\$11.70</u>

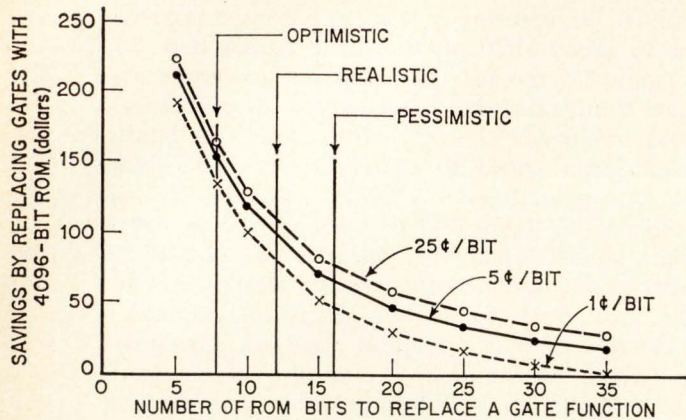

2. Saving bit by bit. From discussions with digital system designers, data has been generated to detail the magnitude of cost saving per 4,096 bits of ROM employed. Estimated savings range from an optimistic \$160 to a pessimistic \$50 per ROM.

fusion for storage time control is no longer required. Gold reduces the current gain of transistors and increases the resistivity of diffused and epitaxial layers in an uncontrolled manner. This can have very adverse effects on complex product yields. In addition, because Schottky diodes permit better resistivity control, a higher collector resistivity can be used, thereby significantly reducing collector-base and isolation capacitances.

The very thin, 3-micron, epitaxial layer conserves real estate and reduces isolation capacitance and saturation resistance. Normally in integrated circuits considerably thicker layers would be used because of problems of back diffusion from the buried layer. But the silane epitaxial process in a low-temperature, vertical reactor minimizes this problem.

Using a starting material of (100) crystal orientation has two major advantages. First, it eliminates any epitaxial pattern shift (getting a false image when trying to align the isolation mask to the buried layer pattern through the epitaxial layer). Second, it enhances the boron diffusion, thereby making it easier to diffuse base and isolation with minimum back diffusion of the buried layer.

Multiple-emitter transistors were chosen for their high inherent speed. To achieve high bit density, npn emitter followers were used rather than pnp types, though the former present higher capacitances to the driving and sense circuitry. With these elements the basic cell size is 1.35 square mils, only slightly larger than a comparable MOS cell.

Presenting approximately 20 picofarads of capacitance to the sense and driver circuitry, emitter followers with 300-ohm impedances could be used for driving. Also used was switchable common mode logic sense circuitry, in which four bits, one for each output, are sensed at the same time (see Fig. 3). The sense circuits operate with small voltage swings on the word and bit lines; this maintains tracking within a

TABLE 4
Savings that result from using 0.25¢/bit ROM in microprogramed control of digital system

	Bits per gate function		
	8 optimistic	12 realistic	16 pessimistic
DIPs saved	170	114	85
PC cards saved (60 DIPs/board)	3	2	1.5
Power saved (watts)	128	85	64
Volume saved (cu. in.)	150	100	75
Cost savings per 4,096-bit ROM	\$168	\$119	\$83

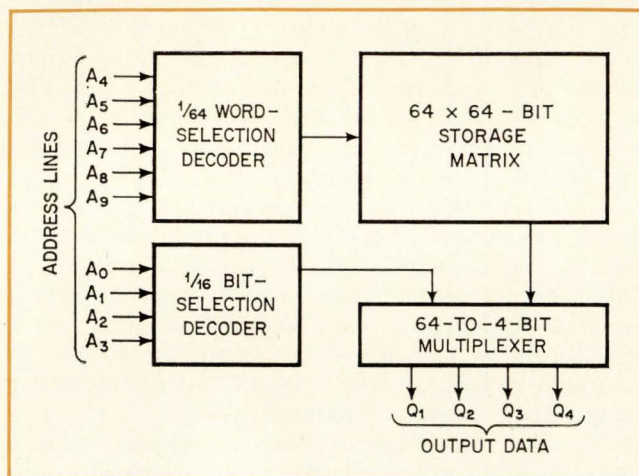

3. Makes sense. In laying out the SMS 4,096-bit ROM, sensing circuitry was used to sense four bits—one for each output—at the same time. This keeps voltage swings small and minimizes capacitance effects.

low temperature range, thus minimizing the effect of the capacitance on these lines.

The use of lateral and vertical pnp transistors and Schottky barrier diodes makes a convenient interface with peripheral circuitry. Since npns have their greatest advantage as input structures, they yield input currents in both the high and low state of under 15 microamperes over the full military temperature range. This 0 input current level, nearly two orders of magnitude lower than typical T²L circuits, is important when driving a number of arrays bussed together. □

Bibliography

- M.V. Wilkes, "The Best Way to Design an Automatic Calculating Machine," Manchester University Computer Inaugural Conference, p. 16, 1951.
- S.G. Tucker, "Microprogram Control for System 360," IBM Systems Journal, Vol. 6, No. 4, p. 222, 1967.
- M.V. Wilkes, "The Growth of Interest in Microprogramming," Computing Surveys, Vol. 1, No. 3, p. 139, Sept. 1969.
- R.F. Rosin, "Contemporary Concepts of Microprogramming and Emulation," Computing Surveys, Vol. 1, No. 4, p. 167, Dec. 1969.
- Samir S. Husson, "Microprogramming Principles and Practices," Prentice Hall, 1970.
- "Design of Microprogrammable Systems," Signetics Memory Systems Application Note SMS 0052AN.

Q. Who makes the only Inertial Measurement Unit designed for ARINC 571 requirements that's flying today?

A. Kearfott, of course.

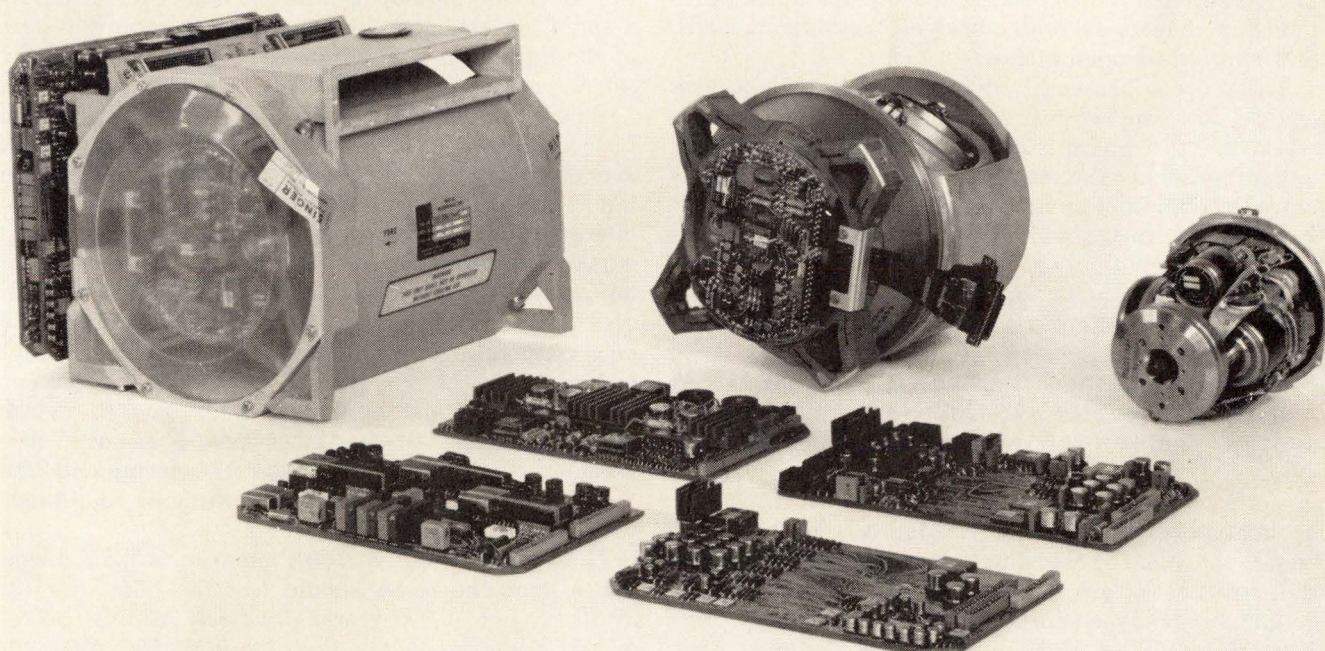

And it's no more than you'd expect from Kearfott—a pioneer in developing inertial navigation systems for military and aerospace programs.

The Kearfott KT-70 IMU (SKI-2071) is now flying as part of the ARINC 571 system in the Lockheed L-1011 test-bed program.

And it's now in production—as one of a family of units we're producing at the rate of over 70 per month.

The Kearfott IMU is the major system element of the Collins INS-60 inertial navigation system now being certified

for the L-1011. It brings to the commercial and general aviation fields a proved combination of high accuracy, dependable operation and low cost of acquisition and ownership.

Ease of maintenance is built into the modular Kearfott IMU. The inertial cluster can be removed in little more than 10 minutes. Access to and replacement of sensors—gyros and accelerometers—is simple and economical. And the electronic boards can be exposed and separated by unplugging from a common motherboard.

So when you're evaluating inertial navigation equipment, ask yourself the only important question:

Which IMU meets ARINC 571 requirements/ is presently being certified/ and is in production now?

There's only one answer. The Kearfott KT-70 IMU. For full details write to Singer-General Precision, Inc., Kearfott Division, 1150 McBride Ave., Little Falls, New Jersey 07424.

SINGER
KEARFOTT DIVISION

Proving out large pc boards: which system is best for you?

There are two: the simple one compares a test board against a good unit, the more complex approach uses a computer-controlled test sequence; the right choice depends on the tradeoffs in your own situation

by William R. Johnson Jr., *Honeywell Information Systems, Framingham, Mass.*

□ Plenty of attention is given to testing integrated circuits before they're put on printed circuit boards. But testing the boards themselves should not be neglected: they must be checked out for such workmanship defects as solder bridges, unsoldered leads, and shorted or open etches.

To assure subassembly reliability, the engineer can choose between two test systems: comparison testers, where the test board is compared with a good board, and programed systems, in which a test sequence is stored in computer memory along with the corresponding outputs that should be expected from a good board. Both methods have tradeoffs; the choice depends on the number and variety of boards to be tested, desired diagnostic and repair capability, and time available to develop test programs.

Comparison testing is simple—all that's required is to connect the two boards (one known to be good and the one to be tested) to a random sequence generator and watch the outputs. No programing is necessary and hardware costs are low. However, an inventory of good pc boards is required; this could represent a substantial investment if many different boards are to be tested. The test procedure could also be time-consuming for complex networks. And then there's a basic limitation: outputs that don't agree do not offer much help in locating and repairing the fault.

Programed testers, of course, require a programing effort that's proportional to the complexity of the test sequence of inputs and the expected corresponding outputs. However, since the designer controls the test sequence, he can arrange the order of test so that if one proves negative, a particular fault can be isolated, and thus diagnosed. This greatly simplifies repair. And with the prearranged test sequence, testing time is considerably lower than in comparison testers, so that if a large number of identical boards is to be tested, the programing investment is justified. Conversely, if only a few boards of several types are to be tested, it probably would not pay to write individual test programs for each type.

In comparison testing, only one input signal is altered between consecutive tests; changing two inputs simultaneously at random could result in indeterminate states of storage elements. For example, in the flip-flop and control circuitry shown in Fig. 1, the

flip-flop is set or reset by applying a logic 0 to the appropriate line. Suppose inputs 1 and 3 are at logic 1 and inputs 2 and 4 are at logic 0. If input 2 is changed to logic 1, the flip-flop will be set. However, if inputs 2 and 4 are changed simultaneously, the output state of the flip-flop is indeterminate: it could assume the set or reset state.

When inputs are changed in a nearly random fashion, all input combinations usually occur, on the average, in $2^n \Delta t$ seconds, where Δt is the time between input changes and n is the maximum number of interdependent inputs (those inputs that affect a monitorable output). The number of interdependent inputs is not necessarily equal to the total number of inputs because separate logic networks may be on the same board, and these could be tested simultaneously in the comparison method. In practice, the test time must be longer than $2^n \Delta t$ to assure that all possible test conditions have been taken into account. Some equipment makers recommend the test time be 10 times longer, but three or four times usually is adequate.

Thus, if n is 60 and Δt is 0.4 microsecond (2.5 megahertz), then the tester should test the board for $(3)^{2^{60}}$ (0.4 μ s) or 40,000 years. Obviously, n must be reduced. For example, in the circuit of Fig. 2a, a 5-minute test time is required for the 20 interdependent inputs. If the number of inputs were decreased to 10, by bringing points a and b out as test points, the test time would be only 1.2 milliseconds.

As another example, consider gate A of Fig. 2b. Four input combinations can be applied to the two interdependent inputs of this gate (1 and 2). If all three gates are considered as one unit, four interdependent inputs and 16 input combinations are possible. But if test points are inserted at the output gate's two inputs, then the output gate could be tested by applying four input patterns. The same is true of the other two gates. Thus, all three gates can be tested simultaneously; the number of interdependent inputs has been reduced from four to two, and the number of tests from 16 to four.

The designer thus trades off test time against the number of inputs and test points that he must monitor in his circuit. To decide on the number of test points, the designer first should select a maximum test time and then add test points until he scales

down the testing time to within acceptable limits.

In comparison testing, the logic circuits to be tested are operated at normal speed so that any problems that could cause deterioration in switching speed will be uncovered, as will faults that occur under only a few input conditions.

However, since only one input is altered in each test, some faults can go undiagnosed. For example, if a gate is slower than specified and its output signal and other logic signals control the inputs of a flip-flop, the faster signals might control the flip-flop incorrectly if both gates changed logic levels simultaneously. Hence, faults that occur when a number of inputs are changed simultaneously will not occur when only one input at a time is changed.

Although comparison testing is well suited to go, no-go testing, it offers no help in locating the fault—it simply indicates a discrepancy. But if there is a good probability that the boards will be fault-free, and thus little repair effort is expected, this method is worth using.

When a discrepancy is detected, the first procedure is to inspect the board for obvious workmanship defects. If none are evident, a search might start at the faulty output, tracking back through the circuit comparing inputs and outputs with those on the known good board until the fault is isolated.

In such situations, the problem could be eased with documentation aids. For example, the logic block diagram should show the logic leading to an output pin. Common signal lines should be drawn instead of locating destinations for signals by signal name. An ordered list of ICs that affect each output also would be helpful in tracing back through the circuit from an output that has shown a discrepancy.

It's also easier to monitor the dynamic and static logic levels of each pin on the IC if dual in-line clips are used. These are clothespin-like spring clips that contact all IC leads on each side of the package.

In a programmed test system, programs are structured so that when a test fails, a specific fault or subset of faults is identified immediately, circumventing the tedious tracing possible in comparison testing. When the programmer generates a test program for a new pc board, he attempts to formulate a test sequence that will model and detect a discrepancy and then diagnose its location. The complexity of the program increases drastically as more faults are included in the program. However, solder bridges, shorted etch, and components mounted upside down or backward occur often enough to warrant inclusion in the program, even though the program costs are higher.

Basically, when a set of tests is generated, considerable thought must be given to two aspects: applying enough inputs to assure that all faults are detected, and locating a specific fault when a logic net has a discrepancy.

The first involves using a minimal set of inputs while the second involves locating the fault to a replaceable package.

The ideal test generation method, though it isn't possible now, would be one where the designer simply supplies the computer with data input and output

Testers: LSI vs pc

The controversy among manufacturers and users of LSI testers [*Electronics*, Dec. 7, 1970, Feb. 1, and March 1] continues to unfold, but the pc board testing field has settled down. The focus is on giving users the maximum in diagnosis capability and ease of programming. However, programmed pc board testers are often just as expensive as LSI units—several are in the \$100,000 range; comparison testers on the other hand, run in the \$10,000 bracket.

Although pc board testers and LSI testers have much in common—each applies bit patterns to test logic—the differences are more significant. The most important is that a programmed pc board tester should have a diagnostic capability so that the user can repair his board, either by replacing a faulty integrated circuit or by fixing the printed wiring pattern itself. This is where the pc unit really pays off, cutting locating time from an hour or more down to 10 or 15 minutes.

Such diagnostic capability, however, is of little interest to LSI users, since they can't repair the chip itself if a fault is found. LSI manufacturers, of course, do want some fault diagnosis in their testers because it can help determine where in the chip fabrication process a problem is occurring.

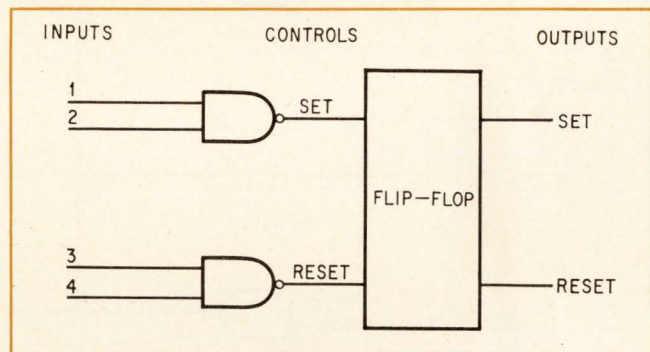

1. Ambiguity. If two inputs to the gates were changed simultaneously, flip-flop could be in an indeterminate state. That's why only one input line at a time is changed in comparison testing with random inputs.

pins; location of all logic packages on the board; a truth table for each of these packages; and a list which defines the interconnections between these packages, inputs, and outputs of the board. With this information, the computer then would develop a specific test routine, with a minimal test sequence, for the particular board.

To appreciate the problem of programmed testing, consider the two basic methods—combinational and serial—in use for developing a diagnostic program. In the combinational test schedule, a fixed series of inputs is applied to the network and the outputs are tabulated and then analyzed after all tests are completed. In the serial test sequence, one test depends on the results of the previous tests. A test pattern is applied, and if the board passes, the operator knows

Designing for fault-finding

Tracking down faults in printed circuit boards need not be limited by the test methods themselves. Engineers can help their own cause by designing the boards with an eye toward expediting and cutting the cost of the fault-finding process.

For cross-coupled gates (Fig. A), the latch circuit should be designed with both gates on the same IC. Then, if an output is stuck at 0, the technician simply replaces the IC rather than having to locate which of the gates is in error, as would be necessary if two ICs were used.

If only one input signal is needed, the other input should be provided at a test point for the latch. If the latch must be designed with gates on two ICs, an easily removed jumper in one feedback line should be used to provide an easy method of isolating stuck at 0 faults on one of the faulty ICs.

If a function is used as a feedback signal to the logic network that generates the function (Fig. B), provision should be made for inhibiting the feedback loop. One method might be to include a gate and bring out a lead to a test point, permitting easy isolation of faults in counters, shift registers, etc.

For wired-or gates, (Fig. C), when any output as-

sumes the low state, it controls the output level. If the output of a gate is stuck at 0, this level cannot be altered by changing inputs to this or any other gate. The use of wired-or thus should be minimized. If a number of gates are to be processed this way, the number of ICs used to implement the function should be minimized. A jumper link would be a useful addition for isolation of the faulty IC package if more than one IC is required on the board.

For multivibrators and oscillators, a lead should be provided to start and stop the oscillation of the network. With this approach, all the related logic can be tested without having to consider malfunctions in the oscillator frequency or pulse width.

Flip-flops should be provided with a method for controlling their initial states. A common reset line would provide the best control. The approach should not require that a number of successful input signals be applied to set or reset the flip-flop. Efforts should be made to have at least one of the outputs of storage elements available at a test point. If not, the design of the gate structure between the inputs to the pc boards and the flip-flop should be held down to a minimum configuration.

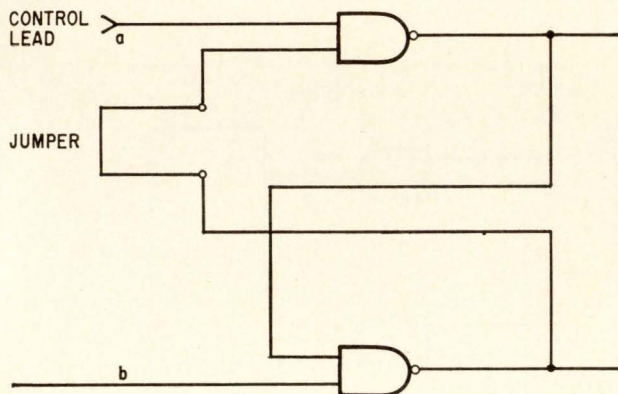

A. All together. Cross-coupled gates should be put on same chip for easy repair. If gates must be on separate chips, jumper lead should be included to allow fault isolation of stuck at 0 faults.

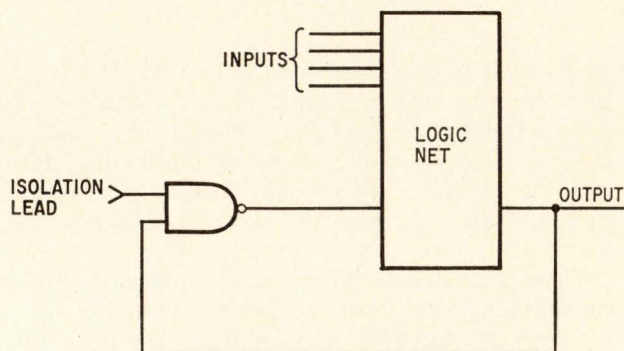

B. Don't close it. Feedback loop should be gated with a lead brought out as test point to allow isolation of faults in shift registers and similar feedback circuits.

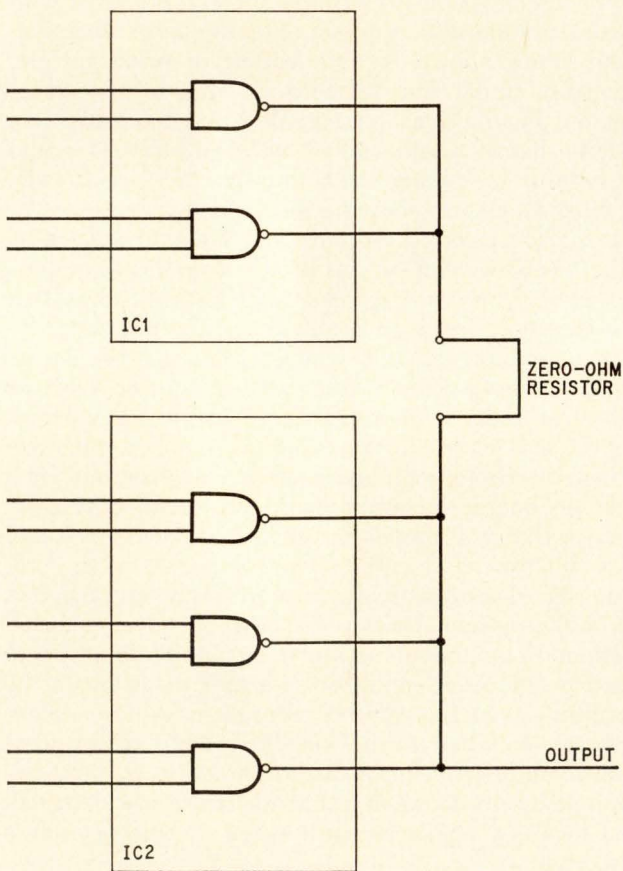

C. Watch wired-ORs. Wired-OR circuits are difficult to diagnose for faults and should be avoided. If they can't be avoided, jumper should be used between packages to at least isolate fault to one package.

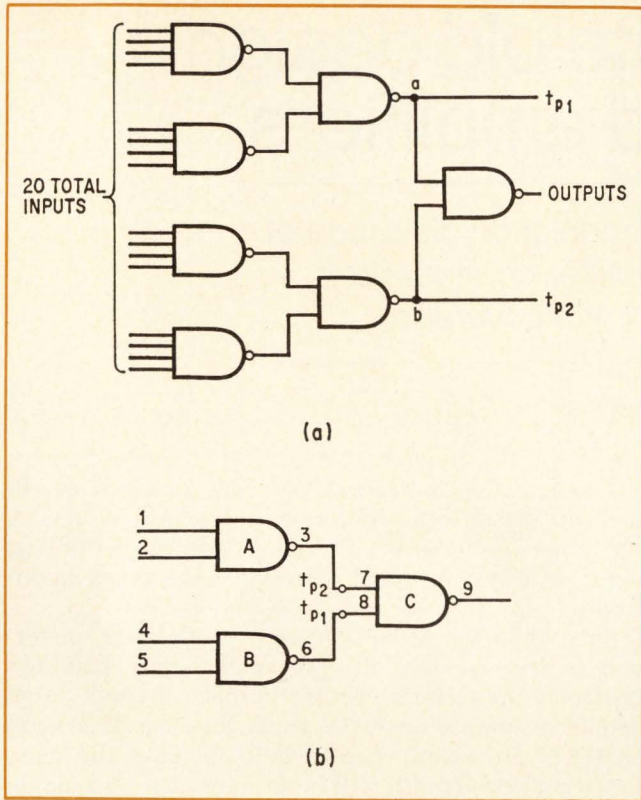

2. Time-saver. Test points at the inputs to the output gate cut test time from 5 minutes (with 2.5-MHz clock) to only 1.2 ms. Similarly, inserting test points at pins 7 and 8 in b cuts interdependent inputs from four to two and number of tests from 16 to four, since each gate can be tested simultaneously.

that a number of faults are not present. The next test eliminates more faults, and so on. The latter approach requires less time to diagnose the location of a fault, but is more difficult to generate.

To formulate a fault table, which would be used in both combinational and serial testers, a matrix must be developed. In it, columns correspond to a specific test pattern, while rows correspond to a given fault that has been modeled. A 1 is entered at any matrix intersection where a fault is detected when the test pattern is applied.

For example, a simple three-gate circuit (Fig. 2b) has nine different input and output points. Since only single-occurrence faults (opens or shorts forcing signal lines to be always at 1 or 0, or in common tester terminology, stuck at 1 or stuck at 0) are considered, there are 18 possible faults. However, with only four inputs, 16 input tests can be performed at most. Thus, all faults cannot be isolated, since at least two tests must indicate two faults (it's obvious in Fig. 2b, since pins 3 and 7 and pins 6 and 8 cannot be isolated).

The fault table for the circuit of Fig. 2b (without test points t_{p1} , and t_{p2}) would be assembled as follows: first define the 16 tests, as in Fig. 3a; then, for the fault table, list the faults as rows and the tests as columns; as in Fig. 3b.

Note that if f_1 is the fault associated with lead 1

FAULT TABLE					
Test No.	Input				
t_0	5421				
t_1	0000				
t_2	0001				
t_3	0010				
	0011				
	↓				
t_{15}	1111				
(a)					
Fault	Test No.				
	t_0	t_1	t_2	t_3	t_{15}
Lead 1 S @ 1, f_1	0	0	1	0	0
Lead 2 S @ 1, f_2	0	1	0	0	0
Lead 3 S @ 1, f_3	0	0	0	0	0
Lead 4 S @ 1, f_4	0	0	0	0	0
	↓				
Lead 9 S @ 0, f_{18}	1	1	1	0	1
(b)					

3. Fault-finder. A test program for the circuit shown in Fig. 2b would be produced by first defining 16 input tests and then deriving the fault table, which relates the tests to the possible faults. A 1 in the fault table indicates that the particular fault is revealed by an incorrect output for that specific test.

stuck at one, an all-0 pattern, t_0 , produces a correct output even though lead 1 is stuck at 1. Thus, a 0 is entered at f_1 , t_0 . Likewise t_1 , in which lead 1 is set to 1, does not detect the fault. But t_2 , in which lead 1 should be set to 0, produces an erroneous output. It follows that a 1 is entered at f_1 , t_2 . This can be continued until the matrix is completed for the all 18 fault conditions.

The matrix expands quickly as the number of inputs and faults is increased, but it can be reduced if data duplications are uncovered. For example, if two columns are identical, two different tests would detect the same faults, since no new information is obtained from the second test, one of them can be eliminated. If two rows are identical, then two faults are detected by the same test, but are not by any of the other tests. Therefore the faults cannot be isolated and one of the rows might as well be removed. □

Bibliography

- Roth, J. Paul, "Diagnosis of Automata Failures: a Calculus and a Method," IBM Journal, July 1966, pp. 278-291.
- Armstrong, D.B., "On Finding a Nearly Minimal Set of Fault Detection Tests for Combinational Logic Nets," IEEE Transactions on Electronic Computers, February 1966, pp. 66-77.
- Chang, Herbert Y., "An Algorithm for Selecting an Optimum Set of Diagnostic Tests," IEEE Transactions on Electronic Computers, October 1965, pp. 706-711.
- Chang, Herbert Y., Manning, Erick G., and Metzger, Gerot, "Fault Diagnosis of Digital Systems," Wiley-Inter-Science, New York.

MOSFETs rejuvenate old design for CATV broadband amplifiers

The large dynamic range and low cross-modulation distortion of low-cost MOSFETs, plus a distributed-amplifier configuration, can provide a high-level output suitable for vhf coverage

by D. V. Lee, *Microelectronics division, General Instrument Corp., Hicksville, N.Y.*

□ With the steady growth of CATV has come a need for broadband amplifiers that can deliver reliable, distortion-free performance at low cost. Economical metal-oxide semiconductor field-effect transistors in a distributed amplifier configuration present an attractive alternative to traditional vacuum tube or bipolar amplifiers for CATV service.

Distributed amplifiers make good broadband elements of CATV systems at vhf frequencies, but using vacuum tubes or bipolar transistors as their active elements has always had drawbacks. The large power consumption, physical size and relatively short life of vacuum tubes limited their usefulness. The relatively high distortion products produced with bipolars ruined signal fidelity, and their low input impedance required complex coupling circuitry to achieve adequate bandwidths.

On the other hand, FETs work well over a large dynamic range and, since they are square-law devices, produce little distortion. With these features they can easily handle widely varying TV signals and provide the necessary high-level outputs. Moreover, their high input impedance matches the distributed-amplifier design requirements. Typical inexpensive MOSFETs have an input impedance of around 10^{15} ohms at dc and about 10,000 ohms at 200 megahertz.

A four-stage distributed amplifier built around four 40-cent MOSFETs can, for instance, provide 11 decibels of gain from 20 to 230 MHz with a noise figure of only 6 dB.

The MOSFET amplifier must be operated in the linear region of the characteristic curve of its gate-to-source voltage, V_{GS} , and drain-to-source voltage, V_{DS} . The relationship between drain current I_D and V_{GS} illustrates the effects of cross modulation and can be approximated by

$$I_D = \frac{W \epsilon_{ox} \mu_n}{2L t_{ox}} (V_{GS} - V_p)^2$$

where

- W = channel width
- ϵ_{ox} = dielectric constant of silicon dioxide
- μ_n = electron mobility
- L = channel length
- t_{ox} = thickness of silicon dioxide
- V_p = pinch-off voltage.

This equation indicates that in an idealized condition the MOSFET can be termed a square-law device. The absence of third- and higher-order terms of V_{GS} in the series expansion of I_D provides low cross modulation.

But, while the MOSFET's cross-modulation distortion is low enough, its gain and power handling capability aren't high enough to make a single-stage amplifier suitable for CATV trunk line use. If several MOSFETs are simply cascaded to increase the gain, the overall bandwidth will be at most that of a single stage, while the coupling capacitance between stages will cause bandwidth shrinkage. Or if several MOSFET stages are simply connected in parallel to improve the amplifier's overall transconductance and thereby increase the gain, the amplifier's bandwidth will suffer since the gain-bandwidth product is that of a single stage.

However, improvements in both gain and bandwidth can be achieved if the MOSFETs can be connected in parallel without introducing any shunting capacitance. This can be done with a distributed amplifier circuit. In this configuration, gain can be increased almost indefinitely by simply adding more MOSFET stages, while input and output impedances of the amplifier remain constant. The advantage of the distributed configuration is increased power handling without bandwidth reduction as extra stages are added, since the bandwidth of the overall amplifier is not limited by the cutoff frequency of the MOSFET.

In its simplest form, a MOSFET distributed amplifier can be looked upon as several active elements in parallel, distributed along two artificial transmission lines (Fig. 1). It's possible to design these lines for equal phase shifts if both the input and output lines—gate and drain—are assumed to be lossless and if they are properly terminated in their characteristic impedance, Z_0 . (Unequal phase shifts can result in signal cancellation along the transmission lines.)

The phase shift constant, β , can be expressed as

$$\beta = \omega \sqrt{LC}$$

where ω = the frequency in radians per second, L = inductance, and C = capacitance. Phase velocity along the transmission line can be expressed as

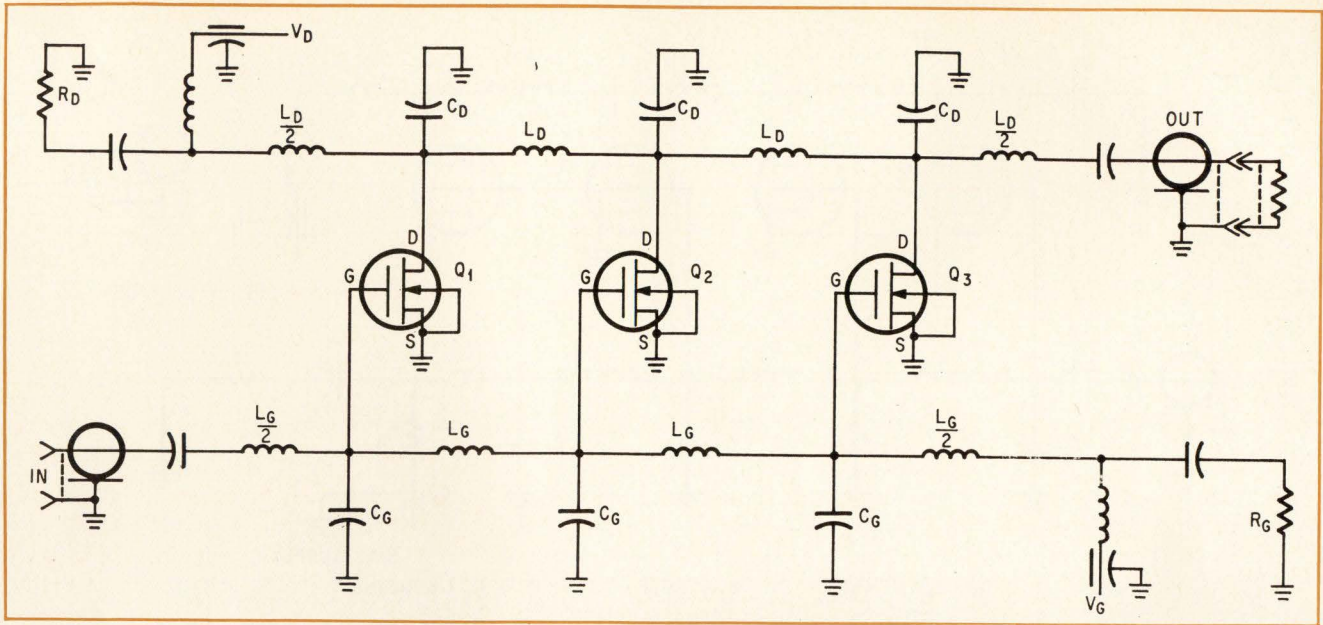

1. Down the line. Distributed amplifier consists of MOSFETs in parallel distributed along artificial transmission line. The gate-to-source and drain-to-source capacitances combine with stray circuit capacitance to form mid-shunt elements of equivalent Tee sections. Each MOSFET receives gate voltage of fixed magnitude, but with phase delay calculated to reinforce the input signal as it travels down the transmission line.

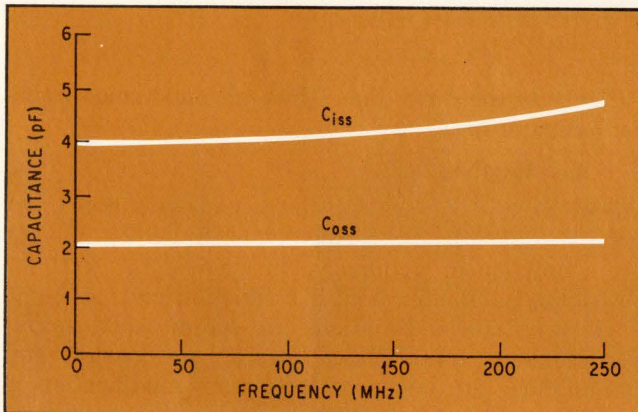

2. Variation. Small signal, short circuit gate-to-source (C_{iss}) and drain-to-source (C_{oss}) capacitances of General Instrument MEM557 MOSFET vary with frequency.

$$\frac{\omega}{\beta} = \frac{1}{\sqrt{LC}}$$

Thus, for gate and drain lines with the same phase shift, the following equality is necessary:

$$\sqrt{L_D C_D} = \sqrt{L_G C_G}$$

where L_D , L_G , C_D , and C_G are the drain and gate line inductances and capacitances, respectively.

In the transmission line design of the distributed amplifier, the MOSFET's input and output capacitances are combined into the shunting capacitances of the mid-shunt elements of the equivalent Tee network sections in the gate and drain lines. Now each MOSFET receives gate voltage, E_G , not only of fixed amplitude,

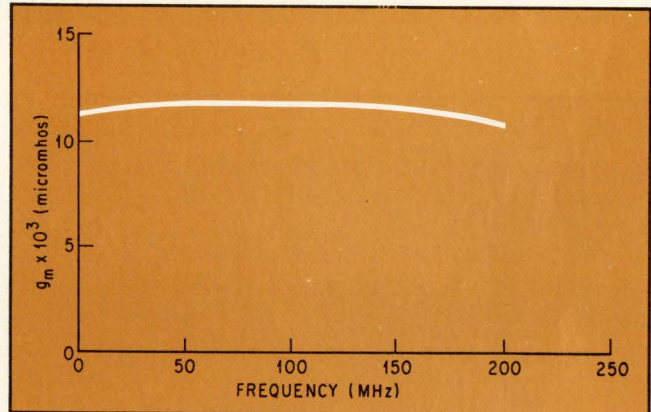

3. Steady gain. Practically constant forward transconductance (g_m) of MEM557 MOSFET produces steady gain in vhf television band. Gain is determined by product of g_m and distributed amplifier's drain-line impedance.

but with proper phase delay, varying with how far along the transmission line the transistor is situated. Each MOSFET then delivers a signal current whose phase is equal to the sum of the individual input phases of the preceding stages plus the phase shift generated by the MOSFET itself.

The signal currents can be expressed as the product of the MOSFET's transconductance, g_m , and the gate voltage, E_G . The currents then combine in phase at the amplifier's output terminal with an amplitude of $\frac{1}{2}g_m N E_G$, where N is the number of MOSFET stages and where the $\frac{1}{2}$ represents the half of the output current that in a distributed amplifier flows through the output terminal—the other half flows

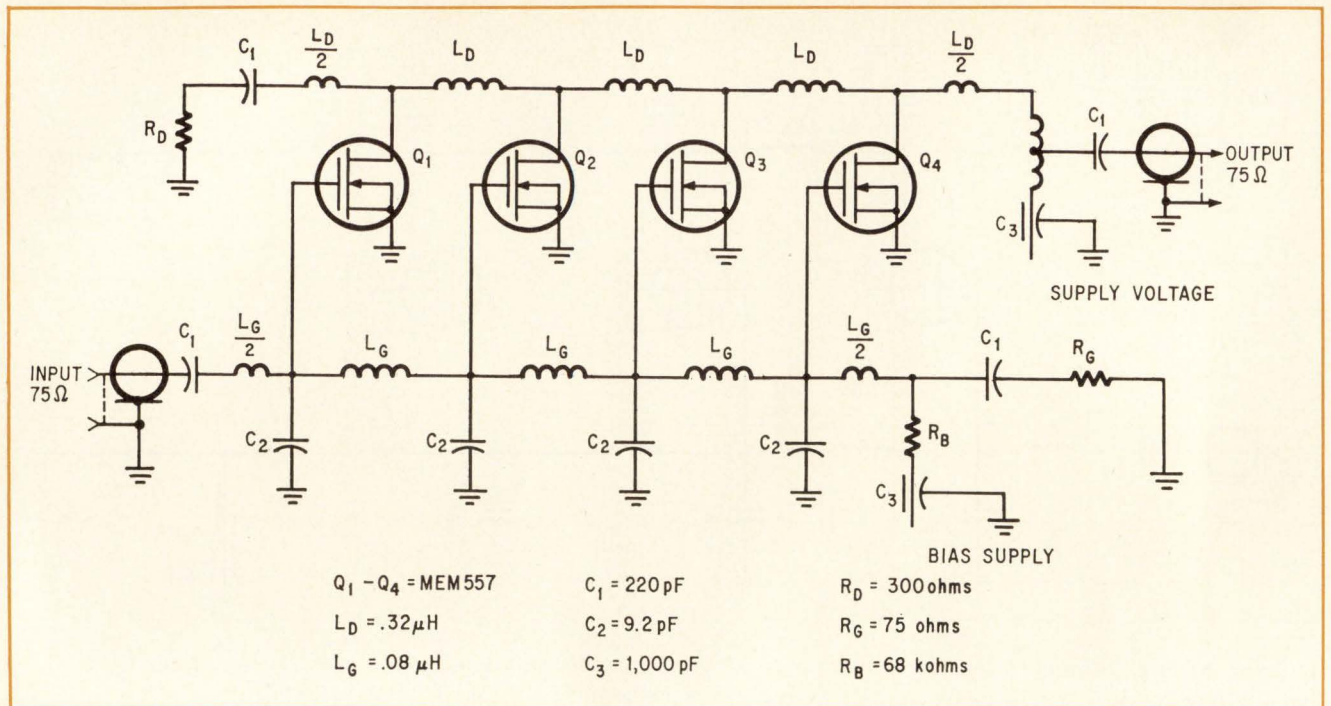

4. Trunk line amplifier. Distributed capacitance in output circuit consists of MOSFET's drain-to-source capacitance, in input circuit consists of the parallel combination of MOSFET's gate-to-source capacitance and C_2 . (Note absence of the equivalents of C_D capacitors of Fig. 1.) The four-stage CATV repeater amplifier produces 11-dB gain and 6-dB noise figure over the vhf band. Power output at 1-dB gain compression is 150 mW.

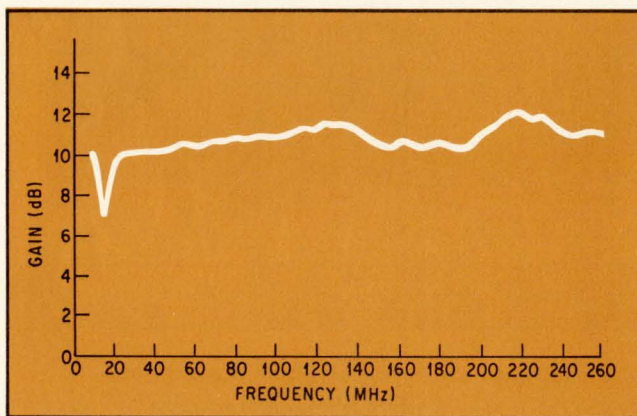

5. Variations. Gain fluctuations of ± 1.0 dB of MOSFET distributed amplifier are adequate for CATV trunk line use. Fluctuations could be reduced to less than ± 0.5 dB by building amplifier with complicated m-derived networks or by producing different phase delay between stages.

through the drain line resistor, R_D , to ground. The output voltage of the amplifier is

$$V_o = \frac{1}{2} g_m N E_G R_L$$

where R_L is the load resistor. Voltage gain of the circuit is

$$A_o = \frac{1}{2} g_m N R_L$$

To hook the MOSFET amplifier to the CATV transmission line with maximum efficiency, the amplifier's output impedance must equal the characteristic im-

pedance of the CATV line. Thus, an impedance transformation is necessary:

$$A = \frac{1}{2} g_m N \sqrt{Z_D Z_G}$$

where Z_D and Z_G are the drain and gate line characteristic impedances, respectively. Since Z_D and Z_G are a function of frequency, the gain of the MOSFET distributed amplifier is also a function of frequency.

However, these equations are for an ideal amplifier and, since transmission lines are not lossless and terminations are never perfect, some modification is necessary. For a transmission line with some loss, the characteristic impedance is

$$Z_o = \sqrt{\frac{R + j\omega L}{G + j\omega C}} \cong \sqrt{\frac{j\omega L}{G + j\omega C}}$$

R , the real part of the inductor, is small enough to be neglected, but the conductance of the shunt element is not negligible and must be taken into consideration, especially at high frequencies. Consequently, the characteristic impedance cannot be matched by just a resistor without causing reflections along the transmission line that make gain fluctuate with change in frequency. If these fluctuations are too high for a particular application, they should be reduced by increasing the mutual coupling between MOSFET stages with an m-derived equivalent Tee.¹ Another method of reducing fluctuations of gain with frequency is to construct the amplifier so that the phase shift in every section is different, thus minimizing signal cancellation between stages.²

The first step in building the distributed amplifier

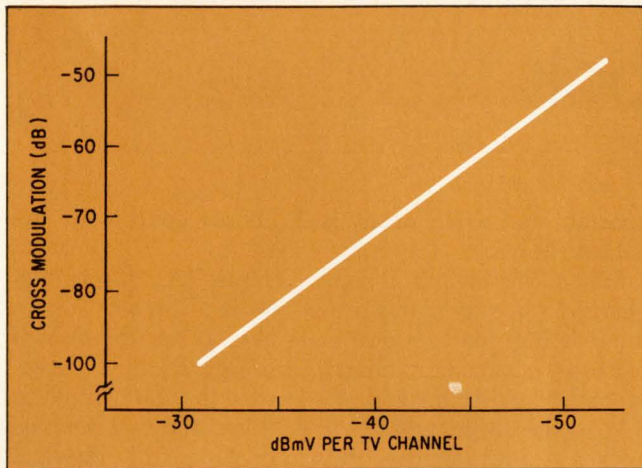

6a. Low distortion. Linear curve with slope of 2 is adequate for CATV trunk line amplifier. If TV channels 2 through 12 are 100%-modulated by a 15.75-MHz square wave, cross-modulation products are yielded that can be measured on unmodulated channel 13. V_{DS} of MOSFET is 18 V, and I_D is 20 mA per stage. Signal level is in dBmV where 1 mV = 0 dBmV.

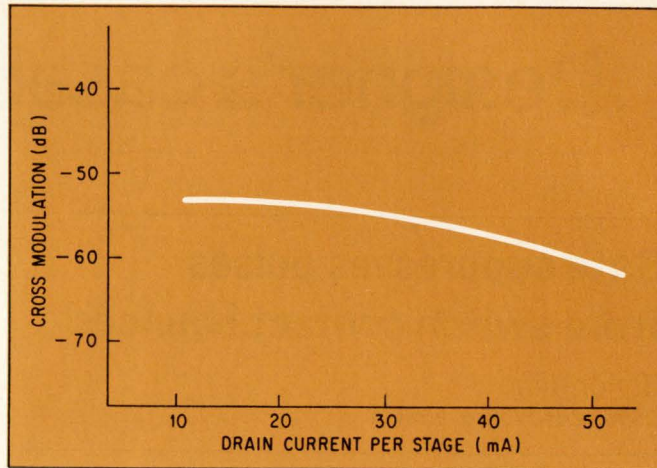

6b. Better picture. Increasing drain current and drain supply voltage from 20 mA to 50 mA per stage and from 18V to 20V improves cross-modulation distortion response of MOSFET distributed amplifier by 6 dB. Lower cross modulation improves television picture quality within the CATV system.

is to select the MOSFET. Its transconductance must be high enough to provide adequate gain and its noise figure low enough to satisfy requirements of the applications. Finally, its gate and drain line capacitances must be small, on the order of a few picofarads, since they will be combined into the mid-shunt elements of the equivalent Tee sections in the input and output lines of the amplifier.

For vhf CATV trunk line amplifier operation, General Instrument's MEM557 MOSFET is a good choice. Its g_m of 12,000 will yield a four-stage amplifier with voltage gain of 11 dB into a 75-ohm load (two amplifiers will satisfy the gain and frequency requirements of the CATV line). Its 2.5-dB noise figure is well below the CATV amplifier requirement of 6 dB, and its cutoff frequency of 1 gigahertz will allow the amplifier to operate within the required range of 50 to 220 MHz.

The input capacitance, C_{in} , of the MEM557 is the sum of its short circuit gate-to-source capacitance, C_{iss} , and the stray capacitance between it and ground—5.0 pF—while the output capacitance, C_{out} , is the sum of its short circuit drain-to-source capacitance, C_{oss} , and the stray capacitance—3.5 pF. Variations of C_{iss} and C_{oss} with frequency are shown in Fig. 2, while transconductance variations of the MEM557 are shown in Fig. 3.

Once the MOSFET parameters have been established, the next step in designing a distributed amplifier for CATV trunk line application is to determine the input parameters, L_G and C_G .

Assuming a lossless transmission line for simplicity, one can calculate L_G and C_G from the following equations using a 250-MHz cutoff frequency and the conventional 75-ohm CATV line input impedance:

$$f_c = \frac{1}{\pi \sqrt{L_G C_G}} = 250 \times 10^6$$

$$Z_G = \sqrt{\frac{L_G}{C_G}} = 75$$

The solution for L_G is 0.08 microhenry, and for C_G is 14.14 pF.

The inductance, L_D , in the output or drain line is determined by setting the output capacitance, C_{out} , equal to the drain line capacitance, and solving the equation:

$$f_c = \frac{1}{\pi \sqrt{L_D C_D}} = 250 \times 10^6$$

The result is $L_D = 0.32 \mu\text{H}$. Substituting the values of C_D and L_D in the equation for drain line impedance gives

$$Z_D = \sqrt{\frac{L_D}{C_D}} = 300 \text{ ohms}$$

However, since input and output impedances must be equal for maximum gain, and the amplifier must operate into a 75-ohm line, an impedance transformation is necessary. After the transformation, the overall gain of the 4-stage amplifier is 11 dB.

This MOSFET distributed amplifier is shown in Fig. 4. Its gain-frequency response is shown in Fig. 5 (no attempt was made to improve gain fluctuations). Its cross-modulation performance in relation to signal level and drain current is shown in Fig. 6. An additional 6-dB improvement is possible if the drain current and the drain supply voltage are increased from 20 to 50 mA per MOSFET and from 18 to 20 V. □

References

1. D.G. Sarma, "On Distributed Amplification," Proc. IEE (London), Vol. 102B, p. 689, 1955.
2. W.S. Chen, "Distributed Amplification: A New Approach," IEEE Trans. on Electron Devices, Vol. ED-14, p. 215, April 1967.

Designer's casebook

Gate suppresses pulses from switch contact bounces

G. Fontaine
College de France, Paris

A gating circuit with an intrinsic dead time of 20 milliseconds will prevent switches from generating more than one logic pulse regardless of contact bounce. Most mechanical switches bounce anywhere from 5 microseconds to 5 milliseconds after the first closure.

Either circuit sets the pulse and bounce-suppression times via two resistors and a small capacitor. One circuit gives a positive-going output pulse and the other a negative-going pulse. Time constants are R_1C_1 for dead time and R_2C_1 for pulse onset. The time

constant for pulse onset is 1 microsecond with the values shown.

When the switch is open, circuit (A), C_1 is discharged since its plates are at 5 volts. The NAND gate input is high and its output is low. When the switch closes, the capacitor charges through R_2 in 1 microsecond. Current through R_2 lowers the gate input to 0 V, so the output goes to 5 V. When the first bounce arrives several microseconds later, C_1 is fully charged and the bounce has no effect. Subsequent bounces also are nullified until C_1 is discharged through R_1 , which takes 20 milliseconds. By this time, the switch contacts are firmly closed.

In circuit (B), with the switch open, C_1 charges to 5 V through R_1 and the gate output is at 5 V. The input to the gate rises immediately to 5 V when the switch is closed, and the output drops to 0 V. C_1 then discharges through R_2 and charges through R_1 to complete the output pulse. All bounces are nullified until C_1 again charges through R_1 .

Noiseless switching. A switch closure in circuit (A) charges C_1 through R_2 , raising the gate output. Contact bounces cannot cause another pulse because C_1 requires 20 milliseconds to recharge through R_1 and set up the gate for another pulse. Circuit (B) provides the same suppression time by discharging C_1 and charging it slowly.

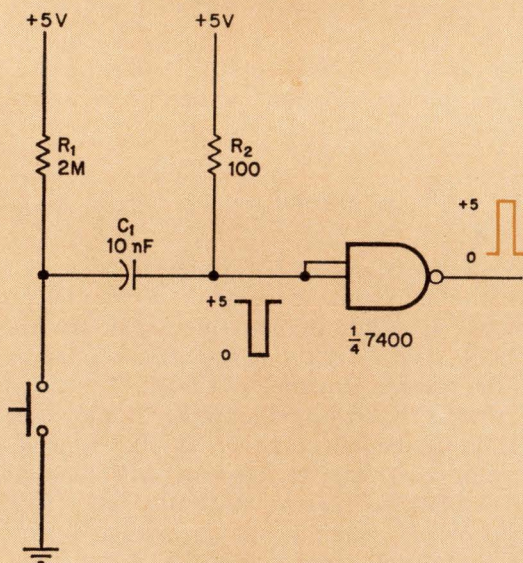

(A) POSITIVE-GOING PULSE

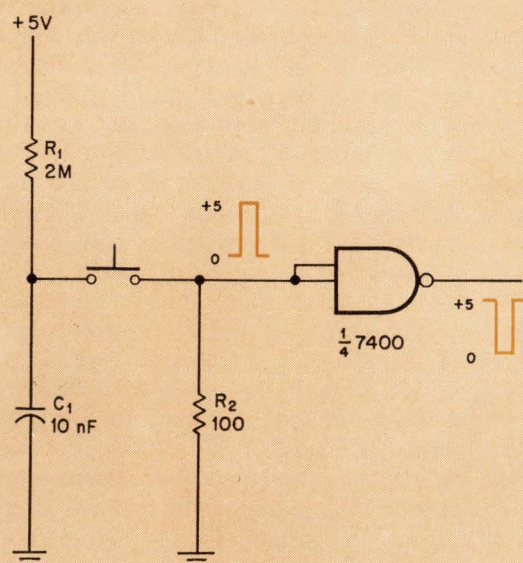

(B) NEGATIVE-GOING PULSE

Feedback amplifier speeds phototransistor's response

by Michael L. McCartney

University of Virginia, Charlottesville, Va.

When difficulty is encountered in detecting low-level ac or pulsed light signals, the problem usually isn't a lack of sensitivity in the phototransistor. More likely it's a loss of bandwidth in conventional photo-current-to-voltage converters.

One solution is to use a high-gain operational amplifier to self-bias the phototransistor and thereby improve its response time. The transistor helps the op amp make the conversion by contributing to feedback; the op amp supplies current to keep the transistor at a more optimum operating point.

The circuit amplifies very low-level modulated light signals. The amplifier, compensated for a gain of 1,000, is saturated by a light level of 100 nanowatts from a 900-nanometer source. Output rise time is well under 1 microsecond at this level.

Selection of component values for other applications begins with determination of the emitter quies-

cent current to be provided by V_1 and R_1 . The best choice generally is a current near the maximum point on the transistor's beta-vs-collector-current curve. This value will minimize changes in circuit gain with changes in signal amplitude. V_2 may have to be reduced to avoid exceeding the power dissipation rating.

Emitter current equals $V_1/R_1 - E_o/R_2$ when the amplifier's output voltage is sufficient to supply base current through R_3 and R_4 . However, the quiescent current essentially is $|V_1/R_1|$ since high conversion gains $|V_1/R_1| \gg |E_o/R_2|$.

The filter formed by capacitor C_1 , R_3 and R_4 is designed to cut off below the lowest desired frequency component of the input optical signal. R_3 must be large enough not to divert any appreciable fraction of the photo-generated collector-to-base current. Together, $R_3 + R_4$ should supply adequate base current when the amplifier output is 2 or 3 volts above ground.

The circuit's voltage gain within the signal band is:

$$\Delta e_o = -\Delta i_2 R_2 = -K \Delta \phi R_3$$

where K is the transistor's conversion factor at the selected bias point, in mA/(mW/cm²) and $\Delta \phi$ is the change in illumination in mW/cm² or in lumens.

Photo-optical bootstrap. A constant flow of emitter current during quiescent operation makes the phototransistor ready to respond to rapid changes in intensity of low-level optical signals. Then signal current generated by the phototransistor is converted to voltage by the operational amplifier. The op amp also biases the transistor.

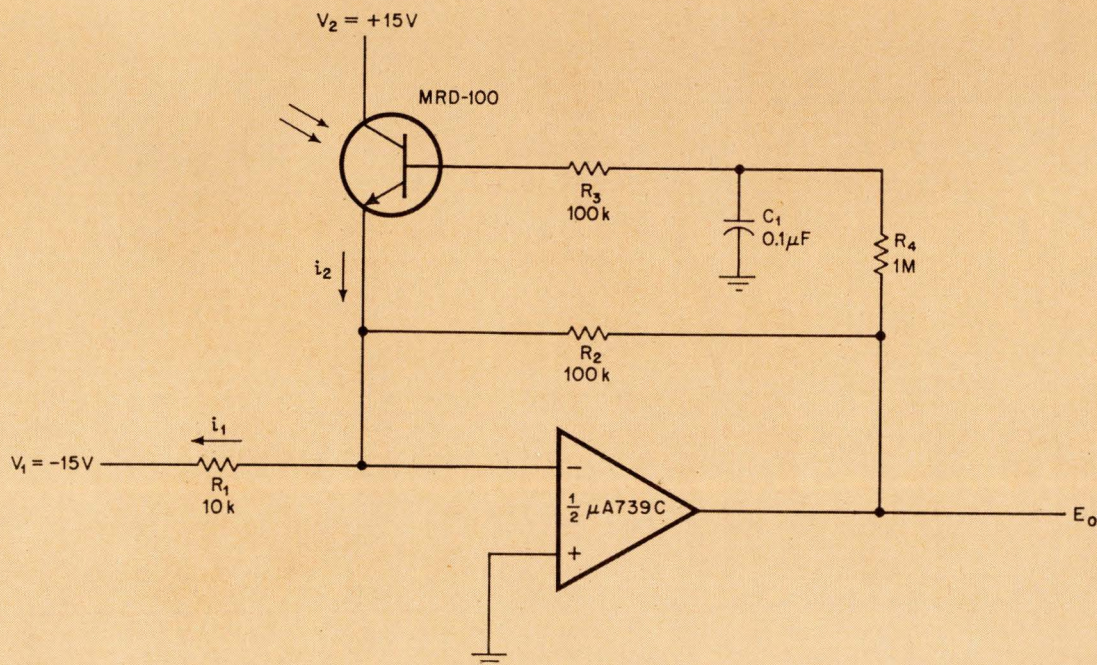

Nonlinear logic detects voltage tolerance levels

by R.N. Basu and A. Dvorak
Bell-Northern Research, Ottawa, Canada

A nonlinear NAND gate in a voltage detector circuit won't switch low until the gate inputs rise well above a conventional NAND's logical 1 level. Thanks to this property, the circuit can detect, with a single gate, whether a signal or supply voltage is within a nominal range, or is too high or low.

The other components establish the nominal range of the dc input voltage V_{in} , which must be done in any detector. So the circuit is quite simple and inexpensive compared with other high-low detectors. High and low levels usually are detected by two transistor circuits containing zener references, by a differential amplifier, or by other circuits that are difficult to make sensitive with good temperature stability. They are costly by comparison, particularly when voltages must be detected at a number of points.

The voltage range can be changed to suit the appli-

Designer's casebook is a regular feature in Electronics. Readers are invited to submit novel circuit ideas and solutions to design problems. Descriptions should be brief. We'll pay \$50 for each item published.

Bilevel detector. Nonlinear NAND gate generates a low output if V_{in} is too high or too low, and a high output if V_{in} is within tolerance. Q_1 conducts while V_L exceeds the reference voltage through D_1 and D_2 , but if V_H and V_g become too high, V_o goes low. When V_L drops below V_{ref} , Q_1 opens and also causes V_o to go low.

cation as long as two conditions are met:

$$V_L = V_{ref}, \text{ at } V_{in} = V_{min}$$

$$V_H = V_c, \text{ at } V_{in} = V_{max}$$

where V_L and V_H are the minus and plus tolerances chosen with potentiometer R_1 ; V_{ref} is the reference voltage established by varistors R_2 and R_3 ; and V_c is the threshold at which a high-input V_g makes the gate output V_o go low.

The components and potentiometer setting of this circuit were selected so that $V_{in} = 4 \text{ V} \pm 1 \text{ V}$.

In this case, transistor Q_1 will be biased on by V_L as long as V_{in} is not lower than 3 V. When V_{in} is between 3 and 5 V, the gate output is high, detecting a normal condition. If V_{in} rises above 5 V, the increase in V_H will cause V_g to exceed the gate's threshold and the gate output will go low. It will also go low if V_{in} drops below 3 V because Q_1 will be cut off.

V_{in} can be a filtered and rectified sample of an ac signal. The choice depends on the actual voltage and stability required, and cost. The number of varistors can be changed to meet particular reference voltage and precision requirements. Or the varistors can be replaced by a zener diode. However, the varistors are less costly.

Since the circuit is digital, the outputs of two or more detectors can serve to perform control logic functions. The example shows how the output could operate a sensitive relay.

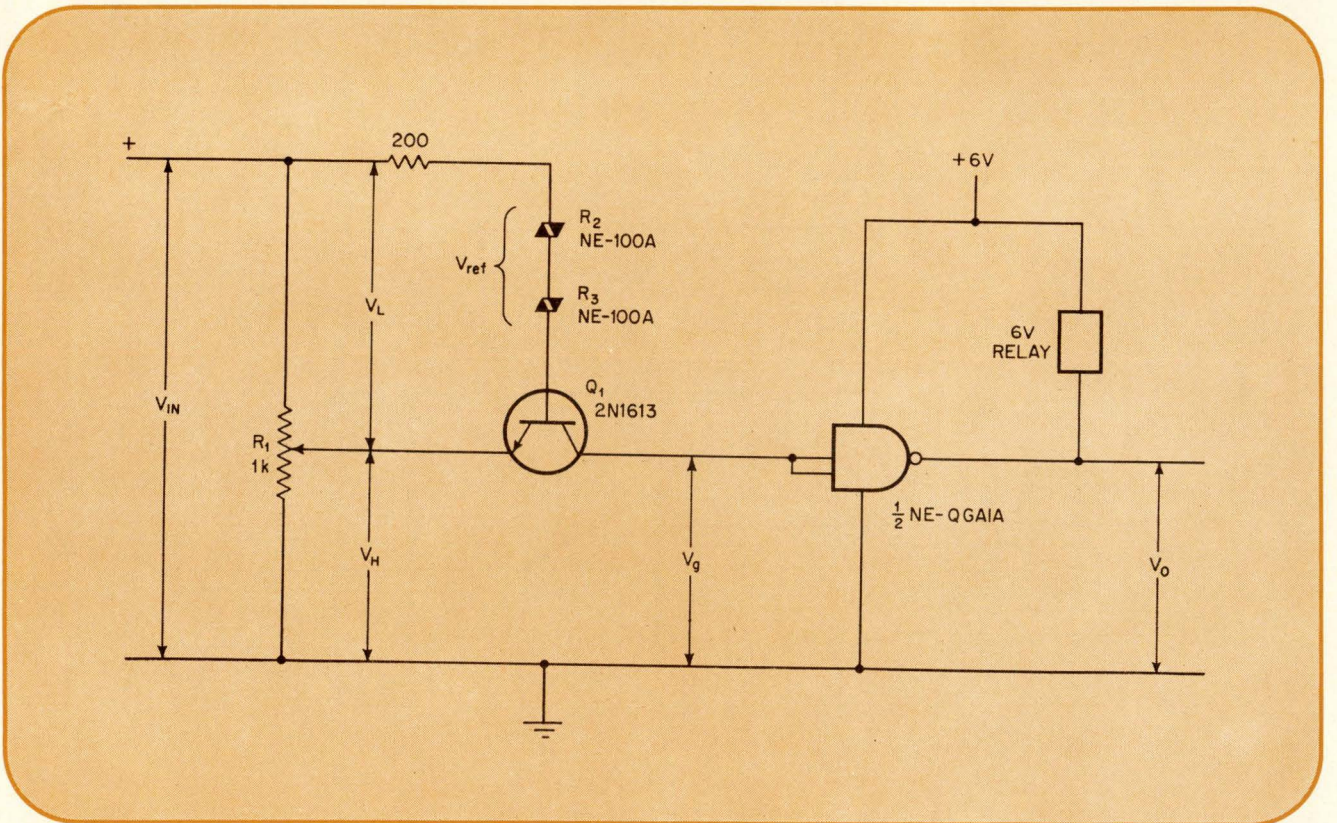

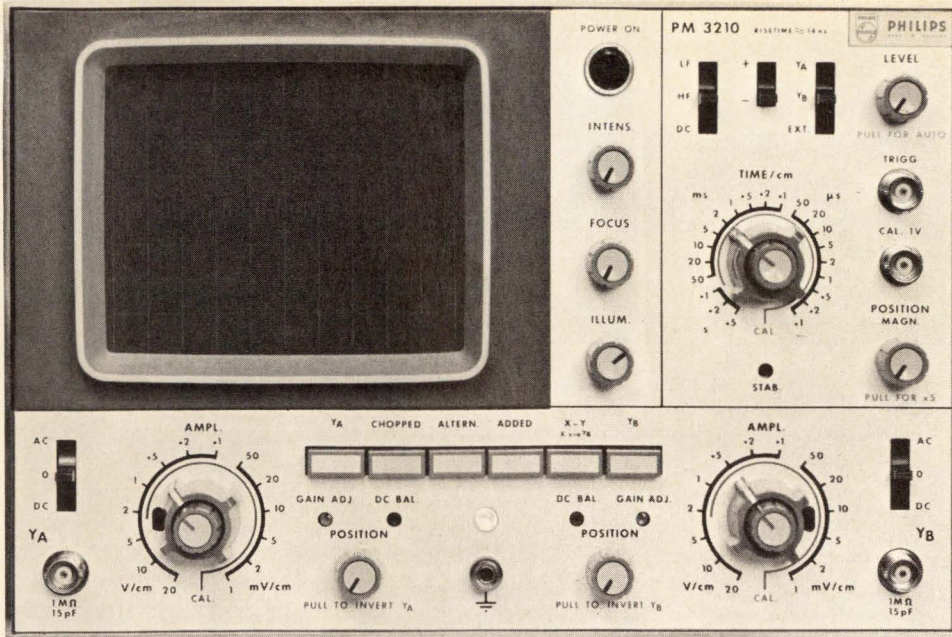

PM 3210
\$1350

easy

**Best
price/
performance
ratio**

**25 MHz/1mV
15 pf input capacitance
No dc drift***

For service application in production testing, quality control, medical research and computer servicing, Philips' new PM 3210 easily gives you the best all around price/performance ratio of any scope in its field: dual trace 25 MHz at 1 mV sensitivity per channel ... dual delay lines ... input impedance 1M Ω / 15pf ... X-Y displays with only 2° phase shift from 0 to 5 MHz ... 16 combinations of vertical display modes

Easy to use

*No correction needed for dc drift, self-correcting ... push button mode selection ... automatic triggering, 10 Hz to 25 MHz

Easy to read

10kV acceleration and 8 x 10 cm screen produce clear, unambiguous displays

Easy to service

Plug-in circuit boards throughout

Easy to buy

Call Dick Rude, Sales Manager, Test & Measuring Instruments today (914-664-4500). He's holding a demonstrator for you.

**PHILIPS
ELECTRONIC
INSTRUMENTS**

750 S. FULTON AVE., MT. VERNON, N.Y. 10550
A DIVISION OF PEPL, INC.

Digital ICs + VOR = simpler navigation

Lightplane pilot will get exact bearing readout from new indicator design; ICs and LEDs upgrade reliability

by Ivars Breikss, *Test Instruments division, Honeywell Inc., Denver*

□ Integrated circuits are as yet seldom found in lightplane avionics, despite the radical improvements they've made in the performance and reliability of military avionics, and despite the size of the potential market—there are now 120,000 lightplanes in the U.S. alone, and their number is growing rapidly.

However, a new converter-indicator for the standard international navigation system, known as the vhf omnidirectional range (VOR) system, uses ICs almost exclusively. This design, in which the standard d'Arsonval meter indicator is replaced by a direct numeric readout using light-emitting diodes, is smaller and lighter than conventional types, consumes less power and offers about a tenfold improvement in reliability. Further, it can be produced and sold for less than the least costly standard system.

Figure 1 shows the display mounted below a standard VOR equipment for flight tests. The processing circuitry, contained in a similar small housing, is mounted behind the instrument panel.

Most omnirange display units have a bearing selector dial, a TO-FROM indicator, and a deviation needle. The pilot selects the desired radial on the bearing selector dial and maneuvers to center the deviation needle. To move the deviation needle off its stops, the aircraft must be less than 10° from the selected radial.

If the reading of the bearing selector dial is in general agreement with the indication of the magnetic compass, the pilot "chases the needle" or makes small

Author Ivars Breikss, principal engineer in the Advanced Design Group of Honeywell's Test Instrument division, is also a lightplane pilot who spends much of his time aloft in a Piper Cherokee 140. One day, while he and his wife were flying from Denver to Minneapolis, his vhf omnirange (VOR) navigation system failed, its pointer needle started a slow uncorrectable peg-to-peg oscillation, and they spent the next few hours navigating by road and creek. "There must be a better way," he thought, and he spent about 100 hours of his spare time over the following year designing an improved indicator. That design, discussed in this article, has already been brassboarded and successfully test-flown, and is being evaluated by Honeywell for possible commercial development.

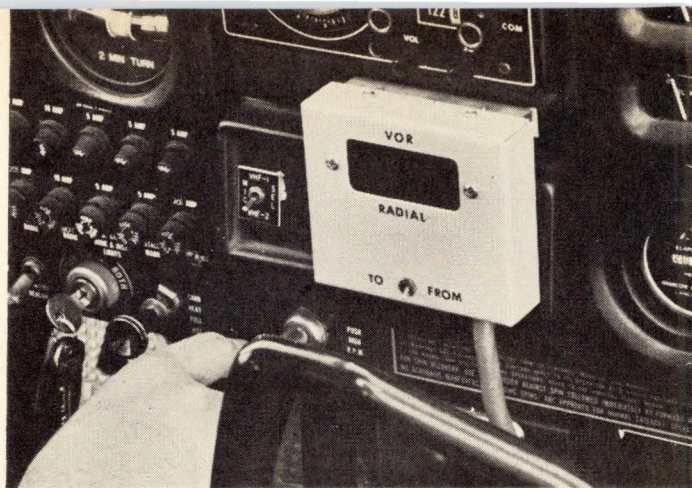

1. **On course.** The new VOR equipment is shown mounted below standard VOR equipment for flight tests.

course corrections in the direction the needle moves as the flight progresses. If, however, the bearing selector dial indicates a bearing roughly 180° away from the indication of the magnetic compass, the pilot must "fly away from the needle" or make course corrections in a direction opposite to its deflection. The TO-FROM indicator changes state at the instant the station is overflown. It and the bearing selector dial tell the pilot his bearing relative to the station.

Figure 2 shows how a pilot navigates between two points. With the bearing selector set at 315°

2. **Lined up.** To navigate by omnirange the pilot must maintain a course that overlies a VOR station. The flight path then automatically corrects for wind drift.

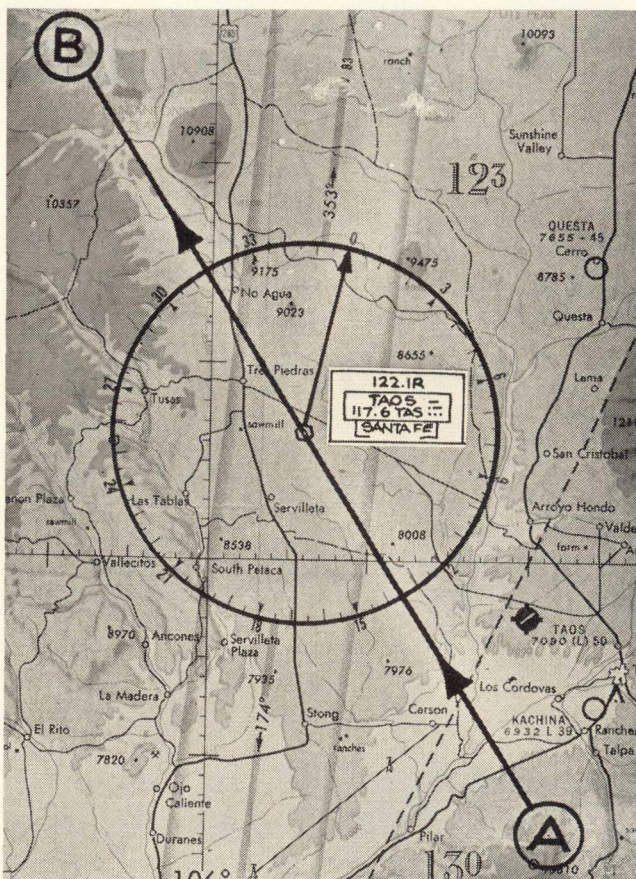

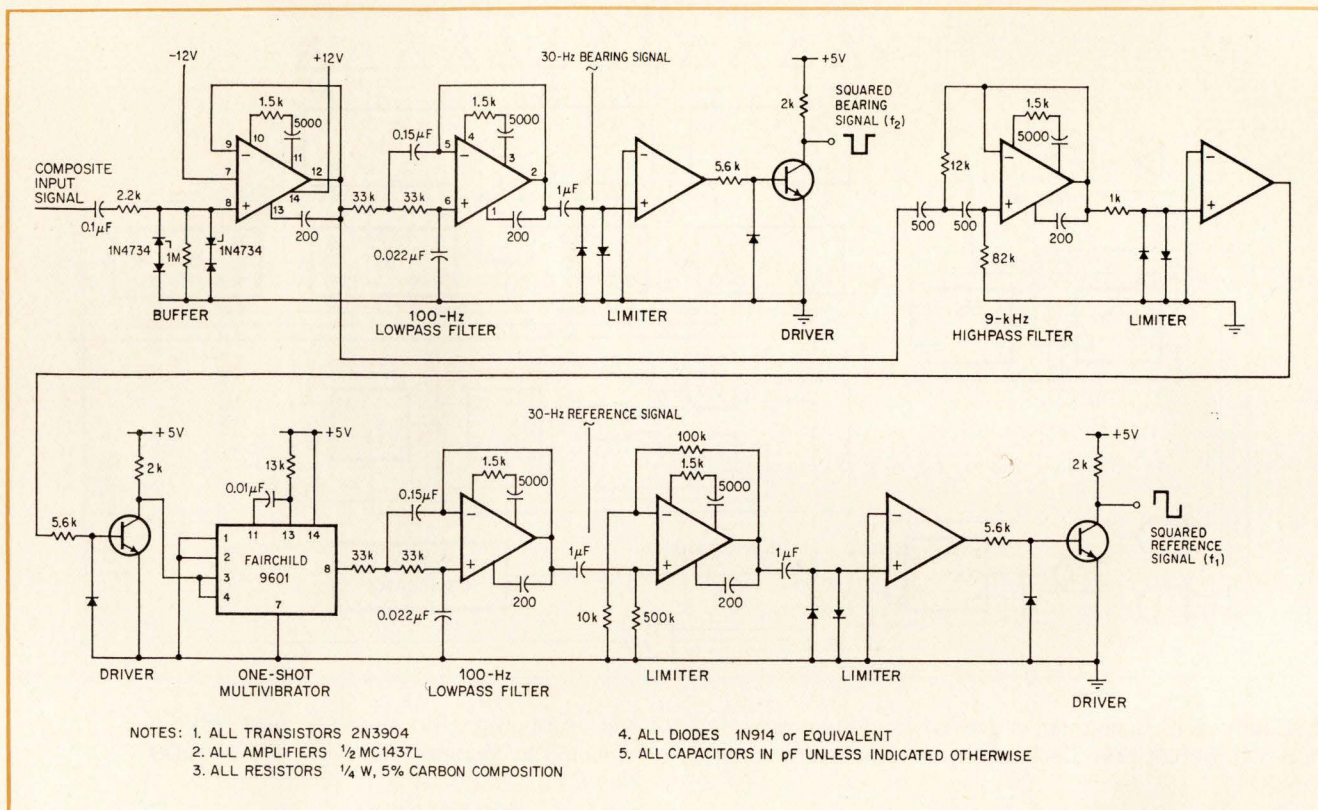

3. Preprocessor. The signal-conditioning circuitry separates the bearing and north-reference signals and shapes them in limiters to provide steep leading and trailing edges as timing marks for the digital circuitry.

the TO-FROM indicator indicates TO. The pilot flies a general heading of 315° and "chases the needle." As he overflies the station the TO indication changes to FROM. He continues "chasing the needle" and flies along the 315° radial to point B. Had he selected the 135° radial (reciprocal of 315°) on his bearing selector at the start of his flight at point A, the TO-FROM indications would have been reversed as well as the necessary course corrections.

The omnirange display system described in this article is rather different, and its differences offer a number of advantages to the pilot. It does away with the bearing-selector dial and the deviation needle, and instead provides a direct readout in degrees of radial bearing to or from the selected station. As a result, the pilot no longer has to fly radial intercept maneuvers, or even set in the desired radial. Virtually all the active components are ICs, the bulk of them digital, offering sharply improved reliability, very low power drain, and the possibility of reducing most of the circuitry to a single LSI chip. A TO-FROM switch, the device's only moving part is included as a concession to pilot habit.

Using this system to navigate from point A to point B in Fig. 2, a pilot would fly a general heading

of 315° magnetic, resulting in a bearing reading of 135° with the selector switch set at FROM. (Note that the TO-FROM sense is the reverse of that in the standard VOR system.) An indication of less than 135° (reciprocal of 315°) would require a correcting turn to the left, while a number greater than 135° would require a right turn to track the 135° radial. At the instant the VOR station was overflowed, the readout would change to the reciprocal of 135° and indicate 315° . Clearly, a reading greater than 315° would now require a course correction involving a turn to the left, while a reading of less than 315° would require a correcting turn to the right.

By throwing a toggle switch, the pilot can select the reciprocal of the FROM radial, adding 180° to the relative bearing signal. The result corresponds to the conventional VOR system in the TO state.

The input signal to the VOR bearing indicator is the demodulator output of any standard navigation receiver that has been tuned to one of the approximately 2,000 VOR stations. This signal consists of:

- A 9,960-Hz fm subcarrier deviated ± 480 Hz at a 30-Hz rate (the VOR north-reference signal).
- A 1,020-Hz Morse-coded station identification.
- A voice channel for communication.

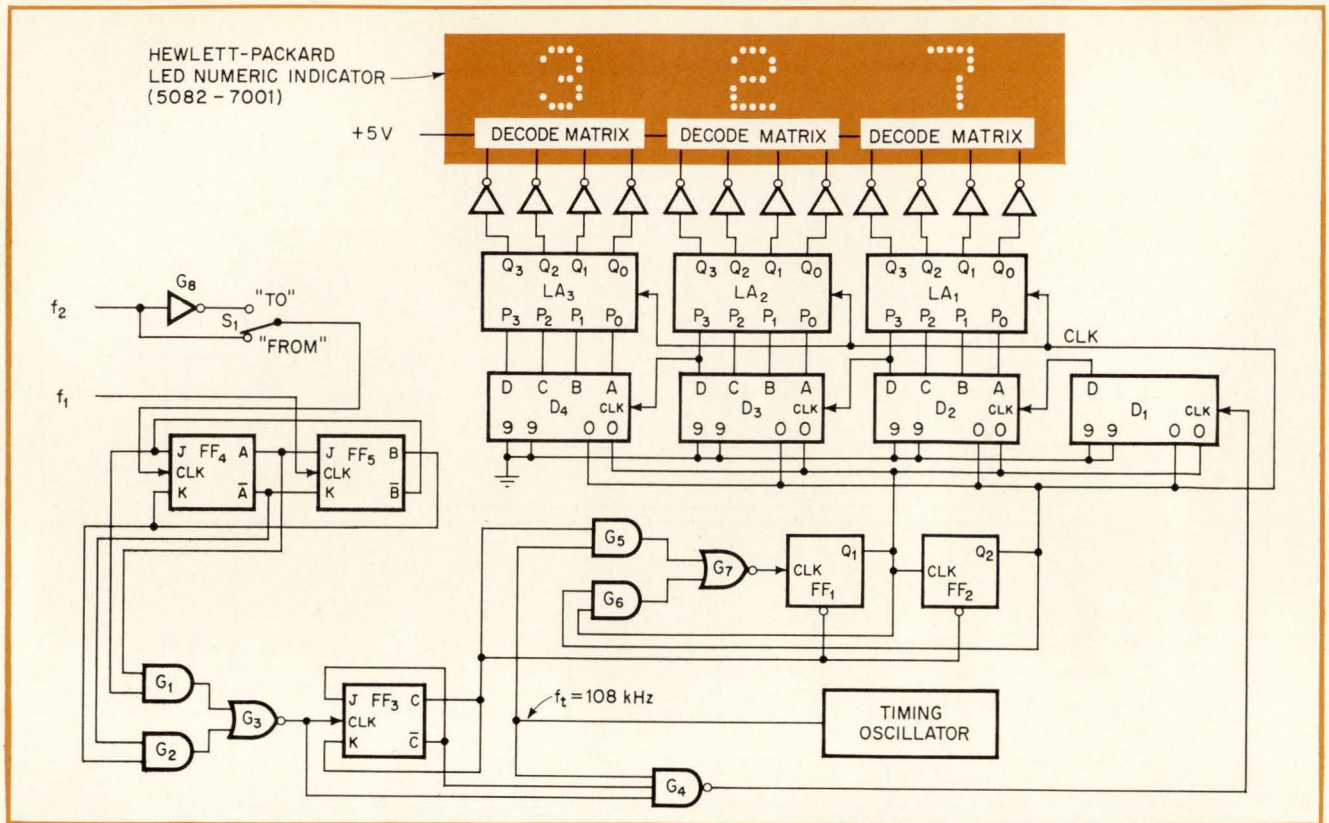

4. Count on it. Timing marks derived from the north-reference and bearing signals are used to start and stop a 108-kHz clock. Clock pulses, at 10 pulses per degree, are counted by decades and displayed on LEDs.

▪ A 30-Hz am signal with relative bearing information. The phase difference between the first and last components, up to the maximum of 360° , is proportional to the magnetic bearing from the selected VOR station.

The first step in converting the north-reference and bearing signals to an angular position reading is to extract them from the composite signal and to shape them in separate channels. This is accomplished by the signal conditioning circuitry of Fig. 3. The composite signal is applied to the input buffer, normally a 1-megohm load to the receiver, but with protective zener diodes at its input to shunt any transients to ground. Its output drives two active filters.

One, a 9-kHz, two-pole, high-pass active filter that separates the 9,960-Hz fm subcarrier from the composite signal, is followed by a limiter that converts the filter output into a square wave. This triggers a Fairchild 9601 IC one-shot multivibrator, generating a train of pulses at the 30-Hz modulated 9,960-Hz subcarrier rate. These are fed to a 100-Hz, low-pass active filter that blocks the carrier terms but passes the 30-Hz reference signal, f_1 . A two-stage limiter then converts this signal to a square wave. The final transistor stage amplifies this signal to a 0- to +5-V level compatible with the transistor-transistor logic ICs used in the phase-measuring circuitry.

The variable-phase 30-Hz signal, f_2 , is separated from the composite signal by a second, identical, 100-Hz low-pass filter, converted to a square wave by a limiter and, finally, amplified to a 0- to +5-V level.

Bearing-reading errors come from differential phase shifts between the two channels, and were eliminated in the prototype by trimming the resistors in one of the 100-Hz filters. The result was phase-shift tracking within 0.8° for temperatures between 0° and 50°C .

The two pre-processed signals can now be converted to a reading of radial bearing by a digital phase comparator. In principle, it uses the signals as a pair of switches to turn a timing clock on and off. The number of clock pulses passed is 10 times the phase difference in degrees, so counting them by tens yields the bearing shown in degrees on the LEDs.

The details of the processing can be understood by referring to the schematic diagram in Fig. 4. The phase difference between f_1 and f_2 is determined by the phase comparator consisting of binaries FF₄ and FF₅, whose initial states are unknown. But regardless of their initial states, a negative-going edge of the f_1 input will transfer the state of binary FF₄ into FF₅. Conversely, a negative-going edge of f_2 will make FF₄ and FF₅ assume opposite logical states.

The relative states of binaries FF₄ and FF₅ are detected by the EXCLUSIVE OR gate, consisting of AND gates G₁ and G₂ and NOR gate G₃. G₃'s output will be a logical 1 only when FF₄ and FF₅ match.

The phase lag of f_2 with respect to f_1 is indicated by the duration of a logical 1 at the output of G₃. There, the maximum time that a logical 1 can exist is a single entire period of f_1 , corresponding to a phase lag of 360° . A shorter output pulse represents

a proportionately smaller phase difference. Since these binaries respond only to the negative-going transitions of f_1 and f_2 , phase difference can be measured unambiguously over the range of 0° to 360° .

With switch S_1 in the position shown in Fig. 4, the phase comparator generates a phase-difference signal corresponding to a FROM bearing. To generate a TO bearing, which is the reciprocal of a FROM bearing, S_1 effects the necessary 180° shift by passing the variable-phase signal through inverter G_8 .

The output of G_3 is connected to the clock input of binary FF_3 , a J-K type that changes state in response to each negative-going transition at its clock input. Since the negative-going edge of G_3 's output is always coincident with the negative-going edge of f_2 , FF_3 divides the f_2 input by a factor of two.

Figure 5 illustrates the timing when the f_2 input lags the f_1 input by 120° . Since one complete cycle of either f_1 or f_2 represents 360° , the output of gate G_3 is a logical 1 for 120° or a third of a cycle.

The three inputs to NAND gate G_4 consist of the G_3 output, the \bar{C} output of binary FF_3 , and the f_t input. Figure 5 shows that the output of gate G_4 will oscillate between logical 0 and 1 at the rate of f_t only when the output of G_3 and the \bar{C} output of binary FF_3 are both logical 1s. Since binary FF_3 effectively divides the output frequency of G_3 by a factor of two, coincident logical 1s from G_3 and \bar{C} can occur only every other cycle of the f_2 input. Therefore, pulse bursts at the output of G_4 will occur once for each two input cycles. The number of pulses in each burst will be proportional to the phase difference between f_1 and f_2 , with 10 pulses equal to 1° .

The output of gate G_4 is connected to the chain of four decade counters, D_1 , D_2 , D_3 , and D_4 . The three four-bit latches, LA_1 , LA_2 and LA_3 , are used to store only the three most significant binary-coded-decimal (BCD) digits of the count: this avoids the flickering associated with the one-bit uncertainty of the least significant digit.

At the end of each counting sequence, the contents of the three most significant decades must be transferred to the corresponding four-bit latches and the decade counters reset to zero. This is done by control circuitry consisting of a two-stage counter made up of binaries FF_1 and FF_2 , plus another EXCLUSIVE OR function assembled from gates G_5 , G_6 , and G_7 . This counter counts in the following sequence:

Count	Q_1	Q_2
0	0	0
1	1	0
2	0	1
3	1	1

Its input is the output of NOR gate G_7 .

The control counter outputs control the main counter and the latches. The first positive-going edge of Q_2 (count 2) is used to transfer the number in decades D_2 , D_3 , and D_4 into the four-bit latches LA_1 , LA_2 , and LA_3 . The decade counters can be reset to zero by simultaneous application of logical 1 to both "set 0" inputs; count 3 is used for this purpose.

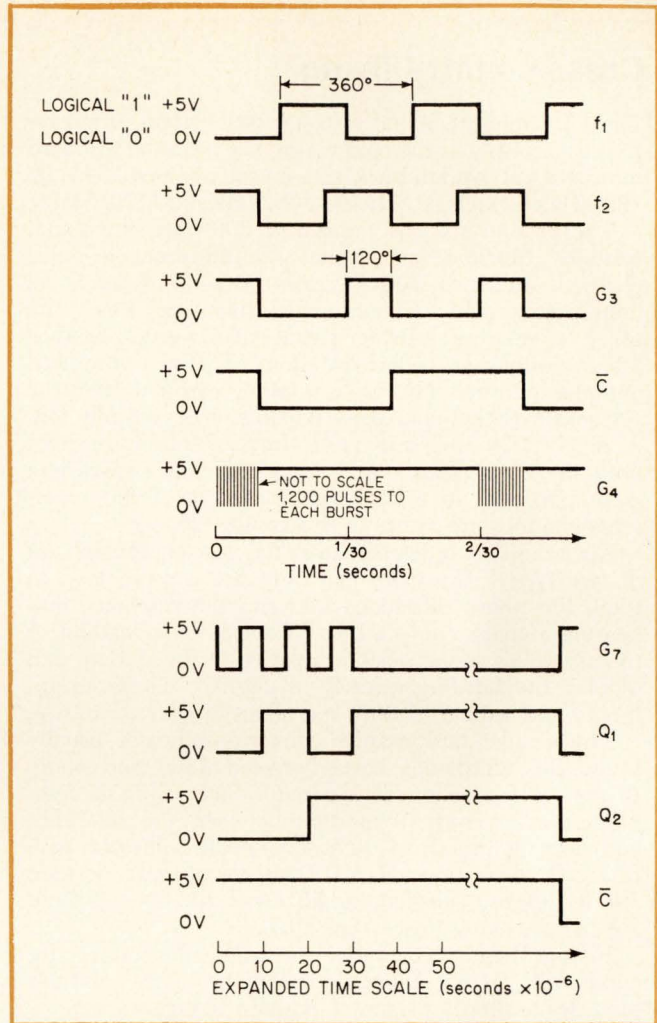

5. Timing diagram. The relationships between the logic signals and the input signals results in a 15-times-per-second phase-measurement and display-update rate.

As soon as binary FF_3 changes state and its output \bar{C} becomes a logical 0, FF_1 and FF_2 are reset, putting the control counter back to zero.

The next counting sequence of the decade counter will commence with \bar{C} in a logical 1 state and a 1 output from gate G_3 .

For a maximum count of 360, the frequency, f_t , of the timing oscillator must be such that during one complete input signal period exactly 3,600 pulses will appear at the output of G_4 . These requirements are met when $f_t = 3,600 f_1$. Since $f_1 = f_2 = 30$ Hz, 108,000 Hz is the required timing oscillator frequency.

Both the count transfer from the decades to the latches and the resetting of the decades are accomplished within four cycles of f_t , or in slightly less than $40 \mu\text{s}$. Phase is remeasured and the display updated every other input cycle, or 15 times per second.

The digital portion of this prototype uses transistor-transistor logic. The two EXCLUSIVE OR functions, consisting of G_1 , G_2 and G_3 , and of G_5 , G_6 and G_7 , are contained in a single package, Texas Instruments' SN7451N. Binaries FF_1 , FF_2 , FF_4 and FF_5

Cross-country flying

The vhf omnidirectional range (VOR) system, often referred to simply as the omnirange, has been the standard international overland navigation system since 1949. Its 100-kHz channels lie between 108 MHz and 117.9 MHz.

The ground stations transmit a 200-watt signal that contains Morse-coded station identification, a voice channel, and two 30-Hz signals. One of these is an omnidirectionally radiated north-reference tone, the other a relative bearing signal that results from a 30-revolution-per-second rotation of the transmitted antenna pattern. This is a rotating cardioid that the system's fixed antenna array radiates when suitably fed. A receiver located due north from a station receives both signals in phase, while phase difference elsewhere is proportional to relative bearing. Over 1,000 omnirange stations are in use in this country alone.

Airborne converter-indicators for VOR equipment are of two types. The more elaborate use a servo loop to track the phase difference between the reference and bearing signals, convert this difference to a reading of the airplane's radial position relative to the station, and display the heading directly in degrees. These equipments cost around \$2,000, and about 50,000 are in use.

The smaller and simpler converter-indicator usually found on lightplanes costs between \$300 and \$500. It uses a frequency discriminator and a phase comparator to measure separation between the reference and bearing signals. A right-left needle indicator with full-scale deflection of $\pm 10^\circ$ shows aircraft position relative to the selected radial. Over 100,000 of these are in use, many in dual installations.

Flying along a VOR radial automatically corrects for wind drift, while triangulation with nearby stations provides a simple means of position fixing.

are two SN7473Ns; FF₃ is a single SN7472N. Each four-decade BCD counter is an SN74090N, while the three latches are Fairchild 9300 types. Gates G₄ and G₈ are parts of an SN7410N.

The highest frequency in this system is the timing frequency—108 kHz. As TTL is not required at this rather low speed, a much more attractive and less costly implementation than the foregoing would be MOS for the entire digital portion of the indicator, preferably on a single chip. MOS-LSI would be the

least costly implementation for production runs of several thousand or more units. It would also increase the reliability of the instrument by orders of magnitude above that of any equipment currently available, and reduce the power consumption of the digital portion, below even its present low level of 2.2 watts.

In an actual production unit, other improvements would be made. For example, the conditioner electronics could use a single +12-V supply rather than the positive and negative supplies used in this prototype design. For those pilots who prefer to follow right-left instructions, the necessary circuitry could be added at little extra cost. An ENTER button would store the displayed heading in a register, after the airplane has been brought onto the desired heading. Simple subtraction in a comparator would then suffice to generate an "R" or an "L" for display on a fourth LED as the heading deviated from the stored value. Pushing the button a second time would clear the register.

Such a feature would also be useful in instrument landing systems: the ILS localizer beam that defines the runway centerline operates in part of the same band as the VOR, with channels at odd-numbered 100-kHz increments to 108-MHz (108.1, 108.3, . . . 111.9). Right-left guidance is needed as the pilot makes his landing approach, and the four LEDs could provide this, as Fig. 6 illustrates. Here lateral error resembles what the pilot would see from the cockpit, as he gradually steered the plane from the extreme left side of the runway into the centerline. Larger arrays, such as Bell Laboratories' 7×70 experimental LED array, could be used, instead of segmented arrays, to yield still greater resolution and realism. Alternatively, LEDs could form a meter display: the bottom row, always lit, would be the meter scale, and a pair of lit columns to the left or right of center would indicate lateral position.

Another possible use for the digital readout of angle from the VOR station is as an input to a new type of area-navigation system, one requiring no distance measuring function (DME). A preliminary design and costing analysis indicates that a flexible and effective area-nav system based in part on this digital VOR indicator could be produced to sell for less than \$3,000, or roughly one-half the price of comparable systems now available. □

6. New view. The LED display can also be used as an ILS localizer indicator for instrument landings. Here it shows the runway in realistic perspective as the pilot maneuvers from the left into proper alignment.

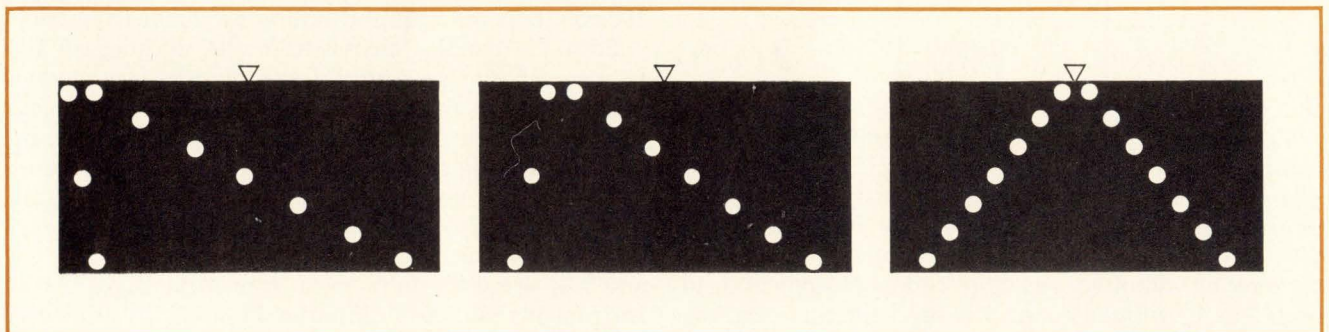

Our 5000 and 7500 permeability Ceramag[®] ferrite materials can pack a terrific amount of inductance into a small size.

And the higher the perm, the fewer turns required. Results. Lower distributed capacity. Material savings. Improved performance.

Ceramag[®] 24H offers the designer a true 5000 permeability. New, Ceramag[®] 24K is also a true 7500 permeability. Both materials hold their permeability over a wide range of sizes.

Ceramag[®] 24H and 24K are production materials, ready for immediate use in your design. Stock available in some sizes.

Precisely engineered, Stackpole ferrite materials are produced by exact processing, density checks, rigid kiln controls and accurate sintering. You get more out of Stackpole Ceramag[®] materials simply because we put more into them.

Study the characteristics of 24H

	$\frac{L}{N^2}$ (nh) TOROID SIZE: 0.230" O.D. 0.120" I.D. 0.060" L.	MAXIMUM PERMEABILITY	SATURATION FLUX DENSITY @ 1.5 OERSTED	RESIDUAL MAGNETISM	COERCIVE FORCE	CURIE POINT	TEMPERATURE COEFFICIENT OF μ_0	
							-25° to 25° C.	25° C. to 75° C.
CERAMAG [®] 24K	1485	9700	4100	700	0.05	175	+1.000	-0.450
CERAMAG [®] 24H	990	6900	3800	850	0.1	175	+0.700	-0.450
2500 PERM REFERENCE	495							

and 24K, then consider how you might use these ferrites.

For more information, samples and applications, contact:

Stackpole Carbon Company,
Electronic Components Division,
St. Marys, Pa. 15857. Ph: 814-834-1521. TWX: 510-693-4511.

Disaccommodation factor for both materials is 1.4×10^{-6} , typical.



STACKPOLE
Electronic Components Division

Producing high quality Ceramag[®] ferrite components for the home entertainment, and computer industries for over twenty-two years.



New 1101 cuts

**Intel's 1101,
the popular
256-bit
MOS RAM,
gets a new
low-cost
silicone
package.**

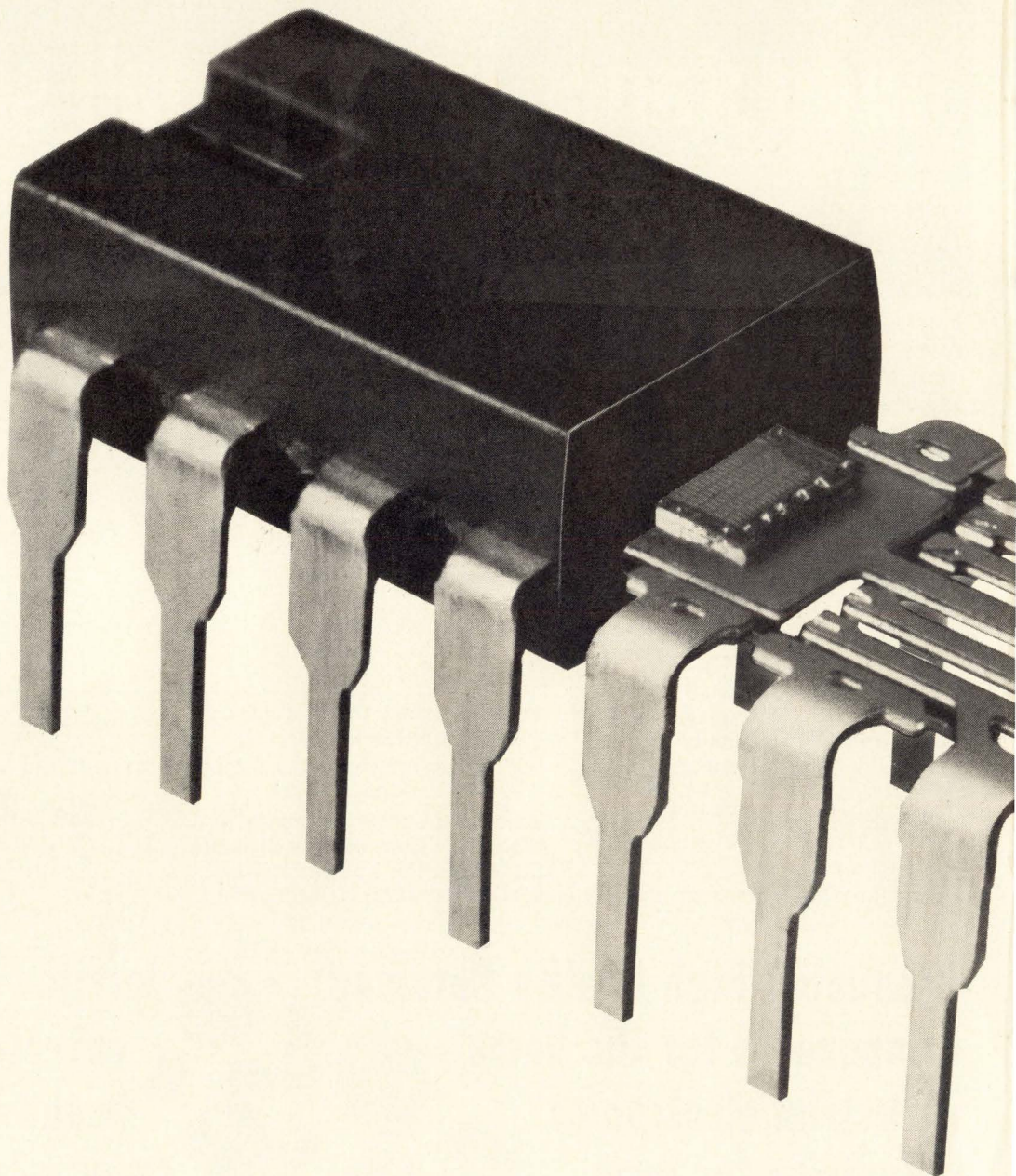

Small RAM costs.

Intel has wrapped a moisture-proof seal of silicone around a smaller, higher-yield chip to obtain a 50% cost reduction on Type 1101, the 256-bit silicon-gate RAM that's become an industry standard for small memories.

A pin-for-pin replacement for Type 1101, the new device carries the designation P1101A (P for plastic, A for improved specifications). And it costs just half as much as the earlier ceramic type:

Quantity	Former price (1101 ceramic)	New low price (P1101A plastic)
1 to 24	\$40.00	\$20.00
25 to 99	\$32.50	\$16.25
100 to 999	\$25.60	\$12.80

Moreover, the new, smaller chip is also available in a ceramic package as Type C1101A for the reduced price of \$15.40 in 100-piece quantities.

Key to providing the highest reliability in this low-cost memory component is the combination of silicone packaging with silicon-gate processing. This has been proven by over 600,000 hours of life tests that produced no failures in the chip or the package. Copies of test data are available on request. Intel's P1101A and C1101A are 256-bit static RAM's using silicon-gate MOS technology. The memories are organized in 256 words by 1 bit, and feature OR-tie capability with a "chip select" lead to simplify systems assembly. The unit is fully decoded, interfaces directly with DTL and TTL logic, and requires no clock since the circuit is dc stable. It is completely specified over the full temperature range from 0°C to +85°C and over a power supply tolerance of $\pm 5\%$. The unit may be operated from either two or three power supplies with no sacrifice in power or speed. Maximum access time is 1.5 μ sec and power consumption is only 1.5 mW per bit during access.

For delivery in the U.S. phone your local Intel distributor: Cramer Electronics, Hamilton/Avnet Electronics or ECR in Minneapolis. In Europe contact Intel at Avenue Louise 216, B 1050 Bruxelles, Belgium. Phone 492003. In Japan contact Nippon IC, Inc., Parkside Flat Bldg., No. 4-2-2, Sendagaya, Shibuya-Ku, Tokyo 151. Phone 03-403-4747.

Intel Corporation is in high-volume production at 365 Middlefield Rd., Mountain View, Calif. 94040. Phone (415) 969-1670.

intelTM
delivers.

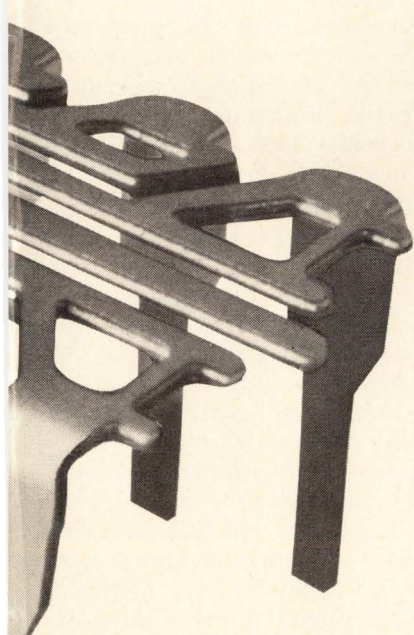

IEEE

Dissension spurs a search for relevance Part one

On the eve of the big show, militants are pressing the institute to abandon its traditional role and get involved in bread-and-butter issues like job security and pensions; 1971's leadership is starting to respond

by Alfred Rosenblatt, *Industrial Electronics editor*

□ "The IEEE maintains an illusion of being an engineer's professional society, yet devotes no planning or forethought to protecting the engineer against what is happening. I think they are perpetrating a fraud."

The statement is harsh, too severe to serve as a consensus for members of the Institute of Electrical and Electronics Engineers. But coming from an engineer who has been an active and serious-minded IEEE member for more than 20 years, it reflects the elemental problems facing the IEEE—problems coming to a head largely because of rising unemployment that has hit its members in the past two years.

Even before it opens, the tone of this year's IEEE Convention and Exposition, which runs from March 22 to 25, has been shaped by the upheavals that have buffeted engineers, the electronics industries, and the IEEE alike. More conference sessions will be given over to topics of "relevance" to today's engineer—environmental problems, business management, and the like (see p. 93). The number of exhibitors and attendees again will decline (see p. 94), and fewer new products will be shown than in the past (see p. 95).

What's more, there will be plenty of lobbying in the halls and corridors for the IEEE to change, both in its relationship to its members and to society at large. Says Arthur L. Rossoff, chairman of the IEEE's 4,000-member Long Island, N.Y., section: "Many

IEEE members are dissatisfied with the institute's exclusively technical role and are asking for changes in its purposes, structure, and tax status, if necessary, to permit it to promote the professional welfare of the membership." Asserts senior IEEE member Richard J. Backe: "We need an 'American Association of Engineers' that would represent us on all fronts the way doctors and lawyers are represented by their professional associations."

An idea like Backe's will take considerable time to prevail—if it ever does. But meanwhile, the movement to promote the "professional welfare" of the engineer is being translated into a push for the IEEE to involve itself in a host of new activities. Among them: a "portable" pension plan, which would follow an engineer throughout his career, rather than end when his job terminates; a Congressional lobby through which the IEEE could exert pressure on legislation and national policies affecting members' jobs and security; a role in determining how engineers are being utilized by industry with statistics on such factors as salary levels and turnover rates at various employers; and more retraining programs to help engineers switch from one specialty to another.

To get the IEEE involved in these areas, some members are trying to amend the institute's constitution. Led by Victor Galindo and James W. Duncan of the Systems Group of TRW Inc., Redondo Beach,

Calif., the group is petitioning to force the IEEE board to place three amendments before the membership. "A petition of only $\frac{1}{3}$ of 1% last year's voting membership—less than 600 signatures—is needed to get a vote on our amendments," Galindo says.

The most important amendment recasts article 1, section 2 of the constitution to say that the "primary purpose of the IEEE is to promote and improve the economic well-being of the membership." This amendment relegates to "secondary purposes" the items in the present constitution that limit the IEEE to functions that are scientific, literary, and educational. The other two amendments give voting rights on economic matters only to members in the U.S.

How the leadership of the 169,000-member IEEE will respond to this storm rests to a great extent on the shoulders and character of its president for 1971, James H. Mulligan Jr. The tall, straight-backed 51-year-old engineer, who was chairman of the electrical engineering department at New York University, has a reputation for energy and hard work. One recent two-week period found him flying from his office in Washington, D.C. to meetings in Geneva, then to New York, Philadelphia, Boston, Los Angeles, and San Francisco. At the same time, he put in a full week in his salaried position as executive secretary of the National Academy of Engineering.

At Mulligan's side is IEEE general manager Donald G. Fink. With his paid staff of management professionals, Fink is charged with maintaining continuity and direction in the programs established by the IEEE's board of directors, the 27 members of which volunteer their services.

In any organization, it is not easy for members to uproot long-established policies. It can be even more difficult when the organization's head is not elected, but appointed from a close-knit board of directors for just a one-year term. Under such conditions, the appointee may consider his position more of an honor than a mandate for change.

However, the evidence thus far indicates that Mulligan has taken an extremely active role in trying to ascertain the wishes of the IEEE's members. And he is willing to do things differently than they've been done in the past. Take the agreement between the IEEE and the National Society of Professional Engineers that encourages IEEE members to join in the NSPE's lobbying and pension plan activities (see "How much involvement," page 90). This agreement was ratified by the board of directors on Jan. 6, only a few days after the new president officially took office. Also in January, the IEEE announced it was halving the dues of unemployed members.

Mulligan sees the arrangement with the NSPE as a model for subsequent actions. "Sometimes you want to engage in a do-it-yourself operation and sometimes you want to bring in specialists," he says. "What I'm really concerned about is taking institutional forms that exist, including the IEEE, and asking how they can best serve the electrical engineering profession. Can they operate cooperatively? Are changes needed, or are new institutions required?"

These questions are now more urgent than ever:

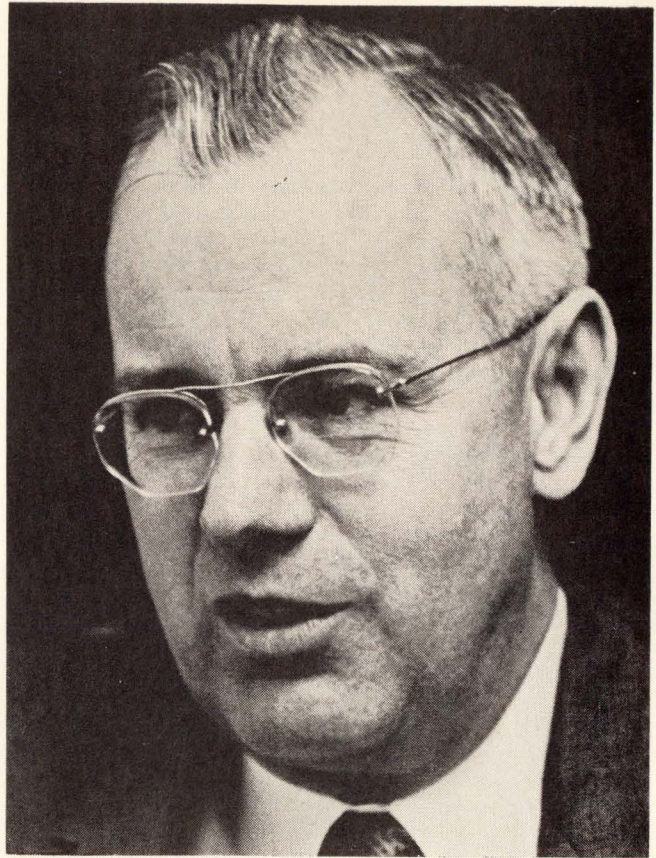

Dynamic duo. Leading the IEEE in troubled times are James H. Mulligan Jr. (above), president for 1971, and Donald G. Fink, general manager since the IEEE's inception in 1963.



How much involvement?

The IEEE's relationship with the National Society of Professional Engineers does not project the institute itself into a lobbyist's role. Rather, it skirts that issue by allowing individual members to decide for themselves whether to support lobbying activities. The decision to do so will be somewhat expensive: in the words of one skeptical engineer, the cost will force members to "put their money where their mouths are." Most NSPE services will be available for IEEE members for only \$15, but fees for voting memberships vary from state to state and range between \$35 and \$75.

Just how IEEE members will take to the new arrangement remains to be seen. However, this may not be the IEEE's final word. IEEE President James H. Mulligan Jr. declares that the agreement "in no way precludes further consideration of IEEE action in these areas." He points out that the pact was "very rapidly negotiated so that our people concerned about action in this area could get wired in virtually immediately."

The agreement between the two organizations was concluded in near-record time. Mulligan began talks with NSPE president Harry C. Simrall in mid-November of last year, while still an IEEE vice president. A month later, Mulligan presented his proposals to the IEEE's executive committee, and on Jan. 6 the IEEE board of directors officially approved the move.

The NSPE, to which 66,000 registered professional engineers belong, has 36 years of lobbying experience, with representatives in 54 states and territories overseas. Points out IEEE's general manager Donald Fink: "It would take time and money for the IEEE to try to duplicate what NSPE already is doing."

NSPE is the "only organization in existence that represents all engineers on all their different problems," claims the society's legislative counsel, Robert H. Doyle. For example, NSPE for several years has been urging Congress to act on behalf of engineers affected by cutbacks in defense-related industries. And in January, its board of directors adopted a plan to set minimum income levels for engineers in relation to other professions; it would take into account rising educational expenses and other living costs.

The society also seeks to testify before Congressional committees on important issues and actively lobbies for legislation. It has supported legislation to establish a mass transportation trust fund, to broaden rules allowing employees to deduct expenses when moving to a new job, and to reduce taxes on pension-plan contributions by professionals who have formed their own consulting companies.

It bases its legislative stances on the opinions of its members, polling them on such matters as the proposed changes in the Selective Service System; a bill, reintroduced in this session of Congress by Rep. John Moss (D., Calif.), that would increase the compensation paid for patented inventions by companies to their employees; and various bills covering the entire gamut of environmental pollution and control.

Other NSPE activities to which IEEE members may subscribe include a job placement service, a statistical review of salaries and a retirement plan. Although an individual pays for the plan with after-tax dollars, legislation may be enacted to make such contributions tax deductible.

engineers, particularly in the electronics industries have come on hard times. After almost 20 years of acclaim and commensurately healthy salaries as the architects of the nation's military and space-age strengths, engineers are being turned out of their jobs in astonishing numbers.

Yet the unemployment situation isn't the only issue bugging IEEE members. Many feel that as a group, electronics people have been treated shabbily, with little recourse against often unfair employment practices. Fired from jobs held for 10 or 15 years, veteran engineers have discovered they have no rights to the pensions their employers had been keeping for them. And seniority, which might have been considered as some protection against a layoff, has even proved a liability. "Invariably, when layoffs come, they hit hardest at guys with seniority because management looks at the combination of their higher salaries and the unvested interest in their pension plans," claims an officer of the IEEE's Antennas and Propagation group. "The pension money reverts back to the pension fund and benefits those who remain."

Others, fortunate enough to hold onto their jobs, have had to endure pay cuts while still doing a full week's work; some companies have even required their engineers to work a six-day week with no additional pay. And still other engineers, out of work for periods ranging from six months to a year and more, have been living with the sickening realization that, with national priorities changed, they may be technologically unemployable.

These are the kinds of problems facing electronics engineers today. Increasingly, they have been trying to make the IEEE headquarters in New York listen—and respond. Local meetings on these issues have attracted noisy and vociferous champions of change in the IEEE's way of doing things. Articles and letters critical of the organization's leadership appear in newsletters published by various groups and sections. Particularly indicative of members' attitudes are the letters appearing in the Institute's own *Spectrum* magazine: for more than 18 months, these have been preponderantly against the status quo.

The few polls taken by individual IEEE groups show much the same leanings. For example, more than 60% of those responding to a poll of members of the Antennas and Propagation group answered yes to the question of whether the IEEE should lobby for portable pensions and to minimize employment disruptions caused by changes in national budgets. (See "The polls tell it," next page.)

The IEEE's agreement with the NSPE goes part of the way toward meeting rank-and-file demands for additional services. But perhaps most important, it marks a sharp departure from the IEEE leadership's long-standing reluctance to change the institute's role as a disseminator of technical information (see "Then and now," page 92). For example, Mulligan's predecessor, John V. N. Granger, said last year that to "put the IEEE in the role of a 'pressure group' would, in the opinion of the board of directors, be morally repugnant to most, if not all, of our membership."

Despite having some degree of lobbying, social

involvement, and pension plan activities now provided through NSPE, the IEEE management may still draw criticism for not, as the nation's largest engineering society, having done these things itself; indeed that it avoided doing so for fear of jeopardizing its tax status. Falling under an Internal Revenue Service category covering charitable, scientific, educational, and technical institutes, the IEEE doesn't have to pay income or real estate taxes, points out Fink. NSPE, as well as lobbying organizations like the American Bar Association and the American Medical Association, come under the "business league" category; they pay taxes and higher postage rates on their periodicals.

Mulligan bristles when the question of tax status is raised. "The question is completely irrelevant because it does not deal with any real issue," he says, adding that the goal should not be to change tax status but to accomplish desired results. "We should first make a judgment about the activities the IEEE should undertake on behalf of the electrical engineering profession. If we make those decisions first, our tax status will follow as a consequence."

Working towards these decisions has high priority at IEEE headquarters. One of Mulligan's prime concerns as he meets around the country with local and regional IEEE groups is communications between headquarters and members. [*Electronics*, Nov. 9, 1970, p. 105]. "We want to be able to identify an individual member's needs and respond to them by offering a number of alternatives," he says. He feels he is finally close to establishing his two-year-old goal of effective two-way communications. This has been accomplished through a continuing series of leadership training programs aimed at informing section and group chairmen about what the institute is doing. They are then able to explain new programs to the members, as well as pass along members' opinions, says Mulligan.

But communications through personal contact and letters to the editor cannot give the board of directors a complete picture of what the members think they want. One way to fill out the picture is "to poll the entire membership on the range of options available to it," says the Long Island section's Rossoff. "If this shows a consensus, it should be regarded as a mandate to offer responsive constitutional and bylaws amendments for enactment," he asserts.

Fink holds out little hope for a poll of the entire membership, although he says the matter is "under active discussion by officers." Polling is being done anyway by subordinate IEEE groups, he points out.

One "poll" Fink does keep close track of is the rate at which members are paying their dues in 1971. As of last month, these renewals were coming in at close to the pace of 1970, when total membership actually increased some 2,000, he points out.

In addition to establishing what it regards as a stronger communications setup, the IEEE is also trying to improve its continuing education programs.

In the past, the institute's educational programs have generally served, through publications, lectures, seminars, and films, to upgrade a member's knowledge in his own field. Now, in many cases the primary objective—job retraining—is much more critical. New

applications-oriented material is being developed by the IEEE's Educational Activities Board, but the mood is cautious. That's because the big question, says Fink, is the kinds of jobs towards which the training should be directed. The fear is an obvious one: retrained, an engineer may still not be able to find a job. A space telemetry specialist could probably put his talents to use designing ground-based systems for a pollution-monitoring network—but only if such systems get to the design stage. The technology in any of the new fields to which the nation is turning its priorities—pollution control, mass transportation, housing—is nowhere near as well developed as in military electronics and aerospace, says Fink.

In time, job retraining may help. What is really needed, however, is the often-predicted yet excruciatingly delayed turnaround of the nation's economy. Even if it comes fairly soon, the wounds opened by

The polls tell it

IEEE headquarters so far has left it to the professional groups to poll the membership regarding the role they want the organization to assume. The few that have done so report that a majority of respondents want the IEEE to move into socially and economically oriented activities. However, many do not like the idea of paying more money to accomplish these goals.

This is evidenced in a poll compiled last month by the 4,800-strong Antennas and Propagation group. Although only 5% of the members responded (the poll totaled 23 questions, mostly dealing with the group's own activities), they represent a "good cross section of the members," says William F. Crosswell, the group's membership chairman. The pertinent "role playing" questions and the responses were as follows:

■ Do you think that the IEEE should become an active lobby to advance the personal and professional interests of its membership, establish portable pensions, and try to minimize employment disruptions caused by changes in national budgets?

162—yes

87—no

■ How much are you willing to increase your IEEE dues payment to achieve a lobby status?

107—\$0

107—\$20-\$50

44—\$50-\$150

5—\$150-\$500

3—\$500-\$1,000

■ Do you feel that the IEEE should remain a strictly technical society while engineers seek their personal goals by other means, such as unions?

90—yes

149—no

Similar results were indicated in another poll taken last July by the Microwave Theory and Techniques group. A total of 1,509 questionnaires were received from about a quarter of the group's membership. Of these, 74.2% said they would like to see the IEEE undertake "action to help the engineer in nontechnical areas such as professionalism, pension plans, and employment," and 59% wanted the IEEE to help "solve some of the sociotechnical problems of our society."

the current recession are likely to heal slowly. Too many engineers feel they have been unfairly treated and they will be more involved than before in looking out for their interests.

Vuk Peric, an engineer at the Goddard Space Flight Center, Greenbelt, Md., lists some professional parameters that engineers should control. He includes:

- The number of engineers in the field. "I believe we have twice as many engineers as we need," he says. "We just don't utilize them properly."

- The job function of engineers, to insure they're not being wasted and used as "glorified clerks." To a great degree, engineering obsolescence is caused, he says, by management not using engineers properly.

- Statistics on the hiring and firing practices of different companies, so that engineers would have access to turnover figures when they apply for a job.

- The levels of separation pay, which should be set high enough to combat the careless-hire, careless-fire policies of some companies.

- Information on salary levels. "Companies encourage employees to keep salaries secret so they can offer you whatever they think you will take," says Peric. "This may be fine when the market is open, and an engineer can go where he will. But it certainly doesn't contribute to an engineer's financial status now, when times are tough."

In addition, Peric thinks the IEEE should provide fledgling entrepreneurs with information and help in setting up their own companies.

To achieve goals such as these, most electronics engineers, Peric and Richard Backe among them, want to work within the structure of the IEEE. Only a very minor fraction of the thousand or so letters received by headquarters have talked about forming a separate engineers' union, reports Fink.

Backe, however, not only criticizes the IEEE's management but his fellow engineers as well. "Organizations that have been around for years could have been made to look out for engineers' interests but hardly anyone was interested in getting involved," he says. Ten years ago, reports Backe, who is a supervisor with the Sperry Support Facility at Goddard, he took part in a recruitment drive on behalf of the NSPE to get nonlicensed engineers into its ranks. "But times were good then, and the whole thing died," he says.

Now he says he is working with the next 10 years in mind. In that time, he hopes an organization to oversee all of the critical interests of engineers will evolve. An important step in that direction could come next week in New York. More than 100 different IEEE group, section and special committees, by Fink's estimate, will be holding meetings during the convention. And Mulligan himself will moderate Monday night's special session, titled "Role of the IEEE in the '70s." Mulligan, as well as the institutes' officers will be on hand to answer questions from the floor. The chance for members to let them know what's on their minds may be too good to pass up. □

Then and now

The IEEE leadership traditionally has resisted attempts to push it into a more activist role on behalf of its membership. A dozen years ago, Ernst Weber, president of the Institute of Radio Engineers, one of the IEEE's predecessor organizations, summed up the official position in a response to an editorial written by Herbert S. Kulik. The editorial ran in the October 1959 issue of *The Pulse*, the monthly publication of the Long Island section of the IRE.

Kulik, now vice president for marketing at Automated Medi-Screening Services Inc., Syosset, N.Y., warned with admirable prescience that "sudden perturbations in our military budget caused by domestic political considerations, interservice rivalry, poor planning, and sometimes unavoidable blunders" could result in hard times for electronics engineers.

He continued: "There should be a voice in Washington that will represent the best interests of our profession—a voice that will be heard and listened to. There are over 60,000 electronics engineers in the country today. Our common desires and problems, our responsibilities toward the defense of our way of life, make it imperative for us to speak in unison. Our contributions to our society give us the right to do so.

"The IRE is the largest and most inclusive organization of electronics engineers in the entire country," he asserted. "Is it not time for us, however, to realize that we are entering into a new period—a period when a new dimension in our activities is called for? Section 2 of article 1 of our constitution says that our 'aims

shall include the advancement of the theory and practice of radio and allied branches of engineering and of the related arts and sciences, their application to human need, and the maintenance of a high professional standing among its members.' We feel that very few believe that in today's world these aims are being fully met by the activities envisioned by our founding fathers in the year 1913.

"Only a very narrow interpretation would insist that the sociological climate has no effect upon the advancement of the art and the professional standing of the electronics engineer. The need exists for a re-evaluation of our activities—let it be answered."

In an unsolicited letter, IRE president Weber quickly set Kulik straight on the chances for his requests:

"Your feeling that the IRE should become actively involved in matters pertaining to possible representation of the engineering profession with respect to economic organization problems is somewhat disquieting. There is no question that IRE comprises the largest number of electronic engineers in any society. Its objects, however, are entirely professional and educational, as stated in its charter. Other societies have taken upon themselves to speak for engineers in the economic and political sphere which, as our Government is constituted, represents lobbying activities attempting to influence legislation. You will recall, I am sure, that such activities are not compatible with tax-exempt status, and would therefore not be included within the scope of IRE."

IEEE

Changing times bring a changing show Part two

The economic slump is taking its toll among U.S. exhibitors and introductions of new products at this year's show; but the technical program is expanded, with emphasis on down-to-earth applications

□ Expect a sharply expanded technical program—with a greater emphasis on down-to-earth applications and subjects of relevance to the engineer as a professional man—at this year's IEEE Convention and Exhibition. There will be 83 technical sessions this year, against 69 last year, and, in contrast to last year, almost none of the sessions are tutorial. Twenty-eight of them will deal with such bread-and-butter topics as automated soldering, production microbonding, and connectors. All of these will be held at the Coliseum to encourage attendance by the nuts-and-bolts engineers who regularly come to the show but rarely trek to the technical sessions at the New York Hilton. Despite this shift in content and location, the program at the Hilton, with its traditional emphasis on new technology, also is upgraded this year.

Here's a rundown of what will be covered in the meetings. At the keynote session, titled "Redirecting Electro-Technology for a Better World," to be held the evening of Tuesday, March 23, Edward E. David, science advisor to President Nixon, will talk on "Opportunities and Pitfalls," an evaluation of the possibilities of redirecting the efforts of the electronics industries to serve urban and social programs. Frank Blecher, director of Bell Laboratories' Electron Device Lab at Murray Hill, N.J., chairman of the technical program and organizer of the keynote session, is quick to point out that David's address "will

not reflect Administration concern for the situation in the electronics community. Ed is just an old friend who agreed to speak."

And there's little cause for hope, says Blecher, that the Administration is turning to the electronics industries' rescue just because Assistant Secretary of Defense David Packard will speak at the IEEE's annual banquet. Packard is expected to discuss the impact on the electronics community of forthcoming DOD programs and doubtless will offer an overview of trends in Federal R&D budgeting, but few expect him to herald any sharp upward shift.

Of course there are several areas in which electronics companies are having an impact—and profiting modestly. Environmental research is one of the most important of these. Session 1E, to be held Monday morning at the Hilton's Gramercy Suite, will offer four papers on the Global Atmospheric Research Program, the international effort to develop the data collection and analytical systems needed for accurate, extended global weather prediction. Session 7G, covering "Earth Resource Management Data from Satellite Observation," will be held in the Regent Room Thursday morning.

Contributing to this special IEEE report were Herman Lowenhar, Alfred Rosenblatt, Owen Doyle, Jim Brinton, and Gail Farrell.

Ballroom, covers the future of global satellite communications, another area where electronics has brought the benefits of space-spawned technology down to earth. Another morning session, in the Trianon Ballroom on Thursday, will cover some of the proposed U.S. satellite communications systems.

Long touted as a vast new market for electronics instrumentation and communication, rapid mass transportation systems that could replace the nation's creaking commuter railroad network are finally getting serious attention from the Department of Transportation, along with some development money. Session 8F, to be held in the Gramercy Suite Thursday afternoon, will feature among five papers one by H.H. Richardson discussing the Department of Transportation's R&D goals. Another, by W.C. Dunlap of NASA's orphaned Cambridge Electronics Research Center, which was adopted by DOT and rechristened The Transportation Systems Center, will be on the center's role in achieving those goals.

Session 8G, "Educational Technology," in the Regent Room Thursday afternoon, will examine another civilian area in which electronics has sought a market—in this case for the better part of a decade—with only limited success. Three papers will emphasize the central importance of the computer language and the student-machine interface in the development of effective instructional aids and programs.

Lasers will be covered in two sessions this year. One, Session 7C, to be held Thursday morning in the Sutton Ballroom South, will be concerned with "Advances in High-Power Long-Wavelength Lasers." Papers will center on high-velocity gas flow techniques for cooling and sweeping out non-lasing, ground-state components, although more conventional techniques will be discussed as well.

An innovation this year is Session 1C, "Computer Art and Music," held in the Sutton Ballroom North on Monday, March 22. The session, organized by Charles Cosuri of Ohio State University, covers not only the interaction between the artist and the computer, but stresses the future impact of technology on the fields of art and music.

More traditional topics will be covered in sessions on the state of the art in radar systems, graphics display and hard-copy technology, integrated microwave subsystems, Gunn and Impatt devices, avionics technology data compression, computer architecture, and imaging devices, among others. Several of the sessions at the Coliseum are intended to aid the novice entrepreneur. Sponsored by EIA, these will cover "How to Start A New Business," "Market Management Techniques," and "Sales Management Techniques." This year, for the first time, there will be a session sponsored by the Ladies Program Committee. Its topic, "The Drug Scene—and You—and Your Children," is one more indication that the IEEE is facing up to contemporary problems.

Noting that last year's technical sessions had an average attendance of 225 persons, Frank Blecher is optimistic that that figure will be up this year. "Travel and technical meeting budgets have really suffered this year, so those shows which cater to

specialized areas have had sluggish attendance, whereas the IEEE convention, offering a solid, broadly based program, is a must for everybody." Even if that expectation is not realized, the much larger program should guarantee a combined attendance of over 11,000 at the technical sessions, which this year offer something for everyone.

At the stands: fewer companies

The magic number for the IEEE's 1971 International Convention and Exposition is 47,738, the attendance at last year's convention. For two reasons, it's a level the institute's management would like very much to exceed. First, greater attendance would reverse the unsettling trend of the past year, which has seen every large regional electronics conference—including Wescon, Nerem, NEC, the Southwestern IEEE conference, and the 1970 IEEE show—draw a poorer audience than in the year before. And second, better attendance could add much-needed vitality to the IEEE's claim that its March event is a "great annual industry meeting."

But the fact is that the IEEE International Convention and Exposition has been declining in both the numbers of attendees and of exhibitors. The attendance peak—74,734—was reached in 1962, and exhibitors, who peaked at 1,307 the same year, have declined for five straight years—from 731 back in 1966 to 589 exhibitors last year. Exhibitors this year should total about 400, hopes William J. Hilty, the IEEE's director of convention and exposition services. Close to 85, however, will be from overseas, up from about 25 from last year. That figures out to a 46% drop in U.S. companies exhibiting.

Much of this decline is, of course, due to the shaky state of the U.S. economy, and of the aerospace and electronics industries in particular. But tight money also has brought a tighter-than-usual scrutiny of how that money is spent. Accordingly, many serious reappraisals are being made of the value of exhibiting at not only the IEEE show but at trade shows in general. And also being examined closely is the old question of which kind of conference is best for exhibiting: the broad, industrywide giant, or the narrow, specialized mini.

More than a few long-time IEEE exhibitors have dropped out in the past year or two. These include such important industry names as Westinghouse Electric Corp., Raytheon Co., General Instrument Corp., Signetics Corp., Fairchild Semiconductor division, and EG&G, Inc. And they are being joined this year by Texas Instruments Inc., RCA and General Telephone & Electronics Corp.-Sylvania, which last year had the show's largest exhibit.

Reasons for not exhibiting vary. But money is generally at the root. When times are good, companies often decide they can't afford not to exhibit. In bad times, companies start looking for "scientific" reasons why one type of trade show is better than another. And they begin making more critical assessments of their entire advertising, promotional, and marketing campaign.

Furthermore, when a company does stop exhibiting, there may be no clear-cut effect on sales. Thus, when times finally do improve, there may be little drive on the part of the company to start exhibiting again, a fact which worries trade show managers.

"A large, omnibus show just doesn't get us the booth traffic we want," comments a spokesman from GTE-Sylvania. "At the IEEE we found we were getting a lot of students and other paper collectors."

Sylvania, he points out, is concentrating on the more specialized shows. "We went into the Computer Designer's Conference and Exhibit in Anaheim in January, and it was superb. We'd take the 15,000 who came to that show anytime, instead of any number at IEEE."

Texas Instruments also reports it will be exhibiting at more specialized shows. A spokesman there says that dropping out of the IEEE was dictated not so much by economics but because "the specialized shows gives you more buyers to talk to." Raytheon is doing the same thing: "We're not in any fewer shows but in more specialized shows, such as the Joint Computer conferences in the spring and fall."

Carl M. Kramer, sales manager, Hybrid Systems Corp., Burlington, Mass., considers the IEEE show good exposure for small companies but is "personally disenchanted with it. Each year we see less and less of the type of people who would buy or specify our products." Nevertheless, Hybrid Systems is showing at IEEE, partly because it provides the opportunity to meet many people. But Kramer complains, "By the time they get to my booth they're too tired. The show management knows how important it is to have good attendance figures, and the exhibitors are not educating but selling. It's a bazaar." Hybrid is seriously considering dropping out of shows altogether.

The extremely high cost of sending people to New York City is also cited as an important reason for skipping the IEEE show. Hewlett-Packard, for example, dispatched more than 200 people to the show in 1970 but is sending less than half that number this year. And they've also cut down the size of their booth space—to 80 feet from 120 feet a year ago.

The cost of mounting and manning a booth also draws criticism. "We just got tired of what it costs to have a carpenter drill one hole, or an electrician splice one wire," explains Ted Esteves, manager of advertising services for General Instruments' Semiconductor Products group. After adding up the costs and the indirect expense of putting engineers in the booths for a week, Esteves suddenly wondered, "What business are we in?" It seemed as though exhibiting had become an end in itself. So in 1969, GI became one of the first semiconductor companies to pull out of the IEEE show.

Several semiconductor companies have come to regard shows in general as of more value to instrument makers than to themselves. This is true of Signetics, which has pulled out of both Wescon and the IEEE show and will concentrate on promotional programs and advertising to reach customers, says Edward Winn, manager for product marketing.

The management of the IEEE show has also come in for criticism. "The management was too uptight, with too many rules and taboos against giveaways," says the exhibits manager of another ex-IEEE-show exhibitor. Comments another, somewhat more bluntly: "They ran the show as if they were Hitler's deputies. They offended me and a lot of other exhibitors."

Probably partly in response to this dissatisfaction, the IEEE has thrown out its old convention managers. Instead the show this year is managed by the IEEE's new conference board, headed by Hilty. In previous years, it had been managed by an outside consultant to the IEEE. By assuming the managerial role itself, the IEEE feels it will stay in closer touch with conditions at the show, and will be in a better position to change exhibition policies as the situation demands. In the longer term, the IEEE hopes that its conference board will be a source of information and practical assistance regarding technical conventions for the entire IEEE. Almost 100 shows and conferences are sponsored annually by various IEEE groups, Hilty points out.

This year he is prepared for a lean exposition. "I haven't seen an industry contract as sharply as the electronics industry has in the last year and a half," says Hilty, who has been working since last June to attract exhibitors to the show. He thinks that things might just be "turning around," judging from the stronger positive response he says he found in potential exhibitors after the first of the year.

Hilty has handled the show gingerly his first year, making only a few changes to give it a somewhat new look. Most obvious will be the exchanging of floors between the instruments and components exhibitors. The instruments makers now will be on the third floor, components people on the second.

Another change, certainly important to those manning booths, is that exhibition hours have been shortened—to 35 instead of last year's 40½. And the exhibit will be open only one evening—Tuesday—instead of three, because "a finer professional audience comes out during the day anyway," asserts Hilty. For the first time, attendees will be able to register at reduced rates in advance by mail. This ploy, it is hoped, will boost attendance by having people commit themselves to coming to the show weeks ahead of time, instead of allowing them to put off the decision to the last day. Unemployed IEEE members will be allowed in free.

On the stands: fewer product debuts

Springtime may mean grapefruit-league baseball, town meetings, and flower shows, but when the 1971 IEEE Convention and Exhibition ushers in spring on March 22, the flowering of new products at the New York Coliseum will be somewhat sparse. The number of exhibitors will be down and many of those remaining will have reduced booth size.

Still, the tradition of spring and fall product introductions lingers on. Companies that will not be on display at the Coliseum will nevertheless be introducing fresh products at about the same time—through

advertising, press conferences, product literature, and the like. For example, Texas Instruments Inc.—absent from the show for the first time—has nearly 50 products ready for the market and is presenting some of them at show time.

“The big companies no longer deliberately time their product introductions to a trade show,” comments a sales manager. “When they’re ready, they’re introduced.” The spring and fall “habit” may be more a matter of budgets, slippages in engineering schedules, and other factors that conspire to bunch the product debuts.

While U.S. companies are dimming their product profiles this year, overseas firms are sharpening theirs. The products of 23 French manufacturers will be exhibited, the largest ever for the French and the first time they have sponsored a block exhibit. United Kingdom companies at the show total 18, and there

will be products from Denmark, Japan, and West Germany. Siemens AG will have an 80-foot booth, largest ever for the German company.

A U.S. giant in the components business, Sprague Electric Co., considers the IEEE Show one of the best avenues for introducing new products. Marketing officials at Sprague see all of the big trade shows turning into regional gatherings and look upon the IEEE convention as a New York-Philadelphia show. Instrument companies, generally speaking, look upon IEEE and similar shows as a necessary part of their sales efforts. Says Kenneth D. Corsetti, sales manager of Millivac Instruments Inc., “For some companies, the IEEE Show is probably more of an espionage than a sales operation. But sale of instruments requires a buckshot approach. We have to be in IEEE.”

Following are some of the more significant products that will be introduced at the 1971 convention.

Counter with diode display squeezes into crowded market

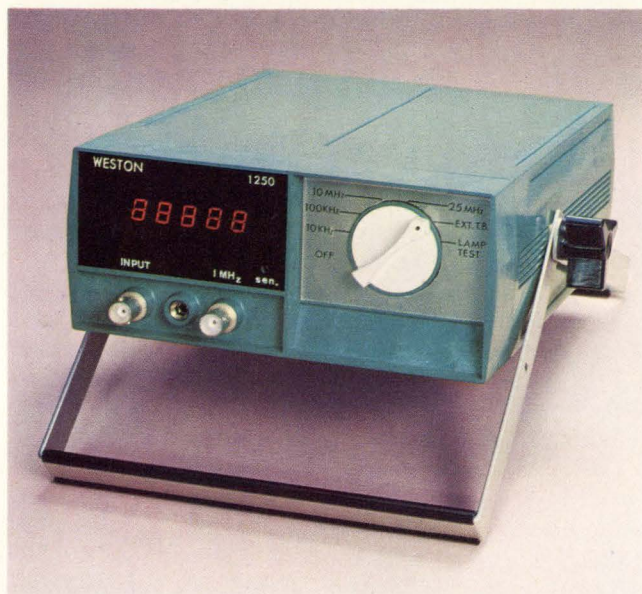

A couple of firsts are tied up in the model 1250 counter developed by the Weston Instruments division. The 25-megahertz instrument marks Weston's

debut in the counter market. It also is the first Weston product that includes a solid state display. Weston chose gallium-phosphide numerics for this debut.

Although the counter market is crowded, the Newark, N.J., company feels the 1250 can attract customers with its small size and price. The portable instrument is packaged in the same 7-by-3-by-8-inch case that holds its 1240 multimeter [*Electronics*, Oct. 27, 1969, p. 149]. It weighs under 3 pounds, and power dissipation is 8 watts. The price at distributor counters will be \$375. “To OEMs, we can sell it at close to \$300,” says Jack Stegenga, digital product manager.

Although it has its own 1-MHz reference, the 1250 can run off an external 1-MHz source. The internal reference is available from the front panel. The 1250 thus can be a complete test setup—source and instrument. It has four ranges—dc to 10 kilohertz, to 100 kHz, to 10 MHz, and to 25 MHz. Accuracy is ± 1 count \pm time base stability, which is 2 parts per million per $^{\circ}\text{C}$ from 16° to 32°C , and 1 ppm/month. Input impedance is 1 megohm shunted by 30 picofarads. Sensitivity is 250 millivolts rms.

Weston Instruments Division, 614 Frelinghuysen Ave., Newark, N.J. 07114 [381]

Memory board widens scope of linear IC tester

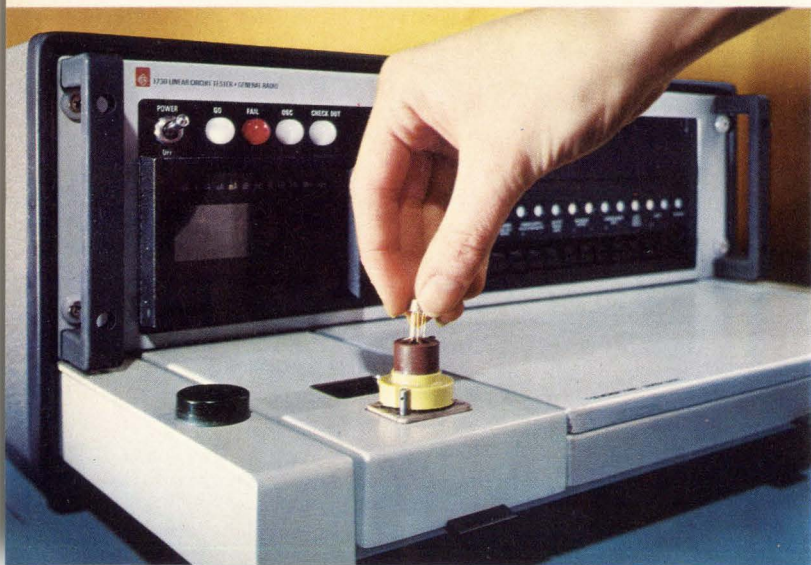

Many test systems for linear integrated circuits were designed by circuit makers, have a fairly narrow capability, and require costly, hard-wired performance boards for different types of devices. General Radio Co.'s model 1730, on the other hand, was built by an instrument maker, handles a broad range of circuits in its standard configuration, and requires only replacement of a sheet metal array of slide switches for different circuit families. The array, called a universal memory board, is described by CR engineers as offering the prospect of testing even some circuits not yet designed, at minimal follow-on cost.

The standard 1730 can test single and dual operational and differential amplifiers, comparators, voltage regulators and followers—all according to Mil Std 883,

and either with or without computer programming. It can display numerical or go/no go data on test conditions, as well as results like offset current and voltage, bias current, and voltage gain. Tests take from 50 to 200 milliseconds each. Data logging is available via a back-panel binary coded decimal output.

Base price of the 1730 is \$6,000. The memory boards for different circuit families are priced from \$25 to \$50. The switches make connections at points along a thin film hybrid resistive-ladder network. A single ladder is used for all tests, with MOS switches multiplexing it among them. Thus, GR has replaced one

of the most costly parts of the performance boards priced at \$400-\$700 with 40-odd slide switches, a printed circuit contact panel, a thin film resistor ladder, and some MOS transistor switches. The slide switches select device type, parameter type, range, and magnitude.

GR has left room for users to wire in their own tests. Out of four buttons marked "option," one is for the line regulation check, another for low-load gain checks, and two are unconnected, awaiting the specific requirements of the user.

General Radio Co., 300 Baker Ave., Concord, Mass. [382]

Wide-ranging amplifier speeds MOS tests



Keithley Instruments Inc. has decided not to take the giant step into automatic test systems. Instead, the company is inching towards systems by developing peripheral devices to complement its line of high-accuracy instruments. Its newest is the 427 current amplifier, a high-speed, low-level unit with wide dynamic range suitable for production testing of MOS.

Gain of the 427 is adjustable from 10^4 to 10^{11} volts

per ampere. For a given gain, the operator selects the desired rise time with a front-panel switch.

For gains between 10^4 and 10^7 V/A, rise time is adjustable from 15 to 100 microseconds. As rise time is slowed, dynamic range goes from 400 to 40,000. At the other end of the scale where the gain is 10^{11} V/A, rise time is variable between 1 and 330 milliseconds. Dynamic range is from 100 to 20,000.

Input range for the amplifier is 10^{-14} A over the eight gain settings. Input impedance is less than 15 ohms at the 10^4 and 10^5 V/A settings, and increases to about 4 megohms at maximum gain.

The output range is ± 10 volts at up to 1 mA, while resistance is under 1 ohm from dc to 30 kilohertz. Accuracy is $\pm 2\%$ of reading at 10^9 V/A and lower, and $\pm 4\%$ at the two higher gains.

Prices of the 427 is \$795.

Keithley Instruments Inc., 28775 Aurora Road, Cleveland, Ohio 44139 [383]

Rf voltmeter goes to 1.5 GHz

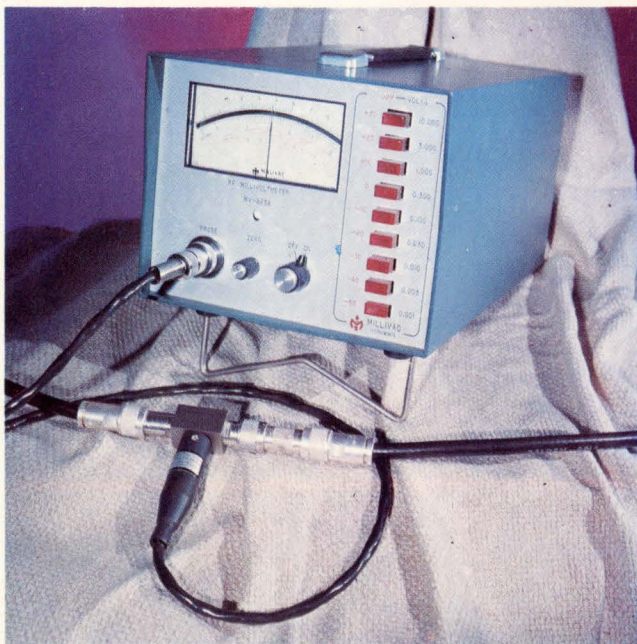

Improved accuracy, wider frequency range, and programability were the three design goals set by Millivac Instruments Inc., an old hand in the rf voltmeter

business, when it set out to develop its newest model, the MV-823A.

The instrument has an accuracy as high as 2% on some ranges, it measures signals from 10 kilohertz out to 1.5 gigahertz, and its voltage range can be set remotely. It measures voltage or decibels-above-1-milliwatt. Full-scale ranges go from 1 millivolt to 10 volts, and the instrument can resolve 1 microvolt. The decibel scale runs from -58 dBm to $+33$ dBm.

Accuracy is 1% full scale, plus a factor determined by frequency and voltage ranges. For example, a signal in the 10- to 50-kHz region and under 1 mV can be measured with an accuracy of 1% full scale $\pm 3\%$ reading. That reading factor is as low as 1% for some ranges and is a maximum of 10% for signals under 1 mV at frequencies over 700 MHz.

A dc output is available from a front-panel connector. Range is 0 to 10 V dc at 200 microamperes. For inputs up to 30 mV, the output is proportional to the input's rms value. Above that, the output is a peak reading. Input impedance of the MV-823A is 200 kilohms and 2.5 picofarads.

Base price is \$675. With the programming option, the cost is \$750; with a battery pack, \$775. □

Millivac Instruments Inc., P.O. Box 997, Schenectady, N.Y. 12301 [384]

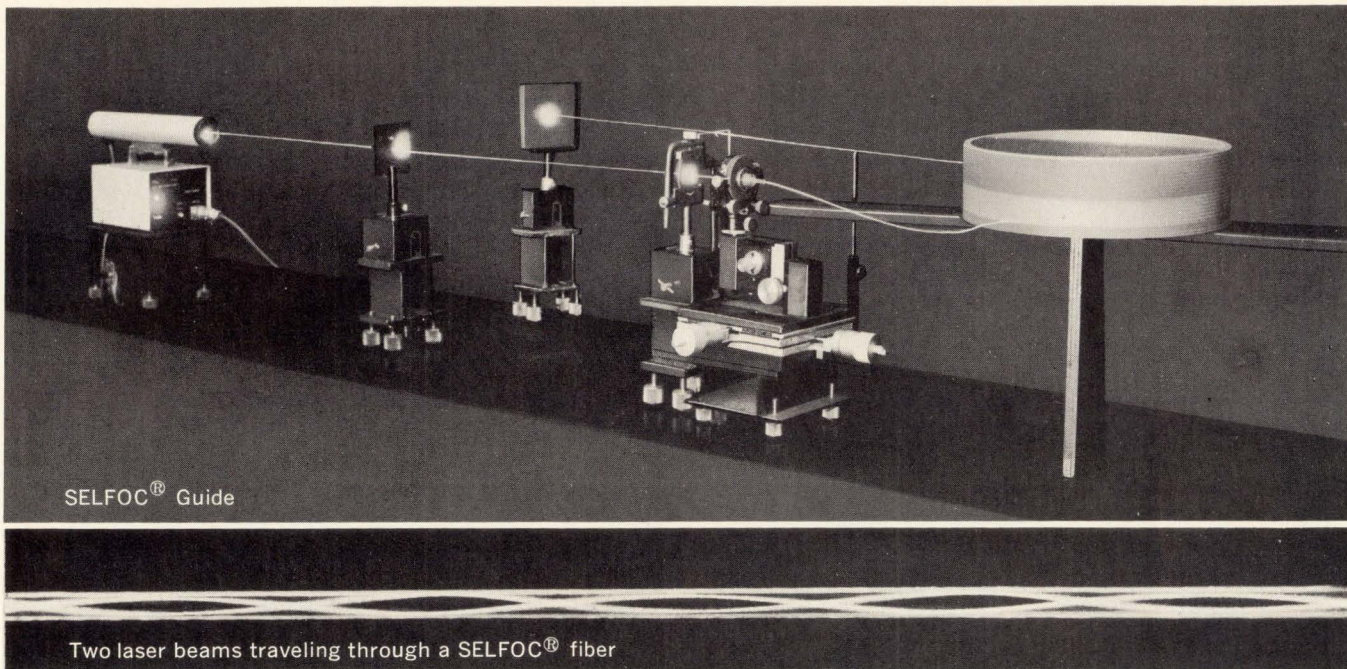

Tying light beams in knots for tomorrow's communications

Leading laser beams around corners may well be one of the keys to the next generation of communication systems. NEC has the problem licked.

Our new SELFOC®* system, still in the development stage, incorporates two exciting breakthroughs in laser technology. Developed in cooperation with Nippon Sheet Glass Co., it employs a special low-attenuation light-focusing fiber with a refractive index that decreases parabolically toward the periphery. This SELFOC® guide is thus perfectly suited for use as an optical transmission line, carrying laser beams in any direction it is bent.

The SELFOC® laser is just as revolutionary. Using a similar active glass fiber it amplifies weak laser beams, so it's ideal as an optical repeater. It also produces a continuous series of ultra-short (pico-

second) optical pulses, raising information volume to unheard of levels.

Just another example of how NEC is in front for tomorrow's communications.

Whether it's satellite station or telephone switching equipment, TV and radio broadcast or microwave and carrier transmission systems, data processing, radar or other electronics equipment or components, Nippon Electric is a world leader in products for today, innovation for tomorrow.

NEC plans to exhibit a selection of its electronic products, including the SELFOC, at the March IEEE Show in New York (Booth Nos. 2000/2002/2004). We look forward to seeing you there.

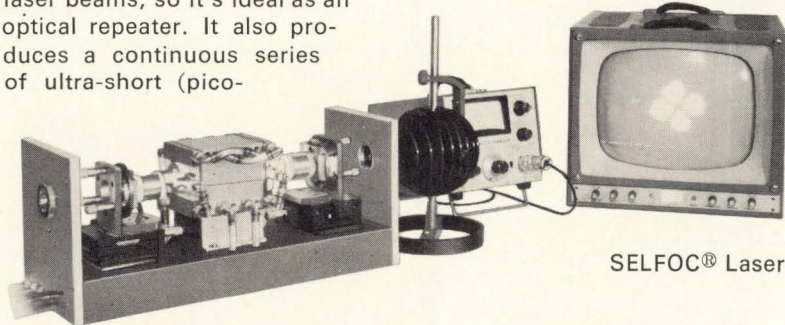

* Trademark registered in four countries including Japan

NEC AMERICA INC. Suite 4321, Pan Am. Bldg., 200 Park Avenue, New York, N.Y. 10017 Tel. New York (212) 661-3420 Cable Address: "NIPPELECO NEWYORK" Telex Address: NIPELCO 234936 NEW YORK

Chicago Office: Room 410, 500 North Michigan Avenue, Chicago, Illinois 60611 Tel. Chicago (312) 828-9494/5 Telex Address: 910-221-2101 NIPP ELEC CGO

Los Angeles Office: Suite 924 Airport Century Bldg., 9841 Airport Boulevard, Los Angeles, California 90045 Tel. (213) 776-5923/4 Cable Address: "NIPPELECO LOS ANGELES CALIF" Telex Address: 910-328-6574 NIPPON ELC LA

Washington D.C. Office: Suite 508, Crystal Mall Bldg. 1, 1911 Jefferson Davis Highway Arlington, Virginia 22202 Tel. 703-920-8228/9 Telex Address: 710-955-0651 NIPP ELEC WASH

**Products for today—
Innovations for tomorrow**

NEC
Nippon Electric Co., Ltd.
Tokyo, Japan

Main Products: electronic computers, data communication systems, telephone systems, carrier transmission equipment, radio communication systems, radio & television broadcasting equipment, satellite communications equipment, electrical household appliances, other applied electronic equipment, and electronic components.

ROTRON
has the
right angle

for your
critical cooling
problems...

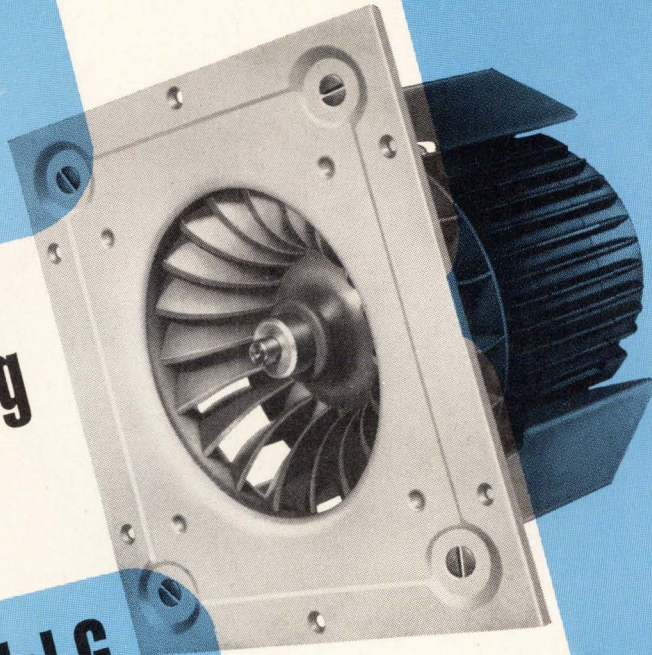

It's our Model G Centraxial Blower

Discharge of air at right angles around the complete periphery of the blower wheel is Rotron's unique solution to difficult applications in which the high pressure of a centrifugal blower is desired, but the concentrated discharge blast is objectionable. These new Centraxial Blowers will supply uniform cooling air in the most out-of-the-way places without the necessity of complicated and costly ductwork. Air flows available from 100 to 400 cfm in a simply installed and extremely compact unit. Available in 50/60 Hz or 400 Hz for single or three phase operation. Other sizes and ranges also available. Send in coupon today for full details or call 914-679-2401 for immediate assistance. Rotron, Inc., Woodstock, New York 12498.

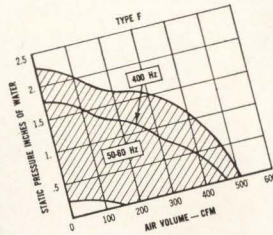

ROTRON, INC. Woodstock, N.Y. 12498
Tell me about the Model G Blower . . .

Name

Title

Company

City

State

Zip

OUR ANGLE: four frequency phase angle voltmeters

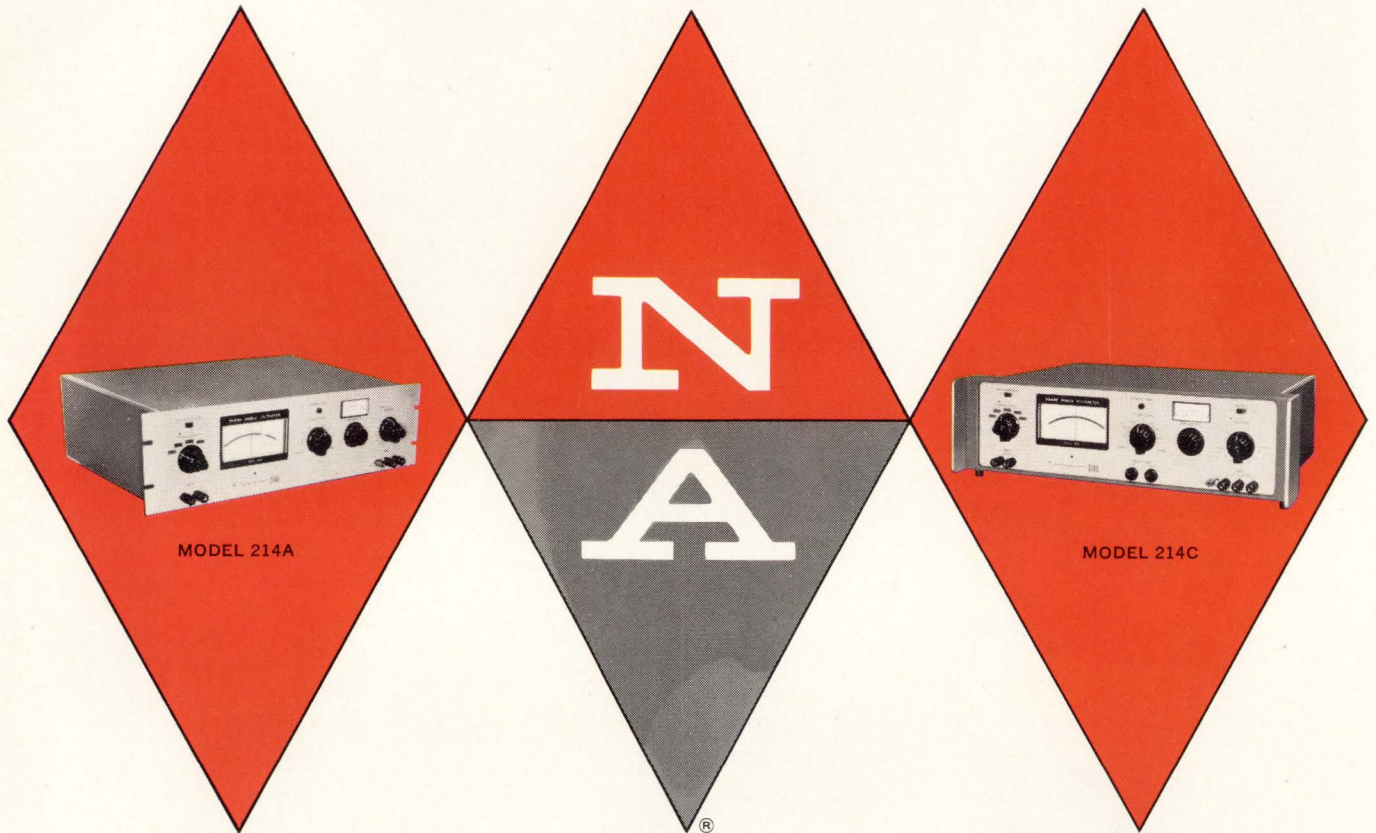

CAN YOU THINK OF A BETTER ANGLE TO AVOID OBSOLESCENCE?

North Atlantic's 214 FOUR-FREQUENCY PHASE ANGLE VOLTMETER introduces a new flexibility in AC voltage measurements. It enables direct reading of null balance, total voltage, fundamental voltage, in-phase voltage, quadrature voltage, and phase angle.

It's also pre-wired to handle four operating frequencies from 30Hz to 20kHz, which means extended longevity and broader application. Even if you only need one frequency, there are three extra spots to add other frequencies later. Frequency changes can be made rapidly and conveniently in the field with plug-in modules. The 214 can be completely recalibrated at the installation site by a single rear-panel adjustment.

Harmonic rejection and high signal overload design of the unit screens out conventional distortion and errors in measurement and calibration. The all solid-state Model 214 offers full accuracy over $\pm 5\%$ bandwidth, 1° phase measurement, adjustable meter scaling for go/no-go testing, and $300 \mu\text{V}$ full-scale sensitivity. Priced from \$1215.00.

Options? Other models offer 0.25° phase accuracy, lower-cost single frequency operation, broadband phase-sensitive performance from 10Hz to 100kHz.

Whether your AC measurements are large or small, contact your North Atlantic sales engineering representative today. He'll show you a new angle to your AC voltage measurements.

NORTH ATLANTIC
industries, inc.

200 TERMINAL DRIVE, PLAINVIEW, NEW YORK 11803
cable: noatlantic / twx: 510-221-1879 / phone: (516) 681-8600

On Display at IEEE Booths 3108-3110

100 Circle 100 on reader service card

Electronics | March 15, 1971

We're not here just to entertain you.

Panasonic, one of the greatest names in home entertainment, has a lot of products to interest industry as well. In order to produce all the home entertainment products we're famous for, the 2,500 engineers who back up Panasonic products have had to do a lot of research. Research that's led to some amazing new products.

For instance. We've developed a new Video Image Printer. A sophisticated device for making single or multiple 35 mm. slides from high density TV broadcast information. The Video Image Printer can be used to record micro data for business. Or invisible ray patterns for science. Or whatever high density information you want to record.

Advances like the Video Image Printer don't come from fooling

around. We've had to invent new electronic components to make them possible. Like our "Hi-ZNR." A voltage dependent, nonlinear, zinc oxide resistor. The "Hi-ZNR" features varistor voltage from 300 to 30,000V and nonlinearity 10 times better than conventional silicon carbide varistors.

Then there are new products like our "Piezonator," our Ga-As pulse generating diode, and our junction type strain transducer. They're highly advanced, highly miniaturized microelectric devices bound to cause a big stir in the electronics industry.

Frankly, there's not enough room on this page to tell about all the good things Panasonic has to offer industry. Go to the IEEE show and see Panasonic at booths #2824-2831. You'll find us more than entertaining.

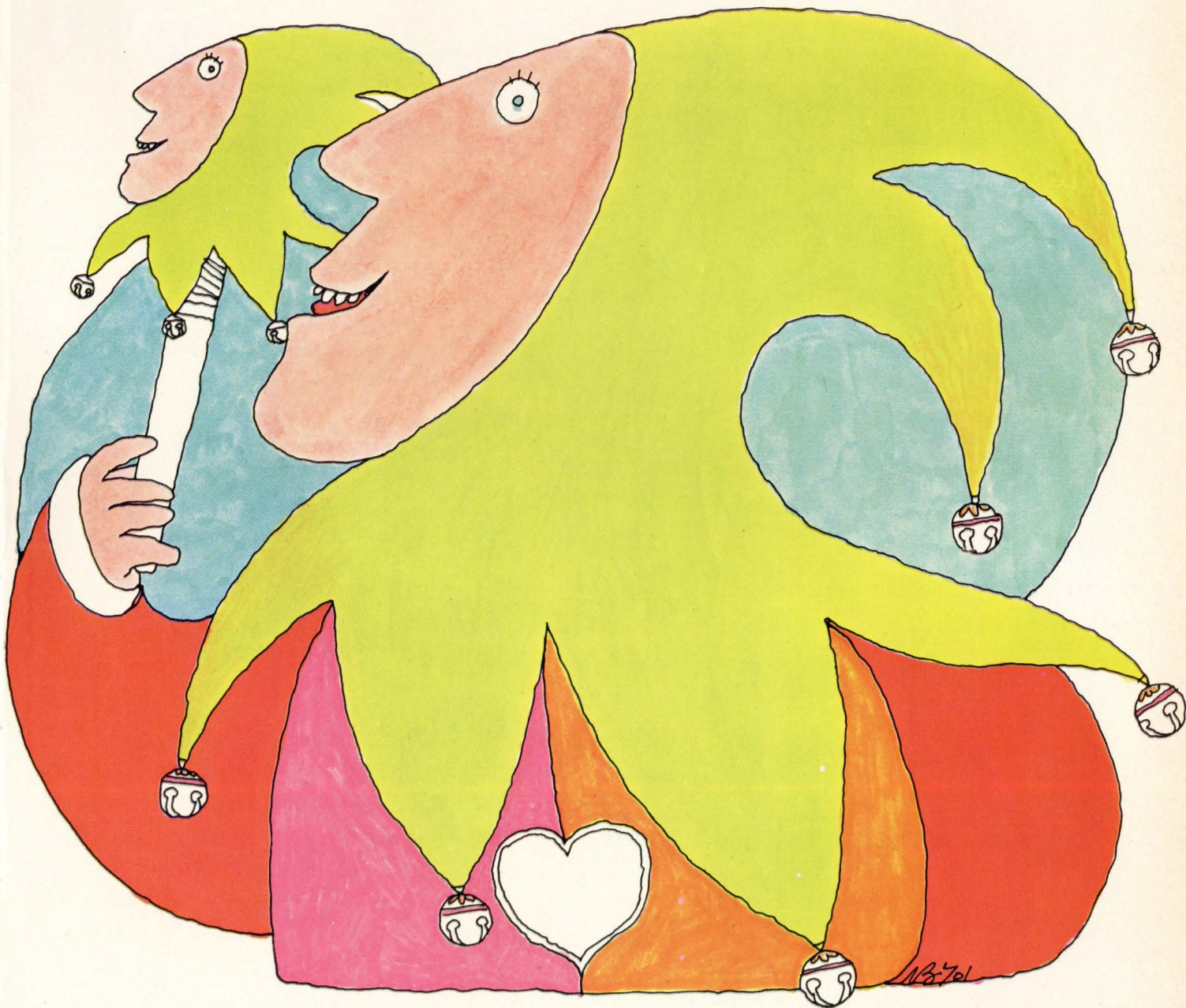

SAVE \$\$\$

GAIN performance

over any other 50-MHz, plug-in oscilloscope.

50-MHz oscilloscope with:

5-mV dual-trace amplifier and delaying sweep	\$2200
5-mV dual-trace amplifier and single time base	1900
5-mV single-trace amplifier and single time base	1650

AND LOOK AT THESE BONUSES:

- 3 plug-in compartments and mainframe mode switching
- 6-1/2-inch CRT — 50% larger than 8 x 10 cm CRT's
- time bases have 5 ns/div sweep rate
- amplifiers and time bases accurate within 2%
- high writing-rate CRT gives a brighter trace

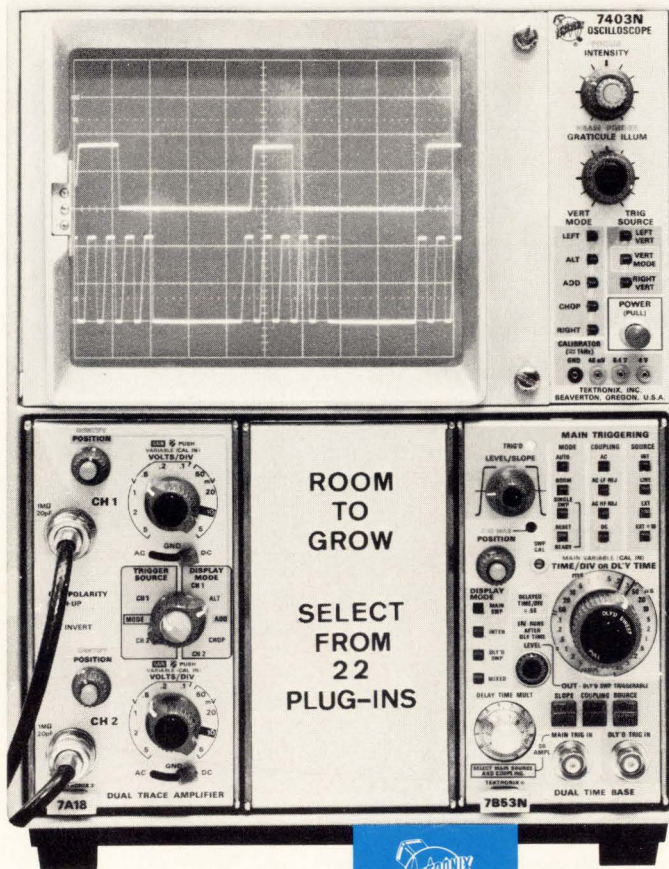

If you wish, select a plug-in for the second vertical compartment to give you 10 μ V/div at 1 MHz or 1 mV/div at 55 MHz or 1 mA/div at 55 MHz or another dual-trace unit for 4-trace capability, etc., etc. Plug-in prices start at a low \$250. Call your nearby Tektronix field engineer today for a demonstration.

7403N Oscilloscope	\$950
7A18 Dual-Trace Amplifier, Option 1	\$500
7A15 Single-Trace Amplifier	\$250
7B53N Dual Time Base	\$750
7B50 Time Base	\$450

U.S. Sales Prices FOB Beaverton, Oregon

Available in U.S. through the Tektronix lease plan.

TEKTRONIX®

committed to
technical excellence

See The Tektronix Display at IEEE Booths 3520 - 3527

Circle 102 on reader service card

EEs find self-help groups help little

Organizations formed by engineers to place, retrain, counsel jobless EEs get Government, professional aid, but lack of jobs limits effectiveness

by James Brinton and Gail Farrell, Boston bureau

With as many as 5,000 unemployed electronics engineers in the greater Boston area and up to 3,000 more pounding the streets in Southern California's Orange County, engineers are banding together in self-help groups. There are also scattered attempts by professional groups, in some cases aided by government funding, to help jobless engineers. But these efforts have been largely ineffective; in some cases only 2% to 3% of group members have actually gotten jobs.

Boston and Orange County admittedly are worst case examples in EE unemployment, but the softness in the electronics industries has thrown engineers out of work across the nation. Firm figures are hard to come by, and any estimates are not only unreliable but probably on the low side. "Some EEs are too proud to apply for unemployment," points out one official at the Institute of Electrical and Electronics Engineers. "They never appear on the rolls. Others hang out a consultant shingle, and some just take their savings and vacation until the job market improves." And when he does see unemployment figures, "I feel that I'm seeing the top of the iceberg," says the IEEE spokesman. "Heaven alone knows how many more are down there."

The self-help groups are centered where unemployment has hit hardest. In Orange County, for example, engineers formed Experience Unlimited. "We decided we were going to lick this unemployment problem one way or another," asserts Thomas Owen, director of job development and placement for

the group and a former engineer at Northrop Corp., Beverly Hills, Calif.

Initially an independent group aimed at job location, Experience Unlimited now gets money and other aid from the Human Resources Development Commission. In fact, chapters, which meet throughout California weekly to

discuss new ideas and opportunities, can be reached through local commission offices. The commission also pays the organization's phone bill and sometimes subsidizes retraining.

Experience Unlimited lists 3,300 applicants, mainly aerospace and electronic engineers, but since last August only 300 jobs have been

Washington tries—hardly

"People don't know—or care—much about unemployed technologists," says an activist; and, reflecting the mood of the people, Congress isn't doing much either. The current session's output probably will only amount to hearings on reconversion and a few bills with doubtful chances.

Most aid now comes from the Executive Branch anyway. One example is a plan that may shift some Model Cities funds to retraining about 2,000 aerospace unemployed. No new funds are requested, so the Department of Housing and Urban Development is optimistic about the effort. But the idea came from Floyd Hyde, Model Cities chief, not Congress.

The Labor Department may be doing the most with its aid to Experience Unlimited, the Route 128 job center, and the IEEE/AIAA workshops. It also is running a national registry of unemployed technologists with the National Society of Professional Engineers. And it's retraining 34 engineers in environmental control in California. All told, Labor may be spending about \$300,000. But that's about twice what the National Science Foundation is paying for its one pilot effort: retraining of 15 California engineers in computer science.

Capitol Hill sources figure the odds are against conversion legislation, but there will be a bipartisan effort to try—a little. Sen. Edward M. Kennedy (D., Mass.) is reintroducing a \$500 million, three-year bill that would help convert aerospace R&D to civilian use. The National Science Foundation would administer 90% of the money, the small Business Administration 10%. But while \$500 million sounds large, "by the time it gets to the people—over three years—it won't buy much," says one disgruntled engineer. And the program is not expected to pass, though Reps. Robert Giamo (D., Conn.) and John W. Davis (D., Ga.) have put it in the House hopper.

Sen. George McGovern (D., S.D.) and Rep. F. Bradford Morse (R., Mass.) would revive bills diverting 12.5% of defense contractors' pre-tax profits to a reserve that would either fund corporate conversions, or be used for up to two years of extra unemployment checks to those jobless because of the defense cuts McGovern himself has been advocating.

Sen. Alan Cranston (D., Calif.) has introduced two bills which would use funds at hand to provide emergency unemployment payments to those whose checks are about to run out, and one-year loans for house payments. But chances for passage are dim.

—Larry Armstrong

Probing the news

found, and some engineers have been forced into sales and other nontechnological fields. "The salvation of many people lies in getting out of the engineering business altogether," admits a spokesman.

With its high rate of technological unemployment, the Boston area has spawned nearly 20 groups of various sizes, ranging from four- and five-man discussion groups to a state-sponsored job opportunity center.

Helped by \$75,000 in Department of Labor funds and the backing of the local IEEE chapter, the Massachusetts State Employment Commission recently opened its professional service center in the hard-hit Route 128 area. If it's successful, the Labor Department will open two more centers in other areas of the country. Since its Jan. 27 opening, 1,442 engineers, 42 of them EEs, have come through the door, and 42, including 12 EEs, have gotten jobs. Besides job counseling, the center offers financial advice, psychological counseling, and an opportunity to discuss ideas for new business ventures with Small Business Administration representatives; so far, 13 engineers have been recommended by the agency for loans.

Meanwhile, the Economic Action Group in Newton, Mass., headed by Gerald Wallick, a former Itek Corp. engineer, is going strong. Talks with hospitals and the state's Community Service Corp. are aimed at finding engineering jobs with "social value," and another project pairs local merchants, insurance agents, etc., with engineers who want to learn a new business. To help those still jobless, Wallick is trying to extend community welfare services, such as Red Feather, into the suburbs.

Last November, the IEEE and the AIAA joined forces in 35 cities to sponsor "workshops for professional employment" that provide job research, resume preparation, and interviewing strategies. Counseling is given by private industry and universities, while the Labor Department came up with \$128,000 in funds. But this is only about

Self-help was no help

Arthur D. Tanner is one engineer who, despite the efforts of self-help groups and his own enterprise, is still out of work. Tanner, 49, of Palo Alto, Calif., until November was senior electrical engineer at Kaiser Aerospace & Electronics Corp., Oakland. He has mailed out more than 600 unanswered resumes, tried vainly to form a company, and worked with both Experience Unlimited and the IEEE/AIAA workshops. "It's not that the groups haven't tried to help," he says, "but there aren't jobs available so they're just not much help to anyone." He adds, "I don't think I'll ever work in engineering again; teaching perhaps . . ."

Somewhat more fortunate is Walter F. Miller, 37, who was in component R&D at Texas Instruments Inc., Dallas, until last July when he was "surplussed." Now at Southern Methodist University, he's earning a bit with a teaching assistantship, the GI bill, and a foundation grant while studying for his master's in electrical engineering. But his family needs more, so he's draining his savings and borrowing from the state. Nevertheless, he says, "I've done well. This was a great chance to go to school."

\$3,000-\$4,000 per city, mostly used for mailing and publicity costs.

That's why C. E. Pappas, chairman of the San Francisco workshop worries that the program isn't reaching enough people. "You read of vast numbers of jobless engineers," he says, "but we've seen only 200 of the 2,000-3,000 unemployed in Santa Clara County."

The problem is similar in Seattle, where an estimated 3,000 engineers are jobless, 500 of them EEs. Only a small portion belong to self-help groups and an even smaller percentage actually find new jobs. The Seattle Professional Engineering Employees Association, the so-called union for Boeing engineers, finds only five to 10 jobs a month for members, usually in the Midwest and East. Seattle's Talent Plus, another self-help group, has only about 55 active members—some with jobs—who get instruc-

tion on interview techniques and, if necessary, reorientation to new jobs, such as manufacturing or sales. Members also donate two days a week to help find new jobs and have found about 50 since July.

A local Presbyterian church has taken a different tack—it helped organize Interex Inc., with former Boeing employees to export electronic equipment and industrial machinery. Now it's helping another ex-Boeing group, Intertec Associates, get off the ground.

Dallas generally enjoys a much lower unemployment rate than the rest of the nation, though an estimated 350 EEs are unemployed in the area due to layoffs by Texas Instruments Inc., Ling-Temco-Vought Inc., and General Dynamics Corp. The only program for them is the IEEE-AIAA's—so far about 300 people have attended four sessions, but interest is dropping off. □

Talent pool. Shanta Murthy, the president of a Seattle self-help group, hopes to market products such as this micromanipulator, shown in model.



WHO ELSE BUT UNIVERSAL COULD INTRODUCE A 19-STATION SEQUENCER FOR ONLY \$20,000?

Meet our new Mini-Sequencer for the medium volume user.

In the automatic sequencing of axial lead components, our new Model 2522 Mini-Sequencer—with only 19 stations—is uniquely justified for the medium volume user. And, if increased volume warrants it, 19 more stations may be added.

At \$20,000 the initial cost is less than that of any other comparable 19 station sequencer.

With its rate of over 7,000 components an hour, our Mini-Sequencer can amortize itself early, by drastically increasing pantograph or N/C component insertion machine rates.

The Mini-Sequencer features random access selection, and its EIA tape format permits very simple programming. Sequence length is infinite.

Operationally, the Mini-Sequencer has most of the same features as its big brother, the 39-station Model 2521, but with half the size, and half the price.

As the original and leading producer of such equipment, Universal backs the new Mini-Sequencer with an unmatched 5 years of field experience and testing in the automatic sequencing of axial lead components.

Get all the facts on "the justifiable one". Write for literature, or call the nearest Universal Sales Office for expert guidance from one of our Sales Engineers.

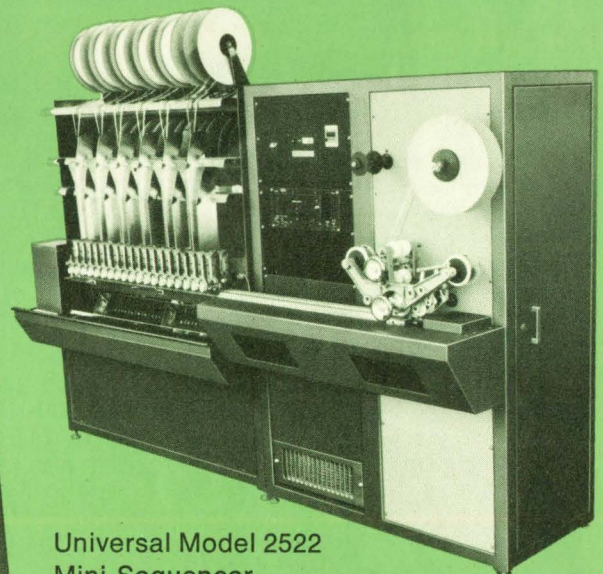

Universal Model 2522
Mini-Sequencer

Universal INSTRUMENTS CORPORATION

East Frederick St., Binghamton, N. Y. 13902
(607) 772-1710 / TWX 510-252-1990

U.I.C. Sales and Service Offices in California: Santa Ana; Connecticut: Hamden; Florida: St. Petersburg; Illinois: Rolling Meadows; New Hampshire: Manchester; New York: Binghamton; North Carolina: Raleigh; Ohio: Columbus; Penna: Philadelphia; Texas: Dallas—as well as Montreal, Toronto, Frankfurt, London, Milan, Paris, Sidney and Tokyo.

Circle 105 on reader service card

Photomechanical reproduction of precision parts is our business

We invented it!

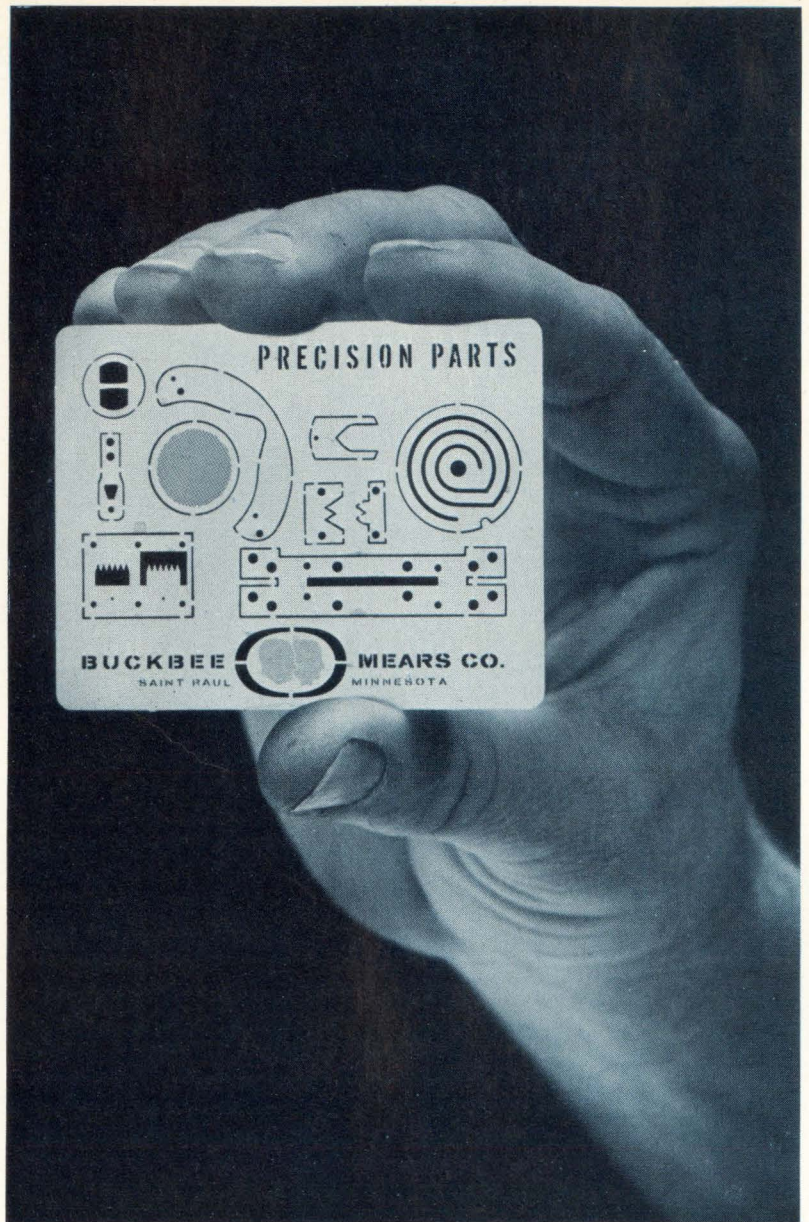

We began precision etching of metal and glass parts for the military during World War II. Today we're the world's largest producer of photo etched metal, glass and electroformed parts. Our new computer-directed automatic plotter is accurate to .001" or better, and it can draw in an hour what would take a draftsman days to do. It's economical, too, because there are no costly dies to make.

METAL ETCHING: We etch round, square, oval or straight holes or lines to tolerances of $\pm .0001$. Currently we are producing shaver grills, hemispheric domes, springs, micro component parts and curved surfaces too complicated for die stamping. We etch mesh, precision circuitry, core loading mats and print out rollers. More than 70 materials have been etched in our plant.

ELECTROFORMING: Our mesh screens go down to four million holes per square inch with accuracy.

Line width tolerances of ± 2 microns are common. Typical production ranges from five to 2,000 lines per linear inch. We electroform copper, nickel, silver and gold. A few standard products include evaporation masks, pin hole apertures, micro-mesh sieves, electron microscope grids, optical wedges, zone plates and a variety of micro-miniature parts.

GLASS ETCHING: We use the same photomechanical techniques in glass etching to provide calibrations and other configurations to tolerances of $\pm .0001$. Straight and cross rulings, calibrated dials, concave and convex reticles, scales, prisms and encoder discs are some of the items we produce in volume.

FREE SAMPLE CARD: The metal card shown on the illustration above contains samples of etched parts we can produce. If you would like one, drop a note to Bill Amundson, Industrial Sales Manager, on your letterhead.

PRECISION METAL AND GLASS ETCHING • ELECTRO FORMING • AUTOMATED DESIGN



BUCKBEE-MEAR'S COMPANY

SAINT PAUL, MINNESOTA 55101

Industrial electronics

Programmable controls hit the line

Barely a year old, versatile controllers are starting to replace specialized relays and hard-wired logic in process control; \$1 billion market envisioned

by Alfred Rosenblatt, *Industrial Electronics* editor

Electronic or electromechanical controls make high-speed industrial production lines hum. But cost-conscious managers groan whenever a changeover to a different production run is necessary—relays and hard-wired logic modules often have to be scrapped. What's needed is flexibility, and that's the bill filled by a series of versatile controllers that have emerged in the last year. Functions in the new units can be modified simply by changing programs and rewriting or replacing memories.

Though not minicomputers (they can't perform arithmetic functions), the programmable controllers operate in a similar manner. The central processor gets orders from read-only or read-write memories to perform all of the counting, sequencing, timing, and logic functions needed in process control. Their cost ranges from \$5,000 to \$12,000, and the programmable units not only are far more versatile than the relay and logic modules they replace, but also are more compact.

There are other advantages, too. The units can be easily interfaced with a minicomputer, which can monitor their performance. In such a setup, at Western Electric Co.'s Merrimack Valley, Mass., plant, a Digital Equipment Corp. PDP-8/L minicomputer keeps a close check on the performance of a five-spindle coil-winder that takes its orders from a PDP-14, DEC's programmable controller. The controller makes it possible to rapidly change over to different types of coils.

Still another advantage is inherent in the programmable nature of

the controllers: a control system design can be debugged with software routines in a minicomputer before the entire system is delivered.

Three companies developed the controllers a little more than a year ago: Information Instruments, now a subsidiary of Allen-Bradley Corp., Milwaukee, Wis., Modicon Corp., Bedford, Mass., and DEC in Maynard, Mass. Since then, other firms have jumped in, but many relay and control-gear manufacturers are still holding back, waiting for the market picture to clarify.

DEC, however, expects sales of the units to begin climbing this year, albeit slowly. Donald E. Chace, PDP-14 product manager, predicts sales volume will reach about \$10 million in 1971. But in five years, say makers, the market for programmable controllers should reach between \$500 million and \$1 billion.

Several manufacturers of conventional relays, solid state logic modules, and control systems have already entered into marketing and sales agreements with the original developers. Allen-Bradley, for example, acquired Information Instruments. And late last summer General Electric Co.'s General-Purpose Control department, Bloomington, Ill., announced its PC-45 controller, which—although it has never been officially announced—is Modicon's 084 unit. At about the same time the Square D Co.'s Industrial Controls division, Milwaukee, announced it would market DEC's unit and also develop a smaller programmed controller.

Latest to introduce a unit is Reliance Electric Co., Cleveland: its Automate 33 is the first controller to offer a cathode ray tube display for entering in and reading out programs. And others are either about to introduce units or are studying the programmable controller market. For example, Struthers Dunn Inc., a Pitman, N.J. relay manufacturer, reportedly is showing a small controller to potential customers. And Cutler Hammer Inc., Milwaukee, a relay module supplier, says it's "interested" in the new controllers but won't say yet whether it intends

Versatile. Functions of control units, such as GE's PC 45, can be altered simply by changing programs on a portable punch-in panel.

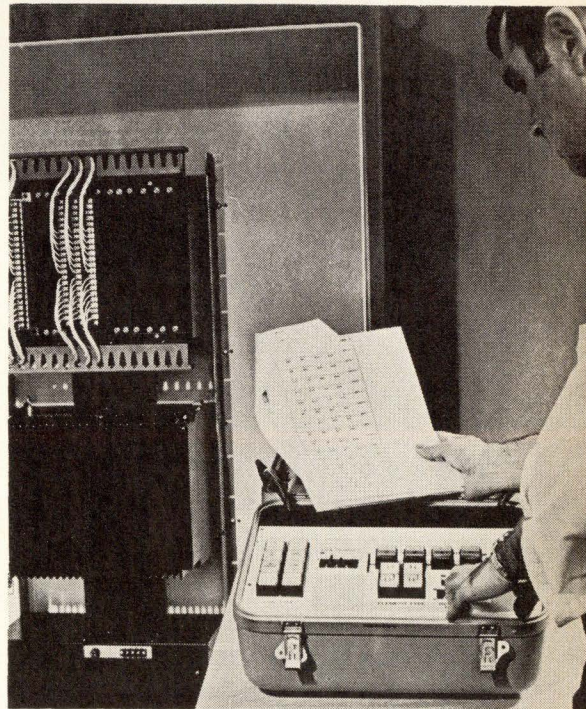

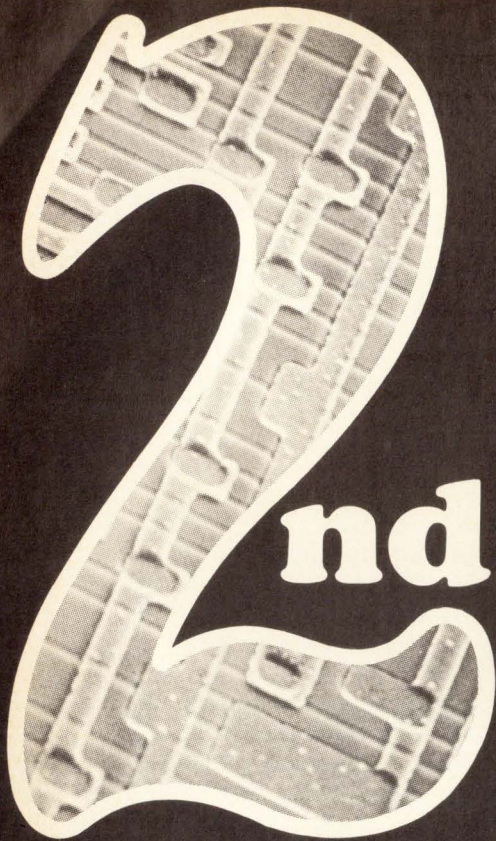

source yourself

**NORTEC will deliver
25 working LSI circuits
to your completed custom
design in less than
30 days for \$3450.**

What processes do you need? We can build MOS/LSI parts using PMOS hi or lo threshold, MNOS (Nitride), NMOS (N-channel), CMOS, or PSOS (silicon gate) for short trial runs or production quantities.

And we also deliver you *complete ownership* of production masks and testing programs. You're your own second source at NORTEC. Plus, whether you own a part but not the tooling . . . or, the tooling but not a part . . . either or both . . . there's an alternate plan at NORTEC.

Ask our local office about our special trial offer. Phone, LA: (213) 541-1186; NY: (516) 997-9830; Santa Clara: (408) 732-2204. Or write: NORTEC Electronics, 3697 Tahoe Way, Santa Clara, California 95051.

NORTEC 
ELECTRONICS CORPORATION

Probing the news

to make the programable units.

Plant engineers and makers of machine control systems are excited over the potential of the controllers. "The programable units allow the engineer to design the control system that makes his assembly machine work," reports John Drake, assistant supervisor of manufacturing development at Packard Electric, Warren, Ohio, a supplier of wiring harnesses for automobiles. "He can do the entire job himself, without having to bring in any electronic or programming consultants."

And Snyder Corp., Detroit, which now supplies a PDP-14 controller with its transfer machines

that turn out parts for automobile engines, says that the 40-inch-high by 18-inch-wide controller takes up only half the space required by conventional solid state control systems at about the same price.

Controller manufacturers, however, are reluctant to make direct cost comparisons between programable units and the equipment they replace. Most concede the new units may cost more initially but point to the savings potential inherent in reduced maintenance and when changeovers to new control sequences must be made. DEC's Chace maintains that the programable controllers can economically replace anywhere from 50 to 300 separate relay modules. DEC does, however, sell a smaller, less-expen-

On line. A DEC PDP-14 controller and a PDP-8/L minicomputer help Western Electric reduce maintenance and lower downtime of coil winder.

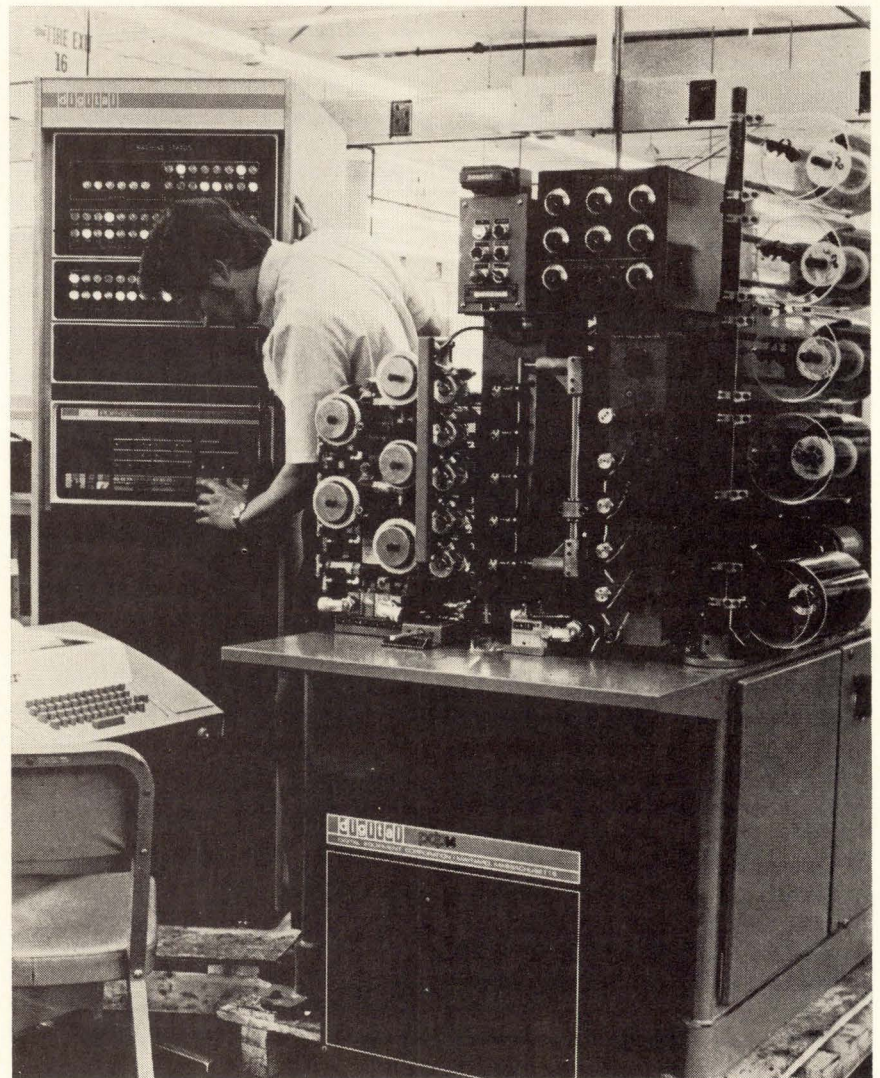

←Circle 108 on reader service card

sive unit—the PDP-14/L for systems requiring as few as 20 relays—and Information Instruments also is working on a similar minicontroller as a complement to its PDQ-2.

Biggest purchasers of the programmable controllers are automobile manufacturers. General Motors' Hydra-Matic division in Ypsilanti, Mich., has some 19 units on order, most to be used on its new transfer machines for auto transmissions, according to supervisor William S. Stone.

The programmable controllers are all solid state and contain some integrated circuits in their processor sections. They are sealed to withstand the severe noise and electrical environment found in many industries.

Volume and weight vary with the type of controller. A PDQ-2, for example, with one 90-pound input/output package, providing anywhere from 16 to 64 inputs and outputs, is 46 inches high, 32 inches wide, and 9½ inches deep. Its logic and memory weigh 107 pounds.

Read-write core memories are used in most controllers; the PDP-14 uses a read-only braided wire memory. Memory capacity and the number of inputs and outputs vary with the unit—the Modicon 084, for example, has 1,800 16-bit words with 128 inputs and outputs, and PDQ-2 from 1,000 to 4,000 eight-bit words and 256 inputs and outputs.

Programing methods vary. With the PDP-14, for example, a PDP-8 is needed to translate the logic diagram for a control system into instructions to be written in the controller's memory. Modicon will develop a program for the customer, then transmit the program over telephone lines to the customer's unit for entry into the core memory. A telephone interface module with a read-only memory on a printed circuit card contains loading instructions needed for reading information into or out of the unit's core. And both the GE and Modicon units offer a \$4,000 programmer's panel that allows logic instructions for a control system to be entered directly into the core memory without using a special programming language. □

Two opportunities for success

Record your test results with a Kienzle* Digital Printer

The Kienzle Digital Printer will print out all the data from your data source and will give you instant print-out.

Kienzle* Digital Printers offer outstanding advantages: Parallel input, incorporated interrogation unit for BCD or decimal outputs.

They are available as tape printers or with carriage, and with optional card or tape punch.

Represent the Kienzle Digital Printer in the U.S.

Kienzle is one of Europe's leading manufacturers of data processing systems with an excellent line of products. Our many satisfied customers are our best recommendation. Only Kienzle offers such a wide choice of Digital Printers with parallel input.

We are looking for well-established companies who can successfully market our instruments and provide proper service.

Visit us during the I.E.E.E. Show third floor booth 3737-3838

Kienzle Digital Printers will be on display.

Please stop in at our booth and discuss details with us.

Drop us a line and we will gladly forward descriptive literature.

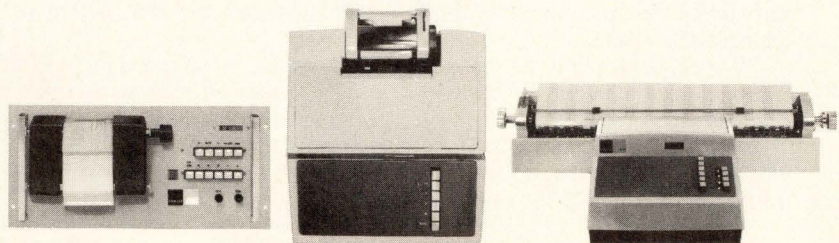

* pronounced Kinsler by the way

**Kienzle Apparate GmbH · 7730 Villingen/West Germany
Postfach 1640 · Telex 07-92838**

Computers

IBM guns failing to sink independents

Peripherals firms' profits will shrink after IBM's effective price cuts, but there's been no major shakeout so far and sales are expected to soar in '71

by Wallace B. Riley, Computers editor

It was a worried bunch of independent peripherals companies when IBM late last year effectively cut prices on its most popular tape drives and disk units. IBM was fighting to retain its share of a market rapidly being eroded by the fast-growing independents, who were promising—and often delivering—“more bang for less buck.” But though profit margins for the independents will be leaner this year since they were forced to cut their own prices, these firms may not have been hurt as badly as they initially had thought.

In fact, despite IBM's pricing pressure, one market watcher, International Data Corp., Newton-

ville, Mass., sees independents' revenue growing by a mighty 26% to \$720 million this year, up from an estimated \$570 million in 1970. The softness of the economy probably plays a big role here: computer operators find they can save money by adding plug-to-plug-compatible equipment—mainly tape and disks—rather than buying a new, larger system.

The continued strength of the independent peripherals makers represents a break for the customer. Not only will prices drop, but the independents' faster turn-around capability will bring new technology into the marketplace more rapidly. And, of course,

there's nothing like competition to move IBM.

Commenting on the independents' ability to bring out new products quickly, Richard Baker, vice president for sales and marketing at Fabri-Tek Inc., a Minneapolis peripherals maker, says, if an independent peripheral maker offers a higher-performance device that's truly compatible with IBM's product, IBM can't easily turn around with something as good or better without greatly increasing its costs. IBM can't get into a specification-upgrading race with the independents because to keep its cost down it has to produce in volume, he notes. And John Labby, marketing manager of the Bryant Computer Products division of Ex-Cell-O Corp., Walled Lake, Mich., adds, in general, the price difference between IBM's products and those of its competitors is due mostly to overhead.

One measure of IBM's overhead is the spread between its manufacturing costs and selling prices. An industry observer reports that manufacturing costs for the company's 2311 disk drive were about \$1,600 and selling price was \$24,000—a 15-to-1 markup.

Even so, independents found their competitive position of underselling the big computer maker shaken for the first time late last year by IBM's three-pronged attack. Not only did it continue to introduce new peripherals offering much higher performance than existing models at only slightly higher prices, but it also announced models that offered essentially identical performance at much lower cost. And it dropped extra-

Cheaper—and better?

Independent makers usually try to improve their peripherals over IBM units to avoid the patent and licensing problems of making carbon copies. But it's not easy. True functional equivalency limits designers to minor performance gains like faster movement of the arm holding the read-write heads to reduce access time. Other improvements, such as changing data storage density by crowding more tracks onto a disk surface, are out because the computer's software won't support such changes. But the independents maintain they've still managed to offer better peripherals than IBM.

“We've beat them in technology,” maintains a spokesman at Telex Corp., Tulsa, Okla. “We've had the most advanced disk pack drive in the industry and have had it since August of 1969. IBM has never delivered one as fast as ours.” And Memorex Corp., Santa Clara, Calif., claims a faster access time for its 630 and 660 disk drives, equivalent to IBM's 2311 and 2314 units, respectively.

Ampex Corp.'s Computer Products division takes a similar tack with its disk drives, but says it hasn't improved on IBM's performance in its tape drives. Instead, the company's prices are a little lower than IBM's. “We started four years ago to make very low-cost tape drives because of a management concept that said that regardless of how good the sales department, price erosion will continue,” says William Slover, marketing manager. “So we've done things like substituting plastic doors for metal ones, put plastic underlays under glass instead of using the more expensive smoked glass, and gone right down to putting five-cent knobs in place of 10-cent knobs.”

HOW CONNECTIONS ARE MADE WITH GARDNER-DENVER WIRE-WRAP TOOLS.

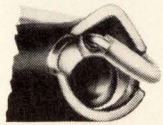

Wire is inserted into bit and sleeve.

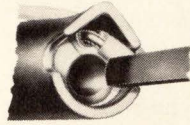

Bit and sleeve are moved over terminal.

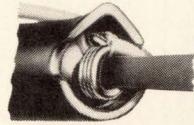

Bit turns, winding wire around terminal.

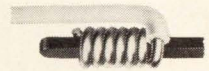

The completed solderless connection.

WIRE WRAP IS A TRADEMARK OF GARDNER-DENVER COMPANY

Gardner-Denver Company manufactures a complete line of solderless terminating equipment. This equipment consists of manual tools, air and electrically operated tools, terminal locators, and the completely automatic Wire-Wrap machine.

CAUTION PLEASE . . .

The term Wire-Wrap should be used only to identify these products of Gardner-Denver Company. Wire-Wrap should never be used to describe similar equipment, tools, or components made by any other manufacturer. Wire-Wrap should not be used as a generic term to describe solderless connections in general.

GARDNER-DENVER

Gardner-Denver Company, Quincy, Illinois 62301
Sales and Service Offices in Principal Cities



The Material of Unlimited Uses...

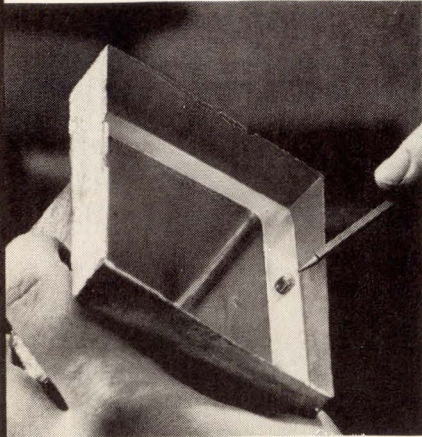

INSTANT DIP-A-MOLD

In seconds, you can make perfect molds, like this one, for potting any encapsulation, and make them economically, with low-melting CERRO® Alloys. Just dip the master in molten alloy. A thin coating of alloy clings to the pattern. Withdraw the pattern, and you have a perfect high fidelity mold. When the encapsulating plastic cures, simply remove the CERRO Alloy. Use it over and over again, almost without limit.

This particular alloy—CERROTRU®—does not shrink, slips easily from the pattern without parting or contaminating compounds or coatings. Because of its low melting point, it is safe and easy to handle.

You can reproduce such unusual details as positioning lugs for transformer cases, as shown above, without the use of cores, inserts or secondary operations.

Instant molding is just one of the many uses for CERRO Alloys. To find out more, contact Cerro Copper & Brass Co., Alloy Dept., Bellefonte, Pa. 16823. Telephone (814) 355-4712. In Europe, contact Mining & Chemical Products Ltd., Alperton, Wembley, Middlesex, England.

CERRO®

Probing the news

time charges on some equipment, thereby allowing 24-hour, seven-day use of the peripherals at the same charges as for one-shift use, five days a week.

"IBM has cut price," says William Sharpe, vice president, marketing, of Potter Instrument Co., Inc., Plainview, N.Y. "It's just as simple as that. It certainly impacts the profitability of the independents; but it doesn't mean the independents can't compete with IBM any more. It just means competing is a little tougher now."

Meanwhile, the independents are grumbling about IBM's latest apparent roadblock: holding back interconnection specifications for some of its new equipment. IBM says it will, as required by law, release specifications when it ships the first units, giving the computer maker an important leg up on independents. "As an independent supplier, we're somewhat aggravated by the delay," says Fabrik-Tek's Baker. "As long as IBM dominates the industry, I think this information should be more readily available," he says.

IBM opted to introduce new, lower-priced peripherals virtually identical with earlier models rather than cut prices on existing gear. It took this tack apparently to keep even the possibility of Government antitrust action at a minimum. None of the independents so far has challenged the legality of IBM's move, though several feel a case could be made. "We feel IBM has been very selective in its efforts to curtail competition," says Robert J. Daniel, manager of planning at Information Storage Systems Inc., Cupertino, Calif. "As a member of the Peripheral Manufacturers Association, we've stated our position [to the Government] that IBM is trying to curtail our position in the market."

Some estimates show that independent peripherals manufacturers have made off with as much as 15% of IBM's market, and IBM is angry to the point of irrationality, comments Frederick G. Withington, a senior staff member at Arthur D. Little, Inc., Cambridge, Mass.

But he feels the computer maker may be cutting off its nose to spite its face: "IBM's loss of revenue [resulting from these price cuts] may be greater than the cost of business lost to the independents."

Nevertheless, he feels that "it's not certain that they [the independents] all will survive. There will be a shakeout," he says. "But the leaders may have much greater business in five years." However, only one independent, BASF Systems, Inc., Bedford, Mass., has withdrawn from the plug-to-plug-compatible market so far, and peripherals were only a small part of its line.

One important factor in the independents' future is equipment rentals. IBM has an advantage here: it created a market for renting in the years when it had a monopoly on computers and peripherals and didn't sell its gear outright. And it also can afford to trade off tying up a lot of capital in rented machines against the higher profits rentals bring. Coupled with its lower manufacturing costs, IBM can realize a profit in this sector sooner than the independents, particularly with today's lower prices. According to one estimate, it takes a year to a year and a half for independents to recover manufacturing costs while IBM can recoup its costs in only three months. However, ties with third-party leasing companies are helping the independents' capital situation.

Watching the IBM-independents battle on the sidelines are other major computer makers, who maintain that IBM's pricing actions don't affect them directly. But Harry Steinberg, vice president-controller of the Univac division of Sperry Rand Corp., Blue Bell, Pa., points out that although the recent IBM pricing moves "were not aimed at other major computer manufacturers as much as at the peripheral manufacturers, the IBM price is always a major consideration and one of the real benchmarks for us in evaluating our pricing." To that extent, he reports, Univac is now weighing the latest IBM moves to determine what response, if any, it will make. To date, though, no major computer maker has cut prices on its peripherals. □

\$35 Lambda-Pak™

FIELD REPAIRABLE, ADJUSTABLE VOLTAGE AC TO DC SINGLE AND DUAL OUTPUT POWER SUPPLIES

"Unencapsulated" regulated supplies designed to power operational amplifiers, linear and digital integrated circuits and transistor circuitry. Ideal for equipment where low power, small size, PC board mounting and low costs are essential.

Voltage and current ratings

LZ-10 SERIES SINGLE OUTPUT MODELS 2 1/2" x 3 1/2" x 7/8"

Model	Voltage ⁽¹⁾ VDC	Current mA	Price ⁽²⁾
LZS-10	5	450	\$35
LZS-11	12	195	35
LZS-11	15	150	35

LZ-20 SERIES SINGLE OUTPUT MODELS 2 1/2" x 3 1/2" x 1 1/4"

Model	Voltage ⁽¹⁾ VDC	Current mA	Price ⁽²⁾
LZS-20	12	268	\$55
LZS-20	15	300	55
*LZD-22	24	73	40
*LZD-23	24	129	55
*LZD-22	28	84	40
*LZD-23	28	143	55

*Single output ratings for dual output models connected in series

LZ-30 SERIES SINGLE OUTPUT MODELS 2 1/2" x 3 1/2" x 1 7/8"

Model	Voltage ⁽¹⁾ VDC	Current mA	Price ⁽²⁾
LZS-30	5	900	\$65
LZS-33	12	336	65
LZS-33	15	400	65
*LZD-32	24	186	65
*LZD-32	28	208	65

*Single output ratings for dual output models connected in series

LZ-20 SERIES DUAL TRACKING OUTPUT MODELS 2 1/2" x 3 1/2" x 1 1/4"

Model	Voltage ⁽¹⁾ VDC	Current mA	Price ⁽²⁾
LZD-21	± 5	300	\$55
LZD-22	±12	73	40
LZD-23	±12	129	55
LZD-22	±15	90	40
LZD-23	±15	150	55

LZ-30 SERIES DUAL TRACKING OUTPUT MODELS 2 1/2" x 3 1/2" x 1 7/8"

Model	Voltage ⁽¹⁾ VDC	Current mA	Price ⁽²⁾
LZD-31	± 5	500	\$65
LZD-32	±12	186	65
LZD-32	±15	220	65

NOTES: (1) LZ Models are adjustable between the following limits: LZS 10 2 to 6V LZD 23 ±8 to ±15V
LZS 11 8 to 15V LZS 30 2 to 6V
LZS 20 8 to 15V LZD 31 ±2 to ±6V
LZD 21 ±2 to ±6V LZD 32 ±8 to ±15V
LZD 22 ±8 to ±15V LZS 33 8 to 15V

Consult factory for current ratings or voltages not listed above.
(2) Prices are U.S.A. list prices only, F.O.B. Melville, N.Y.; North Hollywood, California; Montreal, Canada. All prices and specifications are subject to change without notice.



FEATURES

Outputs

Single and dual (tracking) outputs

Regulation

0.15%—line or load

Ripple and Noise

1.5 mV RMS, 5 mV, pk-pk

Temp. coefficient

0.03%/°C

Tracking accuracy

2% absolute voltage difference (dual output models only) 0.2% change for all conditions of line, load and temperature

Ambient operating temperature

continuous duty from 0°C to +50°C

Wide AC input voltage range

105 to 132 Vac, 57-63 Hz

Storage temperature

—25°C to +85°C

60-day guarantee

LAMBDA
ELECTRONICS CORP.

A Veeco Company

Lambda's Distributor Division maintains a total inventory of over 10,000 power supply units located in Los Angeles, Montreal and New York for 1-day delivery.

515 Broad Hollow Road, Melville, Long Island, New York 11746 • Tel. 516-694-4200 • TWX 510-224-6484.

North Hollywood, California 91605—Telephone: 213-877-0041; Pointe Claire, Quebec, Canada—Telephone: 514-697-6520.

Military electronics

Intrusion detectors score in Laos

DOD claims Igloo White's third-phase seismic and acoustic sensors have helped Air Force destroy 80% of enemy supplies along Ho Chi Minh Trail

by Ray Connolly, Washington bureau manager

Air-dropped seismic and acoustic sensors have made it possible for U.S. aircraft to locate and destroy 80% of North Vietnamese military supplies pouring down the Ho Chi Minh Trail through Laos. Since the beginning of the dry season in October, senior defense officials estimate some 26,000 tons of supplies—nearly twice as much as the year before—have been put on the trail network, but “only 20% has made it through.” The sensors were developed under the Igloo White Program of the Defense Communications Planning Group [*Electronics*, Feb. 1, p. 22].

Success of the Igloo White effort in tracking trucks and other vehicles down the Laotian trail and locating truck parks for Air Force bombing led Deputy Defense Secretary David Packard in January to turn the development program over to the Air Force as an operational system.

Security prevents planning group and Air Force officials from identifying the suppliers of three main

Igloo White components now in their third generation—an acoustic/seismic intrusion detector (Acousid 3), the air-delivered seismic intrusion detector (Adsid 3W), and the AN/GSQ-187 commandable microphone (Commike 3). However, informed sources say suppliers of such tamper-proof hardware, with self-destruct circuits, include Western Electric Co.'s Sandia Corp., Albuquerque, N.M., Hazeltine Corp., Little Neck, N.Y., Magnavox Co., Ft. Wayne, Ind., and Texas Instruments, Dallas.

Opening up discussion about Igloo White and other sensor programs that were classified up to now is clearly designed to impress the Congress that intrusion detection money is well spent. And data on Igloo White's third-phase hardware is impressive. Any of the three components can be employed separately, though the camouflaged, spearlike tubes containing the acoustic/seismic and seismic intrusion detectors are most often dropped in strings of six to nine

from high-speed aircraft so they will implant themselves in a row near the trail. The sensors, as well as the microphone acoustic unit which hangs by its parachute in a tree, both contain transmitters and receivers which can be commanded to operate at different frequencies. Any or all of these transmit to EC-121R aircraft or the smaller, cheaper Pave Eagle, a modified, light commercial plane used to relay signals to ground-based infiltration surveillance centers which perform computer analysis and, when necessary, call in air strikes.

The high degree of automation in the overall Igloo White program is indicated in this Air Force senior officer's description of system operation: “As a truck convoy passes a string, it activates the sensors, one after the other. From the activation pattern, the computer determines convoy direction and speed, and predicts time of arrival at a point further down the road designated as a strike zone.” Successive sensor strings update and refine this data, he points out, so that “estimated time of arrival of the convoy at point X and the coordinates of that point are passed to F-4 fighter-bombers. The pilots enter this data into the aircraft computers. This gives the course to steer and programs an automatic release of the aircraft's ordnance.”

Senior defense officials add that truck parks hidden in heavily-canopied jungle areas or caves can be detected by Igloo White sensors when a convoy passes the first string but fails to activate a second string further along the trail. If this happens several times a night,

The Army's inventory

Army officials attribute lower war zone casualty rates to seismic detectors also developed initially through the Defense Communications Planning Group. Suppliers of the three most popular units range from Texas Instruments, to the smaller, lesser known Dorsett Electronics Inc. of Tulsa, Okla., Research Inc.'s R-1 Controls division, Minneapolis, Minn., and Resdel Engineering Corp., Pasadena, Calif.

Dorsett, for example, makes the AN/GSQ-151 patrol seismic intrusion detector, an Army package of potted discrete components about the size of a brick that can be set to detect footfalls of as few as two or three men. TI makes the smaller AN/GSQ-159 disposable seismic intrusion detector for about \$200; it contains self-destruct integrated circuits, as does the company's \$400-plus microminiaturized version labeled the AN/GSQ-158v. Resdel makes the portable AN/USQ-46 RF monitor set for Army patrols, according to equipment labels.

when
it
comes
to
power
supplies

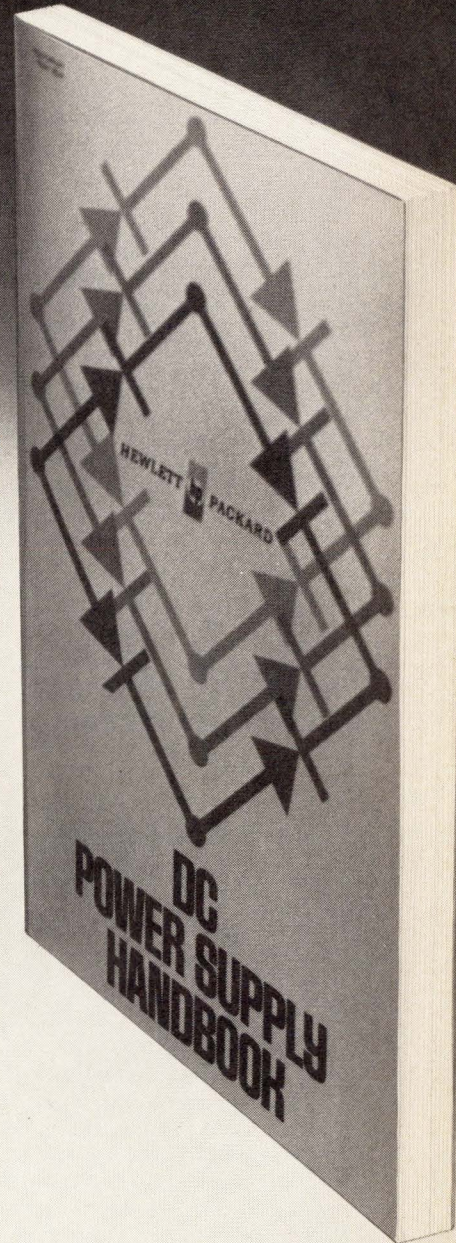
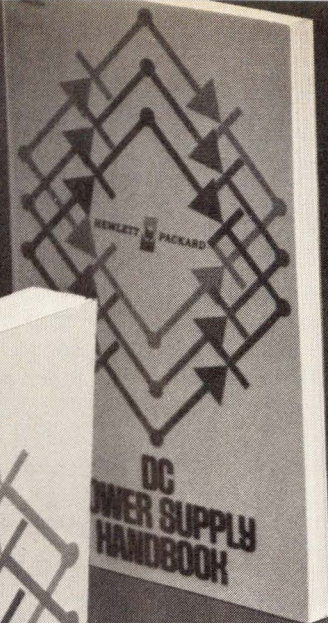
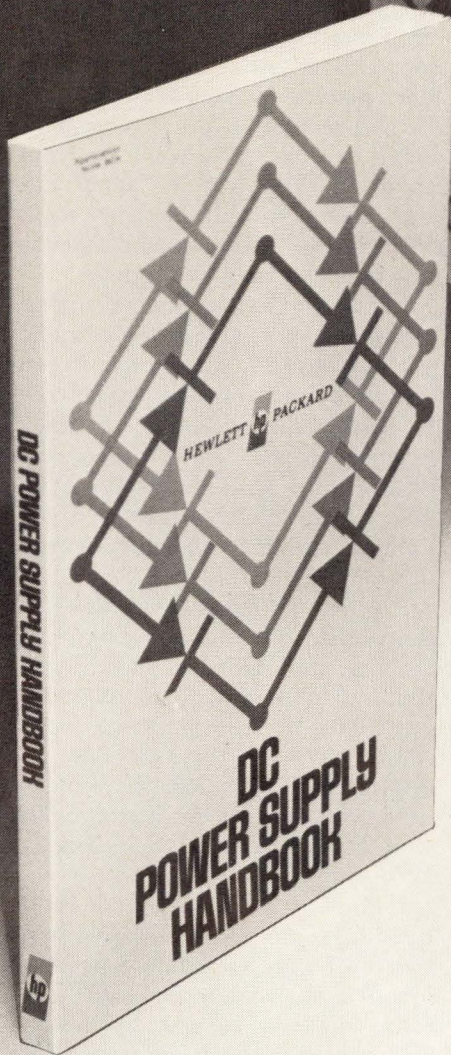

HEWLETT **hp** PACKARD

wrote the books...

... Definitions, principles of operation, load connection, remote programming, performance measurements ... it's all here and more in this 140 page **Power Supply Handbook** ... yours for the asking. Write for your copy.

**PLUS...A NEW
Power Supply
Selection Guide...**

This 36 page selection guide lists over 100 power supplies and makes it easy to find and select the right one for your specific application ... Includes ratings, performance, features, prices, options, etc. **For Your Copy Check Number 320.**

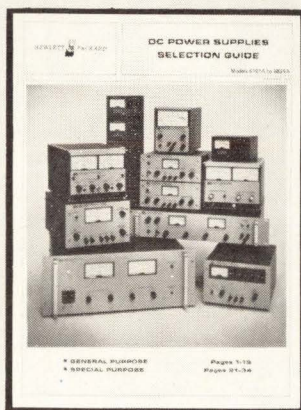

HEWLETT **hp** PACKARD

POWER SUPPLIES

100 Locust Avenue, Berkeley Heights New Jersey 07922 • (201) 464-1234

Whatever your load moving problem . . . Ledex has the answer!

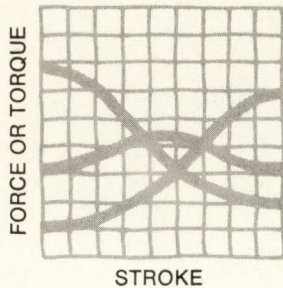

Whether it's rotary or linear motion, a lot of wallop at the beginning, in the middle or at the end of the stroke, or if it's fast response you're after . . . Ledex has the answer to your load moving problem.

If you need fast, direct rotary motion, pick from eight basic *Ledex rotary solenoids*. Available with rotary strokes from 25° to 95° and up to 117 lb. in. of torque.

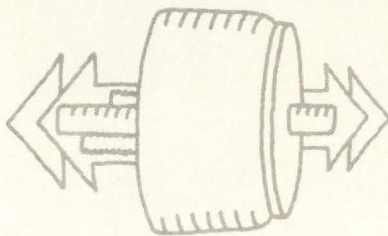
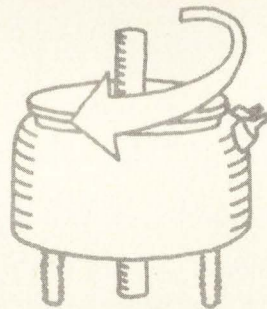

If your application calls for a short or medium length stroke, consider *Ledex push or pull solenoids*. Seven sizes . . . with flat face plungers for short strokes to .060 inch or conical face plungers for

strokes to .390 inch. Force to 85 pounds. Response time less than 10 milliseconds.

For long stroke linear applications . . . *Ledex long stroke, straight pull solenoids*. Four sizes . . . strokes to .750 inch, force outputs to 20 pounds.

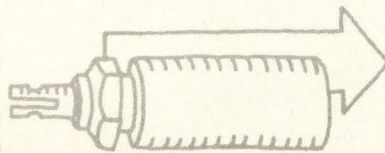

To give you quick starts on your prototypes, small runs you need in a hurry or critical spares, Ledex stocks over 300 solenoid models. If none of these fit your exact requirements, our willing and experienced engineering staff works with you to come up with a custom solution.

Write today for an up-to-date set of *Ledex Solenoid Catalogs* . . . Rotary, Push/Pull, Straight Pull . . . with specifications and application information.

Specialists in remote actuation



LEDEX INC.

123 Webster Street, Dayton, Ohio 45401, phone (513) 224-9891

or if the first string reports trucks heading north that were never reported by a southern string, then visual air reconnaissance craft check likely truck park areas and drop more sensors to locate a park for a later strike. Igloo White's third-generation sensor survivability and reliability "are way up," officials say, and costs are down from about \$2,000 apiece to "about \$1,000." Acousid units are used most often in the seismic mode, officials say, to conserve battery power.

In addition to pre-planned strikes based on time and convoy traffic patterns, the Air Force says it can call in planes loitering above the Ho Chi Minh Trail area for quick reaction strikes. Under this operation, known as Commando Bolt, planes can deliver ordnance in six to nine minutes following convoy detection.

Present Pentagon estimates are that truck kills through bombing, strafing, and gunship attacks are running at a rate of about 100 a day. Since the end of the monsoon season last fall, say officials, an estimated 7,000 trucks have been destroyed, of which about 5,000 were knocked out between Nov. 1, 1970 and Jan. 31, 1971.

If then the sensors and truck bombings are so successful, why did the South Vietnamese need to invade Laos to cut the trail? Defense officials answer by noting that there is a big difference between periodically interrupting trail traffic with air strikes and cutting the trail altogether. And they point out that bombing trucks that cost a few thousand dollars each, while risking aircraft priced at several million dollars each, doesn't make for a very cost-effective war.

They also point to costly ordnance and the \$1 billion-plus price-tag of the Defense Communications Planning Group's sensor program, of which Igloo White is a part. "It's the difference between using an aerosol spray or a flyswatter to kill mosquitoes," one official points out. "Both can do the job, but one is a lot cheaper—especially when you're faced with lots of mosquitoes." □

HOW LOW CAN WE GET?

We looked at the competition, then built a better potentiometer, the Model 3006, a low cost cermet unit for PC board use.

Here's how we did it:

GAVE IT MORE POWER

$\frac{3}{4}$ watt at 70°C

MADE IT SURER

superior setability: longer element, 15 turns and 16 independent wiper contacts to make sure

SEALED IT TIGHTER

to Mil-R-22097

BUILT IT LOWER

only $\frac{1}{4}$ " off the board

PRICED IT LOWER

only 81¢ in 25,000 piece quantity, much lower for more

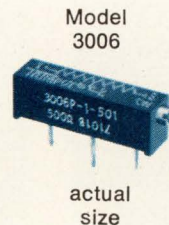

Send for full data on the 3006, and we'll send along dramatic proof of how tough a little unit it really is.

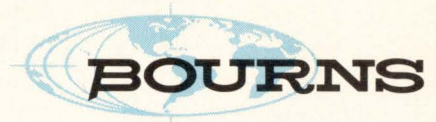

Choose from 47 styles of film capacitors... There's one to meet your exacting requirements

HERMETICALLY-SEALED METAL CASE TUBULAR CAPACITORS



BARE METAL CASE

Style LJ8, metalized polysulfone film
Style LP8, metalized polycarbonate film
Style LM8, metalized PETP-polyester film
Style LS8, metalized polystyrene film
Style AP8, polycarbonate film
Style AM8, PETP-polyester film
Style AS8, polystyrene film
Style AF8, PTFE-fluorocarbon film

METAL CASE WITH INSULATING SLEEVE

Style LP9, metalized polycarbonate film
Style LM9, metalized PETP-polyester film
Style LS9, metalized polystyrene film
Style AP9, polycarbonate film
Style AM9, PETP-polyester film
Style AS9, polystyrene film
Style AF9, PTFE-fluorocarbon film

WRAP-AND-FILL ROUND TUBULAR CAPACITORS



Style LJ66, metalized polysulfone film
Style LP66, metalized polycarbonate film
Style LP88, met. polycarb. film (Fuz-ion Sealed*)
Style LM66, metalized PETP-polyester film
Style LS66, metalized polystyrene film
Style AP66, polycarbonate film
Style AM66, PETP-polyester film
Style AS66, polystyrene film

EPOXY-CASE RECTANGULAR CAPACITORS



AXIAL-LEAD

Style LP7A, metalized polycarbonate film
Style LM7A, metalized PETP-polyester film
Style LS7A, metalized polystyrene film
Style AP7A, polycarbonate film
Style AM7A, PETP-polyester film
Style AS7A, polystyrene film

RADIAL-LEAD

Style LP7S, metalized polycarbonate film
Style LM7S, metalized PETP-polyester film
Style LS7S, metalized polystyrene film
Style AP7S, polycarbonate film
Style AM7S, PETP-polyester film
Style AS7S, polystyrene film



WRAP-AND-FILL OVAL TUBULAR CAPACITORS



Style LP77, metalized polycarbonate film
Style LM77, metalized PETP-polyester film
Style LS77, metalized polystyrene film
Style AP77, polycarbonate film
Style AM77, PETP-polyester film
Style AS77, polystyrene film

HERMETICALLY-SEALED METAL CASE RECTANGULAR CAPACITORS



Style CML, high voltage paper/PETP-polyester film, inserted tab construction.

HERMETICALLY-SEALED CERAMIC CASE TUBULAR CAPACITORS



Style SML, high voltage paper/PETP-polyester film, inserted tab construction.
Style SMLC, high voltage paper/PETP-polyester film, extended foil construction.

HERMETICALLY-SEALED GLASS CASE TUBULAR CAPACITORS



Style GML, high voltage paper/PETP-polyester film, 85 C
Style GTL, high voltage paper/PETP-polyester film, 125 C

EPOXY CASE RECTANGULAR CAPACITORS



Style EFX, high voltage paper/PETP-polyester film.

*Trademark

For engineering bulletins on the capacitor styles in which you are interested, write to Dearborn Electronics, Inc., Box 530, Orlando, Fla. 32802.

Dearborn Electronics, Inc.
(a subsidiary of the Sprague Electric Company)

FOREMOST IN FILM CAPACITORS

MOS/LSI tester is versatile and flexible

Spartan 770 can be used for engineering diagnosis and production tests of a variety of digital IC arrays

The story is familiar: an MOS/LSI manufacturer can't find the features he wants in a commercially available test system, so the company decides to make its own. But there are some new twists in the plot at General Digital Corp., Newport Beach, Calif. For one thing, it's somewhat unusual for an MOS/LSI house that hasn't formally announced a circuit product or custom chip development contract to come out with an LSI tester as its first product [*Electronics*, Dec. 21, 1970, p. 26].

But the move is part of the business plan Alvin B. Phillips put together when he founded General Digital last April—and that's the second unusual twist. Phillips is president and chairman, and he knew from experience at what is now North American Rockwell Microelectronics Co. that his company would need a versatile MOS/LSI tester. He planned from the start to market the unit, not treat it as an afterthought. The people he attracted to develop the Spartan 770 include Baden Parker and John Glade. Parker helped organize and train the group that developed NRMEC's mainstay production test systems and Glade was one of the chief circuit designers.

This experience has been put to good use in what Phillips thinks is as versatile an MOS/LSI test system as there is to date. The Spartan

770 can be used in both engineering diagnostic tests and production testing of all digital MOS/LSI arrays—random logic, shift registers, and read-only and random access memories. And it can do parametric or functional testing, plus dynamic multiphase testing at data rates ranging from 100 hertz to 5 megahertz.

The unit doesn't include a general-purpose minicomputer; Phillips and Parker think that's one of its strengths. It does use a special-purpose mode-control computer that provides overall system and multiplex controls, and coordinates the interfacing of the Spartan 770's main panel controls and indicators with the rest of the system. It also operates input and output data, and provides the clock pattern memory. This special-purpose controller can be programmed automatically with punched cards

or tape, or manually through the front panel.

This automatic or manual control feature will be persuasive with MOS manufacturers, General Digital officials believe. Makers have to debug devices before committing them to production, and the Spartan 770's front panel controls allow considerable freedom in the engineering diagnostic stage. Says Parker, "The usual tester is addressed by means of a Teletype to an on-line computer. This requires special software for diagnostic testing." He feels that with the degree of hands-on control the Spartan 770's front panel provides, the test engineer will feel more at home than he does using a teletypewriter input, and he won't need extensive minicomputer software.

The diagnostician can dial in through the front panel all voltage levels for power supplies, clocks,

Initial entry. The Spartan 770 MOS/LSI test system is the first product of General Digital Corp., a device maker. Front panel permits hands-on operation. Programming by punched cards or tape is also possible.

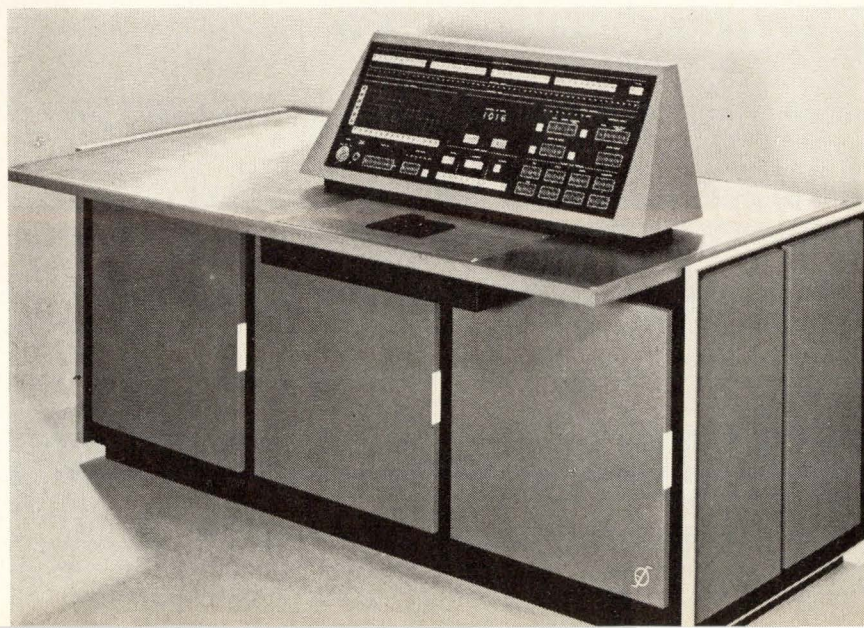

HICKOK

Portable Multimeter

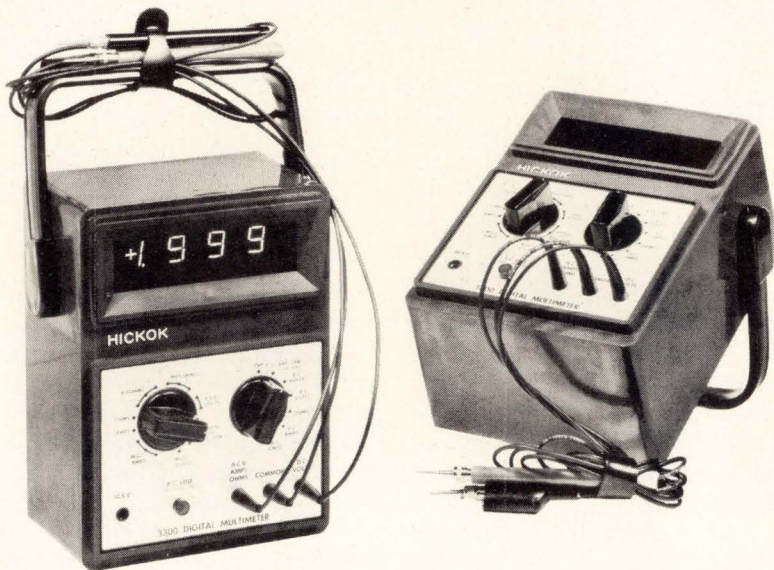

- Hickok's new Model 3300 3 1/2 digit multimeter has 26 ranges of ac-dc voltage and current, and ohms.
- Ranges are 100.0 millivolts to 15.00 kilovolts, 1.000 milliamp to 1.999 amps, 100.0 ohms to 199.9 megohms.
- Measurement conveniences—automatic zeroing and polarity, constant input Z, LSI reliability.
- Operates 24 hours off internal battery pack (more than anyone else's). And the battery pack is standard.
- Recharges overnight (faster than others).
- Or, operates off the ac line, even during the recharge cycle.
- Goof-proof, even in less experienced hands—solid state circuitry is overload protected.
- Rugged case is impact-resistant and shockproof.
- Price: **\$395**, including nicad battery pack.

Really, should you pay more?
And maybe get less?

HICKOK

INSTRUMENTATION &
CONTROLS DIVISION
10514 Dupont Ave.
Cleveland, Ohio 44108
Phone 216-541-8060

New products

input drivers, and comparator reference using thumbwheels. Thumbwheel control also is provided for such functions as setting clock rates, inhibiting clock phases, and selecting any input/output pattern in the system's memory. The memory uses bipolar RAMs to provide 40 data channels of 1,024 bits each that are programmable in one-bit increments, and up to 52 pins.

The front panel also includes 40 pushbuttons to permit manual loading of the functional test pattern for a given bit address. A row of light-emitting diodes beneath these buttons indicates failed bits. Another row of LEDs above the buttons displays the contents of the pattern memory for a given bit address. A third row of LEDs indicates failures detected during parametric testing.

Any of six clock phases can be manually programmed with pushbuttons, and a LED matrix displays the duration of the clock phase as programmed. The clock period has 16-bit resolution. Again, for each clock phase selected, the pulse width is set by 16 pushbuttons.

Once the debugging is completed, the manually entered test pattern as finally frozen can be fed out on paper tape.

A high-speed (80-MHz) clock, the high-speed data pattern memory, and high-speed comparators and drivers located only inches from the test head combine to give the Spartan 770 its 5-MHz data rate for wafer probe or final testing.

High-volume automatic testing on the Spartan 770 will be done with high-speed automatic wafer probes and handlers, for which General Digital will supply the interface electronics. The basic Spartan 770—a 20-data-channel, 1,024-bit test system that includes the test head, memory, and interface electronics—sells for \$98,000. But General Digital expects most users to want 40 channels of data. A 40-channel "expander," including test head electronics and memory, puts the price at \$122,750.

General Digital Corp., P.O. Box 2180,
19242 Redhill Ave., Newport Beach,
Calif. 92663 [338]

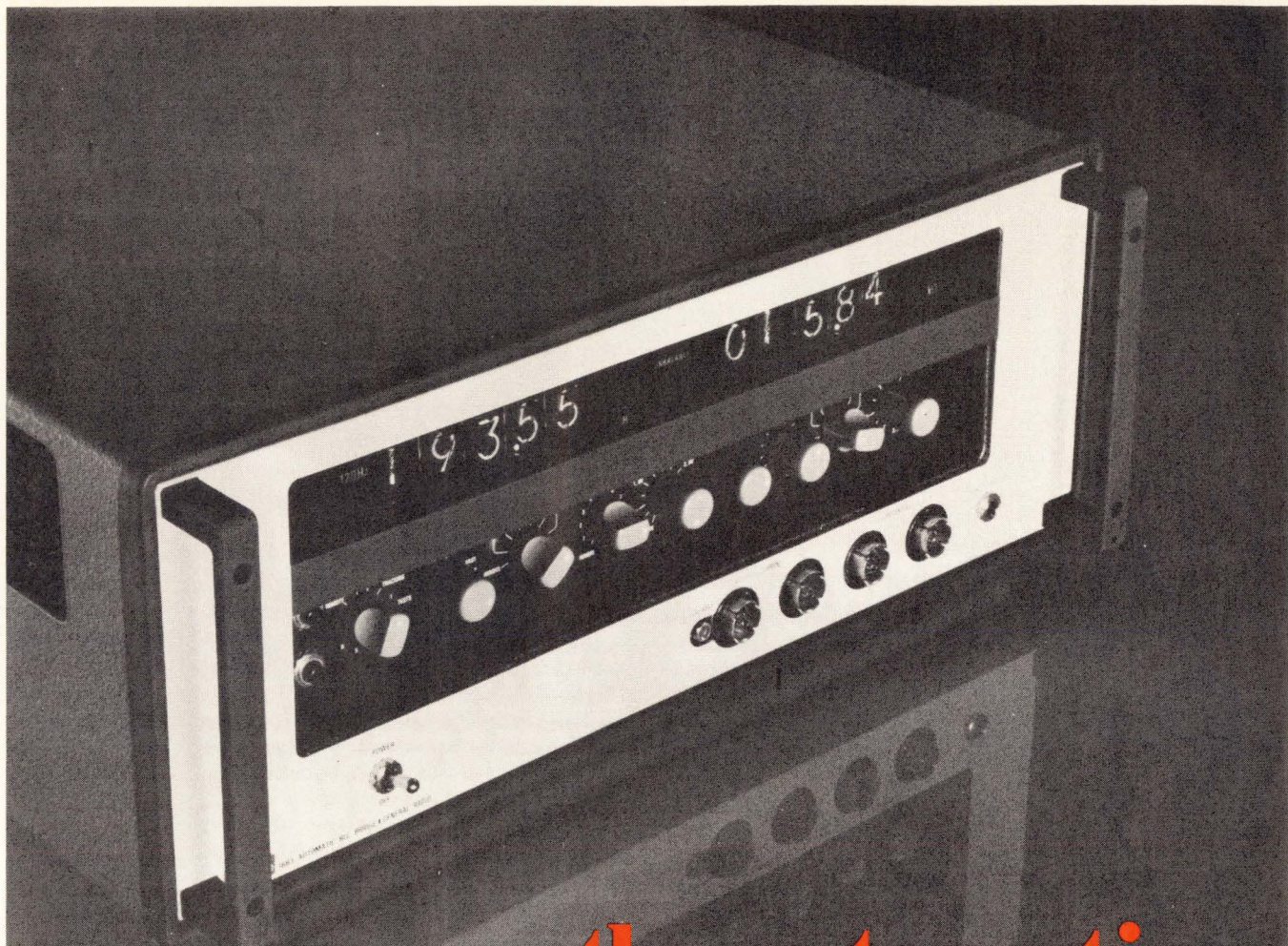

the automatic RLC bridge-and-a-half

If GR's 1683 Automatic RLC Bridge seems to offer more than the usual bridge, it's no illusion.

First, the 1683 handles all kinds of components by measuring R, L, and C over the widest possible ranges: 00.001 m Ω to 2 M Ω , 0000.1 pF to 0.2 F, and 00.001 μ H to 2000 H. The dissipation-factor, equivalent series resistance, and leakage-current ranges are 0 to 2, 00.001 m Ω to 2000 k Ω , and 2.5 μ A to 25 mA.

Second, the 1683 gives you the extra convenience of a test fixture four feet from the bridge instead of connectors directly on the bridge's front panel. Five-terminal connections at the fixture preserve the basic 0.1% accuracy — accuracy that means you throw away fewer marginal components.

Third, the 1683 offers speed and convenience features like the 20-measurements-per-second capability

and the automatic decimal points and units of measurement; like the 120-Hz and 1-kHz test frequencies and the built-in 0- to 3-V bias (or provisions for an external supply up to 600 V); or like the useful remote-programmability and data-output options. And don't overlook the ESR and leakage-current readout options for testing electrolytics.

You can put a 1683 bridge-and-a-half in your plant for only \$4450* plus just \$300 each for the options you need (except the leakage-current readout, which is only \$200). You can also get the 1683-P1 test fixture for axial-lead components for just \$225.

Get all the details on this feature-packed bridge by calling the GR office nearest you or by writing to 300 Baker Ave., Concord, Mass. 01742 or to Postfach 124, CH 8034, Zurich, Switzerland.

*Prices are net FOB Concord, Mass., U.S.A.



General Radio

BOSTON 617 646-0560 / CHICAGO 312 992-0800 / DALLAS 214 637-2240
LOS ANGELES 714 540-9830 / NEW YORK (N.Y.) 212 964-2722 (N.J.) 201 943-3140
SAN FRANCISCO 415 948-8233 / SEATTLE 206 747-9190 / WASHINGTON, D.C. 301 881-5333
TORONTO 416 252-3395 / ZURICH (0511) 47 70 20

the instructor

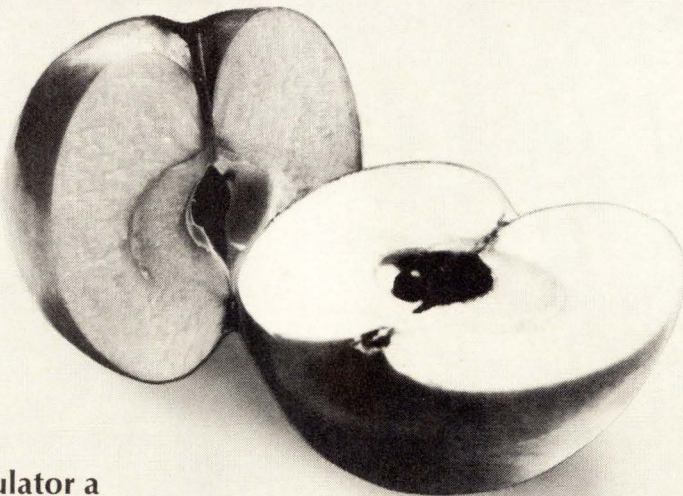

teaches your calculator a thing or 2,000. And vice versa.

So far Cintra has done nothing ordinary in the calculator world. The Instructor 928 carries on that tradition.

The Instructor is a memory device about the size of a paperback novel. It attaches to the rear of the Cintra Scientist 909 or Statistician 911. As the name suggests, its chief job is to instruct the calculator in its operation.

It works like this: You key in your program on the calculator. The signals generated by each keystroke are converted into coded audio tones which may be recorded on any two-channel recorder.

Presto! When the recorder plays back through the Instructor, the calculator operates **automatically**, just as though you pressed the keyboard manually.

But that's not all. Not only can you instruct the calculator, it can interact with and verbally instruct **you** on such mat-

ters as when to enter data. (So, it's only fair to share the apple.)

What's it all good for? First, it gives the calculator operator a potent but low cost means of storing often-used or lengthy programs. Standard tape cassette holds 2,000 program steps or more.

Secondly, the Instructor is an excellent math training tool — fully utilizing the power and simplicity of your Cintra calculator, and completely bypassing machine language.

Price? Only \$245. That's not a typo, that's \$245. Either the 909 or 911 calculator, \$3,780. (Slightly higher outside the U.S. and Canada.) Contact: Cintra, Inc., 1089 Morse Ave., Sunnyvale, CA 94086. Phone (408) 734-3630. In Europe, contact Cintra at Rue Léon Frédéric, 30, 1040 Brussels. Tel 33 62 63. In Canada, contact Allan Crawford Associates Ltd.



New products

Components

Power supply has 4 outputs

Device uses thick film hybrid voltage regulator that dissipates 85 watts

Departing from conventional approaches, Lambda Electronics has developed a power supply that produces four different voltages. The

device is part of a line just introduced by the company—the LY series—in which all models have thick film hybrid voltage regulators that dissipate 85 watts. The supplies are intended chiefly for computer peripherals such as line printers, tape recorders, and memory circuits.

The hybrid regulator, which will also be sold separately, has two parallel thick film substrates—one contains the signal and control circuitry, the other is the power section. Both are thermally isolated to insure low-temperature drift characteristics caused by power-level changes. The regulator provides 0.1% line and load regulation for

any dc power supply with an output rating as high as 28 volts and 5 amperes. With a volume of only 2.5 cubic inches, the new 85-watt hybrid regulator replaces as many as 20 discrete components that follow the filter capacitor in the power supply.

Other power supplies are available with one, two, and three outputs. The single-output units provide 5 to 48 V at 30 A. Dual-output supplies come in two configurations: ± 5 V at 15 A and ± 15 V at 6 A. The triple-output models offer $+5$ V at 20 A and ± 15 V at 1.75 A, while the quadruple-output power supplies produce $+5$ V at 20 A, ± 15 V at 1.25

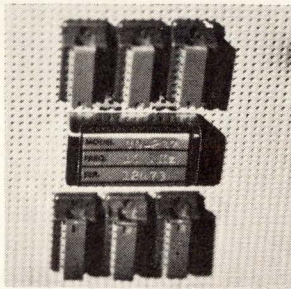

DIP-compatible clock oscillator drives 10 TTL loads at any frequency in the 3-30 MHz range. It operates from 5 V dc and provides stability better than $\pm 0.0025\%$ over 0° to 70°C. This low-profile module plugs directly into a 14-pin dual in-line socket. Price (1-4) ranges from \$80 to \$90 depending on frequency. Vectron Laboratories Inc., Norwalk, Conn. 08854 [341]

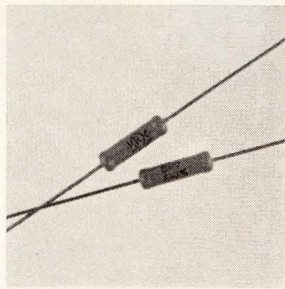

Precision power thin film resistor series BR is offered in three power ratings: BR31, 1 watt, 10 ohms to 25 kilohms; BR5, 2 watts, 30.1 ohms to 50 kilohms; and BR7, 3 watts, 49.9 ohms to 200 kilohms. The 3-W units' dimensions are 0.625 in. long x 0.200 in. diameter. All resistors have a temperature coefficient of ± 25 ppm/°C. TRW Inc., P.O. Box 887, Burlington, Iowa [342]

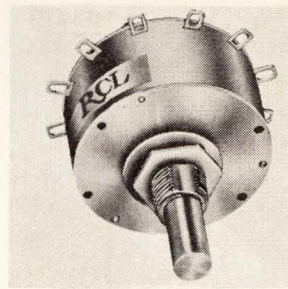

Rotary switch series T is a 30°, 12-position device with a 1 3/8-in. body diameter. It offers from 1 pole, 12 positions to 6 poles, 2 positions, shorting or nonshorting. Contact resistance is 0.010 ohm maximum initial, with a current carrying capacity of 10 A. Unit is explosion-proof per paragraph 4.8.12 of MIL-S-3786B. RCL Electronics Inc., S. 21st St., Irvington, N.J. [343]

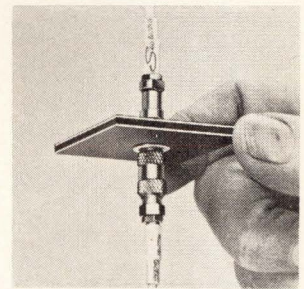

Kwik-Konnect connectors are rf coax devices that feature a lock ring, whereby the connectors are merely pushed together and automatically lock. VSWR is of the order of dc to 12.4 GHz, 1.20:1 and 12 GHz to 18 GHz, 1.30:1. Voltage rating is 400 V rms at sea level. Impedance is 50 ohms. Price ranges from \$2 to \$7 each, depending on model. Sealectro Corp., Mamaroneck, N.Y. [344]

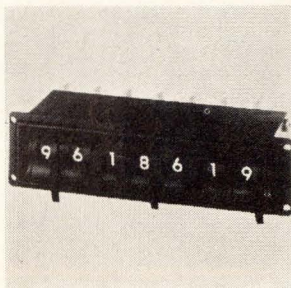

Subminiature leverwheel switches have a readout digit 0.2-inch high—big enough to be read several feet away. Design incorporates an internal gear that revolves the wheel a full 360°. Previously the readout wheel made only a partial revolution. The additional exposed area provides space for the larger digits. Cherry Electrical Products Corp., Sunset Ave., Waukegan, Ill. [345]

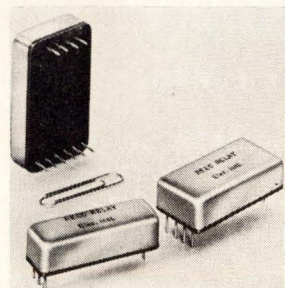

Low silhouette, dry reed relays feature a variety of multiple contact configurations. The AE series has pc pins located on the 1.350 x 0.15 grid pattern, with contact configurations of 1A through 4A, 1B, 2B, 1A1B and 2A2B. Applications are for machine tool controls and telephone-type switching circuits. Electronic Instrument & Specialty Corp., Box 24, Winchester, Mass. [346]

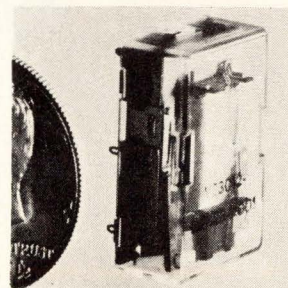

Pc board relay model V23012 is a low profile device that weighs 0.5 oz. It offers long life, low power consumption, single or bifurcated dpdt contacts, and standard 0.1-inch grid spacing for terminals. Coil pull-in power is 250 mW; maximum switching rate, 50/second. Contact rating is 1 ampere resistive at 24 V dc. Siemens Corp., 186 Wood Ave. South, Iselin, N.J. 08830 [347]

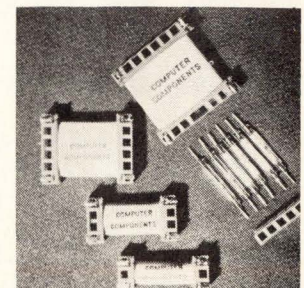

Plug-in, low-profile reed relay comes with true form C dry reed contacts up to 3 poles, and form A mercury wetted contacts up to 6 poles. The form C relay lists from \$5 to \$11 each. The mercury wetted units list from \$4.50 to \$20 each. Availability is from stock on small orders; large quantities, 3 to 4 weeks. Computer Components Inc., 88-06 Van Wyck Expressway, Jamaica, N.Y. [348]

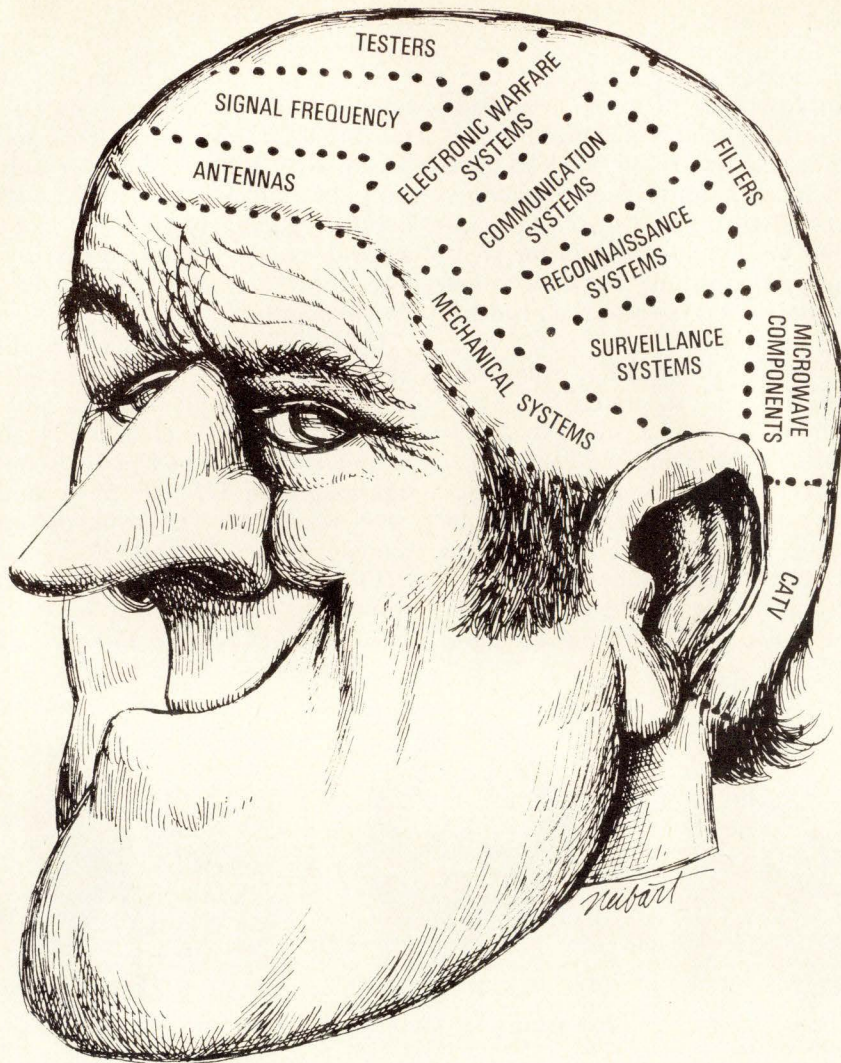

our _____ scientists are better than your _____ scientists!

We call them electronic scientists . . . and they're specialists in their field.

Whether it be Electronic Warfare, Communications or CATV, our brain specialists not only have the electronic capabilities to solve complex problems, but they have the imagination to create advanced electronic designs that not only come alive, but that work. Thousands of satisfied people already know this.

Contact AEL about your electronic plans or problems, our brain specialists are probably creating the answer you need right now.

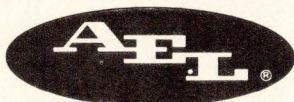

*Leading the way
with creative electronics.*

AMERICAN ELECTRONIC LABORATORIES, INC.
P.O. Box 552 • Lansdale, Pa. 19446 • (215) 822-2929 • TWX: 510-661-4976 • Cable: **AMERLAB**

883

New products

A, and + 28 V at 0.75 A.

Characteristics of the LY series include efficiencies greater than 50%—about twice that of conventional 5 V supplies—0.2% load regulation from no load to full load, 0.2% line regulation from 105 V to 132 V ac, ripple less than 50 millivolts peak-to-peak at 5 V, and operation from -20° to $+71^{\circ}\text{C}$. There's virtually no voltage overshoot during turn-on, while ac power drop-out protection is 20 milliseconds at full load. Dual tracking accuracy for all conditions of line, load, and temperature is 0.2%, while the absolute voltage difference between outputs is 2%.

The basic hybrid voltage regulator has four pins and the following features: up to 5 A dc output, power dissipation as high as 85 W, output voltages up to 28 V dc, 0.1% regulation with line and load, 0.02% per degree centigrade temperature coefficient, thermal protection, and short circuit and over-load protection.

A second hybrid regulator has a 14-pin configuration. It offers all the features of the four-pin unit plus remote sensing, remote programming, dual tracking connection and negative regulator connection with transformer isolation, and high-power operation as a driver for a series regulation transistor.

The LY series power supply is housed in a case that measures 4 by 5 by 1.5 inches, while the regulator itself is 2.5 by 1.5 by 0.65 inches. The single output LY supply costs about \$280 and will be available in several months. The basic four-pin hybrid is priced at \$20 in quantities of 100, with availability set at four to six weeks.

Lambda Electronics Co., 515 Broad Hollow Rd., Melville, N.Y. 11746 [349]

LED in dual in-line package aimed at calculator market

The dual in-line package is an industry standard, not only for sockets and printed circuit-card spacing, but also for automatic handling equipment. That's why Monsanto considered the DIP a

must for its new, low-cost, light-emitting diode display.

Intended for desk calculators and other close-proximity uses, the seven-segment display, called MAN-4, has characters 0.19-inch high with brightness 400 foot-lamberts at 10 milliamps per segment. It mounts on 350-mil centers; package density is three per inch. According to Raymond E. Brown, director of engineering at Monsanto Electronic Special Products, the DIP configuration will simplify board layout as well as device handling. Wirewrap and pc boards that are laid out for standard DIP configurations can accommodate the MAN-4 display.

The display is encapsulated in red plastic, which, says Brown, improves contrast because the red plastic together with a circularly polarized filter makes the lead frame almost completely invisible. For driving the displays, Brown suggests the Monsanto MSD-101 decoder/driver or the Signetics 8T06. Each has its own advantages. The Monsanto device has the current-limiting resistors built in, but the Signetics unit can drive up to 20 MAN-4s. Monsanto's MSD-102 decoder/driver can also be employed with the MAN-4 if it's being used in a multiplexing mode. In this mode, only one decoder/driver is needed for all displays, and a strobing system is used to determine which display is on.

Brown points out that multiplexing increases the perceived brightness of the display. At low duty cycles—less than 20%—light intensity is enhanced through eye persistence. "This is analogous to the phosphor persistence in a CRT, except the image and color are imprinted and stored in the nervous system." As a result, less current need be used to drive the display. This is spurring many users to change to a multiplexing arrangement, Brown says.

The MAN-4 is priced at \$7.50 in quantities of 1,000.

Monsanto Co., Electronic Special Products, 10131 Bubb Road, Cupertino, Calif. 95014 [350]



Here's a seven segment readout that uses a bright approach to get across the fundamentals. Like 10 digital and 11 alpha characters. We even designed a simple (and inexpensive) one that displays only N-S or E-W for navigation applications.

CM5 series readouts operate on only 66 milliwatts per filament segment and are available in red, green, amber, blue-white or yellow colors. We can accommodate special color requirements, too. There's all kinds of mountings with flying leads, pin types for industry standard sockets, or pin type polarized version that mates with a Chicago Miniature CM5-51 connector.

These small fries measure only .446" high x .306" wide x .530" deep, but they're brilliant enough to read in direct sunlight. They can take

thermal extremes, high shock and vibration and have a MTFF of 200,000 hours rated life. Mostly, because we employ a unique filament bonding process that provides total fusion, plus a special evacuation method that gets about as close to a total vacuum as humanly possible.

That's why you can count on them. For application assistance call your local Chicago Miniature sales representative.



CHICAGO MINIATURE
LAMP WORKS

4433 N. Ravenswood Ave.
Chicago, Illinois 60640
(312) 784-1020

a GENERAL INSTRUMENT company

THE LIGHTING BUGS

The Speed Reader bug.

**This
Sweet
MICROVOLT
MULTIMETER is
SENSITIVE to $1\mu\text{V}$,
STABLE within $2\mu\text{V}/\text{day}$
and easy on the budget at
\$545**

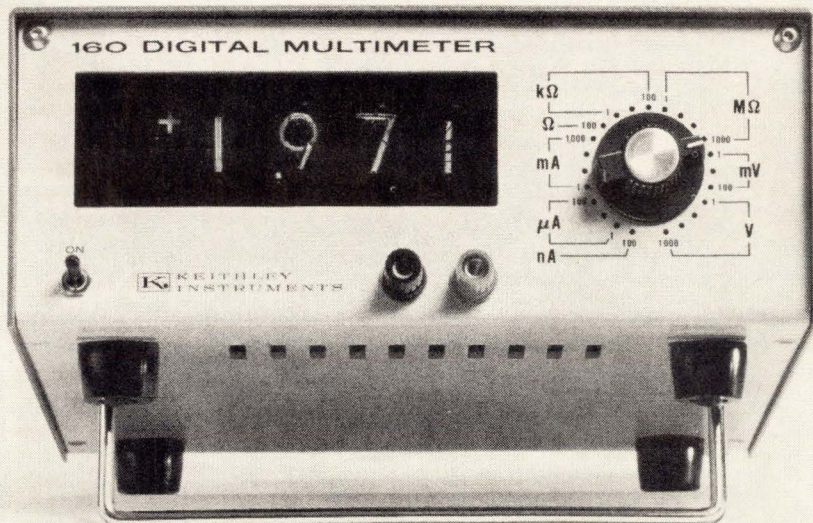

Users call it "the-how-sweet-it-is-meter".
But it's really the Model 160 that . . .

- MEASURES WITH DIGITAL ACCURACY
 - Voltage** — $1\mu\text{V}$ to 1000V
 - Current** — 0.1 nA to 2A
 - Resistance** — 0.1Ω to 2000 M Ω
- 100% OVERRANGING
- ANALOG and OPTIONAL BCD OUTPUT
- MANY MORE SWEET PERFORMANCE FEATURES

SEND FOR FULL DETAILS AND YOUR FREE "HOW SWEET IT IS" BUTTON



**KEITHLEY
INSTRUMENTS**

U. S. A.: 28775 Aurora Road, Cleveland, Ohio 44139
Europe: 14, Ave. Villardin, 1009 Pully, Suisse

New products

**Monolithic memory drivers
reduce pc board area**

A custom line of linear integrated circuits developed for a maker of core memories has blossomed into two off-the-shelf products for Texas Instruments Inc. The monolithic memory drivers, the SN75308 and the SN55/75325, have output current ratings of 500 and 600 milliamperes and are believed to be the only high-current monolithic drivers on the market. The first is a two-by-four transistor array, the second is a dual sink/source memory driver, and both can drive ferrite cores, plated wire, planar film, and other elements.

With these integrated circuits, TI says, designers can reduce printed circuit board area 15% to 20%, depending on the design.

The SN75308 is an array of eight high-current transistors designed for a two-dimensional memory system. One of the eight transistors can be switched by selecting the appropriate base and emitter inputs, which can be driven by standard monolithic buffers and interface circuits. With an output current of 500 mA, collector-emitter saturation voltage is only 0.45 volt. Turn-on time is 36 ns, and turn-off time is 23 ns, each with a 15-picofarad load capacitance.

The SN75308 is available in ceramic and plastic dual in-line packages and in flatpacks at \$5.33 to \$6.35 each in 100-999 quantities.

The SN55/75325 memory driver consists of two 600-mA source-switch transistor pairs and two 600-mA sink-switch transistor pairs. Source or sink selection is determined by logic inputs, and source or sink turn-on by source and sink strobe terminals.

The 75325 can also be used as a hammer driver.

Devices are available in both military and commercial temperature ranges, at prices ranging from \$4.20 to \$9.40 in quantities of 100 to 999, depending on packaging.

Texas Instruments Inc., Inquiry Answering Service, P.O. Box 5012, M/S 308, Dallas, Texas 75222 [351]

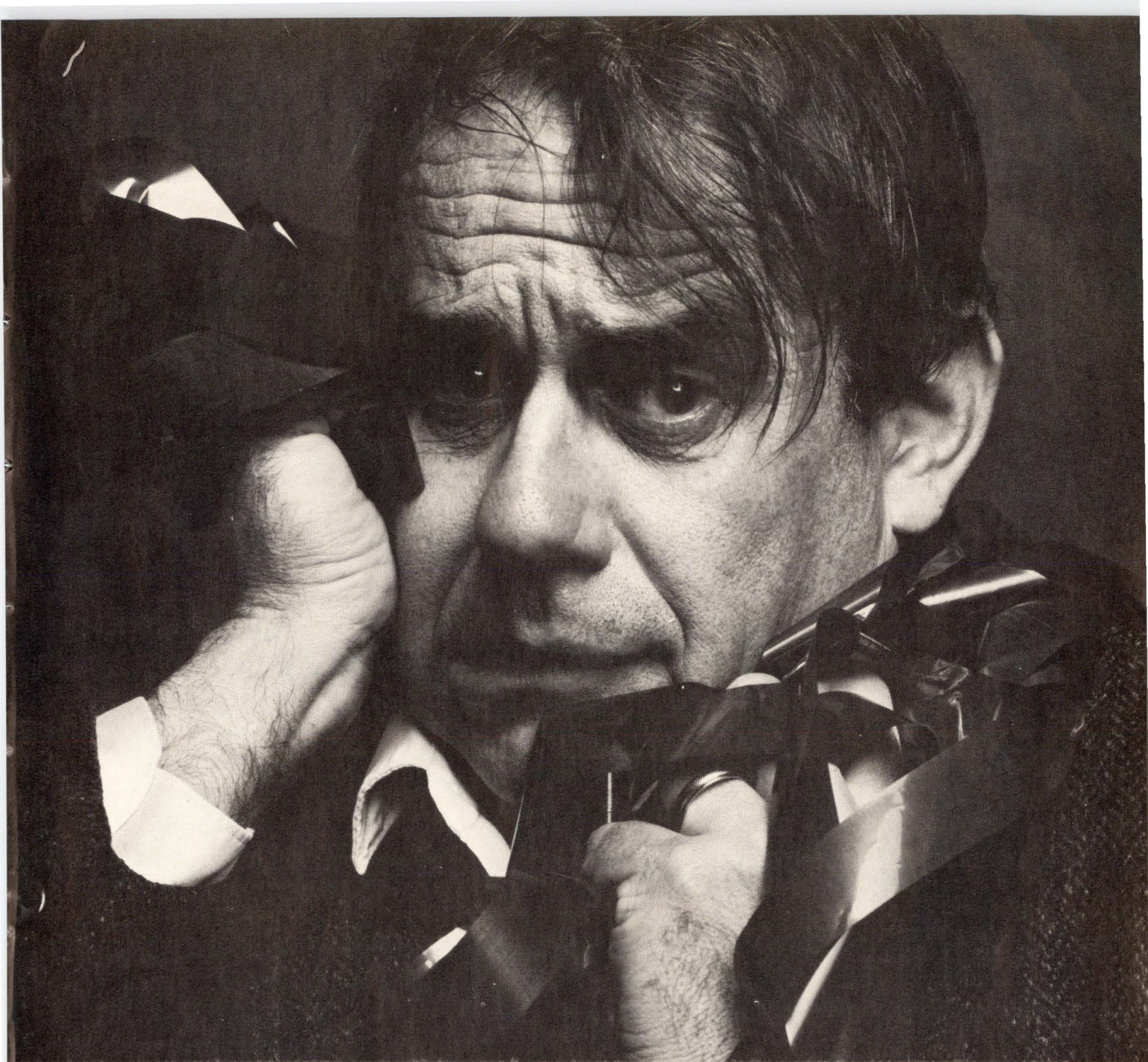

Got the jitters? Take our cure for your tape recording headaches.

HP's 3950 Instrumentation Recorder will take the jitter out of your tape path and all the hassle out of data recording. Specs like jitter of $0.3 \mu\text{s}$ in 0.1 ms at 120 ips, plus a minimal envelope delay of no more than $\pm 250 \text{ ns}$ from 100 kHz to 2 MHz, guarantee that what you're analyzing on the tape is exactly the same as the data you fed into the recorder.

On the 3950, all tape transport components are mounted on a precision-machined frame. You'll never need to shim or have the factory make adjust-

ments. The tape path is a simple open loop. Heads are easy to get at for cleaning. The monitor, test signal selectors and test I/O connectors are all easily accessible on the front panel.

Couple these features with the capability of recording PCM densities as high as 20,000 bits per inch, your choice of 7 or 14 track 2 MHz direct recording and prices that begin at less than \$15,000 — and you've got the best price/performance ratio on the market. And that's not only on the day your recorder comes into the lab but for years

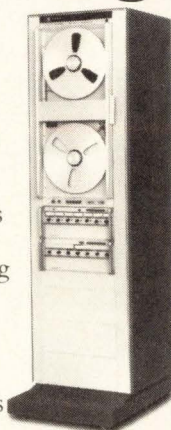

to come — because performance doesn't deteriorate. Let your nearby HP field engineer give you the details and a demo on the recorder that takes the headache out of instrumentation taping. Or write to Hewlett-Packard, Palo Alto, Calif. 94304; Europe: 1217 Meyrin-Geneva, Switzerland.

42102

HEWLETT  PACKARD
RECORDING SYSTEMS

Top performance. Low cost. Two X-Y sizes.

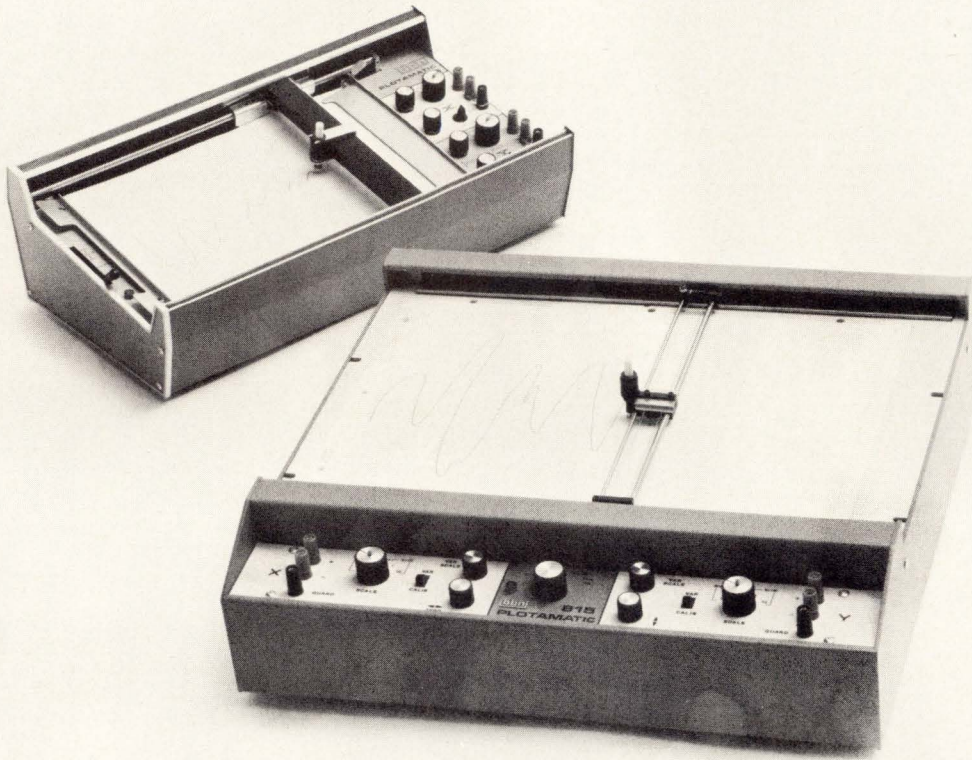

(No one else can hand you that line.)

The BBN/DE PLOTAMATIC 700 series (8½" x 11") is priced from \$750. The 800 series (11" x 17") starts at \$850.

Until now all high-quality X-Y recorders meant a high price. And every low-cost one meant low performance.

If you wanted good performance with an economical price tag, you were just out of luck.

To fill this long-existing gap in the market, we've created our 700 series and 800 series PLOTAMATIC recorders. You might say they're the best of both worlds. High-quality performance at an economy-minded price.

Some of their features usually found only with the higher-priced units (and sometimes not even found there) include: I/C electronic design that eliminates photo and mechanical choppers. No servo compensation or loop gain adjustments. Signal inputs that are differential, guarded, and shielded. Electronic overdrive protection to extend recorder life. Sealed follow-up potentiometers that are buffered for noise immunity. And disposable fiber-tip cartridge pens.

The PAD/LOAD[®] paper handling system on the series

700 is a BBN/DE exclusive. It actually operates three times faster than conventional single-sheet recorders. Load a 50-sheet pad of paper into the recorder and as each page is consumed, simply tear it off exposing a new sheet. No rezeroing of the pen between plots is required. As another user convenience, the disposable cartridge-pen system eliminates ink handling and pen cleaning. Color changes are made in seconds by a simple replacement.

Designed into the low-cost 700 and 800 series recorders are those engineering features which have proven popular with BBN users for years: zero check push buttons, constant 1 megohm input impedance (fixed or variable scale), modular construction, and a one-year warranty.

In addition, something new has been added for use with the 700 and 800 series. It's the Model 7T Plug-In Time Base Generator. Available for \$180, it produces seven calibrated sweep speeds from .5 to 50 seconds/inch. It can be plugged into either the X or Y axis.

We'd be glad to send you full specification data. Write today for a **free** brochure and a personal evaluation test in your own facility.



BOLT BERANEK AND NEWMAN INC.,

Data Equipment Division 1762 McGaw Avenue Santa Ana, California 92705 Tel. (714) 546-5300

New products

Instruments

Synthesizer sweeps up

Speed, accuracy promised by uhf test oscillator with sweeper features

Frequency synthesizers usually stay close to home, putting out a frequency that's controlled to ultra-high accuracy and pegged with

high resolution. A synthesizer with a swept frequency output therefore sounds contradictory. But that's what the new 1065 from General Radio is—a uhf test oscillator combining the features of a synthesizer and a sweeper, and selling for \$8,950.

The concept sounds less strange when GR spokesmen like Robert W. Ingram, applications engineer in the high-frequency equipment group, explain how the 1065 would be a convenience to engineers or technicians when they have to, say, adjust an intermediate frequency strip or a filter or measure magnetic resonance. With an oscilloscope, the results of an adjustment are

visible as soon as it's made. In addition, because the center frequency of the swept band is synthesizer-accurate, and the sweep itself is tightly calibrated, the 1065 should make measurements and adjustments not only faster but more accurately than sweepers can.

The 1065 is modular; its circuit boards plug into electrically shielded enclosures to cut interference and keep the signal as clean as possible. The synthesizer section generates any frequency from 1 hertz to 160 megahertz with a stability of one part in 10^9 per day. If necessary, this output can be used directly as a constant frequency source. Output amplitude



Sweep and marker generator model 160A provides a full one-volt-rms output into 50 ohms over a 1 MHz to 600 MHz frequency range. The sweep generator itself features continuously variable sweep widths and center frequency over the 600-MHz range. Price of the sweep is \$1,195; markers are optional at additional cost. Kay Elemetrics Corp., Pine Brook, N.J. [361]

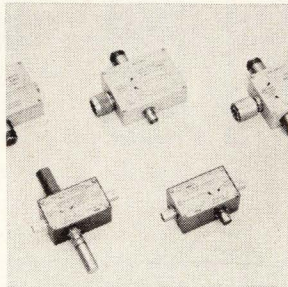

Seven different families of bridges are being offered, some with rf output proportional to VSWR, some with built-in detectors, and others for different frequency ranges. Total frequency range of operation is 50 kHz to 12.4 GHz. Directivity is greater than 40 dB up to 4 GHz and greater than 36 dB to 12.4 GHz. Wiltron Co., 930 East Meadow Drive, Palo Alto, Calif. 94303 [362]

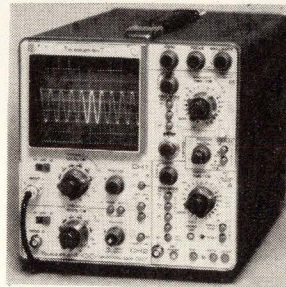

Dual-trace oscilloscope model D67 offers 25-MHz bandwidth and 10-mV sensitivity. A wide range of sweep rates from 2 s/cm to 0.2 μ s/cm (40 ns with X5 magnifier), delayed sweep, 3% accuracy and 14-ns risetime, make the D67 suitable for high resolution analysis of pulse sequences. Price is \$975. Tektronix Inc., P.O. Box 500, Beaverton, Ore. 97005 [363]

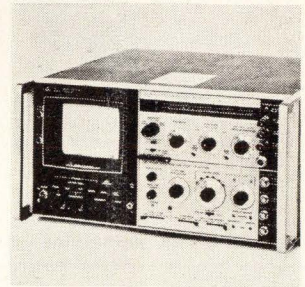

Spectrum analyzer model 8555A, designed for the range 10 MHz to 18 GHz, uses thin-film hybrid ICs to attain absolute calibration of the display from -125 to +10 dBm and to achieve resolution of 100 Hz at microwave frequencies. It uses automatic frequency stabilization to cut residual fm to less than 100 Hz on fundamental mixing. Hewlett-Packard Co., Palo Alto, Calif. 94304 [364]

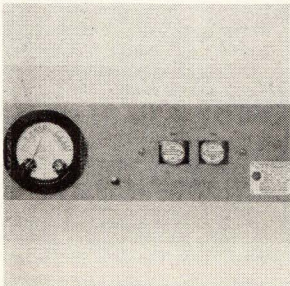

Dual wattmeter-VSWR monitor model 3122 displays all three measurements at once on a single meter face. Forward and reflected power are indicated by individual pointers and VSWR is monitored on a third scale from the intersection of the two power pointers. Price is \$200. Plug-in elements (two required) are \$30 to \$75. Bird Electronic Corp., Aurora Rd., Cleveland, Ohio [365]

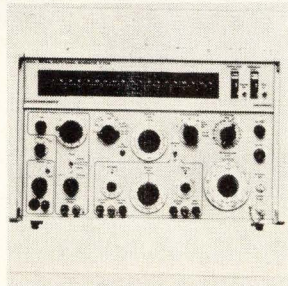

Dynamic transmission simulator model 2008 combines the facilities of a precision fm/a-m signal generator with those of a sweep generator. The frequency range, 10 kHz to 510 MHz, is covered in 11 ranges. Each range may be swept over its entire span and full modulation facilities may be retained in the swept mode. Marconi Instruments, 111 Cedar Lane, Englewood, N.J. [366]

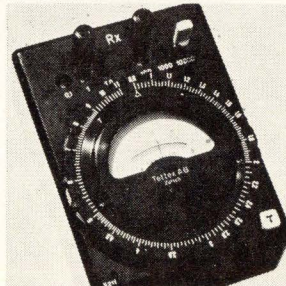

Small Wheatstone bridge model 2101 is for dc resistance measurements from 0.09 ohm to 110 kilohms at 0.5% accuracy. Values are read from an 11-in. circular scale with subdivisions from 0.9 to 11. The six ranges are chosen by a plug. Price is \$147 for the bridge, \$18 for carrying case. Special Instruments & Machinery Co., 6 Lamesa Ave., Eastchester, N.Y. [367]

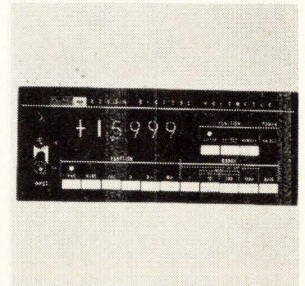

Digital voltmeter model 8200A features a sampling rate of 400 per second, 60% overranging, 0.01% accuracy, autoranging and remote programming. It features as standard 1 millisecond sample and hold, four ranges of dc (0 to 1,100 V), full guarding for 140-dB common mode rejection dc to 60 Hz, and 2-millisecond response time. John Fluke Mfg. Co., Box 7428, Seattle, Wash. [368]

BUSS QUALITY

SMALL DIMENSION FUSES AND FUSEHOLDERS

For The Protection of All Types of Electronic and Electrical Circuits and Devices...

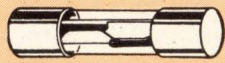

includes dual-element "slow-blowing", single-element "quick-acting" and signal or visual indicating types... in sizes from 1/500 amp. up.

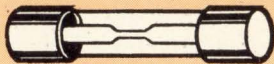

HKA lamp-indicating, signal activating holder.



HMR RF shielded holder for 1/4 x 1 1/4 in. fuses.

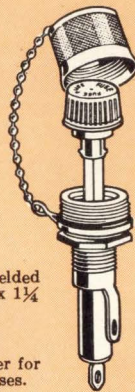

HKP panel mounted holder for 1/4 x 1 1/4 in. fuses.



TRON Rectifier Fuses For the Safe Protection of Solid State Devices.

Provide extremely fast opening on overload and fault currents, with a high degree of restriction of let-thru current. Many types and sizes available. Ampere ratings from 1/2 to 1000 in voltage ratings up to 1500.



Circle 130 on reader service card

\$275
The ~~\$350~~ DMM



- AC
- DC
- Ω
- I
- 0.1%

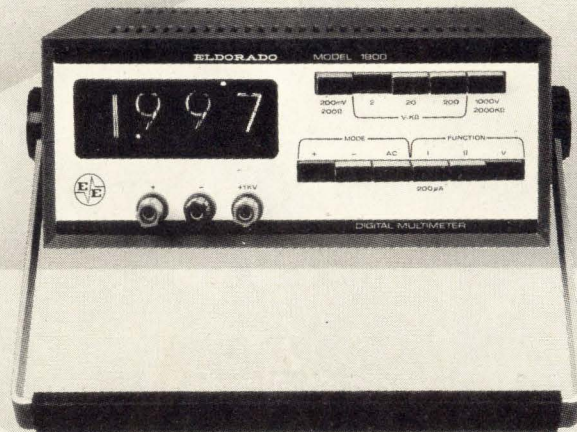

GSA LISTED

ELDORADO

ELDORADO ELECTRODATA CORPORATION

601 CHALOMAR ROAD • CONCORD, CALIF. 94520 U.S.A. • TEL. (415) 686-4200 • TWX 910-481-9476

Circle 167 on reader service card

In MOS/LSI, a speck of dust looks like an epidemic.

If you can keep the dust down to 100 or fewer particles (1/10 of a micron in size) for every million parts of air, you've got a room rated Class 100.

And it takes this kind of dust-free, contamination-free environment to help make a good MOS/LSI product. Because the less dust there is, the more good products you can produce. And that's the name of the game: more good MOS/LSI devices. Fewer rejections. Higher yields. Less cost for the custom MOS/LSI user.

At our new custom MOS/LSI manufacturing facility in San Diego, we have a giant fabrication and assembly area rated Class 100. There's a built-in laminar air flow system that's designed around some simply but strategically placed return air vents. They virtually suck scrubbed clean air down from the force fed ceiling air filters through the bench work areas. So the entire room is dust free—and stays dust free.

This one-of-a-kind contamination control system was expensive, but it helps make our new facility the finest of its kind in the world. And it helps us produce more good products. And remember, in MOS/LSI, that's the name of the game.

Stop by and see it for yourself. Or write for our new facilities brochure. Mr. David A. Beadling, Director of Marketing, Garrett Micro-Circuits Corporation, 16701 West Bernardo Drive, San Diego, California 92127.

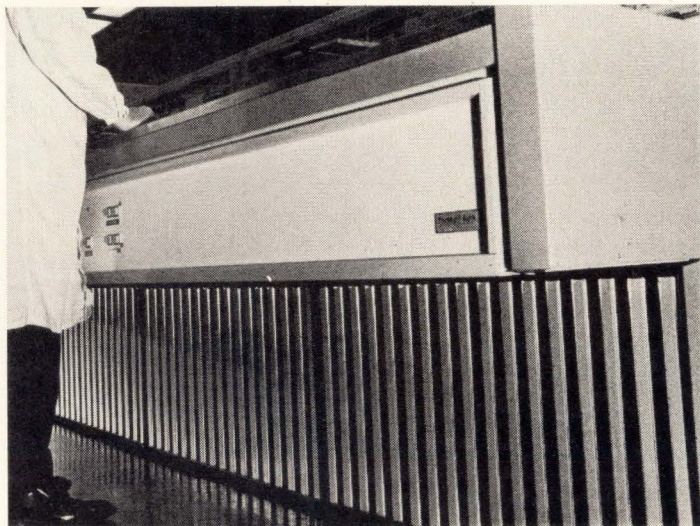

Garrett
MICRO-CIRCUITS CORPORATION

New products

Analyzer offers quick way to measure transfer functions

A key step in developing any system is to make sure it's free of oscillation. The SM2001 frequency response analyzer developed by England's SE Laboratories Ltd. offers a fast, convenient way to climb that step.

A sine-wave generator combined with a correlator, the instrument sends a sinusoidal signal to the system under tests. Then it analyzes the response and presents the results as the system's transfer function. SE engineers say that the unit's main application will be in designing electronically controlled servos.

The generator uses digital synthesis to produce its sine-wave output. This keeps distortion and drift low. Frequency range of the generator is 1 cycle per day to 1 kilohertz. Amplitude is variable between 0 and 20 volts peak-to-peak. Maximum output is 40 milliamperes.

The correlator's job is to measure the transfer function either as the absolute value of system output or as the ratio of system output to system input. The transfer function can be measured in terms of the frequency of generator output, or of any harmonic up to the ninth.

Three plug-ins are available as options: a reference synchronizer, a modulator/demodulator, and a unit that extends the frequency range to 999 kHz. Digital readouts on the instrument's front panel display the results in one of three forms: Cartesian, polar, or polar in decibels.

The unit also is suitable for field work. Packaged in a suitcase-like carrier, it weighs 53 pounds and runs off a 230-volt or 115-v input which can vary by as much as 15%. It also takes input line frequencies from 45 hertz to 440 Hz. Most controls are programable.

The unit will be available in three months.

B & F Instruments Inc. Cornwells Heights, Pa. 19020 [370]

SI-1050A (50 W)

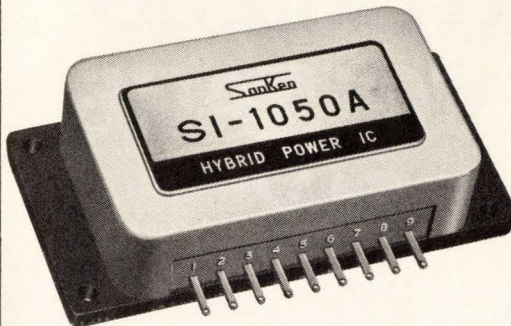

50 WATTS

from Sanken's hybrid audio amplifiers, for hifi, stereo, p.a. systems, musical instruments, hams and experimenters.

Sanken

is represented in the USA by
Airpax Electronics

Sanken
ELECTRIC CO. LTD.

1-22-8 NISHI-IKEBUKURO
TOSHIMA-KU, TOKYO, JAPAN

SI-1050A (50 W)

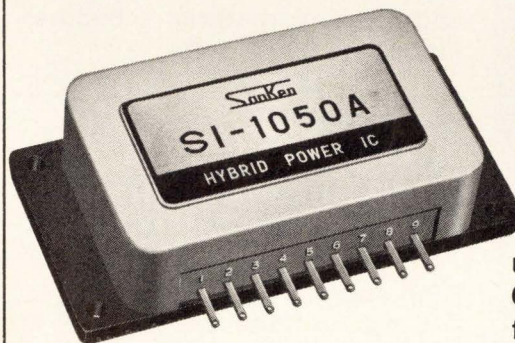

50 WATTS

undistorted audio power. Contact Airpax Electronics for catalog, specifications, application data and engineering assistance.

Also available in 10, 20, and 25 watt units.

AIRPAX

is agent in the USA for
Sanken Electric
TWX 510-955-9866

AIRPAX
ELECTRONICS

BOX 8488, FORT LAUDERDALE,
FLA. 33310 Phone: 305-587-1100

CMS... CMS... CMS... CMS... CMS...

MINIATURIZED HIGH VOLTAGE SUPPLY

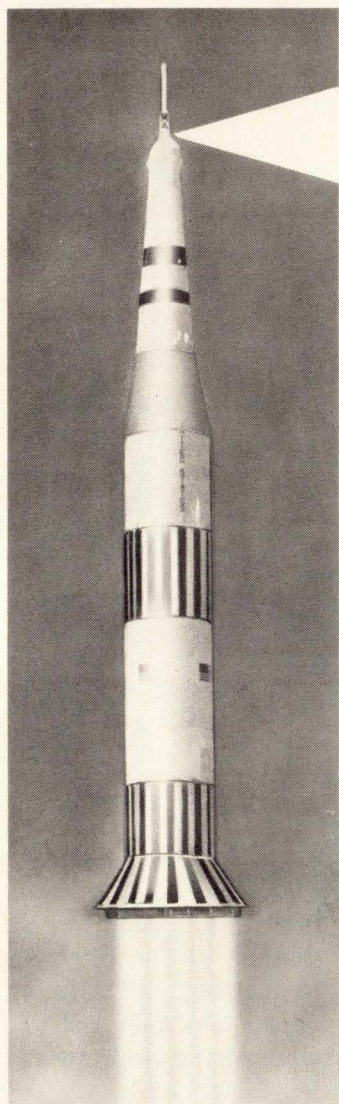

READY FOR USE

..... SAFETYRELIABILITY
..... SAFETY

Selected materials-High stability
STURDINESS..STURDINESS

Assembly moulded in dielectric
and resilient material - Endures
vibrations and shocks.

.....EQUAL TO SPACE
CONDITIONS

CMS compact block : small size
and highest performance - Input :
20 V DC, output 1 to 10 kV DC,
10 to 50 μ A.

High stability
All high voltage generators at
request.

**For literature and information
ask :**

tunzini sames

tam

Siège :
21, rue Jean Macé
38-GRENOBLE
tél. : (76) 44 77 64
télex : 32 814

Bureaux région parisienne :
rue Marcel Cachin - 93-SAINT-OUEN
tél. : 252 02 46 télex : 29.223

Agence région sud-ouest :
BASCOUL-ÉLECTRONIQUE
35, rue Luchet - 31-TOULOUSE
tél. : 48 99 29

pub. gead

New products

High-accuracy bridge offers
BCD output for systems work

These days, it's not enough for a bridge to be accurate. Now it's expected to be able to fit easily into programable test systems.

The Culton 167 automatic component bridge meets both requirements. Its accuracy can be as sharp as 0.01%. In addition, the unit converts its measurement into a binary coded decimal output—the type of signal used in many systems.

Built by engineers at the Quan-Tech division of KMS Industries Inc., the 167 measures resistance, capacitance, or inductance, and displays the result digitally. It also has an edge-reading meter which makes three measurements.

When its control switch is set to "error" and the meter is zeroed with a control dial, the dial setting is the value of residual error involved in the component measurement. Determining this error is what allows accuracies up to 0.01%. Without the adjustment, accuracy is down one order of magnitude.

With the switch set to "°C," the meter and control dial combine to give the temperature of the bridge's internal standard.

The third position is "impurity." When the switch is set here, the 167 can measure not only a component's value, but also its Q.

The frequency of the test signal is 1 kilohertz for all measurements of R and C. A $\pm 1\%$ internal source provides this signal. For L, the frequency is 10,000 radians per second.

The instrument has 18 ranges; six for R, and the same for C and for L. Full-scale ranges go from 109.99 ohms to 10.999 megohms, 109.99 picofarads to 10.999 microfarads, 10.999 millihenries to 1099.9 henries.

The 167 is small enough for benchtop use. It measures 11½ inches high, 9½ inches wide, and 17 inches deep. Weight is 28 pounds. Power dissipation is 15 voltamperes. Price is \$3,000. Delivery time is six weeks.

Quan-Tech, 43 South Jefferson Road, Whippany, N.J. 07981 [371]

THE QUALITY AND PERFORMANCE COUNTER LINE



Featuring the Model 101B MULTI-FUNCTION COUNTER

- 5-50 MHz counting range
- 50 mV, RMS sensitivity
- 1 μ s time interval resolution
- Frequency, totalize, period average, ratio and time interval modes
- BCD output
- 4½ x 7½ x 9 inch case
- FCC type-approval NO3-174

101B 7 digit.....\$815

101B 5 digit.....\$695

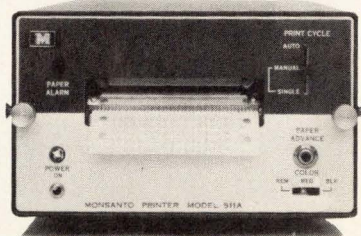

PRINT OUT

with the Model 511A digital printer, compatible with most counters. Compact (only 4½ inches high), 21 columns at up to 3 lines per second, auto zero suppression, BCD input and a price of only \$1195.

For more information on any of these priced-to-fit instruments, call or write:

Monsanto
Electronic Instruments
620 Passaic Avenue
West Caldwell, New Jersey 07006
(201) 228-3800

Select the Counter
that suits your needs.

- 100B, 40 MHz Counter-Timer.....\$575
- 101B, 50 MHz Counter-Timer.....\$695
- 103A, 20 MHz Counter-Timer.....\$420
- 104A, Variable Time Base C/T.....\$795
- 105A, 512 MHz Counter-Timer.....\$1550
- 106A, Up Down Counter-Timer.....\$775
- 107A, Computing Counter.....\$1250
- 109A, Dual Limit Counter.....\$975
- 110B, 150 MHz Counter-Timer.....\$1585
- 114A, 150 MHz Freq. Counter.....\$995
- 120A, 512 MHz Auto/Programmable C/T.....\$2195
- More coming.

Monsanto

New 10 Bit D/A CONVERTER In volume. In stock. Now.



SPECIFICATIONS — MODEL DAC-49

ELECTRICAL

Digital Inputs:

- Resolution 10 binary bits
 Coding Parallel data in the following formats:
 Straight binary (unipolar output)
 Two's complement (bipolar output)
 Data inputs DTL or TTL compatible, positive logic.

Input Code	V Input		Bit Status
	Min.	Max.	
"0"	0V	+0.8V	Off
"1"	+2.0V	+5.5V	On

Loading: one standard TTL load
 $I_L \text{ max.} = 1.6 \text{ ma @ } V_{IN} = 0.4V$

- Update rate 5MHz typical, but voltage output limited by output amplifier settling time.

Analog Output (@ 25°C):

- Accuracy $\pm 0.1\%$ of FS $\pm \frac{1}{2}$ LSB
 Output voltage 0 to +10V FS $\pm 5V$ FS
 Output current $\pm 5 \text{ ma}$
 Output loading 2K ohms for 0 to +10V output or 1K ohms for $\pm 5V$ output, in parallel with 1000 pF
 Output settling time 25 μsec to $\pm 0.1\%$ of FS (typ.)
 Output voltage resolution 10 mV for ten binary bits
 Linearity $\pm \frac{1}{2}$ LSB
 Temperature coefficient $\pm 50 \text{ ppm}/^\circ\text{C}$ of FS
 Long term stability $\pm 0.05\%/YR$
 Reference source Internal
 Input power requirements $\pm 15VDC @ \pm 20 \text{ ma}$

PHYSICAL — ENVIRONMENTAL:

- Operating temperature range .. 0°C to $+70^\circ\text{C}$
 Storage temperature range .. -55°C to $+85^\circ\text{C}$
 Relative humidity Up to 100% non-condensing
 Size 2" L x 2" W x 0.4" H plug-in module
 Pins 0.020" round gold plated
 Case material 0.250" long minimum Black diallyl phthalate, per MIL-M-14
 Weight 2 oz.

36 OTHER A/D AND D/A MODELS TO CHOOSE FROM.
 WRITE FOR OUR FREE 24-PAGE CATALOG.

VARADYNE
SYSTEMS
 A DIVISION OF VARADYNE, INC.

\$49

New products

Data handling

Plated wire thinks small

128 x 10 module is aimed at industrial applications that require little storage

Plated wire memory advocates have always banked on two strong selling points: speed and nonvolatility. But there was one drawback: users

haven't been able to find economical plated wire systems with the smaller storage capacities needed in industrial control.

That's the need Bruce Kaufman, president of Memory Systems Inc., Hawthorne, Calif., believes his firm's MiniRam fills: it can be organized as 128 words by one to 10 bits on one 8-by-10-inch plug-in card. Says Kaufman, "Because we have nondestructive readout and nonvolatility, a lot of potential customers have looked at our larger memories [Electronics, Sept. 28, 1970, p. 109] and said, 'That's great, but it's too big for us. Can you build us a smaller one?' But these customers need a lot of the

smaller units—sometimes thousands of them."

Memory Systems developed the basic 128-word-by-10-bit module as the logical building block. This a domain for which semiconductors have been considered ideal because core and plated wire electronics costs traditionally have to be amortized over a large number of bits to shrink the cost per bit. But semiconductor systems do not yet offer nonvolatility.

The standard MiniRam has an access time of 200 nanoseconds, a nondestructive readout cycle of 500 ns, and a 500-ns write cycle. The plated wire stack actually consists of a 64-word-by-20-bit matrix, but

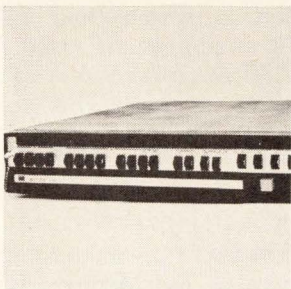

General-purpose microcomputer identified as the Micro 400 weighs 23 lb, including power supply, and measures 3.5 x 17.5 x 21 in. It has a 1.6 μ s cycle time, an 8-bit word length and 1024/4096/8192 words of core memory in the basic unit. Price in single unit quantities for a 1 K core configuration is \$3,250. Microdata Corp., 644 E. Young St., Santa Ana, Calif. [401]

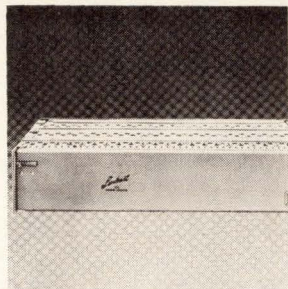

Wideband modulator 973A is a high-frequency, trunk carrier multiplex modulator-demodulator. It permits the output of 50 kilobits/second data systems to be transmitted over Lenkurt 47A or Western Electric N2 cable carrier systems. Fully equipped, the 973A occupies only 3 3/4 inches of vertical space on a 19-in. rack. Lenkurt Electric Co., County Rd., San Carlos, Calif. [402]

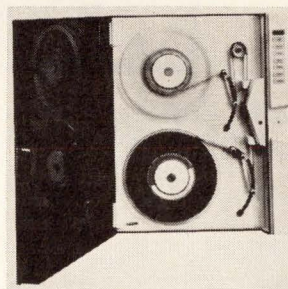

Magnetic tape transport/control system model 1205 is IBM compatible and is for use with all existing 8, 12, 16 and 18-bit minicomputers. It can be supplied for either 7 or 9-track tape, with packing densities from 200 to 1,600 b/in. Tape speeds from 12.5 to 75 in./s can be used. Unit price (1-9) is \$7,500. Dynacoustics Inc., 1980 National Ave., Hayward, Calif. [403]

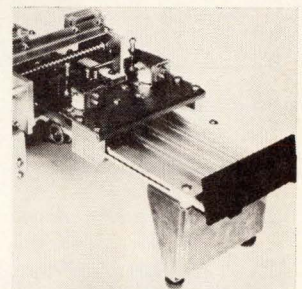

Magnetic card transport permits use of a standard magnetic card for data capture and time-share terminals, and provides a 10,240 character memory and 3 seconds average access time. It is suited for uses that require modest amounts of data storage and updating capability. Magnetic card used stores in a 64-line format. Redactron Corp., Parkway Dr. South, Hauppauge, N.Y. [404]



Measurement of spectral density of random signals may be made in real time with convenience by adding model SD42 memory to real-time data analysis systems. The unit is also valuable when a time or ensemble average must be performed over a predetermined length of data sample to enhance a periodic signal masked in noise. Spectral Dynamics Corp., Box 671, San Diego, Calif. [405]



General-purpose, microprogramed computer model 2100 includes as basic elements: operational registers, core memory, interrupt system, input/output system and control console. It has a data storage capacity of 32,000 memory bytes on four boards. It can be programmed for completely automatic billing and inventory control. C. G. Systems Inc., 313 N. Rexford St., Colton, Calif. [406]

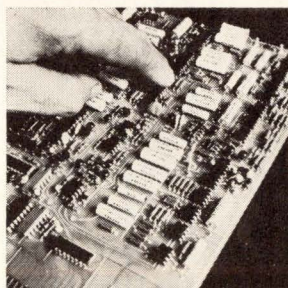

Integral modems IN202 are for use over dial-up or private telephone lines at speeds to 1,800 baud. Two models, 2020 and 2021, available for use over dial-up lines, interface to all currently available data access arrangements. Models 2025 and 2026 are for 2- or 4-wire private lines, with line transformers mounted on the pc card. Intertel Inc., Burlington, Mass. [407]

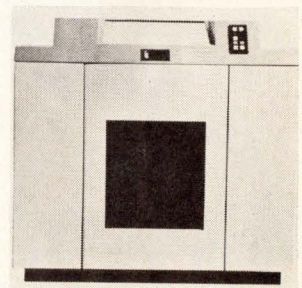

Bar printer model BI-1215 turns out crisp, clean impressions at 300 lines/minute, 132 characters/line, in character sizes up to one-quarter inch. User can select the type font he wishes (even Japanese) and can change fonts in the field in minutes. In OEM quantities, price is well below \$9,000; deliveries, 60 days. Bright Industries Inc., One Maritime Plaza, San Francisco [408]

Vector

Vector systems help you CUT BREADBOARDING TIME

SOLDERLESS U-CLIP TERMINAL

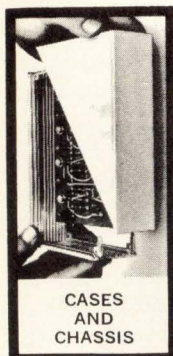

CASES AND CHASSIS

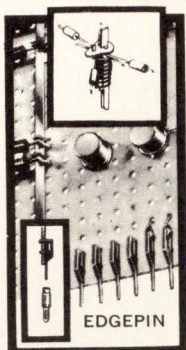

EDGEPIN

Choose the type that meets your needs.

1. Mount D.I.P.'s, Transistors, Round Can Integratseds, directly to board or in sockets. Patch cord hook-up available.
2. Solderable push-in terminals for .042", .062" or .093" holes.
3. Handsome new extruded aluminum rails that make into expandable circuit cases or chassis in virtually any size and shape. Hardware for mounting in plug-in racks or chassis.
4. Pre-punched Copper-Clad Cards for do-it-yourself etching. Also solderless spring terminals.

May we send you complete information including sample Vectorbord® and terminals? There is no obligation.

4 WAYS

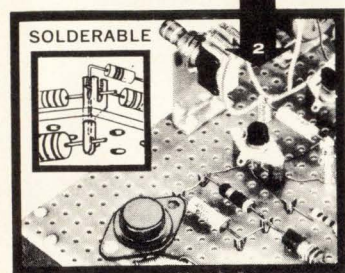

SOLDERABLE

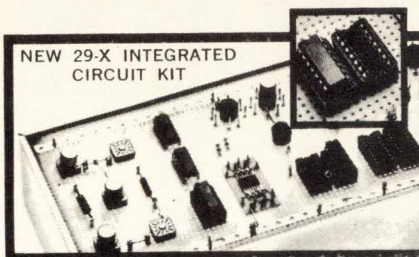

NEW 29-X INTEGRATED CIRCUIT KIT

Vector ELECTRONIC COMPANY, INC.
12460 Gladstone Ave., Sylmar, Calif. 91342

See Us at IEEE Show Booth #1320

Circle 168 on reader service card

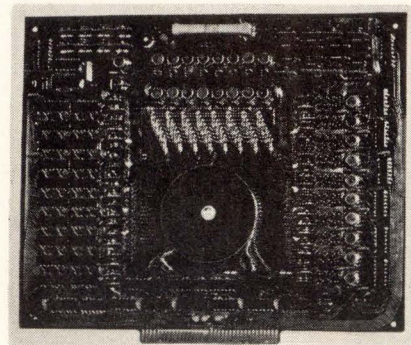

Small deal. MiniRam contains 128 words of one to 10 bits on an 8-by-10-inch plug-in.

the use of what Kaufman calls a 2DM organization makes the stack look like a 128-by-10 configuration. It's a two-dimensional, multiplexed organization in which dual 711-type sense amplifiers are used to select the 10 bits of interest each time 20 bits are read out. This technique cuts the number of sense amps in half, Kaufman says, and thus reduces the electronics parts costs of the system.

The 711 sense amp was designed for core systems, but Memory Systems has found a way to use it in a plated wire setup. And because the sense amps are readily available from many sources, the price is low. Further, Kaufman says, because the output of the stack is close to 20 millivolts, his designers didn't have to worry about the gain of the sense amps.

The word drivers are described as conventional, and are driven directly from a TTL decoder; the digit drivers use TTL gates to directly drive digit currents. Kaufman says, "It's nice to have a 25-cent digit driver." This and the low-cost sense amps have contributed greatly to the MiniRam's price of approximately \$200 in quantities of 1,000 or more.

Special versions are available. For example, Kaufman points out that a number of inquiries specify 100 bits to store control sequences of 100 steps.

Delivery time is 60 days.

Memory Systems Inc., 3341 E. El Segundo Blvd., Hawthorne, Calif. [409]

MICO

Pneumatic Controlled Drill Press

MANUAL CONTROLLED MODELS ALSO AVAILABLE

AMERICAN MADE

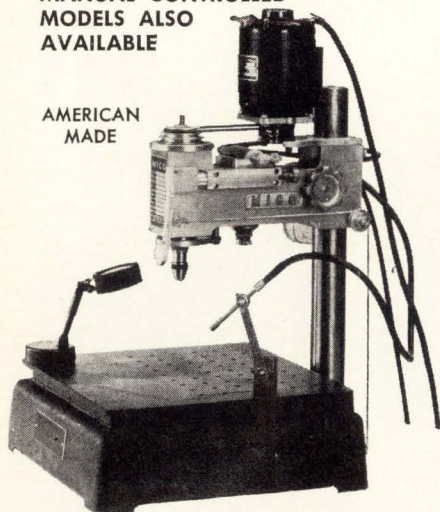

FEATURES OF PRECISION DRILL PRESS

- | | |
|-------------------|---------------------------|
| Sensitive | Quick Spindle Response |
| Accurate | Only 50-75 lb. Air Needed |
| Wide Range | 7500 or 10,000 r.p.m. |
| Keyless Chuck | Motor |
| Dual Air Controls | Air-Mist System Available |
| Sturdy | |
| Easily Adjusted | |

Send for Illustrated Catalogs

MICO INSTRUMENT CO.

77 Trowbridge St. Cambridge, Mass. 02138

FROM MEXICO WIRE WOUND RESISTOR

SILICON INSULATED SMALL SIZE, HIGH STABILITY, LOW T.C.R., LOW PRICE.

TOL	PRICE 100 Pz., US \$	TOL	PRICE 100 Pz., US \$
5%	6,00	5%	10,00
2%	8,00	2%	12,00
1%	10,00	1%	15,00
0,5%	12,00	0,5%	18,00
0,2%	20,00	0,2%	22,00

1 W at 5%	2 W at 5%
0,2 W at 0,2%	1 W at 0,2%
100 Ω Max.	250 Ω Max.
0,1 Ω Min.	0,1 Ω Min.

Price F.O.B., Mexico City
5 Free samples for anybody who writes on Co., letter,
Call or write L., Michel Kun Pres.

SPECIAL T.C.R., AVAILABLE.
We also make:
All types of wire wound, ceramics and fiber glass from $\frac{1}{2}$ W to 1 000 W.
Metal oxide resistors from $\frac{1}{2}$ W to 10W. Down to 1%,
Thick film circuitry, passive and active.
Load resistor assembly up to 20 Mega watts,
Edge wound, punched grid etc. etc.

LEMEX

LEMEX, S. A., - San Esteban No. 23, - MEXICO 16, D.F., MEXICO CITY TEL. 561-30-00

Cut yourself in.

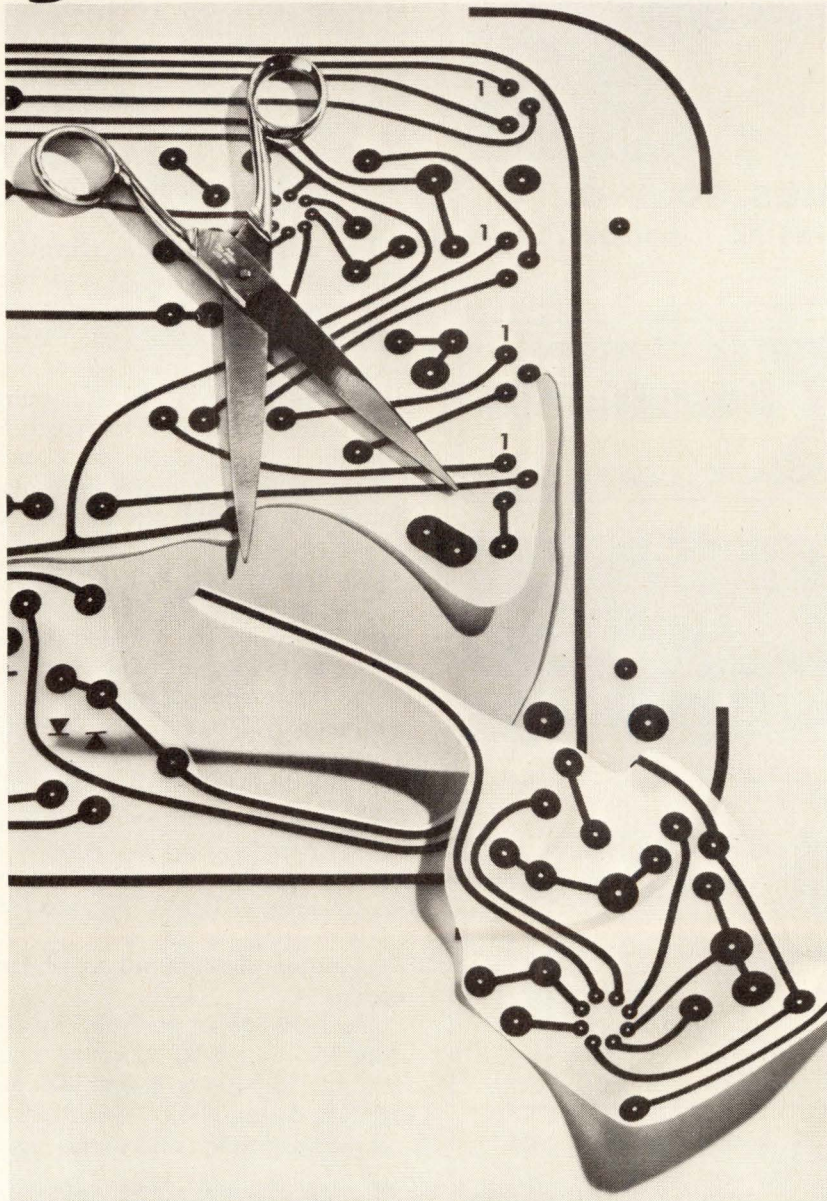

“Scissors draft” your way to increased production with KODAGRAPH Films and Papers.

Why retrace an entire drawing needing only revision? Instead, copy your original photographically on KODAGRAPH Film or Paper. Cut out the unchanged portions (often much of your drawing), mount them on a new drawing form, have a second original made on KODAGRAPH Film, and make your revisions on that.

For more on “scissors drafting” and other time-saving techniques, contact your Kodak Technical Sales Representative, or write Eastman Kodak Company, Business Systems Markets Division, Dept. DP 520, Rochester, N.Y. 14650

DRAWING REPRODUCTION SYSTEMS BY KODAK

Kodak

STRESS RELIEVED AND WEATHERPROOFED

BNC Cable Assemblies

These new cable assemblies feature polyethylene collars which are injection molded directly onto cable jacket and connector body. The resulting encapsulation offers two outstanding advantages:

STRESS PROTECTION

against failure from excessive bending, flexing, twisting;

WEATHERPROOF SEAL

between cable and connector. Available in various lengths and RG58C/U, RG59B/U, or RB62A/U. Connectors have non-tarnish finish and conform to MIL-C-39012. Write for specifications, prices, and delivery.

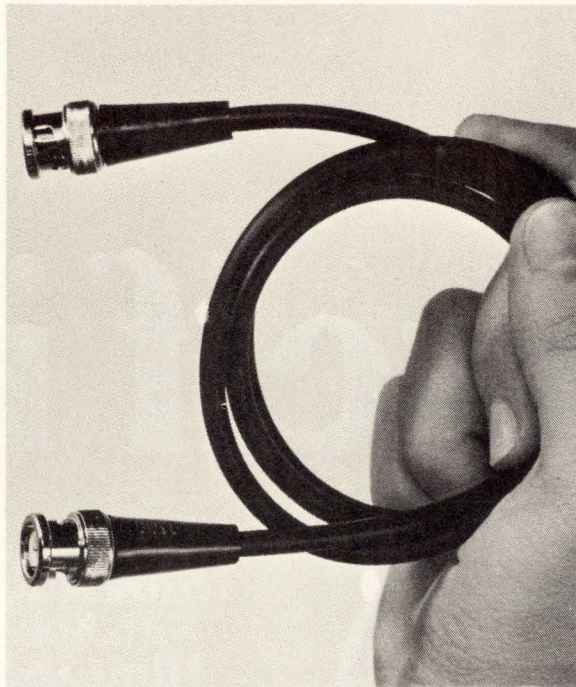

POMONA ELECTRONICS CO., INC.
1500 East Ninth Street, Pomona, California 91766 • (714) 623-3463

Circle 170 on reader service card

New Micro-Miniature Form C Reed Relays

Only .290 OD!

- The First FORM C Micro-Min. Relay Available!
- Measures .435 x .290 OD, only 0.03 cu. in.!
- Min. Overall Length with Bent Leads .600
- High Speed 100 microsec. Operate Time (ex. Bounce)
- Stock Voltages 3, 6, 12 and 24
- Leads or Pins. Also Available with Form A.

Special voltages, resistances, electrostatic and/or magnetic shields available. Write for new Bulletin MR-9.2.



COTO-COIL COMPANY, INC.
61 Pavilion Avenue, Providence, R. I. 02905
Tel: (401) 941-3355

140 Circle 140 on reader service card

New products

Coupler eliminates manual recording of analog data

The user of analog instruments and transducers often runs into a problem in trying to record and use the data. Analog strip charts are suitable in some applications, but frequently a digital record or signal would be far more useful. This is especially true if the data is to be fed into a computer. To eliminate tedious hand recording and key punching, an analog-to-digital converter plus a data coupler can be used with suitable interfacing.

Data Graphics Corp. has developed a device of this kind, the DGC-308 analog-to-Teletype coupler. It converts dc analog signals from a transducer or instrument to the eight-bit ASCII code required by a teleprinter or computer. The DGC-308 can be used for local off-line recording or data logging, or it can be fed to a computer.

The coupler measures, displays and transmits four digits and sign with a resolution of 1 millivolt and a full scale of ± 1.999 volts. Accuracy is $\pm 0.1\%$ of full scale \pm one digit. Analog input is a floating differential for complete isolation from the voltage source. Impedance is 10 megohms minimum, and isolation from the 60-hertz line is 60 decibels.

Conversion time is a maximum of 700 milliseconds per reading. Each recording is initiated by a front-panel switch or remote signal, or the instrument can be operated continuously. Up to nine recordings can be made before a carriage return and line feed are generated.

The output is at the standard teletypewriter rate of 10 characters per second, and is serial-by-character, serial-by-bit ASCII. The level is a 60-mA loop circuit interrupt for Teletype or direct input to phone modem.

The DGC-308 is portable, measuring 5.25 by 8.5 by 15 inches and weighing 12 pounds. It operates on 115 V ac, 60 Hz. The price is \$1,295, and delivery time is 30 to 45 days.

Data Graphics Corp., 8402 Speedway Drive, San Antonio, Texas 78230 [410]

CLASSIFIED ADVERTISING
SEARCHLIGHT SECTION
BUSINESS OPPORTUNITIES
USED OR SURPLUS EQUIPMENT

RADAR SYSTEMS GROUND AND AIRBORNE. AUTOMATIC TRACKING. ANTENNA SYSTEMS. NIKE AJAX. NIKE HERCULES. M-33. MSQ-1A. MPS-19. MPS-9. SCR 584. TPS-1D. TPS-2B. FAA-ASR-2. AIRBORNE SYSTEMS. APN-84. APN-102. APS-20. APS-27. APS-45. DPN-19. DIGITAL COMPUTERS. IBM 650. IBM 704.
LARGEST INVENTORY OF RADAR AND MICROWAVE EQUIPMENT IN THE WORLD.
RADIO RESEARCH INSTRUMENT CO.
45 WEST 45TH ST. N. Y. 10036 212-JU 6-4691
CIRCLE 966 ON READER SERVICE CARD

EMPLOYMENT OPPORTUNITIES

ADDRESS BOX NO. REPLIES TO: Box No. Classified Adv. Dept. of this publication. Send to office nearest you.
NEW YORK, N. Y. 10036: P. O. Box 12
CHICAGO, ILL. 60611: 645 N. Michigan Ave.
SAN FRANCISCO, Cal. 94111: 425 Battery St.

POSITION VACANT

Electrical Engineers. Degree with experience in design of electrical and electronic small consumer products. Good salary and fringe benefits. Employer pays all fees. Executive Personnel, Licensed Employment Agency, 503 Commerce Bldg., Fort Wayne, Indiana.

Learn new applications for electronics in medicine

- Attend technical sessions
- See exhibits and demonstrations
- Participate in workshops

The 3rd National Conference and Exposition on Electronics in Medicine, presented by McGraw-Hill publications—ELECTRONICS, MEDICAL WORLD NEWS, MODERN HOSPITAL, and POSTGRADUATE MEDICINE—will be held April 13-14-15, 1971, at the Sheraton-Boston Hotel, Boston. The technical program will feature experts in the field of hospital equipment and automation, computers in medicine, patient monitoring, prosthetic devices, thermography, plethysmography, cardiac screening, multiphasic screening, and other pertinent applications. Six workshop sessions will be lead by specialists who will invite active participation by conference attendees. New medical electronics instrumentation and support equipment will be featured in the exposition that accompanies the technical program. Pre-registrants may use the following form to avail themselves of the special advance registration rate.

REGISTER NOW — SAVE \$35!
Advance registration fee: \$165
Registration at conference: \$200
 (includes all sessions, exhibits, two luncheons, reception and a digest of technical papers when published). Mail this form along with your check to:
Donald Christiansen
Conference Chairman
Electronics in Medicine
330 West 42nd St., New York, New York 10036
 A block of rooms is being held at the Sheraton-Boston Hotel for registrants. Make your reservations directly with the hotel, identifying yourself as a Conference attendee.

Advance Registration Form EL
 3rd National Conference & Exposition
 on Electronics in Medicine
 April 13-14-15, 1971

- Please pre-register me for meetings, work sessions, and exhibits. My check for \$165 is enclosed.
- I cannot attend the full conference but plan to visit the exhibits. Fee: none for qualified registrants. Please pre-register me for
- first day third day
 second day all three days

Name _____ Title _____
 Company or Hospital _____
 Address _____
 City _____ State _____ Zip _____

If we design it you can count on it being a winner.

Take our new Ink Ribbon Printer. We'll customize it to your special requirements. What do we have to start with? A printer that's front loading, with two spools and 200 inches of true ink ribbon, and a reliable automatic feeding and reversing mechanism. It has a typewriter ribbon advancing action that assures longer ribbon life, doesn't require pressure sensitive tickets or tape, and gives you up to 30 active digits for use with ticket or tape.

The rest is up to you to ask and us to design. Count on us. Write Product Manager, ITT General Controls, 801 Allen Avenue, Glendale, California 91201.

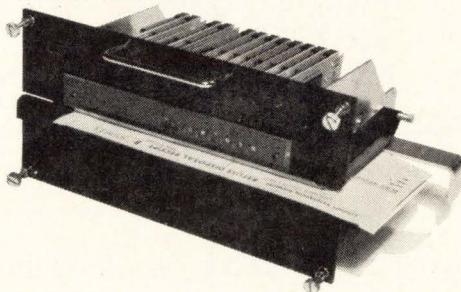

GENERAL CONTROLS



The LSI features a hybrid system of an optimum ten chips, seven registers, five data selectors, three arithmetic logic units and one clock driver. Plus it is bonded face down onto a ceramic substrate with multi layers of aluminum wiring . . . via ultrasonic methods.

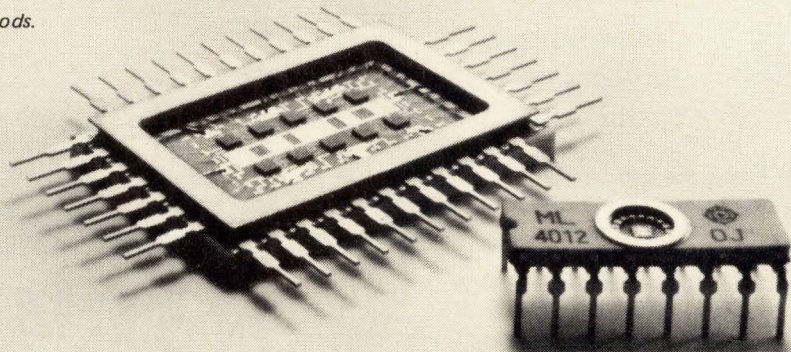

The SSI features LTP, twenty-five and fifty ohm line driving capability, sixteen pin DIL ceramic package with improved GND terminal and, like the LSI, an ultra high switching speed of one nanosecond.

Now.

You can order ECL circuits in volume. SSI or LSI.

Both types feature a propagation delay of one nanosecond per gate.

And a minus-four volt power supply for less dissipation.

And flexible logic design capabilities.

Moreover, each has undergone an eight million component hour high temperature operating life test as well as environmental testing to assure you high reliability.

They're backed by Japan as part of its

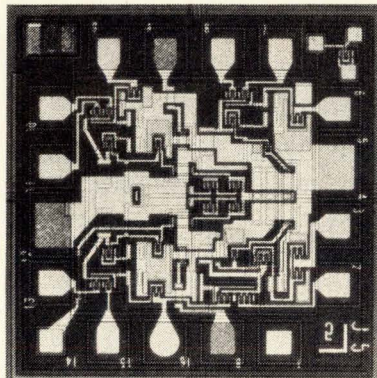

"National Techno Industrial Project", too. And our "old block" of long experience in state-of-art semiconductor technology. Now at one nanosecond.



6-2, 2-chome Otemachi, Chiyoda-ku, Tokyo 100
Tel: Tokyo (270) 2111 Telex: TK2395, 2432, 4491
Cable Address: "HITACHY" TOKYO

Hitachi America, Ltd. Chicago Office
(Electronics Department): 111 East Wacker Drive,
Chicago, Illinois 60601, U.S.A. Tel: (312) 644-6565
Hitachi, Ltd. 1 Berlin 31, Kurfürstendamm 102,
Deutschland Tel: 8865310; West Berlin

A Chip Off The Old Block At One Nanosecond?

**Quick delivery of Quality ECL circuits in
Quantity for high speed computers, instruments and
communications systems.**

7 SSI (Small Scale Integration) & 16 LSI.

New products

Low-cost display provides some graphics capability

Graphic displays have been considerably more expensive than alphanumeric displays—because they were intrinsically more complex. Their prices, in fact, sometimes have been 100 times that of alphanumeric units.

But now a display unit with at least a modicum of graphics capability is available at a price more like twice that of a simple alphanumeric display, and not much more than that of some of the fancier alphanumeric. It's being marketed by the Data Equipment and Systems division of International Telephone and Telegraph Corp. Based on ITT's older Alphascop, it's called the Gralphoscope and will sell for less than \$9,000.

It consists of the basic Alphascop display and keyboard unit and controller with an additional logic card in the controller. The extra card permits the basic alphanumeric data sent from the computer to the controller to be shown in the form of a histogram with up to 74 segments. (The basic Alphascop displays 80 characters per line; the missing six characters are control characters that set up the graphic display.) Under software control this histogram can be redrawn in the form of a more or less continuous curve based on interpolated values taken from the histogram.

Because of the interpolation, the curve, if it were really continuous, would be a series of very short straight lines; but because the Alphascop can't generate true vectors, these lines cannot slant but are all horizontal, so that the curve appears as a series of tiny steps.

Other software-generated displays can be based on the histogram such as mean values, deviations, and maximum-minimum values.

Deliveries will begin during the second quarter of 1971.

ITT Data Equipment and Systems division, East Union Ave., East Rutherford, N.J. 07073 [411]

the Giant Killer strikes again...

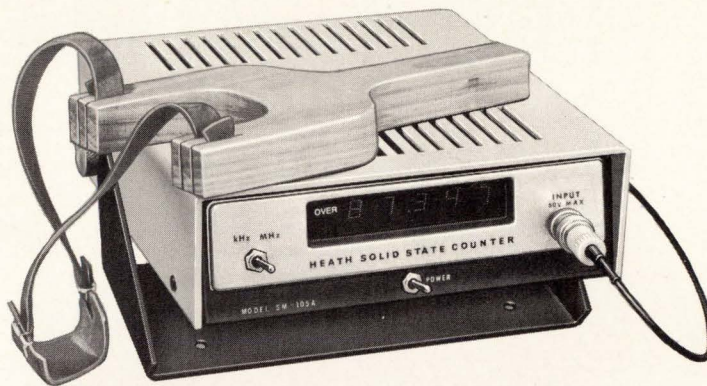

New Heath SM-105A

\$350.00*

ASSEMBLED
& TESTED

- 10 Hz to over 80 MHz range
 - Advanced design — new Texas Instruments 74S Series superspeed Schottky TTL
 - 5-digit LED readout
 - Wide range input without adjustment
 - 1 megohm input
 - Crystal clock
- *Send for free SM-105A spec sheet... and watch the giants fall!*

SM-105A SPECIFICATIONS — Sensitivity: 100 mV RMS to 50 MHz; 250 mV RMS, 50 MHz to 80 MHz. Frequency Range: 10 Hz to 80 MHz. Input Impedance: 1 Megohm shunted by less than 15 pF. Overload: 50 V RMS from 10 Hz to 15 MHz; from 15 MHz to 80 MHz derate linearly at 0.8 V RMS/MHz from 50 V RMS. Maximum DC input is ± 50 V. Time Base: 1 MHz ± 2 Hz. 0° C to 40° C ambient, ± 10 ppm. Readout: Five 7-segment light-emitting-diode displays. One single light-emitting-diode for overrange. Overage: Flashing, 40 ms on, 60 ms off. Power Requirements: 120/240 VAC, 12 watts. Dimensions: 9 $\frac{1}{16}$ " D x 6 $\frac{3}{4}$ " W x 2 $\frac{1}{4}$ " H. Net Weight: 3 $\frac{1}{2}$ lbs. Shipping Weight: 6 lbs.

FREE HEATH SCIENTIFIC INSTRUMENTATION CATALOG

Investigate these and other new ideas in Spectroscopy, Digital Instrumentation, Lab Equipment and Test Equipment. Send for your FREE catalog now.

HEATH COMPANY, Dept. 520-28
Benton Harbor, Michigan 49022

HEATHKIT
a Schlumberger company

Please send free Heath Scientific Instrumentation Catalog

Name _____

Address _____

City _____

State _____

Zip _____

*Mail order prices; FOB factory.

Prices & specifications subject to change without notice. EK-296

A very uncomplicated new OEM recorder with just one thing going for it...

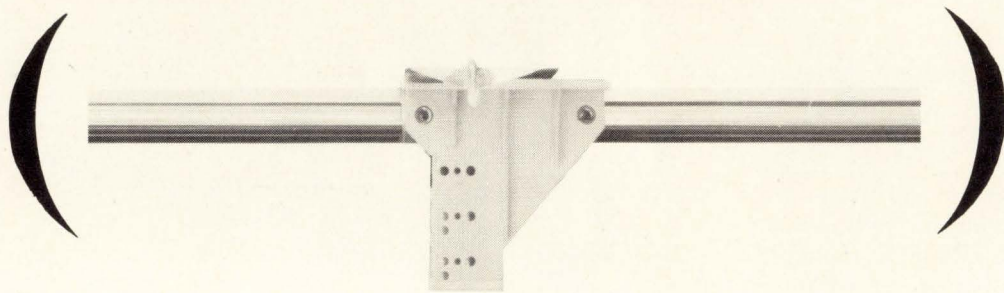

You'll like what you see in our new approach to dedicated OEM strip chart recorders. First, we eliminated all those complicated moving parts from the writing mechanisms. No more pulleys, cables and slip clutches. Instead, there's just one simple moving part—the slider/pen assembly. That's because a linear servo motor keeps the pen going magnetically ... and very reliably.

When you see the HP Model 7123, you'll notice how the low power servo system makes the recorder smooth, precise and trouble-free. You could drive it off scale around the clock without noise or danger.

Even with all that, you've got a lot more going for you with the 7123. Like a swing-out chart paper drive for quick reloading and reinking. The viewing/writing area is slanted so you can make notes right at the disposable pen tip. And you can work without worrying about a lot of circuit adjustments. They're simply not needed anymore.

Since it's an OEM machine from the ground up, the 7123 has options

for everybody. Select any chart speed and voltage span in English or Metric scaling. In all, nearly 50 options will customize the recorder exactly to a specific application.

You'll probably be most intrigued by an option we call electric writing. Normally, the ink system works like a cartridge fountain pen. But electric writing is designed for people who don't even want to mess around with that. A highly stable electrosensitive paper that gives you a crisp, clear

trace without ink.

Available in full rack or half rack versions, the 3½ inch high 7123 makes totally unattended operation a reality. Simplicity, reliability, precision and even electric writing. With all that going for you, you can turn it on Friday and forget about your work all weekend.

To see the uncomplicated new 7123 and its matching price and OEM discount schedule, call your nearest HP sales office. Or write, Hewlett-Packard, Palo Alto, CA 94304; Europe: 1217 Meyrin-Geneva, Switzerland.

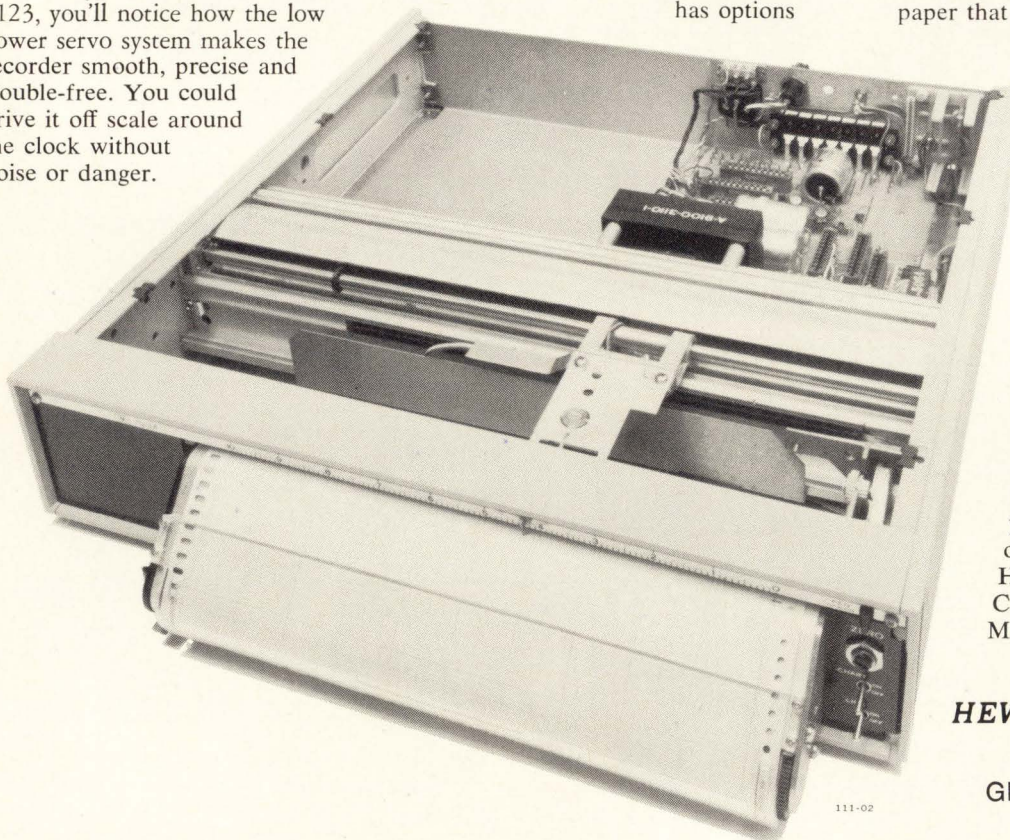

111-02

HEWLETT  PACKARD

GRAPHIC RECORDERS

New products

Semiconductors

Hammer driver handles 6.5 A

Thick film hybrid circuit for printers, plotters can switch 60 volts

Monolithic circuits don't make it where high voltage and current capabilities are needed, and that's why Texas Instruments Inc. stayed

with thick film hybrid techniques in a new series of logic-to-power interface circuits.

The first in the line of hybrids is the TIH101, a dual hammer driver that is compatible with transistor-transistor logic. It can handle an output of 6.5 amperes at a 5% duty cycle with pulse widths to 1.25 milliseconds. The 101 can switch 60 volts.

The circuit is suitable for driving hammers in high-speed printers, stepper motors in computer-operated plotting equipment, paper tape punches, relays, lamps, or other high-current-resistive or inductive loads.

Future products in the logic-to-

power interface line will include relay latch drivers for use in modems, switchboards, and other telephone equipment.

The TIH101 contains two independent drivers, each consisting of a 7400-type gate driving a Darlington power output stage through an intermediate amplifier. The output transistor is a TIP41 chip. The circuit also includes a transient suppressor diode for inductive loads as well as both drive and inhibit inputs.

The standard TIH101 switches 60 V but 100-V versions can be supplied. Continuous output current with one output on is 9.75 A and with both on, 0.5 A. In addition

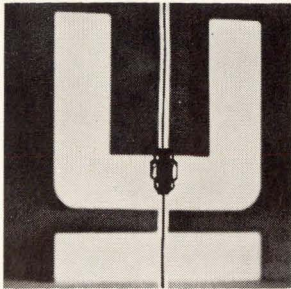

P-i-n diodes series UM4000 have a typical low series resistance of 0.3 ohm at 100 mA and a total capacitance of 2.6 pF. Carrier lifetime is typically 7 microseconds. Units are available in a variety of package styles, with voltages from 100 V to 600 V. Fused-in-glass construction gives high reliability. Unirode Corp., 580 Pleasant St., Watertown, Mass. 02172 [436]

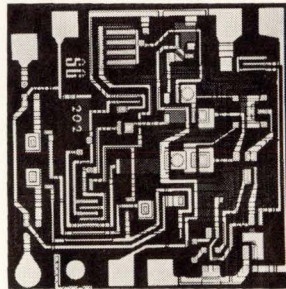

Voltage followers SG110/210/310 are silicon monolithic amplifiers which are internally connected as unity-gain noninverting amplifiers. Input resistances of 10^{12} are achieved through the use of super-beta transistors in the input stage; input bias current is typically 1 nA. Slew rate is in excess of 30 V/ μ s. Silicon General Inc., 7382 Bolsa Ave., Westminster, Calif. [437]

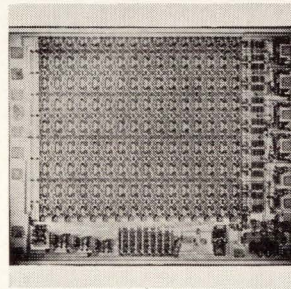

High-speed 256 x 1 MOS random access memory interfaces with DTL or TTL without pull-up or pull-down resistors and operates over the full -55° to 125° C temperature range. Fully bipolar compatible and requiring no clock or clock driver, the RAM offers access time below 1 nanosecond and draws power at only 1 milliwatt/bit. Unisem Corp., P.O. Box 11569, Philadelphia 19116 [438]

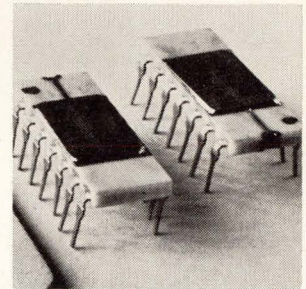

MTOS dual 64/80 bit dynamic shift register model DL-1-2080 features 2 MHz operation, a temperature range of 0° to $+70^{\circ}$ C, monolithic construction, high input impedance, and pyrolytic passivation. The device is primarily for terminal and data processing applications. Price in lots of 100 is \$13.30 each. General Instrument Corp., 600 W. John St., Hicksville, N.Y. 11802 [439]

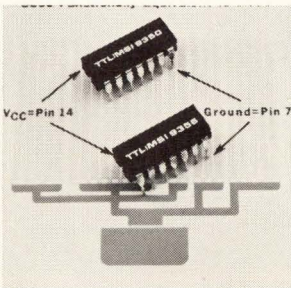

Two TTL/MSI high-speed counters are packaged in 14-pin ceramic DIPs with standard corner power pins to simplify circuit board layout and interfacing with other TTL units. The model 9350 decade counter and model 9356 four-bit binary counter operate at 18 MHz with typical power dissipation of 160 mW. Fairchild Semiconductor, 464 Ellis St., Mountain View, Calif. 94040 [440]

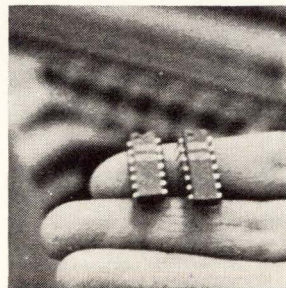

Line driver and line receiver ICs, which meet international communication specifications, are for use in computer terminals and peripheral equipment. The N8T-15A dual line driver accepts standard TTL logic level inputs. Each side of the N8T16A dual line receiver accepts a single EIA input or double-ended Mil inputs. Signetics Corp., 811 E. Arques Ave., Sunnyvale, Calif. [441]

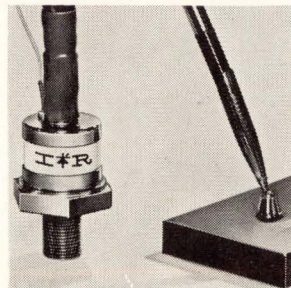

Accelerated cathode excitation, fast firing SCRs from 600 to 1,200 V are 250 A average rated. Suited for fast switching inverter use, series 250 RM offers a di/dt of 800A/ μ s, coupled with a dv/dt of 200 V/ μ s and a turn-off of 40 μ s. Devices come in three case styles in stud-mounted and flat base configurations. International Rectifier, Kansas St., El Segundo, Calif. [442]

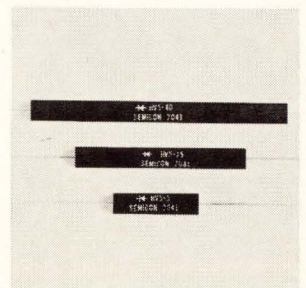

High-voltage, diffused silicon rectifiers series HV5, HV10 and HV25 cover 5, 10 and 25 mA current ratings, respectively. They are available in a complete spectrum of voltage ratings through 40 kV. All feature mono-substrate construction resulting in a mechanically rugged, thermally stable device. Delivery is stock to 2 weeks. Semicon Inc., 10 North Ave., Burlington, Mass. [443]

Read Mostly Memories Plated Wire

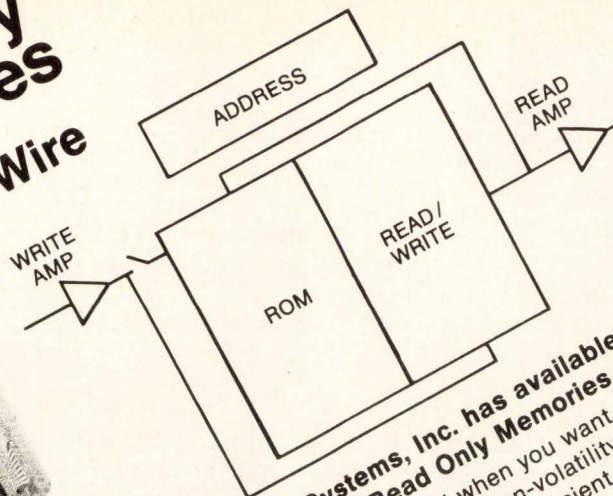
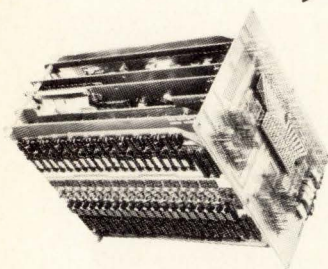

a complete range of Field Programmable Read Only Memories.
These systems feature Non-Destruct Readout (NDRO). Read when you want. As often as you want. Write only when necessary to store. Non-volatility and NDRO provide program integrity against power failure and power transient. Nemonic Data Systems is now offering a complete range of plated wire, stacks, and complete memory systems with off-the-shelf deliveries.

Nemonic Data Systems, Inc. 1301 West 3rd Ave.,
Denver, Colorado 80223 (303) 892-7012

nemonic
DATA SYSTEMS INC.

Circle 171 on reader service card

New products

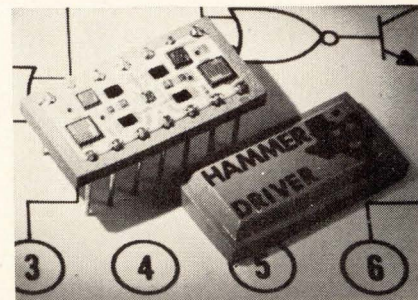

to the IC supply ground, a separate ground is provided for each output terminal to reduce losses at high current. Idling current at the 5-V supply is typically 8 milliamperes, and current with one output on is 110 mA.

The TIH101 comes in a 14-pin dual in-line ceramic and glass package with leads conforming to the standard DIP configuration. It's priced at \$8.46 in 100 to 999 quantities, and is available in four to six weeks.

Texas Instruments Inc. Inquiry Answering Service, P.O. Box 5012, M/S 308, Dallas, Tex. 75222 [444]

ECONOMICAL Thin Film!

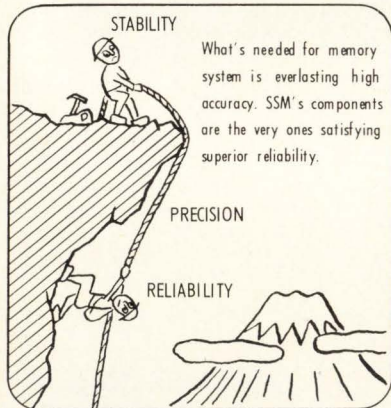

What's needed for memory system is everlasting high accuracy. SSM's components are the very ones satisfying superior reliability.

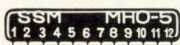

Pla-module:
thin film modulated
C-R circuit.



Plate-ohm:
evaporated metal film resistor.



Pla-con:
organic thin film capacitor by
plasma reaction.

SUSUMU INDUSTRIAL CO., LTD.

Minami Bldg. 1-12 Ebisuminami
Shibuya-ku, Tokyo, Japan.
TEL: Tokyo (03) 712-5990
TELEX: No. 246-6270

THIS SPACE CONTRIBUTED BY THE PUBLISHER

LISTEN TO YOUR BODY.



If something's going wrong, it'll tell you.

1. Change in bowel or bladder habits.
2. A sore that does not heal.
3. Unusual bleeding or discharge.
4. Thickening or lump in breast or elsewhere.
5. Indigestion or difficulty in swallowing.
6. Obvious change in wart or mole.
7. Nagging cough or hoarseness.

If you have a warning signal, see your doctor. If it's a false alarm, he'll tell you. If it isn't, you can give him time to help. Don't be afraid. It's what you don't know that can hurt you.

American Cancer Society

Off-the-shelf mil-spec RAM has 30-ns access time

There are plenty of 64-bit bipolar random access memories around, but few that meet military specifications and are available off-the-shelf.

That's why Advanced Micro Devices Inc. developed the AM31013. "We did not just take an existing design and copy it," says Sven E. Simonsen, director of engineering for complex circuits at AMD. "We redesigned the complete circuit so that we could offer, and guarantee, a full mil-spec device."

The memory, Simonsen says, meets all of the standard specs for 64-bit bipolar RAMs and exceeds them in speed: "Most of them guarantee a 60-nanosecond access time and typically run at 40 ns. Our memory runs at a 30-ns typical access time."

In a system, the memory, organized at 16 words by four bits, is used with a one-out-of-sixteen decoder. An address field of eight

NOW ... Test and analyze ANY individual component on your LSI chip.

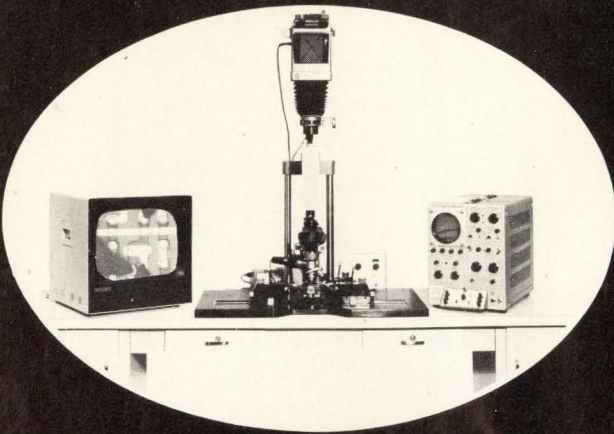

With the MARK TEN MICROTTEST ANALYZER you are no longer restricted to indirect methods in determining why your chips don't work or why a failure occurred. Circuit trace IC chips with the same ease as trouble shooting discrete components on a PC board.

For complete information phone: (516) 488-2525

COMALTEST INC.

124 South 8th Street, New Hyde Park, N. Y. 11040

Circle 172 on reader service card

**We make
100+ different
kinds of
termination
hardware
but that's not the end**

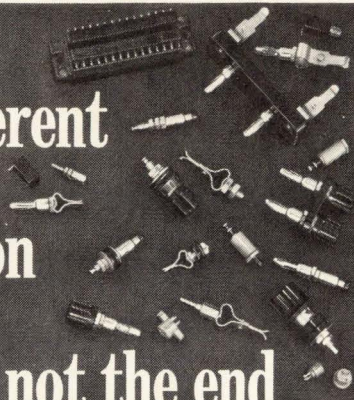

We are in termination hardware because our customers asked us. They had some definite ideas about miniature posts, sockets, plugs or test clips. Binding post caps that don't melt at soldering temperatures, for example.

Most of our termination products were developed for superior insulation, dielectric strength, contact resistance. (Transistor sockets with minimum insulation resistance of 500,000 megohms at 100 VDC.)

But despite the length of our line, it's not the

end. We will develop new hardware for new applications with the same commitment to quality in design, materials and workmanship that has fed the growing demand for our rotary and push button switch lines.

Like to know more? Write or phone for our latest general engineering catalog. Grayhill, Inc., 523 Hillgrove Ave., La Grange, Ill. 60525, (312) 354-1040.

Grayhill

pioneers in miniaturization

Circle 173 on reader service card

**PROVEN RELIABILITY—
SOLID-STATE POWER INVERTERS,
over 260,000 logged operational hours—
voltage-regulated, frequency-controlled,
for missile, telemeter, ground support,
135°C all-silicon units available now—**

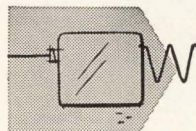
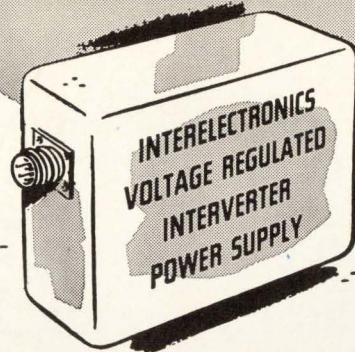

Interelectronics all-silicon thyatron-like gating elements and cubic-grain toroidal magnetic components convert DC to any desired number of AC or DC outputs from 1 to 10,000 watts.

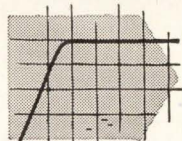

Ultra-reliable in operation (over 260,000 logged hours), no moving parts, unharmed by shorting output or reversing input polarity. High conversion efficiency (to 92%, including voltage regulation by Interelectronics patented reflex high-efficiency magnetic amplifier circuitry.)

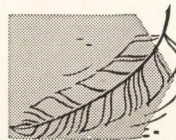

Light weight (to 6 watts/oz.), compact (to 8 watts/cu. in.), low ripple (to 0.01 mv. p-p), excellent voltage regulation (to 0.1%), precise frequency control (to 0.2% with Interelectronics extreme environment magnetostrictive standards or to 0.0001% with fork or piezoelectric standards.)

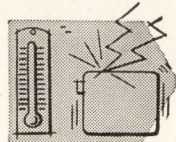

Complies with MIL specs. for shock (100G 11 mlsc.), acceleration (100G 15 min.), vibration (100G 5 to 5,000 cps.), temperature (to 150 degrees C), RF noise (I-26600).



AC single and polyphase units supply sine waveform output (to 2% harmonics), will deliver up to ten times rated line current into a short circuit or actuate MIL type magnetic circuit breakers or fuses, will start gyros and motors with starting current surges up to ten times normal operating line current.

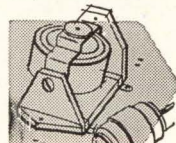

Now in use in major missiles, powering telemeter transmitters, radar beacons, electronic equipment. Single and polyphase units now power airborne and marine missile gyros, synchros, servos, magnetic amplifiers.

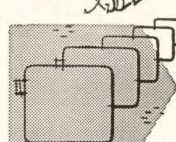

Interelectronics—first and most experienced in the solid-state power supply field produces its own all-silicon solid-state gating elements, all high flux density magnetic components, high temperature ultra-reliable film capacitors and components, has complete facilities and know how—has designed and delivered more working KVA than any other firm!

For complete engineering data, write Inter-electronics today, or call 914 Elmwood 8-8000.

INTERELECTRONICS CORP.

700 U. S. Route 303 Congers, New York 10920

Circle 147 on reader service card

147

Equipments and Systems

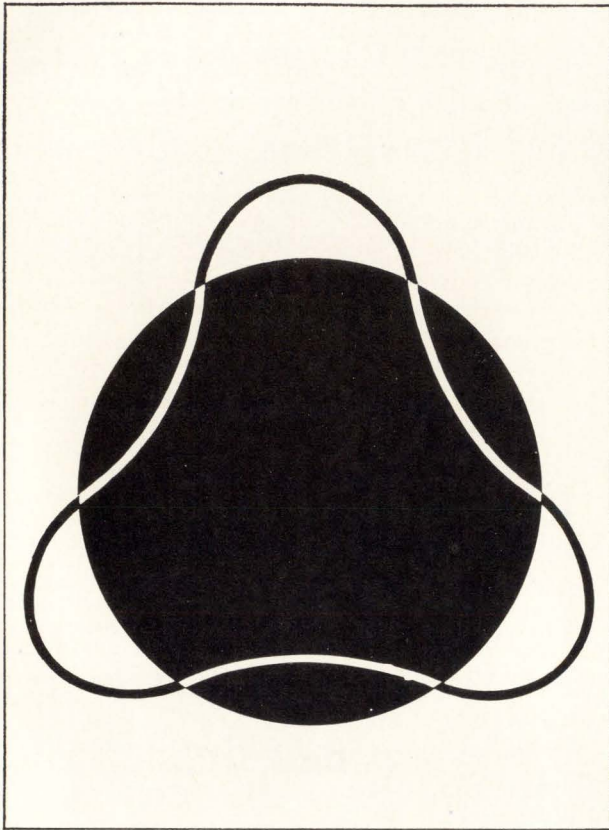

922.833

bearing the
TELEFUNKEN trademark
are symbols of
progress in the World

We manufacture and supply: Broadcasting and television transmitters · Communications transmitters · Maritime transmitters and transceivers · Professional receivers and direction finders · Radars · Radiotelephone sets and systems · Telecommunications equipment and cables · Data processing systems

Write for comprehensive documentation

ALLGEMEINE ELEKTRICITÄTS-GESELLSCHAFT
AEG-TELEFUNKEN
Export Department
79 Ulm · Elisabethenstraße 3
Germany



AEG-TELEFUNKEN

STILL TRYING TO LOCATE THAT INTERMITTENT?
TIRED LUGGING A HEAVY OSCILLOSCOPE?
SPENDING TOO MUCH FOR TEST EQUIPMENT?

GET **DY-NOS-STICK**
DIGITAL TEST PROBE
HUNDREDS NOW IN USE

Ideal for...
Lab Design Verification
Manufacturing Test
Field Service



The versatile digital
servicing aid for DTL
& TTL systems

- RUGGED, LIGHTWEIGHT, EASILY HANDLED
- LOGICAL LEVELS DEFINED BY COLORED INDICATORS
- ABNORMAL AND OPEN CIRCUIT LEVELS DETECTED
- PULSES, INTERMITTENTS AND TRANSIENTS DETECTED
- GATED SYNC CONTROLLABLE PROBE TIP
- OVERLOAD PROTECTED PROBE TIP
- MEMORY ALLOWS UNATTENDED USAGE

5 OR 6 VOLT MODELS
\$59.95



NU-CONCEPT COMPUTER CO.
306 WEST LOGAN ST.
NORRISTOWN, PENNA. 19401
(215) 275-3200
Circle 174 on reader service card

C&K ROTARY PrintSwitch

YOU DESIGN THE
CIRCUITRY

WE WILL GIVE
FAST DELIVERY
AT STOCK PRICES

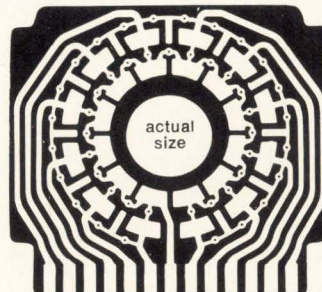

NEW UNIVERSAL PATTERN
stator board gives unlimited
custom design capabilities.

A stock C&K Rotary Print-Switch Kit allows you to make prototype switches by removing unwanted interconnections, as illustrated.

*Send for 16 page catalog 900
SEE YOU AT IEEE BOOTH 2139



C & K Components, Inc., 103 Morse St., Watertown, Mass. 02172

There is a difference in Heath Dynamics' Quartz Crystal Filters!

Heath Dynamics specializes in the design and manufacture of the highest quality Quartz Crystal Filters and Discriminators for the Communications Industry.

Our facility is completely new, inside and out, fully staffed and equipped with the most modern mechanical and electronic test measuring devices.

We employ the assistance of one of the largest time sharing computers available.

Heath Dynamics' area of specialization includes the manufacture of miniature and sub-miniature filters in the range of 10 thru 32 Mhz. Bandwidths may be from .025% thru .35% in the smallest packages and may range up to 2.0% in the larger ones.

We manufacture direct replacement filters for all the current monolithic designs using our half lattice configuration which yield lower insertion loss, lower ripple and greater ultimate rejection. Yet our filters cost less and faster delivery is guaranteed!

All Heath Dynamics' crystal filters designed and manufactured to your particular specifications meet Mil F. 18327.

In short, we want your business and we'll act like it. Do us both a favor and send us your print or specification for a quote. If you have any questions just write or call us... we're here to serve you.

 **heath
dynamics, inc.**
6050 n. 52nd avenue
glendale, arizona 85301
(602) 934-5234
subsidiary of
Heath International, Inc., Richmond, Mich.

New products

bits is then broken down as four bits to the decoder, which next selects one of the 16 chips through the chip enable input, and four bits to the memory address, through which they are connected in parallel to the address inputs on all of the other memories.

Access time, which is measured from chip select to output, is therefore a function of the delay through the decoder and the delay through the memory itself. So even if the delay through the chip were zero, there would still be some finite delay due to the decoder delay. "If I speed up the time from chip select to output as much as I've lost in the decoder (which is typically 25 nanoseconds), then I've got the optimum device," says Simonsen. In practical terms, though, the chip delay time could be cut by 10 ns and not 25.

Another contributor to the memory's speed is the fact that gold is not used in the process; Schottky diodes are used, reducing storage time and making the memory faster. Here, too, the AMD device is not a copy of other Schottky-clamped memories that are now on the market.

"You have to be selective in where you use Schottky diodes," says Simonsen. "In some other circuits the diodes cause breakdown problems. If they are used only at the edges of a device, you can get bad corner effects. To eliminate the breakdown that this causes, you have to operate the memory at lower voltages. But we employ a guard-ring concept which eliminates this problem and allows us to get a high temperature specification as well as a high breakdown voltage."

The memory is available in both the military and the industrial temperature ranges. Price for the mil unit in quantities of 100 is \$29.75; the industrial unit sells for \$21.50 in a hermetic package, and for \$20.50 in a silicone dual in-line package. The military unit's temperature limit is 125°C. ambient.

Advanced Micro Devices Inc., 901 Thompson Place, Sunnyvale, Calif. [445]

98.6°F. Maximum Body Temperature

From No Load To Full Load

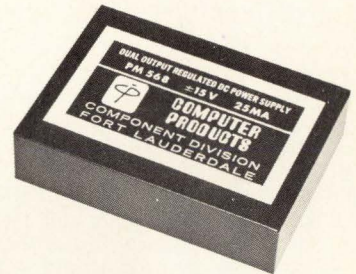

PM568

Dual Output $\pm 15V$, 25mA

- Series Regulated
- 0.02% Temp. Coeff.,
Line and Load 0.1%
- Highest Efficiency —
1½ Watts Input/
¾ Watt Output
- 115 VAC, 50 to 400 Hz
(230 VAC Model Available)
- Compact PC Mount
(3.50"x2.50"x.875")
- 2 Year Warranty
- Same Day Shipment
- Unit Qty. Price \$23⁰⁰

Call or write for bulletins
on our Complete Line
from 3.6V to 180VDC.



COMPUTER PRODUCTS®

Post Office Box 23849
Ft. Lauderdale, Fla. 33307
Telephone (305) 933-5561

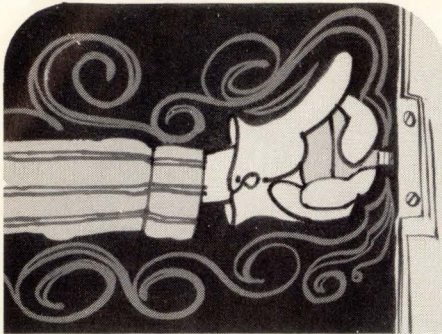

THE SOUND OF
Trouble
ON ITS WAY... ARE
YOU READY FOR IT?

DELTALERT IS!

A door knob rattling in the night... footsteps on the front porch... the shattering of window glass. In that moment you, your family and your property are in danger.

Enjoy new peace of mind with a reliable DeltAlert detection and alarm system. DeltAlert detects motion in 150 to 300 sq. ft. of critical space with a silent ultrasonic blanket...turning on lights automatically to drive away prowlers.

When the separate DeltaHorn is plugged into the DeltAlert unit, the intruder faces the additional obstacle of loud, ear-shattering noise. A built-in 20-second delay switch allows authorized persons to turn off the horn when entering the monitored area. The sturdy units, finished in handsome walnut veneer, are maintenance-free, economical and need no installation.

At home or work, proven economical security begins with DeltAlert alarm and detection protection.

DELTAHORN, \$24.95
3 1/4" w x 3 1/4" h
x 3 1/4" d



Made in U.S.A.

DELTALERT, \$69.95
10 9/8" w x 3 1/4" h x 3 1/4" d

Order your DeltAlert Security System today!
Superior Products At Sensible Prices



DP 70-24
DELTA PRODUCTS, INC.

P.O. Box 1147 E / Grand Junction, Colo. 81501
(303) 242-9000

Please send me literature immediately:

Enclosed is \$____. Ship ppd. Ship C.O.D.

Please send _____ DeltAlert(s) @ \$69.95 ppd.

Please send _____ DeltaHorn(s) @ \$24.95 ppd.

Name _____

Address _____

City/State _____

Zip _____

New literature

Precision power drives. MPC Products Corp., 4200 W. Victoria Ave., Chicago 60646. A comprehensive application manual contains design application data, in tabulated form, on precision power drives that feature long life, low backlash, and high torque-to-weight ratios.

Circle 446 on reader service card

Pulse transformers. The Potter Co., 500 W. Florence Ave., Inglewood, Calif. 90301. An eight-page catalog lists the series 7000 general purpose pulse transformers, both the standard and advanced versions of dual in-line units, and the SCR trigger transformers. [447]

EDP supplies. Columbia Ribbon & Carbon Mfg. Co., Herhill Rd., Glen Cove, N.Y. A 12-page brochure lists a line of fabric and film ribbons, ribbons for IBM Selectrics, composers, high-speed printers, and peripheral equipment, such as card punch machines, accounting machines, interpreter machines, and others. To obtain a copy, write on company letterhead.

Dc solenoids. Hi-G Inc., 580 Spring St., Windsor Locks, Conn. 06096, has published a data folder simplifying selection of the proper miniature dc solenoid. [448]

Pc connectors. Continental Connector Corp., 34-63 56th St., Woodside, N.Y. 11377, has available a 16-page technical catalog covering an expanded group of right-angle plug and socket connectors for pc applications. [449]

Frequency-sensitive relay. Solid State Electronics Corp., 15321 Rayen St., Sepulveda, Calif. 91343. A two-page data sheet describes the model 476 frequency-sensitive relay. [450]

Power supplies. Technipower Inc., Benrus Center, Ridgefield, Conn. 06877. The Practicals, an all-solid state series of open-construction power supplies, are described in a six-page folder. [451]

Operational amplifier. Analog Devices Inc., 221 Fifth St., Cambridge, Mass. 02142. A four-page foldout data sheet covers the model 47 fast-settling, FET-input operational amplifier. [452]

Fabricated insulation boards. National Tel-Tronics Corp., 55 Northern Blvd., Great Neck, N.Y. 11021. A facilities brochure covers the company's capabilities to machine, shape, and affix hardware to all types of insulating boards and printed circuits. [453]

Zip-on jacketing. The Zippertubing Co., 13000 S. Broadway, Los Angeles 90061, has released a catalog of Zippertubing materials for custom cabling, cable shielding, high-and low-temperature en-

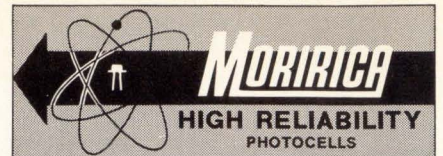

**HIGH QUALITY,
REASONABLE PRICE,
AND FAST DELIVERY**



MAIN PRODUCTS

CdS Photoconductive cell

- * High sensitivity
- * High fidelity for visibility of human eye.
- * Large tolerable power dissipation
- * Highly stabilized

CdSe Photoconductive cell

- * Fast response time
- * Remarkable high sensitivity
- * Spectral response inclined more toward red than visibility

Photocell-Lamp

- * Non-contact structure eliminates mechanical troubles
- * Compact design
- * Allows designing of most simple self-holding mechanism

Se Photovoltaic Cell

- * Photovoltaic characteristics.
- * Thin design
- * Shape can be selected freely

* For catalog, please write to:
MORIRICA ELECTRONICS, LTD.

205, Tozuka-machi, Tozuka-ku, Yokohama, Japan
Tel: 045-881-2331 Cable Address: MORIRICA YOKOHAMA

POWERTEC

THE POWER HOUSE

OEM SERIES POWER SUPPLIES ADJUSTABLE

\$24⁹⁵

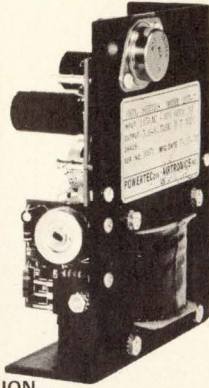

TO 12 AMPS

4 TO 26 VDC 3 TO 12 AMPS
RIPPLE: 1 MVRMS
SHORT CIRCUIT PROTECTED
FOLD BACK CURRENT LIMITING
OPTIONAL OVER VOLTAGE PROTECTION
REGULATION: LINE $\pm 0.25\%$ LOAD $\pm 0.25\%$

MODEL	PRICE		DIMENSIONS
	1-9	100	
2B5 - 3 AMPS	\$24.95	\$19.50	4.8 W X 4 L X 1.8 D
2C5 - 6 AMPS	\$44.00	\$36.00	4.8 W X 5.7 L X 2.8 D
2C5 - 12 AMPS	\$75.00	\$60.00	4.8 W X 9 L X 3 D

OEM CONTRACTS AVAILABLE

POWERTEC AIRTRONICS INC.

A DIVISION OF
9168 DESOTO AVENUE
CHATSWORTH, CALIFORNIA 91311
(213) 882-0004 TWX 910-494-2092

Circle 178 on reader service card

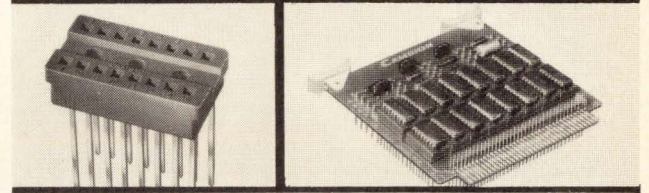
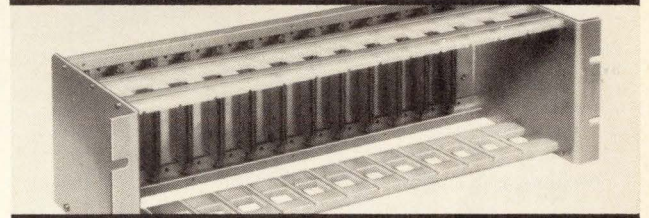
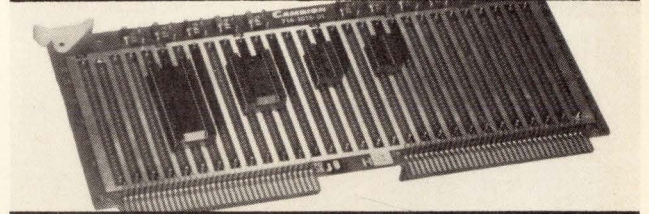
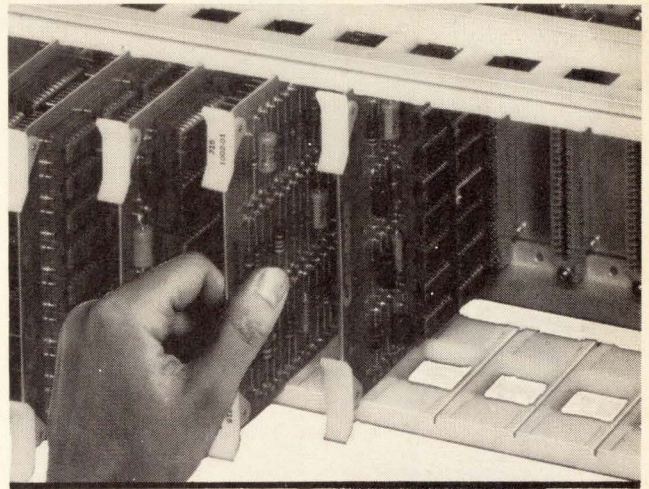

if you design with ic's Cambion has the "works" for your work

If your digital system is a packaging puzzle, CAMBION can provide the solution.

We have the high density sockets, wire-wrappable Cambi-Cards®, PC logic cards, general purpose and discrete component cards for your functional requirements.

And to complete the picture: card files, power planes, card connectors and extenders, plus a complete numerically controlled Wire-Wrap* service.

Result: Tightly integrated packaging systems. The "works" for your work.

For details, call us or write for the latest word on IC accessories and wire-wrapping. Cambridge Thermionic Corporation, 445E Concord Avenue, Cambridge, Mass. 02138. Phone: (617) 491-5400. In Los Angeles, 8703 La Tijera Boulevard 90045. Phone: (213) 776-0472.

*Registered Trade Mark Gardner-Denver Co.

Standardize on

CAMBION®

The Guaranteed Electronic Components

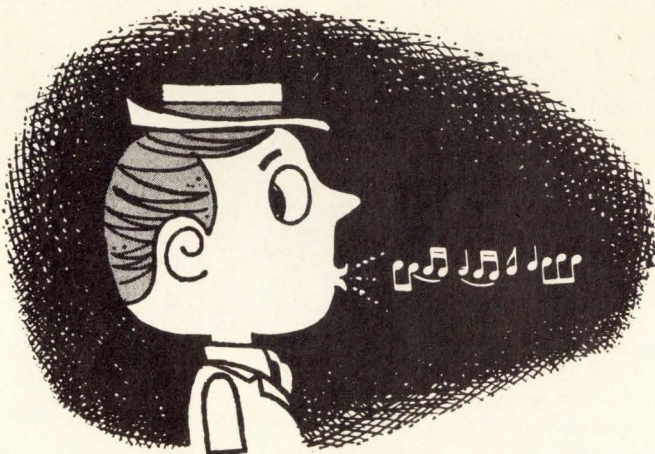

YOU'RE WHISTLING IN THE DARK...

if you think that heart disease and stroke hit only the other fellow's family.

GIVE... so more will live
HEART FUND



Contributed by the Publisher



**OUTSTANDING
THERMAL ENDURANCE
RUNS IN THIS FAMILY:
ELECTRICAL
TEMP-R-TAPE
OF KAPTON.**

Temp-R-Tape® of Kapton* is now available in a complete "family" of tapes—all offering outstanding thermal endurance, retaining their excellent mechanical and electrical properties over an operating range from -100F to +500F. Available in thicknesses from .001 to .0045" with electric strengths up to 10,000 volts... with a choice of pressure-sensitive silicone adhesive on one or both sides, or thermosetting acrylic adhesive, or a flame retardant adhesive... and in ¼", ½", ¾", 1", 1½", and 2" widths, with special widths slit to order.

Find your CHR distributor in the Yellow Pages under "Tapes, Industrial" or in industrial directories. Or write for details and sample. The Connecticut Hard Rubber Company, New Haven, Connecticut 06509.



a HITCO company



*T.M. of DuPont

New literature

environmental protection, shrinkable tubing, and specialized linings and configurations of zip-on jacketing for various applications. [454]

Mica capacitors. JFD Electronics Corp., 15th Ave. at 62nd St., Brooklyn, N.Y. 11219. A four-page catalog describes a complete line of dipped silvered mica capacitors. [455]

Photomultiplier specifier. Bailey Instruments Co., 515 Victor St., Saddle Brook, N.J. 07662, has produced a photomultiplier specifier as an aid to designers in selecting the optimum tube for any application. [456]

Dc voltage regulators. Beckman Instruments Inc., 2500 Harbor Blvd., Fullerton, Calif. 92634. Series 809 and 859 dc voltage regulators, self-contained hybrid, cermet units are described in a four-page catalog sheet. [457]

Beam-lead sensor arrays. Texas Instruments Inc., P.O. Box 5012, M/S 308, Dallas 75222. Bulletin CB-128 explains beam-lead sensor array technology and the advantages of such an array compared to one comprising individual phototransistors mounted and wired separately. [458]

Rheostats. Ohmite Mfg. Co., 3601 W. Howard St., Skokie, Ill. 60076, has published an up-to-date, 40-page guide to close control rheostat selection and availability. [459]

Synchronous motors. Sigma Instruments Inc., 170 Pearl St., Braintree, Mass. 02185. An eight-page catalog describes a line of stepping and slow-speed synchronous motors. [460]

Dynamic IC testing. Teradyne Dynamic Systems Inc., 9551 Irondale Ave., Chatsworth, Calif. 91311, has issued an eight-page brochure describing its S257 computer-operated dynamic test system for integrated circuits. [461]

Precision potentiometers. Computer Instruments Corp., 92 Madison Ave., Hempstead, N.Y. 11550, has available a design guide and engineering handbook on precision potentiometers. [462]

Miniature power supplies. Palomar Engineers, Box 455, Escondido, Calif. 92025. A four-page technical bulletin describes dual op-amp supplies and IC logic supplies in 1½ inch square cases for direct pc board mount or octal-socket plug-in. [463]

Pc board relay. Siemens Corp., 186 Wood Ave., South Iselin, N.J. 08830. Model V23012 low-profile, miniature pc board relay is described and illustrated in a two-page product bulletin. [464]

**HEAT SHRINK BOOTS
FOR RFI CONTROL**

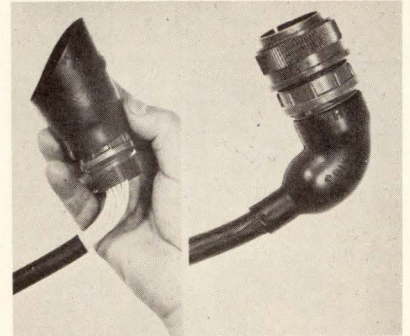

ECCOSHIELD® HS is a line of heat shrink boots and tubing -- electrically conductive -- shield up to 100 db for EMI/EMC applications.

Circle 179 on reader service card

**SPECIFIER'S GUIDE TO
INDUSTRIAL ADHESIVES**

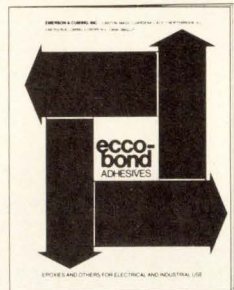

New ECCOBOND® booklet and fold-out wall chart gives specifications and use criteria for a broad line of industrial/electrical adhesives, epoxies and others. Send for FREE copy.

Circle 225 on reader service card

**NEW -- FREE -- DATA
PLASTIC/CERAMIC FOAMS**



ECCOFOAM® is the broadest line of plastic and ceramic foams for electronics. Foam-in-place; sheet stock; pourable syntactic; artificial dielectrics all described and properties tabulated in new booklet. Send for copy.

Circle 226 on reader service card

Emerson & Cuming, Inc.



CANTON, MASS.
GARDENA, CALIF.
NORTHBROOK, ILL.
Sales Offices
in Principal Cities

EMERSON & CUMING EUROPE N.V., Oevel, Belgium

IEEE Booth No. 1202

MICROELECTRONICS Shakedown & Shakeout

CONFERENCE and REPORT

A Quantum Science
Friday, March 26, IEEE Week
Americana Hotel, New York City

The full-day conference and separate report will show you:

- The primary markets
- Dominant technologies within applications
- When industry prices will stabilize
- Japanese competition
- Future industry leaders

The conference will feature . . .

- **Industry forecast and analysis**
Quantum Science Staff

• Industry speakers

Howard S. Bobb, Pres., American Micro Systems . . . Moses Shapiro, Chairman, General Instrument Corp. . . . James Riley, Pres., Intersil, Inc. . . . John O. Pavinin, Pres., MOS Technology, Inc. . . . Steve L. Levy, V. P. & Gen. Mgr., Semiconductor Op., Motorola . . . Floyd Kvamne, V. P. Mkt., National Semiconductor Corp. . . . Chuck Harwood, Pres., Signetics Corp. . . . Bruce Carlson, Pres., Sprague Electric Co., Inc.

Marketing Services Quantum Science Corporation

245 Park Avenue
New York, New York 10017 Tel: 212-986-4410

- Send me your report Microelectronics and make my reservations for the full-day conference at \$370. By ordering the two now, I save \$25.
- Send me your report Microelectronics at \$245.
- I will attend your conference Microelectronics on March 26 for \$150. I understand payment must be made in advance.
- Check enclosed Please bill

Name & Title _____

Company _____

Address _____

Phone _____ ZIP _____

New York State residents please include applicable sales tax.

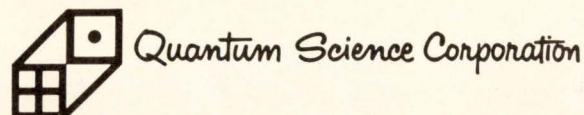

Send your
electrical contact
requirements to—

NEY

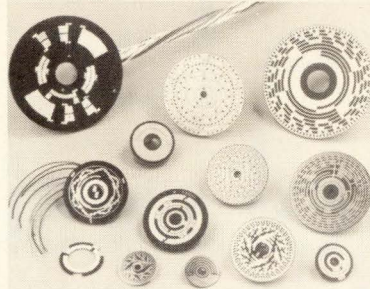

NEYETCH
COMMUTATORS
AND SLIP RINGS

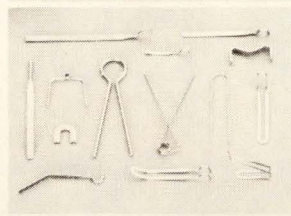

WIRE FORMS



HEADED CONTACTS

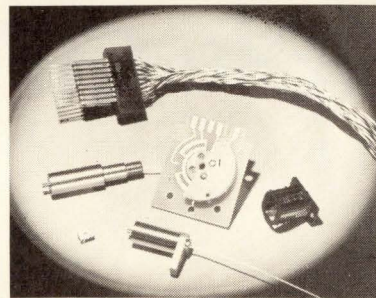

ASSEMBLED
COMPONENTS

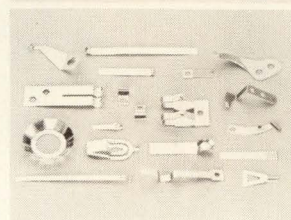

STAMPED AND
FORMED CONTACTS

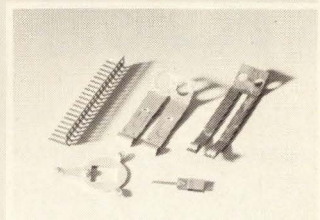

WELDED AND
STAKED ASSEMBLIES

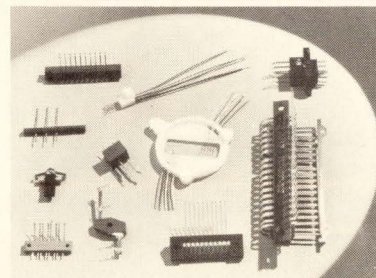

MOLDED
CONTACT
ASSEMBLIES

PALINEY®, NEYORO® ALLOYS

62 PAGE CATALOG ON REQUEST

THE J. M. NEY COMPANY

Maplewood Ave., Bloomfield, Conn.
TEL. HARTFORD 242-2281 (area 203)

NEY

Announcing a new source for control systems, special-purpose processors, and custom microelectronics.

Boeing.

Now you can buy the electronics experience gained from some of the most advanced programs in the aerospace industry.

Boeing Electronic Products, the electronics arm of The Boeing Company, is at your service. With special capability in electronic control systems, special-purpose data processors, and thin and thick film hybrid and special-purpose silicon devices.

You can get a single part or a complete system. A total program including design, development, manufacturing and testing. Or any part of it.

We're organized to respond quickly and efficiently. Our 700-man team has all the engineering, manufacturing, QC,

contract and sales specialists needed to give you direct service. And they're backed by fully equipped facilities and the total technical resources of The Boeing Company.

Our prices are very competitive. Yet you get the same excellent specification compliance, quality control and schedule control for which Boeing is famous.

Contact Boeing Electronic Products for your next requirement. Call Mr. Herb Broadwell at 206-773-6116. Or write him at P.O. Box 3999, Seattle, Washington 98124.

**BOEING
ELECTRONIC
PRODUCTS**

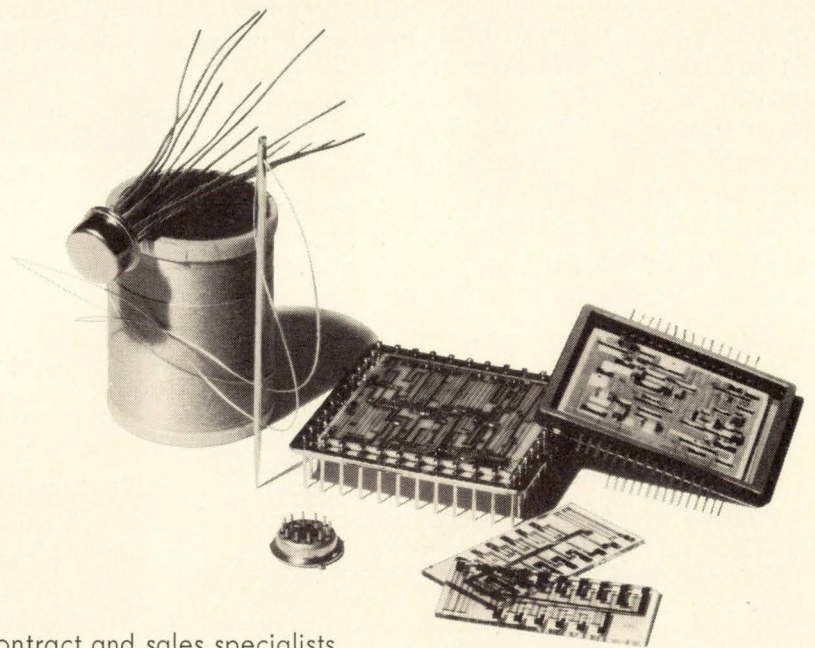

International Newsletter

March 15, 1971

Thomson-CSF plans new mass memories and displays . . .

Watch for some interesting developments in memories and liquid crystal displays from Thomson-CSF, France's leading electronics company. To achieve its long-term goal of 10^{11} or 10^{12} bits at a bit stream rate of 1 gigahertz, the company is working on a 1-mm-diameter microhologram that packs in 10,000 bits and can be reproduced by a molding process that's similar to the way phonograph records are pressed. Another approach uses a manganese-bismuth film whose magnetization reverses wherever it's hit by a focused laser beam. Storage potential is 10^7 bits/cm².

For small memories, Thomson-CSF opts for ferrite devices integrated into a substrate and processed in much the same way as semiconductor ICs. The company will show a 144-bit-by-four-word integrated magnetic memory, with access time of 0.5 microsecond and density of 500 bits/cm², at the Paris Components Show. The technology's potential is said to be 100,000 bits/cm² with a cost per bit lower than core arrays.

Company researchers also feel they're ahead of the pack in liquid crystal dot-matrix displays. The firm has demonstrated a liquid crystal light amplifier consisting of photoconductive and liquid crystal layers sandwiched between transparent electrodes.

. . . but drops waffle-iron storage

Meanwhile, Thomson-CSF is dropping out of waffle-iron memory development. A process control computer using the waffle-iron memory was to have been marketed by Thomson-CSF's computer subsidiary, CII, but this machine also is being dropped. "Waffle-iron memories arrived too late," explains Henri Lerognon, director of Thomson-CSF's Components division. "Semiconductor memories are much more promising."

Accordingly, the company is negotiating with three American firms to sell designs for a penny-per-bit microprogram memory developed by its Cofelec subsidiary [*Electronics*, July 6, 1970, p. 129]. Cofelec will assemble them from ICs made by Sescosem, another subsidiary.

Indium phosphide called promising microwave source

Indium phosphide eventually may overtake gallium arsenide as a microwave source, according to experimental results at Britain's Royal Radar Establishment and Plessey Co.'s Caswell Laboratories. RRE researchers accept as normal tuning ranges of 1.5 octaves and peaks of about 30 gigahertz from n-type epitaxial material pulsed with a field of 5 kilovolts per centimeter, obtained from about 12 volts dc bias. Efficiencies of 1.5% at 25 GHz are normal; so far the peak is 8% at 8 GHz. Low power levels have been observed at 40 GHz with no indication of bumping against a frequency limit. At Plessey's labs, efficiencies of 1%, equivalent to 7.5 milliwatts, have been observed at 36 GHz in cw operation.

RRE men say InP's great advantage over GaAs is that it is likely to provide equal and better efficiencies with less stringent materials technology, plus a broader tuning range and greater temperature tolerance. Domain formation, which limits efficiency and tuning range in GaAs and is difficult to suppress, is inherently suppressed in InP. As in GaAs, output current oscillations are derived from negative resistance characteristic, but in InP negative resistance arises, RRE men speculate, from accumulation-mode operation. Unlike domain modes, accumulation modes have no frequency preference, so tuning is circuit-dependent.

International Newsletter

German company plans to sell small computers in Japan

A decisive step in computer marketing has been taken by West Germany's Nixdorf Computer AG, Europe's leading manufacturer of small-scale data processing equipment. The firm signed a long-term agreement with Japan's Kanematsu-Gosho Ltd. whereby the Tokyo-based trading company will sell Nixdorf computers in Japan, making the German firm the first European computer maker to enter the tough but potentially lucrative Japanese market for small machines that sell for between \$12,000 and \$24,000. In addition to selling Nixdorf computers in Japan, Kanematsu-Gosho will set up a company-owned training center for these machines; Nixdorf will assist with sales and service know-how.

French firm filling Viatron's slot in data-entry terminals

A small French company has moved to fill part of the European niche Viatron Computer Systems Corp. was seeking before its bubble burst. The company, Societe d'Electronique Industrielle et Nucleaire, plans to unveil an all-French data-entry terminal this month. Like Viatron's hardware, SEIN's "Saisix" is intended for decentralized data processing: the raw data is recorded, under control of a hard-wired microprocessor, onto tape cassettes that later can be read by a computer. In fact, apart from larger capacity and alarms that warn operators when they've slipped up, the Saisix consoles are much like Viatron's. But the company's marketing strategy is radically different: "We'll sell, not rent," says Claude Chiarisoli, who did a stint as Viatron's French marketing manager. The terminals will be tagged at about \$4,500.

ITT subsidiary wins right to purchase Swedish data tapes

In a precedent-setting case, ITT Data Service, a subsidiary of the International Telephone and Telegraph Corp., has won rights to purchase data tapes of personal information on Swedes, as filed with provincial authorities. Data service companies have been buying tapes, primarily for advertising use, but one province in West Sweden refused to sell the tapes to ITT, claiming the data was not public. The Swedish Supreme Administrative Court ruled that the tapes are public—no matter what purpose they're used for.

ITT and others pay about \$12,000 to get the tapes on the 8 million Swedes—a marketing man's bargain. ITT also won right to buy updated tapes. But the issue is not closed: a royal commission is investigating the whole matter of computer secrecy, and if anything, the ITT case probably will mean that controls will be tightened to prevent such selling.

Addenda

Now that the switch to transistorized color television in Japan is complete, the push to integrated circuits has begun. The General Corp. claims to be the leader, with 40% of the transistors in its sets replaced by hybrid ICs, but Toshiba has just announced a receiver in which 75% of the transistors are replaced by 13 monolithic and two hybrid ICs . . . The big push at the European Space Research Organization will be in applications satellites, says Ove Hammarstroem, new head of the agency. Hammarstroem expects that at least half of the ESRO money in the near future will go to applications satellites, with initial efforts in telephone and TV communications, to be followed by air traffic control . . . Swedish fm listeners got their first taste of stereo broadcasting this month when the Swedish Broadcasting Corp. carried a hockey match in stereo. About 100,000 listeners heard the Swedes lose to the Soviet team.

Portable DVM bows for less than \$350

Multimeter with automatic range selection has timing, counting, and logic circuits; plus latch memory, on a chip

Since 1967 when it introduced its first digital voltmeter, France's Schneider Radio-Télévision claims to have catapulted to first place in the world multimeter market. Holding onto that lead by bringing out increasingly advanced models may be tougher, but the French firm is convinced it has another winner in its latest meter, the Digitest 750. It will debut this month at the New York IEEE show and at the big international components show opening in Paris on March 31.

Like other Schneider products, it offers sophisticated features at a rock-bottom price. It is the only multimeter in the world, Schneider claims, to offer automatic range selection for less than \$700. Its pricetag in Europe: an eye-catching \$300. Even the U.S. price of \$349 is a stopper.

The comparison is not totally fair. The Schneider meter is accurate to 0.1%, compared with 0.05% or even 0.02% for the expensive automatic-range meters. But the French firm feels the meter fills a major need for typical laboratory applications, bench testing, production control and other areas where high precision is not essential. Schneider says the Digitest 750 is the first portable multimeter at any price to offer automatic ranging.

Says Martin Birnbaum, director of Schneider's professional electronics division: "We think it will have just as much impact as the Digitest 500"—the company's inexpensive, miniature multimeter that is marketed in the U.S. under the Honeywell trademark and which has sold 11,000 units since it was launched two years ago. The original Digitest, marketed in 1967, has accounted for another 14,000 sales.

Like the Digitest 500, the new meter is also pint-sized. It measures 9.25 inches long, 5 in. wide, and 3.6 in. high. It is designed around a new LSI circuit custom developed by Texas Instruments. This chip contains all the meter's counting, logic, and timing circuits, plus its latch memory. It accounts for about 40% of the meter's circuitry, replacing 20 standard ICs.

Low-consumption TTL ICs make up most of the remaining circuitry, though a few discrete transistors are used in the power supply and in the signal conditioning circuits, which convert ac to permit dc measurements.

A keyboard lets the user choose one of five measuring functions: dc and ac voltage, dc and ac current, and resistance. Each function has five ranges. These cover: 100 microvolts to 1,000 volts for dc voltage, 100 microvolts rms to 500 volts rms for ac voltage, 100 nanoamperes to 2 amperes for dc and ac currents, and 0.1 ohm to 2 megohms for resistance.

The user chooses a function, and the meter measures it on the proper range without further ad-

justment. This frees the user's hands for his work—and it also protects the meter against burnout from a strong voltage being applied to the wrong range. As an added safety feature, the Schneider meter is said to be the first in the world to have a thermal electromagnetic circuit breaker. An ordinary fuse cannot protect a DVM because the meter's burnout time is shorter than the fuse's.

For laboratories needing higher measurement precision than the Digitest 750 offers, Schneider is also introducing a souped-up model—the MN-554. This panel multimeter takes up half a standard 19-in. rack and offers automatic range selection, an accuracy of 0.05% and automatic self-calibration. Before each measurement the meter automatically re-calibrates itself. A red light signals if this system fails. The MN-554 is built around the same LSI circuit that the Digitest 750 uses and sells for under \$500.

The Schneider stands at IEEE and in Paris will also show a new industrial frequency counter that

On the job. Schneider's new Digitest 750 has 3.5 digits, 0.1% accuracy.

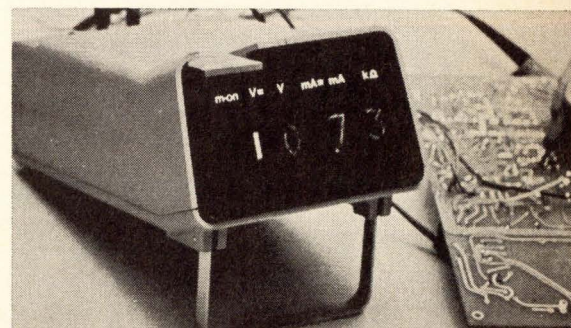

uses an MSI reciprocal counter to compute the frequency of a phenomenon as the inverse of its period. Capable of measuring 50- or 60-hertz phenomena accurate to 0.001% in 1 second, the new counter will sell for less than \$500—versus \$1,200 and up for competing counters made by American companies, says Schneider.

All these new instruments will be sold in the U.S. by Dixon Inc., of Grand Junction, Colo. Honeywell will still market the Digitest 500.

Great Britain

**Electronic aids invade
Scotland Yard's sanctums**

Sherlock Holmes may have had little more than his pipe and violin to help him, but his modern counterparts have some sophisticated electronic aids to abet their own sleuthing. With crime in Britain expanding faster than police manpower, the Police Scientific Development Branch of the Home Office is experimenting with various devices, many of them electronic, to increase the productivity of crime detection teams.

One of these is an infrared thermal imager for body detection. It's hoped the unit will eliminate the need for hundreds of police to comb fields and undergrowth while searching for a body in a murder case.

The method is based on heat reflections and emissions of soil. Recently disturbed soil, as would occur above a grave, emits much more radiation than undisturbed soil, and the difference can be detected by an imager mounted up on a portable tower. Though the effect dissipates with time, it tends to be replaced by similar radiation from the decomposing body, so that evidence may be available for a long time. Likewise, flourishing vegetation emits strong radiation in one range, but trampled vegetation does not. Together, police can use these effects to pick out areas requiring further investigation.

Having determined suspicious

ground the detective can reach for his acoustic body locator, a device that the Home Office has found will react characteristically when soil containing a corpse is subject to low-frequency acoustic vibrations. In operation, an acoustic generator is placed on the ground and swept through a range up to 250 hertz. If the soil has been long undisturbed, the returned signal strength is roughly constant over the returned frequency range. Disturbed soil generates a noticeable peak at a characteristic frequency. If a body has been buried, the peak signal moves up in frequency.

The Home Office also is experimenting with special metal detectors for locating guns and other weapons. Ordinary metal detectors do not indicate how deep a detected object may be buried, but the Plessey Co. Ltd. has built a portable flux-gate gradiometer that will indicate depth with reasonable precision. A rod placed perpendicularly over the buried object takes measurements of the magnetic field at three points along its length. The depth of the object can be calculated accurately up to four feet by comparing the field measurements.

Another depth-measuring instrument also will detect nonferrous metal objects. Operation is similar to an eddy-current mine detector except that it uses two concentric receiver coils instead of one. The nearer the object, the greater will be the difference in the strength of the signal generated in each coil. Ferrous materials are distinguished from nonferrous metals by comparing the phase of the returned signal with the transmitted signal.

The Home Office even is using one of the most up-to-date technologies—holography—to detect one of the oldest of police clues—footprints. The surface of a floor covering, particularly a carpet, may take as long as 24 hours to return to normal after being walked over, during which time the fibers are gradually expanding after compression. Hence a double-exposed hologram of the floor with a suitable time interval, say up to one hour

between exposures, can show a clear outline of footprints as interference fringes. The holographic technique itself is straightforward; the difficulty is to develop sufficiently rigid portable equipment.

Japan

**200 megahertz
under the sea**

The sea is the last frontier open for the development of high-capacity communications channels in Japan—where demand for communications services is highly concentrated in a narrow corridor along the Pacific Ocean coast extending from Tokyo to Osaka. Researchers at the Electrical Communication Laboratory of the Nippon Telegraph and Telephone Public Corp. are now busy designing a submarine cable system with a nominal 200-megahertz bandwidth. The cable will handle about 25,000 telephone channels, or the equivalent in television, data, and other services, when it goes into experimental operation between 1975 and 1977. That's some capacity considering that not too long ago the best a long submarine cable could handle was slow-speed telegraphy.

The backbone of Japan's long lines now is microwaves—4- and 6-gigahertz relay systems. But demand is rapidly increasing and expansion of microwave is limited. There are now four geographically spaced routes between Tokyo and Osaka—three on the Pacific coast and one on the Sea of Japan coast. A fifth inland route would have to follow the 10,000-foot mountains along the island's spine.

Other new transmission methods are being developed, including a coaxial cable system with 10,800 channels per coaxial pair [*Electronics*, Apr. 27, 1970, p. 66] and a quasimillimeter wave system [*Electronics*, July 6, 1970, p. 130]. But in built-up areas installation of coaxial cables is extremely difficult, and the quasimillimeter wave system is still experimental.

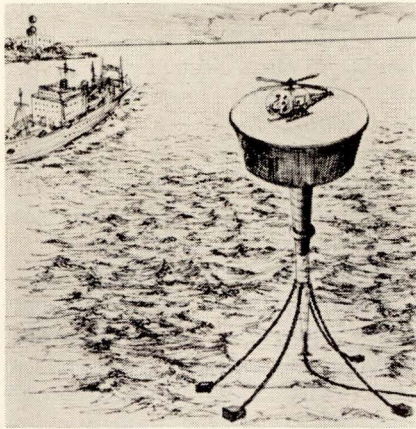

At sea. Japanese undersea cable will start at platform floating 18 miles from shore, where microwave terminal would be built 650 feet above water.

The new undersea cables require both extensive system engineering, different from anything yet attempted, and stretching of amplifier characteristics to achieve wide bandwidth. System engineering led to the elimination of the portion of the cable on the shallow continental shelf, where it is particularly vulnerable to damage by fishing boats. Engineers at ECL decided to use a microwave connection between a station on a hill overlooking the coast and a repeater at the cable end about 18 miles offshore. The towers used by oil drillers were ruled out as too expensive; besides the water is too deep. Instead, a new type of floating platform has been developed and will be tested when a unit is built next year by a shipbuilding company.

The floating platform looks rather like a submarine on end although at 440 feet it is longer than the typical submarine. The platform is ballasted to float with three quarters of its 18-foot-diameter shaft submerged. The top is enlarged to about 50 feet to give space for antennas, power supplies, controls, and other equipment. A 60-foot diameter helicopter deck tops the structure.

The platform's antennas handle signals to and from shore antennas mounted about 650 feet above sea level. Signals travel by two paths from shore—straight lines and one-

bounce propagation off the sea surface. The resulting interference pattern with peaks and nulls several yards apart in the vertical direction can result in severe fading. Vertically spacing the platform antennas the distance from signal peak to an adjacent null and providing appropriate sensing and switching equipment keeps the signal steady even though the level of the antennas above the sea surface varies. Both 4- and 6-GHz signals will be used in these sea-to-shore links.

The amplifier for the undersea cable repeaters is perhaps the most difficult design chore because it requires transistors that suppliers are not yet able to furnish. Amplifiers must have sufficiently low distortion so that repeaters can be located every mile along a 1,500-mile cable without excessively degrading the signal. Exact characteristics will be selected after cable specifications are frozen, but tentative specs call for a three-stage amplifier with a bandwidth of about 200 MHz and an open loop gain of about 40 decibels. A combination of current and voltage feedback around the three stages reduces gain to 18 or 20 dB. To meet these specs the input and second-stage transistors must have gain-bandwidth products of 7 to 8 MHz, and the output transistor needs one of perhaps 4 MHz and an output power of 1 to 1.5 watts.

West Germany

Thick-film ceramic matrix is programmable

A programmable matrix element just out of the labs of Microelectronic, a small components maker in southern Germany, handles high power levels yet owes its compactness to thick-film fabrication techniques.

Dubbed Micro-Matrix, the new element, because of its programmability, is especially well suited as a customized data input device for various types of electronic equipment. It consists essentially of two levels of conductors sandwiched

between ceramic insulating layers. Because the conducting paths in one level are arranged at right angles to those in the other level, the device constitutes an array of ohmic crosspoints. To program this matrix a current is sent through a crosspoint so that the connection between the upper and the corresponding lower path is severed.

Andreas Lewicki, head of Microelectronic, says it's the first time that a fixed memory matrix based on thick-film techniques has been made. The Micro-Matrix will hit the market shortly and is expected to sell for between \$5 and \$250 depending on lot size and number of inputs and outputs.

The new device is aimed for use in environments where shock, vibration, corrosive atmospheres, and abrupt temperature changes would normally cause contact or transfer resistance variations in conventional crossbar distributors or similar systems. Specifically, it is intended as a fixed program input device for test and measuring equipment, for analog computers, and for electronic gear used in control engineering applications.

Microelectronic's new component is no match for conventional monolithic diode matrices as far as size is concerned. But this drawback is balanced by several significant advantages. For one thing, the Micro-Matrix has linear ampere-volt characteristics and can handle ac power from zero hertz through line and audio frequencies to radio frequencies because of its low stray capacitance and inductance. And since it is independent of pulse polarity, it works with digital circuits with both positive and negative pulses. Because of high dielectric isolation between inputs and outputs, the current is zero even when several hundred volts are across an open crosspoint at ambient temperatures of several hundred degrees centigrade. Shorted crosspoints can handle several amperes and up to 500 volts.

Fabricating the matrix starts out with a ceramic substrate, which for a typical device may measure 1 inch on a side and 0.025 inch

thick. In a screen printing process using a noble-metal conducting paste, parallel lines spaced 0.05 in. apart are printed onto the substrate. The paste is dried in an infrared oven and sintered at between 900° and 1,000°C in a conveyor belt furnace. The conductors are covered with perpendicular ceramic strips. In similar screen printing, drying and sintering steps, parallel conductors are deposited on top of the ceramic strip—two per strip.

A typical 1-by-1-in. device has 18 conductors on each level, for a total of 324 crosspoints. Electrical connection at each point is made by means of screen-printed auxiliary electrodes and conducting bars, which compensate for any errors that might occur during alignment procedures.

For programing the Micro-Matrix, unwanted crosspoint connections are burnt through by applying a current of between 2 and 10 amperes, depending on the power-handling capacity of the device. In the burnout process, the higher resistance of the connecting bars insures that the connection is severed at the proper spot.

Programing is generally handled by the customer himself, but when large quantities of devices with the same program structure are involved, programing can be done at the supplier's facility. In this case programing is done with printing masks having a special connecting-bar pattern.

Without altering the fabrication steps, resistance matrices can be manufactured by simply using resistive instead of conductive pastes for making the crosspoints.

Time-division gear multiplies satellite-to-ground links

To carry information around the world via satellites, communications engineers have so far stuck with frequency-division multiple-access principles, which do, however, have drawbacks. Access to a satellite transponder by several ground stations is limited and there are problems with transponder

noise arising from intermodulation between channels.

Cheap, world-wide communications will require demand-assigned speech circuits, so that many ground stations around the world can have access to a satellite transponder. Three West German electronics firms have taken a stride toward that goal with a communications system based on time-division multiple-access (TDMA) principles, an approach that has aroused much interest at the Communications Satellite Corp. in the U.S. and at Japanese companies. For example, Comsat, together with Japan's NEC, has come up with the MAT-1 system. The two firms have also cooperated on a TDMA version called Spade, and the Japanese agency handling overseas communications is known for its TTT system.

Developed by Standard Elektrik Lorenz AG (SEL), AEG-Telefunken and Siemens AG, the German system has a total capacity of 100 megabits per second and can be used to set up about 1,400 speech channels between some 30 ground terminals. It will be tested in May in large-scale field trials using an Intelsat 3 or 4 satellite and West Germany's ground station at Raiting. The three-year development was sponsored by the country's Ministry for Scientific Research under a \$1.375-million contract.

What sets the German system apart is a capacity up to twice as high as others built so far and an equipment design so compact—it fits in a 6-foot high, 2.5-foot wide rack—that all necessary hardware can be installed in one-tenth the space required by others. Compact design comes from using MOSFET shift registers and semiconductor memories throughout, PCM equipment that's already being employed with commercial short-haul PCM links, a more elegant solution to frame synchronization at the receiver end, and a relatively slow encoding and decoding technique. Because fewer components are required, the system is considerably less expensive than others.

Voice transmission in the new

system is performed by pulse code modulation with four-phase shift keying of the 70-megahertz i-f carrier. The voice channels are sampled with a frequency of eight kilohertz, and the samples are encoded in eight bits. Frame duration is 125 microseconds and pulse repetition frequency is 100 megahertz.

The maximum capacity at a ground station is 120 voice channels. The voice signals are sampled in conventional channel units and then encoded, using two continuously operating 6-channel encoders with associated buffer stores. Monitored by a station control unit, the store is read out at high speed during the time segment assigned to a ground station.

In the receive path the incoming signals are demodulated at the output of the i-f amplifier. Only the information destined for that particular ground station is transferred to the receive channel units. Also derived from the received signals are control signals for the station control unit.

One characteristic of TDMA systems is their frame and burst structure. In the German system the frame duration—125 microseconds—has been chosen in accordance with a sampling frequency of 8 kilohertz. The frame is subdivided into bursts, one assigned to each station, consisting of a preamble and the voice channels. The preamble includes auxiliary signals required for the free-fault operation of the system. These signals include synchronization signals for carrier and bit timing recovery of the demodulator, unique words defining the burst starting point, a code word identifying the sending station, a signal channel and a central data channel for specific data on changing the frame structure.

The bursts of different ground stations are separated by a guard time. Taking into account the satellite's movement relative to the ground stations and the method of changing the frame structure, a guard time of 80 nanoseconds is provided. The preamble reduces the overall system efficiency by about 0.4% per ground station.

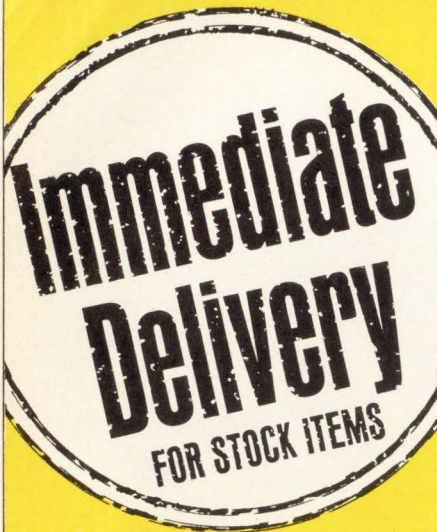

4 to 6 weeks for
custom fabricated
items!

Warehousing and Stocking
Sheet Stock (Co-netic, Netic)
Foil (Co-netic, Netic)
Cathode-ray tube Shields
Photomultiplier Shield
Magnetic Tape Preservers
Field Evaluation Probes

MAGNETIC SHIELD DIVISION PERFECTION MICA CO.

(home office)
740 Thomas Drive
Bensenville, Illinois 60106
(312) 766-7800

(west coast office)
1325 East Esther Street
Long Beach, Calif. 90813
Long Beach (213) 591-5638—39
Los Angeles (213) 775-8079

Abbott Transistor Labs., Inc. Technical Adv. Agency	6	Fairchild Semiconductor Inc. Carson/Roberts Inc. Adv.	9, 10, 11
Adams & Westlake Company Scofield, Hiers & Malone Inc.	7	Florida Dept. of Commerce, Division of Commercial Development	D3
Advanced Micro Devices Keye/Donna/Pearlstein	12-13	William Cook Adv. Inc.	
AEG Telefunken Werbeagentur	148	Fluke Manufacturing Co., John Bonfield Associates	15
Airborne Instruments Laboratory Campbell-Mithun Inc.	58-59	Gardner-Denver Company Buchen Adv. Inc.	111
Airpax Electronics Welch, Mirabile & Co. Inc.	133	Garrett Corporation Microcircuits Division	132
Alco Electronics Products Inc. Marketronix Advertising	D4	J. Walter Thompson Company	
Allen Bradley Company Hoffman-York, Inc.	18-19	General Instrument Europe S. P. A. Studio Hedy	38E
American Electronic Laboratories Inc. Ernest William Greenfield Inc.	124	General Radio Company GRAD Associates	121
American Microsystems Jordan Advertising	2nd Cover	Grayhill Incorporated Carr Liggett Advertising Inc.	147
Anglade et Cie Jacques Bonroy	48E	Heath Company Sub of Schlumberger Ltd.	143
AOIP Jacques Bonroy	39E	Advance Advertising Services	
Arco S. P. A. Studio Dondero	28E	Heath Dynamics Inc. Ira Morton Advertising	149
Asahi Glass Co., Ltd. Asia Advertising Agency Inc.	50E	Hermes Electronics Ltd. Public & Industrial Relations Limited	46
C. Behrens A. G. Bruckner Klischee	52E	Hewlett Packard Dorland Advertising Ltd.	10E-11E
Bell & Howell Electronics & Instruments Group	37	Hewlett Packard Loveland Division Tallant/Yates Advertising	2
Coordinated Communications Inc.		Hewlett Packard Company Lennen & Newell Inc.	1, 127
Boeing Electronic Products N.W. Ayer, F.E. Baker Inc.	154	Hewlett Packard, New Jersey Division McCarthy Scelba and DiBiasi Adv. Agency Inc.	115
Bolt Beranek and Newman Inc. Cochrane Chase & Company Inc.	128	Hewlett Packard, San Diego Division Phillips Ramsey Advertising	144
Bourns Inc. Mariborough Associates Inc.	117	Hewlett Packard Company Lennen & Newell Inc.	48-49
Buckbee Mears Company Midland Associates Inc.	106	Hickok Electrical Instrument Company Key Marketing Associates	120
Bunker Ramo Corp. Amphenol Components Group Marsteller Inc.	55	HI-G D'Italia Studio Duilio Savina	41E
Bussmann Mfg. Division of McGraw Edison Company Henderson Advertising Company	130-131	Hitachi Ltd. Dentsu Advertising	142
Cambridge Thermionic Corporation Chirurg & Cairns Inc.	151	Honeywell Test Instruments Division Campbell Mithun Inc.	43
Carlo Erba Orma	31E	Howard W. Sams & Co., Inc. George Brodsky Advertising Inc.	29
Cerro Copper & Brass Company Sykes Advertising Inc.	112	Hughes Aircraft Company Foote Cone & Belding	38-39
Chicago Miniature Lamp Works Buti-Roberts Advertising	125	Intel Corporation Bonfield Associates	86-87
Cintra Data Systems Bonfield Associates	122	Interelectronics Inc. Samuel H. Meyer Advertising	147
C & K Components Inc. Williams W. Jeffery	148	Interstate Electronics Corporation Leland Oliver Company Inc.	41
Comaltest Inc. Litek Corporation	147	ITT General Controls MacManus, John & Adams Inc.	141
Communication Associates Inc. Caroe Marketing Inc.	48E	Johnson Company, E. F. Martin Williams Advertising	21
Computer Products Inc. Design Technology	149	Kahle Engineering Company Douglas Turner Inc.	36
Connecticut Hard Rubber Chirurg & Cairns Inc.	152	Keithley Instruments Inc. Bayless Kerr Company	126
Cosmicar Optical Co., Ltd. Matsushita Inc.	D4	Kienzle Apparate GMBH Fahrenson + Fehse	109
Coto Coil Company Inc. The Williams Company	140	Kinomat Brouch Publicita	D1
CTS Corporation Reincke, Meyer & Finn Inc.	47	KoKusai Electric Co. Ltd. Asian Advertisers Inc.	40E
Custom Electronics Inc. Laux Advertising Inc.	40	Lambda Electronics Corporation Michel Cather Inc.	113
Data Control Systems Inc. Technical, Industrial & Scientific Marketing Inc.	8	Ledex Inc. Yeck & Yeck Incorporated	116
Dearborn Electronics Inc., Sprague Electric Co. Div. Harry P. Bridge Co.	118	Lemex S. A. C. Gonzalez K	138
Delco Electronics Division General Motors Corporation Campbell Ewald Company	56-57	LTT Publibel	46E-47E
Delta Products Inc. Williams Loughran Company	150	Magnecraft Electric Company Marketronics Inc.	45
Ducati Elettrotecnica Microfarad Studio Busoli Gastone	43E	Magnetic Shield Division, Perfection Mica Co. Duane Rice Advertising	D2
Eastman Kodak Company, Business Systems Markets Div. J. Walter Thompson Company	139	Mico Instrument Company MDS Deutschland Publicitas GMBH	138 29E
E-H Research Labs Inc. Steedman, Cooper and Busse Advertising	24	Monsanto Company The Advertising Promotion Group	135
Elco Corporation Mort Barish Associates Inc.	3rd Cover	Moririca Electronics Ltd. General Advertising Agency, Inc.	150
Eldorado Electrodota Corp. of Concord Moore Mayhew and Fick Advertising	130	Mostek Corporation Continental Communications Incorporated	62
Electro Scientific Industries Hugh Dwight Advertising Inc.	49E	Motorola Semiconductor Products E. B. Lane & Associates Inc.	23E to 26E
Electronics Ries Cappiello Colwell Inc.	22-23	National Electronics Inc. Subsidiary of Varian Associates	16
Electronics in Medicine Conference	50-51, 141	Connor-Sager Associates Inc.	
Emerson & Cuming Inc. Edwin F. Hall	152	Nemicon Data Systems Inc. Seventeen Six Five	146
EMI Electronics Ltd. Bonner Hodgson & Partners Ltd.	12E	Ney and Company J. M. Peck Adams Inc.	153
Executone Inc. Printact Relay Division J.A. Richards	44		

■ Nippon Electric Co. Ltd. Hakuhodo Inc.	98
Nortec Electronics Corporation Paul Pease Advertising	108
North Atlantic Industries Inc. Helme Associates Inc.	100
Nu-Concept Computer Co.	148
□ Olivetti & C. Spa D Studio ECO	36E
Panasonic SPD Dentsu Corporation of America	101
□ Pechiney St Gobain Pema	13E
Phillips Electronics Instruments J.M. Condon Inc.	79
Phillips Eindhoven Nederland Phillips Gad Elcoma	79 8E, 9E, 34E
□ Philips N. V. Pit/Tmi Division Marsteller International S. A.	2E
Plessey Microelectronics Creative Workshop Limited	60
□ Plessey Professional Components Rumrill Hoyt Inc.	14E
Pomona Electronics Company Buxton Advertising Agency	140
□ Polaroid Industrial International Doyle, Dane, Bernbach Inc.	33E
□ Portescap Presse et Publicite	30E
Powertec Division of Airtronics PAC Advertising Agency	151
Quantum Sciences Corporation Fletcher Walker Gessell Inc.	153
RCA Electronic Components Al Paul Lefton Company	20, 4th Cover 14
■ RCL Electronics Inc. Morvay Advertising Agency	14
□ Reliance Controls Bond Publicity Services Ltd.	32E
■ Resco G. Matthaes	7E
Rotron Incorporated Lescarboursa Advertising Inc.	99
□ Sercel Termon Technique	22E
□ Sescoserm Perez Publicite	37E
□ SGS Scuola Di Design Di Novara	19E
Sierra Research Corporation B.P. Myer Associates Inc.	42
Signetics Corp. Sub. of Corning Glass Works	17
□ Silec Electronique Promotion Vente Publicite	54E
Siliconix Inc. Hal Lawrence Inc.	52
Singer Company Ballantine Operation Technical, Industrial & Scientific Marketing Inc.	61
Singer General Precision Inc. Gaynor & Ducas Inc.	67
□ Solartron Electronics Group Ltd. T.B. Browne Ltd.	20E-21E
S. P. Elettronica Studio Sergio Rosata	51
Sprague Electric Company Harry P. Bridge Company	5
■ Stackpole Carbon Company, Electronic Components Division Thomas Farragher and Associates	85
■ Susumu Industrial Co. Ltd. Kyokuto Kikaku Co. Ltd.	146
Tam Tunzini Sames GEAD	134
□ Technique et Produits Ste De Publicite de Films et de Documnetaires	53E
■ Tektronix Inc. Dawson Inc.	35, 102
□ Teledyne Philbrick Ingalls Associates Inc.	44E
Teledyne Relays Company S. Michelson Advertising	30
□ Union Carbide Europe S. A. Agentur IFF	5E-6E
Universal Instruments Corporation Conklin, Labs & Bebee Inc.	105
Varadyne Inc. Systems Division Alden Advertising of California	136
Vector Electronic Company Inc. Buck Advertising	138
□ Weston Instruments Inc. Newark Division Arndt, Preston, Chapin, Lamb & Keen Inc.	27-28

Florida- Where the workers are as productive as the orange groves

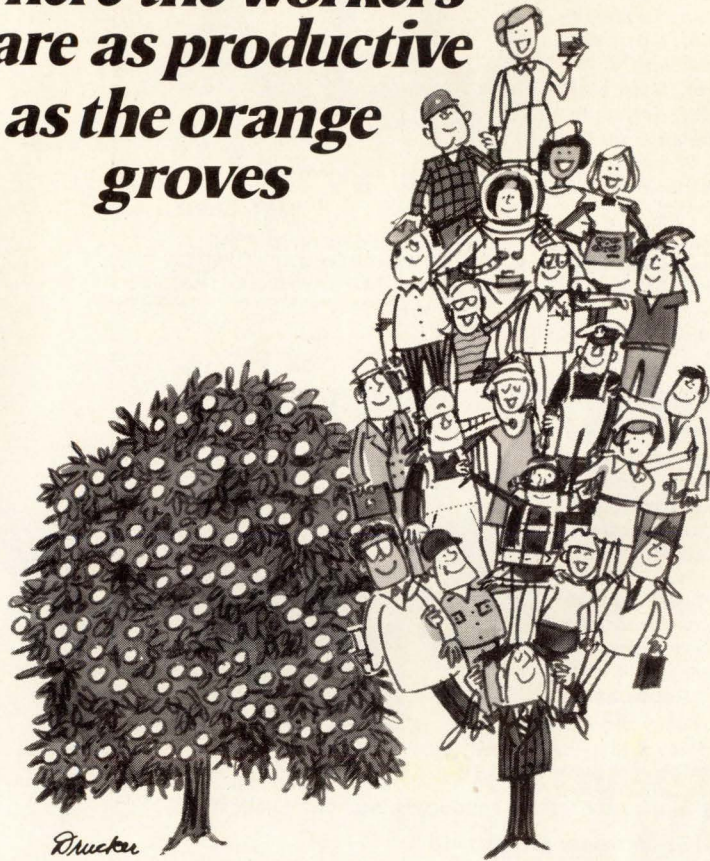

*Read about
a labor picture
that can only
spell profits...
performance...
productivity
for you.*

Here's what we can deliver when you come to Florida.

- We can out-recruit anyone for skilled labor. We'll show you proof of 10-to-1 superiority in competitive recruitment.
- Our skilled work force is growing faster than in any state in the Southeast.
- We now have in Florida a larger working age population (18-65) than any other Southeastern state.

Florida is a great place to live and work. Won't you let us reveal the hidden profit potential in Florida's remarkable labor picture? Just phone (904) 224-1215 or write in confidence.

Dept. D-6
Please send information about:

- Manufacturing plant
 Headquarters office
 Research
 Warehouse
 Other _____

NAME _____
 TITLE _____
 COMPANY _____
 ADDRESS _____
 CITY _____ STATE _____ ZIP _____

Florida

DEPARTMENT OF COMMERCE
 BUREAU OF INDUSTRIAL DEVELOPMENT
 107 WEST GAINES STREET
 TALLAHASSEE, FLORIDA 32304

Classified & Employment Advertising
 F.J. Eberle, Manager 212971-2557
EMPLOYMENT OPPORTUNITIES 140
EQUIPMENT (used or surplus New) For Sale
Radio Research Instrument Co. 140

■ For more information on complete product line see advertisement in the latest **Electronics Buyer's Guide**
 □ Advertisers in **Electronics International**

WORLD'S NO. 1 **MINIATURES**

The original miniature switch is available with standard, flat, long and plastic toggles. Normally supplied with silver contacts. Gold-plating or P.C. terminals are available on request. Common 1/2" case size. Rate 5A @ 115VAC.

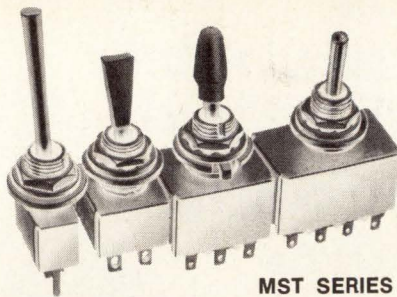

MST SERIES

ALCOSWITCH® 124 STYLES ON THE SHELF FOR IMMEDIATE DELIVERIES.
DIV. OF ALCO ELECTRONIC PRODUCTS, INC., LAWRENCE, MASS.

Circle 180 on reader service card

ROCKER SWITCH

New brilliance in a miniature rocker featuring front panel lamp replacement. Entire switch simply snaps into .655" x .728" hole. Choice of 3 doublepole switching actions; 4 lens colors & 4 voltages. Replaceable lamp. Rated 6A @ 125 VAC.

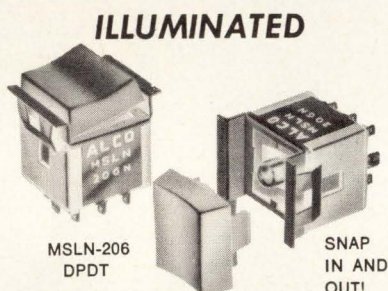

MSLN-206
DPDT

SNAP
IN AND
OUT!

ALCOSWITCH® MINIATURE SIZE
DIV. OF ALCO ELECTRONIC PRODUCTS, INC., LAWRENCE, MASS.

Circle 181 on reader service card

PUSH BUTTON MINIATURES

Unusual momentary magnetic repulsion Alco push button switches have ceramic magnets that eliminate springs. Glass reeds, 1/2" dia. metal case. 100 mA @ 50 VDC. SPST, N.O. or N.C. .110" flat or .058" round terminals.

MAGNETIC ACTION



ALCOSWITCH®
DIV. OF ALCO ELECTRONIC PRODUCTS, INC., LAWRENCE, MASS.

Circle 182 on reader service card

SLIDE SWITCH MINIATURES

The world's best mini slide switch with a compact 1/2" case and new anti-tease design. Available in 1 and 2 pole, double throw models. 2 amps @ 120 VAC. MIL-Grade.

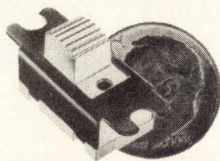

MSS-22 SHOWN ACTUAL SIZE

ALCOSWITCH®
DIV. OF ALCO ELECTRONIC PRODUCTS, INC., LAWRENCE, MASS.

D 4 Circle 164 on reader service card

Perfect your CCTV system with **COSMICAR®** lenses



TV-COSMICAR-EE 25mm F/1.4

The TV-COSMICAR-EE 25mm f/1.4 is a high-speed EE lens specially designed for 1" vidicon cameras. It maintains image luminance 100 lx against subject brightness between LV11 ~ 17 (280 ~ 18,000 cd/m²), about 1,500 ~ 96,000 lx. The automatic electric-eye diaphragm closes down completely when subject brightness exceeds approx. LV20 (144,000 cd/m²), 768,000 lx. When the camera is switch off and not in operation, the automatic diaphragm closes down, completely shutting off the light for protection of the vidicon camera. The "EE-OPEN" switch on the lens controls the operation of the diaphragm. When it is turned to "EE," the diaphragm operates as fully automatic electric-eye; when it is turned to "OPEN," the diaphragm stays fully open.

Be sure to get the finest image recording results with quality Cosmicar lenses.



COSMICAR OPTICAL CO., LTD.

424, Higashi-Oizumi, Nerima-ku, Tokyo, Japan
Cable Address: "MOVIEKINO TOKYO"

Circle 230 on reader service card