

- 95 System aspects of digital-display selection
- 108 Profile: the MOS memory that challenged cores
- 116 Simpler programs with overlaid memory

LIBRARY  
TECHNICAL INSTITUTE  
MEMPHIS

# Electronics®

## Discrete semiconductors blooming in new applications



1420 TCH598 MCSAL JUN73  
ST TECHNICAL INST  
LIBRY  
5983 MACON COVE  
MEMPHIS TN  
38128



**YOUR CUSTOM APPLICATION —  
OUR SKILLS**



*\*Custom-proprietary, shown to indicate capability.*

WE'VE TURNED  
A TECHNOLOGY  
INTO A  
COMPANY



**MOS TECHNOLOGY, INC.**

VALLEY FORGE INDUSTRIAL PARK, VALLEY FORGE, PA. 19481 • (215) 666-7950

**CONTACT US DIRECT**

**EASTERN REGIONAL  
SALES DIRECTOR**  
Mr. William Whitehead  
MOS TECHNOLOGY, INC.  
88 Sunnyside Blvd.  
Suite 307  
Plainview, N.Y. 11803  
Phone: (516) 822-4240

**CENTRAL REGIONAL  
SALES DIRECTOR**  
Mr. Alan Mattal  
MOS TECHNOLOGY, INC.  
10400 W. Higgins Rd.  
Suite 631  
Rosemont, Ill. 60018  
Phone: (312) 298-2035

**WESTERN REGIONAL  
SALES DIRECTOR**  
Mr. Jack Turk  
MOS TECHNOLOGY, INC.  
2172 Dupont Drive  
Suite 221, Patio Bldg.  
Newport Beach, Calif.  
92660  
Phone: (714) 833-1600

**APPLICATIONS  
MANAGER**  
**MR. JULIUS HERTSCH**  
Phone: (215) 666-7950  
EXT. 220 & 294

*an affiliate of*  
**ALLEN-BRADLEY**





# SURPRISE!

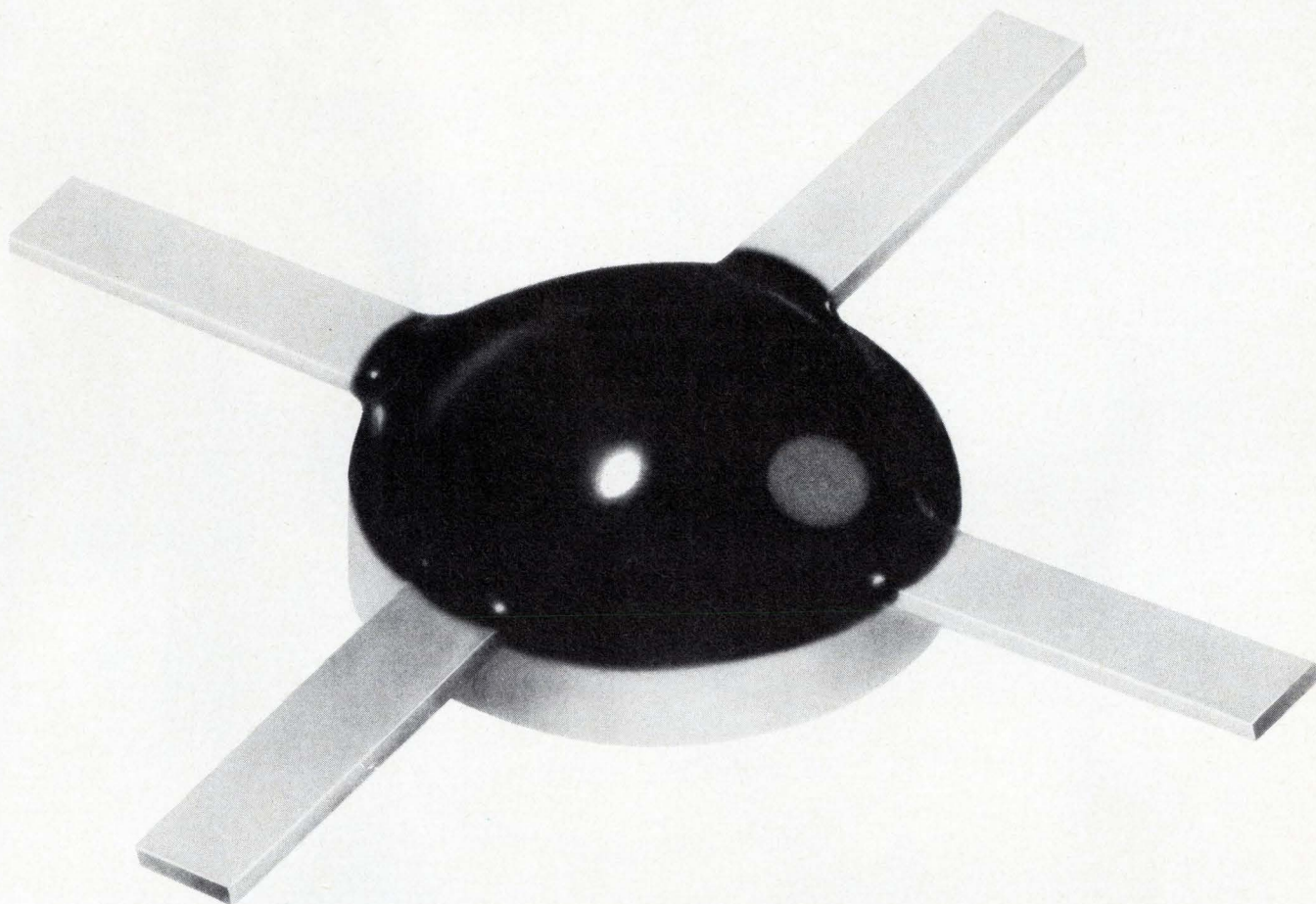

## An inexpensive Schottky diode ring quad.

Only \$2.75 in 10K quantities. In stock. From Hewlett-Packard, the 5082-2830. For your money you get: Wideband operation to 2 GHz. Monolithic construction that provides extremely tight diode match and superior temperature tracking characteristics. Low conversion loss. Very low distortion. The proof is in your breadboard – and your pocketbook. For more information contact your nearby HP sales office.

01317

Domestic USA price only.

HEWLETT  PACKARD

Sales, service and support in 172 centers in 65 countries.  
Palo Alto, California 94304. Offices in principal cities throughout the U.S.



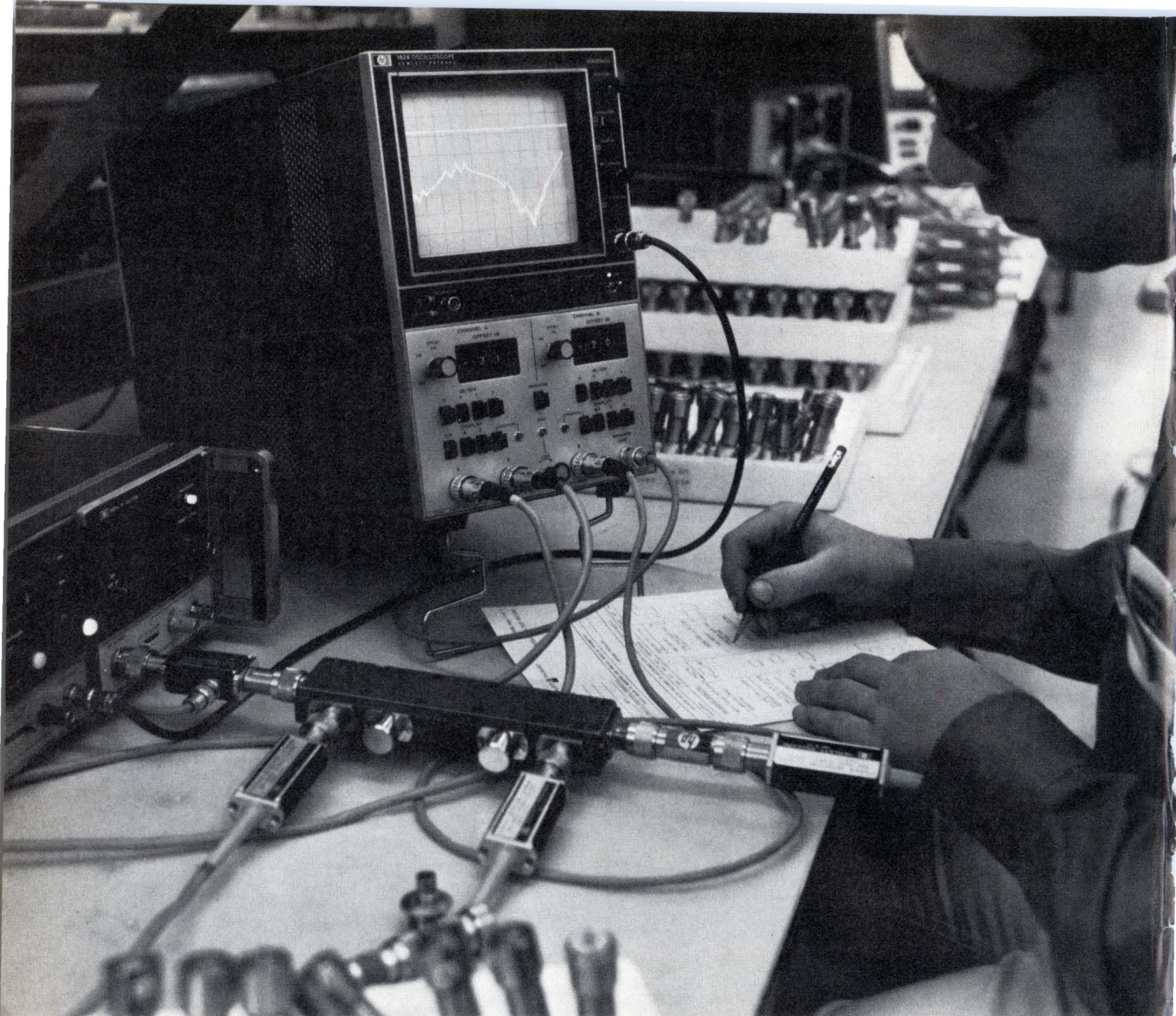

## How to squeeze 60 dB of swept frequency response from 10 mW of RF drive.

It's simple. Just use the new HP 8755 Frequency Response Test Set. Its extremely high sensitivity ( $-50$  dBm) delivers a full 60 dB dynamic measurement range from 100 MHz to 18 GHz using modern solid-state sweepers like the HP 8620.

But that's just the beginning. Its flat ( $\pm 0.5$  dB) response means that you can make accurate swept measurements of insertion loss/gain and return loss, even on frequency translation devices like mixers. And it doesn't drift with time and temperature because it's a modulated system. This high stability means

minimal recalibration. Isn't that what you need for production testing?

Yet with all of its sophistication, the system is really easy to use. It's direct reading and fully calibrated with push-button selection of operating functions. You can simultaneously display forward and return loss either as a ratio or an absolute response. Everything is designed for time-saving, error-free measurement.

You can take this lightweight, all solid-state and rugged system out into the field to test cable runs, antennas and the like. Another important and practical advantage for field use: you can operate

the detectors up to 200 feet away from the display!

There's economy too: a complete 8755 system with analyzer in an HP 182A large screen scope display, modulation unit and three detectors costs just \$3200.

Ask your HP field engineer for the new brochure on the 8755L. It'll give you the complete story on why it's so much system for so little money.

**HEWLETT**  **PACKARD**

04206

HP sales, service and support in 172 cities in 65 countries. For more information write: Hewlett-Packard, 1501 Page Mill Road, Palo Alto, California 94304; Europe: P.O. Box 85, CH-1217 Meyrin 2, Geneva, Switzerland; Japan: YHP, 1-59-1, Yoyogi, Shibuya-Ku, Tokyo, 151.

Circle 2 on reader service card



## 29 Electronics review

GOVERNMENT ELECTRONICS: Nixon trade bill worries industry, 29  
SOLID STATE: Microwave bipolars gain from implants, 30  
Components sales boom in Europe, 31  
AVIONICS: Mini rate sensor works on gas, 31  
PROCESSING: Protons are key to IR detectors, 32  
COMMERCIAL ELECTRONICS: Computer verifies ID from photos, 34  
NAVIGATION: Omega-inertial mix improves nav system, 34  
MEDICAL ELECTRONICS: Russians use laser to treat glaucoma, 36  
PACKAGING: Electrolysis predicts package failure, 36  
INDEX OF ACTIVITY, 38  
COMMUNICATIONS: Cw diode laser emits visible red, 40  
NEWS BRIEFS: 40  
MILITARY ELECTRONICS: Army to map targets from the air, 42

## 53 Electronics International

SWEDEN: IR camera weighs in at 18 pounds, 53  
JAPAN: Glass fiber for communications goes on sale, 53

## 67 Probing the News

SPACE ELECTRONICS: Skylab—a houseful of electronics, 67  
ELECTRONICS ABROAD: The show's the thing, 70  
CONSUMER ELECTRONICS: Hammond's MOS organ, 72  
SEMICONDUCTORS: Beam leads gaining, 76

## 85 Technical Articles

SPECIAL REPORT: Discrete semiconductor devices proliferate, 85  
DISPLAYS: Matching drives to multidigit numeric displays, 95  
DESIGNER'S CASEBOOK: Voltage-to-current converter avoids damage, 102  
Data averager uses panel-meter's clock, 103  
Binary rf phase modulator switches in 3 nanoseconds, 104  
PRODUCT DEVELOPMENT PROFILE: Intel's 1103 MOS memory, 108  
COMPUTERS: Overlaid memory simplifies programs, 116  
ENGINEER'S NOTEBOOK: Scope triggering spots narrow pulses, 121  
Precision comparator circuit satisfies LSI testing needs, 122

## 129 New Products

IN THE SPOTLIGHT: C-MOS process builds monolithic analog gate, 129  
COMPONENTS: Tiny DIP houses two relays, 133  
INSTRUMENTS: Logic probe is designed for C-MOS, 139  
PACKAGING & PRODUCTION: Programable test system is modular, 144  
SUBASSEMBLIES: Hybrid design shrinks converter, 151  
MATERIALS: 160

## Departments

Publisher's letter, 4  
Readers comment, 6  
40 years ago, 8  
People, 14  
Meetings, 20  
Electronics newsletter, 25  
Washington newsletter, 49  
Washington commentary, 50  
International newsletter, 55  
Engineer's newsletter, 124  
New literature, 161

## Highlights

### The cover: Discrete semiconductors flourish, 85

New markets among automobile and TV manufacturers plus a reputation for reliability are helping discrete devices to achieve prosperity. Field-effect transistors and power devices are especially strong. Cover photo by Associate Art Director Charles Ciatto says it fittingly with flowers.

### A house in space, 67

For four weeks in May and June, three astronauts will make their home in Skylab, an earth-orbiting laboratory in which they'll carry out experiments in astronomy, earth observation, and biology.

### Better driver circuitry for displays, 95

Besides making tradeoffs between the different types of multidigit display, it's a good idea to optimize the circuitry that drives the output elements.

### The MOS memory that scored over cores, 108

The inside story of the Intel 1103—the first dynamic MOS random-access memory to break into the computer mainframe market in a big way—is the second of *Electronics'* profiles of unusually successful products.

### And in the next issue . . .

Special report: is electronics making it in the home? . . . 25 years after: a retrospective on information theory . . . simulating sonar displays with minicomputers.



EDITOR-IN-CHIEF: Kemp Anderson

EXECUTIVE EDITOR: Samuel Weber

MANAGING EDITORS: Lawrence Curran, *News*;  
Arthur Erikson, *International*

SENIOR EDITORS: John Johnsrud,  
H. Thomas Maguire, Laurence Altman

ART DIRECTOR: Fred Sklenar

ASSOCIATE EDITORS: John N. Kessler,  
Howard Wolff, Gerald M. Walker

DEPARTMENT EDITORS

*Aerospace*: William F. Arnold  
*Circuit Design*: Lucinda Mattera  
*Communications & Microwave*:

Lyman J. Hardeman  
*Computers*: Wallace B. Riley  
*Consumer*: Gerald M. Walker  
*Industrial*: Alfred Rosenblatt  
*Instrumentation*: Michael J. Riezenman  
*Military*: Ray Connolly

*New Products*: H. Thomas Maguire  
*Packaging & Production*: Stephen E. Grossman  
*Solid State*: Laurence Altman  
*Special Issues*: Harry R. Karp

COPY EDITORS: Margaret Eastman,  
Everett C. Terry

ASSISTANT EDITOR: Marilyn Offenheiser

ART: Charles D. Ciatto, *Associate Director*  
Patricia Cybulski, *Assistant Director*

PRODUCTION EDITOR: Arthur C. Miller

EDITORIAL SECRETARIES: Janet Annunziata,  
Julie Gorgoglione, Penny Roberts

FIELD EDITORS

*Boston*: James Brinton (Mgr.), Gail Farrell

*Los Angeles*: Paul Franson (Mgr.)

*Midwest*: Larry Armstrong (Mgr.)

*New York*: Alfred Rosenblatt (Mgr.)

*San Francisco*: George Sideris (Mgr.),  
Judith Curtis

*Washington*: Ray Connolly (Mgr.),  
William F. Arnold

*Frankfurt*: John Gosch

*London*: Michael Payne

*Paris*: Arthur Erikson

*Tokyo*: Charles Cohen

McGRAW-HILL WORLD NEWS

*Director*: Walter A. Stanbury

*Bonn*: Robert Ingersoll;

*Brussels*: James Smith;

*London*: Marvin Petal;

*Milan*: Peter Hoffmann, Andrew Heath;

*Moscow*: Axel Krause;

*Paris*: Stewart Toy, Michael Johnson;

*Stockholm*: Robert Skole;

*Tokyo*: Mike Mealey

PUBLISHER: Dan McMillan

ADVERTISING SALES MANAGER: Pierre J. Braudé

ADVERTISING SALES SERVICE MANAGER:

Wallis Clarke

BUSINESS MANAGER: Stephen R. Weiss

CIRCULATION MANAGER: George F. Werner

MARKETING SERVICES MANAGER:

Tomlinson Howland

**D**iscrete semiconductors, as you can see by our cover, are blooming. Actually, says Larry Altman, our Solid State Editor, who wrote the 10-page special report that starts on page 85, the strong growth in discretely is a bit of a surprise, considering the attention grabbed by the more glamorous areas of integrated-circuit technology.

"When we started," says Altman, "we planned something along the lines of a state-of-the-market piece. That's because during research for our annual market survey, published in the first issue in January, we were impressed by the great market boost shown by discretelys."

"Once we got behind the numbers, however, we saw all the great technological innovations that have helped discretelys. Of course, these innovations are not being applied across the board. Manufacturers are applying them in growth areas—such as power devices, field-effect transistors, and radio-frequency and microwave devices."

And, speaking of rf and microwave, we had to leave those areas out of the report because of space

limitations. But you can expect a second installment, covering those devices, in an upcoming issue.

**T**he cover, which carries through the "blossoming" theme, is the handiwork of Charles Ciatto, our Associate Art Director. While his photographic work has appeared in *Electronics* before, this marks his first photo cover. He is also, as he says, "a bug on plants." So the combination of horticulture and photography was a natural.

After touring the flower district for the right blossoms, he brought them home and sweated under photoflood lights for hours. To keep the plants from wilting, too, he sprayed them occasionally with water. And, serendipitously, when the slides came back, the ones with the water droplets were far and away more striking. He notes that he used a Nikonmat, close-up lenses, and high-speed Type B Ektachrome.

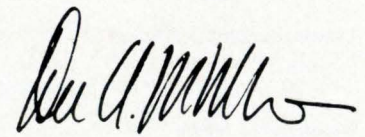

### We're looking for an editor

An exciting career opportunity has just opened on the New York editorial staff of ELECTRONICS. Our editors travel extensively, write and edit technical articles, and cover stimulating new developments in electronic technology.

Specifically, the ideal candidate will have an engineering degree and extensive experience in the application of a wide range of components, both active and passive, to the design of electronic equipment. Writing ability is an obvious requirement.

The salary is as good as or better than industry rates for engineers. We're part of McGraw-Hill, one of the world's best-known publishing companies, and we offer excellent working conditions and fringe benefits.

If you qualify, send your résumé with salary requirements to: The Executive Editor, ELECTRONICS Magazine, 1221 Avenue of the Americas, New York, N.Y. 10020.

April 27, 1973 Volume 46, Number 9  
91,321 copies of this issue printed

Published every other Thursday by McGraw-Hill, Inc. Founder: James H. McGraw 1860-1948. Publication office 1221 Avenue of the Americas, N.Y., N.Y. 10020; second class postage paid at New York, N.Y., and additional mailing offices.

Executive, editorial, circulation and advertising addresses: Electronics, McGraw-Hill Building, 1221 Avenue of the Americas, New York, N.Y. 10020. Telephone (212) 997-1221. Teletype TWX N.Y. 710-581-5234. Cable address: MCGRAWHILL N.Y.

Subscriptions limited to persons with active, professional, functional responsibility in electronics technology. Publisher reserves the right to reject non-qualified requests. No subscriptions accepted without complete identification of subscriber name, title, or job function, company or organization, including product manufactured or services performed. Subscription rates: qualified subscribers in the United States and possessions, Canada, and Mexico \$8.00 one year, \$12.00 two years, \$16.00 three years; all other countries \$25.00 per year, except Japan \$50.00 per year and Brazil \$40.00 per year, including air freight. Limited quota of subscriptions available at higher-than-basic rate for persons outside of field served as follows: U.S. and possessions and Canada, \$25.00 one year; all other countries \$50.00. Single copies: United States and possessions and Canada, \$1.00; all other countries, \$1.75.

Officers of the McGraw-Hill Publications Company: John R. Emery, President; J. Elton Tuohig, Senior Vice President—Services; Donald B. Gridley, Group Vice President; Vice Presidents: Ralph Blackburn, Circulation; John R. Callahan, Editorial; John B. Hoglund, Controller; David G. Jensen, Manufacturing; Jerome D. Luntz, Planning & Development; Joseph C. Page, Marketing.

Officers of the Corporation: Shelton Fisher, President; Wallace F. Traendly, Group President, McGraw-Hill Publications Company and McGraw-Hill Information Systems Company; John J. Cooke, Senior Vice President and Secretary; Ralph J. Webb, Treasurer.

Title registered in U.S. Patent Office. Copyright ©1973 by McGraw-Hill, Inc. All rights reserved. The contents of this publication may not be reproduced either in whole or in part without the consent of copyright owner.

Subscribers: The publisher, upon written request to our New York office from any subscriber, agrees to refund that part of the subscription price applying to copies not yet mailed. Please send change of address notices or complaints to Fulfillment Manager; subscription orders to Circulation Manager, Electronics, at address below. Change of address notices should provide old as well as new address, including postal zip code number. If possible, attach address label from recent issue. Allow one month for change to become effective.

Postmaster: Please send form 3579 to Fulfillment Manager, Electronics, P. O. Box 430, Hightstown, N.J. 08520.



# Precision waveforms at everyone's fingertips with KH pushbutton oscillators.

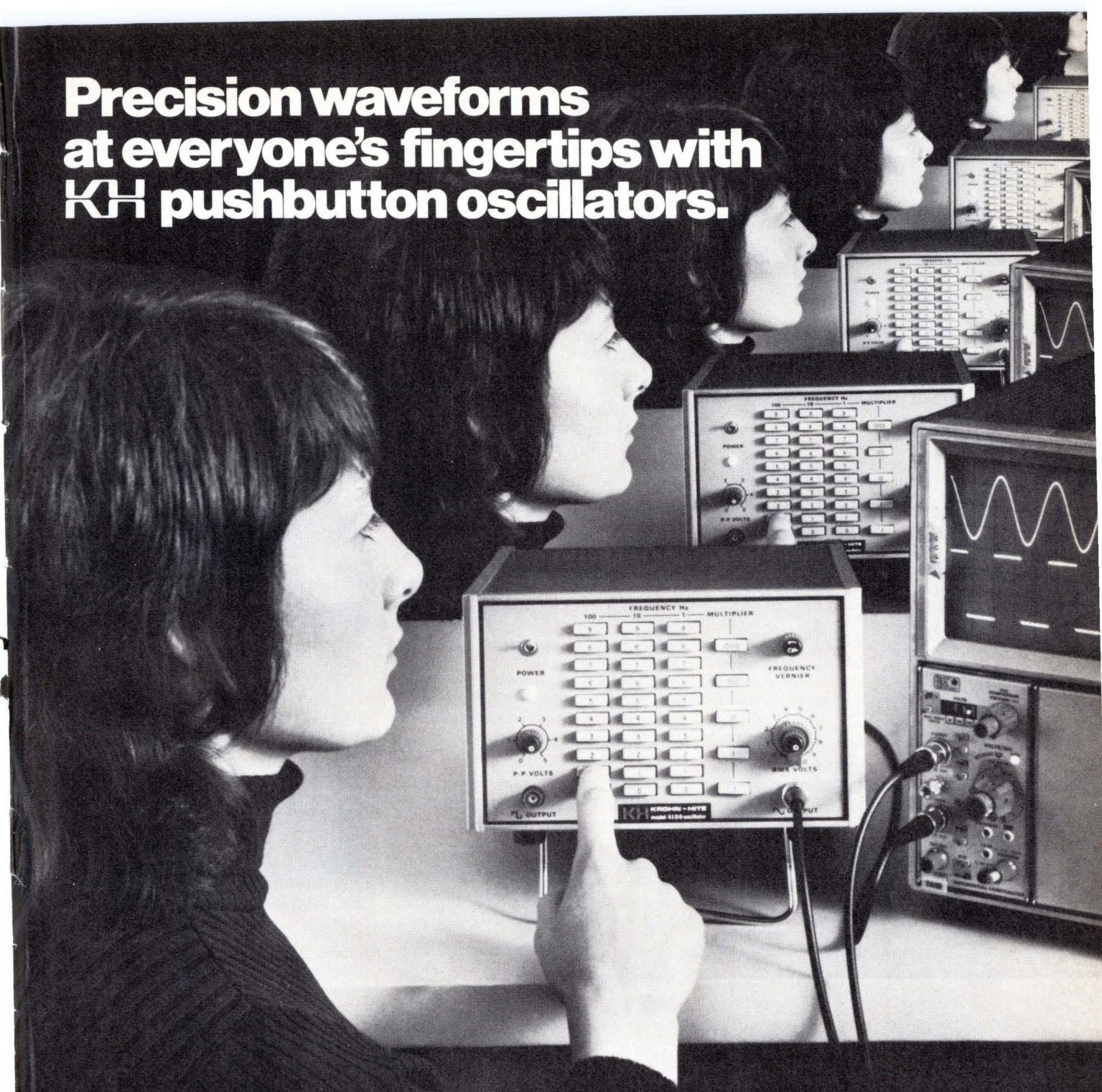

The Model 4100A is as simple to use as a pushbutton telephone—yet it's as precise, stable and distortion-free as instruments costing much more—more to purchase and more to operate. The 4100A is only \$595.00 and you don't need technically skilled people to operate it. Its simplified operation and outstanding speed and accuracy make it ideal for production line testing. The 4100A provides sine and square waves simultaneously from 0.01Hz to 1MHz. Frequency accuracy is within 0.5% and distortion is less than 0.02%. For fast action call (617) 491-3211, TWX 710-320-6583, or contact your local representative listed below.

**KH KROHN-HITE  
CORPORATION**

580 Massachusetts Avenue, Cambridge, Mass. 02139

SALES OFFICES: ALA., Huntsville (205) 534-9771; CAL., Santa Clara (408) 243-2891, Inglewood (213) 674-6850; COLO., Littleton (303) 795-0250; CONN., Glastonbury (203) 633-0777; FLA., Orlando (305) 894-4401; HAWAII, Honolulu (808) 941-1574; ILL., Des Plaines (312) 298-3600; IND., Indianapolis (317) 244-2456; MASS., Lexington (617) 861-8620; MICH., Detroit (313) 526-8800; MINN., Minneapolis (612) 884-4336; MO., St. Louis (314) 423-1234; N.C., Burlington (919) 227-2581; N.J., Bordertown (609) 298-6700; N.M., Albuquerque (505) 255-2440; N.Y., E. Syracuse (315) 437-6666, Rochester (716) 328-2230, Wappingers Falls (914) 297-7777, Vestal (607) 785-9947, Elmont (516) 488-2100; OHIO, Cleveland (216) 261-5440, Dayton (513) 426-5551; PA., Pittsburgh (412) 371-9449; TEX., Houston (713) 468-3877, Dallas (214) 356-3704; VA., Springfield (703) 321-8630; WASH., Seattle (206) 762-2310; CANADA, Montreal, Quebec (514) 636-4411, Toronto, Ontario (416) 444-9111, Stittsville, Ontario (613) 836-4411, Vancouver, British Columbia (604) 688-2619.

Circle 5 on reader service card



# Intronics multiplies your design flexibility

with low-cost, high accuracy M530 IC multiplier/dividers

Intronics IC multiplier/dividers provide the packaging flexibility you need when space is at a premium. These low-cost, fully self-contained, four-quadrant monolithic devices are capable of

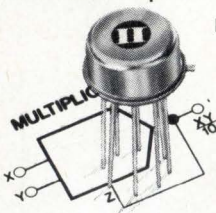
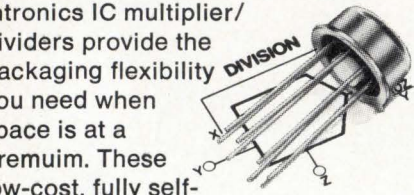

multiplication  $\frac{XY}{10}$ ,  
division  $\frac{10Z}{Y}$ ,  
squaring  $\frac{X^2}{10}$   
and square  
rooting  $\sqrt{10Z}$ ,

and feature high accuracy to 0.5% with excellent stability and a wide bandwidth of one megahertz. Prices start as low as \$20.

Applications include: modulation and demodulation, phase detection and measurement, ratio measurement, power measurement,

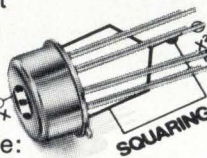

function generation and frequency discrimination. Write for complete applications information in our designer's guide, "Optimizing Analog Multiplier Performance."

When you're in a tight spot specify Intronics M530 IC multiplier/dividers.



**intronics**

57 Chapel Street, Newton, Massachusetts 02158 U.S.A.  
617-332-7350, TWX 710-335-6835

Overseas, call:  
Belgium 35-97-91  
Finland 11-123  
France 270-2255  
Germany 524181

Israel 53459  
Italy 719-518  
Japan 279-0771  
Netherlands 678380  
United Kingdom Maidstone 54224

## Readers comment

### Calculator puzzles

**To the Editor:** The pocket calculator short cuts in the Engineering Notebook section of the magazine are excellent, and I certainly enjoy reading them. I would like to suggest that you include some things on the lighter side that can be done with a pocket calculator.

Here is a mathematical weirdo you may find amusing: Take 15873 times any number one through nine, multiply the result by seven, your answer is the same as your multiplier. For example, if you use the multiplier five, the answer would be 555555.

There must be many mathematical puzzles that can be worked out on the pocket calculator, and I am sure your readers would appreciate knowing what they are.

Philip H. Alspach  
Lafayette Hill, Pa.

### Active filter correction

**To the Editor:** Vittorio Pomo of Olivetti Labs, Ivrea, Italy, brought to my attention an error which appeared in my article in the October 23, 1972, *Electronics*. Here is a listing of the correct capacitor values for section 1 of the odd-order filters in Table 8.

M = 0.2			
Order	C(1)	C(2)	C(3)
3	2.47691	2.33579	0.345685
5	3.22787	1.49698	0.427236
7	3.5182	1.35747	0.437102
9	3.70761	1.30237	0.434685

M = 0.4			
Order	C(1)	C(2)	C(3)
3	2.58726	2.13013	0.362895
5	3.32331	1.48091	0.432982
7	3.62987	1.36148	0.440894
9	3.77101	1.31802	0.443208

M = 0.6			
Order	C(1)	C(2)	C(3)
3	2.70422	1.96242	0.376872
5	3.4203	1.46691	0.438404
7	3.71401	1.36895	0.447313
9	3.85115	1.33283	0.450391

M = 0.8			
Order	C(1)	C(2)	C(3)
3	2.82576	1.82427	0.387978
5	3.51655	1.45504	0.44373
7	3.7984	1.37715	0.453805
9	3.93223	1.34813	0.457678

Farouk Al-Nasser  
Honeywell Test Instrument Div.  
Denver, Colo.

## The Elegant Capacitors



For elegant applications. Zero temperature coefficient  $\pm 10$  ppm/ C ( $-55$  C to  $+85$  C) with .01% accuracy—now 25% smaller in size.

Precise specs from precise craftsmanship. That's what you'll find in all capacitors by EAI. Polystyrene. "Mylar." Polycarbonate. Polysulfone. Polypropylene. Plain and metallized films. Hermetically sealed. RC networks, also. Matching tolerances from 5% to 0.005%.

Plus a growing list of other elegantly crafted etceteras—and fast, fast delivery.

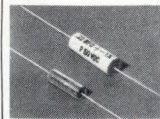

Electronic Associates, Inc.  
185 Monmouth Parkway  
West Long Branch, New Jersey 07764  
Tel. (201) 229-1100



# ac, dc, volts, amps, ohms

## 25 ranges

## \$595 complete

## 5-day delivery



**INTRODUCING** Systron-Donner's all-function 7004A Digital Multimeter  Measures dc and ac voltage, dc and ac current and resistance  New improved circuitry expands AC response to 100 KHz  New color-coded pushbuttons help distinguish functions  New carry case option  New simplified calibration  Optional battery pack with recharger (\$95) mounts internally  1,000 megohm input impedance on 3 lowest ranges  0.01% dc accuracy. For lab, field or systems use (with DTL/TTL compatible BCD outputs, \$45 additional).

Contact your local Scientific Devices office for more 7004A details or: Concord Instruments Division, 10 Systron Drive, Concord, CA 94518. In **Europe**: Systron-Donner GmbH Munich W. Germany; Systron-Donner Ltd., Leamington Spa, U.K.; Systron-Donner S.A. Paris (Port Marly) France. In **Australia**: Systron-Donner Pty. Ltd. Melbourne.

**We made a good DVM better!**

SYSTRON  DONNER

**The Systron-Donner Instruments Group:**

Concord Instruments  Computer Systems  Datapulse  Kruse Electronics  Microwave  Trygon Electronics



Cut package count . . . Simplify board layout . . .  
Reduce equipment size . . . with

# DIP MULTI-COMP<sup>®</sup> RESISTOR-CAPACITOR NETWORKS



(Metanet<sup>®</sup> Film Resistors, Monolithic<sup>®</sup> Ceramic Capacitors)

## STANDARDIZED DESIGNS\* FOR BETTER AVAILABILITY, BETTER PRICES

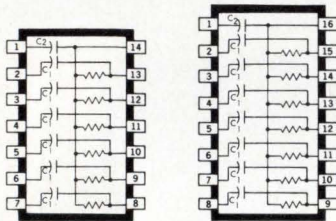

R (Ω)			C <sub>1</sub>
100	470	2000	100pF
150	500	2200	330pF
200	680	3300	0.01μF
220	1000	4700	C <sub>2</sub>
330	1500	6800	

### BYPASSED PULL-UP AND R-C COUPLING NETWORKS

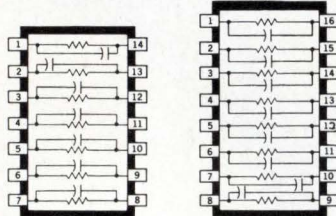

R (Ω)			C
100	470	2000	1000pF
150	500	2200	3300pF
200	680	3300	0.01μF
220	1000	4700	
330	1500	6800	

### SPEED-UP NETWORKS

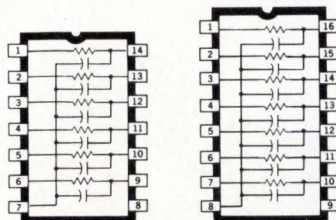

R (Ω)			C (pF)
100	470	2000	100
150	500	2200	
200	680	3300	330
220	1000	4700	
330	1500	6800	

### ACTIVE TERMINATOR NETWORKS

\* OTHER PACKAGES, CIRCUIT CONFIGURATIONS, AND RATINGS AVAILABLE ON SPECIAL ORDER

## Sprague puts more passive component families into dual in-line packages than any other manufacturer:

- TANTALUM CAPACITORS
- CERAMIC CAPACITORS
- TANTALUM-CERAMIC NETWORKS
- RESISTOR-CAPACITOR NETWORKS
- PULSE TRANSFORMERS
- TOROIDAL INDUCTORS
- HYBRID CIRCUITS
- TAPPED DELAY LINES
- SPECIAL COMPONENT COMBINATIONS
- THICK-FILM RESISTOR NETWORKS
- THIN-FILM RESISTOR NETWORKS
- ION-IMPLANTED RESISTOR NETWORKS

For more information on Sprague DIP components, write or call Ed Geissler, Manager, Specialty Components Marketing, Sprague Electric Co., 35 Marshall St., North Adams, Mass. 01247. Tel. 413/664-4411.

THE BROAD-LINE PRODUCER OF ELECTRONIC PARTS



## 40 years ago

From the pages of Electronics, April 1933

President Roosevelt, in the midst of the banking emergency, changes the whole public psychology by a 13-minute talk over the nationwide radio networks.

A great Atlantic liner talks with a ship below the horizon, by means of a modulated light-beam playing on a distant cloud-bank.

New realism in sound reproduction—three-dimensional "talkies" or telephony—is made possible by a binaural or stereoscopic pickup.

An infrared "fog-eye" locates hot ships' funnels through a naval smokescreen—in preparation for ice-berg detection through fog later this Spring.

To eliminate troublesome fading, KDKA engineers obtain baby blimp to hold antenna aloft to a vertical height of 1500 ft.

Professor Theremin, musical-instrument inventor, now applies "space control" principle to industrial uses, machinery operation, police alarms.

Sodium-vapor lamp installations, with luminous efficiency sixfold that of tungsten, are put in operation in England, Holland, Belgium, and Denmark.

Engineers experiment with 8- and 9-prong tubes; on combined detector-output tubes; on two-tube super-heterodynes.

A plane takes off in fog in Washington, never sees ground until it is guided back to earth by short-wave landing beam installed at Newark Airport.

Bergen County Police, Hackensack, N.J., install police radio system on 2480 kc., get reports on reception from all over the state and New York.

Leading radio manufacturer produces a four-tube radio receiver, to retail complete with tubes and dynamic speaker, at \$12.95. Factory price, \$6.40.

We pick the above at random from the crowded record of electronic happenings in a span of thirty days. These examples show how varied, how potent, and how far-reaching are the changes which the electronic tube is injecting into the world around us.



This revealing TV picture was taken with our Pyricon\*, THOMSON-CSF new pyroelectric camera tube. The THX 840 Pyricon\* was realized by incorporating the electronic scanning structure of a vidicon with the infra-red sensitive capability of a pyroelectric retina, an original THOMSON-CSF idea.

A unique pyroelectric material in the retina picks up thermal images from camera scanned scenes and transforms the infrared radiation detected from thermally emitting bodies into a clear video image that can be read on an electron beam. Pyricon\* operates at room ambient temperatures without need for ancillary cooling equipment. Its sensitivity and

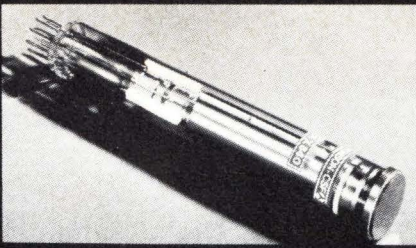

resolution capabilities are compatible with normal industrial surveillance requirements for low light level environments. An additional feature of the Pyricon\* is its inherent capability to distinguish moving targets from stationary objects by cancellation of fixed temperature background scenes when desired. The spectral response of a Pyricon\* is optimized for operation in the wavelength range of 8 to 13 microns or on special request can be optimized for the 3 to 5 microns range. Pyricon\* cameras utilize standard vidicon accessories with optical components chosen to suit the application. And it's definitely on target...

\* THOMSON-CSF trademark

**We shot this man  
on a dark and drizzly night,  
from a distance of 600 feet.**



**THOMSON-CSF**

THOMSON-CSF ELECTRON TUBES, INC. / 50 ROCKEFELLER PLAZA / NEW YORK, N.Y. 10020 / TEL. (212) 489.0400

France - THOMSON-CSF Groupement Tubes Electroniques / 8, rue Chasseloup-Laubat / 75737 PARIS CEDEX 15 / Tel. 566 70.04

Germany - THOMSON-CSF Elektronenröhren GmbH / Am Leonhardsbrunn 10 / 6 FRANKFURT/MAIN / Tel. 70 20.99

Italy - THOMSON-CSF Tubi Elettronici SRL / Viale degli Ammiragli 71 / ROMA / Tel. 638 14.58

Japan - THOMSON-CSF Japan K.K. / Kyosho Building / 1-9-3 Hirakawa-cho / Chiyoda-ku / TOKYO / 〒 102 / Tel. (03) 264.6341

Sweden - THOMSON-CSF Elektronrör AB / Box 27080 / S 10251 STOCKHOLM 27 / Tel. (08) 22 58.15

United Kingdom - THOMSON-CSF Electronic Tubes Ltd / Bilton House, Uxbridge Road, Ealing / LONDON W 5 2TT / Tel. (01) 579 55 11 / Telex : 25 659

See us at SID  
booth 320-330

Circle 9 on reader service card



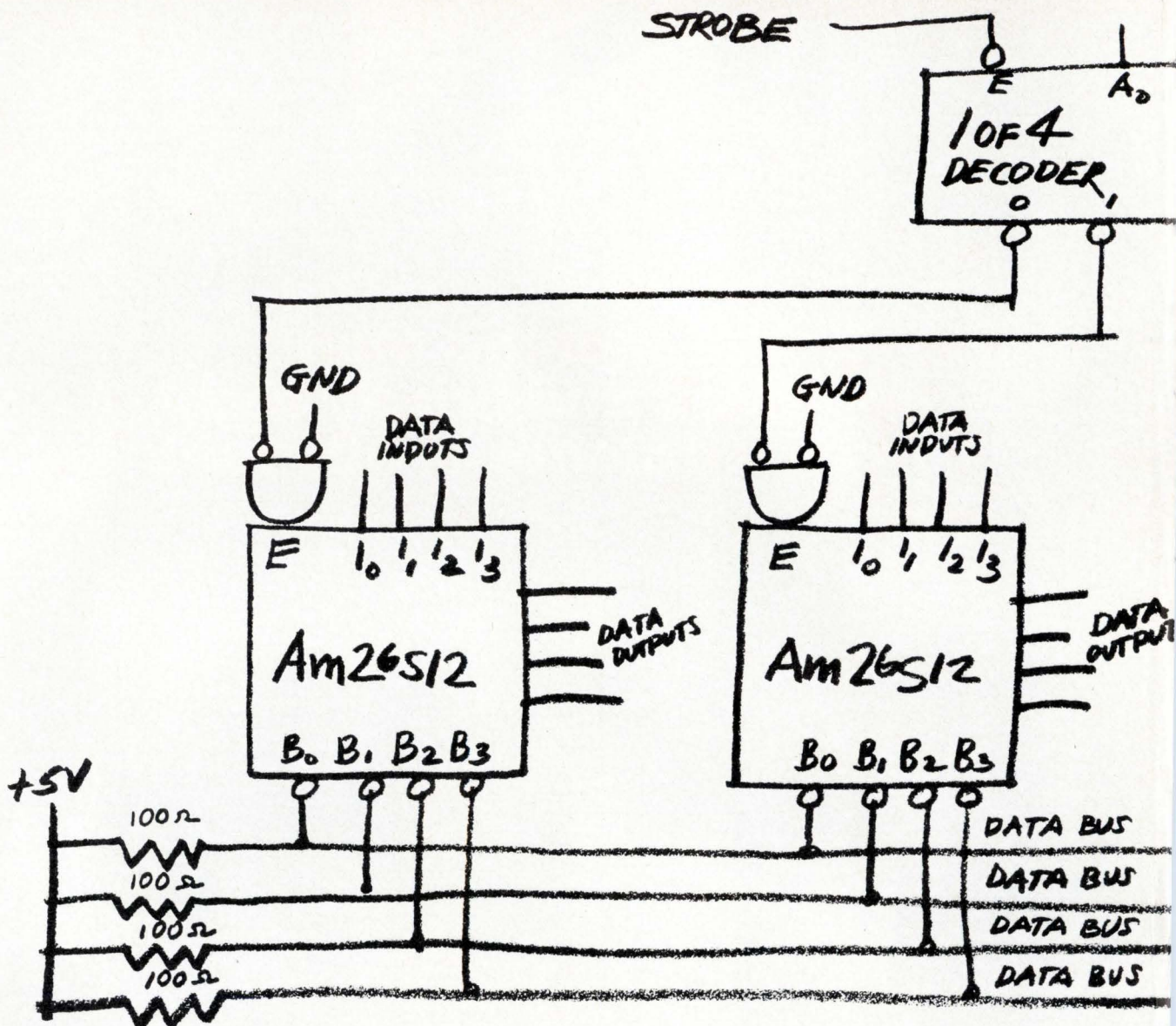

Advanced Micro Devices, Inc., 901 Thompson Place, Sunnyvale, California 94086/TWX 910-339-9280/TLX 346306.  
 For product or sales information, call the AMD sales representative nearest you. In Sunnyvale, Shel Schumaker at (800) 538-7904 (toll free from outside California) or (408) 732-2400; in the eastern United States, Steve Marks or Bill Seifert at (516) 676-4500; in Washington/Baltimore, Ken Smyth at (301) 744-8233; in Mid-America, Chuck Keough at (312) 297-4115; in the Los Angeles area, Steve Zelencik or Russ Almand at (213) 360-2102 or Larry Strong at (213) 870-9191; in the United Kingdom, Des Candy at Herne Bay (Kent) 61611; and in Germany, Hermann Lichotka at (0811) 594-680.  
 Advanced Micro Devices is distributed nationally by Cramer and Hamilton/Avnet Electronics.



# Am26S12 Quad Bus Transceiver.

Designed using Schottky clamped transistors, the Am26S12 has a bus driver current sink capability of 100mA at 0.8V (maximum) which enables it to drive as many as 200 devices. Receiver hysteresis provides high noise immunity with noise margins of greater than 1.0V. The unique terminating scheme of the Am26S12 allows each end of the bus to be terminated with a resistor as low as 100 ohms. Threshold limits are 1.4 to 2.0V  $\pm$  0.2V. Also available: The Am26S12A. Pin-compatible with DM8838. Threshold limits, 1.2 to 2.25V  $\pm$  0.2V.

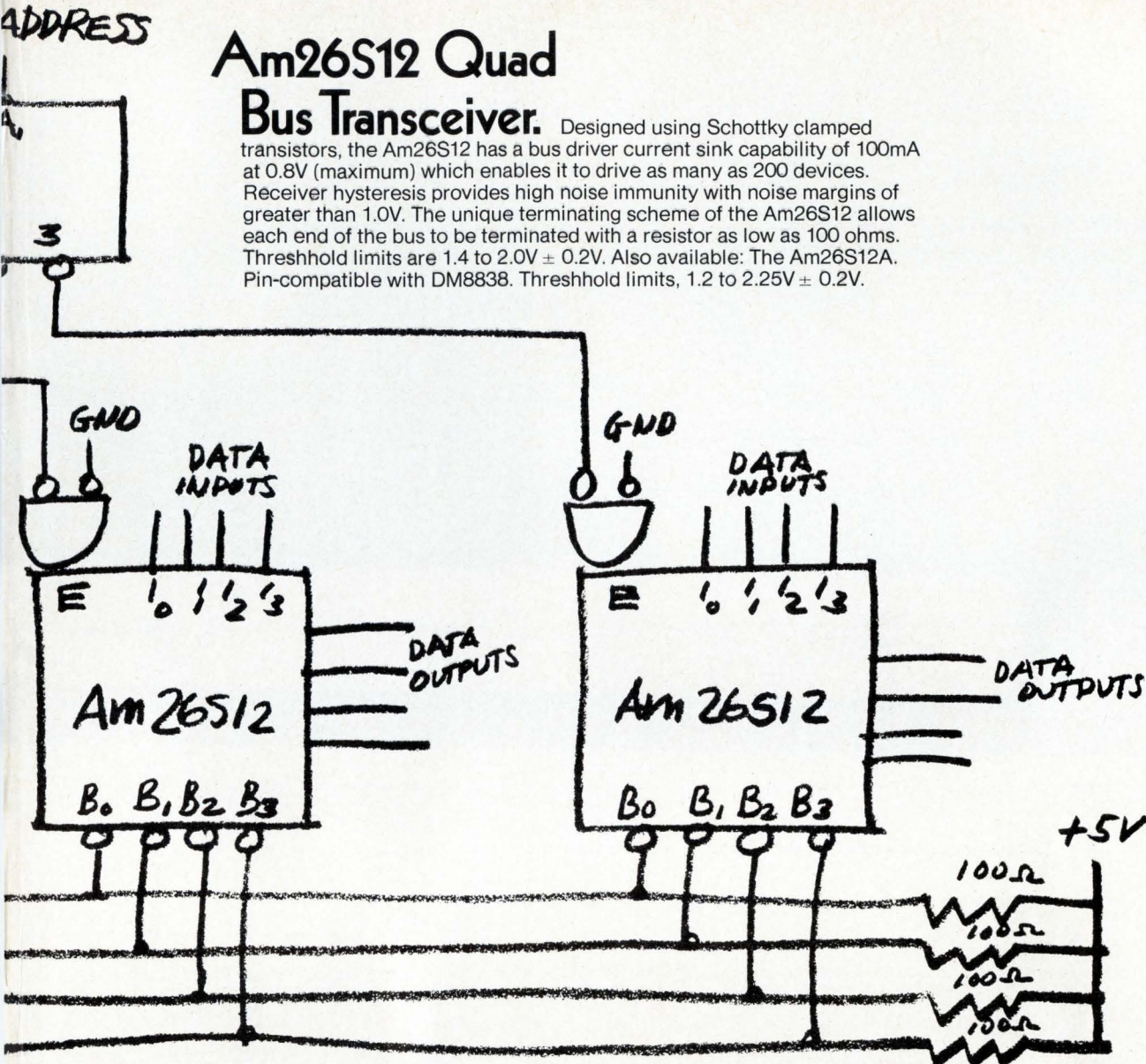

It's a bus driver with the world's highest drive capability and a bus receiver with unbelievably high noise immunity together in a single package.

It's the speedy new Am26S12 Quad Bus Transceiver. Yet another step forward in our relentless effort to become the sixth largest maker of integrated circuits in the country by 1975.

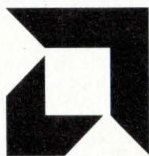

# Advanced Micro Devices Inc.

(We're going to be #6.)



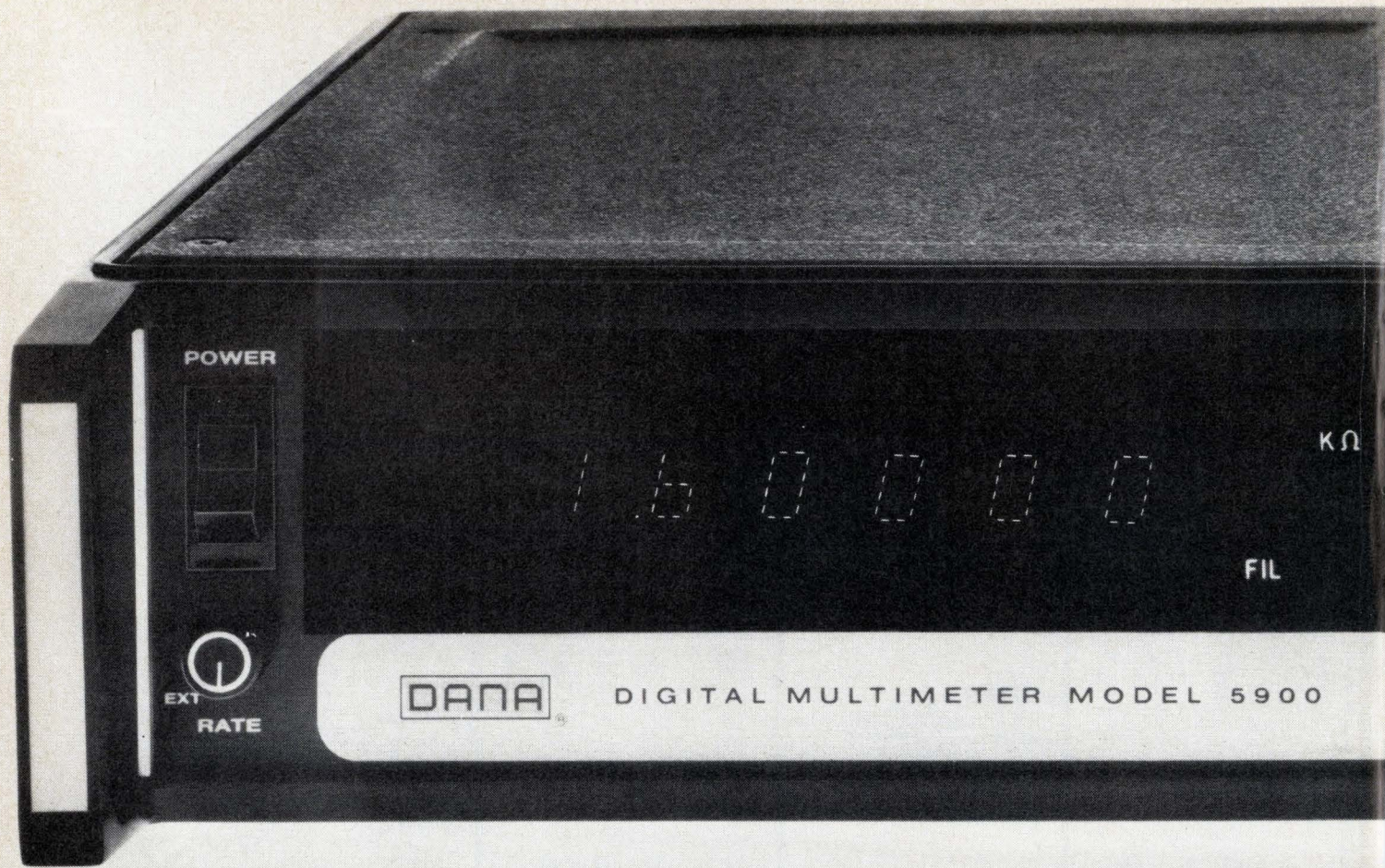

THE INCREDIBLY FAST 5900+. 100 READINGS PER SECOND IN THE 4½ DIGIT MODE.

**You can either make it better.  
Or you can make it cheaper.**

**Now, do both.**



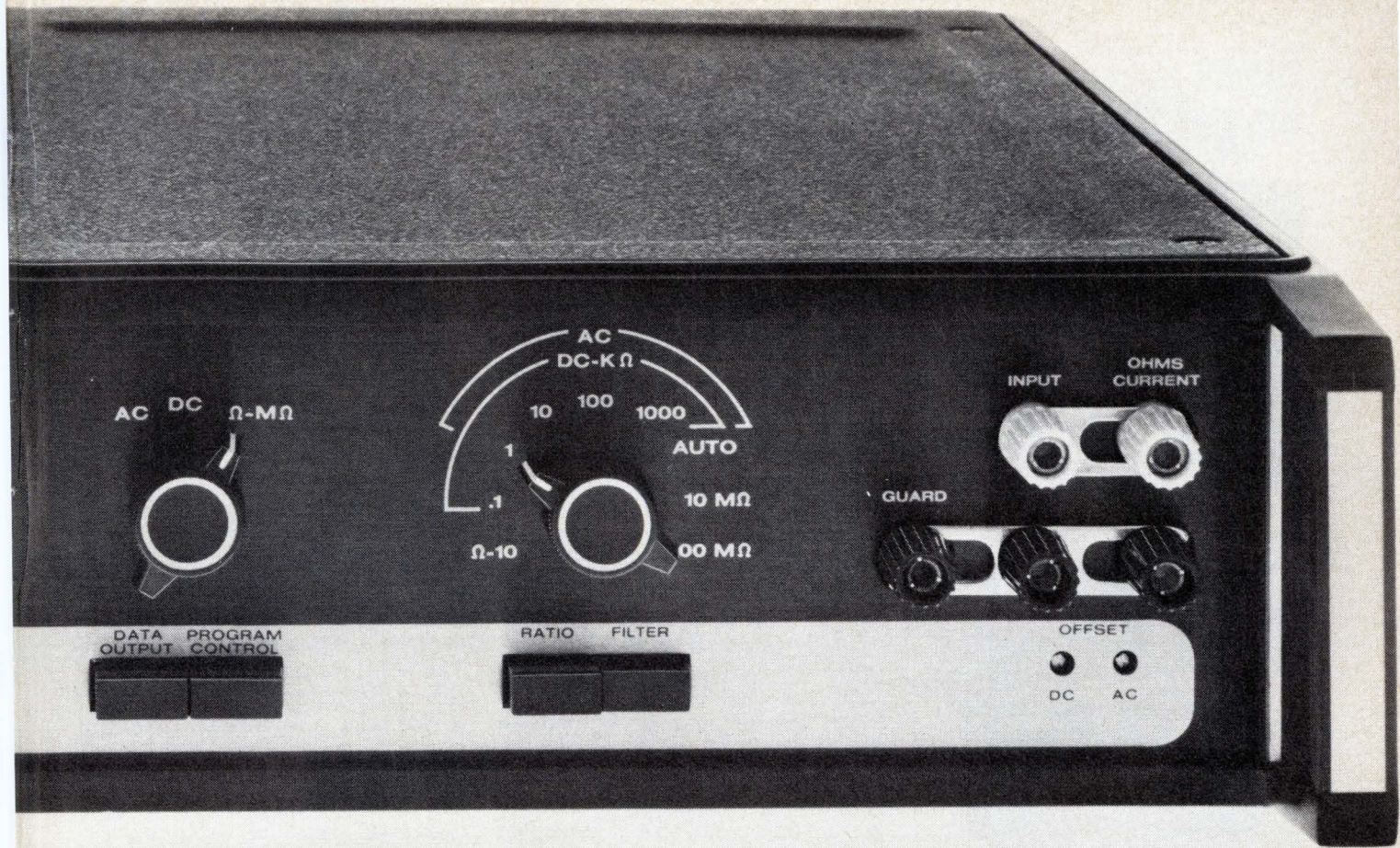

*The challenge infuriates an engineer. Excellence cannot traditionally be compromised by economics. But if you can't afford it, you won't buy it. So sometimes we have to do both.*

*Above you see one of the "plus" machines from Dana. "Plus" because it is truly a better machine. And "plus" because it is priced to give you a new level of quality for the money.*

### **The 5900+. A new standard.**

This new unit may well be the world's most accurate and stable 5-digit multimeter.

It delivers 0.001% total accuracy.

It has 350 volts RMS protection on all ohms measurements.

It provides true systems capability. It has 5 DC ranges, 60% overrange, and full ratio capability. Its basic price is \$1795. Nothing at that price is comparable in accuracy and quality.

### **The 5000+ DVM. The price is lower. The standards aren't.**

This new DVM is the lowest priced 5-digit multimeter we've ever produced. Yet because it was engineered and built by men who have been dealing with units costing ten times as much, the 5000+ reflects their standards.

It is absolutely reliable. (Silicon solid state circuitry plus LED display.)

It has 5 DC ranges capable of measuring from 1  $\mu$ V through 1000V.

It offers autoranging in all functions and 100% overranging on all ranges.

It's available as a complete multimeter. Its basic price is \$995. Nothing with its features and its quality is available for the price.

Examine these products and study their incredible performance/price. Contact Cliff Hamilton at Dana Laboratories, Inc., 2401 Campus Drive, Irvine, California 92664. Or call collect at (714) 833-1234. Ask him about these plus machines.

**DANA**<sup>®</sup>  
**Others measure by us.**

Circle 13 on reader service card



# Tubes? Forget them.

# HERE'S 100 WATTS OF SOLID-STATE RF POWER!

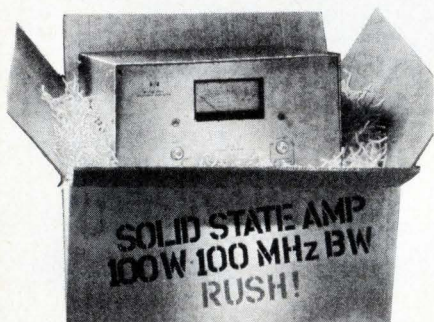

### A state-of-the-art amplifier.

ENI's new Model 3100L *all-solid-state* power amplifier provides more than 100 watts of linear power and up to 180 watts of pulse power from 250 kHz to 105 MHz. This state-of-the-art class A unit supplies over 50 watts at frequencies up to 120 MHz and down to 120 kHz. All this capability is packaged in a case as small as an oscilloscope, and it's just as portable.

### Extraordinary performance.

Featuring a flat 50 dB gain, the Model 3100L is driven to full power by any signal generator, synthesizer or sweeper. AM, FM, SSB, TV and pulse modulations are faithfully reproduced by the highly linear output circuitry. Immune to damage due to load mismatch or overdrive, the 3100L delivers constant forward power to loads ranging from an open to a short circuit.

Solid-state reliability is here.

The price? \$5,690.

Write for complete information: ENI, 3000 Winton Road South, Rochester, N. Y. 14623  
Call (716)-473-6900 or TELEX 97-8283  
Dept. 426

**ELECTRONIC  
NAVIGATION  
INDUSTRIES**

**ENI . . . The world's leader  
in solid-state power amplifiers.**

## People

Ken Dixon's winning mix:  
electronics and horses

If your dream is to start your own company, sell out handsomely in a few years, then retire to a gentleman's life in the country and raise champion horses, you should talk to Ken Dixon. He did just that, but then discovered his interest in robot production equipment was so strong that he founded another company, Dixon Automation, to pursue this business.

Dixon, who was with Hewlett-Packard's Mosely division and with rocket maker United Technology, formed the K Dixon Company in 1968. There he developed and marketed a silvering machine for chip capacitors and a chip sorter. Two years ago, he sold the business to Deval Corp. The machine is still in production and widely used.

With his responsibilities there ended, Dixon moved to a ranch that must have one of the most impressive views in all California, and, with apologies to those living elsewhere, that's saying something. It's on a top of a hill in Camarillo, 50 miles west of Los Angeles where Dixon looks down through a gap in the coastal mountain range near Point Magu. From his living room, he can see the channel islands of Anacapa, Santa Cruz and Santa Rosa, that start 11 miles off the coast and extend 60 miles westward.

In addition, Dixon raises champion Morgan horses, the small but highly regarded breed developed in America and formerly used by the cavalry. Last year, Dixon's Morgan stallion won the Western regional grand championship. And as it turns out, he says, horses are a good business to be in.



**Making it.** Ken Dixon owns champion horses, but still designs equipment.

But Dixon, with an EE from UCLA and a master's in mechanical engineering from Stanford, couldn't keep occupied with horses alone. Remembering his long-time interest in robots, he felt he could do things with electronics technology that no one else seemed to be working on. The result was a sophisticated robot chip handler [*Electronics*, April 12, p. 15] with a small but powerful controller that learns its job as it is moved through the motions. Dixon has found a lot of interest in the two-board controller, which replaces a full-blown minicomputer plus other equipment for this type of application in other automated machines, and he obviously has plans to apply similar techniques to other problems.

Ken Dixon, at 35, has made good use of the free time he sought and earned: "You can't do this in a big company. If you think it can be done, you've got to go off and do it yourself."

Armstrong calls shots  
for Motorola's color TV

In 1950, shortly after Motorola entered the TV business with the first black-and-white set priced under \$200, Merle Armstrong approached



**Knows how it is.** Merle Armstrong started off on Motorola's assembly line. Now, 23 years later, he's in charge of all the Consumer Products division's television receivers and stereo and four-channel components.



# GREAT MOMENTS IN MOS

## TTL/DTL COMPATIBLE RAM

The announcement that a 1024-Bit MOS Random Access Memory was available was quite an event. Indeed, it contained a promise to revolutionize data processing... but there was one serious drawback. The design engineer was faced with a complex problem of developing costly and intricate interface circuitry if he was to utilize the RAM's unique characteristics. MOSTEK approached the problem with its ion-implantation method, fabricating depletion loads to replace the conventional MOS load resistors, and doing the whole job on a single chip! As a result, TTL/DTL compatibility was achieved at all inputs of Mostek's MK 4006 RAM thereby allowing economical use by eliminating the need for special interface circuitry.

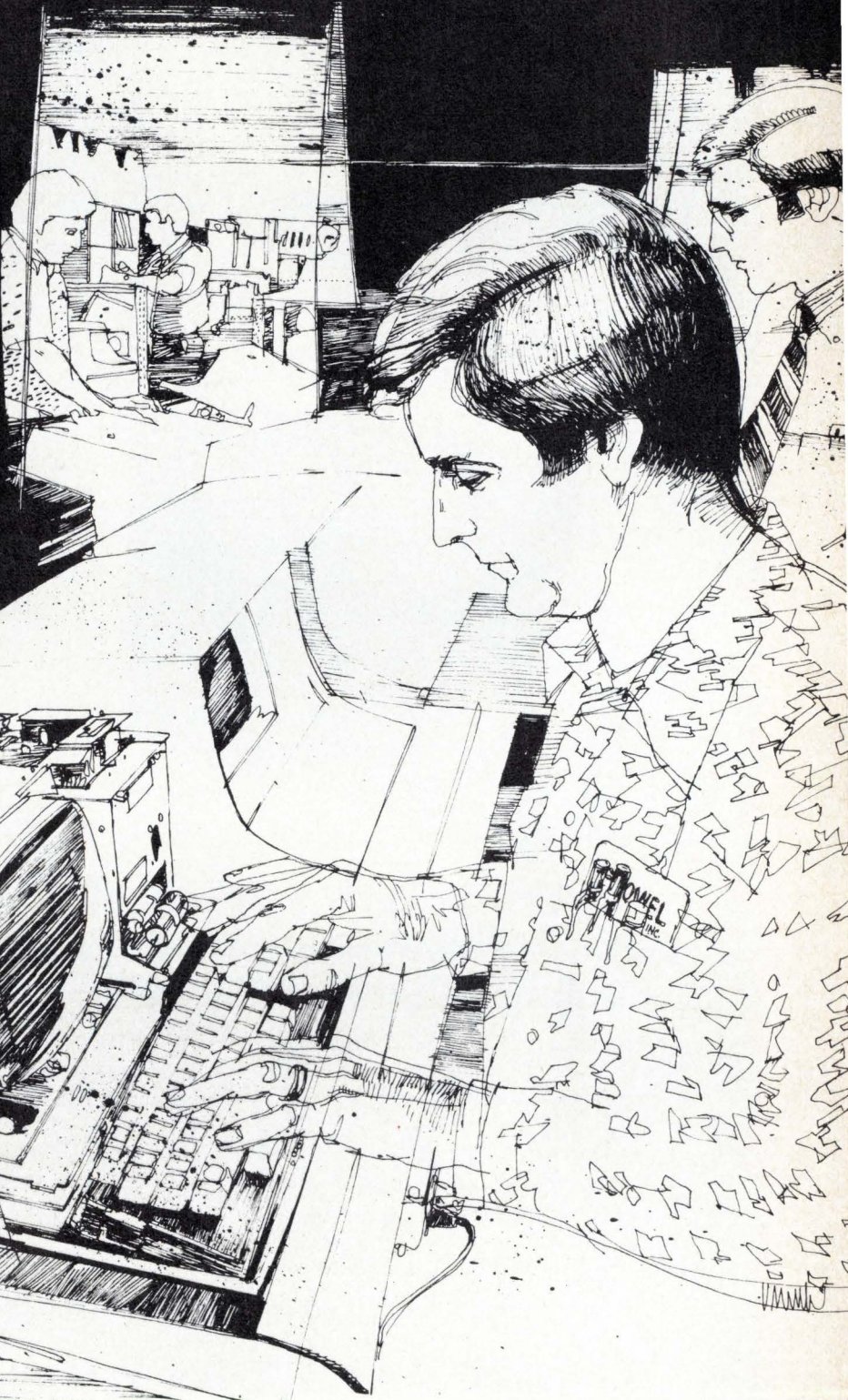

Large-system users could benefit from this MOSTEK innovation, but small-system users could benefit even more. These users, like the manufacturers of display terminal or data terminals, found the MK 4006 and MK 4008 the only 1K RAMs economically suitable for their systems because of reduced interface costs.

Again, our ion-implantation technique demonstrated its ability to meet the

needs of the market; and yet, ion-implantation has just begun to yield its potential. At this moment, we are at work on some MOS devices that we feel will prove to be just as exciting as our MK 4006 RAM family. At MOSTEK, we try to recognize the needs of an expanding technology and develop meaningful contributions. As a result, Great Moments in MOS just seem to follow.

# MOSTEK

MOSTEK Corporation  
1215 West Crosby Road  
Carrollton, Texas 75006  
(214) 242-0444  
TWX 910-860-5975  
TELEX 73-0423

© Copyright 1973 by  
MOSTEK Corporation



the firm with newly-won BSEE in hand. After lining up at the personnel entrance of the plant, he landed a job on the production line—adjusting coils. Still, Chicago looked better than his hometown in Nebraska, and he figured the surplus of engineers was bound to dry up.

Now, 23 years later, Armstrong is the newly appointed manager of product development engineering, with responsibility for all the Consumer Products division's output, including color and black-and-white portable and console TVs, and stereo and four-channel components. Today, color TV provides the bulk of the division's sales. And as the former manager of color-receiver design engineering, Armstrong knows that his group's charter requires substantial innovative inputs—such as Motorola's high-frequency power switching type of low-voltage power supply, and its circuitry for stabilizing color saturation in the company's "instamatic" one-button tuning feature.

"Integrated circuits can do almost anything you want them to," says Armstrong, but the competitiveness of the TV industry forces him back down to earth. "When we put an IC in, it must be equal to or less than its discrete equivalent in cost." Also dictating Motorola's reluctance to leap blindly into the widespread use of ICs in TV products is the firm's emphasis on modular construction and servicing, Armstrong explains.

"But for future chassis, we're designing them in at break-even cost." Top-of-the-line receivers now use ICs for the audio i-f, color processor, and demodulator—ICs largely conceived and designed by the consumer Products division. "Phoenix [the Semiconductor Products division] has a first and second video i-f IC," he adds, "but we're not moving that way today because there's not enough cost reason to."

The next functions to be integrated most likely will be part of the video i-f, automatic gain control, video detector, and automatic frequency control, and Armstrong expects that those can be done on two chips.

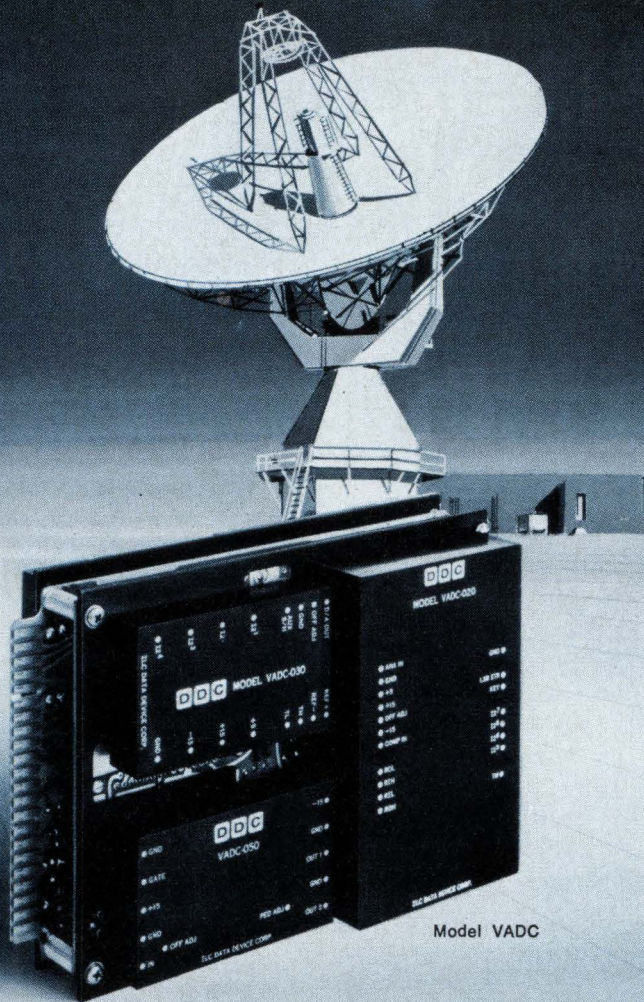

Model VADC

## Our low-cost, small-sized video A/D converter that delivers stability and maintainability.

Stability, accuracy ( $\pm 0.2$ ), and maintainability are just one side of the modular VADC analog-to-digital converter coin. The other is that this performance-proven device is the smallest 6 to 9-bit video converter available. Just 3.0 x 4.5 x 6.8. Speed and resolution vary from 9 bits @ 6 MHz to 6 bits @ 7.3 MHz (or for 8 bits @ 13 MHz, there's the TVADC). Other features include internal sample-and-holds with less than 100 pS aperture time, and a wide (5V) dynamic range.

The VADC models have proven themselves in such applications as moving target indicators, shipboard radar digitizing, auto correlation, color TV digitizing, and others requiring pulse analysis or data logging.

And it is certainly one more reason why DDC is established as the leader in high speed, sophisticated data conversion equipment.

For product or technical applications information, write or call Jim Sheahan or Hans Schloss. They're engineers, so they talk your language.



**ILC DATA DEVICE CORPORATION**

100 TEC STREET, HICKSVILLE, N. Y. 11801 • PHONE: (516) 433-5330

**APPLICATION CENTERS**

Long Beach, Calif.  
(213) 597-5744

Washington, D. C.  
(703) 525-4825

Bruxelles, Belgium  
(Tel.) 62.01.59



# 8K MOS ROMs: Delivered in four weeks flat!



(Just like every other device in Signetics MOS ROM line.)

No ifs, no buts. No gimmicks. Only Signetics guarantees 8K static MOS ROMs—masked, tested, shipped—in less than 30 days time. A fantastic 3-to-1 improvement over any other supplier in the field. Now extended to include the high-speed, high-density capability you need so frequently today: an 8,192-bit static ROM, the new Signetics 2580.

No shot in the dark: Signetics has already proven this incredible four-week turnaround on all our MOS ROMs—1K, 2K, 4K, and now 8K.

8K of memory in 2048x4 organization. Fully optimized to give you the whole shooting match in design simplification and speed. Power supplies +5V and -12V; 700 ns access time.

# 8K

All 2580 inputs/outputs are totally TTL compatible. With a single TTL level clock. Fully operational to your specs within four weeks, at only 0.2¢ a bit, in 100-999 quantities—no premium for our exclusive fast delivery.

And how in the heck do we do it? We verify your coding format from cards and send confirming print-out to you in 24 hours. Masks and test programs are computer-generated. Wafers are pulled from inventory: processed, packaged, tested and shipped. You get the works—on line, on time. In just four weeks. Just the way you wanted them.

And what you want, Signetics makes sure you get. Right down the entire MOS ROM line. Maximized user-oriented circuits, in minimized user-oriented time. To push designs into production faster... and pull systems out the door for quicker profits.

SIGNETICS ROM SELECTION GUIDE					
BIT DENSITY	ORGANIZATION	POWER SUPPLIES	MAX. ACCESS TIME (NS)	COST/BIT (100-999)	TYPE
8,192	2,048 x 4	+5, -12V	700	0.20¢	2580N
5,184	64 x 9 x 9	+5, -12V	750	0.31¢	2526N
4,096	512 x 8	+5, -12V	750	0.39¢	2530N
3,072	64 x 5 x 7	+5, -5, -12V	600	0.29¢	2516N
2,560	64 x 7 x 5	+5, -5, -12V	600	0.35¢	2513N
2,048	256 x 8 512 x 4	+5, -12V	950	0.47¢	2461Y
2,048	256 x 8 512 x 4	+12, -12V	750	0.47¢	2430Y
1,024	256 x 4 128 x 8	+5, -12V	950	0.94¢	2451Y
1,024	256 x 4 128 x 8	+12, -12V	750	0.94¢	2420Y
1,024	256 x 4	+5, -12V	950	0.88¢	2441I
1,024	256 x 4	+12, -12V	750	0.88¢	2410I

Signetics Corporation  
811 E. Arques Avenue  
Sunnyvale, California 94086

MOS ROMs in only 4 weeks? Prove it to me.

Please send:

- delivery quotes on parts circled above.
- specs and data on your new 8K ROM, the 2580, plus your ROM selection guide and cross-reference chart.

Name		
Title		
Company		
Address		
City	State	Zip
Telephone		

Signetics Corporation—A subsidiary of Corning Glass Works.

## signetics



# Siemens introduces the lowest profile in PC-board EMR's.

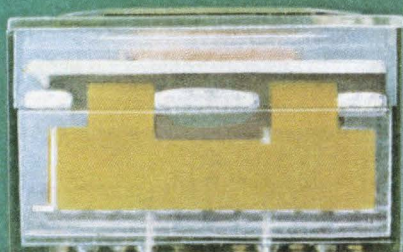

Common  
low profile



Siemens  
low profile

6PDT

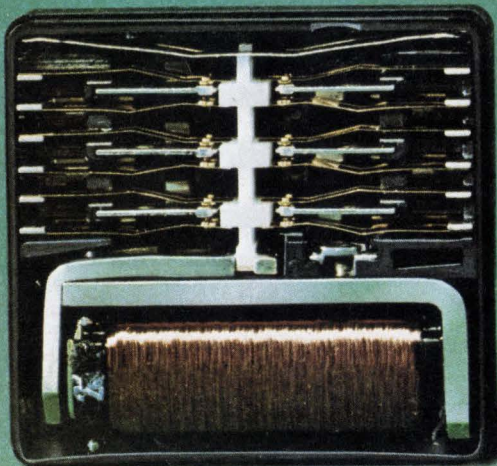

4PDT

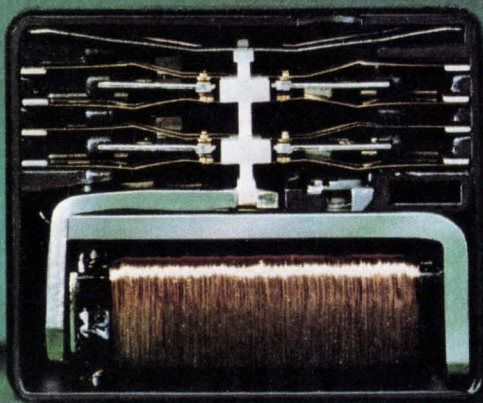

DPDT

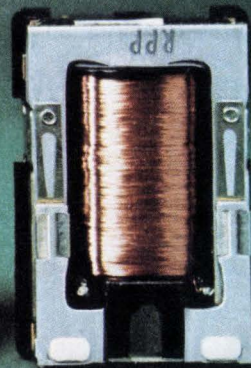



**These new low profile relays with only 0.4" height let you put twice as many PC boards in a rack yet give you over twice the current rating.**

Siemens, one of the world's leading relay manufacturers, has come up with another major relay innovation. This time it's a complete family of general-purpose Electro-Mechanical Relays with a lower profile combined with higher current rating than has been possible with any available design.

The new Siemens family consists of DPDT, 4PDT, and 6PDT models which have uniformly the same 0.4 inch height above the PC-board face and have contact ratings of 1 A at 24VDC (0.3 A at 115 VAC).

No longer need the relay be a limiting design factor. You can use Siemens low profiles on racks with 0.5" center-to-center PC-board spacing instead of up to one inch spacing. Thus you can pack up to twice the circuitry in the same space.

It also means you can design to switch twice the current you had been limited to by earlier PC-board relay types. Or if you don't need more current, you have a much higher safety margin.

The new Siemens relays have bifurcated contacts for high reliability, and a sealed base that keeps flux or solder from contaminating the contacts.

Siemens has many additional high-reliability, general-purpose relays. Write or call us for more information on the new low profile line or for relays for other applications.

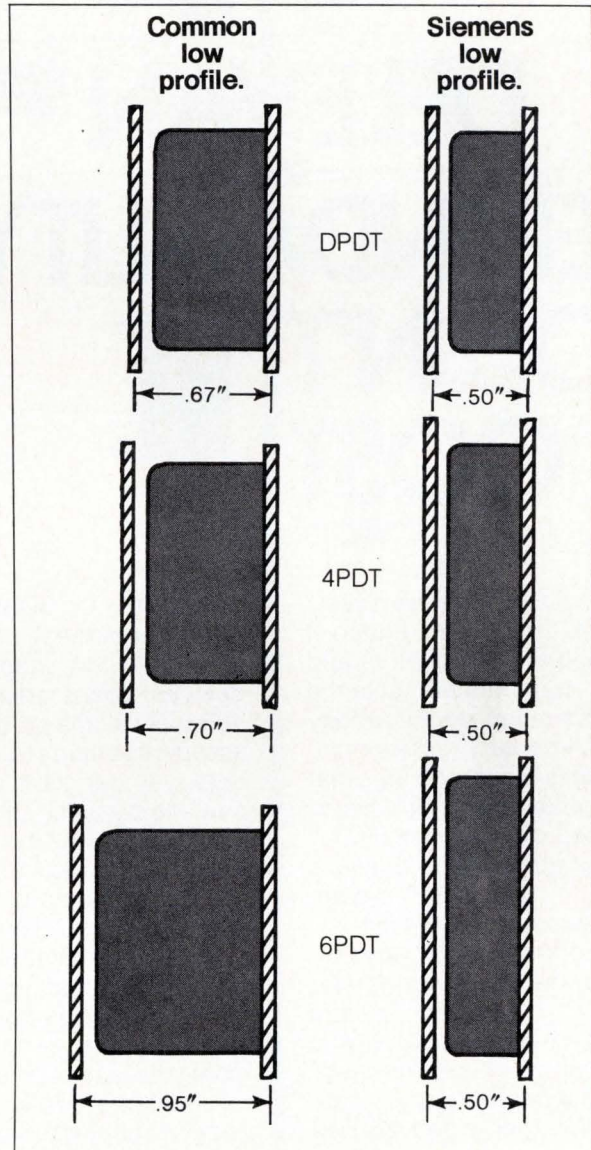

Siemens low-profile relays are easily mounted in racks with 0.5" center-to-center PC-board spacing.

Siemens Corporation, Special Components Department, 186 Wood Avenue South, Iselin, New Jersey 08830. (201) 494-1000.





# DELEVAN

## DEPENDABILITY

## DOESN'T COST

There's a lot more than meets the eye in Delevan's lineup of miniature RF inductors and transformers. Like the unmatched dependability built into each component. Thanks to a lot of things that go on at the factory. Hard-nosed quality controls . . . complete material analysis . . . advanced in-plant environmental testing . . . automated techniques for winding, soldering and molding . . . and conscientious people who take pride in true "no-fault" production. And of course, the dependable delivery and service you always get from Delevan.

Remember . . . the proven reliability of these superior made-in-U.S.A. inductive devices means greater reliability for the products and assemblies *made from them*. Sure, you can save a few pennies by using cheaper components. But this could be expensive in terms of premature failure of the finished product. When your company's reputation is on the line, you can't afford *not to use* Delevan components. Their premium performance more than justifies their use . . . because Delevan dependability pays for itself. Why not prove it to *yourself!*

# IT PAYS

**Delevan**  
Division



AMERICAN  
PRECISION  
INDUSTRIES INC.

270 QUAKER RD./EAST AURORA, N.Y. 14052  
TELEPHONE 716/652-3600 TELEEX 091-293

OTHER DIVISIONS OF AMERICAN PRECISION INDUSTRIES INC.:  
BASCO • DUSTEX • MOELLER INSTRUMENT CO. • OXFORD CORP.

## Meetings

**Electronic Components Conference:** IEEE, EIA, Statler-Hilton, Washington, D.C., May 14-16.

**Naecon:** IEEE, Sheraton, Dayton, Ohio, May 14-16.

**International Symposium:** SID, Statler-Hilton, New York, May 15-17.

**Electron, Ion, and Laser Beam Technology:** MIT and IEEE, MIT, Cambridge, Mass., May 21-23.

**Aerospace Instrumentation Symposium:** ISA, Frontier, Las Vegas, Nev., May 21-23.

**National Aviation System Planning Review Conference:** FAA, Washington Hilton, Washington, D.C., May 21-23.

**Electronic Component Show:** RECMA, Olympia, London, England, May 22-25.

**Conference on Laser Engineering and Applications:** IEEE, OSA, Hilton, Washington, D.C., May 30-June 1.

**International Microwave Symposium:** IEEE, U. of Colorado, Boulder, June 4-6.

**National Computer Conference and Exposition:** AFIPS, New York Coliseum, June 4-8.

**Frequency Control Symposium:** ECOM, Howard Johnson's Motor Lodge, Atlantic City, N.J., June 12-14.

**International Symposium on Electromagnetic Compatibility:** IEEE, New York Hilton, June 20-22.

**International Symposium on Fault-Tolerant Computing:** IEEE, Palo Alto, Calif., June 20-22.

**Design Automation Workshop:** ACM, IEEE, Sheraton, Portland, Ore., June 25-27.

**International IEEE G/AP Symposium and USNC/URSI Meeting:** IEEE, U. of Colorado, Boulder, Aug. 21-24.



# EMI FILTER CAPITAL OF THE WORLD

**FROM CERAMIC POWDER TO MIL-APPROVED TEST LAB...  
ERIE HAS IT ALL, UNDER ONE ROOF**

Only one company can deliver your total EMI Ceramic Filter needs... ERIE. We've been applying sophisticated ceramic and related technologies to developing superior filters for 35 years. Today ERIE has, by far, the broadest line of subminiature EMI Filters in the world. From tiny high frequency filters to broad band filters to custom filter assemblies, ERIE offers the ultimate in quality. And you get single-source responsibility too, for we build the complete filter in a plant devoted exclusively to the design and manufacture of EMI Filters. So come to ERIE for your filter needs. We'll put a team to work on your particular application. Aerospace. Communications. Avionics. Industrial Equipment. Whatever the market, we can help eliminate electromagnetic "noise" and emissions. In the meantime, write for our complete catalog... EMI Filters or call 613/392-2581.

**ERIE TECHNOLOGICAL PRODUCTS, INC.**

Erie, Pennsylvania 16512

Circle 21 on reader service card

# ERIE

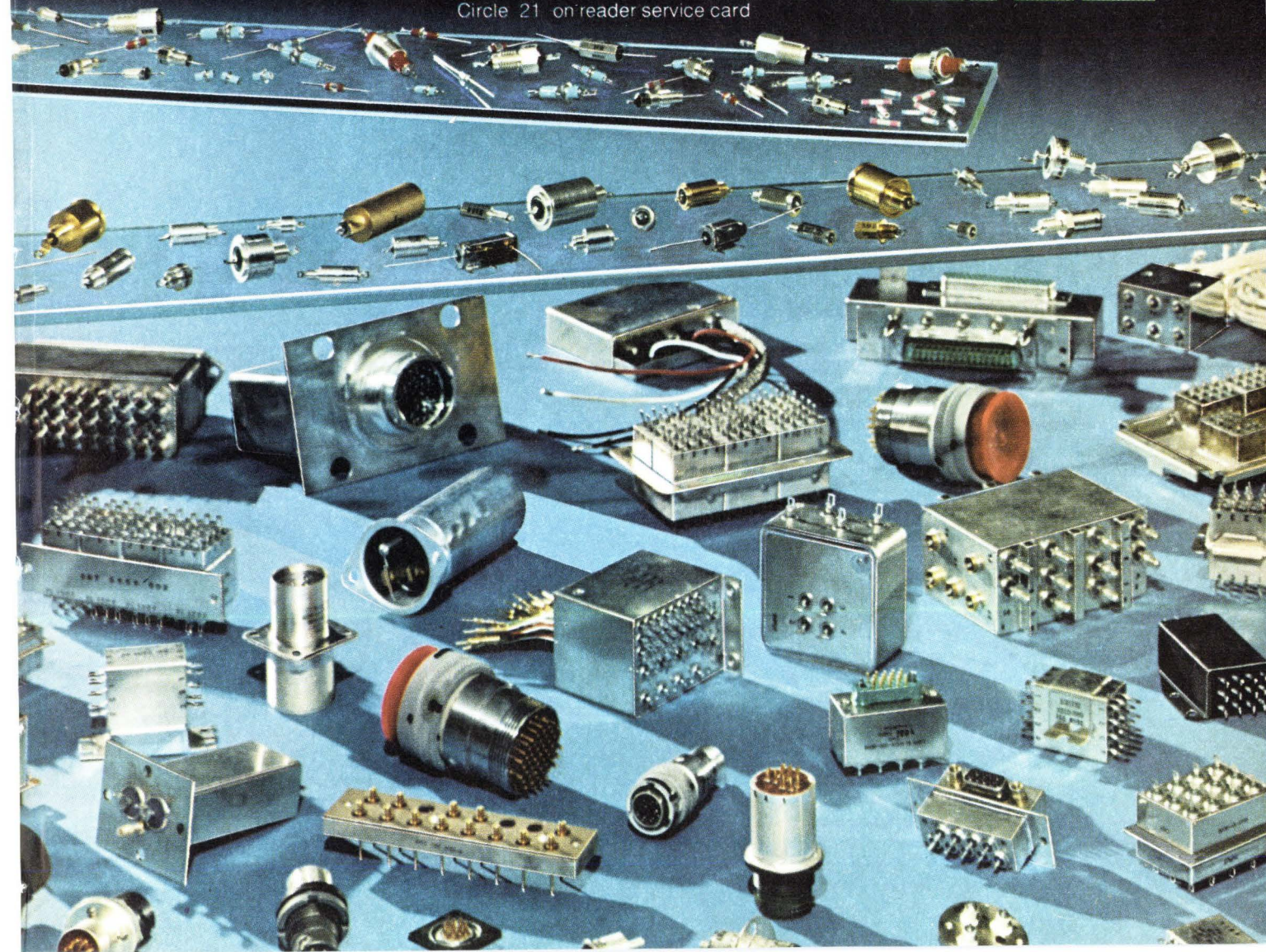



# How Would You Like To Get Answers Like These In Seconds?

It took only 27 seconds for HP's 3042A Automated Network Analyzer System to perform this complete low-pass elliptic filter analysis. Note the detailed plot of amplitude response as well as the tabulated printout of all the important filter characteristics. HP's 50 Hz to 13 MHz network analyzer systems are truly state-of-the-art. They can free you from countless hours of point-by-point measuring and plotting—and they're equally valuable on the production line and in the lab.

**The Most-Powerful 3042A System** not only can perform your entire testing process, but it lets you make measurements that you never could do before. It's a fully-automatic two-channel analyzer that will completely characterize any two-port linear device. Because it's automated, you get outstanding

ELLIPTIC FILTER TEST  
FILTER NO. = 25003  
INSERTION LOSS  
PASS  
0.15 DB  
PASSBAND RIPPLE  
PASS  
≤ 0.3 DB  
STOPBAND REJ.  
PASS  
> 50DB  
1600 HZ REJ.  
-65.87 DB  
2400 HZ REJ.  
-91.97 DB  
3DB FREQUENCY  
1066.9 HZ  
PASSBAND DELAY  
PASS  
≤ 0.4 MSEC

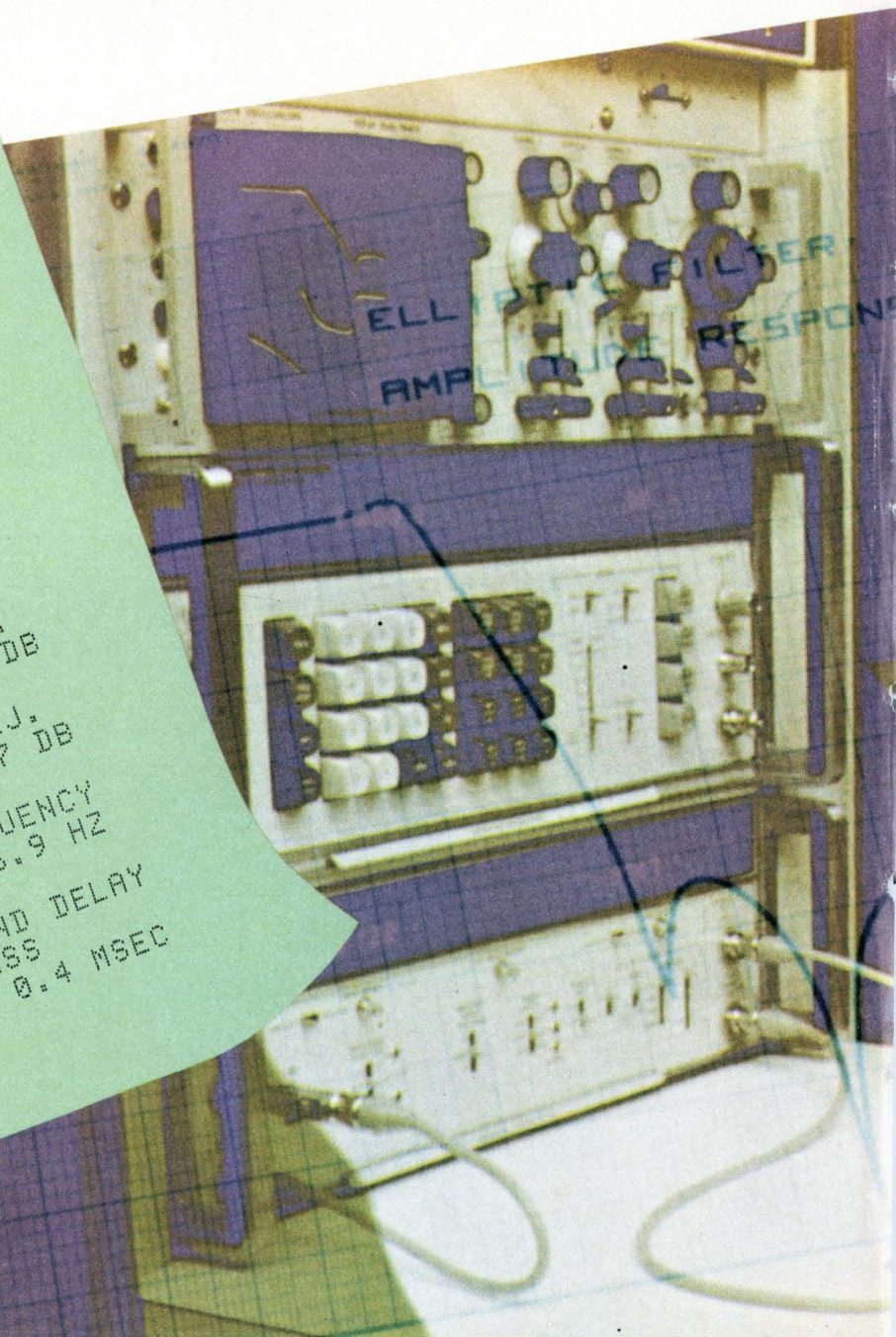



data repeatability along with the dramatic speedup in testing rate. Use it to fully test such time-takers as active filters, crystals or op amps. You can do them in seconds or minutes instead of the usual hours or days.

The system is comprised of three standard HP products—a synthesizer source, a tracking detector, and a calculator. This powerful combination applies equally to one-of-a-kind lab tests, or to repetitive production line testing. And, in addition to being able to make such tests as group delay, limit testing and offset measurements automatically, you also gain the capabilities of data reduction and decision making. You can have this fast, capable 3042A System for \$22,300—ready to operate.

**Semi-Automatic 3041A System** brings you the advantages of partial automation for significantly less money than full automation would cost. It incorporates the same synthesizer source and tracking detector used in the fully-automated system, but is controlled by a more economical marked card programmer (instead of the calculator). You can even make group delay, limit test and offset measurements with the 3041A. At \$14,000, it's modestly priced but does the work of systems costing much more.

**Basic 3040A System** teams the tracking detector with one of four automatic synthesizer sources. It's a budget-priced combination that provides you with many of the capabilities of a dedicated automated system, but at much lower cost. When you select the top-of-the-line automatic synthesizer you get a lab-in-a-box with a "brain." It combines the performance of a synthesizer, a sweeper, a marker generator, a counter, a programmable attenuator, a precision level generator, and a controller in one instrument. Depending on

the synthesizer you choose, these high-capability systems cost from \$6,900 to \$11,000.

All three of the Network Analyzer systems help you do more work in less time and with less labor. With them you can telescope what formerly took hours, or even days, into only minutes or seconds. Optional accessories let you select and pay for only the exact capability you need. For full details on these network analyzer systems call your local HP field engineer. Or, write Hewlett-Packard, Palo Alto, California 94304. In Europe: HPSA, P.O. Box 85, CH-1217 Meyrin 2, Geneva, Switzerland. In Japan: Yokogawa-Hewlett-Packard, 1-59-1, Yoyogi, Shibuya-Ku, Tokyo, 151.

093/40

HEWLETT  PACKARD

NETWORK ANALYZERS

Circle 23 on reader service card





# Five watt power in a cermet pot!



Allen-Bradley Type CJ. That's right, 5 watts at 70°C. Now you can have the stepless control of cermet without sacrificing power-handling capability. Replace wirewounds with performance that's hard to match. Low noise. No inductance. Smooth mechanical operation. Operating temperature range -65°C to +150°C. Less than 10% re-

sistance change over 50,000 cycle rotational life. Resistances from 100 ohms to 5 megs. Single, dual or triple section units with plain or locking bushings. Dust-tight and "splash-proof." Large variety of shaft and bushing options available. Allen-Bradley CJ brings new power handling capability to cermet variable resistors. Request our Publication

5215. Available through your appointed Allen-Bradley Electronic Distributor, or write Allen-Bradley Electronics Division, 1201 South Second Street, Milwaukee, Wis. 53204. Export: Bloomfield, N. J. 07003. Canada: Allen-Bradley Canada Limited, Cambridge, Ontario. United Kingdom: Jarrow, County Durham NE32 3EN.



Actual Size



**Allen-Bradley**

Milwaukee, Wisconsin 53204

Circle 24 on reader service card



## **Magnetic-bubble memory takes megabit shape**

Using the "highest-density shift-register chip ever built" in any technology, Bell Laboratories, Murray Hill, N.J., is putting together a 1.1-megabit bubble memory that "could do all the functions of a fixed-head disk memory," declares J.E. Geusic, magnetics department head. Made of epitaxial garnet film with a permalloy overlay for propagation and conductors for control, the chip is only 200 mils square yet contains 20,000 bits. And only two photo-lithographic steps, versus as many as eight for semiconductor memories, are needed in its fabrication, Geusic points out. **A complete memory, which comes with 56 chips as well as a magnet and rotating field coils, would occupy 1.3 by 3¼ by ½ inches.**

## **Japan space agency to buy U.S. system**

In one of the largest electronic programs let to a foreign country, and the first ever directly to a foreign company, Japan's National Aeronautic and Space Development Agency is buying **over \$3 million in communications equipment for its N-launch vehicle program** from Motorola's Government Equipment division. The equipment will be delivered starting late this year for a late 1975 launch. **The N launch vehicle will use C-band radar-tracking transponders for command data** instead of depending on the usual separate S-band command system.

## **National builds monolithic pentode replacement**

A monolithic replacement for vacuum tubes is being made in prototype quantities by National Semiconductor Corp. of Santa Clara, Calif. Teledyne Semiconductor, Mountain View, Calif., which initially developed hybrid ICs (Fetrons) built around high-voltage junction field-effect transistors (Electronics, April 10, 1972, p. 85), has **estimated the potential market as \$500 million a year.**

The prototype circuits meet the performance specifications for 6AK5 vacuum tubes, but chip yields are still too low for mass production, says Paul Pagnini, product manager at National. He doesn't expect the devices to go into commercial production until late this year.

## **Tests show epoxy IC packages have reliability edge**

Epoxy-packaged ICs are bettering their phenolic and silicone brethren by more than one order of magnitude. That's the news from the site in Panama where the U.S. Army Electronics Command, which is headquartered at Fort Monmouth, N.J., has been conducting environmental tests. **The epoxy-A packages are exhibiting a failure rate of 0.14% per 1,000 hours compared with 5.5% for phenolic and 13.5% for silicone.** The 80 epoxy packages had accumulated 1.4 million hours at the time of the test report, and there had been one failure. Temperatures at the Panama test site range from 80° to 90° F at relative humidities from 85% to 95%.

## **Wafer shortage sends U.S. firm to Japan for chips**

While many of the MOS calculator chip sets made in the U.S. are assembled by Japanese firms, Electronic Arrays Inc., may go all the way and have the chips made in Japan, too. Earl Gregory, EA vice president, says the company is considering **a production arrangement with**



**Mitsubishi Electric Corp. whereby the Japanese firm would process p-channel chips with masks supplied by Electronic Arrays.** Mitsubishi Electric, according to reports, has already made sample quantities of wafers for evaluation.

**The move was prompted, says Gregory, by the shortage of wafer-fabrication capacity in the U.S.** If the deal goes through, it would affect only p-channel MOS chips.

## **Fast fax systems show their stuff**

**Fast facsimile transmission schemes are bidding to take their place in communications of the future.** The latest comes from Comfax Communications Industries Inc., a small New York-based development house. Comfax has a **prototype Comfax-15 that transmits at 9,600 bits per second**—that is, it can send an 8½-by-11-inch, double-spaced, typewritten page in something over 15 seconds. It can operate over leased lines, but—for lack of a suitable modem—not over the dial-up telephone network. Essentially, the company has multiplied by four the data transmission rate of its Comfax-60 one-minute machine first shown as a prototype a year ago.

Electronics Associates Inc., West Long Branch, N.J., will manufacture, market and service the units. Production of the Comfax 15 is slated for year's end; Comfax-60 for June. Also showing a system to prospective users is Dacom Inc., Sunnyvale, Calif. Marketed by Savin Business Machines Corp., Valhalla, N.Y.; it transmits a page in something over 35 seconds.

## **Victor Comptometer enters programable calculator business**

Taking advantage of its penetration of the business and commercial calculator markets, Victor Comptometer Corp. will enter the programable electronic calculator business later this year with a series of four low-cost machines. The Chicago-based firm is aiming at the dead center of the "virtually untouched" business and commercial segments, says J. E. Smith, president of Victor's Business Products group, and he hints **the company will tackle H-P and Wang in the more specialized engineering and scientific market segments later on.** The series will start at about \$1,800 and will offer up to 102 registers and 1,000 steps, programable with a magnetic program card.

## **Addenda**

The Federal Aviation Administration will conduct tests this fall to see how much better for domestic navigation differential Omega is than Omega alone. Bendix Corp.'s Navigation & Control division, Teterboro, N. J., will supply the equipment. . . . At Texas Instruments' annual meeting in Dallas, Mark Shepherd, president, announced first quarter income of \$18.9 million as 75% better than last year's record first quarter. . . . The requirement for automatic fine tuning on uhf dent tuners in black-and-white TV sets will become optional by 1975 under rule changes proposed by the Federal Communications Commission. . . . The Federal Highway Safety Administration has turned down Detroit's request for extending the deadline on seat-belt interlocks. This equipment, which prevents a car from starting if the belts aren't fastened, must be present in 1974 models.



# PIN diode "Micro Pills"

**A CURE FOR STRIPLINE AND MICROSTRIP HEADACHES**



## RUGGED, HERMETICALLY SEALED PIN DIODES ALSO PROVIDE CONTINUOUS RELIEF FROM MICROWAVE CHIP PROBLEMS.

They're immune to shock, dirt, moisture, scratches and other handling hazards, because they're voidless, metallurgically bonded and fused-in-glass for optimum reliability. Though small enough to use like ordinary chips, Unitrode "Micro Pills" can dissipate 15 watts of average power and 60 kilowatts of peak power. And they can withstand thermal cycling from -195°C to +300°C without permanent degradation. Carrier lifetimes exceeding 2.5  $\mu$  sec assures low distortion performance. They're ideal for stripline and microstrip applications. Used as switches, duplexers, phase shifters, attenuators, amplitude modulators, or receiver protectors, they operate

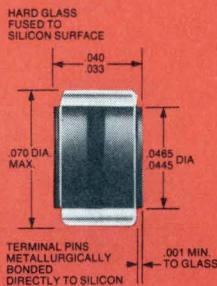

as a variable resistance controlled by a self generated or externally applied bias circuit. The unique construction allows remarkable assembly flexibility, withstanding temperatures up to 400°C when soldering or brazing "Micro Pill" PIN diodes to various circuit media. They're as low as \$4.00 each in 10K quantities. Switch to UM7900 series "Micro Pills" and feel better all day long.

For free samples, call or write Howard Kaepplein at (617) 926-0404 collect, Unitrode Corporation, Dept. 4 Y, 580 Pleasant St., Watertown, Mass. 02172. For the name of your local Unitrode distributor or representative, dial (800) 645-9200 toll free, or in New York State (516) 294-0990 collect.

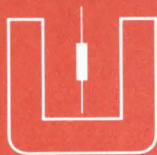

# UNITRODE



### UNITRODE CORPORATION

Dept. 4 Y, 580 Pleasant St., Watertown, Mass. 02172.

Please send technical data on the following PIN diode: "Micro Pills"

Type	Voltage Rating (volts)	Series Resistance @ 100 mA (ohms)	Total Capacitance (pf)
UM7901A	100	1.0 MAX	0.8 MAX
UM7902A	200		
UM7904A	400		
UM7906A	600		
UM7910A	1000		

NAME: \_\_\_\_\_ TITLE: \_\_\_\_\_

CO.: \_\_\_\_\_

ADDRESS: \_\_\_\_\_

CITY: \_\_\_\_\_ STATE: \_\_\_\_\_ ZIP: \_\_\_\_\_

TELEPHONE: \_\_\_\_\_



# POWER-MOV™ VARISTOR



## FOR BETTER VOLTAGE TRANSIENT PROTECTION IN A POWER PACKAGE

General Electric POWER-MOV™ varistors are the newest addition to our growing line of superior metal oxide suppressors which provide better breadth of protection than selenium, silicon carbide, zeners, spark gap, or other older technologies. This new chassis-mount package is ideal for applications requiring high power dissipation and added ruggedness.

Forty-six models are being offered initially including the following:

MODEL	AVG. PWR. DISSIP. (WATTS)	MAX. VOLTAGE		SUGGESTED RESALE PRICE		
		AC	DC	1-99	100-999	1000-9999
V130PA20A	15	130	170	4.90	3.31	2.94
V250PA40A	13	250	330	7.36	4.97	4.42
V480PA80A	10	480	625	12.10	8.17	7.26
V510PA80A	10	510	655	12.60	8.51	7.56
V550PA80A	9	550	755	13.16	8.88	7.90

Other voltages available from 130V to 570V Rms, 170V to 780V DC

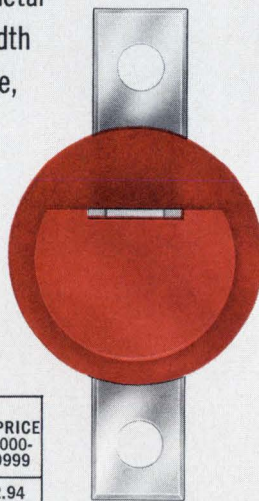

Actual Size

### TYPICAL APPLICATIONS

- Inverters
- Welding Equipment
- Reprographic Machines
- Electric Vehicles
- Motor Controls
- Arc Suppression

### FEATURES

- 15 WATTS DISSIPATION @ 70° C Tab Temp.
- 2,000 Amps Peak Current
- Low Clamping Ratio (1.7-1.9@ 10.0A)
- Meets NEMA strike and creep distance
- Quick disconnect termination

For your POWER-MOV™ varistor DESIGN KIT, call your local authorized GE semiconductor distributor . . . or write to General Electric Company, Semiconductor Products Department, Building 7, Mail Drop #49, Electronics Park, Syracuse, N.Y. 13201, U.S.A.

**GE-MOV™ VARISTORS . . . . . ASSURE YOUR EQUIPMENT WILL ENDURE**

**GENERAL ELECTRIC**





## Electronic industries worry over the cost of Nixon's trade bill

Offshore manufacturers could pay much higher tariffs and taxes if the Trade Reform bill passes

**How much will it cost?** That is the gut question being asked on all sides about President Nixon's sweeping Trade Reform Act of 1973, and the initial assemblers of semiconductors and consumer products in particular are saying that the price of what they are being asked to give up in tariff and tax advantages may turn out to be more than they will get in return.

**Tradeoffs.** "There are always tradeoffs in any situation," observes one Washington counsellor to Electronic Industries Association companies, "but the puzzling thing—maybe clever is better—about this bill is that manufacturers can figure what they are being asked to pay with no substantive guarantees about what they will get." The industry is being asked to surrender the advantages of Items 806.30 and 807 of the U.S. Tariff Schedules, under which unfinished parts exported for foreign assembly may be reimported in a finished product—whether it is an integrated circuit or TV receiver—with tariffs paid only on the value added, usually labor.

Less obvious, but perhaps more threatening to electronics manufacturers in terms of lost revenues, are the prospects for higher taxes contained in the Administration's trade bill. Of particular concern is the request that revenues of what Nixon called "the classic runaway" plant—that ships more than 25% of its out-

put—be taxed in the year they are earned, rather than in the year when the corporation decides to repatriate those earnings.

Among semiconductor makers, however, the threat of repeal of Items 806.30 and 807 attracted the greatest initial attention, although that prospect has been anticipated in Washington for some months [*Electronics*, March 1, p. 25]. Earlier this year, the EIA wrote urging their



**Tough trader.** The President's bill seeks broad powers to control tariffs and taxes.

retention, noting that the tariff savings represent "approximately half of the profit margin" of many of the products covered. At Signetics Corp., Sunnyvale, Calif., marketing vice president Jack Halter concurs with the EIA view and contends that because of the lower tariff on value added only, semiconductor makers with offshore operations have been able to sell at high volume overseas and thus sell at lower prices domestically to minicomputer makers.

Halter also points out that, if a tax is placed on the shipment of materials overseas, many U.S. companies who support the semiconductor manufacturers could also be hurt.

On the issue of higher taxes for offshore operations, John Cobb, vice president and controller at Intel Corp., Santa Clara, Calif., believes the trade bill is "misdirected" since it would "obviously make offshore assembly more expensive" and thus inhibit the price advantage that has helped keep U.S. semiconductor makers dominant in world production of complex devices. Cobb sees the Nixon bill as overreacting to the concerns of U.S. organized labor and wants the electronics industries to "mount a strong lobby against it."

**Opposition.** Assessments of the Nixon bill and early drives to develop a position for the electronics industries have been much on the mind of EIA and the California-based manufacturers group, WEMA, since the package was sent to the Congress in mid-April. EIA was ready early, setting up industry meetings in California and Washington within a week. Although there was some feeling among manufacturers against moving too quickly before settling on a firm position, industry organization officials noted they had to have an outline of their position ready April 27, along with their requests to testify at the first round of hearings set to begin May 7 before the House Ways and Means Committee headed by Rep. Wilbur Mills (D., Ark.).

The Nixon package stands a good chance of passing with only limited changes in many of the President's



requests for new and unprecedented authority. The Congress may give the President the power to wheel and deal in international trade negotiations while restricting imports of specific items at home to protect domestic jobs and industry. With the initial reaction of the powerful Chairman Mills recorded as "I think it will go," the Congress appeared overwhelmed by the White House. To most Washington observers, however, that reaction was simply a reflection of how well the Executive branch had done its homework in consulting with key congressional leaders on the content of the bill.

Nevertheless, the puzzling parts of the bill remain to be spelled out in the months of debate to come. The Congress is expected to tighten somewhat the virtually complete freedom the President has requested for negotiating "free but fairer trade" and expanding trade with Communist and less-developed nations on a bilateral basis. There is also much to be determined as to how and when and under what circumstances Nixon would impose quotas and tariff surcharges on heavy imports from countries like

Japan in order to lever them into a more equitable trade balance.

**Presidential power.** But the President wants the power to raise, reduce, or remove tariffs "in the context of negotiated agreement," and he wants them for five years. He also says he is anxious to negotiate removal of the less visible and stickier nontariff trade barriers like those EIA sees rising in the European Economic Community on imports of U.S. components. But he is asking Congress and U.S. industries not only to take his administration of these new powers on trust but to surrender certain concrete advantages they already have.

In the case of Congress, it is the surrender of more of its powers; for industries like electronics it is Items 806.30 and 807, and tax advantages. While neither group is willing to surrender these benefits readily, they see the threat of the protectionist Burke-Hartke bill as a greater evil. And that is exactly the kind of leverage the White House appears to believe will help it acquire its new powers for the President without having to spell out precisely how they will be used. □

---

## Solid state

---

### Microwave bipolar devices combine ion implantation with Isoplanar

The race is one between microwave field-effect transistors and bipolar devices. Last month, microwave FETs were gaining, particularly in the 6 gigahertz range [*Electronics*, March 1, p. 41], but now it is the turn of bipolar devices.

Fairchild has attained noise figures of 2 to 4 decibels at 2 to 8 GHz in bipolar transistors that combine ion implantation with the Isoplanar process.

John Archer, of Fairchild's Microwave and Optoelectronics division, who developed the new transistors, estimates the chips can be produced for a third the cost of gallium-arsenide FETs developed for low-noise small-signal microwave

amplifiers [*Electronics*, Nov. 1, 1972, p. 90]. The company plans to produce them commercially, but has not yet set a price.

**FETs score.** Archer says Isoplanar transistor noise figures are as low as those of GaAs FETs up to about 6 GHz, after which FETs pull ahead. He prefers to compare them with conventional bipolar microwave transistors, such as Fairchild's FMT4000. At 4 GHz, typical noise figures are 3.6 dB for the FMT4000 versus 2.3 for the new ones. The difference increases rapidly with frequency, reaching 6 to 7 dB versus 3.9 dB at 8 GHz. Gain of the transistors is about par for a small-signal amplifier—a maximum of 8 dB at 6

GHZ, for example.

Ion implantation is used to overcome the high base resistance that usually degrades the noise performance of bipolar microwave transistors. The Isoplanar technique provides better gain at high frequencies through reduction of junction areas and parasitic capacitances.

**Processing steps.** Ordinarily, a bipolar transistor is made with two diffusions, base and emitter. Microwave multi-emitter types have two base contacts on either side of each emitter stripe. To get this structure to work at higher and higher frequencies, the base diffusion must be made shallower and shallower.

In turn, that causes the sheet resistance of the inactive base region surrounding the emitter to rise. The effect of the high resistance between the base contacts can be alleviated by narrowing the emitter stripe, to reduce the active base resistance, but the total resistance remains high.

Archer avoids this problem by first masking the base area with silicon nitride. Then the exposed silicon is deeply oxidized—the Isoplanar step—leaving the transistor area walled in by thick oxide. Next, the inactive-base area is exposed and deeply diffused with boron. Then, 1-micrometer-wide emitter stripes are etched in a silicon nitride film, and arsenic is diffused. Finally, a shallow layer of boron ions is driven through the emitter to form the base, and the wafer is annealed.

The oxide wall eliminates the collector-base sidewall junction capacitance found in conventional transistors, Archer says, and allows lead bonds to be made over very thick oxide, reducing pad capacitance. Thus, the Isoplanar method cuts the collector-base feedback capacitance, giving the transistor high gain at high frequency. Besides cutting inactive-base resistance, the heavy diffusion of boron spreads under the nitride, masking the emitter and reducing the effective emitter width to 0.5 micrometer.

Archer is now working on a new version of the transistor. He thinks the performance will be further improved if he substitutes additional



implantations for the diffusions. If the technique works, he will update the paper he is to present at the Semicon Conference. □

## Avionics

### Mini rate sensor works on gas

Prototypes of a radically different kind of angular rate sensor—one with no rotating or sliding parts—are

being shipped by Hamilton Standard, a division of United Aircraft Corp. What's more, the division thinks it can turn the new sensor into a production unit featuring "virtually unlimited" life and capable of withstanding several thousand g of shock and vibration.

The device is already being evaluated for two military systems, says Eric J. Herzlich, sales manager of Hamilton Standard's operation in Trumbull, Conn. One system is in an advanced version of the Redeye missile, and the other involves a cannon-launched guided missile.

Called the Superjet, the sensor relies on a continuously circulating flow of helium gas that impinges on two hot-wire tungsten resistors, instead of the high-speed rotating wheel of conventional electromechanical gyros. The wires are connected into a resistance bridge.

Any angular rate impressed on the unit causes the helium jet passing over the wires to deflect laterally so that the wires are cooled at different rates. The equations governing this deflection are similar to the well-known Coriolis equations.

Because one wire is cooled more

## Component sales boom in Europe and delivery times stretch out

"We're booked solid." This situation report from Guy Derome, manager of the passive components division of Thomson-CSF, is being heard more and more in Europe these days as the semiconductor business surges.

When asked, "if I ordered today, when could you deliver 200,000 TTL gates?" Jean-Jacques Teillet of LaRadiotechnique-Compelec (RTC) replied, "since you'd be a new customer, at least six months."

This is the rule, not the exception, as European companies face one of the tightest semiconductor supply situations ever. It affects most countries and both active and passive components. Business is so good that vendors have pushed the nagging worry of double ordering to the back of their minds, although marketing experts such as ITT Europe's John Posthuma van der Helm believe that there is some double ordering going on as companies seek to insure sources of supply.

Both Derome and Teillet, who heads the semiconductor and microelectronic division of RTC, point out that their companies are keeping largely on schedule with programmed deliveries. However, even to take care of long-term customers, suppliers are juggling schedules, stretching out large orders, and adding production shifts.

**Why the boom?** Fueling the boom is the color-television market

which is expected to hit 5.7 million sets in Western Europe this year, up from 1972 sales of 4.3 million. And according to recent market forecasts made by Philips Gloeilampenfabrieken, business will continue strong through 1975. Philips forecasters predict sales of 7.2 million units in 1975, up 28% from this year's forecast.

Other factors include an increase in demand from the professional-commercial sector of the electronics industries. Orders from this sector have risen sharply since the beginning of this year, says Erich Gelder, marketing manager for integrated circuits at Siemens AG.

The shortage in the U.S. [*Electronics*, April 12, p. 79] also has its impact. Particularly, importer-distributors note a squeeze. Their suppliers in the U.S. and Japan have trouble keeping up with domestic customers' needs and tend to put export business second. Meanwhile, the European customers are clamoring for components. "There's a tremendous shortage of resistors and capacitors," says François Le Cain of Tranchant Electronique's import division. "We're selling high-price film resistors to some set makers who can't get enough consumer-grade ones."

Delivery times are six months for tantalum capacitors, and on some types Plessey Co. Ltd. is quoting 10- to 12-month delivery. Film and

electrolytic capacitors may take six months. At Stettner and Co., Emil Fries, manager of technical sales, is quoting delivery times ranging from three to seven months on some types of capacitors.

**Price hikes.** Prices are creeping up. Vendors point out that prices were depressed as the industry came out of the recent recession. And, furthermore, labor and material costs are going up.

Shortages are also hampering efforts to increase production. Roy McLauchlan, general sales manager of AEI Semiconductors Ltd., says the silicon shortage has hit planned production increases in thyristors, 90% of which formerly would be delivered from stock but which now require an average four to six weeks for delivery. At Plessey, John Hayden, commercial manager of the company's integrated-circuit facility, is ordering silicon wafers 12 months ahead, and ceramic packages 16 weeks ahead.

Overall, companies remain reluctant to build additional capacity. The most popular moves are to add shifts, and then add production lines in existing space. Explains Gelder of Siemens, "we're not investing as much as our customers think we ought to invest. We don't want to face the same situation we did during the last semiconductor slump when we found ourselves with too much capacity."



than the other, their resistances vary, unbalancing the bridge and producing a signal proportional to the rate input. The result is an extremely rugged rate sensor, about the same size as the conventional \$200 Supergyro unit already in production at Trumbull. It has a full-scale rate range of up to 2,000° per second, a threshold and resolution of 0.05% full scale, and, because no

**It's a gas.** Three-ounce rate sensor measures to 2,000°/s, withstands 1,000 g.

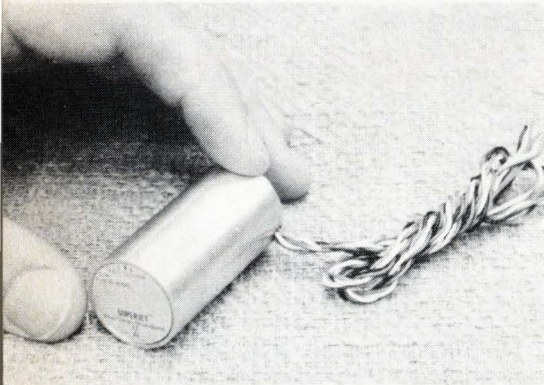

wheel has to be brought up to rotating speed, almost instantaneous startup time, according to Herzlich.

In addition, the absence of mechanical parts such as a rotating motor, tight tolerances, pickoffs, bearings, or small gaps between moving elements, means the unit is exceptionally rugged. "It's like a block of metal for all practical purposes," Herzlich asserts. He says the new sensor has already withstood shocks of over 1,000 g, versus 50 or 60 g for the \$200 unit. "We expect that 10,000 g is well within the Supergyro's capabilities," he continues. And with nothing to break or wear out, life could be extremely long—over 10,000 hours is a "conservative" figure.

**Weight: 3 ounces.** As now designed, the Superjet is in a 1-inch-diameter aluminum cylinder that could be anywhere from 2 to 3.28 inches long, depending on its rate range. Its only moving part is a piezoelectric diaphragm electrically vibrated, much like the diaphragm in an ultrasonic cleaner, to keep the helium gas circulating. Approximately 2.8 watts of power for the di-

aphragm and hot wires are supplied from a +28-volt dc source. And the unit weighs about three ounces, with the bridge and current-sensing electronics producing an output signal of up to  $\pm 5$  v dc.

Hamilton Standard obtained the rights to the fluidic sensor last fall, when it acquired VI Products, a manufacturer of low-cost rate gyros and inertial platforms. Shortly before, VI had acquired a license for the Superjet from Hercules Inc., the chemical company, whose Allegany Ballistics Laboratory, had been developing it for several years. Humphrey Inc., another small gyro manufacturer in San Diego, is also licensed by Hercules.

The acquisition was made to help Hamilton Standard diversify out of its sophisticated space-oriented hardware, and into the low-cost inertial field.

Hamilton Standard is developing the sensor with two basic application areas in mind, according to Herzlich. Its extreme ruggedness and a possible \$50 price would make it quite useful in missiles and projectiles, he points out. The other application would be in aircraft. Here a more accurate sensor would be required—the conventional Supergyro unit has a resolution, for example, of 0.002% of full scale—but the target cost of \$100 would be twice as expensive. □

## Processing

### Protons are key to IR detector arrays

Proton bombardment may become just as valuable in processing optoelectronic devices as the more familiar ion implantation is for processing semiconductor devices.

At the Massachusetts Institute of Technology's Lincoln Laboratory, Lexington, Mass., proton bombardment is being used to produce 20-element arrays of infrared photodetector diodes with what laboratory spokesmen call good quantum efficiencies and "unusually high"

yields. The arrays, which are being supplied in limited quantities by the laboratory's Solid State Division to the U.S. Army Night Vision Laboratory, Fort Belvoir, Va., range in quantum efficiency from "abnormally low figures" of 17% to 20% to a more typical 30% to 35%. The reasons for this spread are not fully understood, but the technique of proton bombardment is being studied, and the answer may very well lie there.

As for yield, 50 arrays of 20 diodes each are laid down on indium antimonide wafers. Generally, half of these arrays are usable: 18 have defects due to photolithographic errors or dirt, which Lincoln says greater care would prevent, and only seven have electrically bad diodes, indicating that the process, once it is refined, may produce high yields.

The laboratory's applied physics group plans to take advantage of proton bombardment's yield potential in a program to develop much larger arrays in an expansion of an indium-antimonide-array vidicon program.

**How to make them.** The diodes are np junction devices. The base material is p-type indium antimonide. A 1,000-angstrom-thick layer of silicon oxynitride is first deposited, followed by a 1,500-angstrom layer of silicon dioxide, 300 angstroms of chromium, 800 angstroms of gold, and 250 angstroms of titanium. The gold doubles as bombardment mask and, later, as the detector's field plate.

This metallic sandwich is etched down to the base to produce windows above those areas that will become diodes; the windows are 4.75 by 2.75 mils and are spaced about 5 micrometers apart. A stream of 100-kiloelectronvolt protons then bombards the wafer so as to convert the exposed areas of indium antimonide to n-type material. The titanium and gold layers are removed where electrical contacts must cross over the active diode area, and the wafer is coated again with silicon dioxide. Afterward, 1-mil-square holes are etched down to the gold, and cross-over contacts are laid down to pro-



# measurements on the move...

With TEKTRONIX you make your measurements quicker and with greater accuracy. The light-weight 465 and 475 portables combine ease-of-operation with laboratory precision to reduce your repair time at your customer's location.

Some of the functions that make the 465 and 475 value leaders are: push-button trigger view, ground reference button at probe tips, delayed and mixed sweep, CRT positioned between the vertical and horizontal controls, easy to interpret push-button mode selection, and more.

With 200 MHz at 2 mV/div, the 475 offers lasting measurement capability. A linear 8 x 10-cm display and one nanosecond sweep speed

illustrate the ability to make complex, precise time measurements.

The 465 with a bandwidth of 100 MHz at 5 mV/div and 5 ns/div qualify it for most of today's measurement needs.

A different approach to battery operation. A 12 and 24 VDC option combined with a detachable battery pack provide continuous operation under a variety of situations. Measurements can be made when power availability is restricted to 12 and 24 VDC, or when commercial power is limited, or when isolation from line or ground is desired. With the detachable battery pack you carry the weight of the batteries only when needed.

Also available are rackmount versions of both the 465 and 475.

465 Oscilloscope ..... \$1725  
(Includes delayed sweep and probes)

475 Oscilloscope ..... \$2500  
(Includes delayed sweep and probes)

DC Operation (Option 7) . Add \$75

1106 Battery Pack ..... \$250

Rackmount ..... Add \$75

Let us help you make your measurements. To see one of these scopes, call your local Tektronix field engineer, he'll be glad to demo one for you. If you prefer, for additional information write Tektronix, Inc., P.O. Box 500, Beaverton, Oregon 97005. In Europe, write Tektronix Ltd., P.O. Box 36, St. Peter Port, Guernsey, C.I., U.K.



**TEKTRONIX®**

committed to technical excellence

**"the value leaders"**

U.S. Sales Prices FOB Beaverton, Oregon

For a demonstration circle 182 on reader service card

Circle 33 on reader service card





vide electrical connection with standard-size bonding pads.

Finally, the wafer is scribed and separated, with arrays bonded to a sapphire header either in groups or individually. The pinout is via standard gold wire, and operation is in a liquid nitrogen-filled dewar flask. □

### Commercial electronics

## Computer verifies ID from photos

A new Swedish identification system may augur the era of "big brother." The system, invented by Eric Rothfjell, the head of Europe's largest identification-card company, makes it possible for computers to identify photographs on identification cards. Until now, attempts at computer-recognition of faces and voices have either required tremendous memory capacity or were not accurate.

Rothfjell's system involves drawing lines on the back of a photograph of the face to outline the main facial characteristics—the curve of the nose, a prominent cheek-bone, cleft chin, deep wrinkle, eye-socket

curve, or the shape of the forehead. The individual is photographed in three positions—full-face, profile, and at a 45° angle. So far, all lines have been drawn by hand on test cards, but Rothfjell says this process could be automated.

To verify a person's identity, the facial curves on a passport or ID card are scanned by an optical scanner and fed into a computer memory, along with other data—such as name, address, and account number. The system needs only about 200 to 250 bits of information to ensure positive identification. Rothfjell says that no two faces are alike and that curves drawn for one person will definitely not match those of another person, except for identical twins.

These curved lines drawn on the reverse of the identification card are not visible on the front. To use a credit card, a shop clerk inserts the card into a special viewer, and the card is lit from behind. The clerk checks to see if the lines on the back of the card match the face on the front. The card is then placed into a scanning instrument, which scans the curves and transmits the information to a computer for confirmation of the customer's credit. Roth-

fjell will not give details of the scanning instruments, but he says that prototypes are being tested by manufacturers.

**"Big brother?"** Why does one need lines or curves for scanning when the middleman—the clerk or teller—is still needed to recognize the bearer of the card from the photo? Rothfjell says: "The time when you can have direct computer-recognition of an individual—by facial recognition or voice-print—is a long way off. My system can be put into use right now. The difference between my system and direct reading of cards by use of magnetic strips or other devices is that here you have a combination foolproof identification card that can also serve as a credit card or in a passport. When you take the big next step, into direct personal recognition by computers, then you are facing 'big brother.'"

The personal-identification-card market—although downstream in many countries—arrived in Sweden several years ago, and today it is a part of life.

Although the market is already here, Rothfjell realized that the system will need worldwide marketing. He says that a company to market the system is being organized in the U.S. A Swedish subsidiary will handle Scandinavia. □

**Computer knows best.** The main facial characteristics, shown in color, are scanned and fed into a computer along with personal data to confirm a person's identity.



### Navigation

## Omega/inertial mix improves nav system

Most ships and aircraft, particularly military ones, have numerous navigation systems for different conditions and for backup. One of the most expensive is inertial guidance, and one of the newest is Omega; officials at Northrop Electronics are betting that a combination of the two may be most popular for military uses, since it would offer significantly lower costs than full inertial, plus better performance than either.

J. Stuart Parsons, director of busi-



# a handful of measurement solutions...

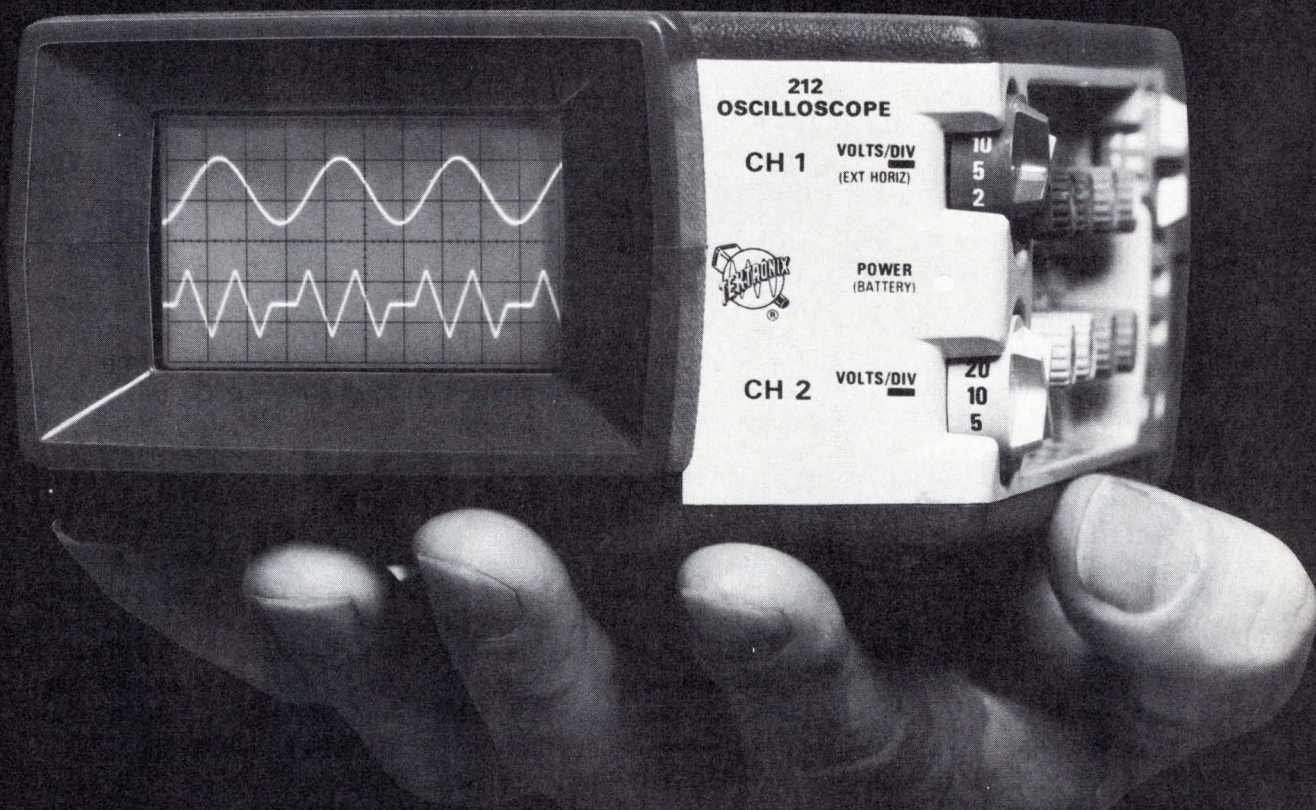

With the 212. A completely new DUAL-TRACE, 500-kHz, 3 x 5¼ x 9-inch scope that weighs only 3.4 pounds and costs just \$725. The high-impact plastic case withstands severe environments — double-insulated construction protects you while floating the scope to make high-voltage measurements.

Many other benefits are available in our first dual-trace mini: (1) 500 kHz and 1 mV/div; (2) Designed, developed and manufactured within the

For a demonstration circle 183 on reader service card

United States; (3) For clarity, probe bodies and vertical deflection controls are color-matched; (4) When not in use, the permanently connected probes and power cord store in an easy-to-use compartment; (5) There are only two trigger controls, one for level and slope, the other for source selection; (6) Controls are recessed to prevent accidental damage; (7) Up to 5 hours operation are provided from rechargeable internal batteries; (8) Vinyl carrying case . . .

For complete information or to arrange a demonstration, contact your local Tektronix, Inc. Field Office. Or, write Tektronix, Inc., P.O. Box 500, Beaverton, Oregon 97005. In Europe, write Tektronix, Ltd., P.O. Box 36, St. Peter Port, Guernsey, C.I., U.K.

212 Oscilloscope . . . . . \$725  
U.S. Sales Price FOB Beaverton, Oregon



**TEKTRONIX®**  
committed to  
technical excellence

Circle 35 on reader service card



ness development at the Hawthorne, Calif., division, estimates that a hybrid system, in which altitude and heading reference inertial platform would be combined with Omega updating, could reduce costs over present full inertial systems from \$100,000 to \$50,000. Such a hybrid system is being installed on a U.S. Air Force WC-130B by prime systems contractor Kaman Aerospace Corp. for the airborne weather reconnaissance system (AWRS). The division also has contracts for the airborne warning and control system (Awacs), and the P-3.

The performance advantages of the Omega/inertial combination according to Parsons include:

- A bounded error with accuracies of 1 to 2 miles.
- Low maintenance and high reliability.
- Reduced reaction time for resetting—from 18 to 25 minutes on the ground to 5 to 8 minutes.

The AWRS system includes a floating-ball platform from the C-5A, a Northrop AN/ARN-99 Omega receiver, plus an IBM 4 PI computer. It is designed for a 1.2-nautical-mile circular error probability in 15 hours flight. The Awacs system will be more complex, using two Delco platforms plus a Ryan doppler radar. □

## Medical electronics

### Russians use laser to treat glaucoma

Soviet doctors have developed a nonsurgical method using Q-switched lasers to treat glaucoma, the second leading cause of blindness. Called laser goniotomy, the method must be repeated periodically but is quick and painless. It also saves patients from the bad side effects of surgery, such as scarring of eye tissue or a second operation for resulting cataracts, or from both with drug treatment.

Glaucoma may start with the blockage of very small passages through which intraocular fluid pas-

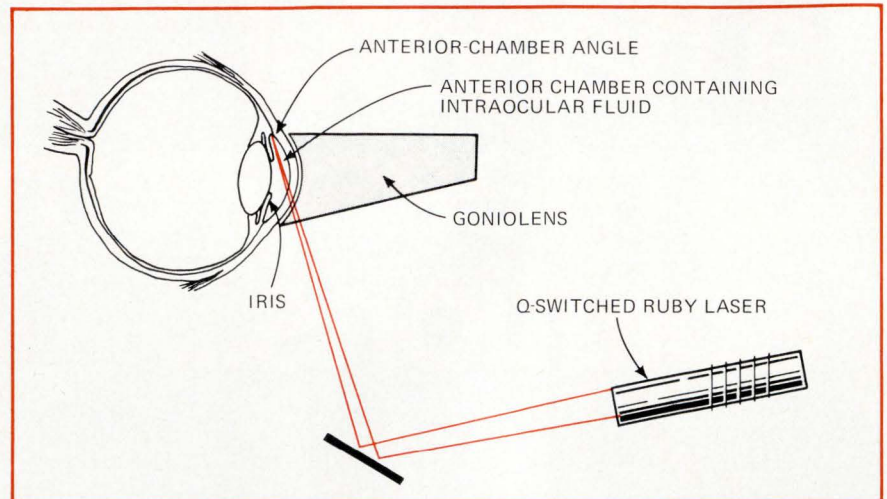

**Painless.** The use of multiple bursts of laser light has been found to be a quick and painless treatment for glaucoma, the second leading cause of blindness.

ses to lubricate the eye. When these passages close up, the buildup of pressure permanently damages the optic nerve. Surgical methods of treatment involve cutting new passages. The Russian method, however, uses the laser to punch through the blockage. This happens so quickly, says its inventor, Dr. Michael M. Krasnov, that the eye nerves cannot detect any pain. Krasnov, who is on the staff of the Second Medical Institute and a member of the Soviet Academy of Medicine, explained the technique at a press conference held in Washington, D.C., this month by Patent Management Inc. Patent Management is making the technique available for license in the U.S. on behalf of the Soviet Union.

**Aiming the light.** Since in most glaucoma a microscopic filtering "mesh" in the anterior-chamber angle of the eye is affected, Krasnov uses an angle lens, or gonioleNS, a conventional slit lamp, and a second low-power neon-helium laser to aim the ruby Q-switched laser precisely. The laser beam strikes the eye at an angle to prevent damage to the cornea, he says. The eye lens is transparent so it transmits the laser beam directly where aimed, he adds.

While for some time U.S. doctors have used the precisely focused heat of a laser beam to "spot-weld" detached retinas to the back of the eye, Soviet scientists turned to Q-

switched lasers to treat glaucoma so that sensitive tissues would not be damaged by heat buildup. "The starting point was to find a laser which will not cause scar tissue to form," the noted ophthalmologist says in explaining why a Q-switched laser was selected, but "such a laser had never been tried on the eye before." Here he had advice from A.M. Prochorov, who shared a Nobel Prize with Charles Townes for co-inventing the laser. Chosen was a 6,943-angstrom laser firing 0.2 joules, or "several megawatts per burst" in 20-nanosecond pulses.

Of the 94 adults treated so far, only a few have failed to respond to the treatment, Krasnov says. Patients must return at two- to eight-month intervals for repeat treatment as the glaucoma reblocks the passages. This takes less than 10 minutes for the 10 to 15 firings. □

## Packaging

### Electrolysis used to predict failure

Basing their analysis on a common electrochemical mechanism—electrolysis—Bell Laboratories researchers say they can predict the failure caused by humidity on plastic-packaged ICs over 30 to 40 years.

Stewart Peck and Connie Zierdt,



# 3 interchangeable CPUs. That's modularity.



SUE's basic CPU gives you a minicomputer that's high in flexibility yet low in cost. A second CPU provides decimal arithmetic functions. And the third meets the requirements of scientific or industrial applications that call for improved math capability.

These all slide easily in and out of the chassis. Without any wiring. In fact, you can change CPUs at your plant (or even in the field if need be) in about 60 seconds. So a SUE system can change and grow as fast as your customer's needs change and grow.

**The component computer.** And you're not limited to one CPU at a time. SUE's multiprocessor capability lets you hook up as many as four on a single Infibus. Just choose the combination of processors that suits the system best.

That's because SUE (the System User Engineered minicomputer) is the first of its kind:

a component computer for systems. Its modular processors, memories and controllers all plug together in almost any combination to solve your application problems.

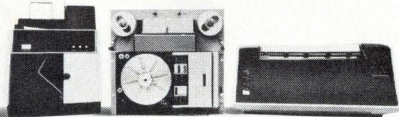

That includes I/O controllers, but you'll never need more than two basic types with SUE: one bit serial, one word parallel. These will adapt to any I/O device.

**Wider choice of peripherals.** We offer a full line of peripherals to go with SUE: IBM compatible 5440 disk drives, CRT/keyboards, printers from 100 cps to 600 lpm, magnetic tapes, cassettes, punched card devices and paper tapes. Anything your system needs.



**Complete software tools.** To make your programming burden lighter, we offer a full set of software tools: sort/merge, DOS, assemblers, utilities and RPG/SUE. That last item is 98% compatible with RPG II, by the way.

And we're the only company we know of that unconditionally warrants all our software for a full year.

**Built for systems builders.** SUE's built-in flexibility makes it fit your systems now, makes it easily changeable later on.

You can be sure we'll be here later on, too. Which is one more advantage of dealing with an established, reputable company like Lockheed Electronics.

Let's talk. Call (213) 722-6810, collect, or write us at 6201 E. Randolph St., Los Angeles, California 90040.

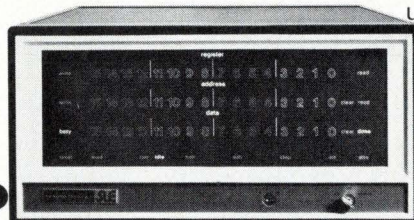

# That's SUE.

**Lockheed Electronics**  
Data Products Division



### Electronics Index of Activity

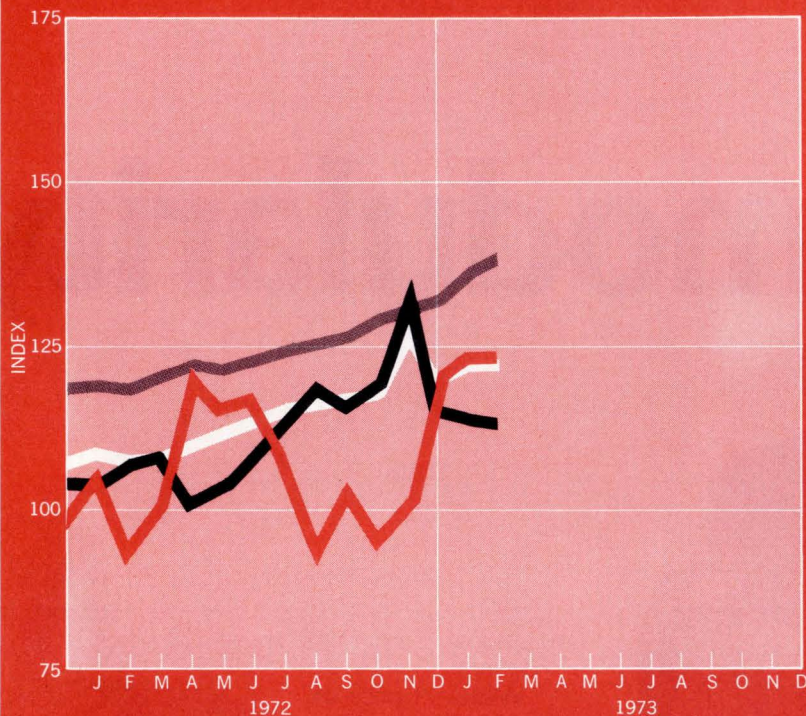

Segment of Industry	Feb. '73	Jan. '73*	Feb. '72
Consumer electronics	124.8	124.2	105.4
Defense electronics	113.6	114.5	104.7
Industrial-commercial electronics	138.3	136.7	119.4
Total industry	122.8	122.8	109.3

The Index was unchanged at 122.8 in February, 12.4% ahead of last year's level. Industrial-commercial-electronics gained 1.2%. This is 15.8% above February 1972's level. Consumer electronics rose 0.5%, 18.4% higher than last year. There was a 0.8% decline in defense electronics in February, leaving this sector 8.5% above 1972's level.

Indexes chart pace of production volume for total industry and each segment. The base period, equal to 100, is the average of 1965 monthly output for each of the three parts of the industry. Index numbers are expressed as a percentage of the base period. Data is seasonally adjusted. \*Revised.

from Bell Laboratories in Allentown, Pa., say their technique is based on establishing failure rates at severe temperature-humidity environments over the short term (tens of hours) and then determining how these conditions accelerate failure. Peck told the Reliability Physics Symposium in Las Vegas in early April that "this predictive technique based on an acceleration rate has not been established before."

For example, if a package might exhibit 0.1% failures at 85°C and 85% relative humidity after 10

hours, its failure acceleration relative to 30°C and 15% humidity might be 20,000. Then one can predict that the device will exhibit a 0.1% failure rate after 10×20,000, hours—more than 20 years.

Electrolysis occurs when two metals are separated by insulation and biased by an electric potential, causing ions to migrate from one metal to the other. What happens is that raising the humidity decreases the surface resistance of the insulator. Therefore, the leakage current across the surface increases, and the

plating rate increases, hastening the destruction of the device. Raising the temperature has the same accelerating effect.

The evidence supporting this theory is by no means complete. For although the correlation of theory with experimental data on epoxy, silicone and phenolic packages is good, a limited number of devices were involved in the tests, and more test data will be needed to substantiate the technique.

Humidity is but one cause of failures in plastic packages. Another one in the news is wire-bond failure due to temperature cycling. □

### Communications

#### Cw diode laser emits in visible red

For the first time a semiconductor laser has been made to operate continuously in the visible spectrum at a wavelength as short as 6,500 angstroms. This is the shortest wavelength obtained for continuous operation of a diode laser.

Surrounded by liquid nitrogen, the aluminum-gallium-arsenide injection laser has an output of 50 milliwatts. The work is being done at RCA Laboratories, Princeton, N.J., under partial sponsorship of NASA.

Henry Kressel, who heads the research team at RCA, says that "these compact, efficient, and easily modulated visible laser diodes are of special interest as a replacement for the bulky and power-consuming gas lasers that are now being used in high-speed film-encoding of data." Kressel says that previous laser diodes were not suitable for film recording because they could only operate continuously in the infrared where the spectral response of the film is poor.

**Uses heterojunction.** The first cw infrared lasers operating at room temperature were announced in 1971, by Bell Laboratories and RCA Laboratories [*Electronics*, Aug. 31, 1970, p. 37]. These devices contained a diode structure called a



First, choice. Choice of 3 to 4¾ digits; of LED, Sperry, or Nixie displays; of line or logic power input; of mounting arrangement; of range selection. And there are numerous OEM options.

Second, reliability. The engineering inside these small packages is the industry's most advanced, with reduced component count, lower heat dissipation, and standard performance features that are usually optional extras.

Third, economy. Look at the prices. And note that for \$52 we provide *three full digits* so you can measure things like 24.6 volts, 850 rpm, 98.6 degrees — useful things.

	full scale	price (100s)	display	power req.
AN2530	999	\$52	LED or Sperry	5v
AN2535	1999	\$85	Sperry	5v
AN2532	1999	\$95	Nixie or Sperry	line
AN2534	3999	\$130	Nixie or Sperry	line
AN2544	39999	\$270	Nixie	line

There are lots of other reasons to buy from the leader, too, such as technical assistance based on years of industrial design experience. Get acquainted by asking for our complete catalog — we'll include our handy A-D/D-A Design Reference Guide. Analogic Corporation, Wakefield, Mass. 01880, (617) 246-0300.

*Northeast*, 617-235-2330, 203-966-2580, 315-446-0220  
*Mid Atlantic*, 201-652-7055, 212-947-0379, 215-272-1444  
*Midwest*, 314-895-4100, 216-267-0445, 513-434-7500, 313-892-2500,  
 312-283-0713, 913-362-0919, 412-892-2953  
*South*, 713-785-0581, 817-268-3505, 305-894-4401, 919-227-2581,  
 305-773-3411, 813-867-7820, 205-534-9771  
*West*, 303-744-3301, 505-523-0601, 602-946-4215, 505-296-8303, 714-540-7160,  
 408-374-5220, 206-762-7664, 503-646-6064, 503-646-3416  
*Canada*, 613-836-4411, 604-688-2619, 416-444-9111, 514-861-1375

**ANALOGIC** ■

Circle 39 on reader service card

# We're No.1 in more ways than 1



Displays unretouched.



heterojunction, which efficiently concentrates the laser light within the cavity. The same heterojunction structure is used with the visible-laser diode, but to make it emit at the

shorter wavelength, it must be doped with aluminum alloy. And because of fundamental limitations in the AlGaAs-alloy structure, operation at this wavelength presently

## News briefs

### No boycott on supermarket electronics

The recent development of a Universal Product Code, standardizing product identification in the grocery industry, has generated more interest in point-of-sale equipment than a steak sale.

NCR, Dayton, O., has recently entered the field with an interactive terminal, model 250, adaptable to reading the selected code, and will show it at the Super Market Institute convention next month. Each unit can be individually programmed to handle food stamps, checks, bottle returns, coupons, and merchandise returns.

Also showing at the convention will be the Pitney Bowes-Alpex Sesame system, which uses a code scanner at the end of the counter tied to the register; Sweda's SupeRegister, which incorporates a nonvolatile core memory using an MOS LSI microprocessor; Nuclear Data's ESIS, which is tied to a central disk memory, and Data Terminal Systems DaCap 44, another stand-alone register.

### Dumont adds support to Thomson

The need for a U. S. source of manufacture is seen by Ernest L. Stern, president of Thomson-CSF Electron Tubes Inc., New York, as the major reason why his parent company, Thomson-CSF, Paris, has acquired Fairchild Camera & Instruments' Dumont Electron Tube division in New Jersey. Stern, who will double as chairman of the board of the Dumont facility, saw his subsidiary's sales increase from about \$1 million in 1969 to \$3 million last year.

### Another push for high-density tape

Another high-density magnetic-tape system has appeared—this time from Telex Computer Products Inc., Tulsa, Okla. The units store data at 6,250 bytes per linear inch of tape and move the tape at speeds of up to 200 inches per second, giving a data transfer rate of up to 1,250,000 bytes per second. The Telex units are said to be compatible with the IBM high-density units recently announced; Telex thus joins Storage Technology Corp. in the high-density business [*Electronics*, March 29, p. 39].

### Sprague switches to profit

After running up a loss of over \$8 million in fiscal 1971, Sprague Electric Co. has turned the corner and reported earnings of \$215,516 on sales of \$146.65 million in fiscal 1972. These earnings exclude Sprague's equity in affiliated companies, chiefly Mostek Corp., in which Sprague holds 48% of the stock. Equity in the unaudited net earnings of affiliates should push final net profit figures up by \$1.2 million

### CAD program from IBM emphasizes speed

IBM's new circuit analysis software package makes use of the latest numerical analysis techniques to minimize computer time and, therefore, cost. Called ASTAP (Advanced Statistical Analysis Program), the package is intended to compete with current major programs like the powerful Sceptre (System for Circuit Evaluation and Prediction of Transient Radiation Effects) and IBM's own ECAP (Electronic Circuit Analysis Program). ASTAP can perform either time-domain, frequency domain, or statistical analysis; it is said to be up to eight times faster than ECAP II for nonlinear transient analysis.

## for more information on Microsystems' linears contact:

### microsystems sales offices

<b>U.S.A.</b>	
CALIFORNIA,	
Palo Alto .....	(415)493-0848
Santa Ana .....	(714)979-6522
PA., Huntingdon Valley .....	(215)W17-5641/2
MINNESOTA, New Hope .....	(612)554-1802
ILLINOIS, Schaumburg .....	(312)894-7660
NEW HAMPSHIRE, Nashua .....	(617)762-8298
<b>CANADA</b>	
<b>ONTARIO,</b>	
Ottawa .....	(613)828-9191
Toronto .....	(416)279-1358
QUEBEC, Montreal .....	(514)875-2814

### sales representatives

<b>U.S.A.</b>	
ALABAMA, Huntsville Tech-Rep Associates .....	(205)881-5925
ARIZONA, Scottsdale Barnhill Five Inc. ....	(602)947-7841
<b>CALIFORNIA,</b>	
Los Altos, W.W. Posey .....	(415)948-7771
Santa Ana Rical Associates .....	(714)557-6543
COLORADO, Denver Barnhill Five Inc. ....	(303)934-5505
CONNECTICUT, New Canaan Stan Pierce Inc. ....	(203)966-4630
<b>FLORIDA,</b>	
Indianatic Tech-Rep Associates .....	(305)723-9140
Largo Tech-Rep Associates .....	(813)595-2834
ILLINOIS, Chicago L-Tec Inc. ....	(312)286-1500
INDIANA, Indianapolis R.E. Marquart & Associates .....	(317)253-3997
MARYLAND, Baltimore L.H. Kolman Co. ....	(301)752-8756
MASSACHUSETTS, Norwood Stan Pierce Inc. ....	(617)762-3164
MISSOURI, Kansas Florence & Meyer Inc. ....	(913)722-5210
NEW JERSEY, Tenafly ABC Electronic Sales .....	(201)568-2354
<b>NEW YORK,</b>	
Cicero Advanced Components Inc. ....	(315)699-2671
New York ABC Electronic Sales .....	(516)747-6610
North White Plains ABC Electronic Sales .....	(914)946-3001
NEW MEXICO, Albuquerque Barnhill Five Inc. ....	(505)299-7658
OHIO, Columbus Tom Mulligan & Associates .....	(614)457-2242
PA, Huntingdon Valley ABC Electronic Sales .....	(215)W17-5641/2
TEXAS, Addison Campion Sales .....	(214)239-9196
UTAH, Salt Lake City Barnhill Five Inc. ....	(801)487-1327
WASHINGTON, Seattle Carlyle Technical Sales .....	(206)632-4290

### distributors

<b>U.S.A.</b>	
<b>ARIZONA, Phoenix</b> Kierulff Electronics .....	
(602)273-7331	
<b>CALIFORNIA,</b>	
Carson Hi-Rel Distributor Sales .....	(213)537-6500
Los Angeles Wesco Electronics .....	(213)685-9525
Menlo Park Bell Electronic Corp. ....	(415)323-9431
Riverside Electronic Supply .....	(714)683-5591
San Carlos Sterling Electronics Corp. ....	(415)592-2353
San Diego Kierulff Electronics .....	(714)278-2112
COLORADO, Denver Kierulff Electronics .....	(303)343-7090
FLORIDA, Clearwater Southland Electronics .....	(813)443-4514
<b>LONG ISLAND,</b>	
Farmingdale Arrow Electronics Inc. ....	(415)323-9431
Freeport Milgray Electronics Inc. ....	(516)546-6000
MARYLAND, Baltimore Arrow Electronics Inc. ....	(301)247-5200
<b>MASSACHUSETTS,</b>	
Boston DeMambro Electronics .....	(617)787-1200
Dedham Gerber Electronics .....	(617)329-2400
Watertown Sterling Electronics Corp. ....	(617)926-9720
NEW JERSEY, Haddonfield Mid-Atlantic Electronics .....	(609)428-8288
<b>NEW YORK,</b>	
Plainview Newark Electronics Corp. ....	(516)822-5000
Rochester Simcona Electronics .....	(716)328-3230
Rome, Rome Electronics Inc. ....	(315)337-5400
NEW MEXICO, Albuquerque Kierulff Electronics .....	(505)247-1055
TEXAS, Dallas Semiconductor Specialists Inc. ....	(214)358-5211
WASHINGTON, Seattle Kierulff Electronics .....	(206)763-1550

### CANADA

B.C., Vancouver R.A.E. Industrial Electronics Ltd. ....	(604)687-2621
<b>ONTARIO, Malton</b>	
Semiconductor Specialists (Canada) Ltd. ....	(416)678-1444
QUEBEC, Montreal Cesco Electronics Ltd. ....	(514)735-5511

Also throughout Europe, Japan, Asia and Australasia





# Microsystems International... **Big in Linears!**

You know us as a major producer of memory products. But did you know that we're also big in linears?

Big in linears means a carefully selected product line that fulfils more than 80% of market requirements. It means industry standard Op Amps: general purpose, dual, precision, high voltage, micropower and high slew rate. It also means voltage regulators, transistor arrays, voltage references and comparators, line drivers and receivers. Our linears are available in industry standard packages, with selections according to your

needs—to commercial, industrial or military specifications including MIL std. 883 class A and B.

We're big in linears because we're big in R & D, in manufacturing capacity, and in Q.C. Our operating base is a modern 340,000 square foot plant and capitalization in excess of \$100 million, all exclusively devoted to the production of semiconductor products.

When considering your next linear order remember the selected linears from Microsystems International—they're available.

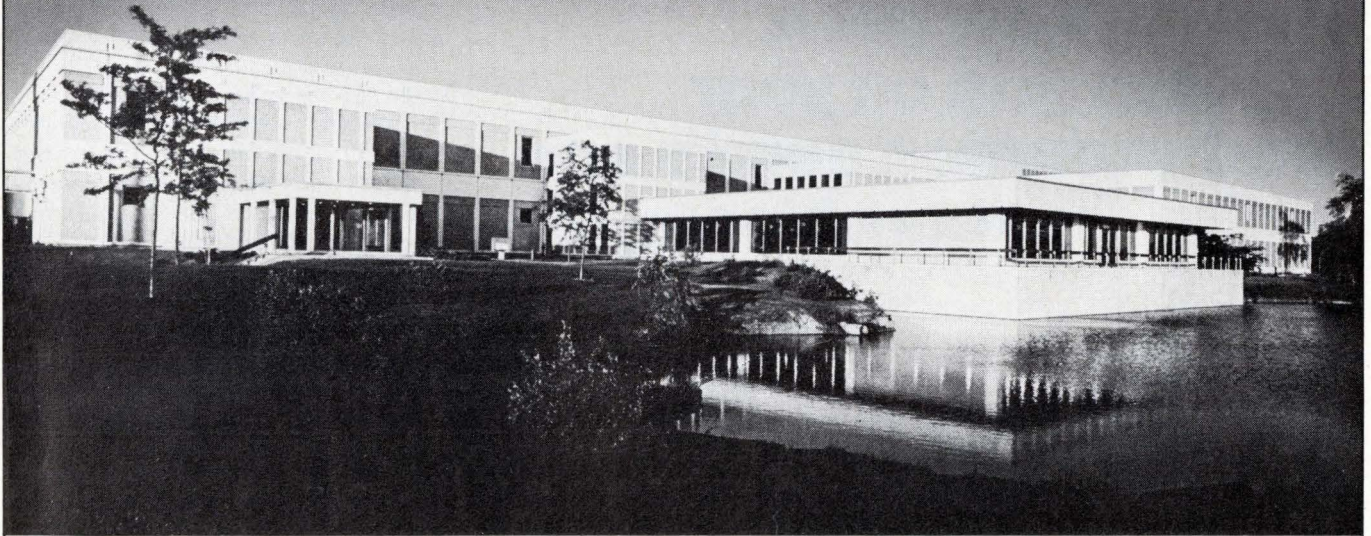

**selected linears from  
the performance leader**

microsystems international limited, box 3529 station c, ottawa, canada K1Y4J1

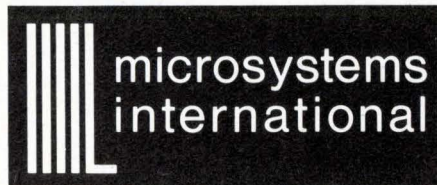





# When you see this

# THOMCAT

## symbol it means the

## company has its catalog in

# Thomas Register

When a manufacturer uses the THOMCAT symbol in his ads and literature, it means his catalog is in the THOMCAT volumes of Thomas Register. And THOMCAT contains detailed catalogs from hundreds of manufacturers of all types of products.

Look for the THOMCAT symbol — it will save you countless hours in product searches — eliminate writing away for data and waiting weeks. Next time you need catalog data, let THOMCAT be your guide.

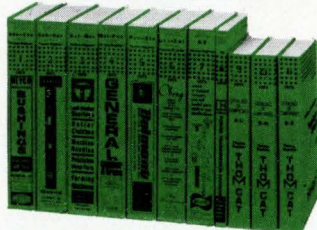

Thomas Register  
Thomas Register Catalog File

THOMCAT

461 Eighth Avenue, New York, New York 10001

Circle 42 on reader service card

## Now get a

# firm grip on your

# lead-mounted semi's and

# heat problems, too

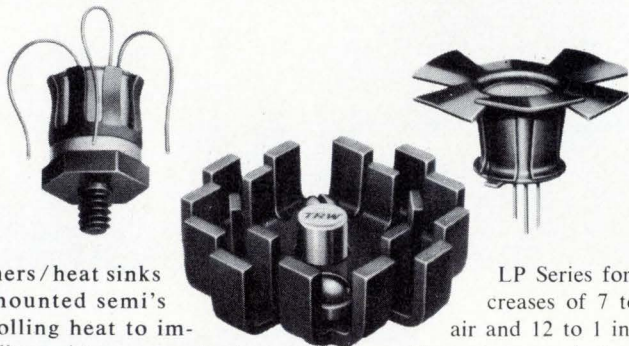

IERC retainers/heat sinks hold lead-mounted semi's while controlling heat to improve reliability or let you operate at higher power levels. Our TXB's for Mil-spec environments are excellent retainers on p-c boards or serve as efficient thermal links between case and heat sink. BeO washers are available for electrically-hot-case applications. Use our staggered-finger

LP Series for power increases of 7 to 1 in still air and 12 to 1 in forced air with no increase in junction temperature. And, if your semi's are already mounted, slip on a Fan Top and get higher wattages for just pennies. Send for catalog. IERC, 135 W. Magnolia Blvd., Burbank, Calif. 91502, a subsidiary of Dynamics Corporation of America.

IERC



Heat Sinks

42 Circle 184 on reader service card

## Electronics review

requires a refrigerated temperature of 77 to 100 degrees kelvin. But this is not considered a significant drawback since the refrigeration advances in IR systems can be readily adapted for this system. □

## Military electronics

### Army to pinpoint targets from air

The latest move in military efforts to map enemy artillery emplacements is to go airborne. Conventional surveying is the technique commonly used, and the Army's Engineering Topographic Laboratory at Fort Belvoir, Va., has been considering the position and azimuth determining system, known as PADS [*Electronics*, July 31, 1972, p. 22], which uses an inertial platform mounted on a jeep.

But now Motorola's Government Electronics division, Scottsdale, Ariz., has developed a seemingly faster, safer, and easier technique using an aircraft to make ranging flights over a 60-by-60-kilometer area at altitudes of 10,000 and 20,000 feet within a two-hour period. This position and surveying system (PASS) transmits and receives information from the ground and can locate artillery sites within 2 or 3 meters in azimuth and range and 5 to 10 meters in elevation.

As many as 27 enemy sites can be pinpointed within the two-hour flight. The ground stations, which transmit data independently on command, weigh only 60 lb so they are easily transportable. The system operates on a single spread spectrum frequency with antijamming capability. And the ground stations need only transmit very short bursts to minimize possible detection.

In addition to the ground positioning sets, PASS includes local ground-reference equipment weighing 130 lb, an airborne reference set, and a computing center. Operation is off line, with transfer of data to the center and reduction taking under 30 minutes. □

Electronics/April 26, 1973



# Power down:

Our new Quad Power Strobe selectively activates system components to permit reduction in standby power requirements by as much as an order of magnitude.

The HD-6600 is the industry's first monolithic, dielectrically isolated quad power strobe. Designed primarily for use with ROM and PROM systems, the device offers four power outputs which can be activated selectively, thereby

greatly reducing standby power requirements—up to as much as an order of magnitude. Each output can deliver up to 150mA simultaneously with no more than a 250mV drop from the power supply to the strobe output. Access time

from the HD-6600 input to a HPROM-1024 memory output is typically 100ns. System access time as low as 50ns can be obtained by powering the memory circuit prior to the read operation. Other applications for the new device include use in telephone relay switching, strobing of general logic circuitry, and multiplexed LED display systems. For more details see your Harris distributor or representative.

**Features:**

- High drive current** 200mA
  - High Speed** Typically 50ns
  - TTL compatible inputs**
  - Quad monolithic construction**
  - Inverting logic**
  - Power supply flexibility**
  - Low power**
    - Standby** 30mW/Device
    - Active** 95mW/Device
  - Supplied 14-pin ceramic DIP**
- 100-999 units

HD-6600-5	0°C to + 75°C	\$5.65
HD-6600-2	-55°C to + 125°C	\$8.50

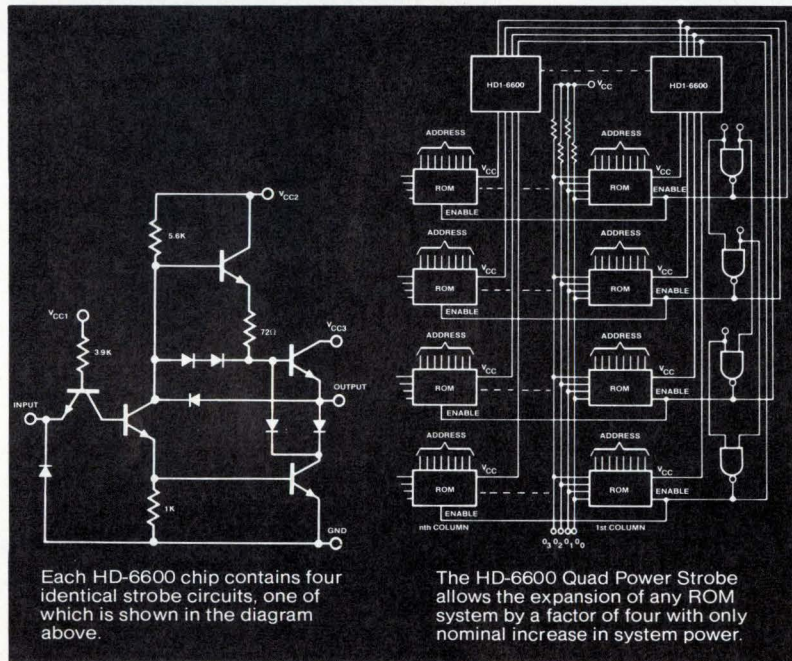

# Harris



**HARRIS**  
**SEMICONDUCTOR**  
 A DIVISION OF HARRIS-INTERTYPE CORPORATION

P.O. Box 883, Melbourne, Florida 32901  
 (305) 727-5430

**WHERE TO BUY THEM:** ARIZONA: Phoenix—Liberty, Weatherford; Scottsdale—HAR (602) 946-3556 CALIFORNIA: Anaheim—Weatherford; El Segundo—Liberty, Glendale—Weatherford; Long Beach—HAR (213) 426-7687; Mountain View—Elmar; Palo Alto—Weatherford, HAR (415) 964-6443; Pomona—Weatherford; San Diego—Weatherford, Western COLORADO: Denver—Elmar, Weatherford WASHINGTON, D.C.: HAR (202) 337-3170 FLORIDA: Hollywood—Schweber; Melbourne—HAR (305) 727-5430 GEORGIA: Atlanta—Schweber ILLINOIS: Chicago—Semi-Specs, Schweber; Palos Heights—HAR (312) 597-7510 INDIANA: Indianapolis—Semi-Specs MARYLAND: Rockville—Schweber MASSACHUSETTS: Lexington—R&D, Waltham—Schweber; Wellesley—HAR (617) 237-5430 MICHIGAN: Detroit—Semi-Specs MINNESOTA: Minneapolis—Semi-Specs MISSOURI: Kansas City—Semi-Specs; St. Louis—Semi-Specs NEW MEXICO: Albuquerque—Weatherford NEW YORK: Melville—HAR (516) 249-4500; Syracuse—HAR (315) 463-3373; Rochester—Schweber; Westbury—Schweber OHIO: Beachwood—Schweber; Dayton—Semi-Specs PENNSYLVANIA: Pittsburgh—Semi-Specs; Wayne—HAR (215) 687-6680 TEXAS: Dallas—Weatherford, Semi-Specs, HAR (214) 231-9031 WASHINGTON: Seattle—Liberty, Weatherford WISCONSIN: Wauwatosa—Semi-Specs.

**LEGEND FOR HARRIS SALES OFFICES & DISTRIBUTORS:** Harris Semiconductor (HAR); Elmar Electronics (Elmar); Harvey/R&D Electronics (R&D); Liberty Electronics (Liberty); Schweber Electronics (Schweber); Semiconductor Specialists, Inc. (Semi-Specs); R. V. Weatherford Co. (Weatherford); Western Radio (Western).



# Excellon

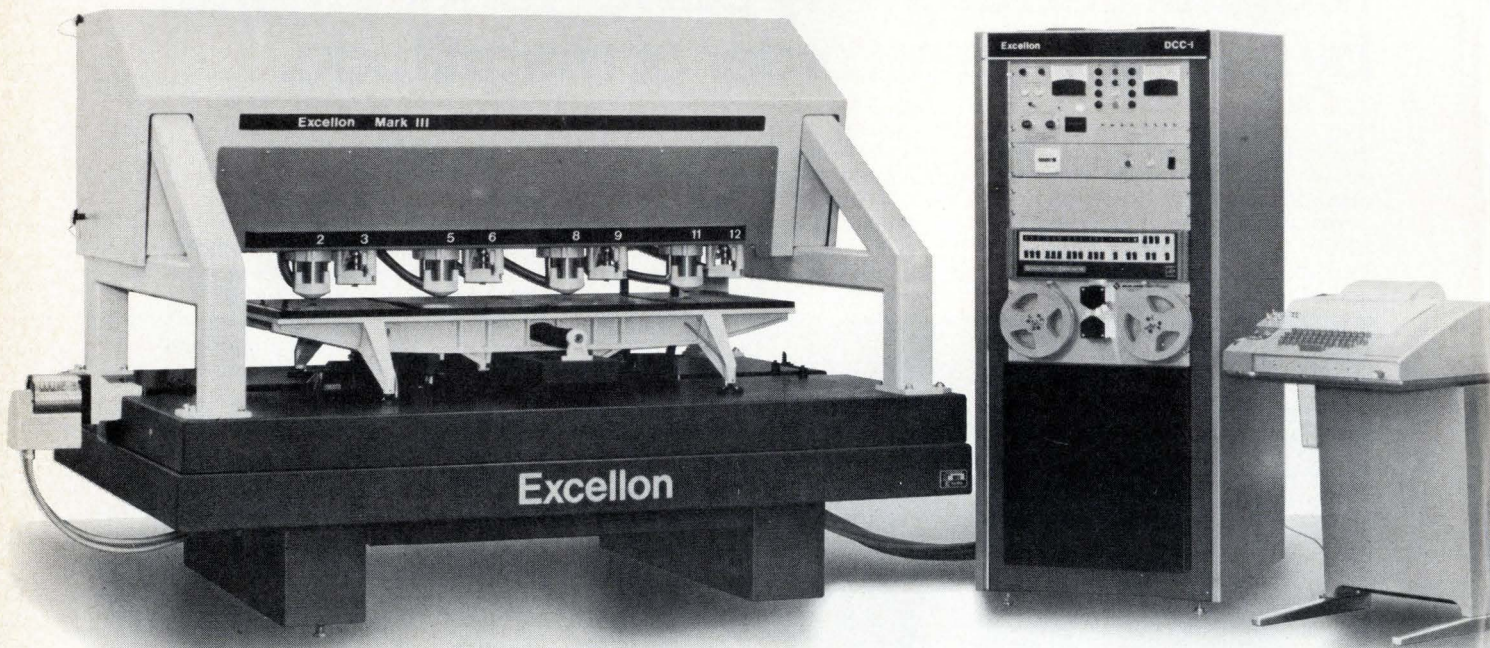

## Mark III. It's more sophisticated than the Monomatic/7.

When it comes to p.c. drilling systems, nobody can compete with Excellon.

So we've decided to compete with ourselves. Our Mark III against our Monomatic/7.

Which is best for you? Judge for yourself.

The Mark III is the most advanced p.c. drilling system in the industry today, designed to give you the *highest* production rates possible for the *lowest* hole costs possible.

It's directed by a General Automation SPC-12/15 Stored

Program Control. The SPC-12/15, with 16K memory, handles a variety of code formats, and is plug compatible with central computers. It offers step and repeat, repeat pattern, stored pattern (16 and 14 pin dual in-line, 8 pin L package), automatic table offset, mirror image and automatic rewind.

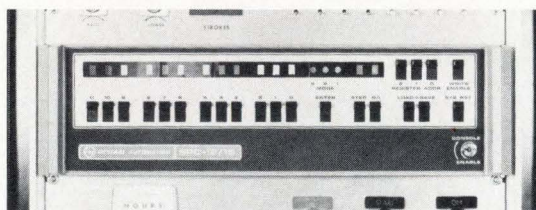

The General Automation SPC-12/15

Table travel speed of the Mark III is 400 ipm on each axis. A computer-driven, high torque, low-inertia servo motor provides *instant* acceleration for unmatched production.

The Mark III can produce drill hit rates of 200 per minute. And we're talking about *quality* holes at .25-inch movement and .002 chip load.

AC, variable-frequency, air-bearing spindle motors reach 80,000 rpm. And spindle feed rates range from 20 to 250 ipm.

If your application calls for high quality, high production rates and high utilization, the Mark III is best for you.



# VS. Excellon

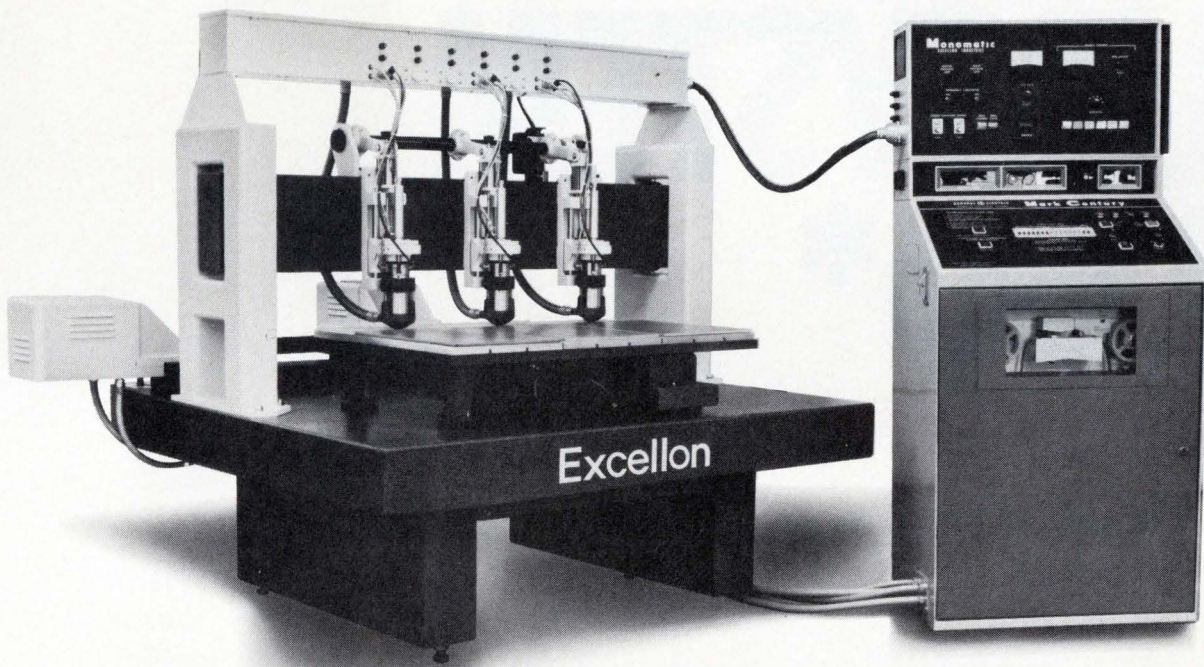

## Monomatic/7. It's more versatile than the Mark III.

If your application calls for medium to high production, the Monomatic/7 is best for you.

It's designed to be economical for short runs and highly profitable for long runs.

And it's designed to *grow* with your growing production needs.

The NC-controlled Monomatic/7 accommodates from one to seven spindles. You can start out with one or two, using the standard work table. Then you

can add more spindles and an extension table that increases the work dimensions to 3 stacks of 12¾" x 25½" panels.

Like the Mark III, the Monomatic/7 can be equipped with optional 80,000 rpm air-bearing spindle motors.

And like the Mark III, it can be fitted with an optional Excellon automatic drill

changer that permits you to drill up to 12 different hole sizes with one setup.

Of course, it's a little less sophisticated than the Mark III. But then it's a little less expensive, too.

For a competitive costs analysis of the Monomatic/7 and Mark III, and complete specifications, call Dick Hogan, Sales Manager, at (213) 325-8000. Or write him at the address below.

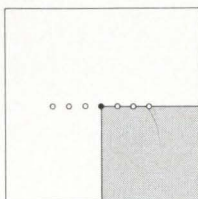

1 Spindle, 1 Stack 25.5" x 25.5"

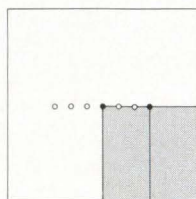

2 Spindles, 2 Stacks 12.75" x 25.5"

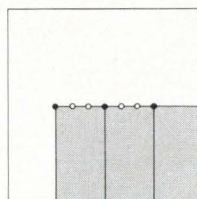

3 Spindles - Extension Table,  
3 Stacks 12.75" x 25.5"

• Active Spindle \* Inactive or Vacant



**Excellon**  
EXCELLON INDUSTRIES  
23915 GARNIER / TORRANCE,  
CALIFORNIA 90505  
Phone: (213) 325-8000

Telex: 674562 - Cable: EXCELLON Torrance

Excellon Sales and Service in ENGLAND • FRANCE  
SCANDINAVIA • W. GERMANY • SPAIN • HOLLAND  
ITALY • ARGENTINA • ISRAEL • AUSTRALIA • HONG  
KONG • TAIWAN • JAPAN



# **NEW SUPERDIGIT™ DISPLAY SUBSYSTEM \$3.60\***





**SUPERDIGIT™ LED+ new decoder/driver:  
brightest, simplest, most cost-effective display  
subsystem to be seen anywhere. Two packages.  
No external components required.**

**Made for each other:** Our new 9368 Decoder/Driver and our FND-70 SUPERDIGIT ¼" LED Display. Just hook them together to make a simple, economical supersubsystem. Super because of the way it looks – great from any point of view. Super because of the way it's priced.

And super because two packages include all necessary gating, storage, decoding, driving and display in a system that's compatible with standard 5V supplies. No external components. Reduced circuitry, installation, size, complexity, wiring.

**SUPERDIGIT** is the sharpest thing in LED displays. Bright, bold numbers that look crisp and clear and uniform over a 140° viewing angle. Thanks to new production techniques, SUPERDIGIT is priced low and we can maintain ½ million in perpetual inventory. With smallest ratio of total package to digit size (2:1), 4 digits occupy less space than 3 conventional units. Leads are straight, so SUPERDIGIT can be stacked horizontally or vertically.

**Superdriver** combines a high-speed 4-bit latch, a 7-segment decoder, and output drivers. Data can be strobed into the latches at normal TTL speed. Leading and trailing zero blanking circuits provide easily readable decimal display. Zero input current when latch is not enabled facilitates multiplex driving from MOS logic. Available in 16-pin DIP.

Production quantities and complete data can be had from your Fairchild distributor or your local Fairchild sales office.

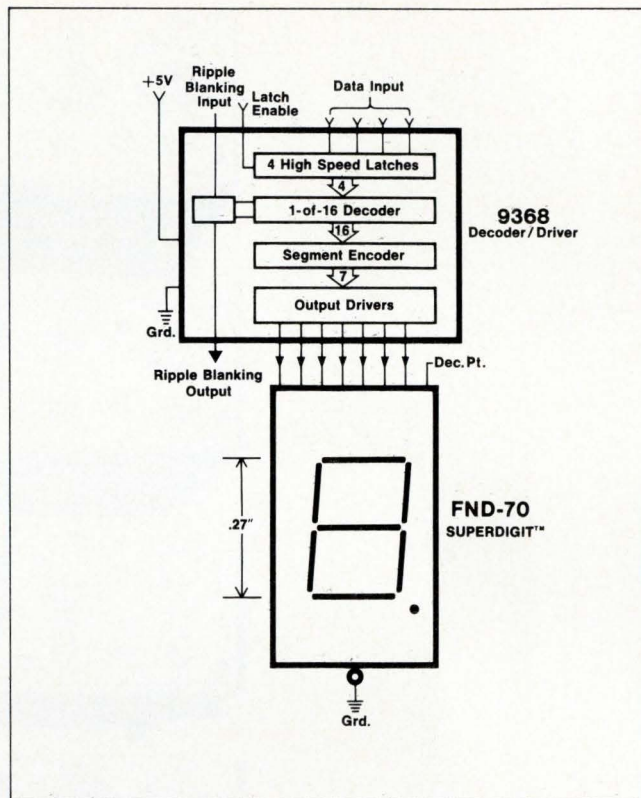

Fairchild's simple, new 2-package digital display subsystem.

Immediately available at these low prices:

	1-24	25-99	100-999	1K-4999	5K-9999	10K Up
9368 Decoder/Driver	\$3.65	\$3.35	\$2.90	\$2.35	\$2.05	\$1.75
FND-70 SUPERDIGIT	3.50	3.50	2.80	2.50	2.10	1.85
Additional Components	None	None	None	None	None	None
Total Subsystem	\$7.15	\$6.85	\$5.70	\$4.85	\$4.15	\$3.60

**MADE IN  
FAIRCHILD**





**One thousand one...  
 one thousand two...  
 one thousand three...  
 one thousand four...  
 one thousand five...  
 one thousand eight  
 hundred one...  
 two thousand...  
 two thousand one...  
 that's how you count  
 to 1.4 GHz in sweepers.**

**SWEeper MODELS\***

1001A	0.5 MHz to 300 MHz	\$ 995
1002	1 MHz to 500 MHz	1095
1003	350 MHz to 650 MHz	995
1004	500 MHz to 1 GHz	995
1005	700 MHz to 1.4 GHz	995
1801A	1 MHz to 950 MHz	1445
2000	1 MHz to 1.4 GHz	1375
2001	1 MHz to 1.4 GHz	1695

\*We also offer a complete line of attenuators and detectors covering the same frequency ranges.

It's also how to tell the story of the most complete line of sweepers in the business. Our latest additions include the 1801A for CATV equipment testing and the 2000—a less expensive version of the spectacular 2001. All of our sweepers have rugged, solid-state design and are suited for laboratory, production and systems use. They are available with both 50-ohm and 75-ohm calibrated RF outputs and feature pin-diode leveling, crystal-controlled markers and excellent display linearity characteristics. All include remote programming of frequency and sweep width, and can be AM or FM modulated. If you'd like more information, use the reader service card or get in touch with us directly. You can count on an immediate response.

**WAVETEK®**  
 INDIANA INCORPORATED  
 P.O. Box 190, 66 North First Avenue  
 Beech Grove, Indiana 46107  
 Tel: (317) 783-3221 TWX 810-341-3226



## OTP seeks over-all navigation-system plan . . .

The White House Office of Telecommunications Policy is readying **requests for proposals to study Government-supported air, sea, and land navigation systems** as part of a plan to consolidate Federal programs and "cast out obvious redundancies," according to informed Government sources. RFPs are expected to be issued shortly to "four or five" qualified companies selected by OTP but as yet unnamed. Winner of the OTP study contract will be expected to use a fall symposium of the Institute of Navigation to elicit the views of equipment makers and users.

The effort would be a "broad-brush study of requirements and capabilities of various navigation systems" and a first step **in helping the Administration determine the most widely used systems** deserving of continued Federal support. Administration intent is to have users with narrow requirements pay their own way.

## . . . in effort to dominate policy

The OTP action comes on the heels of its **move to establish a maritime navigation policy, which is expected to be issued soon** following skirmishes with the Departments of Defense and Transportation, as well as maritime and airline interests [*Electronics*, April 12, p. 59 and March 1, p. 49]. The new drive to set top-to-bottom navigation policy undoubtedly **will embroil OTP with many new Government and industrial interests.**

## X-ray lasers forecast by Naval Research Lab

Development of the first X-ray laser is within the realm of the "possible," in the view of the Naval Research Laboratory, now that it has measured the first gain of **a new laser in the vacuum ultraviolet area from triply-ionized carbon ions (C IV)**. NRL, which says the measurement is the first in this spectral region and **the first use of ions for lasers below wavelengths of 2,000 angstroms**, is optimistic about the prospects for an X-ray laser using ions. Ions have more highly spaced energy levels than molecules and are therefore capable of generating a shorter laser emission. While the 1,548- and 1,550-angstrom wavelengths emitted by the C IV laser are no shorter than wavelengths observed from other lasers, NRL researchers note that the traveling-wave low-pressure-discharge technique used to produce them seems "extendable as far as the X-ray region."

## Air Force to start high-level study of pilotless planes

Remotely piloted vehicles have at last got the high-level military backing they need to qualify them for a larger share of the Defense Department's static R&D budget [*Electronics*, July 31, 1972, p. 51]. Maj. Gen. John J. Burns, chief of operational requirements and development plans, will head **a steering committee of 10 Air Force generals** in a six-month study of the technical capabilities and future missions of RPVs, long advocated as a solution to soaring costs of manned aircraft.

Air Force Under Secretary John L. McLucas, former Mitre Corp. chief and RPV fan himself, formed the 41-man group, which sources say will concentrate a significant portion of its effort on **looking for solutions to the pilotless plane's biggest single weakness: deep-strike missions**, where telemetry and command and control of the aircraft are vulnerable to jamming. First meeting of the committee is set for May 9.



## Medical communications lives on handouts

No one disputes the claim of America's Indians that they have been getting the short end of the stick ever since the founding of the republic. Thus it seemed a refreshing, if relatively small, change was in store when the Secretary of Health, Education, and Welfare Caspar W. Weinberger reported that the Papago Indian Reservation outside Tucson, Ariz., had been selected as the site for the design, installation, and two-year test of a \$13 million medical-care system by Lockheed Missiles and Space Co.

Has technology at last come to the Indian? Yes, but only incidentally. The integrated medical and behavioral laboratory measurement system, dubbed IMBLMS by the acronymists, is a complex of advanced medical instrumentation, computers and modern communications that will enable physicians at a central site to receive medical data from a patient at a remote site for diagnosis and to prescribe treatment by trained technicians with the patient.

The principal goal of the program, however, is not for the benefit of the Papago. It is, in HEW's words, "intended to appraise the technical requirements for remote health care in space" under the joint HEW-NASA program. In brief, it seems, the Indians will serve as guinea pigs for the space program. To be sure, the Public Health Service Indian Hospital, which will operate the display and communications consoles on the reservation, will get to keep the system "based on community willingness to support the costs of the system after the initial two-year test period is over."

### The rest of us

But that is not the whole story. In the context of the nation's emergency medical services, particularly its application of proven communications technology, the Papago will be a lot better off than most Americans. The status of emergency medical services in the United States was recently described by the National Research Council as "one of the weakest links in the delivery of health care in the nation." And the communications segment of those services is "fragmented" because "individuals and institutions needing help have no central place to call," according to National Academy of Sciences president Philip Handler.

In a society that prides itself on a communications expertise that has put a radio in the hands of most cab drivers, the lack of emergency medical communications can be costed out in a number of ways. In lives, the NAS and others estimate that 90,000 could be saved an-

nually by prompt emergency medical treatment. That is more than 11% of the more than 700,000 who die from heart disease and the 115,000 who die from accidents; it comes to nearly double the number of Americans killed in Southeast Asia during the torturous decade of Vietnam involvement. If you factor in the additional 400,000 who suffer long-term disability each year because of accidents, the dollar cost runs to nearly \$3 billion in medical and hospital expenses and more than \$7 billion in lost wages, according to NRC figures.

### Aid from a foundation

Nevertheless, development of regional emergency medical communications nets is still getting short shrift from the Government. The priority is in fact so low that the NAS attached great significance to its recent announcement that a private philanthropic organization, the Robert Wood Johnson Foundation, was going to fund a two-year \$15 million program to provide "basic support" for the establishment of 40 to 50 regional medical communications systems throughout the country. The competitive grants under the program to be administered by NAS will range from \$200,000 to \$400,000. A condition of the grants to be awarded by year's end is that, after the money runs out, the communities receiving them agree, like the Papago tribe, to continue to fund the communications programs on their own.

"That kind of money won't buy much hardware," observes one communications-equipment supplier tracking the effort, "so it looks like we are still sitting on square one." In truth, that is the case, for much of the NAS-Johnson award monies appears likely to go on coordinating and training efforts for medical communications dispatchers and establishing area-wide telephone links between hospitals and special medical centers.

Part of the NAS-Johnson program also calls for a demonstrated ability to produce "immediate citizen access to the emergency medical system through a centralized communication unit open round the clock, with reserved channels and easy-to-remember, well-publicized call numbers, such as 911." In that context it appears that the Papago Indians will benefit nicely at the hands of NASA and HEW, leaving the rest of us with little else but 911 to dial. That number, you will recall, was first proposed for national use by AT&T in January, 1968, after it had been proved out in 30 years of use in England.

—Ray Connolly



# What national semiconductor firm would you turn to to fill the op amp price/performance gap?

**Wrong!** We got it first, the LM 141/142. And we're going to second source it even if the first source isn't ready. Why? Because there's a crying need for an op amp like this from any source.

Here's why: When you're all set to design with op amps and the 741 type simply runs out of gas or the 108 type offers too much performance for the price, the LM 141/142 fills that gap.

The fully compensated 141 offers five times better input bias and offset current than the 741 and faster slew rate. The 142, with standard compensation equals the large signal performance of the 101A without feedforward compensation.

Both perform extremely well in sample and hold circuits, long interval integrators, active filters, and extended frequency range amplifiers with full output swing through the audio range.

We also have an LM 341/342 relaxed specification version priced at 99¢ in 100-999.

## Compare:

Specification	141	142	741	101A	108	
Input offset current (max.)	5	5	200	10	.2	nA @ 25°C
Input bias current (max.)	30	30	500	75	2.0	nA @ 25°C
Slew rate (min.)	1.0	1.0	.3	.3	.1	V/μs @ 25°C
Distributor list price of popular brands (100-999)	\$4.25	\$3.95	\$3.95	\$7.95*	\$12.95*	

**Then Sample Order.** We'll give you a *free* sample of the LM 141/142 or 341/342, if you tell us a little about yourself and intended use. Write on your company letterhead. Or call National and give them a nudge, we need that first source.



I'll Drink to That. (I'll Drink to Anything.)

## the challenger

# TELEDYNE SEMICONDUCTOR

1300 Terra Bella Avenue Mountain View, California 94040 (415) 968-9241 TWX: 910-379-6494 Telex: 34-8416

\*Teledyne's prices on these IC's are lower.



# Sorensen has a bargain for you: DCR power supplies selling for \$360-\$4200.



Sorensen's DCR power supplies offer you the lowest cost per watt in the industry. More power output for each dollar you invest.

And DCR's comprise the broadest lab/systems line available anywhere: 37 models in 10 voltage ranges, 7 power levels.

Features? All silicon solid-state electronics. Precision regulation. Remote voltage, current or resistance programming — and remote sensing at distances to 200 feet. Operation in either voltage or current modes.

For complete data and prices, write Sorensen, a unit of Raytheon Company, 676 Island Pond Road, Manchester, N.H. 03103. Telephone (603) 668-1600. Or TWX 710-220-1339.

**Sorensen**  
POWER SUPPLIES

## Key Data

- 37 models available.
- 10 voltage ranges from 20 to 30,000 Vdc.
- 7 power levels from 400 to 20,000 W.
- Low output ripple.
- Voltage and current regulation with automatic crossover.
- Typical efficiencies to over 80%.
- Fits standard 19" rack (except 20 kW models).
- Optional overvoltage protection for all models (except 20 kW).
- Series or parallel operation.
- MTBF greater than 25,000 hours.



## Low-loss glass fibers step up plans for optical communications

**The era of optical** communications over glass-fiber cables has been ushered in with the first sales of 100-meter lengths of Selfoc cable by Nippon Electric Co. and Nippon Sheet Glass Co. During the first year, the two companies expect to sell between 500 and 1,000 lengths. Export price will be \$2,100 each.

Two developments enabled the companies to open a market for the cable: the ability to fabricate low-loss fibers in long lengths at reasonable prices, and the discovery of a method for coating the individual fibers with plastic, without which they are prone to snap when bent.

**Low loss.** Typical transmission loss of the cables is about 20 decibels per kilometer, but the companies have allowed themselves a margin for safety and describe it as less than 48 dB/km.

They also allow for a loss of up to 0.5 dB for mismatch when an optical signal enters or leaves a length of cable, so they guarantee a less than 5-dB loss for each 100-meter length. The figure is low because each cable end has been polished and then equipped with a connector that butts mechanically onto the next cable end with precision.

All loss measurements are in the 0.81- to 0.85-micrometer wavelength range of the semiconductor lasers that Nippon Electric assumes will be the standard signal source for future optical communications systems. However, the cables have low loss in the 1.06- $\mu$ m wavelength of YAG lasers and also work well at the 0.63- $\mu$ m wavelength of helium-neon lasers.

**Different glasses.** In the new process, the fibers are drawn from a double crucible with coaxial nozzles so that different types of glass form the center and outside of the fiber. At first glance, this would appear to give a clad fiber with separate indexes of refraction for center and

outside. But the glasses are molten, and instantaneous exchange of thallium and sodium ions takes place between the thallium-oxide-doped borosilicate glass in the center and the sodium-oxide-doped borosilicate glass on the outside.

The resultant fiber has a refractive index that is maximum at the center and falls off with an S-shaped curve to a nearly constant value for the outside region. For fibers currently in production, the diameter at half value for the region of decreasing index of refraction is about 30  $\mu$ m, the total variation in refractive index is about 0.02, and fiber diameter is 200  $\mu$ m. The protective sheath gives the cable an outside diameter of 1.5 millimeters. The outside diameter of the connecting plug is about 2 mm.

**Spurious modes suppressed.** The single-fabrication process enables production of almost unlimited lengths of fiber. Fluctuations in the refractive index distribution are very small, keeping the generation of spurious modes to a very low level. Thus the effects of modes with different group velocities are minimized and bandwidth is very large. The large slope of the change in refractive index keeps the light beam continually close to the axis of the fiber, even if the fiber itself bends back and forth. □

---

### Sweden

---

## IR camera system, weighs 18 pounds

Sweden's AGA has come up with an infrared camera that, because of its light weight, is even more significant from a marketing and applications view than the company's original unit, which was the first

real-time infrared camera and was put on the market by AGA in 1965.

The new IR system, Thermovision 750, features a hand-held miniature camera—about the size of an amateur movie camera—and a portable thermal-picture display unit. AGA's present Thermovision—as well as competing IR cameras—are large units, requiring a sturdy tripod or support. The display is on a relatively heavy, definitely nonportable oscilloscope or TV monitor.

**Hot-spot detection.** With the 750 system, users will be able to carry the camera around easily, use it in cramped quarters, and aim it simply and quickly. Readout is either on a display unit carried in a harness by the user, or on a larger remote screen. AGA sold its first system to the Central Electricity Generating Board of Great Britain, after taking engineers on a demonstration flight over power lines in a helicopter.

The camera, which weighs 3.3 pounds, uses prism scanning of an indium antimonide photovoltaic detector and requires liquid nitrogen coolant—the same system as the one used in earlier models. For the normal lens, the focusing range is from 20 inches to infinity, while the scanned area at 20 in. is 6 by 5¼ in.

The camera's spectral range is 2 to 5.6 micrometers, and the minimum detectable temperature difference is 0.2°C. For object temperatures around 30°C, the temperature measurement range is 20° to 900°C, which can be increased to 2,000°C by using a special IR filter.

The display unit, carried on a chest harness, weighs 7.5 pounds and is connected to a separate 12-volt battery pack weighing 7.3 pounds. The camera and display can also be operated from a tripod to pan both units in unison, which allows the display to function as a hot-spot locating device. □



# Either our drives outdrive their drives or your money back.

## Plus interest.

Chances are we'll never have to pay off because our drives are the best you can buy. And we know it. We design them ourselves and build them to exceed the most demanding requirements in the industry today.

**SERIES 6000 MAGNETIC TAPE UNITS.** Tape speed 12.5 to 45 ips. Reel size 10.5 or 8.5 inches. Seven or nine track, half inch tape. High speed (200 ips) fast forward and rewind. All standard densities. Industry compatible interface. Simple design with few moving parts. File protect. Self seating reel hold down hubs. Controlled dynamic braking. Automatic multi-level read thresholds. Channel-by-channel electronic deskewing.

**SERIES 8000 CARTRIDGE DISC SYSTEMS.** 100 and 200 tracks-per-inch. 25 or 50 and 50 or 100 million bits storage capacities. Single and dual drives. IBM 5440 removable disc cartridge. Access time 10 milliseconds track to track. Data error during read or write less than 1 in  $10^9$ . Disc rotation 1500 or 2400 rpm. MTBF 5000 hours. Simple design with few moving parts. Only 8.75 inches high including power supply. Positive optical head positioning.  Try us. See if you can get your money back. Write for details, or ask for a call from

one of our salesmen.  
Microdata Corporation.  
17481 Red Hill Avenue.  
Irvine, California 92705.  
(714) 540-6730.

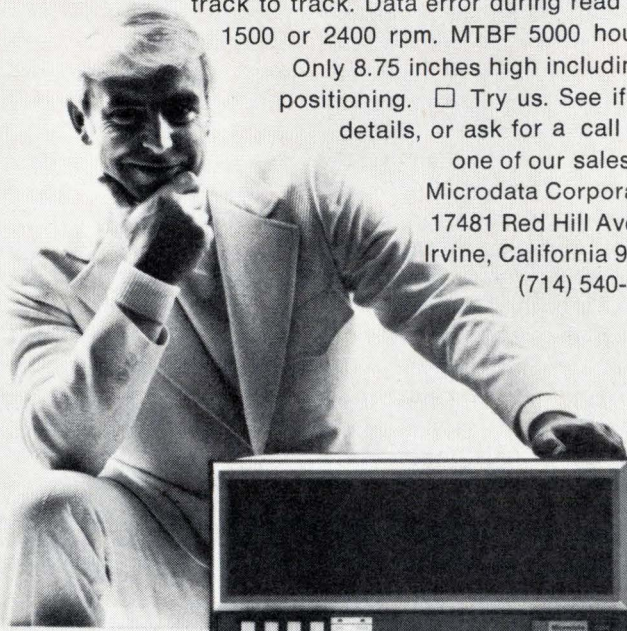

from the bold guys at

# Microdata™





### **British missile, based on Sparrow, will have new head**

In a three-cornered deal, Hawker Siddeley Dynamics Ltd. will use Raytheon Co. Sparrow technology as the basis of a new air-to-air missile. Marconi Space and Defence Systems Ltd. will supply the homing head for the new missile, being developed for Britain's Ministry of Defence, but Raytheon gets the right to build the head. This head, a semi-active radar type, homes in on reflections from the target of radar waves transmitted from the attacking aircraft or from the ground. **It was originally intended for U.S.-built Sparrows bought for the Royal Air Force. But Hawker Siddeley proposed a similar, but higher-performance, missile to use the head,** and this view has prevailed. Meanwhile, the RAF will use Sparrows with U.S.-built homing heads.

### **Diodes show promise in analog displays**

Now that light-emitting diodes have begun to prevail for alphanumeric readouts, display makers on both sides of the Channel are **turning their talents to LED substitutes for swinging needles and similar analog displays.** At a colloquium on alphanumeric-readout devices held in Paris earlier this month, RTC-La Radiotechnique Compelec, a French unit of Philips Gloeilampenfabrieken, disclosed details of a diode-bar display it has developed. RTC's base element is a row of 16 diodes driven by a bipolar IC chip mounted on the same substrate. **Up to 16 elements can be ganged simply, making the device, in practice, a 256-diode display.**

The driver circuit, compatible with transistor-transistor-logic inputs, gives a choice of three kinds of display. Addressed diodes alone can light up, giving the optical effect of a moving point. Or the addressed diode and all those below it can be powered, for a bar display that resembles a thermometer. The third choice, the addressed diode and all those above it, gives an upside-down thermometer display.

Standard Telecommunication Laboratories in Britain has come up with something quite similar. **STL's version, though, is made up of 100-diode bar elements, each 60 mils long.** The drive circuits are nine MOS shift-register chips first designed for seven-by-five-matrix displays.

### **Decca pushes data link for temporary use**

A production prototype of a portable solid-state Q-band (36-46-gigahertz) data link has been built by the Instrument division of Decca Radar Ltd. It hopes to sell the unit for establishing **temporary data links over a maximum of about six miles where a land line is not practical.** The company believes that there's a worthwhile market for such a link, particularly for temporarily connecting peripherals to computers.

Identical transmitter-receiver modules at each end use a 25-five milliwatt continuous-wave Gunn diode for transmission. Amplitude modulation is by a p-i-n diode, which produces pulse data rates up to 15 megabits per second. The superhet receiver uses a similar Gunn diode, with a lower output, as the local oscillator.

**The company chose Q band partly because it believes that radio authorities will be more likely to grant licenses there than in X band (5.2-10.9 GHz).** Also Q-band antennas can be kept small, and the band has sectors where atmospheric absorption is low, an important consideration in low-power equipment. Transmitters and receivers will be standardized, but the antenna will be chosen to suit the intended application. **Decca hasn't decided price, but it is aiming for \$3,500.**



### **Bosch buys half of Teldix, boosting its anti-skid R&D**

To broaden its already strong base in the automobile accessory market, West Germany's Robert Bosch GmbH has bought a hefty share of Teldix GmbH, a firm heavily involved in the automotive electronics. **It acquired the 50% interest held by Bendix International Finance Corp. The other 50% is retained by AEG-Telefunken.** Although Teldix is primarily known for its expertise in navigational and control equipment for land, marine, and aerospace vehicles, the 800-man Heidelberg company has become quite active in automotive electronics, **particularly in developing anti-skid systems for passenger cars.** Bosch will combine its anti-skid design efforts and concentrate them at Heidelberg.

### **Two LED displays have memory properties**

Solid-state displays with inherent memory are in the pipeline in Japan and Great Britain. Sharp Corp. has fabricated experimental gallium arsenide light-emitting-diode matrixes in a four-layer construction that has both negative resistance and dynamic memory. **Depending on the rise rate of the scanning pulses, diodes can be turned on, kept turned on, or erased. Writing and erasing can be done by a light pen, too.**

In Britain, Ferranti Ltd. is working on a self-latching gallium phosphide diode it calls a Thyroptor. Here, **the light-emitting junctions are underlaid with a high-resistivity region that acts as an avalanche photoconductor and gives the diodes negative resistance.** Once turned on, the diode has to be pulsed off.

### **Grundig markets Secam adapter for its PAL sets**

To overcome the incompatibility of Europe's two color-TV transmission standards, Grundig AG has come up with a relatively simple and inexpensive adapter, which allows reception of either PAL or Secam programs on Grundig-made Supercolor sets. **The new adapter—designed to handle television programs from East Germany, where Secam is used—will hit the market next month and retail for only \$60.** The company will later come out with similar units accommodating programs from France, the homeland of Secam; France has different line- and sound-transmission norms.

### **Poland now has home-grown TV sets**

Poland's fledgling color-TV market is fast gaining its independence from foreign imports—particularly from goods from neighboring East Germany and the Soviet Union—now that domestically designed models are being produced. **For the new all-Polish models, called the Rubin 707 P, rapidly rising production figures are predicted: 10,000 by the end of this year, climbing to between 30,000 and 40,000 units annually during the years to come.**

### **Addenda**

Nippon Electric Co. has notched up another contract for a complete Intelsat ground station, this time in Zambia. The contract, for roughly \$5 million, calls for completion of the station within 16 months and technical support during the first year of operation by NEC and Technology Resources, a Paris-based consulting outfit. . . . British mini-computer maker Computer Technology Ltd. has landed a \$700,000 order with ESRO, the European space research agency. The company will supply two Modular One systems to process telemetering data from a geostationary scientific satellite that ESRO has in development.



# CLOCKWATCHERS



Assign your "clockwatching" to specialists:  
the Guardian Angel and

## GUARDIAN TIME DELAY RELAYS

Need a time delay relay that counts parts of a second . . . or one that counts half an hour? From 25 milliseconds to 2,000 seconds, Guardian's got them all. In your choice of electromechanical, hybrid or pure solid state. In standards that come right off the shelf or in custom designs. In just about any size, shape, form, or delay range your application can demand. Isn't it time you get all the facts on Guardian Time Delay Relays? Send today for specs and application data.



# GUARDIAN<sup>®</sup>

GUARDIAN ELECTRIC MANUFACTURING CO.  
1566 West Carroll Avenue, Chicago, Illinois 60607

*In a hurry? Call your Guardian Distributor.*

Circle 57 on reader service card



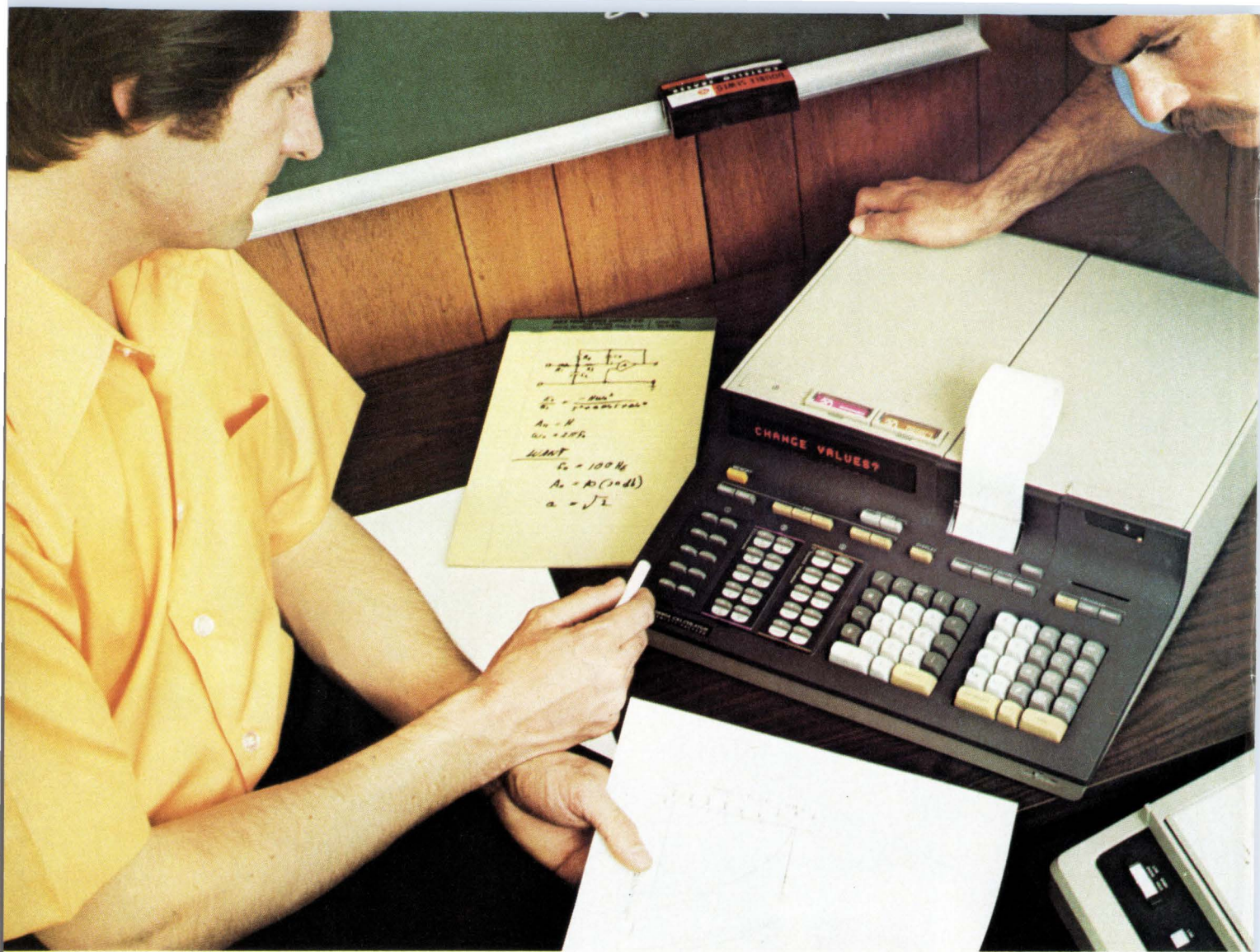

# HP's Calculator Aided Design-- Your Answer To The High Cost Of Engineering

New HP calculators and program software put the advantages of interactive modeling right on your desk top. HP's calculator aided design is a tool that enables you to go from an idealized design to a practical case as fast as you can enter the data and read the results. And you can try a dozen alternatives in less time than it would take you to modify a circuit. Use Quine-McCluskey techniques for logic minimization; do network analysis using a program similar to ECAP. Have the power, at your finger tips, to take a complex transfer function and quickly realize an actual circuit. See the results of your design inquiry graphically pictured on labeled X-Y plots. It's a wide ranging electronic engineer's design tool that helps you solve the everyday design problems, at a cost you can afford.

**For example, in filter design,** enter your data into one of our Series 9820 calculators and let HP's software program automatically de-



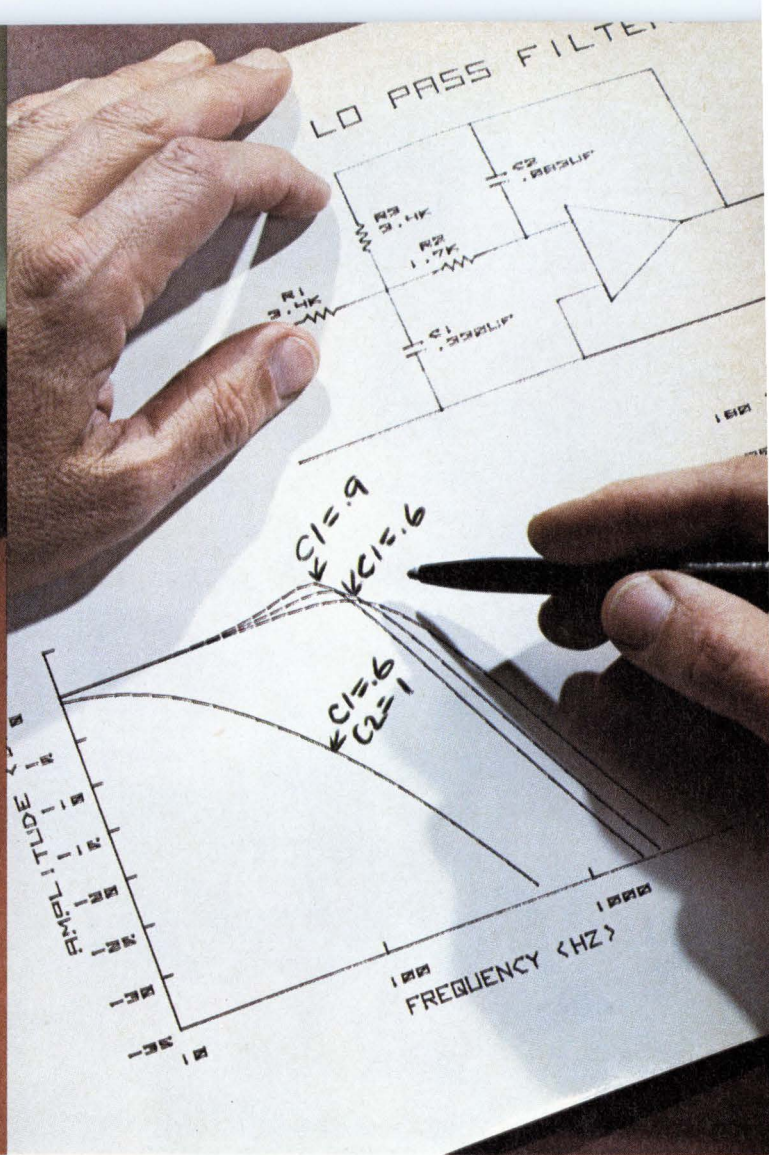
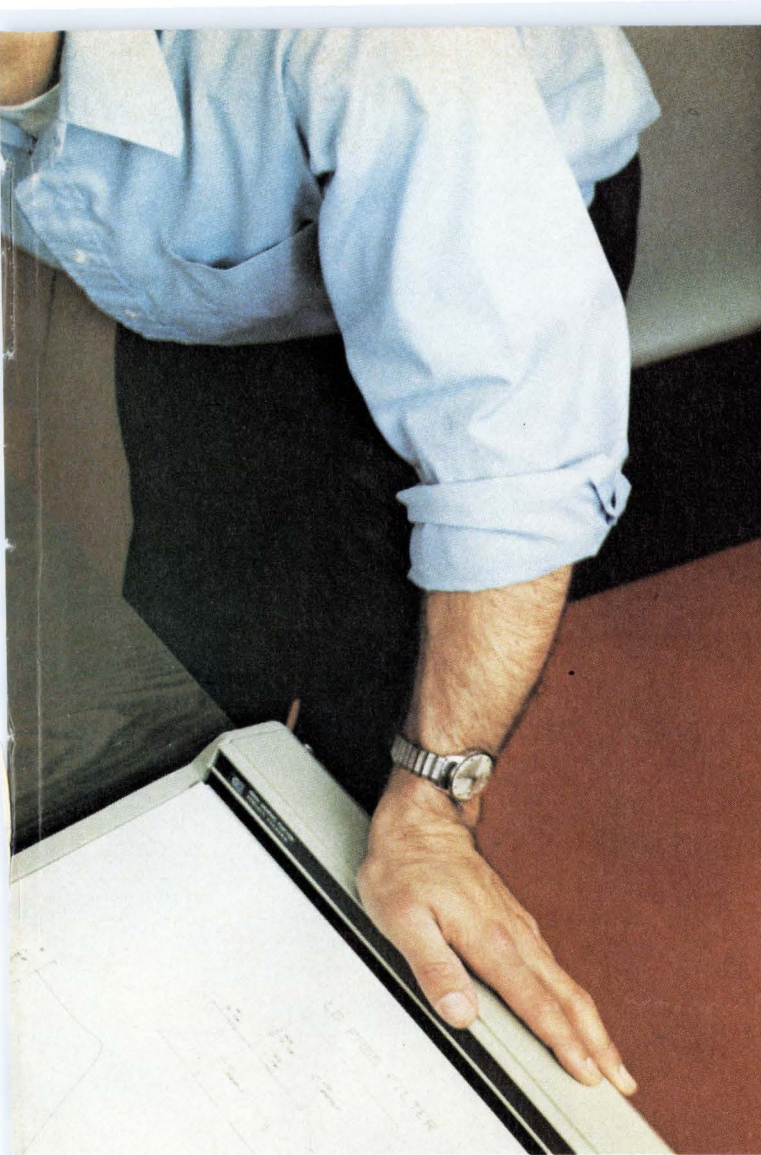

sign your 2-pole active filter. HP's X-Y plotter will draw your circuit schematic, calculate all component values, label those components, and plot gain and phase versus frequency—all automatically. Or try another component value and see the results of your changes, immediately. We have other programs for multiple-pole filter design.

**If your job is microwave design**, you'll be interested in the HP Model 9820 and its accompanying S-parameter design programs. With this powerful combination, you'll perform microwave circuit design with more confidence and achieve better results, in much less time.

**For magnetic designers**, we offer transformer design techniques that have been used and refined for five years. You'll be amazed when you watch your Model 9830 print out both primary and secondary wire sizes, turns, layers, percent fill, temperature rise, and all the other important physical and electrical

characteristics you need to physically build and test your transformer. But that's not all, with another program, you can enter your shop practices and quickly generate a costed material list with complete details of time and cost from assembly through final test. This program eliminates the most tedious of tasks, from the time you start on a quote, through delivery.

**Control systems** engineers can really put the advantages of interactive design to work. Start with our Series 9830, enter your pre-recorded program, key in your parameters, press EXECUTE and perform a time domain analysis or find the root locus of your system. Now add the plotter and watch the time waveform of a selected node or watch the poles and zeroes move as you change system parameters. With the 9830 calculator system, it's hard to believe that control system analysis and design can be so easy.

If you're designing components, cir-

cuits, networks or systems, there's probably an HP calculator program waiting to make your job easier. So check into calculator aided design with HP software: Write or call—



Sales, Service and support in 172 centers in 65 countries. Loveland, Colorado 80537. Offices in principal cities throughout the U.S.

For More Info

Hewlett-Packard, P.O. Box 301, Loveland, Colorado 80537.  
 Please send me more information on HP's Software Programs.  
 Please have your nearest calculator field engineer call for an appointment.

Name \_\_\_\_\_  
 Title \_\_\_\_\_  
 Company \_\_\_\_\_  
 Address \_\_\_\_\_  
 City \_\_\_\_\_  
 State \_\_\_\_\_ Zip \_\_\_\_\_  
 Phone \_\_\_\_\_ Ext. \_\_\_\_\_  
 My application is:

For a demonstration, circle reader service no. 58  
 For information, circle reader service no. 59



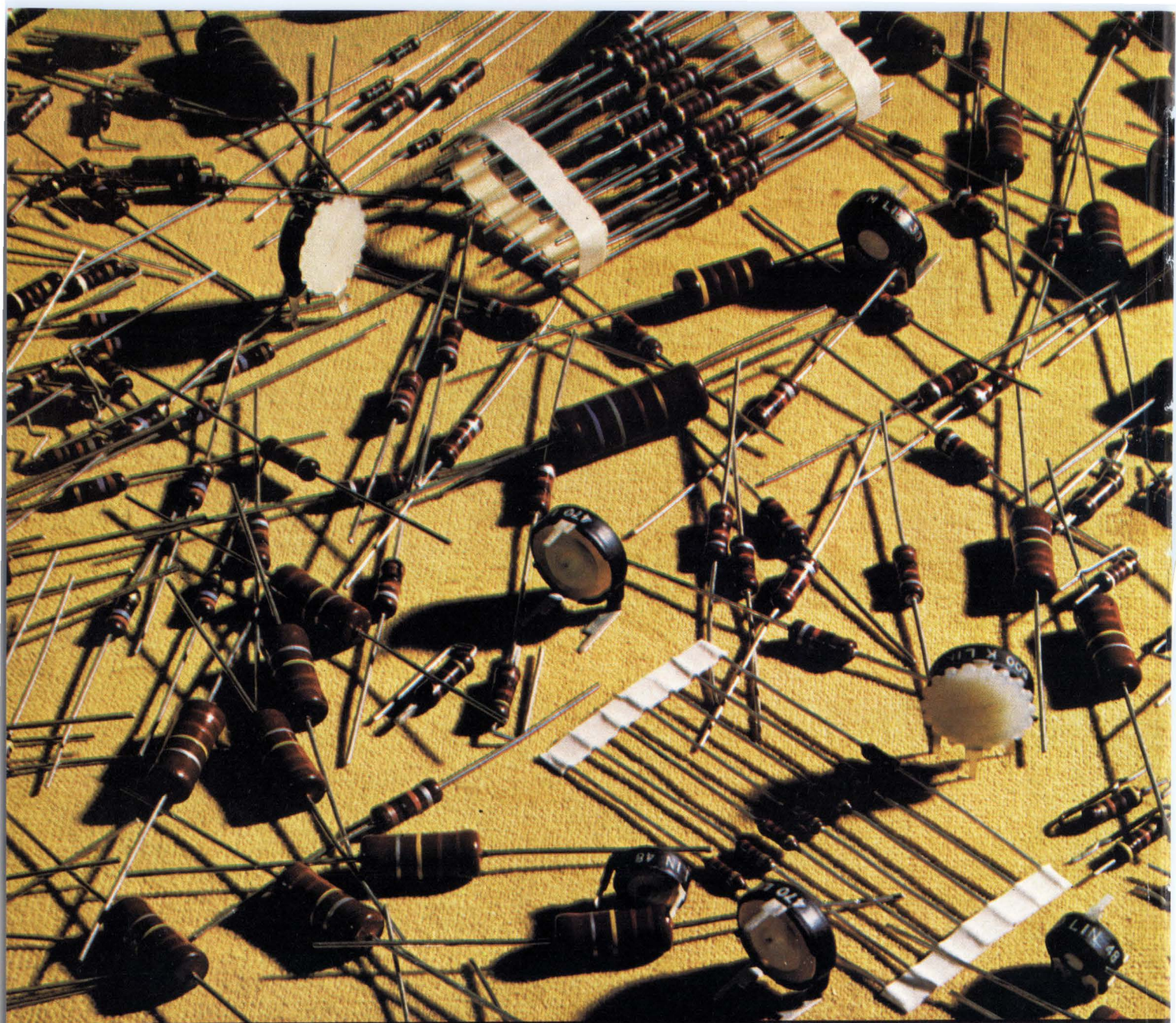

# From start to finish

No licence agreements, no sub-contract work. From start to finish we are in control of every product that goes out to you, the customer, bearing the name Piher. We take a pride in the name. We take a pride in our products. That's why we are now a world leader in component technology.

Don't take our word for it. Let the facts speak for themselves.

We produce over 7 million carbon film resistors per day to meet world demand and have the largest variety of quality preformed resistors available anywhere.

We also provide the best range of quality, low-cost encapsulated trim-

mer pots on the market for every type of application - custom built to your own specific requirement where the need arises.







# - Piher technology

And these components are only the beginning.

Piher is a company that works in professional electronics, developing the best in closed circuit and professional TV, radio-telephones, etc.

And with our ferrites we are in the forefront of magnetic ceramic technology.

We are a high technology company with 6 manufacturing centres employing over 3000 people. And our world-wide distribution network is backed by 5 Piher companies in the U.S.A., Germany, U.K., France and Italy.

That's why our exports have increased by 75% in the past three

years. That's why, when people think components, they should think Piher.

*Find out more about us. It pays.*



**USA - 1239, Rand Road, Des Plaines - Illinois, 60016.**  
Tel: (312) 297-1560. Telex: 0282514.

**GERMANY - 85 Nuremberg, Westtorgraben, 5.**  
Tel: (0911) 260469. Telex: 623354.

**UK - Romar House, The Causeway, Staines, Middlesex.** Tel: 56157. Telex: 934167.

**FRANCE - 83 Rue Etienne Dolet, 94230 Cachan, France.** Tel: 6562607. Telex: 27107.

**ITALY - Via Soldati, 16, 20154 Milano.**  
Tel: 314.532/316.213.



# PIHER

**Head Office - SPAIN**  
Riera Canado, s/n. Apartado de Correos, 53 Badalona  
(Barcelona), Spain. Tel: 389 03 00. Telex: 59521.



**“We subjected the Augat plug-in socket panel to an accelerated-life test in order to induce contact failure.**

**“We failed.”**

Dave Fillio  
Principal Engineer, Component & Materials Engineering  
Honeywell Information Systems



"We needed an interconnection system for controllers on the H716 minicomputer that could help us meet four basic requirements:

- "High density to get as much as possible into a small package and still meet the increasing customer demand for a broad range of peripherals, each requiring a separate controller.

- "The capability of automatically wiring, with a minimum of two-levels.

- "Flexibility to permit anticipated design changes and still allow us to meet a very tight schedule.

- "And finally, all these features had to be available in a standard product.

"The most logical approach seemed to be printed wiring boards. But to accommodate all our controllers could have required as many as eight boards. And we couldn't afford the room. Also, when recycling changes are taken into consideration, the design cycle of printed wiring boards becomes too long and, consequently, too costly.

"Multi-layering offered a minimum of flexibility, and it, too, was rejected.

"The only practical solution was the plug-in socket panel. And of all the vendors, Augat was the only manufacturer that could provide a completely uniform, broad range of standardized products, the lowest possible profile and maximum reliability.

"The reliability tests we conducted on the Augat machined sockets included environmental exposures, accelerated-life, vibration, thermal shock, and durability. All tests with the Augat system were positive.

"From a field service standpoint, a key consideration with increasingly complex and flexible systems like the H716 is keeping them on the air at all times. Because of the reliability of the Augat interconnection system, we've had no reports of machine down-time associated with the Augat product since the introduction of the H716 eight months ago."

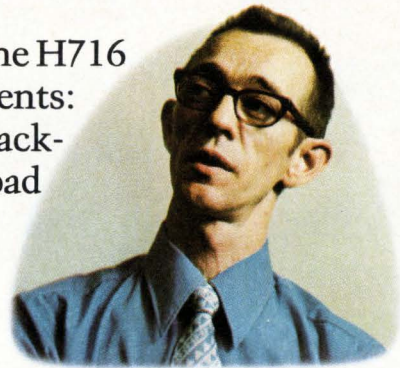

Dave Fillio

More and more companies like Honeywell are realizing that Augat socket-panels are an economical, reliable and totally flexible solution to interconnection problems, including development, production and field service requirements.

Augat's precision-machined tapered entry contact has made Augat the reliability standard for the industry. As the world's leading manufacturer of socket panels and other IC interconnection products, Augat is ready to help you solve your interconnection problems.

Call or write today for a free brochure and complete product information. Augat, Inc., 33 Perry Avenue, Attleboro, Massachusetts 02703. Represented and distributed internationally.



The H716

**Plug into Augat®. Honeywell did.**



CONTROL DATA  
CYBER 70

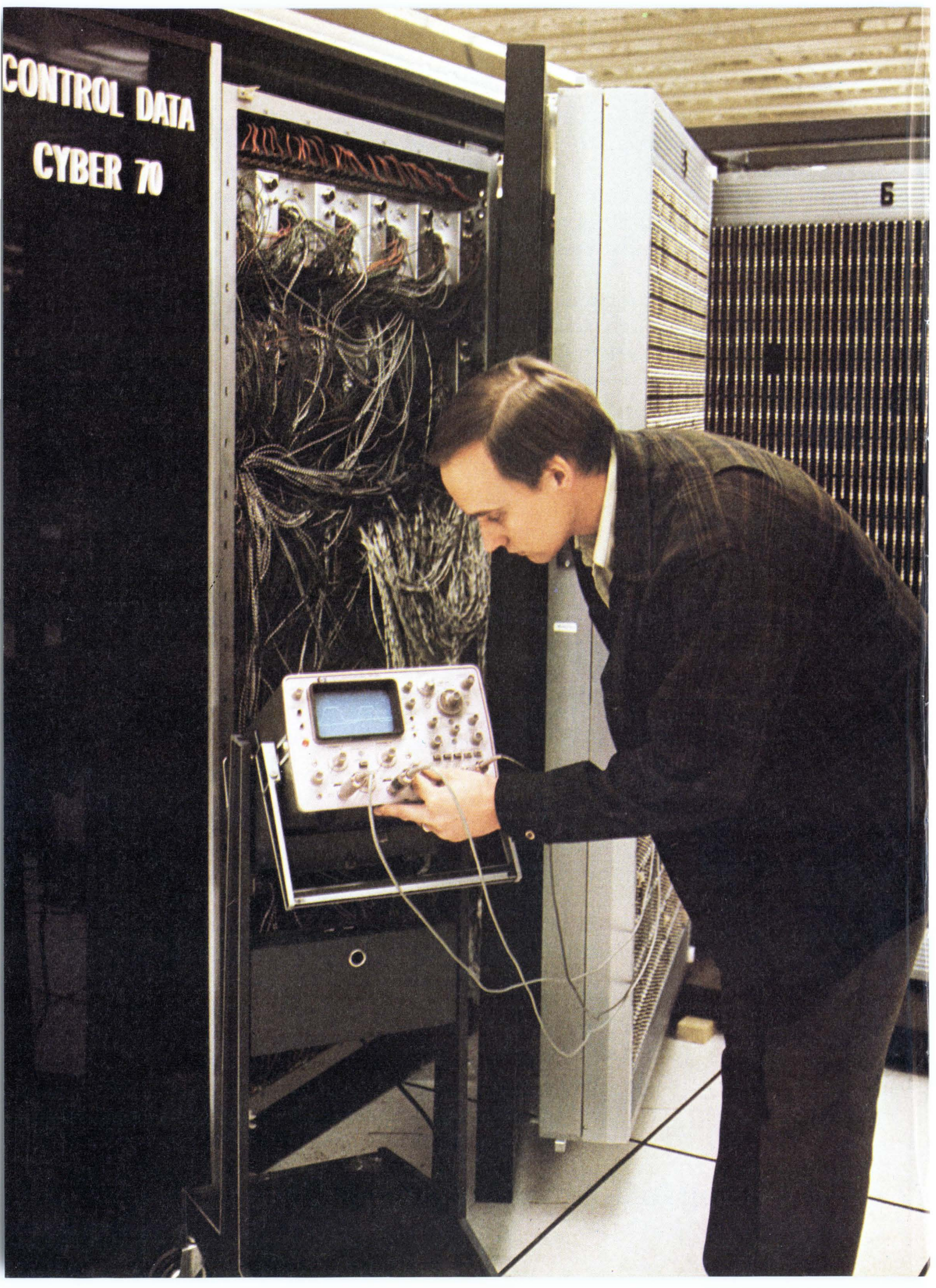
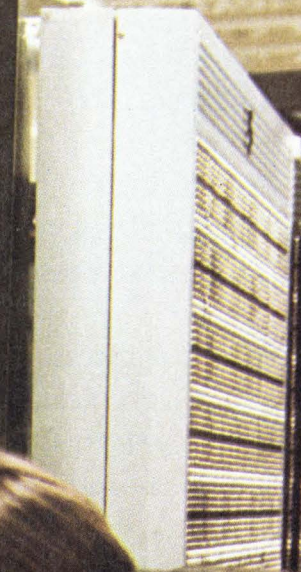



# Think Twice:

## Control Data Did

Control Data's reputation was built on providing computers with high throughput/dollar capabilities. That capability must be protected by assuring their customers ultra-reliable computers. Therefore, when Control Data assigns a scope to a computer, that scope must be as reliable as their computer. This makes reliability equally as important a consideration as performance—In both categories, H-P's portable is a scope that meets Control Data's rigid requirements.

### It Pays To Compare.

Before choosing any scope—from the smallest portable to the most sophisticated lab model—make a careful evaluation and comparison. **If you need a portable**, remember that HP portables with self-contained batteries give you go-anywhere capability to meet your most demanding field service requirements. A sealed case with no fan or vent holes frees you from worry about dust and moisture. **For a lab system**, compare the flexibility offered by the broad range of compatible plug-ins. Then call us for a hands-on demonstration of the combination that best fits your needs.

### Look Into Price.

Analyze your total measurement

needs, then ask both manufacturers to submit prices. On currently available models, you'll find that HP can save you money—lots of it in most cases. Check carefully on all aspects of cost and performance. Whether you are comparing real-time systems with or without delayed sweep, or sampling units, you'll find that HP still offers a cost/performance advantage.

### Check Ease-of-Use.

Compare simplicity of controls, display size and error-prevention devices. Does the scope have useful, time-saving features; like selectable input impedance, variable-persistence storage and simplified sampling? Check writing speed; HP's new burn-resistant storage scopes are brighter than scopes have ever been, and write at a speed up to 400 cm/ $\mu$ sec. This means you no longer need to bury your head under a scope hood to view fast-risetime, low-rep rate signals.

### Don't Neglect Calibration And Service.

Compare calibration time needed for each manufacturer's unit. You'll find it takes less time with an HP scope. In fact, some companies bought HP scopes because of this one fact alone. You'll also

discover that HP scopes are backed by video tapes which cut the time you spend training your calibration people.

### Think Twice: Like Control Data.

You owe it to yourself to make these comparisons before you choose your next scope. To help you compose the check list for the scope that meets your personal needs, send for our "No-Nonsense Guide to Oscilloscope Selection." Or, contact your local HP field engineer for a demonstration. Think twice and check before you choose. Hewlett-Packard, Palo Alto, California 94304. In Japan: Yokogawa — Hewlett-Packard, 1-59-1, Yoyogi, Shibuya-Ku, Tokyo 151, Japan. In Europe: HPSA, P.O. Box 85, CH-1217 Meyrin 2, Geneva, Switzerland.

**Scopes Are Changing;  
Think Twice.**

083/2

**HEWLETT  PACKARD**

**OSCILLOSCOPE SYSTEMS**



# More than half the people who buy bench-top digital-IC testers buy this one.

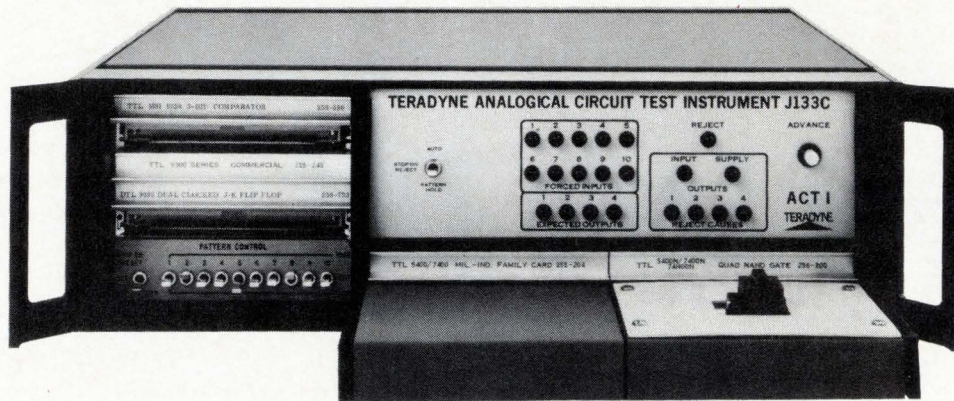

## Here's why.

### It's Thorough

The J133C makes both functional and dc parametric tests, based on field-tested plug-in program cards that ensure correlation with vendors' specs.

### It's Versatile

Program cards are available for thousands of ICs, from flip-flops to ROMs and RAMs, from TTL and DTL to CMOS. The J133C even tests 24-pin devices.

### It's Easy to Use

No setup; just turn it on and use it. No programming; plug-in program cards do it all. No operator controls; just insert the IC to be tested. No meters to read; just watch the pass/fail lamps.

### It's Expandable

The J133C can grow as your needs grow. With its evaluation test deck, you can look at function, voltage, or current at any pin. With the pattern control unit, you can functionally evaluate bad devices. With blank program cards, you can even "write" your own programs if you choose.

### It's Compatible

Interfaces are available for automatic handlers, wafer probers.

### It's Dependable

The J133C is built to take hard industrial use. That means no calibration adjustments, no fans, 100%-tested components, plus a 10-year warranty for extra peace of mind.

### It's Inexpensive

The J133C costs so little it can pay for itself in months, at even moderate IC usage rates.

Most important, when a J133C says an IC is good, you can put that IC in your product without worry. And that, of course, is the real reason why industry has settled on the J133C as the best answer to the IC-inspection problem. Learn more. Write: Teradyne, 183 Essex Street, Boston, Mass. 02111. In Europe: Teradyne Europe S.A., 11 bis, rue Roquépine, 75 Paris 8<sup>e</sup>.

# TERADYNE

CHICAGO (312) 298-3600 / DALLAS (214) 231-5384 / NEW ENGLAND (617) 245-5340 / NEW YORK (201) 871-4052 / SUNNYVALE (408) 732-8770  
LONDON (093-28) 61111 / PARIS 265 72 62 / ROME 59 47 62 / MUNICH (0811) 33 50 61 / TOKYO (03) 263-9358



# Probing the news

Analysis of technology and business developments

## Skylab: a houseful of electronics

NASA's orbiting space lab to be launched next month will look at sun, space, stars—and man's ability to live among them

by William F. Arnold, Aerospace Editor

Early in the afternoon of May 14, a Saturn V rocket, made familiar by the Apollo program, is scheduled to blast off from Cape Kennedy. But instead of bearing an Apollo spacecraft toward the moon, the missile will carry NASA's Manned Space Program in a new direction: the launch of Skylab, an earth-orbiting space laboratory the size of a small three-bedroom house. A day later, a smaller Saturn rocket will send the first team of three astronauts to live there for 28 days. In the course of the program, three such teams will take turns at inhabiting the floating laboratory for periods up to 56 days.

Supported by a load of electronics, Skylab will transport a large mission of solar investigation, earth observation, and medical analysis of the effects of prolonged weightlessness on man. This data will be used to help NASA plan for the permanent space station on the drawing boards for the 1980s. Thus, Skylab carries an impressive array of high-resolution, short-wavelength solar astronomy equipment, earth survey gear, and biomedical monitoring equipment.

Basically, Skylab is a cluster of elements that will automatically unfold to resemble a tubular windmill when it reaches the 270-mile orbit. The elements:

- The orbital workshop (built by McDonnell Douglas Astronautics Co.) containing the crew's quarters, the experiment area, and the structural support for the large solar arrays.

**Windmill.** Two astronauts, below, work in multiple docking adapter trainer. That's the module to which windmill-like antenna is attached in the drawing above.

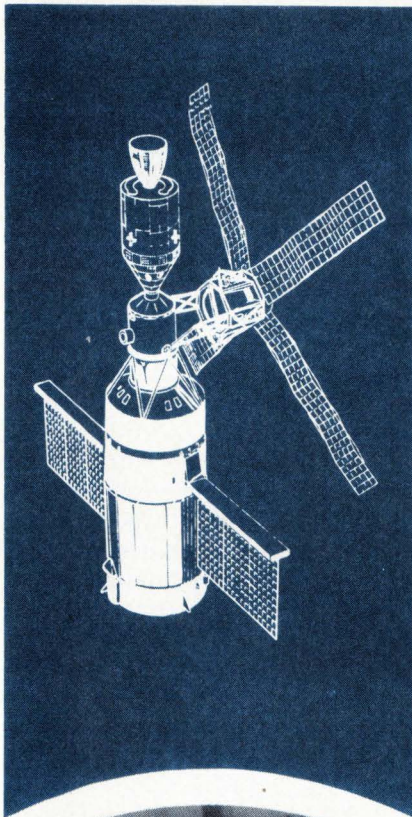

- The Apollo telescope mount, including the solar experiments and a solar array providing electric power.

- The airlock module (from McDonnell Douglas) containing an airlock for extravehicular excursions—the NASA term for walking in space—plus the main data and communications links.

- A multiple docking adapter (from Martin Marietta) providing the telescope-mount control panel, a window for earth-resources viewing, and the docking port for the modified Apollo command-service module in which the astronauts will be ferried back and forth.

Overall, the Skylab cluster, an assemblage of modified Apollo and Saturn pieces left over from the truncated Apollo program, will be 118 feet long, 90 feet wide, and weigh 181,300 pounds. Total program costs will be \$2.6 billion, about a tenth of the 17-mission Apollo program's cost. Inside the silo-like chambers and tubular passageways of Skylab, the astronauts will have lots of room and plenty to do during their stays in orbit.

"It's not a rigid flight schedule, unlike Apollo which was planned down to the last second," says lunar astronaut Charles P. Conrad, commander of the first Skylab crew. He explains that this is "because we have enough experiments on board that we can stay busy for more than 140 days," adding that a mission-planning computer keeps experiments together.

Electronics

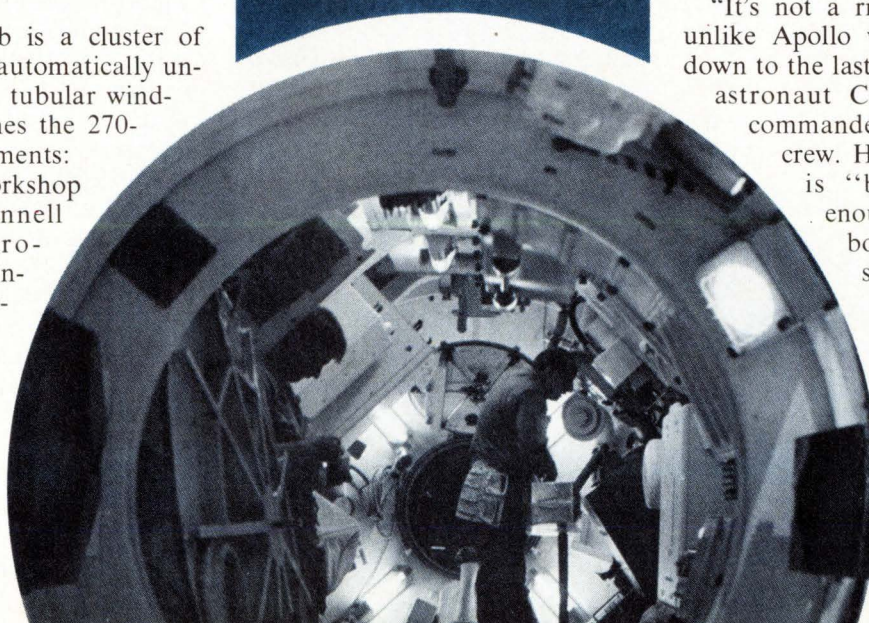



## Probing the news

figure in a good share of the 60 experiments aboard, particularly in the earth-resources experiments package (EREP), and in the equipment for studying solar physics, astrophysics, and the life sciences. Another set of experiments of interest to electronics manufacturers are those concerned with the manufacture in space of such semiconductor materials as gallium arsenide crystals, to determine whether low-cost, high-yield automated production out there is ultimately feasible [*Electronics*, Jan. 18, p. 107].

**What next?** With the Earth-Resources Experiments Package, "we fly six instruments to find out what we can do and what instruments we should design for future missions," says Arnold Aldrich, deputy manager, Skylab research office at Houston Johnson Space Center. Elaborating, Harold Granger, Earth Resources program officer, says the EREP instruments are in three categories: object detection and pollution monitoring; the surveying of water, mineral, forestry and agricultural objects; and meteorology.

To accomplish those wide objectives, NASA will use complementary infrared and microwave techniques. The infrared gear will "determine and take out atmospheric effects as measured by the sensors to classify and determine things on the ground," explains Granger, while the microwave equipment, not severely attenuated by cloud cover or rain, will provide the only all-weather sensing system. Designed to be complementary with survey data from the Earth Resources Technology Satellite 1 [*Electronics*, July 3, 1972, p. 31], EREP's results will be compared with ground and aircraft sensing "to tell the difference between what we're reading on the

ground and what we get from the air," says Granger. A complementary package, the infrared experiments will be loaded, operated, and maintained by the crew.

**Sun gazing.** But the astronauts will look at the sun and stars, too. Here, they will use the ultraviolet region because the earth's atmosphere attenuates about 80% of ultraviolet radiation and, since Skylab will float above the atmosphere, "we hope to gain information that we're unable to obtain on earth," explains Reg Machell, manager of the orbital assembly office, Skylab program office.

The X-ray/UV solar photography experiment (Naval Research Laboratory with Martin Marietta Corp. as subcontractor) will peer into the 10- to 200-angstrom wavelength, the lower end of ultraviolet and upper end of X ray, to determine the effects of the sun's energy on the earth's environment, ionosphere, and weather, Machell says. A similar UV stellar astronomy experiment (Northwestern University) will use the 14- to 3,000-angstrom wavelength to look at the stars because stars emit "a large amount of energy in the UV but we can't see it from earth," he says.

**Horizon photo.** The UV experiments also include an airglow horizon photograph (also WRL-Martin) to look at the earth's ozone; a UV panorama, a French experiment to measure the UV brightness of stars; a UV scanning polychrometer spectroheliometer (from Harvard College Observatory with Ball Brothers Research Corp.) which will be used to observe changes in the sun's environment by measuring the extreme UV region of 300- to 1,350-angstrom wavelengths, and a similar experiment by NRL and Ball Brothers for 150 to 650 angstroms.

Other solar experiments include the Tandem H-Alpha telescopes

(from Perkin-Elmer) which will measure solar UV and X-ray phenomena with vidicon and photographic techniques; a TV-movie camera system (from High Altitude Observatory and Ball Brothers) to view the corona; and two X-ray telescope systems by American Science and Engineering and NASA's Marshall Space Flight Center.

**Life in space.** Of the 30-odd experiments on crew health and performance in prolonged zero-gravity living and the habitability of the quarters, the most interesting electronically is the one monitoring the crew's sleep. Here, "a small computer sorts out signals into seven categories to monitor sleep patterns," explains Richard S. Johnston, life sciences director.

To do this, the drowsy astronaut will enter a cocoon, don a special cap containing monitoring electrodes, and doze off. A preamplifier will transmit the signals to the panel assembly containing the computer, which will convert the analog signals to 3-bit binary codes for near-real-time telemetry, sampled every 10 seconds, to mission control. There the data will be shown as: the astronaut's current sleep state, cumulative time in each of the seven stages of sleep, and a continuous graphic display of his sleep profile. The analog signals will be recorded for later analysis.

**Two channels.** Communications among the crew and between them and the ground are handled by a two-channel setup, in which one channel is for internal communications and not recorded and the second is recorded for "experiment debriefing" to the ground, explains Conrad. There's also TV in the command module in which selected segments can be recorded up to 25 minutes.

Early in April, the Russians orbited a Salyut spacecraft, which would become a manned orbital space station when they send a crew up to man it. Two years ago, a record 26-day mission aboard Salyut 1 met disaster when the cosmonaut crew died during re-entry. Another Salyut launching attempt last year was unsuccessful. □

**Looking.** Astronaut Joseph P. Kerwin at the console of Apollo telescope mount.





# OPEN WIDE AND SAY "Ahhh... Now that's what I call a THUMBWHEEL CATALOG!"

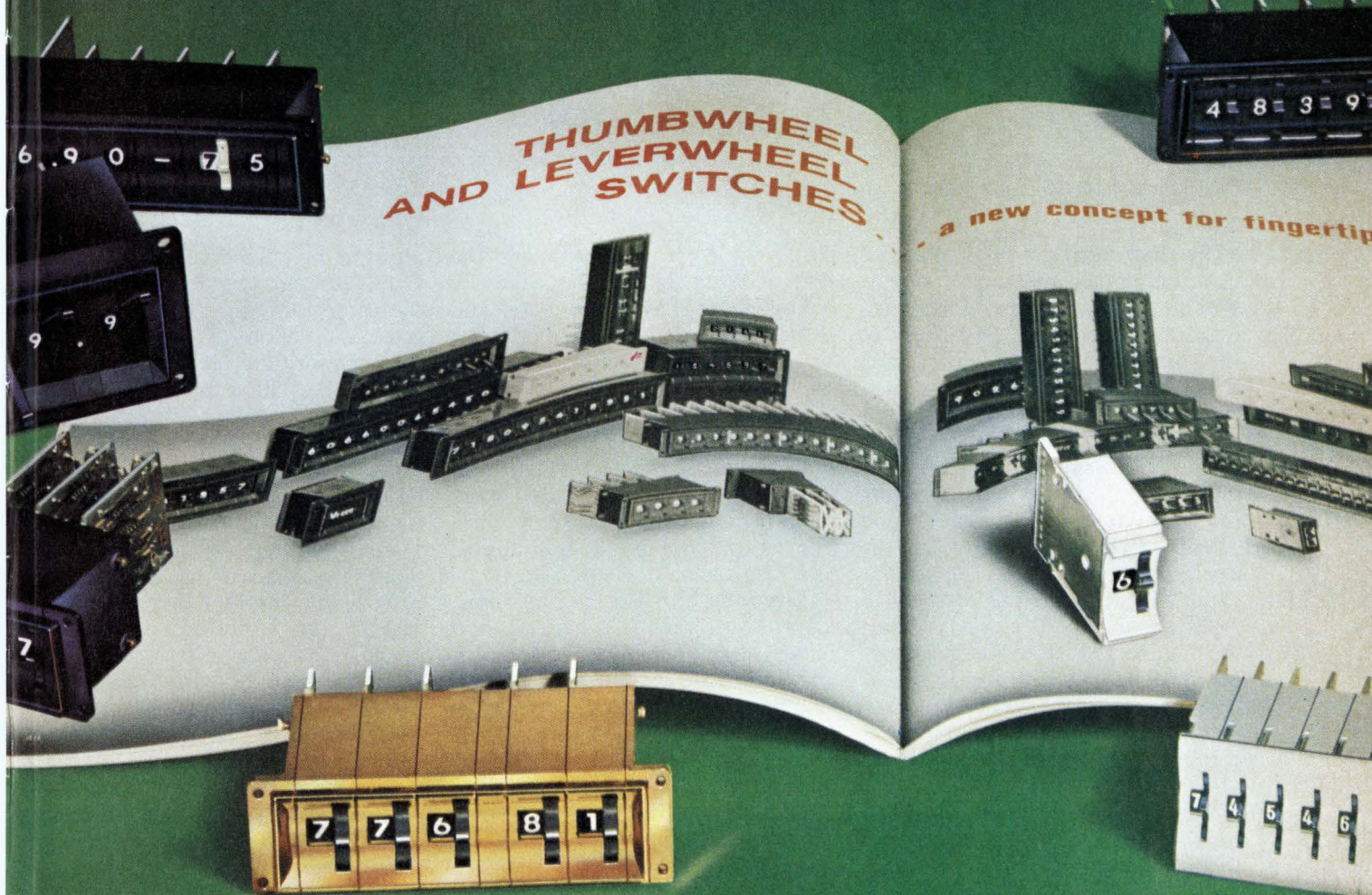

## Send for this new Cherry Handbook and Guide

For everything you could possibly want to know about Cherry Thumbwheel and Leverwheel Switches, this new catalog is just what the doctor ordered. You'll find details and specs on nine series of Thumbwheels and Leverwheels—available in hundreds of variations. You'll find truth tables . . . cross-indexed product listings . . . application data . . . specials . . . and more. You'll also find never-before-published "inside" information on Cherry's Thumbwheel Switch **total** in-house manufacturing capabilities: Including printed circuit, precious metal plating, silk screening, metal stamping and plastic molding operations. All in a handsome, new, easy-to-use 72-page format. **And it's yours for the asking:** Just TWX 910-235-1572 . . . or PHONE 312-689-7703 . . . and ask for Frank.

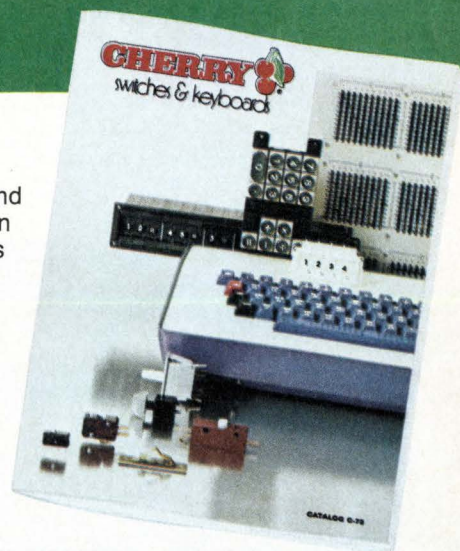

**CHERRY ELECTRICAL PRODUCTS CORP.**  
3608 Sunset Ave., Waukegan, Ill. 60085



Cherry affiliates worldwide • Hirose Cherry Precision Co., Ltd., Tokyo • G. W. Engineering Pty. Ltd., Sydney  
Cherry Electrical Products (U.K.) Ltd., St. Albans, Herts • Cherry Mikroschalter GmbH, Bayreuth, Germany

Circle 69 on reader service card



Electronics abroad

## The show's the thing . . .

. . . as Europeans in healthy numbers eat and drink at a staggering round of exhibitions; the contacts, not the sales, are the point

by Arthur Erikson, Managing Editor, International

"The show must go on" is a sacred tradition among theatrical troupers. By and large, companies doing business in Western Europe adhere to the same credo, albeit seldom with the same conviction.

For electronics companies, putting on a performance at the plethora of shows, exhibitions, expositions, and salons now crowding the calendar means frustration and often hefty expenses. And when the final curtain comes down on a show, exhibitors are hard put to reply to questions about exactly what they've gained from their efforts. More often than not, the answer is that they've been able to make low-key sales pitches to customers over drinks in the back-of-stand bars that abound at European shows.

The round of major shows in Europe started earlier this month with the Salon International des Composants Electroniques. It started its six-day run in Paris just a few days after the doors closed at the kingpin U.S. show, the IEEE's Intercon. Then, the week after the components show, Paris was the scene of Mesucora, an instruments and controls exposition. Later this month, the action will

shift to West Germany for the Hanover fair. In late May there are components shows in London and Milan. Every other year there's the big late-fall Electronica in Munich. And month in and month out there are smaller, specialized shows all over, so much so that for Thomson-CSF, France's largest electronics firm, show time is almost every week throughout the year, whether for the company itself, for a subsidiary, or for a major distributor.

**Overkill.** Needless to say, most companies feel it's become too much. "It's inflation," says an executive of a major West German components producer. "In West Europe we need only one international show a year," says Tony Fletcher, administration manager of the Electron Tube division of EMI Electronics Ltd.

Even the Paris show's sponsors admit that the current round of components show is too much of what for them, anyway, is a good thing. But serious talks among the organizers of major shows in France, Britain, and Germany have yet to start. "It will be another three years at least before we can have

any sort of unified salon," predicts Guy Baumont, executive director of the French components-producers trade associations—Sipare/Sitelesc—that sponsor the Paris show.

There are all sorts of reasons. A major one is that considerable financial interests are at stake. The organizers' budget for this year's Paris show, financed mainly by fees for booths and catalog advertising, was a whopping \$1.8 million. Then there's national prestige, and for the French the fact that they were the first to run a truly international components salon. Another hitch in "Europeanization" turns up in the long-term contracts that some companies have with the Hanover fair.

Baumont thinks one possible solution could be a biannual European rotating salon to introduce new products, paired with annual national shows to refresh customer contacts.

**Rotation wanted.** A rotating European show, something machine-tool makers achieved years ago, would bring applause from nearly every big electronics company. At Siemens AG, West Germany's largest electronics/electrical producer, the preference would be a four-year cycle: Paris, Munich, London, and then Italy. Others would be satisfied, for starters, with better scheduling for the Paris and Munich shows; in alternate years they come only five months apart.

Until the show organizers get together, electronics companies seem condemned to spend a lot of money getting their wares and their sales engineers onto the stands. At the Paris show, most companies figure to spend about \$250 in direct costs for each 10 square feet of stand. The

**Show time.** Thomson-CSF alley at Salon International des Composants Electroniques.







**Jungle.** RTC stand at Paris components show is a kind of garden spot on the aisle.

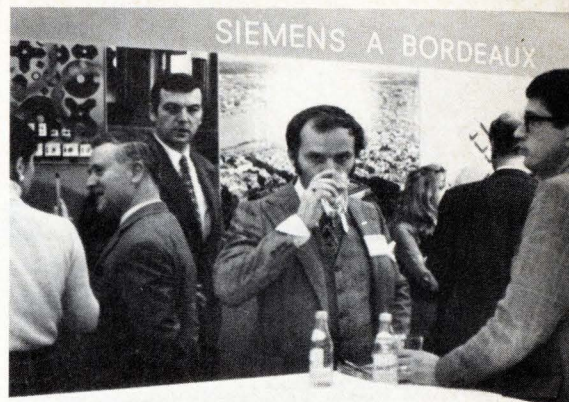

**Over the border.** West Germany's Siemens tells Paris about its new Bordeaux plant.

figure includes mainly stand rental, decoration, equipment costs, and food and drink. Stands range from 100 ft<sup>2</sup> on up to Thomson-CSF's 15,000 ft<sup>2</sup>. Thomson-CSF's tab, then, ran over \$300,000, not counting the time of salaried salesmen and executives. At Hanover this year Siemens expects to spend \$1 million, counting personnel costs.

In a recent survey of French industrial companies by the Association Française de Publicité Industrielle, about 50% of some 200 companies that responded indicated they spend between 10% and 30% of their "advertising" budgets for expositions.

**No sale.** For their show money, few companies get any immediate return, and practically none expect any. "We don't sell any more during the salon than we do during any comparable period during the year," maintains Jean la Chesnay, a market promotion executive at RTC-La Radiotechnique-Compelec, who is nonetheless a strong backer of the salon.

For Bernard de Charentenay, marketing manager of Thomson-CSF's Sescosem Semiconductor division, the show is mainly a chance for sales engineers to meet customers in a relaxed setting. Seated at a table in the indoor garden that flanked the bar in the back of Sescosem's booth this year, de Charentenay emphasized, "We don't sell here." Smaller firms feel the same way. "We're here for contacts," says François le Cain of Tranchant Electronique, a major importer-distributor. "We rarely get an order, but mainly all we get is more names for our mailing list."

French companies large and

small, then, turn up mainly to strengthen their bonds with customers. That's why some stands have more space for entertaining than for showing new products. Motorola Semiconductor carried the concept almost all the way. The company had a striking stand in pop colors and not one single new-product display in plain view.

Foreign companies, unless they're breaking into the European market, show up for much the same reason French companies do. "For a company that supplies to European companies, the show is essential," maintains Andrew Procassini, a product marketing manager for Fairchild Semiconductor. Says W.B. Miller, the marketing manager of Video-Color SpA, an Italian firm that's jointly owned by RCA and Thomson-CSF, "The show allows executives of our company to chat with practically all of our customers in a week's period. I personally have a chance to see people I never get to see in a normal sales situation." Alan Risley, assistant manager for international operations, explains Teledyne-Philbrick's presence: "We rarely get a purchase order, but we get good coverage, which pays off in sales later on."

**Technology gauge.** East European components outfits participate for somewhat different reasons. East Germany's VEB/RFT components combine comes to Paris to "compare its level of technology with that of the West as well as to make business contacts," says Gerhard Mathea, a VEB/RFT sales manager. Yugoslav's Iskra mounted its stand to introduce itself to new French customers.

A lot of companies, though, show

up only because they're afraid they'd be conspicuous by their absence. Michael Riley, sales promotion manager at RCA's European headquarters in London, wanted to pull out of the Paris show this year, but the company's marketing people insisted on taking a stand. Herbert Jesse, the commercial director at TRW Composants Electroniques SA feels the show is a waste of time. "But," he quickly adds, "you must attend because otherwise people you do business with wonder why you weren't there."

**Counting feet.** Mullard Ltd., a British unit in the Philips group, participates mainly for the benefit of British customers who come over for the show. "If they didn't put their feet up here," says Mullard stand manager Arthur Cookney, "they might put them up at ITT."

Some of the performers, then, are reluctant, but the Paris show—unlike the New York IEEE exhibition—goes onward and upward. This year, with instrument makers diverted into the Mesucora show, some 865 electronics companies took some 258,000 ft<sup>2</sup> booth space. That's 30 companies and 21,500 ft<sup>2</sup> more than the comparable figures for 1972. And the salon show still draws big crowds. The Société pour la Diffusion des Sciences et des Arts, a nonprofit company set up by the Fédération Nationale des Industries Electroniques to organize industry trade shows, reports it logged nearly 58,000 visitors this year, some 7,000 of them foreigners. The total is roughly a thousand more than it logged last year, not bad considering Mesucora siphoned off visitors this year. □



Consumer electronics

# How does an organ maker go LSI?

For Hammond, retreats in Wisconsin led to five-year plan, lessons from a consultant—and eight new models

by Larry Armstrong, Midwest bureau manager



Until the 1960s, Hammond Organ Co. virtually owned the consumer organ market because of its 1935 development of the electromechanical tone-wheel generator. Then, taking a hard look at static and decreasing market shares, the Chicago-based pioneer realized it had to change technologies or lose its leadership position.

It wasn't easy to ditch 35 years of mechanical technology, experience, and patents, and start from scratch, but that's what Hammond did via electronics. Although it still sold as many organs as its two closest competitors combined, increasing cost pressures—labor, materials, service, size, and features—forced the leader to seriously weigh the high initial cost of getting into the electronics business against the high eventual cost of staying in the mechanical business. And Hammond's confidence and competence were showing as it managed to become the first consumer organ manufacturer to switch entirely to custom MOS LSI circuitry.

In 1967, top management and planning people from Hammond retreated to a Wisconsin resort to outline a five-year plan to improve competitiveness, increase market share, and insure long-range growth. Out of that meeting came specific goals. After six weeks of study, the individual task forces met again in Wisconsin, and decided MOS LSI was the only way to go.

Hammond's five-year plan culminated last summer with the introduction of the under-\$6,000 Con-

corde model, quickly followed by seven more LSI organs—a big step for a firm that's been averaging two or three new products annually. "We originally planned to start incorporating electronics at the low end, because the Hammond has never been known as a low-priced organ," says James C. McLin, product and musical development manager. "Instead, we elected to hit the top end head-on to show what we could do." The Concorde, using 47 MOS LSI chips from Mostek and American Micro-systems Inc., flaunts more features than the firm's \$10,000 organ introduced in 1965.

And February's announcement of the under-\$700 Dolphin series proves that the electronic technology is as economically feasible at the bottom of the Hammond product line as at the top.

**Learning LSI.** But first, Hammond faced a massive job of educating its personnel. "Arthur D. Little Inc. was brought in to teach LSI and adapting to LSI," says Harwood B. Moore, Hammond's engineering vice president. "And we realized that there must be a marriage between the manufacturer and the MOS house." Initial exploratory work and some original chip development was done at General Instrument, General Electric, and Philco-Ford, but Hammond decided it had made a false start. It changed its approach in 1969, and from a field that included GE, GI, Motorola, and Texas Instruments, chose AMI and Mostek.

The Hammond MOS LSI circuits "generate from the master oscillator all of the frequencies for each note by division," Moore explains. "They also sense whether the key is up or

**Music box.** This is what's under the hood of Hammond organ. Harwood B. Moore, engineering vice president, checks it out.





## For the really tough applications, OEM's like VIDAR choose HP.

How do you record millions of telephone calls daily, process this data, and bill millions of customers monthly — without any errors? The VITEL division of VIDAR tackled this problem and solved it with their unique new telephone message metering system.

To record the raw data, VIDAR needed a magnetic tape drive with proven reliability at a competitive price. That's why VIDAR chose HP's 7970E Tape Drive. They needed the best of both worlds and knew that HP quality was the result of 33 years of experience in engineering and mass production techniques that lower costs and improve reliability.

The VITEL system records "one-shot" data at a telephone company central office to provide accurate usage

information. For instance, one system in a major metropolitan area handles 3.6 million telephones in over 100 offices. The system replaces mechanical message registers to bring a new level of accuracy to customer billing procedures.

But OEM's like VITEL want — and need — more than rugged construction, reliable performance, and competitive pricing.

They want a broad range of data rates. Like 200,556,800 cpi NRZI, or 1600 cpi phase-encoded recording that's ANSI/IBM compatible. And flexibility, like 7 and 9 track, multi-density, NRZI and PE; all in one read-only tape drive.

Plus OEM Specials. Like 50-Hz 230-volt operation. Or personalized labels or logos. Even different paint on

the front panel. And how about OEM discounts, and a one-page OEM agreement written in plain English.

For the full story call your local HP sales engineer or write: Hewlett-Packard, 1501 Page Mill Road, Palo Alto, California 94304; Europe: P. O. Box 85, CH-1217 Meyrin 2, Geneva, Switzerland; Japan: Yokogawa — Hewlett-Packard, 1-59-1, Yoyogi, Shibuya-ku, Tokyo, 151.

HEWLETT  PACKARD

22231

Circle 73 on reader service card

HP sales, service and support in 172 cities in 65 countries



# Dialight sees a need:

(**Need:** Single source supply for all indicator lights.)

## See Dialight.

Dialight has so many kinds of indicator lights—approximately 1,500,000 on our shelves—that we have set up a special magic eye seek-out system to help you find the one you need in a wink. Whether it's a flasher, placard, press to test, oil tight, water tight, dust tight, dimmer, or nondimmer, we have them all, some with incandescent, neon or LED lamps, from 1.35 to 220 volts. Sizes vary from small indicators (mount in 0.120" clearance holes) to large indicators (mount in 1 3/8" clearance



holes), and are available in a variety of terminations and finishes, lens-cap shapes and colors with or without hot-stamped, engraved or film legends. We've developed a 14-digit code number that tells any of our 120 stocking distributors in the U.S. and Canada just what indicator you want for off-the-shelf prompt delivery. If you would like to see for yourself how our code works, just write for your free copy. At Dialight it's a designer's choice because we see your need.





Dialight is a company that looks for needs . . . and develops solutions. That's how we developed the industry's broadest line of indicator lights, readouts, and LED light sources. No other company offers you one-stop shopping in visual displays. And no one has more experience in the visual display field. Dialight can help you do more with indicator lights than anyone else because we have done more with them. Talk to the specialists at Dialight first. You won't have to talk to anyone else.

And also be sure to send for your free copy of our latest 56-page Indicator Light Selector Guide. It will show you how easy it is to quickly find your way to the indicator light you need. This handy guide describes in detail the many indicator light choices—shapes and colors of their lens caps, available terminations, mounting data, available finishes, and LED, incandescent and neon light sources for which they are compatible.

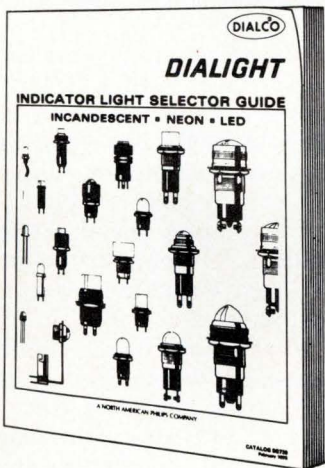

Please send me INDICATOR LIGHT SELECTOR GUIDE.

NAME \_\_\_\_\_  
 TITLE \_\_\_\_\_  
 COMPANY \_\_\_\_\_  
 ADDRESS \_\_\_\_\_  
 CITY \_\_\_\_\_ STATE \_\_\_\_\_

**DIALIGHT**

Dialight Corporation, A North American Philips Company  
 60 Stewart Avenue, Brooklyn, N.Y. 11237 (212) 497-7600

Circle 75 on reader service card

## Probing the news

down, do dc control work for turning harmonics on and off, and mix the harmonics and regulate their amplitudes." Those functions require 27 chips on the top-of-the-line Concorde; an additional 20 chips generate complex waveforms for more dramatic percussive sounds, like piano, banjo, and harpsichord.

**Never before.** "Circuits like the ones Hammond asked for had never been successfully manufactured in MOS," comments Gordon Hoffman, director of marketing at Mostek, "let alone for cost-sensitive consumer electronics." Hammond had studied a digital scan approach similar to that used by Allen Organ Co. for its more expensive institutional organs [*Electronics*, May 24, 1971, p. 79], but decided to translate its musical needs into electrical specifications calling for linear and digital integration.

Each chip type uses up to 34 matched resistor networks coupled with a four-bit counter to achieve a 16-step staircase waveform. Restrictions are placed on resistor tolerance so that chip-to-chip variations do not require individual adjustments for each chip in the final organ, and because accuracy of the resultant waveform determines spurious harmonic content.

Hammond's production is currently running about 70% electronic and 30% mechanical—it is still manufacturing every mechanical organ introduced in the past three years. Cost for the LSI organ and its mechanical predecessor are running about the same, estimates John L. Lavey, manufacturing vice president. "But we recognize over the

long term what's happened to labor availability and costs," he says. Capital costs, however, are tremendous: "Over five years, we could easily spend \$10 million, and that's probably a conservative estimate," he adds.

"The change in technology has not been as important a factor in manufacturing as component availability and quality," Lavey notes. "The inability of components manufacturers to supply parts on time has interrupted our flow," he explains, "and we were getting a quality problem from the diode vendors. For example, the legends were backwards on a whole roll of diodes, and it screwed up every board on the floor for weeks. Now we catch almost every bad diode, and it's improved our yields tremendously," Lavey points out.

**Strict inspection.** Quality, however, has been within contractual limits, points out Jack Buick, manager of quality assurance, but even a 1% failure rate presents problems in the volumes Hammond uses—a million diodes a month and up to 10 million transistors per year. "At one point, a less than 1% failure rate in transistors was causing 70% organ fallout at final inspection," he explains. So Hammond has set up sophisticated inspection equipment, unusual for a traditionally non-electronic manufacturer. The firm has gone to 100% incoming inspection on diodes, transistors, and resistors, and will add equipment to automatically check capacitors and ICs later this year. Incoming inspection costs a fraction of a cent per transistor, "but it costs about \$3.50 to find a bad one at the subassembly level, and about \$5 or \$6 in the final organ," Buick adds. □

**The new and the old.** John L. Lavey, manufacturing vice president, holds Hammond's new LSI tone generator. Old electro-mechanical model is atop the desk beside him.

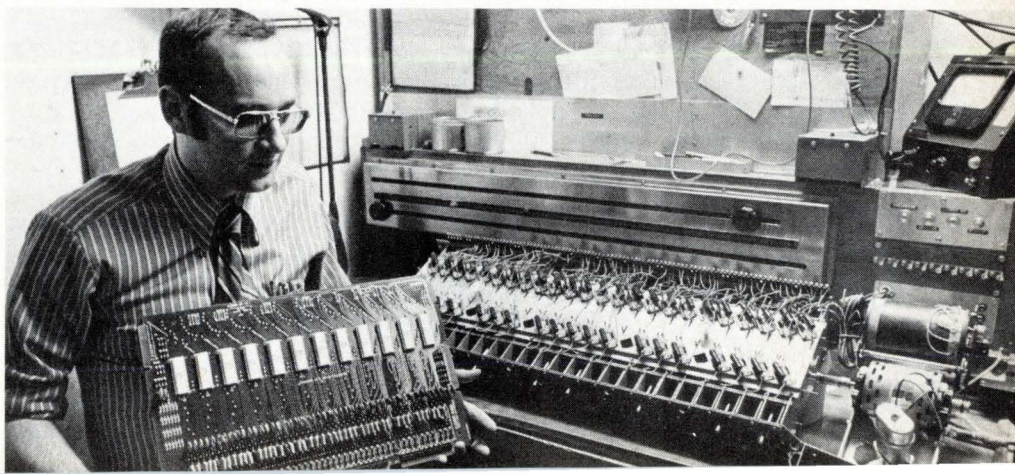



Semiconductors

## Beam leads gaining

Manufacturers are optimistic about commercial chances as they fill the gaps in their product lines

by Paul Franson, Los Angeles bureau manager

**Is the beam-lead** semiconductor about to go civilian in a big way? Fallouts from high-reliability military programs, the parts are inching their way into more commercial products. But even though users of hybrids would like to switch to beam leads—costs are lower, they use less space, and they save fabrication time—the devices are unlikely to find immediate broad commercial application.

The obstacle is one that could vanish gradually: not all the common chips are available in the beam-lead catalog. Since this would often force hybrid designers to mix beam-lead and venerable chip-and-wire, an unattractive prospect, the older technology usually wins out. And while makers of beam leads say they're filling in those gaps in the catalog, they've been having a difficult time with the more complex chips containing many inputs and outputs, and beam-lead devices can't be used above 1 watt.

**Business growing.** Nevertheless, two of the three U.S. producers of beam-lead semiconductors report growing commercial business as they add available parts. At one of them, Raytheon Semiconductor, Mountain View, Calif., marketing director Gene Selven reports that his firm will ship \$4 million in beam-lead devices this year, compared to \$100,000 last year. He puts the total U.S. market at \$8 million this year. Though the Raytheon business will be mostly military, with sister division Raytheon Missiles and Space taking a big chunk for the SAM-D programs, Selven also reports sales to Singer's Kearfott division, Bendix in Kansas City, and Medtronic, maker of heart pacers.

**On the beam.** Motorola beam-lead IC is shown at right, while wobble-bonding process at Raytheon is shown below. Some 90% of devices are wobble-bonded.

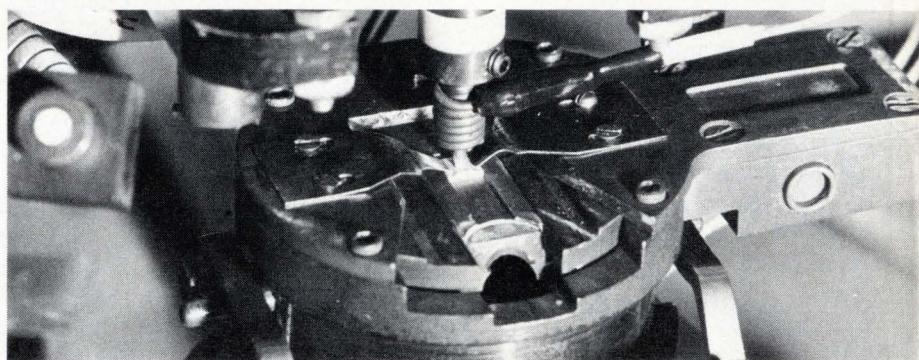

And the division recently received a substantial second-source contract from a watch maker.

Expectations are similar in Phoenix, Ariz., where Motorola Semiconductor Products division also reports growing commercial sales. According to Paul V. White, manager of high-reliability market, the telephone industry is especially interested since phone equipment is expected to last at least 20 years. White says sales of Motorola's package beam-lead crosspoint switch are growing rapidly, and he sees other applications in other telecommunications, portable communications equipment, and medical electronics—the same as the markets Raytheon is eyeing. Motorola recently received a 300,000-piece commercial add-on order.

As for the other U.S. supplier, Texas Instruments is sticking to the Government market at present.

**Origins.** The classic beam-lead process, developed by Bell Labs in 1962 and reaching its highest promise in the Safeguard missile pro-

gram, involved mounting semiconductor chips face down with small flat beams or tabs that also provided the electrical connections to the chip. Its biggest feature for military applications is its high reliability, a result of a complex metal system and nitride passivation that eliminates the need for hermetic sealing and substitutes thick metal beams for fragile wire bonds. The beams, being attached to the chip, also eliminate half the bonds required.

This last feature also is the main appeal for many commercial hybrid-IC users. Not only does it reduce the number of bonds, the greatest source of failures, but it also permits die- and wire-bonding in one step instead of generally required die-bonding, followed by two wire bonds for each lead.

Motorola's White attributes lack of commercial success to inertia, fixation on materials cost, and, especially, product availability. Motorola offers 12 linear parts and 21 TTL products in the 54/74 series, and is introducing 20 diode and transis-



**This problem should take you  
about 42 minutes to solve.**

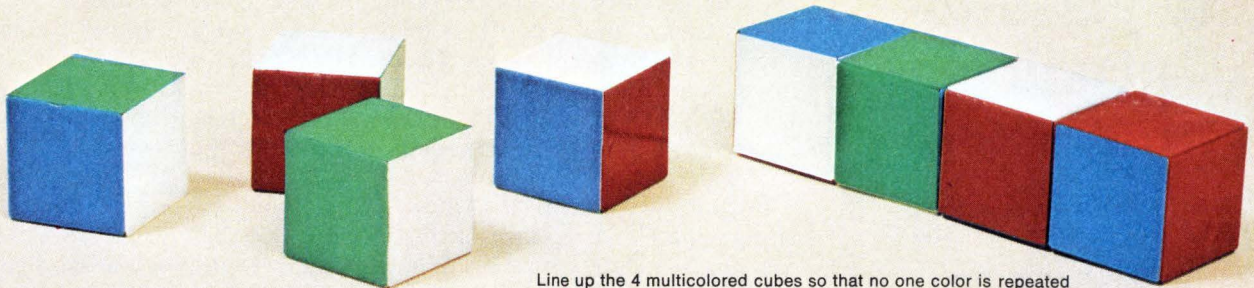

Line up the 4 multicolored cubes so that no one color is repeated on any side.† As an engineer you should do this in 42 minutes.\*

**With P&B's four new time delay relays  
you solve cost, accuracy and size problems.  
Immediately.**

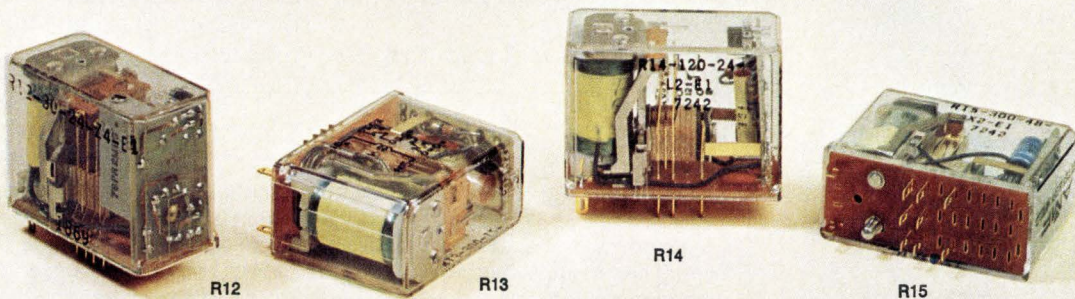

These new solid state time delays—each designed to solve different design problems—are built around our compact, widely accepted R10 relay. Each is available in 2 or 4 Form C contact arrangements and may be mounted directly to a chassis, printed circuit board, special mounting strip or in sockets having solder or printed circuit terminals.

**R12 Series.** A high resolution, 15-turn potentiometer provides delay on operate timing variations within ranges of 0.1 to 2.0, 1.0 to 30 and 5.0 to 120 seconds. Coils are for 12, 24 or 48V DC. Six contact styles cover a load range from dry circuit to 10 amperes.

**R13 Series.** These fixed, delay on operate time delays are available in 10 timing ranges from 1 to 300 seconds. They require less than 240 milliwatts of DC to operate. Operating voltages are 12, 24 and 48V DC. Contact ratings: dry circuit to 5 amperes.

**R14 Series.** Seven timing ranges provide delay on operate (R14) or interval timing (R14A) from .025 to 600 seconds. Available fixed or externally adjustable with coil voltages of 6, 12, 24 and 48V DC. Contacts may be specified from dry circuit to 10 amperes.

**R15 Series.** AC operated from 12, 24, 48 and 115V power sources,

these compact time delays may be ordered fixed or externally adjustable in seven timing ranges from .025 to 300 seconds. Delay on operate (R15) or interval timer (R15A) modes are available.

Get complete specifications from your local P&B representative or call Potter & Brumfield Division AMF Incorporated, Princeton, Indiana 47670. 812-385-5251.

*\*Think you can readily solve the puzzle shown above? Ask your P&B representative for one.*

**Solving switching problems is what we're all about.**





# For bonding metal- to-metal- to-glass- to-glass-to- plastics- to-plastics- to-rubber-to- rubber-to- metal-to-etc- to-etc.

One drop goes a long way in fastening almost anything to almost anything.

Eastman 910<sup>®</sup> adhesive bonds fast, too. Almost instantaneously. With only contact pressure.

Tensile strength? Up to 5000 psi at room temperature.

New Eastman 910 MHT and THT/Grades hold when the heat's on. Even over 400° F.

For further data and technical literature, write: Eastman Chemical Products, Inc., Kingsport, Tennessee 37662.



## Probing the news

tor chips. Raytheon, which alone offers commercial devices at about 65% of military prices, has about 70 parts: 15 transistors, three field-effect transistors, eight diodes including zeners, 13 linears, and 28 TTL in SUHL (Ray I and Ray II), not as popular as the 54/74 series. Texas Instruments offers low-power 54L TTL, low-power Schottky 54Ls, some standard 54 TTL, some transistors, and one linear circuit.

In spite of the relatively wide offering, there's not much second-sourcing and standardization. White says that Motorola and TI work closely in exchanging data, and Raytheon also says it is working with an EIA committee. But White admits, "there's no real interchangeability." The EIA specs give standard chip sizes for a number of beams, but not much more yet. And TI and Motorola use the Bell Labs process while Raytheon uses its own technique.

One area of beam leads that has

been drawing much interest is the large gate array that permits fast turnaround and relatively economical custom LSI. Raytheon is making a 60-gate "universal slice" for SAM-D, with 120 combinations possible by changing metalization. Robert Goedjen of Raytheon says the part is also being evaluated for other military programs, and possibly for commercial use. He says the array can reduce costs by replacing 10 to 20 individual chips. Motorola also has an 86-gate array for military use."

In addition to the large arrays, Motorola has made sample beam-lead versions of C-MOS parts. The low power consumption of C-MOS is ideal for beam-lead devices which have limited power dissipation—most heat must be conducted through the relatively small beams. At the other extreme, the company is working on power-transistor chips for beam-lead construction. Here, due to the power-handling problem, chips are die-bonded face up, and the beams provide only electrical connections. □

## Beams on the substrate, not the chip

In beam leading, the beam is normally attached to the semiconductor chip and bonded to the substrate. But the reverse is also possible—bonding the chips to beams already on the substrate. In that case, they are called inverse beam leads. Motorola Semiconductor attempted to make an 8,192-bit memory module this way a few years ago, and it's not clear whether its failure was due to the interconnection scheme, problems with the MOS memory chips, or, as the firm claimed, lack of a market.

More recently, Northrop Electronics has developed a related technique called BLIP (for beam-lead interconnect packaging) for some military programs such as Task-Oriented Processing Systems [*Electronics*, April 12, p. 44] and for classified equipment. The company is also investigating commercial applications and licensing, particularly for uses where conventional packaging is inadequate, as in watches and cameras.

The biggest appeal to Northrop, however, is that the process gives the advantages of the beam-lead technique without the need for the special beam-lead devices. Virtually any semiconductor chip can be used.

Northrop's BLIP is a laminate containing an alumina substrate, a thin photo-etched plate with holes for chips, and then one or more thin, double-sided "circuit boards," the top one supporting an etched metal pattern incorporating beams that are bonded to the chip. Very-high-density packaging is possible, and the system lends itself to multilayer interconnections, as well as the incorporation of thin- and thick-film resistors and capacitors. Further, the fact that the chips, too, are bonded to the substrate improves heat dissipation over conventional beam leads.

So far, Northrop has used ultrasonic bonding rather than mass bonding such as the wobble bonding used for beam-lead chips, but this still halves the number of wire bonds normally required. The company has been using gold beams—the complex metal system needed for conventional beam-lead semiconductors isn't required—but is also working with other metals, notably aluminum, which is well known for superior performance in radioactive fields.



# Basic switches that help do everything from print a baby's picture to play a top tune.

Think MICRO SWITCH when you're in the market for precision, snap-action switches.

Because we offer the largest selection in the world. With most of them available right off your distributor's shelf.

MICRO SWITCH basics are extensively used on applications ranging from coin-operated phonographs (V3) to automatic film splicers (BZ). In other words, just about any application that demands

dependability and stable operating characteristics.



These features are designed into our complete line.

From our standard-size BZ to our sub-miniature 1SX. So no matter how demanding

or unique your application is, you can be confident we have the right switch for the job.

Engineers have put this design freedom to use in some unusual places. For example, the next time you're in an eye doctor's chair, there's a good chance a BA switch will be helping to make you comfortable.

To help with your applications, we have a staff of Application Engineers standing by to provide field support.

Contact your MICRO SWITCH Branch Office or Authorized Distributor (Yellow Pages, "Switches, Electric") for more information.

For additional assistance in solving your basic switch application problems, we've written a 145-page book, *APPLYING PRECISION SWITCHES*. Write us on your letterhead and we'll send you a copy.



MICRO SWITCH makes your ideas work.

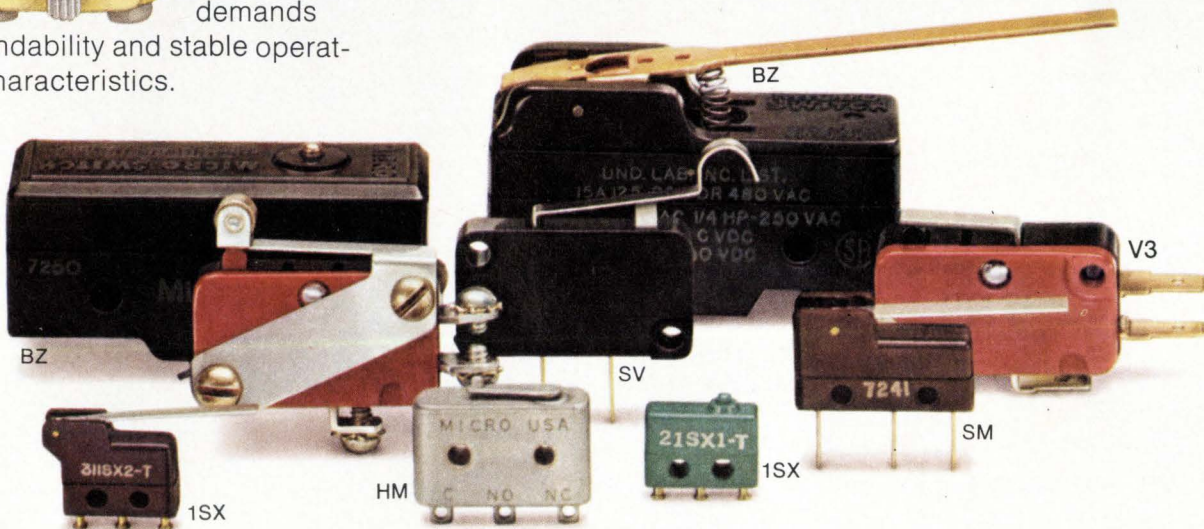

**MICRO SWITCH**  
FREEPORT ILLINOIS 61032  
A DIVISION OF HONEYWELL

MICRO SWITCH products are available worldwide through Honeywell International.



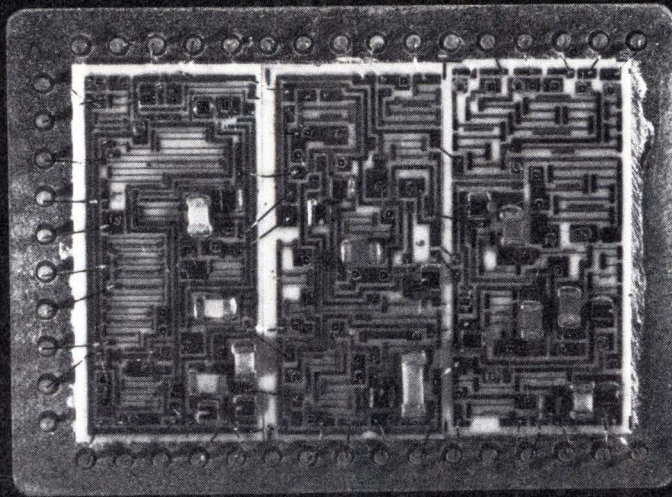

1. Is this circuit a thick film or thin film hybrid?  
 Thick     Thin

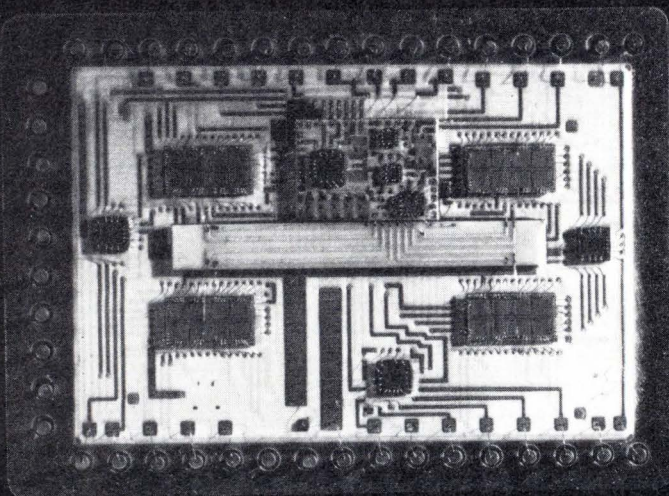

2. Is this hybrid's package designed for a hermetic seal?  
 Yes     No

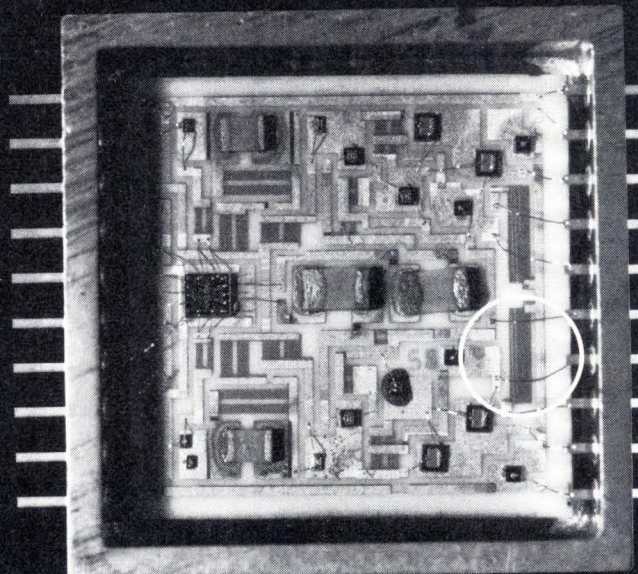

3. Has this resistor been abrasive or laser trimmed?  
 Abrasive     Laser

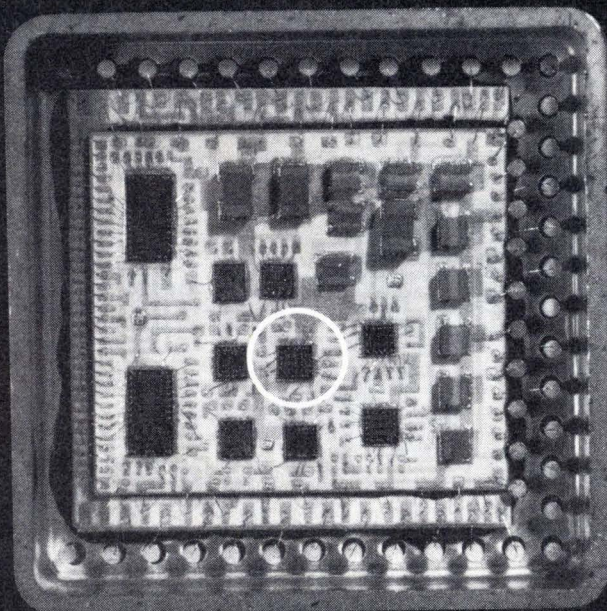

4. Is this semiconductor chip an integrated circuit or transistor chip?  
 IC     Transistor

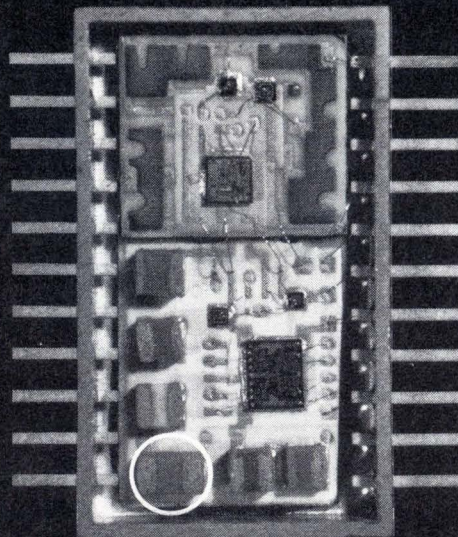

5. Is this passive chip a resistor or capacitor?  
 Resistor     Capacitor



# Test your Hybrid IQ:

Eight out of ten people in this business can't get 100% on the Boeing Electronics Hybrid IQ test. That's not surprising. It's a highly technical, complicated science.

If you wound up with five right answers, we'd like to give you special recognition. It's a Hybrid Genius identification card, made of metal and stamped with your name.

But you have to be absolutely honest with us. Did you, or did you not, get all five correct, without peeking? Even though you missed one or two, there's still another chance. Just ask for the Second Chance Hybrid IQ test.

This little examination is our way of letting you know Boeing knows quite a lot about hybrid microcircuits. Each of the circuits shown in the

test was produced by Boeing for very specialized product requirements.

Boeing is especially adept in supplying the right technical support to the equipment designer. Our engineers know how to design with your unique specifications in mind, and how to keep the price in line. But just as important, they know the importance of keeping your job on schedule. In other words, you'll never get lost in the shuffle at Boeing Electronics. We'd like to tell you more about our abilities.

## The right answers:

1. **Thin Film.** This is a digital logic circuit being used in a military guidance and control system.
2. **Yes.** This is a 4096 bit random access memory circuit for a digital computer.
3. **Laser.** This hybrid dual current switch circuit handles .4 amps per switch in an airborne computer.
4. **IC.** This 16-channel multiplexer hybrid is used in an aircraft on-board maintenance and test system.
5. **Capacitor.** This circuit is an accelerometer restoring amplifier used with a gyro in a guidance and control system.



P. O. Box 24666  
Seattle, Washington 98124





# THE SCOPE MEETS THE BLUE BOX

If you now use a scope for spectrum display, you should consider the advantages of our blue box — the EPC Model 4600 Graphic Recorder.

The EPC Model 4600 is an XYZ recorder that prints continuous hard copy on dry paper over a display of 19.2 inches. This permanent history-plot permits comparative data examination and, in spectrum analysis, reveals spectrum lines buried as much as 6 DB below the noise level.

The model 4600 operates at sweep speeds between  $\frac{1}{8}$  second and 8 seconds per scan, and is completely tape compatible. Sweep speeds can be varied to match the dump speeds of the analyzer data discharge. Up to 3000 data points can be presented with each sweep.

Scale lines are generated by an internal crystal. The digital drive mechanism for the scan system is virtually jitter free.

<b>SWEEP RATES</b>	0.125, 0.25, 0.50, 1.0, 2.0, 4.0 sweeps per second; plus variable.
<b>SINGLE SWEEP</b>	Available at rates of 1.0 seconds per sweep or greater.
<b>SCALE LINES</b>	10, 100 or 1000 millisecond intervals.
<b>SWEEP DIRECTION</b>	Left-to-right (right to left can be supplied).
<b>PRINT DELAY</b>	Gate or print from 1 to 4 sweeps.
<b>EVENT MARK</b>	Manual — Internal and remote in or out.
<b>PAPER TYPE</b>	Dry electrosensitive (NKD), 19 $\frac{3}{4}$ " wide by 80' roll length.
<b>RECORDING WIDTH</b>	19.2 inches.
<b>PAPER DYNAMIC RANGE</b>	23db from white to black.
<b>PAPER ADVANCE</b>	Variable 50 to 200 lines per inch. Rapid advance provided.
<b>INPUT IMPEDANCE</b>	10k ohms; all inputs.
<b>AMPLIFIER GAIN</b>	Linear 0-1000.
<b>FREQUENCY RESPONSE</b>	Flat $\pm 1$ db from DC to 100KHz; $E \geq 0.1v$ .
<b>CONTRAST</b>	Print current limiter, adjustable by front panel control.
<b>INPUT THRESHOLD</b>	Adjustable by front panel control.

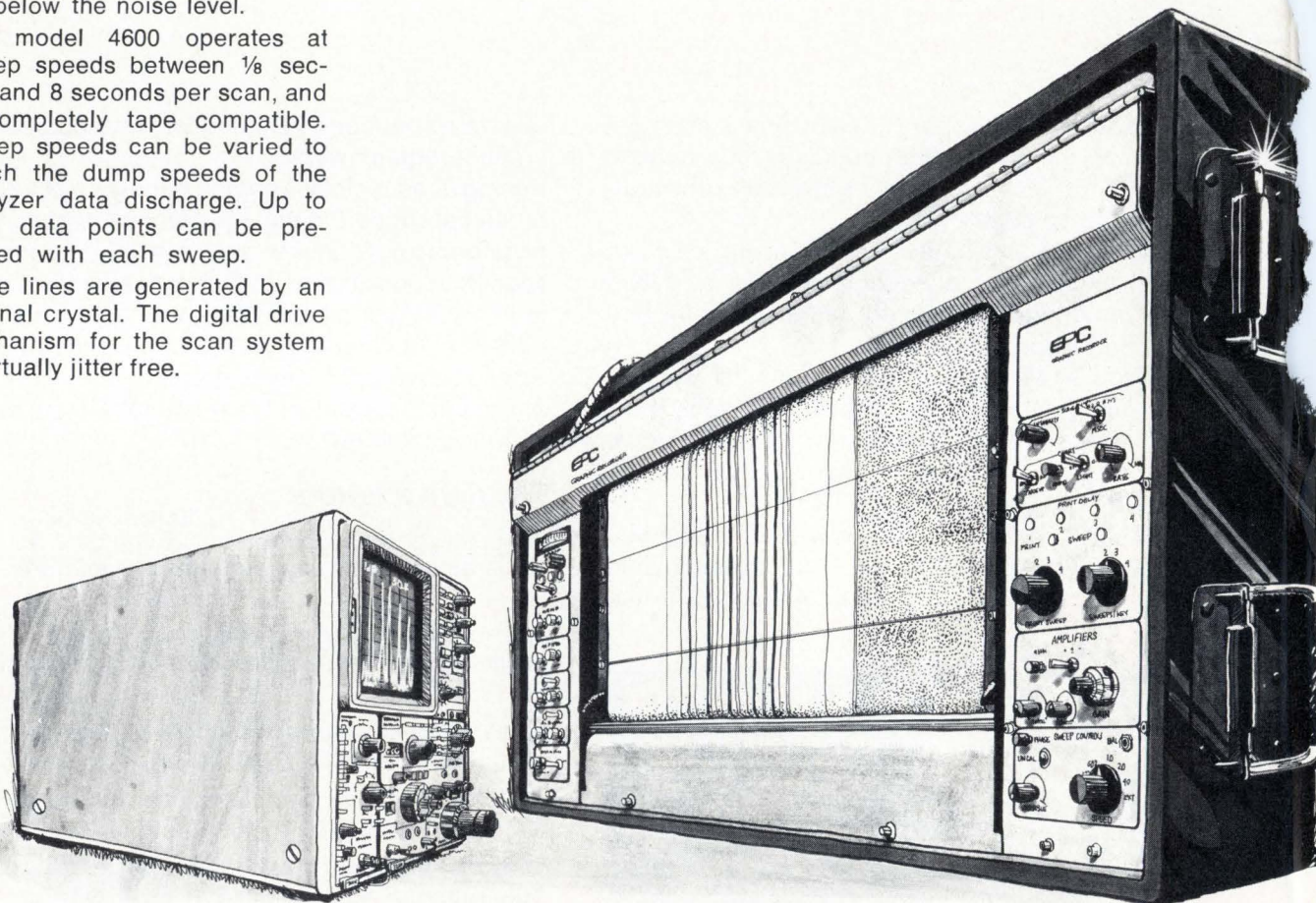

Please write  
for  
complete  
specifications.

# EPC

EPC LABS INC.  
P.O. Box 97  
123 Brimbal Avenue  
Beverly, Mass. 01915  
(617) 927-2523



# Discrete semiconductor devices proliferate and prosper

Field-effect transistors are big movers, and so are power devices, which have new markets in automobiles and television; but even old established components are selling well in this unexpected boom year

by Laurence Altman, *Senior Editor*

□ Once again discrete semiconductor devices are blooming, and this season especially they are refusing to yield their place in the sun to integrated circuits. Indeed, whole new areas of application are opening up for power devices, and field-effect transistors face a glorious future. Just now, however, thanks to the boom, just about every variety of transistor or diode is flourishing.

Total U.S. factory sales for discrete semiconductors (excluding optoelectronic devices) reached the \$675 million mark in 1972, an 11% increase over 1971's activity and the equal of IC sales. More significantly, over three billion discrete components were consumed in U.S.-manufactured equipment last year, with an estimated increase of 500,000 units to be used in 1973.

Feeding this vigorous growth is a continually expanding technology:

■ Discrete field-effect transistors with micrometer dimensions can now operate in amplifier and tuner front ends with ultra-low noise and ultra-high gains, boosting the sensitivity, reducing the size, and lowering the cost of television and radio chassis.

■ Microwave FETs made with gallium arsenide are now available with a maximum frequency of oscillation as high as 20 gigahertz for millimeter-wave communications links.

■ Junction-FETs can now be built with input-bias current requirements in the picoampere range for high-performance analog-to-digital conversion.

■ Double-diffused metal-oxide-semiconductor FETs are being used in the input structures of vertical amplifiers in top-of-the-line oscilloscopes because they keep intermodulation distortion lower than any IC device (new D-MOS products can operate up to 1 GHz with gains of 10 decibels and noise of 5 dB at power levels of 300 milliwatts, and soon D-MOS transistors will operate at the gigahertz level with 1-watt outputs).

■ High-voltage silicon transistors capable of supplying 700 to 2,200 volts to the tube of a TV chassis are now routinely available, sounding the death knell to the last vacuum-tube holdout in today's sets.

■ Power Darlingtontons capable of handling 100 watts are now driving heavy-duty motors in any number of industrial applications.

■ Ion-implanted power transistors with improved heat-

sinking packages can now routinely supply 600 w of continuous-wave power.

■ Ion implantation is revolutionizing the tuning diode as well, allowing a single device to be tuned over the entire TV band with low voltage and high stability, and promises to open up a whole new field of electronic tuning in the United States.

■ Multiple discrete transistors and diodes (duals and quads) matched to a particular parameter are taking over many of the computer-switching and memory-driving functions formerly handled by individual discretes, as well as finding their way into industrial process-control systems.

Even the established discrete components are experiencing a renaissance. Equipment makers, at great cost, have found that the IC promise of lowering costs and increasing reliability is not yet a reality, and many have decided to stay with the discrete devices they have learned to trust, at least for the short term.

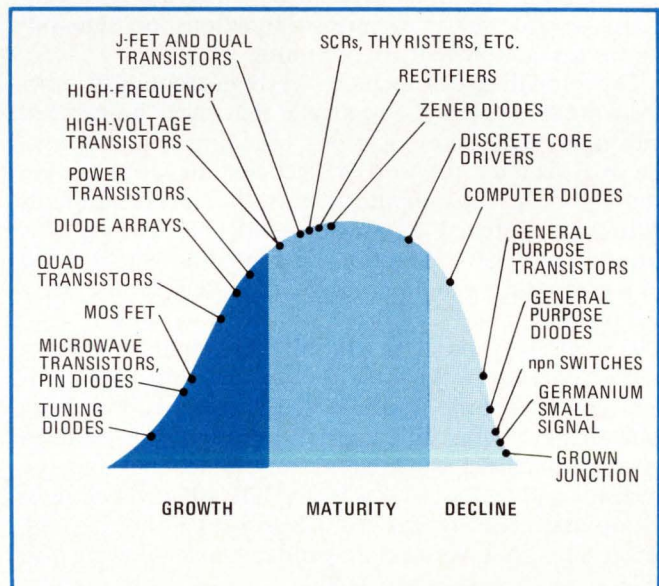

**1. Life cycles.** Like biological species, electronic products flourish and become extinct. Dying out are small-signal discrete components whose functions have been taken over by ICs. On the increase are high-performance FETs, tuning diodes, power devices, and arrays.



This preference is particularly evident among the high-volume manufacturers of TV sets, calculators, and automobile electronics. TV makers, for instance, have at their disposal as many as six ICs that can do almost the entire job for a TV chassis, yet TV sets are loaded with discrete semiconductors, from input FETs in the tuner and preamp front ends, small-signal and power transistors in the sound channel, high-voltage and medium-power small-signal transistors in the i-f, uhf, and vhf stages, and high-power discrete drivers in the deflection and color circuits.

Other equipment combines ICs with a heavy endowment of discretes. Hand-held calculators often contain as many as eight high-current drivers to power the displays, plus four small-signal sensing transistors, and that's a surprising number of discretes to find alongside a single IC chip containing the calculator's entire memory and logic functions. Similarly, one seat-belt interlock design scheduled for 1974 automobiles has a single complementary-MOS logic and control chip surrounded by 14 individual transistors and diodes to supply the functions of biasing, zener regulation, and current sources.

### Tradeoffs

The question is: when should the designer use the discrete component and suffer an increase of package count, wire costs, and space requirements, and when should he go to an IC? Although the ground keeps shifting as ICs improve, the basic rule is: when a demanding parameter must be met, use a discrete (or in some cases a hybrid, but that's another story). Picoampere leakage input currents, low intermodulation distortion, low input noise, high output powers, high oscillation frequency, tight voltage regulation, and high-current switching can generally best be obtained with a discrete device.

Figure 1, which shows the product life cycle of discrete components, illustrates clearly which are on the increase because they can perform functions too demanding for ICs—and which are declining.

The growth areas include the high-frequency, low-noise MOSFETs, the diode arrays that meet high-speed and high-current core-memory switching requirements, the high-voltage i-f and deflection-tube circuits, the J-FETs and their low input currents, the duals and quads with their matched parameters and space-saving features, all the power functions of 5 W and over, and the high-frequency and microwave functions of the FETs and p-i-n diodes.

The middle ground, or mature area, includes the rectifiers, zeners, and the 1- to 5-W silicon-controlled rectifiers and thyristors. Many of these intermediate-grade functions are being integrated onto the IC chip—witness the high-powered Darlington pairs (2 to 5 A) and the thyristor and SCR equivalents that lately have been integrated into linear IC designs. Clearly it will not be long before this group of mature products now peaking will slide down the curve into decline.

Actually on the decline, according to the chart, are all the low-current, low-gain, low-power electronic functions—computer diodes, general-purpose transistors and diodes, npn switches, grown junctions—which are out-



**Power's big and getting bigger.** The heaviest new demand for discrete semiconductors is in power. Above, this germanium power transistor from Motorola is capable of 600-V operation. Automobile ignition is big consumer of power devices; the car ignition system built by Ford has an RCA device capable of 6-A, 40-V service.

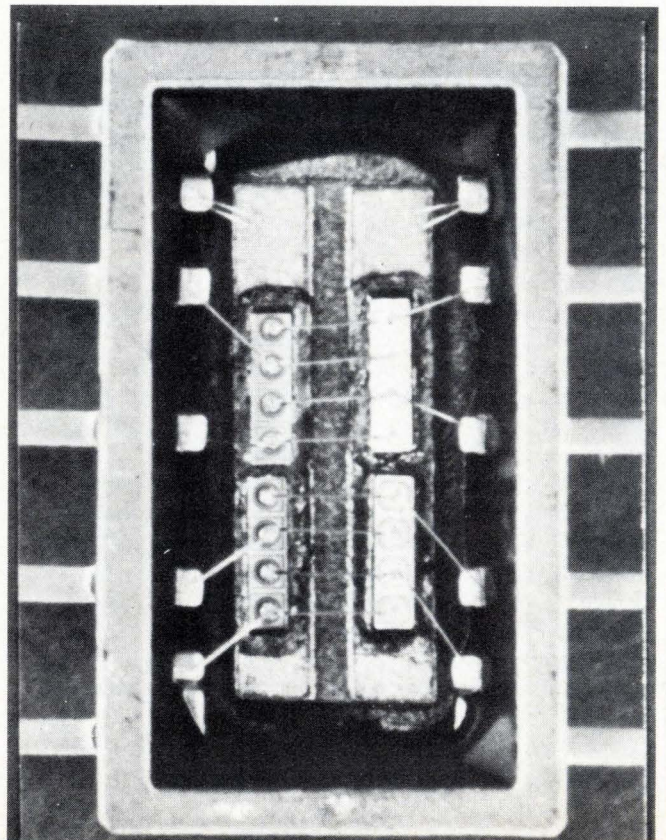
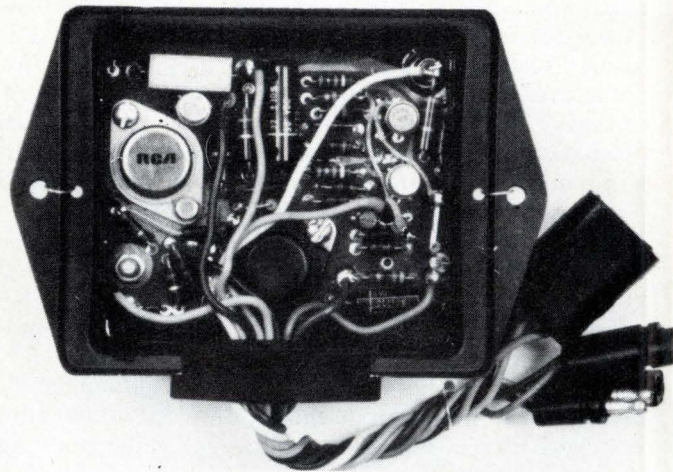



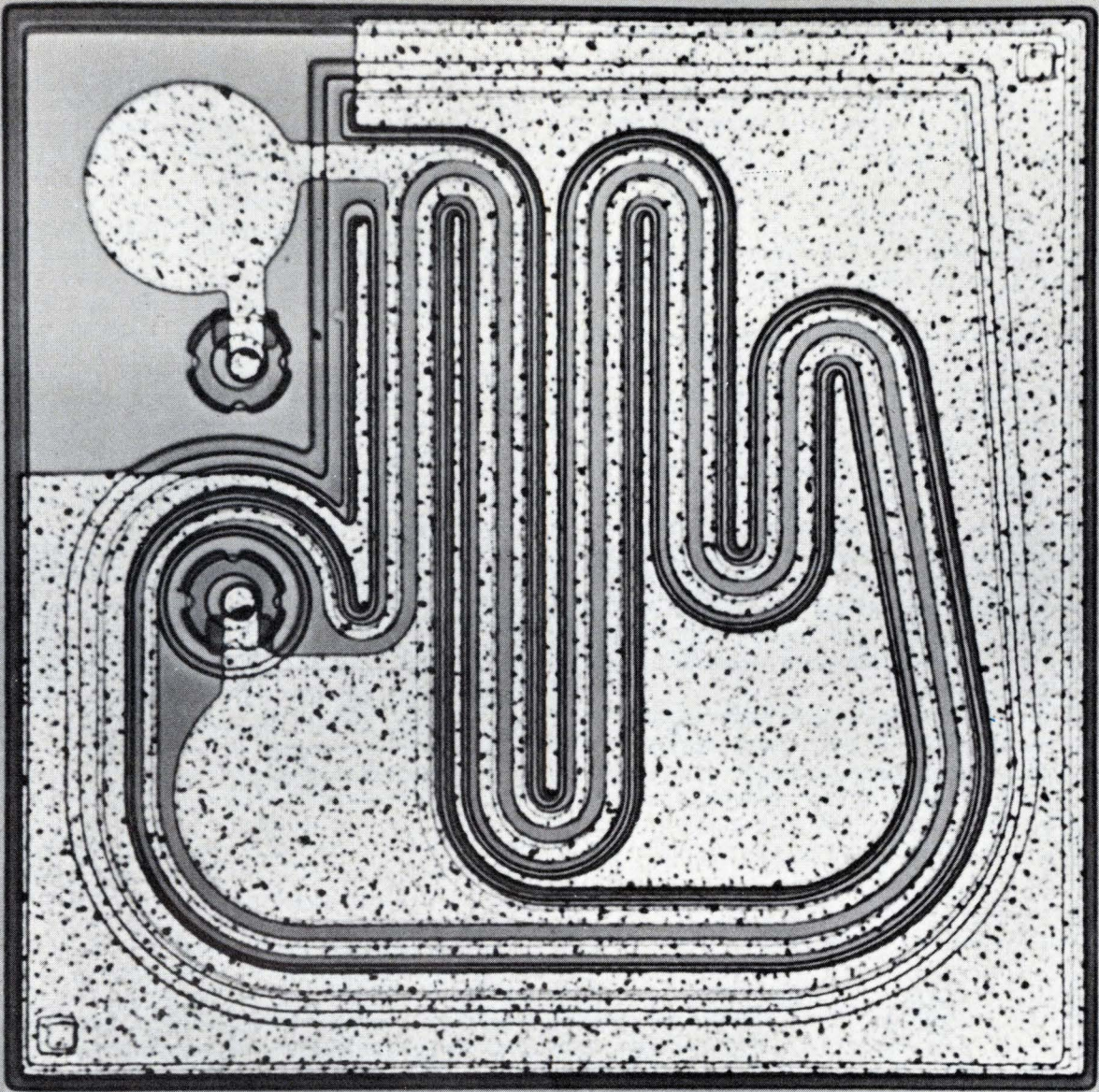

**Growth.** Outside the power area, field-effect transistors and multiple devices are hot items and growing hotter. Above is a dual-gate FET for tuner/mixer applications; left, a diode array in a single package for computer switching; right, four diodes on a single lead-frame for driving core memories. All are from TI.

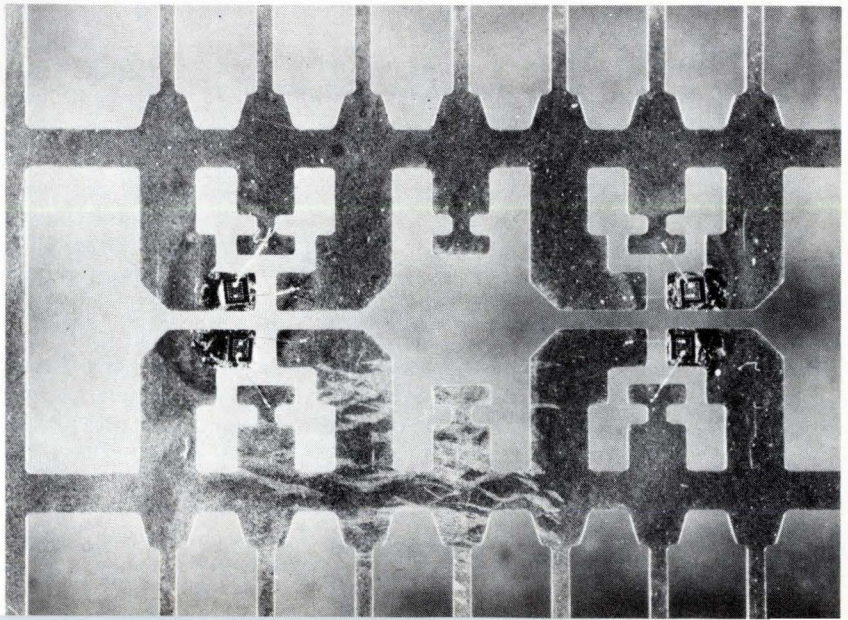



CHARACTERISTICS	VACUUM TUBE	BIPOLAR	MOSFET	J-FET
Input impedance	High	Low	Very high	High
Noise	Low	Low	Low	Very low
Size	Large	Small	Small	Small
Power consumption	Large	Small	Very small	Very small
Aging	Noticeable	Negligible	Negligible	Negligible
Bias voltage temp coefficient	Low, unstable	Low, consistent	Consistent	Low
Typical gate/grid current	1 nA	—	10 pA	0.1 nA
Reliability	Low	High	High	High

performed by an IC, whether a digital memory or logic array, or a linear device like an op amp or multiplex switch.

But in this boom year for all semiconductor products, the mature devices still have some good times ahead of them. Zeners with precision-controlled voltages now regulate voltages from as low as 2 to 3 v to up to several hundred volts for such diverse applications as analog-to-digital conversion, analog process control, and high-density computing. Silicon-controlled rectifiers and thyristors are at the heart of recent efforts by manufacturers of industrial plant equipment, like printing presses and textile power looms, to modernize plant and process control. Core memories continue to resist the inroads of semiconductor ICs and require high-current (600-milliampere) discrete transistors and arrays to drive the bit lines.

Moreover, even the theoretically declining segment of Fig. 1 is thriving. Even the grown-junction device, long considered an antique by most designers, continues to be the work-horse in many military programs such as gun control mounts, automatic firing systems, both in ground and air installations, and in some of the early computer-controlled firing systems.

The general-purpose diode is doing better yet—it's

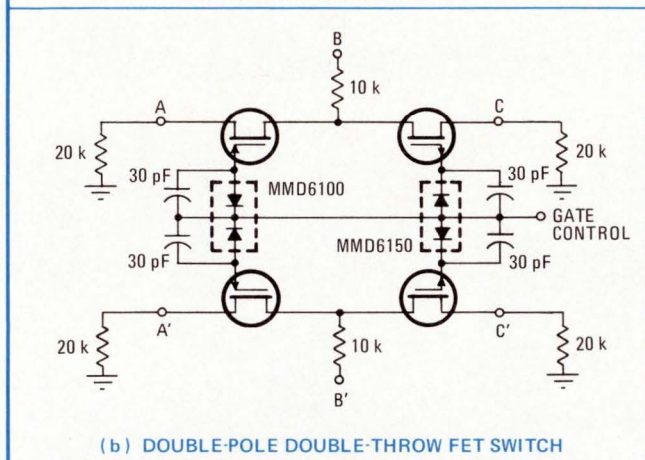
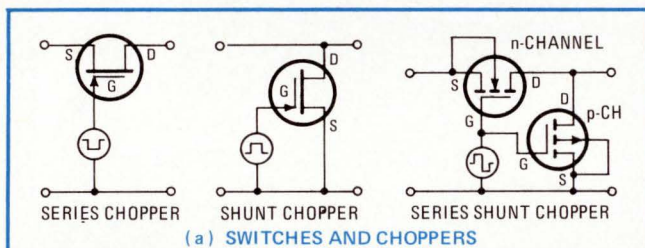

**2. Switching and chopping.** FETs make good switches and choppers. The series chopper (a) performs connect-disconnect functions and acts as a single-pole single-throw switch. Four J-FETs and four dividers (b) make a double-pole double-throw switch

## D-MOS comes on line

Heralded as a major advance in discrete and integrated-circuit MOSFET technology [*Electronics*, Feb. 15, 1971, p. 99], the double-diffused field-effect transistor pioneered by Signetics Corp. is ready for production. Initially four D-MOS products in metal cans will be available: two tetrodes, plus two double-gate tetrodes for use in circuits with automatic gain control. All four are n-channel-MOS, enhancement-mode devices with a channel length of only 1 micrometer.

They have impressive specifications. In standard configurations they can operate to 1 gigahertz with a gain of 10 decibels and noise of only 5 dB at power levels of 300 milliwatts. What's more, these new D-MOS devices will operate up to 2 GHz in a micro-wave strip-line configuration with the same specifications—a feature that makes them not only desirable for the front end of most S-band equipment, but also ideal input structures for many vertical amplifiers used in measuring equipment.

In addition, since they exhibit linear power-frequency characteristics, they may find applications at power levels not normally associated with bipolar FET devices operating at ultrahigh frequencies.

Also useful is the double-diffused FET's low parasitic capacitance at the inputs and outputs, a property that will make the device appropriate as an analog switch because output spikes will be eliminated.

The high performance of double-diffused FETs stems from the designer's ability to make micrometer-long channels without undesirably low breakdown voltages. It's the combination of short channels with high-drain-source voltages that is responsible for the high gains at the high frequencies. Ion implantation is now used in the process to control device doping profiles, thereby adding to the stability of the device.

The first tetrode products will operate at 25 volts. Moreover, experimental D-MOS FETs have been built with 300-V operating voltages and 1-W power ratings. Indeed, it's expected that the D-MOS technology will soon yield 1-W production devices operating at 1 GHz.

been pushed up the life cycle curve by the emergence of consumer products that have built-in battery chargers. In calculators, lawn mowers, shavers, hand-held driers and similar equipment, designers have found the general-purpose diode a very cheap way of achieving the rechargeable function, and in fact it is taking the place of the more expensive rectifier in most recharging circuits handling currents of up to 0.5 A.

For the general-purpose transistor, on which the transistor radio industry depends, the change is in the package, with inexpensive plastic found almost everywhere. The small-signal metal-can devices are presently in demand only by the military, and even here, designers of military equipment are expected to convert to plastic as its reliability improves.

The npn switch is another product with a new lease on life, being suddenly in strong demand among computer designers for use in some of the older logic modules. It's liked partly for its very reliable operation and partly because of its availability amid the sudden shortage of transistor-transistor-logic gates and flip-flops. For, although these logic chips have taken over the



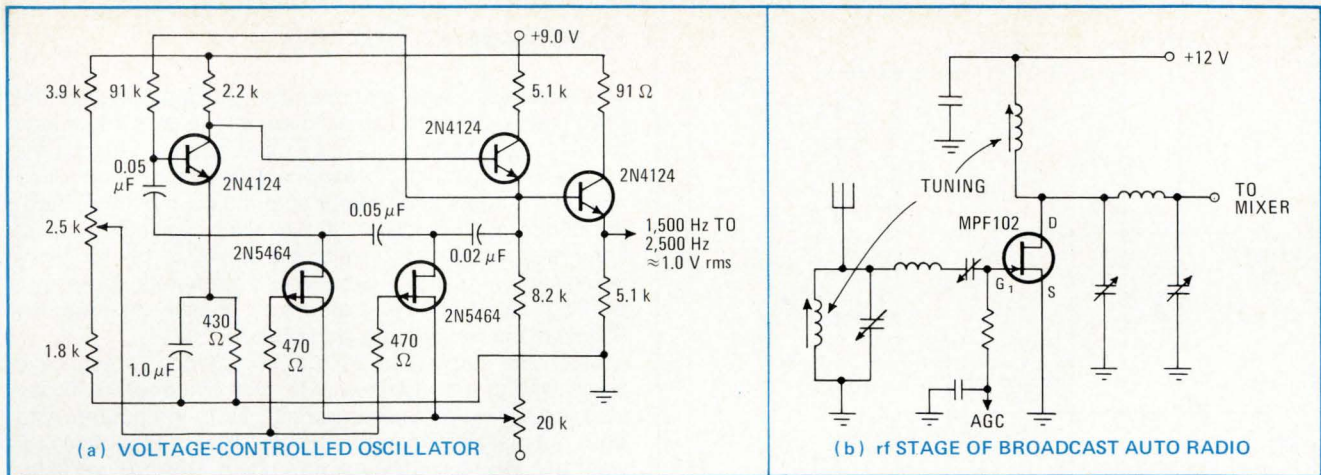

**3. FETs in audio.** A three-section voltage-controlled oscillator (a) contains two FETs in feedback loop and generates a linear sinewave over 1,500 to 2,500 Hz. Typical FET rf stages in an auto radio (b) replace tubes with only minor circuit changes. Circuits are from Motorola.

switching function of new designs on paper, in practice they are suffering from backlogs of as much as six months, especially the versions that use medium-scale integration. Still, most designers see it eventually dying as TTL becomes more readily available, and the demand is expected to trickle away by 1975.

Somewhat similarly, the computer diode is also gaining from 1973's sudden brisk demand. And the facts here are that many computer manufacturers, because of a huge backlog of equipment orders, are staying with some of the older memory designs that use the readily available diode instead of the equivalent hard-to-get integrated circuit. This demand, however, appears temporary, not so much because of the declining popularity of diode memories as because the discrete computer diode is rapidly being replaced by the diode array. Arrays with as many as 16 diodes in a single package are now available at half the price per diode of the old discrete. Also, such an array occupies only three times the area of a single-packaged device.

### Growth beyond the boom

The use of the 16-element diode array points up a general trend in the discrete component industry toward multiple devices—dual and quad transistors, diode arrays, Darlington pairs, complementary npn pnp devices. The advantage a multiple device offers the equipment designer is that it can be matched to a particular parameter, cutting out the costly selection process that is especially troublesome in high-volume equipment. For example, dual J-FET devices are now available with matched impedances, eliminating the need for external balancing resistances in many amplifier designs. Transistors can also be matched for input current, gain,  $g_m$ , betas, indeed almost any transistor parameter.

New dual power Darlington transistors recently introduced from Unitrode follow this trend to more power in less space. Duals can be obtained with 5-A and 10-A service for use in motor drives, converters, send servos, and lamp and relay drivers.

A second area of growing demand is the core driver, both the discrete transistor driver and the multiple quad device. Here, because of the high currents (600 mA) re-

quired to drive the bit lines of today's core memories, ICs have been slow to take over the function. It is only recently that an IC core-memory driver has become available, and it is too soon to determine its penetration into this market. In any case, the stubborn resistance of core memories to the onslaughts of the new MOS and bipolar semiconductor memories means that the discrete memory driver will remain strong throughout 1975.

Over the long term, however, they are doomed—on the one side by the IC driver that will eventually be cheaper and smaller than the discrete devices, and on the other side by the ever increasing penetration of semiconductor memories, which have on-chip drive circuits or can be driven by a driver sense amp IC. Indeed, much the same could be said for the general-purpose devices and computer diodes and arrays, all devices whose functions will either be taken over by the IC or eliminated in new designs.

However, the field-effect transistor, like the power device, represents real long-term growth and stability in the discrete-product arsenal. In recent years the FET has become almost as ubiquitous as the bipolar transistor, finding its way into such diverse pieces of equipment as video amplifiers, analog switches, balanced mixers, voltage-controlled resistors, and rf amplifiers, and serving as switches in choppers, as voltage-controlled oscillators, vhf varactor tuners and amplifiers, and as zener source elements in discrete logic circuits such as half adders.

### Mainly about FETs

Feeding this application growth are a host of new junction-FET and MOSFET devices. For instance, newly available from several component manufacturers, including Motorola, General Instruments, Siliconix, Intersil, Fairchild, National, TI, Teledyne, RCA, and Analog Devices, are both n- and p-channel dual-gate MOSFETs that offer lower noise and higher power gains than devices of a couple of years ago. A case in point is the dual-gate 3N204 series from TI, which has typical noise figures ranging from 2 dB at 200 MHz to 7 dB at 900 MHz with gains of 24 dB at 200 MHz to 12 dB at 900 MHz. Offered in TO-72 metal cans, FETs of this type are being



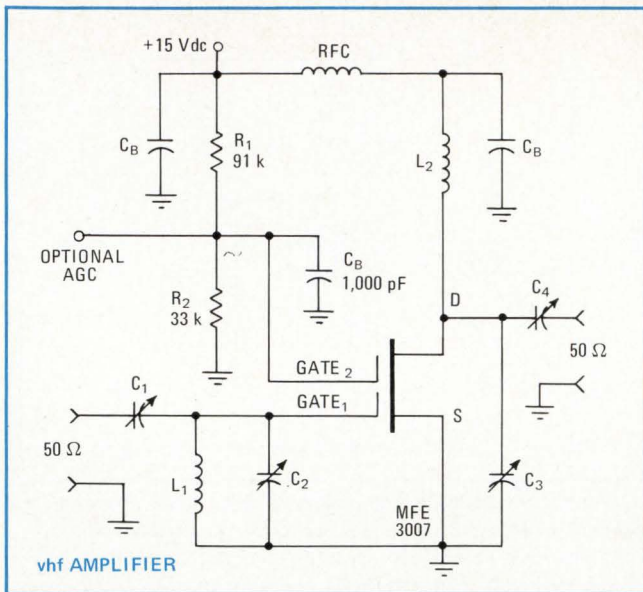

**4. FETs over tubes.** J-FETs substitute for tubes in these kinds of vhf amplifiers. Here, a J-FET has replaced the old 12BL6 pentode.

used extensively in vhf-rf amplifiers in TV and fm tuners and for uhf-rf amplifier applications as well as vhf mixer application. All these devices have low cross-modulation distortion, a trait especially useful in tuned high-frequency amplifiers such as those found in TV i-f strips.

As for J-FETs, a new Analog Devices' n-channel J-FET has very low noise, specified at less than 15 nanovolts at 10 hertz, and low offset voltage (5 mV maximum). It is intended especially for sensing small signals in optoelectronic, biomedical, nuclear, and in low-level transducer applications. Systems designers are finding this type of device more economical and easier to use than hybrid dual-chip equivalents.

The J-FET and MOSFET differ in their construction. The J-FET uses a reverse-biased junction (which produces the depletion region) to control the drain-source current, while in the MOSFET the gate is a metal film deposited on an oxide layer and is insulated from the source and drain. Although both devices use an electric field to control a channel current, the control mechanisms for the two are different, and their characteristics, especially the gate characteristic, consequently differ

## Discretes in Europe

The Europeans who manufacture consumer equipment have been quicker than the Americans to pick up on new trends in solid state. FETs are a case in point. Throughout Europe for a number of years now they have been found in tape recorders and uhf portable radios, mostly as high-frequency input transistors in the mixer-oscillator circuits. They are based on conventional mesa or planar technology and were first put to this use about four years ago, by Grundig AG of West Germany, closely followed by Philips of the Netherlands and others.

Much the same is true for tuning diodes, which have been used in uhf radios and TV sets since 1965. Today it's hard to find a major European TV manufacturer who does not make varactor tuned sets—Philips Electrical Ltd. was the pioneer in England, using Mullard varactor diodes. American manufacturers are expected to follow suit. Recently Intermetall GmbH, a member of the ITT Semiconductor group and the firm that pioneered tuning diodes, began investigating ion implantation methods for diode fabrication—a hot development item also in America—but such diodes are likely to be too expensive to impact consumer applications at all soon.

An innovation in consumer products in Europe is p-i-n diodes in TV sets, an idea taken over from the measuring-equipment industry. Again, Grundig was first, using the diodes in the tuner section where they perform a control function. Supplied by Siemens, the diodes are arranged electrically in  $\pi$  form and feed uniform and steady-state signals to the input transistors of the subsequent vhf and uhf stages. This eliminates the need to adjust these stages and also allows the use of high-current input transistors. The result: interference between signals, such as occurs with closely spaced transmission channels or with maladjusted community-antenna equipment, is no longer a problem.

Similarly, high-voltage transistors and thyristors are finding their way into consumer products, for example, in deflection stages in TV sets. Intermetall has received orders from several European TV set makers for large quantities of thyristors, a figure which the company says

considerably. In short, the input of the J-FET behaves like a reverse-biased diode, while the input of a MOSFET is similar to a small capacitor. It is the reverse-biased property of the J-FET that accounts for its low input current, while it is the capacitor-like action of the MOSFET that accounts for its low noise and high gain.

### Design with FETs

Both types of FET have several advantages over the conventional bipolar transistor. They are relatively free of noise, they are more resistant to the degrading effects of nuclear radiation, and they are inherently more resistant to burnout. The parameters, both for the MOSFET and for the J-FET, are compared with those of the vacuum tube and the bipolar transistor in Table 1, supplied by Motorola.

Other attributes of the FETs are advantageous for certain design considerations. The inherently high input impedance—typically many megohms—is useful in impedance transformation, chopper and switching applications. Since it is a voltage-controlled device, the FET can be readily self-biased, which frequently makes for a

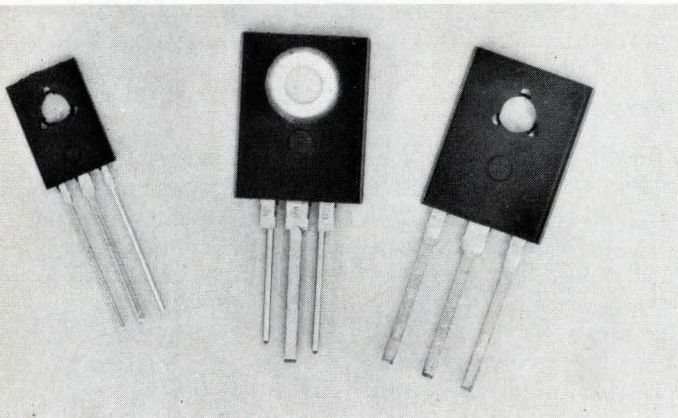

**Plastic on the rise.** Plastic-package transistors, like these from Motorola, are penetrating the industrial market.



represents one of the ITT group's biggest sales of discrete semiconductor devices for entertainment electronic applications. Since it currently lacks the capacity to produce the thyristors at its own plant, Intermetall will have them made at ITT's facility in Footscray, England.

The thyristors, types BT 119, BT 120 and BT 121, were designed by Intermetall in cooperation with the Stuttgart-based ITT applications labs and are intended for the horizontal deflection circuitry in color and black-and-white TV receivers. In this transformerless circuit concept, the thyristors, together with fast diodes and rectifiers, replace the tubes formerly used in horizontal deflection stages of PAL and Secam receivers.

British companies are also active in developing devices for horizontal line deflection circuits. As in American sets, using 1,500-V transistors for these circuits is fairly standard, and now 1,700-V devices are coming in, for instance, in sets from British Radio Corp., a division of Thorn Electrical Ltd.

Higher voltage switching with these units means a cheaper regulator handling less current. In this category is Texas Instruments Ltd.'s 2,200-V transistor (see p. 94), now being evaluated by set makers. It has an interdigitated structure made by triple diffusion. The color-set device is rated at 4 A, the mono device at 3 A, and each comes in a TO-3 can bolted to a heat sink.

Like RCA in America, ITT Components Group Ltd.'s Semiconductor division reckons this voltage requirement is pushing the transistor technology to its limit and believes a double thyristor-switch operating at around 700 V is more reliable because it operates well within its capability. The ITT device is used on the continent, and ITT is trying to persuade British set makers to take it up.

For industrial applications, Intermetall will shortly unveil a family of high-voltage pnp silicon epiplanar transistors capable of handling a collector-emitter voltage of 250 V. Designed to work as a driver in conjunction with linear ICs, the BSS54 high-voltage transistor is intended for use in the push-button type of telephone set, where it replaces conventional mechanical components.

simpler circuit than would be possible with a bipolar transistor. Its ability to operate at a gain-source voltage less than pinch-off can be exploited for automatic gain control. Also, the FET has a very high output resistance, making the device useful as a constant-current source, again when operated at a drain-source voltage greater than pinch-off.

The chief shortcoming of the FET is its relatively small gain/bandwidth product. Although this limits its use in many high-frequency applications, the FET can provide excellent results in vhf circuits, where its linearity overload resistance makes it far superior to bipolar transistors.

Some typical FET applications have been identified by Motorola, a major supplier of FET products, and include switches and choppers, a typical double-pole double-throw FET switch, a voltage-controlled oscillator, the rf stage of an auto radio, the vhf amplifier of a TV set and a zener source element for any number of circuit applications.

The simple series chopper shown in Fig. 2a performs the connect-disconnect function or acts as a single-pole

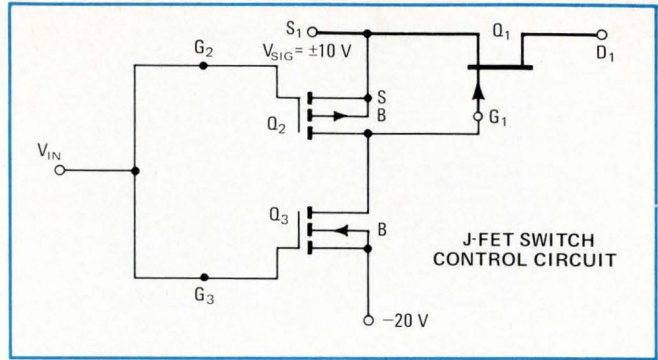

5. Switch to FETs. FETs are increasingly being used as solid-state analog switches. Typical circuit from Siliconix contains J-FET.

single-throw switch placed in a signal path to the load. The shunt chopper is a straightforward way of providing shunting signals with high impedances. It may also be used in conjunction with the series chopper to remedy the latter's speed limitation. Here, when the series chopper is turned off, the gate-drain capacitance must discharge through the load impedance, which limits the upper frequency of operation; but when the series device is turned off, the shunt device is turned on, discharging the series' gate-drain capacitance, and allowing for higher operating frequencies.

The double-pole, double-throw FET switch (Fig. 2b) is made up of four J-FETs and four dividers controlled by a common gate circuit. When the gate control goes negative, the p-channel J-FETs are turned on, and the n-channel device is off. The opposite happens when the gate goes positive, implementing the dpdt control.

The voltage-controlled oscillator (Fig. 3a) is obtained by including an RC phase-shifting network in a typical amplifier's feedback loop. In this three-section phase-shift oscillator a linear sine wave is generated over the range of frequencies from 1,500 to 2,500 hertz with an output signal amplitude of approximately 1 v. This 1-kHz frequency swing is controlled by an input control voltage that varies from 2 to 5 v dc.

The types of rf amplifier that are based on FETs are practically unlimited. Indeed, many designers are finding that circuits designed around small-signal pentode tubes can use FETs as replacements with only minor modifications.

Figure 3b shows the circuit of a typical rf stage for a broadcast auto radio, in which an n-channel J-FET has replaced the old 12BL6 pentode. FETs have also replaced tubes in the vhf amplifier of Fig. 4, which has been designed to operate at 100 to 400 MHz. To set the proper bias in this circuit, resistors  $R_1$  and  $R_2$  are adjusted for 4V dc at gate 2. They have high values to minimize current drain. Note that gate 2 must be well bypassed at the signal frequency lest the low impedance to ground cause instability or loss of gain. Included are capacitance values for different frequencies.

A FET is also an ideal zener current source, a property that stems from its ability to perform as a constant-current generator. As a zener-diode source element, the constant-current FET has a distinct advantage over the use of a series resistor by itself, because variations in input voltage have virtually no effect on output voltage when the load current is constant.



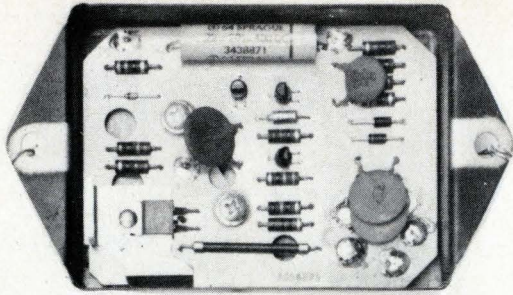

**Power takes a ride.** Biggest new power market is in the car. In this Chrysler Corp. ignition system is an RCA 200-V, 5-A transistor.

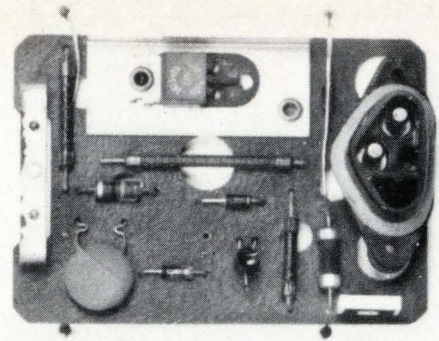

**Under the hood.** Chrysler unit contains a 40-V, 3-4-A discrete device from RCA, typifying use for cars' voltage regulators.

Stimulated by the growth of industrial analog-to-digital systems is the increased need for a solid-state analog switch—and that function is performed admirably by both J-FETs and MOSFETs. The operation of the FET as an analog switch springs from the fact that the device is in effect a conductor whose cross-sectional area may be varied by the application of appropriate voltages. When the conducting area or channel is maximum, conductance is also maximum. When the conducting area is minimum, resistance is maximum. Consequently when conductance is maximum, a FET switch is on, and when conductance is minimum, the switch is off.

Two types of FET switches are available: the depletion-mode devices, which have high channel conductance with zero gate-channel voltage and are “normally on” switches, and the enhancement-mode FET, which require that voltage be applied to the control gate to create a conducting channel—the “on” state—and are “normally off” devices.

Figure 5 shows a typical J-FET switch circuit developed by Siliconix, a major supplier of FETs of this kind. Here  $Q_1$  is an n-channel J-FET,  $Q_2$  an enhancement-mode p-channel MOSFET, and  $Q_3$  an enhancement-mode n-channel MOSFET. In this configuration, an input voltage of  $-20$  v will turn  $Q_2$  on and  $Q_3$  off so that the points  $S_1$  and  $G_1$  shown in the figure will be connected ( $V_{GS} = 0$  v) and  $Q_1$  is on.

### A new market in power

Since IC designers are unlikely to be able to integrate power circuits above 10 W in the audio range and 1 W in the rf range for some time, the discrete power semicon-

ductor device is truly a long-term growth area in such applications as audio and TV equipment, mobile rf radio and communication equipment, automotive equipment, and white goods—in short, wherever high power and high reliability are demanded.

Just how fast the power market is growing can be seen from Fig. 6a, which shows it reaching a total of \$150 million in U.S. factory sales in 1975. Indeed, the demand for power products is so great, having increased suddenly in the latter half of 1971 with the upturn in market activity, that throughout 1972 the supply dramatically lagged demand. And the situation is expected to become worse. Figure 6b shows that the suppliers will begin to meet the market's needs in power products only in 1974, when the newly designed power transistors and Darlington products go on stream.

Worldwide demand is even stronger, and the total dollar value of the market is expected to exceed \$220 million in 1973. European equipment makers have long been more innovative in the use of solid-state components in consumer products, and this trend will accelerate in 1973 when European automobile manufacturers begin using power devices in their fuel-injection and seat-belt interlock systems. Based on an average unit price of 85 cents per power device, the total number of power devices consumed worldwide in 1973 will exceed 300 million in 1973 and rise to 600 million by 1977.

As with small-signal discrettes, the consumer and automotive industries have most need for power components (Fig. 7). Starting in 1971 the market share for automotive power products began to increase at a rate twice that of other major segments, with home enter-

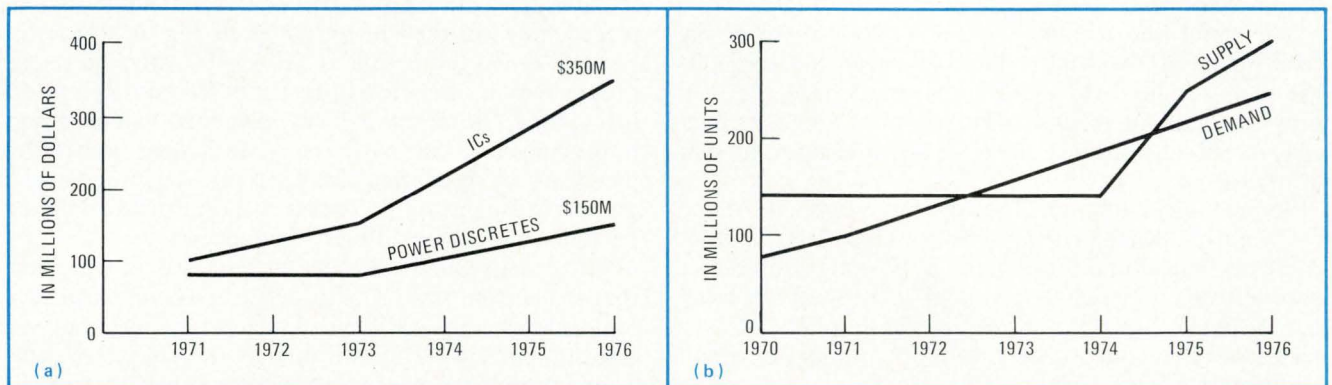

**6. Rosy prospect.** Texas Instruments sees the U.S. demand for power paralleling the strong growth of ICs, reaching \$150 million in 1975. Trends are for higher power and more plastic packages. Demand will be so high that TI planners see shortages through 1974.



## Four paths to power

To provide the wide range of characteristics required in power devices, the major semiconductor component manufacturers have developed four different processes (see figure, courtesy Motorola).

The oldest technique puts a simple epitaxially grown base area on a standard collector substrate. This epi base process is used for general-purpose power devices ranging in output up to 25 watts and intended for a host of amplifier applications, with both npn and pnp polarities available for complementary design. Most audio amplifier circuits are still served by this process.

Taking the place of the epi base method for newer high-powered applications are the single- and multi-diffused processes.

The single-diffused process, which is best suited for rugged, low-frequency applications requiring powers up to 50 W, is the mainstay of power designs. Here, collector and emitter areas are diffused simultaneously into the base substrate so that low junction temperatures are maintained at high powers.

For higher-frequency operation at moderate power outputs, a double-diffused device is generally fabricated on the basis of techniques developed for integrated circuits. The base is first diffused on a collector epi layer, and then a second emitter diffusion is made. Because the base and emitter require independent process steps, they can be separately doped to make them yield the high currents at high frequencies necessary in uhf and vhf applications.

The newest power transistor process is a triple-diffused system that was developed principally for high-voltage applications in TV deflection circuits, automobile ignition, and power supply switching. The key here is the ability of the process to reduce collector resistance so as to obtain breakdown voltages of up to 1,600 volts. Here, a first diffusion lowers the collector substrate resistance, after which the conventional base and emitter diffusions are made.

More recently, some suppliers, principally RCA, have been able to modify their double-diffused process so that they can achieve similar high voltages without the need for a third diffusion.

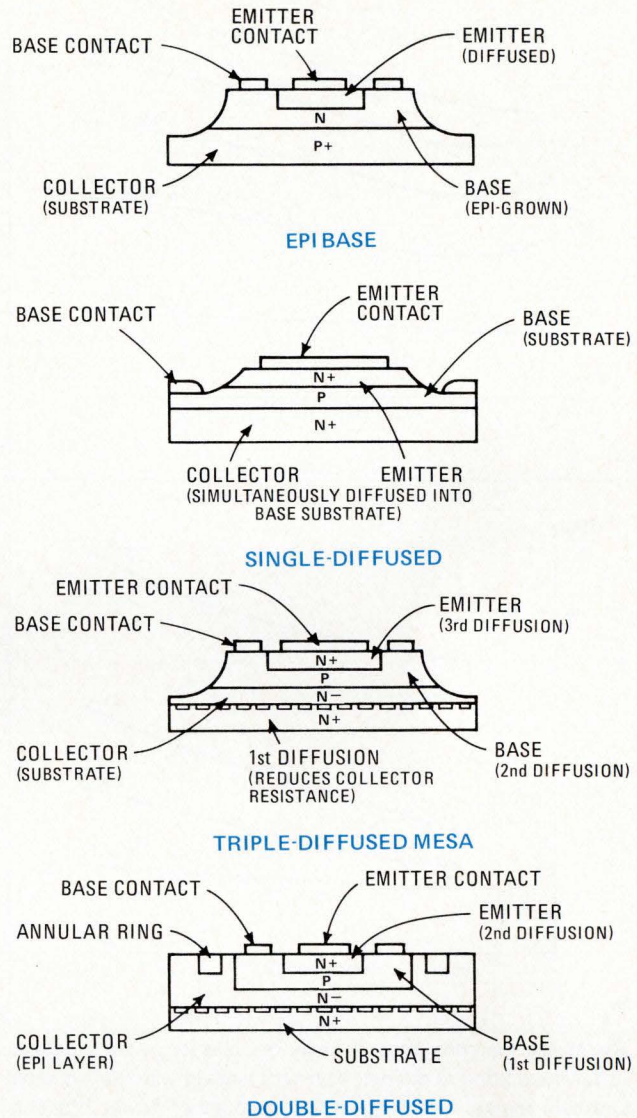

tainment and the appliance industry next in line. Only in the industrial computer market will power needs remain constant through 1975.

The automobile is a very new consumer of power discretely. For example, the ignition system of all 1973 Chryslers will contain two power transistors, a 2-A, 40-V plastic device, and a 300-V, 5-A output transistor in a metal can. The voltage regulator of many 1973 cars has a 3- to 4-A, 40-V transistor in a plastic package in its circuit. Designers of the seat-belt interlock system presently required in all cars in the 1974 model year will have at least two power devices, a 1- to 2-A plastic transistor to power the buzzer, and a 2-A plastic device to control a blocking solenoid in the ignition system. In all, six or seven power sockets will exist on 1975 model year cars, representing a unit demand of almost 100 million in 1974. This is in addition to any control devices such as windshield motor variable drives and heater control devices and those required for the anti-skid control—all of them 4- to 5-A, 40-V devices.

Satisfying these circuit functions are two types of semiconductor: the standard metal-can or plastic transistor for the high-voltage application and the newer Darlington pair for the high-voltage, high-current applications. Both are now available from all the major semiconductor suppliers. The plastic devices will be generally confined to low-duty applications—as in the seat-belt interlock where the power rating is less than a watt—while the hermetically sealed products will perform the more critical high-powered functions in the ignition and regulator systems.

Television is another major consumer of power devices. There is an average of five power sockets in a color set. The horizontal deflection circuit driving the picture tube now requires either a thyristor or a high-voltage power device. The vertical drive requires an 80- to 100-V complementary pair capable of supplying 3 to 4 A at the output. The chroma circuits are driven by two or three power devices in the 300-V, 100-mA range. With TV production forecast at 10 million sets this year,



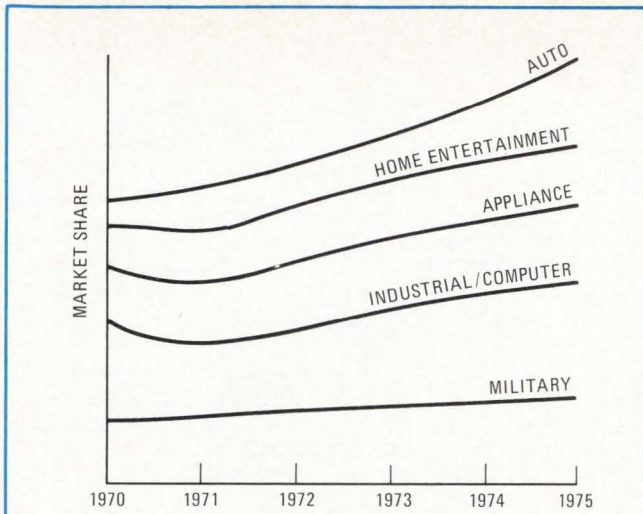

(a)

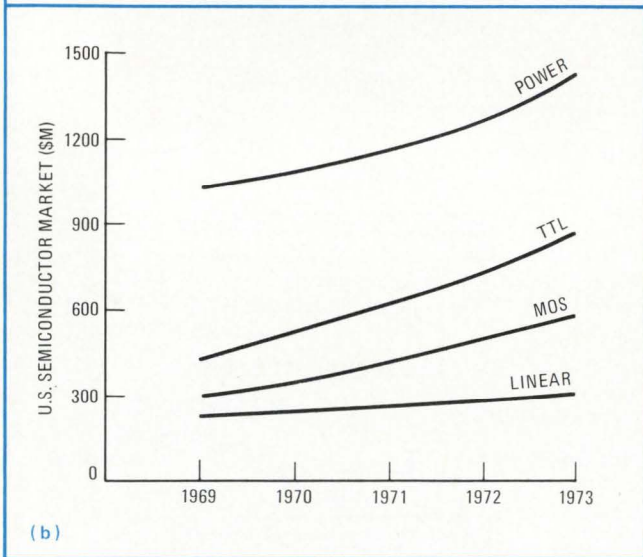

(b)

**7. Satisfying the consumer.** Industry demand for power products, (a), shows auto and home entertainment leading with the industrial and military market remaining steady. Altogether power products represent a 25% share of the semiconductor market.

this market represents a 50 million unit demand.

To meet the horizontal-deflection requirements, output voltages as high as 1,500 v in unregulated systems and 700 to 800 v in regulated systems are necessary, as well as blocking voltage as high as 2,000 v. One of the newest devices that can do the job is a power transistor from TI rated at 2,200 v and 2 A. With its exceptionally high output voltage, it was developed mainly for use in the European 220-v, line-operated sets. But it is capable of operating directly off an unregulated line, according to TI, and can be cost-effective with lower line voltages because it eliminates the need for regulation.

RCA has been recently innovative in TV deflection devices with a double-diffused 800-v device which it feels will be more useful than the higher-voltage devices, especially for the in-line TV tubes of 1974 set designs. But perhaps more important, the ability of these devices to switch in less than a microsecond will also help to meet the growing demand for faster high-frequency switching applications.

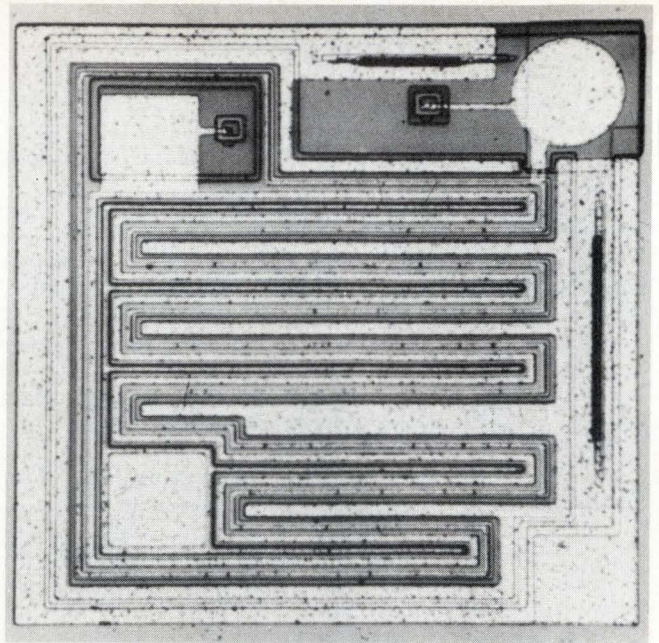

**FET blanket.** TI's new double-gate FET is one of many that have a nitride-passivated coating to increase stability.



**Established.** SCRs represent a mature industrial portion of discrete demand. Motorola device has puck-type package for easy mounting.

Indeed, RCA, Motorola, Fairchild, TI, and others have developed devices that can switch high power-supply voltages at frequencies above 20 kilohertz. This means that, because of the higher-frequency operation, the manufacturers of power supplies can use smaller transformers and less elaborate heat-sinking methods and greatly reduce the size and cost of their supplies. Motorola's devices, the 2N6306, 07, and 08, have 8-A collector current ratings and voltage breakdowns of 700 v and can switch at speeds less than 0.05  $\mu$ s. This represents a 2:1 improvement over existing devices in speed/power switching capabilities and should evoke strong interest from power-supply manufacturers, the computer industry, and audio and TV circuit designers. And it must be kept in mind that each power-supply circuit requires three devices, one inverted driver and two output units, representing 4.5 million new sockets that must be filled over the next few years. □

Reprints of this article are available at \$3.00 each. Write to Electronics Reprint Department, P.O. Box 669, Hightstown, N. J. Copyright 1973 Electronics, a McGraw-Hill Publication.



# Matching driver circuitry to multidigit numeric displays

It is worthwhile for the designer to choose the optimum combination of parallel and serial circuitry to drive the output elements, rather than simply making tradeoffs between various readout devices

by Alan Sobel, Zenith Radio Corp., Chicago, Ill.

□ All too often, the design of an electronic numeric display system is based primarily on the characteristics of the various display devices available, with only secondary regard for the necessary driver circuitry. However, the display-system designer will find it profitable to consider such important criteria as driver power, element-switching time, and decoding-circuit complexity.

For a particular application, there may be several system organizations that can give low total cost and good performance. To find these, however, the characteristics of the output elements and the drive electronics must be considered together.

## Display-system organization

The design of a display system must begin at the source of the information to be displayed. This may be the output of a counter or an analog-to-digital converter, for example, and it may have such outputs as binary or binary-coded-decimal (BCD). The display device, on the other hand, may require a drive system for seven-segment digits, seven-by-five-element dot matrixes, or some other format. All digital readouts considered in this discussion contain more than one digit, and it is therefore often desirable for corresponding segments of several digits to time-share a common driver.

For such multidigit display systems, there are two fundamental drive-system configurations—full-parallel and matrix. Most practical display-system designs are compromises between the two. The “full-parallel” configuration (Fig. 1) is simpler, but usually more expensive. Because separate lines from the information source are routed to each individual digit in the display, each set of lines from the source is translated in the decoder to the format required by the drivers and the display devices. Using the full-parallel configuration, the duty cycle of each of the energized digits is, for all practical purposes, 100%.

Such a full-parallel display, however, requires a maximum amount of circuitry, since a decoder and driver must be supplied for each digit. The “matrix-drive” configuration (Fig. 2), which reduces this hardware requirement, is also called a “full-serial,” “strobed,” or “multiplexed” display system.

## Matrix-driven display

Although it reduces hardware needs, the matrix design is more complex, and it makes tougher demands on the display elements. Thus, a careful analysis of the total system is necessary in order to make a proper choice between the two.

In matrix configurations, data from the source feeds a

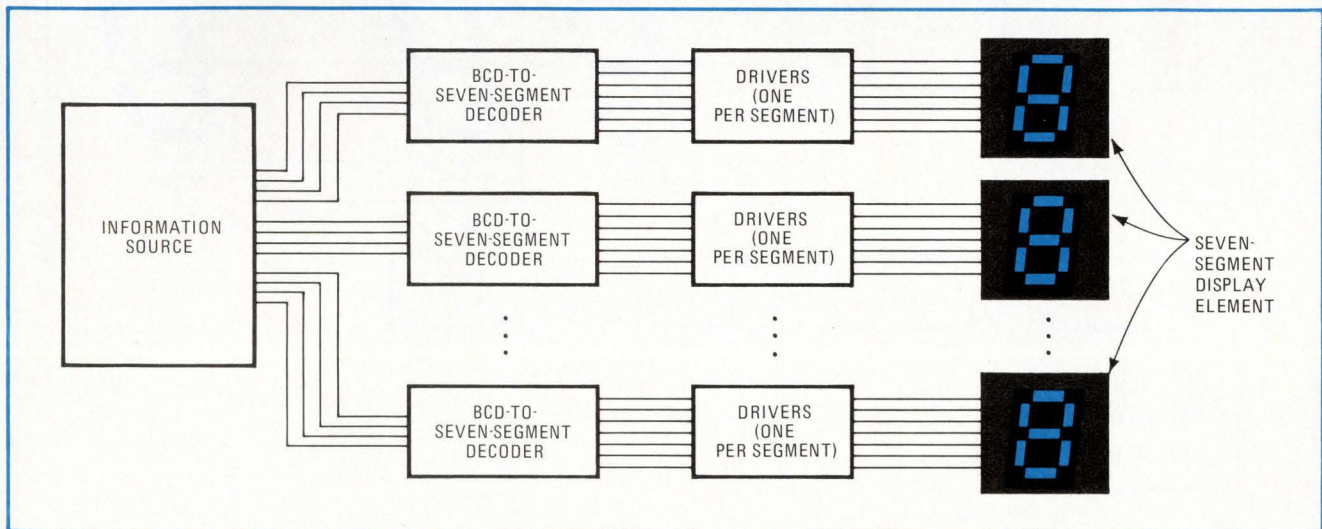

**1. Full parallel.** In the most straightforward approach to display-system design, one decoder and seven drivers are required for each digit. Such designs, however, are generally wasteful of decoding and drive-circuit hardware in displays of more than three or four digits.



single decoder, either over a single set of lines, which is switched in the source from digit to digit, or via a switch that takes the information from the individual digit sources and transmits it sequentially to the decoder. Corresponding segments of each digit are connected together, and the particular digit to be energized is selected by activating another switch.

Besides reducing the number of decoders, the number of drivers required in a multidigit display can also be substantially reduced. In a 10-digit display with seven elements per digit, for example, the matrix configuration would require 17 drivers, in contrast to the 70 that would be required in the full-parallel approach.

Most numeric display and driver configurations today fall somewhere between the full-parallel and the matrix systems. For example, a single decoder can be time-shared among separate sets of drivers for each digit, but the drivers may include storage capability to keep each element energized for a duty factor close to 100%. Such an arrangement, shown in Fig. 3, has 28 drivers (seven segments times four digits). The particular design shown has been used for a digital-voltmeter readout.

### Duty factor and repetition rate

In the matrix arrangement, the operating duty factor for each digit cannot be larger than  $1/n$ , where  $n$  is the number of digits in the display. The duty factor will usually be less, since time must be allowed for the new information for each digit to be transmitted to the decoder. Some display devices (multiple-digit gas-discharge devices, for example) may require dead times between adjacent digits to avoid inadvertent illumination of elements when they should be off.

Average light output is the peak output times the duty factor. Therefore, to radiate, say, 50 foot-lamberts average luminance from each element in a 10-digit display, each digit must generate at least 500 foot-lamberts

while on. Some devices, like gallium-arsenide-phosphide light-emitting diodes, thrive on this pulsed treatment. Other devices, however, simply cannot meet the instantaneous requirements in some applications. Limitations on the peak-output capabilities for some devices, then, limit the number of digits that can be multiplexed. Thus, to maintain adequate luminance for each display element, it may be necessary to divide a display-drive matrix into several smaller matrices.

The lowest frame-repetition rate is fixed as the lowest rate at which the devices can be operated without noticeable flicker. This is typically 30 frames per second, although in applications where the device is subjected to a great deal of vibration, it may be desirable to use repetition rates as high as several hundred frames per second to avoid annoying breakup of the display. On the other hand, the highest frame rate is sometimes limited by switching times of the display elements used (see table, p. 99).

### How duty factor affects contrast

Specifications concerning brightness and ease of viewing a display are partly established on the basis of subjective factors, but probably the most important criterion for legibility—and an important factor in designing matrix-drive systems—is contrast. If the duty factor is less than unity, both the output of the display and the contrast, that is, the ratio of output from an on segment to that from an off segment, will be reduced. (The ratio of output from a segment to light scattered from the surroundings will also be reduced.)

An off segment is not totally blank; it scatters some ambient light, and it may also be energized partially by undesired current paths in the drive matrix. The output of an energized device, then, is:

$$L_{on} = CL_{off} \quad (1)$$

where  $C$  is the contrast ratio and  $L_{off}$  is the output of the

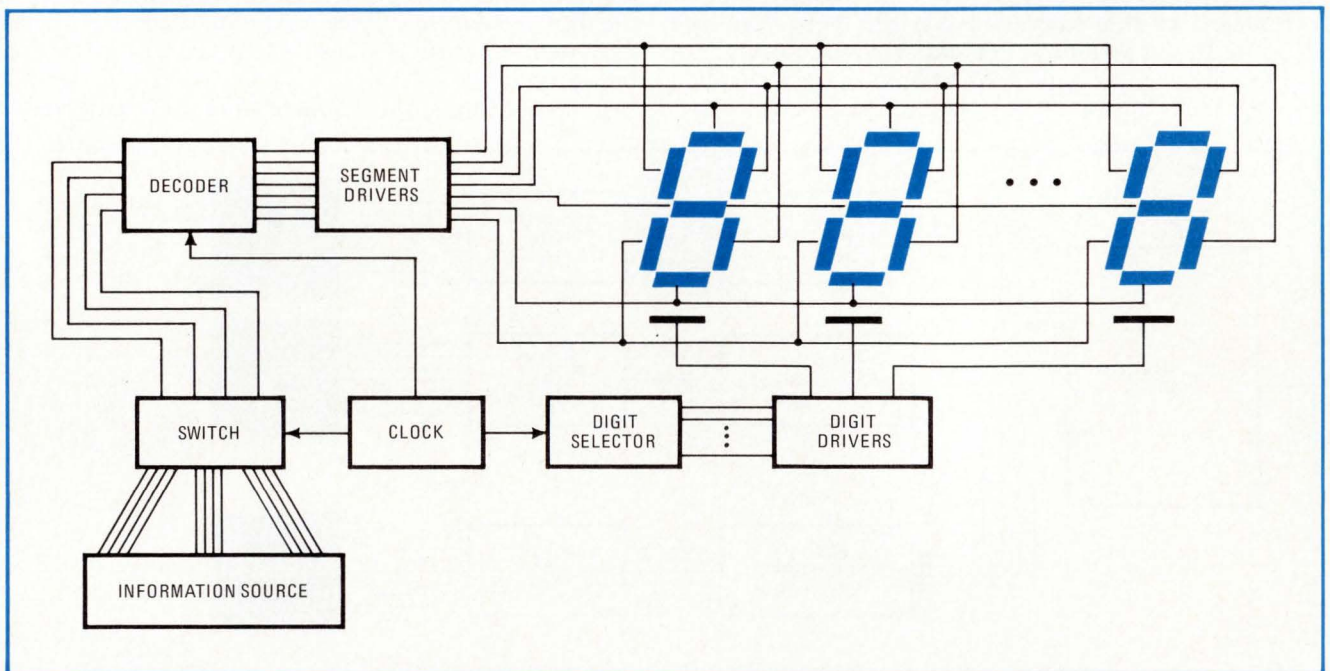

**2. Matrix magic.** When displays are matrixed, fewer decoders and drivers are required than in the full-parallel system in Fig. 1. The relative advantage of the matrix system is increased further as more digits are added to the display.



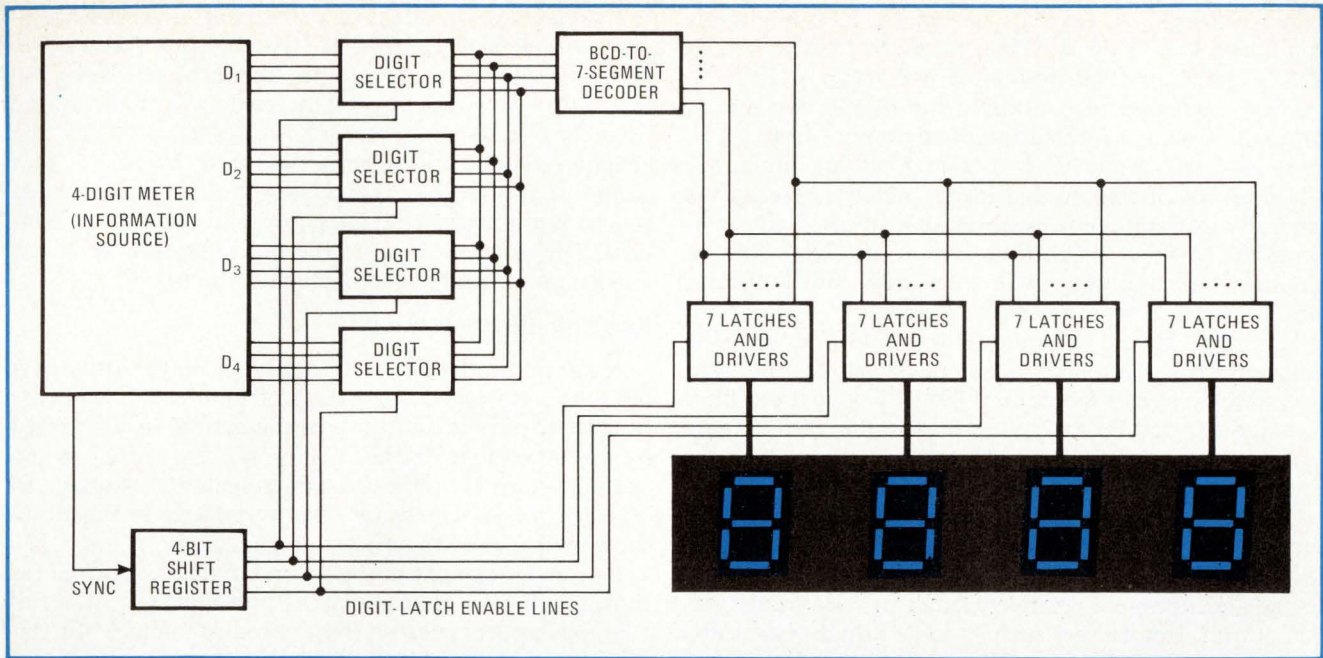

**3. Voltmeter readout.** For use as a voltmeter readout, this system trades an increase in decoder circuits for less complex selector switches and latching circuits. Latches are synchronized with the digit selectors. Thus, each element is energized with a duty factor of nearly 100%.

device that is off. Because of the duty factor,  $F$ , of matrix displays, the effective contrast ratio is:

$$C_{\text{eff}} = [FL_{\text{on}} + (1 - F)L_{\text{off}}]/L_{\text{off}} \quad (2)$$

which combined with Eq. 1, reduces to:

$$C_{\text{eff}} = F(C - 1) + 1 \quad (3)$$

The importance of the difference between contrast and effective contrast can be seen by plugging numbers in for typical display situations. In an LED display, for example, if  $C = 10$  and  $F = 1/4$ , then the effective contrast is only  $3\frac{1}{4}$ , while for a display contrast of 50 and  $F = 1/10$ ,  $C_{\text{eff}}$  is only 5.9.

Alternatively, if an effective contrast of 10 is needed in a particular application, and the duty factor is  $1/10$ , then a display element must be chosen with contrast of 99. Such a requirement is not impossible for a light-emitting display, particularly if appropriate filters are used over the elements.

#### Filter can optimize contrast

If the effective contrast is found to be less than desirable for a given combination of drive technique and display elements, filters can often be used to improve viewing ease. A neutral filter (one with a constant output over a broad range of light wavelengths) attenuates both the ambient light and the output of the device equally.

However, the ambient light is attenuated in two transits of the filter, while the light from the display passes through the filter in only one direction. The result is a net gain in contrast at the expense of luminance. It has been shown<sup>1</sup> that the effective contrast when using such a filter is:

$$C_{\text{eff}} = [F(L_{\text{on}} - L_n)/L_n + L_aSG] + 1 \quad (4)$$

where  $L_n$  is the light output from an unenergized element with no ambient light,  $L_a$  is the ambient illuminance, and  $G$  is the filter transmission. The quantity  $L_aS$  is the output of scattered light from a display ele-

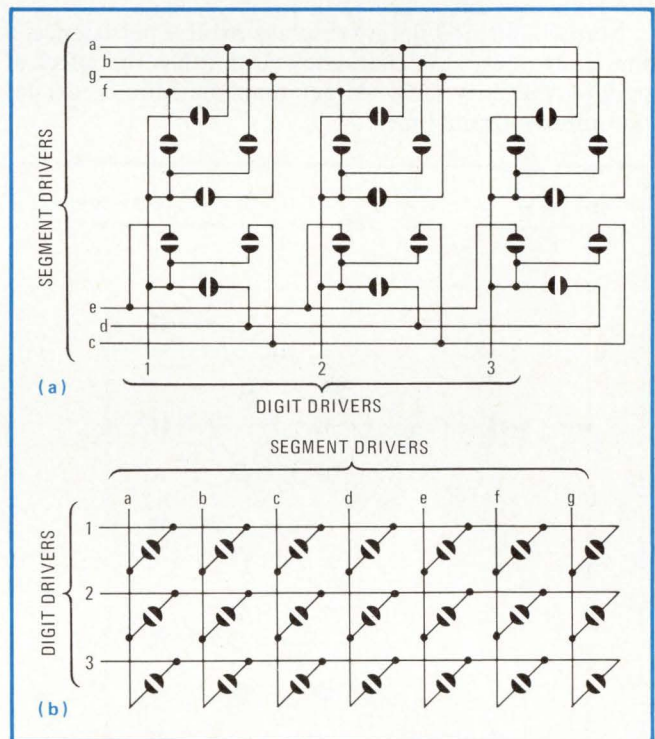

**4. Three-digit multiplex.** Three seven-segment numeric elements (a) are multiplexed for better drive-circuit utilization. The same circuit is redrawn in (b) to illustrate the three-row, seven-column matrix configuration, and the matrix is further restructured in Fig. 5 to better explain the effects of parasitic driver currents.

ment, assumed to be unaffected by whether the element is energized or not.

From Eq. 4, it is readily seen that the effective contrast increases substantially as the filter transmission decreases. Again, plugging in numbers for a typical 10-digit LED matrix-driven display illustrates the point. In



such a system,  $F = 1/10$ ,  $L_{on} = 500 \text{ fL}$ ,  $L_n$  is negligibly small, and  $L_a S = 30 \text{ fL}$ . Then for  $G = 1$ ,  $C_{eff} = 2.67$ ; or  $G = 0.5$ ,  $C_{eff} = 4.3$ , and for  $G = 0.1$ ,  $C_{eff} = 17.7$ .

These increases in contrast come at the expense of luminance, which in this example decreases from 50 fL for  $G = 1$  to 5 fL for  $G = 0.1$ , since output luminance is  $L_{on}FG$ . Sacrificing luminance for increased contrast is generally desirable, however, because in low-light environments, display brightness is not needed, while in brighter surroundings, there is usually still sufficient contrast for the display to be read.

The use of a colored filter that matches the wavelength of the display element output can be even more effective than the neutral filter. A typical red filter matched to a red GaAsP LED, for example, can increase contrast by as much as tenfold without attenuating the desired output by more than 30%.

Depending on the application and the environment, circular polarizers and other types of filters may also dramatically attenuate light reflected from the display device and impose a relatively small penalty on the device output. For devices such as some liquid-crystal displays that operate by modulating ambient light, performance cannot be improved by neutral filters, since these will attenuate both useful and undesired light by the same amount.

Many light-modulating displays exhibit persistence, a sometimes desirable characteristic that has the effect of making the duty factor larger than the ratio of excitation time to frame time.

To illustrate the effect of persistence, consider a display with element contrast of 10 and a duty factor of  $1/4$ . If the element turns on rapidly but turns off slowly, so that once energized, it remains on for  $3/4$  of the frame time, the effective duty factor is  $3/4$ . In such a display, the effective contrast will be improved from  $3/4$  to  $7/4$ . This is one of the reasons that some liquid-crystal devices can be multiplexed effectively, despite their lower contrast. The slow response of the liquid crystal, however, may be unacceptable in some applications.

### Keeping off-elements off

A second fundamental limitation of matrix-drive systems—the unwanted energizing of unselected segments because of parasitic currents in the matrix—is illustrated by the three-digit display in Fig. 4a. Each digit in the example consists of gas-discharge elements, arranged in seven segments. The same array is redrawn in Fig. 4b to show more clearly the matrix arrangement.

If a single segment of the second digit is energized (as shown in Fig. 5a for the display of a minus sign), a full 100 volts appears across the desired segment.<sup>2,3</sup> In this case, the signal path is from segment-driver  $g$  to digit-driver 2.

However, a substantial fraction of this voltage can appear across the  $g$  segments of digits 1 and 3, as well as across all the other segments of digit 2. Depending on source impedances and current-sinking capabilities of the drive circuits, unselected segments may be lit. The problem of turning on unwanted segments gets worse as

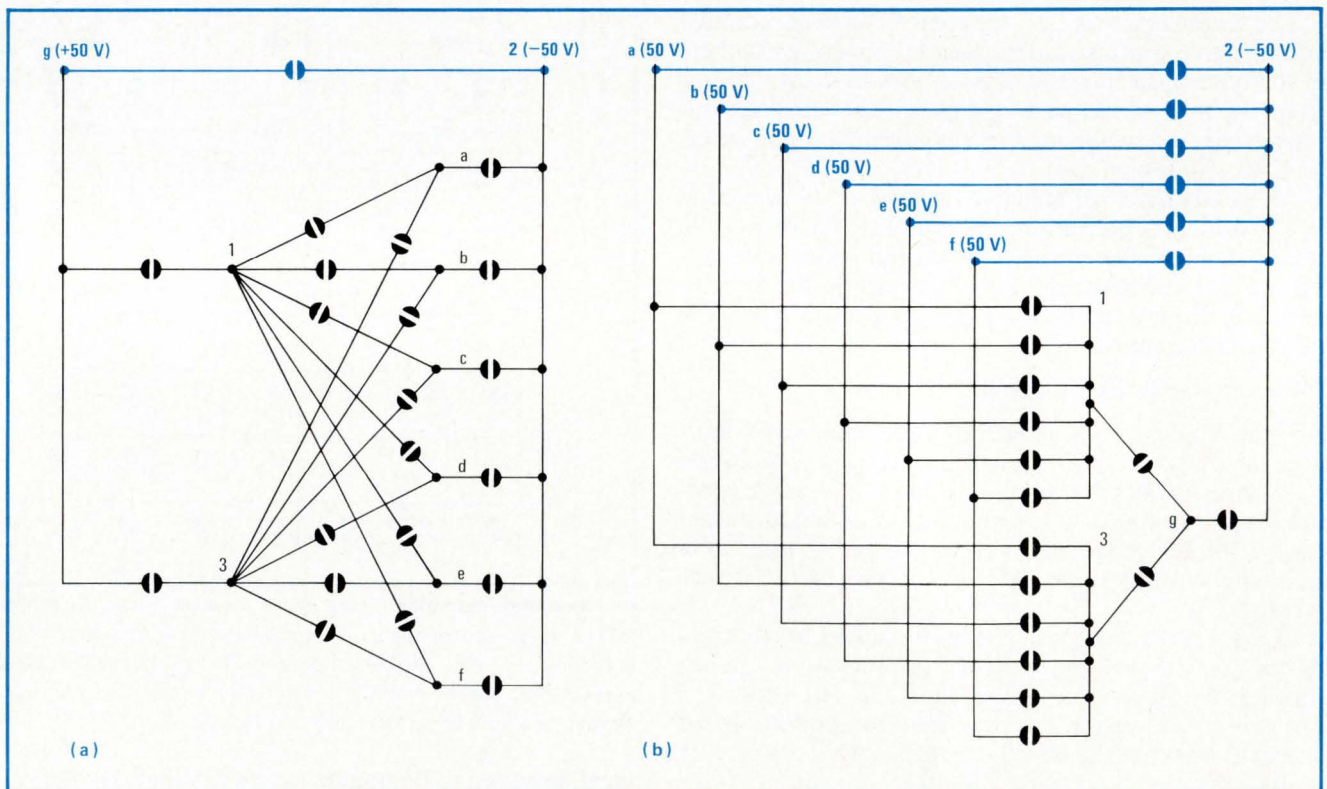

**5. Sneaky currents.** Parasitic currents within a display matrix must not inadvertently turn on unselected segments. In case (a), where only segment  $g$  of digit 2 is biased on, a total of 100 volts is placed between nodes  $g$  and 2. All other nodes are driven at 0.0 V. Since most gas-discharge segments start to turn on at about 80 V, no other segment will light up. However, if two segments are driven on (as for displaying the number 1) some of the unselected segment driver outputs may begin to rise above 0 V. This problem becomes most severe when all but one segment is biased on (as for displaying a zero, shown in b).



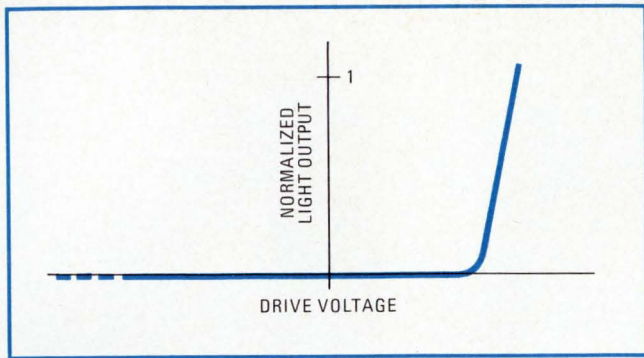

**6. Ideal matrix device.** Ideal element for matrix displays is highly nonlinear (there is no light output when biased below a given threshold) when forward-biased, and it emits no light when reverse-biased.

more selected segments are biased on, and it is worst when all but one segment are biased on (as for displaying a 0 in 5b). Here, parasitic currents from six segments converge on nodes 1 and 3. If not adequately clamped to 0 volts, segment g of digit 2 could be turned on. To keep this unselected segment from turning on, it is therefore necessary to provide a low impedance with adequate current-sinking capability at the digit-drivers so that they are clamped to 0 v.

On the other hand, segment-drivers should generally have high output impedances. This makes the drivers look like constant-current sources to the segment elements, and it gives uniform illumination from each diode in the display.

The matrix arrangement will work only if each display element is nonlinear and has a well-defined threshold, as shown in Fig. 6. Even if the digit drivers in Fig. 5b have zero impedance, half the applied voltage will appear across all segments, except g of digits 1 and 3. If half the applied voltage is below the knee of the curve in Fig. 6, there will be no output, but if the knee of the input-output curve is not well-defined, the unselected segments will begin to light up.

### Choosing the best element

For display devices that do not have sharp thresholds, nonlinear elements can be inserted in series (such as diodes in series with incandescent filaments). Or for dynamic-scattering nematic liquid crystals, two-frequency operation can be used.<sup>4,5,6</sup> The amount of softness of the knee that can be tolerated depends on the number of digits in the matrix and the contrast required. Because of the additional display elements needed, the nonlinearity requirement is generally more rigorous for dot-matrix digits than for seven-segment digits.

Typical characteristics of the more common display elements are compared in the table. The quantities provided are intended only to give general comparisons of today's performance. Detailed data must, of course, be obtained from each manufacturer's product specification sheets.

The over-all attractiveness of the LED for matrix displays is readily apparent in the table. In addition to having excellent input-output curves, LEDs can be switched in about 1 microsecond, and they have excellent luminance. Their efficiencies are low, however, and their deep red output is difficult for some people to see.

**TABLE: LEADING DISPLAY ELEMENT CANDIDATES WITH TYPICAL CHARACTERISTICS MOST AFFECTING DRIVE-CIRCUIT CONFIGURATION**

Device type	Relative brightness/contrast	Typical switching time On	Off	Input-output curve*
Light-emitting diode	Good to excellent	1 ns	1 ns	
Gas-discharge tube	Excellent	5-10 μs	100 μs	
Thin-film electro-luminescent	Excellent	100 μs	1 μs	
Liquid crystal	Fair to good	5 to 10 ms	10 to 20 ms	
Incandescent	Excellent	15 ms	20 ms	
Vacuum fluorescent	Good	5 μs	50 μs	

\*Curves normalized to typical full-scale light output (Y-axis) and to drive excitation magnitude (X-axis)

Gas-discharge devices also lend themselves to matrix displays, while liquid crystals, with their more linear input-output curve and their dependence on ambient light, have thus far been primarily limited to use with parallel-type drive systems.

Incandescent elements have been used in multiplexed displays of two to four digits, but difficulties in obtaining the higher peak power required in displays with more than about four digits have so far tended to inhibit their use in larger displays.

There are also a few less-well-known candidates for use in matrix displays. Fluorescent displays have been used successfully in multidigit matrix-type displays, especially where small size has been a requirement. Also, electroluminescent displays, while requiring a high-voltage ac drive, are capable of excellent contrast. □

### REFERENCES:

1. Sobel, Alan, "Duty Factor and Contrast in Scanned Displays," Proc. IEEE, Vol. 57 pp. 1,758-1,761, October 1969.
2. Sobel, Alan "Selection Limits in Matrix Displays," Proc. 1970 IEEE Conf. on Display Devices.
3. Sobel, Alan, "Some Constraints on the Operation of Matrix Displays," IEEE Trans. Electron Devices, Vol. ED-18, pp. 797-798 September 1971.
4. Wild, Peter J., and Nehring, Jurgen, "Turn-on Time Reduction and Contrast Enhancement in Matrix-Addressed Liquid-Crystal Light Valves," Appl. Phys. Letters, Vol. 19, pp. 335-336, Nov. 1, 1971.
5. Stein, C.R., and Kashnow, R.A., "A Two-Frequency Coincidence Addressing Scheme for Nematic-Liquid-Crystal Displays," Appl. Phys. Letters, Vol. 19, pp. 343-345, Nov. 1, 1971.
6. Gooch, C.H., and Low, J.J., "Matrix-Addressed Liquid-Crystal Displays," J. Phys D: Appl. Phys., Vol. 5, pp. 1,218-1,225, 1972.

### Closing the loop

Readers who are interested in discussing this article with the author may call Alan Sobel on May 3 during business hours at (312) 745-4861.



# Centralab perspectives

FOR USERS OF ELECTRONIC COMPONENTS

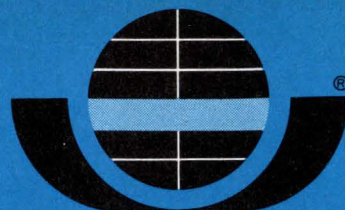

CENTRALAB

Electronics Division  
GLOBE-UNION INC.

5757 NORTH GREEN BAY AVENUE  
MILWAUKEE, WISCONSIN 53201

## There are dozens of ways rotary switches can meet the needs of standardization.

Their flexibility is often overlooked. Now, Centralab offers 12 series of 1½" diameter miniature and 1" subminiature types with standard options to optimize your design.

Today many designers are specifying rotary switches to meet their needs for small size in miniaturized applications. And Centralab is helping them achieve extraordinary design freedom with its 12 series of standard 1½" miniature and 1" subminiature switches and an almost endless choice of standard options.

What kind of design flexibility can you expect? Power handling capability is one. The 1" subminiature switches are designed for current carrying capacities of 7 and 9 amps; the 1½" miniature provides for 9 and 12 amps. Resistive load ratings for subminiatures range from .170 to .335 amps @115 VAC; for miniatures, .230 to .450 amps @115 VAC.

Three index types are standard — flat spring, single ball hill and valley or the unique dual-ball side thrust. The dual-ball detent features field adjustable torque, for best "feel." Switches having multiple switching decks can be adjusted for uniform torque.



Three standard index styles provide positive switch action with good torque and feel.

Circle 100 on reader service card

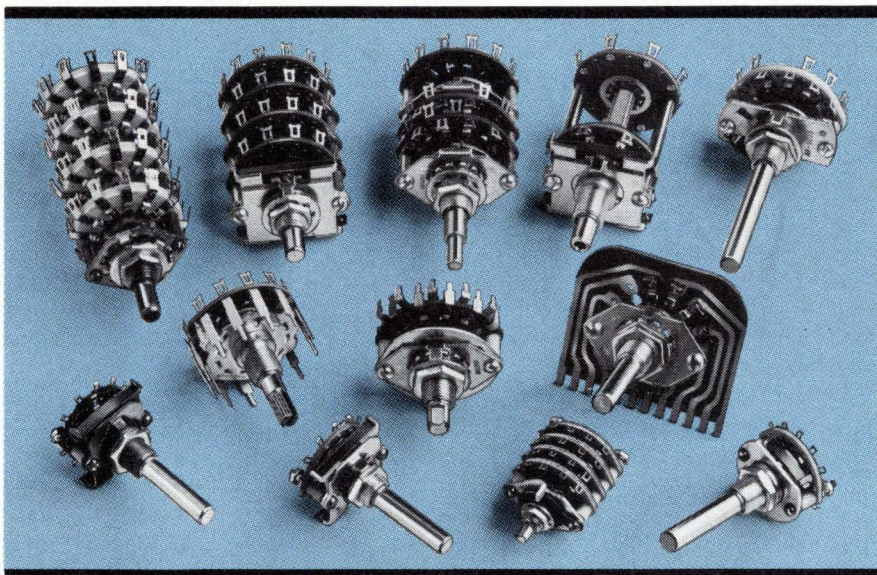

Centralab is helping design engineers meet the needs of standardization and miniaturization with this complete line of rotary switches. Options include PC terminations with clips mounted either to the front or rear of index.

Centralab offers you a big choice in providing the number of positions and index angles to meet the switching requirements of your circuit. More than 27 different options are available for switches with 4 to 24 positions in fixed or adjustable stop models. With the latter, you can easily change stops without disassembly of the switch or removal of stop tabs. Switches can be furnished with index angles of 15°, 30°, 36°, 45°, 60°, 90° or 120°.

Design freedom is expanded by the many styles of contact switch sections and the wide variety of section materials. Choose from four standard types of insulation — dialyl phthalate, for highest insulation resistance, phenolic, ceramic and glass epoxy or silicone. Four termi-

nals and rotor contact styles in brass, coin silver or optional high temperature alloys help meet desired contact ratings. And, Centralab supplies 1" and 1½" switches with PC board and plug-in terminals.

Sophisticated designers appreciate the extraordinary design versatility of these Centralab rotary switches in the way they accept add-on components. Most can be furnished with an A/C line switch, potentiometer or push button switch.

Availability? There's flexibility there too. You can get immediate delivery on custom assembled switches from your Centralab Selectashaft™ Distributor or standard types from any Centralab Industrial Distributor. For design application help, write for Centralab Bulletin 1101S.





## Centralab perspective:

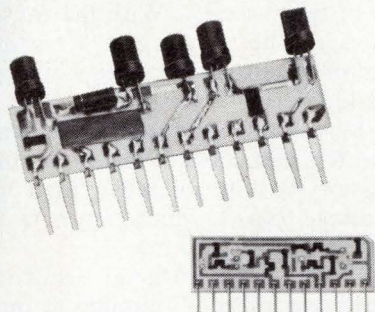

### Two thick film hybrid systems. PEC and MEC.

Centralab offers the flexibility to design and fabricate thick film modules to fit virtually any application and cost parameter.

Low-cost silver/carbon or  systems for consumer applications:

- Resistor Range.....10 ohms to 10 megohms
- Resistor Tolerance...±10% preferred minimum
- Ratio Matching.....±5% minimum
- Capacitor Types.....Ceramic and tantalum
- Active Devices.....Diodes, transistors & IC's
- Operating Temp. Range...-55° C to +85° C

Noble metal/cermet or MEC systems for commercial and industrial uses:

- Resistor Range.....3 ohms to 3 megohms
- Resistor Tolerance.....±.5% minimum
- Ratio Matching.....±1% minimum
- Capacitor Types.....Ceramic and tantalum
- Active Devices.....Diodes, transistors & IC's
- Operating Temp. Range...-55° C to +150° C

For more information write A. R. Wartchow, Marketing Manager, Electroceramic Products. Or ask for Centralab Bulletin No. 1429H.



## Centralab perspective:

### Push button switches. Now in 5 spacing options.

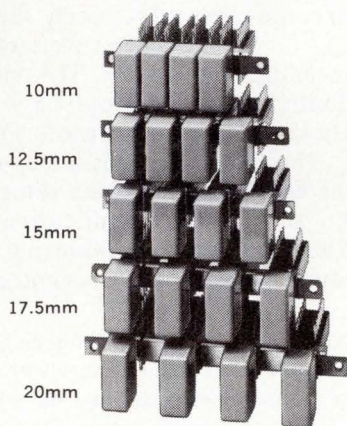

Center-to-center push button module spacings of 10, 12.5, 15, 17.5 and 20 mm are now available standards from Centralab. This, plus a choice of 2 to 8 pole switching functions, coupling arrangements and 26 standard button styles in 18 colors present added dimensions of design flexibility. Other features:

- Optional epoxy sealed terminals
- Interlock/lockout variations
- Lighted push button options
- Modular LINE SWITCH (mounts in any station)

Write Centralab for push button switch\* Bulletin No. ELC2.

\*Isostat licensed



## Centralab perspective:

### EMI/RFI FILTERS FROM USCC/CENTRALAB

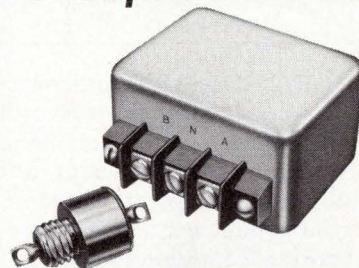

Now . . . the broadest line of filters ever available from USCC — from precise, miniature ceramics, through general purpose filters to specific application "tailored" types.

Our ceramic line starts off with the 1000 and 2000 Series Pi, L and T section low pass filters. The 3000 and 9000 Series "screw-body type" offer up to 500 VDC in Pi, L and multi-section units.

The General Purpose 5000 Series utilize paper and film type capacitors. They are available in 200, 400 and 600 VDC and 115, 250 VAC, 0-400 Hz ratings. Specifically designed for electronic data processing units and systems, USCC's new 8000 series are available in tubular, rectangular and "bathtub" styles.

Whether your application is suppression of noise interference in auto ignition systems, improving the quality of phone lines, or suppression of nuclear pulses (EMP) WE HAVE A FILTER FOR YOU.

Write USCC for complete EMI/RFI Filter catalog.

USCC/Centralab  
2151 N. Lincoln Street  
Burbank, California 91504





## Voltage-to-current converter for process-control systems

by Harry L. Trietley, Jr.  
Taylor Instrument Process Control Div., Sybron Corp., Rochester, N.Y.

To avoid damage to process-control instruments, such as controllers and chart recorders, the maximum value of the signal current that drives these devices must be limited. This signal current, which corresponds to a control signal voltage, can become too large if the control-signal voltage exceeds its normal range or if some other abnormal condition occurs.

Without requiring a series output resistance, the voltage-to-current converter in the diagram limits output current to between 24 and 40 milliamperes, a safe range for much process-control instrumentation. The circuit converts an input signal of 0 to 1 volt to a current of 4 to 20 mA for driving a load of 0 to 1,300 ohms.

Under normal operating conditions, the zener diode does not conduct. The amplifier and transistors  $Q_1$  and

$Q_2$  perform as an operational amplifier, the output of which is at the emitter of transistor  $Q_2$ . With the resistance values shown, the circuit has a gain of 1. Resistors  $R_1$ ,  $R_2$ , and  $R_3$  form an offset zero adjustment, while resistor  $R_4$  provides precision gain adjustment.

The output current,  $I_{OUT}$ , equals the sum of the currents in resistors  $R_5$  and  $R_6$ , regardless of the size of the output load. Since resistor  $R_5$  is much larger than resistor  $R_6$ , the output voltage ( $E_{OUT}$ ), which ranges from  $\frac{1}{4}$  to  $1\frac{1}{4}$  V, produces a current of 4 to 20 mA.

Integrated op amps, such as the National Semiconductor LM101 used here, are internally limited to output currents of about 25 mA. When the converter's output reaches the zener's voltage, the zener will conduct, grounding the amplifier's output current and clamping the converter's output voltage to a nominal level of  $3\text{ V} \pm 10\%$ . The output voltage is actually limited to between 1.5 and 2.5 V because of the base-emitter voltage drops of transistors  $Q_1$  and  $Q_2$ . The output current is then limited to a maximum value of between 24 and 40 mA.

If the value of resistor  $R_6$  is lowered to 25 ohms, the output current range becomes 10 to 50 mA, with limiting occurring between 60 and 100 mA. Other outputs, gains, or current limits can also be realized. □

**Instrument Interface.** Circuit converts control signal voltages to signal currents for driving process-control instruments, such as chart recorders. For the components values shown, this converter limits output current to between 24 and 40 milliamperes to protect the instruments from excessive driving currents due to out-of-range control voltages. The zener diode limits output voltage to 1.5–2.5 volts.

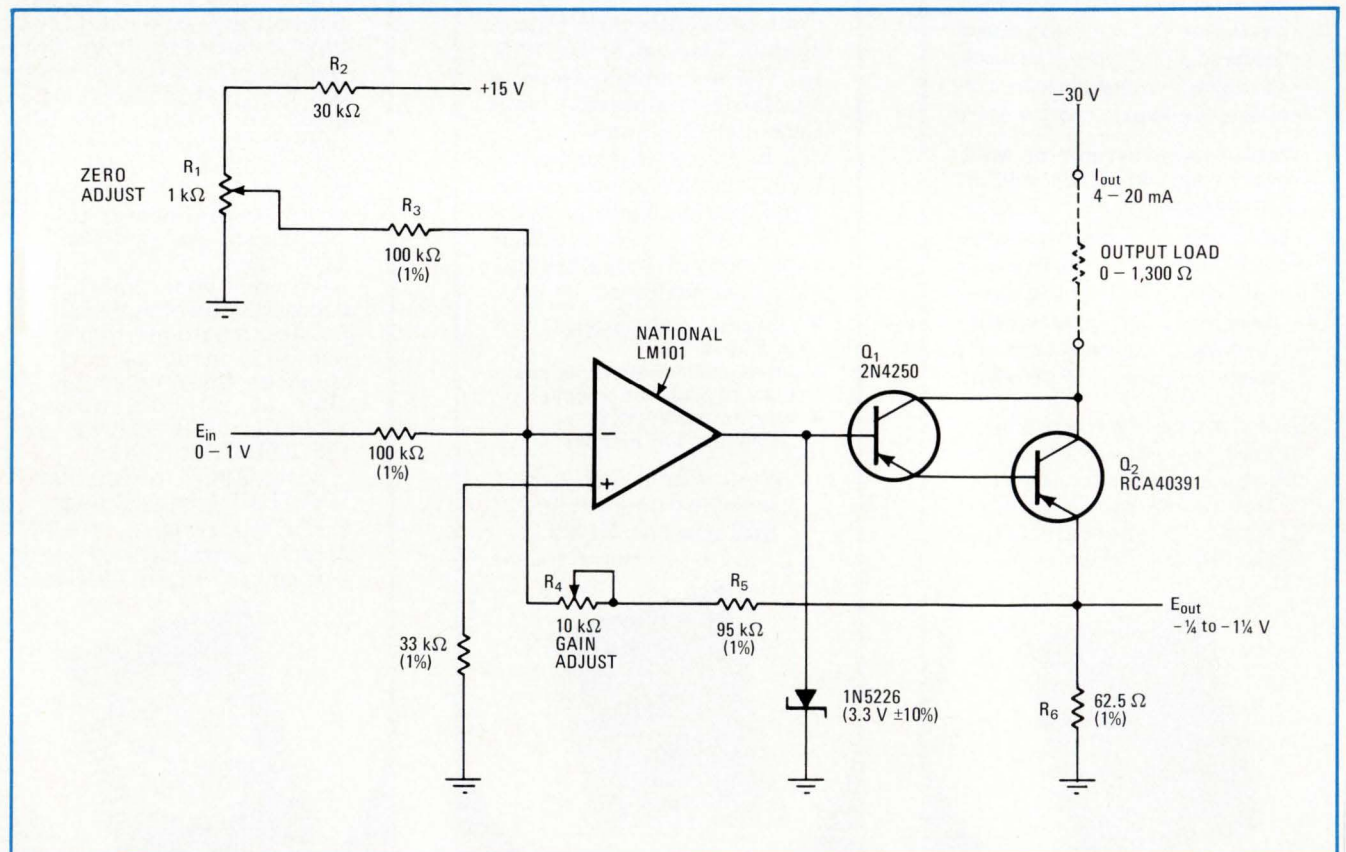



# Data averager for panel meter operates from meter's clock

by George Mitchell and Richard D. Spencer  
University of Illinois, Urbana, Ill.

In many scientific applications, measurements made with a digital voltmeter require time-averaging to reduce the measurement uncertainty of a noisy signal. A simple averaging circuit can be easily added to a digital panel meter for summing independent measurements so that the uncertainty of the data is reduced.

The averaging circuit shown here causes the DPM to sum 10 or 100 measurements (depending on switch position), thereby reducing data uncertainty by a factor of 3.2 or 10, respectively. Although this circuit is intended for an Electro-Numerics' model 305 4½-digit ratio panel meter, it can be readily adapted to any DPM that uses a dual-slope converter.

The circuit, which is activated with an initiate pulse (trace A in the figure), takes advantage of the clock

pulse train (trace C) from the DPM's dual-slope converter. The clock train is transmitted during the integration period (trace B) of the analog signal and reference inputs. The count-up pulse (trace D) corresponds to the fixed integration time of the analog signal input.

NAND gates  $G_1$  and  $G_2$  use the count-up pulse to gate the clock output of the DPM's dual-slope converter so that the input to either decade counter 1 or 2 (trace E) is directly proportional to the ratio (in this case) of the analog inputs. As can be seen, counters 1 and 2 are scalars of 10 and 100, respectively, for the gated clock pulse train. Counters 3 through 7 form the decimal accumulator, and counters 8 and 9 are tally registers that inhibit averaging of data past the required number of samples (10 or 100).

The averaging circuitry is synchronized to the DPM's converter cycle by the two flip-flops and three NAND gates. Grounding the initiate line clears the tally registers and scalars, as well as the accumulator, and initiates the accumulation of a new average. The average, or scaled, output is displayed by light-emitting-diode readouts that have their own decoder/drivers. The binary-coded decimal output of the accumulator may also be used to transfer data directly to a printer or computer. □

**Averaging out noise.** Measurement uncertainty of noisy signals is reduced by time-averaging circuit for digital panel meter. The circuit, which runs from clock of DPM's dual-slope converter, sums 10 to 100 measurements, reducing data uncertainty by 3.2 or 10. Counters 1 and 2 are the scalars, counters 3 through 7 make up the accumulator, and counters 8 and 9 are the tally registers.

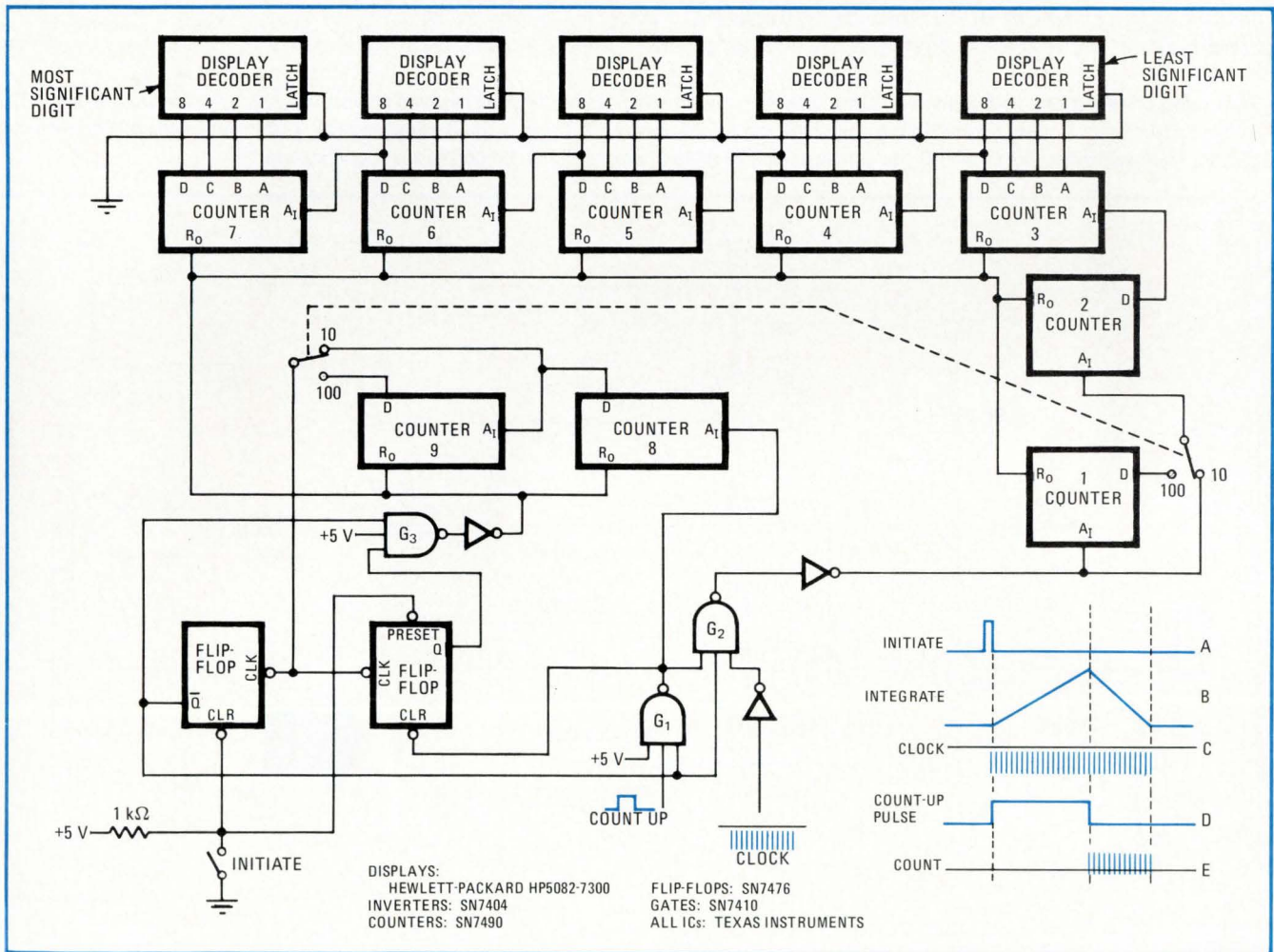



# Binary rf phase modulator switches in 3 nanoseconds

by Roland J. Turner  
AEL Communications Corp., Lansdale, Pa.

By employing a diode-steered current source, binary rf phase modulation is accomplished by translating transistor-transistor-logic levels to a bidirectional current drive in less than 3 nanoseconds. The rf modulator is intended to provide phase coding and correlation in jamming-resistant radar and secure communication links, where transmission and reception are essential in a hostile environment.

The binary ( $0^\circ$  and  $180^\circ$ ) phase modulation is effected by switching Schottky diodes in a ring modulator at high video/i-f rates. These high data rates require TTL signal levels to be translated to a  $\pm 15$ -milliampere current drive for the ring modulator in extremely short time intervals. The complete binary rf phase modulator consists of the video driver (a), which employs stripline techniques, and the ring modulator (b).

When the input logic level to the video driver is at  $-5$  volts, transistor  $Q_1$  is off, diode  $D_1$  is on, and diode  $D_2$  is off. This forces current source  $Q_2$  to deliver  $15$  mA to the ring modulator. When the input logic level increases positively from  $-5$  v to  $0$  v, transistor  $Q_1$  turns on, reverse-biasing diode  $D_1$  so that this device turns off.

Diode  $D_2$  now turns on, and current source  $Q_3$  forces  $15$  mA to be drawn from the video port of the ring modulator. The i-f/rf signal phase is then shifted by  $180^\circ$  as it passes through the ring modulator.

This binary phase modulation is accomplished in only  $3$  ns because the current sources can force rapid charging of any circuit capacitance. Also, load-circuit switching is forced by impressing a large negative or positive voltage on diode  $D_1$ . Since  $D_1$ 's switching voltage transition is low relative to the drive voltages, switching can be done in a small time interval. (Current sources  $Q_2$  and  $Q_3$  are temperature-stabilized by diodes  $D_3$  and  $D_4$ .)

The switching current from the video driver is applied to the video port of the ring modulator. When the driver supplies current ( $+I$ ) to the video port, Schottky diodes  $D_5$  and  $D_6$  conduct, and the output phase is  $180^\circ$ . When the driver sinks current ( $-I$ ) from the video port, Schottky diodes  $D_7$  and  $D_8$  are forced to conduct, and the output phase is  $0^\circ$ .

This switching technique is quite useful in applying coded rf phase modulation to an interrogating radar or in applying secure modulation to a secure communication link. The system then becomes very difficult to jam since correlation reception at the receiver enhances detection and suppresses the effects of noise, whether the noise source is Johnson noise or intentional noise jamming. □

Designer's casebook is a regular feature in Electronics. We invite readers to submit original and unpublished circuit ideas and solutions to design problems. Explain briefly but thoroughly the circuit's operating principle and purpose. We'll pay \$50 for each item published.

**Reversing phase at radio frequencies.** Phase modulator switches phase of rf signals between  $0^\circ$  and  $180^\circ$ . Video driver (a) translates TTL inputs to bidirectional switching current for Schottky-diode ring modulator (b) in under 3 nanoseconds. The driver employs diode-steered current sources (transistors  $Q_2$  and  $Q_3$ ) to supply or sink  $15$  milliamperes for the video port of the ring modulator.

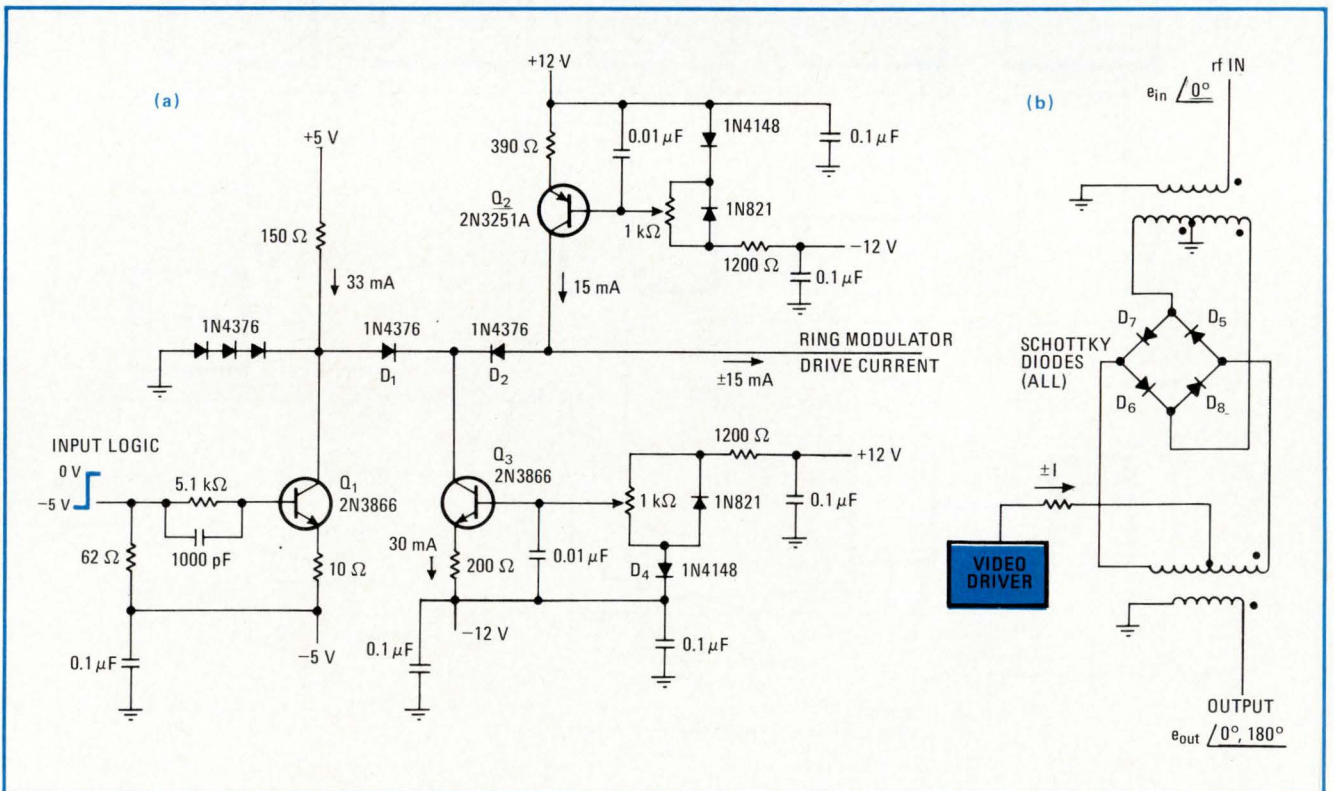



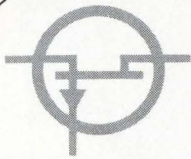

P-channel  
J FET



N-channel  
J FET

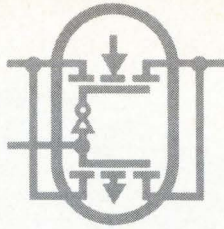

CMOS  
FETs

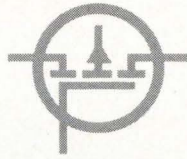

P-channel  
MOS FET

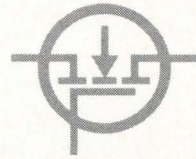

N-channel  
MOS FET

Since 1962, Siliconix has evolved FET technology and applied it to a complete line of singles, duals, arrays, and ICs. So what's new?

# Switch 10 MHz Signals with better than 60 dB OFF Isolation

The Siliconix DG181-DG191 family of FET switch/IC drivers is well-suited for processing high-frequency signals, and is directly compatible with most computer logic. FET switch/monolithic driver combinations are available in SPST, SPDT, or DPST functions.

Features include:

- Constant ON resistance with signals to  $\pm 10$  V and 100 MHz
- 60 dB OFF isolation at 10 MHz with 75  $\Omega$  load
- $t_{on}$  and  $t_{off}$  = 150 ns typical
- 1 nA max (100 pA typical) leakage from signal channel in either ON or OFF state.

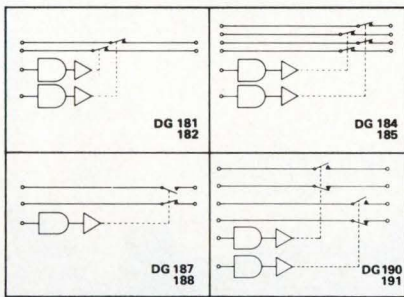

DG181-DG191 Functional Diagrams

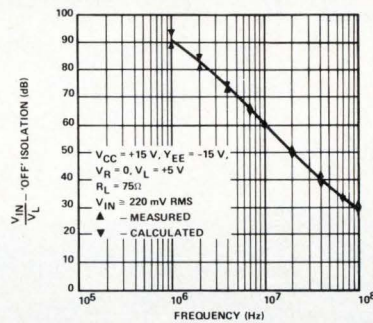

Switch OFF Isolation vs Frequency — DG181

The key to this exceptional performance is the Siliconix concept of monolithic driver design, with careful attention to critical details such as low driver output impedance. DG181-DG191 driver (switch OFF) resistance

to ground is only 200  $\Omega$ , providing good a-c by-pass on the FET switch gate. Contrast this with other driver circuits with impedances as high as 26 M $\Omega$ , which adversely affect isolation characteristics.

The DG181-DG191 series of FET analog switches is an ideal solution to most switching problems. If your case is unique—and whose isn't—our applications people are eager to help. For complete information

## write for data

Applications Engineering (408) 246-8000, Ext. 501



Siliconix incorporated

2201 Laurelwood Road, Santa Clara, California 95054



# BOURNS

POTENTIOMETERS

QUALITY · DELIVERY  
PRICE

83 DISTRIBUTOR INVENTORIES

## CONTROLS AND VARIABLE RESISTORS

- CHOOSE FROM 6 POPULAR "SPACE SAVER" CONTROLS
- LOWEST PROFILE IN THE INDUSTRY
- CERMET... FOR BETTER STABILITY AND POWER
- 3 POPULAR VARIABLE RESISTOR MODELS; HORIZONTAL AND VERTICAL MOUNT EITHER CERMET OR COMPOSITION ELEMENTS
- COMBINED FACTORY/DISTRIBUTOR CONTROLS STOCK: 167,000 PCS.
- VARIABLE RESISTORS: 715,000 PCS.



# TOTAL SOURCE... BUILT ON BASICS!

COMPONENTS FOR LOW-PRICED COMMERCIAL . . . TO MAN-ON-THE-MOON APPLICATIONS!

## PRECISION POTENTIOMETERS

- SELECT FROM OVER 20 DIFFERENT STANDARD MODELS INCLUDING THE FAMOUS KNOBPOT® FAMILY
- 260,000 UNITS IN COMBINED FACTORY/DISTRIBUTOR STOCK
- CUSTOM PRECISIONS FOR EVERY SERVO-MOUNT APPLICATION

TRIMPOT®

## ADJUSTMENT POTENTIOMETERS

- WORLD'S LARGEST LINE OF ADJUSTMENT POTENTIOMETERS!
- SELECT FROM OVER 60 MODELS . . . WIREWOUND OR CERMET!
- SINGLE-TURN . . . MULTI-TURN! ROUND, SQUARE AND RECTANGULAR!
- OVER 12,000 "MODEL/TERMINAL/RESISTANCE" COMBINATIONS!
- OVER 3,500,000 UNITS IN COMBINED FACTORY/DISTRIBUTOR STOCK

**BOURNS**  
INC.

TRIMPOT PRODUCTS DIVISION  
1200 COLUMBIA AVENUE  
RIVERSIDE, CA. 92507

Circle 107 on reader service card.



## Product development profile

# The Intel 1103: The MOS memory that defied cores

A young company banked on a silicon-gate p-channel dynamic MOS random-access memory to replace cores in mainframes: a Honeywell team aided in the design, which has become an industry standard

by George Sideris, *San Francisco bureau manager*

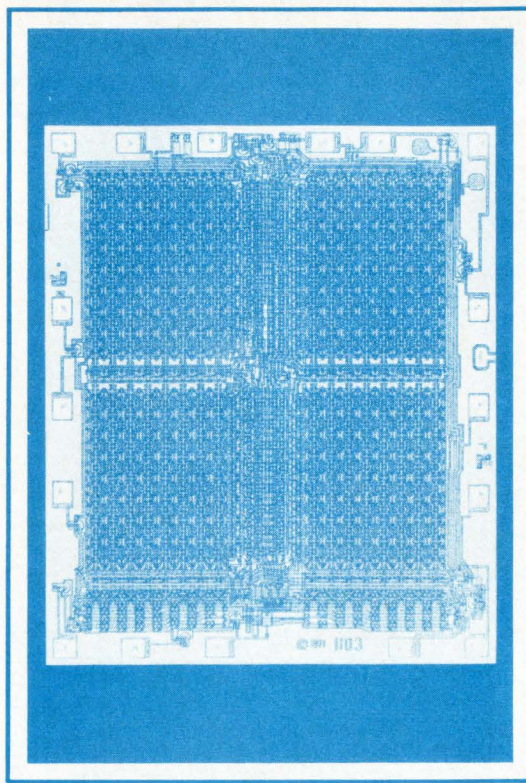

□ Next month, Intel Corp. will start reducing production of the 1103 random-access memory and phase in an easier-to-use replacement, the 1103A. The new chip, which can be slipped directly into 1103 sockets, has simpler timing procedures and higher speed, and it is TTL-compatible. When the original 1103 design is retired in a year or so, the frontier days of solid-state memory development will end. But the trends set by the 1103 in 1970 will probably continue through the decade.

The 1103 showed that dynamic MOS RAMs could compete with cores in the computer mainframe and peripheral markets. It firmly established semiconductor-memory organization in multiples of 1,024 bits. And it made silicon-gate MOS the dominant process technology throughout the world of non-IBM memories. Few contenders for the market created by the 1103 depart radically from that concept.

Fairchild's 709 amplifier and Texas Instruments' 7400 TTL gate, two other landmark circuits, have been used by more engineers than the 1103. However, Intel's RAM is unquestionably the greatest economic success. Intel's second-source list reads like a "Who's Who in the Semiconductor Industry."

### Costs drop

Since the 1103 was introduced at \$60, cost and volume curves have quickly intersected like two parabolas. This year, 6 million 1103s will be shipped at an average price of \$4–0.4¢ a bit—estimates A.C. "Mike" Markkula, Intel's sales manager.

True, 6 gigabits is small, compared with core volumes. But huge numbers of solid-state RAMs will be used in new computers. Moreover, 4,096-bit versions of the silicon-gate dynamic RAM built with a high-density

n-channel cell structure—costing still less per bit—are already being aimed at that market. And with the 1103-type RAM, megabyte solid-state add-on memories are becoming commonplace in the IBM System/370 peripheral market.

Perhaps the 1103's true measure is that system designers have been willing to struggle with its idiosyncracies for months at a time because it is economical. "They hate it, but they use it," Markkula jokes. Others have used more pungent phrases to describe the 1103. But whatever phrase is used, the fact is the 1103 was the first widely used device that put 1,024 bits of memory on a chip in a form that was economical for the user.

The Intel and Honeywell Inc., design teams who developed it accepted the system design difficulties in order to cram 1,024 bits on a manufacturable chip. Timing with the 1103 is difficult because it requires overlapping cycles that are timed to narrow windows. However, the quirks will be retired with the 1103, Intel promises.

### Early explorations

In 1968, when Intel was spun out of Fairchild Semiconductor, it was widely predicted that semiconductor memories would find a \$500 million market in the 1970s and perhaps a \$2 billion market in the 1980s. Robert Noyce, formerly Fairchild's general manager, and Gordon Moore, who was engineering manager and R&D director at Fairchild, started Intel with that market as their goal.

However, a review of memory technology convinced them that none of the then-popular concepts could catch up quickly with the falling cost curve of core memories. They decided to pursue Schottky TTL for a



quick entry into the small, high-speed memory market and silicon-gate MOS for the longer haul into the mainframe market.

The silicon-gate technology was then developmental. The first definitive paper was published in 1968 by Bell Telephone Laboratories researchers, but some of Intel's founders had begun their silicon-gate work in 1967 at Fairchild. Fairchild's initial silicon-gate product was a multiplexer, though [*Electronics*, Sept. 15, 1969, p. 67].

Noyce and Moore, already contemplating 1,024-bit RAMs, foresaw silicon-gate MOS as the most likely solution to chip-density and yield problems. In addition, the silicon gate's low threshold voltage offers high speed and can be made bipolar-compatible.

Intel's MOS staff cut its teeth on silicon-gate design with the 1101, a 256-bit static RAM introduced in 1969. Initial yields of good chips were pleasantly high—10% or better, compared with an anticipated range of 2% to 5%. Metal-gate yields were then running around 5%.

The 1101 was a significant advance. It could be operated directly by system logic because it had TTL-compatible address decoders and sense amplifiers on the chip. Low logic overhead made it useful in small systems, but the complex static cell structure (Fig. 1a) made the 1101 too slow and costly for mainframe memories.

#### A new trail

Static RAMs were the style in 1968. In the proceedings of the 1968 Fall Joint Computer Conference, for example, the only paper that discussed solid-state memories covered static RAMs. The author, W. B. Sander, of Fairchild, accurately predicted: "Both (bipolar and MOS) will be developed, and the final edge of one over the other will require some dramatic development in one of the technologies."

At Intel, M. E. "Ted" Hoff Jr., a young Ph.D. from Stanford University, devised a simple dynamic storage cell. It needed only three transistors, compared with the conventional four (Fig. 1b). More importantly, the intraconnections, which in conventional cells occupied more room than the transistors, were sharply reduced.

Since the cell promised three to four times the density of a static design, Noyce and Moore started a team developing dynamic RAMs. Leslie Vadasz, Joel Karp, and Hoff were assigned to design circuits with variations of the cell. (Vadasz, the team leader, is now Intel's engineering manager, Hoff is applications research manager, and Karp, long a mainstay in Intel's design staff, has recently joined Intersil Inc.)

They worked mostly on three versions: 1102, 1103, and 1104. The 1102 (Fig. 1c) and 1103 (Fig. 1d) were 1,024-bit designs (Fig. 2 is the chip diagram) that could be paralleled to form 1,024 words with any number of bits per word. The 1104, a 512-bit device, was soon rejected as not cost-competitive (it was later produced experimentally to test n-channel processes).

At first, the 1102 was deemed the most promising design. Hoff wrote an article about it [*Electronics*, Aug. 3, 1970, p. 69]. Karp and William Regitz, then a Honeywell engineer, described it in a paper at the 1970 International Solid State Circuits Conference. But at the conclusion of system trials in 1970, the 1103 got the nod.

Another bullet that had to be bitten during the conceptual design stage was the fact that, unlike static RAMs, dynamic operation would raise system overhead and design costs. However, core memories also have

### The RAMs to come

The Intel Corp. 1103 merely blazed the trail to mainframe computer memories. Coming closely behind are several more efficient MOS random-access devices that are larger by multiples of 1,024 bits. Two with quadrupled capacity are already nearing production.

Microsystems International Ltd., on its own, has enlarged the 1103 to 4,096 bits with n-channel substrates, doubling the chip size. And Intel has started pilot-line production of an n-channel 4,096-bit RAM. Conceptually, this RAM is similar to the 1103A, retaining a three-transistor cell and single-clock operation. However, the n-channel design is TTL-compatible and has an on-chip sense amplifier—features that will enable it to go further than the 1103A in reducing memory overhead.

The n-channel design makes it only about 50% larger than the 1103. Its chip measures 137 by 164 mils, compared with the 1103's 113 by 139 mils. The chips will probably cost about four times as much as the 1103 to manufacture, but the overhead reduction will make them less costly at the systems level (a rule of thumb is that, once a chip reaches 100 mils on a side, each 15% increase in area approximately doubles processing cost.)

Intel will introduce a medium-speed version of the 4,096-bit RAM this summer, following up with a high-speed version later in the year. Whether or not these, too, will become industry standards is still moot. This time, memory-system designers will have a choice of many RAMs. But each one builds on the basic 1103 concept—a simple dynamic cell.

**Undoubted originals.** Robert Noyce and Gordon Moore, founders of Intel, join in admiring some of the first 1103s produced.





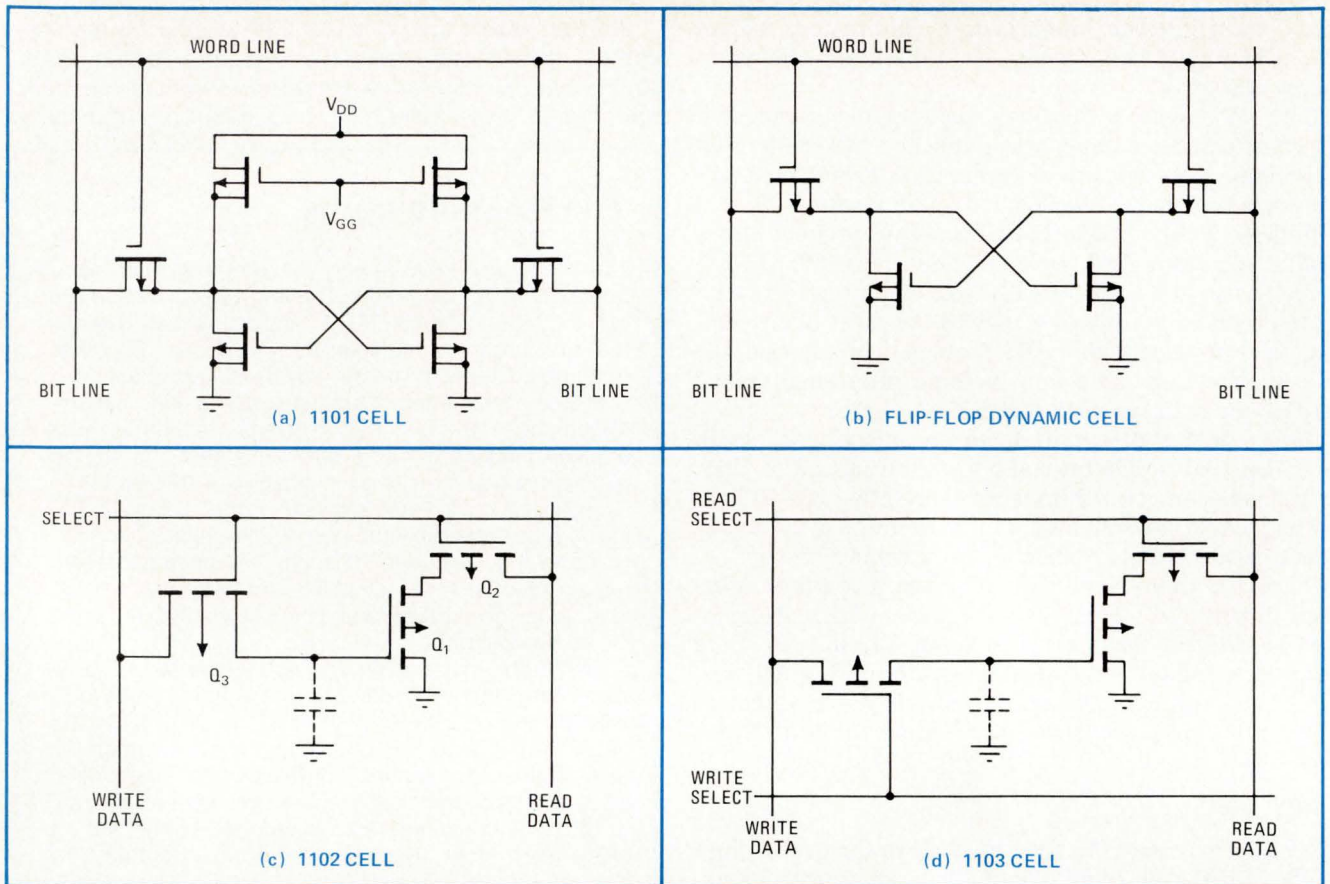

**1. Shrinking cells.** Static cell used by Intel in 1101 RAM was too slow and costly for mainframe memories (a). Leapfrogging conventional dynamic cell designs (b), the 1102 and 1103 1,024-bit RAMs contained three-transistor cells (c and d). Though smaller in area because it had one select line, the 1102 cell was rejected in favor of the easier-to-make 1103 design.

high overhead costs—divided among many bits. The team went for broke.

To increase speed, the team opted for large logic swings in hopes of winning additional cost-performance tradeoffs in the inevitable comparison with cores. The decisions were to require multiple clocks (Fig. 3), powerful drivers, level shifters, sense amplifiers, timing and control subsystems, and other support circuitry shown in Fig. 4.

The dynamic design promised brutal noise levels and noise-related problems in system control, timing, and sense circuits. Heavy capacitive loads would have to be driven at rates around 1 volt per nanosecond, assuring large current surges in the printed-circuit traces. Then, there were such complications as cell-refresh and volatility (loss of data) to be considered.

The 1103 requires three clocks with carefully timed overlays: precharge, enable (chip-enable) and write. Precharge was not really an innovation, Vadasz remarks. Precharge and enable are comparable to an MOS shift register's  $O_1$  and  $O_2$  clocks—one charges up the MOS capacitances so that the nodes can be discharged very rapidly or not be discharged in the following logic operation.

Of more lasting importance, Vadasz thinks, is a technique of building into the MOS transistors varactor diodes that bootstrap the logic levels. Once Intel's secret method of speeding up decoders, varactor bootstrapping is periodically rediscovered, he notes.

Uncertain whether or not the designs would work well in a memory system and reluctant to choose between the 1102 and 1103 arbitrarily, Noyce and Moore sought the opinions of potential customers. Here the risk that industry gossips might cause damage by broadcasting the design ideas was less immediate than the risk of expending large amounts of time and money on a design that might fail.

#### A new partner

Honeywell's interest in developing a standard product to compete with cores coincided with Intel's. If either the 1102 or 1103 evolved into an industry standard, Honeywell would be assured a supply of low-cost components. Other semiconductor manufacturers would surely second-source any circuit chosen by major computer manufacturers.

Honeywell assigned to the project a group at the computer plant in Framingham, Mass. William Jordan was group leader, William Regitz the principal components designer, and Henry Bodio the systems engineer (Regitz went to Intel as manager of MOS-memory engineering in 1971, then Jordan became manager of Intel's new Systems division, and Bodio joined the division as engineering manager).

In effect, Jordan's group acted as the non-IBM-computer industry's semiconductor-memory steering committee. They helped Vadasz' team firm up timing specifications, skew tolerances, control configurations, and a



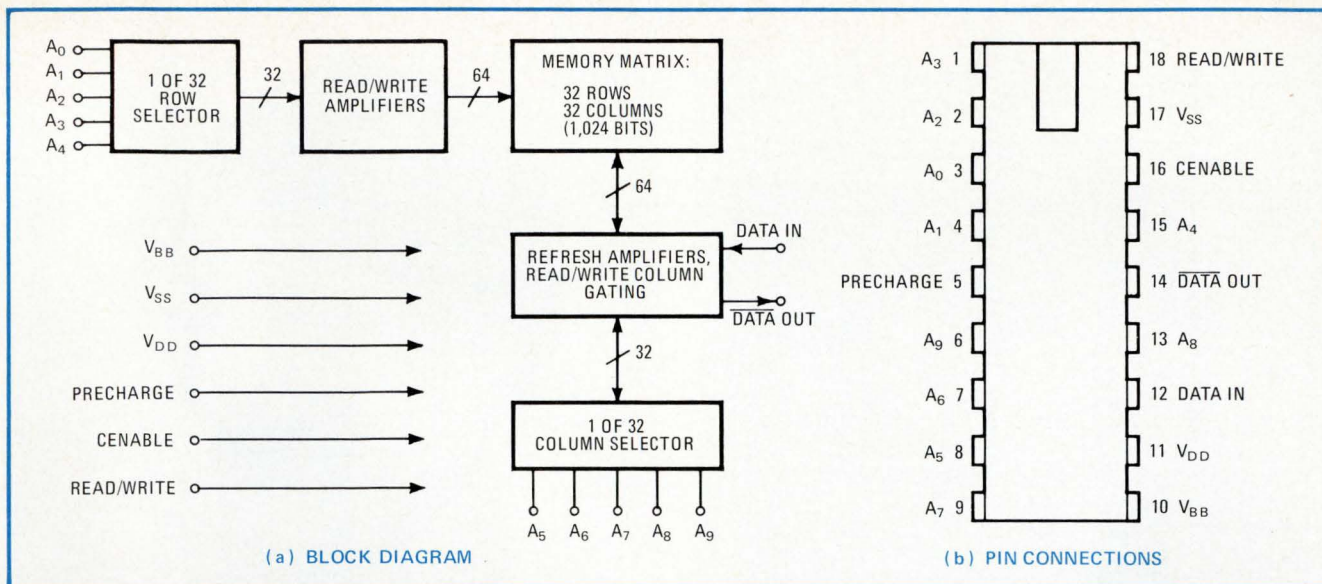

2. **Chip block.** Outline of the 1103 chip is identical with the 1103A, except for the latter's elimination of precharge.

most of other system design aspects during 1969 and 1970.

But the 1102 and 1103 were largely paper designs when the work started, Jordan recalls. "We worked right along with Vadasz's group." First, they assembled 16-bit prototype cell arrays. When those were debugged, 1,024-bit arrays were prepared. Finally, prototype systems were assembled.

As the quirks became known, they were compensated for by changes in chip or system design. For instance, certain address sequences that "bombed out" stored data forced chip changes. Timings sensitive to process or temperature variables might be compensated on the chip and in the system logic. The 1103 is sensitive to certain system operating conditions, involving, among other things, certain combinations of line-charging rates, addressing patterns, and timing patterns. Determining how to avoid these problems through system design took much of the group's time.

At Intel, thousands of chips were "wrung out." Known also as characterization, wringing-out means that chips, produced in batches under varying processing conditions, are tested under every conceivable combination of operating conditions. One objective is to find out what process controls give the best yield to the customer's specifications—and in this case, the customer was to be the computer industry. Thousands of performance curves were laboriously prepared.

### The showdown

The 1102 emerged from development first. It was the more advanced concept and fitted on a smaller chip, which could eventually mean higher yields and lower cost. Early in 1970, Jordan presented Honeywell's engineering manager with an H516 minicomputer with an 1102 memory instead of the standard core memory. Soon afterwards, the 1103 design was completed.

"We chose the 1103 because it was the more conservative," Vadasz reports. Jordan indicates that Honeywell decided to buy the 1103 because of fears that 1102 might have yield problems that would impede sec-

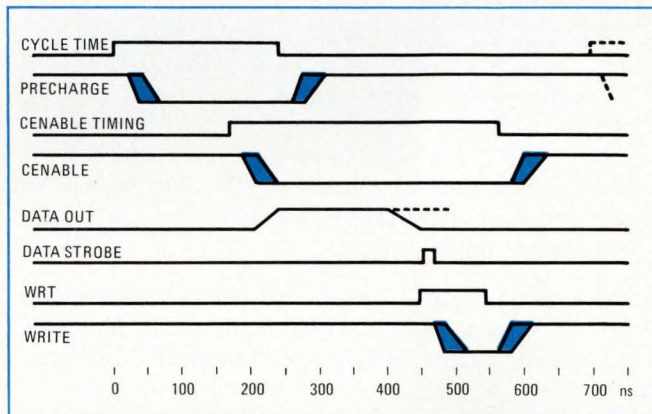

3. **Cycle slowdowns.** The 1103's complex timing diagram is now world-famous. This simplified version shows how system skews and tolerances add nearly 200 nanoseconds to the basic cycle time.

ond-sourcing (the 1103 has two operating voltages, while the 1102 cells operated at three voltage levels and required tighter tolerances).

"We decided on the part with the highest confidence level," says Jordan. "Today, we would probably choose the 1102, but that is academic now. The whole key was to settle on a standard part in order to realize the economies of scale in high-volume production."

The 1102 was also somewhat slower than the 1103. Was that a factor? No, says Jordan, because both were fast enough to compete with 18-mil and 20-mil cores. Besides the speed difference became slight, once system delays and skews were added to basic operating times (see Fig. 4).

Intel quickly established a second source. Microsystems International Ltd. took a license. In return, Intel helped MIL buy equipment and set up a plant, and Intel also supplied mask sets and taught MIL to make the 1103. In a short time, the Canadian company was more than a second source—MIL became Intel's chief competitor.

Markkula says of companies that have copied the design without the formalities of licensing, "I stopped



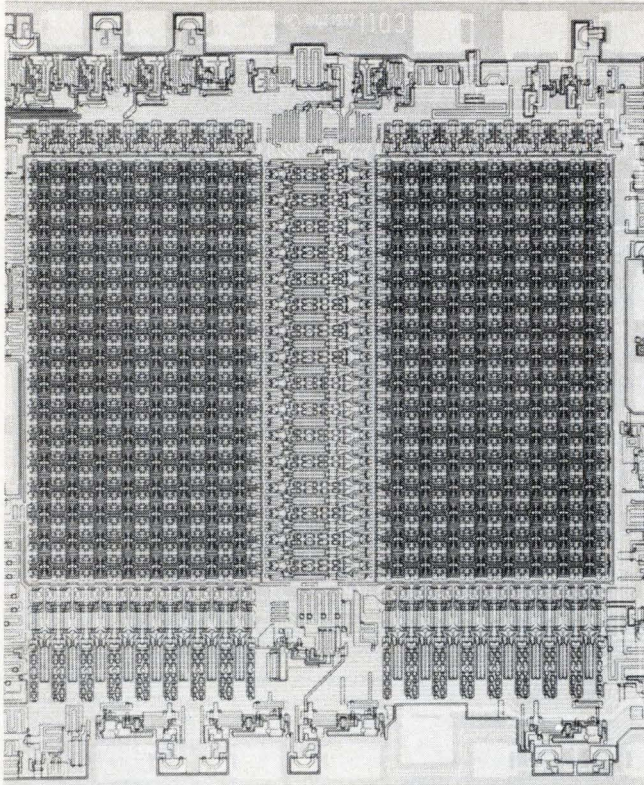

**4. New standard.** Retiring the venerable 1103 will be this improved version. Called the 1103A, this improved version is faster, TTL compatible, and has simpler timing.

counting at 18." They include Fairchild, Texas Instruments, Motorola, National Semiconductor, Signetics, General Instrument, Philips, and American Microsystems.

Even though a number of small-systems manufacturers adopted the 1103 quickly (\$3.9 million worth of 1103s were sold in the latter part of 1970), bigger companies hung back to make evaluations and design studies. Mainframe computer shipments started building up in mid-1972. Among major systems containing 1103s, Markkula lists the Digital Equipment Corp. PDP 11/45, Burroughs 7400, Texas Instruments Advanced Scientific Computer, Univac 9480, and the Honeywell 5800. Intel itself is penetrating the IBM market—Jordan's Systems division makes a 9-megabit add-on memory for IBM Systems/370-155 and 370-165.

The 1103 has also generated a kind of sub-industry of producing special clock drivers, address latches, and other support circuits. These have helped bring overhead costs down to a small fraction of a cent per bit.

#### Round two

When the dust of development settled, Hoff wrote a 28-page note to explain the operation of the 1103. It was sprinkled with warnings about operating conditions that could cause the 1103 to malfunction, and it recommended ways to solve those problems.

To spare system designers further grief—and to make the 1103 more competitive—Intel began redesigning the 1103 late in 1971. The result was the 1103A, scheduled for introduction in May of this year after only six months of wringing out and system trials. Among the

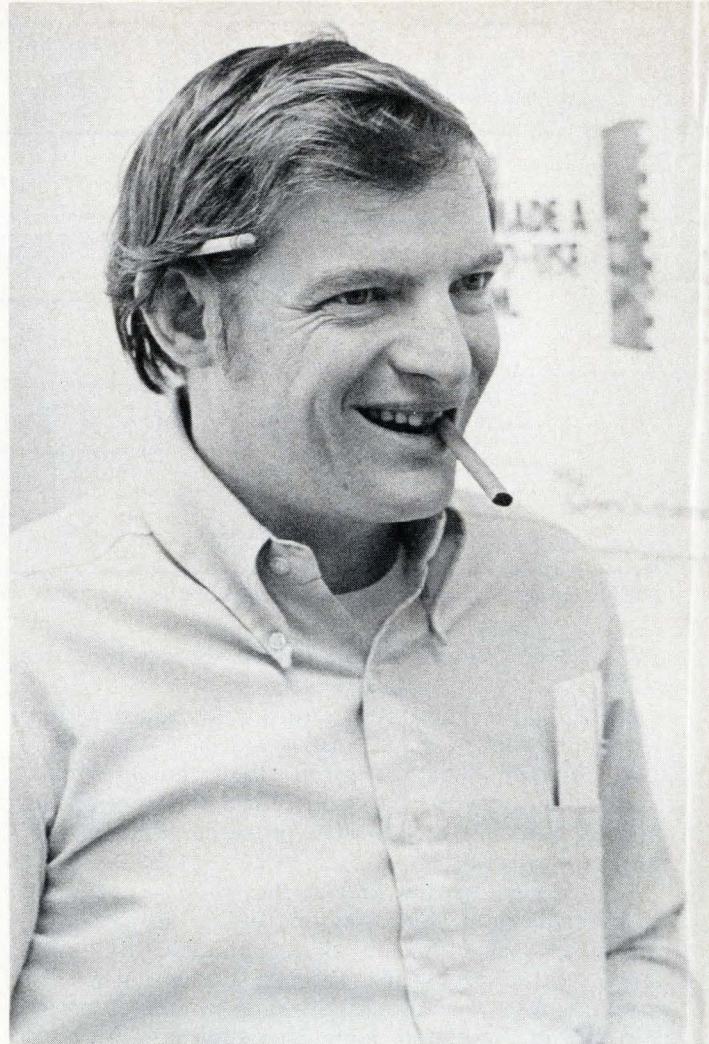

**Circuit fixer.** At Honeywell, William Regitz helped debug the 1103 and built prototype array assemblies.

changes cited by the designers are:

- Precharge and critical timing problems are gone.
- Sensitivity to process, temperature, and timing variations is reduced.
- Access time is almost halved in system operation.
- Address buffers are on the chip.
- Standby power is 1/40th that of the 1103, and operating power drops more rapidly with clock frequency.
- The chip is smaller, promising higher yield and lower cost than the 1103 might achieve.

But, Regitz stressed, the 1103A was developed as a direct "socket replacement" for the 1103. Existing system designs need not be changed because:

- Package pinouts are the same (the precharge pin is not connected to the chip).
- Cycle time is the same.
- Cell design and refresh methods are the same.
- Clock formats are the same (except that precharge can be removed).

Regitz calls the 1103A a single-clock RAM. On the leading edge of enable, one-shot and other chip delays take the place of an 1103 system's timing overlaps. The chip itself controls timing sequences. When the read pulse or write clock arrives, the chip is all set up for



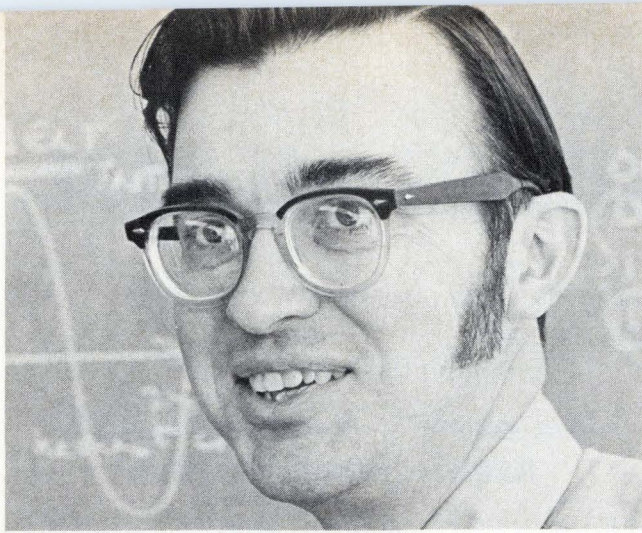

**Cell mate.** Ted Hoff is credited with inventing the three-transistor cell that sparked the 1103 dynamic design.

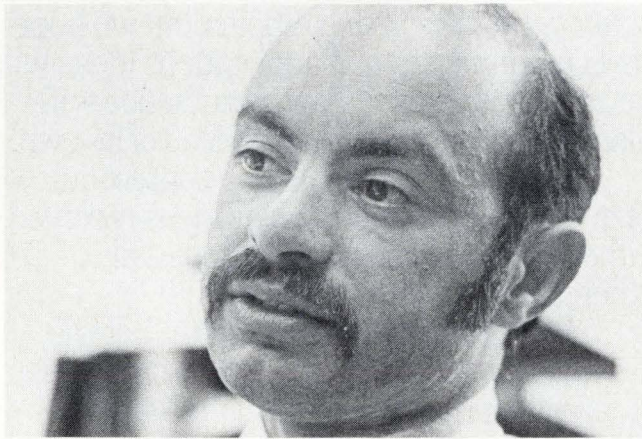

**Happy Hungarian.** Leslie Vadasz, who was head of the 1103 design team, now manages all Intel engineering.

**Systems man.** William Jordan led the Honeywell group that tried out early 1103 designs in computer memories.

the operation. When *cenable* goes off, inverters on the chip keep the logic nodes charged (cells are refreshed as in the 1103, however).

For the older chip, the address input had to be stabilized with latches throughout the cycle time. Now, inputs are picked up by a buffer register on the chip. The buffers are isolated within 100 nanoseconds of the onset of *cenable*. After that, the addresses can vary without affecting decoding.

A system with an 1103-type timing controller need not be redesigned. But if the cycle is tightened to reflect elimination of precharge, overlaps, and skew tolerances, access time will drop from about 450 to 250 ns and cycle time from about 675 to 650 ns, Regitz estimates.

To conserve power in an 1103 system, precharge had to be decoded (addressed to selected memory segments) and unselected segments switched into a power-down mode. Not counting driver and control-logic dissipations, power consumption averaged 300 mW per chip without precharge decoding and 100 mW with decoding.

In operation, the 1103A consumes full power only during *cenable* transitions. The chip is driven through dynamic buffers that dissipate little dc power. The on-chip logic is all made of low-power dynamic circuits

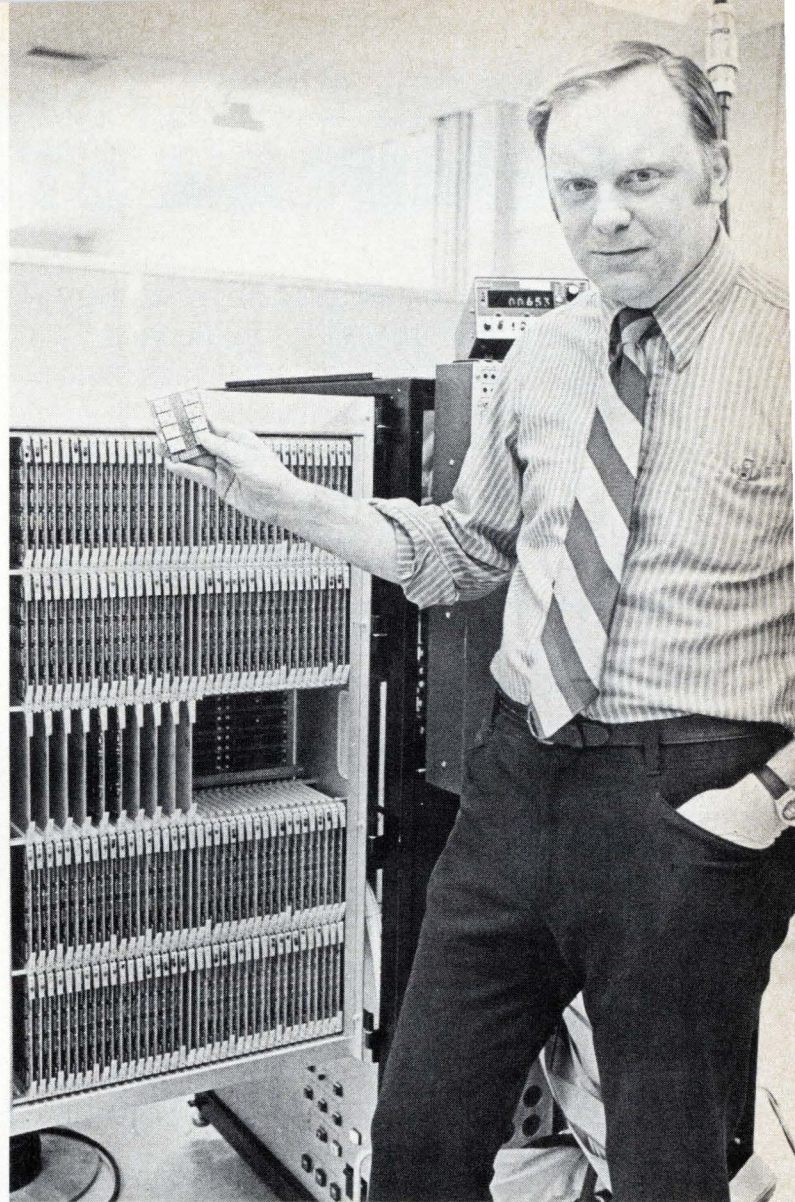

controlled by *cenable*. When *cenable* turns off, the chip drops into a low-power mode automatically.

Even though the 1103A is more complex than the 1103, the chip is smaller. Familiarity with silicon-gate processing allowed the designers to shrink the cells to 1.8 square mils—exactly the same area as single-transistor cells that are proposed for 4,096-bit RAMs, Vadasz points out.

He ruled out single-transistor cells since they require special sense amplifiers on the chip and would have made the 1103A incompatible with system designs based on the 1103.

Regitz adds that the 1103A is more tolerant of processing and temperature ranges than the 1103 because of the on-chip timing controls. The timing circuits tracks better in monolithic form. "We wouldn't produce the 1103A—we'd stick with the 1103—if yields were not improved," he asserts.

Although the 1103 is near retirement, Markkula doubts that it will fade away before 1980. The 1103 concept is not yet fully developed, he points out. But Intel's original goal of developing a standard RAM has merely been amended to one of providing a smooth transition from one standard part to the next. □



# THE CMOS-MADE-EASY SEMINAR STRIKES AGAIN.

A lot of water, not to mention technology, has gone under the bridge in the year-and-a-half or so since the industry's first CMOS seminar.

It's about time for another one.

A chance for you to get the full story on the latest in CMOS, plus the two-way interchange of an extended question-and-answer period.

The seminars will be held at hotels in about a dozen leading cities across the country. And cities where we don't at the moment plan to hold a seminar will get one if enough of you express an interest in attending. (By happy coincidence there's a coupon in this ad designed for just that purpose.)

Why's National doing all this?

Because we've developed a terrific logic family, 54c/74c which we believe has such an overwhelming competitive advantage that it's destined to become the standard of the industry. But the trouble is, most design engineers aren't familiar enough with CMOS yet to design it into their systems. A seminar is the best way to tell them.

## Our CMOS whiz-kids.

Bob Bennett, our marketing honcho on CMOS will lead the seminars, discuss the product and its advantages, and do his bird call imitations.

Dale Mrazek and Steve Calebotta are our applications specialists. They'll talk about how CMOS can be

used, and field questions about CMOS applications.

Come pick their brains.

## The world's very first CMOS Applications Contest.

But Dale and Steve aren't going to stand up there and spiel off all the applications in the world. They don't know them. They can spark you with some examples, but we hope that communication of applications ideas will be a two-way affair. That the audience will also have some applications ideas of its own.

In fact, we'll be making a contest out of it. For the best applications ideas received, either at the seminars or later by mail, there'll be lots of neat prizes.

We haven't figured out yet what the prizes will be. But some things being considered are a weekend date with Raquel Welch, a chest full (no pun intended) of ancient Roman coins





worth a million dollars, and a parrot that speaks 14 languages. But who knows? We may end up settling for a box of popcorn and two tickets to a rerun of The Sound of Music.

### Here's your homework.

Here's a very basic primer on CMOS to help get you ready for the seminar.

You may take notes.

CMOS dissipates low power. Typically, the static power dissipation is 10 nW per gate, compared to a typical dissipation of one mW for an LP T<sup>2</sup>L gate. A 100 to 1 power savings will be realized when changing a system from LPTTL to CMOS, or 1000 to 1 from standard TTL to CMOS.

CMOS has a propagation delay of 25 to 50 ns through a typical gate.

CMOS has a controlled rise and fall time as opposed to T<sup>2</sup>L saturated logic, which greatly simplifies system design.

There's less noise generated. The output current spiking caused by devices switching logic state is only 2 to 3 mA by CMOS while bipolar approaches 20 to 40 mA. CMOS 54c/74c also has a higher noise margin than 7400 TTL: 1 volt instead of .5V.

CMOS can operate over a large power supply range of 3 to 15 volts. This means that lower cost power supplies can be tailored to the application and tight regulation is not necessary.

### It costs more, but it's cheaper.

CMOS will show a systems cost savings when the following facts are taken into account: smaller power supply, less power supply regulation, fewer bypass capacitors, simpler design because of controlled rise and fall time, and simplified power distribution resulting in reduced cost because of low noise and low current.

Its lower power dissipation reduces costs by cutting down on fans and associated cooling equipment.

# NATIONAL.

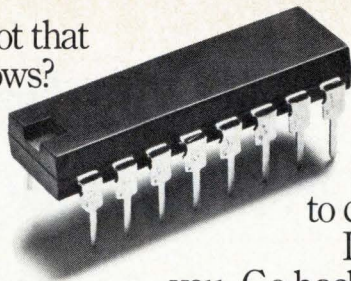

### Surprise quiz.

How much power savings will typically be realized when changing a system from TTL to CMOS?

If you don't know, shame on you. Go back seven paragraphs.

### The 7400 design tricks and applications you know and love.

Finally, the National 54c/74c line consists of CMOS parts which are pin and functional equivalents of many of the most popular parts of the 7400 TTL series.

The pin outs and functions are familiar to the design engineer because he's designed with the 7400 for years. With CMOS he can take full advantage of the learning curve he went through years ago because he already knows the 7400 design tricks and applications.

This is one of many important advantages of our CMOS over the competitive CMOS.

### If you've got it, flaunt it.

And we've got it.

In the past ten months we've introduced twenty-seven 54c/74c products, and another 18 will be introduced by the end of 1973.

This makes a total of 45 54c/74c products that will be available to designers this year. But complete systems can now be designed with the products we have now.

### Your invitation.

Our distributors will be making many of the arrangements for the seminars, but if you'd like to be sure you're invited, mail us the coupon below.

See you there.

- |  |   |
|--|---|
| <input type="checkbox"/> I think your CMOS seminar idea is terrific. I'd like to attend. Tell me when and where. | <input type="checkbox"/> I think your CMOS seminar idea is dumb/terrific (circle one) and/or but I don't want to/can't attend but send me further details about CMOS, including data sheets and applications notes. |
| <input type="checkbox"/> I think your CMOS seminar idea is dumb, but I'd like to attend anyway.                  |   |
| <input type="checkbox"/> None of the above. In 15 words or less.   |   |

NAME \_\_\_\_\_

COMPANY \_\_\_\_\_

ADDRESS \_\_\_\_\_

CITY \_\_\_\_\_

STATE \_\_\_\_\_

ZIP \_\_\_\_\_

Mail to: National Semiconductor Corporation, 2900 Semiconductor Drive, Santa Clara, California 95051.



# Overlaid memory simplifies programs, has hidden nooks for diagnostics

Storing critical and special routines in a read-only memory protects them from harm, but individual words or routines can be altered if the read-only module overlays a conventional read-write memory

by James F. Townsend, *Honeywell Information Systems Inc., Billerica, Mass.*

□ Significant increases in computer software efficiency can be obtained by a new technique, called overlaying, that combines read-write and read-only memory. With this technique of overlaying read-only onto read-write memory, the system designer can intermix the two types of memory on a word-by-word basis, and thus combine the flexibility of read-write memory in general-purpose applications with the reliability and permanency of read-only memory in dedicated applications at nearly the lowest addressable level.

Standard routines stored in the ROMs can work with direct rather than indirect addresses, thereby saving much valuable read-write storage space. And since the routines are stored in ROMs, they are protected from accidental alteration. The overlay can also store diagnostic and maintenance routines that are needed only occasionally. ROMs of as few as 265 words can be used in overlay, although the standard pluggable module is 2,048 words.

Overlaying is an improvement on the direct replacement of read-write modules by read-only modules, which has been used increasingly for the past several years in minicomputers for dedicated applications. In such computers, the program, once loaded into the memory, is likely to stay there indefinitely, so that putting a program in a read-only memory protects it from everything except the memory's physical destruction. In contrast, general-purpose computers load different programs, execute them, and dump, often once every few minutes. In the latter case, even a slight fault in hardware or software can create a program bug that leads to difficult problems.

Programs in read-only memories, of course, can't be altered; they must be completely debugged before being committed to the read-only form. Making read-only and read-write memory modules interchangeable, therefore, facilitates program-debugging while protecting the perfected programs.

But read-only modules usually come in clumps of 1,000 or more words. This leaves the system designer with the choice of making his program fit economically into these big clumps, or living with the hazards of read-write memory in a dedicated application. If he chooses the former alternative, he may find that one of several read-only modules contains dozens or hundreds of unused locations or that a software routine is only a few words too large to fit into a single module, and it over-

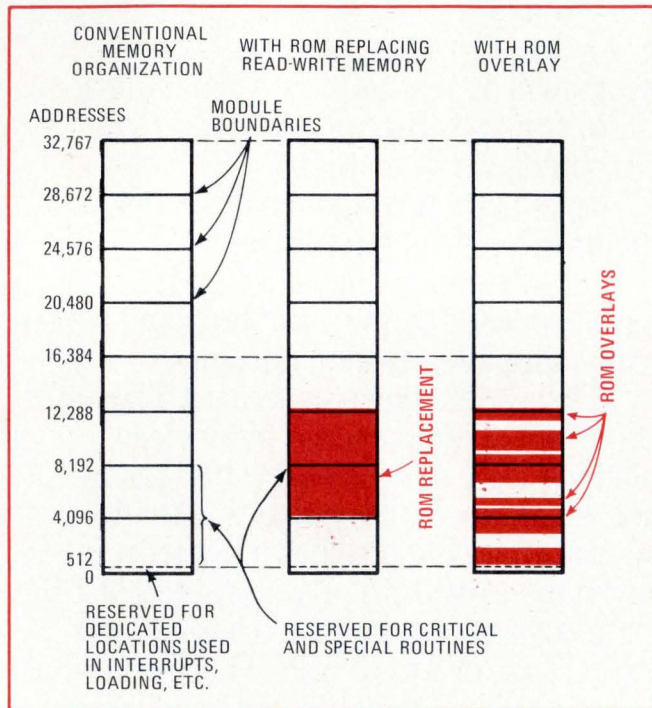

**1. Three alternatives.** Most software systems reserve certain portions of the main memory, usually with low addresses, for dedicated and critical tasks (left); remaining memory is available for the user. The critical routines, for protection, are often stored in read-only memories, but the ROM modules are large and must match main-memory module boundaries (center). However, when the ROM overlays the main memory (right), critical routines, perhaps with alterable segments, can be freely scattered among read-write locations.

flows into an adjacent read-write memory module.

Now, with the overlay technique, the system designer is free to intermix read-only and read-write words whenever and wherever he likes. A dedicated program, after debugging, can go into the read-only memory, but it can still contain words here and there that can be altered; other routines that are properly kept in the read-write memory can include fixed instructions in their midst. Data bases and look-up tables can benefit in the same way.

In the Honeywell System 700 central processor, the overlay technique improves software flexibility and power. Loaders and other critical routines are rendered immune to all disturbances—power transients, software



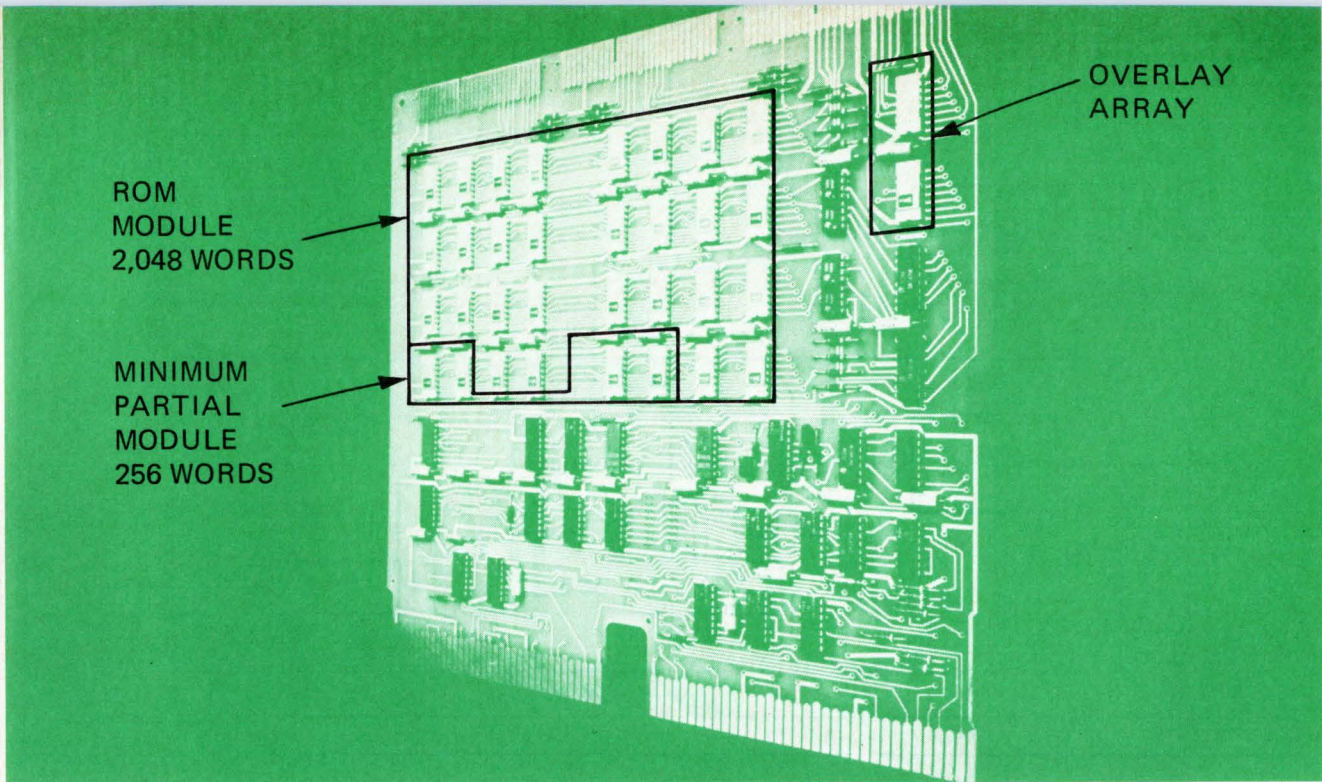

**2. Overlay key.** In this implementation, ROM module is 2,048 words, but the minimum ROM block is 256 words. To permit overlay by individual words, an extra 2,048-bit overlay array (upper right) is added to the module, identifying each word as "valid" or "not valid."

errors, and improper operating procedures—that do not physically destroy the memory, but the read-write memory is still physically present (Fig. 1).

### Powerful but inefficient alternative

Without the benefits of overlaid read-only memory, mixtures of fixed and alterable instructions require the programmer to resort to indirect addressing. While under some circumstances, indirect addressing is a powerful programming tool, it can also be a nuisance and a source of program inefficiency. In a program, an instruction with a direct address consists of a command plus the address of the operand upon which that command is executed. When an indirect address is used, the address is not that of the operand, but of a word containing the address of the operand.

Sometimes many levels of indirect addresses are necessary. When that happens, the instruction contains the command plus the address of a word containing the address of a word; this sequence continues until the command eventually locates its designated operand.

A routine in a read-only memory may include an instruction for an operand in a location that depends on the circumstances at the particular time the routine is executed. Obviously, the address of this operand must be alterable; without an overlay, the only way it can be altered is by keeping it outside the ROM and going to it from the instruction via an indirect address.

Another advantage of the overlaid memory is that the read-write module can be brought into use, even when overlaid, for diagnostic and maintenance routines and other special operations that are performed only occasionally.

The read-only memory modules are assembled from 256-word by 4-bit bipolar ROMs. Since the word length

in the System 700 is 16 bits, four ROM packages operating in parallel provide 256 words to overlay an equivalent number of read-write words. This is the minimum block size of an overlaid memory; however, the ROM comes in modules of 2,048 words—that is, eight blocks or 32 IC packages (Fig. 2). Partial modules of 256, 512, or 1,024 words can be installed within any range of 2,048 addresses that begins with 0, 2,048, 4,096, or any other multiple of 2,048.

Pin-compatible 512-word-by-4-bit ROMs are being contemplated for use in the overlaying modules, although they are not yet available in that size. They would require only a minor modification of the control logic in the module and would double the module capacity, decrease power dissipation per bit, and reduce the cost per bit.

### Either ROMs or PROMs

Read-only memory can be installed in either masked or programable form. The latter is normally used during the prototype and debugging stages of a system design, and the program is changed over to the masked form when volume of production and confidence in memory contents justify it. The programable ROMs are not alterable in the field at present, and they are not erasable.

Since the read-write-memory module size is 4,096 words, two read-only modules are required to overlay one read-write module. Each word in the read-write memory includes 18 bits, and the two extra bits are parity bits for the two bytes in the word. However, parity checking is an option in the System 700; when it is not installed, these extra bits remain unused. Read-only memory modules contain no parity bits. However, if the option is installed, parity is calculated on read-only-memory output, and the extra bit accompanies each



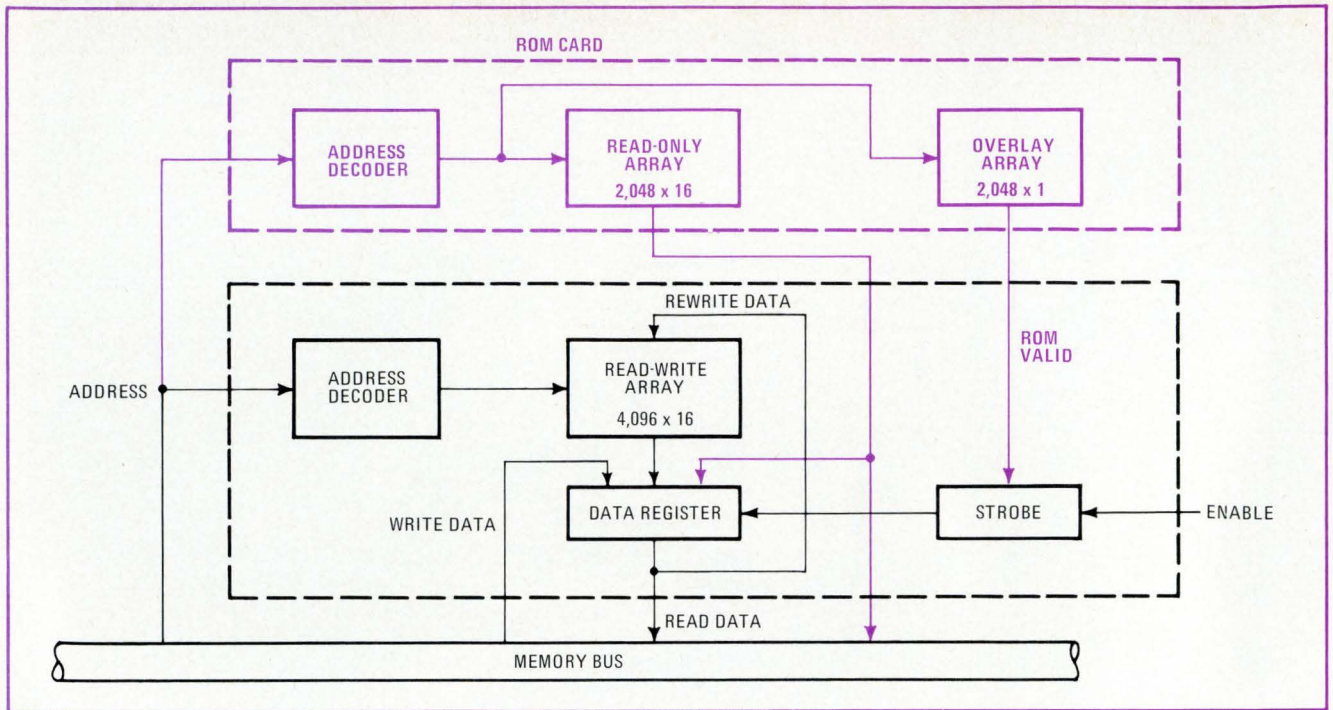

**3. Overlaid connections.** Read-write memory is conventional in every respect (black). Data from overlaid read-only memory (color) enters data register and is copied back into read-write array. Overlay array identifies the ROM words for which overlay occurs.

byte to the memory bus and on to the system.

In a normal memory cycle, lasting 775 nanoseconds and involving only a read-write word that has not been overlaid, the memory operates in the conventional way. Data is taken from the addressed location during the first half-cycle and, if the operation is a read, placed in a memory data register (Fig. 3). From this register, the data is transferred to the memory bus and thence to the processor or elsewhere in the system. Also from this register, the data, during the second half-cycle, is rewritten into the addressed location, which was erased in the process of reading. If the operation is a write, the data removed during the first half-cycle is lost; the data to be written, having previously been placed in the memory data register from the memory bus, is stored in the addressed location during the second half of the normal memory cycle.

### Substitution by overlay

However, if the addressed location is covered by an overlay, the read-write memory goes through its normal cycle, but its output is suppressed. In its place, the read-only output goes into the register with approximately the same timing as the data from the first half of the read-write cycle. From the register the read-only output is copied into the read-write memory. Thus, over a period of time, a randomly addressed read-write module acquires a copy of the data in the read-only module that overlays it.

In general, no more than a small proportion of either read-write or read-only memory can be economically included in an overlay scheme. To put it another way, most of both memory forms should lie outside the overlaid region. Because the computer still needs large amounts of read-write memory for such operations as normal instruction modification, data manipulation,

and indexing, no purpose is served by trying to overlay these areas.

Furthermore, although a properly designed overlay adds significantly to system performance, an overlaid read-write location isn't normally accessible, so that the user gets one location for the price of two. Obviously, if carried to an extreme, this would represent too much paid for too little capacity. Contributing to this potential imbalance is the fact that, if a particular routine in read-write memory needs only one overlaid read-only word, the user is obliged to install a minimum of 256 words of read-only memory because that is the size of the block packaged in integrated form; of these, 255 would be unused.

### Word-for-word overlay

But even though the minimum block size of a read-only overlay is 256 words, the overlays need not be used only in such large clumps. On the contrary, individual words can be overlaid or not, as desired, by the inclusion of two more read-only-memory ICs in the module, besides the 32 that actually store the data. These two ICs, called the overlay array, provide 2,048 more read-only bits—one for each word in the module. These are the same type of 256-by-4 ICs used in the main ROM array, but their outputs are gated by part of the address so that they look from the output as if they were a single 2,048-by-1 array.

The one output signal, called "ROM valid" is connected to the second of two single-shot circuits in the controls of the read-write module (Fig. 4). The first single-shot controls the delay of the read strobe relative to the beginning of the memory cycle, and the second controls the strobe width. Both single-shots have two inputs, but in the absence of an overlay, only one input is used on each.



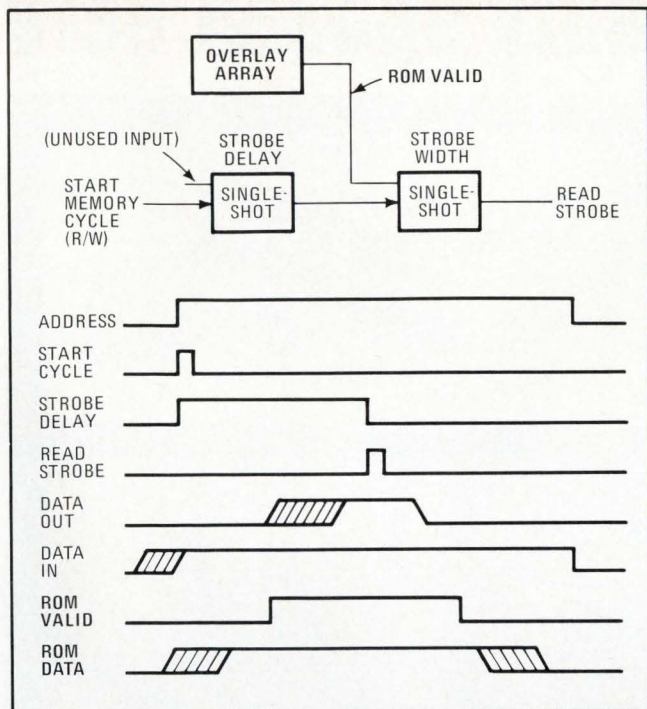

**4. Strobe suppression.** To accomplish the overlay, the data coming from the read-write memory is suppressed by a "ROM valid" signal that prevents the read strobe from being generated. The read strobe otherwise would set read-write data into the data register.

**5. Hidden ROM.** When a large block of the ROM module is not allowed to overlay the main memory, as determined by the overlay array, it is available for diagnostic and special routines. These are retrieved with a manual switch that overrides the overlay array.

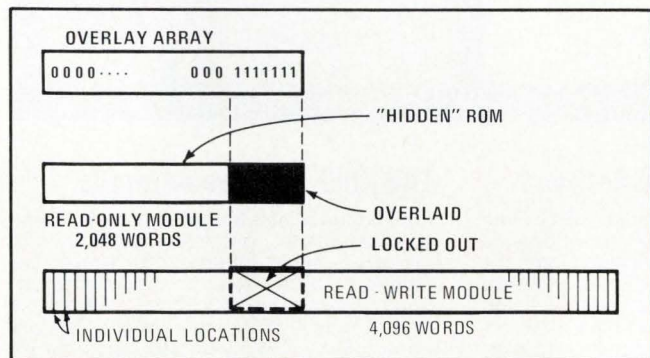

With the overlay installed, if the addressed word generates the "ROM valid" signal, the second single-shot is disabled and the strobe pulse is not generated, which means that the data read from that location in the read-write memory is not set into the memory data register, and data from the read-only memory effectively takes its place. Since from the output of the overlaid memory, the operation looks like a clear-write operation, the data from the read-only memory ends up loaded into the read-write memory.

### Hidden ROM

With the capability of overlaying individual words comes the inaccessibility of certain words in the ROM because the overlay array says for the corresponding address, "ROM not valid," and because the minimum



**6. Honeywell System 700.** Central processor has a 78-instruction repertoire, a real-time clock, and other features. Its high performance is due in part to its use of a read-only-memory overlay.

block size is 256 words. Where blocks of such potentially wasted words occur, a "hidden ROM" can contain diagnostic routines at virtually no cost (Fig. 5).

Suppose that only one word of a block of 256 contains data that overlays the read/write memory. The corresponding bit in the overlay array is 1, but the overlay array bits corresponding to the other 255 bits are all 0 because only the read-write memory is used for those addresses. With the aid of a three-position maintenance switch that can override the control of the overlay array, such otherwise unused read-only locations can contain routines that are never used by the programmer, but may be vital for diagnosis by a field engineer.

These routines might conventionally be loaded separately from punched cards or magnetic tape carried by the engineer, or they might be kept on a storage medium such as one of the several types of "floppy disks" that have appeared on the market recently. But with the hidden ROM, they can be kept permanently in the machine and transferred to read-write memory at a moment's notice.

The maintenance switch that permits the use of the hidden ROM would ordinarily be kept in its "normal" setting. But it can be changed to either of two other settings: one which turns off the "ROM valid" line, then locking out the overlay array and permitting a conventional memory diagnostic program to be loaded in the usual way to check out the read-write memory, and one which forces the "ROM valid" line to 1 for all addresses, thus overriding the overlay array and bringing out all the data in the hidden ROM. By cycling the memory through all the ROM-overlaid addresses with the switch in the ROM-only setting, the special routines in the hidden ROM are transferred to the read-write memory, whence they can check out the rest of the machine. □



# Total resistor capability spoken here

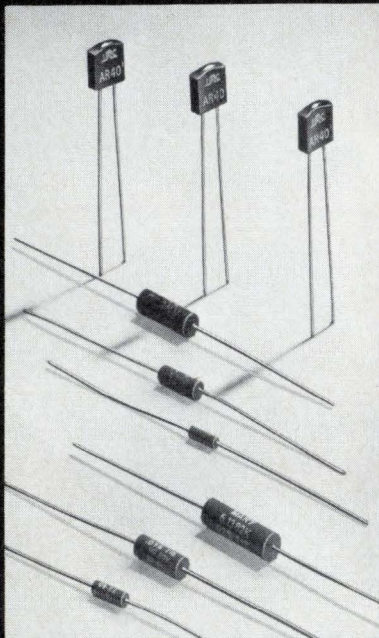

METAL FILM

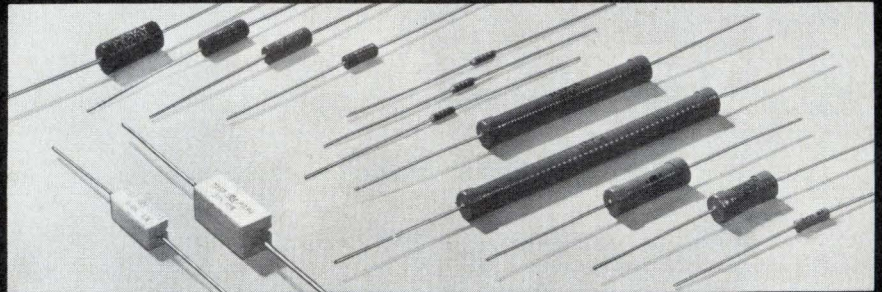

METAL GLAZE™



NETWORKS

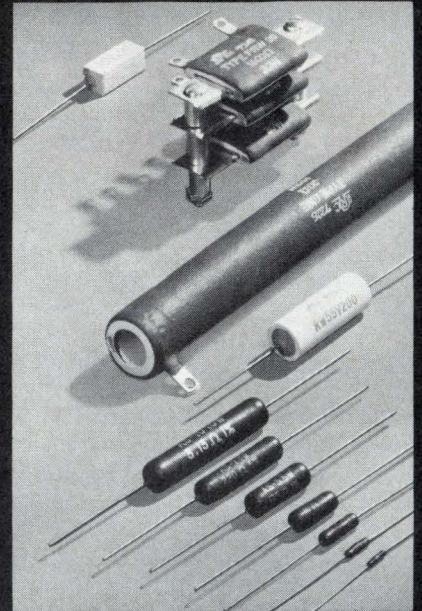

WIREWOUND

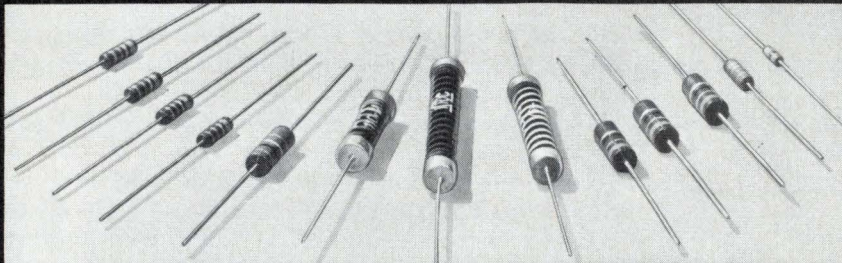

CARBON COMPOSITION

## TRW/IRC Carbon Composition Resistors

Used by *billions* in consumer, industrial and military applications, TRW/IRC carbon composition capability ranges from standard commercial type through established reliability RCR's, to ultra-high range ( $10^{11}$  ohms). Where you are using carbon comp.'s in automated assembly, TRW/IRC packaging techniques can help cut the cost of interfacing with your machines. Card packs, lead tape reels, cut and formed leads . . . we'll be glad to explore the potential economies with you.

## TRW/IRC Metal Glaze™ Resistors

This is TRW/IRC's thick-film technology—for every type of low power resistor application. Metal Glaze is widely accepted for its built-in power handling reliability, resistance range, and cost effectiveness. Available in numerous standard and special designs—precision, semi-precision, flameproof, high-reliability, high-voltage.

## TRW/IRC Wirewound Resistors

The line starts with molded wirewound resistors—"space-savers" that bridge the cost-performance gap between composition resistors and precision wirewounds. It proceeds to standard, non-insulated types for appliance/automotive use . . . to precision subminiatures offering high power density . . . to ceramic, flameproof units for TV and computer applications . . . to tubular and flat power wirewounds with ratings to 250 W.

## TRW/IRC Metal Film Resistors

TRW/IRC has brought the state-of-the-art in thin-film resistors to an equal performance level with high-stability wirewounds. Capabilities here include resistors with tolerances to  $\pm 0.01\%$  . . . high-reliability units to MIL and aerospace specs . . . precision subminiatures . . . and standards, of course. You can also look at alloy films offering high-temperature and high-voltage capability at low cost.

## TRW/IRC Resistive Networks

Advanced resistor technology here. These IC compatible, precision tantalum-film circuits provide inherent low noise, excellent stability, and hermetic performance without hermetic cost. Tolerances from 5% to 0.05% are available in custom designs. TRW/IRC also offers the industry's most complete line of discrete fixed resistors.

## All types . . . all technologies . . . from one source

To wrap it up, TRW/IRC offers you the broadest line of fixed resistors in the business, with extensive, nationwide distribution. All available from one source—your local TRW/IRC distributor. With a direct pipeline to each of our plants, he can give you fast delivery. Contact your local TRW/IRC sales office for application assistance, custom designs, and special engineering help when you need it. TRW/IRC Fixed Resistors, 401 N. Broad Street, Philadelphia, Pa. 19108 — (215) 922-8900 • Greenway Road, Boone, N.C. 28607 — (704) 264-8861 • 2850 Mt. Pleasant Street, Burlington, Iowa 52601 — (319) 754-8491.

# TRW<sup>®</sup> IRC RESISTORS



## Scope detects narrow pulses with its triggering system

by Peter T. Uhler  
Tinker Air Force Base, Midwest City, Okla.

The presence of single narrow pulses can be easily detected by an average oscilloscope without the need for special probes or adapters. By simply operating the instrument in its external-trigger mode, the scope can be made to display short-duration pulses, troubleshoot logic ICs, store a one-time transient permanently, or record transient hits. The scope's own triggering system and front-panel lamps detect the pulses.

Usually, special probes are required to detect the presence of short-duration pulses in complex logic-IC systems. These narrow pulses generally have very low repetition rates or even occur singly, making them difficult to observe on even the fastest storage scope.

What has been overlooked, however, is that the triggering system of the average scope can readily duplicate the function of these special probes while providing much more flexibility. Most modern scopes employ solid-state amplifiers coupled to tunnel-diode trigger-pulse generators, enabling them to respond to very-short-duration pulses. Such triggering systems are essential to allow triggering out to and beyond the stated bandwidth of the instrument.

Good triggering systems are designed so that if the signal can be displayed at all, the trigger generator will initiate the sweep. For example, the triggering system in the Tektronix 453A-series oscilloscope, which has a rated bandwidth of 60 megahertz, will trigger to beyond 200 MHz when signals are fed directly into its external-trigger input.

Although the measurement techniques described here apply mainly to the 453-series dual-trace scope, they should be suitable for most high-quality lab scopes with bandwidths of 50 MHz or greater. For the most part, the triggering system in these scopes can be considered to function like the one shown in the figure.

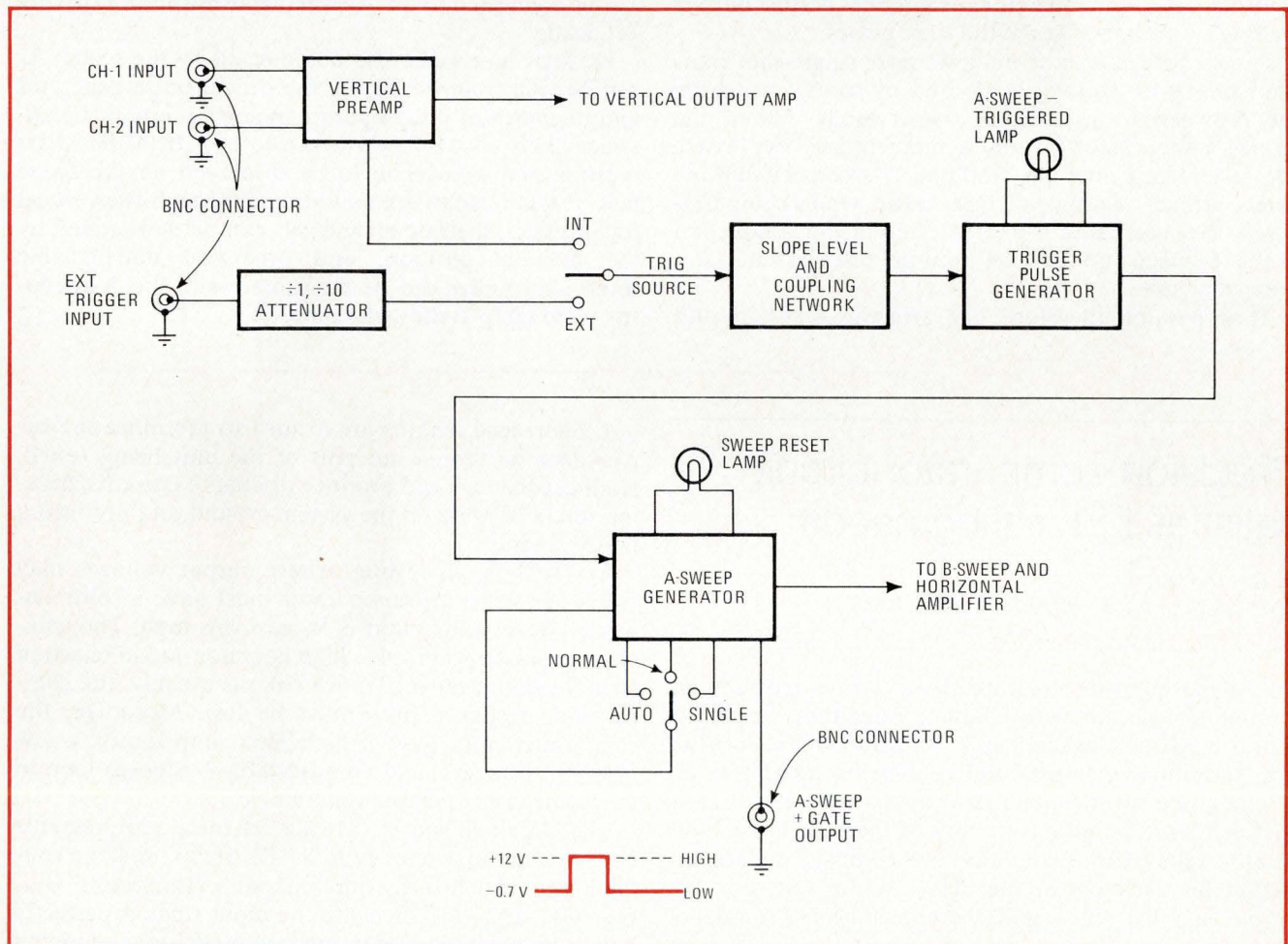

**Scope triggering system.** In its external trigger mode, an oscilloscope can detect pulses that are only a few nanoseconds wide. The front-panel A-sweep-triggered lamp acts as a visual monitor, lighting when the trigger pulse generator responds to a trigger signal input. Because the lamp stays lit for awhile, it acts as a pulse stretcher, enabling the operator to detect the narrow trigger signal.



Trigger signals can be either routed through the vertical preamplifier or applied directly to the external-trigger input. The latter approach bypasses the relatively bandwidth-limited preamplifier and allows the triggering system to operate to full bandwidth. All trigger signals then pass through the slope and level comparator into the tunnel-diode trigger-pulse generator, which starts the main (A) sweep.

The front-panel A-sweep-triggered lamp, along with its associated sensing and driving circuitry, monitors the trigger-pulse generator, lighting for about 100 milliseconds each time the generator recognizes a trigger signal. This one-shot characteristic of the lamp monitor effectively stretches out short-duration trigger signals so that the operator can easily detect their presence.

Just by observing this lamp, therefore, single-event pulses (that are coupled directly into the external trigger input) with amplitudes of under 250 millivolts and durations on the order of a few nanoseconds can be detected. Transistor-transistor-logic signals can also easily be coupled into the external-trigger input with a standard  $10\times$  probe. (If the Tektronix type P-6061 miniature  $10\times$  probe is equipped with a type 015-0201-00 DIP IC probe-tip adapter, the scope/probe combination becomes a compact and effective logic-IC troubleshooting tool.) The setting of the trigger-slope and level controls determines whether triggering occurs on the leading or trailing edges of the logic pulses.

The scope can also be made to store single-shot transient pulses for as long as desired by simply switching the A-sweep to its SINGLE sweep mode. When the scope's sweep reset button is momentarily depressed, the reset lamp goes on, and the A-sweep circuit becomes armed, awaiting a trigger pulse. Upon being triggered, the reset lamp is extinguished at the completion of the A-sweep and stays off until the reset button is depressed again.

The operator, therefore, can arm the A-sweep, and

leave the scope unattended. The reset lamp will go off only when triggered, and it will stay off until it is manually reset. This feature is especially useful for detecting "once-in-a-lifetime" transient pulses.

Additionally, the scope can be transformed into a recording transient-hit monitor by connecting a chart recorder or suitable event counter to the A-sweep gate output and setting the A-sweep mode to its NORMAL position. While the A-sweep is not sweeping, the gate output rests in its low state. Upon initiation of the A-sweep, this output goes high and remains there for the duration of the sweep. The gate output returns to its low state as the A-sweep resets itself, and the cycle is completed.

The duration of the positive-going gate pulse equals the sweep time per division times the sweep length, plus any inherent time delays. A sweep time of 10 milliseconds per division over a sweep length of 10 divisions will cause a positive output pulse of approximately 100 ms at the gate output. This is ample time to produce a sharp time-mark on most slow-moving chart recorders—such a time-mark will be produced each time a transient triggers the A-sweep.

The transient-recognition threshold of the scope can be set initially by using an auxiliary pulse generator or power supply and adjusting the scope's trigger slope and level controls appropriately. If necessary, a buffer can be connected to the A-sweep gate output for driving TTL loads.

Dc logic levels can also be detected by the scope. As can be seen from the figure, the trigger-pulse generator and its indicator lamp operate independently of the A-sweep. This allows the A-sweep to be left in the AUTO position and a baseline to be displayed on the scope face. If logic signals are now routed through the vertical preamplifier, their dc logic levels can be determined by the baseline position, and otherwise undetectable single-shot pulses can be monitored with the A-sweep-triggered lamp at the same time. □

---

## Precision comparator circuit satisfies LSI testing needs

by George Niu  
*Fairchild Systems Technology division, Palo Alto, Calif.*

Testing large-scale integrated-logic arrays requires an analog comparator with characteristics that cannot be found in an off-the-shelf unit. To perform state-of-the-art LSI testing, you must build your own comparator.

The modern LSI functional-testing system needs low-cost comparators because many of them must be used in any test system. Generally, two comparators are required for each pin of the device under test. For example, in a 240-pin system, there must be 480 comparators.

Another consideration is miniaturization—a basic requirement for an LSI test-system comparator that allows it to be mounted as close as possible to the device under

test. Short lead lengths are a must to minimize the capacitance on the output pins of the unit being tested. High capacitance will produce discharge currents, causing spikes or noise on the system ground and producing faulty readings.

For MOS-circuit testing, where output voltages may reach  $\pm 30$  volts, the comparator must have a common-mode voltage range that is at least this high. The comparator must also provide high common-mode rejection over the entire range. To test circuits quickly, the comparator's response time must be low. Moreover, the comparator must have a high input impedance, a low input bias current, and an adjustable hysteresis loop to overcome unpredictable system noise.

The circuit shown in (a) satisfies these requirements and provides an accuracy to 0.01%. Its input stage contains two matched Darlington pairs (transistors  $Q_{1A}$ ,  $Q_{1B}$ ,  $Q_{2A}$ , and  $Q_{2B}$ ). Because the input stage is perfectly balanced and has an extremely high resistance looking into its constant-current source (transistor  $Q_3$ ), a high common-mode rejection ratio is obtained. The first and second stages (transistors  $Q_4$  and  $Q_5$ ) form a "negative



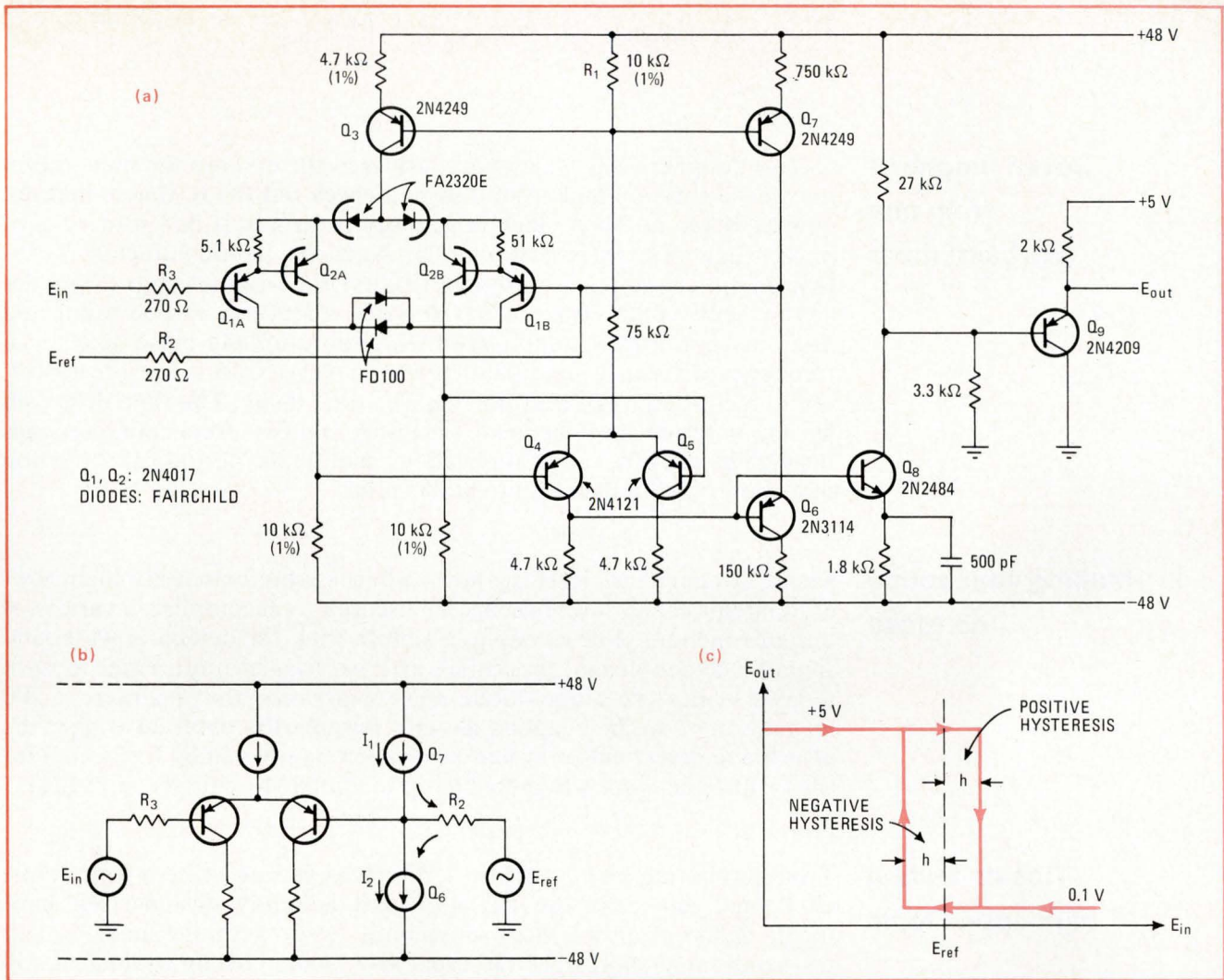

**Designed for LSI systems.** High-performance inexpensive comparator (a) meets the special requirements of testing LSI circuits. Besides a fast response and a high input impedance, the comparator has a wide common-mode voltage range, making it ideal for use with MOS circuits. It also provides (b) an adjustable hysteresis loop (c) to avoid false readings due to system noise.

common-mode feedback" circuit through resistor  $R_1$ , reducing the current drift in the first stage's constant-current source.

Transistor  $Q_6$  provides positive feedback and supplies a current that enables the comparator's hysteresis to be adjusted with the current flowing through transistor  $Q_7$ . The hysteresis is controlled by the currents from transistor  $Q_6$  and  $Q_7$  and the value of resistor  $R_2$ , as shown by the equivalent circuit in (b). If the currents from  $Q_6$  and  $Q_7$  are kept fixed, the hysteresis loop can be adjusted by changing only the value of  $R_2$ . This resistor can be conveniently located away from the rest of the comparator circuit, permitting an adjustable hysteresis to be obtained easily.

The output stage (transistors  $Q_8$  and  $Q_9$ ) provides a level-shift for interfacing to DTL or TTL circuits. If the input voltage,  $E_{in}$ , is lower than the reference voltage,  $E_{ref}$ , a high (logic 1) output signal is obtained. When  $E_{in}$  is higher than  $E_{ref}$ , a low (logic 0) signal is present at the output.

Under quiescent conditions, both  $E_{in}$  and  $E_{ref}$  are shorted to ground, and transistor  $Q_6$  is reversed-biased. Since  $Q_6$  is off, current  $I_2$  is zero, and the current ( $I_1$ )

from transistor  $Q_7$  must flow through resistor  $R_2$ . The voltage drop across  $R_2$  then produces the positive half of the hysteresis loop drawn in (c).

As input voltage  $E_{in}$  is increased, the positive half of the hysteresis must be overcome before the output can switch from high to low. When the hysteresis is overcome, transistor  $Q_6$  turns on, and current  $I_2$ , which is twice the value of current  $I_1$ , flows through  $Q_6$  to the negative supply voltage. At the same time, the current through resistor  $R_2$  changes direction, reversing the polarity of  $R_2$ 's voltage drop. This produces the negative half of the hysteresis loop. To switch the comparator output back to the high state, the negative hysteresis must be overcome in the same manner as the positive half is overcome.

Because of the action of the two differential pairs at the input, the real hysteresis experienced by input voltage  $E_{in}$  is half of the IR drop across resistor  $R_2$ . The total hysteresis, therefore, will be equal to the actual IR drop across  $R_2$ . □

Engineer's notebook is a regular feature in Electronics. We invite readers to submit original design shortcuts, calculation aids, measurement and test techniques, and other ideas for saving engineering time or cost. We'll pay \$50 for each item published.



## Seven functions from one (bargain) timer

Circuit designers who've always considered the op amp the most useful inexpensive design tool around should **check out the IC timers that are now available at 75¢ a piece in quantity** from a half-dozen or so suppliers—Signetics, Intersil, Motorola, National Semiconductor, Texas Instruments. Compare this for flexibility: the original chip (Signetics 555), which contains two comparators and a flip-flop, can be connected as a one-shot, a free-running multivibrator, a missing-pulse detector, a frequency divider, a modulator (PWM or PPM), and a test sequencer, not to mention its original function as a time delay. **The time delay, set by an external resistor and capacitor, ranges from microseconds through hours.** Innovative applications include the periodical activation of a deodorizer in bathrooms and hospitals.

## Making your scope do tricks

Smart designers are learning how to harness the extremely high-powered circuit capability of their oscilloscopes to accomplish a variety of design functions. For example, a simple trick for detecting wideband signals is to couple into the scope's external trigger input. Since most of today's scopes use tunnel-diode pulse generation that operates at 200 megahertz or so, **by coupling directly through the external trigger it's possible to detect pulses as narrow as a few nanoseconds.** Just watch for the front-panel sweep-triggered lamp to light. (More tricks on p. 121).

## Tips on testing high-speed logic

Troubleshooting high-speed logic boards is getting to be a formidable challenge, especially the new ECL and Schottky designs that have toggle delays of only 1 to 2 nanoseconds. So do keep the leads to your test equipment short since **the capacitive loading of the equipment will often mask the presence of narrow pulses.** Making calibration standards with good boards for comparison won't hurt either.

## This minicomputer will moonlight on making memories

Here's a bit of useful fallout from H-P's new top-of-the-line 2100 minicomputer, which has variable microinstructions instead of the fixed microinstructions usual on microprogrammed computers. That feature **lets you use the 2100 to load a solid-state random-access memory from a disk file** or, with the aid of a pulse-programming attachment called a PROM writer, to fuse new patterns into a read-only memory.

## More power to the programmer

You'd better either brush up on your programming skills or acquire some, now that microprocessing is becoming the handy and cost-effective way of generating logic. Three single-board computers based on one-chip microprocessors showed up on the market within the past month, and within the next year they'll be coming out of the woodwork. They've so inexpensive—under \$1,000 in most cases—and so easy to fit into any design that **before long you'll be drawing program flow charts instead of logic diagrams.**

## Ohm's law again

An ordinary digital voltmeter, together with an ordinary FET, which makes a dandy constant current source, can be used to measure resistance. The result is a **readily available digital ohmmeter.**



# Don't overdraw. Use these Kodak shortcuts:

---

The snappy restoration shortcut.

---

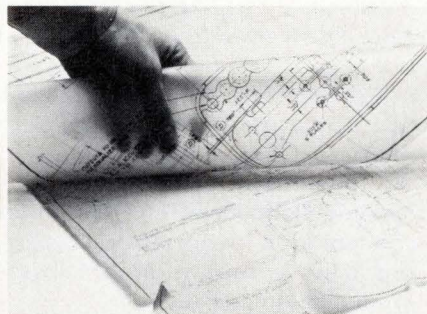

Why waste time retracing your old, battered drawings? Restore them by making sharp, clean photographic reproductions on Kodagraph film. Weak lines come back strong and clear. Stains virtually disappear. And instead of gray lines on yellow, you'll have snappy, contrasty, black-on-white prints.

---

The drop-of-water shortcut.

---

Why retrace the whole design for a few revisions? Just

order a second original on Kodagraph wash-off film. Then use a drop of water and erase unwanted details.

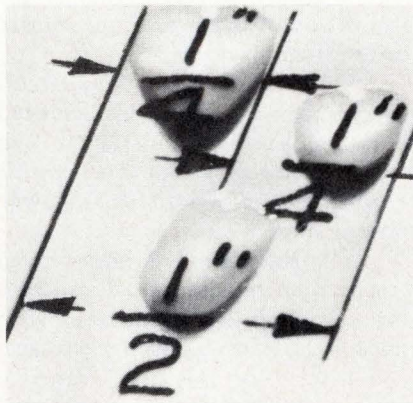

Draw your design revisions on the film and you're done.

---

The multiplication shortcut.

---

Why draw the same detail over and over? Kodagraph film will do the job for you. That way you draw the detail just once. Make as many photoreproductions as you need. Cut them out, paste them down, and make a

Kodagraph film print of the paste-up.

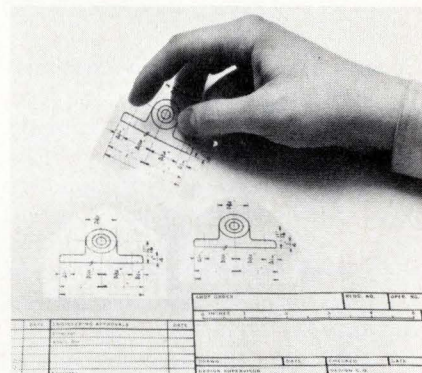

Now you have a superb second original for subsequent printmaking.

---

Get the facts from Kodak.

---

Drop us a line for more facts on how you can reduce drafting time and save money too, with Kodagraph films and papers. Eastman Kodak Company, Business Systems Markets Division, Dept. DP850, Rochester, N.Y. 14650.

**Kodak products for engineering data systems.**





## Tough-minded advanced linear technology delivers the first true Quad 741 Op Amp!

Several so-called quad op amps have been introduced lately to "replace" the standard 741's. The truth of the matter is this: Only Raytheon Semiconductor makes a true quad op amp that literally replaces four 741 types — the new 4136. For unlike the other quad op amps, no electrical redesign is necessary to substitute the 4136 for 741's.

The 4136 meets or exceeds all specifications for the 741. With low noise PNP front-end transistor, the 4136 is ideally suited for low-noise signal processing applications.

Its 14-pin dual in-line package

can be used with standard pc-board layout techniques and automatic insertion equipment.

Simplicity of design and circuit layout was the objective achieved with the 4136. It consists of two stages of voltage gain and a class AB complementary emitter follower output stage.

The input stage is biased by a constant current source. This stabilizes DC and AC parameters with wide variations in supply voltage.

Instead of the usual resistive load, a current source was used. This provides a means for obtain-

ing single-ended differential voltage gain. The high output impedance of the input stage provides a convenient node for internal frequency compensation with a relatively small capacitor.

The input bias current is a maximum of 500nA. The PNP input configuration performs level shifting with a minimum of noise-producing junctions.

The second stage is a Darlington configuration to provide a high-gain common emitter stage.

The complementary emitter follower output stage is short-circuit protected.

In summary, there are at least four good reasons why Raytheon Semiconductor's new 4136 Quad Op Amp should replace 741's.

(1) The 4136 outperforms 741's. Just look at the comparison table.

(2) The 4136 is about half the cost of four 741's in lots of 1000.

(3) The 4136 has a true 741 input stage, so there's no need to change your design rules.

(4) The 4136 comes in a standard 14-pin dual in-line package for commercial and military applica-

4136 vs. 741

Parameter	RC4136	741
Large Signal Voltage Gain	110dB	106dB
Input Resistance	5M $\Omega$	1M $\Omega$
Slew Rate (Unity Gain)	1.2V/ $\mu$ s	0.5V/ $\mu$ s
Input Bias Current	40nA	100nA
Unity Gain Bandwidth	3MHz	1MHz
Channel Separation	125dB	—



tions — so you need only one mechanical assembly step instead of four.

Raytheon Semiconductor delivers the first *true* Quad 741 Op Amp — so you can get twice your money's worth with the new 4136.

Reader Service No. 241



Raytheon Semiconductor now offers a reliable second source for the 54/74 MSI line. We have more than 24 types, including these hard-to-get ones:

54/74123	54/74163	54/74181
54/74150	54/74174	54/74194
54/74160	54/74175	54/74195
54/74161		

In addition, we have our own 54R/74R products — which give you higher performance with no change in price or operating requirements. If you're an engineer who wants more out of the commonplace 54/74, just place an "R" on your order.

Reader Service No. 245

### A Look at Our New Hi-Rel JAN TXV Transistors

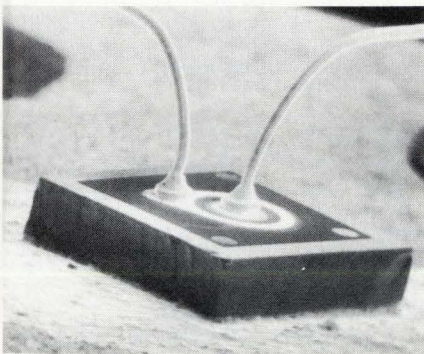

Microscopic inspection assures defect-free hi-rel JAN TXV transistors.

Raytheon Semiconductor now offers you 29 types of hi-rel transistors

with "precap" inspection at lower costs and with faster delivery. Designated JAN TXV, each transistor is 100% inspected with 30- and 100-power microscopes before it's hermetically sealed. This precap visual inspection prevents visible contamination or defects which could affect long-term reliability.

In addition, for those transistors not listed in the military JAN TXV listing, Raytheon Semiconductor offers R TXV transistors tested to the same standards as JAN TXV.

For hi-rel as well as standard small-signal silicon transistors, take a look at Raytheon Semiconductor.

### JAN TXV Devices

JAN TXV 2N718A	JAN TXV 2N2904A
JAN TXV 2N918	JAN TXV 2N2905
JAN TXV 2N1613	JAN TXV 2N2905A
JAN TXV 2N2060	JAN TXV 2N2906
JAN TXV 2N2218	JAN TXV 2N2906A
JAN TXV 2N2218A	JAN TXV 2N2907
JAN TXV 2N2219	JAN TXV 2N2907A
JAN TXV 2N2219A	JAN TXV 2N2920
JAN TXV 2N2221	JAN TXV 2N3019
JAN TXV 2N2221A	JAN TXV 2N3057A
JAN TXV 2N2222	JAN TXV 2N3250A
JAN TXV 2N2222A	JAN TXV 2N3251A
JAN TXV 2N2369A	JAN TXV 2N3553
JAN TXV 2N2484	JAN TXV 2N3700
JAN TXV 2N2904	

Reader Service No. 243

### How Hi-Rel Beam Leads Can Lower Hybrid Costs

In the majority of applications Raytheon Semiconductor hi-rel beam lead devices can reduce the costs of your hybrid modules.

One big factor is bonding. Beam lead bonding is far less complicated than the bonding operation for conventional chips or dice, so your operator needs less training. You'll get higher yields when bonding beam leads, too. That's because Raytheon Semiconductor's beam lead devices are hermetically sealed by nitride passivation. This minimizes the chance of damaging the chip during the bonding operation.

With Raytheon Semiconductor beam lead devices, the hybrid designer can obtain greater packaging densities. And more parts per

module mean greater manufacturing economies.

If you have a hybrid circuit that requires high reliability but you

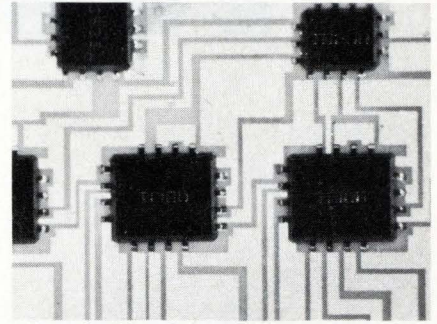

Beam lead bonding techniques are simpler and permit closer spacing of chips.

thought you couldn't afford beam lead devices, contact us. Raytheon Semiconductor may be able to offer you the best of two worlds with our beam lead know-how.

Reader Service No. 242

### Attention! Now a Military 256-Bit Bi-Polar RAM

Raytheon Semiconductor introduces a full MIL 256-bit TTL random access memory. The device is not only guaranteed to operate at specified DC parameters but also AC parameters over the entire temperature range of  $-55^{\circ}\text{C}$  to  $+125^{\circ}\text{C}$ .

Designated RR5300, it is a fully decoded bi-polar read/write RAM organized as 256-words by 1-bit. Readout is non-destructive, and data is maintained in the array without regeneration.

The access time from address to output is 85ns over the full MIL temperature range. Power consumption is a low 475mW. At present the RR5300 is available in a ceramic 16-pin dual in-line package; a flat package version will be offered in the future.

For more information, contact your nearest Raytheon Semiconductor sales outpost.

Reader Service No. 244

Raytheon Semiconductor, 350 Ellis Street, Mountain View, California 94040. Phone (415) 968-9211.

**RAYTHEON**



# HOW'S YOUR BRIDGE IQ?

1. Who ships over two million bridge rectifiers per month and maintains a domestic stock of over one-half million bridges at all times?
2. Who can deliver bridges in production quantities faster than anyone else can deliver rectifiers or bridges in production quantities?
3. Whose standard delivery time on bridges is 4 weeks?
4. What is the lowest price you should pay for a quality 1.5 ampere, 400 volt, single-phase bridge?

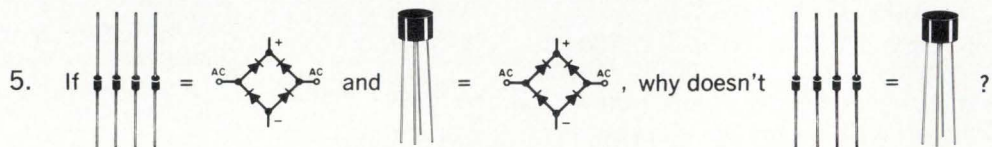

ANSWERS: 1 thru 3: General Instrument. 4: 25¢\* (For any one of General Instrument's "W", KBP or KBD bridges). 5: Because it will cost you more to buy and assemble the rectifiers into a bridge than to buy an assembled bridge from General Instrument.

(If you scored high, you probably know us. If you didn't, you should.)

If you have any questions of your own, you can call Bob "Buster" Brown, product line manager, toll-free at 800-645-1247. In New York State call 516-733-3234.

\*Conditions of Sale (Applicable only in the continental United States): Minimum Order Quantity—10,000 units scheduled within 60 days.

For complete information write: General Instrument Corporation, Dept. B, 600 West John Street, Hicksville, N.Y. 11802, or call, In New York: 516-733-3333; in Chicago: 312-338-9200; in Los Angeles: 213-641-7411. In Canada, call or write: General Instrument Canada, Ltd., 61 Industry Street, Toronto 337, Ontario, Canada, Tel: 416-763-4133. In Europe, write: General Instrument Europe S.P.A., Piazza Amendola 9, 20149 Milano, Italy. In the U.K., write General Instrument (U.K.) Ltd., Cock Lane, Highwycombe, Buckinghamshire, England. In the Far East, write General Instrument of Taiwan Ltd., P.O. Box 22226, Taipei, Taiwan.



GENERAL INSTRUMENT CORPORATION • 600 WEST JOHN STREET, HICKSVILLE, L. I., NEW YORK 11802



# New products

## C-MOS forges monolithic analog gate

New high-voltage process creates chips for common switching functions, carrying monolithic technology a step further into industrial system design

by Laurence Altman, Solid State Editor

The designers of industrial and process-control systems are eagerly awaiting monolithic versions of the analog components to go with the digital chips they already use. Monolithic designs are clearly the way to go for analog circuits, too, because they are cheaper, and the great advances in monolithic differential amplifiers, operational amplifiers, comparators, digital-to-analog converters, timers, and phase-locked loops, all testify to this trend.

One exception stands out: the simple analog gate, which generally has been built with the more expensive module or hybrid techniques or, if it does come in monolithic form, generally requires a complex and expensive technology, such as dielectric isolation. An improved C-MOS technique has now put the analog gate within the reach of simple monolithic processing. Intersil, using a high-voltage process, has built a family of gate chips that provides all the common switching functions: single-pole single-throw, single-pole double-throw, double-pole single-throw, double-pole double-throw, and four-pole single-throw (see table).

According to Jack Gifford, manager of Analog Products at Intersil, these devices provide "ease of use and performance advantages not previously available from monolithic solid-state switches." Gifford points out that the improved C-MOS technology provides input over-voltage capability— $\pm 25$  volts can be applied without damage to the device. This is important because most often the switch will be driven by the output of an op amp, which normally is as high as  $\pm 5$  V.

A key feature of Intersil's IH

5040 series of gates is that they will not latch up or self-destruct. Latch-up has been a frequent and thorny problem with monolithic analog gates. Up to now, most analog gates and multiplexers manufactured with standard C-MOS technology have suffered from it; they go into a non-operative state and will recover only if both the power supplies and the input are removed and reapplied in a specific order.

Technically, latch-up occurs when a negative-going analog signal is applied to either the drain or source of an MOS transistor whose negative-potential gates are at zero voltage. Since analog switches are frequently used to interface with different systems and subsystems, these conditions occur surprisingly often, especially if independent parts of the system or subsystem have independent power supplies. To make matters worse, latch-up conditions need only occur briefly, as transients, to put the freeze on.

**Floating bodies.** During a latch-up condition, a negative potential on the analog input or output causes a high-current path to exist from the source, through the forward-biased body of the FET, to the drain junction of the n-channel device. This path, coupled with an SCR effect that will occur between the n-type and p-type field-effect transistors in a C-MOS device, causes the latch-up.

Intersil's answer is to enlarge the C-MOS process to incorporate an additional diode in the connection going to the body of the n-channel FET. The cathode of this diode is then tied to the positive-going gate, so that the body is floating (see schematic below). The diode not only blocks the big current path but also prevents the SCR from turning on. As a further precaution, processing changes also have been incorporated which reduce to less than 1 the beta product of the npn-pnp C-MOS transistor combination (when  $\beta$  exceeds 1, an SCR is formed). Now,

INTERSIL PART NO.	TYPE	R <sub>ON</sub>
IH5040	SPST	75 Ω
IH5041	Dual SPST	75 Ω
IH5042	SPDT	75 Ω
IH5043	Dual SPDT	75 Ω
IH5044	DPST	75 Ω
IH5045	Dual DPST	75 Ω
IH5046	DPDT	75 Ω
IH5047	4PST	75 Ω
IH5048	Dual SPST	30 Ω
IH5049	Dual DPST	30 Ω
IH5050	SPDT	30 Ω
IH5051	Dual SPDT	30 Ω



# Finally! A filter so precise, filter characteristics for every setting are printed on top.



We've built a variable electronic filter that's so precise, it has enabled us to print the cutoff frequencies, center frequency, bandwidth, noise bandwidth and filter gain, for every setting, *on top of the instrument*. Besides being the easiest-to-use filters on the market, our 4200 series filters are twice as accurate, have less than half the self-noise, and provide 10 dB greater outband rejection than any other filters. Frequency coverage is .01 Hz to 1 MHz. Built-in selectable post-filter gain and remote preamplifiers are optional. A Butterworth response is used in the NORMAL mode and a Bessel response in the PULSE mode (transient response is superior to conventional "RC" or "Low Q" modes of other filters).

The price? \$695.

For complete specifications and your free copies of our variable electronic filter application notes, write to: Ithaco, Inc., Box 818-7R, Ithaca, New York 14850. For immediate response, call Don Chandler at 607-272-7640 or TWX 510-255-9307.

## ITHACO

## New products

even when an excessive overvoltage is applied that could break down the blocking diode, the SCR effect will not occur.

It should be noted that before the floating-body design, solutions to the latch-up problem involved using either a more expensive manufacturing process (like dielectric isolation), or external components (such as current-limiting resistors), which always added complexity and often compromised performance.

Other important features of the switch series are: they can switch more than 20 V peak to peak from  $\pm 15$ -V supplies; they are compatible

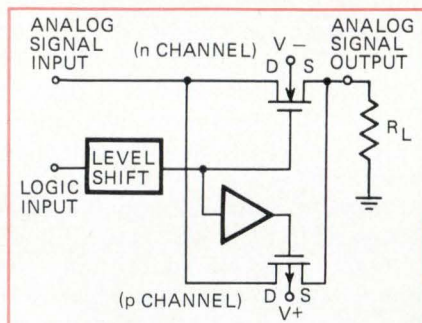

**Analog switch.** Latch-up is avoided by floating gate with extra diode (not shown).

with all commonly used logic—TTL, DTL, C-MOS, p-MOS; they have the all-important break-before-make switching feature; their leakage current is less than 1 nanoampere; they're fast (less than 1 microsecond), and their on resistance is low (only 30 ohms).

Worth stressing is the 5040 series' ultra-low-power operation—quiescent current requirement is less than 100 microamperes. The feature stems from the low-power, 40-v C-MOS process.

The break-before-make feature of the gates also eliminates the external logic normally required to avoid channel-to-channel shorting during switching. It's done by extending the on time (typically 500 nanoseconds) so that it exceeds the off time (250 ns typically), insuring that an on channel will be turned off before an off channel can be turned on.

Large-quantity prices are in the \$2-per-channel range.

Intersil Inc., 10900 No. Tantau Ave., Cupertino, Calif. 95014 [338]



# DIGITEC'S NEW DATA LOGGERS



## HAVE ALL THIS VERSATILITY

- Models to measure Voltage, Current, Resistance, Temperature & other transduced parameters.
- 20 selectable scan points standard, expandable to 200.
- Real-time digital clock with program interval for unattended operation, standard.
- Digital printout arranged for quick, easy reading.
- BCD and system interlocks brought out to interface peripherals such as: comparators, tape punch, and mini-computer.
- Loss of power indication.
- All LED long-life displays.

## WITH PRICES UNDER \$1900

To see the DigiTec 1200 or 1500 series Data Loggers, simply contact your DigiTec representative. Or, you can call or write; **United Systems Corporation**, 918 Woodley Rd., Dayton, Ohio 45403 Phone (513) 254-6251.

All DigiTec instruments are available for rental or lease through Rental Electronics, Inc.

**DIGITEC**  
UNITED SYSTEMS CORPORATION  
subsidiary of **Monsanto**

Circle 131 on reader service card



# Support a good cause: You.

The U.S. Savings Bond Program provides an easy and safe way for you to plan for the future. And it benefits the country, too.



Robert W. Sarnoff

For the second consecutive year, Robert W. Sarnoff, RCA Chairman of the Board and Chief Executive Officer, has agreed to head the U.S. Savings Bond Program in the electronics industry.

RCA and its employees have been enthusiastic supporters of the Program since it began. Last year, 88% of RCA employees participated in this systematic method of saving.

So if you want to support a good cause, think about yourself and your country. Buy U.S. Savings Bonds.

## Take stock in America.

Buy U.S. Savings Bonds



## New products

Components

### DIP houses two relays

Units in tiny package can be driven by TTL or DTL; contacts rated at 2 amperes

When equipment design requires transistor-transistor or diode-transistor logic to directly drive circuits that must switch up to 2 amperes (resistive) at up to 150 volts dc, a dual in-line package developed by AMP Inc. and containing two identical high-speed relays may be the answer.

The DIP, which is specially designed for mounting on printed-circuit boards, packs two independent double-pole, double-throw relays into a space 0.9 inch wide, 0.36 in. long, and 0.4 in. high for a volume of less than 0.13 cubic inches. The relay package is priced at \$5 each in production quantities, and AMP claims that it offers the most switching capability per unit volume of any device on the market.

Pull-in time for the high-speed electromechanical unit is 5 milliseconds maximum, including bounce, and 4 milliseconds on dropout. The coil resistance is 100 ohms, and it is rated for a maximum operating voltage of 7.5 v. The drive power required is 170 milliwatts. Pull-in voltage is about 4.1 v, and dropout voltage is approximately 2 v.

The relays' low-contact resistance and medium-current capability make them suitable for multiplex-

ing, as well as for power switching. Mounting options include solder, Wire-Wrap, and Termi-Point. Lead spacing is conventional for a 16-pin DIP: the input-output pins are on 100-mil centers, and rows are spaced 300 mils apart. Cross-section of the pins is 8 by 20 mils, and weight of the device is 0.143 ounce, the company says.

Delivery time is six to eight weeks.

AMP Inc., Harrisburg, Pa [341]

### Air-control components perform logic functions

A series of miniature air-control components can perform logic functions. The nonmetallic devices, called Minivalves, fit into standard electrical control boxes and limit-switch housings, and they mount behind electrical push buttons. Thirty components plus regulator and

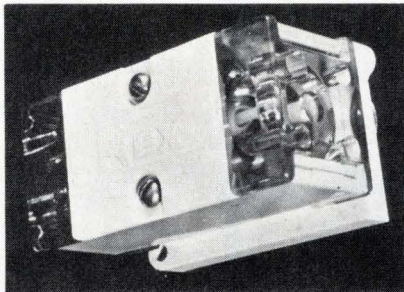

pressure gauge mount in a 17-by-20-inch panel box. Taper-lock fittings connect valves to a 1/4-inch plastic tubing.

ir Valves Division, Rexford Inc., 1760 Maplelawn Blvd., Troy, Mich. 48084 [345]

### Fuseholder protects against shocks

A shock-safe fuseholder, type 345001, is designed with an electrical insulating shield that completely encloses the contacting-ring section of the fuseholder side terminal. Electrical continuity is established by a bayonet-style fuse-extractor knob through a slotted section of the electrical insulating shield. The fuse-extractor knob is connected to

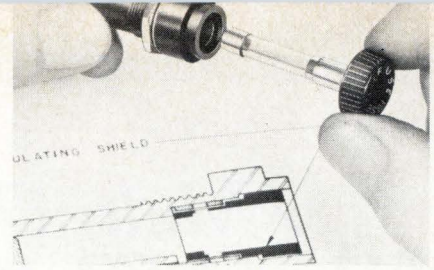

the contact ring by depressing and rotating it 90° after fuse insertion.

Littlefuse Inc., 800 E. Northwest Highway, Des Plaines, Ill. 60016 [344]

### T transformer measures 0.75 by 0.75 by 0.6 in.

A precision Scott T transformer, model 12393, converts synchro information into resolver information and is used for synchro-to-digital, digital-to-synchro, synchro-to-linear outputs, and similar computer interface operations as well as analog-to-digital applications. Measuring 0.75 by 0.75 by 0.6 inch, the unit operates over the temperature range of from -55 to +125°C and input is 11.8 volts rms line-to-line. With 400-hertz synchro information, standard output is 6 v sine- and cosine-resolver information. Price is \$19 each in 100 lots.

Magneto Inc., 6 Richter Ct., E. Northrup, N.Y. [343]

### Momentary-action switch uses LED light source

The series 913 miniature momentary-action switch has a light-emitting diode for its light source and operates from a 5-volt dc supply, but external resistor can supply voltages over this rating. The switch is suitable for application where extra-long life or low power is required. It is available in either normally open, normally closed, or two-circuit versions, and it is supplied with a long cylindrical lens cap with an internal

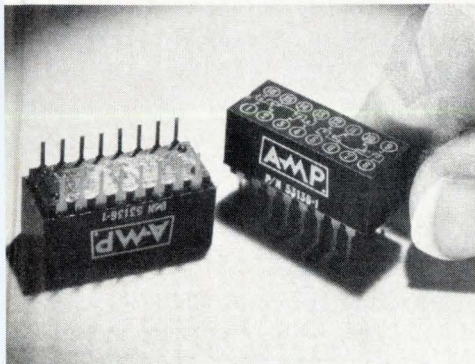
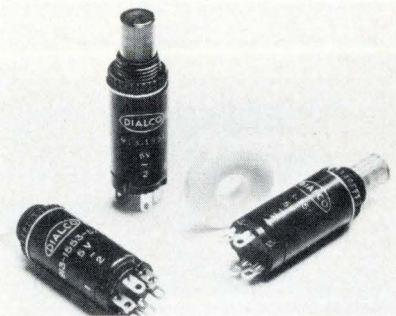



# New Multi-Octave Double Balanced Mixers

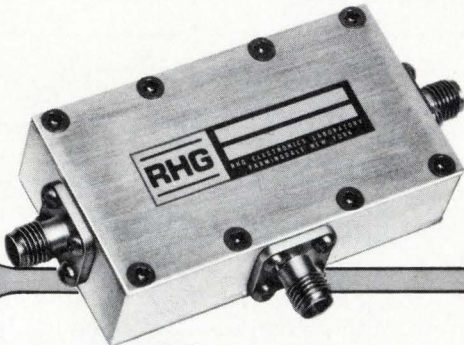

Now Available  
RF to 18 GHz  
IF to 2.3 GHz

0.5 to 12 GHz  
COVERAGE  
IN A SINGLE MIXER  
UNIQUE DOUBLE  
BALANCED MICROWAVE  
CONFIGURATION\*

Excellent noise performance is maintained over several octaves along with low IM distortion and high isolation.

#### MULTI-OCTAVE • OCTAVE MODELS

Model No.	Freq. (GHz)	NF (db)	Price
DM 1-4	1.0 to 4.0	7.5	\$325
DM 1-8	1.0 to 8.0	8.5	345
DM 1-12	1.0 to 12.0	10.0	425
DM 5-12	0.5 to 12.0	10.0	450
DM 1-18	1.0 to 18.0	10.0	595
DM 1-2	0.8 to 2.2	7.2	295
DM 2-4	1.8 to 4.2	7.5	295
DM 4-8	3.7 to 8.2	8.2	325
DM 8-12	7.8 to 12.2	10.0	345
DM 12-18	11.8 to 18.2	10.0	495

#### NOTES:

1. LO-RF isolation 20 db.
2. Based on 1.5 db IF N.F.
3. RF & LO VSWR: 2.0:1.
4. LO injection: +5 to +10 dbm.

Mixers are available with or without built-in low noise preamplifiers — one group of hundreds of standard RHG waveguide and coaxial mixer-preamplifiers.

Write for technical performance curves and detailed data sheets. \*U.S. Pat. #3,652,941

**RHG** **RHG ELECTRONICS  
LABORATORY • INC**

161 EAST INDUSTRY COURT ■ DEER PARK  
NEW YORK 11729 ■ (516) 242-1100 ■ TWX 510-227-6083

for Reliability, Innovation and Service

## New products

Fresnel ring for uniform light distribution. Price is \$2.59 each in 1,000 lots for normally open and normally closed types and \$2.73 for the two-circuit versions. Dialight Corp., 60 Stewart Ave., Brooklyn, N.Y. 11237 [346]

Trimming capacitors are microminiature types

The Thin-Trim is a microminiature variable capacitor for applications from quartz-crystal watches to phased-array microwave ICs. The model 9402-4 has a capacitance range of 3.0 to 12.0 picofarads and a Q of less than 750. It is 0.140 inch in diameter and 0.030 inch thick. It is tuned from the top with a miniature dielectric tool.

Price is \$3.05 in 1,000 lots.

Johanson Manufacturing Corp., 400 Rockaway Valley Rd., Boonton, N.J. 07005 [347]

Molded inductors provide electromagnetic shield

The model IMS-5 molded inductor meets the requirements of MIL-C-15305D, Grade I, Class A, and is provided with an electromagnetic shield. Inductance range is from 0.10 microhenry to 100,000  $\mu$ H, and inductance tolerance is  $\pm 10\%$ . Self-resonant frequencies are from 250 to 0.11 megahertz, and rated dc current is from 1,790 mA to 11 m. The IMS-5 is 0.410 inch long by 0.162 in. in diameter. Price is 46 cents each in quantities of 1,000.

Dale Electronics Inc., Dept. 860, Box 609, Columbus, Neb. 68601 [349]

Flat-top lamps mount on circuit boards

The T-2 TU-PIN series of subminiature flat-top lamps for status indication and related systems are for mounting on printed-circuit boards. They may be used in a va-



# The Big Sweep 100 kHz-18 GHz.

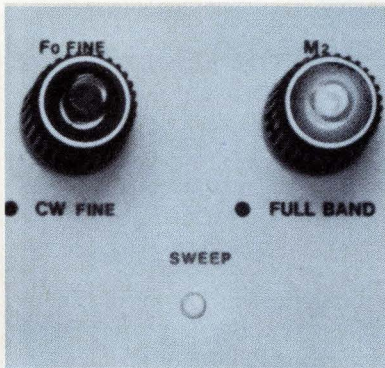

It's a whole new generation of solid state sweep oscillators from Singer.

The 6600 Sweep Oscillator with its wide selection of plug-ins covers the 100 kHz to 18 GHz range. Below 1000 MHz, you have as many as three units

from which to choose the one best suited to your application. One model includes a power-set meter

adjustable over a 140 dB range for applications requiring sweeper and signal-generator-like performance. Microwave plug-ins are pin-leveled, internally or externally, all the way up to 18 GHz. And with a 20 dB power control range. But there is much more than exceptional performance to the 6600.

The uncluttered front panel with its lighted, push-button controls, makes operation self-evident and confusion-free. With four sweep modes, full band, marker,  $\Delta F$ , and manual — each with frequency markers — the 6600 sets a new standard for ease and flexibility of operation.

Take a little time to find out more about the big sweep. Write for complete data bulletin now.

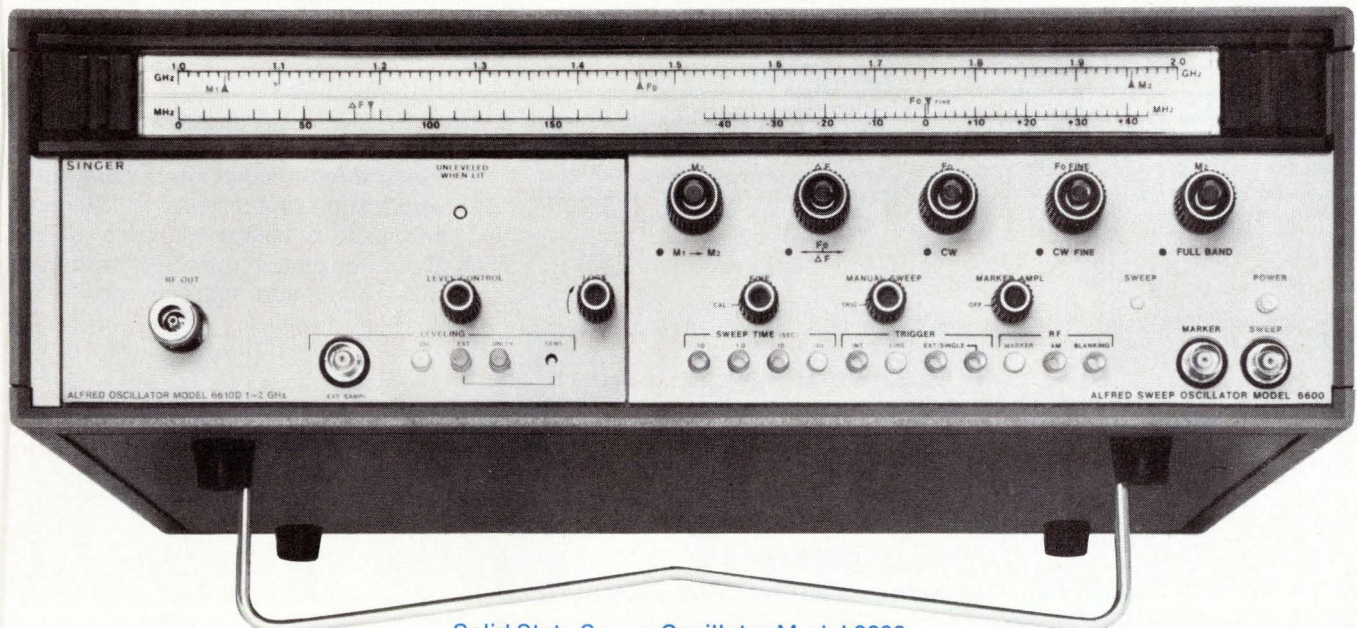

Solid State Sweep Oscillator Model 6600

## SINGER

INSTRUMENTATION

The Singer Company, Palo Alto Operation • 3176 Porter Drive, Palo Alto, Calif. 94304 • Telephone (415) 493-3231



The new Hickok 3420 is different: it's a full 5-digit counter to 20 MHz and it also measures DC/AC voltage from 10  $\mu$ V to 1 kV, and resistance from 10 m $\Omega$  to 10 M $\Omega$  with 4-digit resolution. Frequencies are measured to 0.01-Hz resolution, accurate to  $1 \times 10^{-6}$  for 1 year. Sensitivity of 100 mV and the 20-MHz bandwidth make the 3420 useful in logic circuitry

and communications systems testing. Internal rechargeable battery is optional. Price, only \$750.

## HICKOK

the value innovator

Instrumentation & Controls Division  
The Hickok Electrical Instrument Co.  
10514 Dupont Ave. • Cleveland, Ohio 44108  
(216) 541-8060 • TWX: 810-421-8286

# 5-digit counter & 4-digit multimeter in one package



Circle 161 on reader service card

The new Hickok 5310 gives you high performance at a low price — performance like ultrastable triggering to 15 MHz, 5 mV/cm sensitivity and full overload protection. Even for low repetition rate signals, the CRT display is clear and sharp because of the high accelerating potential and P31 phosphor. For broadcast work, the 5310 has an

easy-to-use automatic VITS capability. Also, trace invert and beam finder.

## HICKOK

the value innovator

Instrumentation & Controls Division  
The Hickok Electrical Instrument Co.  
10514 Dupont Ave. • Cleveland, Ohio 44108  
(216) 541-8060 • TWX: 810-421-8286

**Bright,  
8x10 cm  
display  
and 10 MHz  
for \$425**

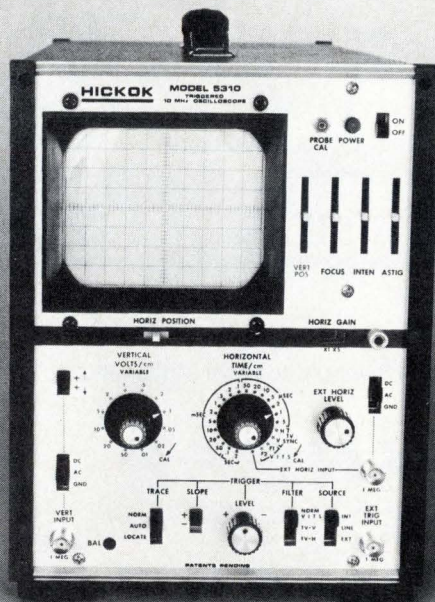

## New products

riety of applications, such as panel-display of logic functions and busy-lamp applications. The flat-top bulb allows maximum end viewing. Seventeen voltages from 4 to 48 v are offered, with current ranges from 17

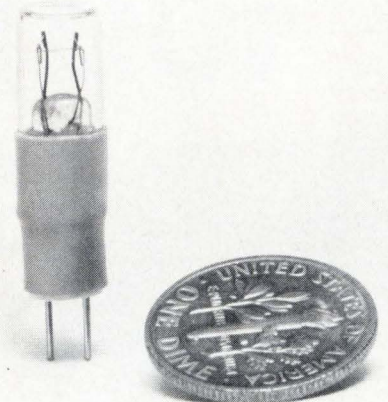

to 80 milliamperes. Mounting construction makes the T-2 series interchangeable with Sylvania's T-1  $\frac{3}{4}$ -inch bi-pin types. Price is 36 cents each in 1,000-lots, and delivery is from stock.

Sylvania Miniature Lighting Products Inc.,  
West Main St., Hillsboro, N.H. 03244 [348]

Miniature indicator light incorporates resistor

A line of miniature indicators provides intense neon brightness with application of 115 volts ac. The entire unit is comprised of a Mini-Brite housing, a standard wire-lead neon lamp and snap-on caps. The

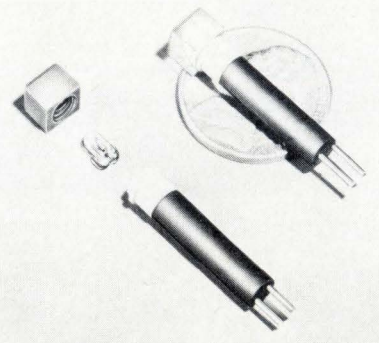

subminiature housing also incorporates a  $\frac{1}{8}$ -watt encapsulated resistor with various life expectancies. Price is \$1.30 each for one to 99 pieces.

LVC Industries Inc., Bloc-Lite Division, 135-25 37th Ave., Flushing, N.Y. 11354 [350]





**EMPLOYMENT OPPORTUNITIES**

**POSITION VACANT**

**Communication / Microwave / Electro-Optical Engineers**—\$15-\$25,000. Immediate nationwide Design opportunities for engineers with expertise in: RF Circuit, Video Circuit, VHF/UHF, Stripline Components, Microstrip, Test Equipment, ECM Systems, EW Systems, Antenna, Radar Systems, Power Supply, E/O Systems, E/O Components, Laser Systems, Display Systems, or CATV ... For confidential consideration, rush your resume including current salary: Dunhill Search, 22 E. Mitchell Dr., Phoenix, AZ 85012 or 1922 The Alameda, San Jose, CA. 95126—100% Employer Retained.

CLASSIFIED ADVERTISING

**SEARCHLIGHT SECTION**

BUSINESS OPPORTUNITIES  
USED OR SURPLUS EQUIPMENT

**INFRARED VIEWERS & PARTS**

**TYPE 6929 INFRARED IMAGE TUBE ...**  
Late-date monovoltage Image Converter. Features high resolution & single input of 12,000 vdc. Self-focusing. 1.36" dia. by 2.33" long. Good Mtrs' seconds. Normal price \$170.00. New Surplus ... **ONLY \$29.95 ppd.**

FOR:

• Crime Detection • Laser Study • Research

**MINIATURE HIGH-VOLTAGE POWER SUPPLY**

Solid state power supply for 6929 tube & 9902 Metascope. Input 1.34 vdc (RM-1R battery). Output 12,000 vdc. Size 1.0" dia. x 2.5" long. 1st-Quality. List \$350.00. **BRAND NEW ... ONLY \$74.95 ppd.**

**COMBINATION OFFER: 6929 Tube & Power Supply ... \$99.95 ppd.**

**COMPLETE METASCOPE INFRARED VIEWERS**

Model 9902 Late-date Viewer utilizing 6929 tube. Military version of and identical to 5900C Metascope. Complete with light source. Ready to use. Current list \$675.00. **Like-New Surplus ... \$225.00 ppd.**

**McNEAL ELECTRIC & EQUIPMENT CO.**  
4736 Olive St. St. Louis, Mo. 63108

**IMMEDIATE DELIVERY**  
Minis & Peripherals  
**DEC—HIS**  
**SEL—HP—NOVA**

Card, Printer, Tape, Disk  
**TELETYPES**  
**33, 35, 37**

For Sale/Rent  
**617/261-1100**

Send For **FREE Price List**  
**AMERICAN USED COMPUTER CORP.**  
15 School St., Boston, MA. 02108

CIRCLE 952 ON READER SERVICE CARD

**RESUME KIT**

**Free Engineer's Resume Kit for Electrical Mechanical and Industrial Engineers.** Scientific Placement, Inc., Employment Service 5051 Westheimer, Houston, TX 77027.

**REAL ESTATE**

**Ideal 5-Acre Ranch. Lake Conchas, New Mexico.** \$3,475. No Down. No Interest. \$29/mo. Vacation Paradise. Money Maker. Free Brochure. Ranchos: Box 2003YD, Alameda, California 94501.

**BOEING**

**Printed circuit manufacturing engineer.**

**Pacific Northwest Opening.**

The Boeing Aerospace Company has an immediate opening for a Printed Circuit Manufacturing Engineer. Applicants should have a thorough knowledge of all process requirements in fabrication of printed circuit boards including multilayer. This position requires interface with design engineers, facility and equipment coordination and interface with shop personnel.

You'll enjoy the wholesome environment of the Pacific Northwest. Live minutes from work. Relax on the water, in the mountains or in the cool green of your own backyard. Salary is commensurate with experience. A full range of company benefits is available.

Please send your résumé to the Employment Office, The Boeing Company, P.O. Box 3707-EBB, Seattle, WA 98124. An equal opportunity employer.



**SEARCHLIGHT SECTION**

**AUTOTRACK MOUNT**

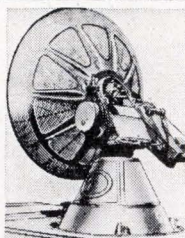

**AUTOTRACK SCR-584 RADARS**

360 degree azimuth, 210 degree elevation sweep with better than 1 mil. accuracy. Missile velocity acceleration and slewing rates. Amplidyne and servo control. Will handle up to 20 ft. dish. Supplied complete with control chassis. **ALSO** in stock—10 cm. van mounted radar system. Conical scan. PPI. 6 ft. dish. Ideal for S band telemetry, weather, balloon trk, missile trk, rocket trk, ECM range. Write for complete data. 600 pg. instr. bk. avail. at \$25 ea.

**1 MEV LINEAR ACCELERATOR**

Dual Mode, Ion or Electron. RF Drive, 300 KHZ at 45 KW. Includes control console, RF unit, accelerator, etc.

**MOD IV HIGH RESOLUTION TRACKER**

Instrumentation radar; freq. 8.5-9.6 GHz, Pwr: 250 KW, .1 mil tracking accuracy. 6' Fresnel lens antenna with 4 horn monopulse feed. Tracking range 50 or 200 miles. Formerly used as range safety radar at Cape Kennedy.

**MIT MODEL 9 PULSER 1 MW—HARD TUBE**

Output 25kv 40 amp., 30kv 40 amp. max. Duty cy. .002. .25 to 2 microsec. Also 5 to 5 microsec. and 1 to .5 microsec. Uses 6C21. Input 115v 60 cycle AC. Mfg. GE. Complete with driver and high voltage power supply. Ref: MIT Rad. Lab. Series, Vol 5, p. 152.

**2 MEGAWATT PULSER**

Output 30 kv at 70 amp. Duty cycle .001. Rep. rates, 1 microsec. 600 pps. 1 or 2 msec. 300 pps. Uses 5948 hydrogen thyratron. Input 120/208 VAC 60 cycle. Mfr. GE. Complete with high voltage power supply.

**17 MEGAWATT LINE PULSER**

Output 17kV at 1000 Amps. Rep. rate 150-2000 PPS. 2.5 Microsec. Keyer tube 5948 thyratron. Pwr: 208V. 3Ph. 60HZ. 38KVA.

**HV POWER SUPPLIES**

6.3 KV @ 5. Amp; 20KV @ 1.3 Amps; 35KV @ 1.5 Amps; 28KV, 70MA; 12KV @ 800MA  
18KV @ 2.25 Amps; 17.5KV @ 1.8 Amps.

**RECON DRONE CONTROL RADARS**

X Band systems autotrack and search complete with plotting boards. Fully mobile van mounted. Gives PPI, slant range, altitude data. Ground to air control links and beacons also in stock. AN/MPQ-29 & AN/UPW-1

**PARAMETRIC AMPLIFIER**

Collins type. 2.3 Ghz, 30 Mhz band width, 1.7 DB noise figure, 20 DB gain, 5-way power splitter output.

**SPARE PARTS IN STOCK**

Nike Ajax, Nike Hercules, M-33, MPS-19, TPS-ID, TPS-10D, FPS-6, SPS8, SCR-584, HIPAR.

**RADAR & RF PKGS.**

34ghz 40kw Pulse RF pkg  
24ghz 40kw Pulse bomb toss system  
16ghz 130 kw Pulse B-58 search radar system  
**X BAND SEARCH 40 KW PULSE WEATHER RADAR**  
**X BAND AUTOTRACK 250KW PULSE M-33** compl w/ plot boards

**X BAND BEACON 400 W PULSE AN/DPN-62**

**X BAND AUTOTRACK 50KW PULSE B-47** fire control complete

**C BAND WEATHER RADAR 250 KW PULSE**

**C BAND HEIGHT FINDER**

AN/FPS-26.5 megawatt output.

AN/TPS-37. 1 megawatt output.

**C BAND 1 MEGAWATT AUTOTRACK**

10ft dish mortar locator MPQ-21

**C BAND 285KW PULSE** Search AN / SPS-5

**S BAND AUTOTRACK 500 KW PULSE 10' DISH**

**S BAND 1 MEGAWATT COHERENT AN / FPS-18**

**S BAND 1 MEGAWATT PULSE NIKE ACQ.**

**S BAND 5 MEGAWATT HEIGHT FINDER AN/FPS-6**

**L BAND BEACON 1 KW PULSE**

**L BAND 500KW PULSE AN / TPS-ID / E**

**L BAND 5 to 20KW PULSE**

400mhz 1KW CW AN / FPS-23

225mhz 1 MEGAWATT PULSE AN/TPS 28

2-30mhz 100KW PULSE

CW, 950-5ghz 150 WATTS

CW 1.5mhz-10.5ghz 5 WATTS

CW 7.4 GHz 2 KW

**AN / GPG-1 SKYSWEEP TRACKER**

3 cm. auto. tracking radar system. Comp. pkg. w/ indicator sys. Full target acquisition & auto. tracking. Input 115v 60 cy. new. In stock for immed. del. Entire sys. 6' x 3' x 10'. Ideal for infrared tracker, drone tracker, missile tracker, R & D.

**HUNDREDS MORE IN STOCK**  
**LARGEST RADAR**  
**INVENTORY**  
**IN WORLD.**  
**WRITE FOR CATALOG ON YOUR LETTERHEAD**

**Radio-Research Instrument Co. INC.**

3 Quincy St., Norwalk, Conn. 06850 • 203-853-2600

CIRCLE 951 ON READER SERVICE CARD



# RCA introduces its one-transistor Darlington.



No we haven't changed the Darlington circuit. We've just turned it into the Darlington transistor. By putting the whole circuit on a single monolithic chip.

In the RCA Darlington transistor design, optimum use of the silicon real estate and single level metallization provide improved performance characteristics. You get greater control over parameters and increased peak current handling capacity . . . up to 15 amps.

It's all spelled out in black and white.  $I_S/B$   $E_S/B$  and Thermal Cycle ratings are all specified . . . even the output diode is characterized.

And they don't come any more rugged. All steel (TO-3) package, controlled solder chip mounting and heavy duty clip connections make the RCA Darlington transistor a dependable workhorse in your system.

So if you're working with discretes, you can now get higher packaging densities, lower your overall system cost and, at the same time, increase system reliability by reducing the number of external connections.

Why not give your system the advantage of all these benefits by switching from the Darlington circuit to the RCA Darlington transistor. It's at your

distributor, waiting for you right now in the following configurations:

TO-3 pkg.	$T_D@25^\circ\text{C}$	VERSAWATT plastic pkg.	$T_D@25^\circ\text{C}$	$V_{CE0}^{(sus)}$ $V_{CER}^{(sus)}$
2N6385	100W	2N6388	40W	80V
2N6384	100W	2N6387	40W	60V
2N6383	100W	2N6386	40W	40V

Want more data? Write RCA Solid State, Section 70D26/UTL37, Box 3200, Somerville, N.J. 08876. Phone (201) 722-3200.

**RCA Solid State**  
products that make products pay off

International: RCA, Sunbury-on-Thames, U.K., or Fuji Building, 7-4 Kasumigaseki, 3-Chome, Chiyoda-Ku, Tokyo, Japan. In Canada: RCA Limited, Ste-Anne de Bellevue 810, Canada.



## New products

### Instruments

## Probe built for C-MOS

Unit designed for logic families from 5 to 15 volts; uses three-lamp readout

Now that complementary-MOS is being used more extensively in equipment, there's a need for a C-MOS-logic probe to give engineers and technicians the capability for

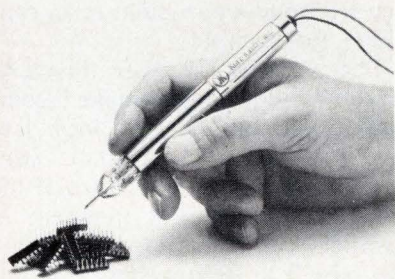

fast system-checkout in field service, quality control, bench service, and some design steps.

Kurz-Kasch Inc. has developed such a probe—the LP-570, designed for positive logic families from +5 to +15 volts. Like earlier Kurz-Kasch probes, this new version uses a multilamp display concept, and the three-lamp incandescent display located near the probe-tip flashes white for logic lows, red for logic highs, and blue for positive- or negative-going excursions, says Tom Barth, general manager of the firm's Electronics division, Dayton, Ohio.

"Crossover points float with the power supplies," Barth explains. "Logic lows are 0% to 30% of a  $V_{DD}$ , and logic highs are 70% to 100% of a  $V_{DD}$ ." The probe will detect open circuits and will identify deadband, that is, there is no display for logic levels from 30% to 70% of  $V_{DD}$ .

Input impedances are greater than 10 megohms at either logic low or high and "on a test bench setup, we're able to capture pulses of 100 nanoseconds in duration, independent of rise and fall times, for a fre-

quency response of about 9-megahertz bandwidth," Barth says. Internal circuitry, including two RCA COS MOS chips and a handful of discretes, stretches narrow pulses to 200 milliseconds for display.

The probe clips onto the appropriate power pins and derives its power from the system under test. Current drain is 20 milliamperes in standby; maximum drain for full display is 140 mA. Kurz-Kasch plans an all-solid-state LED version, the LP-575, featuring a total maximum drain of 30 mA under full display conditions, at some sacrifice in display. Both probes are protected for lead reversal and overvoltage.

The insulated probe, which is magnetically shielded, is  $\frac{5}{8}$  inch in diameter by  $5\frac{3}{4}$  in. long, with a test-probe tip 0.08 in. in diameter, tapering to a needle point. The firm offers a series of probe adapters for various wire-wrap configurations. Power leads are  $26\frac{3}{4}$  in. long and are terminated in miniature alligator clips.

The LP-570, available June 15, will sell for about \$80, and the LP-575 will be in stock 60 days later at about \$90.

Kurz-Kasch Inc., 2876 Culver Ave., Kettering, Ohio 45429 [351]

### Analyzer displays logic states in real time

The oscilloscope is the time-honored tool for displaying analog waveforms for examination. For digital waveforms, however, it leaves something to be desired. How, for example, does one examine the

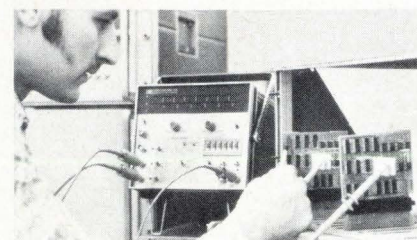

343,929th bit of a digital data stream on an oscilloscope? Or how does one examine the bits immediately preceding an error condition if one doesn't know where in the bit sequence the error occurs?

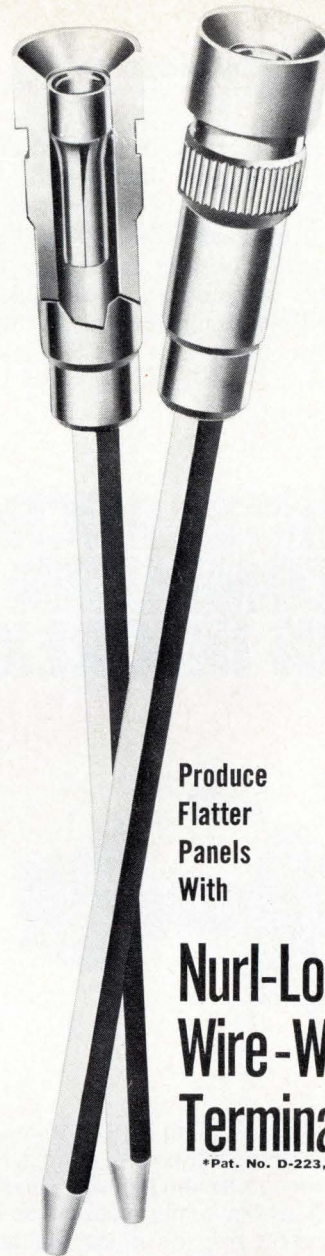

Produce  
Flatter  
Panels  
With

**Nurl-Loc<sup>®</sup>**  
**Wire-Wrap<sup>®</sup>**  
**Terminals**

\*Pat. No. D-223,109

- Time-proven Nurl-Loc features a knurled cylinder for greater torque resistance; distributes pressure evenly to avoid board warp; permits removal without damage to board.
- Funnel-Entry™ (pat. pend.) facilitates loading IC's by automatic equipment.
- Low profile: only .046 above PC board.
- 4-Finger contact assures a positive electrical contact.
- Terminals available separately or assembled in panels.

**Write, TWX or Phone for  
Computer Products Catalog**

CALL TOLL-FREE: 800-556-6969



**ELECTRONIC MOLDING CORP.**

96 Mill Street, Woonsocket, R. I. 02895  
Phone (401) 769-3800 TWX 710-387-1350

Wire-Wrap<sup>®</sup> Gardner-Denver Co.



## New products

One answer to these problems, and many others that involve the display of digital logic states vs time, is Hewlett-Packard's 5000A logic analyzer. Loosely speaking, the analyzer is the digital equivalent of an oscilloscope. Instead of an internal time base, it uses the master

clock of the system under test, so it displays logic levels as functions of clock intervals—regardless of the actual repetition rate of the clock.

The analyzer's analog of a scope's vertical axis is a pair of inputs that are connected, through high-input-impedance amplifiers, to two rows

of 32 light-emitting diodes. After receiving a trigger signal, the analyzer uses the clock input to strobe the data inputs and display their logic states on the LED arrays. A turned-on LED indicates a logic 1, a turned-off LED indicates a logic 0.

To examine a 32-bit sequence far downstream from the trigger input, the analyzer is equipped with a delay register that acts like an oscilloscope's delay generator except that it counts clock periods instead of time. And, because the analyzer is constantly monitoring and storing the input data while waiting for a trigger signal, it can display the 32 bits preceding the trigger—if the user wants to examine the events that led up to a particular error condition, for example.

The analyzer's voltage threshold levels are adjustable to make it compatible with all popular logic levels—RTL, DTL, TTL, HTL, ECL, MOS, and C-MOS. Input impedance of the basic instrument is 1 megohm in parallel with 25 pF. Divider probes can raise it to 10 megohms in parallel with 10 pF. Maximum system clock rate is 10 MHz.

Inquiries Manager, Hewlett-Packard Co.,  
1501 Page Mill Road, Palo Alto, Calif. 94304  
[352]

## INTEL MICRO COMPUTER WORKS IN INFOREX CHECK PROCESSOR



Inforex is using an Intel micro computer in a system that processes incoming bill-paying checks for banks, retail stores, credit card companies and the like. The system reads the return portion of the bill with a numeric optical scanner, endorses the check for deposit and records the entire transaction on magnetic tape. By performing several clerical tasks at one station under the control of one operator, the system speeds processing and greatly reduces clerical costs.

An Intel one-chip computer performs as a micro processor in the character recognition system for the optical scanner.

Inforex says the one-chip computer does the work of about 100 discrete components and replaces an entire 9" x 10" PC board otherwise required. They estimate that the micro computer reduces the cost of the character recognition system by about 20%.

intel  
delivers.

## Programmable filter system handles up to 16 channels

A programmable multichannel analog filter system is meant primarily for band-limiting signals prior to sampling and a-d conversion. Up to



16 filter channels with cutoff frequencies from 10 to 150 kilohertz are provided. Roll-off is 48 decibels per octave.

The standard Butterworth low-pass configuration of the System 816 can be altered to high-pass, making



it possible to form bandpass and band-reject filters by cascading two channels.

The system mainframe is priced at \$750. Each filter card costs \$650. Deliveries begin in June.

Rockland Systems Corp., 230 West Nyack Road, West Nyack, N.Y. 10994 [401]

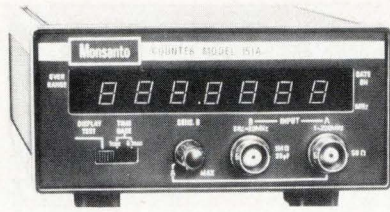

holds the prior count as a new one is being made. Display is a seven-digit LED array with a built-in self check and a half-life reliability of 100 years. The unit is equipped with two inputs, selectable by a dc switch on the sensitivity pot mounted on the front panel. Gate time choices of

## Electrolytic recorder has 128-kHz bandwidth

When standard facsimile recording techniques are combined with an array of 512 individually addressable fixed recording styli, the result is a chart recorder that adds high speed to intensity modulation. The model 200 electrolytic recorder offered by ITT Electro-Physics Laboratories Inc. has a passband extending from dc to 128 kilohertz, an input resistance of 3.3 kilohms, and an all-electronic, adjustable sweep-control system. Sweep rates can be varied from 500 microseconds per inch to 200 milliseconds per inch in 10 overlapping ranges.

The 512 fixed recording styli are spaced over an 8-inch recording span at a uniform density of 64 to the inch. Each stylus is powered by an individual driver circuit, which weights the marking current proportional to the input voltage. This configuration gives the recorder a great deal of flexibility. It can, for example, be used in radar imaging applications with radar range measured along the X-axis, return signal strength plotted as intensity, and time measured along the Y-axis. It can also record the spectrum analysis of a comb-filter response.

ITT Electro-Physics Laboratories, Inc., 9140 Old Annapolis Road, Columbia, Maryland 21045 [340]

## Frequency counter measures from 5 Hz to 220 MHz

The model 151A is a small crystal-controlled frequency counter capable of measuring from 5 Hz to 220 MHz. The counter provides display storage with a memory circuit that

# INTEL MICRO COMPUTER WORKS IN SEIKO'S DESK-TOP COMPUTER



An Intel micro computer put the full calculating power of a computer in a simple-to-operate machine no larger than a typewriter.

Seiko's S-500 is a sophisticated computer that can be operated without learning a complex programming language. Most function keys are coded in the universal language of mathematics. Programming is accomplished by inserting magnetic cards. Results are printed out in two colors. Most people can begin to use the machine effectively after only a few days practice.

Seiko designed the machine from the ground up to use Intel's MCS-8 micro computer. The micro computer performs all calculations, controls the keyboard, reads and writes the magnetic cards, generates displays and controls the printer.

Seiko estimates they saved 1 to 1½ years in development time by using an Intel micro computer in place of a conventional TTL design. They say that the Intel 8008 one-chip computer replaced about 200 TTL packages and cut costs in half for that part of the machine.

intel  
delivers.



## New products

100 ms and 1 s are available. The 151A is 4½ in. wide, 2 in. high, and 8½ in. deep. Price is \$795, and an optional 10-hour battery pack with charger is priced at \$200.

United Systems Corp., a Subsidiary of Monsanto, 918 Woodley Rd., Dayton, Ohio 45403 [353]

Component tester handles to 1,000 units per hour

A components tester for incoming inspection, laboratory, or assembly line is used for measuring, matching

and rejecting components. Designated the E-2 comparison bridge, the unit allows about 0.1% error and handles up to 1,000 components per hour.

Hathaway Industries, Box 45381, Southeast Station, Tulsa, Okla. [354]

# INTEL MICRO COMPUTER WORKS IN HELENA LABS BLOOD ANALYZER



Helena Laboratories is using an Intel micro computer in an instrument that measures the protein content of blood, printing a separate quantitative reading for each of several different proteins.

The Intel micro computer translates the raw data from a sensing instrument into medically meaningful numbers.

The people at Helena Labs say that the micro computer on one PC board replaced three PC boards plus a power supply, cutting the overall size of the electronics package in half. They estimate that using the micro computer reduced the cost of the electronics about 30%.

intel  
delivers.

Transmission level tester works from 50 Hz to 15 kHz

The model 420 transmission-line test set weighs 35 pounds and is designed for easy operation. The instrument measures return loss, attenuation, impedance, frequency response, and noise. Test results are displayed on a built-in oscilloscope. Features include swept or single frequencies from 50 Hz to 15 kHz, stepped attenuation control on both transmitter and receiver, and lighted display grid. Price is \$1,995. A

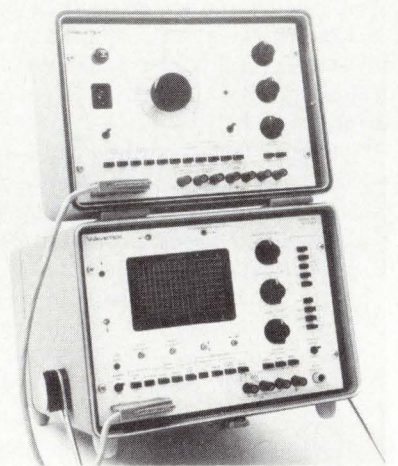

noise-measuring option is priced at \$345.

Wavetek, Box 651, San Diego, Calif. 92112 [355]

Frequency response analyzer covers 0.005 Hz to 10,000 Hz

Measuring amplitude ratio in decibels and phase shift in degrees, the model 911A-DS single-channel frequency-response analyzer covers the range of 0.005 to 10,000 Hz, with over 100:1 rejection of noise and harmonics. The unit can sweep frequencies and simultaneously plot



the amplitude ratio and phase shift versus log frequency.

Bafco Inc., 717 Mearns Rd., Warminster, Pa. 18974 [356]

Modules measure ratio, rate, time interval

A digital line of rate, ratio and time-interval measurement indicators in modular packages provides the user with the functions required to speed

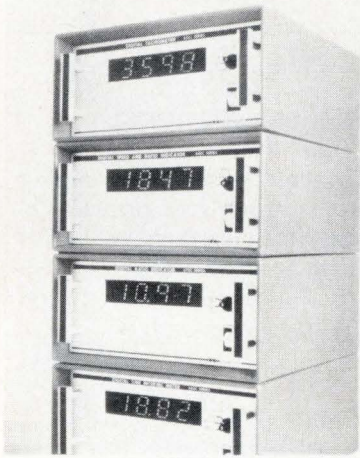

up machine operation without great expense. Units are available with speed readout or ratio readout or both. Other units provide time interval or speed difference or draw indication. Applications include counting parts per minute and cycle times.

Dynapar Corp., 1675 Delany Rd., Gurnee, Ill. 60031 [358]

ROM programmer built for Signetics 256-bit device

A portable field programmer for the Signetics 8223 256-bit field-programmable ROM is called the PR-23A

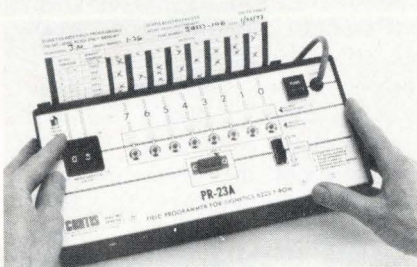

and allows manual programming of the Signetics device in the laboratory or in the field. To program one, the operator places a blank device in the test socket, selects the proper octal word address, and presses one of eight output push buttons to open the selected fusible link. The pro-

gram sequence is automatic and independent of operator timing, to ensure uniform program conditions. A typical pattern can be programmed in about five minutes. Price of the programmer is \$199.50.

Curtis Electro Devices Inc., Box 4090, Mountain View, Calif. 94040 [359]

## INTEL MICRO COMPUTER FOR PITNEY BOWES-ALPEX POINT-OF-SALE TERMINAL



Pitney Bowes-Alpex is incorporating an Intel micro computer in their SPICE™ point-of-sale terminal to perform arithmetic and data processing functions.

The terminals are now in use at retail stores and supermarkets nationwide. Operating in conjunction with an in-store controller, the terminals can automatically read price tags with a scanner, print sales slips, adjust inventory and even check the customer's credit.

The people at Pitney Bowes-Alpex say they selected Intel micro computers in order to reduce package size, cut the IC count, shorten development time and lower costs.

Size reduction, compared to space required using conventional off-the-shelf ICs, is estimated to be about 35%.

Cost reduction, compared to alternative techniques, is estimated to range from 20% to 30% for the arithmetic and data processing functions performed by the micro computers.

Development time was cut an estimated 25%, compared to the time required using conventional methods.

intel  
delivers.



Packaging &amp; production

## Test system is modular

---

Programable checkout isolates faults in cards, LSI arrays, and subsystems

---

Equipment manufacturers seeking a low-cost programable tester may find it in the Data Test Corp. model 570, which will be introduced at the National Computer Conference, June 4 to 8, at the Coliseum in New York City. The model 5700 isolates faults in mixed-logic cards, screens LSI arrays, tests cables, and exercises such subsystems as line printers, disk memories, and chip sets.

The minimum version tests TTL, DTL, and low-voltage MOS with pulse patterns generated by a 40-line code generator at rates to 2 megahertz. The test program, loaded manually into a 1,024-word memory, runs 128 drive, sense, and power-supply-pin circuits. This version costs about \$18,000.

Testing capability can be added modularly to a capacity of 16,384 words of memory, a maximum of 1,024 pins, pin circuits to test ECL and other devices, a dozen programable power supplies and instruments, a tape-cassette reader for bulk program storage, and a mini-computer. Computer options include an on-line Nova, a Nova time-shared by several testers, and a modem through which any computer can be time-shared.

If a computer isn't used, the console displays fault signatures to indicate which outputs of the device under test were false during an exercise sequence. A fault-signature dictionary lists the predictable signatures and their causes. Data Test says that about half of all faults found in typical logic assemblies can be identified by signatures.

Unpredictable faults are isolated manually by attaching test probes to the device in the assembly, exercising the unit, and counting pulse

transitions at each node. The operator simply probes back along the path from the faulty output until the probe head displays a count that matches a count recorded at the same node when a good unit was exercised during a setup run.

A computer will make these comparisons automatically. It can also be programmed to guide placement of the probes by the operator, make discrete tests, and test internal nodes through the probe head. The latter method is used when nodes cannot be fully tested through the normal input-output pins.

Testing can be simplified by a cylindrical test head that rotates through a 120° arc. A board plugged into the head can be flipped between a lap position, handy for probe attachment, and an easel position for inspection of wiring under the board. Most malfunctions in board assemblies are caused by solder bridges, which can be removed in the easel position while the operator checks to make sure the removal clears the malfunction.

Two test heads may be used to test large boards with two edge connectors. If one head is put atop the cabinet and rotated down to face the one in the cabinet, the board can be checked in the easel position.

Data Test supplies test-executive, assembly, encoding, and setup programs with computer-controlled configurations of the system.

Data Test Corp., 822 Challenge Dr., Concord, Calif. 94520 [391]

---

## Programable solid-state load dissipates up to 1,000 W

Working in a constant-current mode to test dc power regulators, a programable solid-state load dissipates up to 1,000 watts in the voltage



range of 2 to 50 v dc and a maximum current of 110 amperes when derated per the power-dissipation curve. If higher current-level testing is desired, units can be hooked up in parallel. There are two modes of operation: constant-current and constant-resistance, which can be used independently or with one as a limit for the other. The two modes have amplifiers and control circuitry that are coupled in parallel.

Acme Electric Corp., Cuba, N.Y. 14727 [394]

---

## Connector series designed for solderless wrapping

For programed solderless wrapping applications, 0.100-grid printed-circuit-board connectors have 0.025-inch-square terminals. The connectors are designed to be inter-

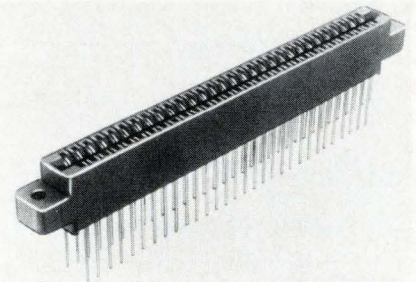

changeable with commonly used components. The series 186-295 units are available in position sizes 5/10 through 60/120, and have a low-contact-resistance bifurcated bellows-form contacts.

Methode Electronics Inc., 7447 W. Wilson Ave., Chicago, Ill. 60656 [396]

---

## Dual-pin plug requires no patch cords, jumpers

A dual-pin plug for Sealectro's matrix-board programmers is available with shorting-type and skip-type pins, which reach selected junctions on multiple decks. The unit permits rapid connection between buses without the need for patch cords or wired jumpers. The modules are secured in place by detent-type pins, which are silver-plated;



# THE MICRO COMPUTERS

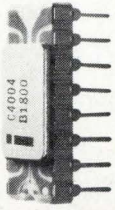

Intel's 4004 4-bit central processor typically replaces about 90 TTL MSI and SSI packages. It's the heart of the MCS-4 set of four micro computer devices—which includes a 2048-bit ROM with a 4-bit I/O port, a 320-bit RAM with a 4-bit output port and a 10-port shift register for I/O expansion. They fit together without any interfacing circuitry to make complete systems with 32K bits of ROM and 5K bits of RAM. Using a few simple interfacing devices, you can build much larger systems with up to 96K bits of ROM.

Intel's 8008 8-bit central processor typically replaces about 125 TTL MSI and SSI packages. It's the heart of the MCS-8 micro computer set—which includes standard Intel ROMs, RAMs and shift registers. The central processor can directly address 16,000 8-bit bytes stored in any combination of these memory devices. The processor has interrupt capability, operates asynchronously or synchronously, and can perform as many as seven nesting sub-routines. Systems require some interfacing circuitry.



## SUPPORT THAT MAKES SYSTEM-BUILDING EASY

### FOR MCS-4™ SYSTEMS

1. **Prototyping Board, SIM4-01.** Forms operational micro-programmed computer with Intel erasable PROMs in place of mask-programmed ROMs. Holds up to 8k bits of PROM and 1280 bits of RAM.
2. **Larger Prototyping Board, SIM4-02.** Like SIM4-01 above, but it holds 32k bits of PROM and 5k bits of RAM.
3. **4008/4009 Standard Memory and I/O Interface Set.** Provides direct interface between the 4004 and standard Intel PROMs, ROMs, and RAMs for program storage, and increases the available number of I/O ports.
4. **PROM Programmer, MP7-03.** Intel erasable PROMs plug into this board for programming using a teletypewriter.
5. **SIM4 Hardware Assembler.** Four PROMs plug into either SIM4 prototyping board, enabling your micro computer prototype to assemble its own programs. PROM types A0740, 741, 742, and 743.
6. **SIM4 Hardware Simulator on PROMS.** Enables prototype to simulate its own operation.
7. **System Interface and Control Module.** Interconnects all other support hardware and a TTY for program assembly, simulation, PROM programming, prototype operation and debugging. MCB4-10 for SIM4-01 and MCB4-20 for SIM4-02.
8. **Fortran IV Assembler.** Gives you the assistance of any general-purpose computer in developing MCS-4 programs.
9. **Fortran IV Simulator.** Permits any general-purpose computer to simulate the micro computer you are designing.
10. **Users Manual for MCS-4.** This 176 page manual tells you all you need to know to use MCS-4 components successfully.
1. **Library of Programs.** Contributed by users, free to users.

### FOR MCS-8™ SYSTEMS

1. **Prototyping Board, SIM8-01.** Forms operational micro-programmed computer with Intel's erasable PROMs in place of mask-programmed ROMs. Holds up to 16k bits of PROM and 8K bits of RAM.
2. **PROM Programmer, MP7-03.** Intel erasable PROMs plug into this board for programming using a teletypewriter.
3. **SIM8 Hardware Assembler.** Eight PROMs plug into SIM8 board, enabling the prototype to assemble its own programs.
4. **System Interface and Control Module.** Interconnects all other support hardware and a TTY for program assembly, simulation, PROM programming, prototype operation, and debugging. Intel MCB8-10.
5. **Chip-Select and I/O Test Program.** On PROM which plugs into prototyping board, Intel A0801.
6. **RAM Test Program.** On PROM that plugs into prototyping board, Intel A0802.
7. **Bootstrap Loader.** Enables you to enter data or a program into the RAMs from a teletypewriter paper tape or keyboard, and execute the program from the RAMs. Consists of three PROMs (A0860, 861 and 863) that plug into the prototyping board.
8. **Fortran IV Assembler.** Gives you the assistance of any general-purpose computer in developing MCS-8 programs.
9. **Fortran IV Simulator.** Permits any general-purpose computer to simulate the micro computer you are designing.
10. **Users Manual for MCS-8.** This 128 page manual tells you what you need to know to use MCS-8 components successfully.
11. **Library of Programs.** Contributed by users, free to users.

intel<sup>®</sup>  
delivers.

Intel Corporation  
Micro Computer Systems Group  
3065 Bowers Avenue  
Santa Clara, California 95051  
(408) 246-7501



LIGHTED DECORATOR  
PUSH BUTTON SWITCHES.

**250,000  
colorful operations  
per button.**

These Grayhill 1/4 amp lighted decorator push button switches offer a wide selection of popular styles and colors. Square or round, front or sub-panel mounts. Full range of colors, single or two-tone. Legends to order.

And that's only on the surface of things. There's an equally imposing variety in the circuitry available. SPST, momentary N.O. or N.C.; SPDT, momentary or alternate action; and DPDT, momentary or alternate action.

And every Grayhill lighted decorator push button switch variation has a tested life expectancy of 250,000 operations.

To learn more about these and other Grayhill quality products, write for our latest Engineering Catalog. Grayhill, Inc., 523 Hillgrove Avenue, La Grange, Illinois 60525. (312) 354-1040.



Circle 146 on reader service card

**WISH TO IMPORT**

**EXCLUSIVELY TO JAPAN**

ELECTRICAL MATERIALS, EQUIPMENTS, PARTS, CHEMICALS FOR ELECTRICAL USE, ETC. WHICH ARE NEWLY DEVELOPED OR PATENTED IN USA. WE ARE WHOLESALERS AND IMPORTERS OF ALL KINDS OF ELECTRICAL MATERIALS, ETC. IN JAPAN. HAVING BRANCHES ALL OVER JAPAN, TOKYO, NAGOYA, FUKUOKA, SHIKOKU, KASHIMA, HIROSHIMA, ETC. OUR MONTHLY TURNOVER IS ABOUT US\$2,400,000.00. OUR BANKERS: SUMITOMO, FUJI, KYOWA, DAI-ICHI KANGIN, KOBE. PLEASE CONTACT US DIRECTLY.

**Z. KURODA & CO., LTD.**

56-2, 5-CHOME KIGAWA HIGASHINOCHO  
HIGASHI YODOGAWAKU OSAKA, JAPAN  
TELEX: 523-8426 CABLE: KURODEN OSAKA

146 Circle 230 on reader service card

**connectors**

NEED INFORMATION ON  
**connectors?**

Who makes them?  
Where to get them?

PICK UP YOUR PHONE  
AND DIAL TOLL FREE

**800-645-9200**

(or, in New York State, call collect (516) 294-0990)

**this service is  
FREE**

use it whenever you're about to specify  
any **electronic product**

**eem**

645 Stewart Ave., Garden City, N. Y. 11530

Circle 193 on reader service card



**YOU'RE WHISTLING IN THE DARK...**

if you think that heart disease and stroke  
hit only the other fellow's family.

**GIVE ... so more will live  
HEART FUND**



*Contributed by the Publisher*

Electronics/April 26, 1973



## New products

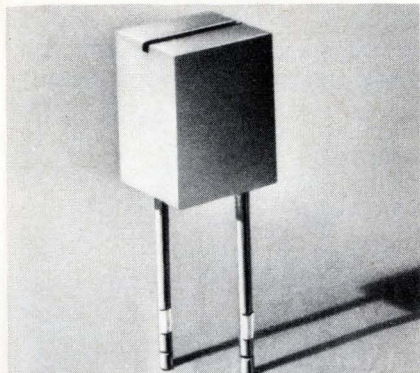

gold is available on special order.  
Sealectro Corp., 225 Hoyt St., Mamaroneck,  
N.Y. 10543 [397]

## Conformal coater for pc boards has two nozzles

An automated self-cleaning spray unit applies conformal coatings on assembled printed-circuit boards. Two reciprocating nozzles are angled to coat evenly around components. Circuits travel on a paper

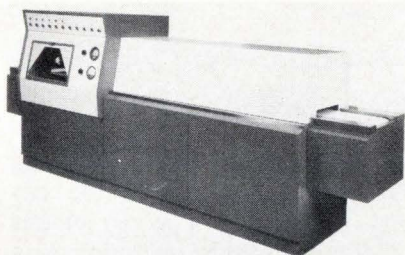

throw-away conveyor, which unrolls from the loading end and is rerolled at the unloading end. An air-dry process follows the spraying application to level and drive off fast solvents.

In-line Technology Inc., 30 Mill St., Assonet,  
Mass. 02702 [399]

## Multicontact connectors have hermetically sealed mounts

A line of ultraminiature 4-, 7-, and 12-contact connectors features hermetically sealed panel mounts and are designed for applications in high-density packaging, aerospace systems, integrated circuits, instrumentation, transducers, and medical

Electronics/April 26, 1973

# PEOPLE make a product great!



Sure, we have a fine product, we think it's the best in-circuit component test system on the market, but what sets us apart from all others is our outstanding people.

Our people back up our FF101 test system with their experience, qualifications, and integrity. Our engineers started in-circuit testing back in 1954. They refined the product through ten generations and have more in-circuit testing experience than anyone in the industry.

A thorough understanding of our testing technology requires formal training and specialized knowledge. That's why you'll find so many EEs at Faultfinders, in management, sales, programming and product application. No one is better qualified than our engineers to explain the practical advantages of using in-circuit testing and just what the FF101 can do to solve your particular problems. They will make no exaggerated claims. They have a personal integrity you can rely on, under any circumstances. That means a lot when you have a production schedule to meet and need reliable information.

Our people will keep you happy long after the sale is made. They'll be there when you need them most. That's important to you, and also to us, because we realize that our best salesmen are our many satisfied customers. Call us, we can arrange for you to talk to the ones in your area. They can tell you more about Faultfinders people . . . the kind that make a product great!

WE HELP MANUFACTURERS MAKE BETTER ELECTRONIC PRODUCTS

**FF** **FAULTFINDERS Inc.**  
24 Wade Road, Latham, N.Y. 12110 (518) 783-7786

Circle 147 on reader service card



# at the bottom...

of every portable low-voltage operated instrument, tape recorder/player, calculator, garden tool, toy, etc. is a

## WALL PLUG-IN CHARGER/CONVERTERS

designed and built by **DYNAMIC**

... with each manufacturers' product having specific requirements demanding careful planning and designing to match the required performance to the usage demand.

**DYNAMIC's** close cooperation with the battery manufacturers keeps them right **ON TOP** of all the latest requirements of the battery you choose. Mass-produced to specific needs at highly competitive prices and designed within U/L and CSA Standards, makes **DYNAMIC's** low-voltage power supplies, chargers and converters, the most widely used throughout industry today.

Feel free to call our Engineering staff for a complete discussion of your needs — just ask for Sales Engineering and get **"to the bottom"** of your project right at the beginning.

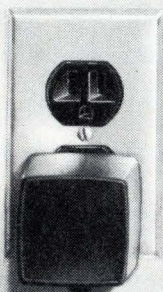

**DYNAMIC INSTRUMENT CORP.**

MANUFACTURERS OF POWER CONVERSION AND  
BATTERY CHARGING SYSTEMS TO THE  
ORIGINAL EQUIPMENT MANUFACTURER

115 E. Bethpage Rd.,  
Plainview, N. Y. 11803  
516 - 694-6000

### New products

equipment. Simplified assembly is also a feature, made possible with factory-preassembled parts requir-

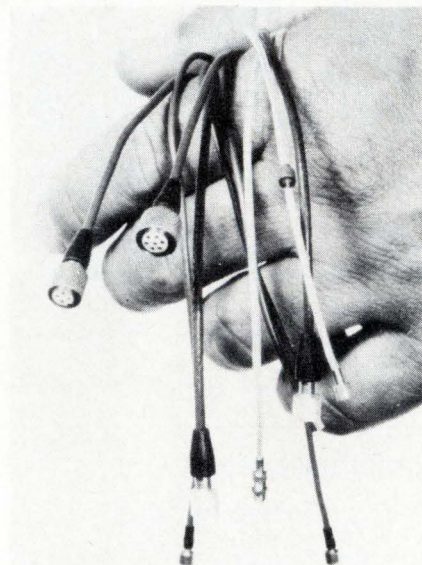

ing a minimum number of operations. Price is as low as \$2.75 in quantities over 1,000.

Microtech Inc., 777 Henderson Blvd., Folcroft, Pa. 19032 [398]

Console provides both  
stereo plotter, digitizer

A digitizer console, called the model GDC/5000, combines all the circuitry needed for a stereo plotter and digitizing table operation in a single cabinet. The unit consists of an alphanumeric keyboard, verifier, three-axis display, fixed address, three axes preset, utility counter, and magnetic-tape unit. Four modes of operation are possible.

Instronics Inc., Bridge Plaza, Ogdensburg, N.Y. 13669 [400]

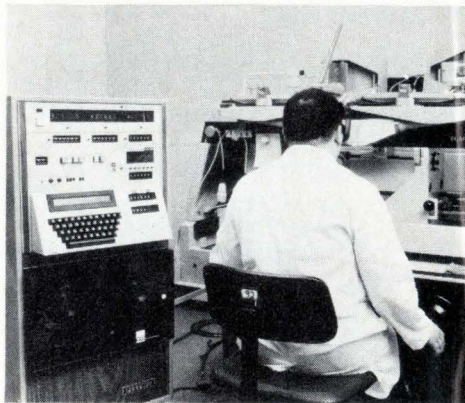



# And here's another of our low-cost solutions to your conversion problems.

If you're converting for a remote display, or if you've got a special display requirement, this converter was made for you.

Maybe you're timesharing a display with several data sources. Or rescaling the converter output to display pounds, gallons, rpm, or other engineering units. Or using a special display you designed yourself.

Then meet the ADC1100. A dual-slope converter with a  $3\frac{1}{2}$ -digit BCD-plus-sign output and automatic zero correction. It'll give you normal mode rejection of 40dB (up to 120dB with a phase lock loop circuit). Plus 5VDC operation and guaranteed monotonicity. And the ADC1100 is equally well suited for feeding a computer.

That's an awful lot for only \$67 in 100's. (\$99 in singles.)

But after all, we're the people who wrote the book on converters. So you expect a lot from us.

And here's what else you can expect.

Two high-resolution, high-accuracy, A/D converters that can save you time and money. Both with parallel and serial outputs, both with user-selected input ranges. The ADC10Z has 10-bit resolution and accuracy, 20  $\mu$ sec (max) conversion time, for \$67 in 100's. The ADC12QZ converts in 40  $\mu$ sec

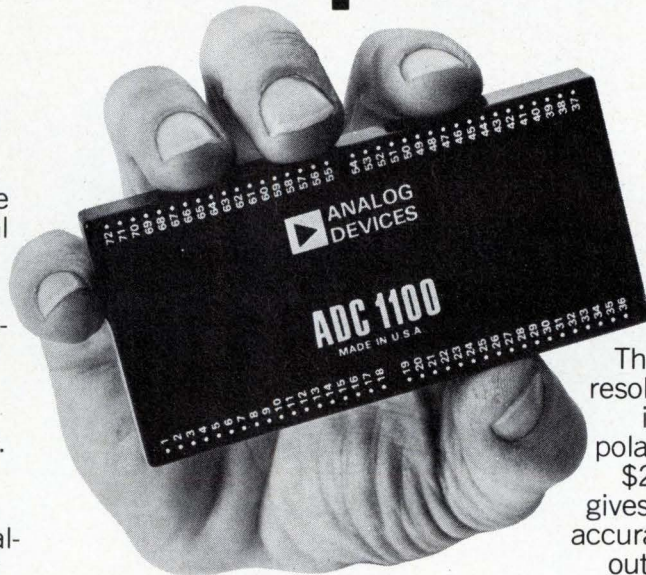

**This 5-volt A/D converter gives you dual-slope noise immunity and BCD-plus-sign output for only \$67/100's. The ADC1100.**

(max), gives you 12-bit resolution and accuracy — \$92 in 100's.

Two low-cost general-purpose D/A converters. The DAC10Z provides 10-bit resolution and accuracy, built-in IC output amplifier, unipolar or bipolar outputs — only \$27 in 100's. The DAC12QZ gives you 12-bit resolution and accuracy and five user-selected output ranges for only \$47 in 100's.

A low-cost sample and hold amplifier. For \$32 in 100's, the SHA 5 will hold your attention, too. The perfect companion to our low-cost converters.

For more information on what you can expect from us, give us a call. We can send you samples, comprehensive data sheets, and, for only \$3.95, a 400-page handbook on A-D conversion.

Analog Devices, Inc., Norwood, Mass. 02062



**ANALOG DEVICES**

## Call 617-329-4700

for everything you need to know about A-D converters.



# mighty mods...



## Now... High Efficiency, Switching Regulated Power Supplies

The new Switching Regulated Series is the most recent addition to the expanding line of Hewlett-Packard Modular Power Supplies. The MIGHTY MODS started with the 62000 Series — a complete line of modular power supplies with coverage from 3 to 48 volts, up to 192 watts.

The new Switching Regulated Supplies, Series 62600, feature advanced transistor switching design with up to 80% efficiency. You get more power in a smaller, cooler operating package... with 4 to 28 volts, up to 300 watts, 0.2% combined line and load regulation, 20mV rms/30mV p-p ripple and noise. And, HP thinks ahead to give you all the protection you need: overvoltage, overcurrent, over-temperature, reverse voltage and protected remote sensing. What it all adds up to is: selection, performance, reliability plus competitive pricing (with quantity and OEM discounts). Whether it's a modular, laboratory, or digitally programmable power supply — be confident when you specify... specify HP.

For detailed information, contact your local HP field engineer. Or write: Hewlett-Packard, Palo Alto, California 94304. In Europe, Post Office Box 85, Meyrin-Geneva, Switzerland.

HEWLETT  PACKARD

21303



## New products

### Subassemblies

## Hybrid design shrinks converter

Synchro-digital devices also consume a third less power than discrete designs

Applying hybrid-circuit technology, ILC Data Device Corp. has produced a line of synchro converters that are dramatically smaller and consume far less power than discrete-component equivalents. Data Device's new H-series is a tenth the size of the modules in its conventional A-series line. And power consumption is reduced by two thirds—to less than 1 watt for a complete synchro-to-digital converter channel.

Both tracking synchro-to-digital and digital-to-synchro converters, using the same type II servo-loop approach as in the A-series, are available. The s-d converters come with 14- or 16-bit resolution, resulting in accuracies of  $\pm 5.3$  minutes and  $\pm 1$  minute respectively. Parallel digital output voltage levels are compatible with diode-transistor and transistor-transistor logic.

Input rates for the 14-bit converter can vary to 1,440° per second with full accuracy; up to 360° per second for the 16-bit unit. Either positive or negative power-supply voltages can be specified. D-s converters are also available in 14- and 16-bit designs, with worst-case accuracy to within  $\pm 4$  min.

Five separate hermetically sealed, 24-pin dual in-line modules—measuring 2.2 by 0.6 by 1.5 inches high—are combined to form an s-d converter. The modules consist of most-significant-bit and least-significant-bit function generators, octant switch, error processor, and up-down counter. A solid state Scott-T synchro-input module in a 16-pin dual in-line package is also included. A complete d-s converter can be made up of four of these same modules. Multiplexed hybrid

synchro converters are also available.

Operating range for the H series units is  $-55^\circ$  to  $+105^\circ\text{C}$ . And they're supplied to MIL-STD-883, level C requirements; level B qualification is available at extra cost. In addition, the modules meet the dimensional requirements of the standard hardware program sponsored by the Naval Avionics Facility at Indianapolis, points out Stephen A. Muth, product manager for data converters at DDC.

Key to the hybrid design is the availability of complementary metal-oxide-semiconductor chips, he says. Without them, the "circuits would have run very hot and we would have had to divide up the converters into more modules to distribute the power. Or we would have had to rely on different packaging with more heat sinking."

Most difficult was the design of the up-down counter. It's a straightforward circuit, but "it calls for five layers of conductive patterns because of the number of interconnection wires," Muth explains.

Another point he makes is that the hybrid design is easier than the discrete to produce. "There's not as much trimming required on the production line compared with the discrete modules."

Price of the hybrid H-series is relatively high—\$1,800 for a complete s-d channel compared to \$990 for an A-series unit. But Muth expects the price to come down as volume picks up. Eventually, a channel might sell in the \$200 to \$300 range.

ILC Data Device Corp., 100 Tec St., Hicksville, N.Y. 11801 [381]

### Nine-digit panel display is MOS LSI-compatible

A nine-digit numeric display panel, with  $\frac{1}{4}$ -inch-high characters and multiplex operation, interfaces directly with MOS LSI circuits. Planar in configuration, the display is aimed primarily at hand-held and desk calculators. However, it is applicable to a variety of multidigit equipment applications such as fre-

## NEW SHORTER CASE! SCHAUER 1-WATT ZENERS

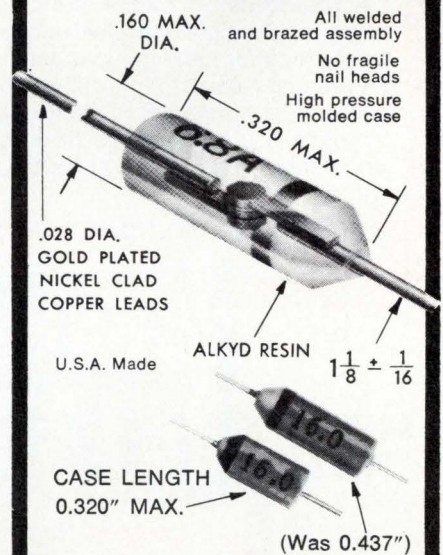

**SAME LOW PRICES FOR 1% TOLERANCE ZENERS ANY VOLTAGE FROM 2.0 TO 18.0**

Quantity	Price Each
1-99	\$1.07
100-499	.97
500-999	.91
1000-4999	.86
5000 up	.82

### IMMEDIATE SHIPMENT

Send for rating data and 20%, 10%, 5% and 2% tolerance prices.

Semiconductor Division

## SCHAUER

MANUFACTURING CORP.

4514 Alpine Ave., Cincinnati, Ohio 45242  
Telephone 513/791-3030



...switch, indicator, and circuit protector *all in a single compact package.*

## AIRPAX™ TYPE 203 Electromagnetic Circuit Protector

Airpax Type 203 Electromagnetic Circuit Protectors offer a choice of many mechanical and electrical configurations for maximum versatility. Series, shunt, and relay trip internal circuits are available and can be combined in single, two and three-pole versions. Current ratings from 0.02 to 20 amperes at 120V ac and 0.02 to 10 amperes at 250V ac. Inverse time delay or instant trip.



Photo courtesy of Kappa Scientific Corp.

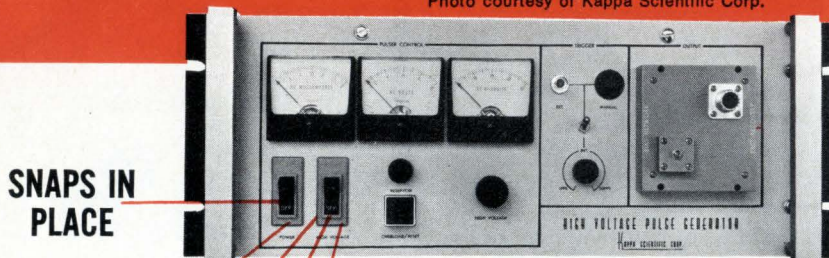

SNAPS IN PLACE

SAVES SPACE

STYLISH DESIGN

REDUCES COST

LOW MAINTENANCE

Here's why Kappa Scientific selected Airpax Type 203 Circuit Protectors for their new High Voltage Pulse Generator. We quote: "... because it features a switch, indicator, and circuit protector all in a single compact package. This is an advantage because we require switching, indication, and protection for both input power and high voltage. Especially important is that total cost is competitive with individual switch, light, and fuse components. This approach eliminates unsightly fuseholders and fuse replacement, but better, prevents the not-uncommon practice of substituting high amperage fuses (the penny-in-the-fusebox remedy) with subsequent circuit damage."

**Shouldn't your next design include a Type 203?**

Write for full specifications.

Airpax Electronics / CAMBRIDGE DIVISION / Cambridge, Md. 21613 / Phone (301) 228-4600

**AIRPAX™** 25 YEARS OF PROGRESS

### New products

quency counters. The display reads out in orange, and red is available through the use of filters. Price of the panel display is \$15.70 in quantities of 1,000.

Sperry Information Displays, Box 3579, Scottsdale, Ariz. 85257 [383]

A-d converter does 4-bit conversion in 40 ns

The model ADC-4B25-MHZ analog-to-digital converter can be used in video-digitizing, pulse analysis, high-speed data-handling and X-ray analysis applications. The converter is 3 inches wide by 5 inches long by



1 inch deep, and it uses a parallel/serial/parallel conversion scheme. The unit can handle a four-bit conversion in 40 nanoseconds (throughput rate is 25 MHz). Price is \$1,250.

Datel Systems Inc., 1020 Turnpike St., Canton, Mass. 02021 [384]

Remote display is 9/16-inch thick, mounts on panel

The Slimline remote display provides up to six digits of 0.270-inch-high LEDs from any TTL-DTL source of parallel 1,248 positive true BCD data. The display is 9/16-inch thick





## The Color Guard comes on strong in color control.

Get the brights, with a rainbow of Silikrome® color filters that slip easily over clear miniature lamps, automotive lamps, even potted lamps... to make them any color you want. The interchangeable, field-replaceable silicone rubber boots stay color-fast and pliant, even after 1000 hours at 500°F, so you can put color to work when you want it, where you want it, as long as you want it.

**THE CLEAN FIGHTERS.**

And for applications where light is critical, they come on strong two ways—as a seal of safekeeping against light leakage, and as shockmounts for sensitive lamps. All this, with no plastic caps to melt or crack, no coated bulbs to fade or chip, no mounting hardware needed.

Find out more—write or phone today for free literature, price information and samples: APM-Hexseal, 44 Honeck St., Englewood, N.J. 07631; (201) 569-5700.

**APM-HEXSEAL**  
DIVISION OF APM CORPORATION

Circle 195 on reader service card



**5 V Logic Probe TKL-5**

Switching levels of logic circuitry can be determined easily and swiftly; thus saving much time in servicing, in developing and in testing your product. The quasi-oscilloscopic display enables viewing the states of pulses – high level or low level – as well as appraising the duty factors of pulses ( $\geq 1, 1:1, \leq 1$ ). With an open input, or potentials between 0,8 and 2,4 V (indefinite range), there is no indication. For additional information or a demonstration at your place, please contact us.

**Wandel u. Goltermann** 

D 741 Reutlingen · W. Germany · P.O.B. 259 · Tel. (07121) 8441 · Telex 0729 833

Circle 196 on reader service card

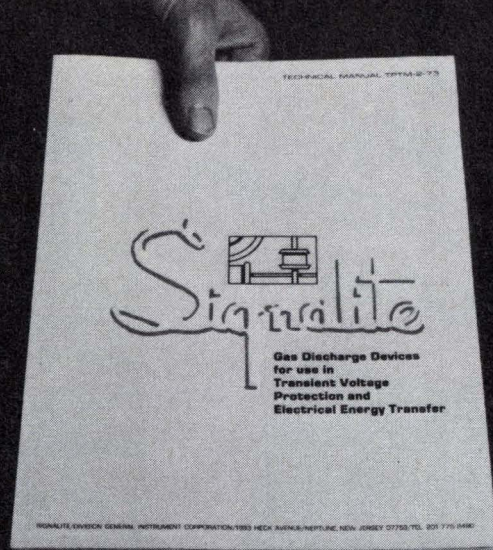

## When it comes to TRANSIENT VOLTAGE PROTECTION

# Signalite wrote the book!

### And, It's Yours FREE!

**It's all part of the SIGNALITE TRANSIENT VOLTAGE PROTECTION KIT!**

Including a 28-page book entitled, "Gas Discharge Devices For Use In Transient Voltage Protection and Electrical Energy Transfer." Part I, Transient Voltage Protection, details sources of voltage transients, operation and construction of protectors, comparison of various transient protection devices, pulse breakdowns, V & I characteristics of protectors in AC & DC circuits, follow-on current, etc. Part II, Electrical Energy Transfer, details various devices, applications and glow-to-arc transitions. Included in the Signalite Transient Protection Kit are specification bulletins on Signalite's UNI-IMP, the fastest surge arrester in existence... COMM-GAP, a high quality, low cost protector with a wide range of applications... TWO ELECTRODE & TRIGGERED SPARK GAPS... AC/DC LINE PROTECTORS... plus an Applications Engineering Worksheet so that the Signalite Application Department can help in the design of your protection circuitry.

**Signalite**  
DIVISION OF GENERAL INSTRUMENT CORPORATION  
1933 Heck Ave., Neptune, New Jersey 07753  
Area Code 201-775-2490 ■ TWX 201-775-2255

Circle 153 on reader service card 153



# Carter Quality germanium diodes

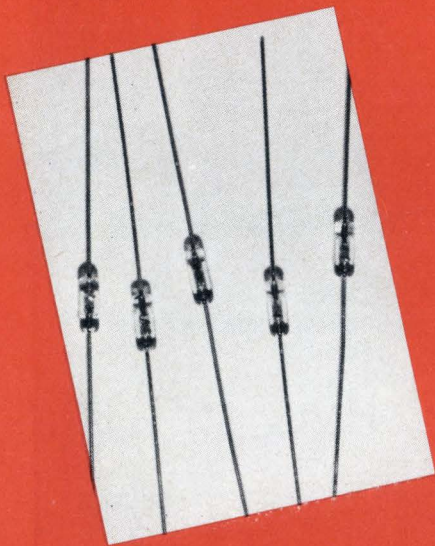

## Point Contact and Gold Bond

...and we're the *only* U.S. manufacturers of Point Contacts! We can deliver them when and where you need 'em. Quality devices, qual tested to ensure reliability and performance.

We've built our reputation on:

- Competitive Pricing
- On-Time Delivery
- Strictly Enforced Qual Tests

1N34A	1N100	1N295
1N60	1N270	1N995

...and all the others to round out a complete line.



WRITE TODAY  
FOR OUR  
NEW CATALOG!

## CARTER SEMICONDUCTOR, INC.

Diode Facility • 361 Aiken St., Lowell,  
Mass. 01853, (617) 454-9141  
Main Office & Eastern Region •  
6901 Jericho Turnpike, Syosset, N.Y. 11791,  
(516) 364-2244  
Western Region • (415) 941-7066  
MidAmerica Region • (312) 297-8416  
ASK YOUR DISTRIBUTOR FOR CARTER SEMICONDUCTORS

Circle 154 on reader service card

## New products

and mounts on the panel so that no space is required behind the panel. The unit is available in a variety of formats for display of data from digital clocks, counters, and stop-watches. Power requirement is 5 V dc  $\pm$ 1% at 300 mA.

Nationwide Electronic Systems Inc., Rte. 53, Itasca, Ill. 60143 [386]

## Modular power supply delivers 500 watts

Designed to provide high power levels in space-restricted systems, the 668 series of modular power supplies delivers 500 watts of power

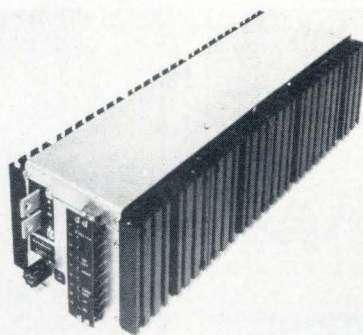

over the operating temperature range of  $-20^{\circ}\text{C}$  to  $+40^{\circ}\text{C}$  with no moving air required. Efficiency is 70%, and combined line and load regulation is  $\pm 0.2\%$ . The model 668A-05 offers 5 volts at 100 amperes output and accepts 102 to 130 V ac or 198 to 256 V ac input without circuitry changes required. Price is \$750.

Trio Laboratories Inc., 80 DuPont St., Plainview, N.Y. 11803 [389]

## Sample-and-hold module offers low feed-through

With a low feed-through of 1 millivolt maximum for a 20-v step, the model 4853 sample-and-hold amplifier provides an aperture time of  $\pm 1$  nanosecond. Acquisition time is rated at less than 1 microsecond to 0.01%. Applications include multi-channel data-acquisition and distribution systems, pulse stretchers, d-a and a-d converters, and digitally controlled process-control systems.

## FOR YOU TO COMPARE

CM20R

\$729.00

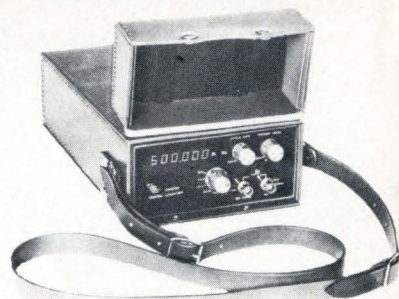

- 5 Hz to 515 MHz
- 50 mV sensitivity
- Units Annunciation
- 5 Gate Times
- LED Display
- Leading Zero Suppression
- Optional Snap-on Battery
- High Stability TCXO's

## AND DECIDE

### analog digital research

1051 Clinton Street  
Buffalo, N. Y. 14206

Circle 197 on reader service card

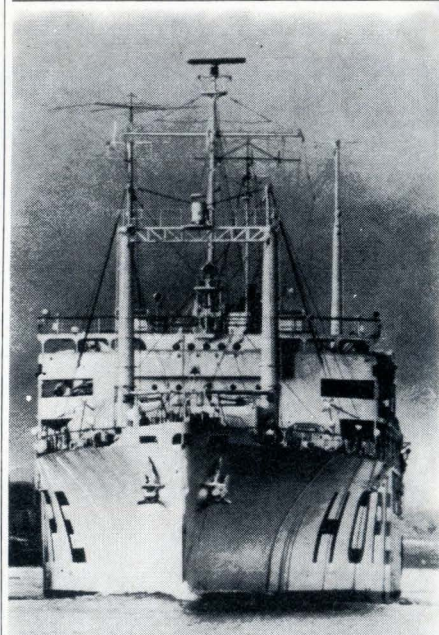

## S.S. HOPE, M.D.

Doctor . . . teacher . . . friend to, millions on four continents—this floating hospital is a symbol of America's concern for the world's disadvantaged.

Keep HOPE sailing.

**PROJECT  
HOPE**

Dept. A, Washington, D.C. 20007

Electronics/April 26, 1973



# Another introductory offer to new members of the ELECTRONICS AND CONTROL ENGINEERS' BOOK CLUB

	<p>404/445 <b>ELECTRONIC CIRCUITS MANUAL</b> by J. Markus Pub. price, \$19.75 Club price, \$15.75</p>		<p>286/515 <b>INTEGRATED CIRCUITS: A Basic Course for Engineers and Technicians</b> by R. G. Hibberd Pub. price, \$9.95 Club price, \$8.45</p>	<div style="border: 2px solid black; padding: 10px; text-align: center;"> <h2 style="font-size: 48px; margin: 0;">ANY ONE</h2> <p style="font-size: 24px; margin: 0;">of these great professional books</p> <p style="font-size: 48px; margin: 0;">for only \$ <b>1.00</b></p> <p style="font-size: 24px; margin: 0;">VALUES FROM \$9.95 to \$34.75</p> <p style="font-size: 18px; margin: 0;">Special \$1.00 bonus book comes to you with your first club selection</p> </div>	
	<p>637/458 <b>DESIGNING WITH TTL INTEGRATED CIRCUITS</b> by Texas Instruments Inc. Pub. price, \$18.50 Club price, \$13.50</p>		<p>162/212 <b>INTEGRATED CIRCUITS &amp; SEMI-CONDUCTOR DEVICES</b> by Deboo &amp; Burrous Pub. price, \$13.95 Club price, \$10.50</p>		
	<p>404/437 <b>SOURCEBOOK OF ELECTRONIC CIRCUITS</b> by J. Markus Pub. price, \$19.75 Club price, \$14.75</p>		<p>313/059 <b>HANDBOOK OF SEMI-CONDUCTOR ELECTRONICS, 3/e</b> by P. Hunter Pub. price, \$27.50 Club price, \$21.50</p>		
	<p>259/607 <b>COMMUNICATION SYSTEM ENGINEERING HANDBOOK</b> by D. H. Hamsher Pub. price, \$29.50 Club price, \$22.50</p>		<p>287/341 <b>STANDARD HANDBOOK OF ENGINEERING CALCULATIONS</b> by T. G. Hicks Pub. Price, \$18.50 Club Price, \$14.25</p>		
	<p>388/458 <b>MAGNETIC RECORDING</b> by C. E. Lowman Pub. Price, \$14.50 Club Price, \$9.75</p>		<p>124/035 <b>HANDBOOK OF PHYSICS, 2/e</b> by Condon and Odishaw Pub. price, \$34.75 Club price, \$14.95</p>		<p>209/731 <b>STANDARD HANDBOOK FOR ELECTRICAL ENGINEERS, 10/e</b> by Fink and Carroll Pub. price, \$32.50 Club price, \$24.95</p>

## Save time and money by joining the Electronics and Control Engineers' Book Club

HERE is a professional club designed specifically to meet your day-to-day engineering needs by providing practical books in your field on a regular basis at below publisher prices.

**How the Club operates:** Basic to the Club's service is its publication, the *Electronics and Control Engineers' Book Club Bulletin*, which brings you news of books in your field. Sent to members without cost, it announces and describes in detail the Club's featured book of the month as well as alternate selections which are available at special members' prices.

When you want to examine the Club's feature of the month, you do nothing. The book will be mailed to you as a regular part of your Club service. If you prefer one of the alternate selections—or if you want no book at all for that month—you notify the Club by returning the convenient card enclosed with each *Bulletin*.

As a Club member, you agree only to the purchase of four books over a two-year period. Considering the many books published annually in your field, there will surely be at least four that you would want to own anyway. By joining the Club, you save both money and the trouble of searching for the best books.



### MAIL ATTACHED POSTPAID CARD

(If card removed, send coupon below)

**ELECTRONICS AND CONTROL ENGINEERS' BOOK CLUB**  
582 Princeton Road, Hightstown, N.J. 08520

Please enroll me as a member of the Electronics and Control Engineers' Book Club and send me the two books indicated below. I am to receive the bonus for just \$1.00, and my first selection at the special Club price shown. These books are to be shipped on approval, and I may return them both without cost or further obligation. If I decide to keep the books, I agree to purchase as few as four books during the next two years at special Club prices (at least 15% below list).

Write Code No. of  
bonus book  
here

Write Code No. of  
first selection  
here

Name \_\_\_\_\_

Address \_\_\_\_\_

City \_\_\_\_\_

State \_\_\_\_\_ Zip \_\_\_\_\_

E 33221



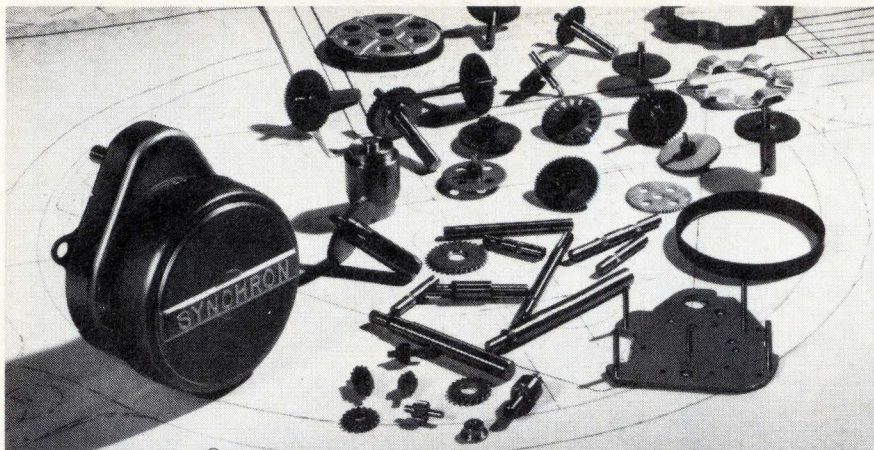

## Synchron<sup>®</sup>. Your own personal timing motor.

Every Hansen synchronous timing motor is built for a designer like you. To specific requirements, with our confidential help.

We have several thousand models designed, tooled, and ready-to-build in any quantity. In five major styles.

Many speeds. Torque from 8 to 98 oz.-in. at 1 rpm. All competitively priced.

Add Hansen to your design staff. Call or write for complete specs, or contact one of our representatives below.

**MALLORY**



**HANSEN MANUFACTURING CO.**

a division of P. R. MALLORY & CO. INC.  
Princeton, Indiana 47670

Hansen Representatives: **Carey & Associates**, Houston and Dallas, Texas; **R. S. Hopkins Co.**, Sherman Oaks, Calif.; **Melchior Associates, Inc.**, San Carlos, Calif.; **The Fromm Co.**, River Forest, Ill.; **John Orr Associates**, Grand Rapids, Mich.; **H. C. Johnson Agency, Inc.**, Rochester, N.Y.; **Winslow Electric Co.**, Essex, Conn.; **Kiley Electric Co.**, Villanova, Pa.; and **Herbert Rude Associates, Inc.**, Teaneck, N.J.



Circle 158 on reader service card

# Switching?

You have difficulties. You have to solve the most difficult switching problems within the smallest amount of space. You don't know how?

We'll help you. Our Miniatur-Slider-Switch 4134 is the smallest, with the greatest variety of uses, extra durable, and high precision, something for the electronics industry for use in construction of radio equipment, tape recorders and in cassette recorders. And most important, it is operated with very little effort, because of its easy action.

If you want it even easier — our Miniatur-Slider-Switch 4135 with smoothed sliding contact surfaces offers even greater ease in operation, with yet substantially less switching effort being necessary. Do you still have switching problems? Then you ought to inquire about our Miniature-Slider-Switches.

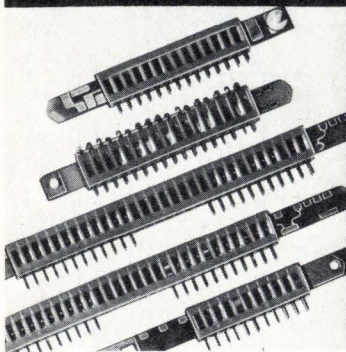

**Schoeller & Co.,**  
Elektrotechnische Fabrik,  
6 Frankfurt a. M. 70,  
Mörfelder Landstr. 115-119

158 Circle 198 on reader service card

## New products



Price is \$125 each in small quantities, and this drops to \$99.50 in 100-lots.

Teledyne Philbrick, Allied Dr. at Rte. 128, Dedham, Mass. 02026 [385]

## Uninterruptible power supply is for volatile memory systems

Aimed at volatile semiconductor memory-systems applications, an uninterruptible power supply is part of the PM 2400 line of OEM multiple-output computer power supplies. The model 2412 is a 140-watt

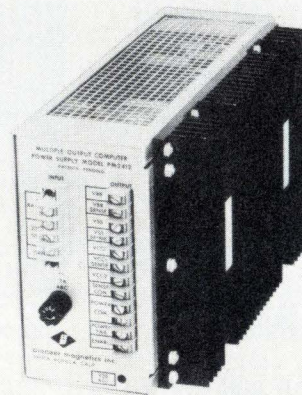

convection-cooled converter that provides power for up to 32,000-word-by-18-bit or 65,000-by-9 MOS RAMs at worst-case temperatures. The unit furnishes no-break power over power outstages of 20 milliseconds or longer.

Pioneer Magnetics Inc., 1745 Berkeley St., Santa Monica, Calif. 90404 [388]

## Analog multiplier has accuracy to within 0.1%

The model 4200 pulse-modulation analog multiplier provides an untrimmed accuracy guaranteed to



within 0.2%, and external trimming improves this specification to within a guaranteed 0.1%. Maximum total error drift over the full operating temperature range of  $-25^{\circ}\text{C}$  to  $+85^{\circ}\text{C}$  is 0.02%/°C and 0.005%/%

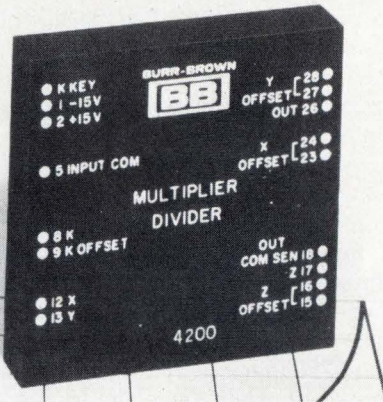

supply change. The unit features an absolute maximum input rating of  $\pm 30$  volts, and rated output is  $\pm 10$  v at  $\pm 5$  milliamperes minimum. All semiconductors in the multiplier are hermetically sealed to ensure reliability. Small-quantity price is \$129.

Burr-Brown Research Corp., International Airport Industrial Park, Tucson, Ariz. 85706 [387]

Low-priced double-balanced mixer is broadband

Priced at \$7 for a single unit, the model MD-108 broadband double-balanced mixer is packaged in a subminiature, eight-pin, relay-header configuration. The unit pro-

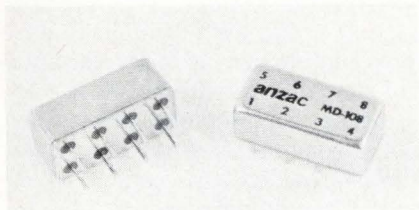

vides local-oscillator and rf port bandwidths of 5 to 500 megahertz and an i-f port bandwidth of dc to 500 MHz. Conversion loss is 7.0 dB maximum from 5 to 150 MHz and 9.0 dB maximum from 150 to 500 MHz. The unit can be microstrip- or stripline-mounted.

Anzac Electronics, Division of Adams-Russell, 39 Green St., Waltham, Mass. [389]

your best value is a

# TRYGON

## SYSTRON-DONNER POWER SUPPLY

QUALITY/RELIABILITY/SERVICE

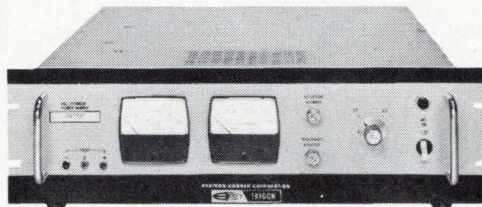

VP Series  
**\$595**

A high power, economical systems supply that powers and protects critical and sensitive IC circuits.

Up to 30VDC Up to 135AMPS  
in your choice of ranges

- Adjustable current limiting
- Low Noise
- Meters and Overvoltage Protection optionally available

**FEATURES** • Standard ratings are 5V/135A, 12V/90A, 15V/85A, 24V/60A, 28V/50A • automatic load share paralleling • low output impedance • remote sensing and programming • 0.02% line regulation • 0.05% load regulation • less than 1mV RMS ripple . . . all for only \$595.

*Write directly or call your local Scientific-Devices sales office for complete specifications and applications.*

TRYGON ELECTRONICS  
SUBSIDIARY

SYSTRON  DONNER  
CORPORATION

1200 Shames Drive, Westbury, N.Y. 11590 (516) 997-6200

The Systron-Donner Instruments Group:

Concord Instruments  Computer Systems  Datapulse  Kruse Electronics  Microwave  Trygon Electronics



# FOR SMALL PC MOUNTED SEMICONDUCTOR DEVICES

## We can cool'em

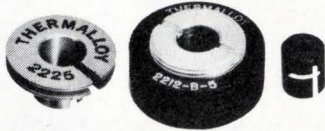

### TO-5's

Complete line includes exclusive 2-piece heat sinks in 3 models from economy to high performance. Also low cost press-on and clip-on coolers.

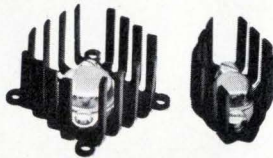

### TO-3 and TO-66's

Unique fin design (left) uses slanted van fins. Highly efficient and lightweight. Diamond-shaped cooler (right) is designed for high-density applications. All available in variety of finishes and fin heights.

ALL ARE AVAILABLE

FROM YOUR LOCAL THERMALLOY DISTRIBUTOR



Thermalloy's other products include coolers for plastic packaged and disc compression devices. Write for FREE CATALOG.



## Thermalloy

P.O. Box 34829/2021 W. Valley View Lane/Dallas, Texas 75234  
Phone 214-243-4321/TWX 910-860-5542

Circle 160 on reader service card

## The HS-200S... a wire memory offering speed, capacity, cost and reliability of ample proportions.

This is our latest wire memory. It gives you access time of 180 ns and cycle time of 250 ns. Memory elements, of course, consist of our own special development, magnetic wires. Non-destructive read-out is featured. HS-200S means maximum reliability at minimum cost. In fact, you get a 65 kilo-byte assembly with an MTBF figure of 10,000 hours. HS-200S is a component precisely matched to computers of the new age.

### Wire Memory System HS-200S Specifications

1. **Memory elements** Non-destructive read-out
2. **Storage capacity** 8 kwords/80 bits, 16 kwords/40 bits, 32 kwords/20 bits
3. **Access time** 180 nanoseconds
4. **Cycle time** Write-in Read-out 250 nanoseconds
5. **Interface levels** TTL logic... H +2.4—+5V L -0.5—+0.5V
6. **Dimensions** 500×300×112mm (Basic unit capacity is 65 Kbytes. Expansion to one megabyte is possible.)
7. **Required power** +30V, +15V, +5V, -15V

Please contact our sales department if you have special requirements.



## TOKO, INC.

Head Office: 1-17, 2-chome, Higashi-Yukigaya, Ohta-ku, Tokyo, Japan

New York: Toko New York Inc.

350 Fifth Avenue, New York, N.Y. 10001 U.S.A. Tel: 565-3767

Los Angeles: Toko, Inc. Los Angeles Liaison Office

3440 Wilshire Blvd., Tishman Building, Suite 1106 Los Angeles, Calif. 90010, U.S.A. Tel: 380-0417

Düsseldorf: Toko, Inc. Europe Liaison Office

4 Düsseldorf, Kolner Straße 246, Düsseldorf, W. Germany Tel: 78-7064

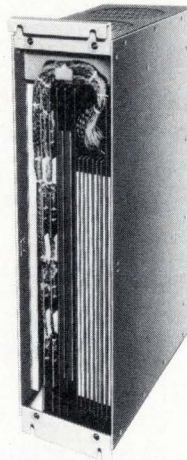

## New products/materials

A two-part gold epoxy, designated Epo-Tek H-81, is for chip bonding in microelectronics applications. Conductivity rating is from 0.0005 to 0.0009 ohm-centimeter. The material cures in five minutes at 150°C, 15 minutes at 120°C, or 90 minutes at 80°C. Pot life is two days, and shelf life is a minimum of two years. Price is \$80 for a ½-ounce evaluation kit.

Epoxy Technology Inc., 65 Grove St, Watertown, Mass. 02172 [476]

A family of laser-trimmable thick-film resistor compositions, called the Certi-fired 1300 series, has a thermal resistance coefficient of less than 250 parts per million per degree centigrade over the range of -55 to +125°C. Trimmed resistors drift less than 1% in sheet resistivities, and individual compositions can be blended to obtain resistivities intermediate to the six values offered.

DuPont Co., Wilmington, Delaware [477]

Ultra-Bond 52 is a single-component 3,000°F alumina-base adhesive with the ability to bond to ceramics and metals, such as stainless steel, aluminum, and copper. The material comes in a premixed paste and can be used after drying at room temperature. It works in almost any atmosphere, including hydrogen, and has a dielectric strength of 250 volts per mil. Price is \$25 per pint or \$40 per quart.

Aremco Products Inc., Box 145, Briarcliff Manor, N.Y. 10510 [478]

Encapsulation of semiconductor and solid-state devices without the use of a junction coating to separate the device from the encapsulating medium is provided by Eccomold 4119 and 4125 molding powders. This is possible because the materials exhibit low ionizable extractables in water, thereby eliminating corrosion of the devices while providing a moisture seal, and mechanical and thermal protection. Material 4119 is priced at \$1.70 a pound and 4125 at \$1.94 a pound in 2,500-pound lots. Emerson & Cuming Inc., Canton, Mass. [479]



## New literature

**D-a converters.** Cycon Inc., 1080 E. Duane Ave., Sunnyvale, Calif. 94086. Series 9 digital-to-analog converters are described in a four-page catalog that provides technical specifications and applications information. Circle 421 on reader service card.

**Printed-circuit assemblies.** Ansley Electronics Corp., Old Easton Rd., Doylestown, Pa. 18901, has issued a data sheet describing Free-Flex flexible printed-circuit assemblies. [422]

**Recording systems.** Bulletin 1250H from the Brush Division, Gould Inc., 3631 Perkins Ave., Cleveland, Ohio 44114, is an eight-page publication on analog and digital recording systems for industrial, medical, military, and scientific applications. [423]

**Data systems.** A 12-page technical brochure describes the H4200-series digital data system available from Howell Instruments Inc., 3479 W. Vickery Blvd., Fort Worth, Texas. 76107 [424]

**Strip printer.** Facit-Addo Inc., 501 Winsor Dr., Seacaucus, N.J. A data sheet provides design and technical data on the model 4552 alphanumeric strip printer. [425]

**Indicating devices.** Condensed data and specifications on elapsed-time indicators, events counters, fault indicators and stop clocks are contained in four-page bulletin MR-102-R3 from North American Philips Controls Corp., Cheshire, Conn. 06410 [426]

**Thermal cutoffs.** A family of thermal cutoffs for backup protection in electronic devices is described in a 12-page brochure from the 3M Co., Box 33600, St. Paul, Minn. 55133. The brochure gives capabilities and performance characteristics, as well as applications notes. [427]

**Epoxy compounds.** Two epoxy compounds having low coefficients of thermal expansion are described in a data sheet from Bacon Industries

Inc., 192 Pleasant St., Watertown, Mass. 02172 [428]

**Data set.** Tele-Dynamics Division, Ambac Industries, 525 Virginia Dr., Fort Washington, Pa. A 1,200 bit-per-inch data set is described in a two-page product bulletin that provides specifications and operations information. [429]

**Time-code formats.** A handbook on time-code formats with detailed information on the 22 most common time codes is available from Moxon Inc., SCR Division, 2222 Michelson Dr., Irvine, Calif. 92664. Reference time, typical time frames, index count, index markers, and other data pertinent to each time code is provided. [430]

**Switches.** Oak Industries Inc., Switch Division, Crystal Lake, Ill. A bulletin describes the operation, specifications, and pricing of the illuminated and nonilluminated push-button-switch lines. Engineering specifications, performance data, line drawings, photographs, and a lens selection guide are included. [431]

**Control transmitter.** The electrical outputs of a synchro or resolver-control transmitter that can be simulated by the SS and RS series of synchro standards and resolver standards are described in data bulletin SRT-6 available from Singer Instrumentation, 2311 S. La Cienega Blvd., Los Angeles, Calif. 90016 [432]

**Line-printer subsystem.** Custer Research Inc., Box 305, Fleetwood, Pa. A lineprinter subsystem for the HP 2100 series processors is described in a product bulletin. [433]

**Power-supply line.** Lambda Electronics Corp., 515 Broad Hollow Rd., Melville, N.Y. 11746. A 196-page catalog and handbook details the company's power-supply line and includes a section on power-supply applications. The book also includes information on power components, power kits, power instruments, and applications. [376]

# How to ship small packages in a big hurry.

## DELTA'S DASH

DELTA AIRLINES SPECIAL HANDLING

Delta guarantees delivery on the flight or routing you specify between most Delta cities.

Packages accepted up to 50 lbs. with length plus width plus height not to exceed 90" total, with only one dimension exceeding 30"

Delivery to Delta's passenger counter or air freight terminal at the airport at least 30 minutes prior to scheduled departure time.

Pick-up at DASH Claim Area next to airport baggage claim area 30 minutes after flight arrival at destination.

Charges for DASH shipments are nominal. Delta reservations will be pleased to quote actual charges between specific points.

Payments accepted in cash, by company check, most general-purpose credit cards, special credit arrangements or on government shipments by GBL.  DELTA  
The airline run by professionals

### Rate examples (Tax included)

Atlanta-Washington . . . . .	\$21.00
Boston-Miami . . . . .	\$26.25
Cincinnati-Louisville . . . . .	\$21.00
Cleveland-Phoenix . . . . .	\$26.25
Los Angeles-New Orleans . . . . .	\$31.50
Dallas-Los Angeles . . . . .	\$26.25
San Francisco-Atlanta . . . . .	\$31.50
Philadelphia-Houston . . . . .	\$26.25
New York-Tampa . . . . .	\$26.25

For full details, call Delta reservations.



## Delta is ready when you are!



# WHY CHOOSE RENTAL ELECTRONICS WHEN YOU RENT, LEASE, OR RENTAL-PURCHASE?

Because REI is the recognized leader when it comes to supplying you the most complete selection of electronic/scientific test equipment—to rent, to lease, or to rental-purchase—at the most attractive costs.

Now, more than ever, you must expand along with the pace of economic and technological development. To avoid the handicap of obsolete equipment, to help you maintain a flexible budget, to keep abreast of the competition, to assure growth with increased production and sales—Rental Electronics offers you the instruments you need, when you need them, for as long as you need them.

REI offers you precisely the right instruments—everything from amplifiers to oscilloscopes to synthesizers—with a plan custom-designed to meet your specific requirements!

Our staff of sophisticated financial planners is ready to help you choose the rental, lease, or rental-purchase package that best fits your situation.

And your needed equipment is ready for almost instantaneous delivery, direct from one of nine strategically-located "Instant Inventory" Centers across the U.S. and Canada.

Every Rental Electronics customer is our *very special* customer, receiving the service he needs under a rental, lease, or rental-purchase plan custom-tailored especially for him. The results are increased **PROFITS** for you!

**Ask for our full catalog today! Write or call:**



## Rental Electronics, Inc.

A **PEPSICO** LEASING COMPANY

99 Hartwell Avenue, P. O. Box 223  
Lexington, Massachusetts 02173 Tel. 617/862-6905

Gaithersburg, Maryland 301/948-0620 / Lexington, Massachusetts 617/861-0667 / Anaheim, California 714/879-0561 / Rosemont, Illinois 312/671-2464 / Fort Lauderdale, Florida 305/771-3500 / Dallas, Texas 214/638-4180 / Oakland, New Jersey 201/337-3757 / Ontario, Canada 416/677-7513 / Palo Alto, California 415/328-4525

### Advertising Sales Staff

**Pierre J. Braudé** [212] 997-3485  
Advertising Sales Manager

**Atlanta, Ga. 30309:** Joseph Lane  
100 Colony Square, 1175 Peachtree St., N.E.  
[404] 892-2868

**Boston, Mass. 02116:** James R. Pierce  
607 Boylston St. [617] 262-1160

**Chicago, Ill. 60611:**  
645 North Michigan Avenue  
Robert W. Bartlett (312) 751-3739  
Paul L. Reiss (312) 751-3738

**Cleveland, Ohio 44113:** William J. Boyle  
[716] 586-5040

**Dallas, Texas 75201:** Charles G. Hubbard  
2001 Bryant Tower, Suite 1070  
[214] 742-1747

**Denver, Colo. 80202:** Harry B. Doyle, Jr.  
Tower Bldg., 1700 Broadway  
[303] 266-3863

**Detroit, Michigan 48202:** Robert W. Bartlett  
1400 Fisher Bldg.  
[313] 873-7410

**Houston, Texas 77002:** Charles G. Hubbard  
2270 Humble Bldg. [713] CA 4-8381

**Los Angeles, Calif. 90010:** Robert J. Rielly  
Bradley K. Jones, 3200 Wilshire Blvd., South Tower  
[213] 487-1160

**New York, N.Y. 10020**  
1221 Avenue of the Americas  
Warren H. Gardner [212] 997-3617  
Michael J. Stoller [212] 997-3616

**Philadelphia, Pa. 19102:** Warren H. Gardner  
Three Parkway  
[215] 997-3617

**Pittsburgh, Pa. 15222:** Warren H. Gardner  
4 Gateway Center, [212] 971-3617

**Rochester, N.Y. 14534:** William J. Boyle  
9 Greylock Ridge, Pittsford, N.Y.  
[716] 586-5040

**San Francisco, Calif. 94111:** Don Farris  
Robert J. Rielly, 425 Battery Street,  
[415] 362-4600

**Paris:** Alain Offergeld  
17 Rue-Georges Bizet, 75 Paris 16, France  
Tel: 720-73-01

**Geneva:** Alain Offergeld  
1 rue du Temple, Geneva, Switzerland  
Tel: 32-35-63

**United Kingdom:** Keith Mantle  
Tel: 01-493-1451, 34 Dover Street, London W1

**Milan:** Robert Saidel  
1 via Baracchini Phone 86-90-656

**Brussels:** Alain Offergeld  
23 Chaussée de Wavre  
Brussels 1040, Belgium  
Tel: 13-65-03

**Stockholm:** Brian Bowes  
Office 17, Kontor-Center AB, Hagagarten 29,  
113 47 Stockholm. Tel: 24 72 00

**Frankfurt/Main:** Fritz Krusebecker  
Liebigstrasse 27c  
Phone 72 01 81

**Tokyo:** Tatsumi Katagiri, McGraw-Hill  
Publications Overseas Corporation,  
Kasumigaseki Building 2-5, 3-chome,  
Kasumigaseki, Chiyoda-Ku, Tokyo, Japan  
[581] 9811

**Osaka:** Ryji Kobayashi, McGraw-Hill  
Publications Overseas Corporation, Kondo  
Bldg., 163, Umegae-cho Kita-ku [362] 8771

**Australasia:** Warren E. Ball, IPO Box 5106,  
Tokyo, Japan

### Business Department

**Stephen R. Weiss, Manager**  
[212] 997-2044

**Thomas M. Egan,**  
Production Manager [212] 997-3140

**Carol Gallagher**  
Assistant Production Manager [212] 997-2045

**Dorothy Carter,** Contracts and Billings  
[212] 997-2908

**Frances Vallone,** Reader Service Manager  
[212] 997-6057

### Electronics Buyers' Guide

**George F. Werner,** Associate Publisher  
[212] 997-3139

**Regina Hera,** Directory Manager  
[212] 997-2544



# Electronics advertisers

April 26, 1973

§ <b>Ablestik Laboratories</b> Fortune Advertising	179	§ <b>Golden Gate Enterprises, Inc.</b> Associated Ad-Ventures	176	<b>Schauer Manufacturing Corp.</b> Nolan, Keelor & Sities	151
<b>Advanced Micro Devices</b> Keye/Donna/Pearlstein	10-11	■ <b>Grayhill, Incorporated</b> Carr Liggett Advertising, Inc.	146	* <b>Schneider R. T.</b> Intermedia	14E
* <b>Advanced Micro Devices</b> Keye/Donna/Pearlstein	20E	‡ <b>Guardian Electric Mfg. Co.</b> Kolb/Tookey and Associates, Inc.	57	<b>Schoeller &amp; Co.</b> Sigma Studio 1	158
* <b>AEROCOM</b> Jacster Enterprises, Inc.	26E	<b>Hansen Mfg. Company</b> Keller-Crescent Co.	158	§ <b>SCS Corporation</b> Popejoy & Fischel Advertising Agency, Inc.	174
■ <b>Airpax Electronics</b> Welch, Mirabile & Co., Inc.	152	<b>Harris Semiconductor</b> Tucker Wayne & Company	43	§ <b>The Sel-Rex Company</b> O.S. Tyson and Company, Inc.	178
<b>Allen-Bradley Company</b> Hoffman, York, Baker & Jackson, Inc.	34	■ <b>Hewlett Packard</b> Richardson, Seigle, Rolfs & McCoy, Inc.	1	* <b>Sescosem</b> Perez Publicite	2E-3E, 10E
<b>AMF/Potter &amp; Brumfield Division</b> Fuller & Smith & Ross, Inc.	77	■ <b>Hewlett Packard</b> Tallant Yates Adv., Inc.	64-65	‡ <b>Siemens</b> Ries Cappiello Colwell, Inc.	18-19
* <b>American Microsystems, Inc.</b> Wilton Coombs & Colnett, Inc.	22E-23E	■ <b>Hewlett Packard</b> Richardson Seigle Rolfs & McCoy, Inc.	73	* <b>Siemens Aktiengesellschaft</b> Linder Presse Union GmbH	52
■ <b>Analog Devices, Inc.</b> Schneider Parker Guy, Inc.	149	■ <b>Hewlett Packard</b> Tallant/Yates Advertising, Inc.	58-59	■ <b>Signalite, Inc.</b> MSD Advertising Agency, Inc.	153
<b>Analog Digital Research</b> Analogic Corporation	154	■ <b>Hewlett Packard</b> Tallant Yates Advertising, Inc.	22-23	<b>Signetics Corp., Sub. of</b> <b>Corning Glass Works</b> Hall Butler Blatherwick, Inc.	17
<b>Analogic Corporation</b> Grover and Erickson, Inc.	39	■ <b>Hewlett Packard</b> Richardson, Seigle, Rolfs & McCoy, Inc.	2	* <b>Silec Electronique</b> France M-1	9E
* <b>Anritsu Electric Co., Ltd.</b> Diamond Agency Co., Ltd.	21E	■ <b>Hewlett Packard</b> McCarthy, Scelba, and DeBiasi Adv. Agcy., Inc.	150	<b>Silliconix</b> Robertson West, Inc.	105
■ <b>AMP-Hexseal</b> The Sommer Agency, Inc.	153	<b>Hickok Electrical Instrument Company</b> Key Marketing Associates	136	<b>Singer Instrumentation—Alfred Div.</b> N. W. Ayer/Jorgensen/McDonald, Inc.	135
■ <b>Augat</b> Creamer, Trowbridge, Case & Basford, Inc.	62-63	■ <b>ILC Data Device Corporation</b> Marchin Weltman Advertising, Inc.	16	‡ <b>Sorenson Company, A Unit</b> <b>of Raytheon Company</b> Providence Eastwood & Lombardi, Inc.	52
* <b>Bayer, A.G.</b> Werbeagentur	18-19	§ <b>In-Line Technology, Inc.</b> R & A Zens	172	■ <b>Sprague Electric Company</b> Harry P. Bridge Company	8
<b>The Boeing Aerospace Company</b> Cole & Weber, Inc.	80-83	<b>Intel Corporation</b> Bonfield Associates	140-143, 145	■ <b>Systron Donner Concord Instruments</b> Bonfield Associates	7
‡ <b>Bourns, Inc.</b> Marlborough Assoc., Inc.	106-107	<b>International Electronic Research Corporation</b> Van Der Boom, McCarron, Inc., Advertising	42	* <b>TEAC Corp.</b> Dentsu Advertising Ltd.	107
* <b>Burndy</b> Intermarco Publicem	4E	■ <b>Intronics</b> Impact Advertising Incorporated	6	* <b>Techmasheport</b> Vneshtorgreklama	106
■ <b>Cambridge Thermionic Corporation</b> Chirurg and Cairns, Inc.	28E	§ <b>IPT Corp.</b> Roy Minor/Graphic Arts	177	* <b>Techrabsexport USSR</b> Office Publicitaire DeFrance	24E
■ <b>Carter Semiconductor</b> RAMA Adv.	154	■ <b>Ithaco, Inc.</b> Hart Conway Co., Inc.	130	<b>Tektronix, Inc.</b> Dawson, Inc.	33,35
<b>Centralab, Electronics Div. of Globe Union, Inc.</b> The Brady Co.	100-101	<b>Krohn-Hite Corporation</b> Impact Advertising, Inc.	5	<b>Teledyne Semiconductor</b> Regis McKenna, Inc.	51
<b>Cherry Electrical Products Corp.</b> Kolb/Tookey and Assoc., Inc.	69	■ <b>Lambda Electronics Corporation</b> Michel Cather, Inc.	3rd cover	<b>Teradyne, Inc.</b> Quinn & Johnson, Inc.	66
* <b>CIT Alcatel</b> Promotion Industrielle	27E	* <b>Leonische Drahtwerke A.G.</b> Werbeagentur	57	<b>Thermalloy</b> Warren-Guild	160
§ <b>Cobilt Div. of ComputerVision Corp.</b> Associated Ad-Ventures	173	<b>Lockheed Electronics Company</b> McCann-Erickson, Inc.	37	<b>Thermotron Corporation</b> Enterprise Advertising	164
§ <b>Coors Porcelain Company</b> Arvada Art & Advertising Co.	166	* <b>LTT</b> Publibel	25E	<b>Thomas Publishing Co.</b> Black-Russell-Morris	42
■ <b>Dale Electronics, Inc., A Sub. of The Lionel Corporation</b> Swanson, Sinkey, Ellis, Inc. Advertising	4th cover	§ <b>JMaterials Research Corporation</b> Black-Russell-Morris	171	■ <b>Thomson CSF</b> Bazaine Publicite	7E
<b>Dana Laboratories</b> Dailey & Associates	12-13	‡ <b>Microdata Corporation</b> James Brunton Advertising	54	* <b>Thomson CSF Electron Tubes, Inc.</b> Mohr & Co.	9
<b>Delevan Division, American Precision Industries, Inc.</b> Cornstock Advertising, Inc.	20	■ <b>Micro Switch Division of Honeywell</b> N. W. Ayer & Son, Inc.	79	<b>Toko, Inc.</b> HakuHodo, Inc.	160
<b>Delta Air Lines</b> Burke Dowling Adams, Inc.	161	<b>Microsystems International Ltd.</b> Media Advertising Ltd.	40-41	<b>TRW/IRC Resistors</b> Gray & Rogers, Inc.	120
■ <b>Dialight Corporation</b> Michel-Cather, Inc.	74-75	§ <b>Monsanto Commercial Products Co.</b> Advertising & Promotion Services	167	■ <b>Trygon Electronic Subsidiary of Systron Donner Corp.</b> RAMA Advertising	159
■ <b>Dynamic Instrument Corp.</b> Adrian E. Clark, Inc.	148	<b>MOS Technology, Inc.</b> Henry S. Grodsett Advertising, Inc.	2nd cover	<b>United Technical Publications</b> Gilbert S. Nearman Co., Inc. Advertising	146
■ <b>Eastman Chemical Products, Inc., Industrial Chemicals</b> J. Walter Thompson Company	78	<b>Mostek Corporation</b> Kaufmann Advertising, Inc.	15	<b>United Systems Corp., A Sub. of Monsanto Co.</b> Advertising & Merchandising, Inc.	131
<b>Eastman Kodak Company, Business Systems Markets Div.</b> J. Walter Thompson Co.	125	■ <b>National Semiconductor Corp.</b> Chiat/Day, Inc. Advertising	114-115	■ <b>Unitrode Corporation</b> Impact Advertising	27
■ <b>Electronic Associates, Inc.</b> Gerald Clarke, Inc.	6	■ <b>Nelson Ross Electronics, Div. Polarad Electronics</b> McCarthy-Scelba-DeBiasi Advertising Agency, Inc.	164	§ <b>Varian Associates, Vacuum Div.</b> Botsford Ketchum, Inc.	175
■ <b>Electronic Molding Corp.</b> The Williams Company	139	§ <b>Nortec</b> Com/Mark Communications Group	179	<b>Wandel &amp; Goltermann</b> Werbeagentur Heinrich Hartmann	153
■ <b>Electronic Navigation Industries</b> Hart Conway Co., Inc.	14	* <b>Norton</b> Technik Marketing	16E	■ <b>Wavetek Indiana</b> Chapman Michetti Advertising	48
<b>Electronics &amp; Control Engineers Book Club</b>	155-157	* <b>Oscilloquartz SA, Neuchatel</b> M. R. Hofer Werbeagentur BSR/EAAA Bern	12E	<b>Z. Kuroda &amp; Co., Ltd.</b> JTS Co., Ltd.	146
<b>EPC Labs., Inc.</b> Superfine Productions	84	§ <b>Oxy Metal Finishing Corp.</b> O.S. Tyson and Company, Inc.	178		
■ <b>Erie Technological Products Co., Inc.</b> Altman Hall Associates Advertising	21	* <b>Philips N.V. Pit/T &amp; M Division</b> Marsteller International S. A.	54		
§ <b>ETEC Corporation</b> Allen & Dorward, Inc.	169	‡ <b>Piher International</b> Scott MacTaggart Advertising	60-61		
<b>Excellon Industries, Inc.</b> Elgin Davis, Inc.	44-45	* <b>Plessey Capacitors</b> Roles and Parker Ltd.	11E, 13E		
<b>Fairchild Semiconductor, Inc.</b> Carson/Roberts, Inc. Adv., Division of Ogilvy & Mather, Inc.	46-47	* <b>Procond S.p.A.</b> Quadrangolo	18E		
<b>Faultfinders, Inc.</b> D. J. Moore Advertising, Inc.	147	* <b>Radiometer Copenhagen</b>	17E		
§ <b>The Fluorocarbon Company</b> Dan Ebberts and Company Advertising	168	■ <b>Raytheon Semiconductor</b> Durel Advertising	126, 127		
§ <b>Gasonics, Monte Toole &amp; Assoc., Inc.</b>	174	<b>RCA Corporate</b> J. Walter Thompson Company	132		
■ <b>General Electric Co., Semiconductor Products Department</b> Advertising & Sales Promotion Syracuse Operation	28	<b>RCA Solid State Division</b> Al Paul Lefton Company, Inc.	138		
■ <b>General Instrument Corporation, Semiconductor Products Div.</b> Graphics & All, Inc.	128	■ <b>Rental Electronics, Inc.</b> Communications Unlimited, Inc.	162		
		* <b>Retia S.P.A.</b> Publicitas	19E		
		■ <b>RHG Electronics Laboratory, Inc.</b> Samuel H. Goldstein	134		
		* <b>Rohde &amp; Schwarz</b>	1E		

## Classified & Employment Advertising

F. J. Eberle, Manager 212-971-2557

<b>Equipment (Used or Surplus New) For Sale</b>	
<b>American Used Computer Corp.</b> .....	137
<b>Boeing Corp</b> .....	137
<b>McNeal Electric &amp; Equipment Co.</b> .....	137
<b>Radio Research Instrument Co., Inc.</b> .....	137

■ For more information on complete product line see advertisement in the latest Electronics Buyer's Guide  
 \* Advertisers in Electronics International only  
 ‡ Advertisers in Electronics domestic edition only  
 § Advertisers in Electronics Semicon III section only



# From stock-ALL NEW

**THERMOTRON TABAI SERIES ovens**

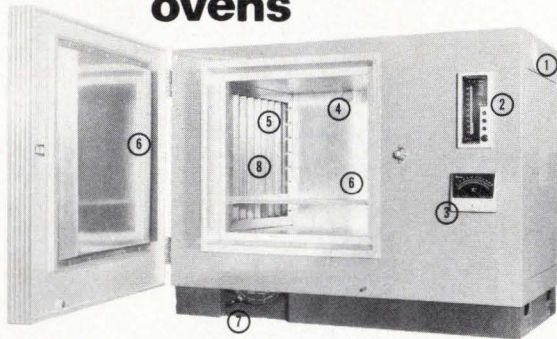

LOOK AT THE FEATURES THAT ARE INCLUDED IN THE PURCHASE PRICE OF THIS ALL-NEW OVEN SERIES:

1. OVERHEAT PROTECTOR
2. SOLID STATE TEMPERATURE CONTROL WITH BOTH MANUAL AND AUTOMATIC SETTING
3. TEMPERATURE INDICATOR
4. INTERIOR LIGHT (ON MOST MODELS)
5. ADJUSTABLE AIR BAFFLES FOR BEST POSSIBLE GRADIENT
6. AVAILABLE IN STAINLESS OR COLD-ROLLED STEEL WITH HIGH TEMPERATURE FINISH
7. EXHAUST VENTS
8. FORCED AIR CIRCULATION

(SEND FOR COMPLETE CATALOG)

West Coast:  
8934 Mason Ave.  
Chatsworth, California 91311  
Phone 213 882-5030

Kollen Park Drive / Holland, Michigan 49423 / 616-392-1492

**IMMEDIATE,  
OFF THE SHELF  
DELIVERY**

Available in 3 Ranges:  
+ 70° F to + 392° F  
+ 176° F to + 572° F  
+ 212° F to + 932° F



**THERMOTRON  
CORPORATION**

Circle 164 on reader service card

Presenting  
in your  
corner:  
**THE  
ELECTRONICS  
BOXER!**

Why mess around when you can have the **ELECTRONICS BOXER** clean up your copies—keep them in top condition.

And, it's easy and inexpensive to keep the **ELECTRONICS BOXER** in your corner. Just complete the coupon and mail. Your order will be processed immediately, postpaid.

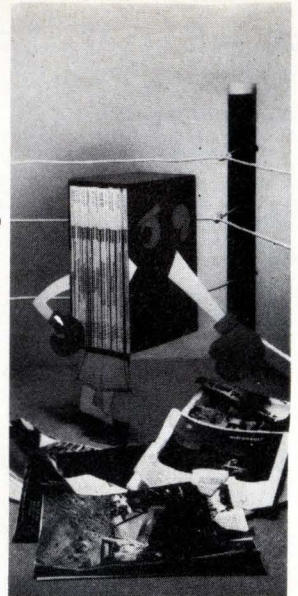

**ELECTRONICS BOXER**

**Jesse Jones Box Corporation**

2250 E. Butler St., Philadelphia, Pa. 19137

Please send me:  boxes @ \$4.25 each;  
 3 boxes @ \$12.00;  6 boxes @ \$22.00

My check or money order is enclosed.

Name \_\_\_\_\_

Address \_\_\_\_\_

City \_\_\_\_\_ State \_\_\_\_\_ Zip \_\_\_\_\_

# Value Packed **SPECTRUM ANALYZERS**

**0.5 Hz — 6.5 GHz**

**The Specs You NEED at the Price You Want**

... You choose from the largest selection of complete Spectrum Analyzers and plug-ins.\* Get the specifications you need at lowest cost. Our analyzers cover Sub-Audio, Audio, Ultrasonic, Video, Telemetry Subcarrier, RF/SSB, RF/UHF, CATV, and Microwave applications. And, Nelson-Ross' reliability has been proven by thousands of users for more than a decade.

**Get your Nelson-Ross Spectrum Analyzer Catalog;** phone, write or circle the reader service number.

\* For HP 140/141 series, Tektronix 530/540/550/580 "Letter" series and 560 series scopes.

**nelson • ross  
electronics**

A DIVISION OF POLARAD ELECTRONICS CORP.  
5 Delaware Drive/Lake Success, N.Y. 11040  
516-328-1100 • TWX: 510-223-0414

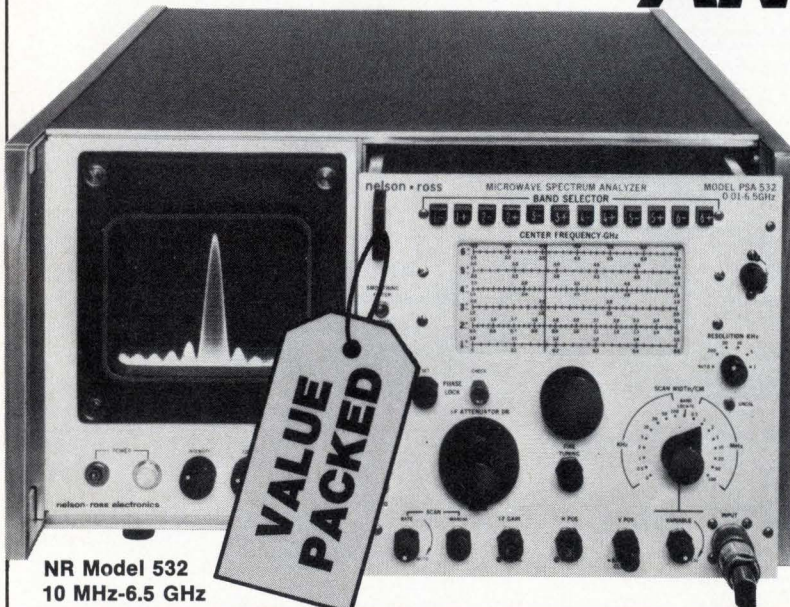

**NR Model 532  
10 MHz-6.5 GHz**

164 Circle 165 on reader service card

Electronics/April 26, 1973