

- 89 Minicomputers in action: simulating sonar displays
- 100 Information theory's impact after 25 years
- 109 Printed-circuit laminate eliminates discrete resistors

LIBRARY  
STATE TECHNICAL INSTITUTE  
AT MEMPHIS

# Electronics®

## CONSUMER CAPERS

IN THIS ISSUE:  
THE CHALLENGE OF HOME ELECTRONICS...



# 3 Wire Synchro to Linear D.C. Converter

ACCURACY 1/2 %



#MAC 1422-1

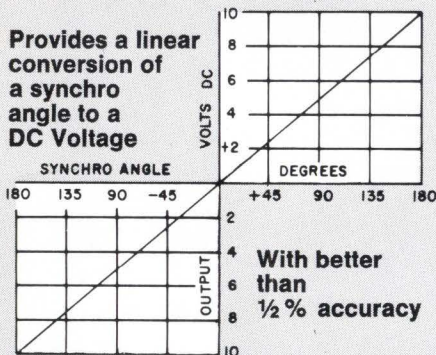

- Scaled for  $\pm 10V$  DC output
- Operates from  $\pm 15V$  supplies
- No external adjustments
- Hermetically sealed
- Output short circuit protected
- Units can be altered to operate with different L-L Voltages or frequency

## Specifications

**Accuracy:**  $\pm 1\%$  over temperature range  
**Input:** 11.8V, 400HZ line to line 3 wire synchro voltage  
**Output impedance:** less than 10 Ohms  
**Input impedance:** 10K minimum line to line  
**Reference:** 26V  $\pm 10\%$  400HZ (Unit can be altered to accommodate 115V if available at no extra cost)  
**Operating temperature range:**  $-25^{\circ}C$  to  $+85^{\circ}C$   
**Storage temperature range:**  $-55^{\circ}C$  to  $+100^{\circ}C$   
**DC power:**  $\pm 15V \pm 1\%$  @ 75ma (approx.)  
**Case material:** High permeability Nickel Alloy  
**Weight:** 6 Ozs.  
**Size:** 3.6" x 2.5" x 0.6"

There is No Substitute for Reliability



**GENERAL MAGNETICS, INC.**

135 Bloomfield Avenue  
 Bloomfield, New Jersey 07003  
 (201) 743-2700

## Precision Analog Components for Signal Manipulation and Function Generation

- Radiation Hardened Analog Multipliers and Modulators
- Linear DC to Synchro Converter
- Sine-Cosine to 3 Wire Converter
- 3 Wire to Linear DC Converter
- 3 Wire to Sine-Cosine Converter
- Sine-Cosine Generators
- Precision Modulators
- Precision Analog Multipliers
- Squaring/Square Root Modules
- Precision Analog Divider
- Precision A.C. Regulators
- Demodulators
- Transformers

## Analog Computing Applications

- Trigonometric Manipulations
- Multiplying
- Dividing
- Squaring
- Modulating
- Automatic Gain Control
- Demodulation
- RMS Computation
- Phase Measurement
- AC Amplitude Regulation and Modulation
- Linearizing
- Square Rooting
- Power Measurement
- Ratio Measurement

## 4 Quadrant Magnetic Analog Multiplier

DC x AC = AC Output



#MCM 1351-2

**Product Accuracy is  $\pm 1/2\%$  of all readings Over Full Temperature Range of  $-55^{\circ}C$  to  $+125^{\circ}C$**

- Product accuracy is specified in % of reading for all output analog voltage product points over the full military temperature range instead of % of full scale error giving superior results for small values.
- Linearity, product accuracy, and zero point virtually unaffected by temperature changes.
- All units are hermetically sealed and completely shielded from external electric or magnetic fields.

## Specifications Include:

**Transfer equation:**  $E = XY/3$   
**X & Y input signal ranges:** 0 to  $\pm 3V$  Peak  
**Maximum static and dynamic product error:**  $1/2\%$  of point or 2 MVRMS, whichever is greater, over entire temperature range  
**Input impedance:** X = 10K; Y = 10K  
**Full scale output:** 3 VRMS  
**Minimum load resistance for full scale output:** 2000 ohms  
**Output impedance:** Less than 50 ohms  
**X input bandwidth:**  $\pm 0.5db$ , 0 to 200 hertz  
**Y input bandwidth:**  $\pm 0.5db$ , 20 hertz to 1000 hertz  
**DC power:**  $\pm 15V$  unless otherwise required @ 20 ma  
**Size:** 1.8" x 1.1" x 0.5"

There is No Substitute for Reliability



**GENERAL MAGNETICS, INC.**

135 Bloomfield Avenue  
 Bloomfield, New Jersey 07003  
 (201) 743-2700

# Self-Test Plus Sample And Hold... Now You Get Them Both In HP's 3490A.

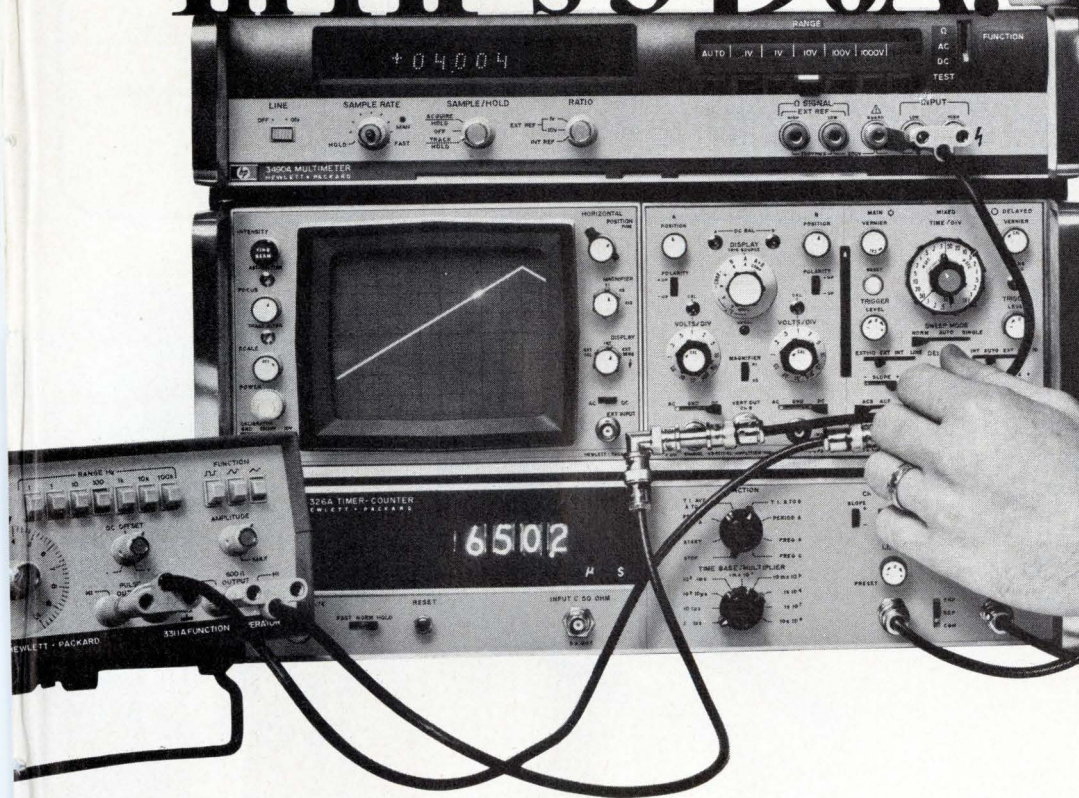

By adding a Sample and Hold option to our Self-Test 3490A, we've made a good DMM even better. And more accurate. Now, you'll be equipped to test ramp linearity; and pulse droop; and hysteresis; and peak amplitude — all at 0.01% resolution.

The Sample and Hold operates in either of two modes: **Track and Hold**, triggered from an external input; or **Acquire and Hold** that offers a built-in delay before reading. You'll find both modes valuable for testing network performance and production line testing.

**We Put It To Work**  
At HP, the 3311A Function Gen-

erator was one of the first instruments to benefit from the new Sample and Hold capability. We knew the 3311A offered exceptional value for the money — but we suspected that in some ways it was even better than we'd claimed. So we used the 3490A equipped with Sample and Hold to give us a much more accurate measurement of the 3311A's ramp linearity. The results: linearity was nearly ten times better than we'd originally spec'd it (triangle waveform mode). And while we were at it, we resolved the square wave flatness within 1mV.

So when you talk to our HP field engineer about the capable new

Sample and Hold option for the 3490A (base price \$1,650\*. Sample and Hold \$450\* extra), why not ask him to give you details on the better-than-we-thought 3311A. It was a bargain at \$249\* — now it's even more so when you consider the excellent ramp linearity.

\*Domestic USA Prices Only

**For new standards in digital voltmeters and signal sources, think HP.**

093/49

**HEWLETT  PACKARD**

Sales, Service and support in 172 centers in 65 countries. Palo Alto, California 94303. Offices in principal cities throughout the U.S.

Circle 1 on reader service card

# THE SCOPE MEETS THE BLUE BOX

If you now use a scope for spectrum display, you should consider the advantages of our blue box — the EPC Model 4600 Graphic Recorder.

The EPC Model 4600 is an XYZ recorder that prints continuous hard copy on dry paper over a display of 19.2 inches. This permanent history-plot permits comparative data examination and, in spectrum analysis, reveals spectrum lines buried as much as 6 DB below the noise level.

The model 4600 operates at sweep speeds between  $\frac{1}{8}$  second and 8 seconds per scan, and is completely tape compatible. Sweep speeds can be varied to match the dump speeds of the analyzer data discharge. Up to 3000 data points can be presented with each sweep.

Scale lines are generated by an internal crystal. The digital drive mechanism for the scan system is virtually jitter free.

<b>SWEEP RATES</b>	0.125, 0.25, 0.50, 1.0, 2.0, 4.0 sweeps per second; plus variable. Available at rates of 1.0 seconds per sweep or greater.
<b>SINGLE SWEEP</b>	10, 100 or 1000 millisecond intervals.
<b>SCALE LINES</b>	Left-to-right (right to left can be supplied).
<b>SWEEP DIRECTION</b>	Gate or print from 1 to 4 sweeps.
<b>PRINT DELAY</b>	Manual — Internal and remote in or out.
<b>EVENT MARK</b>	Dry electrosensitive (NKD), 19 $\frac{3}{4}$ " wide by 80' roll length.
<b>PAPER TYPE</b>	19.2 inches.
<b>RECORDING WIDTH</b>	23db from white to black.
<b>PAPER DYNAMIC RANGE</b>	Variable 50 to 200 lines per inch. Rapid advance provided.
<b>PAPER ADVANCE</b>	10k ohms; all inputs.
<b>INPUT IMPEDANCE</b>	Linear 0-1000.
<b>AMPLIFIER GAIN</b>	Flat $\pm 1$ db from DC to 100KHz; $E \geq 0.1v$ .
<b>FREQUENCY RESPONSE</b>	Print current limiter, adjustable by front panel control.
<b>CONTRAST</b>	Adjustable by front panel control.
<b>INPUT THRESHOLD</b>	

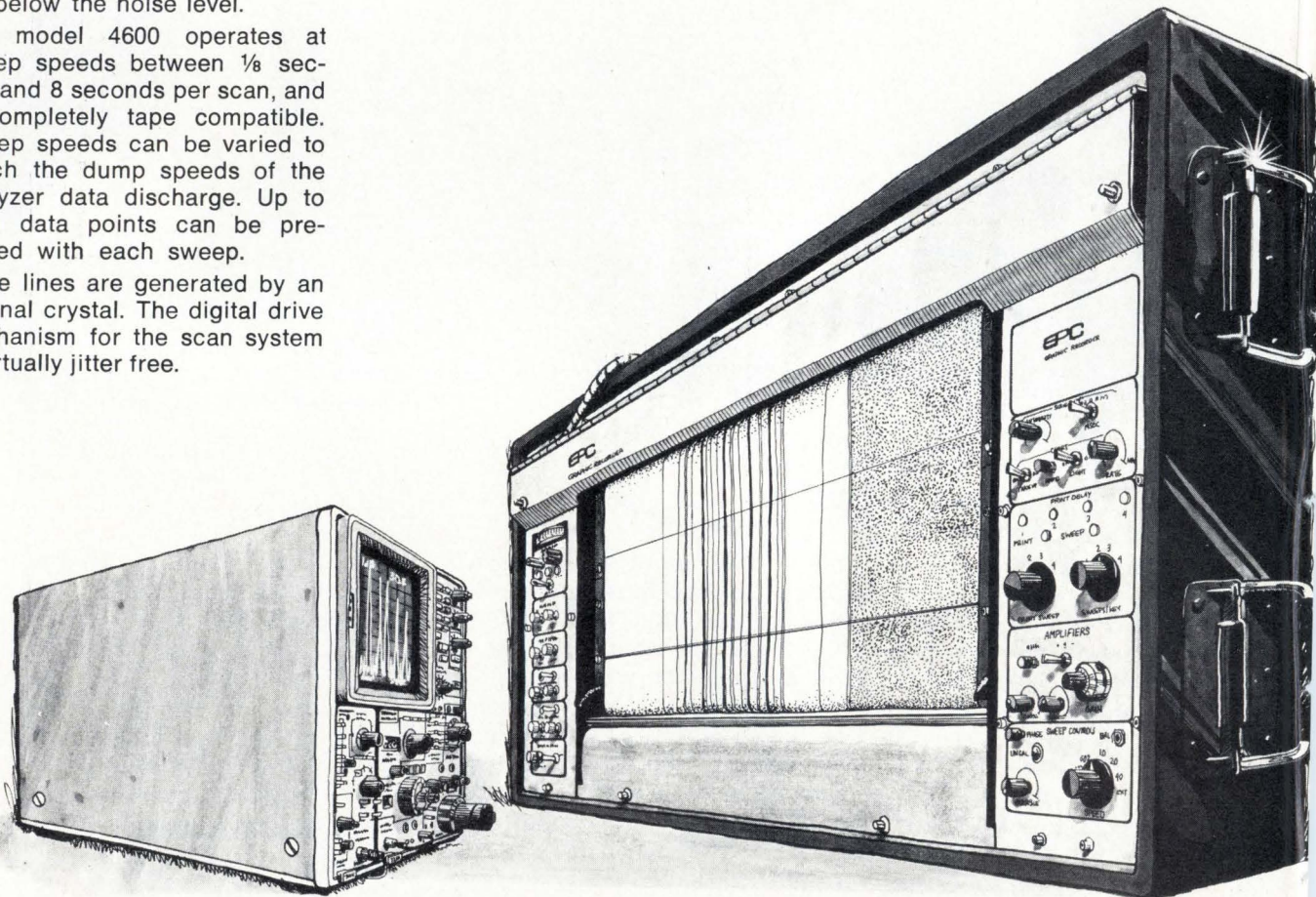

Please write  
for  
complete  
specifications.

# EPC

EPC LABS INC.  
P.O. Box 97  
123 Brimbal Avenue  
Beverly, Mass. 01915  
(617) 927-2523

## 29 Electronics Review

COMMUNICATIONS: Spectrum fight shapes up at 900 MHz, 29  
INSTRUMENTATION: Matrix recording traps transients, 30  
MICROWAVE: Solid-state receivers for X band, 30  
Thin-film circulator advances MIC art, 32  
COMPUTERS: Restaurant terminals link motorist to home, 31  
COMPUTER-AIDED DESIGN: Network handles pc boards, 32  
SOLID-STATE: Thin film and silicon merged in devices, 34  
COMMERCIAL ELECTRONICS: Computers control freeway signs, 34  
MILITARY ELECTRONICS: Industry wary of 'design-to-cost,' 36  
NEWS BRIEF: 38  
PACKAGING: 'Coupon' IC carrier trims package height, 40

## 53 Electronics International

GREAT BRITAIN: Quartz wafer controls its own ion machining, 53  
FRANCE: Modules combine for uhf transmitter, 53

## 65 Probing the News

COMMUNICATIONS: The third network—MDS, 65  
COMPANIES: Small firm big in power transistors, 68  
AUTOMOTIVE: Deadline near for truck-brake systems, 70  
MICROWAVES: Traveling-wave tubes advance, 74

## 81 Technical Articles

SPECIAL REPORT: Electronics in the home: waiting the right price, 81  
COMPUTERS: Minicomputers simulate ocean, evaluate sonar design, 89  
DESIGNER'S CASEBOOK: Varying comparator hysteresis, 96  
Circular voltage divider needs fewer resistors, 96  
Link-coupled tank circuit steps up C-MOS drive voltage, 97  
Square-wave generator stresses frequency stability, 98  
COMMUNICATIONS: Information theory after 25 years, 100  
PACKAGING & PRODUCTION: Etching leaves resistors in pc board, 109  
ENGINEER'S NOTEBOOK: Timer ICs and LEDs form cable tester, 115  
Charting capacitor frequency and temperature performance, 116

## 121 New Products

IN THE SPOTLIGHT: Gold-free film cuts LSI package cost, 121  
COMPONENTS: Adapter paves way for leadless ICs, 122  
INSTRUMENTS: Electrometer goes digital, 130  
SEMICONDUCTORS: Static n-channel ROM stores 8,192 bits, 135  
SUBASSEMBLIES: IC is building block for a-d converter, 145  
DATA HANDLING: Naked Mini sells for under \$1,000, 154  
MATERIALS: 164

## Departments

Publisher's letter, 4  
Readers comment, 6  
40 years ago, 8  
People, 14  
Meetings, 20  
Electronics newsletter, 25  
Washington newsletter, 49  
International newsletter, 55  
Engineer's newsletter, 118  
New literature, 168

## Highlights

### The cover: Electronics at home, 81

Now that audio equipment has sold the consumer on solid state, home-appliance manufacturers are again eager to try electronic controls. One problem is getting the price right. Cover picturing the future is by John Celardo of King Features.

### A third type of TV network, 65

To be tested shortly in four major cities are networks that combine broadcast, cable, and closed-circuit television with point-to-point microwave transmission. But equipment manufacturers are less sanguine about their future than are license-holders.

### Let's pretend we're at sea, 89

At the Naval Underwater Systems Center, a minicomputer that is the heart of a simulated sonar system sounds out another minicomputer that models the ocean. This is the third article in the series, "Minicomputers in action."

### Applications of information theory pay off, 100

Published 25 years ago in the Bell System Technical Journal, Claude Shannon's theory has been clarified and refined to the point where it is directly affecting the design of communications systems.

### And in the next issue . . .

Communications processors . . . preview of the National Computer Conference . . . a new type of analog-to-digital converter.

EDITOR-IN-CHIEF: Kemp Anderson

EXECUTIVE EDITOR: Samuel Weber

MANAGING EDITORS: Lawrence Curran, *News*;  
Arthur Erikson, *International*

SENIOR EDITORS: John Johnsrud,  
H. Thomas Maguire, Laurence Altman

ART DIRECTOR: Fred Sklenar

ASSOCIATE EDITORS: John N. Kessler,  
Howard Wolff, Gerald M. Walker

DEPARTMENT EDITORS

*Aerospace*: William F. Arnold  
*Circuit Design*: Lucinda Matterna  
*Communications & Microwave*:

Lyman J. Hardeman  
*Computers*: Wallace B. Riley  
*Consumer*: Gerald M. Walker  
*Industrial*: Alfred Rosenblatt  
*Instrumentation*: Michael J. Riezenman  
*Military*: Ray Connolly

*New Products*: H. Thomas Maguire  
*Packaging & Production*: Stephen E. Grossman  
*Solid State*: Laurence Altman  
*Special Issues*: Harry R. Karp

COPY EDITORS: Margaret Eastman,  
Everett C. Terry

ASSISTANT EDITOR: Marilyn Offenheiser

ART: Charles D. Ciatto, *Associate Director*  
Patricia Cybulski, *Assistant Director*

PRODUCTION EDITOR: Arthur C. Miller

EDITORIAL SECRETARIES: Janet Annunziata,  
Julie Gorgoglione, Penny Roberts

FIELD EDITORS

*Boston*: James Brinton (Mgr.), Gail Farrell  
*Los Angeles*: Paul Franson (Mgr.)  
*Midwest*: Larry Armstrong (Mgr.)  
*New York*: Alfred Rosenblatt (Mgr.)  
*San Francisco*: George Sideris (Mgr.),  
Judith Curtis  
*Washington*: Ray Connolly (Mgr.),  
William F. Arnold  
*Frankfurt*: John Gosch  
*London*: Michael Payne  
*Paris*: Arthur Erikson  
*Tokyo*: Charles Cohen

McGraw-Hill WORLD NEWS

*Director*: Walter A. Stanbury  
*Bonn*: Robert Ingersoll;  
*Brussels*: James Smith;  
*London*: Marvin Petal;  
*Milan*: Peter Hoffmann, Andrew Heath;  
*Moscow*: Axel Krause;  
*Paris*: Stewart Toy, Michael Johnson;  
*Stockholm*: Robert Skole;  
*Tokyo*: Mike Mealey

PUBLISHER: Dan McMillan

ADVERTISING SALES MANAGER: Pierre J. Braudré

ADVERTISING SALES SERVICE MANAGER:  
Wallis Clarke

BUSINESS MANAGER: Stephen R. Weiss

CIRCULATION MANAGER: George F. Werner

MARKETING SERVICES MANAGER:  
Tomlinson Howland

**T**he pervasive quality of electronics—the way developments in the electronics industries have an impact all across society—is exemplified in information theory. While it covers more than just electronics, that body of thought, first codified 25 years ago by Claude Shannon (see article on p. 100), had a strong effect on the way communications systems were designed. But its all-encompassing nature gave it an uncanny application to other fields, such as cryptology. It was even tried in such disparate disciplines as psychology, art, and semantics.

Lyman Hardeman, our Communications and Microwave Editor, summed up the role Shannon's work has played in the quarter century since he published his "The Mathematical theory of Communications," a work that was heavily overshadowed by the announcement of the transistor.

"Shannon gave a mathematical rigor to what many people already knew. But their knowledge was intuitive, a seat-of-the-pants approach. Take Morse Code, for example. It uses short codes for often-used letters, longer code groups for the seldom-used letters. Thus, fewer bits of data were needed to transmit a given message."

Hardeman likes to describe a demonstration that Shannon used to illustrate his concept of "entropy," a measure of the number of bits of data needed to efficiently transmit a message. As he points out in his article, it would take an average of 4.7 bits of data to convey a single letter in English—if every letter had an equal chance of occurring in a word. But that is not the case, since "a" tends to be used much more often than "z" in normal messages. Ac-

tually, fewer total bits are needed because of such frequency distribution and because of context.

"Shannon would ask someone to open a book and pick a paragraph," says Hardeman. "Then, to see how few yes-no questions—or 'bits'—were needed to 'decode' the text, he would ask such limiting questions as 'Is it in the first half of the alphabet.' That would pinpoint the first letter in, at most, five questions. That's roughly equal to the 4.7 bits necessary to code the letter.

"In the case of the word 'Clearly,' the same approach might be used to define the second letter. But then, using the facts that a vowel must come next and that 'e' is the most used vowel, only one question would be needed to define the third letter. The 'a' is easy to get, too, on one or two tries, as is the 'r.' Only a half-dozen letters can be expected next and, because the word starts a paragraph, 'ly' is favored. Thus the word can be "decoded" in only about 15 questions, an average of about 2 per letter."

**A**nd speaking of the pervasiveness of electronics, we'd like to point you in the direction of the special report on page 81. There, you'll find a round-up on "Electronics in the Home." The non-entertainment applications of electronic around the house is growing, as electronic controls appear in more and more small appliances, ranges, washers, driers, air conditioners, and security systems—as we graphically proclaim on our cover.



May 10, 1973 Volume 46, Number 10  
91,430 copies of this issue printed

Published every other Thursday by McGraw-Hill, Inc. Founder: James H. McGraw 1860-1948. Publication office 1221 Avenue of the Americas, N.Y., N.Y. 10020, second class postage paid at New York, N.Y., and additional mailing offices.

Executive, editorial, circulation and advertising addresses: Electronics, McGraw-Hill Building, 1221 Avenue of the Americas, New York, N.Y. 10020. Telephone (212) 997-1221. Teletype TWX N.Y. 710-581-5234. Cable address: MCGRAWHILLN.Y.

Subscriptions limited to persons with active, professional, functional responsibility in electronics technology. Publisher reserves the right to reject non-qualified requests. No subscriptions accepted without complete identification of subscriber name, title, or job function, company or organization, including product manufactured or services performed. Subscription rates: qualified subscribers in the United States and possessions, Canada, and Mexico \$8.00 one year, \$12.00 two years, \$16.00 three years; all other countries \$25.00 per year, except Japan \$50.00 per year and Brazil \$40.00 per year, including air freight. Limited quota of subscriptions available at higher-than-basic rate for persons outside of field served, as follows: U.S. and possessions and Canada, \$25.00 one year; all other countries \$50.00. Single copies: United States and possessions and Canada, \$1.00; all other countries, \$1.75.

Officers of the McGraw-Hill Publications Company: John R. Emery, President; J. Elton Tuohig, Senior Vice President—Services; Donald B. Gridley, Group Vice President; Vice Presidents: Ralph Blackburn, Circulation; John R. Callahan, Editorial; John B. Hoglund, Controller; David G. Jensen, Manufacturing; Jerome D. Luntz, Planning & Development; Joseph C. Page, Marketing.

Officers of the Corporation: Shelton Fisher, President; Wallace F. Traendly, Group President, McGraw-Hill Publications Company and McGraw-Hill Information Systems Company; John J. Cooke, Senior Vice President and Secretary; Ralph J. Webb, Treasurer.

Title registered in U.S. Patent Office; Copyright ©1973 by McGraw-Hill, Inc. All rights reserved. The contents of this publication may not be reproduced either in whole or in part without the consent of copyright owner.

Subscribers: The publisher, upon written request to our New York office from any subscriber, agrees to refund that part of the subscription price applying to copies not yet mailed. Please send change of address notices or complaints to Fulfillment Manager; subscription orders to Circulation Manager, Electronics, at address below. Change of address notices should provide old as well as new address, including postal zip code number. If possible, attach address label from recent issue. Allow one month for change to become effective.

Postmaster: Please send form 3579 to Fulfillment Manager, Electronics, P.O. Box 430, Hightstown, N.J. 08520.

If you want an automatic  
crossover precision voltage  
and current stabilizer,  
but don't want a lab-type unit,  
look into

**KEPCO**

**PTR**

**automatic crossover**  
in an OEM-type power supply module.  
There are six Kepco PTR models  
ranging from a 0-7V, 0-5.5A  
unit to a 0-100V,  
0-600mA supply

**PTR** is the no-compromise power supply for the demanding applications. They're true automatic crossover, 0.001% source effect in voltage mode 0.005% source effect in current mode, 0.1 mV/0.5 mA ripple. What's more, both modes are fully programmable by analog or digital control. PTR's don't compromise with their temperature rating, either. You get full output at +71°C with no derating.

Ask your Kepco man for details about the Kepco automatic crossover PTR module. If you don't know who he is, call (212) 461-7000 collect, or write Dept. EL-14 and we will be glad to direct you to the only automatic crossover modules on the scene.

**KEPCO**®



**IN STOCK**

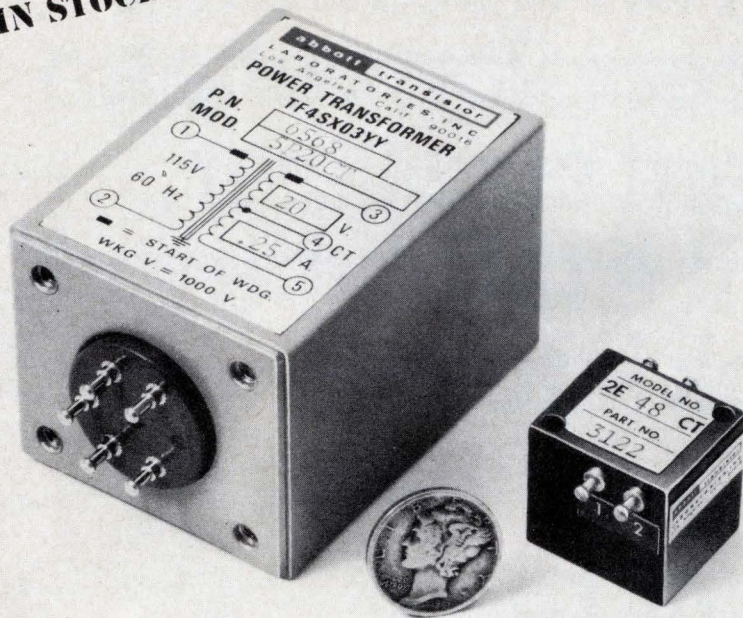

# If You Need A Power Transformer Tomorrow - Call Abbott Today

Now Abbott Stocks 60 Hz and 400 Hz Transformers  
With Output Voltages from 5 to 5000 Volts

Both the 60 Hz and the 400 Hertz transformers are built to meet the specifications of MIL-T-27C. Long life and reliability are inherent in these hermetically sealed, ruggedly built power transformers. The 60 Hertz line comes in eleven power ratings from 5 to 300 watts. The 400 Hz line comes in six power ratings from 2 to 175 watts. Most all of your power transformer needs can be found in this line of Abbott transformers.

	60 Hertz	400 Hertz
<b>Input Primary</b>	115 VAC, 60 Hz $\pm$ 5 Hz, 1 phase	115 V, 400 Hz $\pm$ 20 Hz, 1 phase
<b>Insulation</b>	1750 VAC or 150% of secondary voltage (whichever is higher)	2500 VDC or 150% of secondary voltage (whichever is higher)
<b>Construction</b>	TO MIL-T-27C, grade: 4, class: "S", life: "X" (10,000 hrs.), case: steel	TO MIL-T-27C, grade: 5, class: "S", life: "X" (10,000 hrs.), case: smaller
<b>Environment</b>	To operate in 105°C maximum ambient temperature. Encapsulated to meet MIL-E-5272C and MIL-E-5400H for vibration, shock, acceleration, sand, dust, humidity, salt spray, fungus, sunshine, rain, explosion, and altitude (to a vacuum)	Encapsulated to meet MIL-E-5272C, including vibration to Proc. XII, temperature to 105°C, shock, sand, dust, humidity, salt spray, fungus, sunshine, rain, explosion, and altitude (to a vacuum)
<b>Secondary</b>	From 5 volts to 5000 volts at 32 milliamperes to 20 amperes	From 5 volts to 5000 volts at 14 milliamperes to 35 amperes

A complete description of all of these power transformers together with their prices is contained in Abbott's 10 page transformer brochure, available FREE on request.

Please see pages 618 to 632 of your 1971-72 EEM (ELECTRONIC ENGINEERS MASTER Catalog) for complete information on Abbott modules. Send for our new 56 page FREE catalog.

**abbott transistor**

**LABORATORIES, INCORPORATED**  
5200 W. Jefferson Blvd./Los Angeles 90016 (213) 936-8185 Cable ABTLABS  
1224 Anderson Ave./Fort Lee, N.J. 07024 (201) 224-6900

## Readers comment

### In and out

**To the Editor:** The Engineer's newsletter is generally interesting and occasionally outstanding. But the last item on page 122 of the March 15 issue, entitled "How to attack the TTL-ECL interface," strongly implies that Motorola's MC10124 and MC10125 move you in one direction between ECL and TTL, and states that Motorola's MC1067 and MC1068 take you in the opposite direction. I would like to point out that that is only half right.

The MC 10124 and 10125 are members of the MECL 10K family; the 10124 takes you from TTL to ECL, and the 10125 takes you from ECL to TTL. The MC1067 and 1068 are members of the MECL II family, and their logic levels are a few tens of millivolts different from those of MECL 10K. As with the previous pair, one—the 1067—takes you from TTL to ECL and the other—the 1068—goes the other way, from ECL to TTL.

The 1068 and 10124 are not pin-for-pin, or even functionally, equivalent as far as logic is concerned. Note also that 5-nanosecond propagation delay is not guaranteed for any of the four devices.

Lawrence W. Johnson  
Manager  
Materials Engineering  
Hewlett-Packard Co.  
Santa Clara, Calif.

■ We want to thank reader Johnson for clarifying this point. We did, indeed, mix up the pairs.

### Different specs

**To the Editor:** Your March 15, 1973 issue (page 170) carried a new products write-up about Cornell Dubilier, concerning our exclusive 4-terminal aluminum electrolytic capacitor. The article contained one slight but very significant error.

This particular capacitor's impedance decreases at frequencies above 10,000 hertz, not 1,000 Hz as stated in your description.

John R. Reed  
Public Relations Manager  
Cornell Dubilier Electronics  
Newark, N.J.



# Dramatic new product opportunities ... yours with new 3C8 ferrites



The market is ripe for product breakthroughs. Just look, for example, at the growth of such items as the hand-held calculator, small camera flashguns, ultra-mini portable radios and recorders. The key to these tremendous sales successes is high frequency power conversion circuits.

And the key to still *more* efficient, high-frequency power conversion is Ferroxcube's new 3C8!

This important new ferrite material gives significantly higher flux densities at higher temperatures, and lower losses at high excitation levels than any other magnetic core material. It is available in practical size cores for use up to kilowatt power levels.

3C8 is already being used with great success in: inverters, battery chargers, fluorescent lamp ballasts,

strobe light devices for highway markers and harbor buoys, power oscillators, power amplifiers, ultrasonic generators.

In all of these circuits Ferroxcube's 3C8 material has led to greater efficiency, lower cost, less weight, and smaller sized units. In one power supply, for example, the size of the core was reduced from 13 lbs. at 60Hz to 4 lbs. at 20,000 Hz and the volume from 35 to 9 cu. inches—savings of 70 to 75%!

Can 3C8 improve your present products or suggest new products and markets for your company? If you've got the imagination, we've got the core! Call 914•246-2811, TWX 510-247-5410 or write today.

Ferroxcube linear ferrites—made in Saugerties, N.Y. and stocked in seven U. S. locations.



**FERROXCUBE CORPORATION, SAUGERTIES, N.Y. 12477**  
A NORTH AMERICAN PHILIPS COMPANY

Distributed through North American Philips Electronic Components Corporation with warehouses in Boston, 617-449-1406; New York, 516-538-2300; Saugerties, 914-246-5861; Philadelphia, 215-927-6262; Chicago, 312-593-8220; Santa Clara, 408-249-1134; San Diego, 714-453-9250

16404

## 40 years ago

From the pages of *Electronics*, May 1933

The public is now being offered radio sets at prices all the way from \$12 to \$400. Is it any wonder that the man or woman ready to buy a set, stands confused by this wide range of prices? The advertisements call them all "radio sets," and there has been little to make clear to the public the wide difference in the service they deliver.

The little "pee-wees," the cigar-box models, the midgets, the personal radio sets, all bring in voice, speeches, news, etc., distinctly and understandably, even if (as in a telephone) the full tones are missing. So let's classify that whole group of little sets as "speech radios." And let's enthusiastically sell and recommend these little sets—these "speech radios" for use where voice and speech are chiefly to be received.

But if the customer wants to listen to music—to the great singers, to the great symphonies, to jazz orchestras, or to a brass band—then there is no question that he needs a *musical instrument, a musical reproducer*—a "music radio" to bring the great music that is on the air, and which the broadcasters have spent so much to transmit.

Most modern of light sources, gaseous discharge tubes will be called upon to do their spectacular best at the World's Fair Century of Progress Exposition in Chicago. According to recent estimates, when the exposition opens formally in June it is probable that between 75,000 and 100,000 ft. of gaseous discharge lighting will be in use.

"The technology which produced radio broadcasting, seems destined to revolutionize advertising methods still further, both by providing wholly new electronic media now as little known as broadcasting once was, and by radically revising present printing methods," declared Orestes H. Caldwell, president of the New York Electrical Society and editor of *Electronics*, speaking before the Advertising Club of New York City, on the subject "New Things Up Radio's Sleeve for Advertising Men."

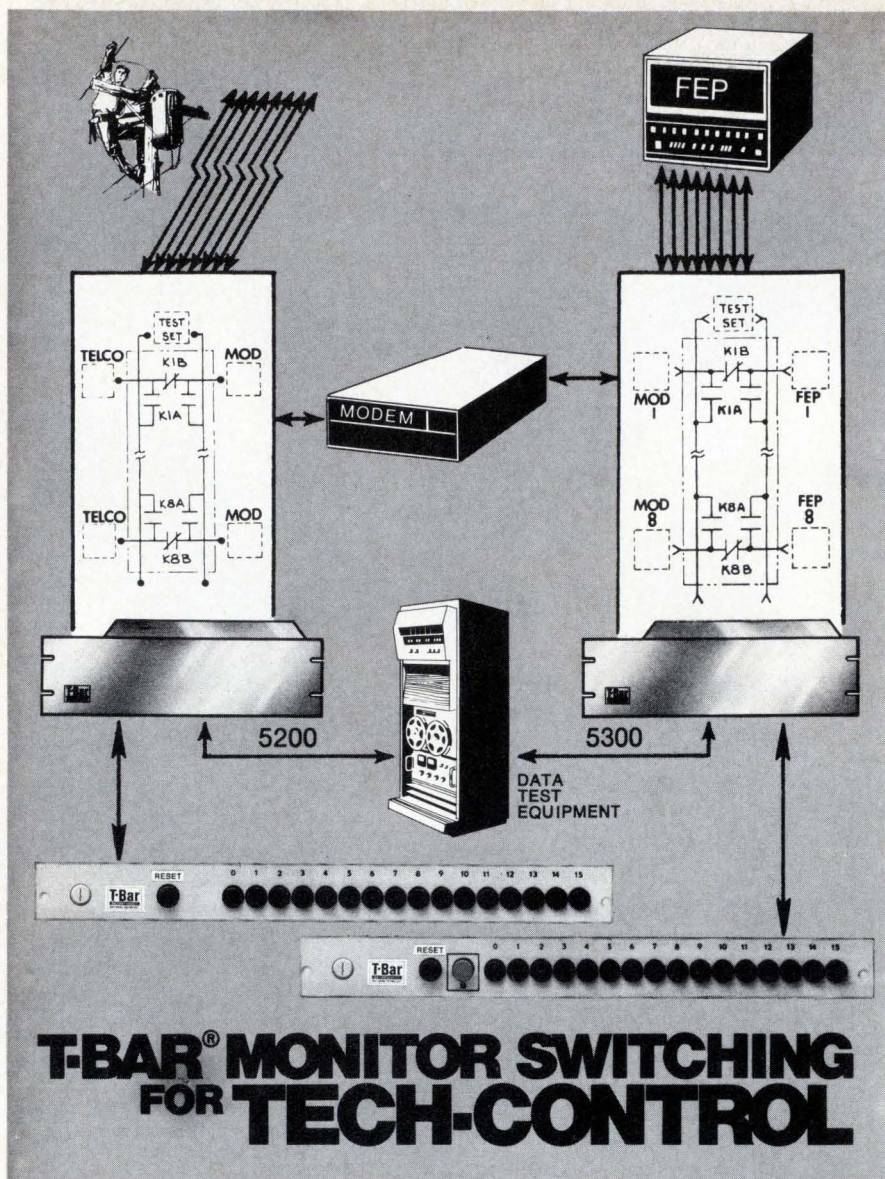

## T-BAR® MONITOR SWITCHING FOR TECH-CONTROL

... including BRIDGE-DOWN and LINE-INTERRUPT

**T-BAR Series 5200/5300 Remote Control Monitoring Switches give fast, reliable connection between 4-wire Telco or 25-wire EIA (RS232) lines and the user's monitoring equipment**

Series 5200 has a bridge-down-only function, while Series 5300 includes a line-interrupt and bridge-down on both sides of the line-interrupt point.

The systems include a Switcher, lighted Pushbutton Control Panel,

Control Cable, plus screw-type Telco interface terminal strips, in 8- or 16-channel standard packages for rack, wall or under-floor installation. Write or phone today for complete literature and prices.



141 Danbury Road, Wilton, CT 06897  
phone 203/762-8351

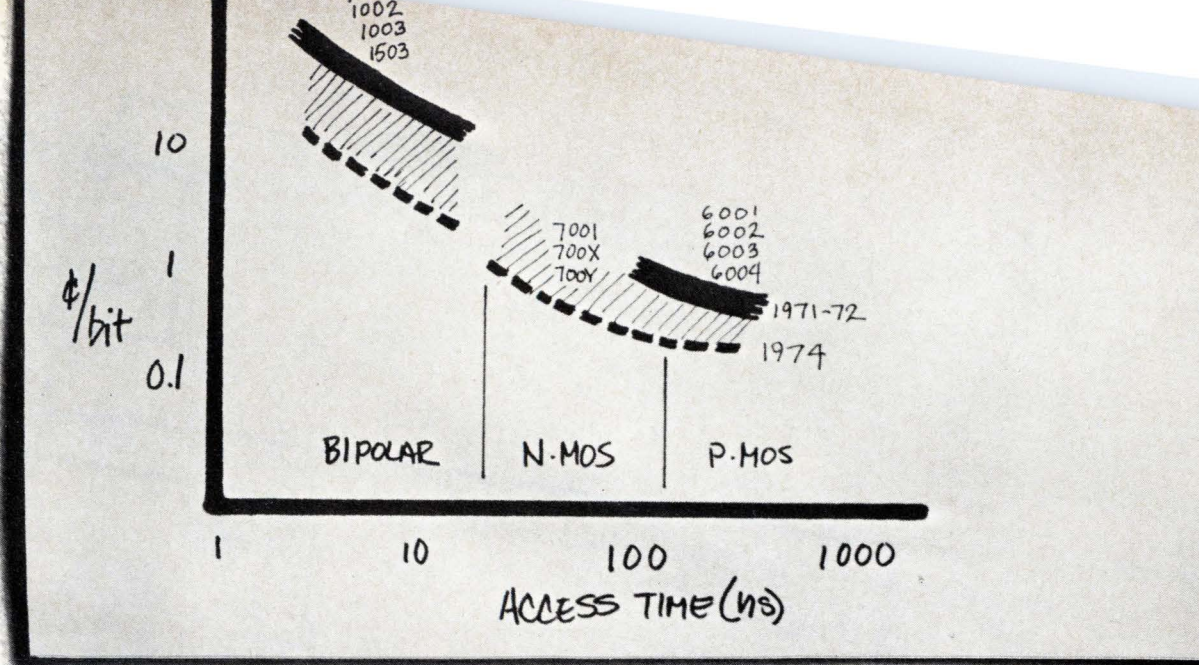

# RAM COST

## Devices are the critical path...AMS knows!

Count the full cost of monolithic main memory: include not just devices, but boards, back panels, power supplies, cabinetry, diagnostics, final test. You'll discover, as main memory capacities rise in every class of machine, that the component is an *increasing* proportion of solid-state memory cost, even though individual device costs are declining (see historical chart above). Conclusion: select the RAM supplier at the cutting edge of the cost curve in every class of RAM—bipolar, N-channel, P-channel. The supplier: AMS.

Solid-state computer memory is now superior to every other main memory technology in performance and price. Only one independent semiconductor

memory company has always gone all the way from silicon to systems: AMS. Result: we have delivered more monolithic memory, installed and operating worldwide, than all the other suppliers put together.

Ask for the facts. We've got them. Facts on AMS semiconductor memories: cost, performance, reliability, our process technologies. Facts on how to get AMS memory when you need it, who is using our memory, what they think about it. Proof that we do the whole job, from silicon to systems, and do it right.

We've got it all together, to give you better memories. In this business, if you haven't got it all together, you haven't got it.

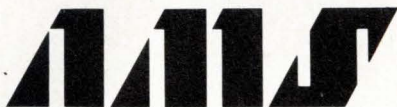

**Advanced Memory Systems, Inc.**  
1276 Hammerwood Avenue  
Sunnyvale, California 94086

AMS means advanced memories. From silicon to systems.

•ADVANCED MEMORY SYSTEMS• ADVANCED MEMORY SYSTEMS•

ADVANCED MEMORY SYSTEMS

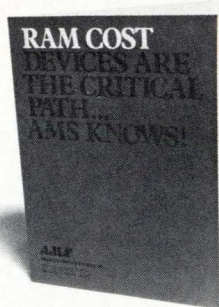

Name \_\_\_\_\_

Title \_\_\_\_\_

Company \_\_\_\_\_

Address \_\_\_\_\_

City \_\_\_\_\_

State \_\_\_\_\_ Zip \_\_\_\_\_

Tel.: (     ) \_\_\_\_\_

ADVANCED MEMORY SYSTEMS

•ADVANCED MEMORY SYSTEMS• ADVANCED MEMORY SYSTEMS•

Clip and mail to us

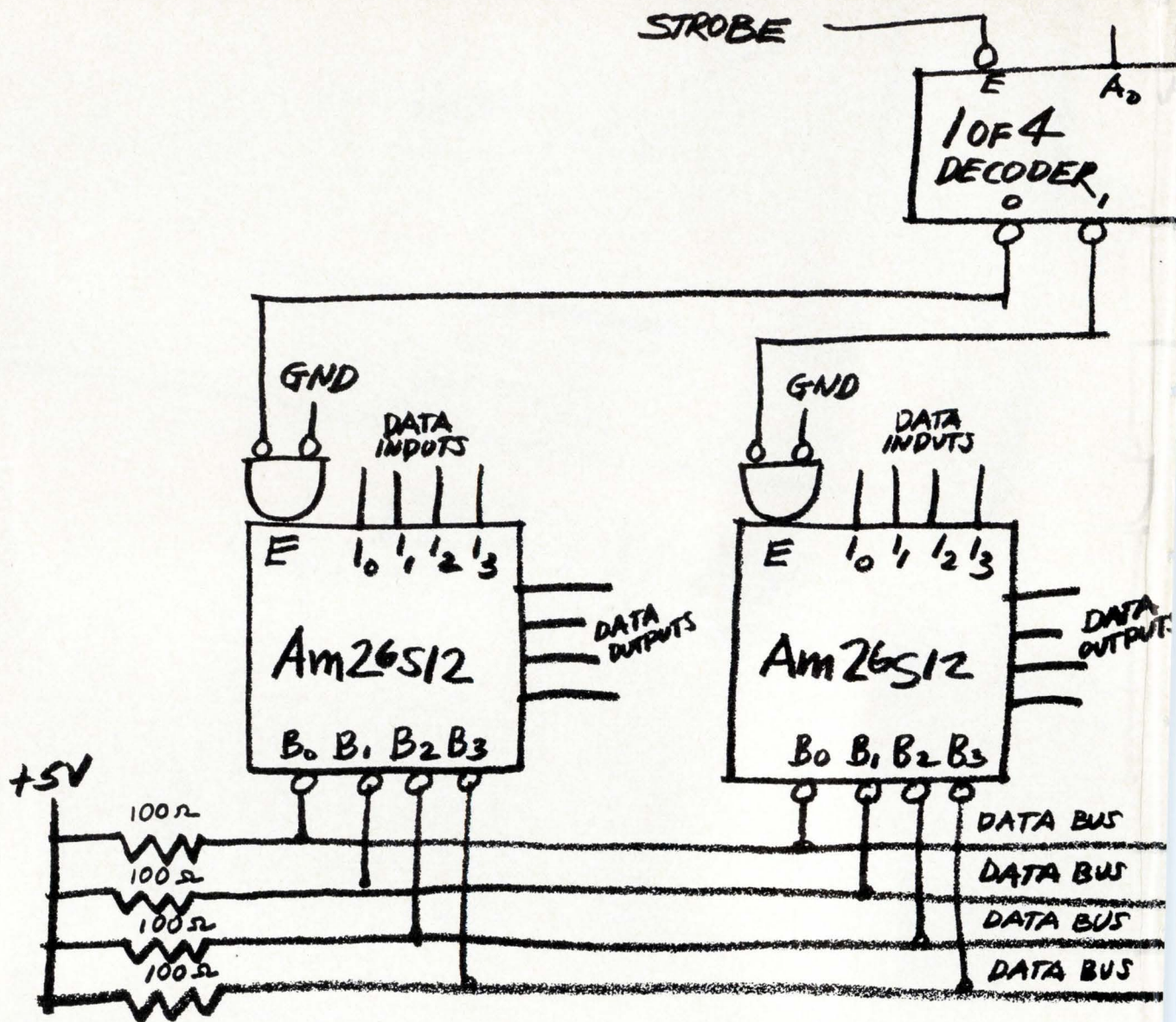

Advanced Micro Devices, Inc., 901 Thompson Place, Sunnyvale, California 94086/TWX 910-339-9280/TLX 346306.  
 For product or sales information, call the AMD sales representative nearest you. In Sunnyvale, Shel Schumaker at (800) 538-7904  
 (toll free from outside California) or (408) 732-2400; in the eastern United States, Steve Marks or Bill Seifert at  
 (516) 676-4500; in Washington/Baltimore, Ken Smyth at (301) 744-8233; in Mid-America, Chuck Keough at (312) 297-4115;  
 in the Los Angeles area, Steve Zelencik or Russ Almand at (213) 360-2102 or Larry Strong at (213) 870-9191;  
 in the United Kingdom, Des Candy at Herne Bay (Kent) 61611; and in Germany, Hermann Lichotka at (0811) 594-680.  
 Advanced Micro Devices is distributed nationally by Cramer and Hamilton/Avnet Electronics.

# Am26S12 Quad Bus Transceiver.

Designed using Schottky clamped transistors, the Am26S12 has a bus driver current sink capability of 100mA at 0.8V (maximum) which enables it to drive as many as 200 devices. Receiver hysteresis provides high noise immunity with noise margins of greater than 1.0V. The unique terminating scheme of the Am26S12 allows each end of the bus to be terminated with a resistor as low as 100 ohms. Threshold limits are 1.4 to 2.0V  $\pm$  0.2V. Also available: The Am26S12A. Pin-compatible with DM8838. Threshold limits, 1.2 to 2.25V  $\pm$  0.2V.

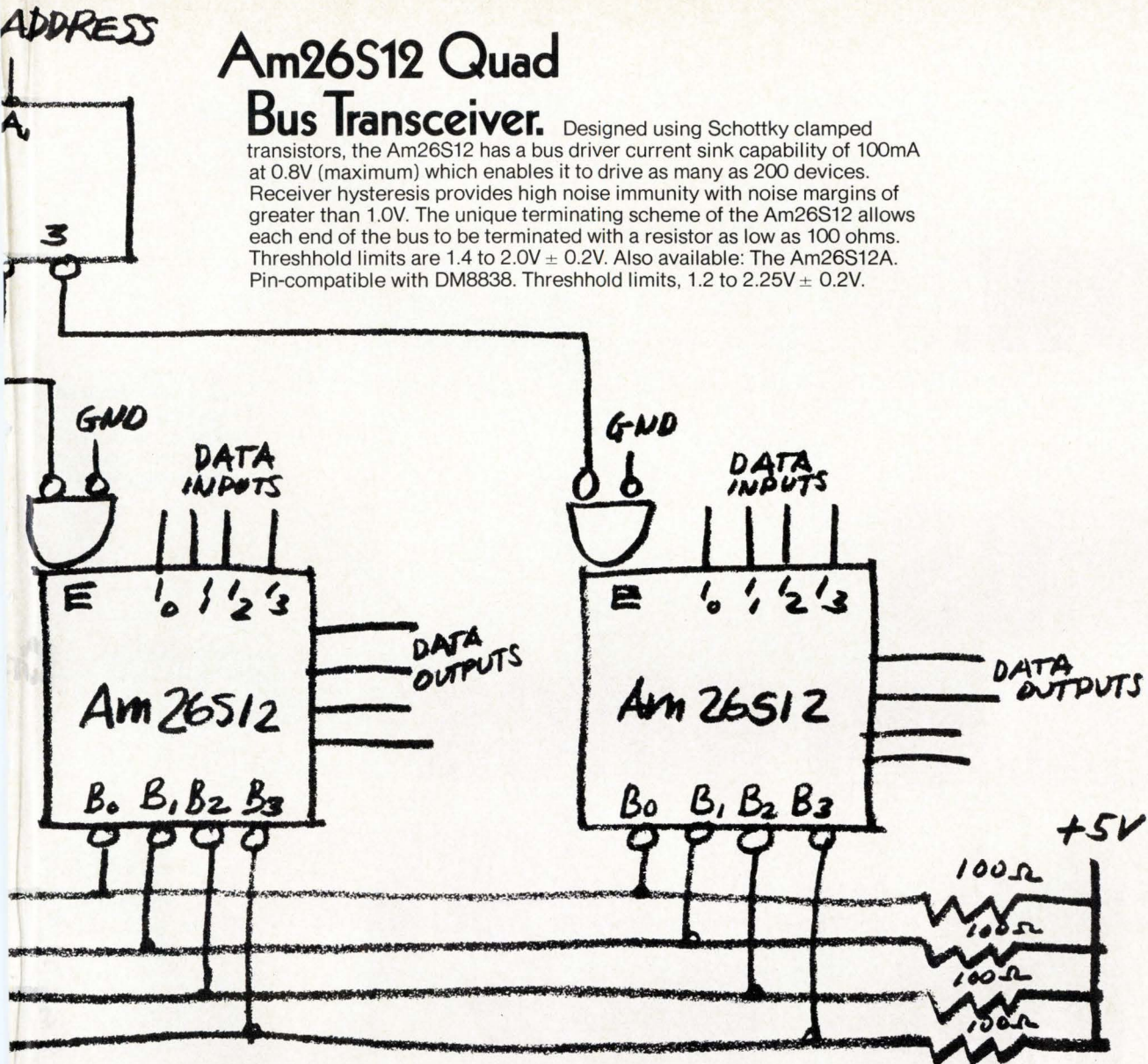

It's a bus driver with the world's highest drive capability and a bus receiver with unbelievably high noise immunity together in a single package.

It's the speedy new Am26S12 Quad Bus Transceiver. Yet another step forward in our relentless effort to become the sixth largest maker of integrated circuits in the country by 1975.

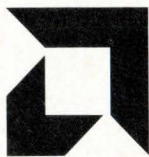

# Advanced Micro Devices Inc.

(We're going to be #6.)

# Now.

# CMOS analog gates for $\pm 12V$ signals ...with their problems solved.

**1.** No more "latching-up." Intersil's new Floating Body technology eliminates the problem.

**2.** No more channel-to-channel shorting. Intersil's new gates guarantee break-before-make switching.

**3.** No more costly low-reliability hybrid construction. Intersil's new CMOS gates are all monolithic.

## Floating Body technology does it.

Up to now, high level CMOS analog gates had real problems. Worst of all was the "latch-up" which occurred when a negative signal came along and the power supplies were off (Figure 1). At best, the switch just stopped operating, but all too often the whole IC was destroyed and had to be replaced.

But no more. Intersil's new IH5040 Series CMOS analog gates utilize a new technology—the "Floating Body" process—which not only eliminates latch-up but protects against over-voltages to  $\pm 25V$  without degrading ON resistance. It does this by effectively placing a diode in series with the body, isolating the entire device from the body of the chip (Figure 2).

Figure 1. A high current path exists when the negative supply is off and a negative input signal is present. Under these conditions, latch-up or destruction of the device will occur.

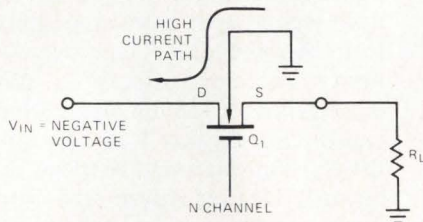
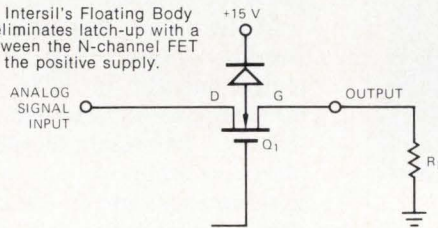

Figure 2. Intersil's Floating Body Process eliminates latch-up with a diode between the N-channel FET body and the positive supply.



## The IH5040 Series CMOS analog gates.

These monolithic switches will handle positive or negative signals greater than 25V p-p with  $\pm 15V$  power supplies. Their ON resistance is as low as 30 ohms, quiescent current is less than  $50\mu A$ , and they can be controlled and switched in 500nS (typ.) from TTL, DTL, CMOS and PMOS circuitry.

Available in military and commercial temperature ranges, with volume prices of some models approaching \$2.00 per SPST channel, they are equivalent replacements for many more expensive hybrid analog gates.

Intersil Part No.	Type	R <sub>ON</sub>	Replaces
IH5040	SPST	75 $\Omega$	New function
IH5041	Dual SPST	75 $\Omega$	DG182A/B
DG200	Dual SPST	70 $\Omega$	DG200
IH5042	SPDT	75 $\Omega$	DG188A/B
IH5043	Dual SPDT	75 $\Omega$	DG191A/B
IH5044	DPST	75 $\Omega$	New function
IH5045	Dual DPST	75 $\Omega$	DG185A/B
IH5046	DPDT	75 $\Omega$	New function
IH5047	4PST	75 $\Omega$	New function
IH5048	Dual SPST	30 $\Omega$	DG181A/B
IH5049	Dual DPST	30 $\Omega$	DG184A/B
IH5050	SPDT	30 $\Omega$	DG187A/B
IH5051	Dual SPDT	30 $\Omega$	DG190A/B

## Get 'em here

Intersil stocking distributors. Schweber Electronics. Semiconductor Specialists. R. V. Weatherford Co.

Intersil area sales offices. Boston (617) 359-7188. Chicago (312) 371-1440. Los Angeles (213) 370-5766. Minneapolis (612) 925-1844. New York (201) 567-5585. San Diego (714) 278-6053. San Francisco Bay Area (408) 257-5450.

Overseas representatives. Copenhagen: E. V. Johanssen A/S. Helsinki: Digelius Electronics Finland OY. London: Tranchant Electronics (UK) Ltd. Milan: Auriema Italia SRL. Munich: Spezial Electronic. Paris: Tranchant Electronique. Stockholm: Elektroholm. Tel Aviv: Schweber Electronics. Tokyo: Internix. Zurich: Laser- & Electronic-Equipment.

U.S. Representatives in all major cities.

# Intersil



# FREE Engineering Handbook from RCL Electromagnetic Delay Lines

Including Dual-In-Line  
(DIP)

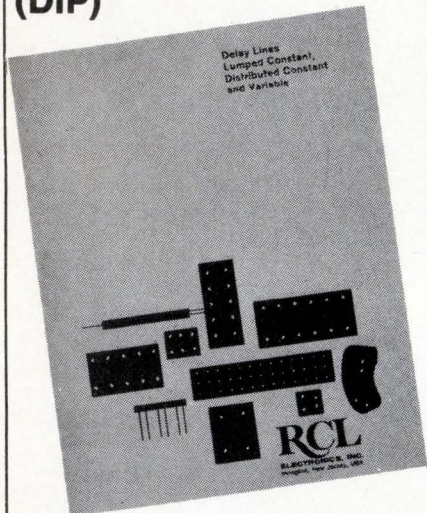

**NEW  
'73**

## EDITION

Terms... engineering definitions... test methods ... how to specify delay lines ... characteristics of various types ... specifications ... they're all included in this concise, easy-to-read handbook... yours for the asking.

**LUMPED CONSTANT ...  
DISTRIBUTED CONSTANT  
... VARIABLE**  
all three types are covered in this reference handbook.

# RCL

RCL ELECTRONICS, Inc.,

General Sales Office:

Seven Hundred  
South Twenty First Street  
Irvington, New Jersey 07111

## People

Profits and apples: both concern Quotron's Mohr

If, as Churchill said, recreation is only a change in worries, Milton E. Mohr, president of Quotron Corp., Los Angeles, is getting plenty of recreation. His avocation is raising apples; he has 14,000 trees planted near San Luis Obispo, Calif. Last year frost wiped out most of the crop.

Like Quotron, which was Scantlin Electronics until last month, his apples now show a lot of promise. But at Quotron, Mohr has a great deal more control over the elements than he does in his orchards. It's probably because he's exercised that control carefully that Quotron appears ready to bear fruit.

Mohr, who was president of Bunker Ramo Corp. before he joined Scantlin in 1970, feels that the company will become profitable this year. Its present business is supplying communications to brokerage houses, and it's taken a great deal of front-end money to get going. The industry's confidence in the company, though, is shown by heavy investments from Dow Jones, Dun and Bradstreet, and Rockefeller interests. Quotron has major contracts from Wheaton and Solomon Brothers for quotes, trading, and research systems—including electronic billboard displays—and is now expanding into other fields.

High on the list is credit checking for banks and Dun and Bradstreet. D&B has three systems to process data, and is adding 95 around the country, all replacing tedious manual collection systems with computer systems that collect, edit, store, communicate, and type out reports.

**What it took.** Mohr feels that his major contribution has been in making the company a going concern by finishing system development, building the field force, and obtaining financing. His main work is in management, but he sometimes falls back on his background in electrical engineering (University of Nebraska, 1938): "I even get into the lab occasionally."



**Mohr for the money.** Quotron's Mohr helped firm obtain new financing.

After a stint at Bell Labs, he went to Hughes Aircraft Co., then to Ramo Wooldridge, where he managed the computer division (by then part of TRW). This merged with a division of Martin Marietta to become Bunker Ramo, and Mohr became president in 1966. He left in 1969, disagreeing with new management from Amphenol ("There were too many second-guessers"). While there, though, Mohr negotiated a contract for Bunker Ramo to supply the Nasdaq (National Association of Security Dealers Automated Quotation) system for over-the-counter stocks.

With the expected profitability of the company this year, Mohr can worry more about his apples. He expects a good crop this year, but is still thinking about frost: "We can't use smudge pots because of the pollution, and fans are expensive. It looks like helicopters, which could fly over when the temperature drops, may be a good solution."

In-Line founders are in tune with photoprocessing trend

A company that started as a part-time effort some 18 months ago has recently become its founders' sole business concern, and indeed, they appear in a good position to profit from semiconductor manufacturers' growing enthusiasm for automating their photoprocessing operations.

While Hendrik F. Bok and Eugene R. St. Onge worked together in the Systems division of EPEC Industries Inc., New Bedford, Mass., they saw the need for systems that could automatically handle cleaning, dry-





## Sangamo Recorders. For people who need 32 channels of data. And people who don't.

When you tackle a job that calls for 32 channel recording, you've pretty well got to come to us. We make the Sabre V, the only IRIG all-band portable tape recorder on the market with up to 32 channels on one-inch tape.

But not all jobs need the Sabre V, and we want you to depend on Sangamo anyway. So we also offer the Sabre III, Sabre IV and the Sangamo/Tandberg TIR 100—newest addition to our line.

Sabre III gives you lab quality and total bandwidth convertibility in a compact all-band portable.

Sabre IV is our laboratory model that's setting new standards of accuracy in recording and reproduction.

Both Sabre III and IV let you process data up to 2.0 MHz in the direct mode, 500 KHz in the FM mode, and with full

serial and parallel PCM capability. They feature total bandwidth convertibility, too.

The Sangamo-Tandberg TIR 100 does almost everything you'd expect a \$16,000 recorder to do but costs under \$4,500. It features four channels including one for voice or data recording, a built-in CRT monitor and a portable size smaller than a cubic foot.

That's four Sangamo recorders in all. One of them is bound to do the best possible job on your data recording job—whatever it is.

For more information, write:

Sangamo Electric Company, Data Systems,  
P.O. Box 3347, Springfield, Illinois 62714.  
Or call (217) 544-6411/Telex 406-421.

**SANGAMO RECORDERS**  
THE INNOVATORS IN TAPE INSTRUMENTATION

# Cast moulded WIMA<sup>®</sup> capacitors



**Encapsulated  
in cast resin under  
vacuum to eliminate  
air inclusions.**

**Advantages:  
Small physical size;  
high resistance to  
moisture, favourable  
a. c. characteristics.  
Voltage ratings  
up to 1000 V d. c.**

**For stringent  
requirements.**

## Types:

**WIMA MKS 3** Metallized polyester capacitors for 100 and 250 V d. c. 0.022  $\mu$ F ... 0.47  $\mu$ F.

**WIMA FKS 3** Polyester film and metal foil capacitors for 160 and 400 V d.c. 1000 pF... 0.1  $\mu$ F.

**WIMA FKS 3** Polycarbonate film and metal foil capacitors suitable for frequency divider circuits. Close tolerances available. 160, 400, 630 and 1000 V d. c. 100 pF ... 0.1  $\mu$ F.

**WIMA FKS 2 min.** Polyester film and metal foil capacitors, subminiature, suitable for very small equipment. 100 V d. c. from 100 pF ... 0.047  $\mu$ F.

## WILHELM WESTERMANN

Spezialfabrik  
für Kondensatoren  
Augusta-Anlage 56  
P.O. Box 2345  
D-68 Mannheim 1  
Fed. Rep. of Germany  
Tel.: (621) 40 8012

*Please send for  
our latest  
catalogue.*



## People

ing, etching, and developing. "There are a lot of different systems available," notes Bok, "but you have to buy the etcher from one company, the coater from another. To form a complete line of equipment, a plant manager needs to buy four or five makes of equipment that aren't always compatible."

The two men joined forces to make specialized turnkey photoprocessing systems, and In-Line Technology Inc. was born in Assonet, Mass. By now, In-Line has emerged from a custom-equipment phase with a number of standard items, including cleaners, coaters, dryers, developers, etchers, wet strippers, and plasma strippers, all of which are interfaced for either manual or automatic loading.

**Cutting loose.** During In-Line's first year, Bok and St. Onge kept their jobs at EPEC, but last October they were able to buy out EPEC's Spray division and devote full time to In-Line, of which they are sole owners. Sales this year may reach \$1 million.

Bok thinks part of their success is a result of "the imagination to come up with something new," but part of it is traceable to their backgrounds also. Bok, 47, founded his first company in 1954 in his native Netherlands. (He still speaks with a Dutch accent.) It made spray coaters, and in 1958 he brought the process with him to the U.S. where three years later he founded another company with expertise based on the same process. Joining EPEC in 1967 as a vice president, he gained experience in coating and first started to build integrated systems including sprayers, dryers, exposure equipment, and developers.

While Bok considers himself a "concept" engineer, St. Onge, 36, is a process engineer. One need they see is for better yields, and they believe their automatic production lines, which include automatic wafer handling, can help. Since wafers and plates are untouched throughout production, and the line is so timed that clean plates don't have to wait before being coated, dirt-caused pinholes and other faults are cut down.

# UHF demanded 1 GHz FETs. Signetics D-MOS does it.

FETs? From Signetics?

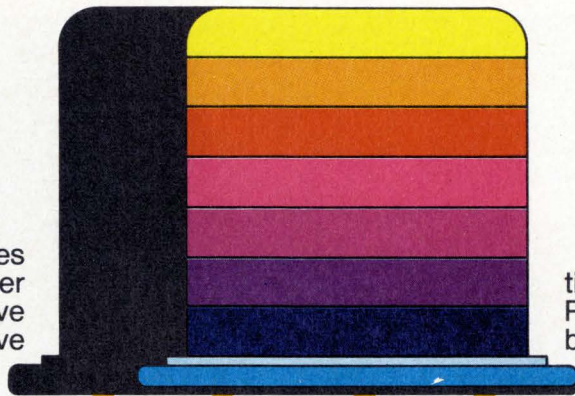

Surprise! Signetics goes discrete. With the first FETs ever produced for frequencies above 450 MHz. And everything we've poured into optimized ICs for years — ingenuity, painstaking research, user-oriented problem solving — has gone into developing these trouble-shooting UHF FETs. All double-diffused MOS devices of the N-channel enhancement mode type.

Four of them to start. Providing UHF designers unique performance that bipolar has never matched for mobile units, marine phones, TV tuners... and hundreds of similar applications.

Two single-gate D-MOS FETs. SD-200, unprotected by design. SD-201 with diode protection against transients. Both offer exceptionally low gate leakage. Plus unbeatable high-gain, low-noise figures.

And two dual-gate diode-protected FETs, that show excellent linearity in cross- and inter-modulation. SD-300 with AGC capacity, and ultra low noise SD-301.

Superb cross modulation characteristics at 1 GHz. Remarkably low input and feedback capacitance. Extremely high transconductance. The lowest noise figures

of any existing FETs. And simpler bias schemes.

**1 GHz**

Record-breaking low cost too. Our D-MOS FETs obviously outperform standard bipolars, hands down — for less than one-fifth the cost. Under four bucks in 100-piece quantities, instead of the \$20 or \$30 you'd expect.

Available now through your distributor in TO-46 hermetic cans, with four leads. Call for immediate delivery. Or tune in for the news behind the news, by sending for complete data sheets, technical and editorial back-up information, and of course, our application notes.



**Public notice.** Be one of the first 100 inquiries we receive, and you'll get the D-MOS FET of your choice

FREE to play around with.

## N-Channel D-MOS FETs

CHARACTERISTIC	SD-200/201	SD-300	SD-301
Gain at 1 GHz	10dB	13dB	14dB
Noise at 1 GHz	4.5dB	8dB	6dB
Fwd. Transconductance ( $\mu$ MHO)	15,000	10,000	10,000
Input Capacitance	2.0pF	2.0pF	2.0pF
Output Capacitance	1.0pF	1.0pF	0.6pF
Feedback Capacitance	0.13pF	0.02pF	0.02pF
Drain-to-Source Voltage	+30V	+30V	+30V

Signetics—D-MOS FETs  
811 E. Arques Avenue  
Sunnyvale, California 94086

Show me what a great IC supplier is up to in FETs. Send everything you've got on these discrete devices (and hopefully my FREE D-MOS FET: #SD-\_\_\_\_\_).

Name \_\_\_\_\_  
Title \_\_\_\_\_

in care of the letterhead address on the sheet of company stationery I have stapled, glued, clipped or otherwise appended to this coupon.

Signetics Corporation. A subsidiary of Corning Glass Works.

**signetics**

**Siemens has made  
more cradle relays than  
anyone in the world.**

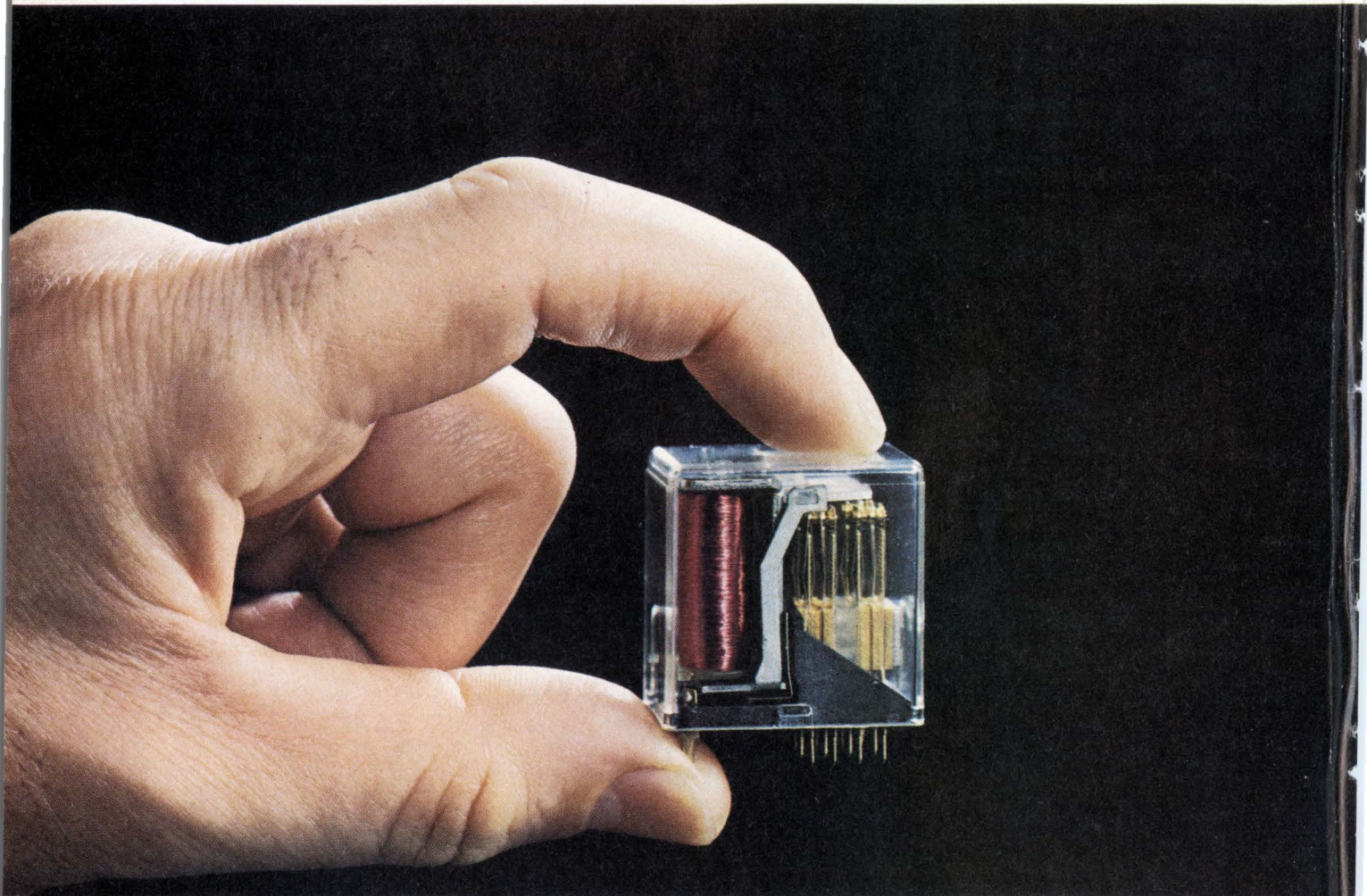

**Whatever your application,  
Siemens can offer you the right  
cradle relay at the right price.  
And in the quantity you require.**

In the years since we designed and built the first cradle relay, we've produced over 100 million of them. And we've developed highly automated mass production and quality control techniques that have made possible a new order of product quality and uniformity at the lowest possible prices.

Siemens cradle relays are UL listed at no extra cost to you. And they are freely interchangeable with cradle relays of other manufacturers.

The Siemens line of cradle relays includes the industry's widest variety of contacts, terminals and mounting styles. And magnetic latching, hermetic and sensitive versions are also available.

Siemens cradle relays are ideal for circuitry in computer peripherals, communications, industrial controls, alarms and signal equipment, medical electronics and office machines.

While the cradle relay is still the most popular relay around, Siemens continues to introduce new designs. Our latest is a new family of low-profile PC board relays that we expect will start another major trend.

Write or call us for more information.  
Siemens Corporation, 186 Wood  
Avenue South, Iselin, N.J. 08830.  
(201) 494-1000 Ext. 239.

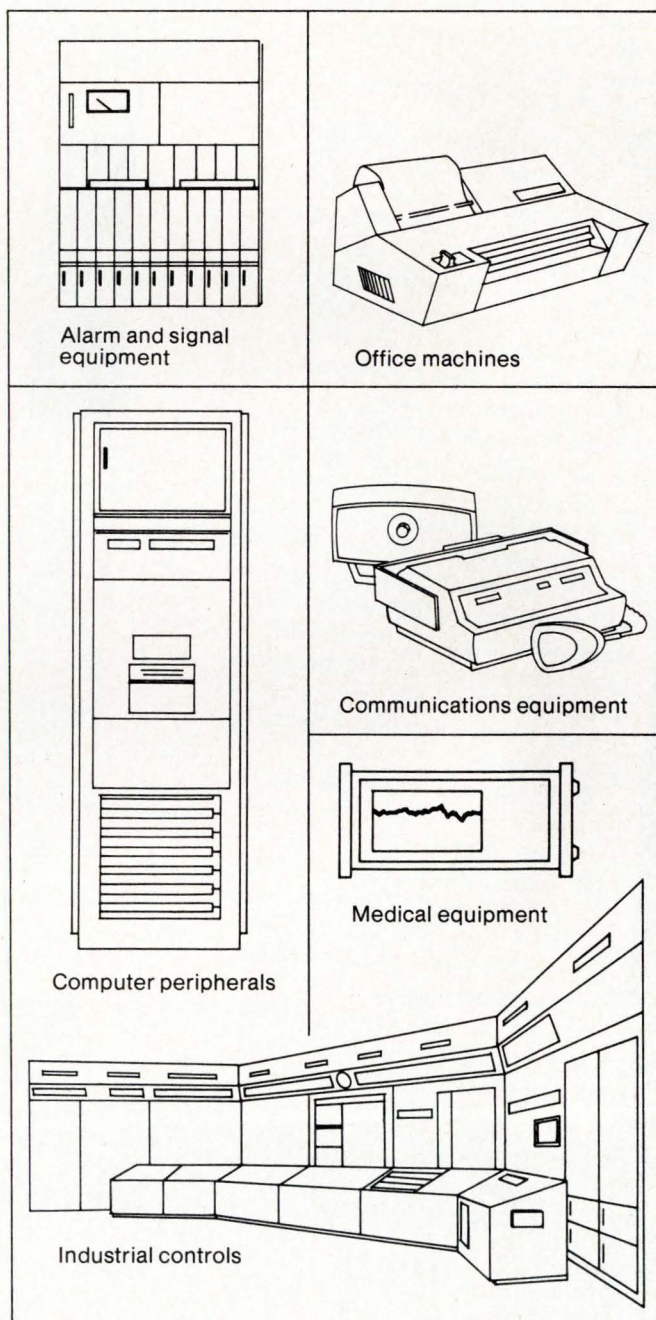

Dear Gabby: \_\_\_\_\_

**"1728 Combinations  
with \$90 worth of  
Shelly Multi-Message  
Modules."**



**Datatron's Girl Gabby**

**D**EAR GABBY: A math whiz at our firm bet me he could display over 1700 different message combinations for under \$100. Impossible, isn't it?

**WINSOME WAGERER**

**D**EAR WINSOME: This time you lose some. On the 3 Shelly Multi-Message Modules at the right you could display 1728 different combinations of phrases, words, letters, numerals, symbols or pictures. Anything photographable, for that matter. And you can choose mixed colors to add more meaning to the messages.

Take the center module. Any of the 12 messages shown can be flashed on the viewing screen from a decimal or BCD input. For \$30 you can display 12 different messages. That's only \$2.50 a message! And the compact modules can be mounted in groups to provide large vocabularies at a fraction of the cost of CRT terminals, teleprinters or other expensive information displays.

Shelly Multi-Message Displays give you more usable viewing area too. Our SRO-90 with a 0.435" high display has a 20% larger image in a 20% smaller housing. And our 0.7" high SRO-600 is 10% larger than older types, yet the housing is 30% smaller.

Before you make any more bets, better send for Shelly's Multi-Message Readout brochure.

GABBY



**shelly/datatron**

1562 Reynolds Ave. Santa Ana, Calif. 92711  
(714) 540-9330

**moving up fast in...**

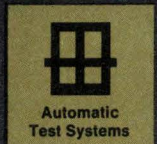

## Meetings

**Aerospace Instrumentation Symposium:** ISA, Frontier, Las Vegas, Nev., May 21-23.

**National Aviation System Planning Review Conference:** FAA, Washington Hilton, Washington, D.C., May 21-23.

**Electronic Component Show:** RECMF, Olympia, London, England, May 22-25.

**Conference on Laser Engineering and Applications:** IEEE, OSA, Hilton, Washington, D.C., May 30-June 1.

**International Microwave Symposium:** IEEE, U. of Colorado, Boulder, June 4-6.

**National Computer Conference and Exposition:** AFIPS, New York Coliseum, June 4-8.

**Consumer Electronics Show:** EIA, McCormick Place, Chicago, June 10-13.

**Chicago Spring Conference on Broadcast and TV Receivers:** IEEE, Marriott, Chicago, June 11-12.

**Frequency Control Symposium:** ECOM, Howard Johnson's Motor Lodge, Atlantic City, N.J., June 12-14.

**National Cable TV Association Annual Convention:** NCTA, Convention Center, Anaheim, Calif., June 17-20.

**International Symposium on Electromagnetic Compatibility:** IEEE, New York Hilton, New York, June 20-22.

**International Symposium on Fault-Tolerant Computing:** IEEE, Palo Alto, Calif., June 20-22.

**Design Automation Workshop:** ACM, IEEE, Sheraton, Portland, Ore., June 25-27.

**International IEEE G/AP Symposium and USNC/URSI Meeting:** IEEE, U. of Colorado, Boulder, Aug. 21-24.

# New **TY-RAP**® Tool completes one million ties every month

Triggered 70,000 times each day without a misfire!

As you read this message, the production model of this pneumatic hand tool, TR-225, is continuing its life cycle test... 1,000,000 cycles per month without a falter.

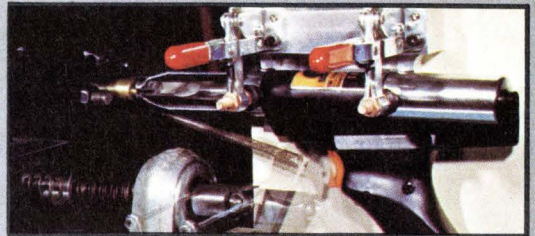

This 20 ounce tool ties wire bundles from 1/16" to 4" diameter with just about every regular and "Slim Line" type TY-RAP® cable tie... 16 sizes in all. It reduces operator fatigue... and is particularly well suited for close-up work, break-out points and tying in confined places in equipment.

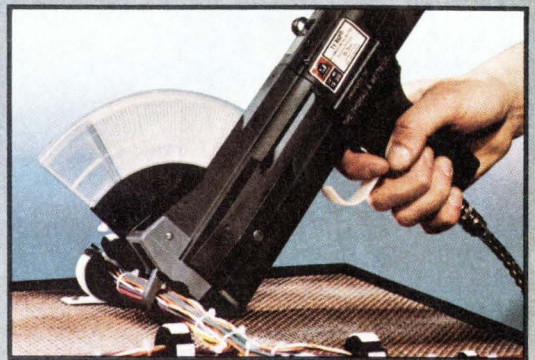
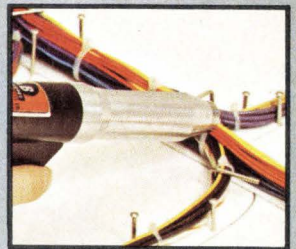

Our other new production tool, the high speed TR-300, automatically positions a TY-RAP tie around bundle, cinches to a preset tension, locks tie securely and trims evenly... all in 8/10 of a second... and on bundle diameters ranging from 1/32" to 5/8".

Write for new catalog. The Thomas & Betts Co., Elizabeth, New Jersey 07207, (201) 354-4321. In Canada, Thomas & Betts Ltd., P.W.

**Sold Only Through Authorized T&B Distributors**



## **THOMAS & BETTS**

Division of Thomas & Betts Corporation

Circle 21 on reader service card

524

**“Augat’s interconnection system appeared to have more advantages for use in the AN/TPX-42A Air Traffic Control System.**

**“Our extensive testing confirmed it.”**

Robert A. Mesard, Group Leader  
Transportation Systems Division  
A.I.L. Division of Cutler Hammer.



"When work began on the AN/TPX-42A, we started looking for an interconnection system that offered high reliability and design flexibility, without sacrificing lower initial costs or low field maintenance.

"Our program staff ran detailed reliability and cost analyses of the four basic interconnection systems under consideration: P.C. boards, multi-layering, welded wire-stitching, and wire-wrapped plug-in panels.

"The system meeting all of our requirements was wire-wrapped plug-in panels. We compared several manufacturers of socket panels and selected the Augat panel based on overall quality, range of products, and their willingness to respond to our needs.

"Our findings were incorporated into our proposal to the Air Force. But as the wire-wrapped plug-in panel concept was comparatively untried in U.S.A.F. equipment, they requested additional testing. So we ran a series of in-depth reliability and stability studies and tests as part of our systems qualification and reliability demonstration program.

"After 13,200 test hours, we experienced no mechanical failure or intermittence with the Augat system.

"Electronic Systems Division of U.S.A.F. accepted these findings and approved the Augat system.

"We now have used substantial production quantities of Augat panels without a single contact failure."

Augat first pioneered the socket-panel concept in 1965, and the exclusive precision-machined tapered-entry contact has made Augat the reliability standard for the plug-in interconnection industry.

A.I.L.'s record of not a single contact failure is one of the reasons why Augat supplies more panels than all other manufacturers combined.

As the world's leading manufacturer of wire-wrapped panels and other IC interconnection products, Augat is ready and willing to help with all your interconnection requirements.

Call or write today for free brochure and complete product information. Augat, Inc., 33 Perry Ave., Attleboro, Massachusetts 02703. Represented and distributed internationally.

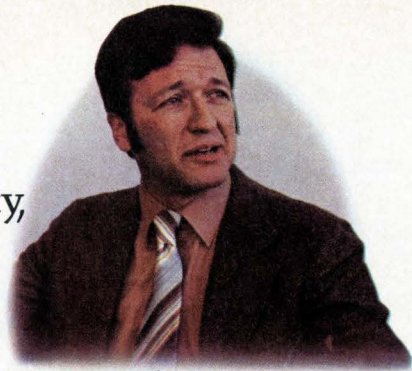

Robert A. Mesard

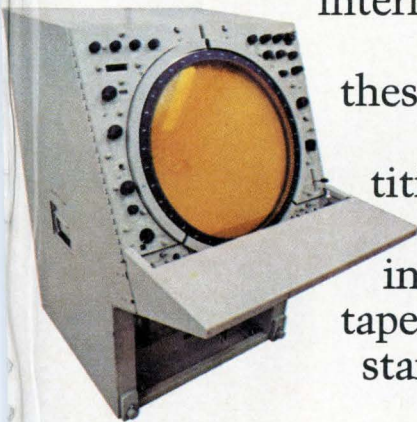

The AN/TPX-42A

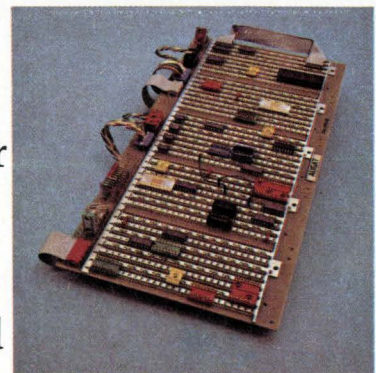

Augat I.C. Socket Panel

**Plug into Augat.® A.I.L. did.**

Type EJ, the pot  
with rotational life  
in excess of  
1 MILLION CYCLES.

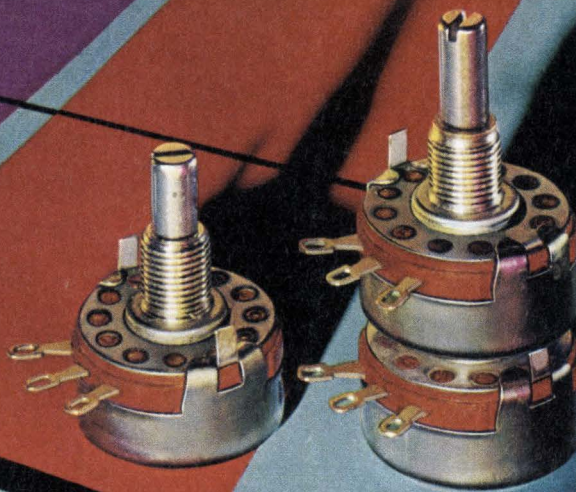

Actual Size

If you're really  
serious about cost,  
be serious about quality.

This is the EJ, an extended life version of our famous "J" pot. Same dependable performance. Same power handling capability. Same quality throughout, but with a tremendous difference in rotational life. One good turn after another for more than 1,000,000 cycles (under normal use

within ratings per Publication 5230). Specify the EJ for electronic organs, lift trucks, automotive and process control applications. Hot molded composition, 2.25 watts. Resistances from 50 ohms to 5.0 megs. Usable from  $-55^{\circ}\text{C}$  to  $+120^{\circ}\text{C}$ . Five standard tapers. Single or dual sections.

Request Publication 5230. Allen-Bradley Electronics Division, 1201 South Second Street, Milwaukee, Wisconsin 53204. Export: Bloomfield, New Jersey 07003. Canada: Allen-Bradley Canada Limited, Cambridge, Ontario. United Kingdom: Jarrow, County Durham NE32 3EN.



## **Solitron drops 74C as GI debuts with 4000 series**

National Semiconductor's 54C/74C, the complementary MOS family that's pin-to-pin compatible with the widely used 54/74 transistor-transistor-logic line, has lost more ground to the rival 4000 series. Solitron Devices, which last year announced a number of 74C functions, **has quietly canceled them because of demand for RCA's more popular 4000 series.** Motorola Semiconductor is also sticking with 4000.

At the same time, General Instrument has decided to enter the C-MOS market with a quad bilateral switch similar to RCA's 4016. It will be available this month. Ed Kramer, a product marketing manager in GI's Semiconductor Components division, says **GI will announce eight 4000-type C-MOS products by the end of the year.**

**But National appears to be unfazed.** The company, which started slowly with 74C, says it now has a complete line of functions with TTL output and is still determined to make 74C its standard C-MOS product line. One reason: **most designers, National says, are familiar with TTL and would tend to favor the compatibility of 74C.** A big question, though, has been whether or not Texas Instruments will build 74C; a spokesman says flatly, "TI has no plans to introduce commercial 74C CMOS."

## **Fairchild wins Navy award for CCD work**

Nosing out Texas Instruments and RCA, **Fairchild Camera & Instrument has won an \$800,000-plus phase 2 award for further development of charge-coupled devices.** Earlier, Fairchild had built for the contractor, the Naval Electronics Systems Command, a 500-element linear imaging array and a 100-by-100 area-imaging array, as well as a 100-by-100 CCD television camera [*Electronics*, Feb. 15, p. 31].

The nine-month phase 2 program calls for prototype cameras fabricated from still larger arrays, with emphasis on perfecting anti-blooming and on-chip amplification techniques. Eventually, **the program aims to develop triservice low-light-level cameras.**

## **Westinghouse tube stores halftones and alphanumerics**

Westinghouse is about to test an experimental scan-converter storage tube, which is binary-addressable, for turning digital data into either alphanumeric or halftone displays. **The tube stores information as charges on a mesa target.** This is done after a collimated beam of electrons floods through a 512-by-512 array of 1-mil-diameter holes drilled in three aligned pairs of silicon plates, each 3 inches in diameter. Charge patterns on the plates, in effect, close selected holes. The technique is similar to that used in the digitizer stack of Northrop Corp.'s direct-view Digisplay tube [*Electronics*, June 21, 1971, p. 30].

To read out the information, the target is scanned with an electron beam as in an ordinary vidicon camera. **All of the more than a quarter-million elements are individually addressable.** The Army Electronics Command at Ft. Monmouth, N.J., is sponsoring the work. Video-frequency range of the tube is 0 to 10 megahertz.

## **Monolithic IC contains Hall-effect sensor**

Monolithic integrated circuits containing silicon Hall-effect sensors are being made by Interdesign Inc., of Sunnyvale, Calif. Hans Camenzind, president, says **the devices will compete with electromagnetic proximity switches in machine tools and other industrial control systems.** The sen-

sor is part of an uncommitted array that also contains some 30 npn and npn transistors and a variety of diffused resistors. Called a Monochip, the array is converted to custom analog, digital, or analog-digital control circuits with custom metalization patterns.

While the silicon Hall platelet is much less sensitive than the inter-metallic ones used in tape readers [*Electronics*, Feb. 1, p. 91], **it generates 50 millivolts in a field of less than 2 kilogauss.** That allows the tiniest magnets made for industrial controls to actuate the circuit, and if more powerful outputs are required, the 50 millivolts can be amplified on the chip.

## In dense Ampex array, cores rub together

Ampex Corp.'s Computer Products division, Marina del Rey, Calif., is reported to be developing a new ferrite-core-memory array so dense that **the cores are literally rubbing against one another.** The fully populated result of this design, which is a step up from the company's heringbone pattern [*Electronics*, Nov. 9, 1970, p. 119], looks like a thick film; **the individual cores are not distinguishable to the naked eye.**

In the array, conventional 18-mil cores are stacked on edge and essentially in contact, **but staggered at a 40° angle instead of the usual 45°.** A single wire passes through one row of cores at the steep angle and two wires through a row at right angles to the first at the shallower angle, for a 2½-dimensional system organization.

## Laser lines up sender, receiver for communications

A major limitation of mobile laser communications—keeping both ends of the path aligned—appears to have been overcome by a new stabilized laser transceiver. Developed by American Laser Systems of Santa Barbara, Calif., **the unit can be hand-held on rolling ships, moving cars, and speeding helicopters.**

American Laser has combined a stabilized telescope with a small diode laser transmitter and receiver to form a 5-pound device about the size of a home movie camera with a 15- to 20-mile range. It operates from rechargeable D cells, drawing one-third the current of a standard flashlight. To use it, the operator just roughly sights in the target through a 10-power telescope, then talks. **Both the U.S. Navy and police departments are interested in the device for secure communications.**

## Addenda

The Bell System has announced the first availability outside AT&T of a new teleprinter unit called Dataspeed 40. The unit, developed by Teletype Corp., will be the first Bell System offering with a cathode-ray-tube display and is **another step toward having one vendor provide "end-to-end" service.** . . . Siemens AG of West Germany has awarded a contract to a small three-year-old New Jersey firm **for an \$855,000 automated test system for pc boards.** More than a dozen of the systems, called System 390 by Instrumentation Engineering of Franklin Lakes, N.J., have been sold to RCA, Raytheon, Xerox, ITT-Europe, and the Navy. . . . Production of mated-film memory modules is being doubled at the Federal Systems division of Univac in St. Paul, Minn. The bulk of past production has been for Univac's 1830 aerospace computer—**but the company is rumored to be preparing to change from ferrite cores to mated film** in its AN/UYK-7 computer for Navy ships, and the change will absorb some of the increased production.

# Φ-LINE POWER SWITCHING TRANSISTORS

## 100 WAYS TO GET MORE INDUSTRIAL SWITCHING PERFORMANCE FOR YOUR MONEY

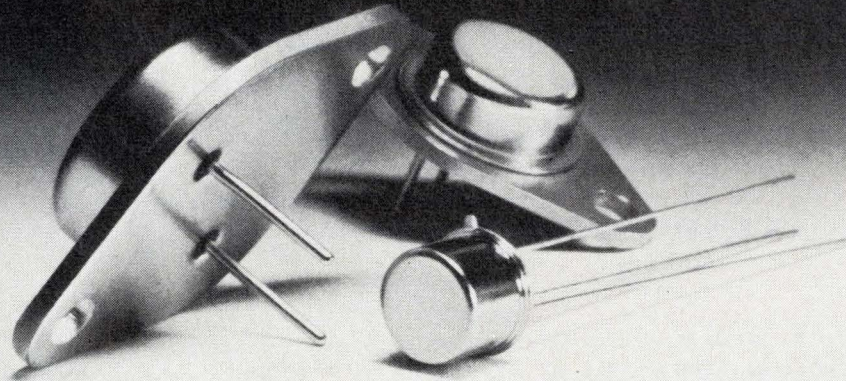

Unitrode's UPT Power Switching Transistor series offers the optimum combinations of price and performance from 0.5A to 20A, and up to 400V in 3 package types. Choose from 100 different transistor types for more efficient and simplified circuit design in power supplies, switching regulators, inverters, converters, solenoids, stepper motors and other inductive load driving applications. They're available off-the-shelf from your local Unitrode distributor or

representative. For the one closest to you, dial (800) 645-9200 toll free, or in N.Y. State (516) 294-0990 collect.

For immediate action on any specific problem, call Sales Engineering collect at (617) 926-0404, Unitrode Corporation, Department 5Y, 580 Pleasant Street, Watertown, Massachusetts 02172.

For specific data sheets containing full characterization of devices check the table/coupon below.

**Unitrode Corporation** Dept. 5 Y, 580 Pleasant St., Watertown, Mass. 02172

Please send data sheets on specific Φ-Line Power Switching Transistor series checked below.

Check Here	I <sub>c</sub>	V <sub>CER</sub>	SERIES/ PACKAGE	t <sub>on</sub>	t <sub>off</sub>	100 Qty prices each
<input type="checkbox"/>	0.5ADC	up to 400V	UPT011 -T05 UPT021 -T066	50ns	400ns	\$1.02 to 2.30
<input type="checkbox"/>	1ADC	up to 150V	UPT111 -T05 UPT121 -T066	100ns	250ns	0.83 to 1.86
<input type="checkbox"/>	2ADC	up to 150V	UPT211 -T05 UPT221 -T066	130ns	300ns	1.08 to 2.42
<input type="checkbox"/>		up to 400V	UPT311 -T05 UPT321 -T066	200ns	800ns	1.25 to 2.73
<input type="checkbox"/>	3ADC	up to 400V	UPT521 -T066 UPT531 -T03	200ns	900ns	2.30 to 3.80

Check Here	I <sub>c</sub>	V <sub>CER</sub>	SERIES/ PACKAGE	t <sub>on</sub>	t <sub>off</sub>	100 Qty prices each
<input type="checkbox"/>	5ADC	up to 150V	UPT611 -T05 UPT621 -T066	250ns	550ns	\$1.25 to 2.72
<input type="checkbox"/>		up to 400V	UPT721 -T066 UPT731 -T03	250ns	800ns	3.38 to 5.43
<input type="checkbox"/>	10ADC	up to 150V	UPT821 -T066 UPT831 -T03	250ns	550ns	3.14 to 5.05
<input type="checkbox"/>		up to 400V	UPT931 -T03	500ns	1200ns	7.67 to 13.92
<input type="checkbox"/>	15ADC	up to 150V	UPT1021-T066 UPT1031-T03	450ns	350ns	3.69 to 5.93
<input type="checkbox"/>	20ADC	up to 150V	UPT1131-T03	300ns	600ns	4.52 to 6.91

Name: \_\_\_\_\_ Title: \_\_\_\_\_  
 Co.: \_\_\_\_\_ Address: \_\_\_\_\_  
 City: \_\_\_\_\_ State: \_\_\_\_\_ Zip: \_\_\_\_\_  
 Telephone: \_\_\_\_\_

See EEM Section 4800 and EBG Semiconductors Section for more complete product listing.

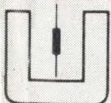

**UNITRODE** quality takes the worry out of paying less.

# When a power company needed SCR's fast, GE delivered-- overnight.

Last April, the exciter on a generator for Public Service Company of New Mexico failed, taking 22 GE high current silicon rectifier stacks out with it. And 75 MW of power away from Albuquerque.

Public Service contacted the exciter's manufacturer. Fixing it was no problem, they learned, but new rectifiers might take a couple of weeks to get. They'd been custom-built for that one exciter.

But two weeks was far too long for Public Service to wait. So they called GE direct. They got in touch with Carolen Quinn, a Sales Assistant in the Electronic Components Sales Department.

Immediately Carolen went to work to get those SCR's. Her first move was to call GE's SCR plant in Auburn, New York.

Carolen explained the problem and how critical those rectifiers were. The Auburn plant then went to work for the customer. People were put on overtime. Production was expedited.

Next day GE had all 22 completed and air freighted to Albuquerque. Public Service got them installed, the generator back on line, and the system back up to normal.

GE people like Carolen Quinn want to keep our customers satisfied. Customers like you. Because good business for us is being good for you to do business with.

690-15

GE won't leave you alone.

GENERAL  ELECTRIC

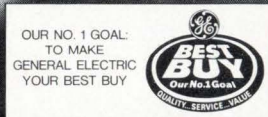

## Further controversy shaping up over 900-MHz allocations

AT&T, Motorola are the chief antagonists as equipment makers and users face FCC

**Should 75** out of the 115 megahertz allocated for land-mobile radio service in the controversial 900-MHz region belong to AT&T? That lingering question is the official frame for two days of what is expected to be heated argument. On May 14 and 15, the Federal Communications Commission will hear contesting interests on how the spectrum should be divided and used.

The real issue—how much of the booming market AT&T is entitled to—pits the communications giant against a leading equipment maker, Motorola—along with General Electric, RCA, and smaller manufacturers—with a host of land-mobile operators and users also worried about how the 900-MHz portion of the spectrum will be split up. At stake is who will design the systems and make the equipment.

Under relentless pressure from radio land-mobile interests contesting AT&T's lion's share, the FCC is nearing the end of a year's study over how to divide the precious spectrum. Two years ago, it gave AT&T and other wire-line common carriers the 75-MHz region from 806 MHz to 881 MHz as a step toward developing a nationwide, broadband, common-carrier mobile service. It gave the remaining 40 MHz (881-902 MHz and 928-947 MHz) to the private land-mobile radio users. Last year, it removed the "wire-line" restriction on AT&T's allocation, a Solo-

mon-like decision that, in effect, still left the band to AT&T.

**Gut issues.** Although the verbal battle between AT&T and the equipment makers will involve such questions as efficient spectrum use, system design, and the public interest, it is based also on bread-and-butter issues. AT&T says there are two key issues: whether or not common carriers should be given exclusive use of that 75 MHz for a nationwide system, and whether dispatch-type service should be provided separately. Ma Bell claims that it needs the whole 75 MHz for telephone service in order to provide efficient service with room for future expansion.

Inherent in AT&T's arguments are

### The users speak

Most of the witnesses at the two-day presentations aren't equipment makers. They'll be representatives of public-safety, transit, dispatch, and health-user associations. They, although having no business interest, are concerned that they have a choice among competing systems, says George Petrutsas, assistant chief of the FCC's Industrial and Public Safety Rules division. Other issues of FCC interest include whether the national network envisioned by AT&T is really needed and what technical standards it needs.

The FCC doesn't have to make a big decision now, but it has to redress the allocation to meet the market realities, contends Motorola's William Drake. Chances are quite good, though, that the commission will make a final policy statement this summer.

the propositions that only it can provide the expertise and economies of scale to implement a nationwide system. But, apparently to placate equipment makers, AT&T says it expects all equipment manufacturing to be done outside its manufacturing arm, Western Electric.

The equipment makers argue that AT&T, being big enough already, could easily monopolize the marketplace with the 75-MHz share. And since it doesn't need the whole 75 MHz, it should get only 30 MHz at the most. "It's not fair competition to put such services under the aegis of a regulated common carrier," says Motorola vice president William C. Drake. AT&T however, will probably contend that eventually it can make good use of the 75 MHz.

**Fear monopoly.** Motorola, which says it will still sell equipment, no matter what, claims that a virtual AT&T monopoly will hamper its ability to compete worldwide and hinder its efforts to build communications networks overseas. Another fear is that if AT&T standardizes equipment, U.S. companies could be underbid by foreign manufacturers, especially the Japanese.

The current allocation doesn't reflect the balance between the two markets of telephone and radio dispatch, contends Glenn R. Petersen, general manager of the mobile-radio department of GE's Communications System division, Lynchburg, Va. He will testify for the Electronic Industries Association along with an RCA representative. "Everyone, including AT&T, recognizes that the mobile telephone market isn't that large right now." He says EIA will repeat its recommendation that the spectrum be split approximately

into four parts: public-message mobile telephone, user-operated private dispatch, multiple-user private dispatch, and a reserved portion to handle future needs. □

Instrumentation

Matrix recording traps transients

Researchers are often interested in analyzing single transient signals that are of extremely short duration, such as phenomena that occur in a nuclear explosion. To capture such fleeting transients with accuracies of a nanosecond or better, scientists at Lawrence Livermore Laboratory, Livermore, Calif., have developed an unusual technique, which they call magnetic matrix recording.

The technique essentially "draws a picture" of the transient signal in a rectangular array of thin-film

memory elements. This "picture" corresponds to the familiar oscilloscope trace and the area under it. All thin-film memory elements are magnetically anisotropic—that is, they have an easy axis and a hard axis of magnetization. Along the easy axis they are readily magnetized in either direction, in binary ones and zeros, but along the hard axis their magnetism can be maintained only by an external field.

At the start of the experiment, all the elements in the array are magnetized along the hard axis by word currents along wires in the vertical direction through the array. In addition, bias currents pass along wires in the horizontal direction, decreasing from most positive bias near the bottom of the array to least positive toward the top. The bias currents tilt the magnetization vector to one side or the other of the hard axis.

**Dominoes.** The signal to be recorded is represented by a current pulse, which is added to the individual horizontal bias currents. As the

signal begins, the vertical word currents are turned off in rapid-fire order, rather like a row of falling dominoes. The intervals between successive turn-offs equal the desired resolution for the recorded signal.

When any particular word current turns off, every element in that column is exposed to a combination of bias and signal currents that cause the elements near the bottom of the array to assume the one state (the magnetization vector falls into the easy axis in the one direction) and those near the top to assume the zero state (the vector falls the other way). The number of elements acquiring the one state depends on the strength of the signal current at the moment the word current turns off. The result, after the signal has ended, is a pattern of ones in the array that forms a picture of the signal.

The technique has been implemented with a mated-film memory from the Federal Systems division of Sperry Univac, under a contract from EG&G Inc., which built the measurement system for Livermore. Univac has been building the mated-film memories for several years for use in various military and aerospace computers [*Electronics*, April 1, 1968, p. 31]. However, the elements used in the magnetic matrix recorder were specially designed for uniformity and low dispersion—parameters that, although important in thin-film computer memories, sometimes are subordinated to compactness, low cost, yield, and other factors in commercial design. □

**Magnetic matrix.** Recording in matrix (top right) shows waveform imposed on previous all-zero pattern (top left). In the matrix itself (bottom), which is actually a 32-by-38 array, signal added to the bias current either sets memory element (at matrix intersection) to one or allows it to go to zero when word currents in vertical lines turn off.

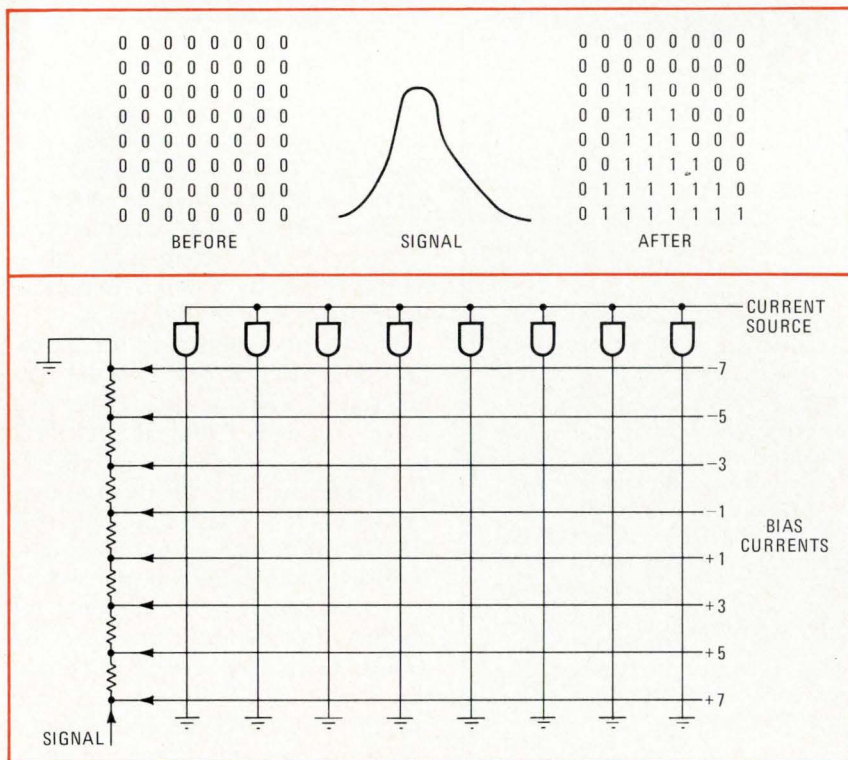

Microwave

Solid-state receivers for X and Ku bands

In hopes of developing a commercial product line, Watkins-Johnson Co., Palo Alto, Calif., last month began designing X-band and Ku-band solid-state microwave receivers. Although integrated receivers oper-



ating in these microwave bands are being developed for military systems, none is yet available commercially, says Richard I. Disman, manager of W-J's microwave IC department.

Disman thinks it will be possible to develop low-cost narrowband "front ends" with new gallium-arsenide, field-effect transistors. The target cost of about \$500 would be about a quarter that of traveling-wave-tube X-band and Ku-band (7-18-gigahertz) receivers. He says some of the GaAs FETs being developed by Hewlett-Packard Co. and Fairchild's Microwave and Optoelectronics division look as if they will prove suitable.

A \$500 front end, Disman notes, would make it economically practical for underdeveloped countries such as India to put educational television classrooms in remote villages, beaming programs from a satellite to microwave receivers in television sets. Other potentially high-volume commercial applications for solid-state receivers include short-range digital communications links, cable television, and aircraft instrument-landing-system (ILS) receivers. The closest Watkins-Johnson comes now to a commercial line of microwave ICs are amplifiers used at frequencies to 4.2 GHz in communications satellite ground stations. The company also produces military ICs operating to 6.4 GHz.

**Fallout.** To get the project rolling, Disman's department will first develop an integrated front end operating at 9.2 to 9.8 GHz for an undisclosed military customer. Disman says that one of the reasons the two-year contract was accepted was the prospect of being able to adapt the military design for commercial applications.

GaAs FETs will be used in two stages—the radio-frequency amplifier and the oscillator. The oscillator will be tuned by a varactor diode, controlled through a circuit that will convert an exponential tuning sweep to a linear control voltage. Disman says bipolar transistors, although preferred at lower frequencies, were ruled out of the rf amplifier because of the noise prob-



## Remote terminals in restaurants link highway traveler to home or office

A businessman traveling alone on a highway often has no convenient way of receiving important messages from family or office. But the Stuckey restaurant chain of Pet Inc. has a new application of remote-data-terminal technology that brings traveler and home base together. The computerized service is called Helps, for Highway Emergency Locating Paging Service, and allows a motorist to receive messages in any of Stuckey's 350 restaurants across the country.

The system is composed of a message center at Stuckey headquarters in Eastman, Ga., and terminals in each store. The center is equipped with a Burroughs 3500 digital computer system that stores telephone messages until they are retrieved by the traveler. Messages are held until they have been transmitted twice or for a maximum of 120 hours.

The terminal is made by Digi-Log Systems Inc., Willow Grove, Pa., and combines a cathode-ray tube and 12-key numeric keyboard. The traveler enters his home or office

phone number at the terminal keyboard to receive the message sent for him. A network of privately leased lines links the terminals with the central processor.

First installations were made in April, and the entire system, covering 41 states, will be completed by September. The service is free to travelers, except for the initial message that must be phoned to Stuckey's headquarters. A company spokesman says that FCC regulations now permit only phone numbers to be sent and received on the system, so that the only message a motorist will receive is to call a certain number.

The message is held on the terminal until a clear button is pressed. The clear button is also used to clear an incorrect entry. The computer will send all messages placed in the computer and, if a message has been previously relayed, this will be indicated on the screen. A "no message" is transmitted if no one is trying to reach the motorist, and an error message is displayed in the event of faulty transmission.

lems they present beyond 6 GHz. Gunn diodes were rejected for the oscillator because they draw too much power and are not efficient enough for X-band ICs.

The two new stages will be integrated with a mixer already made by W-J's Relcom division, a conventional 400-megahertz transistor amplifier, and a bandpass input filter, to complete the solid-state front end. Disman notes that TWTs would

still be required for broad-band amplifiers at X and Ku bands because input matching problems limit GaAs-FET amplifiers to narrowband designs.

Bipolar amplifiers, which handle an octave frequency range, have largely displaced tubes in lower-frequency microwave receivers during the past four years, Disman says. The major exception is in applications where the rf amplifier might

be subjected to high-power bursts of rf energy from nearby transmitters. Tubes can withstand bursts around a kilowatt that would burn out integrated front ends. □

### Thin-film circulator advances MIC art

Microwave ICs are ICs apart from others. They're often much like miniature low-frequency hybrids because some functions necessary at microwave frequencies simply can't be made successfully by using diffusion techniques. One of these is the ferrite circulator.

Available circulators have been something of a limit to the size and performance of MICs. They usually have been strip-transmission-line devices, restricted in frequency sometimes to the uhf band. They also have been large relative to the rest of the circuit, and often had to be outboarded.

Now Bell Telephone Laboratory research scientist Reinhard H. Knerr has developed a lumped-constant, thin-film circulator that promises to boost the MIC state of the art. Knerr's circulator is not only just a tenth of the size of stripline devices but its performance is said to be better as well. Far from being limited in frequency, it may be the first of a series of devices good for operation well beyond 10 gigahertz. Also, the devices show promise of batch producibility.

**Tiny.** Having designed successful circulators at L band, Knerr aimed this time for the range between 4 and 5 GHz. The result is a round sandwich composed of ferrite material, a conductive layer, a dielectric, and a ground plane, with the whole a mere 0.175 inch across, and at its junction only 0.075 inch in diameter. The whole substrate is only about 0.025 inch thick, and thus Knerr feels that batch-processed circulators could easily be dropped into holes in MICs in somewhat the same way beam-lead devices are installed in lower-frequency circuits. Knerr found his device was far from

limited to its 4-to-5-GHz design range. Instead, the circulator could be tuned magnetically to operate at frequencies as high as 7 GHz, maintaining a 10% bandwidth.

Importantly, insertion loss, at only 0.5 to 1 decibel, is lower than that of many circulators—and the figure includes losses caused by the test fixtures, which made up at least 20% of the total. Losses in real circuits would be far lower.

Knerr figures that it should be possible to scale up the design run well into X band, although its small junction diameter of 0.04 inch might require careful handling. But as soon as the circulators come out of the Allentown, Pa., lab—Knerr is now busy “optimizing” what already appears to be good performance—users will have circulators of a size matched to microwave semiconductors. And the result can only be a lift for MIC applications. □

### Computer-aided design

#### Nationwide network handles pc boards

Automated drafting systems, although very productive, are expensive and therefore not widely available, except at large companies. But a new dial-up nationwide network may change that. It opens an extensive library of drafting and circuit design programs to anyone with a teletypewriter. For most prospective

users, however, a remote job-entry terminal with plotter would be more desirable and would offer very fast turnaround. This contrasts with the usual requirement for a dedicated drafting system plus access to a large computer with specialized drafting software.

The system, set up by ADREC Inc., Sherman Oaks, Calif., has access to an IBM 370/158 computer and is acquiring and adapting existing automated programs already proven in the field. Much of the drafting is for civil engineering, but ADREC offers two programs of special interest to the electronics profession. One draws finished schematic diagrams from rough sketches; the other is a powerful program that prepares printed-circuit-board layouts from logic net lists or from logic equations. Other programs will be added.

**Tied to 370.** ADREC's network is the brainchild of A.T. Materna, the company's president. He has arranged for use of the large computer installation at System Development Corp., in Santa Monica, Calif. This arrangement permits SDC to more fully utilize its expensive installation, while providing the drafting network access to the powerful computers needed.

Although teletyped input, with mailed plots, is possible, local drawing output is especially attractive because it permits turnaround in as little as 15 minutes. ADREC has agreements with two plotter firms, California Computer Products and Xynetics Inc., for suitable terminals.

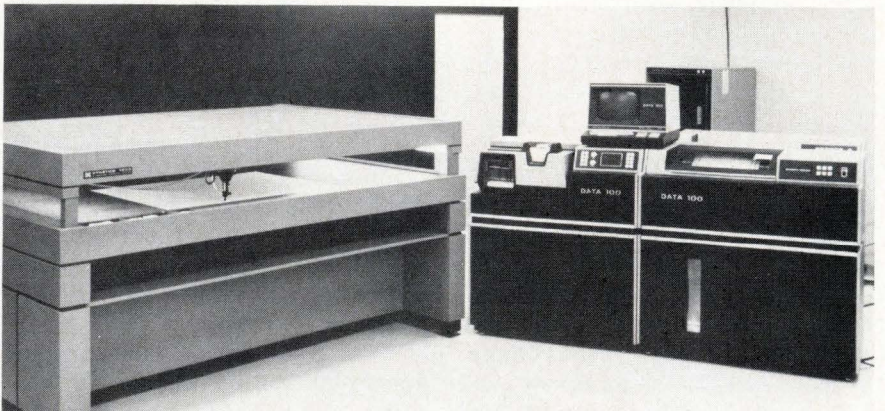

**Gaining access.** Xynetics remote job-entry system is one that permits communication with ADREC's national drafting library. Output is produced on the plotter.

# New...from DATEL SYSTEMS

## a breakthrough in price/performance

# 16 bit D/A Converter



# \$89<sup>00</sup>

Single Quantity

Datel System's growth is based on breakthroughs. We make it our business to produce products that are a combination of increased reliability, with more sophistication, smaller in size, yet lower in cost.

If you're at the IEEE Show, come to Booth 2609 and we'll show you some of the things we're proud of. If you miss the Show, call our nearest representative or write us for complete details.



### Features

- High Resolution – one part in 65,535<sup>(1)</sup>
- Programmable Voltage Output – 0 to +10V, to –10V, or  $\pm 5V$ <sup>(2)</sup>
- Programmable Current Output – 0 to +2.0 mA or  $\pm 1mA$
- Binary and Four Digit BCD Coded Models
- 150  $\mu$ volt or 30 nA Output Resolution
- 5 MHz update Rate
- 750 nsec Output Settling Time
- Thin Film Stability
- Includes Reference Source and Output Amplifier
- TTL Compatible Inputs
- 2" L x 2" w x .375" h Total Size

<sup>(1)</sup> Four Digit BCD Model – one part in 10,000

<sup>(2)</sup> Output Current –  $\pm 5mA$

Xynetics' typical smart terminal includes a card reader, central processor, line printer, cathode-ray-tube console, and the company's model 1100 high-speed flatbed plotter. This installation leases for about \$2,500 a month, little different from the lease cost of a stand-alone drafting system without large computer, and obviously less expensive than the salaries for draftsmen.

To operate the system, the user enters the 370 by means of cards

### Solid state

## Thin-film and silicon technologies merged in developmental devices

A promising push toward active thin-film devices a decade ago gave way to the more reliable silicon semiconductor technology, even though the latter requires the expensive processes of single-crystal and epitaxial growth. Now, scientists at Johns Hopkins University's Applied Physics Laboratory, Silver Spring, Md., have developed a technique that combines the two approaches to yield circuitry with the geometric freedom of thin films and the quality of silicon technology.

The long-sought technique converts pure amorphous silicon thin films on silica-glass substrates to crystalline films to produce pn junction diodes and field-effect transistors. So contend Charles Feldman, head of the solid-state research

group, and Richard Plachy, project supervisor in the microelectronics group, in a paper at the IEEE Electron Device Techniques conference, May 2, in New York. While reluctant to call the technique a breakthrough, Feldman says "it's the first time that polycrystalline silicon films on insulating glass substrates have been successfully processed into practical devices."

He adds that his company is charging less for the service than normal service bureau charges just for computer time, and is able to absorb distant telephone costs. □

One advantage is that silica-glass substrates of any size may be used. Because circuits won't need to be fabricated from slices of single crystals 2 to 4 inches in diameter, devices such as resistors and inductors that need larger areas become practical. The technique also promises economical production and gives greater electrical isolation than silicon alone.

**Discovery.** New instrumentation proved to be the key. What hung up thin-film researchers before, Feldman says, was that they weren't able to assure the purity of the films nor could they tell whether impurities were from the film or the production process. He turned to new sputtered-ion-source mass spectrometry to solve the problem. The ion microprobe sweeps the surface of the film with a beam of argon ions, sputtering off everything on the surface,

**Discovery.** New instrumentation proved to be the key. What hung up thin-film researchers before, Feldman says, was that they weren't able to assure the purity of the films nor could they tell whether impurities were from the film or the production process. He turned to new sputtered-ion-source mass spectrometry to solve the problem. The ion microprobe sweeps the surface of the film with a beam of argon ions, sputtering off everything on the surface,

**Sample.** Amorphous thin-film test pattern. Diodes and FETs have been made.

and the stray matter is sent on to a mass spectrometer for analysis.

Using "this powerful tool," Feldman was able to find the impurities and work backwards to eliminate them in production and get film "the same purity as bulk, or near it." The next stage was to add the impurities needed to make successful pn junctions, "and the whole thing fell into place," he says. The extremely pure amorphous silicon films on glass substrates can be crystallized during device fabrication.

The amorphous samples are obtained by melting silicon with electron beams in a molybdenum-lined stainless-steel crucible and depositing it on the fused silica substrates. Electrical test data on his film compare favorably with those of bulk silicon.

The pure film can go through standard processes of oxidation, etching and diffusion. To produce n-type or p-type material, samples may be crystallized directly in a diffusion furnace where either phosphorous or boron dopants can be introduced into the film simultaneously. Thin-film transistors fabricated years ago from vacuum-deposited germanium, tellurium, cadmium sulphide and cadmium selenide lacked the versatility and stability to compete with silicon technology, Feldman notes.

Before the technique is ready for production, much more needs to be done, Feldman says, such as determination of optimum processing times and temperatures for films, compared with wafers and diffusion contrasts in polycrystalline evaporated films. □

### Commercial electronics

## Computers control L. A. freeway signs

In Los Angeles, undisputed freeway capital of the world, public pressure has halted miles of new road construction, forcing highway engineers to turn their talents to making better use of existing routes. Latest in their

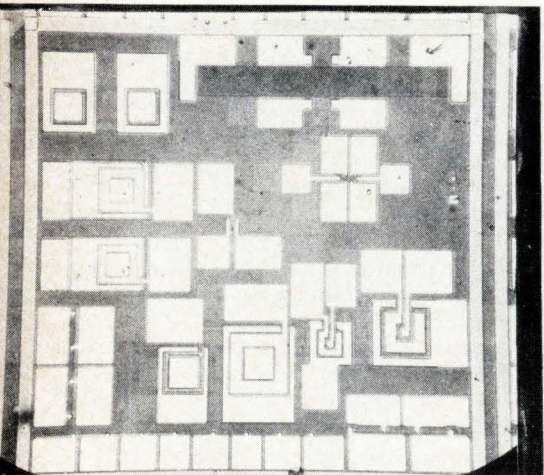

# We've developed more than 50 custom ICs in the last 18 months

More than 50 times in the last 18 months, customers have brought us IC problems that couldn't be solved with standard circuits. In every case we've developed a custom circuit that filled the bill. Our circuits are now in TV sets, watches and clocks, electronic organs, calculators, automobiles, office copiers and a host of other applications. We've delivered samples in as little as 8 weeks ARO; few problems have required more than 20 weeks to solution. Shouldn't a semiconductor company with a record like that get a shot at your custom circuit requirement?

## We're doers, not talkers!

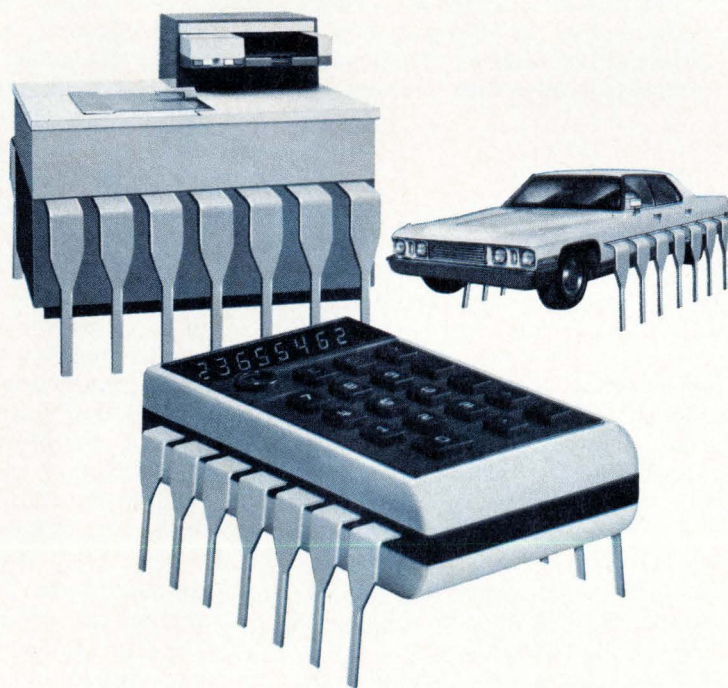

# semiconductors

ITT Semiconductors is a division of International Telephone and Telegraph Corporation, 3301 Electronics Way, West Palm Beach, Florida 33407. Phone 305/842-2411. Factories in West Palm Beach, Florida • Lawrence, Massachusetts • Footscray, England • Colmar, France • Freiburg, Germany • Cascais, Portugal • Sydney, Australia.

# ITT



17 MINUTES TO  
HARBOR FREEWAY

**Traffic director.** Computer-controlled signs on Los Angeles freeway alert motorists to problems in time for them to change lanes or alter their routes.

efforts is a system of large, alterable signs much like football scoreboards that warn motorists of obstructions ahead so that they change lanes, take alternate routes, or at least relax and chew a few more antacid tablets.

The 35 signs are installed on a 13-mile stretch of the Santa Monica Freeway, one of the area's busiest because it's the only east-west freeway near downtown. Each sign consists of a matrix of about 3,000 lamps that are controlled over leased lines by a Data General Nova 1220 minicomputer in the downtown area. Various sensors and reports are used to instruct the signs to display such information as: "Right lane closed in 1½ miles." The signs are normally off; if they

are on, there are problems ahead. Some 100 messages are stored in a disk pack in the system, but an operator can prepare his own in emergencies such as a circus lion escaping from a wrecked truck.

The system with 35 signs cost \$1.2 million—less, it turns out, than a single scoreboard in some new athletic coliseums. It was designed by the California Department of Highways, with the prime contractor Federal Sign and Signal, and systems work by GTE Sylvania. Operation began in late April, about six months late because of problems with the light bulbs and wiring.

The system is to get a year-long evaluation by the University of California at Los Angeles, then possible extension to other area freeways. □

### Military electronics

## Industry wary of Pentagon's design-to-cost procurement

Contractors don't much like the Pentagon's "design-to-cost" philosophy and strongly told Defense Department officials so during a joint sitdown meeting in late April. Despite assurances by the officials that the "design-to-cost" emphasis in new contracts won't burden companies, electronics and aerospace company executives remain skeptical—if not downright wary—of the cost-cutting concept [*Electronics*, Jan. 4, p. 70].

During a two-day DOD-industry

forum sponsored by the Electronics Industry Association in Washington, D.C., industry representatives expressed the fear that DOD's year-old efforts to match performance specifications to unit production costs would saddle them with another round of rigid contracting requirements. Specifically, the executives charged that design-to-cost:

- Looks like a new version of the total-package-procurement concept of the McNamara era, under which some companies feel they got

burned, especially with its seeming inflexibility.

- Still doesn't provide any way to prevent some companies from "buying-in" to major contracts by excluding research and development costs in calculating production figures.

- Could stifle needed technological innovation for the sake of lower costs.

- Can't mean too much until the 30-some odd contracting agencies of DOD agree among themselves on how to manage it.

- Doesn't make clear how ceiling prices on program costs are derived and who derives them.

**DOD rebuttal.** Attempting to counter the mistrust expressed by some representatives, Jacques S. Gansler, assistant director for electronics, Defense Department Research and Engineering, told the 200 attendees that "the only similarity" between total-package and design-to-cost procurement "is that price is a consideration." Otherwise, where under total-package procurement companies bid once for the whole program without first developing hardware, design-to-cost is "a totally incremental program," with competitive bidding between the design, development, and production phases. There is "no commitment made to producing the item until we've finished the development program," he said; however, the development program should have the "maximum information" on the production program's costs so that DOD can choose among competing firms.

Gansler termed it "unrealistic" to have both performance requirements and production prices firmly fixed in the design-to-cost concept. In choosing performance requirements, DOD hopes to "call out the three or four most important items" and make the others options, he said. The performance-oriented concept emphasizes functional requirements, not design specifications, he said. Having detailed specifications heretofore has "allowed incompetent people to bid because we told them how to solder," Gansler observes. Stressing the concept's

# INCREASE CIRCUIT DENSITY WITH AISI Mag<sup>®</sup> HYBRID COMPONENTS BRAND

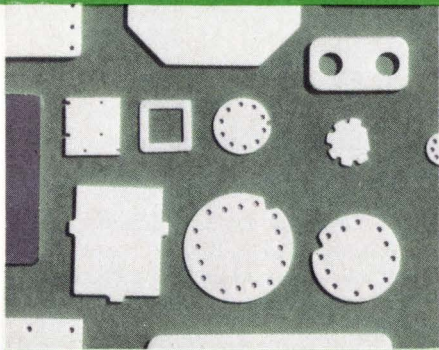

## SUBSTRATES

Extra strong ceramic substrates for thick and thin film processes. Special purpose substrates to get rid of heat, to save space, to match thermal expansion of glass, for light sensitive devices or for a contrasting background. Substrates with high dielectric constants. Bulletin 712 on request. Phone 803/682-3215.

Telex 570449.

Circle 216 on reader service card

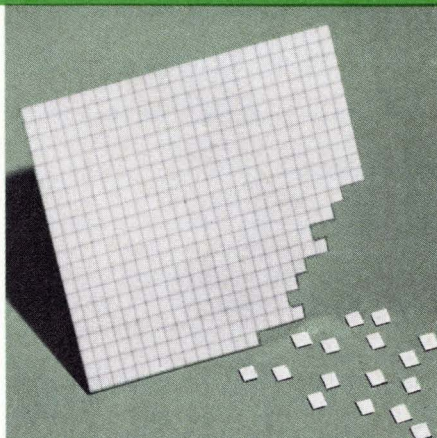

## SNAP-STRATES

From tooling for economy or from laser for accuracy, Snap-Strates are a proven cost reducer. Have you considered how much Snap-Strates and multiple processing can save you? Bulletin 712 on request. Phone 803/682-3215.

Telex 570449.

Circle 217 on reader service card

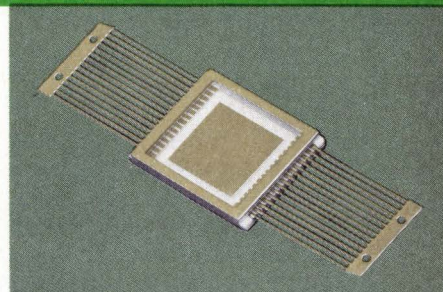

## HYBRID PACKAGES

All ceramic construction plus brazed-on leads for maximum reliability. Co-fired monolithic ceramic structure eliminates hermeticity problems, greatly increases thermal conductivity and structural strength. Ceramic construction permits mounting the package over conductors on circuit board. Custom made or write for current list of standard packages. Phone 615/265-3411.

Telex 558432.

Circle 218 on reader service card

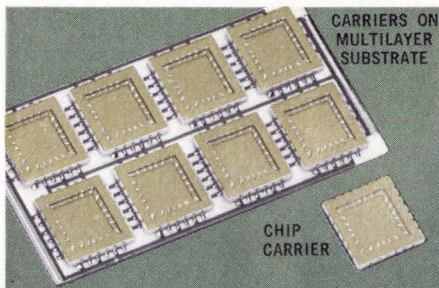

## CHIP CARRIERS

These small hermetic chip carriers allow far greater circuit density. Electrical testing after hermetic sealing allows storage of good devices in a less expensive package before committing to the circuit. The design permits conventional die attach, wire bonding and lid sealing operations . . . and re-flow solder attachment to a multilayer ceramic substrate, hybrid substrate or phenolic circuit board. Phone 615/265-3411.

Telex 558432.

Circle 219 on reader service card

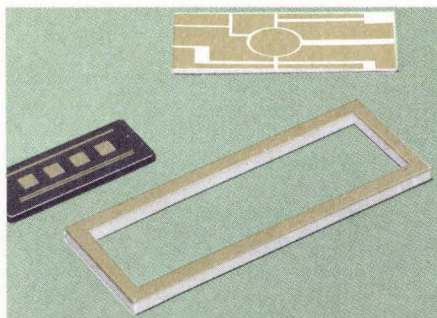

## CUSTOM METALLIZING

Tailored for maximum bond strength on wide choice of our own ceramic compositions including Black Alumina, White Alumina and Beryllia. All popular metallizations and platings, applied by both precision generation and photo-etching. Where air firing is required, ceramics can be supplied with noble metals, surface or buried in multilayer ceramics. Phone 615/265-3411.

Telex 558432.

Circle 220 on reader service card

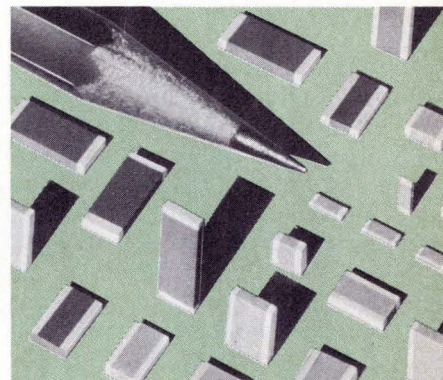

## CAPACITOR CHIPS

Single or multilayer, custom made or stock. Diced chips from 1 pf to .05 mfd. Sizes .020" square and up. Multi-Cap<sup>®</sup> capacitors in all EIA preferred sizes, .080" x .050" and up. Available in TC compositions from P120 to N5600 and in all high dielectric constant materials. Bulletins 689 and 694 on request. Phone 803/682-3215.

Telex 570449.

Circle 221 on reader service card

see us at  
BOOTH 4531  
NEPCON EAST

AMERICAN LAVA CORPORATION

Chattanooga, Tennessee 37405 Laurens, South Carolina 29360

SUBSIDIARY OF  
**3M**  
COMPANY

innovative competitive technological nature, he noted that at each phase it "won't keep out the guy who hasn't been in the business before," nor new bidders.

As for prevention of buying in, Gansler answered, "you don't prevent buy-ins—ever" because "people are competitive by nature," but such practices "miss the point of procurement," which is ascertaining the unit cost in production.

Both industry and defense panelists agreed that rising costs of weapons systems produced problems for industry and defense. TRW's Donald Pitts, director of Government-business policy, summarized, "Cost credibility is a problem we, DOD, and industry have with Congress and the public.

**Carrot and stick.** But, while holding out the carrot of "let's all work together," the defense officials brandished the stick, too. In answering a question of how DOD would hold down program costs, Donald N. Fredericksen, assistant director (land warfare), DDR&E, replied that in programs where there weren't competing companies "we may get competition in other ways." He suggested using backup programs to fill the same mission, turning to another program in an earlier phase, improving existing systems, or buying foreign systems. The DOD panelists also stated a strong preference for contractor warranties.

DOD faces other problems in implementing design to cost, according to Donald W. Srull, Office of the Deputy Defense Secretary for Cost Analysis. Among them are: how to handle programs already on stream, how to effect "a change in the whole contractual process" by insisting on realistic costs—"we're not looking for bargains," Srull insisted—and whether DOD should share its own cost estimates with bidders. He concluded, "Solutions in the past where we got more money are over" so that "we have no other alternative but to put the squeeze on costs."

Meanwhile, however, "industry is very leary," commented Robert F. Finnell, new business manager for Rockwell International's Autonetics division, which doesn't have a de-

## News briefs

### **Signetics to sell stock publicly**

Signetics Corp. is planning to sell 715,000 shares of common stock after publishing its first profit and loss statement last month in a sale prospectus. The company had a net income of \$15.4 million on sales of \$48.4 million in 1972, after losing \$5.7 million in 1971 and \$8.4 million in 1970. During the first quarter of 1973, it had a net income of \$1,342,469 on sales of \$17,840,911. None of the shares being sold is owned by parent company, Corning Glass Works, although the sale will reduce Corning's ownership of outstanding shares from 92% of the total to 80.5%.

### **EIA to oppose repeal of tariff and tax benefits**

The Electronics Industries Association plans to testify against parts of the President's trade bill asking for authority to repeal tariff advantages and tax benefits for offshore assembly. The May hearings, before the House Ways and Means Committee, follow two April meetings with industry representatives to discuss the problem.

### **Solitron enters vacuum-tube FET market**

Latest to hop into the market for solid-state replacements for active vacuum-tubes, behind Teledyne Semiconductor and National Semiconductor, is Solitron in San Diego. The company's Fetrotode—Teledyne calls its versions Fetrons—uses a cascode arrangement of field-effect transistors, including a 430-volt FET. The FETs, which mount on a socket, replace a type of 6AK5 tetrode widely used in communications equipment.

### **SSB ham transceiver is fully solid-state**

Amateur radio operators, who constitute one of the largest markets for single-sideband transmitters, can finally buy a medium-power fully solid-state transceiver. Swan Electronics, Oceanside, Calif., a subsidiary of Cubic Corp., makes the equipment, which generates 200 watts on high-frequency amateur bands directly from a 12-volt automotive supply. The basic equipment puts out 15 watts and costs \$579.

### **Motorola to open MOS plant in Texas. . .**

A late starter in the MOS products race, Motorola Semiconductor Products division is increasing its commitment to MOS with a multimillion-dollar plant to be built in Austin, Texas. It is the firm's first in the U.S. outside Arizona. Stage one of the 300,000-square-foot plant will be built in a year, with completion due in 3½ years. The plant will house all MOS production.

### **. . . as Fairchild settles in Poughkeepsie. . .**

Also expanding manufacturing capacity for MOS, Fairchild Semiconductor has announced plans to buy a 44,000-square-foot plant near Poughkeepsie, N.Y. Occupancy is scheduled to begin after June 1 of this year.

### **. . . and announces CCD prices**

Fairchild Semiconductor Components group announced a single-unit price of \$1,200 for its 500-element charge-coupled-device image sensors [*Electronics*, March 29, p. 25]. Quantity prices will be negotiated, a spokesman said. Reticon Corp., Mountain View, Calif., a leading supplier of diode arrays, charges \$1,600 for one 512-diode linear array, or \$800 in 100-unit lots. However, Reticon says it would accept orders for large production lots at as little as \$100 an array.

### **Army awards contract to Sperry Rand**

Sperry Rand's Univac division has received a \$30 million contract for 15 Model 1108 processing systems to be installed at the Army's Personnel Center in Alexandria, Va. The General Services Administration is expected to buy the computers for the Army after a year's lease.



# "THE PRACTICALS"

A COMPLETE FAMILY OF LOW-COST  
HIGH PERFORMANCE PACKAGED AC-DC  
REGULATED POWER SUPPLIES

*They make systems engineers cost-efficiency experts*

Today's OEM Engineer must assume many responsibilities beyond the pure design of systems.

He must realistically specify the components and sub-systems; buy the required performance specifications at competitive prices; package the system in its most compact form. In short, he must achieve the greatest cost-efficiency and reliability per dollar invested.

Just compare the basic specifications and prices of "The Practicals" with other open construction power supplies. Then consider that we give "The Practicals" the identical 5-Year Warranty as our premium mil spec units.

Standard output voltages and power availabilities satisfy the most popular circuits. Custom specifications can easily be adapted to order.

"The Practicals" are an OEM Engineer's most realistic answer to any power supply need. Call, wire or write today for immediate delivery.

## TECHNIPOWER "PRACTICALS"

### Standard Specifications

#### Single, Dual, Triple, and Quadruple Output Models

Source voltage range: 105-125 volts  
Source frequency range: 47-420 Hz  
Combined Source and Load Effects (Regulation):  $\pm 0.5\%$   
Pard (Ripple) (RMS): 2mv.  
Temperature Coefficient: (TYP.) 0.02% / °C.  
Polarity: May be used positive or negative.  
Output voltage and current: See model listing.  
Short circuit protection: Automatic circuit protects the power supply if the output is shorted continuously. Automatic return upon removal of short circuit.  
Remote sensing: Provisions are made for remote sensing to eliminate effects of lead resistance on dc regulation.  
Ambient Operating Temperature: 0°C to +55°C for current ratings specified in model listings.  
Storage temperature: -20°C to +85°C.  
Recovery time: (TYP.) Less than 50 usec, 1/2 L to FL.  
Fixed Output and Dual Input Available: Consult factory  
OEM quantity and less than 25 unit prices quoted upon request.  
Custom specifications easily adapted to order.

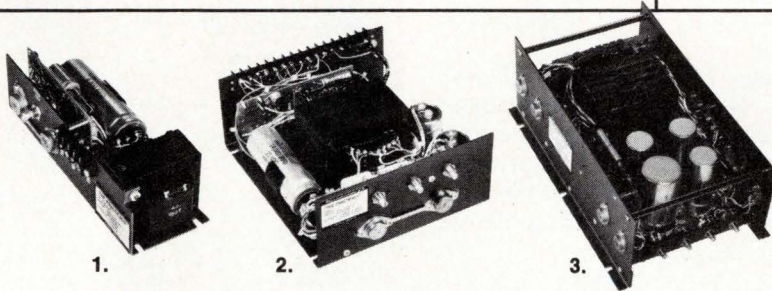

### 3 CASE SIZES

Case Size	L	W	H
#1	8 1/2"	3 1/8"	2 5/8"
#2	8 1/4"	7 1/2"	3 3/8"
#3	14"	8 1/2"	5"

## NEW! HIGHER POWER MODELS IN 3 CASE SIZES

**SINGLE OUTPUT SERIES** designed for logic, op-amp, signal and other commercial applications

Adjustable Output Voltage	Output Current Amperes	Standard Model No.	Output Current Amperes	Standard Model No.	Output Current Amperes	Standard Model No.
5.0 $\pm 5\%$	5.0	LP5.0-5.0	10.0	LP5.0-10.0	20.0	LP5.0-20.0
6.0 $\pm 5\%$	4.5	LP6.0-4.5	9.0	LP6.0-9.0	18.0	LP6.0-18.0
12.0 $\pm 5\%$	2.5	LP12.0-2.5	8.0	LP12.0-8.0	16.0	LP12.0-16.0
15.0 $\pm 5\%$	2.0	LP15.0-2.0	7.0	LP15.0-7.0	14.0	LP15.0-14.0
24.0 $\pm 5\%$	1.5	LP24.0-1.5	4.5	LP24.0-4.5	9.0	LP24.0-9.0
28.0 $\pm 5\%$	1.2	LP28.0-1.2	4.0	LP28.0-4.0	8.0	LP28.0-8.0

#### CASE SIZE #1

**\$39<sup>80</sup>**

ALL MODELS  
25 or more  
combined units  
Unit Price \$49.75

#### CASE SIZE #2

**\$79<sup>80</sup>**

ALL MODELS  
25 or more  
combined units  
Unit Price \$99.75

#### CASE SIZE #3

**\$131<sup>80</sup>**

ALL MODELS  
25 or more  
combined units  
Unit Price \$164.75

Overvoltage protection available on all models (LPC series). Add \$5.00 for case size 1, \$10.00 for case size 2, \$15.00 for case size 3.

**BACKED BY TECHNIPOWER 5-YEAR WARRANTY  
U.L. APPROVED.**

See Technipower products in Volume 1 of the 1972/1973 EEM, Pages 964-989.

**TECHNIPOWER, INC.**   
A BENRUS DIVISION

Benrus Center, Ridgefield, Ct. 06877 203-438-0333 TWX: 710-467-0666

## DUAL OUTPUT TRACKING SERIES designed for op-amp and other commercial applications.

### CASE SIZE #1

Adjustable Output Voltage	Output Current Amperes	Standard Model No.
$\pm 12.0 \pm 5\%$	1.2	LPDT-12.0-1.2
$\pm 15.0 \pm 5\%$	1.0	LPDT-15.0-1.0

**\$64<sup>60</sup>**

25 or more  
combined units  
Unit Price \$80.75

Overvoltage Protection available on all models (LPDTC series). Add \$10.00. Independent output adjustment (non-tracking) provided at slight additional cost. Modification of standard output voltages can be provided over the range of  $\pm 5$  to  $\pm 28$  volts at slight additional cost. Voltages below  $\pm 7$  volts not available in Tracking models.

## TRIPLE OUTPUT SERIES combines single and dual output functions

### CASE SIZE #2

Adjustable Output Voltage	Output Current Amperes	Standard Model No.
+5.0 $\pm 5\%$	5.0	LPM-1
+12.0 $\pm 5\%$	1.2	
-12.0 $\pm 5\%$	1.2	
+5.0 $\pm 5\%$	5.0	LPM-2
+15.0 $\pm 5\%$	1.0	
-15.0 $\pm 5\%$	1.0	

**\$124<sup>60</sup>**

25 or more  
combined units  
Unit Price \$155.75

Overvoltage Protection is standard on 5 Volt Output at no additional cost. Available on the  $\pm 12$  or  $\pm 15$  volt output (LPMC series). Add \$10.00. Modification of standard output voltages can be provided at slight additional cost.

## QUADRUPLE OUTPUT SERIES combines triple output functions plus output for indicator or drive voltage

### CASE SIZE #3

Adjustable Output Voltage	Output Current Amperes	Standard Model No.
+5.0 $\pm 5\%$	10.0	LPQ-1
+15.0 $\pm 5\%$	2.0	
-15.0 $\pm 5\%$	2.0	
+28.0 $\pm 5\%$	1.0	
+5.0 $\pm 5\%$	7.5	LPQ-2
+15.0 $\pm 5\%$	4.0	
-15.0 $\pm 5\%$	4.0	
+28.0 $\pm 5\%$	1.0	
+5.0 $\pm 5\%$	10.0	LPQ-4
+12.0 $\pm 5\%$	2.5	
-12.0 $\pm 5\%$	2.5	
+28.0 $\pm 5\%$	1.0	

From  
**\$203<sup>80</sup>**

25 or more  
combined units  
Unit Price  
From \$254.75

Overvoltage Protection is standard on 5 Volt Output at no additional cost. Available on the  $\pm 12$  or  $\pm 15$  volt output (LPQC series). Add \$20.00 Modification of standard output voltages can be provided at slight additional cost.

Circle 39 on reader service card

sign-to-cost contract. "DOD hasn't thought it through completely," he said, adding that even parts of DOD aren't in agreement. "Industry has a wait-and-see attitude," observed Martin Marietta's Darwin C. Middlekauf, design-to-cost manager for the Orlando division, which is performing three contracts with design-to-cost features. "Management has to be strongly behind it or it won't work," he said. One good thing is that "it puts the engineer in the loop" so that he knows the cost of his decisions, Middlekauf said. Overall, he thought, "right now it's a buzzword; it may become a way of life later." □

Packaging

'Coupon' IC carrier trims package height

When beam-lead integrated circuits first came on the scene, one of the promises they held out was elimination of IC packages, because the chip itself could be hermetically sealed. Getting rid of the package cuts costs and allows greater pack-

ing density on circuit boards. Engineers at the Defense Systems division of Bunker Ramo Corp., Westlake Village, Calif., near Los Angeles, have gone a long way toward those two goals with their "coupon" carrier. Bonded to the flat copper carrier, ICs can be mounted directly on inexpensive circuit boards that make up a dense "planar coaxial" assembly.

The carrier could also be mounted on regular circuit boards. Howard "Bud" Parks, director of advanced technology at the division, estimates that the cost would be about 5 cents per 24-pin carrier compared to the usual 25 to 30 cents now charged for a conventional package.

**Dense.** Heart of the new approach is planar coax technology, which Bunker Ramo developed (see "What is planar coax?") and which, in turn, led to the need for the direct mounting. Planar coax permits very high packaging density, but even very small IC packages that are 50 to 75 mils thick add significant extra volume. To overcome this, Bunker Ramo has mounted chips directly on one of the interconnection layers, or substrates.

Conventional wire bonds, beam

What is planar coax?

The name "planar coax," while accurate, suggests only a part of the three-dimensional packaging system developed by Bunker Ramo. It basically consists of copper substrates—containing buried coax interconnections—on which parts such as ICs are mounted. These copper wafers are stacked vertically, with spacers where needed because of the thickness of components. Connections from layer to layer are made by small copper-gold bumps placed in insulating plastic. These vertical connections are also coaxial, being surrounded by copper on each level. Pressure holds the assembly together.

According to Howard Parks at Bunker Ramo, a big appeal of the system is its economy. He estimates a two- to five-times reduction in cost over conventional DIP circuit-board and connector packaging. The planar coax costs about \$30 per cubic inch, with about 1,500 terminals in that volume. Design and processing costs are similar to those of regular circuit boards, but total costs are much lower because of the high density. Another advantage is circuit speed; the dense packaging and coax interconnections are ideal for high-speed logic, permitting 100-picosecond typical propagation delays.

Using the technique, Bunker Ramo has developed an 8,192-word semiconductor memory that occupies less than 2 cubic inches. The size does not include interconnections. The company is also looking at commercial markets, probably through licensing, and it is expected to use the technique in its BR1018 military-oriented minicomputer.

for more information on Microsystems' memories contact:

microsystems sales offices

<b>U.S.A.</b>	
<b>CALIFORNIA,</b>	
Palo Alto.....	(415)493-0848
Santa Ana.....	(714)979-6522
PA, Huntingdon Valley.....	(215)W17-5641/2
MINNESOTA, New Hope.....	(612)554-1802
ILLINOIS, Schaumburg.....	(312)894-7660
NEW HAMPSHIRE, Nashua.....	(617)762-8298
<b>CANADA</b>	
<b>ONTARIO,</b>	
Ottawa.....	(613)828-9191
Toronto.....	(416)279-1358
QUEBEC, Montreal.....	(514)875-2814

sales representatives

<b>U.S.A.</b>	
ALABAMA, Huntsville Tech-Rep Associates.....	(205)881-5925
ARIZONA, Scottsdale Barnhill Five Inc.....	(602)947-7841
<b>CALIFORNIA,</b>	
Los Altos W.W. Posey.....	(415)948-7771
Santa Ana Rical Associates.....	(714)557-6543
San Diego Transdynamics Inc.....	(714)583-7018
COLORADO, Denver Barnhill Five Inc.....	(303)934-5505
<b>FLORIDA,</b>	
Indialantic Tech-Rep Associates.....	(305)723-9140
Largo Tech-Rep Associates.....	(813)595-2834
ILLINOIS, Chicago L-Tec Inc.....	(312)286-1500
INDIANA, Indianapolis R.E. Marquart & Associates.....	(317)253-3997
MARYLAND, Baltimore L.H. Kolman Co.....	(301)752-8756
MASSACHUSETTS, Waltham Ran-Tek.....	(617)890-5110
MISSOURI, Kansas Florence & Meyer Inc.....	(913)722-5210
NEW JERSEY, Tenafly ABC Electronic Sales.....	(201)568-2354
<b>NEW YORK,</b>	
Cicero Advanced Components Inc.....	(315)699-2671
New York ABC Electronic Sales.....	(516)747-6610
North White Plains ABC Electronic Sales.....	(914)946-3001
NEW MEXICO, Albuquerque Barnhill Five Inc.....	(505)299-7658
OHIO, Columbus Tom Mulligan & Associates.....	(614)457-2242
PA, Huntingdon Valley ABC Electronic Sales.....	(215)W17-5641/2
TEXAS, Addison Champion Sales.....	(214)239-9196
UTAH, Salt Lake City Barnhill Five Inc.....	(801)487-1327
WASHINGTON, Seattle Carlyle Technical Sales.....	(206)632-4290

distributors

<b>U.S.A.</b>	
ARIZONA, Phoenix Kierulff Electronics.....	(602)273-7331
<b>CALIFORNIA,</b>	
Carson Hi-Rel Distributor Sales.....	(213)537-6500
Los Angeles Wesco Electronics.....	(213)685-9525
Menlo Park Bell Electronic Corp.....	(415)323-9431
Riverside Electronic Supply.....	(714)683-5591
San Carlos Sterling Electronics Corp.....	(415)592-2353
San Diego Kierulff Electronics.....	(714)278-2112
COLORADO, Denver Kierulff Electronics.....	(303)343-7090
FLORIDA, Clearwater Southland Electronics.....	(813)443-4514
<b>LONG ISLAND,</b>	
Farmingdale Arrow Electronics Inc.....	(415)323-9431
Freeport Milgray Electronics Inc.....	(516)546-6000
<b>MARYLAND,</b>	
Baltimore Arrow Electronics Inc.....	(301)247-5200
Rockville Pioneer Electronics Inc.....	(301)424-3300
<b>MASSACHUSETTS,</b>	
Boston DeMambo Electronics.....	(617)787-1200
Dedham Gerber Electronics.....	(617)329-2400
Watertown Sterling Electronics Corp.....	(617)926-9720
NEW JERSEY, Haddonfield Mid-Atlantic Electronics.....	(609)428-8288
<b>NEW YORK,</b>	
Plainview Newark Electronics Corp.....	(516)822-5000
Rochester Simcona Electronics.....	(716)328-3230
Rome, Rome Electronics Inc.....	(315)337-5400
NEW MEXICO, Albuquerque Kierulff Electronics.....	(505)247-1055
TEXAS, Dallas Semiconductor Specialists Inc.....	(214)358-5211
WASHINGTON, Seattle Kierulff Electronics.....	(206)763-1550

<b>CANADA</b>	
B.C. Vancouver R.A.E. Industrial Electronics Ltd.....	(604)687-2621
<b>ONTARIO, Milton</b>	
Semiconductor Specialists (Canada) Ltd.....	(416)678-1444
QUEBEC, Montreal Cesco Electronics Ltd.....	(514)735-5511

Also throughout Europe, Japan, Asia and Australasia



# Microsystems International... **Big in Memories**



It's an understatement! We're about the biggest semicon memory components manufacturer in the business—and we're getting big in memory systems too. (The board in the photo is Microsystems latest 8K X 12 memory module).

We're big in memory technology with p and n channel silicon gate MOS LSI for low cost, low power applications; and the complimentary Schottky clamped bipolar for high speed requirements. Our broad product line includes RAMs, ROMs, pROMs, Shift Registers, Special Purpose and Peripheral Circuits. The line features TTL compatibility, a range of bit capacities from 64 to 4096, access times from 20 ns to 1500 ns and a choice of static or dynamic operating modes. Deliveries are the best. Our high volume 3 inch wafer fab facility is running around the clock. And product of the highest quality is assured by a fully approved test lab, backed-up by our unique SEM failure analysis program.

We haven't overlooked new products either. Over 350 engineers and technicians are dedicated to the development of advanced circuits and processes. When it comes to service we're hard to beat, with our worldwide network of sales and applications engineering offices, stocking distributors and sales representatives.

When considering your next order for memory components and systems remember Microsystems International—we're about the biggest in the business.

**MOS & Bipolar Memories from  
the performance leader**

microsystems international limited, box 3529 station c, ottawa, canada K1Y4J1

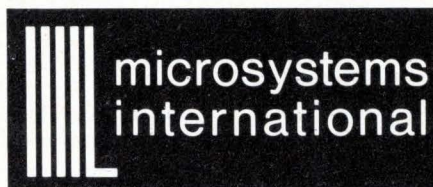

# nimo CRT THE 64 GUN SALUTE



BOOM . . . big information in a small package. *nimo*®, a 1.5" MINI-CRT requiring no internal or external focusing or deflection.

Each of 64 independent guns can display a single letter, number or symbol up to .6" high, or a complete message of up to 3 lines of 6 characters (.187" high). In effect, this ingenious display provides a Read-Only-Memory for your fixed data with extremely simple and inexpensive T<sup>2</sup>L interfacing; i.e., an 8 x 8 drive structure requires only two SN 7442N decoders, and four MC 1820 P Hex inverters to complete the package.

Unmatched legibility (true form characters), and contrast ratio, boom loud and clear, all on a single plane.



Don't restrict your thinking about the *nimo 64's* applications, they're great for key-to-tape/disc terminals for character entry verifications, digital instrumentation, annunciator systems, computer prompters, optical data scanning systems, teaching machines, and point of sale terminals.

The price? At ease men . . . 60¢ a message. *nimo 64*, the ultimate display—GIVE IT A SHOT!

Give us a call. Industrial Electronic Engineers, Inc., 7740 Lemona Avenue, Van Nuys, Calif. 91405, Telephone: (213) 787-0311, TWX 910-495-1707. Our European Office: 6707 Schifferstadt, Eichendorff-Allee 19, Germany, Phone: 06235-662.

## Electronics review

leads, or inverse beam leads can be used. A small ceramic preform is placed around the chip (though this isn't required if there are beam-lead connections), and a top can be added. Coupon thickness with the preform and top is 25 mils.

The interconnection layer is largely copper, with a small amount of insulation to isolate leads, and provides excellent thermal characteristics. In line with current trends, Parks says that epoxy die bonding is used, although a Kovar substrate can be used to provide the proper

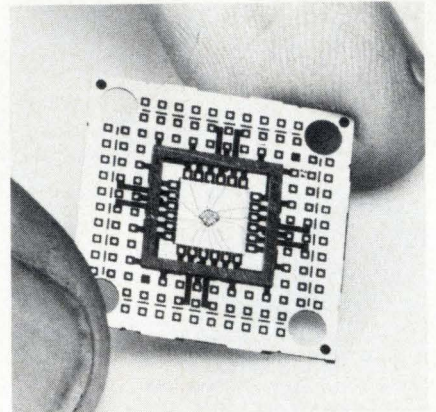

**Coupon carrier.** Bunker Ramo's technique combines IC carrier and interconnects.

thermal expansion coefficient for eutectic bonding.

**Cutting the coupon.** At this stage, the most practical approach seems to be to mount one or two ICs on a separate coupon formed by cutting a full 2-by-2-inch copper substrate into sixths. This permits testing the IC before installation, and also simplifies replacement if required. With more experience and higher IC yields, a full layer containing a number of ICs would be practical, and the whole wafer could be discarded and replaced for quick servicing.

Much of the low cost of the scheme results from its use of only small quantities of inexpensive materials. Some gold had to be used but, with skyrocketing gold prices, it is significant that only the small connection bumps, a few mils in diameter, need to be gold-plated and then only with 0.2 mil of gold. In conventional packages, it is often necessary to plate all metal parts. □

## MACHINE OR PROCESSOR CONTROL

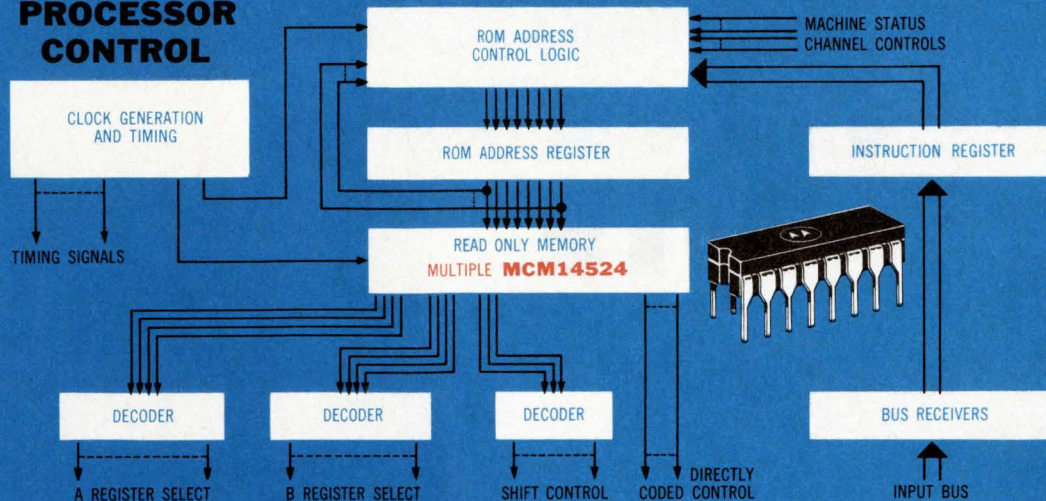

# FIRST 1K CMOS ROM

## *Creates All-CMOS System Capability—*

The interest aroused by Motorola's new MCM-14524 McMOS\* ROM was predictable. After all, it's the first 1024-bit CMOS memory. And the interest is much deeper than simple curiosity. The growing ranks of designers with requirements for low power operation and/or high noise immunity have recognized the MCM14524 as the closing link in the solution to many of their problems. The all-CMOS system.

For example, this machine or processor control section using microprogramming techniques can now take full advantage of CMOS. No need to mix in bipolar ROMs. Until the MCM14524 provided an alternative, no matter how the rest of the logic was executed, only relatively power hungry memory options were available for the ROM function. None of them offered any simple approach to noise immunity. With availability of the MCM14524, integrity of low system power use and high system noise immunity may be maintained.

Because it's a mask programmable ROM, the MCM14524 is ordered as a factory special, with the desired unique pattern for the 256 x 4 organization specified on punched computer cards, or if preferable by means of a completed truth table. The memory is

expandable by virtue of memory enable on the chip. Output latches provide a storage register, and full address decoding circuitry is on the chip, too.

Somewhat paradoxically, though the McMOS ROM is generally considered in the medium speed category, 70ns data retrieval is possible under certain conditions, i.e., in the chip enable access mode where addressing already has been established.

General McMOS family characteristics serve as a good guide to further definition of the MCM14524. Each of two versions is designed for single supply operation. The AL suffix version operates over a wide supply voltage range of +3 to +18 volts with a -55 to +125°C operating temperature range. The CL version operates over the +3 to +16 V supply range and a -40 to +85°C temperature range.

Mask charges are \$1,400.00 on orders to 24, but gradually decline to nothing when order quantities reach 500. 100-999 prices are \$24.70 and \$13.75 for the AL and CL respectively. Documentation, including programming instructions, is available from Motorola Semiconductor Products Inc., P.O. Box 20912, Phoenix, AZ, 85036. Your Motorola sales office will be pleased to entertain enquiries, too.

\*Trademark of Motorola Inc.



## MOTOROLA MOS

*Expanding Dimensions In Digital Design*

# McMOS

LOGIC OF THE 70's

# Fast Stored Writing Speed, With Long Viewing Times.

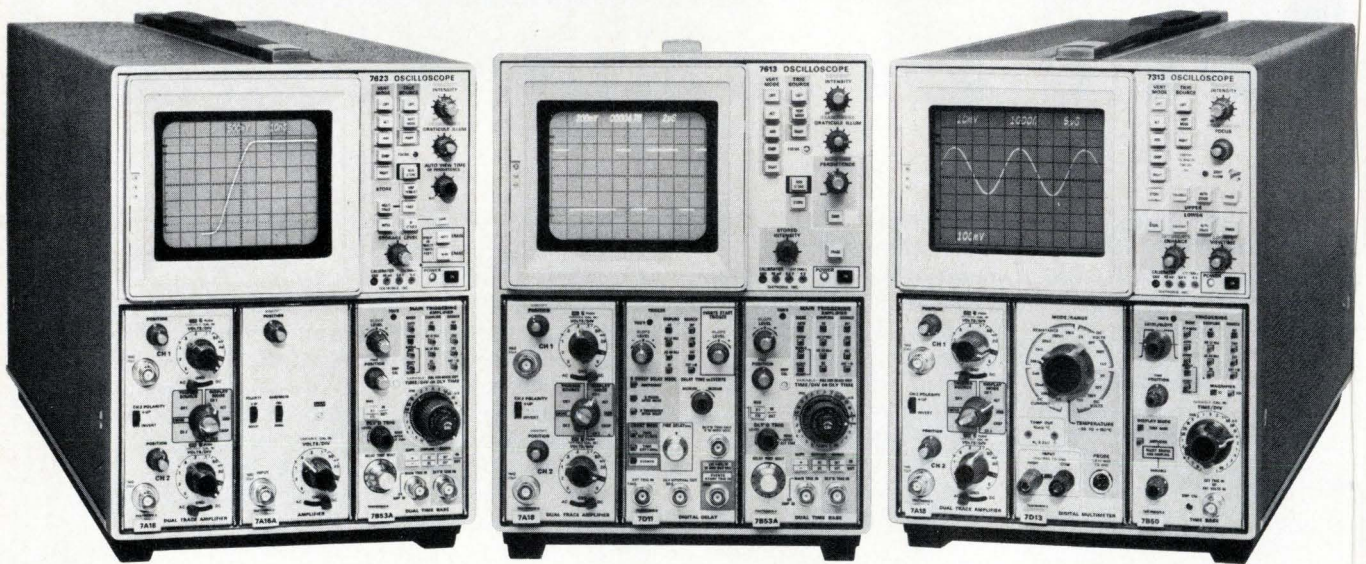

## The Tektronix 7000-Series Storage Family

Your requirements, to store and look at increasingly-faster waveforms, spurs us on in our storage R & D effort. Storage technology is not new to TEKTRONIX, we are now in our 11th year of delivering Storage Scopes. We believe that the multimode 7623 Storage Oscilloscope, our latest and fastest storage mainframe, offers you the very best storage/view-time capability available today

(200 cm/ $\mu$ s for hours). We invite you to try this multimode scope in your application and see for yourself. And high-speed storage is just one of the modes available in this mainframe. You may also choose Variable Persistence, Bistable Storage or Non-storage operation at the push of a button.

There are four other members in the TEKTRONIX 7000-Series

Storage Family with each one offering an excellent price/performance ratio. Choose the 7613/R7613 for Variable Persistence Storage or the 7313/R7313 for Bistable Phosphor Storage. All four models have stored writing speeds up to 5 cm/ $\mu$ s and operate in two modes: STORE and NONSTORE (conventional).

# Three Types of Storage, Six Mainframes

## Multimode Storage (7623/R7623) 4 modes of Operation 100 MHz bandwidth

**FAST**—stores up to 200cm/ $\mu$ s with the FAST CRT option and up to 100 div/ $\mu$ s (0.9 div/cm) in the standard model.

**VARIABLE PERSISTENCE**—in those bright high contrast or halftone displays.

**BISTABLE**—for the lower writing speed requirements of 30 div/ms and slower.

**NONSTORE**—for the conventional oscilloscope applications.

## Variable Persistence Storage (7613/R7613) 2 modes of operation 100 MHz bandwidth

**VARIABLE PERSISTENCE**—gives bright high contrast display of fast-risetime low rep-rate signals, ideal display for the 7L12 Spectrum Analyzer. Stores up to 5 div/ $\mu$ s (0.9 div/cm).

**NONSTORE**—for the conventional oscilloscope applications.

## Bistable Phosphor Storage (7313/R7313) 2 modes of operation 25 MHz bandwidth

**STORE**—retains fast waveforms moving up to 5 cm/ $\mu$ s. Features split-screen operation for realtime and stored waveform comparisons.

**NONSTORE**—for the conventional oscilloscope applications.

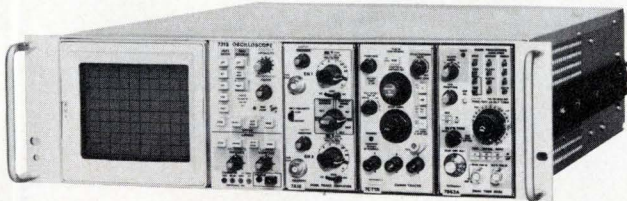
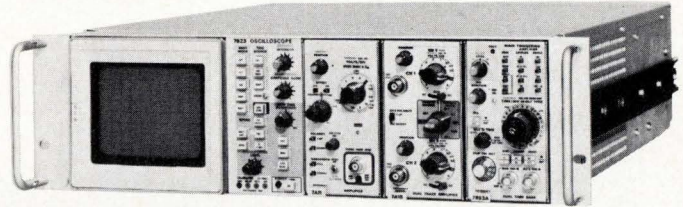

complex, in many disciplines, are solvable with 7000-Series plug-ins. Choose from: Amplifiers, Time Bases, Curve Tracer, Digital Multimeter, Digital Counters, Digital Delay, Sampler and Spectrum Analyzer Plug-ins . . . and there are more coming.

Tektronix, Inc. . . . the pioneering pacesetter in storage display technology, offers sales, after sales support, and service . . . world wide.

## All oscilloscopes with CRT READOUT

You gain overall efficiency in operator speed and accuracy and simplify your measurements by using CRT READOUT. It puts the measurement parameters, right on the CRT, adjacent to the waveform you are viewing, measuring or photographing.

With CRT READOUT you can use the complete line of Digital plug-ins available in the 7000 Series.

All CRT's are extremely burn resistant . . . requiring no special operating precautions.

## 7000-Series . . . more than just an oscilloscope.

A 7000-Series mainframe equipped from a selection of over 22 plug-ins plus an entire line of probes, cameras, SCOPE-MOBILE carts and other accessories offers you the widest scale of measurement solutions available today.

Measurement problems, ranging from the very simplest to the most

## PRICES without plug-ins:

Mainframe	w/o CRT READOUT	STANDARD
7623	\$2450	\$2850
R7623	\$2550	\$2950
<b>for FAST WRITING CRT add \$500</b>		
7613	\$2100	\$2500
R7613	\$2200	\$2600
7313	\$1600	\$2000
R7313	\$1700	\$2100

For a "hands-on" demonstration of the only total storage capability, contact your nearby TEKTRONIX Field Engineer or write: Tektronix, Inc., P.O. Box 500, Beaverton, Oregon 97005. In Europe write: Tektronix Ltd., P.O. Box 36, St. Peter Port, Guernsey, Channel Islands.



# Excellon's Mark III Nobody's equal

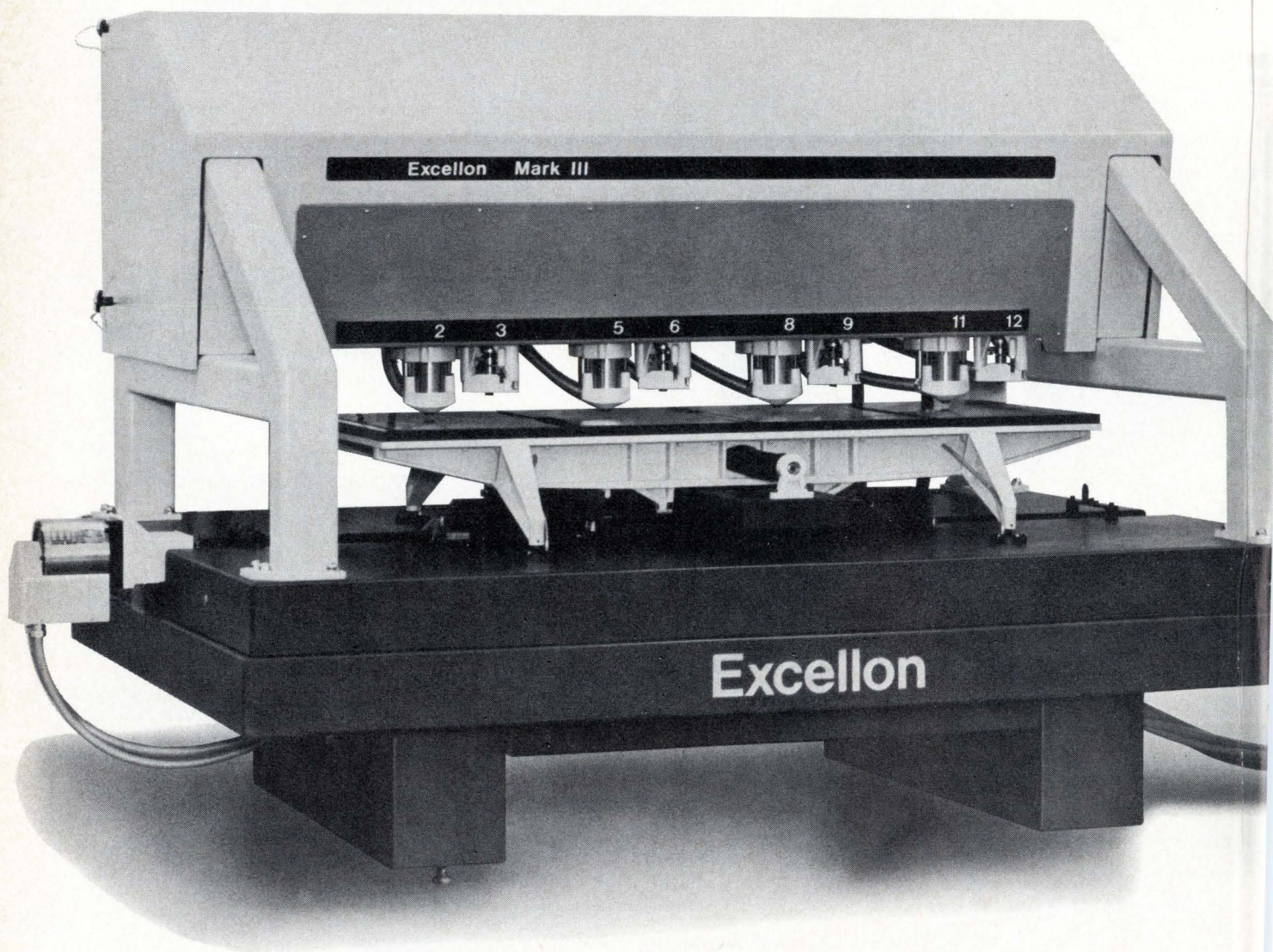



# d it yet.

The Mark III is unquestionably the most advanced p.c. drilling system ever produced by us or anybody else.

It has no competition.

Of course, that doesn't mean they're not out there *trying* to equal it.

But just look what they're up against.

The Mark III is computer-directed, utilizing a General Automation SPC-12/15. The SPC-12/15, with 16K memory, handles a variety of code formats and is plug-compatible with central computers. It offers step and repeat, repeat pattern (16 and 14 pin dual in-line, 8 pin L package), automatic table offset, mirror image and automatic rewind. In its own right, it, too, has no competition.

The Mark III can produce drill hit rates of 200 per minute. And we're talking about *quality* holes at .25-inch movement and .002 chip load.

Table travel speed is 400 ipm on each axis. A computer-driven, high-torque, high-speed, low-inertia servo motor provides *instant* acceleration for unmatched production.

Spindle motor speeds are from 45,000 to 80,000 rpm. AC variable-frequency motors with air bearings easily exceed the practical limits of common ball bearing motors.

Spindle feed rates range from 20 to 250 ipm. Constant feed rate accuracy is assured to within 2.0 percent of setting. The stroke limit is adjustable in .001-inch increments.

And as a unique option, there's the Excellon automatic drill changer. It selects from 12 drill sizes on computer command.

Call or write Dick Hogan, Sales Manager, today. His number is (213) 325-8000.

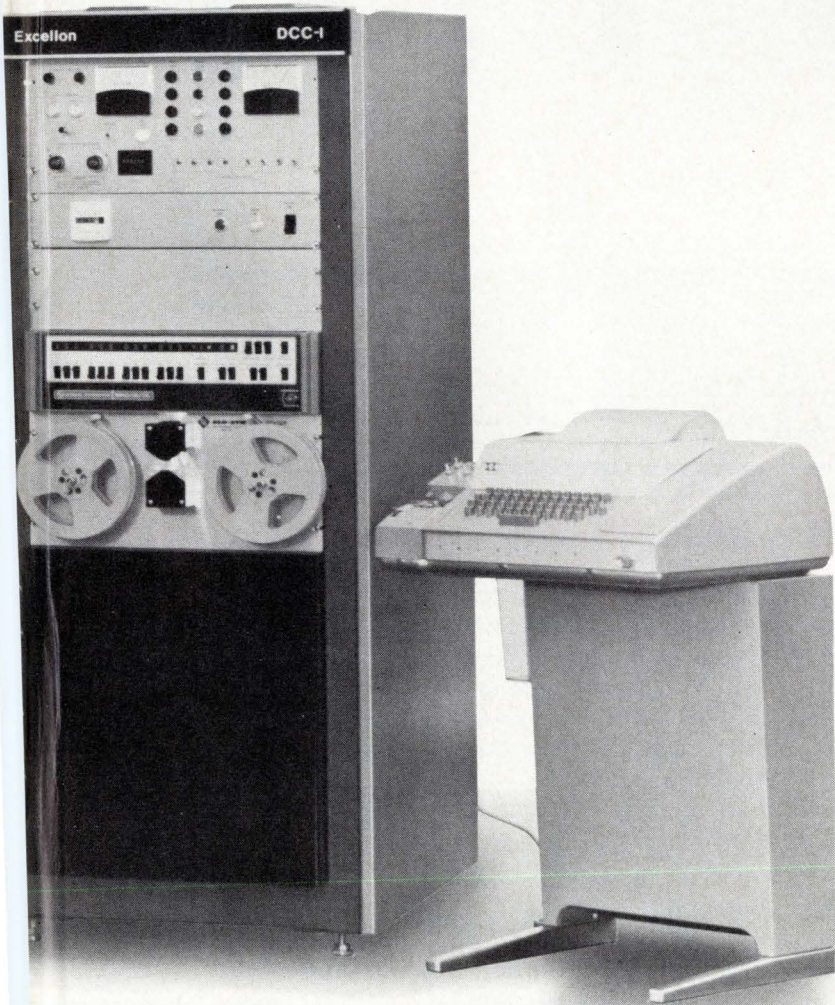

## Excellon

EXCELLON INDUSTRIES  
23915 GARNIER / TORRANCE,  
CALIFORNIA 90505  
Phone: (213) 325-8000

Telex: 674562 - Cable: EXCELLON Torrance

Excellon Sales and Service in ENGLAND • FRANCE  
SCANDINAVIA • W. GERMANY • SPAIN • HOLLAND  
ITALY • ARGENTINA • ISRAEL • AUSTRALIA • HONG  
KONG • TAIWAN • JAPAN

**Another New Signal Generator—from Narda**

# NOW - in one instrument sweep from 2 to 18 GHz

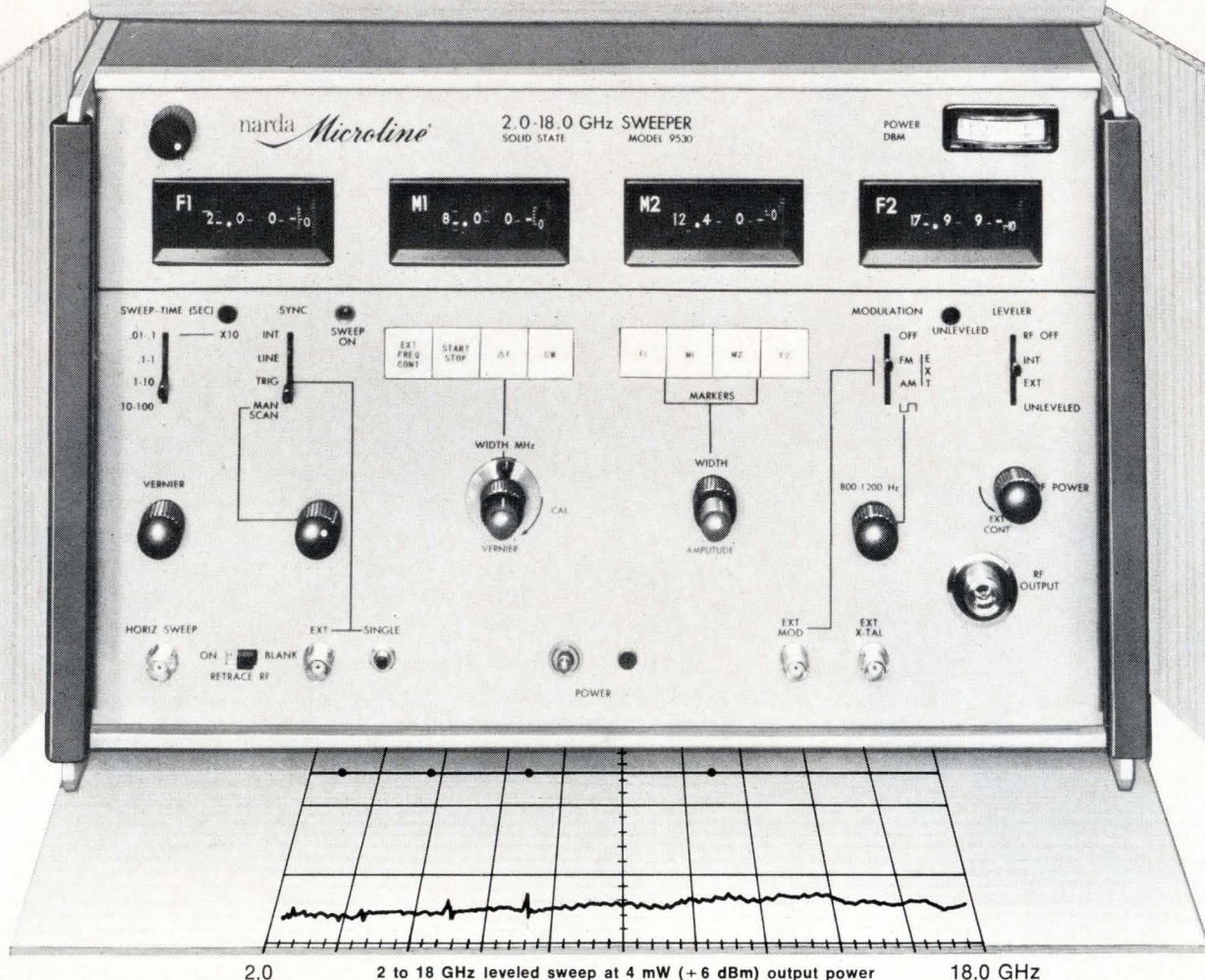

**no BWO tubes - no extra plug-ins - no other gimmicks**

Now sweep continuously from 2 to 18 GHz and anywhere in between with the Narda 9530 all solid-state sweeper. Use it also as an accurate stable CW signal generator. Make more significant measurements quickly . . . one broadband instrument, with 0.5% frequency accuracy, at least 0 dBm calibrated leveled output power, low residual FM, and modulation capabilities. Save man hours by eliminating plug-ins and warm-up time . . . no need for separate signal generators. Save too by eliminating your BWO and Klystron tube replacement costs.

Narda now offers you an extensive line of broadband accessories to work with the 9500 (1 to 12.4 GHz) and the 9530 signal generator/sweeper . . . turret attenuators, DC to 18 GHz for sensitivity and attenuation measurements — broadband high directivity couplers to 18 GHz for precise return loss and insertion loss measurements.

**Get all the facts about our Broadbands . . . write for new literature.**

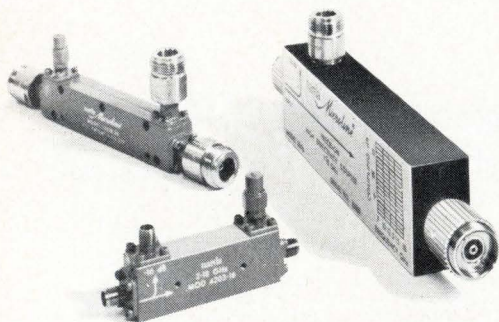

Circle 48 on reader service card

wherever microwaves go... **narda** *Microline*<sup>®</sup>

THE NARDA MICROWAVE CORPORATION • PLAINVIEW, L.I., NEW YORK 11803  
516-433-9000 • TWX: 510-221-1867 • CABLE: NARDACORP PLAINVIEW NEW YORK

## Postal Service begins automation of business mail

The multibillion-dollar network of preferential mail centers, eagerly awaited by equipment contractors, will be kicked off by the U. S. Postal Service with **development of the Automatic Business Mail Processing System** to handle business reply mail [*Electronics*, Nov. 6, 1972, p. 67]. Responses to two requests for proposals are due back from industry within a month. **One contract will call for automation of about 30 manual sorting machines**, coupled with purchase of 10 or more Digital Equipment PDP-8E minicomputers, for at least \$1.5 million. **The other will be for prototype equipment to automate Burroughs' manual sorting machines**, followed a year later by a planned contract to upgrade 400 Burroughs' sorters. The Postal Service also has contracted with Philco Ford for the upgrading of 20 optical character readers in 13 cities. The business-mail system will precede the mammoth automation of preferential mail centers by one or two years, say postal sources.

## Collision-avoidance systems cause FAA more trouble . . .

The Federal Aviation Administration is about to collide with Congress again over aircraft collision-avoidance systems. The Senate Commerce Committee will hold hearings in June on **a bill by Sen. Frank E. Moss (D., Utah) requiring the agency to select a national CAS standard by June 30, 1974**, and is expected to grill FAA officials on why they have not selected one by now. Certain FAA topside are known to favor an improved ground-based air-traffic control for CAS functions and are uninterested in choosing from among competing airborne systems by Honeywell, McDonnell Douglas and RCA [*Electronics*, Dec. 20, 1971, p. 69]. To sidestep an earlier Moss bill, the FAA had agreed to set up a special program to evaluate the systems and was to have reported back to Congress last January [*Electronics*, Jan. 31, 1972, p. 29].

## . . . and anti-crash device is another agency headache

**Whether or not to require ground-proximity warning devices on airliners** also is causing the FAA some grief, since the National Transportation Safety Board and equipment makers favor them but parts of the agency and the airlines don't. Spurred by the Dec. 29, 1972 crash of an Eastern Airlines Lockheed L-1011 in Florida, the agency is asking for comments from interested parties by July 24, but says that **the big problem is that there already are too many warning gadgets in cockpits**. It has, however, okayed a Sunstrand system for European Douglas DC-10s and says that United and TWA have modified their radio altimeters to achieve a similar purpose. It also has a contract with Boeing Co. to study concepts in which Honeywell, too, is reportedly interested, the FAA says.

## Small Applications Satellite changes name, maybe form

A funny thing happened to the proposed 500-pound Small Applications Satellite project [*Electronics*, Dec. 18, 1972, p. 34] as the idea went through NASA channels: it lost its name and may lose its spacecraft as well. **Currently called the heat-capacity mapping mission**, it is being viewed at in-house conferences as either a satellite or **a sensing package to go onboard another satellite**. Deliberations could go well into fiscal 1974 before a design contract could be let, though sources indicate that NASA may opt to build the unit itself in either form. The

# Washington newsletter

small satellite has been considered one of a projected family of "mass-produced" craft on which specific sensing packages could be mounted.

## DOT mulls a unified air-sea SOS system

A committee at the Department of Transportation is considering **the possibility of creating a unified distress alerting system for planes and ships**, and its report, expected this summer, could help shape equipment policies and specifications for communications and individual transmitting gear. The group is looking at the FAA's Electronic Location Transmission System now required on most planes, at maritime systems, and the Coast Guard's idea for a satellite-monitored Global Rescue Alarm Network and its present coastal Distress Alerting and Locating system.

Although DOT eventually wants commonality, **initial problems include potential high user equipment costs and a difficult marriage of systems**. The Defense Department already is funding its own Advanced Survival Avionics Program.

## Private equipment harms network, says AT&T report

In response to **an FCC inquiry into whether to extend the private-attachment rules to include customer-provided interconnection equipment**, AT&T weighed in with a lengthy statistical report charging that, among those using non-Bell equipment, about 9% used too much data signal power and nearly 30% of reported troubles harmed the network. AT&T figures, based on analysis in several areas, also show that **nearly half of the reported trouble came from the private equipment**. Worse, the company complained that "customers employing their own equipment rely on the telephone company to determine whether trouble exists in their equipment, thus diverting our maintenance resources from maintaining telephone company equipment."

AT&T's report was requested by the FCC's Common Carrier Bureau, which within a few weeks will ask the communications giant to clarify whether the report applies to data and/or voice usage.

## Ship-shore-satellite program may get help from Comsat

Looking to find a satellite for its automated ship-shore-satellite program, **the Maritime Administration is talking with Communications Satellite Corp.** about using space onboard the proposed Navy-Comsat interim navigation satellite [*Electronics*, March 15, p. 36]. The program, which was momentarily stopped when NASA dropped further communications work, will **produce a large communications-equipment market**. Marad also has sounded out American Satellite Corp. for space onboard its domestic satellite system. Marad will perform L-band experiments on Applications Technology Satellite F, to be launched in 1974.

## EIA reports big jump in 1972 sales of color-TV tubes

A striking leap in the export market for color-TV tubes paced a strong rise in factory sales of color tubes during 1972, according to figures recently released by the Electronics Industries Association. **The export market ran 180% above 1971**, to 622,000 units from 1971's 222,000, while the total 1972 volume rose 22%, or to 8.4 million units versus 6.9 million the year before. On the other hand, **imported color picture tubes declined almost 6%** from 122,000 units to 115,000 during the year.

# The first

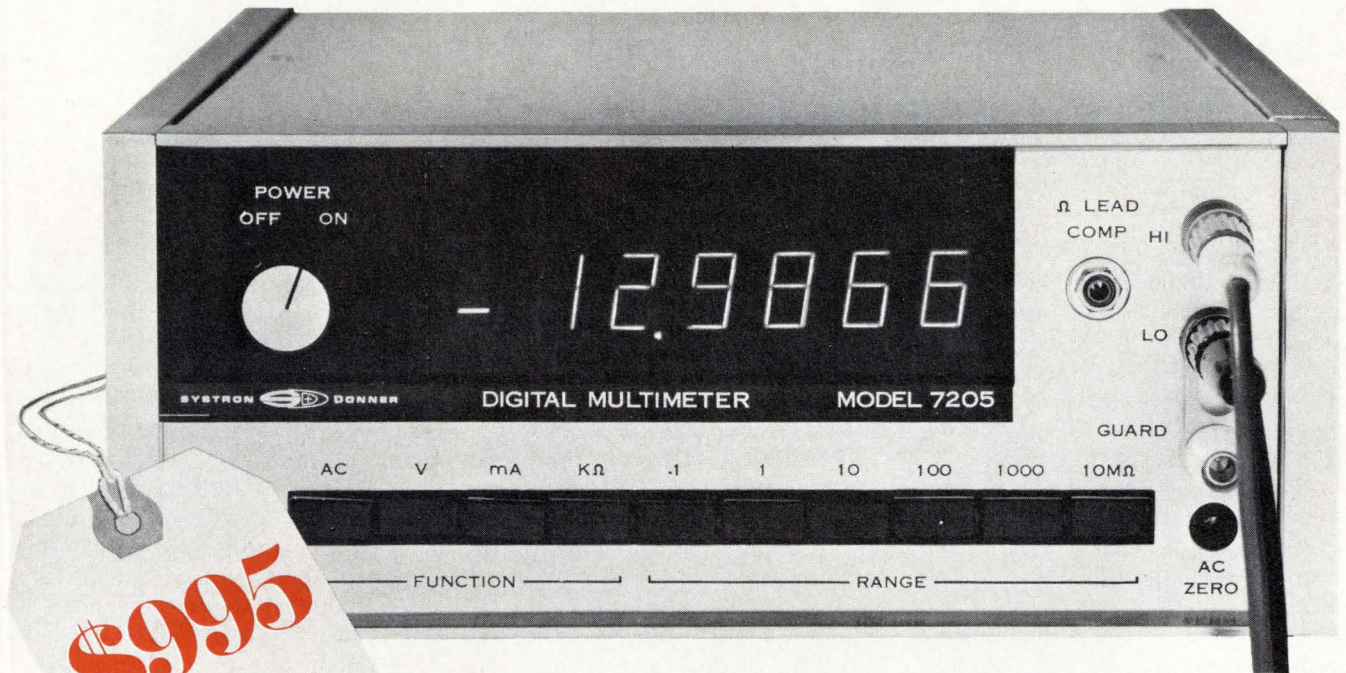

**\$99.95**  
fully loaded

## at this price!

**$\pm 1\mu\text{V}$  resolution**

**5 full functions**

**26 ranges**

**Lead-compensated ohms**

For immediate information on Systron-Donner's new Model 7205 5½-digit Multimeter, call us collect on our **Quick Reaction** line: (415) 682-6471. Or you may contact your Scientific Devices office or S-D Concord Instruments Division, 10 Systron Drive, Concord, CA 94518. **Europe:** Systron-Donner GmbH, Munich, W. Germany; Systron-Donner Ltd., Leamington Spa, U.K.; Systron-Donner S.A., Paris (Le Port Marly) France. **Australia:** Systron-Donner Pty. Ltd. Melbourne.

SYSTRON  DONNER

The Systron-Donner Instruments Group:

Concord Instruments  Computer Systems  Datapulse  Kruse Electronics  Microwave  Trygon Electronics

## Quartz wafer, without being disturbed, controls its own ion machining

By lapping, quartz crystals that will oscillate at 30 megahertz can be easily made. Even 45-MHz operation is possible—if low yields are acceptable. At 45 MHz, the wafer is about 40 micrometers thick. Lapping, cleaning, and checking something that thin destroys many samples.

Now G. V. Planar Ltd. of Sunbury-on-Thames, with support from the Ministry of Defence, is developing an ion-bombardment thinning technique that produces very thin quartz wafers. What's more, a probe contacting the wafer gives a readout of the resonant frequency reached without disturbing it, minimizing damage risk. Planar has made 65-MHz wafers—about 30 micrometers thick—and says it can be done with good yields. Wafers for 100-MHz operation—about 18 micrometers thick—should be possible.

**Turning.** The ion machine is a straight-forward 7,000-volt argon accelerator, costing about \$7,000, that was developed originally by Planar for fine etching of semiconductors. It produces a collimated flood beam about 5 inches in diameter, moving upwards. Paul Reimann, one of the development engineers, has mounted a small turntable, which revolves at 1 revolution per minute, in the beam path. It has recesses to take a dozen standard 300-mil-diameter quartz wafers.

A mask covers the rim of the wafer so that only the central section, about 200 mils in diameter, and a path through the rim to take the electrode lead are eroded away. Leaving the rim thick makes the final product stronger and easier to handle. With lapping, of course, all the surface is thinned. Reimann says the wafer surfaces have a good polish, and uniformity variation between wafers is 1%.

The planing rate is about 1 micro-

meter per hour at maximum energy. Reaching 35 micrometers takes some 30 hours. For the last micrometer, the energy is cut to about 4,000 v. When the elapsed time indicates that the wanted thickness is near, the probe monitor is used.

The contact surface of the probe is a gold disc about 100 mils across. It faces upwards, under the wafer, and its support extends through the vacuum envelope. A thin layer of gold—about 1,000 angstroms—is sputtered off the probe face onto the underside of the wafer, forming an electrode. The gold remaining on the probe contacts this electrode.

Peter Evison, senior scientist, says that this probe gives a resolution of 0.005%, or 3 kilohertz at 60 MHz. The Ministry of Defence is interested in the approach because scientists at the Royal Aircraft Establishment think the crystals could be useful for calibration purposes. Planar intends to sell both finished crystals and the production equipment, if there is a market. Evison also has in mind a single wafer blank with many wells etched into it, each with a bottom of different thickness, producing a band filter in a single wafer. □

---

### France

---

## Modules combine for uhf transmitter

It's still not child's play, but building airborne uhf transmitters with the modules that RTC-La Radio-technique-Compelec has developed gets close to it. RTC's power packages can be combined to get outputs up to 80 watts over the frequency band from 225 to 400 magahertz.

All avionics makers need do, essentially, is mount the modules on a heat sink and tack on modulator, antenna, and power supply.

RTC, a French unit in the Philips Gloeilampenfabrieken group, builds the power packages from two basic elements—a 25-w (peak-power) hybrid amplifier and an interdigitated  $\lambda/4$  coupler. The company is just getting into pilot production of the modules, but already has a quartet of different versions in the works. The most elaborate is a 45-w module, a pair of amplifiers, and a pair of couplers tucked into the same package. Then there's a driver package, a pair of amplifiers, and a coupler. As you'd expect, the basic amplifier and the coupler can be had packaged by themselves. All the packages have 50-ohm input and output impedance.

**Package.** The kingpin component in the hybrid amplifier, of course, is a silicon power transistor. The chip measures 1 by 2 millimeters and has five 7-w cells laid down on it. This chip mounts on a beryllium oxide substrate, along with a silicon resistor plus MOS and ceramic capacitor chips. The inductance needed for the LC-impedance-matching circuits consist of gold over nichrome meanders deposited directly on the substrate by photogravure. The lines are 100 micrometers wide, and they're spaced 100 micrometers apart. In its own 18-mm-diameter can, the amplifier is rated for an output of at least 25-w peak and a gain of 5.5 decibels or more.

To parallel these amplifiers, RTC designed a -3-decibel coupler that can handle up to 100-w peak. It consists essentially of interdigitated  $\lambda/4$  delay lines terminated by a 50-ohm nichrome resistor. There's no trouble pairing two of the 45-w modules to obtain an 80-w peak

transmitter amplifier. In fact, that's what RTC's sister company, Télécommunications Radioélectriques et Téléphoniques is doing for the uhf radio it's building for the Anglo-French Jaguar trainer/attack jet. □

## Italy

### Point-of-sale system checks out in Turin

Europe's first complete electronic point-of-sale data-processing system has been installed in a new department store in Turin owned by La

Rinascente, one of Italy's leading retailing groups.

The system includes 60 stand-alone intelligent terminals with magnetic-tag readers, a duplex minicomputer processor, and two dedicated back-office terminals for accounting and installment-plan and credit-card processing. It is somewhat more sophisticated, according to Litton, than similar systems that it has installed recently in two American department stores.

**Purposeful.** The system was designed and manufactured, mostly in Europe, by Litton's cash-register subsidiary, Sweda. It is not only aimed at eliminating cashier errors, but also at improving customer ser-

vice and providing management with up-to-the-minute information on the inventory situation and sales performance of individual departments and the store as a whole.

La Rinascente executives say that early operating experience indicates the system has virtually eliminated the problem of "lost" transactions. Aldo De Thierry, the group's information systems and EDP director, says that in standard sales-control operations small punch-card-type labels attached to the merchandise are collected and processed to indicate sales volume and stock turnover. But, because of missing or ripped tags, plus clerical errors, up to 10% of all sales transactions are lost and cannot be retraced.

**Found.** With the new system nearly 100% of sales are recorded. De Thierry says that in the first 10 days of operations there were only 450 erroneous entries out of a total of about 130,000 transactions. He emphasizes that these 450 were not lost but merely wrong; many of them were caused by unfamiliarity with the processor. What's more, all 450 were identified and re-entered later into the store's records.

The Datapen reads at speeds from 5 to 50 inches per second at signal frequencies from 400 to 4,000 bits per second. It can read from either end of the label, upside down, from curved surfaces, and even through transparent surfaces. If information must be entered manually—a marked-down special sale price, for instance—a special key erases the magnetic information and new data can be punched in by hand. □

**At work.** Shoppers at Turin's new department store get their bill fast as data on merchandise tags (left) is read magnetically into electronic cash-register terminal (right).

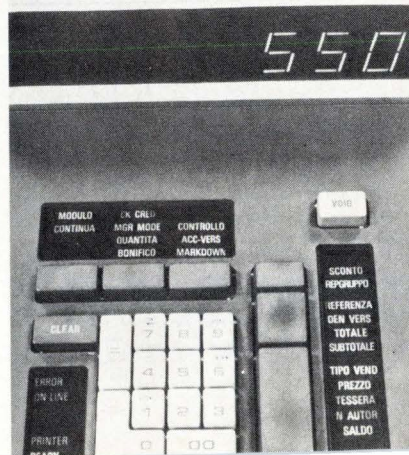
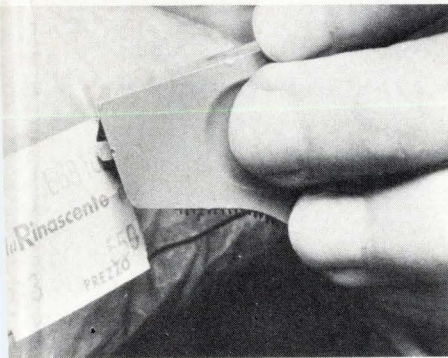

# We'll build your circuit that: Beeps, Smells, Listens, Reads or Goes Bump in the Night. Fast and Cheap.

## We call it Monochip.

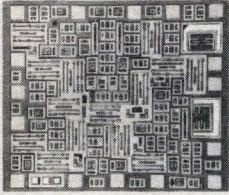

Monochip is a one-chip custom bipolar IC that can be made into a fantastic variety of linear and digital circuits. Plus, it gives all the performance and reliability you could want in a world of applications.

**Beeps** One of our customers builds a small clip-on heart monitor that beeps when the heart beats and buzzes when it doesn't. Circuit complexity and reliability made Monochip a must.

**Smells** Bacharach Instrument Co. Inc. needed a gas analyzer circuit in one package. A tough challenge. Low cost, ruggedness and precise performance were crucial. Monochip met all these conditions.

**Listens** Then, there's this alarm clock that shuts off when you yell at it. Very satisfying. R. W. Enterprises picked Monochip for its size/performance capability.

**Reads** Monochip gave Tekelec, Inc. a great cost advantage in their panel meters. Contents: a MOS device, some LEDs, and of course, our customized IC to do the measuring.

**Goes Bump in the Night** Somebody (possibly the C.I.A.) gave us just their I/O specs. Nothing else. We shipped Monochips that met their cost and delivery requirements. That's all we know. Spooky.

**Fast and Cheap** \$1800 gets you 50 packaged, evaluation units in only 3 weeks. That's fast. And no matter how many production units you order, they'll cost less than other custom ICs, hybrids, or discrete assemblies of equal complexity. That's cheap. There is an Interdesign Design Kit that contains everything needed to breadboard and simulate your circuit's performance, including stray effects. 16 DIP kit parts, designer's handbook and more. All for \$39. Or, we can do the design work for you. Just send in your schematic and/or specs for free evaluation.

Either way, Monochip makes a lot of sense. Now, while you're thinking of it, call or write us.

**INTERDESIGN**

1190 Elko Dr., Sunnyvale, California 94086  
(408) 734-8666



## Italy's cities wire up for cable TV

Italy, if the pace doesn't slacken, could shortly have one of the largest cable-TV networks in Europe. On April 16, a company was set up in Milan to start a cable-TV station covering two sections of the city. This, however, is just the latest of a rash of projects and operating stations that have shot up in the last few months. Last July, in Biella, a quiet textile town in Northern Italy, a former government-station TV director put out the first programs in what appeared to be a flagrant affront to the state monopoly of RAI-TV. **The town's magistrate ruled, however, that cable TV was not competitive broadcasting. It was more in the nature of video newspaper or magazine publishing,** and that Article 21 of the Italian constitution gave it justification. Today, the station, which uses the call-letters A 21, says that it has 1,200 sets linked up and that the number is growing. The local legal success of Telebiella led to a desire to set up stations in some 30 Italian cities. However, each station will have to fight its own legal battles, even though the experience of Telebiella makes a good legal precedent.

**There are two reasons for this sudden development. First come the political battles over the reform of RAI-TV.** Its contract from the government expired last year, but the station continues operating on a year-to-year basis. No political party wishes its demise since it is a powerful mouthpiece for them, and yet all opposition parties are battling the hold that the Christian Democrats have on it. **The growth of the CATV stations is a direct measure of the exasperation of political parties, local and regional interest groups, and businessmen who are unable to get the amount of advertising time they want on TV.** The second element is the low cost of setting up a station. A spokesman for Telebiella says that a station can begin operating for an outlay of \$35,000, not counting the cost of cables.

## Europa 2 killed as ELDO dies

After a long illness, Europe's joint space launcher organization ELDO died last week. The Paris-based organization announced it is **dropping plans to carry out the last two scheduled test firings of Europa 2, the Franco-British-German-Italian launch vehicle that was to give Europe an independent orbital capability.** High costs and a series of abortive launch attempts caused its downfall. Europa 2 was the last surviving project of ELDO, which now is being absorbed—along with ESRO, the satellite development organization—into a new European Space Command that will deal only in satellites [*Electronics*, Jan. 4, p. 59].

**Future launches will be farmed out to NASA, with the outside possibility of occasional launches by the Russians.** Except for the 300 French and German employees of ELDO who lost their jobs, the biggest blow comes to the Franco-German Symphonie satellite program, originally set up as a model of European cooperation to work toward busting the U.S. lead in orbital communications systems. Symphonie now will most likely be orbited in 1975 by NASA.

Meanwhile, still determined to see Europe get its own launch capability, **the French are working on the West Germans to pin down a commitment for participation in the development of the L3S rocket,** a vehicle that the French have hopes could be operational at a development cost of \$500 million, or about \$100 million less than the Europa 3, which ELDO abandoned at the end of December.

### Siemens readies green-light luminescence diodes

With its red- and infrared-light emitters already hot-selling items, Siemens AG is now getting set for large-scale entry into the market for green-light luminescence diodes. A relative latecomer in this field, the company says its diodes exhibit an efficiency several times better than that of devices offered by some other firms. It puts the efficiency for production-type devices at up to 0.08%, and operating life at more than 100,000 hours before the half-light level is reached.

The Siemens gallium-phosphide green diodes will hit the market within two to three months and sell at a price "somewhat higher than that for red-emitting type." **In anticipation of big sales—particularly to instrument, radio, and camera makers—the company is preparing for volume production so that orders of 10,000 units and more can be filled on relatively short terms.** They will be available in three versions: as single devices, of 3- and 5-millimeter diameters, designated the LD37 and LD57, respectively, and as the LD147 linear array with up to 10 diodes. Responsible for high efficiency, Siemens says, is the use of epitaxial, instead of diffusion, methods in diode fabrication.

### 300-W transmitter uses no tubes

Rohde and Schwarz has unveiled a fully-transistorized 300-watt radio transmitter, which it believes to be the first tubeless type with this power level on the market. **The ultra-shortwave transmitter occupies about one third the space of a conventional 360-w version** and uses as key components four BLX15 power transistors, supplied by Valvo GmbH, a Philips subsidiary. Transistor cooling is by convection. The new R&S transmitter, priced at about \$14,000, will go into operation at Radio Bavaria in Munich, where **it will be used for local broadcasts of frequency-modulated mono and stereo programs.**

### South Africa takes another step toward color TV

The South African government will allow a sixth television manufacturing company to be set up in the country. It will join the five companies that received licenses last September **to make sets in preparation for the introduction of the TV-transmission service scheduled to start in January 1976.** The new licensee is a joint venture by the South African subsidiaries of Thorn Electrical Industries Ltd., Britain's largest TV set maker, and ITT. **The new company still has to be set up, but most likely its sets will be engineered by Thorn, using many ITT components.**

The other five licensees are South African Philips; Electra Television Appliances and Partners, which is associated with the U.S. General Electric Co. and AEG-Telefunken; Barlow Rand, which is associated with Matsushita and the British TV-program distributor Rediffusion Ltd.; Tedalex, which is associated with Sony, Blaupunkt, and Bosch; and Fuchs Electronics and Partners. At the start of broadcasting, there will be only one television channel, using the PAL color standard developed by West Germany's AEG-Telefunken.

### BASF to handle Mohawk Data Sciences equipment

West Germany's BASF and Mohawk Data Sciences Corp., of Utica, New York, have signed an agreement whereby the German company will market MDS-made magnetic-tape stores. **BASF, which manufactures magnetic tape, will handle marketing in all countries, except in Japan, Canada, and the U.S.** In its marketing area, BASF anticipates a business volume of about \$5 million during the next two years alone.

Now . . .

# MEASURE ANTENNA CHARACTERISTICS Even in presence of strong interfering signals.

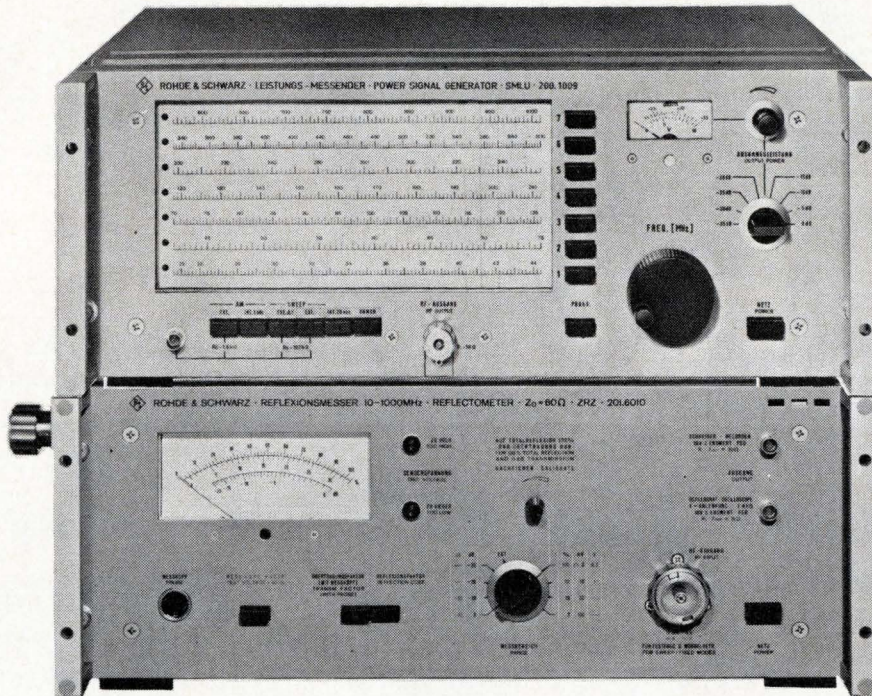

Type SMLU  
(2 Watts Output)

Type ZRZ

## PROGRAMMABLE - SWEEPABLE - DIRECT READING REFLECTION & TRANSMISSION TEST SYSTEM

### FEATURES

- Covers 25 – 1000 MHz Freq. Range
- Measure Reflection Coefficient 0.5% – 100%
- Directivity > 50 dB
- Measure Attenuation 0 – 70 dB
- ZRZ available in 50 Ω, 60 Ω or 75 Ω
- Recorder & Oscilloscope Outputs
- BCD Programmable
- Up to 2 Watts output with ALC from SMLU
- AM Modulation provided

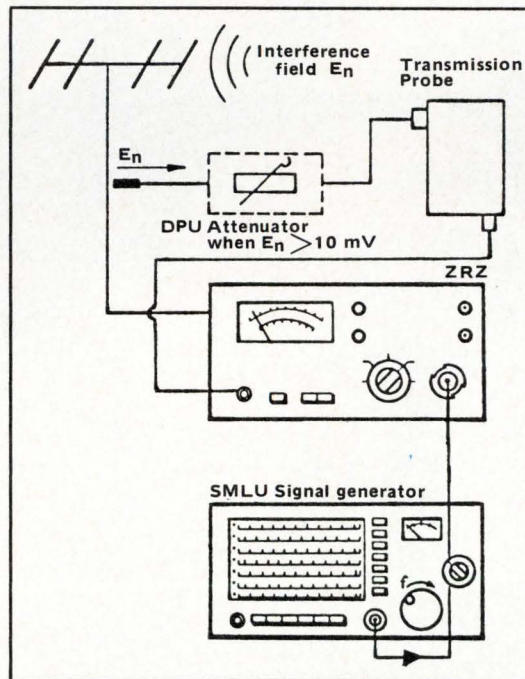

### APPLICATIONS

- Check two & four terminal networks
- Measure & adjust filters, diplexers, attenuators, & couplers
- Low test voltage (1 mV) on active components such as transistors, tuners & amplifiers
- Higher test voltage (1 V) for antenna measurement in presence of interference
- Ideal for production testing on cables & CATV installations

Get The Extra Capability,  
Greater Reliability, and  
Longer Useful Life . . .



## ROHDE & SCHWARZ

111 LEXINGTON AVENUE, PASSAIC, N. J. 07055 • (201) 773-8010





# AVX

## believes there is a tomorrow

Today, our capability is the industry's best. We're making it better. AVX is doing something today about tomorrow. We're building a new addition at Myrtle Beach — substantially increasing our two million a day capacity. We're beefing up our capability to help fill the ever-increasing demand for multi-layer ceramic capacitors.

AVX is refining what is already a proven production process. Computerized control speeds product off the end of the line. Every conceivable means, including proprietary mechanization and in-line testing, is used to deliver customer orders to spec and on time.

AVX believes there is a tomorrow and that's why we're doing so much today. If you need help with multi-layer ceramic capacitors, ceramic discs, tubular feed-thrus, chips or ceramic filters, write AVX Ceramics Corporation, P.O. Box 867, Myrtle Beach, S.C. 29577 or telephone (803) 448-3191. We'll help you.



*THE* Ceramic Capacitor Manufacturer

Braintree, MA.



# HP's Calculator Aided Design-- Your Answer To The High Cost Of Engineering

New HP calculators and program software put the advantages of interactive modeling right on your desk top. HP's calculator aided design is a tool that enables you to go from an idealized design to a practical case as fast as you can enter the data and read the results. And you can try a dozen alternatives in less time than it would take you to modify a circuit. Use Quine-McCluskey techniques for logic minimization; do network analysis using a program similar to ECAP. Have the power, at your finger tips, to take a complex transfer function and quickly realize an actual circuit. See the results of your design inquiry graphically pictured on labeled X-Y plots. It's a wide ranging electronic engineer's design tool that helps you solve the everyday design problems, at a cost you can afford.

**For example, in filter design,** enter your data into one of our Series 9820 calculators and let HP's software program automatically de-

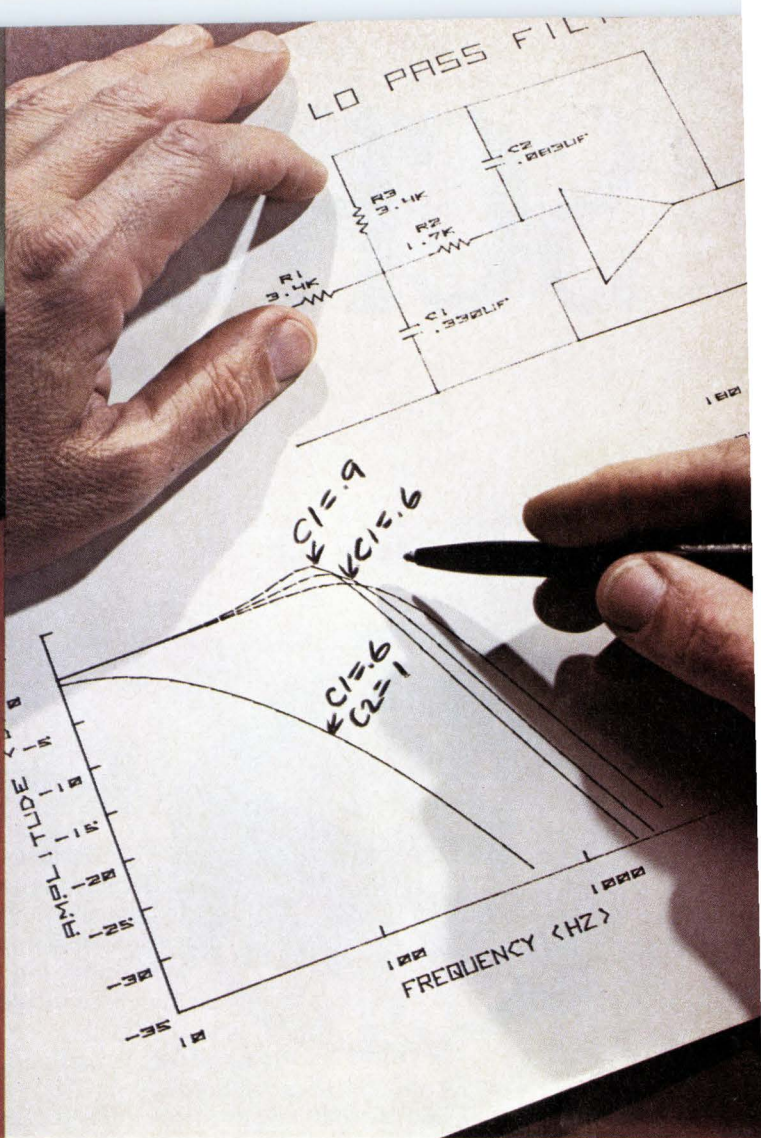
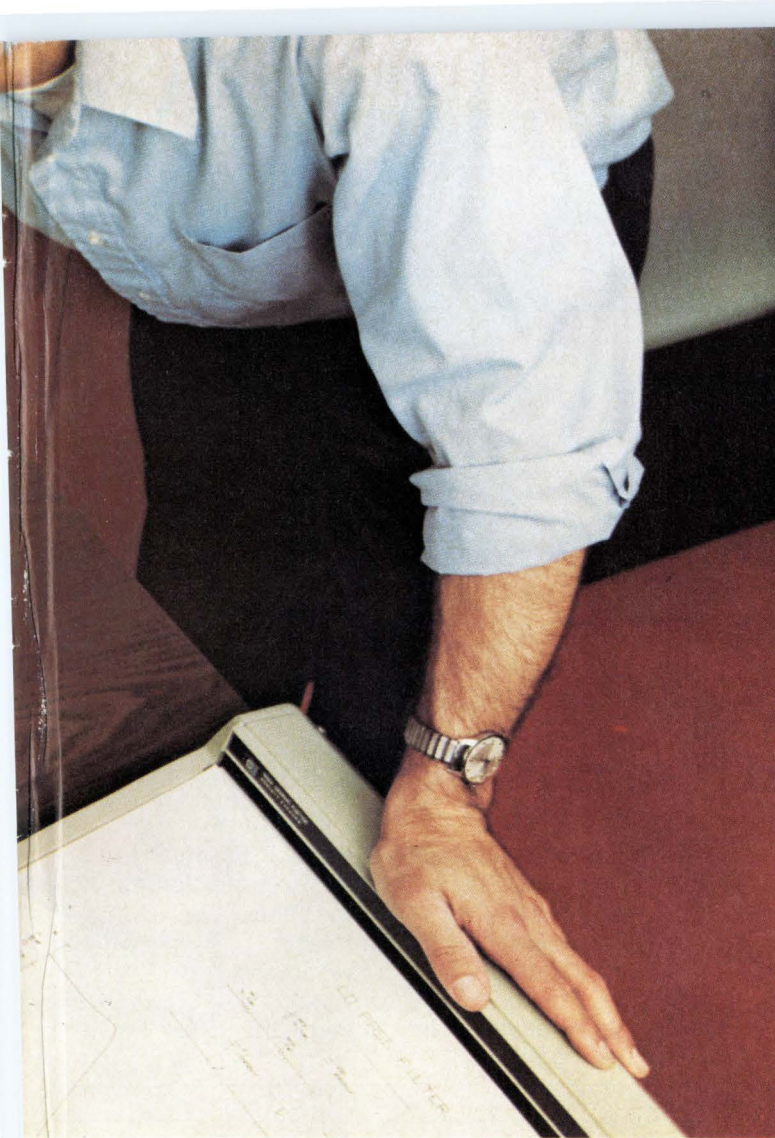

sign your 2-pole active filter. HP's X-Y plotter will draw your circuit schematic, calculate all component values, label those components, and plot gain and phase versus frequency—all automatically. Or try another component value and see the results of your changes, immediately. We have other programs for multiple-pole filter design.

**If your job is microwave design,** you'll be interested in the HP Model 9820 and its accompanying S-parameter design programs. With this powerful combination, you'll perform microwave circuit design with more confidence and achieve better results, in much less time.

**For magnetic designers,** we offer transformer design techniques that have been used and refined for five years. You'll be amazed when you watch your Model 9830 print out both primary and secondary wire sizes, turns, layers, percent fill, temperature rise, and all the other important physical and electrical

characteristics you need to physically build and test your transformer. But that's not all, with another program, you can enter your shop practices and quickly generate a costed material list with complete details of time and cost from assembly through final test. This program eliminates the most tedious of tasks, from the time you start on a quote, through delivery.

**Control systems** engineers can really put the advantages of interactive design to work. Start with our Series 9830, enter your pre-recorded program, key in your parameters, press EXECUTE and perform a time domain analysis or find the root locus of your system. Now add the plotter and watch the time waveform of a selected node or watch the poles and zeroes move as you change system parameters. With the 9830 calculator system, it's hard to believe that control system analysis and design can be so easy.

If you're designing components, cir-

cuits, networks or systems, there's probably an HP calculator program waiting to make your job easier. So check into calculator aided design with HP software: Write or call—



Sales, Service and support in 172 centers in 65 countries. Loveland, Colorado 80537. Offices in principal cities throughout the U.S.

For More Info

Hewlett-Packard, P.O. Box 301, Loveland, Colorado 80537.

- Please send me more information on HP's Software Programs.
- Please have your nearest calculator field engineer call for an appointment.

Name \_\_\_\_\_  
 Title \_\_\_\_\_  
 Company \_\_\_\_\_  
 Address \_\_\_\_\_  
 City \_\_\_\_\_  
 State \_\_\_\_\_ Zip \_\_\_\_\_  
 Phone \_\_\_\_\_ Ext. \_\_\_\_\_

My application is:

For a demonstration, circle reader service no. 60  
 For information, circle reader service no. 61

# SCHOTTKY ON



## One-stop TTL shopping for 74S MSI, SSI...

At last. Available now, all in one place. The whole mix in Schottky logic—to match every high speed TTL function in demand today. Signetics

broad line of 74S circuits. Plus our compatible 82S series of enhanced MSI devices that help Schottky give you a competitive step-up in speed, in design-ease, in versatility... and of course, in MSI complexity.

And you get it where you want it, when you want it. Fast service directly from distributor stock. Signetics knocks off the waiting list tie-ups, the multi-stop shopping. After all, how can we encourage you to boost system speed by replacing TTL with Schottky equivalents, if you can't get the circuits to work with? All the parts you need—without delays, without runarounds, without making six calls when one should do the job.

Here's where Signetics makes the difference. One call does the job. Completely. SSI Schottky to cover full function range:



### SSI SCHOTTKY 74S TTL

74S00	Quad 2-Input NAND Gate
74S03	Quad 2-Input NAND Gate (Open Collector)
74S04	Hex - Inverter
74S05	Hex - Inverter (Open Collector)
74S10	Triple 3-Input NAND Gate
74S11	Triple 3-Input Positive AND Gate
74S15	Triple 3-Input Positive AND Gate (Open Collector)
74S20	Dual 4-Input NAND Gate
74S64	4-2-3-2-Input AND/OR/INVERT Gate
74S65	4-2-3-2-Input AND/OR/INVERT Gate
74S74	Dual D-Type Edge-Triggered Flip-Flop
74S112	Dual J-K Edge-Triggered Flip-Flop
74S113	Dual J-K Edge-Triggered Flip-Flop
74S114	Dual J-K Edge-Triggered Flip-Flop
74S40	Dual 4-Input NAND Buffer
74S140	Dual 4-Input NAND Line Driver

You can make the same call encompass MSI too. Signetics 74S MSI circuits offer the same volume availability as SSI, as well as the same total TTL compatibility—pin-for-pin fits with standard TTL and low-power Schottky. Ten MSI devices in stock now, with more to be announced in the next few months.

### MSI SCHOTTKY 74S TTL

74S151	8-Input Data Selector/Multiplexer
74S153	Dual 4-Input-to-1-Line Selector/Multiplexer
74S157	Quad 2-Line-to-1-Line Data Selector/Multiplexer
74S158	Quad 2-Line-to-1-Line Selector/Multiplexer (Inverting)
74S174	Hex D-Type Flip-Flop w/Clear
74S175	Quad D-Type Flip-Flop w/Clear
*74S181	Arithmetic Logic
*74S194	4-Bit Bidirectional Shift Register
*74S195	4-Bit Parallel Access Shift Register
74S251	8-Input Data Selector/Multiplexer w/tri-state
74S253	Dual 4-Input-to-1-Line Selector/Multiplexer w/tri-state
74S257	Quad 2-Line-to-1-Line Data Selector/Multiplexer w/tri-state outputs
74S258	Quad 2-Line-to-1-Line Selector/Multiplexer (Inverting) w/tri-state

\*January-February announcement

Complementing 74S, Signetics 82S series MSI circuits offer significant advantages in sophisticated Schottky systems designs. The conventional TTL input circuit found in all Schottky logic, other than Signetics 82S, suffers from low input impedance.

Signetics advanced PNP structure produces significantly higher input impedance. You can drive far more devices from one output since input current is one-fifth that of standard Schottky inputs. With Signetics 82S MSI you need not worry about noise when driving long lines since, in addition to 10 PNP loads, a termination resistor can be accommodated when needed without fan-out reduction.



# THE DOUBLE.

...and now optimized 82S MSI too.

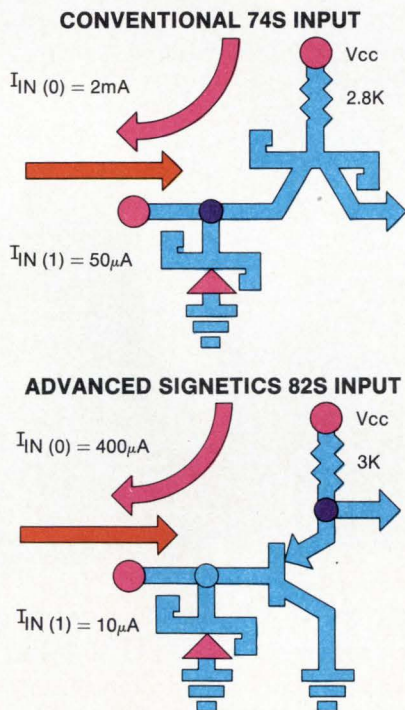

The growing line of 82S includes ultra high speed pin-for-pin replacements for the popular 8200 series MSI. In addition, the 82S90/91 100 MHz counter will replace the 74196/197, and the 82S70/71 70 MHz shift register will replace the 74178/179 in systems requiring improved speed performance.

The BCD arithmetic unit 82S82 replaces at least six MSI packages previously needed for the same function while at the same time operating speed is improved by a factor of 3. For BCD applications that only require addition, the 82S83 adder will replace three MSI circuits, and double operating speed. The 82S62 parity generator/checker is unsurpassed in speed.

Of course the 82S MSI line interfaces with 74S logic directly, operating in the same design environment as all 7400 circuitry but with the added advantage of direct replacement without violating fan-out rules.

MSI SCHOTTKY 82S TTL		SPEED
82S30/31/32	8-Input Digital Multiplexer	15 ns
82S33/34	2-Input, 4-Bit Digital Multiplexer	15 ns
82S41/42	Quad Exclusive-OR/Quad Exclusive-NOR	5 ns
82S50/52	Binary-to-Octal/BCD-to-Decimal Decoder	12 ns
82S62	9-Bit Parity Generator / Checker	17 ns
82S66/67	2-Input, 4-Bit Digital Multiplexer	15 ns
82S70/71	4-Bit Shift Register	70 MHz
82S82	BCD Arithmetic Unit	20 ns
82S83	BCD Adder	20 ns
82S90/91	Presetable Decade/Binary Counter	100 MHz

74S/82S Schottky TTL. Just one call to one of our distributors, reps or salesmen. And Signetics puts it on the line. Your line.

Signetics-Schottky 811 East Arques Avenue Sunnyvale, California 94086		
High speed response requested on Schottky TTL data, specs, applications and delivery for 74S SSI, 74S MSI and 82S MSI.		
Name		
Title		
Company		
Address		
City	State	Zip
Telephone		
<small>Signetics Corporation, a subsidiary of Corning Glass Works.</small>		

**signetics**

# Cinch Dura-Con 0.050" centers Small. Dependable. Available.

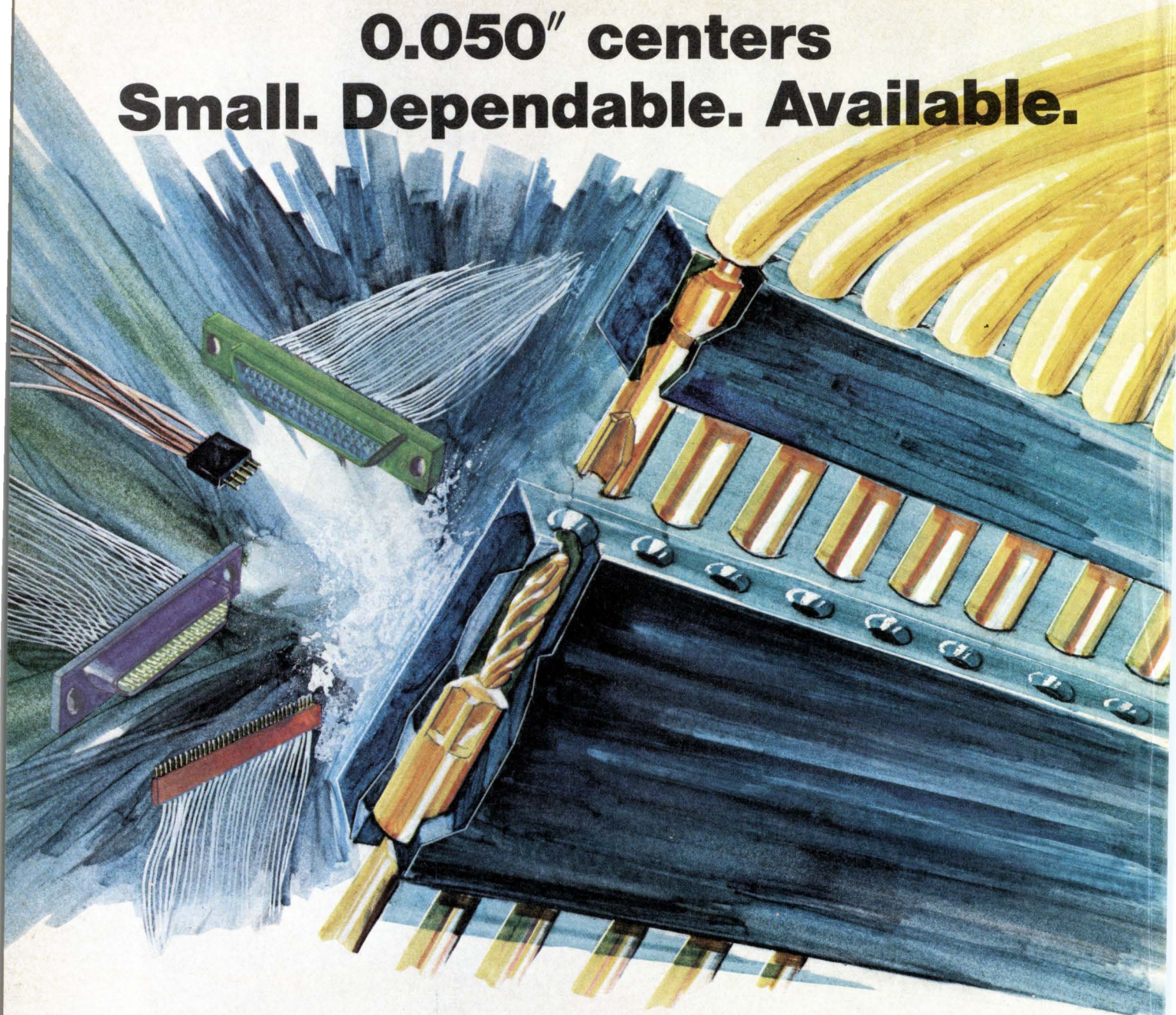

Now you have an effective source for your micro-miniature connector needs. Cinch can produce and deliver these rugged reliable connectors on a timely basis, with size 24 contacts on 0.050" centers.

These connectors utilize the proven pin-socket contact system, where the pin, made from a precision spring cable, is the spring member. The seven cable strands are fused in a hemispherical weld, resulting in a strong flexible shock and vibration resistant contact with assured alignment and no discontinuities.

The Dura-Con pin is available in five sizes of Dura-

Con D-configurations as well as single row strip configurations. It can also be supplied in custom insulators.

The size 24 contacts with 0.050" centers are supplied factory terminated, with pigtail or wire leads. Size 22 contacts, on 0.075" and 0.100" centers, are crimp removable.

Cinch Dura-Con Micro-Miniature Connectors are described in Bulletin PBC-174, available from Cinch Connectors, an Electronic Components Division of TRW Inc., 1501 Morse Avenue, Elk Grove Village, Illinois 60007, (312) 439-8800

CM-7304

**TRW**® CINCH CONNECTORS

Circle 64 on reader service card

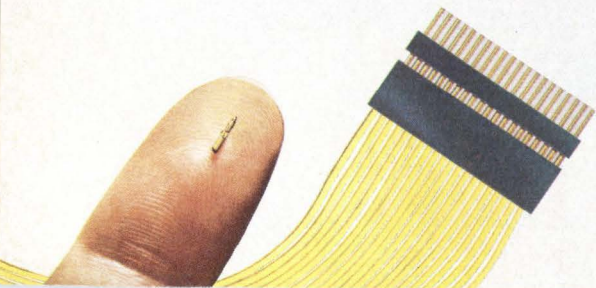

# Probing the news

Analysis of technology and business developments

## TV network has bright future—maybe

Multipoint Distribution Service, using microwave transmission, to begin tests soon; scheduled broadcasts to start in fall

by William F. Arnold, Aerospace Editor

A new form of metropolitan telecommunications service that's touted in some quarters as the future third type of TV network will begin test-broadcasting soon in Washington, Houston, Chicago, and Philadelphia. It's scheduled to go into operation in the fall.

Called Multipoint Distribution Service, the system combines the features of over-the-air, cable, and closed-circuit television with point-to-point microwave transmission. Wide use is promised in private-network entertainment, medical, and industrial applications. And keen interest, if not actual investment, is shown by the more than 350 license applications received by the Federal Communications Commission since it authorized the new service two short years ago.

But, amid all the ballyhoo, MDS also is attracting its share of skepticism. License holders wax enthusiastic, but equipment makers are less thrilled.

"We look at the market as being very, very wide," says Paul Taft, whose Taft Broadcasting Co. in Houston and Dallas staked out the first licenses. "The market is difficult to predict at the moment," Joseph J. Pomparelli, national sales manager for Varian Associates' Micro-Link in Beverly, Mass., cautiously observes. "It will be a nice market but not a windfall," predicts Steve Koppelman, marketing vice president for Electronics, Missiles and Communications Inc., White Haven, Penn., chief Varian competitor for the MDS market. He charges that there have been "exaggerated claims for the market" and asserts that "the industry itself is guilty of drumming up manufacturers' inter-

est in order to drive the prices down."

Essentially, MDS is an omnidirectional closed-circuit real-time television system, in which a central transmitter broadcasts line-of-sight microwave signals to receivers within a 25-mile radius. The master antenna-receivers relay the signals through a building's internal cable system to individual TV sets [*Electronics*, Dec. 4, 1972, p. 44]. In transmitting, the a-m video and fm aural signals go through an up-converter and local oscillator to step them up to the 2,150-megahertz MDS frequency, explains Varian's Pomparelli. In receiving, the signals are down-converted and decoded before transmission to a TV set.

Pomparelli says "ballpark figures" for Varian's transmitter and receiver are \$15,000 and \$800, respectively, while EMC's Koppelman says his prices will be \$13,500 and \$800. A key element in MDS systems are the encoder-decoders that prevent broadcasts from being pirated.

Working on these are Athena Cablevision; Laser Link Corp., and Reach Communications. Also producing equipment for multipoint service are International Video Corp., Tektronix, and the Andrew Corp.

MDS came about when Varian, seeking a new market for its equipment in the not hugely successful instructional-television fixed-service (2,500-kilohertz) market, searched the FCC regulations for an unused radio spectrum and found it. Varian petitioned the FCC, which without fanfare enlarged the bandwidth to 10 MHz from 3.5 MHz in the 2,150-MHz range, allowing 6 MHz for eventual colorcasting and 3.5 MHz for data transmission.

**Monopolies.** But, unsure of the demand for MDS, the commission allocated only one license per metropolitan area, thus creating a monopoly situation. As word got out, the stampede was on with TV station owners, audiovisual companies, radio dispatch firms, and

**From here to there.** Schematic of typical MDS layout. Each receiving station would have parabolic dish antenna 2 to 6 feet in diameter. A decoder unit would activate receivers for which signal is intended, but signal must be converted to broadcast spectrum to be seen.

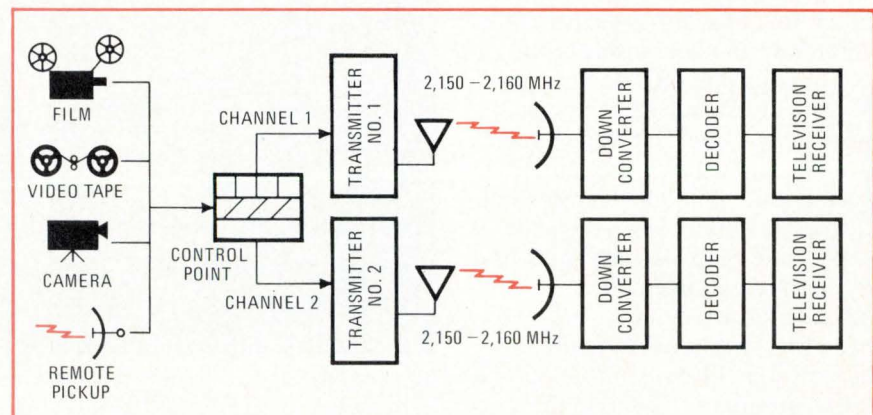

## Probing the news

more traditional communications companies—including Cox Cable, Datran, and Newhouse Publishing—clamoring for licenses.

Although Taft got the first license, prime mover for MDS service is the New York-based Microband organization, which as Microband Corp. of America holds exclusive broadcasting licenses in many major cities, among them New York and Washington, and as Microband National Systems Inc. controls the program time in about 200 of the top metropolitan markets.

And it is Microband's Washington station where MDS probably will receive its first big test. Motorola, which has options with Microband for four hours of prime time entertainment in 50 major cities, soon will begin evaluating the concept for motel and hotel rental viewing. Wells National Services Inc. of New York, which holds TV rental franchises in 600 major hospitals across the country, will test the MDS concept in D.C.-area hospitals "in late summer or early fall," says Arnold Wells, president.

Motorola, whose officials say that "MDS represents about the cheapest and fastest way yet until cable comes along," eyes a lucrative entertainment market providing movies and perhaps live entertainment to hotel and motel guests on a variation of pay TV. It has created an institutional electronics unit cutting across divisional lines to explore the idea, with the possibility of getting into data transmission and producing its own equipment, including collection boxes atop the TV sets.

Arnold Wells sees the Washington operation as the possible forerunner to "providing health information and medical information on a continuous basis for doctors, medical people, paramedical personnel, and patients." But, "it takes time as it's a whole new way to distribute information," he adds. Rumors persist that an automaker also is about to buy time to broadcast sales and service training information.

Of course, it remains to be seen where the MDS market really goes. Mark Foster, Microband's national system president, says that beyond

entertainment and medicine a "bigger potential" is in retailing, where, for example, a chain store merchandiser could use MDS for data exchange, sales pep talks, and executive meetings. Paul Taft avers that the "real sales potential is in training programs."

**Nationwide.** A potential national network intrigues many. Taft believes the network will come into being, but "the number of cities that will have to become interconnected will take a whole hell of a lot of line cost." Foster says that the domestic satellite system now aborning, coupled with low-cost ground stations, will give MDS a boost. Others predict that an MDS-domsat combination may be the direction cable and pay TV will take.

A factor that should influence the market is the FCC, which "has no intention of promulgating a monopoly," according to W. Randolph Young, chief of the microwave branch. The commission hopes to complete by June its proposed rule-making creating a second MDS channel in the 50 largest cities, he says. The proposed channel will be the next one up—2,156 to 2,162 MHz, or 2,163 MHz if there's a 1-MHz separation. The channel has been under consideration for a year, but

technical problems presented by having adjacent channels in the same city, compounded by industry comments "which were less than we had hoped for," slowed work. At any rate, the FCC already has stated that it won't give any applicant more than 6 MHz out of the 10 MHz now available in any area.

How much MDS equipment can be sold is conjectural. Foster says that the "big market is in receivers and decoders since there'll be one to a set." He adds that "studies show a substantial market for equipment," amounting to \$50 million by 1975 and 1976. EMCI's Koppelman, in predicting a sales top of 4,000 receivers over the next four years, points out, however, that the 50th largest area of the top 200 is Wilkes-Barre/Scranton. Even a Motorola official says that in formulating its plans "we want to guard against selling our customers a white elephant."

"What sort of market they find is anyone's guess," comments Young, since "not everyone is serious" in filing for applications. Alluding to "a lot of claim-staking in there," he adds that "there's got to be a lot of people who filed applications just to see what happens—but that's just my opinion." □



**Now see this.** Mark Foster, president of Microband National Systems, steps before cameras. He foresees impetus for MDS coming from a U.S. domestic communications satellite.

# the New **BUSS**<sup>®</sup> **SNAP-LOCK** Rear Panel Mounted **FUSEHOLDERS**

*It's a "SNAP"  
to install....*

*Easy...  
Quick...  
Time Saving...*

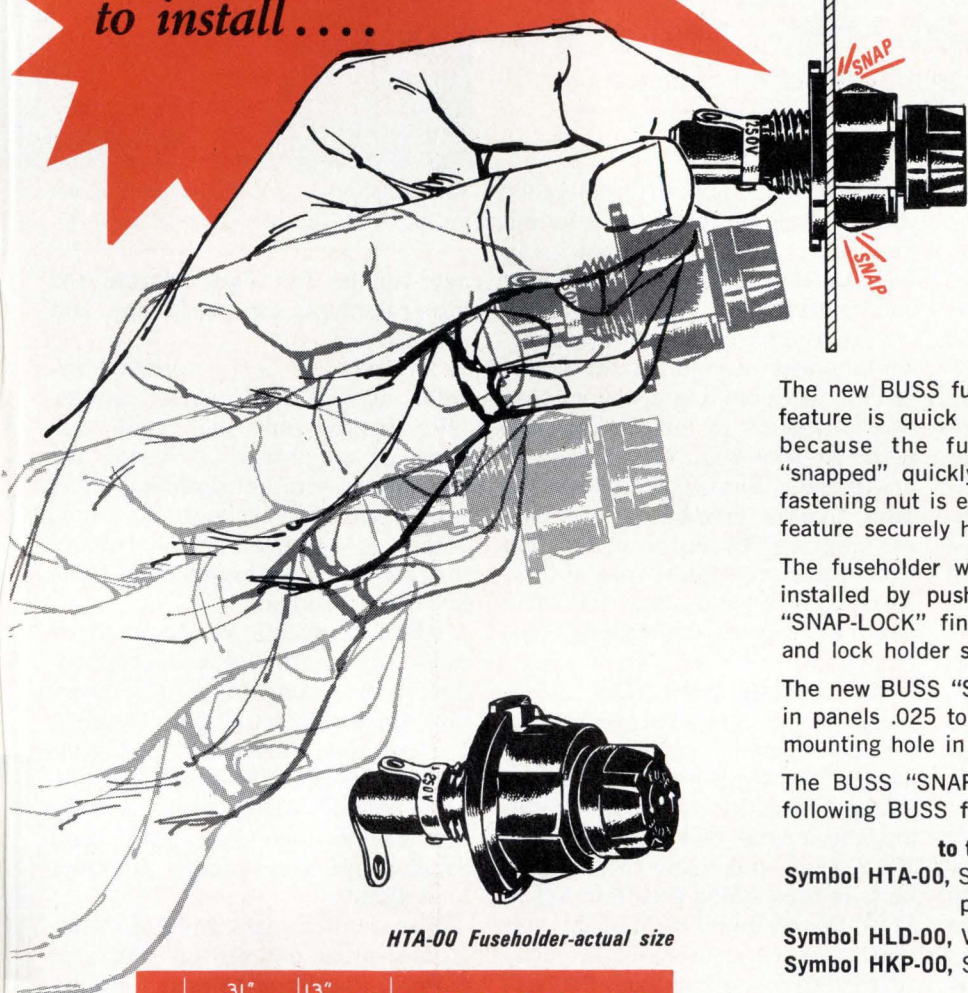

HTA-00 Fuseholder-actual size

The new BUSS fuseholder with special "SNAP-LOCK" feature is quick and easy to install. It saves time because the fuseholder can be **pre-wired** and "snapped" quickly into place from rear of panel. A fastening nut is eliminated because the "SNAP-LOCK" feature securely holds the fuseholder in place.

The fuseholder with "SNAP-LOCK" feature is simply installed by pushing it into panel from rear side. "SNAP-LOCK" fingers engage edge of hole in panel and lock holder securely in place.

The new BUSS "SNAP-LOCK" fuseholder can be used in panels .025 to .085 inch thick. (See recommended mounting hole in dimensions below).

The BUSS "SNAP-LOCK" feature is available on the following BUSS fuseholders:

**to take 1/4x1 1/4 inch fuses:**

Symbol HTA-00, Space Saver, extends just 1 in. behind panel.

Symbol HLD-00, Visual Indicating Fuseholder.  
Symbol HKP-00, Standard Fuseholder.

**to take 1/4x1 inch fuses:**

Symbol HJM-00, Standard Fuseholder.

All are available with quick connect terminals, if so desired.

*Also fits 1/2 in. knock-out in electrical boxes*

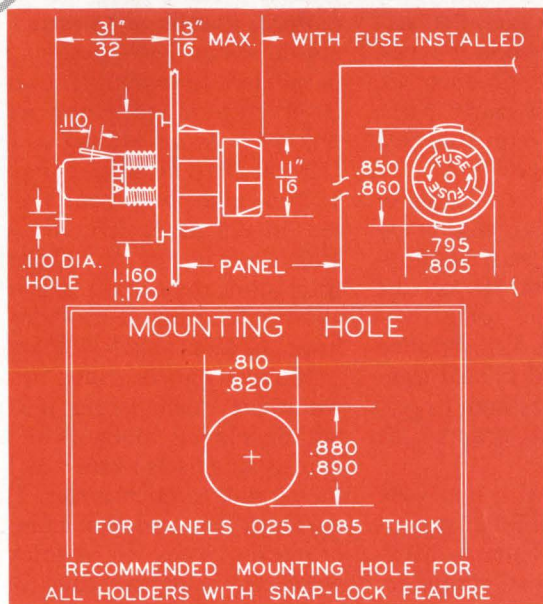

RECOMMENDED MOUNTING HOLE FOR ALL HOLDERS WITH SNAP-LOCK FEATURE

Dimensions of HTA-00 holder.

When tooling up for mounting get latest blueprint.

**BUSSMANN MFG. DIVISION**  
McGraw-Edison Company  
St. Louis, Mo. 63107  
Makers of a full line of Electric Fuses

SUPPLIED THE ECONOMICAL WAY  
... THRU DISTRIBUTORS

**BUSS QUALITY**  
FUSES

Companies

## Power from transistors

Communications Transistor Corp. started in 1969, has half the market for power devices in mobile communications

by George Sideris, San Francisco bureau manager

**Inside** one of the world's largest power-tube plants, a small semiconductor company—Communications Transistor Corp.—is eating away at its host's business. CTC makes radio-frequency power transistors with ratings into hundreds of watts—using the chemical plumbing, power buses, and other support facilities of Varian Associates' Eimac grid-tube plant at San Carlos, Calif.

Yet Varian is not alarmed by the situation—because CTC is an affiliate. Shortly after CTC was founded in 1969, Varian bought a large block of preferred stock and offered CTC room and board. However, CTC is legally an independent corporation, says Thomas Ciochetti, the firm's president. He says Varian continues to nurture his company because it has been highly profitable from its inception.

The nearly 100 transistors in CTC's catalog no doubt are a worry to other tube manufacturers. Those in production now operate at a minimum of 60 watts in the 225–400-megahertz band and at up to 200 w at the low end of the mobile-communications spectrum. Next on the schedule is one that dissipates 400-w peaks and 150-w continuous outputs at 80 MHz. Being developed are 100–400-w transistors for the 225–400-MHz band.

**Big boy.** The 400-w chip is dubbed Huge Huey. Measuring a giant 180 by 266 mils, the chip will be produced as soon as a package big enough to handle it is developed. Worked into the metalization pattern along with 24 base areas and 960 emitter fingers is a picture of a hungry monster and the legend, "San Carlos amp eater." Huge Huey draws up to 20 amperes.

Moreover, like most CTC transistors, the device is designed to withstand an infinite mismatch, so that it can be paralleled safely in higher-power combinations.

CTC commands half the mobile-communications market for power transistors, including a major share of the sockets in land-mobile sets made by Motorola, RCA, and General Electric. But Ciochetti keeps the sales figures private, saying only that they tripled last year and that CTC's regular customer rolls now include 25 large and about 100 small communications-equipment companies.

**Big average price.** The orders aren't large, compared with those for small-signal transistors, but the average selling price is—a big customer is one that orders 1,000-unit lots and a small one may want only 100 a year, and many of the stock parts in the catalog cost from \$25 to \$150. Big or small, most of the customers want transistors with special characteristics or packages. CTC second-sources some low-power types, but the majority of its products are sole-source and prime-source parts. As a result, Ciochetti estimates, 60% of his business is in "specials."

Ciochetti quit a job as manager of five product lines at Fairchild Semiconductor division to start his transistor-catering business. He says he did so at the urging of some Fairchild customers who had unfilled needs for small lots of special transistors. "Big companies aren't organized to handle such orders," he contends.

Leaving Fairchild with him were Robert Reber, head of the power-transistor line, and Thomas Moutoux, applications engineering man-

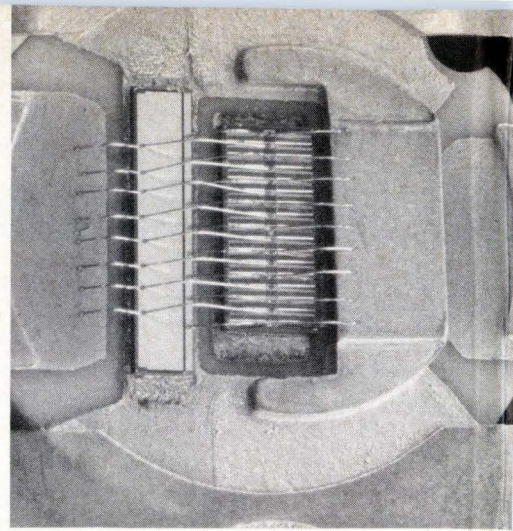

**Assembly.** 80-W, 100 to 200 MHz power transistor, MOS capacitor, an RLC network.

ager for the line. They became CTC vice presidents for production and engineering.

"We weren't just another Fairchild spin-off," Ciochetti asserts. "We wanted only that small segment of the transistor market the big houses were not servicing." The firm is still relatively small: its 80 employees occupy a 20,000-square-foot "cocoon" surrounded by some 800 Eimac workers.

All chip layouts are designed by radio engineers because semiconductor designers might not recognize the subtle pitfalls of rf design. For example, Ciochetti says, a semiconductor designer wants to "improve specs," perhaps not realizing that a minor increase in power gain could cause a customer's amplifier to oscillate.

To ease their tasks, Moutoux's engineers often use proven transistor patterns as cells, as LSI-array designers do. Four 10-w designs may be paralleled, for example, to make an 80-w chip—Huge Huey was born this way. More typical is the new C2M60-28 (2N6439) composed of 16 base areas with nearly 100 emitter fingers in each area. A large-scale array of some 1,500 npn silicon transistors, the chip measures nearly 100 by 200 mils. It provides a minimum of 60 w at 225–400-MHz.

**Narrow fingers.** Such transistors would be much larger if CTC had not developed methods of etching emitter fingers as narrow as 1 micrometer and 0.5 micrometer. The standard for less-complex chips, 2-micrometer lines in 4-micrometer windows, is tighter than most LSI



**Movers.** Above, Thomas Giochetti, CTC president; top right, Thomas Moutoux, vice president of engineering and development; and Robert Reber, vice president, manufacturing.

manufacturers use, Reber notes. Emitter diffusion depths are controlled to  $\pm 0.1$  micrometer, he adds.

Such precise work is based on proprietary techniques. Wafers are etched in a circuit that quenches the etch when sample transistors on the wafer are operating properly. A digitally controlled technique deposits aluminum-silicon-copper alloy.

The alloy-deposition technique took 18 months to develop. Adding silicon to the aluminum, a technique IBM developed, keeps the aluminum from eating away the underlying silicon and wrecking the diffusion-depth tolerance. Reber says that he knows of no other company that adds copper, however. The copper prevents the narrow lines from migrating to a lump at one end of the chip in high-power operation.

**Dense currents.** The 0.5-micrometer lines must withstand current densities of 100,000 to 1 million amperes per square centimeter of cross-section. When an aluminum-silicon alloy was tried, the lines migrated in 100 to 200 hours in stress tests at 500,000 A per square centimeter at 325°C. After 10% copper was added to the alloy, the lines withstood the stress for 5,000 hours. That, says Reber, represents 20 to 40 years of normal operation.

Most chips go into specially made packages that are thickly plated with gold wherever conductivity is required. "We pay more for our packages than anyone in the industry," Reber claims. He also claims that CTC is the first to put power transistors in epoxy-sealed ceramic packages. Both TRW Inc. and

Hughes Aircraft Corp. have verified that the seals meet military hermetic specifications, he says.

The assemblies are designed for "infinite VSWR"—the ability to withstand mismatches causing a voltage/standing-wave ratio of 30:1. This prevents the transistors from burning out.

Custom matching networks are built into each transistor assembly by adding an MOS capacitor chip and connecting it to the transistor chip with stiff, arched, aluminum-silicon wire. MOS chips were first used by TRW to raise power-transistor input impedance. A big chip like the C2M60-28 has such low impedance that it looks like a short in the circuit unless an input impedance transformer, such as a MOS capacitor, is used.

The wires are connected to each cell on the chip. A special stitch-bonding machine varies the length, positioning, and height of the arched wires, thus varying the resistance and inductance of the RLC network.

**Tough testing.** Final tests are made in an amplifier circuit fixed-tuned to the customer's specifications. Tweaking-in transistors is now allowed, says Reber, because the customer might then have to tweak-in his own circuit. Also, maximum current stress is applied to heat the transistor before the voltage-breakdown stress is applied. Reber calls these procedures unique.

CTC designers try out transistors in passive networks to develop matched sets. Reber says that CTC is considering packaging the most use-

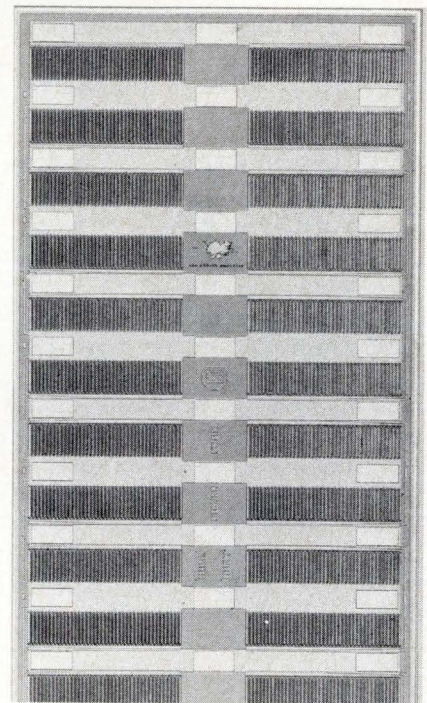

**Huge Huey.** This is the 70-MHz, 300-W power transistor on a chip 266 mils long. There are 960 emitters in the transistor.

ful chip-network combinations as hybrid-IC power modules. Then, customers could simply plug in gain-stage components and leave the subtler details for CTC to work out. It would be more like ordering a combination dinner from a Chinese restaurant than using an à la carte menu. □

Automotive electronics

## Truck-brake controls set to roll

Federal requirement for shorter stopping distances on heavy rigs is expected to add up to a possible \$100 million annual market

by Alfred Rosenblatt, New York bureau manager

**While electronics** in passenger cars gathers most of the publicity, a promising market for electronics in heavy-duty trucks is about to bloom. The spur is the Department of Transportation requirement that braking systems appreciably shorten the stopping distance of air-brake trucks on both dry and wet roadways.

And although Motor Vehicle Safety Standard 121 makes no mention of electronics, experts agree the job can be done only with some form of electronic skid-control or anti-wheel-lock system. At stake: a market that—when the standard goes into effect on Sept. 1, 1974, for 1975 models—could reach \$100 million yearly.

As many as a dozen companies are competing for the business. Among them are Rockwell-Standard division of Rockwell International, Detroit; Bendix-Westinghouse's Air Brake division, Elyria, Ohio; Eaton Corp.'s Brake division, Southfield, Mich.; Wagner Electric Corp.'s Automotive Products division, Newark, N.J.; Kelsey-Hayes Corp., Romulus, Mich., and B.F. Goodrich Co., Troy, Mich. And in Europe, Fiat, Daimler-Benz, Robert Bosch, and others are experimenting. The decisions as to which systems the truck builders will buy must be made within weeks or months if the suppliers are to be able to tool up in time to meet production deadlines.

Kelsey-Hayes may have the biggest lead—it already has some 5,000 of its Computer Brake Control axle sets installed as optional equipment. Other companies number their installed systems in the hundreds.

Of the various adaptive-braking

designs known to be in development, only one uses an all-digital technique—implemented with the metal-oxide-semiconductor, large-scale-integration technology. This is Rockwell-Standard's Skid-Trol system, designed with the close cooperation of the Rockwell Microelectronics division, Anaheim, Calif., a longtime supplier of MOS LSI calculator chips.

The other designs range from the strictly analog Eaton system to combinations of analog and digital processing, such as used by Bendix-Westinghouse. The analog designs may seem old-fashioned to the technology-conscious electronics industry, but to truck builders they may make sense.

"An analog system is easier to change during the development stage," explains D. Dean Forester, assistant chief engineer for General Motors' GMC Truck and Coach division in Pontiac, Mich. "With a cus-

tom design, integrated in silicon, you must be absolutely right before you lock in." What's more, he continues, "anything as new as this should have the opportunity for further development even for several years after we go into production."

However, Earl H. Schaefer, Skid-Trol program manager, points out that it's not at all difficult to change capabilities with his digital IC design. It can be done simply by changing the programming of the MOS chip's read-only memory. As many as 800 decisions can be handled on the chip, he says.

**On the job.** Regardless of how the systems are implemented, however, they all perform the same functions. Generally some sort of electromagnetic pickup on each wheel senses speed, a "computer" determines whether safe operating conditions are being met, and a controller opens or closes the brake's air line. One such set of electronics is used

### Stopping standard spells it out

Impetus for the installation of anti-skid or adaptive-braking systems comes from Motor Vehicle Safety Standard 121 issued by the Department of Transportation's National Highway Traffic Safety Administration. It's the first Federal regulation setting performance requirements for new vehicles using air brakes. Thus, generally speaking, it applies to trucks, buses, and trailers with a gross vehicle weight of 19,500 pounds and more. Hydraulic braking systems also used on such big vehicles are unaffected by the standard.

Nowhere does the standard mention anti-skid devices specifically. Rather, it spells out the stopping distances and calls for straight-line stops with a minimum of side-to-side motion. These requirements can be met, vehicle manufacturers agree, with some form of electronic anti-skid system, as well as by beefing up the brakes themselves.

The requirements are that a vehicle going at 20 miles per hour must stop within 33 feet on dry pavement, 54 feet on wet. At 60 mph, the dry-pavement stopping distance is 345 feet. There's no specification for stopping at 60 mph on wet pavement because the traffic-safety agency has no test facility where that performance can be measured safely. At all speeds, the vehicle must keep within a 12-foot lane.



# The AILTECH RF Power Source

Line  
means  
one  
thing —

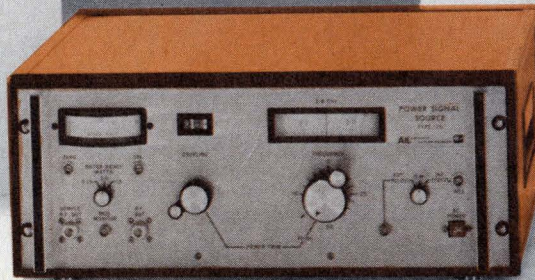

# POWER

AILTECH RF Power Signal Sources provide more power at every frequency than any comparable instrument around. Power for susceptibility testing to Mil Std 461/462; power for pattern measurements and VSWR tests of antennas; power for the testing of RF Power Transistors and for RF wattmeter calibration; power for the researcher for NMR, plasma and related investigations.

Covering the complete 0.01 to 2500MHz range, there's Model 445 VHF-UHF Power Oscillator. Features include plug-in heads for eight frequency ranges, positive no-load protection, and power outputs to 50 watts with full AM and FM capability. The most versatile power source available,

with direct frequency readout, single dial control and monitoring of both forward and reflected power.

For broad frequency coverage, from 200MHz to 8000MHz, we offer Models 125 and 126. Model 125 has CW power available as high as 90 watts with continuous adjustment of power to 30dB below maximum. Model 126 covers all S- and C-bands from 2 to 8GHz in a single range.

For any application that requires power — stable, abundant power — there's an AILTECH Power Signal Source. Write today for the complete story or for a really powerful argument, ask for a demo.

PART OF THE GOLD LINE SERIES FROM

**AILTECH**   
A CUTLER-HAMMER COMPANY CONTROL

EAST COAST OPERATION • 815 BROADHOLLOW ROAD • FARMINGDALE, NEW YORK 11735 • TELEPHONE: (516) 595-6471 • TWX: 510-224-6558

WEST COAST OPERATION • 19535 EAST WALNUT DRIVE • CITY OF INDUSTRY, CA. 91748 • TELEPHONE: (213) 965-4911 • TWX: 910-584-1811

Crowthorne, Berks, England (Crowthorne 5777) • 92 Gennevilliers, Paris, France (733.72.20) • Munich, West Germany (0811) 5233023

Circle 71 on reader service card

OTHER SOLID GOLD PRODUCTS FROM AILTECH INCLUDE SPECTRUM ANALYZERS, NOISE MEASUREMENT EQUIPMENT, FUNCTION GENERATORS, OSCILLATORS AND TRANSDUCERS.

## Probing the news

on each truck axle, controlling the both sets of wheels.

If a wheel begins to slide over a slick road surface and lock up because of excessive braking, indicated by excessive deceleration, the computer opens the valve in short pulses to "pump" the brakes until

the wheel "catches" again, and traction is restored. The systems also generally incorporate a self-checking function and a display box in the truck cab to indicate whether it is operating faultlessly.

Rockwell's computer is based on a microprogramed variation of one of its single-chip calculator circuits. However, its read-only memory is mask-programed in production to

perform the braking functions. In addition, the system contains an accurate clock controlled by an inexpensive 3.6-megahertz quartz crystal for time and rate control. Dividers provide the required clock pulses.

Eaton's analog system, on the other hand, relies largely on discrete components. The alternating signal picked up by each wheel sensor is converted to a dc level, which is then processed with operational-amplifier circuitry.

Engineering manager Mack Lawrence, like GMC's Forester, values the analog approach during the development phase because "changes can be made easily." In addition, he's "a little skeptical" about the ability of semiconductor suppliers to make "economically" a large quantity of custom digital ICs with the reliability needed.

In fact, he is pretty caustic about semiconductor reliability. "They've been making off-the-shelf operational amplifiers for years, and they still can't make them reliable enough," he declares. And he is also concerned about the tough noise environment the systems must operate in. A digital system, he feels, may be much more susceptible to noise.

Somewhere between the Rockwell and Eaton systems is Bendix-Westinghouse's. Digital circuits are used for a mode-selection section, which sets certain operation parameters based on such factors as vehicle load and road conditions, according to engineering manager Ralph W. Rothfusz. Signal processing is basically analog with some custom IC op-amp and speed-processing circuits. "We picked areas where we wouldn't be hurt too much if changes must be made, Rothfusz says. "The functions being performed by the ICs are really pretty basic."

But once their designs are frozen and committed to production, both Rothfusz and Lawrence say they'll look further into integration. Reducing costs will, of course, be the main goal here. Right now, these costs will bring the price to a truck builder to anywhere from \$100 to \$140 per axle. With 60,000 to 70,000 heavy truck axles on driver tractors and trailers being turned out each month, that \$100 million market is easy to estimate. □

# You should know about the real cost advantages of custom CMOS.

Most discussions concerning the use of custom CMOS/LSI circuits acknowledge the obvious technical advantages of this approach to implementing complex systems—things like low power requirements, high noise immunity and fanout, good transfer characteristics and the ease of logic simulation.

What many people overlook, however, is the dramatic cost saving often realized by employing custom CMOS in place of multiple-package systems using conventional logic circuits. The fact is this: one of the most significant advantages of custom CMOS/LSI is its ability to shrink system costs—even in moderate production volumes.

We've just published a Cost Analysis File on just this subject. In it are four detailed examples of specific systems in which dramatic savings resulted from the use of CMOS/LSI. One example explains how a single CMOS circuit replaced a 21-package logic system and saved the customer over \$200,000 on a run of only 4500 units. Another shows why CMOS/LSI is competitive even with today's very low TTL prices.

A copy of this publication may help you understand more about the very real cost advantages of the technology. To get one, circle reader service number 245.

**We can help.**

## MICRO POWER SYSTEMS

3100 Alfred Street, Santa Clara, California 95050 Telephone (408) 247-5350

TECHNICAL REPRESENTATIVES IN EUROPE AND THE FAR EAST

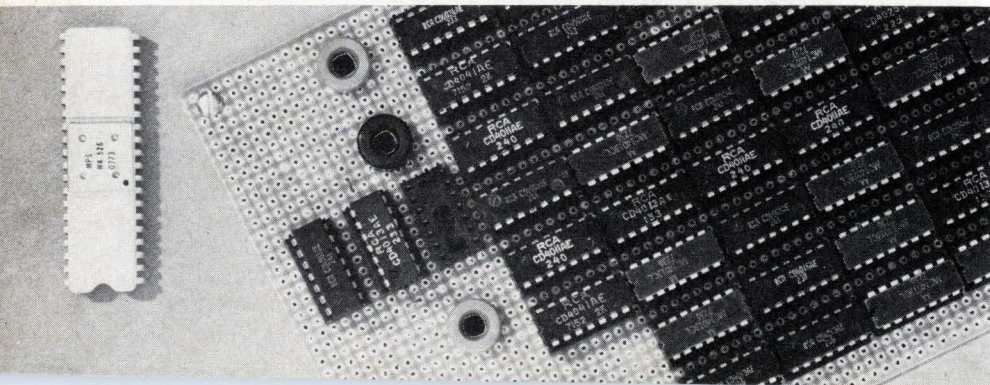

## HERMES LOOP ANTENNA

THREE SAMPLE SITES  
ON THE NORTH AMERICAN  
CONTINENT —

DIFFERENT LATITUDES  
DIFFERENT CLIMATE

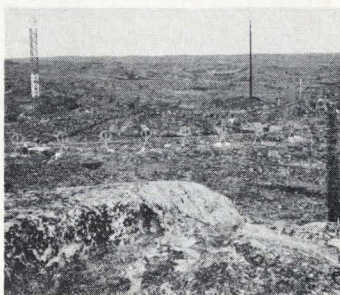

FROBISHER BAY, CANADA

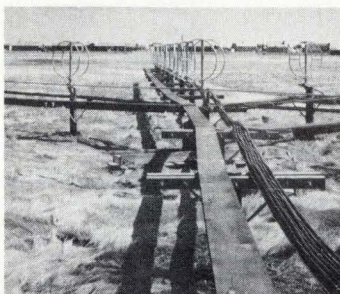

MARSHFIELD, MASS.

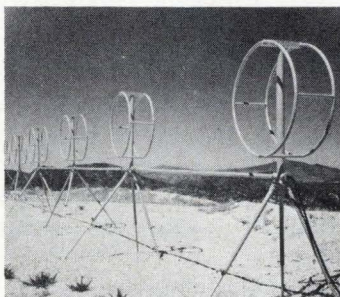

NEAR SAN DIEGO, CALIF.

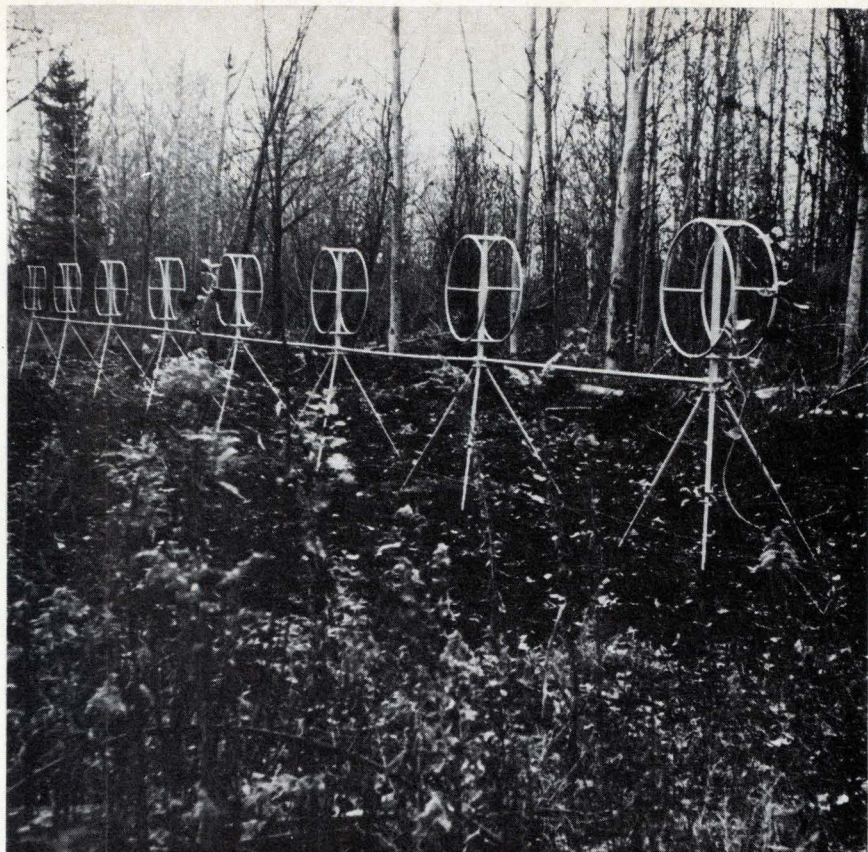

# Good Listeners maintain a low profile

Even in the solitude of the forest depths, from rooftops, arctic tundra, swamps to sweltering tropics, 'neath snow, sand or ice, the Hermes Loop antenna keeps an ear to the sky. The amazing aperiodic antenna does away with vast log periodic and rhombic arrays - those towering antenna farms.

Excellent directional characteristics in rosette configuration, the Hermes loop antenna provides an omnidirectional broadband receiving array in space merely 1/100th that of the traditional antenna farm. More than 53 government agencies around the world have pressed the loop antenna into service.

A new, even more compact version is available. Only Hermes Electronics makes it.

**2-32MHz  
BROADBAND**



**ASK US Send for our Brochure**

Hermes Electronics Limited  
Suite 315  
2020 F Street NW  
Washington, DC 20006 USA  
202-296 2978  
TWX 710 822 1106

Microwaves

# Traveling-wave tubes advance

Upshot of developments—such as pc version and improved magnets and cathodes—could be stiffer competition for Gunns, Impatts

**Next month**, Varian Associates plans to send to the Army Electronics Command a traveling-wave tube built on a printed-circuit board with \$30 worth of parts, including two thin-film circuits that replace the helix winding and some 200 other ele-

ments of a conventional TWT. If the sample passes muster, Varian intends to produce the tube—and others with different printed-circuit patterns—on an automated line at a cost of about \$100 a copy. Sales price would be higher.

could drop \$50 apiece if production volume reaches 100,000. And even as Varian builds its tubes with planar techniques, other manufacturers are taking evolutionary approaches in attempts to make TWTs that cost less and last

longer. They are working with new magnets and new cathode designs, for example, to come up with tubes that are smaller and need less power. At Varian the TWT development staff, headed by Allen W. Scott, is confident the tube will meet the specs set last year by the Army: a 20-decibel signal gain at S band, with a peak output power of 2 kilowatts at an 8% duty cycle. Prototypes of the tube, assembled with two 10-dB stages, already have passed tests at Varian's plant in Palo Alto, Calif. Scott's staff was reading in April a production model with the same patterns printed on the ceramic walls of a single tube.

The S-band tube will be almost 100 times as powerful, and twice as big, as the 6-inch-long feasibility model that won Varian development contracts from the Air Force as well as the Army. The model, not powerful enough to compete with transistor amplifiers, exhibited 10-dB gain at L band but produced outputs of only about 22 watts [*Electronics*, Dec. 4, 1972, p. 35]. The Air Force contract, which started this January, calls for delivery of an X-band tube with a gain of 30 dB and peak outputs of 100 w at 10% duty cycle. S-band tubes with continuous power ratings of 10 w already have been made to prove that the complex patterns needed to attain 30-dB gain can be printed. In addition, Scott and his staff are studying techniques of combining two or more functioning tubes in the same printed patterns. One of his more promising ideas is to let one channel run as a backward-wave oscillator and amplify the output of that stage with a better-behaved TWT stage. Another is to operate adjacent TWTs at different frequencies and duty cycles. Neither technique is expected to present difficult design problems since the way already has been opened by the Army and Air Force tubes, which produce high gains through mergers of several microwave interaction structures.

The oscillator-amplifier concept has been proposed as an expendable countermeasures transmitter. Powered by small battery supplies, such devices could produce kilowatts of broadband noise, or signals at voltage-controlled frequencies. Varian suggests they be dropped from aircraft to confuse enemy fire-control equipment. They would

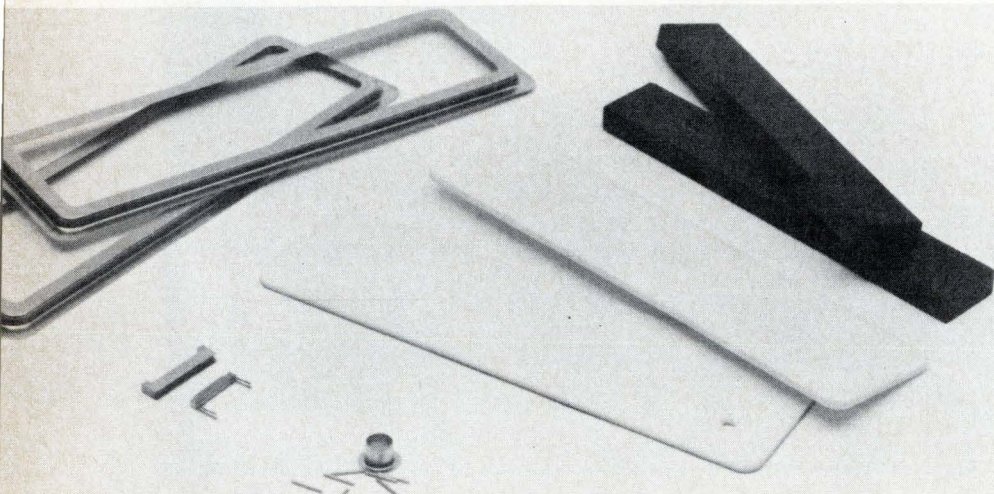

**Piece offering.** These are the parts of the pc-board TWT built by Varian for the military. Two thin-film circuits replace helix winding as well as other parts of conventional tubes.

Compare this with the \$1,000 to \$2,000 it costs to make a conventional TWT—which has many parts unique to each tube design—and it might be concluded that a quiet revolution is building in this microwave amplifier sector. What such a revolution could do is move TWTs into a more competitive position with solid-state microwave sources, such as Impatt and Gunn diodes, particularly since Varian estimates cost

longer. They are working with new magnets and new cathode designs, for example, to come up with tubes that are smaller and need less power.

At Varian the TWT development staff, headed by Allen W. Scott, is confident the tube will meet the specs set last year by the Army: a 20-decibel signal gain at S band, with a peak output power of 2 kilowatts at an 8% duty cycle. Prototypes of the tube, assembled with two 10-dB stages, already have passed tests at Varian's plant in Palo Alto, Calif. Scott's staff was reading in April a production model with the same patterns printed on the ceramic walls of a single tube.

We clamp all the way down  
on voltage drain, current  
drain, and heat emission...  
give you a single-plane  
phosphorescent display  
you can see across the room.



We clamp down fully  
on the disadvantages of other displays.

Our digital readouts,  
including the extremely lightweight,  
mini-size Multi-Numerical Indicator  
with 8, 10, and 12 digit readout,  
offer low-voltage,  
low-current drain,  
and stability advantages over  
conventional displays.

All have eye-easy phosphorescent  
segments with digits on a single-plane  
for optimal visibility  
under ambient light.

It's a natural green glow,  
so soft and clear you can see  
it across the room.

But the best comes last:  
They're competitively priced  
for all modern applications  
in calculators,  
digital clocks, voltmeters and counters,  
and a host of others.  
Count on us.

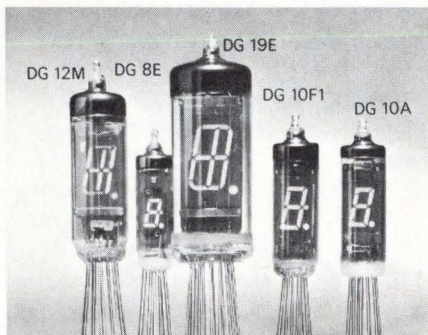
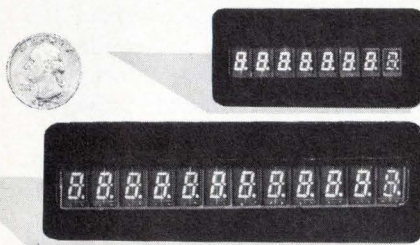

*The Brighter Side of Electronics*



**ISE ELECTRONICS CORP.**

P.O. Box 46 Ise City, Mie, Japan Tel: 05963-5-2121

*International Div.*

**ISE INTERNATIONAL CORP.**

Shinbashi Kokusai Bldg.  
No. 7-7-2, Higashi Shinbashi Minato-ku, Tokyo, Japan  
Tel: 433-6618 Cable: Iseworldrep  
Telex: J26546 Iseinter

*USA Sole Distributor*

**LEGI ELECTRONICS CORP.**

1472 West 178th Street, Gardena California 90248  
Tel: (213) 532-0470, 0471

## Probing the news

burn out in a few minutes and smash to pieces when they hit the ground, but by then the plane that dropped them would be miles away.

It was the prospect of being able to buy cheap tubes by the tens of thousands for expendable systems that spurred the military interest in Varian's novel design, says John Gibon, R&D product manager of the firm's TWT division.

**Evolution.** Most of Varian's competitors appear willing, for the time being, to concentrate on evolutionary improvements in TWTs. In Palo Alto, Calif., Watkins-Johnson Co. is emphasizing development of solid-state amplifiers operating through Ku band—12 to 18 GHz. The company has developed a C-band device that operates at 4.8 GHz, and is now developing amplifiers in the 7-12-GHz band, some of them under military contracts.

The company also has revived the depressed-collector technique, combined it with periodic-permanent magnet focusing and shadow grids, and come up with a half-dozen broadband tubes for counter-measure applications. And RCA, using samarium-cobalt magnets, has built three tubes covering 2 to 18 GHz with 30 w of power.

One of the major TWT developers is Hughes Aircraft's Electron Dynamics division in Torrance, Calif. Work is under way there to improve the efficiency of TWTs for smaller, more powerful airborne devices by optimizing conventional design methods. Results are impressive. At X band, using a single-stage depressed collector and an improved method of controlling the beam by focusing with a periodic permanent magnet, developmental tubes have exhibited an over-all efficiency of 50%.

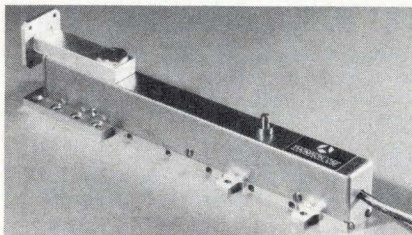

**From France.** This traveling-wave tube from Thomson-CSF features a waveguide output.

Thomson-CSF, the top French producer of nonconsumer electronics hardware, has put evolutionary improvements together in its 20-w tubes for satellite communications transponders. These tubes operate at 12 GHz and should have a life of at least seven years in orbit.

Daniel Maillart, microwave tubes sales manager for Thomson-CSF, points out three kingpin improvements that make 20-w operation possible at K-band frequencies. First, because cathode loading becomes too high under these conditions for ordinary coated cathodes, Thomson uses impregnated cathodes—sintered tungsten impregnated with alumina. Their life expectancy is more than 200,000 hours. Second, the helix has a double taper, with variable pitch, at both the gun end and the collector end; the gun-end taper helps meet tight specifications for fine gain and for phase shift between input and output signals, while the taper at the collector end helps increase efficiency. But the most dramatic design difference from earlier tubes is a three-stage collector, which is largely credited for a boost in TWT efficiency to 40% from 28%.

**Wider bands.** In Britain, EMI-Varian Ltd., a jointly owned subsidiary of Varian and EMI Electronics, is working to increase bandwidth in powerful tubes with output up to 5 megawatts. Researchers expect to have working tubes in about 18 months. Also, for about a year the company has been making TWTs in which the cathode has a mean current loading in excess of about 100 milliamperes per square centimeter and also incorporates a technique that's claimed to increase cathode life by three or four times.

Another British manufacturer, GEC Telecommunications Ltd., is building equipment for MCI Communications Corp.'s planned U.S. microwave links. For this equipment M-O Valve Co. has developed a 10-w C-band tube with expected life of 50,000 hours, compared to the 200,000-hour average usually achieved with established tube designs, M-O says. Long life has been obtained by cutting cathode current density to about 50 mA per square centimeter, which is about a quarter of the figure for the older tubes. □

# CANNON DISTRIBUTORS ARE INNOVATIVE, TOO. CALL THEM.

**ALABAMA**  
Hall-Mark Electronics  
Corp.  
Huntsville  
205/539-0691

**ARIZONA**  
Liberty Electronics/  
Arizona  
Phoenix  
602/264-4438

**CALIFORNIA**  
Kierulff Electronics, Inc.  
Los Angeles  
213/685-5511  
Kierulff Electronics, Inc.  
Palo Alto  
415/968-6292  
Liberty Electronics  
El Segundo  
213/322-8100  
Richey Electronics, Inc.  
Sun Valley  
213/875-2862  
Time Electronics  
West, Inc.  
Inglewood  
213/673-5900  
Western Radio/  
Liberty  
San Diego  
714/235-6571

**COLORADO**  
Cramer Electronics, Inc.  
Denver  
303/758-2100

**CONNECTICUT**  
A.S.I./Connector  
Corporation of  
America  
New Haven  
203/624-0127

**FLORIDA**  
Hall-Mark Electronics  
Corp.  
Orlando  
305/855-4020

**GEORGIA**  
Electro Air Corp.  
Atlanta  
404/351-3545

**ILLINOIS**  
Cramer Electronics, Inc.  
Mt. Prospect  
312/593-0230  
Radio Distributing  
Company, Inc.  
Chicago  
312/237-1105

**INDIANA**  
Radio Distributing  
Company, Inc.  
South Bend  
219/287-2911

**KANSAS**  
Hall-Mark Electronics  
Corp.  
Lenexa  
913/888-4747

**MARYLAND**  
Schweber Electronics  
Rockville  
301/881-2970

**MASSACHUSETTS**  
Cramer Electronics, Inc.  
Newton  
617/969-7700  
Schweber Electronics  
Waltham  
617/891-8484

Time Electronics/  
New England  
Woburn  
617/935-8080

**MINNESOTA**  
Cramer/Bonn  
Minneapolis  
612/941-2770

**MISSOURI**  
Hall-Mark Electronics  
Corp.  
St. Louis  
314/521-3800

**NEW JERSEY**  
A.S.I./Resco  
Electronics  
Pennsauken  
609/662-4000

**NEW MEXICO**  
Cramer Electronics, Inc.  
Albuquerque  
505/265-6767

**NEW YORK**  
A.S.I./Progress  
Electronics Co., Inc.  
Plainview, L.I.  
516/433-1700  
Schweber Electronics  
Westbury, L.I.  
516/334-7474  
Summit Distributors, Inc.  
Buffalo  
716/884-3450  
Time Electronic Sales  
Hauppauge, L.I.  
516/273-0100

**OHIO**  
Radio Distributing  
Company, Inc.  
Cleveland  
216/946-0900

**OKLAHOMA**  
Hall-Mark Electronics  
Corp.  
Tulsa  
918/835-8458

**PENNSYLVANIA**  
Aercon, Inc.  
Clifton Heights  
215/622-2500  
Philadelphia  
Electronics, Inc.  
Philadelphia  
215/568-7444

**TEXAS**  
Hall-Mark Electronics  
Corp.  
Dallas  
214/231-5101  
Hall-Mark Electronics  
Corp.  
Houston  
715/781-6100

Harrison Equipment  
Co., Inc.  
Houston  
713/224-9131  
Kierulff—Dallas  
Garland  
214/271-2471

**UTAH**  
Cramer Electronics, Inc.  
Salt Lake City  
801/487-3681

**WASHINGTON**  
Kierulff Electronics, Inc.  
Seattle  
206/763-1550

**WISCONSIN**  
Cramer Electronics, Inc.  
Milwaukee  
414/462-8300

**CANNON**

# JOHNSON INSISTS ON CANNON® BURGUN-D CONNECTORS. POINTS TO UNIVERSALITY, COST SAVINGS. MANAGEMENT RECOILS.

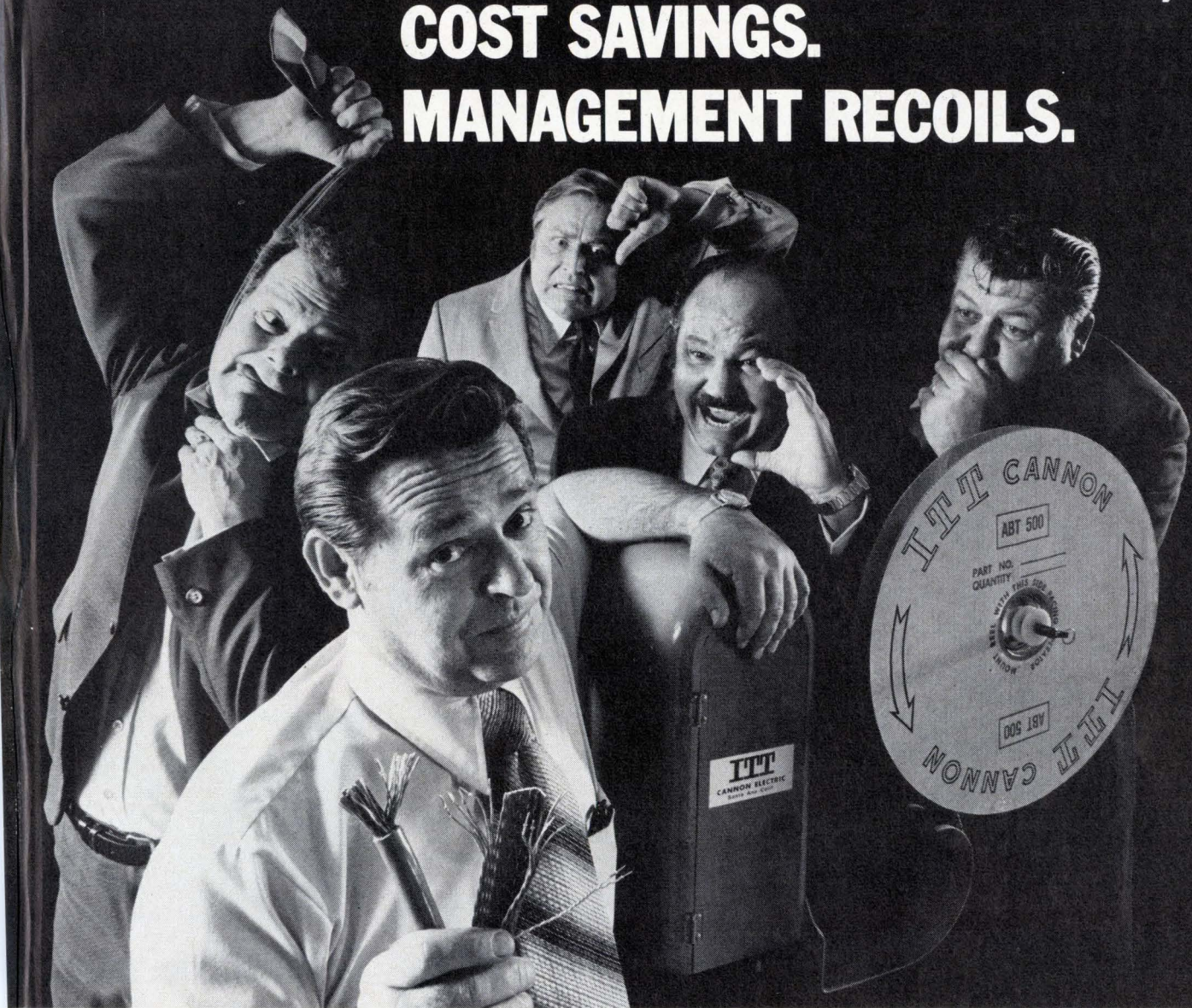

## "IF IT DOES A LOT, IT COSTS A LOT," they chorus.

Johnson understood: "You keep translating universality into aerospace over-engineering. That's the wrong message. What happened was that Cannon just took its aerospace expertise and put it into a low-cost crimp contact connector that works with stranded or solid wire, flex circuits, pc boards or what have you!"

That mollified them a little but they still balked at linking Cannon with low cost. Johnson pressed on: "Low cost in a couple of ways. First, we can bulk-buy Burgun-D connectors, yet still tailor them to our applications with Cannon's variety of connectors and accessories. That saves

inventory cash and record keeping. Then there's Cannon's automatic strip-and-crimp machine..."

"We thought ours was AMPle," they complained. Johnson chuckled: "It is, if you enjoy hand operations or straightening twisted pairs and adjusting for jacket thickness. But seriously, Cannon's strip-and-crimp machine takes twisted pairs, jacketed cable and hard-coated wire, handles up to four gage sizes at a single setting and lets one operator terminate about 10,000 contacts per shift. See what I mean?"



Now Johnson could have laid the worldwide availability of Burgun-D on them, and the machine leasing deal that pays for itself many times over, but why bother? They got the message. Did your management? Try it on them. It could be more than just amply rewarding.

Start by writing for our free catalog. ITT Cannon Electric, International Telephone and Telegraph Corporation, 666 E. Dyer Road, Santa Ana, CA 92702. Phone (714) 557-4700.



European facilities in: Brussels, Belgium; Basingstoke, Hants, England; Toulouse, France; 7056 Beutelsbach/1.R., Germany; Milano, Italy.

# CANNON ITT

Circle 77 on reader service card

# Harris CM

Here are the eight latest additions to our DI/CMOS family-- the fastest low-power logic devices on the market. And they're completely free of SCR latch-up problems.

Last fall we introduced our first eight DI/CMOS logic devices.\* Now, through our continuing development program, we've added eight more. Like the first group, these offer speeds twice as fast as any comparable IC's (typically 10ns with 10-volt power supplies) and extremely low power dissipation. Power dissipation for each of the eight new devices is typically  $1nW$ . These units also permit a wide power supply range (3VDC to 18VDC), while providing large noise immunity—typically 45% of supply voltage. And because of our dielectric isolation process, SCR latch-up problems are completely eliminated.

Chip reliability is currently reported at more than 325,000 device hours at +125°C without failure.

The first six devices diagrammed here (HD-4000 series) are pin for pin compatible with the CD-4000A series. The last two are Harris proprietary devices (HD-4800 series). All are available in 14-pin DIP's except the HD-4814, which comes in a 16-pin package. For details see your Harris distributor or representative.

## 9 HD-4002 Dual 4 NOR Gate

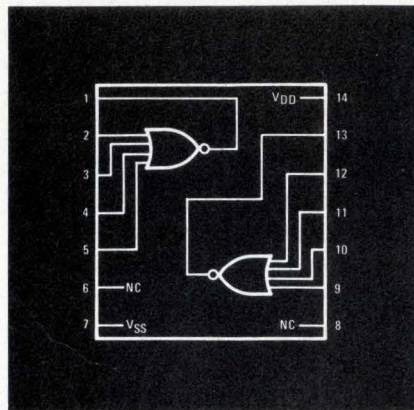

Pin for pin compatible with CD-4002A.  
100-999 units  
-40°C to +85°C \$1.00  
-55°C to +125°C \$3.40

## 10 HD-4007 Dual Complementary Pair Plus Inverter

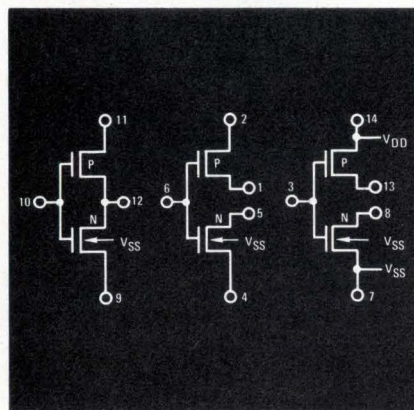

Pin for pin compatible with CD-4007A.  
100-999 units  
-40°C to +85°C \$1.00  
-55°C to +125°C \$2.65

## 11 HD-4019 Quad AND/OR Gate

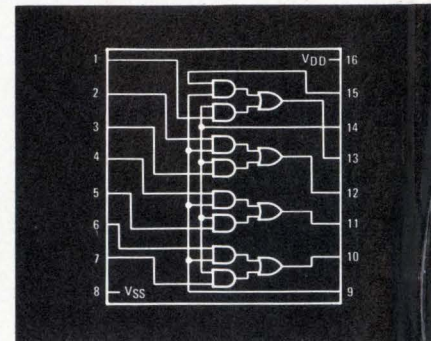

Pin for pin compatible with CD-4019A.  
100-999 units  
-40°C to +85°C \$2.45  
-55°C to +125°C \$5.05

## 12 HD-4023† Triple 3 NAND Gate

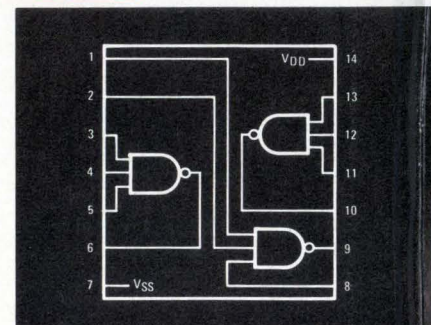

Pin for pin compatible with CD-4023A.  
100-999 units  
-40°C to +85°C \$1.00  
-55°C to +125°C \$3.40

## 13 HD-4025 Triple 3 NOR Gate

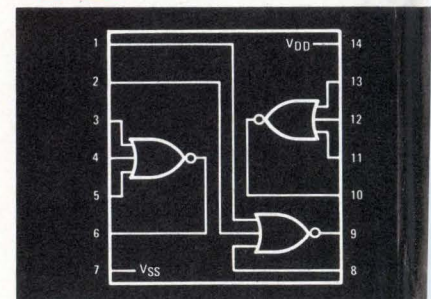



# OS cont'd:

Pin for pin compatible with CD-4025A.  
 100-999 units  
 -40°C to +85°C \$1.00  
 -55°C to +125°C \$3.40

**14** HD-4030†  
 Quad Exclusive OR Gate

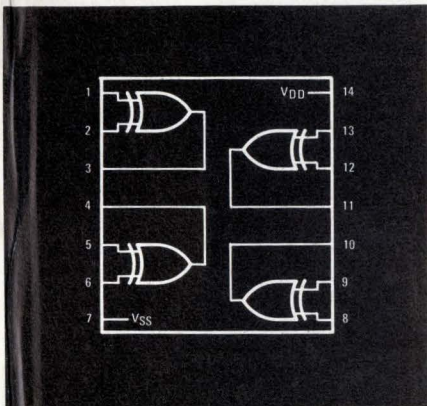

Pin for pin compatible with CD-4030A.  
 100-999 units  
 -40°C to +85°C \$2.10  
 -55°C to +125°C \$3.80

**15** HD-4811†  
 Quad Exclusive NOR Gate

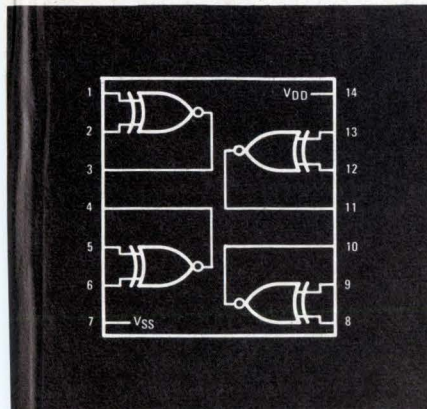

A Harris proprietary device.  
 100-999 units  
 -40°C to +85°C \$2.10  
 -55°C to +125°C \$3.80

† Available through distributors  
 in late May.

**16** HD-4814  
 Hex Inverter

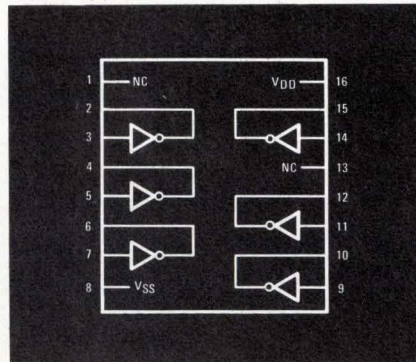

A Harris proprietary device.  
 Replaces HD-4009 in applications  
 requiring only the inverting function.  
 100-999 units  
 -40°C to +85°C \$2.10  
 -55°C to +125°C \$3.80

## \*1 thru 8

In case you missed the ad describing  
 our first eight CMOS devices, here  
 they are again. All are high-speed,  
 low-power units. The HD-4000  
 series is pin compatible with  
 the CD-4000A series. The HD-4809  
 is a Harris proprietary device.

	100-999 units	
	-40°C to +85°C	-55°C to +125°C
1. HD-4000 Dual 3 NOR Gate	\$1.00	\$3.10
2. HD-4001 Quad 2 NOR Gate	\$1.00	\$3.30
3. HD-4009 HEX Inverter	\$2.20	\$5.25
4. HD-4010 HEX Buffer	\$2.20	\$5.25
5. HD-4011 Quad 2 NAND Gate	\$1.00	\$3.30
6. HD-4012 Dual 4 NAND Gate	\$1.00	\$3.45
7. HD-4013 Dual "D" Flip Flop	\$2.10	\$4.75
8. HD-4809 Triple/True Complement Buffer	\$2.25	\$5.30



**HARRIS**  
**SEMICONDUCTOR**

A DIVISION OF HARRIS-INTERTYPE CORPORATION

P.O. Box 883, Melbourne, Fla. 32901  
 (305) 727-5430

**WHERE TO BUY THEM:** ARIZONA: Phoenix—Liberty, Weatherford; Scottsdale—HAR (602) 946-3556  
 CALIFORNIA: Anaheim—Weatherford; El Segundo—Liberty; Glendale—Weatherford; Long Beach—HAR (213) 426-7687; Mountain View—Elmar; Palo Alto—Weatherford, HAR (415) 964-6443; Pomona—Weatherford; San Diego—Weatherford, Western  
 COLORADO: Denver—Elmar, Weatherford  
 WASHINGTON, D.C.: HAR (202) 337-3170  
 FLORIDA: Hollywood—Schweber; Melbourne—HAR (305) 727-5430  
 GEORGIA: Atlanta—Schweber  
 ILLINOIS: Chicago—Semi-Specs, Schweber; Palos Heights—HAR (312) 597-7510  
 INDIANA: Indianapolis—Semi-Specs  
 MARYLAND: Rockville—Schweber  
 MASSACHUSETTS: Lexington—R&D; Waltham—Schweber; Wellesley—HAR (617) 237-5430  
 MICHIGAN: Detroit—Semi-Specs  
 MINNESOTA: Minneapolis—Semi-Specs  
 MISSOURI: Kansas City—Semi-Specs; St. Louis—Semi-Specs  
 NEW MEXICO: Albuquerque—Weatherford  
 NEW YORK: Melville—HAR (516) 249-4500; Syracuse—HAR (315) 463-3373; Rochester—Schweber; Westbury—Schweber  
 OHIO: Beachwood—Schweber; Dayton—Semi-Specs  
 PENNSYLVANIA: Pittsburgh—Semi-Specs; Wayne—HAR (215) 687-6680  
 TEXAS: Dallas—Weatherford, Semi-Specs, HAR (214) 231-9031  
 WASHINGTON: Seattle—Liberty, Weatherford  
 WISCONSIN: Wauwatosa—Semi-Specs.

**LEGEND FOR HARRIS SALES OFFICES & DISTRIBUTORS:** Harris Semiconductor (HAR); Elmar Electronics (Elmar); Harvey/R&D Electronics (R&D); Liberty Electronics (Liberty); Schweber Electronics (Schweber); Semiconductor Specialists, Inc. (Semi-Specs); R. V. Weatherford Co. (Weatherford); Western Radio (Western).

# First we souped-up super beta transistors. Then we closed the gate on FET leakage.

And as if that's not enough, we've come up with the lowest noise, lowest drift dual FET around, too.

These three are just part of the broad line of high performance dual monolithic FETs and transistors we've designed to solve more of your linear circuit problems.

Our AD815 super beta dual monolithic NPN transistor features 2000 beta at a breakdown voltage of 20V. It can reduce your input noise current by a factor of ten. Plus, you get a 0.5mV offset. Price: \$5.50 in 100's.

Our AD830 dual monolithic FET gives you an extremely low leakage current — less than 0.1pA. That's as low as they come. Price: \$11.10 in 100's.

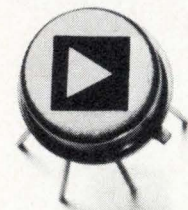

**0.1pA  $I_g$**   
**AD830 FET**



**2000 $\beta$ @20V**  
**AD815 NPN**

And when it comes to super-low noise and drift, our AD840 dual monolithic FET has the lowest noise of any dual FET you can get anywhere: 9nV/ $\sqrt{\text{Hz}}$ . It delivers an adjusted drift of 1 $\mu\text{V}/^\circ\text{C}$ , too. Price: \$7.80 in 100's.

These designs are just right for upgrading existing circuits in low-current measurement instruments, preamplifiers, and applications involving high impedance sources. Or build them into brand new circuits; they'll make your design a lot better than anybody else's.

We've got samples and comprehensive data sheets. And our 1973 Product Guide. Just ask.

Analog Devices, Inc., Norwood, Mass. 02062.



**9nV/ $\sqrt{\text{Hz}}$**   
**1 $\mu\text{V}/^\circ\text{C}$**   
**AD840 FET**

## Call 617-329-4700

for everything you need to know about dual monolithic transistors and FETs.

# ELECTRONICS IN THE HOME: AWAITING THE RIGHT PRICE

While Spike the burglar (see cover) may have found a lot of electronic wonders in the comic-strip house, the fantasy is unlikely to become a reality for a couple of years yet

by Gerald M. Walker, *Consumer Editor*

□ The automated household, crammed with silent electronic servants, is still just a part of science fiction lore. In reality, most appliances and tools that consumers can buy now are virtually bereft of sophisticated electronic controls and sensors.

But, thanks mainly to the marketing value in the term "solid state," home-appliances manufacturers are now beginning to design new types of electronic controls into their products, and some of these products—air conditioners, ranges, washers, and dryers—have already reached the upper end of sales catalogs.

The current spate of blenders, mixers, white goods (kitchen appliances), and power tools with such controls is not a new direction for the highly competitive appliances manufacturers. At least 10 years ago some appliances were introduced and promoted as electronically controlled. A few companies had appliances ready, but held off.

While some of these early efforts endured, most flopped for a couple of reasons. First, the housewife couldn't see any real improvement over the previous electromechanical means of running the appliances. Second, she certainly wasn't willing to pay a higher price for something she didn't really need.

Engineers for these companies agree that most of the initial offerings were premature. After being once burned, appliance designers have been slow in showing renewed interest. The prime reason for the lack of enthusiasm is that standard components—switches, timers, thermostats, tapped motors—do the job well and at a cost consistently under the more-precise solid-state substitutes. In addition, say the manufacturers, semiconductor companies have not been aggressively pushing applications assistance.

Nevertheless, Robert J. Scott, vice president of engineering for Rival Manufacturing Co., Kansas City, Mo., states, "Any company without a significant effort in electronics will get caught with its pants down, and in this industry, that's fatal." Admittedly much of the interest is based on the marketing points that solid state

can add to a product, rather than any intrinsic improvement in what is already acceptable performance. Since the entertainment-products industry has glamorized "all solid state" in the home, appliance companies can see a ready-made set of coat tails on which to ride into the kitchen and laundry room.

### Magic in solid state

This promotion notion has led to some stretching of meaning, as when an "all-solid-state control" consists of a single diode used to rectify motor current. "To most of these designers," an engineering vice president scoffs, "solid state means anything without tubes. So," he adds, slamming his hand down, "this is a solid-state desk—there are no tubes anywhere in it. Engineers in this industry are lost once they get beyond motor windings."

But the search for marketing gambits has put companies back on the electronics track. This time there has to be a change in emphasis, says William E. Beller, director of engineering for Controls Co. of America, Chicago, a major supplier of electromechanical assemblies to appliance firms. He notes that until now the effort has been simply to substitute a semiconductor device for an electromechanical part, which immediately puts electronics at a price disadvantage. Instead, the effort should be to find a new contribution from electronics.

For example, Controls Co. of America pioneered a moisture-sensing unit for dryers that not only controlled the running time of the machine by sensing when the contents were dry, as is the case in those now on the market, but provided a range of dryness that could be selected. This added feature did not catch on. In the same way, electronic speed controls for automatic washers were tried and did not stick. An electronic pulsating device to control blenders also did not fly.

But there's another way of looking at the problem, Beller continues. Most appliances operate on time-dependent controls, which may not be the best parameter. Thus it may be more logical to think of a dryer that dries until the clothes are dry or a washer that washes

until it cleans the contents rather than merely operating for a preset time. "Engineering activity toward this end will stimulate a more appropriate long-range use of electronics than previously," he says.

### Solid state stirring in mixers and blenders

Generally considered to be the first company to put an electronic speed control on a blender, Rival had two versions on the market starting in 1966. Scott recalls that "One had a dimmer-type SCR and the other had feedback control to adjust motor speed to the blender's load. But consumers did not appreciate what we had given them, and we killed these models because we couldn't sell against lower-priced units."

He found that the electronic controls cost \$2 to \$3 more than standard units. Similarly, about four years ago Scott developed an electric fry pan rated at 1,500 watts with a \$6 electronic control. Heat setting was very accurate, and the home economists loved it. But the alternative design had a thermostat costing 50¢ to 60¢, so this prototype went by the board.

Scott has not given up on electronic controls. He's convinced that the cost curve will make applications more attractive, particularly for precise heating control as in the fry pan and in room heaters. "Still," he muses, "the thermostat people won't give up making improvements either."

While Rival has been cooling its heels, other blender and mixer firms—such as Hamilton Beach, Waring, and Oster—have brought out units featuring motor controls primarily intended to increase the number of speeds available from the motor. At its simplest, this function is accomplished with one or two diodes, depending on the product.

Hamilton Beach, a division of Scovill Mfg. Co., Waterbury, Conn., developed its blender and mixer units from experience in using a diode rectifier for an electric knife back in 1962. Because of space limitations, use of a small permanent-magnet motor with a diode to rectify current was the best way to go, particularly since price was not a factor in this product. At that time the diodes cost 27 cents each; now they're at 9 cents. The tradeoff in the blender and mixer lines was between using a motor with 14 taps or a less expensive, standard seven-tap motor with a diode rectifier. "As we use a permanent-magnet motor, we had no option but to design in the

**1. Mixer feedback.** Iona Co. designed this feedback speed control to adjust mixer's motor effort to working load. Although it's a simple design, added cost made electronics risky in marketing.

diode to rectify the current and thus make a virtue of necessity," comments Gus W. Wallin, manager of engineering.

Dropping a diode or two into a mixer is not such a big deal, yet doing anything more to add cost to these appliances is very risky due to their price sensitivity. Thus when the Iona Co., Manchester, Conn., began to develop and then produce a mixer with a feedback electronic control, the only precedents were failures suffered by other companies—not a very encouraging starting point.

### Opting for a feedback circuit

Essentially the goal was to provide a variable-speed unit with the capability of adjusting power output to match the load on the mixing blades. "There are a couple of ways to achieve this end," Gerald Rideout, vice president for engineering, remarks, "but from our viewpoint, electronics, while still more costly, is superior for quality and performance." The payoff, aside from convenience, is a motor that is never overloaded and therefore lasts longer.

This control unit is now into its "third generation." The first unit (Fig. 1) consisted of a 1.6-ampere plastic-encapsulated silicon-controlled rectifier, a 1-microfarad tantalum capacitor, a 1,000-ohm trimming potentiometer, four resistors, a 0.5-A diode, and a 3-A potentiometer. Simple enough, but still costly for Iona, so a second version was developed with the help of the supplier to "get the frills out."

This version (Fig. 2) consists of just four resistors, the 1-microfarad tantalum capacitor, the 1.6-A SCR, two diodes, and the 3-A pot, which provides a linear speed-rise characteristic rather than an exponential rise. And now that he has had enough experience with the second-generation unit to be sure of its reliability, Rideout completely encapsulated the third version to make handling and assembly easier. The assembly, which is supplied complete by two vendors, was designed by Iona. It appears in five mixer models now, having been phased in one model at a time.

Rideout readily admits that competition has forced him to reconsider use of this feedback-type unit. "However," he states, "we chose to challenge the design and costs of electronics rather than give up on it too quickly." And now the components shortage has come

**2. Next try.** A second configuration of the Iona control cut cost by eliminating a couple of components and mounting the unit in a smaller space. A third version is plastic-encapsulated.

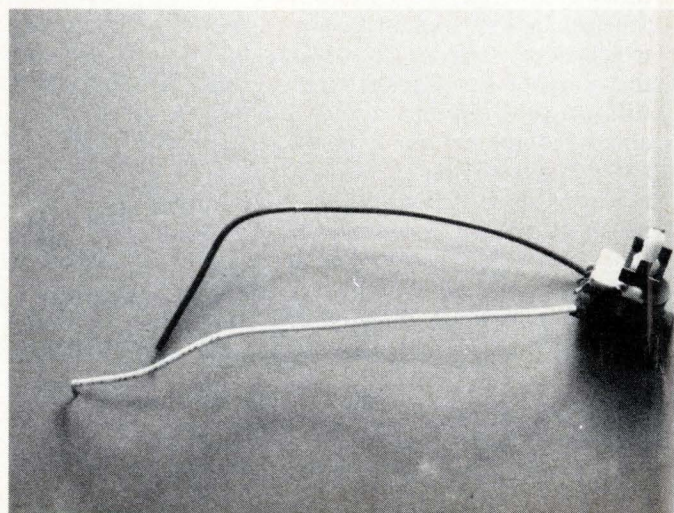
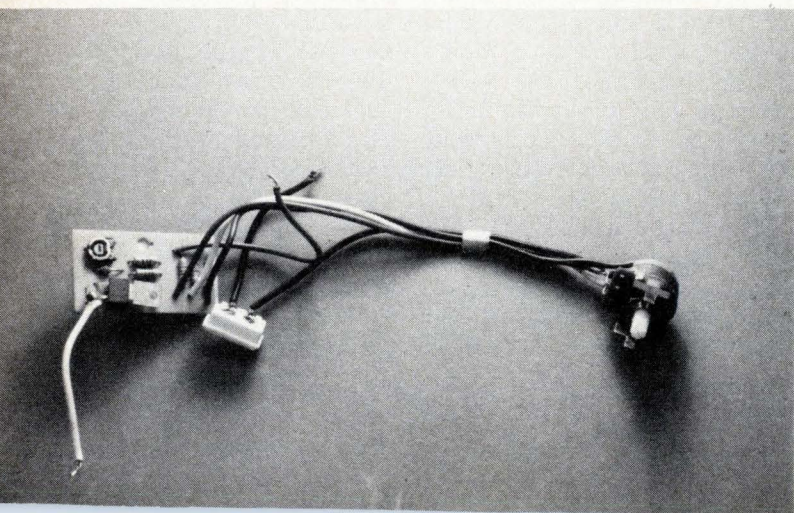

to plague him. "Lead times are definitely longer, but I have a stack of family photos to send to the suppliers in the hope of convincing them that I'm a nice person," Rideout jests.

"Electronics as we understand it will play a prominent role in our products as the cost factors come down," he continues. "How widespread this use will be depends on cost, plus the advantages to the consumer—but mainly cost, because we are always competing with people who force us into considering cost factors."

Another boost to electronics in small appliances may come in the form of regulations concerning electromagnetic interference, according to Rideout. EMI suppression is required in products for foreign sales, and he fully expects it to be a factor in the U.S. and Canada one day. "We recognize that one day suppression will be a requirement and R&D must factor this into its planning. Electronics is certainly one element to consider."

### Major appliance makers think ICs

White goods manufacturers also have been cautious users of electronic devices and for much the same reason—cost. That's why the arrival in the next two months of a new electric range from Frigidaire division of General Motors, Dayton, Ohio, is being watched with more than usual interest in the industry [*Electronics*, Feb. 1, p. 44]. For its Touch Control range, Frigidaire has gone all out for electronics, using three MOS large-scale integrated circuits supplied by American Micro-systems Inc., Santa Clara, Calif., and a digital display made up of flat-envelope gas-discharge tubes from Sperry Information Displays, Scottsdale, Ariz.

Since unveiling the unit earlier this year, Frigidaire, typically, has been mum about design details and so far has not revealed even the selling price. An industry guess puts the price premium above present top-of-the-line electric ranges at more than \$200.

The leap into ICs and digital displays, as well as solid-state power controls for the top burners of the range, is all the more remarkable because Frigidaire introduced a solid-state washer several years ago, only to abandon it as too costly. Now, a spokesman claims, cost problems have been solved with this range.

Frigidaire has virtually ripped out all the electromechanical components of the range and replaced them with an electronic system. With precise timing and control, it overcomes one of the longtime headaches of cooking on an electric range. Oven cooking is also carefully controlled. All the controls are set and displayed from a glass-covered panel mounted above the rear of the range (Fig. 3).

When not in use, the display serves as a digital electronic clock. To cook a three-hour roast, for example, the homemaker touches the control marked "start time," which takes the display out of the clock mode, and then the numerals "300," indicating that the oven will go on at 3 o'clock. Next she touches the control marked "oven" and sets the oven temperature by touching the proper numerals. To shut off the oven after three hours, she touches "stop time" and "600". Finally, she returns the display to interface with the digital clock circuits, by touching the "clock" panel. From this point on, the operation is automatic, having been filed in

memory. Any errors in setting will set off a flashing display, while a double touch of the "off" pad turns off all cooking simultaneously. The new range also has an automatic broil cycle that controls heater wattage and broiling time for varying degrees of "doneness".

Application of electronics to gas ranges has also been tried, although not on the grand scale of Frigidaire's new electric unit. Pilot lights are a notorious nuisance to housewives and a cause for costly service calls simply to relight them when they go out. When they're burning, they create hot spots on stove tops and contribute to the overheating of kitchens.

Caloric Corp., Topton, Pa., recently introduced a relatively simple solution to this problem, the Direct Burner Ignition System, that eliminates the pilot entirely (Fig. 4). The system features a safety device con-

### Japanese retrench, too

In Japan, which often leads the U.S. in consumer-product innovations—and where the large electronics companies also manufacture appliances—electronics in home products is still not making major inroads. Realization that they were adding functions not needed—or even annoying to customers—has caused many manufacturers to abandon products after introducing them with great hoopla.

For example:

- Most of Japan's dozen or so manufacturers of fans have in the past offered products with continuous-speed control using thyristors and have reverted to three- or four-speed push-button control using tapped motor windings or reactors.
- Hitachi Ltd. and Matsushita Electric Industrial Co. Ltd. had offered washing machines with continuous-speed control. But Hitachi has dropped the product, and Matsushita is allowing its to die a slow death.
- Hitachi has stopped producing a refrigerator with a hybrid IC in the temperature-control unit.
- Matsushita's continuous-speed control for vacuum cleaners has not sold well against those with a simple air bleed.
- Blenders with electronic speed control have not sold well on the domestic market.

Like the U.S. electronic-components manufacturers, the Japanese electronics firms are competing with tried-and-true electromechanical devices on price alone. For instance, Hitachi says that its hybrid IC was too expensive for use in the refrigerator mentioned above, but next time around a monolithic IC will be tried because the price is right. Another promising application is MOS LSI with read-only memory and countdown, plus logic circuits, to replace the mechanical timer and programmer on washing machines.

Hitachi's new line of fans includes models with a safety feature—a proximity control to turn the fan off when an object approaches the fan guard. Every Japanese manufacturer has models in which the fan motor is turned off either by a proximity switch or by a touch switch keyed to the fan guard. The Hitachi innovation, however, involves a trimmer capacitor for adjustment of proximity-switch sensitivity. On one model the trimmer is brought out at the front panel, labeled "distance" control. The rest of the proximity circuit is fairly straightforward.



**3. Housewife as programmer.** This new Frigidaire range, scheduled to be on the market this summer, features a digital display panel and ICs to control operation of the oven. The home owner "programs" the oven with the touch panel, selecting cooking time and temperature.

sisting of a thermocouple-and-relay combination supplied by ITT General Controls, Glendale, Calif. The top-burner igniter coil is a 1.5-volt, 5-A, 7.5-W pilot that heats to a temperature of 2,200 to 2,400°F at ignition and is only activated when needed. The oven and broiler have a similar igniter, but it glows constantly in the oven cavity. This approach is a departure from previous igniter-type designs in that the Caloric igniters light the gas flame directly. In previous versions, the igniter lit a pilot, which in turn started the flame.

According to Howard Tomlin, manager of product planning for Caloric, the direct ignition system permits use of a fail-safe system in the oven. It consists of two circuits working interdependently. An extremely sensitive thermocouple controlling a single-pole, double-throw relay in both circuits keeps the gas valve open after flame ignition and instantly shuts down the gas flow in the event of igniter failure. Since the control circuits close only when there is flame from the main burner, it's impossible to keep the gas on without ignition.

The igniters have undergone three years of field testing, while the safety controls have been tested for 18 months at 25 utilities to determine if fuel differences in various localities alter performance of the system. Retail sales will begin in less than a year.

While the ignition system is a relatively unsophisticated design, Tomlin believes that electronics will be making a larger contribution in temperature controls in

the near future. He, too, believes that attempts to apply solid-state controls some years ago were premature.

As for the future in ranges, some manufacturers feel the appeal of so-called "cool-top cooking," in which the burners heat by ultrasonic power, may open the way to more electronics. As envisioned now, thyristors and power transistors would control the ultrasonic power source. This possible configuration would have, below the ceramic top, a magnetic coil that pumps 20 to 50 kilohertz of ultrasonic energy into a transformer, which then emits energy into any ferrous-metal cooking pot placed on the stove. All the controls would be electronic. Still, this is a fairly expensive range at this time. The concept has been demonstrated in one range, mainly to show that it can be done, but the final product was priced at \$2,000, precluding wide acceptance.

#### **Air conditioners still cooling it**

Air-conditioner manufacturers want to reduce the size and weight of motor and compressor units and improve temperature control. One possible way of accomplishing this would be with a variable-speed motor, driving it with an inverter operating at 5 or 10 kHz. This approach would shrink the magnetics to reduce the motor's size and weight. Also, it would be desirable to run an air-conditioning system continuously, rather than shutting down and starting up periodically. This capability would improve humidity control, for there are

many cases when the air conditioner is not just cooling but also dehumidifying the air.

While this likely application of electronics would make a power-semiconductor supplier happy, its time has not arrived. Electromechanical devices are still more efficient and cheaper. Nevertheless, Carrier Air Conditioning Co., Syracuse, N.Y., employs electronics in 13 models of room air conditioners and in the outdoor condenser for eight central residential systems.

The room units contain a wave-chopping circuit that furnishes infinitely variable fan speed, from stop to full capacity. In the central air conditioner, there's a solid state Compressor Protect and Control System (CPCS) guarding the compressor, which is the most important and failure-prone part of these units (Fig. 6). It's a proprietary assembly composed of discrete components and was designed in-house by Carrier's corporate R&D lab, jointly with the three operating divisions.

Essentially, the CPCS protects the compressor from strains created by power interruption, brownouts, and excessively high temperatures—the common summer-time syndrome in this time of electricity shortages. The circuit within the outdoor unit monitors critical electrical parts, shifts the fan to high speed when the outdoor temperature reaches 90°F, senses voltage drop and adjusts motor load, and delays restart after an electric outage to avoid a compressor-damaging power surge.

Heil-Quaker Corp., Nashville, Tenn., a Whirlpool Corp. majority-owned subsidiary, has also developed a central-air-conditioner control. It's simply a circuit that was introduced last year for an outdoor fan control used in the top-end models to replace a two-speed switch. Basically, it's an SCR within a bridge circuit that is wired in series with the motor. A thermistor senses the temperature at the condenser coils, so it's actually measuring the outside temperature and the heat energy being exhausted from the house. That combined temperature signal is amplified and phase-controls the SCR; the control is calibrated to match the system. In addition, a resistor is installed in parallel with the SCR, or in series with the motor, to reduce the harmonics fed into the motor and back into the power line.

"This approach," Robert Ramsey, senior development engineer in Heil-Quaker's advanced development department, explains, "substantially reduces mechanical noise in the motor and improves the life of the electronic components. With this control we are regulating the flow of refrigerant inside the system over a wider range of outdoor temperatures and indoor heat loads. It does not replace the indoor thermostat, which is still employed as a time-proportional control."

"There's always a real value battle for engineering to use electronic controls," he adds. "One of the things we face in central air conditioning is a tremendous number of hours of usage, so we must make sure the components are reliable. Design homework has to be done. Customers don't want to call a serviceman to adjust the electronics in air conditioning twice a year, so we have to use a factory-calibrated system that will maintain its calibration for 10 to 15 years."

Frigidaire is marketing what it calls an Electronic Air Cleaner (Fig. 5) to operate with its room air conditioners. It involves the same principle as the large-scale

## What about microwave ovens?

With sales for the year bubbling along briskly, microwave ovens suddenly cooled off last month when Consumers Union published in its "Consumers Report" a "not recommended" advisory for all ovens tested. According to CU, although all the ovens tested met the Bureau of Radiological Health standards for allowable emission, any stray radiation from these appliances could be harmful [*Electronics*, Mar. 29, p. 64].

Thus CU had reopened a safety issue first raised three years ago, before the present standards were hammered out. "We've gone through this before," one oven manufacturer recently confided, "only this time, the Government is on our side."

That appeared to be the case, as BRH spokesmen volleyed back CU's charge to the effect that the emissions requirement—1 milliwatt per square centimeter measured 2 in. from the oven at the factory and 5 mW/cm<sup>2</sup> measured 2 in. from the oven at retail or for the oven's operating life—would stick.

But retail sales were immediately affected, and dealers became uneasy about the slowdown. And although manufacturers made confident statements that the ovens are safe and that sales would continue to rise, a counterattack on the CU findings was mounted.

The most elaborate rebuttal has come from Amana Refrigeration Inc., Amana, Iowa, which claims to be the No. 1 U.S. company in home microwave-oven sales and, further, to be marketing the only all-American-made types. Amana's biggest flame in roasting CU's report was James A. Van Allen, discoverer of the earth's radiation belt and researcher into radiation hazards. He labeled the CU findings "thoroughly unsound and, by innuendo, untrue."

At a press conference organized by Amana, Van Allen volunteered to sit on top of a running microwave oven for a year to support his contention that these appliances are safe. He charged that Consumers Union had failed to make scientific distinctions among types of radiation, strength, and duration in attempting to evaluate the health hazard. Van Allen, who has owned and used a microwave oven in his home since 1969 says, "It's safer than a gas oven."

The whole issue may blow over once the barrage of public statements subsides. Even CU gave this indication when a spokesman recently shrugged, "People continue to smoke, too."

electrostatic precipitators used to clean factory air. Room air is drawn into the precipitator cell, where it's electrically charged. Particles or impurities are attracted to plates of opposite charge and then deposited in the cell. This cell requires periodic cleaning in soapy water.

## Washers and dryers getting over Monday blues

Out in the utility room, not much new has happened to automatic washing machines and dryers since the manufacturers first ventured into electronic controls, then pulled in their horns several years ago. Electronic sensing for the top-of-the-line dryers has become a staple among the major companies. General Electric's version, for example, is an interdigitized-electrode-and-capacitor arrangement connected to a moisture sensor. In this circuit, moisture from the clothes completes an

electric contact. Because of a time constant the dryer continues running until the sensor makes contact with the clothing. When the contents are dry enough to break contact in the circuit the machine shuts off.

More elaborate designs are in the works. For example, one major appliance firm is working with an integrated-circuit manufacturer on a circuit to perform the logic for a moisture-sensing system in a dryer. The machine could be set by degree of dryness and adjust to the weight and volume of the load, thus providing a demonstrable improvement over the present moisture-sensing units.

"Basically, we recognize that we can't look to electronics to replace any one function or to replace a timer alone," comments Allan L. Wennerberg, director of electronics research at Whirlpool Corp., Benton Harbor, Mich. "Electronics really is cost-prohibitive now, but at some point in time, a crossover has to occur. The cost of materials for electromechanical systems is rising faster than those of semiconductors. We're learning that in the semiconductor business we haven't exploited the volume opportunities that exist for a company the size of Whirlpool. We know full well that the more functions we can perform, the less the cost per function. So when electronics comes, it will allow us to apply electronic-type sensors, which will allow more features."

#### **Tools are old hands at variable speed**

Makers of portable power tools have been using electronic variable-speed control circuits for several years, and while these have been successful, there's not much inspiration for revising the original designs. Black &

Decker Mfg. Co., Towson, Md., for example, is heavily involved in speed-control devices and rectification for permanent-magnet motors on both drills and jig saws. Originally, the latter units used selenium rectifiers, but they have been replaced by silicon-junction, half-wave, or full-wave diodes.

According to Carl Amrein, electrical design manager of Black & Decker's Home Products division, the speed-control features added to the cost of some products, but helped boost sales. The diode rectifier, on the other hand, was justified because it reduced both size and cost of the tool models in which it appeared. Although incorporation of electronics in its products is minimal, Black & Decker uses electronics extensively in its testing equipment and procedures.

Says Amrein, "Sophisticated factory testing methods have become important to us as more and more automated testing systems, based on electronics, have been developed. In the future, these systems will allow new, more stringent testing of power tools, so you'd have to say that electronics is having an indirect effect on our products."

The Singer Tools division, Pickens, S.C., of the Singer Corp., benefited from its family ties to sewing-machine manufacture when it converted part of its private-label power-tool line to electronics. The first tool to use an SCR variable-speed switch employed a circuit developed by corporate R&D for a sewing-machine foot pedal. It contains an SCR and a resistor strip wiped by a contact to vary the speed as the tool trigger or foot pedal is depressed. The ability to use one switch in two divisions gave Singer a leg up in terms of initial cost, since vol-

**4. Lighting up.** This Caloric range has a new Direct Burner Ignition System, which eliminates the usual pilot light. An igniter coil lights the gas flame directly, making it possible to use a fail-safe device that, if it senses the gas has failed to ignite, shuts down the range.

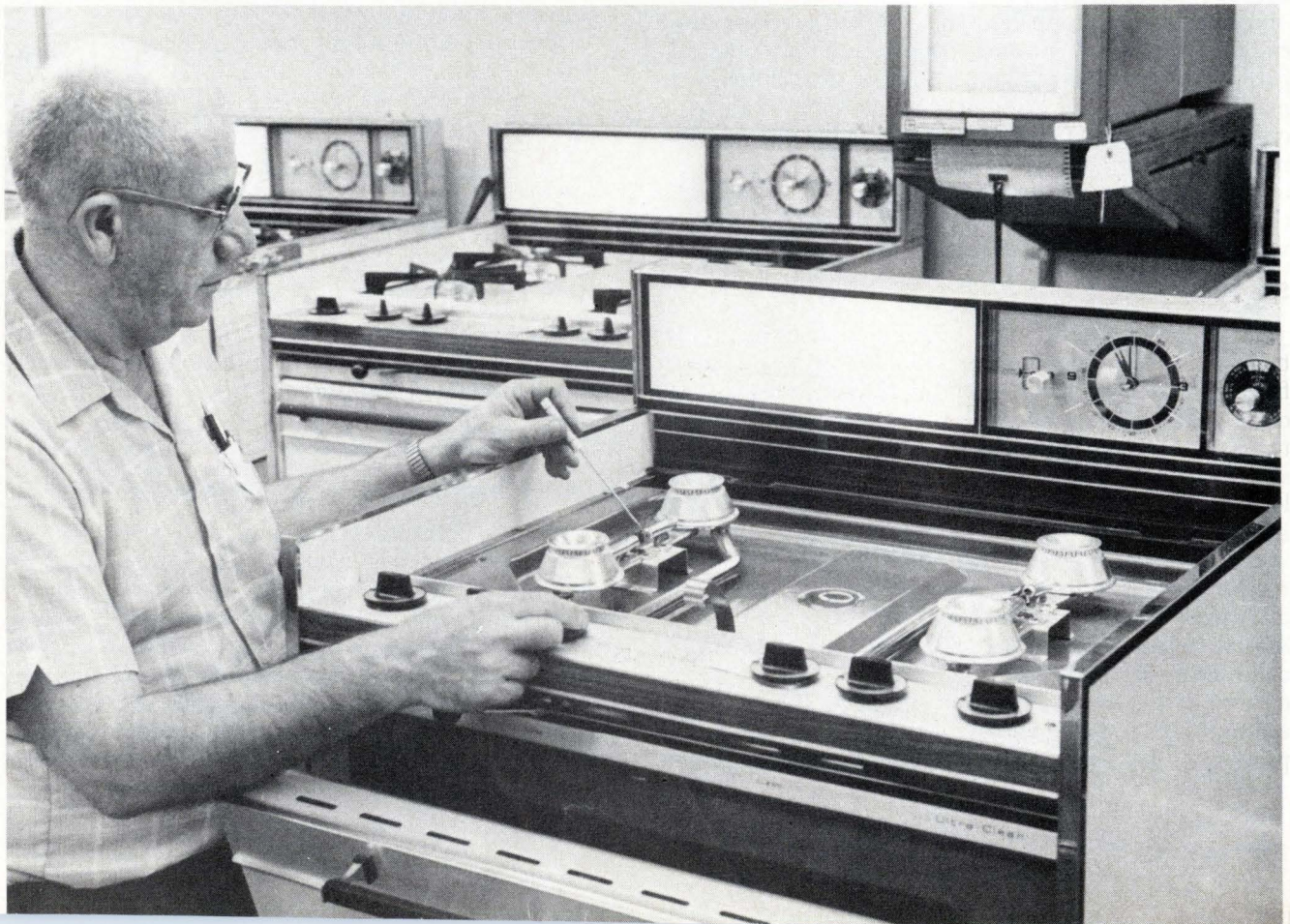



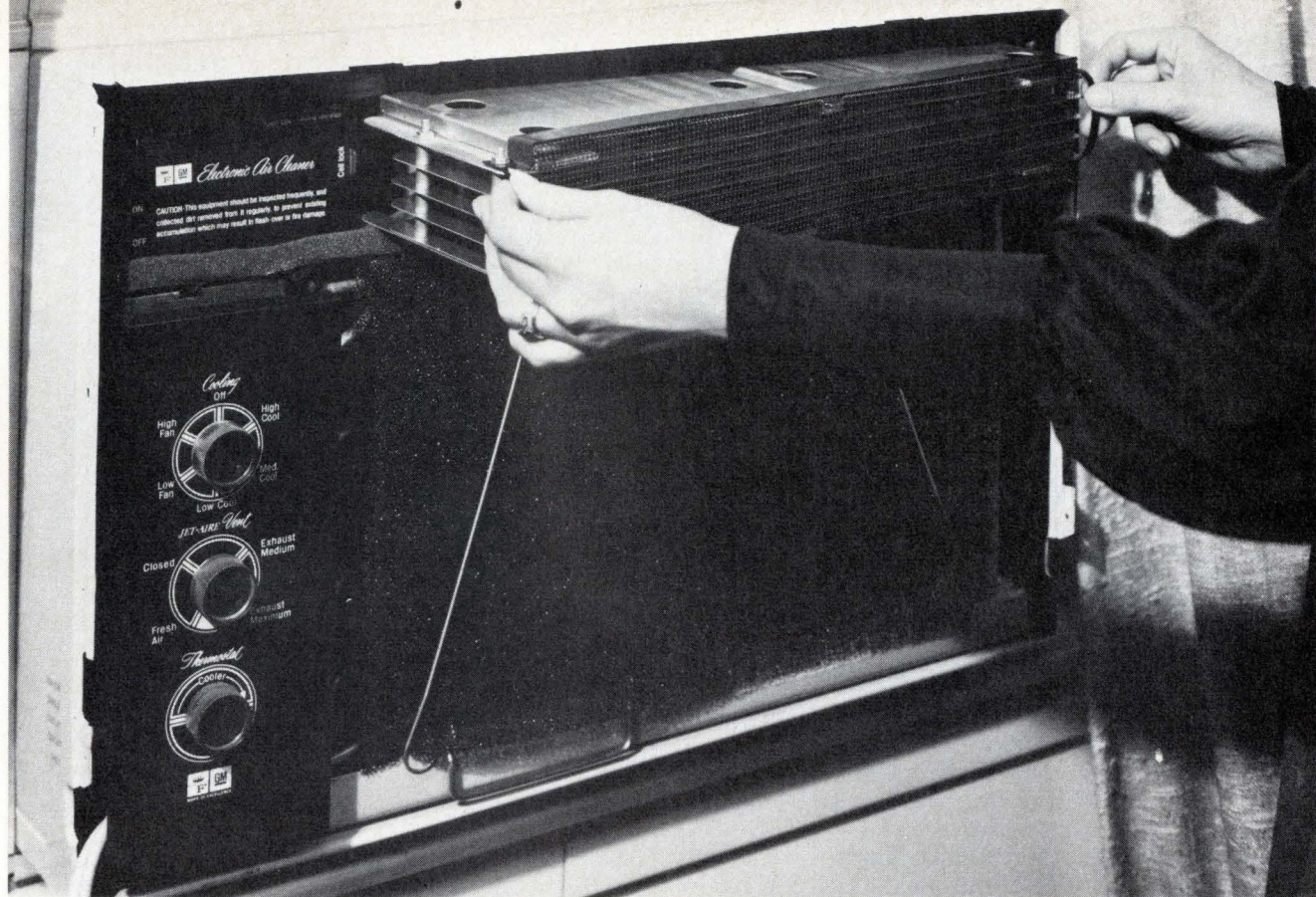

**5. Clean air.** An electrostatic precipitator, which attaches to a residential room air conditioner, has been developed by Frigidaire to provide an air-cleaner feature. Electrically charged dirt particles drawn into the room are attracted to a collection plate of opposite charge.

ume purchases covered both the tool and sewing-machine requirements.

In addition, as Gene Holland, Singer Tools R&D head explains, "speed control added new interest to an old product." On the other hand, it added a negative element, too. The use of the variable-speed control increased field failures from a range of 1% to 1.5% in models with standard on-off switches to between 3.5% and 4% in the electronic versions. The company found that most failures occurred not in the SCR, but in the wiping contacts and resistor strips.

### Safeguarding the home

Probably the most complex—and, thus, costly—task to be handled in the home by electronics is security and fire protection. But with increasing affluence, a rising crime rate, and the lucrative potential market that these two trends import, several companies have begun designing systems for residential applications. The problems turned out to be more difficult than those of most industrial installations.

For one, homes have a random pattern of occupancy, while factories and stores have a known pattern. False alarms are more frequent in homes than in commercial locations because family members, pets, or innocent callers can trip sensors inadvertently. Finally, home owners are not prepared to pay the same high price for a system as is a company that can write off such expenses. As a result, security systems—as opposed to

simple electromechanical home sirens—still remain poised to gain entry to the home market, but are finding it more difficult than burglars to break in.

Considerable design effort has been expended to develop systems that are sensitive enough to respond to an intruder, but rugged enough to resist family abuse, and at the same time are sophisticated enough to foil the burglar's attempt to defeat it, but low enough in cost to open the homeowner's pocketbook. Failure to consider all of these factors, plus lack of understanding of the technology needed to accomplish them, has led to some false starts in this market.

And a lot of design effort is still necessary. For example, "there is a need to concentrate on sensors that would detect would-be intruders before they enter the home," comments Paul Corbell, technical director, Security-Devices division of Systron-Donner Corp., Dublin, Calif.

Today, after a period of technical obstacles, companies are emerging with products that are designed to fit the realities of the home environment. For example, Advanced Devices Laboratory Inc., Santa Clara, Calif., makes two advanced products for home security—a 10.5-gigahertz microwave system and a passive infrared detector.

Packaged to look like a stereo receiver, the microwave system radiates at 10.5 GHz, using a Gunn diode as the signal source. Power rating is 1.5 mw, but at the antenna aperture the radiated power is an order of

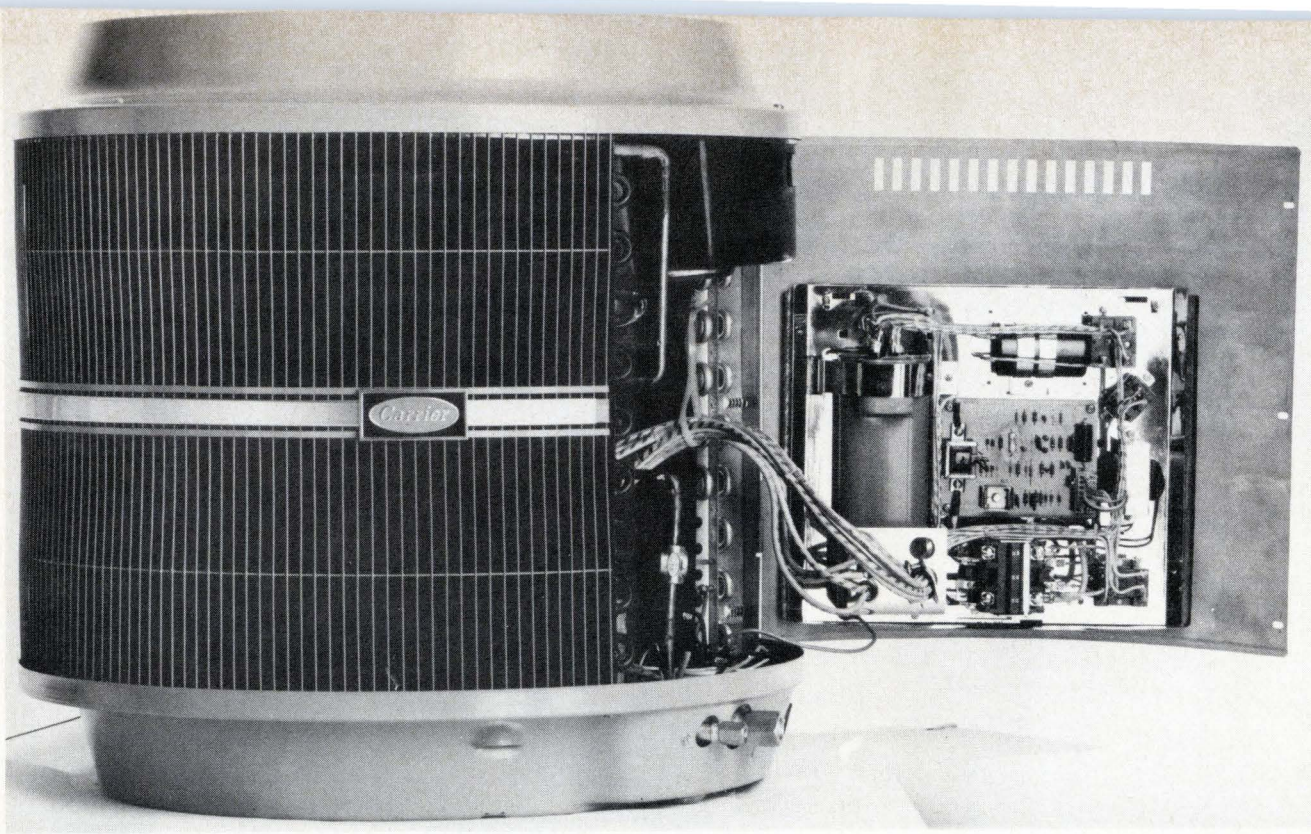

**6. No sweat.** Carrier Corp.'s central air conditioner has a Compressor Protect and Control System designed to extend life of the compressor by adjusting to varying loads. It's also intended to control compressor motor during summertime power brownouts, blackouts, and surges.

magnitude below the maximum allowed by Government regulations that have been established for microwave radiation.

It uses the Doppler-shift effect for sensing. But the key to making the system work in the home, according to ADL, lies in the diode oscillator cavity, a special design that allows several types of antennas to be used; that is, it can be adapted to a specific situation with a columnar beam, an area beam, or multiple beams using a phased-array antenna. The columnar beam has a range of 100 feet. The area beam spreads over 50 by 24 by 9 ft or 24 by 24 by 9 ft.

ADL chose 10.5 GHz as the operating frequency because there are no communications assignments at this frequency. Lower frequencies, says Charles F. Fontana, national sales manager, can be absorbed too easily and higher frequencies produce a beam too small to be practical. In addition, 10.5 GHz allows use of small, inexpensive antennas.

By using both microwave and ultrasonic detection in combination, Security Systems division of Bourns Inc., Riverside, Calif., has attempted to eliminate most potential false alarms. Basically, by having both types, the total system can establish a steady-state field of ultrasound or microwave, depending on which approach fits a particular area. It can sense any disturbance, process or amplify the disturbance signal, activate a mechanism, and turn on an alarm, either a phone dialer, digital communicator, horn, or other source of sound.

Hardwired connections to police stations, tape dialers, and digital telephone dialers have been used as communications links in home security, and cable television is now entering the picture, too. Bourns has been working on this approach, as has Oak Securities

Inc., Crystal Lake, Ill. Meanwhile, Theta-Com of Los Angeles, Calif., is one of a handful of companies concentrating on the transmission of security alarms via two-way CATV. These setups require a computer at the cable-transmission center that sends digital signals to interrogate the user's sensors. A digitally encoded message alerts the computer to the location and type of alarm (breaking and entry, fire, emergency). This data can then be transmitted to police stations, fire house, or hospital by cable or by telephone lines.

Another indication of the rethinking done in home security is the system to be marketed by AMF Inc.'s new security systems division in Alexandria, Va., in about a year. Still undergoing tests, this system features a household signal processor with diode-transistor-logic and transistor-transistor-logic ICs to perform logic functions in handling intrusion and fire-sensor signals. Another version for apartments employs ICs in the on-site processor.

Sensor inputs will go into the master unit that is programmed to account for most typical false alarms and will provide the user time to override inadvertent alarm triggering, according to AMF. The ac-powered system will have standby batteries in case of power outage. It will also have an LED display for indicating at the master panel the status of the complete system in order to detect component failure.

The whole concept is aimed at eliminating false alarms by recognizing that areas being protected are usually occupied and including this situation in the system plans. The household processor therefore has logic modules to make it "forgiving" of possible false alarms. It also gives the home owner a chance to check the operating condition of the entire system. □

# Minicomputers simulate the ocean, evaluate sonar-system designs

Costing far less than trials at sea, sonar simulation system checks out signal-processing techniques and operator responses, besides offering an applied research facility for display development

by Jerry C. Lamb, Andrew C. Krajec, and W. Allan Clearwaters, *Naval Underwater Systems Center, New London, Conn.*

□ Designers of modern sonar systems are caught between human limitations and the deep blue sea. On the one hand, the flood of data generated by a complex system needs to be processed into displays that make full use of the information but do not ask the operator to detect, track and classify more targets at one time than he possibly can. On the other, it's prohibitively expensive and often inconclusive to test a prototype system at sea.

The Naval Underwater Systems Center, faced with the task of developing new digital techniques for processing and displaying data in a new U.S. Navy sonar system, measures an operator's capabilities and avoids the cost of testing at sea with a simulated sonar system implemented with minicomputers.

A simulated sonar system does away with much of the expense of prototype development and engineering redesign, since it is simpler to alter software than a hardware system. A simulated ocean is not subject to the drawbacks of the real ocean, in which certain tests may be impossible if they require certain environmental conditions, multiple vessels, or both. Moreover, simulation allows the operator's actions to be related very precisely to "operational" conditions and to be automatically recorded.

Simulation has one disadvantage as opposed to operational testing: the mathematical models that describe

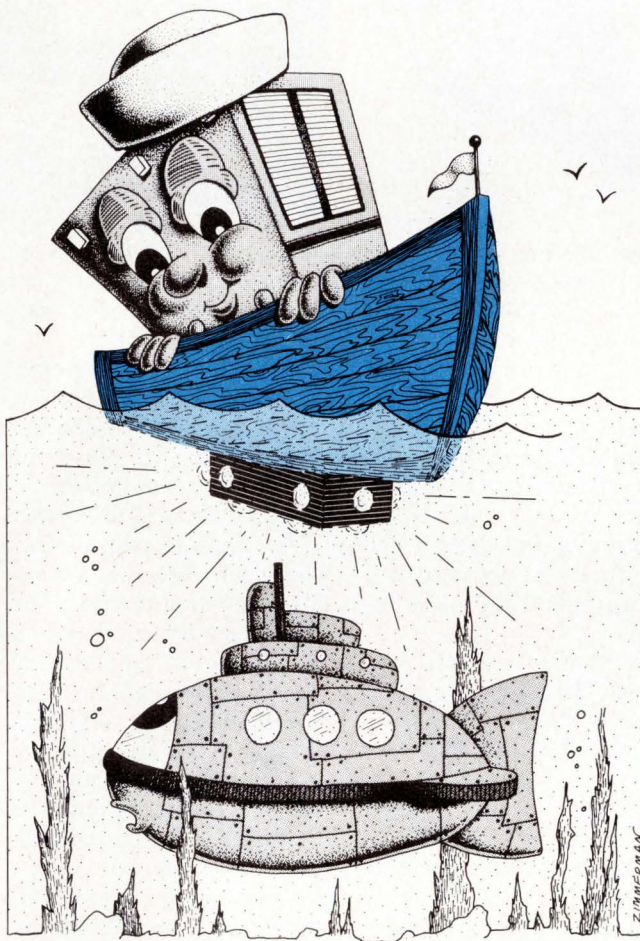

the environment and the operational system may be inaccurate. However, in this case, minicomputers containing well-tested mathematical models of the ocean (they are used for training sonar-system operators) were available, so the risk of inaccuracy was minimized.

Long term, the NUSC's objective was to create a simulation facility for applied research on general display formats and operator performance. But the facility would also satisfy the center's immediate need for a way to evaluate different algorithms for processing and displaying sonar data in the light of operator response.

The system that ultimately took shape out of these considerations has, at one end, a minicomputer that models the ocean and, at the other end, cathode-ray-tube monitors and interactive

devices that interface the human operator to the system. In between is a second minicomputer, which controls the entire system, and a display controller. This second minicomputer—the experimental stand-in for the special-purpose processor to be found in actual sonar systems—processes the ocean data and inputs from the operator and passes the results on to the display controller for translation into visual form on the CRTs.

Figures 1 and 2 show the hardware already described, plus an external core memory. Not shown are the interactive devices and various peripherals. The computers

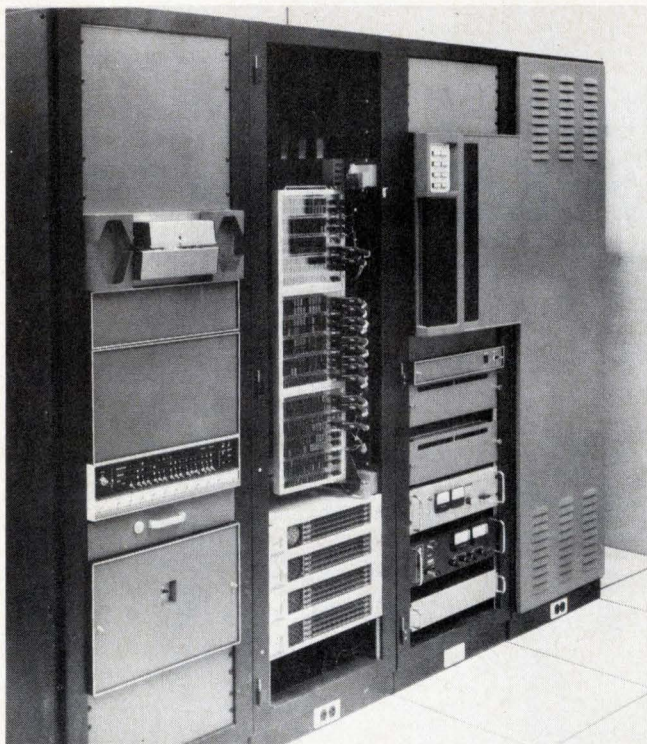

**1. Sonar simulator.** One minicomputer, the two display-control channels, and additional memory are all housed in these four racks. Central computer, a Supernova, is visible in the middle of the nearest rack; the second computer, containing a model of the ocean, stands alone and is not visible here.

are a Data General Supernova and a Honeywell DDP-516. The Supernova is the system controller. It accepts data from the DDP-516 and peripherals, formats it, and sends it to the display controller, which transforms it into displays like those in Figs. 3 and 4. In addition, the Supernova either records inputs from the operator and interrupts by the controller or transmits them to appropriate subprograms for action.

The Honeywell DDP-516 computer is a special system serving as a peripheral device. Since its sole function is to produce the data base for the display experiments, it stores an extensive set of mathematical models of the sonar environment.

The system contains two independent display-control channels, each simultaneously generating displays in accordance with the data and instructions of the Supernova and also passing on operator interaction requests. Interconnections with the rest of the system are shown in Fig. 5. These two high-resolution display channels each consist of a display controller interface that, in response to instructions and data stored in the refresh memory by the Supernova, activates a raster generator, graphics generator and video processor, as well as a refresh buffer memory. The refresh memory is a ferrite-core array that contains 65,536 16-bit words and stores the data its channel is to display plus a few control words.

The two channels drive two CRT units. One CRT unit is a simulated sonar display console. On this console, the appearance and "feel" of the controls are important

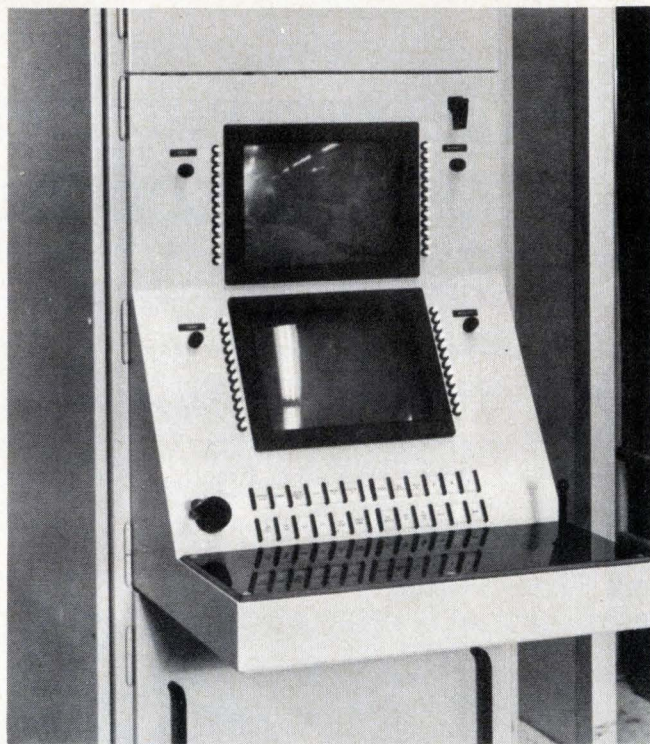

**2. Simulated sonar console.** Vertical rows of switches beside the two screens are programmable function switches; labels for them appear alongside on the screen, as in Figs. 3 and 4.

because they must resemble actual shipboard equipment. The initial version (see Fig. 2) resembles the console in a proposed new sonar system and will be evaluated before the Navy releases specifications for the system to be installed in the fleet. Later, the console can easily be changed to resemble other systems.

The console consists of a single electronics bay in which two CRT monitors are installed, along with various interaction devices. The latter include several function keys, a force joystick—a non-moving device that responds to an applied force through strain gauges instead of responding to displacements through shaft encoders—and a single-axis cursor manipulator. Arranged about the sonar console are 72 switches—two rows of 12 single-legend, back-lit function keys below the screen, and 12 more back-lit push-button switches arranged vertically on either side of each screen. The rows across the bottom carry permanent legends, but the vertically arranged switches do not. Their functions change with the simulation program, so their legends are displayed on the adjacent CRT.

The other CRT console, the research console, is used for research and development of new display formats and to study operator/computer interaction, in an ongoing project that will continue after the current simulation project is complete. At present the research console, which does not resemble a sonar console, contains more or less conventional interactive devices, including a light pen, track ball, a keyboard with 63 keys, and 12 back-lit function keys. These are used in conjunction with one of the two CRT screens on the sonar console. Eventually the research console will have its own large

CRT with the smallest available spot size and maximum resolution in both direct-write mode (in which the information is traced directly on the screen) and raster mode (in which the display is built up from a sequence of horizontal or vertical scans). The console also has room for other interactive devices, which can be installed to take advantage of new developments.

### Why two different computers?

For any simulation setup, the prime need is for proven mathematical models, and proven models of the sonar environment were fortunately available in the Navy's 14E19 sonar trainer. This trainer consists of two Honeywell DDP-516s and incorporates many of the basic real-time mathematical models that simulation of the sonar environment requires. Redeveloping these models from scratch would have been costly, yet a direct copy of the trainer was not suitable, because it was designed for a specific system and was not flexible enough for display research. Therefore an integrated hardware/software package was developed, using 14E19 concepts in a modified form that met the simulation facility's requirements.

Even so, the mathematical models as programmed for the trainer required the entire capacity of one DDP-516. That meant that a separate central computer would be necessary for display formatting and system control. To decide whether it should also be a DDP-516, or whether a different minicomputer would be better, the designers examined three aspects of the system requirements: hardware, software, and availability.

The central computer had a variety of simulation requirements that affected the choice of hardware. Its basic task was to reformat the data base for display, forward it to the display controllers, and perform all input-

output operations. This computer needed a high throughput while processing display data to develop displays in real time.

Three conditions dictated speed requirements. First, the timing of the basic sonar system displays is established partly by the rate at which the second computer, which contains the mathematical model, provides data for display formatting, and partly by the amount of formatting necessary.

The second condition, probable specifications of forthcoming new display formats, referred to one in particular. This format consists of a 100-by-100 matrix of echo-signal points, upon each of which a new calculation may have to be made rapidly enough to permit showing the changing data at flicker-free rates—about 30 frames per second.

The third condition was development of new sonar signal-processing algorithms—one of which was selected as a bench mark. The algorithm combined space and time averaging, computing a weighted average of the returns on several adjacent or successive sonar beams as the return on the central one of those beams. This process tends to eliminate transient noise and to reinforce echoes from real objects.

These considerations dictated the choice of a modern machine with multiple registers, which would permit easy data links between programs as well as fast computation. For communication with the display controllers, the computer required a fast data channel with a flexible interrupt structure. Standard peripheral equipment and support should be available, and special-purpose peripherals should be easy to include in the system, preferably in the same manner as standard peripherals. The sonar display is one such special-purpose peripheral unit. Another is a proposed eye-tracking device,

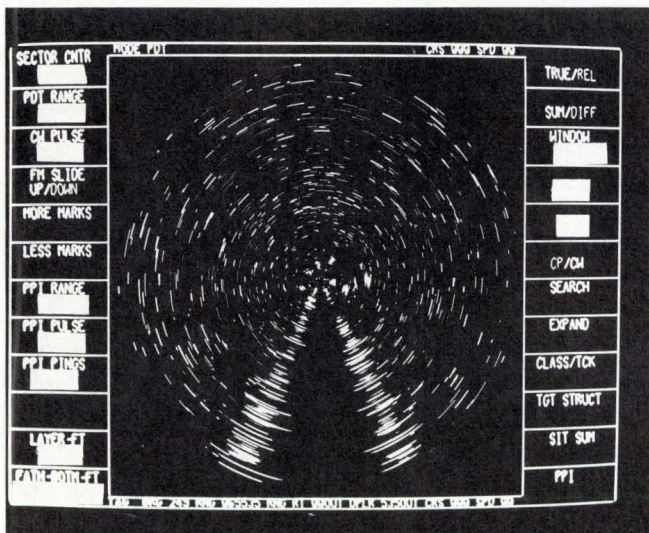

**3. PPI display.** Center of circular display, called plan position indication, represents the sonar operator's ship. Echoes form a maplike pattern. Top of the display can represent either "dead ahead" (ship coordinates) or "north" (true coordinates). The dark wedge-shaped area is a baffle that screens the ship's engine noise from the receivers. Characters along sides label function switches beside the display, visible in Fig. 2. Blanked areas obscure classified data.

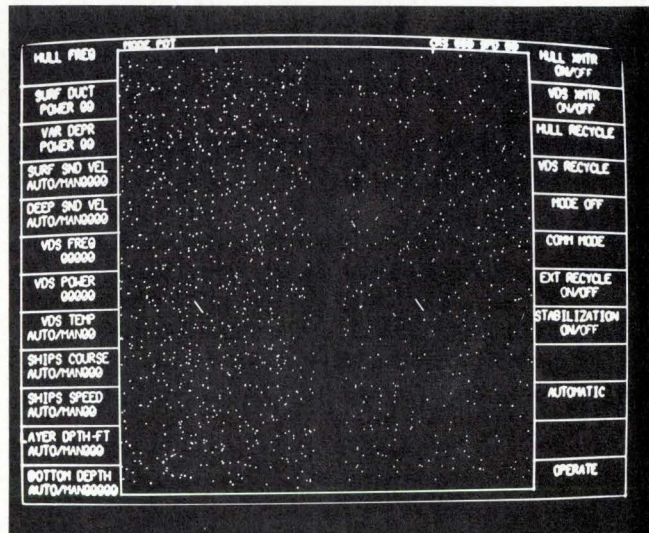

**4. Variable depression search.** The pips in this simulated display, apparently random, actually lie along vertical lines. One line shows echoes along a single beam, with range increasing from bottom to top; six such adjacent lines produce data history for a beam. Several beams make up one half display. Two halves of screen show echoes from two kinds of pings separately generated and processed. Short lines identify an area to be expanded on another screen.

which in the simulator will determine where on the screen the operator is looking under various conditions, thus measuring his response at a new level of detail.

Besides being fast, the control computer had to be commercially available, because time constraints mandated the use of low-risk technology. On the other hand, the possibility of including new features, such as semiconductor memory and floating-point processors, made a machine with flexible architecture desirable.

**Programing aspects**

Software had to be usable by those system users—research scientists and engineers—who were not primarily programers but who needed hands-on operation for research purposes. For them, problem-oriented languages and corresponding compiler software were a requirement. Other general-purpose software and easily modified operating-system software also had to be available.

To avoid duplicating costly peripheral equipment, the system's designers decided to attach the devices only to the main computer, with access by the second computer through the coupler linking the two computers. This meant that the central computer's operating-system software should regard the second computer as another peripheral device. But it also meant that the satellite computer would require a new operating system for

itself because of its unusual means of access to peripheral equipment.

Many machines were tested against specific criteria developed from these general requirements, and benchmark programs actually were written for three machines. At the time of design (in early 1971), the Data General Corp. Supernova was the most appropriate.

The math models, however, were already programed in DDP-516 assembler language for the sonar trainer. Converting these DDP-516 programs to Supernova code would have been prohibitively expensive—nearly 25% of the original estimate for the total system.

This cost ruled out using two Supernovas, but still left the designers with a choice between using two DDP-516s, which would have enough capability for the basic simulation but without full growth potential desired, or taking the design risk of having two different machines, which would present severe programing difficulties.

**Revising the operating system**

Two independent studies indicated that the second alternative, using two different computers, was feasible, although it would cause some delay in the original schedule.

With the identity of the two computers established, the means of treating the two display controller inter-

**5. Simulation system.** The display controller is a two-in-one device that controls both the sonar console and the research console. The central computer is the Supernova. Most of the system's input-output equipment is conventional, except for DDP-516, a second computer that masquerades as another peripheral on the Supernova channel but actually contains a model of the ocean.

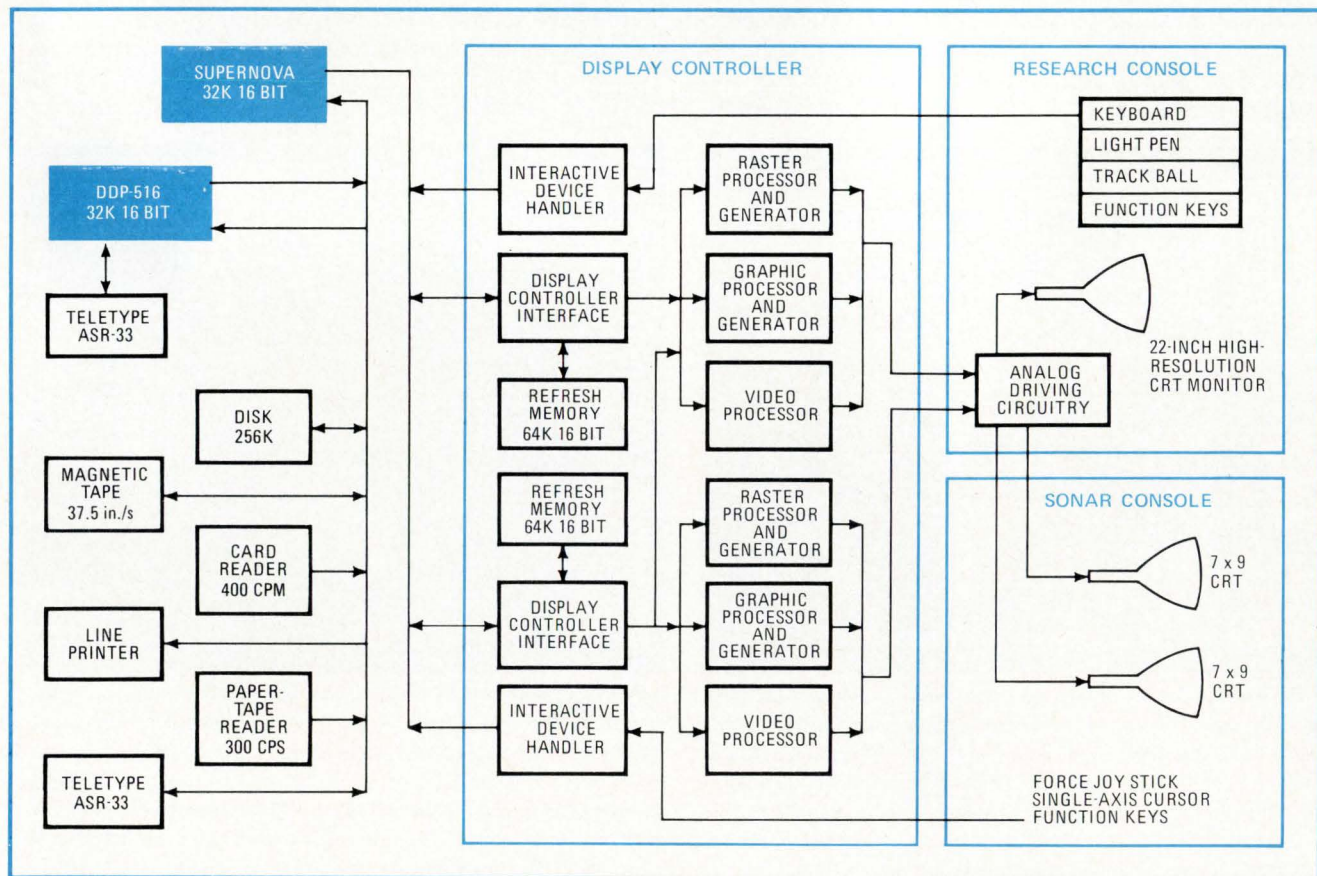

faces and the interaction tools became clear. To the system they appear as standard peripherals with high priority; they are controlled by a modification of the basic disk-operating system supplied by the manufacturers. The resulting monitor system is called an integrated disk-operating system, IDOS (Fig. 6).

In an off-line mode, the DDP-516 communicates through IDOS with all the peripherals connected to the Supernova. Meanwhile, all DDP-516 standard software is utilized, and normal disk-based functions for Supernova programs and peripherals are performed.

While executing real-time experimental programs, IDOS controls all output to the display controller, monitors all inputs from the interaction tools and controls the timing of inputs from the DDP-516. Since the DDP-516 contains a model of the ocean, these inputs represent acoustical noise originating in such things as wave action, movements of sea animals, and passing ships that are not targets.

### Broad-based controller

The display-controller design was constrained by display research and console simulation applications. To simulate most present-day sonar display consoles, the display requires two independent channels with separate refresh memories.

In addition, the projects for research into displays planned at NUSC in general demand flexible and expandable hardware that can accommodate new ideas. At least one display channel must have better resolution than present commercially available displays. In this case, both channels were designed with higher resolution because duplication was more economical than designing separate channels.

### Scans and rasters

Simulating present sonar display formats requires several different writing modes such as spiral scan for plan position indication, rectangular raster for type B range-vs-azimuth, other formats unique to sonar, and direct write for graphics and alphanumerics. Raster and direct-write modes can be combined in many ways on one CRT at any time.

Core refresh memories were chosen because they were easily available and reliable. They are also non-volatile, an important advantage in this kind of simulation. Nonvolatility is often desirable in a memory, but in NUSC's sonar simulator it is important for an unusual reason. In the course of present and future experimentation, a variable refresh rate for the display was considered desirable. Since a volatile memory would itself have to be refreshed independently of the display,

**6. Integrated software.** Two software packages—one for each computer—are modified to interact with one another. The Supernova regards the DDP-516 as just another input-output device, whereas the DDP-516 obtains access to its peripheral devices, except for the teleprinter, through the Supernova. Colored arrows represent data flow; black arrows are controls.

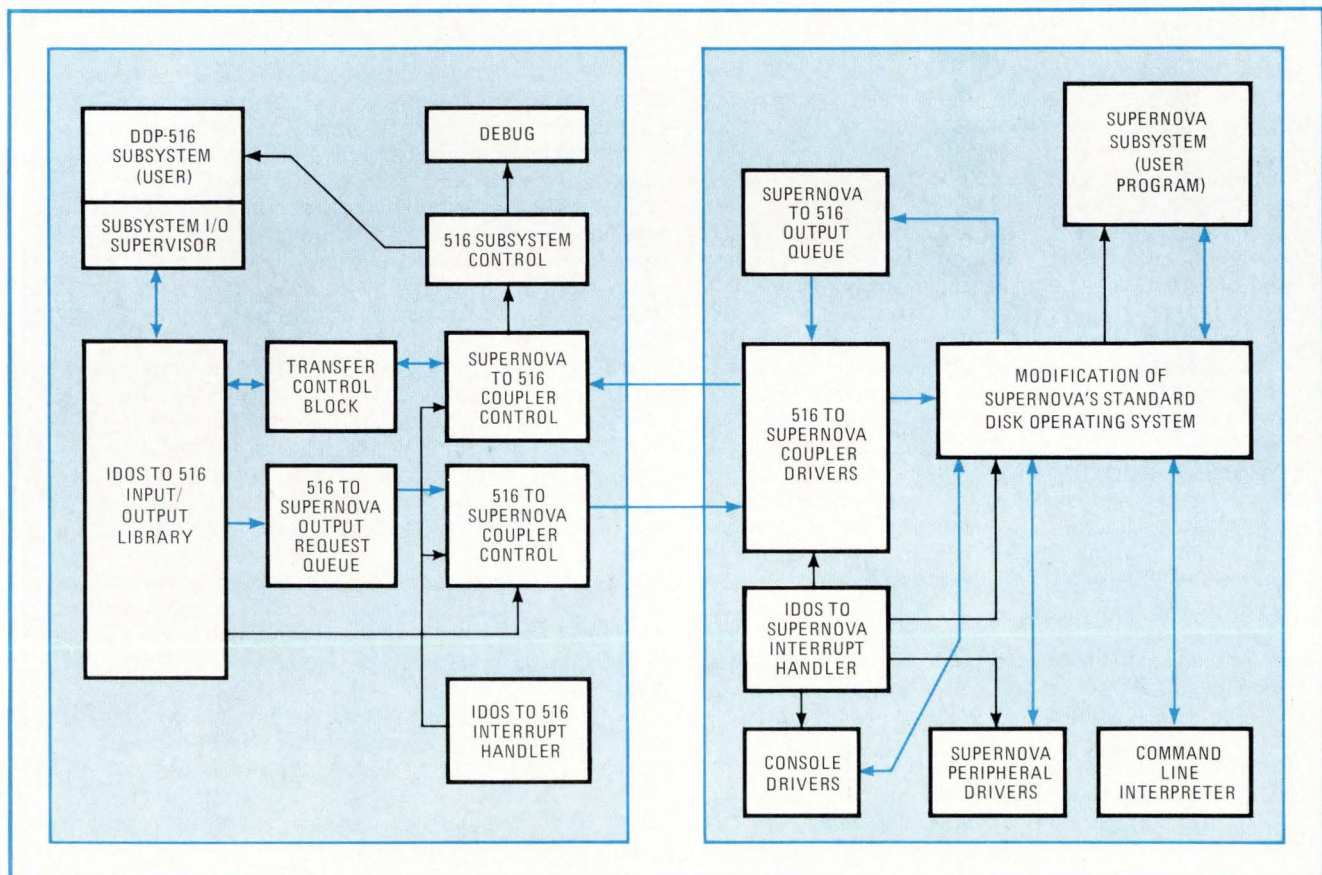

the synchronizing of the memory refresh and the display refresh was viewed as a potentially difficult problem that would divert too much effort from the prime goal of developing new sonar systems.

Core memories, of course, also have the advantage, thanks to their long dominance, of ease of use and application. The units chosen were large enough to work with typical sonar formats—for example, a 512-by-512 grid with 4 bits of intensity information. For use with the large, high-resolution CRT monitor of the research console, the two memories can be combined to drive one display channel showing, for example, a 2,048-by-256 grid with 4 bits for intensity.

### Peripheral selection

The laboratory's supporting computer center was a prime factor in selection of the peripheral equipment. Magnetic tape is the primary medium for exchanging data with the computing center for off-line processing and conversion. Individual reels of tape are also used by programmers for personal storage. The magnetic-tape unit reads and writes nine tracks at 800 bits per inch and 37.5 inches per second—fast enough to record real sonar data in real time.

With this magnetic-tape capability and the computer center, the simulation system does not need things like card punches or paper-tape punch. But both a card reader and a high-speed paper-tape reader are neces-

sary for software development, as is either a line printer or a teletypewriter.

A mass-memory storage device—specifically a disk unit—is required for software development, when the programmer uses the disk for temporary storage, and for program storage during real-time operations. For the latter, a fixed-head disk has the fast-access and fast-transfer characteristics required for quick recall of display formats and other on-line programs.

### Afterthoughts

Since the design of the simulation system was frozen early in 1971, newer computers, some of which may be better suited to the system requirements, have come on the market. Some of them utilize new technology that might have a significant effect on the selection process were it to be repeated.

For example, microprogramming techniques might permit the use of two identical computers in the system—one microprogrammed to emulate the mathematical models in the DDP-516, and the other microprogrammed for special display-format instructions.

In addition, MOS memory, now generally available in many machines, would help make real-time display processing more easily attainable. Newer, more flexible hardware interrupt structures also have become available and might change the choice of machines even if selection criteria did not change. □

## The simulator in action

In using the simulator to study how a design for a sonar system would operate at sea, the experimenter divides his work into three phases: initialization, experimentation, and analysis.

Initialization occurs off line. Since the real-time mathematical models stored in the DDP-516 generate the data base from a series of tables and equations, the tabular data and equation coefficients must be calculated off line ahead of time by special initialization programs. To use these programs, the experimenter first specifies the experimental conditions.

These conditions include, for example, the sonar environment—depth and temperature, which affect the propagation of acoustic energy in water—and the characteristics of the supposed ship—its noise sources, such as the engines, the deployment of sonar transducers on the hull, and so on. And, of course, the experimenter specifies the target characteristics. He then loads the initialization programs into the DDP-516; as it executes them, it produces the tables and equations necessary for real-time experimentation.

At the start of an experiment, the researcher tells the sonar operator what task he is to do. He might be asked, for example, to search for and detect a target, track it, or classify it; or he might be assigned any combination of these or other tasks.

The researcher then leaves the operator alone at the sonar console; the operator observes the CRTs and uses the sonar controls as if he were literally at sea. For example, he may change range scales, cursor positions,

and even the course and speed of his ship. He can also change the characteristics of the "ping" emitted by the sonar transmitter, since the range and the nature of the echo change with pings of different frequencies, amplitudes, and durations.

Meanwhile, the experimenter monitors the operator's activities at the line printer and the teleprinter, in another room. From that location the experimenter can also modify the program on line by introducing, for example, new targets, a new ocean depth, or different weather conditions.

To illustrate, the onset of a storm stirs up waves, and, while these are in a different frequency range from the sonar echo and don't contribute significantly to it, they do tend to break up both the transmitted signal and its echo. Large waves in the presence of a target create interference that changes a clean, sharp echo pulse into a broader, weaker signal whose characteristics are difficult to ascertain.

During the experiment, significant events are recorded for analysis. These include parameter changes, major changes in the progress of the experiment (such as acquisition or disappearance of targets), and operator responses.

These measurements form the data base for analytical programs, which are executed after the experiment to produce a statistical breakdown of the operator's response to different conditions. Meaningful results, of course, require a particular experiment to be repeated several times with different operators.



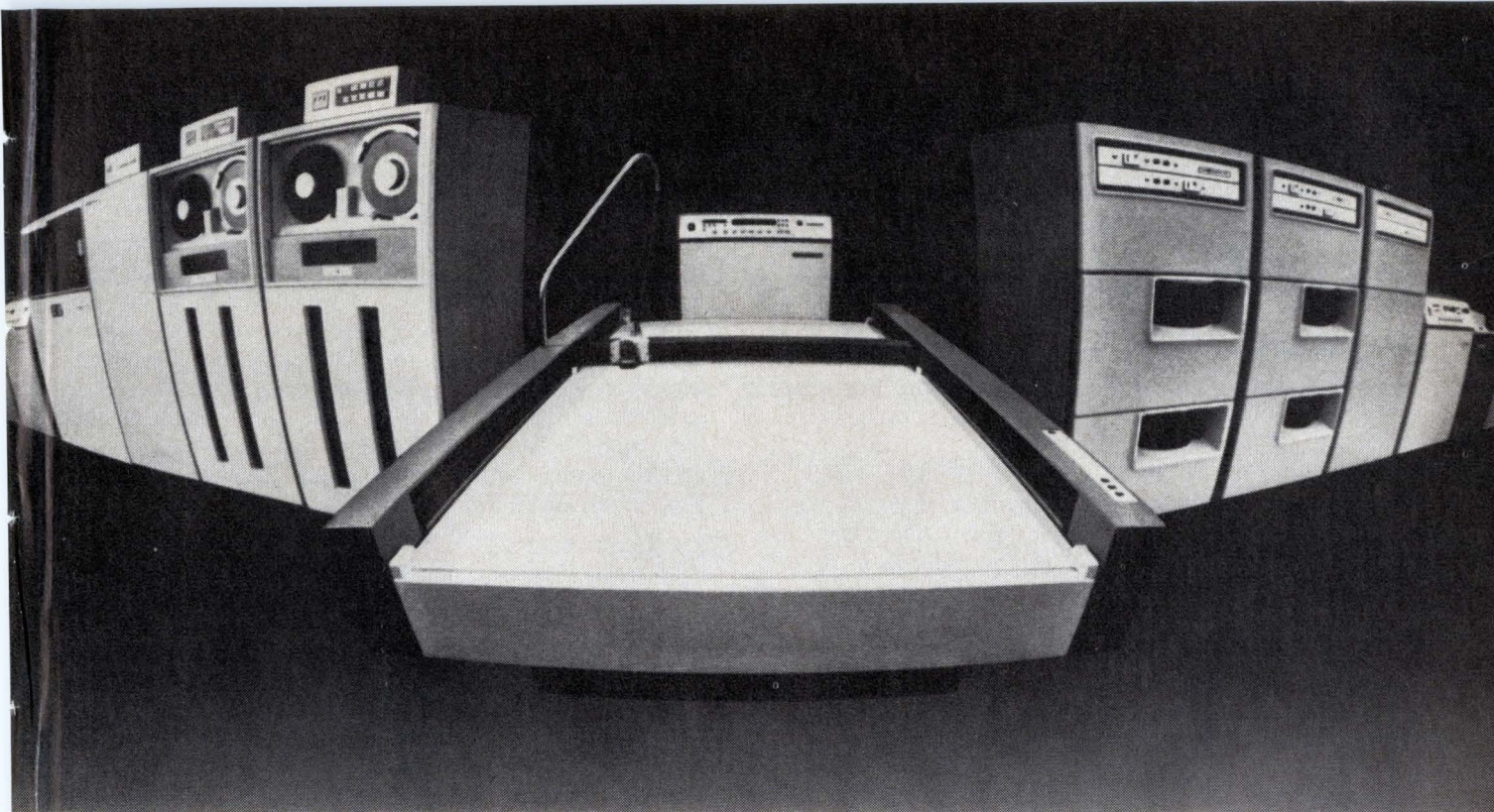

# Peripheral vision.

From the beginning, we have preferred concentration to diversification. We don't supply everything that attaches to your computer. But the things we do supply are the best.

What do we supply?

*Drum plotters.* We're the world's leading supplier of both hardware and software.

*Flatbed plotters.* Several years ago, we saw a need and an opportunity to expand the plotter's uses. The flatbed plotter allows a variety of materials to be substituted for paper; and it has expanded the

market for computer graphics, as well.

*Microfilm plotters.* Here, we got bigger by getting smaller. With microfilm. Our 1675 COM plotter/printer and our 2100 COM printer deliver the best price/performance in the industry.

*Disk memory equipment.* This was our second area of concentration. In a remarkably short time, we have become the leading independent supplier.

*Tape systems.* We've recently begun to concentrate on tape. The result is that

our new 1040 Tape Drive combines the features of others with our own experience. We intend to be a leader in this field.

The point is we have not grown by accident. Thirteen years after our beginning, we have become a leader in computer peripherals.

For information on peripheral products, call your local CalComp office, or contact California Computer Products, Inc., EM-M5-73, 2411 West La Palma Avenue, Anaheim, California 92801. (714) 821-2011.

**CALCOMP**

## Varying comparator hysteresis without shifting initial trip point

by Jerald Graeme  
Burr-Brown Research Corp., Tucson, Ariz.

An operational amplifier is a convenient device for analog comparator applications that require two different trip points. The addition of a positive-feed-back network will introduce a precise variable hysteresis into the usual comparator switching action.<sup>1</sup> Such feedback develops two comparator trip points centered about the initial trip point or reference point.

In some control applications, one trip point must be maintained at the reference level, while the other trip point is adjusted to develop the hysteresis. This type of comparator action is achieved with the modified feedback circuit shown in the figure.

Signal diode  $D_1$  interrupts only one polarity of the positive feedback supplied through resistor  $R_2$ . Hysteresis, then, is developed for only one comparator state, and one trip point remains at the original level set by the reference voltage,  $E_R$ . The second trip point, the one added by hysteresis, is removed from the original trip point by:

$$\Delta V = R_1(V_Z - E_R)/(R_1 + R_2)$$

where  $V_Z$ , the zener voltage, is greater than reference voltage  $E_R$ . Varying resistor  $R_2$  will adjust the hysteresis without disturbing the trip point at  $E_R$ .

The circuit's other performance characteristics are similar to the common op-amp comparator circuit. The accuracy of both trip points is determined by the op amp's input offset voltage, input bias current, and finite gain. Resistor  $R_3$  limits the current drain through the zener diode, and resistor  $R_4$  provides a discharge path for the capacitance of diode  $D_2$ .

The output signal can be taken either directly from the op-amp output or from the zener diode, as shown. With the latter hookup, the output signal voltage alternates between zero and zener voltage  $V_Z$ , which might

be desirable for interfacing with digital logic circuits. It should be noted, however, this output cannot sink current in the 0-volt state.

Switching speed is determined by the op amp's slewing-rate limit for high-level input-drive signals. When the input drive is a low-level signal, the output rate of change is limited by the gain available to multiply the input signal's rate of change. Both the slew-rate limiting and the gain limiting of switching time are eased if phase compensation is removed from the op amp. □

### REFERENCE:

1. G. Tobey, J. Graeme, and L. Huelsman, "Operational Amplifiers: Design and Applications," McGraw-Hill, 1971.

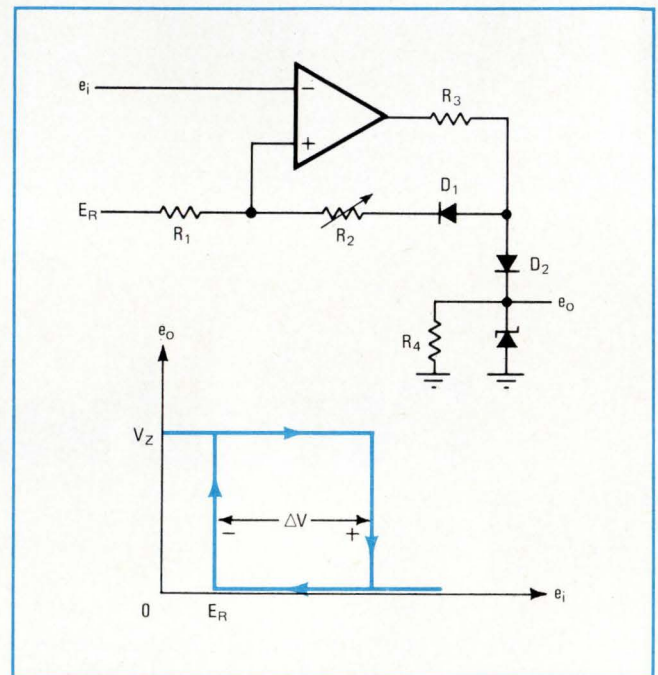

**Controllable hysteresis.** Positive feedback circuit for analog op-amp comparator does not shift the initial reference trip point while introducing hysteresis in the second trip point. The voltage difference,  $\Delta V$ , between the trip points can be adjusted by varying resistor  $R_2$ . When the output voltage is taken from the zener diode, as shown, it switches between zero and  $V_Z$ , the zener voltage.

## Circular voltage divider needs fewer resistors

by Dale Hileman  
Physiometrics Inc., Malibu, Calif.

A bridge that provides precision dc voltages from 0 to 10 volts, in steps of 0.01 v, can be easily and economic-

ally realized with a "circular" voltage divider. In this uncomplicated divider arrangement, the point from which the output is taken remains fixed, while the voltage source is moved from one point to another.

In a conventional voltage-divider setup, the fixed voltage is applied across the entire network, and the output voltage is taken from a selectable tap. This approach, however, may involve complex switching and usually requires a large number of resistors, which is undesirable because precision resistors are expensive.

As shown in the diagram, a total of only 31 resistors is

needed to provide a settability to within 0.01 v. Each ring has 10 resistors, except the last, which contains 11. The value of the resistors in a given ring must be 1.1 times the value of the resistors in the preceding ring. The bridge in the illustration is set up to produce an output of 6.43 v.

The tighter the tolerance of the resistors, of course,

the more accurate the output voltage can be. And the more sensitive the null indicator is, the more closely the bridge output can be read. As lower-value resistors are used, the bridge output impedance becomes lower.

The principal limitation of this arrangement is the allowable power dissipation of the resistor in the first ring across which the full supply voltage is applied. □

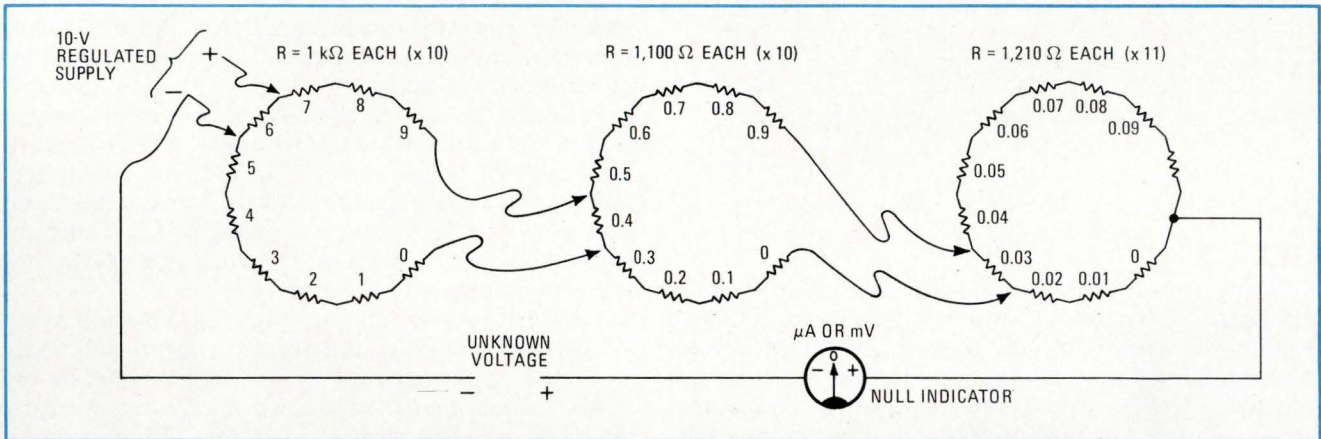

**Dial a voltage.** Circular resistor arrangement trims resistor count without sacrificing precision. The output voltage of this bridge can be set from 0 to 10 volts, to within 0.01 V. All resistors in the same ring have the same value, which is 1.1 times larger than the value of the resistors in the preceding ring. Resistors in the first ring must be able to withstand the full supply voltage. Just 31 resistors are used here.

## Link-coupled tank circuit steps up C-MOS drive voltage

by R.W. Mouritsen  
National Research Council of Canada, Ottawa, Canada

Because of their low power dissipation, low leakage current, and high noise immunity, complementary-MOS devices are a sound design choice for portable or battery-operated equipment—such as counter chains or clocks driven from standard oscillators. However, several volts, typically 5 to 7 volts, are usually required to turn on the C-MOS device, whereas most standard oscillators normally have an output of only about 1 v root-mean-square at 50 ohms.

A simple way around this problem is to use a link-coupled tuned circuit as a voltage step-up transformer. Since the input impedance of the C-MOS device is extremely high, the tank circuit is loaded only by the primary source impedance reflected across the secondary winding. This allows the use of a fairly high-Q coil. The link-to-secondary turns ratio is adjusted to produce, across the tuned circuit, a sine wave with a peak-to-peak amplitude of approximately 90% of the supply voltage, when the driving signal is 1 v rms at 50 ohms.

The squaring circuit shown in the figure is an example of this link-coupling technique. It consists of a C-MOS quad two-input NOR gate package, connected as a forced latch.

With the input at 0 v (logic 0), the outputs of gates  $G_1$

and  $G_2$  are logic 1, while the output of gate  $G_3$  is logic 0. As the input rises (towards logic 1), the outputs of gates  $G_1$  and  $G_2$  go to logic 0 when the C-MOS turn-on threshold voltage is reached. This forces the output of gate  $G_3$  to go to logic 1 and remain there until the input falls below the threshold level. At that time, gate  $G_1$  goes to logic 1, allowing gate  $G_3$  to return to logic 0 and causing gate  $G_2$  to go to logic 1.

When the supply voltage is 12 v and the input signal is 1 v rms at 50 ohms and 1 megahertz, the squaring circuit produces an output that approximates a square

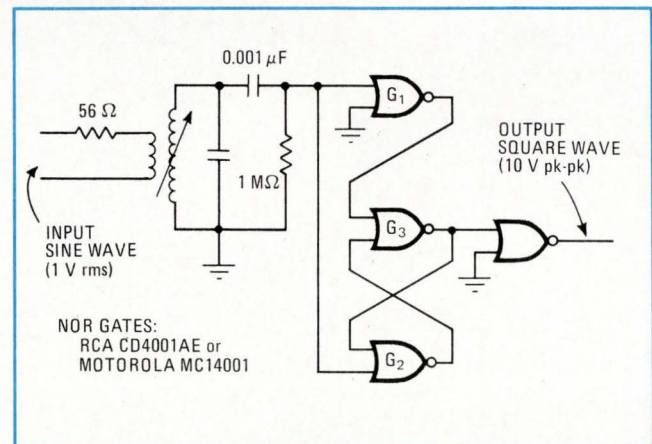

**Squaring circuit.** Link-coupled tuned circuit provides transformer-like action, stepping up the low-level drive signal supplied by most standard oscillators. This permits complementary-MOS gates, the threshold voltages of which are generally 5 to 7 volts, to be used without adding extra active devices. With this squaring circuit, a 1-v sine wave is converted to a 10-v square wave at megahertz rates.

wave with an amplitude of around 10 v pk-pk and with rise and fall times of about 50 nanoseconds. The tuned circuit used here has a narrow operating band. A wider band may be obtained by employing a small toroid

having a bifilar secondary with a link-coupled primary. This will yield about the same output waveform, but operating frequency will range between 500 kilohertz and 3.5 MHz, depending on the ferrite used. □

## Square-wave generator stresses frequency stability

by S.F. Aldridge  
IBM Corp., General Products Div., San Jose, Calif.

Offering features that are usually found only in more elaborate oscillators, a simplified voltage-controlled square-wave generator produces very symmetrical complementary square-wave outputs that exhibit good frequency stability over a wide operating temperature range. Output frequency repeatability can be held, without adjustment, to within a 5% range, and operating frequencies can exceed 50 megahertz.

The circuit's noise insensitivity is excellent due to its current-source decoupling (provided by capacitors  $C_1$  and  $C_2$ ). Moreover, noise generation within the generator is held to a minimum because of the constant-current nature of the circuit.

Power-supply variations as large as 15% produce a negligible shift in output frequency because of the action of the circuit's current sources (transistors  $Q_1$  and  $Q_2$ ) and the configuration of the circuit's oscillator sec-

tion. The generator can be considered to provide linear operation throughout the entire range of its input frequency control voltage.

Basically, the oscillator section consists of two Schmitt triggers: one formed by transistors  $Q_3$  and  $Q_4$ , and the other formed by transistors  $Q_5$  and  $Q_6$ . The triggers share the two current sources (transistors  $Q_1$  and  $Q_2$ ), as well as resistor  $R_1$  because of capacitor  $C_3$ . Transistors  $Q_4$  and  $Q_5$  form a differential switch that allows only one Schmitt trigger to be on at a time.

The charge rate of capacitor  $C_3$  determines the switching frequency of the Schmitt triggers and, therefore, the output frequency. This charge rate can be controlled by varying the voltage on the frequency-control input line, which, in turn, changes the current of transistors  $Q_1$  and  $Q_2$ . The output frequency can also be altered by changing the value of capacitor  $C_3$ .

Temperature compensation is provided by zener diodes  $Z_1$  and  $Z_2$ . Transistor  $Q_7$  compensates the base-emitter junctions of transistors  $Q_1$  and  $Q_2$ , while transistor  $Q_8$  compensates transistors  $Q_3$  and  $Q_6$ . To achieve the best circuit performance, matched transistors and components having 1% tolerances should be used. □

Designer's casebook is a regular feature in Electronics. We invite readers to submit original and unpublished circuit ideas and solutions to design problems. Explain briefly but thoroughly the circuit's operating principle and purpose. We'll pay \$50 for each item published.

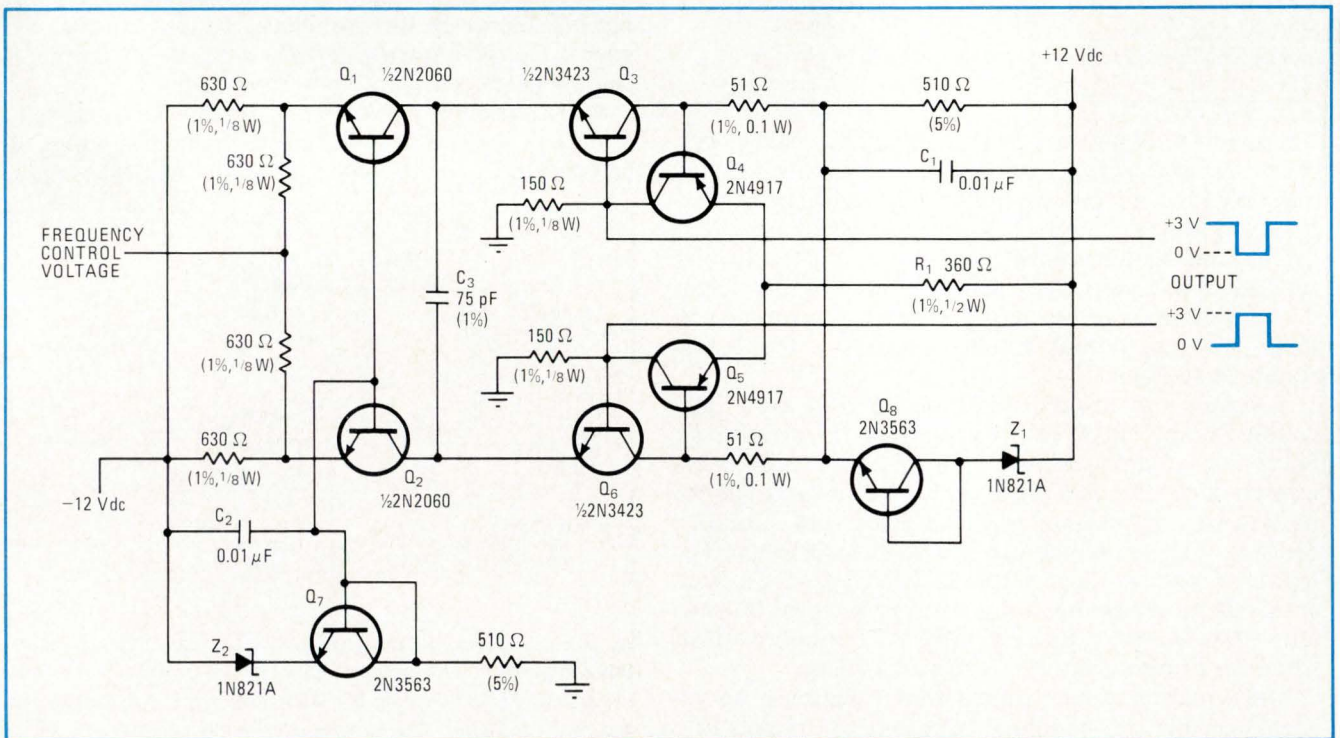

**Simplified design.** Square-wave generator supplies complementary outputs whose frequency is determined by an input control voltage. This control voltage determines the current provided by transistors  $Q_1$  and  $Q_2$  to charge capacitor  $C_3$ . The charge rate of this capacitor sets the switching frequency of the two Schmitt triggers, which are formed by transistors  $Q_3$  and  $Q_4$  and transistors  $Q_5$  and  $Q_6$ .



P-channel  
J FET

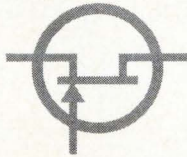

N-channel  
J FET

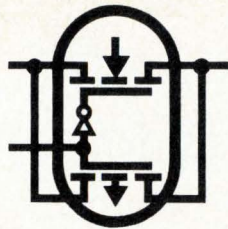

CMOS  
FETs

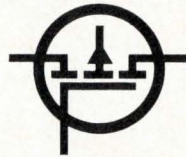

P-channel  
MOS FET



N-channel  
MOS FET

Since 1962, Siliconix has evolved FET technology and applied it to a complete range of singles, duals, arrays, and ICs. So what's new?

# Industrial Analog Switch: 80¢ Per Channel

Now available: analog switches specially selected for industrial control service, at per-channel prices as low as 80c (DG501CJ) and 90c (DG172CJ) in 1000-unit quantities.

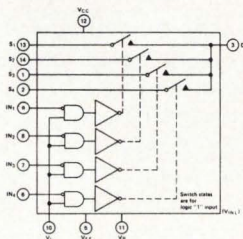

DG172CJ

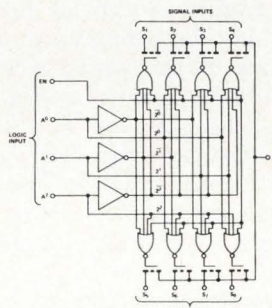

DG501CJ

You can't go wrong with our epoxy analog switches if you're a designer of industrial control circuits. Choose from a variety of switch configurations and structures:

- PMOS monolithic—DG501CJ, 8 channels, break-before-make switch action,  $\pm 5$  V analog signal range
- PMOS/bipolar—DG172, 4 channels, 20 V peak-to-peak signal capability, PMOS FETs and bipolars on a single chip

All of these FET switch/driver combinations are *off-the-shelf* and at your nearest Siliconix distributor *right now*. They're priced to compete with reed relays and other electromechanical devices—and they switch 1000 times faster, last far longer, require less drive power and associated hardware, and operate directly from industrial computer logic.

Our catalog line of FET analog switches will cover most applications. If your switching problems are unique—and whose aren't—call our applications people. They're eager to help. For complete information

## write for data

Applications Engineering (408) 246-8000, Ext. 501



### Siliconix incorporated

2201 Laurelwood Road, Santa Clara, California 95054

# Information theory after 25 years: applications begin to pay off

Shannon's theory of communications has been clarified and refined to the point where it is influencing the design of practical systems; more efficient communications with lower error-rates are the result

by Lyman J. Hardeman, *Communications Editor*

□ In mid-1948, barely noticed in the wake of the worldwide publicity given to the announcement of the transistor, a 32-year-old researcher at Bell Telephone Laboratories disclosed a detailed theory that was destined to have profound effects on the development and understanding of communications systems.

"The Mathematical Theory of Communications," published in the Bell System Technical Journal by Claude E. Shannon, did not tell communications engineers how to design data-transmission-systems hardware. Shannon's more subtle but most powerful contribution was to show systems engineers how to defeat their arch-enemy—noise—by encoding of signals. The theory is important, for the most part, less as a design tool for synthesizing efficient methods of communication, than as a yardstick with which communication techniques can be compared.

Out of the original theory has grown an enormous body of work concerned with achieving reliable communications with low error-rates. Without it, the space program, the growth of pulse-code-modulation systems, and the current explosion in data communications would not be as far advanced. Even today, the mainstream of activity in information theory still follows the outline of Shannon's original papers, which addressed two fundamental communications problems: source coding and channel coding (see Figs. 1 and 2).

Source coding can be further defined as either discrete-source coding or source coding of continuous waveforms with a fidelity constraint. Discrete-source coding involves countable pieces of information, such as numbers or letters in the alphabet, that can be encoded into a fixed number of discrete levels. Familiar examples are the alphanumeric codes used for transmitting teletypewriter messages.

## Source coding and entropy

Fundamental to the understanding of discrete-source coding is the concept of entropy, which Shannon introduced back in 1948. Mathematically, the concept of entropy applied to communications systems is analogous to that of entropy in thermodynamic systems, which was well understood by the time that Shannon's theory was published. To information theorists, entropy is a measure of the degree of uncertainty that exists in a given information source. Therefore, entropy is the average amount of information provided by the source, or the

average amount of uncertainty that exists at the receiver before information is transmitted from the source.

In mathematical terms, the entropy of an information source that generates one of a set of symbols ( $s_1, s_2, \dots, s_n$ ) is:

$$H = \sum_{s=1}^n P(s) \log \frac{1}{P(s)}$$

where  $P(s)$  is the probability of occurrence of symbol  $s$ . If a logarithm to the base 2 is used, then entropy is measured in binary units (bits).

With his concept of entropy, Shannon introduced a way of thinking of information in terms of probability: the greater the probability of an event's occurrence at an information source, the lower the entropy. Entropy is maximum, then, when all events are equally likely.

The statistical importance of the concept of entropy is better understood if the English alphabet is taken as an example. Consider the case where any one of a set of 26 letters is emitted from a source with equal probability. Such a source spews out letters entirely at random, and the probability of its emitting any particular letter is  $1/26$ . Entropy for such a source is  $H = \log_2 26 = 4.7$  bits per letter.

Such an information source emits much more information than actual English text, which has been estimated to have an entropy of less than 1 bit per letter. In English text, the probability of occurrence of each letter is different—vowels and certain consonants, for example, occur much more frequently than the letters Q, X, or Z. Here, efficiency can be increased (or entropy decreased) if the information receiver is made aware of the probability assigned each letter. Once these probabilities are known, the occurrence of a letter of low probability yields more information than the occurrence of a letter that can be predicted with high probability.

Furthermore, once a few letters or words have been received from a source, then succeeding letters and entire words can often be predicted with high degrees of certainty, based on the text that has already been transmitted. Thus, source coding, which describes the statistical values and orders of elements in a given source, permits a reduction in the number of symbols that must be transmitted to achieve the same amount of information transfer.

In the case where a human operator is the ultimate

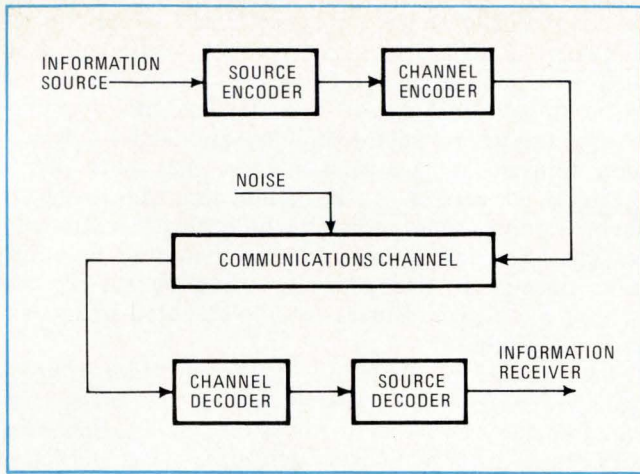

**1. Communications model.** Coding schemes for electronic communications fall into two categories. Source coding reduces redundancy in the information source, while channel coding combats the effects of noise introduced in the communications channel.

receiver of transmitted text, redundant information that is removed by coding can be replaced (decoded) based on the operator's knowledge of the language. But in the more general case where a human is not involved in the system, a coder-decoder can be programmed to perform this function.

### Coding for continuous sources

Coding for discrete information sources such as alphanumeric requires a finite number of coded symbols and introduces no errors. To code a continuous analog waveform perfectly, however, an infinite number of discrete coding levels would have to be taken.

In practice, fortunately, somewhat less than perfect coding can be tolerated. Thus, analog waveforms can be approximated, despite the resultant loss of complete fidelity to the information source. A universally accepted technique for coding continuous sources is pulse-code modulation (PCM), where the source is sampled and the samples are quantized into discrete levels.

Thus, the efficiency, or entropy, of encoded continuous waveforms can be defined in terms of the entropy of the discrete coding levels at some specified fidelity limit. The quantizing errors can be made arbitrarily small—and therefore the fidelity of the encoded signal arbitrarily high—by the choice of appropriate sampling and quantizing intervals.

Looking at all this another way, one could consider the quantizing errors as a source of distortion; hence, the term "rate-distortion theory" is often applied to source coding of continuous channels. In actual communications systems, rate-distortion theory brings a cost function into the analysis of source-coding efficiency. Since the number of quantization levels in a PCM encoder-decoder can be directly related to equipment costs, the designer can readily trade off costs versus system fidelity.

### Coding for voice signals

PCM-encoded telephone networks are used extensively both in local transmission loops, where the associated time-division multiplexing gives such systems an

economic advantage, and in satellite and transoceanic-cable systems, where reduced signal-to-noise levels are handled most easily with PCM.

Unfortunately, the sampling rate required to convert a voice signal to digital format (about 8,000 samples per second), combined with the necessity to encode each sample into about 128 levels (seven bits), results in a data rate of about 56 kilobits per second. This rate is about an order of magnitude higher than can be accurately transmitted on a typical voice-grade communications channel.

As in written language, however, there is considerable redundancy in spoken language, both in pauses between words and sentences, and in the sound patterns when words are being spoken. And for expensive transmission systems such as those used in satellite communications links, it becomes necessary to find ways of reducing some of the redundancy that is inherent in each voice channel.

A system developed by Comsat Laboratories, Clarksburg, Md., uses the statistical patterns in speech to reduce the bandwidth required for digital communications over satellite links. The system, known as SPEC for speech-predictive-encoding communications, removes redundancy in speech waveforms by predicting sample levels to be transmitted on the basis of previous sample levels. Only those samples that least meet these predictions are transmitted, along with signaling blocks to tell the receiver decoder what channels have been sampled. For each channel in which a new sample is not

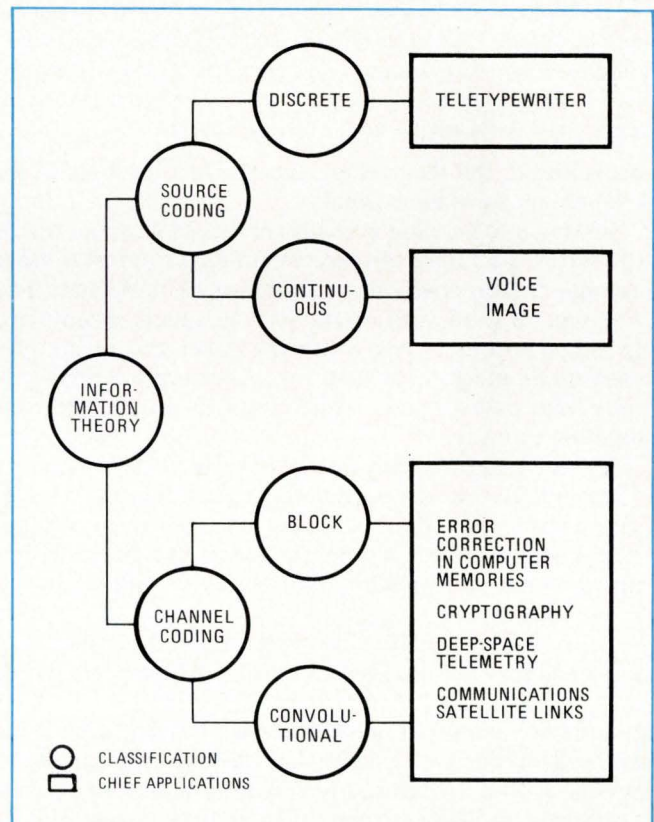

**2. Family tree.** Mainstream of activity in information theory continues to follow the outline of Shannon's original paper. Expanding applications in data communications have underscored the need for greater use of techniques developed around the theory.

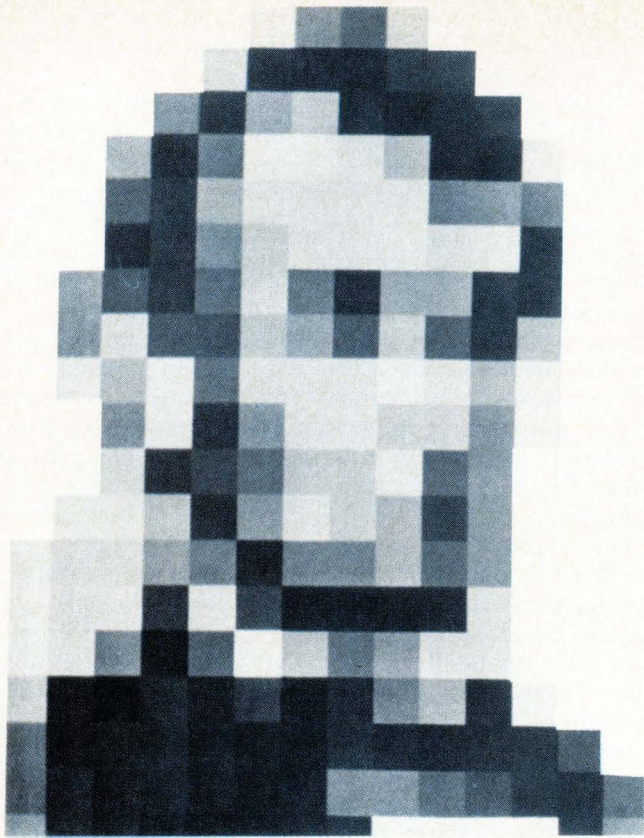

**3. Computer cubism.** To learn what is the least amount of visual information a picture may contain and still be recognizable, researchers at Bell Labs, with the help of a computer, processed this picture of Lincoln. The picture contains about 800 bits of information (about 200 picture elements, each containing four bits of gray-shade information). With conventional teletypewriter codes, only about 12 to 15 words could be transmitted using the same 800 bits.

transmitted, the receiver repeats the last level stored in its memory for that channel.

Since source-coding systems such as SPEC make use of the statistical nature of speech signals, they must sample enough speech channels to make use of these statistics. For SPEC, a minimum of about 48 channels is sampled. In practice, this is not a limitation for the technique, since such encoding systems are designed for high-volume routes where many voice channels are multiplexed together anyway.

By using SPEC, according to J. A. Sciulli, manager of Comsat Laboratories signal-processing branch, "a bit-rate compression ratio of 2:1 is achieved over conventional PCM carrier systems." Consequently, twice as many voice conversations can be transmitted at the same bit rate.

Sciulli believes that such a system will be economical not only for satellite communications links, but in future digital long-haul terrestrial links. He says that, in reasonable quantities, a SPEC terminal could be built for under \$100 per voice channel. A fully operational SPEC system will be field-tested next month between points in California and Hawaii over an Intelsat IV satellite.

### Problems with images

Because of the much greater bandwidths required to transmit images, it is perhaps even more important than

in voice transmission to develop schemes to remove redundancy in images. For space probes, where encoding of telemetered images can allow increased resolution or faster transmission rates for a fixed communications bandwidth, or in video-telephone applications, where data transmission requirements on the order of 50 megabits per second can be significantly reduced with source coding, such coding techniques are extremely feasible. And the future of under-1-minute facsimile over voice-grade telephone lines can be greatly enhanced by efficient and easily implemented image-encoding techniques.

Two problems impeding the application source-coding theory to the transmission of still, black-and-white images were recently noted by David J. Sakrison, a professor at the University of California at Berkeley. First, it is hard to formulate statistics for a "typical" image. For example, the probability distribution of picture elements containing different shades of grey varies substantially from one image to another, and even within segments of the same image. What's more, the distribution is almost never gaussian, which is the easiest type of distribution for the communications engineer to analyze.

The second and possibly most difficult problem, according to Sakrison, is that of finding a distortion measure that is consistent with the subjective evaluations of human observers. It is known, for example, that the human eye and brain are more sensitive to some spatial frequencies than to others, more sensitive to intensity errors in grey areas than in white, and more sensitive to the edges of objects than to the middle of a blank area.

### Picturephone research

In an attempt to determine the smallest amount of information in an image that could be meaningful to human perception, workers at Bell Labs several years ago developed a picture of Abraham Lincoln in a minimum recognizable form (Fig. 3). Transmitting this image requires only about 1,000 bits compared with over 1 million bits contained in each image frame transmitted in commercial monochromatic television.

Meanwhile, another group at Bell Laboratories has been at work developing source-coding techniques for motion pictures. The effort is directed toward practical systems that will eventually form the basis of Bell's Picturephone service.

In coding for images, such as Picture-phone, each frame is divided into a matrix of small elements, and the light intensity level of each element is sampled. Across any vertical or horizontal line of elements within the matrix there is generally a series of elements that have the same light intensities. Successive elements in such series, then, can be predicted with high degrees of certainty, and therefore contain much redundant information. Thus, if use is made of methods similar to those employed in coding for voice signals, much of this element-to-element redundancy can be reduced.

Furthermore, in Picturephone coding, where relatively still images are transmitted at rates of 30 frames per second, the corresponding elements in each successive frame can be predicted with even greater probability. Thus, there is generally more redundancy from one



## Shannon after 25 years

Claude Elwood Shannon, as anyone will attest, has made by far the largest single contribution to information theory. In addition to the publication 25 years ago of his now-famous "Mathematical Theory of Communications," Shannon, at periodic intervals until the late 1960s, supplied a variety of detailed insights in closely related disciplines.

Now 57, Shannon is relatively inactive in the field. He lives with his wife and three children in a 115-year-old house in the Boston suburb of Winchester, Mass.

In a recent interview with *Electronics*, Shannon reflected only briefly on information theory, and spoke mostly of hobbies and interests which include jogging, unicycle riding, camping, listening to jazz, and investing in stocks.

To maintain his trim 5-foot-10-inch, 140-pound frame, Shannon begins each day with a three-mile jog. When asked if he doesn't make a few exceptions for extremely cold or wet days, he insists that he does not. "The first year was a form of hell," he admits, "but it's easy now, and I feel fantastic."

Getting exercise is nothing new for Shannon, though. His wife gave him a unicycle more than 20 years ago, and since that time he has expanded his collection of one-wheelers to 26. They come in a wide variety of sizes and shapes, and many of them he built himself. Since they are all housed in his two-car garage, his automobiles and his mobile camper have to be parked outside in the weather.

After a hard day's jogging and cycling, Shannon enjoys listening to jazz. He believes most mathematicians have an ear for music, although he admits that he has no talent for playing musical instruments himself, nor does he "dig" modern rock.

Over the years, Shannon has applied some of his mathematical talent toward investing in the stock market and is reported to have netted profits into seven figures. "I've been very lucky in the over-all picture," he agrees, "mostly in small venture-capital investments . . . they are some of the best bets around."

Some of the "small venture-capital" stocks that he got into early include Teledyne, where he is a member of the board of directors, and Hewlett-Packard. However, although he has from time to time applied information-theory-type concepts to investing, Shannon credits more conventional investment techniques with his success on Wall Street.

Asked what he felt information theory's future was at the time of his original publication, Shannon replies, "I was quite surprised at the publicity and reaction." On several occasions since then, he has modestly warned against the danger of overselling information theory, especially to those trying to apply its concepts to disciplines that happen to be rather far removed from electronic communications.

What about the next 25 years? Shannon believes that "information theory will continue to find its central application in communications and computers. But this is not to say that it will not be successfully applied to other areas—notably in the development of artificial intelligence."

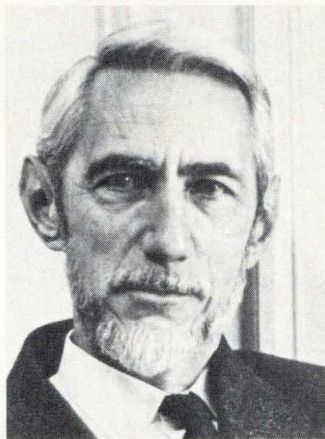

frame to the next than from element to element within a frame.

Workers at Bell Laboratories in Holmdel, N.J., take advantage of this fact in the techniques they are devel-

oping for Picturephone coding. "Using our latest techniques," says John B. Millard, supervisor of the laboratory's Picturephone coding-techniques group, "we can now transmit a full-quality Picturephone signal at a rate

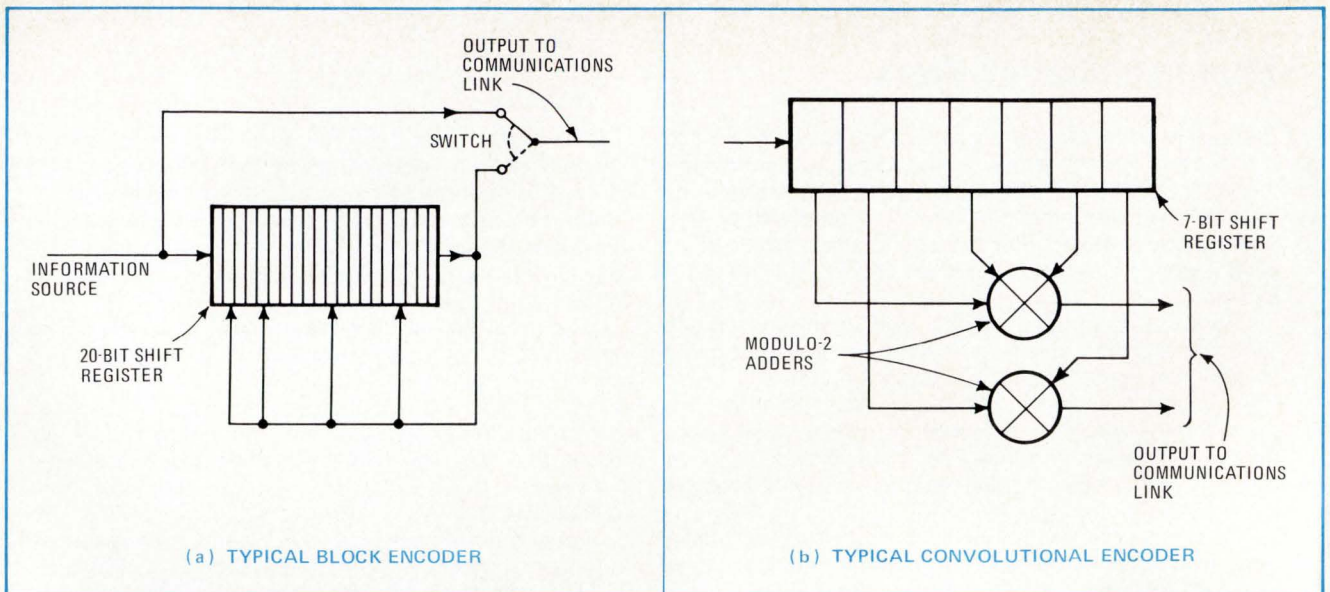

**4. Code generators.** Typical block encoder (a) first transmits a block of raw data from an information source, then sends the contents of a shift register as redundant parity information that allows the receiver to detect and correct any errors introduced by the communications channel. With the convolutional encoder (b), information is fed continuously into a shift register. Simultaneously with each input bit, contents of predetermined positions in the register are added in modulo-2 adders and transmitted.

of 1.544 megabits per second. This rate is about a quarter of that required only one or two years back, and is achieved predominately by the use of frame-to-frame coding.”

The largest obstacle to implementing frame-to-frame coding is the need for a memory of 440 kilobits at each Picturephone central office terminal to support a one-way transmission. A 320-kilobit memory is needed to store a full frame of information (250 lines, by 160 elements per line, by 8-bit element coding levels) for comparison with the corresponding elements in the succeeding frame, and a buffer memory of 120 kilobits. “Such a memory is currently the most costly portion of the Picturephone coding equipment now under development,” says Millard.

### Channel coding

Source coding, as outlined earlier, is used to reduce redundancy in an information source so that less capacity is required of the communications channel over which the data is transmitted. Thus, source coding is generally performed independently of the type of communications channel used: it is assumed that there are no errors introduced between the signal source at one end of a communications link and the receiver at the other end.

Attacking a somewhat different problem, channel coding is used to reduce the effects of noise introduced in the communications channel. Unlike the source encoder, a channel encoder generally expands the bandwidth required of the communications channel, but in the process it reduces the signal-to-noise level required in the link, or yields a lower error rate for the information transmitted.

This relationship between information capacity and the signal-to-noise ratio of a communications link was another fundamental subject that Shannon addressed in his original paper. In that paper, Shannon defined a

limit on the information-carrying capacity,  $C$ , of a channel in a concise equation now well known as Shannon’s Law:

$$C = W \log (1 + S/N)$$

where  $S$  is the power of the information-carrying signal in a channel of bandwidth  $W$  which is characterized by additive white gaussian noise  $N$ . When  $W$  in the equation is measured in hertz, then the units of  $C$  are bits per second.

In theory, any information source with a rate lower than channel capacity can be transmitted with virtually zero errors. But as this channel-capacity limit is exceeded, it is impossible, according to theory, to transmit error-free information.

It must be emphasized that Shannon’s Law is a special case of his general theory. In practice, this limit on channel capacity has never been reached, for several reasons. First, the band edges of a real-world channel are not well defined, unlike the ideal channels assumed by Shannon. Also, most communications channels are characterized by noise bursts instead of the white gaussian noise assumed by Shannon.

Thus, a typical voice-grade telephone channel, even when using the most efficient modulation techniques, is capable of transmitting at a maximum rate of only about 10,000 bits per second. If an ideal 3,300-Hz channel met theoretical limits—assuming gaussian noise and a typical signal-to-noise ratio of 400 (26dB)—the identical channel would achieve an information-carrying capacity of about 25,000 bits per second with virtually no errors.

### Combatting channel noise

Unlike the largely *ad hoc* methods developed for source coding, techniques used to combat noise in a communications channel are generally much more vigorous mathematically. Because of this, work in channel coding is more closely associated with Shannon’s origi-

nal work, and workers in this field are more directly tied to pure information theory.

Two fundamental classes of codes stand out as efficient ways of achieving reliable communication—the block code and the convolutional code. While detailed analysis of these codes is beyond the scope of this article, important characteristics of each are readily apparent from the methods by which they are generated (Fig. 4).

A block code is formed by dividing data source into finite blocks of data. In the encoder shown, each block is then transmitted and at the same time entered into a shift register, with feedback paths added at predetermined positions in the shift register. After the information bits have been transmitted, the contents of the shift register are transmitted as parity-check bits. Block by block, the encoded data is then decoded at the receiver, where the parity bits are used to detect (and sometimes correct) errors that have been introduced in the communications channel.

Convolutional coding, on the other hand, is generated by sequentially clocking data from a source into a shift register, then combining the information in predetermined positions in the register in a modulo-2 adder. The outputs of the gates, which are a function of the data in several shift-register positions, are then transmitted over the communications link.

In both block and convolutional encoders, the ratio of information bits to the total number of bits transmitted depends on the configuration of the encoder. Generally, the more check bits added, the more capable the coding scheme is of detecting or correcting errors. Rate one-half (one information bit for every two bits transmitted) to rate three-fourths (three information bits for every four bits transmitted) codes yield a practical compromise between coding effectiveness and the added transmission bandwidth required.

### Convolutional coding more powerful

Although block coding is sometimes attractive when only error-detecting capability is needed, convolutional coding is generally considered to be a more effective technique, especially in one-way communications channels where error correction is needed. Linkabit Corp., one of the few companies that base their existence solely on information theory, recently introduced a commercial convolutional coder-decoder. "While we have built both block and convolutional systems under NASA and military contracts, we definitely believe now that convolutional-coding systems are more powerful," says Irwin M. Jacobs, president of the San Diego firm.

Linkabit's model LV7015 (Fig. 5) is designed to improve efficiency in satellite data-communications links. As a measure of its economic feasibility, Jacobs offers the following example: a typical phase-shift-keyed (PSK) modulation system will ideally provide a  $10^{-5}$ -bit error rate when the channel signal-to-noise ratio is 9.6 dB. Use of the LV7015 with the PSK system will allow the same error rate to be achieved with a signal-to-noise ratio of 4.5 dB. This permits a 5-dB decrease in transmitter power, or an equivalent increase in receiver noise temperature.

"Perhaps even more important economically," notes

Jacobs, "is the fact that an alternative method of gaining a 5-dB power advantage would be to more than triple the area of an earth station's receiving antenna."

To date, the major applications of channel-coding schemes have been in space-communications links, where the channels are not bandwidth-limited and channel noise matches closely the properties of white gaussian noise. Coding for many non-space links, also, can significantly combat the effects of noise.

Unfortunately, some channels of practical interest—including telephone lines and narrowband radio links—are characterized by noise bursts and do not lend themselves to the same mathematical analysis as the space channel. Consequently, rigorous coding techniques for such channels have generally been less successful. It is because of this non-gaussian nature of noise, as well as the narrow bandwidths associated with the conventional telephone channel, that Bell Laboratories is no longer active in research efforts looking for new codes to help improve error rates when transmitting data through the Bell System network, according to Robert W. Lucky, head of the Laboratory's advanced data-communications department, Holmdel, N.J.

### Theory as blueprint

Where channel-coding techniques have been moderately helpful in reducing the effect of errors introduced in a telephone channel, more rapid progress in reducing error rate has been achieved by efforts to build the ideal channel assumed by Shannon. Lucky identifies the major problem in real-world telephone channels as that of phase and amplitude distortion caused by imperfect frequency-response characteristics. "This results in interference between digital symbols, and the effect is about an order of magnitude worse than that of channel noise," says Lucky.

At Codex Corp., a company set up to exploit channel-coding technology, the effort to counter intersymbol interference has strongly influenced the methods it uses to design high-speed modems for the telephone network. Although the Boston-based company applied some of the ideas of channel-coding theory to its first-generation modems, according to G. David Forney, Jr., vice president of research, all efforts now are directed toward the design of adaptive equalizers and efficient modulation techniques to reduce intersymbol interference.

Forney also points out that the availability of return channels in the telephone system allows the use of error-detection and retransmission schemes. Such schemes are much easier to implement than channel coding for forward error correction over a single one-way channel.

### Applications in other fields

While Shannon's "Mathematical Theory of Communications" gave the engineer a tool with which to measure communications effectiveness, the central concepts introduced by Shannon, and further developed by others since, have been applied to fields not directly related to electronic communications.

Cryptography, for example, has traditionally followed closely many of the techniques used in information theory. In fact, Shannon himself was active in de-

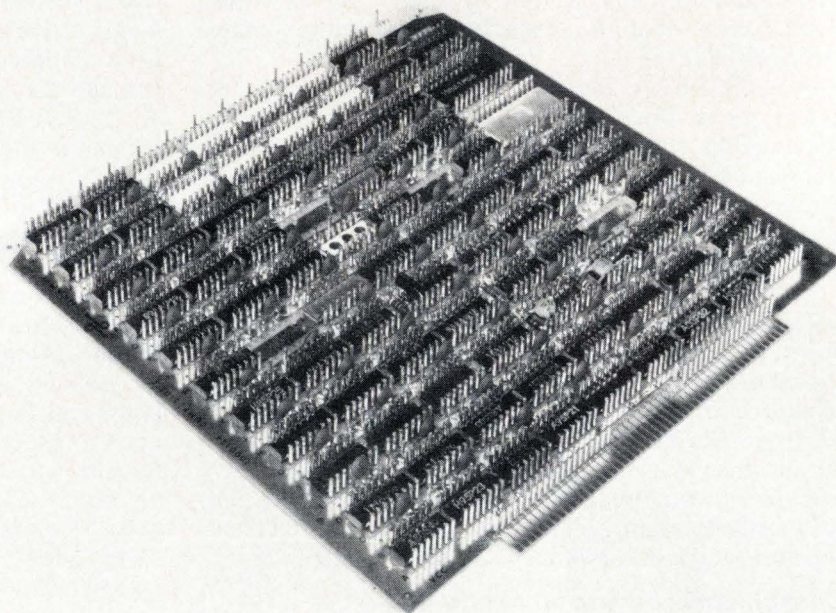

**5. Workhorse.** The model LV7015 (a) is one of the first convolution coder/decoders to have become commercially available. It reduces signal-to-noise level requirements in a communications-satellite data link by over 5 dB—a reduction otherwise attainable only by tripling the area of the receiving earth station's antenna. Most of the ICs used in the single printed-circuit board (b) in the LV7015 are devoted to decoding the test functions.

veloping such cryptographic codes even before 1948.

In the computer field, channel-coding theory has been successfully applied to the problem of detecting and correcting errors when data is being stored in computer memories. Here, the memory bank is thought of as a communications channel, and write and read circuitry are no different from a communications transmitter and receiver, respectively.

The universal appeal of the term "information theory" itself has stimulated much work in areas far afield from electronic communications. Thus, researchers working in fields such as psychology, art, theology, and semantics have attempted to apply information theory to their respective disciplines. Such attempts have, by and large, been unsuccessful and have often even discredited the general theory by introducing a feeling of skepticism toward its usefulness.

#### A decade of application

The first decade following the publication of Shannon's paper has been characterized as a period of fundamental discovery in the field of information theory.

Next, the 1960s can best be described as an era of progress through clarification and education. Not until the 1970s has information theory begun to be effectively applied.

Several major factors contribute to making its practical application possible. For source coding, the trend toward all-digital communications, as well as the explosive volume of data—whether alphanumeric, voice, or images—has stimulated a growing need to compress such data into more manageable quantities.

Also, for both source and channel coding, the rapid advances in integrated-circuit and memory technology in the last decade have reduced the cost, weight, and power consumption of typical decoding operations, while at the same time increasing operating speed. And the advent of the communications satellite has provided the coding theorist with a channel that lends itself to rigorous mathematical analysis, thus further stimulating efforts to find even-more-powerful codes.

These factors alone promise to continue to push information theory toward more and more practical applications in communications systems of the future. □

# 23 speeds for only \$675\*?

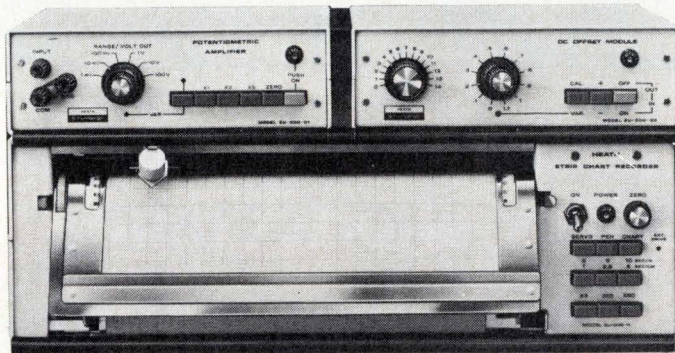

## Prove it to yourself with the Heath/Schlumberger 30-day trial offer

- 23 pushbutton-selected speeds, 30 in/min to 0.2 in/hr
- 18 calibrated spans, 1 mV to 500 V full scale
- completely programmable with TTL-levels or contact closures
- 15 full scales of calibrated suppress on all spans
- true potentiometric input
- easy conversion to metric system

Everything you'll ever need in a strip chart recorder...at less than you planned to spend. That's the Heath/Schlumberger EU-205B system. Unlike most other recorders that require a considerable investment in optional extras to get what you want, the 205B is loaded with features from the start. Enough digitally-derived speeds to satisfy the most exacting requirements...18 calibrated spans with 15 full scales of offset available on each span...complete programmability for all functions...true potentiometric input...easy change-over to metric system work. Plus full 10" scale...writing speed less than half a second...0.1% tracking accuracy and linearity...±0.2% accuracy...disposable pens...3-position removable writing table...bench or rack mountable. And all solid-state design, of course.

A value? You decide. Check the details at right for our trial offer and put one in your lab for 30 days. We think you'll keep it.

Assembled EU-205B system ..... \$675.00\*



Other modules are available to permit pH and temperature measurement, digital readout, limit detection and 4-channel multiplexing. Send for our new 1973 Electronic Instruments catalog for details.

How we can sell high performance instrumentation at low cost. Heath/Schlumberger sells direct to you, through the mail. We have no salesmen or distributors. Result? Lower selling costs...

lower prices. Heath/Schlumberger is a division of the Heath Company, the world's largest manufacturer of electronic kits...and one of the world's largest buyers of electronic components. Example: Heath buys over 30 million resistors every year...and that means real purchasing power for us, and lower costs for you. And we're not a small company struggling with high overhead. We're a small division of a very large company, and we get the benefit of sharing some very important (and expensive) facilities...purchasing, engineering, production etc. Again, this means lower costs for us...and for you. We've been producing high performance electronic equipment at low cost for over 25 years. Take advantage of our 30-day trial offer (described below) and prove it to yourself.

**The Heath/Schlumberger 30-day trial offer.** We're so sure that our products can deliver on our claim of high performance and low cost that we make this offer: try this or any other Heath/Schlumberger product in your lab for 30 days. Just send us your purchase order with the statement below typed on it.

If, in *your* opinion, the product is not suitable for *any* reason, just return it to us within the 30 day limit and pay the shipping costs. After the 30 day limit we'll process your PO and bill you for the product. Send your PO now...and prove it to yourself.

**"This order is placed for 30-day evaluation. The equipment ordered may be returned within 30 days if, in the buyer's opinion, it is not suitable. The buyer agrees to pay transportation costs in both directions."**

HEATH	
<b>Schlumberger</b>	
Heath/Schlumberger Scientific Instruments Dept. 531-285 Benton Harbor, Michigan 49022	
<input type="checkbox"/> Please send 1973 Electronic Instruments catalog.	
<input type="checkbox"/> Enclosed is my purchase order for a 30-day trial evaluation.	
Name _____	
Title _____	
Company/Institution _____	
Address _____	
City _____	State _____ Zip _____
*Mail order prices; FOB factory.	
EK-381	

# Centralab perspectives

FOR USERS OF ELECTRONIC COMPONENTS

DISTRIBUTOR PRODUCTS

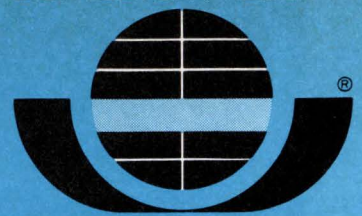

**CENTRALAB**

Electronics Division  
GLOBE-UNION INC.

5757 NORTH GREEN BAY AVENUE  
MILWAUKEE, WISCONSIN 53201

## New Selectashaft Rotary Switch program corrects industry shortcoming.

**Users of custom rotary switches can now get delivery within days, thanks to this new field assembly program offered by participating Centralab Distributors.**

If it's taking you several weeks or even months to get delivery of custom rotary switches, you'll want to look into a new field assembly program pioneered by Centralab and available from their Selectashaft™ Distributors.

The thrust of the program is to ship orders of custom rotary switches within hours of their receipt. Eliminated are lengthy factory delays and special factory set-up charges.

Customers are finding the scope of Selectashaft switches indeed awesome. More than 100,000 combinations of miniature and subminiature

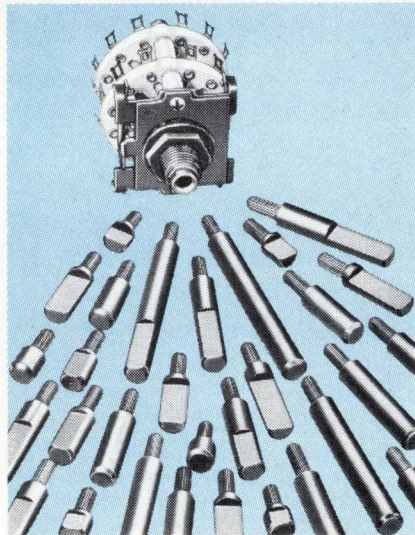

Custom switch assemblies with more than 100,000 combinations are available in days from Centralab Selectashaft Distributors.

switches are available, filling 95% of user needs.

The program enables you to select the exact length front shaft,

Circle 213 on reader service card

exact shaft end details, and the exact shaft flat angles required. You can choose from 92 types of rotary switches for field assembly by the Distributor to your choice of three .250 inch diameter shaft styles: plain round, .218 inch flat, or .156 flat configurations. The shafts themselves are offered in 24 sizes from .687 inch to 2.375 inches long from the mounting surface. Shaft flat angles can be specified in increments of 15°.

The Selectashaft Distributor program has been underway barely a year, and both Distributors and customers agree it meets a definite shortcoming that previously existed. In that short span, the number of participating distributors has grown to make the benefits of Selectashaft rotary switches available nationwide — on a local basis.

For complete product and price information, contact the Centralab Selectashaft Distributor nearest you. Or write Centralab Distributor Products, Dept. SAS-2.

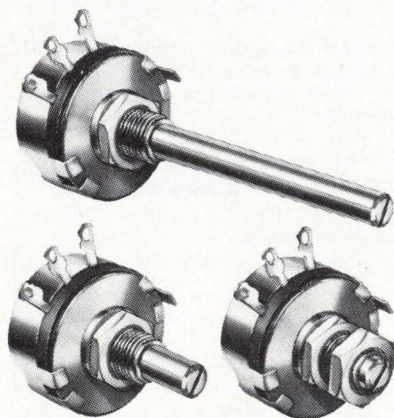

Circle 212 on reader service card

**MIL spec pots. A few words about a big bargain.** What more can be said about a line of hot molded potentiometers that meets MIL-R-94C requirements—and can be purchased for as little as 92¢ each, in quantities of 251-500? How about the fact that the pots are shelf items and available immediately. And that they're made by Centralab, whose quality control sets the standard for the industry. Why not write for the catalog which gives a few more reasons to try them before buying them. Ask for Catalog 34-I supplement.

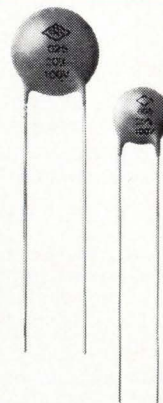

**New 100 VDC transistor circuit caps.** Low voltage rating of 100 VDC is combined with high capacitance of .005 mf to .1 mf in these new ceramic disc capacitors from Centralab. Their miniature size is specially designed for transistor circuits, where tighter tolerances are essential. Write for Bulletin 42D562.

Circle 214 on reader service card

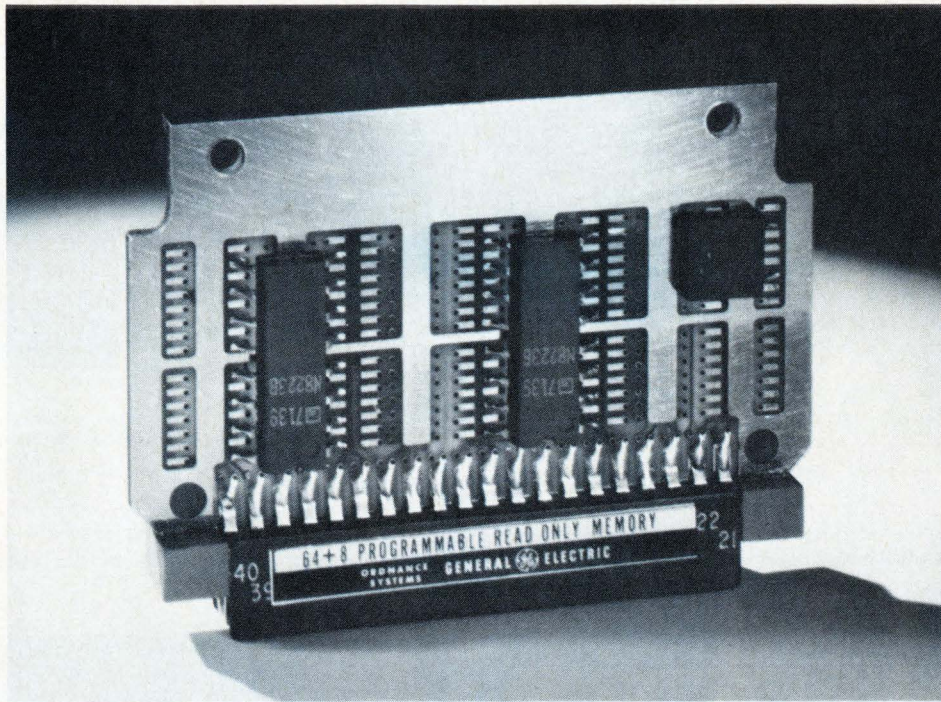

## Etching pc-board sandwich eliminates discrete resistors

A resistive layer inserted between the substrate and copper foil allows resistors to be formed within the board, leading to a very high component packing density

by Al Ertel and J. R. Mars, *The Mica Corp., Culver City, Calif.*

□ Planar geometry, the key to many of the recent innovations in integrated-circuit technology, is showing up now in printed circuits. And the reasons are the same: a saving in circuit real estate, faster fabrication, and reduction in over-all costs, in comparison with discrete-component packaging.

The heart of the new approach is a different way of building a printed-circuit board. The board, called Micaply- $\Omega$ mega, is a sandwich of resistive material laminated between the substrate and a layer of copper foil. The resistive layer, a 5,000-angstrom-thick metallic-alloy thin film, is applied to a substrate such as epoxy-glass G-10. Resistors can then be formed by a subtractive process of selective plating and etching.

By providing a planar alternative to discrete resistors, this packaging technique saves space because the resistors are in, rather than on, the board. The combination of traditional planar conductors and the planar resistive surface makes for high packing density.

When standard EIA  $\frac{1}{4}$ -ohm resistors make up one-sixth or more of the circuit board area, costs become

lower than those for equivalent conventional printed circuits with discrete resistors. Similarly, when the board is used as an alternative to thick or thin film on ceramic for hybrid circuits, fabrication time is cut substantially because the copper-resistor laminate can be worked in large panels using a subtractive process that requires no screening, firing, or vacuum equipment. Also, there is no need to attach discrete resistors, and semiconductor chips can be bonded to the board by reflow soldering or with an epoxy adhesive.

The boards come in four configurations—single-sided, double-sided, double-sided with resistor film only on one side, and double-sided with an aluminum layer, which provides electrostatic shielding between the two substrates and can act as a heat sink. These variations are shown in Fig. 1.

The metal-alloy film has a sheet resistivity of 25 ohms

**On the job.** A multilayer printed-circuit board (top of page) with a thin-film resistive sheet beneath the copper foil enables programmable-read-only-memory sub-unit to be packed into 0.75 cubic inch.

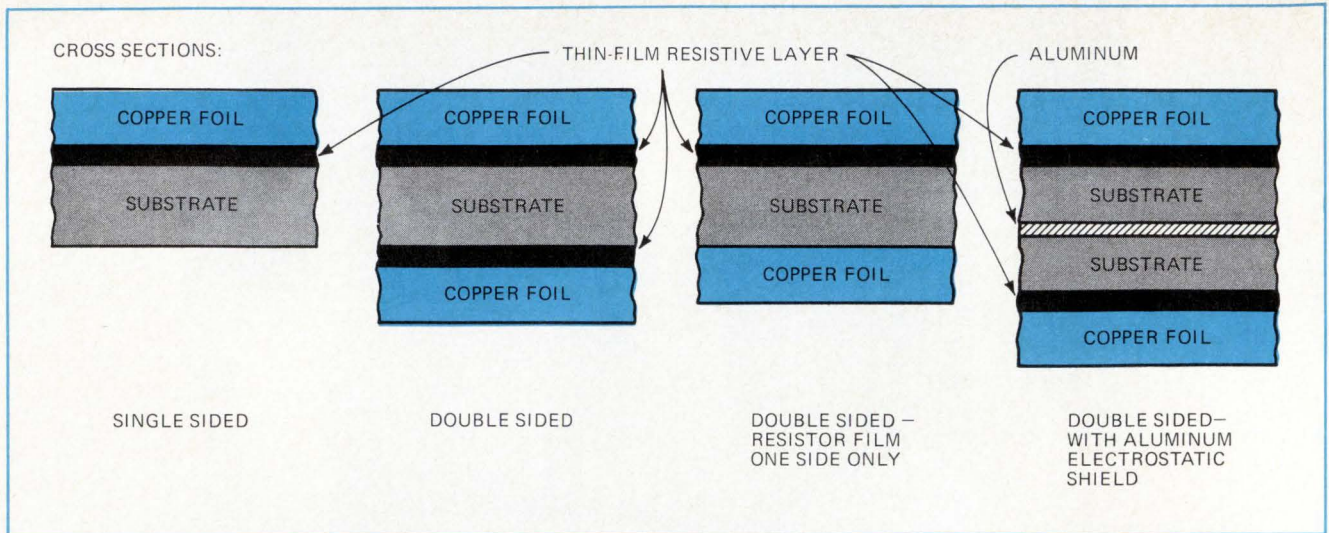

**1. Resistor-filled sandwiches.** Copper-resistor printed-circuit-board laminate can be fabricated in single- and double-sided variations. Copper foils can serve as conductors or as heat sinks to soak up power dissipated by planar resistors.

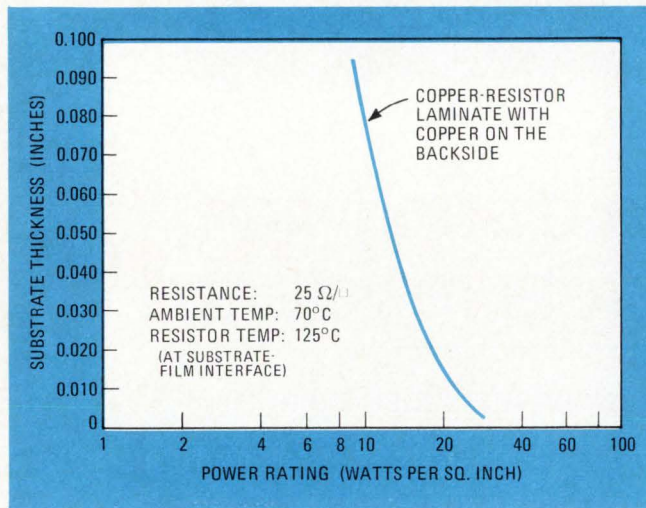

**2. The path out.** Negative slope of the curve indicates that the thinner the board, the higher the dissipation capability of the laminate. Higher dissipation for the thinner board is due to the shortened thermal path from the resistive film to the foil on the back.

per square, and line widths as narrow as 5 mils can be etched successfully. Over-all board thickness range is 2.5 to 93 mils. Peel strength of the film when clad to epoxy-glass G-10 is a minimum of 5 pounds per in.

A higher-temperature requirement can be satisfied if the epoxy-glass substrate is replaced by a thermosetting polyimide-glass substrate. This material can withstand continuous operating temperatures as high as 200°C. It is used where temperatures encountered will exceed the 125°C capability of epoxy-glass. The copper-resistor material on epoxy-glass or polyimide-glass lends itself to lay-up and processing in multilayer boards. Resistors can be buried in the multilayer. Prepreg, or B-stage, partially cured sheets are available for the multilayer lamination.

Embedding resistors in the pc board meant that the problem of heat dissipation had to be solved. Figure 2 indicates that the typical dissipation rating for a heat-sink configuration ranges from 10 to 30 watts per square

**TABLE 1**  
**TEST RESULTS - COPPER-RESISTOR LAMINATE IN**  
**A MULTILAYER MODULE**  
 (Resistor area: 0.025 square inch; R = 1,000 ohms)

Test	Ambient temp.	Loading	Test time	$\Delta R$ at end of test
Load life	25°C	30 W/in. <sup>2</sup>	340 hrs.	+0.15%
	25°C	11 W/in. <sup>2</sup>	next 1,000 hrs.	+0.10%
	105°C	11 W/in. <sup>2</sup>	500 hrs.	-0.1%
	105°C	11 W/in. <sup>2</sup>	next 500 hrs.	+0.5%
Thermal cycle (no power)	105°C	zero	250 hrs.	-
	22°C	zero	next 12 hrs.	+0.5%*
Step power	22°C	5 cycles at 6 levels up to 115 W/in. <sup>2</sup>	½ second on; ½ second off	zero
		105°C	same as above	same as above

Notes: \*After four cycles of testing.  
 The temperature coefficient of resistance did not change following load life or thermal cycle tests.

inch, depending on the thickness of the board. The limiting factor is the maximum temperature the substrate can withstand. If additional heat-sinking is necessary, an internal layer of copper or of anodized aluminum can be added.

### Sink the heat

The dissipation values represented by the curve in Fig. 2 apply to epoxy-glass substrate with a maximum continuous operating surface temperature of 125°C in a free-air ambient of 70°C. This curve would be shifted to the right if a polyimide base (200°C maximum) were used and operated at 200°C surface temperature. The curve would also shift right if the board were operated in a lower ambient temperature.

To evaluate the stability of the planar resistors, an array of 1,000-ohm resistor segments was etched on one double-sided board and then fabricated into a multilayer board. This board was time-temperature-tested



## Designing an SHP module

It is no easy matter to cram a complex circuit into a Navy Standard Hardware Program (SHP) 1A module, which has a maximum allowable circuit volume of 0.75 cubic inch. But engineers at the Ordnance System department of the General Electric Co. in Pittsfield, Mass., employed computer-aided design and Micaply Omega to pack an 8-bit programable-read-only-memory arithmetic sub-unit into that space. The area available was 2.32 by 1.086 in., and module depth was a maximum of 0.29 in.

To determine the maximum number of 14- or 16-lead flatpacks that could be used within the SHP module, a mock-up of the module was prepared to an enlarged scale (8:1). Models of the component configuration were then arranged within the boundary limits, using both trial and error and CAD procedures. Initially, it appeared that the maximum number of flatpacks that could be accommodated, while maintaining a minimum of 10-mil clearance between conductors, would be two horizontal rows of five each. But by using a combed placement and by mounting the flatpacks on both sides of the board, the designers were able to raise the number to 18.

A multilayer board was developed that employs three double-sided boards for interconnection. As shown, one board (layers 1 and 2) was constructed from a double-sided copper-resistor laminate. Nine 1/4-watt, 950-ohm resistors, plus some trimming resistors, were etched to provide programming resistors. The boards were sandwiched

together with partially cured (B-stage) epoxy-glass, known commonly as prepreg. The outer boards were made out of copper-aluminum bimetallic sheet. The 7-mil-thick aluminum outer layer served as a heat sink and also as a platform to raise the flatpacks clear of the board, thereby reducing the possibility of shorts. The leads of the flatpacks were attached to the 31-by-50-mil copper pads beneath the aluminum.

One departure from conventional fabrication methods for printed-circuit boards was the anodization of all exposed conductive areas. The anodizing procedure insulated the heat sink and dissolved plated-conductor areas that might have inadvertently contacted the heat-sink regions, causing short circuits.

Conductor lines were etched 12.5 mils wide with 12.5-mil spacing between lines. Although the available real estate would have accommodated 15-mil lines, the CAD techniques employed could not easily have handled them.

The 7-mil aluminum heat sink was chemically contoured after the multilayer board had been laminated and drilled. The passive-to-copper etchant selected produced a 3/7 etching taper of this 5052 aluminum alloy.

Details about the program are contained in the "Navy Standard Hardware Program, Navelex 0101-054," published by the Naval Electronic Systems Command, Washington, D. C.

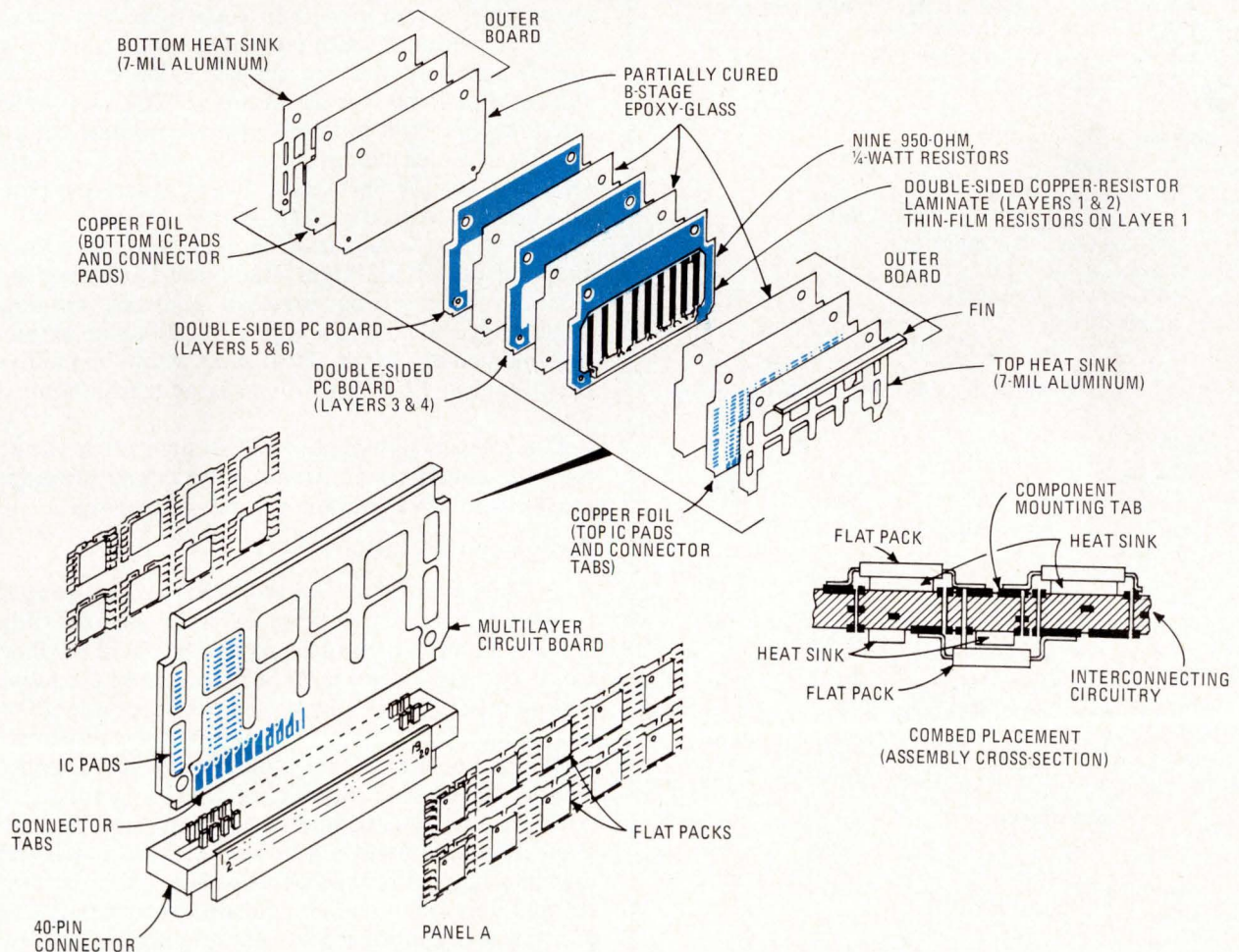

at 25°C, with resistors loaded initially at 30 w/in.<sup>2</sup> and subsequently at 11 w/in.<sup>2</sup> The results, listed in Table 1, indicate that resistance values varied only slightly—at most 0.15%. At 105°C with loading of 11 w/in.<sup>2</sup> resistance varied only 0.1% for the first 500 hours and no more than 0.5% for the next 500 hours. Also, no detrimental change could be detected in the temperature coefficient of resistance in any of these tests. Under a stepped—power test of five cycles at six levels to a maximum of 115 w/in.<sup>2</sup> at 22°C, there was no resistance variation. However, under stepped-power conditions, at 105°C, resistance varied 1.2%.

**TABLE 2**  
COPPER-RESISTOR LAMINATE VERSUS THICK FILM —  
A COST COMPARISON

**CONSIDER THE FOLLOWING HYPOTHETICAL CIRCUIT**

- 1 substrate (1 by 1 by 0.025 inch)
- 10 resistors (±10 percent)
- 5 chip capacitors
- 3 transistors
- 1 integrated circuit (8 lead)

**ASSUMPTIONS**

- Since chip bonding is employed in either case, it is appropriate to compare the resistor-conductive substrates only.
- Production run is 1,000 circuits per day.
- Yield is 100 percent in both cases, actually thick-film yield would be slightly lower than resistive-copper laminate.
- Tooling and design costs are neglected (they are slightly lower for the thick-film).

**MATERIAL COSTS**

Thick film		Copper-resistive sheet laminate	
Ceramic substrate	\$0.12		\$ .104
Gold conductive ink (33% of surface)	.058		
Resistive ink (20% of surface)	.025		
Screen loss (both) (5% of total)	.004		
	<u>\$ .207</u>		<u>\$ .104</u>
	or \$207.00 per thousand		or \$104.00 per thousand

**LABOR**

Thick film	Rate	1,000 pieces	Set-up time
Step			
Print conductor pattern (gold-palladium)	10 parts/min.	100 min.	15 min.
Print bonding pads (gold)	10 parts/min.	100 min.	15 min.
Fire conductor pattern	30 parts/min.	33 min.	15 min.
Inspect	10 parts/min.	100 min.	none
Print resistor pattern	10 parts/min.	100 min.	15 min.
Fire resistor pattern	30 parts/min.	33 min.	15 min.
Trim resistors	1 part/min.	1,000 min.	15 min.
		<u>1,466 min.</u>	<u>90 min.</u>

**Copper-resistor sheet laminate**

Step	Rate	1,000 pieces	Set-up time
Board processing (all steps)	1.38 parts/min.	725 min.	none

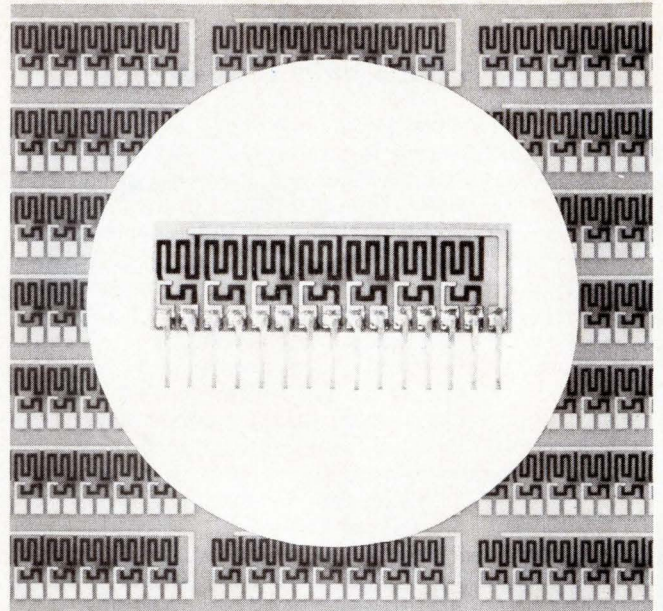

**3. Mass production.** Dark regions are the thin-film resistors and light regions are the conductors on this desk calculator plug-in resistor board. Printed-circuit techniques etch both conductors and resistors of 95 such circuits prior to their separation.

The copper-resistor laminate offers an unexpected dividend: a relatively good resistance to radiation. The copper, nickel, and aluminum in this laminate are less susceptible to radiation than such thick-film materials as gold, platinum, and tantalum, which have higher atomic numbers and are subject to destruction when subjected to X rays or gamma rays. This characteristic makes these circuit boards a prime candidate for applications in which circuits may be subjected to intense radiation, such as in nuclear blasts, where gamma-ray emission would produce high-current pulses.

Such a blast would turn on every transistor and destroy circuits left and right. Radiation-hardening can be achieved by inserting overload resistors, ranging in value from 1 to 10 ohms, which can dissipate extremely high momentary surges. Heat sinks would be ineffective for this purpose because of their large thermal time constant.

The most radiation-resistant design for a thick- or thin-film circuit would probably be a long meandering resistor with a low resistance rating per square.

**Design considerations**

The package designer will find that resistor-conductor laminates make sense when efficient use of available space is of primary importance. The General Electric Co. is currently developing a highly compact memory package. In one module, a 64-by-8 programable-read-only-memory sub-unit, the programing resistors are built into an internal layer of a multilayer board (see "Designing an SHP module," p. 111).

The copper-resistor laminate is a natural for hybrid microcircuit step-and-repeat fabrication, and is better than the snap-chip approach because it can be power-shared into individual circuits after fabrication. Sheets of material are produced in sizes ranging up to 10 by 36 inches. For example, an array of 95 resistor networks

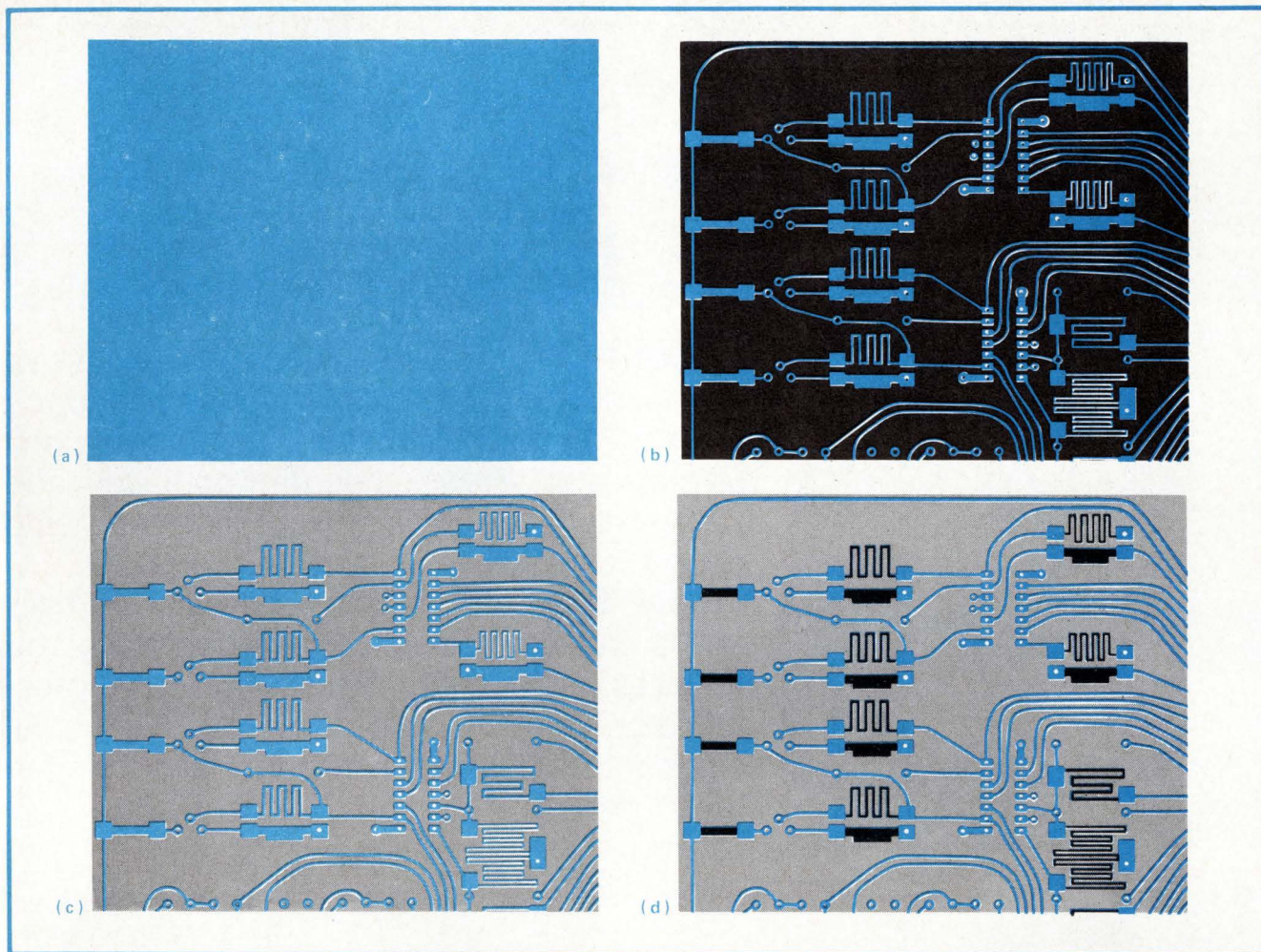

**4. Step-by-step.** After a surface treatment with sodium chlorite and a nickel sulfamate strike (a), the conductor-resistor-pattern resist and a second resistor-only resist are applied, and the excess copper foil stripped away (b), leaving the resistive film exposed. This film is etched away with ferric sulfate and sulfuric acid (c). A final etch with chromic sulfuric acid removes the foil from the resistor areas (d).

before separation is shown in Fig. 3. The various etching steps can be performed on each of these desk-calculator resistor networks before they are separated. The cost of copper-resistor laminate fabrication is compared with thick-film fabrication in Table 2.

The user can bond semiconductor chips to the laminate board by reflow-soldering or use of an epoxy adhesive. If one plans to wire-bond, then nickel plating, gold plating—or both—or aluminum will ensure secure bonds. Ultrasonic bonding will work successfully on nickel and aluminum surfaces. But either ultrasonic or pulse-heated capillary thermocompression bonding will work if the surface is first gold-plated. Thermocompression-bonding-tip temperatures will range from 150°C to 450°C, depending on the mass of the conductor and the chip.

### Making resistors

The first step in processing the copper-resistor laminate is to treat the board (Fig. 4a) with a solution of sodium chlorite followed by a nickel sulfamate strike, to deposit a thin layer of nickel. This enhances the bond that will be required when the board is ultimately mated with a prepreg board to form a multilayer. It also masks the conductors during the final etch phase, when

the resistance regions are stripped of copper.

A photoresist, or alternately a resist ink, is applied to define the pattern of conductors and resistors. The chlorite treatment is then stripped away with ferric sulfate and sulfuric acid to produce shiny copper outside the conductor pattern.

A second resist is applied to define the resistance areas only. Sufficient overlap must be provided over the first photoresist to guarantee electrical continuity between resistive regions and the adjoining conductors. The copper not masked by resist is then stripped away to leave the resistive-film surface exposed (Fig. 4b). This film is then removed by applying an etchant of ferric sulfate and sulfuric acid (Fig. 4c). All resist is now stripped. Finally, an etchant of chromic sulfuric acid is used to remove the foil from the film resistors (Fig. 4d).

This solution not only etches away the overlying copper, but it also passivates the resistance regions. It does not etch the conducting pattern because the copper is protected by the pretreatment of the sodium-chlorite/nickel-sulfamate solution. As in each of the previous steps, the board is rinsed and dried, then conformally coated to protect the lines of resistors. The processed laminate is then ready for lay-up in a conventional multilayer process. □

# Why we think the Brush 500 is your best choice in an XY recorder.

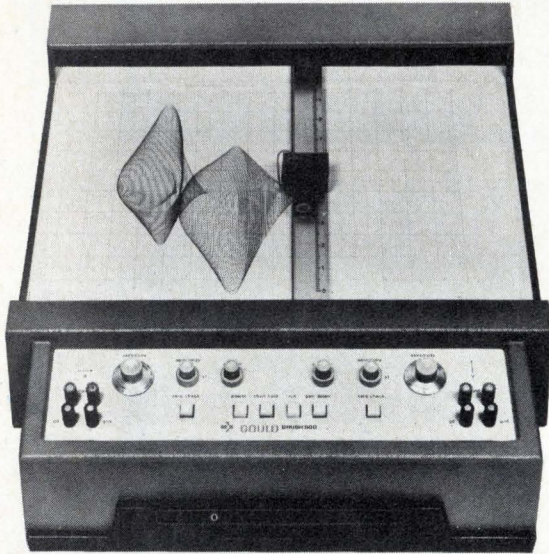

**RELIABILITY.** It's guaranteed by our exclusive Metrisite® non-contact servo-loop feedback system. You get 99.85% linearity. But you don't get noise, slide wire troubles, dirty pots, wear and the maintenance problems of potentiometric feedback systems.

**CRISP TRACES.** We don't believe in smear tactics. But we must say others don't give you traces as crisp as ours. Reason: we have pressurized inking that forces ink into the paper, instead of simply laying it on the surface. Our pen never needs priming, even

after long periods of not being used.

**SPEED.** The 500 does a fast 40 inches a second. Which makes it 50% or 100% faster than most anyone else's. And it

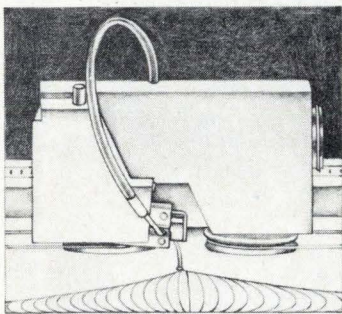

accelerates at 1650 in/sec<sup>2</sup>. It's a mover.

**MORE FEATURES.** Like electrostatic holddown. Easy rack mounting. Electronic limiters that eliminate collisions between pen and frame. And a price we think will please you.

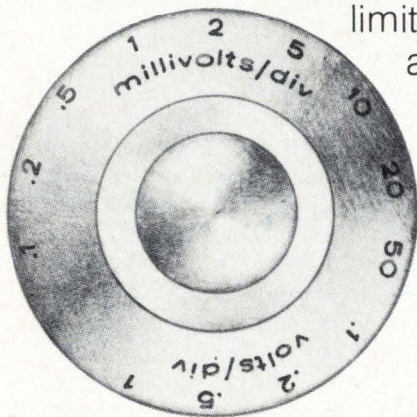
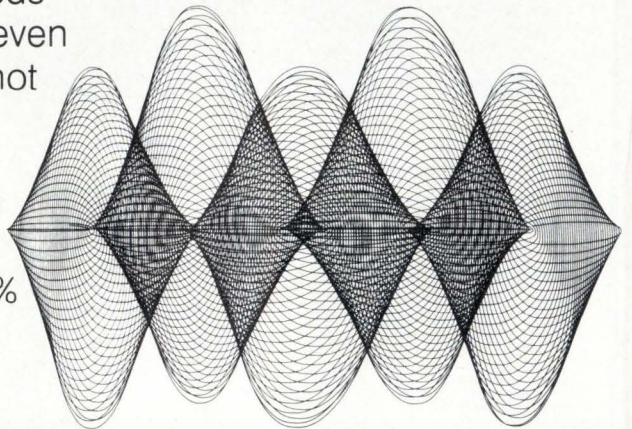

For information on this excellent XY recorder with built-in preamps with a sensitivity range of 100 $\mu$ V/div. to 1.0 V/div., write Gould Inc., Instrument Systems Division, 3631 Perkins Avenue, Cleveland, Ohio 44114. Or Rue Van Boeckel 38, Brussels 1140, Belgium.

BRUSH INSTRUMENTS

 **GOULD**

## Timer ICs and LEDs form cable tester

by L.W. Herring  
Showco Inc., Dallas, Texas

Recent developments in integrated circuits and light-emitting diodes make it possible to build a cable-fault indicator that is both inexpensive and compact. A tester of this sort is a convenient time-saving accessory to have on hand if you must periodically check a number of test and interconnection cables.

The circuit, which can fit into a small box, makes use of the versatile 555-type timer IC and single-package two-color LEDs. It can be designed to test from two-wire to 10-wire cables. It nicely indicates which lines are open, shorted, or OK on a simple readout panel. Since each line is tested and indicated individually, faulty ca-

bles are quickly located and, therefore, easy to repair.

The circuit's clock is constructed with several 555-type timer ICs, operating as a ring timer. As each timer turns on in sequence, a positive pulse is applied to each of the lines under test. For a maximum of four lines, therefore, at least four timer ICs will be needed to satisfy the clock requirements.

The other section of the tester contains the LED indicators. For each line under test, there is a differential transistor pair driving a two-color red/green LED. With the hookup shown, red indicates a short, and green indicates an open. (The newer red/yellow LEDs might be a little less confusing for the display than the red/green LEDs.)

Each differential pair looks for clock pulses at two places—obviously, each end of the cable. If the same pulse is at both ends of the same line, the differential pair remains balanced, and the LED for that line will not glow. But if the clock pulse appears only at the clock end of the line, the differential pair becomes un-

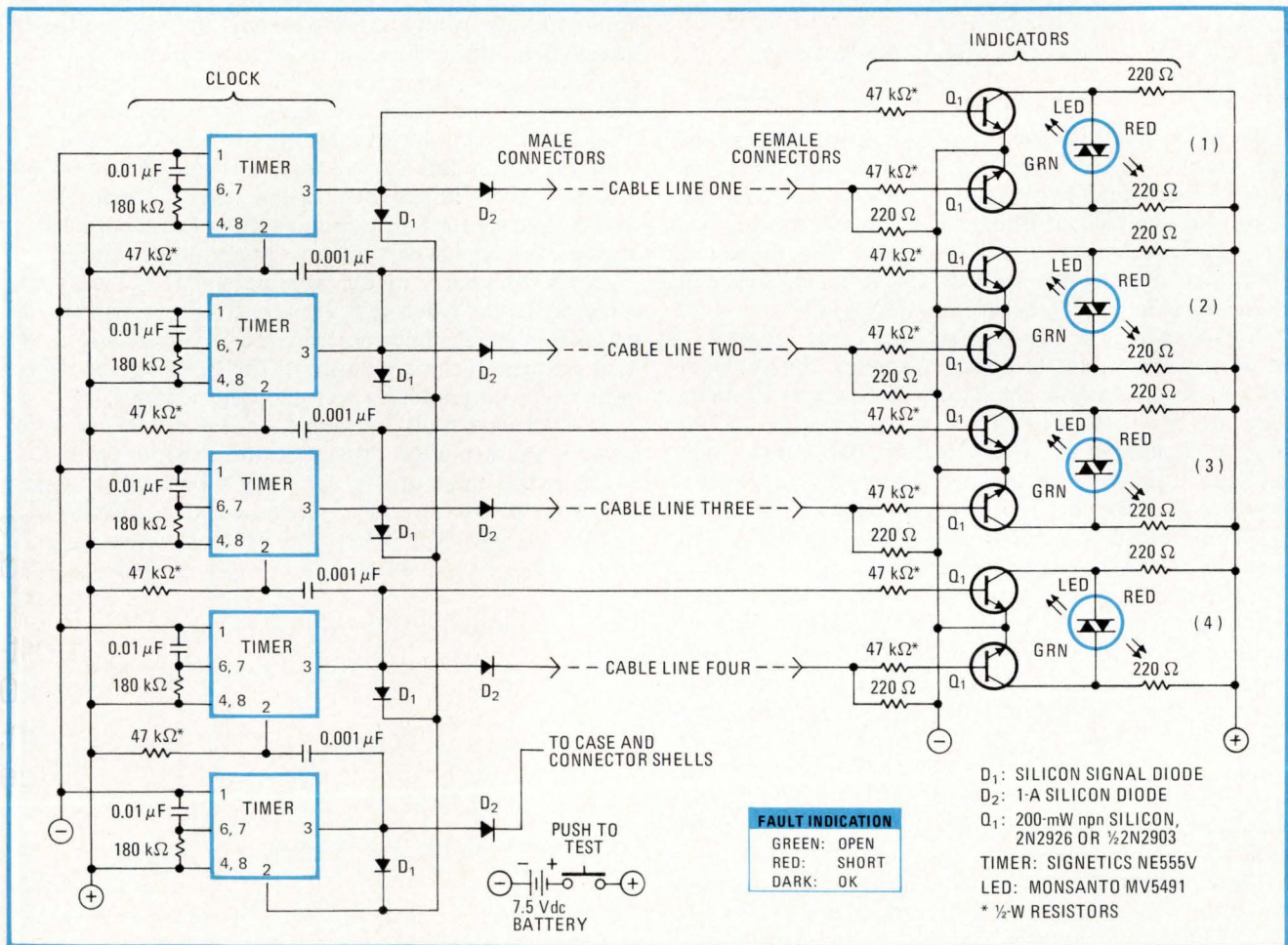

**Finding cable faults.** Compact tester checks cables for open-circuit or short-circuit conditions. A differential transistor pair at one end of each cable line remains balanced as long as the same clock pulse—generated by the timer ICs—appears at both ends of the line. A clock pulse just at the clock end of the line lights a green light-emitting diode, and a clock pulse only at the other end lights a red LED.

low) diode, indicating that the line is open.

Likewise, if a pulse appears only at the indicator end of the line, the differential pair tilts the other way, causing a reverse current and making the red diode light to show a short. When both LEDs remain dark, the cable line is OK.

The connectors on the cable lines introduce another possible fault—a short to the connector shell. This can be checked by adding another position to the clock and applying this additional clock pulse to the case of the tester. (The tester case cannot be tied to the positive supply as a solution, since the duty cycle of the LED is undesirably increased to 100%.) When there are more connector pins than there are lines to be tested in a given cable, the open indication on the unused pins can just be ignored.

The timing component values indicated for the timer

ICs set the clock pulse width at 2 milliseconds, which is fast enough to prevent lamp flicker, but not so fast as to cause capacitive coupling problems on long cables. (Cables as long as 500 feet can be tested.) The input to the differential pairs can be loaded to indicate a fault on high-resistance connections, but a lower value of resistance will then be needed to indicate a short.

The diodes in the clock section prevent a short from resetting the timers. The clock can also be implemented with an oscillator and a ring counter or, alternatively, with flip-flops and a one-of-10 or one-of-16 decoder.

Nickel-cadmium batteries are used to power the tester to avoid the problems of line-operated equipment. Over-all cost can be lowered by building the tester with discrete LEDs in place of the dual LEDs and by using penlight batteries. The tester becomes impractical for cables containing more than 10 wires. □

## Charting capacitor frequency and temperature performance

by John Kropp

Mepco/Electra Inc., a North American Philips Co., Morristown, N.J.

In demanding applications, particularly those involving high frequencies or high temperatures, the specifications of the common capacitor, like capacitance value, cannot be assumed to remain constant. At times, even capacitor lead length must be accounted for, since lead length can significantly shift a capacitor's self-resonant frequency [*Electronics*, Sept. 25, 1972, p. 123].

Capacitance is a function of frequency. Figure 1a shows the equivalent lumped-parameter circuit that is realistic for electrolytic capacitors up to about 20 megahertz, for film capacitors up to about 30 MHz, and for ceramic capacitors up to about 200 MHz. Above these "realistic" frequencies, lumped-parameter representations break down, because the capacitor begins to behave somewhat like a distributed-parameter device—for example, a very short unterminated transmission line.

The distributed configuration, shown in Fig. 1b, is a valid representation when the frequency is high enough—when the longest dimension from the point of lead connection to the edge of the capacitor electrode is about 10% of the wavelength of the operating frequency. This is not as simple a constraint as it seems to be, since the velocity of propagation along a transmission line is inversely proportional to the square root of the dielectric constant of the material separating the capacitor conductors.

Consequently, in capacitors with high dielectric constants, the wavelength at a given frequency may be as much as 100 times shorter than it is in an air capacitor. And the frequency at which the distributed-parameter effect begins may then be 100 times lower than it is for an air capacitor.

The series inductance of the lumped-parameter case, as well as the transmission-line nature of the distributed-parameter case, cause a reduction of the effective capacitance with increasing frequency. For ceramic capacitors, the loss in capacitance is negligible up to about 50 MHz. Above this frequency, the loss gradually increases until the dimensions of the capacitor and the dielectric constant of its ceramic plate introduce the transmission-line effect. The capacitance then begins to drop sharply, approaching zero in the next octave or so.

Figure 2 contains curves that illustrate the variation of capacitance (impedance, in the case of electrolytics) with frequency for four popular types of capacitors. The plots are for typical capacitances and voltage ratings.

As the frequency of the applied signal is increased, some capacitors reach self-resonance before distributed-parameter effects become apparent. Above this resonant frequency, the reactance of the capacitor becomes inductive, with gradually increasing impedance.

Another important consideration is the effect of temperature on insulation resistance and dissipation factor, which is the ratio of the capacitor's equivalent series resistance to its capacitive reactance at a specific frequency and temperature. Insulation resistance is

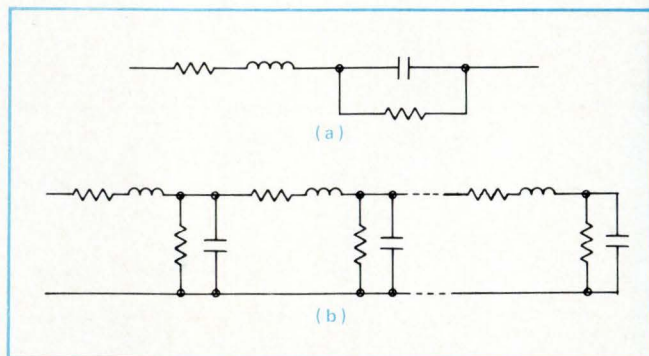

1. **A look inside.** Lumped-parameter equivalent circuit (a) can be used to model the capacitor at very high frequencies. But in the microwave region, a distributed-parameter configuration (b) must be used instead. Capacitance increases with rising frequency.

frequently confused with the equivalent capacitor shunt resistance. The two are only equal at dc. For ac operation, the equivalent shunt resistance is lower to account for dielectric and series losses.

Insulation resistance is the ratio of a specific dc test voltage that is impressed across the capacitor to the current flowing through it at a specified capacitor temperature. The current is measured after the capacitor charges up to the test voltage. A time interval is often specified before the resistance is measured to allow ca-

pacitor stabilization. In film capacitors, this interval is normally 2 minutes. Insulation resistance is usually given in megohms for small capacitors and as a time constant (megohm-microfarads) for large units.

The curves of Fig. 3 show the broad variation of insulation resistance and dissipation factor with temperature for two types of film capacitors. □

Engineer's notebook is a regular feature in Electronics. We invite readers to submit original design shortcuts, calculation aids, measurement and test techniques, and other ideas for saving engineering time or cost. We'll pay \$50 for each item published.

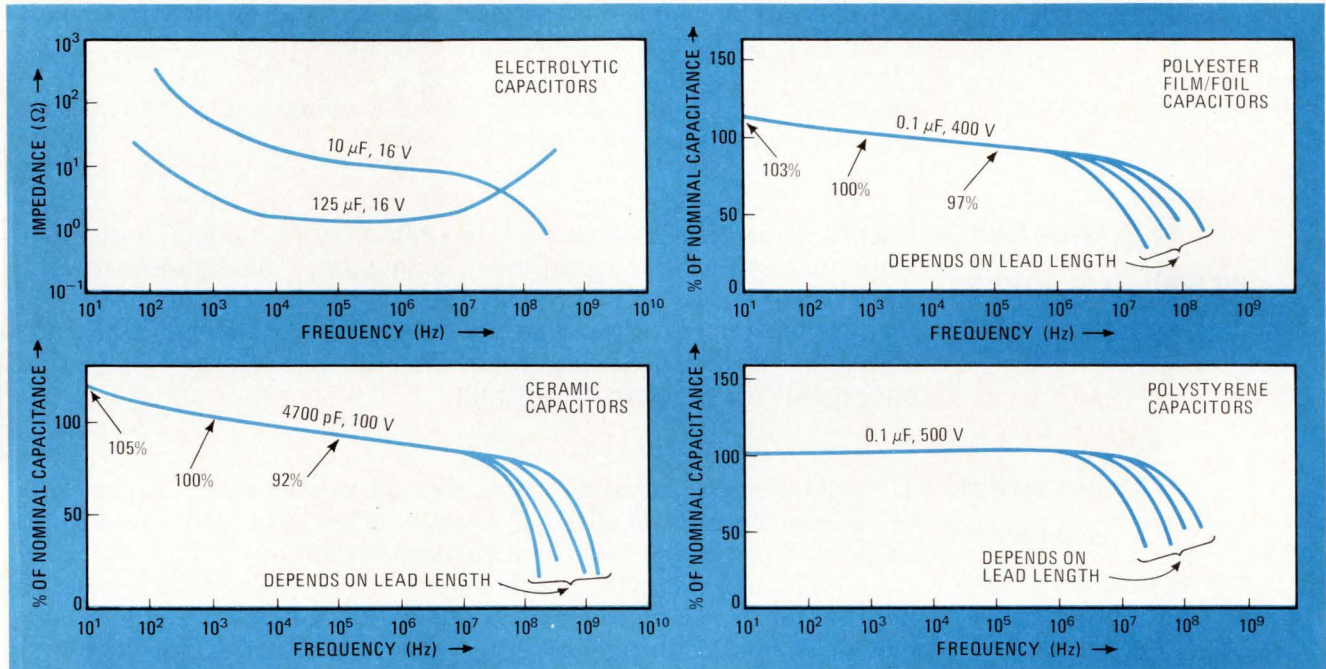

**2. High-frequency behavior.** Curves for four widely used types of capacitors show how effective capacitance changes with frequency.

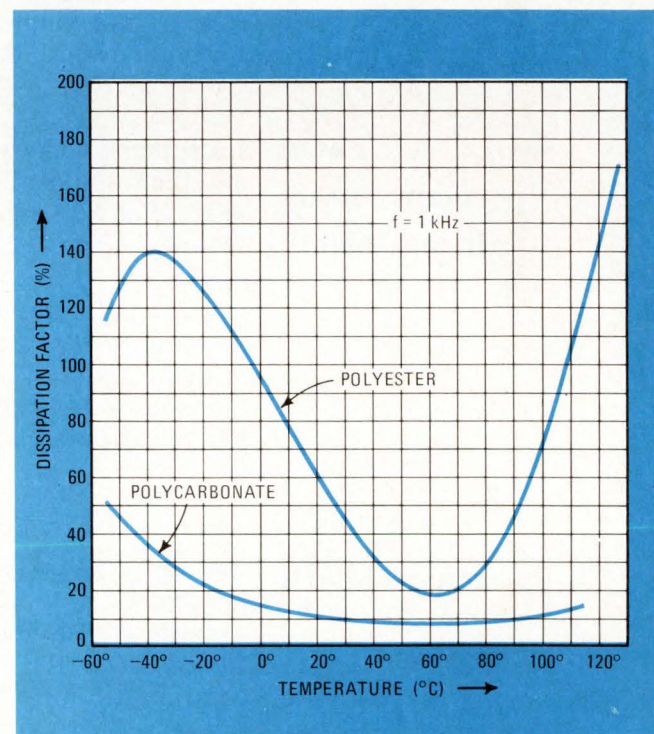
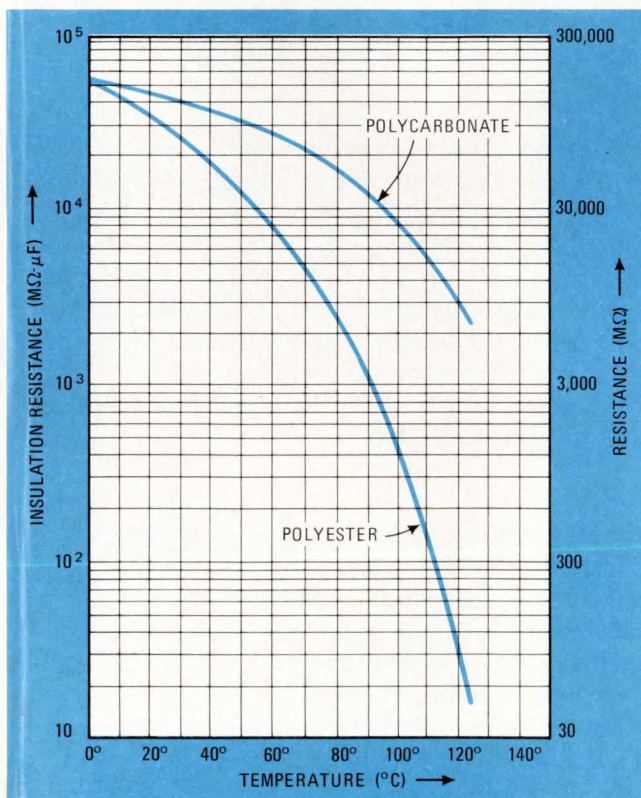

**3. Temperature effects.** Increasing temperature produces wide variations in capacitor insulation resistance and dissipation factor.

## One-chip op amp gets the signal

If you do a lot of conditioning of low-level signals buried in noise, you end up needing a good closed-loop gain block, with differential inputs, high input impedance, good common-mode rejection, and an accurately predictable gain. And that means either buying an expensive modular instrumentation amplifier or wiring up the equivalent from a collection of op amps and resistors. Instead, **you could check out a single-chip differential instrumentation amplifier** from Analog Devices, Norwood, Mass. The AD 520 comes in a TO-116 DIP and costs \$12 in quantity. Specs: input impedance  $2 \times 10^9$  ohms; CMRR, 80 decibels; and gain adjustable from 1 to 1,000.

## A wide band as well as low noise

Microwave-system designers are finding that field-effect transistors, while they meet the required low-noise figures, have bandwidths that are too narrow for many systems. Instead, some engineers are trying the **new bipolar transistors that are built with oxide isolation** (for example, the Isoplanar devices from Fairchild) and that have low noise but provide the necessary bandwidth.

## Why not switch to a switch within a switch?

The high-density techniques of integrated-circuit manufacturers are being emulated by suppliers of panel switches, who can now furnish **single switches that perform multiple operations.**

For example, the shaft of a single unit may contain both rotary and push-button switching functions, so that a designer could build a voltmeter, say, and control its range by rotary action and its on/off power by the push button. Timing circuits governed by multiple-value resistor switches could be reset by the push button and varied in delay by the rotary. On a counter, the rotary could dial the count, and the push button could refresh the display. The possibilities are endless.

## . . . or to many testers in one tester?

Instrument makers are putting **multiple instruments in one package**, and the result can lower the cost of a test facility, as well as save bench space. For example, the Versatester 1 by Datapulse division of Systron Donner, Culver City, Calif., has a single package containing the equivalent of five power supplies (+5 v,  $\pm 15$  v,  $\pm 30$  v), three signal generators (pulse, sine wave, and square wave) from 20 Hz to 20 MHz, and a four-digit multimeter that measures frequency from audio to 20 MHz, dc and ac volts from 0 to 500 v, and dc ohms from 0 to 5 megohms in five ranges. **Not bad for \$1,250, since the equivalent test capability by the piece might cost close to \$2,000.**

## So that's where I read it

Avoid spending half the day poking through a pile of magazines for that lost article. Technical Information Distribution Service, 40 West Ridgewood Ave., Ridgewood, N.J. 07450 (201-444-8889) is putting out **a quarterly containing abstracts of recently published technical articles.** Called Précis, the magazine covers a wide range of subjects: automatic controls, circuits, components, communications, computers and peripherals, instrumentation and measurement, microwave, packaging, reliability, and so on. They'll send you reprints of any article abstracted for a small charge. Get on their list—it's free.



# Raytheon Semiconductor is dominant in beam leads.

## No gimmicks. Just products.

Raytheon Semiconductor's beam lead product line gives designers a choice like they've never had before. More than a hundred standard types in both military and commercial versions.

Now you can appreciate the quality, reliability, high yield and related economy of Raytheon Semiconductor beam leads. And do away with costly, low yield chip-and-wire on your hybrid modules.

We're adding to this list every week.

### Transistors

BT918	NPN UHF Amp
BT929	NPN Low-level Amp
BT930	NPN Low-level Amp
BT2221A	NPN General Purpose Amp
BT2222A	NPN General Purpose Amp
BT2369A	NPN Hi-speed Switch
BT2483	NPN Low-level Amp
BT2484	NPN Low-level Amp
BT2604	PNP Low-level Amp
BT2605	PNP Low-level Amp
BT2906A	PNP General Purpose Amp
BT2907A	PNP General Purpose Amp
BT2946	PNP Chopper
BT3906	PNP Hi-gain Amp
BT4856	N-channel FET*
BT4857	N-channel FET*
BT4858	N-channel FET*
BT5109	NPN UHF Power Amp

\*Available in second half of 1973.

### Diodes

BD914	2 Anode, 2 Cathode Leads
BD2914	1 Anode & Cathode, 2 Open Leads
BD3600	2 Anode, 2 Cathode Leads
BD23600	1 Anode & Cathode, 2 Open Leads
3Z752	5.6V Zener
3Z758	10V Zener

BZ821T	6.2V Temp Comp Zener
BZ969	22V Zener

### Linears

RM101ABL	Op Amp
RM104BL	Negative Voltage Regulator
RM105BL	Positive Voltage Regulator
RM106BL	Voltage Comparator
RM709BL	Hi-gain Op Amp
RM710BL	Hi-speed Differential Voltage Comparator
RM711BL	Dual Differential Voltage Comparator
RM741BL	Op Amp
RM1741BL	Op Amp
RF9601BL	Monostable Multivibrator
RF8601BL	Monostable Multivibrator
RC4131BL	Hi-gain Op Amp
RM4132BL	Micropower Op Amp

### TTL

RF50BL	J-K Flip-flop (AND Inputs)
RF60BL	J-K Flip-flop (NOR Inputs)
RF100BL	Dual J-K Flip-flop (Separate Clocks)
RF110BL	Dual J-K Flip-flop (Common Clock)
RF200BL	J-K Flip-flop (AND Inputs)
RF210BL	J-K Flip-flop (OR Inputs)
RG40BL	Dual 4-input NAND Gate
RG50BL	AND-OR Inverter Quad 2-input Gate
RG80BL	Dual Pulse Shaper AND Gate
RG130BL	Dual 4-input Line Driver
RG140BL	Quad 2-input NAND Gate
RG200BL	Expandable Single 8 NAND Gate
RG220BL	Quad 2-input NAND Gate
RG231BL	Quad 2-input A01 Gate
RG240BL	Dual 4-input NAND Gate
RG250BL	Expandable Quad 2 A01 Gate
RG310BL	Expandable Dual Output 2-input A01 Gate
RG320BL	Triple 3-input NAND Gate
RG380BL	Hex Inverter
RL10BL	Fast Full Adder

RL20BL	Dependent Carry Fast Adder
RL30BL	Independent Carry Fast Adder
RL60BL	4-bit Storage Register
RL70BL	4-bit Storage Register
RG3380BL	Hex Inverter
RG3390BL	Dual 4-input AND Gate (Split Outputs)
RG3410BL	Quad 2-input NOR Gate
RR5102BL	64-bit Bipolar RAM

### Arrays

Universal 60-gate Arrays. Many MSI functions from registers to counters, both custom and standard functions.

Don't compromise your next design. Be dominant with Raytheon Semiconductor beam lead products. Contact your local Raytheon Semiconductor sales office or clip the coupon for more information.



Raytheon Semiconductor  
350 Ellis Street  
Mountain View, CA 94040  
Phone (415) 968-9211

Send me a copy of your Beam Lead brochure.

Send me a mechanical sample.

NAME \_\_\_\_\_

TITLE \_\_\_\_\_

COMPANY \_\_\_\_\_

ADDRESS \_\_\_\_\_

CITY/STATE/ZIP \_\_\_\_\_

E

It's our new RT-02.  
Whereas our RT-01 has  
been a big hit because people  
know they can count on it.

It's numeric.

Our new RT-02 is  
alphanumeric.

32 alphanumeric characters  
on a single-line gas-discharge  
type readout panel to be exact.

It has its own self-contained  
power supply and weighs so

little, it's really portable.

It's ASCII compatible so  
you can interface it, input and  
output, to any computer that's  
got a Teletype port.

And it doesn't cost much  
more, really, than our RT-01  
that's sold so well.

And it's simple as saying  
your A,B,C's to use.

We're the Logic Products  
Group, Digital Equipment

Corporation, Maynard, Massa-  
chusetts 01754/(617) 897-5111  
in the U.S.

81 route de l'Aire, 1211  
Geneva 26/(022) 42 79 50 in  
Europe.

And we'll be happy to show  
it to you, no matter how remote  
you are.

**digital**

## Introducing a remote data entry terminal that you can read as easy as A,B,C. Anywhere you want to read it.



# Gold-free film cuts LSI package cost

Palladium-silver metalization, familiar to hybrid-circuit designers, now offers cost savings of 20% to 50% to monolithic-device makers

by Stephen E. Grossman, Packaging & Production Editor

**Offering** semiconductor makers lower as well as more stable prices than are possible in today's highly volatile gold market, Du Pont will introduce this month a line of gold-free LSI ceramic packages.

Scheduled to bow at the Semiconductor Equipment and Materials Institute Conference in San Mateo, Calif., May 22-24, the packages will be priced 20% to 50% lower than goldmetalized units. Also, they will offer a choice of eutectic or epoxy-die bonding.

Joseph P. McGonnell, product marketing manager for semiconductor packaging products, says that a key to this package development is a palladium-silver thick film developed by Du Pont. McGonnell says that if the user chooses to eutectic-bond the chip using a gold preform, the bonding temperature—approximately 410°C—will melt the preform. But it will merely wet the palladium-silver metalization in the cavity. This wetting ensures that a secure bond is achieved. "Because the metalization on the cavity floor does not melt—silver-palladium melts above 1,000°C—there is no danger of scrubbing through molten metal. Such damage can occur when gold-metalized cavities are employed," he says.

Palladium-silver is no newcomer to microelectronics. McGonnell points out that palladium-silver thick-film pastes have been successful in hybrid fabrication and were natural candidates for replacing gold. What's more, this gold-free alloy has good solderability, and the lead frames can be attached using Du Pont's "lead-frame-last" reflow-soldering technique. Sheet resistivity is low enough to provide low-

resistance paths for satisfactory MOS performance. If the user plans to mount bipolar devices, the company can supply a thick film with an even lower resistance. For users who prefer epoxy-die bonding, Du Pont supplies a package with a palladium-silver finger on the floor of the cavity. This finger provides an electrical path from the chip to the outside world yet leaves plenty of ceramic exposed on the cavity floor for secure adhesion.

A 40-lead package employing an adhesive-sealed lid and epoxy-die attach will sell for 66 cents in lots of 100,000. This includes the lid, the preform, and the leads. The price of fastening the leads is about 2 cents a package, including amortization of the tooling required to perform the "lead-frame-last" attachment. By contrast, a conventional gold-system 40-lead package with lid and preform would cost approximately

\$1.35 company engineers say.

Du Pont's fully metalized cavity and metallurgical seal, which enables the package to meet MIL STD 883 leak tests, adds about 10 cents, bringing the price up to 76 cents.

Wire bonding and die-attach to thick film differs from gold metalization in the bonding time-temperature values and bonding forces needed. But McGonnell estimates that it would take a user probably no more than a day to adapt his techniques to the thick-film packages.

Two major device houses have committed themselves to volume purchase—in the millions of packages, according to Du Pont. Market estimates are that U.S. requirements for ceramic packages in 1973 will total 35-40 million.

Semiconductor Packaging Products, Electronic Materials Division, Du Pont Co., Wilmington, Delaware [338]

**Choice.** Gold-free package can be sealed metallurgically (left) using silver-plated Kovar lid and silver-tin preform, or adhesively with ceramic, plastic, quartz, or metal lid.

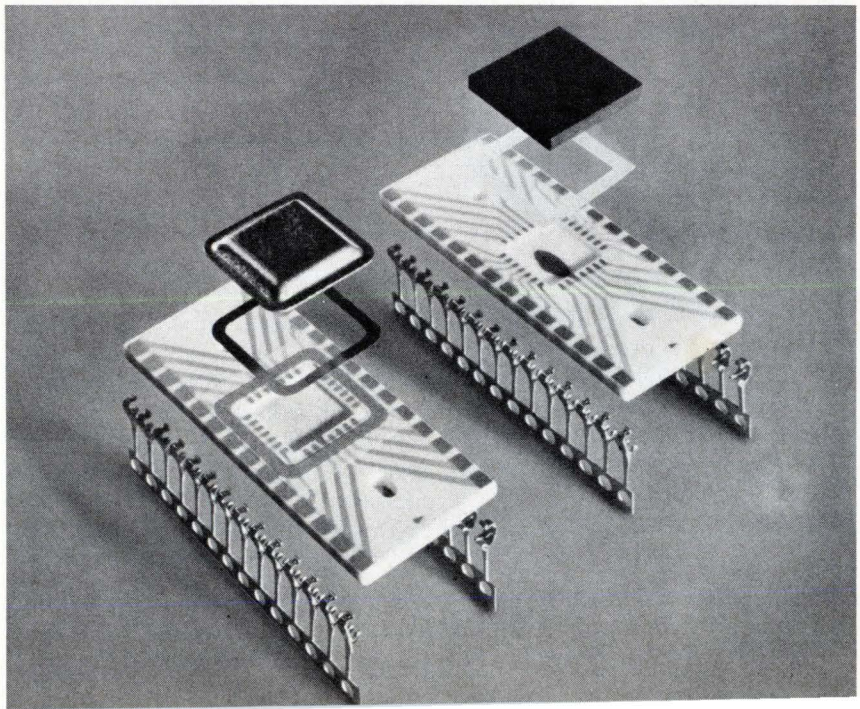

## Components

**Making ready for leadless ICs**

---

Adapter will permit leaded ICs to fit in receptacle that awaits leadless units

---

Up to now, leadless-IC receptacles—which are available—could accommodate only leadless ICs—which are not yet available. But AMP Inc. has now developed an adapter that permits leaded devices to be mounted in the company's leadless-IC package [*Electronics*, Jan. 4, p. 132]. If a leadless device is selected later, it can be inserted merely by removing the adapter.

The adapter was designed for those who are convinced of the potential for leadless ICs but hesitate to commit themselves now. The receptacle accepts leaded or leadless 24-, 28-, or 40-lead circuits.

A leadless device is plugged into the receptacle by being placed between the contact rows and pressed down until it clicks into position. With the device in place, contacts are exposed for use as test points. Although the spring contacts provide adequate retention for the package under most circumstances, a plastic hold-down strap is available for vibration conditions.

The adapter, which enables the receptacle to accept conventional

leaded packages, consists of a glass-filled thermoplastic frame that provides a rigid backing for the leads. Although the photo shows the leaded package being inserted into the adapter first and the package/adapter then "plugged" into the receptacle as a unit, the adapter can be inserted into the receptacle first and the leaded package plugged in subsequently.

The low-profile receptacle accommodates side-metalized leadless ceramic packages up to 2.020 inches long and 0.528 in. wide. The receptacle is only slightly larger than the package itself.

The high normal contact forces, averaging 120 grams and provided by the preloaded leaf-type stainless-steel contacts, are in part responsible for the low (5-9 milliohms) contact resistance. Contact surfaces are protected by selectively plated gold or by a tin-lead plating. Leads are 0.100 in. apart, with 0.600 in. between rows.

AMP Inc., Harrisburg, Pa., 17105 [341]

---

**Rf relays have rigid coaxial cables**

A series of radio-frequency relays is constructed with rigid coaxial cables for direct insertion on a printed-circuit board. The rigid cable saves space on the pc board and reduces assembly time. In addition, costs are decreased since no connectors are required. The full- and half-size crystal-can types can switch signals from rf to 500 megahertz and have a pickup power of 250 milliwatts.

Datron Systems Inc., Electronic Specialty Div., 18900 NE Sandy Blvd., Portland, Ore. [347]

---

**Rotary switch measures 3 inches in diameter**

A plug-in rotary switch is designed for high packing-density on printed-circuit boards. Units in the JMP 36 series of sub-micro-miniature devices measure 3 inches in diameter and are dimensionally compatible with



discrete components normally used on pc boards. The switch pin terminals are set to fit a TO-100 grid pattern. The unit has a 36° angle of throw, 10 positions, and one or two poles, in addition to bridging functions. Voltage breakdown is 500 v ac minimum between mutually insulated parts, and electrical rating is 2 A continuous.

Janco Corp., 2111 Winona Ave., Burbank, Calif. 91504 [343]

---

**Ceramic-disk trimmer capacitor is leadless**

A leadless ceramic-disk trimmer capacitor for thick-film-hybrid and printed-circuit mounting has a range of from 5 to 35 pF and a working voltage of 100 v dc to 85°C and 50 v dc to 125°C. The projecting ears on the stator are metallized to provide terminal points. Diameter of the vertical-tuning unit

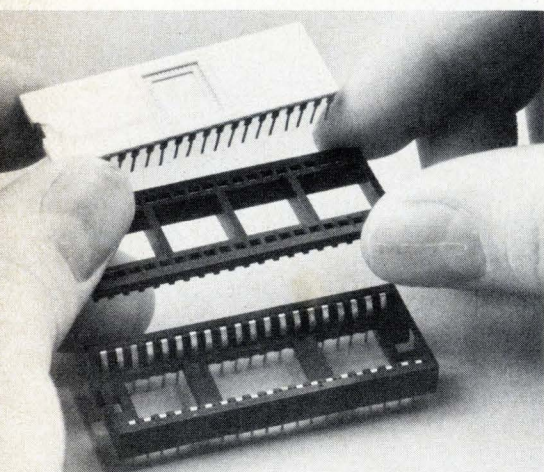
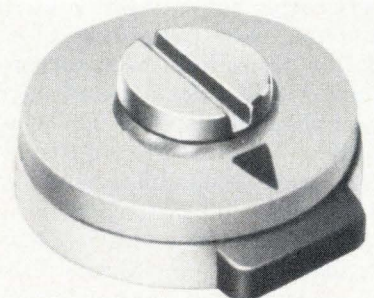

# a great new way to "pick" CHERRYS

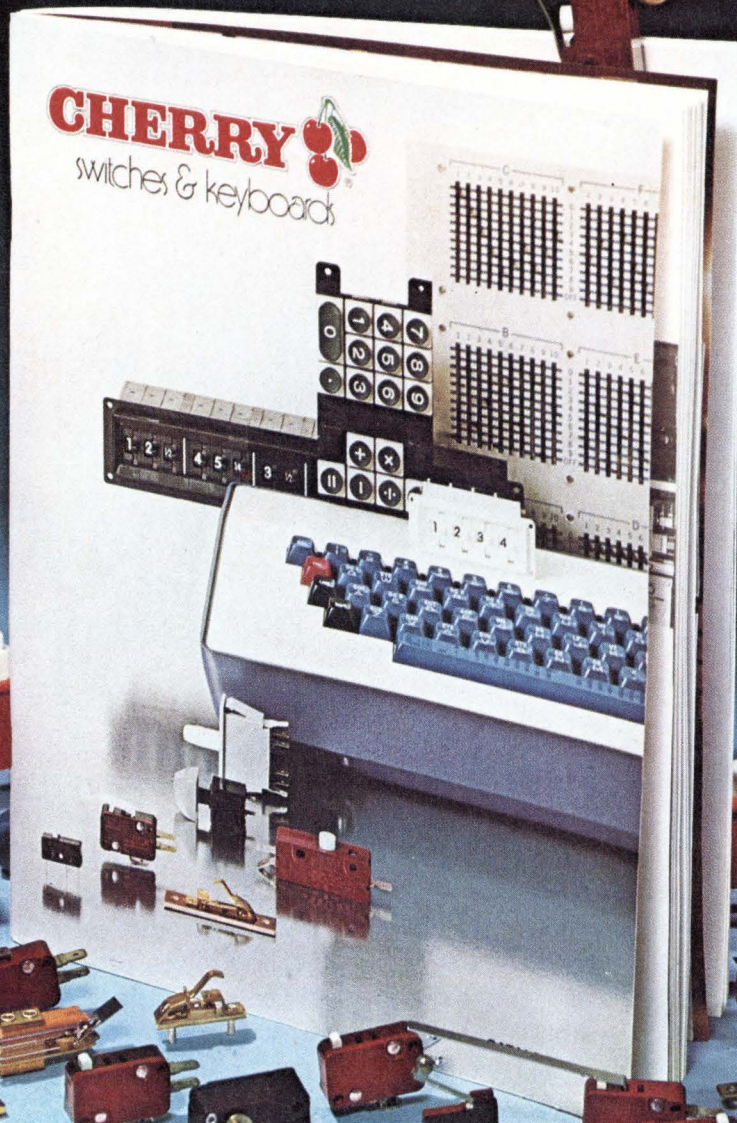

**this new 72-page  
Cherry Products Handbook is actually  
five catalogs in one.**

Packed in a unique new "tell-all" format is everything you could possibly want to know about Cherry's: 1. Unique Snap Switch Selector-Locator that lets you choose—in seconds!—the right switch for any application. 2. Thumbwheel and Leverwheel Switches in nine basic series available in hundreds of variations and specials. 3. Keyboards . . . Keyboard Switches . . . and unique new Matrix Keyboards. 4. Matrix Selector Switches for rapid circuit selection and programming. 5. Gold "Crosspoint" Contact Switches for low energy circuits.

. . . and it's yours for the asking: Just TWX 910-235-1572 . . .

. . . or PHONE 312-689-7702 and ask for Frank

# CHERRY



CHERRY ELECTRICAL PRODUCTS CORP.  
3600 Sunset Ave., Waukegan, Ill. 60085



Cherry affiliates worldwide • Hirose Cherry Precision Co., Ltd., Tokyo • G. W. Engineering Pty. Ltd., Sydney  
Cherry Electrical Products (U.K.) Ltd., St. Albans, Herts • Cherry Mikroschalter GmbH, Bayreuth, Germany

Circle 123 on reader service card

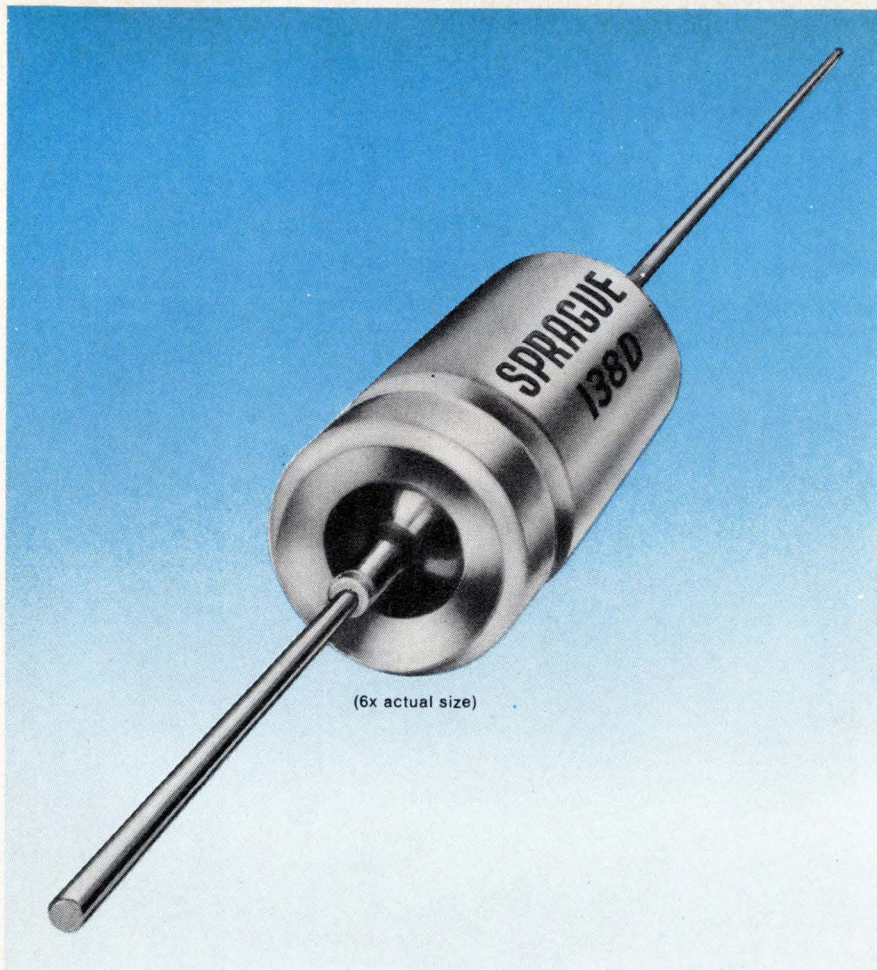

(6x actual size)

## seal of improval

Improved reliability through the use of a glass-to-tantalum true hermetic anode seal is the prime feature of new Type 138D gelled-electrolyte sintered-anode Tantalex® Capacitors. This new construction eliminates all internal lead welds while retaining the strength of conventional internal lead-welded parts. In addition, the new construction offers outstanding resistance to extensive temperature cycling.

Type 138D Tantalox Capacitors are designed to meet or exceed

the environmental and life test requirements of MIL-C-39006. The gelled-electrolyte employed in these new capacitors gives premium performance for all capacitor parameters with respect to frequency and temperature variations.

Originally developed for use in aerospace applications, this capacitor design is now available for general industrial and aviation use where the utmost in component performance and reliability are primary necessities.

For complete technical data, write for Engineering Bulletin 3704A to: Technical Literature Service, Sprague Electric Co., 35 Marshall St., North Adams, Mass. 01247.

THE BROAD-LINE PRODUCER OF ELECTRONIC PARTS



### New products

is 0.212 inch, except for the terminal portion, which is 0.232 in.

E.F. Johnson Co., Waseca, Minn. 56093 [345]

Miniature relay provides operating speed to 500 Hz

Operating with as little as 40 mw of power, a precision miniature relay takes up less than 1/16 of a cubic inch. The single-pole, double-throw unit has a switching capacity of up to 1 A at 200 v dc, a life of more than a billion operations, and operating speed up to 500 Hz. The unit is

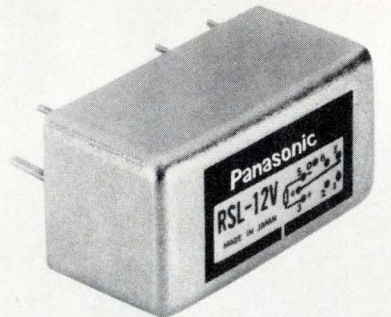

available with a bistable latch, providing a memory function that makes it possible to keep a circuit closed after all power has been eliminated. It will maintain this position until power has been reapplied.

Matsushita Electric Corp. of America, 200 Park Ave., New York, N.Y. 10017 [346]

Plug-in switch is aimed at low-energy circuits

A miniature single-pole, single-throw, normally open snap-action switch has gold crosspoint contacts for low contact resistance in low-

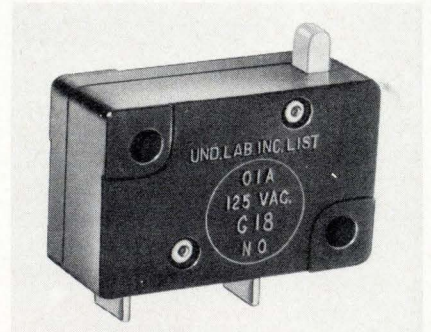



## Modularity lets you pick and choose for "custom" DIP assemblies off-the-shelf.

You get flexibility, lots of it, so you can start small and think bigger as you go. Choose 14, 16, 28 and 36-pin sockets, socket boards and I/O cards from the largest selection available anywhere. Allow for hybrids and discretes when and where you need them. Choose frames in multiples to fit your particular design, for up to 1440 IC's in a plane. Choose dedicated or undedicated power routing. Get low impedance power distribution and noise-free decoupling, and eliminate

much of the post-wiring debugging of MSI based systems. Then choose connectors, plugs, clips, drawers, frame assemblies and power supplies. All from the same place.

Voila! EECO modularity and flexibility are yours for fast changes in breadboards, prototypes, and production models.

Convenience, reliability and economy are yours in a wide spectrum of packaging hardware, plus computer aided design and manufacture. From punch cards, pin list, or

logic diagram we'll furnish complete wired hardware and documentation. Single source responsibility from the house with 25 years of logic experience. For fast answers up-front, call Electronic Packaging Products (714) 835-6000. ELECTRONIC ENGINEERING COMPANY of California, 1441 E. Chestnut Ave., Santa Ana, Calif. 92701.



Would the engineer who asked us to design a marking system to imprint electronic anti-hazard golf balls please call (603) 352-1130.

It's ready.

If for some strange reason you're not making electronic golf balls, how about your semiconductors, switches, bulbs, circuit breakers, motors, generators, connectors, circuit boards or whatever? Markem can handle those, too. We've got the marking systems, printing elements, foils, inks, supplies and services to mark whatever you make, and mark it right. Plus do-it-yourself pressure-sensitive labelmakers.

If you want a better way to solve your marking problems, write to us now. Markem Corp., 305 Congress St., Keene, N.H. 03431. We'd like to help you avoid a few hazards.

**MARKEM®**

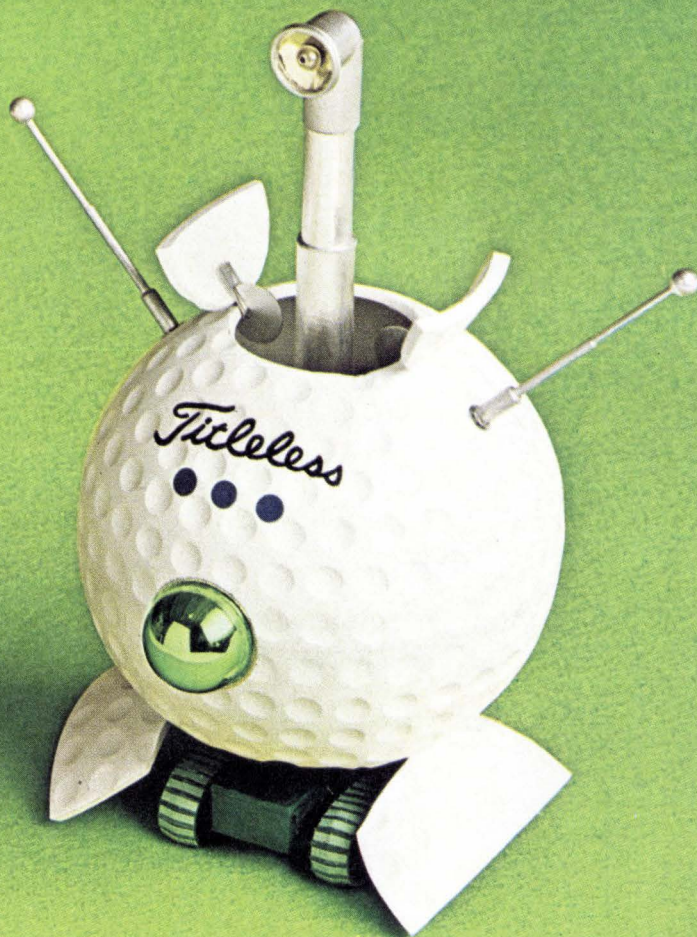

**Sales Offices:**

Chicago

New York

Boston

Los Angeles

Charlotte

Dallas

Cleveland

Kitchener, Ontario

Dorval, Quebec

Rugby, England

Schipol Oost, Holland

Circle 126 on reader service card



## New products

energy solid-state circuits. The contacts are shaped in the form of prisms at right angles to each other, in order to increase contact pressure and decrease susceptibility to contact-closure interference. Price is \$1.41; in 2,000 lots, the price drops to 64.9 cents.

Cherry Electrical Products Corp., Box 718, Waukegan, Ill. 60085 [348]

## Hexadecimal switch houses four Form C units

A hexadecimal switch, a 16-pin DIP type unit, houses four cam-operated Form C switches. The cam is binary-encoded and can be rotated to the desired setting in either direc-

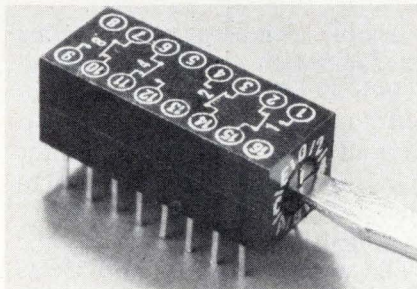

tion. A slot in the end of the switch housing provides screwdriver access to rotate the cam. Settings are indicated by a pointer and associated legend, while the contacts provide positive detent action to eliminate off-center stopping. A minimum of 2-oz-in. torque is required to release the detent.

AMP Inc., Harrisburg, Pa. 17105 [344]

## Miniature rotary switch incorporates push button

A miniature rotary switch, combined in a package with a push button, provides shorting and nonshorting on any single deck. The series T is a 12-position version, and the series E is a 24-position type, with up to six poles and 12 poles per deck available, respectively. There are provisions for up to 20 decks, and the switches can be ordered with concentric-shaft, spring-return features. Body diameter of the switches

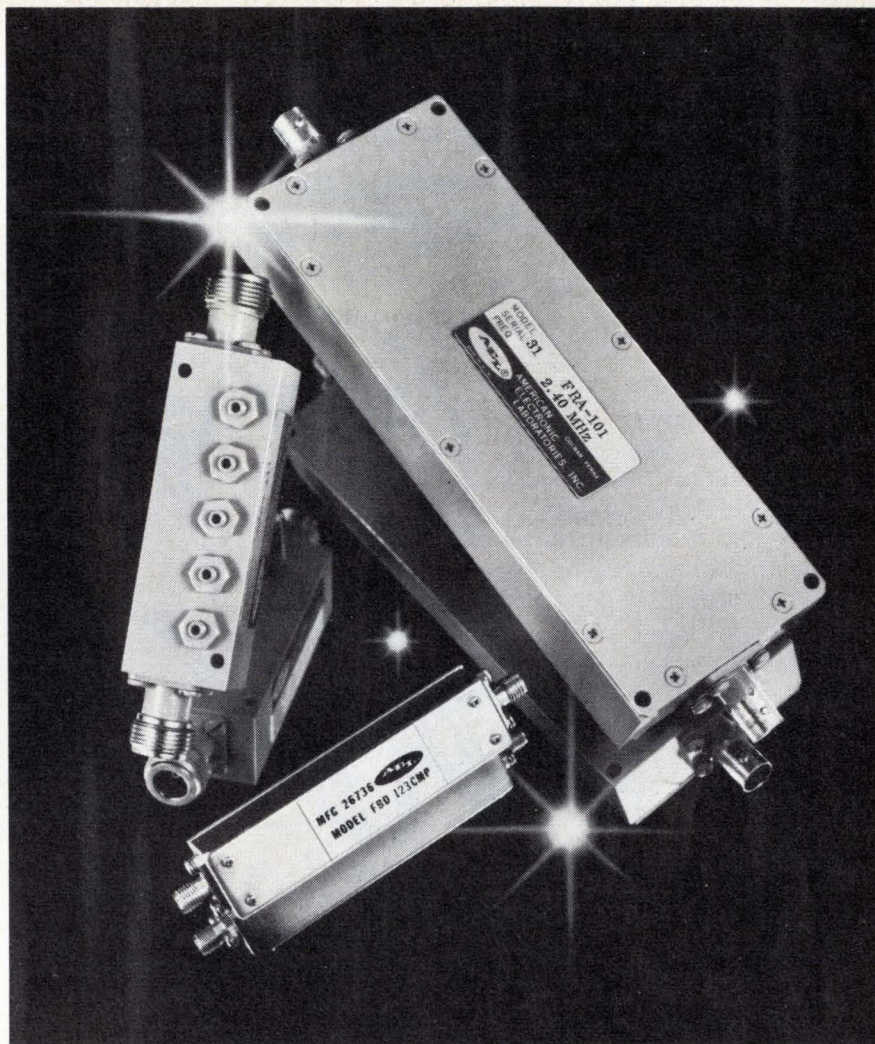

For most  
filter needs—  
AEL provides  
off-the-shelf,  
quick delivery.



For customized filter needs—AEL's computer banks have the answers. This, combined with AEL's ENGINEERING EXCELLENCE, provides filters such as:

**Lumped-Constant Filters • Tubular Filters • Combine Filters • Inter-digital Filters • Low Pass Filters • High Pass Filters • Bandpass Filters • Band-reject Filters**

*Call or write today for more information about our filter line. Our product, as well as our ideas, are off-the-shelf.*



WASHINGTON DIVISION

**A MERICAN E LECTRONIC L ABORATORIES, INC.**

6629 Iron Place, Springfield, Va. 22151 • (703) 354-5700, ext. 275

# The handy 417 recorder goes where the going's rough.

## Shakey Skyways.

The shake, rattle and roll of copters are sweet music to the 417. If vibration's a problem, either in the air or on the ground, the 417 is what you need.

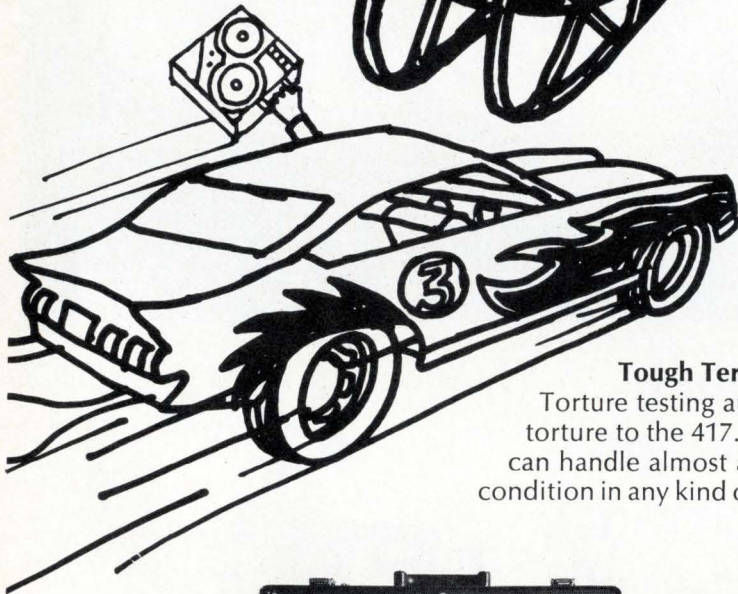
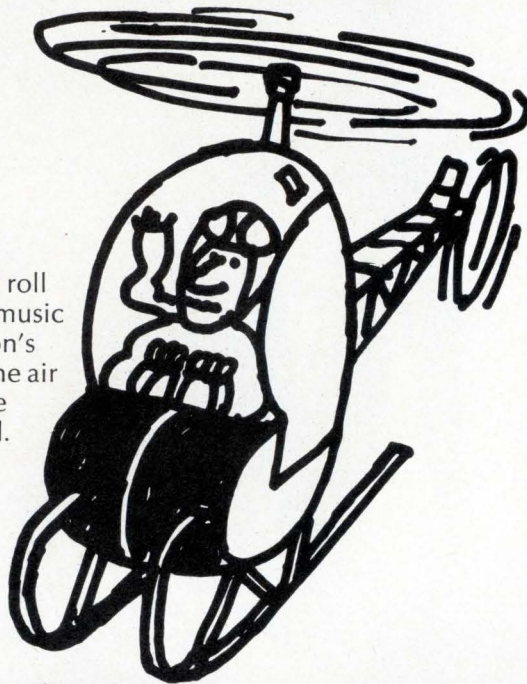

## Tough Terrain.

Torture testing autos is no torture to the 417. In fact, it can handle almost any field condition in any kind of vehicle.

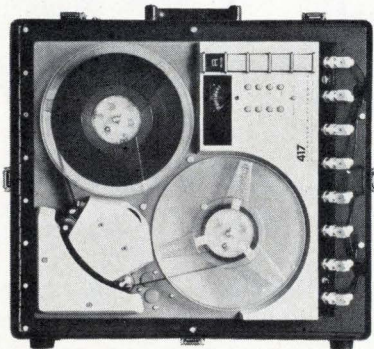

The 417 fits under an airplane seat. Weighs 28 pounds. Wide or intermediate band, it operates in any position. As accurately as large rack machines. Prices as low as \$7000. Earl Nadeau's the man. Dept. 413-402, Lockheed Electronics, Plainfield, N.J. 07061. Or call him collect at (201) 757-1600.

Our European representatives: Aveley Electric, Essex; PTK, Cologne; Technitron, Rome; BDL, Paris; LAIAG, Geneva.

## LOCKHEED ELECTRONICS

A Subsidiary of Lockheed Aircraft Corporation

## New products

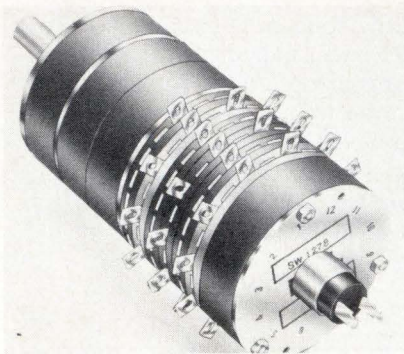

measures 1 $\frac{3}{8}$  in. Delivery of the switches is from stock.

RCL Electronics Inc., 700 S. 21st St., Irvington, N.J. 07111 [349]

Switch can be backlighted or used to project display

A flexible membrane switch called the Cue-Switch can be backlighted to indicate status, or display projected messages. Its low cost and versatility make it a contender for applications from consumer calculators (without lighting) to military equipment.

The switch consists of two sheets of flexible polyester plastic, each with a conductor laminated to it. The conductors are at right angles and separated by a thin perforated spacer, so when one sheet is pressed, the two conductors touch. The whole assembly is 50 mils thick ( $\frac{1}{2}$  in. with mounting bracket) with 5 mils travel and can be assembled in linear or square matrices to form keyboards for all types of applications.

The switch is made from clear plastic, permitting backlighting, with light bulbs or rear-projection displays. Numerals or complex messages or symbols can be shown, and any color can be used.

The unlighted switch in a small matrix for keyboards sells for 15 to 50 cents in quantity. Illuminated, it's about \$1 per position. The projection displays are more expensive. Applications include elevator controls, computer terminals, appliances, and industrial and military equipment.

Industrial Electronic Engineers Inc., 7720 Lemona Ave., Van Nuys, Calif. 91405 [350]

# Mil spec synchro/digital converters:

## We've got 'em in cards. Or cased. For off-the-shelf delivery.

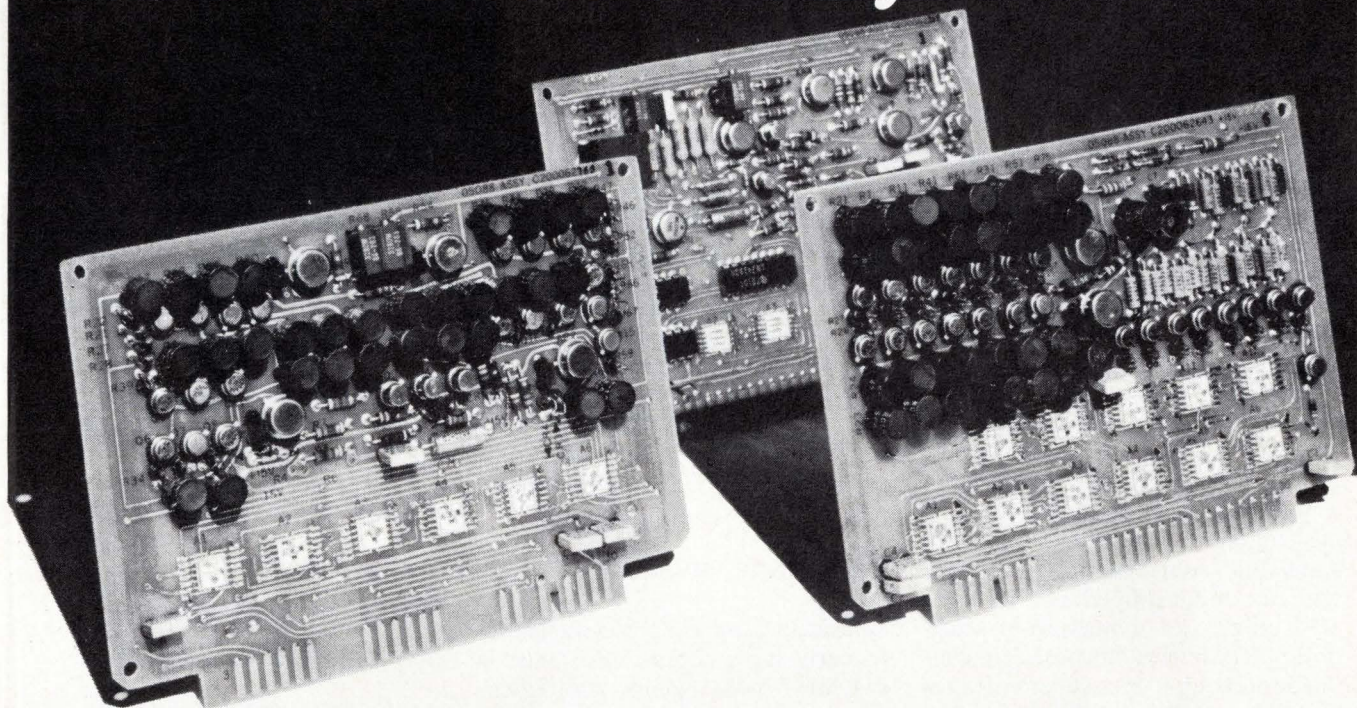

Kearfott can solve your synchro-to-digital and digital-to-synchro conversion problems with three production model solid state converters. All three meet MIL-E-5400.\*

TRIGAC I—A low cost synchro to digital converter, accurate to 12 minutes.

TRIGAC III—Synchro to digital tracking converter dynamically similar to an electro mechanical follow-up servo.

TRIGAC IV—Digital to synchro converter, accurate to four minutes.

### Typical Characteristics

		TRIGAC I		TRIGAC III	TRIGAC IV
Model Number	C70 4773 017	C70 4773 011	C70 4773 019	C70 4773 022	C70 4773 020
Package	2 P C cards	metal enclosure	2 P C cards	3 P C cards	3 P C cards
Input Signal	4 wire resolver	3 wire synchro	4 wire resolver 4 channels	4 wire resolver	12 bit parallel
Output	13 bit BCD			14 bit natural parallel	3 wire 11.8V 400Hz
Resolution	6 minutes of arc				
Accuracy	12 minutes of arc			4 minutes of arc	
Logic Levels	Logic "1" = $\pm 5V \pm 10\%$ , Logic "0" = 0-0.5V				

\*Commercial version available

We can supply any of the cards shown in corrosion-resistant metal enclosures. Write today for new catalog. The Singer Company, Kearfott Division, 1150 McBride Avenue, Little Falls, New Jersey 07424.

# SINGER

AEROSPACE & MARINE SYSTEMS

## Instruments

**Electrometer goes digital**

---

High-performance multimeter goes up to  $2 \times 10^{14}$  ohms, down to  $10^{-16}$  A; costs \$995

---

To many engineers an electrometer is an exotic and rarely used research tool that they turn to when a voltmeter with a super-high input impedance is needed, or when an infinitesimal current must be measured. Often regarded as delicate and unreliable instruments, electrometers are usually used only when nothing else will do.

Modern instruments are changing these notions, and Keithley's latest—the model 616 digital electrometer—represents a major step in this direction. Essentially, the instrument is an easy-to-use autoranging multimeter with the specifications of an electrometer. Its heart is an all-solid-state autoranging voltmeter with an input impedance of  $2 \times 10^{14}$  ohms and a maximum sensitivity of 10 microvolts per digit. This voltmeter can measure voltages from 10  $\mu$ V (10-mV full scale) to 200 V with a maximum error of  $\pm(0.2\%$  of reading + 0.1% of full scale) over the range from 20° to 30°C.

In addition to measuring voltage, the 616 can measure current, resistance, and charge, and it can be used as a precision constant-current source. When used as an ammeter, the instrument can resolve currents as small as  $10^{-16}$  A ( $10^{-13}$  A full scale) or it can measure currents as large as 200 mA. Ranging is semi-automatic in the current-measuring mode: the range switch can be set to any of 11 decade ranges, and the meter will autorange over five decades. Five different switch settings, corresponding to five different combinations of resistance and voltmeter sensitivity, allow the user to opt for a high-resistance (low-noise) measurement or a low-resistance (high-speed) measurement.

When used as an ohmmeter, the 616 puts out a constant current (equal to the reciprocal of the range switch setting) and measures the voltage drop across the unknown. Resistances from 1 ohm per digit (1,000 ohms full scale) to  $2 \times 10^{14}$  ohms can be handled. The ohms range also allows the instrument to be used as an excellent constant-current source. Eight currents in decade steps from  $10^{-5}$  to  $10^{-12}$  A are available with up to 200 V of compliance.

In its coulombmeter (current-integrating) mode, the electrometer spans the range from  $10^{-15}$  coulombs per digit ( $10^{-12}$  coulombs full scale) to  $2 \times 10^{-5}$  coulombs.

The 616 can be operated with its input floating up to 1,000 V above chassis ground. Common-mode rejection ratio is greater than 140 dB, and power consumption is 9 W at line voltage. Price is \$995.

Keithley Instruments, Inc., 28775 Aurora Rd., Cleveland, Ohio 44139 [351]

---

**Fault locator recognizes early-stage variations**

A fault locator recognizes variations in early-stage contact resistance in switches, solder joints, printed-circuit boards, connectors, other electronic components, and telecommunications equipment. Called the K2007, the device operates over 3 kHz to 10 MHz. If an ac voltage

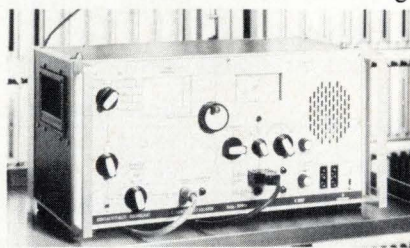

with a constant amplitude is applied to the input of the object under test, contacts sensitive to vibrations cause a variation of the output voltage at the rate of the change in resistance. The voice-frequency signal resulting from the rectification and amplification of this a-m voltage is heard as a crackling sound in a loudspeaker. The K2007 has an adjustable gener-

ator and a detector. Price is in the \$2,000 range.

Siemens Corp., 186 Wood Ave. South, Iselin, N.J. 08830 [353]

---

**Multimeter offers 0.001% error for 24 hours**

The model 5900 multimeter is a five-digit instrument with a total error of  $\pm 0.001\%$  of full scale for 24 hours on the 10-volt range and  $\pm 0.001\%$  of reading +  $0.001\%$  of full scale for 90 days over a 10°C temperature range. Input impedance is high so that it causes less than 0.001% loading error from up to a 100-kilohm source. With an ac converter, the unit will measure over a frequency range from 20 Hz to 1 MHz. The 5900 will maintain an accuracy over a range of 300 Hz to 20 kHz of ( $\pm 0.03\%$  of reading +  $0.002\%$  of full scale) for 90 days with a temperature variation of  $\pm 5^\circ$ C. Price is \$1,795.

Dana Laboratories, 2401 Campus Drive, Irvine, Calif. 92664 [354]

---

**Contact-chatter test set provides 0.1- $\mu$ s resolution**

With its 0.1- $\mu$ s measurement resolution of contact-chatter duration over a preselected period moving continuously with time, the model 4201 test set permits uninterrupted observation unless maximum allowable duration of chatter is exceeded. The preselected period can be from 100 microseconds to 1 millisecond in increments of 100  $\mu$ s. The maximum total duration of chatter during this period can be selected from 0 to 99.9  $\mu$ s. Price is \$2,685.

Atec Inc., Houston, Texas 77024 [355]

---

**Full-wave rectifier operates from dc to 1 kHz**

A precision full-wave rectifier, designated the model 85, has a digital input-offset control that helps the user to display the absolute

# The wraps are off—and the new Macrodata MD-500 general-purpose LSI test system is now a reality!

We designed it, we produced it, we field-tested it — and now it's ready for you. It's the world's finest and most versatile, general-purpose, LSI test system. We call it the MD-500. With both hardware and software modularized for your selection — at last you can have a system that's built the way *you* want it. Now you can put together in one general-purpose system the functions you need for your applications.

The MD-500 tests both MOS and bipolar devices up to 64 channels at data rates as high as 10 MHz, and DC parametric tests are conducted independently or simultaneously with high speed functional tests at the user's option. It tests random logics, RAM's, ROM's, and shift registers — both synchronous and asynchronous devices, as well. And instead of a single pattern storage medium, it offers the user a choice of one or more of the following: a serial data simulator; a bipolar RAM buffer; and Macrodata's exclusive MD-104 microprogrammable multiprocessor for algorithmic pattern generation. All this provides you a testing capability well beyond that of other existing systems with limited hard-wire pattern generators.

Also, in the tradition of being first with such innovations as random bit masking, channel masking, I/O-in a single clock period, error delay counting, and galloping 1's and 0's, etc., Macrodata now adds such other exclusive new features in its MD-500 as — Initial Vector Compare, Random Vector Compare, and Deterministic Vector Compare. But that's not all. Instead of just a major and minor loop, the MD-500 offers up to 256 loops, nested in any fashion. And the MD-500 software system offers multi-station operation — up to two parallel stations and up to four active stations, plus a test compiler station. Programs may be compiled on line while other stations are testing, without test interruption. The test pattern data base and programs are independent of each other . . . you can program off the front panel . . . and, in addition, you can even talk to a single bit.

Why wait for the me-too-ers to say — “Oh yes, we have that too”? Macrodata — the company the others are following — has it all now in the MD-500. Send for your free copy of the MD-500 brochure.



## Macrodata



**Macrodata Corporation, 6203 Variel Avenue, Woodland Hills, California 91364, Phone: (213) 887-5550, Telex: 65-1345**

**Sales Offices:** Northern California Area Tel. (408) 247-6633 • West/Central Area — Denver Tel. (303) 934-5505 • Scottsdale Tel. (602) 947-7841 • Albuquerque Tel. (505) 299-7658 • Dallas Tel. (214) 231-2573 • Houston Tel. (713) 621-0040 • New York Area Tel. (914) 962-7797 • New England Area Tel. (617) 273-2450 • Southeast Area Tel. (205) 883-0140 • International: West Germany — Munich Tel. (0811) 34 56 00 Telex: (841) 521-5969 • Milan, Italy Tel. 871-988/899-248 Telex: (843) 34314 • Sweden and Norway — Stockholm Tel. (08) 87 03 45 • Switzerland and Austria — Bern Tel. (031) 22 44 81 Telex: (845) 33172 • Tel Aviv, Israel Tel. 25 55 69 • Tokyo, Japan Tel. (03) 985-5266 Telex: (781) 272-2171 • Buckinghamshire, England Tel. 36381 Telex: (851) 837236

Circle 131 on reader service card

# Dialight sees a need:

(Need: Single source supply for all indicator lights.)

## See Dialight.

Dialight has so many kinds of indicator lights—approximately 1,500,000 on our shelves—that we have set up a special magic eye seek-out system to help you find the one you need in a wink. Whether it's a flasher, placard, press to test, oil tight, water tight, dust tight, dimmer, or nondimmer, we have them all, some with incandescent, neon or LED lamps, from 1.35 to 220 volts. Sizes vary from small indicators (mount in 0.120" clearance holes) to large indicators (mount in 1 $\frac{3}{16}$ " clearance



holes), and are available in a variety of terminations and finishes, lens-cap shapes and colors with or without hot-stamped, engraved or film legends. We've developed a 14-digit code number that tells any of our 120 stocking distributors in the U.S. and Canada just what indicator you want for off-the-shelf prompt delivery. If you would like to see for yourself how our code works, just write for your free copy. At Dialight it's a designer's choice because we see your need.



Dialight is a company that looks for needs . . . and develops solutions. That's how we developed the industry's broadest line of indicator lights, readouts, and LED light sources. No other company offers you one-stop shopping in visual displays. And no one has more experience in the visual display field. Dialight can help you do more with indicator lights than anyone else because we have done more with them. Talk to the specialists at Dialight first. You won't have to talk to anyone else.

And also be sure to send for your free copy of our latest 56-page Indicator Light Selector Guide. It will show you how easy it is to quickly find your way to the indicator light you need. This handy guide describes in detail the many indicator light choices — shapes and colors of their lens caps, available terminations, mounting data, available finishes, and LED, incandescent and neon light sources for which they are compatible.

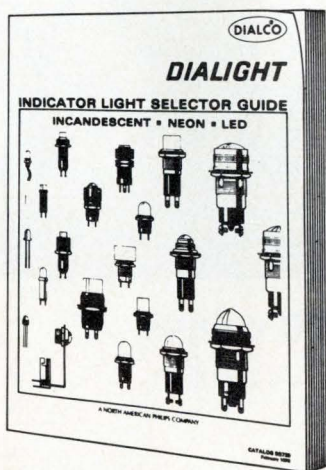

Please send me INDICATOR LIGHT SELECTOR GUIDE.

NAME \_\_\_\_\_  
 TITLE \_\_\_\_\_  
 COMPANY \_\_\_\_\_  
 ADDRESS \_\_\_\_\_  
 CITY \_\_\_\_\_ STATE \_\_\_\_\_

**DIALIGHT**

Dialight Corporation, A North American Philips Company  
 60 Stewart Avenue, Brooklyn, N.Y. 11237 (212) 497-7600

## New products



magnitude of small-signal variations around a dc voltage level. The unit permits inexpensive voltmeters and panelmeters to display the average rectified value of frequency components from dc to 1 kHz. Price is \$285.

Fogg System Co. Inc., Box 22226, Denver, Colo. [358]

Lock-in amplifier offers a stability to 10 ppm/°C

A lock-in amplifier is able to maintain low drift under high-overload conditions. Stability is to 10 ppm/°C with overloads to 3,000

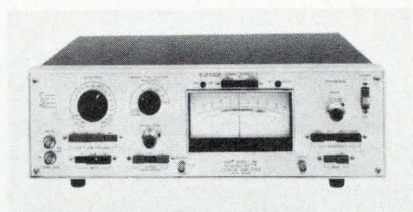

times full scale, and 100 ppm is typical with overloads to 30,000 times full scale. Operating frequency range is 0.5 Hz to 100 kHz, but the signal does not have to be frequency-stable. Applications include spectroscopy, fluorescence studies, semiconductor property analysis, and measurement of any signal buried in noise. Price of the model 186 is \$2,295.

Princeton Applied Research Corp., Box 2565, Princeton, N.J. 08540 [356]

Impact analyzer measures peak level of noise bursts

The model IMP 103 impact analyzer is used as a plug-in accessory to Columbia Research Laboratories'

SPL 103 sound-level meter. The instrument is designed to meet Occupational Safety and Health Act requirements for impact-noise measuring, and the meter will hold the peak noise for 1 minute within

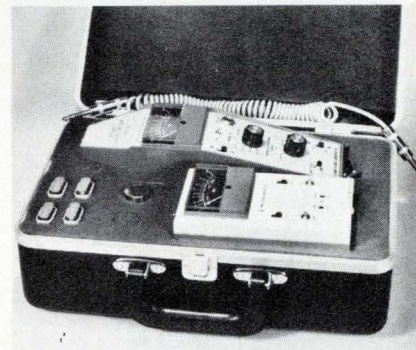

0.5 dB, so that an exact reading of the peak level may be taken. This also gives enough time for picture taking of the reading for OSHA records. Price is \$250.

Columbia Research Laboratories, MacDade Blvd. & Bullens Lane, Woodlyn, Pa. 19094 [357]

Sensitive scope has 100-MHz bandwidth

The model 1100 oscilloscope offers a 100-MHz bandwidth at 5mV/cm sensitivity and 100-MHz triggering selection on channels one or two. Another feature is a variable hold-off to allow synchronous triggering

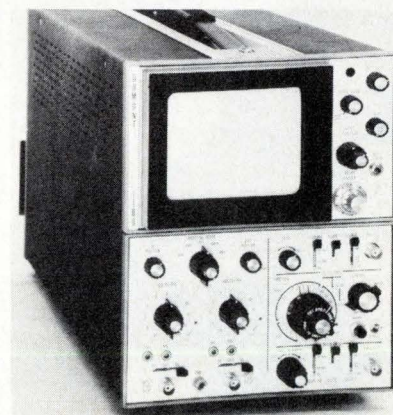

on digital word lengths. Price is \$1,675, or \$1,775 for a rack-mounted version.

Dumont Oscilloscope Laboratories Inc., 40 Fairfield Place, West Caldwell, N.J. 07006 [359]



**Deltrol's New catalog lists 1570 relays, 232 solenoids and 218 timers ... and it's yours, free!**

One of Deltrol's relays, solenoids or timers may be just what you're looking for. You'll find engineering specs and prices for 5, 10, 15 amp AC and DC general purpose relays, including the popular new 160/165 series...25 amp heavy duty power relays with or without auxiliary switch...magnetic latching relays up to 6PDT...low, medium and highpower intermittent and continuous duty solenoids with optional buzz trimmer that eliminates AC hum...medium and heavy duty clappers with adjustable stops...and interval, pushbutton, repeat cycle, fixed or adjustable automatic reset timers. We'll send you this catalog free if you circle the number below or write to...

**DELTROL**  
*controls*  
 Division Of Deltrol Corp.

2745 S. 19th St., Milwaukee, Wis. 53215  
 Phone (414) 671-6800 Telex 2-6871



## New products

Semiconductors

### N-channel ROM stores 8,192 bits

Static device offers TTL compatibility, access time of 300 nanoseconds

Introducing its first standard n-channel MOS product, Motorola Semiconductor Products is starting at the top with an 8,192-bit read-only memory. The memory offers TTL compatibility and easy-to-use static operation.

The device, which has a typical 300-nanosecond access time, is available as a custom-programmed part and as a standard character generator. In either case, the price is under ¼ cent per bit (with a separate mask charge required for custom products).

Each part contains 128 characters arranged in 7-by-9 matrices. The ROMs can automatically shift characters such as g or y that ordinarily extend below the normal base line of the display. The standard MCM6571L generates a modified Usascii code that includes upper- and lower-case letters of the English alphabet, lower-case Greek characters, numerals 0 to 9, and various mathematical symbols and punctuation marks. A total of 126 characters plus a blank and a solid are stored in the 7-by-9 matrices. The circuit automatically blanks the display for invalid input combinations.

Custom versions (MCM6570L) can be programmed to supply characters from codes such as EBCDIC, Selectric or Baudot. Japanese or other symbols can also be generated. The ROM can be programmed in non-shifted format for a significant reduction in access time.

Though this is Motorola's first standard n-channel product, the company has been supplying significant quantities of custom parts, including 4,096-bit ROMs. Motorola's MOS effort emphasizes n-channel and C-MOS.

Both versions, being static in operation, do not require any external clocks as do dynamic memories. The static units require +12- and -3-volt supplies as well as +5 v, but these can be easily generated from the 5-volt supply due to their low power requirement. The 8k ROM dissipates about 600 milliwatts, and is packaged in a 24-pin dual in-line ceramic package. Unit cost for both parts is \$18 in 100 quantity, with a nonrecurring \$1,000 mask charge and 25-piece minimum order for custom parts. The standard part (6571L) is available from stock, and the custom version requires eight weeks from receipt of verified programming instructions. The user supplies programming in the form of coded sheets.

Major use for the ROM is in cathode-ray-tube displays in computer terminals, and in test equipment and instruments. The wide variety of character display offers improved readability over smaller, all-capital sets, the company says.

Motorola will follow this character-generator ROM with other types of the 8k memory. Examples are a column-selected character generator, and ROMs organized as 1,024 8-bit words or 2,048 4-bit words.

Motorola Semiconductor Products Inc., P. O. Box 20924, Phoenix, Ariz. 85036 [411]

### Stereo receiver circuit eliminates multiple coils

Four integrated circuits for stereo receivers are the  $\mu$ A758 phase-locked-loop fm stereo multiplex decoder, the  $\mu$ A753 fm gain block, the 3075 fm i-f amplifier, limiter, detector and audio preamplifier, and the  $\mu$ A720 a-m radio subsystem. The  $\mu$ A758 decoder eliminates the coils normally required in multiplex decoder stages, and the  $\mu$ A753 uses ceramic filters, while the 3075 is a pin-for-pin replacement of the RCA CA3075 stereo circuit. The  $\mu$ A720, on a single circuit package, functions as an rf amplifier, rf oscillator/converter, i-f amplifier, voltage regulator and an automatic-gain-

# High Voltage Diffused Silicon Rectifiers

Six series in a wide range of minimum size packages with low leakage currents for commercial and industrial applications requiring high reliability at economical cost.

These devices feature 1kV to 40kV PRV with 5mA to 2A, I<sub>o</sub>. All series available in fast recovery versions.

Typical applications: CRT power supplies, RF transmitters, microwave ovens, electrostatic copiers and precipitators.

Series VG; 20kV PRV. **\$1.49** (1000).

Rectifiers for medical and industrial X-Ray equipment and high voltage multipliers also available from Varo.

Write for free catalog.



Design us in —  
We'll stay there



VARO

VARO SEMICONDUCTOR, INC.

P.O. BOX 676, 1000 NORTH SHILOH,  
GARLAND, TEXAS 75040  
(214) 272-4551 TWX 910-860-5178

Distributed by:

ALLIED ELECTRONICS, Chicago, Ill. 312/421-2400.  
THE ALTAIR CO., Richardson, Tex. 214/231-5166.  
BELL ELECTRONICS, Menlo Park, Cal. 415/323-9431.  
BLUFF CITY DIST., Memphis, Tenn. 901/725-9500.  
BRIDGEFIELD SUPPLY, Twinsburg, Ohio, 216/425-4209.  
CRAMER ELECTRONICS, Nationwide; Newton, Mass. 617/969-7700; Rochester, N. Y. 716/275-0300.  
ELECTRONIC PARTS CO., Denver, Colo. 303/266-3755.  
FARWEST, INC., Bellevue, Wash. 206/747-1155.  
MERQUIP ELECTRONICS, Skokie, Ill. 312/965-7500.  
MERRILL ELECTRONICS, Chicago, Ill. 312/286-2525.  
MILGRAY ELECTRONICS, Freeport, N. Y. 516/546-6000.  
WESTATES ELECTRONICS, Chatsworth, Calif. 213/341-4411.

In Canada:

ELECTRO SONIC, Toronto, Ont. 416/924-9301.  
PRELCO ELECTRONICS, LTD, Montreal 357. P.Q. 514/389-8051. R. A. E. IND. ELECTRONICS, Vancouver, B. C. 604/687-2621. WESTERN RADIO SUPPLY, Hamilton, Ont. 416/528-0151.

# You gain fundamental design advantages with General Electric infrared SSL's (LED's).

For example, General Electric guarantees\* every SSL-55B and SSL-55C infrared lamp for:

Precision beam alignment, to within 3 degrees of the mechanical axis of the lamp.

Power output of each lamp will be within the less than 2 to 1 range, as published; the SSL-55B

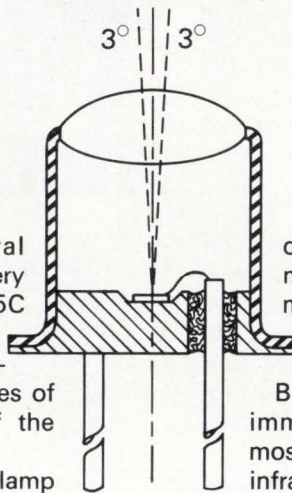

output ranges from 3.5 mW minimum to 6.0 mW maximum; the SSL-55C from 4.8 mW minimum to 7.5 mW maximum.

Both types are available for immediate delivery, as are most other General Electric infrared SSL's. For prices and complete SSL infrared data write or call today.

## Green Glow Lamp for flexibility.



Actual Size

This GE broad spectrum bright green glow lamp gives you greater design flexibility than ever before. It also emits blue, with suitable color filter.

Called the G2B, it is directly interchangeable electrically and physically with GE's high-brightness C2A red/orange/yellow glow lamp. You can use the G2B alone for 120 volt green indicator service. Or together

with the C2A to emphasize multiple functions with colors. For example: for safe/unsafe functions, for dual state indications and to show multiple operations in up to 5 colors.

They should be operated in series with an appropriate current limiting resistor. Both the G2B and C2A save money because of low cost, small size and rugged construction.

## Now Wedge Base Lamps in two sizes.

If space for indicator lights is your problem, the GE T-1¾ size all-glass wedge-base lamp is your solution. It measures only .240" max. diam. The wedge-base construction virtually ends corrosion problems; it won't freeze in the socket. Like



its big brother — the T-3¼ wedge base lamp with a .405" max. diam., the filament is always positioned in the same relation to the base.

And it makes possible simplified socket design.

For free technical information on any or all of these lamps, just write: General Electric Company, Miniature Lamp Products Department, #4454- , Nela Park, Cleveland, Ohio 44112.

\*Lamps not meeting published specifications will be replaced or money refunded.

**GENERAL  ELECTRIC**

## New products

control detector. Price from 100- to 999-quantities ranges from \$1.18 to \$3.95.

Fairchild Camera & Instrument Corp., 464 Ellis St., Mountain View, Calif. 94040 [417]

Diodes are arranged back to back

In a back-to-back arrangement, two varactors are connected in a common-cathode configuration with the ribbon leads adaptable for pc-board connection. The center lead is welded to the common base of two capacitor tuning diodes, which are tested so that Q exceeds 1,200 at 4 v. The diode pairs can be matched for capacitance to ±1% prior to assembly. Price is \$40 in 100-999-lots. MSI Electronics Inc., 3432 57th St., Woodside, N.Y. 11377 [401]

Light switch detects position of analog-meter pointer

A light switch for detecting limit positions of a needle on an analog panel meter is an IC containing a photodiode, Schmitt trigger and output buffer amplifier on a 0.040-by-0.040-inch chip. It is packaged in a TO-18 window can. The output supplies typically 20 mA to drive a small relay or to provide base current to a buffer transistor to drive larger loads. Alternatively, a version

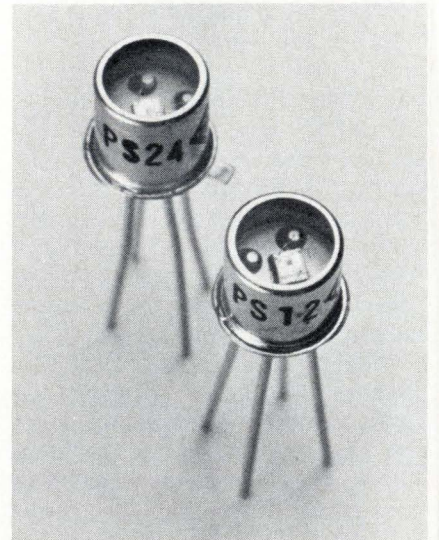

# When it comes to electronic alloys we speak your language.

## “Exactly,” “Precisely,” “Unequivocally,” the properties you need.

### **We specialize in magnetic and controlled expansion alloys**

Ni-Fe. Ni-Co. Ni-Co-Fe. Ni-Mo-Fe. Ni + selected additives. Complete nickel-iron families. Also stainless steel, beryllium, copper, etc., in strip down to 0.0005" thick. Or we'll custom-make alloys to your requirements.

### **We pride ourselves on tight physical property control**

Rigid chemistry control of the alloy ingredients assures exact lot-to-lot consistency of electronic parameters—permeability, resistivity, saturation flux, expansion, thermal conductivity. Impurities concentration less than 0.005%.

Circle 193 on reader service card

**You can get evaluation lots or production lots**  
Strip, rod or wire—order five pounds or five tons.

### **Also, consider photo-etching your parts. Send us a print and we'll send you a quote**

We can produce any configuration in nearly any magnetic or specialty alloy. With precision replicas in pilot or production quantities. And without expensive dies. Photo-etching is especially effective—and economical—for thicknesses of 0.000125" to 0.030".

Circle 194 on reader service card

**For information about other alloys**  
we make, Circle 195 on reader service card



**MAGNETICS**

A DIVISION OF SPANG INDUSTRIES INC.

Butler PA 16001.

# NEW!

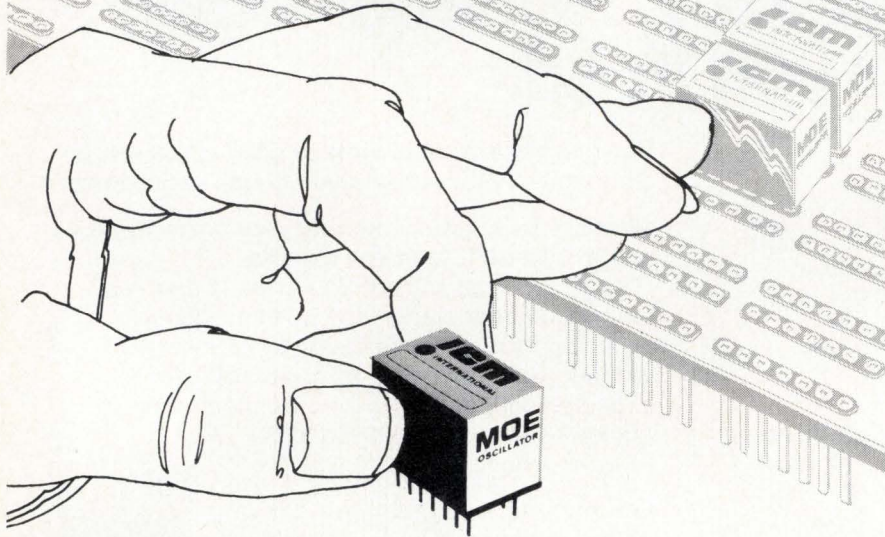

## INTERNATIONAL'S MOE Crystal Oscillator Elements provide a complete controlled signal source from 6000 KHz to 60 MHz

The MOE series is designed for direct plug-in to a standard dip socket. The miniature oscillator element is a complete source, crystal controlled, in an integrated circuit 14 pin dual-in-line package with a height of 1/2 inch.

Oscillators are grouped by frequency and temperature stability thus giving the user a selection of the overall accuracy desired. Operating voltage 3 vdc to 9 vdc.



10 NO. LEE • OKLA. CITY, OKLA. 73102

TYPE	CRYSTAL RANGE	OVERALL ACCURACY	25°C TOLERANCE	PRICE
MOE-5	6000KHz to 60MHz	+ .002% -10° to +60°C	Zero Trimmer	\$35.00
MOE-10	6000KHz to 60MHz	+ .0005% -10° to +60°C	Zero Trimmer	\$50.00

### New products

is available with TTL-compatible output. Price in 100-lots is \$1.80.

Teknis Inc., Plainville, Mass. 02762 [420]

#### Calculator chip has power-saving feature

A calculator chip, designated the model 4026, has a built-in power-saving feature that changes the internal clock frequency when the chip is idle. Normal operational power of 50 milliwatts is thereby reduced to about 20 mW. Power required by display devices can also be reduced. After depression of any key, a delay is triggered that causes the display only to be turned off after from 10 to 30 seconds. Display is restored by depressing a D key or by entering new data.

Nortec Electronics Co., 3697 Tahoe Way, Santa Clara, Calif. 95051 [413]

#### Low-distortion power op amp is rated at 100 w

A multipurpose 7-ampere low-distortion operational amplifier, designated the TA8651A, is a 100-w linear unit. The power hybrid circuit has an output section that can be externally biased class AB for low intermodulation and low harmonic distortion. Terminals are available for external frequency compensation, external short-circuit protection, and inverting and noninverting inputs. Applications are in high-fidelity audio equipment where less than 0.1% intermodulation distortion at 50 mW is required. Price is

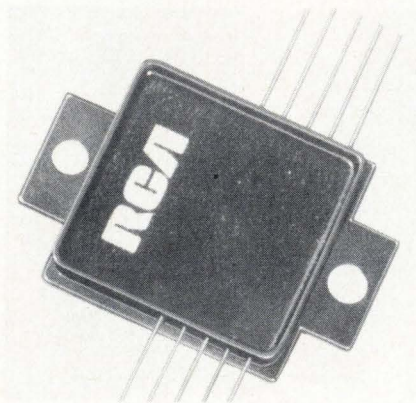

# Two new digital multimeters with price and performance you can't refuse.

## 8350A

5½ digits, autoranging  
0.005% accuracy  
5 ranges dc volts  
5 ranges of ohms  
4 ranges ac volts  
\$1495, complete DMM



## 8375A

5½ digits, autoranging  
0.003% accuracy  
Functional self-test  
5 ranges dc volts  
7 ranges of ohms  
4 ranges **true RMS** ac volts  
Powerful systems options  
\$1995, complete DMM



Both instruments use Fluke's patented recirculating remainder a-to-d converter for low parts count, low power consumption and boast a calculated MTBF of at least 10,000 hours. ● Either instrument gives you more multimeter for your money. **Now isn't that an offer you can't refuse?**



For details call your local Fluke sales engineer. In the continental U.S., dial our toll free number, 800-426-0361 for his name and address. Abroad and in Canada, call or write the office nearest you listed below. Fluke, P.O. Box 7428, Seattle, Washington 98133. Phone (206) 774-2211. TWX: 910-449-2850. In Europe, address Fluke Nederland (N.V.), P.O. Box 5053, Tilburg, Holland. Phone 13-670130. Telex: 884-55237. In the U.K. address Fluke International Corp., Garnett Close, Watford, WD2, 4TT. Phone, Watford, 33066. Telex: 934583. In Canada, address ACA, Ltd. 6427 Northam Drive, Missisauga, Ontario. Phone 416-678-1500.

Speed measurement...  
 motion sensing...  
 and control...

USING MAGNETIC PICKUPS OR DIGITAL OUTPUT TRANSDUCERS



# WE SENSE YOUR EVENT CONTROL REQUIREMENTS

and provide you with the best system indication or control available!

HIGH-SPEED, LOW-SPEED, ZERO-SPEED . . . ANY-SPEED the AIRPAX WAY eliminates worn bearings and bushings, broken or bent drive cables—all of the problems associated with other control methods.

Indicating Tachometry



Precision electronic tachometry to measure, monitor or indicate "events-per-unit-time", rotational or linear speed, flow rates, feed rates or production rates. Nine standard and special purpose models to select from.

Control Tachometry



Precision control tachometry that provides proportional control compatible with recorders and process controllers. Switching tachometry providing control utilizing relay closures to initiate multiple process operations. Eight versatile models available.

Digital Instruments



Instruments for control and/or indication incorporating precise digital read-out and logic — circuitry control. Flexibility for computer or analog process equipment interface is "built-in" — as are many other features. E.P.U.T., accumulator and ratio mode models are available.

Our phone number is (305) 587-1100. Call or write us...

CONTROLS DIVISION / 6801 W. Sunrise Blvd. / Ft. Lauderdale, Florida 33313

# AIRPAX™

25 YEARS OF PROGRESS

## New products

\$12.90 in 1,000-lots.

RCA Solid State Division, Rte. 202, Somerville, N.J. 08876 [415]

FET op amp provides

$\pm 50 \mu\text{V}/^\circ\text{C}$  drift

With a guaranteed input bias current of  $-25$  picoamperes and a maximum voltage drift of  $\pm 50 \mu\text{V}/^\circ\text{C}$ , the model 3542J FET operational amplifier is hermetically sealed in a

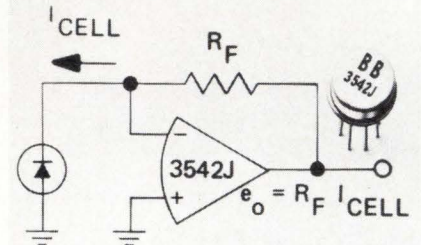

TO-99 package. Initial voltage offset at  $25^\circ\text{C}$  is  $20 \text{ mV}$ , and the minimum dc voltage gain is  $88 \text{ dB}$ . Full power frequency response is  $8 \text{ kHz}$ , and slew rate is  $0.5 \text{ V}/\mu\text{s}$ . Both output short-circuit protection and input-to-supply-voltage protection are provided. Price is about  $\$4.50$ .

Burr-Brown Research Corp., International Airport Industrial Park, Tucson, Ariz. [414]

Switch drivers operate

in less than  $10 \text{ ns}$

Exhibiting total switching time of less than  $10 \text{ nanoseconds}$ , the models SD-1001A and SD-1003A are noninverting switch drivers that are TTL- and DTL-compatible. They provide current from the positive or negative supply voltage, depending

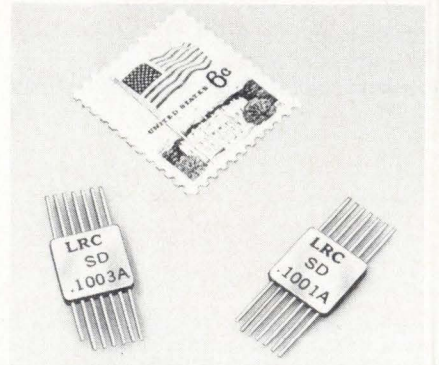

# Pushbuttons that help do everything from make a copy to call a cop.

Think MICRO SWITCH when you're in the market for pushbuttons.

Because we offer one of the world's largest selections. With most of them available off your distributor's shelf.

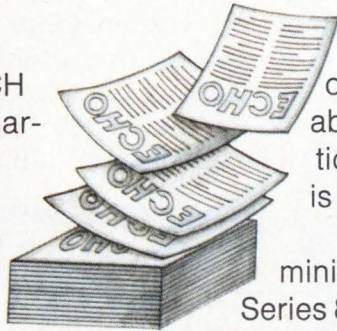

other words, just about any application where reliability is important.

From our smallest miniature (unlighted Series 8) to our most ver-

unusual places. For example, when an underwater sphere was designed to explore the Continental Shelf, our pushbuttons were used to help make the dive a safer one.

For help with your application, we have a staff of Application Engineers standing by to provide field support.

For more information, contact your MICRO SWITCH Branch Office or Authorized Distributor (Yellow Pages, "Switches, Electric").

satellite lighted pushbutton (Series 2), each of our devices feature the most reliable switching in the industry. So no matter how tough or unique your application, you can be confident we have a pushbutton to handle it.

Engineers have put this design freedom to use in some



MICRO SWITCH pushbuttons are in use right now on jobs ranging from office copiers (DM) to police communications systems (Series 2). In



use in some

**MICRO SWITCH makes your ideas work.**



# Beware the un-opportunity

Opportunity. You've read enough employment opportunity ads and listened to enough employment personnel by now to know that they all like to discuss opportunity. But, unfortunately, they would usually rather talk about opportunity than offer it. We at Fairchild believe that if you're going to talk about something, you'd better be able to back it up.

And back it up we can. First, there's the Fairchild opportunity. A chance to build a career with a company that's headed in the right direction at the right speed. Second, there's the individual opportunity. A chance to use both your brains and your

initiative in an environment that doesn't let protocol stand in the way of a good idea. We at Fairchild believe that opportunity exists within the individual, not the system. If you feel that way too, we should get together. Call or send us your resume. Employment Opportunities, Fairchild Semiconductor Components Group, Dept. 35, 465 National Avenue, Mountain View, California 94040. (415) 962-3401.

An Equal Opportunity Employer M/F

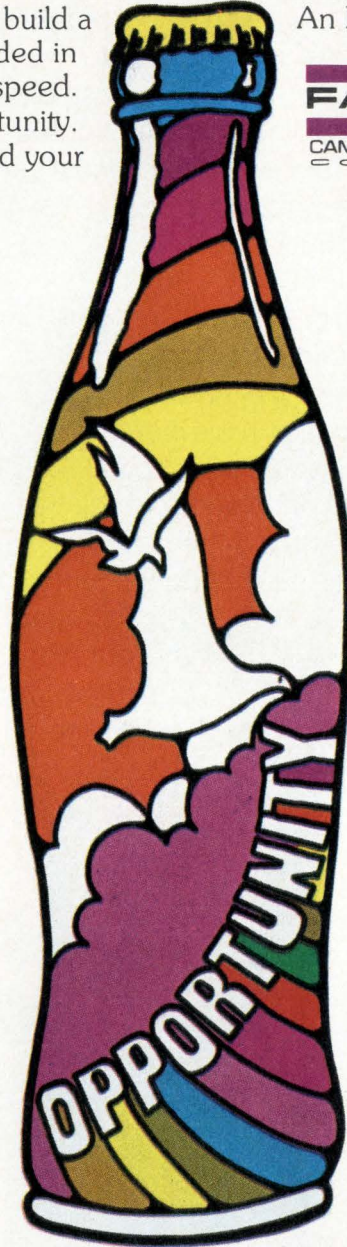

**FAIRCHILD**  
CAMERA AND INSTRUMENT  
CORPORATION

**A Fairchild career... more than a pretty package**



## New products

on the input from a TTL gate. To permit high-speed diode switching, current spikes are provided to inject and remove carriers from the switching-diode junction. Price for one to nine units is \$65 each.

LRC Inc., 11 Hazelwood Rd., Hudson, N.H. [418]

Multiplier-divider is a monolithic circuit

The series M530 multiplier is a monolithic IC comprising X- and Y-channel differential input amplifiers, a transconductance multiplication stage, an operational amplifier output stage, and stable reference—all on a single silicon chip. In addition, the circuit uses thin-film resistors instead of diffused resistors in all critical locations, thereby eliminating a significant source of drift. All models offer a 3-dB bandwidth of 1 MHz. Price is from \$20 to \$44 depending on multiplication-error rating.

Intronics, 57 Chapel St., Newton, Mass. 02158 [416]

Dual FET delivers low-noise performance

A dual n-channel monolithic JFET provides a voltage noise specified at less than  $15 \text{ nV}/\text{Hz}^{1/2}$  at 10 Hz. The device, which is designated the AD840/AD841, also features a low offset voltage—5 mV maximum—and a drift of  $5 \mu\text{V}/^\circ\text{C}$ . The units, available in TO-52, TO-71, or TO-78 packages, are designed for operation over the temperature range from  $-55^\circ$  to  $+125^\circ\text{C}$ . Prices for 1 to 99 pieces are \$9.40 and \$7.80 for the 840 and 841, respectively.

Analog Devices, Rte. 1 Industrial Park, Box 280, Norwood, Mass. [419]

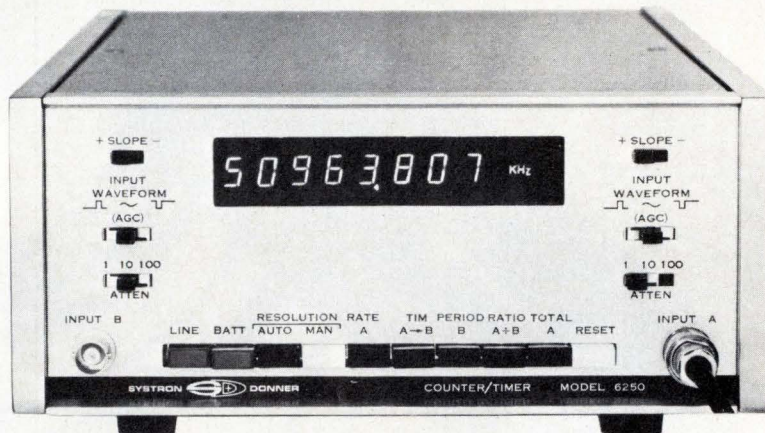
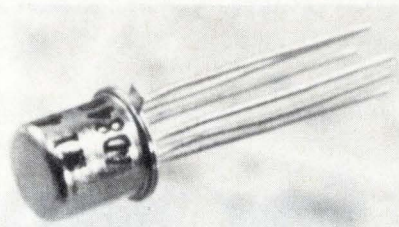

## 50 MHz automatic counter/timer

Frequency, TIM, period, ratio, totalize

Automatic gain control

Autoranging

Leading zero suppression

8-digit readout (standard)

25 mV input sensitivity

BCD output

### Model 6250 Options include:

Choice of 5 higher oscillator stabilities

Internal battery pack

Contact your Scientific Devices office or Concord Instruments Division,  
10 Systron Drive, Concord, CA 94518. (415) 682-6161  
Europe: Munich, W. Germany, Leamington Spa, U.K.

**SYSTRON**  **DONNER**

Circle 143 on reader service card

Why mess around when you can have the ELECTRONICS BOXER clean up your copies—keep them in top condition.

And, it's easy and

inexpensive to keep the ELECTRONICS BOXER in your corner. Just complete the coupon and mail. Your order will be processed immediately, postpaid.

### ELECTRONICS BOXER

Jesse Jones Box Corporation

2250 E. Butler St., Philadelphia, Pa. 19137

Please send me:  boxes @ \$4.25 each;  
 3 boxes @ \$12.00;  6 boxes @ \$22.00

My check or money order is enclosed.

Name \_\_\_\_\_

Address \_\_\_\_\_

City \_\_\_\_\_ State \_\_\_\_\_ Zip \_\_\_\_\_

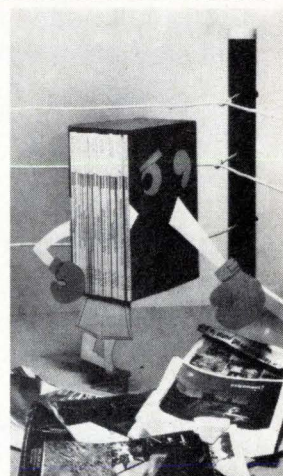

*A flexcircuit for crossbar switch horizontal multiple.*

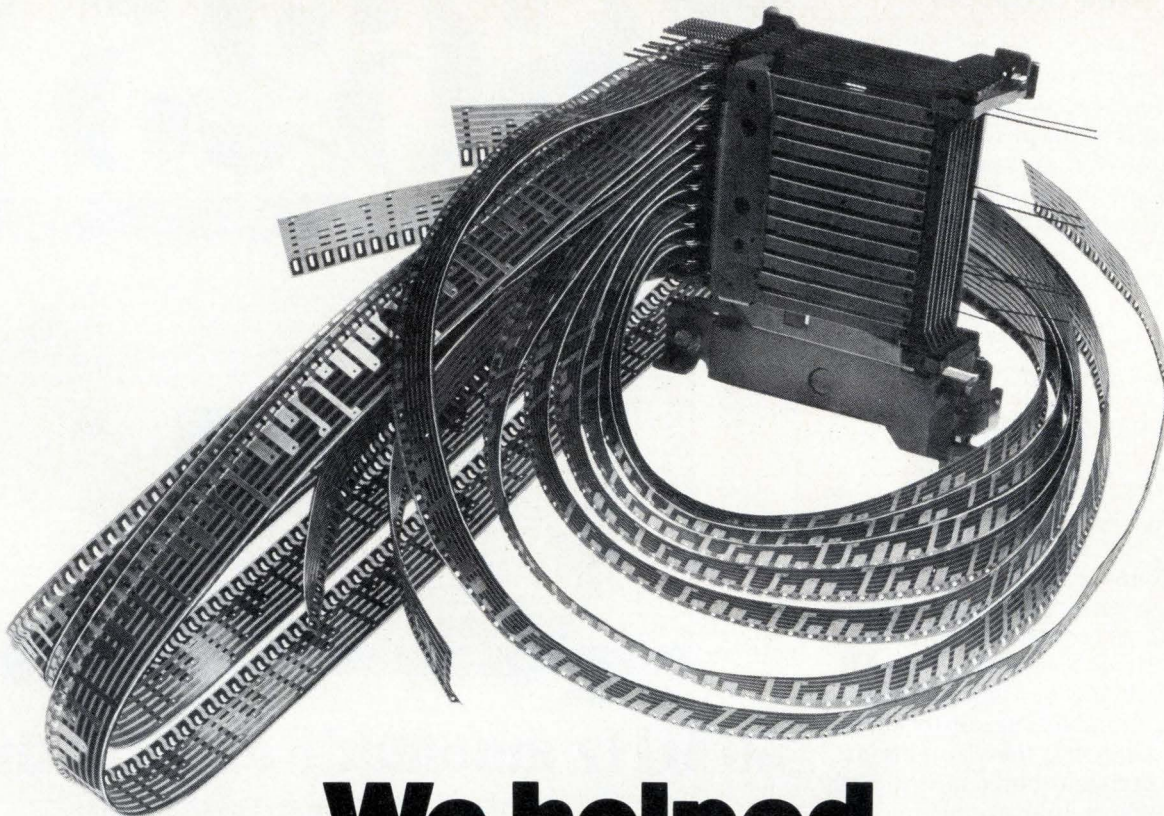

## **We helped solve a problem for Western Electric.**

Western Electric was looking for a better way. A better way to provide the horizontal multiple connections for their small crossbar switch.

Working closely with them we helped them find it.

The Schjeldahl flexcircuit above, provides a density of 1,200 connections in 50 cubic inches using a double sided circuit with 120 plated through holes per 25 inch strip. It provides all repetitive horizontal connections and leaves terminal ends free for specific wire wrap connections. Just as important, it virtually eliminates connection errors. Outside edge of the flexible strip is slotted then ridged at the connection points so that terminals for the entire horizontal group fall neatly into the slots. A touch of the finger assures that all terminals are in place and will stay there while being resistance soldered. Base material is Kapton®.

Western Electric served up a tall order. A reliable circuit that would provide 1,200 connections in just 50 cubic inches, eliminate random wiring errors, save installation time, and one that could be produced at the rate of millions of connections per week.

Schjeldahl helped solve a problem for Western Electric.

® DU PONT TRADEMARK.



**Schjeldahl Company**

Electrical Products Division  
Northfield, Minnesota 55057  
Phone: (507) 645-5633

*The state of the art people in volume flexible circuits*

# **And we can do it for you.**

## New products

Subassemblies

# IC is nucleus of a-d converter

Combined with d-a converter and counter, chip forms high-speed eight-bit unit

Now that monolithic digital-to-analog converters are on the market and gaining wide acceptance, IC manufacturers are working on the harder analog-to-digital conversion. Motorola's entry in the IC a-d con-

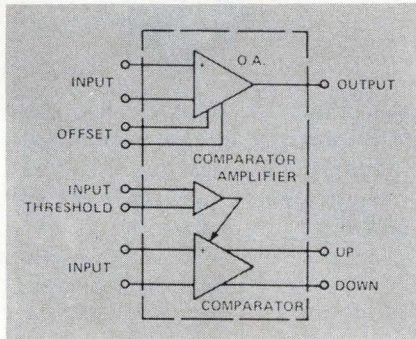

verter race isn't on one chip, but it is a building block that, combined with a d-a converter and a counter, forms a complete, high-speed tracking eight-bit a-d converter for under \$20 in 100-unit orders. Complete a-d converter modules are considerably higher in price.

The new Motorola MC1507/MC1407 a-d converter control circuit is designed to work with the firm's MC1408, eight-bit monolithic d-a converter and standard TTL or MOS up-down converters. In this application, the system takes advantage of the MC1408's current output to eliminate other circuitry that would be required—and that would slow down conversion—if the converter had a conventional voltage output. Input voltage range is up to 11 volts, but signals with much lower levels can be used.

The new control circuit is especially suited for tracking conversion, but can also be used for successive approximation. In tracking applications, it can give an update every

200 nanoseconds or oftener, with a system accuracy of within 0.4%.

The MC1407 incorporates a high-speed operational amplifier/buffer and a dual comparator. The op amp has a typical slew rate of 20 V/microsecond in both inverting and noninverting modes and a propagation delay of 30 nanoseconds. It is capable of settling to within 0.1% of a 10-v swing in less than 1 ms. The dual comparator is TTL-compatible and has an adjustable symmetrical threshold. The offset threshold is used to eliminate jitter and false triggering. The MC1407 is a 0-70° C commercial version; the MC1507 has a -55-+125° C rating.

The system functions by comparing the output of the d-a converter to the input signal. If they are not equal, the external counter counts up until they are the same. Donald A. Campo, linear IC product planner, says that the system can be speeded up even more, if required. That can be done by adding another MC1407 and digital circuitry that would put the response of the system in a "panic" mode—four times the standard clock rate—when the slow rate of the input signal exceeds that of the system. In this mode, the system could slew up to 0.8 v/μs until it catches the signal, then revert to its standard operating mode. Improvement in speed could also come from a faster counter, such as MECL; conversion takes only 300 ns.

Campo sees a major use in converting from sensors and other analog inputs in digital systems. The MC1407 operates from ±15 v and from +5 v, and it is packaged in a standard dual in-line package. It is priced at \$3.90 in 100 quantity, with the MC1408L-8 \$5.95, and the two counters \$4.95 each.

Motorola Semiconductor Products Inc., P.O. Box 20912, Phoenix, Ariz. [382]

Photoelectric controls have interchangeable modules

A series of photoelectric controls consists of a universal control base and a range of plug-in function

# TRIACs & SCR's NEW ELECTRICALLY ISOLATED 1/2" press-fit series



**TRIACs:** 6A to 40A [ $I_{T(RMS)}$ ]  
50V-600V ( $V_{DROM}$ )  
**SCR'S:** 8A to 35A [ $I_{T(RMS)}$ ]  
50V-600V ( $V_{DROM}$ )

Three new additions to Hutson's 1/2" press-fit series: isolated press-fit package; isolated press-fit and stud mount with Beo insulators for greatly improved thermal characteristics.

All 1/2" press-fit devices feature patented Di-Mesa construction of void-free glass-passivated center gate chips.

Write for complete information.



## HUTSON INDUSTRIES

BOX 34235 • 2019 W. VALLEY VIEW, DALLAS, TEX. 75234 (214) 241-3511 TWX 910-860-5537

Distributed by:

In Canada: WEBER-SEMAE ELECTRONICS, Downsview, Ont. 416/635-9880

Vice-President, European Operations:  
30 Rue Pierre Semard, Yerres, 91 France Tel:  
Paris 925-8258 • TELEX 21-311

Distributed in Europe by:

Belgium: C. N. ROOD S.A. Brussels 02-352135  
Denmark: E. V. JOHANSEN A/S, Copenhagen (01)\* 295622  
Norway: INTELCO, Box 158, 47 2 207451, Sentrum, Oslo  
Spain: BELPORT, Madrid 234.62.62  
Sweden: ELEKTROFLEX, Sundyberg 08-28-9290  
Switzerland: D. LEITGEB, Dubendorf 051 85 9666  
UK: CLAUDE LYONS, LTD, Hoddeston, Hertfordshire (09924) 67161

# Three Simple, Safe



## Temperature Indicators for Electronics

Let you know when rated temperature is reached . . . with an accuracy of  $\pm 1\%$

**1. TEMPILABELS<sup>®</sup>:** self-adhesive temperature monitors consisting of one or more heat-sensitive indicators sealed under transparent, heat resistant windows. The centers of the indicator circles turn from white to black irreversibly at the temperature ratings shown on the label. Tempilabels<sup>®</sup> are available in several sizes, and in single or multiple temperature ratings from 100° to 500°F. Accuracy is within  $\pm 1\%$  of the stated rating. They are particularly useful for monitoring operating temperatures of equipment or processes; obtaining temperature data of components as a guide to design and material selection; safeguarding temperature-sensitive materials in storage or transit. To serve as a permanent record, Tempilabels<sup>®</sup> can be removed from the surface and attached to a report.



**2. TEMPILAQ<sup>®</sup>:** materials of calibrated melting points suspended in an inert, volatile non-flammable vehicle. Available in over 100 systematically spaced temperature ratings from 100° to 2500°F. Tempilaq<sup>®</sup> indicates its temperature rating by liquefying within  $\pm 1\%$  of its rating. Available in bottles or spray cans.

**3. TEMPILSTIKS<sup>®</sup>:** temperature-indicating crayons of calibrated melting points. Available in over 100 systematically spaced temperature ratings, Tempilstiks<sup>®</sup> cover the range from 100° to 2500°F. Tempilstiks<sup>®</sup> indicate the specified temperature, by liquefying with a tolerance of  $\pm 1\%$  of its rating.

Detailed data and price sheets as well as samples are available upon request.



**Tempil<sup>®</sup>** DIVISION, BIG THREE INDUSTRIES, INC.

Hamilton Blvd., South Plainfield, N. J. 07080  
Phone: 201 • 757-8300 • Telex: 138662

## New products

modules for specific applications. Changing the function of the control is accomplished by changing the module, and each module locks in place, thereby eliminating vibration problems. The modules can also be removed without using tools. They are satisfactory in most industrial

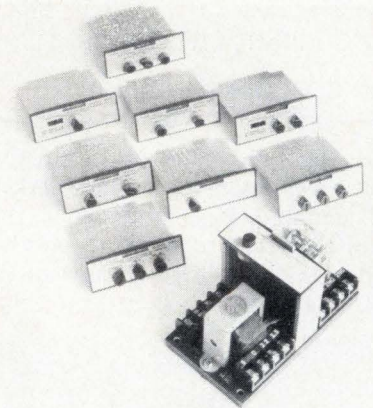

applications for photoelectric controls. Functions offered include on-off, time delay, and impulse types for registration. Other functions are planned for future additions.

Electronics Corp. of America, Photoswitch Division, 1 Memorial Dr., Cambridge, Mass. 02142 [383]

## Operational amplifier settles to 0.1% in 7 microseconds

Settling to 0.1% in 7  $\mu\text{s}$ , an operational amplifier provides an 18-V/ $\mu\text{s}$  slew rate, achieved through the use of an internal feed-forward frequency-compensation network. No external capacitors are required

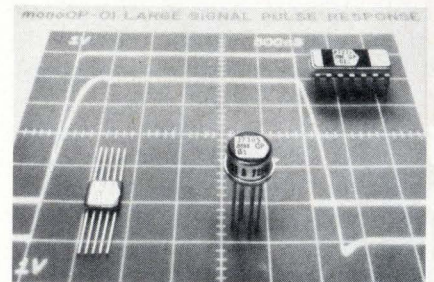

for stable high-speed performance. Other features are a 250-kHz power bandwidth and a 2.5-MHz small-signal bandwidth despite bias currents of 20 nA and power consumption of 50 mW. Price in 100-lots ranges

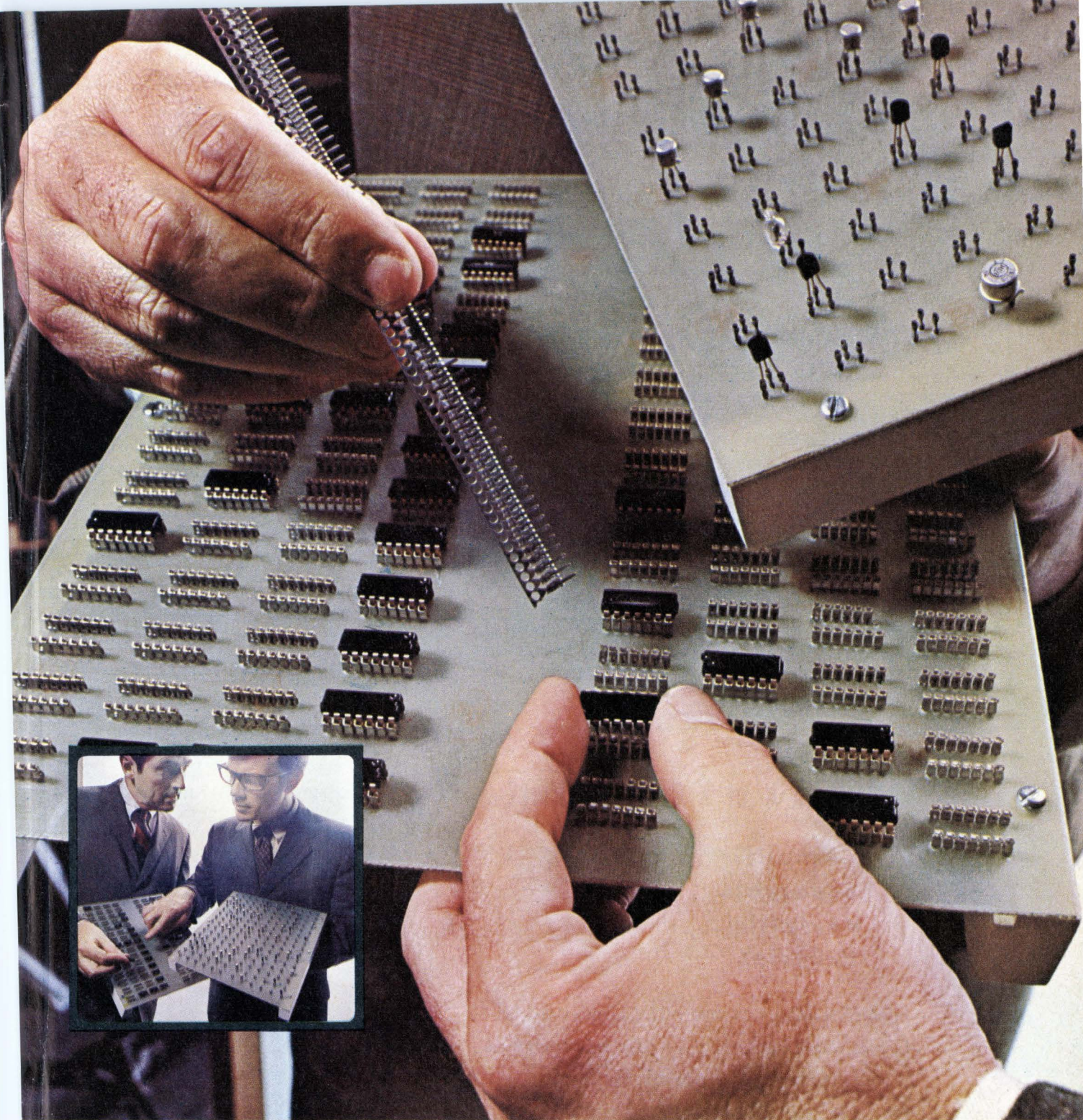

**HERE'S A NEW AND BETTER WAY:** To make printed circuit board connections. Reliably. At low, low cost. They're Molex Soldercon<sup>®</sup> terminals. Integrated circuit and transistor terminals. Offering the convenience of plug-in I.C.'s and transistors *without* the cost of insulators. They fit directly on the board. And there is equipment available to do the job *automatically*. Fast! Soldercon terminals save time. Money. Speed installation. Make

testing easier, too. And simplify service problems. It's another example of Molex ingenuity . . . in creating components that simplify circuitry. Molex has the know-how and facilities to provide the interconnecting system you need. You can make connections by calling (312) 969-4550. Or write . . . Molex Incorporated, Lisle, Illinois 60532.

*... creating components that  
simplify circuitry*

Circle 147 on reader service card



# TEC LITE

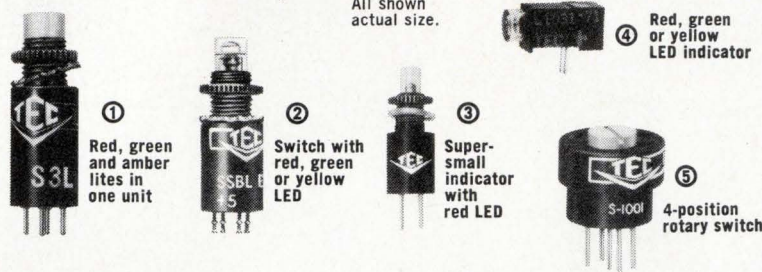

All shown actual size.

① Red, green and amber lites in one unit

② Switch with red, green or yellow LED

③ Super-small indicator with red LED

④ Red, green or yellow LED indicator

⑤ 4-position rotary switch

## THE SUBMINIATURE SPECIALISTS

We've licked the space problem with highly reliable, long life devices that fit most any application. Just 5 are shown here . . . we have 35 more in stock. And if you have a unique space problem, we'll design a unit for you at a surprisingly low price.

① Three incandescent lamps with color filters in a single .360" diam. body offer 3 color indications. ② Momentary SPST N.O. DB switch/indicator with .360" diam. body; also available as indicator only. ③ Indicator with 1/4" diam. body; also available as N.O., N.C., or N.O. & N.C. momentary switch. ④ PCB-mounted indicator only .625" long. ⑤ PCB-mounted N.O. maintained switch with 1/2" diam. body.



9800 NORTH ORACLE ROAD  
TUCSON, ARIZONA 85704 — (602) 297-1111

INCORPORATED

Circle 148 on reader service card

## New products

from \$3.65 to \$12.95, depending on temperature range.

Precision Monolithics, Inc., 1500 Space Park Dr., Santa Clara, Calif. 95050 [384]

Liquid-crystal displays have 4-by-5-inch area

A family of liquid-crystal displays includes 3- and 4-inch-high models, which come in either seven- or 16-segment types. Each has an area of 4 by 5 in. In addition to good contrast, high speed, and uniform transmissive-mode dynamic scattering, the units are hermetically sealed. Operating temperature range is from 0° to 50°C, and typical dissipation is 15-18 mW with a 24-v, 60-Hz drive. The displays have solderable terminations and provision for mounting into a back-lighted display structure. Price is \$100 for samples, with quantity pricing expected to drop to the \$10 range.

Transparent Conductors Inc., 26 Coromar Dr., Box 549, Goleta, Calif [385]

## Need an H of a Good Amplifier?

### Try Amplifier Research's Versatile H-Series

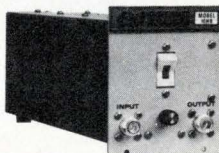

Model 10HB

- Infinite Mismatch Tolerance • OEM Models Available
- Low Harmonic Distortion • Adjustable Output Power
- Instantaneous Bandwidth - No Tuning

The H-Series solid-state, broadband laboratory amplifiers combine advanced engineering, top-rate performance, and low cost to offer the best value in moderate power units available today. These amplifiers are designed for antenna and component testing, wattmeter calibration, EMI susceptibility testing, and other broadband applications. Each model is completely self contained and operates from 115 Vac line.

Model	Frequency Range (MHz)	RF Power (watts)	Price
10HA	225-410	10	\$1445
10HB	300-500	10	\$1485
6HC	400-700	6	\$1735

For complete information, write or call  
Amplifier Research, P. O. Box 7,  
New Britain, Pa. 18901. Phone: 215-822-0161



Display is a miniature cathode-ray-tube device

Sixty-four independent guns display an alphanumeric character up to 0.6-inch high, or a complete message of up to three lines of six characters, on a 1.5-in. CRT data display



# THE HUGHES CONNECTION.

**It's a breakthrough, instead of a breakdown. With C-21 connectors, the greater the pressure change, the tighter the seal.**

Today's environmental connectors often begin to fail at pressures as low as 5 psi. The new C-21 keeps sealing even at 250 psi.

That's because we make atmospheric pressure changes work for you, not against you.

First, we got rid of the interfacial rubber seal commonly used today. It can take only low pressure changes before it starts leaking. Also, risk of leakage rises as the connector is coupled and uncoupled. And you can't change individual contacts without

endangering the whole seal.

Not good enough. So we developed a true environmental connector with individual pressure seals in front of and behind each contact.

They block out moisture, dust and other contaminants. As pressure rises, these small cup-shape seals, within their own special cavities in the connector body, only grip tighter.

Finger pressure is enough for connector mating. You can change contacts individually. And seals on

individual contacts.

The C-21 is designed for airborne, deep space, shipboard, and undersea applications in a wide range of sizes.

No other connectors with crimp-removable size 16 contacts approach the C-21 in sealing capabilities, versatility, or long life. Yet prices are competitive.

More information? Write: Hughes Connecting Devices, 500 Superior Ave., Newport Beach, CA 92663. Or call (714) 548-0671

**HUGHES**  
HUGHES AIRCRAFT COMPANY  
CONNECTING DEVICES

**CONNECTORS, CABLES, CIRCUITS...ONLY HUGHES PUTS IT ALL TOGETHER.**

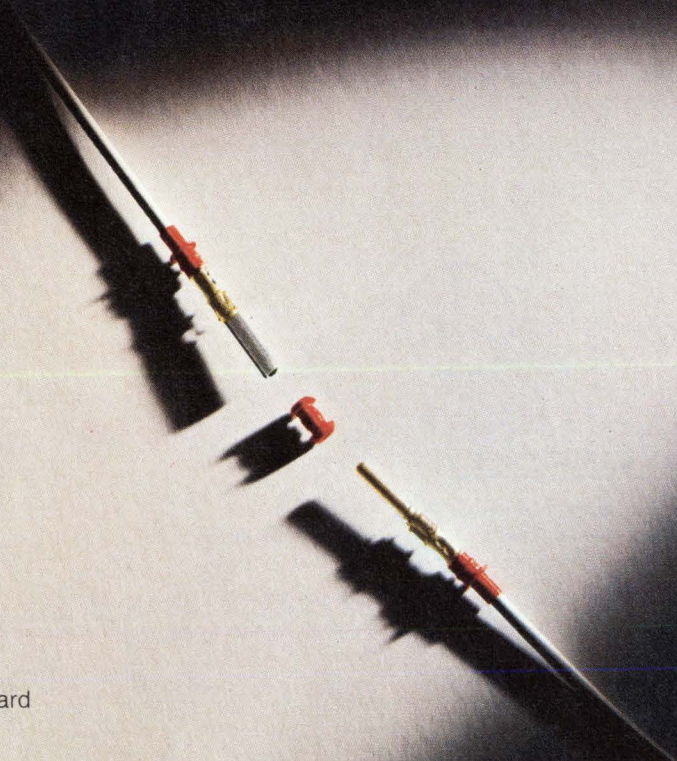

# WHY CHOOSE RENTAL ELECTRONICS WHEN YOU RENT, LEASE, OR RENTAL-PURCHASE?

Because REI is the recognized leader when it comes to supplying you the most complete selection of electronic/scientific test equipment—to rent, to lease, or to rental-purchase—at the most attractive costs.

Now, more than ever, you must expand along with the pace of economic and technological development. To avoid the handicap of obsolete equipment, to help you maintain a flexible budget, to keep abreast of the competition, to assure growth with increased production and sales—Rental Electronics offers you the instruments you need, when you need them, for as long as you need them.

REI offers you precisely the right instruments—everything from amplifiers to oscilloscopes to synthesizers—with a plan custom-designed to meet your specific requirements!

Our staff of sophisticated financial planners is ready to help you choose the rental, lease, or rental-purchase package that best fits your situation.

And your needed equipment is ready for almost instantaneous delivery, direct from one of nine strategically-located "Instant Inventory" Centers across the U.S. and Canada.

Every Rental Electronics customer is our *very special* customer, receiving the service he needs under a rental, lease, or rental-purchase plan custom-tailored especially for him. The results are increased **PROFITS** for you!

**Ask for our full catalog today! Write or call:**



## Rental Electronics, Inc.

A **PEPSICO** LEASING COMPANY

99 Hartwell Avenue, P. O. Box 223  
Lexington, Massachusetts 02173 Tel. 617/862-6905

Gaithersburg, Maryland 301/948-0620 / Lexington, Massachusetts 617/861-0667 / Anaheim, California 714/879-0561 / Rosemont, Illinois 312/671-2464 / Fort Lauderdale, Florida 305/771-3500 / Dallas, Texas 214/638-4180 / Oakland, New Jersey 201/337-3757 / Ontario, Canada 416/677-7513 / Palo Alto, California 415/328-4525

### New products

device called the nimo 64. The tube acts as both a read-only memory and a display for fixed data. The unit requires six TTL packages for interfacing, and applications include point-of-sale terminals, computer prompters, and record-retrieval systems. Price is \$38.50 in 1,000-lots.

Industrial Electronic Engineers Inc., 7720 Lemona Ave., Van Nuys, Calif. 91405 [386]

### Dual in-line unit

offers delays to 1,000 ns

A dual in-line 14-pin lumped-constant delay line provides delays of up to 1,000 nanoseconds. The unit incorporates 10 equal-delay taps

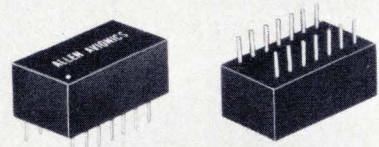

and is available with time delays starting from 10 nanoseconds in delay-to-rise-time ratios of 5:1. Working voltage is 50 v dc. Price is \$20.

Allen Avionics Inc., 224 E 2nd St., Mineola, N.Y. 11501 [387]

### LED displays are low

in price; save on material

Using a manufacturing process called encapsulated light diffusion, a line of 0.3-inch LED displays is designated the Data-Lit 700 series. The devices require 85% less gallium ar-

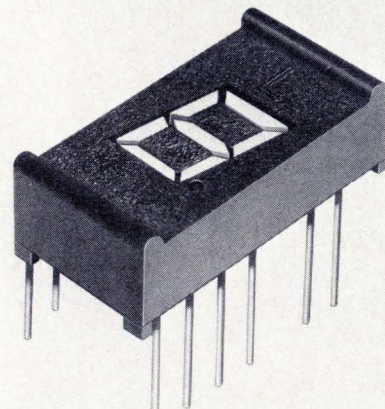



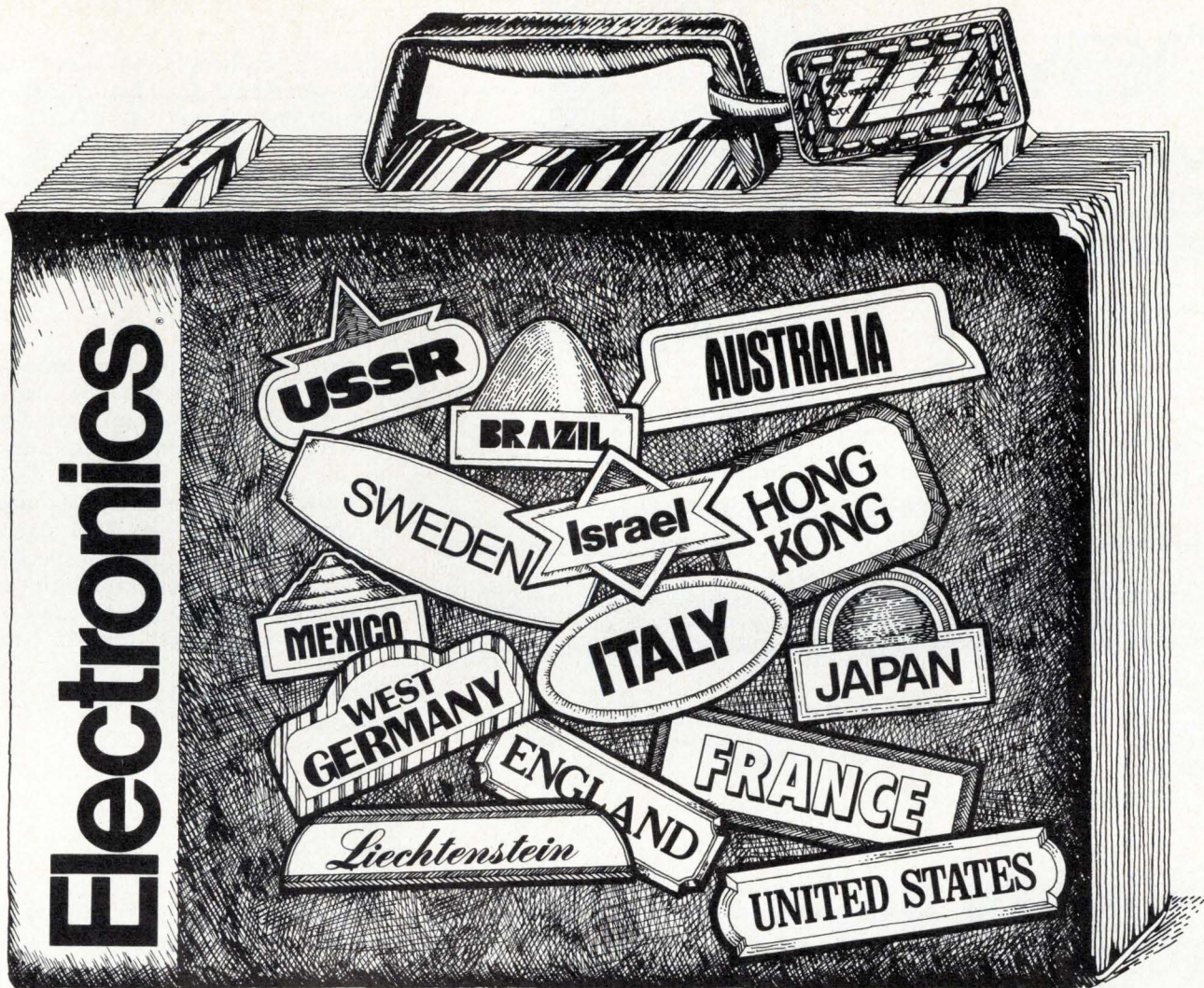

What are your colleagues doing  
around the world?

Find out in **ELECTRONICS**.

Go first class. Go to **ELECTRONICS** and you'll find out first hand where the biggest growth potential is today. And where it'll be tomorrow.

**ELECTRONICS** knows, because its 31 editors, 11 World News Bureaus and 200 correspondents make it their business to stay on top of what's happening in the ETM—the Electronics Technology Marketplace—worldwide. Only **ELECTRONICS** offers readers annual market reports and forecasts on Japan and Europe as well as the U. S.

**ELECTRONICS** is *the Source*, disseminating information, and establishing and maintaining communications among people in electronics,

wherever in the world those people may be.

We sell over 86,000 subscriptions to 122 countries all over the globe. You should be getting your own copy of **ELECTRONICS** right off the press because the world of electronics—your world—is between the covers of **ELECTRONICS** magazine.

Fill out the enclosed subscription card and send it off. **ELECTRONICS** is the one magazine you can't afford to be without.

**Electronics**   
**IS THE SOURCE.**

# new

## SWITCHING VOLTAGE REGULATORS

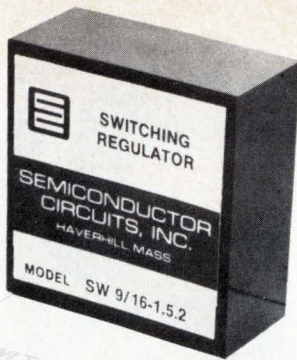

### HIGH PERFORMANCE

High Efficiency . . . to 90%  
 MTBF > 100,000 hrs  
 Low Case Temperature Rise . . .  
 < 10°C above ambient  
 Load Regulation . . . 0.1%

### SMALL SIZE

2" x 2" x 7/8" Encapsulated Module

LOW COST **From \$29<sup>95</sup>** (1-9)

### FOR USE IN

Point of Load Regulation  
 High Efficiency Power Supply  
 Designs  
 Battery Powered Applications

**1 or 2 Amp Models from 5 to 28 Vdc**

**Also Available: High Efficiency Power Supplies and Power Supply Kits**

Our NEW 32 page catalog describes our full line of component module, PC card, open-frame, cased, and laboratory power supplies, DC/DC converters, DC/AC inverters, DC/DC isolators, switching regulators, and power kits.



**SEMICONDUCTOR CIRCUITS, INC.**  
 306 RIVER STREET ■ HAVERHILL, MASSACHUSETTS 01830  
 (617) 373-9104

Circle 152 on reader service card

# How to be beautiful, strong and colorful, in 24 small sizes.

Bold design and quality construction are hallmarks of Optima Small Case enclosures. Mobile, versatile and rugged, these cases offer hundreds of two-color combinations in durable vinyl finishes, with useable inside space ranging from 133.6 to 1445.4 cubic inches. Get information on the complete Optima line. Write

Optima Enclosures, division of Scientific-Atlanta, Inc., 2166 Mountain Industrial Blvd., Tucker, Ga. 30084. Or call (404) 939-6340.

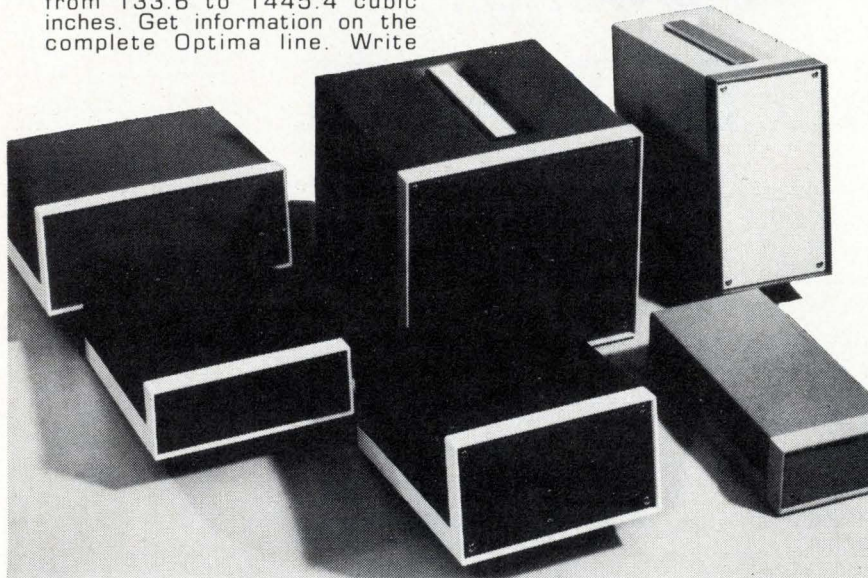

152 Circle 223 on reader service card

## New products

senide phosphide than standard seven-segment displays because they use only a single LED diode per segment. Price is \$3.25 in 100-lots. Litronix, Cupertino, Calif. [388]

## Dual power supply aimed at op amp market

A regulated dual-power-supply module, designated the P31, supplies  $\pm 15$  v at 25 mA and provides 0.1% regulation. It is useful as a supply for operational amplifiers. The module can be printed-circuit mounted and supplied with fixed voltages from  $\pm 4$  to  $\pm 24$  v on special order. Other features include a ripple and noise of 0.5 mV and a temperature range of from  $-25^\circ$  to  $+71^\circ$  C.

Polytron Devices Inc., Box 398, Paterson, N.J. 07524 [389]

## Analog multiplier offers accuracy to within 1%

The model 4202 analog multiplier is intended for OEM applications and is an internally trimmed four-quadrant device. A -3-dB small-signal bandwidth of 1 MHz is provided, in addition to a slew rate of 25 V/ $\mu$ s.

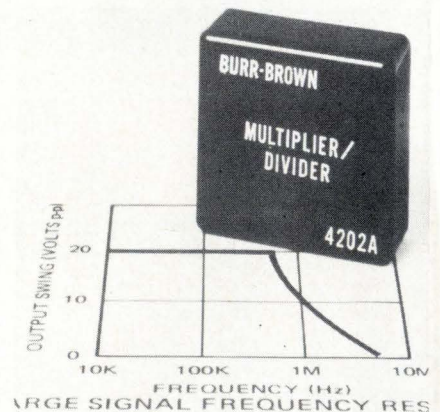

Offset voltage versus temperature is 0.4 mV/ $^\circ$ C. Without external trimming, accuracies are guaranteed to within either 1% or 2%. Price is \$29 or \$45, depending on accuracy. Burr-Brown Research Corp., International Airport Industrial Park, Tucson, Ariz. 85706 [390]

# Not all 327's are created equal.



Face it. The industry standard for subminiature incandescent lamps only establishes a minimum level of acceptable performance. There's a big difference between Chicago Miniature and other "acceptable" alternatives.

And we can prove it.

Customer tests—as well as our own—show surprising variations in brightness, stability and life characteristics. For example,

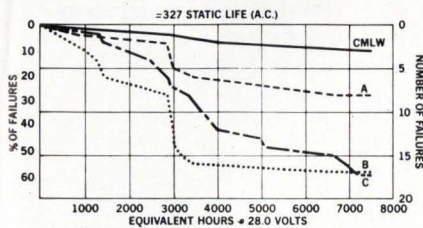

Chicago Miniature's 327, tested under static life conditions, rated an average life of 7,000 hours. Another "standard" lamp doesn't even provide 3,500 hours. That means means Chicago Miniature's 327 gives you more than twice the life.

Obviously, the static life test doesn't guarantee performance under really tough operating conditions. But we can show the same kind of optimum

performance test data under shock and vibration conditions.

The big difference is in how carefully you make things. Chicago Miniature designs and manufactures for optimum—not minimum—performance. And we go a lot farther in quality control than some people might think necessary. We do that for everything—683's, 715's, 385's, 387's, etc.—just to make sure there is a difference.

The way we figure it, there's no standard for quality. And since it doesn't cost anything more, you might as well start at the top.



CHICAGO MINIATURE  
LAMP WORKS  
4433 N. Ravenswood Ave.  
Chicago, Illinois 60640  
(312) 784-1020

a GENERAL INSTRUMENT company

**THE LIGHTING BUGS**

We've published a general discussion of subminiature lamp performance under various operating conditions—complete with text data. Send for your free copy.

Name \_\_\_\_\_

Title \_\_\_\_\_

Company \_\_\_\_\_

Address \_\_\_\_\_

City \_\_\_\_\_ State \_\_\_\_\_ Zip \_\_\_\_\_

Data handling

## Naked mini sells for under \$1,000

16-bit general-purpose computer is contained on 15- by 16-inch circuit board

Dropping prices have boosted mini-computer demand, and the latest move by Computer Automation of Irvine, Calif., should boost it even more. CA, whose earlier stripped-down Naked Mini set new price

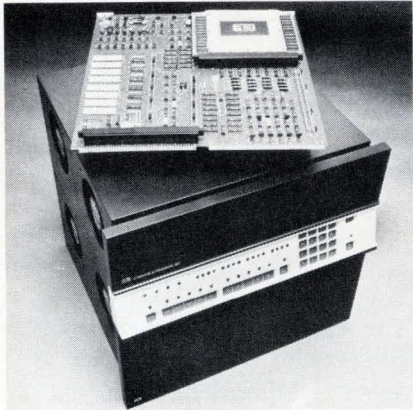

standards two years ago, now has a full 16-bit minicomputer on a single plug-in 15-by-16-inch circuit board for under \$1,000.

The computer, called the Naked Mini/LSI, offers all the capability of the company's earlier \$1,995 Naked Mini, but at half the cost—\$990 in quantities of 200, including 4,096 words of core memory. And it even includes direct memory access, previously a \$400 option. The Alpha/LSI, a packaged version in a case with panel and power supply, is priced at \$1,990 in single quantity. Both versions are fully compatible with the company's earlier machines, though their 1.6-microsecond cycle time is slightly slower.

David Methvin, president of CA, emphasizes that the new machine is a "fully operational general-purpose computer with all of the performance of other 16-bit computers (including ours) priced at several times as much." In particular, it is far

more powerful than micro-computers: it has 162 instructions, including standard hardware multiply and divide, up to 256 vectored priority interrupts, and a "Maxibus" with five input/output systems that provide 58 parallel lines.

Methvin states, "Typical users will find that the Naked Mini/LSI actually costs less than micro-computers for most applications. This is because of the weak instruction sets and limited logic versatility of microcomputers, which cause them to require considerably more memory to accomplish the same tasks—and memory is the most expensive part of small computers." Though it may not require as much memory, the Naked Mini/LSI can have plenty. It comes with 4,096 words of core as standard (the board will hold up to twice as much), and can be expanded to 256 kilowords. MOS memory is also available, at a higher cost, in 1,000-, 2,000- or 4,000-word increments.

The company attributes much of the reduced size and price of the new computer to the use of a seven-chip MOS LSI central processing unit. The p-channel silicon-gate chips, which were designed by Computer Automation engineers, include four identical processor chips and three identical control chips. The seven have only 280 terminals, compared to 8,000 to 10,000 in conventional-mini CPUs.

The Naked Mini/LSI uses an innovative approach for micro-program storage; instead of the usual read-only memory, a programmed logic array (PLA), or associative ROM, is used. The PLA is a form of logic which, unlike the regular ROM, does not waste space storing unused bits. Only product terms are built into the matrix, not all possibilities. This permits much faster speed and reduces memory requirements in a computer with an extensive instruction set, according to company engineers.

Computer Automation is anticipating huge requirements for its new minicomputer. Sol Zasloff, marketing vice president, states, "The minicomputer is now so low in cost, you don't need a terminal

# Help college help you.

Businesses like yours gave over \$340,000,000 to higher education last year.

It was good business to do so. Half of all college graduates who seek work go into business. The more graduates there are, and the better educated they are, the more college serves the business community.

Your money was vital to colleges. It relieved financial pressures, made planning more flexible, and contributed to the kind of basic and applied research that puts new knowledge and technology at the service of industry.

So that colleges can continue to help you, give to the college of your choice now. For information on ways to do it, please write on your letterhead to Council for Financial Aid to Education, Inc., 6 East 45th Street, New York, N.Y. 10017. Ask for the free booklet, "How Corporations Can Aid Colleges and Universities."



Council for Financial Aid to Education, Inc.

Advertising contributed for the public good.



# The Book of MOS.

It's incredible. Some people still think we're just a custom MOS supplier. When here we are with the broadest range of standard MOS products on the market.

To help spread the word about these off-the-shelf items, we've printed a new standard products guide. This little book lists our RAMs, ROMs, shift registers, multiplexers, timing circuits, discretes, music circuits, UARTs, keyboard encoders and character generators. Even off-the-shelf LSI circuits for things like programmable processors, digital clocks and calculator kits.

Our distributors have all these ready and waiting for you in quantity. And they also have plenty of our booklets to give away. If one doesn't land on your desk soon, call your nearest distributor and

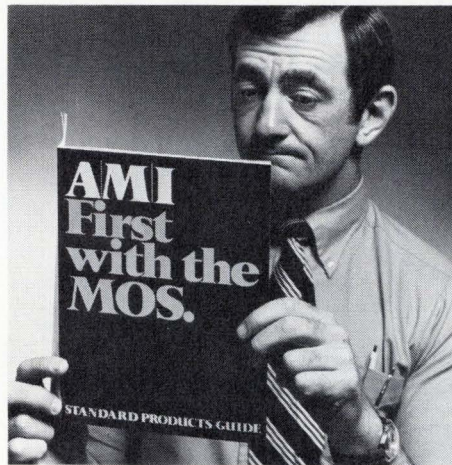

**It'll make a believer out of you.**

demand a copy. Or write us.

And if our standard products aren't exactly what you're looking for, we'll be happy to discuss designing a custom circuit for you.

We've already created more than 800 of them. That makes us number one

in the business.

We also have more MOS production processes going for you than anyone else in the world. P-Channel, N-Channel, Silicon Gate, Ion Implant and C-MOS.

So there you have both sides of our story: standard and custom. Whichever you choose, you'll be getting MOS products you can really have faith in.

**AMI**  
AMERICAN MICROSYSTEMS, INC.

American Microsystems, Inc.,  
3800 Homestead Road,  
Santa Clara,  
California 95051.

## Vector systems help you CUT BREADBOARDING TIME

# Vector

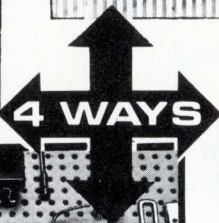
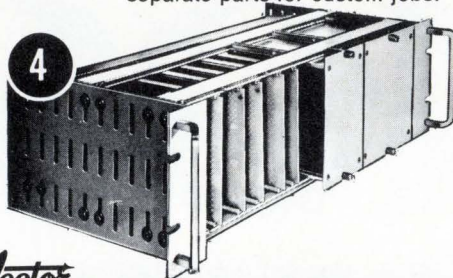
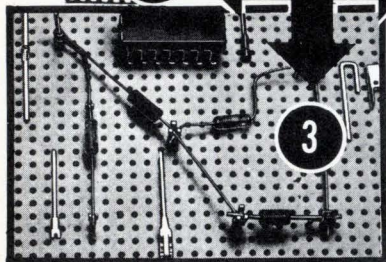
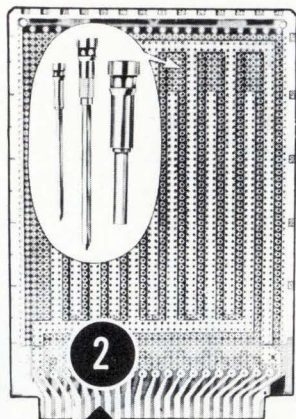
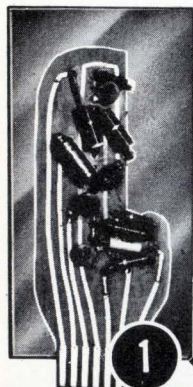

1. Finished etched circuits in your lab within an hour! Photo sensitized copper clad boards have POSITIVE ACTING resist coating which eliminates usual negative reversing step.
2. Dozens of standard off-the-shelf Plugboards in many sizes and connector styles for mounting DIPS or discrete components. New socket pins & wrappable/solderable pins, too.
3. Terminals for .025", .042", .062" and .093" holes for soldering, wire wrapping. New impact terminal staking tools speed production.
4. Versatile, adjustable Vector Strut Cage systems accommodate cards and/or modules of various sizes. Supplied completely assembled, in kits, or as separate parts for custom jobs.

**Vector ELECTRONIC COMPANY, INC.**  
12460 GLADSTONE AVE., SYLMAR, CA. 91342  
TEL. (213) 365-9661

Circle 156 on reader service card

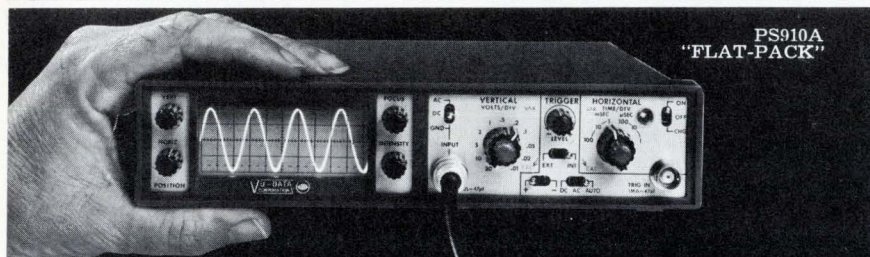

# 20MHz ... and small enough to fit in your brief case!

- Mini-portable Oscilloscope • Battery or AC powered
- DC-20 MHz bandwidth • 10 mV/div sensitivity
- Recharging circuitry • Rack mountable • Laboratory Quality

The PS900's are the first mini-portable scopes to bring lab-quality to "on-site" DC to 20 MHz test and measurement applications. These are "true" portables, since they are of rugged construction, small size (will fit into your tool kit or brief case) and light weight (only 7 pounds with batteries), and since they will operate from internal batteries for up to 5 hours. Recharging circuitry is included, and standard "C" size cells can be used... nickel-cadmium, alkaline or in a pinch, even common flashlight batteries!

- Interested? Call Bill Kraus at (714) 279-6572, or write us at 7170 Convoy Court, San Diego, California 92111.



PS920A  
"STACK-PACK"

Two configurations are available...

"FLAT-PACK"—

1 3/4" H x 8 1/2" W x 12" D

"STACK-PACK"—

3 1/2" H x 4 1/4" W x 12" D

AVAILABLE NOW FROM

## \$595

From the leader in Multi-Channel Monitor Oscilloscopes

# VU-DATA CORPORATION



## New products

hooked up to a large-scale computer unless you need access to a massive data base."

Computer Automation Inc., 18651 Von Karman, Irvine, Calif., 92664 [361]

## Data system handles up to 16 video terminals

Packaged in a 26-inch-high pedestal, the model IV/40 intelligent terminal system features a 72,000-byte LSI processor with an integrated diskette or cartridge drive and an integrated communications controller. It is intended for applications requiring as few as two



video terminals at a remote site and can be expanded to handle up to 16 video terminals and 16 printers. The unit is communications-compatible with IBM computers. The IV/40 may additionally be used with a central data base for real-time data entry and retrieval.

Four-Phase Systems Inc., 10420 N. Tantau Ave., Cupertino, Calif. 95014 [363]

## Writable control store built for Interdata 70 computers

Designed for Interdata model 70 users who want to develop and use their own firmware, a writable control store peripheral is designated OmniROM. Installation consists of a high-speed plated-wire electrically alterable ROM and a controller that connects to the model 70 back plane via one cable. No modifications to

# THE GENTLE LEPRECHAUN.

It's sensitive. It's gentle. It's rugged. It has a character all its own. It's Bell & Howell's Gentle Leprechaun Digital Cassette Recorder.



## How gentle can you be?

Maybe it was our 35 years of experience supplying top quality reel-to-reel magnetic tape equipment that led to innovations like *externalizing* the tape drive system in our quick, little Gentle Leprechaun Recorder.

Or maybe it was the "wee folk" who inspired exclusives like our Autoload™ mechanism, a little finger-like device that ever-so-gently pulls out a 2-inch loop of tape from the cassette and then gently and automatically positions it on the capstan in a precision tape guide path. (We even removed those arch troublemakers, pressure pads, the main cause for head and tape wear, oxide shed and dropout.) What we left in was *rugged reliability*. The kind that stands up to MTBF of 2,300 hours. *And precision*. The kind you need for incremental character search. *And speed*. The kind that whittles down a

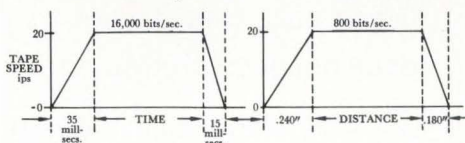

big pile of work in the twinkling of an eye!

## The Gentle Leprechaun at work.

Once the cassette is inserted, like magic, the recorder automatically seeks the beginning of the tape to prevent the operator from inadvertently writing on the leader.

Tiny strain gages go to work sensing the tape tension and holding it to 1.25 ounces. The sensitive capstan motor tachometer helps maintain just the right rotational speed. Your tape cassettes will last more than three times longer than in any other recorder. (2,000 passes guaranteed!)

## A rainbow of extras.

But that's just part of the inventory in the Gentle Leprechaun's pot of gold. The unit is adaptable to a wide range of commands giving the user plenty of freedom with his interface.

It also features a 50 ips fast forward/reverse speed (block search at 50 ips). Data search (reading data) at 20 ips. Bi-phase encoded recording at 800 bpi. Plus a data transfer rate of 16,000 bits per second. (Character incremental mode up to 400 characters per second.) The Gentle Leprechaun offers one or two-track read/write or single-track read-after-write with ECMA standard compatibility.

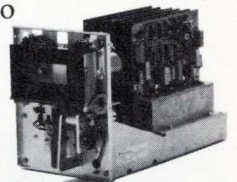

A perfect companion to minicomputers, word processing systems, data communications, numeric control, data entry and data acquisition systems, it can be used in both synchronous and asynchronous environments as replacements for paper tape or expensive reel-to-reel equipment.

You don't have to be Irish to obtain a free copy of our Interface Manual and to talk discounts. Bell & Howell's Gentle Leprechaun will work for anyone.

Bell & Howell  
360 Sierra Madre Villa, Pasadena, California 91109  
I'd like to see the Gentle Leprechaun. Call me:

Name  Title

Company

Address

City  State  Zip

Phone number

© Copyright 1973 Bell & Howell

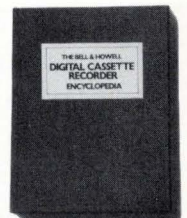

**BELL & HOWELL**  
WE'RE REWRITING THE BOOK.

# NEW 1000:1 SWEEP GENERATOR (It's a function generator too!)

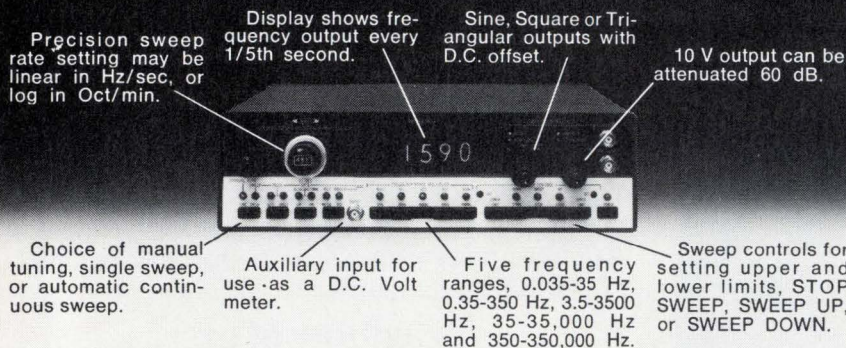

The new VIC Model 965A is exceptionally easy to use, highly versatile and modestly priced too! Send today for detailed specs and prices to: Vibration Instruments Co., 1614 Orangethorpe Way, Anaheim CA 92801, or phone 714/879-6085.



**VIBRATION INSTRUMENTS CO.**

Circle 158 on reader service card

## FOR YOU TO COMPARE

CM50 \$399.00



- Frequency, Ratio, Period, Totalize
- 5 Hz to 50 MHz
- 50 mV Sensitivity
- 6 Digit LED Display
- Leading Zero Suppression
- Trigger Control Status Lamps
- Units Annunciation
- 110 Vac or 12 Vdc

**AND DECIDE**

analog digital research

1051 Clinton Street  
Buffalo, N. Y. 14206

### LOW COST SEMICONDUCTOR MEMORY SYSTEM

**MONOSTORE IV/Planar** capacity 1K x 1 to 4K x 20 on a single P. C. card 9 3/4" x 14". Cycle time 650 ns access time 450 ns. System includes timing control, refresh, address register, output data register, decoding, sense and memory array. Interface TTL compatible. Multiple cards can be packaged on 0.5" centers. Single quantity 4K x 16 priced at \$900.00. Available off the shelf.

**MONOLITHIC SYSTEMS CORPORATION**  
2700 S. Shoshone,  
Englewood, CO 80110  
(303) 761-2275

158 Circle 225 on reader service card Circle 226 on reader service card

## New products

the computer's hardware are required. The controller logic card and a power supply are contained in a 5 1/2-inch rack-mounted cabinet. Status of the ROM data and address are displayed on the OmniROM front panel. The unit is priced at \$4,298 for 1,000 words of memory and \$5,500 for 2,000 words. The prices include cabinet with controls and indicators, memory module, controller logic card, power supply, cabling, driver and diagnostic software, and full documentation. Delivery time is 60 days.

Memory Systems Inc., 3341 W. El Segundo Blvd., Hawthorne, Calif. 90250 [364]

Card reader offers speeds of 300 or 600 per minute

A card reader, available with reading speed of either 300 or 600 cards per minute, has a vacuum pick that



allows accurate single selection of cards even when the cards are worn or damaged. A finger-like device brings a vacuum to the leading corner of the card, drawing it down to meet the friction transport system for positively controlled, constant-velocity travel past the read station. Electronic Associates Inc., West Long Branch, N.J. 07764 [365]

Digital cassette recorder does not need precise drive

An incremental digital cassette recorder designated the STR-2001 is a portable unit that, using a speed-



# The Diskette Deal

**1.** A complete Diskette "floppy disk" drive — featuring Innovex's unique stationary magnetic cartridge and rotating, moving head mechanism for unmatched reliability and data integrity.

**2.** A Diskette formatter — provides all seek, read-write, error detection and data formatting functions for up to eight Diskette drives, and plug-in interfacing to all popular 8-, 12- and 16-bit minicomputers.

**3.** Power supply, limited diagnostics, and free and guaranteed installation of your first unit — by Innovex at your site.

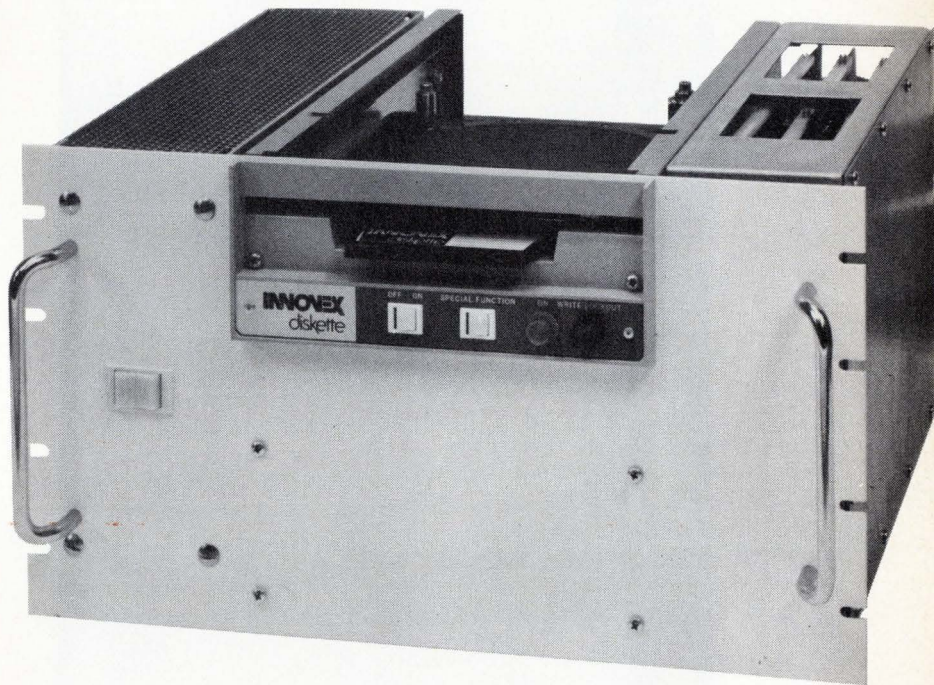

**Total-  
\$2,740.00  
Complete**

\$2,740.00 is the price for the first Diskette drive and formatter you buy. Substantial OEM discounts for quantity purchases make an already great deal even better. For complete details on The Diskette Deal for your application, contact:

INNOVEX CORPORATION  
FOUR ALFRED CIRCLE  
BEDFORD, MASS. 01730  
(617) 275-2110

**INNOVEX**

# VIDEO COMPRESSOR

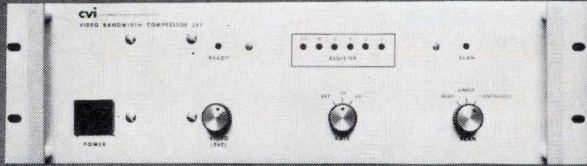

## FOR LAB AND COMMUNICATION SYSTEMS

The CVI Model 260 Video Compressor samples conventional "real time" television signals to achieve a large reduction in bandwidth. The compressor also digitizes the signals for computer input and image analysis. A special 260 feature incorporates a "real time" video output which allows users to monitor the sampling process.

### TYPICAL APPLICATIONS INCLUDE:

- Computer data input, linear or semi-random scanning
- Communications: transmission of TV images over voice grade circuits for conference or data distribution purposes
- Environmental monitoring: transmission of TV signals for remote observation and computer analysis
- Data recording: utilization of conventional audio cassette or reel-to-reel tape recorders for image storage
- Biomedical image analysis
- Industrial control
- Computer image enhancement

Video instruments for data acquisition, processing, transmission, and display.

# cv*i*

Colorado Video, Inc.

P.O. Box 928 Boulder, Colorado 80302 (303) 444-3972

## New products

tolerant recording technique, eliminates the need for an ultra-precise drive mechanism. This same technique produces a single-track, self-clocking recording that makes the unit compatible with any digital computer system or data-collection device. Price is \$495 for a single unit and \$465 in quantities from two to nine. Additional discounts are available on larger quantities. Delivery time is 30 days.

Electronic Processors Inc., 5050 S. Federal Blvd., Englewood, Colo. 80110 [366]

Alphanumeric display is designed for Nova units

Intended for Nova computers, an Alphanumeric display, called the Lexiscope 2000, is packaged on a single printed-circuit card. The unit

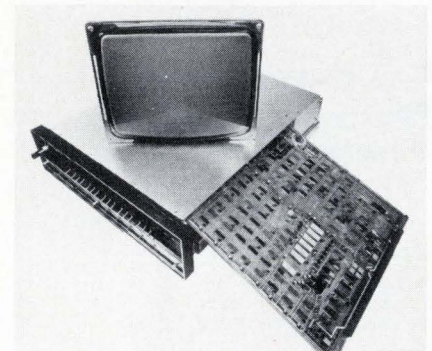

features a 2,000-character MOS random-access memory that is organized to give an 80-column-by-25-row format. Use of the RAM eliminates latency time and the need for interrupt programming. The unit also includes a keyboard control, the operation of which does not require a teletypewriter interface. Price is \$1,585.

Lexicon Inc., Waltham, Mass. [367]

Reader accepts punched and pencil-marked cards

Operating at a rate of 300 cards per minute, an internally buffered, serial, optically-marked-card reader, called the model 7260A, accepts nearly all types of marked or punched cards. The unit can be

# DC to AC Sine Wave Inverters



## SPECIFICATIONS

### Output Voltage Regulation:

less than  $\pm 5\%$  for line and load

### Frequency Stability:

$\pm 0.5\%$  of fixed frequency; 0.05% optional

### Total Harmonic Distortion:

less than 5% at full load and nominal line

GW Series — Typical 60 Hz Models				
Power (VA)	Input (VDC)	Output (VAC)	Priced from	Delivery
250	12/24, 28, 48, 125	115, 230	\$ 695	Stock
500	12/24, 28, 48, 125	115, 230	1195	Stock
1000	12/24, 28, 48, 125	115, 230	1700	Stock
2000	12/24, 28	115, 230	3000	3 days
3000	12/24, 28	115, 230	4400	3 days

(50 and 400 Hz models available)

# TOPAZ

**ELECTRONICS**

SOLUTIONS TO  
POWER PROBLEMS

3855 Ruffin Road, San Diego, CA 92123 Phone (714) 279-0831

Circle 227 on reader service card

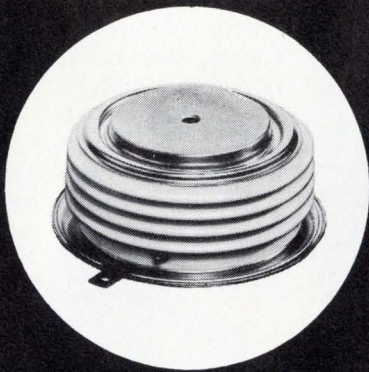

## TWO *New* SCRs

from NATIONAL ELECTRONICS  
featuring

- Patented Regenerative Gate
- High di/dt with low power gate drive

**F-390** 850 A RMS, 500-1300 V. DC motor control and power supplies.

**F-395** 700 A RMS, 100-600V. Fast switching, high frequency for inverter use.



**NATIONAL ELECTRONICS**  
a varian division  
geneva, illinois 60134 (312) 232-4300

Circle 228 on reader service card

# Marco-Oak Rainbow switch

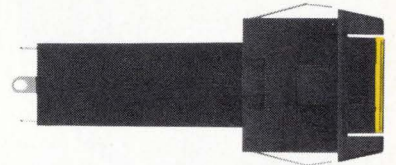

## with or without a lamp

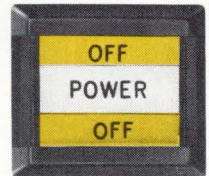

## changes color changes legend

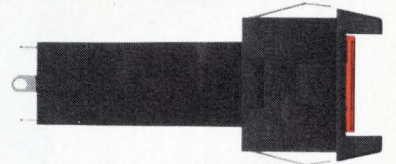

## and latches down.

- 10.5 amps/28VDC, 125/250 VAC
- 1 or 2 pole form Z
- Contact module U.L. Listed
- Choice of on-off colors
- Ideal for high ambient light service.

Lighten your decisions  
contact . . .

## MARCO-OAK

A Subsidiary of OAK Industries Inc.

P.O. Box 4011  
207 S. Helena Street, Anaheim, Calif. 92803  
Tel. (714) 535-6037 • TWX — 910-591-1185

Circle 161 on reader service card 161

# The long-billed heat sucker.

Cool bird. Reaches into tight places and sucks out heat. Does it with Hughes heat pipes.

Nesting places include transformer cores, solid state devices, tightly stacked circuit boards, electro-optical systems, and other congested hot spots. Any place the finned heat sinker can't nest.

Only Hughes has the long-billed heat sucker. Several

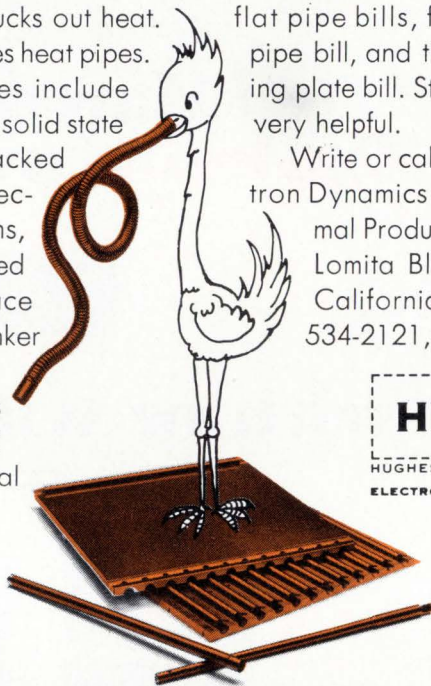

subspecies available: round and flat pipe bills, flexible round pipe bill, and the cold mounting plate bill. Strange bird, but very helpful.

Write or call: Hughes Electron Dynamics Division, Thermal Products, 3100 West Lomita Blvd., Torrance, California 90509. (213) 534-2121, Ext. 451.



Circle 162 on reader service card

High-Accuracy

## Phase Meters

0.5 Hz to 2 MHz  
Digital or meter readouts

As low as \$885



930 E. Meadow Dr. Palo Alto, Ca. 94303  
(415) 321-7428

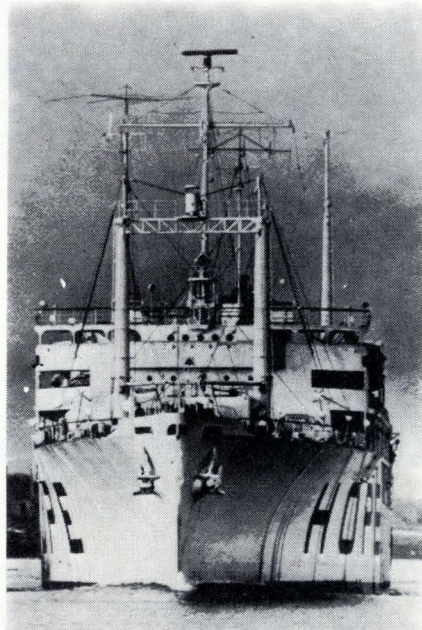

## S.S. HOPE, M.D.

Doctor . . . teacher . . . friend to millions on four continents—this floating hospital is a symbol of America's concern for the world's disadvantaged. Keep HOPE sailing.



Dept. A, Washington, D.C. 20007

## New products

used in an office or for remote-terminal applications; it is designed for use with terminals, computers or re-

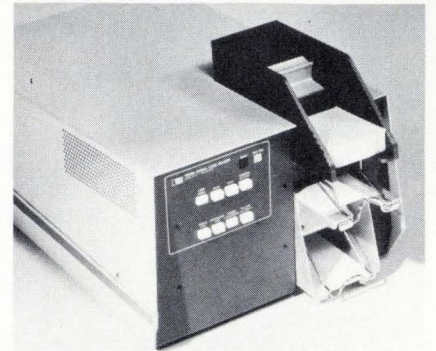

mote data systems via a modem or direct connection. Any number of columns may be read from one to 80, and data rates are switchable from 110 baud through five intermediate rates up to 2,400 baud. Price is \$2,975.

Hewlett-Packard Co., 1501 Page Mill Rd., Palo Alto, Calif. 94304 [368]

Data acquisition system offers up to 1,024 channels

A multichannel data-acquisition system, designated the Milliverter II, accommodates up to 64 low-level signals for about \$125 per channel, up to 256 high-level channels for less than \$35 per channel, or any combination of low- and high-level signals. The unit is constructed

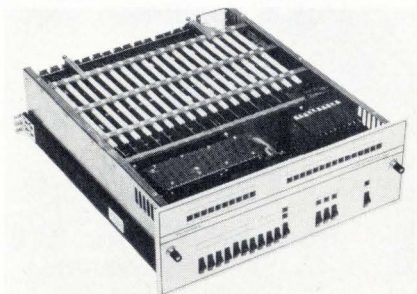

modularly and can be expanded to 1,024 channels. Applications include production testing, simulation instrumentation, and vibration analysis. The unit is available with interfaces to most computers. Basic system price is \$3,250, plus amplifier cards.

Data Technology, 2700 S. Fairview Ave., Santa Ana, Calif. 92704 [369]



## Mike Truitt, in cap and gown, the day he graduated as a dental technician.

While he was in the Navy, Mike Truitt went to class. Had experienced teachers. And, in very little time, became a dental technician. But that's not all he learned in the Navy. He also learned about people. About life. About himself. And while he learned, he got paid for it. If your son joins today's Navy, there are many different career opportunities he may be able to choose from. The Navy recruiter in your neighborhood can tell him all about it. Or, send this coupon for a full-color information brochure. In the last 20 years, the Navy has graduated over a million young men. So when you suggest us, you know you're giving some good advice.

Please send complete information about the U.S. Navy.

COMMANDER, NAVY RECRUITING COMMAND  
U.S. NAVY  
BLDG. 157  
WASHINGTON NAVY YARD  
WASHINGTON, D.C. 20390

Call toll-free:  
(800) 841-8000

Your Name \_\_\_\_\_

Your Son's Name \_\_\_\_\_ Age \_\_\_\_\_

Address \_\_\_\_\_

Phone # (       ) \_\_\_\_\_

City \_\_\_\_\_ State \_\_\_\_\_ Zip \_\_\_\_\_

### The Navy

E 2



# SIMPLY GREAT!

Their simple design is what makes them so GREAT! AirBorn's new WT connector series features rugged, right-angle or straight through contacts .030 dia. for printed circuit or subminiature applications.

Available in 22 sizes — 1 through 22.

For literature, call 214-357-0274 or write 2618 Manana Drive, Dallas, Texas 75220.

## ***AirBorn, Inc.***

### **New products/materials**

A line of evaporation sources for thin-film vacuum coating includes tungsten, tungsten filaments, molybdenum, and tantalum evaporation boats. They are supplied in a variety of shapes, sizes and configurations

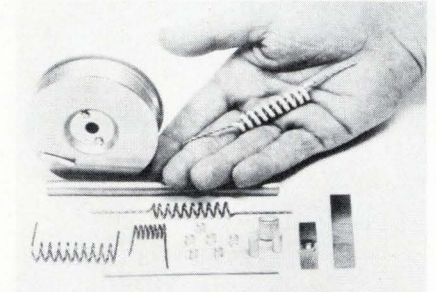

and are manufactured from very pure metals. The sources are available with adherent alumina coatings for applications where a chemical reaction between charge and source is of concern. For electron-beam evaporators, liners and tungsten emitters can be made to order.

Materials Research Corp., Rte. 303, Orangeburg, N.Y. 10962 [476]

**Hi-Per 350 P** is a hot melt for manual and product-assembly bonding applications. The material has good hot-tack capability and combines creep resistance at temperatures up to 210°F with low-temperature bond strength. It is available in granular form or in cartridges. Free samples are available.

Ornstein Chemicals Inc., Folly Mill Rd., Seabrook, N.H. 03874 [477]

A two-part gold epoxy, designated Epo-Tek H-81, is intended specifically for chip bonding in micro-electronic applications. The conductivity rating of the material is 0.0005 to 0.0009 ohm-cm. Curing takes place in five minutes at 150°C, in 15 minutes at 120°C or 90 minutes at 80°C. Pot life is two days, and shelf life is a minimum of two years. Price is \$80 for a ½-ounce trial evaluation kit.

Mason Associates, 1 Frost Rd., Lexington, Mass. 02173 478

An epoxy casting material is formulated for small-mass encapsulating applications of miniature electronic components. Called Tra-Cast 3103, the material is a solventless, two-

**Here's everything  
you'd expect from a high-priced  
portable multimeter.**

**Except a high price.**

Compare our major features: Both high and low power ohms ranges; a .1 V low voltage scale (AC & DC); a DC current range of  $1\mu A$  full-scale; fuse protection; input impedance of  $15 M\Omega$  on DC; 1% precision resistors; a  $4\frac{1}{2}$  inch,  $50\mu A$  mirrored scale meter; frequency response flat to 150 KHz and 59 ranges; battery operated.

You'd expect to pay a lot more for a portable multi-meter like the B & K 277. Check the specs. Call your B & K distributor or write Dynascan Corporation.

**\$99<sup>95</sup>**

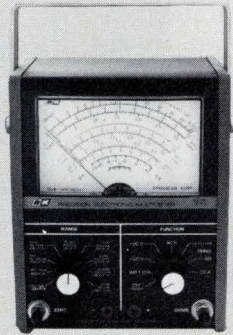

**B&K** Very good equipment at a very good price.

Product of Dynascan Corporation  
1801 West Belle Plaine Avenue, Chicago, Illinois 60613

Circle 230 on reader service card

**All-purpose data gatherer.  
Highest accuracy/dollar ratio.**

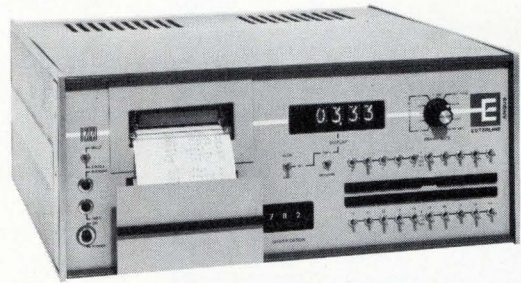

Esterline Angus D-2020 P.D.A.S. (programmable data acquisition systems) give you 5 to 200 channels, 0.1% accuracy, a hard copy record, computer compatibility—and a cost per hundred channels comparable to multi-point analog recorders. Ours is second-generation, with more than 100 in use—many repeat customers.

Programming is with simple switches. The D-2020 gives you digital read-out, digital print-out, or computer input data, or all three. New print-skip option permits random access. Ask for a catalog or a demonstration. Box 24000, Indianapolis, Indiana 46224. Phone (317) 244-7611.



**ESTERLINE ANGUS**

A UNIT OF ESTERLINE CORPORATION

Circle 231 on reader service card

# When you're hot, you're hot!

So you need a rugged cement that really stands up to hostile heat?

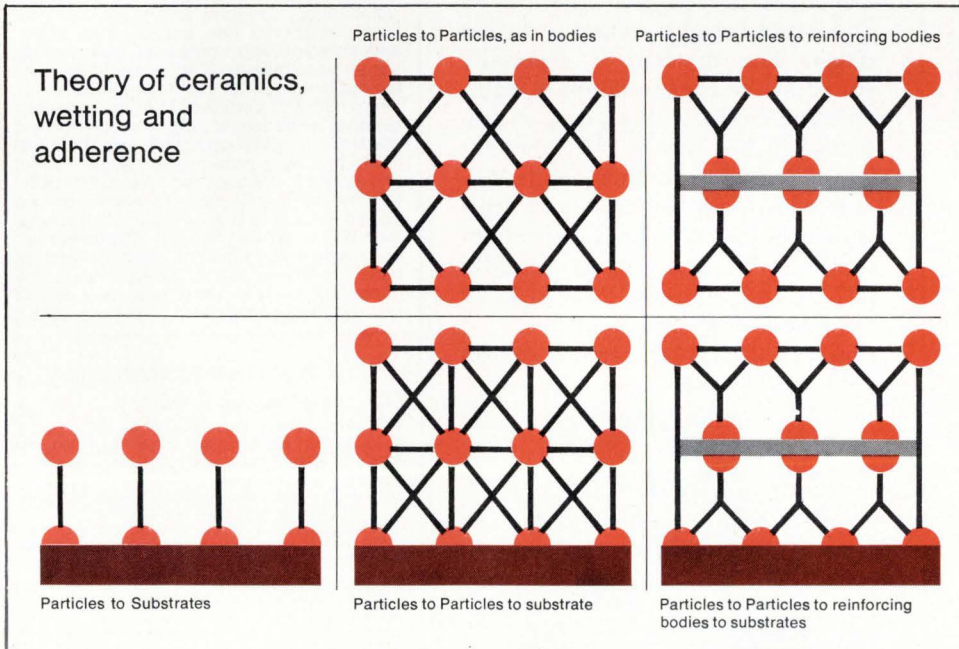

SermeTel bonding product systems have the answer to difficult applications. Can be custom mixed to offer electrical properties ranging from non-conductors to high conductors and bonding for temperatures from  $-375^{\circ}F$  to  $6000^{\circ}F$ .

**APPLICATIONS:**

- High temperature instrumentation
- Missile systems
- Strain Gauges
- Turbine engines
- Thermocouples
- Abradable seals
- Transducers
- Potting and joining compounds
- Steam turbines
- Electronic Assemblies
- Heat exchangers
- Nuclear reactors

For a basic introduction to a fascinating new family of proven SermeTel products offering advantages that generate big money savings, write on your company letterhead for a copy of the newest in a series of definitive documents entitled "The Sciences of SermeTel Bonding Products."

P.O. Box 187  
North Wales, Pa.  
19454



**SERMETEL®**

A DIVISION OF **Telexflex®** INCORPORATED

there is only  
**one**  
calibrator  
designed for  
**DIGITAL** (as well as analog)  
**METERS**



**ROTEK'S**  
**NEW Series 300**  
**E/I/R Calibrator**

This versatile, high-precision instrument introduces a new concept in voltage, current and resistance calibration for the digital instruments of the 70's, as well as for classic analog meters. No other calibrator on the market can match its combination of high accuracy, operating speed and safety, and flexibility. It gives you:

- **High accuracy** — 0.005% DC; 0.05%, AC
- **Broad operating range** — 6 voltage ranges; 6 resistance ranges; 7 current ranges; frequencies to 10 kHz
- **Closed-loop operation** — provides instant, automatic response to dial settings . . . eliminates fussy manual adjustments
- **Four-terminal sensing**
- **Programmable operation available** — Model 310
- **Unprecedented flexibility** — ideal for calibrating analog meters and panel meters of all types, including 3, 4 and 4½ digit AC or DC ammeters, voltmeters, multimeters and A-to-D converters

Complete specifications and data are now available on the Series 300. Send for your free copy today.



**ROTEK**

**INSTRUMENT CORP.**  
40 Guinan Street  
Waltham, Massachusetts  
Tel. (617) 899-4611

**New products/materials**

part system that mixes to a smooth, low-viscosity fluid. It cures overnight at room temperature with low exotherm and minimum shrinkage. Tra-Con Inc., Resin Systems Div., 55 North St., Medford, Mass. 02155 [479]

**Tyox thick-film-switch** composition 9253 is intended for use in automotive, instrumentation, and communications applications and can be processed by standard thick-film techniques to form thermal or threshold switches. Such applications include thermal sensors, surge protectors, and solid-state relays. DuPont Co., Wilmington, Del. 19898 [480]

**Screen-printable materials** for optoelectronic applications are for use in the construction of plasma liquid crystals and light-emitting-diode displays. The materials include: a low-temperature firing conductor and both clear and black dielectric compositions for firing on glass; screen-printable sealing-glass pastes; conductive and dielectric compositions for alumina, and tin-oxide etching aids.

Electro-Science Laboratories Inc., 1601 Sherman Ave., Pennsauken, N.J. 08110 [392]

**Stycast 1269-A** is an epoxy casting resin that can be used in windows and lenses because it cures to a clear finish. The material is especially suited to the encapsulation of light-emitting diodes. It is a two-part system, which cures in 16 hours at 210°F, adheres to most materials, and withstands sunlight and temperatures to 300°F. Index of refraction is 1.5401, and volume resistivity is  $7 \times 10^{14}$  ohm-cm. Price is \$2.60 per pound in 18-pound lots.

Emerson & Cuming Inc., Dielectric Materials Division, Canton, Mass. 02021 [391]

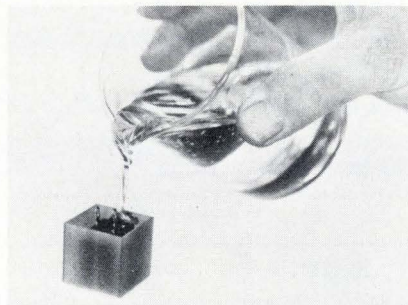

Find out how today's  
**low-cost minicomputers**  
can maximize your output.

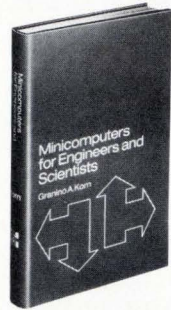

**MINICOMPUTERS**  
**FOR ENGINEERS**  
**AND SCIENTISTS**

By **Granino Korn**  
WITH MORE THAN  
**100 ILLUSTRATIONS**  
352 pages, \$17.75

They're small, they're powerful, they're low-cost. They comprise the fastest growing segment of the fastest growing industry today. And this remarkable new breed of computers can perform near-miracles for people like yourself—electronics specialists, engineers, and other scientists—*IF* you know how to put them to work for you.

That's why this single volume—written expressly for people who are using or are planning to use a minicomputer—is one of the most valuable working tools ever made available to you.

In the shortest time possible, this concise and always clear book can give you a sound understanding of the minicomputer units available, where you can use them, what you can expect from them, and how you can realize all their exceptional possibilities. The sometimes confusing language of the manufacturers is simplified and codified. Minicomputer assembly language is explained. Detailed guidance is given on how to use the minicomputer as a live mathematical model and how to operate front-panel controls, peripherals, and system software. An added feature is a briefing on how to use macros for writing simple "home-made" computer languages for special applications. Examine the book and see how minicomputers can help you do a better job. At your bookseller, or use coupon.

**10 DAYS' FREE EXAMINATION**

**McGraw-Hill Book Company**

1221 Ave. of the Americas, N.Y., N.Y. 10020  
Send **MINICOMPUTERS FOR ENGINEERS AND SCIENTISTS (353387)** for 10 days on approval. In that time, I will remit the price of \$17.75, plus tax, postage, and handling costs, or return the book without further obligation. (Remit with coupon, plus tax, and McGraw-Hill pays postage and handling. Same return privilege applies.)

NAME \_\_\_\_\_  
ADDRESS \_\_\_\_\_  
CITY \_\_\_\_\_  
STATE \_\_\_\_\_ ZIP \_\_\_\_\_

Offer good in U.S. only, and subject to acceptance by McGraw-Hill. 23L573



**Flameless  
Compressed-Air  
Heat Torches** —  
Lightweight and  
portable for  
pinpoint  
intense heat  
performance.

**Heat Blowers** — Built for  
continuous 24-hour duty.

**New! Mite Heat Gun**  
— Lightweight  
versatility  
with three  
interchangeable  
nozzles and  
heat ranges.

**Standard  
Heat Gun**  
— Compact  
and  
economical,  
die-cast  
aluminum  
housing.

250° to 1,000°F.

**Chrome Heat Gun** — Designed for  
labs, R & D, and professional use.

**Another fine OEM product from C. Itoh.**

Model EP-101

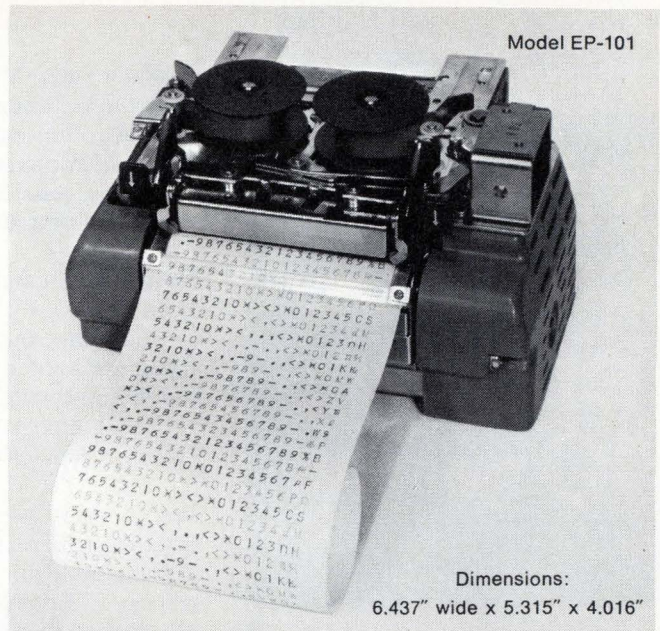

Dimensions:

6.437" wide x 5.315" x 4.016"

## Printing Mechanism for digital devices.

The EP-101 model simplifies the parallel entry printing mechanism by using a much smaller number of component parts. The result is a top-quality printing mechanism with a high degree of reliability and durability. As small as it is, the EP-101 still produces a fast 21-column print-out at a speed of three lines per second.

Other features include low electrical power consumption (150 mA at 15V-DC) and a long-life transistorized motor.

It is designed for the widest possible applications—everything from cash registers and measuring devices to computers—and provides you with a hard copy.

There are other models available for many specific applications, each ready for immediate delivery at a most attractive C. Itoh price.

Send in the coupon for more information.

### C. Itoh & Co. (America) Inc.

270 Park Avenue, New York, N.Y. 10017 • (212) 953-5452

**West Coast office:** 555 S. Flower Street, Los Angeles, Calif. 90071.  
(213) 687-0610.

**Canadian office:** 401 Bay Street, The Simpson Tower,  
P.O. Box 78, Toronto 103, Ontario, Canada. (416) 366-9263/4.

Attention: Industrial Electronics Div.  
C. Itoh & Co. (America) Inc.  
270 Park Avenue  
New York, N.Y. 10017  
Tel.: (212) 953-5452

Please send me more information on your printing mechanism for digital devices.

Name \_\_\_\_\_ Title \_\_\_\_\_

Company \_\_\_\_\_ Telephone No. \_\_\_\_\_

Street \_\_\_\_\_

City \_\_\_\_\_ State \_\_\_\_\_ Zip \_\_\_\_\_

Specific Application \_\_\_\_\_

# A flameless heat tool for every need: Master makes them all

Master offers you the world's most complete line of flameless heat tools. Each one is precision built for rugged dependability and versatile performance. And every Master heat tool features a complete line of attachments for every production need.

Heat Guns and Blowers are available in U.L. and L.A. approved models. CSA approved in Canada. In Canada, contact Martin Industrial Sales, P.O. Box 576, 4445 Harvest Road, Burlington, Ontario.

Send for your free 12-page catalog and price list on the world's most complete line of flameless heat tools.

**MASTER**  
appliance corporation  
Racine, Wisconsin 53403

YOUR PLASTIC  
PACKAGE  
DEVICES

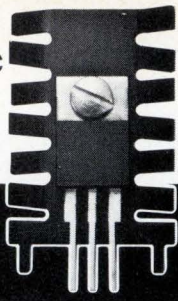

We  
can cool  
'em for  
10¢ each\*

No board room required

Low-cost vertically mounted heat sinks accept all types of plastic packaged SCR's, transistors, and triacs, including center-tabbed devices. Typical  $R_{\theta}$ :  $26^{\circ}/W$ . Black anodize is standard, but also available gold chromated or nickel-plated for dip soldering to PC board. Weight only 0.07 oz.

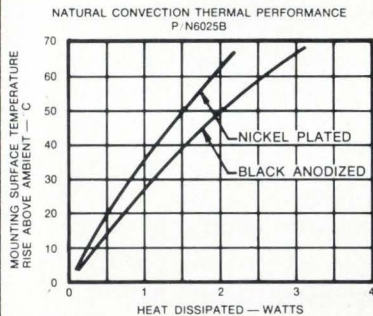

Available from your local  
Thermalloy distributor.

Thermalloy offers a complete line for cooling everything from TO-5's to disc compression devices.

Write for  
FREE  
CATALOG.



\*Chromate finish, 1000 quan.



**Thermalloy**

P.O. BOX 34829  
2021 W. VALLEY VIEW LANE/DALLAS, TEXAS 75234  
PHONE 214-243-4321/TWX 910-860-5542

## New literature

**Resistor inks.** Matthey Bishop Inc., Electronic Materials Group, Malvern, Pa., has published data sheet EMG-2.2A providing drift information on resistor thick-film inks. Circle 421 on reader service card.

**Switches.** A catalog of switches has been issued by Molex Inc., 2222 Wellington Court, Lisle, Ill. Cataloged are lighted push-button types, nylon and phenolic switch housings, rocker switches, and combination switch-receptacle units. [422]

**Epoxy.** A 16-page booklet describing the properties and test results of a semiconductor IC package material called Epoxy B is available from National Semiconductor Corp., 2900 Semiconductor Dr., Santa Clara, Calif. 95050

**Power modules.** A series of silicon power modules and unmounted power-generating cells is described in a data sheet from the Semiconductor Division of International Rectifier Corp., 233 Kansas St., El Segundo, Calif. 90245 [423]

**Controls.** Bourns Inc., Trimpot Products Division, 1200 Columbia Avenue, Riverside, Calif. 92507. A controls and variable resistor brochure contains technical data, specifications, and outline drawings. [424]

**Magnetic shielding.** The problem and solution of designing and manufacturing magnetic shielding for storage tubes is detailed in data sheet 207-2PS, available from Advance Magnetics Inc., 226 E. 7th St., Rochester, Indiana 46975 [425]

**Microwave components.** A 256-page catalog from Anzac Electronics, 39 Green St., Waltham, Mass., describes the company's line of microwave signal-processing components. These include double balanced mixers, impedance-matching transformers, frequency doublers, standing-wave-ratio bridges, and attenuators. [426]

**Silicone fluids.** Properties and benefits of 14 silicone fluids are listed in

# PLAY THE FIELD

## In Rochester, N.Y.

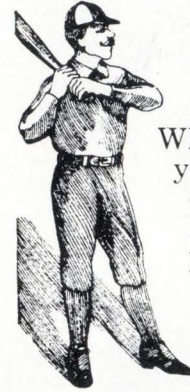

Whatever your sport, you'll find the best of all seasons in Rochester. Spring: pro baseball, putting and sand-blasting at 20 golf courses. Summer: sailing, skiing and

splashing at 11 lakes. Fall: pro soccer, college football, leaf-watching at 12 parks. Winter: pro hockey, skiing (and falling down) at 13 slopes. You can play the field in Rochester with these varied forms of recreation.

But, did you know that aside from being a sporting city, we also have 5 million sq. feet of plant space available for occupancy now?

If you'd like data on plant sites... or information on any aspect of plant or site selection, call collect, or write to Bob Hall, Director of Area Development, Rochester Gas & Electric, 89 East Ave., Rochester, New York 14649 (Telephone: 716-546-2700).

Nobody knows more about this area than we do. We'd like to share our knowledge of our home grounds with you.

Rochester Gives You a Sporting Chance.

**RGE**

ROCHESTER GAS AND ELECTRIC  
89 EAST AVENUE ROCHESTER N.Y. 14649 • 546 2700

## New literature

a 12-page information bulletin being offered by Dow Corning Corp., Midland, Michigan 48640. Easy-to-use tables simplify selection of fluids. [427]

**Quartz devices.** Statek Corp., 1233 Alvarez Ave., Orange, Calif. A four-page quartz crystal and crystal oscillator brochure outlines technical characteristics and typical specifications, in addition to dimensional data for the TO-5 and flat-pack devices. [428]

**Power transistors.** Solitron Devices Inc., Semiconductor Division, Riviera Beach, Fla., has published a 68-page catalog detailing the company's line of power transistors, hybrids, and microwave transistors. [429]

**Photomultipliers.** Varian LSE, 601 California Ave., Palo Alto, Calif., is offering an 8-page catalog describing the company's line of photomultiplier tubes. [430]

**Instrumentation amplifier.** A data sheet from Zeltex Inc., 1000 Chalomar Rd., Concord, Calif., describes the 391 series instrumentation amplifiers suited for low-level signal amplification in research instrumentation or data acquisition systems. [431]

**Semiconductor test system.** E-H Research Laboratories Inc., 515 Eleventh St., Box 1289, Oakland, Calif. 95604. A brochure describes the 4500/4600 automated semiconductor test system and provides information on the cost of hunting down pc-board failures as functions of the number of devices per board and the percentage of bad ICs passed. The brochure also examines typical IC device operating frequencies. [432]

**Circuit-board hardware.** A 16-page booklet describes circuit board hardware. It is available from Richco Plastic Co., 5925 N. Tripp Ave., Chicago, Ill. 60646, and details board supports, hold-down strips, spacers, card pullers, and edge protectors. [433]

## DIP REED RELAYS

Available in all standard configurations  
From distributor stock

Elec-Trol's totally encapsulated DIP REED RELAYS can be driven directly by TTL logic. Available in 1 and 2 Pole Form A, 1 Form B, 1 Form C with 5 through 24 VDC standard coil voltages. Contact ratings up to 10 watts. Available in .225" and .275" heights. Clamping diode and electrostatic shielding optional.

Phone, wire or write.

### ELEC-TROL, INC.

26477 N. Golden Valley Road  
Saugus, California 91350  
(213) 788-7292  
TWX 910-336-1556



1973-74  
**eem**  
VOL. TWO

Circle 169 on reader service card

## Wanted by the authorities.



Crystal Detectors 350 KHz-12.4 GHz

Singer is on the most wanted list for crystal detectors. Experts recognize Singer's two series of broadband Crystal Detectors covering the 350 KHz to 12.4 GHz range as excellent performers. Both Series 1001 (10 MHz to 12.4 GHz) and Series 1006 (350 KHz to 1000 MHz) offer flat frequency response of better than  $\pm 0.5$  dB and high sensitivity. Series 1001 offers three choices of input connectors.

For power leveling, absolute power measurement, peak power measurement, broadband detection and for use in reflectometer systems Singer Crystal Detectors offer high reliability, stable performance and low cost: from \$50 for Series 1006 to \$140 for Series 1001.

Contact the Singer Company, Palo Alto Operation, 3176 Porter Drive, Palo Alto, California 94304, Telephone (415) 493-3231.

**SINGER**  
INSTRUMENTATION

# “Let’s kill all the lawyers!”

*“The first thing we do, let’s kill all  
the lawyers!”*

*—Henry VI, Part II, Act IV*

Jack Cade, in Shakespeare’s play, was leading a rebellion and looking for a scapegoat.

He hit upon a somewhat bloodthirsty, but extremely popular, idea.

There is a new and different kind of rebellion in America today. An angry revolt against the pollution and despoilment of our environment.

And some people, again seeking a scapegoat, have also hit upon a popular idea.

**P**ut the blame, and the burden, on business.

Indict U.S. industry as “The perpetrator of an irresponsible assault on the environment.”

Demand that industry immediately stop all pollution, end all depletion, and forthwith “restore our natural heritage.”

And enforce these demands with new, harsh and punitive, laws and regulations. Impose criminal penalties on the owners and officers of offending companies. Launch an onslaught of “Citizens’ and workers’ suits for environmental damages.” Attack, harass, threaten, punish and compel.

The idea has its appeal. It focuses on a convenient, conspicuous and vulnerable target. It offers immediate action and immediate release for accumulated frustration and anger. Most temptingly, it promises a quick, easy and painless solution to the whole environmental problem.

Against this attack, and in the face of this appeal, industry is at a crippling disadvantage. It has, to put it bluntly, been hit with charges that cannot be denied—demands that cannot be satisfied. And, backed into its corner, it is in an awkward position.

A position in which anything it says is likely to be taken as defensive or evasive, anything it does is questioned in advance as inadequate.

**N**evertheless, some things need to be said.

First, that industry *is* guilty of an assault upon the environment, and *is* responsible for the consequences.

But, second, that the guilt has long since been acknowledged, the responsibility long since accepted. Today, however belatedly, U.S. industry stands firmly and fully committed to the environmental cause.

The commitment is sincere. It is also specific and binding. The U.S. Commission on Environmental Quality has designed a massive pro-

gram to cleanse and restore the American environment in the 1970's, at a total cost of \$287-billion. Industry's share of this cost is set at \$195-billion.

Clearly, this assigned task and this imposed burden will strain the financial, and test the technical and managerial, capacities of U.S. industry to the utmost. It adds an enormous responsibility and a formidable challenge to all of the other responsibilities and challenges that industry must continue to confront in a competitive and demanding world.

The responsibility has been accepted, the job will be done. But beyond this assigned task, beyond this designated goal, beyond these outer limits of the possible, industry probably cannot go. It is not a question of will, but of capacity. The issue is not what industry *ought* to do, but what industry *can* do.

To the extremists' premise that industry can be threatened, harassed and driven to exceed its utmost capacities—that it can somehow be *made* to do what it manifestly cannot do—a frank and unequivocal response must be made.

Industry cannot immediately stop all pollution, end all depletion, and overnight restore our natural heritage. It is impossible. It is financially impossible, technically impossible, economically impossible, morally impossible, and physically impossible.

It is financially impossible for industry to immediately allocate and spend \$195-billion. There is not that much money to be had, from any source, by any means, using any device.

It is technically impossible, at any price, to totally eliminate all forms of pollution.

It is economically impossible to bring all of U.S. industry to a complete halt while pollution control is given absolute priority over production.

It is morally impossible to close every offending plant, shut down every faulty operation, and throw thousands of people out of jobs, whole communities into bankruptcy.

And it is physically impossible, even if everything else could be done, to compress the work of a decade into a day, a month, or a year.

To these obvious impossibilities, one more must be added. It is impossible to separate industry from the society to which it belongs—and which it serves and reflects.

The environmental crisis is not an isolated, but a total, national crisis. The result of universal neglect and unanimous irresponsibility. And of a prolonged, overwhelming, devastating *mass* assault on the environment, made by millions of American citizens and consumers, in ignorance or blithe disregard of the consequences.

**W**e are no longer ignorant. We are no longer quite so blithe. But the assault continues. Because the insistent, unrelenting pressure of consumer needs, wants, desires and demands continues.

And this, ultimately, is the problem. Not for industry alone, but for the whole of a truly interdependent society. Any major solution to the environmental crisis requires a profound change in the personal expectations, habits, attitudes and actions of millions of individual Americans.

But the point, with regard to industry's responsibility, is simple. Industry cannot dictate change. It can control its own actions and reform its own habits. But it cannot refuse to meet needs, ignore wants, desires and demands, and reform the habits, attitudes and actions of 200-million Americans.

Killing lawyers does not further the cause of justice. Persecuting and punishing industry will not advance the cause of a better environment. The sacrifice of a scapegoat solves nothing and gets us nowhere.

Except off the track. A common, national problem demands a common, united, national effort. The job belongs to us all.

It is time to forget the diversion and get on, *together*, with the job.

---

*We at McGraw-Hill believe in the interdependence of American society. We believe that, particularly among the major groups—business, professions, labor and government—there is too little recognition of our mutual dependence, and of our respective contributions. And we believe that it is the responsibility of the media to improve this recognition.*

*This is the sixth of a series of editorial messages on a variety of significant subjects that we hope will contribute to a broader understanding.*

*Permission is freely granted to individuals and organizations to reprint or republish these messages.*

*John R. Emery*  
John R. Emery, President  
McGraw-Hill Publications Co.



CLASSIFIED ADVERTISING  
**SEARCHLIGHT SECTION**  
 BUSINESS OPPORTUNITIES  
 USED OR SURPLUS EQUIPMENT

**EMPLOYMENT OPPORTUNITIES**

# HELP!

**Q. How do I reply to a box number ad?**  
**A.** Address an envelope with the box number indicated in the ad, c/o Electronics, Class. Adv. Dept., P.O. Box 900, NY, NY 10020

**Q. Whom do I contact or call to renew my classified ad or make corrections?**  
**A.** Write Electronics, Class. Adv. Dept., P.O. Box 900, NY, NY 10020 or call: (212) 997-6585 or 6586. Give full company name, size of ad, & date or dates it is scheduled to appear.

**IMMEDIATE DELIVERY**  
**Minis & Peripherals**  
**DEC—HIS**  
**SEL—HP—NOVA**  
**Card, Printer, Tape, Disk**  
**TELETYPES**  
**33, 35, 37**  
 For Sale/Rent  
**617/261-1100**  
 Send For **FREE Price List**  
**AMERICAN USED COMPUTER CORP.**  
 15 School St., Boston, MA. 02108

CIRCLE 952 ON READER SERVICE CARD

**POSITION VACANT**

**Community College—Electronics Technology**—Instructor needed teaching basic theory & applications leading to Associate in Science degree BSEE degree required. Masters degree preferred. Must meet State requirements for certification. Contact: Daytona Beach Community College, Personnel Department, P.O. Box 1111, Daytona Beach, Fla. 32015.

**RESUME KIT**

**Free Engineer's Resume Kit for Electrical Mechanical and Industrial Engineers.** Scientific Placement, Inc., Employment Service 5051 Westheimer, Houston, TX 77027.

**Radlatlon Devices Co.**

**BROADBAND AMPLIFIERS**  
 Our Economical Line of Broadband RF Amplifiers Covers The Frequency Region From 3 MHz. to 800 MHz. With Noise Figures As Low As 3.0 dB. Remotely Powered Versions Are Available. Brochures and Application Notes Are Available Upon Your Request.  
 RADIATION DEVICES CO., BOX 8450, BALTO., MD. 21234

CIRCLE 953 ON READER SERVICE CARD

When Answering

## BOX NUMBERS

to expedite the handling of your correspondence and avoid confusion, please do not address a single reply to more than one individual box number. Be sure to address separate replies for each advertisement.

**FREE ALARM CATALOG**

Full line of professional burglar and fire alarm systems and supplies. 80 pages, 400 items. Off-the shelf delivery, quantity prices.

**mountain west alarm**  
 4215 n. 16th st., phoenix, az. 85016

CIRCLE 954 ON READER SERVICE CARD

**RADAR SYSTEMS GROUND AND AIRBORNE. AUTOMATIC TRACKING ANTENNA SYSTEMS. NIKE AJAX. NIKE HERCULES M-33. MSQ-1A. MPS-19. MPS-9. SCR 584. TPS-1D. TPS-28. FAJ-ASR-2. AIRBORNE SYSTEMS. APN-84. APN-102. APS-20. APS-27. APS-45. DPN-19. DIGITAL COMPUTERS IBM 650. IBM 704.**

**LARGEST INVENTORY OF RADAR AND MICROWAVE EQUIPMENT IN THE WORLD.**

**RADIO RESEARCH INSTRUMENT CO.**  
 3 QUINCY ST., NORWALK, CONN. 06850 (203) 853-2600

CIRCLE 956 ON READER SERVICE CARD

**SCIENTIFIC PAPERBACKS**  
 Hundreds of books on electronics, mathematics, physics, computer sciences, chemistry, optics, astronomy, and many other topics. Complete MIT Radlab series.  
**FREE 96 PAGE CATALOGUE**  
**SHPRENTZ CO., BOX 83-Y, IRVINGTON NY 10533**

CIRCLE 957 ON READER SERVICE CARD

**REAL ESTATE**

**Ideal 5-Acre Ranch. Lake Conchas, New Mexico. \$3,475. No Down. No Interest. \$29/mo. Vacation Paradise. Money Maker. Free Brochure. Ranchos: Box 2003YD, Alameda, California 94501.**

## HIRE A STUDENT THIS SUMMER. DO EVERYBODY A FAVOR.

First, and most important, you'll be giving a deserving student worthwhile career-oriented employment.  
 Second, because of the habitual scarcity of summer jobs, you'll be able to select the cream of the crop from the many applications you'll receive.  
 This means you can evaluate your choice while gaining an inside track towards hiring him when, as a coveted graduate, the job market will be in his favor.  
 Third, it's in the industry's best interest to encourage and hold its' life-blood by providing practical experience in their future profession.  
 Because we believe in the mutual benefits of the above marriage, we've taken the role of match-maker.  
 Just fill out and return the coupon below and we'll include your name, organization, address, and student preference in a free listing to be sent to Placement Directors and Department Heads at leading colleges and universities across the nation.

**Free summer help listing**

MAIL TO: ELECTRONICS/P.O. BOX 900/NEW YORK/NY 10020

NAME/TITLE of individual to be contacted: \_\_\_\_\_

ADDRESS: (Mailing address of your personnel office) \_\_\_\_\_

ORGANIZATION: (Firm, Company, Government Agency or Institution) \_\_\_\_\_

TYPE AND NUMBER OF STUDENTS SOUGHT: ELECTRICAL ENGINEER

Other Preferences \_\_\_\_\_

MONOLITHIC  
CRYSTAL FILTERS



Thank you, Ma Bell . . .



For years, mobile radios operating in urban areas have been plagued with interference problems. One of the biggest is intermodulation. This is where Ma Bell comes in. Mobile telephone channels assigned to her can generate IM products at nearby frequencies allocated to local cab companies.

The solution—a monolithic front-end filter in each cab radio to protect the first stage. We started making these filters five years ago as custom jobs. Now we're making them in low-cost OEM quantities for paging, medical telemetry and other single-channel receivers.

Speaking of intermodulation . . .



It should be noted that crystal filters—even ours—can generate IM products. Happily, this non-linear proclivity can be controlled. If your application involves IM requirements for either out-of-band or in-band signals, we may be able to help where others have failed.

Drop us a line about your project or, if you're really in a hurry, give us a call via Ma Bell at (305) 425-1574.



**Piezo Technology Inc.**  
2400 Diversified Way  
Orlando, Fla. 32804  
(305) 425-1574

The standard in monolithic  
crystal filters.

**Advertising Sales Staff**

**Pierre J. Braudé** [212] 997-3485  
Advertising Sales Manager

**Atlanta, Ga. 30309:** Joseph Lane  
100 Colony Square, 1175 Peachtree St., N.E.  
[404] 892-2868

**Boston, Mass. 02116:** James R. Pierce  
607 Boylston St. [617] 262-1160

**Chicago, Ill. 60611:**  
645 North Michigan Avenue  
Robert W. Bartlett (312) 751-3739  
Paul L. Reiss (312) 751-3738

**Cleveland, Ohio 44113:** William J. Boyle  
[716] 586-5040

**Dallas, Texas 75201:** Charles G. Hubbard  
2001 Bryant Tower, Suite 1070  
[214] 742-1747

**Denver, Colo. 80202:** Harry B. Doyle, Jr.  
Tower Bldg., 1700 Broadway  
[303] 266-3863

**Detroit, Michigan 48202:** Robert W. Bartlett  
1400 Fisher Bldg.  
[313] 873-7410

**Houston, Texas 77002:** Charles G. Hubbard  
2270 Humble Bldg. [713] CA 4-8381

**Los Angeles, Calif. 90010:** Robert J. Rielly  
Bradley K. Jones, 3200 Wilshire Blvd., South Tower  
[213] 487-1160

**New York, N.Y. 10020**  
1221 Avenue of the Americas  
Warren H. Gardner [212] 997-3617  
Michael J. Stoller [212] 997-3616

**Philadelphia, Pa. 19102:** Warren H. Gardner  
Three Parkway,  
[215] 997-3617

**Pittsburgh, Pa. 15222:** Warren H. Gardner  
4 Gateway Center, [212] 997-3617

**Rochester, N.Y. 14534:** William J. Boyle  
9 Greylock Ridge, Pittsford, N.Y.  
[716] 586-5040

**San Francisco, Calif. 94111:** Don Farris  
Robert J. Rielly, 425 Battery Street,  
[415] 362-4600

**Paris:** Alain Offergeld  
17 Rue-Georges Bizet, 75 Paris 16, France  
Tel: 720-73-01

**Geneva:** Alain Offergeld  
1 rue du Temple, Geneva, Switzerland  
Tel: 32-35-63

**United Kingdom:** Keith Mantle  
Tel: 01-493-1451, 34 Dover Street, London W1

**Milan:** Robert Saidel  
1 via Baracchini Phone 86-90-656

**Brussels:** Alain Offergeld  
23 Chaussee de Wavre  
Brussels 1040, Belgium  
Tel: 13-65-03

**Stockholm:** Brian Bowes  
Office 17, Kontor-Center AB, Hagagarten 29,  
113 47 Stockholm. Tel: 24 72 00

**Frankfurt/Main:** Fritz Krusebecker  
Liebigstrasse 27c  
Phone 72 01 81

**Tokyo:** Tatsumi Katagiri, McGraw-Hill  
Publications Overseas Corporation,  
Kasumigaseki Building 2-5, 3-chome,  
Kasumigaseki, Chiyoda-Ku, Tokyo, Japan  
[581] 9811

**Osaka:** Ryji Kobayashi, McGraw-Hill  
Publications Overseas Corporation, Kondo  
Bldg., 163, Umegae-cho Kita-ku [362] 8771

**Australasia:** Warren E. Ball, IPO Box 5106,  
Tokyo, Japan

**Business Department**

**Stephen R. Weiss, Manager**  
[212] 997-2044

**Thomas M. Egan,**  
Production Manager [212] 997-3140

**Carol Gallagher**  
Assistant Production Manager [212] 997-2045

**Dorothy Carter,** Contracts and Billings  
[212] 997-2908

**Frances Vallone,** Reader Service Manager  
[212] 997-6057

**Electronics Buyers' Guide**

**George F. Werner,** Associate Publisher  
[212] 997-3139

**Regina Hera,** Directory Manager  
[212] 997-2544

**NEW  
SHORTER  
CASE!  
SCHAUER  
1-WATT  
ZENERS**

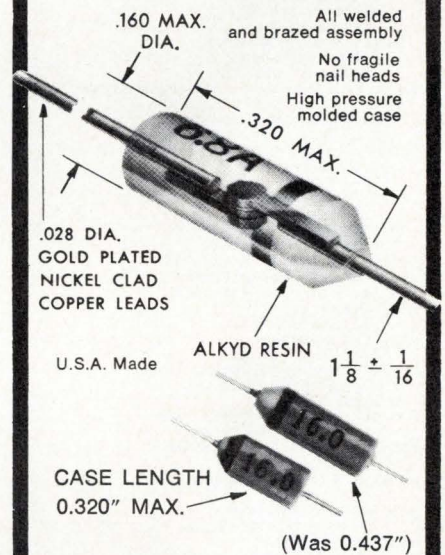

**SAME LOW PRICES FOR  
1% TOLERANCE ZENERS**

**ANY VOLTAGE  
FROM 2.0 TO 18.0**

Quantity	Price Each
1-99	\$1.07
100-499	.97
500-999	.91
1000-4999	.86
5000 up	.82

**IMMEDIATE SHIPMENT**

Send for rating data and  
20%, 10%, 5% and 2%  
tolerance prices.

Semiconductor Division

**SCHAUER**

MANUFACTURING CORP.

4514 Alpine Ave., Cincinnati, Ohio 45242  
Telephone 513/791-3030

# Electronics advertisers

May 10, 1973

<b>Abbott Transistor Labs, Inc.</b> Technical Adv. Agency	6	<b>* G. E. Co., Semi Prod. Dept.</b> General Magnetics	19E 2nd cover	<b>‡ Rohde &amp; Schwarz, Inc.</b> R + S Sales Company	57
<b>‡ Ablestik Laboratories</b> Fortune Advertising	183	<b>* General Radio</b> Grad Associates	9E	<b>* Rohde &amp; Schwarz</b> Buck Associates	1E 166
<b>Advanced Memory Systems</b> Writing Unlimited	9	<b>§ Golden Gate Enterprises, Inc.</b> Associated Ad-Ventures	188	<b>Sangamo Electric Company</b> Winius-Brandon Company	15
<b>Advanced Micro Devices</b> Keye/Donna/Pearlstein	10-11	<b>■ Gould, Inc./Instrument Systems Div.</b> Carr Liggett Adv., Inc.	114	<b>Schauer Manufacturing Corp.</b> Nolan, Keelor & Stites	173
<b>* Advanced Micro Devices</b> Keye/Donna/Pearlstein	20E	<b>G. T. Schjeldahl Co.</b> Chuck Ruhr Assoc. Advertising, Inc.	144	<b>* Schoeller</b> Sigma Studio 1	24E
<b>* AEG Telefunken</b>	22E	<b>Harris Semiconductor</b> Tucker Wayne & Company	78-79	<b>Scientific-Atlanta, Inc.</b> NOW Advertising	152
<b>AILTECH/RF</b> R. L. Thompson Advertising	71	<b>■ Heath/Schlumberger Scientific Instruments</b> Advance Advertising Services	107	<b>§ SCS Corporation</b> Popejoy & Fischel Advertising Agency, Inc.	184
<b>AirBorn, Inc.</b> Cullum Advertising	164	<b>Hermes Electronics Ltd.</b> Public & Industrial Relations Limited	73	<b>§ The Sel-Rex Company</b> O. S. Tyson and Company, Inc.	190
<b>■ Airpax Electronics/Controls Division</b> Van Mourik and Associates, Inc.	140	<b>■ Hewlett-Packard</b> Tallant/Yates Advertising, Inc.	60-61	<b>* S. E. Laboratories Ltd.</b> Graphic Publicity Ltd.	4E-5E
<b>Allen-Bradley Company</b> Hoffman, York, Baker & Johnson, Inc.	24	<b>■ Hewlett-Packard</b> Tallant/Yates Advertising	1	<b>Semiconductor Circuits</b> SermeTel, Division of	152
<b>American Electronic Laboratories, Inc.</b> Ernest Williams Greenfield, Inc.	127	<b>Hughes Aircraft Company</b> Foote, Cone & Belding	149, 162	<b>Teleflex Incorporated</b> Rambo Advertising	165
<b>■ American Lava Corporation</b> Sub. of Minnesota Mining & Mfg. Co. Designers, Inc.	37	<b>Hutson Industries</b> Warren-Guild	145	<b>* Sescosem</b> Perez Publicite	16E
<b>‡ American Microsystems, Inc.</b> Wilton, Coombs & Colnett, Inc. Advertising	154-155	<b>Industrial Electronics Engineers, Inc.</b> S. Michelson Advertising	42	<b>‡ Siemens</b> Ries Cappiello Colwell, Inc.	18-19
<b>Amplifier Research Corporation</b> Dean Craig Associates	148	<b>§ In-Line Technology, Inc.</b> R & A Zens	186	<b>* Signal Analysis Industries Corp.</b> Samuel H. Goldstein Adv. Agency	12E
<b>■ Analog Devices, Inc.</b> Schneider Parker Guy, Inc.	80	<b>Innovex Corporation</b> Weber Donohue Cooper, Inc.	159	<b>Signetics Corp., Sub.</b> of Corning Glass Works	17, 62-63
<b>Analog Digital Research</b>	158	<b>‡ Interdesign, Inc.</b> Hornisher & Associates	54	<b>Silec Electronics</b> France M-1	52
<b>■ Augat</b> Creamer, Trowbridge, Case & Bastford, Inc.	22-23	<b>International Crystal Mfg. Co.</b> Robert V. Freeland & Associates	138	<b>Siliconix</b> Robertson West, Inc.	99
<b>AVX Ceramics</b> Allied Advertising Agency, Inc.	58-59	<b>Intersil</b> Herrick Associates, Inc.	12-13	<b>Singer Instrumentation-</b> Alfred Div.	169
<b>Bausch &amp; Lomb, Inc.</b> Wolff Assoc., Inc.	175	<b>§ IPT Corp.</b> Roy Minor/Graphic Arts	189	<b>Singer Company, Kearfoot Div.</b> Gaynor & Ducas, Inc.	129
<b>Bell &amp; Howell—Electronics</b> & Instruments Group Boylhart, Lovett & Dean	157	<b>Ise Electronics Corp.</b> Shinwa International, Inc.	75	<b>* Sodeco</b> PR Service	6E
<b>■ Bussmann Mfg. Division of McGraw-Edison Co.</b> Henderson Advertising Company	67	<b>C. Itoh &amp; Co. (America) Inc.</b> AC&R Advertising Inc.	167	<b>* Sodern</b> Realisations Publicitaires Industrielles	11E
<b>California Computer Products</b> Dailey & Associates Advertising	95	<b>■ ITT Cannon</b> D'Arcy-MacManus & Masius, Inc.	76-77	<b>■ Sprague Electric Company</b> Harry P. Bridge Company	124
<b>Centralab, Electronics Div.</b> of Globe Union, Inc. The Brady Co.	108	<b>ITT Semiconductors</b> Hall & McKenzie Advertising	35	<b>■ Systron Donner Concord Instruments</b> Bonfield Associates	51, 143
<b>Cherry Electrical Products Corp.</b> Kolb/Tookey and Assoc., Inc.	123	<b>* Kennedy Co.</b> R. L. Thompson Advertising	64	<b>* Tandbergs Radiolabfabrik A/S</b> Holter, Young & Rubicam AS	57
<b>Chicago Miniature Lamp Works</b> Buti-Roberts Advertising	153	<b>■ Kepco Incorporated</b> Weiss Advertising	5	<b>■ T-Bar, Incorporated</b> The Robert A. Paul Advertising Agency, Inc.	8
<b>‡ Cinch Connectors, Operation of</b> TRW Electronic Components Stral Advertising Company, Inc.	64	<b>■ Lambda Electronics Corporation</b> Michel-Cather, Inc.	3rd cover	<b>TEC, Inc.</b> TEC-AD	148
<b>* CIT Alcatel</b> Promotion Industrielle	14E	<b>Lockheed Electronics Company</b> McCann-Erickson, Inc.	128	<b>Technipower Division</b> of Benrus Corporation	39
<b>■ Clairex Corporation</b> Black-Russell-Morris	4th cover	<b>* LTT</b> Publibel	23E	<b>Technitron, Inc.</b> Freeman Pratt Barrows Advertising Associates	44-45
<b>§ Cobilt Div. of Computervision Corp.</b> Associated Ad-Ventures	181	<b>McGraw-Hill Book Company</b> 170-171	166	<b>Tektronix, Inc.</b> Dawson, Inc.	19
<b>Colorado Video, Inc.</b> O'Connell-Colburn, Inc.—Creative Business Communications	160	<b>McGraw-Hill Magazines</b> 170-171	166	<b>* Teledyne Relays</b> S. Michelson Advertising	19
<b>* Communication Associates, Inc.</b> Caroe Marketing, Inc.	18E	<b>Macrodata Company</b> JMR Advertising	139	<b>Tempil Ind., Div. of Big Three Ind.</b> Black-Russell-Morris	146
<b>* Computer Components, Inc.</b>	24E	<b>■ Magnetics, Inc.</b> Lando, Inc.	137	<b>Thermalloy</b> Warren-Guild	168
<b>§ Coors Porcelain Company</b> Arvada Art & Advertising Co.	178	<b>Marco-Oak</b> Jansen Associates, Inc.	161	<b>‡ Thomas &amp; Betts Company</b> McCarthy, Scelba, DeBiasi, Advertising Agency, Inc.	21
<b>■ DATASCAN, INC.</b> McCarthy, Scelba, and DeBiasi Advertising Agency, Inc.	176	<b>Markem Corp.</b> Creamer, Trowbridge, Case & Bastford, Inc.	126	<b>■ Topaz Electronics</b> Mesa Copy	161, 176
<b>Datatron, Inc.</b> Larry Courtney Company	20	<b>Master Appliance</b> Klau-Van Pietersom-Dunlap, Inc.	167	<b>■ Unitrode Corporation</b> Impact Advertising	27
<b>■ Datel Systems, Inc.</b> John Dolan Advertising	33	<b>§ Materials Research Corporation</b> Black-Russell-Morris	191	<b>§ Varian Associates, Vacuum Div.</b> Botsford Ketchum, Inc.	187
<b>‡ Deltrol Controls</b> Industrial Advertising Services	134	<b>Microsystems International Ltd.</b> Media Advertising Ltd.	40-41	<b>■ VARO Semiconductor, Inc.</b> Warren-Guild	135
<b>■ Dialight Corporation</b> Michel-Cather, Inc.	132-133	<b>Micro Power Systems</b> Associated Adventures	72	<b>Vector Electronic Company, Inc.</b> Communications Management Company	156
<b>Digital Equipment Corporation</b> Schneider Parker Guy, Inc.	120	<b>■ Micro Switch Division of Honeywell</b> N. W. Ayer & Son, Inc.	141	<b>Vibration Instruments Co.</b> Jansen Associates, Inc.	158
<b>* The Digitran Company</b> Jansson Advertising, Inc.	21E	<b>Miller Tronics-Electronics Div.</b> Molex Incorporated	175 147	<b>Vu-Data</b> Manning/Bowen and Associates	156
<b>■ Dynascan Corporation (Industrial</b> Products Division) Albert Jay Rosenthal & Company Advertising	165	<b>Monolithic Systems</b> Broyles, Allebaugh & Davis, Inc.	158	<b>Wiltron Company</b> Frank Burkhard Company	162
<b>Elec-Trol, Inc.</b> S. Michelson Advertising	169	<b>§ Monsanto Commercial Products Co.</b> Advertising & Promotion Services	179	<b>Wima, Westermann</b>	16
<b>Electronic Engineering Company</b> of California, Elec. Prod. Div. Mealer & Emerson, Inc.	125	<b>Motorola Semiconductor Products, Inc.</b> E B Lane & Associates, Inc.	43	<b>WEI Corp.</b> Advertiser's Services, Inc.	176
<b>EPC Labs., Inc.</b> Superline Productions	2	<b>■ Narda Microwave</b> McCarthy, Scelba, DeBiasi Advertising Agency, Inc.	48	<b>* Yokogawa Electric Works Ltd.</b> General Advertising Agency, Inc.	21
<b>Esterline Angus, A Unit of</b> Esterline Corporation Odiorne Industrial Advertising, Inc.	165	<b>National Electronics</b> Lea Advertising	161		
<b>§ ETEC Corporation</b> Allen & Dorward, Inc.	185	<b>§ Nortec</b> Com/Mark Communications Group	183		
<b>‡ Excellon Industries, Inc.</b> Elgin Davis, Inc.	46-47	<b>* Oscilloquartz SA, Neuchatel</b> M. R. Hofer Werbeagentur BSR/EAAA Bern	13E		
<b>Fairchild</b> StanbroDrummond Advertising, Inc.	142	<b>§ Oxy Metal Finishing Corp.</b> O. S. Tyson and Company, Inc.	190		
<b>Ferroxcube</b> Black-Russell-Morris	7	<b>* Philips N. V. Pit/T &amp; M Division</b> Marsteller International S. A.	54		
<b>Fluke Manufacturing Co., John</b> Bonfield Associates	131	<b>■ Piezo Technology, Inc.</b> Shattuck/Roether Advertising, Inc.	173		
<b>§ The Fluorocarbon Company</b> Dan Ebberts and Company Advertising	180	<b>Radiometer Copenhagen</b> Raytheon Semiconductor	28 119		
<b>§ Gasonics, Monte Toole &amp; Assoc., Inc.</b> General Electric	186	<b>RCA Ltd.</b> Marsteller, Ltd.	2E-3E		
<b>‡ General Electric</b> Electronic Components Robert S. Cragin, Inc.	28	<b>* RCA Electronic Components</b> Al Paul Lefton Company, Inc.	15E		
<b>■ General Electric Co.</b> Miniature Lamp Div. Carr Liggett Advertising, Inc.	136	<b>■ RCL Electronics, Inc.</b> Morvay Advertising Agency	14		
		<b>■ Rental Electronics, Inc.</b> Communications Unlimited, Inc.	150		
		<b>* Rheinisch-Westfaelische</b> Verlag Werbewirtschaft	47		
		<b>Rochester Gas &amp; Electric -</b> Advertising Group Hutchins Advertising Company, Inc.	168		

## Classified & Employment Advertising

F. J. Eberle, Manager 212-971-2556

<b>EQUIPMENT (Used or Surplus New) For Sale</b>	
American Used Computer Corp	171
Employment	171
Mountain West Alarm Supply	171
Radio Research Instrument Co.	171
Radiation Devices Co.	171
Shprentz Co.	171

■ For more information on complete product line see advertisement in the latest Electronics Buyer's Guide  
\* Advertisers in Electronics International only  
‡ Advertisers in Electronics domestic edition only  
§ Advertisers in Electronics Semicon III section only



# Introducing - MilerTronics' Model H-2448

## Automatic ROM Programmer

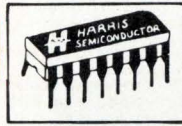
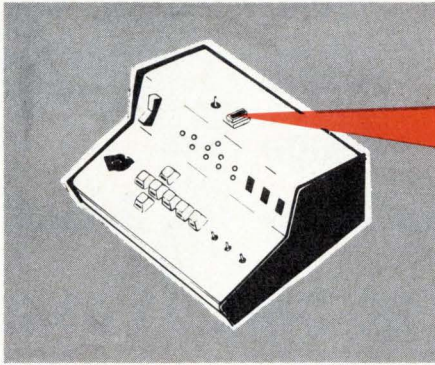

HARRIS  
HPROM-1024 OR HPROM-2048  
PROM\*

INTRODUCTORY OFFER  
**\$995.00**

**DESCRIPTION:** Portable system designed to program Harris 1024 and 2048 BIT PROMS\*. Human engineered keyboard controls for simple operation. Remote control plug is provided for automatically duplicating existing ROMS and for programming from tape cassettes, paper tapes, or computers. Compact Unit 10" x 9" x 6"

**FEATURES:** Insert Mode - removes power from ROM socket and initializes system.  
Pre Check Mode - automatically verifies a ROM has no programmed bits.  
Verify Mode - prevents programming while data is being checked.  
Program Mode - automatic programming of selected words, one at a time.  
Address is easily incremented to next word from the keyboard or a random address may be rapidly accessed by the use of three additional address switches.

# Miler Tronics

DIVISION OF GEORGE MILER INC.

\*TM Harris Semiconductor

525-A AIRPORT ROAD • GREENVILLE, S. C. 29607 • (803) 242-9232

Circle 175 on reader service card

# THE CHAMP

...PICTURE TAKER



Visual images are fleeting—so, for the record, . . . you need pictures. No telling when or how often they can prove invaluable.

That's why so many of your peers are routinely snapping pictures while looking at specimens and samples with Bausch & Lomb's StereoZoom 7 visual-photographic system. The Champ's superb optical system which gives unbeatable visuals will put the images on film right while you're looking. And they will be

available as often as you want to refresh your memory, make comparisons, prove points.

There's a choice of most camera formats with the new Integrated Cameras, Series II with optional exposure meter. They're integral, but do not interfere with the optical system and interchange to fit varying needs.

**Be ready. Write for our new Stereomicroscope catalog 31-15 and our free demonstration offer.**

**BAUSCH & LOMB** 

SCIENTIFIC OPTICAL  
PRODUCTS DIVISION

61417 Bausch Street, Rochester, N.Y. 14602

StereoZoom, Reg. T.M.  
Bausch & Lomb.

For Literature Circle #196 on Reader Service Card.  
For Demonstration Circle #197 on Reader Service Card.

# Noise sensitivity problems go away

with Topaz Ultra-Isolation Transformers

Box-shielding techniques achieve maximum coupling between windings while offering a very low impedance for common-mode noise to ground.

Primary to secondary effective interwinding capacitances of:  
0.005 picofarads  
0.001 picofarads  
0.0005 picofarads

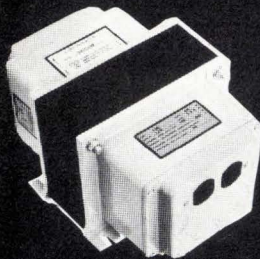

#### SPECIFICATIONS:

**Common-Mode Noise Rejection:** to more than 145 dB.

**Transverse Noise Suppression:** greater than 125 dB at 1 kHz.

**Input/Output Voltages Available:** 115, 230, 240 and 480 VAC at 50 or 60 Hz.

**Models Available:** 125 VA to 20 kVA 1 phase; 3 kVA to 60 kVA 3 phase.

**Priced from \$75.00**

**TOPAZ** SOLUTIONS TO POWER PROBLEMS  
ELECTRONICS

3855 Ruffin Road, San Diego, CA 92123

Phone (714) 279-0831

Circle 236 on reader service card

cut cost of power supply design with new

## Heat Sink Chassis

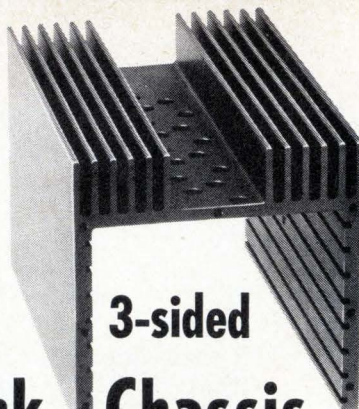

3 sides eliminate extensive sheet metal work. P.C. cards held firmly in inside slots. Custom fabricated to your design requirements. A large selection of heat dissipating extrusions including the hard-to-find 30-fin, 1.312" by 9.875" ... forced convection heat assemblies ... all immediately available.



**WEI** "Natural and forced convection heat sink specialists"  
**CORPORATION**

2140 So. Santa Fe St., Santa Ana, Calif. 92705

Box 10577, 92711 TWX 910-595-1709 (714) 540-4688

Circle 237 on reader service card

# go portable

## Introducing THE Digital Panel Meter for Portable Instruments

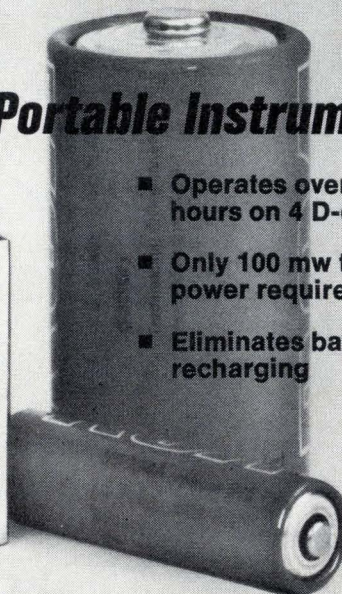

- Operates over 600 hours on 4 D-cells
- Only 100 mw total power required
- Eliminates battery recharging

NOW, make your portable instruments smaller, lighter, less expensive and more reliable. With the Datascan Model 820 battery powered DPM, you also get a bright, reliable and readable 3½ digit LED display, 0.1% (of reading) accuracy, battery input voltage from 4.8 to 8.0\* volts and an attractive miniaturized metal case that's only 3.5" deep x 2.5" wide x 1.3" high.

To get complete specs or to arrange for a demonstration, call or write. We're anxious to help you GO PORTABLE.

\*other ranges available.



Datascan  
Electronic  
Products

P.O. Box 785  
1111 Paulison Ave.  
Clifton, N.J. 07013  
Telephone: (201) 478-2800

**Datascan**

176 Circle 176 on reader service card

Electronics/May 10, 1973