

Mini-Micro Systems

A CAHNERS PUBLICATION

AUGUST 1985

Laser printstation runs complex graphics fast

Multibus II, VMEbus battle

Pyramid challenges DEC with calculated RISC

46556 NUTRAVHLLR04/ 02
507 11 2 F 4 GIK 4597
R HELLENTHAL APRUF
NOTRE DAME UNIV
BIOLOGY DEPT
NOTRE DAME IN 46556

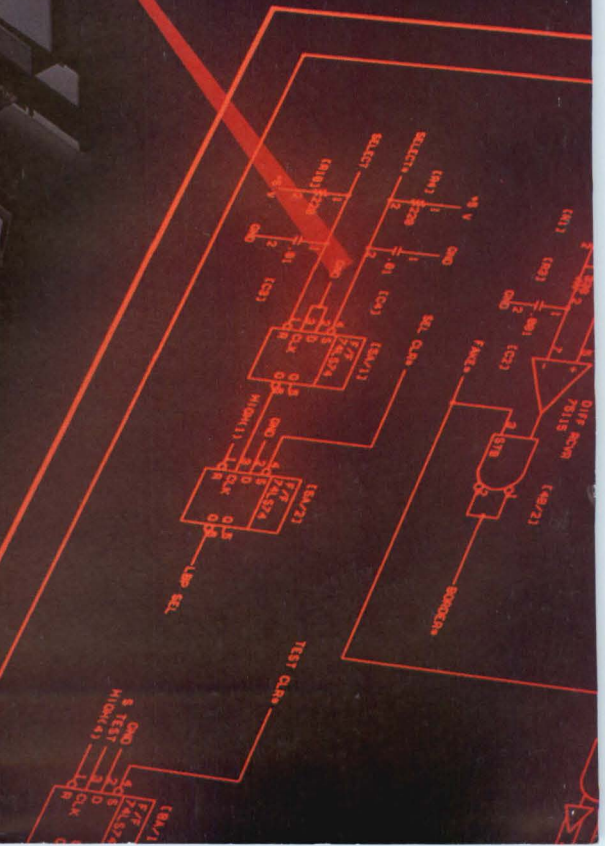
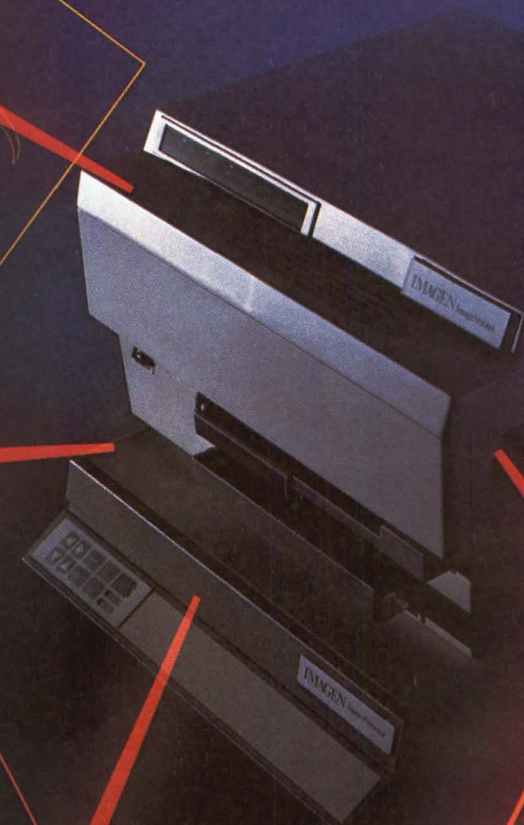
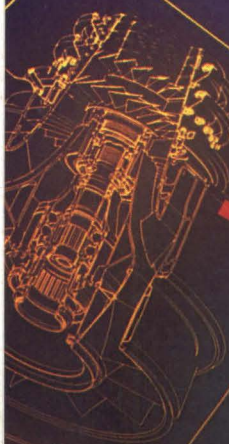

VME and Multibus: Packaging That Makes The Difference



Now there's a complete, integrated line of Multibus™ and VMEbus system enclosures that lets you match your system needs today — with the flexibility to expand or reduce your requirements in the future.

For Multibus, choose from visually-compatible 4, 7, 10, 12, and 15-slot enclosures with Multi-Cage® card cages and backplanes, all designed to meet FCC class A EMI/RFI requirements with typical systems installed. The 7-slot upright DeskMate™ and the 7-slot tabletop models have room for two half-height 5¼" peripherals, plus an additional 5¼" full height Winchester drive. All but the DeskMate are available for rack mounting.

For VMEbus, there are 3, 5, 7 and 12-slot models, with peripherals available on the DeskMate, rack mount and tabletop 5-slot versions. All use Electronic Solutions' VMEasy™ card cage and backplane design for rugged, reliable card mounting and easy servicing. If you're into Multibus now, you can even convert your enclosures later for VME.

Talk to us about your unique requirements. Build upon the industry's most comprehensive system of Multibus and VMEbus enclosures, and reduce your lead time to market. We'll provide front or rear card

loading, or special slot spacing, special power supplies, or I/O connections. See how our custom design gives you an entire enclosure line instead of a single box.

Electronic Solutions' entire line is backed by our three year limited warranty—your assurance of built-in reliability.

Call us today, and find out how Electronic Solutions can make the difference in your system packaging.

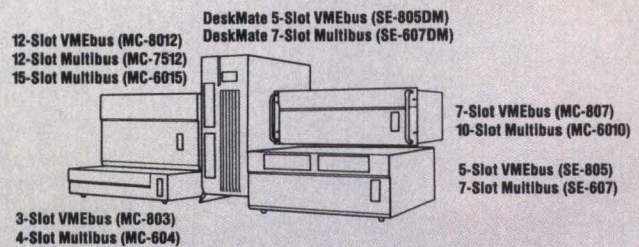

3 Year Limited Warranty

9255 Chesapeake Drive, San Diego, CA 92123 • (619) 292-0242 Telex II (TWX): 910-335-1169

Call Toll Free: (800) 854-7086 In Calif: (800) 772-7086

CIRCLE NO. 2 ON INQUIRY CARD



**If you have one of these,
Infotron can have you
communicating data
in just 48 hours.**

**Modems and stat
muxes, to go.**

Infotron offers a complete line. And now, with our unique distributor warehousing program, we can have any of them on your doorstep within 48 hours of your call. 48 hours, max. Just say the word.



Full system flexibility.

Infotron modems combine advanced features and inherent reli-

bility. Our statistical multiplexers handle from 4 to 32 channels in a range of models—with full provision for expansion.

All with the same high quality that earns us top marks in per-

formance and reliability from our present users.

Add competitive pricing, and we start making real sense.

Then add our 48-hour delivery,

and we're awfully hard to beat.

1-800-345-4636

**To find out more.
Your Infotron distributor.**

There are Infotron distributors nationwide, ready to give you more information, provide equipment and offer expert advice on the best way to meet your needs. For the name of the distributor near you, dial toll-free 1-800-345-4636 and ask for ISO. Or write Infotron Independent Sales Organization, 9 North Olney Avenue, Cherry Hill, NJ 08003.

**Infotron. First in
performance and reliability.**

 **INFOTRON SYSTEMS**

CIRCLE NO. 3 ON INQUIRY CARD



p. 101 *Image processing enhances laser printing. Produced by Franson & Associates. Courtesy of Imagen Corp.*

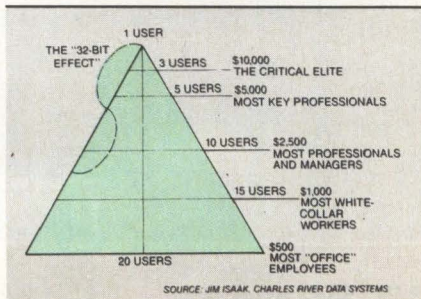

p. 55 *Micros add value*

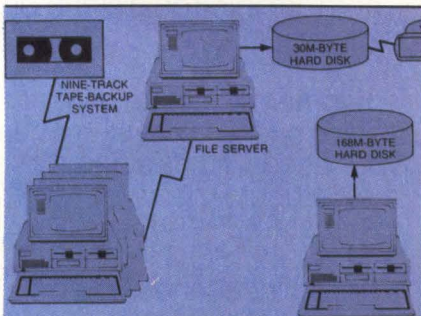

p. 65 *Automating insurance*

MINI-MICRO WORLD

NEWS

Pyramid challenges DEC with RISC supermini	33
DEC's new entries shaped for CAD/CAE markets	35
Silicon design gives system integrators new role	37
GKS-3D implementation presages full standard	41
As profits fall, Taiwan turns to AT-compatibles	44
Heard on the Hill: Computer crime bills debated on Capitol Hill	48

*EUROPEAN NEWS

India pushes software at European markets	E1
Europeans speak up with voice-recognition	E2
UNIX 32-bit systems gain momentum	E4

*Appearing in the European edition only

INTERPRETER

Multuser micros add value to PC LANs	55
--	----

VERTICAL MARKET INTEGRATOR

Network automates insurance services	65
--	----

MINI-MICRO SYSTEMS (ISSN 0364-9342) is published monthly (with 4 special Digest issues) by Cahners Publishing Company, Division of Reed Holdings, Inc., 275 Washington St., Newton, MA 02458. Norman L. Cahners, Chairman; Saul Goldweitz, President and Chief Executive Officer; Ronald G. Segel, Executive Vice President and Chief Operating Officer. MINI-MICRO SYSTEMS is published by the Cahners Magazine Division; J. A. Sheehan, President; William Platt, Executive Vice President. Circulation records are maintained at Cahners Publishing Co., 270 St. Paul St., Denver, CO 80206. Second class postage paid at Denver, CO 80202 and additional mailing offices. Postmaster: Send address changes to MINI-MICRO SYSTEMS.

FEATURES

Feature Highlights	75
Multibus II, VMEbus clash in 32-bit arena	77
The business stakes are high as two heavyweight single-board computer buses compete for high-end multiprocessing applications	
OEM market spotlight shifts to 'PC OEMs'	89
A new breed of emerging OEMs offers system integrators the ability to "roll their own" IBM PCs and to address novel applications	
Image processing enhances laser printing (Cover story)	101
Real-time rastering with a page compiler and image library lets image-processor-based laser printers run complex graphics at 1 page per second	
Graphics cards flood PC market	113
Software developers and turnkey vendors are rushing out PC-based products that promise higher resolution and processing speed	
Latest languages link data to diverse tasks	135
Non-procedural fourth-generation languages groom databases for multiple applications	

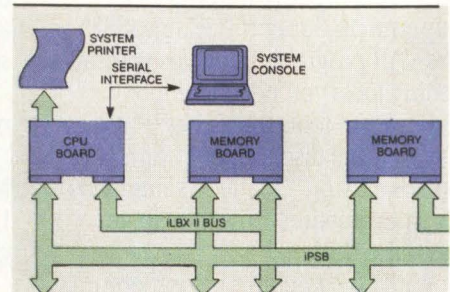

p. 77 *Multibus II vs. VMEbus*

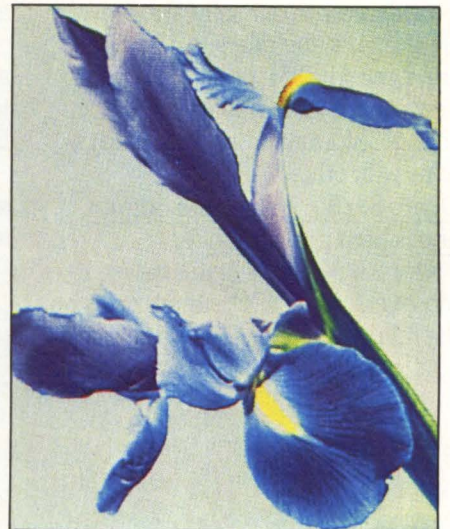

p. 113 . . *Promises of high resolution*

DEPARTMENTS

Editorial Staff	4
Editorial	11
Letters	16
Breakpoints	16
New Products	144
Calendar	164
Career Opportunities	166
Classified Advertising	168
Index to Advertisers	170
Market Track	173
Artful Intelligence	174
Mini-Micro Marketplace	175

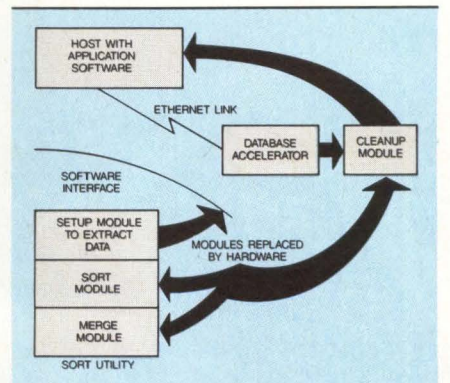

p. 135 *Linking data*

270 St. Paul St., Denver, CO 80206. MINI-MICRO SYSTEMS is circulated without charge by name and title to U.S. - and Western European-based corporate and technical management, systems engineers, and other personnel who meet qualification procedures. Available to others at the rate of \$65.00 per year in the U.S.; \$70.00 in Canada and Mexico; \$95 surface mail in all other countries; air mail surcharge, \$35.00 (16 issues). Special DIGEST issues, \$15.00. Single issues \$5.00 in the U.S.; \$6.00 in Canada and Mexico; \$7.00 in all other countries.

1985 by Cahners Publishing Company, Division of Reed Holdings, Inc. All rights reserved.

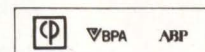

Dual's new Supermicro Support Package for VARs: The slant is on performance.

We know how tough it is to land those big systems contracts. That's why Dual proudly introduces its Supermicro Support Package (SSP)—the VAR program that gives you the selling tools you need to win.

Powerful tools that include attractive volume discount programs. Co-op advertising. Qualified sales leads. Even evaluation units to help you close the deal.

With SSP, you also get in-depth documentation. Nationwide field support through Braegen Corporation. Quick access to our software and applications engineers. And a link to our electronic SSP bulletin board, a new service that enables you to exchange information about Dual systems with other VARs.

Dual's 83/80: When the bottom line is high performance.

Our 83/80 is one of the fastest, most versatile UNIX* supermicros on the market.

For instance, it features an SMD disk controller that reads and writes data at sustained speeds of 800KB/sec. and 560KB/sec. respectively. (Peak speeds are even higher.)

Plus serial ports that permit transmission rates up to 38.4K baud.

In addition, there's a 10MHz MC68000 CPU that runs the new UNIX system V. And main memory capacity for up to 6.5MB.

All this and much more make the 83/80 ideal for most office automation, medical, scientific, or analytical applications.

For details about the SSP program and our 83/80, call or write Dual today. Because it's time to look at UNIX systems from a different angle.

DUAL

Dual Systems Corporation
2530 San Pablo Avenue
Berkeley, CA 94702
(415) 549-3854

*UNIX is a trademark of AT&T Bell Laboratories

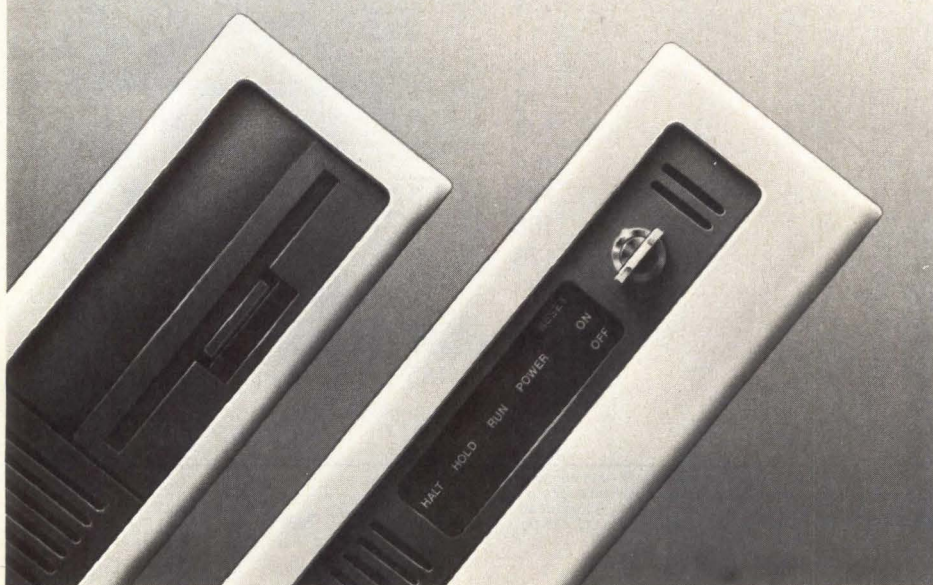

STAFF

Vice President/Publisher
S. Henry Sacks

Editor-in-Chief
George V. Kotely

Managing Editor
James F. Donohue

Assistant Managing Editor
Bruce J. MacDonald

Senior Western Editor: **Jerry Borrell**
San Jose, (408) 296-0868
Senior Projects Editor: **Rick Dairymple**

Western Editor: **Carl Warren**
Irvine, (714) 851-9422

Senior Associate Editor: **David Simpson**
Associate Editor: **Frances T. Granville**
Associate Editor: **Lynn Haber**
Associate Editor/Research: **Frances C. Michalski**
Associate Western Editor: **Mike Seither**
San Jose, (408) 296-0868

Associate Editor: **Gregory Solman**
Associate Editor: **Michael Tucker**
Associate Editor: **Jesse Victor**
Assistant Editor/New Products: **Eileen Milauskas**
Assistant Editor/Research: **Pamela Gorski**
Assistant Editor/Research: **Megan Nields**

Contributing Editors

Raymond C. Freeman Jr.
Freeman Associates
Taiwan: **Charles Hintermeister**
London: **Keith Jones**, (011-441-661-3040)
Tokyo: **Ichiro Kakehashi**
Data Communications: **Walter A. Levy**
Frankfurt: **Maureen O'Gara**
United Kingdom: **Denise Danks**
Washington, D.C.: **Stephen J. Shaw**
(202) 387-8666
Gene R. Talsky
Professional Marketing Management Inc.

Editorial Production

Senior Copy Editor: **Arsene C. Davignon**
Production Editor: **Mary Anne Weeks**
Assistant Copy Editor: **Sharon Hassell**

Editorial Services

Terri Gellegos

Assistant to the Publisher: **Linda L. Lovett**

Executive Editor,
Cahners Computer Publications
Alan R. Kaplan

Art Staff

Art Director: **Vicki Blake**
Assistant Art Director: **Cynthia McManus**
Artist: **Anne Tregay**

Director of Art Dept.: **Norm Graf**

Production Staff

VP Production: **John Sanders**
Supervisor: **William Tomaselli**
Production Manager: **Susan Shaver**
Composition: **Diane Malone**

Editorial Offices

Boston: 275 Washington St., Newton, MA 02158, (617)964-3030. **Irvine:** 2041 Business Center Dr., Suite 109, Irvine, CA 92715. **Los Angeles:** 12233 W. Olympic Blvd., Los Angeles, CA 90064. **San Jose:** 3031 Tisch Way, San Jose, CA 95128. **London:** P. O. Box 37E, Worcester Park, Surrey, KT4 8RQ, England.

Reprints of Mini-Micro Systems articles are available on a custom printing basis at reasonable prices in quantities of 500 or more. For an exact quote, contact Art Lehmann, Cahners Reprint Service, Cahners Plaza, 1350 E. Touhy Ave., Box 5080, Des Plaines, IL 60018. Phone (312)635-8800.

Looking for a product that combines display and multifunction on one PC board?



Don't give up. Persyst.

Introducing Color Combo and Mono Combo, a new breed of multifunction. You'd expect any multifunction board to pack memory, clock and I/O functions into one slot. Now you can expect more... the function of a SixPak™ plus Monochrome or color on a single board, in a single slot.

Our new Color Combo and Mono Combo Cards are the only ones combining an IBM compatible monochrome or color display adapter with a parallel printer port, serial port, up to 384K of socketed RAM, RAM-Disk emulation, print spooling, and an optional clock/calendar. All on one board.

Advanced technology saves us space and saves you slots. Thanks to state-of-the-art custom VLSI circuitry, we were able to shrink the size of our color and monochrome display adapters. This gave us the space to put all the functions your PC needs onto one circuit board.

And, since you get everything you need on one board, you save expansion slots. So why fill up the slots in your PC, XT, AT or PC compatible with boards you don't need.

One board or two: It's that simple.

QUADRAM SOLUTION	AST SOLUTION	PERSYST SOLUTION
1. Quadboard +	1. SixPak Plus +	1. Mono or Color Combo Card
2. Monochrome or Color Adapter	2. Monochrome or Color Adapter	
2 Boards/2 Slots	2 Boards/2 Slots	1 Board/1 Slot

And, our one board is fully IBM compatible. That means you can run all of your favorite software and use standard IBM or IBM compatible color or monochrome monitors. What could be simpler!

Persyst quality backed by a two year warranty. We go to great lengths to insure reliable performance and top quality.

Every Persyst board goes through one of the most stringent testing and quality assurance programs in the industry. So we give you one of the best warranties in the business: a full two years on every Persyst board.

Persyst products are manufactured by Emulex Corporation, an industry leader in high performance controllers, communication products and packaged subsystems for micros to super minis.

Call (800) EMULEX3 for literature or the name of your nearest dealer. In California call (714) 662-5600. Or write us at Persyst Products, Emulex Corporation, 3545 Harbor Blvd., P.O. Box 6725, Costa Mesa, CA 92626.

PERSYST
PERSYST
EMULEX PERSYST

IBM PC, XT, AT are registered trademarks of International Business Machines Corporation. SixPac and SixPacPlus are registered trademarks of AST Research, Inc. Quadram Solution is a registered trademark of Quadram.

CIRCLE NO. 5 ON INQUIRY CARD

U.S. Regional Offices: Anaheim, CA (714) 385-1685; Schaumburg, IL (312) 490-0050; Roswell, GA (404) 587-3610; Nashua, NH (603) 882-6269. International Offices: Australia, Eastwood, N.S.W. (02) 858-4833; Canada, Mississauga, Ontario (416) 673-1211; France, Montrouge (1) 735-7070; United Kingdom, Bracknell, Berkshire (344) 484234; West Germany, Munich (089) 304051.

THE MOST SPECTACULAR BUS ANNOUNCEMENT SINCE MULTIBUS® II.



INTEL CORP.

- 2940 MEAD AVE., SANTA CLARA, CA 95051
- 5200 ELAM YOUNG PKWY., HILLSBORO, OR 97123
- 2420 WEST BEARDSLEY RD., PHOENIX, AZ 85027
- 5000 WEST WILLIAMS FIELD RD., CHANDLER, AZ 85224
- OTHER: _____

SHIP TO:

Advanced Systems Inc.
77 Industry Drive
San Francisco, CA 94108

RECEIVED

DATE
ACC

Attention: Mark Dickerson
(415)445-3000

REF. NO. _____

VENDOR MUST
ABOVE MEMO
DENCE, INVO
WHEN RETURN

SHIPPING MEMO NO. 87121

ITEM	QUANTITY	UNIT	INTEL PART NO.	DESCRIPTION
1	10	--		iSBC 286/100 8MHz MBII CPU board
2	2	--		iSBC MEM/312 512 Kbyte Mem board
3	4	--		iSBC MEM/310 1 Mbyte Mem board
4	2	--		iSBC MEM/320 2 Mbyte Mem board
5	2	--		iSBC MEM/340 4 Mbyte Mem board
6	10	--		iSBC CSM/001 Cent. Serv. Module
7	1	--		iRMX 86II R.0 RMX86 MBII R-t OS
8	5	--		iSBC PKG/609 9 slot cardcage & PSB backplane
9	5	--		iSBC PKG/903 3 slot iLBXII backplane
10	1	--		iSDM 286 R.0 286 System Debug Mo

You've heard the announcements about MULTIBUS II specs.

But now there's an even more spectacular announcement:

The first wave of MULTIBUS II products is here.

Take the 286/100 Single Board Computer. It's the first commercially available 286-based board that runs at 8

MHz. It also introduces the iLBX II™ interface and is iSBX™ compatible.

Then there's our family of cached-based memory boards, from ½ to 4 MB, which give zero wait state performance over the iLBX II bus. And because the boards are configured in software, there are no jumpers. Anywhere.

There's software support, too, with the iRMX™ 86 MULTIBUS II support package. It supports the same tools, languages and utilities as the iRMX 86 operating system.

And for software development support, the iSDM 286 System Debug Monitor is also available. So you'll be up and running in no time with products based on the advanced MULTIBUS II architecture.

We designed the 32-bit MULTIBUS II architecture to give you a quantum leap in performance where you need it: in a multiprocessing environment.

To get such radically improved performance we had to redefine bus architectures with radically advanced concepts.

Like distributed arbitration. It breaks the bus access bottleneck and helps maximize system level performance for multiprocessing environments.

And we're taking a unique approach to interprocessor communication. It's called message passing. It'll free up

the CPU from bus management tasks and put it back to work on your application.

And the MULTIBUS II architecture has the reliability to back up that performance — reliability that surpasses everything else commercially available.

How?

By being the first open systems bus to incorporate parity protection on address, data and control lines. By being the only bus that allows every board to perform self-test.

Even the 32-bit bus inter-

face is reliable. It not only fits onto one DIN connector, but it's been designed to be integrated onto one VLSI chip. And that's more reliable than two or three or more.

But the most important feature of MULTIBUS II is that Intel and other manufacturers are already working on dozens more MULTIBUS II products.

Just the kinds of products you need to meet the needs of your market.

For complete information, call us toll free at (800) 538-1876. Or write Intel Corporation, Lit. Dept. W225, 3065 Bowers Avenue, Santa Clara, CA 95051.

So don't miss this bus. Because you could have a short ride on any other.

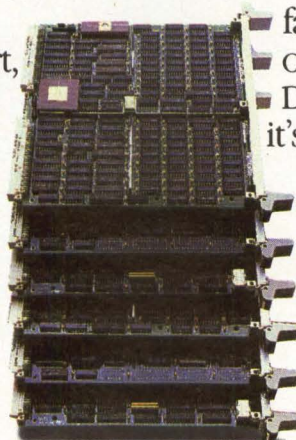

SHIPPING MEMO

April 12, 1985

CODE 0404 / 348

DIVISION / DEPT.

REFERENCE THE
NO. ON ALL CORRESPONDENCES,
PACKING LISTS, ETC.
INCLUDING MATERIALS TO INTEL.

intel®

Our brain

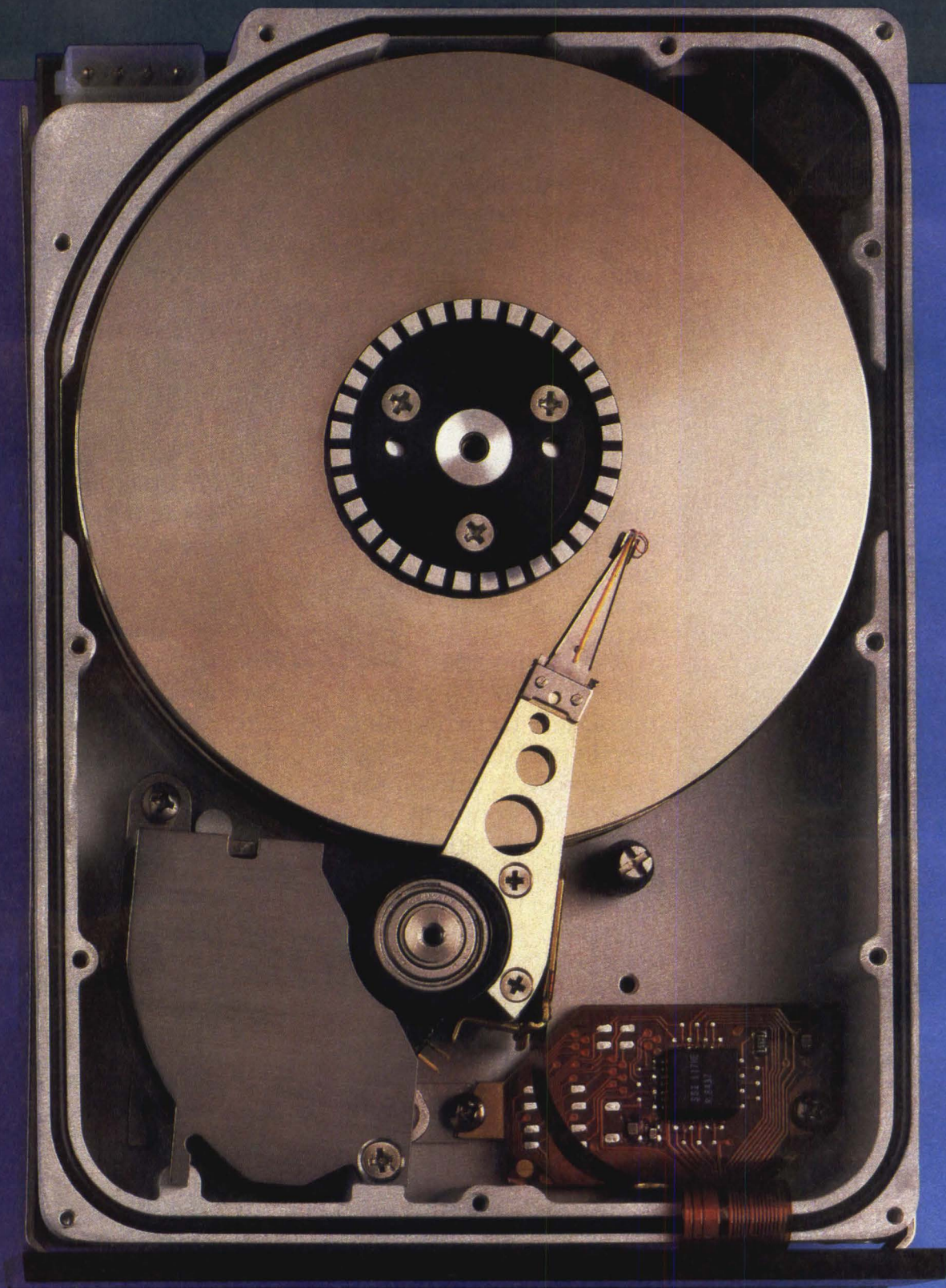

child.

Announcing the Q200™ intelligent disk drive.

The first half-high, 5¼-inch disk drive with the brains and the capacity (53 and 80MB, formatted) to outwit high costs now, and in generations of systems yet to come. And the first disk drive smart enough to step beyond simply enhancing peripheral functionality, to improving total system performance.

We combined the drive and controller as a fully functional mass storage unit to give you a number of advantages. Controller/drive interfacing problems are eliminated, and it takes a lot less time to test and integrate a single component.

The Q200 has its own media defect and error-handling capability, so it not only recognizes errors, but is clever enough to correct them itself. That means a major savings of time and work at your end, with no defect mapping to worry about.

With the SCSI interface, the Q200 breaks through the limits of existing drive technology, into a new way of thinking about system architecture as a whole. Your system no longer has to be designed and redesigned to accommodate a mixed bag of peripheral interfaces. System upgrades will no longer mean expensive hardware and software overhauls.

And like every Quantum drive that's come before it, our latest brain child was born to run longer, on less power, with fewer parts. This lean breeding not only delivers more in your system, but makes it possible for us to deliver the Q200 to you in very high volumes. At prices that will make this baby look very, very smart, indeed.

Please call us for more information.

Quantum Corporation, 1804 McCarthy Boulevard, Milpitas, CA 95035, (408) 262-1100. TWX 910-338-2203. Eastern Regional Sales Office: Salem, NH (603) 893-2672. Western Regional Sales Office: Santa Clara, CA (408) 980-8555. European Sales Office: Frankfurt, West Germany 069-666-6167. Quantum products are distributed in the United States and Canada by Arrow Electronics.

Quantum

CIRCLE NO. 7 ON INQUIRY CARD

RODIME

The optimum
combination of
capacity, reliability
and price

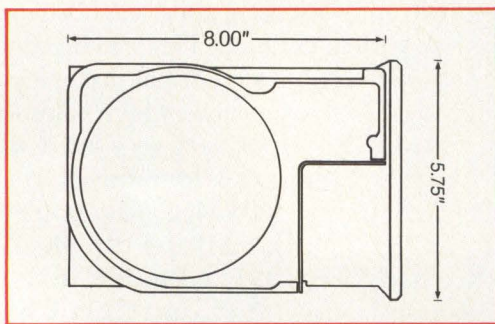
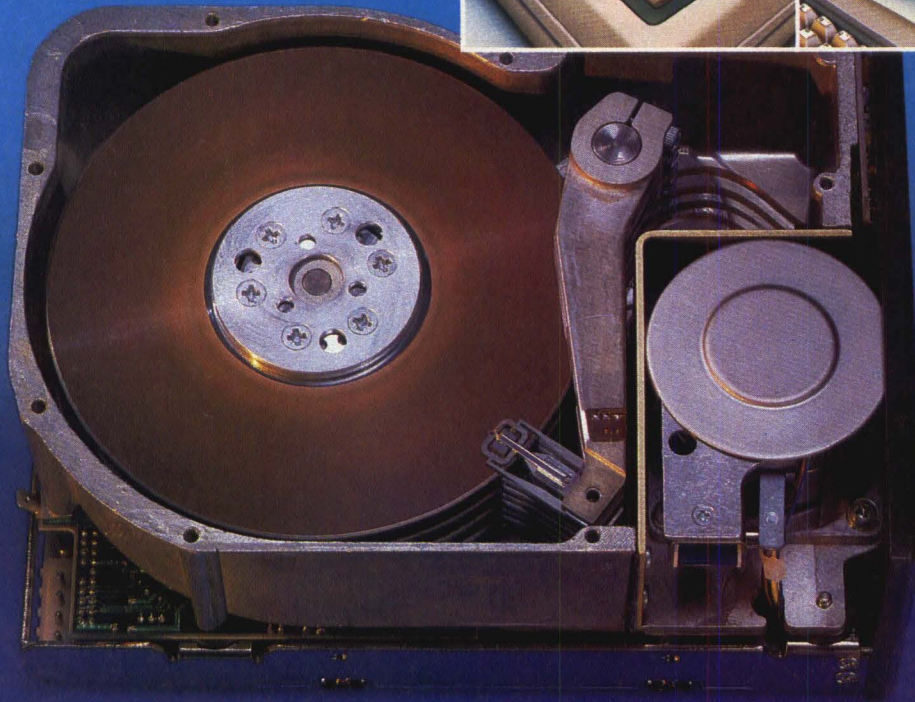
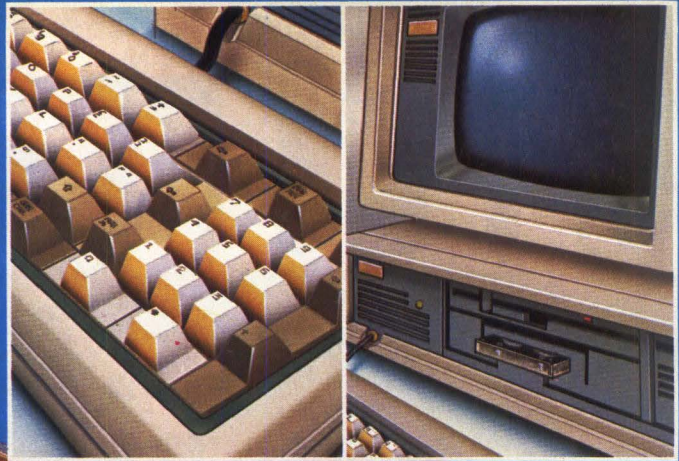

Our 200E hard disk drives are the lowest-priced medium capacity (13-53 Mbyte) 5 1/4" drives on the market. Technology, not compromise, gives you this price advantage. Our leadership in micro-processor-controlled stepper motor design has enabled us to bypass expensive closed loop voice coil actuators, giving you

optimum performance at a significant savings.

This third generation of 5 1/4" drives reflects our four years of production and field experience. Rugged construction and ultra-reliable performance—as expected from Rodime—have been still further enhanced. Phone or write for our 200E Series data sheet and brochure.

RODIME

901 Broken Sound Parkway, N.W. • Boca Raton, FL 33431 • (305) 994-6200
West Coast—Mission Viejo, CA (714) 770-3085 • Central—Austin, TX (512) 453-5135

CIRCLE NO. 8 ON INQUIRY CARD

EDITORIAL



AT CLONES AWAIT THEIR CUE

Repeating the IBM Corp. PC-lookalike scenario of a few years ago, a half dozen or so manufacturers have introduced clones of IBM's Intel Corp. 80286-based PC-AT microcomputer. The reason? Without a doubt, the IBM PC-AT will become both a standalone and a multiuser de facto standard. Indeed, market research company Future Computing Inc. estimates that 102,000 AT-compatibles will be shipped in 1985, 418,000 in 1986 and 718,000 in 1987.

Because IBM immediately ran into chip and disk drive production and delivery problems, AT-compatible makers quickly rushed their products to market. But most industry analysts believe the AT-compatible market window will soon shut. That is, once IBM ramps up to production delivery quantities, the AT-lookalikes will be on the outside looking in.

In fact, Arthur D. Little Inc.'s Information Systems Consulting Group claims that IBM's AT order backlog delivery has shrunk to one and a half months, compared to nine months earlier this year. In addition, market research concern International Data Corp. predicts that 1985 PC-AT shipments will total 300,000 units, compared to just 25,000 units in 1984.

To survive this onslaught, then, AT-compatible makers must follow Clone Rule No. 1: furnish more functionality at much less cost. Unfortunately for the clone makers,

though, IBM PC-AT buyers appear to be patient. They have not clamored for AT-compatibles from such vendors as Compaq Computer Corp., Corona Data Systems Inc., Kaypro Corp., NCR Corp., TeleVideo Systems Inc., Texas Instruments Inc. and Zenith Data Systems. Marketing independently, these vendors supply a mixed bag of performance features. Some include monitors; some don't. The number of flexible and hard disk drives, plug-in cards and expansion slots vary. Clock rates differ. Application software compatibility blurs. And prices range from about \$2,500 to \$7,000.

The key questions, then, are which AT-compatible products will survive? And how? Obviously, the answers center on marketing basics: product reliability, quality and service. Other important success criteria focus on system configuration, integration and implementation. For example, Compaq Computer has achieved immense sales through its vast dealer distribution channel. Likewise, Texas Instruments employs the value-added reseller channel.

In other words, knowledgeable system integrators can solve your PC-AT-based computer system problems. They have the skill to sift and sort through the numerous AT-compatible feature and price combinations and permutations to meet your needs. Now it's okay to send in the clones.

A handwritten signature in cursive script that reads "George V. Kotelly".

George V. Kotelly
Editor-in-Chief

Optimum

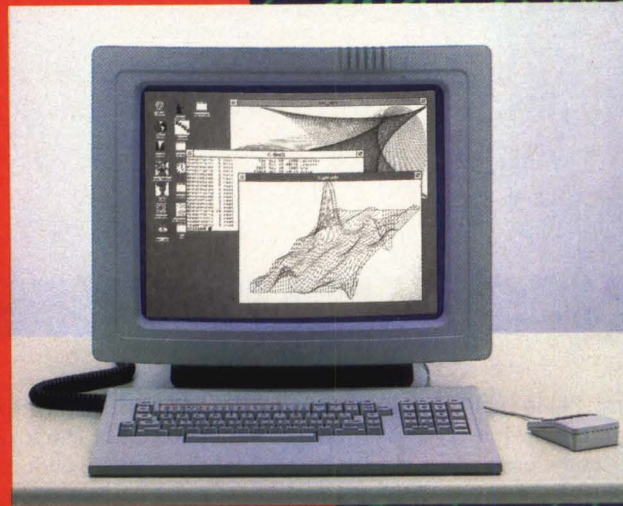

What is a clustered workstation?

Get more than you bargained for.

**A powerful high-performance, VME based
graphics workstation that's easy to
upgrade to the MC68020.**

Upgrades to the new Motorola 68020 are as easy as a single board swap in the Optimum V Series. And when you're ready to add on even more processing power, you have a wide range of sophisticated Integrated Solutions' products to choose from. Peripherals. Packaging alternatives. Performance features. Applications. All at low incremental cost.

High-performance graphics for the technical professional.

The Optimum V offers impressive features. Like a high-resolution (1280 x 1024), bit-mapped graphics display in monochrome or color. 32-bit VME architecture and AMD 29116 graphics display processor. Together with 11.2 MHz 68010, dual ported

high-speed memory and UNIX 4.2 BSD, the Optimum V is designed to provide you, the technical professional, with state-of-the-art technical processing.

And Integrated Solutions makes processing even easier with a unique user interface. Multiple windows, icons and pop-up menus mean convenient access to programs, files and directories.

Support and more.

Integrated Solutions is behind you all the way with on-site hardware maintenance and local software support. Call us now for more information.

Integrated Solutions

An NBI Company
2240 Lundy Avenue
San Jose, CA 95131
800-538-8157, ext. 823
In California, 800-672-3470,
ext. 823



CIRCLE NO. 9 ON INQUIRY CARD

Call Integrated Solutions.

**Introducing
The Single
Solution To
Many Problems
That Can
Tie Up Your
Personal
Computer.**



Transet 1000™ The print buffer, communications buffer, port expander, printer sharer and I/O switcher. All in one.

Anyone with a personal computer and one or more peripherals has faced the all-too-familiar dilemma. You need your computer to do an important job. But you're forced to wait for the system to finish one job (printing, communicating, whatever) before you can go on to the next one. Or you need to stop what you're doing to switch cables when you want to use another peripheral.

Wait no more. Now Hayes introduces an innovative new device that lets you perform many jobs—at the same time—independent of your computer. Transet 1000. It works with a wide range of systems and configurations. And it allows you to continually expand your system as your needs grow.

Transet 1000 frees your computer from waiting on your printer or modem—so you and your computer can go on to another task. It even lets you

print out documents in pre-set formats without having to go back into your computer. At the same time, Transet 1000 can operate unattended mailbox communications—24 hours a day—even if your computer is turned off.



In addition, Transet 1000 is a port expander and software-controlled I/O switcher. Now files can be easily directed and redirected to different peripherals, without physically changing cable connections.

Transet 1000 contains a stand-alone microprocessor, and comes with 128K of memory. It operates with any RS-232 interface computer, and has optional accessory kits available for the IBM® PC and PC XT, Macintosh™ and

Apple® IIc. Kits contain the necessary host cable, a user guide and menu-driven software that lets you graphically set up or customize port

parameters and printing formats. Cables available for IBM PC AT, other computers and peripherals.

Like all Hayes products, Transet 1000 combines sophisticated capabilities with easy operation. Just as Hayes set the standard in personal computer communications, now Hayes is taking the lead in computer task management.

Contact your authorized Hayes dealer to see how Transet 1000 can help you get a lot more productivity



out of your computer system—without tying up your computer or you.

Hayes Microcomputer Products, Inc., P.O. Box 105203
Atlanta, Georgia 30348
404/441-1617

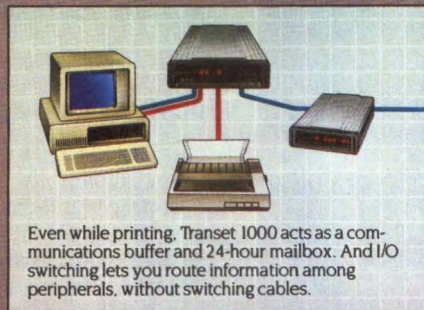

Even while printing, Transet 1000 acts as a communications buffer and 24-hour mailbox. And I/O switching lets you route information among peripherals, without switching cables.



Hayes products
now available
under GSA Contract
No. GS00K85AGS5080.

Hayes® Transet 1000

Innovative products for enterprising people

Attend!

1985
MICROFOCUS
CONFERENCE

Micro Vendor
Strategies for Success:
Adding Value
to Increase
Bottom-Line Profits

September 12 - 13, 1985

Red Lion Inn
San Jose, CA

For more information and to receive a Program Brochure,
contact Diane Testa at 617-872-8200.



5 Speen Street, Framingham, MA 01701 / (617) 872-8200 / Telex 95-1168

LETTERS

AMENDED ADDRESS

To the editor:

The February 1985 issue of *Mini-Micro Systems* has an incorrect address listed for our client Scientific Micro Systems. For future reference, the correct address is:

Scientific Micro Systems
339 N. Bernardo Ave.
Mountain View, Calif. 94043

Carolyn Demeter
Publicity Coordinator
Cortani, Brown, Rigoli
Advertising and Public Relations
2073 Landings Drive
Mountain View, Calif. 94043

PIONEER IN ADA

To the editor:

Concerning the article on Ada validation in Europe that appears in *Mini-Micro Systems*, November 1984, Page E1 (MMS European edition), I would be grateful if you would correct several facts.

There exist two European-based validation centers. The first one is B.N.I. (Bureau d'Orientation de la Normalisation en Informatique) that received its charter from the Ada Validation Office (AVO) on September 10, 1984. The second one (IABG) received its charter on September 21, 1984.

B.N.I. in December of last year validated the first European industrial Ada compiler, ALSYCOMP 0001. The compiler was developed at Alsys SA [La Celle Saint Cloud, France]. Alsys is the company of J. Ichbiah, who is the principal author of the Ada programming language. This compiler is a cross-compiler hosted on several VAX machines running VMS. It executes code on an Altos MC68000-based computer running UNIX System III.

The pre-validation was done in November and the official validation started on December 8. The validation report was signed by R. Mathis, director of the AVO, on December 14, 1984.

This validation was the first executed with the version 1-5 of the validation test suite.

N. Malagardis
Director
Bureau d'Orientation
de la Normalisation
en Informatique
Rocquencourt, France

DEMO UNIFY: THE MOST POPULAR DBMS IN ITS CLASS.



Order the UNIFY Demo Kit, and learn why UNIFY is the DBMS chosen by more applications developers and UNIX-based computer vendors.

You can interactively demo UNIFY's speed advantages, made possible by its automatic selection of four access methods.

You can see the simplicity of UNIFY's menu-based design and Query-By-Forms capability. Witness the power of its SQL query language and RPT™ report writer.

Companion documentation

details UNIFY's easy forms design, multiple security features and unmatched host language interface—and proves

why this is the one DBMS that can keep pace with your needs.

Test it yourself. The Demo Kit includes disk or tape, demo handbook, plus comprehensive manuals that show how to build virtually any application—all for \$150. Contact UNIFY, 4000 Kruse Way Place, Lake Oswego, OR 97034, 503/635-6265.

UNIFY THE PREFERRED DBMS.

COMPAQ could have stopped here



...but we didn't.

Introducing the new COMPAQ PORTABLE 286™ More features, more speed...more useful.

Most people think the IBM® Personal Computer-AT™ can do more than any other personal computer. But now COMPAQ offers a personal computer that does more in a package *half* the size, complete with a handle.

Incredibly fast

Most computer companies would consider it a breakthrough to make a computer with the power and speed of the IBM PC-AT. But not COMPAQ. The new COMPAQ PORTABLE 286 runs all the popular programs 30% *faster*.

And no doubt most would have been elated to put 20 Megabytes of fixed disk storage in a portable computer. But we didn't stop there. We designed the COMPAQ PORTABLE 286 to accept an internal fixed disk drive back-up system as well. It protects your data on pocket-sized tape cartridges, something not even the IBM PC-AT can do.

Room to grow

Once we got started, it was hard to stop. There's room for up to three internal storage devices. Choose from 1.2-Megabyte or 360-K byte diskette



It simply works better.

drives, the fixed disk drive and fixed disk drive back-up.

Add up to 640-K bytes of memory on the main board. Then add up to 2 more Megabytes using an expansion board. That gives you more memory than most desktop computers.

For displaying your work, a built-in monitor shows high-resolution text *and* graphics. A second monitor isn't necessary.

Does more—anywhere

Together, all these features add up to our fastest, most powerful portable computer. It helps you do more, in more places.

Of course, if you need a computer with even more power, we designed a model that stays in one place.

The new COMPAQ DESKPRO 286™. With up to 8.2 Megabytes of memory and 70 Megabytes of storage, it can take you beyond today's limits of desktop personal computing.

COMPAQ offers personal computers beyond compare. Because we make them without compromise.

For a free brochure or the location of your nearest Authorized COMPAQ Computer Dealer, call toll-free 1-800-231-0900 and ask for operator 6.

COMPAQ

PORTABLE 286™



**PRO/VENIX in the
Laboratory**

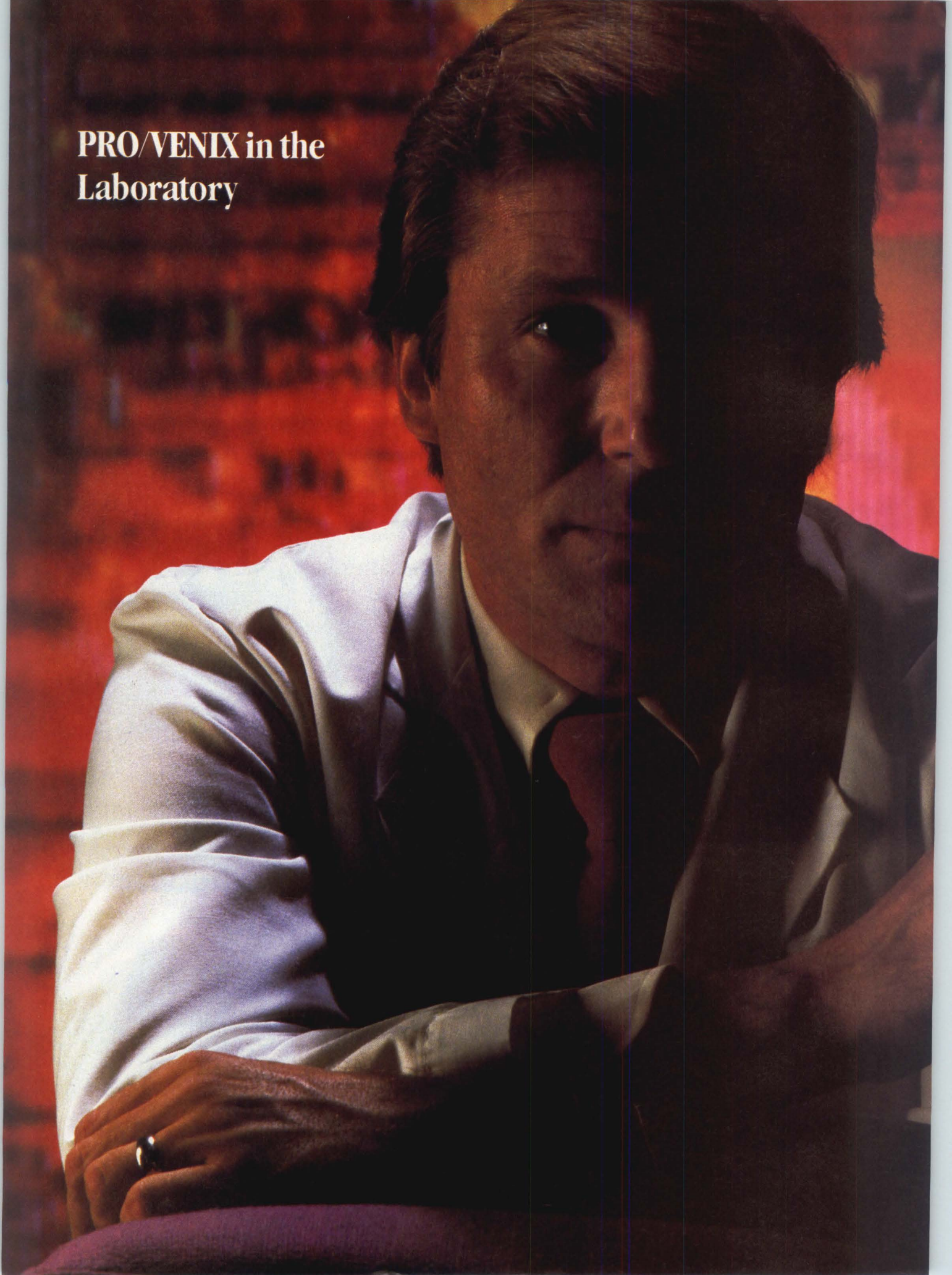



Give Intelligent People Powerful Tools and They'll Work Wonders.

PRO/VENIX,* Digital's enhanced UNIX* product for the Professional* Workstations, has everything you need to design sophisticated laboratory systems and applications. It has the basic features you expect from a UNIX product. Like System V compatibility. Berkeley enhancements. And multiuser and multitasking support.

But you didn't get where you are by relying only on the basics. And that's why PRO/VENIX offers intelligent enhancements.

Realtime Interface. Whether laboratory data acquisition or process control, PRO/VENIX has unique capabilities that let you create the environment you need. Pre-emptive priorities. Interprocess communication. Shared data segments. Asynchronous I/O. And process timing with suspension units as small as 1/60th of a second.

High-resolution Color Graphics. Powerful ideas warrant powerful presentations. PRO/VENIX offers a Graphics Kernel System (GKS), utilities, and libraries that let you create graphics from the UNIX shell or from an application.

Ethernet Communications. Your PRO/VENIX resources can be shared in distributed computing or Local-Area Network environments with the Professional Ethernet Controller. XNS* and TCP/IP* protocols let your Professional become a full-featured distributed UNIX workstation.

Powerful tools are useless without a strong company that can deliver service, support, and long-term commitment. The Digital Commitment—87,000 people in over 660 engineering, service, sales, and manufacturing facilities worldwide devoted to delivering high-quality products and service.

Call 1-800-DIGITAL Ext. 695 for more information on PRO/VENIX Workstations.

Isn't it time you had tools powerful enough to create the UNIX applications you envision?

digital[™]

CIRCLE NO. 13 ON INQUIRY CARD

Copyright 1985. All rights reserved. PRO/VENIX is a member of Digital's family of ULTRIX products. VENIX is a trademark of VenturCom, Inc. Professional, Digital, and the Digital logo are trademarks of Digital Equipment Corporation. UNIX is a trademark of Bell Laboratories. XNS and TCP/IP are trademarks of Xerox Corporation.

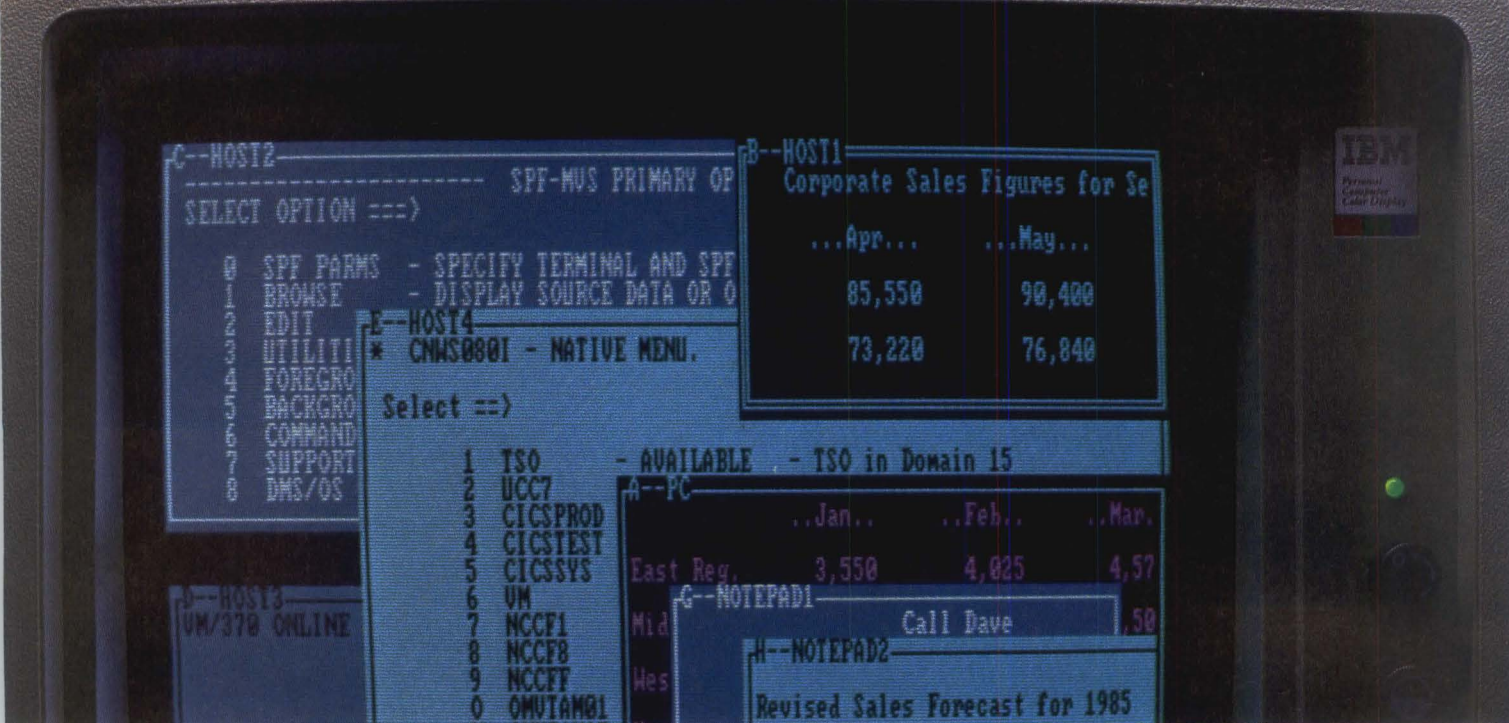

How to turn the PCs you have into the 3270 PCs you need.

Simple.

Just plug in the CXI 3270 PC connection. It's an add-in board with software. And it can turn your IBM® PC, XT, AT or compatible into a full-fledged coaxial- or modem-attached 3270 PC.

Just like that.

So you can access and "window" up to five host applications at the same time. On the same screen. There's also a window for running a PC DOS application. Which can be programmed to talk with any host session—or all five at once. Not to mention two electronic notepads.

The coaxial connection attaches to a 3274 cluster controller. While the modem connection lets you work remotely without the need for a controller.

It gets better.

Our 3270 PC connection lets you use inexpensive PC-attached printers in place of

host-addressable IBM 3287s. And it can run all the software already written for the IBM PC.

What's more, international keyboard mapping and file transfer come standard.

For those who don't require full 3270 PC capability, we also offer the CXI 3278/79 PLUS PC connection. It's not your everyday 3278/79 emulator. Rather, it lets you work with one host session, one PC program and two notepads—concurrently.

So for more information about our line of CONNECTWARE™ products, or for the name of your nearest distributor, call 800/221-6402. In California, call 415/424-0700. Or write CXI, Inc., 3606 West Bayshore Road, Palo Alto, CA 94303. TELEX 821945.

And find out how to turn the PCs you have into the 3270 PCs you need.

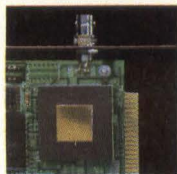

CXI

BREAKPOINTS

IBM SET TO LAUNCH 'PC II' WITH PROPRIETARY 32-BIT PROCESSOR

IBM Corp. is expected to debut by the end of September the "PC II," its much-anticipated successor to the PC. The new machine is said to employ a proprietary 32-bit chip, at least temporarily ending IBM's reliance on Intel Corp.'s 8088 processor family and more closely tying microcomputer users to IBM's own operating systems and software. The new microcomputer reportedly will have a built-in, 40M-byte hard disk drive and incorporate IBM's Logic Unit 6.2 Systems Network Architecture protocol, which will permit linked devices to communicate with each other directly on a peer-to-peer basis. The PC II is also said to be extremely communications-oriented and most likely will be the foundation of the company's long-awaited token-passing local area network.—*J. Victor*

CORVUS-ONYX MERGER NEARS COMPLETION

The Securities and Exchange Commission is expected to give its final blessing later this month to the merger of Corvus Systems Inc. and Onyx + IMI Inc. The two San Jose, Calif., companies hope the marriage will capitalize on individual corporate strengths: Corvus in local area networks and Onyx in UNIX-based multiuser systems. Both companies have felt the slump in the industry—Corvus with a loss of \$6.5 million on sales of \$53.2 million for its fiscal year ending May 31, and Onyx with a \$4.6 million loss on revenues of \$19.3 million through its third quarter ending in June. Corvus hopes to leverage Onyx's muscle in OEM distribution channels for a new networking scheme to be introduced next month.—*M. Seither*

TURBO-CARD TECHNOLOGY TAKES ANOTHER STEP

Applied Reasoning Corp. (ARC), Cambridge, Mass., has pushed IBM Corp. PC "turbo-card" technology a step further. Besides providing a 7.2-MHz, Intel Corp. 80286 processor with up to 2M bytes of RAM on one plug-in card, ARC's PC-elevATor loads its own PC basic input/output system emulator from a supplied disk. This "softboard" approach lets the 80286 run "upstairs" while the PC's own 8088 runs "downstairs" as an I/O processor. ARC claims the board boosts AT performance by 50 percent while maintaining total PC compatibility. PC-elevATor supports an optional 5- or 8-MHz Intel 80287 arithmetic coprocessor, and the autoexec-loadable "softboard" software additionally provides RAMdisk, disk-cache and print-spooler capabilities.—*A. Kaplan*

ASHTON-TATE OFFERS CUSTOM dBASE III TO VARs

Ashton-Tate hopes to attract value-added resellers with an enhanced version of its dBASE III programming language. Called Developer's Release and unavailable through the retail channel, it is part of a larger effort by the Culver City, Calif., software company to get VARs to bundle their

BREAKPOINTS

proprietary applications around Ashton-Tate products, such as Framework. The release includes a number of utilities to encrypt custom applications and link program files, as well as a debugging facility not available in the current retail dBASE III. More than 50 enhancements to the programming language are said to be included in the \$695 Developer's Release.—*M. Seither*

BULLETIN BOARD TRACKS DELAYED EXPORT LICENSES

The Department of Defense has initiated an electronic bulletin board to help exporters track their export licenses by telephone. Called the Export License Status Advisor (ELISA), the service can be used to check the progress of export license applications that have been referred from the Department of Commerce to the DOD for review. ELISA's phone number is (202) 697-6109.—*S. Shaw*

MULTIMATE TO RUN ON MINIS AND MAINFRAMES

Multimate International Corp. recently announced plans to sell minicomputer and mainframe computer versions of its popular Professional Word Processor software. The East Hartford, Conn., company will support IBM Corp.'s System/36 minicomputer architecture and VM and MVS mainframe operating systems. The System/36 version will be priced from \$1,800 to \$2,200, while mainframe versions will range from \$20,000 to \$30,000. Delivery will reportedly begin in the first quarter of 1986. Multimate is also developing word-processing software for minicomputers manufactured by Data General Corp., Digital Equipment Corp. and Prime Computer Inc.—*L. Haber*

MITSUBISHI READIES NEW THERMAL-TRANSFER GRAPHICS PRINTERS

Mitsubishi Electronics America Inc., Torrance, Calif., revealed a series of black-and-white and color thermal-transfer graphics printers at the National Computer Conference in Chicago in July, for possible product introduction early in 1986. The monochrome Models P-60 and P-70 and the color Model P-100 provide 160-dot-per-inch (dpi) resolution on 8 1/2-inch and 5-inch paper. The company also showed the Model G-650 thermal-transfer graphics printer. The bit-mapped unit can handle B-size (17-inch-by-22-inch) paper and prints 1 page per minute with 300-dpi resolution. Planned for formal introduction in November, the G-650 will cost under \$4,500.—*C. Warren*

TECH FILES: A QUICK LOOK AT INDUSTRY DEVELOPMENTS

MICRO FILES: **Panasonic Industrial Co.** of Secaucus, N.J., has introduced the Exec. Partner, an IBM Corp. PC-compatible computer with a 25-line-by-80-column plasma display and a built-in 30- or 60-character-per-second thermal printer. The system uses an Intel Corp. 16-bit, 80862 CPU running at 4.77

The fastest Perkin-Elmer compatible disk controller you can buy.

Console configuration supports future SMDs without PROM changes.

Reads and writes P-E's IDC and MSM packs.

World-wide maintenance available from P-E.

Install any size SMD drive without OS/32 software patches.

High speed formatting.

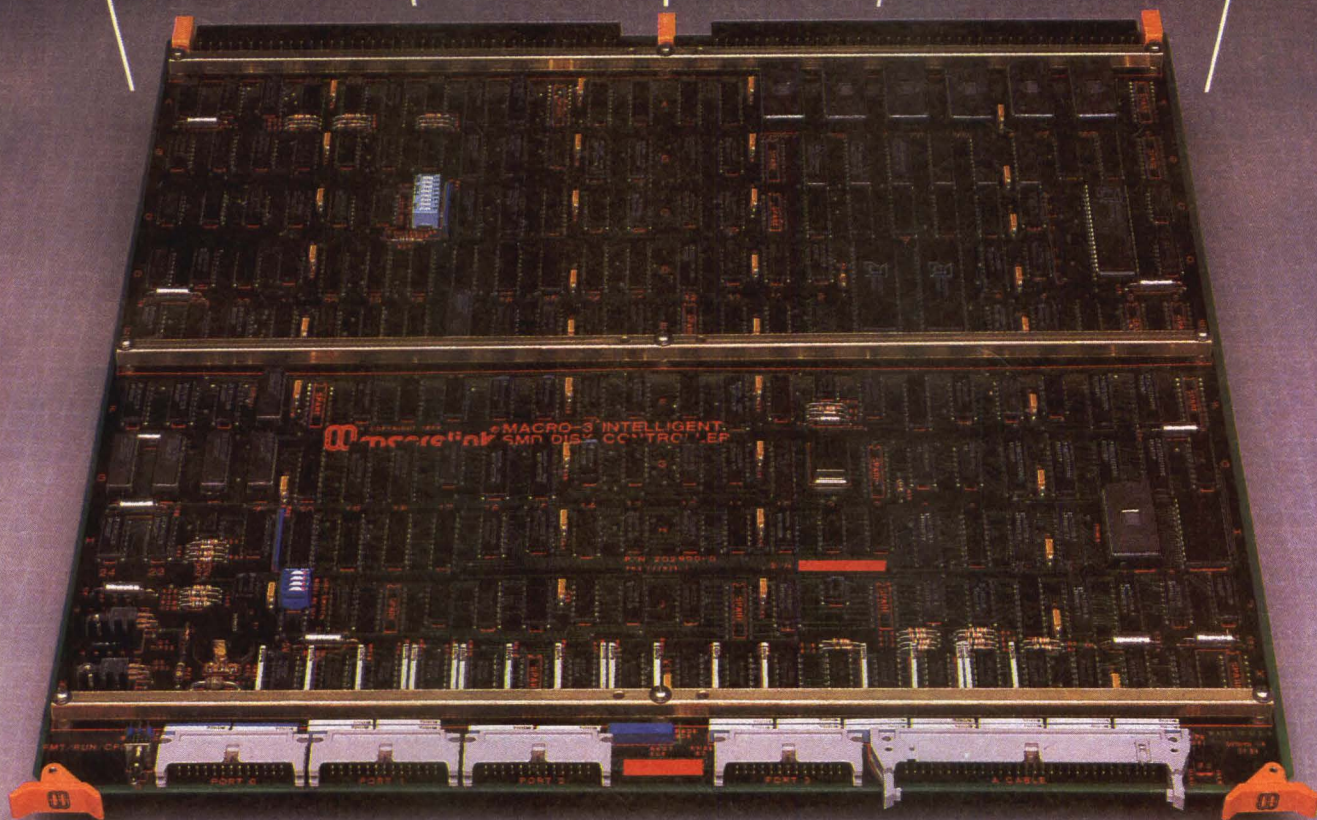

You're ready for the new generation of high performance SMD disk drives with the MACRO-3. High speed drives (over 2MB/Sec) are no problem. Only the MACRO-3 SMD controller offers full emulation of P-E disk systems, and supports advanced drives like the Eagle & CDC's FSD and XMD on any 3200 CPU. It can read

both IDC and MSM packs at the same time, a feature that P-E just can't match. And it's /XELOS/proven.

MACRO-3 is shipped from stock with installation manual, cables and a one year warranty. Of course it comes with the high reliability, tested performance and attractive pricing you'd expect from Macrolink. After all, we

invented the P-E emulating disk controller board.

Find out about the largest family of P-E compatibles going — including memory, COMM, tape and more. Call today for prices and details.

 **macrolink® Inc.**

Macrolink Inc. 1500 N. Kellogg Drive, Anaheim, California 92807 Phone (714) 777-8800 TWX 910-591-1671

XELOS and Perkin-Elmer are registered trademarks of Perkin-Elmer.

CIRCLE NO. 15 ON INQUIRY CARD

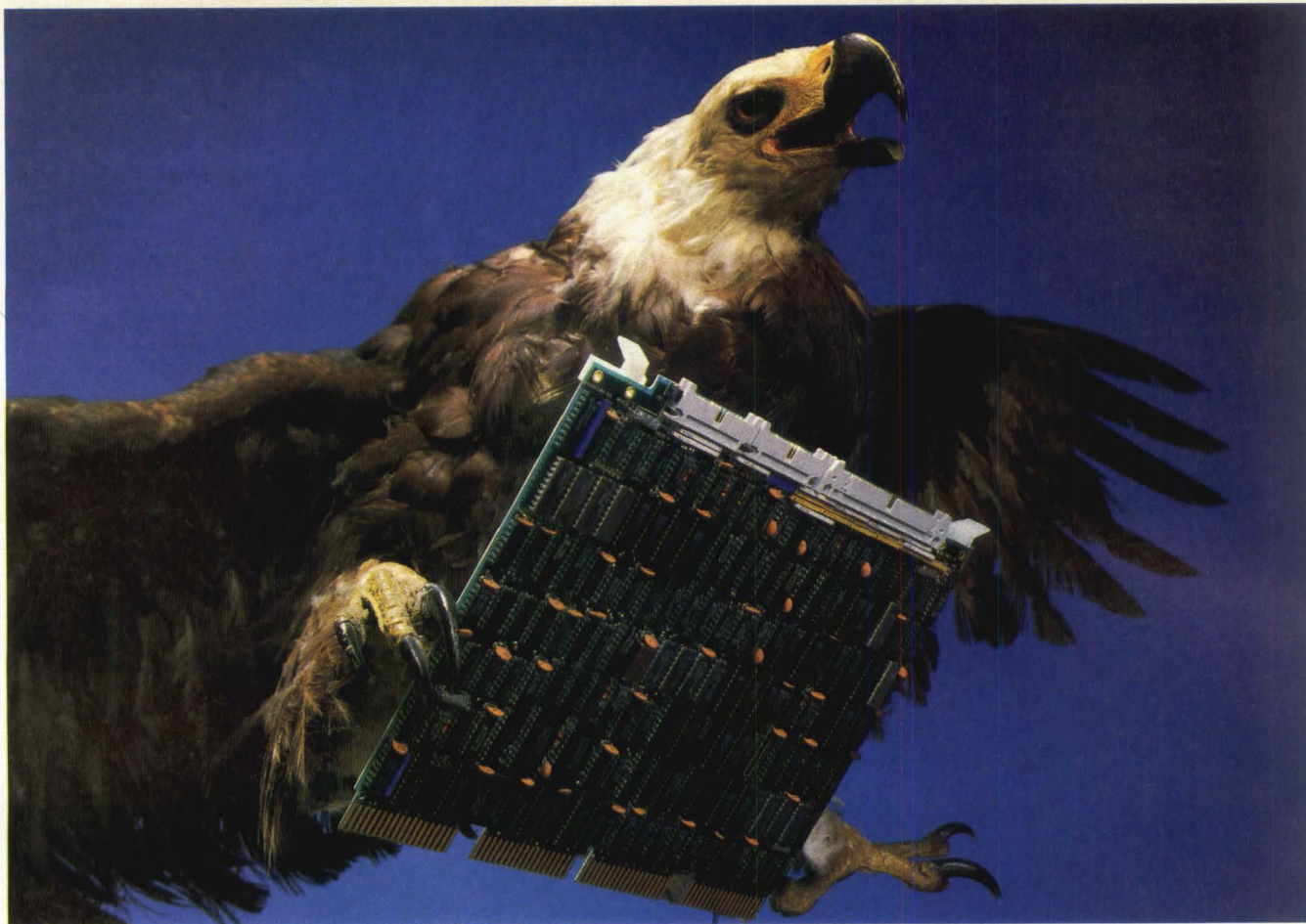

Only our disk controller can soar with the new Highspeed Storage Module Drives.

MDB's New 2.5 Mbyte Disk Controller.

Now that we're in the world of Highspeed Storage Module Drives with data transfer rates up to 2.4 Mbytes per second, you need a disk controller that can keep pace. MDB's new MLSI-DK11, for Q-bus* systems, is a bird of that feather with rates of 2.5 Mbytes per second.

Not only does this quad size controller operate the new genre of disk drives, like the new Fujitsu Eagle XP or their new Swallow III,** (M2333), it also operates at the standard rate of 1.2 Mbytes to run slower drives.

It also offers up to 22 bit direct addressing range for computer memory and has Block Mode DMA transfer capability to keep up with the computer. Like our standard tape controllers this HSMD can be software configured from the operator's console for all the major parameters.

Since it's from MDB, the new MLSI-DK11 offers the most popular emulation modes RM03, RM05, RM80

or RP06, that give you the flexibility of vertical, horizontal and direct mapping, even up to an 8.3 gigabyte capability to better format the drive size selected. And, like our other Q-bus add-ons, it is transparent to most DEC* operating system software.

Access delay has also been avoided. Thanks to its high performance micro engine architecture, Block Mode DMA and multi-sector buffer RAM, you can count on maintaining the highest possible sequential data throughput rates without sector interleave.

In fact, up to 6 consecutive sectors of data can be transferred at the 20MHz serial data rate (2.5 Mbytes) before a slip of a disk revolution time may be interposed, without sector interleave.

The MLSI-DK11 Highspeed Storage Module Drive. It's our way of proving we intend to be the leader of the flock.

Get complete details by contacting us today.

MDB
SYSTEMS INC.

Corporate Headquarters
1995 N. Batavia Street, Box 5508
Orange, CA 92667-0508
Tel. 714-998-6900 TWX: 910-593-1339
FAX: 714-637-4060

MDB Systems U.K., Ltd.
Basingstoke, Tel. 44 0256 464767
TELEX: 858389 MDBSYS G

*TM Digital Equipment Corp

**Trademark of Fujitsu America, Inc.

In the western states MDB products are also distributed by **WYLE** ELECTRONICS MARKETING GROUP
LABORATORIES

CIRCLE NO. 16 ON INQUIRY CARD

"See us at FCC Booth #1262"

BREAKPOINTS

or 7.16 MHz, the MS-DOS 2.11 operating system and the BASICA version 2.0 programming language. It comes with 256K bytes of RAM, expandable to 640K bytes, two 5¼-inch, 360K-byte floppy disk drives, an 80872 math coprocessor socket and serial and parallel ports. The system is priced at \$2,595.—*E. Milauskas*

DISK FILES: **Canon Inc.** plans October availability of its Canofile System 5500, a combination optical-disk and microfilm electronic filing system. With a picture density of 400 dots per inch to produce half-tone images in 64 tonal gradations, the 5500 reads originals with an optical scanner, codes them and either stores or prints them with a light-emitting-diode laser printer. Images are stored on 20-cm diameter, double-sided optical disks that store 1G byte per side. The system includes a mouse and multiple windowing that allows the operator to switch from one function to another, making copies from microfilm or entering data. The suggested price of about \$58,800 will include terminal scanner, printer, optical disk drive, microfilm scanner and automatic cartridge loader.—*I. Kakehashi*

SOFTWARE FILES: **Lexidata Corp.**, Billerica, Mass., has introduced a "Virtual Window Manager" option for its Lex/90 graphics system that gives users a real-time, true-color windowing environment. A refinement of standard bit-map technology, Virtual Window Manager works by dropping the bit-map display into a buffer memory rather than directly onto the screen. A processor then selects and displays whatever segments, or windows, of that bit map the user wishes to see. The local processor can manipulate or modify the segments in the buffer, freeing the host machine's CPU for other tasks. Virtual Window Manager can support up to eight active windows, display solid overlays and perform panning and scrolling of graphics. It is priced \$3,000 higher than the \$17,000 to \$23,000 Lex/90 itself.—*M. Tucker*

PORTABLE FILES: Signs of maturity are beginning to show in **Hewlett-Packard Co.'s** baby laptop computer. The Portable Plus, which the Palo Alto, Calif., computer maker began shipping several weeks ago, is an enhanced version of the HP 110 portable. HP has expanded memory capacity on the Portable Plus from 272K bytes to 896K bytes and opened up the system to accept a variety of ROM cartridges for software packages, among them Lotus Development Corp.'s 1-2-3 and Microsoft Corp.'s Word. The liquid crystal display has grown too, from 16 to 25 lines, and an optional 300/1,200-bits-per-second modem is offered instead of the built-in 300-bps unit. The only reduction is in price—down 30 percent to \$2,295.—*M. Seither*

NCC FILES: Providing six standard fonts with an option for an additional 25, **Enter Computer Corp.'s** TYP-SET graphic arts lettering software, demonstrated at the National Computer Conference in Chicago in July, generates high-quality lettering with variable spacing, shading and coloring, and character

BREAKPOINTS

size from $\frac{1}{2}$ inch to 72 inches. The San Diego company reports that the \$299 package works with virtually all plotters. Additional sets of four fonts each are priced at \$199.—*C. Warren*

The battle for the low-end, alphanumeric terminal market has gotten even hotter with the announcement by **Lear Siegler Inc.**, Anaheim, Calif., of its ADM 3E, priced at \$399. The new terminal incorporates seven programmable keys for 14 functions, a standard 14-inch green or amber screen, dynamically allocated function-key memory, basic editing capabilities and an optional bidirectional printer port with independent baud rate. Lear Siegler has also introduced its first two color graphics terminals, Models 7105 and 7107, previously marketed as the Envision Models 220 and 230, respectively.—*B. MacDonald*

Digital Communications Associates Inc., Alpharetta, Ga., has introduced Fastlink, an asynchronous modem that transmits information over

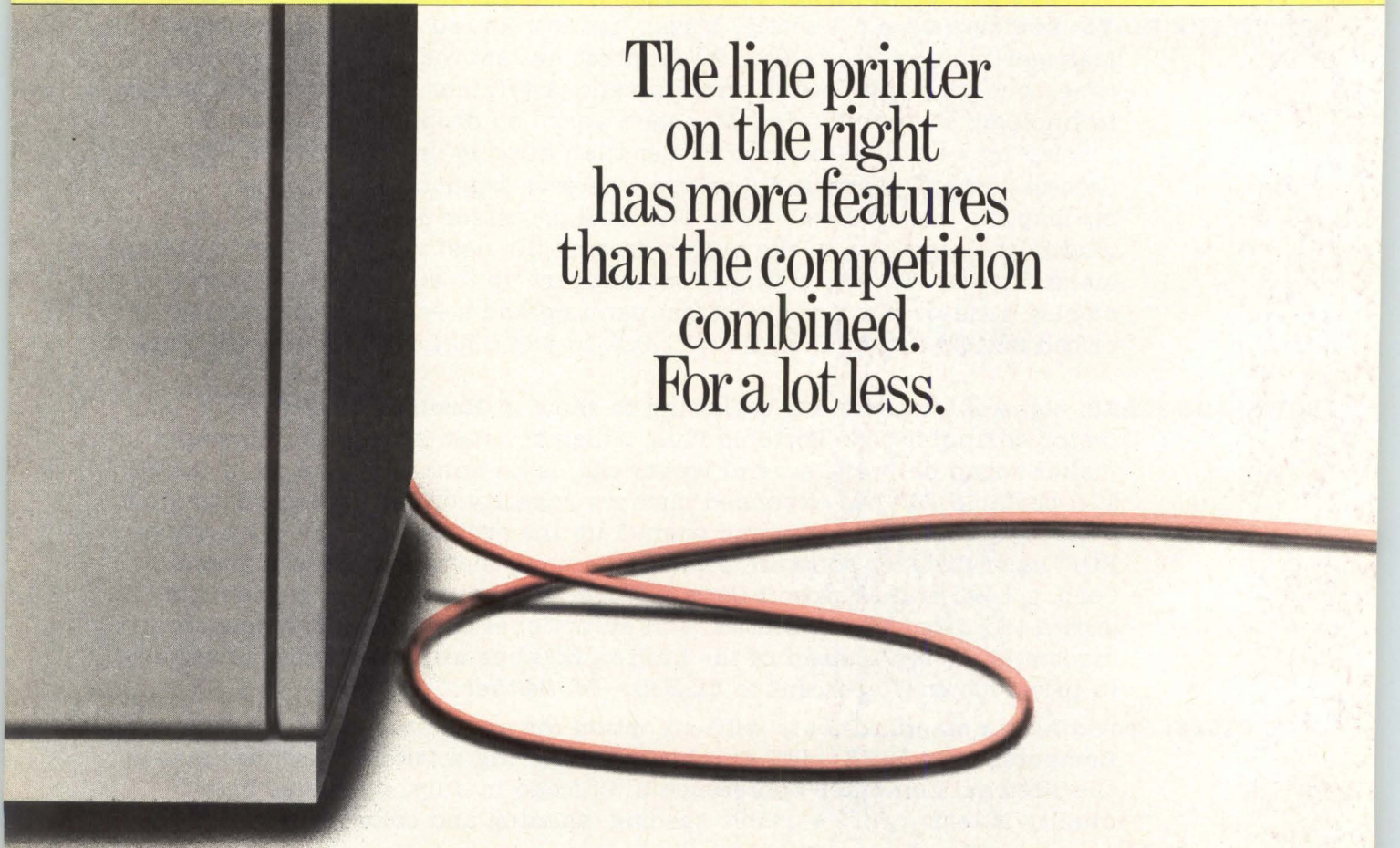

The line printer
on the right
has more features
than the competition
combined.
For a lot less.

ordinary phone lines at speeds of up to 10,000 bits per second, thanks to a unique method of encoding and modulation. Fastlink is available in either an IBM Corp. PC-compatible printed-card version for \$1,995, including communications software, or as a standalone unit for \$2,395, excluding software.—*E. Milauskas*

Fujitsu America Inc., San Jose, Calif., has expanded its range of storage devices with the M244XAC streaming-tape drive and the M2451A half-inch cartridge-tape drive. The streaming-tape unit features cache buffer, IBM Corp. and ANSI compatibility and variable data-transfer rates from 60K bytes per second to 1M byte per second, with a total of 180M bytes of storage. Pricing is \$6,760 in OEM quantities. The M2451A half-inch cartridge-tape drive can store 120M bytes, features an ESDI level drive interface and comes in the 5¼-inch form factor. Dual streaming-tape speeds are 75 inches per second (ips) and 50 ips; and 50 ips start/stop. OEM-quantity pricing is \$1,800.—*B. MacDonald*

That's priceless to the computer on the left.

The way it usually goes, you find a printer with all the features you need. Then you hold your breath and peek through your fingers at the price tag.

Or you just go for low price and learn to live with inconvenience.

The trade-off is over. With CIE Terminals CI-300+ and CI-600+ Matrix Line Printers.

While our so-called competitors offer you less features and costs as much as 300% higher, the 300+/600+ offer you more features.

Like data processing and letter-quality printing. Up to 200x 288DPI graphics resolution. Compressed print. Bar code generation. Serial, parallel and IBM interfacing.

Along with the highest quality in their class. More choices for more uses.

So when the time comes to choose line printers, go ahead and compare us. Feature for feature.

You'll pick the plus. Its value is priceless.

For more information on the CI-300+/CI-600+ Matrix Line Printers, contact CIE Terminals at 2505 McCabe Way, Irvine, CA 92714-6297 (800) 624-2516.

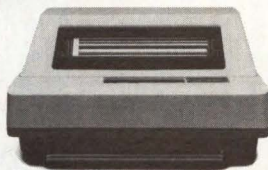

CIE TERMINALS
A CITECH ELECTRONICS COMPANY

Because your computer is only as good as its peripherals.

© 1985 CIE Terminals

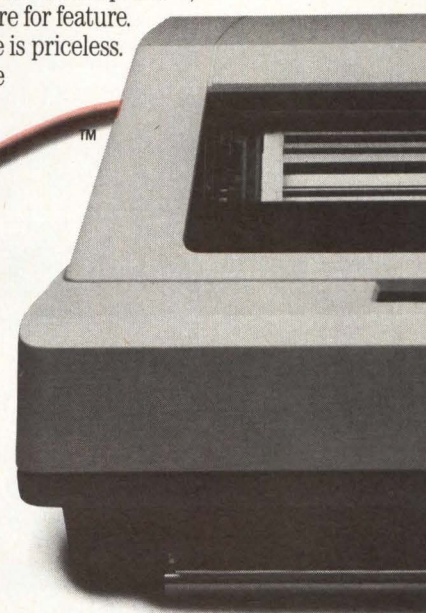

The Hewlett-Packard A-Series Automators:
a rugged family of real-time computers with
total software compatibility.

Available as boards, boxes,
systems or microsystems.

256K RAM error-correcting memory.
Up to 24 MB. So flexible, it can manage
large data bases or work as a true
memory-based controller.

4 MB/sec I/O bandwidth
for fast performance.
(DMA per channel).

Virtual code and data for large
program support.

State-of-the-art pipeline
architecture, with cache,
optimized for real-time
performance.

Performance range: 1-3 MIPS.

Why you should consider buying one of our real-time computers.

Low maintenance fees (half the rate of the closest competitor) due to the exceptional reliability of our products.

A profitable Sales Support Program. Direct selling, if you need us. Sales aids, if you don't.

HP's program for system designers, software suppliers and resellers includes discounts from 5 to 39%.

CPU prices start at U.S. list \$2278 (with average quantity discount).

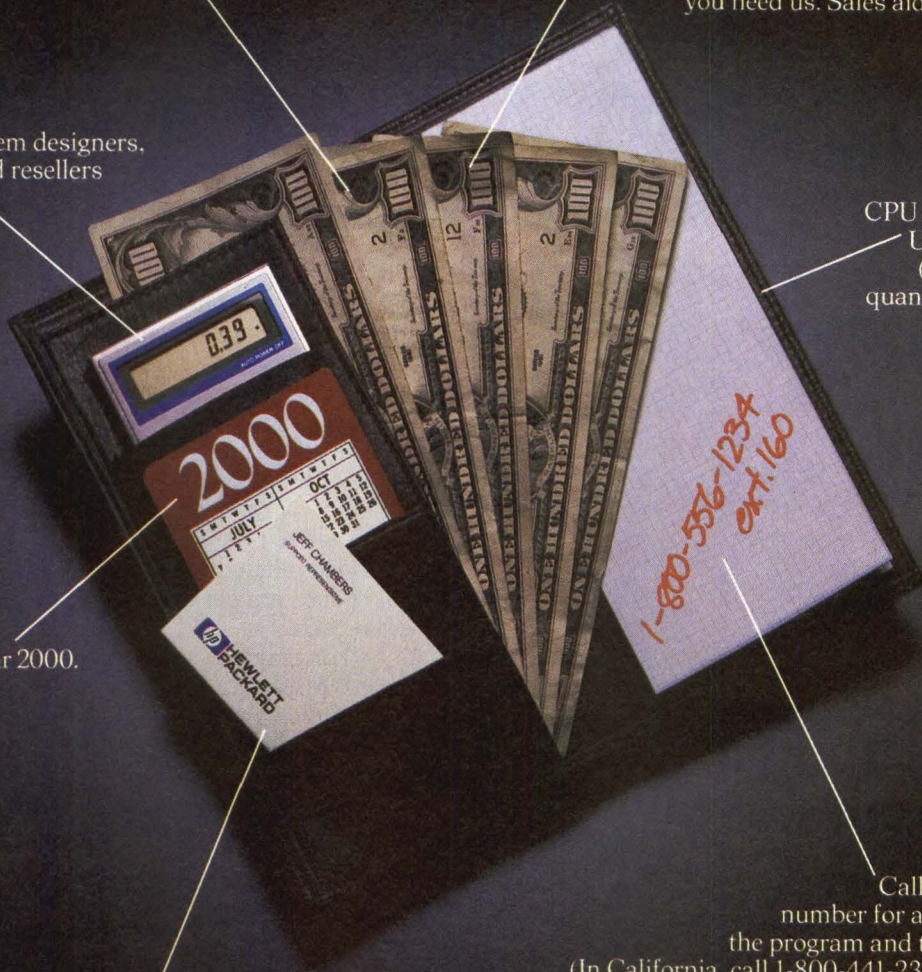

Support beyond the year 2000. Guaranteed.

Call this toll-free number for a brochure on the program and the products. (In California, call 1-800-441-2345, ext. 160.)

Local HP support representatives. Datapro has rated our support #1 for four consecutive years.

Why you should consider buying a lot of our real-time computers.



CIRCLE NO 18 ON INQUIRY CARD

THE GATE TO A SMARTER STD BUS.

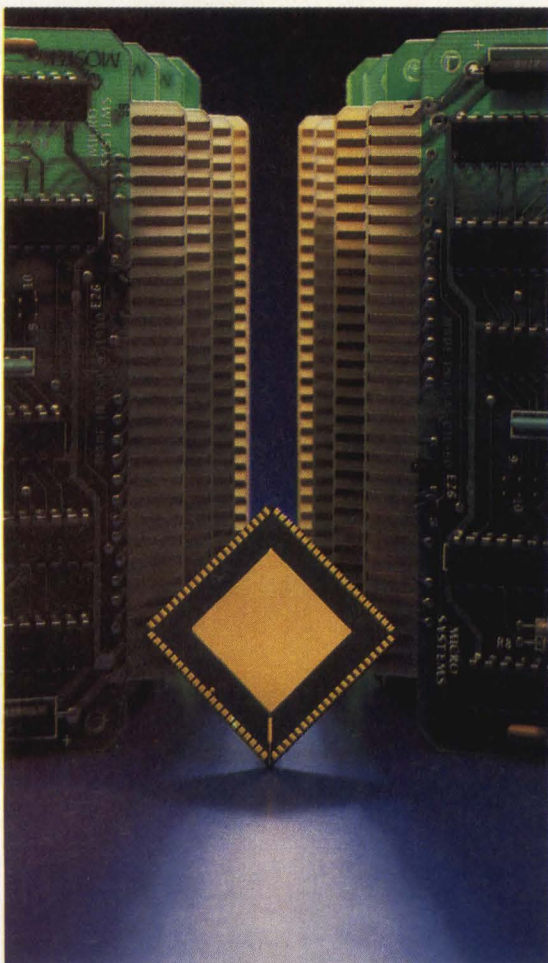

STD BUS has always been a smart choice for flexible, cost-effective Z80® systems. And now, Mostek has made it smarter still. By adding a proprietary gate array to provide more intelligence to your system.

Our family of intelligent STD boards all feature a Z80 processor, DMA controller and on-board memory. And our custom gate array, which took three man years to develop. But that's where the similarity ends. Because we've provided different features on each board to make sure you get the best possible performance from each.

For example, we've got intelligent serial boards for short (250 feet) and long (1 mile) communication distances. We have another that implements the IEEE 488 General Purpose Interface Bus standard with speeds up to 300 Kbytes/second. And an IPIO with 32-bits of parallel I/O, suitable for high-speed control and data transfer.

The point is, Mostek designed these to be the most sophisticated STD BUS boards available today. Which is one more way in which we show our continuing commitment to STD BUS.

So to give your system some extra smarts, contact Mostek Corp., 1215 W. Crosby Road, MS1051, Carrollton, Texas 75006, or call 1-800-635-0200. In Texas, 1-214-466-8801. In Europe, (32) 02/762.18.80. In Japan, 03/496-4221. In the Far East (Hong Kong), 5.681.157-9.

Z80 is a registered trademark of Zilog, Inc.



MINI-MICRO WORLD

NEWS

Pyramid challenges DEC with RISC supermini

Mike Seither

Associate Western Editor

When Pyramid Technology Corp. introduced its first reduced-instruction-set computer (RISC) two years ago, the strategy was clear: carve out a piece of the high-end UNIX market by taking on Digital Equipment Corp.'s superminicomputer, the VAX 11/780.

By last March, a year after Pyramid began shipping its first RISC product—the 32-bit 90X—in volume, the Mountain View, Calif., company had racked up sales totaling \$25 million in such diverse markets as aerospace and office automation.

Now the privately held company is ready to confront DEC's latest powerhouse—the VAX 8600—with a new, beefed-up superminicomputer of its own, the 98X. Not only do Pyramid officials believe the 98X will outperform the VAX 8600 in busy, multitasking UNIX environments but they also intend to price it 70 percent to 75 percent below similarly outfitted entry-level DEC machines (see "How the Pyramid 98X and VAX 8600 compare," Page 35).

Pyramiding performance

The 98X uses the same RISC architecture that Pyramid implemented in its 90X. Based on a RISC chip developed at the University of California at Berkeley, the 90X uses fast Schottky TTL logic and a series of overlapping 32-bit registers that allow 16 levels of procedure calls without performing a save-and-recall operation. The intensive use of registers (528 in all) and a

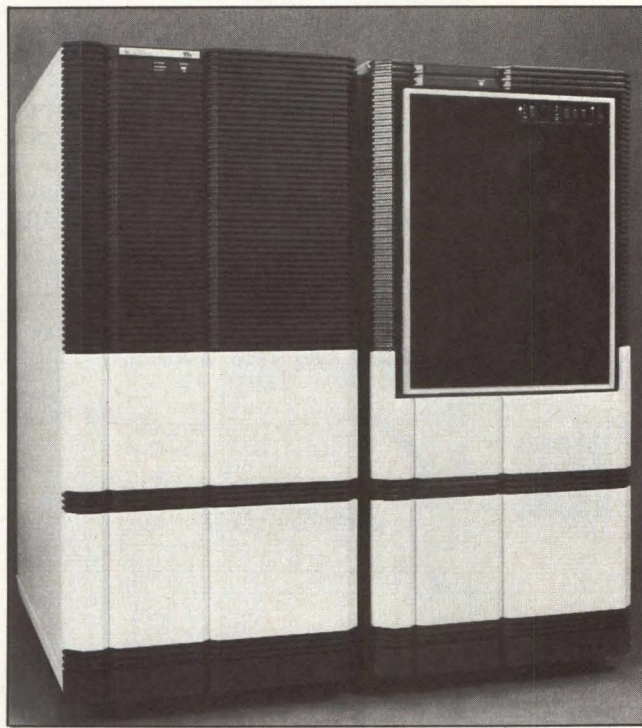

Pyramid's UNIX-based 98X features two "equal" processors, a clock rate of 100 nsec and a pair of half-height 470M-byte Winchester disk drives.

simplified set of instructions make up the backbone of Pyramid's 90X and 98X architecture. That results, say Pyramid officials and other proponents of RISC machines, in fewer general commands for the system to execute. It also makes it possible for RISC machines to run high-level languages, such as C, more efficiently than can computers with complex instruction sets.

"The 98X reflects an evolutionary rather than revolutionary change in product design [over the 90X]," says Paul Lego, Pyramid's product manager for systems and peripherals. "For a

typical large-user UNIX system, we believe we have at least equivalent performance to a VAX 8600, and perhaps 30 percent to 50 percent more."

The key features of the 98X include a faster cycle time than the 90X (100 nsec, from 125 nsec), a new "iso-processor" system with two fully symmetrical CPUs, a redesigned I/O subsystem to take advantage of faster disk drives, double storage capacity and a new tape drive. In addition, Pyramid incorporated into its proprietary OSX operating system the enhancements to UNIX System V that AT&T Information Systems introduced earlier this

NEWS

year. These enhancements include record and file locking.

Second CPU frees slaves

Unlike the 90X, which has a single CPU, the 98X is designed around two "equal" processors to speed up performance. According to Lego, part of the problem of running UNIX on a single-CPU system is that the processor must dedicate as much as 50 percent of its time to handling UNIX kernel calls such as read, write, fork and execute. That kernel activity slows down system throughput when users add work to the load.

Although some system designers have tried to get around the bottleneck by adding slave processors and leaving the master to do UNIX's dirty work, limitations still remain. For example, when user processes require system resources, those calls can only be handled by the master CPU. Each time a

slave encounters such a call, it must stop and place the task in line for the master. Then the master must switch from what it was doing and handle the slave call. This so-called context switching takes up time that otherwise could be used for processing, Lego says.

Pyramid claims to have solved this problem with a "semaphore" mechanism that allows both user and kernel code to execute on either of the two symmetrical CPUs. The semaphore system protects critical sequences of code and controls simultaneous access to kernel data structures.

More drives added

The benefit of the dual-processor architecture, says Lego, is throughput that is 1.6 to 1.8 times faster than a single-processor machine. And, unlike a master/slave design, if one of the CPUs on the 98X fails, the system can

still operate when rebooted, though with degradation in performance.

Another major change in the 98X is a reduction in the number of I/O subsystem boards from five to two. One board contains controllers for tape drive, Ethernet and printer. The other has a disk controller with an extended storage-module-device interface and an 11M-byte-per-second, general-purpose I/O channel that can support another eight external disk drives.

The 98X will still support Motorola Inc. MC68000-based Multibus adapters used for many I/O functions in the original machine. Consequently, Pyramid can offer customers features such as a second Ethernet link or other communications capability.

The I/O subsystem connects to Pyramid's proprietary Xtend bus, the 32M-byte-per-second, message-based spine that also connects the CPUs, memory and intelligent-terminal processors, each of which supports up to 16 users.

Pyramid has doubled the disk storage capacity in the 98X by using smaller half-height NEC Corp. drives. A pair of the 470M-byte (formatted) drives occupies the same space inside the 98X as does the single 456M-byte drive in the 90X. The new drives have a data-transfer rate of 2.45M bytes per second, up from 1.8M bytes per second on the older drives.

Other enhancements include a 125-inch-per-second, 6,250-bit-per-second tape and an increase in standard main memory from 16M to 32M bytes.

Version designed for VARs

Chick Kraehling, Pyramid's marketing manager, says the entry-level 98X will sell for considerably less than a VAX 8600 configured with the same basic equipment. "We don't want to be any more than 75 percent of DEC's price on the 8600," he says.

According to Kraehling, about 80 percent of Pyramid's business comes from direct sales. But he adds that in order for the company to achieve sustained growth rates, it will have to concentrate on reaching value-added resellers. As part of that effort, Pyramid has introduced the 90XE—a bare-bones version of its original machine—

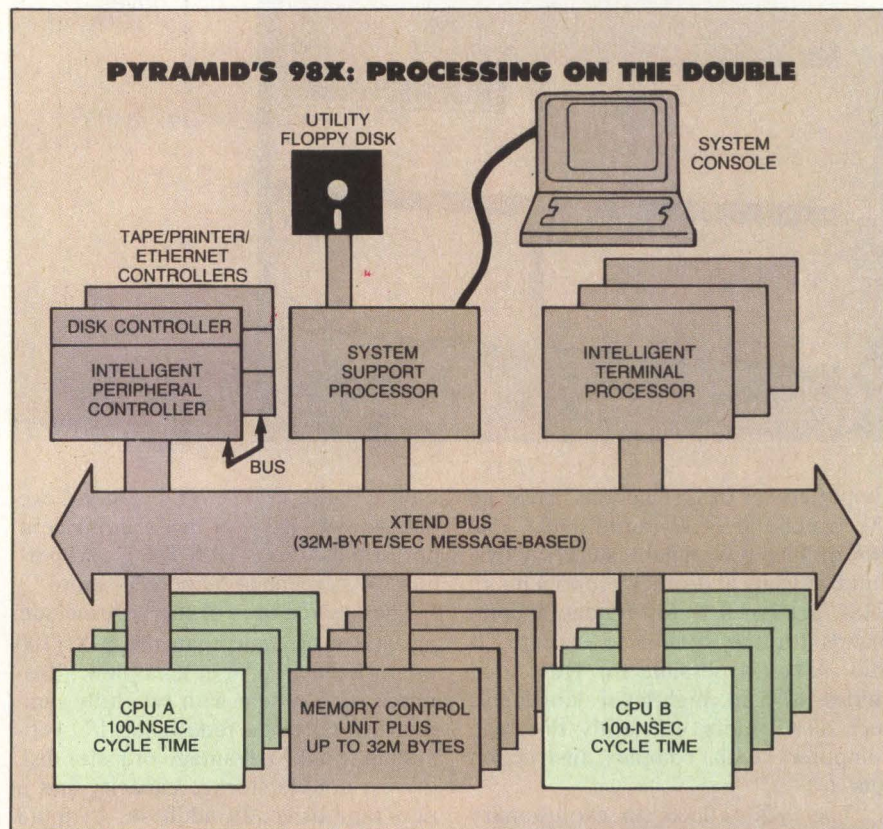

The two "equal" processors in Pyramid's 98X can execute both UNIX kernel calls and user code. The result is a higher throughput than is possible with typical master/slave UNIX implementations.

HOW THE PYRAMID 910X AND DEC VAX 8600 COMPARE

	98X	8600
Technology	high-speed TTL	ECL
Cycle time (nsec)	100	80
CPU	isoprocessors	CPU kernel
Main memory (M bytes)	8	8
Operating system	OSX (UNIX System V, 4.2)	ULTRIX 32 (UNIX 4.2)
Disk drive (1) (M bytes)	470	456
Tape drive (bpi)	6,250	6,250
Ports	32	24
Console	1	1
List price (\$)	289,000	442,000

Source: Pyramid and DEC

which will be targeted at system integrators and priced at about \$85,000.

For that price, users will get a 16-user system with 2M bytes of main

memory, a single 160M-byte disk drive, a 5¼-inch cartridge tape drive and the OSX operating system, all housed in a 29-inch-high cabinet.

For a young company, Pyramid seems to be gaining a solid reputation in the UNIX marketplace, says editor Deborah Hurst. Hurst is with the "Yates Perspective," a newsletter published by market research company Yates Ventures Inc., Berkeley, Calif. "Pyramid's dual port of [UNIX] System V and Berkeley [UNIX Version] 4.2 was very clean," says Hurst. "I've heard no criticism of the 90X whatsoever." According to Yates Ventures, DEC will have 440 of its VAX 11/780 units in the market by the year-end, while Pyramid is expected to have 310 90X systems installed. □

DEC's new entries shaped for CAD/CAE markets

Eileen Milauskas, Assistant Editor

Digital Equipment Corp.'s MicroVAX II and VAXstation II product lines, introduced in May, are expected to put DEC into not only the low-end segment of the small-business/technical/industrial market for supermicrocomputers but also into the high-performance workstation market traditionally held by Apollo Computer Inc. and Sun Microsystems Inc. However, the products may have the most impact on DEC's own minicomputer product line.

Based on 32-bit VLSI technology, the MicroVAX II employs DEC's 78032 processor and includes a floating-point coprocessor. According to DEC officials, the systems will offer 85 percent of the performance of the VAX 11/780. A \$9,700 field-upgrade kit, available for the MicroVAX I, includes a MicroVAX II CPU with 1M byte of on-board memory. Computer industry analysts say the four-user configuration of the MicroVAX II should prove the most significant in opening new markets for DEC, particularly in

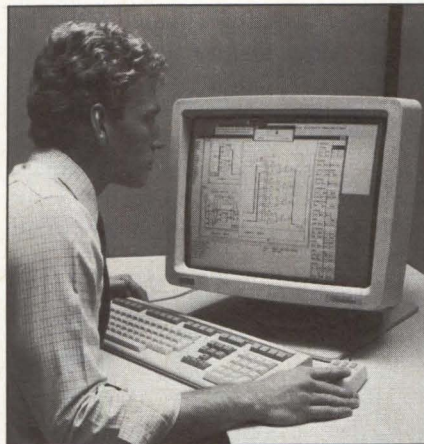

Offered in two workstation configurations, the VAXstation II targets CAE, CAD and software engineering and development applications.

the small-business sector.

Like the MicroVAX II, the VAXstation II employs a VLSI-chip implementation of the VAX system. The system targets the engineering, commercial, educational and computer-graphics markets and will serve computer-aided engineering, com-

puter-aided design, software engineering and development applications. The monitor emulates DEC VT100 and Tektronix Inc. 4014 terminals. DEC provides licenses for the MicroVMS operating system, MicroVMS workstation software and graphical kernel system software.

Will open new doors

According to Masimo Dezzani, principal marketing specialist for DEC's supermicrocomputer systems, "The MicroVAX II and the VAXstation II are going to provide access to a lot of marketplaces that in the past we have not done as well in, such as in CAD/CAE." Dezzani attributes DEC's anticipated entrance into the CAD/CAM arena to the floating-point capability both systems offer and to the fact that many OEMs already have application packages written on the VAX/VMS software.

Dezzani says users of the new systems "will begin to see performance that will start rivaling" DEC's VAX 11/780 minicomputer.

Kenneth G. Bosomworth, president

NEWS

of International Resource Development Inc. (IRD), a Norwalk, Conn., market research concern, maintains that the MicroVAX II and the VAXstation II "will not kill the [VAX 11/] 780, but there are a number of applications in which the VAXstation II will be used. The 780 still proves to be better in scientific number-crunching applications, whereas the new systems are better in signal-processing and image-handling applications."

Threatens earlier products

But some are worried about the effect the MicroVAX II and VAXstation II will have on DEC's higher end minicomputer models, the 11/725, 11/730 and 11/750. "It obviously wipes out the 725 and 730, and it will impact over half of the potential 750 sales," says William Rosser, vice president, small computer systems at the Gartner Group, a market researcher in Stamford, Conn. Because the 11/750 can be clustered, however, some demand for the system will continue, he says, adding that the follow-up product to the MicroVAX II, which will have an improved I/O structure, will replace the 11/750. The result will be a high-low structure within DEC's product line, with the 8600 on one end and the MicroVAX II on the other, Rosser says.

The key question is whether DEC's

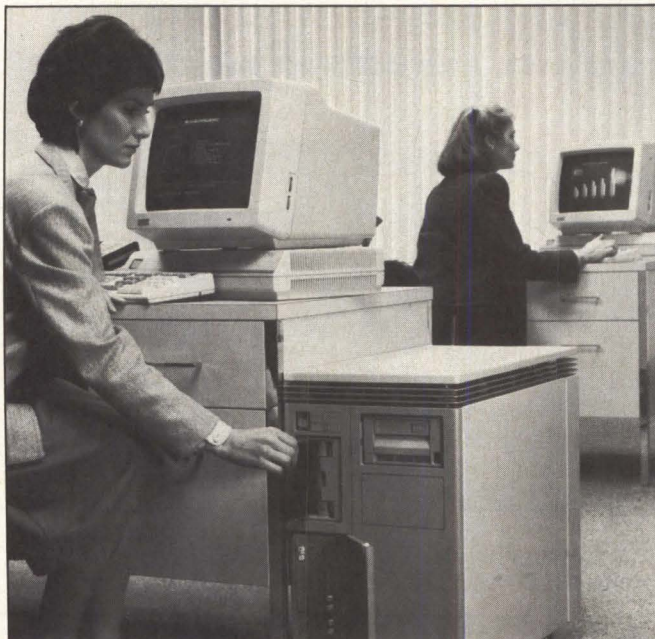

The MicroVAX II accommodates 16 users, stores 5M bytes of memory and comes in four configurations.

technical-workstation product line poses a severe threat to companies such as Sun and Apollo which have had the computer workstation market largely to themselves. Many agree that the move will strengthen DEC's installed base by attracting the 40,000 VAX users to lower end computing. Brad Smith, associate director of research in the Technical Computer Systems Industry Service at Dataquest Inc., San Jose, Calif., shares this view: "DEC is answering the needs of its

customer base by offering a physically small computer with high-quality graphics and the ability to network to a VAX, all at the right price."

But how many non-VAX workstation users will DEC's new line attract? Sandy Gant of market-research concern InfoCorp, San Jose, thinks Apollo and Sun will hold their own in the non-VAX market. "Clearly, in DEC accounts, DEC will do a good job of locking out its competition. But people will still want to buy Apollo and Sun

CONFIGURING THE MICROVAX II

Single-user	4-user	8-user	16-user
2M-byte memory	2M-byte memory	3M-byte memory	5M-byte memory
31M-byte, RD52 Winchester disk subsystem	71M-byte, RD53 hard disk subsystem	71M-byte, RD53 hard disk subsystem	Three 71M-byte hard disk subsystems
400K-byte, RX50 dual floppy disk subsystem	95M-byte, TK50 streaming cartridge tape drive	400K-byte, RX50 dual floppy disk subsystem	95M-byte, TK50 streaming cartridge tape drive
Ethernet adapter	DZQ11 multiplexer	95M-byte, TK50 streaming cartridge tape drive DHV11 multiplexer	Two DHV11 multiplexers
\$18,840	\$21,580	\$29,430	\$43,780

VAXSTATION II: PLAIN AND FANCY

Basic	Enhanced
2M-byte memory	2M-byte memory
bit-mapped graphics	bit-mapped graphics
DECnet/Ethernet LAN interface	DECnet/Ethernet LAN interface
19-inch, 1,024-by-860-pixel-resolution monitor	19-inch, 1,024-by-860-pixel-resolution monitor
400K-byte, RX50 dual floppy disk subsystem	71M-byte, RD53 hard disk subsystem
31M-byte, Winchester disk drive	95M-byte, TK50 streaming cartridge tape drive
\$26,500	\$29,640

systems because of the application software that they run."

But IRD's Bosomworth thinks all vendors of engineering and scientific microcomputer systems are in trouble. "They have been dealt a blow from two separate ends," he says. "IBM's introduction of the PC-AT represented a blow from the bottom end of the supermicrocomputer market, and now DEC is hitting them from the other end. IBM is increasing performance while DEC is decreasing price. Pretty soon there will not be a niche left for the smaller microcomputer vendors."

Networking will impact

Analysts comparing Sun and Apollo graphics workstations to DEC's VAXstation II note the Sun product is the closest in price. Sun's model 2/120, using a 68010 microprocessor with a floating-point unit, 2M bytes of memory, a 20M-byte tape drive and a 42M-byte disk drive, is priced at \$33,400. Apollo's Domain 320 is priced at \$36,650. It holds 3M bytes of memory and uses a 16/32-bit, 68010 microprocessor with floating-point capability.

"The thing that is making Sun and Apollo successful is distributed processing and the integration of graphics and networking," says Dataquest's Smith. "The MicroVAX II and VAXstation II are systems that do not have that kind of software yet." Smith adds that the DEC system lacks true transparency in its file sharing among multiple users.

Apollo's systems and graphics manager, Lou Reynolds, identifies DEC's networking capability as the major weakness of the system. DEC's networking system, DECnet, is based on Ethernet protocols. "It is not similar in any way to the transparent-file and resource-sharing capability that has made Apollo unique in the industry," Reynolds says.

Tom Fisher, DEC's senior marketing specialist for VAX workstations, acknowledges that transparency "requires some level of setup. VMS facilitates this under DECnet and Ethernet." This extra step, he says, is bridged by a network manager who

sets up a "hunt list" which checks the local node and distributed nodes for a file.

Carol Bartz, vice president of marketing at Sun, believes her company has the edge over the VAXstation II because Sun has an open-systems concept facilitated by the Berkeley UNIX Version 4.2 operating system and Sun's Ethernet network. "DEC worries more about connecting to itself than it does to the outside world," she says. "The computing environment today is heterogeneous. You've got to be able to connect to a lot of different computers."

Analysts and competitors criticize the lack of a color monitor on the VAXstation II. Apollo's Reynolds states, "What defines a workstation is not only a dedicated computing engine but also integrated graphics and integrated networking. Especially in those price bands where they are targeting the machine, color seems to be the dominant market demand and is be-

coming a de facto standard."

Recognizing this deficiency, DEC later announced a color workstation, named the VAXstation 520, which comes with a 19-inch, Tektronix 4125 monitor with 1,280-by-1,024-pixel resolution. Based on the floating-point processor incorporated into the MicroVAX II, the unit runs the MicroVMS operating system and stores 2M bytes of memory. It performs 2-D transforms and offers windows with up to 64 viewports. The workstation is priced at \$42,790.

How much of a threat?

Sun and Apollo see DEC as a major player in expanding the technical-workstation market, consequently opening new markets for them. Sun's Bartz says, "DEC has legitimized the technical workstation market, but Sun doesn't feel threatened." Apollo's Reynolds concurs, "We can grow along with that market even though we may be losing market share." □

Silicon design gives system integrators new role

Michael Tucker, Associate Editor

Advances in the automated design of VLSI circuits are giving system integrators the power to work at the chip

level. Where, traditionally, integrators have restricted themselves to the board level or above, new computer-aided design/computer-aided engineering services now make it possible for them

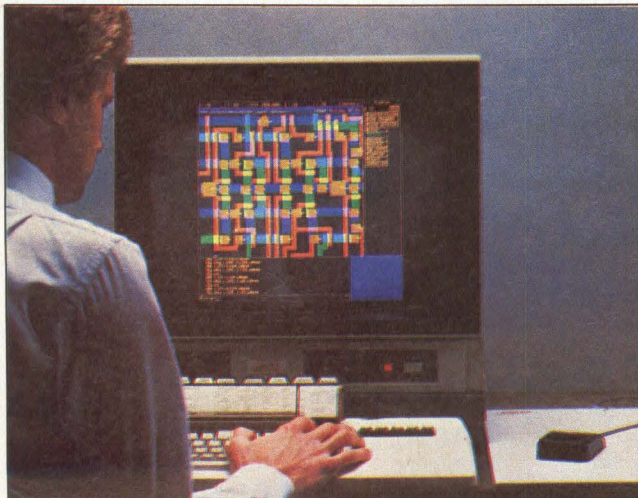

With the Concorde VLSI compiler from Seattle Silicon, shown here on a Valid Logic Scaldstar workstation, a system integrator merely draws a block diagram of a desired circuit (seen on screen) and the compiler responds with a system-level schematic of that circuit.

NEWS

to exploit semicustom integrated circuits (ICs) or even to configure entire systems in silicon.

"Clearly, system integrators are going to get involved at the chip level," says Andrew Rappaport, president of the market research company The Technology Group Inc., Boston. "I think there will be some very large fortunes coming out [of semicustom ICs]. Fortunes both for the people who market the tools that make it possible, and for the people who apply those tools."

Three things are turning system integrators into IC developers: new chip fabrication companies—"silicon supermarkets"—that offer one-stop shopping for circuit design and manufacture; design techniques that make chip layout resemble system configuration; and "silicon compilers," CAD tools that allow developers with almost no chip-design experience to design integrated circuits.

VLSI vaults to victory

VLSI chips are tailor-made for vendors selling into vertical markets. By shrinking entire boards (and, in some cases, even entire card cages) into a sliver of silicon, VLSI technology can reduce the cost and size of systems by several orders of magnitude. "A chip may cost \$10 more than the ICs it replaces, but it may save me \$100 to \$1,000 in the system as a whole," notes B.P. Agrawah, senior director for advanced development of M/A Com Tele-

communications, Germantown, Md. The company recently incorporated semicustom ICs into its line of data-communications products.

Primarily, system integrators didn't exploit VLSI technology because VLSI chips were designed by hand by IC specialists—an expensive, complicated task requiring extensive, esoteric knowledge. Now, however, the silicon supermarkets, which are CAE concerns, gently take system integrators by the hand and lead them through the wilderness of chip design.

M/A Com Telecommunications, for example, picked VLSI Technology Inc. (VTI), San Jose, Calif., to help develop ICs for its line of data communications products. VTI maintains design centers across the country where its customers can consult with IC engineers, take classes in chip design, use workstations operating on VTI's own CAD software and transmit completed designs via leased line to VTI's fabrication facilities.

One of VTI's particular strengths is "standard-cell" design. When system integrators become VTI customers, they receive access to a catalog of chip components or "cells"—literally everything from individual transistors to complete microprocessors. They can use VTI's software, either on VTI's machines or their own, to lay out the chip using these components. VTI then contracts for the chip's manufacture.

As cells grow more complex, the task of standard-cell designing falls in-

creasingly to system integrators, because the cells themselves become more like system components. VTI, for example, markets what it calls "megacells," such as microprocessors, RAMs, ROMs and CRT controllers—the sort of products, in short, that system integrators already know as boards. Stepping down to chip level, particularly with CAE workstations to ease the transition, is relatively easy.

Compilers configure full custom

Semicustom chips are so called because they incorporate standard elements—such as cells—into a custom configuration. They are not quite so fast, nor so small, as fully customized designs done by human craftsmen.

But the new CAD tools, silicon compilers, are starting to bring authentic custom design into striking range of automation. In principle, these compilers accept a designer's high-level description of a circuit and respond with a completed design of the chip—just as regular software compilers convert programs written in high-level languages into machine code.

Concorde takes off

For example, Seattle Silicon Technology, Bellevue, Wash., introduced in October 1984 its Concorde compiler software. While Concorde is actually a cell compiler much like VTI's design tools, rather than a true silicon compiler, Concorde still manages to bring custom IC design into the range of

A new industry defines its terms

Silicon compiler: a device which automatically converts a designer's chip specifications into a completed integrated-circuit (IC) design. Silicon compilers should be distinguished from "cell compilers," which automate the design of major chip components—"cells"—and then may or may not assist in the layout of those cells into the completed circuit.

Silicon foundry: an IC-fabrication facility which manufactures chips to the specifications of independent customers. In theory, a silicon foundry would never market its own line of standardized, "merchant" chips.

Semicustom IC: a chip containing standardized parts which are then arranged for custom applications. There are two methods most often used to produce semicustom ICs. In the "gate array" method, chips are mass-produced with dense coats of transistors, and connections are laid out between those transistors to fit the applications. This is the quickest way to get a chip into production, but it's also wasteful of transistors. In the "standard cell" technique, chips are configured using standard components—such as RAMs, ROMs, microprocessors—from a catalog supplied by a semicustom IC vendor.

"The wait is over. You can evaluate this 1/2" cartridge tape drive today.

Fujitsu delivers products, not just promises."

It's here—a high-performance 1/2" cartridge tape drive, in a 5/4" form factor.

Fujitsu America has it. We're ready today with evaluation units. And we have a product that performs.

Our M2451A cartridge tape drive gives you up to 120 MB of formatted storage capacity. It runs in both streaming and start/stop modes, at streaming speeds of 75 and 50 ips, so it fits almost any application. Its ESDI interface assures easy, cost-effective system integration.

And for your SCSI system, the optional high-performance MI008A SCSI controller is now available.

Most importantly, these cartridge tape drives are already proven and working in systems today. And with

second sources available for both drives and media, you can be sure of protecting your investment in this technology.

For more information about Fujitsu's 1/2" cartridge, or other tape drives, call (408) 946-8777.

Or write Fujitsu America, Inc., Storage Products Division, 3055 Orchard Drive, San Jose, CA 95134-2017.

Fujitsu tape drives meet the quality standards and technical requirements that have made this one of the world's leading companies. That's leadership you can depend on to develop the technology you need. And deliver it.

We're developing technology for you.

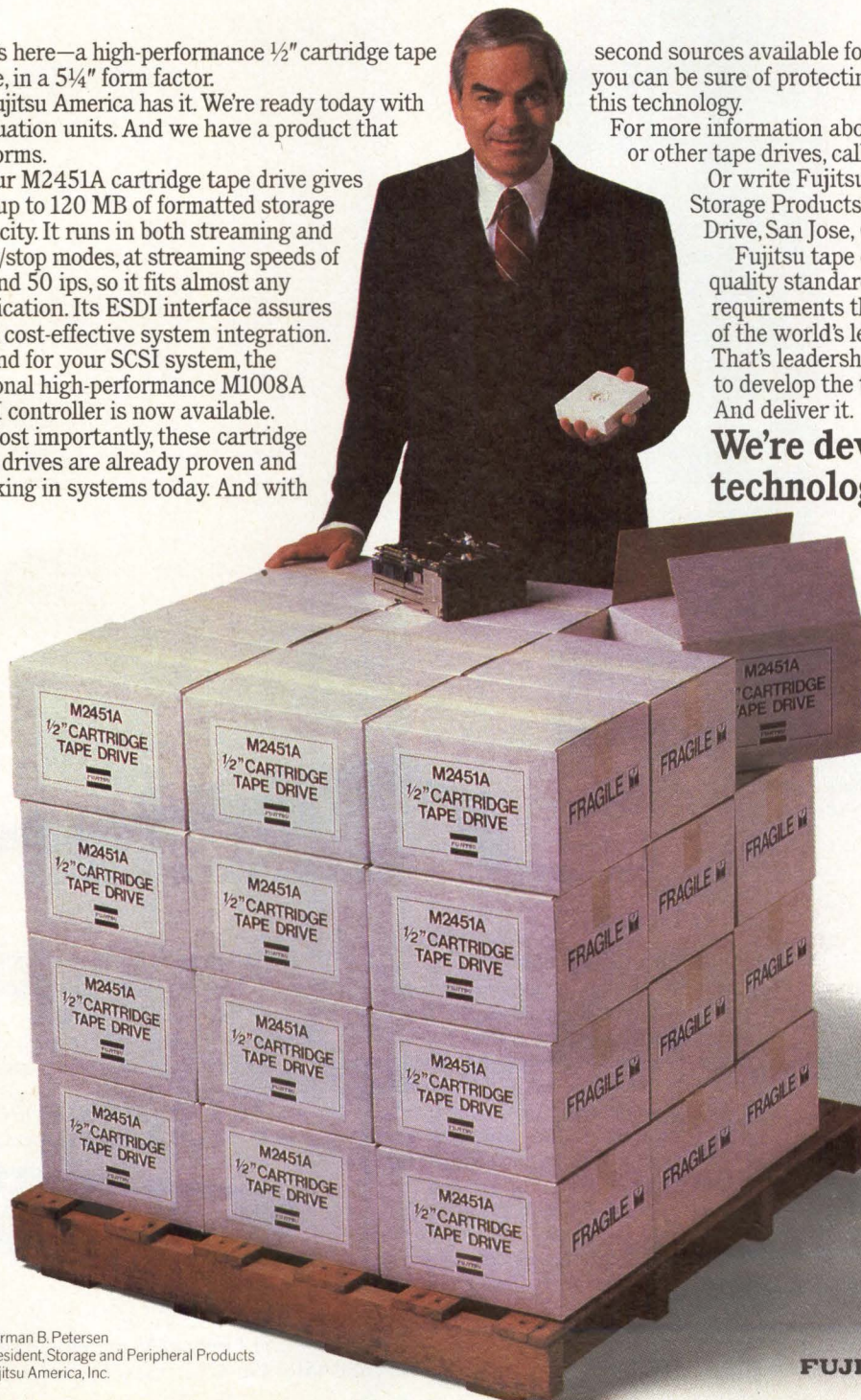

One new terminal offers exceptional reliability through advanced technology.

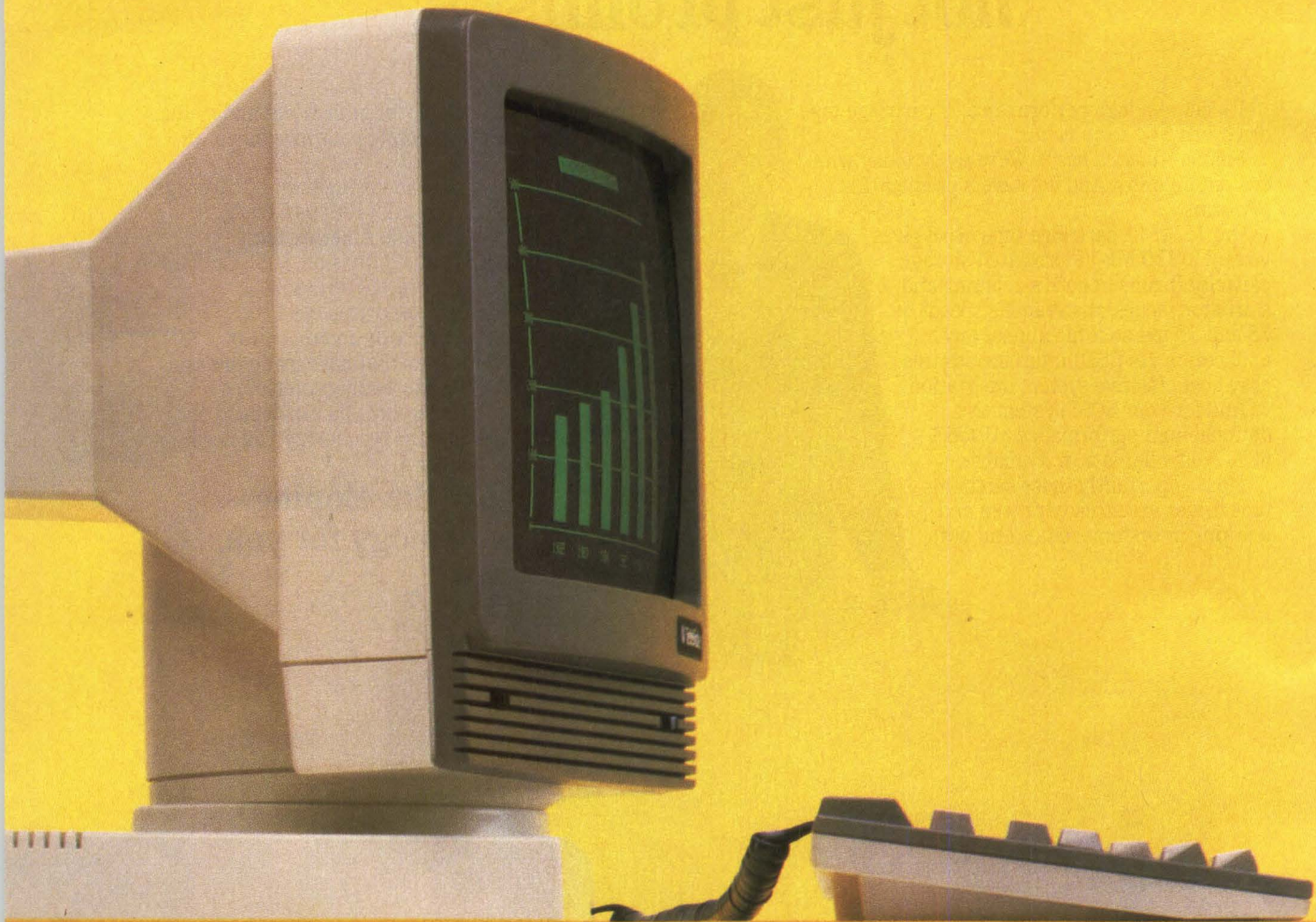

The new TeleVideo 955.

This begins a new generation of superior quality machines from the world's number one independent terminal maker.

At its heart is an incredibly hard working custom microchip that has permitted us to eliminate many of the components found in other less advanced terminals. And many of the problems they caused.

So the 955 is a more reliable terminal which promises less down time and remarkably low cost of ownership.

What's more, this is the first TeleVideo® terminal to be warranted for one full year.

950 Family compatibility.

The 955 works with our extremely popular 950 Family standard and offers two sets of 32, a total 64, function keys you can customize with ease. As well as up to four pages of display memory at 80 or 132 characters.

This is the only terminal with upgrade flexibility built in. And its comfortable new keyboard has earned twice the reliability rating of earlier models.

Improved pinpoint resolution.

Advanced technology is also responsible for a high contrast, 14 inch, tilt and swivel screen (amber optional) that's dramatically

easier to read than the ordinary CRT.

The new TeleVideo is \$699.

The new 955. Unequalled value from a terminal company with the experience and resources to be your single source for guidance, hardware and support.

Call (800) 521-4897 or, in California, (800) 821-3774. Ask for Operator 7.



Regional Sales Offices: California/Santa Ana (714) 476-0244, California/San Jose (408) 971-0255, Georgia/Atlanta (404) 447-1231, Illinois/Chicago (312) 397-5400, Massachusetts/Boston (617) 890-3282, New York/New York (516) 496-4777, Texas/Dallas (214) 258-6776.

CIRCLE NO. 21 ON INQUIRY CARD

Irma takes the VLSI plunge

Silicon supermarkets—chip fabrication companies that can supply developers with all their computer-aided engineering needs under one roof—are taking VLSI where no chip has dared to go before. For example, Digital Communications Associates, Atlanta, which makes the Irma communication board, found it needed chips for the newest generation of Irma products that major integrated-circuit (IC) makers couldn't supply.

So, Peter Wilcox, DCA's senior design engineer, decided to design the chips from scratch— using

the facilities of VLSI Technology Inc., San Jose, Calif.

"I picked VTI because it was a combined package," Wilcox says. "All the services were in one place, from one vendor, meaning there was little possibility for finger-pointing if anything went wrong."

Wilcox had no experience in IC design. He describes himself as a programmer and a system designer. Yet, he notes, "It took me only about seven weeks to do the design the first time. Then I took a week and a half to do some modifications on that design. Now we're already in production."

medium-sized development budgets. The program is relatively inexpensive (a complete typical configuration is about \$55,000) and runs on some relatively inexpensive hosts—specifically the IBM Corp. PC-AT-based Tekstation that Tectronix Inc.'s CAE Systems Division in Sunnyvale, Calif., introduced in May.

In addition, Concorde offers considerable independence from foundries. While maintaining no fabrication capacity in its own right, Seattle Silicon can find competitive rates for customers at some of the foundries that it, itself, patronizes. Should you want to shop around for a fabrication price, Concorde allows you to "recompile" your design to fit the specifications of whatever foundry happens to bid lowest.

Concorde is easy to use, even by those with little or no training in IC design. It's so user-friendly, in fact, that early this year Seattle Silicon announced a design contest. System designers, engineering students and even high school electronics hobbyists were invited to submit a circuit design in block diagrams (hand drawn if necessary). The company said it would set the winning entry in silicon at no charge.

An engineer in a box

Silicon Compilers Inc., Los Gatos, Calif., may have come closest of all to producing a true silicon compiler. Its Genesil system, introduced in October 1984, comprises a specifically-config-

ured Digital Equipment Corp. VAX 11/750 and software that borrows techniques from expert systems to provide an integrator with a kind of "IC engineer in a box."

Genesil isn't a cheap and easy entry to IC design for your average "Mom and Pop" VAR shop; a complete sys-

tem can cost \$600,000. On the other hand, Genesil has already scored some impressive triumphs. In early 1984, for example, Silicon Compilers used Genesil to design an Ethernet data-link controller chip in only five months. Seeq Technologies, Palo Alto, Calif., now markets the chip. □

GKS-3D implementation presages full standard

Keith Jones, European Editor

Even though the 3-D version of the graphical kernel system, GKS-3D, is still two years away from becoming a full international standard, West German software house GTS-GRAL, Darmstadt, has released a portable implementation of the functions specified for developers of 3-D graphics programs.

Called GKSGRAL-3D, it is upwardly compatible with the company's 2-D implementation. According to GTS-GRAL product development manager Dr. Günter Pfaff, the product runs on a wide variety of workstations and personal computers, including the IBM Corp. PC/XT and PC-AT and compatibles.

The primary difference between the 2-D and the new 3-D implementations, Pfaff continues, is that the latter supports calls from application programs that invoke functions specific to

GKS-3D, notably the generation of projections and perspective views of 3-D objects. GKSGRAL-3D will support calls made from FORTRAN and Pascal programs, and Pfaff reveals that implementations supporting calls from C and Ada programs are under development.

However, not all the names of these calls, referred to within the International Standards Organization (ISO) as GKS language bindings, have been precisely defined. Terry Hewitt, a member of ISO's graphics working group, WG2, acknowledges that changes to the names, of which there are up to 40, should be fairly easily made. But he hints that more fundamental changes to the GKS-3D standard will be made before it is completely stable. More comment and voting, he explains, will be made by ISO's national member organizations before GKS-3D becomes a Draft International Standard, in 1986, and an Interna-

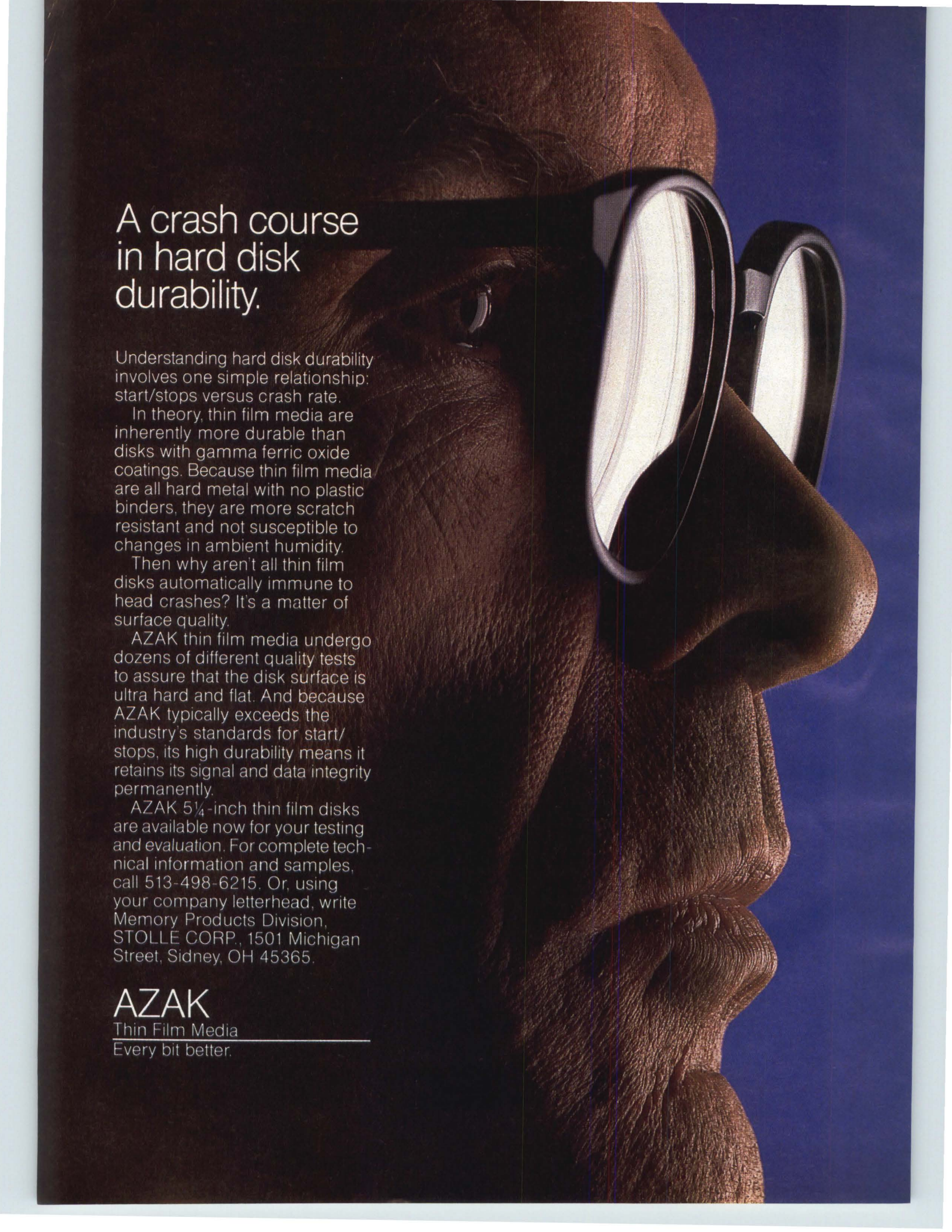

A crash course in hard disk durability.

Understanding hard disk durability involves one simple relationship: start/stops versus crash rate.

In theory, thin film media are inherently more durable than disks with gamma ferric oxide coatings. Because thin film media are all hard metal with no plastic binders, they are more scratch resistant and not susceptible to changes in ambient humidity.

Then why aren't all thin film disks automatically immune to head crashes? It's a matter of surface quality.

AZAK thin film media undergo dozens of different quality tests to assure that the disk surface is ultra hard and flat. And because AZAK typically exceeds the industry's standards for start/stops, its high durability means it retains its signal and data integrity permanently.

AZAK 5¼-inch thin film disks are available now for your testing and evaluation. For complete technical information and samples, call 513-498-6215. Or, using your company letterhead, write Memory Products Division, STOLLE CORP., 1501 Michigan Street, Sidney, OH 45365.

AZAK

Thin Film Media

Every bit better.

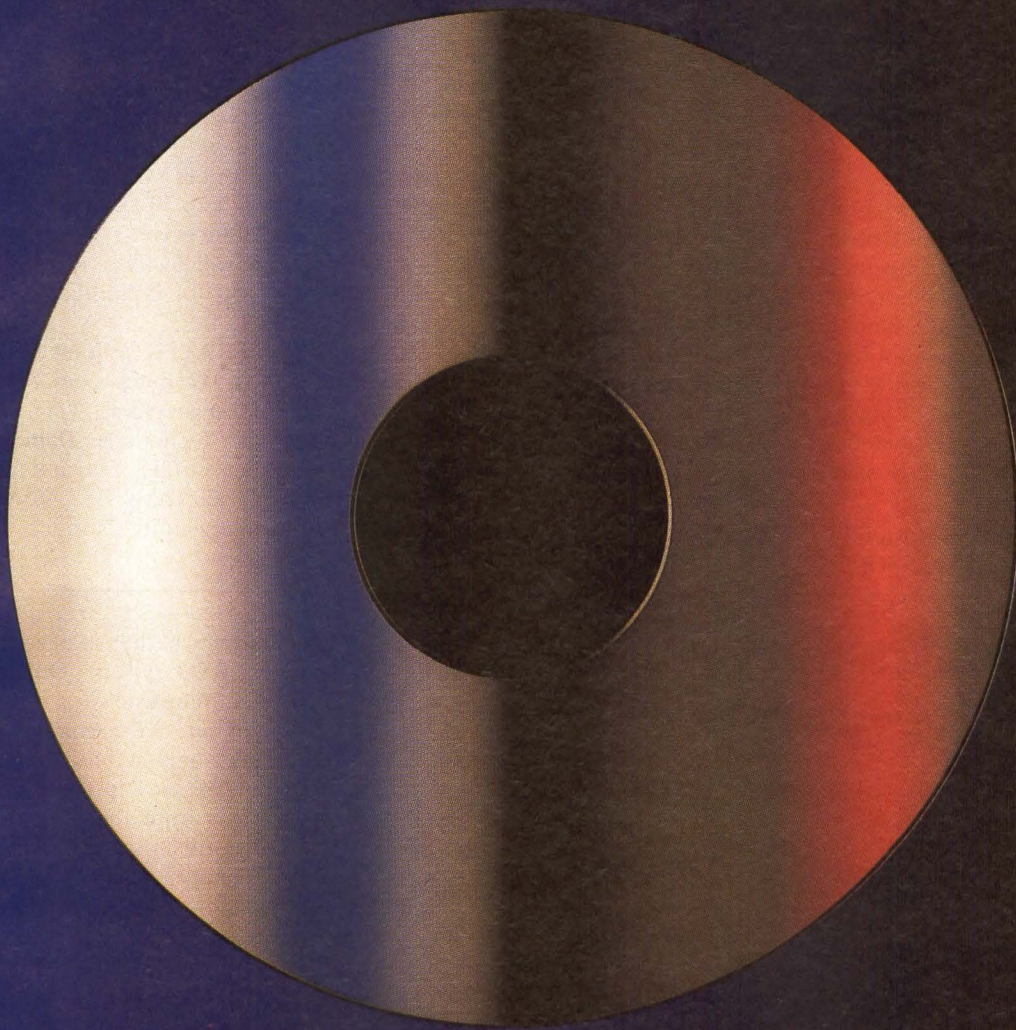

MEMORY
PRODUCTS
DIVISION

The Stolle
Corporation

CIRCLE NO. 22 ON INQUIRY CARD

NEWS

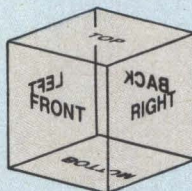
GTS-GRAL PUTS GRAPHICS INTO PERSPECTIVE

With **GKSGRAL-3D** from GTS-GRAL, 3-D objects—in this case a glass cube with writing on each side—can be manipulated on the screen of a workstation or personal computer. Both are views in perspective, seen from the front (left) and from above and to one side (right).

tional Standard, probably in 1987.

Dale Sutcliffe, chairman of the computer graphics panel within the British Standards Institution of London, Great Britain's ISO member, notes that the decision to include among GKS-3D functions the removal of hidden lines and hidden surfaces from 3-D projections of solid objects has yet to be resolved. GKSGRAL-3D includes these functions, says GTS-GRAL sales manager Klaus Starke.

Starke attributes his company's close involvement with the GKS-3D stan-

dardization efforts to the participation of its staff members in the graphics groups of DIN, the West German standards organization in Berlin. DIN represents West Germany within ISO. GKSGRAL-3D itself was developed in a cooperative effort between GTS-GRAL and IBM's Kingston, N.Y., laboratory, initially for the IBM 5080 interactive graphics workstation.

GKSGRAL-3D will be available next month to manufacturers and system integrators in the United States through GIXI Inc., Minneapolis. Pfaff

says that prices for the product will be approximately 50 percent higher than those for the existing 2-D implementation and will include a license fee of about \$850 for unlimited use on one IBM PC/XT.

GTS-GRAL is a joint venture of two West German companies with common ownership: GTS, Gesellschaft für Technologie-Beratung und Software mbH, Darmstadt, and GRAL, Graphische Rechneranwendungen und-lösungen GmbH, Saarbrücken. □

As profits fall, Taiwan turns to AT-compatibles

Charles Hintermeister

Taiwan Correspondent

Stiff competition and thin profit margins are forcing Taiwanese companies to turn from the manufacture of IBM Corp. PC/XT-compatibles and look toward greener pastures—namely PC-ATs.

"The Intel [Corp.] 8088 [the microprocessor in the PC/XT] is dying fast," says a manager of one large Taiwanese computer manufacturer. "Nobody is introducing new 8088-based computers now." Prices (f.o.b) for stripped-down IBM PC-compatible CPUs made in Taiwan are now as low as \$600, compared with over \$1,000 a year ago. Partly in response to the collapse in the price of the PC/XT, there's been a flurry of 80286-based PC-AT-compatibles coming on the market—in some cases with financial support provided

by the Taiwanese government.

Taiwan's Industrial Development Bureau (IDB), part of the Ministry of Economic Affairs, and the government-supported Electronics Research Service Organization (ERSO) are jointly sponsoring a development project to produce an IBM PC-AT-compatible system. They look for a finished prototype this month.

Half of the project's \$1.57 million budget, says an IDB spokesman, will be supplied by the government as a non-interest loan to the participating manufacturers. The rest is to be paid in advance by the four participating companies, Cal-Comp Electronics Inc., Tatung Co., Copam Electronics Corp. and Systex Corp. Each is heavily involved in OEM computer manufacturing, and each has high hopes for its AT-compatible systems.

Other Taiwanese companies are now

considering whether to purchase rights to the ERSO system. One of them, Multitech Industrial Corp., has already designed an AT-compatible system that lacks only a basic input/output system. "We may just buy an off-the-shelf BIOS from the United States," says a Multitech spokesman.

ERSO also developed the prototype for most of the IBM PC-compatible systems now produced in Taiwan. The BIOS of the first PC system that ERSO released in late 1983, however, ran afoul of IBM lawyers and had to be redesigned. Some of the nine companies that had commissioned ERSO to develop it and had begun exporting machines based on it lost considerable time and money from the resulting legal squabble and adverse publicity.

The dispute was quickly and amicably resolved and IBM has since given the original ERSO PC BIOS a clean bill of health. In spite of that, fewer than half of the nine computer makers which participated in the original ERSO project decided to take part in the AT-compatible development.

Learn this integrated office program on one system, and you'll already know three more.

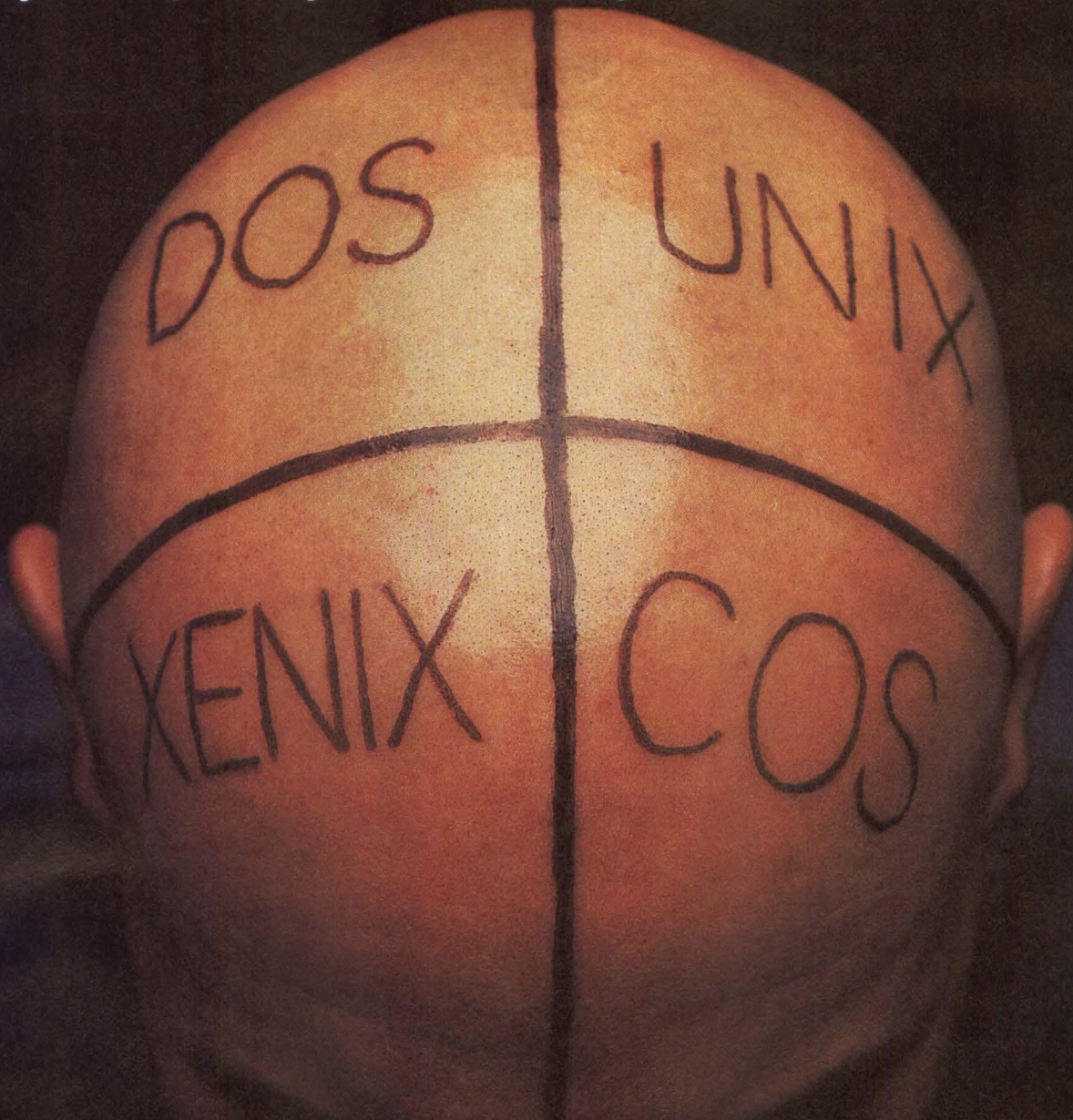

R Office ties a powerful word processor together with the file management, table spreadsheet, report generation and desktop management chores common to nearly every modern office.

Incredibly, the UNIX version is identical to the DOS version. And the RM/COS. And the XENIX.

Now you can switch from a stand-alone PC to multi-user computer systems without missing a beat. You take all the functions, all the commands, all your learning with you.

Yates Laboratories gave R Office highest scores in its recent Competitive Edge report, praising its "straightforward and efficient user interface which products designed by committee typically lack."

It's the only office automation program

many companies need to own. (And the only one their suppliers need to support.)

We designed R Office to make the most out of very little memory, too. After the first 320K bytes of RAM for installation, each additional terminal requires only 32K. (Compare that with other, so-called multi-user software.)

R Office is already helping small companies and major corporations improve their office productivity. And unlike hopeful imitators, R Office is available, today, to help yours.

Write for information to R Systems, Inc., 11450 Pagemill Road, Dallas, Texas. Or phone toll-free, (800) 527-7610. In Texas, call collect, (214) 343-9188.

R Office
BY R SYSTEMS, INC.

UNIX AND COS ARE TRADEMARKS OF AT&T LABS AND RYAN-McFARLAND CORP., RESPECTIVELY. XENIX IS A REGISTERED TRADEMARK OF MICROSOFT, INC.

CIRCLE NO. 23 ON INQUIRY CARD

**Surprise! ONYX™ is the
value leader in 68010
OEM systems. (Not NCR.
Not Convergent.)**

**Start with a major price/
performance advantage. Surprised?**

If you thought NCR — or anyone else — offered the best performance value on multi-user UNIX™ based 68010 OEM computer systems — *It's time to look at Onyx:* Onyx systems let you give your customers added value, quality and reliability at a highly competitive cost per user. Take that pure price/value advantage, add Onyx systems' built-in growth path, and you've got tremendous selling edge. **No surprises from Onyx when it comes to performance. Or delivery. Or support. You get results.** Onyx was the first to put UNIX on a microcomputer. In the last five years, we've installed nearly 10,000 UNIX systems. And in our industry, experience is the name of the game. It makes sense to make Onyx your success partner: Our commitment to product quality, delivery and support goes back further than some companies' entire corporate histories. No surprises: Just experience. Results. And quality. **Onyx results mean you get your product to market faster.** If you've been dealing with the others, you'll be pleasantly surprised at how easy it is to work with Onyx: Configure Onyx systems with the hardware and interface specifications you need, whether it's the Onyx 6810 with UNIX or our 80186-based Onyx 6001 with XENIX™. Onyx software products, tools and technical engineering support can help get your product to market faster. Then see how simple it is to sell customers optimum value in an expandable, serviceable, solidly-designed Onyx business system. *No surprise, then, that it's time to look at Onyx.*

CIRCLE NO. 24 ON INQUIRY CARD

Onyx Systems, Inc.
25 East Trimble Road
San Jose, CA 95131-1162

Onyx Systems (Europe) Limited
7 Fairmile
Henley-on-Thames
Oxfordshire RG9 2JR England
Telephone: (0491) 571100
Telex: 847282 ONYX

Trademarks:
Onyx — Onyx Systems, Inc.;
UNIX — AT&T Bell Laboratories;
XENIX — Microsoft Corporation.

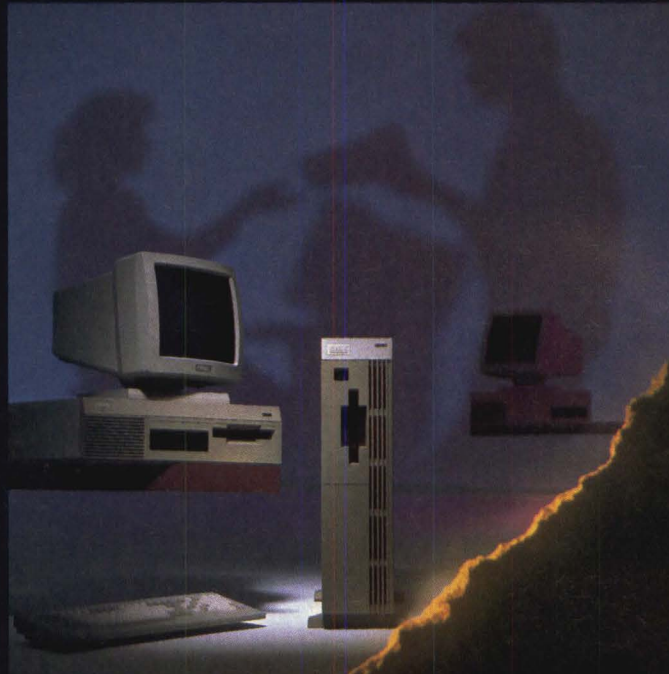

The next step for OEMs

who want results:

Call 800-538-6815

In CA: 800-624-4122

ONYX

"Once bitten, twice shy," says the export department manager of a large Taiwanese computer company which had its computers seized by U.S. Customs. "It wasn't only the money," he says. "It was the damage to our reputation. We can't afford to be associated in any way with computer counterfeiting."

ERSO, while acknowledging that it is developing an IBM PC-AT-compatible system, has declined to reveal technical details of the prototype or what steps it has taken to ensure its legality. An ERSO spokesman did say, however, that the system now under development largely conforms to the specifications of the original PC-AT and that the technology for the system will be transferred to participating private-sector companies in this month. Most industry observers in Taiwan believe it's unlikely that ERSO will repeat the mistakes it made in designing the original IBM PC-compatible BIOS.

The optimism of Taiwanese AT-compatible computer makers rests largely on their ability to quote low prices. Although prices have not been set, the end-user cost of a Taiwanese PC-AT-compatible CPU is expected to be less than half the genuine item's current retail price of around \$3,995.

Hope to export 10,000 units

ERSO members agree that sales will not be nearly as great as with traditional Taiwanese PC/XT-compatible systems, but they hope they can export 10,000 units in the first year of production.

AT-compatible makers fear, however, that they may encounter some of the same availability problems that delayed manufacture of Taiwan's PC/XT-compatible systems. For instance, there is no guarantee that the supply of dynamic RAMs will continue to exceed demand by the time mass production begins. Supplies of the all-important 80286 microprocessor may also dry up unexpectedly.

Despite their optimism, most of the companies involved in the project agree that a number of the same problems that held back export sales of Taiwanese IBM PC-compatible sys-

tems will remain unsolved. Chief among these are difficulties in providing service to U.S. or European customers and the fact that few users have ever heard of Taiwanese companies like Tatung—even though it's one of IBM's largest OEM suppliers. Executives of the ERSO-project companies say that, while they may attempt to sell their AT-compatible systems under their own name, they will focus their sales effort on U.S. and European OEM buyers.

Several Taiwanese manufacturers are said to be planning to export AT-compatible computers that they claim were independently developed. At least one company is already doing that. Asked about the origin of the BIOS in an AT-compatible system already in production, the company's manager replied, "Well, a friend of ours copied it for us."

Two take precautions

Two Taiwanese companies which believe the AT-compatible market is risky have introduced enhanced IBM PC/XT systems based on the Intel 80186 microprocessor.

Tatung last April announced such a machine. Called the TCS-6000, it is built around the 80186 microprocessor. Clocked at 8 MHz, the system comes standard with either 128K or 256K bytes of user memory. The CPU's rear panel has four RS232C ports and one printer port. The machine's power supply will support up to a 30M-byte hard disk drive.

The BIOS, which allows the TCS-6000 to run 99 percent of all IBM PC/XT software, was designed by Ta-

tung Scientific Technology Co., a Tatung subsidiary. Equipped with 256K bytes of main memory, the system carries an f.o.b. price of between \$1,000 and \$1,500, depending on quantity. An enhanced version of the TCS-6000 with both an 8- and a 16-bit data bus will be available this month, according to a Tatung official. The company also recently introduced an IBM PC/XT-compatible system based on the Intel 8086.

Taiwan's First International Computer Inc. recently announced an 80186-based system called the Leo AT/PC, which the company claims is "the world's fastest PC." The system, jointly developed by First International and Challenger Computer Inc., Bedford, Mass., specializes in computer-aided design/computer-aided manufacturing applications. Because the 80186 chip is clocked at up to 10 MHz, says First International chairman Ming Chien, the system has enough speed to handle any of the IBM PC/XT-compatible CAD/CAM packages now on the market. The IBM PC-AT, he notes, can run many of these packages but is too slow to satisfy some users.

The Leo AT/PC, which runs MS/DOS 3.0 and higher, as well as Concurrent CP/M-86, comes standard with 512K bytes of main memory, expandable to 1M byte, and a 16K-byte ROM BIOS.

Although prices have not been set, Chien says a Leo PC/AT will "definitely" cost less than a similarly configured IBM PC/XT. The computer will be marketed in the United States by Challenger and First International. □

CONVERTER SUPPORTS DIABLO, EPSON, HP

Start-up manufacturer Zvert Corp., Los Angeles, has developed the ZVT series of laser-printer protocol converters/sharers. The standalone devices allow as many as three users to print from a Hewlett-Packard Co. Laserjet printer. The ZVT also permits Diablo Systems Inc. model 630 and Epson America Inc. FX printer series emulations. Each port on the ZVT supports data rates from 9,600 baud to 19.2K baud. The ZVT-100 three-port emulator sells for \$299; each extra emulation is \$100. A Zvert spokesman says users can mix Diablo and Epson modes and can program each user port for the printer emulation and function they desire.

HEARD ON THE HILL

Computer crime bills debated on Capitol Hill

Stephen J. Shaw
Washington Editor

Two members of Congress are seeking to expand the 1984 Computer Fraud and Abuse Act to include commercial computers. As signed last October by President Reagan, the law created a new class of federal crime. It made punishable any unauthorized access to classified information in a government computer system or other systems protected by the Right to Privacy Act or the Fair Credit Reporting Act.

This year, Reps. William Hughes, D-N.J., chairman of the House Subcommittee on Crime, and Bill Nelson, D-Fla., have introduced H.R.1001 and H.R.930, respectively, in an attempt to extend criminal sanctions to unauthorized computer access of commercial systems. Both bills came under immediate attack as being potentially discouraging to federal whistleblowers.

Hughes' bill would create two computer-related misdemeanors. First, anyone who accesses a computer without authorization and gains anything of \$5,000 value or more during one year could be punished by up to 10 years' imprisonment and a fine of up to \$10,000 or double the amount of the value gained, whichever is greater. Second, anyone who causes losses or damages of \$5,000 or more through unauthorized access would face up to a year in prison and a fine of either \$5,000 or twice the value of the loss or damage, whichever is greater.

Nelson's bill would extend the Com-

puter Fraud and Abuse Act to provide protection for computers of financial institutions and computers used in interstate or foreign commerce. It establishes felony penalties of up to 10 years' imprisonment or fines of up to \$250,000, or both.

At hearings held in late May before the Subcommittee on Crime, chairman Hughes noted that his legislation would restore protection to those commercial systems deleted from last year's Act. Nelson, testifying before the subcommittee, asked that it complete the job that was started during the previous session of Congress.

"I urge the subcommittee to report legislation that will give our nation's prosecutors the precise and necessary tools to convict high-technology criminals who are threatening the economic security and integrity of this country's banking and business computer systems," Nelson stated.

John Keeney, deputy assistant attorney general, criminal division, of the Department of Justice, told the subcommittee that the Reagan administration is expected to submit its own computer-crime proposal to Congress. Also, Keeney objected to several provisions of the legislation introduced by Hughes.

The bill, Keeney stated, is not coordinated with existing mail and wire fraud statutes. As with mail and interstate telephone wires, he said, a computer is the vehicle through which the fraud or other crime is committed.

Under Hughes' legislation, the Justice spokesman contended, federal prosecutors would have to prove that the offense affected interstate or foreign commerce, rather than be able to focus on the central issue of the fraudulent scheme itself.

Keeney also argued that the \$5,000 annual floor on fraudulent gains or losses is too restrictive and could provide a loophole for certain types of computer crimes. He said a dishonest bank employee who managed to repeatedly divert a small amount of money from individual accounts over a long period of time would not be liable for prosecution as long as the diversions amounted to less than \$5,000 annually.

Hughes responded that the \$5,000 requirement was only for prosecution under federal statutes. Fraudulent computer access involving lesser amounts could be dealt with under state or local laws, he said.

On behalf of the Association of Data Processing Service Organizations (ADAPSO), P. Michael Nugent, government affairs counsel of Electronic Data Systems Corp., Dallas, stated that the industry association generally favored the approach taken by both bills. Nugent recommended, however, that the \$5,000 proviso be dropped in order to discourage computer crimes involving lesser amounts.

Arguing against the proposed legislation, attorneys representing the American Society of Newspaper Editors and the American Civil Liberties Union (ACLU) testified that the two bills, as well as the Computer Fraud and Abuse Act itself, could discourage federal whistleblowers from disclosing information concerning fraud and waste in government. ACLU counsel Allen Adler argued that federal employees could be prosecuted if they obtained such information from computers through unauthorized means.

Now you can sell into the fast growing departmental computing market in ways IBM can't.

Canaan's Departmental Computer brings IBM 370 applications to the departmental level.

There are over five million IBM PC and terminal users in corporate America.

And the number of users is growing daily. As it does, their need for immediate access to corporate mainframe applications and databases becomes even more crucial.

Finally, there is a way for VARs and OEMs to satisfy this urgent need. Canaan's DCS 5400, the only low cost, multi-user Departmental Computer with full IBM VM/CMS compatibility.

By loading System 370 applications into the Canaan DCS 5400, departmental terminal and PC users have immediate access to powerful mainframe applications *locally* without any costly retraining or conversion. Canaan not only increases productivity but also generates an identifiable return on investment.

Extensive third party mainframe software library. Canaan runs an extensive library of certified third party mainframe software—including FOCUS, RAMIS II® and decision support packages such as STRATAGEM™, MODEL™ and many others.

You can use these powerful productivity tools to tailor applications for your customers, supplying a *total* solution that is completely compatible with your customer's IBM mainframe.

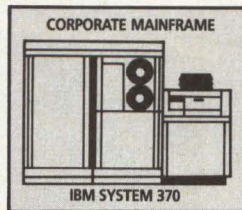

What's more, this software is available on the Canaan DCS 5400 Departmental Computer at a fraction of its mainframe cost.

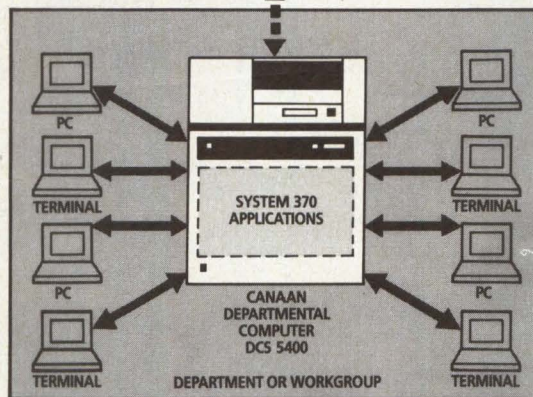

We're your partner, not your competitor. The Canaan DCS 5400 is sold through VARs and OEMs only. We do *not* sell directly to your customers.

In fact, we offer you one of the most comprehensive market support programs available anywhere. Technical and marketing training. Nationwide field engineering support. Co-op seminars. Demo support. Customer roundtables. Lead generation and much, much more.

The way we see it, the more successful you are, the more successful we are.

For complete information on how Canaan—and only Canaan—can help you fill the profitable niche between the IBM corporate mainframe environment and departmental users, write: Canaan Computer Corporation, 39 Lindeman Drive, Trumbull, CT 06611. Or call today: **1-800-382-4100.** (In CT, call 203-372-8100.)



The Departmental Computer Company.

IBM is a registered trademark of International Business Machines. RAMIS II is a registered trademark of Mathematica Products Group, Inc.

MODEL is a trademark of Lloyd Bush Software Products. STRATAGEM is a trademark of Integrated Planning, Inc.

THE ALTOS 3068, SIX BREAKTHROUGHS IN ONE FOR OEM'S.

CPU BOARD

32-bit MC68020 microprocessor running at 1.5 MIPS with no wait states; 8 Kb high speed cache memory; up to 16 MB virtual address space per program; optional floating point processor.

FILE PROCESSOR SUBSYSTEM

Controls 4 DMA channels for disk, tape, floppy, and parallel printer port; overlapped seeks on up to 3 disks.

RAM BOARD

Can be configured to OEM needs, up to 16MB using 1MB, 2MB, & 4MB boards.

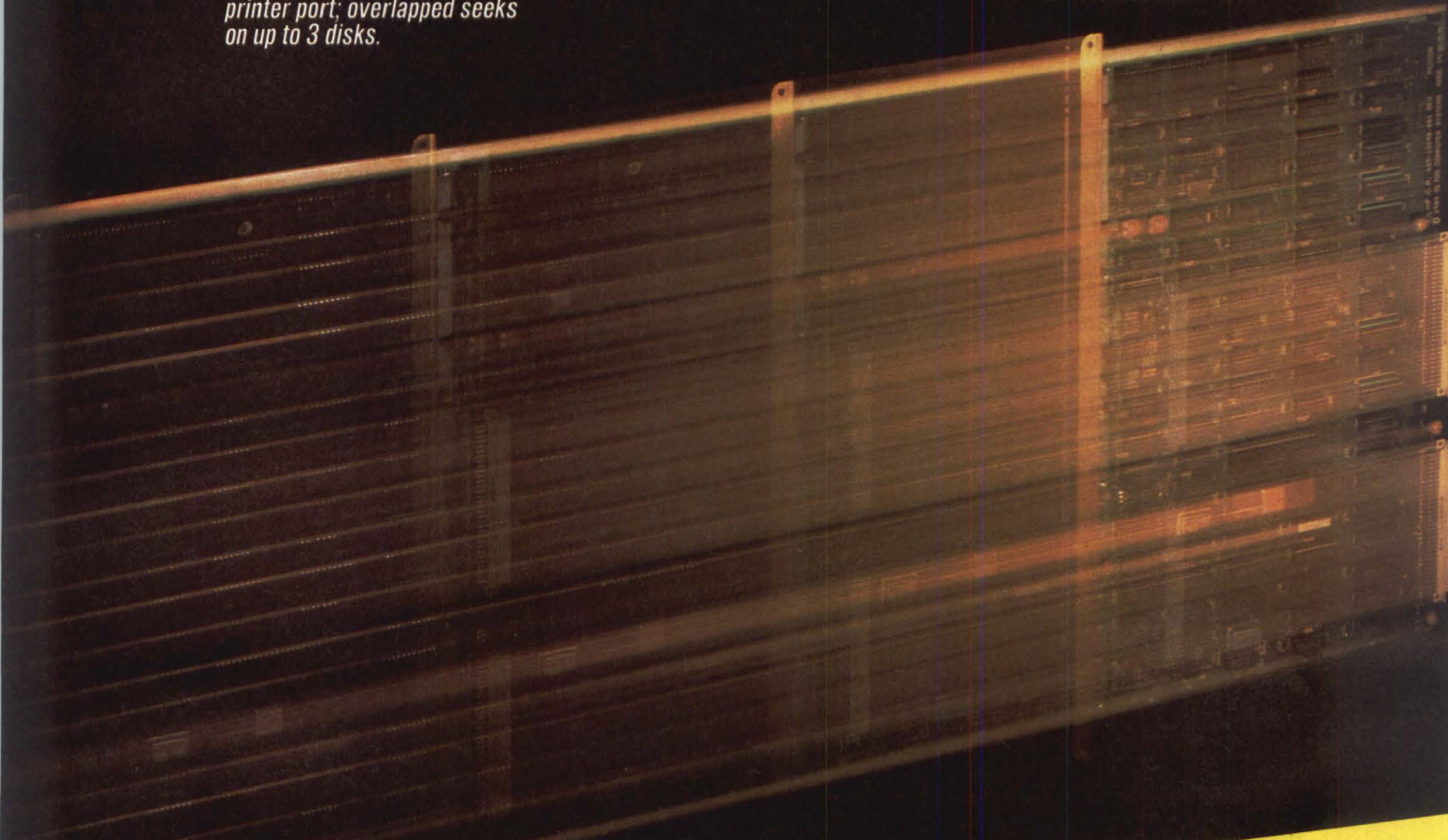

BREAKTHROUGH PRICE/PERFORMANCE

Combining the 32-bit MC68020, multiple auxiliary processors, and a tuned version of UNIX™ System V, the 30-user 3068 "is capable of a performance that rivals large mini-computers." (Computerworld, April 1985). And it does it for a micro computer price - from \$7,000 for OEM quantities.

BREAKTHROUGH MODULARITY

"Using plug-in boards the way a personal computer does really sets Altos apart." (research firm Creative Strategies, Computerworld, April 1985). OEM's can choose from a wide range of modules: 10 to 40 serial ports; 1 to 16 MB of memory; 17 to 200 MB (formatted) hard disk storage.

BREAKTHROUGH HARDWARE DESIGN

"Altos is way ahead of everybody else." (Creative Strategies, Computerworld, April 1985): high speed 8 KB cache maximizes CPU speed, with no wait states; cache is simultaneously shared between many processors; high performance memory management supports demand paged virtual memory; on-board microprocessors handle all I/O processing.

SERIAL COMMUNICATION BOARD

8 MHz 8086 with 10 serial ports; 32 KB RAM on standard board supports Async. and LAN; 128 KB of additional RAM to support X.25, SNA or custom protocols.

STREAMING TAPE

60 MB, 90 IPS cartridge tape drive.

1.2 MB FLOPPY DISK DRIVE

HARD DISK

Expandable to over 200 MB (formatted) using up to three 17, 33, or 68 MB drives, each with its own power supply.

EXPANSION BOARD SLOTS

Up to three field installable boards can be added for more users or memory.

BREAKTHROUGH UNIX™ SUPPORT

To meet the most rigorous applications requirements, the 3068 incorporates demand paged virtual memory, record locking, and sophisticated interprocess communication. An optimizing C compiler, symbolic debugger, and a full set of development tools and languages form a complete development environment. Productivity tools include an integrated package of word processing, spreadsheet, DBM, graphics, and electronic mail.

UNIX is a trademark of Bell Labs

BREAKTHROUGH COMMUNICATIONS AND NETWORKING

With a variety of protocols and the Altos Worknet™ LAN, 3068 communications span PC's to mainframes. The standard communication board has 10 serial ports, an on-board micro-processor, and up to 128 KB of RAM. The system can be configured with up to four communications boards.

BREAKTHROUGH DIAGNOSTICS

Remote diagnostics minimize downtime by isolating problems to an easily exchanged Field Replaceable Unit.

CIRCLE NO. 27 ON INQUIRY CARD

Get a step ahead of your competition. Put our innovative supermicro engineering to work on your application.

In hardware, software, communications, service, and reliability, Altos has a breakthrough for you.

For more details on the 3068 please call:

1 (800) 538-7872

Inside California:

1 (800) 662-6265

Altos Computer Systems
2641 Orchard Parkway
San Jose, Calif. 95134



COMPUTER SYSTEMS

WORLD LEADER IN
MULTI-USER MICROSYSTEMS

HERE'S WHAT IT'S LIKE TO GET A HAND



Major Accounts Sales Program.

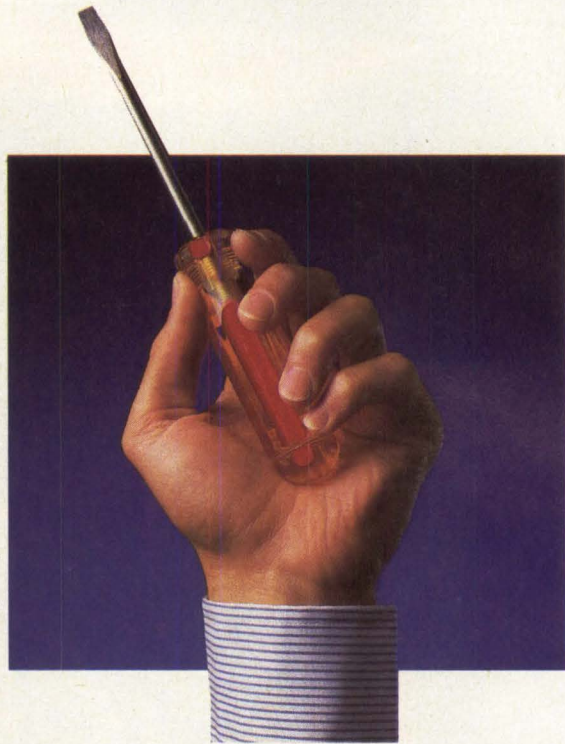

Service.

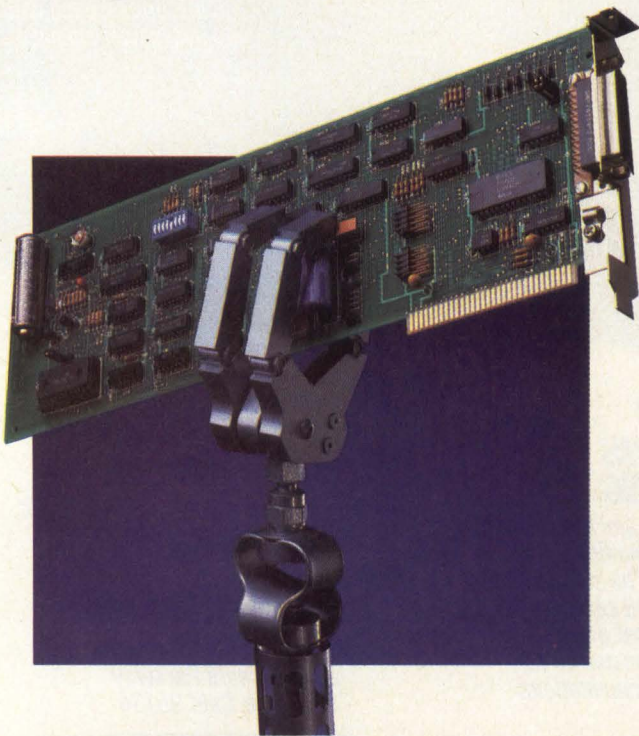

High-volume manufacturing and distribution.



Lead Referral Program.

FROM A \$4 BILLION COMPANY.



System and software support.



Co-op advertising support.

Most computer companies are eager to tell you about their product line. Especially when you ask about their VAR support programs.

NCR's approach is a little different. Sure we have an outstanding product line. The IBM PC-compatible NCR PC4™. The IBM PC/XT-compatible NCR PC6™. The IBM PC/AT-compatible NCR PC8™ and NCR PC2PC™, a simple local area network.

But we're also very proud of the programs we've put together for VARs.

Take our Major Account Sales Program. You use NCR Direct Sales prices and discounts for 2000 NCR-targeted accounts. Big-name companies. Including most of the largest in your potential markets.

You get 10% of product list prices. Plus 100% of all add-on revenues. We maintain the inventory, schedule shipments, invoice the customer, and accept responsibility for receivables.

If you want NCR service for your customers, they can get it from any of our 7,000 qualified service reps in over 400 locations nationwide. We'll also pay you a commission for selling NCR service agreements to your customers. Covering both our products and those of other vendors.

If you want to provide your own service, we can help you there, too. We'll even train your service technicians tuition-free.

We have a toll-free number for any and all questions about any industry-standard hardware or software.

Our automated assembly lines are designed to turn out highly reliable products in high volume. So you're always assured of getting products configured to your specifications when you need them.

Our Electronic P.O. Service lets you use a local phone and an assigned access number to order directly from our strategically-located regional distribution centers.

We'll even drop-ship directly to your customers, if you prefer.

Our Lead Referral and Cooperative Marketing Programs reward NCR's Direct Sales Reps for referring prospects to you.

And our co-op ad program is one of the most generous in the business. With the money paid up front, when you need it.

Our products and our programs are the reasons why you should become an NCR VAR today. It's easy to do. Just call (513) 445-7478.



WE'RE GIVING VARs A HAND. AND VICE VERSA.

NCR
Personal Computer Division

NCR Corporation, Personal Computer Division, World Headquarters, Dayton, OH 45479. (513) 445-7478.

NCR PC4, NCR PC6, NCR PC8 and NCR PC2PC are trademarks of NCR Corporation.

CIRCLE NO. 28 ON INQUIRY CARD

SWITCH!



This is draft printing
at 12 characters per inch and
160 characters per second

*Select fast draft quality printing with a very high
throughput. Then flick the switch...*



This is NLQ printing
at 10 characters per inch

...to select NLQ printing for your wordprocessing.

You can assign the 80-column Facit 4513 and 132-column Facit 4514 to whatever printing tasks your application requires.

From wordprocessing NLQ printouts with automatic sheet feeding to high-speed draft printing. Select 10, 12 or 17 characters per inch.

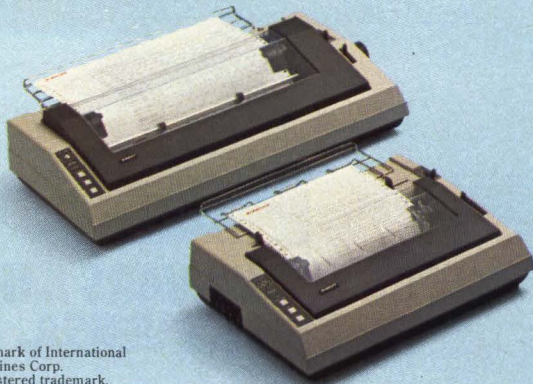

Or proportional printing.

All at the flick of a switch.

The printers incorporate both the IBM/Epson and Epson FX command sets. And thus easily make friends with both IBM PC:s and UNIX supermicros.

Naturally, the printers handle any output from your graphic software packages – logos, business graphics, pictures, semi-graphics, etc.

And when it comes to reliability, the component materials, printhead life and stringent testing ensure that your Facit 4513/14 printers will deliver many years of quality printings. Just like every other printer in the Facit family.

Switch to Facit 4513/14 matrix printers!

FACIT

Head Office: Facit AB, S-17291 Sundbyberg, Sweden. Phone (8) 7643000.

IBM is a trademark of International Business Machines Corp.
Epson is a registered trademark.
UNIX is a trademark of AT&T Bell labs.

AUSTRALIA: EAI Electronics Associates Pty Ltd., 427-3322. AUSTRIA: Ericsson Information Systems GmbH, 0222-613641. BELGIUM: Ericsson S.A., 02-2438211. CANADA: Facit Canada Inc., 416-821-9400. CYPRUS: LBM (Lilytos) Ltd 5164634. DENMARK: Facit A/S, 02-922400. FINLAND: OY Facit, 90-42021. FRANCE: Facit S.A., 1-7807117. GREAT BRITAIN: Facit, 0634-401721. GREECE: Computer Application Co., Ltd., 01-6719722. HONGKONG: Gilman & Co. Ltd., 5-7909555. ICELAND: Gisli J. Johnsen HF, 354-173111. INDIA: Forbes Forbes Campbell & Co. Ltd., 22-268081. IRELAND: Memory Ireland Computers Ltd., 1-989733. ITALY: Facit Data Products S.p.A., 039-636331. JAPAN: Electrolux (Japan) Ltd., 03-479-3411. THE NETHERLANDS: Ericsson Information Systems B.V., 03480-70911. NEW ZEALAND: McLean Information Technology Ltd., 501-801, 501-219. NORWAY: Ericsson Information Systems A/S, 02-355820. PORTUGAL: Regisconta Sarl, 1-560091. SINGAPORE: Far East Office Egpts Pte Ltd., 7458288. SPAIN: Facit, 91-457111. SWEDEN: Ericsson Information Systems Sverige AB, 08-282860. SWITZERLAND: Ericsson Information Systems AG, 01-3919711. USA: Facit Inc., 603-424-8000. WEST GERMANY: Ericsson Information Systems GmbH, 0211-61090.

CIRCLE NO. 29 ON INQUIRY CARD

INTERPRETER

An analysis of news, issues and trends affecting the computer industry

MULTIUSER MICROS ADD VALUE TO PC LANs

Despite the booming PC LAN business, most observers still see a place in the market for multiuser microcomputers

Frances T. Granville, Associate Editor

With a multitude of standalone personal computers in the office environment, business managers are looking for ways for users to share resources, data and peripherals with their co-workers or with other departments. What they're finding is that the obvious solution—a local area network connecting standalone personal computers—is not the only solution. Multiuser microcomputer vendors are offering an alternative scheme to share resources and increase the performance, storage capacity and speed of their LANs.

In an effort to tap into the lucrative LAN market, multiuser microcomputer vendors, such as Altos Computer Systems Inc., Convergent Technologies Inc. and North Star Computer Systems Inc., are selling their systems into already-installed networks. In such applications, the multiuser microcomputers play the role of powerful file servers in LANs. As a result, market observers predict, these vendors may well end up coexisting with personal computer LAN vendors.

"If multiuser microcomputer vendors are smart and realize that personal computer LANs are the wave of the future, they need to find a way to sell those systems as file servers or departmental 'minis'—a way to coexist peacefully with LANs," says Robert Lefkowitz, director of software research at InfoCorp, a market research concern in Cupertino, Calif. "Those that try to compete head-to-head with LANs and say, 'Buy my multiuser micro,' will lose out."

According to analysts, both the personal computer LAN market and the multiuser microcomputer market have optimistic outlooks: Sales of multiuser microcomputers are expected to grow

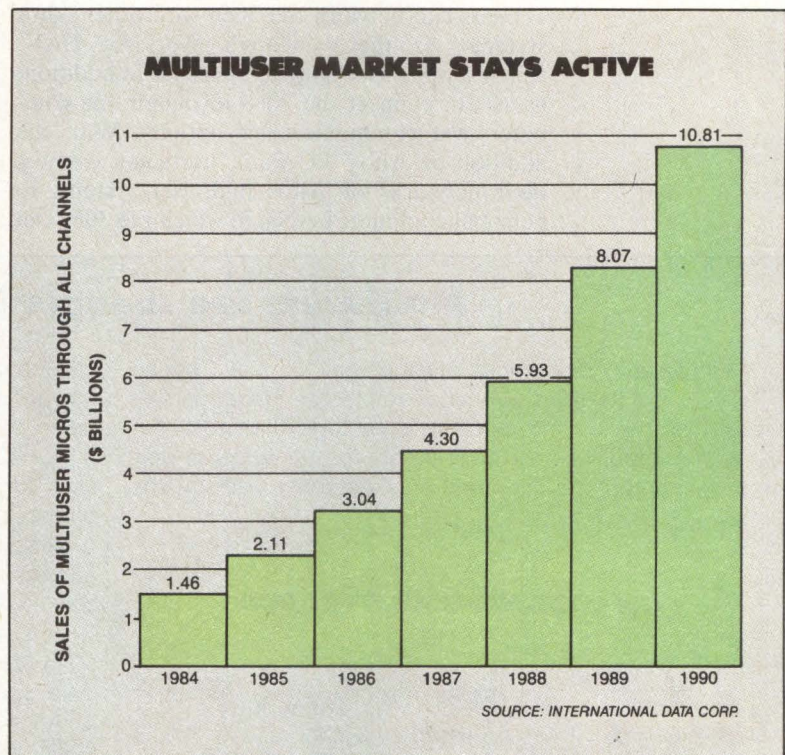

from \$1.46 billion in 1984 to \$4.3 billion by 1987 and \$10.81 billion by 1990, according to research concern International Data Corp. (IDC), Framingham, Mass.

The personal computer segment of the LAN market is expected to reach \$3 billion in sales by 1987, according to research concern Future Computing, Richardson, Texas. Also optimistic about personal computer LAN growth is Venture Development Corp. (VDC), Natick, Mass. VDC expects personal computer LAN shipments to increase from \$250 million in 1984 to

'Someone could plunk down \$5,000 to \$6,000 for a PC, and in six months it will have paid for itself.'

\$4.6 billion by 1990. What's more, the number of personal computers installed in LANs reached 15,500 by the end of 1984—up from 10,100 in 1983—a 60 percent growth rate that is expected to “continue if not accelerate,” according to IDC analyst Jeffrey Kaplan.

One company tapping into the lucrative personal computer LAN market is Altos, San Jose, Calif., which leads the market for multiuser microcomputers. “PC LANs are just a great way for us to enlarge our market and reinforce our position,” says Phillip E. White, senior vice president of marketing at Altos. He points to the company's recently unveiled Model 3068, a 32-bit supermicrocomputer that some analysts see as a price/technology breakthrough. “In price and performance, no one can touch it at this time,” states Evan Moltz, director of micro-services at IDC.

Users can network the 3068 with other Altos systems via the company's WorkNet LAN, which supports as many as 30 users. In addition, users can connect the 3068 to mainframe computers via communications options. With the addition of Altos' PC Path, users can connect their networks of Altos multiuser systems to personal computer LANs, in which the 3068 can



The Altos 3068 multiuser supermicrocomputer supports 30 users via Altos' WorkNet LAN.

act as a file server.

But, says Moltz, a more important reason for Altos' market leadership than the 3068 is the

Multiusers are cheaper by the dozen

Jim Isaak, director of product planning at Charles River Data Systems, Framingham, Mass., sees cost per user as the most important advantage that multiuser microcomputers have over local area networks of personal computers. The number of personal workstations

that can be cost-justified on a per-user basis grows (toward the bottom of the pyramid) as the systems being purchased decrease in price.

The 32-bit multiuser area (green) covers the “critical elite,” for whom the cost per user is \$10,000; key professionals, for whom the cost is \$5,000 per user; professionals and managers, for whom the cost is \$2,500 per user; white-collar workers (\$1,000 per user); and all other “office” employees (\$500 per user).

In a hypothetical example, a company wanting to computerize might be able to cost-justify buying only three systems selling for \$10,000. Then, about five key professionals might receive the next group of systems at \$5,000 each. In the next step, the company could buy additional systems for as many as 10 more employees for \$2,500 and then for the next 15 users for \$1,000. If the cost per user dropped to \$500, the company could afford to buy systems for its entire staff.

This low cost per user could not be achieved with a personal computer LAN network. Because personal computer LANs cover only the areas in blue. Another group, represented by the “s” curve, covers professional employees that require 32-bit systems, typically engineers and financial analysts. Isaak calls this the “32-bit effect.” These users can justify high workstation cost only if the workstation provides 32-bit capability.

THE COST-PER-USER PYRAMID

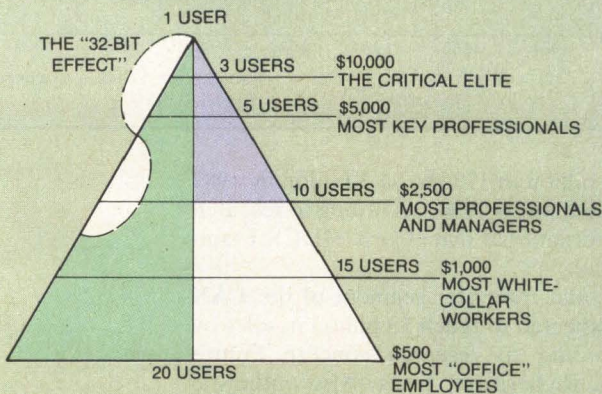

SOURCE: JIM ISAAK, CHARLES RIVER DATA SYSTEMS

A NEW LOW FROM LEAR SIEGLER.

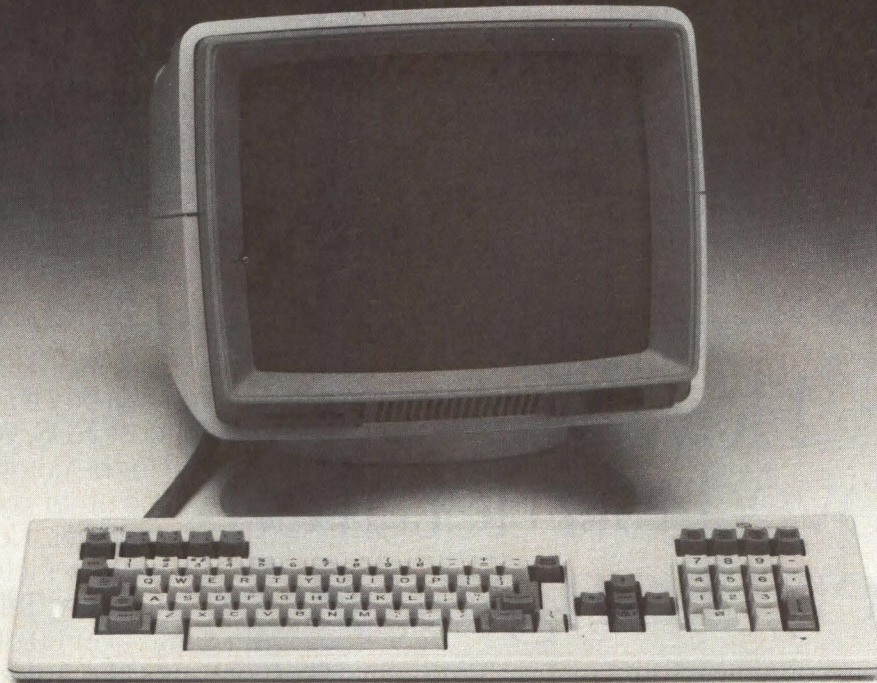

Introducing the ADM 3E for under \$400.

When it comes to quality display terminals, absolutely no one sets a higher standard than Lear Siegler.

So it may raise a few eyebrows when word spreads that we've reached an all-time low. It's the new ADM 3E and, at under \$400, it will change forever the way you think of low-end terminals.

For starters, we've included a wide variety of features you'd expect to pay more for.

Like a superior keyboard design with seven programmable keys shiftable for fourteen non-volatile functions. Dynamically allocated function key memory. Plus, a 14" screen in your choice of green or amber—all standard.

You get compatibility with our ADM 3A and ADM 5 terminals, as well as ADDS Viewpoint. There's even a bidirectional printer port with independent baud rate available. All this with legendary Lear Siegler quality.

Give us a call today. And find out why we're so high on our new low.

800-LEAR-DPD (800-532-7373).



**LEAR SIEGLER, INC.
DATA PRODUCTS DIVISION**

901 E. Ball Road, Anaheim, CA 92805, (714) 778-3500

ADDS Viewpoint is a trademark of Applied Digital Data Systems, Inc.
© 1985 Lear Siegler, Inc.

CIRCLE NO. 30 ON INQUIRY CARD

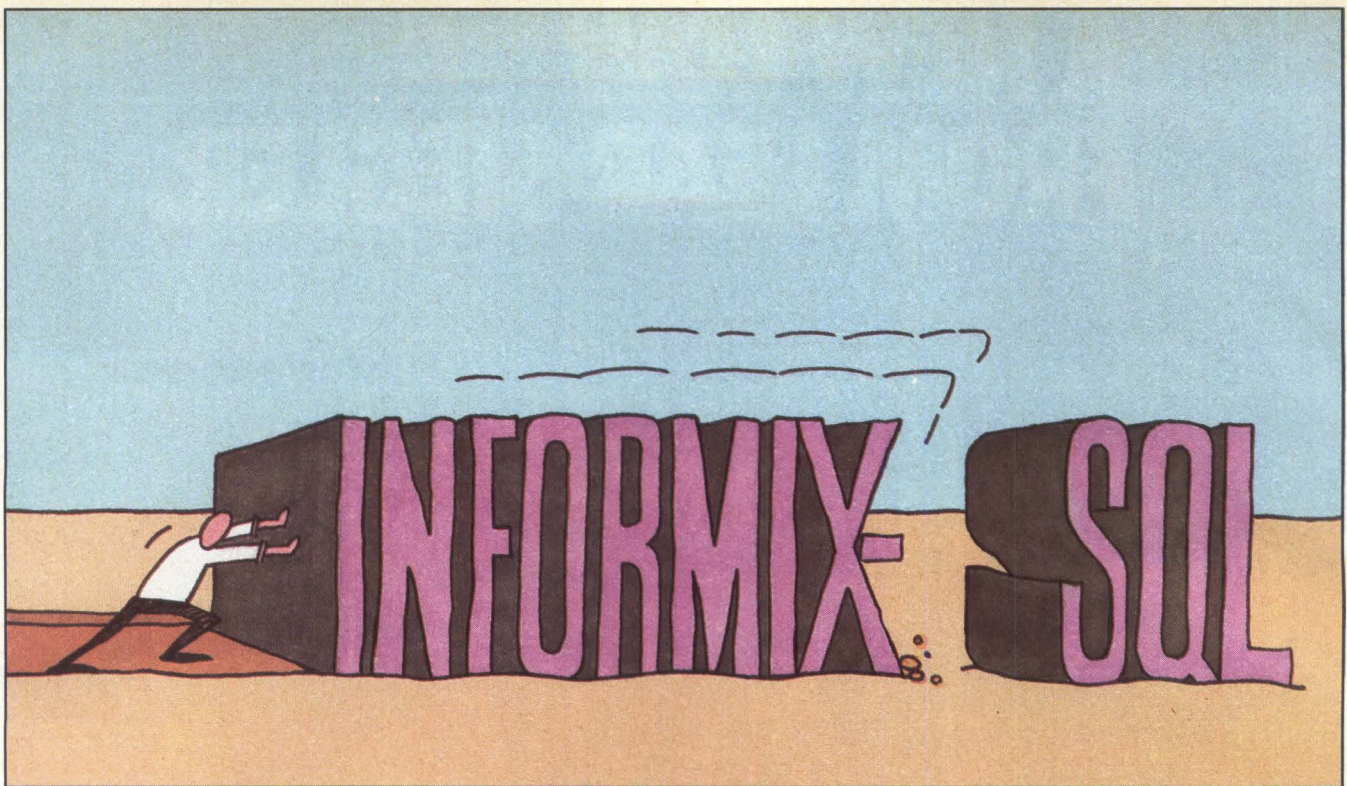

How we improved Structured Query Language.

Actually, we didn't change a thing.

We just combined it with the best relational database management system.

Introducing INFORMIX[®]SQL.

It runs on either UNIX[™] or MS[™]-DOS operating systems. And now with IBM's SQL as part of the program, you can ask more of your database. Using the emerging industry-standard query language.

To make your job easier, INFORMIX-SQL comes with the most complete set of application building tools. Including a full report writer and screen generator. Plus a family of companion products that all work together.

Like our embedded SQLs for C and COBOL. So you can easily link your programs with ours. File-it![™] our easy-to-use file manager. And C-ISAM,[™] the de facto standard ISAM for UNIX. It's built into all

our products, but you can buy it separately.

And when you choose RDS, you'll be in the company of some other good companies. Computer manufacturers including AT&T, Northern Telecom, Altos and over 60 others.

And major corporations like Anheuser Busch, First National Bank of Chicago and Pacific Bell.

Which makes sense. After all, only RDS offers a family of products that work so well together. As well as with so many industry standards.

So call us for a demo, a manual and a copy of our Independent Software Vendor Catalog. Software vendors be sure to ask about our new "Hooks" software integration program. Our number: 415/424-1300.

Or write RDS, 2471 East Bayshore Road, Palo Alto, CA 94303.

And we'll show you how we took a good idea and made it better.



RELATIONAL DATABASE SYSTEMS, INC.

INFORMIX is a registered trademark and RDS, C-ISAM and File-it! are trademarks of Relational Database Systems, Inc. IBM, UNIX and MS are trademarks of International Business Machines Corporation, AT&T Bell Laboratories and Microsoft, respectively. © 1985, Relational Database Systems, Inc.

company's distribution channel: value-added resellers. InfoCorp's Lefkowitz agrees. According to him, the 3068 has only adequate performance and represents merely the "next step in Altos' product evolution." But he emphasizes the importance of the company's sales force of 2,000 VARs. "Altos is the traditional leader in price, and VARs are looking for the best hardware margins they can find," he notes.

According to Altos' White, the company adds 50 to 75 new dealers a month. Since its founding in 1977, the company has never had an unprofitable quarter, and its net sales rose from \$8.2 million in 1980 to \$102.7 million in 1984.

Vendors aim at different buyers

Some microcomputer vendors, however, believe that LANs and multiuser microcomputers do compete—but only indirectly. "There's definitely a battle in the market," says Jim Isaak, director of product planning at Charles River Data Systems (CRDS), Framingham, Mass., and chairman of the IEEE committee on operating systems standards. "But it's not a head-to-head battle because the players—the buyers—are different." Isaak believes that individuals buying computers want the status symbol that having a personal computer on the desktop represents. In addition, he says, the pay-back periods for personal computers are good. "Essentially, someone could plunk down \$5,000 to \$6,000 for a PC, and in six months it will have paid for itself," he says.

Multiuser microcomputer buyers, on the other hand, are typically responsible for outfitting a small business or a department. Such buyers are concerned with more than one user. "The PC won't solve this problem as efficiently," says Isaak. "The multiuser approach starts to pay off when you are concerned with many users."

Although LANs and multiuser microcomputers are competing in the same general market, the two solutions are suited to different environments. LANs can support two to several thousand standalone personal computers, whereas multiuser microcomputers typically support two to 12 users. Support of fewer workstations makes multiuser microcomputers more suitable for small businesses or departments within large organizations. For connecting users in a large company, a LAN would be more appropriate.

In a LAN, the common connection method is twisted-pair wire or coaxial cable. Data transfer between personal computers and peripherals occurs serially, often resulting in slow transfer rates. Consequently, LANs are also slower in performing tasks that require heavy use of common peripherals, especially shared hard disks.

With multiuser microcomputers, on the other hand, devices are connected to the CPU via a high-speed bus and share data via direct-memory-access channels. The superior speed makes multiuser microcomputers a better choice for users who require frequent access to a shared database and common peripherals.

"It's clearly a separate market," says Charles Grant, president of North Star, San Leandro, Calif. "We're focused at upgrading people who already own PCs. Multiuser micros have a clear performance advantage." Grant believes that multiuser micros for use with personal computer networks are an afterthought. What's more, he adds, "the two approaches solve different problems. People are trying to jury-rig a system together with PCs and multiuser micros, but it comes down to a question of which can best get the job done."

North Star offers Dimension, which is compatible with IBM Corp.'s PC/XT. Dimension supports 12 users at a base price of \$7,000, with each additional workstation selling for approximately \$2,500. In addition, North Star plans to introduce its version of Novell Inc.'s NetWare operating system, which will link individual personal computers to the Dimension system.

However, some competitors in the market, particularly LAN vendors, aren't quite so gung ho about using multiuser microcomputers to upgrade personal computer LANs. "They're saying, 'If you already have a PC LAN, you've made a mistake,'" says Craig Burton, vice president of Novell, Orem, Utah. "But, in the real world, using shared processors is doing it the old-fashioned way."

Claim made for micro muscle

In spite of such criticism, multiuser microcomputer vendors are claiming improved performance over personal computers. "It comes down to a question of whether you want just another PC, or do you want a more powerful system?" says Altos' White. He cites a published study in which Altos' Model 586 microcomputer was shown to have five times the performance of a personal computer. "We don't force people to put files and memory on their PCs," says White. If users can perform these functions on a multiuser system, it leaves more space on the networked personal computers for other uses. "And our systems are really not that much more costly," he adds. The 586 reportedly sells for \$7,900 as a file server in a personal computer network, compared to \$5,000 to \$6,000 for a personal computer.

CRDS' Isaak concurs. "PCs alone don't solve the problem. You have to put in a network, and,

'People are trying to jury-rig a system together with PCs and multiuser micros, but it comes down to a question of which can best get the job done.'

even if you have 10 PCs, each having 256K bytes of memory, you have 4M bytes of memory floating around. But, if you have a spreadsheet requiring that much memory, there is no place to run all 4M bytes." With CRDS' Universe 68 running the company's UNIX-compatible UNOS operating system, he says, users get a higher speed connection and better bandwidth than is possible with a personal computer.

He also points out that CRDS' UniverseNet II networking software, which the company had planned to introduce at last month's National Computer Conference, will provide users with distributed-resource-management capability on three levels. Implementing the seven-layer open-systems-interconnection scheme of the International Standards Organization, the network will support the Ethernet standard and the OpenNet interconnection scheme, and it will act as a distributed-file server between UNIX and other environments. As such, it will be a global file system that "spans networks in a literally transparent way," says Isaak.

"What it comes down to," claims Nathan

Brookwood, director of product strategy at Convergent, Santa Clara, Calif., "is performance, response time and money."

According to Brookwood, "with more than three or four users, the cost per user is less for multiuser micros. Our MiniFrame [multiuser microcomputer] is \$8,000, but each additional terminal is \$1,000. A PC workstation sells for \$5,000 to \$8,000. So, for up to three or four users, it's a wash. For more than that, multiuser micros have a lower cost per user."

Isaak agrees: "For the first three users on a multiuser system, you pay \$10,000 [each]; for [the next] five users, it's \$5,000 per user, for [the next] 20 users, it's \$500 per user (see "The cost-per-user pyramid," Page 56). You could never put that many users on a PC LAN. You couldn't afford it. You can't justify even a diskless PC. With multiuser micros, you can support a mix of people—some needing more power, some needing less. It's a cost trade-off."

But some personal computer LAN vendors, including Novell's Burton, don't entirely buy the cost-per-user argument: "On a cost-per-user basis, they're probably right," admits Burton, "but I'd much rather have a PC on my desk than a dumb terminal. Having my own PC offers better personal capability for the workers and better control for the managers."

David Potter, vice president of research and development at Micom-Interlan Inc., Boxborough, Mass., takes a similar viewpoint. "It becomes a question of degree of ownership," he says. "With your own PC, you control your own destiny." What's more, Potter—along with other LAN vendors and analysts—sees the prices of LAN hardware and peripherals dropping in the near future. "There's no question in my mind that LANs, disks and printers are going to decrease in price, and what advantage is the multiuser micro going to have in the long run?"

However, multiuser microcomputers are also expected to decrease in price. According to Convergent's Brookwood, "The same hardware and the same trends that make the PC cheaper are going to make the multiuser micro cheaper."

As prices for both types of systems decrease and as more vendors offer schemes to connect personal computers and microcomputers, users will have more ways to share their data and peripherals with their co-workers.

9-TRACK MAG. TAPE SUBSYSTEM FOR THE IBM PC/XT/AT



For information interchange, backup and archival storage, IBEX offers a 9-track, IBM format-compatible 1/2" magnetic tape subsystem for the IBM PC, featuring:

- 42 M-Bytes on a single reel.
- IBM format 1600 cpi.
- Software for PC-DOS, MS-DOS.

Write, phone or TWX for information

IBEX

IBEX COMPUTER CORP.
20741 Marilla St.
Chatsworth, CA 91311
(818) 709-8100
TWX: 910-493-2071

Interest Quotient (Circle One)
High 474 Medium 475 Low 476

THE ONLY 4TH GENERATION LANGUAGE FOR THE PC.



What can it do for you?

The first 4th generation language for the PC is now a reality: PC/FOCUS.

It's a complete database and information management system for your Personal Computer! Yet, its design, function and capabilities are identical to its big brother FOCUS, the leading Information Center 4GL/DBMS for IBM and compatible mainframes. Therefore, it's the most powerful and comprehensive system available in the Personal Computer marketplace.

APPLICATIONS UNLIMITED

At last you can have the same variety of database application possibilities as mainframe FOCUS users, including the ability to perform local data analysis and prototype applications without consuming mainframe resources, collect transaction data for application processing...even establish a distributed database network using a mainframe database with PC transaction workstations.

PRODUCTIVITY AT ALL LEVELS OF USER PROFICIENCY

For the novice user, PC/FOCUS with TALK™

Technology permits nearly instant productivity! Based on A.I. concepts, TALK™ Technology permits easy creation of files and reports with simple, menu item selections in failsafe sequence.

For experienced business users, PC/FOCUS has powerful facilities designed to tackle the most demanding applications; facilities including Lotus, 1-2-3,* DIF and word processing interfaces plus full Graphics and Reporting Symmetry, so that reports can be turned into graphs and vice versa, with a single command!

Even Application Developers and other DP Professionals will find something special in PC/FOCUS, including a built-in Text Editor, compiled screen procedures and more.

There's a lot more to learn about what PC/FOCUS can do for you. For complete details, write to Don Wszolek, Dept. R3, Information Builders, Inc., 1250 Broadway, New York, NY 10001.

*LOTUS, 1-2-3 is a trademark of Lotus Development Corp.



PC/FOCUS

INFORMATION BUILDERS, INC.

• New York: (212) 736-4433 • Washington D.C.: (703) 276-9006 • St. Louis: (314) 434-7500 • Chicago: (312) 789-0515 • Boston: (617) 272-8600
Dallas: (214) 659-9890 • San Jose: (408) 293-6600 • Los Angeles: (213) 615-0735 • Houston: (713) 952-0260 • Atlanta: (404) 980-0874

CIRCLE NO. 33 ON INQUIRY CARD

You can buy a
Maxtor drive.

Or you can wait.

Sure, plenty of companies have announced high-capacity 5¼-inch Winchester's with more than 100 megabytes. And one of these days they'll be shipping in volume.

But Maxtor already is. And has been for over two years.

So if you need 5¼-inch Winchester's with over 100 megabytes, don't wait.

You know who to call.

Maxtor Corporation, 150 River Oaks Parkway,
San Jose, CA 95134, (408) 942-1700, TELEX 171074.
Eastern Regional Sales Office: (617) 872-8556.
Southwest Regional Sales Office: (714) 859-3100.

Maxtor

CIRCLE NO. 34 ON INQUIRY CARD

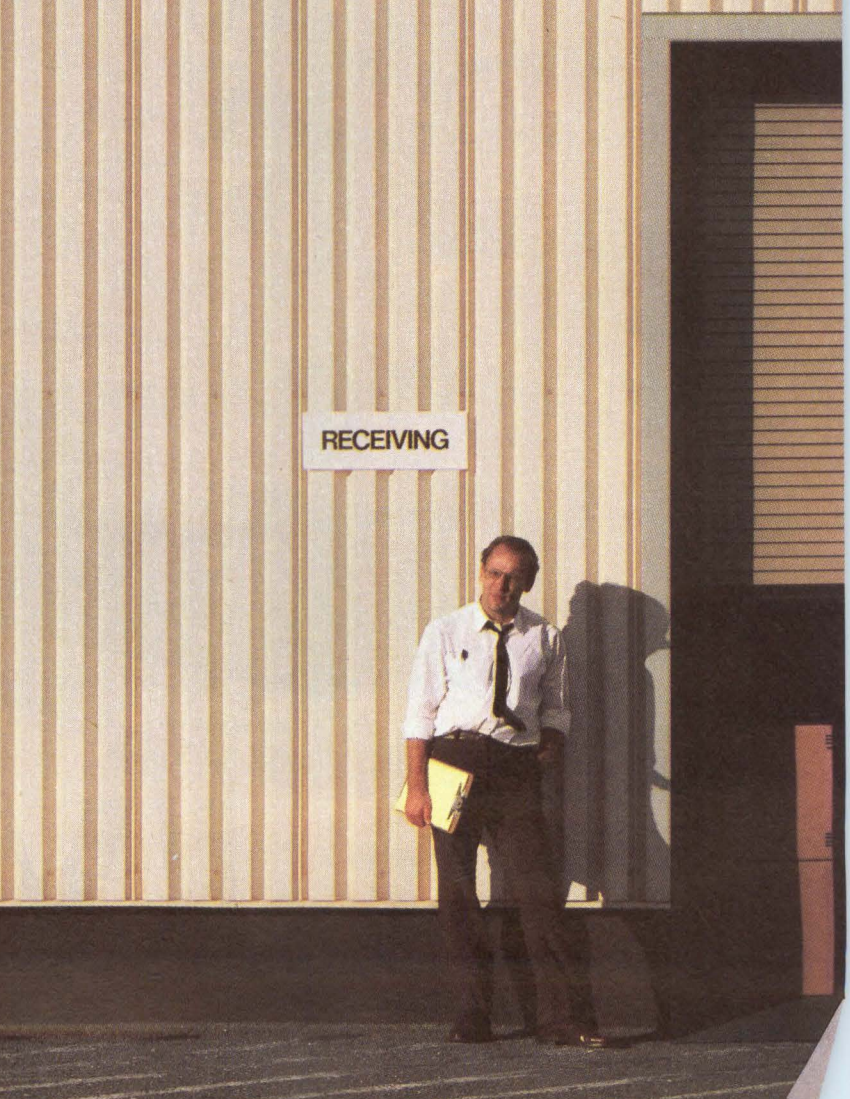
A man in a white shirt and tie stands in front of a building with a 'RECEIVING' sign. The building has a light-colored, vertically-ribbed facade. The man is holding a yellow folder and is looking towards the camera. The sign is a small white rectangle with the word 'RECEIVING' in black capital letters. The man is standing on a dark surface, possibly a sidewalk or driveway, and his shadow is cast on the building behind him.

RECEIVING

At \$395, still no competition.

Why hasn't Wyse, TeleVideo or Esprit offered you an ACSII editing terminal under \$400 with this many features? Or 25,000-hour reliability? Or a one year end-user warranty?

We think the answer is simple:

Only Qume, with the resources of ITT behind us, can deliver and support a new generation of fully optimized, lower-cost editing terminals to meet your need for more productivity with less investment. The QVT 101™ is the first of Qume's lower-cost terminals. Nothing comes even close to matching it.

Today, if you want to save up to 40% of your terminal costs without sacrificing performance or support, we'll be there. With no competition. For more information, call (800) 223-2479. Qume Corporation, 2350 Qume Drive, San Jose, CA 95131.

Qume
A Subsidiary of ITT

QUME

QVT 101™

VERTICAL MARKET INTEGRATOR

*Applying integrated systems
in industry, engineering and commerce*

NETWORK AUTOMATES INSURANCE SERVICES

LAN-linked desktop personal computers, bundled with proprietary application software, provide a true, real-time multiuser system

Michael R. Tankle, FutureGuard Inc.

In many insurance companies, an excess of paperwork—the result of government regulations; customized policies for special coverage; and payments of premiums, claims and commissions—often creates a backlog. This backlog would worsen if insurance personnel had to access up-to-date information manually. To avoid this, most major insurance carriers automate their data-processing operations using mainframe or minicomputer systems.

But the costs of such systems have prevented most smaller insurers from automating. Although using microcomputers might seem to be a cost-effective alternative, a lack of adequate microcomputer-based, application-specific software has also hindered office automation in small companies.

One insurance company addressing these problems is AmGuard Enterprises Inc. AmGuard's approach was to create a subsidiary, FutureGuard Inc., Wilkes-Barre, Pa., to develop an office-automation system to link all AmGuard subsidiaries. Besides FutureGuard, the subsidiaries are AmGuard Insurance Co., specializing in workers' compensation; InterGuard Ltd., a managing general agent (MGA) and program manager; and Insurance Support Services Inc., an insurance claims and engineering management company.

The office-automation system that FutureGuard developed is called the MGA information-management system. Based on Deskpro personal computers from Compaq Computer Corp., Houston, the system is connected over EtherSeries, the Ethernet-compatible local area



network from 3Com Corp., Mountain View, Calif. A typical FutureGuard system includes 20 Deskpro workstations, the EtherSeries network, four printers and a hard disk/tape backup subsystem. This configuration, including all application software, sells for less than \$200,000—one-third the price of a comparable minicomputer system. For example, one available minicomputer-based turnkey system for MGAs supports only 13 workstations and sells for more than \$600,000.

FutureGuard developed the MGA information-management system using a TeleVideo Systems Inc. multiuser system. However, the company soon switched to Compaq computers because of TeleVideo's hardware limitations, including its 8-bit architecture. Because of the complexity of the application software, the MGA system demands 16-bit architecture. In addition, FutureGuard officials believe that, to be competitive in today's business market, compatibility with the IBM Corp. PC—which the

Compaq Deskpro Model 1 computers serve as workstations on the FutureGuard network. Users can connect more than 1,000 workstations on a single network.

The company selected the Deskpro because it has a faster clock speed—8 MHz—compared with the PC/XT's 4 MHz.

TeleVideo system lacks—is necessary.

In addition, the TeleVideo system offers 64K bytes of RAM per workstation, compared with the Deskpro's 256K bytes, and a maximum of 16 workstations on the network, compared with the MGA system's 1,024. Further, the TeleVideo network requires thick 15-wire cable, making installation difficult. The 10M-bit-per-second 3Com EtherSeries LAN, on the other hand, operates over less expensive, thin coaxial cable, which is easier to install than either the TeleVideo cable or Ethernet. What's more, EtherSeries is fully compatible with the Deskpro and can be installed without alterations.

After eliminating the TeleVideo system as an option, FutureGuard considered the Deskpro and the IBM PC/XT, both 16-bit machines, for the network. The company selected the Deskpro because it has a faster clock speed—8 MHz compared with the PC/XT's 4 MHz.

Developers use in-house expertise

More than a year ago, FutureGuard installed the beta-test system at its MGA. There, InterGuard staff members test the system and advise FutureGuard on developing application software for MGAs. As an MGA, InterGuard mediates between major insurance carriers and independent agents, provides sales and marketing support to insurance carriers, handles insurance proposals, writes and codes policies, reports to government authorities, reviews claims and deals with local, independent insurance agents and brokers.

The MGA system incorporates Microsoft Corp.'s MS-DOS operating system and general application software, including the Multiplan spreadsheet program. Other software for the system includes MicroPro International Corp.'s WordStar word-processing package and Mail-Merge file-merging package and 3Com's EtherMail electronic mail. Because the Deskpro is compatible with the IBM PC, users can also run a wide variety of industry-standard application-software packages. FutureGuard's bundled application software is written in Ashton-Tate's dBASE II, whose relational database architecture allows storage of as many as 65,000 files with minimum redundancy and no overhead for pointers and sets.

The core MGA information-management system incorporates several modules—marketing, policy management, underwriting and accounting—each of which has a report generator. The marketing module stores lists of prospective customers grouped by territories and assigned to appropriate independent agents. Using the mod-

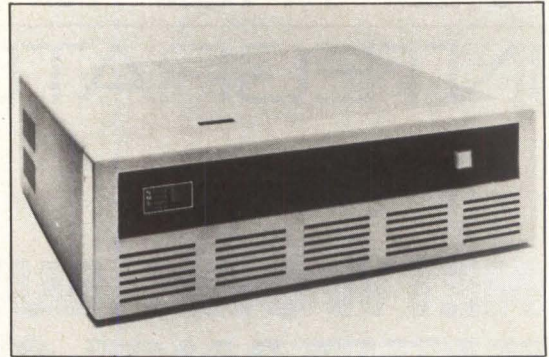

A 168M-byte hard disk subsystem from National Memory Systems stores the application software and data files for the FutureGuard network. When a user stores a data file on the hard disk, all other workstations on the FutureGuard network can gain immediate access to the updated information.

ule's report generator, InterGuard can provide its independent agents with lists of companies in a specific region that have annual sales in a specified range. Using WordStar and Mail-Merge, agents can then create direct-mail campaigns targeted at specific prospects. The marketing module also tracks results of an agency's marketing efforts, allowing insurance companies to monitor their agencies' compliance with company-agency agreements and to coordinate marketing representatives' sales campaigns.

The underwriting and policy-management modules handle the issuance, endorsement, cancellation or reinstatement, coding and reporting of policies. Once policy information is entered into the system, an operator can retrieve it by using one of several fields, such as status (active or canceled), agency, inception and expiration dates and dividends.

The MGA accounting module automatically calculates fees, commissions and other receivables and payables. As policies are issued, canceled or endorsed, the system immediately updates all information and maintains an audit trail of accounting transactions. Like the underwriting/policy-management modules, the accounting module permits users to access information from several fields, including policy type, agency, date or range of charges and payment status. The module's report generator, which displays easy-to-understand user prompts, enables users to create a wide range of financial reports, such as bordereaux (monthly financial/statistical reports), accounts receivable and payable, commissions and premiums.

An optional claims-information-management

Make your Eagle Fly.

2.5 MB/sec. transfer rates make your DEC or Data General soar.

It's all that you could ask for. Greater speed. Higher disk capacity. Total line compatibility. Unprecedented flexibility. And all at lower costs than you would imagine.

Look to Spectra Logic for two families of high-performance controllers to make your Eagle Fly.

One series with Q-BUS and UNI-BUS SMD disk & formatted ½" tape

for DEC LSI-11, PDP-11 and others.

One series with support for BMC/DCH on Data General Nova, Eclipse, MV series and DG Plug compatible systems with extensive mapping for EXACT emulation of DG disk.

Both series feature our exclusive streaming tape backup utility—Spectra Stream. Plus, enhanced read-ahead buffering, block/mode transfer and a host of other performance-plus features on the DEC series.

But only from Spectra Logic. Call now and we'll prove to you our high flying controllers outperform the competition.

Call (415) 964-2211.

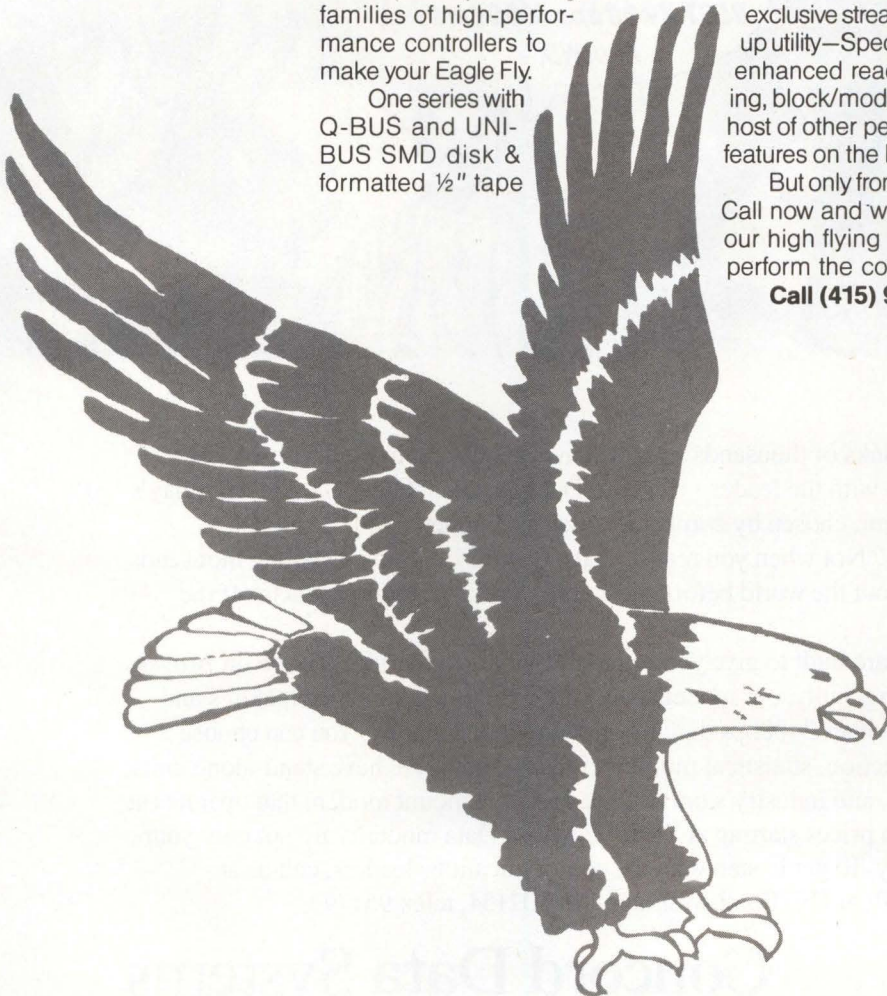

SPECTRA LOGIC
A CIPHER DATA PRODUCTS COMPANY

Spectra Logic Corporation 297 North Bernardo Avenue, Mountain View, California 94043. TWX 910-339-9566. Telex 172524 SPL MNTV.

CIRCLE NO. 36 ON INQUIRY CARD



"THERE ARE
THOUSANDS OF THEM,
AND THEY'RE ALL HEADED
FOR CONCORD!"

"AND RIGHTLY SO.
THEY'VE GOT THE
BEST 2400bps MODEMS
AROUND."

H. Pyle. *Victory Parade*, 1783. Courtesy The Bettman Archive.

If you're ready to join the ranks of thousands who are saving time and money with 2400bps dial line communications, go with the leader—Concord Data Systems. Our CDS 224[®] is today's largest selling 2400bps modem, chosen by companies such as Tymnet[®], ADP[®], AutonetSM, Dysan and others. Surprising? Not when you realize that Concord Data was installing thousands of 2400bps modems throughout the world before most companies had their products off the drawing board.

Concord Data modems are built to give you years of trouble-free service. Based on *proven* VLSI designs and Concord ingenuity, our modems pack more high-performance features and time-saving options than any other 2400bps dial line modem on the market. You can choose automatic dialing, error protection, statistical multiplexing and more. We have stand-alone units, plug-in PC-compatible cards, and industry's only single-card rackmount modem that operates at 2400, 1200 and 300bps. With prices starting at \$450* Concord Data modems are not only your best bet, they're your best buy. To get in step with the communications leaders, call us at (617) 890-1394 or write 303 Bear Hill Road, Waltham, MA 02154, telex 951793.

Concord Data Systems

Leading the Communications Revolution

*CDS 224 Autodial, single unit price. Quantity discounts available. 224 is a registered trademark of Concord Data Systems, Inc.

CIRCLE NO. 37 ON INQUIRY CARD

system, which runs independently of or along with the basic system, ensures that each claim has a matching valid policy. By typing a policy-identification number into the system, an operator can check if a claim is being made against a policy that has been canceled or that has excessively late premium payments.

The claims system also tracks workers' compensation insurance records, including medical and indemnity amount; and property insurance records, including building, contents and expenses entries. The system records the methods used to report a claim, the date the claim was reported, the closing date, the location and date of the loss and the next follow-up date of the claim. The claims program also offers a "virtual diary," which provides space to describe the loss and to list other pertinent information. Using the report generator, insurers can produce loss runs according to type of claim, policy, line of coverage, agency, location, carrier or range of dates.

Menus simplify system operation

Both the management-information and claims system are menu-driven and thus are easy to learn and operate because users need to use only one menu to operate all the modules. The system's software also provides security via password protection. In addition, the modules use on-line transactional—rather than batch—processing. Transactional processing provides all network users with immediate access to up-to-

date information after one user stores a new or updated file.

The InterGuard configuration has 20 Deskpro Model 1 personal computers, each incorporating an 8086 microprocessor from Intel Corp. and each offering six expansion slots. In addition, each workstation includes a 320K-byte floppy disk drive, 256K bytes of RAM and the 3Com EtherLink, a plug-in board that connects the Deskpro workstations to the EtherSeries network. Users can upgrade the workstations with a 10M-, 20M- or 30M-byte fixed disk and an integral tape backup. The network revolves around a 3Com AP file server and a workstation with 640K bytes of RAM, which acts as an additional file server.

As InterGuard's insurance operations expand, FutureGuard will add 10 more Deskpro workstations to the InterGuard network. Because the EtherSeries LAN supports 1,024 terminals—with an additional file server required for every 25 connections—users can adjust the size of the network to suit their needs.

Because the beta-test site's proprietary software requires 128M bytes, a 168M-byte hard disk subsystem from National Memory Systems, Livermore, Calif., stores the application software and data files. Backing up the hard disk is a file-oriented, nine-track tape-cartridge drive, also from National Memory Systems. Peripherals include three ML92 system printers from Okidata Corp., Mount Laurel, N.J., three ML92

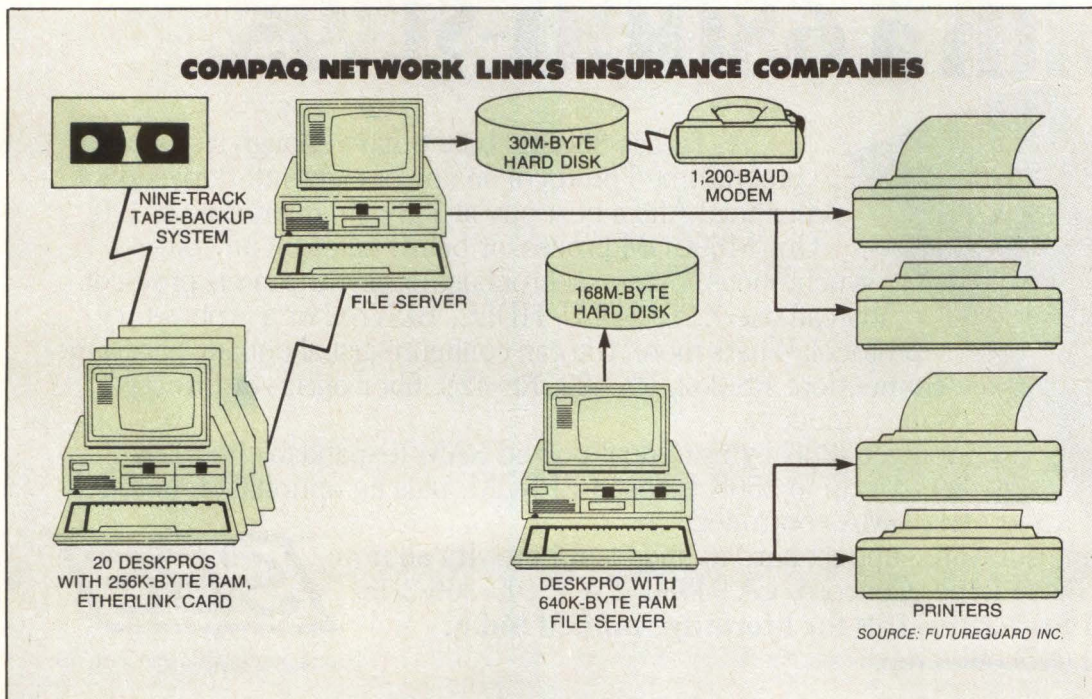

FutureGuard's MGA information-management system combines 20 Compaq Deskpro workstations, National Memory Systems hard disk/tape backup subsystems, four Okidata printers, a 3Com AP file server and a Hayes 1,200-baud modem for remote electronic mail and data access.

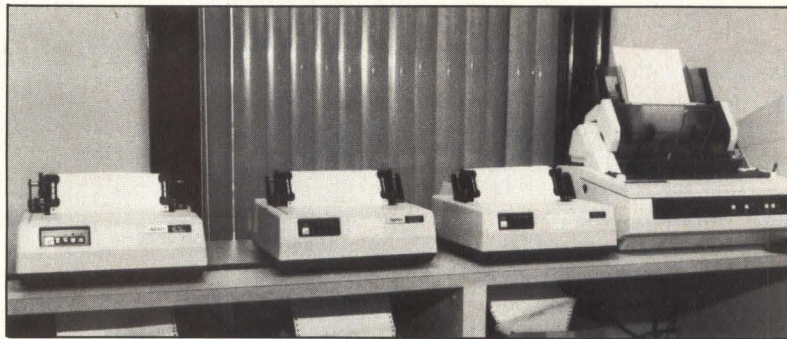

High-speed Oki-data printers in the FutureGuard network produce insurance forms and provide letter-quality print for correspondence.

local printers to handle checks and special forms and a Spinwriter 3510 letter-quality printer from NEC Information Systems Inc., Lexington, Mass. The system also includes a 1,200-baud modem from Hayes Microcomputer Products, Norcross, Ga., for remote electronic mail and data access. The MGA system requires no special electrical connections to install, but FutureGuard recommends the use of separate 120V-AC outlets with surge protection for each device on the network.

The MGA system has provided InterGuard

with significant employee productivity gains, says InterGuard President Y. Judd Shoval. He says that 12 employees with the FutureGuard system can do the work formerly done by approximately 50 employees working manually. In addition, Shoval says, "Less back-office overhead means more money for payments, agent commissions and profit." He adds, "Many insurance companies spend one-third of their revenues on operational expenses, leaving only two-thirds of every premium dollar for claim payments. At InterGuard, operational expenses averaged only 22 percent for the past year." □

Michael R. Tankle, vice president of operations at FutureGuard Inc., Wilkes-Barre, Pa., is the principal architect and programmer of the company's MGA information-, property- and casualty-management systems.

Interest Quotient (Circle One)
High 477 Medium 478 Low 479

Multibus communications become faster and smarter with a 68000-\$1395.

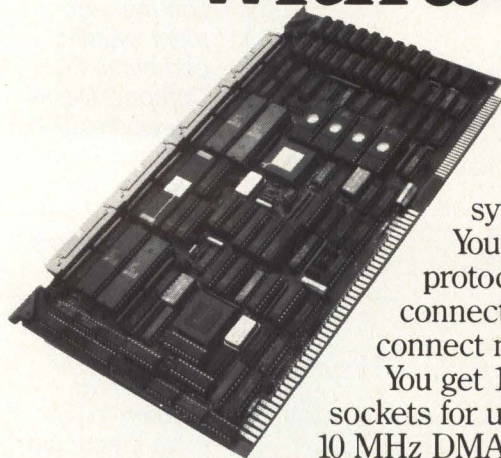

As fast as 800,000 bps. Smart enough to run any programmed protocol on any of eight full-duplex data channels. And a best buy at \$1395 in quantities of 100.

Our M68COM processor board takes on any bit-synchronous, byte-synchronous, or asynchronous protocol. You can use X.25, SDLC, HDLC, BISYNC or a proprietary protocol. What's more, you can configure just about any hardware connection: RS-232, RS-422, RS-423, fiber optics or direct-connect modem.

You get 128K bytes of dual-ported RAM (expandable to 512K), sockets for up to 256K bytes of EPROM, plus an optional on-board 10 MHz DMA controller.

We offer ongoing software support hard to find elsewhere. It's all from SBE, Inc., 2400 Bisso Lane, Concord, CA 94520. TWX: 910-366-2116.

Phone free 1-800-221-6458 for literature mailed today.

In California call (415) 680-7722.



Computer boards and systems.

Multibus, iSBX and Multimodule are trademarks of Intel Corp.

CIRCLE NO. 38 ON INQUIRY CARD

INTRODUCING THE FASTEST PC IN THE WORLD. WHAT YOU DO WITH IT IS YOUR BUSINESS.



Think what you could do with a personal computer whose sheer power and speed simply leave the competition in the dust.

ITT proudly announces the new ITT XTRA™ XP, carefully crafted around the powerful Intel 80286.

Imagine, up to 2 MB of memory to match all of that muscle.

Imagine over three and a half times faster and fully compatible with the IBM XT and twenty-five percent faster than the AT on a Lotus recomputation.

Imagine proven dependability, flexibility and serviceability. And the partnership of a \$20 billion international corporation.

Now stop imagining. And start dialing.

Call (800) 321-7661, or in California, (800) 368-7300. Or clip the coupon for much more information on one of the most powerful weapons in the VAR's arsenal yet.

Whatever you do, do it soon. Before the rest of the business world passes you by. Faster than you can imagine.

ITT Information Systems-Mail Stop 38
2350 Gume Drive
San Jose, California 95131
Please send me more information on the ITT VAR Program.

Name _____
Title _____
Company _____
Address _____
City _____
State _____ Zip _____
Phone _____

ITT
PERSONAL COMPUTERS

HELPING AMERICA WORK SMART.

© 1985, ITT Systems, Inc.
IBM XT and AT are registered trademarks of International Business Machines. Intel 80286 is a registered trademark of Intel Corporation.
The new ITT XTRA™ XP is scheduled to be available summer of 1985.

CIRCLE NO. 39 ON INQUIRY CARD



COMDEX/Fall '85...

The COMDEX Exposition... for your best prospects!

COMDEX delivers the largest national audience of your best prospects—at one time, in one place, in an environment designed for doing business.

SUPPLIERS—COMDEX will attract over 100,000 resellers (exclusively!) who depend on companies like yours for the products their customers demand. You'll do business with VARs, System Inte-

grators, Commercial OEMs, Retailers, Dealers, Distributors and other successful resellers who can move your products in the marketplace.

RESELLERS—You'll find hardware, software, related products and support programs from over 1,000 companies that will keep your customers coming back and new ones coming in. And, you can take advantage of special offers, discounts and incentives that many vendors feature at COMDEX!

The COMDEX Conference... for building profits now!

From value-added reselling, to vertical marketing, to effective promotion and all the other sales, marketing and management issues facing today's reseller, no industry forum can match The COMDEX Conference. Leading industry experts will show you the proven ideas and techniques that you can use *now* to keep products



World's leading producer of computer conferences and expositions including: COMDEX/Winter, COMDEX/Spring, COMDEX/Fall, COMDEX/Europe, COMDEX in JAPAN, INTERFACE, FEDERAL DP and COMMUNICATIONS Conference & Expo, The Nationwide COMPUTER SHOWCASE EXPOS and THE BYTE COMPUTER SHOWS.

©Copyright 1985 • 300 First Avenue, Needham, Massachusetts, USA 02194 • (617) 449-6600 • TELEX - 951176 • FAX (617) 449-6953

Offices In:

Los Angeles

San Francisco

Washington, DC

Amsterdam

Tokyo

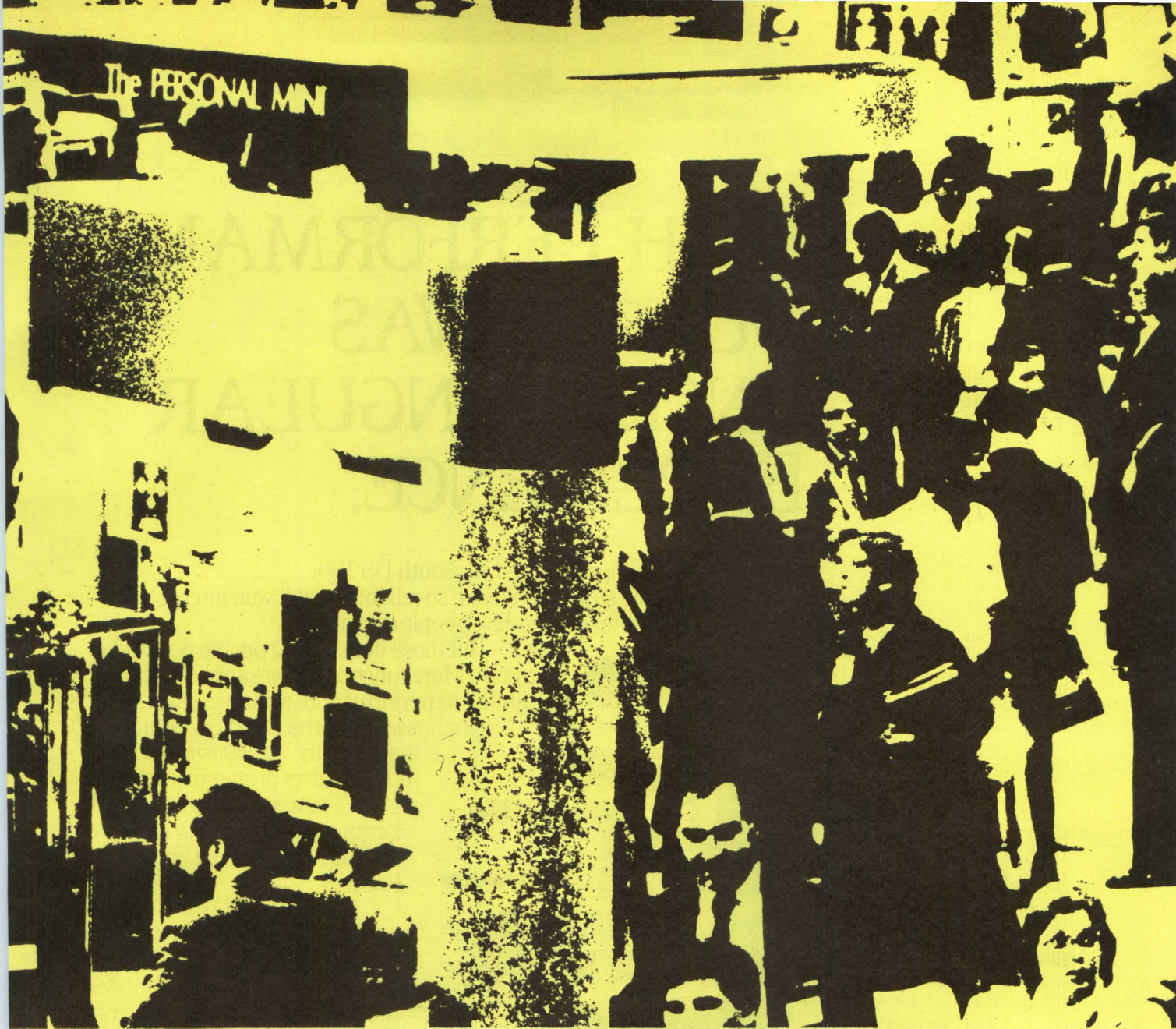

for new business now!

moving from your shelves...and
add profits to your bottom line.

Now, more than ever before,
the best place to find new busi-
ness, new ideas, new contacts and
new profit opportunities is
COMDEX/Fall, November 20-24,
1985 in Las Vegas.

COMDEX/Fall '85

Nov. 20-24, 1985
Las Vegas, Nevada

YES, I want to find new business *now* at COMDEX/Fall '85!

- Let me know today what space is still available
- Please send me complete attendee information
- Please send me complete exhibitor information

Name _____

Title _____ Phone () _____

Company _____

Address _____

City _____ State _____ Zip _____

For exhibitor or attendee information, complete and return this coupon to:
COMDEX/Fall '85, 300 First Avenue, Needham, Massachusetts 02194;
or call (617) 449-6600.

CIRCLE NO. 41 ON INQUIRY CARD

HIGH PERFORMANCE OUTPUT WAS ONCE A SINGULAR EXPERIENCE.

That experience was the Datasouth DS 180.

The machine so sophisticated, so reliable, that it won international acclaim as the printer demanding people demand.

But those demanding people demanded more. More functions, more applications, the ability to perform more printing tasks.

Our answer was the DS 220. A multi-mode that actually *outperformed* every other matrix printer in its class.

Then, we brought high performance to the personal computer, with our own line of Personal Printers.

Our DaisyWheel 36 brought the Datasouth reputation to daisy-wheel printing.

And our CX and TX models freed once-captive IBM users from the need to buy overpriced IBM printers.

We even improved on the original, with the new DS 180 Plus and the new DS 180DD for demand document applications.

So, what was once a singular experience is now plural: the Datasouth High Performance printer *family*.

IBM is a registered trademark of International Business Machines.



datasouth

H I G H P E R F O R M A N C E P R I N T E R S

Datasouth Computer Corporation
Box 240947 • Charlotte, NC 28224
704/523-8500 • Tx 6843018 DA50U UW

AVAILABLE NATIONWIDE
THROUGH OUR NETWORK OF
SALES AND SERVICE DISTRIBUTORS

CALL TOLL FREE:
1-800-222-4528
Extension number 603

CIRCLE NO. 42 ON INQUIRY CARD

FEATURE HIGHLIGHTS

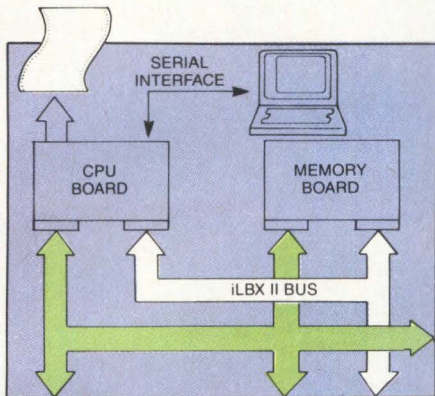

p. 77 . Multibus II, VMEbus compete

SINGLE-BOARD COMPUTERS: MULTIBUS II, VMEBUS CLASH IN 32-BIT ARENA 77

Backers of Multibus II and VMEbus tend to associate superior multiprocessing and real-time capabilities with their respective buses and concede little to their opponents. This is the first of a two-part series comparing the two dominant 32-bit buses.

OEM MARKET SPOTLIGHT SHIFTS TO 'PC OEMS' 89

Taking advantage of two new de facto standards — the MS-DOS/PC-DOS operating system and the PC bus — a new breed of OEMs allow integrators to configure systems from the ground up with “mix-and-match” kits ranging from single-board computers to complete subsystems.

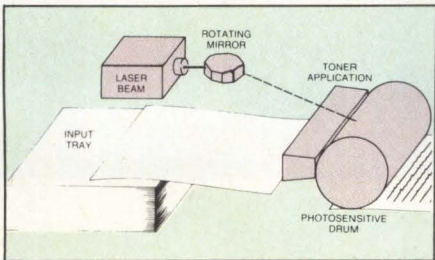

p. 101 Running graphics fast

IMAGE PROCESSING ENHANCES LASER PRINTING (Cover story) 101

Laser printers are proven alternatives to letter-quality impact printers and plotters, and they are increasingly being differentiated on the basis of their intelligence. That's where the image processor comes into play.

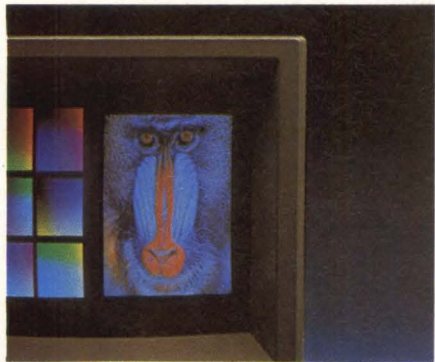

p. 113 PC graphics cards

GRAPHICS CARDS FLOOD PC MARKETPLACE 113

Encouraged by enthusiastic buyer response and a growing body of application software, dozens of manufacturers are supplying high-performance graphics cards for the IBM PC family. Our coverage includes a comprehensive product table, beginning on p. 125.

DATABASE SOFTWARE: LATEST LANGUAGES LINK DATA TO DIVERSE TASKS 135

Fourth-generation languages, such as SQL, are powerful non-procedural languages that facilitate developing DBMS applications. Although there are a variety of approaches, a move to standardize is firmly underway.

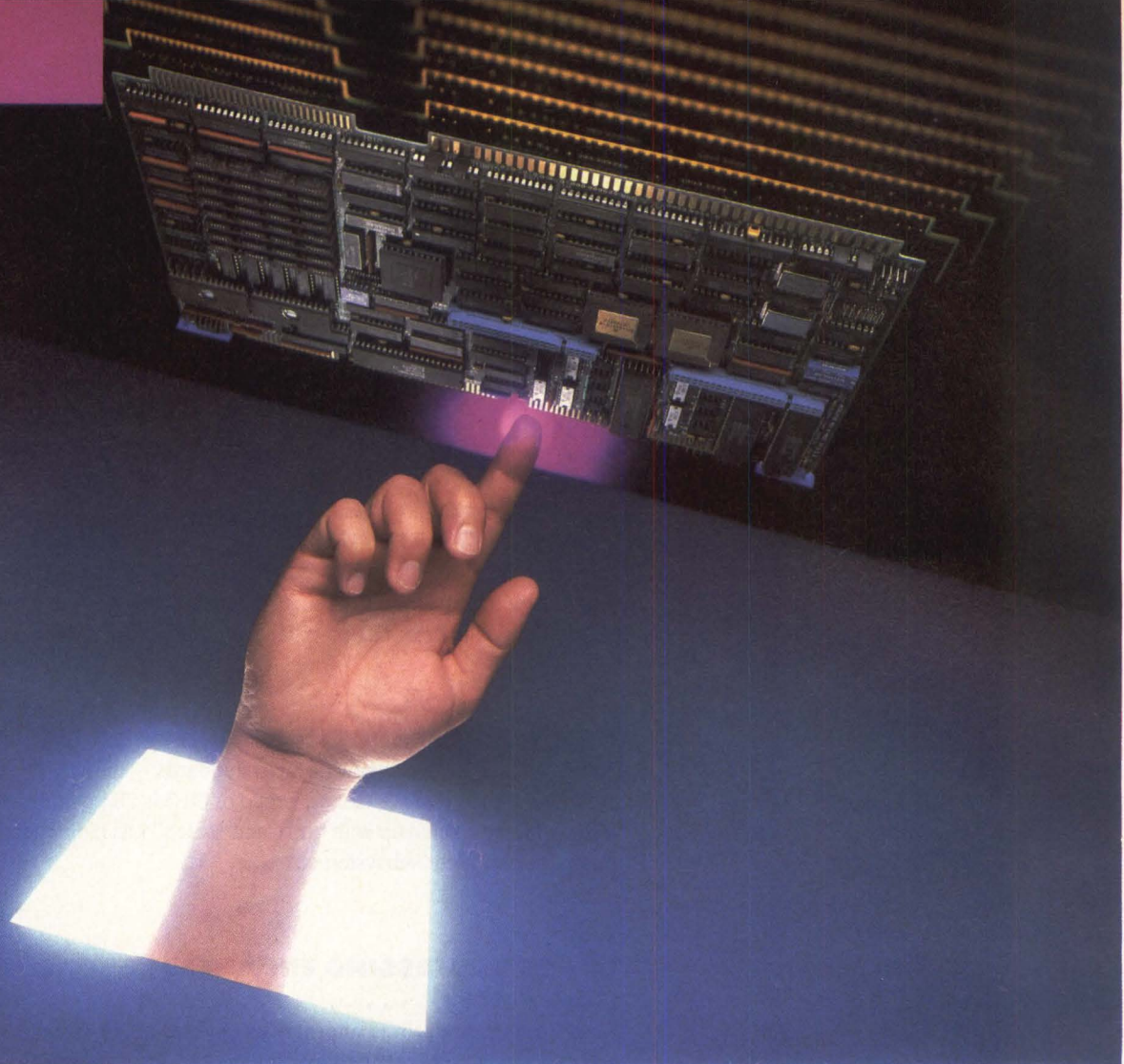

**Heurikon
Brings
Complex
Applications
Within
Reach**

Introducing The Power To Break Through Barriers. The HK68/M™ Family Of Microcomputers.

Heurikon's new family of Multibus™ single board microcomputers unleashes your creativity in demanding technical applications. The HK68/M10 and HK68/ME represent powerful, single board solutions to complex applications. With these 16 bit processors, the barriers of complexity are broken. The HK68/M family combines the versatility you want with the features you require. Heurikon keeps you and your application moving. Now and in the future. Smoothly. Dependably. Toward success.

There is no more powerful single processor board for UNIX™, image processing, communications and scientific applications than the HK68/M10.

- No wait state 10 or 12.5 MHz 68010 CPU
- Up to 1 MByte of on-card dual access DRAM
- 128K of EPROM
- Single cycle mode DMAC
- Optional MMU
- iLBX™ high speed memory expansion bus

- Full SCSI high speed parallel bus
- 4 serial ports
- Twin 16 bit iSBX™ connectors
- Optional floating point processor

The HK68/ME provides the power of the HK68/M10 with the economy and speed required for real time systems. For industrial vision, data acquisition or control applications, the HK68/ME is unsurpassed in price/performance characteristics.

Heurikon also offers another powerful tool: *Technical Assistance* in your search to break through and solve complex application problems. Just call:

1 800 356 9602
HEURIKON CORP.

3201 Latham Drive, Madison, WI 53713.
(608) 271-8700.

Specifications may change without notice.
Multibus, iLBX and iSBX are trademarks of Intel Corp.
Unix is a trademark of Bell Laboratories, Inc.

CIRCLE NO. 43 ON INQUIRY CARD

MULTIBUS II, VMEBUS CLASH IN 32-BIT ARENA

The business stakes are high as two heavyweight single-board-computer buses compete for high-end multiprocessing applications

Jesse Victor, Associate Editor

The leading 32-bit buses, Multibus II and VMEbus, are battling for the hearts and minds of system integrators preparing to step up from today's 16-bit systems to tomorrow's 32-bit systems. Other would-be contenders, IEEE P696 ("Futurebus") and NuBus, lack vendor support so have not yet, in effect, entered the 32-bit arena. VMEbus and Multibus II, however, are rallying vendors into their camps and rolling out the "big guns:" new 32-bit, single-board-computer-based products designed to meet the rigorous demands of industrial and business multiprocessing applications.

The stakes are high. Vendors are contending for what the Multibus Manufacturer's Group predicts will be a total board market of nearly \$2.2 billion by 1990. And the "armed camp" metaphor is accurate. Backers of Multibus II and VMEbus tend to associate superior multiprocessing and real-time capabilities with their respective buses and concede little to their opponents. Because of this highly partisan attitude, it is necessary to focus clearly on each bus' strengths and weaknesses—in terms of both technology and market position—to accurately weigh the claims of their advocates.

In terms of technology, system integrators

This is the first of two articles comparing Multibus II and VMEbus. The next article will appear in the September issue of *Mini-Micro Systems* and will focus on methods of arbitration and the synchronous vs. asynchronous debate.

should take particular note of the fact that the two buses have very different approaches to interrupt handling and message passing. In terms of market position, both buses have unique advantages. VMEbus has a significant lead in installed products, but, Multibus II has real advantages in industrial-automation applications.

Multibus sends a message

Multibus II defines a hardware-based message-passing protocol, which its backers claim offers significant benefits for multiprocessing systems by off-loading interrupt-handling tasks to each board's message-passing coprocessor and special interface. Each message packet can contain as many as 32 bytes of information—in addition to source and destination addresses and message bytes. This "virtual" interrupt-handling scheme supports 255 interrupt sources or destinations.

Handling I/O through this approach, says Jeff Roloff, president of Central Data Corp., Champaign, Ill., saves time in servicing I/O and simplifies the implementation of interprocessor communication. "Message passing is one of the easiest ways of sharing the work load in multiprocessing systems. [In a dedicated system,] you have to pull an interrupt line and then poll the processor. With message passing you send a message to a predefined source, which picks it up off the bus. Once the message is passed, no more interaction to service I/O is necessary," Roloff says.

"The overriding superiority of Multibus II over VMEbus is its message-passing capability,

Backers of Multibus II and VMEbus tend to associate superior multiprocessing and real-time capabilities with their respective buses.

which doesn't tie up the bus for long periods of time," agrees W. E. Potter, vice president of marketing and sales at Multibus-board vendor Micro Industries Corp., Waterville, Ohio. "Without it, if a peripheral board wants to get on the bus, it must sit and wait, not performing its functions. With it, the information is put on the bus interface chip's registers, which does the waiting instead of the CPU or the peripheral board."

"If, for example, an Intel [Corp.] 80286 or 80386 CPU card specifies that it wants to do, say a 2K-byte transfer," Intel technical marketing manager at Hillsboro, Ore., John Beaston explains, "it will pass that information [to the message-passing coprocessor], which will handle the transfers over the bus." Because the coprocessor, and not a board's main processor, effects the message passing, Beaston emphasizes, Multibus II can support 32-bit data transfers with 16-bit processors on the I/O boards.

Message passing, Beaston contends, eliminates the need for dual-ported memory structures and

prevents bus saturation with a high number of bus masters. "Dual-port architectures typically work well with two or three bus masters talking back and forth," he comments. "The minute you go beyond that you need to use semaphores and similar methods. But these techniques are not usually workable beyond two or three masters."

"It's very difficult to put more than two or three CPU cards on a VMEbus system," says Potter. "With Multibus II, you can string them out to the hundreds. It is thus easier to do an automated factory in Multibus II."

VMEbus responds

VMEbus supporters scoff at Multibus II's claimed superiority for multiprocessing and what they see as Intel's pretense that it invented message-passing capability and virtual interrupts.

"VMEbus is designed specifically to take advantage of the distributed intelligence of multiprocessing systems," says John Black Jr., manager of the systems and technology group at

THREE MARKET-SHARE PROJECTIONS

**FROM MULTIBUS II CAMP
(TOTAL BOARD MARKET)**

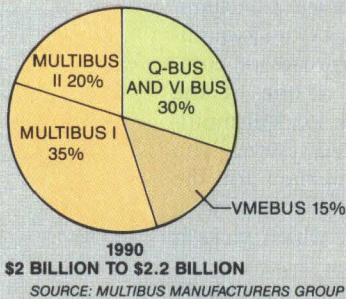
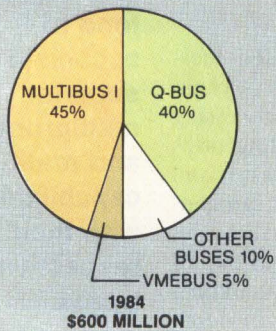

**FROM VMEBUS CAMP
(WORLDWIDE 16/32-BIT
MICROCOMPUTER BOARD MARKET)**

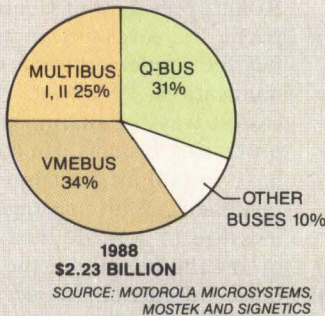
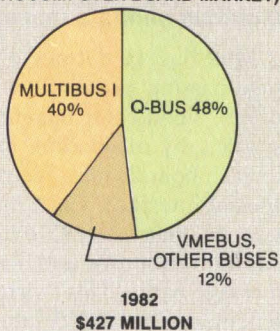

**FROM INDEPENDENT ANALYSTS
(WORLDWIDE MERCHANT
SINGLE-BOARD COMPUTER SHIPMENTS)**

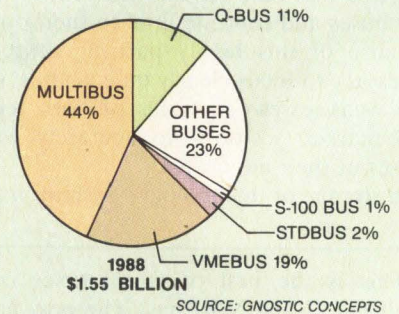
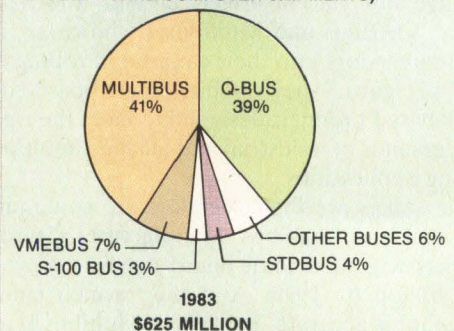

Chairman of the boards

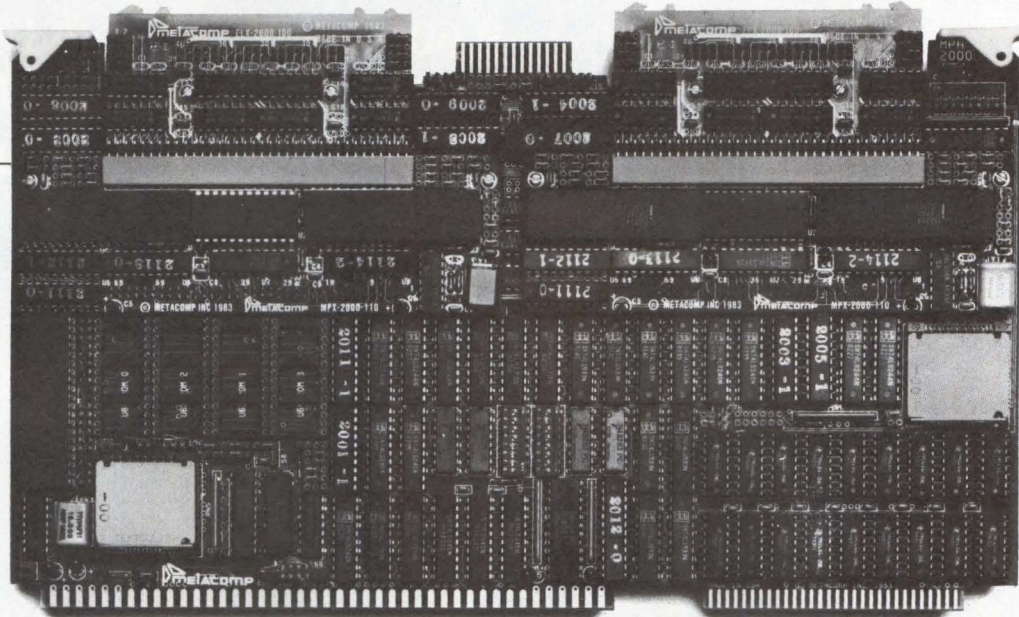

The first true Multibus single-board computer

The MPA-2000 is highly qualified for the top slot. It's the first to offer the iAPX-186 CPU. The first to offer 512KB of dynamic RAM. And, the first with architecture that allows plug-in modules with multiple DMA channel support.

That makes it the first CPU and I/O processor that combines: data processing, data communications, local area networking, disk I/O and similar peripheral functions. Standard data communications packages available include; CCITT-1980 X.25, IBM-3270 SNA (LU 1, 2 & 3), SDLC, HDLC (LAPB) and IBM-3270 BISYNC. Operating system portations include; PC-DOS, iRMX-86, VRTX/86 and MTOS-86. In all, it has the performance and capability to replace 2, 3 or 4 board members in most applications.

With that outstanding resume, it's easy to see how the MPA-2000 became the unchallenged Chairman of the Boards.

For complete specifications and ordering information, call or write METACOMP, Inc., 9466 Black Mountain Road, San Diego, California 92126, (619) 578-9840. TWX 910-335-1736 METACOMP SDG.

Ask for the resume of the Chairman of the Boards.

METACOMP™

The MPA-2000 is a trademark of METACOMP, Inc., Multibus, and iRMX-86 are trademarks of Intel Corp., PC-DOS is a trademark of IBM Corp., MTOS-86 is a trademark of Industrial Programming, Inc. VRTX/86 is a trademark of Hunter and Ready, Inc.
© Copyright 1984 METACOMP, Inc. All rights reserved.

INTERNATIONAL

#51 Mr. Roger Phebey
MICRO-MARKETING, LTD.
Unit 11A, Rose Industrial Est
Bourne End, Bucks SL8 5AS
United Kingdom
TLX: 848080 Micro G
Tel: 44-06285-29222

#52 Mr. Alan Tingaud
TEKELEC-AIRTRONIC
BP No. 2 Cite Des Bruyeres
Rue Carle-Vernet
92310 Severes, FRANCE
TLX: 204522 TKLC
Tel: (1) 53-475-35

#53 Mr. Thomas Ferber
ALLMOS ELECTRONIC GMBH
Fraunhoferstrasse 11A
D-8033 Martinsried
West Germany
TLX: 5215111 AlecD
Tel: 89-857-20-86

THE MULTIBUS BREAKTHROUGH PEOPLE

CIRCLE NO. 44 ON INQUIRY CARD

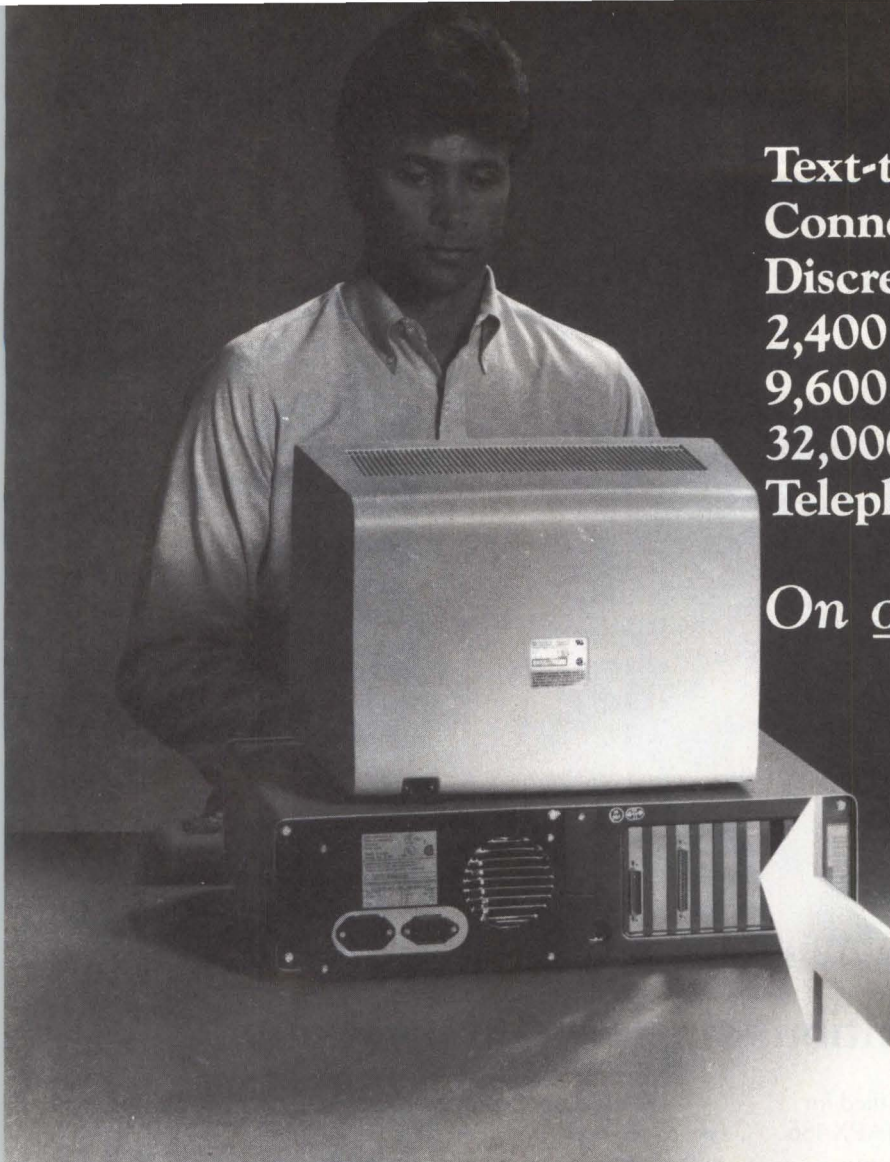

Text-to-Speech
Connected Word Recognition
Discrete Word Recognition
2,400 bps Record and Playback
9,600 bps Record and Playback
32,000 bps Record and Playback
Telephone Interface (optional)

On one PC option board!

The TI-Speech™ option says it all ...for under \$1,000.

The TI-Speech option gives you versatile speech capabilities on one plug-in option board—for both the Texas Instruments Professional Computer family and IBM® Personal Computer products.*

The Text-to-Speech capability allows any English information stored as ASCII text to be spoken—and the natural, computer-generated voice provides the flexibility of an unlimited vocabulary.

Connected word recognition lets the computer understand specific commands spoken in a natural, conversational manner. For situations that require it, discrete word recognition allows the computer to listen for specific commands spoken individually. In either case, spoken commands can replace a number of predetermined keystrokes.

You get a range of 2,400, 9,600, or a full 32,000 bps for voice storage and playback. This lets you balance the maximum recording time with high-quality, natural voice output, depending on your application requirements.

With the optional telephone interface, your computer can place a telephone call, send and receive Touch Tone® signals, or answer your phone. You may combine any of the telephone and speech functions to create applications that can dramatically extend the capabilities of your computer.

Let's start talking.

For more information on the TI-Speech option and how you can get started, call

us toll-free at 1-800-527-3500. If you want to hear an example of TI-Speech, call 1-512-250-4114 (this is a toll call).

*(Not for use on the TI Pro-Lite™ computer or the IBM PCjr™ computer.)

TI-Speech and Pro-Lite are trademarks of Texas Instruments.

IBM is a registered trademark and PCjr. is a trademark of International Business Machines Corporation.

Touch Tone is a registered trademark of AT&T.

© 1985 TI

TEXAS 
INSTRUMENTS

Creating useful products
and services for you.

CIRCLE NO. 45 ON INQUIRY CARD

Motorola Microsystems Inc., Tempe, Ariz. "Anything you can do with message passing in Multibus II you can do in VME. Message passing can be done in many different ways. Multibus II has chosen to implement it using dedicated modules. It's a rather rigid approach."

Multibus II's message-passing scheme, Black

says, is "awkward to use" for very long messages, when the volume of traffic might overrun a first-in-first-out buffer, or when message sizes differ from one another.

According to Schlomo Pri-Tal, staff engineer in Motorola Microsystems' systems and technology group, VMEbus has location monitors that

Two Multibus II buses—the iPSB and iLBX—guide data transfer and handle memory access for Micro Industries MIB II 86/40 measurement and control board and MIB II 86/78 color video controller in an industrial process-control and measurement system.

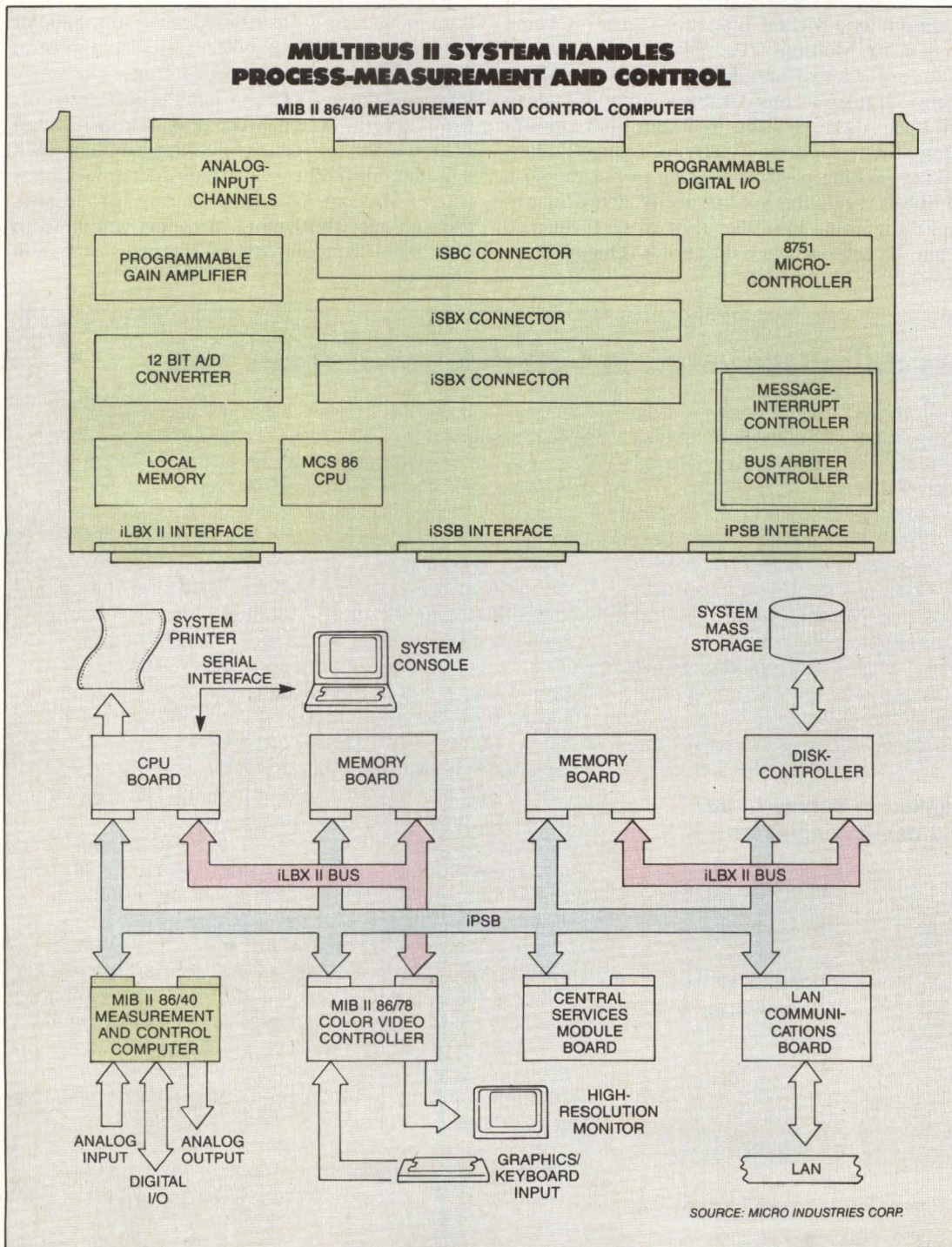

can implement various kinds of message-passing mechanisms. "Message passing is very much dependent on what the microprocessors on the bus are being used for. Software determines the best way to pass messages between devices that share the bus. By imposing a specific method of passing messages you have to change your software to adapt to the bus' scheme," he asserts.

VMEbus uses seven interrupt request lines, in addition to a virtual interrupt-register scheme similar to Multibus II's, Black says, because there are a lot of peripherals designed to drive them. "It takes a considerable amount of logic to interface these devices to a bus that doesn't allow them to drive [interrupt-request] lines. Taking existing parts and trying to put them on Multibus II requires you to specify all the logic to make the chips look like they work through a requester scheme when they don't. That can be a problem."

VMEbus' interrupt structure, Black says, ensures that all interrupts will be serviced in some finite, bounded time—a crucial need in real-time systems. "The VMEbus arbiter can signal the board controlling the bus to stop its data transfer and remove itself from the bus when a higher priority request is pending," he explains, adding, "Multibus II lacks a similar capability."

VMEbus guarantees flexibility, he says, with both single and distributed interrupt-handler schemes. In single-handler systems, a central system supervisory processor monitors all seven interrupt-request lines to handle bus interrupts from several other processors. A distributed system has two to seven interrupt handlers, each handling different prioritized interrupt-request lines. Message passing among processors through global memory prevents attempts to simultaneously access system resources or system "lock-up."

VMEbus claims the edge in board-level-systems poll

A survey of 537 system and design engineers by Market Information Center Inc., Framingham, Mass., furnishes some perspective on inflated claims to bus supremacy by bus advocates.

Although Multibus I and the IBM Corp. PC bus were given as the buses of choice for current board-based systems, VMEbus emerged as the one most likely to be used over the next two years. VMEbus also held an edge over Multibus II in "versatility and long-range usefulness" among engineers polled.

Harry Henry, Information Center president, warns, however, that these results may not accurately reflect each bus' future market share, which is based on the number of boards shipped, because the survey indi-

cates only the choice of bus and not the number of boards specified for a particular application. "A system integrator who chooses Multibus II may need, say, thousands of boards while someone who decides on VMEbus may specify only a few hundred," Henry notes, although both bus choices count as one "vote" in the survey.

Engineers chose "approved standard" and "future compatibility" as the most important criteria for bus-selection. "These were the factors that really made a difference to people," Henry concludes. "They don't want to buy a one-and-only design or something that doesn't have a future upgrade path." Other considerations deemed less crucial were arbitration method, bandwidth, board size and connector type.

Although they were not further defined, Henry feels that most "proprietary bus" survey responses probably allude to only slightly modified versions of standard bus products. "Everyone wants to have his own unique thing. Someone may take a standard product, alter it ever so slightly and call it proprietary."

Henry attributes the relative decline of the 16-bit IBM PC bus in the standings and the growing ascendancy of the 32-bit Multibus II and VMEbus to companies seeking to diversify their product line. They want to move away, he says, from "straight business automation" to areas such as medical imaging, factory automation, robotics, computer-aided design/computer-aided manufacturing and militarized systems.

"These are areas which lend themselves to more industrialized products where the IBM name has less influence," Henry observes, "and they are areas in which both Multibus II and VMEbus will shine."

How buses ranked in survey of 537 system and design engineers

Buses in use now	Buses expected to be used during the next two years
1. IBM PC bus, Multibus I (tie)	1. VMEbus
2. Proprietary	2. Multibus II
3. VMEbus	3. IBM PC bus
4. Q-bus	4. Proprietary
5. STDbus	5. STDbus
6. Unibus	6. Q-bus
7. S-100	7. Unibus
	8. S-100

Source: Market Information Center Inc.

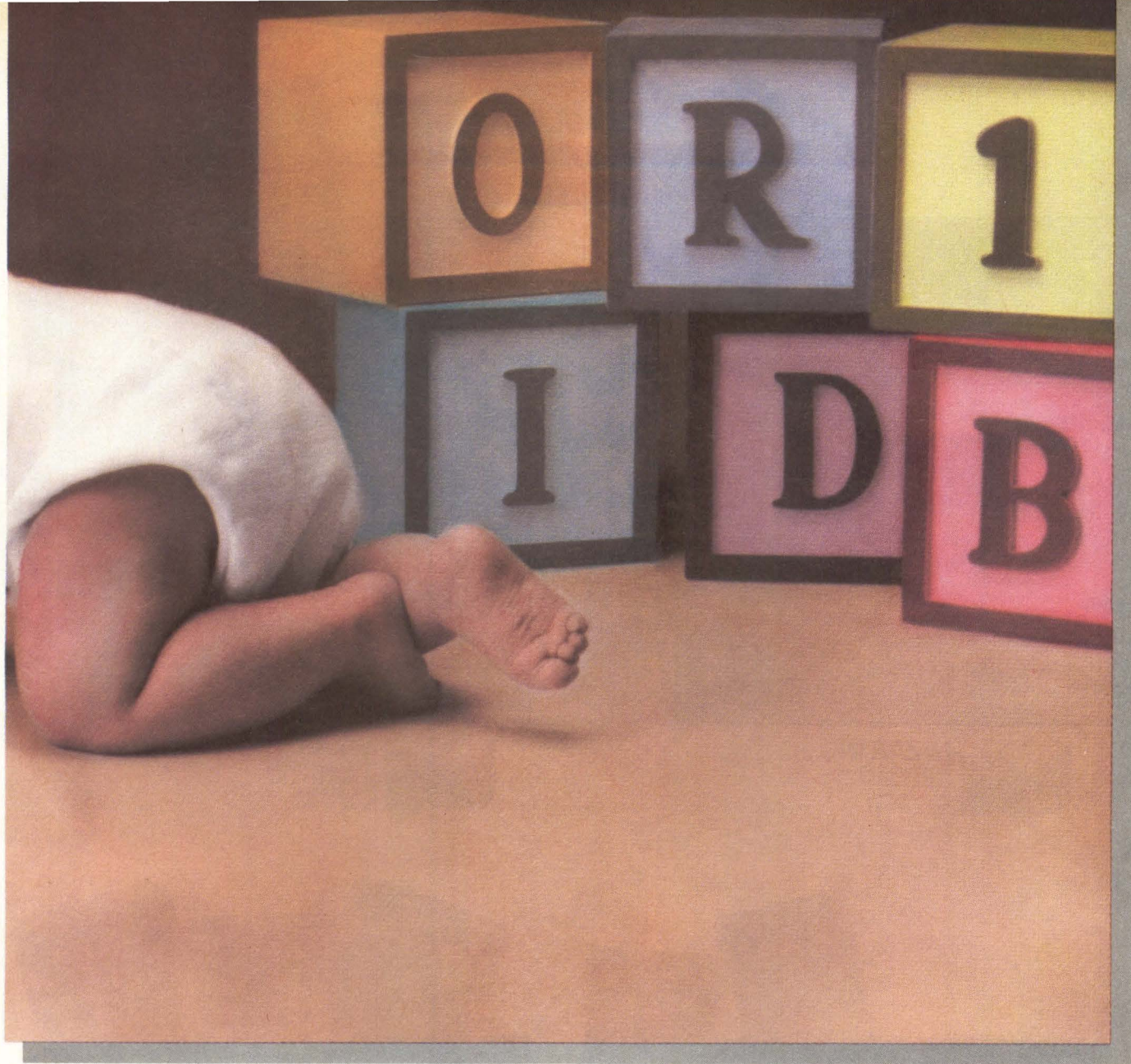

 SOFTWARE AG

When you're ready to leave the toys behind.

Software AG is ready with ADABAS(VMS) and NATURAL(VMS)—database management and information processing for VAX supermini-computers. Advanced software solutions that meet the requirements of a high-volume production environment. Call us today at 1-800-336-3761. (In Virginia and Canada, call 1-703-860-5050).

 SOFTWARE AG

Where the future
comes as no surprise.

© 1985 Software AG of North America, Inc.
ADABAS and NATURAL are trademarks of Software AG of North America Inc.
VAX and VMS are trademarks of Digital Equipment Corporation.

CIRCLE NO. 46 ON INQUIRY CARD

MM0885



**FOR VMEbus
CPU MODULES,
CALL MIZAR.
612-224-8941**

We have the CPU module that fits. Our top-quality single- and double-height CPU modules support the 68000 family of microprocessors at speeds of 8, 10 and 12.5 Mhz; have on-board memory from 16K bytes to 1/2M of RAM; and have 32K bytes to 128K bytes of EPROM. Double-height modules have many additional features.

For full details, call Mizar...
the VMEbus authority.



MIZAR INC.

302 Chester Street
St. Paul, MN 55107
(612) 224-8941
Telex: 469542



**FOR VMEbus
I/O MODULES,
CALL MIZAR.
612-224-8941**

Our top-quality line of single-height I/O modules includes Quad Serial Port and Quad Parallel Port cards, Analog Input and Output cards, and Counter-Timer card. Our double-height 8-channel serial communications processor is an intelligent self-contained VMEbus serial communications center.

For full details, call Mizar...
the VMEbus authority.



MIZAR INC.

302 Chester Street
St. Paul, MN 55107
(612) 224-8941
Telex: 469542



**FOR VMEbus
CONTROLLERS
AND INTERFACE
MODULES,
CALL MIZAR.
612-224-8941**

We have the modules you need: quality single-height and intelligent double-height VME disk controllers for floppy and Winchester disk drives; single- and double-height GPIB controllers with or without DMA; and single- and double-height video and graphics controller modules. All available in evaluation units from stock.

For full details, call Mizar...
the VMEbus authority.

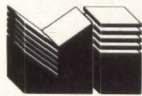

MIZAR INC.

302 Chester Street
St. Paul, MN 55107
(612) 224-8941
Telex: 469542



**CALL MIZAR.
THE VMEbus
AUTHORITY.
612-224-8941**

You can't beat Mizar for top-quality VMEbus boards, systems, software... and service. We have a complete line of VMEbus products... single- and double-height CPUs, memory modules, controllers, and I/O modules; auxiliary hardware; and operating systems and software. Call us to discuss how we can help make VMEbus technology work for you. We're Mizar... the VMEbus authority.



MIZAR INC.

302 Chester Street
St. Paul, MN 55107
(612) 224-8941
Telex: 469542

In determining which bus best meets their needs, system integrators also have to keep track of market forces—and both products are actively jockeying for position. Multibus II and VMEbus vendors have rolled out 32-bit single-board computers—based on Motorola's MC68020, Intel's 80286 or National Semiconductor Corp.'s NS32032 microprocessor—to back up their claims of bus superiority and to meet the stringent requirements of real-time multiprocessing systems.

VMEbus vendors naturally gravitate to the 68020. Ironics Corp., for example, uses a 12.5- or 16-MHz version in its IV-3201 processor board. It has no-wait-state access to 1M byte of dual-ported local dynamic RAM and supports an optional MC68851 memory-management unit and the MC68881 floating-point coprocessor. The on-board bus interrupter and interrupt handler deal with the VMEbus in multiprocessor environments. The VMXbus interface supports high-speed access to additional local memory on that bus.

Motorola also offers both 12.5- and 16-MHz versions of the 68020 on its MVME130 and MVME131 (on-board memory management) processor boards. Operating at a sustained rate of 2 to 3 million instructions per second (MIPS), both boards also have sockets for the MC68881.

Most VMEbus vendors that furnish single-board computers based on the 68000 or 68010 microprocessors plan to step up to 32-bit-data-path, 32-bit-addressing products. Heurikon Corp., Madison, Wis., for example, will be introducing a 68020-based board, in both VMEbus and Multibus II versions, in the 3rd or 4th quarter, according to marketing manager, Joe Ramunni.

Multibus contenders appear

Multibus II vendors have also introduced, or are slated to introduce, 32-bit boards. Intel offers 13 Multibus II products, including the iSBC 286/100 80286-based processor board, four 32-bit cache-based memory boards with up to 4M bytes of RAM, the iSBC CSM/1001 central services module and Release 6 of the iRMX real-time operating system. The 286/100 uses an 8-MHz 80286 and contains iLBX and iSBX interfaces; message-interrupt, bus-arbiter and self-test controllers; two programmable serial I/O channels; and a socket for the 80287 floating-point coprocessor.

Microbar Systems Inc., Sunnyvale, Calif., has departed from the norm by using a 16-MHz MC68020 microprocessor for its Multibus II DBC II/68020 single-board computer. With on-board cache memory, memory management and

optional 68881 coprocessor, it can address 4G bytes of memory, cycles in 125 nsec, provides 2- to 4-MIPS performance, and will, in the future, support UNIX System V, according to the company.

Goodspeed Systems Inc., East Haddam, Conn., provides an alternative to 80286- or 68020-based cards with its GS-32 board utilizing the NS32032 CPU. It can operate in either Multibus II or VMEbus systems via compatibility modules plugged into its expansion bus and includes an NS32082 MMU, NS32081 floating-point coprocessor, Z80 coprocessor for I/O management, up to 2M bytes of on-board RAM, 24-bit parallel port and small computer systems interface. The MMU supports extensive debugging and error-trapping capabilities.

Support boards load up

Because a 16-bit disk controller or memory board will create bottlenecks when integrated with high-throughput buses, Multibus II and VMEbus vendors are providing support boards able to fully utilize the buses' 32-bit capabilities.

Central Data, for example, furnishes a Multibus II octal serial communications controller supporting as many as eight RS232 or RS423 ports and the bus' message-based interrupts, self-diagnostics and 32-bit direct-memory access. Micro Industries offers the MIB II 86/40 measurement and control computer and MIB II 86/78 color video controller and is planning to introduce a general-purpose, 32-bit processor board and 8M-byte memory board.

New Multibus II products will also be forthcoming from Xylogics Inc., Burlington, Mass., which will market a high-performance storage module device (SMD) controller early next year, and Analogic Corp., Danvers, Mass., which plans to introduce intelligent analog-input, expansion-multiplexer and I/O cards.

Support boards are not lacking from VMEbus vendors. For example, Interphase Corp., Dallas, offers the V/SMD 3200 SMD controller, supporting 32-bit data transfers and addressing, virtual buffering and intelligent caching. Multitasking architecture allows simultaneous disk and bus activity.

Ironics, Ithaca, N.Y.; Charles River Data Systems, Framingham, Mass.; Force Computers Inc., Los Gatos, Calif.; Micro Memory Inc., Chatsworth, Calif.; Mizar Inc., St. Paul, Minn.; and Performance Technologies Inc., East Rochester, N.Y., are among the VMEbus vendors that have introduced memory boards supporting 32-bit data transfer. Performance Technologies' PT-VME200, dual-ported, 2M-byte dynamic RAM, for example, comes in 256K-byte to 2M-

Multibus II and VMEbus vendors are providing support boards that fully utilize the buses' 32-bit capabilities.

Multibus II vendors do not see VMEbus's head start as an insurmountable obstacle.

byte versions and supports block-mode operation as well as 24-bit addressing and 32-bit data transfer on the VMX bus.

Multibus looks to industry

Both VMEbus and Multibus II have advantages in their battle for market share. "VMEbus has a considerable lead in the market," comments Central Data's Roloff. "Multibus II is going to take a number of years to get up to speed. There are a number of medium-sized, respected companies that are committed to using VME in their next-generation products."

Multibus II's strength, Roloff predicts, will be in larger industrial-control systems that need the functionality afforded by its double-height cards and in multiprocessing business-oriented systems.

"If you go to General Motors, they won't talk to you about anything but VMEbus," asserts Glen Allmendinger, president of the Harbor Research Corp., Boston. "It is very much the engineers' toy for embedded applications, such as machine-vision systems. Multibus II's strength is in more general-purpose, non-embedded

applications...of which there are plenty."

Multibus II vendors do not see VMEbus' head start as an insurmountable obstacle. "VMEbus has the advantage of having been on the market [since 1981], while Multibus II is probably two years late," observes Micro Industries' Potter. "But we think Multibus II can catch up. We are betting our dollars on it. Multibus II will win in the end because it is highly integrated. You can put more local intelligence on it than you can with VMEbus."

"VMEbus has a large number of vendors selling compatible products," concludes Harry Henry, president of Market Information Center Inc., Framingham, Mass. "Multibus II has the installed base of Multibus I users. Both will have a large enough number of users behind them—and enough staying power—that a system integrator or vendor would be comfortable with either one." □

Interest Quotient (Circle One)
High 480 Medium 481 Low 482

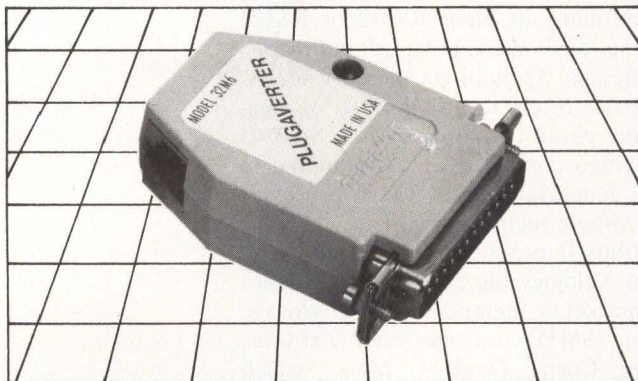

PLUG-A-VERTER

MODEL 32

- Convert RS-232 to modular phone connector
- Simplify cabling and installation
- Reduce cabling costs-use telco cable in place of bulky RS-232 cable
- Standard or custom wiring
- Priced from \$13

TELEBYTE

A PUBLIC COMPANY

Remark Division • Telebyte Technology, Inc. • 270 E. Pulaski Rd.
Greenlawn, NY 11740 • (516) 423-3232 **800-835-3298**

CIRCLE NO. 49 ON INQUIRY CARD

**Wondering
Where
To Turn
Next?**

**Turn To
Mini-Micro Systems**

**Career
Opportunities
Section**

CIRCLE NO. 98 ON INQUIRY CARD

MINI-MICRO SYSTEMS/August 1985

Only Microware's OS-9 Operating System Covers the Entire 68000 Spectrum

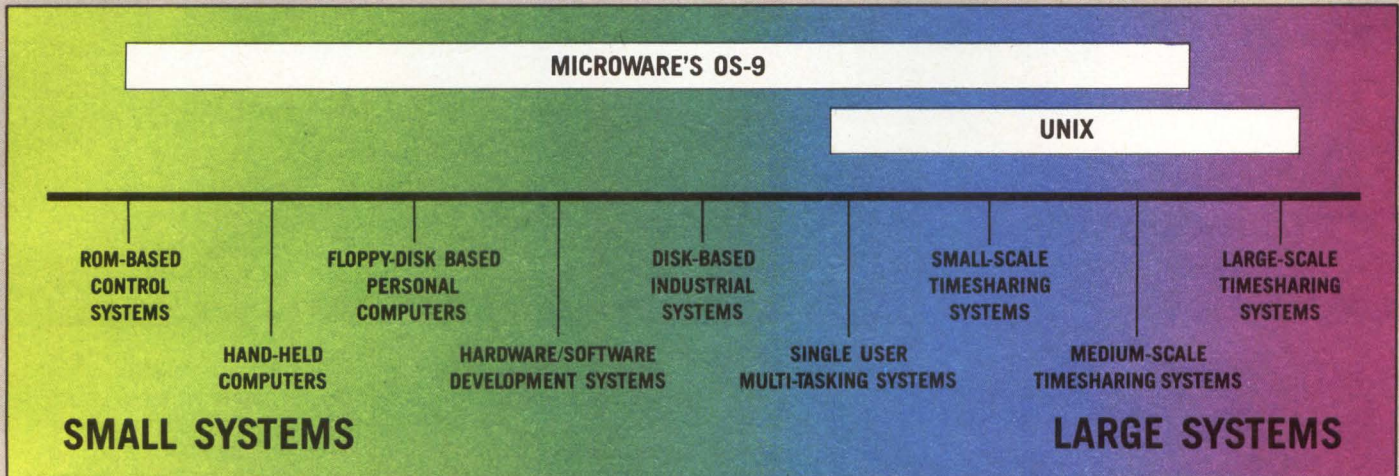

Is complicated software and expensive hardware keeping you back from Unix? Look into OS-9, the operating system from Microware that gives 68000 systems a Unix-style environment with much less overhead and complexity.

OS-9 is versatile, inexpensive, and delivers outstanding performance on any size system. The OS-9 executive is much smaller and far more efficient than Unix because it's written in fast, compact assembly language, making it ideal for critical real-time applications. OS-9 can run on a broad range of 8 to 32 bit systems based on the 68000 or 6809 family MPUs from ROM-based industrial controllers up to large multiuser systems.

OS-9'S OUTSTANDING C COMPILER IS YOUR BRIDGE TO UNIX

Microware's C compiler technology is another OS-9 advantage. The compiler produces extremely fast, compact, and ROMable code. You can easily develop and port system or application software back and forth to standard Unix systems. Cross-compiler versions for

VAX and PDP-11 make coordinated Unix/OS-9 software development a pleasure.

SUPPORT FOR MODULAR SOFTWARE — AN OS-9 EXCLUSIVE

Comprehensive support for modular software puts OS-9 a generation ahead of other operating systems. It multiplies programmer productivity and memory efficiency. Application software can be built from individually testable software modules including standard "library" modules. The modular structure lets you customize and reconfigure OS-9 for specific hardware easily and quickly.

A SYSTEM WITH A PROVEN TRACK RECORD

Once an underground classic, OS-9 is now a solid hit. Since 1980 OS-9 has been ported to over a hundred 6809 and 68000

systems under license to some of the biggest names in the business. OS-9 has been imbedded in numerous consumer, industrial, and OEM products, and is supported by many independent software suppliers!

Key OS-9 Features At A Glance

- Compact (16K) ROMable executive written in assembly language
- User "shell" and complete utility set written in C
- C-source code level compatibility with Unix
- Full Multitasking/multiuser capabilities
- Modular design - extremely easy to adapt, modify, or expand
- Unix-type tree structured file system
- Rugged "crash-proof" file structure with record locking
- Works well with floppy disk or ROM-based systems
- Uses hardware or software memory management
- High performance C, Pascal, Basic and Cobol compilers

microware[®]
OS-9[™]

MICROWARE SYSTEMS CORPORATION
1866 NW 114th Street
Des Moines, Iowa 50322
Phone 515-224-1929
Telex 910-520-2535

Microware Japan, Ltd
41-19 Honcho 4 Chome Funabashi City
Chiba 273, Japan
Phone 0474-22-1747
Telex 298-3472

OS-9 is a trademark of Microware and Motorola. Unix is a trademark of Bell Labs.

CIRCLE NO. 48 ON INQUIRY CARD

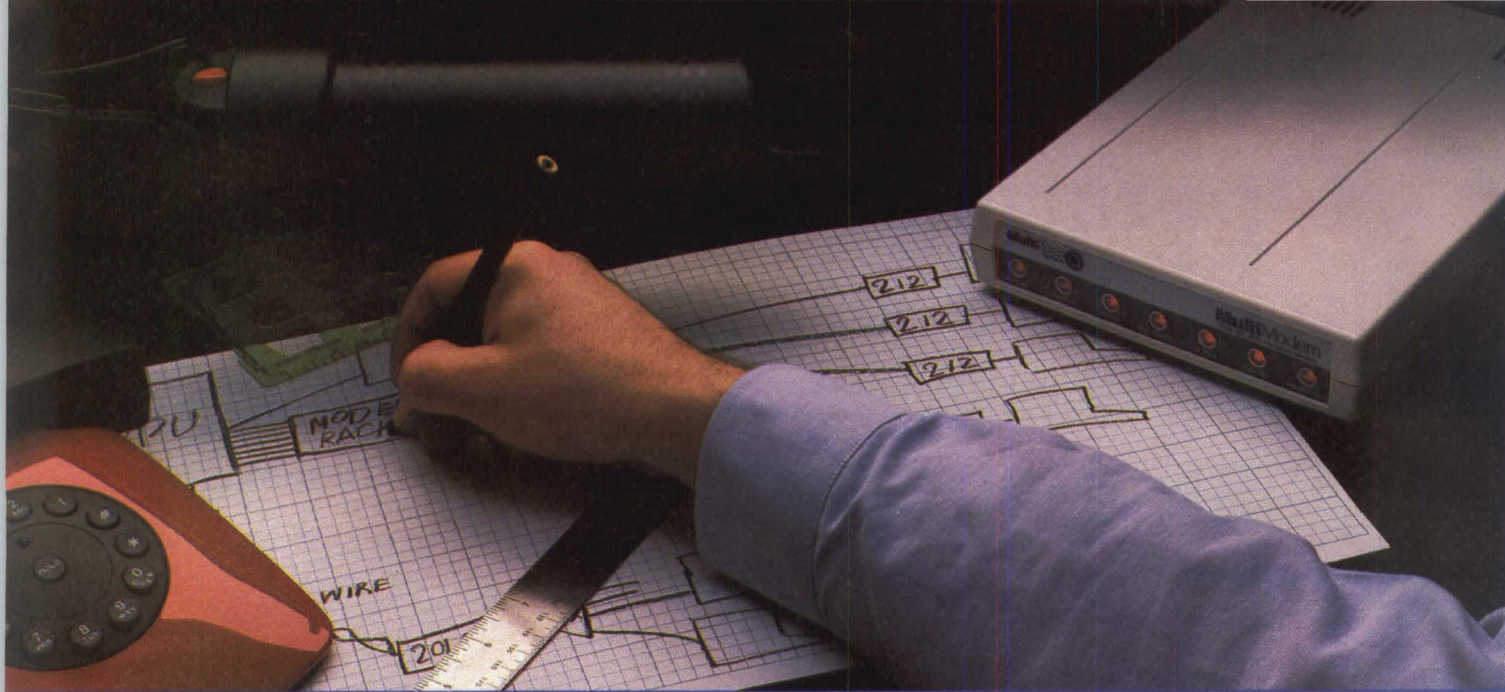

Is this the year of the Modem?

- If you aren't already including modems in your systems, maybe you should be. Because whether you do or not, there is an increasing user demand for on-line capability. This trend will make communications a selling advantage for you now, and an absolute necessity in the not-too-distant future. Communications can now expand the potential of your systems, without creating more headaches for you.

- When looking for a communications supplier, experience and support can be as important as price. Multi-Tech Systems has been providing modems and other datacomm equipment to systems integrators since 1970. Our Technical Support people are second to none. Our products include 300, 1200 and 2400 bps intelligent modems (Hayes-compatible autodial and auto-answer, in desktop, in-board and rack-mount versions), multiplexers, breakout boxes and communications software. And our prices (and margins) are right where they should be.

- So whether your systems are for your own use, or you sell systems to others, Multi-Tech modems can make them better. On-line software updates and maintenance make life easier for you, and on-line capability provides better system versatility for your users.

- Why not let Multi-Tech help make this year of the modem your best year yet?

For more information, call us toll-free at
1-800-328-9717 (in Minnesota, call **1-612-631-3550**).

CIRCLE NO. 51 ON INQUIRY CARD

MultiTech
Systems

The right answer every time.

82 Second Ave. S.E., New Brighton, MN 55112 (612) 631-3550, TWX: 910-563-3610

MultiTech
Systems

MultiModem
1200/300 BPS Intelligent Modem

OEM MARKET SPOTLIGHT SHIFTS TO 'PC OEMs'

A new breed of emerging OEMs offers system integrators the ability to 'roll their own' IBM PCs and to address novel applications

Frances T. Granville, Associate Editor

System integrators haven't exactly ignored the IBM Corp. PC, but they might just now be beginning to appreciate the utility of two new de facto standards that the PC has engendered—the MS-DOS/PC-DOS operating system and the PC bus.

However, building yet another PC-compatible desktop clone would be overkill, so these system integrators are now beginning to "roll their own" PC-compatible systems from kits. These systems may neither look nor act like an IBM PC, but, because they include features that IBM "forgot," they are finding use in specialized applications, such as engineering and industrial and office automation.

To address the needs of system integrators who want to build PCs economically, a new breed of PC-compatible equipment makers, or "PC OEMs," is emerging. These OEMs are offering their customers a wide variety of "mix-and-match" PC-compatible kits. Their products can range from single-board computers to complete systems and can be used to build anything from a single-board embedded controller to a full-blown computer graphics system. In addition to providing system integrators with access to a vast library of MS-DOS/PC-DOS software, these kits—by virtue of their PC compatibility—reduce customers' capital investment risk and shorten product lead times.

The kits might include PC bus enclosures containing built-in PC bus hardware, fans and power supplies; disk drive subsystems in a variety of capacities; display peripherals such as monitors and terminals; input devices such as key-



OEMtek's line of PC-compatible products allows system integrators to configure their own PCs.

boards and card readers; and software that may support not only MS-DOS but also networking and other operating systems.

How a kit works

To understand how a kit from a PC OEM works, system integrators should consider the mix-and-match configuration possibilities from companies like OEMtek Inc., Alloy Computer Products Inc. and Personal Computer Products Inc. (PCPI).

OEMtek, San Jose, Calif., is focusing on the office-worker segment of the market. The company provides a line of IBM PC/XT-compatible

modules, including hardware, software and communications. OEMtek's products include the 83000 series low-profile computing and data modules, the 84000 series standard-profile system and data modules, the 87400 series detachable keyboards and the 87500 series monochrome and color displays.

According to Diane Malik, director of marketing communications at OEMtek, IBM does not offer the low prices and quantity discounts that system integrators have come to expect. "IBM is addressing only 9 percent to 10 percent of the

OEM market," says Malik. She says the value OEMtek adds lies in "reliability and a strong commitment to service: We work with the customer to fix the equipment if it breaks."

Malik says that a typically configured OEMtek system sells for about 50 percent the cost of a comparable system from IBM. She attributes her company's lower prices to overseas manufacturing: 80 percent of OEMtek's production is done at OEMtek Taiwan, a joint venture of OEMtek and Wytek Electronics Inc., Taipei, Taiwan. OEMtek began shipping to about 20 evaluation

Multuser systems accent PC bus versatility

System integrators can implement the versatile PC bus in multiuser systems in two ways. One way would be in a local area network configuration with multiple workstations and operating systems hanging from the bus, using, for example Alloy Computer Products Inc.'s PC-Xbus cabinet containing 12 long slots and a power supply. The other way would be in a file-server configuration.

One company that used the file-server approach is value-added reseller In-Touch Management Systems

Inc., Dallas. In-Touch integrated Alloy's PC-Xbus boards for the In-Touch radio-common-carrier Asset Manager system. In-Touch wanted PC bus boards for the market edge they provide, says company president Sheldon Hills.

"We wanted the PC and the IBM [Corp.] name," Hills explains. "We wanted a system based on IBM. Everybody's got one [a PC]. Everybody wants one. [To the customer,] it's an IBM-based system, even though it's 90 percent Alloy equipment."

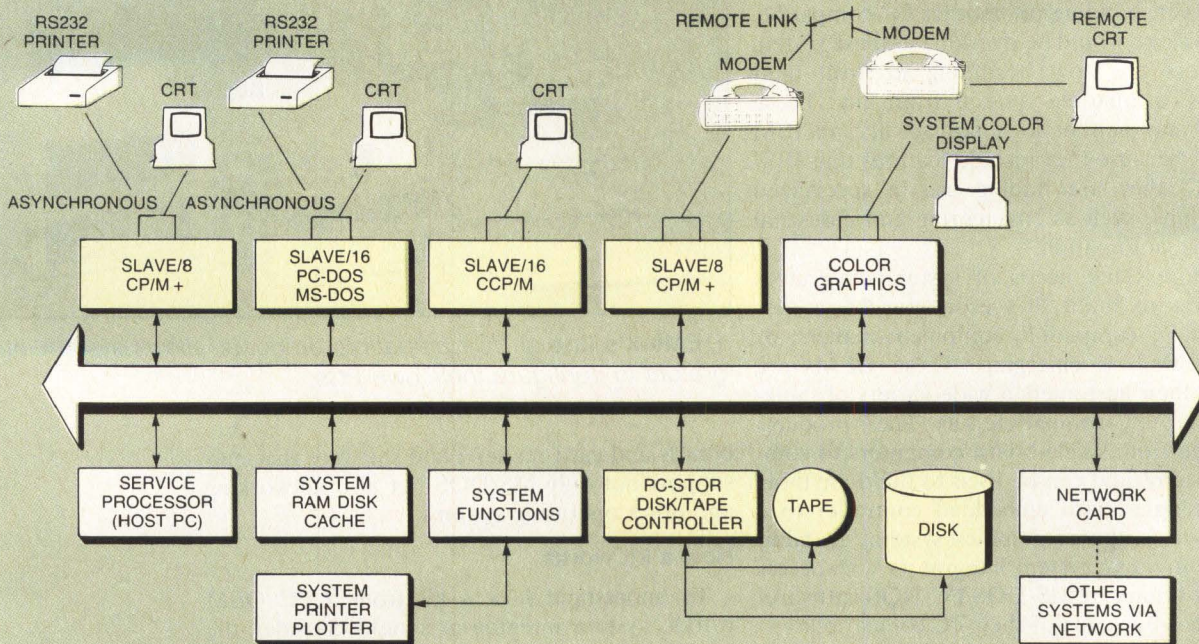

SOURCE: ALLOY COMPUTER PRODUCTS INC.

A PC-Plus configuration might include the PC-Xbus expansion module with 12 expansion slots. A system integrator could connect two PC-Slave/16 and two PC-Slave/8 multiuser expansion boards and the PC-Stor disk/tape controller. Each PC-Slave can support its own terminal and printer or modem.

sites in November 1984 and planned to have begun shipping in production quantities by the end of March.

Customers 'pick and choose'

Malik claims that system integrators are "thrilled" with the way OEMtek is dealing with them because the company allows them to "pick and choose" what they want. "We'll put their name and even their colors on the final configuration," she adds.

Offering system integrators another set of

The stability that the IBM connection conveys in a highly volatile industry is a big selling point for PC bus boards, Hills emphasizes. "Nobody expects IBM to go out of business. I don't think Alloy is going out of business. Most of my competitors are on their third or fourth suppliers."

But what really sold Hills on Alloy's PC-Slave multiuser boards and PC-Qicstor hard disk subsystem, Hills says, were their performance and ease of integration. In-Touch's original system, based on the IBM PC Network and another manufacturer's hard disk drive, did not provide adequate multiuser performance, Hills claims; specifically, it did not hold up under heavy data loads.

In-Touch's Alloy board-based system uses the PC as a file server to control a paging business' inventory, accounts receivable, billing and management reports. "The performance we are getting is unbelievable," Hills asserts. "The average access time is twice as fast as with our previous drive, and we have not had a failure. Integrating the system required very little work on our part and zero changes to our software.

"IBM has bid against us for jobs, saying there is no way a PC can do it [what the Asset Manager system does.]" Hills concludes. "They were saying you have to buy a System/36 [minicomputer,] get this program, hire this consultant—and it will take a year to develop the thing. I take customers and show them that the PC and my system are doing it now—and with 10 or 12 terminals."

—Jesse Victor, Associate Editor

building blocks with which to assemble a PC is Alloy, Framingham, Mass. (see "Multiuser systems accent PC bus versatility," below). With Alloy's PC-Plus family, system integrators can create clusters of as many as 31 dumb terminals operating off a single expansion slot of a host PC.

The PC-Plus family includes the PC-Slave/16, a multiuser expansion board with an Intel Corp. 8088 microprocessor and 256K bytes of RAM. System integrators can merely plug the \$1,095 board into the long slot of a PC and add a dumb terminal to create a two-user system that can share disks and printers. Alternatively, system integrators may want to use the \$1,495 PC-Xbus, an expansion module that contains 12 full-sized PC-compatible expansion slots and its own power supply. When connected to a host PC, it accommodates as many as 12 PC-Slave/16 or lower capacity PC-Slave/8 expansion boards for multiuser capability, each supporting its own terminal and printer or modem.

Another possible configuration would be to add one of Alloy's peripheral subsystems to the PC to increase capacity. For example, the Qicstor-Plus integrates a high-capacity hard disk drive, a streaming cartridge-tape backup unit, five IBM PC-compatible expansion slots and the PC-Slave/16 in one enclosure. Prices range from \$5,595 for a 20M-byte version to \$10,595 for 128M bytes.

Offering another modular approach to building a PC is PCPI, San Diego, with the PC/Solution Series. The series includes the PC/CPU card, which contains an 8088 CPU; enhancement boards that function as standard IBM PC add-ons, such as multifunction cards, video display cards and memory cards; and boxes with the IBM PC bus structure, designed to accept both the company's board-level products and other industry-available add-on boards.

The series also includes three expansion units: the PC/CPU unit, which provides four add-on slots; the PC/Disk unit, which accepts two half-height, 5¼-inch drives and supports floppy and hard disks; and the PC/Expansion unit, which provides five additional expansion slots.

PCPI, founded in 1982, addresses both the OEM and end-user markets, but company officials see its strongest advantage in its ability to sell to the OEM market.

Board level singled out

Because the market is so diverse, some PC OEMs are focusing on just one building block, such as single-board computers, rather than all the modules that comprise a PC. For example, Faraday Electronics, Sunnyvale, Calif., offers a

'We increasingly see our competitors as the VMEbus and the Multibus rather than the low-end S100 bus and STDbus.'

series of single-board, IBM-compatible micro-computers for use in industrial-automation and instrumentation applications. "What we've done is to build a \$12 million company around supplying single-board computers using the same size and form factor as the IBM PC while offering 50 percent to 100 percent more functionality," says Ron Mazza, vice president of marketing at Faraday.

Faraday is focusing on industrial automation and instrumentation because, according to Mazza, those segments consume 40 percent and 20 percent, respectively, of the single-board computer market and because industrial automation is the fastest growing segment. This market has traditionally been addressed at the high end by Intel, Digital Equipment Corp. and Motorola Inc., rather than IBM. To compete with the established vendors in the industrial markets, Faraday is also beginning to aim its products at the high end. "We increasingly see

our competitors as the [Motorola] VMEbus and the [Intel] Multibus rather than the low-end S100 bus and STDBus," says Mazza.

Faraday is lowering costs by incorporating VLSI and semicustom circuits like gate arrays to implement functions on one chip that may take several chips to implement on the IBM PC. Another strategy, according to Mazza, is to add value by adding extra built-in features to its boards, thus eliminating the need to add options to finished boards.

For example, for industrial customers, Faraday plans to introduce a board with an RS422 slot. "We surveyed our industrial-automation customers and found that they wanted an RS422 slot, so we're adding it to our [AT-compatible] product," he says. Faraday is also planning to offer a product with jumper-selectable RS232/RS422 slots. Buying the IBM PC, on the other hand, would mean that the system integrator would have to add these options—at extra cost.

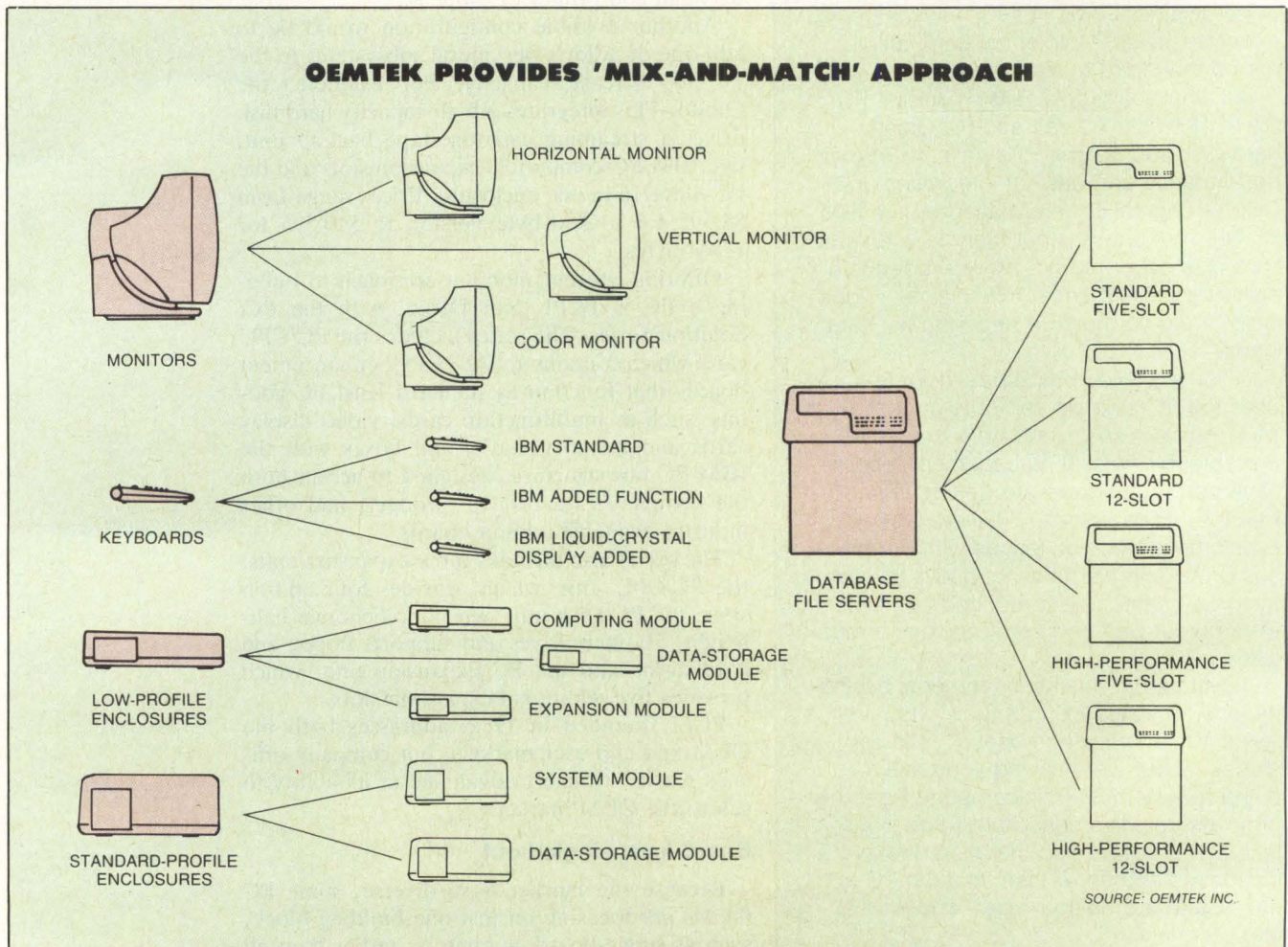

OEMtek's product line comprises low-profile computing and data modules, standard-profile system and data modules, detachable keyboards and monochrome and color displays.

Candy is dandy but it won't do diddly for your throughput

There are Life Savers®
and there are life savers.

When your PDP-11 or VAX system is slow as molasses because of the data transfer bottleneck between your main memory and disk, you need more than a sugar-coated answer from your computer salesman.

What you need is the BS-207, the High-Speed Storage Subsystem from Dataram which breaks that bottleneck by storing your most frequently used data and providing CPU access in microseconds, instead of milliseconds.

It means your computer's CPU can function at its full design speed and the overall performance of your computer can be greatly increased — providing as much as five times more throughput than a conventional disk-based system. Performance that can't be gained simply by acquiring a more powerful (and expensive) computer.

That performance adds up to new life for your PDP-11 or VAX system...eliminating the need to consider a new, more powerful CPU (which won't solve the I/O bottleneck anyway!).

The Need for High-Speed Storage

Whether for transaction processing, commercial data processing, data base management, CAD/CAM, artificial intelligence, simulation or process control applications, many programs spend relatively little time performing calculations on data. A system will spend most of its time transferring data back and forth between main memory and disk (often referred to as "thrashing"). As a result, the full power of the CPU is hardly used.

These throughput problems cannot be solved by acquiring a more expensive CPU which operates at higher speeds. For even if the CPU could perform calculations in zero time, your system would still bog down because most of its time is spent moving data between high-speed main memory and the much slower disk memory.

The Dataram BS-207 High-Speed Storage Subsystem changes all that by bringing to the computing world a peripheral storage device that can respond at microsecond CPU speeds.



BS-207 is a trademark of Dataram Corporation. PDP-11, Q-Bus, UNIBUS, and VAX are trademarks of Digital Equipment Corporation. Life Savers is a registered trademark of Nabisco Brands, Inc.

CIRCLE NO. 52 ON INQUIRY CARD

A hole in your candy is one thing;
a hole in your system is something else.

There's no longer a need to ignore the gap in your throughput that's created because disk access times are magnitudes longer than main memory cycle times. The BS-207 bridges that gap, saving you time and money in the process.

The BS-207 High-Speed Storage Subsystem can be acquired with as little as 2.0 MB and increased in similar increments to a maximum of 256 MB.

The BS-207 High-Speed Storage Subsystem from Dataram. Learn how sweet it is.

DATARAM

Dataram Corporation, Princeton Road, Cranbury,
New Jersey 08512 (609) 799-0071, TWX: 510-685-2542

A LIFESAVING IDEA FOR YOUR PDP-11 OR VAX

- Call me at once to tell me more about your high-speed storage subsystem.
- Send me more information.

Name _____

Title _____

Company _____

Address _____

City _____ State _____ Zip _____

Phone _____

- Tell me about your family of VAX, Q-Bus, and UNIBUS plug-compatible memory products.

I/O WITH I.Q.

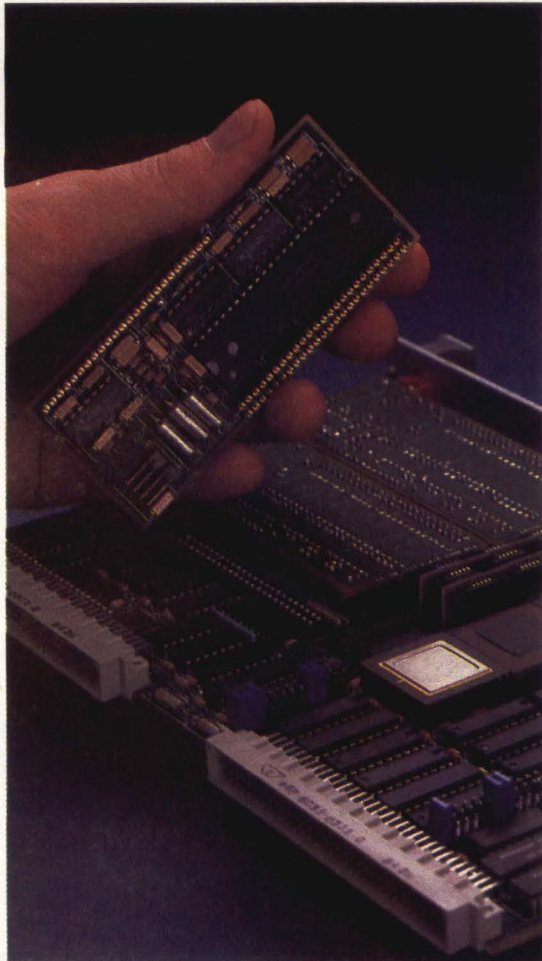

These plug-in modules make the Mostek Intelligent VMEbus board completely user-configurable.

The Mostek VMEbus Intelligent I/O board.

VMEbus has always been a smart choice for flexible system solutions. And now, Mostek has made VMEbus even smarter. By introducing the MK75804 VMEbus Intelligent I/O board.

Using the VMEbus I/O board in your system gives you a high-performance communications interface that places minimal demands on system resources. And since we designed the I/O board to accept up to three plug-in modules, it's completely user-configurable.

You can select up to six independent, full-duplex serial channels in pairs, or combinations of serial, parallel or other interfaces. Either RS232 or RS422 for serial I/O, or a Centronics-compatible printer port, or a general-purpose, 16-bit parallel I/O port.

The choice is yours. And because the I/O board incorporates a 68000 16-bit microprocessor and 128K to 512K of DRAM, it's not just smarter. It's fast also. In fact, it's capable of a transfer rate in excess of 1 Mb/s when used with our optional four-channel DMA controller. What's more, we built in a firmware monitor, an optional power-up ROM that provides download, debug and diagnostic functions.

When you add it all up, our Intelligent I/O board is easily the most flexible hardware solution available for VMEbus applications. Which is just one of the ways we show our continuing commitment to VMEbus technology.

For more information, contact Mostek Corp., 1215 W. Crosby Road, MS2205, Carrollton, Texas 75006, or call 1-800-635-0200. In Texas, 214/466-8801. In Europe, (32) 02/762.18.80. In Japan, (03) 496-4221. In the Far East (Hong Kong), 5.681.157-9.



CIRCLE NO. 53 ON INQUIRY CARD

Faraday is also taking advantage of the IBM PC's open architecture. "We're offering more software-development tools and hardware options for the PC, using the IBM's open architecture to take OEMs to the next degree of application," says Mazza, which for Faraday will be "communications, private branch exchanges and portable instruments, to name a few."

A company taking a similar approach is Mostron Inc., Milpitas, Calif., which is focusing on the industrial-automation, office-automation, engineering/scientific and medical segments of the single-board computer market. Mostron, like Faraday, claims to offer a lower cost alternative to the traditional single-board computer architectures of the DEC Q-bus, the Multibus and the VMEbus. It does this, according to company president Francis Siu, by using semicustom CMOS gate-array chips to integrate key peripheral functions onto the motherboard.









Mostron's first product, announced in January, is the SBM-88 PC Engine, which Siu calls a building block whose PC compatibility eliminates the usual development risks faced by system integrators. It integrates monochrome video and floppy disk controllers, an 8088 CPU, memory, serial ports, an I/O expansion bus and connectors directly onto the motherboard.

I/O expander adds value

Taking another approach to building PCs is Display Telecommunications Corp. (DTC), Dallas, whose customers are divided evenly between system integrators and end users. The company's product offerings include the MegaBoard line of IBM PC/XT-compatible boards, sockets and enclosures.

According to Robert Aldred, general manager, the company adds features to the PC/XT to make it more adaptable to harsh industrial envi-

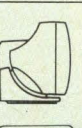
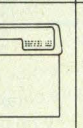
OPTIONS ALLOW FOR MANY CONFIGURATIONS

<p>ASCII WORKSTATION</p> <ul style="list-style-type: none"> • MONITOR • KEYBOARD 	<p>NETWORK WORKSTATION</p> <ul style="list-style-type: none"> • LOW-PROFILE FILE COMPUTING MODULE • MONITOR • KEYBOARD 	<p>PC WORKSTATION</p> <ul style="list-style-type: none"> • SINGLE-OR DUAL-FLOPPY • LOW-PROFILE COMPUTING MODULE • LOW-PROFILE DATA MODULE • KEYBOARD 	<p>XT WORKSTATION</p> <ul style="list-style-type: none"> • 10M-BYTE HARD DISK • FLOPPY • LOW-PROFILE COMPUTING MODULE • LOW-PROFILE DATA MODULE • KEYBOARD 	<p>PC OR XT WORKSTATION</p> <ul style="list-style-type: none"> • SINGLE DUAL FLOPPY OR 10M-BYTE HARD DISK/ FLOPPY • MONITOR • KEYBOARD • STANDARD-PROFILE SYSTEM MODULE 
<p>XT EXTENDED STORAGE</p> <ul style="list-style-type: none"> • 20M-BYTE HARD DISK • LOW-PROFILE FILE COMPUTING MODULE • STANDARD DATA MODULE • MONITOR • KEYBOARD 	<p>XT EXTENDED - FULLY EXPANDED</p> <ul style="list-style-type: none"> • STANDARD SYSTEM MODULE • LOW-PROFILE DATA MODULE • EIGHT EXPANSION SLOTS • MONITOR • KEYBOARD 	<p>FILE SERVER</p> <ul style="list-style-type: none"> • TYPICAL 10-USER ENVIRONMENT • 140M-BYTE STORAGE • DATABASE MANAGER • TWO STANDARD-PROFILE MODULES • MONITOR • KEYBOARD 	<p>DATABASE FILE SERVER</p> <ul style="list-style-type: none"> • MAIN-FRAME POWER • TO 50 USERS • MAGIX ENVIRONMENT • 8086 CPU • 85M- TO 540M-BYTE DISK • 60M-BYTE, 1/4-INCH STREAMER • 160M- BYTE, 1/2-INCH STREAMER • 360K-BYTE FLOPPY FILE TRANSFER 	<p>DATABASE FILE SERVER</p> <ul style="list-style-type: none"> • MAIN-FRAME POWER • TO 100 USERS • COAXIAL CONNECTION • 80286 CPU • MAGIX ENVIRONMENT • TO 168M-BYTE DISK • TO 160M- BYTE, 1/4-INCH STREAMER • 10-MHZ OPERATION 

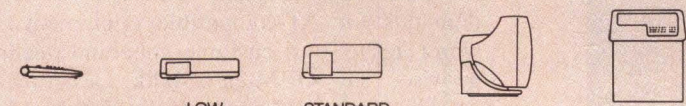

KEYBOARD **LOW PROFILE** **STANDARD PROFILE** **MONITOR** **FILE SERVER**

- FIVE BASIC MODULES FOR ALL CONFIGURATIONS
- COMMON ELECTRONICS FOR ALL CONFIGURATIONS
- UNIFIED AESTHETICS ACROSS ALL CONFIGURATIONS

SOURCE: OEMTEK INC.

OEMtek provides a range of configuration options from a basic ASCII workstation to a database file

server that supports 100 users. All configurations use the same five basic modules and common electronics.

'IBM is addressing only 9 percent to 10 percent of the OEM market.'

ronments. One such feature is the MegaBoard's I/O expansion slot that Aldred believes is DTC's most important added value to the PC. The expander allows users to put modules together more easily than do the IBM PC's seven slots. The DTC I/O expansion slot extends from the side of the motherboard, and DTC's enclosure gives users access to the slot from outside the case. The design makes the product well-suited for such applications as quality control for PC-compatible expansion boards. With the readily accessible slot, untrained personnel can test boards merely by plugging them in—without opening the system enclosure.

PC-AT compatibles make headway

Aldred believes that DTC offers better support and service than IBM. "It's a well-known fact that IBM is not as concerned with quality and workmanship as some of the smaller companies are," he asserts.

DTC and other companies are also addressing the PC-AT-compatible market because the PC-AT is more adaptable to industrial applica-

tions than the standard PC. Although the 8088-based PC is popular as the basis for desktop systems, its low speed and the fact that it is a single-terminal system have been a hindrance to system integrators trying to resell it into harsh industrial and engineering environments. At two to three times the speed of the PC, the PC-AT is fast enough for most industrial applications, and it allows the connection of multiple terminals.

Other companies are retaining PC/XT—rather than AT—compatibility but are substituting the AT's 80286 processor for the XT's 8088. One such company is Wave Mate Inc., Hawthorne, Calif., which is adding a perceived need for performance and speed. "The only way to survive in this market is to add more value," says Dennis Painter, Wave Mate's vice president of research and development. "In our case, the value added is performance. We are increasing performance while reducing costs."

Wave Mate's Bullet-286 board is an 80286-based substitute for the PC/XT motherboard. Because it uses the 80286 with no wait states, the 6-MHz Bullet-286 also executes code faster than the 4.77-MHz PC/XT. Thus, without achieving true PC-AT-compatibility, Wave Mate provides AT performance and speed at about one-fourth the cost of an AT. A 640K-byte Bullet-286 sells for \$2,495.

Painter cites IBM and Seattle Telecom & Data Inc., Redmond, Wash., as his company's main competitors. Like Wave Mate, Seattle Telecom is also aiming for PC-AT performance with PC/XT compatibility. The company offers the PC-286, an 80286-based add-in board aimed at allowing users of PC/XTs to expand their systems' capabilities without abandoning the investment they've already made in the PC/XT. The PC-286 with 640K bytes of RAM sells for \$2,395 in single-unit quantities.

Faraday also plans eventually to introduce an AT-compatible product, according to Mazza. The board will have all the functions of an AT as well as Centronics parallel and serial ports. In addition, OEMtek plans to meet its customers' demands for AT-compatible equipment. "We won't leave our customers behind technology-wise," says OEMtek's Malik.

"The key is IBM compatibility," she adds. "If you're not IBM-compatible, you can't be in the market." And Wave Mate's Painter agrees: "Anyone not addressing the [IBM-compatible] market will be caught between IBM and the market." □

**Interest Quotient (Circle One)
High 483 Medium 484 Low 485**

Your low-cost direct line to the value-added market

Mini-Micro Systems
DIRECT RESPONSE INFORMATION CARDS

- Sell products and services directly
- Introduce new products
- Distribute catalogs and literature
- Investigate new applications
- Develop quality sales leads

Format	1984 Postcard Schedule
Loose Card Deck / Card	Materials Closing Date:
Size—3½" × 5½", Live	2/7 4/13 8/10 10/8
Copy—3½" × 5½"	Mailing Date:
	March May Sept. Nov.

Mechanical Requirements	Rates	Non-Advertisers	Advertisers
Negatives—right reading emulsion side down. Camera ready mechanicals—110 line screen	1 card 2 cards 3 or more cards	1350 1300 1250	1600 1550 1500

Contact: Carol Anderson, Sales Manager
Mini-Micro Systems
Direct Response Postcards
 221 Columbus Avenue, Boston, MA 02116
 (617) 536-7780

CIRCLE NO. 99 ON INQUIRY CARD

REAL-TIME IMAGE PROCESSOR — \$2,995

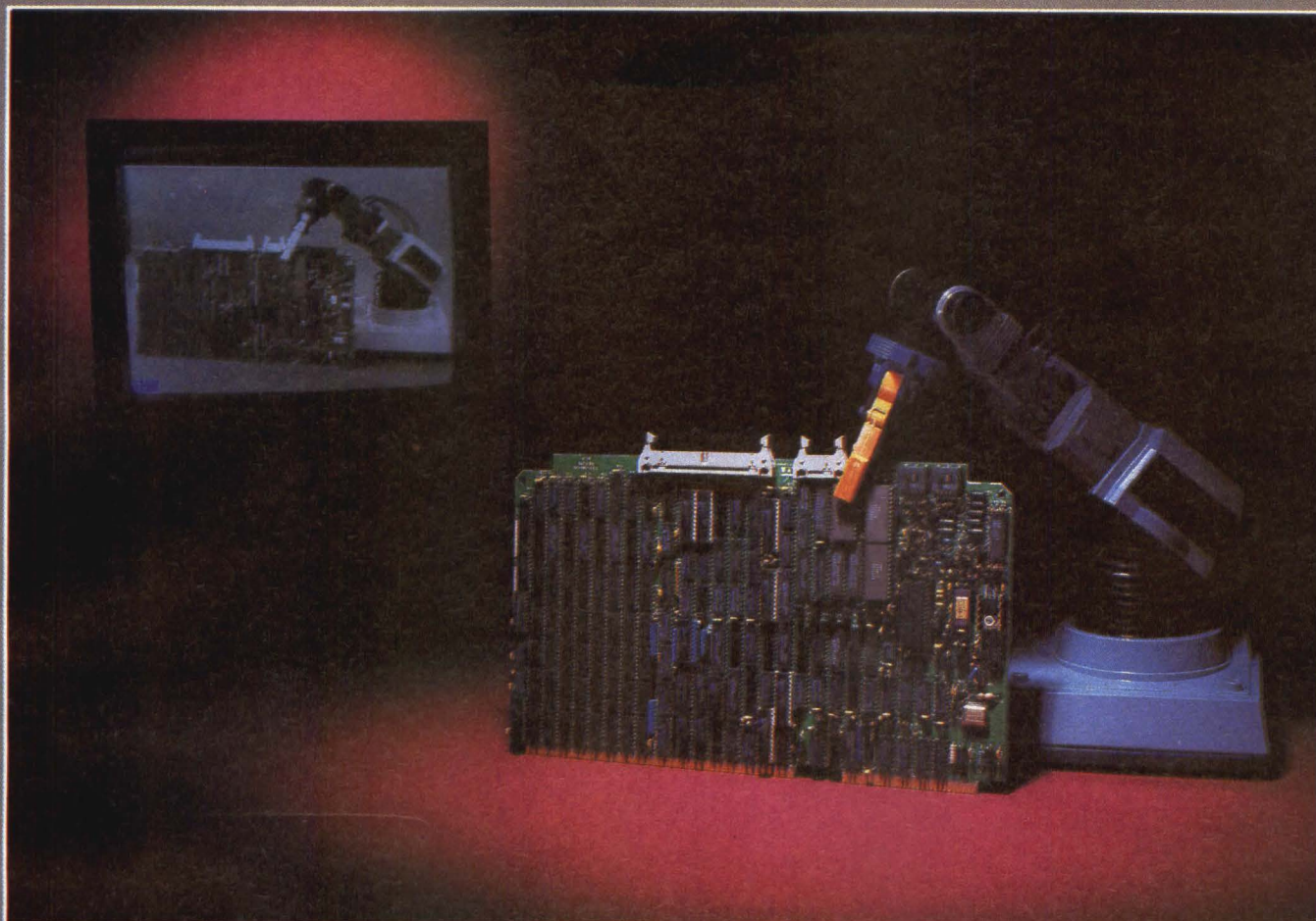

MIP-512 - The Single Board Multibus Machine Vision System

- 512 x 512 or 1024 x 1024 resolution
- 8 bits/pixel up to 24 bits/pixel
- 4:3 or 1:1 aspect ratio
- 16.7 million color LUT
- Hardware pan, scroll and zoom
- Dual ported video RAM for true DMA
- IEEE-796 (Multibus) compatible

Image processing technology need not cost an arm and a leg. With the Matrox MIP-512 you can get full 8 bit data acquisition, 8 bit image storage and 90nsec/pixel image processing **all on one Multibus board and for only \$2,995 in singles.**

REAL-TIME IMAGE ACQUISITION

An 8 bit flash A/D converter is used for digitizing an external video signal. External sync genlock or internal sync generation are software selectable. On-board programmable offset and gain controls and input look-up tables are provided for real-time pre-processing of raw video data.

IMAGE STORAGE AND DISPLAY

The MIP-512 contains 256K Bytes of dual ported video RAM for storing a 512 x 512 x 8 image. The new MIP-1024 contains 1M Byte of dual ported video RAM for storing four 512 x 512 x 8 images or one **1024 x 1024** image. Images can be loaded or unloaded from Multibus to video memory under DMA control in just a fraction of a second.

MULTIBUS - TM INTEL

Call now for a complete documentation package.

- 8 bit frame grabber
- 90nsec/pixel video ALU
- MIP-LIB image processing software library
- Image processing functions:
 - addition & subtraction
 - averaging
 - convolution (N x M)

The MIP-512 supports instantaneous pixel by pixel panning and scrolling of images, and zooming by a factor of x2 or x4. Up to 256 colors or shades of gray can be displayed from the 16.7 million color LUT.

REAL-TIME IMAGE PROCESSING

A 90nsec/pixel video ALU is provided for performing real-time arithmetic and logical operations on image data. The MIP-512 supports several standard image processing functions including frame addition and subtraction, exponentially weighted frame averaging, low and high pass filtering and convolution with an N x M kernel. All computations are performed at high speed by the MIP-512 without burdening the host CPU.

The new **MIP-LIB** image processing software library is available for free to all MIP-512 customers. MIP-LIB lets you get your application up and running quickly.

In addition to state-of-the-art graphics and imaging boards, Matrox also supplies monitors, cardcages, CPU cards, memory boards and communication controllers for complete OEM display system requirements.



matrox
electronic systems ltd.

1055 St-Régis Blvd
Dorval, Québec
H9P 2T4
Tel.: (514) 685-2630
Telex: 05-822798

CIRCLE NO. 54 ON INQUIRY CARD

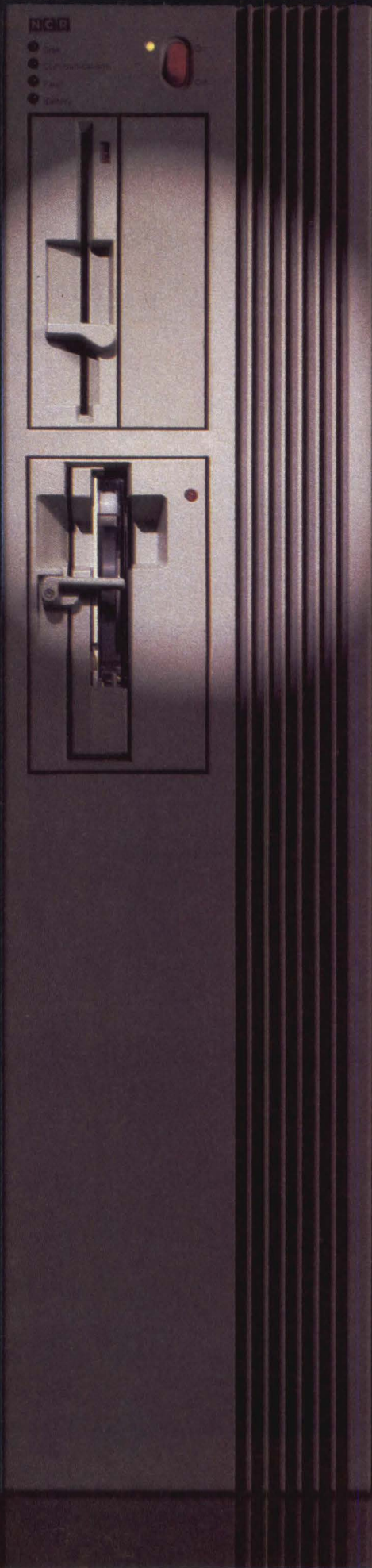

IF A POWER LINE FALLS IN THE MIDDLE OF THE NIGHT AND NO ONE'S AROUND, IS THERE A CRASH?

There's a very strong work ethic at NCR. Every system we build must work. And work. And work. And our reliability fanatics spend thousands of hours making sure that every Tower[®] XP lives up to that philosophy.

But we've gone even further, protecting the XP from circumstances beyond your control. Power failure.

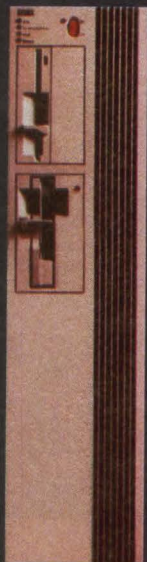

When the Tower XP's power supply senses voltage fluctuation beyond an acceptable threshold, the automatic Power Failure Recovery (PFR) feature instantly interrupts the main processor with a failure indication. The system immediately takes control to preserve all applications, including the all-important super block, for up to six hours. In competitive systems without PFR, this entire chunk of the file system could just disappear, leaving your customers in the dark.

But the Tower XP recovers so smoothly, so completely, your customers may never know there was a power failure. And that means no more late night calls to restart systems or rebuild lost files. You save time, money and headaches.

Add to this the Tower's other integral reliability features: extensive remote and in-service diagnostics, consistent error logging, an NCR-enhanced UNIX* that virtually never PANICs. And you've got an irrefutable argument for selling Tower XP.

If you've had enough of systems that go crash in the night, look to NCR and the Tower XP. The power of the Tower never fails for OEMs.

**TOWER XP
BUILT FOR SYSTEMS BUILDERS
BY NIT-PICKING FANATICS.**

NCR

OEM Systems Division

NCR Corporation, U.S. Data Processing Group, OEM Systems Division, USG-1, Dayton, OH 45479. Nationwide (800) CALL NCR. In Ohio (513) 445-2190.

*UNIX is a registered trademark of AT&T.

Tower is a registered trademark of NCR Corp.

©1985 NCR Corporation

CIRCLE NO. 55 ON INQUIRY CARD

Both letter-quality and draft hard copy

Fastest document throughput in its class

Both friction and tractor paper feed

Industry standard serial and parallel interfaces.

Better, more versatile operator controls

TI reliability

Compatibility with third-party and proprietary software

Better, more durable easy-access font modules

The TI 855 microprinter. No other printer says better so many ways.

Feature for feature, no other microprinter can match the versatility, compatibility, reliability and productivity of the OMNI 800* Model 855 microprinter. Here's why.

Two Printers In One. With the TI 855 you get the speed of dot matrix draft copy. Plus the precise clarity of the most advanced matrix technology for letter-quality print. It's two printers in one — at one low price.

A Great Family Name. Texas Instruments is known for providing the world with the industry standard for printers — the TI 810. TI builds the same reliability into every 800 series microprinter. Both the 855 and the data processing Model 850 are part of the expanding TI line of high-performance, low-cost microprinters.

Hardware Compatible. The TI 855 microprinter is compatible with all major PC hardware. And it provides both serial RS232C subset and "Centronics-type" parallel as standard interfaces.

Software Compatible. The TI 855 uses industry standard escape sequences for compatibility with virtually all third-party software. And for those with proprietary software needs, a model is available with ANSI standard escape sequences.

Tough Font Modules For Quick Character Change. Three font modules can be inserted into the front of the printer at one time, and are accessed individually. Each contains both draft- and letter-quality character sets. They're easier to use, more reliable and more durable than traditional metal or plastic daisy wheels.

More Productivity Than Any Other Microprinter. The 855 offers both friction and tractor paper feed, to handle all types of word and data processing applications. A quick-change snap-in cartridge ribbon. Raster and mosaic graphics. And intelligent printing which maximizes document throughput — regardless of format.

Get the printer that makes for better information systems. For more information visit your nearest TI authorized dealer or write Texas Instruments Incorporated, P.O. Box 809063, I DEPT. NO. 083MY Dallas, TX 75380-9063. Or call toll-free: 1-800-527-3500.



TEXAS INSTRUMENTS

Creating useful products and services for you.

IMAGE PROCESSING ENHANCES LASER PRINTING

Real-time rasterizing with a page compiler and image library lets image-processor-based laser printers run complex graphics at 1 page per second

David Buchanan, Imagen Corp.

Laser printers are a proven alternative to letter-quality impact printers, plotters and even line printers. Falling costs are bringing low-end systems, such as the LaserJet from Hewlett-Packard Co., head-to-head with traditional daisywheel solutions. In addition, increased capability and sophistication are opening new application areas, such as "personal typesetting." Therefore, system integrators should consider laser-printers as possible substitutes for other hard-copy devices when configuring a system.

Indeed, the non-impact printer market is in an explosive growth phase, particularly for laser printers. The \$1.4 billion expected to be spent on laser printers in 1985 should grow to \$3.1 billion in 1987, according to Dataquest Inc., San Jose, Calif. Moreover, laser printers should displace daisywheel, graphics and line printers. It seems likely they'll even supplant some photocopiers. The cost of laser-written copy is reaching parity with photocopiers now, and the convenience of quietly and quickly running off extra high-quality copies with a laser printer may prove compelling to buyers.

To put the new laser printers into perspective, let's first look at their technological history. Laser printers have been commercially available since 1978, when Xerox Corp. introduced the 9700. It was a large, 120 pages per minute (ppm), \$500,000 solution for printing listings and forms or for high-volume billing. The market remained small until late in 1979 when Canon U.S.A. Inc. introduced the LBP-10, the first low-cost (less than \$10,000 in OEM quantities)

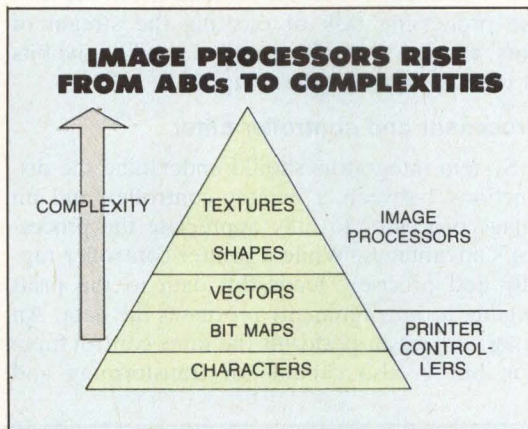

Fig. 1. The hierarchy of image primitives ranges from the relatively simple, such as characters, to high-level primitives, such as textures.

laser printer. Unlike earlier laser printers, the Canon was only an engine, and required an added "brain"—an image processor.

The next significant introduction came in 1983 with another engine-only product from Canon, the LBP-CX. HP, Apple Computer Inc., Imagen Inc. and others have built systems by adding various types of image processors to the LBP-CX. Since 1983, the advances in laser printers have been made in the development of image processors, while the rapidly growing market and technical refinements in laser engines have led to incremental cost/performance improvements. Increasingly, laser printers are differentiated on the basis of their intelligence, which means the ability to understand and process higher level descriptions of images (Fig. 1).

Aside from the challenges of producing a laser engine, implementation of the requisite image processor has proved formidable. Computer systems traditionally send page descriptions to con-

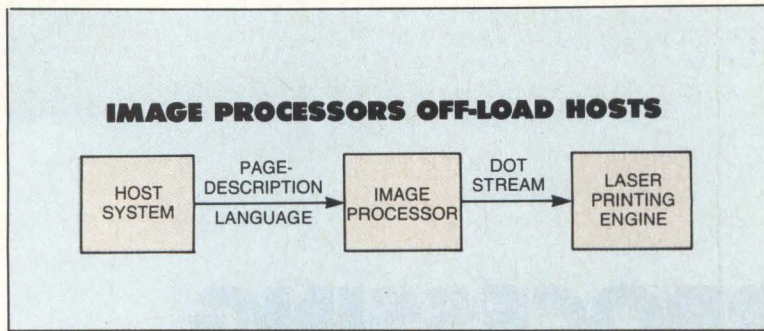

Fig. 2. Image processors relieve hosts of the processing task of creating the stream of dots (represented by bits) and the controlling task of sending those bits to the laser printing engine speedily.

ventional printers at a host-selected transfer rate, and in a form that differs little from the text file that was originally created with an editor or by another process. Laser engines, on the other hand, demand a stream of dot information at speeds comparable to video (1 million pixels per second and above), and within tight time constraints—once the paper has started through the printer, the stream of data must stay on schedule. The image processor off-loads from the host the processing task of creating the stream of dots, and the controlling task of sending the bits at the appropriate times (Fig. 2).

Processor and controller differ

System integrators should understand the distinctions between a printer controller and an image processor to fully appreciate the processor's advantages. While a printer controller rapidly and precisely feeds dot data to the print engine, it only minimally processes the data. An image processor performs the same control function but is also capable of transforming and

expanding a wide range of input formats. Consider an analogy with programming languages. An image processor can understand high-level languages, while a printer controller understands only low-level languages that resemble assembly code.

To look at it in another way, as image processors increase in sophistication, the image description can be more sophisticated, leading to a hierarchy. At the low end of the scale, a processor understands only bit-maps and characters. As such, the box acts as a simple printer controller. Interfacing this type of controller to a low-speed engine produces a laser printer that is essentially a typewriter or daisywheel replacement, such as the LaserJet.

Understanding what the print engine does makes it easier to understand the image processor's function. The engine contains a drum, which is scanned by the laser beam via rotating mirror, which allows the laser diode itself to remain fixed. The scanning is analogous to raster scanning within a television set. The beam striking the drum's surface creates a difference in charge that attracts toner powder from the toner supply. The paper is pre-charged before passing against the drum and carrying away the toner, which is subsequently fused onto the paper by a heat source (Fig. 3).

The laser printing engine requires a constant data rate higher than 1 million bits (one for each dot on the page) per second because the paper cannot be slowed or stopped while receiving data. The unique timing demands, and the engine's need for simple dot information, call for

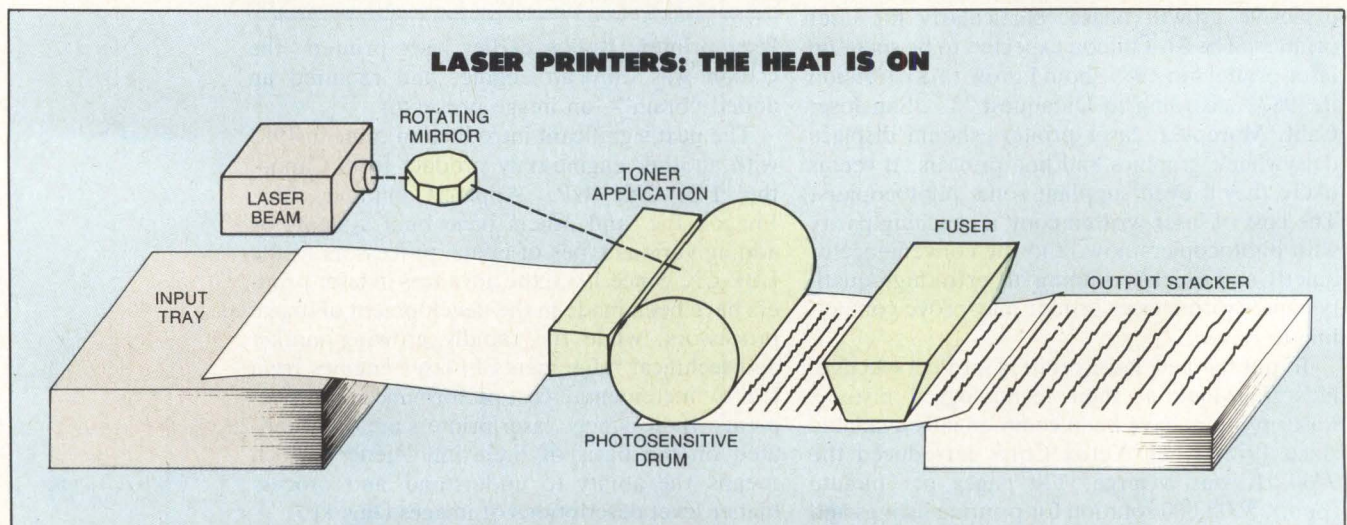

Fig. 3. A laser printing engine's laser scans a photosensitive drum by way of a rotating mirror, creating a charge differential that is transferred to paper

by contact with the drum. Toner attaches to the charged portions of the paper and fuses there by heat.



Our Low-Cost Voice Data Entry Peripheral Could Double Your Computer System's Productivity

Verbox voice data entry has improved the speed and accuracy of data entry operations for companies across the country. We're helping firms in material handling, inventory control, inspection, test and other applications save thousands of dollars in time and labor costs, often resulting in productivity gains of 100% and more. Now *you* can offer this proven technology in a new, low-cost voice data entry peripheral—the Verbox Series 4000 Voice Recognizer.

Integrating seamlessly with your own system, the Series 4000 Voice Recognizer adds simultaneous voice input to keyboard data entry for virtually any mainframe, mini, micro or personal computer. It loads voice patterns and applications vocabularies

directly from your host system, or from its own reusable CMOS voice cartridges. Users simply drop their own cartridges into the Series 4000 Voice Recognizer console and it instantly responds to verbal commands despite accent, dialect, or interference from loud background noise.

Simple software tools let you create custom vocabularies.

With our Series 4000 Voice Planner™ software, you can program vocabularies for any customer application. Voice Planner software runs on IBM® PC, PC compatible, and DEC VAX™ systems, and is readily adaptable to other computing environments.

True continuous speech recognition: the key to your success.

With Verbox, the user inputs data in a natural voice, so there's no risk of fatigue or irritation caused by the staccato diction that other products require. And while others may claim it, only Verbox's patented continuous speech recognition achieves this natural man/machine interface without sacrificing accuracy or vocabulary size.

For details on the Series 4000 or our OEM/VAR programs, call toll-free 1-800-343-4458. In Mass., call (617) 275-5160. Or write on company letterhead and ask for a free video tape of voice applications. Verbox, Two Oak Park, Bedford, MA 01730.

Verbox

A DIVISION OF EXON ENTERPRISES

Voice Planner is a trademark of Verbox. IBM is a registered trademark of International Business Machines Corp. VAX is a trademark of Digital Equipment Corp.

Equinox didn't invent the Data PBX...



we just perfected it!

All the Data PBX features you need

Port selection: User-controlled terminal switching between computers.

Access control to keep your database secure from unauthorized personnel and to protect dial-in lines from "hackers".

Port contention or sharing for maximum port utilization and economy.

Network control from a central point; alter system configuration, collect statistics and perform diagnostics.

Non-blocking architecture permits 660 full-duplex connections at 9600 bps.

Plus these Equinox only features

Expandable from 24 to 1320 lines without taking your system down.

User-friendly menu-driven battery-backed configuration plus on-line help.

Compact dimensions: 360 lines in the unit shown above. Less than one sixth the size of Micom or Gandalf PBXs!

Simple do-it-yourself installation using low-cost modular telephone wiring.

Complete system backup with auto-switchover power and logic, plus comprehensive on-line diagnostics.

And the price: under \$100 per line. No other LAN compares!

Call 1-800-DATA-PBX* for a free color brochure and on-site demonstration.

EQUINOX

Systems

12041 SW 144th Street, Miami, Florida 33186 * In Florida call (305) 255-3500 · Telex 289307

CIRCLE NO. 58 ON INQUIRY CARD

MINI-MICRO SYSTEMS/August 1985

an image processor that can convert higher level image descriptions (characters, lines, area shadings, etc.) into a simple dot stream. Most image processors separate the task of image processing from the task of controlling the printer. Except in simple cases—such as only handling characters—most image processors accumulate an entire page image before starting the paper through the engine.

Avoids wait states

So how does this new piece of intelligence fit into computing? Consider a description of a document as it progresses through the system. First, the user creates a document via some user interface that may deal with images at a high level (a library of pictures, for instance). Then, the system must convert the remaining representation into a language that the image processor will understand. The more complex the objects that the image processor can construct from brief, high-level commands, the less processing the host system has to do. The relationship between host and image processor is one of peer processor, rather than host driving a dumb controller.

The most popular approach to image processing is to create a simple full-page bit-map (1 bit of memory for every dot position on the page), process each page, and then proceed with the

control task (sending it out to the print engine). Such an approach is straightforward—the image processor performs only one task at a time—but its limitations are equally clear. Resources are poorly used in a single-page design. For instance, the bit-map of a page ranges in size from 1M to 3M bytes, (or more, depending on the resolution and maximum paper size of the print engine to be supported). Also, although over 90 percent of a typical page is white space, memory must nonetheless be allocated to it. More important, the bit-map can be used by only one task at a time: either image processing or controlling.

Furthermore, to provide tolerable page-processing time, the image-processor CPU must be fast. However, this speed is wasted during the controlling task, during which the CPU is occupied perhaps 20 percent of the time, but still cannot process any of the next page because the single bit-map is tied up. Therefore, even with low prices for memory, the solution of creating two complete bit-maps—one for each task—is shortsighted. It could result in increased demand for more-complicated bit-maps driving up overall costs, despite low memory costs.

Imagen's real-time rasterization involves a sophisticated approach to image-processor design (Fig. 4). Instead of processing the input description directly into a full-page bit-map, an intermediate page description is created. The image

The relationship between host and image processor is one of peer processor, rather than host driving a dumb controller.

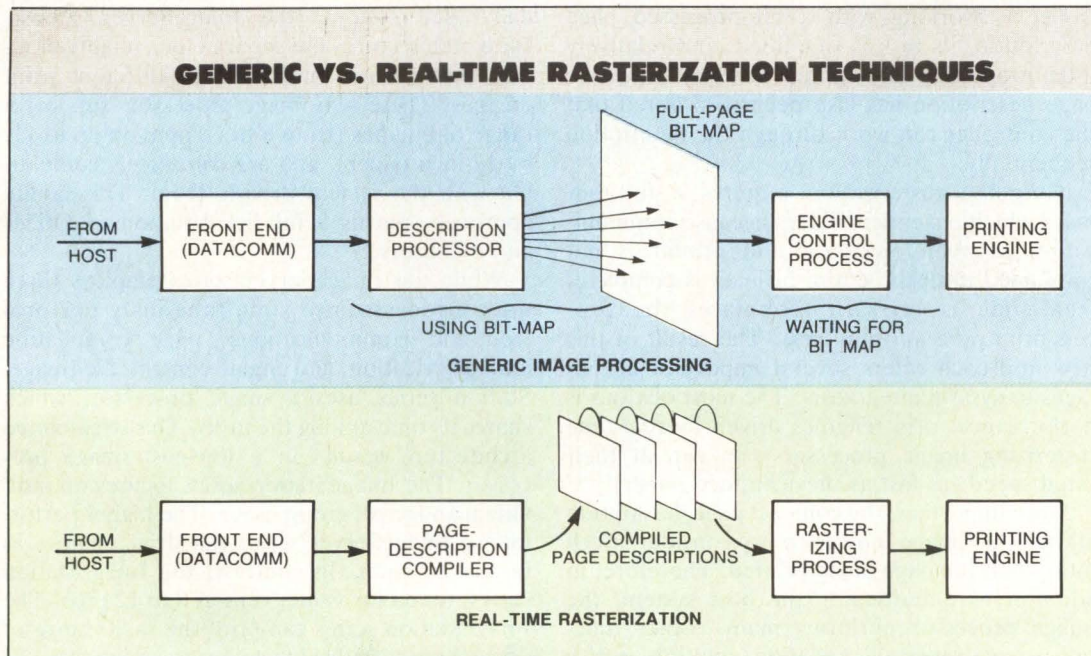

Fig. 4. The most popular approach to image processing uses a full-page bit map, in which there is 1 bit of memory for each dot on a page. Imagen's real-time ras-

terization creates an intermediate page description, typically using 10,000 to 20,000 bytes—about 1 percent to 2 percent of the memory required for a typical bit-map.

POPULAR PAGE DESCRIPTION LANGUAGES

Language	Year	Type
Script	1960	document composition
TeX	1978	document composition
Scribe	1980	document composition
imPRESS	1982	page description
QUIC	1982	page description
PostScript	1984	page description
Interpress	1984	document description
DDL	1985	document description

Sometimes real-time rasterization is not appropriate, such as when a densely detailed drawing must be reproduced.

processor scans the document and takes note of each character or image (but not of blank space). It then matches those characters and images with their equivalents in its library of characters and image primitives and stores, not the characters themselves but, rather, their addresses in this library. In effect, real-time rasterization converts the document into a list of software pointers.

This description normally takes up 10,000 to 20,000 bytes of memory—about 1 percent to 2 percent of the size of a typical bit-map. The controller paints the dot image of the page, one scan-line at a time, staying just ahead of the print engine, which is printing while both processing and controlling are occurring. Because the controller is working with a pre-processed page description, its task is simplified, and relatively little processing is required. The intermediate page description has also been so ordered that the controller can work through the description sequentially.

Normally, rasterization requires a full bit-map, which engenders delays because communication between processor and printer is not transacted until the entire bit-map is complete. Real-time rasterization obviates the process/print/process/print cycle. The result of this new approach offers several important advantages to system integrators. The most obvious is performance: print engines driven by real-time rasterizing image processors can run at their rated speed (as fast as they can feed paper).

More important, the compact page description allows the image processor to consider much more than the page being printed. Therefore, in addition to unburdening the host system, the image processor performs many copier functions: page reversals, collation, multiple copies and jam recovery (automatic reprinting of pages passing through the print engine during a paper jam).

Sometimes real-time rasterization is not ap-

propriate, such as when a densely detailed drawing must be reproduced. Here, the scan-line being rasterized may have too many vectors passing through it, each of which must be rasterized. In these cases, pre-rasterization is best applied. If a pre-rasterization code is attached to the job header, the image processor will pre-process the pages in a different manner. So, instead of processing partial-page descriptions, full-page descriptions are created. And, though a full-page bit-map is essentially created, the system remains intelligent. Again, no memory is used for white or redundant areas. In extreme cases this process might require as much memory as a full-page bit map, but most of the time requires much less.

Product uses three processors

Pages requiring pre-rasterization are rare in business documents, but more common in exotic, detailed engineering graphics. The only other situation when real-time rasterization does not provide dramatic compression of memory requirements occurs when bit maps are sent from the host. Rather than alter the host data in any way, the bit-map is faithfully accumulated. Naturally, this method requires sufficient memory to store the bit-map.

Imagen's product line centers on two architectures: a single-board ROM-based system, (the ImageStation series), and a Multibus floppy disk-based system (the ImageServer series). Both architectures use separate personality modules that permit interfacing to different print engines. These two image processors support a range of engines (from 8 to 60 ppm on up to 11-by 17-inch paper), and are completely compatible with the system driving them. This family approach spawns a full-line solution to OEMs and end-users.

While the ImageServer series employs three microprocessors to simultaneously perform front-end communications, page compilation and rasterization, and engine control, the ImageStation series uses a single processor, which shares its time among the tasks. This streamlined architecture results in a low-cost image processor. The ImageStation series focuses on individual and small group usage. The higher performance ImageServer series can drive engines as fast as 60 ppm. In contrast, the ImageStation series, tuned for value, runs at 8 to 12 ppm. The ImageStation series can print the same range of documents that the ImageServer series can.

The ImageStation series consists of three models, providing a continuum in capability. The Executive model, suitable for text and business graphics, has 256K bytes of memory. The De-

Raster's Model One family.

CAE growth without the growing pains.

Raster's Model One family of 2-D and 3-D color graphics systems is designed for compatibility.

So it's a simple matter to choose just the resolution, refresh and color you need for your application.

Then, as your needs expand, it's just as easy to add more functionality.

All the way up to 1280x1024 resolution at 60 Hz non-interlaced refresh, 4 Mbytes of local Display List, 24 bit-planes of brilliant, true-to-life color, and more.

Since each Model One system uses the same software architecture, once you've written a program for one system, you've written it for every Model One system. Both now and in the future.

And, of course, the Model One family is compatible with virtually every leading CAD, geophysical, simulation, modeling and business graphics software package.

Just as importantly, Raster's Model One family shares the same unparalleled graphics application development tools to help you reduce software costs. Including flexible text handling and window management, local debugger, command stream translator, macro programming, local command interpreter, and a complete HELP facility.

In fact the only thing more remarkable than how much our graphics systems *do* is how little they *cost*.

For complete information about Raster's entire compatible Model One family, call 1-800-4RASTER today. (In Massachusetts, 617-667-8900).

FEATURES	Model One/10	Model One/75	Model One/80	Model One/380
Low cost terminal	✓			
High resolution		✓	✓	✓
Imaging		✓	✓	✓
Genlock			Optional	Optional
Local 2-D display list	✓	Optional	Optional	✓
Local 3-D display list				✓
DMA port		Optional	✓	✓
Application development tools	✓	✓	✓	✓
24 bit true color capability			Optional	Optional

Raster
Technologies

The benchmark of computer graphics.

Nine Executive Park Drive
North Billerica, MA 01862
(617) 667-8900 TWX 710-347-0202
1-800-4RASTER

Turbine image courtesy of NEO-VISUALS INC.



Now... nationwide on-site service.

CIRCLE NO. 59 ON INQUIRY CARD

"DOTS INCREDIBLE."

You're looking at letter-quality text created by an AMT printer. The same printer that produced the CAD/CAE diagram you see on the right. **Dots incredible!** But that's not all. With the AMT, you can print letters or documentation at 45, 100 and 250 cps. Print in *italics* and different **type styles** and **sizes**. Print scientific and special symbols--even other languages 中文字. You can print on transparencies and multipart forms. And you can do it all in a **RAINBOW** of **COLOR**.

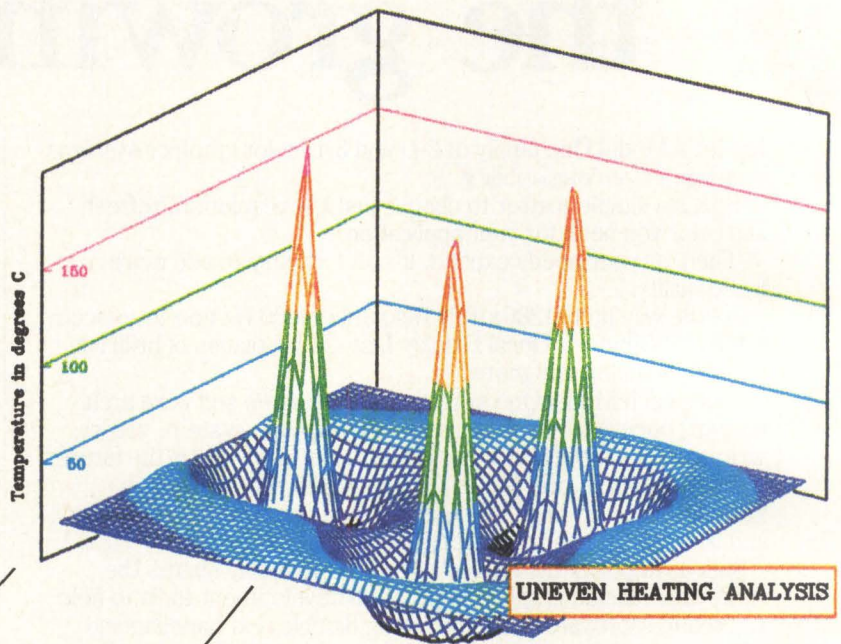

Actual size—you can't get quality like this on a plotter, but you can with AMT.

AMT is the highest resolution dot matrix color printer available—with dot addressable graphics to 480x240 dpi.

Naturally, AMT prints bar graphs and pie charts. But it also does incredible, 3-dimensional diagrams so precise you can use them for measurements.

You're looking at AMT, the first dot matrix color printer so advanced it's better than a desk top plotter. Why?

Because our new AMT color printer is the first dot matrix to combine letter-quality text with plotter-quality graphics. You get the speed, flexibility and industrial strength reliability of a top-notch dot matrix. Without the toner, pens and nuisance of a plotter.

And as you can see, AMT actually out-performs many plotters, large or small, on high precision applications.

For more product and distribution information, write to Don Lawrence, V.P. Sales and Marketing, Advanced Matrix Technology Inc., 1157 Tourmaline Drive, Newbury Park, CA 91320. Or call (805) 499-8744.



Advanced Matrix Technology Inc.

CIRCLE NO. 60 ON INQUIRY CARD

© 1985 Advanced Matrix Technology Inc.
Graphic software by Cerritos Computer Services, Inc., Long Beach, CA.

signer model has 512K bytes of memory, which allows for large documents to be collated or reversed, as well as for more sophisticated graphics. The top of the line Innovator, with 1.5M bytes of memory can collate or reverse 100-page documents, or pre-rasterize the most demanding graphic. All three models contain the same main board, allowing font ROMs to be added either in the factory or later in the field.

Most hardware is consolidated on one board in the ImageStation. The engine-dependent portions, however, are isolated on a separate personality module. This setup permits easy adaptation of the ImageStation image processor to different print engines and allows OEMs the flexibility of choosing the engine that fits their needs. All three models of the ImageStation series use the industry-standard Canon LBP-CX. Like the HP LaserJet and Apple LaserWriter, ImageStations can print on up to 8½-by-14-inch paper, transparencies and labels. The cartridge contains the toner supply and 60 percent of the moving parts, leading to simplified maintenance.

Words describe a page

The power of non-impact printing technologies such as laser printers is a mixed blessing. Because the smallest unit that can be printed is a tiny dot (at any location on the page), such technologies can print a wider range of images than older printers, which were limited to some fixed character set. But along with the greater freedom lasers provide comes greater complexity: a page description must now accommodate the wider range of possible images. The host system could simply talk to the printer in a "native mode" of dots, but even at low speed (8 ppm), the processing and I/O load are considerable—over 100,000 bytes describing the dot stream must be computed and sent every second. Page-description languages allow the host application to describe a page image in higher level terms—the characters, lines, textures, and other primitives that make up complex images.

Like programming languages, page-description languages evolve from some heritage that defines what functions each language performs best, how each language spreads the computing load between host and printer, and which applications support which languages. In general, as the language supports higher level objects, the host driver program that generates the description works less, and the image processor must work more to expand the description to the required dot stream.

In general, the newer the language, the more flexible and powerful it is. The earliest languages were document-composition languages, in-

tended mainly for text-oriented output devices. More recently, software has been written to allow these languages to drive laser devices. Languages that gracefully support graphics include imPRESS (from Imagen) and QUIC (from QMS Inc.). Other languages evolved to primarily support typesetting, including TeX, Scribe and troff. The laser printer's emulation of other printers and displays allows many applications to output on a laser printer without changing the application. In addition to simple line-printer emulators, popular emulators include the Tektronix 4014 from Tektronix Inc., and the Diablo 630 ECS from Diablo Systems Inc. Although these are not true page-description languages, they get the job done, while not generally allowing access to the full power of the printer.

More recent languages reflect the higher sophistication that has come from years of experience with non-impact technologies. PostScript (from Adobe Systems Inc.), DDL (from Imagen), and Interpress (from Xerox) reflect next-generation designs. All these languages allow any page imaginable to be described. The differences between them are more subtle than a simple feature-set comparison: equivocal characteristics such as language difficulty and implementation become significant. It is one thing to say that a language allows a certain image to be described. The real issues are how difficult that description is to assemble, and how efficiently it can be executed by the printer. Implementation of a given language can drastically effect performance or even the actual end-result image. Like programming languages, it appears that several of the page-description languages, in use or proposed, may emerge as separately applied standards.

Although laser printers clearly provide a leap in print quality, standards are still emerging. Although basic printer-controller functions are well-defined, image processors are still adding major features. Because of the flux in printing-engine features and page-description technologies, the near future is more likely to be described in ink than engraved in stone. □

David Buchanan, a product manager at Imagen Corp., previously worked for IMSAI and Hewlett-Packard Co. He received his bachelor of science degree in electrical engineering from the University of California at Berkeley.

Real-time rasterization converts the document into a list of software pointers.

Interest Quotient (Circle One)
High 486 Medium 487 Low 488



It's hard to believe all those people who say they have an easy-to-use, inexpensive parallel computer.

That's probably because they don't. But we do.

The Practical Parallel™ from Sequent.

We're shipping a true parallel computer that starts at — are you ready for this — fifty grand. It'll do 1 to 9 MIPs with 2 to 16 real 32-bit processors.

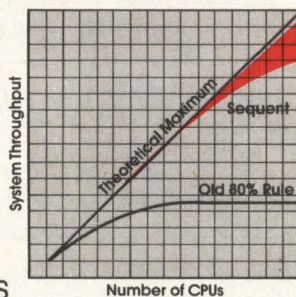

**HOW WE MADE IT
AROUND THE CURVE.**

It's based on standard UNIX™. And it's totally transparent to existing applications, while allowing access for large and fine grain parallel processes.

Best of all, you don't have to be one of the lunatic fringe to be crazy about it.

We already have sixty Practical Parallels up and running at places like Hughes Aircraft Company. And Dataproducts. And Ampex. And Lawrence Livermore Labs.



**“SURE, WE HAVE
AN EASY-TO-USE
PARALLEL COMPUTER
RIGHT NOW.”**

They're doing simulation, text processing, microprocessor development, ATE, data base management, image rendering, software engineering.

And they're reporting price/performance gains as high as 50x!

Okay, we know all this is hard to believe.

But if you really can build a family of products based on one expandable computer, or expand a single system as your needs grow, without ever changing software, literature, spares, or training, isn't that worth a phone call?

The number is 800-854-0428. Or write to Sequent, 14360 N.W. Science Park Dr., Portland, Oregon 97229. (In Europe, call EMS Ltd. at 01-499-6746.)

We've got a truly practical parallel computer. And we've got it now. Honest.



SEQUENT

The parallel computer you can believe in.

CIRCLE NO. 61 ON INQUIRY CARD

What You've Been Waiting For...
GKS Compatible Firmware!

A High Performance Graphics Display Controller

OMNI 1000 GDC™

BUS Independent Single Board

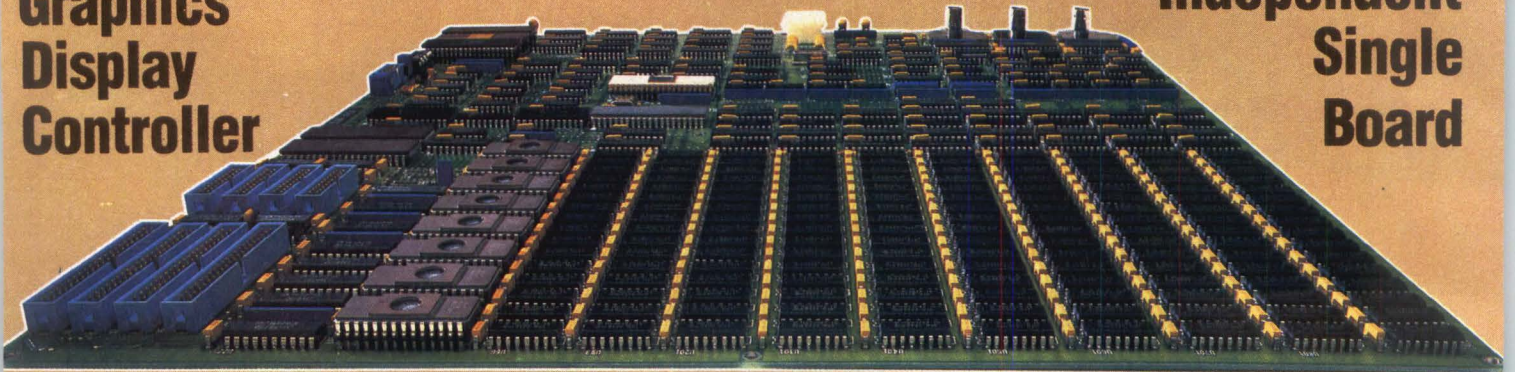

Features

The OMNI 1000 GDC is a 16 x 16-inch single-board graphics controller with a display resolution of 1024 x 1024 by 8 planes. The board houses Intel's 8086 CPU, 8087 NDP, 8089 IOP, and the 7220 graphics processor for local drawing and list processing. The support for eight image memory planes allows simultaneous display for 256 colors from a palette of 4096 colors. Also included on board are 256KB of list-processing RAM, and 64KB of EPROM.

Benefits

Overall system performance is enhanced by the OMNI 1000 GDC multiple processor design. Local scale, rotate, translate, polyfill, drag, clip, highlight, rubberband,

etc. are provided by the display list processor.

Reduce software development cost. Use the OMNI 1000 GDC together with OMNILIB host interface library (FORTRAN or C) for full GKS compatible functionality. The programmer or engineer can begin immediately to accomplish his task with greater efficiency than ever before.

Interface the bus independent OMNI 1000 GDC to your host via DMA, Parallel I/O or Serial RS-232C with off-the-shelf hardware available for most bus architectures, including IBM PC/XT/AT, MULTIBUS, VME, Q-BUS and UNIBUS. Choose the OMNI 1000 GDC configuration which fits

your needs; circuit board only, rack-mount/tabletop enclosure or complete graphics terminal.

Conclusions

High performance graphics, segmented display list architecture, BUS independence, GKS firmware compatibility, and an extraordinary high level of field proven reliability are hallmarks of the OMNI 1000 GDC.

The cost of such a system? You'll be pleased to find a surprisingly low cost for a graphics performance so high. Use the coupon below to R.S.V.P. for a local showing of the OMNI 1000 GDC in the UK at locations indicated.

Please send additional information.
 have a sales representative contact me.

Name _____ Title _____
 Company _____
 Address _____ City _____ Zip _____ Country _____
 Telephone _____ Ext: _____
 My Application is _____
 My Product Requirements Are: _____ Immediate _____ 1-3 months _____ 4 to 6 months
 Projected Number of Units Used Over Next 12 Months _____

See us at
Booth 306-308
Computer Graphics '85
August 13 through 15
in Boston

Omnicom
Graphics Corporation

Optimizing Computer Graphics... by Design.

1734 West Belt North, Houston, Texas 77043 • 713/464-2990 • Telex 285801 OMNICO UR

MULTIBUS is a registered trademark of Intel Corporation.
DEC, Q-BUS, UNIBUS are registered trademarks of Digital Equipment Corporation.
IBM PC/XT/AT are registered trademarks of IBM Corporation.
OMNI 1000 GDC, OMNILIB, OMNICOOMP GRAPHICS are trademarks of Omnicomp Graphics Corporation.

CIRCLE NO. 62 ON INQUIRY CARD

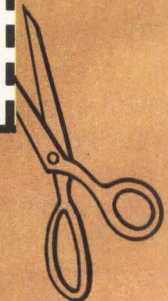

GRAPHICS CARDS FLOOD PC MARKETPLACE

Software developers and turnkey vendors are rushing out IBM PC-based products that promise higher resolution and processing speed

Jerry Borrell

Senior Western Editor

Encouraged by enthusiastic buyer response and a growing body of application software, dozens of manufacturers are supplying high-performance graphics cards for the IBM Corp. PC family. The Intel Corp. 80286-implemented generation of microcomputers has provided a push to the buying activity. These machines give users access to graphics applications heretofore available only on minicomputers.

Sales of microcomputer-based application software for computer-aided design, computer-aided engineering and business reflect this new access to graphics. More of this software is coming because PCs are being installed in greater numbers than are graphics terminals.

IBM encouraged competition from independent vendors by announcing the Enhanced Graphics Adapter (EGA) and the Professional Graphics Controller (PGC), which cleared the way for higher quality graphics for PCs. More important, the products' technical weaknesses further opened the door to competition. Sources suggest that IBM believes the PGC represents a strategic error for the company, because it made the PC-AT package competitive with IBM's own mainframe-based software and graphics terminals. IBM has since disbanded the technical group responsible for the design of the PGC, but it has created significant user dissatisfaction about PGC service and support.

The PC and its graphics cards have reached the performance levels of minicomputers and smart terminals. Accelerated VLSI development

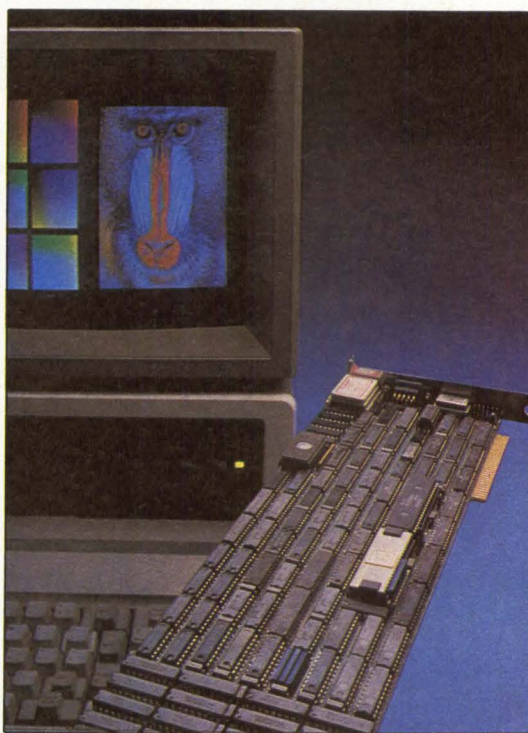

Increased resolution of the IBM PC display is the goal accomplished by the transformer board by Frontier Technology.

has hastened the performance advances. For their part, graphics-terminal manufacturers have fostered growth by implementing low-cost VLSI-based chips, thus reducing the overall cost of manufacturing. The Motorola Inc. MC6845 and NEC America Inc. 7220 chips are good examples. These two devices are, respectively, monochrome and color CRT controller devices implemented in VLSI. They were primarily responsible for the wealth of lower cost graphics

terminals that began to appear in 1982 and 1983. Control Systems Inc. and Hercules Computer Technology were the first to market monochrome and color graphics cards for the PC employing these chips. Control Systems in 1982 released the first high-performance color card,

with 1,024-by-1,024 resolution and 16 colors. Hercules has sold over 300,000 of its cards, according to company president Kevin Jenkins.

The new generation of graphics cards is based on several approaches to providing faster graphics processing. NEC has introduced a second group of 7220 parts offering clock rates of 20 MHz and 60 MHz. This extra speed enables BNW Inc. and Tat Advanced Technology Ltd. to offer greater than 1,204-by-780 resolution at higher pixel drawing speeds, albeit with a sacrifice in the displayable colors.

Other manufacturers are building cards around Hitachi America Ltd.'s new 63484 graphics chip. These include C.S.D. Inc., Frontier Technologies Corp. and Modgraph Inc. Some are even designing graphics processors with semi-customized tools such as gate arrays at the 4,000- to 6,000-gate level. These companies include Metheus Corp., Parallax Graphics Inc., Ramtek Corp. and Vectrix Corp.

Although all of these manufacturers place the controller within the PC, Cubicomp Corp. was first to build a graphics card external to the PC, an approach that decreases the cost of integra-

For your eyes only: *The image created by AT&T Information Systems' "Image Capture Board" demonstrates that color, and not resolution, often determines quality.*



How VLSI impacts PC graphics

1. Off-the-shelf graphics processors, like Motorola Inc.'s MC6845 and NEC's 7220, brought graphics capability to a wider group of designers. Second generation devices such as the Hitachi HD 63484 bring

more functionality to single-board devices.

2. Dynamic RAM prices dropped to where 64K-by-1 RAMs now sell for under 80 cents each in OEM quantities. Graphics requires massive amounts of RAM. New chip architectures such as 16K by 4 and 64K by 4 are ideally suited to graphics.

3. Cost decreases for standard-cell and gate-array design brought fast-turnaround, custom design to small manufacturers.

4. Programmable logic array (PLA) technology allowed manufacturers to consolidate medium-scale integration/large-scale integration discrete parts into fewer chips.

5. Programmable memories gave to the vendor the ability to customize designs and to the OEM flexibility in creating applications.

6. Digital-to-analog converters (DACs), which are single-part chips, allowed the card to support much more color (256 or more simultaneous shades out of multimillion color-selectable palettes).

7. Some vendors incorporated another CPU chip as the cost of microprocessors decreased—further off-loading graphics processing from the host.

8. The first high-speed VLSI chips on the personal computer for 32-bit, floating-point math were introduced by Weitek Inc., Sunnyvale, Calif.

9. The PC/AT's 16-bit bus speeded data transfer between host and graphics card.

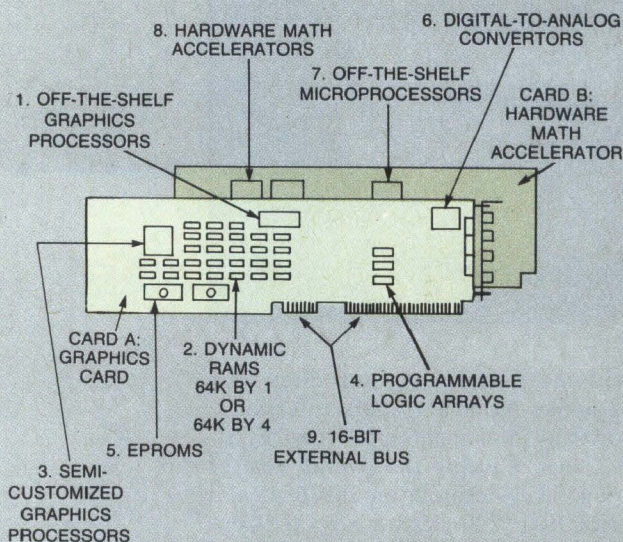

A NEW CATEGORY OF DATA TRANSMISSION - V.H.S.



 ADCoMM 96/48

Advanced Communications Modem/Multiplexer

THE FIRST ERROR PROTECTED, DATA COMPRESSED, FDX V.H.S. (*VERY HIGH SPEED*) DDD DATA TRANSMISSION PRODUCT

While application areas include a high speed telecomm capability for asynchronous terminals in large systems such as IBM and DEC, the ADCoMM has an optional statistically multiplexed secondary channel to support additional independent devices, such as printers. ADCoMM's are your perfect cost saving/avoidance approach where high speed throughputs are required and/or data integrity is a must.

STANDARD FEATURES "ALL-IN-ONE"

- Very High Speed (V.H.S.) Operation/Up to 19.2 Kbps
- 100% Error Protected
- Data and Character Compression
- Voice Grade Dial-up
- Asynchronous Operation
- Half Speed Fall Back Mode
- Alternate Bell 103 Compatible Mode

Call your nearest distributor or call us directly

1-800-527-1169



Carterfone Communications Corporation (CCC)

A SUBSIDIARY OF CABLE & WIRELESS

1341 WEST MOCKINGBIRD LANE • SUITE 1100 WEST • DALLAS, TEXAS 75247

7/85



SEE YOUR WAY CLEAR.

On screen. Or paper. Or transparency film. You'll see your data represented with unmatched visual acuity.

For instance, look into the family of Seiko color graphics terminals. You'll get high resolution. From 1024 x 780 on our GR-1100 Series to 1280 x 1024 on our GR-2400 Series. Plus you'll choose the features you want most. Like 2D transformations, zoom and pan with true magnification, TEK 401x Plot 10 compatibility, interactive tablet support and mouse. You can even get enhanced VT100 video terminal emulation with a true VT100 keyboard.

If you want a record of your data for later analysis or presentation, just push the

button on your CH-5201 color hard copier. You'll get curves that look like curves. Details that remain sharp. And a built-in frame buffer that captures the image and instantly frees your terminal. So you can go on working while the 5201 gives you up to 99 copies off line.

Of course, there's more. So see your way clear to making a phone call, we'll make sure you see your data clearer than ever before. Call Martin Nelson at (408) 943-9100 today.



© 1985 Seiko Instruments U.S.A., Inc. TEK and Plot 10 are registered trademarks of Tektronix. VT100 is a trademark of Digital Equipment Corp. Image Credits: PDA Engineering; Swanson Analysis Systems; Lasergraphics.

tion and provides longer product life by allowing easier access to upgrades. Companies doing this include Aydin Controls, General Parametrics Corp., Gould Inc. and Omnicorp Graphics Corp.

Support features needed

The IBM machines themselves may limit graphics function, even as graphics processors become more powerful. This is especially true of the PC and PC/XT. One company, Seattle Telecom and Data Corp., has a unique solution in its card: an on-board Intel 80286 processor that replaces the PC's narrower, slower 8088. Because the Intel processor runs at a faster clock rate than the IBM processor, the card overcomes some of the speed limitations of the PC's 8-bit internal bus.

Despite the wider data bus and faster processing speed of the 80286, the old bottlenecks of graphics—processing graphics data and manipulating floating-point data—remain. To overcome these drawbacks, Marinco Computer Products Inc., San Diego, offers array processors.

Tackling the floating-point manipulation problems, Weitek Inc. makes a PC/AT Solids Modeling Engine, implemented in two cards. It currently works with the 8820 graphics controller from Vermont Microsystems Inc. (VMI). The engine will offload graphics tasks from the main CPU, allowing the PC/AT to process, render and interactively manipulate shaded 3-D models. Two other companies unite on-board processors with specific graphics processors. Orchid Technology Inc. uses Intel's 80188 and programmable logic arrays, while Verticom Inc. combines the Motorola MC68000, Zilog Inc. Z80 and a gate array.

The performance of the Weitek/VMI combination on a PC (priced at about \$15,000) compares favorably with a low-range Digital Equipment Corp. VAX minicomputer and graphics terminal, which have a combined price of about \$70,000.

Software developments follow

To be truly competitive for design, engineering and graphic-arts applications, however, the PC must access high-performance output devices such as electrostatic plotters, laser printers, pen plotters and film recorders. A third group of manufacturers builds the interface cards needed for the PC to handle such devices. The group comprises AMF Logic Sciences Inc., Concept Technologies Inc. and KMW Systems Corp.

The success of the vendors listed in the chart accompanying this article will enjoy depends on their ability to use popular graphics software and

upon their ability to market hardware/software combinations. It's not clear whether software availability has led to more powerful graphics cards or vice versa, but examples support both claims. AutoDesk Inc. produces AutoCAD and has during the last two years sold over 25,000 copies. This success exemplifies how software can drive card development forward. Most card developers prefer to interface their package to AutoCAD and often cite the software as holding their major market potential.

Still other vendors, particularly turnkey system vendors that possess a body of software, are waiting for better IBM PC-card performance before extending their product offerings. Included among these are Auto-Trol Technology Corp., Computervision Corp. and MCS Inc.

The new generation of graphics cards is based on several approaches to providing faster graphics processing.

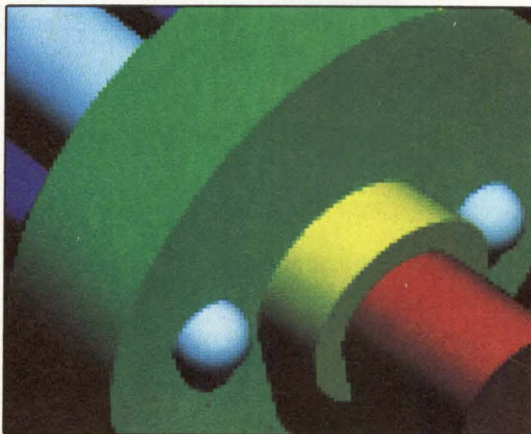
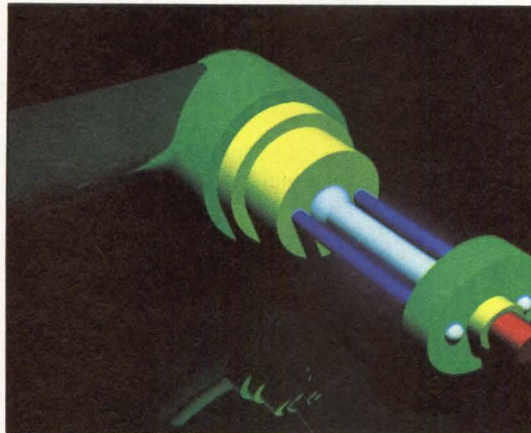

Images generated on minicomputers can now use IBM PC workstations as remote display terminals, as shown by this graphic produced by Number Nine Computer's Revolution PC graphic board and Visual Engineering's Visual:GeniSys modeling software. Detail shows pixel definition is not discernable even when the graphic is blown up to five times its normal size.

These three CAD vendors say they are trying to prevent further erosion of market share to a growing body of PC-based CAD software vendors.

With the increase in the number of both hardware and software graphics products, the difficulties in making combinations of card and software work together have also increased. If these problems are to diminish, two standards issues must be addressed. First, the need for a standard interface between graphics software and graphics cards, and, second, the need for a common body of graphics functions. The virtual device interface (VDI) addresses the first issue, while a body of graphics-function definitions—graphical kernel system (GKS) and several independently developed packages—address the second issue.

IBM contracted with Graphic Software Sys-

tems Inc. (GSS) to provide the VDI, programmers toolkit and GKS library for the PC. A lack of support from IBM has let third parties work directly with GSS on the software. It remains unclear whether or not IBM's lack of support results from the fact that the VDI provides benefits for a large body of UNIX-based systems. Many of these systems—such as those from AT&T Information Systems—compete directly with IBM's products. The effect has been dissatisfaction with the GSS software due to (a) its slow porting to non-IBM cards, (b) IBM's initial specifications for the products, which left out certain functions such as multiwindowing, (c) inefficient graphics-driver development by card manufacturers and (d) lack of 3-D implementation.

Another area of graphics functionality may provide even less agreement. IBM, again via

Representative directory of manufacturers

Applied Computer Products Inc.

1622 Republic Road
Huntington Valley, Pa.
19006

Circle 399

AST Research Inc.

2372 Morse Ave.
Irvine, Calif. 92714

Circle 400

AT&T Information Systems Electronic Photography and Imaging Center

2002 Wellesley Blvd.
Indianapolis, Ind. 46219

Circle 401

Aydin Controls

414 Commerce Drive
Fort Washington, Pa.
19034

Circle 402

BNW Inc.

Suite 9
15951 Lost Gatos Blvd.
Los Gatos, Calif. 95030

Circle 403

California Computer Systems

740 S. Milpitas Blvd.
Milpitas, Calif. 95035

Circle 404

Chorus Data Systems

6 Continental Blvd.
Merrimack, N.H. 03054

Circle 405

Concept Technologies Inc.

P.O. Box 5277
Portland, Ore. 97208

Circle 406

Conographic Corp.

17841 Fitch
Irvine, Calif. 92714

Circle 407

Control Systems Inc.

2855 Anthony Lane
Minneapolis, Minn. 55418

Circle 408

Cubicomp Corp.

3165 Adeline St.
Berkeley, Calif. 94703

Circle 409

Datacube Inc.

4 Dearborn Road
Peabody, Mass. 01960

Circle 410

Emulex Corp./

Persyst Inc.
3545 Harbor Blvd.
Costa Mesa, Calif. 92626

Circle 411

Everex Systems Inc.

47777 Warm
Springs Blvd.
Fremont, Calif. 94539

Circle 412

Frontier Technologies Corp.

3510 N. Oakland Ave.
Milwaukee, Wis. 53211

Circle 413

General Parametrics Corp.

1505 Solano Ave.
Berkeley, Calif. 94707

Circle 414

Genoa Systems Corp.

73 E. Trimble Road
San Jose, Calif. 95131

Circle 415

Gould Inc. Imaging and Graphics Div.

1870 Lundy Drive
San Jose, Calif. 95131

Circle 416

H.M. Technologies Inc.

#300 1737 N. First St.
San Jose, Calif. 95112

Circle 417

Hercules Computer Technology

2550 Ninth St.
Berkeley, Calif. 94710

Circle 418

IBM Corp. Entry Systems Div.

P.O. Box 1328
Boca Raton, Fla. 33432

Circle 419

ID Systems Corp.

6175-W Shamrock Court
Dublin, Ohio 43017

Circle 420

IDEAssociates Inc.

35 Dunham Road
Billerica, Mass. 01821

Circle 421

Imaging Technology Inc.

600 W. Cummings Park
Woburn, Mass. 01801

Circle 422

MA Systems Inc.

2015 O'Toole Ave.
San Jose, Calif. 95131

Circle 423

GSS, provides a library of graphics functions adhering to the international GKS standard. But the IBM version is intended only for the IBM graphics cards, leaving independent vendors with enormous application development. Third-party vendors have, as a result, written proprietary function libraries such as Halo, from Media Cybernetics Inc., Takoma Park, Md. Widely used, Halo has attained de facto-standard status. It's certainly the most widely used library.

The advantages of both standards are straightforward. They allow the software vendor to utilize any graphics controller for which drivers can be written. By the same token, the graphics-controller vendor can write software drivers more easily for their cards because functions are standardized. Last spring the National Computer Graphics Association (NCGA) endorsed yet another standard, the Programmers Hierarchical



Digital painting can realistically aspire to art with boards such as *Number Nine Computer's Revolution PC graphic board.* (Drawing by Scott Lewczak)

Matrox Electronic Systems Ltd.
1055 St. Regis Blvd.
Dorval, Quebec
H9P 2T4, Canada
Circle 424

Metheus Corp.
5289 N.E. Elam
Young Pkwy.
Hillsboro, Ore. 97123
Circle 425

Modgraph Inc.
56 Winthrop St.
Concord, Mass. 01742
Circle 426

Mylex Corp.
5217 N.W. 79th Ave.
Miami, Fla. 33166
Circle 427

Number Nine Computer Corp.
691 Concord Ave.
Cambridge, Mass. 02138
Circle 428

Omnicom Graphics Corp.
1734 W. Belt North
Houston, Texas 77043
Circle 429

Orchid Technology Inc.
47790 Westinghouse Dr.
Fremont, Calif. 94539
Circle 430

Paradise Systems Inc.
217 E. Grand Ave.
S. San Francisco, Calif.
94080
Circle 431

Parallax Graphics Inc.
Suite 215
1095 E. Duane Ave.
Sunnyvale, Calif. 94086
Circle 432

Personal Computer Products Inc.
11590 W. Bernardo Court
San Diego, Calif. 92127
Circle 433

Plus Products (Div. of LF Technologies Inc.)
2800 Lockheed Way
Carson City, Nev. 89701
Circle 434

Princeton Graphics Systems
601 Ewing St., Bldg. A
Princeton, N.J. 08540
Circle 435

Profit Systems Inc.
Suite 173
30150 Telegraph Road
Birmingham, Mich. 48010
Circle 436

Quadram Corp.
4355 International Blvd.
Norcross, Ga. 30093
Circle 437

Quintar Corp.
2525 Maricopa St.
Torrance, Calif. 90503
Circle 438

Ramtek Corp.
2211 Lawson Lane
Santa Clara, Calif. 95050
Circle 439

Scion Corp.
12310 Pinecrest Road
Reston, Va. 22091
Circle 440

Sigma Designs Inc.
2023 O'Toole Ave.
San Jose, Calif. 95131
Circle 441

STB Systems Inc.
601 N. Glenville
Richardson, Texas 75081
Circle 442

Tat Advanced Technology Ltd.
1270 Lawrence
Station Road
Sunnyvale, Calif. 94089
Circle 443

Tecmar Inc.
6225 Cochran Road
Solon, Ohio 44139-3377
Circle 444

Tektronix Inc.
P.O. Box 1700
Beaverton, Ore. 97075
Circle 445

Tseng Labs Inc.
205 Pheasant Run
Newtown, Pa. 18940
Circle 446

Vectrix Corp.
2606 Branchwood Drive
Greensboro, N.C. 27408
Circle 447

Vermont MicroSystems Inc.
1 Main St., Box 236
Winooski, Vt. 05404
Circle 448

Verticom Inc.
545 Weddell Drive
Sunnyvale, Calif. 94089
Circle 449

XTAR Electronics Inc.
2262 Landmeier Road
Elk Grove, Ill. 60007
Circle 450

Turnkey system vendors that possess a body of software are waiting for better PC-card performance before extending their product offerings.

Interactive Graphics Standard (PHIGS), thereby offering little hope of resolving the standards debate.

Some bundle card and monitor

Connecting a monitor to a new high-performance card presents one of the PC's intractable problems, having to do with the cards' refresh rates. Monitors only operate within a narrow range of refresh rates, as many card purchasers have discovered. Several vendors avoid this issue by bundling card and monitor. These include Amdek Inc., Emulex Corp., Quadram Corp., Tecmar Inc. and Verticom Inc.

Several card vendors provide a disk that allows users to perform a setup routine that specifies what type of monitor is needed. Princeton Graphics Systems produces a version of its HX-12 monitor that allows users to switch between different refresh rates, allowing various graphics cards to run.

Another problem stems from the type of signal output. IBM's original CGA adapter outputs a TTL-type signal, limiting the display to 16

colors. Fortunately, both EGA and PGC produce analog or red-green-blue (RGB) signals and thus offer a wide range of colors. This shift from TTL to RGB has brought into the market traditional suppliers of high-quality monitors for graphics terminals such as Mitsubishi Electronics America Inc.

New applications are imminent

While the search for solutions to the hardware and software issues is proceeding apace, new applications areas are developing quickly, particularly in imaging, graphics arts, business and manufacturing.

As resolution and color availability increase, applications formerly limited to high-cost image processing systems migrate downward to personal computers. The PC Eye card from Chorus Data Systems, for example, has permitted the company to expand its software into areas such as machine vision (for robot vision, pattern recognition and automatic inspection) and on-line personnel files that incorporate photographs and data. Number Nine Computer Corp., one of the first suppliers of "true color" (24 bits of color per pixel) for the IBM PC, has seen its card implemented in several turnkey systems for the graphics arts. Software developers such as Cubi-comp and West End Films Inc., make use of solids-modeling packages on the PC to serve filmmaking and animation.

Several more mundane, but potentially more profitable, areas remain to be exploited. Emulex, Quadram and Paradise Systems Inc. have incorporated graphics control onto cards, including memory and communications ports. Others offer combination cards that join monochrome and color display functions. These companies include Genoa Systems Corp., Personal Computer Products Inc. and Profit Systems Inc. Their lucrative potential lies in solving hardware problems for business users at prices below those of IBM.

Marketing approach must change

As the number of graphics products changes from hundreds to thousands of units, changes must follow in marketing. Graphics terminal vendors rightfully point out that graphics purchasers require more support, training, and maintenance of products than do buyers of other personal computer technology. Turnkey vendors similarly wonder how efficient it is to sell sophisticated graphics software through retail outlets.

Interest Quotient (Circle One)
High 489 Medium 490 Low 491

**Wondering
Where
To Turn
Next?**

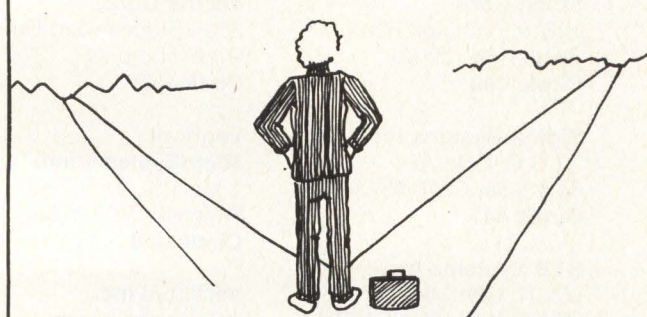

**Turn To
Mini-Micro Systems
Career
Opportunities
Section**

Introducing seven different
ASCII displays...



The new IBM 3161 ASCII Display Station is really seven different ASCII displays in one.

In addition to its own function-rich native mode, the new IBM 3161 can emulate the IBM 3101 Model 881, ADDS Viewpoint, Hazeltine 1500, Lear Siegler ADM-3A and ADM-5 and TeleVideo 910*.

Besides fitting nicely into existing systems, the IBM 3161 also offers impressive improvements in ergonomics.

Improved Ergonomics For Improved Productivity

Take the 102-key ASCII-style keyboard, for example. Its low profile, gentle contour and typewriter touch make for faster keying with fewer errors. The keyboard has programmable function and editing keys so it can be custom-tailored to meet your application needs.

Then, for comfortable viewing, there's the tilt and swivel of the 12" display. And the sharp, clear 8 x 16 character matrix for easy reading. Plus cursor, character and field attributes (blink, reverse video, underscore, dual intensity, etc.). And scrolling. And partitioning. And lots more.

The IBM 3163 with Plug-in Cartridge

And, as if that weren't enough, we're also announcing

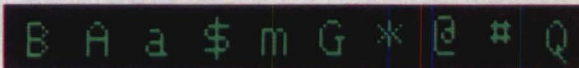

The sharp 8 x 16 character matrix helps make for easier reading and fewer operator errors.

a second new ASCII display station with even higher function—the IBM 3163.

Outwardly, these two new displays look alike. But the 3163, in addition to its built-in emulation of the IBM 3101 Model 881, also offers the ability to emulate the DEC VT 52 and VT 100* by means of a unique plug-in cartridge.

And while you'll like the power and flexibility of the 3161, for your high-function applications the 3163 goes even further. For example, a 7,680-character buffer and up to three windows enable you to view and modify portions of different host data bases. The 3163 lets you redefine and even recap the keys.

On both displays the setup is menu-guided and written in plain English, so it can be done easily and quickly. The point is, both are designed to improve your user productivity.

Very Attractive Prices

The price per terminal is \$695 for the 3161 and \$1,095 for the 3163. Quantity discounts are available. What's more,

IBM maintenance offerings start as low as \$35 per year per terminal for

customer carry-in repair.

Now there's a new family of ASCII displays with the quality, service and support IBM is famous for. Both displays are available through IBM Authorized Distributors and IBM marketing representatives.

FEATURES	3161	3163
Lines x Characters	25 x 80	25 x 80
Double-sized chars	No	Yes
Line drawing chars	24	24
Vertical scroll	Jump	Jump/ Smooth
Definable function keys	24	24
Windowing	No	Yes
Partitioning	Horiz	Vert/Horiz

Call 1 800 IBM-2468, Ext. LE/96 for the name of an Authorized Distributor near you.



*ADDS Viewpoint is a trademark of Applied Digital Data Systems, Inc.; Hazeltine 1500 is a trademark of Hazeltine Corp.; Lear Siegler ADM-3A/ADM-5 are trademarks of Lear Siegler, Inc.; TeleVideo 910 is a trademark of TeleVideo Systems, Inc.; DEC VT 52/VT 100 are trademarks of Digital Equipment Corporation.



in one.



The IBM 3161 ASCII Display Station

CIRCLE NO. 65 ON INQUIRY CARD

INTRODUCING THE DIGITIZING POWER OF TRUE GRID™

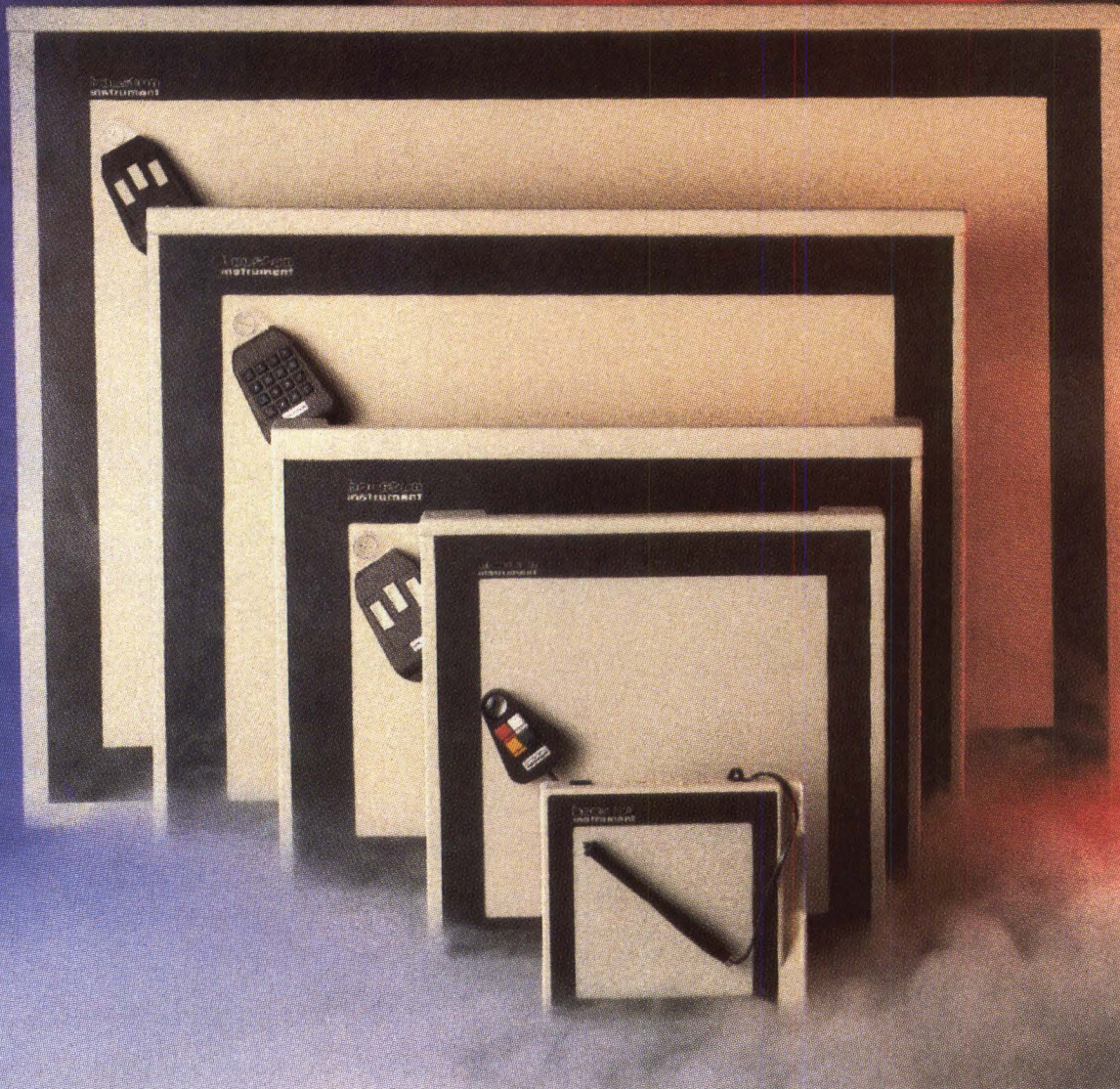

Houston Instrument offers you the ultimate match between high performance and low price with our new TRUE GRID Digitizers. These flexible and intelligent digitizers are designed to offer system builders a versatile collection of powerful, productive, graphics input tools.

Whether you need a digitizer for cursor control or to complement a computer-aided design configuration, these new products give you all the graphics features you need to match your particular application.

If you want a compact digitizer for menu picking or cursor control, we offer our TRUE GRID 1000 Series tablets with active areas ranging in size

TRUE GRID is a trademark of Houston Instrument.

from 5 × 5 inches to 11 × 17 inches. These tablets feature a resolution of .005 inch, a built-in RS-232-C compatible interface, and a choice of a stylus, one-button cursor, or four-button cursor.

For mechanical, electrical, mapping, architectural, and surveying applications, we've designed the TRUE GRID 8000 Series digitizers with active areas ranging in size from 11 × 11 inches to 24 × 36 inches. Featuring a high resolution of .001 inch and built-in RS-232-C compatible interface, these precision digitizers can be used with either of our new three-button or 16-button cursors.

All of our TRUE GRID Digitizers are easy to configure, durable, and so reliable we can offer you a one-year

warranty plan. You'll also find that these sleek, wedge-shaped digitizers will fit into any environment . . . or system configuration.

At Houston Instrument, we're confident our TRUE GRID Digitizers are the natural choice for high-performance graphics communication. For more information, write us at 8500 Cameron Road, Austin, Texas 78753 or call us at 1-800-531-5205. (In Texas, please phone 512-835-0900.) Houston Instrument products are designed, marketed, and manufactured in Austin, Texas.

**houston
instrument**

4P021

CIRCLE NO. 66 ON INQUIRY CARD

REPRESENTATIVE LIST OF PC-COMPATIBLE GRAPHICS CARDS

Manufacturer	Product	Resolution in picture elements	Additional display resolution possible?	Graphics Processor	Colors displayable/ colors in palette or monochrome	Display output: TTL, Analog-RGB, NTSC	Emulations: CGA, EGA, VGA, or other	VDI, GKS or Halo	Cost (\$)	Comments
Applied Computer Products Inc.	Bigraphix	720 x 345	yes	M 6845	mono and color, 16/16	TTL, NTSC, RGB	CGA	—	395	
AST Research Inc.	Color Graph Plus	640 x 200	yes	M 6845	mono, 16/16	TTL	CGA	Halo	NA	memory expansion needed for 16 colors, parallel port
AT&T Information Systems	Image Capture Board	256 x 256	yes	WE 229DW	32,768/32,768	NTSC, RGB	no	no	1,295	frame grabber and frame buffer
	Video Display Adapter	256 x 256	yes	WE 229DW	256/32,768	NTSC, RGB	no	VDI, Halo	695	
	Targa	512 x 512	no	WE 229DW	64M/64M	NTSC, RGB	no	Halo	NA	frame grabber and frame buffer
Aydin Controls	2010 Tribune	1,024 x 1,024	yes	NEC 7220	256/4,096	RGB	no	no	9,300*	external; includes on-board 8086/8087
BNW Inc.	Precision Graphics Adapter, Model-15	1,024 x 1,024	yes	NEC 7220	16/16	TTL, RGB	Tek 40XX, Tek 4105/07	VDI	2,295	NEC chips run up to 62-MHz clock rate
	Precision Graphics Adapter, Model 15-2	1,024 x 1,024	yes	NEC 7220	16/256	TTL, RGB	Tek 40XX, Tek 4105/07	VDI	3,995	2 slots required
California Computer Systems	Supervision	720 x 348	no	M 6845	mono	TTL	Hercules	Halo	599	
	Model A229	640 x 200	yes	M 6845	mono, 4/16	TTL	CGA	no	245	
Chorus Data System	PC Eye	640 x 400	yes	discrete	256 grey scale, 256/256	NTSC, TTL	CGA	no	1,495	sold with IMIGIT software and input camera
Concept Technologies Inc.	Graphcard 100	720 x 352	yes	NA	mono	TTL	Hercules, CGA	VDI	1,250	part of Conceptcard that drives laser printer
Conographic Corp.	Cono-Color 40	640 x 400	yes	M 6845	16/256	TTL, NTSC, RGB	CGA	Halo	995	firmware uses parametric primitives
Control Systems Inc.	Artist 1	1,024 x 1,024	no	NEC 7220	16/4096	TTL, NTSC, RGB	Tek 4110, 4105, 4115	—	2,995	
	Artist 2	640 x 400	no	NEC 7220	16/4,096	TTL, NTSC, RGB	Tek 4110, 4105, 4115	—	1,395	
	Artist Transformer	640 x 480	yes	NEC 7220	256/4,096	TTL, NTSC, RGB	Tek 4110, 4105, 4115, CGA	—	1,995	tran. card converts all PC software to high resolution
Cubicomp Corp.	CS/16	512 x 512	no	discrete logic	64,000/16M	NTSC, RGB	no	no	25,000*	CS-161S hardware for picture maker animation system; external
Datacube Inc.	IVG-128	512 x 384	yes	discrete-PALS	mono, 256/16M	NTSC, RGB	no	no	2,995	frame grabber and frame buffer
Emulex Corp./ Persyst Inc.	Bob Display Adapter	640 x 400	yes	M 6845	mono, 4/4	TTL	CGA	no	525.* 750	daughter card needed for 640 x 400; switches from mono to color monitor
Everex	Graphics Edge	720 x 348	yes	M 6845	mono, 16/16	TTL	CGA	no	499	runs mono, color monitors simultaneously
	The Edge	720 x 348	yes	M 6845	mono, 16/16	TTL	CGA	no	399	
Frontier Technologies Corp.	Cadgraph 1	1,024 x 1,024	yes	NEC 7220	4/16	TTL	no	GKS	995	
	Cadgraph 2	1,024 x 1,024	yes	NEC 7220	2/16	TTL	no	GKS	795	
	IHR 2	1,024 x 1,024	yes	Hitachi HD 63484	16/4,096	RGB	no	GKS	NA	includes on-board 80188/80187
General Parametrics Corp.	Videoshow150	2,048 x 480	no	discrete-PALS	1,024/1,024	TTL, RGB, NTSC	no	no	3,499	external; include on-board 8086, PictureIt presentation software
Genoa Systems Corp.	Spectrum	720 x 320	yes	M 6845	mono, 16/16	TTL, RGB	Hercules, CGA	no	459	runs mono, color simultaneously
Gould Inc.	FD-5000	512 x 512	yes	discrete	16.7M/16.7M	RGB	no	no	10,000	image-processing software from minicomputer-based FD-5000 included; external
HM Technologies Inc.	Color Graphics Card	640 x 400	yes	M 6845	4/16	TTL, NTSC, RGB	no	no	185	

*Includes monitor

REPRESENTATIVE LIST OF PC-COMPATIBLE GRAPHICS CARDS

Manufacturer	Product	Resolution in picture elements	Additional display resolution possible?	Graphics processor	Colors displayable/ colors in palette or monochrome	Display output: TTL, Analog, RGB, NTSC	Emulations: CGA, EGC, PGC, Tektronix or other	VDI, GKS or Halo	Cost (\$)	Comments
Hercules Computer Technology	Hercules Graphic Card	720 x 348	yes	M 6845	mono	TTL	no	no	499	
IBM Corp.	Color Graphics Adapter (CGA)	320 x 200	no	—	4/16	TTL	no	no	—	
	Enhanced Graphics Card (EGC)	640 x 350	yes	gate array	16/64	RGB	CGA	VDI, GKS	524*	
	Professional Graphics Controller (PGC)	640 x 480	yes	discrete-PALS	256/4,096	RGB	CGA, EGC	VDI, GKS	2,995*	includes on-board 8088; 2 slots required
ID Systems Corp.	ID-1501	1,024 x 1,024	yes	Hitachi HD 63484	256/4,096	RGB	PGC, Tek 40XX, 4105/07	VDI, GKS	2,950	
IDEAssociates Inc.	IDEAGRAPH	1,024 x 1,024	yes	NEC 7220	256/4,096	RGB, TTL	no	no	995-1,895	
Imaging Technology Inc.	PFM PC Frame Grabber	512 x 480	no	discrete array	mono, 256/16.7M	NTSC, RGB	no	no	3,995-4,495	
	FG-100-AT	512 x 580	yes	gate array	mono, 4,096/16.7M	NTSC, RGB	no	no	3,995-4,495	same as above but only PC-based real-time capture
M.A. Systems Inc.	Peacock II	640 x 200	yes	M 6845	16/16	TTL	CGA	Halo	249	
	Mono Magic	740 x 350	yes	M 6845	mono	TTL	Hercules	no	395	
	At Optimizer	640 x 350	yes	M 6845	16/16	TTL	CGA	Halo	NA	on-board 5M-byte RAM; serial/parallel option
Matrox Electronic Systems Ltd.	PG-640	640 x 480	no	discrete	256/4,096	RGB	PGC, CGA	VDI	2,495	8-bit bus, 2 slots required
	PG-1280	1,280 x 1,024	no	gate array	256/4,096	RGB	PGC, CGA	VDI	4,995	16-bit bus, 2 slots required
	AP-512	512 x 512	yes	discrete	256/16.7M	RGB	no	no	1,995	8-bit bus, 2 slots required
	PIP-1024	1,024 x 512	yes	discrete	256/16.7M	RGB	no	no	2,495	8-bit bus, 2 slots required
Metheus Corp.	Omega PC Graphics Controller	1,024 x 768	no	bipolar discrete	16/4,096	RGB	CGA	VDI	2,500	2 slots required
Modgraph Inc.	GX2250	1,024 x 1,024	yes	Hitachi HD 63484	16/4,096	RGB	no	GKS	2,500*	16-bit bus
	GX2150	1,024 x 1,024	yes	Hitachi HD 63484	16/4,096	RGB	no	GKS	2,400*	8-bit bus
	GX2101	1,024 x 1,024	yes	NEC 7220	mono	—	no	GKS	1,000*	8-bit bus
	GX2201	1,024 x 1,024	yes	NEC 7220	mono	—	no	GKS	1,200*	16-bit bus
Mylex Corp.	Chairman	640 x 400	yes	M 6845	mono, 4/4	TTL	CGA	no	595	
	Mylex Enhanced Graphics Adapter	640 x 400	yes	M 6845	mono, 16/16	TTL	CGA	no	NA	
Number Nine Computer Corp.	Revolution 512 x 8	512 x 512	no	NEC 7220	256/16.7M	RGB, NTSC	no	VDI, GKS, Halo	2,045*	
	Revolution 512 x 32	512 x 512	no	NEC 7220	16.7M/16.7M	RGB, NTSC	no	VDI, GKS, Halo	4,995*	only PC graphic card
	Revolution 1024 x 8	1,024 x 1,024	yes	NEC 7220	256/16.7M	RGB, NTSC	no	VDI, GKS, Halo	4,995*	offering 32 bits of color memory
	Revolution 1280 x 4	2,048 x 1,024	yes	Hitachi HD 63484	16/4,096	RGB, NTSC	no	VDI, GSK, Halo	NA	
Omnicom Graphics Corp.	Omni 1000 GDC	1,024 x 1,024	yes	NEC 7220	256/4,096	RGB	no	GKS	6,000-7,695	external
Orchid Technology Inc.	Turbo Graphics Controller	640 x 480	no	discrete-PALS	256/4,096	RGB	PGC, CGA	GKS, Halo	1,995	2-card set includes 80186
Paradise Systems Inc.	Modula Graphics Card	640 x 200	yes	M 6845	mono, 4/16	NTSC, TTL	CGA	no	395	multifunction card that runs color PC software in mono
	Multi-Display Card	720 x 350	yes	M 6845	mono, 4/16	NTSC, TTL	CGA	no	295	switchable between color and mono card

*Includes monitor

Last year, people like you got away with
nearly \$200 million from us.



Hewlett-Packard's VAR discounts added up to some pretty good getaway money. Enough for a lot of trips to exotic, faraway places.

Take a look at Hewlett-Packard's commercial VAR Program and think how far you could go.

It offers discounts up to 35% on HP 3000 computers and peripherals. 40% discounts on demo/development systems. 10% credits on system upgrades if your customer decides to upgrade through us.

Of course, Hewlett-Packard's commercial VAR Program offers more than discounts. For instance, worldwide service and support, rated #1 by Datapro four years in a row.

And one of our strongest selling points: the new HP 3000 Series 37.

It's a full-fledged mini-computer, expandable from 2 to 28 users. But the price for CPU, 1/2 Mbyte memory (expandable to 2 Mbyte), system software, console, 55 Mbyte disc drive and 67 Mbyte cartridge tape drive is just \$21,950 (before quantity discounts).

So first get it all from Hewlett-Packard. Then get away from it all.



The HP Program for Value-Added Resellers

- Send me information on your commercial VAR program and the HP 3000 Series 37.
- Have an HP representative call me right away.

Name _____

Company _____

Address _____

City/State/Zip _____

Phone _____

Mail to: Bob Hall, Hewlett-Packard, Dept. 084223,
10520 Ridgeview Court, Cupertino, CA 95014 ISO 2516



CIRCLE NO. 67 ON INQUIRY CARD

REPRESENTATIVE LIST OF PC-COMPATIBLE GRAPHICS CARDS

Manufacturer	Product	Resolution in picture elements	Additional display resolution possible?	Graphics processor	Colors displayable/ colors in palette or monochrome	Display output: TTL, Analog-RGB, NTSC	Emulations: CGA, EGC, PGC, Tektronix or other	VDI, GKS or Halo	Cost (\$)	Comments
Parallax Graphics	600 PC	640 x 480	yes	gate array	16.7M/16.7M	RGB, NTSC	CGA,EGC	no	4,500	switchable from 30 to 60 Hz; 2 slots required
	1280 PC	1,280 x 1,024	yes	gate array	256/16.7M	RGB, NTSC	CGA,EGC	no	6,000	card set supports 3-D floating point match; 2 slots required
Personal Computer Products Inc.	PC/Multi-Video	1,056 x 350	yes	M 6845	16/16	TTL	CGA	no	495	
Plus Products (a division of LF Technology Inc.	Kaleido Card	640 x 400	yes	M 6845	mono, 4/8	TTL	CGA	no	595	
Princeton Graphics Systems	Colorview	640 x 200	yes	M 6845	16/16	NTSC,TTL	CGA	no	289	
Profit Systems Inc.	Multi-Graph II	640 x 400	yes	M 6845	mono, 4/16	TTL,NTSC	Hercules, CGA		NA	
Quadram Corp.	Palette Master	640 x 200	yes	M 6845	256/256,000	TTL,RGB	CGA	Halo	895	
	Quadcolor	640 x 200	yes	M 6845	4/16	TTL,NTSC	CGA	Halo	255	
	Quadcolor II	640 x 200	yes	M 6845	16/16	TTL,NTSC	CGA	Halo	445	upgrade for quadcolor: RAM, game port
	Quadcolor Gold	320 x 200	no	M 6845	4/16	TTL	CGA	no	795	640K-RAM, clock, serial and parallel ports
Quintar Corp.	Quintar 1000	512 x 512	no	NEC 7220	16/4,096	RGB	HPGL, Chromatics CG	VDI	1,995*	
	Quintar 1080	832 x 630	no	NEC 7220	16/4,096	RGB	HPGL, Chromatics CG	VDI	2,995*	
	Graphport	640 x 480	yes	NEC 7220	16/4,096	RGB	CGA	VDI	1,995*	
Ramtek Corp.	2901	1,280 x 1,024	no	gate array, bipolar	256/16.7M	RGB	Tek 4115, CGA	GKS	3,000* (quan.) 1,000)	external
Scion Corp.	PC 640	640 x 480	no	discrete	16/4,096	RGB,TTL	no	Halo, VDI	1,595*	
	FAX 640	640 x 480	yes	discrete-PALS	16 grey scale	NTSC	no	no	1,595	frame grabber card
	PC 640-32	640 x 480	yes	discrete-PALS	16.7M/16.7M	RGB	no	VDI, Halo	NA	
Sigma Designs Inc.	Color 400	640 x 400	no	M 6845	16/16	TTL	no	VDI, Halo	795	
	Dazzler	1,024 x 1,024	yes	NEC 7220	4/8	TTL	no	no	895	
	Dazzler II	640 x 400	no	NEC 7220	16/16	TTL	no	no	995	
STB Systems Inc.	Graphix Plus II	640 x 352	yes	M 6845	mono, 16/16	NTSC,TTL	CGA	Halo	495	allows switch between mono, color monitors
	Chauffeur	640 x 352	yes	M 6845	mono	TTL	CGA	Halo	395	runs color PC software in green shades
TAT Advanced Technology Ltd.	Galaxy 640	640 x 480	no	NEC 7220	16/4,096	RGB,TTL	Tek 4010/4014, Tek 4105/07/09	no	1,850*	
	Galaxy 800	800 x 600	no	NEC 7220	16/4,096	RGB,TTL	Tek 4010/4014, Tek 4105/07/09	no	1,850*	
	Galaxy 1024	1,024 x 1,024	yes	NEC 7220	16/4,096	RGB,TTL	Tek 4010/4014, Tek 4105/07/09	no	2,400*	
	Galaxy 1024-1	1,024 x 768	no	NEC 7220	mono	TTL	Tek 4010/4014	no	1,500*	option allows 32-x-200 mono and 640-x-480 color selection
Tecmar Inc.	Graphics Master	720 x 700	yes	M 6845	mono, 16/16	RGB, NTSC,TTL	CGA	Halo	695*	
Tektronix Inc.	614 F32 PC Graphics Attachment	4,096 x 4,096	no	discrete	mono	analog	IBM 3277	no	1,495*	card interfaces a direct view storage tube
Tseng Labs Inc.	Ultrapak	720 x 348	yes	M 6845	mono	TTL	CGA, Hercules	no	680	drives color software in mono; clock, RAM, serial port, spooler

*Includes monitor

We have 2400 feet to stick in the door.
So you can put yours in the sand.

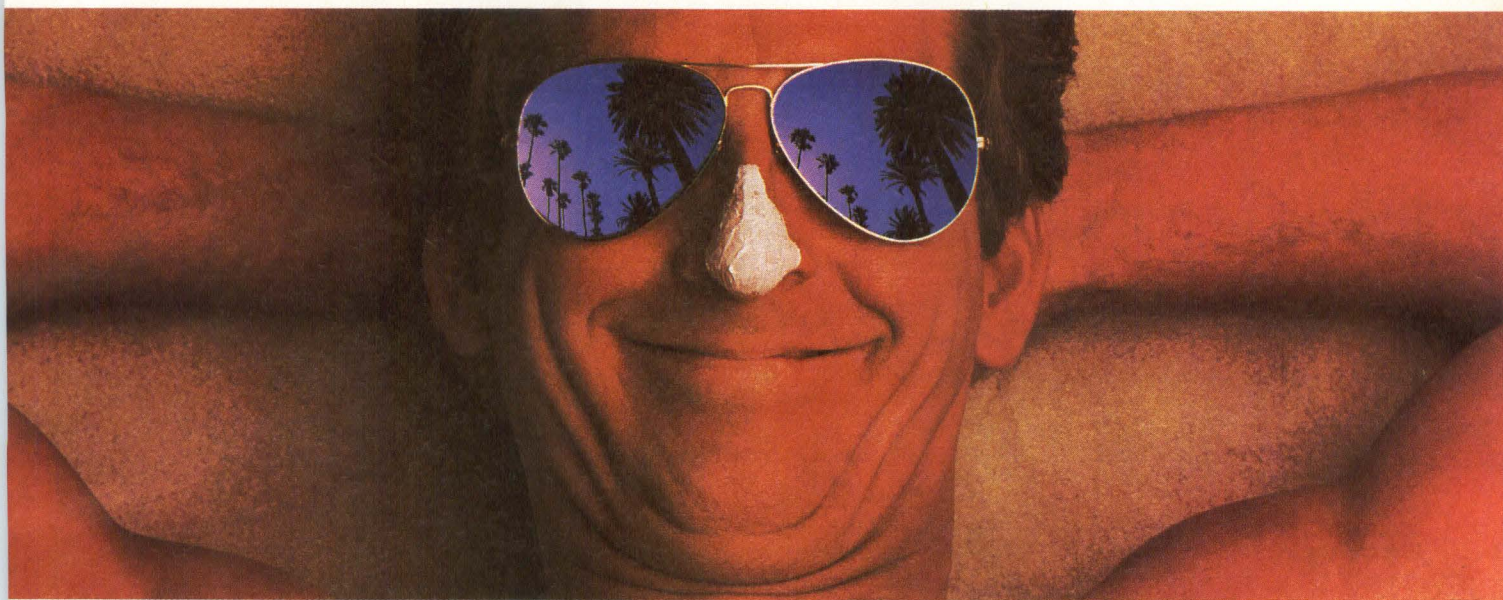

You've all been working around the clock on the new software. It's finished. It's terrific. And you're exhausted.

You really need a vacation. But, first you have to get out there and drum up business. Unless, of course, you'd rather Hewlett-Packard did the drumming for you.

Join our commercial Software Supplier program, and that's exactly what happens. Our worldwide sales force will go to work, opening doors you may never know existed.

Your side of the bargain is to write software to run on HP 3000 business computers. For any kind of business you choose. Then help us close the deals.

For this, we'll give you a bonus of up to 6% of the HP hardware price on any system sale leveraged by your software. That's on top of your full price to the customer.

The HP Program for Software Suppliers is full of nice incentives like this. To find out about all of them, send in the coupon for our brochure.

Pretty soon, you could be on your way somewhere they've never even heard of computers. While we take care of business.



The HP Program for Software Suppliers

- Send me details of your commercial HP 3000 Software Supplier Program. Maybe we have been working too hard.
 Have an HP representative call me.

Name _____

Company _____

Address _____

City/State/Zip _____

Phone _____

Mail to: Bob Hall, Hewlett-Packard, Dept. 008224,
10520 Ridgeview Court, Cupertino, CA 95014 ISO 2517



CIRCLE NO. 68 ON INQUIRY CARD

REPRESENTATIVE LIST OF PC-COMPATIBLE GRAPHICS CARDS

Manufacturer	Product	Resolution in picture elements	Additional display resolution possible?	Graphics processor	Colors displayable/ colors in palette or monochrome	Display output: TTL, Analog-RGB, NTSC	Emulations: CGA, EGA, PGC, Tektronix or other	VDI, GKS or Halo	Cost (\$)	Comments
	Ultrapak-S	720 x 348	no	M 6845	mono	TTL	CGA, Hercules	no	545	
	Colorpak	640 x 400	yes	M 6845	16/16	NTSC, TTL	CGA	VDI	679	Softpack daughter card allows PC software to run on 640-x-480 monitor
Vectrix Corp.	VX/PC	672 x 480	no	NEC 7220	512/16.7M	RGB, NTSC	no	Halo	2,995*	2 slots required
	Pepe	1,024 x 1,024	yes	gate array	161/4,092	RGB	no	VDI	2,995- 4,495	20,000-vector-per-second drawing; 2 slots required
Vermont Micro-systems Inc.	8820	640 x 480	yes	discrete-PALS	256/262,000	RGB, NTSC	CGA, PGC	GKS, VDI	3,000 (retail), 1,500 (quan. 1,000)	only 100 percent PGC-compatible card; on-board 80188; 2 slots required
Verticom Inc.	M-16	640 x 480	yes	standard cell	16/4,096	RGB	CGA	GKS, Halo, VDI	2,250*	1-megapixel drawing; on-board Z80A, M68000; 2 slots required
	M-256	640 x 480	yes	standard cell	256/4,096	RGB	CGA	GKS, Halo, VDI	2,875*	includes on-board Z80A, M68000; 2 slots required
XTAR Electronics Inc.	Polygone IBM/PC Graphics Board	640 x 400	yes	full-custom X-TAR chip	16/4,096	TTL, RGB	no	no	2,900* (OEM quan. 2-24)	100,000 vectors per sec; 100-megapixel drawing

*Includes monitor

This Publication is available in Microform.

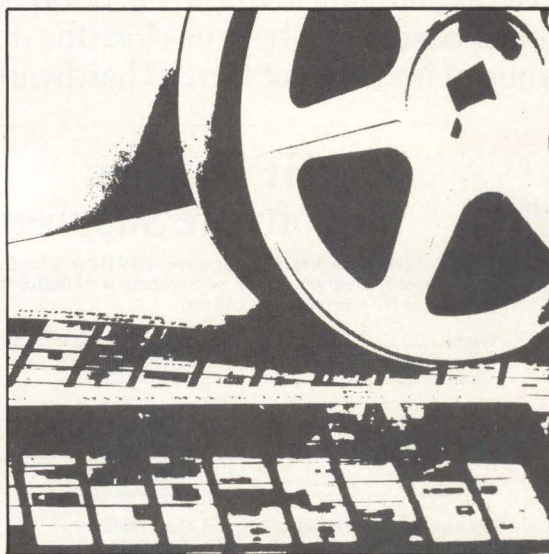

University Microfilms International

Please send additional information

for _____
(name of publication)

Name _____

Institution _____

Street _____

City _____

State _____ Zip _____

300 North Zeeb Road
Dept. P.R.
Ann Arbor, Mi. 48106

THE POWER OF PORTABILITY.

Now—in the time it takes you to read this message, this BASIC interpreter from Control-C Software can port a Business BASIC program to any microcomputer operating system—including UNIX,[™] MS-DOS[™] and CP/M.[™] That's only one reason why CCS Business BASIC already provides solutions at 90,000 micro sites.

Whether you're an application developer, computer OEM or integrator, CCS Business BASIC can instantly enrich your software catalog with high-demand libraries of proven programs. And your new Business BASIC programs will port to the same environments just as quickly.

**CIRCLE NO. 70
ON INQUIRY CARD**

CCS Business BASIC also makes new programming easier—for faster market entry, and its hardware/operating system independence protects your programs from costly future updates. Written in high-level "C," CCS Business BASIC provides transparent and concurrent multi-user file-handling, plus local-area networking capabilities.

Call or write Control-C Software for your 30-day free examination. Get your hands on its powerful portability—right now.



Control-C Software, Inc.

6441 S.W. Canyon Court
Portland, Oregon 97221
(503) 292-8842
TELEX: 151215
JLICCS PTL



CCS BUSINESS BASIC

CCS BUSINESS



SONY

Micro Floppydisk
Single Sided

WHO MAKES THE HIGHEST QUALITY 3.5" DISK? ASK SONY. WE INVENTED IT.

Long before there was a market for 3.5" disks, in fact, four years before, there was Sony.

And while every single 3.5" disk manufacturer has duplicated the Sony design, there's one thing they haven't been able to duplicate. Sony quality.

Such error-suppressing materials as VIVAX™ magnetic particles (the very core of the disk itself) have been developed by Sony. As is the case for our manufacturing process. It includes a burnishing technique that eliminates projections as small as 1/1,000,000 of a millimeter from the disk's surface.

The result? Every time you use a Sony 3.5" disk you're assured you're using the best magnetic medium you can buy.

With somebody else's, you can only guess.

SONY®

Introducing **Human Designed Systems'**
HDS200 Display Terminal Family

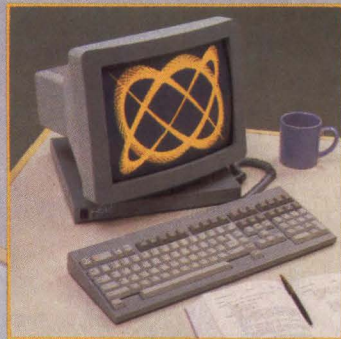

**EASY ON
YOUR EYES**

Ended December 31, 1984 1983

Statement Data:

Revenues	\$145,200	\$104,558
Income	14,003	10,266

arnings per common share:

132-col. characters actual size

Large, high-density characters make the HDS200 terminal the easiest to work with, even if you work with terminals all day. Our 15" monitor has more viewing area (62% more than competitive screens) so you can work comfortably.

**EASY ON
YOUR SPACE**

A small, one-square-foot footprint lets the HDS200 terminal coexist comfortably with all your desktop tools. A far cry from other 15" displays that dominate your desk.

**EASY ON
YOUR BUDGET**

In addition to the high resolution and small footprint that identify all terminals of the HDS200 family, each display has a unique set of advanced capabilities. The HDS200 ANSI/DEC-compatible terminal — 80/132 columns, 50 user-defined non-volatile keys, smooth scroll, double-high/-wide lines, four pages of memory (optionally eight), windows, viewports, multiple character sets and multiple computer networking. And only \$995.* The HDS200G graphics terminal — all the above plus 720 x 350 high-resolution screen, Tektronix 4010/4014 emulation (also Retro-Graphics, Visual, and others), local printer support with large buffer, and more. For only \$1295.* And there are advanced APL models also.

*Single quantity price. Significant quantity discounts available.

HDS
human designed systems, inc.

3440 Market Street □ Philadelphia, PA 19104
 215-382-5000

It's easy to get your hands on a HDS200 Display Terminal. Call 215-382-5000 or Atlanta: 404-391-9763, Boston: 617-449-6446, Detroit: 313-471-2807, Los Angeles: 213-410-9454, New York Metro: 201-624-1372, Philadelphia: 215-382-5000, Upstate NY: 716-223-4490, San Francisco: 415-692-4184, Toronto: 416-362-1063 or Washington, DC: 301-670-1813 for a free trial in your office.

CIRCLE NO. 72 ON INQUIRY CARD

LATEST LANGUAGES LINK DATA TO DIVERSE TASKS

Non-procedural fourth-generation languages groom databases for multiple applications

Carl Warren, Western Editor

So-called fourth-generation languages (4GLs) enhance database management system application development. They allow users to quickly define databases and to input fields and reports by using non-procedural references.

Unlike other high-level languages such as COBOL, which are procedural in nature and require application programs to be carefully defined in terms of program flow, 4GLs permit users to concentrate on the importance of the data within the database. Therefore, data handling becomes more important. In fact, some companies, such as Pro Computer Sciences Inc., Laguna Hills, Calif., claim their 4GL DBMS—the Pro-IV—can supplant the operating system.

Software vendors that offer database managers all assert the same thing: replacing the operating system, or at least making it transparent to the user, is an important feature of 4GLs.

“Database applications are the platforms upon which other applications are built,” says Roger Sippl, president of Relational Database Systems Inc., Palo Alto, Calif. “Unfortunately,” he argues, “applications are fragmented over many different database languages.” (see “SQL: an argument to standardize,” Page 138).

The new 4GLs are designed to be used in interactive environments. Therefore, these languages provide statements that allow data retrieval and updating, and specification of data dictionaries. This allows a programmer to write programs on a terminal and use data either in local databases or in remote mainframe storage devices.

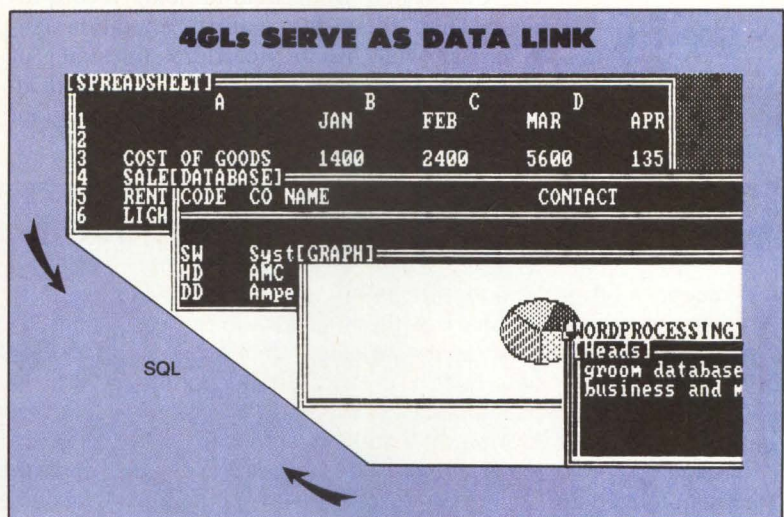

The prime purpose of a 4GL is to serve as the interface between the application program and the DBMS. Therefore, these languages, of which many different approaches exist, are often referred to as data-manipulation languages. Moreover, 4GL syntax can be embedded into other languages such as COBOL or C.

Among the functions found in a 4GL are commands that open and close a file or set of records, and commands that find specific records, record types or elements of records. Fourth-generation languages also allow modification of data within a record and insertion of new information into the database.

An important feature of a 4GL such as IBM Corp.'s Structured Query Language (SQL) is its ability to serve data to diverse applications.

Fourth-generation languages, such as IBM's Structured Query Language (SQL), link data elements from diverse applications, including spreadsheets, graphics and word processing.

The prime purpose of a 4GL is to serve as the interface between the application program and the DBMS.

Therefore, a pool of data (databank) can be used for more than one application. However, several problems can arise:

- Data elements can be scattered and have no common link
- Each application module requires a different formatting, thus varying field sizes
- Multiple references to the same data element can exist in the database, which complicates choosing specific items.

Additionally, large common database pools that have multiple references, or occurrences (sets) of the same data, tend to make inefficient use of disk storage space. Also, old records can be updated and new ones purged by accident.

To overcome these problems, 4GLs provide a method of linking data elements to many different applications. As a result, data need not be rekeyed, which eliminates multiple references and frees up storage space. Moreover, the data becomes more cohesive as better relationships are established from field-to-field, record-to-record and file-to-file. Fourth-generation languages provide macro procedures (grouping of commands) that connect the data elements in an efficient manner, while dictating the program flow in relationship to the data.

Alan V. Cameron, chairman of MegaGroup Inc., Irvine, Calif., believes that establishing a common information area (e.g., database or spreadsheet) and using high-level languages to link applications allow the creation of complex applications. "Users not only need access to the data, but also a way of using it for decision support, such as via a spreadsheet. A 4GL such as IBM's SQL provides that link," says Cameron.

Interchange formats link data

Vendors are offering a wide range of DBMS solutions from which to choose. These solutions range from mainframe to microcomputer implementations, or a combination of both using micro-to-mainframe communication (MMS, May, Page 91). Micro-to-mainframe links hold great promise for business applications because they allow the mainframe to act as a giant file server providing many microcomputers and users with access to records.

DBMS vendors also concern themselves with the various file formats used by microcomputer-based software. Lotus Development Corp. 1-2-3 files, for example, are saved in an internal format called worksheet files (WKS). These files

Glossary of database terms

Access method: The technique of moving data between the computer and a peripheral storage device. Databases usually use access methods that allow quick retrieval of data based on keys. An example is the indexed sequential access method (ISAM).

CODASYL (Conference on Data Systems Languages): The Conference specifies programming languages such as COBOL. It also defines manufacturer and application-independent languages for database management.

Cylinder concept: The concept that data on all tracks above and below the one currently being used is available by merely switching read/write heads. Allows access to large amounts of information with no extra movement of the access devices.

Data-description language: A language that describes data in logical terms for the database software to use.

Data dictionary: A special catalog that describes all the data types by name, structure, size and attributes.

Field: Also referred to as a data item. The smallest unit of data used to describe information in a database. A record format consists of a list of field names, with each field possessing a fixed number of bytes and having a fixed data type.

ISAM: Indexed-sequential-access method, in which

indexes and blocks are designed to fit specific file units. Typically, ISAM files are grouped to fit onto physical disk tracks. On one track of a cylinder is an index that contains pointers to the information stored in the cylinder. Thus, accesses are minimized since the index item points to the location(s) of the data.

Schema: Basically a map of the overall logical structure of a database. However, the CODASYL definition says that a schema consists of a data-description language and defines all the set occurrences and associated data items as they exist in the database.

Set: A collection of record types that establishes the characteristics of an arbitrary number of occurrences. Each set defined in a schema must have one of its record types declared its owner and one or more declared as members.

Subschema: Whereas a schema gives the logical view of the data, a subschema gives the programmer's view of the data he intends to use. Theoretically, he derives this by analyzing the complete view of the data, but in practice defines it as he sees the need for various data fields and relationships.

Tuple: A group of related data fields. For example, the fields that make up a street address, city, state and zip code are all related and thus can be considered a tuple.

SEED

SOFTWARE

The DBMS designed to withstand the test of time.

Data base management software packages come and go because they were never designed to handle the software life cycle of the organizations who buy them. The SEED DBMS is designed to grow with your organization and withstand the test of time.

Transportability for constantly changing hardware.

SEED is the most powerful transportable DBMS software available today. You can transport SEED applications from your DEC VAX, DEC 10 or 20, and PDP 11 to an IBM 30XX, 40XX, 370, or PC to a PRIME, Gould SEL or any other compatible computer. No other DBMS offers you such a wide range of hardware compatibility. SEED Software allows you to do applications on your mini with the same results of your mainframe and do applications on your mainframe for the same cost of developing them on a mini.

Performance you won't outgrow

SEED provides optimized use of your hardware for exceptional application performance. With SEED, DBMS designers now have the ability to quickly control and fine tune the physical data base design and memory utilization to optimize data storage and retrieval speed. The application programmer is provided with an entity/relationship model of the data base, while the end-user's view of the same data base is relational.

The complete SEED system is now available for Perkin-Elmer users under OS/32. Call us for more details.

Circle 1 for Info Kit

SEED consists of an Application Development System and a Decision Support Option.

Complete Application Development Tools For The Data Processing Professional

- DATA DEFINITION AND HOST LANGUAGE PROCESSORS
- INTERACTIVE DATA MANIPULATION LANGUAGE
- SCREEN FORMATTER
- INTELLIGENT FILE CONVERTER
- LARGE DATA VOLUME CAPABILITY
- SECURITY
- INTEGRITY
- DATA DICTIONARY

Artificial Intelligence Based Tools for Managers and Decision Makers

- QUERY LANGUAGE
- REPORT WRITER

Increased productivity

With SEED Software, you can increase productivity and response time, reduce errors and save precious programming time. Its English-like commands make it easy to learn and use.

SEED's comprehensive data base design facilities eliminate the need to define or manipulate inter-record relationships for each application or end-user; once a DB designer has described the data base, that definition works for everybody. End-users do not need to know how to "JOIN" records to pose a query or write a report. DP and project managers in business, government, military, research and academia are using SEED to get the maximum productivity from both their hardware and human resources.

You can count on SEED to withstand the test of time.

SEED backs its DBMS Software with a comprehensive hands-on training program that helps you get your system on-line quickly and easily. The full resources of SEED Software are available to quickly answer your questions through our toll-free Technical Service Hot Line. We also offer top quality, cost-effective data base consulting and applications development services.

SEED Software is backed by ManTech International Corporation, a multi-million dollar engineering, consulting and management organization. With twenty-six offices in the U.S. and major European, Asian and Middle Eastern cities, the ManTech family of companies is dedicated to providing comprehensive high technology services to its customers.

SEED

SOFTWARE CORPORATION

SEED Software Corporation MMAugust
2121 Eisenhower Avenue
Alexandria, VA 22314
(703) 683-4944 (800) 428-9400

For more information, send in this coupon or call today.

- Send me your Information Kit.
- Call me, I would like a demo.
- I would like to discuss my data base application requirements, please call me.

Name _____
Title _____
Company _____
Address _____
City _____ State _____ Zip _____
Phone _____
Computer(s) _____
Operating System(s) _____

Circle 40 for a Demo

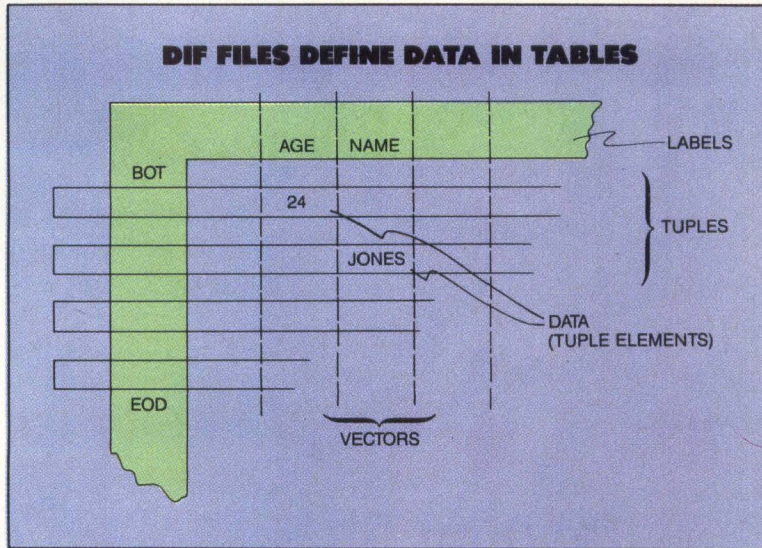

Document interchange format (DIF) files define data in terms of tables. Columns and rows are called vectors and tuples, respectively. Each DIF data file has a header section that defines the labels and tuples. The data section starts with the beginning of tuple (BOT) and ends with an end of data (EOD), both of which serve as flags to the importing application.

contain data arranged in an order that defines their locations in the Lotus matrix. To either export data to or import data from the Lotus environment, the DBMS has to do the translation. For example, Relational Technology Inc., Alameda, Calif., has developed INGRES/PCLINK with the Visual Query Language that lets you use Lotus files and manipulate data from INGRES databases while dispensing with the syntactical details of the query language and the complexities of data communications.

But the Lotus environment is only one of several formats. Microsoft Corp., Bellevue, Wash., has a series of products that use the symbolic link (SYLK) file format. Like WKS, it defines the order of data in tabular form. Specifically, SYLK defines the internal structure of records and files. It provides a degree of compression by eliminating redundant field identifiers and through separation of data cells or points (e.g. graphics elements). Moreover, because SYLK is a defined format, it allows easy translation to other formats with standard routines.

Although software vendors have developed a variety of interchange formats—such as WKS, SYLK and Sorcim/IUS Microsoftware's super data file (SDF), the data interchange format (DIF) has emerged over the last five years as the

SQL: an argument to standardize

Roger Sippl, Relational Database Systems Inc.

Software developers selling to business users find database management applications are taking the place of operating systems. Increasingly, database management systems, and not UNIX or DOS, are the platforms upon which applications are built. Unfortunately, and unlike operating systems, there are few standards in databases.

The time has come for a database language standard. The best candidate for that role is the well-known and popular Structured Query Language (SQL). Devised by IBM Corp. during the 1970s, SQL is the "grandfather" relational database language. It features an English command structure that embodies the complete relational database model.

Applying SQL as a database management standard will permit application developers to promote the functionality of new software and to achieve the kind of integrated packages the next generation of hardware will need.

A database management standard language would provide developers a number of advantages. It would, for instance, help keep down the costs of application development and harness some of the man-hours that are now wasted learning more than one set of lan-

guage principles and syntax. In addition, standardization would make systems easier to move from one machine to another. Database standardization could even provide system designers with cross-compatibility among operating systems.

At present, the lack of a standard database language costs system developers, software houses, the government and users billions of programming dollars. In many cases it also adds months or years to the time it takes to bring a product to market, or in-house applications into use.

But with SQL as a standard database language, both software developers and in-house applications programmers could realize increases in several ways. They could:

- Simplify development by reducing the amount of source code in an application
- Make application porting easier
- Reduce training time of programming analysts, making them more productive
- Promote the kind of transportability between operating systems that integrators and system developers require
- Allow multiple applications to integrate with each other through a common database.

In addition, SQL is relatively well-known. Simply be-

universal standard. In addition, DIF files can be written using any language—including 4GLs. Furthermore, DIF isn't dependent on the specific features of a computer or application. Therefore, the format is independent of the data elements and avoids special, or vendor-unique, features.

Similar to WKS, SYLK and SDF interchange formats, the DIF format represents data in tables which include data point location and descriptive information. Although tables are made up of rows and columns, DIF elements are called vectors and tuples. Each tuple contains data from each vector (rows cut across columns). Therefore, a tuple can represent more than one data element.

A DIF file begins with a topic name, (e.g. travel expenses), the vector number and data values. The data is organized in the form of tuples. Within the tuples, values are arranged according to the order of the vectors. Each data entry consists of three fields on two lines. The tuples also contain the data and the location of the data as it should exist in the table, as defined by the vector. The important point is that the various data can be used by several applications.

WKS, SYLK and SDF allow the same interpolation, but, unlike DIF, are vendor unique.

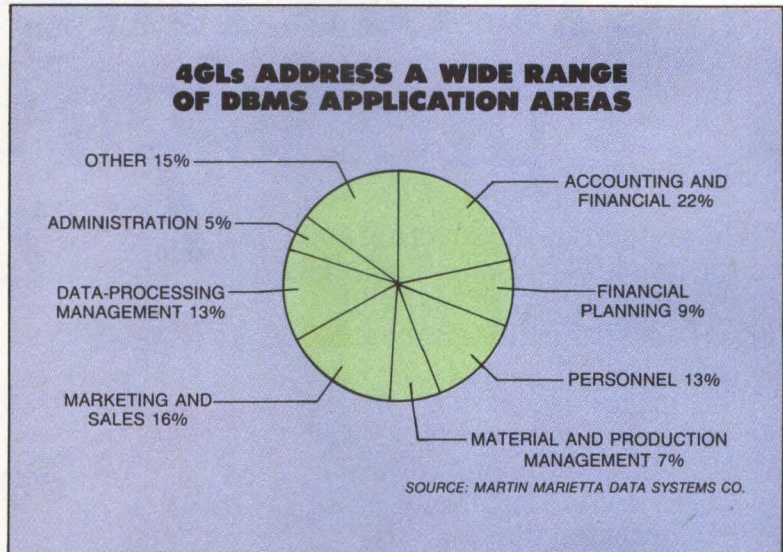

However, once the layout of the format is known, translation can be performed to use the data. And a 4GL, albeit database oriented, can be used to handle the translation across machine and application types.

In the early 1970s, procedural languages such as COBOL were the mainstream business languages. Now, says Richard Cobb, vice president and general manager of information technology

cause it is the one of the oldest database languages, with almost a decade of development time behind it, there are few database programmers who don't already know something about it.

Also, an SQL database product is generally implemented with a front-end/back-end architecture, where one "back-end process" runs on a machine that does the database retrievals and manipulations while the "front-end" processes interact with the user. This architecture makes it ideal for micro-to-mainframe, or other, intermachine networking.

Then again, SQL has a wide base of support. It already has caught on particularly well with suppliers of database software for UNIX-based superminicomputers and is picking up popularity on personal computers as well.

Finally, SQL can provide the foundation for cross-vendor integration. Many products use databases of information, even though they may not be built on database management systems. For example, word-processor products generally have mail/merge facilities allowing the user to send out form letters. But it's often next to impossible for that word processor to enter a company database—or other software, such as accounting packages—and extract the information necessary to make a letter really useful.

However, if that word processor's mail/merge facili-

ty is written in Embedded SQL, for example, and the accounting package, database system or other in-house application had been as well, the word processor could go straight to the database and get information. Similarly, a graphics program would be able to get the information straight from an accounting or scientific database, and draw graphs immediately, based upon absolutely current data.

The companies building these different applications would never have to meet each other. But they would have to meet SQL and use it in their applications.

Relational Database Systems Inc., Palo Alto, Calif., is promoting the SQL standard with its "Hooks" program. The company will license, at no fee, an initial development copy of its Informix-ESQL/C (embedded SQL for C programmers) to any legitimate software supplier.

The free copy is available for several of the many machines to which Informix-SQL and other RDS products are being ported. The software developer must agree to submit any product so integrated to RDS for inclusion in RDS' Independent Software Vendor catalog, as well as some other conditions of the license.

Roger Sippl is president and founder of Relational Database Systems Inc., Palo Alto, Calif.

TEMPLATE. We're offering more than precision visuals.

There's more to engineering and scientific graphics software than pretty pictures. At TEMPLATE® we build quality functionality into graphics software tools.

That makes us feel so good about our family of products that we're offering you our \$300 MICRO TEMPLATE® package free, just for seeing the rest of our show.

Surprised at our generosity? You shouldn't be. Who more than TEMPLATE is committed to providing you high-technology graphics and sensible software solutions?

Whether you're a sophisticated user, or just starting out, our product family—including TEMPLATE, 2D TEMPLATE®, CONTEMPLATE™, DIMENSION-GKS™, MICRO TEMPLATE and a variety of options—is designed to address your specific problems. And solve them.

TEMPLATE people know this. They include specialists in dedicated device driver development and customer support. Hot-Line accessible and always professional. Together they provide technical expertise around the world.

Isn't this the blend of product and service you've been looking for? Precisely. So contact TEMPLATE. If you qualify, we'll bring you a free MICRO TEMPLATE package—compatible with IBM PCs, ATs, XTs and TI Professionals. Then we'll remind you of all we can offer. And what our competitors can't.

TEMPLATE
THE SOFTWARE DIVISION OF MEGATEK CORPORATION

The Innovators in Graphics Software.

9645 Scranton Road, San Diego, CA 92121 619/457-5359 TWX: 910-337-1270

TEMPLATE is a Registered Trademark of Megatek Corporation. CONTEMPLATE and DIMENSION-GKS are trademarks of TEMPLATE.

CIRCLE NO. 73 ON INQUIRY CARD



at Martin Marietta Data Systems Co., Greenbelt, Md., we are seeing nonprocedural, or 4GL systems, enter that mainstream to supplement, and in some cases replace, COBOL for applications development.

Cobb says that 4GLs are accounting for a larger segment of application development because databases are the foundations on which many applications are developed. Accounting and financial applications make up about 22 percent of the current base of 4GL-implemented applications, with marketing and sales accounting for 16 percent. "The trend is clearly toward 4GLs, because they provide the easiest way of creating applications and maximizing the use of databases," says Cobb.

Making 4GLs acceptable to vendors and users alike is the fact that most of the effort put into

the application is for production, rather than program flow and control. Cobb maintains that procedural languages waste time in setting up program flow and speculates that 4GLs yield a 5-to-1 productivity advantage.

Company requirements differ

Due to the increasing trend toward decentralized databases, companies such as The Standard Oil Co. of Ohio, are seeking ways of using data existing on different machines at different locations. "We are developing internal standards on how the data is to be accessed and used," says Teri B. Kozsey, SOHIO's senior information consultant. Consequently, SOHIO wants a DBMS that allows easy generation of application code but that eliminates the need to change the database file structure.

Fifth generation is in hardware

Not all database innovations are in software. Hardware database support systems are taking database management systems to the next, or fifth, generation.

A new approach—the side-by-side processor—has been developed by start-up company, ACCEL Technologies Inc., San Diego. Rather than provide another complex computer to handle database tasks, ACCEL's method provides a sorting engine that works alongside the main processor.

Dubbed the Database Accelerator, this side-by-side processor combines technology with patented data-rearrangement techniques. The Database Accelerator handles data in much the same manner as a floating-point processor manipulates numbers.

According to company president Walter Foley, most databases are powerful, but they tend to be slow, especially when it comes to sorting data. He contends that even with large system-memory arrays and fast storage, the I/O bottleneck can bring most systems, including the Digital Equipment Corp. VAX series of minicomputers, "to their knees."

The ACCEL product offloads the sort burden and presents ready-to-process, rearranged data back to the general purpose computer in seconds. For example, a 5M-byte, 2,000-line item-inventory file can take as much as 12 to 16 minutes on a Data General Corp. MV8000 but only 10 to 20 seconds on the Database Accelerator, claims Foley. Thus the main processor can spend its time processing data and presenting it to users, rather than sorting it.

The ACCEL sorting processor links to the main processor via the Ethernet local area network. Software patches to the sorting software are required to pass the data, via Ethernet, to the ACCEL system. Once the data is sorted, it is returned via the same

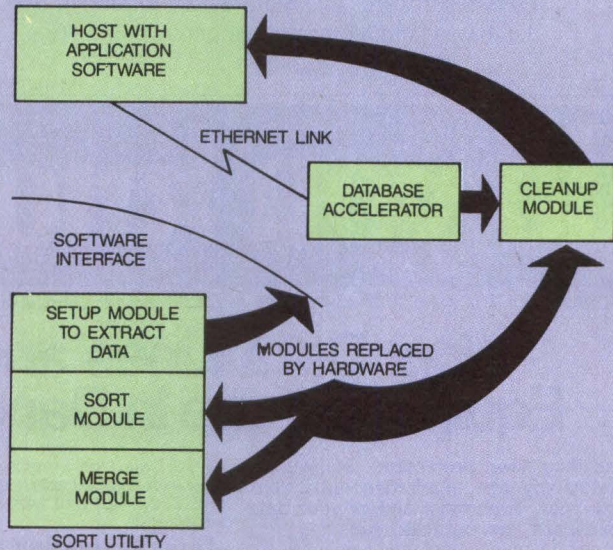

The ACCEL Database Accelerator is physically linked to the host computer via an Ethernet LAN connection. The software connection is via the sort module, a merge module and a cleanup module. Output from the setup module is directed to the Accelerator where it is ordered in the desired form. The ordered data is then sent to the cleanup module, which returns it to the application.

path, only in ordered form.

The Database Accelerator costs from \$23,000 to \$51,000, depending on memory configuration, and can handle up to 5M bytes of main memory.

Other companies are looking for the same thing. Most users say they are interested in flexibility in size of records, the ability to have multiple data volumes and easy applications generation. Generally, most agree that 4GLs offer the solution. The question is which 4GLs. "We're trying to minimize the risk—we want what will do the job for a long time," stresses Kozsey.

Not classified as 4GLs, but serving much the same purpose, are database products that allow database definitions, reports and multiple-file links to be created via a menu system.

One such product is Power-base from PowerBase Systems Inc., New York. Using a series of menus, database structures can be quickly created along with desired input screens. Additionally, users can define how reports, including mailing labels, are to be formatted.

Also, Power-base links multiple database files, a function not easily implemented in most databases, or with 4GLs for that matter. With most DBMS software, this requires the joining of two databases and determining entry points (e.g.,

key fields). The associated code can be cumbersome, and providing multiple associations to more than one database can be difficult.

Power-base uses the menu-selection method to establish links, so that multiple files can be used to create detailed records. For example, in a customer record file the first database may only hold the name and address information; the next database, details about purchases; and a third, product information. The linking key becomes the company name, or a customer number. Each record in the database can have many different links, depending on the need.

Even with numerous DBMS innovations already in place, there are still more possibilities on the horizon. The advantages offered by 4GLs and products such as Power-base will expand so that even the most complex applications can be created by non-programmers. □

Interest Quotient (Circle One)
High 492 Medium 493 Low 494

do you know!

INFORMATION ABOUT SAVING YOUR ELECTRONIC EQUIPMENT

Your Data Lines and Equipment are in Danger!

And they need protection...24 hours a day! At any time, in microseconds, your data lines, equipment and/or your data base, itself, can be destroyed.

The Cause High Voltage Transients. These destructive surges can be caused by lightning, power company switching, heavy machinery, etc. Directly coupled into a data line, these transients can cause immediate and cumulative damage to lines, sensitive equipment, or data base.



The Solution MCG Data Line Protectors. This mature, field proven family of protectors is expressly designed to guard signal/data/telephone equipment against transient overvoltage surges. The protectors interface between the data lines and the sensitive circuits to provide a sophisticated blend of high speed (5ns) voltage limiting and brute force protection. After each operation, they recover to a stand-by mode automatically.



12 Burt Drive, Deer Park, NY 11729 • (516) 586-5125

Specialists in Circuit Protectors, Transients, Lightning & Surges.

MCG Data Line Protectors are designed for use with coaxial cable, single or twisted pairs, RS-232, -422 and -423, 20 ma loops and video lines.

Total Protection MCG provides the widest variety of data line protection devices available (protecting over 5,000,000 circuits to date). There is probably an existing model ideally suited to fulfill your particular need. So call or write today for cost effective insurance against data error and equipment downtime.



Call or write for our
FREE CATALOG



This Publication is available in Microform.



University Microfilms International

Please send additional information for _____
Name _____
Institution _____
Street _____
City _____
State _____ Zip _____

300 North Zeeb Road
Dept. P.R.
Ann Arbor, Mi. 48106

CIRCLE NO. 74 ON INQUIRY CARD

CIRCLE NO. 102 ON INQUIRY CARD
MINI-MICRO SYSTEMS/August 1985

STAND SMALL.



The end of Mostek's low profile on low profile SIPs.

If you've been looking for an alternate source for SIPs, look no further. Because Mostek has created six new SIPs which provide an effective solution to high-density memory needs.

Like TI™'s SIPs, ours come in 22 pin (64x4, 256x4, 256x1, 1Mx1) or 30 pin (64Kx9, 256Kx9) packages and provide a 3:1 density improvement over DIPs. But unlike theirs, Mostek x9 SIPs feature a low profile .455" package. Plus an optional on-board parity generator.

Mostek SIPs are manufactured using state-of-the-art surface mount technology. And our progressive SMT equipment and processes even allow us to meet your needs for non-standard surface mount parts.

We'll execute or build-to-print from your layout, or work with you to implement custom designs using surface mount or through-hole manufacturing. And we'll continue to work with you at every stage through testing the final product.

It all goes to show that you can count on Mostek for innovative solutions to your high-density and surface mount needs. So for more information contact Mostek Corp., 1215 W. Crosby Road, MS1051, Carrollton, Texas 75006, or call 1-800-635-0200, in Texas, 214/466-7474.

TI is a trademark of Texas Instruments.



CIRCLE NO. 75 ON INQUIRY CARD

NEW PRODUCTS

SYSTEMS

Eileen Milauskas, Assistant Editor

AT-COMPATIBLE SYSTEMS EMPLOY 80286 CPU

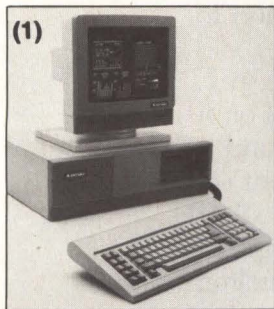

- 256K-, 640K-byte memory
- 1.2M-byte disk storage
- 9-, 25-inch screen

Five new microcomputer systems, two of which are transportable, claim IBM Corp. PC-AT compatibility: Compaq Computer Corp.'s Deskpro 286 and Portable 286, Corona Data Systems Inc.'s Corona AT Transportable (ATP), NCR Corp.'s PC8, TeleVideo Systems Inc.'s TeleVideo AT and Zenith Data Systems Corp.'s Z-200 Advanced PC. Targeted toward multiuser, multitasking business applications, the systems come in two basic storage configurations and range in capacity from 256K to 640K bytes.

Although all five systems incorporate Intel's 80286 microprocessor, the TeleVideo AT and the Deskpro and Portable 286 operate at 8 MHz, a processing speed one-third faster than the PC-AT. The remaining systems run at 6 MHz, as does the PC-AT. All models run without any modification software written for the PC-AT. They vary, however, in the type of operating systems used. Both the ATP and the Z-200 models come with Microsoft's MS-DOS version 3.1 operating system. As a single-user system, the PC8 uses the proprietary NCR-DOS 3.1 operating system. For multiuser applications, it works with XENIX. MS-DOS version 3 and BASIC are offered as options on the Portable and Deskpro 286; MS-DOS 3.1 and GW BASIC are optional on the TeleVideo AT.

Basic disk-storage configuration for all systems consists of one 1.2M-byte floppy

disk drive, with the exception of Corona's model ATP-6-QD, which comes with an additional 360K-byte floppy disk drive. The enhanced ATP-6-Q20 model comes with one 1.2M-byte floppy disk drive and one 20M-byte Winchester disk drive. Storing 512K bytes of system memory, it also includes a PC-AT-compatible hard disk controller. The PC8, with 256K or 512K bytes of main memory, offers an optional 20M-byte hard disk drive in addition to its half-height, 1.2M-byte floppy disk drive.

Model I of the Portable and Deskpro 286 provides 256K bytes of RAM. Model II of both delivers 640K and 512K bytes, respectively, and adds 20M- and 30M-byte hard disk storage capacities. The TeleVideo AT, with 256K bytes of system memory on its model I, offers 512K bytes of main memory and a 20M-byte hard disk drive with model II. The 512K-byte Z-200 incorporates an internal, 20M-byte hard disk drive.

All system monitors, whether optional or standard, support text and graphics. The 9-inch and optional 12-inch, green or amber, dual-mode monitors that come with the Portable and Deskpro 286, respectively, produce 720-by-350-pixel text and 640-by-200-pixel graphics on the same screen. The TeleVideo AT's 14-inch, non-glare screen supports 640-by-200-pixel resolution as well as 640-by-400 bit-mapped graphics. The 9-inch, green ATP monitor displays text-on-graphics overlay, reverse video, underline, blink-view, and high intensity through 640 by 400

pixels. The ATP comes with a color/monochrome video graphics card. A color monitor attaches to the system via a jack. PC8 options include a 15-inch monochrome or 14-inch, 16-color monitor each with 640-by-400-pixel resolution. The Z-200 offers a choice from the company's line of 13-inch to 25-inch monitors.

The least expensive PC-AT-compatible system, in its basic configuration, is the TeleVideo AT, priced at \$3,395 for model I and \$4,795 for model II (1). The basic PC8 costs \$3,795; the enhanced version (2), \$5,505. The Z-200 sells for \$3,999 without the internal hard disk drive and \$5,599 with the drive (3). The Deskpro model I (4a) costs \$4,244 without the monitor and \$4,499 with it; model II costs \$5,999 without the monitor and \$6,254 with the monitor. The Portable 286 (4b) costs \$4,499 for model I and \$6,299 for model II. Prices for the ATP are \$4,500 for model I and \$5,500 for model II (5). **Compaq Computer Corp.**, 20555 FM149, Houston, Texas 77070, (713) 370-0670; **Corona Data Systems Inc.**, 275 East Hillcrest Drive, Thousand Oaks, Calif. 91360, (805) 495-5800; **NCR Corp.**, Dayton, Ohio 45479, (513) 445-2075; **TeleVideo Systems Inc.**, 550 East Brokaw Road, San Jose, Calif. 95112, (408) 971-0255; **Zenith Data Systems Corp.**, 1000 Milwaukee Ave., Glenview, Ill. 60025, (312) 391-8949.

Circle 300

Kimtron

MULTI-USER SOLUTION for IBM PC, XT, AT

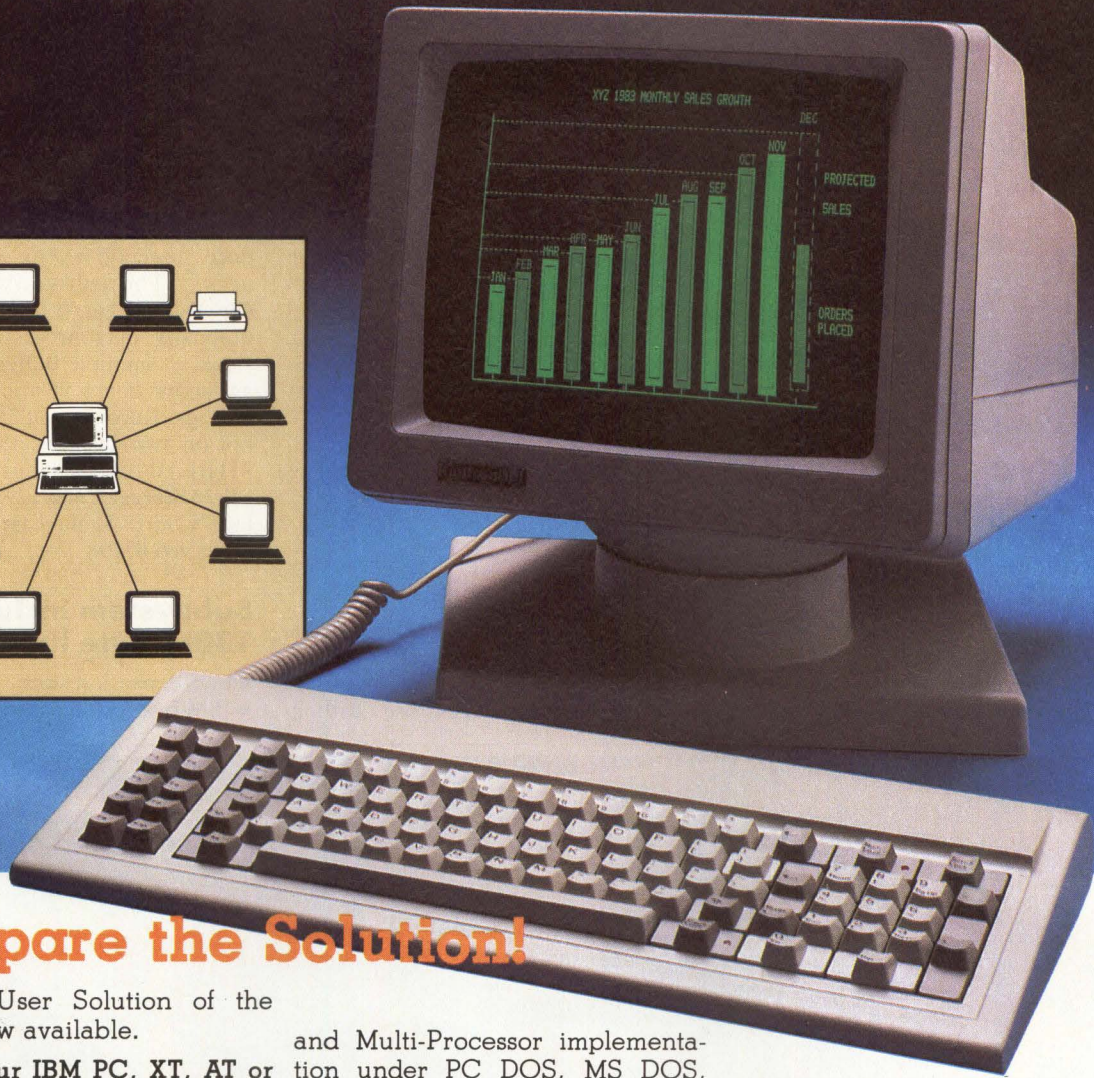
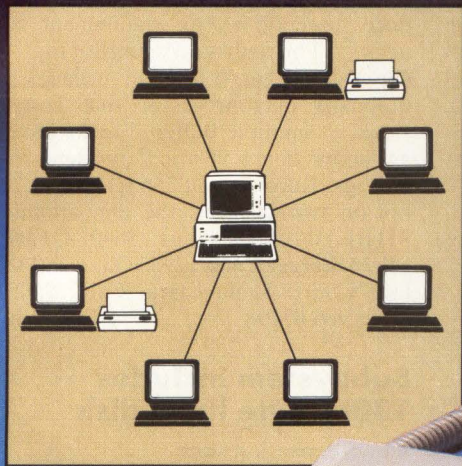

Compare the Solution!

The Multi-User Solution of the future is now available.

Convert your IBM PC, XT, AT or Compatibles to a true multi-user system while maintaining display, keyboard and software compatibility.

Since the KT-7/PC display is the same as your PC monochrome monitor, with its look-alike keyboard, operators will feel they're using an IBM PC and can also use the same software manual. Kimtron's multi-user solution includes file and record locking, shared data access, and communication between users. It is **the** intelligent alternative.

The KT-7/PC supports Time Sharing, Enhanced Time Sharing

and Multi-Processor implementation under PC DOS, MS DOS, UNIX, XENIX, CPM 86, Multilink, Concurrent PC DOS, and other compatible multi-user operating systems.

Kimtron's multi-user solution may be tailored for cost effectiveness; as low as \$1095 for an additional user, and for speeds more than ten times faster than LAN. You can add one or as many as 31 additional users per PC. Kimtron delivers the future now by allowing an ever-widening network of multi-user PC's.

The KT-7/PC may be complemented with one (or more) I/O Card, Memory Card, 8086 Speed

Enhancer Card, 80286 AT Card, 8088 Multi-Processor Card, 80186 Speed Enhancer Card, 68000 Card, and related software.

For more information about Kimtron's Multi-User Solution, or general video data terminals for other mini or micro multi-user systems, call your local computer dealers, distributors or Kimtron Corporation Today!

Kimtron Corp.
1705 Junction Court
Building 160
San Jose, CA 95112
408-286-8790
TWX: 910-338-0237



NOTE: IBM PC, XT, AT, PC DOS, MS DOS, UNIX, XENIX, CPM 86, Multi-Link, Concurrent PC DOS are registered trademarks of IBM Corporation, Microsoft Corp., Bell Labs., Digital Research Inc., Software Link Inc. respectively.

CIRCLE NO. 76 ON INQUIRY CARD

NEW PRODUCTS

DISK/TAPE

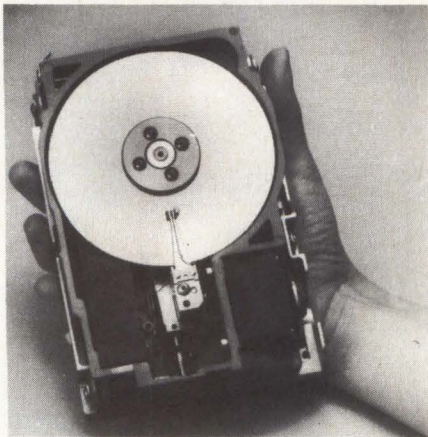

Disk drives store 20M bytes

- ST412/ST506 interface
- 5M-bps transfer rate
- 804 tpi

Achieving an average access time of 80 msec, the models TM362 3½-inch and TM262 5¼-inch hard disk drives provide 20M bytes of formatted capacity. Both

drives employ a closed-loop head-positioning system. Using two 3½-inch plated disks with a sputtered carbon overcoat, the drives incorporate the ST412/ST506 interface. Transferring data at 5M bps, the units achieve an 804-tpi track density. A recording density of 14,335 flux reversals per inch is obtained via the modified frequency modulation recording method using 612 recording cylinders. Power consumption is 14 watts. \$300, model TM362, model TM262. **Tandon Corp.**, 20320 Prairie St., Chatsworth, Calif. 91311, (818) 993-6644.

Circle 301

Removable cartridge drive suits IBM PC

- 10M-byte capacity
- 5¼-inch
- ST506/412 interface

A half-height, 5¼-inch, removable cartridge disk drive for the IBM PC, the MS212 holds 10M bytes of formatted storage. The cartridges use carbon-



coated, thin-film, sputtered media to reduce susceptibility to contaminant failures. The drive, employing a closed-loop, servo system, includes an on-board microprocessor that accepts single or multiple buffered seeks. Average access time is 98 msec; transfer rate is 5M bps. Recording at 556 tpi and 10,700 bpi on two surfaces, the unit attains a MTBF of 10,000 hours. \$640, Q1,000. **Micro Storage Corp.**, 2986 Oakmead Village Court, Santa Clara, Calif. 95051, (408) 986-0770.

Circle 302

Subsystem includes 130M-byte hard disk

- Five expansion slots
- 10M-bps transfer rate



• 18-msec access time

Integrating five IBM PC-compatible expansion slots, a 130M-byte hard disk drive and a 69M-byte, 1/4-inch, cartridge tape drive, the Super Qicstor-Plus subsystem accesses data in 18 msec and transfers data at 10M bps. Streaming-tape backup is file-oriented. IBM PC-AT-compatible, the system functions as a file server on LANs such as the IBM PC Network, 3Com EtherSeries, Corvus Systems' OMNINET and Proteon Inc.'s ProNET. \$10,595. **Alloy Computer Products Inc.**, 100 Pennsylvania Ave., Framingham, Mass. 01701, (617) 875-6100.

Circle 303

**Systems back up
60M, 100M bytes**

- Streaming-tape
- 1/4-inch
- Backup/restore options

Backing up a 10M-byte hard disk in two minutes, the Excel Stream-100 and Excel Stream-60 1/4-inch, streaming-tape

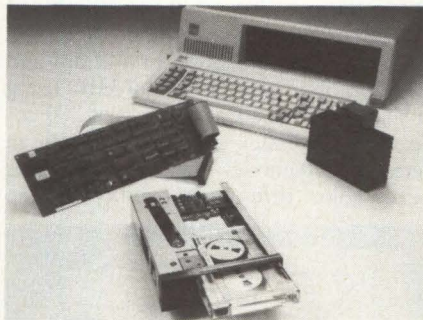

backup systems hold 100M and 60M bytes, respectively. Backup/restore options include image backup/image restore, image backup/file-by-file restore and file-by-file backup/file-by-file restore. Because the Stream-100 uses a QIC-02 controller, the system can be moved between personal computers. The Stream-60 offers universal data interchangeability, automatically aligning itself to read and write from different tape cartridges. \$1,345, Stream-60; \$1,895, Stream-100. **Everex**, 47777 Warm Springs Blvd., Fremont, Calif. 94539, (415) 498-1111.

Circle 304

Tape systems

operate at 90 ips

- IBM PC-compatible
- Image save/restore
- 90K bytes per second

Transferring data at 90K bytes per second, the StorageMaster model 760 external and model 860 internal 1/4-inch, streaming-tape cartridge systems run at 90 ips. Storage capacity is 60M bytes. Using version 2.1 of the proprietary cartridge-tape software, the systems provide image save/restore operations at 5M bytes per minute. An /M option saves only those files that have been modified since the last save operation. Saves can extend to additional cartridges containing a label record with name and description. The systems are compatible with IBM fixed-disk systems and with the proprietary 500 series and model 630 fixed-disk systems used with the IBM PC, PC/XT and PC-AT. \$1,795, model 860; \$2,295, model 760. **Control Data Corp.**, 11128 John Galt Blvd., Omaha, Neb. 68137, (308) 339-4760. Circle 305

250,000 customers made us do it. The WYSEpc.

We established a precedent on better than 250,000 desktops with our terminals. So when our customers got ready to include PCs in their plans, they didn't think they should have to settle for less than Wyse style, performance and economy.

We agree. And now you can get the WYSEpc with IBM compatibility in hardware, software and expandability. We've thoroughly tested more than 350 software packages and accessories. It runs even the acid-tests—Lotus 1-2-3 and Flight Simulator—in beautiful Wyse style.

Our price *includes* dual floppy drives, monochrome 14" tilt/swivel monitor, height-adjustable keyboard, 256K RAM, two serial ports, one parallel port, MS-DOS with GW-BASIC—and more.

There's also an IBM PC/XT compatible model with a 10-Megabyte Winchester disk. A color graphics option is available on either model.

For more information about how much less all this costs from Wyse, call the regional office nearest you.

WYSE
| | | |

Regional Sales Offices: Northeast (201) 725-5054; Southeast (305) 862-2221; Midwest (313) 471-1565; Southwest (818) 340-2013; Northwest (408) 559-5911; OEM Inquiries (408) 946-7115.

IBM and IBM PC/XT are trademarks of International Business Machines Corporation. Lotus 1-2-3 is a trademark of Lotus Development Corporation. MS-DOS and GW-BASIC are trademarks of Microsoft Corporation.

CIRCLE NO. 77 ON INQUIRY CARD

PRINTERS

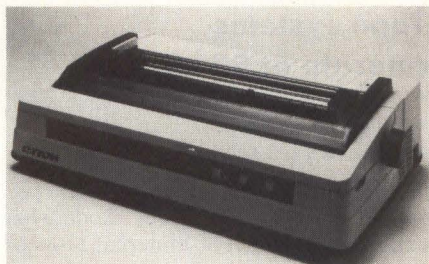

Printer offers 24-pin printhead

- 200 cps
- Letter-quality
- Seven colors

Serving letter-quality printing needs with a seven-color capability, the Pro-Writer 24 LQ dot-matrix printer produces 360-by-360-dpi graphics resolution using a 24-pin printhead. Operating at 67 cps for letter quality and 133 cps for memo quality, the unit achieves 200 cps for data processing applications. Throughput rates for the wide-carriage model are 27 lpm, letter quality; 50 lpm, memo quality; and 70 lpm, data processing. Features include a 16K-byte buffer, movable tractor and friction feed, plug-in letter-quality character generation and either a Centronics or RS232C interface. Print characters are provided for 14 languages plus a Greek character set for medical and scientific applications. \$1,295. **C. Itoh Digital Products Inc.**, Suite 220, 19750 S. Vermont St., Torrance, Calif. 90502, (213) 327-2110.

Circle 306

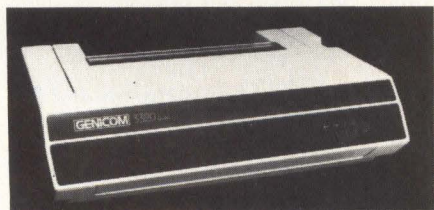

Printers meet data-processing needs

- ANSI X3.64 support
- 18-, 9-wire printhead
- 55 dB(a)

Four dot-matrix printers operating at a 55-dB(a) noise level, emulate the Diablo 630 protocol, support IBM PC graphics and the ANSI X3.64 protocol and provide serial and parallel interfaces. Employing an 18-wire printhead, the model 3320/Quiet achieves letter-quality print-

ing at 180 cps, 12 cpi; 150 cps, 10 cpi; and 300 cps, data-processing mode. Standard graphics resolution is 72 or 144 dpi and 288 dpi, optional. The model 3310, using a 9-wire printhead, is capable of 300 cps in data-processing mode and 90 cps in letter-quality mode. The 3310/Color adds seven-color printing capability to the

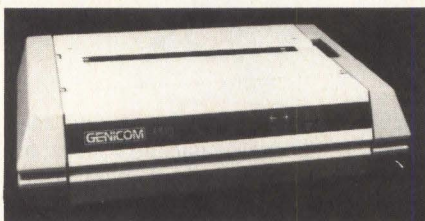

3310 features. Both the 3310 and the 3310/Color achieve the 3320/Quiet graphics resolution. Model 3410 prints 400 cps in data-processing mode and 100 cps in letter-quality mode and uses an 18-wire printhead. All printers include expanded, oversize characters; emphasized and double-strike modes; underlining; and proportional spacing support. \$2,395, model 3320/Quiet; \$1,995, model 3310; \$2,295, model 3310/Color; \$2,450, model 3410. **Genicom Corp.**, 1 General Electric Drive, Waynesboro, Va. 22980, (703) 949-1188.

Circle 307

Inkjet printer produces graphics, text

- All points addressable
- 19,200 dpi
- Seven colors

The ink-jet, Color Jetprinter, attaching to the IBM PC family as well as

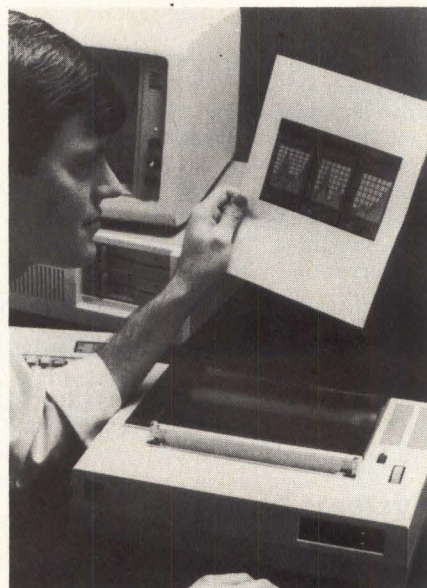

IBM-compatible personal computers, prints on 8½-by-11-inch, coated transparencies and accepts micro-perforated, continuous-form, micro-perforated roll or cut-sheet paper. Seven colors are stored in removable cartridges. Graphics achieve a 9,600-dpi density in a single pass and 19,200 dpi in double-printing mode, all points addressable. At 10 cpi, the unit prints near-letter-quality documents at 20 cps and drafts at 33 cps; at 16.7 cpi, it prints near-letter-quality at 30 cps and drafts at 50 cps. Normal and condensed pitches can be printed in 5- and 8.3-cpi expanded mode, respectively. \$745. **IBM Corp.**, Information Systems Group, 900 King St., Rye Brook, N.Y. 10573, (914) 934-4488.

Circle 308

ANSWERS TO JULY'S PUZZLES

S	U	R	G	E	O	R	D	A	T	A	
T	S	P	L	A	M	A	R	L	A	G	
A	R		A	R	A	W	A	K	L	A	
T	S	L	I	E	R	D	I	G	I	T	
I	T	A	N	S	A	I	L				
C	L	O	N	E	S	P	O	O	L	E	R
E	R	G	I	A	S	B	U	G			
Q	U	E	U	I	N	G	S	Y	S	O	P
		A	C	T	B	I	T	T	I		
M	U	N	G	O	F	O	G	E	Y	X	
I	N	E	N	S	I	G	N		M	E	
T	I	P	S	A	L	S	A	G	A	L	
E	X	I	T	W	E	L	O	O	P	S	

B	M	U	D	E	V	I	A	T	I	O	N	T
Y	P	A	W	E	L	G	A	R	L	F	O	R
A	O	E	C	I	N	A	O	O	R	L	L	A
L	P	T	R	I	N	M	M	P	P	A	T	N
E	O	A	R	M	K	T	P	R	E	G	Y	S
R	O	T	A	L	U	G	E	R	E	N	I	L
R	S	S	M	R	R	T	D	G	B	H	E	A
B	O	O	T	S	T	R	A	P	R	S	T	T
A	U	L	K	A	O	T	R	T	R	A	R	O
T	E	F	C	N	S	A	G	A	I	A	L	R
C	T	S	F	E	I	H	P	U	C	O	D	E
H	I	O	N	E	S	L	U	E	B	O	N	M
M	B	C	O	R	R	E	L	A	T	I	O	N

WE CAN MAKE YOU THE BIGGEST EASIEST TOUGHEST GUY ON THE BUS TODAY

To find out how: Call 214-350-9000
High Performance Disk, Tape and Communications
Controllers, MULTIBUS™ AND VMEbus.



INTERPHASE
corporation

2925 Merrell Road
Multibus is a trademark of Intel Corp.

Dallas, Texas 75229

Telex: 9109976245

NASDAQ: NMS INPH

PRINTERS

Printer combines daisywheel, dot matrix

- 140 cps, dot matrix
- 36 cps, daisywheel
- Bidirectional

Employing a dual printhead, the Twinriter 5 printer permits letter-quality text printing with a daisywheel printhead and

near-letter-quality, draft and graphics operation with a dot-matrix printhead. Using 16½-inch, maximum-width paper, the unit offers a choice of six bit-image densities for graphics. Print speed is 36 cps in daisywheel mode and 140 cps in dot-matrix mode with a 9-pin printhead. The bidirectional, logic-seeking unit includes a 3K-byte buffer, auto-underline,

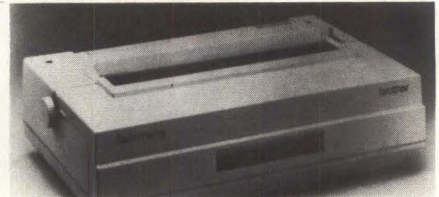

superscript and subscript, proportional spacing, an ASCII character set plus an IBM extended character set and a Centronics interface. \$1,295. **Brother International Corp.**, 8 Corporate Place, Piscataway, N.J. 08854, (201) 981-0300.

Circle 309

ONE-STOP ARCnet™ LAN SOLUTIONS

Now you can get all the tools you need to build industry standard **TOKEN-PASSING** networks from one source. InterContinental Micro.

Our networking packages let you configure any combination of nodes (PC s and compatibles, ATs, XTs, Jrs., Z-100 s) to a common Fileserver in just a few minutes with our menu-driven installation program.

Active and passive hubs allow you to integrate up to 255 users on a single network with *increased efficiency* as the network grows.

In addition, our stand-alone ARCnet™ Workstation/Fileserver and complete line of S-100 Bus products (single board computers, slaves and controllers) give you and your customers even more options.

ARCnet is a trademark of Datapoint Corporation.

We're also compatible with other industry-leading ARCnet PC™ and S-100 products, and our PC networking boards include an optional 256K of system RAM.

All with InterContinental Micro's reputation for outstanding reliability, exceptional service, and highly competitive pricing.

Call InterContinental Micro today, or circle the bingo number below for ARCnet™ LAN solutions.



4015 Leaverton Court, Anaheim, CA
92807; Phone: (714) 630-0964
Telex: 821375 SUPPORT UD; Easylink: 62562040.

Spooler connects five devices

- Z80A processor
- 64K-byte buffer
- 9,600 baud

Employing the Z80A microprocessor, the Data Manager multiple-device spooler links five systems providing RS232 ports with one printer; the printer appears dedicated to each computer. Offering 64K bytes of buffering capability, the spooler sends data asynchronously at 9,600 baud. Each incoming device is handled independently and data is distributed in the first-in-first-out (FIFO) method. \$795. **Intek Manufacturing Inc.**, 728 Charcot Ave., San Jose, Calif. 95131, (408) 946-9041.

Circle 310

Printer handles multiple forms

- 400 cps, data processing
- Automatic sheet feeder
- 240-by-240-dpi graphics

The model 8250, color, dot-matrix printer allows semiautomatic loading of continuous forms and cut sheets. Offering an automatic sheet feeder and demand document capability, the unit switches from data-processing mode on continuous forms to word-processing mode on cuts sheets in 30 seconds. Print speeds are 400 cps in data-processing mode with 150 lpm; 100 cps in near-letter-quality mode and 50 cps in letter-quality mode. At 240 by 240 dpi, the printer produces graphics at 10 ips. It can store seven job formats for future recall. The bidirectional, logic-seeking unit operates at a 55-dB(a) noise level and features a 16-digit LCD. \$2,650. **Dataproducts Corp.**, 6200 Canoga Ave., Woodland Hills, Calif. 91365, (213) 887-8451.

Circle 311



CIRCLE NO. 79 ON INQUIRY CARD

OEMs... Is Your Input Strategy As Sound As Your CPU Strategy?



Computer users are demanding additional input devices from you. Key Tronic can help you meet the demand for these input devices, and minimize your development costs.

Key Tronic is integrating the most popular input devices into OEM keyboards. All processing is done in the keyboard and no additional system ports are required . . . using existing electronics saves money. Also, all input can be presented as a series

of key presses to assure compatibility with existing and future software.

Speech Recognition, Touch Pad, Mouse, Bar Code and Joy Disk are available to enhance your product with unique, value added benefits. Distinguish your product from the ordinary! Talk to your Key Tronic representative today.

A. **Joy Disk** — Four keys in one; rapid cursor control.

B. **Touch Pad** — Multi-purpose input device; programmable key pad, cursor control, drawing tablet.

C. **Speech Recognition** — Natural, language independent command entry. Hands free operation.

D. **Mouse** — Popular pointing and selecting tool.

E. **Bar Code** — Fast, accurate data capture.

“Feel the Key Tronic Touch”

key tronic
The Responsive Input Company

P.O. Box 14687 • Spokane, WA 99214 • USA
(509) 928-8000 • TWX 510-773-1885

CIRCLE NO. 93 ON INQUIRY CARD

TERMINALS



Graphics terminal offers Tektronix emulation

- 128K-byte memory
- VT100, VT220 emulation
- Four display formats

Providing 128K bytes of memory for multiple pages of off-screen scrolling and graphics, the GP-29 graphics terminal achieves 1,024-by-500-pixel and 512-by-250-pixel resolution. Compatible with the Tektronix 4014 graphics display terminal, the unit is capable of zoom, pan, area-fill, area-move, arc-drawing and area-erase functions. Multiple images can be stored in off-screen memory. In

text mode, the terminal emulates DEC VT100 and VT220 terminals, with four standard column-by-line display formats: 80 by 24, 80 by 49, 132 by 24 and 132 by 49. An off-screen memory feature stores 75 pages of text that can be scrolled on screen. \$1,695. **Northwest Digital Systems**, P.O. Box 15288, Seattle, Wash. 98115, (206) 524-0014. **Circle 312**

Monitors suit IBM PC, PC/XT

- 14-inch, color
- 17-inch, monochrome
- Dot addressability

A 640-by-240-dot-addressable color monitor for the IBM PC and compatibles, the Quadchrome II displays 16 colors as well as 25 lines by 80 characters on a 14-inch screen. Controls include brightness, contrast and vertical hold. For the IBM PC or PC/XT, the Quadscreen offers a 17-inch, monochrome screen displaying 10,240 characters. Spreadsheet and split-screen functions provide two 64K-byte screens of memory. Features

include IBM PC DOS and BIOS compatibility, set determination, dot addressability, software and flicker-free controller board. \$599, Quadchrome II; \$1,995, Quadscreen. **Quadram Corp.**, 4355 International Blvd., Norcross, Ga. 30093, (404) 923-6666. **Circle 313**

Graphics terminal displays 64 colors

- DEC VT100-compatible
- Tektronix 4010-compatible
- 1,024 by 1,024 pixels

Suiting applications requiring fast image transfers, the model 6120 color-graphics terminal achieves 1,024-by-1,024-pixel resolution. Displaying 64 colors simultaneously from a palette of 264,000, the unit includes pan, zoom and polygon-fill graphics commands. It is DEC VT100- and Tektronix 4010-compatible. A direct-memory access port sends and receives information. \$5,875. **Intecolor Corp.**, 225 Technology Park, Norcross, Ga. 30092, (404) 449-5961. **Circle 314**

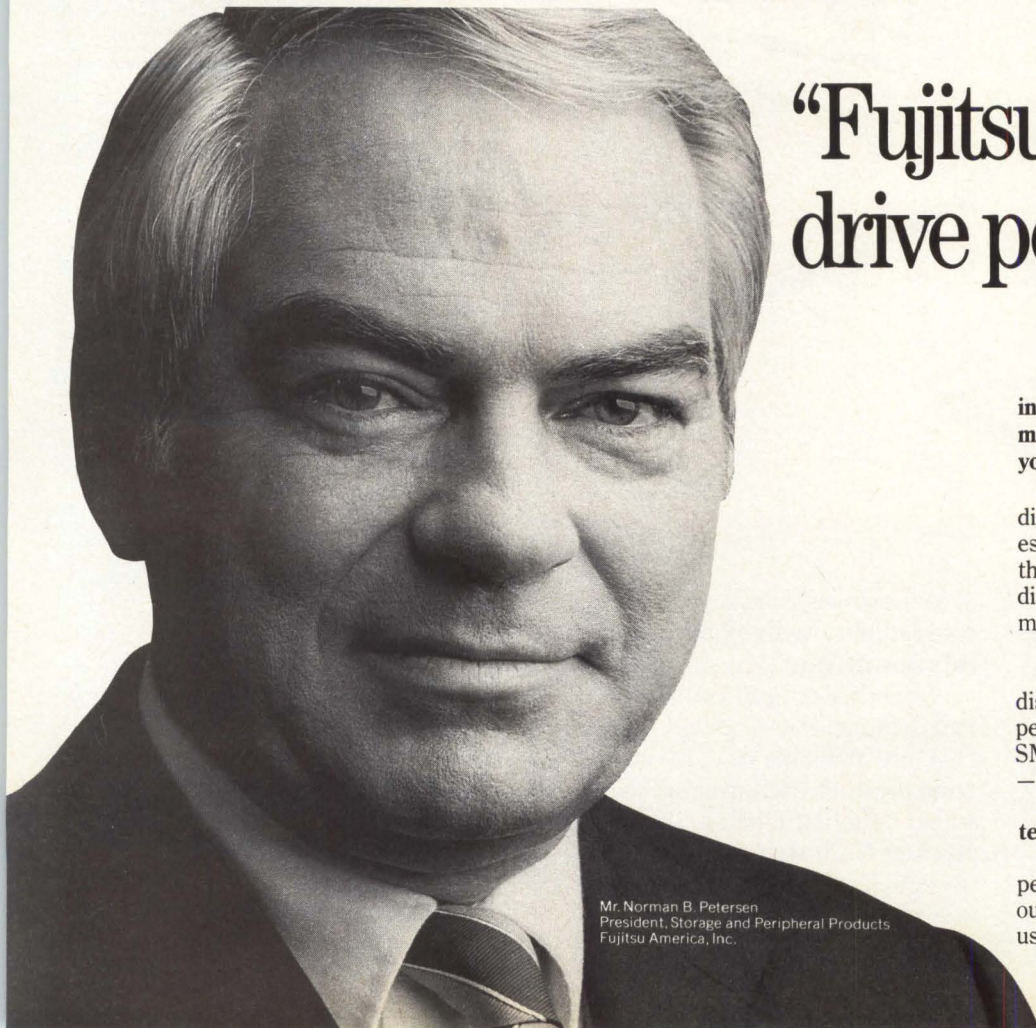

Mr. Norman B. Petersen
President, Storage and Peripheral Products
Fujitsu America, Inc.

"Fujitsu has done it drive performance,

Put these new 10½" and 8" Fujitsu drives into your existing design, and with only minor changes you'll significantly increase your system's performance and capacity.

With the introduction of the 10½" Eagle disk drive three years ago, Fujitsu established a new performance standard for the industry. The Eagle quickly became the disk drive against which others were measured. In both performance *and* quality.

And now we've done it again.

We've expanded both our 10½" and 8" disk drive lines with two new maximum-performance models. They set a high-speed SMD (HSMD) standard for data transfer — 2.4 Megabytes per second!

And it's done using RLL encoding technology.

That means you get this new level of performance without sacrificing one bit of our world-proven reliability. These drives use the same basic head, media and

INTELLIGENT BUFFER ENACTS MULTIPLE OPERATIONS

- 128K bytes
- 19.2K baud
- 68008 processor

An intelligent print and communications buffer, the Transet 1000 enables a personal computer to perform multiple tasks simultaneously. Using an RS232 or Centronics-compatible port, the unit sends or receives data via a modem while directing a printer to produce hardcopy. It comes with 128K bytes of memory and incorporates a 68008 microprocessor with 32K bytes of ROM.

Operating at up to 19.2K baud, the Transet 1000 supports XModem or XON/XOFF protocols. Communications features include time-date stamping, overflow control and dynamic memory allocation. A "24-hour mailbox" feature includes a log-on message feature and options for sending, scanning and printing mail. The unit performs space compression, pagination, automatic page

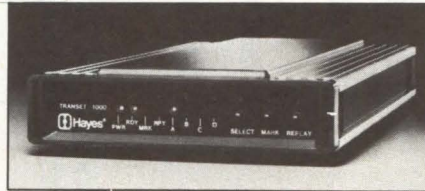

numbering, format control, collated printing of multiple copies and time dating.

Two serial ports and one parallel port are offered. Two printers or a printer and a modem can be connected to one computer port. Alternatively, two computers can be connected to the Transet 1000 and share a single printer. Ports are reconfigurable via front-panel switches, ASCII commands or menu-driven software provided by a utility disk offered separately. The unit is priced at \$399. **Hayes Microcomputer Products Inc.**, P.O. Box 105203, Norcross, Ga. 30348, (404) 449-8791. **Circle 315**

Communications system includes bundled software

- 300 to 1,200 baud
- Asynchronous
- AT Hayes command set

An integrated desktop system for the Apple Macintosh, the Apple II and the IBM PC, ComputerPhone supports two separate telephone lines and operates in single-line, voice/data mode or a dual-line mode that provides simultaneous voice and data communications. It incorporates a Bell 212A-compatible modem that achieves 300- or 1,200-baud, asynchronous communication rates. The modem also supports auto-dial, auto-answer, auto-speed detect features and utilizes the AT Hayes command set. The system comes bundled with the proprietary MacDesk communications program integrated with a desk organizer. The software includes a calendar, appointment alarm, memo pad, electronic Rolodex filing system and a telephone directory. \$399.95. **Intermatrix**, 5543 N. Satsuma Ave., North Hollywood, Calif. 91601, (818) 509-0474. **Circle 316**

again. We've set another standard in disk with a new, high-speed SMD interface."

actuator technology as our previous designs. Plus the same SMD interface.

Both models offer expanded storage capacity as well. The new M2361 Eagle

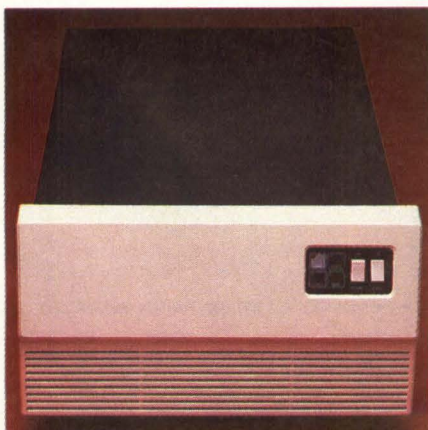

The M2361 10 1/2" Eagle Disk Drive—689 MB
MINI-MICRO SYSTEMS/August 1985

provides 689 Megabytes and the new M2333 8" drive has 336 Megabytes. And you can stack four of the 8" units in a standard 19" rack, providing 1.3 Gigabytes



The M2333 8" Disk Drive—336 MB

CIRCLE NO. 80 ON INQUIRY CARD

of storage in the space of one 14" drive.

Both units offer fast access (18 and 20 milliseconds, respectively). Both use the same track capacity and controller. And both offer Fujitsu's field-proven quality, backed by a 20,000-hour MTBF specification.

And to top it all off, they offer you the lowest cost of ownership.

For more information or to arrange for evaluation units on the new 8" or Eagle disk drive, call (408) 946-8777 or write Fujitsu America, Inc., Storage Products Division, 3055 Orchard Drive, San Jose, CA 95134 Fujitsu Storage Products. Maximum Performance. Maximum Quality.

FUJITSU AMERICA, INC.

FUJITSU

Down and running.

When an ordinary computer breaks down, it's down for the count. Which is however long it takes for someone to come out and revive it again.

But not so with any computer in the Parallel family.

In fact, your customers can count on a Parallel computer to be running 100 percent of the time. Even when something goes wrong. Because thanks to our redundant, self-checking hardware, reliability is built right into the system. And with dual uninterruptible power sources, data is no longer at the mercy of nature. No matter what happens,



there's never any worry about scrambled or lost data.

All of which makes the Parallel computer 80 times more reliable than any conventional

computer. With a 28 year MTBF.

Our open system means more opportunities.

Of course, we provide all the standard features you require in a computer. Like the power to support 8-32 users. And the ability to expand from 1MB to 8MB of memory and from 84MB to 2.7GB of storage. Along with offering a rich set of industry standard networking, such as Ethernet, X.25, SNA and a Network File System.

Plus, with Parallel you're not locked into any proprietary system, because it runs standard UNIX software and provides a standard Multibus interface. And you can count on your existing UNIX applications to keep working all the time, without modification for our ultra-reliability.

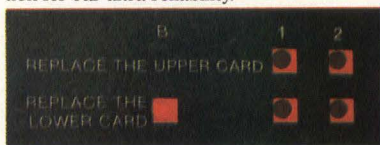

Now on-site service is a thing of the past.

Parallel just didn't stop with an ultra-reliable computer. Instead we've taken a long overdue step by embedding the service right into the architecture of the computer.

Quite simply, we've done away with the need for on-site service. Which instantly does away with the cost and headaches that go along with it.

UNIX is a trademark of Bell Laboratories. Multibus is a trademark of Intel. Ethernet is a trademark of Xerox. SNA is a trademark of International Business Machines, Inc.



If something does go wrong with a Parallel computer, the system automatically diagnoses and isolates the problem, then signals the user.

Your customer just gets the replacement part, usually overnight, and installs the part himself. All in a matter of minutes. It's so simple that it requires absolutely no tools. And no specialized training.

Of course, the system is up the entire time, with no data loss.

Naturally, this means more opportunity for you. Because you can sell Parallel computers to just about anyone, just about anywhere.

An unparalleled five-year warranty.

With other computers, the best you can offer your customers is a 90-day warranty. But when you sell them any

5 year warranty

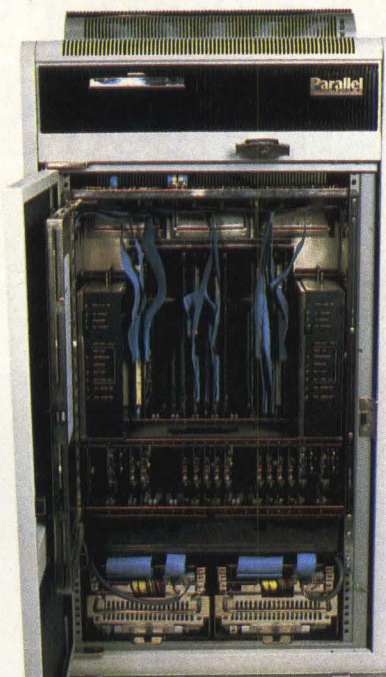

computer in the Parallel family, you can give them something no other manufacturer can match. A five-year warranty. Because we believe a Parallel computer is every thing we say it is. And then some.

CIRCLE NO. 81 ON INQUIRY CARD

More computer for less.

Now, you'd think that in order for us to offer something this unique, your customers are going to end up spending a fortune. But, not so. What they'll pay is the same cost they're paying now for a conventional com-

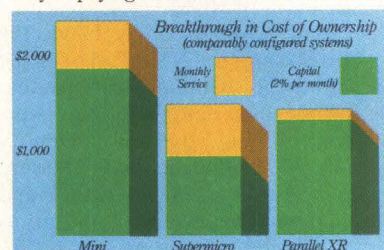

puter. And in some cases, even less.

What's more, the economics will let you make more money with Parallel than with any other supplier. In fact, two to three times as much.

So just imagine the success you'll have selling a Parallel computer. A powerful system that won't break down. Won't lose data. Doesn't need on-site service. And doesn't cost your customers any more. It can earn you more profit and it can make you the quality leader in your market. With a competitive advantage no other manufacturer can come close to.

So fill out and return the attached coupon or call us directly at (408) 429-1338. We'll give you all the data on how you can offer your customers the most reliable, most self-sufficient computer available. Unless you think they'd prefer to be down and out.

Parallel Computers, Inc. 3004 Mission St., Santa Cruz, California 95060.

Call me right away with more information.

Patience is an inherent trait of mine. Just send me additional literature.

Name _____

Company _____

Address _____

City _____ State _____

Zip _____ Phone (____) _____

Parallel Computers, Inc. 3004 Mission St., Santa Cruz, CA 95060 (408) 429-1338 MM

Parallel

Minicomputers that won't break.

Program transfers binary files

- MS-DOS compatible
- Error-correction reports
- ASCII protocol support

Ptel, a binary-file-transfer program for MS-DOS-compatible systems, allows an IBM PC, PC/XT, PC-AT or compatible to transfer binary and ASCII files to other network systems. Files can be uploaded or downloaded from electronic bulletin boards or moved among different operating systems. The program includes the Modem7 and XModem protocols with cyclic redundancy check. Menu-driven, it supports Kermit and ASCII protocols and operates in VT102 terminal-emulation mode and originate and answer mode. Requiring 90K bytes of memory, the program handles 9,600-baud transmission speeds and supports Bell 103 and 212A and Racal-Vadic formats. Reports of error correction, blocks transferred and time-to-completion for files being uploaded or downloaded are provided. \$195. **Phoenix Computer Products Corp.**, Suite 220, 1416 Providence Highway, Norwood, Mass. 02062, (617) 762-5030.

Circle 317

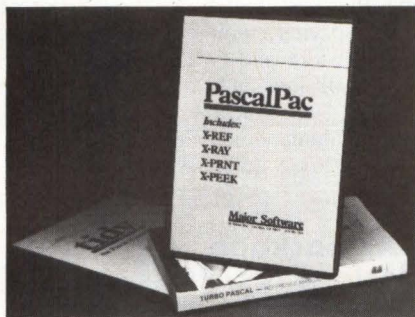

Package aids Pascal programming

- Cross-referencing
- 80 or 132 columns
- DOS 2.0 requirement

A set of four Pascal programming tools, PASCALPAC runs under DOS 2.0 on the IBM PC, PC/XT and PC-AT. X-REF generates a cross-reference table of all symbols in a program except Pascal-reserved words. It facilitates debugging and locates misuse of program variables. It lists an ASCII file in either 80- or 132-column widths with headings on each page. The headings contain the file name, the date and time of the listing and the page number. X-RAY, an interactive program for browsing through the output

of the cross-reference program, displays both the Pascal file and the cross-reference file in separate regions of the screen. X-PEEK allows the programmer to browse through any text file. \$195. **Major Software**, 66 Sylvian Way, Los Altos, Calif. 94022, (415) 941-1924.

Circle 318

Terminal emulator transfers files

- Tektronix, DEC emulation
- ASCII file transfer
- Zoom facility

As a graphics terminal emulator, the SmartTerm 4014 software package enables an IBM PC to be used as a Tektronix 4010, 4012 or 4014 terminal. As an intelligent text terminal, it offers DEC VT100, VT102 and VT52 emulation as well as TTY mode. Text is displayed in 132 columns, like the VT102, by offering horizontal scrolling within an 80-column window. Transferring ASCII or binary program or data files between the IBM PC and host computer system, the package provides two "error-free" protocols, the proprietary PDIP and XModem. A Zoom facility magnifies or compresses graphics images while a Picture Replay feature allows these images to be captured on a disk during a session and redrawn off-line. Graph-Mode controls include standard line drawing with written or dark vectors, write-through mode, point plotting, vector line formats and incremental plotting. Alpha Mode offers optional processing of character size and spacing commands. The software requires 256K bytes of memory, PC DOS 2.0, one double-sided disk drive and an IBM Color Graphics adapter and 80-column monitor or a Hercules graphics adapter and monochrome monitor. \$225. **Persoft Inc.**, 2740 Ski Lane, Madison, Wis. 53713, (608) 273-6000.

Circle 319

Package offers 150 application programs

- Bit-mapped graphics
- File transfer
- Multitasking capability

Requiring 128K bytes of memory on the IBM PC, PC/XT, PC-AT and compatibles and supporting a monochrome or color monitor, Desqview multitasking software runs 150 application programs without modification. The software

Available, Reliable, Affordable Solutions for Computerization

Little Board™/186 ... \$499 ^{with (128K)}
Single Board 16-Bit Computer with SCSI/PLUS™ Bus

- Data and file compatible with IBM PC
- Three times the COMPUTING POWER of a PC
- Boots PC-DOS 2.10, 3.00
- Runs most MS-DOS generic software
- Mounts directly to a 5-1/4 inch disk drive
- Includes: 8 MHz 80186 CPU, 128K or 512K RAM, 16K-128K EPROM, 2 RS232C Serial Ports, Centronics Printer Port, Floppy Disk Controller, SCSI/PLUS™ Multi-Master bus for: hard disk / networking / I/O expansion
- Available with 512K RAM

NEW for PC-DOS

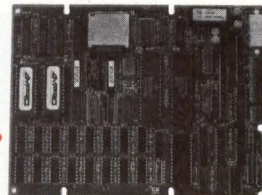

NEW for CP/M

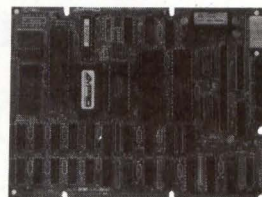

Little Board™/PLUS ... \$349
Single Board 64K CP/M Computer with SCSI/PLUS™ Bus

- Same as Little Board/186 except:
- 4 MHz Z80A (8-bit) CPU
 - 64K RAM, 4K to 16K EPROM
 - CP/M 2.2 included

Little Board™ the (original) now **\$289**
same as Little Board/PLUS except no SCSI, 4K EPROM

Bookshelf™ Series

Cost Effective, Compact, Versatile computer systems

Choice of Little Board CPUs, 1 or 2 floppy drives (48 or 96 tpi); 10MB internal hard disk option. 6 1/2" high, 7 1/4" wide, 10 1/4" deep, 12 1/2 lbs.



DISTRIBUTORS

Argentina-Factorial, S.A.	1-41-0018
Australia-ASP Microcomputers	613-500-0628
Belgium-Centre Electronique Lempereur	041-23-45-41
Canada-Dynacomp	(604) 872-7737
Denmark-Danbit	03-66-20-20
England-Quant Systems	01-534-3158
Finland-Symmetric OY	358-0-585-322
France-EGAL+	1-502-1800
Israel-Alpha Terminals	03-491695
Spain-Xenios Informatica	3-593-0892
Sweden-AB AKTA	08-54-90-90
USA:	CALL AMPRO

IBM is a registered trademark of Int'l. Bus. Mach.
MS-DOS is a registered trademark of Microsoft.
Z80A is a registered trademark of Zilog, Inc.
CP/M is a registered trademark of Digital Research.

AMPRO

COMPUTERS INCORPORATED
67 East Evelyn Ave. • Mountain View, CA 94041
(415) 962-0230 • TELEX 4940302

CIRCLE NO. 69 ON INQUIRY CARD

SOFTWARE

transfers data between programs such as word processing or spreadsheets and offers bit-mapped graphics support allowing graphics programs to be viewed in separate windows. An integrator feature incorporates multitasking capabilities that permit the operation of a communications program or the printing of files,

while working on another program. Compatible with IBM's Program Interface Files which allow application programs to work with IBM's TopView software, the program supports both keyboard and mouse commands interchangeably. A telephone auto-dialer comes with the package. \$99.95. **Quar-**

terdeck, 1918 Main St., Santa Monica, Calif. 90405, (213) 392-9851.

Circle 320

Software interfaces LaserJet to Macintosh

- Three modes
- 75, 150, 300 dpi
- Prevents word collisions

Compatible with Macintosh application software and supporting the 128K, 512K and XL Macintosh computers, Laserstart software interfaces the Hewlett-Packard LaserJet printer to the Apple Macintosh computer. Laserstart is installed only once on application disks where it modifies the printer drivers for support of the LaserJet printer. The modified printer drivers run transparently when printing. In Macintosh Standard printing mode, the LaserJet prints text and graphics at 75 dpi; in Macintosh High printing mode, the printer produces text and graphics at 150 dpi. In Macintosh Draft printing mode, Laserstart uses the LaserJet printer's cartridge fonts for 300-dpi, high-speed and letter-quality printing. The software automatically selects the LaserJet cartridge font providing the best match to the Macintosh font's spacing, point size, character style, stroke width and typeface and prevents word collisions and extra spaces between words. \$95. **SoftStyle Inc.**, Suite 205, 7192 Kalaniana'ole Highway, Honolulu, Hawaii 96825, (808) 396-6368.

Circle 321

CAE package designs ICs, PCBs

- Graphics editor
- Hardware compiler
- Post processor

The CT2000 CAE design system for use with the IBM PC/XT and PC-AT aids the design of integrated circuits and printed-circuit boards. It includes a fully implemented version of the structured computer-aided logic design (SCALD) tools. The software consists of a structured graphics editor for schematic entry and design capture, SCALD hardware compiler, netlist post processor, hard-copy post processor, cross-reference generator, firmware compiler and component libraries. \$5,200. **Case Technology Inc.**, Suite 250, 633 Menlo Ave., Menlo Park, Calif. 94025, (415) 322-4057.

Circle 322

E-Z-DOS-IT™

gives you
concurrent processing
in only 8K of RAM.

Unique, E-Z-DOS-IT™ Concurrent Processing Software lets your PC wear several different hats *at the same time*—and it operates on only 8K of RAM.

With E-Z-DOS-IT, your IBM PC, PC/XT, or PC/AT can run your choice of background tasks while you continue to work at the screen. No waiting, because your single-tasking PC now behaves like two or more PCs. And E-Z-DOS-IT is compatible with the most popular software and hardware on the market today.

To find out more about E-Z-DOS-IT, or to order directly, call toll-free:

800/228-9602

In California, call 800/423-5592

Ask for operator #14.

HAMMER

Redefining Your PC Productivity.

Hammer Computer Systems, Inc.
900 Larkspur Landing Circle, Suite 250
Larkspur, CA 94939. 415/461-7633

E-Z-DOS-IT is a trademark of Hammer Computer Systems, Inc.

The following registered trademarks are acknowledged: IBM PC, PC/XT, and PC/AT—International Business Machines; Lotus 1-2-3 and Symphony—Lotus Development Corp.; dBase II and Framework—Ashtron-Tate; Wordstar—Micro Pro International; PFS:File—Software Publishing; Multi-Plan—Microsoft Corp.; Crosstalk—Microstuf, Inc.



CIRCLE NO. 82 ON INQUIRY CARD

The Firebreathers continue on the cutting edge of high performance computers.

The most powerful line of computer systems made. Gould PowerNodes™ and CONCEPT/32s®

Any way you slice it they beat the VAX™.

Our main-frame PN9000 and CONCEPT 32/97

are up to twice as fast as the VAX 8600.

And even though the mid-range PN6000 and CONCEPT 32/67 are 30-50% smaller than the VAX 11/780, they're still up to three times more powerful.

More power for a slice of the price.

Despite their superior power, our mid-

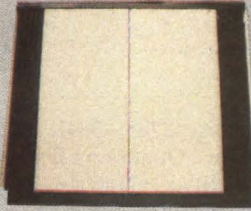

range models cost 40% less than the VAX 11/780. Our mainframes cost about 30% less than the new VAX 8600. The bottom line is more power for less money.

Operating environments that are a cut above the rest.

There's also a choice of system software to consider. Gould's unique UTX/32® is the first operating system to combine UNIX* System V with Berkeley BSD 4.2. So it allows you to access virtually any command format you want whenever you want.

And in real-time environments, Gould's MPX/32™ operating system offers performance that's unmatched in the industry, as well.

Delivery that's right on the mark.

Unlike the VAX 8600, that has up to a 12 month wait for delivery, when you

order either a Gould PowerNode or a CONCEPT/32 system, they'll be shipped within 90 days ARO.

You can also be sure with Gould you're getting a computer that's backed by years of experience—the kind of experience we used to develop the first 32-bit real-time computer.

If you need more information or just have a few questions, give us a call at 1-800-327-9716.

See for yourself why VAX no longer cuts it. Go with a Gould computer and ax the VAX.

CONCEPT/32 and UTX/32 are registered trademarks and PowerNode and MPX/32 are trademarks of Gould Inc. VAX is a trademark of Digital Equipment Corp. UNIX is a trademark of AT&T Bell Labs.

 **GOULD**
Electronics

Only Gould computers have a big enough edge to ax the VAX.

CIRCLE NO. 83 ON INQUIRY CARD



CAHNERS PUBLISHING COMPANY

Cahners Magazine Division

publishes the following 34 specialized business magazines, directories and newsletters:

Building/Construction Group

*Brick & Clay Record
Building Design & Construction
Building Supply Home Centers
Ceramic Industry
Construction Equipment
Corporate Design & Realty
Interior Design
Professional Builder
Security Distributing & Marketing
Security World
Specifying Engineer*

Foodservice Group

*Bar Business
Foodservice Equipment Specialist
Hotels & Restaurants International
Restaurants & Institutions*

Electronic/Computer Group

*Business Computer Systems
EDN
Electronic Business
Electronic Packaging & Production
Mini-Micro Systems
PC Products
Semiconductor International*

Manufacturing Industries Group

*Appliance Manufacturer
CPI Purchasing
Design News
Design News Directories
Modern Materials Handling
Packaging
Plastics World
Purchasing
Traffic Management
U.S. Industrial Directory*

Medical-Health Care Group

*Cardiovascular Medicine
Emergency Medicine
Physicians Travel & Meeting Guide*

Newsletter Division

*Electronic Business Forecast
Plastics Business News
Buying Strategy Forecast
Early Warning Forecast
Oil Spill Intelligence Report
Tradeshow Week
Energy Design Update
CIM Strategies
Communications In Medicine*

Cahners Exposition Group

is the largest producer, operator and manager of trade and consumer shows in the world . . . with over 100 shows, 6,000,000 square feet of exhibition space and total annual attendance of over three million.



**CAHNERS
PUBLISHING COMPANY**

275 Washington Street
Newton, MA 02158
617/964-3030

CIRCLE NO. 104 ON INQUIRY CARD

NEW PRODUCTS SUBASSEMBLIES

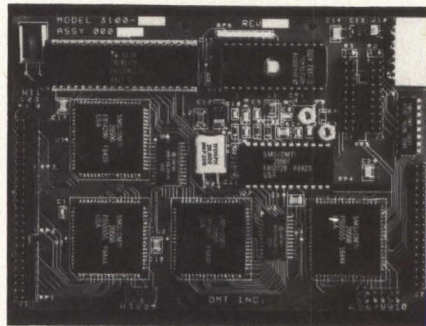

Controller supports ST506/412 interface

- Programmable formatting
- Implied, overlapped seeks
- Automatic error retries

Handling up to two 3½- or 5¼-inch fixed disk drives, the OMTI 3100, SCSI-compatible, controller board serves the ST506/412 interface. Through one-to-one interleaving, the board transfers data on the SCSI bus at 1.3M bytes per second. A 2K-byte buffer with three independent ports allows simultaneous transfers between Winchesters and the host bus. A programmable formatting feature formats disk block size for 256, 512, or 1,024 bytes per sector. Features include automatic error retries, multiblock data transfer, implied and overlapped seeks, automatic head and cylinder switching and programmable interleaving. Data integrity is ensured through 32-bit error-correction code, automatic retry, bus parity checking and automatic media handling protocol. \$219, Q10. **Scientific Micro Systems Inc.**, 339 N. Bernardo Ave., Mountain View, Calif. 94043, (415) 964-5700. **Circle 323**

Board offers color graphics

- Keysaver function
- 64K to 640K bytes
- IBM PC-compatible

The Gold Quadboard, a multifunction board for the IBM PC, comes with 64K, 384K or 640K bytes. RAM-expandable in 64K-byte increments, it enables I/O expansion via a parallel printer port and an RS232C serial port. Capable of RGB, RGBI and color-composite output, the board is IBM PC color graphics-compatible. A keysaver feature holds 8K bytes of keystrokes in battery-powered memory and stores data for later use or restores data that has been destroyed or contaminated. \$595, 0 bytes; \$620, 64K

bytes; \$795, 384K bytes; \$995, 640K bytes. **Quadram Corp.**, 4355 International Blvd., Norcross, Ga. 30093, (404) 923-6666. **Circle 324**

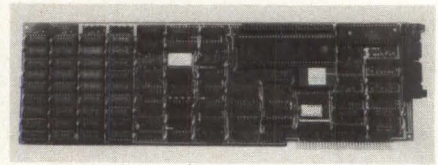

Coprocessor board works with IBM PC-AT

- 68000 CPU
- 16, 32 bits
- Two serial ports

Pro68, a coprocessor board for the IBM PC, PC/XT and PC-AT, or compatible systems, consists of a 16/32-bit coprocessor and fits into an IBM PC bus slot. Employing the 10-MHz, 68000 microprocessor, the board contains two serial ports, a real-time clock, provisions for the National Semiconductor 32081 math processor chip, a 32-bit expansion bus interface connector and a custom dual-port, no-wait-state IBM PC bus interface. Memory is configurable with 256K, 512K or 1,024K bytes of parity-checked memory and is expandable to 3,072K bytes via a piggyback expansion board. It runs under Digital Research's CPM68K or Microware's OS9/68 operating system. Applications include UNIX and 68000 software development, scientific processing, parallel processing and number-crunching. \$1,195, 256K-byte version; \$1,495, 512K-byte version; \$1,895, 1,024K-byte version. **Hallock Systems Co. Inc.**, 267 N. Main St., Herkimer, N.Y. 13350, (315) 866-7125. **Circle 325**

SBCs based on Multibus II bus

- Video-display control
- Analog-to-digital conversion
- Three modes

Based on Intel's Multibus II 32-bit architecture, the MIB II 86/78 single-board computer (SBC) controls color-video display while the MIB II 86/40 SBC manages analog-to-digital data conversion. Both models operate as a stand-alone controller, a bus multimaster or an intelligent slave controller. Supporting 1,024-by-1,024-pixel resolution, the model MIB II 86/78 suits process-monitoring, machine-control, robotics and

Only from Topaz...

Line 2[®] Power Conditioners with PowerLogic[®] Control

**The logical choice
in computer-grade
power**

They're in a class by themselves.

Highly efficient and completely reliable, these microcomputer-based Line 2 Power Conditioners eliminate computer problems caused by power-line noise and voltage disturbances.

With exclusive Powerlogic control, our Power Conditioners are able to perform with exceptional speed and accuracy. An internal microcomputer monitors incoming power and instantaneously corrects overvoltages and undervoltages.

Harmful power-line noise is also eliminated. A built-in Ultra-Isolator[®] Noise Suppressor provides common-mode noise attenuation in excess of 2 million-to-one (126 dB).

Available in micro, mini, and mainframe models, Line 2 Power Conditioners feature computer-compatible design, durability and top performance.

Find out more about our new Line 2 Power Conditioners. Call us today at (619) 279-0831, or contact your local Square D distributor.

CIRCLE NO. 84 ON INQUIRY CARD



TOPAZ[®]

Excellence in Computer Power

SQUARE D COMPANY

NEW PRODUCTS SUBASSEMBLIES

2-D or 3-D modeling applications. It holds 512K bytes of display memory and uses three Intel 8-MHz MCS microprocessors. Windowing, split-screen and zoom capabilities are supported. The model MIB II 86/40 handles the conversion of analog information into digital signals, to be stored or manipulated by a processor. It includes a 12-bit, 20-kHz

analog-to-digital converter with programmable gain control, 16 differential or 32 single-ended analog input channels for data acquisition, 16 digital I/O channels and 32K bytes of static RAM. \$3,000, MIB II 86/78; \$2,350, MIB II 86/40. **Micro Industries**, 691 Greencrest Drive, Westerville, Ohio 43081, (614) 895-0404. **Circle 326**

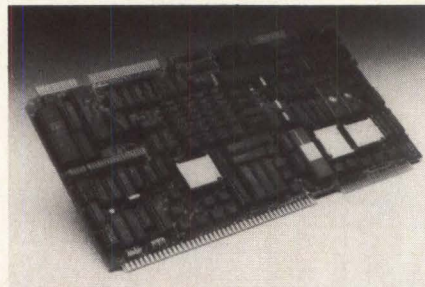

SBC suits Multibus applications

- 16M-byte addressing
- 512K-byte RAM
- 80286 CPU

Based on the 80286 CPU, the Multi 286 Multibus-compatible single-board computer (SBC) addresses up to 16M bytes of physical memory and 1G byte of virtual memory. It comes with 512K bytes of dual-ported RAM, upgradeable to 1M byte. Features include 16K to 128K bytes of ROM space with diagnostics and loader-debugger; numeric processor extension; four programmable, multiple-protocol, serial I/O interfaces; Centronics-compatible parallel interface; 5¼- and 8-inch controllers; 16 levels of vectored interrupt control and counter timer. \$3,500. **Future Data Systems Inc.**, 5432-B Production Drive, Huntington Beach, Calif. 92649, (714) 898-3000.

Circle 327

Multifunction board provides ECC

- IBM PC-AT-compatible
- Zero wait state
- 15M-byte buffer

A fault-tolerant, multifunction board for the IBM PC-AT, ECCELL offers error-correcting code (ECC) operation via 2-bit error detection and 1-bit error correction per 16-bit word. A read-modify-write capability corrects the memory cell after error detection. Storing 128K to 1.5M bytes on the main board and 512K to 2.5M bytes on the daughter board, the unit is expandable in 64K- or 256K-byte increments. Split-memory addressing allows two start addresses. Features include parallel printer port, asynchronous serial port, zero-wait-state capability, disk caching, print spooling and virtual volumes—a utility that splits the hard disk drive into several independent volumes. \$595. **Orchid Technology**, 47790 Westinghouse Drive, Fremont, Calif. 94539, (415) 490-8586. **Circle 328**

The Light. At the End of the DEC Tunnel.

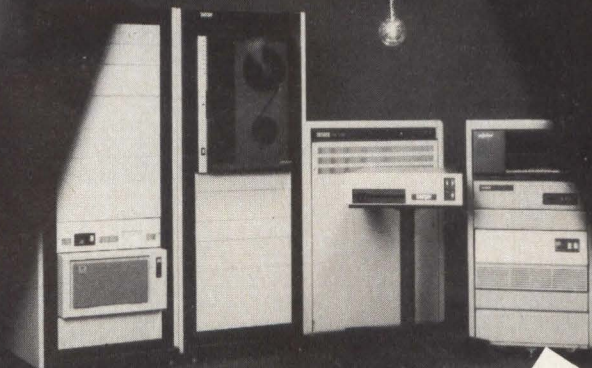

At Cambridge Digital we don't have tunnel vision! We customize DEC-based systems to your specifications, not vice-versa. And we use only the finest high performance equipment and high level applications. Nothing less!

Systems and software for Data Acquisition, Process Control, Software Development and Office Automation

based on equipment from DEC, Fujitsu, CDC, Cipher, Emulex, Sigma, Interlan, Data Translation and others.

So, call for a **FREE** catalog, or better yet, talk to a salesman. There's no need to feel like you are still in the dark. We're waiting for you just at the end of the tunnel.

**FREE
SYSTEMS CATALOG**

**Cambridge
Digital**

The Edge in System Integration.

In MA 617-491-2700 • 800-343-5504 • In NY 516-935-3111

P.O. Box 568 • 65 Bent Street • Cambridge, MA 02139

CIRCLE NO. 85 ON INQUIRY CARD

If you've been seeking a profitable partnership, this coupon has a lot of redeeming value.

It's your ticket to the AT&T VAR program, a chance to get in on the ground floor and profit from a major contender that is gathering momentum. AT&T has a flexible, high-performance product line that will be adding to your bottom line for years to come. With AT&T backing it, you'll be glad to be their partner, long after all of those fly-by-night operations have folded.

When you sign up with AT&T, here's how your future takes shape. AT&T Account Executives will work with you to share sales leads generated by our comprehensive computer marketing program. The products you'll be selling will be backed by a national advertising program. And a co-op advertising program will enable you to reach your customers in your markets with your own message. Promotional materials and trade show support are also included.

An extra edge is provided by AT&T's comprehensive service support package. This includes nationwide field-service team coverage and a full maintenance package with a 24-hour hotline. Plus complete training on AT&T Computers.

The future of your bottom line is further assured by our full line of computers. These high-performance products include our 3B family of UNIX™ System V-based super micro and minicomputers, as well as our popular new AT&T UNIX PC, and the enhanced AT&T PC 6300 which runs MS-DOS* and Xenix.* Because they're the computers with the future built in, they're a sound, long-term investment that your customers will want to make.

For more information about why AT&T's aggressive, all-encompassing VAR program is the right choice for you, call 1-800-247-1212, or clip the coupon.

There's no commitment, except the one we've made to your success.

CUTTING ON THE DOTTED LINE COULD CHANGE THE FUTURE OF YOUR BOTTOM LINE.

FOR MORE INFORMATION, MAIL TO:

AT&T Information Systems, P.O. Box 45042,
Jacksonville, Florida 32232-5042

Name _____
Company _____
Address _____
City _____
State _____ Zip _____
Sales Volume _____
UNIX™ System User Yes No MS



AT&T

The right choice.

This publication
is available in microform.

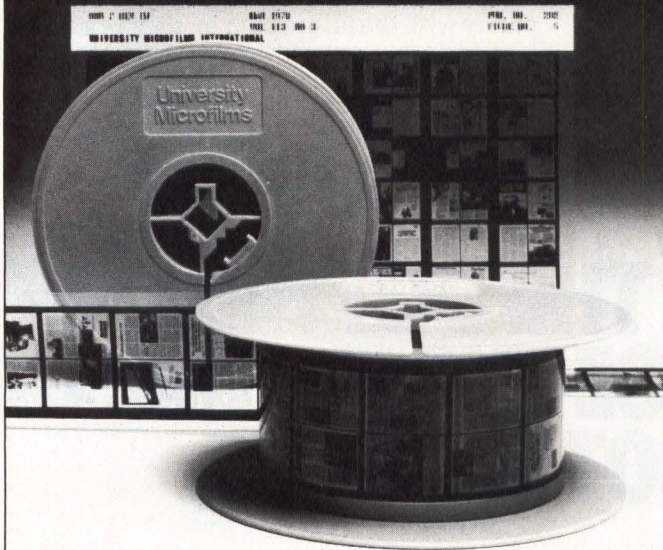

University Microfilms International

Please send additional information
for Mini-Micro Systems
Name _____
(name of publication)

Institution _____

Street _____

City _____

State _____ Zip _____

300 North Zeeb Road
Dept. P.R.
Ann Arbor, Mi. 48106
U.S.A.

30-32 Mortimer Street
Dept. P.R.
London W1N 7RA
England

CIRCLE NO. 101 ON INQUIRY CARD

NEW PRODUCTS LITERATURE

Book discusses Lotus 1-2-3 software

The Illustrated Lotus 1-2-3 Book offers frequent screen layouts and examples to explain how data should be entered when using Lotus 1-2-3. The book also discusses advanced techniques such as macros, graphics and how to move data to Symphony software. \$17.95. **Wordware Publishing Inc.**, 1104 Summit Ave., Plano, Texas 75074, (214) 423-0090.

Circle 329

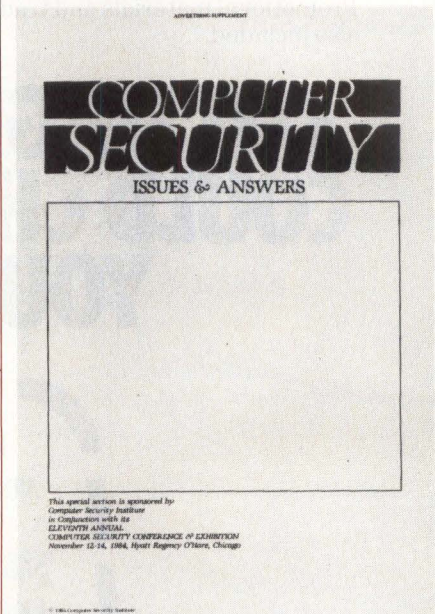

Supplement covers data security

"Computer Security Issues & Answers" is a 24-page magazine supplement containing eight articles. The articles cover planning, computer-crime prevention, society's responsibility for data security, legal aspects, software security and disaster recovery. **Computer Security Institute**, 43 Boston Post Road, Northborough, Mass. 01532, (617) 845-5050.

Circle 330

NEXT MONTH IN MMS

Data communications carries the spotlight in the September issue of Mini-Micro Systems. MMS will review the following issues: physical media, topology, architecture and usage.

GET THE **CLEAR** WINNER

ULTRA HIGH RESOLUTION COLOR FOR BOTH TEXT AND GRAPHICS

For the IBM PC, XT, AT or IBM compatible system

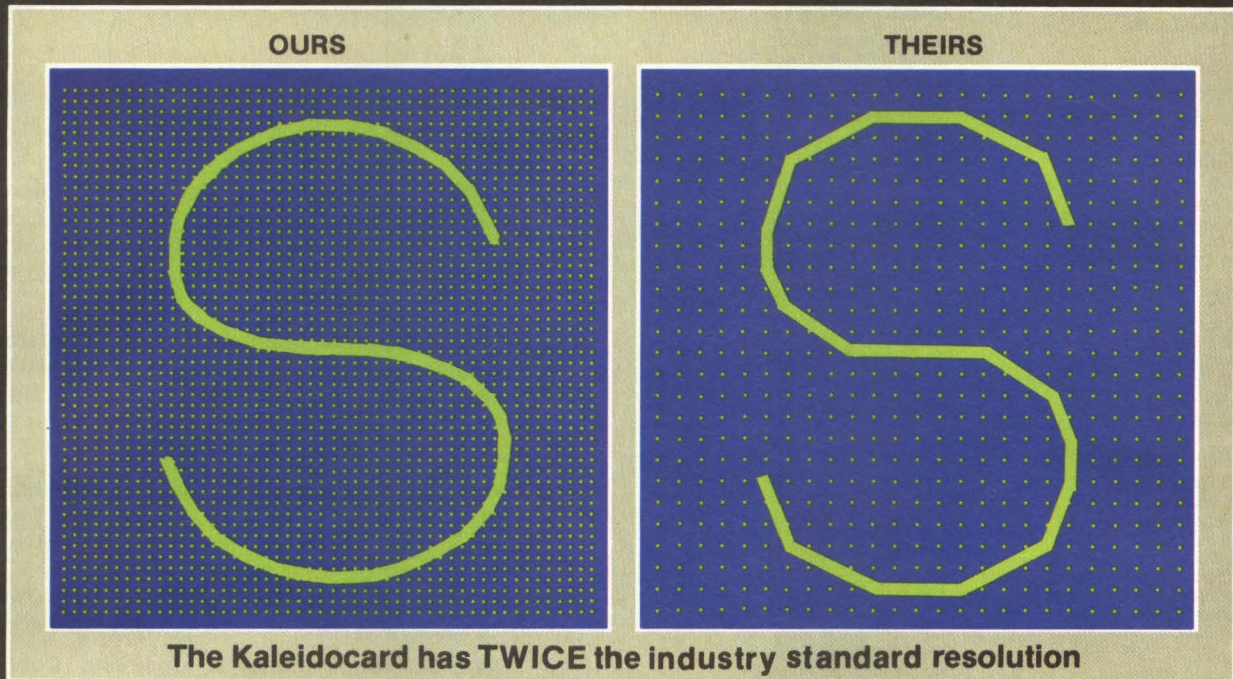

The Kaleidocard provides clear, ultra high resolution for both **TEXT AND GRAPHICS** with **ONE** high-resolution color graphics monitor.

TEXT — The alphanumeric display of 1280x400 pixels is rated with the best of any monochrome card. Crisp, incredibly-defined characters result from the intense 12x11 character inside a 16x16 dot grid. Because each character is created more precisely, arcs are rounded and smooth — not jagged and choppy.

GRAPHICS — The high resolution definition of 640x400 pixels elevates the industry standard 320x200 pixels to a new level. **NO OTHER 16 COLOR CARD COMES CLOSE.** And it works with all the popular PC software (such as Lotus 1-2-3, Symphony, Framework, Flight Simulator and WORD).

Look at the picture again.

The decision to use the Kaleidocard should be CLEAR-ly obvious.

KALEIDOCARD

For the finest in color and clarity... at a very affordable price!



CORPORATE OFFICES: 2800 Lockheed Way, Carson City, Nevada 89701 • Telephone (702) 883-7611 • TWX (910) 395-6051 IMS CARS

REGIONAL SALES OFFICES

BOSTON

Robert K. Singer
National Sales Manager
Norma E. Lindahl
Assistant To The National
Sales Manager

John J. Fahey
Regional Manager
Katie Kress
Sales Coordinator
275 Washington St.
Newton, MA 02158
(617) 964-3030

PHILADELPHIA

Stephen B. Donohue
Regional Manager
1873 Route 70, Suite 302
Cherry Hill, NJ 08003
(609) 751-0170

ATLANTA

Larry Pullman
Regional Manager
6540 Powers Ferry Rd.,
Suite 170
Atlanta, GA 30339
(404) 955-6500

CHICAGO

Robert D. Wentz
Regional Manager
Marianne Majerus
Sales Coordinator
Cahners Plaza
1350 E. Touhy Ave.
P.O. Box 5080
Des Plaines, IL 60018
(312) 635-8800

DALLAS

Don Ward, Regional Manager
13740 Midway Suite 515
Dallas, TX 75234
(214) 980-0318

DENVER

John Huff
Regional Manager
270 St. Paul St.
Denver, CO 80206
(303) 388-4511

LOS ANGELES

Len Ganz
Regional Manager
12233 West Olympic Blvd.
Suite 236
Los Angeles, CA 90064
(213) 826-5818

ORANGE COUNTY

Debra Huisken
Regional Manager
2041 Business Center Dr.
Suite 109
Irvine, CA 92715
(714) 851-9422

SAN FRANCISCO

Frank Barbagallo
Northwestern Region Sales Manager
Rick Jamison
Regional Manager
Kathleen Maxwell
Sales Coordinator
Sherman Building, Suite 100
3031 Tisch Way
San Jose, CA 95128
(408) 243-8838

AUSTRIA

Elan Marketing Group
Neutor g. 2
P.O. Box 84
1013 Vienna, Austria
Tel: 43-222-663012 or -638461

BENELUX

Elan Marketing Group
Boschdijk 199B
5612 HB Eindhoven
The Netherlands
Tel: 31-40-455724

ISRAEL

Elan Marketing Group
13 Haifa St., P.O. Box 33439
Tel Aviv, Israel
Tel: 972-3-252967 or -268020
Telex: 341667

JAPAN

Kaoru Hara
General Manager
Trade Media Japan Inc.
R. 212 Azabu Heights
1-5-10 Roppongi Minato-ku,
106, Japan
Tel: (03) 587-0581

TAIWAN

Mr. Donald H. Shapiro
Trade Winds, 2nd Floor
132 Hsin Yi Road, Sec. 2
Taipei, Taiwan

UNITED KINGDOM

Elan Marketing Group
5th Floor, Suite 10
Chesham House
136 Regent St.
London W1R 5FA
Tel: 437-6900
Telex: 267653

SWEDEN

Elan Marketing Group
Humlegardsgatan Nr. 5
11446 Stockholm, Sweden
Tel: 46-8-677243 or -676243

WEST GERMANY

Elan Marketing Group
Sudring 53
7240 Norb/Neckar, West Germany
Tel: 49-7451-7828

Mini-Micro Marketplace

Norma Lindahl
275 Washington St.
Newton, MA 02158
(617) 964-3030

Direct-Response Postcards

Carol Flanagan
275 Washington St.
Newton, MA 02158
(617) 964-3030

Career Opportunities

Norma Lindahl
Recruitment Advertising Manager
275 Washington St.
Newton, MA 02158
(617) 964-3030

Cahners Magazine Division

William Platt, President
T.M. McDermott, Vice President
Electronics/Computer Group
Tom Dellamaria, VP/Production
Ira Siegel, VP/Research

Promotion Staff

Susan Rapaport
Marketing Communications Director
Mary Gregory
Promotion Manager
Elizabeth Phillips
Marketing Assistant

Circulation

Denver, CO:
(303) 388-4511
Sherri Gronli
Group Manager

CALENDAR

SEPTEMBER

- 5 1985/86 U.S. Invitational Computer Conference (ICC)**, Newton Marriott Hotel, Newton, Mass., sponsored by B.J. Johnson & Associates Inc. Contact: B.J. Johnson & Associates Inc., 3151 Airway Ave., #C-2, Costa Mesa, Calif. 92626, (714) 957-0171.
- 9-11 The Eighth Annual Federal Computer Conference**, Washington Convention Center, sponsored by the National Council for Education on Information Strategies. Contact: Dallas Kinney, Conference Communications, P.O. Box N, Wayland, Mass. 01778, (617) 358-5356.
- 10-12 Midcon/85 High-Technology Electronics Exhibition and Convention**, O'Hare Exposition Center, Rosemont, Ill., sponsored by Electronic Conventions Management. Contact: Jerry Fossler or Nancy Hogan, Electronic Conventions Management, 8110 Airport Blvd., Los Angeles, Calif. 90045, (213) 772-2965.
- 10-13 "Data Communications—A Complete Overview and Update" Course**, Orlando, Fla., offered by Zatyko Associates. Contact: Douglas Grube, Data Tech Institute, Lakeview Plaza, P.O. Box 2429, Clifton, N.J. 07015, (201) 478-5400. Also to be held Sept. 18-20, Dallas; 30-(2), Princeton, N.J.
- 10-13 "Teleconferencing" Seminar**, Selfridge Hotel, London, sponsored by Frost & Sullivan Inc. Contact: Carol Every, industry representative, Frost & Sullivan Inc., 106 Fulton St., New York, N.Y. 10038, (212) 233-1080.
- 10-13 "Packet-Switching Networks For Modern Data Communications" Course**, offered by The George Washington University Continuing Engineering Education Program. Contact: Ron Donais, The George Washington University, Washington, D.C. 20052, (202) 676-8523.
- 11-13 "Database Administration and Data Resource Development" Seminar**, Ramada Hotel, Dallas, sponsored by Software Institute of America. Contact: Digital Consulting Associates Inc., 6 Windsor St., Andover, Mass. 01810, (617) 470-3870.
- 12-13 Third Annual Computer Vertical Markets Conference**, Stouffer's Inn, White Plains, N.Y., sponsored by Frost & Sullivan Inc. Contact: Carol Every, industry representative, Frost & Sullivan Inc., 106 Fulton St., New York, N.Y. 10038, (212) 233-1080.
- 16-18 Data Storage85 International Forum**, Red Lion Inn, San Jose, Calif., co-sponsored by Disk/Trend Inc. and Freeman Associates. Contact: Cartledge & Associates Inc., Suite M-259, 1101 S. Winchester Blvd., San Jose, Calif. 95128, (408) 554-6644.

- 16-20 FOC/LAN '85, The Ninth International Fiber Optic Communications and Local Area Networks Exposition**, Brooks Hall/Civic Auditorium, San Francisco, organized by Information Gatekeepers Inc. Contact: Information Gatekeepers Inc., 214 Harvard Ave., Boston, Mass. 02134, (617) 232-3111.
- 17-19 "Writing Better Computer Software Documentation for Users" Course**, Atlanta, sponsored and conducted by the Department of Continuing Education, Georgia Institute of Technology. Contact: Trish Stolton, Department of Continuing Education, Georgia Institute of Technology, Atlanta, Georgia 30332-0385, (404) 894-2547.
- 18-20 The UNIX Operating System Exposition and Conference**, the New York Hilton and Sheraton Hotels, New York, sponsored by Unigroup of New York. Contact: Don Berey or Robert P. Birkfeld, National Expositions Co. Inc., 14 W. 40th St., New York, N.Y. 10018, (212) 391-9111.
- 22-24 OA: The Next Generation Conference**, Andover Inn, Andover, Mass., sponsored by Institute for Graphic Communication. Contact: Institute for Graphic Communication, 375 Commonwealth Ave., Boston, Mass. 02115, (617) 267-9425.
- 30 "Digital Switching" Seminar**, Logan Airport Hilton, Boston, sponsored by Communications and Information Institute. Contact: Danae Fasano, conference assistant, Information Gatekeepers Inc., 214 Harvard Ave., Boston, Mass. 02134, (617) 232-3111.
- 30-(2) "Information Systems Architecture: Making Information Engineering Work,"** Boston, sponsored by Software Institute of America Inc. (SIA). Contact: SIA, 8 Windsor St., Andover, Mass. 01810, (617) 470-3880.

OCTOBER

- 2-4 First International Conference in Japan on Optical Storage Technology**, Keidanren Kaikan, Tokyo, Japan, sponsored by the Technology Opportunity Conference (TOC). Contact: TOC, P.O. Box 14817, San Francisco, Calif. 94114-0817, (415) 626-1133.
- 7-10 IEEE International Conference on Computer Design: VLSI in Computers**, Port Chester, N.Y., sponsored by the IEEE Circuits and Systems Society and the IEEE Computer Society. Contact: ICCD '85, Suite 300, 1109 Spring St., Silver Spring, Md. 20910, (301) 589-8142.

MegaRam Disc Emulator

Revolutionary, Non-rotating,
Solid-state Replacement for
Fixed or Moving Head Discs.

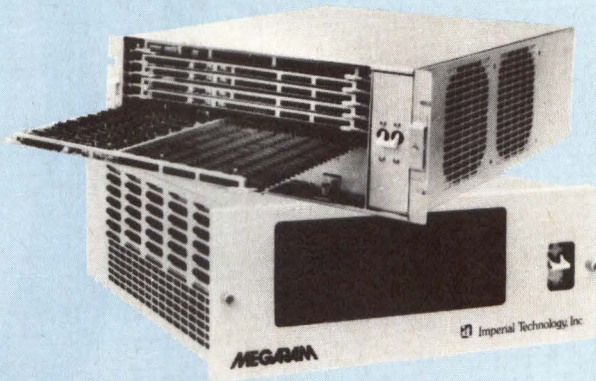

- Capacities from 2 megabytes to 40 megabytes in 2 megabyte increments.
- Up to 10 megabytes in a 7" chassis.
- Battery back-up.
- Streaming drive back-up in 7" chassis.

Advantages of The MegaRam Over Rotating Discs:

With no moving parts and easily replaceable sub-assemblies, the use of the solid-state MegaRam Disc Emulator assures dramatically increased performance and reliability. It further simplifies field maintenance.

Designed for use with the following computers:

- DEC • Data General • Sperry Univac (V77 Series)
- Hewlett Packard (HP1000 Series) • Modcomp
- SEL • CDC (System 17)

Replaces the Following Fixed Head Discs:

- DDC • Data Flux • Vermont Research
- Alpha Data

Typical Applications Include:

- Process Control • Mobile Equipment
- Telecommunications • Data Base Management
- Data Acquisition • Swapping Files • Automated Test Equipment • Graphics • Array Processors

Other configurations may also be available.
Please consult factory for information.



Imperial Technology, Inc.

831 S. Douglas Street • El Segundo,
California 90245 • Phone: (213) 536-0018

This Publication is available in Microform.

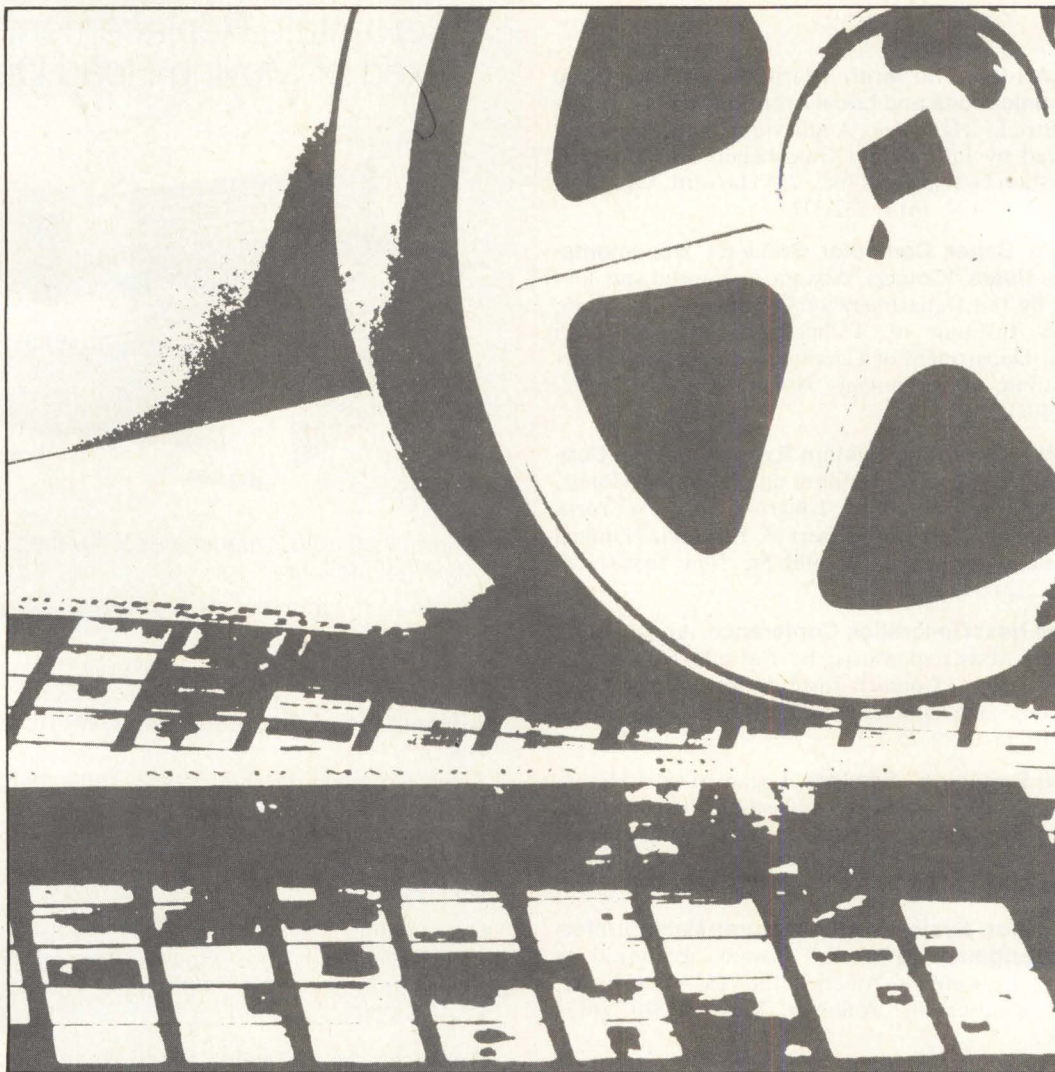

Please send additional information for _____
(name of publication)

Name _____

Institution _____

Street _____

City _____

State _____ Zip _____

**University
Microfilms
International**

300 North Zeeb Road, Dept. P.R., Ann Arbor, Mi. 48106

Mini-Micro Systems

CAREER OPPORTUNITIES/RECRUITMENT ADVERTISING

Reach over 136,000 Computer Professionals in these targeted issues...
plus thousands more with MINI-MICRO SYSTEMS' bonus trade show distribution.

ISSUE DATE	RECRUITMENT ADVERTISING CLOSING DATE	HARDWARE EMPHASSIS	SOFTWARE EMPHASSIS	TRADE SHOW BONUS DISTRIBUTION
JUN	5•17•85	<ul style="list-style-type: none"> ■ State of the Market Report (including Hardware and Software) ■ NCC Preview Issue 		■ <i>PC Expo/NY</i>
JUN 14	5•29•85	■ Mini-Micro Computer Digest		■ <i>NCC '85 Chicago, IL</i>
JUL	6•17•85	<ul style="list-style-type: none"> ■ Graphics/Color Terminals, ■ Desktop Plotters 	■ Graphics Software	<ul style="list-style-type: none"> ■ <i>NCC '85 Chicago, IL</i> ■ <i>Siggraph San Francisco, CA</i>
AUG	7•18•85	<ul style="list-style-type: none"> ■ Single Board Microcomputers ■ Personal/Professional Computers 	■ Data-Base Management Software	
SEPT	8•19•85	<ul style="list-style-type: none"> ■ Data Communications Networks, ■ Computer Buses 	■ Communications Software	■ <i>INFO '85 NY, NY</i>
OCT	9•17•85	<ul style="list-style-type: none"> ■ Memories Mass Storage, ■ Add-in/Add-on Boards 	■ Software Standards & Portability	■ <i>PC Faire San Francisco, CA</i>
NOV	10•17•85	<ul style="list-style-type: none"> ■ Terminals, Power Supplies 	■ Terminal Emulation & Control Software	■ <i>Comdex/Fall Las Vegas, NV</i>
NOV 15	10•30•85	■ Fall Peripherals Digest		■ <i>Comdex/Fall Las Vegas, NV</i>
DEC	11•14•85	<ul style="list-style-type: none"> ■ State of the Technology Report: Hardware and Software 		■ <i>Dexpo/West Anaheim, CA</i>

For more information, call Norma Lindahl, Recruitment Advertising Sales Manager,
at (617) 964-3030, MINI-MICRO SYSTEMS, 275 Washington Street, Newton, MA 02158-1630.

CLASSIFIED ADS

software

Z80 MADE E-Z

EZT, the most POWERFUL Z80* software debug tool available today for CP/M* systems features:

- Assembly Language Input.
- Disassembler.
- Direct Instruction Execution.
- Trace with Traps.
- Up to Seven Breakpoints.
- Search Mode.
- On Line Calculator.
- Binary, Octal, Decimal, Hex, ASCII.

\$29.95 includes complete 100 kbyte source program on diskette. Visa, MC, P.O. or personal checks accepted.

TAYLOR MICRO TECHNOLOGY
1800 Mariposa Lane
Fullerton, CA 92633
(714) 773-4882

*registered trademarks of Zilog and Digital Research

CIRCLE NO. 227 ON INQUIRY CARD

software

D-M-DRIVER Disk in Memory

for Micro/R SX, 11M, 11M+

Call 415-420-9579

Proto Systems

1238 Josephine St, Berkeley, CA

*TM of Digital Equip Corp 94703

CIRCLE NO. 228 ON INQUIRY CARD

inventions wanted

INVENTIONS, IDEAS,
NEW PRODUCTS WANTED!

Presentation to industry.
National Exposition.

Call: 1-800-528-6050, X831
ISC-MMS, 903 Liberty,
Pittsburgh, PA 15222

CIRCLE NO. 229 ON INQUIRY CARD

**YOU
NOTICED
THIS SPACE!**

so will
your customers
when you
advertise in
**Mini-Micro
Systems
Classified**

Call: Linda Lovett
(617) 964-3030

Copy Deadline:

Call

(617) 964-3030

Space reservations and advertising copy must be received by the 10th of the month preceding the issue date. Camera-ready mechanicals must be received by the

15th of the month preceding the issue date. For example, to appear in the February issue, copy must be received by January 10; mechanicals by January 15.

CLASSIFIED ADVERTISING ORDER FORM

Mini-Micro Systems classifieds reach more mini-micro people

Rates: \$90.00 per column inch (non-commissionable)

6x program earns 5% discount; 12x program earns 10% discount.

There is no charge for typesetting classified listings. Plan approximately 50 average words to a column inch, 8 lines of approximately 38 characters per line (3 inch maximum). Please send clean typewritten (double-spaced) copy.

Category: The following categories are available; be sure to specify the category you wish to be listed under: Business Opportunities, New Literature, Selling, Buying, Trading, Seminars, Services, Software, Supplies & Accessories. (Other categories may be employed at our discretion.)

Run this ad in _____ (number issues) Reader Inquiry No. YES NO
Ad size 1 col. wide by _____ inches deep Under _____ (category)
Check enclosed for \$ _____ (Pre-paid orders only)

Signature _____

Name _____ Title _____

Company _____ Telephone No. _____

Address _____

City _____ State _____ Zip _____

MAIL TO: Linda L. Lovett, Classified Advertising, Mini-Micro Systems,
Cahners Building, 275 Washington St., Newton, MA 02158



If you're a major league VAR, we want you on our team.

IBM is scouting for the most valuable of VARs: those with outstanding new ideas and a great batting average.

If you're one of them, you could become a Value Added Remarketer of IBM products. And what could that mean to you?

First, IBM can add clout to your marketing efforts. For example, we can help with product literature, direct mail and business show support. To add to your skills, IBM offers a wide range of professional classes for VARs.

Furthermore, thanks to the online referencing system used by our own sales force, we can direct prospects with special needs right to VARs with appropriate solutions.

And, as one of the finest of VARs, you'll be selling the finest equipment: some of IBM's most competitive products. Our VARs can apply for the IBM 4300 systems, Series/1, System/38, System/36 and the IBM personal computers.

To find out more about the advantages of becoming an IBM VAR, simply send in the coupon below or call 1 800 IBM-VARS, Ext. 96.

If you think your company can qualify, now's the time to touch base.



Paula Palmer	96/8-85
IBM Distribution Channels	
P.O. Box 76477	
Atlanta, GA 30358	
Please send me your free booklet, "Looking for Leaders."	
Name _____	Title _____
Company _____	
Address _____	
City _____	State _____ Zip _____
Phone _____	Product Interest _____

CIRCLE NO. 88 ON INQUIRY CARD

ADVERTISERS INDEX

Advanced Matrix Technology Inc.	108	Macrolink	25
Altos Computer Systems	50-51	Matrox Electronic Systems Ltd.	97
Ampro	155	Maxtor Corp.	62-63
AT&T Information Systems	161	MCG Electronics	142
Cambridge Digital Systems (Div. of Compumart)	160	MDB Systems Inc.	26
Canaan Computer	49	Megatek Corp.	140
Carterfone Communications Corp.	115	Memory Products	42-43
CIE Terminals	C3, 28-29	Metacomp	79
Compaq Computer Corp.	18-19	Microware	87
Concord Data Systems	68	Mizar Inc.	84
Control-C Software	131	Mostek Corp.	32, 94, 143
CXI	22	Multi-Tech	88
Dataram	93	NCR Corp.	52-53, 98-99, 171
Datasouth Computer Corp.	74	Omnicom Graphics Corp.	112
Digital Equipment Corp.	20-21	Onyx System Inc.	46
Dual Systems	4	Parallel Computer	154
Electronic Solutions	C2	Quantum Corp.	8-9
Emulex Corp.	5, 178	Qume	64
Equinox Systems	104	R-Systems	45
Facit Data Products	54	Rastor Technologies	107
Fujitsu America Inc.	39, 152-153	RDS-Relational Database Systems	58
Genicom	175	Rodime	10
Gould Inc., Computer Systems Div.	157	SBE Inc.	70
Hammer Computer Systems Inc.	156	Seed Software	137
Hayes Microcomputer Products	14-15	Seiko Instruments USA	116
Heurikon Corp.	76	Sequent Computer Systems	110-111
Hewlett-Packard Co.	30-31, 127, 129	Software Labs	83
Houston Instrument Div. of Bausch & Lomb	124	Sony Corp.	132-133
Human Designed Systems Inc. (HDS)	134	Spectra Logic	67
Ibex Computers Corp.	60	TAT Technologies Inc.	E3
IBM Corp.	121-123, 169	Telebyte Technology	86
Imperial Technology Inc.	165	TeleVideo Terminals	40
Information Builders Inc.	61	Texas Instruments Inc.	80, 100
Infotron Systems Corp.	1	Topaz Electronics Div.	159
Integrated Solutions Inc.	12-13	Unify Corp.	17
Intel Corp.	6-7	Universal Data Systems Inc.	C4
Intercontinental Micro	150	Verbex	103
Interface Group	72-73, 172	Wyse Technology	146-147
International Data Corp. (IDC)	16		
Interphase Corp.	149		
ITT Information Systems	71	See P. 168 for Classified Advertisers	
Keytronics	151	See P. 166-167 for Career Opportunity Advertisers	
Kimtron	145	See P. 179-180 for Mini-Micro Marketplace	
Lear Siegler Inc.	57		
L/F Technologies Inc.	163		

This index is provided as an additional service. The publisher does not assume any liability for errors or omissions.

SCSI.

Four letters that let you hook any host...

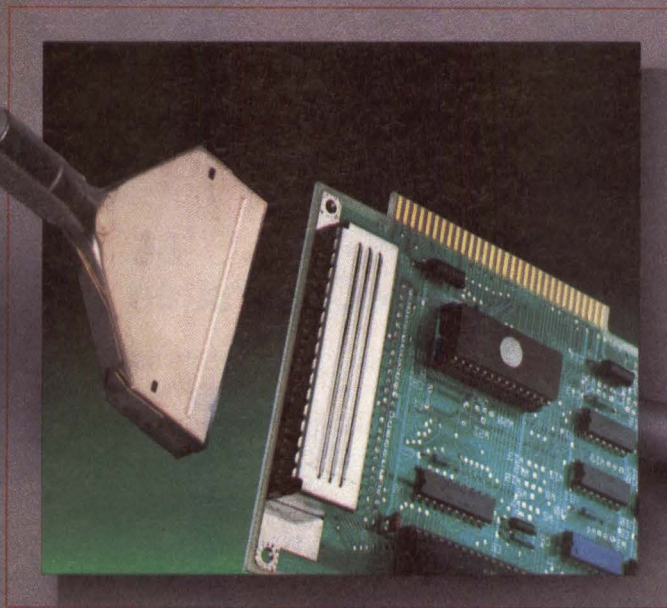

to any peripheral.

Presenting SCSI. Small Computer Systems Interface. An interface standard that lets you connect small computers with virtually any peripheral device — even those still on the drawing board. Without overhauling your hardware and software. So the best can go with the best, period — not the best of what's compatible.

SCSI works by masking the internal structure of the peripherals from the host. It uses an eight-port bus which can accommodate either single- or multiple-host systems. Its impressive transfer rate of 1.5 Mbytes per second allows direct copying between devices, too. Freeing the host for more important work. And giving it lots of power for lots of I/O activity.

In developing SCSI as a truly versatile standard interface, the American National Standards Institute (ANSI) enlisted some of the best minds in the industry — including more than a few from NCR-Wichita.

NCR is the undisputed leader, too, in designing and manufacturing SCSI components. We offer a complete line, from host adapters for Multibus and

IBM PC architecture to ST-506 and SMDO disk controllers to PERTEC and QIC-02 tape controllers. We've also made numerous advancements in reducing the size of the components — and in reducing their price.

And this same quality of expertise in applications engineering is available to our OEM customers, as well.

SCSI is changing the face of system integration. And NCR has been there all the way. With capacity and technology second to none... and a century of quality behind us.

If you want to know more about what SCSI can do for you, call NCR at 1-800-325-SCSI.

SCSI products from...



Product Marketing-Wichita, KS 67226



Jonathan Yarmis
General Instrument Corp.

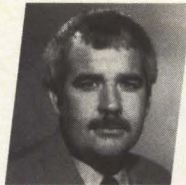

Ronald Zucker
CBS

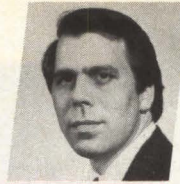

A. A. Carlson
AAC Associates



Dr. Wushow Chou
N. Carolina State U.



Frank Dzubeck
Communications Network Architects



Amy Wohl
Amy D. Wohl Assoc.

Meet the Members of the Board

The INTERFACE '86 Program Committee

The leaders of an industry create the industry-leading show. For fourteen years, the world's INTERFACE between Communications and Computers, Technology and Management.

- Data Communications
- Telecommunications
- Information Processing
- Networking
- Systems Integration
- Information Management



Richard L. Deal
R. L. Deal & Assoc.



Einar Stefferud
Network Mgmt. Assoc.



Dr. Dixon Doll
The DMW Group

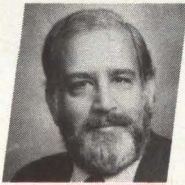

Michael Rothberg
Michael Rothberg Assoc.

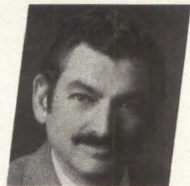

Daniel Fidlow
Price Waterhouse

*Don't miss the best and biggest
INTERFACE show yet!*

INTERFACE '86

FOURTEENTH ANNUAL CONFERENCE & EXPOSITION

Co-Sponsored by **BusinessWeek** and **Data Communications**
Georgia World Congress Center □ Atlanta, Georgia
Conference & Exposition □ March 24-27, 1986



Christopher Meyer
Temple, Barker & Sloane

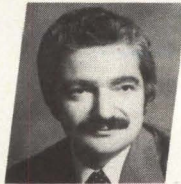

Dr. Howard Frank
Consultant



Gordon Lew
American Airlines



Charles Joyce, Jr.
Network Strategies Inc.

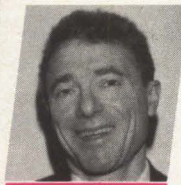

David Hanson
CitiCorp

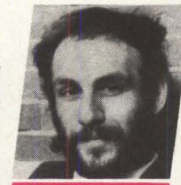

Dale Kutnick
Consultant

Another Conference and Exposition from: The Interface Group, Inc., 300 First Avenue, Needham, Massachusetts 02194

MARKET TRACK

Sharon Hassell, Assistant Editor

Multi micro shipments to show threefold jump

Dollar-value shipments of multiuser microcomputer systems are expected to grow from \$3.9 billion in 1985 to \$12.5 billion in 1990, according to a new study by Venture Development Corp. (VDC), Natick, Mass. The 1990 figure will represent a compound annual growth rate of 24.6 percent per year.

Although multiuser microcomputers have long been a part of the computer industry, single-user local area network-based personal computers have overshadowed the multiuser systems. However, increased need to share data, software and peripherals has created a new level of interest in the less-expensive, more efficient multiuser microcomputers, says VDC.

A lack of standardization in LANs will also contribute to the growth of multiuser systems. According to VDC's study, since an IBM Corp. token-passing LAN will not be available for a few years, multiuser system manufacturers will benefit from a general reluctance to purchase networking equipment before the IBM LAN is available. Moreover, connecting personal computers by LANs is expensive, inadequate and lacks user friendliness, the study says.

Multiuser microcomputers should enjoy a larger market share than network-based personal computers through 1990. Nevertheless, personal computer LAN shipments are expected to increase from \$250 million in 1984 to \$4.6 billion by 1990. Fueled by the proliferation of personal computers and IBM's token-passing LAN for office environments, personal computer LAN shipments will eventually catch up to, and surpass, multiuser microcomputer shipments, says VDC.

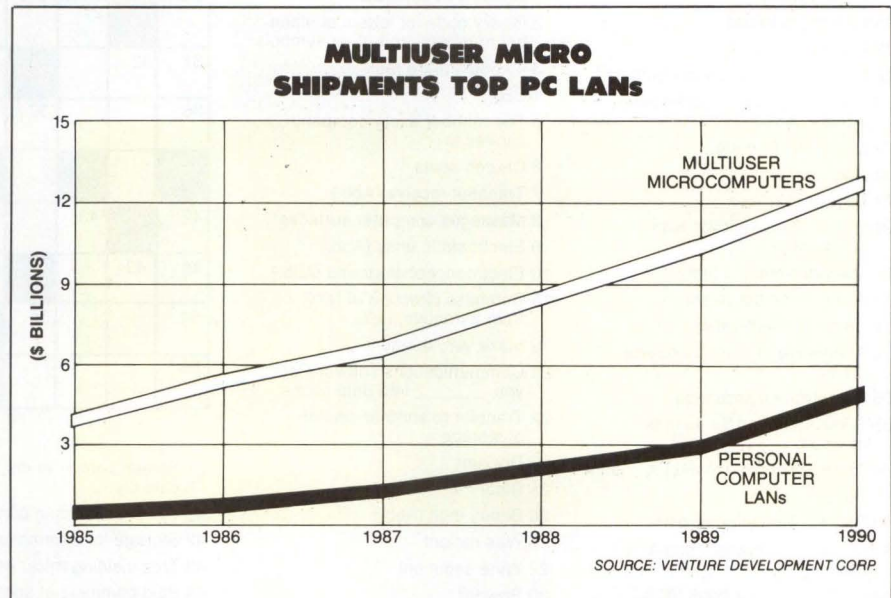

Multiuser microcomputer shipments are expected to total \$12.5 billion in 1990, a threefold increase over 1985 shipments.

Low cost, innovation spur letter-quality market surge

Revenues for letter-quality and near-letter-quality printers will grow at a 32 percent compound annual rate over the next few years, yielding a \$13.6 billion market by 1988, according to a recent report from Frost & Sullivan Inc., New York.

Spurring this growth, says the report, is stiff competition and recent technological innovation. These factors also will lower prices of letter-quality and near-letter-quality printers, prompting increased sales, say the analysts.

A survey done in conjunction with the report cites print clarity as the most important factor considered by users

of letter-quality printers, followed by ease of repairs, endurance and price.

Although Frost & Sullivan forecasts tremendous growth for the letter-quality and near-letter-quality printer markets, the report warns there are a number of outside forces that could affect the prediction. For one thing, the market for printers may have "temporarily" stopped growing while buyers wait to see what printers will be the most popular before deciding on the model they will buy. □

Interest Quotient (Circle One)
High 495 Medium 496 Low 497

ARTFUL INTELLIGENCE

By John K. Young

ACROSS

- 1 Undergraduate degree
- 4 Thick head of hair
- 7 Topology type
- 11 You and me
- 12 Near-copy of computer
- 13 Trick
- 14 Wound mark
- 15 Mini-Micro World
- 17 Problem
- 18 Prefix meaning "on the outside"
- 20 Re_____ let you start over if paper jams
- 22 Dot in Morse code
- 24 Had a meal
- 27 Loss of precision
- 28 Create many records with similar keys
- 31 Married woman's title
- 33 Awful computer event
- 35 Seventh Greek letter
- 36 Alternative to external device driver
- 38 Remember information
- 39 Thousands and thousands of years
- 40 Army rank below master sergeant (Abb.)
- 43 Sudden sensation of pain
- 46 Ink color computer companies hate
- 48 New Testament book (Abb.)
- 50 Information that goes into or out of computer
- 52 Entry in an account

- 54 Made a false statement
- 56 Speaks earnestly
- 57 Musical note
- 58 It performs photosynthesis
- 59 Tint
- 60 Data processing (Abb.)

DOWN

- 1 Wires connecting different sections of computer
- 2 Binary code for letters of alphabet numbers and other symbols
- 3 43,560 square feet
- 4 CRT
- 5 The number every company aspires to
- 6 Church seats
- 7 Transmit-receive (Abb.)
- 8 Massages computer surfaces
- 9 Electrostatic units (Abb.)
- 10 Electroencephalograms (Abb.)
- 16 Compass direction of NYC from Syracuse, N.Y.
- 19 Make very thirsty
- 21 Communications software lets you _____ into data bases
- 22 Transfer to another section of storage
- 23 Dry run
- 25 Clear
- 26 Binary digit (Abb.)
- 28 Was radiant
- 29 Wine sediment
- 30 Powder
- 32 Impermanent computer memory
- 34 It accepts, keeps and recalls instructions

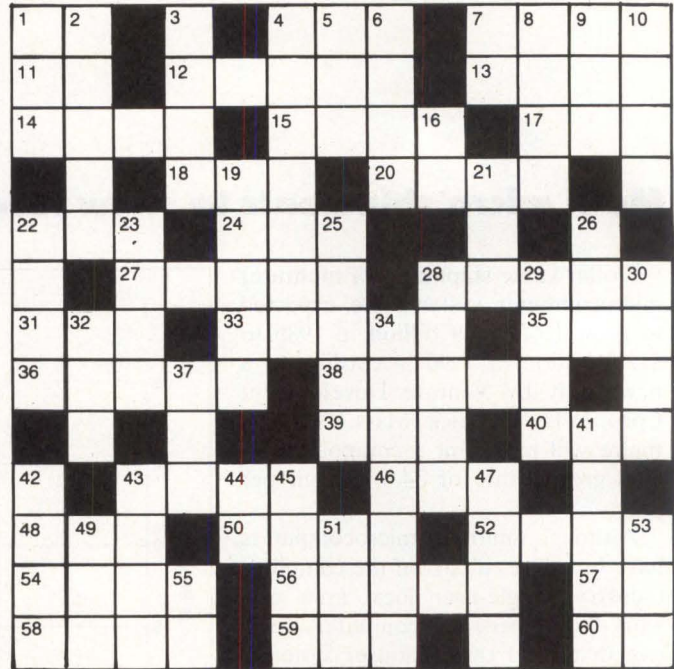

- 37 Screen computer displays data on
- 41 Set of columns in punch cards
- 42 Storage for information unit
- 43 Tree yielding thick, white fat
- 44 Paid commercial announcement
- 45 Speed of data transfer from one computer to another
- 47 Magnetic storage medium
- 49 Kind of chart some software displays
- 51 If at first you programmers don't succeed, _____, _____ again
- 53 To get this out of memory and on to paper you need a plotter
- 55 It tells you where radio signals are coming from (Abb.)

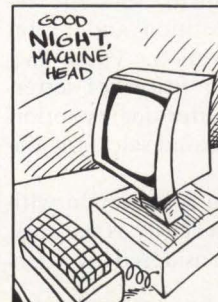

Solution will be printed next month.

Answers to July's puzzles can be found on Page 148.

Interest Quotient
(Circle One)
High 498
Medium 499
Low 500

We've been accused of refusing to break under pressure.



You Be The Judge.



In a reliability test, the Genicom 4000 line printer shuttle mechanism worked 24 hours a day

non-stop for two and a half years without a failure... that's the equivalent of 20 years normal operation.

This remarkable reliability is the result of a totally new, patented resonance shuttle mechanism. It's so perfectly balanced, vibration is virtually eliminated. And the Genicom 4000 is free of those moving parts that commonly fail in other line printers. In-

deed, the design is so innovative and simple, it has to be reliable.

The Genicom 4000 offers 300 or 600 lpm, data processing and letter quality printing, bar codes, 20 inch/sec paper slew, plus dual 6 pin tractors with paper reverse. But best of all, even under the pressure of extensive evaluations, it refused to break.

Call our Toll Free number for all the evidence.

GENICOM[®]

The Printers That Mean Business.

Genicom Corporation, Dept. 425J, Waynesboro, VA 22980. TOLL FREE 1-800-437-7468, In Virginia, call 1-703-949-1170.

CIRCLE NO. 94 ON INQUIRY CARD

Analyze your growth opportunities in the \$61.7 BILLION VALUE-ADDED MARKET

In 1985, Mini-Micro Systems readers in the value-added market will spend over \$61.7 billion on minicomputers, microcomputers, peripherals, software and supplies. This 23% increase over last year's planned expenditures reflects a marketplace that has rapidly become the key distribution channel for marketers of minicomputer and microcomputer products.

The 14th Annual Mini-Micro Computer Market Report tracks projected spending trends and key growth areas. Market data highlights sales potential in product categories including:

- Software
- Computer Graphics
- Data Communications
- CRT Terminals
- Disk Drives
- Tape Drives
- Printer/Plotters
- Computer Supplies

The bound Report, plus an Executive Summary, is available for \$195. Contact your regional sales manager for more information.

Mini-Micro Systems
 Your key to sales in the value-added market.

Please send _____ copies of the 14th Annual MINI-MICRO MARKET REPORT to the address below. (Please make checks payable to Mini-Micro Systems. Only orders with payment accepted. \$195/report.)

Payment will be refunded within 2 weeks of receipt if not fully satisfied.

MINI-MICRO SYSTEMS MARKET REPORT 275 Washington St., Newton, MA 02158-1630

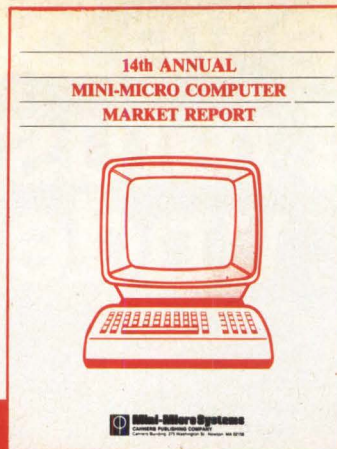

WITH

Mini-Micro Systems

14TH ANNUAL

MINI-MICRO COMPUTER MARKET REPORT

The extensive, detailed tables, based on responses from value-added OEMs, value-added resellers and value-added users, include:

- 1984 expenditures for minicomputers, microcomputers, peripherals, software and supplies.
- 1985 planned expenditures for minicomputers, microcomputers, peripherals, software and supplies.
- Type of organization (value-added OEM, value-added reseller, value-added user.)
- Geographical breakdown.
- Minicomputers/microcomputers currently in use by
 - Vendor name and model number
 - Units acquired in 1984 vs. prior years
 - Major applications
- Minicomputers/microcomputers planned for purchase in 1985 by
 - Vendor name and model number
 - Number of units
 - Major applications
 - Fail-safe operations
 - Plans for integrated office functions

Name _____
 Title _____
 Company _____
 Address _____
 City _____ State _____ Zip _____
 Telephone _____

CIRCLE NO. 103 ON INQUIRY CARD

Get results with

Mini-Micro Systems

CAREER OPPORTUNITY SECTION...

When you advertise in **Mini-Micro Systems**, you can be sure of reaching only the people you are trying to recruit. Every reader is a potential employee. We reach the highest percentage of all significant personnel in our industry. You'll find us not only effective, but a more economical magazine.

for space reservation
contact:

Norma Lindahl
617-964-3030

ONE-STOP SHOPPING FOR A HOST OF DEC SUBSYSTEM ALTERNATIVES.



ASSEMBLED BY EMULEX. EXCLUSIVELY FOR VAX & PDP-11.

Here's a great selection of high-performance subsystems. With all the speed, capabilities and cost-effectiveness you're looking for.

It all begins with highly reliable, software transparent Emulex controllers.

Then we integrate drives of your choice from leading manufacturers. Including Fujitsu and CDC 8" to 14" disk units, with either removable media or fixed Winchester and SMD interface. In 1/2" tape, Emulex offers CDC, Cipher and Kennedy

drives in start/stop and streamers. Tape and disk storage capacities range from 67-705 megabytes (formatted).

Finally, everything is tested to assure plug-and-play performance.

On the service and support side, Emulex provides expert installation and application assistance nationwide. Also, you can obtain service through CDC, DEC and other third parties.

Enjoy the convenience of a single,

reliable source for everything you need in subsystems. For product or sales information, call toll-free 1-800 EMULEX3. In California call (714) 662-5600. Or write, Emulex



Corporation, 3545 Harbor Boulevard, P.O. Box 6725, Costa Mesa, California 92626.

The genuine alternative.

U.S. Regional Offices: Anaheim, CA (714) 385-1685; Schaumburg, IL (312) 490-0050; Roswell, GA (404) 587-3610; Nashua, NH (603) 882-6269. International Offices: Australia, Eastwood, N.S.W. (02) 858-4833; Canada, Mississauga, Ontario (416) 673-1211; France, Montrouge (1) 735-7070; United Kingdom, Bracknell, Berkshire (344) 484234; West Germany, Munich (089) 304051. DEC, VAX, PDP-11 are trademarks of Digital Equipment Corporation. CDC is a trademark of Control Data Corporation.

CIRCLE NO. 96 ON INQUIRY CARD

MINI-MICRO MARKETPLACE

A special section for advertisers of hardware, software and services.

Please circle reader service numbers for additional information.

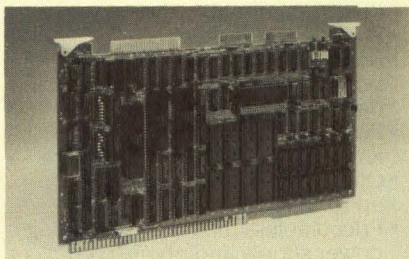

CP/M-8000™ MULTIBUS™ SYSTEM

The CP/M-8000 operating system is now available for our 10 MHz Z8000™ Single Board Computer. This high-performance system has all the familiar CP/M commands. File compatibility with CP/M-80 and CP/M-86 makes it easy to transport files to CP/M-8000. A 'C' compiler and MACRO assembler are included. Call for further information. CP/M™ Digital Research, Multibus™ Intel, Z8000™ Zilog. SINGLE BOARD SOLUTIONS, 7669 Rainbow Drive, Cupertino, CA 95014. (408) 253-0181

CIRCLE NO. 200 ON INQUIRY CARD

IBM PC TAPE BACKUP

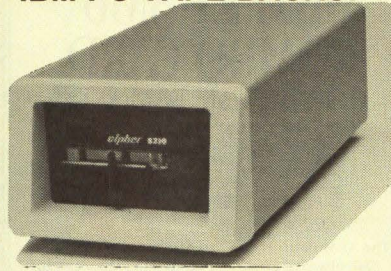

- Cipher 5210 Subsystem
 - 25MB (formatted) capacity
 - Menu Driven Software
 - No Additional Card
 - \$1025⁰⁰ with 6 mos. warranty
- Available From:

Microware Inc.

41711 Joy Road • Canton, MI 48187
(313) 459-3557

CIRCLE NO. 201 ON INQUIRY CARD

ZX-5000™ EXTENDED RANGE™ SURGE SUPPRESSORS

The ZX-5000 Extended Range series surge suppressors provide the most advanced protection available on the market today against spikes, surges and noise disturbances.



SUTON DESIGNS INC.
COMPUTER SECURITY DIVISION
300 North Tioga • Ithaca, NY 14850
6072774301

CIRCLE NO. 202 ON INQUIRY CARD

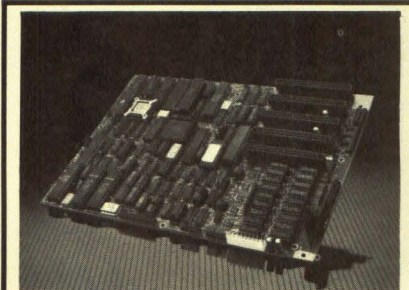

8088 SINGLE BOARD COMPUTER IS IBM PC compatible in form and function. 4.77 MHz Intel 8088 CPU, 8087 socket, 64K to 640K bytes RAM with parity, two 28 pin EPROM sockets, 4 DMA channels, 2 software controlled timers, 5 user available interrupts, floppy controller for up to 4 drives, TTL compatible video output, IBM PC compatible keyboard port, 2 RS-232 serial ports, Centronics printer port, speaker & reset ports, 5 IBM PC compatible I/O expansion slots. BIOS ROM supports MS-DOS, PC-DOS, CP/M-86, Concurrent CP/M, PC-iRMX. DAVIDGE CORP., PO Box 1869, Buellton, CA 93427 (805) 688-9598.

CIRCLE NO. 203 ON INQUIRY CARD

for Serious Software Developers

TARGET MICROPROCESSORS

80286, 8086/80186, 8096, 8080/8085, 8051, 8048, Z8002, Z80, Z8, NSC 800, 9900, 68000/08/10, 6809, 6800/01/02, 6805, 6301, 6305, 6500, G65SCXX, G65SC1XX, R65C00, R6500/1, and others.

HOST COMPUTERS

DEC VAX, PDP-11, DG MV-Series, DG Eclipse, Apollo, UNIX Systems, IBM PC, Data General/ONE, HP 150, DEC Rainbow and others.

SOFTWARE TOOLS

C Compilers, Pascal Compilers, PLM Compiler, Assemblers, Linking Loaders, Librarians, Download, Communications, VT-100 Emulator, CPM/80 Emulator.

If you are a serious software developer, shopping for software development tools, call or write today for more information: 800-551-5554 in CA call (408) 733-2919



**MICROTEC®
RESEARCH**

3930 Freedom Circle, Suite 101, Santa Clara, CA 95054
Mailing Address: P.O. Box 60337, Sunnyvale, CA 94088
(408) 733-2919 Telex (ITT) 4990808

CIRCLE NO. 204 ON INQUIRY CARD

New 64K SBC



Only
\$375.
4" x 6"

- Requires no terminal. Includes Video Controller and CP/M® 2.2
- Runs any size floppy drive
- Substantial OEM Discounts Available

Other models include Hard Disk Controller, CP/M® 3.0, 128K or 256K RAM, Time of Day Clock, EPROM, Peripheral Expansion & RGB Color Video Display

64K SBC includes:

- 6 MHz Z808*
- Video Controller
- 2 Serial Ports
- 4 Parallel Ports
- I/O Expansion
- Source Code and Drivers included
- CP/M® 2.2

CP/M is a registered trademark of Digital Research Inc. Z808 is a registered trademark of Zilog Inc.

Megatel Computer Technologies
Head Office and Technical Support Center
150 Turbine Drive, Weston, Ontario M9L 2S2
Telephone: (416) 745-7214 Telex: 065-27453 MEGATEL TOR.
U.S. Sales and Service Office
2311 South Anthony, Fort Wayne IN 46805
Telephone: (219) 745-0310

megatel

CIRCLE NO. 205 ON INQUIRY CARD



**NEW DIGITAL TEMPERATURE TESTER
MODEL 383**

Complete temperature tester in one compact hand-held instrument. Features include 3" display, dual type J thermocouple inputs, differential/normal temperature mode, DC millivolt range, analog output. All these features and more in this unique instrument. Unit is supplied with 2 type J glass-braided thermocouples, test lead kit, 9v battery, and operator's manual.
For more information, call 203/359-7613 or write Omega Engineering, One Omega Drive, Box 4047, Stamford, CT 06907.

CIRCLE NO. 206 ON INQUIRY CARD



SWITCH BOXES CAN ADD TO THE VERSATILITY OF YOUR HARDWARE. Data Set Cable provides ABC & ABCDE boxes in a wide variety with all kinds of connectors. Avoid need to change cables manually. Economical, too - ultra-compact ABC Single Coax box only \$55. In addition, Data Set has the biggest selection of interface cables, test equipment and other essentials to support your DP department. Send for catalog to Data Set Cable Co., 722 Danbury Road, Ridgefield, CT 06877 - (203) 438-9684 or Las Vegas - (702) 382-6777.

CIRCLE NO. 209 ON INQUIRY CARD

**Micromate
CP/M 3.0 COMPUTER**

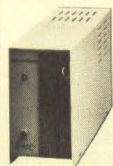

System or Board Level to suit your application



- Use with RS 232C terminals
- Thousands delivered - in use
- 128KB RAM and autoboot ROM
- Interfaces four 400 KB disks
- 10-20MB hard drive add-on
- Abundant software available
- Excellent price/performance

Personal Micro Computers, Inc.
275 Santa Ana Court
Sunnyvale, CA 94086
Phone 408-737-8444



CIRCLE NO. 212 ON INQUIRY CARD

**Q-BUS DISK DILEMMA?
TRY THE SCSI SOLUTION!
THE TDL-12 FROM TD SYSTEMS**



- Emulates DEC* RL01/RL02's with 22-bit addressing.
- 100% compatible with all DEC Q-Bus processors and operating systems.
- Supports all popular SCS/SASI controllers and disk drives in any combination up to a maximum of 41.6 MBytes.
- High performance - 5 MBit/sec maximum throughput.
- On-board bootstrap, comprehensive utilities, and diagnostics.
- Configuration and drive characteristics stored in non-volatile EEPROM.
- \$595 each in small quantities with manual and cable. Attractive OEM discounts available.



24 PAYTON STREET, LOWELL, MA 01853
(617) 937-9465

*DEC is a registered trademark of the Digital Equipment Corp.
CIRCLE NO. 207 ON INQUIRY CARD

**IBM AT 3Mb
COMBO CARD
WITH LIFETIME WARRANTY***

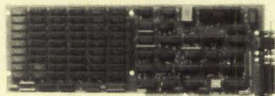

The AT Multifunction Card that can give you up to 3Mb of added memory plus added I/O features.
Expandable from 128K to 3Mb. Add memory as you need it. • IBM AT Compatible • Parallel Port • Serial Port • Spooler • Supports IBM VDISK • User Upgradable • Parity Checking Standard • Split Memory Addressing.
Complete with 128K RAM, Serial and Parallel Port \$299
AT RAM Expansion Card (0K) \$109
Additional RAM available at our low prices. OTHER ADD ONS 384K RAM/ Clock, 512K RAM Card, Spoolers, RAM Cards for PPCs and more.



4401 So. Tamarac Parkway / Denver, CO 80237 / 303/741-1778

ORDERING AND DEALER INFORMATION
800/525-7674

Stores in Denver & Chicago / *On all cards sold after June 1, 1984

CIRCLE NO. 210 ON INQUIRY CARD



**THE
RSX/11M PLUS
SPECIALISTS**

THE LSI-11/73 BASED
CM-300/Q22 COMPUTER
SYSTEMS WITH RSX-11M +
SUPPORTING SUPERVISOR-
MODE LIBRARIES AND
SEPARATE I AND D SPACE

CM-300/Q22 computer systems are configured with DEC's LSI-11/73 CPU, giving these systems 11/70 PERFORMANCE AT LSI-11 PRICES. CM-300/Q22 systems can be configured with up to 1200MB of fixed Winchester disk, up to 4MB of main memory and up to 64 terminals. System back-up is provided by an industry standard 9 track 1/2" 1600 BPI tape drive. Optional software packages include Automatic Date/Time for RSX, Memory Assisted Disk, Cached Pseudo Disk, Memory Dump, Mail List RSX, accounting software, FORTRAN 77, FMS-11, BASIC + 2 and DATATRIEVE. An LSI-11/73 based 300MB system including RSX-11M+ license, media and documentation may be purchased for \$21,461.

Call A.C.S. and let us configure a hardware/software solution for your specific problems.

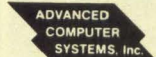

250 Prospect Street
Waltham, Massachusetts 02154
617-894-3278

CIRCLE NO. 213 ON INQUIRY CARD

**T-310
Telephone
Access Unit**



Connect the unlimited capabilities of your computer to the telephone system

- A complete telephone line controller
- FCC-approved for direct connection
- RS-232 compatible
- Provides call following
- Couples audio sources (speech synthesizers, tape players) onto the phone line
- Permits remote data entry from any Touch-Tone phone anywhere
- Offers incoming call security - up to 15 digits
- Priced at less than \$375, including power supply and phone cord

Use the T-310 and your computer to dial and control outgoing calls or receive incoming calls - automatically! For more information, call Teltone today:

(206) 827-9626, ext. 437



Teltone Corporation, P.O. Box 657
Kirkland, WA 98033
In Canada contact Teltone Ltd., 183 Amber St. Markham,
Ontario L3R 3B4, (416) 475-0837

CIRCLE NO. 211 ON INQUIRY CARD

**Promote
New Literature
at a LOW
COST**

If you've got catalogs or literature, distribute them at a low cost in the MINI-MICRO MARKETPLACE.

Call Norma Lindahl
(617) 964-3030

CIRCLE NO. 214 ON INQUIRY CARD



The terminal
on the right
outperforms the
competition.
And costs less.

The computer
on the left
doesn't care
about
the price.



A computer is born to perform. No matter what the price.

You, however, have practicalities to think about. Making your computer perform the way it's meant to is one. Watching costs is another. And you have to blend the two to create the most valuable, cost effective system possible.

CIE Terminals has a video terminal that'll make you both happy. The CIT-220+.

It's a remarkably reliable piece of technology that yearns to show its stuff as much as the computer it's hooked up to. Something they'll both get plenty of chances to do. That's because the 220+ is so reliable, it's always up and running. Which

means your computer is, too.

The 220+ is compatible with the DEC VT220. But it's not comparable. That's where the plus is. You'll find no less than 20 improvements and additions that make the most of your computer.

And because the 220+'s price is in direct contrast to its high performance, you get the best value for your money. So although the computer doesn't care about the cost, you don't have to think about it, either. For more information on the CIT 220+, contact your distributor or CIE Terminals at 2505 McCabe Way, Irvine, CA 92714-6297 (800) 624-2516.

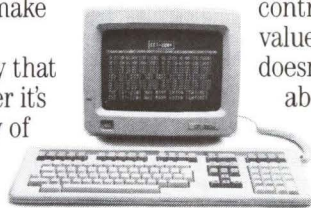

CIE TERMINALS
A C.I.T.O.H. ELECTRONICS COMPANY

Because your computer is only as good as its peripherals.

UDS UPDATE:

Bigger performance, smaller size for the 212 modem family

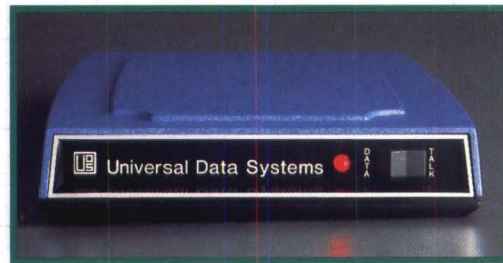
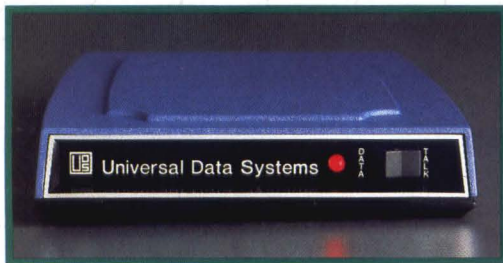

While the members of the UDS 300/1200 bps modem family have grown progressively smaller, the family itself has grown larger. The family now consists of:

- **The microprocessor-powered 212A.** It's a fully optioned, automatic-answer modem, but it's now packaged in the new 7" x 9½" x 2¼" UDS "minibox." The full range of test capabilities is included.

- **The microprocessor-powered 212A/D.** Also packaged in the new minibox, its auto-dial storage capacity has been extended to 10 numbers. Screen-prompted auto log-on procedures can now be executed by the modem.

- **The line-powered 212 LPs.** These ultra-compact units are also 300/1200 bps. They draw their operating energy directly from the telephone circuit and need no external power source. The 212 LP is an originate/answer unit which requires manual answering; as an alternative, you may specify the 212A LP, a line-

powered unit with auto-answer capability.

Check out the expanded family of UDS 212s — for technical details and attractive quantity discounts, contact Universal Data Systems, 5000 Bradford Drive, Huntsville, AL 35805. Telephone 205/837-8100; Telex 752602 UDS HTV.

QUANTITY ONE PRICES					
212A	\$495	212 LP	\$295
212A/D	\$545	212A LP	\$345



Universal Data Systems

MOTOROLA INC.
Information Systems Group

Inquiry Hotline: 800/633-2252, Ext. 368.

UDS modems are offered nationally by leading distributors. Call the nearest UDS office for distributor listings in your area.
DISTRICT OFFICES: Atlanta, GA, 404/998-2715 • Aurora, CO, 303/368-9000 • Blue Bell, PA, 215/643-2336 • Boston, MA, 617/875-8868 • Columbus, OH, 614/895-3025 • East Brunswick, NJ, 201/238-1515 • Glenview, IL, 312/998-8180 • Houston, TX, 713/988-5506 • Huntsville, AL, 205/837-8100 • Issaquah, WA, 206/392-9600 • Mesa, AZ, 602/820-6611 • Milwaukee, WI, 414/273-8743 • Minnetonka, MN, 612/938-9230 • Mountain View, CA, 415/969-3323 • Richardson, TX, 214/680-0002 • St. Louis, MO, 314/434-4919 • Silver Spring, MD, 301/942-8558 • Tampa, FL, 813/684-0615 • Thousand Oaks, CA, 805/496-3777 • Tustin, CA, 714/669-8001 • Willowdale, Ont, Can, 416/495-0008 • Ypsilanti, MI, 313/483-2682

CIRCLE NO. 92 ON INQUIRY CARD

Created by Dayner/Hall, Inc., Winter Park, Florida