

VOL. 29 NO. 1  
JANUARY 1970

CHILTON'S **THE**  
**ELECTRONIC**  
**ENGINEER**



Dr. Albert J. Kelley of Boston College proposes "planned parenthood" for new firms p. 36

- Survey of word generators p. 47**
- Sweep testing for microwave components p. 57**
- Meet four practical active filters p. 50**

# If price and performance are important— here's a 7 MHz value

This is a lab-quality, all-solid-state scope—at a price you'd ordinarily expect to pay for older vacuum-tube models.

**Value**—DC to 7 MHz bandwidth. This frequency range covers audio, video and most control circuit applications.

**Value**—5 mV to 20 V per division deflection factor. Here is sufficient capability to pick up most electronic or electro-mechanical system outputs without distortion or need for additional amplifiers.

**Value**—Rock solid triggering with capabilities ordinarily found only in more expensive lab type oscilloscopes . . . triggered or recurrent sweep, single-sweep, and automatic triggering.

**Value**—Low drift, long-term stability. Field effect transistors virtually eliminate drift from temperature changes, shock or vibration. Long-term stability means less frequent calibration.

**Value**—Easy to use. Logical arrangements of controls, beam finder, auto-triggering make operation easy. Interlocking controls on sweep time and magnifier prevent readout errors.

**Value**—Easy-to-see display. Internal graticule, 8 x 10 cm CRT for measurement accuracy. Bright, small spot-size trace increases visibility and resolution.

**Value**—Available in single channel cabinet or rack versions (1215A or 1215B), or in dual-channel cabinet or rack versions (1217A or 1217B). Electrical characteristics are identical. Rack version is only 5¼" high. Panel on the cabinet version is about the size of this page.

**Value**—Price, 1215A/B, \$950; 1217A/B, \$1175. Add up the features, then divide by price and you'll find this is the greatest performance/dollar value ever offered.

These 7 MHz oscilloscopes are new members of HP's growing family of low- and mid-frequency oscilloscopes. In addition to these new mid-range scopes you have 500 kHz scopes in 14 models with your choice of: Single or dual trace, 100  $\mu$ V/cm or 5 mV/cm deflection factors, conventional display or variable persistence and storage, all in cabinet or rack versions.

If you're looking for accurate mid-frequency measurements, ease of use, reliability—all at a low cost—here's a real 7 MHz value!

Call your local HP field engineer. Or, write to Hewlett-Packard, Palo Alto, California 94304. Europe: 1217 Meyrin-Geneva, Switzerland.

**HEWLETT  PACKARD**  
OSCILLOSCOPE SYSTEMS

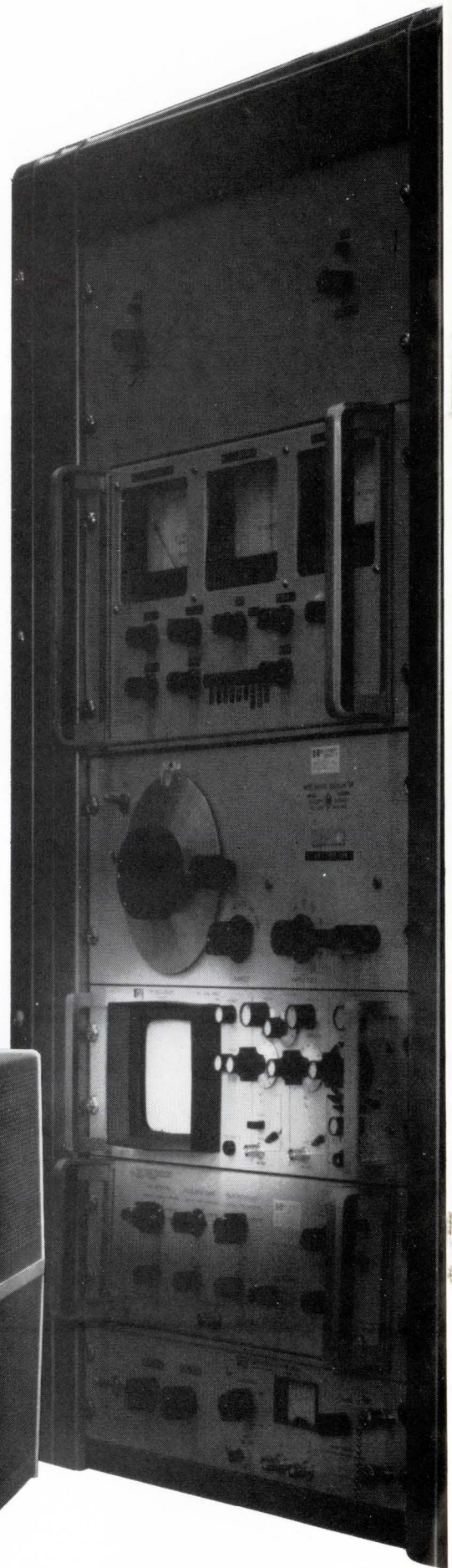
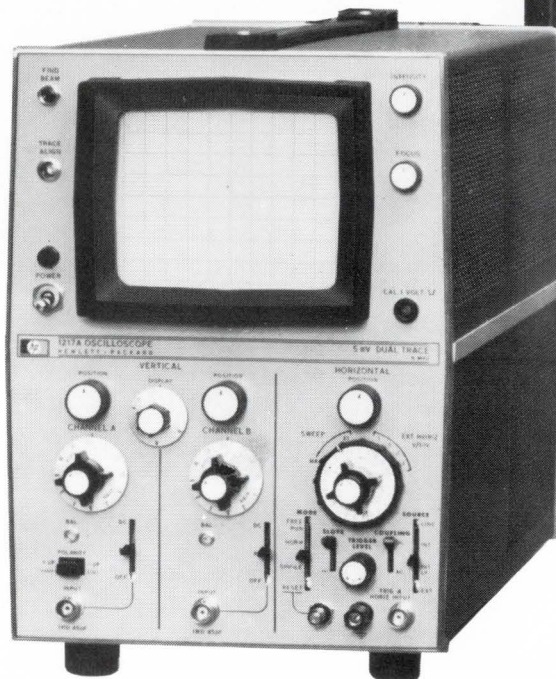

Circle 1 on Inquiry Card

*...want a tantalum capacitor with proven performance?*

## Buy TYPE 150D TANTALEX<sup>®</sup> SOLID-ELECTROLYTE CAPACITORS

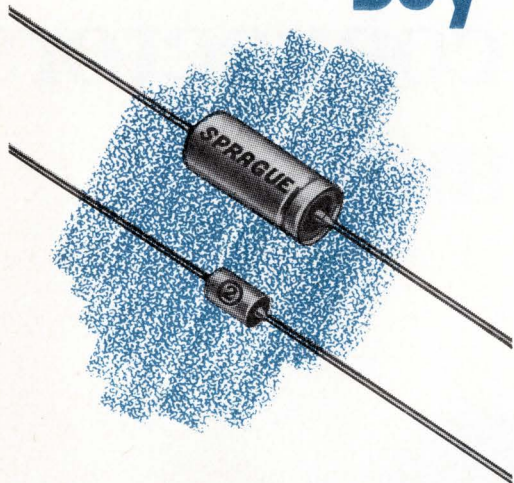

INFORMATION RETRIEVAL NO. 4

- Hermetically-sealed in metal cases
- Four case sizes, ranging from 1/4" to 3/4" length
- Value-packed performance characteristics—low impedances at high frequencies, low dissipation factor, minimal capacitance drift with temperature, practically no change in capacitance with life
- Low leakage current limits
- New higher capacitance ratings
- Request Engineering Bulletin 3520F

4SC-9144R2

*...stymied by costs of stacked-mica capacitors?*

## Try SPRAGUE DIPPED SINGLE-FILM MICA CAPACITORS

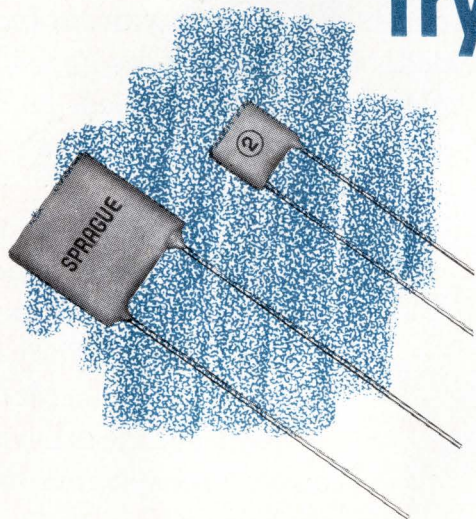

INFORMATION RETRIEVAL NO. 5

- Mass produced silvered-mica capacitors for entertainment and commercial equipment
- Combine excellent stability and retrace characteristics with economy
- Ideal alternative to more expensive stacked-mica and ceramic disc capacitors
- Exclusive manufacturing process prevents dielectric delamination as a result of temperature cycling
- Designed for operation at 500 volts d-c
- Capacitance values from 10 pF through 470 pF
- Request Engineering Bulletin 1010A

4SC-9151R1

For Engineering Bulletins as noted above, write to:  
Technical Literature Service, Sprague Electric Co., 233  
Marshall Street, North Adams, Massachusetts 01247.



<sup>®</sup>'Sprague' and '®' are registered trademarks of the Sprague Electric Co.

**THE BROAD-LINE PRODUCER OF ELECTRONIC PARTS**

# In a world that offers a million different connectors, who needs 7 more?

We don't want to complicate your life.  
We want to make it easier for you.

And we think these 7 printed circuit  
connectors are just the ones that can do it.

Each one started as a special order for a  
customer like Univac, Automatic Electric,  
or Mohawk. Each had so many possibilities  
that we got permission to make them for  
everybody.

So here's the biggest little line of connec-  
tors in the business. Utterly unique, not  
available as standard items anywhere else.

216-pin, 8-position

196-pin, 2-position

44-pin, 1-position

27-pin, 1-position

220-pin, 5-position

All connectors are made with our famous  
welded gold-dot contact design that puts  
gold only where it's needed, yet holds  
contact resistance below 5mV drop  
at 5A.

Until recently, you couldn't  
buy off-the-shelf connectors  
like these for love or money.

You still can't buy them  
for love. Sylvania Metals &  
Chemicals, Parts Division,  
Warren, Pennsylvania 16365.

98-pin,  
1-position

40-pin, male-connecting module

**SYLVANIA**  
GENERAL TELEPHONE & ELECTRONICS

# THE ELECTRONIC ENGINEER

Jan. 1970 Vol. 29 No. 1

Editorial	9
It happened last month	10
Up to date	12
Forefront	17
Speak up	21
Western Column	23
Calendar	24
Product Seminars	30
Welcome	32
Courses	34
Challenge	36
Get Ahead	40
Lab	42
Microwave	57
IC Ideas	65
Abstracts	73
New Product Feature	77
Lab Instruments	80
ISSCC	81
Microworld New Products	88
New Products	92
Seminar Ad	102
Literature	103
Books	112
Ad Index	113
Product Index	114

## Planned parenthood for new electronic companies 36

Dr. Albert J. Kelley looks at the new wave of engineers-entrepreneurs and proposes a new approach to open up the whole ball game. By Dr. Albert J. Kelley

## All word generators are not women 42

A relatively uncommon instrument, the word generator is often reinvented by test engineers. Read how it works, and find out which of its operating parameters are important in your applications. By Jerry Heyer

## Commercially available word generators 47

By Stephen A. Thompson

## Four ways to get active . . . with filters 50

With low-cost IC op amps readily available, you can now design active filters to suit your specific needs. Here are four filters that can help you get started. By Harmon G. Washington

## Sweep measurements cut costs 57

Sweep-frequency test techniques, do their thing again—this time on a production line for large and complex waveguide assemblies. By Walter White, Jr.

## VOTE for the best IC Idea of the year 65

This month, we are asking you to vote for a double winner. The eleven circuits you will find in the following pages are the ones you voted as the monthly winners between May, 1968, and March, 1969. Now that the polls are closed for those months, look at those circuits again and select the winningest winner. The lucky colleague selected by most of you, gets an oscilloscope.

- Voltage regulator has extended range, remote shutdown
- Add-on network improves op amp bandwidth and slew rate
- Stable square-wave generator
- Low cost voltage regulator from one IC
- For a square-law transfer function, try this op amp connection
- Regulated supply has two outputs
- Collector junction compensates current source in this diff amp
- Make a crystal-controlled clock with DTL gates
- Threshold testing too tedious? Automate
- Bidirectional ripple counter counts up or down
- Digital filter replaces bulky components

## TTL memories get faster, smaller, and cheaper 79

### COVER

Dr. Albert J. Kelley, Dean of the School of Management of Boston College, discusses a new concept to aid the would-be scientist-entrepreneur—planned parenthood for emerging companies. Kelley, who was formerly with NASA, also gives a realistic appraisal of the possibilities of success for the high technology firm and how to avoid potential pitfalls. Before you leap, look at CHALLENGE on page 36. (Cover photograph: James F. Coyne, Hingham, Mass.)

# FOR ELECTRONIC ENGINEERS ON THE WAY UP... A Course in **PROJECT MANAGEMENT**

This *Project Management* course appeared originally in *The Electronic Engineer* and was devised for the engineer who wants to grow in his job and to help assure this the course was developed in collaboration with Booz, Allen and Hamilton, one of the largest management consulting firms in the world. Their experience includes the development of project plans and control systems for over 1,000 projects involving the expenditure of many billions of dollars.

## What it does for you

*Project Management* is a relatively new discipline in the field of management sciences. And the course emphasizes the methods used to reach an objective while remaining within the prescribed product specifications, budget and schedule. It also helps the individual electronic engineer or manager to increase his personal skills, sharpen his capability and broaden his understanding of project management problems, both large and small. *And, it shows you how to achieve certain specified results at a particular point in time.* It can make you more valuable to your employer.

The 5 part course costs just \$3.00 and includes a test paper for your use. All those passing the examination will receive a Certificate of Completion that is suitable for framing. Why not put this course to work for you now? Fill out and mail the coupon below. Your course will be sent to you promptly. Send your order to *The Electronic Engineer*, Chestnut and 56th Streets Philadelphia, Pennsylvania 19139.

E-1

Yes, I want to take advantage of your *Project Management* course. Send me \_\_\_ complete course(s) for only \$3.00 each. Check, cash or money order is enclosed. Send the course to:

Name \_\_\_\_\_

Address \_\_\_\_\_ Company \_\_\_\_\_

City \_\_\_\_\_ State \_\_\_\_\_ Zip \_\_\_\_\_

Send me special quantity prices

K. Robert Brink, *Publisher*

Alberto Socolovsky, *Editor*

John E. Hickey, Jr., *Managing Editor*

Smedley B. Ruth, *Associate Editor*

Sheldon Edelman, *Western Editor S.F.*

Stephen A. Thompson, *Western Editor L.A.*

Arthur J. Boyle, *Technical Editor*

John McNichol, *Assistant Editor*

Dr. O. M. Salati, *Consultant*

Anne Axe, *Editorial Assistant*

Alice C. Bach, *Editorial Assistant*

Lynda Rothstein, *Editorial Assistant*

Mae Moyer, *Editorial Reader Service*

Andrew Mittelbrunn, *Chilton Art Director*

Phaua Featherson, *Artist*

George Baker, *Washington News Bureau*  
Neil Regeimbal,

Chilton 

### Executive and Editorial Offices:

One Decker Square, Bala-Cynwyd, Pa. 19004  
Tel. (215) SH 8-2000

Address Mail to: 56th & Chestnut Sts.  
Philadelphia, Pa. 19139

### Western Offices:

Stephen A. Thompson, 1543 W. Olympic Blvd., Los Angeles,  
Calif. 90015  
Tel. (213) DU 7-1271

Sheldon Z. Edelman, 199 First St. Rm. 335  
Los Altos, Calif. 94022  
Tel. (415) 941-6655

Chilton Officers & Directors: Chairman of the Board: G. C. Buzby; President: R. E. McKenna; Financial Vice-President: S. Appleby; Senior Vice-Presidents: J. Kofron, L. King; Vice-President: H. Barclay; Publishing Vice-Presidents: C. W. Hevner, W. A. Barbour, R. H. Groves, K. Robert Brink; Treasurer: James Miades; Secretary: J. A. Montgomery, Jr.; Other Directors: T. J. Casper, S. H. Collmann, R. Rimbach, Jr.; Asst. Secretary: I. C. Holloway.

Monthly publication of Chilton Company, Chestnut & 56th Sts., Phila., Pa. 19139. (Area Code 215) SHERwood 8-2000. Controlled circulation postage paid at Philadelphia, Pa. \$1 a copy. Subscription rates U. S. and U. S. Possessions: 1 yr. \$12.00; 2 yrs. \$20.00. Canada 1 year \$14.00; 2 yrs. \$25.00. All other countries 1 yr. \$20.00; 2 yrs. \$35.00. © Chilton Company 1970. Title Reg. U.S. Patent Office. Reproduction or reprinting prohibited except by written authorization.

*The Chilton Electronics and Instrumentation Group* •  
The Electronic Engineer ■ Instruments and Control  
Systems ■ Instrument & Apparatus News ■ Medical  
Electronics News ■ Electronic Component News



***"You're in luck, Charlie...now that we have our new Digivider, you can select the exact voltage you want!"***

Digivider®. The accurate, repeatable thumbwheel switching system that puts a 10-turn potentiometer to shame. Divides voltage with resolution up to six digits (.0001%). Then there's Digidecade®. Works just like Digivider, but selects any resistance you want. Either way, you get clear, precise, positive click-position settings. Enjoy quick

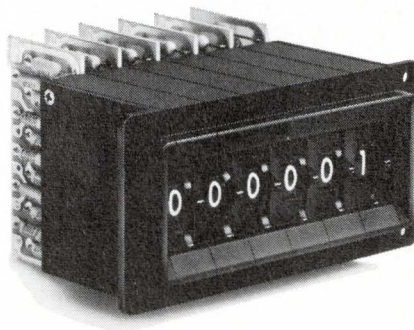

re-set, too. From maximum to minimum in a couple of clicks. And big, bold characters made for human eyes to read — not a microscope.

There's a lot more you should know about Digivider/Digidecade. But you'll have to ask for it. Just call or write:

## **THE DIGITRAN COMPANY**

A Division of Becton, Dickinson and Co. **B-D**  
 855 S. Arroyo Parkway, Pasadena, Calif. 91105  
 Telephone (213) 449-3110 • TWX 910-588-3794

**the**  
**GIANT**<sup>TM</sup>

GENERAL INSTRUMENT ADVANCED NITRIDE TECHNOLOGY

**QUADS**



**with the 4-bit byte**



# the first and only 25-bit and 32-bit QUAD Static Shift Registers directly compatible with TTL/DTL and MOS are GIANTS.

Logic Diagram  
QUAD 25-Bit or 32-Bit  
Static Shift Register

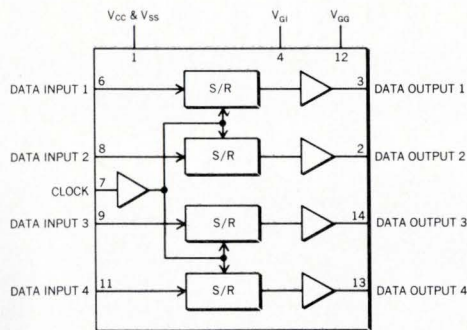

TTL/DTL Operation

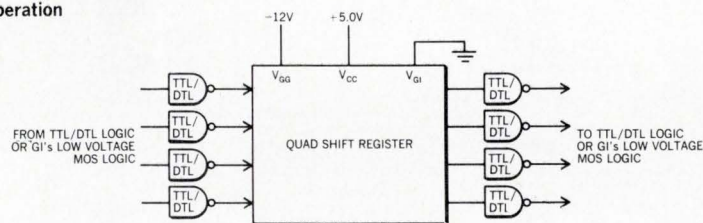

MOS Operation

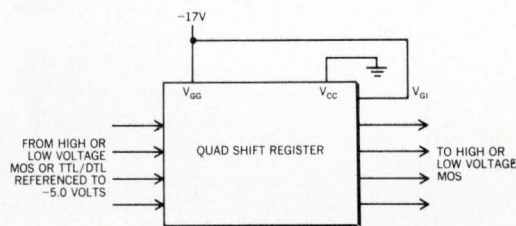

General Instrument's 4-bit byte 25-bit and 32-bit QUAD Static Shift Registers are the newest additions to the growing family of GIANTS. And, like all GIANTS, they are products of General Instrument's exclusive MTNS (Metal-Thick Oxide-Nitride-Silicon) process.

A most significant feature of these GIANT QUADS—and of every standard GIANT product—is the  $V_{GI}$  terminal, which gives the user the choice of interfacing directly with TTL/DTL or MOS.

Each register has one serial input and one serial output, and the clock input is common to the four registers. All inputs, including clock, can be driven directly from TTL/DTL logic levels, and each output can directly drive TTL/DTL without external interfacing components.

Additional features of the GIANT QUADS include: opera-

tion over the full military temperature range of  $-55^{\circ}\text{C}$  to  $+125^{\circ}\text{C}$  and series or parallel operation. And the well-known performance and reliability advantages inherent to MTNS devices are, of course, also present in the GIANT QUADS.

Both the 25-bit (#SL-6-4025) and the 32-bit (#SL-6-4032) QUADS are available in 14 lead dual in-line ceramic packages at your authorized General Instrument Distributor. For full information write, General Instrument Corporation, Dept. Q, 600 West John Street, Hicksville, L.I., N.Y. 11802.

(In Europe, write to General Instrument Europe S.P.A., Piazza Amendola 9, 20149 Milano, Italy; in the U.K., to General Instrument U.K., Ltd., Stonefield Way, Victoria Road, South Ruislip, Middlesex, England.)

Price in quantities of 100 pcs: QUAD 25-bit (#SL-6-4025) @ \$18.20 ea.; QUAD 32-bit (#SL-6-4032) @ \$26.50 ea.



GENERAL INSTRUMENT CORPORATION • 600 WEST JOHN STREET, HICKSVILLE, L. I., NEW YORK

# Clever engineers specify our standard Impatt oscillators. And more power to them.

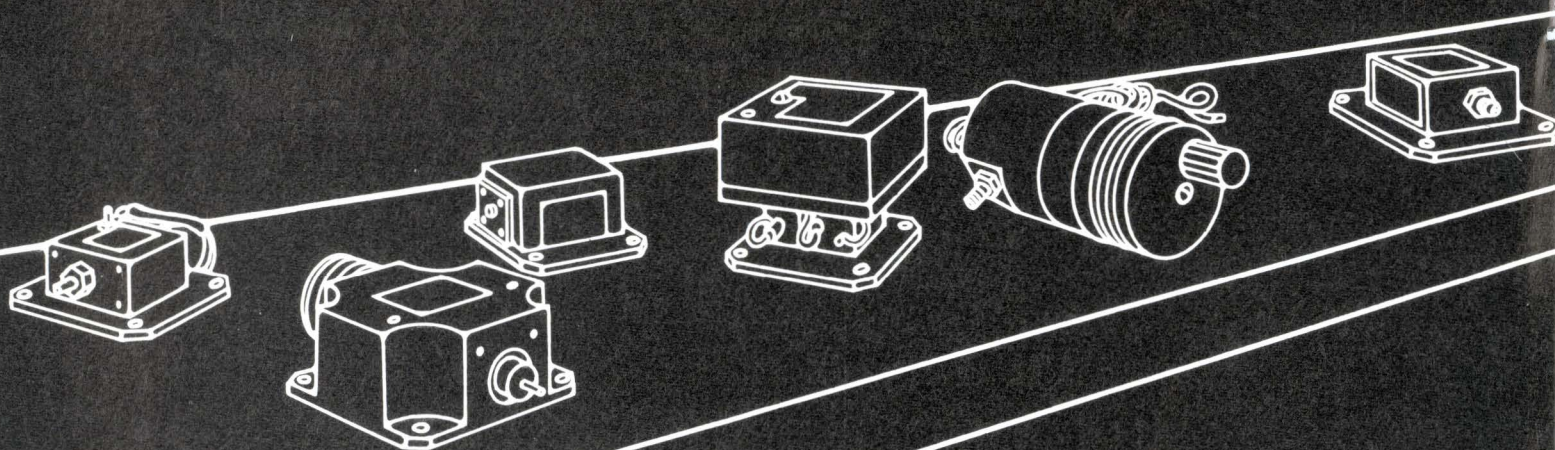

Varian's Impatt oscillators are the highest CW power fundamental oscillators available in C, X and Ku bands. And this is the industry's complete standard line, with outstanding stabilities, efficiencies and reliability: Seven low-Q Impatt oscillators, on life test in avalanche mode, have already turned in 17,000 hours per device without failure or degradation of performance. Let Varian help you get this kind of performance for your system.

#### **Low-Q, high power oscillators.**

Featuring power from 100 mW to 1 W, and typical efficiencies to 6-7%, these devices come in 15 models, covering frequencies from 4.0 to 15.0 GHz. Some are fixed-frequency models, and some provide mechanical tuning through  $\pm 250$  MHz.

#### **High-Q, low noise oscillators.**

Typical FM noise is only 65 Hz deviation at 100 kHz displacement from carrier and 1 kHz bandwidth. Typical AM noise is 105 dB down from carrier at 100 kHz. Thirty-six models are stocked, covering from 8.0 to 18.0 GHz, with fixed-frequency and mechanically tuned versions. Efficiencies and frequency stabilities in all models are excellent.

#### **Very high-Q frequency stabilized oscillators.**

These devices consist of Varian low-Q Impatt oscillators driving very high-Q stabilized cavities. They deliver higher stabilized power than any other CW solid state oscillator, and provide up to 20 ppm frequency stability, with superb AM and FM noise performance. Varian offers 15 models, covering frequencies from 4.0 to 18.0 GHz.

And there you have it. Precisely what you need in standard or custom Impatt oscillators to complement Varian's outstanding line of solid state and thermionic devices.

Get them at any of more than 30 Electron Tube and Device Group Sales Offices throughout the world, or from Varian's Solid State Division, Salem Road, Beverly, Mass.



**varian**

solid state division

## The electronic engineer of the Seventies

Have you seen an idea germinate? Perhaps one of your colleagues, perhaps you yourself, has one that he would like to propose to his management to explore—or even form his own company to try it. In either case, that idea will have plenty of room to grow—and company—in the Seventies. Yet today less than one percent of these budding companies has a chance to come to fruition.

Of the rest, most wither at the first serious attempt to convince others of the chance the idea has for success. Be it in discussions with management or with people who have capital to invest in such ideas, few of them pass this test. Of the ideas that do succeed, most would-be firms stumble over such hurdles as raising capital, organizing the operation, recruiting help, making a profit, and avoiding stagnation.

This Darwinian process of natural selection, survival of the fittest, produced the Hewlett-Packards, the Tektronixes, the Digital Equipment Corporations, the Fairchild's and the Unitrodes—companies that were all started by electronic engineers in the last few decades. The process, however, will not be enough to produce the amount and quality of companies that the world of electronics needs—and that electronic engineers will start in the next decade. The reason is that the role of the electronic engineer of the Seventies will transcend the technical field and will reach into management, into the relations between what is produced and how it is used, into the work engineers do and the way they do it.

We at THE ELECTRONIC ENGINEER look forward to this challenge, and to provide you with both the technical and the professional information to face it. As a matter of fact, you will see in this issue a new section called just that—CHALLENGE. In it, you will read the opinion and ideas of engineers who are doing something about this challenge. For example, in this issue you will meet Dr. Albert Kelley of Boston College, whom you may remember as the former Deputy Director of NASA's Electronics Research Center in Cambridge, Mass. Dr. Kelley proposes a new way—which he calls “planned parenthood”—to help the engineer who has initiative and ideas and wants to be an entrepreneur.

In future issues, you will meet more engineers who, like Dr. Kelley, play an important role in the future of electronics—and in your future. If you have an opinion about their points of view, please feel free to express it. You, too, can be an electronic engineer of the Seventies.

*Alberto Socolovsky*  
Editor

### A popular communications link is in danger

Have you ever thought what's our most common, yet slowest communications channel? It's the mails. A faster one is, of course, the telephone, yet you send and receive much more information (including this magazine) by mail. In spite of its popularity, this heavily burdened communications channel is giving us increasingly poorer service because the Post Office is still organized as it was back in 1789, when it was founded. Such management. Even minor decisions, such as building a new Post Office or raising salaries, must wait for an act of Congress.

There is a solution. The recent Kappel report (named after Frederick K. Kappel of AT&T) served as the basis for a bill that calls for postal reform—HR-11750. Yet your Congressman has before him HR-4, a bill that would simply build another layer on top of the present crumbling structure. Won't you ask him to substitute the provisions of HR-11750 for those of HR-4? If you do, you may keep this wonderful communications channel from stopping altogether.



# It happened last month . . .

The editors of THE ELECTRONIC ENGINEER have sifted through the various technical and significant happenings of the past month and selected the items that would be of the most interest or use to you.

**New solid state light source . . .** Bell Telephone Labs. has discovered new phosphors that can supply colored lights in different colors, or give a rainbow effect. The phosphors are painted on the surface of a gallium arsenide diode and the infrared radiation from the GaAs diode activates the phosphors, making them glow very brightly.

**A 2-mil plated wire memory . . .** A "Mini-Wire" aerospace computer memory element is expected to have greater reliability, speed, power and size advantages over standard 20-mil core memories. Honeywell's Aerospace Div. in Florida is developing the memory which will be priced competitively with the core units. A production version is expected by Honeywell by mid-1970.

**Magnetic shift registers . . .** Cambridge Memories, Inc. of Newtonville, Mass. will have magnetic domain shift registers available during the early part of 1970. In addition, mass memories using these approaches should be on the market by 1972. These shift registers operate on the same principles as the magnetic bubble memory from Bell Labs. However, there is one important difference; CMI makes their devices with a common nickel iron compound, using vacuum deposition and printed circuit techniques.

**Looking for bids . . .** The Electronic Systems Div. of the USAF is soliciting bids for a standardized family of computers. The initial procurement could have a price tag of \$75-150 million. The data-processing systems will be used in the Defense Department's World-Wide Command and Control System and would also form part of the Intelligence Data Handling System.

**Beam leads for Safeguard . . .** Western Electric, the company that has the major electronics contact for the Safeguard ABM System, is using beam-leaded chips for most of the ICs in the system. W.E. bonds the chips with a special "wobble bonder" developed by Kulicke and Soffa. Wobble bonding consists of rotating the bonding tool to bond one lead at a time, in rapid sequence. This is the first instance of such chips going into a military system.

**How to test their hermeticity . . .** Since beam-leaded chips have no cavities to trap moisture, in most hermeticity tests specified by Mil specs cannot be applied. Raytheon Co., which is making most of its products available as beam-leaded

chips, is using a penetration test on the chips by exposing them to Sodium 22. Raytheon feels that this test yields meaningful data on how well the chip has been passivated.

**Nanodollar transistors . . .** Westinghouse is going ahead with its research work on field effect transistors printed on low cost substrates, such as paper or aluminum foil. Dr. T. P. Brody, Manager of Dielectric-Solid State Devices at Westinghouse's R & D Center, said that for a production volume of 100 billion transistors/year, the cost attainable today would be 0.001¢ per transistor. In the next generation, it could be one microcent per transistor for an annual volume of 100 trillion transistors. The present industry volume, incidentally, is about 10 billion/year, including discrete transistors and those made as part of integrated circuits.

**Surge of semiconductor memories . . .** It seems that semiconductors are rushing to catch up with magnetic memories on their weakest flank—memories with capacities of less than 4,000 bits. During the Fall Joint Computer Conference in Las Vegas, Motorola introduced an 8,000-bit memory, consisting of sixteen memory chips of 512-bits, mounted on a ceramic substrate and packaged as a unit. The Motorola memory has an access time of about 20 ns. Other companies, such as Cogar Corp. of New York, and Advanced Memory Systems of California, are working on memories that consist of dual-in-line packages mounted on a printed circuit board. The Cogar memory has 1,000 words by 9 bits on an 8-in. card, with an access time of 40 ns. The AMS card, with 32 packages of 250-bits each, is based on (ECL-coupled logic) interfaceable with TTL or DTL, with a so far unbeaten access time of 5 ns.

**Successful chemical lasers . . .** Professors at Cornell's College of Engineering have produced two purely chemical lasers that operate continuously without an external source of energy. As you probably know, other types of lasers must have bulky power sources to make them work. The more efficient of the two lasers operates in the carbon dioxide molecule at 10.6 microns. The laser energy is provided from a chemical chain reaction that forms deuterium fluoride molecules. This laser operates with an output of better than 8 W. Conversion of chemical energy into laser output is better than 4%. An efficiency of 15% is obtainable with improved laser design.

# SOLVE YOUR D/A

## INTERFACE PROBLEMS

NEW PHILBRICK NEXUS MODEL 4850 PROVIDES THE VERSATILITY TO SOLVE YOUR CONVERTER INTERFACING PROBLEMS.

**Three Mode Integrator** Model 4850 is a multi-purpose module with reset, integrate, and hold operation modes that may be controlled by external digital signals applied to two internal mode command comparators. The input command levels to these comparators is directly compatible to DTL and TTL logic levels. Provisions have been made for elevating the reference input above common or interchanging inputs for inverted logic commands. The comparators control FET electronic switches that provide excellent "feedthrough" characteristics and eliminate the need for cumbersome relays in your system. Combined with excellent stability, the Model 4850 has the versatile performance necessary to solve those converter interfacing problems.

### Electrical Specifications

Low Hold Decay Rate	— $30\mu\text{V/S}$ with $C_f = 1\mu\text{F}$
Wide Feedback Capacitor Range	— $0.001\mu\text{F}$ to $10\mu\text{F}$
Command Logic Input Step Level	— $\pm 0.35\text{V}$ to $\pm 5\text{V}$
Low Switching Jump	— $\pm 20\mu\text{V}$ with $C_f = 1\mu\text{F}$
Low Feedthrough Voltage	— $\pm 40\mu\text{V}$
Low Aperture Time	— $800\text{nS}$
Temperature Coefficient	— $20\mu\text{V}/^\circ\text{C}$
Overload Recovery Time	— $35\mu\text{S}$

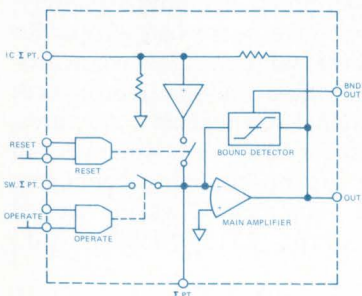

Contact us for a copy of Model 4850 Applications Guide.

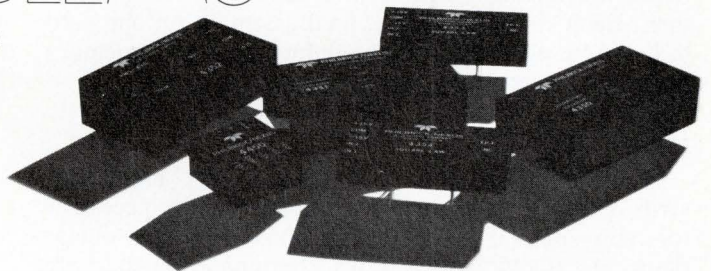
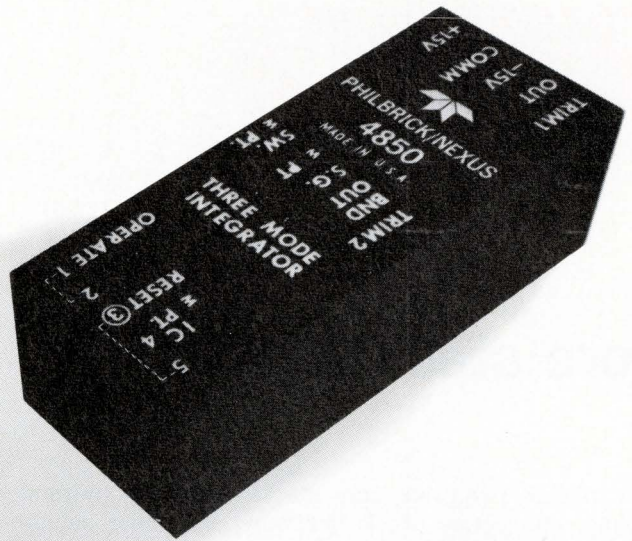

For other specialized applications try these Philbrick Nexus non-linear function modules.

**Square Law Elements** Models 4353 and 4354 are temperature-compensated, straight-line approximation, ten-section diode function fitters with break points adjusted to fit a square law relationship.

**Temperature Compensated Logarithmic Operators** Models 4350 and 4351 are complete modules providing an output voltage proportional to the log or antilog of the input signal, without a requirement for external amplifiers or components.

**Average-RMS-Vector Operator** Model 4352 is a small, encapsulated unit designed to find the average value of an input signal, Y; find the RMS value of an input signal, X; or perform the operation  $\sqrt{X^2 + Y^2}$  on the input signals X and Y.

**Multiplier-Continuous Function Operator** Model 4450 is a true four-quadrant multiplier whose output represents the instantaneous product of the two input signals, with no limitations as to the polarity of the input signals.

For further information on any of these Philbrick Nexus products, call your local Philbrick Nexus field representative, or write today for your free copy of the new 1970 Philbrick Nexus Catalog, Teledyne Philbrick Nexus, 67 Allied Drive at Route 128, Dedham, Massachusetts 02026, U.S.A. Telephone (617) 329-1600

No. 1 should do more . . . you expect us to.

**TELEDYNE  
PHILBRICK NEXUS**

## Core stacks go planar

New planar pluggable core stacks eliminates normal cabling, connectors, stack hardware and other subassemblies used in the past on core memories.

The planar pluggable stacks contain cores on one or both sides of a single printed circuit card, all in one plane. These stacks are then terminated to etched connector fingers for plugging into printed circuit connectors. Each stack is a single, final assembly on one card that can be plugged into a manufacturer's core memory as a customized part of the system.

### Higher reliability

A typical planar stack will contain only about one-sixth of the normal number of solder joints necessary for conventional memories. Continuous-wire planar pluggable stacks, where wires continue through more than one row of cores instead of terminating, contain as few as one-twelfth the solder joints of past stacks. Hence, the reliability is much higher in these new planar assemblies.

Because of shorter drive lines, greater memory speed is possible. Also, drive lines in the planar pluggable stacks are one-third the length of drive lines in other types of stacks. Increased tolerances in the memory system and lower cost of memory circuitry is possible

because of the uniformity of electrical performance from bit-to-bit and from stack-to-stack in the new planar assemblies. These assemblies also eliminate adjustments normally needed with conventional stacks for increased memory performance. Stacks are manufactured by Ampex Corp., 9937 W. Jefferson Blvd., Culver City, Calif. 90230.

**Conventional stack** on the left has two dozen subassemblies and contains 328 connector cables. The **planar pluggable core stack** on right contains no cables or hardware.

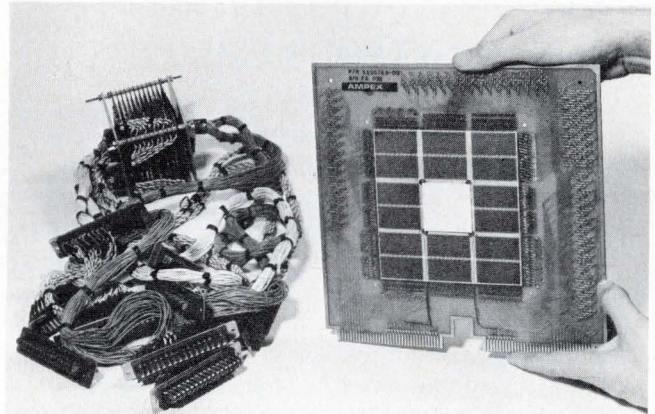

## Microwave materials can be sprayed

A new thick-film deposition method developed by Monsanto uses commercially available arc-plasma spray (APS) equipment. The APS method is simple and can give high deposition rates for low-cost production of thick films used for microwave applications. The spray method produces a polycrystalline film of high density, high remanence, high resistivity and good chemical uniformity over the surface.

Unlike other techniques, such as chemical vapor and sputtering, the APS equipment can produce multilayered films of several different materials without wasting time with evacuation equipment changes. Also, this method allows selective masking, complex geometries and the production of composite structures, all with identical crystalline composition of the bulk start-

ing material.

After the material is deposited, Monsanto anneals the device to increase grain size to predetermined levels so as to set films to desired coercivity values. In addition, they improve their high power handling capability, while at the same time having the microwave properties of the bulk material. APS is ideal for microwave microstrip and stripline devices where multilayer structures are required over conventional ferrimagnetic structures. This method is also perfect for batch or continuous run fabrication because there are no confining containers and atmospheres involved. The method was developed by Monsanto Research Corp., 1515 Nicholas Rd., Dayton, Ohio 45408.

# Local one-stop shopping for linear ferrites. Only from Ferroxcube.

Only Ferroxcube gives you nationwide ferrite Stocking Centers for fast local off-the-shelf delivery. These Centers are loaded with the industry's broadcast line of linear ferrites. Pot cores, toroids, E,U, and I cores, H-cores, shielding beads and RF chokes in an unmatched variety of sizes and materials.

This stock includes our money-saving new ready-coated toroids ... among them our 3E3 type with

permeability of 12,500, the highest on the market.

In short, we give you the widest selection and stock it closest to you. With this unique one-stop shopping, you can turn a design or production crisis into a picnic. Just check the bottom of this ad

for Stocking Center locations.

And remember, these are Ferroxcube ferrites. Made to the tightest tolerances in the business by the oldest, largest supplier of linear ferrites.

Write now for complete technical literature on Ferroxcube linear ferrites, and take your pick. We'll make your shopping cart go like a Ferrari.

**Ferroxcube**   
Saugerties, New York

A NORTH AMERICAN PHILIPS COMPANY



**STOCKING CENTERS:** Burbank, Calif.—(213) 849-6631; Chicago—(312) 852-0450; Dallas—Gillett Industries, (214) 363-0107; New York—Kahgan Sales, (516) 538-2300; Philadelphia—Eastern Components, (215) 927-6262; San Francisco—Wm. J. Purdy Corp., (415) 347-7701; Waltham, Mass.—(617) 899-3110; Woodstock, N.Y.—Elna Ferrite Labs, (914) 679-2497; Toronto, Ont.—Philips Electron Devices, Ltd., (416) 425-5161.

**SALES OFFICES:** Atlanta—Cartwright & Bean, (404) 237-2273; Baltimore—Eastern Components, (301) 322-1412; Cedar Rapids—Thomas & Modricin, (319) 377-6261; Columbus, Ohio—Mulligan & Mathias, (614) 486-2976; Denver—Wm. J. Purdy Corp., (303) 794-4283; Huntsville, Ala.—Cartwright & Bean, (205) 852-7670; Hyde Park, N.Y.—R. P. Kennedy Co., (914) 229-2269; Indianapolis—Thomas & Sukup, (317) 251-4574; Kansas City—Thomas & Modricin, (913) 432-2131; Minneapolis—(612) 920-1830; No. Miami Beach—Cartwright & Bean, (305) 945-2962; Orlando—Cartwright & Bean, (305) 425-8284; Phoenix—(602) 264-3129; Rochester, N.Y.—R. P. Kennedy Co., (716) 271-6322; Saugerties, N.Y.—(914) 246-2811; St. Louis—Thomas & Modricin, (314) 338-6446; Union, N.J.—(201) 964-1844.

## Two hull-mounted antennas avoid shipboard EMI

The problem of acquiring satellite data in the presence of high ambient electromagnetic interference (EMI) is a severe test under favorable circumstances. But when it must be done on the moving, pitching deck of a carrier with its restrictions on obstructions to flight operations, the task is exceptionally difficult.

The solution, developed by Radiation Incorporated, is a computer-controlled system that employs two antennas mounted on each side of the ship, below the level of the flight deck. When the satellite appears on the horizon, the near-side antenna tracks the orbiting spacecraft until EMI emissions obstruct the track. At this point, data collection is automatically assumed by the far-side antenna and continued until the satellite disappears below the horizon.

The system uses two antennas and two separate receiving chains (down to and including the demodula-

**By mounting antennas** on the hull, below the ship's deck, antennas are shielded from shipboard radiations. The antennas are on a computer controlled platform to offset roll and pitch of the ship, and to keep locked on satellite.

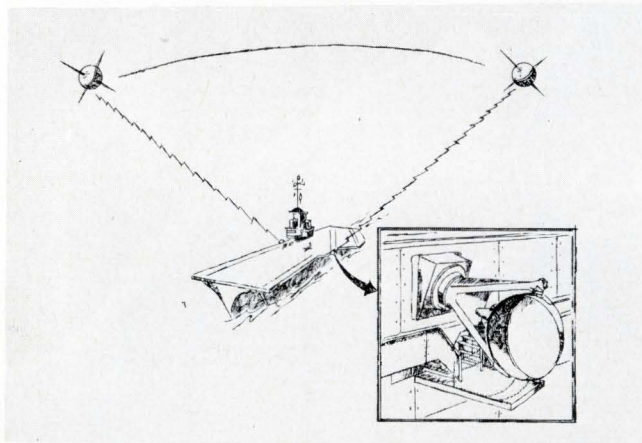

## A new idea in solid state light sources

Two problems with solid state light devices has been lack of brilliance and limited colors available. Now Bell Telephone Laboratories, Murray Hill, N.J., has come up with a unique solution to this problem. They have discovered improved phosphors that can convert invisible infrared radiation into dazzling green, red, and blue lights or any variation of them through a rainbow of colors.

The light sources can be made to emit all three primary colors and any of the rainbow of colors in between them. The new phosphors employ rare earth

tors) to circumvent the presence of EMI.

The antennas are 6 ft. sections of a paraboloid equipped with off-sets feeds and absorber lined shrouds. These elements effectively reduce the side and back lobe levels on the inboard side, sharply decreasing the system's susceptibility to signals emanating from the ship. A 20 dB (100:1) reduction in these patterns over conventional methods is achieved.

The antennas are positioned by low profile, wide yoke elevation-over-azimuth pedestals. These pedestals can be mounted with the azimuth axis vertical, horizontal, or canted to any angle through about 20° below the deck horizon.

A digital computer controls the servo-mechanism in an auto-track, or program track mode. Auto-track, the primary operating mode, positions the antennas from error signals out of the antennas. Program track is used as a backup to the primary mode and provides azimuth and elevation pointing angles in real-time with computer-generated commands based on raw orbital data. Two additional modes, manual and slew, are provided for maintenance and acquisition operations. A sub-mode, called space search scan, can be superimposed on the program or manual modes for faster acquisition of the satellite.

A ruggedized version of the Honeywell DDP-516 is the heart of the control and pointing system. It interfaces with the ship's navigation package to space stabilize the rf axis of the antennas. Using raw orbital data and ship's timing inputs, the computer generates pointing angles, performs coordinate conversions and drives digital displays depicting the position of the antennas in either deck or space coordinates.

The "handover" between the two antennas during the course of a mission is initiated by the computer and is based on a pre-determined angular contour that avoids the tracking area obstructed by EMI.

elements in crystals.

Phosphors used in the past produced one color and they were much less efficient at light conversion than are the new Bell Labs materials. Now, here is the cute development that the Bell people have come up with—they coat the invisible infrared gallium arsenide diodes with the new phosphor material "paint" that can be applied to standard IR diodes. When the infrared diode emits IR, it causes the phosphors to glow brilliantly, hence giving you a light. Light intensity can be varied by the amount of drive to the diode.



## Monitor senses weld faults

A monitoring device detects metal strip "faults," which produce bad welds, and automatically interrupts high-speed welding to protect against material loss or equipment damage. The device is designed for 450 kHz contact resistance welders.

In operation, the monitor continually senses conditions at the sliding contacts bearing on weldments traveling at up to 1000 ft/min. Should an arc or flashover occur, due to the irregularity in metal strip condition or improper guidance, which could cause a weld defect or damage to the high frequency weld contacts, the monitor shuts off welding power. The device's control circuit distinguishes between momentary and sustained welding "faults" and automatically recycles for intermittent "faults" such as nicks, burrs and slivers on unusually rough welding edges.

The device's operation can be keyed to welding of either ferrous and nonferrous materials. The monitor senses the voltage level across the two high-frequency contacts sliding on the weldment. A sudden change in voltage, caused by the "fault" will fire a thyatron in the device. The thyatron, in turn, acts as an electronic switch, applying a negative potential to the grids of the

oscillator tubes in the weld power generator to instantly block power output. Because of the power levels involved, tubes, not SCRs, must be used. The unit was developed by AMF Thermatool, Inc., New Rochelle, N.Y.

**Weld monitor** for 450 kHz welding equipment monitors "faults" in the welding cycle. Device maintains continuous surveillance over electrical conditions at high frequency contact-weld zone interface.

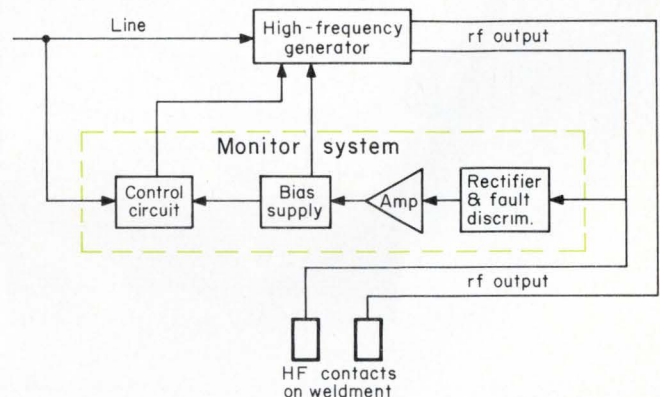

Wanted by the FBI—



Your help in locating Howard I. Sands, a white male, born Jan. 11, 1918, at Grand Junction, Mich., 5'-9½", 133 lbs, gray hair, blue eyes, ruddy complexion and slender build. Sands is wanted for transporting stolen automobiles. The reason we are asking for your help is that Sands has been employed as an electronic engineer in the past. Your cooperation will help in protecting your company. If you have any information concerning this man, please notify the nearest office of the FBI.

## DOUBLE YOUR FUSE FUNCTION

In the design of high-powered solid state equipment there often occurs the need for equalizing resistors. Consider the case of parallel series pass elements in a regulated power supply. It may not have occurred to the designer that a Littelfuse 275 Series Picofuse will fulfill a dual purpose, in that the voltage drop across the fuse is in the approximate range necessary for equalization purposes, in addition to the provision of over-current protection. Picofuses are now available with ratings from 1/16 through 15 amps.

Write for a free copy of our 275000 Series Resistance Data Chart.

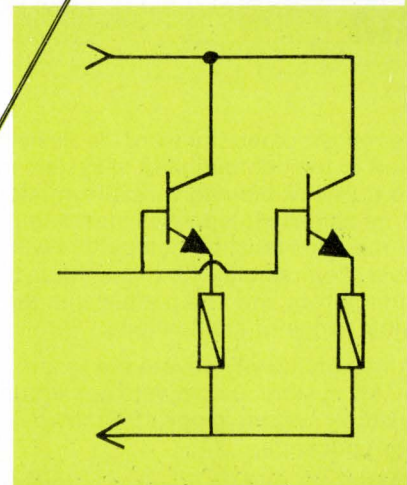

# LITTELFUSE

DES PLAINES, ILLINOIS

## An exclusive: the Beckman ANSCAN™ system with INCLUSIVITY

We recently coined the word "inclusivity" as applied to the compatibility of system modules. To be truly flexible and versatile, modules must be as easy to apply as inserting a plug. Such modules must be compatible with one another, compatible with those made by all other manufacturers and compatible with the widest possible range of applications.

Beckman inclusivity covers the Model 3700 ANSCAN system, a complete analog data-acquisition system in one 19-inch x 7-inch x 22-inch package.

The ANSCAN system features automatic ranging and zeroing, and accurately measures very small signals in the presence of very large noise. Channel access can be sequential or random. Data can be fed to most types of digital recorders or the ANSCAN system can interface directly with couplers, computers or other peripheral equipment.

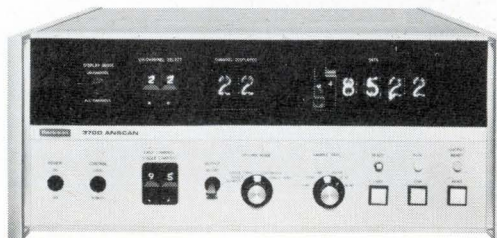

Circle 11 on Inquiry Card

### ANSCAN SPECIFICATIONS

Analog Inputs:	100 channels in 10-channel increments
Conversion Accuracy: (Guaranteed, 0–50°C)	± .01% of full scale
Sample and Hold:	Aperture-time uncertainty < 200 nsec
Data Output:	Output word 16 bits BCD, Sign, Address and Range or 13 bits binary Sign, Address and Range

### The following control functions are local or programmable

Sample Rate:	1, 10, 60, 100, 1000, 5000 samples/sec
Operating Modes:	Continuous, Single Scan, Single Channel, Remote Address
Channel Address:	Sequential or Random
Command Inputs:	Start, Stop, Reset, Channel Address, Address Load (remote start), Recorder Ready

For full information on Model 3700 or any of our systems modules, contact your local Beckman sales representative or the factory

**Beckman**® INSTRUMENTS, INC.

ELECTRONIC INSTRUMENTS DIVISION  
2500 Harbor Boulevard, Fullerton, California 92634

OTHER INTERNATIONAL SUBSIDIARIES: AMSTERDAM, CAPE TOWN, GLENROTHES, SCOTLAND, LONDON, MEXICO CITY, MUNICH, PARIS, STOCKHOLM, TOKYO, VIENNA

Major products include: voltage-to-binary converters, voltage-to-BCD converters, current-to-binary converters, current-to-BCD converters, frequency-to-BCD converters, events accumulator, binary-to-BCD converters, digital comparators, digital clocks, digital recorders, analog multiplexers, digital multiplexers, data formatter, teletype formatters, data processors.

# FOREFRONT

The EE Forefront is a graphical representation of the practical state of the art. You will find here the most advanced components and instruments in their class, classified by the parameter in which they excel.

## A word of caution

Keep in mind the tradeoffs, since any parameter can

be improved at the expense of others. If there is no figure-of-merit available, we either include other significant parameters of the same products, or we provide additional bar graphs for the same products.

Do not use these charts to specify. Get complete specifications first, directly from the manufacturers.

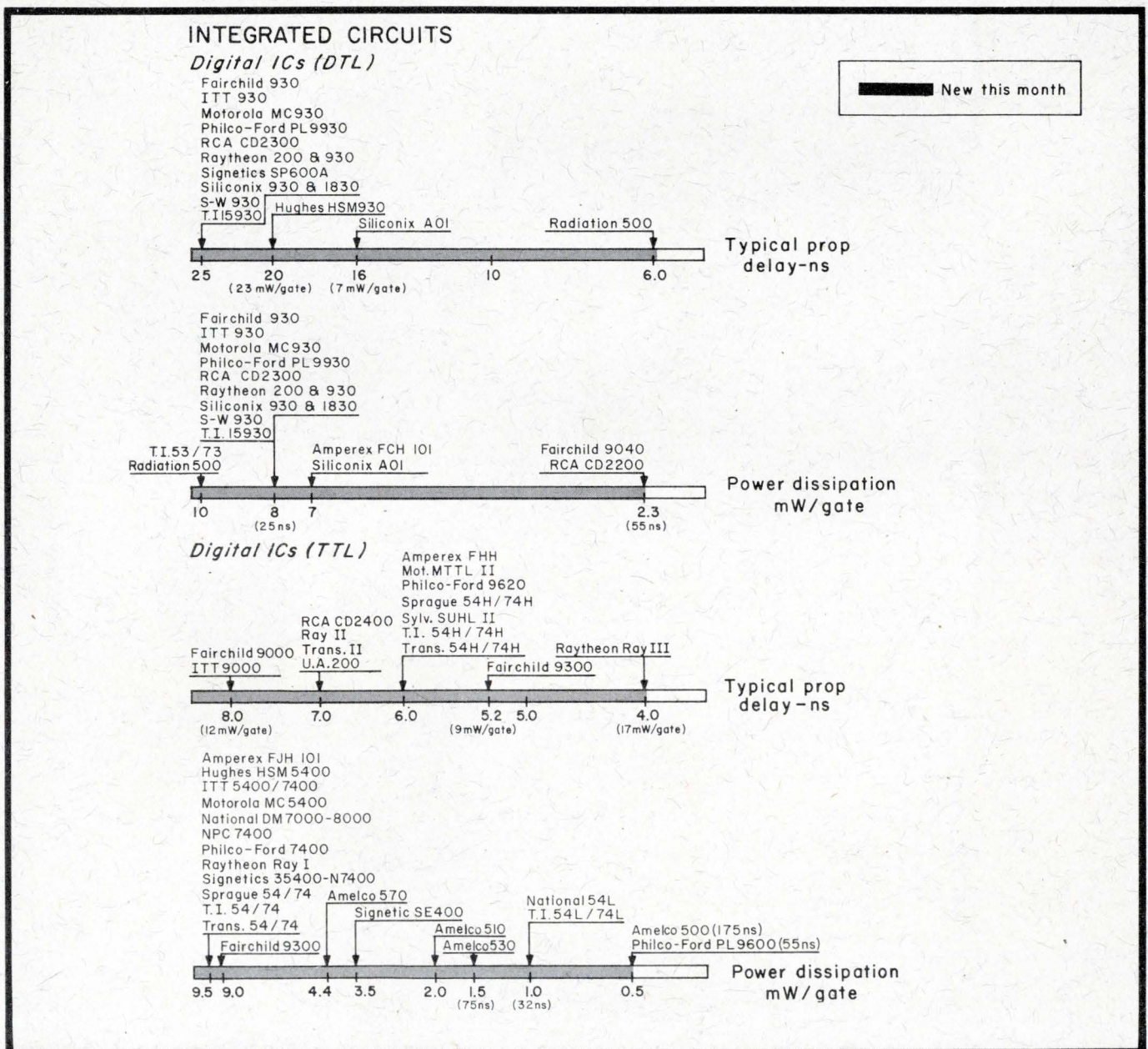

**SEMICONDUCTORS**

*Silicon power transistors (npn)*

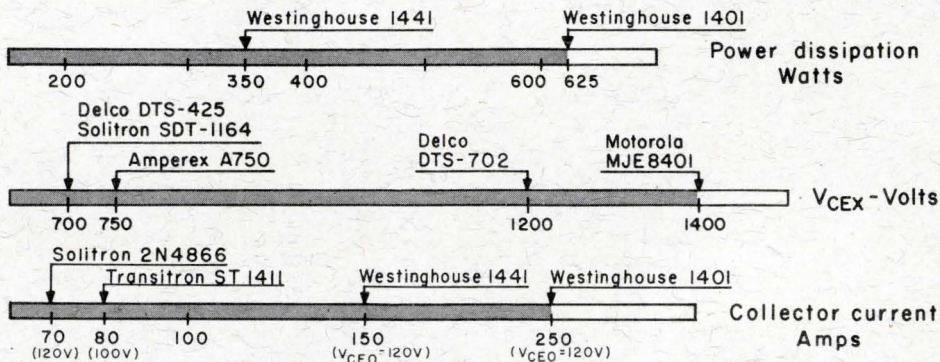

*Dual bipolar transistors*

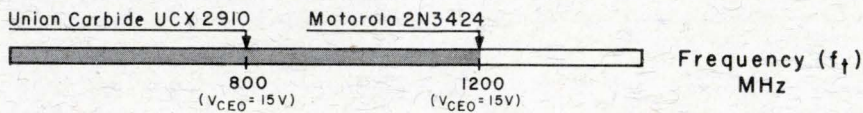

*Thyristors*

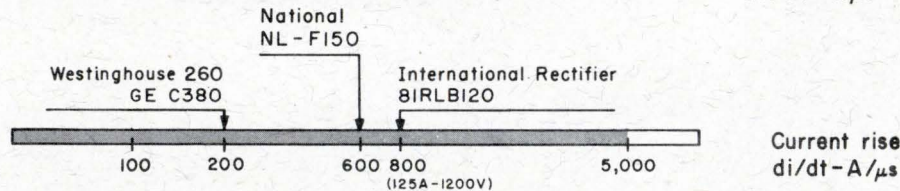
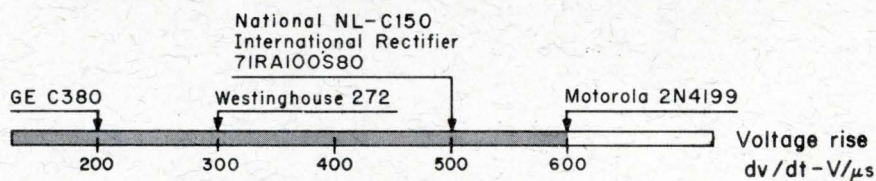
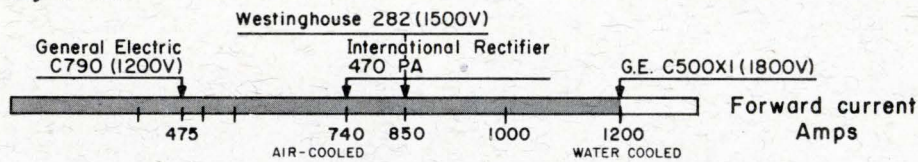

*Microwave semiconductors (low noise)*

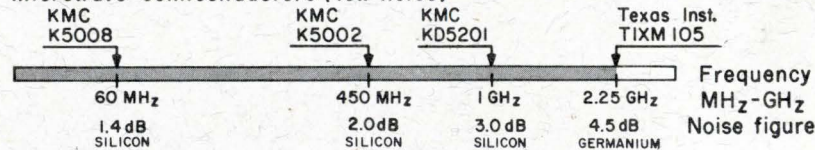

*Microwave semiconductors (power)*

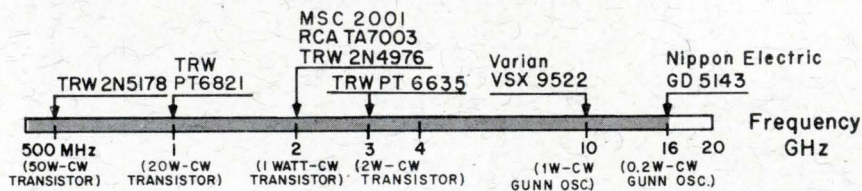

*Microwave multiplier diodes*

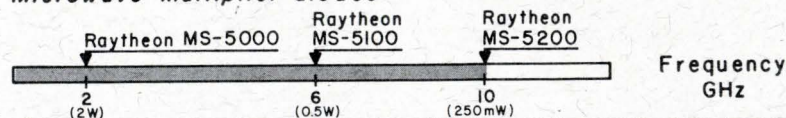



*The  
Standard of  
Excellence*

## S/D D/S converters by CLIFTON

Excellent means — "first class, of great worth, eminently good." Definite qualities of our ADverter S/D, D/S converters. But we should add one other feature: *not expensive!* (Model SD12A1, \$795 qty. 1-9.)

In fact, their low cost, combined with such other features as: reliable, all solid state circuitry, easily interchangeable

encapsulated sub-modules, no calibration or adjustments, multi-channel capability, wide variety of options, make them superior in many ways to brush encoders.

Although designed especially for the process control and machine tool fields, this system can easily be modified for military applications.

So take advantage of our

application engineering know-how which is yours for the asking. Call our DITRAN division in Burlington, Mass. (617) 272-6210, or your local Clifton sales office. When you consider Litton, Clifton, Ditrans quality, you couldn't do better!

**CLIFTON**   
DIVISION OF LITTON INDUSTRIES

Pearls by J. E. Caldwell Co., Philadelphia—\$5,600

# AMP makes the only no-solder, no heat, SMA, MIL-C-39012 connectors in the world.

## And that's telling you everything except details:

- terminate semi-rigid subminiature cable in one-tenth the time required by conventional heat-and-solder method
- no special skills required to achieve consistently reliable electrical and mechanical performance levels
- completely pre-assembled plug
- single tool does the entire operation
- 70-pound (plus) tensile strength
- salvageable for reapplications
- field maintainable
- intermateable with *all* presently available SMA connectors

More details? They're available right now.  
So is an AMP sales engineer with  
samples. Write: **AMP Incorporated,**  
**Harrisburg, Pa. 17105**  
today.

**AMP**  
INCORPORATED



## SPEAK UP

### Is out-house an "in" word?

Sir:

Writers sometimes coin a word to convey a thought or meaning, assuming it will mean the same to the reader. However, the coined word may convey to the reader an entirely different meaning. In some cases the results of this failure to communicate are sad, in other cases they can be laughable.

Mr. Stephen A. Thompson, in writing "To share or not to share" [*The Electronic Engineer*, Nov. 1969, p. 20], overlooking the diverse backgrounds of his readers, coined a word and used it. I am sure the coined word gave a different twist to the article the first time your readers read it, at least to many of us.

Compound words are formed by writing a prefix and a base word. This conveys a meaning. Often we may use the antonym of the prefix and add it to the base word to convey an opposite meaning, such as on-shore and off-shore. This does not always work as intended because the antonym-base word combination may have a long established meaning far removed from what the writer (coiner) had in mind.

Early in the 1950's, the term *in-house* became one of the "in" words in the research and development community. And it is the use of this word that caused Mr. Thompson to fall through one of two or three holes. He failed to check the meaning of his compound word [*out-house*] after using an antonym as a prefix in coining it.

I was raised on a farm in the Ozark Mountains of northwest Arkansas. I am sure many of your readers, especially the more senior ones, were raised well beyond the ends of paved roads and power lines in a somewhat austere environment. Therefore, we must have received a mental jolt when we read the second sentence in the opening paragraph of his column. Frankly, I never considered there was any decision to be made if an *in-house* capability was available.

The *out-house* capability was the subject of many jokes by a humorist named Chic Sale during the Twenties. I remember reading one of his books, *The Specialist*, in which he describes, as only he could, how they are designed and constructed, even to carving a half moon emblem on the door. In some areas these structures were known as Chic Sales. As late as 1936 I worked at a broadcast transmitter site having one of these structures out back as standard equipment for the operator, complete with monitor

speaker. Years ago when I was learning to fly an airplane, long before the days of our modern system of electronic aids to air navigation, my instructor told me that if I doubted my magnetic compass on a cloudy day, to drop down and fly low over some farm houses and look closely. The little house out back usually faced south.

I have checked my desk dictionary and also "The Random House Dictionary of the English Language (Unabridged)" and "Webster's Third New International Dictionary (Unabridged)" without finding the word, *out-house*, defined in the manner suitable for Mr. Thompson's column. It is defined as I somewhat painfully remember it.

I thought I would bring this to your attention so that other writers, seeing it used in this manner and without further checking of its meaning might assume it is now an "in" word, not realizing there are still many readers who did not enjoy a sheltered childhood.

The subject is laughable now, but it was not then. Thanks for a first class magazine. I enjoy it, and I promise not to pick a fight with the technical editor.

Lester C. Harlow, P. E.  
San Diego, Calif.

**Steve Thompson replies:** I am well acquainted with the standard definition of *out-house*. I can't take credit for assigning an additional meaning to the term, though, since I was quoting what the speaker said at the meeting on time-sharing. Personally, I would have left that picturesque noun alone.

I learned to fly a little later than Mr. Harlow did. The only useful information to be gleaned from the landscape, as I recall, was that on a forced landing the direction of the wind could be determined by noting which way the cows stood. They were supposed to prefer a hindsides-to-the-wind posture. I hope that builders of out-houses were more faithful in facing south than cows were in standing the way they were supposed to.

### Hermetic seals for Ta

Sir:

The *Electronic Engineer*, Vol. 28, No. 3, March 1969, page 75, cites a need for a hermetic seal for "wet" tantalum capacitors.

Ta-to-glass, high-vacuum seals accomplished in 1962 using 0.005 in. thick Ta ribbon. If anyone is interested, write

Donald R. Bellis  
7646 Barnhart Pl  
San Jose, Calif. 95129

# If you think uniquely styled enclosures have to cost a bundle... then take a look at INTERFACE-33

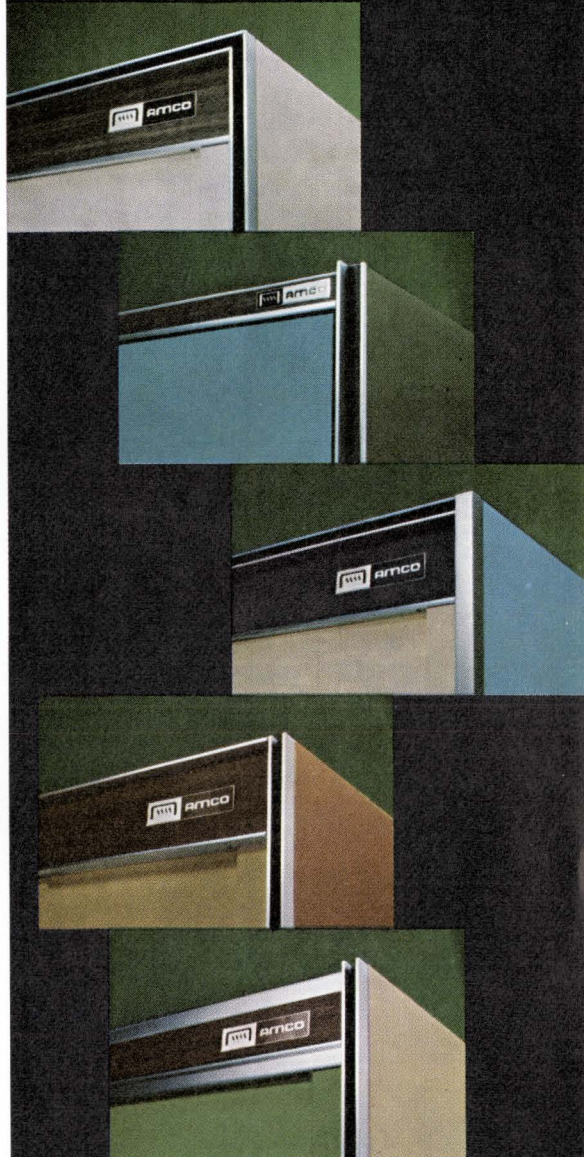

IT'S A WHOLE NEW  
CONCEPT THAT WILL SAVE  
UP TO 75% OF YOUR  
STYLING COSTS.

READ ABOUT IT... JUST  
CHECK THE READER  
SERVICE NUMBER BELOW.



AMCO ENGINEERING CO.  
7333 West Ainslie Street  
Chicago, Illinois 60656



← Circle 13 on Inquiry Card

Circle 14 on Inquiry Card →

See us at Nep-Con West-Booth 501

# BLACKBOXING...?

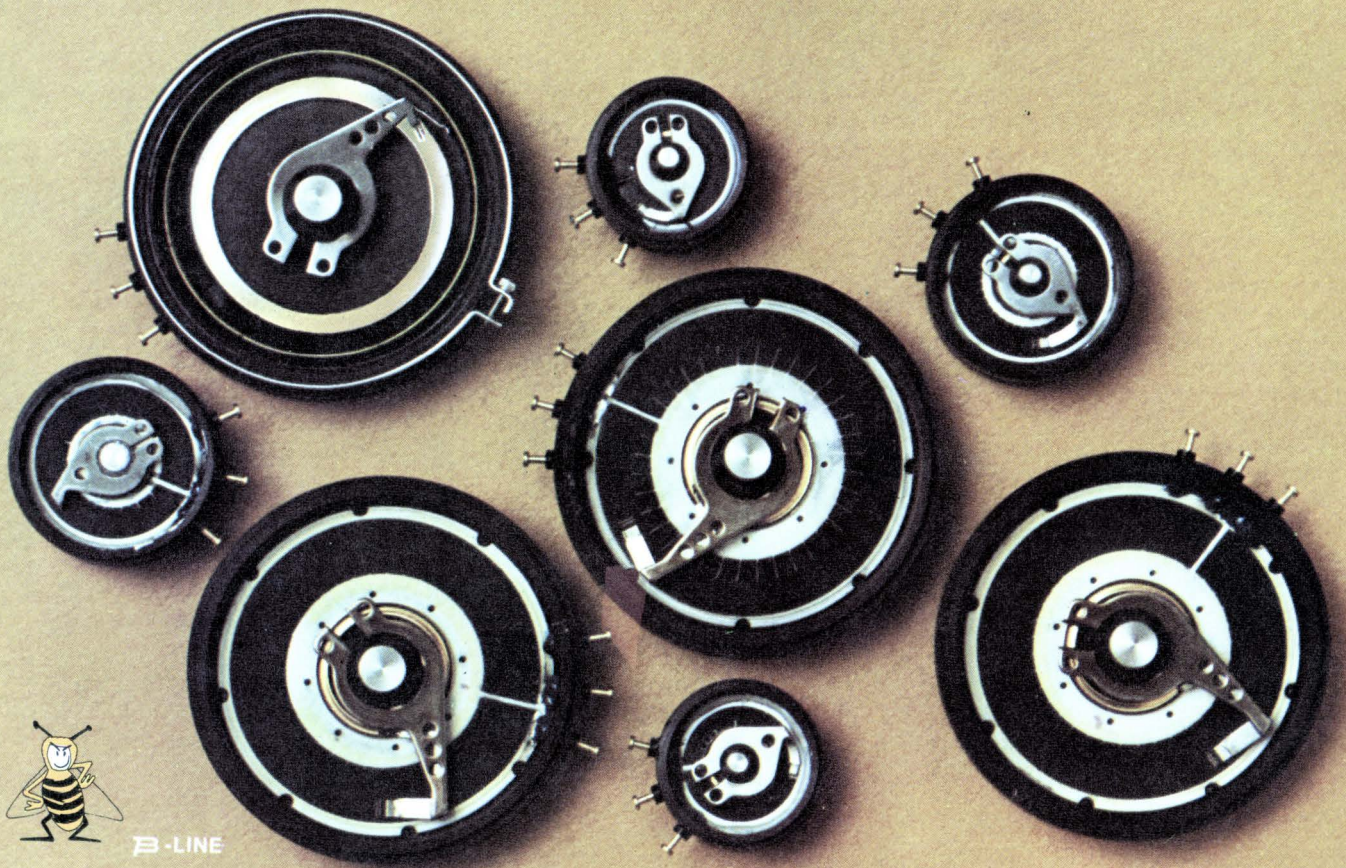

B-LINE

## FORGET ABOUT POTENTIOMETER ELEMENT— ... DESIGN FOR SIZE AND DEPTH!

Eliminate size restrictions previously imposed by electrical application! The B-LINE™ series does it! Regardless of the type of element—wirewound, conductive plastic, cermet or BiFilm™\* . . . The B-LINE series, in the new standard size and a compact, sturdy package, lets you design your black box before the elements are chosen!

### *To the packager*

Three standard diameters— $\frac{7}{8}$ " ,  $1\frac{1}{16}$ " , 2". No more "hands-tied" electrical specifications that dictate overall size!

### *To the buyer*

Standard size—0.2" per extra cup—avoid headaches of "almost the same as", "just like", etc.

### *To you*

Whatever your function, Bourns B-LINE potentiometers can solve a problem in your responsibility area. They truly provide an answer where no one before has dared to tread!

Get complete details on the versatile, slim, trim B-LINE series from the factory, your local Bourns Sales Office or Representative today!

\*BiFilm is Bourns new, low TC Conductive Plastic





## THE WESTERN COLUMN

### Trade secrets: the engineer is caught in the middle

As R & D budgets and the technological content of products rise, so does the incentive for industrial espionage. To counter the wave of spy as co-worker, J. J. Berliner & Staff of New York City, a management education firm, sponsors seminars concerned with protecting trade secrets. Leading officials of several West Coast firms who are disturbed by this problem attended the most recent seminar in Palo Alto, California.

#### Key point

Mr. Sanford Kaufman of the law firm of Adams, Giaimo, & Kaufman, located in Jamaica, New York, supervised the session and provided many insights into this complex subject. Mr. Kaufman repeatedly stressed his primary point. "For a company to protect its trade secrets it must recognize what it has that is proprietary, and then treat it as such." Employers must inform employees of the nature of their work and their responsibility, as well as take active steps to safeguard trade secrets. If this is not done, the company will have no basis for a successful court case against anyone who may steal valuable information. Despite the sophistication of electronic eavesdropping, a firm's most effective competitors, by far, are its own employees.

John B. Sheehan, director of Security and Safety for Fairchild, defined proprietary information as "any data, which includes unclassified documents, information, or material of a privileged nature, the unauthorized disclosure of which would be detrimental to the best interests of the company." It is anything that maintains lead time over your competitors. He listed three ideal situations for the industrial spy:

- a. To be a janitor on the second shift.
- b. To see the contents of waste baskets.
- c. To have access to tab runs from the trash can.

#### Ounces of prevention

One way to reduce the possibilities of hiring troublesome employees is to run a background check on each one. Jeremiah P. McAward, president of McAward Associates of New York City, used numerous illustrations of how simple background checks—not worthless reference checks—could have saved many companies untold dollars.

According to Richard J. Healy, head of Security for Aerospace Corp., the security of trade secrets is one part of an overall security program that includes emergencies, disasters, fires, etc.

#### Legal developments

Many states have enacted laws with teeth in the past two years concerning trade secrets. Convictions are rising and guilty parties are going to jail. Courts now treat computer programs and tapes as having intrinsic value greater than the value of the material they are printed on. Stealing them is grounds for conviction, as two men in Texas now serving ten-year sentences can testify.

#### What about engineers?

Engineers are deeply involved in this problem. They are mobile, desire to change jobs and locations, and often are forced to seek new employment. In the Motorola-Fairchild dispute, Lester Hogan is using a unique defense that may apply to all engineers. He is contending that the Thirteenth Amendment, abolishing slavery, would be violated if a person is kept on a job on the assumption that he might take trade secrets, because this puts him into a position of involuntary servitude.

The dodge of hiring technology under the guise of hiring a "great manager" has already been struck down by a court ruling that forced one company to take such an individual and place him in a management position in a division of his new company not related to the products he had formerly worked on.

The ethics of this subject are elusive. On one hand, what engineer can say that he learned most of what he knows about his field outside of the companies he has worked for? On the other hand, he observes unusual company practices such as:

- Reverse engineering. This is the breaking down of another company's products to find out how they are made. This is legal; stealing them is not.
- Giving R & D engineers working on government contracts a company charge number to charge one hour a day to.
- Hiring a mass of engineers to bid on a large contract. If they lose the bid, the company happily reduces its payroll by letting them go to work for the winner.

Stephen A. Thompson, Western Editor

# Down with the cost of time code generators



Down to only \$870. That's all you pay for the basic Chrono-log Series 4,000 Integrated Circuit Time Code Generator. Yet it will provide time code information in an IRIG or NASA format in both modulated carrier and shift level codes, simultaneously. It will also provide a parallel 8-4-2-1 BCD output as well as a visual BCD indication of hours, minutes and seconds. And it's only 1 3/4 in. high.

The Series 4,000 Time Code Generator can also be supplied with a choice of low-cost optional features. These include:

- NIXIE digital display
- Choice of IRIG-A, B, C or E format or NASA-36 or -28 bit format
- Operation from 115 or 230 volts ac or 5 volts dc
- Five different time bases ranging from the 60 Hz line to a 1x10<sup>-7</sup> per week internal oscillator

For the complete low-down, including the down-low prices, write Chrono-log Corp., 2583 West Chester Pike, Broomall, Pennsylvania 19008 or call (215) 356-6771.



# DATA TRANSMISSION

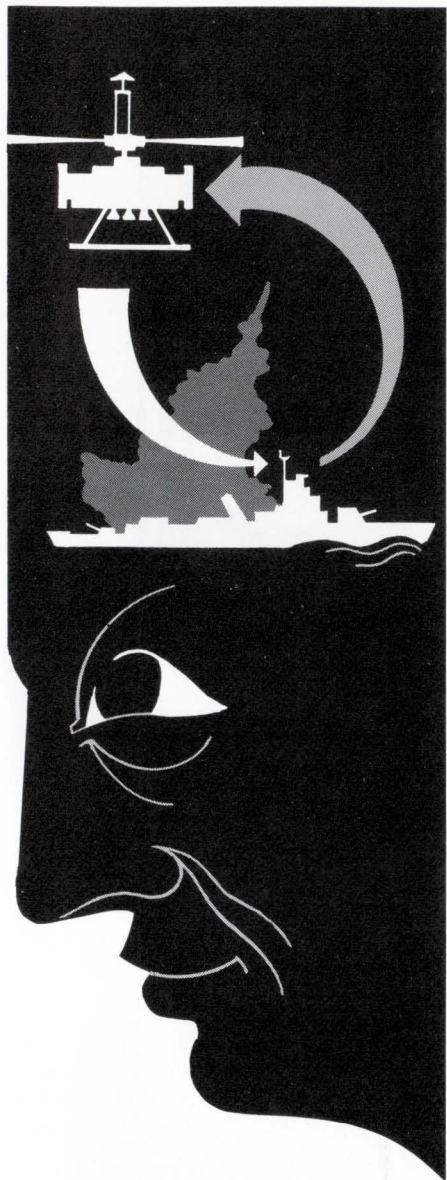

TOTAL ELECTRONIC  
SYSTEMS CAPABILITY.  
SPECIALISTS IN  
TIME/FREQUENCY,  
RADAR AND  
DATA SYSTEMS  
OFFERING RAPID  
GROWTH.

**SIERRA**   
RESEARCH CORPORATION  
an equal opportunity employer  
P.O. BOX 222, BUFFALO, N. Y. 14225

Circle 17 on Inquiry Card

## CALENDAR

### JANUARY

			1	2	3		
4	5	6	7	8	9	10	
11	12	13	14	15	16	17	
18	19	20	21	22	23	24	
25	26	27	28	29	30	31	

Jan. 13-15: 1970 Microwave Exposition, Cabana Motor Hotel, Palo Alto, Calif. Addtl. Info.—Exposition Management, Technical Industry Expositions, Inc., 34 West Putnam Ave., Greenwich, Conn. 06830.

Jan. 25-30: 1970 IEEE Winter Power Meeting, Statler Hilton Hotel, N.Y. Addtl. Info.—W. C. Hayes, Publicity Chairman, 1970 Winter Power Meeting, 33rd St. & 7th Ave., N.Y., N.Y. 10017.

Jan. 27-29: 1970 Annual Symposium on Reliability, The Ambassador Hotel, Los Angeles, Calif. Addtl. Info.—W. R. Abbott, Program Chairman, Lockheed Missiles & Space Co., Dept. 60-01, Bldg. 104, Box 504, Sunnyvale, Calif. 94088.

Jan. 30-31: Winter Television Conf., Mariott Motor Hotel, Atlanta. Addtl. Info.—Program Chairman Bondy, SMPTE, Att: Conference Program, 9 E. 41st., New York, N.Y. 10017.

### FEBRUARY

1	2	3	4	5	6	7
8	9	10	11	12	13	14
15	16	17	18	19	20	21
22	23	24	25	26	27	28

Feb. 4-6: 5th Annual Conference on the Use of Digital Computers in Process Control, Baton Rouge, Louisiana Addtl. Info.—Al Krigman, "ICS Magazine," Chilton Company, 1 Decker Square, Bala-Cynwyd, Pa. 19004.

Feb. 10-12: Aerospace & Electronic Systems Convention (WINCON), Baltimore Hotel, Los Angeles, Calif. Addtl. Info.—G-AES, L. A. Council.

Feb. 11-13: AMA Conference—Annual Personnel Conference, Palmer House, Chicago. Addtl. Info.—AMA News Relations, American Management Association Bldg., 135 W. 50th St., New York, N. Y. 10020.

Feb. 12-14: 2nd National Conf. & Exposition on Electronics in Medicine, Fairmont Hotel, San Francisco, Calif. Addtl. Info.—Mr. Jerry Brown, Nat'l Expositions Co., 14 West 40th St., New York City, N. Y.

Feb. 18-19: The Era of Thermosets (RETEC), Park Plaza Hotel, New Haven, Conn. Addtl. Info.—Wm. H. Smith, Waterbury Companies, Inc., 835 S. Main St., Waterbury, Conn., 06720.

Feb. 18-19: Instrumentation Fair, International Hotel, Los Angeles, Calif. Addtl. Info.—Instrumentation Fair, Inc., c/o Larry Courtney Co., 16400 Ventura Blvd., Encino, Calif. 91316.

Feb. 18-20: Int'l Solid State Circuits Conference, Sheraton Hotel, Univ. of Penna., Phila., Pa. Addtl. Info.—T. Bray, Gen'l Elec. Col., Bldg. 3, Rm. 261, Electronic Park, Syracuse, N. Y. 13201.

Feb. 25-26: Instrumentation Fair, Fairgrounds of San Mateo, Calif. Addtl. Info.—Instrumentation Fair, Inc., c/o Larry Courtney Co., 16400 Ventura Blvd., Encino, Calif. 91316.

Feb. 25-27: AMA Conference—Annual EDP Conference, Americana Hotel, New York. Addtl. Info.—AMA News Relations, American Management Association Bldg., 135 W. 50th St., New York, N. Y. 10020.

### '70 Conference Highlights

IEEE—Institute of Electrical and Electronics Engineers Int'l Convention & Exhibition, March 23-26; New York, New York.

WESCON — Western Electronic Show and Convention, Aug. 25-28; Los Angeles, Calif.

NEC—National Electronics Conference, Oct. 26-28; Chicago, Illinois.

NEREM—Northeast Electronics Research Engineering Meeting, Nov. 4-6; Boston, Mass.

### Call for Papers

July 21-24: 1970 IEEE Annual Conf. on Nuclear and Space Radiation Effects. Submit a two-to four-page summary (including figures) appropriate to a 15-minute presentation by Feb. 16 to the 1970 Technical Program Chairman: R. K. Thatcher, Batelle Memorial Institute, 505 King Ave., Columbus, Ohio 43201.

Sept. 21-24: 1970 IEEE Int'l Conf. on Engineering in the Ocean Environment, Panama City, Fla. Authors must submit both a 35-word abstract and 300-500 word summary, appropriate to a 20-minute paper by March 3, 1970 to C. B. Koesy, Code P750, Naval Ship Research and Dev'l Lab., Panama City, Fla. 32401.

# Integrated Circuits



## The ABCs of MIL-STD-883: MACH IV

TI is ready now to deliver integrated circuits "in accordance to MIL-STD-883." We're committed to the task. Money, manpower and facilities.

What's more, we're ready to tell you exactly how we'll do it.

### *In detail.*

You'll find most of the answers in TI's 40-page MACH IV procurement specification covering 883—supplemented by 100 pages of detailed product specifications.

It is the most comprehensive book of its kind. By far.

If you need more answers, you'll get them from the men pictured above. They're members of a special HI-REL Task Force organized for TTL ICs (we have Task Forces for DTL and linear, too).

These men are managers from

the areas of reliability engineering, process engineering, product planning, military marketing, product sales, product engineering, quality control, manufacturing, and HI-REL assembly.

They'll help you determine the specific procedures and reliability levels you'll need to meet 883.

Then they'll see your order through. Successfully. Even if they have to cross departmental boundaries and step on a few toes to break bottlenecks.

They'll focus TI's experience and abilities on your job. You see, we've been delivering 100% tested ICs for years. Millions of them for Minuteman, Sprint, Poseidon, F-111 and other programs.

And some of these had even tighter requirements than 883.

Another thing. You'll have the industry's best facilities going for you at TI. From more than 50,000 burn-in sockets to environmental shake, rattle and roll labs, to IR scanners, microprobes, Radiflo and variable data loggers.

With our commitment, experience and facilities, we're doing our best to make MIL-STD-883 as simple as ABC.

Write for "MACH IV High Reliability Procurement Specification MIL-STD-883" on your company letterhead. Texas Instruments Incorporated, PO Box 5012, MS 308, Dallas, Texas 75222. Or call your local TI Sales Office.



## TEXAS INSTRUMENTS INCORPORATED

# To make a Quad Latch that's both R/S and D compatible,

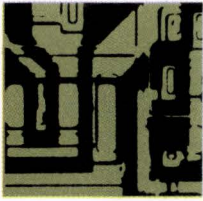

Fairchild's new MSI 9314 Quad Latch is a versatile, high-speed device that can be used in any application requiring a single-input D-type latch or an R/S-type latch. It has no undefined states in the R/S mode. Its unique multi-function capabilities make it useful in a number of applications:

four-bit storage latches, contact bounce eliminators, multi-input active high set/reset latches, counting and holding display systems, eight-bit addressable latches, A/D conversions, zero and ones catching storage.

The addition of this device to our MSI family gives you everything you need for just about any latching application you could name. Use the new 9314 for maximum function versatility. Or the 9308 Dual Four-Bit Latch when minimum package count is most important. Your Fairchild Distributor has complete specs on both MSI devices.

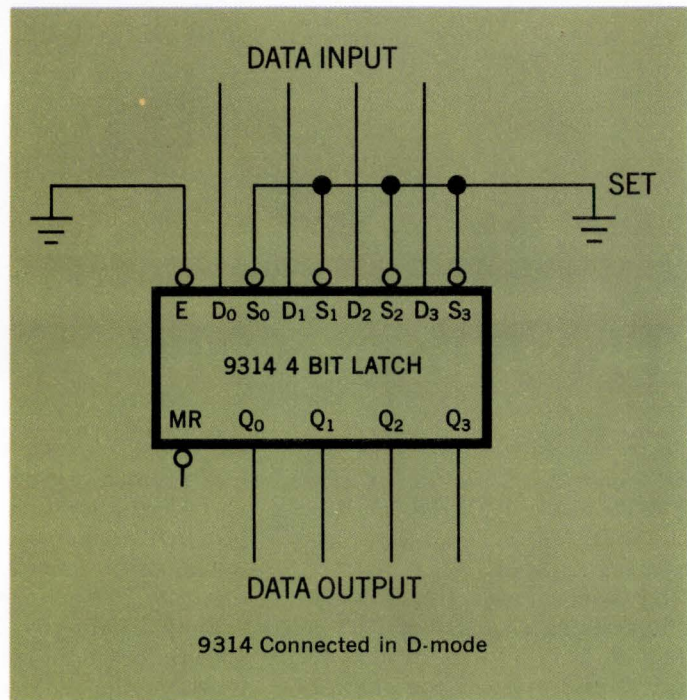

To order the 9314, ask for:

PART NUMBER	PACKAGE	TEMPERATURE RANGE	PRICE (1-24)	PRICE (25-99)	PRICE (100-999)
U6B931451X	DIP	-55°C to +125°C	\$19.40	\$15.50	\$13.00
U6B931459X	DIP	0°C to + 75°C	9.70	7.75	6.50
U4L931451X	Flat	-55°C to +125°C	21.35	17.05	14.30
U4L931459X	Flat	0°C to + 75°C	10.70	8.55	7.15

To order the 9308, ask for:

PART NUMBER	PACKAGE	TEMPERATURE RANGE	PRICE (1-24)	PRICE (25-99)	PRICE (100-999)
U6N930851X	DIP	-55°C to +125°C	\$25.40	\$20.20	\$17.00
U6N930859X	DIP	0°C to + 75°C	12.70	10.10	8.50
U4M930851X	Flat	-55°C to +125°C	27.95	22.20	18.70
U4M930859X	Flat	0°C to + 75°C	13.95	11.10	9.35

# you have to get serious about MSI family planning.

We put together a family plan by taking systems apart. All kinds of digital systems. Thousands of them.

First we looked for functional categories. We found them. Time after time, in a clear and recurrent pattern, seven basic categories popped up: Registers. Decoders and demultiplexers. Counters. Multiplexers. Encoders. Operators. Latches.

Inside each of the seven categories, we sifted by application. We wanted to design the minimum number of devices that could do the maximum number of things. That's why, for example, Fairchild MSI registers can be used in storage, in shifting, in counting and in conversion applications. And you'll find this sort of versatility throughout our entire MSI line.

Finally, we studied ancillary logic requirements and packed, wherever possible, our MSI devices with input and output decoding, buffering and complementing functions. That's why Fairchild MSI reduces—in many cases eliminates—the need for additional logic packages.

The Fairchild MSI family plan. A new approach to MSI that's as old as the industrial revolution. It started with functional simplicity, extended through multi-use component parts, and concluded with a sharp reduction in add-ons. Simplicity. Versatility. Compatibility. Available now. In military or industrial temperature ranges. In hermetic DIPs and Flatpaks. From any Fairchild Distributor.

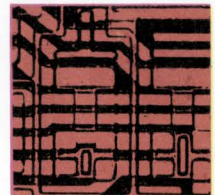

**OPERATORS**  
9304 — Dual Full Adder/Parity Generator

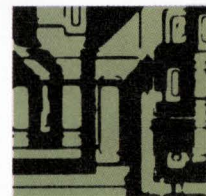

**LATCHES**  
9308 — Dual 4-Bit Latch  
9314 — Quad Latch

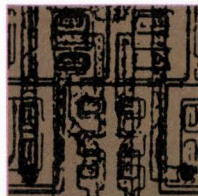

**REGISTERS**  
9300 — 4-Bit Shift Register  
9328 — Dual 8-Bit Shift Register

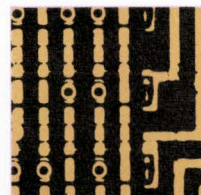

**MULTIPLEXERS**  
9309 — Dual 4-Input Digital Multiplexer  
9312 — 8-Input Digital Multiplexer

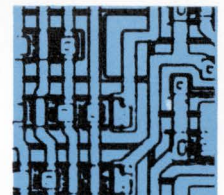

**DECODERS AND DEMULTIPLEXERS**  
9301 — One-Of-Ten Decoder  
9315 — One-Of-Ten Decoder/Driver  
9307 — Seven-Segment Decoder  
9311 — One-Of-16 Decoder  
9317 — Seven-Segment Decoder/Driver

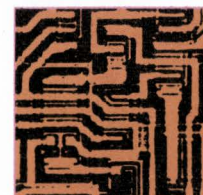

**COUNTERS**  
9306 — Decade Up/Down Counter  
9310 — Decade Counter  
9316 — Hexadecimal Counter

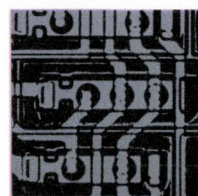

**ENCODERS**  
9318 — Priority 8-Input Encoder

Nobody makes MSI the way  
Fairchild does.



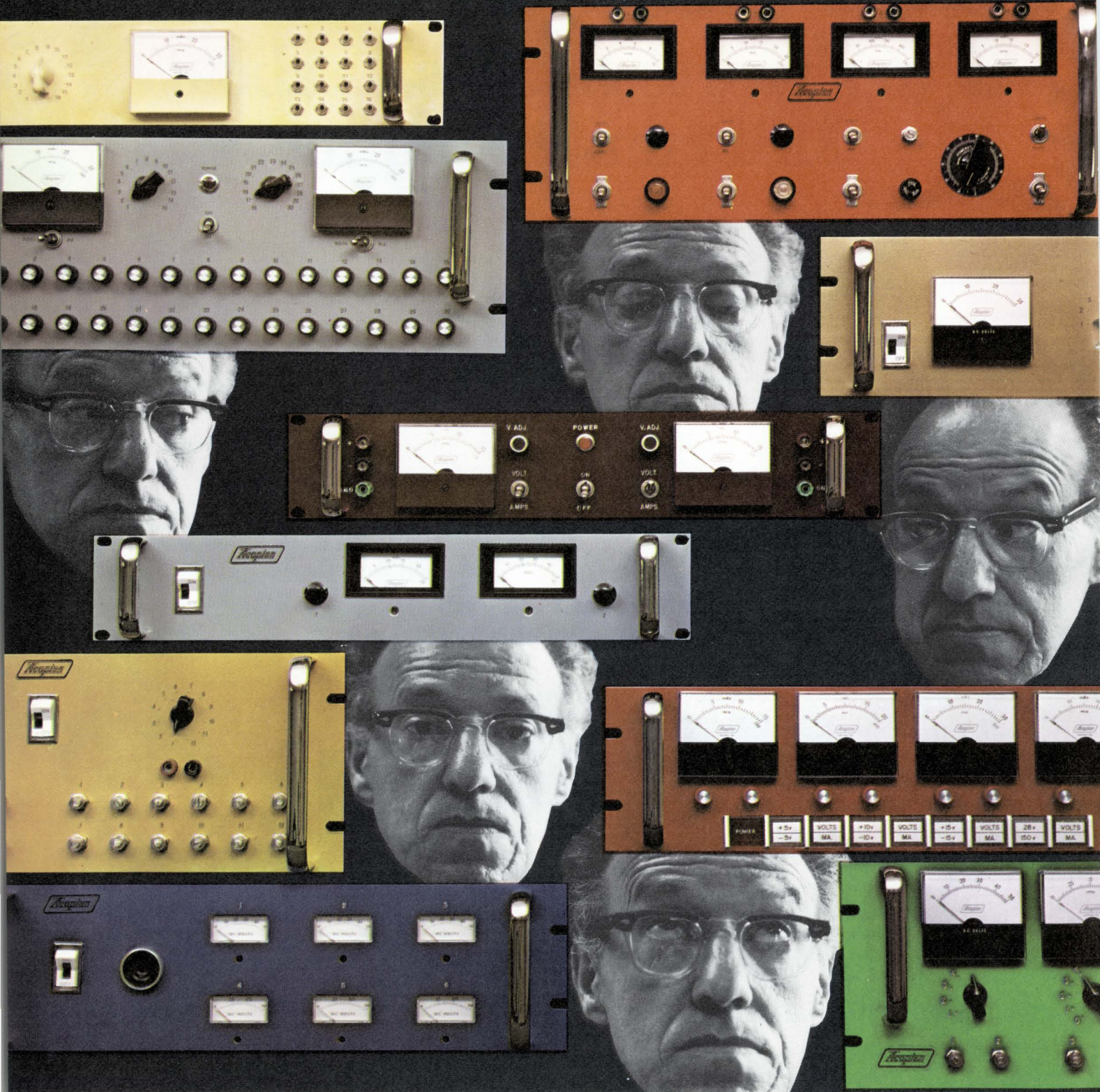

**Looking for a special power supply system?  
Acopian will ship it in just 9 days!**

When you're looking for a multiple-output power supply system, and you need it in a hurry, look no further. Acopian will design it, build it, test it, and ship it...fully wired...*in just 9 days!*

Call 'hot line' 215-258-5441. Simply tell us the DC voltages and currents you need. We'll discuss—on the phone—the power modules, the panel size, accessories such as meters, terminations, test jacks, rotary

switches or any other feature you feel is important. Then—on the phone—we'll give you a firm price—and get the order going for guaranteed 9-day shipment.

Others make promises. Acopian makes power supplies. Power modules in 3 days, and now power systems in 9 days. For immediate service, call 215-258-5441. For literature, write Acopian Corporation, Easton, Pa. 18042.

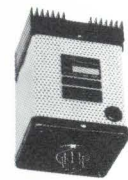

# Special Designs

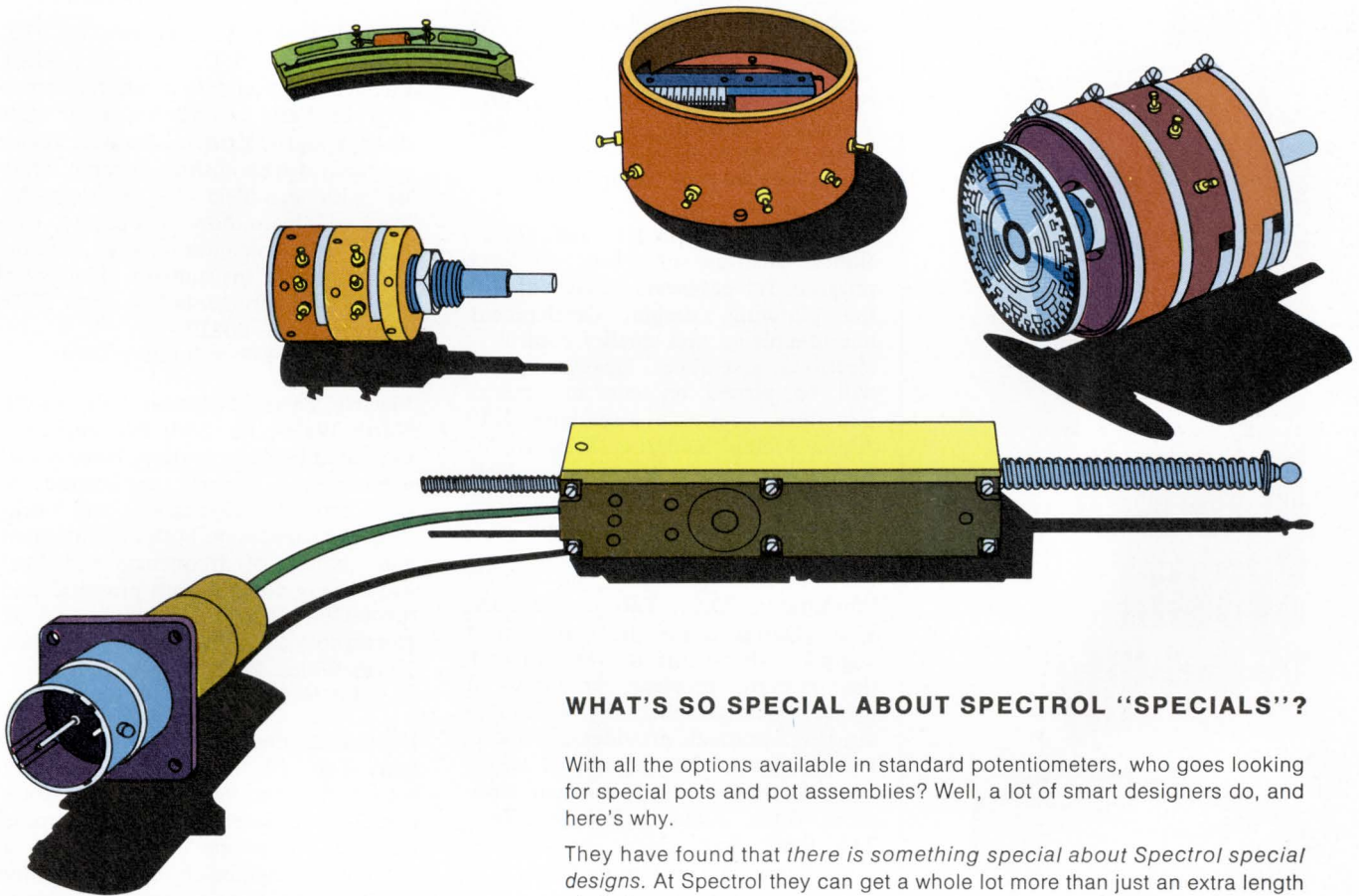

## WHAT'S SO SPECIAL ABOUT SPECTROL "SPECIALS"?

With all the options available in standard potentiometers, who goes looking for special pots and pot assemblies? Well, a lot of smart designers do, and here's why.

They have found that *there is something special about Spectrol special designs*. At Spectrol they can get a whole lot more than just an extra length of shaft or beefed up stops in a special pot. More and more designers are entering into an engineering partnership with Spectrol. They are coming early enough in their developments to let Spectrol specials help them expand their design opportunities.

Some of them like the way Spectrol can combine switches, brakes, and motors into a single pot assembly. Others go for the space and cost savings they can realize by the use of unpackaged Spectrol pot sectors. And, of course, with the trend toward greater component density, many instrument designers are looking to Spectrol for new component packaging ideas that can be implemented promptly and inexpensively. Whatever your requirement, remember that for over 15 years Spectrol has led the industry in the design and production of special potentiometers.

*We have prepared a helpful brochure entitled, "Special Designs." Get your copy today. Discover how your design options can be greatly expanded when you think ahead about using Spectrol "specials." Circle the reader service card, or contact us directly.*



SPECTROL ELECTRONICS CORPORATION A Subsidiary of Carrier Corporation 17070 E. GALE AVE., CITY OF INDUSTRY, CALIF. 91745 • PHONE: (213) 964-6565 • TWX: (910) 584-1314

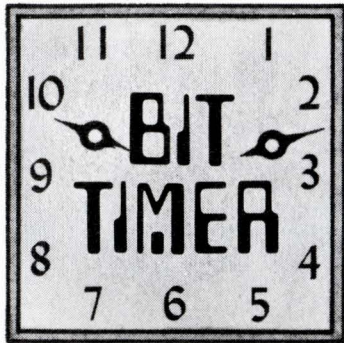

# Bliley CLOCK OSCILLATORS use Bliley Crystals to Insure System Reliability

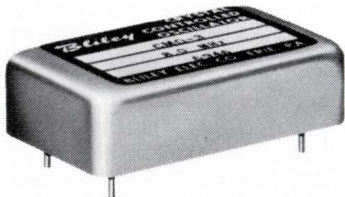

## Our New CMO Series offers

- Frequency Range 50 Hz-25 MHz
- Custom Stability per your Specs
- TTL Compatible Output
- Operation on 5 VDC
- PC Board Mounting
- Low Profile Packaging

Call or write us today  
with your specification requirements

**Bliley** if you buy quality

## BLILEY ELECTRIC COMPANY

2545 W. Grandview Blvd  
Erie, Pa. 16512

Circle 21 on Inquiry Card

## PRODUCT SEMINARS

This column lists product seminars that electronic companies offer to users of their products.

**Digital Systems Engineering:** Jan. 19-23, Los Angeles, \$395. Here is a program designed to help you obtain an understanding of digital design principles. In addition to studying the central processing unit of a digital computer, you will be introduced to interfacing techniques which involve such subjects as sampling theory, analog-to-digital and digital-to-analog conversion, as well as modern encoders. RCA Institutes Inc., Institute for Professional Development, Box 962, Clark, N.J. 07066.

Circle 409 on Inquiry Card

**Soldering Technology:** Jan 20-21, Illinois Institute of Tech., \$175. A program for engineers concerned with the planning, design, development, manufacturing and quality control of electronic assemblies. Heavy emphasis will be placed on pcs and micro-miniature electronic assemblies. IIT/Alpha Metals Soldering Seminar, W. R. Dunbar, Grover M. Hermann Hall, Illinois Institute of Tech., Chicago, Ill.

Circle 410 on Inquiry Card

**Project Management:** Jan. 20-22, Washington, D.C.; Feb. 2-4, Seattle, \$350. Designed for the management engineer who wants to keep up with the modern, practical principles of project management. The workshop-seminar approach provides a working knowledge of the techniques which comprise this new management discipline. Booz, Allen & Hamilton Inc., 245 Park Ave., New York, N.Y.

Circle 411 on Inquiry Card

**Sputtering and Electronic Production:** Jan. 26-28, Pebble Beach, Calif., \$300. Applications of the thin film "sputtering" desposition technique in the electronic industry will be discussed in this seminar. Another major part of the program is to review the continual modernization of desposition equipment and methods which apply to the practical manufacture of electronic products. "Sputtering," Materials Research Corp., Orangeburg, New York, 10962.

Circle 412 on Inquiry Card

**Hybrid Microelectronic Packaging Technology Workshop:** Jan. 26-29, Monrovia, Calif. The seminar is arranged to progress from lecture and discussion to student participation in actual package fabrication. The seminar covers bonding principles, beam-

lead technology with interfusion of flip-chip, thin-thick-film technology, substrate physics and economic/design criteria as related to designing the optimum hybrid package. Unitek Corp./Weldmatic Div., 1820 S. Myrtle Ave., Monrovia, Calif. 91016.

Circle 413 on Inquiry Card

**Operation and Maintenance of Visicorders:** Feb. 2-6, Denver, Colo., \$180. For those of you with a general knowledge of basic electronics, solid state devices and electro mechanical repair procedures who wish to become familiar with the field of oscillography. You will learn how to operate, calibrate and maintain many different oscillographic instruments. Honeywell Inc., Test Instruments Div., Box 5227, Denver, Colo. 80217.

Circle 414 on Inquiry Card

**Electric Power Seminar:** Feb. 16-20, North Wales, Pa. \$50. For engineers interested in the operation, basic maintenance and general application of L&N products. Discussions and workshop experiences on both measurement and control of frequency and load dispatching contain both practical and theoretical information. Leeds & Northrup Co., Sumneytown Pike, North Wales, Pa. 19454.

Circle 415 on Inquiry Card

**Communications ICs Application Seminar:** Feb. 17, Phila., Pa. The day before the International Solid State Circuits Conference, The Electronic Engineer magazine will sponsor a seminar highlighted in the morning by six papers on the new ICs for communication (i-f limiters, agc amplifiers, rf amps, etc.) and in the afternoon by a "hands on" workshop session. For information, price and registration forms

Circle 416 on Inquiry Card

**Relays and Their Applications:** Feb. 18, Los Angeles, \$10 pre-registration; \$15 at the door. Recognized experts in the field of relay application and use will discuss relays. The morning will be devoted to papers, and after lunch, a panel of experts will answer any questions concerning relays. The registration fee covers the coffee break, lunch and a copy of the papers. To register for Relay Think-in #3, or for more information, contact H. J. Roeser, Ohmite Manufacturing Co., 3601 Howard St., Skokie, Ill. 60076.

Circle 417 on Inquiry Card

Circle 22 on Inquiry Card →



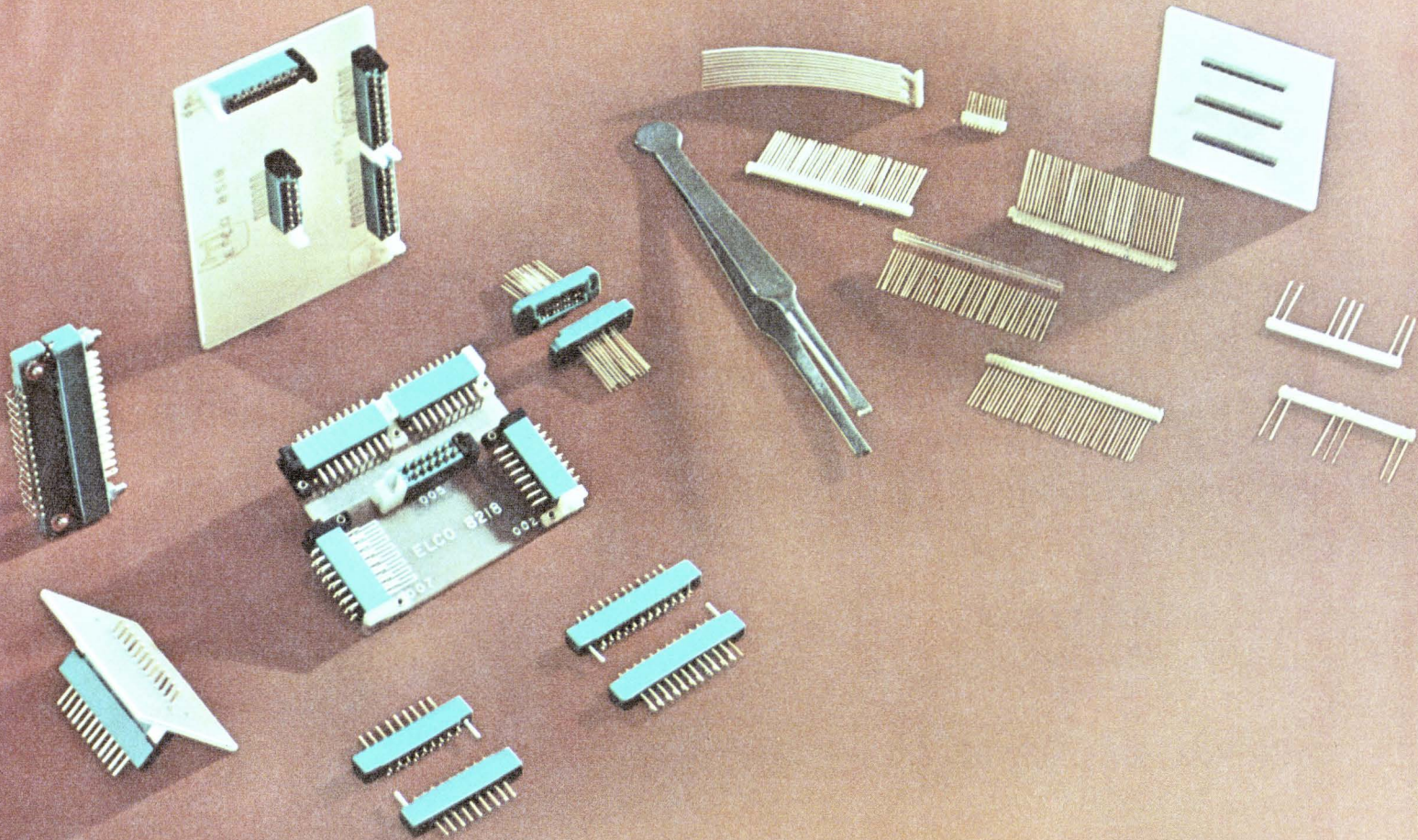

## Miniature, subminiature connectors, yes.

### Miniature, subminiature contacts, no.

Microelectronics can give you a pain in the tweezers. You have to be perfect. And you have to be perfect in places so small that a flea would have trouble scratching his back.

Actually, the electronics part isn't too hard, what with piezoelectric this's and thin-film that's to work with.

But, inevitably, there comes the day when all the this's and that's have to be put together. It's a problem. Mechanically. Electrically.

You don't want to put a big fat plug on a skinny little mini-circuit.

So you need miniature or subminiature connectors. Those we have. By the catalogfull.

But you sure don't need undernourished contacts. You need all the strength you can get, all the contact area you can get, all the hang-togetherness you can get.

Those we give you. Every miniature in our catalog is made with our patented Varicon™ contacts (you probably already know about them). Our newer sub-miniatures are made with Bi/Con™ contacts (which

is sketched at the left).

See the four mating surfaces?

Four mating surfaces, coined so that they're exceptionally hard and smooth.

Four mating surfaces, held together snugly by the spring-like action of the design. And by the innate characteristics of the phosphor-bronze.

Four mating surfaces, strengthened by a reinforcing web.

Four mating surfaces, on a contact that floats in its insulator to make sure that the four mating surfaces mate.

No comparably sized contact can match the Bi/Con's dimensional, electrical, and mechanical characteristics.

And no subminiature contact can match the Bi/Con's incredibly low price, either.

For more information, write, wire, call or TWX us for our Microelectronics catalog.

Elco Corporation, Willow Grove, Pa. 19090.  
(215) 659-7000. TWX 510-665-5573.

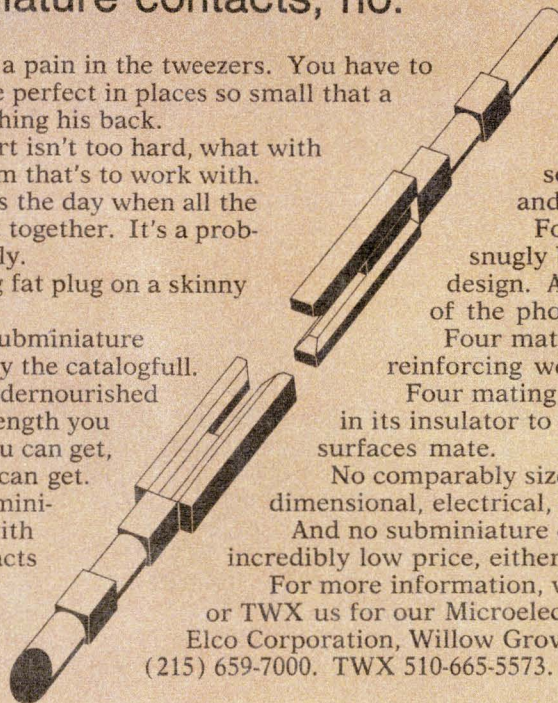

**ELCO** Varicon® miniatures  
Bi/Con® subminiatures

See us at Nepcon West 1970. Booth #509.

# MUCON<sup>®</sup> CERAMIC CAPACITORS

## NPO

STABILITY  $\pm .3\%$   
-55°C to +125°C

Q GREATER THAN  
1000 ... UP TO 1000 MHz

CAPACITANCE 1/2 PF.  
to 56000 PF.

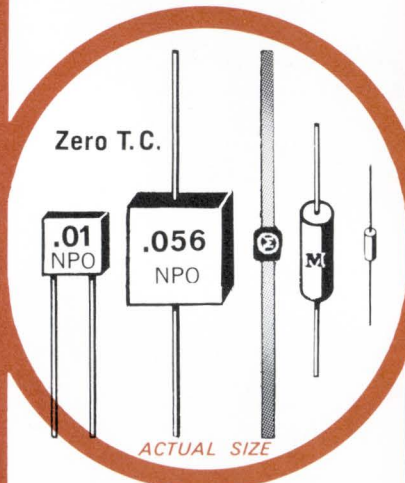

RIBBON LEADS AVAILABLE  
FOR LOW INDUCTANCE

ALSO COMPLETE RANGE OF  
TEMP. COMPENSATION  
thru N5600 PPM/°C

write for  
NEW CATALOG

Republic Electronics makes a broad  
line of Mucon Subminiature Ceramic  
Capacitors to meet any requirement.

**REPUBLIC ELECTRONICS CORP.**  
176 E. 7th St. PATERSON, N. J. 07524  
201 - 279-0300 TWX 710-988-5908

Circle 23 on Inquiry Card

## WELCOME

This column welcomes new companies or new divisions in the electronics industry.

### Specialized semiconductor products

Supplying precision thin-film hybrid microcircuits to the aerospace, communications and instrumentation markets is the task that Micro Networks Corp. has set for itself. Located at 5 Barbara Lane in Worcester, Mass., the new company's main objective is to develop a leadership position in thin-film technology for hybrid circuits.

Product capabilities include memory drive circuits capable of handling several hundred milliamps of current at low dissipation and high voltage ratings; regulator circuits, fixed or externally variable; positive and/or negative output dc voltage regulators; D-A conversion circuits with accuracy up to 12 bits; ladder switches for driving A-D ladder networks; buffer switches capable of operating from DTL or TTL inputs, and a quad power driver which consists of a monolithic quad gate and four transistor output stages. Presently under development is a voltage regulator with load regulation of 0.001% and a 10-v regulated output which is expected to be available some time in February.

Because the new corporation is concentrating its efforts on a narrow segment of the semiconductor products area, its management feels that Micro Networks can assure a greater degree of competence in supplying standard and custom hybrid circuits than its competitors with diverse interests.

Circle 418 on Inquiry Card

### A little light on the subject

The opto-electronic market will find Optron, Inc., a progressive participant in the field. This contemporary company manufactures and markets silicon light sensors and light sensor arrays for use in computer peripheral equipment.

Mr. R. J. Kirk, vice-president in charge of marketing, considers the strength of his company its concentration on specific product applications. "Because Optron specializes in light sensors we are purposely limiting our field of production so as to concentrate on single and specific applications. To avoid any compromise in design, Optron provides complete PC board optical arrays, pre-assembled and pretested, according to individual specifications."

Another notable feature of the new company is the development of de-

vices in matched sets, designated as tracking and matching sets. It's a "package deal" in which light sensors are produced as a series, tightly specified for use together in specific linearity requirements.

At present, the company is in the production of nine primary, and numerous secondary devices. In keeping with the planned growth of Optron, several new products are to be announced shortly with additional expansion of the facilities planned for February.

Circle 419 on Inquiry Card

### New approach to miniature connectors

"An original and better approach to solving connector problems" was the incentive for creating Omnetics Inc., according to Mr. Paul Stover, manager of marketing for the new firm. And thus Omnetics Inc. was formed for the specific purpose of developing advanced electronic circuit components.

After contacting computer companies to learn of existing connector problems, the new company developed a new engineering approach. The unique aspect of their approach lay in its method of joining pins. The female portion of the connector is comprised of hollow pins which fit into holes in a plastic frame. These pins are then guided over the recessed metal male pins. Crushing and bending of the male pins are avoided; the connector is made more compact; and the method results in reduced cost and longer life.

Microminiature connectors, or multi-pin connectors on 50-mil centers or less, are the featured product of the company. For this specific market, Omnetics has designed and patented a contact compatible with existing industrial contacts. The company will also undertake the custom manufacturing of precision components for other firms where the techniques of Omnetics can be applied.

The newly formed company, presently located in suburban Minneapolis, has 45 employees at present, and will expand in the near future. Omnetics has acquired property in Fridley, Minn., where it is planning the construction of engineering and manufacturing facilities.

Circle 420 on Inquiry Card

Circle 24 on Inquiry Card →

# Try to do this with semiconductors

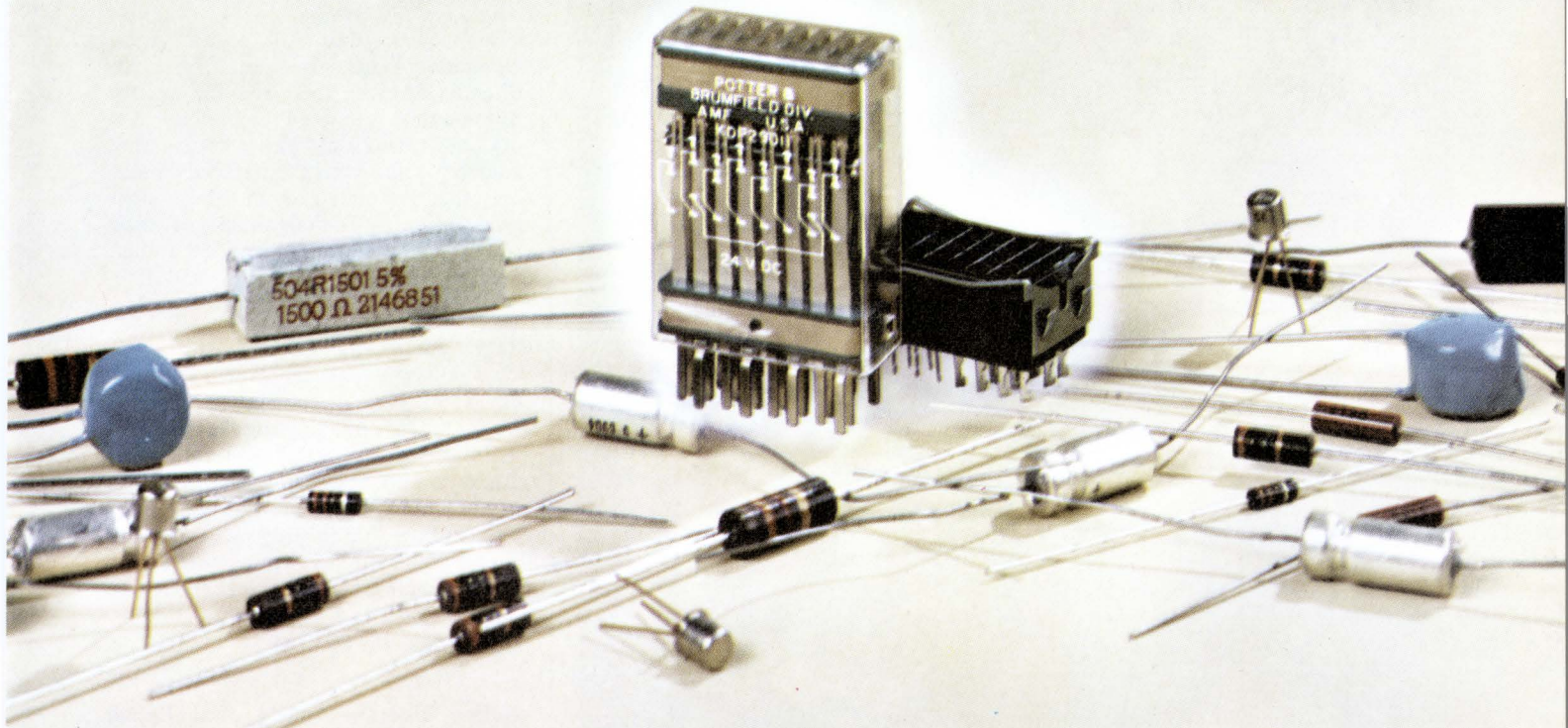

Where else can you get 8 Form C switching in a package that measures just over a cubic inch and costs less than 50¢ per pole?\* You can't with semiconductors. You'd wind up with a much larger, more expensive array.

Speaking of cost, the KDP has a single lot price of \$9.35. The list price, by the way, is less than two of our most popular 4-pole relays.

The compact KDP is ideal for logic circuits where a single input will give you a fan-out of eight. Open-minded engineers will find that a strong case for this relay over solid state switching. Remember, too, you get electrical isolation on both the input and switching sides.

Bifurcated contacts are rated at 1 ampere at 30V DC or 120V AC, resistive. Standard relays have an 8 Form C contact arrangement. Combinations of Form C and Form D (make-before-break) are available on special order. Coil voltages range from 6 to 48V DC.

Order prototype models today from your local P&B representatives or call us direct. Potter & Brumfield Division of American Machine & Foundry Company, Princeton, Indiana 47570. 812-385-5251.

\*Maximum discount

## KDP SPECIFICATIONS

### General

Temperature range  $-45^{\circ}$  to  $+70^{\circ}$ C.

### Contacts

Arrangements: 8 Form C (8PDT).  
Rating: 1 amp at 30V DC or  
120V AC, resistive.

### Coils

Voltages: To 48V DC  
Duty: Continuous  
Pick-up @  $25^{\circ}$ C: DC, 75% of nominal  
voltage.  
Operate Time: 15 ms maximum at nominal  
voltage @  $25^{\circ}$ C.

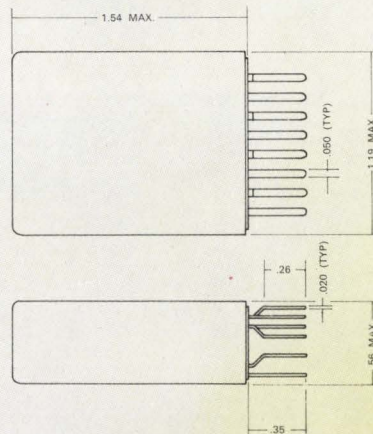

NOTES:  
1. DIMENSIONS APPLY TO TERMINAL CENTERS

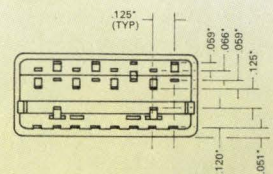

POTTER & BRUMFIELD



EXTRA DRY

In a martini, it's a matter of taste — in a K-Grip Jr. RF connector in wet, humid climate, it's essential. That's why our new series of plugs and jacks is moisture-proof.

The dry is extra. All the rest is K-Grip Jr. — the lowest cost, high-reliability RF connector installed. Almost 50% smaller, 50% lighter, it's a crimp type version of our standard RF connector reduced to its simplest form. Assembly is foolproof — in seconds.

With K-Grip Jr. RF connectors it's a matter of savings. We save you time, weight, space and, in our new series of plugs and jacks, we save you from weather-worry. Write for details.

**KINGS**

ELECTRONICS CO., INC.  
40 Marbledale Road/Tuckahoe, N.Y. 10707  
(914) SW 3-5000 / TWX 710-562-0110

## COURSES

**How to Make Money with ICs:** Jan. 19-22, Phoenix, \$500. As an independent consulting company, ICE is able to present the pros and cons of processing and fabrication techniques as practiced throughout the IC industry. With this knowledge, the attendee may relate these practices to those at his company and apply the most desirable practices effectively. ICE Corp., 4900 East Indian School Rd., Phoenix, Ariz. 85018.

**Computer-Aided Design:** Jan. 23, Phoenix, \$175. This one-day course follows (but is not an immediate part of) ICE's four-day basic engineering course, and offers material more directly associated with the background and job assignment of each student. ICE Corp., 4900 East Indian School Rd., Phoenix, Ariz. 85018.

**Real Time Digital Filtering and Spectrum Analysis:** Jan. 25-28, St. Charles, Ill., \$390. The course is designed to give you an understanding of theory, familiarity with design techniques, introduction to applications, and methods of implementation. You will learn how and be able to judge when to use digital filtering in your company's products. NEC Office, Oakbrook Executive Plaza #2, 1211 W. 22nd St., Oak Brook, Ill. 60521.

**Active Filters—Analog and Digital:** Jan. 26-27, New York Univ. Practicing, teaching and research engineers will be interested in this course for it deals with current techniques found to be practical in the design of analog and digital filters in ICs. NYU Applied Science and Technology Institutes, Room 9J, 1 Fifth Ave., New York, N.Y. 10003.

**Minicomputers—Application of small computers to research, development and manufacturing:** Feb. 8-11, St. Charles, Ill., \$390. For the engineer who is interested in gaining a practical knowledge of how to use and how to select the most effective minicomputer to meet his needs. NEC Office, Oakbrook Executive Plaza #2, 1211 W. 22nd St., Oak Brook, Ill. 60521.

**Brazing and Soldering Symposium:** Feb. 19-20, Pick Carter Hotel, Cleveland. Dr. William M. Mueller, Dir. of Education, ASM, Metals Park, Ohio 44073.

# WATT'S NEW? A 2000 WATT LINEAR POWER AMPLIFIER FOR 10¢ A WATT!

We came through, again!

Our customers have long recognized Control Systems Research as their very best source for low cost, high performance, transistorized DC servo amplifiers. Frankly, they weren't overly surprised when we told them about this exciting new breakthrough. They've come to expect this sort of thing from CSR.

But we wanted *YOU* to know that CSR is introducing the PFM SERIES of DC servo amplifiers for high volume servo applications like tape drives, film drives, machine tool drives, and other servo motor applications. This new generation of amplifiers utilizes a unique combination of pulse width and frequency modulation techniques to achieve a linear bipolar output — at a cost of **LESS THAN 10¢ PER WATT.**

The new PFM SERIES of amplifiers is available in a variety of continuous voltage and current ratings from  $\pm 60$  VDC and  $\pm 40$  amps on down. We review your amplifier requirements with the aid of a computer and supply an amplifier with the exact voltage and current you require.

Our OEM customers also like the fact that the PFM SERIES operates from a unipolar, non-regulated power supply and not the old-fashioned bipolar supplies. (That's why we designed it that way.)

You might be wondering how we can get 2000 watts of continuous power out of a  $3\frac{1}{8} \times 3\frac{1}{8} \times 1\frac{1}{2}$  module at less than 10¢/watt — especially with internal power dissipation and the like. Call us today! We'd like to tell you all about it.

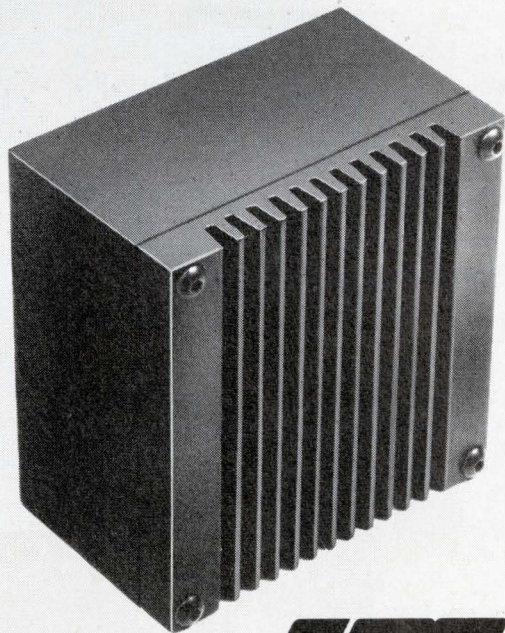

**CSR**

**CONTROL SYSTEMS RESEARCH, INC.**  
1811 Main Street, Pittsburgh, Pa. 15215  
412-781-1887



70SA1

## *Planned parenthood for new electronic companies*

Dr. Albert J. Kelley  
looks at  
the new wave of  
engineers-entrepreneurs  
and proposes a  
new approach  
to open up the whole  
ball game



***Challenger:*** *Dr. Albert J. Kelley* of Boston College

*Q. (The ELECTRONIC ENGINEER). At the NEREM meeting you proposed a "planned parenthood" approach for emerging companies. How do you define it?*

*A. (Dr. Albert J. Kelley).* Obviously, you want to make sure the baby (such as the new electronics company) is born under the best possible conditions. Either a venture capital firm or a large company who wants to spin off ideas will set up a new type of venture management corporation—a company to put together companies. This concept would prevent the situation where too often the engineer-entrepreneur is expected to know the technology, the money market, accounting, marketing, and everything else. Actually, the successful entrepreneur, who has certain strengths himself, will realize his managerial weaknesses and will take steps to compensate for them.

In the past, good venture capital firms, like American Research & Development, Arthur Rock, the Rockefeller operation and others, have used the planned parenthood or the "second generation" approach intuitively. They have a little more organized—a systems—approach. If the original team doesn't have the right manager, they'll go out and get the right one.

The successful entrepreneur needs a market, management, technology and money. Money and management sometimes go hand in hand, but often the new entrepreneur with a technical base really doesn't understand money. In many instances, he approaches the money market with his concept decked out with Fourier transforms, pole-zero plots, polar coordinates, etc.; he doesn't realize that he has to present his idea to the financier who really represents John Q. Public.

*Q. Are there any companies at present working on the "second generation" approach?*

*A.* You must realize first that this is an evolutionary approach, and not a revolutionary one. Actually, it's just going a step further than AR&D, Rockefeller and others have gone with the teamwork concept.

Now, there are some firms that are attempting something like the planned parenthood attack. Innovative Systems on the West Coast, New Business Resources in Dallas, and General Economics in Boston are different examples of new approaches. New Business Resources, which acted as a midwife for Pirgo and Mostek, offers management to the new firm all the way through. They "mother" the new firm. General Economics in Boston offers central business services to computer firms. The wise entrepreneur will know when he needs help and will be receptive to it. However, when these entrepreneurships reach maturity, the management midwife kisses them goodbye.

*Q. Could planned parenthood be closer to potential entrepreneurs than they think—perhaps in their own company? If so, shouldn't employers look at these*

*engineers with hope, rather than with fear?*

*A.* Yes, in fact the big companies can get a piece of the action. Planned parenthood allows the management of the large corporation to have their cake and eat it too. If the entrepreneur just goes off without management's help, they wind up with nothing. If his former employer supports the would-be entrepreneur in taking a crack at his dream, everyone stands to gain.

### **Ethics and the spin-off**

*Q. Unfortunately, we have seen lawsuits rather than help. This is a great danger with the two basic types of spin-offs: those that pursue a refinement of a product made by the former employer, and those that use (and become customers for) the products made by their former company.*

*A.* Ethical considerations are terribly important. The spin-off should leave on good terms; most successful firms have. Good venture capital firms will not touch such a deal if there is a hint of a lawsuit. Let's face it, the larger company can really clobber the new firm. In many cases, it is a punitive action.

But the really successful ones have left with a good relationship with their former employers. Everybody understands that everyone wants his chance. Very often there is a particular idea that the potential entrepreneur worked on at the parent company. The parent company didn't want to explore it and said "old Joe is a good guy." In such instances, they help him start his own firm and he might even get a contract from them. They know he won't raid the company of its techniques or people.

### **The nitty-gritty**

*Q. What's the mark of the successful entrepreneur?*

*A.* The successful ones have a concept, an avenue to explore, a progression—rather than a gimmick. Digital Equipment Corporation is a perfect example—a plan for a whole family of mini-computers. Ken Olsen had the best wishes of his former employer—Mitre Corporation.

*Q. Is the time propitious for starting a new company?*

*A.* I think it's good, very good. Money is supposed to be tight because it has dried up in regular sources for various reasons, but there is a lot of private money around. Now is a good time to be thinking of starting a company because if you want to go public three to five years from now, the economy should be on the up side.

*Q. How do you judge if the entrepreneur is successful?*

*A.* It usually takes three to five years to demonstrate success. There seems to be a plateau between two and five million dollars. Beyond that, success depends on whether the entrepreneur can break out of the mold. Up to that mark, the founders sometimes have to do anything by themselves, working 18-hour days.



Dr. Kelley emphasizes a point to Alberto Socolovsky (left) and John McNichol (center) of *THE ELECTRONIC ENGINEER*.

## ***“People talk about putting defense and space money into social needs,***

At this point, the entrepreneur should delegate authority and concentrate on strategy. Companies that do not make the transition can be seen on Route 128 (Boston's electronic belt) and everywhere else. They are 10 years old, doing two to five million dollars business, happy, busy and making money. But for investors that isn't enough; investors are looking for a Xerox, a Teledyne, a company that is going to have explosive growth. Some firms that look healthy are Damon Corporation, Unirode, and TYCO Labs. They have been able to adjust to the management mold of the big company.

### **Chasing the blues away**

*Q. What are some of the social implications of the scientist-entrepreneur?*

*A.* Basically, the major benefit to society is the economic development of a particular area. Many other sections of the country would like to duplicate what's been happening in Boston, Palo Alto, Dallas and other areas. The high technology company acts as an economic stimulus to geographic area, which may, in turn, solve

some of the area's social problems. This is not all beautiful and easy; it is very difficult.

*Q. I think you've just answered our question: what's a nice electronics man like you doing in a place like this?*

*A.* Well, I can give several answers to that but, in essence, we are attempting to aid the economic development of an area and the resulting technology transfer by encouraging the high technology entrepreneur. I'm kind of a spin-off myself.

*Q. Do you see technology transfer as the “space program of the 70's?”*

*A.* People talk about putting defense and space money into social needs, but where is it? It isn't there on the federal level. Some of the university labs that want to convert from defense to social problems are having a difficult time. They have a large staff and a large overhead, and the money to support this activity isn't there. On the local level, we have the New England Regional Commission and the New England States Technical Services Agencies, which are very definitely trying to





*“Engineering demands a logical mind and a rational approach, as does successful management.”*

*“The engineer doesn’t realize that he has to present his idea to the financier who really represents John Q. Public.”*



*but where is it? It isn’t there.”*

encourage technology transfer. I believe this transfer is the way to solve our problems. O.K., federal government money just won’t be available so the private sector may have to take over. But a company must be able to do an honest job, and allowed to make an honest profit. Actually, this area offers a fractionated market, technology which is beginning small and going to grow big—an ideal situation for a company with a low overhead to get in there and grow. The big companies have not been successful with fractionated markets. They’re forced to think in terms of the multi-million dollar contracts. That’s why the spin-off has been so successful: the big company sees promise in an idea, but the multi-million dollar market for next year isn’t there. Get the managers you need with the proper incentive to spin off the technology and you may solve some of the domestic problems.

INFORMATION RETRIEVAL

Careers

## The CHALLENGE of the Seventies

Beginning this month, The ELECTRONIC ENGINEER presents CHALLENGE—a forum for top industry figures who will speak on the significant trends that will affect our readers in the coming years. In these pages you will meet distinguished engineers who will outline new and unexploited areas for the electronic engineer and will examine their implications, both social and professional.

Representative of this new breed is Dr. Albert J. Kelley, who kicks off the series by looking into “the phenomenon of venture technology entrepreneurship—the wedding of creative men, ideas, management and capital.” This mating of technological concepts with financial and managerial expertise has allowed some very bright electronic engineers to explore new ideas and concepts. In addition, these new entrepreneurs have enabled some of the most sure-footed companies in the country, such as Jersey Standard and 3M, to participate in, and help shape, this exploration.

Dr. Kelley, Dean of the School of Management at Boston College, was the keynote speaker at NEREM in November, 1969. Kelley has been extremely active at Boston College in developing new management concepts and encouraging interface between entrepreneurs and state and regional government agencies.

Dr. Kelley, who graduated from the U.S. Naval Academy in 1945, served as a shipboard officer in World War II, as a carrier pilot in Korea, and as an experimental test pilot in early jet aircraft. He completed graduate work in electronics at MIT in 1948, and was awarded the Doctor of Science degree in 1956 from the Department of Aeronautics and Astronautics, majoring in instrumentation and flight control. He was then assigned to the Navy Bureau of Aeronautics where he later became Project Manager of the Eagle Missile System.

He joined NASA on military assignment in 1960 as manager of the Agena Space Vehicle Program. In 1961, Dr. Kelley was appointed Director of Electronics and Control for NASA, where he organized the NASA R&D Program in electronics and headed the study which led to the establishment of the NASA Electronics Research Center where he became Deputy Director. He was awarded the NASA Exceptional Service Medal for these efforts.

## EES GET AHEAD

Engineering disciplines are essential to management



*Al Grant*  
Group vice president

"The engineering disciplines of analytical and quantitative evaluation are becoming almost mandatory for modern day business managers," observes Al Grant, group vice president of Fairchild Camera and Instrument Corporation. Grant has applied his scientific experience to general management positions he has held at Autonetics, Litton, Lockheed and now Fairchild.

In step with the times, Grant believes that the current revolution in semiconductor technology must be matched in the managerial field. Modern day executives not only must be up on technological developments, but also must know about advances in the behavioral and management sciences.

Grant began his engineering career on the faculty of Illinois Institute of Technology, where his interests were focused in the field of automatic controls and computer technology. From there he moved to the practical engineering field, eventually heading up all the system engineering activities for Autonetics' guidance and navigation systems. His major contribution to the aerospace field was his leadership of the engineering organizations which introduced the first production designed inertial navigation system, the first production integrated circuit computer system and the first commercial inertial navigator.

"A modern day manager must be familiar with the economic, legal and financial aspects of the business world," Grant cautions. "Engineers have the tendency to think of themselves only in terms of research, development and design, but they must be cognizant also of the impact their designs have from an economical standpoint. The most rewarding aspect of scientific leadership for an engineer-turned businessman is to set a course or specification for his organization and have the organization achieve it."



no lower  
price.  
no higher  
performance.  
anywhere.

### Texscan's LA Series Rotary Attenuators.

#### KEY SPECIFICATIONS

**ATTENUATION:** Model LA-50, 0 to 10db in 1db steps; Model LA-51, 0 to 70db in 10db steps; Model LA-53, 0 to 1.0db in 0.1db steps; Model LA-54, 0 to 60db in 1db steps

**FREQUENCY RANGE:** DC-500 MHz

**ACCURACY:** LA-50,  $\pm 0.3\text{db}$ ; LA-51,  $\pm 0.5\text{db}$ ; LA-53,  $\pm 0.05\text{db}$ ; LA-54,  $\pm 0.5\text{db}$

**DELIVERY:** From Stock for Quantities of 10 or less

**PRICES:** Models LA-50, 51 and 53 — \$60.00, \$67.50 and \$65.00  
Model LA-54 — \$120.00

All four models offer a variety of attenuation steps, connector options. Choice of 50 or 75 ohm impedance. Circle the reader service number below for descriptive literature containing complete technical details.



*Texscan* CORPORATION

2446 NORTH SHADELAND AVENUE  
INDIANAPOLIS, INDIANA 46219  
Phone: 317-357-8781 TWX: 810-341-3184

# Heroes of the Resistance.

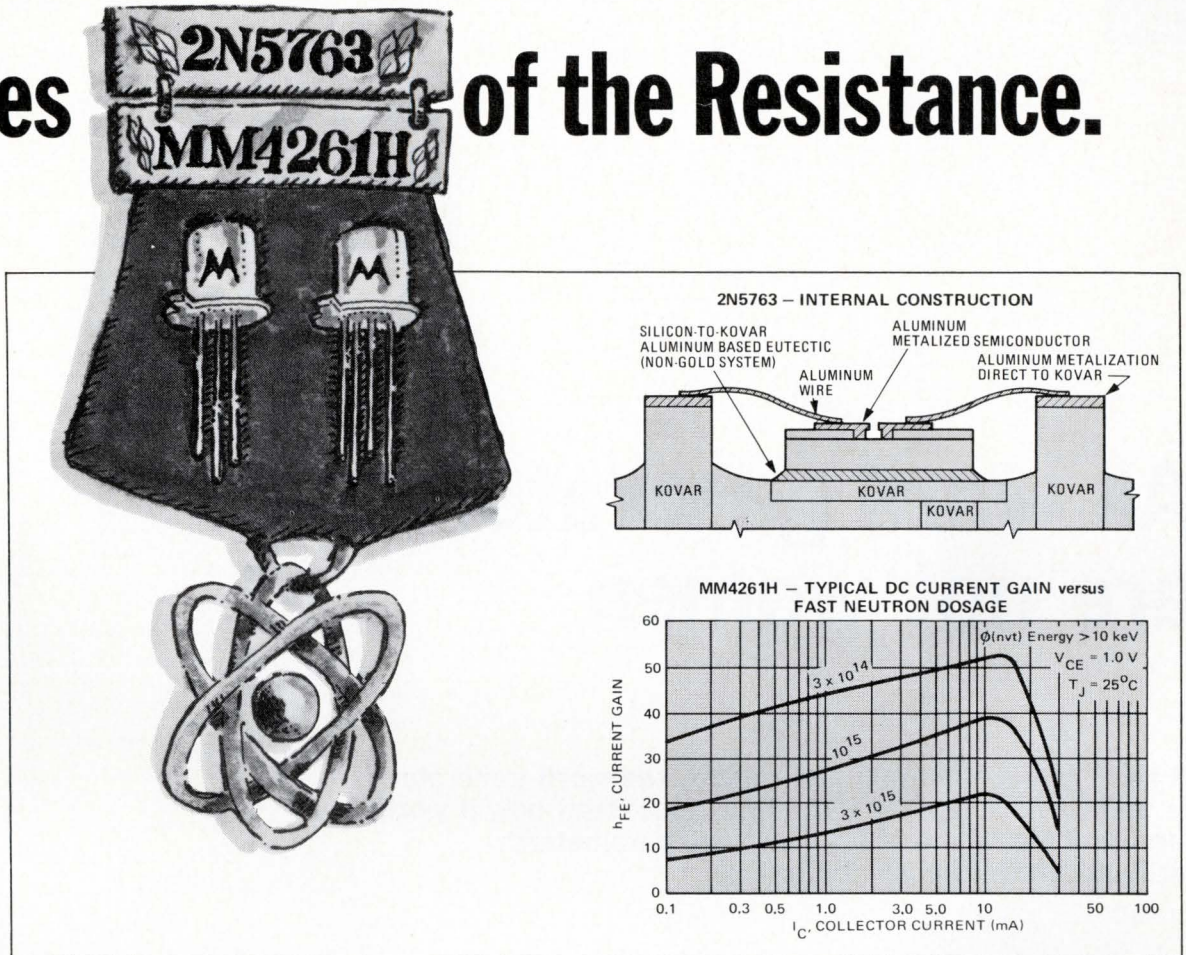

## True, and only a sample of Motorola's total radiation resistant device capability.

"Hero" is a strong term, but mono-metallic construction helps Motorola's PNP 2N5763 radiation resistant transistor live up to it. All-aluminum wire bonding and an aluminum based eutectic for the die bond provide outstanding thermo-mechanical reliability. In fact, the 2N5763 displays radiation resistance in all types of radiation environments and Motorola's Transistor Radiation Department has the supporting information.

Another "Hero", the PNP MM4261H transistor, exhibits exceptional tolerance to neutron radiation. Even after exposure to  $5 \times 10^{14}$  neutrons/cm<sup>2</sup>,  $h_{FE}$  degradation is typically less than 50%. This fully documented Hi-Rel device is tested even beyond standards specified for typical JAN-TX requirements.

Heroes they are, and the 2N5763 and MM4261H Silicon Annular† transistors are

just two references to the radiation resistance capability Motorola has gained in six years of involvement.

Motorola can design-in device Photocurrent compensation to simplify circuit design, utilize mono-metallic technology for significant reliability improvement in radiation environments, and provide full neutron exposure information for more than 50 top-of-the-line types. Add ability to do quick turn-around radiation resistance evaluation on any transistor and the *total* scope of Motorola's radiation resistance capability is apparent.

Data sheets for the 2N5763 and MM4261H are available from Motorola Semiconductor Products Inc., P.O. Box 20912, Phoenix, Arizona 85036. For *any* answers on Motorola's radiation resistant transistors write to Transistor Radiation Department or call (602) 273-4645.

†Annular Semiconductors Patented by Motorola Inc.

-where the priceless ingredient is care!



**MOTOROLA**  
 Silicon Annular Transistors

# All word generators are not women

**A relatively uncommon instrument, the word generator is often reinvented by test engineers. Read how it works, and find out which of its operating parameters are important in your application.**

**By Jerry Heyer, Marketing Manager**  
SRC Division, Crescent Technology Corp., Newport Beach, Calif.

Engineers who design sophisticated products inevitably face the problem of finding efficient, economical test equipment. With the advent of medium- and large-scale integrated circuits, this need has become even more critical. One tiny chip now contains logic functions that formerly occupied an entire printed circuit card. The need to test logic functions still exists, but the multitude

of test equipment available in most laboratories, or on the production lines, is inadequate in terms of ease of operation and total cost. Many engineers have developed data generators for their own use because none were commercially available.

If there is no convenient method of supplying digital inputs to system components, or to simulate the heart of the system—the computer—system assemblers must wait until all components have been received and wired together before troubleshooting can begin. It is very

## What is a word generator?

A word generator is simply an instrument that generates a data stream of ones and zeros under complete control of the operator with regard to bit position, bit frequency, and so forth. It may be considered to be a read-only memory, a paper-tape-reader substitute, a computer simulator, a data-transmission-line tester, a programming device, or even a programmable pulse generator.

Figure 1 illustrates a typical word generator block diagram. A bank of mechanical switches provides the fixed memory for the unit. These fixed programming elements may be toggle switches, thumbwheel switches, diode matrix boards, or linear switches. They also provide a visual readout of the pro-

grammed information.

High-speed logic circuits sense the position of each switch. Position information, corresponding to the bit pattern of the data stream, is loaded into a shift register. From there it can be shifted out in serial or parallel to buffer drivers, which control the output pulse format with regard to amplitude and polarity. A variable clock controls the pulse rate.

Front-panel controls enable the operator to make program changes easily and to adapt the output signals to the device being tested. While it provides the versatility and flexibility necessary for general test equipment, a typical word generator is not overly complex and is relatively easy to troubleshoot.

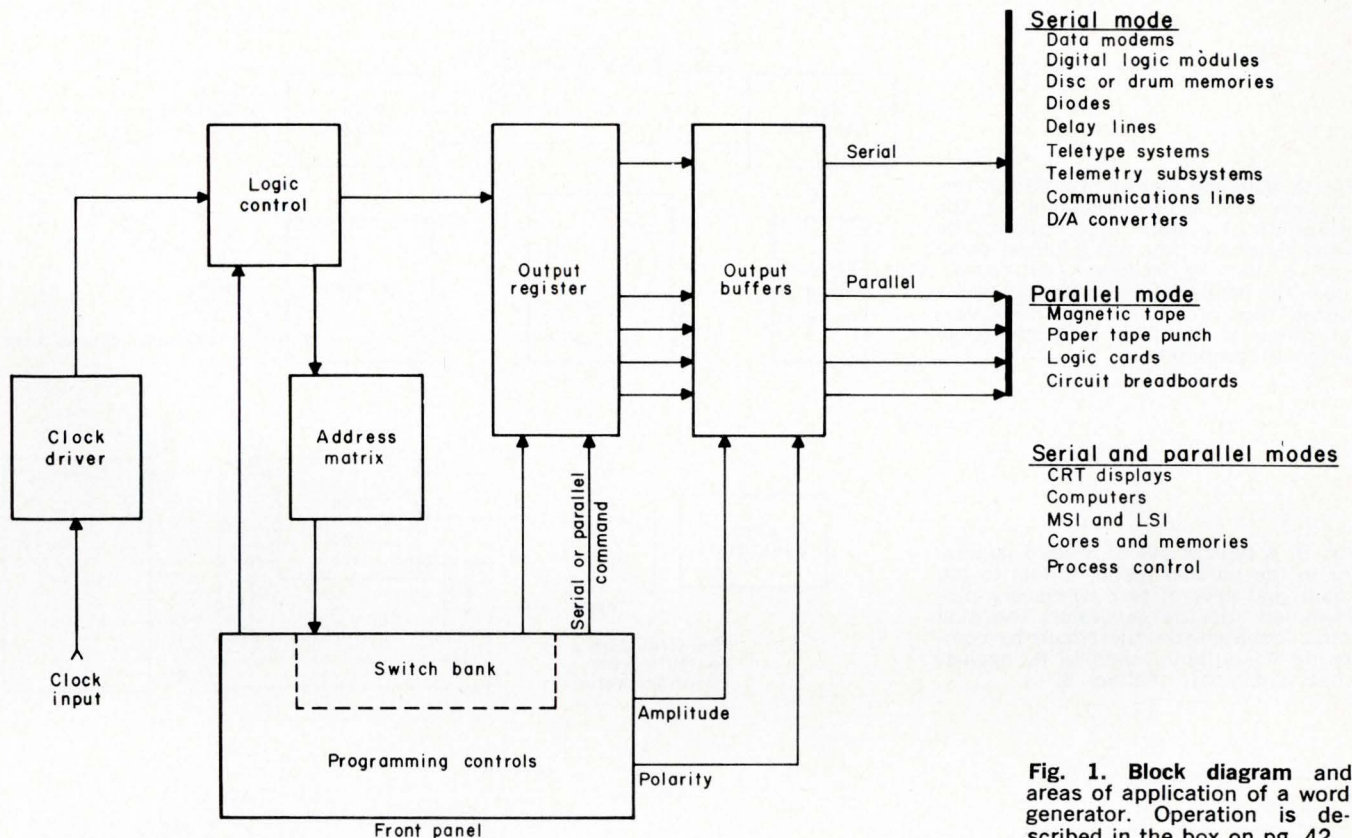

Fig. 1. Block diagram and areas of application of a word generator. Operation is described in the box on pg. 42.

difficult to troubleshoot at the system level, and if a vital component does not arrive until a few days before shipment is scheduled, then the checkout phase becomes the panic phase.

Obviously, a system and subsystem tester is urgently needed in such cases. It should be easily and rapidly programmable and provide a visual readout, allowing the operator to verify the program he generates. When a test program includes varied digital devices, serial and parallel capability becomes necessary. Word generators are designed to meet all of these requirements.

### Applications

Component and logic card testing are two major uses of word generators. Figure 1 lists these and other areas of application. Figures 2 and 3 illustrate two typical serial and parallel uses, respectively.

A word generator is useful and productive in checking-out complete assemblies, and will reduce costs in production testing of many products. Where you must enter data in parallel to test units such as digital-to-analog converters, core arrays, and so forth, the parallel outputs must have enough bits per word and a sufficient number of total words so that all necessary combinations of bit patterns can be generated.

In the parallel mode, several channels can output identical data for use at several stations performing the same test. Proper programming and control of the word generator will also provide several simultaneous

but independent data streams, which can be used at several different types of test stations. Operators can be furnished with test procedures dictating when a program is to be used, what the program is, and what the desired results should be.

Interfacing of a word generator with a test station is usually straightforward. The word generator can interface directly if the device under test accepts IC logic levels. If not, adapters, converters, or buffer amplifiers are readily available to solve the interface problem.

When the number of words needed does not exceed its capacity, a word generator may prove to be more useful than a paper-tape control unit in process control applications. The simple, manual operation of changing the programming board is substituted for paper-tape processing to give complete flexibility and control over processing changes.

For some applications, such as magnetic core testing, the output of the word generator may not be compatible with the item under test. Additional wave shaping and/or current driving units must be interposed between the generator and the unit to be tested.

Features such as adjustable delays and adjustable rise- and falltimes add to the cost, yet the user may not need them. He can always buy special interface units when he has to adapt the basic generator to specific applications.

There are applications in which a universal word generator will not match a particular requirement.

**Fig. 2. Marginal testing of a data transmission link is an example of the utilization of a serial data stream. The word generator puts out a known pulse train of varying frequency and amplitude. The scope monitors what is transmitted, thus providing data on the useful range of the line, or modem-line-terminal combination.**

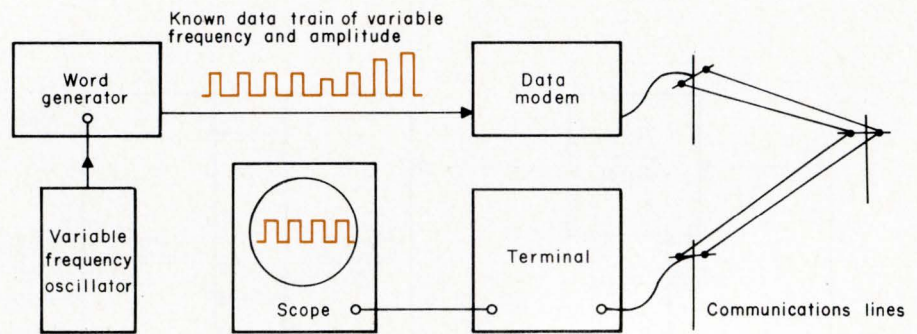

**Fig. 3. A typical use of a word generator in the parallel mode. Inputs to the adder and several test points are programmed into the generator. The dual trace scope checks the circuit by comparing its outputs, channel A, against what is desired, channel B.**

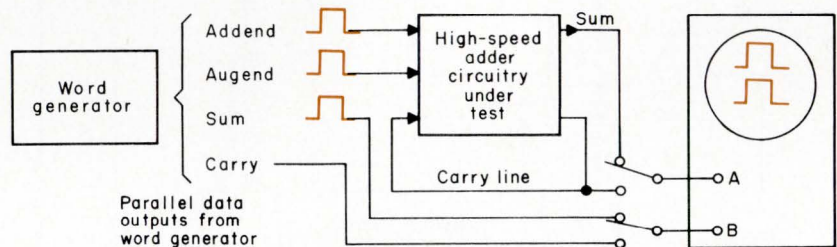

Telemetry system testing, for example, requires a very specific wave form, and in the timing field a specific time code generator might be more useful. However, the word generator is able to test subsystems of these larger units, primarily the individual PC cards and ICS.

### Choosing a word generator

Certainly, any given instrument cannot fulfill every application. The specific application and the particular unit should be matched as closely as possible to maximize economies and benefits for the user.

Factors such as frequency limitations, bit capacity, the number of parallel outputs, ability to vary the bit pattern, and others may seem incidental until you consider them for your specific application. Weigh them in terms of present cost versus the necessity for peripheral modification of the basic word generator later.

### Bit capacity

Estimating the ideal number of bits necessary in a word generator is difficult. Several hundred bits with a recycle capability seems to satisfy most requirements. The higher the bit capacity, the more likely the unit is to retain its usefulness as new requirements arise. Practical and mechanical reasons dictate bit capacity as much as a specific capacity goal. The number of switches that can be packaged in a given piece of equipment determines the upper limit. Note that switch area increases proportionally to bit capacity. However, the linear switch used at SRC minimizes this effect. (See Fig. 4.) Designing-in the capability to synchronize more than one generator (to get added serial or parallel out-

put) is one way to extend capability. Another way is to increase the nonunique output by repeating the entire sequence, or nested portions of the sequence.

### Universal testers

If universality is the most desirable quality, the following figure of merit is suggested:

$$\frac{(\text{total number of bits}) (\text{high frequency limit}) \cdot 10^{-6}}{(\text{cost in dollars})}$$

Costs normally rise with flexibility and higher frequency, so there are trade-offs in terms of flexibility and performance which you must weigh against the intended applications of the equipment.

The operator can select the frequency he wants by varying an internal or external clock. Internal clocks, when available, add to the cost because they use expensive oscillators. But companies owning waveform generators or oscillators can often use such equipment in conjunction with a less expensive word generator without an internal clock.

In order for a word generator to be really flexible, it should have both parallel and serial output capabilities. It also should have a sufficient number of individually programmable bits available to adequately exercise the devices under test. A fixed data word, rapidly positioned anywhere in the format, allows for error mode testing.

Other features also can increase flexibility. The operator should be able to stop the scanning cycle at selectable points, rapidly change the number of bits, rearrange groups of bits in the data streams, and provide various synchronizing signals so that the equip-

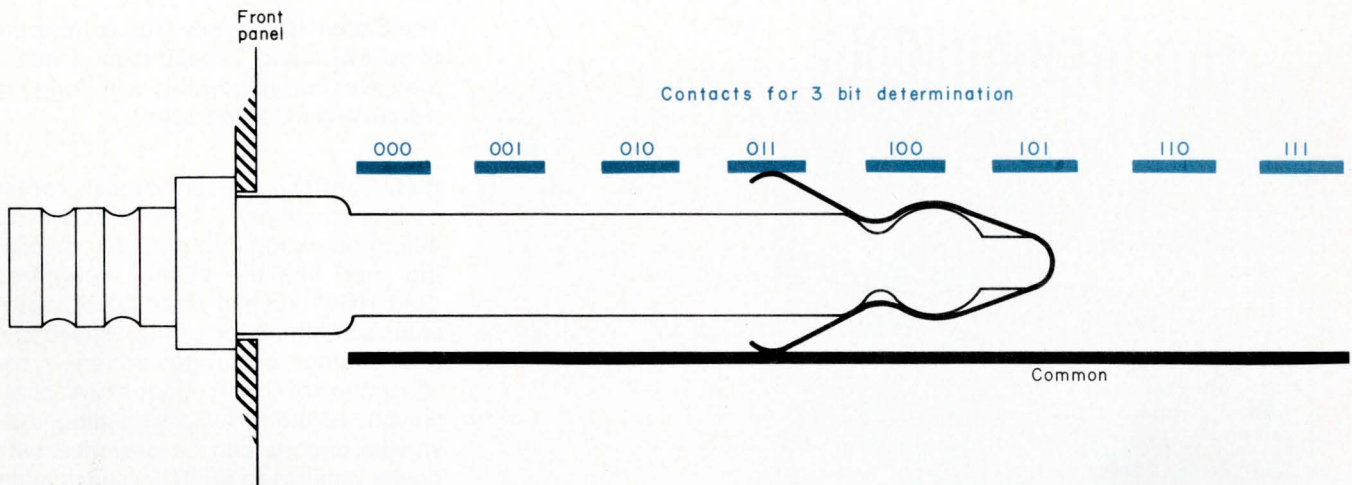

**Fig. 4. Octal programming "linear switch" used in SRC word generators.** By using a three-dimensional, or volume, approach, three bits can be programmed in a  $\frac{1}{4}$  by  $\frac{1}{4}$  in. space on the front panel. This translates to 48 bits/in.<sup>2</sup> of panel space. One side of the metal clip is always in contact

with the common leg of the circuit. The depth of the plastic pin determines which of eight contacts will conduct a current when interrogated. Logic gates determine the three bits of information corresponding to conduction in a given leg (011 in the case shown here).

### Word Generators

Feature	Advantages to User
Programming switch density	Saves rack space and provides portability.
Total bit capacity	Meets more requirements, now and in the future.
Serial and parallel outputs	Enlarges potential applications.
Unit can be synchronized to other word generators	Permits expansion to larger words at minimum investment.
Selectable synchronized word	Provides movable synchronized pulse for scope examination of data, or provides system synchronization.
Bit frequency	Should have a wide range, preferably from dc to at least 10 MHz, to give maximum flexibility in all testing situations.
Internal or external clock	Internal clocks add expense to unit, but may be required in situations where existing waveform generators or oscillators are not available.
Flexibility of front-panel control over data format, bits/word, polarity, and amplitude	Gives maximum utility and adaptability of unit. No need for peripheral equipment.
Simple, straightforward programming with visual indication of content	Quicker, more economical than complex methods, such as programming a computer.

ment under test can be easily "locked" to the word generator. There should be an adjustable amplitude control on the outputs so that the instrument can interface with many types of devices and allow marginal testing of equipment. It should also have a polarity reversal switch for rapid inversion of the output signal.

#### Other features

It is desirable to be able to examine the bit pattern on an oscilloscope. Such a feature is provided by an adjustable sync pulse that can be positioned anywhere in the data stream by front panel controls. Thus the operator can start the scope scan at any point in the data stream.

The ability to step the generator through its paces, one bit, one word, or one cycle at a time, is a significant consideration, as is built-in protection circuitry for the integrated circuits. Without these minimum features, a word generator would probably require so much peripheral logic that it would become uneconomical.

#### Summary

Design and test requirements for digital equipment become more sophisticated as the state of the art advances. So, to be useful, the word generator itself must be state of the art with enough flexibility and capacity to prevent short-term obsolescence.

**INFORMATION RETRIEVAL:**  
Instruments & measurements, Digital design, Testing

# lowest profile – smallest over-all mercury-wetted contact relay

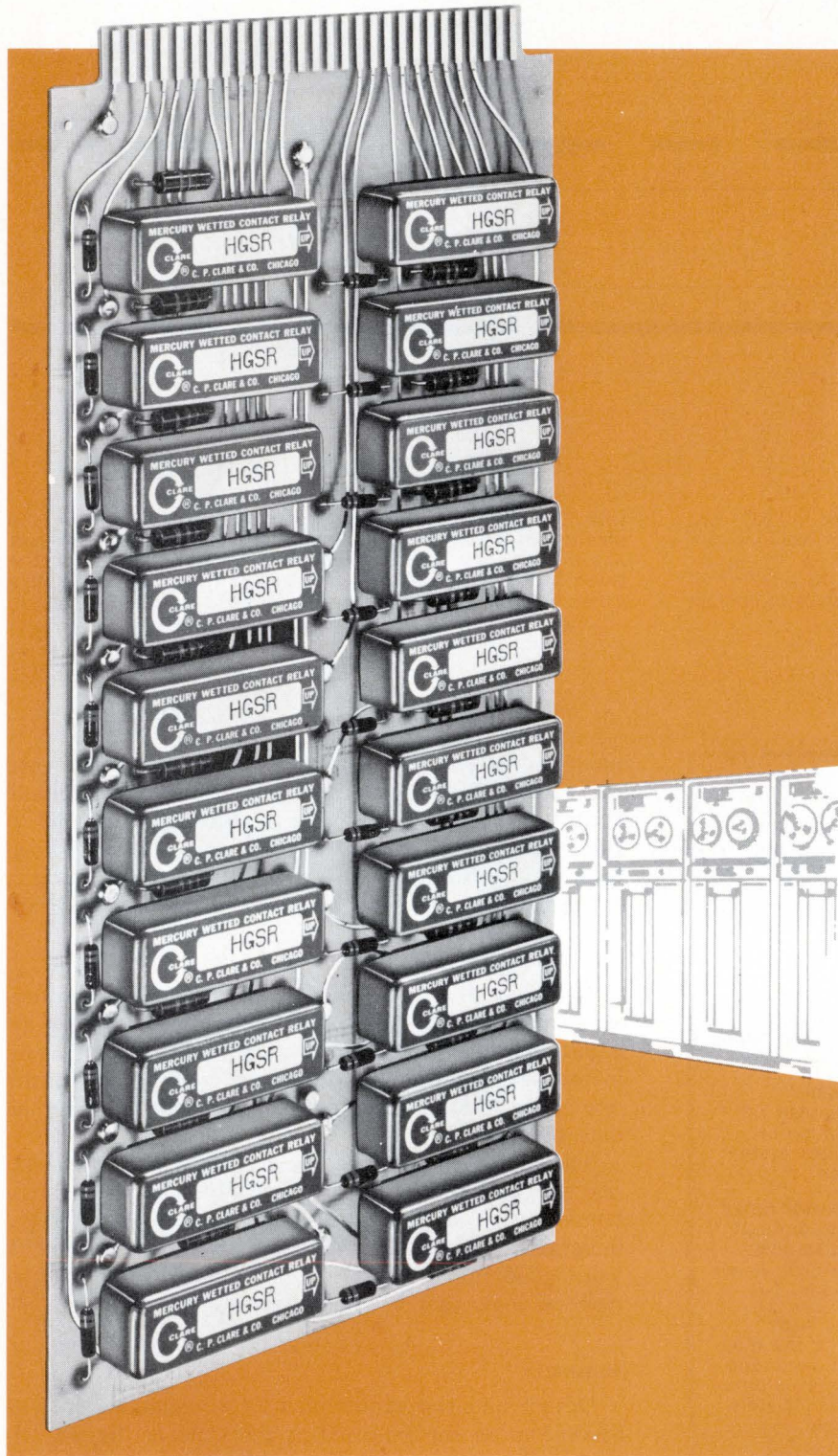

The Clare HGSR (only .33 cu. in.) puts more switching capacity on a board than ever before possible with long life mercury-wetted contacts.

It's fast and tough—serves most process control operations . . . provides over 22 billion operations without fail or falsing. And like the widely recognized Clare HGM and half-size HGSM, it provides a combination of high speed and low contact noise generation . . . the elimination of contact bounce and chatter and resulting false signalling. Advanced circuits can be designed with power gain up to 5000 . . . sensitivities as low as 20 mw. For solid state buffering, you get built-in input/output isolation . . . for measurement circuitry, minimal contact resistance, constant over billions of operations.

For information, circle Reader Service number, or, call your Clare Sales Engineer or local Clare Distributor. Or write for Data Sheet 802. C. P. Clare & Co., Chicago, Ill. 60645 . . . and worldwide.

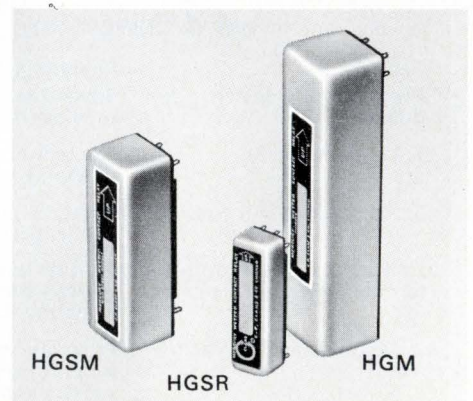

- Life:  $22 \times 10^9$  operations—with no maintenance
- Low, constant contact resistance—no mechanical wear or electrical erosion
- No contact bounce
- Switching speeds to 1 ms
- Versatile contact load capabilities—low level to 250 va
- High power gain—to 5000 with no noise sensitivity
- Sensitivities as low as 20 mw

LOOK FOR



ON THE RELAY

a GENERAL INSTRUMENT company



# Commercially available word generators

**Stephen A. Thompson**  
Western Editor

One convenient method of testing or exercising digital equipment is with a word generator. These instruments provide you with a binary data stream that allows you to preselect the combination of 1's and 0's to suit your particular requirements. The accompanying table lets you compare the specs of commercially available units.

Relatively few manufacturers are presently making word generators as evidenced by the small number in our market survey—seven manufacturers of twenty models. The compilation of word generator specifications is arranged in order of ascending price.

In the serial mode, some units break the data stream into several words that can vary in length. Others have only one word, or fixed word lengths. The table lists the number of bits per word, the number of words available, and the maximum bit length of a unique serial data train.

Most units offer repeat functions which allow the entire pulse train, or specific segments of it, to be repeated, in some cases, endlessly. However, the maximum unique data train is presented rather than the maximum extended capacity, because a comparison of

the infinities is of little value. This does not mean that the value of repeat functions should be minimized, because they are of great value in applications such as magnetic core testing.

The number of parallel channels, bits per channel and total unique parallel bits are also listed. The highest unique serial bit capacity is the 960 bits offered by the SRC 912. The Non-Linear Systems 22-1 has the most parallel capacity with 22 channels of 100 bits each. Total bit capacity can usually be increased by sequencing or paralleling more word generators.

Typical frequencies vary from below 10 Hz to several MHz. In the range from 75 MHz to 125 MHz, the Tau-Tron WG-100 series is the only entry. The output voltage range of each instrument in the illustration is tabulated and charted separately.

Non-return-to-zero (NRZ) format is standard, but several machines offer return-to-zero (RZ). The difference is illustrated in the accompanying graph on following page.

**INFORMATION RETRIEVAL**  
Instruments and measurements,  
Digital design, Testing.

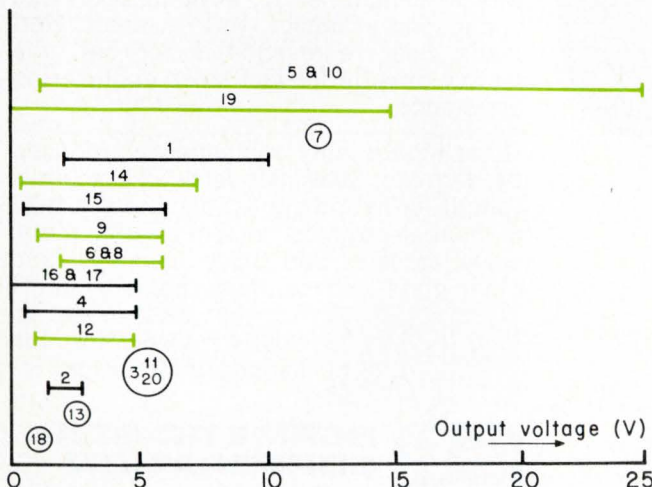

**Word generator output voltage range.** The numbers refer to the number assigned each instrument in the table. Color indicates that the output can be plus or minus.

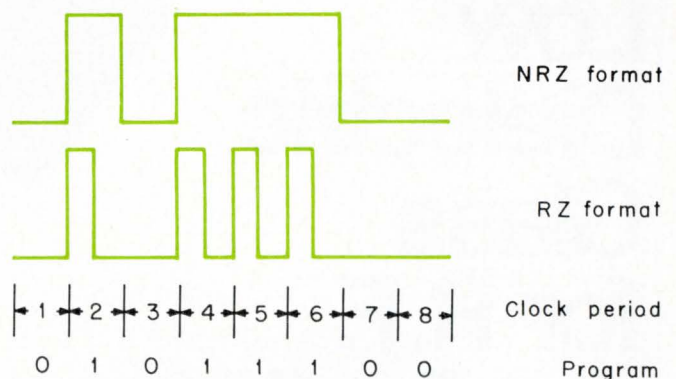

**The difference between NRZ and RZ data formats.** Both outputs shown correspond to the same program. In the NRZ format, if the output is a 1, the pulse amplitude remains high until a 0 is encountered. In RZ format, the voltage returns to the 0 level some time during each clock period, thus providing a self-clocking format that is useful in applications such as low-density magnetic recording.



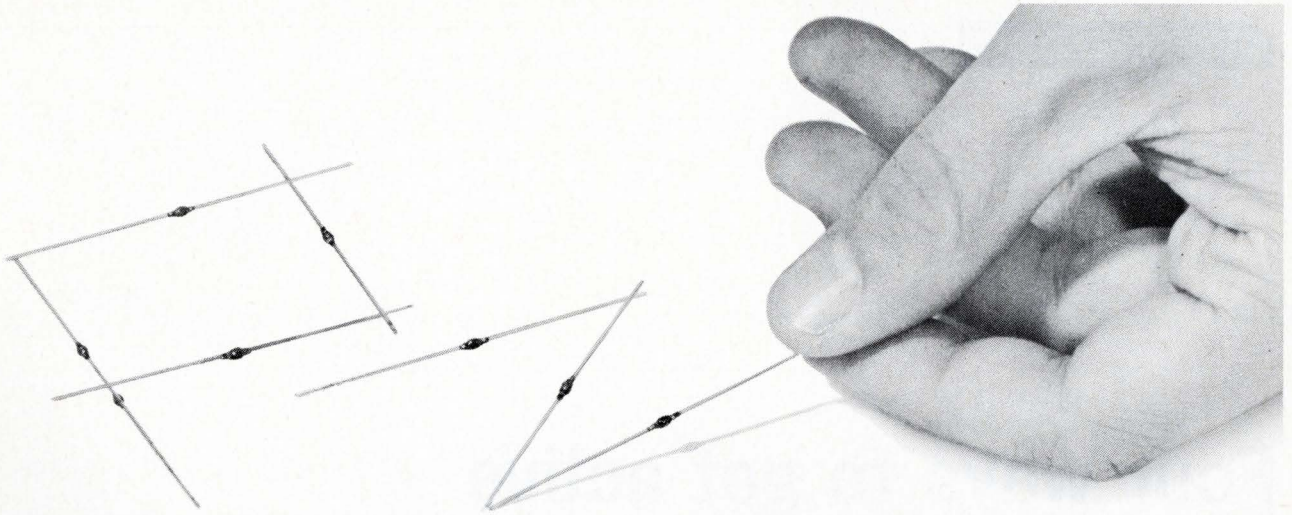

## Introducing the PZ Zener

The new fused-in-glass  
1 watt zener . . .

Typical Unitrode fused-in-glass  
stability and high-performance at  
the price of an ordinary device

Order your free samples today

- Fills the bill from 400 mw thru 1 watt
- Voltages from 6.8 to 200 V
- 8 millisecond surges to 30 watts
- Low reverse current — to 500 nA
- A quarter the size of a conventional 1 watt
- Weighs less than 1/4 gram
- No plastics, epoxies, silicones, oxides, gases, or solders are used

580 Pleasant St., Watertown, Mass. 02172 • (617) 926-0404

# UNITRODE

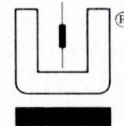

TOUGH AS ALL GET-OUT FROM THE INSIDE OUT

With the silicon die metallurgically bonded between terminal pins of the same thermal coefficient, the hard glass sleeve is fused to the entire outer silicon surface. Result — a voidless, monolithic structure.



### 4 EASY WAYS TO GET FREE SAMPLES AND SPECS

1. Call Bud Anderson COLLECT, at (617) 926-0404.
2. Call your nearest Compar office.
3. Call your nearest Daniel & Co. office.
4. Check off the magazine Reply Card number.

# Four ways to get active ...with filters

With low-cost IC op amps readily available, you can now design active filters to suit your specific needs. Here are four filters that can help you get started.

**By Harmon G. Washington**, Senior Engineer  
Motorola Inc., Chicago, Ill:

The advent of inexpensive IC op amps has reduced the need for LC filters with large, expensive inductors. Now, you can design RC active filters with high  $Q$  and better stability characteristics—and at less cost—than is possible with conventional LC types.

Let's evaluate the complexity, stability, and sensitivity of four active filters:

- a multiple inverse feedback bandpass
- a controlled gain bandpass
- a current negative impedance converter (INIC)
- a balanced twin-T feedback bandpass

These four circuits have transfer functions with quadratic poles and linear zeros and may be cascaded to form Butterworth, Chebycheff, or elliptic function Cauer filters. Their transfer functions can all be put in the form

$$\frac{E_{out}}{E_{in}}(s) = \frac{Hs}{s^2 + (2D\omega_0)s + \omega_0^2} \quad (1)$$

where  $H$  = overall gain of the circuit  
 $\omega_0$  = resonant angular frequency (center frequency)  
 $D$  = dissipation factor

Using this basic transfer function, the  $Q$  of the filter is easily found from

$$Q = \frac{\sqrt{\omega_0^2}}{2D\omega_0} \quad (2)$$

Figure 1 shows the simplified equivalent circuit for the operational amplifier used in all four active filters.

## The Multiple Feedback Circuit

The multiple inverse feedback bandpass filter, shown in Fig. 2, has a transfer function that is obtained by using the equivalent circuit for the operational amplifier and solving node equations.

$$\frac{E_{out}}{E_{in}}(s) = \frac{-\left(\frac{K}{K+1}\right)G_1C_3s}{s^2 + s\left[\left(\frac{G_5}{C_4} + \frac{G_5}{C_3}\right) + \frac{G_{in}}{K+1}\left(\frac{1}{C_4} + \frac{1}{C_3}\right)\right] + \left[\frac{G_5(G_1+G_2)}{C_3C_4} + \frac{G_{in}}{K+1}\left(\frac{G_1+G_2}{C_3C_4}\right)\right]}$$

where

$$G_1 = \frac{1}{R_1}, G_2 = \frac{1}{R_2}, G_5 = \frac{1}{R_5}, G_{in} = \frac{1}{R_{in}}$$

(Note that in future derivations,  $G$  and  $R$  will be used interchangeably with the understanding that  $G = \frac{1}{R}$ .)

If you compare this with Eq. (1) you find

$$\omega_0^2 = \left(\frac{G_1+G_2}{C_3C_4}\right)\left(G_5 + \frac{G_{in}}{K+1}\right)$$

and

$$2D\omega_0 = \left(\frac{1}{C_4} + \frac{1}{C_3}\right)\left(G_5 + \frac{G_{in}}{K+1}\right)$$

To keep these values as independent of  $G_{in}$  (which usually varies widely from amp to amp) as possible,  $K$  must be made as large as possible. Now, if you assume  $K \gg 1$ , and  $G_{in} \ll 1$ .

$$Q = \frac{\sqrt{\omega_0^2}}{2D\omega_0} = \frac{C_3C_4}{G_5(C_3+C_4)} \sqrt{\frac{G_5(G_1+G_2)}{C_3C_4}}$$

This expression shows that  $Q$  is relatively independent of gain.

### The Controlled Gain Circuit

Now, look at the controlled gain bandpass filter in Fig. 3. Note that

$$\frac{e_2}{e_1} = \frac{(A - 1)R + R}{R} = A$$

Also,  $R_{in}$  has been included in  $R_3$

$$\left( R_3 = \frac{R'_3 R_{in}}{R'_3 + R_{in}} \text{ where } R'_3 \text{ is the actual resistance at } R_3 \right).$$

The transfer function is then:

$$\frac{E_{out}}{E_{in}}(s) = \frac{AC_1G_1s}{s^2 + s \left[ \frac{1}{C_1}(G_1 + G_2) + \frac{1}{C_2}(G_1 + G_3) + (1 - A)\frac{G_2}{C_2} \right] + \left[ \frac{G_3(G_1 + G_2)}{C_1C_2} \right]}$$

and

$$\omega_o^2 = \frac{G_3(G_1 + G_2)}{C_1C_2} = \frac{(G'_3 + G_{in})(G_1 + G_2)}{C_1C_2}$$

Notice that the resonant frequency is independent of gain  $A$ , but that  $G_{in}$  does affect it. Now,  $Q$  is given by:

$$Q = \frac{\sqrt{\frac{G_3(G_1 + G_2)}{C_1C_2}}}{G_1 \left( \frac{1}{C_1} + \frac{1}{C_2} \right) + G_2 \left( \frac{1}{C_1} + \frac{1}{C_2} - \frac{A}{C_2} \right) + G_3 \left( \frac{1}{C_2} \right)}$$

By increasing  $A$ , you can make  $Q$  arbitrarily large. However, you reach a point where the  $s$  term in the denominator of the transfer function becomes negative and the circuit begins to oscillate. Thus, to maintain a high  $Q$  without causing oscillation, gain stability is a must.

### The INIC

The current negative impedance converter bandpass filter is shown in Fig. 4. Its transfer function is

$$\frac{E_{out}}{E_{in}}(s) = \frac{-\frac{G_1}{C_2}As}{s^2 + s \left[ \frac{G_1}{C_1} + \frac{G_2}{C_2} - A\frac{G_1}{C_2} \right] + \frac{G_1G_2}{C_1C_2}}$$

where  $A$  is the INIC "gain"

$$A = \frac{i}{i_2} = \frac{R_o + (1 - \alpha)R_A}{R_3 + \alpha R_A}$$

Here, as in the last circuit, the resonant frequency

$$\omega_o^2 = \frac{G_1G_2}{C_1C_2}$$

is independent of gain. For high  $Q$ ,

$$Q = \frac{\sqrt{\frac{G_1G_2}{C_1C_2}}}{\frac{G_1}{C_1} + \frac{G_2}{C_2} - A\frac{G_1}{C_2}}$$

The gain  $A$  must be set very accurately so that the  $s$  term in the denominator of the transfer function does not become negative. A trimmer pot may be used to achieve the exact value desired. Note that when  $Q$  is large

$$\left( A\frac{G_1}{C_2} \text{ is slightly smaller than } \frac{G_1}{C_1} + \frac{G_2}{C_2} \right)$$

a small change in component values or in  $A$  will cause a large change in  $Q$ .

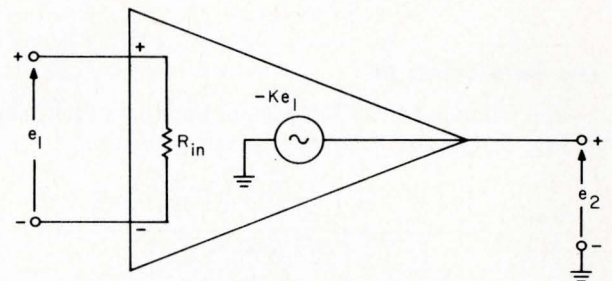

Fig. 1: Simplified equivalent circuit for an operational amplifier.

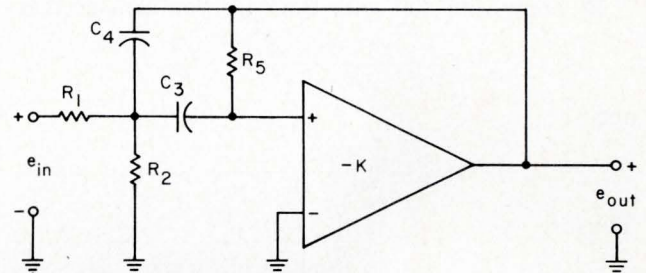

Fig. 2: This multiple inverse feedback bandpass filter offers good stability of frequency and  $Q$ . The final design is shown in Fig. 8.

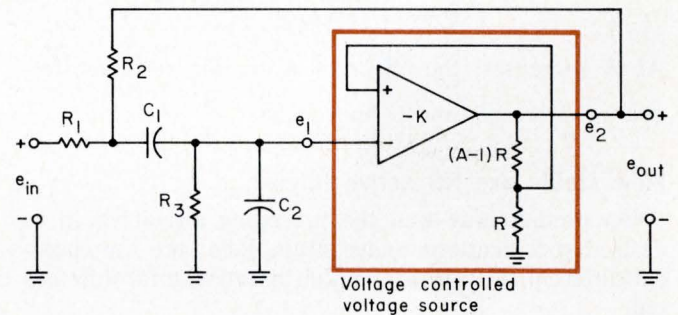

Fig. 3: Here is the controlled gain bandpass filter. The voltage-controlled voltage source section has a gain of  $\frac{e_2}{e_1} = A$ . For high  $Q$  operation, gain stability is needed to prevent the circuit from oscillating.

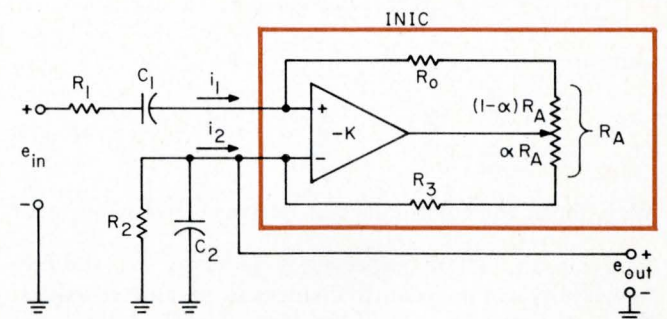

Fig. 4: The current negative impedance converter bandpass filter (INIC, for short) has simplicity of design to its advantage. However, INIC gain stability is sacrificed except at very low  $Q$ .

## The Twin-T Circuit

The balanced twin-T feedback bandpass filter, shown in Fig. 5, has the following transfer function:

$$\frac{E_{out}}{E_{in}}(s) = \frac{-\left(\frac{K}{K+1}\right)\left(\frac{2G_s}{C^2}\right)(G+sC)}{s^2 + 2s\left[\frac{2G+G_{in}+G_s}{(K+1)C}\right] + \left[\frac{2G_{in}G+2G_sG}{(K+1)C^2} + \frac{G^2}{C^2}\right]}$$

$C_s$  is a dc blocking capacitor and does not affect the response.

By comparing this with Eq. (1), you can see that

$$\omega_o^2 = \frac{2G_{in}G + 2G_sG}{(K+1)C^2} + \frac{G^2}{C^2}$$

and

$$2D\omega_o = 2\left[\frac{2G+G_{in}+G_s}{(K+1)C}\right]$$

Thus

$$Q = \frac{\sqrt{\omega_o^2}}{2D\omega_o} = \frac{\sqrt{\frac{2G_{in}G + 2G_sG}{(K+1)C^2} + \frac{G^2}{C^2}}}{2\left[\frac{2G+G_{in}+G_s}{(K+1)C}\right]}$$

Now, assuming  $K \gg 1$  and  $G_s = G_{in} \approx 0$

$$Q = \frac{K}{4} \text{ and } \omega_o = \frac{G}{C}$$

As  $K$  increases, the effect of  $K$  on the resonant frequency decreases and  $Q$  approaches  $\frac{K}{4}$ .

## How stable are RC active filters?

To predict how well the preceding circuits hold to desired specifications under stress, let's take the classical differential approach, which uses the total differential.

In general

$$\omega_o = \omega_o(G_i, C_j, K)$$

Then

$$\frac{\Delta\omega_o}{\omega_o} = \frac{1}{\omega_o} \left[ \sum_{i=1}^M \frac{\partial\omega_o}{\partial G_i} \Delta G_i + \sum_{j=1}^N \frac{\partial\omega_o}{\partial C_j} \Delta C_j + \frac{\partial\omega_o}{\partial K} \Delta K \right] \quad (3)$$

Similarly, for  $Q$

$$Q = Q(G_i, C_j, K)$$

and

$$\frac{\Delta Q}{Q} = \frac{1}{Q} \left[ \sum_{i=1}^R \frac{\partial Q}{\partial G_i} \Delta G_i + \sum_{j=1}^S \frac{\partial Q}{\partial C_j} \Delta C_j + \frac{\partial Q}{\partial K} \Delta K \right] \quad (4)$$

With these formulas you can derive  $\frac{\Delta\omega_o}{\omega_o}$  and  $\frac{\Delta Q}{Q}$  for

each circuit. These expressions indicate the stability (sensitivity) of a circuit to changes in parameter values. In general, the fewer the parameters involved, the more stable the circuit will be. Also, you will eliminate a great source of instability if you avoid delicate balances between parameters.

## The multiple feedback filter

Application of Eq. (3) for the multiple feedback bandpass filter gives

$$\frac{\Delta\omega_o}{\omega_o} = \frac{1}{2} \left[ \frac{\Delta G_o}{G_o} - \frac{\Delta C_3}{C_3} - \frac{\Delta C_4}{C_4} + \frac{G_o \Delta G_5 + \frac{G_o}{K+1} \Delta G_{in} + \frac{G_{in} G_o}{(K+1)^2} \Delta K}{G_5 G_o + \frac{G_{in} G_o}{K+1}} \right]$$

where  $G_o = G_1 + G_2$ . If the terms divided by  $K$  are assumed negligible, then for the worst case (wc) this reduces to

$$\left. \frac{\Delta\omega_o}{\omega_o} \right|_{wc} = \frac{1}{2} \left\{ \left| \frac{\Delta C_3}{C_3} \right| + \left| \frac{\Delta C_4}{C_4} \right| + \left| \frac{\Delta G_o}{G_o} \right| + \left| \frac{\Delta G_5}{G_5} \right| \right\}$$

This implies, for example, that a 1% change in all component values will cause at most a 2% change in frequency. If, in addition, a three to one change in  $K$  is assumed (as is the case for many monolithic IC op amps), then the change in frequency is 2.00225% with maximum gain. Thus, the terms containing  $K$  are indeed negligible since they affect the frequency by less than 0.00225%.

Similarly, the terms divided by  $K$  can be neglected in the expression for  $\frac{\Delta Q}{Q}$ . From Eq. (4),

$$\frac{\Delta Q}{Q} = \frac{1}{2} \left\{ \frac{\Delta C_3}{C_3} + \frac{\Delta C_4}{C_4} - \frac{\Delta G_5}{G_5} + \frac{\Delta(G_1 + G_2)}{G_1 + G_2} \right\} - \frac{\Delta(C_3 + C_4)}{C_3 + C_4}$$

Thus, a 1% change in all five elements results in at most a 1% change in  $Q$ . Notice that  $\frac{\Delta Q}{Q}$  and  $\frac{\Delta\omega_o}{\omega_o}$

change simultaneously since they both depend on the same components.

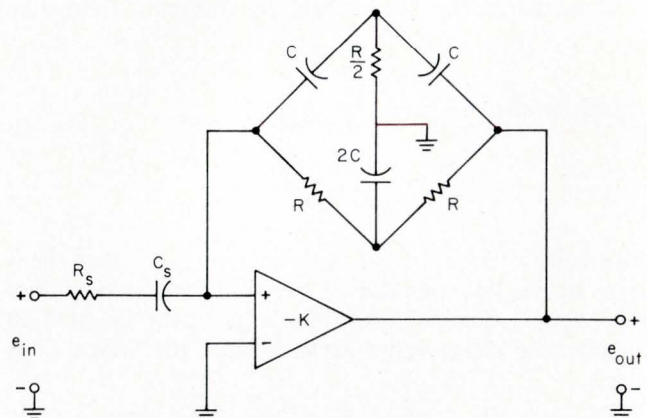

Fig. 5: This balanced twin-T feedback bandpass filter, like the multiple inverse feedback filter, has good frequency and  $Q$  stability. Problems with implementation of this circuit have been ironed out, and the final circuit is shown in Fig. 7.

In this case,

$$\frac{\Delta Q}{Q} = \frac{\Delta \omega_o}{\omega_o} + c$$

where  $c$  is a constant. Also, since  $Q = \frac{f_o}{BW}$ , then

$$\frac{\Delta Q}{Q} = \left| \frac{\Delta f_o}{f_o} \right| \pm \left| \frac{\Delta BW}{BW} \right|$$

where  $f_o$  is the resonant frequency, and  $BW$  is the bandwidth. Thus if  $\frac{\Delta Q}{Q} > \frac{\Delta \omega_o}{\omega_o}$ , then the bandwidth must be changing so as to increase the change in  $Q$ . Conversely,  $\frac{\Delta Q}{Q} < \frac{\Delta \omega_o}{\omega_o}$  means that the change in bandwidth is tending to "overcompensate" for the change in frequency,  $\omega_o$ . However, if  $\frac{\Delta Q}{Q} = \frac{\Delta \omega_o}{\omega_o}$  then the change in bandwidth compensates exactly for the change in frequency.

### The controlled gain filter

The frequency sensitivity of the controlled gain band-pass filter is derived from Eq. (3) as

$$\frac{\Delta \omega_o}{\omega_o} = \frac{1}{2} \left[ \frac{\Delta G_3}{G_3} + \frac{\Delta (G_1 + G_2)}{G_1 + G_2} - \frac{\Delta C_1}{C_1} - \frac{\Delta C_2}{C_2} \right]$$

Again, a worst-case change of 1% in all components produces only a 2% change in the center frequency. For  $Q$

$$\frac{\Delta Q}{Q} = \frac{1}{2} \left[ \frac{\Delta G_3}{G_3} + \frac{\Delta (G_1 + G_2)}{G_1 + G_2} - \frac{\Delta C_1}{C_1} - \frac{\Delta C_2}{C_2} \right] - \frac{C_2 \Delta G_o + G_o \Delta C_2 + (G_o + G_3 - A G_2) \Delta C_1 + C_1 \Delta (G_o + G_3 - A G_2)}{C_2 (G_1 + G_2) + C_1 (G_o + G_3 - A G_2)}$$

where  $G_o = G_1 + G_2$ . Now, for a balanced configuration, the following design formulas are used:

$$\begin{aligned} C_1 &= 2C_2 \\ G_2 &= 3G_1 \\ G_1 &= 2G_3 \end{aligned}$$

Using these formulas, and assuming 1% changes in all component values, you can simplify the original equation for  $Q$ :

$$Q = \frac{1}{6.5 - 3A}$$

and  $\frac{\Delta Q}{Q}$  becomes

$$\frac{\Delta Q}{Q} = \frac{3\Delta A}{6.5 - 3A}$$

Thus, choice of the desired value of  $Q$  fixes the value of  $A$ , which in turn determines the sensitivity of  $Q$  to change. Table 1 gives some representative values for  $Q$  and shows how the sensitivity is affected (assuming changes of 1% for all components except the divider resistors, which change 0.1% each; and gain stability of 0.2% =  $\frac{\Delta A}{A}$  which is determined by the divider resistors).

Note that since  $A$  doesn't appear in the expression for  $\omega_o$  in any meaningful way, most of the instability shows up as bandwidth variations rather than as changes as center frequency.

### The INIC filter

Results for the INIC are similar to those for the controlled gain circuit. In this case

$$\frac{\Delta \omega_o}{\omega_o} = -\frac{1}{2} \left[ \frac{\Delta C_1}{C_1} + \frac{\Delta C_2}{C_2} + \frac{\Delta G_1}{G_1} + \frac{\Delta G_2}{G_2} \right]$$

Then, as before, 1% variations in these elements result in a 2% change in frequency. For the sensitivity of  $Q$ ,

$$\frac{\Delta Q}{Q} = \frac{1}{2} \left[ \frac{\Delta C_1}{C_1} + \frac{\Delta C_2}{C_2} + \frac{\Delta G_1}{G_1} + \frac{\Delta G_2}{G_2} \right] - \left[ \frac{C_2 \Delta G_1 + G_1 \Delta C_2 + C_1 \Delta G_2 + G_2 \Delta C_1 - A C_1 \Delta G_1 - A G_1 \Delta C_1 - G_1 C_1 \Delta A}{C_2 G_1 + C_1 G_2 - A G_1 C_1} \right]$$

Again, for a balanced configuration

$$\begin{aligned} G_1 &= G_2 \\ C &= C_2 \end{aligned}$$

Table 1

List of  $Q$  sensitivities for values of desired  $Q$  for the controlled gain bandpass filter.

Q	6.5-3A	A	$\Delta Q/Q$
1	1.0	1.835	0.011
10	0.1	2.135	0.128
50	0.02	2.160	0.65
100	0.01	2.1633	1.3
500	0.002	2.1660	6.5
1000	0.001	2.16633	13.0

Table 2

List of  $Q$  sensitivities for values of desired  $Q$  for the INIC.

Q	2-A	A	$\Delta Q/Q$
1	1.00	1.00	0.002
10	0.10	1.90	0.038
50	0.02	1.98	0.198
100	0.01	1.99	0.398
500	0.002	1.998	2.00
1000	0.001	1.999	4.00

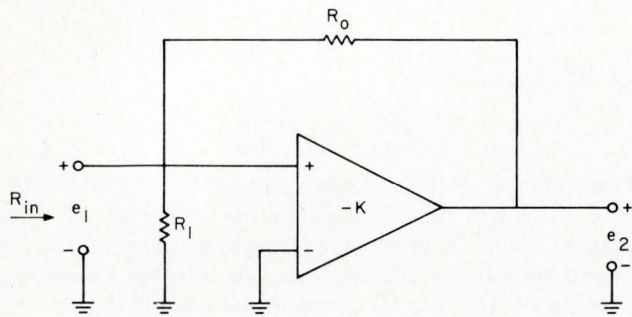

$$\text{Gain} = \frac{e_2}{e_1} = \frac{R_0}{R_1} \text{ as } K \rightarrow \infty$$

**Fig. 6:** Here is a simple method for controlling the gain in an op amp. The higher the original open loop gain, the better is the approximation given above.

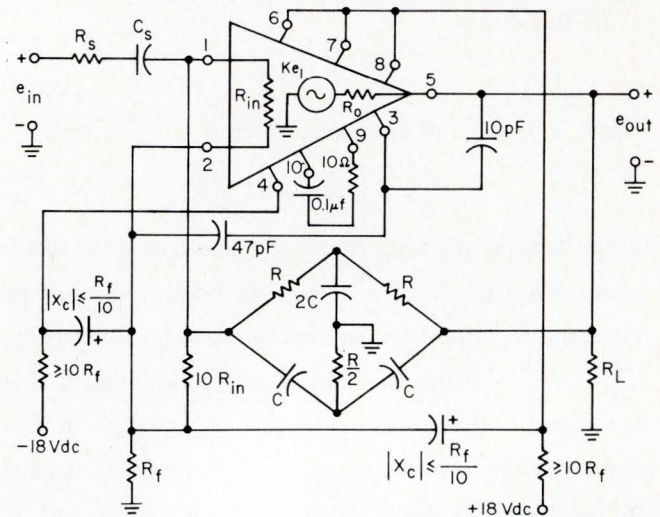

**Fig. 7:** The final version of the balanced twin-T filter shows the biasing, T, and compensation networks. The pin connections are shown for the Motorola MC 1533G op amp.

and  $\frac{\Delta Q}{Q}$  reduces to

$$\frac{\Delta Q}{Q} = -\frac{\Delta A}{2 - A}$$

while  $Q$  reduces to

$$Q = \frac{1}{2 - A}$$

As in the case of the controlled gain circuit, choice of  $Q$  fixes the INIC "gain,"  $A$ , which in turn determines the sensitivity of  $Q$  to changes. Table 2 shows some representative values of  $Q$  and their corresponding sensitivities (assuming 1% variations in all components except the divider resistors, which have 0.1% variations and which determine the INIC gain stability of  $0.2\% = \frac{\Delta A}{A}$ ).

A comparison of Tables 1 and 2 shows the INIC to be slightly more stable for a given  $Q$  than is the controlled gain circuit; but both are inferior to the multiple feedback circuit. However, high  $Q$  is not as easily obtained from the multiple feedback filter as it is from the other two.

The frequency sensitivity for the twin-T feedback bandpass filter is derived from Eq. (3) as

$$\frac{\Delta \omega_o}{\omega_o} = \frac{1}{2} \left[ \frac{2\Delta G}{G} - \frac{2\Delta C}{C} + \frac{\Delta \left\{ 1 + \frac{2(G_s + G_{in})}{(K+1)G} \right\}}{1 + \frac{2(G_s + G_{in})}{(K+1)G}} \right]$$

If  $K \gg 1$  and  $G_s = G_{in} \approx 0$  then

$$\frac{\Delta \omega_o}{\omega_o} = \frac{\Delta G}{G} - \frac{\Delta C}{C}$$

Thus 1% changes in component values produce a 2% change in center frequency. To see what effect the

inclusion of  $K$  has on  $\frac{\Delta \omega_o}{\omega_o}$  assume a  $K$  of 200 (corresponding to a moderate  $Q$  of  $\frac{K}{4} = 50$ ) and  $\frac{\Delta K}{K} = 0.02$ .

$$\frac{\Delta \omega_o}{\omega_o} = 2.005\%$$

Hence, gain variations have little effect on  $\omega_o$ . In fact, even a three to one change of open-loop gain has little effect; and the higher the gain, the less effect it has.

Variations in  $Q$  are found from Eq. (4) and are given by

$$\frac{\Delta Q}{Q} = \frac{\Delta G}{G} - \frac{\Delta(G + G_s + G_{in})}{G + G_s + G_{in}} + \frac{\Delta K}{K}$$

If  $G_s = G_{in} \approx 0$ , then

$$\frac{\Delta Q}{Q} = \frac{\Delta K}{K}$$

Thus, variations in  $Q$  can be made as small as variations in gain,  $K$ . In fact, if 0.1% gain adjustment resistors are used, gain (and  $Q$ ) variations are only 0.2%.

Since all four types of circuits have the same order of frequency stability (about 2% for 1% changes in the elements), your choice of circuit type should depend more on whether you can achieve a low or high frequency value without using extremely large or small component values. The multiple feedback circuit is good for very low frequencies (sub audio to low audio) when you want to avoid large components—but at the expense of high  $Q$ . The others also achieve low frequencies and high  $Q$  but require larger  $R$ 's and  $C$ 's.

The  $Q$  stability factor favors the multiple feedback and the twin-T circuits. For very high  $Q$  applications the twin-T circuit is best. Using precision resistors in the T with opposite and nearly equal temperature characteristics from the capacitors, you can achieve stability more easily with this than with the other circuits where high theoretical  $Q$  is possible. The other two circuits



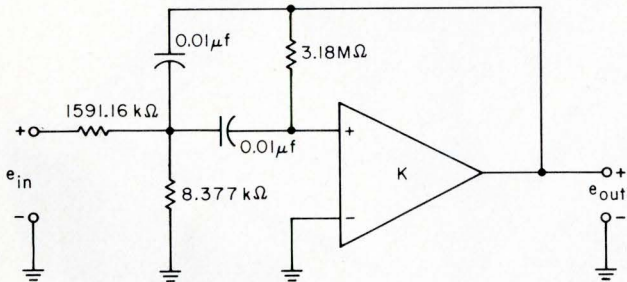

**Fig. 8:** All the component values are shown in this final design of the multiple feedback filter. Resistors are 1% metal film type and capacitors are 5% polystyrene.

(the controlled gain and INIC) easily oscillate if the design parameters are not carefully controlled. In general, the twin-T is the most versatile and stable circuit at high  $Q$ , the multiple feedback at low  $Q$ , and the INIC is the simplest to implement.

### Building the twin-T

Except for the twin-T feedback, all the circuits described are easy to implement. As previously explained,  $Q$  is determined by controlling gain. The most common way to control gain in an op amp is to use a resistor divider network. The gain is then approximately the ratio of the resistances (see Fig. 6). The higher the original gain the better the approximation. For example, the input impedance to the circuit in Fig. 6 is approximately

$$R_{i_n} = \frac{R_1 \left( \frac{R_o}{K} \right)}{R_1 + \frac{R_o}{K}}$$

where  $K$  is the open loop gain of the amplifier. But this severely loads the twin-T feedback section.

Several approaches can be taken to correct this, such as inserting an emitter follower between the output of the T and the input to the amplifier; but dc variations in the follower would saturate the amplifier. And if you attempt to isolate the amplifier from the follower with a capacitor, a peak response is introduced at dc which results in a two-peaked response curve.

Instead, try current feedback combined with voltage feedback. The voltage feedback lowers the output resistance of the amplifier but also lowers the input impedance and the open-loop gain. The current feedback raises the input impedance and returns the gain to the desired level. Choose the voltage feedback so that the resultant intermediate gain is approximately

the geometric mean between the open-loop gain and the final desired gain.

Figure 7 shows a twin-T filter complete with biasing, T, and compensation networks that was built by the author. The decoupling resistors and large capacitors provide an ac path such that the current feedback resistor  $R_f$  will set the gain. The frequency and gain determining elements are 1% metal film resistors and 5% polystyrene capacitors.

The op amp, a Motorola MC1433G, has an open-loop gain of 60,000 (96 dB) nominally and an input impedance of at least 300 kΩ. With frequency compensation the open-loop gain dropped to about 70 dB at 5 kHz (6 dB/octave break at about 60 Hz).

The twin-T circuit was designed for a resonant frequency of 5000 Hz with a  $Q$  of 50. The value of  $R$  in the bridge was 3.18 kΩ; the value of  $C$  was 0.01 mfd. A test of the T alone showed a deep null of 60 dB at 5010 Hz  $\pm$  5 Hz. After the T was connected to the amplifier, the peaking frequency became 5005 Hz  $\pm$  0.1%. The current feedback and load resistors were adjusted so that  $Q$  became very nearly 50.

Cooling the T-elements to about  $-10^\circ\text{F}$  from  $85^\circ\text{F}$  caused a shift in frequency from 5005 Hz down to about 4975 Hz (about a 0.6% change); the  $Q$  dropped to about 39. The worst case change over our temperature range (about  $50^\circ\text{C}$ ) caused a 1.55% change in frequency, which was well within predicted limits.

### Other Results

The multiple feedback bandpass and the INIC bandpass circuits were also built by the author with 1% resistors and 5% capacitors, as in the twin-T circuit. The multiple inverse feedback bandpass circuit was designed to have a peak frequency at 100 Hz with a  $Q$  of 10. After it was constructed, experimental results showed a peak of 103 Hz and a  $Q$  of 10.32. Cooling this circuit to about  $-10^\circ\text{F}$  caused about a 1% change in frequency with a similarly small change in  $Q$ . There was no change in amplitude. The final design is shown in Fig. 8.

The INIC was constructed with a resonant frequency of 36.9 Hz (design was for 33 Hz). Here 5% resistors and 10% capacitors were used. When the INIC circuit was first built, it oscillated at 36.9 Hz. Although reducing the gain by about 10% stabilized the circuit, the  $Q$  was only 6.15. This is evidence of the difficulty in adjusting  $Q$ . The INIC was readjusted so that it was stable at an  $f_o$  of 38.5 Hz and a  $Q$  of 12.5. The 20-kΩ resistors which determine the INIC gain were cooled to about  $0^\circ\text{F}$ . The gain increase which resulted raised  $Q$  to 13.8 without affecting the center frequency.

On the basis of these results, you can see that where stability of frequency and  $Q$  are very important, the twin-T feedback and multiple feedback circuits are best. When simplicity of circuitry is utmost, the INIC comes out on top but with a sacrifice in gain stability (except for very low  $Q$ ).

INFORMATION RETRIEVAL  
Integrated circuits, Amplifiers,  
Circuit design, Circuit theory

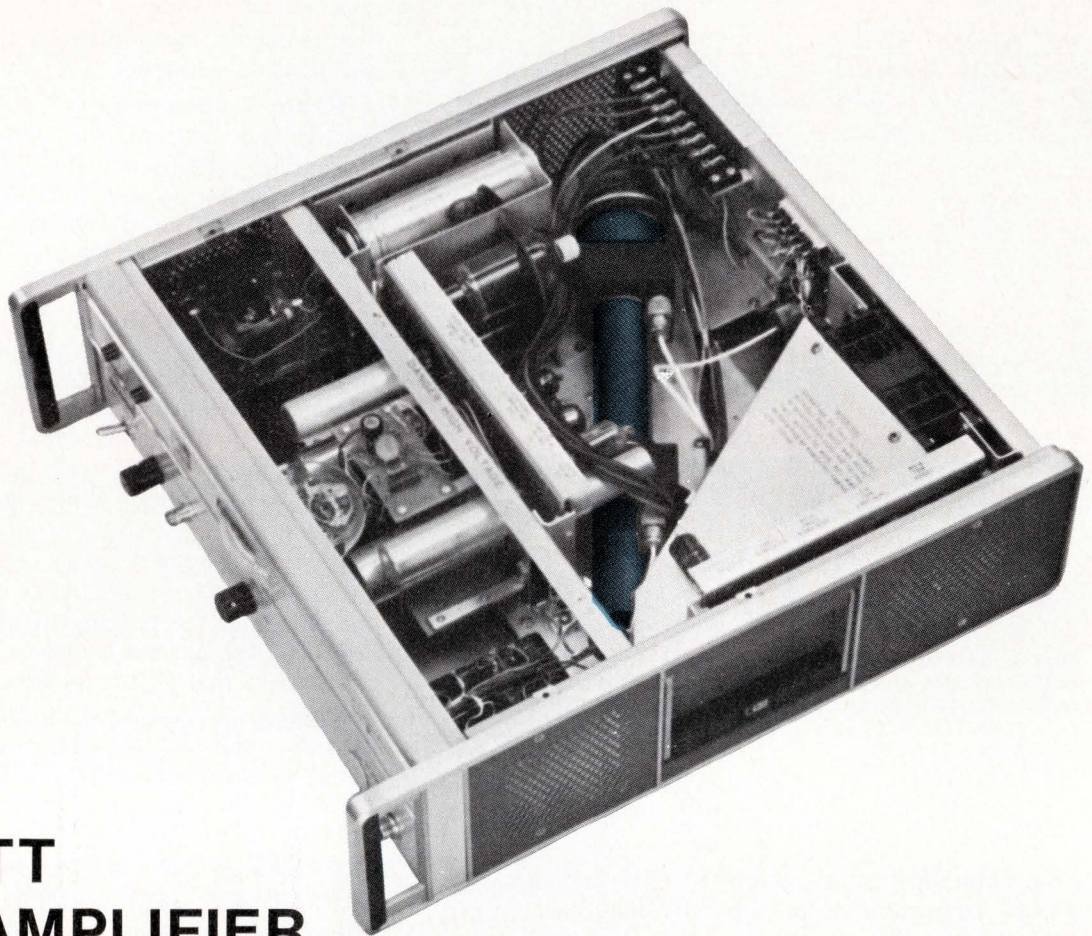

# NO 1-WATT POWER AMPLIFIER SHOULD BE WITHOUT ONE...

## ...One of W-J's 1-Watt Traveling-Wave Tubes

Any one of our L-, S-, C- or X-band tubes will do the job for you. Designed for use in broadband microwave amplifiers, these rugged PPM-focused TWTs combine high power and high gain in a small package. Details:

SPECIFICATIONS					
	Band	Frequency Range	Power Output	Small Signal Gain	Noise Figure
WJ-2500	L	1 to 2 GHz	1 watt min.	30 dB min.	30 dB max.
WJ-2501	S	2 to 4 GHz	1 watt min.	30 dB min.	30 dB max.
WJ-2502	C	4 to 8 GHz	1 watt min.	30 dB min.	30 dB max.
WJ-2503	X	8 to 12 GHz	1 watt min.	30 dB min.	30 dB max.

Size and weight for L- and S-band units: 2.7 x 2.85 x 14.5 inches, 3.5 lbs.  
 Size and weight for C- and X-band units: 2.5 x 2.5 x 12.75 inches, 3.5 lbs.

3333 HILLVIEW AVE., STANFORD INDUSTRIAL PARK, PALO ALTO, CALIF. 94304 • (415) 326-8830

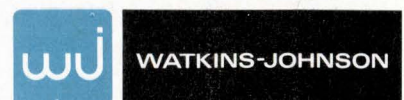

# Sweep measurements cut costs

Sweep-frequency test techniques do their thing again—this time on a production line for large and complex waveguide assemblies.



By **Walter White, Jr.**, Planning Engr.  
Western Electric Company, North Andover, Mass.

Most of us have seen microwave relay towers at one time or another—perhaps set in prairie farmlands, or atop mountains, or even rising resolutely above city rooftops. Taking these towers for granted, we rarely pause to consider their importance in our lives.

But they are important to us, for many of these towers with their clusters of antennas are parts of common-carrier systems—telecommunication networks which serve the general public. And if these systems are not quite up to par, then neither is the quality of our TV and telephone communications.

So what does all of this have to do with sweep testing? To find out, let's take a brief look at the tower's function.

Mounted on each relay tower are several horn reflector antennas with their associated waveguide runs. These antennas receive or transmit broadband microwave signals in the 4-, 6-, and 11-GHz common-carrier bands, with both vertically and horizontally polarized signals present in each band.

Now, each reflector antenna operates with several rf systems. In fact, there can be as many as six systems operating across the common-carrier bands with a single, common antenna. And the heart of this multi-band, multifeed system lies in a component called a **system combining network**.

Several system combining networks together form, in effect, a type of multiplexer. In particular, a full com-

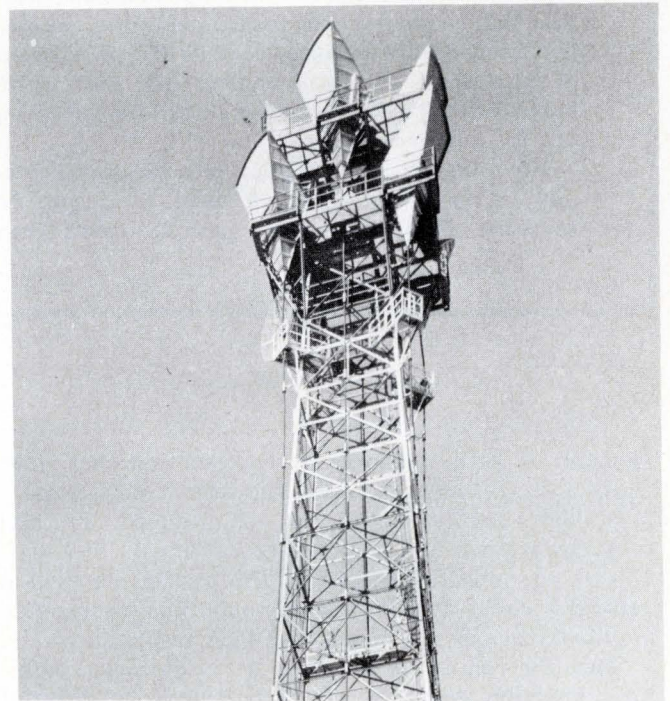

**Fig. 1. Familiar sight.** Towers such as these support clusters of horn reflector antennas and their waveguide runs. The antennas are parts of a relay system for the 4-, 6-, and 11-GHz common-carrier bands, and carry signals for the general public (telephone, television, and so forth).

## System combining networks

System combining networks route multiband signals as a function of signal polarization. Since individual 4-, 6-, and 11-GHz common-carrier signals may be either vertically or horizontally polarized, relay systems use combining networks not only to sort signal polarities, but also to change them to a single polarity. This means that all of the input waveguide runs can be brought together to feed a single antenna.

The combining network consists of a square waveguide section—open at its ends, which are called arms 1 and 2—mounted to a rectangular section which has only one opening, called arm 3. Small slots and antennas electrically couple the square and rectangular guides along their common wall.

The figure shown here is a sketch of a combining network (you may wish to compare it to the photograph in Fig. 3) together with three other items: an input transducer, and input and output polarizers. These are part of the test set-up, and are not used in an actual waveguide antenna run. The arrangement as shown might be a typical bench set-up having an input signal (polarized as shown) from a sweeper. This signal first enters the input transducer, then the polarizer, and finally arm 2.

The 1406 network has five electrical terminals, or *ports*, although there are only three physical openings. By using two polarizations of the electromagnetic wave, you get the two remaining ports. The square waveguide can carry signals in all of the common-carrier bands (4, 6, and 11 GHz), and also supports two input and two output polarizations (vertical and horizontal). The orientation of the connecting rectangular waveguides controls the polarization of the signal. In a typical antenna run, you can remove both polarizations by using two 1406 networks, one for each polarization.

Now, before we go further, let's define polarization in waveguide terms. A wave is said to be vertically polarized in a rectangular waveguide when

the electric field component lays in a plane perpendicular to the wide axis of the guide. In other words, the dominant, or  $TE_{10}$ , mode in rectangular waveguide is vertically polarized. Since a square waveguide is equidimensional in cross section, it can support two orthogonal, vertically polarized waves. From the sketch, you can determine the placement of the network which will give you either the vertically or the horizontally polarized wave during test.

At arm 1, the solid arrows 1 and 2 (and 3 and 4 at arm 2) denote the ports. The arrow at the transducer shows vertical polarization as defined. And the arrows at the front of the input polarizer illustrate the vertical and horizontal polarizations of the signals passing through.

The rectangular waveguides, which connect to the combining network, set the signal polarizations. For instance, if the short dimension of the guide that connects to port 1/arm 1 is parallel to the short dimension of port 5/arm 3, then the polarizations at these ports are identical and the signal passes through the network. This is a *coupled* mode.

But suppose the short side of the input guide is parallel to the long side of port 5 (as in the illustration, where the input guide connects to the input transducer in the position shown). In this case, the polarizations are different and the ports are uncoupled. To propagate the input signal through the network to port 5, you must rotate the combining network as shown, through  $90^\circ$ .

During test, you can eliminate either the vertical or the horizontal polarization by using vane polarizers at the input and output of the square waveguide. These polarizers are short lengths of square guide with a central, very thin, resistive strip which acts as a termination. The vane has the property of being able to absorb energy from fields polarized perpen-

plement of such networks at a tower site lets you connect six *rectangular* waveguide runs (six systems) to a single, *circular* waveguide, antenna feed. The six runs correspond to full coverage of the 4-, 6-, and 11-GHz common-carrier bands. The system combining networks either reject or pass, and thus route, the multiband signals as a function of their polarization.

Since the combining networks are in the signal path, their insertion loss and VSWR characteristics directly affect system operation. And thus enters sweep-frequency testing, which allows you to measure quickly and thoroughly these characteristics of the system combining network.

### Near miss not good enough

After production and mechanical inspection, the combining networks must pass return loss (VSWR) and insertion loss tests at a number of frequencies in each of the three common-carrier bands. In the past, these networks had been checked mechanically, then electrically on a point-to-point basis. But with the advent of modern sweep testing methods it became both practical and economical to electrically test each network for return loss over a complete band. In addition, minor modifications to the test setup let you test insertion loss.

Production specifications usually call out three to five test frequencies. In other words, the designer assumes

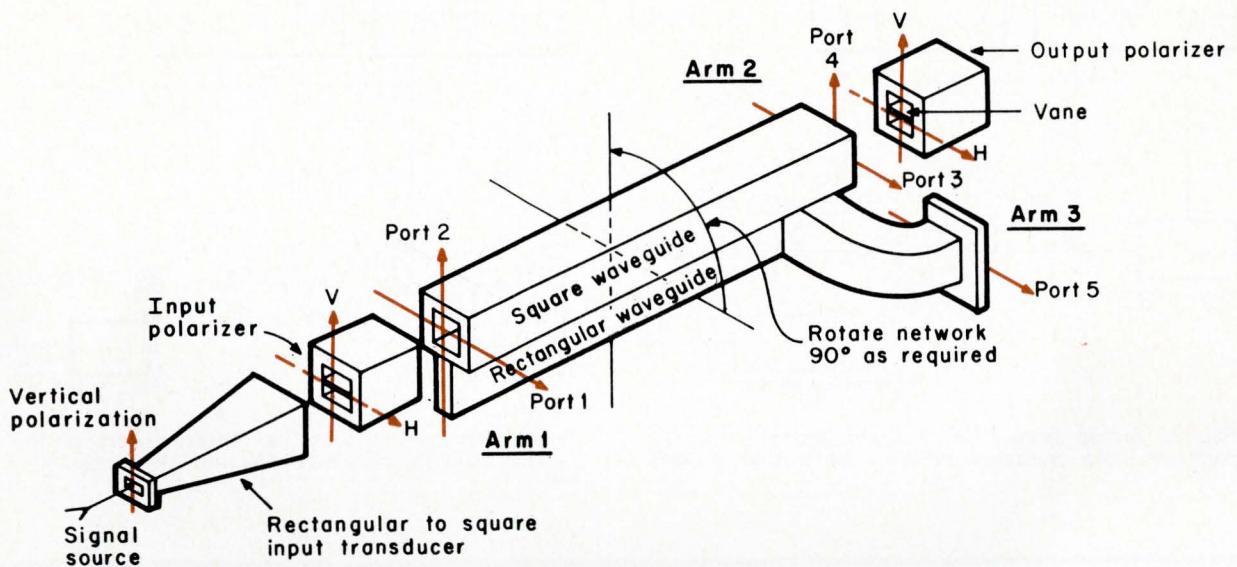

dicularly with respect to the width of the vane across its guide. It passes energy from fields polarized parallel to the vane's width. You use the polarizers whenever you must look between two ports while making insertion-loss measurements for cross-polarization discrimination.

For example, an insertion loss measurement at 11 GHz between ports 1 and 3 would not require the polarizers, as the orientation of the ports is such as to make them unnecessary. But to look at the 11-GHz insertion loss between ports 1 and 4, you would need two polarizers. The input polarizer would have its vane parallel to the long axis of the rectangular-guide end of the input waveguide transducer. The output polarizer, on the other hand, would have its vane vertical. In this position, it absorbs the horizontal wave, but passes the vertical wave. And this is the

energy of port 4 for which the insertion loss is desired.

An 11-GHz insertion-loss measurement between ports 1 and 5 would require the input polarizer but not the output polarizer, because rectangular port 5 does the job of the polarizer. The same measurement between ports 3 and 5 would not require either polarizer, since ports 3 and 5 are similarly polarized.

In summary, when a cross-polarized wave is launched, you try to detect coupled polarization coming out of the far end of the combining network. To do this, you excite the network with the polarization you want, and eliminate that same polarization at the far end while measuring the cross-polarized component. The polarizer's resistive vane absorbs the undesired energy, eliminates multiple bounces, and in general lets you make more effective measurements.

that if at several frequencies the network meets the requirements for return loss and insertion loss, then all frequencies will test satisfactorily. But there are hundreds of points which could be checked, and sweep tests give you this capability. One look at the frequency band of interest shows immediately the nature of any spike or other irregularity. In point-to-point testing, on the other hand, it is possible to have a poor return loss at 6.2 GHz that is detrimental to the system, but which you could not see with tests at only, say, 6.175 and 6.425 GHz.

Sweep testing is thus a good check on quality. And although it may not be as accurate as point-to-point

testing (for any given frequency), it is faster. The time needed for point-to-point testing is on the order of three to five times as long as that needed for sweep testing. If you need ten minutes to make a swept return loss measurement, then you will need 30 to 50 minutes to make the same measurement on a point-to-point basis. And this means money. Setup time, too, is longer for point-to-point measurements than for swept measurements.

#### Cost-saving improvements

Western Electric's 1406A system combining network is a case in point. In its redesign, sweep tests proved

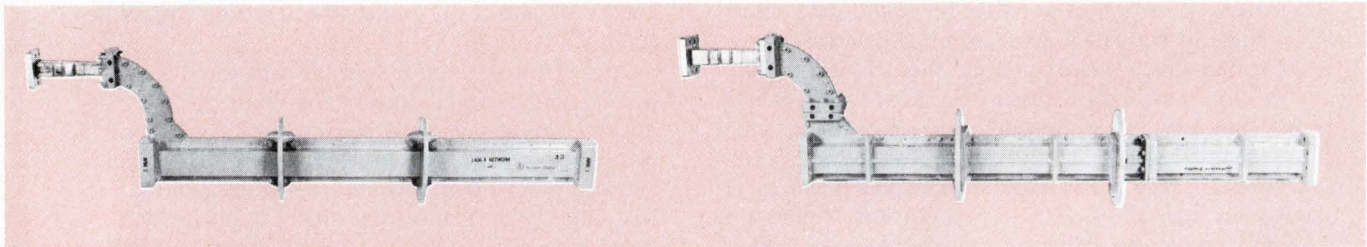
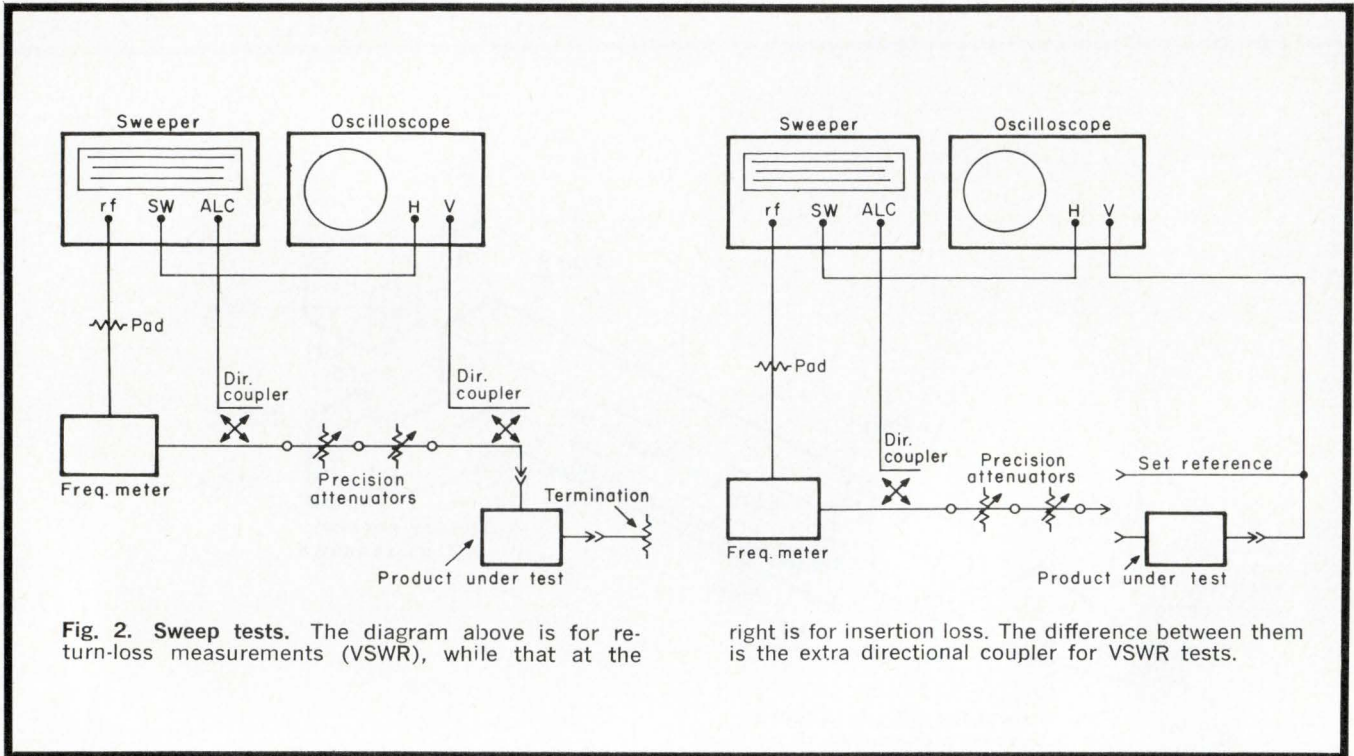

**Fig. 3. Redesign.** The improved 1406A combining network (left) costs less to produce, and performs better than the

original device (right). Sweep testing revealed a production problem—a need for better machining specifications.

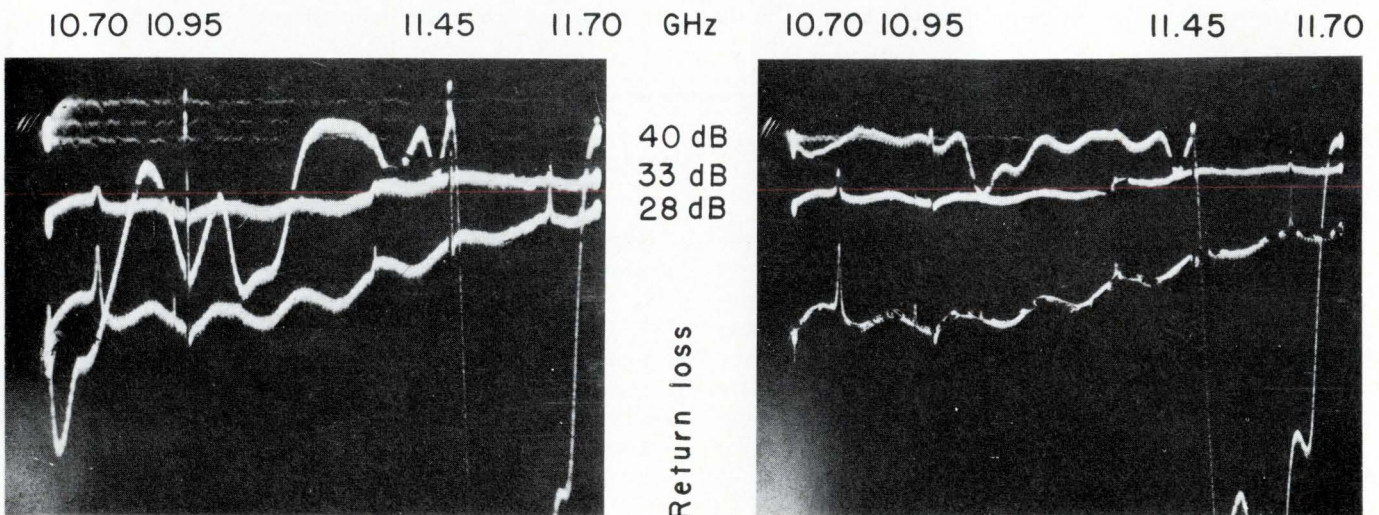

**Fig. 4. Problem solved.** These return-loss traces are before and after photos of the 1406A network during its redesign. The 33-dB return-loss trace represents the minimum tolerable spec except at 11.45 GHz, where 28 dB is acceptable.

The left-hand photo shows return loss early in production; it's out of spec at 10.7 and 10.95 GHz. Surface sanding gave the improvement evident in the right-hand photo, where the return loss hovers about a 40-dB level.

of great value in developing a new extrusion (Fig. 3), and at a substantial savings over the old device.

For example, during production testing the 1406A networks failed return loss tests at 10.70 and 10.95 GHz. The specification calls for 32.8 dB return loss (1.047 VSWR) at a particular port. ( $Return\ loss = -20 \log [(VSWR + 1)/(VSWR - 1)]$ .) All network dimensions were in tolerance, and the machined surface of the wide- and narrow-channel extrusions was within the requirements of a 32- $\mu$ in. finish. But the surface showed sharp ridges in the form of whorls or convolutions, which were left by the cutting tool.

On the basis that such well defined, recurring ridges might cause discontinuities or reflections, the extrusions were lightly sanded with fine emery cloth and the networks reassembled and tested. At this point, the return loss measured 40 dB (1.02 VSWR) and surpassed the test requirements (Fig. 4). This meant that the convolutions left by the cutting tool were within the machining spec, but had been too large for satisfactory electrical performance. Sweep testing had let the supplier correct an in-house problem before it had become serious.

You can see that sweep testing is a powerful production tool. It assures the microwave manufacturer that he can meet his electrical requirements, as well as his mechanical requirements. For instance, suppose several hundred such networks had been shipped simply because they met "good" mechanical specifications. They would have been rejected during electrical test by the user, which is after all the only reasonable way a user can check the product. Both user and supplier would have had a costly exercise on the basis of shipping costs as well as production delays while the problem was corrected.

#### Measurement errors

Our sweep systems allow us to read return loss from 30 dB to more than 40 dB, which is adequate for most production tests. Preinsertion techniques for return losses to 40 dB eliminate any effects of the detector's square-law characteristics, because the crystal operates near the same rf level during both calibration and test.

Possible error sources are the effective source reflection coefficient, an imperfect calibrating short, reverse coupler directivity, coupling coefficient differences, and detector frequency response differences between forward and reverse couplers. (For a detailed description of measurement errors, see Hewlett-Packard's Application Note 65, "Swept-Frequency Techniques.") But all things considered, from a manufacturing point of view the accuracy of sweep testing is more than adequate to ascertain that a product meets its specifications.

**INFORMATION RETRIEVAL:**  
Microwaves and microwave products,  
Instruments and measurements, Communications

## Motorola VIBRASPONDER Resonant Reeds

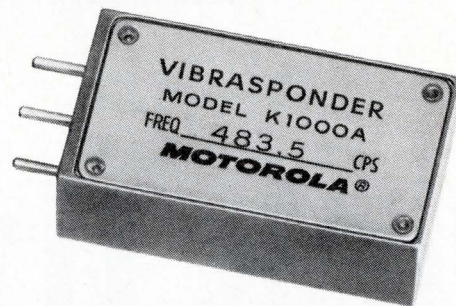

**Performance proven, they're the industry's smallest and most rugged reeds.**

Proven in thousands of remote control and signaling applications, VIBRASPONDER reeds provide unlimited potential in supervisory control, aerospace, military, and telemetry applications, or whenever selective tone signaling or stable audio tones are required.

Special construction gives VIBRASPONDER reeds maximum protection against shock and vibration. Contactless design allows its use as either a tone generator or a decoder. Multiple reeds may be used for sequential coded tone applications.

Over one hundred-fifty standard tone frequencies are available from 67 Hz to 3150 Hz. Other frequencies available on request.

For more information on VIBRASPONDER reeds, write for Bulletin TIC-3521 to Component Products Dept., Motorola Communications & Electronics, Inc., 4501 W. Augusta Blvd., Chicago, Illinois 60651. Or call (312) 772-6500.



Circle 33 on Inquiry Card



## CIRCUIT DESIGN ENGINEERS

A leader in inertial navigation systems, such as the F14 and S3A programs, announces openings for circuit design specialists. BSEE's with 5-10 years experience in either platform electronic and control systems, power conversion or signal processing.

Please write J. D. Anderson  
5500 Canoga Avenue,  
Woodland Hills, California 91364

 **GUIDANCE & CONTROL  
SYSTEMS DIVISION**  
LITTON INDUSTRIES

An equal opportunity employer M/F

**Pick the  
biggest  
winner yet.**

**We did.  
i-3301**



# New LSI memory is largest bipolar ever. A 1024-bit ROM with 60 nsec maximum access.

Introducing Intel Model 3301, a Schottky-process bipolar ROM memory with 256 x 4 organization. It's fully-decoded and dissipates only 0.5 mW/bit power. All inputs are Schottky diode clamped, and all outputs are capable of wired OR operation.

Two "chip select" leads permit expansion to a 1024 word memory without need for external decoding. Addition of two quad gates allows further expansion to 2048 words.

Memories offered as standard products will translate ASCII-8 to EBCDIC-8 and vice versa. Custom units to match your truth table can be delivered in 4 to 6 weeks.

**Order now from over 40 locations.** Phone your local Intel distributor: Cramer Electronics or Hamilton Electro Sales. Or phone us collect at Mountain View, California (415) 961-8080.

Intel Corporation is in production at 365 Middlefield Road, Mountain View, California 94040.

**Intel delivers.  
Try us.**

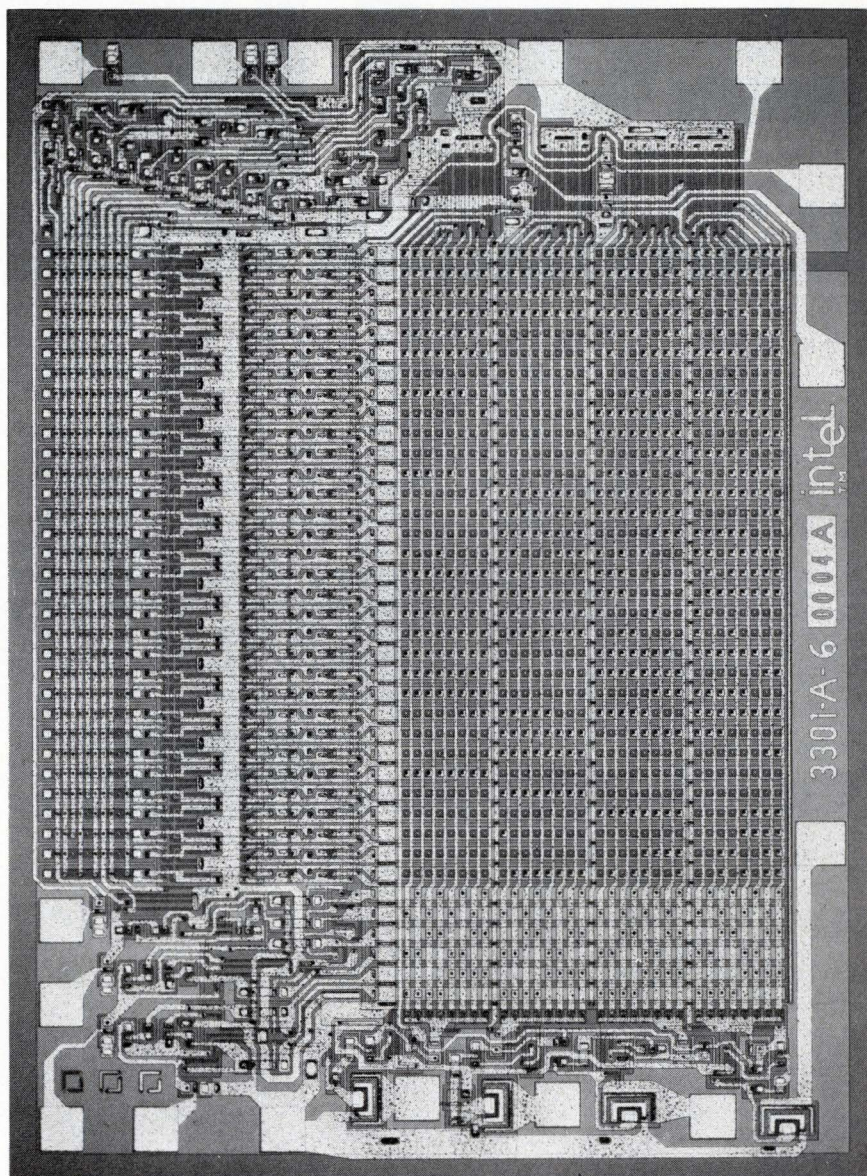

**intel**<sup>TM</sup>

# $\pm 50 \text{ ppm}/^\circ\text{C}$ in all Helipot Cermet Trimmers

This significant advance in Helipot's cermet technology is now available at only a dime/unit more . . . 100 ohms thru 2 megohms. In addition, you get essentially infinite resolution, environmental stability, reliability, no catastrophic failures — all superior to wirewound trimmers. We'll also deliver off-the-shelf, locally stocked trimmers with a standard tempco of  $\pm 100 \text{ ppm}/^\circ\text{C}$  in the 100 ohm thru 2 megohm range.

**Beckman**<sup>®</sup>

INSTRUMENTS, INC.  
HELIPOT DIVISION  
FULLERTON, CALIFORNIA • 92634

INTERNATIONAL SUBSIDIARIES: AMSTERDAM; CAPE TOWN; GENEVA; GLENROTHES, SCOTLAND; LONDON; MEXICO CITY; MUNICH; PARIS; STOCKHOLM; TOKYO; VIENNA

# Vote for the best IC Idea of the year

This month, we are asking you to vote for a double winner. The eleven circuits you will find in the following pages are the ones you voted as the monthly winners between May, 1968 and March, 1969. Now that the polls are closed for those months, look at these circuits again and select the winningest winner. The lucky colleague selected by most of you, gets an oscilloscope.

---

<b>For this Idea</b>	<b>Vote for No.</b>
Voltage regulator has extended range, remote shutdown . . . . .	980
Add-on network improves op amp bandwidth and slew rate . . . . .	981
Stable square-wave generator . . . . .	982
Low cost voltage regulator from one IC . . . . .	983
For a square-law transfer function, try this op amp connection . . . . .	984
Regulated supply has two outputs . . . . .	985
Collector junction compensates current source in this diff amp . . . . .	986
Make a crystal-controlled clock with DTL gates . . . . .	987
Threshold testing too tedious? Automate . . . . .	988
Bidirectional ripple counter counts up or down . . . . .	989
Digital filter replaces bulky components . . . . .	990

---

## **Vote** for the one you like best

Choose the IC Idea you like best. Write its number in box on the Inquiry Card, and send to us.

---

**Send us** practical, reproducible ideas that are original with you and have been implemented with linear or digital ICs.

- If we publish your idea you win a check for \$25.00.
- If our readers vote yours the best of the issue in which it appears, you have your choice of a Simpson 270 or a Triplet 600 multimeter.
- After 12 issues our readers will vote on the best

idea for all 12 issues. The winner gets his choice of either a Hewlett-Packard 1206A or a Tektronix 310A oscilloscope.

Submit your IC Ideas to:  
Alberto Socolovsky  
Editor  
THE ELECTRONIC ENGINEER  
Chestnut & 56th Sts.  
Philadelphia, Pa. 19139

# 980 Voltage regulator has extended range, remote shutdown

**Walter C. Jung**  
MTI, Cockeysville, Md.

A good, economical voltage regulator, National Semiconductor's LM300, is even more attractive in the circuit shown here. Besides upping the output voltage beyond the IC's specified limit, the circuit adds external short-circuit protection and remote shutdown capability.

Resistors  $R_5$  and  $R_6$  sense the output voltage. Although the values shown are for 30-V operation (the spec sheet max. is 20 V), there is no inherent limit if you choose suitably rated transistors. To accommodate the larger input voltages, you must add a preregulator ( $D_1$ ) and a level-shifter ( $Q_1$ ) to the basic regulator.

For high-voltage applications,  $R_5$  can be at least ten times  $R_6$ . Thus, you can set  $R_6 = 2.2 \text{ k}\Omega$ —the optimum resistance for the LM300 at the pin 6 feedback terminal. Because there is 1.8 V at this point,  $I = 1.8 \text{ V}/2.2 \text{ k}\Omega$ , or 0.82 mA. For a 30-V output, then,  $R_5$  is simply  $(E_o - 1.8)/I$ , or  $28.2 \text{ V}/0.82 \text{ mA} = 34.4 \text{ k}\Omega$  (use 36 k $\Omega$ , the nearest 5% value).

The isolation of pins 1 and 8 from the output terminal negates the LM300's internal short-circuit protection. But adding  $Q_4$ —a low cost epoxy transistor—gives you very good external short-circuit protection. When the load current flow through  $R_{sc}$  is large enough,  $Q_4$  saturates and clamps pin 7 (the compensation terminal). This clamping action switches the regulator into a current mode, which protects the IC. ( $R_{sc} = V_{be4}/I_{sc}$ )

Similarly, you can collector-OR additional transistors with  $Q_4$  to shut the regulator down with a dc signal.  $Q_5$  is

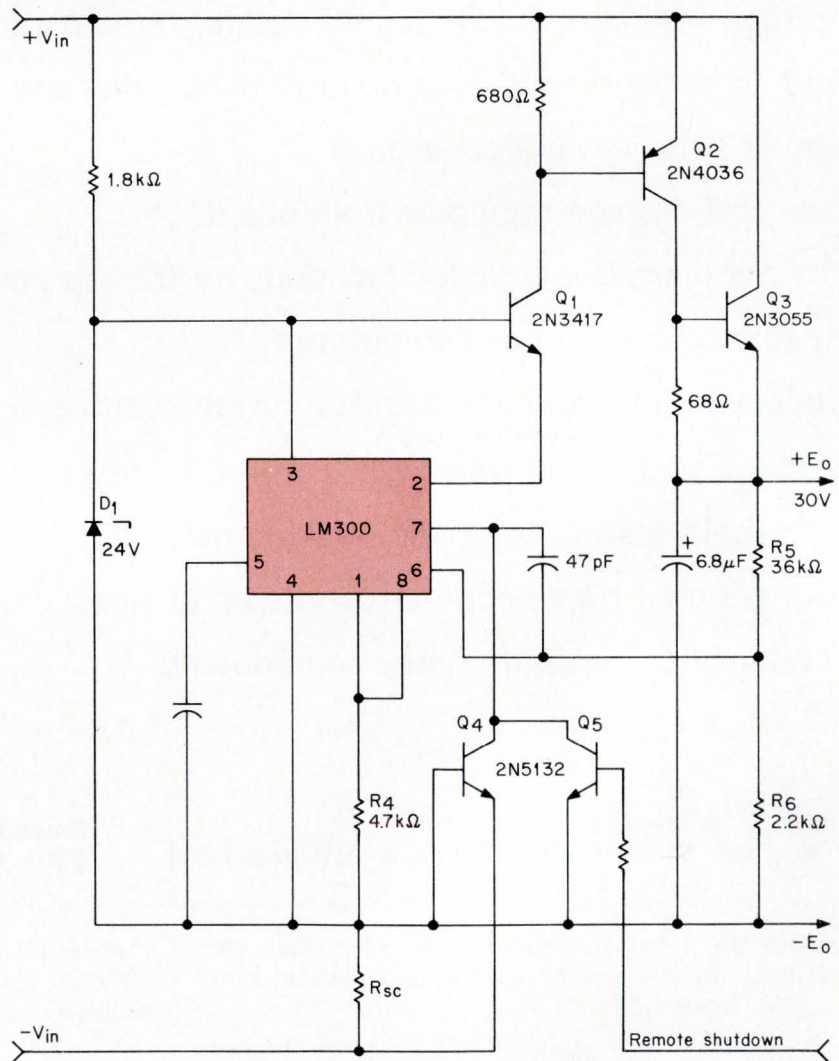

a single-transistor example of this technique.

Input (line) regulation is better than 0.002%/V at 1-A load current. Load regulation is better than 0.05%, again

at a 1-A load. The temperature performance is the same as the original IC specs, since the reference voltage source is untouched.  $R_4$  supplies the minimum chip current, 3 mA.

## 981 Add-on network improves op-amp bandwidth and slew rate.

**Brent Welling**

Motorola Semiconductor Products, Phoenix, Ariz.

*Feedforward* circuitry routes the higher frequency components of an input signal around the early stages of an amplifier and reinserts them at a later point. A wider bandwidth than that of the chain of earlier stages follows this point, and the result is a greatly improved frequency response for the complete amplifier.

Many IC operational amplifiers provide access to the input of the last stage, and this pin can often serve as the terminal connection for a feed-forward network. The op-amp in the circuit shown here has, by itself, a 50

kHz power bandwidth and a 25 V/ $\mu$ s slew rate.

When the feedforward network is added the power bandwidth jumps to 1 MHz, and the slew rate to 250 V/ $\mu$ s. The amplifier now can swing 20 V pk-pk across a 1K $\Omega$  load, with less than 5% slew rate distortion.

The outboard circuit feeds high frequencies directly to the input of the last stage, increasing this particular amplifier's slew rate 10X, and the power bandwidth 20X.

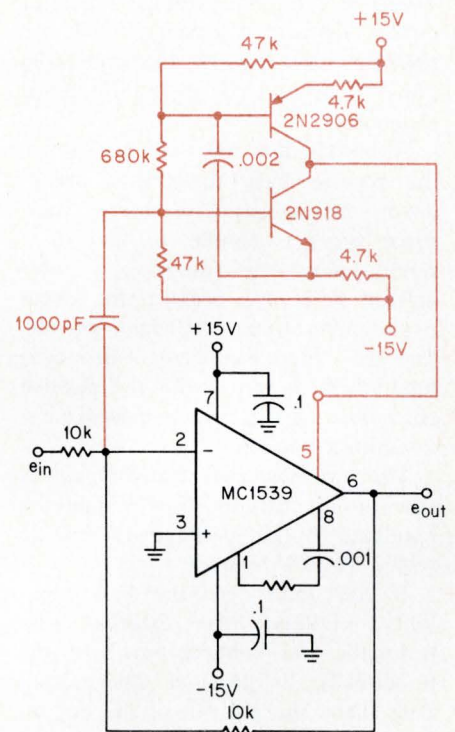

## 982 Stable squarewave generator

**Arnold J. Steinman**

Lawrence Radiation Lab., Livermore, Calif.

Here is an inexpensive squarewave source that should prove useful around the lab. A unijunction oscillator, an IC flip-flop, and an emitter-follower output driver make up the circuit.

Capacitor *C* charges through  $R_1$  and  $R_2$  until it reaches the firing voltage of  $Q_1$ , a unijunction transistor. When *C* discharges through  $Q_1$ , the JK flip-flop—a Texas Instruments SN7470N—receives a pulse and changes state. (Because  $Q_1$ 's  $\eta$  is 0.5-0.7, you can approximate the oscillator's frequency as  $1/(R_1 + R_2)C$ .) The flip-flop changes state each time the capacitor discharges, giving a squarewave output. The output emitter-follower,  $Q_2$ , gives the circuit a low output impedance—it can drive a 50- $\Omega$  cable.

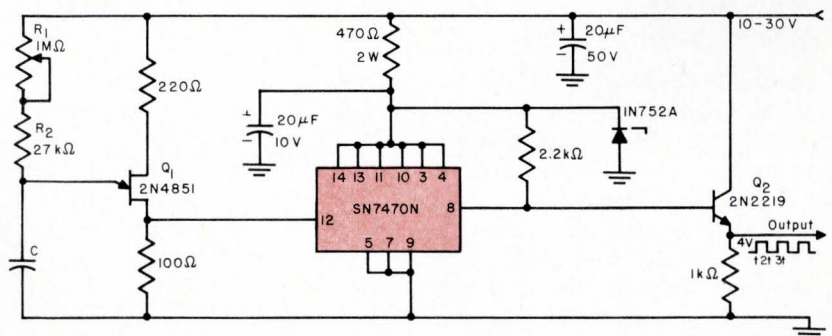

The upper frequency limit for this circuit is about 50 kHz, which you can increase by adding a buffer amplifier between  $Q_1$  and the flip-flop. The lower limit is set simply by the size of *C* that you can tolerate. A 10- to 30-V supply gives you a 4-V output; risetime is 25 ns, while capacitive loading will set the

falltime.

Frequency is stable to better than 100 Hz at 50 kHz, with a temperature coefficient of about 0.08%/°C. (Precision components for  $R_1$ ,  $R_2$ , and *C* improve this figure.) The voltage coefficient of frequency is about 0.05%/V.

## 983 Low cost voltage regulator from one IC

**Les Toth**

Cohu Electronics, San Diego, Calif.

With a single IC—the RCA CA3018—you can build a voltage regulator circuit. Instead of a zener diode, this regulator uses one of the transistors (pins 3, 4, and 5) as the reference element.

Although it's not widely known, the reverse base to emitter breakdown characteristic of many transistor types is similar to that of a zener diode. And you have a *stable* voltage reference because the negative temperature coefficient of the forward - biased collector - to - base junction is in series with the positive coefficient of the reverse-biased base-to-emitter junction.

The external pass transistor gives you output currents to 1 A, and the regulated output voltage is 9 Vdc with a 12-20 Vdc input.

If you don't need the 1 A capability, eliminate the external pass transistor and connect pin 1 of the IC directly to point *a* (the output bus). Take the pot out of the circuit,

This regulator gives you 1 A at 9 Vdc. Eliminate the external transistor, and the circuit can still supply up to 50 mA. For a given output voltage, you must determine the exact values of  $R_1$  and  $R_2$ , because the reverse breakdown voltages vary from transistor to transistor (IC to IC).

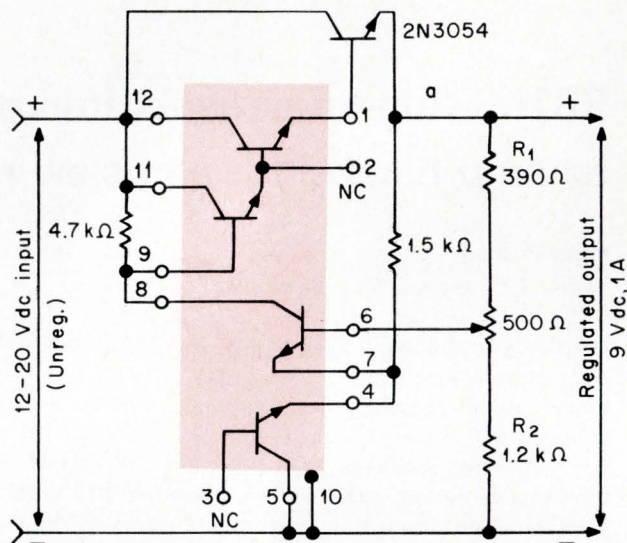

change  $R_1$  to 470Ω, and  $R_2$  to 1.5 kΩ. You now have a very simple regulator that can supply up to 50 mA at 9 Vdc.

For high input voltages, keep the output current low enough so that the IC's power dissipation doesn't exceed 300 mW.

## 984 For a square-law transfer function, try this op amp connection

**Robert P. Hennick**

Bell Aerosystems, Buffalo, N. Y. 14240

A resistor-diode network at the input to the amplifier shown in the figure forms a divider referenced to a positive voltage (or ground). The diodes conduct at predetermined levels of the input signal, placing the network's resistors in parallel with each other. As the input increases, the total network resistance decreases, and the gain of the op amp increases.

Four straight-line  $e_o/e_{in}$  segments (each of higher gain than the preceding one) approximately a square-law characteristic.

Using the circuit values shown in the figure, a 0-3 V, 1μs pulse input gives a 0-10 V pulse output. Rise/fall times are less than 300 ns.

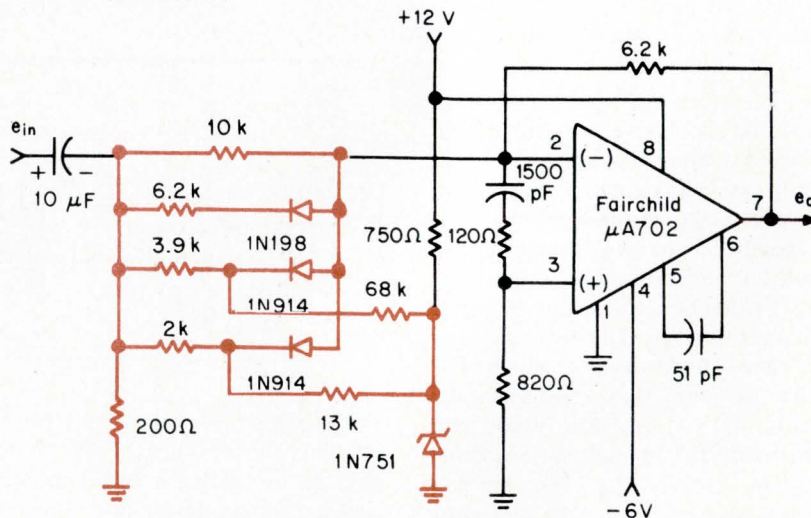

As the input signal increases, each branch of the input network adds its share to the amplifier input current.

The effective gain of the amplifier thus increases piecewise with the signal.

## 985 Regulated supply has two outputs

**Don Purland**

Research Incorporated, Minneapolis, Minn.

Digital equipment that has both low- and high-speed counting circuits needs two regulated voltage supplies. One supply feeds the high-speed DTL/TTL devices, while the other is for the lower-speed RTL circuits.

This power supply uses IC op amps, which are now inexpensive enough to use economically in such applications. By using them, you get circuit simplicity and excellent supply characteristics. For example, the line and load regulations for this supply are both 0.1%, and the rms ripple output is less than 1 mV. The load ratings are 3.5 V, 1.5 A and 5 V at 0.5 A.

This dual voltage supply uses ICs to get its excellent characteristics. Further economies result from the dual use of the transformer and diodes. Such a connection is common in transmitters, for instance, where the full winding voltage is used only on the final stage.

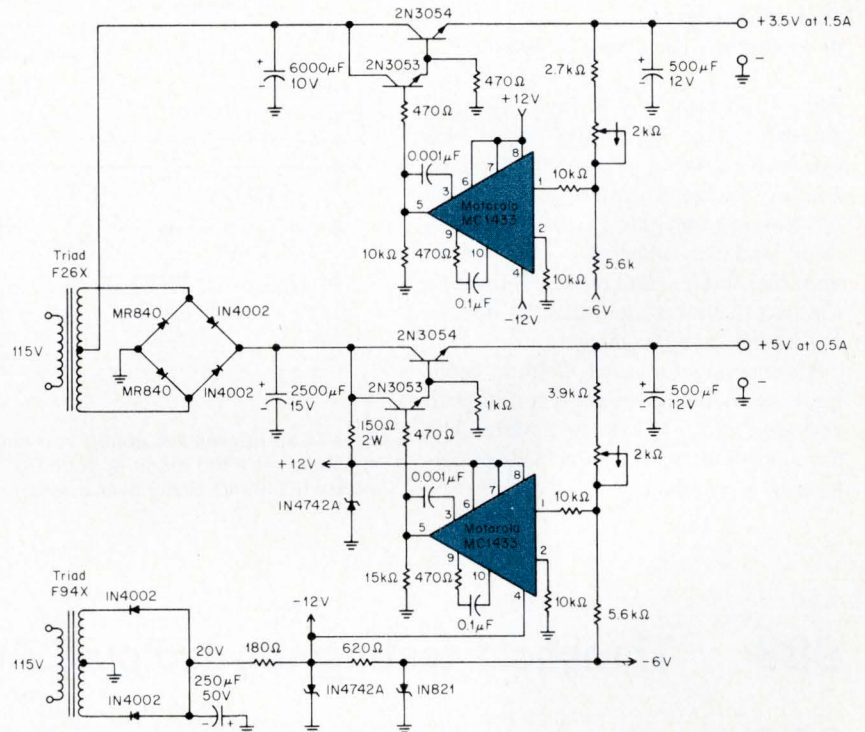

## 986 Collector junction compensates current source in this differential amplifier

**Walter G. Jung**

MTI, Cockeysville, Md. 21030

You can connect the four transistors of the RCA CA3018 to form a differential amplifier with a temperature-compensated current source. This IC is especially suited to such an application because the transistor characteristics are closely matched.  $Q_1$  and  $Q_2$ , in fact, are fully specified for  $h_{FE}$  and  $V_{BE}$  match, and are used for the differential pair. The Darlington pair ( $Q_3$  and  $Q_4$ ) make up a temperature-compensated current source. With the emitter-base junction of  $Q_3$  shorted, the collector diode is used to match the  $V_{BE}$  drift of  $Q_4$ . The small temperature differential among the elements on the chip aids the temperature compensation.

Here are the four transistors of the RCA CA3018 connected as a temperature-compensated differential amplifier.  $R_E$  sets the combined emitter currents of  $Q_1$  and  $Q_2$ .

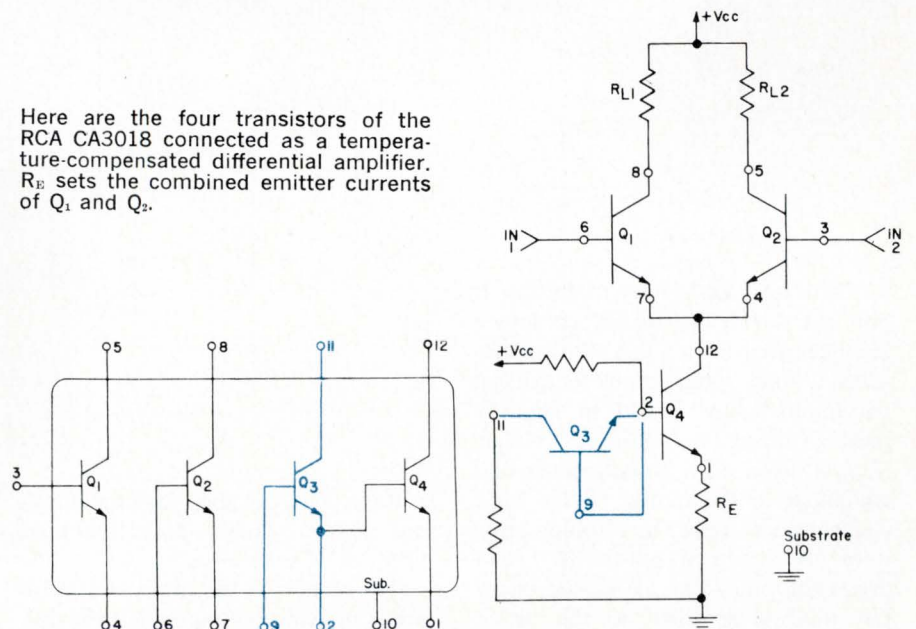

## 987 Make a crystal-controlled clock with DTL gates

**Richard Juengel**

Barrett Electronics Corp., Palo Alto, Calif.

Here is an easy way to build a crystal oscillator. The T. I. SN15846N is a quadruple 2-input DTL NAND/NOR gate. Biasing the device in its active region lets you use one gate (G1) as an oscillator, and the other gate (G2) as an amplifier/buffer. DC feedback through the two rf chokes stabilizes the operating points of both gates.

Connecting G1 as a Colpitts oscillator, as shown, gives good results with crystals from 500 kHz to 5 MHz. The amplifier/buffer, G2, interfaces directly to DTL circuits.

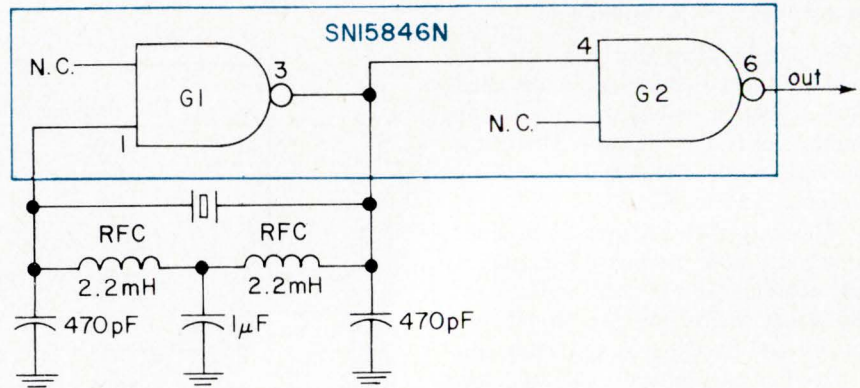

This is an interesting idea if you need a crystal-controlled clock in your DTL circuitry. Running nicely over a wide range

of crystal frequencies, the Colpitts oscillator drives a buffer/amplifier which interfaces directly with other DTL circuits.

## 988 Threshold testing too tedious? Automate

**R. K. Repass**

Fairchild Semiconductor, Mountain View, Calif.

Conventional threshold measurements for digital ICs are tedious. The engineer must manually adjust input voltage until he gets a specific output voltage,  $V_{set}$ , then he can measure the input voltage.

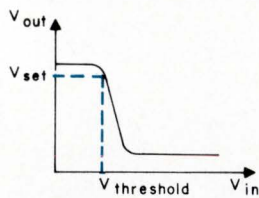

There is an easier way to do this. If you put the device under test into a feedback loop with a  $\mu A 709^*$  operational amplifier, the output voltage can be automatically forced to equal a preset voltage,  $V_{set}$ . A reference voltage,  $V_{set}$ , is taken off a potentiometer and compared to the output of the logic element under test. The resulting error signal is amplified by the 709 and drives the output of the device under test until it is equal to the preset

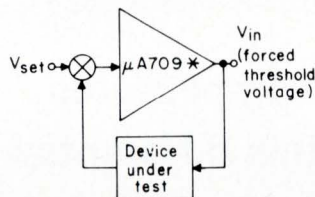

Threshold measurements for digital ICs can be made easier if you use an op amp.

Here's the outboard circuitry for using an op amp for threshold measurements. Switch is for handling both inverting and non-inverting circuits.

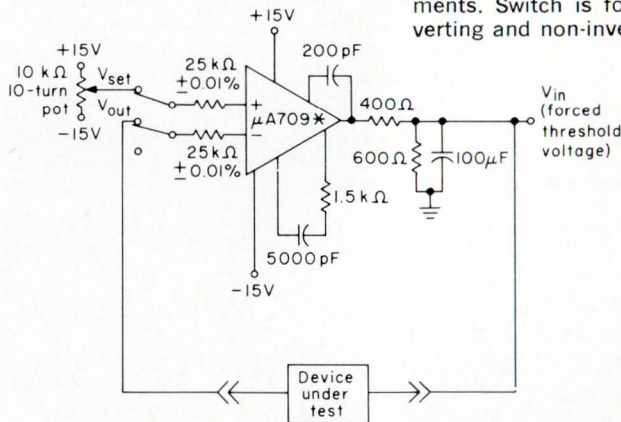

voltage. You can then read the threshold voltage directly from the input terminal of the device.

The switch at the input of the 709 accommodates both inverting and non-

inverting circuits, while the regulated +15 and -15 volts applied to the 10 turn pot are adequate to supply a stable reference voltage for CDSL, RTL, CTL, GML, and MOS circuitry.



## 989 Bidirectional ripple counter counts up or down

**Robert G. Burlingame**

Motorola Semiconductor, Phoenix, Ariz.

You can build a bidirectional binary ripple counter that has only  $\frac{3}{4}$  of a package per stage. Such a counter uses dual J-K flip-flops and exclusive-OR gates.

A HIGH level on the Direction Control line gives you a binary UP count, while a LOW level results in a DOWN count. The INHIBIT line should be LOW while counting, and HIGH while performing operations such as INITIAL CLEAR and reversal of the counting direction.

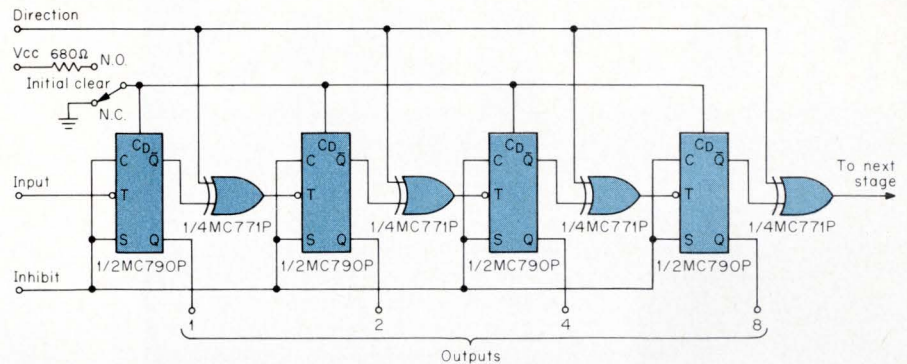

This bidirectional ripple counter is unique in that it has a low pin-count of only  $\frac{3}{4}$  of a package per stage. And

it has a minimum number of external connections. Thus, the circuit-board layout is straight forward.

## 990 Digital filter replaces bulky components

**Mario Humberto Acuña**

Fairchild-Hiller, Hyattsville, Md.

When you need a narrow-band filter, you should consider using a digital type. At low frequencies, for example, equivalent passive filters are of considerable size, so a digital filter saves you space.

An external clock sets the center frequency of the filter. You can change it without altering the band-pass characteristic. The clock also sets the stability of the center frequency.

Four JK flip-flops with two NAND gates from a self-starting, self-correcting ring counter that drives a four-position sequential switch. A quad 2-input NAND gate (without dc collector returns) makes up this switch. The switch and the counter make up the main filter.

A switched low-pass filter ( $R_1C_1$ ) sets the digital filter's bandwidth and response curve. The equivalent bandwidth is  $nR_1C_1$ , where  $n$  is the number of positions of the sequential switch.  $R_1$  adjusts the bandwidth, which is independent of the center frequency.

$R_2$ ,  $C_2$ , and  $Q_2$  form an active low-pass filter that removes the sampling

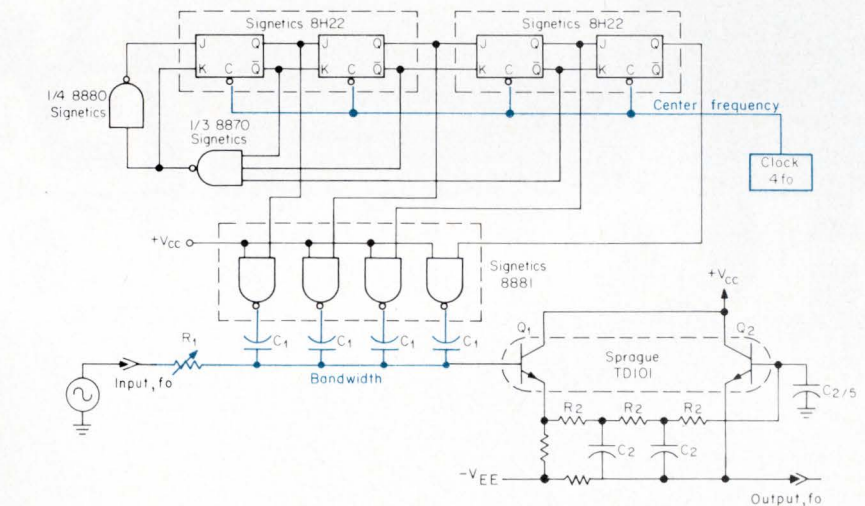

ripple from the output waveform. Its cutoff frequency is  $\frac{1}{2}\pi R_2C_2$ , and should be slightly higher than the center frequency of the digital filter.

A filter was built for a center (clock) frequency of 500 Hz, with  $R_1 = 51\text{k}\Omega$ ,  $R_2 = 5.1\text{k}\Omega$ ,  $C_1 = 2.2\ \mu\text{F}$ , and  $C_2 = 0.68\ \mu\text{F}$ . The measured 3 dB bandwidth was 2 Hz, with an

(equivalent) skirt roll-off of 6 dB/octave. The insertion loss was 6 dB.

Note that in filters such as these, if you synthesize the center frequency from the output of the filter itself (instead of using an external clock), you get a tracking filter. Such a filter tracks its center frequency while keeping the bandwidth constant.

# LAST YEAR THE TOMORROW MOSFETS.

The complex LSIs are Tomorrow-minded, too. These Metal Oxide Semiconductor Integrated Circuits are loaded with Tomorrow features. Low-voltage threshold and nitride passivation have been production processes for more than a year. The advanced Mosinc device pictured is our new up-down counter with seven-segment decoder, Hughes Part No. HCTR0107. It includes 512 Mosfets; performs up to 100 functions; and serves as a universal, presettable counter and a storage register. We'd like to tell you more about our total capability in microelectronics—including our custom CMOS (Complementary MOS) and IMOS (Ion-Implantation MOS) logic, shift-register and memory capability. Check pages 1606-1620 in the 1969 EEM Catalog. Or write to us at this address: Hughes MOS Division, 500 Superior Ave., Newport Beach, Calif. 92663.

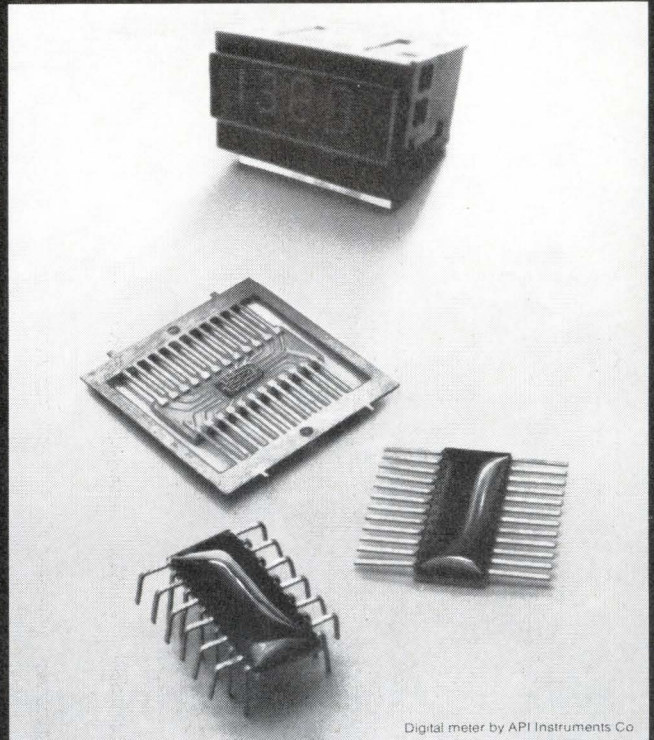

Digital meter by API Instruments Co

**HUGHES**  
HUGHES AIRCRAFT COMPANY  
MOS DIVISION

# THIS YEAR THE HUGHES MOSINCS.

#### COUNTERS

HCTR 0107: Reversible Decade Counter with Seven-Segment Decoder and Drivers  
HCTR 0507: Seven-Stage Binary Counter, 7 Outputs  
HCTR 0102: Commercial/Entertainment Binary Divider  
HCTR 0201: RST Flip-Flop

#### STATIC SHIFT REGISTERS

HSSR 2016: Dual-16 Bit  
HSSR 2064: Dual-64 Bit

#### DYNAMIC SHIFT REGISTERS

HDSR 2025: Dual-25 Bit  
HDSR 2050: Dual-50 Bit

#### ION-IMPLANTED MOS (IMOS)

LISR 0064: 20MHz/64-Bit Dynamic Shift Register

#### MULTIPLEXERS

HMUX 1756: 4-Bit D-to-A Converter  
HMUX 1784: 4-Bit D-to-A Converter  
HMUX 2542: Dual 2-Bit Commutator  
HMUX 2641: 4-Bit Commutator

#### LOGIC ELEMENTS

HLOG 2304: Triple 3, Dual 2 NOR Gates  
HLOG 2306: Dual J-K Flip-Flop

#### MULTIPLES

HMUL 1441: General Purpose Quad  
HMUL 1444: General Purpose Quad

HMUL 1445: General Purpose Quad  
HMUL 1446: General Purpose Quad  
HMUL 1447: General Purpose Quad  
HMUL 1463: Quad Dual-Switch  
HMUL 1884: Quad Dual-Switch  
HMUL 2661: Six-Channel Switch  
HMUL 3362: Triple Differential Pairs  
HMUL 3551: Five-Channel Switch  
HMUL 3651: Five-Channel Switch  
HMUL 3661: Six-Channel Switch

#### DUALS

HDIG 8049: Low-Level Modulator  
HDIG 8551: Amplifier  
HDSW 8050: Modulator-Demodulator  
HDSW 8550: High-Level Switch

#### DISCRETE MOS TRANSISTORS

HDIG 1030: General Purpose  
HDIG 1886: Electrometer  
HDSW 2106: Low-Resistance 20 Ohm Switch, General Purpose  
HDSW 3005: Low-Leakage Switch  
HDSW 8300: 30-Volt Switch  
HDSW 8318: Switch, General Purpose  
HDSW 8338: Chopper Switch  
HDSW 8346: Linear Amp  
HDSW 8348: 50-Ohm Switch, General Purpose

# Feature article abstracts

Published information is vital to your job.

To save time in finding this information,  
we have abstracted the important technical features  
from eight electronic engineering publications.

Should any of these articles interest you, contact the magazine—  
names and addresses are listed below.

Reprints of articles with an asterisk are available free.

Save this section for future reference.

## Amplifiers

**Caution: test op amps carefully**, William A. Attridge, Teradyne, Inc., "Electronic Design," Vol. 17, No. 23, Nov. 8, 1969, pp. 84-86. To completely check an op amp's performance may require 40 or more tests. To ensure that the test circuit does not affect the results while testing rapidly and accurately is tricky. Possible sources of error and test circuit hints are provided. A list of the basic dc tests for the 709 op amp accompanies this article.

**Build stable current-feedback pairs**, Howard T. Russell, Fairchild Semi-conductor, "Electronic Design," Vol. 17, No. 23, Nov. 8, 1969, pp. 66-69. Because the characteristics of dual transistors, or "sister dice" are very closely matched, they make excellent two-stage feedback amplifiers. A CFP amplifier is designed using a 2N2060B.

## Communications

**Applications of Walsh functions in communications**, Henning F. Harmuth, University of Maryland, "IEEE Spectrum" Vol. 6, No. 11, November 1969, pp. 82-91. Substituting a different set of orthogonal functions, namely Walsh functions, for the conventional sine-cosine in communication theory, leads to a set of equipment that is easily implemented with semiconductor technology. The author shows why the Walsh functions are especially useful in filter design.

**The future of cable TV**, Archer S. Taylor, Malarkey, Taylor, and Assoc., "IEEE Spectrum," Vol. 6, No. 11, November 1969, pp. 77-81. The increasing pressure on the available space in the electromagnetic spectrum forecasts a bright future for cable TV. The author presents some background on the growth of cables and sees better quality broadcasts at lower costs and more freedom for programmers in the future.

## Computers and Peripherals

**Comparing Binary-to-BCD conversion techniques**, Bob Macdonald and Stan Sklar, "EDN," Vol. 14, No. 23, Dec. 1, 1969, pp. 33-39. This article summarizes the available methods of binary-to-BCD conversion, reviews their relative merits and briefly considers their makeup when using integrated circuits. These techniques break into the following general categories: parallel; counter; Coulieur's; divide by ten; and multiply by ten.

**1969 Fall Joint Computer Conference**, Milton J. Lowenstein, Technical Editor, "Electronic Design," Vol. 17, No. 23, Nov. 8, 1969, pp. C8-C25. This special report is divided into two parts. Part 1 deals with the various design aid computer programs. Time-sharing services now make it possible for engineers without any knowledge of computer programming to design circuits. Interactive terminals and specialized programs for circuit analysis, stimulation and logic design are discussed. An analysis of the future of the design engineer is offered. Part 2 is a picture sequence showing the design of a single-stage transistor amplifier using an interactive terminal and ECAP.

**Small motors: how to select them**, Sidney C. Silver, Associate Editor, "Electronic Products," Vol. 14, No. 6, Nov. 1, 1969, pp. 120-123. The article gives you a quick view of what you should avoid and look for when considering the purchase of fractional horsepower motors. As with all specifying today, you should consult the vendor before locking in your design.

## Circuit Design

**Computer-aided design of hybrid-microelectronic active filters**, William R. Broyles and David Miller, Sprague Electric Co., "EEE," Vol. 17, No. 10, October 1969, pp. 64-67. RC active filters lend themselves well to be designed by computer because their losses are low (the calculated results correlate well with the actual ones) and because each pair of poles determines each stage rather uniquely, with little influence from other stages. The article explains how to capitalize on this advantage to go from a set of specifications for the filter to its computer design and practical implementation.

**Logarithmic converters**, Robert C. Dobkin, National Semiconductor Corp., "IEEE Spectrum," Vol. 6, No. 11, November 1969, pp. 69-72. The bipolar transistor, with its logarithmic relationship between collector current and emitter-base voltage, is a natural element for use in logarithmic converters. Mr. Dobkin describes five bipolar circuits, and analyzes their performance. The article includes two log generators (one for optimum dynamic range, the other for response time), an antilog generator, a cubic function generator, and a divider-multiplier network. Circuit schematics, including component values, are shown for all circuits.

## Magazine publishers and their addresses

### EDN

Cahners Publishing Company  
270 St. Paul Street  
Denver, Colo. 80206

### EEE

Mactier Publishing Co.  
820 Second Avenue  
New York, N. Y. 10017

### Electronic Design

Hayden Publishing Co.  
850 Third Avenue  
New York, N. Y. 10022

### Electronic Products

United Technical Publications  
645 Stewart Avenue  
Garden City, N. Y. 11530

### Electronics

McGraw-Hill, Inc.  
330 W. 42nd Street  
New York, N. Y. 10036

### Electro-Technology

Industrial Research Inc.  
Industrial Research Bldg.  
Beverly Shores, Ind. 46301

### IEEE Spectrum

Institute of Electrical & Electronics  
Engineers  
345 East 47th Street  
New York, N. Y. 10017

### The Electronic Engineer

Chilton Company  
56th & Chestnut Streets  
Philadelphia, Pa. 19139

\*Reprints available free. Request them on your company letterhead.

**Tunable RC null networks**, Ralph Gasgal, Siemens AG., *EEE*, Vol. 17, No. 10, October 1969, pp. 70-74. The article examines the transfer function of several types of tunable filter circuits (8-element ladder, isolated integrator, isolated differentiator, bridged differentiator, twin-T, and bridged integrator) to determine the ones that are tunable with either a variable resistor or a potentiometer. It concludes that the first four types are.

**Universal graphs map direct route to mismatched pi and tee filters**, Robert B. Cowdell, General Steam Corp., *Electronics*, Vol. 42, No. 23, Nov. 10, 1969, pp. 12-128. Charts and nomographs make the solution to practical determining of low-pass filters insertion losses under mismatch condition easy. A handy 6-page pull-out chart is the main part of this article, and the charts are very useful.

**FET's anchor op-amp drift**, Richard B. Mann, Texas Instruments Ltd., *EDN*, Vol. 14, No. 23, Dec. 1, 1969, pp. 51-54. By using FETs with monolithic op amps, input drift can be reduced by two orders of magnitude. This can be accomplished while having stable gain up to 60 dB. The FETs are used in the role of choppers.

**A step-by-step active-filter design**, J. Tow, Bell Telephone Labs, Inc., *IEEE Spectrum*, Vol. 6, No. 12, Dec. 1969, pp. 64-68. If you have ever designed passive filters, you can now add a new line to your resume. This article gives you a five-step approach to active filter design and relates the steps to those you would take if you were using passive components.

**Eliminate a capacitor in low-frequency multivibrators**, Robert Muth, General Electric, *EDN*, Vol. 14, No. 23, Dec. 1, 1969, pp. 61-62. While most low-frequency multivibrators need two large value capacitors for timing, the circuit described here can do it with one capacitor.

## Integrated Circuits

**Build flip-flops with AOI gates**, R. M. Walker and R. B. Derjckson, Fairchild Semiconductor, *Electronic Design*, Vol. 17, No. 23, Nov. 8, 1969, pp. 72-80. AND-OR-INVERT (AOI) gates use less space, have lower delays, and use less power than the equivalent function using NAND gates. Examples are given to show how this is advantageous in LSI arrays. Applications in J-K, tristable, multifunctional, and special-purpose R-S flip-flops are discussed, along with the gated latch.

**New applications for IC active filters**, G. James Estep, Kinetic Technology Inc., *EEE*, Vol. 17, No. 10, October 1969, pp. 60-63. Describes the applications of a "universal active filter"—a hybrid circuit that consists of monolithic op amps, capacitors and resistors—as a notch filter, for resistive-controlled electrical tuning combined (using with field-effect transistors as control elements), as phase filters for radar, and in a feedback loop as audio oscillators. In addition, the article mentions other applications of active filters in general, such as coin sorting and touch-tone systems.

## Materials

**Learn the ABCs of metal purity**, G. T. Murray, Materials Research Corp., *Electronic Design*, Vol. 17, No. 23, Nov. 8, 1969, pp. 90-91. The need to know about metal purity can crop up in many areas. Purity is defined in many ways with many techniques, but high purity comes in three categories. Values of these three categories are tabulated for several metals.

## Medical Electronics

**Ultrasonics in medicine**, Nilo Lindgren, Technology Communication, Inc., *IEEE Spectrum*, Vol. 6, No. 11, November 1969, pp. 48-57. Ultrasonics can do many of the same things that X-rays can, but they can do them without the accompanying hazards. Mr. Lindgren describes how ultrasonic techniques are being applied in the medical field.

## Microwaves and Microwave Products

**Solid state image intensifiers, radiographics amplifiers, and infrared converters**, Dr. Zoltan Szepesi Westinghouse, *Electro-Technology*, Dec. 1969, Vol. 84, No. 6, pp. 47-53. Much research and development work remains to be done on display and imaging devices, but there are some specific applications that are now practical. Dr. Szepesi discusses the current status of these devices and then shows where they can be applied.

**Tapping microwave acoustics for better signal processing and applying surface wave acoustics**, *Electronics*, Vol. 42, No. 23, Nov. 10, 1969, pp. 94-96. 1st article—Today's radar, navigation and communication systems need better signal processing techniques. The method being looked at is acoustic signals. Two types of delay lines are being given close scrutiny: one a surface wave device and the other a bulk delay line. Applying surface wave acoustics, by ..... 2nd article—This article explains how acoustic signals can handle today's radar, navigation and communication systems. The article also explains how these acoustic delay lines work.

**Solid-state microwave relay systems in Japan**, Fumio Ikegami and Yasuaki Ninomiya, Nippon Telegraph and Telephone Public Corp., *IEEE Spectrum*, Vol. 6, No. 12, Dec. 1969, pp. 48-56. Here is a history of how Japanese engineers have upgraded that country's microwave links with the advent of solid-state devices. The article includes some comparisons of failure rates of the solid-state systems vs the vacuum tube systems.

## Semiconductors

**Special report on tunnel diodes**, Thomas L. Baasch, Associate Editor, *Electronic Products*, Vol. 12, No. 6, Nov. 1, 1969, pp. 22-29. When tunnel diodes first appeared several years ago, they held wide hope to the engineer. Unfortunately, because of basic material problems and lack of knowledge by the user, early tunnel diodes failed miserably. Today, they have gained a foothold and are being used in many applications. Here is your chance to learn more about tunnel diodes, what they can do, and ideas on how you may be able to use them.

**The state of tunnel diode technology**, Sukhbir Virk, Aertech Industries, *Electronic Products*, Vol. 12, No. 6, Nov. 1, 1969, pp. 30-32. This article tells you where tunnel diodes are supposed to be today. Price has been one factor in preventing their widespread use—a simple tunnel diode costs about \$30 and runs to several hundred dollars. Manufacturing is still not easy to accomplish.

## Systems

**Systems applications for voltage-controlled active filters**, Philip Harvey, Aritech Corp., *EEE*, Vol. 17, No. 10, October 1969, pp. 57-59. Contains a brief review of three applications for active filters: adaptive filtering systems, signal conditioning circuits, and detector circuits. The first one, adaptive filtering systems, mentions the re-

jection elimination of noise and of background signals from applications such as moving-target-indicator radar, burglar alarms and music recording.

## Test and Measurement

**Noise rejection in industrial measurements**, Jack JoQuay, Dana Labs, *Electronic Products*, Vol. 14, No. 6, Nov. 1, 1969, pp. 146-150. Variations in measurements can take place if you are not careful. The author points out how proper filtering of test and measurement equipment can avoid erroneous readings.

**Know your d-a converter's capability**, James J. Pastoriza, Pastoriza Electronics, Inc., and David R. Weller, Bell Labs, *Electronics*, Vol. 42, No. 23, Nov. 10, 1969, pp. 129-130. This short article explains how you can accurately measure D/A converter's settling time on a scope.

## Miscellaneous

**The laser—a decade of problems/progress**, Len Berringer, Managing Editor, *Electronic Products*, Vol. 12, No. 6, Nov. 1, 1969, pp. 110-119. This article discusses, in general terms, where lasers are today and what progress they are making in acceptance and applications. In many cases, methods other than lasers can be used to do a task cheaper. Most of the laser's applications are still to come.

**Fluidics—a new control tool**, Rolf E. Wagner, Mechanical Technology Inc., *IEEE Spectrum*, Vol. 6, No. 11, November 1969, pp. 58-68. Fluidic circuits can perform much of the same logic that electronic circuits can. However, fluidic devices can operate in environments that would give an electronic designer fits. Here's a look at the current state of the art and some possible prospects.

**Market trends in the electronics industry**, Donald G. Fink, General Mgr., *IEEE*, *IEEE Spectrum*, Vol. 6, No. 12, Dec. 1969, pp. 57-60. The author reviews the figures in the *EIA Yearbook—1969* and sees a significant trend. The one product area that has increased its percentage share of the market since 1958 was the industrial area. Mr. Fink suggests that the engineer who wishes to stay abreast of the changing electronics marketplace had better familiarize himself with the problems of the industrial user.

**Yes! Engineering management is "sinful"**, Richard L. Turmail, Management Editor, *Electronic Design*, Vol. 17, No. 23, Nov. 8, 1969, pp. 94-97. The author discusses the responses to a previous article outlining six management sins. Most respondents felt that the sins were real and prevalent, but solutions to them were difficult to obtain. Several engineers reluctantly suggested unions because they did not know what else to do.

**Solving artwork generation problems by computer**, Kenneth B. Sanderson, staff engineer, IBM Corp., *Electro-Technology*, Nov. 1969, Vol. 84, No. 5, pp. 63-65. The author describes computer-aided design techniques and tells how they can be used to save time and cost when designing mask-artwork for cards and boards. These techniques can also be used to generate the artwork for chips and modules. Another application, the high-quality scaled engineering drawing, is a possibility that the author also mentions.

For Capacitors with **GREATER RELIABILITY . . .**

*Choose*

**EL-Menco**

*The Capacitors You Find Wherever There's Electronics!*

**EL-MENCO DUR-MICA CAPACITORS**

**Only 1 Failure Per 43,000,000 Unit-Hours!**

- It has been computed that "debugged" DM30, 10,000 MMF units, when subjected to 257,000 hours of life at 85°C with 100% of the rated DC voltage applied, will yield only 1 FAILURE PER 43,000,000 UNIT-HOURS!
- DM15, DM16, DM19, DM20 . . . perfect for miniaturization and for new designs using printed wiring circuits. Also available in DM30, DM42 and DM43.
- New "hairpin" parallel leads insure easy application.
- Exceed all electrical requirements of military specification MIL-C-5A.

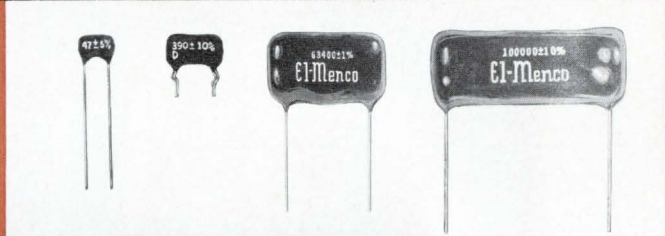

**EL-MENCO TRIMMERS & PADDERS**

**Design Versatility!**

- Available in 350 VDC and 500 VDC as well as other test voltages.
- All bases are of low-loss steatite.
- Special lugs are obtainable for printed circuitry.
- Miniature units are available.
- Solder Lugs can be bent in any position without affecting the capacity setting due to the rigid construction.
- Various types of mounting brackets are available for all trimmers.
- Units can be constructed for special applications.

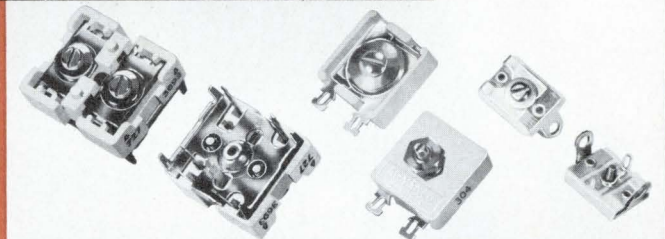

**EL-MENCO \*MYLAR-PAPER DIPPED CAPACITORS**

**Only 1 Failure in 7,168,000 Unit-Hours!**

- Life tests at 100°C with rated voltage applied have yielding only 1 FAILURE PER 716,800 UNIT-HOURS for 1 MFD. Since the number of unit-hours of these capacitors is inversely proportional to the capacitance, 0.1 MFD Mylar-Paper Dipped capacitors will yield only 1 FAILURE PER 7,168,000 UNIT-HOURS!
- Working volts DC: 200, 400, 600, 1000 and 1600.
- Durez phenolic resin impregnated.
- Tolerances: ± 10% and ± 20% (closer tolerances available).
- Dielectric strength: 2 or 2½ times rated voltage, depending upon working voltage.
- Exceed all electrical requirements of E.I.A. specification RS-164 and military specifications MIL-C-91A and MIL-C-25A.

\*Registered Trademark of DuPont Co.

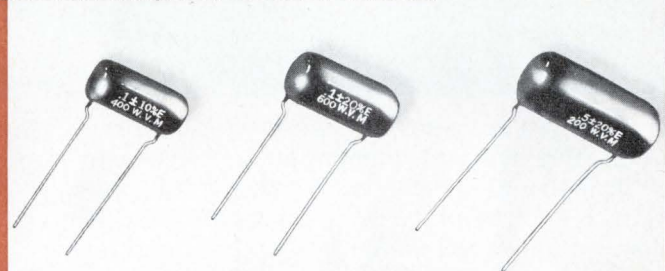

**EL-MENCO MOLDED MICA CAPACITORS**

**Superior Performance!**

- Unmatched for excellent stability, dielectric strength, high insulation resistance, extremely high "Q" and correspondingly low power factor.
- Units can be subjected to a short "debugging" life test at elevated voltage and temperature for removal of early life failures and for improved reliability.

*Write for Free Samples and Booklets on Any of The Above Capacitors*

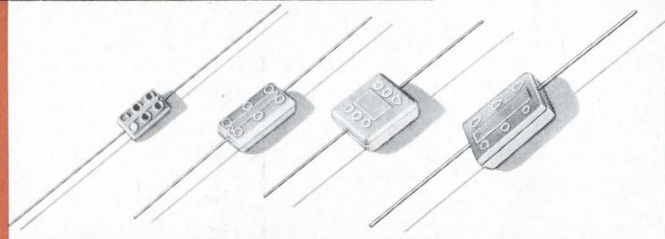

**THE ELECTRO MOTIVE MFG. CO., INC.**

WILLIMANTIC, CONNECTICUT 06226

Dipped Mica • Molded Mica • Silvered Mica Films • Mica Trimmers & Padders  
Mylar-Paper Dipped • Paper Dipped • Mylar Dipped • Tubular Paper

West Coast Manufacturers contact: COLLINS & HYDE CO., 900 N. San Antonio Rd., Los Altos, California 94022  
5380 Whittier Blvd., Los Angeles, California 90022

ALSO SOLD NATIONALLY THROUGH ELECTRONIC PARTS DISTRIBUTORS

# write your own ticket



Program your measurement system: write your own ticket for fully automated testing and process control. You can direct, without expensive hardware changes, a test or process to proceed exactly as you like — under full computer control. Each test can be run exactly like the previous one, or changed incrementally by your program. You can measure voltages, frequencies, and resistances, getting processed data in formatted readouts as the test progresses. You can scan in a sequence and rate determined by the data itself. You can program to compare measurements against limits to actuate safety alarms, alter sequences, control or shut down a process.

It's all practical with the VIDAR 5206 Digital Data Acquisition System, which includes a mini-computer for measuring and controlling tests and processes — exactly as you want them, and far more accurately than you could do it yourself. The way you use one of these systems is limited only by your imagination. Important capabilities include speeds to 70 channels per second; measures signals from a few microvolts on up, with  $0.1\mu\text{v}$  resolution; over 140 dB CMR at any frequency; scans up to 1000 channels; and has 32 control outputs as standard.

The VIDAR 5206 D-DAS tells you what's *really* happening now in your tests or processes. For the facts, send today for your copy of VIDAR Bulletin 104C.



## VIDAR®

77 Ortega Avenue, Mountain View, California 94040 • (415) 961-1000

the automatic-measurement people

# NEW PRODUCTS

## TTL memories get faster, smaller, and cheaper

A new semiconductor technology, called RAY VI, will be used in a product line to be introduced by Raytheon Semiconductor beginning in the second half of 1970. According to Mel Snyder, Marketing and Product Planning Manager, Raytheon plans to introduce a 256 bit, monolithic, bipolar, random access memory (RAM) in July. It will have write and sense amplifiers and decoding on the chip, and will be available in a 16 lead dual in-line package. A line of digital MSI and LSI circuits will follow.

The table compares parameters of three Raytheon semiconductor technologies. RAY II is comparable to other existing high speed TTL circuits, RAY III, a higher speed TTL family, is a more advanced technology, now in high volume production. RAY VI prototypes are now being evaluated in the Advanced Development Group. Mel Snyder indicated that nothing comparable to it is now available. (RAY IV and V are radiation resistant and low power TTL technologies, respectively.)

Identical power/gate specs for the three families indicate identical circuitry. It is the semiconductor technology that changes. The two main advantages of RAY VI are faster speed, or propagation delay, and smaller transistor area. The read time spec for the 64-bit RAY III RAM is 60 ns max., although 40-45ns is typical. The 256-bit RAY VI RAM will have a read time spec of 25ns.

Washed emitter technology eliminates the need for an emitter contact cutout in RAY VI. This technology is explained in Fig. 2. The key is the ability to make shallow diffusions. Emitter size determines everything else, and Fig. 1 shows the effect on transistor area of diminishing this parameter. A RAY VI transistor is only about  $1\frac{1}{2}$  mil<sup>2</sup>.

Shallower diffusions also allow epitaxial layers to be thinner. This reduces capacitance due to isolation. Using Schottky barrier diodes instead of gold doping to reduce stored charge aids speed and improves yield.

Decreased area and increased yield

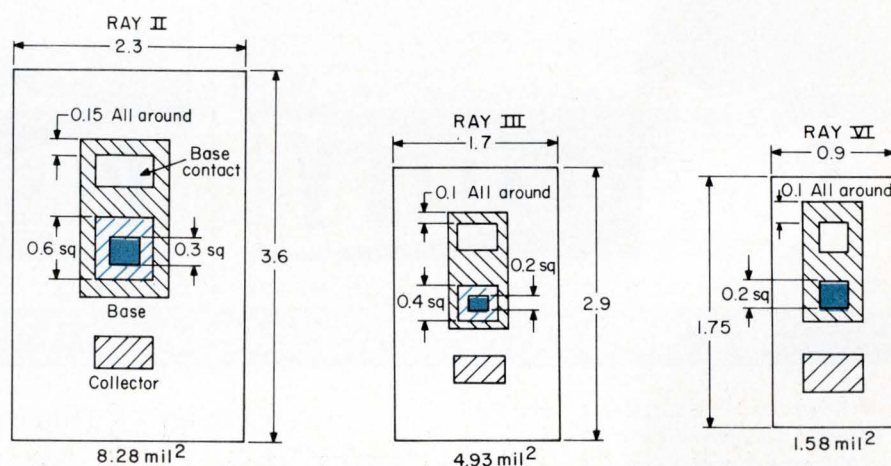

**Figure 1. Effects of high density technology on basic IC transistor size.** The emitter contact cutout is shown in solid color. In RAY II & III it is inside the boundary of the oxide covering the emitter diffusion area, shown in hashed color. In RAY VI, using washed emitter

techniques, it coincides. The base and collector diffusions are shown in black hashed lines. All dimensions are in mils. Tightening tolerances on the emitter size allows other dimensions to shrink. The net effect is greatly reduced transistor area.

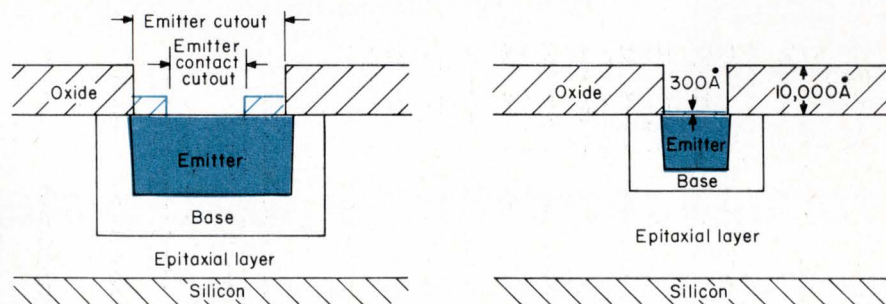

**Figure 2. Advantages of washed emitter technology.** In (a), a typical RAY II wafer has been prepared for the emitter contact metallization. During the relatively deep emitter diffusion (solid color), a thick layer of SiO<sub>2</sub> (hashed color) grows up and covers the emitter. An oxide etch is required to make the emitter contact cutout and tolerances must be provided for this step. (b) illustrates RAY VI technology, where the emit-

ter cutout and the emitter contact cutout are the same hole. Because the furnace time for the shallow diffusion is short, the oxide build-up is only about 300Å. This is insignificant compared to the 10,000Å SiO<sub>2</sub> layer, so it can be removed by a quick dip, or wash, into the etchant without harming the rest of the assembly. The emitter is quickly readied for the on-size metallization and no extra tolerances are required.

### The Complete Line of Signal-Indicating Alarm-Activating Fuses

For use on computers, microwave units, communication equipment, all electronic circuitry.



BUSS GLD-1/4 x 1 1/4 in. Visual-Indicating, Alarm-Activating.

BUSS-GBA-1/4 x 1 1/4 in. Visual-Indicating.

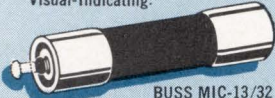

BUSS MIC-13/32 x 1 1/2 in. Visual-Indicating, Alarm-Activating.

BUSS MIN-13/32 x 1 1/2 in. Visual-Indicating.



FNA FUSETRON Fuse 13/32 x 1 1/2 in. slow-blowing, Visual-Indicating, Alarm-Activating. (Also useful for small motors, solenoids, transformers in machine tool industry.)



BUSS Grasshopper Fuse, Visual-Indicating, Alarm-Activating.



BUSS ACH Aircraft Limiter, Visual-Indicating.

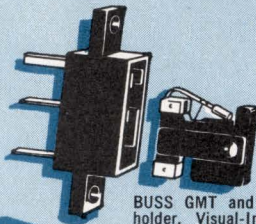

BUSS GMT and HLT holder, Visual-Indicating, Alarm-Activating.

Write for BUSS Form SFB



BUSSMANN MFG. DIVISION, McGraw-Edison Co. St. Louis, Mo. 63107

### The Complete Line of Fuses For The Protection of Semi-Conductor Rectifiers

## TRON Rectifier Fuses

Provide extremely fast opening on overload and fault currents, with a high degree of restriction of let-thru current. Many types and sizes available. Ampere ratings from 1/2 to 1000 in voltage ratings up to 1500.

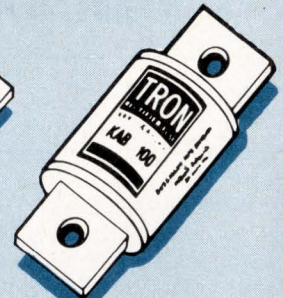
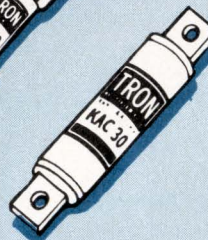
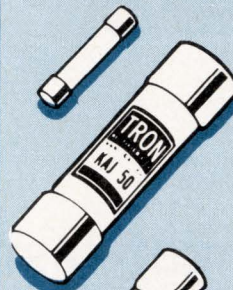

Write for BUSS Form SFB



BUSSMANN MFG. DIVISION, McGraw-Edison Co. St. Louis, Mo. 63107

# BUSS: The Complete Line of Fuses and . . .

show up as a reduced cost per bit. Though quantity dependent, the projected cost for RAY VI is 15¢/bit. A longer run goal for Raytheon is to get RAM bit cost down to about 1 1/2¢ in 1973, which will enable semiconductor memories to compete directly with core memories at that time.

All RAY VI circuits will be offered in a beam lead configuration. Raytheon plans to package as many as 16 chips in a multichip array to make up a 4096 bit RAM. Other multichip arrays of MSI and LSI circuits are also contemplated.

Circle 291 on Inquiry Card

### COMPARISON OF THREE RAYTHEON TECHNOLOGIES

Parameter	RAY II	RAY III	RAY VI
Power/gate (mW/gate)	22	22	22
Propagation delay (ns)	10	5.5	2
Read time (ns) (Including Decoding)	—	60	25
Nominal transistor area (mil)	8	5	1.6
Emitter cutout tolerance (mil)	0.15	0.1	none
Stored charge reduction	gold doping	gold doping	Schottky diode
Epitaxial thickness (μ)	5-7	5-7	2 1/2-3
Base diffusion depth (μ)	3.3	1.8	0.9
Emitter diffusion depth (μ)	2.4	1.2	0.6
Emitter size (mil <sup>2</sup> )	0.36	0.16	0.04
Cost (¢/bit)	—	30-50	15-30

## Voltage regulator for logic systems

### Monolithic device needs no external components.

With only three external leads, this regulator can give you up to 1 A of load current. The device, National's LM109, has the pass transistor, normally an external component with ic regulators, included on the chip. The only connections to the outside world are input, output and ground.

Virtually blowout-proof, the circuit uses both thermal- and current-limiting for overload protection. In ad-

dition, you can instantaneously short or reverse the input supply and still not damage it (you do have to limit the reverse current to 1 A).

#### Low-voltage operation

Because of a unique approach, the regulator does not use a temperature-compensated Zener (with its 7- to 9-V breakdown) as a reference. Instead, the device uses the emitter-base volt-

age of the transistor. This junction voltage is equal to the energy band gap voltage of the material: 1.218 V for silicon. This means that you can operate the device with a minimum input restriction of 6.5 V for a 5-V output (the circuit actually will operate down to 2.1 V). Naturally, with the lower input voltage, the unit can handle larger currents for the same power dissipation. As an added bonus



## NEW PRODUCTS

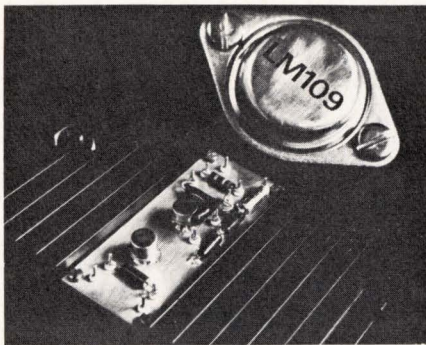

with this approach, the emitter-base voltage of the transistor is highly predictable, giving the regulator a long-term stability of better than 10  $\mu$ V.

### On-card regulation

This unit is basically intended for use as an at-the-load regulator for 5 V digital logic systems. It becomes particularly attractive in TTL systems with

their susceptibility to false triggering with poorly regulated supplies. You can also adjust it for higher output voltages or use it as a current regulator.

### Two packages

National offers this device in two packages. The Kovar TO-5 has an output rating of 200 mA (with heat-sinking), while the TO-3 version lets you draw better than 1 A: Prices for the regulator (in quantities of 100 or more) are as follows: LM109 ( $-55$  to  $125^{\circ}\text{C}$ ), \$20 for the TO-5 and \$25 for the TO-3; LM209 ( $-25$  to  $85^{\circ}\text{C}$ ), \$7.50 for the TO-5 and \$8.95 for the TO-3; LM309 ( $0$  to  $70^{\circ}\text{C}$ ), \$5.50 for the TO-5 and \$6.50 for the TO-3. National Semiconductor Corp., 2975 San Ysidro Way, Santa Clara, Calif. 95051. (408) 245-4320.

Circle 292 on Inquiry Card

## MODULAR POWER SUPPLIES

For use with op amps.

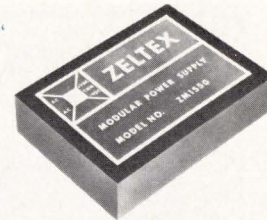

These dual-output supplies are guaranteed to operate without derating from  $-25^{\circ}\text{C}$  to  $+71^{\circ}\text{C}$ . Output voltage ratings are specified at  $\pm 1\%$ . Load reg. is 0.05% max., worst case reg. 0.07% max., tracking error  $< 0.1\%$  between supplies and line reg. 0.01% typ. Outputs—12, 15, 18, 24, and 30 V units. Model ZM1550 ( $\pm 15$  V @ 50 mA) is \$39.00 and ZM15100 ( $\pm 15$  V @ 100 mA) \$49.00. Zeltex, Inc., 1000 Chalomar Rd., Concord, Calif. 94520. (415) 686-6660.

Circle 293 on Inquiry Card

## Fuseholders of Unquestioned High Quality

### SUB-MINIATURE FUSES

Ideal for space tight applications, light weight, vibration and shock resistant. For use as part of miniaturized integrated circuit, large multi-circuit electronic systems, computers, printed circuit boards, all electronic circuitry.

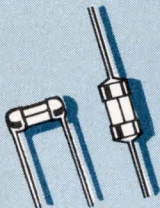

### TRON Sub-miniature Pigtail

Fuses — Body size only  $.145 \times .300$  inches. Glass tube construction permits visual inspection of element. Hermetically sealed. Twenty-three ampere sizes from 1/100 thru 15.



### BUSS Sub-miniature GMW Fuse and HWA Fuseholder

Fuse size only  $.270 \times .250$  inches. Fuse has window for visual inspection of element. Fuse may be used with or without holder. 1/200 to 5 amp. Fuses and holders meet Military Specifications.

Write for BUSS Form SFB

INSIST ON  
**BUSS QUALITY**  
FUSES

BUSSMANN MFG. DIVISION, McGraw-Edison Co. St. Louis, Mo. 63107

Circle 41 on Inquiry Card

### THE COMPLETE LINE OF *Small Dimension* FUSES

*For The Protection of All Types of Electronic and Electrical Circuits and Devices . . .*

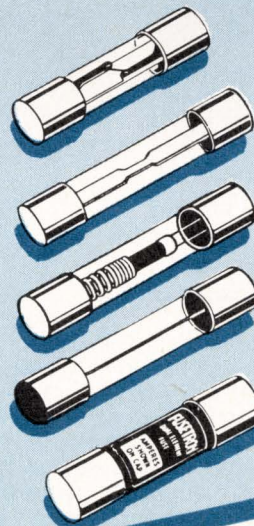

. . . includes dual-element "slow-blowing", single-element "quick-acting" and signal or visual indicating types . . . in sizes from 1/500 amp. up.

For special fuses, clips, blocks or holders, our staff of fuse engineers is at your service to help in selecting or designing the fuse or fuse mounting best suited to your requirements.

Write for BUSS Form SFB

INSIST ON  
**BUSS QUALITY**  
FUSES

BUSSMANN MFG. DIVISION, McGraw-Edison Co. St. Louis, Mo. 63107

Circle 41 on Inquiry Card

## NEW LAB INSTRUMENTS

### PROGRAMMABLE COUNTER/CONTROLLER

Counting capability from 0 to 2.5 MHz.

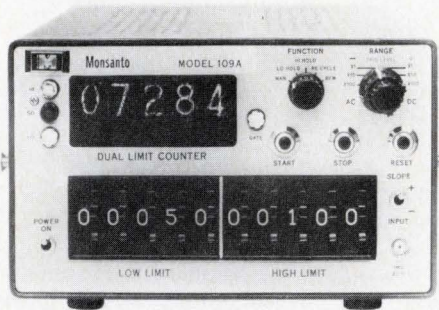

Model 109A has the capabilities of a 5-digit counter/timer, a high-speed digital comparator and a high- and low-limit counter. You can adjust the high- and low-limits from 0 through 99,999 with five decade thumb-switches for each limit. With pulsed signals, sensitivity is 200 mV with a minimum pulse width of 200 ns at 50% amplitude and 1 kHz repetition. Sinewave sensitivity is 50 mV, rms. The trigger level is continuously adjustable in three ranges of  $\pm 1$  V,  $\pm 10$  V, or  $\pm 100$  V, and has a preset position for triggering about the zero-volt level. You can select positive or negative slope for triggering. The 109A is priced at \$975 with delivery within 12 weeks. Monsanto Electronic Instruments, 620 Passaic Ave., West Caldwell, N.J. 07006. (201) 228-3800.

Circle 219 on Inquiry Card

### COMPACT 8-CHANNEL RECORDER

For lab or field use.

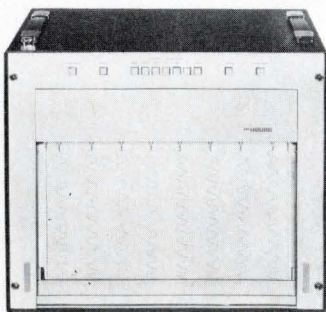

The 480 comes with a slide adapter for rack mounting, or in a portable carrying case. The instrument uses a pressurized ink system with disposable, easily replaced ink cartridges. The pen writes dry, smudge-free traces and has a servo system based on a frictionless transducer for position accuracy. Both penmotor and transducer are completely enclosed. The unit is compatible with the manufacturer's multichannel signal conditioners for measurements in the range from 50 mV to 500 V/division. Chart capacity is 300 ft. with high contrast paper and 450 ft. with reproducible paper. The basic unit is \$6500, and delivery is 30 days. Marketing Services, Brush Instruments Div., Gould, Inc., 3631 Perkins Ave., Cleveland, Ohio 44114. (216) 361-3315.

Circle 220 on Inquiry Card

### AUTOMATIC COMPONENT COMPARATOR

And test-limit selectors.

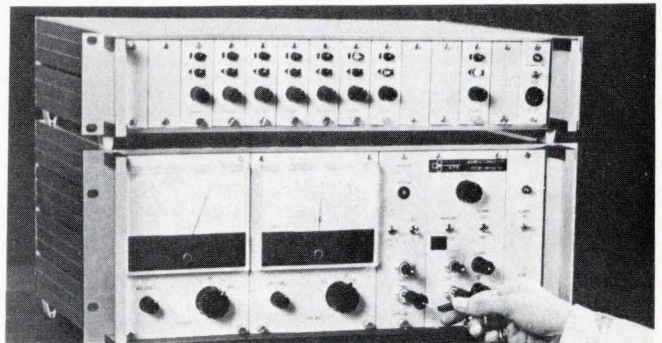

This system tests resistors, capacitors and inductors and displays their impedance and phase-angle directly (in percent) on a meter. Interchangeable frequency modules let you perform tests at fixed frequencies of 60 Hz, 120 Hz, 1 kHz or 100 kHz. Guaranteed accuracy is  $\pm 2\%$  of reading, and resolution is 0.05%. The impedance-deviation range covers from  $\pm 1\%$  to  $+100, -50\%$ . The output of the meter can be fed to accessory test-limit selectors and to a lamp for visual go/nogo indication for any percent deviation within the unit's range. The basic comparator costs \$1050, and the basic three-limit, test-limit selector is \$575. Delivery is three to four weeks. Advanced Technology and Systems Corp., 1143 Post Rd., Riverside, Conn. 06878. (203) 637-4337.

Circle 221 on Inquiry Card

### FREQUENCY SYNCHRONIZER

Converts rf oscillators into precision sources.

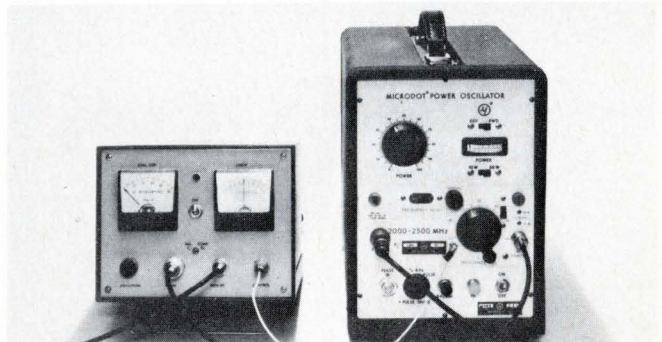

The Model 1929 is a frequency synchronizer that you can use to transform a power oscillator into a crystal-controlled laboratory source. Frequency coverage is 2 MHz to 2500 MHz and it has a power output of up to 50 W. You can also frequency modulate the unit, and have the oscillator function as an fm transmitter with up to 500 kHz deviation at rates from 300 Hz to 1 MHz. The synchronizer includes a meter to show you any drift in oscillator frequency. Three jacks on the unit carry an rf sample from the oscillator to the synchronizer, the dc control signal from the synchronizer to the oscillator, and the modulation signal input to the synchronizer. Microdot Inc., Instrumentation Div., 220 Pasadena Ave., So. Pasadena, Calif. 91030. (213) 682-3351.

Circle 222 on Inquiry Card

# ISSCC-1970

The 1970 International Solid State Circuit Conference will be held February 18-20, in Philadelphia, Pa. As in the past, the daytime information sessions will be on the campus of the University of Pennsylvania, while a series of evening discussion sessions are scheduled for the Sheraton Hotel.

A total of 66 papers are on the agenda, and the subjects range from consumer applications to a technology paper on Bell Lab's magnetic domains. Beside many familiar names from this country, authors from Belgium, The Netherlands, Japan, Canada, France and Germany will present papers.

Continuing the trend of the last several years, the conference reflects a great deal of activity in microwave

devices and techniques with a total of 16 papers on the topic. An evening session will compare different schemes of combining microwave devices for high power output. Considerations such as circuit efficiency, noise, tunability, stability, complexity and cost will be among the topics.

Another area receiving a good deal of coverage is semiconductor memories. Two complete daytime sessions are devoted to the subject, and there are separate discussion sessions on read-only-memories and random-access-memories.

Keynote speaker for the conference is Hubert H. Heffner, Deputy Director of the Office of Science and Technology. Mr. Heffner will treat the proper level of government support for science and the role of government in technological innovation.

Preregistration fee for the conference is \$20 for IEEE members and \$25 for non-members. If you wait to register at the door it will be \$25 for members and \$30 for non-members. Programs, along with registration forms, can be obtained from H. G. Sparks, The Moore School of Electrical Engineering, University of Pennsylvania, Phila., Pa. 19104, or from Lewis Winner, 152 West 42nd St., New York, N.Y. 10036.

## INFORMATION SESSIONS University of Pennsylvania

Date	Time	Irvine Auditorium	University Museum	Annenberg Auditorium
Wed. 2/18/70	9:00-11:00	Session I Avalance diode circuits	Session II Display and storage	
	12:00-1:15		Lunch	
	1:45-3:00		Session III Formal open./keynote	
	3:10-5:45	Session IV Semi conductor memory I	Session V Microwave transistor amplifiers	
Thurs. 2/19/70	9:00-12:00	Session VI Semi conductor memory II	Session VII CAD and device modeling	Session VIII New devices and circuit techniques
	12:00-1:15		Lunch	
	1:30-5:00	Session IX Consumer applications	Session X Logic and interface	Session XI Acoustic and transfered electron circuits
Fri. 2/20/70	9:00-12:00	Session XII Technology for ICs	Session XIII Linear circuit techniques	Session XIV Photo-sensors and low-level sensing

## INFORMAL DISCUSSION SESSIONS Sheraton Hotel—8:00 P.M.

Room	Wed. 2/18/70	Thurs. 2/19/70
West Ballroom	WE 1 Semiconductor RAMs	THE 7 Multichip IC assembly technology
East Ballroom	WE 2 Wideband high power amplifiers	THE 8 Microwave power generation
Penn-West	WE 3 Reliability	THE 9 Consumer electronics
Penn-East	WE 4 CAD of integrated circuits	THE 10 Read-only memories
Independence/Constitution	WE 5 Electronic access circuits A limiting function in matrix displays	THE 11 Data communications
Hall of Flags	WE 6 Biomedical applications of solid-state technology	

## NEW LAB INSTRUMENTS

### POSITION/DISPLACEMENT TRANSDUCER

With effective infinite resolution.



This unit gives you an electrical signal proportional to the linear extension or retraction of a cable. Model TCC-PT-101 comes in a series of units with displacement ranges from 1/2 in. to 140 ft. You merely attach the cable to the moving part and the body of the transducer to a fixed surface. The instrument has a non-linearity of less than 0.1% of its range, and you can get acceleration response rates to 100 G's. A ruggedized version withstands shock of 2,000 G's for 6 ms and vibration to 50 G's without changes in calibration. Options include analog or digital display systems and a magnetic base. With the magnetic base, the unit does not require clamping or bolting. Transducer Controls Corp., 737 N. Dodsworth, Coving, Calif. 91722. (213) 331-0917.

Circle 223 on Inquiry Card

### AUTOMATIC IC HANDLER

For 14- or 16-lead dual-in-line packages.

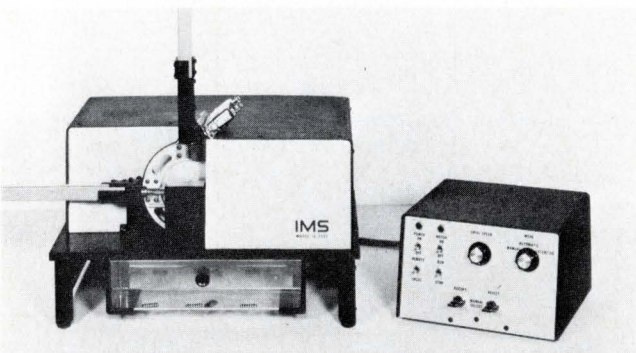

You can test up to 1500 devices/h with this unit. The Model IC 2500 uses a rotary index mechanism to move IC packages through the test and sort operation in a 2-step sequence. You feed packages directly from their shipping magazines and eliminate the need for separate carriers. The indexer feeds accepted circuits into another shipping magazine, and rejected circuits automatically fall into a plastic bin. At the full operating rate, you get a test time of 340 ms/device (min.). An optional manual control permits off-line operation, or interfaces with IC testers that are not equipped to control automatic handlers. Price is \$3150; the optional control unit is \$495. Delivery, 45 days. Scientific Measurement Systems, 351 New Albany Rd., Moorestown, N.J. 08057. (609) 234-0200.

Circle 224 on Inquiry Card

### CHARGE AMPLIFIERS

Use ICs to improve cost and performance.



Designated as the 4100, this series consists of three models. The 4101 is a charge follower with a dynamic measuring capability of better than  $\pm 1$  to  $\pm 10,000$  pC at the input. You can use it over 1000 ft. of cable and still maintain low noise levels. Model 4102 is a charge amplifier that can normalize transducer sensitivity so that the readout is made directly in terms of full scale output. The third unit, Model 4103, is a special charge follower for shock and low level vibration applications. It has a max. input of  $\pm 500,000$  pC, a noise level of  $< 50$  mV, and two gain ranges, 0.1 mV/pC and 1 mV/pC. Prices are: Model 4101, \$79.95; 4102, \$195; 4103, \$250. Columbia Research Laboratories, Inc., MacDade Blvd. & Bullens Lane, Woodlyn, Pa. 19014. (215) 532-9464.

Circle 225 on Inquiry Card

### DIGITAL MULTIMETER

Portable unit weighs only 4 lbs.

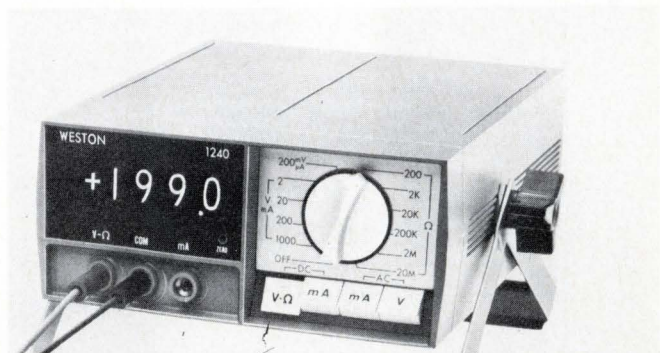

This digital multimeter has 26 ranges for measuring ac and dc voltage, ac and dc current, and resistance. As a bench tester, the Model 1240 is equipped with a tilt stand. This stand converts to a handle for portable use, or you can remove it altogether for rack mounting the unit in a standard 3 1/2 in. panel. All circuits are protected from overloads through a resistor-diode network, or through fuses, replaceable from outside the case. The ends of the handle locking knobs double as fuse removal tools. An external switch gives you 115 or 230 V operation, or you can get an optional battery pack for field use. The 1240 costs \$379.50 with test probes and line cord. Weston Instruments Div., Weston Instruments Inc., 614 Frelinghuysen Ave., Newark, N.J. 07114. (201) 243-4700.

Circle 226 on Inquiry Card

With due respect to Hewlett-Packard, General Radio, and other "biggies"



## LogiMetrics audaciously introduces the world's most accurate RF signal generator with continuously viewable (non-ambiguous) display.

- Unprecedented stability and resolution ● No separate counter or accessory equipment required
- A true combination of improved performance and reduction in cost!

Until now, a signal generator with an accuracy of 10,000 parts per million was considered acceptable. LogiMetrics' new 920A RF signal generator automatically, directly, and continuously measures the frequency to an accuracy of 60 parts per million (0.006% of full scale)! Think about that. Accuracy to 10,000 parts per million now improved to 60 parts per million, taking into account error due to all causes.

**PATENTED IMPROVEMENTS AND EXCLUSIVES** The 920A provides a significant improvement in accuracy, resolution, and repeatability due primarily to a patented new feature, ddc™—direct digital calibration. (There's no dial at all.) The frequency generated is displayed visually—to four significant digits. The frequency you see is the frequency you're getting—continuously! In addition, leveling is accurate to  $\pm 1/2$  dB across the complete spectrum of the generator and at all output levels. Modulation capability provides unmatched AM performance with both internal 400/1000 Hz modulation or external.

**CLEANER AND MORE FLEXIBLE** Unwanted spurious by-products are practically non-existent. For example: hum and noise, 70 dB down; residual or incidental FM, 1PPM; RFI leakage, better than MIL-I-6181D. That's performance! The unique design (primarily integrated circuit), makes calibration a snap. It also facilitates a range of options including computer and/or printer compatible read-out of frequency and narrow band frequency programming.

**ASK US!** If accuracy counts in your laboratory, write or call for catalog data describing LogiMetrics' "ddc" signal generators from 100 kHz to 80 MHz. Or use reader service number below.

**Comparative Costs:**

Conventional signal generator plus separate counter (typical) . . . . .	\$3,500.00
LogiMetrics Model 920A . . . . .	\$1,975.00

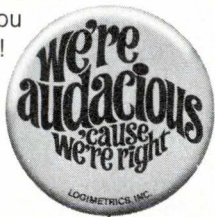

**LogiMetrics** INC.  
 A Subsidiary of Slant/Fin Corp.  
 100 Forest Drive, Greenvale, New York 11548  
 Phone: (516) 484-2222

## NEW LAB INSTRUMENTS

### RESISTOR NOISE TEST SET

For resistors from 10 $\Omega$  to 100 k $\Omega$ .

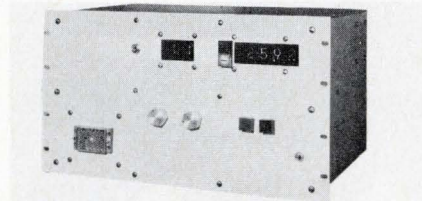

Model 5012 automatically tests up to 20 resistors sequentially. The instrument measures the resistance (to  $\pm 0.1\%$ ), computes and applies the correct dc voltage for a given dissipation, and measures the noise index. Quan-Tech Laboratories, Div. KMS Industries, 43 S. Jefferson Rd., Whippany, N.J. 07981. (201) 887-5508.

Circle 241 on Inquiry Card

### VSWR/WATTMETER

Measures vswr under power.

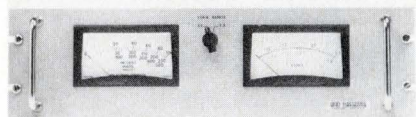

This unit, Model 3121, combines a precision vswr meter and an rf wattmeter. The vswr meter gives you two expanded scales, 2.5/1  $\pm 0.2$ , and 1.3/1  $\pm 0.06$  full scale vswr. The forward power meter has six ranges (25 to 1000W), and three frequency ranges (100 to 1000 MHz). Bird Electronic Corp., 30303 Aurora Rd., Cleveland, Ohio. 44139.

Circle 242 on Inquiry Card

### POWER MULTICOUPLER

From 250 kHz to 110 MHz.

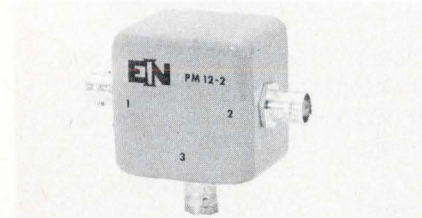

Model PM 12-2 can handle 12 W of average rf power at 65°C ambient. Specs include: max. insertion loss of 0.4 dB, amplitude balance of 0.1 dB, phase balance  $\pm 1^\circ$ , vswr 1.2:1 max. and isolation of 25 dB min. Price of the unit is \$95 in small quantities. Electronic Navigation Industries Inc., 1337 Main St., E. Rochester, N.Y. 14609. (716) 288-2420.

Circle 243 on Inquiry Card

### LOW NOISE AMPLIFIER

Up to 1 mA at 3 V pk-pk output.

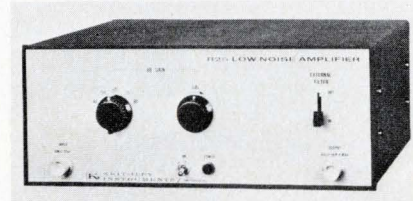

You can vary the gain of this unit, Model 825, from 40 to 80 dB in five steps. A 12 dB variable control allows interpolation between steps. The unit has a range of 1 Hz to 1 MHz, and total harmonic distortion is  $< 0.05\%$ . \$400. Keithley Instruments, Inc., 28775 Aurora Rd., Cleveland, Ohio 44139. (216) 248-0400.

Circle 244 on Inquiry Card

### RADAR SIMULATORS

C-band, S-band and X-band.



These units interrogate and measure the parameters of a radar transponder or beacon. Measurements include receiver frequency, receiver sensitivity, transmitter frequency, transmitter power output, code spacing, pulse width, rise time and fall time. Vega Precision Laboratories, Inc., 239 Maple Ave., Vienna, Va. 22180. (703) 938-6300.

Circle 245 on Inquiry Card

### TRUE RMS VOLTMETER

From 0.1 Hz to 500 kHz.



Model 144D35-II is a true rms voltmeter specifically for random signal analysis. It has time constants ranging from 0.1 to 100 s and a voltage range of 0.001 to 300 V. The unit has an internal calibration circuit and you can get 0.0003 V sensitivity as an option. DISA-S&B, Inc., 779 Susquehanna Ave., Franklin Lakes, N.J. 07417. (201) 891-9460.

Circle 246 on Inquiry Card

### BYTE GENERATOR

Plugboard loaded.

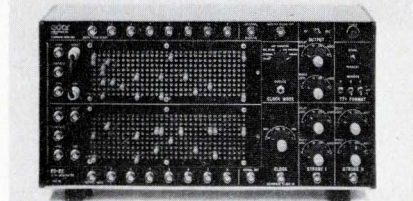

Model EC-22 provides 32 or 64 eight-bit bytes at rates of 10 Hz to 8 MHz. Outputs are TTL compatible and can be RZ or NRZ. Patch-panel control allows master-slave combinations. \$2,500, with additional plugboard at \$1,000. Delivery 30 days. Adar Associates, Inc. 85 Bolton St., Cambridge, Mass. 02140. (617) 492-7110.

Circle 247 on Inquiry Card

### FILTER/AMP/VOLTMETER

Also performs spectrum analysis.

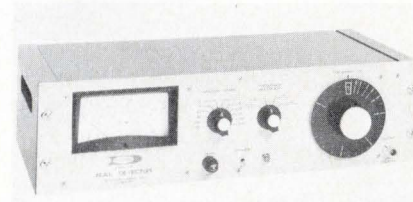

You can use the Model 717S as a tunable, narrow-band filter from 20 Hz to 20 kHz. Or, it's an amplifier with a variable gain of +60 dB to -50 dB. As a narrow-band voltmeter, you can adjust full-scale sensitivity from 1 mV to 300 V. Price, \$990; available from stock. Dytronics Co., Inc., 4800 Evanswood Dr., Columbus, Ohio. 43224. (614) 885-3303.

Circle 248 on Inquiry Card

### ATTENUATION CALIBRATOR

With built-in noise generator.

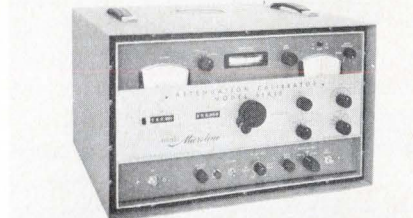

Model 61A1B covers a dynamic range of 100 dB in a single-step and it can make power and attenuation measurements to -117 dBm. You can also use the instrument as a lin-log receiver or as an extremely sensitive microwave detector. Price is \$2825, with delivery from stock. Narda Microwave Corp., Plainview, L.I., N.Y. 11803. (516) 433-9000.

Circle 249 on Inquiry Card

# When You Choose An AC Meter Best Isn't Always Most Expensive

So you're going to buy an AC meter. You want the best meter for your job—at the best price. Right? You have a problem! Let's talk about it.

We have AC meters, lots of AC meters. We have AC meters that sell for more than \$4500—and for their job, they can't be beat.

But how about the engineer who doesn't have a big production problem or need 5-digit resolution? How about the engineer who is making only two or three measurements a day... or week? We have a series of meters for him, too.

A series that has built a solid reputation for accurate performance and reliability—most of you have used them in the past. About three years ago, Hewlett-Packard updated with three redesigned, solid-state instruments—the 400 E/EL for broad frequency, 10 Hz and 10 MHz; the 400 F/FL for high sensitivity, 100  $\mu$ V to 1000 V; and the 400 GL for broad dB range, -100 to +60 dB, 100  $\mu$ V to 1000 V sensitivity.

These instruments are packed with convenience features. Two of these meters have a built-in 100 kHz low-pass filter to take out unwanted high frequencies for low-level audio mea-

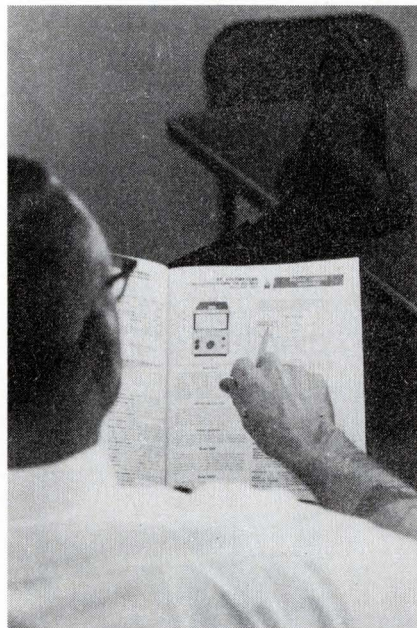

surements. You get fast response—a reading in less than 2 seconds after turn-on, and <2 seconds overload recovery. These instruments have an internal wideband ac amplifier, with an 80 dB gain—so we put an output on the back. With all these you can have the log scale uppermost for greater resolution in dB measurements.

Each HP-made taut-band suspen-

sion friction-free meter movement is individually calibrated to its scale for accurate readings over the entire range. Elimination of friction gives these meters excellent repeatability.

These, and more, are the features that assure reliable, day-in, day-out performance that gets the job done on time. If your problem is in sonar, acoustics, audio response, communications, calibration, ac to dc conversion and amplification—or any other application where precision ac voltage measurements are a must—then consider the HP 400 series carefully. They will fit your measurement requirements, leave your wallet fatter, and make your job easier and faster.

Check your HP catalog, starting on page 201, and choose the meter that best meets your measurement needs. Order today by calling the nearest HP order desk. For data sheets, write to Hewlett-Packard, Palo Alto, California 94304. Europe: 1217 Meyrin-Geneva, Switzerland. Price: \$275 to \$390.

099/18

**HEWLETT *hp* PACKARD**  
ANALOG VOLTMETERS

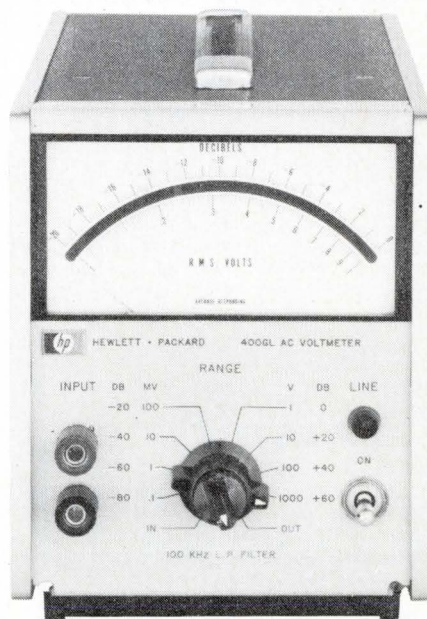
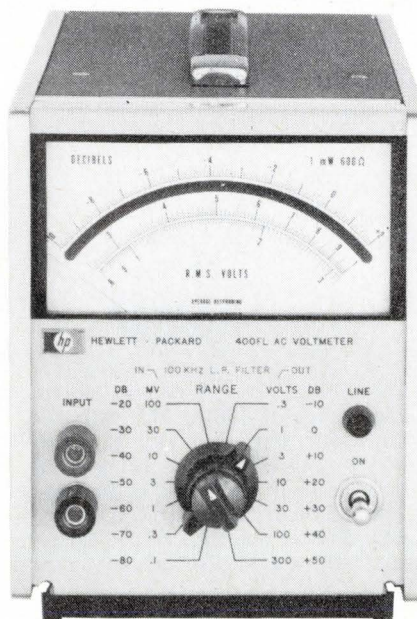
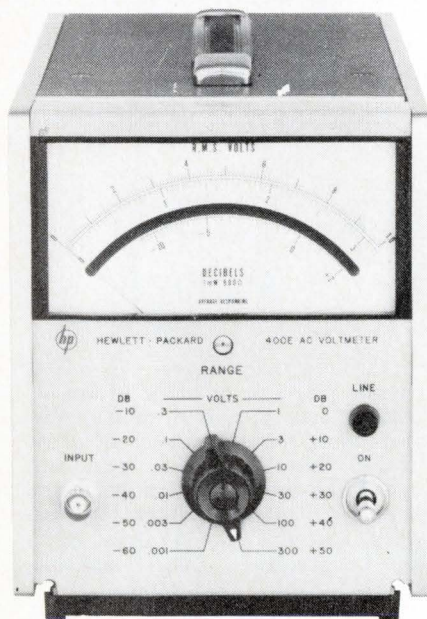

For a true record  
of temperature  
in service...

**Tempilabel<sup>®</sup>**

Easy to use . . .



BEFORE

Easy to read

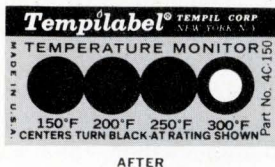

AFTER

Self-adhesive Tempilabels<sup>®</sup> assure dependable monitoring of attained temperatures. Heat-sensitive indicators, sealed under the little round windows, turn black and provide a permanent record of the temperature history. Tempilabel<sup>®</sup> can be removed easily to document a report.



AVAILABLE

Within the range 100° to 500°F Tempilabels<sup>®</sup> are available to indicate a single temperature rating each — and also in a wide choice of four-temperature combinations per Tempilabel<sup>®</sup>.

**JUST A FEW OF  
THE TYPICAL APPLICATIONS**

- Electrical Apparatus
- Electronic Assemblies
- Appliance Warranties
- Aircraft and Rockets
- Machinery and Equipment
- Storage and Transportation of Heat Sensitive Materials.

For descriptive literature and a sample Tempilabel<sup>®</sup> for evaluation . . . (please state temperature range of interest).



132 WEST 22nd St., NEW YORK, N.Y. 10011  
Phone: 212 • 675-6610 TWX: 212 • 640-5478

Circle 44 on Inquiry Card

**NEW LAB INSTRUMENTS**

**FUNCTION GENERATOR**

Has a range of 0.0005 Hz to 1 MHz.



You can get sine, square, triangular and sawtooth waveforms from the Model 9030. The unit supplies output levels up to 30 V with  $\pm 5$  V offset and has a constant output impedance of 50 $\Omega$ . Electronic Instruments Div., Beckman Instruments, Inc., 2200 Wright Ave., Richmond, Calif., 98404. (415) 526-7730.

Circle 232 on Inquiry Card

**DIGITAL AMPERE-HOUR METER**

With better than 1% accuracy.



You can use the Model PD-25-P to turn-off other equipment at a pre-set ampere-hour count. The unit accepts inputs from 500 mA to 25 Adc or you can count signals as low as 25 mA with a slight loss of accuracy. \$348 ea.; 1-9 pcs. Deflecto Mfg Corp., Div. of Amperite Co., Inc., 600 Palisade Ave., Union City, N.J. 07087. (201) 865-5648.

Circle 233 on Inquiry Card

**WAVE/DIP METER**

And marker oscillator.

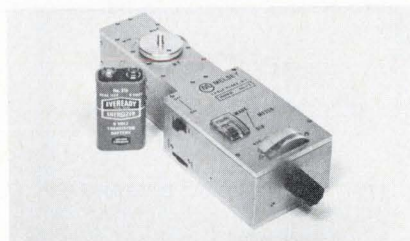

The SN-2 has a fundamental frequency range of 400 to 1150 MHz. A 30 in. steel tape provides 1% calibrated tuning. You can also use this unit as a signal generator, or to measure inductance, capacitance and relative Q, or field strength. \$185. Melsey Corp., 202 Carle Rd., Carle Place, L.I., N.Y. 11514. (516) 333-0655.

Circle 234 on Inquiry Card

**SIGNAL CONDITIONER**

For strain gages.

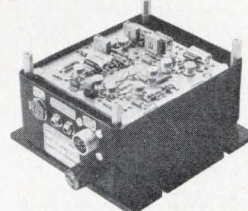

This differential input unit amplifies 1, 2, or 3 mV/V signals to a 10 V full scale output. Model BAO4 has a gain accuracy of  $< 70$  PPM/ $^{\circ}$ C and zero stability of  $< 3$   $\mu$ V/ $^{\circ}$ C. CMR is  $> 100$  dB within a common mode range of  $\pm 8$  V. Integrated Controls, Inc. Box 17296, San Diego, Calif. 92117. (714) 453-5800.

Circle 235 on Inquiry Card

**X-Y STEPPING SYSTEM**

Semiautomatic operation.

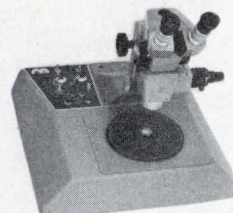

This unit, Model 2000, has a total travel of 2 in. in each direction. Standard stepping increments range from 0.01 to 0.16 in. with special increments also available. The "Z" plainarity is within 0.0002 in. and axis rectangularity is 0.0004 in./in. of travel. \$1,450. Mechanization Associates, 140 S. Whisman Rd., Mountain View, Calif. 84040. (415) 967-4262.

Circle 236 on Inquiry Card

**PHASE JITTER METER**

Amplitude and phase measurements.

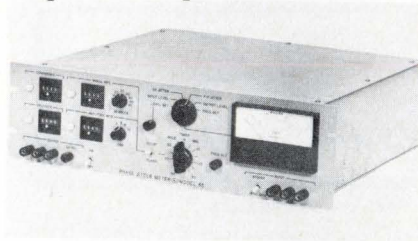

Beside phase parameters, Model 45 measures gain hits or dropouts. You can measure the coincidence of phase and gain hits, or totalize gain hits, phase hits, or coincident gain and phase hits over a selectable time period. \$2,450. Delivery, 45 days. Hekiman Laboratories, Inc., Rockville, Md. 20850. (301) 424-3160.

Circle 237 on Inquiry Card



## DIGITAL VOLTMETER

Up to 1000 V with 20% overrange.

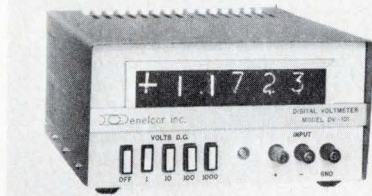

Model DV-101 has an accuracy of 0.01% and a sensitivity of 100  $\mu$ V. Printed circuit board construction gives you simple maintenance. Options include ac, ohm and  $\mu$ V measurements plus a BCD output. \$499; stock to 30 days delivery. Denelcor, Inc., 5975 Broadway, Denver, Colo. 80216. (303) 892-0987.

Circle 238 on Inquiry Card

## PRESSURE TRANSDUCERS

Use semiconductor strain gages.

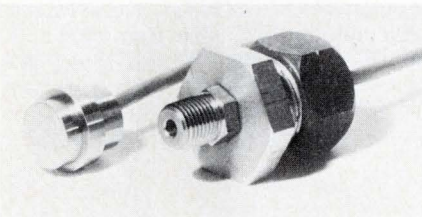

The AB Series transducers come in pressure ranges from 15 to 10,000 psi. These units have an accuracy of 1% at room temperatures. Excitation voltage is 5 Vdc or ac (rms). Output at the rated pressure is 100 mV. They cost \$80 ea. in quantities of 100, and delivery is 15 days. Bytrex Div., Tyco, 223 Crescent St., Waltham, Mass. 02154. (617) 899-5600.

Circle 239 on Inquiry Card

## SOLID-STATE OSCILLOSCOPE

With triggered sweep.

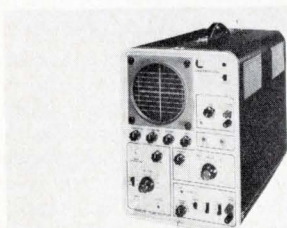

The TO-50 features a 10 MHz bandwidth, dc amplifiers to eliminate pattern bounce, calibrated vertical attenuator and horizontal time base, and an automatic sync mode. A TV sync selector and a vectorscope input make the unit suitable for TV servicing. \$329.50. Lectrotech, Inc., 4529 N. Kedzie Ave., Chicago, Ill. 60625.

Circle 240 on Inquiry Card

# The Breadboard Is Obsolete Now There's A New Design Technique That's Faster, Easier And More Economical!

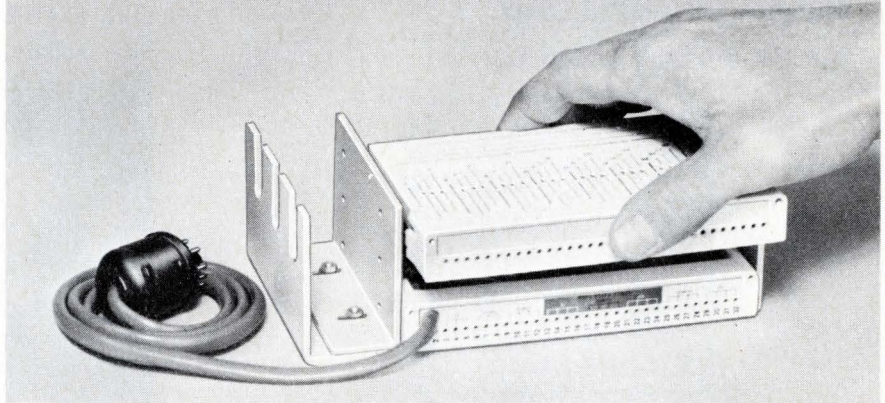

## The New Heath "Stack-n-Patch"

**Old Methods Can't Solve New Problems.** Critical specs, higher density circuits, costly devices, tight schedules... these are today's design problems. Conventional breadboarding can't solve them. A more efficient method is needed. That method is here... the Heath EU-53A "Stack-n-Patch"... a totally new technique for circuit design and teaching.

**A Better Way.** The "Stack-n-Patch" eliminates soldering... just insert hookup wire or component leads into the special connectors. Because there's no soldering, there's no waste... no need to dike out components and throw them away. Expensive FET's can't be damaged from heat... limited quantity samples can be reused. The problems of the multi-layered rat's nest of breadboarding are also eliminated... the 177 patch connectors on the Component Patch Card are laid out according to common circuit board practice and closely simulate the circuit density and "stray" interaction of today's printed circuits.

**Your Design—Stack It... Patch It.** Included in the "Stack-n-Patch" are the Desk-Top Chassis, the Power Patch Card for bringing power from your choice of supply and the Component Patch Card. Designing is fast and simple. Pick your supply and connect it to the Power Patch Card... stack the Component & Power Patch Cards in the chassis... patch power to the Component Card and you're ready to go.

**Pick A Card... Any Card.** For IC work and other types of design that can't be built conveniently on the Component Card, Heath offers a wide variety of factory assembled cards to stack in the Chassis... Dual & Quad J-K Flip Flops, And-Or-Invert, Nand Gate, Dual Monostable, Op Amp... even a Dual Inline IC socket card and a blank circuit card ready to etch. Pick the one that meets your needs... stack it... patch it.

**There Is A Better Way To Design.** Order your Heath "Stack-n-Patch" now... and discover it!

Assembled EU-53A, 6 lbs. .... \$37.50

### What You Get

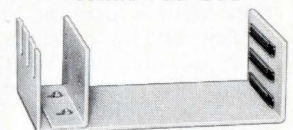

Desk-Top Chassis



Power Patch Card



Component Patch Card

### Pick Your Power Supply



EU-801-11 delivers 5 V @ 2 A max; 170 V @ 40 mA max; Plus and Minus 15 V @ 150 mA max. \$75.00, 8 lbs.



EU-41A delivers 0-15 V @ 0-750 mA. \$50.00, 6 lbs.

### FREE Heath Scientific Instrumentation Catalog



Describes these and other precision instruments for laboratory, engineering, education and R & D applications. Send for your FREE copy now... just write on your school or company letterhead.

HEATH COMPANY, Dept. 580-25  
Benton Harbor, Michigan 49022

Please send FREE Heath Scientific Instrumentation Catalog

Name \_\_\_\_\_

Address \_\_\_\_\_

City \_\_\_\_\_ State \_\_\_\_\_ Zip \_\_\_\_\_

Prices and specifications subject to change without notice.

\*Mail Order Prices; F.O.B. Factory



## NEW MICROWORLD PRODUCTS

### FOUR BIT ARITHMETIC UNIT

Eight MSI devices in one package.

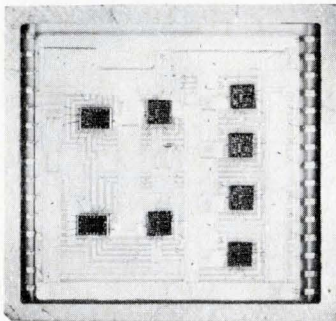

In addition to adding and subtracting two 4-bit words, the SH8081 can perform any of six other logic functions. You select these functions with 3-bit control word and they include AND, OR, and exclusive-OR combinations. The device has high fanout characteristics and is compatible with all members of the current sinking logic families (TTL, DTL, etc.). Propagation times of 16 ns are typical for  $X \times Y$  functions. The SH8081 comes in a 1 x 1 in. flat-pack. Prices for a military rated version are \$215 ea., 1-24 pcs; \$173 ea., 25-99 pcs; and \$140 ea., 100-999 pcs. Industrial version is \$140, \$112 and \$92 in the same quantities. Fairchild Semiconductor, 313 Fairchild Dr., Mountain View, Calif. 94040. (415) 962-3563

Circle 227 on Inquiry Card

### HIGH SPEED LSI SHIFT REGISTERS

From dc to 10 MHz over the full temperature range.

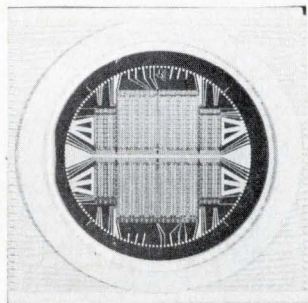

These bipolar, TTL devices come in dual 253-, dual 349-, and dual 501-bit configurations, or you can get them in custom lengths. The registers have four-bit cells that are discretionarily routed in series plus an additional one-bit output driver. This makes chains available in lengths of  $4N+1$  bits. Short internal connections minimize capacitive coupling and give high noise immunity. They are packaged in a standard 78-pin ceramic package. Prices, (100 to 249 pcs.) are: DRA-2001 (dual 253-bit) \$295 ea.; DRA-2002 (dual 349-bit) \$335 ea.; DRA-2003 (dual 501-bit) \$390 ea. Small quantity delivery is eight weeks. Texas Instruments Inc., Inquiry Answering Service, Box 5012-M/S 308, Dallas, Tex. 75222. (214) 238-3741.

Circle 228 on Inquiry Card

### FIVE STANDARD READ-ONLY MEMORIES

Both military and industrial versions.

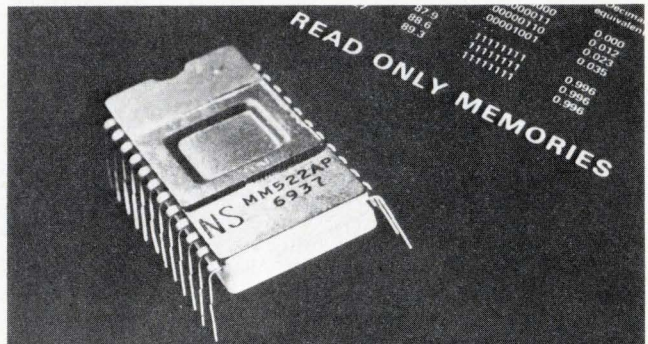

You can use two of these units in radar and arithmetic applications or for performing fast Fourier transforms. These are a sine lookup table, and an arctangent table ( $0$  to  $45^\circ$ ). The other circuits are an IBMBCD to ASCII converter; a BCD to Selectric converter; and a Selectric to BCD converter. You get a choice of arrangements between a 256 word by 4-bit unit (MM421/521) and a 128 word by 8-bit unit (MM422/522). Industrial rated units in 1-24 piece lots are MM521, \$67.50 ea.; MM522, \$90 ea. The military version in the same quantities are MM421, \$108 ea., and MM422, \$120 ea. All units are available from stock. National Semiconductor Corp. 2975 San Ysidro Way, Santa Clara, Calif. 95051. (408) 245-4320.

Circle 229 on Inquiry Card

### DOT CODE CHARACTER GENERATOR

In a 24-pin, ceramic and metal DIP.

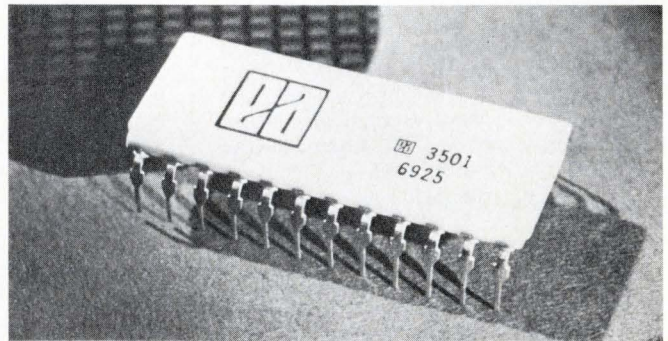

This unit, the EA 3501, is a MOS read-only-memory containing 512 words of 5 bits each. It generates the 64 basic ASCII characters in horizontal scan CRT applications. The device accepts ASCII encoded inputs and provides 35 bits per ASCII symbol ( $5 \times 7$  matrix). Typical power consumption is 90 mW at 1 MHz when driving an MOS load. Typical access time is 750 ns. The circuit also has bipolar output drive capability. You can also get specialized bit patterns permanently programmed in the ROM that let you perform other functions. Price of the 3501 is \$76 ea. in 100 piece lots, and they are available from stock. Electronic Arrays Inc., 501 Ellis St., Mountain View, Calif. 94040. (415) 964-4321.

Circle 230 on Inquiry Card

## LOW-COST INTEGRATED CIRCUITS

For consumer applications.

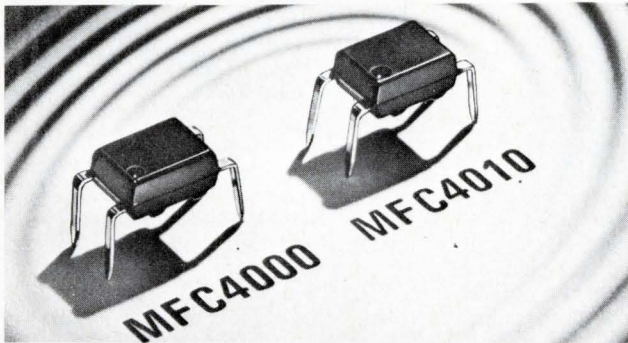

These plastic-packaged, monolithic devices are suitable for applications such as pocket radios and cassette recorders. The MFC4000 is a low-power audio amplifier with 250 mW of output power and low total harmonic distortion (0.7% typical at 50 mW). In a four-lead package, it costs \$1.40 ea. in quantities of 100 and up. The MFC4010 is a wide-band amplifier with a 60 dB min. gain and a typical output noise of 1 mV rms. You can use it as a driver for the MFC4000. Also in a four-lead package, it sells for \$1.25 ea. in 100-up quantities. Both devices are available from stock. Technical Information Center, Motorola Semiconductor Products Inc., Box 20924, Phoenix, Ariz. 85036. (602) 273-6900.

Circle 231 on Inquiry Card

## MORE NEW MICROWORLD PRODUCTS

Here are some more products just announced. For more information, please use the circle number indicated.

### LINEAR ICs

*TV video amplifier.* Motorola's MC1352 gives you an integral keyed AGC amplifier circuit, plus an IF stage for \$2.75. Its in a plastic TO-116 package. Circle 201

*IF amplifier.* The MC1350 from Motorola, has a high power gain and wide-range AGC. Probable uses include am and TV receivers and tape recorders. \$2.50. Circle 202

*Zero-crossing ac trigger.* The  $\mu$ A742 Trigac gives you an interface between low-level sensors and SCRS or triacs. Fairchild charges \$7.45 ea., 1-25 pcs. Circle 203

*Second source op amps.* Intersil's ICB8741 and ICB8741C are pin-for-pin replacements for the 741. Circle 204

*Op. amps; 741 family.* The  $\mu$ A747 gives you two 741's in one package, while the  $\mu$ A748 has external frequency comp. for tailoring slew rates. From Fairchild. Circle 205

*Op amp with low bias and offset.* Motorola's MC1556 has 15 nA max. bias, and 2 nA max. offset. Circle 206

### DIGITAL ICs

*Series 54/74 data selector.* The SN54153/74153 has two, 4-wide, AND-OR gates. Common input circuitry selects data from one of four sources. Texas Instruments. Circle 207

*MOS arrays.* Electronic Arrays Inc. has announced the EA 1806, a variable hex gate unit, and the EA 1808, which is a fixed logic array. Both are in DIPs. Circle 208

*DTL circuits.* National Semiconductor now markets the 930 series of DTL for industrial applications. Circle 209

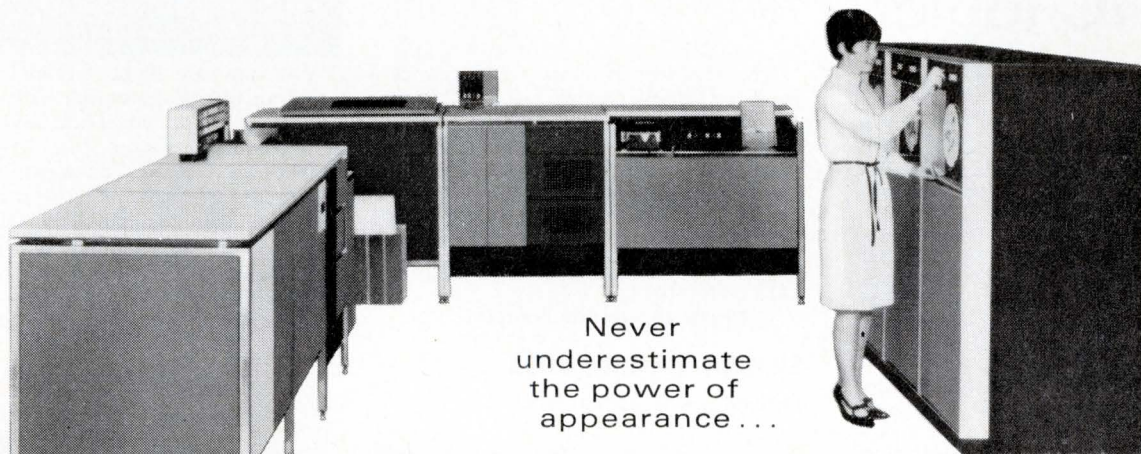

Never underestimate the power of appearance...

## MET-L-WOOD panels add beauty and backbone to machine housings

First impressions often influence final decisions. To compete in today's marketplace, even sophisticated machinery cries out for housing design that says . . . beauty . . . purpose . . . versatility. And nothing says it better than unique MET-L-WOOD. MET-L-WOOD is a laminate, consisting of a core of plywood or other lightweight material with metal or other durable facings structurally bonded to both surfaces. The result is a panel of great durability and versatility that lends itself to dramatic design, withstands abuse and continues to look like new for years. MET-L-WOOD panels are easy to work with, requiring no special tools, or may

be prefabricated for easy assembly. Learn for yourself how MET-L-WOOD fits into your housing plans. Write for brochure to: MET-L-WOOD CORPORATION, 6744 West 65th Street, Chicago 60638.

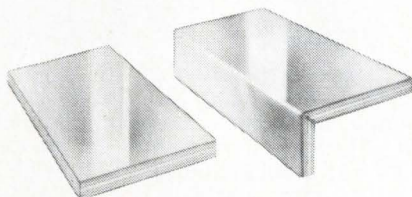

**MET-L-WOOD**  
Corporation

STRUCTURAL LAMINATES SINCE 1925

ANNOUNCING:

# Cool power

Model CP-5-5  
Price: \$145.00



## for IC logic

These new power modules from ERA provide *cool performance, total protection* for specialized use in IC, computer, telemetry, strain gauge and transistor applications.

The Transpac CP series is equipped with unique heat sinking for cool (71°C, free air) operation at high currents, protects itself and your equipment through built-in short circuit protection with instant recovery, adjustable current limiting and overvoltage protection.

A special burn-in test program at the factory assures reliability while compact silicon design saves space.

Send for catalog. Write today — before you design.

### STANDARD MODELS

Output Voltage VDC	Current @			Model	Price
	50°C	60°C	71°C		
3.6	3.2	2.8	2.5	CP-3P6-2P5	\$125.00
5	3.2	2.8	2.5	CP-5-2P5	\$125.00
3.6	6.5	5.7	5.0	CP-3P6-5	\$145.00
5	6.5	5.7	5.0	CP-5-5	\$145.00
3.6	13.0	11.4	10.0	CP-3P6-10	\$185.00
5	13.0	11.4	10.0	CP-5-10	\$185.00
3.6	22.0	19.5	17.0	CP-3P6-17	\$230.00
5	22.0	19.5	17.0	CP-5-17	\$230.00
3.6	32.0	28.5	25.0	CP-3P6-25	\$310.00
5	32.0	28.5	25.0	CP-5-25	\$310.00



## ERA TRANSPAC CORPORATION

A Subsidiary of  
Electronic Research Associates, Inc.  
67 Sand Park Road, Cedar Grove, N.J. 07009  
(201) 239-3000

Circle 47 on Inquiry Card

## NEW MICROWORLD PRODUCTS

### VOLTAGE COMPARATOR

Dissipates less than 30 mW.

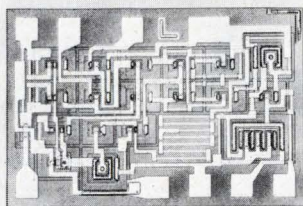

The ICB8001C has an offset voltage drift  $< 3 \mu\text{V}/^\circ\text{C}$ , offset current drift  $< 37 \text{pA}/^\circ\text{C}$ , and a gain of 60,000. The device can drive bipolar loads over the full temperature range. In a TO-100 package, price is \$15 ea., 1-99 pcs. \$10 ea.; 100-999 pcs. Delivery from stock. Intersil Inc., 10900 N. Tantau Ave., Cupertino, Calif. 95014. (408) 257-5450.

Circle 250 on Inquiry Card

### CERAMIC CAPACITORS

In four standard chip sizes.

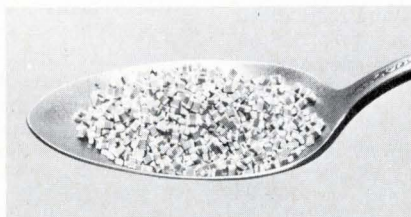

The series encompass a capacitance range of 10 pf to 0.27  $\mu\text{f}$  at 50 Vdc and includes three different body formulations in various parts of the capacitance range. Terminals include silver and gold, as well as different solder coatings. Technical Literature Service, Sprague Electric Co., Marshall St., North Adams, Mass. 01247. (413) 664-4411.

Circle 251 on Inquiry Card

### SILICON WAFER PROBE

Determines impurity type.



With the thermal P-N probe you can determine the type of material diffused into a silicon wafer. The control box has a tip storage aperture that lets you store the probe in a non-oxidizing  $\text{N}_2$  atmosphere when not in use. This feature eliminates waiting for warm up. HLS, Inc., 2576 Lafayette St., Santa Clara, Calif. 95050. (408) 296-7436.

Circle 252 on Inquiry Card

### VOLTAGE REGULATOR

In an 8-lead TO-5 package.



This monolithic device gives you 0.025% line and load regulation and an output current of 100 mA. The CA3055 operates from inputs of 7.5 to 40 V and has an output range of 1.8 to 34 V. Output R is typically  $0.075 \Omega$ . \$2.95 ea.; 1000 pcs. RCA/Electronic Components, Commercial Engineering, 415 S. 5th St., Harrison, N.J. 07029. (201) 485-3900.

Circle 253 on Inquiry Card

### THIN-FILM LADDER NETWORKS

Provide 1/4-bit accuracy.

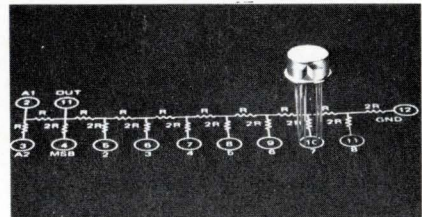

You can use Type CDAL1 R/2R tantalum nitride networks with hybrid D/A ladder switches. They have built-in feedback resistors that give you gains of 1/2, 1, or 2. Packaged in a low profile TO-5, they are \$90 ea., 1-99 pcs. and \$60 ea., 100-999 pcs. Delivery from stock. Crystalonics, A Teledyne Co., 147 Sherman St., Cambridge, Mass. 02139 (617) 491-1670.

Circle 254 on Inquiry Card

### POWER OP AMP

Gives you 150 mA at 10 V.

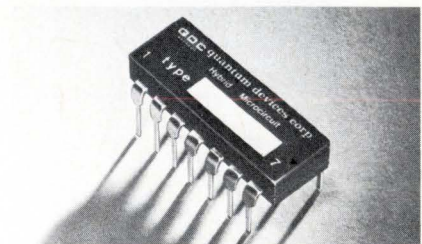

You can use this thin film, hybrid device as a buffer, line driver, level shifter or booster amplifier. Model OA201, has an input bias current of 200 nA, an offset voltage of  $25 \mu\text{V}/^\circ\text{C}$  and its open loop gain is  $> 100,000$ . The device comes in a DIP or in a hermetically sealed version. Quantum Devices Corp., 15 W. Main St., Bergenfield, N.J. 07621. (201) 185-9600.

Circle 255 on Inquiry Card

## HYBRID ANALOG GATES

Full military temperature range.

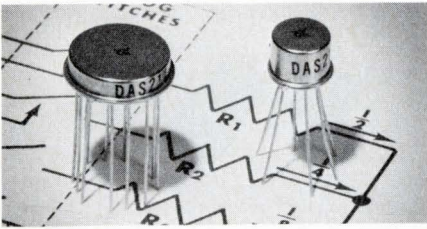

You can use these units in A/D and D/A, sample and hold, and multiplexing applications. They have high switching speeds (down to 300 ns), and "on" resistance as low as  $30\Omega$ . In 100-999 lots the DAS2107 (SPST) is \$5.50, DAS2110 (SPST) is \$8.50 and the DAS2126 (SPDT) is \$18. Dickson Electronics Corp., Box 1390, Scottsdale, Ariz. 85252. (602) 947-2231.

Circle 256 on Inquiry Card

## INFRARED DRYER

For photofabrication.

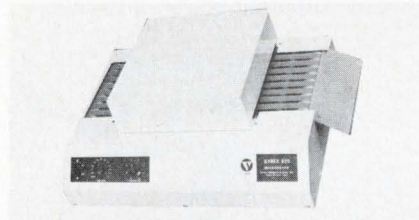

The 825 Microdryer gives you fast and uniform drying of photoresists and other coatings. The unit accepts parts up to 8 in. wide by  $\frac{1}{2}$  in. thick and, depending on type and thickness of coating and part, photoresist drying takes 10 to 90 s. The price is \$1,400. Gyrex Products, Varo Inc., 402 E. Gutierrez St., Santa Barbara, Calif., 03101. (805) 966-7131.

Circle 257 on Inquiry Card

## CONDUCTIVE EPOXY

For bonding semiconductor chips.

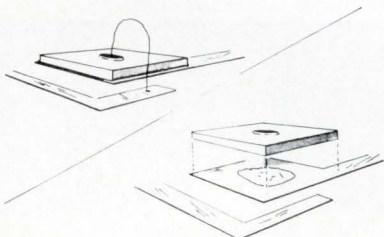

Epo-Tek H-20 has good pot life and fast curing at relatively low temperatures. You can use it from 300 to 400°C intermittently, or at a continuous operating temperature of 250°C. The curing schedule ranges from 1 h at 80°C to 20 min. at 120°C, and it has a lap shear strength of 100 psi. Epoxy Technology, Inc., 65 Grove St., Watertown, Mass. 02172.

Circle 258 on Inquiry Card

# THE New GENERATION SCR



## DISC PACKAGED REGENERATIVE GATE SCR's

Operation to 20 KHz with low switching losses  
⊕ di/dt capability to 800 A/ $\mu$ sec. ⊕ low power gate drive  
⊕ dv/dt capability to 500 V/ $\mu$ sec.  
⊕ 175 and 370 amperes RMS ⊕ turn-off time capability to 10  $\mu$ sec.  
⊕ also available in stud type package to 470 amperes RMS.

For additional information and application assistance, write or call National Electronics, Inc., a varian subsidiary, Geneva, Ill. 60134, phone (312) 232-4300.

## NATIONAL ELECTRONICS, INC.

a varian subsidiary

1969 COMPETITION WINNER  
Cited by Industrial Research Inc.  
as one of the 100 most  
significant technical products of the year.



A NATIONAL® exclusive,  
Patent Pending.

## NEW PRODUCTS

### LIGHT CONTROLLED SWITCH

Turn-on time of 100 ns.

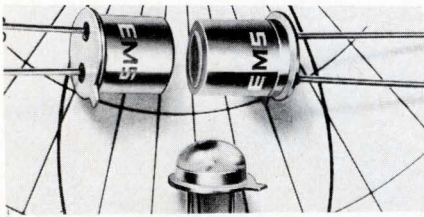

New silicon planar, two element switch can perform the dual function of light sensing and load actuating. The LCS BiPhotran bistable switch has a high sens. to light, and voltage ratings to 400 V. Output current is determined primarily by load. Surge current rating is 2 A for 8 ms. Electronic Micro Systems, 1672 Kaiser Ave., Santa Ana, Calif. 92705. (714) 549-2295.

Circle 210 on Inquiry Card

### LV INDICATOR TUBE

Can be driven by ICs.

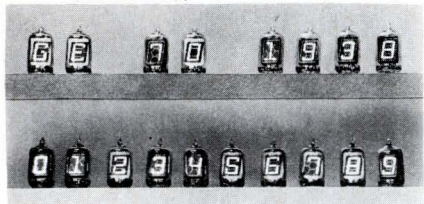

Y-1938 readout tube has its seven bar segments in a single plane on ceramic substrates. Thus, there aren't any parallax problems. It operates at 25 V anode, compared with up to 170 V for some other display tubes. Its max. seated height is 1 3/4 in. while max. height of the tube is 2 in. Tube Dept., General Electric Co., 316 E. 9th St., Owensboro, Ky. 42301.

Circle 211 on Inquiry Card

### SOLDER, DESOLDER TIP

For DIP's.

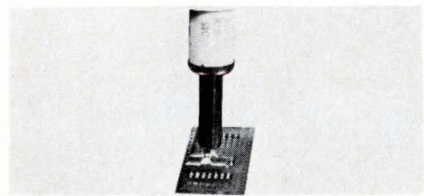

The #4918 DIP desoldering, soldering tip is easily inserted in a std. 3/8 in. screw-type soldering gun of 35 W or more. Grooved and channeled for 10, 14, or 16 lead DIPs, it will effectively desolder a complete DIP in one pass. It also has end tips shaped for straightening bent connector pins. Resoldering the DIP is also possible. Techni-Tool, Inc., 1216 Arch St., Phila., Pa. 19107. (215) 568-4457.

Circle 212 on Inquiry Card

### POWER TRANSISTOR

For microwave applications.

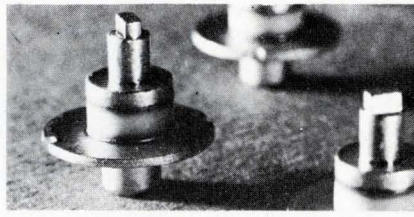

New TA7205 power transistor has 5 W minimum output with 7 dB gain at 2 GHz and a typical 10 W output with over 10 dB gain at 1 GHz. Applications include DME, collision avoidance, ECM, relay links, telemetry and drives for varactor chains. Cost \$180 each in 100 lot quantities. RCA/Electronic Components, Commercial Engineering, Harrison, N.J. 07029. (201) 485-3900.

Circle 213 on Inquiry Card

### KNURLED PLASTIC KNOBS

With spun aluminum plates.

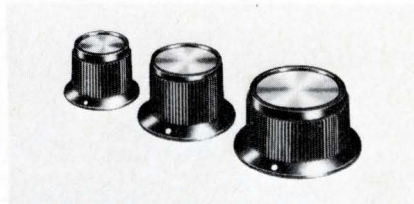

New instrument knobs have a mold-in brass bushing and a std. 6/32 in. set screw. The PK series straight knurl knobs have a 1/4 in. shaft hole dia. in three sizes: 0.500, 0.750 and 0.937 in. O.D. The 0.500 in. is also available with 1/8 in. shaft holes. Alcocnob Div., Alco Electronic Products Inc., Box 1348, Lawrence, Mass. 01842. (617) 686-3887.

Circle 214 on Inquiry Card

### SCR's

Available in disc packages.



NL-F350 and NL-C350 series rectifiers are rated at 175 A rms. Voltage ranges from 100 to 1000 V. They are also available with fast turn off capabilities to 10  $\mu$ s and dv/dt capabilities to 500 V/ $\mu$ s. Operation is to 20 kHz with low switching losses and low power gate drive and with a di/dt capability to 800 A/ $\mu$ s. National Electronics, Inc., Geneva, Ill. 60134. (312) 232-4300.

Circle 215 on Inquiry Card

### INDICATOR LIGHTS

Mount in 3/8 in. dia. hole.

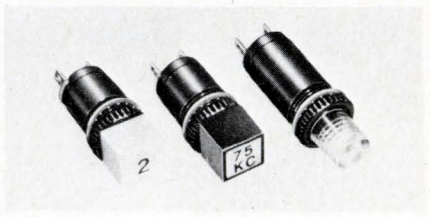

"Easy-Mount" midget flanged indicator lights, Series 5154 & 5155, use both T-1 3/4 incand. and T-2 neon lamps. Series 5154 have a choice of transparent or translucent cylindrical lens, or the Fresnel lens cap. The 5155 series features a 3/8 in.<sup>2</sup> lens cap with friction fit shank for orientation. Drake Mfg. Co., 4626 N. Olcott Ave., Harwood Heights, Ill. 60656. (312) 887-7227.

Circle 216 on Inquiry Card

### RF POWER TRANSISTOR

Saturated output power of 21 W.

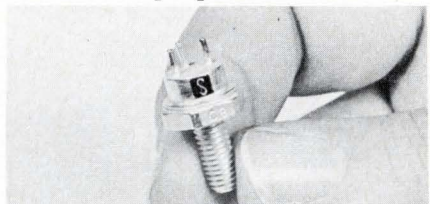

The 2N5016 silicon npn interdigitated transistor is capable of 15 W output power at an op freq. of 400 MHz. It features emitter resistors for increased stability and ruggedness. It can dissipate 30 W at case temp. of up to 50°C. \$35.10 each (1-99). Solitron Devices, Inc., 1177 Blue Heron Blvd., Riviera Beach, Fla. 33404. (305) 848-4311.

Circle 217 on Inquiry Card

### CERMET RESISTORS

In up to 1 G $\Omega$  values.

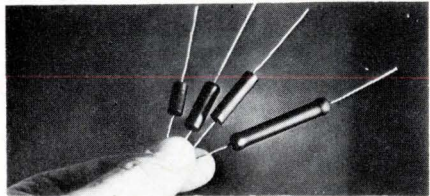

These thick-film resistors are made to a std. 0.5% tol. or 0.1% on special order. They will stay within 0.5% of design value, even after 1000 hrs at max. permissible op. temp. and power. TCR is 60 ppm/°C. They come with high-temp. alloy fused junctions. All are furnished with a silicone protective coating. Cermetrics, Inc., 116 E. 16th St., New York, N.Y. 10003. (212) 677-3344.

Circle 218 on Inquiry Card

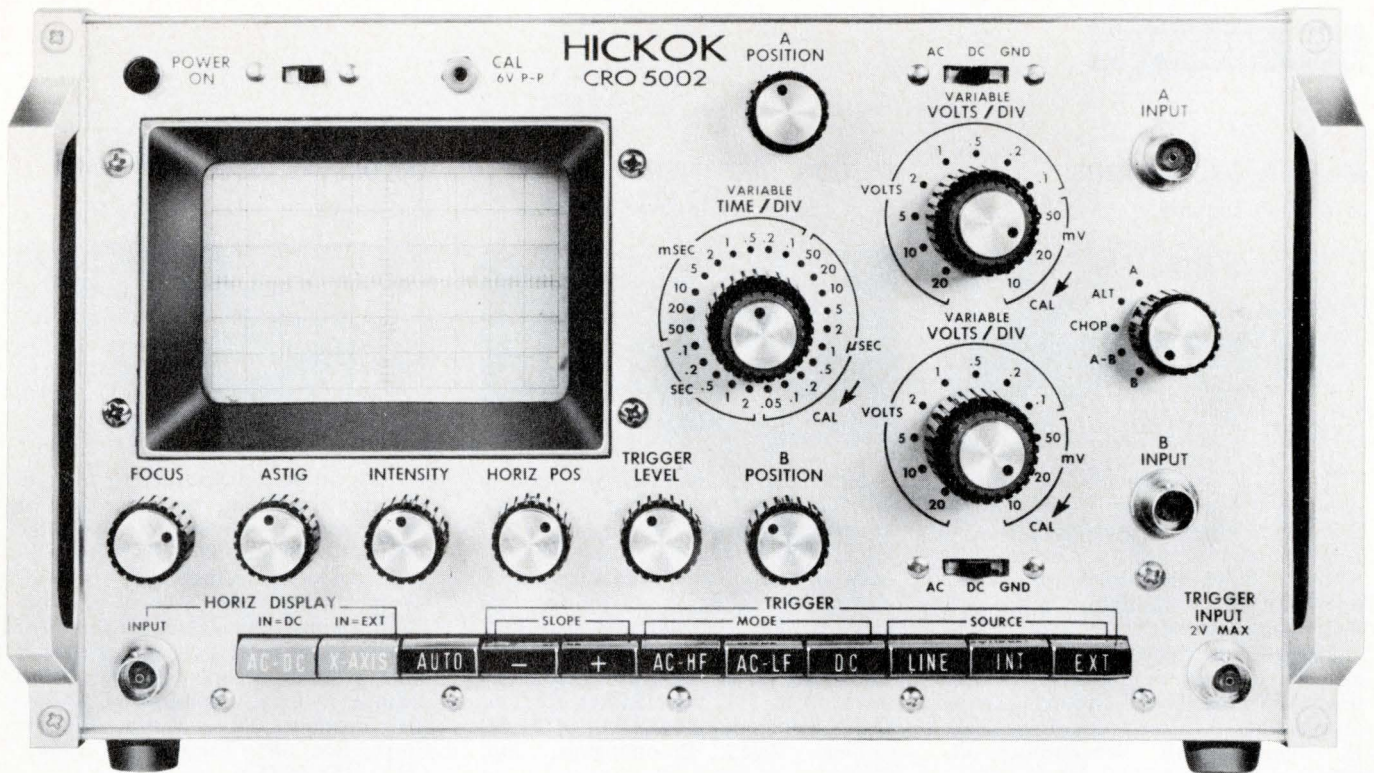

CRO-5002 ILLUSTRATED

**CRO-5000**  
**\$725**  
 SINGLE TRACE

**CRO-5002**  
**\$995**  
 DUAL TRACE

- DC to 25MHz
- All Solid State
- Vertical Delay Line
- Light, Portable, Reliable

These new oscilloscopes give you the most for your dollar. No frills. Just performance. You owe it to your budget to see Hickok before you buy any other. In stock at franchised electronic distributors. Call the one nearest you for a detailed brochure and a demonstration.

The Hickok Electrical Instrument Company  
 10514 Dupont Avenue • Cleveland, Ohio 44108

***Hickok***

## NEW PRODUCTS

### MASTER OSCILLATORS

With high stability.

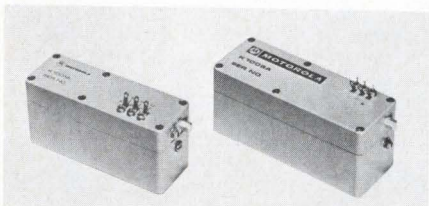

The K1001A series oscillator measures 15 in.<sup>2</sup> and is for 3 MHz operation, with other frequencies between 2 MHz and 4 MHz optional. The K1008A series oscillator is for 1 MHz operation. The oscillators meet Mil Specs for both airborne and ground equipment in rigorous environments and have high aging freq. retrace specs of  $5 \times 10^{-10}$ /day. Motorola Communications & Electronics, Inc., 1301 E. Algonquin Rd., Schaumburg, Ill. 60172. (312) 358-7900.

Circle 294 on Inquiry Card

### SILICON RECTIFIERS

Only 15¢ to 47¢ in large quantities.



New plastic encased Si rectifiers are for ss uses where high op. temps are not encountered and higher priced, higher ambient rated units are unnecessary. 2AF series units have a dc current rating of 2 A, res. or ind. load, at 25°C and come in six different PIV ratings from 100 to 1000 Vdc. Maximum rms input voltages range from 70 to 700 Vdc. Sarkes Tarzian, Inc., Semiconductor Div., 415 N. College Ave., Bloomington, Ind. 47401.

Circle 295 on Inquiry Card

### SOLDERING ACCESSORY

For removing DIPs.

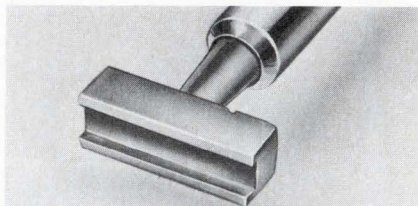

New tip is for desoldering and removing DIPs from PC boards. The DIT-1 assembly is for use with the company's Model W-TCP-L and W-TCP soldering stations. It is wide enough to span all 14 leads of a DIP simultaneously. Inasmuch as the basic soldering station is a controlled output unit, possible component and board damage is greatly minimized. Industrial Products Div., Weller Electric Corp., Box 345, Easton, Pa. 18042. (215) 258-5371.

Circle 296 on Inquiry Card

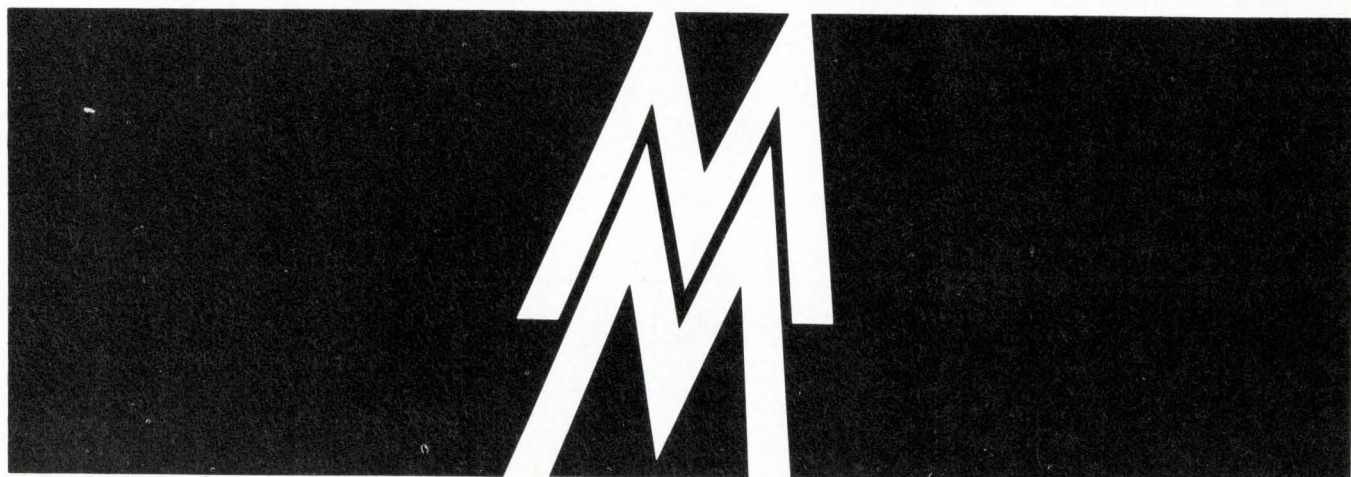

## Leipzig Trade Fair

## German Democratic Republic

Twice yearly centre of trade and technology. Leipzig Trade Fair, reflecting the dynamic development of the German Democratic Republic, offers the buyer and the technical specialist alike an unmatched opportunity to see the world's latest achievements in design and technology. Leipzig Trade Fair, now over 800 years old, brings the goods of all the world together for all the world to see. See you in Leipzig!

Leipzig Spring Fair 1970  
March 1/March 10  
Leipzig Autumn Fair 1970  
August 30/September 6

Fair Cards and information about travel to Leipzig obtainable from Globe Travel Service, Inc.

127 North Dearborn Street, Chicago 2 (Illinois), Tel. Dearborn 2-0090. Krueger's Travel Service, Bergenline Ave. at 65th St., P.O.B. 209, West New York, N.J. 07093, Tel. 868-9623 (N.J. Area Code 201), 564-6654 (N.Y. Area Code 212).

Trans-Global Travel Bureau, 6333 Wilshire Blvd., Los Angeles 48, Calif., Tel. Olive 3-6100 or at the GDR State frontier.



## SERVO AMPLIFIER

For less than 10¢/W.

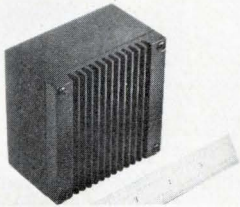

By using a combination of pulse width and fm techniques, the Model 900PFM achieves a nearly ideal linear power output of 900 W. It comes in an encapsulated module only 3 1/8 x 3 1/8 x 1 1/2 in. From this module, it delivers a continuous output of  $\pm 15$  A and  $\pm 60$  Vdc. It operates from a single, non-regulated, high current power supply of  $\pm 65$  Vdc. Control Systems Research, Inc., 1811 Main St., Pittsburgh, Pa. 15215. (412) 781-1887.

Circle 297 on Inquiry Card

## SOLDER MASK

For hybrid substrates.

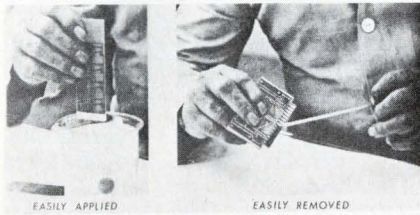

SC-300 material masks the application of solder on undesired areas of ceramic and plastic circuit boards. SC-300 is easily peeled from the masked surface and will withstand short exposures to solder temps of 500°F. The mask also functions as a protective coating during assembly operations. Starnetics Co., 10639 Riverside, N. Hollywood, Calif. 91602. (213) 769-8437.

Circle 298 on Inquiry Card

## FEED-THRU TERMINAL

For use in buss-bar assembly.

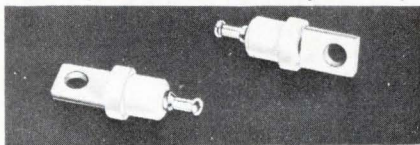

Press-Fit® Part No. 007-0155 is for mounting in a 0.136 in. hole. It has a bushing diameter of 0.148 in. and can be inserted in a chassis 0.100 in. thick. The thru hole of the part has been drilled parallel to the chassis and perpendicular to the lug for ease of buss-bar assembly. Circuit Components Div., Sealectro Corp., 225 Hoyt St., Mamaroneck, N. Y. 10543.

Circle 299 on Inquiry Card

# NOW...

## Hamilton precision metals has added facilities...and is in the Photoformed® Parts business...



# BIG!

Hamilton has added a new plant—just to produce precision, Photoformed® parts!

This new facility is equipped with the most modern photo-etching machinery on the market. The new equipment will produce precision parts in large quantities to the highest standard of dimensional accuracy.

Now, you can get from the Precision Metals Division, finished parts to the same degree of precision as world wide metal users have come to expect in Hamilton's strip and foil.

Hamilton offers the Total Capabilities of a completely integrated facility controlling every step from melt to finished strip or foil—and now to finished parts. This means that you get the same adherence to metallurgical standards and dimensional accuracy that has become the hallmark of Hamilton.

For the complete story on the capabilities of Precision Metals Division and what it can do for you, write for your copy of the new Photoforming brochure. It's yours for the asking—write today!

PRECISION METALS DIVISION  
**HAMILTON**  
WATCH COMPANY • LANCASTER, PA. 17604  
• PHONE (717) 394-7161

# TV Multipliers for color or black and white television.

Available in production quantities now!

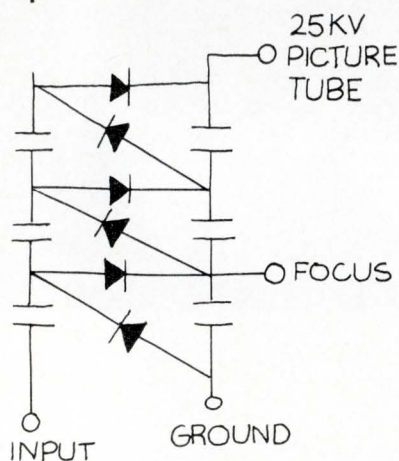

Doublers.  
Triplers.  
Quadruplers.

These specially designed TV multipliers incorporate the latest in silicon high-speed rectifiers.

They offer significant improvement in the performance, reliability, and economy of all TV high-voltage systems.

When you think of Varo Semiconductor products, remember this—we're the company that not only received the first order for multipliers to be used in consumer TV production, but we made the first silicon high voltage rectifier ever used in consumer TV sets, too.



SEMICONDUCTOR DIVISION, 1000 N. SHILOH ROAD, GARLAND, TEXAS 75040, (214) 272-4551

Circle 52 on Inquiry Card

## NEW PRODUCTS

### EPITAXIAL TRANSISTOR

Low profile.



The MSC 2010 is an epitaxial npn small L & S band transistor that can deliver 10 W at 2 GHz with 5 dB power gain at 35% eff., 20 W at 1 GHz with 10 dB gain at 60% eff. and 50 W at 1 GHz in pulsed operation. It comes in a Stripac™ package which provides very low input Q, making it ideal for use in broadband circuits. Microwave Semiconductor Corp., 100 School House Rd., Somerset, N.J. 08873. (201) 469-3311.

Circle 259 on Inquiry Card

### VOLTAGE MODULE

Dual tracking.

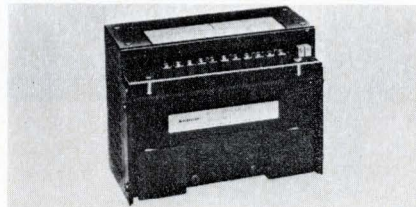

DTM 2X16-0.6 is for linear IC and discrete amplifier uses. It produces a pair of accurately tracked voltages, adj. from zero to + and -16 Vdc. The DTM has a 600 mA rating for each output, operates to +71°C without additional heat sinking or derating and includes remote error sensing to provide 0.05% reg. at the load. \$120 each. Kepco, Inc., 131-38 Sanford Ave., Flushing, N.Y. 11352. (212) 461-7000.

Circle 260 on Inquiry Card

### DECAPSULATION SOLVENT

For epoxy resins.

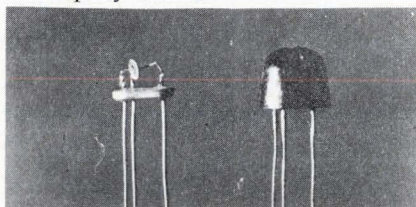

Dynasolve 160 is effective against all room temp. cured epoxy resins and most heat cured resins. It is nonflammable and may also be used for decomposing urethanes. For decapsulation, a part is immersed in Dynasolve 160 and allowed to stand at room temp. The cast epoxy will break up with no further procedures. Dynaloy, Inc., 7 Great Meadow Lane, Hanover, N.J. 07936. (201) 887-9270.

Circle 261 on Inquiry Card

### READOUT

Features high visibility in amb. light.

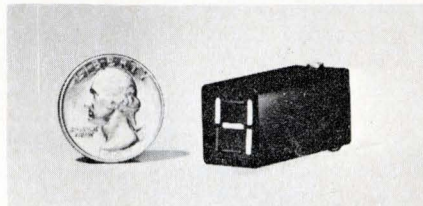

Type 213 is an electromechanical unit which is not dependent on lamp bulbs or continuous power. The seven magnetic rotor segments require no shafts or bearings and can be set or reset by electrical pulses. Because the segments are viewed by reflected light, the stronger the impinging light, the higher the visibility. Allard Instrument Corp., 770 Main St., Westbury, N.Y. 11590. (516) ED 4-8742.

Circle 262 on Inquiry Card

### CHIP RESISTORS

Feature beam leads.

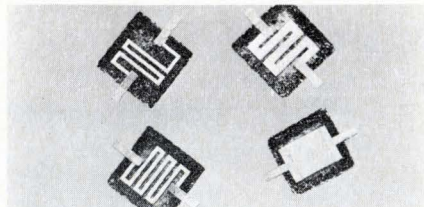

These unencapsulated resistors feature small size (50 mil sq.) and gold beam leads. Resistance values range from 5 to 5000Ω. The thin-film resistors, Types MCH5862-67-71-75-80 and 83, are made of 400 Å thick nichrome film deposited on a 2-mil thick glass substrate. TC is 50 ppm/°C and max. power diss., 125 mW. Motorola Semiconductor Products Inc., Box 20924, Phoenix, Ariz. 85036. (602) 273-6900.

Circle 263 on Inquiry Card

### MINIATURE TERMINAL PINS

Hold up to 5 leads.

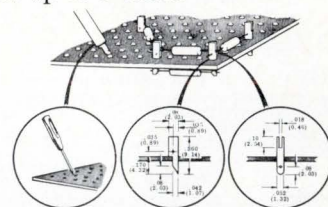

New type of terminal pin, designed for miniature circuitry, holds up to five leads using the three possible directions. Easily inserted into 0.052 in. dia. holes because of their spring form, the miniature pins may be reused if necessary simply by pulling them out of the board. Pins are phosphorous bronze with a bright tin finish. Vero Electronics, Inc., 176 Central Ave., Farmingdale, N.Y.

Circle 264 on Inquiry Card

### CONTACT STRIP

Build your own sockets.

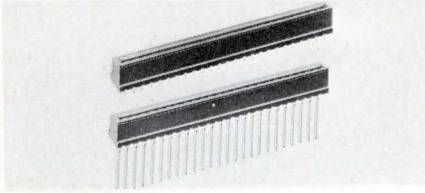

Strip of 25 contacts lets you build to your individual socket requirements. Strips may be mounted side by side or end to end for any required pattern. They may also be cut off on ends for continuous spacing on 100 in. centers for more than 25 contacts in one row. Augat Inc., 33 Ferry Ave., Attleboro, Mass. 02703.

Circle 265 on Inquiry Card

### RINSER-DRYER

For cleaning wafers and substrates.

The K-15 has automatic 2-phase operation. During rinse, water is sprayed from nozzles in the door dome. Rinse time can be preset for 0 to 120 s, with the basket turning at low speed. During drying, the tank is purged with dry nitrogen, and speed is increased to preset speed up to 3000 rpm, drying the material by centrifugal force. Fluoroware, Chaska, Minn. 55318.

Circle 266 on Inquiry Card

### SNAP-ACTION

For low energy SS circuits.

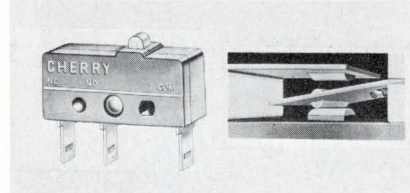

Series E63 unit provides repeatably low contact resistance in low level switch applications from 5 to 100 mA at 4 to 30 V. Gold alloy (69% gold, 25% silver, 6% platinum) contacts are shaped like prisms and are at right angles to each other to increase contact pressure and decrease susceptibility to contact closure interference. Cherry Electrical Products Corp., 1650 Old Deerfield Rd., Highland Park, Ill. Circle 267 on Inquiry Card

### BNC-TNC CONNECTORS

Meet Mil-C-39012.

These rf connectors meet all applicable requirements of Mil-C-39012. For use in all types of electronics and communications equipment, they are available in Duraplate® finish at no extra cost as well as in other standard finishes. ITT Greomar, Inc., 10 Micro Dr., Woburn, Mass. 01801.

Circle 268 on Inquiry Card

### BIAXIAL CONNECTORS

Spring action tip.

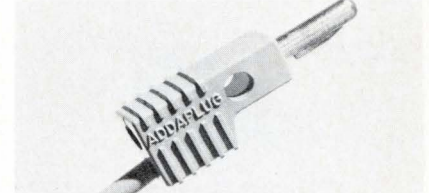

Short tip biaxial connecting lead has an Addaplug spring action tip. Spring loaded pressure bar knife edge compensates for wear caused by many insertions. Self-wiping action of the spring tip provides uniformly low contact resistance. Addaplug Div., Farmer Electric Products Co., Inc., Tech Circle, Natick, Mass. 01760.

Circle 269 on Inquiry Card

### CRT DISPLAY

Unlimited character presentation.

This CRT readout combines unlimited character display with high resolution, modularity, and single plane viewing. The Madatron Display System can display almost any type of graphic symbol—letters, numerals, foreign alphabets or characters, and so forth. These characters can be displayed in any size or style. Madatron Corp., 110 Route 10, Whippany, N.J. Circle 270 on Inquiry Card

# improve MTBF with MS-180

MS-180 FREON® TF Degreaser increases the reliability of electronic equipment by removing grease and dirt. Use MS-180 on the production line or in your maintenance program to clean up assemblies, components and connections. It's safe to apply



even while equipment is operating. MS-180 is available in 16-oz. cans for plant use, convenient 6-oz. cans for field service kits. You can try it—FREE—merely by writing for a sample on your company letterhead.



**miller-stephenson chemical co.,inc.**

Route 7, Danbury, Conn. 06813

© DuPont TM

## NEW PRODUCTS

### PC CARD RACK

Easily assembled, rigid Al cage.

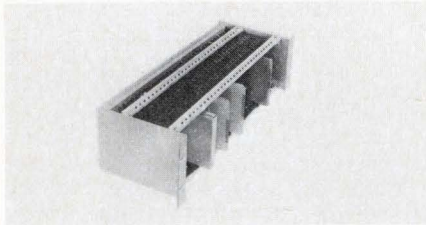

Versa-Cage® is completely drilled—all that is needed for assembly is a screw driver. Side rails are drilled to hold snap-in, one piece molded polycarbonate Unitrack® PC card guides. Rack is std. 19 in. long and will hold 32 cards 4½ in. wide and up to 6½ in. long (on ½ in. centers). End plates, side rails, bolts and nuts are packaged with easy set-up instructions. \$15.00. Unitrack, Div. of Calabro Plastics, Inc., 8738 West Chester Pike, Upper Darby, Pa. 19082. (215) 789-3820.

Circle 271 on Inquiry Card

### SUBMINIATURE LAMP

In a special 0.165 in. version.

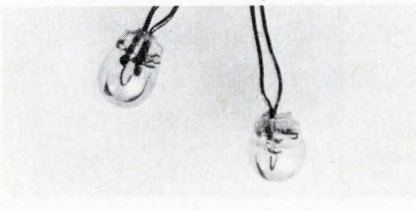

T-1 "Shortie" lamp now comes in a 0.165 in. MOL (max. overall length envelope) version in addition to the industry std. 0.145 and 0.187 lengths. Dimensions (other than the length), are the same as for a std. length (0.250 MOL) T-1 unbased lamp. You can use them where you need a std. type T-1 but lack space for a 0.250 in. long envelope. They come in various AS15 and AS25 types. Industrial Electronic Engineers, Inc., 7720-40 Le-mona Ave., Van Nuys, Calif. 91405.

Circle 272 on Inquiry Card

### FREQUENCY CHANGERS

From 150 VA to 6 kVA.

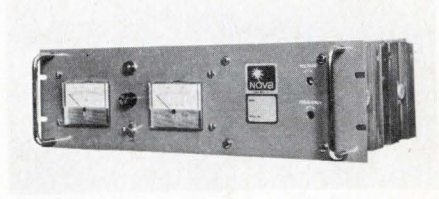

There are 100 std. model 3-phase changers available in this new series. Included are portable "Portaversers" as well as flatpack, low silhouette, LS types. Almost complete phase-to-phase output isolation is a feature. Distortion is < 4% rms. Standard output freqs. are 50, 60, and 400 Hz. Efficiency is better than 70%. Nova Electric Mfg. Co., 102 Route 46, Saddle Brook, N. J. 07662. (201) 478-2555.

Circle 273 on Inquiry Card

### CONTROL RELAY

For printed circuit.

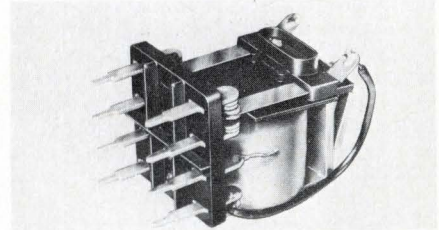

New CPC series relay is available in voltages to 220 ac or 110 dc, with resistances up to 16,000Ω and in any freq. from 25 to 60 Hz. It is 1 11/32 x 2 x 1¼ in. and has contact arrangements to 3 PDT as well as DB and DM configurations. Relays are rated at 10 A for 110 Vac. Mechanical life expectancy is about 5 million operations. Chicago Relay & Mfg. Corp., 4626 Olcott Ave., Chicago, Ill. 60656.

Circle 274 on Inquiry Card

### EPOXY CASTING RESIN

With high thermal conductivity.

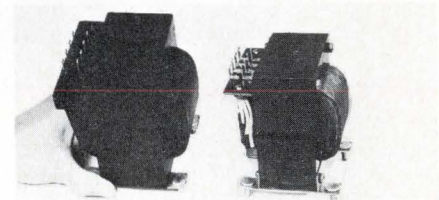

Stycast 2850KT has a thermal conductivity of 30 (BTU)(in.)(hr)(ft²)(°F), about three times that of normal epoxy casting resins. The high thermal conductivity is achieved with little sacrifice of flowability. Thermal expansion has been reduced below that of regular epoxy resins from 20 x 10⁻⁶ /°F to 16 x 10⁻⁶ /°F. Emerson & Cuming, Inc., Canton, Mass. 02021. (617) 828-3300.

Circle 275 on Inquiry Card

## HOCKEY PUCK HEAT SINKS

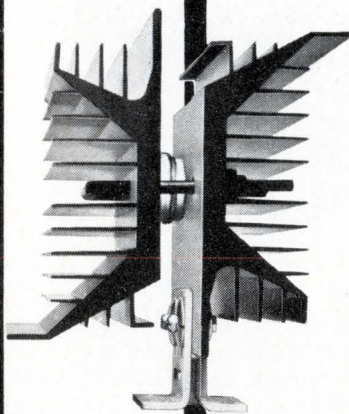

This is one of five new Astrodyne heat sinks designed to provide optimum performance plus practical, effective mounting of high-power flat-pack SCR's we call "hockey-puck rectifiers."

Model 2554 provides a unique combination Electrical Terminal and pressure-grip Mounting Clamp which permits easy attachment and also allows removal of rectifier without disassembling the heat sinks.

Thermal resistance of this model (two 6" long sections arranged for double-sided natural convection cooling) is 0.180°C/watt at 500 watts and 0.230°C/watt at 300 watts.

Astrodyne's uniquely designed high-pressure clamp used with the entire hockey-puck line provides up to 2,000 pounds pressure evenly, simply and with positive indication of applied pressure.

COMPLETE CATALOG ON REQUEST

**astrodyne, inc.**

SUBSIDIARY OF ROANWELL CORP.  
207 CAMBRIDGE ST., BURLINGTON, MASS. (617) 272-3850



Circle 54 on Inquiry Card

### POWER SUPPLY MODULE

For integrated circuits.



Model PSM-2026 will meet virtually all 6 V, 0 to 2 A integrated circuit requirements. Silicone encapsulation assures long life under environmental extremes. Only 2 x 2 x 3 in., it has an aluminum base. Ripple is < 10 mV rms. Line:  $\pm 6$  mV max. Load: 24 mV max. \$59.00 (1-9); \$49.00 (100+). Modular Circuits, Inc., 4420 E. Transmission Rd., Phoenix, Ariz. 85034. (602) 276-4203.

Circle 276 on Inquiry Card

### POWER SUPPLY

For cold cathode display tubes.



Model PS2A dual voltage supply provides 200 V unregulated at 50 mA and 5 V regulated at 1 A which is enough to drive up to 15 decades of display. It operates from 115 Vac and is protected against momentary short circuit and overload conditions. Cost is \$60 in single quantity and \$45 in quantities of 100. Instrument Displays, Inc., 18 Granite St., Haverhill, Mass. 01830. (617) 373-1501.

Circle 277 on Inquiry Card

### TERMINAL BOARD

With heavy barriers.

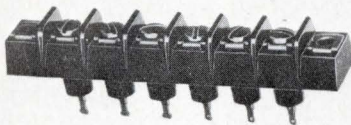

New 1699 series insulated feedthru terminal board comes with up to 25 terminals. It has integral saddle plates and heavy barriers for better protection and less breakage. It can be mounted with Tinnerman nuts or through mounting holes. The board comes with either solder terminals or "Kliptite" terminals. Kulka Electric Corp., 520 S. Fulter Ave., Mt. Vernon, N.Y. 10551. (914) 664-4024.

Circle 278 on Inquiry Card

### QUICK RELEASE CONNECTOR

For gnd, pwr and signal bussing.



Bussblok connector will handle sizes 22 through 18 and you don't need any tools to connect or disconnect. Connections will not pull or shake out and each one may be individually released. Ratings are 4000 Vac standoff voltage and 10 A current capacity. Each unit has 5 common connection points; one for input and four for distribution. Elcomp General, 110 E. Wilshire Ave., Fullerton, Ga. 82632. (714) 525-6253.

Circle 279 on Inquiry Card

### PUSHBUTTON SWITCH

Illuminated and easily relampable.

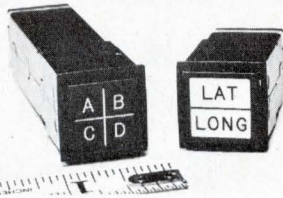

These 0.700 in. square C series illuminated pushbutton switches and matching N type indicators accommodate two or four T-1 or T-1 $\frac{3}{4}$  lights. Individual colored filters, bulbs or silicon boots are available. Switch is available in SPDT or DPDT, 3 A resistive rating. Good for matrix mounting on 0.700 in. centers. Clifton Div. of Litton Industries, 425 E. Fillmore, Colorado Springs, Colo.

Circle 280 on Inquiry Card

### STABILIZED AMPLIFIER

Features MOSFET chopper design.

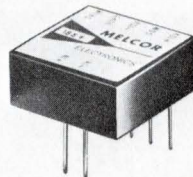

Model 1859 low drift, chopper stabilized amplifier has a gain of  $10^7$  and output of  $\pm 10$  V at 5 mA. It comes in a 1 $\frac{1}{2}$  x 1 $\frac{1}{2}$  x  $\frac{1}{2}$  in. package and operates from 0°C to +60°C. Frequency response is 500 kHz small signal, 20 kHz full power. Voltage drift is 0.5  $\mu$ V/°C max., and offset current drift 1.0 pA/°C max. Melcor Electronics Corp., 1750 New Highway, Farmingdale, N.Y. 11735.

Circle 281 on Inquiry Card

DELIVERY FROM STOCK

\$ 69.<sup>00</sup>

BUYS THIS

dual output  
POWER  
SUPPLY



for OP AMPS and IC'S

An exceptional value, the new Deltron Model OS 15-.3D is a dual output tracking Power Supply for use with operational amplifiers and integrated circuits. Its features include . . .

- Built to top quality standards.
- All Silicon.
- Regulation—0.05% typical.
- Ripple and noise—500 microvolts typical.
- No overshoot on turn on, turn off or power interruption.
- Output ratings:  
Positive —8-15 VDC, 0-300 MA  
Negative—0-15 VDC, 0-300 MA
- Plug or wire-in.
- Mounting—horizontal, vertical or card cage.
- Size—4 $\frac{1}{2}$ " H, 7 $\frac{1}{2}$ " L, 1 $\frac{7}{8}$ " D.

Write for full details.

See our complete catalog  
in eem . . . Section 4000

D 101

**Deltron**

WISSAHICKON AVE., NORTH WALES, PA. 19454  
PHONE: (215) 699-9261 TWX: (510) 661-8061

Circle 55 on Inquiry Card

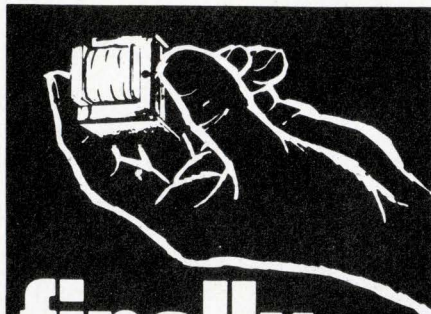

# finally a dynamic transformer

The  
World's Finest  
At The  
Lowest Cost!

Only DYNAMIC's  
Internal, External and  
Wall-Mounted  
Transformers offer:

- ★ Superior DESIGN  
More Power in Less Space  
Better Regulation
- ★ Superior COMPONENTS  
Nylon Bobbins instead of paper  
Silicon diodes instead of  
Selenium plates
- ★ Superior PERFORMANCE

And yet — DYNAMIC Transformers  
cost LESS! Here's why:

- ★ Exclusive Custom Equipment
- ★ High Speed Automation
- ★ Patented Processes
- ★ No Cost For Prototypes
- ★ Short Run Availability
- ★ Unlimited Run Availability

## WANT PROOF?

Write for this  
FREE Engineers  
Working Handbook  
and Technical  
Brochure today ...

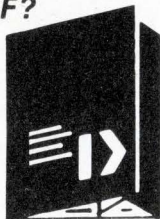

**D**  
**Dynamic Instrument** CORP.  
Dept. T1 115 E. Bethpage Rd., Plainview, N.Y.

Circle 56 on Inquiry Card

## NEW PRODUCTS

### SOLID STATE OSCILLATOR

Tunable from 2200 to 2300 MHz.

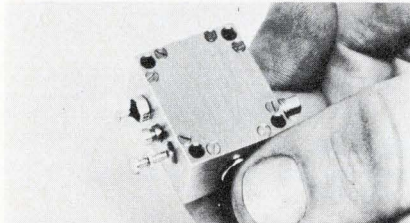

Model M2250-50 fundamental oscillator is for S-band uses such as telemetry and communications where small size and light weight are important. Centered at 2250 MHz, it is manually tunable from 2200 to 2300 MHz. Output power is 50 mW min., 70 mW typ. Second harmonic content is 20 dB down from the fundamental. Microwave Products Group, Inc., 100 Express St., Plainview, L. I., N. Y. 11803. (516) 938-8200.

Circle 282 on Inquiry Card

### BURN-IN TEST SYSTEM

For semiconductors.

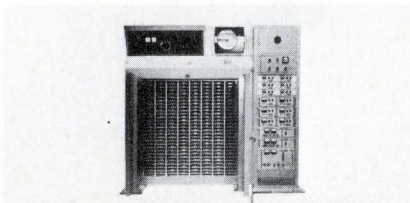

Model 707 burn-in and life test system is for diodes, transistors, hybrids and ics. It will test devices at temps to 200°C at reverse or forward-bias operating conditions. It has specially designed separable device and load trays and will operate to 150°C. Basic tray structure comprises a scannable semiconductor-device PC board and a removable load board. Aerotronic Associates, Inc., Contoocook, N.H. 03229. (603) 746-3141.

Circle 283 on Inquiry Card

### LOW-PROFILE RELAYS

Offer bounce-free switching.



Mercury-wetted relays, offer virtually unlimited operating life. Designed for PC board mounting, they measure 0.550 in. from mounting surface to top. They come with single-sided stable or bi-stable contacts, and have switching speeds comparable to larger dry reed switch relays. New Product Engineering, Wabash, Ind., 46992.

Circle 284 on Inquiry Card

### A/D, D/A CONVERTERS

DTL and TTL compatible.

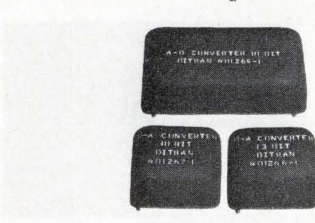

The MAD10A1 A/D converter is a 10-bit, 2-channel unit which will totally convert an input signal of 0 to 4 Vdc in 22µs with a linear accuracy of ±1 LSB. The 13-bit Model MDA10A1 D/A converter has a ±1 LSB linear accuracy and the 10-bit MDA13A1 D/A unit has a ±½ LSB linear accuracy. Both settle to 99.9% of final value in < 20 µs. Ditrans Corp., Div. of Clifton Litton Industries, 25 Adams St., Burlington, Mass. 01803.

Circle 285 on Inquiry Card

### MINIATURE POWER RELAY

Only 0.9 x 0.9 x 0.4 in.

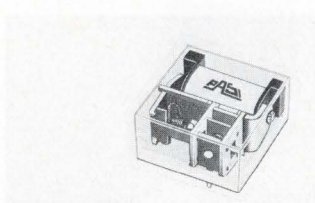

Series 800 relays are low power input (500 mW) units that can switch 6 A, 250 V, 500 W. These SPDT relays are most appropriate for high level logic switching and control uses. PC board mounting is standard. Operate time is < 9 ms and release time < 5 ms. Operating voltages 6 to 60 V. \$1.25 (3000 quan.) A. L. Controls Co., Box 412, New Haven, Conn. 06502. (203) 562-9164.

Circle 286 on Inquiry Card

### PLUG-TO-PLUG ADAPTOR

Of gold-plated stainless steel.

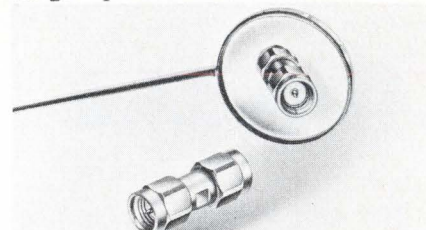

Designated #50-673-0000-31, this new straight plug-to-plug adaptor mates with connectors of similar series including OSM—all being SMR connectors. The new SRM unit is < 1 in. in overall length and comes with 0.218 in. wrench flats on the main connector body. Sealectro Corp., RF Components Div., 225 Hoyt St., Mamaroneck, N. Y. 10543.

Circle 287 on Inquiry Card

## SEQUENCING SWITCH

No by-pass cable needed.

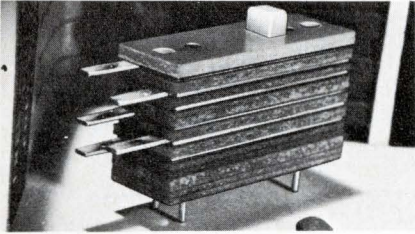

Series 22-000 internal leaf sequencing switches are completely enclosed. The long-life Mil device is used in portable communications units (handsets and so forth), and similar applications, to activate power and microphone control circuits in proper sequence. Switch life is a dependable half million actuations, at 1/2 A, 24 V res. load. Standard 22-000 is DPST, but can be expanded to DPDT if required. Chicago Switch, Inc., 2035 Wabansia Ave., Chicago, Ill. 60647. (312) 489-5500.

Circle 288 on Inquiry Card

## LINE ACTIVATED RELAYS

Switch high inrush currents.

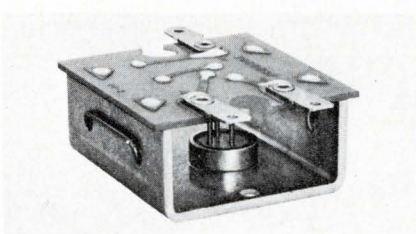

A new LAR series of ss relays is for ac power switching functions in single pole normally open applications. They use a thyristor design, which eliminates moving contacts, resulting in a reliable unit with virtually infinite switching life. Relays come in 4, 6, 8, 10, and 15 A ratings for either 120 or 240 Vac. Peak one-cycle current rating for the 4 A relay is 60 A. Electronic Control Corp., 1010 Pamela Dr., Box J, Euless, Tex. 76039. (817) 267-2601.

Circle 289 on Inquiry Card

## SYNCHRO TO DC CONVERTER

Replaces mechanical servo.



Model 655 MP4, is an ss device which converts 3-wire synchro inputs to dc sine-cosine outputs. Only 0.58 x 2.03 x 2.28 in., its specs include:

Accuracy: 5 min. of arc.

Input: 3-wire, 11.8 ±10% Vrms, line-to-line.

AC ref.: 26 ±10% Vrms, 30 mA (isolated).

Load: 100 kΩ ±1%.

Transmagnetics, 134-25 Northern Blvd., Flushing, N. Y. 11354. (212) 539-2750.

Circle 290 on Inquiry Card

## GREAT MOMENTS

..... in electrical history



... the day each budding electronics buff bumps into Mueller Clips and forms a lifelong friendship. "Mueller Clips are to men what safety pins are to women," wrote A. E. Rose of Canadian Westinghouse Company Limited, in a recent fan letter we treasure most in our 60-year collection. Think you can find the 1001st use for our supergadgets for quick, temporary electrical connections?

At Jobbers everywhere.

Write factory for FREE sample clips and catalog.

**Mueller Electric Co.**

1585H East 31st Street • Cleveland, Ohio 44114

Circle 57 on Inquiry Card

## PANDUIT announces the PENNY-TY cable tie

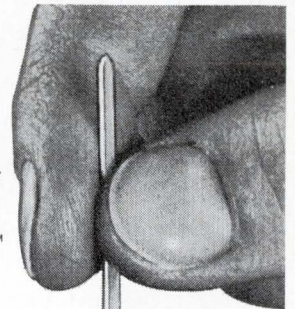

The PANDUIT SST1M "PENNY-TY" Miniature Cable Tie is now available for 1¢ each in quantities of 50,000\* or more.

■ On Qualified Products List (QPL) of MIL-S-23190B since 1964. Meets new Military Standard MS-3367-4 and previous Standards MS-17821-4, MS-18034-4.

■ Harness diameter range 0 to 3/4"; loop tensile strength 18 lbs. minimum.

■ Self-locking and releasable prior to final tightening by hand or with tension-controlled PANDUIT GS2B Harnessing Tool. No twisting or tugging. No metal barbs.

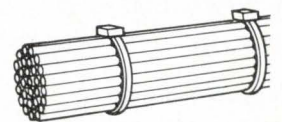

At your PANDUIT Distributor. FREE SAMPLES

**PANDUIT**®  
CORP.

Tinley Park, Illinois 60477 • Phone: 312-532-1800 • Telex 25-4560

FROM THE MANUFACTURERS OF PANDUIT® PLASTIC WIRING DUCT

\* In accordance with standard conditions of PANDUIT Price Sheet effective 12-1-69

Visit PANDUIT NEP/CON WEST Booth 709

Circle 58 on Inquiry Card

101

# Seminar and Workshop

## APPLICATIONS OF INTEGRATED CIRCUITS TO COMMUNICATIONS

sponsored by  
**THE  
ELECTRONIC  
ENGINEER**  
magazine

### When:

Tuesday, February 17, 1970  
8:00 A.M. to 5:00 P.M.  
(the day before the International Solid State  
Circuits Conference in Philadelphia)

### Where:

Pennsylvania East Room  
Sheraton Hotel  
Philadelphia, Pa.

### THE SEMINAR: (8:00 A.M. to 12:30 P.M.)

A series of papers devoted to practical applications  
of the new families of ICs to communications and  
consumer products.

**Moderator: J. Lightsey Wallace, Atlantic Research  
Corp.**

#### Phase-lock loops in communications systems

**Arthur Fury**  
Signetics Corp.

How and where to use phase-locked loops. Applica-  
tions in telemetry and fm stereo include decoders,  
demodulators, i-f strips and limiters, etc.

#### AGC—the old dynamic range with good signal-to-noise trick

**Jack MacIntosh and Tom Mills**  
Fairchild Semiconductor

Automatic gain control and how to apply it to high  
gain, wideband and wide dynamic range i-f ampli-  
fiers. Ssb generators, i-f product detectors, and two-  
tone intermodulation distortion will be demonstrated.

### ADVANCED REGISTRATION FORM

#### Tear off and mail to:

Communication ICs Seminar  
THE ELECTRONIC ENGINEER  
Chilton Publishing Co.  
One Decker Square  
Bala Cynwyd, Pa. 19004

\*Make check or money order payable to  
Communications ICs Seminar; all  
payments will be acknowledged.

#### Complex communications functions with ICs

**Ted Hanna**  
National Semiconductor

How to combine a few ICs to obtain a multitude of  
communications functions, such as ssb and video  
amplifiers.

#### Modulation, rf/i-f amplification, and multiplexing

**Roy Hejhall**  
Motorola Semiconductor Products Div.

Integrated circuits are changing rf design concepts.  
Here's how to use them for balanced modulators,  
vhf i-f's, ssb receivers, etc.

#### A-m/fm receivers with ICs

**Ronald W. Lutz**  
Sprague Electric Co.

ICs for limiter/detector circuits a-m/fm i-f strips as  
used in both TV and fm receivers.

#### Large scale integration of TV circuits

**Dan Gertzis**  
Amperex Electronic Corp.

A complex circuit, whose functions include video  
preamplification, agc detection and amplification,  
noise gating, sync separation, etc., serves as central  
processor and distribution circuit in TV receivers.

#### Luncheon

### THE WORKSHOP: (2:00 P.M. to 5:00 P.M.)

Here's an opportunity to get your hands on the  
circuits described in the morning session. There  
will be test equipment and breadboards available to  
test the circuits.

Enclosed is my check (money order) in the amount of \$45.00\* (\$55.00 after Feb-  
ruary 6) to enroll me in the Seminar and Workshop on the "Applications of Integrated  
Circuits to Communications" to be held Tuesday, February 17, 1970 at the Sheraton  
Hotel in Philadelphia, Pa. This fee covers attendance, one issue of the Proceedings,  
and luncheon and coffee break.

NAME \_\_\_\_\_ TITLE \_\_\_\_\_  
COMPANY \_\_\_\_\_ DIVISION \_\_\_\_\_  
STREET \_\_\_\_\_  
CITY \_\_\_\_\_ STATE \_\_\_\_\_ ZIP \_\_\_\_\_



# LITERATURE

## IC logic

All available data about Motorola's high threshold logic line of ICs for industrial high-noise environment control has been compiled into this single-source 50-page "library" for your design use. Included are condensed

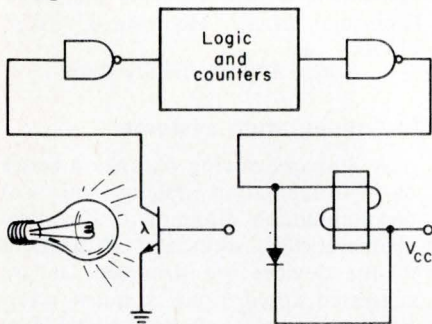

data specs for all MHTL circuits, as well as application design information to assist you in making greater use of these high-noise immunity circuits. Motorola Semiconductor Products Inc., Box 20924, Phoenix, Ariz. 85036.

Circle 321 on Inquiry Card

## Metal plate connectors

A 36-page manual contains complete design information for back-panel connector arrays. The manual defines the Variplate™ metal plate interconnection concept and its associated terminating technique, automatic wire wrapping. It discusses in detail the voltage/ground plane and bus bar techniques of power distribution, connector grid pattern, plate size, layout dimensioning, material and finish. Elco Corp., Willow Grove, Pa. 19090.

Circle 322 on Inquiry Card

## Reliability report

An 11-page report (R-169) covers the manufacturer's line of fused-in-glass zener diodes, rectifiers and assemblies, thyristors and microwave pin diodes. Product design as it affects reliability, failure analysis and corrective action procedures is discussed, as are acceptance testing procedures. A table providing a summary of operating life test data is included along with a table on environmental tests and their effects on the manufacturer's fused-in-glass devices. Unitorde Corp., 580 Pleasant St., Watertown, Mass. 02172.

Circle 323 on Inquiry Card

## Trigac applications handbook

A 32-page manual has been designed to acquaint engineers with applications for a new linear IC. Designated Trigac, the interface circuit operates from either ac or dc supplies and has provisions for hysteresis and time proportioning controls. A circuit description demonstrates how the Trigac interfaces between an analog sensor and the gate terminal of a power switching thyristor. Various schematics are included, along with applications. Distribution Center, Fairchild Semiconductor, Box 1058, Mountain View, Calif. 94040.

Circle 324 on Inquiry Card

## Terminal blocks

A 4-page brochure describes 600-volt control circuit and power circuit sectional terminal blocks. Featured are such characteristics as snap-in and snap-out flexibility, direct panel or channel mounting, three terminal choices and three marking methods. Accessories are illustrated, and fuse and switch blocks that can be mated with control circuit blocks are shown. Cutler-Hammer, Box 463, Milwaukee, Wis. 53201.

Circle 325 on Inquiry Card

## Relay catalog

A 6-page illustrated brochure describes a new type of relay that allows the safe control of machinery and appliances from a remote distance. Five models are listed and illustrated, including the basic models FR-101 and FR-102, and special types such as

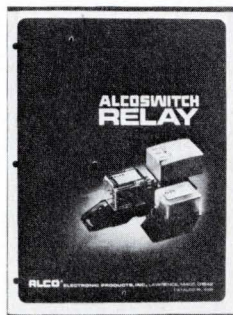

the FRE-103 plug-in complete unit, and the FRP-104 octal base plug industrial relay. Typical applications with schematic drawings and brief descriptions are included. Alcoswitch, Div. of Alco Electronic Products, Inc., Box 1348, Lawrence, Mass. 01842.

Circle 326 on Inquiry Card

## Zener selector chart

A pocket-size selector chart contains voltage and power ratings for a line of zener diodes with tolerances of  $\pm 5\%$ . Suggested as a design guide for engineers, the chart details the limits of each series of the diodes. Mullard Inc., 100 Finn Court, Farmingdale, N.Y. 11735.

Circle 327 on Inquiry Card

## Hybrid microcircuits

An 8-page brochure provides some ground rules for thin film hybrid design in order to assist the circuit designer toward the optimum combination of performance and space considerations. It discusses active and

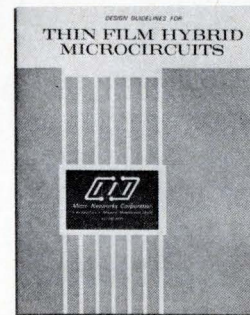

passive component selection, factors affecting reliability, resistor design rules and circuit design layout approach. Micro Networks Corp., 5 Barbara Lane, Worcester, Mass. 01604.

Circle 328 on Inquiry Card

## Telemetry modules

A 40-page catalog describes a line of FM-FM telemetry modules. Included in the catalog are voltage-controlled oscillators, dc amplifiers, dc signal isolators and frequency-to-dc converters. All units are of solid state and miniature design. Solid State Electronics Corp., 15321 Rayen St., Sepulveda, Calif. 91343.

Circle 329 on Inquiry Card

## Casting resins

Crystal clear casting resins for the visual display, embedment or inspection of electrical and electronic components are the subject of a 6-page bulletin. Material classes available include epoxies, silicones, urethanes, polyesters and hydrocarbons. Emerson & Cuming Inc., Canton, Mass. 02021.

Circle 330 on Inquiry Card

# TRYGON HAS THE POWER

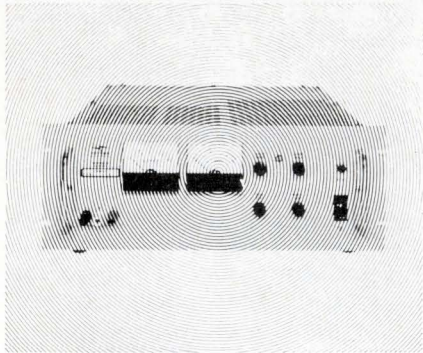

**to deliver wide  
range constant voltage  
constant current  
performance for  
every lab and system  
application.**

- All silicon design—precision performance
- Wide voltage ranges—currents to 100 amps
- Positive convection cooling—no derating
- Overvoltage and ultra-high stability options
- Automatic load share paralleling
- Priced from \$575.

Super-Mercury from TRYGON . . . the competitively-priced series of fully programmable wide-range power supplies, power and value packed.

Super-Mercury: Designed for bench or rack installation with slide provisions at no extra cost . . . in ranges up to 160 volts and up to 100 amps. Regulation of 0.005% and 0.015% stability are standard (0.005% stability optional) as is MIL Spec, RFI-free performance. Total ripple and noise: less than 1 mV RMS; Master-slave tracking, auto-load share paralleling and remote sensing and programming also standard. Write for the full TRYGON power story.

TRYGON DOES HAVE THE POWER!



## TRYGON POWER SUPPLIES

111 Pleasant Avenue, Roosevelt, L.I., N.Y. 11575  
Trygon GmbH 8 Munchen 60, Haidelweg 20, Germany  
Write for Trygon 1968 Power Supply Handbook.  
Prices slightly higher in Europe.

Circle 59 on Inquiry Card

## LITERATURE

### Industrial connectors

High density circular industrial connectors are described in a 16-page catalog. Color photos, line drawings, electrical characteristics and mechanical specs are provided for the complete line of 224 and 222 series connectors. The 224 series Ultra-mite®

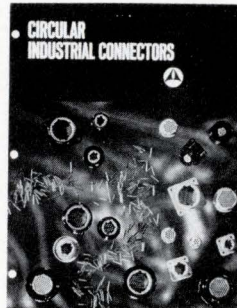

connectors are microminiature units providing performance and reliability parallel to standard size connectors. The 222 series Mighty-mite® connectors serve applications where space is at a premium. Amphenol Industrial Div., 1830 South 5th Ave., Chicago, Ill. 60650.

Circle 331 on Inquiry Card

### Miniature lamp works

A 21-page catalog offers you basic design information, technical discussions of the various parameters involved in lamping and a cross-reference guide for lamp substitution. Technical data is included with each lamp description. Chicago Miniature Lamp Works, 4433 N. Ravenswood Ave., Chicago, Ill. 60640.

Circle 332 on Inquiry Card

### Load cell systems

A 24-page catalog describes load cells, electronic readouts and accessories. The load cells described are compression, tension and push/pull models, with choice of 36 ranges, covering varying capacities from 0-10 lbs. up to 0-300,000 lbs. W. C. Dillon & Co., Inc., 14620 Keswick St., Van Nuys, Calif. 91407.

Circle 333 on Inquiry Card

### ECL systems

The effect of temperature on logic levels in emitter-coupled logic circuits is discussed in a 12-page application report. The bulletin details a method for estimating the temperature limits within which an air-cooled ECL system can be operated error-free. Texas Instruments Inc., Box 5012-M/S 308, Dallas, Tex. 75222.

Circle 334 on Inquiry Card

### Transistorized amplifiers

A set of 11 data sheets covers the supply of transistorized power amplifiers over the frequency range of 2 MHz to 2.4 GHz. The data sheets fully describe the operation, characteristics and specs of various narrow- and wide-band amplifiers in power levels of 1 watt to over 100 watts. Microwave Power Devices Inc., 556 Peninsula Blvd., Hempstead, N.Y. 11550.

Circle 335 on Inquiry Card

### Instrumentation systems

A 20-page catalog outlines a series of instrumentation systems and PCM decommutation equipment. Electrical characteristics, specs and illustrations of the devices are provided, as are suggested applications, a quick reference guide and a typical signal flow diagram. Data Control Systems, Inc., Commerce Dr., Danbury, Conn. 06810.

Circle 336 on Inquiry Card

### Terminal catalog

A 32-page terminal catalog is for OEM applications and features vinyl-insulated, nylon-insulated and uninsulated terminals and splices for either hand or automatic installation. Reference tables provide specs, and wire ranges, dimensions and recommended installation tooling are shown. Burndy Corp., Norwalk, Conn. 06852.

Circle 337 on Inquiry Card

### A/D converters

The ADC-F high speed analog-to-digital converters are the subject of a 6-page user's manual. The ADC-10F and ADC-8F converters provide 10-bit and 8-bit conversions in only 1 $\mu$ s and

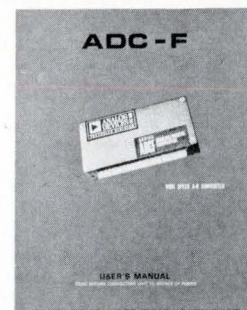

0.8 $\mu$ s respectively. The manual goes into detail on theory of operation, specs, operating instructions, maintenance, adjustment and repair. Analog Devices Inc., Pastoriza Div., 221 Fifth St., Cambridge, Mass. 02142.

Circle 338 on Inquiry Card

### Digital multimeter

An 8-page data sheet describes the new series 4500 digital multimeter, covering in detail specific features such as accuracy, measurement capability, operation and reliability. The



data sheet shows the instrument in two configurations suitable for use in rack-mounted or bench-type applications. Measurements Div., Dana Laboratories Inc., 2401 Campus Dr., Irvine, Calif. 92664.

Circle 339 on Inquiry Card

### Noise measurement

An 8-page paper, entitled "How to Characterize and Measure Noise in Operational Amplifiers," gives you a unique outlook on the problems involved in noise measurements. The paper also serves as a guide to types of noise encountered, how to measure and minimize noise, noise specsmanship, etc. Philbrick/Nexus Research, Allied Dr., Dedham, Mass. 02026.

Circle 340 on Inquiry Card

### Counters and timers

A design concept significantly lowering the ownership costs for electronic counters and timers is highlighted in a 4-page bulletin. The model 6155 100-MHz counter and timer is described, featuring field-replaceable, plug-in ICs instead of standard PC boards. Beckman Instruments Inc., 2200 Wright Ave., Richmond, Calif. 94804.

Circle 341 on Inquiry Card

### Vibration handbook

Vibration as it is associated with rotating machinery is the topic of this 34-page guide. The relationships among displacement, velocity and acceleration are discussed as is the correction of unbalance in rotating machinery. Vibration charts and tables are included. Dytronics Co. Inc., 4800 Evanswood Dr., Columbus, Ohio 43229.

Circle 342 on Inquiry Card

### Optical shaft encoders

An 8-page catalog devotes itself to incremental optical shaft encoders. The series described range in size from 1.5 to 10 in. in diameter with resolutions to 1.24 arc-seconds. All models feature self-contained IC electronics. Product descriptions, performance specs and schematics are included. Itek Corp., Wayne-George Div., Dept. 530, Christina St., Newton, Mass. 02161.

Circle 343 on Inquiry Card

### Solenoid selections

A 44-page catalog discusses a line of tubular solenoids. A "how to select" section outlines consideration factors in choosing a particular device for a specific application. Specs, graphs and schematics of the 25 models are provided along with details of available variations. Guardian Electric Manufacturing Co., 1550 W. Carroll Ave., Chicago, Ill. 60607.

Circle 344 on Inquiry Card

### A selection of semiconductors

A 16-page design guide covers semiconductors recommended for use in new designs. Thyristors, transistors and special purpose devices are listed in numerical order for easy selection. Specs are included for each product along with outline drawings. Solid State Products Div., Unitorde Corp., 1 Pingree St., Salem, Mass. 01970.

Circle 345 on Inquiry Card

### Ceramic capacitors

Thorough technical information regarding ceramic capacitors is provided in this 48-page catalog. Each capacitor model is briefly described, and tables and charts provide detailed

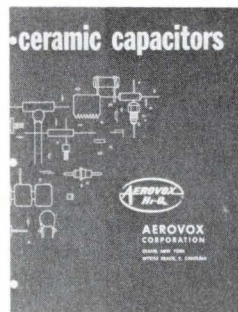

specs. Ceramic dielectrics are discussed, giving information on the construction of the capacitors and their specific characteristics. Aerovox Corp., Hi-Q Factory Sales Office, Olean, N. Y.

Circle 346 on Inquiry Card

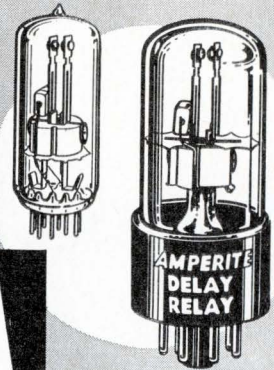

AMPERITE

## GLASS ENCLOSED Thermostatic DELAY RELAYS

Offer true hermetic sealing.  
Assure maximum stability  
and life.

### Delays: 2 to 180 seconds

Actuated by a heater, they operate on A.C., D.C., or Pulsating Current... Being hermetically sealed, they are not affected by altitude, moisture, or climate changes... SPST only — normally open or normally closed... Compensated for ambient temperature changes from  $-55^{\circ}$  to  $+80^{\circ}$ C... Heaters consume approximately 2 W. and may be operated continuously. The units are rugged, explosion-proof, long-lived, and inexpensive!

TYPES: Standard Radio Octal and 9-Pin Miniature... List Price, \$4.

Recognized under component program of Underwriters' Laboratories, Inc. for all voltages up to and including 115V.

PROBLEM? Send for Bulletin No. TR-81.

## AMPERITE

### BALLAST REGULATORS

Hermetically sealed, they are not affected by changes in altitude, ambient temperature ( $-50^{\circ}$  to  $+70^{\circ}$  C.), or humidity... Rugged, light, compact, most inexpensive.

List Price, \$3.00

Write for 4-page Technical  
Bulletin No. AB-51

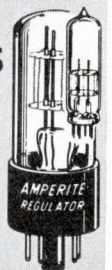

## AMPERITE

600 PALISADE AVE., UNION CITY, N.J. 07087

Telephone: 201 UNION 4-9503

In Canada: Atlas Radio Corp., Ltd.,  
50 Wingold Ave., Toronto 10

Circle 60 on Inquiry Card

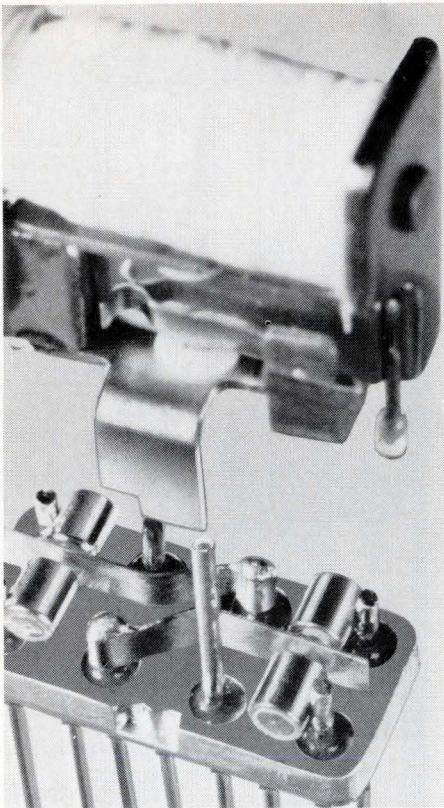

## mite-size relays with macro-size contacts

Couch 2X relays are true 1/7-size, yet the contacts are as large or larger than many full and half-size crystal can units. Couch 2X relays meet MIL-R-5757D/19 and /30 specs in 1/25th of a cu. in. Design simplicity and oversize contacts assure the ultimate in performance. Each relay is fully tested. Ideal for missile and aerospace switching applications or wherever reliability in small space is of prime importance. Available in many terminal styles and a wide choice of mountings.

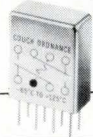

Write for Data Sheets No. 9 and No. 10 today.

	2X (DPDT)	1X (SPDT)
Size	0.2" x 0.4" x 0.5"	same
Weight	0.1 oz. max.	same
Coil		
Operating Power	100 mw or 150 mw	70 mw or 100 mw
Coil		
Resistance	60 to 4000 ohms	125 to 4000 ohms
Temperature	-65°C to 125°C	same
Vibration	20G	same
Shock	75G	same

RUGGED ROTARY RELAYS  Dynamically and Statically Balanced



## S. H. COUCH DIVISION

ESB INCORPORATED

3 Arlington St., North Quincy, Mass. 02171

Circle 61 on Inquiry Card

## LITERATURE

### Subminiature lamps

A 4-page catalog and price list describes "Rodan" subminiature lamps and indicator lights. Diagrams illustrate lamp configurations; charts show their characteristics; and a table lists

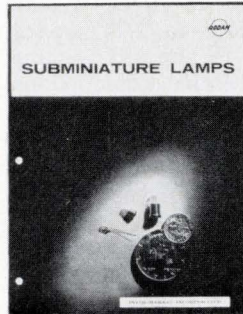

essential specs for numerous models. A price list provides ordering information for a range of T-1, T-1 1/4, and T-1 3/4 lamps and indicator lights. Inter Market Inc., 312 Waukegan Rd., Glenview, Ill. 60025.

Circle 347 on Inquiry Card

### Curve tracers

Plug-in/console characteristic curve tracers are the subject of a 4-page brochure. These units, which plug into or attach to any X-Y oscilloscope, provide curve tracer capacity, enabling the oscilloscope to act as a characteristic curve tracer for testing solid state devices. U-Tech, Div. of Industrial Physics and Electronics, 4190 S. State St., Salt Lake City, Utah 84107.

Circle 348 on Inquiry Card

### Shielded enclosures

A 4-page data sheet will help you select the correct size rack-mounted enclosure meeting EMI/RFI shielding requirements for 19- and 24-in. cabinets. Engineering drawings show standard enclosures. Shielding information, material specs and a parts list are included. Technical Wire Products Inc., 129 Dermody St., Cranford, Conn. 07016.

Circle 349 on Inquiry Card

### Time code generator

A solid state IC modular time code generator and a compatible time decoder are described in two 2-page bulletins, 138 and 139 respectively. Typical applications include time inputs to data processing systems, computers, visual time displays and telemetering devices. Specs and wiring diagrams are included. A. W. Haydon Co., 232 N. Elm St., Waterbury, Conn. 06720.

Circle 350 on Inquiry Card

### Electronic drafting aids

Pressure sensitive electronic drafting aids are the subject of a 28-page illustrated catalog. The indexed brochure contains descriptions and specs for the line, which includes transistor pads, microcircuits, flat packs and plug-ins. Applications are provided. Circuit Aids Inc., 172 Walker Lane, Englewood, N.J.

Circle 351 on Inquiry Card

### Precision motors

An 8-page catalog discusses precision instrument motors. It shows how the manufacturer's high speed digital computer plots curves relating motor RPM to shaft torque, power factor, percent efficiency and other variables to achieve optimum predictable motor performance. McLean Engineering Laboratories, Princeton Junction, N.J. 08550.

Circle 352 on Inquiry Card

### Photofabrication

A 12-page design manual deals with the photofabrication process and helps you to decide both when to use the photochemical machining process and how to design for your needs most effectively. The manual describes the engineering parameters which must be considered in photofabrication design. Fotofabrication Corp., 2512 W. Fullerton Ave., Chicago, Ill. 60647.

Circle 353 on Inquiry Card

### PC connector guide

The Varicon metal-to-metal connector series that conform to Mil-C-5400, Mil-E-8189, and Mil-T-21200 are the subject of this 52-page guide. Also described are 14- and 16-pin DIP receptacles and test probe receptacles.

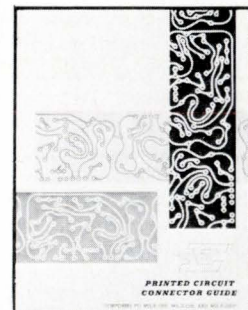

Connector contact spacings and terminations are described, and a 3-page foldout chart helps you to identify the connector required by the application. Elco Corp., Research & Engineering Center, 155 Commerce Dr., Fort Washington, Pa. 19034.

Circle 354 on Inquiry Card

## Lenses

Complete lens diagrams and technical data for nine precision lenses ranging in focal length from 28mm to 155mm are provided in a 12-page booklet. These lenses are designed primarily for making negatives for contact printing of ICs, LSIs and for pre-

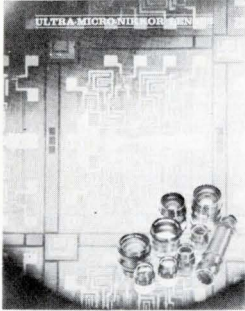

paring master negatives for the step-and-repeat photo reduction process. Also included are graphs of spectral transmission of filters, a lens selection table, and data on lens speed and resolution. Photo-Technical Products Inc., 623 Stewart Ave., Garden City, N. Y. 11530.

Circle 355 on Inquiry Card

## Industrial ceramic components

The combining of ceramics and metallurgy to produce components and assemblies which take advantage of thermal, dielectric and mechanical properties of beryllium oxide is discussed in a 19-page brochure. The metallizing and plating process is illustrated and described and applications for the finished product are provided. A table indicating thermal conductivity of the ceramics used in the metallized components is included, as are temperature graphs depicting comparative electrical, thermal, and mechanical data. National Beryllia Corp., Cermetrol Div., Haskell, N.J. 07420.

Circle 356 on Inquiry Card

## Application notes

A graph correlating reduction of vswr with dB of attenuator pads is the feature of a 6-page application note on trade-offs in rf measurements and line impedance selection. A brief history of the selection of 50Ω as the standard impedance for coaxial power transmission is also included, along with basic breakdown-voltage and power-capacity formulas for concentric lines. Bird Electronics Corp., 30303 Aurora Rd., Cleveland, Ohio 44139.

Circle 357 on Inquiry Card

## Electronic protection

The second edition of a 16-page paper, entitled "The Choice of Protection," includes additional material on methods of protecting electrical/electronic circuits and components from the damaging effects of short circuits. Nuisance tripping of conventional circuit breakers on inrush transients and its remedies are discussed. Airpax Electronics, Cambridge Div., Cambridge, Md. 21613.

Circle 358 on Inquiry Card

## Measuring instruments

A broad range of precision measuring instruments are discussed in a 12-page condensed catalog. New instruments added to the line include the DVD-108J double voltage divider, the DVP-108J double voltage potentiometer and the TDV-1000/1 differential voltmeter. Julie Research Laboratories Inc., 211 West 61st St., New York, N.Y. 10023.

Circle 359 on Inquiry Card

## Microwave connectors

A line of miniature microwave connectors designed to meet specification Mil-C-39012-A, Type SMA, is described in a 6-page catalog. Design and performance characteristics of each unit are included as are environmental, electrical and mechanical specs. Phelps Dodge Communications Co., 60 Dodge Ave., North Haven, Conn. 06473.

Circle 360 on Inquiry Card

## H-V capacitors

Over 300 high-voltage capacitors and nearly 70 capacitor "stacks" are described in this 28-page catalog (710-8). Electrical and dimensional data are included for capacitors from

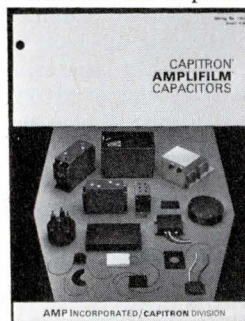

0.0015 to 1.0 μF with voltage rating of 2kV to 50kV and above. The catalog is fully illustrated and provides information on practical applications for each product. Capatron, Div. of AMP Inc., Elizabethtown, Pa. 17022.

Circle 361 on Inquiry Card

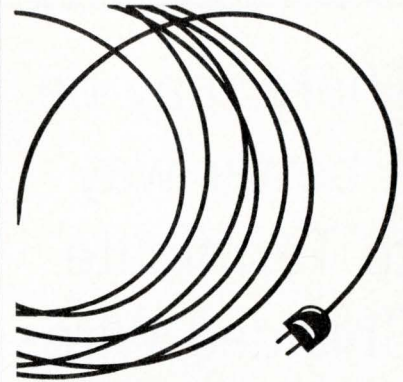

# OBSOLETE!

Harsh judgement? Yes, but the only one that applies to this old fashioned method of pouring hot, high voltage AC into a battery operated product to add the capability of house current operation —or using it with a low voltage DC operated product!

Modern manufacturers now use the simple, low cost, DYNAMIC SYSTEM which keeps hot AC at the wall outlet and delivers only cool, low voltage DC to the product and completely eliminates the need for a bulky internal transformer in the product!

Go MODERN with the U/L listed SAFE-T-PLUG, the heart of the DYNAMIC SYSTEM!

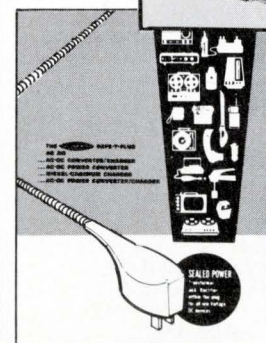
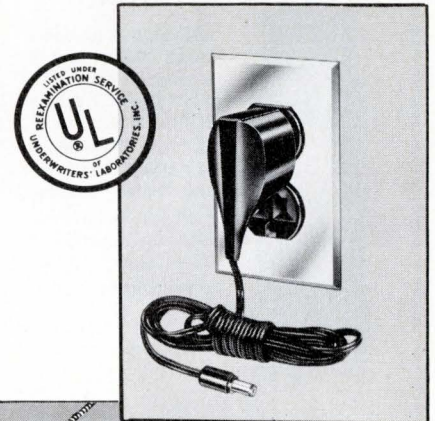

SEND FOR . . .  
your free copy of  
Dynamic's Technical  
Brochure which de-  
scribes the Dynamic  
System TODAY!



## Dynamic Instrument CORP.

115 E. Bethpage Rd., Plainview, N.Y.

Circle 62 on Inquiry Card

There may be a better way to Terminate Shielded Wires ... it's just waiting to be discovered.

**TAG Ring®**

For common termination of individual shields, TAG Ring's got them all beat.

Rapid assembly — no special tools. Reduced weight. Full reparability. ... and more

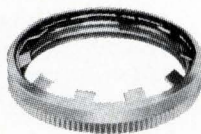

**TAG Ring® ADAPTERS**

TAG Ring is available as an integral part of a series of EMI/RFI adapters for a variety of functions.

Common termination of individual shields and "outer" shields. Electrical isolation of individual shields from "outer" shield. Environmental sealing



Adapters to fit all standard Cylindrical Connectors. For fast, shield termination relief . . . try a TAG Ring or TAG Ring Adapter.

Call or write for demonstration and technical literature . . . today.



**GLENAIR, INC.**

1211 Air Way, Glendale, California 91201  
Phone (213) 247-6000, TWX 910-497-2066

TAG Ring is a registered trademark of Glenair, Inc.  
U.S. Patent #3,465,092

Circle 63 on Inquiry Card

**LITERATURE**

**TTL integrated circuits**

This 42-page booklet describes a line of 5400/7400 series TTL integrated circuits, giving an introduction to TTL as well as parameters and circuit diagrams for 38 devices. The introductory section discusses input cir-



cuits, input clamping, output circuits, noise immunity and logic definition. Parameter measuring information and switching test circuits are included. ITT Semiconductors, 3301 Electronics Way, West Palm Beach, Fla. 33407.

Circle 362 on Inquiry Card

**Pressure transducers**

Potentiometric pressure transducers and LVDT-actuated pressure transducers are the subjects of an 8-page catalog. Complete electrical specs are given, including adjustments and power requirements. Each model description is accompanied by a functional diagram or application type drawing, and information on special options is included. Ametek, 860 Pennsylvania Blvd., Feasterville, Pa. 19047.

Circle 363 on Inquiry Card

**Intercom system**

An illustrated, 4-page brochure provides complete information and technical data on the new Norelco M100 Mastercom System. The M100 is a decentralized, duplex intercom system, featuring all-electronic switching for noise-free operation and an easy-to-install single cable interconnection. North American Philips Corp., 100 East 42nd St., New York, N.Y. 10017.

Circle 364 on Inquiry Card

**Ceramic materials**

A chart of electrical, thermal and mechanical properties of ceramic materials, as beryllia, alumina and magnesium oxide, is contained in a 4-page booklet. Applications for each material are covered, as are design considerations. National Beryllia Corp., Haskell, N.J. 07420.

Circle 365 on Inquiry Card

**D/A converters**

A 6-page bulletin covers the DA-035 series digital-to-analog converters. This series offers, on plug-in PC boards, 8, 10, and 12-bit D/A's (binary and BCD) with or without input data storage. Included in the bulletin are complete specs on the D/A cards, mounting cases, 16-channel packages and the appropriate companion power supplies. Computer Products, 2709 N. Dixie Hwy., Box 23849, Ft. Lauderdale, Fla. 33307.

Circle 366 on Inquiry Card

**Light measurement**

A 16-page folder contains information on the measurement of optical radiation (200-1200 nm). Included are reference charts, graphs and conversion factor tables along with detailed articles on such topics as photometric calibration and radiometric color measurement. International Light Inc., Dexter Industrial Green, Newburyport, Mass. 01950.

Circle 367 on Inquiry Card

**Capacitors**

Specs are given for seven capacitor lines in an illustrated 6-page brochure. Electrical specs are presented in tabular form for seven dielectric materials. Case styles and sizes are given for each dielectric to aid in the selection of a capacitor for a particular requirement. Electro Cube Inc., 1710 South Del Mar Rd., San Gabriel, Calif. 91776.

Circle 368 on Inquiry Card

**Circuit card guides**

A one-piece, molded polycarbonate card guide is the subject of a new 8-page brochure. Complete test information, dimensional data and price lists are included. The brochure also



describes Versamount brackets and introduces a new card guide cage able to hold 32 PC cards of 1/2 in. centers. Unitrak, 8738 West Chester Pike, Upper Darby, Pa. 19082.

Circle 369 on Inquiry Card

### Connector kit

Bulletin 401 discusses Proto Pac, a connector kit that aids in the design, development, prototyping and testing of electronic circuitry. Designed to appear as a handbook, the kit features information on rapid set-up of complex test circuits, change and interchange of components and circuits at will, and re-use of connectors without affecting reliability. The 4-page bulletin describes the kit's parts and includes photos illustrating how the parts are used. Berg Electronics, Inc., New Cumberland, Pa. 17070.

Circle 370 on Inquiry Card

### Quartz crystals

A line of coldweld and solderseal crystal units, including operational parameters, is described in a 16-page brochure. Technical data on the various crystal types, which cover frequencies from 850 Hz to 125 MHz, is included. Applications are discussed and specs are provided. Reeves-Hoffman Div., Dynamics Corp. of America, 400 W. North St., Carlisle, Pa. 17103.

Circle 371 on Inquiry Card

### Glass digital memories

The function of low-cost, high-speed glass digital memories in low-speed applications is described in Application Note 7. Interlacing techniques which allow memory modules with operating ranges between 2 and 20 megabits per second to function in systems with rates of less than 2 megabits per second are explained, and a detailed schematic is included. Corning Glass Works, Raleigh, N.C. 27602.

Circle 372 on Inquiry Card

### Electronic digitizer

Data sheets and a 6-page brochure describe the new Datagrid™ digitizer. The new position-measurement device is based on a recently developed electromagnetic measuring concept. Illustrated are a digitized drafting room, a semi-automatic designer, a computer-input digitizer and a graphic digitizer. You will find information on the machine's capabilities and applications, and on available models. Bendix, Advanced Products Div., Bendix Center, Southfield, Mich. 48075.

Circle 373 on Inquiry Card

### Video amplifiers

A 4-page data sheet on a new low-noise video amp discusses interface considerations between rf detectors and post-detection video amps. Also explained are source impedance considerations, max output voltage, temp performance and noise sensitivity. New models, specs, bandwidths, performance tables, options and prices are included, plus logarithmic video amp preliminary data. Aertech Ind., 825 Stewart Dr., Sunnyvale, Calif. 94086.

Circle 374 on Inquiry Card

### Art preparation

An 8-page technical bulletin discusses the use of photographically separated red and blue patterns on a single master artwork for both sides of two-sided printed wiring boards. Included is a step-by-step description of the drafting techniques, materials and shortcuts developed through research. Photographic processes are discussed. Bishop Graphics Inc., 7300 Radford Ave., North Hollywood, Calif. 91605.

Circle 375 on Inquiry Card

## FOR EXCELLENCE IN PUSH BUTTON SWITCHES SPECIFY GRAYHILL

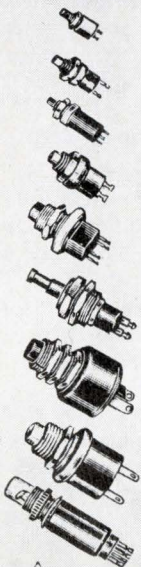

### A WIDE SELECTION TO CHOOSE FROM...

- Ratings To 10 Amp.
- SPST, SPDT, DPST, DPDT
- Diameters From 1/4" To 7/8"
- Behind Panel Dimension As Small As .32"
- Momentary - Push-Pull - Lighted - Alternate Action (Push-On, Push-Off)
- Wiping, Snap Action And Butt Contacts
- Solder Lug, "Faston" Or Printed Circuit Terminals
- Life Expectancy Up To 1,000,000 Operations

For your  
Grayhill Engineering  
Catalog offering complete  
technical data—contact



543 Hillgrove Avenue  
LaGrange, Illinois 60525  
Area Code 312, Phone 354-1040



... the Difference Between Excellent and Adequate

Circle 64 on Inquiry Card

Varflex invites you to . . .

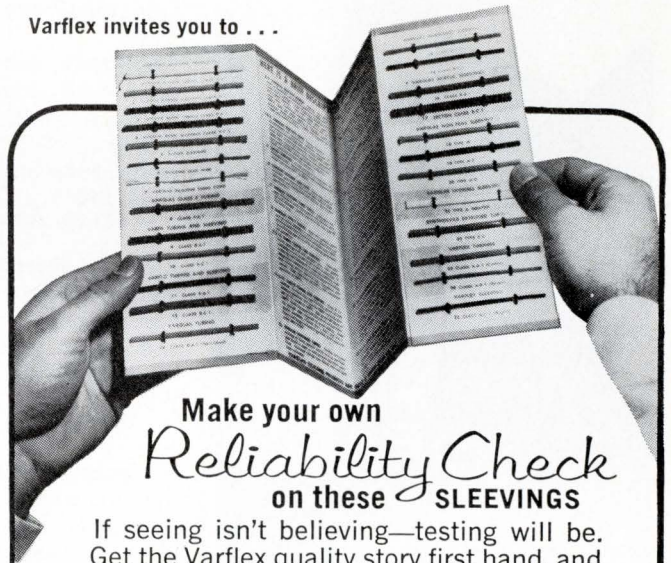

### Make your own *Reliability Check* on these SLEEVINGS

If seeing isn't believing—testing will be. Get the Varflex quality story first hand, and you can count on exactly the same quality every time you order.

Send today for your free folder containing test-length samples of **Silicone**, **Varglas**, **Varfil**, and **Varflo** flexible insulating sleeveing and tubing.

Let us know how we can serve you.

Send For Free Folder of  
Actual Test Samples

**Varflex**  
CORPORATION

506 W. Court

Rome, New York

Circle 65 on Inquiry Card

109

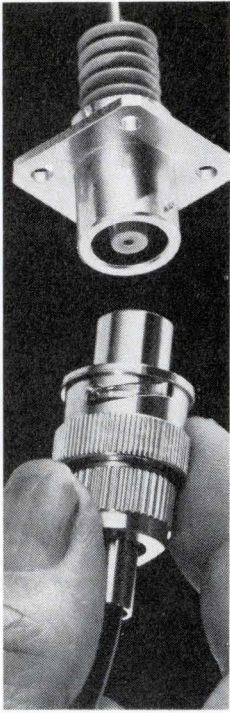

**NEW**  
**High-Voltage Corona-Free Type JA Connectors**

Type JA Rowe Connectors for economical use in lasers, power supplies, display systems, etc.

- Unmated flash-over value 12KV DC
- Mated 20 KV DC, unmated 10 KV DC
- Corona inception in excess of 5 KV at 75,000 feet
- Operating temperature range -55°C to 125°C
- Current 2 amps DC
- Quick-disconnect

Also available in complete cable assembly form.

Type JA Connectors are adaptable to standard coaxial cables RG-58, -59, -54, etc. with reduced ratings.

Phone or write today.

**ROWE INDUSTRIES, INC.**

1702 Airport Highway,  
 Toledo, Ohio 43609  
 Phone: 419-382-5666,  
 TWX: 810-442-1734

Circle 66 on Inquiry Card



**NORTON®**  
**MAGNETIC HEADS**

**MULTITRACK**  
**ERASE**  
**RECORD**  
**PLAY**

Send now for complete technical literature.

**NORTON**  
 ASSOCIATES, INC.

10 Di Tomas Court, Copiague, N.Y. 11726  
 Phone: 516 598-1600

Circle 67 on Inquiry Card

**LITERATURE**

**Precision slicing device** works on a counter-balancing mechanism that varies the feed rate and reduces the thermal and mechanical damage to a minimum—4 pages. Metals Research Instrument Corp., 40 Robert Pitt Drive., Monsey, N.Y. 10952.

Circle 376 on Inquiry Card

**Wire bonder** for use in manufacturing hybrid circuits, ics and transistors, can bond aluminum or gold wire up to .003 in. in diameter. Mech-El Industries, Inc., 73 Pine St., Woburn, Mass. 01801.

Circle 377 on Inquiry Card

**Training center** for electronic services in data processing, communications, electro-optics and systems analysis (8 pages). Available on company letterhead from: Monmouth Engineering Center, Park Rd., New Shrewsbury, N.J. 07764.

Circle 378 on Inquiry Card

**Silicon power rectifiers** housed in a glass-to-metal hermetically sealed package permit reliable operation under extreme humidity and environmental conditions—Bulletin 125. Edal Industries, 4 Short Beach Road, E. Haven, Conn. 06512.

Circle 379 on Inquiry Card

**Impedance converters**, which when used with couplers replace charge amps in single range applications—Bulletin 314-5/69. Kistler Instrument Corp., 8989 Sheridan Drive, Clarence, N.Y. 14031.

Circle 380 on Inquiry Card

**Electrical sheet insulation samples** primarily composed of asbestos fibers, high temperature synthetic textile fiber and some heat stable elastomeric binder—booklet DT-80A. Johns-Manville, Box 359, New York, N.Y. 10016.

Circle 381 on Inquiry Card

**Temperature and pressure controls**, thermometers and recorders (electric, electronic, and pneumatic)—Catalog K2 (26 pages). United Electric Controls Co., 85 School St., Watertown, Mass. 02172.

Circle 382 on Inquiry Card

**CLASSIFIED ADVERTISING**

**GROWTH POSITIONS \$12,000-\$25,000**  
 MANAGEMENT — ENGINEERING — SALES  
 RESEARCH — MANUFACTURING  
*Nationwide Coverage*  
 Fees company paid. Include present salary, minimum salary requirement and location flexibility with resume. Longberry Employment Service, Inc., 910 Niles Bank Bldg., Niles, Ohio 44446. (216) 652-5871.

**Op-amps**, including FET input models, chopper stabilized amps (and accessories) and electronic multipliers—16 pages. Zeltex, Inc., 1000 Chalomar Rd., Concord, Calif. 94520.

Circle 383 on Inquiry Card

**Film adhesives** for bonding metals, plastics, rubber, cellulose and ceramics, including samples, 4 pages. USM Corp., Girder Chemical Div., 1 Carleton Ave., E. Rutherford, N.J. 07073.

Circle 384 on Inquiry Card

**RF-Diode sputtering units** for thin-film coating, microelectronic devices and corrosion resistance—8 pages. Varian, Vacuum Div., 611 Hansen Way, Palo Alto, Calif. 94303.

Circle 385 on Inquiry Card

**Resistor stop-and-test bridges** for use in the trimming of thick-film resistors (12 pages). Teradyne, Inc., 183 Essex St., Boston, Mass. 02111.

Circle 386 on Inquiry Card

**Semiconductor replacement guide** for entertainment equipment (67 pages). Available for 75¢ from Sylvania Electric Products, Inc., 1100 Main St., Buffalo, N.Y. 14209.

Circle 387 on Inquiry Card

**Power line filters**, heavy-duty, 100-dB attenuation from 14 kHz through 10 GHz (6-pages). Technical Literature Service, Sprague Electric Co., Marshall St., North Adams, Mass. 02147.

Circle 388 on Inquiry Card

**Transistor sockets**, both fabricated and molded, and the Universal Transistor Clamp for semiconductor mounting (7 pages). Robinson-Nugent, Inc., 800 E. 8th St., New Albany, Ind. 47150.

Circle 389 on Inquiry Card

**Modular indicators**, for measurement of vacuum, pressure, differential pressure, and temperature—Bulletin 4100 (8 pages). Beckman Instruments, Inc., Process Instruments Div., 2500 Harbor Blvd., Fullerton, Calif. 92634.

Circle 390 on Inquiry Card

**Data sets** with either magnetic or acoustic receive coupling, with configurations for originate or answers, 4 pages. Electronic Voice Inc., 2059 E. 223rd St., Long Beach, Calif. 90810.

Circle 391 on Inquiry Card

**Timing instrumentation** for use in acquisition and reduction of data (16 pages). Datatron Inc., 1562 Reynolds Ave., Santa Ana, Calif. 92705.

Circle 392 on Inquiry Card



**Insulated terminals**, for chamfered and non-chamfered holes, feature high shock and vibration resistance and wide operating temperature range—6 pages. Sealectro Corp., 225 Hoyt St., Mamaroneck, N.Y. 10543.

Circle 393 on Inquiry Card

**Power meter** combined with a thermocouple mount comprise a system for measuring rf and microwave power over a wide range of amplitude and frequency.—Bulletin 437 A (4 pages). Hewlett Packard, 1501 Page Mill Rd., Palo Alto, Calif. 94304.

Circle 394 on Inquiry Card

**Resistor products** with low temperature coefficients are available with rise times of less than 1 nanosecond and tolerances less than  $\pm 0.005\%$ —Bulletin G. Vishay Resistor Products, 63 Lincoln Highway, Malvern, Pa. 19355.

Circle 395 on Inquiry Card

**Proximity limit switches**, magnetically shielded against actuation, are suggested for applications which require mounting a switch in an inaccessible location.—4 pages. Tann Controls Co., 20210 Sherwood, Detroit, Mich. 48234.

Circle 396 on Inquiry Card

**Panel Instruments**, including round and edgewise types, for scientific, industrial, medical and commercial use. Sigma Instruments, Inc., 170 Pearl St., Braintree, Mass. 02185.

Circle 397 on Inquiry Card

**RFI strip gaskets** consist of conductive filters dispersed in silicone binders—4 pages. Chomerics Inc., 77 Dragon Court, Woburn, Mass. 01801.

Circle 398 on Inquiry Card

**Scattered transmission accessory**, for use in investigating absorbing samples with high light scattering characteristics—4 pages. Cary Instruments, 2724 S. Peck Rd., Monrovia, Calif. 91016.

Circle 399 on Inquiry Card

**Test equipment** for electronic applications, including voms of different types, Bulletin 2080 (16 pages). Simpson Electric Co., 5200 W. Kinzie St., Chicago, Ill. 60644.

Circle 400 on Inquiry Card

**Servo amps** including ac amps from 6 watts to 10 horsepower and dc amps from 50 watts to 400 horsepower. Westamp Inc., 1542-15 St., Santa Monica, Calif. 90404.

Circle 401 on Inquiry Card

**Universal breadboard** for developing new circuits, teaching analog circuit principles and involving building blocks in circuit design and evaluation (2 page data sheet). Analog Devices, 221 5th St., Cambridge, Mass. 02142.

Circle 402 on Inquiry Card

**Carriers and contactors** for 16 lead ic flat packs accept packages that are  $\frac{1}{4}$  in. x  $\frac{1}{4}$  in. and  $\frac{1}{4}$  in. x  $\frac{3}{8}$  in.—Bulletin TB 538. Barnes Corp., 24 N. Lansdowne Ave., Lansdowne, Pa. 19050.

Circle 403 on Inquiry Card

**Precision connectors**, including rack and panel, micro-miniature, sub-miniature, wire wrap arrays and other interconnection devices and systems. Transatron Electronic Corp., 108 Albion St., Wakefield, Mass. 01880.

Circle 404 on Inquiry Card

**RF shielded rooms** which utilize 20 gauge steel wall panels and a door design which conforms to Mil-Std 285, Mil-E-8881 (ASG) and NSA 65-6—6 pages. Ace Shielded Products Corp., 60 Tomlinson Rd., Huntingdon Valley, Pa. 19066.

Circle 405 on Inquiry Card

## NATVAR'S New Silicone Rubber Fiberglass Sleeving

- Unmatched durability under stress at high temperatures
- Excellent abrasion resistance

Natvar's new improved silicone rubber fiberglass sleeving is engineered to take extreme punishment. The sample shown here was given maximum stress...total push back. Then we oven-aged it for 1000 hours at 250°C. Results—no cracking, splitting or loss of dielectric strength and still going strong.

Notice what happened to five other major brands given the same test. They all cracked after oven-aging for periods of 16 to 336 hours.

Put Natvar silicone rubber fiberglass sleeving to test yourself. Send for specifications and FREE SAMPLE.

ORDINARY SILICONE RUBBER FIBERGLASS SLEEVING



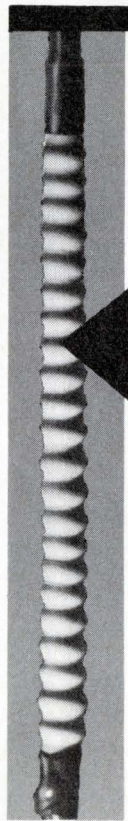

**NATVAR CORPORATION**  
P. O. BOX 67 • RAHWAY, N. J. 07065

Circle 68 on Inquiry Card

## HYBRID CIRCUIT CERAMIC CHIP CAPACITORS...



### ... THAT ARE REALLY THUMBTHING!

Put your finger on those so-and-so design problems with a selection of type K 1200's. Capacitance range is 10 pF to 2.5 Mfd. Dissipation factor is less than 2% @ 1 kHz. Working voltages available, 25 thru 200 WVDC and more. Tempco is  $\pm 15\%$  max.  $-55^{\circ}\text{C}$  to  $125^{\circ}\text{C}$ . Our full line meets the applicable portions of MIL-C-11015 and MIL-C-39014.

Want a complete description, characteristics curves, etc? . . . write us for our latest pattern K-1200.

Monolithic  
Dielectrics



P.O. Box 647  
Burbank, Calif. 91503  
Phone 213 848-4465

Circle 69 on Inquiry Card

111

## READ THESE BOOKS

### Background on magnetic bubbles

#### Magnetic Domains

By R. S. Tebble. Published 1969 by Barnes & Noble, Inc., 105 Fifth Ave., New York, N. Y. 10003. Price \$4.00. 98 pages.

Last year we would simply have listed this book. Now, however, it has acquired new significance because it contains the background necessary to understand the memory that Bell Labs has developed based on "magnetic bubbles" domains orthoferrites. These bubbles are based on the properties of cylindrical magnetic domain was that occur in thin films of orthoferrites.

So far, the literature available on these walls have either been scarce, or had to be retrieved from innumerable books on magnetics. Fortunately, this book by Mr. Tebble has an entire chapter on magnetic thin films, particularly on the domain walls (Neel walls) and on cross-tie walls (Bloch lines) upon which are based magnetic bubbles.

If you are interested in memories, or are wondering what the theory of the new magnetic bubbles are, the last chapter of this short book will be useful. Aside from that, it is a short, easy-to-read book on magnetic theory.

### Engineering of Dynamic Systems

By William R. Perkins and Jose B. Cruz, Jr. Published 1969 by John Wiley & Sons Inc., 605 Third Ave., New York, N.Y. 10016. Price \$13.95. 568 pages.

This book does a good job of covering complex interconnection devices for components for system engineering. Extensive use is made of mathematical models, computer-aided analysis, design simulation and optimization with respect to quantified goals.

Book provides an introduction to the areas mentioned above and the authors emphasize the basic concepts and techniques used in design of dynamic systems. They use a "theme" example, in this case an attitude control problem. There are aspects of this problem that are used throughout the book to illustrate the applications of the various solutions discussed.

#### Optimumization Theory with Applications

By Donald A. Pierre. Published 1969 by John Wiley & Sons Inc., 605 Third Ave., New York, N.Y. 10016. Price \$16.95. 612 pages.

#### Quantum Electronics

Vol. I and Vol. II. Published by V. M. Fain and Ya. I. Khanin. Both volumes published 1969 by The MIT Press, 50 Ames St., Cambridge, Mass. 02142. Each volume contains 312 pages and each volume's price is \$16.50.

### Numerical Control

By Glenn Ertell. Published by John Wiley & Sons Inc., 605 Third Ave., New York, N.Y. 10016. Price \$9.50. 149 pages.

If somehow you have missed or bypassed numerical control and now have "a need to know" this is a good book. It was written for engineers and technicians who must supply and maintain numerical controls.

The book develops techniques that are common to all numerical controls, with emphasis on logic functions. It covers binary numbers in arithmetic, basic digital circuits, binary counters, typical selection and collection, numerical control, a numerical positioning using a stepping motor, the power servo, numerical positioning using a servo, a typical single access continuous-positioning numerical control, a typical 2-access continuous positioning numeric control, punched tape readers, and a technique of troubleshooting. In a few words, it is a basic book that will let you get your feet wet.

#### Solar Cells 1969

By Dr. M. W. Ranney. Published by Noyes Development Corp., Noyes Building, Park Ridge, N.J. 07656. 270 pages. Price \$35.00.

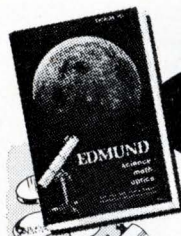

## FREE CATALOG!

### OPTICS! SCIENCE! MATH!

### GIANT 148 PAGES

#### THOUSANDS OF UNUSUAL BUYS FOR INDUSTRY

Many on-the-job Helps . . . Quality Control Aids! Write for this completely new, 1970 Catalog. New items, new categories, new illustrations, 148 easy-to-read pages packed with hundreds of charts, diagrams, illustrations. A treasure-house of optical and scientific information . . . unusual bargains galore. Optics for industry, research labs, design engineers, experimenters, hobbyists! Instruments for checking, measuring—to speed work, improve quality, cut production costs. We give you facts: what it is—how it works—where it's used!

#### Comparators, Magnifiers, Microscopes

Hard-to-get war surplus bargains—ingenious scientific tools—imported—domestic. Thousands of components: lenses, prisms, wedges, mirrors, mounts, accessories of all descriptions. Dozens of instruments: lasers, magnifiers, stereo, microscopes, telescopes, binoculars, infrared equipment, photo attachments. Shop by mail. No salesman will call. Use the Catalog of America's greatest Optics—Science—Math Mart. Known for reliability. Mail the coupon below to:

Edmund Scientific Company,  
300 Edscorp Building, Barrington, New Jersey 08007  
Ask for Catalog "EE"

#### MAIL COUPON FOR GIANT FREE CATALOG

EDMUND SCIENTIFIC CO.  
300 EDSCORP BLDG., BARRINGTON, N. J. 08007

Please send FREE Giant 148-page Catalog "EE"

NAME \_\_\_\_\_

ADDRESS \_\_\_\_\_

COMPANY \_\_\_\_\_

CITY \_\_\_\_\_ STATE \_\_\_\_\_ ZIP \_\_\_\_\_

Circle 70 on Inquiry Card

Are you interested in

COMMUNICATIONS and  
INTEGRATED CIRCUITS?

Then, you must be interested in

COMMUNICATIONS ICs

Plan now to attend the Seminar being organized by The Electronic Engineer magazine, at the Sheraton Hotel in Philadelphia, on February 17, 1970. (this is the day before ISSCC)

For Details

Circle 420 on Inquiry Card

or see page 102

of this issue

# Advertisers—January 1970

This Index is published for a convenience.  
No liability is assumed for errors or omissions.

ACOPIAN CORP. .... 28 Mort Barish Assoc., Inc.	KINGS ELECTRONICS ..... 34 Caroe Marketing, Inc.
AMCO ENGINEERING CO. .... 21 Buti-Roberts Adv.	LEIPZIGER MESSEAMT ..... 94 Interwerbung GmbH
AMELCO SEMICONDUCTOR ..... IBC Steven Jacobs Design Assocs.	LITTELFUSE, INC. .... 15 Burton Browne Adv.
AMERICAN MACHINE & FOUNDRY CO., POTTER & BRUMFIELD DIV. .... 33	LITTON GUIDANCE & CONTROL SYSTEMS ..... 61 Diener & Dorskind Adv., Inc.
AMPERITE CO. .... 105 H. J. Gold Co.	LOGIMETRICS, INC. .... 83 Greenvale Marketing Corp.
AMP, INC. .... 20 Garceau, Hallahan & McCullough, Inc.	MET-L-WOOD CORP. .... 89 Drew & Carr, Inc.
ASTRODYNE, INC. .... 98 Robert J. Allen	MILLER-STEPHENSON CHEMICAL CO. .... 97 Michel-Cather, Inc.
BECKMAN INSTRUMENTS, INC. EID/FULLERTON DIV. .... 16	MONOLITHIC DIELECTRICS ..... 111 Eastman Adv.
HELIPOT DIV. .... 64 N. W. Ayer/Jorgensen/MacDonald, Inc.	MOTOROLA COMMUNICATIONS & ELECTRONICS, INC. .... 61 Griswold & Eshleman Co.
BLILEY ELECTRIC CO. .... 30 Barber & Drullard, Inc.	MOTOROLA SEMICONDUCTOR PRODUCTS, INC. .... 41 Lane & Wampler Adv., Inc.
BOURNS, INC. .... 22 The Lester Co.	MUELLER ELECTRIC CO. .... 101 Carlson & Co., Adv.
BUSSMANN MFG. DIV. .... 78, 79 Henderson Adv. Co.	NATIONAL ELECTRONICS, INC., SUB. VARIAN ASSOCS. .... 91 Connor-Sager Assoc., Inc.
CHRONO-LOG CORP. .... 23 Mort Barish Assoc., Inc.	NATVAR CORP. .... 111 Sanger-Funnell, Inc.
C. P. CLARE & CO. .... 46 Reincke, Meyer & Finn	NORTON ASSOCS., INC. .... 110 J. J. Coppo Co., Inc.
CLIFTON DIV. OF LITTON INDUSTRIES ..... 19 Ivey Adv., Inc.	PANDUIT CORP. .... 101 Donald L. Arends, Inc.
CONTROL SYSTEMS RESEARCH ..... 35 De Sales Adv., Inc.	PHILBRICK/NEXUS RESEARCH ..... 11 Renaccio Adv., Inc.
COUCH ORDNANCE, INC. .... 106 Culver Adv., Inc.	POTTER & BRUMFIELD DIV. AMERICAN MACHINE & FOUNDRY CO. .. 33 Grant, Wright & Baker, Inc.
DELTRON, INC. .... 99 Benn Assocs., Inc.	RCA, INTEGRATED CIRCUITS DIV. .... BC Al Paul Lefton Co., Inc.
DIGITRAN CO. .... 5 Jansson Adv., Inc.	REPUBLIC ELECTRONICS CORP. .... 32 Kardonne Adv.
DYNAMIC INSTRUMENT/OEM ..... 100, 107 Tri-County Adv., Inc.	ROWE INDUSTRIES ..... 110 Carr Eyster Assoc., Inc.
EDMUND SCIENTIFIC CO. .... 112 Walter S. Chittick Co., Inc.	SIERRA RESEARCH CORP. .... 24 B. P. Myer Assoc., Inc.
ELCO CORP. .... 31 Schaefer Adv., Inc.	SPECTROL ELECTRONICS CORP. .... 29 Jones, Maher, Roberts, Inc.
ELECTRO MOTIVE MFG. CO. .... 75 Culver Adv., Inc.	SPRAGUE ELECTRIC CO., CAPACITOR DIV. .... 1 Harry P. Bridge Co.
ELECTRONIC RESEARCH ASSOC. .... 90 Josephson, Cuffari & Co.	SYLVANIA PRODUCTS ..... 2 Doyle Dane Bernbach, Inc.
FAIRCHILD SEMICONDUCTOR ..... 26, 27 Chiat/Day, Inc.	TEMPIL DIV. .... 86 Black-Russell-Morris
FERROXCUBE CORP. .... 13 W. H. Schneider, Inc.	TEXAS INSTRUMENTS INC., COMPONENTS GROUP ..... 25 Albert Frank-Guenther Law, Inc.
GENERAL INSTRUMENT CORP. MICROELECTRONICS DIV. .... 6, 7 Norman Allen Assoc., Inc.	TEXSCAN CORP. .... 40 Burton Browne Adv.
GLENAIR, INC. .... 108 T. F. Murray & Assoc., Inc.	TRYGON ELECTRONICS, INC. .... 104 Technical, Industrial & Scientific Marketing, Inc.
GRAYHILL, INC. .... 109 Carr Liggett Adv., Inc.	UNITRODE CORP. .... 49 Silton Co., Inc.
HAMILTON WATCH CO. .... 95 Beaumont, Heller & Sperling, Inc.	VARFLEX CORP. .... 109 Barlow/Johnson, Inc.
HEATH CO. .... 87 Advance Advertising Service	VARIAN ASSOCIATES ..... 8 Botsford-Ketchum, Inc.
HERMETIC SEAL CORP. .... 48 J. Bunce Adv.	VARO, INC. .... 96 Tracy-Locke Co., Inc.
HEWLETT-PACKARD CO. COLORADO SPRINGS DIV. .... IFC LOVELAND DIV. .... 85 Tallant/Yates Adv., Inc.	VIDAR CORP. .... 76 Bill Fisher Adv.
HICKOK ELECTRICAL INSTRUMENT CO. .. 93 Parsells Advertising Service	WATKINS-JOHNSON CO. .... 56 William C. Estler
HUGHES AIRCRAFT CO., MOS DIV. .... 72 Foote, Cone & Belding	
INTEL CORP. .... 62, 63 Bonfield Assoc.	



## DISTRICT SALES MANAGERS

<b>EDWARD G. SHAUD</b> PHILADELPHIA 19139—56th & Chestnut Sts. (Area Code 215) SHerwood 8-2000
<b>JOSEPH DRUCKER</b> NEW YORK 10017—100 East 42nd St. (Area Code 212) OXFord 7-3400
<b>JOHN UPHUES</b> <b>JOHN W. BERNHARDT</b> CHICAGO 60606—120 S. Riverside Plaza (Area Code 312) 782-1400
<b>G. T. ALFANO</b> NEEDHAM HEIGHTS, MASS. 02194— 570 Hillside Ave. (Area Code 617) 444-0010
<b>TERRENCE D. BUCKLEY</b> <b>THOMAS R. BORIS</b> LOS ANGELES 90015—1543 W. Olympic Blvd. (Area Code 213) DUUnkirk 7-1271
<b>RALPH PETERSEN</b> LOS ALTOS (San Francisco) 94022 199 First St., Room 335 (Area Code 415) 941-6655
<b>ROBERT C. BRUNER</b> CLEVELAND 44114—601 Rockwell Ave. (Area Code 216) SUperior 1-2860
<b>FRANK A. SMITH</b> HOLLYWOOD, FLA. 33020— 2419 Hollywood Blvd. (Area Code 305) 927-7829
<b>NEWTON B. COLLINSON</b> ATLANTA 30309—1776 Peachtree St. N.W. (Area Code 404) 872-4723
<b>HAROLD E. MOTT</b> <b>WAYNE L. LOVING</b> DALLAS 75206—Meadows Bldg. Expressway at Milton (Area Code 214) EMerson 3-6426
<b>BRENT GILBERT</b> HOUSTON 77027—West Loop Bldg. Rm. #209, 4848 Guiton (Area Code 713) 621-7550

## INTERNATIONAL BUSINESS OFFICES

London, S.W. 1 ..... Max F. Holsinger 67/68 Jermyn St., St. James's Dir. European Sales TRA 6318/9 ..... Roy V.C. Hall, A. Berg Cables ..... WHIP LONDON S.W. 1
Manchester 22 ..... D.I. Goulden Haletop, Wythenshawe Civic Centre ..... MERCURY 3293
4 Dusseldorf-Rath ... E. Hillerbrand, R. Schomburg, Eitelstrasse 32 ..... W. Heckelmann Dusseldorf 632031 Cables ..... WHIP DUSSELDORF
Paris, 8e ..... S. Brown-Joussard 70 Rue de Ponthieu ..... ELYsees 65-77 Cables ..... UIIP PARIS 16e
Tokyo ..... C.T. Sakaguchi Room 814, Togin Bldg. Marunouchi CPO Box No. 1572 ..... Tel: 211-3506-3509 Cables ..... CLARENCE SAKA TOKYO

## BUSINESS STAFF

<b>K. ROBERT BRINK</b> Publisher
<b>STEPHEN A. FARKAS</b> Marketing Services Manager
<b>DENNIS J. PERKINS</b> Promotion Manager
<b>JOHN E. JAENISCH</b> Eastern Advertising Manager
<b>PAT KAUFFMAN</b> Production Manager
<b>WILLIAM M. COFFEY</b> Circulation Director
<b>JAMES F. NAGY</b> Circulation Manager
<b>JOSEPH P. BABCOCK</b> Reader Service Manager
<b>JOHN H. KOFRON</b> Chilton Research Services
<b>C. R. WILHIDE</b> Washington Vice-President



# AMELCO

## has the solution to the

# SPEED

---

# POWER

## trade-off

### LPDT $\mu$ L 9040 LOGIC TO MIL 883

Having sourcing problems with 9040 series? Amelco makes them all and at more than competitive prices! For ultra-high reliability specify pace III (that's what we call our in-house reliability program designed around mil std-883). As a bonus, we've replaced the dual J-K flip-flop (9007) hybrid with a monolithic version.

### ULTRA-LOW POWER LOGIC TO MIL 883

If you want to get really low-down on the power curve, check our ULP logic, the very ultimate in speed/power performance. The 525 flip-flop dissipation is 1 mw max/unit and the gate is 260  $\mu$ w/gate maximum.

To make things easier we designed ULP so it is completely pin and functionally interchangeable with 9040—right down to the last resistor. If you're willing to give up a little speed you can reduce system power drain by a factor of 4—quite a reduction when related to satellite battery life! Blindfolds in place? Then the choice is up to you!

Amelco Part #	Description	ULP Replacement
6007 BH (LPDT $\mu$ L9007)	Dual J-K Flip-Flop	_____
6040 BH (LPDT $\mu$ L9040)	J-K Flip-Flop	529 BH
6041 BH (LPDT $\mu$ L9041)	Dual Three Input Gate	528 BH
6042 BH (LPDT $\mu$ L9042)	Dual Three Input Gate	526 BH
6044 BH (LPDT $\mu$ L9044)	Dual Four Input Gate	527 BH
6046 BH (LPDT $\mu$ L9046)	Quad Two Input Gate	525 BH
6047 BH (LPDT $\mu$ L9047)	Triple Three Input Gate	_____

↳  $\frac{1}{4}$  x  $\frac{1}{4}$  flat package—also available in "N" pkg ceramic dip  
 ↳ -55 to +125°C—also available in C grade -20°C to +100°C



TELEDYNE

## AMELCO SEMICONDUCTOR

1300 Terra Bella Ave., Mountain View, California (415) 968-9241 • Westwood, Massachusetts (617) 326-6600  
 Orlando, Florida (305) 423-5833 • Ridgefield, New Jersey (201) 943-4700 • Des Plaines, Illinois (312) 439-3250  
 Anaheim, California (714) 635-3171 • Wiesbaden, Germany 372820

# OTA—NEW DIMENSION IN OP AMPS FOR THE CREATIVE DESIGNER

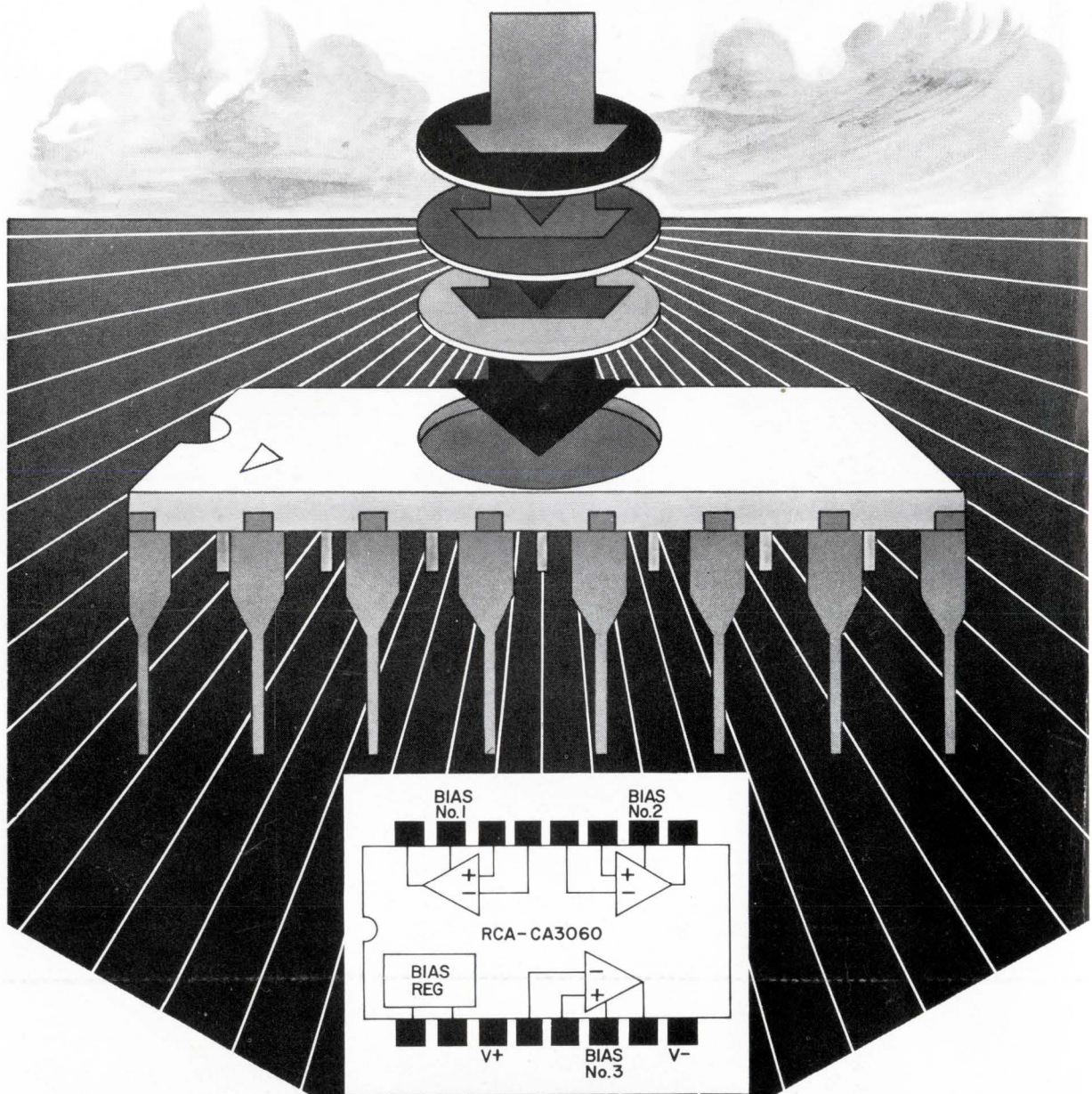

Here's the IC design breakthrough that may change your entire approach to op amps. In the CA3060, RCA brings you a monolithic array of three independent Operational Transconductance Amplifiers and a bias regulator with features that will send you back to the drawing board on current designs and start a new chain of ideas for the future. You can externally adjust the supply current for each amplifier over the range from  $10 \mu\text{A}$  to 1 mA. At the low end of this range, you can have three amplifiers working for you on less than 300  $\mu\text{watts}$ .

The CA3060 has the characteristics of classical op amps with the added feature of externally variable transconductance ( $g_m$ ). Hence, open-loop voltage gain is a function of  $g_m R_i$ . Think about it and look into it for applications calling for low-power op amps, active filters, gyrators, mixers, modulators, or multipliers. Price \$5.95 (1000 units) in 16-lead dual-in-line ceramic package (full military temperature range  $-55^\circ\text{C}$  to  $+125^\circ\text{C}$ ).

#### Typical Highlight Parameters (Per Amplifier)

Amplifier Bias Current	$1 \mu\text{A}$	$100 \mu\text{A}$
Supply Voltage	$\pm 2$ to $\pm 6 \text{ V}$	$\pm 2$ to $\pm 6 \text{ V}$
Power Consumption	$\leq 100 \mu\text{W}$	$\leq 10 \text{ mW}$
Input Bias Current	33 nA	2500 nA
Transconductance ( $g_m$ )	$380 \mu\text{mho}$	35 mmho
Output Resistance	200 $\text{M}\Omega$	2 $\text{M}\Omega$

(No compensation required in many applications)

For further information, contact your local RCA Representative or your RCA Distributor. For technical bulletin, File No. 404, write RCA Electronic Components, Commercial Engineering, Section J-1 / CA 24, Harrison, N. J., 07029. In Europe: RCA International Marketing, S. A., 2-4 rue du Lièvre, 1227 Geneva, Switzerland.

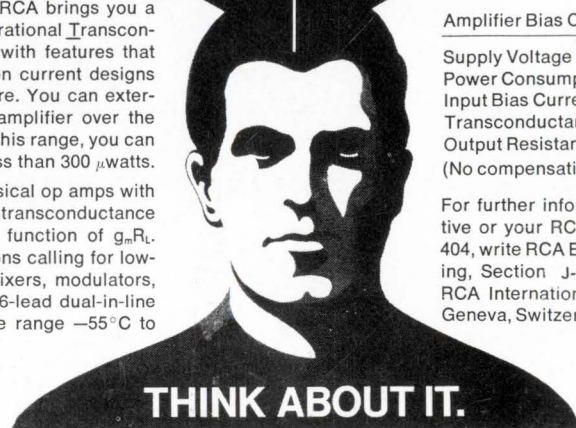

**THINK ABOUT IT.**

**RCA** Integrated  
Circuits

Circle 3 on Inquiry Card