

systems engineering today

THE ELECTRONIC ENGINEER

a CHILTON publication / DECEMBER 1972

A buyer's guide for low-cost IC op amps:
Select from the most popular parameters.

Digital readout course—Part 6
What's available in multi-line displays?

It's all power to power semiconductor makers as
technology changes and IC growth fuel the market.

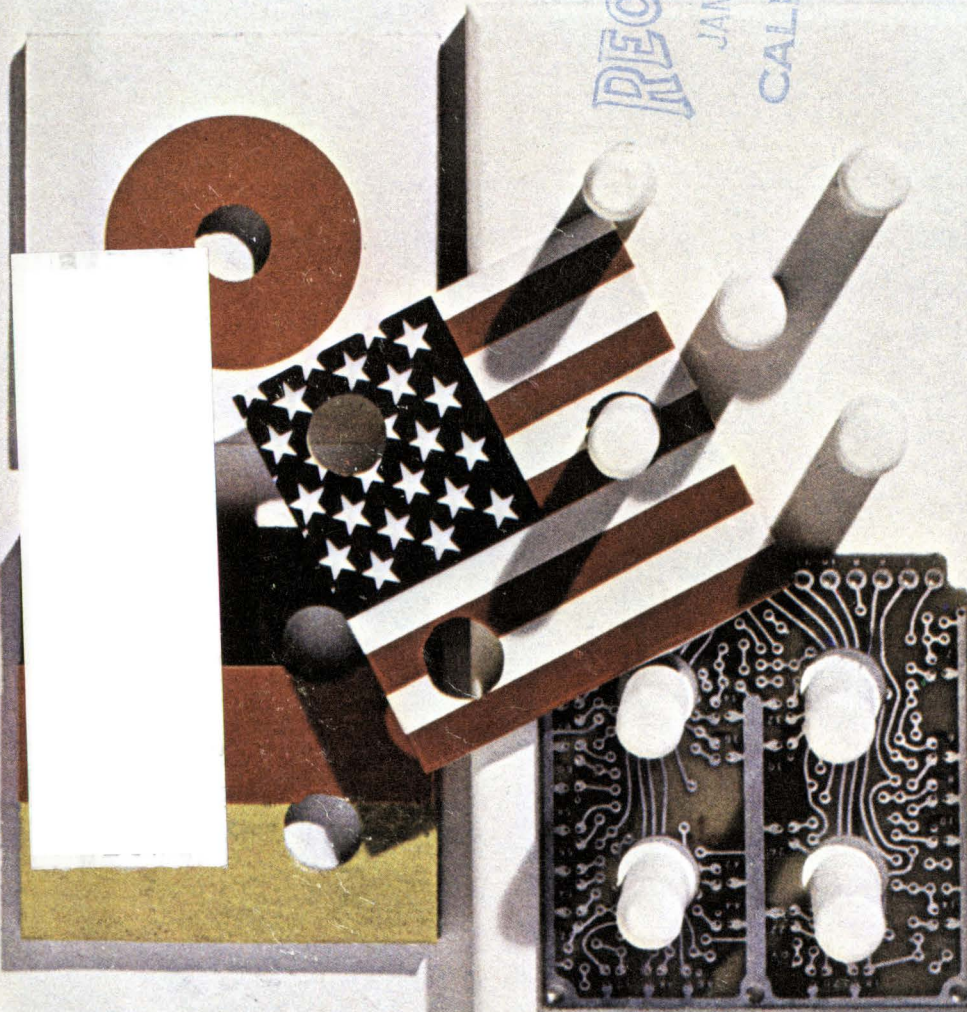
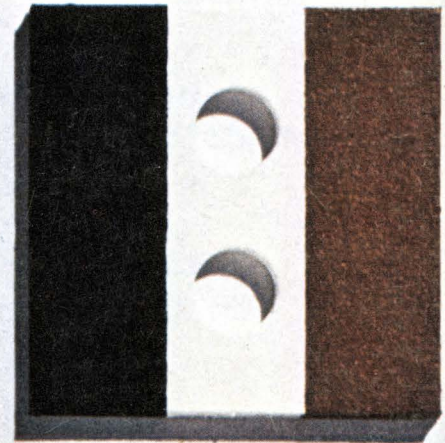

Foreign Standards: Can U.S. Electronics Fit In?

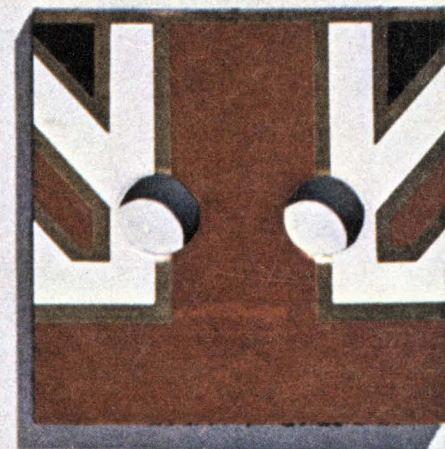

WANTED:

Individuals of Demonstrated Ability, Innovation and Leadership:

The Electronics Systems Group of GTE Sylvania has been extremely successful in securing major systems business. The Needham, Massachusetts Operation of The Electronics Systems Group is comprised of two divisions: The Communications Systems Division and the Eastern Division which can offer assignments from

conceptual activities through final equipment delivery. The broad range of tasks underway present a unique opportunity to choose assignments which will satisfy your career interests and goals. Our suburban Boston location affords a unique opportunity for educational, recreational and cultural activities.

ANALOG CIRCUIT DESIGN

A major design effort will involve analog circuits for hybrid electronic surge arrestors, pulse generators, sophisticated power supplies, low and high pass filters, fault detection and radio communications. You will be responsible for design, build, test and perform worst case analysis. Positions are available at most levels of experience.

DIGITAL CIRCUIT DESIGN

Major efforts will be to design, build, test, and perform worst case analysis of digital control electronics and computer interface equipment. Positions are available at most levels of experience.

EMI/TEMPEST ENGINEERING

Will interpret DOD EMI/TEMPEST specification and perform electromagnetic emanation/susceptibility analysis on complex electronic systems/subsystems. Will also perform EMI/TEMPEST analysis, design and test functions on secure communication systems/equipment and write detailed TEMPEST design plans, test plans and test reports for submittal to procuring agency. Requires BSEE and one year experience in Radio Frequency Circuit Design or Electromagnetic Design and practical measurement experience in radio frequency techniques.

DIGITAL SIGNAL PROCESSING

We are seeking an experienced professional to lead the design and development of advanced digital signal processing systems. Reporting to the Manager of Systems Engineering, you will be able to influence strongly the direction of our future signal processing activities. You will develop a fundamental understanding of customer needs and guide the systems engineering effort directed toward design solutions for these needs. You will develop techniques and designs for such applications as radar signal processing, sonar signal processing and communication modulation/demodulation. Requires an advanced degree in Engineering, Math or Physics and a minimum of 10 years professional experience in the engineering analysis and design of communications, radar or sonar systems. A knowledge of the theory and techniques of digital signal processing and the types of machine architecture suitable to this function is necessary. Some experience in the digital implementation of signal processing functions is essential.

To investigate these positions which are with our Eastern Division, please forward your resume outlining salary history and specific position of interest to Mr. Richard I. Hawes.

ADVANCED MODELING TECHNIQUES

Unique opportunities for Engineers to draw on the capabilities of a major company and satisfy their professional ambitions. We seek innovators with experience in any of the following areas: Electromagnetic Propagation and Coupling; Antenna Theory; Network Modeling and Simulation and Systems Modeling. Requires BS in EE or Math and minimum of 10 years experience in system design, network analysis and a familiarity with computer aided network software.

RESEARCH & DEVELOPMENT ENGINEERING

Systems Integration

You will solve system integration problems including functional compatibility, subsystem definition, interconnection, prime power generation and distribution. You will also develop subsystem interface specifications and resolve any interface ambiguities or problems arising during the design and assembly of electronic systems. In addition, responsibilities will involve technical liaison and coordination between functional groups. Requires BSEE or equivalent and 5 years experience, including 2 years of power or signal distribution network design.

COMMUNICATIONS ENGINEERING RADIO & WIRE COMMUNICATION SYSTEMS

Positions are available at various levels including the design and evaluation of various radio and wire communication systems for military and civilian users, as well as responsibility for preparation of proposals and contract performance. Systems will carry analog and digital voice telegraph and data traffic and will often include communications security. Systems may range in frequency for VLF to SHF. Requires BS or Advanced Degree in EE and minimum 8 years experience in any of the following fields: antennas, modulation systems, analog and digital circuits, radio wave propagation, multichannel point-to-point communication systems and application of digital techniques. Background should include strong personal design experience, supervision and proposal and presentation development.

To investigate these positions which are with our Communications Systems Division, please forward your resume outlining salary history and specific position of interest to Mr. James D. Bailey.

GTE SYLVANIA
INCORPORATED

An Equal Opportunity Employer M/F

GTE Sylvania — Central Employment Office
Industrial Relations Support Organization — Eastern Area
189 "B" Street, Needham, Massachusetts 02194

MDR

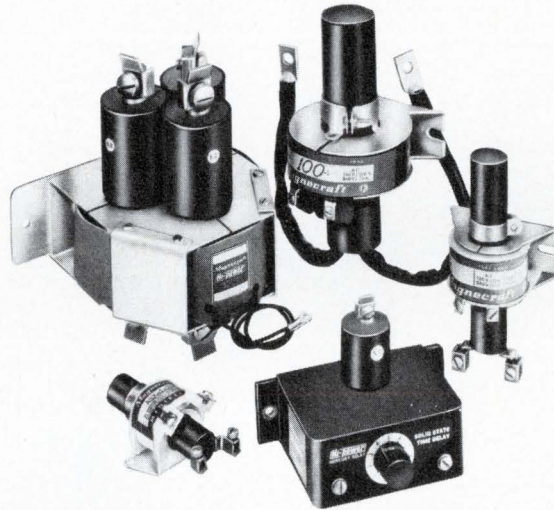

MERCURY DISPLACEMENT POWER RELAYS

Where sealed contact protection is required for explosive, corrosive, dirty or moist ambient conditions; where the use of contactors does not permit contact maintenance; where noiseless operation is required; where weight, size, and cost must be a minimum for contact ratings up to 100 amps,

Mercury Displacement Relays are unsurpassed.

This unique design, which incorporates broad cross-sections of liquid mercury for switching, is what makes the Mercury Displacement relay a high current, high voltage, high power device. Whereas conventional relays, which use hard contacts are destroyed by pitting and sticking under high load conditions, the perpetually self-renewing, mercury-to-mercury contacts insure maximum contact life and in-rush capabilities up to 15 times rated loads.

In a highly competitive business, delivery can be a deciding factor. If delivery is important to you, be aware that Magnecraft ships better than 90% of all incoming orders for stock relays, received before noon, **THE SAME DAY** (substantiated by an independent auditing firm). In addition to our shipping record, most stock items are available off-the-shelf from our local distributor.

FREE!



MDR CATALOG

The purpose of this 16-page catalog is to assist the design engineer in specifying the proper relay for a given application. The book completely describes 20, 35, 60, and 100 amp versions with one, two, or three poles as well as Time Delay models of Mercury Displacement Power Relays.

Magnecraft[®] ELECTRIC COMPANY

5575 NORTH LYNCH AVENUE • CHICAGO, ILLINOIS 60630 • 312 • 282-5500 • TWX-910 221 5221

Teradyne's L100 Automatic Circuit Board Test System speaks for itself.

<pre> PASSED GOOD: 43 BAD: 8 </pre>	<pre> FAILED FAILURE COUNTERS (BAD/TOTAL): FTEST 0/36 MTEST 5/83 BTEST 0/1 TTEST 0/2 </pre>
<pre> MT44 D8 THIS TEST PASSED MTEST ON PINS: M LIMIT :+ 500. MV ACTUAL:+ 248. MV </pre>	<pre> TT39 THIS TEST FAILED TIME FROM PIN 18 TO 21 ACTUAL: 00.195 US TMIN: 00.050 US TMAX: 00.190 US </pre>
<pre> FT35 THIS TEST FAILED <ALARMS>S1 FAILING PINS: 20 Z K </pre>	<pre> FT15 THIS TEST FAILED FAILING PINS: S R P N M L J </pre>

If you test circuit boards, you get the message. The L100 doesn't just tell you a bad board is bad. It helps you find out why. And in a fraction of the time you'd usually spend troubleshooting. We'd like to send you a brochureful of reasons why the L100 is the most money-saving system you can buy.

Write: Teradyne
183 Essex Street
Boston, Mass. 02111

In Europe:
Teradyne Europe
S.A., 11 bis, rue
Roquépine,
75 Paris 8^e, France.
Tel. 265 72 62.

TERADYNE

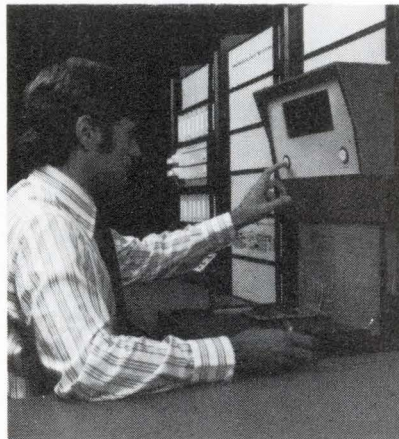

THE ELECTRONIC ENGINEER

Dedicated to the engineer who designs electronic systems for a competitive environment.

December 1972 Vol. 31 No. 12

Cover. Would you like a piece of the foreign market but find that you're puzzled by unfamiliar international standards? You're not alone. Foreign markets are becoming more attractive to many American manufacturers, but even those who haven't had any trouble selling abroad in the past are beginning to realize that they'll have to take international standards more seriously. Turn to p. 38 to learn *why* international standards are suddenly important, *how* they are set, and *where* you can get information about specific foreign standards. (Photo credit: Alberto Socolovsky.)

- 7 Editorial
- 10 Up to Date
- 23 Digital Readouts Course
- 38 Cover Story
- 47 Op Amp Buyers' Guide
- 59 System Products
- 70 Lit Items
- 78 Samples
- 79 Advertising Index
- 80 Consciousness π

16 POWER SEMICONDUCTORS . . . still the main movers Arthur J. Boyle

While the smaller discrete power semiconductors have disappeared in the wake of the trend to ICs, the larger power semiconductors are doing better than ever, thanks to new markets. But there have been changes. Fueling these changes are the 20-kHz "revolution" and the hybrid approach.

23 DIGITAL READOUTS COURSE—PART 6

As always, the application shapes your choice of displays. But when your application calls for more than one-line displays and numerics, what's available? Here's a look at the diversity of panel and CRT multi-line displays from which to choose.

- Introduction** Stephen A. Thompson, **The Electronic Engineer**
- Self-scan** Richard Saxon, Burroughs Corp.
- Ac plasma panels** H. Gene Slottow, Owens-Illinois
- Flat CRT panels** Edmond N. Elowe, GTE Sylvania
- Electromagnetics** H. O. Peprnik, Ferranti-Packard Ltd.
- CRTs in cable TV** Ray M. Unrath, MSI Television
- Generating characters for phototypesetting** David W. Pinkney, Compugraphics Corp.

38 IGNORE AT YOUR OWN RISK? Christopher P. Kocher

Can electronic engineers afford to ignore international standards? The answer is an unequivocal 'No!' if EEs and their firms want to participate in the fastest growing area of the industry—the over-seas market. Top government and industry experts analyze the intricacies of standards.

47 BUYERS' GUIDE FOR LOW-COST IC OPERATIONAL AMPLIFIERS

Deborah P. Wilkins and Arthur J. Boyle

Last year's Guide listed 688 IC op amps; this year's version contains over 1000 under-\$30 devices. To help make the optimum system choice in the midst of this ever-increasing variety, this comprehensive list classifies op amps by input bias current, offset voltage drift, slew rate, and price.



KEPCO TALKS POWER SUPPLY TECHNOLOGY:

A new tool for system designers...

Almost all of today's programmable d-c power supplies are controlled with respect to their *positive* output terminal. That means that when you seek to program such power supplies with a voltage signal, or the output of a DAC, the power supply's *plus* terminal is common to your signal source. When silicon NPN power transistors are used in a *series* regulator; that's the way the polarities work out.

Kepeco's new interface devices, the NTC, employ a *shunt* regulator configuration to reverse the normal control polarities. Each NTC is a complete power supply, capable of what we term "operational programming," which means that its output can be determined on the basis of input and feedback parameters with its *NEGATIVE* terminal common. Other power supplies couple to it in a non-inverting, unity-gain fashion to function as repeaters or voltage followers.

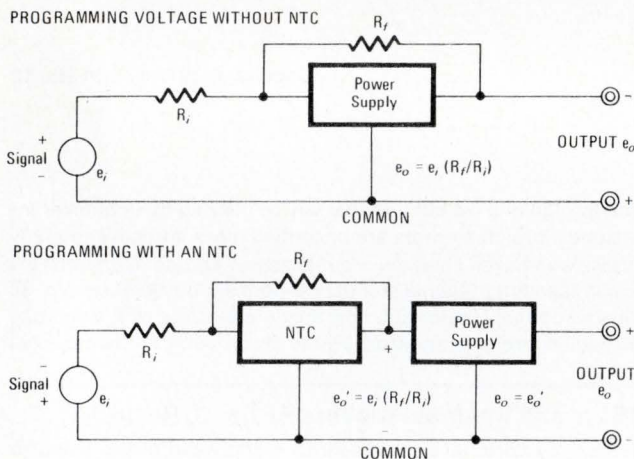

There are two NTC models:

NTC 200	0-200V at 0-10 mA	\$190.00
NTC 2000	0-2000V at 0-1 mA	\$325.00

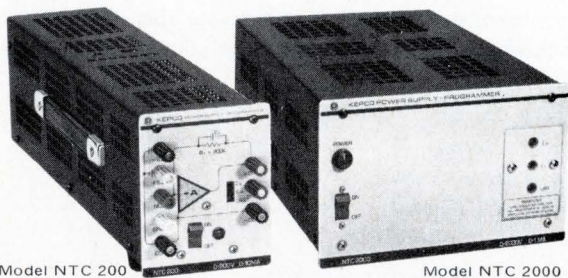

When not functioning as the inverting amplifier for a power supply-booster, the NTC can serve in its own right as a low-powered (2 watt) d-c source with fast-slewing capability: 3V/ μ sec. for the NTC 2000, 1V/ μ sec. for the NTC 200; and low ripple: less than 0.01% or 5 mV, whichever is greater. Their high gain: $>0.5 \times 10^6$ volts per volt, suits NTC for a variety of complementary OP-Amp roles.

For full information on NTC, request Bulletin 146-1267.



Write Department DU-19

KEPCO, INC. • 131-38 SANFORD AVENUE • FLUSHING, N.Y. 11352
(212) 461-7000 • TWX # 710-582-2631
Circle Reader Service #3

THE ELECTRONIC ENGINEER

December 1972
Vol. 31 No. 12

Bernard M. Gittelman.....Publisher
Alberto Socolovsky.....Editor
Arthur J. Boyle.....Managing Editor
John E. Hickey, Jr.....Features Editor
Sheldon Edelman.....Western Editor S. F.
Stephen A. Thompson.....Western Editor L. A.
John McNichol.....New Directions Editor
Deborah P. Wilkins.....Assistant Editor
Christopher P. Kocher.....Assistant Editor
Dr. O. M. Salati.....Consultant
Mae Moyer.....Editorial Reader Service
Phaue Featherson.....Artist
George Baker.....Washington News Bureau
Neil Regeimbal.....Washington News Bureau

Executive and Editorial Offices:
One Decker Square, Bala-Cynwyd, Pa. 19004
Tel: (215) SH 8-2000

Address Mail to:
56th & Chestnut Sts., Philadelphia, Pa. 19139

Western Offices:
Stephen A. Thompson
3727 W. 6th St., #202, Los Angeles, Calif. 90005
Tel: (213) DU 7-1271

Sheldon Z. Edelman
199 First St., Rm. 335, Los Altos, Calif. 94022
Tel: (415) 941-6655

Chilton Officers & Directors: Robert E. McKenna, Chairman; William A. Barbour, President; Richard H. Groves, K. Robert Brink, Executive Vice Presidents; John H. Kofron, Charles W. Hevner, Senior Vice Presidents; James Miades, Vice President, Finance; Thomas J. Casper, Spencer H. Collmann, John P. Kushnerick, Raymond O. Nelson, Eugene C. Beaudet, William A. Phair, David Acton, Donald P. Jones, Richard C. Sorlien, Directors; James A. Naughton, Vice President, Creative Services; Christian H. Miller, Secretary.

Monthly publication of Chilton Company, Chestnut & 56th Sts., Phila., Pa. 19139 (Area Code 215) SHerwood 8-2000. Controlled circulation postage paid at Philadelphia, Pa. \$1 a copy. Subscription rates U.S. and U.S. Possessions: 1 yr. \$12.00; 2 yrs. \$20.00. Canada 1 year \$14.00; 2 yrs. \$25.00. All other countries 1 yr. \$20.00; 2 yrs. \$35.00. © Chilton Company 1972. Title Reg. U.S. Patent Office. Reproduction or reprinting prohibited except by written authorization. Microfilm reproductions of **The Electronic Engineer** and its predecessors, **Electronic Industries** and **Tele-Tech**, may be obtained from University Microfilms, 313 N. First St., Ann Arbor, Mich.

The Chilton Electronics and Instrumentation Group
The Electronic Engineer
Instruments and Control Systems
Instrument & Apparatus News
Medical Electronics and Equipment News
Electronic Component News



YOUR
EDITORS
CARE

**...We care about
our readers**

When money was tight and jobs were in danger, this magazine fought for its readers' jobs.

Now that the economy is up, it points out the growth areas to its readers, because it wants them to share in this growth.

**...We care about
the industry we serve**

We were the first magazine to identify the opportunities for U.S. electronic manufacturers to make and market calculators and data communications equipment.

And, as new opportunities appear, we'll report them here first.

**In good times and bad,
your editors care.**

WE CARE
ABOUT YOU

MONO-KAPSTM

Unique in Availability, Price and Quality

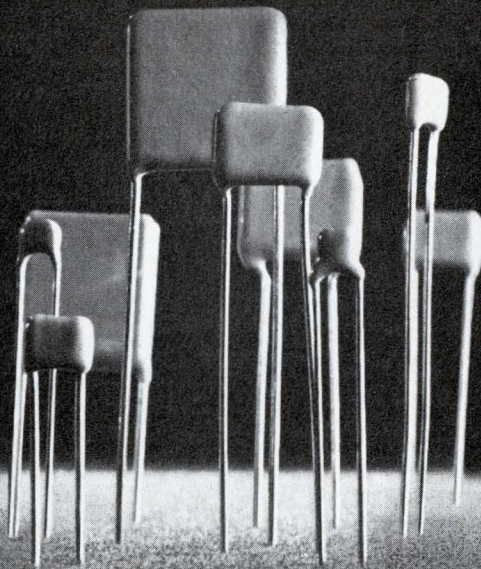

* FREE Samples

USCC/Centralab Mono-Kap Ceramic Capacitors have availability, price and quality inherent in every part.

AVAILABILITY. Immediately available from over 150 distributors are stock units in six sizes from .100 x .100 to .500 x .500. Our four dielectrics are NPO, W5R, Z5U and Y5V, with capacitance values from 4.7 pF to 10 Mfd in 50, 100 and 200 VDC ratings.

PRICE. \$.09 average in production quantities. This low price is due to USCC's development of highly automated assembly techniques resulting in large volume production of Mono-Kaps.

QUALITY. USCC is currently under contract to produce chip capacitors (the heart of Mono-Kaps) at the rate of 25,000 per hour, with a failure rate level of only .001% per 1000 hrs.



*Want FREE evaluation samples? Write on company letterhead to USCC/Centralab. For complete technical data on MONO-KAPS and other quality USCC components, circle the information retrieval number below.

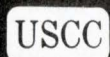

USCC/Centralab

Electronics Division • Globe-Union, Inc.



2151 North Lincoln Street • Burbank, California 91504
(213) 843-4222 • TWX: 910-498-2222

Circle Reader Service #4

For every electronic protection need **BUSS**[®] has a quality Fuse & Fuseholder



1/4 x 1 1/4 inch
Time Delay Fuses
From 1/100 to 30 amps,
MDL MDX
for 32V, 125V, or 250V

1/4 x 1 1/4 inch
Normal Blowing Fuses
AGC GLH MTH
From 1/500 to 30 amps,
for 32V, 125V, or 250V

Space-Saver Fuseholder for 1/4 x 1 1/4 inch fuses projects only one inch behind panel

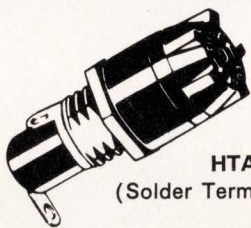

HTA
(Solder Terminals)



HTA-HH
(1/4" Quick-Connect
Terminals)

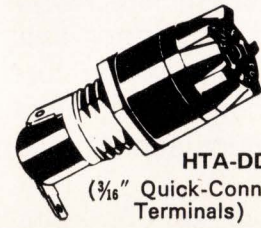

HTA-DD
(3/16" Quick-Connect
Terminals)

ALL FUSE HOLDERS HAVE THESE FEATURES IN COMMON

- Rated for 15 amps at 250 volts
- Dielectrically capable of withstanding 1500 volts a.c. between terminals and between terminals and panel
- Bayonet-type knob grips fuse so that fuse is withdrawn when knob is removed; strong compression spring assures good contact
- Made for installation in D-hole to prevent turning in panel
- Terminals are mechanically secured as well as soldered in holder.

The BUSS line of small dimension fuses and mounting hardware covers the complete spectrum of electronic applications. Use the coupon at right to order the complete catalog.

**BUSSMANN MFG. DIVISION, McGraw-Edison Co.,
St. Louis, Mo. 63107**

SUPPLIED THE ECONOMICAL WAY
... THRU DISTRIBUTORS

BUSS QUALITY

FUSES

BUSSMANN MFG. DIVISION, McGraw-Edison Co.
St. Louis, Missouri 63107

EE 1272

Please send me a copy of BUSS Bulletin SFB

NAME _____
TITLE _____
COMPANY _____
ADDRESS _____
CITY _____ STATE _____ ZIP _____

Think systems

Overview. The big picture. Take a look around.
Tell the forest from the trees.

It doesn't matter what it's called. To have an overview, to get the big picture, to look around, to tell the forest from the trees, you must apply the systems approach.

If you do, you have other engineers, who don't, working for you.

If you don't, you are working for an engineer who does.

This magazine is for those who do. For those engineers who, brought up in the booming days of the 1960s, have learned the sobering lessons of the 1970s. The economic lesson, and the technological lesson.

The economic lesson teaches that progress doesn't automatically lie in the next job, or the next assignment. To progress, you must take a look around, at the opportunities for your talents, for your company's long suit. You must tell the forest from the trees, the real opportunity from the inconsequential one, the clear need from the technological refinement.

The technological lesson teaches that circuit design, which was the most creative occupation for electronic engineers in the 1960s, belongs now in the domain of the component manufacturer, more than in that of the equipment and systems manufacturer. The lesson teaches that you buy circuits, even minicomputers, the way you buy capacitors. It teaches, in two words, to think systems.

We, too, have learned these lessons, and we apply them to give you the information a systems engineer needs today. Look at our cover. We have been a systems magazine for the past three years. Now systems is part of our name. Make it part of yours. Think systems.



Alberto Socolovsky
Editor

The IM7552 1024 bit static MOS RAM.

1. N-channel silicon gate processing.
2. TTL compatibility.
3. Fully decoded on-chip.

**What makes it
so easy to use?**

Did we say easy to use?

Here's a 1024-bit static MOS RAM that's truly TTL compatible. It uses one 5-volt supply and requires no TTL interfacing at all. It's static. No clocks, drivers or refresh circuits needed. It's fully decoded on-chip and comes in standard 16-pin ceramic or plastic DIPs.

What else? How's this: Typical access and read-cycle times are less than 400 nS, typical power 0.2 mW per bit. Output is tri-state. And the device is available in 0 to +75°C or -55 to +125°C temperature ranges. 100-piece prices start at \$20.50 (400 nS version) and \$16.50 (800 nS version). It's the perfect device for peripheral, buffer and minicomputer memories.

N-channel silicon gate with thin film resistors yet.

Here's an exclusive: Combining our N-channel and thin-film technologies lets us achieve much higher packing densities with commensurate lowering of costs and power dissipation.

With the addition of N-channel silicon gate MOS to the processes we're already using—bipolar TTL, complementary MOS (C/MOS) and P-channel silicon gate MOS—Intersil now offers more production techniques, with a wider range of performance and prices, than any independent solid-state memory manufacturer.

Just what you'd expect from Intersil, 10900 North Tan-tau Ave., Cupertino, CA 95014

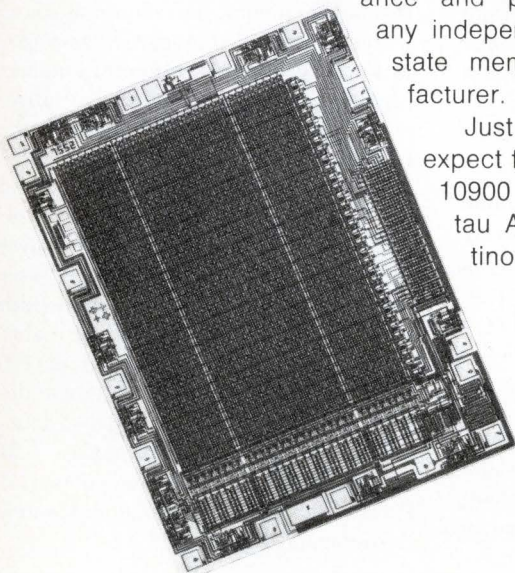

Get 'em here.

Intersil stocking distributors. Schweber Electronics. Semiconductor Specialists. R. V. Weatherford Co.

Intersil area sales offices. Boston (617) 359-7188. Chicago (312) 371-1440. Los Angeles (213) 370-5766. Minneapolis (612) 925-1844. New York (201) 567-5585. San Diego (714) 278-6053. San Francisco Bay Area (408) 257-5450.

Overseas representatives. Copenhagen: E. V. Johanssen A/S. Helsinki: Digelius Electronics Finland OY. London: Tranchant Electronics (UK) Ltd. Milan: Auriema Italia SRL. Munich: Spezial Electronic. Paris: Tranchant Electronique. Stockholm: Elektroholm. Tel Aviv: Schweber Electronics. Tokyo: Internix. Zurich: Laser- & Electronic-Equipment.

U.S. Representatives in all major cities.

Intersil

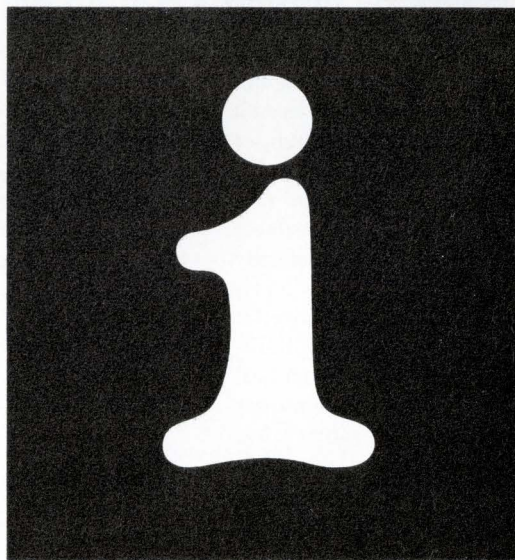

Thin film modulates lasers

A magnetically controlled switch for modulating laser light has been developed by Dr. P. K. Tien and R. J. Martin of the Electron Physics Research Dept. of Bell Labs, Holmdel, NJ.

The new switch consists of a yttrium gallium scandium iron garnet film, about $2.5 \mu\text{m}$ thick, grown on a gadolinium gallium garnet substrate. The film serves as a waveguide for the light waves. Two types of light waves can propagate in this film: one type has magnetic transverse (TM) fields; the other type has electric transverse (or TE) fields.

A prism is positioned at either end of the garnet crystal wafer, one prism to guide the beam from an external laser into the film, and a second "exit" prism, which guides the laser beam out of the film in one direction for the TM light-waves and in another direction for the TE lightwaves.

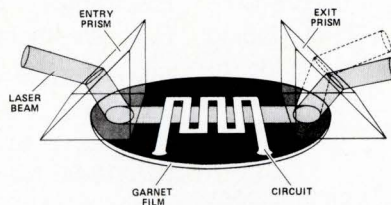

A tiny serpentine electric circuit, made by conventional integrated circuit techniques, applied to the surface of the garnet wafer, overlaps the path followed by the laser beam through the garnet film. Light is fed into the film by the "input" prism in a TM mode. A current passing through the serpentine circuit induces a small magnetic field (on the order of a fraction of a gauss) which converts the light wave from the TM mode to the TE mode because of the magnetic-optic property of the film. The exit prism guides the TE and the TM light waves out of the film in two

different directions. Turning the induction current on and off switches the light back and forth.

The magnetic field required to switch the light is several times smaller than the earth's magnetic field, and because of the serpentine structure, the inductance of the circuit is less than $0.1 \mu\text{H}$. In the experiment, less than 100 mW of electrical power was used to modulate the light from a $1.15 \mu\text{m}$ He-Ne laser at a modulation frequency of 80 MHz.

In an eventual optical system, the input prism may be unnecessary since the light wave may be generated in the film by a thin-film laser. The exit prism could be replaced by a thin film polarizer and a film-fiber coupler. The modulator or switch thus would be extremely simple, involving only a magnetic film and a tiny electric current. ■

Circle Reader Service #210

Deflect lasers by tipping a 'sound column'

RCA scientists have developed a laser-beam deflector that employs a tipping "sound column" within a crystal to provide four times the resolution of conventional acousto-optic deflectors.

Key to the RCA development is a simplified, easy to fabricate transducer that both generates and automatically tips the column of sound waves to efficiently deflect a laser beam over a broad angular range. Because the transducer can be made with economical evaporation and masking techniques commonly employed in fabricating electronic devices, the deflector has great potential for such applications as high-speed, high-capacity optical computer memories and laser scanning for TV picture projection.

In acousto-optic deflectors, a laser beam is diffracted as a result of the periodic disturbance created by sound waves propagating through certain crystals or liquids. The frequency of the acoustic waves determines the amount, or angle, of deflection.

Thus, by electronically altering the input to a transducer that converts radio

frequency (rf) waves to sound waves, a laser beam can be directed to a number of different spots very quickly.

But deflectors with a fixed column of sound waves have a limited deflection range because acoustic waves diffract or deflect light efficiently over only a narrow angular range (*i.e.*, the Bragg angle). The angular deflection range can be enlarged by tipping the column of sound waves to change the angle at which the laser beam strikes the acoustic waves.

Scientists have known that a sound column could be tipped by changing the frequency of sound waves passing through an acoustic grating, but up to now have been unable to develop a practical inexpensive mechanism for accomplishing this. Prior techniques involved cutting steps in the acousto-optic material and bonding several transducers to it, a relatively complicated procedure requiring a great deal of handling that often resulted in damage to the acousto-optic material.

RCA's solution, on the other hand,

uses a single transducer platelet bonded to a lead molybdate crystal. The interdigitated electrodes within the transducer are deposited in layers through masks by an evaporation technique.

The electrode arrangement acts like an acoustic grating so that for any given rf-input frequency, the column of sound waves is tipped at a particular angle. Any change in the rf-input frequency produces changes in the tipping angle of the sound column as well as in the frequency of the sound waves.

This automatic tipping of the sound column in combination with the frequency change in the acoustic waves enables the deflector to move the laser beam over a much wider bandwidth than conventional deflectors can. Laboratory results show bandwidths of 210 MHz compared with conventional deflector bandwidths of 54 MHz—a four-fold improvement in performance. ■

For additional information contact Al Pinsky, David Sarnoff Research Center, Princeton, NJ 08540.

Circle Reader Service #211

Their FIFO isn't half the data buffer ours is.

So ours will only cost you about half as much to use.

Because the Western Digital FIFO (First-In First Out) buffer memory is 9 bits wide, just like your data. And you don't have to pay for two devices to do the job of one.

That makes our FR1502A FIFO ideal for terminals, computers or data communications systems. For interfacing high and low speeds or synchronized and unsynchronized systems. For formatting. And even as a digital delay line.

To use it, simply insert our FIFO into your data stream. It's fully TTL-compatible, with three-state inputs and outputs for bus compatibility, and can be expanded with no additional hardware.

Characters loaded into memory automatically "ripple" to the last unoccupied position. As a character is unloaded, the remaining characters automatically shift towards the output. Because there is no common clock, inputs and outputs operate simultaneously at independent data rates up to 1 MHz.

It's the most cost effective method of data speed buffering available. But then, maybe that's why Western Digital has more data communications subsystem chips, standard and custom, working in more applications than anyone.

Contact us now and see what we can do for you. Western Digital Corp., 19242 Red Hill Avenue, Newport Beach, Calif. 92663. Tel: 714/557-3550.

FIFO FEATURES

- 9 bits x 40 characters
- 1 MHz input/output
- TTL-compatible
- Three-state data lines
- Master reset and status flags
- Expandable with no external hardware.

9 x 40 FIFO (FR1502A)

DATA IN

DATA OUT

INPUT REG. EMPTY

INPUT ENABLE

MASTER RESET

OUTPUT STROBE

OUTPUT DATA READY

WESTERN DIGITAL
CORPORATION

**MOS/LSI
that works.
Harder.**

RCA does it again . . . Last month it was three million power transistors for Chrysler's electronic ignition systems; this month it's cos/mos integrated circuits for a non-stop electronic clock by Patek Philippe, a Swiss clock and watch manufacturer. Putting another dent in the consumer electronics market, RCA will provide ics to replace mechanical moving parts of conventional clocks. Output signals from the ic control the display (clock hands or digital display), providing accuracy to within a few seconds a month and, if standard power supplies are not used, operation for a year off one small battery.

Circle Reader Service #225

Mini or calculator . . . or terminal? . . . The less-and-less distinct line between minicomputers and desk top calculators has been completely erased by Hewlett-Packard. Their new Model 9830 desk calculator offers an alphanumeric keyboard, both semiconductor and cassette memory, and programmability in a version of BASIC more powerful than some time-shared versions of the same language. The calculator drives an optional 80 char./line, 250 line/min. thermal line printer. By adding a plug-in ROM, you can use other peripherals as well, including an X-Y plotter, a card reader, and a teletype input. If you have a program too long to run on the 9830, you can add another ROM and a modem and use both calculator and printer as a terminal to access your time sharing system. For information,

Circle Reader Service #226

TV display panel uses gas discharge principle . . . Following the defeat of past attempts to produce panel displays with incandescent lights, electroluminescence, and liquid crystals, Zenith has come up with a matrix device producing a TV picture of sufficient quality to warrant comparison with a CRT. Using a Burroughs SELF-SCAN® panel 0.63 in. thick, the experimental unit produces a 2.4 x 6.3-in. red picture composed of 80 columns and 212 rows of gas cells. The panel has a peak luminance of 8 ft-L and a contrast ratio of 40:1. In operation, a full line of cells in the panel is addressed at the same time. Illumination time of the full line of gas discharge cells is 60 μ s, compared to the 100-ns excitation time of each phosphor dot in the CRT.

Circle Reader Service #227

A new role for the IEEE . . . In an imposing vote, the IEEE received a clear-cut mandate from its members to take a more socially conscious role. Some 42,899 engineers from the 50,950 respondents sanctioned the IEEE leadership to change the present charter. According to GE's Dr. Harold Chestnut, president-elect, the society will concentrate on improving the engineer's situation by working with government agencies on manpower planning, the continued need for unemployed engineers' programs like VEST, support for legislation such as S.32 for civilian R&D spending, and technology assessment. Pension improvement, another likely area, will be initiated. As for that 40% increase in dues, 20% will go to these new areas, plus the traditional scientific goals, while most of the other 20% was necessitated by inflation.

Monsanto: moving in on bubble memories . . . Firmly established as a top manufacturer of light emitting devices, Monsanto appears to be making a pitch for the memory market with their introduction of a bubble memory. Their strength in materials processing makes the bubble memory, emerging as a possible replacement for disc memories, right up their alley. Already they've marketed the first purchasable sample bubble memory kit for \$2400 (the memory is a small shift register) aimed at potential buyers who want to experiment with bubbles. If you're interested in more details, contact Dr. Ramo Pellin, Monsanto Co., 800 N. Lindbergh, St. Louis, MO (314) 694-4848, or

Circle Reader Service #228

Some say the electronics industry is slowing down . . . Industry spokesmen from Bell Labs, NCR, Xerox, IBM, Fairchild, TI, IEEE, and others have compiled a study of the U.S. electrical/electronics industry and its current trends and potential impact on the overall economy. Scanning the bleak picture of the '70s, the committee sees the demand for engineers increasing only 2% per year, and industry growth at 7-8%. They predict that government spending in domestic areas during the decade will not offset decreases in military and space programs. Aggressive government action to reduce trade barriers for fair competition is critical, as is more support for R&D if we are to maintain our technical leadership. The study, with details on these and other observations, is available from IEEE, 345 E. 47th St., New York, NY 10017. (Members, \$6; non-members, \$12.)

And many are inVESTing talent elsewhere . . . Just one year ago, VEST (Volunteer Engineers, Scientists, and Technicians) opened the facilities of state employment offices to out-of-work engineers who wanted to help themselves find jobs. Today, VEST is still hard at work and although the picture isn't as rosy as they would like it to be, they are making progress. More corporations are accepting more aerospace and highly specialized engineers into other industries: this year VEST officers placed approximately 20,000 men in new jobs. And now VEST is working jointly with the Technology Mobilization Reemployment Program, funded by the Dept. of Labor which offers up to \$500 for job interview travel and expenses, relocation grants up to \$1200, and up to \$2500 for job training tuition and expenses. If you'd like to inVEST your time finding a job, contact your local state employment office.

Conferences and shows coming up . . . **1973 Winter Consumer Electronics Show**, sponsored by the Electronic Industries Association at the Conrad Hilton Hotel, Chicago, Jan. 12-16 . . . **International Solid State Circuits Conference**, Philadelphia Marriott Motor Hotel, Feb. 14-16 . . . **'73 INTERCON**, sponsored by the Institute of Electrical and Electronics Engineers, New York Coliseum, March 26-29.

Φ-LINE PLASTIC PUTs

24¢

more of the best for less for more types of timing circuits

The Programmable Unijunction Transistor (PUT) has superseded conventional Unijunctions. It has become the preferred device for low-cost timing circuits, oscillators, sensing circuits, and many other variable voltage level threshold applications. Now with the addition of 4 new plastic PUTs, Unitrode has the broadest line available—15 standard types including hermetically sealed. And we will select to meet your specific needs. Unitrode also offers the highest voltage PUTs and the first with better than 1% oscillator timing accuracy guaranteed from -55°C to $+125^{\circ}\text{C}$. Φ-Line plastic PUTs are available off-the-shelf for as low as 24¢ ea. in quantity, and they come complete with the services of a strong applications engineering staff. For fast action and the name of your nearest Unitrode distributor, call Sales Engineering collect at (617) 926-0404. Unitrode Corporation, Dept. 12 W
580 Pleasant Street, Watertown, Mass. 02172



UNITRODE quality takes the worry out of paying less.

Unitrode Corporation

Dept. 12W, 580 Pleasant St., Watertown, Mass. 02172

Please send free samples of Φ-Line plastic PUTs

P13T1 for general purpose. P13T2 for long interval timing
 2N6027 2N6028

Please send PUT information folder, complete with data sheets and application notes.

NAME _____ TITLE _____

COMPANY _____

ADDRESS _____

CITY _____ STATE _____ ZIP _____

High-Voltage

...the universal answer?

We've got more power Darlington's than anyone else. First to introduce them. First to offer complements. First to do what they said couldn't be done — single-diffused, UniBase † power Darlington's. Now we're offering high-voltage types in state-of-the-art, triple-diffused, etch-cut technology.

Impressive, you say. "I can use high-voltage power Darlington's right now to get a competitive edge in my equipment market."

Hold on. Maybe one of the other high-voltage techniques, in a discrete device, would be a better answer. Double-diffused or triple-diffused Annular.* And unless you understand the basics of all three HV technologies you won't get what you really want — an optimum device matched to true design needs, with the best tradeoffs in device characteristics.

Lots of designers are educating themselves before using any process. Questioning and comparing to find out which is best for their needs. Studying. Checking. Challenging.

"Why should structure make a difference?"

"Which is best for high-speed inverters?"

"Are there SOA tradeoffs?"

"Can I get high-voltage and high-current in one?"

"What about complementary designs?"

If you're satisfied with your supplier's answers, your education, your design, fine. If not, listen.

YOUR POWER STRUCTURE . . .

Know it before you use it.

Emitter and base on old-reliable, double-diffused Annular types are diffused into an epitaxial substrate. Devices are characterized by high frequency response, excellent switching efficiencies and complementary capability. The Annular ring retards inversion layer leakage and shapes surface electrical fields eliminating fringing field effects. But inherently narrow base width limits optimum safe operating areas. Result — devices that switch fast at high currents with excellent beta linearity . . . as long as they're not required

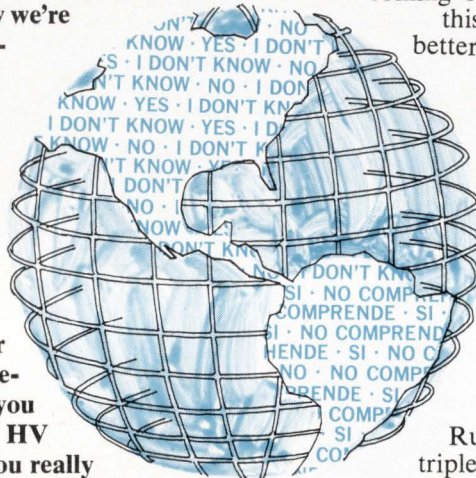

to operate into overly reactive loads.

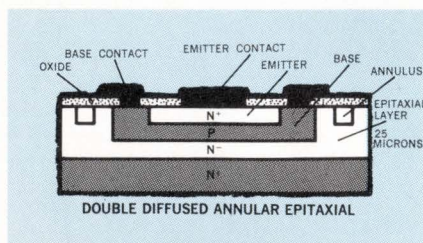

More sophistication, and more SOA, can be had with triple diffused. The Annular approach is applicable but base, emitter and collector are separately diffused. Collector layer can be 1/3 or more thicker than double-diffused with emitter and base profiles coming on proportionately deeper. Net effect of all this is allowance for wider depletion regions and better defined fringing fields (i.e. higher voltage), increased SOA and moderate f_T . One pays the price with poorer switching efficiency and lower gain.

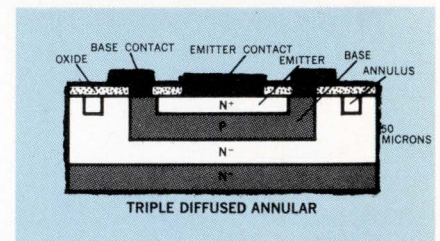

Ruggedness with a reverse twist characterizes triple-diffused, etch-cut technology. Mesa structuring is used for ultra-deep base diffusions. But this precludes use of metal overlays to retard fringing field effects. Etch-cutting from the back side at a precise angle to define the junctions solves this problem and provides high operating voltage and SOA potential.

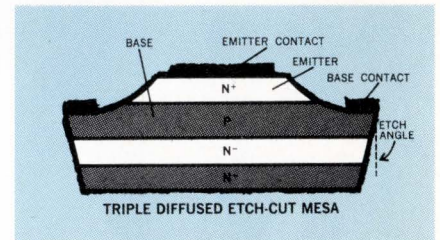

TECHNOLOGY OVERVIEW . . .

If you're at home with high-speed, high-current switching, double-diffused can't be beat. Generally, gain linearity with voltage is better, too, with sat voltage coming in low because of limited epi layer thickness. In a high-speed design where most device heat stems from switch losses, it's a mistake to use super-rugged, slow types. Triple-diffused, however, is your best bet where speed and efficiency take a back seat to operating voltage and ruggedness. But the wider the base, the lower the current — and triple-diffused is basically wide-base.

You can't have everything.

Process Characteristic	Double Diffused Annular	Triple Diffused Annular	Triple Diffused Etch Cut
f_T	30-80 MHz	10-30 MHz	5-10 MHz
SOA@ 100V	7W	15W	30W
Voltage	20-300V	40-1000V	To 2000V
Current	100A	20A	20A

Power Darlington

THE APPLICATIONS . . .

High voltage is everywhere and more! Regulators, converters, inverters, TV, line-operated amps, auto ignition, ad infinitum. Where to plug the process? Simple. Follow our recommendations: we've factored in trade-offs — gain, f_T , ruggedness and breakdown voltage. In pulse mode designs where you're responsible for fast-changing load conditions and junction heating is minimal, double-diffused is desirable. As you go up the voltage/SOA ladder, triple-diffused tips the scales in its favor. In some cases, such as high voltage switches, all three technologies will fill the bill—and the speed/SOA demands of your application will determine your choice. HV complements can be had too — but there are two processes involved that must be matched and slight variations in f_T and SOA have to be considered.

Application	PROCESS		
	Double Diffused Annular	Triple Diffused Annular	Triple Diffused Etch Cut
Series Pass. Regulator			•
Inverter			•
TV Deflection		•	•
Small Screen			•
Large Screen			•
Auto Ignition		•	•
High Voltage Amplifier		•	•
High Voltage Switch	•	•	•
Power Switch			•
Slow		•	
Medium Speed		•	
Fast	•		

THE PACKAGING . . .

For your optimized form factor: plastic discretes, metal TO-66 and TO-3 discretes, plastic and TO-3 Darlington, plastic and metal discrete complements. For your optimized cost factor: HV prices start at 65¢, 100-up.

THE DARLINGTONS . . .

It's been said before — Monolithic power integrated circuits with revolutionary new levels of super-high gain, direct logic-to-Darlington interfacing, simplicity, cost-savings. It bears repeating. Now all the advantages are there in triple-diffused HV Darlington. Depending on your conclusions and your needs, your choice will be Darlington or discretes, in the technology that fits best.

Draw those conclusions now. Match your design need with an unmatched high voltage power capability. Write us at Box 20912, Phoenix, AZ 85036 — contact your Motorola distributor for prototype or production.

Motorola is the source for high-voltage power. No question about it.

*Patented Process of Motorola Inc.

†Trademark of Motorola Inc.



MOTOROLA POWER
—Technology By Design, For Design

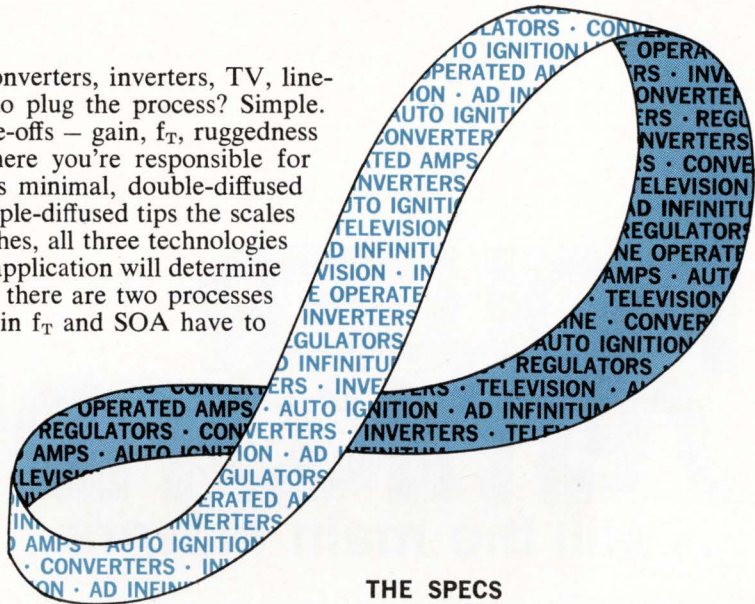

THE SPECS

. . . NEW HIGH-VOLTAGE DISCRETES

DEVICE	BREAKDOWN VOLTAGE	SAFE OPERATING AREA	FREQUENCY
2N6306-8 Triple-Diffused Etch Cut	500-700V	250V @ 40mA	5 MHz
MJ7160, 61 Triple-Diffused Annular	300, 400V	100V @ 200mA	30 MHz
2N6277, 81 Double-Diffused	150V	10V @ 20A	30 MHz

. . . plus a choice between these HV discretes

2N3439, 40	2N5838-40	MJ701	MJ3430
2N3738, 39	2N6233-35	MJ704, 721	MJ4645-48
2N3902	2N6259, 62	MJ702, 723	MJ9000
2N4240	2N6341	MJ1800	MJE341, 344
2N5051, 52	MJ105	MJ2251, 52	MJE350
2N5157	MJ400	MJ3010-12	MJE2160
2N5241	MJ410, 411	MJ3026, 27	MJE2360
2N5344, 45	MJ413, 423, 431	MJ3028-30	MJE3439, 40
2N5555, 56, 57	MJ420	MJ3201, 02	MJE3738, 39
2N5655-57	MJ424, 425	MJ3260	MJE5655, 56, 57

. . . NEW HIGH-VOLTAGE DARLINGTONS

MJ3040-42 Triple-Diffused Etch Cut	400-500V	300V @ 40mA	5 MHz
---------------------------------------	----------	-------------	-------

. . . NEW HIGH-VOLTAGE COMPLEMENTS

2N3583-85 Triple-Diffused Annular	175-300V	70V @ 500mA	15 MHz
MJ3583-85 Double-Diffused PNP			30 MHz
MJE340 Triple-Diffused Annular	300V	250V @ 15mA	15 MHz
MJE350 Double-Diffused PNP			30 MHz

POWER SEMICONDUCTORS

... still the main movers

**When the application calls for brawn as well as brains,
the power semiconductor is still the workhorse of the electronics industry.**

Arthur J. Boyle, Managing Editor

Power semiconductor manufacturers are wearing big smiles these days. The combination of technical innovation with the changing nature of the electronics industry has kept power devices in the ballgame, while many small signal semiconductors have struck out to ics. Instead of seeing a decrease in demand, the discrete power device, which is still the primary source of electronic muscle used to interface with the outside world, is riding the wave of the pervasiveness of electronics into new markets.

The era of the power transistor began back in the days when germanium was king. Surprisingly enough, despite the revolution brought on by silicon technology and the annual predictions of an early demise, germanium power transistors are showing an amazing tenacity. Although used in only a limited number of applications (with the automobile radio the most widely known) germanium still ranks as a very profitable line for the two major suppliers still in the business—Motorola and Delco.

If the germanium transistor still shows amazingly good health in its old age, the prognosis for silicon devices can only be described as excellent. With the advantages of the material itself, the advances in processing, and packaging improvements, silicon

power devices have evolved into a family with great flexibility. Most of the silicon power transistors on the market today are produced by one of five processes. The table shows the main characteristics of each, and as with anything else, tradeoffs are the order of the day.

Happiness is at 20 kHz

The big news in power semiconductors is what Leo Lehner of Motorola calls the 20-kHz revolution. What Lehner is advocating is that the switched mode of power supply design, long attractive for a number of reasons, has at last become a practical alternative to the more common pass-transistor design approach. The savings in size and weight in the power transformer alone make the switched mode approach desirable. This is true not only in the obvious case of portable equipment, but across the board since ics have shrunk equipment to the point where power transformers stick out like a sore thumb. The driving force behind this move is the availability of high-speed power transistors at competitive prices. (High speed, in this case, means a fall time of significantly less than 1 μ s. For example, Lehner points to the 2N6307.)

Ralph Hartz, RCA/Solid State Div., is also a proponent of the switched power supply school. And

(text continues on p. 20)



THIS LOOK-ALIKE

CUTS 20% FROM YOUR PACKAGE COSTS

Elco's Series 6064 discrete card edge connectors look like . . . and work like . . . other discrete card edge connectors. With one major exception. Ours can save you up to 20% of your total package cost.

Because we'll supply our Series 6064 connectors mounted on our Variframe™ back panel which we'll custom design and build to your requirements. With connectors wired (up to three levels of wire wrapping) to your specs. And with input/output connectors and voltage and/or ground buses. To give you the best performing package at lowest cost. Fast.

Then again, if you're in a hurry for a look-alike that is, call your local Elco distributor. He has our Series 6064 connector in three sizes: 36/72, 40/80 and 50/100 contacts. With bifurcated bellows contacts on .125" grid. All with .025" square tails. And diallyl phthalate insulators that accept .062" printed circuit cards. And he's got them all on his shelf. Plus other card edge connectors at .100", .150", .156" and .200" spacings. Ready to go.

Availability. And economy. These are what distinguish our look-alikes from theirs. Just two more services in keeping with CONNECTRONICS, Elco's Total Connector Capability.

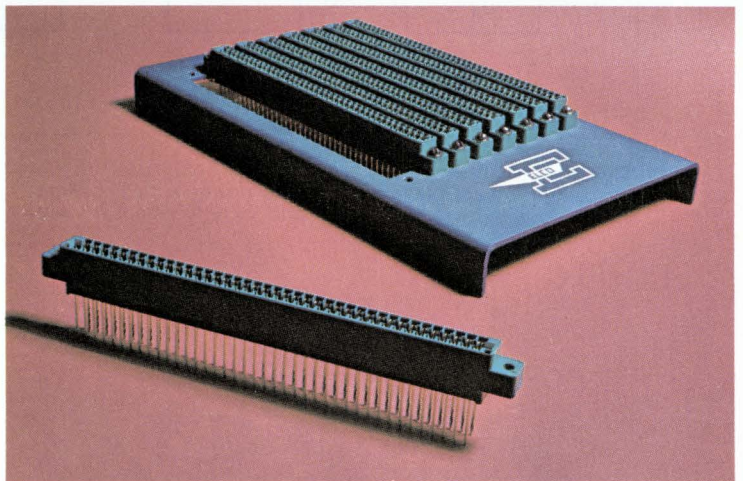

For full details and specifications on our Series 6064 connectors, contact:

Elco, Willow Grove Division,
Willow Grove, Pa. 19090
(215) 659-7000

Elco, Pacific Division, 2200 Park Place,
El Segundo, Calif. 90245
(213) 675-3311



Circle Reader Service #8

POWER SEMICONDUCTORS

Comparison of Common Transistor Diffusions

Process	Epi-base	Single-diffusion	Triple-diffusion (annular)	Triple-diffusion (etch-cut)	Double-diffusion (epitaxial)
Characteristics	$I_c = \text{to } 50 \text{ A}$ $BV_{CE0} = \text{to } 140 \text{ V}$ SOA* = Exc. $f_T = 4\text{-}8 \text{ MHz}$ SW = Slow	$I_c = \text{to } 30 \text{ A}$ $V = \text{to } 140 \text{ V}$ SOA* = Exc. $f_T = 1\text{-}2 \text{ MHz}$ SW = Slow	$I_c = \text{to } 10 \text{ A}$ $V = \text{to } 400 \text{ V}$ SOA* = Fair $f_T = 20\text{-}30 \text{ MHz}$ SW = Medium	$I_c = \text{to } 10 \text{ A}$ $V = \text{to } 800 \text{ V}$ SOA* = Good $f_T = 4\text{-}10 \text{ MHz}$ SW = Medium	$I_c = \text{to } 30 \text{ A}$ $V = \text{to } 200 \text{ V}$ SOA* = Low $f_T = 40\text{-}150 \text{ MHz}$ SW = Very fast
Complements	NPN/PNP	NPN	NPN	NPN	NPN/PNP
Outstanding features	Versatility	Ruggedness	High frequency response	High voltage performance	High speed
Typical application	General purpose NPN/PNP complementary	Pwr sup. regulators	Inverters—Converters	TV defl. circuits	High-speed switching

*Safe operating area

(Courtesy of Motorola Semiconductor)

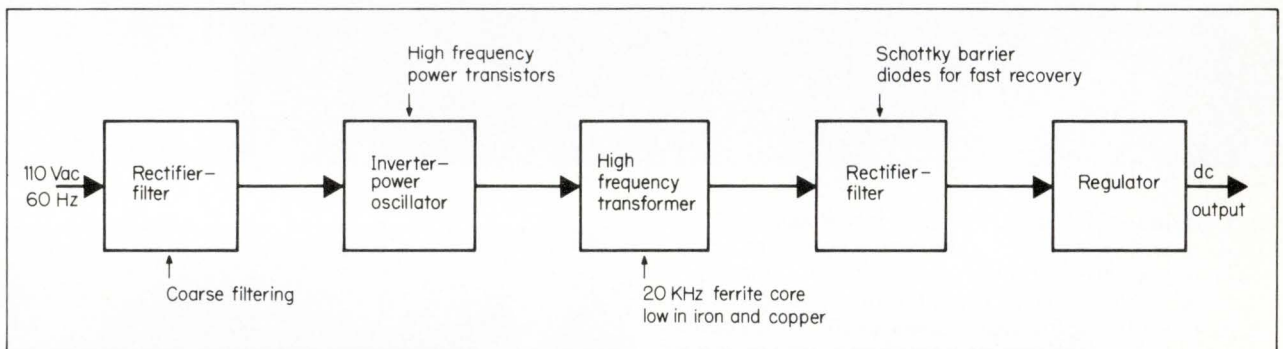

The 20-kHz revolution. That's the term being used to describe the impact of switched-mode power supplies. High-speed, high-voltage transistors and Schottky-barrier recti-

fiers are combining to make this approach very attractive in a great number of applications.

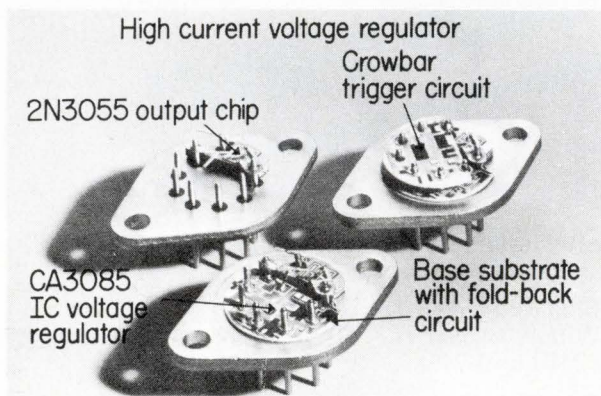

Hybrid power function modules are one area due for substantial growth and corresponding price reductions. These two devices from RCA illustrate the traditional advantages of

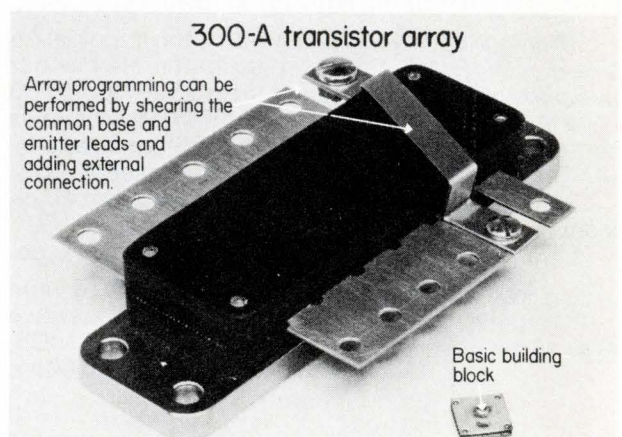

hybrid circuits: less space than discrete designs and more flexibility and power handling capability than monolithics

Right for the times!

Here's why these new counters—offered in four frequency ranges of **50, 200, 512 MHz** and **3 GHz**—are right for today's requirements:

New 6150 series expandable universal counter-timers.

S-D developed this line to handle almost every counter/timer requirement—bench and systems. Four basic models cover frequency ranges of 50, 200, 512 MHz, and fully automatic 3 GHz. Buy for current requirements and upgrade frequency range at any time. These instruments were designed from scratch for **programmability**: single line or binary, total control including attenuators, and analog or digital trigger level control.

6150 options and features: Choice of 100 nsec or 10 nsec TIM resolution—choice of five oscillators—four types of BCD output—up to 9-digit readout—versatile remote programming—3½" height in full rack width—10mV rms resolution to 0.1 Hz.

Expandability. The expandable counter concept satisfies many needs, present and future. Why? Because it's so simple and economical to **upgrade** the frequency range of your counter and add options. BCD output, additional readout digits, and a 200 MHz frequency range (in place of 50) are added by inserting new plug-in PC cards right inside your lab in minutes. Go to 512 MHz or 3 GHz, higher stability oscillators, 10 nsec TIM resolution (on 6150 universal series), and remote programming—all are offered as expandable option kits installed by your local S-D service center.

	50 MHz	200 MHz	512 MHz	3 GHz
--	-----------	------------	------------	----------

Universal Model:	6150	6151	6152	6153
Counters	Price: \$1195	\$1495	\$1795	\$2995

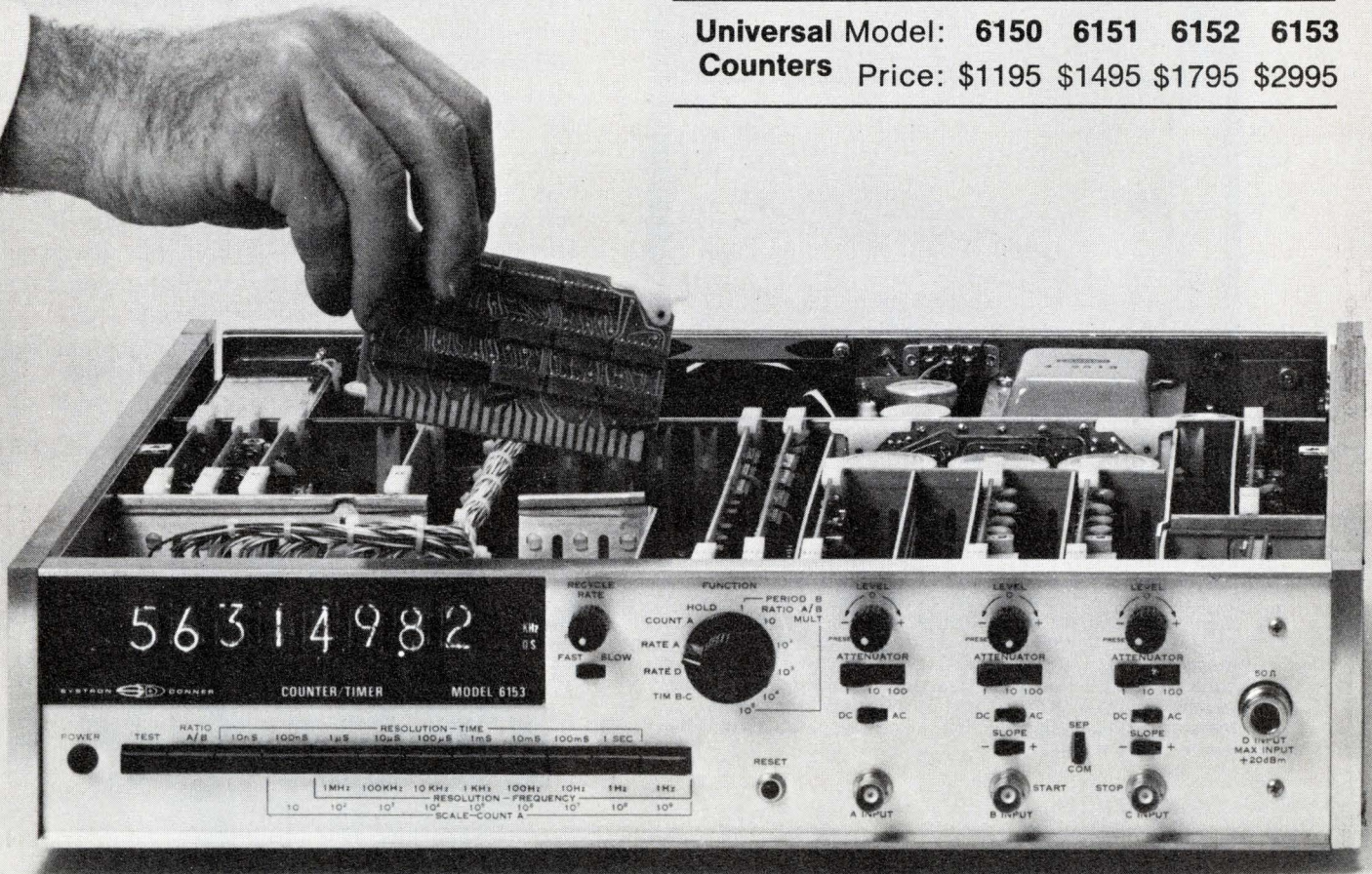

SYSTRON  **DONNER**

Concord Instruments Division, 888 Galindo Street, Concord, CA 94520. Phone: (415) 682-6161

Circle Reader Service #9

POWER SEMICONDUCTORS

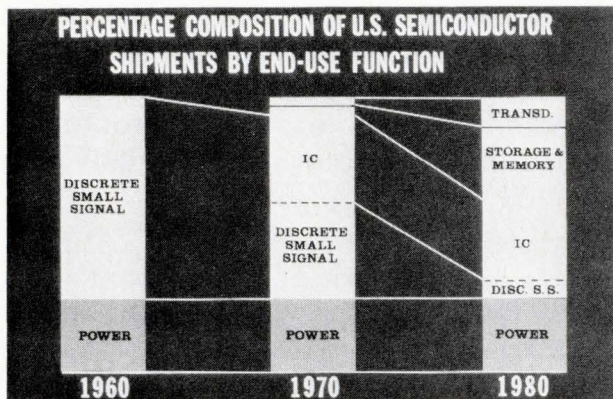

The endurance of the discrete power semiconductor. This estimate of U.S. semiconductor shipments by Texas Instruments shows discrete power devices retaining a constant percentage of the market over two decades. The chief reason for this longevity is that user demands for higher power handling capability are increasing at least as fast as the power capabilities of ICs.

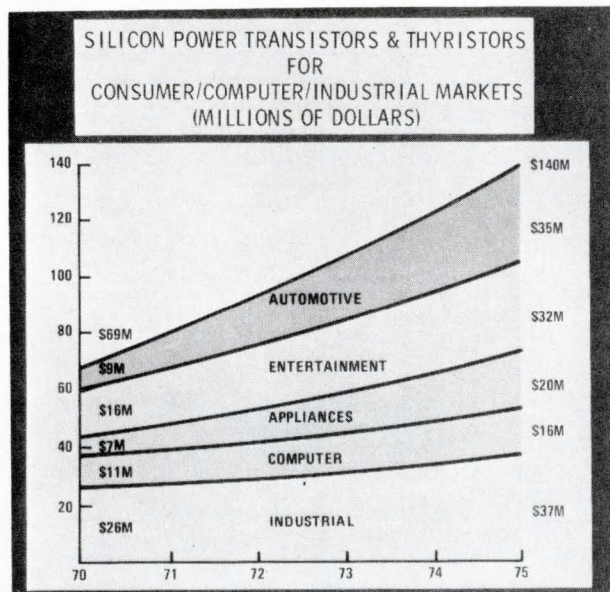

Fueling the growth of discrete power semiconductors is their penetration into the consumer, computer, and industrial markets. The estimated \$140 million total for these market segments accounts for about 50% of the total world-wide market for silicon power devices in 1975. Supporting evidence for these figures appeared recently when Chrysler Corp. announced that it had purchased three million silicon power transistors from RCA for use in the electronic ignition systems of 1973 Chrysler, Plymouth, and Dodge automobiles. (Source: Texas Instruments)

Indicative of what's coming down the pike in power hybrids is this power NAND gate from Motorola. This prototype "solid-state relay" is in a 9-pin TO-3 package and can switch up to 10 A at 60 V.

he sees the situation continuing to improve for the systems designer. "High volume production of high-voltage, high-speed transistors for automotive ignition systems will lower prices even more and further boost the switching regulator market."

Another advocate of switched power supply design as the wave of the future is Dave Cooper of International Rectifier. In fact, Cooper enthusiastically predicts that "there will not be a logic power supply for a major line in the foreseeable future that will not be a switching supply." While Cooper agrees on the importance of the high-speed transistor, he also draws attention to the Schottky-barrier rectifier diodes as an important factor in the popularity of switched mode supplies.

If you can't beat them, . . .

If power devices have withstood the assault of ICs, the power guys haven't been above borrowing a trick or two from the monolithic side of the house. The result is a growing number of hybrid power circuits, ranging from Darlingtons and dual Darlingtons to complex, very high-power functions. Most of the major manufacturers are very interested in this hybrid approach, and there is evidence of growing acceptance on the part of the users. RCA's Ralph Hartz points to the power handling capabilities and the ability to mix technologies as the real strong points of power hybrids. Although generally more expensive than a discrete design, hybrids do offer real savings in inventory and assembly costs. In fact, Hartz contends that today's hybrids can successfully compete on the basis of cost alone if the user is realistic and looks at the overall system cost.

All in all, the power semiconductor picture looks rosy. Of course, a new development could come along and change things drastically, but right now power semiconductor manufacturers are too busy building devices to worry about that eventuality. ■

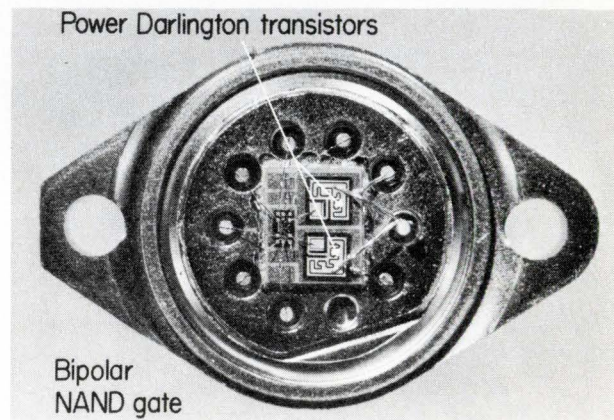

There's only one good way to solder posts and contacts to a PC board.

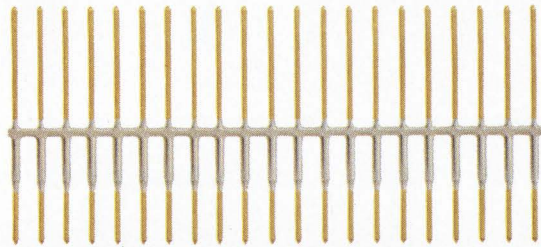

Presolder them before insertion.

That's how we do it. And it's proved to be less costly and more reliable than wave, dip or hand soldering. Here's how it works.

We predeposit solder bands on our feedthrough posts, IC receptacles and PC connectors. In the exact widths and locations you want—within .005-inch. So—with solder already in place—all you have to do is insert and reflow. No masking, preforms or complex wave soldering.

And no problems with wicking,

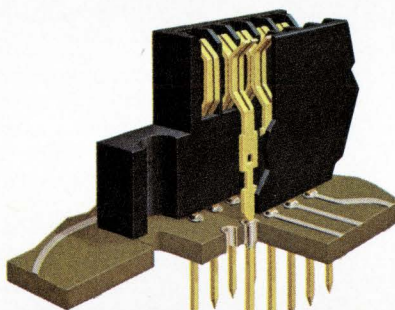

Two-sided PC board

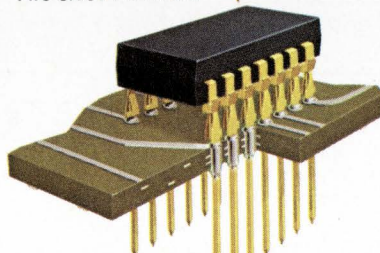

Multilayer board

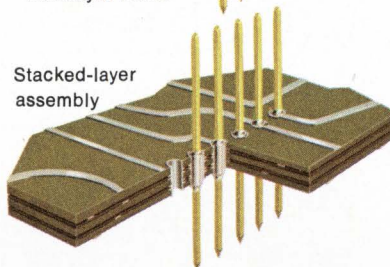

Stacked-layer assembly

bridging, peaks, icicles, board delamination or damaged plated through-holes. After reflow, post and contact ends are clean and ready for point-to-point wiring. And can be replaced without damage to the board.

Find out *specifically* how our selective presoldering can give you better panels at lower cost. In your house or ours.

Write to: **AMP Incorporated,
Industrial Division,
Harrisburg, Pa. 17105.**

AMP
INCORPORATED

Manufacturing and direct sales facilities worldwide: Barcelona, Brussels, Buenos Aires, Frankfurt, London, Mexico City, Paris, Puerto Rico, Sao Paulo, s'Hertogenbosch (Holland), Sydney, Stockholm, Tokyo, Toronto, Turin, Vienna.

#42 Please send literature — possible future interest.

#43 Please send literature — immediate interest.

WALL-TO-WALL GREEN



NEW SOLID-LITE® LEDs

Wall-to-wall green describes the bright, even lighting of Opcoa's new line of numeric displays and wide-view lamps.

Here is what you'll find:

CLEARLY BETTER IN LOOKS

Opcoa displays have large 1/8" characters with high brightness, high contrast . . . lamps give a large, attractive evenly-lighted "dome" of green light . . . both enhance any front panel.

CLEARLY BETTER IN READABILITY

Opcoa's original reflector technology, made possible by the high efficiency electroluminescence of GaP, assures better lighting in all directions . . . evenly-lighted display segments . . . lamps with wide-angle visibility.

CLEARLY BETTER IN RELIABILITY

Opcoa maintains the highest quality control standards . . . each display and lamp is 100% electrically and optically

tested . . . is mechanically constructed for high reliability, uniformity and long life. Opcoa's high efficiency diodes operate with low voltage/low power . . . no other LED units offer such dependability.

Opcoa green is ready for off-the-shelf delivery. See for yourself how much better they really are. Contact our Customer Service Department and arrange an immediate demonstration. OPCODEA, INC., 330 Talmadge Road, Edison, N. J. 08817 • Tel.: (201) 287-0355 • TWX 710-998-0555.

AND IF YOU ALSO WANT TO SEE RED . . .

OPCOA red LED numeric displays and lamps feature all of the same characteristics of OPCODEA green . . . clearly better in looks, readability and reliability. Check the specifications and order now . . . green or red, OPCODEA is clearly better!

DISPLAYS

Green	Red	Description
• SLA-11	• SLA-1	• 7-segment numeric with DP or colon. Std. 14-pin DIP. Char. ht. of .33".
• SLA-12	• SLA-2	• Numeral "1" and a "±". Complements of SLA-11, SLA-1.
—	• SLA-3	• 7-segment numeric with DP. Char. ht. of .77". Readable at distances of over 40 ft.—.100" space leads on 1" centers.
—	• SLA-4	• Numeral "1", a "±" and DP. Complement of SLA-3.

Display and Lamp Assemblies also available

LAMPS

Green	Red	Description
• OSL-11	• OSL-1	• .100" dia. coaxial—180° viewing angle.
• OSL-11S	• OSL-1S	• Two lead version of OSL-1.
—	• OSL-3	• .200" dome—.100" lead spacing—150° viewing angle.
—	• OSL-3L	• Elongated dome version of OSL-3 — mounts thru panels up to 1/8".
• OSL-16-2	• OSL-6	• .200" dia. dome—.100" lead spacing—60° head-on viewing angle. Useful for panel back lighting.
• OSL-16L-2	• OSL-6L	• Elongated dome version of OSL-6 — mounts thru panels up to 1/8".

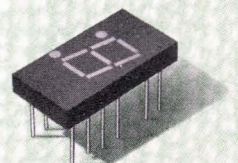

clearly better

Circle Reader Service #10

DIGITAL READOUTS COURSE

PART 6

Multiple line displays deliver big messages

Stephen A. Thompson, Western Editor

Sometimes a single row of characters will not suffice to carry your message. Although that precise point of changeover is hard to define, engineers recognize it when they see it. The abandonment of pure numerics in favor of alphanumeric often coincides with this expansion. Because there is more to say, it's difficult to comprehend more than a few numerics at a time, and the incremental cost of going to alphanumeric is a smaller percentage of the system cost than in one-liner applications.

Panel, multi-line, or x-y character matrix displays can take advantage of many technologies. Such display systems and subsystems tend to be complex, very often custom. In this area, much more so than in few-digit cases, the application dictates the display choice. The "Readouts Illustrated" page in this chapter indicates the diversity. In most of the applications, it is difficult to see how a better choice could have been made.

This chapter begins with plasma panels, which span the small- to medium-size range. The best known is the Burroughs SELF-SCAN® panel, which can range from a single line to a full-fledged terminal panel. The Owens-Illinois type of plasma panel uniquely combines a plasma dot matrix with projected images. This approach can save a system designer untold dollars of software and hardware graphics generation costs.

Plasma panels have progressed rapidly. Plasma panel manufacturers have taken dead aim on the area where CRTs would constitute over-kill, and as resolution improves and size expands, these firms hope to compete across the board. But their competition is not without resources. A small, flat, 2-in. wide CRT made by GTE Sylvania has the same 512-character capability as the larger plasma panels. With this terminal GTE Sylvania hopes to compete head-to-head with plasma for the same terminal sockets.

An undisputed CRT digital display application is the home TV set. Services provided by CATV operators include increasing amounts of digital data in the form of stock quotes, weather, etc. MSI Television describes a system that incorporates such services.

Finally, we look at a method of displaying very large characters, indoors or outdoors. The electromechanical disc or bar provides a rugged, all-weather, all-color solution for stock exchanges or stadium scoreboards. And, although routine testing rarely includes explosion survival, such a display, made by Ferranti-Packard for the Montreal Stock Exchange, was operative after an explosion blew out one wall and moved another six inches.

The next, and final, chapter will talk more about CRTs, outdoor displays, and an experimental LED matrix. It will also include an exam on digital displays. You can convert your knowledge into a certificate for successful course completion.

Multiple line displays: the SELF-SCAN plasma panels

Richard Saxon
 Burroughs Corp., Plainfield, NJ

One of the displays filling the application gap between a series of single-character readouts and 1,000-character CRTs is the Burroughs' SELF-SCAN® panel. These eight-to-512-character display subsystems operate entirely from digital logic level signals and interface with standard 5-V DTL, TTL, or MOS ICs.

Among the advantages and characteristics are the following:

- Although this display requires an ionization potential of about 250 V dc for reliable operation, it needs only 15 mA for a 16-character panel display.
- The incorporation of the x- and y-axis addressing and high voltage drive functions into the subsystem eliminated 90% of the external components formerly required by gas discharge panels. The inclusion of the necessary character generation and scan control circuits completely overcomes the engineering inconvenience of driving high-voltage displays in a typical logic system.

- The user's logic level voltages propagate the glow discharge from cell to cell in a linear scan.
- This narrow, front-panel-mounted, self-contained assembly has only six data inputs (USASCII) representing the display character plus a single data entry clocking pulse.

Characters are written by addressing anode wires with 250 V simultaneously with a glow priming ionization at a cathode. The intersection of the anode and cathode determines where a dot is to appear. To accomplish this timing, the system clock pulse that controls glow priming, also connected to the character generator, controls its output.

The internal character generator IC converts 6 bits of data and a clock pulse into a dot matrix character format. The character is made available column-by-column, 7 bits in parallel, to match the scanning requirements. The system must present input data in a serial-by-word, parallel-by-bit format. A typical data source would be six 16-bit shift registers in parallel or the multiplexed outputs of a parallel-type circuit.

The display can be elongated by adding more cathodes, or heightened by adding front and rear anode sets and a taller cathode matrix sheet. The scanning method remains the same: as length increases, however, more phases are required to insure sufficient time for gas deionization before re-energizing the same bus. (A fixed number of buses and a

(Continued on p. 26)

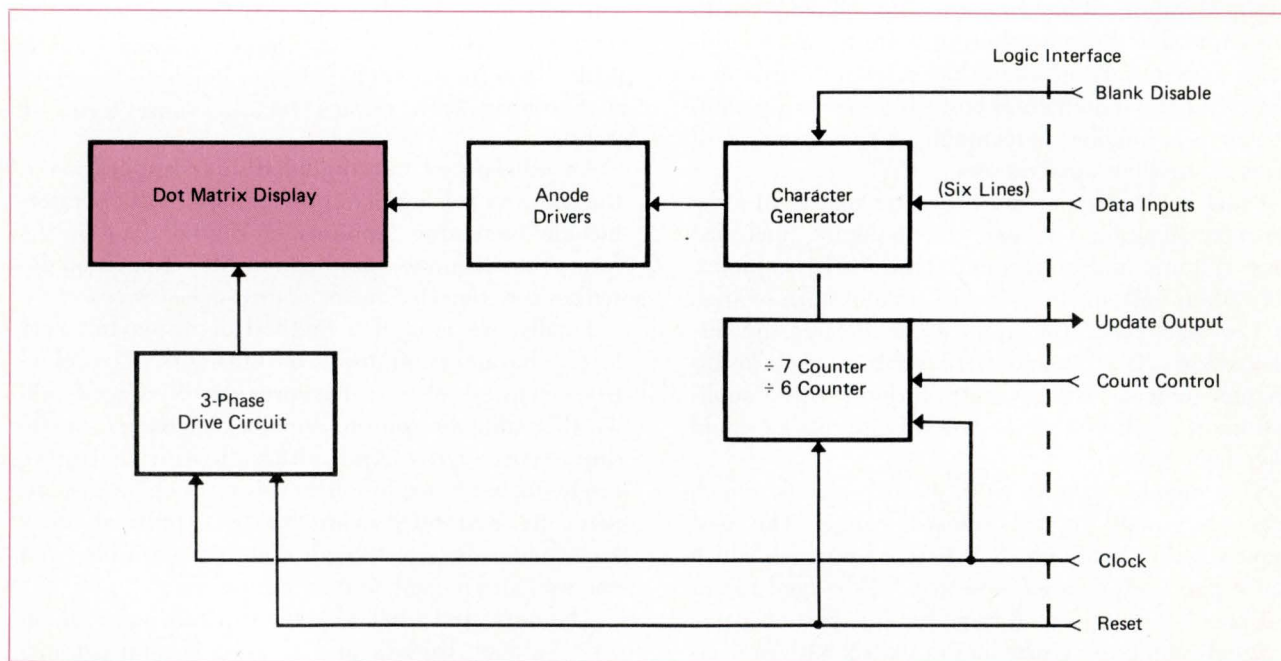

Only 11 input leads control this display subsystem, in sizes between eight and 256 alphanumeric characters. Since all high voltage switching is done internally on the SELF-SCAN®,

the interface design only concerns standard 5-V digital logic levels.

CRTs

Easily the most common digital display panels are cathode ray tubes. A Tektronix 613 storage display (a) is shown combined with a hard copy printer. The CATV display from MSI Television (b) continuously displays data from randomly changing sources in a segmented, variable color format. The 2-in. wide Sylvania Digisplay panel (c) eliminates the CRT's major drawback, volume. The Raytheon unit (d) is shown in an air traffic control application.

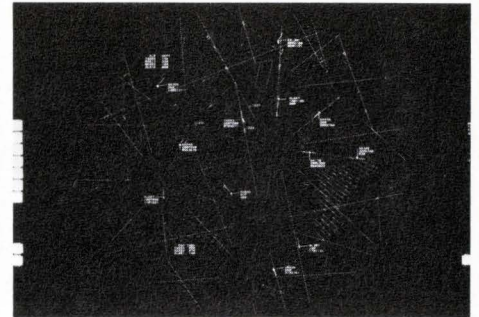
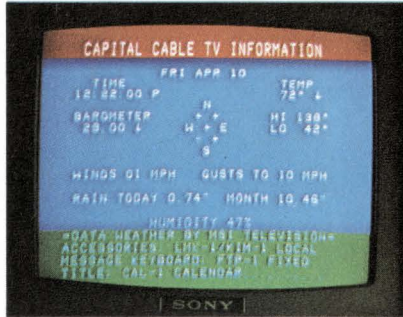
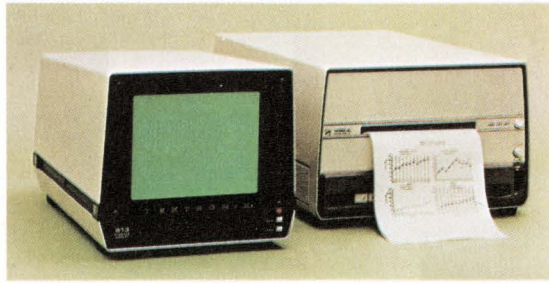

PLASMA PANELS

Thin, flat plasma panels form characters from a matrix of tiny gas discharge cells. Burroughs SELF-SCAN (a) panels cover a range from eight to 512 characters. For a credit verification application, the Owens-Illinois panel (b) combines rear-projected images with digital data formatting.

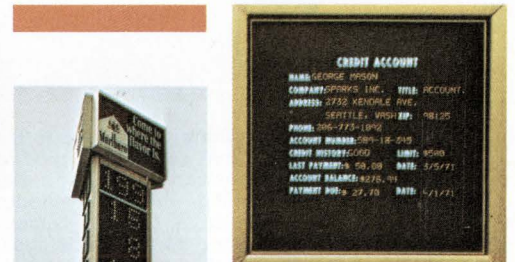
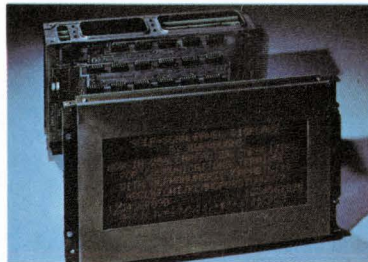

INDOOR-OUTDOOR

Many people view displays at long distances. The Ferranti-Packard electro-magnetic disc-type Special Status Board (a) installed at the Pentagon offers inherent memory, unlimited color variation and a wide size range: Three 65-ft. tall Conrac pylons (b) at the Ontario Motor Speedway use the more traditional incandescent lights to display the lap number and the top nine cars.

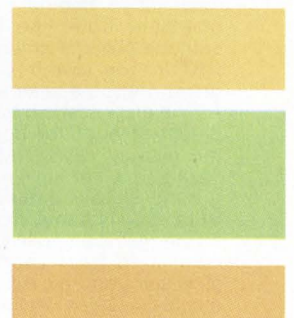
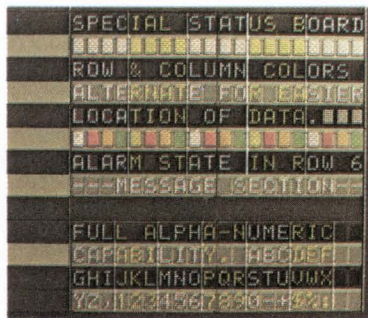

EXPERIMENTAL

A liquid crystal tic-tac-toe panel from GE occupies the kids.

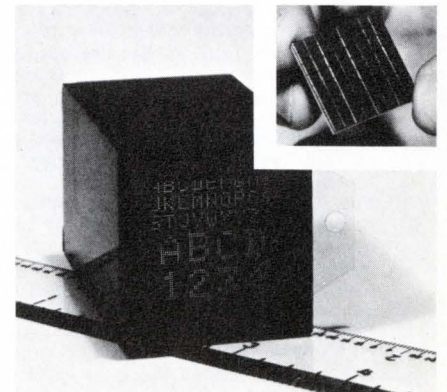
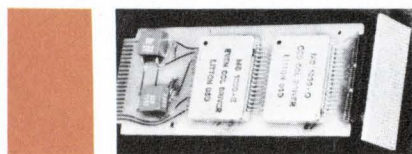
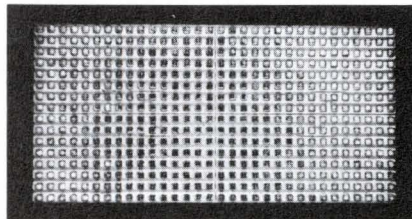

PART 5
COURSE

fixed panel scan rate implies that the time until a cathode re-energizes decreases as the number of cathodes increases.)

Multi-row panels can be scanned sequentially. If each row is scanned 80 times/s, each cathode has to be scanned at higher speeds. For example, two rows would require a 160 scans/s rate, with the reduced duty cycle lowering the light output. It is better to scan all rows simultaneously using one anode driver per line. For economy, the character generator can

be multiplexed among the rows of characters. While data for one column is displayed, data for the next column can be processed through the character generator and put into the storage register.

Panels with over 14,000 cells (77 rows of 192 columns) are available for graphic applications. Only 5-V logic level signals are required to drive the panel subsystem. Gray scale is wide with variable intensity for individual dots ranging from several foot-lamberts to over 300 ft/L.

Three functional sections correspond to the three glow discharge phenomena that combine to produce a display. The parts are glow scan—scan anodes and the rear side of the cathodes; glow priming—the tiny cathode strip apertures, and glow display—display anodes, center insulating sheet with display cavities, and the front side of cathode strips. The structure is hermetically sealed and the envelope is filled with a primarily neon gas mixture, similar to NIXIE™ tubes.

During glow scan, a glow that is invisible to the viewer is established behind the reset cathode and transferred sequentially down the length of the panel, from cathode to cathode. This is analogous to scanning the entire face of a CRT in one sweep. Glowing priming allows the glow to be drawn from the scan side of the panel to the viewing surface. As the glow scans past the rear of each cathode, metastables diffuse through the apertures and prime, or pre-ionize, gas in the display cavity. (Metastables are gas ions, which when raised to a certain energy level, are unable to return to the ground state without interacting with other particles. In the SELF-SCAN panel, neon metastables ionize atoms of an additive gas upon collision.) The glow display phenomenon occurs when front anodes are addressed synchronously with glow scan and glow priming to establish a visible glow in the display cavities. At 80 Hz, glows illuminate and extinguish above the flicker perception rate. A matte black finish on the insulating sheet enhances contrast and reduces reflected light.

Current between the keep-alive anodes and cathodes establishes a permanent discharge in the keep-alive grooves. Metastables from those discharges diffuse into the scan grooves behind the reset cathode. To initiate a left to right scan, a counter is reset, which grounds the reset cathode and causes ionization in the seven scan grooves behind it. The seven scan anodes are bused to +250 V through seven current limiting resistors. The next clock pulse advances a three-phase counter, which grounds every third cathode on bus #1 and returns the reset cathode and all other cathodes to +100 V dc. Ionization rapidly forms a discharge behind cathode 1 and is no longer supported at the reset cathode. Metastable concentration decays such that the glow only transfers to the nearest grounded cathode. Once ionization occurs, current flow in the cell drops the anode voltage to a level that will support, but not initiate, ionization at any other cathode anyhow. Sequentially grounding the three buses linearly propagates the glow discharge along this gas discharge shift register.

The typical display anode circuit couples the display anode to the 250-V supply through a current limiting resistor to display a dot. When the character generator indicates that no dot should be displayed, the circuit clamps the display anode at 120 V, which is below either the ionization or the sustaining voltage.

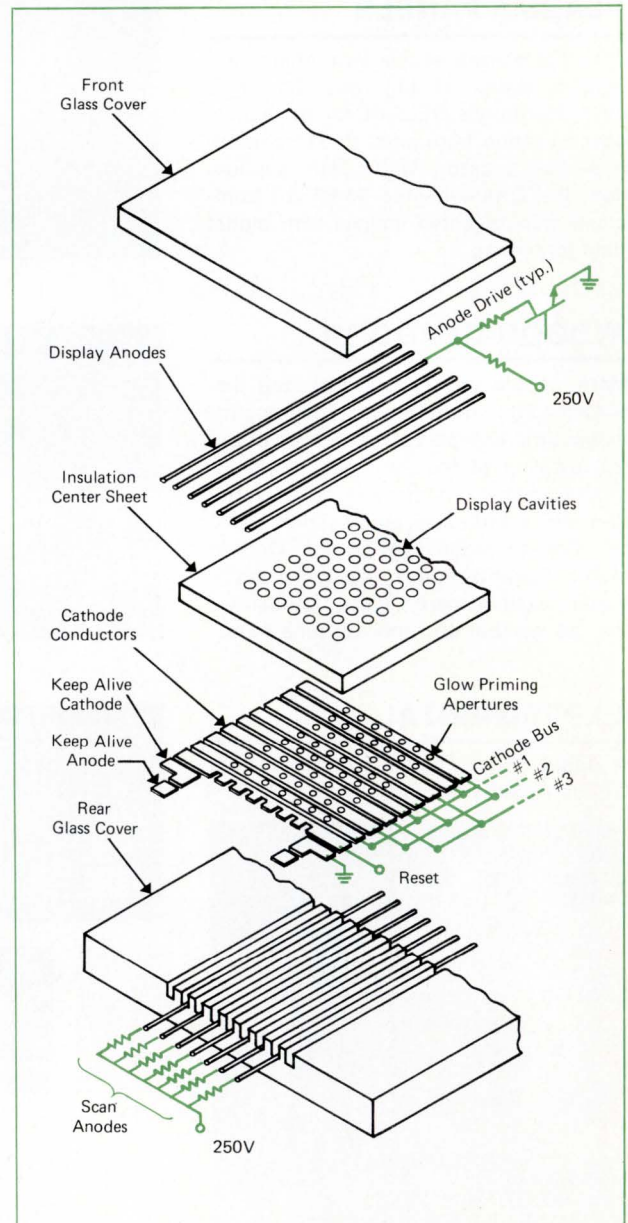

Multiple line displays: ac plasma panels

H. Gene Slottow

Owens-Illinois, Toledo, OH

The ac plasma display panel forms graphic and alphanumeric images with an array of coincident addressable gas discharge elements. This technique can greatly reduce the digitizing or generation of complex graphics, which can make a system prohibitively expensive. Because the elements are bistable, they can also store images and eliminate display-associated bulk memory in a system. The panel's thin physical structure allows images to be superimposed from behind the panel. Slides, films, and photographs can be projected onto the display face.

A sufficiently high voltage applied across an electrode intersection gap will exceed the gas breakdown threshold and establish a light-emitting gas discharge. It is apparent from the figures that a continuous dc discharge cannot be maintained, because the resulting charge flow to the insulating end walls of a cell continuously reduces the gap voltage until the discharge extinguishes.

If the polarity of the applied voltage reverses at the proper time, the residual wall charges enhance the reversed gap voltage and produce another discharge. A sufficiently high alternating voltage produces a sequence of pulsed discharges, once every half cycle. A typical pulsed light emission rate is 100,000 pulses/s.

Once a discharge develops, the applied voltage that will sustain the discharge sequence is less than the initiating voltage, because the wall charges from the first discharge provide a substantial part of the voltage required to create the next discharge. The plasma cell is bistable, i.e., a voltage range exists that will maintain, but not initiate, a discharge. To sustain an image on the panel, all electrodes are effectively connected in parallel and an ac voltage in the bistable range is applied across the entire panel. Off cells cannot initiate a discharge, and on cells maintain their discharge sequence. Discharges are confined by local electric fields at electrode intersections.

Addressing is a process of changing the wall volt-

age at a cell. To write into a cell, a write signal augments the sustaining voltage at that cell.

Ideally, reducing wall voltage to zero erases a cell. A non-zero wall voltage below some critical level will be further reduced in subsequent discharges until the combined wall voltage and sustaining voltage cannot support a discharge.

The display's inherent memory eliminates the need to refresh, thereby avoiding flicker. High contrast images exhibit uniform quality over the entire panel. Present display systems accept serial information at the rate of 50,000 b/s, and selectively write or erase any cell. Systems have been built that accept 800,000 b/s by addressing 16 cells in parallel. Development programs point to million-element displays, densities up to 10,000 per square inch, and multi-color capability.

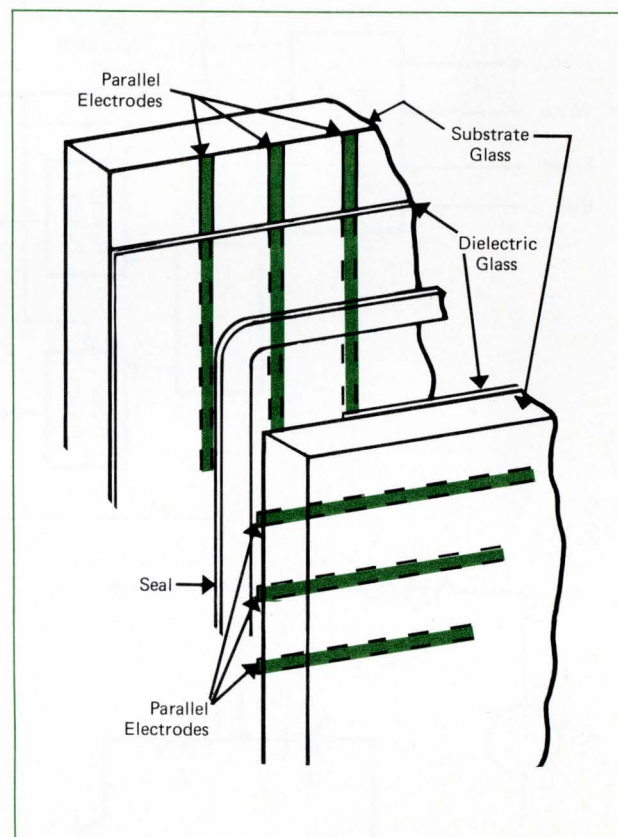

Plasma display panel structure. Sets of parallel, orthogonal electrodes are deposited on two glass substrates. Thin layers of dielectric material cover each electrode set. The small gap left between layers is filled with gas. Each intersection of two electrodes defines a single gas discharge site, or cell. The portions of the dielectric layers at the intersection are the cell walls.

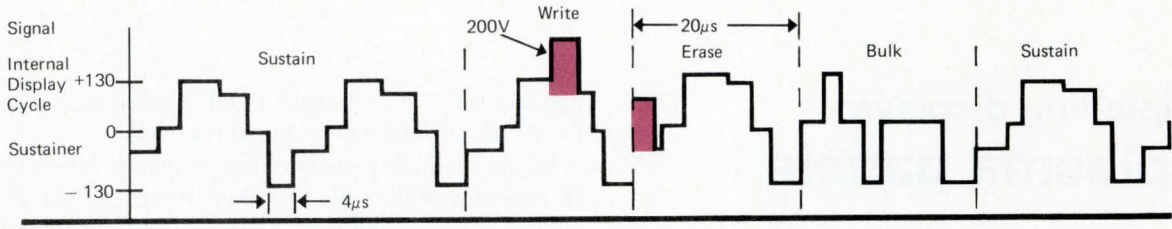

Cell voltage waveforms. A sustaining voltage pattern is continuously applied to all cells. This sustains the discharge in on cells, but will not initiate any new discharges. To write into a new cell, additional voltage combines with the sustain volt-

age and initiates a discharge. To erase a cell, voltage is superimposed at a different time during an erase cycle. The bulk erase signal blanks the entire display.

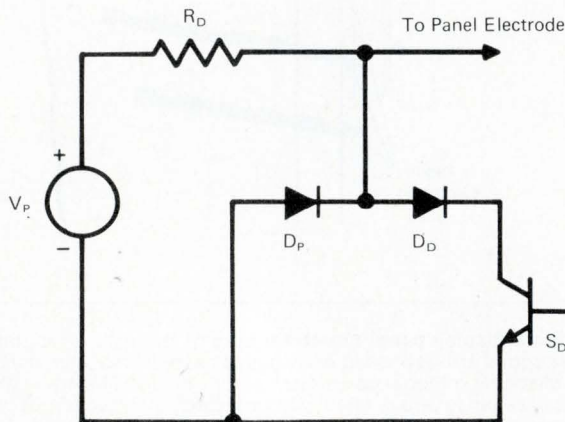
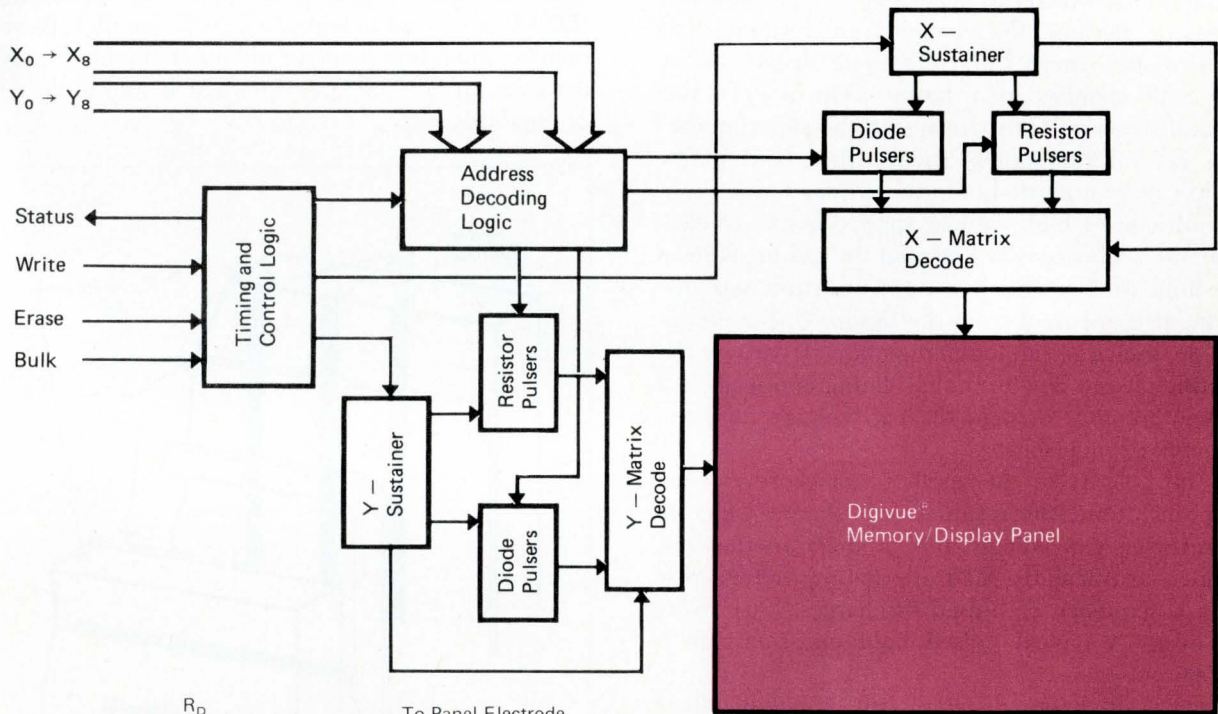

On each 512-line axis, ▲ selecting one resistor-pulsers and one diode switch uniquely selects an electrode. Resistors are in groups of 16 with a pulser connected to each group. Diodes are in groups of 32, with a diode switch for each group. Four of the nine address lines/axis select a resistor-pulsers and five select the appropriate diode switch.

▲ This circuit (b) floats on the sustain generator. When the diode switch, S_d opens, the sustain voltage is augmented by the voltage pulse, V_p . If V_p is absent, or S_d is closed, the electrode is not selected. During the time images are sustained, diode D_d and switch S_d (closed) provide a low impedance current path in one direction. D_p does not provide a logic function but is included to provide a low impedance current path in the opposite direction.

"Black Magic™" Cable for Fast Rise Time Pulse Applications: Lowest Crosstalk Yet!

Transmission of high speed data and communications signals demands low crosstalk. With Schottky clamped TTL and EDL in wide use in high speed computer systems, performance requirements have become more demanding on the medium carrying these fast logic signals. Now, with Ansley "Black Magic™" cable, which utilizes two insulating materials with selective dielectric properties, the field of signal electro-magnetic propagation is confined to produce a dramatic improvement in crosstalk. Here is lightweight, flexible cable that is easy to terminate, with a tough, flame-retardant outer jacket that can be used singly or in layers without crosstalk interference. "Black Magic" cable is UL listed. In addition, cost is significantly less than coaxial cable and only slightly higher than conventional flat cable.

We can produce your assemblies using "Black Magic™" cable or for bulk cable users, Ansley engineers are available for application of standard 50, 93, or 100 ohm or special "Black Magic™" cable to your requirements.

Ansley

ANSLEY ELECTRONICS CORP.
Subsidiary of Thomas & Betts Corporation
Old Easton Road, Doylestown, Pa. 18901 (215)345 1800
2828 N. Figueroa St., Los Angeles, Ca. 90065(213)223 2331
TWX: Doylestown 510-665-8105 Los Angeles 910-321-3938

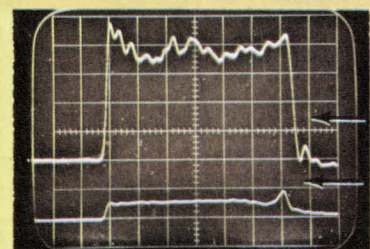
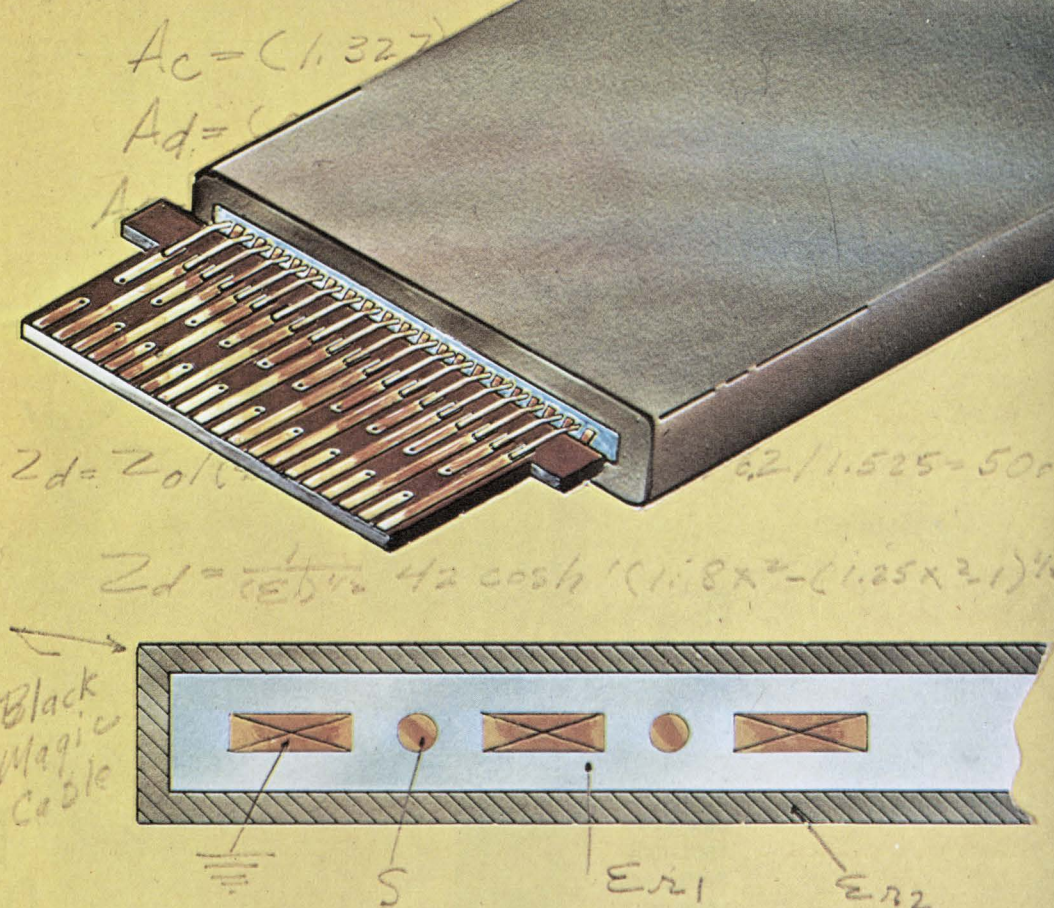
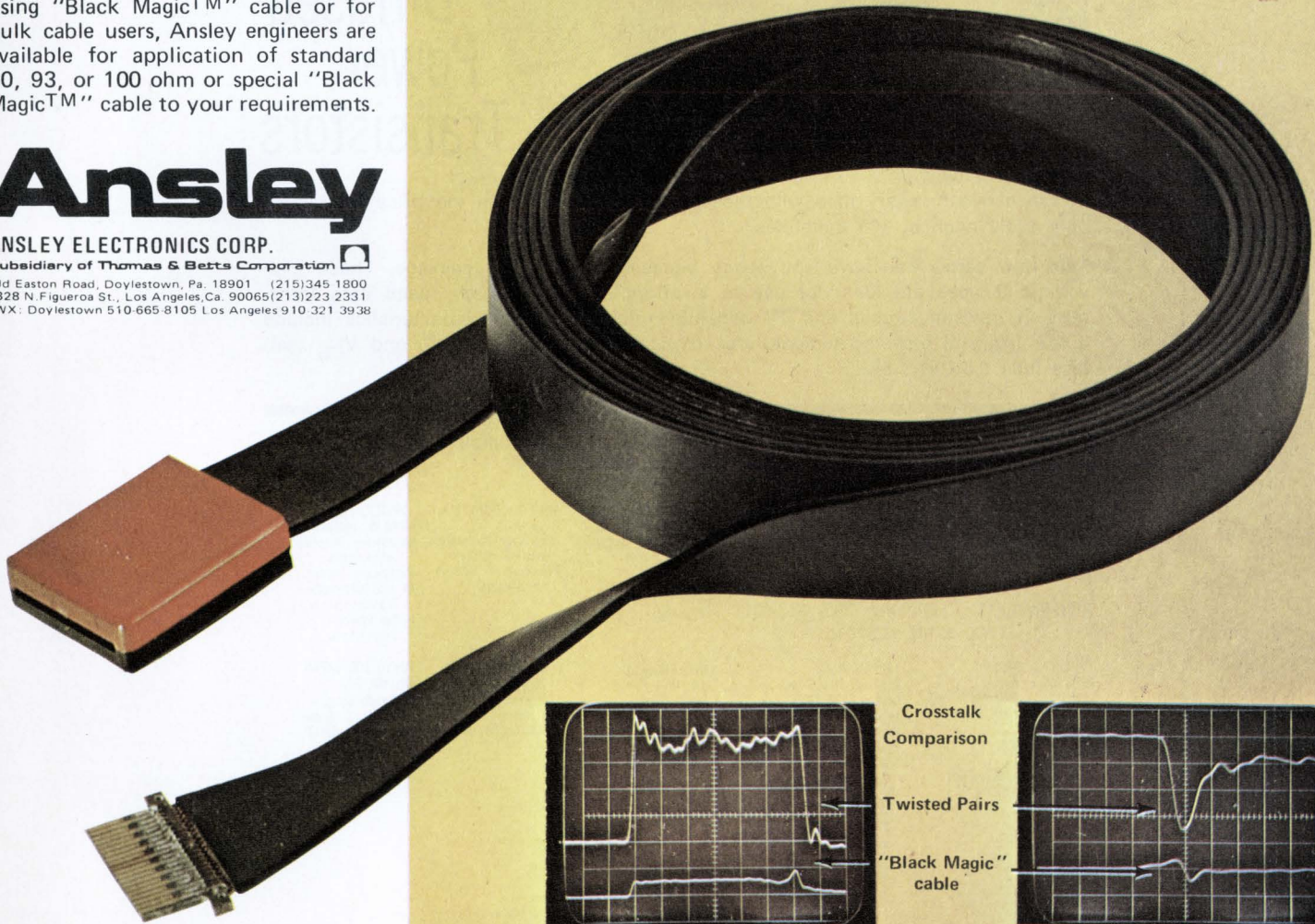

Near End Crosstalk
5.2 times improvement

Twisted pairs:	18.8%
"Black Magic" cable:	3.6%

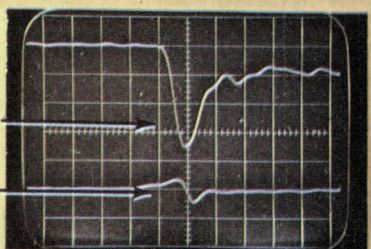

Far End Crosstalk
8.7 times improvement

Twisted pairs:	14.0%
"Black Magic" cable:	1.6%

**ANSLEY —
YOUR SOURCE FOR FLAT
CABLE, CONNECTORS AND INTER-
CONNECT SYSTEMS**

Tests conducted on "Black Magic™" cable (PV 490-41 vs. Twisted Pairs (6 bundled twisted pairs approximately 50 ohms) 10' long. Horizontal scale 5 nsec./Div. Vertical scale 4% crosstalk/Div.

the price is right

on our new 400V, 5A Triple Diffused Power Transistors

Solitron's new SDT 1301-1304 Series with voltages of either 360V or 400V are NPN silicon triple diffused planar power transistors in stock and ready for delivery.

You're a winner every time with these 5 Amp units because the price is right — only \$1.80 each in 100 quantities.

This new series can save you space because of its TO-66 package. These high voltage devices are ideal for use in inverters, converters, high speed data transmissions, sweep circuits and TV deflection circuits. Typical characteristics include a low I_{CBO} at elevated temperatures (typically 1.0 mA @ 150° C) and V_{CE} (sat) less than 0.5V @ 1.5A.

Solitron

DEVICES, INC.

1177 BLUE HERON BLVD.
RIVIERA BEACH, FLORIDA / (305) 848-4311
TWX: (510) 952-7610

SAN DIEGO, CALIF.
8808 Balboa Ave.
CMOS, PMOS Circuits
Diodes, Rectifiers, &
Zeners
FET & Dual FET
Transistors
High Voltage Assemblies
Linear & Monolithic IC's

TAPPAN, N.Y.
256 Oak Tree Road
Diodes & Rectifiers
Ferrite & Ferrite Devices
High Voltage Assemblies
Power Rectifiers
Thick Film
Hybrid Circuits

KENT, ENGLAND
Tubbs Hill House
London Road,
Severn Oaks
Solidev, Ltd.
Full line of
Solitron devices

BEN BARAQ, ISRAEL
51 Hayarkon Street
AEL Israel, Ltd.
Full line of
Solitron devices

TOKYO 105, JAPAN
Rm. No. 21,
Kyodo Bldg.
No. 4-10, 2 Chome
Higashi Shinbashi
Minato-ku
Full line of
Solitron devices

Contact us now for complete details . . .
and the lowest price!

RIVIERA BEACH, FLA.
1177 Blue Heron Blvd.
Hi-Rel Power Transistors
SI & Ge. Power
Transistors
Hi-Rel Power Hybrids
PNP-NPN Industrial
Transistors

PORT SALERNO, FLA.
Cove Road
Microwave Connectors
Plaxial (R) Cable
Precision RF Coaxial
Connectors

JUPITER, FLA.
1440 W. Indiantown Rd.
Microwave Stripline
Components
Microwave Diodes
RF and Microwave
Transistors
Hi-Rel Power
Transistors

Multiple line displays: flat CRT panels

Edmond N. Elowe, Electronic Tube Div., GTE Sylvania
Seneca Falls, NY

Among the various advantages of the flat panel, multiple-beam CRT are the following:

- The digital nature of the display permits it to handle input signals from digital equipment with minimum interfacing.
- Physical alignment of the switching plates provides a distortion-free, stable display. Since multiplexing increases individual beam dwell time, brightness is enhanced.
- This type of display has random scan capability, i.e., the time required to change the beam position is

independent of the distance between two beam positions. Random scan permits a reduced frame rate without flicker.

- Simultaneous data inputs can be assigned to different portions of the display.

Originally, the Northrop Corp. developed such a display, calling it DIGISPLAY®. Now GTE Sylvania Inc. is working on a commercial product version designated the FTA-512, for Flat Tube Alphanumeric, 512-character.

The basic display element of the FTA-512 is a stationary electron beam. An area cathode supplies electrons, which form multiple small beams and are accelerated through a series of axially aligned aperture plates toward a phosphor screen. A sufficiently negative potential on any aperture repels the beam, in which case the phosphor emits no light. Since none of the deflection components of conventional CRTs are used, the result is a 2-in. thick display.

Controlling electron beam planar grids. The area cathode (a) emits thermionic electrons. A positive voltage on the beam-forming plate attracts them up to and through the plate. Its holes initially form and position 17,920 separate electron beams. If voltage permits, these beams pass through axially aligned aperture holes in the four subsequent switching plates and the beam forming plate, before illuminating a spot on the phosphor screen.

Each aperture (b) acts upon a beam independently. The first switching plate is the row selector plate. The upper half divides into eight independently controlled horizontal row electrodes, each containing a hole pattern seven holes high and 160 holes long (32 characters). Applying positive or negative voltage passes or repels all beams in a given row. The bottom half of the plate divides similarly, and corresponding rows in both halves, such as rows one and nine, are connected. Since messages start at the top row, a positive voltage appears on rows one and nine, passing all beams in those rows. All other row electrodes carry a negative potential and repel all other beams.

The column selector plate splits into a series of 32 vertical electrode bars arranged in four groups of eight each. Each bar has a pattern five holes high and 112 holes long. Every eighth bar is connected, i.e., rows 1, 9, 17, 25, etc. The voltage sequence starts with a positive voltage on the common first column of each group. All other columns are negative. The first two plates define eight beam bundles (character positions), each seven beams high and five beams wide.

The row bit selector plate subdivides each of the row electrodes of the first (row selector) plate into seven separate bit bars. Corresponding bit rows in every character row are connected, resulting in seven leads to this plate. The row bit selector begins scanning only the very top row of beams. Only the top row bit electrode in each row is positive, reducing the beam bundles to eight discrete ribbons of beams, each one beam high and five beams wide.

The column bit selector plate subdivides each of the vertical character columns into five bit bars. Each group of eight character columns has five leads. Each lead connects corresponding column bit positions in each of the eight character columns. The four groups should result in 20 leads, however, this plate is split similarly in half to the first plate, so there are 20 top leads and 20 bottom leads.

The column bit selector plate individually controls each of the 40 beams to produce the top dot(s) necessary for the desired characters. Selected beams pass through this plate and the beam focusing plate to strike the phosphor and produce the partial display shown at the bottom of the figure.

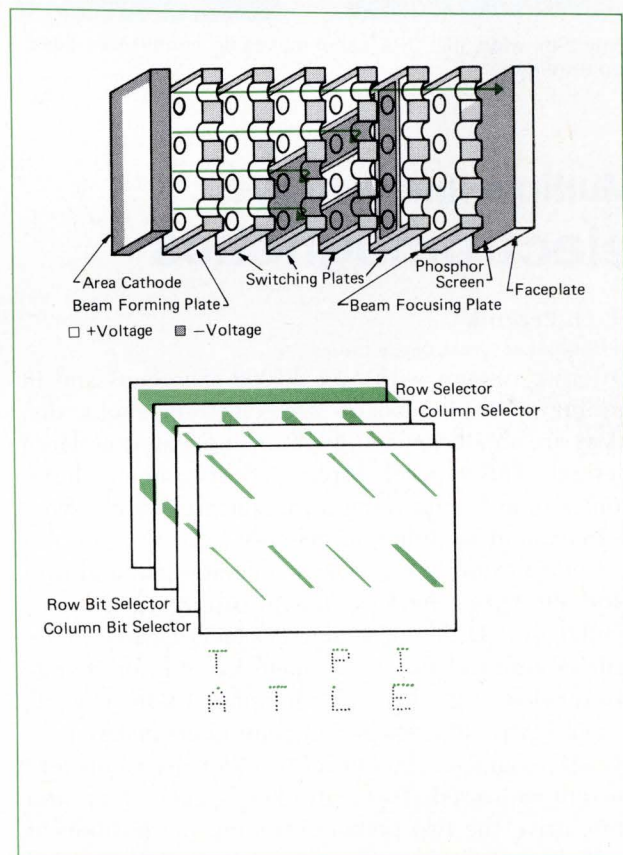

Sequencing proceeds through top bit rows of each column, then the top bit rows of each remaining character row, then the second bit row of the top character row, etc. The 68 leads go to the following plates: cathode, 2; beam forming plate, 1; switch plate #1, 8; #2, 8; #3, 7; #4, 40; beam focusing plate, 1; and high voltage anode, 1.

READOUTS **PARTE.** COURSE

The multiple switching plates inside the tube reduce the number of leads necessary to address the required apertures of each character's dot matrix. Proper electroding of four plates permits 63 external leads to generate 512, 5 x 7 dot matrix characters in 16 rows of 32 characters each. The appropriate electrode patterns on the switch plates also permit simul-



Only 2-in. wide, this CRT panel makes an unobtrusive desktop terminal.

Multiple line displays: electromagnetics

H. O. Peprnik

Ferranti-Packard Limited, Ontario, Canada

Offering systems with over 20,000 characters and in unlimited display board size, electromagnetic displays are an attractive option for implementing large designs. This type of display reflects ambient light, comes in any color, ranges in character height from 1-18 in., and has inherent memory.

Color flexibility can clearly separate data and provide alternating backgrounds to ease reading a particular row. Different character colors clearly segregate columns of data. Customers can add or change fixed titles. Legibility in high ambient light is good.

Dot matrix characters and continuous matrix panels with character sizes of 2.7 to 4.1 in. are coincident current addressed. Two control coils, each on an iron core, drive the two poles controlling the position of each disc. Coils interconnect in horizontal rows and vertical columns. A 200- μ s pulse on a row and a column causes the disc at the intersection to change. Current magnitude is not critical because the magnetic circuit uses a gating principle rather than algebraic addition of ampere turns. The operating cur-

rent must exceed a minimum value, yet can be up to three times this value. A 40-module display panel has only 156 connections to the control windings for 1400 discs.

taneous addressing of several beams, thereby increasing brightness. For a given display application, the number of switching plates, number of external leads, electroding patterns, capacitance, and writing rate are all system design parameters.

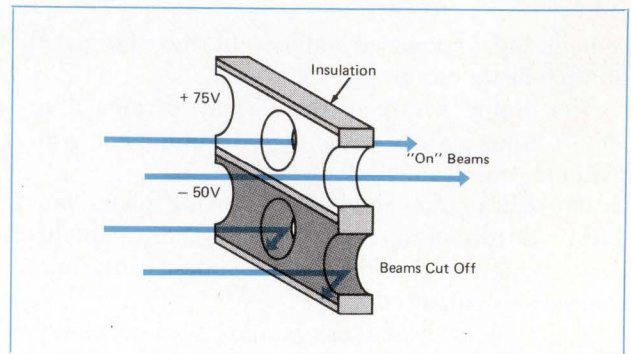

Basic switching principle for flat CRTs. An electron beam that encounters an electrode with a positive potential can continue on its path if it is properly aligned with a hole in the electrode. If it encounters a negative potential, it will be repelled and, therefore, cannot reach the phosphor screen.

rent must exceed a minimum value, yet can be up to three times this value. A 40-module display panel has only 156 connections to the control windings for 1400 discs.

The display's inherent memory greatly reduces the electronics. Data is written sequentially, so only one set of logic and drive circuits accommodates any system size. A system can expand greatly without adding any electronics. A complete controller that accepts ASCII input code weighs only 68 lb. and occupies about 5 ft.³

Financial applications

The Montreal Stock Exchange System was installed in 1965. This typical application was 18,720 characters formed from 483,840 dots. Important data is shown with 2.7-in. high characters formed from 5 x 7 dot matrices. Other data is shown with 1.9-in. high, 3 x 5 dot matrix characters.

Power dissipation and reliability were major selection criteria. Information retention in case of a power failure or interruption was also very important. One disc failure per character does not cause ambiguity. A display board with 8400 disc assemblies has an anticipated MTBF of about one year.

Average power dissipation is less than 1 kW. Data changes at about 140 characters/s through a single controller, and there is a standby control. Elec-

tromechanical systems would have needed many parallel controllers to attain this speed and would have introduced a weight and space problem. Electromagnetic displays weigh about 8 lb-ft.², including framing and cabling. Light-generating displays present significant air conditioning and maintenance problems and dramatically increase operating and backup power.

Operating experience shows that only about 150 disc assemblies per year (0.03%) are changed, notwithstanding an explosion in 1969 that perforated one board and distorted the framework on others by up to 6 in. Fortunately, there were no fatalities, but damage to the building was considerable. The wall adjacent to the blast virtually disappeared, while a wall 160 ft. away moved several inches. The next morning, this rugged display system was ready for

operation, except for the perforated board.

The American Stock Exchange's special requirements called for a new 1-in. high, 7-bar character visible at 50 ft. A 40,000-character system was needed, visible from at least 25 ft., but with a minimum of obstruction between traders and their associates on the ends of the floor, so hand signals could be seen.

Two 160-character/s controls, with a drive capability of over 100,000 characters (including backup and changeover units), fit into a 7-ft., 19-in. rack. Two 0.7-in. diameter signal cables service each post. Average power consumption is about 100 W.

The excellent visibility in full sunlight, light weight, and low power requirements make this an ideal outdoor display for traffic control, sports, etc. At night they're illuminated like advertising billboards.

100- μ s to 1-ms pulse depending on coil type

Thin, Permanently Magnetized Disc Free to Rotate on its Axis

Pole Pieces Electromagnetic Core With High Remanence

Set Common Reset

Axis

Colored Side

Dark Side

Permanent Magnet

Residual Magnetism Provides Memory

(Set Pulse)

(Reset Pulse)

Electromagnetic display operating principles. A short pulse in the set coil magnetizes the poles of the core (top). The remnant magnetic field interacts with the field of the permanently magnetized disc, rotating it to show its colored side. No power is needed to keep the disc in position. Further set pulses cause no change. A reset pulse causes the disc to rotate and show its opposite side, which is usually the background color. For large discs, up to 2.2 in. in diameter (bottom), a permanent magnet is attached to one end of the disc and there is a single driving coil and pole assembly.

Black Plastic Frame

Exposed Colored Bar

Retracted Bar

Magnetic Repulsion

Pivot

Center Frame Pivot

Bar Magnets

Switching Coils

Stator Magnet Pins

Circuit Card

Magnetic Attraction

A 1-in. high, 7-bar character application. A short electrical current pulse in the switching coils sets the polarity of the stator magnets. The remnant magnetic field of these stator magnets interacts with the permanent bar-magnet field to expose or retract selected bars. Even if the bars are physically moved, the remnant magnetism returns them to their set state. The indicator bars rotate about 30 degrees.

One of the eleven six-sided display posts at the American Stock Exchange.

Multiple line displays: CRTs in cable TV

Ray M. Unrath

MSI Television, Salt Lake City, UT

The cable TV industry (CATV) provides viewers with systems designed for completely automatic color TV program production. It uses existing news, stock quotes, and weather forecast services originally intended only for hard copy teleprinter terminals. Systems also incorporate locally generated services such as weather, company identification, time, calendar,

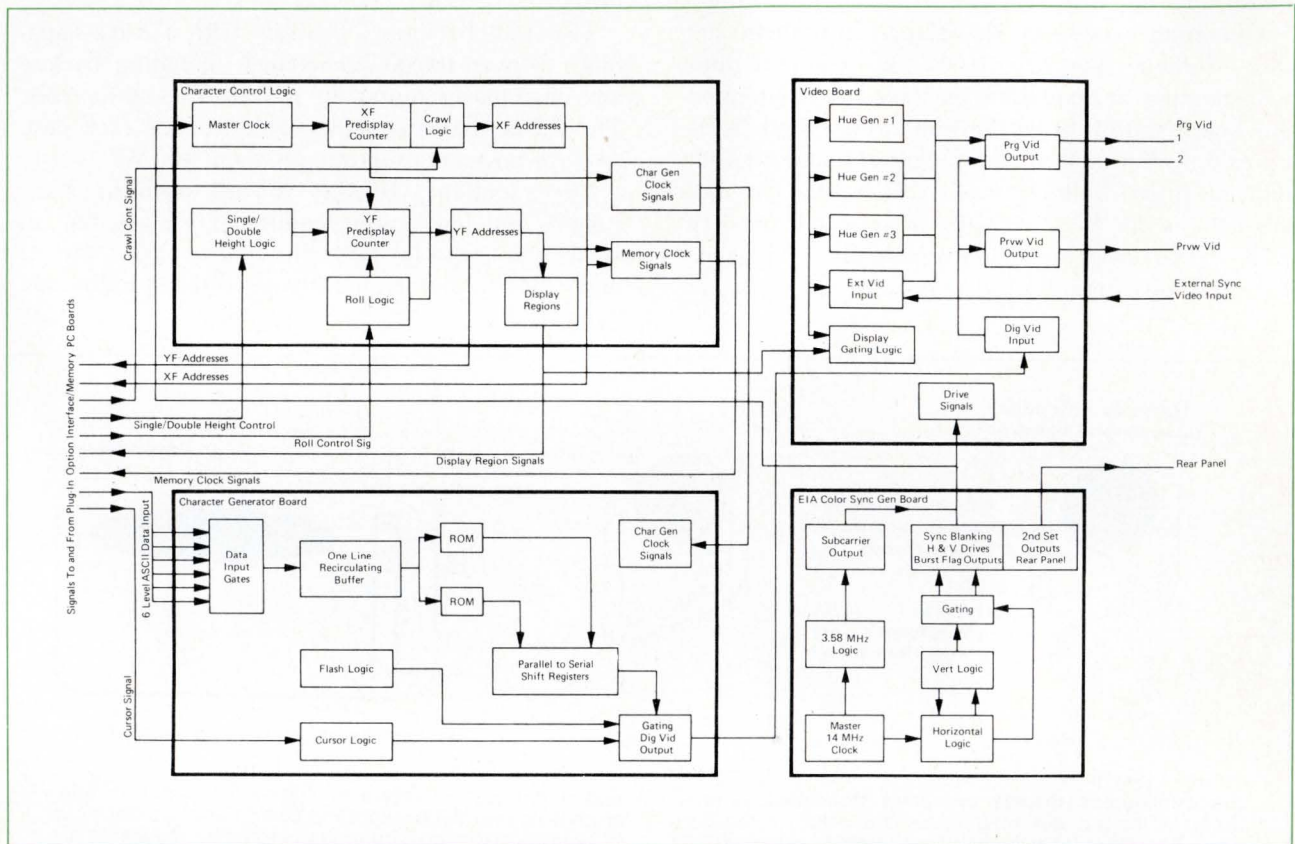

The basic alphanumeric character generator required for all services. The sync generator board begins with a master clock frequency of 14 MHz and provides both basic timing for all electronics and the composite EIA color video signal at the output of the video board. It outputs two sets of drive signals consisting of 3.58-MHz subcarrier, composite sync, composite blanking, horizontal drive, vertical drive, and burst flag. One set of drives, source terminated outputs, are available at the rear panel of the chassis for driving external peripherals such as a flying spot scanner or a TV camera. That equipment, in turn, provides a synchronous external video input to the character generator for advertising purposes. The second set of drives is used in the character generator.

The character generator board sends digital data representing the characters viewed on the TV screen to the video board. At the video output stage, the incoming data is added to one of three color backgrounds generated by individual hue generators. External video input provides isolation and clamping.

The resulting signal is processed with EIA blanking and composite sync. Synchronous external video can be mixed with the digital data in the video output circuit. A preview video output aids in composing and previewing locally generated keyboard messages prior to display on the program output of the system.

The character control logic board is the heart of the system, since it provides all clock and memory signals, display

region pulses, and X and Y address information. The Xf information provides the address for each of the 32 characters on a row. Likewise, the Yf information is the address of each row of characters. The Xf and Yf circuit logic can offset addresses to produce a roll or crawl mode. The roll and crawl offset information is generated on each plug-in interface/memory board and will only affect the region where that information is displayed on the TV screen. Thus, different segments of the screen can provide roll, crawl, or static displays simultaneously in single height or double height characters. The character control logic board also provides all memory clock signals, character generator clock signals, and special YC information for the ROMs on the character generator board. YC information determines which bit groups are read on specific 2:1 interlaced (A/B fields) TV raster scan lines.

The character generator board produces the 10 x 14 dot matrix characters. The input is six level ASCII. At the appropriate time, a given interface/memory board is commanded to load one character row of information into the character generator one-line memory. As the data circulates in the buffer, the ROMs are addressed and the appropriate dot pattern is read into the parallel to serial shift registers. Each ROM stores 64 characters or symbols. One stores all numerics; the other, all punctuation. The serially shifted data is processed to provide cursor location and flash capability for a given letter, word, or row of information, then forwarded to the video board for processing.

and keyboard entries, which might include a community events schedule, tv program guide, or classified advertising.

Flexibility of tv raster display formats and the necessity to combine several different program services on one tv channel, or on several tv channels, present

unique system design considerations. The MSI DATACASTING® System illustrates such a system, which readily adapts to any tv rf distribution system serving apartments, schools, commercial, industrial, or military facilities. Broadcast tv stations are also potential users.

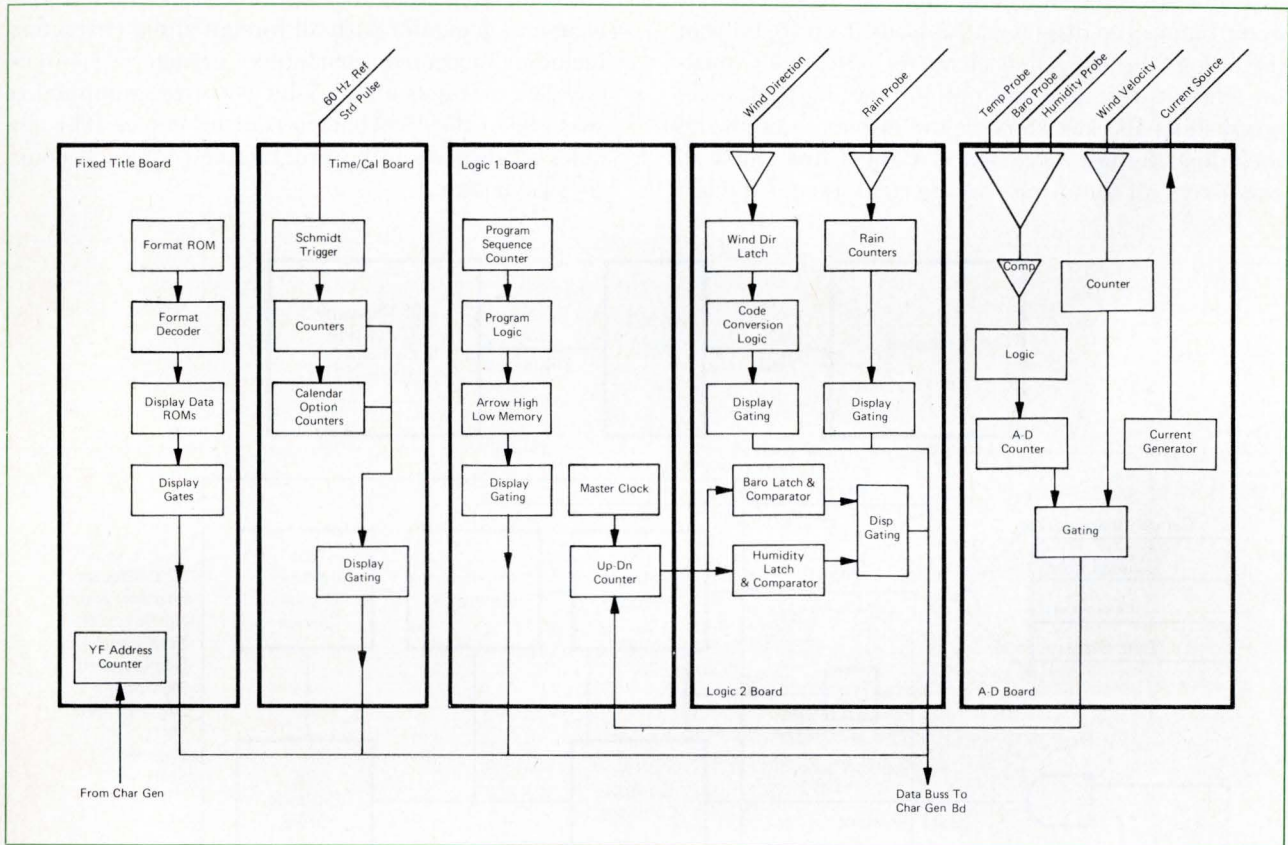

Local weather interface subsystem option. These five boards provide as many or as few weather functions as each customer wants. The fixed title board provides permanent readouts for identifying the service or sponsor and for titles such as temperature, humidity, etc. The remaining boards interface to the weather sensors, sampling logic, and data storage registers. Three incoming signals, temperature probe, barometer probe, and humidity probe, are analog and share a common A/D converter. Each sensor is sampled every 34 s and its input enters a temporary storage register. Each new

sample is compared with the previous one, which is stored in a separate register. If the new sample differs, the memory register is updated. If it is identical, it is discarded. At predetermined times, each register presents its information for readout onto the common ASCII data bus, which is the input to the character generator. Indications such as arrows for rising or falling readings and daily highs and lows are also possible. Abbreviated day and month alphas are stored in a PROM.

Generating characters for phototypesetting

David W. Pinkney

Compugraphics Corp., Wilmington, MA

In phototypesetting and TTS (teletypesetting) tape perforating machines, SELF-SCAN® displays represent a reasonably priced alternative between blind keyboarding, where the operator verifies his key-

board input by "reading" the holes in the tapes, and a typewriter, with its attendant cost and mechanical problems.

In the CompuWriter, our most popular typesetting machine, the SELF-SCAN is used as illustrated. It is loaded at the same time keyboard char-

READOUTS
PART 6
 COURSE

acters are shifted into the 256-character line memory. As characters enter the 32-character display on the right, all previously entered characters shift left one position. Though the display shows only the last 32 characters, the last 256 are stored in the line memory. This aids other functions, such as line canceling.

There are three canceling functions. **Cancel character** blanks the display and reloads it up to, but not including, the cancelled character, effectively shifting the display one position to the right. **Cancel word** shifts all characters off the display to the right, including the last word space. **Cancel line** shifts all characters off the display to the right, except the last

return code. This causes the last 32 characters of the previous line to be displayed. The **line display** feature causes all characters in the present line to shift through the display at a readable rate. It is used to proofread lines of more than 32 characters before photographing the line.

Machines sold in the U.S. can generate 64 different characters. Machines sold abroad contain a 128-character generator with all foreign alpha characters, including accented characters, monetary symbols, etc. The user gets a 96 x 7-bit PROM programmed to select 96 of the 128 characters of his choice. This enables all displays to be programmed for each country's keyboards.

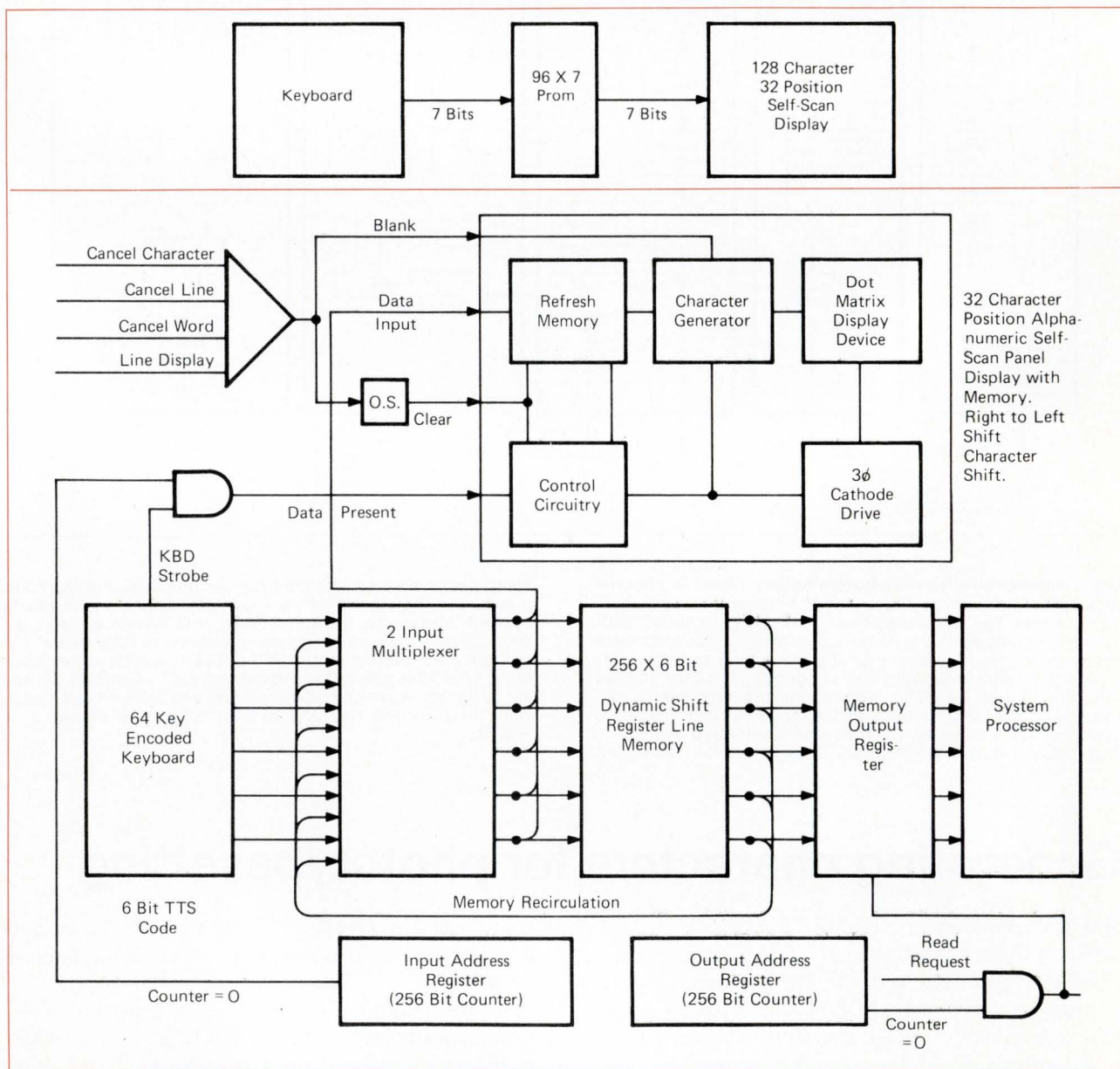

SUPERDIGIT*

The new LED Display that Obsoletes Conventional Displays

Now available as a 1/4" LED display for instrument, terminal and industrial control applications, the Fairchild FND 70 represents a three-way breakthrough that enables you to design tomorrow's displays today.

SUPERIOR PRICES

\$3.95 (100 up)—A low price made possible by a breakthrough in manufacturing technology which uses low cost plastic package assembly techniques.

Inherent high costs of conventional displays, which require extensive hand fabrication and large amounts of gallium arsenide phosphide materials, have been eliminated. The small-quantity price is also indicative of the low prices that will accompany large-scale production.



SUPERIOR STACKING DENSITY

More Packages Per Inch—The FND 70 has the smallest ratio (2:1) of total package to digit size. Four digits, each 300 mils wide \times 500 mils, occupy less space than three conventional units, and, because of the straight leads, can be stacked both vertically and horizontally.

SUPERIOR APPEARANCE

Advanced Optics Technology—Provides bright, bold digits with a pleasing uniform appearance for viewing up to a full 140°. No masks required.

Seeing is Believing—You only have to see the Superdigit to realize why it is so superior to any other display on the market, whether it be Nixie tubes, LEDs or what have you. Your Fairchild Semiconductor sales engineer or distributor salesman can give you a visual demonstration.

*SUPERDIGIT is a trademark of Fairchild Camera & Instrument Corp.

AN OFFER YOU CAN'T RESIST

Fairchild's 5-Digit Display Kit

A \$49.65 Value For Only \$34.50

Includes Five FND 70 1/4" Displays • Five FND 70 Sockets • Two Integrated Circuits • Thirteen Transistors • Sixteen Resistors • Special Plug-In Printed Circuit Board • Complete Step-by-Step Kit Instructions

Order Now From Any Fairchild Semiconductor Distributor. Offer Expires March 1, 1973

**MADE IN
FAIRCHILD**

FAIRCHILD SEMICONDUCTOR/MICROWAVE AND OPTOELECTRONICS

A Division of Fairchild Camera & Instrument Corp., 4001 Miranda Avenue, Palo Alto, Ca 94304. (415) 493-3100.

IGNORE AT YOUR OWN RISK?

International standards may be the key to a much wider market in the future.

Christopher P. Kocher, Assistant Editor.

People often have difficulty relating abstract ideas to concrete decisions. And to many, including systems engineers and management types, standardization, particularly international standardization, is no more than an abstract idea. But we are entering a time when many people claim that the most successful manufacturer or designer will be the one who designs his product with an eye to a broad international market.

Is this because the American market for electronic goods is drying up? Hardly. "Electronics-1985" a "report on the future,"^o sponsored by the Electronic Industries Association, projected consumption of electronic equipment in the U.S. jumping from \$28.3 billion in 1970 to \$80.9 billion in 1985—a healthy jump indeed. But the same study predicted that the non-U.S. market would jump from \$28.5 billion in 1970 to \$123.9 billion in 1985. Thus, although the U.S. market for electronics will continue to increase, foreign markets will increase even faster. Standards can either inhibit or promote foreign trade.

Moreover, Richard O. Simpson, U.S. Deputy Assistant Secretary of Commerce for Product Standards, claims that "The '70s will be a critical decade for international standards. The number of international standards written will increase dramatically in the '70s, and these standards will be used."

These two observations suggest that now is the time for manufacturers who have not already done so to start learning the implications of international standardization.

But what is standardization?

Unfortunately, the related concepts of standardization, certification, and metrication are hopelessly tangled together in the minds of many.

^oSee *The Electronic Engineer*, July 1972, p. 6. "Electronic 1985: the best thing that happened was that it happened."

Simpson: The critical standards decade will be the 1970's.



Hoppe: Many countries will take an IEC publication, put a front page on it, and call it a national standard.

Paul Hoppe of the Amphenol Industrial Div. of Bunker-Ramo Corp., who speaks about international standards with both knowledge and authority, defines standardization as simply "getting the maximum usage from the minimum number of parts." This is a good definition because it recognizes that standardization is more than just an abstract Christian virtue; it can be an engineering concept as well.

This definition also brings out the most apparent dollars-and-cents implication of standardization. The key idea is economics of scale: manufacturers can produce a limited variety of goods more efficiently than they can produce a wide variety of goods in moderate quantities.

Who sets standards?

Standards are set in three ways: by edict, by *de facto* acceptance in the marketplace, or by negotiation and arbitration. They vary in scope from corporate through national and international; they may be voluntary or compulsory; specific or performance oriented; realistic or naive.

A standard "set by edict" is practically synonymous with a national standard set by the government. Government standards, which often regulate quality or performance in an effort to protect the user, are usually compulsory. Ideally, government standards should reflect mature consideration of technical factors; in practice they are sometimes politically motivated or even arbitrary.

De facto standards determined by user preference are seldom compulsory, although in many instances they might as well be. As Harry Kleinburg, RCA's director of Corporate Standards Engineering, points out, "If you want to become an entrepreneur and design and sell lightbulbs with a left-handed thread you're perfectly free to do so. There's no law that says you can't. But anybody with any sense won't buck the well-entrenched standard of the right-handed thread."

If a single manufacturer (or manufacturers from a single country) introduces a device that is innovative, important, and produced quickly in sufficiently large



quantities, its specifications may become *de facto* standards. In the past, the U.S. has been so technologically precocious that many of her standards have been accepted worldwide. Thus, 12-in. phonograph records and 1/4-in. magnetic tapes are accepted as standards even in countries that are predominantly metric.

If two manufacturers simultaneously develop and market devices that do the same job in different ways, it is possible that both will be accepted; thus, you can buy both 45 and 33 rpm phonograph records. But for some goods the community of users protects its interests by accepting one scheme as a standard and rejecting all incompatible schemes. Although RCA, Columbia, and several others have developed different schemes for encoding quadraphonic stereo on discs, only one of these schemes will ultimately survive.

It is an unfortunate and basic fact of life that not all governments, manufacturers, or communities of users accept the same or even compatible standards. The third method of setting standards, negotiation, sometimes (and only sometimes) offers a means of reconciling diverse standards. A number of national, multinational and international bodies^{°°} exist for the expressed purpose of harmonizing the standards of various nations; the two most noteworthy international bodies are the International Electrotechnical Commission (IEC) and the International Organization for Standardization (ISO).

Paul Hoppe, Secretary to IEC Technical Committee 48 (TC 48) for Electromechanical Components, describes how IEC operates "One country will cite the

^{°°}A pamphlet entitled "The ABC's of International Standardization" lists the more important international standards organizations and is available from ANSI. To receive a copy, circle reader service #350.

need for a certain type of component. The chairman requests countries submit proposals for components that will satisfy that need, and as secretary I distribute these proposals world-wide and receive comments. Following comments and discussion at the next meeting, I can be instructed to issue a secretariat document, also for comment. If comments are positive, the next step is the preparation and distribution of a six-month rule document; this is the most critical review of the proposed product for IEC recommendation. Should there remain any segment of the proposal that must be clarified, we issue a two-month rule document. When comments are received on the two-month rule document, the committee accepts the final version or amends it accordingly. The Editing Committee for English and French Translations prepares it for publication, and the amended proposal then becomes an IEC recommendation. The average time from proposal to publication is about two years." Hoppe emphasized that IEC publishes *recommendations*, not standards.

Clearly, negotiation is the only standard-setting mechanism that can result in a homogeneous set of world-wide standards.

Why bother?

If we accept the argument that international trade is desirable, we must accept the need for some sort of international standardization. Divergent standards inhibit trade by partitioning the world market for certain items into so many equivalence classes: thus, because the three countries use different encoding schemes, color tv sets that are popular in France cannot be sold in Germany; those popular in the U.S. cannot be sold in France; manufacturers in any of these "equivalence classes" could reduce their production costs substantially if they could sell one product to all three countries.

But are standards differences an important barrier to American participation in international trade? In the past, they haven't been. The U.S. metric study has indicated that adherence to U.S. standards is far from the most important barrier inhibiting the acceptance of U.S. exports. In fact, the study indicates that some customers buy U.S. goods *because* they are manufactured to U.S. standards. Nonetheless, President Nixon's advisors in international trade relations have estimated that approximately 10% of all non-tariff trade barriers are standards related.

Important Acronyms

ANSI	American National Standards Institute, Inc.
IEC	International Electrotechnical Commission
ISO	International Organization for Standardization
CEN	European Committee for Standardization
CENEL	European Electrical Standards Coordinating Committee
THE	Technical Help to Exporters (U.K.)

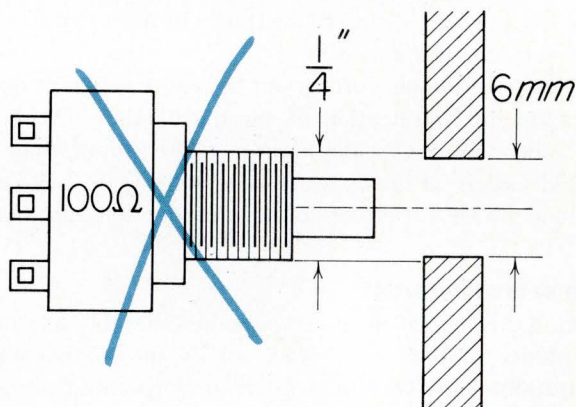

An American pot with a 1/4 in. shaft will not fit a standard 6 mm hole. Will American component manufacturers lose their place in the growing international market if they fail to pay more attention to international standards?

In the past, U.S. manufacturers have been rather unexcited about international standardization efforts for several reasons. First, American technical precocity has meant that for many products, American standards became the *de facto* international standards. Where standards differed, the American standards were generally more demanding than similar foreign standards; compliance to American standards was often a "Mark of Excellence" and did not lock American goods out of foreign markets.

Second, the U.S. has been the largest homogeneous market in the world. For this reason many European manufacturers produced goods for export to the U.S. even when U.S. standards differed from their own.

An Engineer's Garden of Standards

You're designing an electronic system—say an electronic sforlitz sifter. Although you know that there will be a good domestic market for your final product, you and your company have decided that you can sell almost as many sforlitz sifters abroad, since the foreign market is growing. You would like, therefore, to design a sforlitz sifter that will meet various foreign standards as well as the domestic standards that you know well. Where do you find specific information on foreign standards for electronic goods, and what kind of information can you hope to find?

Although there is a bewildering alphabet soup of national and international bodies that write and coordinate technical standards, your first contact should probably be ANSI (the American National Standards Institute, Inc., 1430 Broadway, New York, NY 10018. (212) 868-1220). Although ANSI does not write standards, it coordinates American national standards and represents the interests of the U.S. voluntary standards system in programs carried out by non-treaty organizations such as the International Electrotechnical Commission (IEC).

Through ANSI you can also contact Technical Help to Exporters (THE), a joint venture of the British Standards Institution and the British Department of Trades and Industry, which oper-

ates on a membership and a consulting basis.

ANSI has a catalog that will tell you which ANSI or international standards cover the sforlitz sifter you're designing, and they can tell you where to get copies of those standards. THE can tell you if a country has national standards that go beyond the international standards.

If no standards for your product exist in the country you plan to sell to, what you do next depends on the country. In the Soviet Union you deal with the government. If there is an existing standard, they'll probably accept that standard; if there is none, they'll write their requirements into the standard as in a procurement specification. In a country like West Germany, on the other hand, you would have to check with the authority having jurisdiction over similar equipment for which standards do exist. You may have to submit the device to their testing organization and let them dream up a set of performance and safety tests. In either case THE can help; they know who has jurisdiction and can advise you of the proper procedure.

Suppose you obtain a copy of the standards governing your sforlitz sifter and you happily note that your product complies 100%. Unfortunately, that's not the end of the game. Before you can actually sell your product in a

foreign country, its compliance with the standard must be certified. You might be able to get your sforlitz sifter certified in this country, but many countries accept only the imprimatur of their own certification facilities. Moreover, there may be other regulations—shipping or packaging regulations for instance—that pertain to your product.

How do you thread your way through an unfamiliar and sometimes obscure maze of foreign regulations to be sure that your product won't be turned back at the port of entry? THE engineers travel all over the world, consulting with foreign authorities, and THE compiles digests country by country, for major categories of equipment, spelling out foreign import regulations and translating foreign codes and standards into English. They publish and sell the digests to inquirers.

If you have a question the digest can't answer, THE also maintains an inquiry service. For members, the service is free if it doesn't take over an hour-and-a-half of an engineer's time to find the answer; for non-members and for over an hour-and-a-half's work, they charge about 6£ an hour. If THE finds that a number of organizations are interested in similar information they will put together the same sort of report a consulting firm would give, spreading the cost over all the interested parties. ■

American manufacturers, on the other hand, were not motivated to produce goods to different foreign standards because there was no single homogeneous market large enough to be worth wooing.

But both of these philosophies are rapidly losing their validity. Since the world consumption of electronic equipment is now growing faster than American consumption, it is unrealistic to assume that all innovations, and hence all standards, will come from the U.S. As RCA's Kleinberg points out, "Once you can no longer set standards by being first and best you had better start negotiating."

And diverse foreign markets are starting to coagulate into homogeneous markets that rival the size of the

American market. As William McAdams, president of the U.S. National Committee to IEC relates, "Western Europe has committed itself to unifying its market. The most powerful force in the development and use of international standards is the harmonization program for standardization being carried out in Western Europe. When the Common Market and European Free Trade Association were formed in 1960, they recognized the need to eliminate differences in standards. They immediately formed two European Standard-Coordinating committees: CENEL for electrical standards and CEN for standards in other fields. . . . It is going to be some time before this huge market area has the uniformity in standards that we have in the U.S., but the com-



McAdams: In order to sell in the world of the future, you're going to have to comply with international standards.

In 1971, the German Committee for Standardization DNA (Deutscher Normenausschuss), studied ISO standards produced up to a certain date and found that fewer than 25% of the standards that had been produced were, in fact, used.

But things are improving. According to Paul Hoppe, "Many countries will take an IEC publication, put a front page on it, and call it a national standard." Developing nations are generally quick to adopt IEC or ISO standards; it saves them the expense of developing their own.

But developed nations are also starting to accept IEC and ISO standards. William McAdams notes that "The European standards coordinating committees, CEN and CENEL, use ISO and IEC standards as a base where practical. . . . Since all CEN/CENEL members are members of ISO and IEC, they constitute a strong, well-prepared voting bloc. As a result, more and more of the standards coming out of ISO and IEC are being accepted by Western European countries as their national standards."

But according to McAdams, "For years we've had an unwritten position in the U.S. committee that we'll support a document *if* we can meet it. This is a lot different from saying we're going to accept the document. If our product is better than what IEC requires, then we'll accept the IEC document and then try to persuade the customer that our product is much better than anything required by the international standard. But we're re-evaluating that whole approach now, to determine if it's still a position we can stand by."

Other countries protest that the U.S. is imposing an unfair nontariff barrier by requiring standards tougher than the international agreement. They feel that if a country does not intend to use a document, it should cast a negative vote, and once a document is passed, all countries should do what they can to help the document, whether they voted for or against it. Negative votes and the reasons for them may be recorded in the prefaces of IEC documents.

But there are some standards conflicts that can't be resolved, no matter how sincere the negotiations. As an example, American line current is 110 V, 60 Hz, while European line current is 220 V, 50 Hz. The IEC can issue recommendations until Hell freezes over and it won't change that fact because both continents have a lot of money invested in power distribution equipment and the cost of changing from one system to the other would obliterate any possible benefits. Some people

mitment there to make maximum use of international standards is beginning to work." In 1967, American manufacturers got their first unpleasant taste of what it's like to be on the outside. England, France, and Germany formed a tripartite agreement for the mutual certification of electronic components. Their standards threatened to exclude certain components made to American specifications.

But the implications of the growing homogeneity of the European market could affect more than the U.S. export market. Foreign manufacturers who have been manufacturing for smaller domestic markets will undoubtedly expand to meet the demands of the larger common market; the larger markets will enable them to achieve product cost reductions that could make their products competitive for export to the United States. Thus, international standards agreements, even those to which the U.S. is not a party, could have an indirect effect on domestic sales.

The U.S. would benefit from a unified world market even if the standards of that market were different from her own standards. But truly international standardization would offer certain other advantages; OEMs could look to foreign as well as domestic suppliers for multiple sourcing; engineers would not have to waste time reinventing systems already designed by foreign engineers, and manufacturers would not have to stockpile a separate set of components and replacement parts for foreign equipment.

Do standardization agreements really standardize?

But even if we agree that international standardization is the greatest thing since sliced bread, we must ask "how effective are current standardization efforts?" How many of the standards recommended by the IEC and agreed to by its members are, in fact, implemented by the member nations?

Factors DETERRING U.S. Exports of Machinery, Instruments, and Other Measurement Sensitive Products

(Percent of total rankings by respondents)

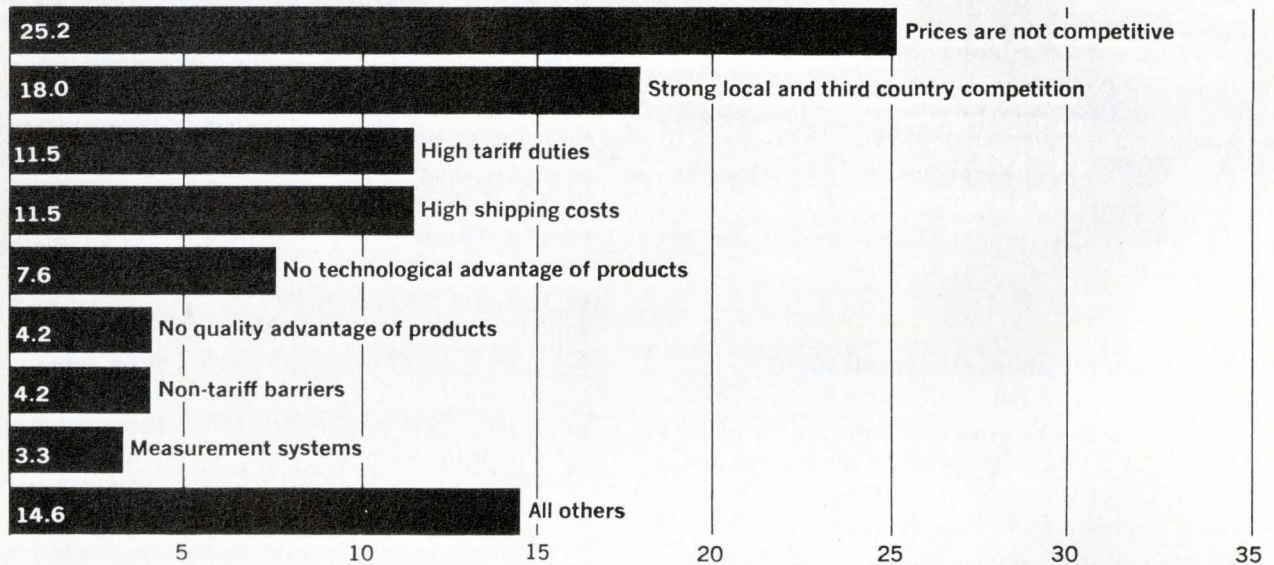

Factors PROMOTING U.S. Exports of Machinery, Instruments, and Other Measurement Sensitive Products

(Percent of total rankings by respondents)

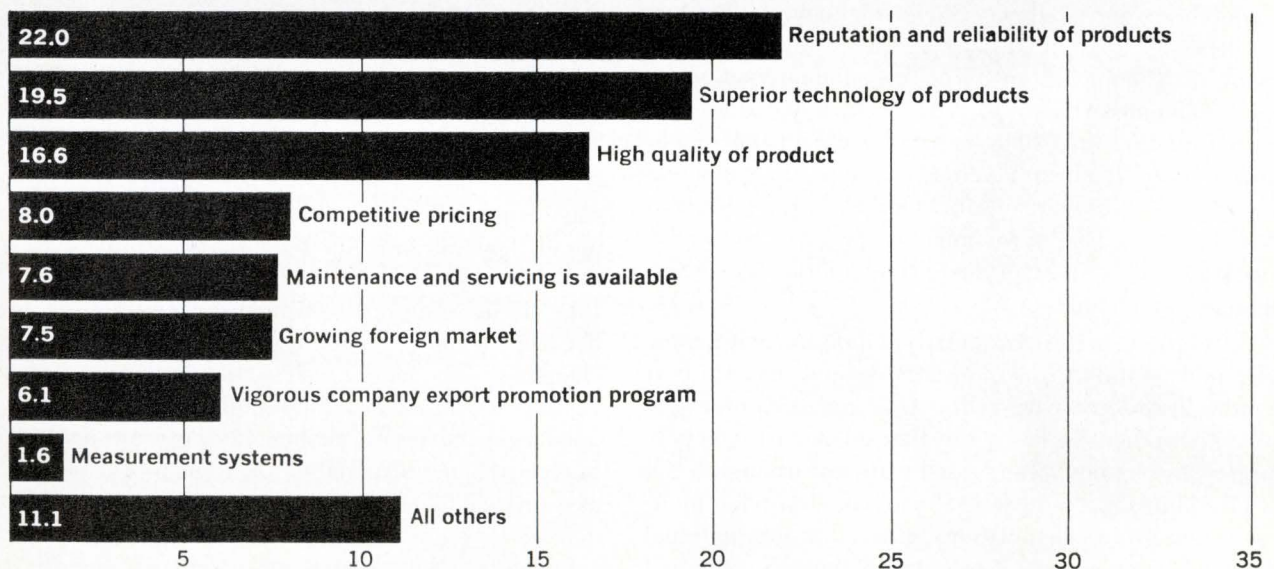

This chart, from the report to Congress of the U.S. Metric Study, indicates that differences in standards are not cur-

rently important in either promoting or deterring U.S. exports.

Kleinberg: Once you can no longer set standards by being first and best you had better start negotiating.



would interpret such unresolvable conflicts as flaws in the argument for standardization, but they aren't. In fact, they make a strong argument *for* negotiating international standards, and for negotiating them as soon as possible, before divergent technologies can become well-entrenched.

Is the U.S. serious about standardization?

According to McAdams, American participation in international standards work has grown substantially in the past several years; he estimates that participation quadrupled from 1962 to 1972. Although depth of participation is sometimes lacking, he notes that U.S. delegates to standardization conferences are highly respected, especially in electronics.

Simpson agrees that standardization activities have been supported by technical people, but feels that people who make funding decisions are just beginning to get the message; standards just isn't a "sexy subject."

Kleinberg agrees that while management may see the necessity for standardization, they can't get excited about it. "People often shrug off standardization as being like motherhood," he says, "which gets me upset every time. For one thing, motherhood isn't that popular any more; it's been given a bad name by Mrs. Portnoy, the mother who so dominated the life of her son that she stunted his development as a man. But effective standards should promote, not inhibit, the development of a technology."

Yet in the U.S. it is particularly important that people who make funding decisions understand and support standardization activities. The U.S. government is the only government in the world that does not financially support its National Standards Institute. Although a Bill (S 1798) introduced into the Senate could provide money for non-profit organizations engaged in international standardization activities, ANSI and the U.S. National Committee to IEC are currently supported by member corporations. Moreover, membership in ANSI is com-

pletely voluntary. Simpson estimates that of the 400-odd organizations around the U.S. that write standards in the private sector, only about 165 are members of ANSI.

As Deputy Assistant Secretary of Commerce for Product Standards, Simpson has been trying to encourage more recognition of the role of ANSI and more support of ANSI as a coordinating organization. In a recent series of industrial conferences sponsored by ANSI, Simpson pointed out to his audience of company presidents that ANSI was representing *their* companies, doing work for *their* companies in international standards. The response has been positive; ANSI picked up new members and is starting to operate in the black.

The major reason why executives have been slow to realize the value of standardization activities is that nobody has yet succeeded in putting a dollar value on the potential value of international standardization. Some of the benefits can be easily quantified; you can tally up the savings derived when you use a standard drawing or design for both domestic and international use instead of making two separate designs. But other numbers are more elusive: how much do you save when you avoid double stocking of similar parts? What does the availability of a wider array of second sources mean to you in dollars?

It would be nice to have such a number, to be able to say, "Since full cooperation with IEC and ISO recommendations will save American manufacturers x billions of dollars a year, you should cooperate." But when the U.S. Metric Study tried to answer a question of a similar scope, namely, how much would the U.S. benefit by changing to the metric system, the study took over two years, cost over a half-million dollars, and came up with only a general figure for benefits. Any estimate of the monetary benefits of standardization would be at least as expensive to determine and possibly more difficult to defend. It would be simpler and cheaper to merely accept the fact that greater international standardization is a desirable end, and to work toward that end with all deliberate speed. ■

The road to hell is paved with good intentions.



Rise/Fall Times from 1ns; Propagation Delays as low as 800ps; CTL; Schottky TTL; ECL. Promises. Promises. High speed logic is full of them—idealized switching time specs, developed under ideal load and environmental conditions in the manufacturers' labs.

But in this not-so-perfect world, how will the devices perform when stressed to your particular circuit conditions? What happens to all your plans when a 2ns circuit slows down to 2.5 or 3.0ns? Let's face it, if those few hundred picoseconds didn't make a difference, you wouldn't have used those sophisticated high-speed devices in the first place.

Now you can test these critical parameters with the Time Machine, Fairchild Systems' revolutionary, on-the-spot Real Time add-on to our Sentry Test Systems. We characterize what you want to know about TTL, Schottky, CTL and ECL device switching time parameters. Automatically, with picosecond accuracy and repeatability that only a digital approach can guarantee while precisely simulating the actual device environment. Rise times, fall times, propagation delays, all in a single pass—with just one insertion—regardless of test complexity. Up to 100,000

times measurements per second...a fantastic improvement over anything else operational today.

And because the Time Machine is a Sentry add-on, you can perform functional, time parametric and D.C. parametric measurements all in a single test without moving from one test head to another.

Developed out of a decade of leadership in advanced semiconductor testing systems, the Time Machine uses our

own digital techniques for Real Time dynamic measurements. It's available integrated into factory shipments of new Sentry Systems—or retro-fit to existing systems in the field.

Today's super-fast designs have slammed shut the gap between optimum device capability and the demands your designs make on that capability. It's no longer academic whether or not logic delivers the tightest switching time specs touted in data sheets. You've got to make dead certain that every part is TIME-characterized within your circuit use conditions. Before all hell breaks loose.



Fairchild Systems
3500 Deer Creek Road
Palo Alto, California 94302

- Send us complete data and specs on the new Time Machine option for high speed logic testing.
- Include complete material on the Sentry series.
- Please have your rep call us for a personal fill-in.

Name _____

Title _____

Company _____

Street _____

City _____ State _____

Zip _____ Telephone _____

TEE

Fairchild Systems

Fairchild Systems Technology, a division of Fairchild Camera & Instrument Corporation.

W-J's FREQUENCY SYNTHESIZERS for Precision Frequency Generation in Your Automatic Test System

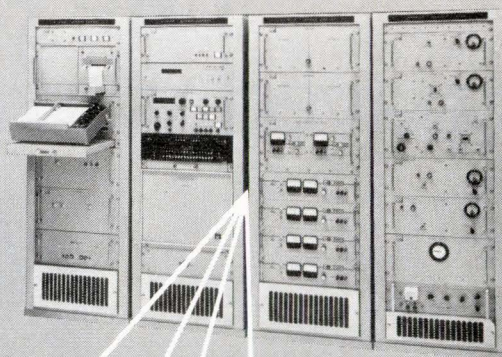

With the WJ-1154 series of frequency synthesizers, you have several choices of frequency coverage and performance. Some of these choices are listed here.

	WJ-1154	WJ-1154-2	WJ-1154-3	WJ-1154-7
Frequency Range	1-12.4 GHz	5.37-5.87 GHz	1-2 GHz	1-18 GHz
Frequency Steps	100 kHz	100 kHz	100 kHz	100 kHz
Frequency Accuracy	1 part in 10 ⁹ for all frequency synthesizers			
Settling Time	100 msec	10 msec	10 msec	100 msec
RF Output Power	1 mW	2 Watts	1 Watt	10 mW

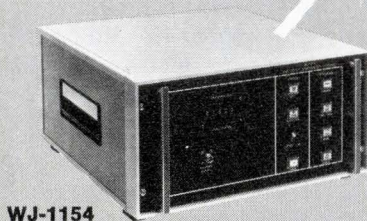

WJ-1154



WJ-1154-2

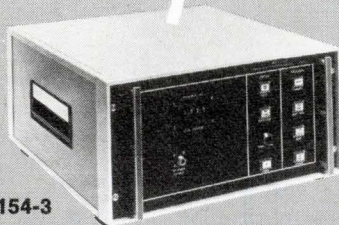

WJ-1154-3

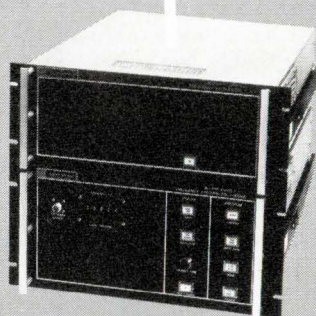

WJ-1154-7

For complete details on these and other frequency synthesizers, contact our local Field Sales Office/Representative in your area or call Watkins-Johnson Applications Engineering.



3333 HILLVIEW AVE., STANFORD INDUSTRIAL PARK, PALO ALTO, CALIF. 94304 • (415) 493-4141

THE
ELECTRONIC
ENGINEER

BUYERS' GUIDE

for Low Cost IC
Operational Amplifiers

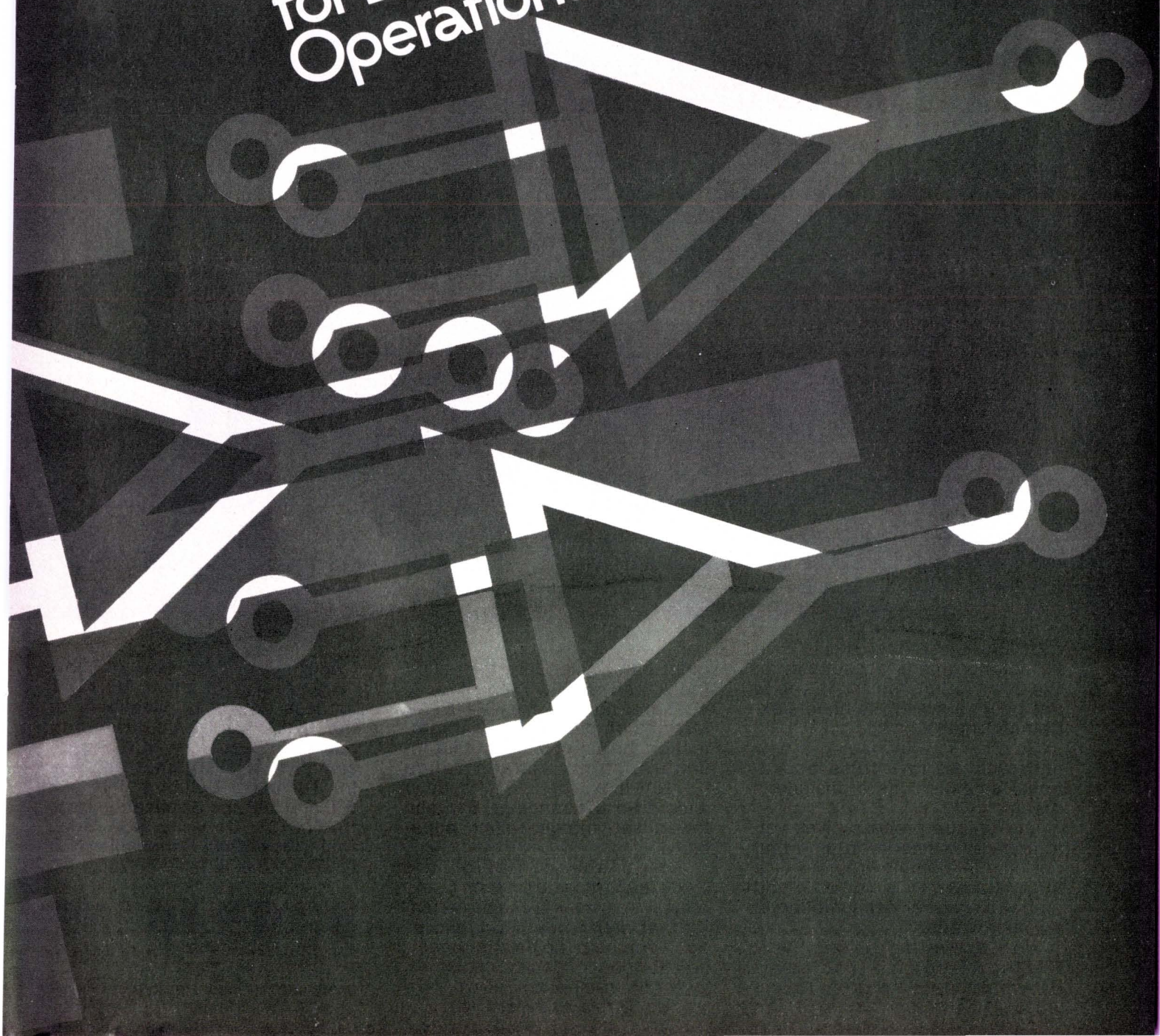

This is no time for popcorn noise...

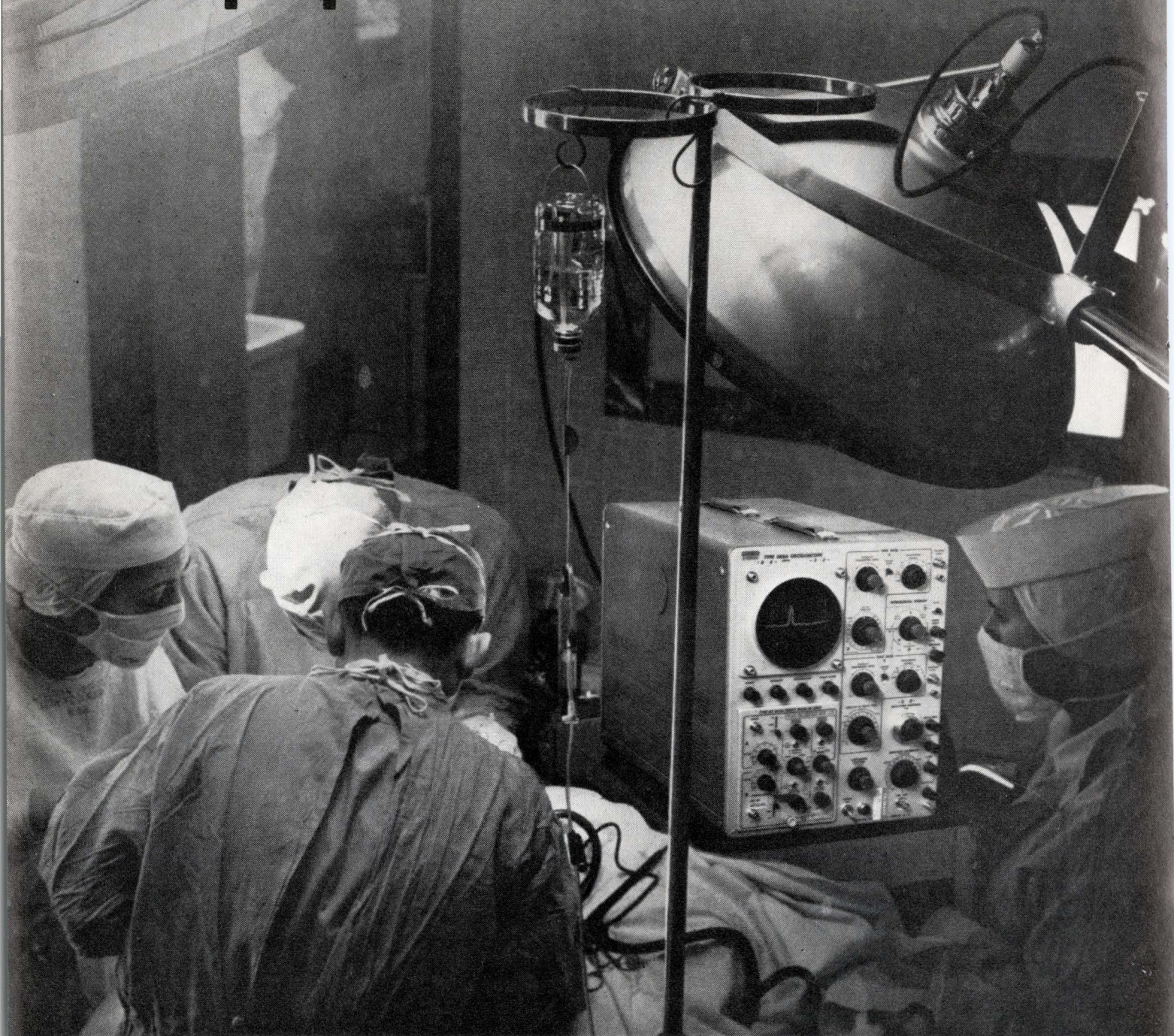

In fact, no time is acceptable for Popcorn (burst) noise, if you're designing a system to handle extremely small signals.

So RCA is announcing a new micropower, low noise operational amplifier. It's a designer's dream.

Our unique process gives you a monolithic silicon op amp that not only exhibits low burst noise but operates from a single 1.5-volt cell with a power consumption of 1.5 microwatts.

How low is the noise? Every CA6078AT op amp that leaves RCA must operate with equivalent

input burst noise less than 20 μ V (peak) at $R_s=200,000$ ohms.

That's not all, the CA6078AT features output short-circuit protection through built-in output resistors, input voltage range (± 15 V max. for ± 15 V supply) wide dif-mode range (± 6 V), and low offset-voltage nulling capability.

So go ahead! Design the CA6078AT into your system...and relax. Because you can be certain that with the new RCA micropower op amp, no time is acceptable for popcorn (burst) noise.

Want more data on the
Circle Reader Service #16

CA6078AT or CA3078AT (the low cost version of the CA6078AT for less critical applications) or the CA6741T, RCA's low-burst-noise 741? See your RCA Representative or Distributor and ask for Technical Bulletins, File No. 530 and 592 and Application Note ICAN-6732. Or write RCA Solid State, Box 3200, Somerville, N.J. 08876. Phone (201) 722-3200.

RCA Solid State

products that make products pay off

BUYERS' GUIDE

for Low Cost IC Operational Amplifiers

Deborah P. Wilkins, Arthur J. Boyle
The Electronic Engineer

The op amp has become as ubiquitous in today's electronic equipment as the vacuum tube and transistor in their days of glory. And, as the popularity of the op amp has grown, so has the number of models available from the various manufacturers.

On the following pages, you will find a list of just about 1000 different op amps. It includes all integrated circuit op amps, both hybrid and monolithic, that you can buy for less than \$30.00 each in quantities of 100.

The list is arranged in order of ascending price, beginning with a plastic-packaged 709 for 46¢ from TI and continuing on up to the AD508L, a \$30.00 hybrid device from Analog Devices. All in all, 24 dif-

ferent manufacturers are represented.

In addition to the model number, price, and manufacturer, the list includes typical values for input bias current, offset voltage drift, and slew rate. If you're looking for ultra high performance in one of these areas, the list may also be of help. Op amps with an input bias current of 10 pA or less are identified by a color tint in the bias current column. If offset voltage drift is your thing, the color tint identifies those which boast of 1 $\mu\text{V}/^\circ\text{C}$ or less. Finally, if you happen to be a speed freak, color in the slew rate column indicates slew rates of 100 V/ μs or greater.

For more information on a specific device, we recommend that you contact the manufacturers directly at the addresses listed. For general information use the Reader Service Number. ■

Advanced Micro Devices 901 Thompson Place Sunnyvale, CA 94086	RSN #250	ITT Semiconductors 3301 Electronics Way West Palm Beach, FL 33407	RSN #258	Silicon General Inc. 7382 Bolsa Ave. Westminster, CA 92683	RSN #266
Amperex Electronic Corp. Hybrid Integrated Circuits 99 Bald Hill Rd. Cranston, RI 02920	RSN #251	Motorola Semiconductor Products Inc. 5005 E. McDowell Rd. Phoenix, AZ 85008	RSN #259	Siliconix 2201 Laurelwood Rd. Santa Clara, CA 95054	RSN #267
Analog Devices Rte. One Industrial Park Box 280 Norwood, MA 02062	RSN #252	National Semiconductor 2900 Semiconductor Dr. Santa Clara, CA 95051		Sprague Electric Co. 551 Marshall St. North Adams, MA 01248	RSN #268
Bell & Howell Control Products Div. 706 Bostwick Ave. Bridgeport, CT 06605	RSN #253	Optical Electronics Inc. Box 11140 Tucson, AZ 85706	RSN #261	Teledyne Philbrick Allied Dr. at Rte. 128 Dedham, MA 02026	RSN #269
Burr-Brown Research Corp. International Airport Ind. Park Tucson, AZ 85706	RSN #254	Precision Monolithics Inc. 1500 Space Park Dr. Santa Clara, CA 95050	RSN #262	Teledyne Semiconductor 1400 Terra Bella Ave. Mountain View, CA 94040	RSN #270
Fairchild Semiconductor 464 Ellis St. Mountain View, CA 94040	RSN #255	Raytheon 350 Ellis St. Mountain View, CA 94040	RSN #263	Texas Instruments Inc. Box 5012 MS/84 13500 N. Central Expwy. Dallas, TX 75222	RSN #271
Harris Semiconductor Box 883 Melbourne, FL 32901	RSN #256	RCA Solid State Div. Route 202 Somerville, NJ 08876	RSN #264	Transitron Electronic Corp. 168 Albion St. Wakefield, MA 01880	RSN #272
Intersil Inc. 10900 N. Tantau Ave. Cupertino, CA 95014	RSN #257	Signetics 811 E. Arques Ave. Sunnyvale, CA 94086	RSN #265	Zeltex Inc. 1000 Chalomar Rd. Concord, CA 94520	RSN #273

MODEL	H/M	BIAS nA	SLEW V/ μ s	DRIFT μ V/ $^{\circ}$ C	COST \$/100	MANUFACTURER	MODEL	H/M	BIAS nA	SLEW V/ μ s	DRIFT μ V/ $^{\circ}$ C	COST \$/100	MANUFACTURER
SN72709P	M	1500.00000	0.30	6.0	0.46	TEXAS INSTRUMENTS	MC1435G	M	1200.00000	0.67	3.0	1.50	MOTOROLA
MC1709CP1	M	300.00000	0.25	3.0	0.50	MOTOROLA	MCC1458-2	M	200.00000	0.80	*****	1.50	MOTOROLA
SN72709N	M	1500.00000	0.30	6.0	0.54	TEXAS INSTRUMENTS	741C-LN	M	80.00000	0.40	25.0	0.50	INTERFIL
LM709CN	M	500.00000	0.30	6.0	0.55	NATIONAL SEMICONDUCTOR	SN72747N	M	500.00000	0.50	7.0	1.55	TEXAS INSTRUMENTS
741C	M	200.00000	0.50	6.0	0.55	INTERFIL	CA3015	M	9600.00000	7.00	3.5	1.56	RCA
748C	M	120.00000	0.50	3.0	0.55	INTERFIL	ULN-2158M	M	70.00000	0.60	15.0	1.58	SPRAGUE
SN72741P	M	500.00000	0.50	7.0	0.56	TEXAS INSTRUMENTS	ULN-2158D	M	70.00000	0.60	15.0	1.58	SPRAGUE
MC1741CP1	M	200.00000	0.80	3.0	0.56	MOTOROLA	RC4131T	M	50.00000	2.50	5.0	1.60	RAYTHEON
RC709DP	M	1500.00000	0.40	6.0	0.58	RAYTHEON	LM1303N	M	400.00000	0.50	10.0	1.60	NATIONAL SEMICONDUCTOR
MC1709CP2	M	300.00000	0.25	3.0	0.58	MOTOROLA	MC1439L	M	200.00000	4.20	3.0	1.60	MOTOROLA
CA3029	M	5300.00000	3.00	1.2	0.59	RCA	RM709T	M	300.00000	0.40	4.0	1.63	RAYTHEON
SN72301A	M	250.00000	0.50	6.0	0.60	TEXAS INSTRUMENTS	NS709	M	200.00000	*****	6.0	1.65	SIGNETICS
SN72307P	M	250.00000	0.50	6.0	0.60	TEXAS INSTRUMENTS	SN52709L	M	500.00000	0.30	6.0	1.70	TEXAS INSTRUMENTS
SN72748P	M	500.00000	0.50	7.0	0.60	TEXAS INSTRUMENTS	LM709H	M	1500.00000	0.30	5.0	1.70	NATIONAL SEMICONDUCTOR
LM709CH	M	500.00000	0.30	6.0	0.60	NATIONAL SEMICONDUCTOR	ULN-2151M	M	70.00000	0.60	15.0	1.74	SPRAGUE
LM301AN	M	30.00000	0.50	30.0	0.60	NATIONAL SEMICONDUCTOR	ULN-2151H	M	70.00000	0.60	15.0	1.74	SPRAGUE
MCC170902	M	300.00000	0.25	3.0	0.60	MOTOROLA	SN72771P	M	30.00000	2.50	10.0	1.74	TEXAS INSTRUMENTS
MLM301AP1	M	70.00000	10.00	6.0	0.60	MOTOROLA	SN72770P	M	30.00000	2.50	10.0	1.74	TEXAS INSTRUMENTS
MC1709CL	M	300.00000	0.25	3.0	0.61	MOTOROLA	TOA8709	M	30.00000	0.50	*****	1.75	TRANSITRON
MC1709CG	M	300.00000	0.25	3.0	0.61	MOTOROLA	SG1760	M	15.00000	0.10	10.0	1.75	SILICON GENERAL
TOA301A	M	70.00000	*****	6.0	0.63	TRANSITRON	SG741CD	M	500.00000	0.50	10.0	1.75	SILICON GENERAL
TOA307	M	70.00000	*****	6.0	0.63	TRANSITRON	1339	M	150.00000	34.00	5.0	1.75	TELEDYNE PHILBRICK
SN72741N	M	500.00000	0.30	5.0	0.64	TEXAS INSTRUMENTS	MC1709G	M	200.00000	0.25	3.0	1.75	MOTOROLA
MC1741CP2	M	200.00000	0.80	3.0	0.64	MOTOROLA	MC1709L	M	200.00000	0.25	3.0	1.75	MOTOROLA
TOA2741	M	80.00000	0.50	*****	0.65	TRANSITRON	MC1437L	M	400.00000	0.25	1.5	1.75	MOTOROLA
CA3010	M	5300.00000	3.00	1.2	0.65	RCA	307	M	70.00000	0.50	15.0	1.75	ADVANCED MICRO DEVICES
LM301AH	M	30.00000	0.50	30.0	0.65	NATIONAL SEMICONDUCTOR	SN72550N	M	15.00000	0.10	30.0	1.78	TEXAS INSTRUMENTS
MLM301AG	M	70.00000	*****	6.0	0.65	MOTOROLA	RC112T	M	7.00000	*****	30.0	1.80	RAYTHEON
LM301AG	M	70.00000	10.00	6.0	0.65	MOTOROLA	MC1420G	M	800.00000	5.00	2.0	1.80	MOTOROLA
MC1741CG	M	200.00000	0.80	3.0	0.68	MOTOROLA	201	M	120.00000	0.50	5.0	1.80	ADVANCED MICRO DEVICES
MC1741CL	M	200.00000	0.80	3.0	0.68	MOTOROLA	ULN-2139D	M	250.00000	4.20	15.0	1.83	SPRAGUE
CA3741CT	M	80.00000	0.50	2.0	0.69	RCA	ULN-2139M	M	250.00000	4.20	15.0	1.83	SPRAGUE
MCC1748C2	M	80.00000	0.80	3.0	0.70	MOTOROLA	MCB1709C	M	200.00000	0.75	3.0	1.85	MOTOROLA
CA3080	M	120.00000	50.00	1.0	0.71	RCA	MC1712CF	M	2500.00000	1.50	5.0	1.85	MOTOROLA
RC741T	M	500.00000	0.50	6.0	0.71	RAYTHEON	SN72660L	M	15.00000	0.10	30.0	1.88	TEXAS INSTRUMENTS
CA3029A	M	2500.00000	3.00	1.2	0.71	RCA	CA3047	M	70.00000	2.70	6.6	1.90	RCA
RC748T	M	500.00000	0.50	6.0	0.71	RAYTHEON	TOA1709	M	200.00000	0.50	3.0	1.90	TRANSITRON
301A	M	70.00000	0.50	6.0	0.72	INTERFIL	MCC1539-2	M	200.00000	4.20	3.0	1.90	MOTOROLA
MCC1741C2	M	200.00000	0.80	3.0	0.75	MOTOROLA	SSS301AP	M	60.00000	0.40	7.0	1.90	PRECISION MONOLITHICS
MC3401	M	50.00000	0.60	*****	0.75	MOTOROLA	SSS741CP	M	45.00000	1.50	4.5	1.90	PRECISION MONOLITHICS
CA3010A	M	2500.00000	3.00	1.2	0.78	RCA	SSS307P	M	60.00000	0.40	7.0	1.90	PRECISION MONOLITHICS
MC3301	M	50.00000	0.60	*****	0.80	MOTOROLA	CA3747E	M	80.00000	0.50	2.0	1.95	RCA
SG741CN	M	500.00000	0.50	10.0	0.85	SILICON GENERAL	CA3741T	M	80.00000	0.50	2.0	1.95	RCA
TOA2709	M	300.00000	0.50	*****	0.85	TRANSITRON	SG308T	M	7.00000	0.25	30.0	1.95	SILICON GENERAL
SG3014M	M	250.00000	0.50	30.0	0.85	SILICON GENERAL	SG3118T	M	7.00000	0.25	30.0	1.95	SILICON GENERAL
SG741CM	M	500.00000	0.50	10.0	0.85	SILICON GENERAL	LM312H	M	7.00000	0.30	6.0	1.95	NATIONAL SEMICONDUCTOR
SG307H	M	250.00000	0.50	30.0	0.85	SILICON GENERAL	LM747CN	M	200.00000	0.50	*****	1.95	NATIONAL SEMICONDUCTOR
TOA2748	M	80.00000	5.00	*****	0.85	TRANSITRON	LM301AD	M	30.00000	0.50	30.0	1.95	NATIONAL SEMICONDUCTOR
HC4558DN	M	200.00000	0.50	6.0	0.88	RAYTHEON	LM1458N	M	1500.00000	0.50	*****	1.95	NATIONAL SEMICONDUCTOR
709CE	M	1500.00000	0.30	50.0	0.90	TELEDYNE SEMICONDUCTOR	MC1433L	M	500.00000	0.80	10.0	1.95	MOTOROLA
MUA709C	M	1500.00000	0.30	10.0	0.90	FAIRCHILD	MC1433G	M	500.00000	0.80	10.0	1.95	MOTOROLA
SG310AT	M	250.00000	0.50	30.0	0.95	SILICON GENERAL	MC1709	M	200.00000	0.40	3.0	1.95	ITT
SG741CT	M	500.00000	0.50	10.0	0.95	SILICON GENERAL	MUA709A	M	500.00000	0.30	10.0	1.95	FAIRCHILD
SG307T	M	250.00000	0.50	30.0	0.95	SILICON GENERAL	AD308	M	1.50000	0.30	6.0	1.95	ANALOG DEVICES
SG748CM	M	500.00000	0.50	10.0	0.95	SILICON GENERAL	308	M	1.50000	0.20	5.0	1.95	ADVANCED MICRO DEVICES
CA3748CT	M	80.00000	0.50	2.0	0.95	RCA	312	M	1.50000	0.20	5.0	1.95	ADVANCED MICRO DEVICES
SN72702N	M	4000.00000	1.70	5.0	0.96	TEXAS INSTRUMENTS	741C	M	80.00000	0.50	10.0	1.95	ADVANCED MICRO DEVICES
LM308N	M	*****	0.30	6.0	0.98	NATIONAL SEMICONDUCTOR	SN72308L	M	1.50000	0.25	6.0	1.96	TEXAS INSTRUMENTS
RC101AT	M	275.00000	0.50	6.0	1.00	RAYTHEON	CA3030A	M	4700.00000	7.00	1.2	1.98	RCA
RC107T	M	250.00000	0.50	15.0	1.00	RAYTHEON	RC4131D	M	50.00000	2.50	5.0	2.00	RAYTHEON
RC4558T	M	200.00000	0.50	6.0	1.00	RAYTHEON	709BE	M	500.00000	0.30	10.0	2.00	TELEDYNE SEMICONDUCTOR
TOA3709	M	200.00000	0.50	3.0	1.00	TRANSITRON	MCC1748-2	M	80.00000	0.80	3.0	2.00	MOTOROLA
AD741C	M	80.00000	0.50	*****	1.00	ANALOG DEVICES	AD741	M	80.00000	0.50	*****	2.00	ANALOG DEVICES
AD301A	M	70.00000	0.50	6.0	1.00	ANALOG DEVICES	CA3037	M	5300.00000	3.00	1.2	2.04	RCA
LM741CN	M	200.00000	0.50	*****	1.05	NATIONAL SEMICONDUCTOR	ULN-2157A	M	70.00000	0.60	15.0	2.08	SPRAGUE
SG748CT	M	500.00000	0.50	10.0	1.10	SILICON GENERAL	ULN-2157K	M	70.00000	0.60	15.0	2.08	SPRAGUE
MCC1439-2	M	200.00000	4.20	3.0	1.10	MOTOROLA	LM1458H	M	1500.00000	0.50	*****	2.20	NATIONAL SEMICONDUCTOR
HA2301A-5	M	250.00000	0.50	3.0	1.10	HARRIS	MCB1709F	M	200.00000	0.25	3.0	2.20	MOTOROLA
HA2307-5	M	250.00000	0.50	3.0	1.10	HARRIS	SSS841CJ	M	45.00000	0.50	5.0	2.20	PRECISION MONOLITHICS
MUA748C	M	500.00000	0.50	7.0	1.10	FAIRCHILD	CA3015A	M	4700.00000	7.00	1.2	2.22	RCA
LM301A	M	250.00000	0.50	6.0	1.10	FAIRCHILD	RC1556T	M	30.00000	1.50	20.0	2.25	RAYTHEON
SN72558P	M	500.00000	0.50	7.0	1.14	TEXAS INSTRUMENTS	LM725CN	M	*****	*****	1.0	2.25	NATIONAL SEMICONDUCTOR
SN52741L	M	500.00000	0.50	7.0	1.15	TEXAS INSTRUMENTS	LM316H	M	0.15000	*****	*****	2.25	NATIONAL SEMICONDUCTOR
SN52748L	M	500.00000	0.50	7.0	1.15	TEXAS INSTRUMENTS	MC1712CL	M	2500.00000	1.50	5.0	2.25	MOTOROLA
MC1456CG	M	15.00000	2.50	*****	1.19	MOTOROLA	MC1456G	M	15.00000	2.50	*****	2.25	MOTOROLA
TOA1558	M	80.00000	0.50	*****	1.20	TRANSITRON	MCC1741-2	M	200.00000	0.80	3.0	2.25	MOTOROLA
TOA2747	M	80.00000	0.50	*****	1.20	TRANSITRON	MUA702C	M	7500.00000	3.50	10.0	2.25	FAIRCHILD
CA3450E	M	80.00000	0.50	2.0	1.20	RCA	MUA739C	M	2000.00000	1.00	4.0	2.25	FAIRCHILD
MC1458CG	M	200.00000	0.25	3.0	1.20	MOTOROLA	AD741K	M	30.00000	0.50	2.0	2.25	ANALOG DEVICES
MC1458CG	M	200.00000	0.80	*****	1.23	MOTOROLA	316	M	0.05000	0.20	30.0	2.25	ADVANCED MICRO DEVICES
SN52702L	M	4000.00000	1.70	10.0	1.25	TEXAS INSTRUMENTS	CA3008	M	5300.00000	3.00	1.2	2.28	RCA
SG3217CT	M	500.00000	0.50	10.0	1.25	SILICON GENERAL	ULS-2158D	M	35.00000	0.60	15.0	2.28	

Four new linear integrated circuits worth talking about. Again.



Maybe you remember our ads which introduced some of our new integrated circuits this year.

Better yet, maybe you sent for our product information and evaluation samples.

A lot of people did because sales have been excellent.

And that's because everything we said about their

performance was absolutely true.

Our AD508. No one else gives you this kind of long term drift performance.

Our AD520. The world's first and only I.C. instrumentation amplifier. A complete system all by itself.

Our AD523. It has the lowest bias current of all high performance I.C. operational amplifiers.

Our AD830 dual monolithic FETs. Their performance is so revolutionary, we gave them a new name and came up with a new way to measure them.

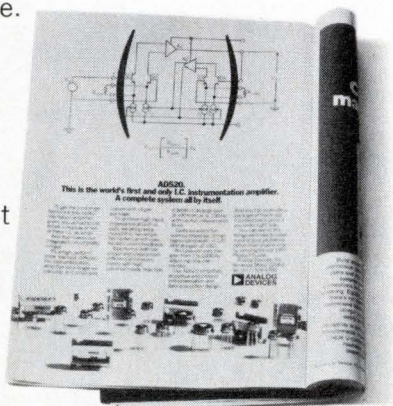

They're all worth talking about again so you'll get an idea of the kind of linear I.C.'s we make: multipliers, FET input op amps, high performance op amps, A/D and D/A conversion components, dual monolithic transistors.

And so you'll know what to expect from us.

We'll be using innovative FET, bipolar, and CMOS technology to give you the special and often unique performance you're looking for. At a reasonable price.

It isn't going to be all that hard to do when you look at what we've already done.

We enjoy the leadership position in analog circuitry.

We'd be happy to send you all the details on our four new integrated circuits. As well as our Product Guide which shows the rest of our

I.C. line and all the other things we make to solve more of your problems better than anyone else.

Analog Devices, Inc., Norwood, Mass. 02062 (617) 329-4700.

 **ANALOG DEVICES**



NEW TES



TAMENT.

We've just succeeded in putting together the world's largest, most complete source book of Linear ICs. A 2½ pound, 468-page testament to our in-depth design capabilities. Nearly double the size of our last linear catalog.

It was only right that we should do this, since we've been building the best linear circuits for many years.

We're still building them. *In fact, since the printing of our catalog last year, we've added 53 new circuits, 13 of them proprietary devices such as the new LM119 Precision High Speed Comparator, the new LM3900 Quad Amp and the new LM380 Audio Power Amp.*

Even now, as we offer our new 468-page catalog to you, new linear devices are being designed by each of our three linear circuit design teams. Bright, eager groups headed by superstars like Bob Dobkin, Al Howard and Jim Solomon. (See if you can spot them in the picture to the left. Winners get a genuine imitation leather bookmark.)

Your nearest National sales rep will be glad to put our new linear catalog into your hands, as well as data sheets for all linear devices designed since the catalog was printed. At the same time, ask him for a copy of our 304-page Linear Applications Handbook — a perfect companion to our Linear Catalog.

So call your nearest sales rep today, or write on your letterhead to National Semiconductor Corporation, 2900 Semiconductor Drive, Santa Clara, California 95051.

National

MODEL	H/M	BIAS nA	SLEW V/μs	DRIFT μV/°C	COST \$/100	MANUFACTURER	MODEL	H/M	BIAS nA	SLEW V/μs	DRIFT μV/°C	COST \$/100	MANUFACTURER
RC4741	M	500.00000	0.50	6.0	2.90	RAYTHEON	201	M	250.00000	0.50	6.0	4.00	INTERSIL
RC747T	M	500.00000	0.50	6.0	2.90	RAYTHEON	747C	M	80.00000	0.40	10.0	4.00	ADVANCED MICRO DEVICES
SG4250CM	M	30.00000	0.20	6.0	2.95	SILICON GENERAL	AD512K	M	40.00000	0.50	20.0	4.00	ANALOG DEVICES
LM741H	M	1500.00000	0.50	*****	2.95	NATIONAL SEMICONDUCTOR	SSS747CP	M	45.00000	0.70	4.5	4.05	PRECISION MONOLITHICS
SSS308J	M	1.50000	0.20	5.0	2.95	PRECISION MONOLITHICS	HA2101A-2	M	75.00000	0.50	3.0	4.07	HARRIS
SSS312J	M	1.50000	0.10	5.0	2.95	PRECISION MONOLITHICS	RC4132U	M	10.00000	0.13	5.0	4.12	RAYTHEON
TOA7809	M	2.00000	0.50	6.0	3.00	TRANSITRON	ULS-2158H	M	35.00000	0.60	15.0	4.13	SPRAGUE
CA3558T	M	80.00000	0.50	2.0	3.00	RCA	ULS-2158G	M	35.00000	0.60	15.0	4.13	SPRAGUE
NS741	M	80.00000	0.50	*****	3.00	SIGNETICS	RC45310N	M	400.00000	35.00	5.0	4.13	RAYTHEON
SSS841CP	M	45.00000	0.50	5.0	3.00	PRECISION MONOLITHICS	RC4531T	M	400.00000	35.00	5.0	4.13	RAYTHEON
AD502J	M	3.00000	0.40	40.0	3.00	INTERSIL	CA3060AU	M	1500.00000	8.00	1.1	4.20	RCA
741J	M	50.00000	4.00	5.0	3.00	INTERSIL	CA3038A	M	4700.00000	7.00	1.2	4.20	RCA
LM201A	M	75.00000	0.50	3.0	3.00	FAIRCHILD	SG741D	M	500.00000	0.50	7.0	4.20	SILICON GENERAL
AD502JH	M	5.00000	1.00	15.0	3.00	ANALOG DEVICES	MCH1741F	M	200.00000	0.80	3.0	4.25	MOTOROLA
AD101A	M	30.00000	0.50	3.0	3.00	ANALOG DEVICES	MCH1748F	M	80.00000	0.80	3.0	4.25	MOTOROLA
TDAL748	M	80.00000	5.00	*****	3.10	TRANSITRON	LM741F	M	1500.00000	0.50	*****	4.45	NATIONAL SEMICONDUCTOR
ULN-2174D	M	7.00000	0.30	15.0	3.10	SPRAGUE	RC108T	M	7.00000	0.30	30.0	4.45	RAYTHEON
ULN-2174M	M	7.00000	0.30	15.0	3.10	SPRAGUE	ULN-2156D	M	15.00000	2.50	15.0	4.47	SPRAGUE
1303	M	300.00000	3.00	5.0	3.10	TELEDYNE PHILBRICK	ULN-2156M	M	15.00000	2.50	15.0	4.47	SPRAGUE
1301	M	300.00000	3.00	5.0	3.10	TELEDYNE PHILBRICK	SG747CD	M	500.00000	5.00	10.0	4.50	SILICON GENERAL
ULN-2172M	M	30.00000	1.50	15.0	3.10	SPRAGUE	MC1741F	M	200.00000	0.80	3.0	4.50	MOTOROLA
ULN-2172D	M	30.00000	1.50	15.0	3.10	SPRAGUE	MC1436G	M	15.00000	2.00	*****	4.50	MOTOROLA
CA3038	M	9600.00000	7.00	3.5	3.12	RCA	MC1431F	M	100.00000	1.00	*****	4.50	MOTOROLA
CA3016	M	9600.00000	7.00	3.5	3.12	RCA	MC1430F	M	5000.00000	1.00	*****	4.50	MOTOROLA
CA3037A	M	2500.00000	3.00	1.2	3.12	RCA	MC1747CL	M	80.00000	0.50	3.0	4.50	MOTOROLA
SN52101AL	M	75.00000	0.50	3.0	3.14	TEXAS INSTRUMENTS	308	M	1.50000	0.30	6.0	4.50	INTERSIL
SG4250CT	M	30.00000	0.20	6.0	3.25	SILICON GENERAL	115A	M	20.00000	*****	2.0	4.50	INTERSIL
SG3250T	M	30.00000	0.20	6.0	3.25	SILICON GENERAL	1424	M	0.05000	6.00	75.0	4.50	TELEDYNE PHILBRICK
LM310H	M	7.00000	30.00	10.0	3.25	NATIONAL SEMICONDUCTOR	ULS-2151H	M	35.00000	0.60	15.0	4.56	SPRAGUE
LM4250CH	M	30.00000	1.00	10.0	3.25	NATIONAL SEMICONDUCTOR	ULS-2151G	M	35.00000	0.60	15.0	4.56	SPRAGUE
LM316AH	M	0.05000	*****	*****	3.25	NATIONAL SEMICONDUCTOR	SN52747J	M	500.00000	0.50	7.0	4.58	TEXAS INSTRUMENTS
MC1537L	M	200.00000	0.25	3.0	3.25	MOTOROLA	ULS-2139H	M	150.00000	4.20	15.0	4.60	SPRAGUE
MC1709F	M	300.00000	0.25	3.0	3.25	MOTOROLA	ULS-2139G	M	150.00000	4.20	15.0	4.60	SPRAGUE
MLM310G	M	2.00000	30.00	6.0	3.25	MOTOROLA	3057/01	M	200.00000	1.20	15.0	4.70	BURR-BROWN
LM101A	M	75.00000	0.50	3.0	3.25	FAIRCHILD	ULN-2159D	M	70.00000	25.00	15.0	4.74	SPRAGUE
310	M	2.00000	30.00	10.0	3.25	ADVANCED MICRO DEVICES	ULN-2159M	M	70.00000	25.00	15.0	4.74	SPRAGUE
316A	M	0.05000	0.20	10.0	3.25	ADVANCED MICRO DEVICES	CA3016A	M	4700.00000	7.00	1.2	4.75	RCA
ULS-2157A	M	35.00000	0.60	15.0	3.26	SPRAGUE	TOA318	M	600.00000	50.00	*****	4.85	TRANSITRON
ULS-2157K	M	35.00000	0.60	15.0	3.26	SPRAGUE	L144CJ	M	125.00000	0.40	3.0	4.90	SILICONIX
MUA776C	M	50.00000	0.70	3.0	3.28	FAIRCHILD	TOA207	M	30.00000	*****	3.0	4.90	TRANSITRON
SN52558L	M	500.00000	0.50	7.0	3.31	TEXAS INSTRUMENTS	TOA210A	M	30.00000	*****	3.0	4.90	TRANSITRON
1339-01	M	150.00000	34.00	5.0	3.35	TELEDYNE PHILBRICK	9300	M	*****	30.00	50.0	4.90	OPTICAL ELECTRONICS
MCC1436-2	M	15.00000	2.00	*****	3.40	MOTOROLA	AD540J	M	0.00200	6.00	30.0	4.90	ANALOG DEVICES
ULN-2158G	M	70.00000	0.60	15.0	3.43	SPRAGUE	SG201AT	M	75.00000	0.50	15.0	4.95	SILICON GENERAL
ULN-2158H	M	70.00000	0.60	15.0	3.43	SPRAGUE	ULN-2174G	M	7.00000	0.30	15.0	4.95	SPRAGUE
ULN-2173D	M	7.00000	0.30	15.0	3.44	SPRAGUE	SG207T	M	75.00000	0.50	15.0	4.95	SILICON GENERAL
ULN-2171M	M	30.00000	1.50	15.0	3.44	SPRAGUE	ULN-2174H	M	7.00000	0.30	15.0	4.95	SPRAGUE
ULN-2173M	M	7.00000	0.30	15.0	3.44	SPRAGUE	ULN-2172H	M	30.00000	1.50	15.0	4.95	SPRAGUE
ULN-2171D	M	30.00000	1.50	15.0	3.44	SPRAGUE	ULN-2172G	M	30.00000	1.50	15.0	4.95	SPRAGUE
1319	M	70.00000	0.60	6.0	3.45	TELEDYNE PHILBRICK	LM318H	M	200.00000	50.00	7.0	4.95	NATIONAL SEMICONDUCTOR
TOA1741	M	80.00000	0.50	*****	3.45	TRANSITRON	LM201AH	M	20.00000	0.50	5.0	4.95	NATIONAL SEMICONDUCTOR
SSS308Y	M	1.50000	0.20	5.0	3.45	PRECISION MONOLITHICS	LM316AD	M	0.05000	*****	*****	4.95	NATIONAL SEMICONDUCTOR
HA2101-2	M	500.00000	0.50	3.0	3.45	HARRIS	MN0P01C	M	40.00000	15.00	3.5	4.95	PRECISION MONOLITHICS
SSS312Y	M	1.50000	0.10	5.0	3.45	PRECISION MONOLITHICS	MLM201AG	M	30.00000	10.00	3.0	4.95	MOTOROLA
CA3033	M	70.00000	2.70	6.6	3.48	RCA	MLM207G	M	30.00000	*****	3.0	4.95	MOTOROLA
CA3047A	M	100.00000	3.00	6.6	3.48	RCA	RC4132T	M	10.00000	0.13	5.0	4.95	RAYTHEON
SG201AM	M	75.00000	0.50	15.0	3.50	SILICON GENERAL	SSS841GJ	M	45.00000	0.50	5.0	4.95	PRECISION MONOLITHICS
MC1533G	M	500.00000	2.00	8.0	3.50	MOTOROLA	SSS741GP	M	45.00000	1.50	4.5	4.95	PRECISION MONOLITHICS
MC1533L	M	500.00000	2.00	8.0	3.50	MOTOROLA	MUA715C	M	1500.00000	18.00	6.0	4.95	FAIRCHILD
MC1741CF	M	200.00000	0.80	3.0	3.50	MOTOROLA	MUA749A	M	750.00000	1.50	3.0	4.95	FAIRCHILD
MC1431G	M	100.00000	1.00	*****	3.50	MOTOROLA	3501A	M	5.00000	0.20	10.0	4.95	BURR-BROWN
MC1430P	M	5000.00000	1.00	*****	3.50	MOTOROLA	3500A	M	10.00000	1.00	10.0	4.95	BURR-BROWN
MC1430G	M	5000.00000	1.00	*****	3.50	MOTOROLA	318	M	150.00000	60.00	10.0	4.95	ADVANCED MICRO DEVICES
HA911-5	M	750.00000	2.00	10.0	3.50	HARRIS	201A	M	30.00000	0.50	5.0	4.95	ADVANCED MICRO DEVICES
ULN-2178U	M	0.80000	0.20	15.0	3.57	SPRAGUE	207	M	30.00000	0.50	5.0	4.95	ADVANCED MICRO DEVICES
ULN-2178M	M	0.80000	0.20	15.0	3.57	SPRAGUE	715C	M	400.00000	20.00	6.0	4.95	ADVANCED MICRO DEVICES
ULN-2176D	M	4.00000	1.50	15.0	3.57	SPRAGUE	LH0042CH	M	0.01000	3.00	10.0	4.95	NATIONAL SEMICONDUCTOR
ULN-2176M	M	4.00000	1.50	15.0	3.57	SPRAGUE	3503A	M	0.00500	5.00	30.0	4.95	BURR-BROWN
ULN-2151H	M	70.00000	0.60	15.0	3.59	SPRAGUE	709AE	M	200.00000	0.30	10.0	5.00	TELEDYNE SEMICONDUCTOR
ULN-2151G	M	70.00000	0.60	15.0	3.59	SPRAGUE	MC1558G	M	200.00000	0.80	*****	5.00	MOTOROLA
RM4558T	M	200.00000	0.50	3.5	3.60	RAYTHEON	MC1558L	M	200.00000	0.80	*****	5.00	MOTOROLA
LM1558H	M	200.00000	0.50	*****	3.65	NATIONAL SEMICONDUCTOR	RM747T	M	500.00000	0.50	6.0	5.00	RAYTHEON
LM741D	M	1500.00000	0.50	*****	3.65	NATIONAL SEMICONDUCTOR	RM4741	M	500.00000	0.50	6.0	5.00	RAYTHEON
MN0P01CJ	M	40.00000	15.00	4.5	3.65	PRECISION MONOLITHICS	RM4131T	M	30.00000	2.50	3.5	5.00	RAYTHEON
ULN-2139H	M	250.00000	4.20	15.0	3.68	SPRAGUE	MIC709A	M	100.00000	0.40	2.0	5.00	ITT
ULN-2139G	M	250.00000	4.20	15.0	3.68	SPRAGUE	101	M	120.00000	0.50	3.0	5.00	INTERSIL
CA3008A	M	2500.00000	3.00	1.2	3.72	RCA	101A	M	30.00000	0.50	3.0	5.00	INTERSIL
SS709	M	200.00000	*****	6.0	3.75	SIGNETICS	8007C	M	0.00050	6.00	20.0	5.00	INTERSIL
LM741CD	M	200.00000	0.50	*****	3.75	NATIONAL SEMICONDUCTOR	SS741	M	80.00000	0.50	*****	5.00	SIGNETICS
MCC1558-2	M	200.00000	0.80	*****	3.75	MOTOROLA	SSS201AJ	M	50.00000	0.40	5.0	5.05	PRECISION MONOLITHICS
RM709A	M	200.00000	0.80	3.0	3.75	RAYTHEON	SSS207J	M	50.00000	0.40	5.0	5.05	PRECISION MONOLITHICS
SG748T	M	500.00000	0.50	7.0	3.80	SILICON GENERAL	1319-01	M	30.00000	0.60	3		

MODEL	H/M	BIAS nA	SLEW V/μs	DRIFT μV/°C	COST \$/100	MANUFACTURER	MODEL	H/M	BIAS nA	SLEW V/μs	DRIFT μV/°C	COST \$/100	MANUFACTURER	
ULN-2177H	M	0.80000	0.20	15.0	5.81	SPRAGUE	MC1520F	M	800.00000	5.00	2.0	8.00	MOTOROLA	
ULN-2175G	M	4.00000	1.50	15.0	5.81	SPRAGUE	208M	M	0.80000	0.30	3.0	8.00	INTERISL	
ULN-2175H	M	4.00000	1.50	15.0	5.81	SPRAGUE	308A	M	1.50000	0.30	1.0	8.00	INTERISL	
ULN-2177G	M	0.80000	0.20	15.0	5.81	SPRAGUE	3056/01	M	200.00000	1.20	5.0	8.00	BURR-BROWN	
SG777T	M	75.00000	0.50	3.0	5.85	SILICON GENERAL	3501B	M	5.00000	0.20	5.0	8.00	BURR-BROWN	
RM101T	M	1500.00000	0.50	6.0	5.85	RAYTHEON	3500H	M	10.00000	1.00	3.0	8.00	BURR-BROWN	
CA3033A	M	100.00000	3.00	6.6	5.88	RCA	1413	H	2.00000	0.60	20.0	8.00	TELEDYNE PHILBRICK	
TOA2725	M	42.00000	*****	2.0	5.90	TRANSITRON	1421-01	H	0.01000	*****	20.0	8.00	TELEDYNE PHILBRICK	
MC1433F	M	500.00000	0.80	10.0	5.90	MOTOROLA	RC116T	M	0.01500	*****	*****	8.20	RAYTHEON	
CA3078AT	M	7.00000	0.02	6.0	5.94	RCA	RC118T	M	600.00000	50.00	*****	8.20	RAYTHEON	
SG101T	M	500.00000	0.50	3.0	5.95	SILICON GENERAL	L144CL	M	125.00000	0.40	3.0	8.20	SILICONIX	
LW725CH	M	125.00000	*****	1.0	5.95	NATIONAL SEMICONDUCTOR	L144CP	M	125.00000	0.40	3.0	8.20	SILICONIX	
LM101H	M	1500.00000	0.50	5.0	5.95	NATIONAL SEMICONDUCTOR	AD504J	M	50.00000	0.20	0.5	8.40	ANALOG DEVICES	
LM318D	M	600.00000	50.00	40.0	5.95	NATIONAL SEMICONDUCTOR	MC1530G	M	3000.00000	1.00	*****	8.50	MOTOROLA	
LM201AF	M	20.00000	0.50	5.0	5.95	NATIONAL SEMICONDUCTOR	MC1531G	M	25.00000	1.00	*****	8.50	MOTOROLA	
LM201AU	M	20.00000	0.50	5.0	5.95	NATIONAL SEMICONDUCTOR	MC1535G	M	1200.00000	0.67	3.0	8.50	MOTOROLA	
LM207D	M	*****	0.50	15.0	5.95	NATIONAL SEMICONDUCTOR	MC1535G	M	102M	3.00000	*****	6.0	8.50	INTERISL
HA2605*5	M	25.00000	4.00	5.0	5.95	HARRIS	110M	M	1.00000	*****	10.0	8.50	INTERISL	
HA2625*2	M	25.00000	20.00	5.0	5.95	HARRIS	SG1250T	M	10.00000	0.20	4.0	8.50	SILICON GENERAL	
MUA777A	M	75.00000	0.50	3.0	5.95	FAIRCHILD	1422-01	H	0.01500	8.00	50.0	8.50	TELEDYNE PHILBRICK	
CA3060D	M	2500.00000	8.00	1.1	5.95	RCA	LH0041CHG	H	50.00000	6.00	3.0	8.50	NATIONAL SEMICONDUCTOR	
101M	M	120.00000	0.50	5.0	5.95	ADVANCED MICRO DEVICES	ULS-2173M	M	1.50000	0.30	15.0	8.60	SPRAGUE	
TOA1458	M	80.00000	0.50	*****	6.00	TRANSITRON	ULS-2171M	M	8.00000	1.50	15.0	8.60	SPRAGUE	
TOA1747	M	80.00000	0.50	*****	6.00	TRANSITRON	ULS-2171M	M	8.00000	1.50	15.0	8.60	SPRAGUE	
LM210H	M	3.00000	30.00	6.0	6.00	NATIONAL SEMICONDUCTOR	LM4250H	M	10.00000	1.00	10.0	8.75	NATIONAL SEMICONDUCTOR	
RM4131D	M	30.00000	7.50	3.5	6.00	RAYTHEON	SS5841GL	M	45.00000	0.50	5.0	8.75	PRECISION MONOLITHICS	
MLM210G	M	1.00000	30.00	6.0	6.00	MOTOROLA	SG4250T	M	10.00000	0.20	4.0	8.75	SILICON GENERAL	
MCC1536*2	M	8.00000	2.00	*****	6.00	MOTOROLA	L140CA	M	100.00000	0.20	900.0	8.80	SILICONIX	
9314	M	500.00000	30.00	10.0	6.00	OPTICAL ELECTRONICS	MUA776A	M	50.00000	0.70	3.0	8.80	FAIRCHILD	
101A-LN	M	80.00000	0.40	25.0	6.00	INTERISL	ULS-2178M	M	0.30000	0.30	15.0	8.90	SPRAGUE	
AD502K	M	3.00000	0.40	40.0	6.00	INTERISL	ULS-2178M	M	0.30000	0.30	15.0	8.90	SPRAGUE	
741K	M	50.00000	4.00	5.0	6.00	INTERISL	ULS-2176M	M	1.30000	1.50	15.0	8.90	SPRAGUE	
AD502KH	M	2.00000	1.00	7.0	6.00	ANALOG DEVICES	ULS-2176M	M	1.30000	1.50	15.0	8.90	SPRAGUE	
AD741L	M	30.00000	0.50	1.0	6.00	ANALOG DEVICES	LM2160	M	0.15000	0.20	40.0	8.95	NATIONAL SEMICONDUCTOR	
210	M	1.00000	30.00	10.0	6.00	ADVANCED MICRO DEVICES	LM212H	M	2.00000	0.30	3.0	8.95	NATIONAL SEMICONDUCTOR	
202	M	3.00000	20.00	10.0	6.00	ADVANCED MICRO DEVICES	LM101AD	M	100.00000	0.50	15.0	8.95	NATIONAL SEMICONDUCTOR	
LH0002C	M	500.00000	160.00	33.0	6.00	NATIONAL SEMICONDUCTOR	SG2118T	M	2.00000	0.25	15.0	8.95	SILICON GENERAL	
AD512S	M	40.00000	0.50	25.0	6.00	ANALOG DEVICES	SG208T	M	2.00000	0.25	15.0	8.95	SILICON GENERAL	
ULN-2156H	M	15.00000	2.50	15.0	6.32	SPRAGUE	MUNDP01HP	M	18.00000	15.00	2.0	8.95	PRECISION MONOLITHICS	
ULN-2156G	M	15.00000	2.50	15.0	6.32	SPRAGUE	SS5208J	M	0.80000	0.20	1.5	8.95	PRECISION MONOLITHICS	
NE533V	M	5.00000	0.03	6.0	6.35	SIGNETICS	HA2602*2	M	25.00000	4.00	5.0	8.95	HARRIS	
MC1520G	M	800.00000	5.00	2.0	6.50	MOTOROLA	HA2622*2	M	25.00000	30.00	5.0	8.95	HARRIS	
NE536T	M	0.01000	5.00	20.0	6.50	SIGNETICS	HA2107*2	M	75.00000	0.50	3.0	8.95	HARRIS	
1421	M	0.01500	5.00	20.0	6.50	TELEDYNE PHILBRICK	SS5212J	M	0.80000	0.10	1.5	8.95	PRECISION MONOLITHICS	
NE531V	M	400.00000	35.00	6.0	6.50	SIGNETICS	212M	M	0.80000	0.20	1.0	8.95	ADVANCED MICRO DEVICES	
NE531T	M	400.00000	35.00	6.0	6.50	SIGNETICS	208	M	0.80000	0.20	1.0	8.95	ADVANCED MICRO DEVICES	
MUNDP01HJ	M	18.00000	15.00	2.0	6.60	PRECISION MONOLITHICS	TOA7747	M	10.00000	1.00	*****	9.00	TRANSITRON	
RC725T	M	75.00000	*****	3.5	6.75	RAYTHEON	SS5725CP	M	40.00000	0.01	1.4	9.00	PRECISION MONOLITHICS	
SS5725CJ	M	40.00000	0.01	1.4	6.75	PRECISION MONOLITHICS	MUNDP08CP	M	0.17000	0.01	3.0	9.00	PRECISION MONOLITHICS	
MUNDP08CJ	M	0.17000	0.01	3.0	6.75	PRECISION MONOLITHICS	SS5201AL	M	50.00000	0.40	5.0	9.00	PRECISION MONOLITHICS	
MUNDP016J	M	40.00000	15.00	4.5	6.80	PRECISION MONOLITHICS	SS5207L	M	50.00000	0.40	5.0	9.00	PRECISION MONOLITHICS	
SS57416L	M	45.00000	1.50	4.5	6.80	PRECISION MONOLITHICS	SS5741BL	M	30.00000	1.40	4.5	9.00	PRECISION MONOLITHICS	
SS58416P	M	45.00000	0.50	5.0	6.85	PRECISION MONOLITHICS	LH740AC	H	0.10000	6.00	5.0	9.00	NATIONAL SEMICONDUCTOR	
NE533T	M	5.00000	0.03	6.0	6.85	SIGNETICS	AD513K	H	0.00600	40.00	10.0	9.00	ANALOG DEVICES	
SS5201AF	M	50.00000	0.40	5.0	6.85	PRECISION MONOLITHICS	TOA3748	M	30.00000	10.00	6.0	9.20	TRANSITRON	
SS57418P	M	30.00000	1.50	4.5	6.85	PRECISION MONOLITHICS	TOA3741	M	4.00000	1.00	*****	9.20	TRANSITRON	
SS5207P	M	50.00000	0.40	5.0	6.85	PRECISION MONOLITHICS	1323	M	5.00000	20.00	30.0	9.25	TELEDYNE PHILBRICK	
LM216H	M	0.15000	*****	*****	6.95	NATIONAL SEMICONDUCTOR	MUNDP01GP	M	40.00000	15.00	4.5	9.25	PRECISION MONOLITHICS	
LM101D	M	1500.00000	0.50	5.0	6.95	NATIONAL SEMICONDUCTOR	HA2704*4	M	20.00000	10.00	5.0	9.35	HARRIS	
HA2705*5	M	40.00000	10.00	5.0	6.95	HARRIS	MUNDP05CJ	M	1.80000	0.25	0.4	9.45	PRECISION MONOLITHICS	
3053/01	M	200.00000	1.20	15.0	6.95	BURR-BROWN	3227/03	H	80.00000	1.50	20.0	9.50	BURR-BROWN	
216	M	0.15000	0.20	30.0	6.95	ADVANCED MICRO DEVICES	AD506J	H	0.00500	6.00	30.0	9.50	ANALOG DEVICES	
MUNDP05CJ	M	1.80000	0.25	0.4	6.95	PRECISION MONOLITHICS	AD516J	H	0.01000	40.00	30.0	9.50	ANALOG DEVICES	
AD507J	H	15.00000	35.00	15.0	6.95	ANALOG DEVICES	ULS-2174H	M	1.50000	0.30	15.0	9.60	SPRAGUE	
8017C	M	50.00000	130.00	10.0	7.00	INTERISL	ULS-2172H	M	8.00000	1.50	15.0	9.60	SPRAGUE	
4250C	M	7.00000	0.16	5.0	7.00	INTERISL	ULS-2172G	M	8.00000	1.50	15.0	9.60	SPRAGUE	
MUA702A	M	5000.00000	3.50	10.0	7.00	FAIRCHILD	ULS-2174G	M	1.50000	0.30	15.0	9.60	SPRAGUE	
AD208	M	0.80000	0.30	3.0	7.00	ANALOG DEVICES	1426	H	0.02500	3.00	50.0	9.75	TELEDYNE PHILBRICK	
AD3085	M	2.00000	0.30	3.0	7.00	ANALOG DEVICES	11T	M	60.00000	*****	*****	9.80	INTERISL	
1422	H	0.05000	8.00	50.0	7.00	TELEDYNE PHILBRICK	ULS-2177D	M	0.30000	0.30	15.0	9.90	SPRAGUE	
LH0005C	H	20.00000	0.30	20.0	7.00	NATIONAL SEMICONDUCTOR	ULS-2175U	M	1.30000	1.50	15.0	9.90	SPRAGUE	
RM116T	M	0.15000	*****	*****	7.10	RAYTHEON	ULS-2177M	M	0.30000	0.30	15.0	9.90	SPRAGUE	
CA3060BD	M	2500.00000	8.00	1.1	7.15	RCA	ULS-2175M	M	1.30000	1.50	15.0	9.90	SPRAGUE	
SN52107L	M	75.00000	0.50	3.0	7.20	TEXAS INSTRUMENTS	AD503	M	0.01000	6.00	30.0	9.90	INTERISL	
2515	M	125.00000	40.00	30.0	7.35	INTERISL	3500R	M	10.00000	1.00	5.0	9.90	BURR-BROWN	
2525	M	125.00000	80.00	30.0	7.35	INTERISL	3501R	M	5.00000	0.20	5.0	9.90	BURR-BROWN	
2505	M	125.00000	20.00	20.0	7.35	INTERISL	TOA7709	M	10.00000	0.50	6.0	9.95	TRANSITRON	
ULS-2174D	M	1.50000	0.30	15.0	7.44	SPRAGUE	LM101AF	M	100.00000	0.50	15.0	9.95	NATIONAL SEMICONDUCTOR	
ULS-2174H	M	1.50000	0.30	15.0	7.44	SPRAGUE	LM212D	M	2.00000	0.30	15.0	9.95	NATIONAL SEMICONDUCTOR	
1324	M	300.00000	25.00	30.0	7.50	TELEDYNE PHILBRICK	SS5212L	M	0.80000	0.10	1.5	9.95	PRECISION MONOLITHICS	
LH201H	M	500.00000	0.50	6.0	7.50	NATIONAL SEMICONDUCTOR	SS5212Y	M	0.80000	0.10	1.5	9.95	PRECISION MONOLITHICS	
RM101A	M	75.00000	0.50	6.0	7.50	RAYTHEON	SS3084Y	M	1.50000	0.20	1.0	9.95	PRECISION MONOLITHICS	
NE537T	M	1.50000	0.20	6.0	7.50	SIGNETICS	SS5208Y	M	0.80000	0.20	1.5	9.95	PRECISION MONOLITHICS	
HA909*2	M	300.00000	2.00	10.0	7.50	HARRIS	SS5208Y	M	0.80000	0.20	1.5	9.95	PRECISION MONOLITHICS	
HA2505*5	M	250.00000	20.00	20.0	7.50	HARRIS	SG747T	M	500.00000	0.50	7.0	9.95	SILICON GENERAL	
HA2515*5	M	250.00000	40.00	20.0	7.50	HARRIS	MUA740C	M	20.00000	6.00	20.0	9.95	FAIRCHILD	
HA2525*5	M	250.00000	80.00	20.0	7.50	HARRIS	MUA747A	M	500.00000	0.50	7.0	9.95	FAIRCHILD	
MUA725H	M	125.00000	5.00	0.5	7.50	FAIRCHILD	747	M	80.00000	0.40	5.0	9.95	ADVANCED MICRO DEVICES	
LM201H	M	250.00000	0.40	6.0	7.50	SILICONIX	216A	M	0.05000	0.20	10.0	9.95	ADVANCED MICRO DEVICES	
725C	M	50.00000	0.01	1.5	7.50	ADVANCED MICRO DEVICES	LH0042H	H	0.00500	3.00	5.0	9.95	NATIONAL SEMICONDUCTOR	
SS57478K	M	30.00000	0.70	4.5	7.50	PRECISION MONOLITHICS	LH0022C	H	0.01000	4.00	5.0	9.95	NATIONAL SEMICONDUCTOR	
AD513J	H	0.01000	40.00	30.0	7.50	ANALOG DEVICES	LM110H							

MODEL	H/M	BIAS nA	SLEW V/ μ s	DRIFT μ V/ $^{\circ}$ C	COST \$/100	MANUFACTURER
AD507K	H	10.00000	35.00	8.0	10.00	ANALOG DEVICES
1317	M	250.00000	30.00	5.0	10.00	TELEDYNE PHILBRICK
LM747D	M	1500.00000	0.50	*****	10.45	NATIONAL SEMICONDUCTOR
HA2405*5	M	250.00000	15.00	15.0	10.45	HARRIS
ULS-2173G	M	1.50000	0.30	15.0	10.46	SPRAGUE
ULS-2173H	M	1.50000	0.30	15.0	10.46	SPRAGUE
ULS-2171H	M	8.00000	1.50	15.0	10.46	SPRAGUE
ULS-2171G	M	8.00000	1.50	15.0	10.46	SPRAGUE
LM201F	M	250.00000	0.40	6.0	10.50	SILICONIX
1421-02	H	0.00500	5.00	10.0	10.50	TELEDYNE PHILBRICK
LM201D	M	250.00000	0.40	6.0	10.50	SILICONIX
SS57476P	M	45.00000	0.70	4.5	10.60	PRECISION MONOLITHICS
ULS-2178H	M	0.30000	0.30	15.0	10.76	SPRAGUE
ULS-2178G	M	0.30000	0.30	15.0	10.76	SPRAGUE
ULS-2176H	M	1.30000	1.50	15.0	10.76	SPRAGUE
ULS-2176G	M	1.30000	1.50	15.0	10.76	SPRAGUE
RM112T	M	3.00000	*****	15.0	10.80	RAYTHEON
2740CE	H	0.01000	1.00	25.0	10.80	TELEDYNE SEMICONDUCTOR
LM741CF	H	0.02000	1.00	50.0	10.80	TELEDYNE SEMICONDUCTOR
27120D	M	3.00000	30.00	6.0	11.00	NATIONAL SEMICONDUCTOR
1324*01	M	200.00000	25.00	15.0	11.00	TELEDYNE PHILBRICK
RM4132D	M	4.00000	0.13	3.0	11.00	RAYTHEON
108	M	0.80000	*****	3.0	11.00	INTERMIL
1426*02	H	0.02500	3.00	10.0	11.00	TELEDYNE PHILBRICK
AD516K	M	0.00500	40.00	10.0	11.00	ANALOG DEVICES
AD506K	M	0.00250	6.00	10.0	11.00	ANALOG DEVICES
ULS-2156D	M	8.00000	2.50	15.0	11.18	SPRAGUE
ULS-2156M	M	8.00000	2.50	15.0	11.18	SPRAGUE
3055*01	M	200.00000	1.50	3.0	11.30	BURR-BROWN
3052*01	M	200.00000	1.50	5.0	11.30	BURR-BROWN
SN52771L	M	15.00000	2.50	10.0	11.40	TEXAS INSTRUMENTS
SN52660L	M	25.00000	0.10	25.0	11.40	TEXAS INSTRUMENTS
SN52770L	M	15.00000	2.50	10.0	11.40	TEXAS INSTRUMENTS
1323*01	M	10.00000	20.00	30.0	11.50	TELEDYNE PHILBRICK
SS5107J	M	35.00000	0.40	5.0	11.50	PRECISION MONOLITHICS
SS5841J	M	30.00000	0.50	3.0	11.50	PRECISION MONOLITHICS
8008M	M	2.00000	0.50	7.0	11.50	INTERMIL
SS5101AJ	M	35.00000	0.40	5.0	11.50	PRECISION MONOLITHICS
SS5741J	M	30.00000	1.50	3.0	11.50	PRECISION MONOLITHICS
1425	H	0.01000	3.00	50.0	11.50	TELEDYNE PHILBRICK
ULS-2159M	M	30.00000	25.00	15.0	11.63	SPRAGUE
ULS-2159D	M	30.00000	25.00	15.0	11.63	SPRAGUE
ULS-2175G	M	1.30000	1.50	15.0	11.75	SPRAGUE
ULS-2177G	M	0.30000	0.30	15.0	11.75	SPRAGUE
ULS-2175H	M	1.30000	1.50	15.0	11.75	SPRAGUE
ULS-2177H	M	0.30000	0.30	15.0	11.75	SPRAGUE
L140CL	M	100.00000	0.20	900.0	11.80	SILICONIX
MN0P01GL	M	40.00000	15.00	4.5	11.90	PRECISION MONOLITHICS
RM4131Q	M	30.00000	2.50	3.5	12.00	RAYTHEON
MC1556G	M	8.00000	2.50	*****	12.00	MOTOROLA
AU55K	M	50.00000	130.00	10.0	12.00	INTERMIL
108-LN	M	3.00000	*****	15.0	12.00	INTERMIL
AD505K	M	50.00000	120.00	15.0	12.00	ANALOG DEVICES
TOA218	M	250.00000	50.00	*****	12.45	TRANSITRON
LM747F	M	1500.00000	0.50	*****	12.50	NATIONAL SEMICONDUCTOR
MC1747L	M	80.00000	0.50	3.0	12.50	MOTOROLA
LM101H	M	500.00000	0.40	5.0	12.50	SILICONIX
LM101M	M	500.00000	0.40	5.0	12.50	SILICONIX
SG747D	M	500.00000	0.50	7.0	12.50	SILICON GENERAL
AD108	M	0.80000	0.30	3.0	12.50	NATIONAL SEMICONDUCTOR
LH0021CH	M	45.00000	6.00	3.0	12.50	NATIONAL SEMICONDUCTOR
SS57476M	M	45.00000	0.70	4.5	12.70	PRECISION MONOLITHICS
2502	M	125.00000	20.00	20.0	12.70	INTERMIL
2512	M	125.00000	40.00	30.0	12.70	INTERMIL
2522	M	125.00000	80.00	30.0	12.70	INTERMIL
3054*01	M	200.00000	1.50	3.0	12.70	BURR-BROWN
1426*01	H	0.01000	3.00	25.0	12.75	TELEDYNE PHILBRICK
LM218H	M	200.00000	50.00	7.0	12.95	NATIONAL SEMICONDUCTOR
LM112H	M	2.00000	0.30	3.0	12.95	NATIONAL SEMICONDUCTOR
SS5112J	M	0.80000	0.10	1.5	12.95	PRECISION MONOLITHICS
SS5108J	M	0.80000	0.20	1.5	12.95	PRECISION MONOLITHICS
HA2502*2	M	250.00000	20.00	20.0	12.95	HARRIS
HA2512*2	M	250.00000	40.00	30.0	12.95	HARRIS
HA2522*2	M	250.00000	80.00	30.0	12.95	HARRIS
218	M	120.00000	60.00	10.0	12.95	ADVANCED MICRO DEVICES
112	M	0.80000	0.20	1.0	12.95	ADVANCED MICRO DEVICES
108	M	0.80000	0.20	1.0	12.95	ADVANCED MICRO DEVICES
SG108T	M	2.00000	0.25	15.0	12.95	SILICON GENERAL
SG1118T	M	2.00000	0.25	15.0	12.95	SILICON GENERAL
LH0005H	M	50.00000	1.00	10.0	13.00	NATIONAL SEMICONDUCTOR
3226*03	H	50.00000	1.50	10.0	13.00	BURR-BROWN
20-007C1	H	200.00000	2.00	10.0	13.00	BELL & HOWELL
20-107C1	H	200.00000	2.00	10.0	13.00	BELL & HOWELL
ULS-2156G	M	8.00000	2.50	15.0	13.04	SPRAGUE
ULS-2156H	M	8.00000	2.50	15.0	13.04	SPRAGUE
SS57478P	M	30.00000	0.70	4.5	13.25	PRECISION MONOLITHICS
3500S	M	10.00000	1.00	5.0	13.30	BURR-BROWN
3501S	M	5.00000	0.20	5.0	13.30	BURR-BROWN
1321*01	M	5.00000	35.00	30.0	13.50	TELEDYNE PHILBRICK
RM1556	M	15.00000	1.50	15.0	13.50	RAYTHEON
L144AL	M	100.00000	0.40	3.0	13.65	SILICONIX
L144AP	M	100.00000	0.40	3.0	13.65	SILICONIX
LM112D	M	2.00000	0.30	3.0	13.95	NATIONAL SEMICONDUCTOR
LM112D	M	250.00000	50.00	40.0	13.95	NATIONAL SEMICONDUCTOR
LM112D	M	2.00000	0.20	15.0	13.95	NATIONAL SEMICONDUCTOR
SS5128Y	M	0.80000	0.20	1.5	13.95	PRECISION MONOLITHICS
MN0P08BJ	M	0.14000	0.01	2.5	13.95	PRECISION MONOLITHICS
SS5725BJ	M	30.00000	0.01	1.0	13.95	PRECISION MONOLITHICS
SS5112Y	M	0.80000	0.10	1.5	13.95	PRECISION MONOLITHICS
MN0P10CY	M	1.80000	0.25	0.4	13.95	PRECISION MONOLITHICS
MC1538R	M	*****	*****	14.00	14.00	MOTOROLA
8017M	M	50.00000	130.00	10.0	14.00	INTERMIL
AD505S	M	50.00000	120.00	15.0	14.00	ANALOG DEVICES
1429	H	0.00100	3.00	90.0	14.00	TELEDYNE PHILBRICK
LH0029C	M	200.00000	0.50	8.0	14.00	NATIONAL SEMICONDUCTOR
LH0002	M	500.00000	160.00	20.0	14.00	NATIONAL SEMICONDUCTOR
AD511A	H	0.00500	5.00	30.0	14.00	ANALOG DEVICES
ADP511A	H	0.00500	5.00	30.0	14.00	ANALOG DEVICES
AD508J	H	10.00000	0.12	0.5	14.00	ANALOG DEVICES
AD523J	H	0.00040	5.00	25.0	14.00	ANALOG DEVICES
AD513S	H	0.00660	40.00	20.0	14.00	ANALOG DEVICES
AD503K	H	0.00250	6.00	10.0	14.00	ANALOG DEVICES

MODEL	H/M	BIAS nA	SLEW V/ μ s	DRIFT μ V/ $^{\circ}$ C	COST \$/100	MANUFACTURER
MN0P*01J	M	18.00000	15.00	2.0	14.35	PRECISION MONOLITHICS
RM4531T	M	300.00000	35.00	3.5	14.40	RAYTHEON
TOA4709	M	100.00000	0.50	2.0	14.50	TRANSITRON
1428	H	0.02500	3.00	50.0	14.50	TELEDYNE PHILBRICK
L140AA	M	75.00000	0.20	500.0	14.70	SILICONIX
3051*01	M	200.00000	1.50	3.0	14.70	BURR-BROWN
3503S	H	0.00200	5.00	15.0	14.70	BURR-BROWN
1425*01	H	0.00500	3.00	25.0	14.75	TELEDYNE PHILBRICK
SS5208AJ	M	0.80000	0.20	1.0	14.95	PRECISION MONOLITHICS
MN0P05EJ	M	1.20000	0.25	0.2	14.95	PRECISION MONOLITHICS
TOA1725	M	42.00000	*****	0.6	14.95	TRANSITRON
HA2600*2	M	10.00000	4.00	5.0	14.95	HARRIS
HA2620*2	M	15.00000	30.00	5.0	14.95	HARRIS
LM110D	M	3.00000	30.00	6.0	15.00	NATIONAL SEMICONDUCTOR
LM725H	M	100.00000	*****	1.0	15.00	NATIONAL SEMICONDUCTOR
LM110F	M	3.00000	30.00	6.0	15.00	NATIONAL SEMICONDUCTOR
LM101H	M	1500.00000	0.50	5.0	15.00	NATIONAL SEMICONDUCTOR
725B	H	50.00000	0.01	58.0	15.00	ADVANCED MICRO DEVICES
102	M	2.00000	20.00	10.0	15.00	ADVANCED MICRO DEVICES
LH0024C	H	500.00000	500.00	20.0	15.00	NATIONAL SEMICONDUCTOR
LH0024C	H	500.00000	500.00	20.0	15.00	NATIONAL SEMICONDUCTOR
3503C	H	0.00100	5.00	30.0	15.00	BURR-BROWN
C-118C	H	0.00500	0.50	50.0	15.00	BELL & HOWELL
AD504K	M	25.00000	0.20	0.5	15.30	ANALOG DEVICES
LM101D	M	500.00000	0.40	5.0	15.50	SILICONIX
LM101F	M	500.00000	0.40	5.0	15.50	SILICONIX
LM101M	M	500.00000	0.40	5.0	15.50	SILICONIX
LM101F	M	500.00000	0.40	5.0	15.50	SILICONIX
SS5107P	M	35.00000	0.40	5.0	15.55	PRECISION MONOLITHICS
SS5741P	M	30.00000	1.50	3.0	15.55	PRECISION MONOLITHICS
SS5101AP	M	35.00000	0.40	5.0	15.55	PRECISION MONOLITHICS
SS5841P	M	30.00000	0.50	3.0	15.55	PRECISION MONOLITHICS
RC108AT	M	7.00000	0.30	5.0	15.75	RAYTHEON
1420	H	0.01500	0.30	5.0	15.75	TELEDYNE PHILBRICK
SS5747K	M	30.00000	0.70	3.0	15.80	PRECISION MONOLITHICS
SS5747M	M	30.00000	0.70	4.5	15.90	PRECISION MONOLITHICS
SS5208AY	M	0.80000	0.20	1.0	15.95	PRECISION MONOLITHICS
HA2700*2	M	20.00000	10.00	5.0	15.95	HARRIS
HA2404*4	M	200.50000	15.00	15.0	15.95	HARRIS
SS5208AL	M	0.80000	0.20	1.0	15.95	PRECISION MONOLITHICS
3050*01	M	200.00000	1.50	3.0	16.00	BURR-BROWN
1429*01	H	0.00050	3.00	30.0	16.00	TELEDYNE PHILBRICK
9906	H	*****	300.00	100.0	16.00	OPTICAL ELECTRONICS
SS5725EJ	M	30.00000	0.01	0.7	16.30	PRECISION MONOLITHICS
LH0004C	H	100.00000	2.00	4.0	16.50	NATIONAL SEMICONDUCTOR
RM118T	M	250.00000	50.00	*****	16.65	RAYTHEON
RC116AT	M	0.05000	*****	*****	16.67	RAYTHEON
3501T	M	2.00000	0.20	3.0	16.70	BURR-BROWN
3500T	M	10.00000	1.00	3.0	16.70	BURR-BROWN
3500MP	M	10.00000	1.00	0.5	16.70	BURR-BROWN
AD523K	H	0.00020	5.00	15.0	16.75	ANALOG DEVICES
SS5108L	M	0.80000	0.20	1.5	16.95	PRECISION MONOLITHICS
SS5112L	M	0.80000	0.10	1.5	16.95	PRECISION MONOLITHICS
LM112F	M	2.00000	0.30	3.0	16.95	NATIONAL SEMICONDUCTOR
9308	M	500.00000	60.00	10.0	17.00	OPTICAL ELECTRONICS
LH0001C	H	100.00000	0.50	4.0	17.00	NATIONAL SEMICONDUCTOR
20-107B1	H	150.00000	2.00	5.0	17.00	BELL & HOWELL
20-007B1	H	150.00000	2.00	5.0	17.00	BELL & HOWELL
20-247C1	H	100.00000				

MODEL	H/M	BIAS nA	SLEW V/ μ s	DRIFT μ V/ $^{\circ}$ C	COST \$/100	MANUFACTURER
HUA715A	M	750.00000	18.00	6.0	20.00	FAIRCHILD
3500E	M	15.00000	1.00	0.5	20.00	BURR-BROWN
715	M	400.00000	20.00	6.0	20.00	ADVANCED MICRO DEVICES
9412	H	*****	200.00	100.0	20.00	OPTICAL ELECTRONICS
LH0033C	H	0.05000	1400.00	25.0	20.00	NATIONAL SEMICONDUCTOR
3503T	H	0.00100	5.00	30.0	20.00	BURR-BROWN
C-118C	H	0.00500	0.50	25.0	20.00	BELL & HOWELL
AD508K	H	6.00000	0.12	0.3	20.00	ANALOG DEVICES
ATF404	H	0.05000	13.00	50.0	20.00	AMPEREX
AD504L	M	10.00000	0.20	0.3	20.40	ANALOG DEVICES
MONOP08BL	M	0.14000	0.01	2.5	20.95	PRECISION MONOLITHICS
SS5725BL	M	30.00000	0.01	1.0	20.95	PRECISION MONOLITHICS
MONOP10EY	H	1.20000	0.25	0.3	20.95	PRECISION MONOLITHICS
F-418C	H	0.00100	1.00	50.0	21.00	BELL & HOWELL
AD511C	H	0.00100	5.00	15.0	21.00	ANALOG DEVICES
ADP511C	H	0.00100	5.00	15.0	21.00	ANALOG DEVICES
MONOP-08J	M	0.12000	0.01	2.0	21.60	PRECISION MONOLITHICS
SS5725J	M	30.00000	0.01	0.7	21.60	PRECISION MONOLITHICS
SS52108L	M	0.80000	0.25	3.0	21.95	TEXAS INSTRUMENTS
SS5725EP	M	30.00000	0.01	0.7	22.00	PRECISION MONOLITHICS
27408E	H	0.01000	1.00	25.0	22.00	TELEDYNE SEMICONDUCTOR
27418F	H	0.02000	1.00	50.0	22.00	TELEDYNE SEMICONDUCTOR
2741CH	H	0.02000	1.00	50.0	22.00	TELEDYNE SEMICONDUCTOR
LH0003C	H	2000.00000	70.00	4.0	22.00	NATIONAL SEMICONDUCTOR
3350/03	H	0.05000	3.00	12.0	22.00	BURR-BROWN
20-00883	H	0.00500	3.00	75.0	22.00	BELL & HOWELL
C-218C	H	0.00500	0.50	50.0	22.00	BELL & HOWELL
20-007A2	H	150.00000	2.00	2.0	22.00	BELL & HOWELL
20-107A2	H	150.00000	2.00	2.0	22.20	BELL & HOWELL
SS5747P	M	30.00000	0.70	3.0	22.40	PRECISION MONOLITHICS
RM725T	M	50.00000	*****	2.5	22.50	RAYTHEON
LH0023CH	H	0.00300	3.00	5.0	22.50	NATIONAL SEMICONDUCTOR
LM1180	M	200.00000	50.00	7.0	22.95	NATIONAL SEMICONDUCTOR
SS5108AY	M	0.80000	0.20	1.0	22.95	PRECISION MONOLITHICS
1408	H	0.02500	5.00	50.0	23.00	TELEDYNE PHILBRICK
1408-10	H	0.02500	5.00	50.0	23.00	TELEDYNE PHILBRICK
3521J	H	0.00500	0.80	3.0	23.00	BURR-BROWN
C-118H	H	0.00500	0.50	10.0	23.00	BELL & HOWELL
HA2400-2	M	200.00000	15.00	15.0	23.65	HARRIS
1323-02	M	10.00000	20.00	30.0	24.00	TELEDYNE PHILBRICK
30545/01	M	200.00000	1.50	2.0	24.00	BURR-BROWN
20-24883	H	0.00500	6.00	75.0	24.00	BELL & HOWELL
20-00882	H	0.00500	3.00	50.0	24.00	BELL & HOWELL
20-24781	H	100.00000	2.00	5.0	24.00	BELL & HOWELL
20-107A1	H	150.00000	2.00	1.0	24.00	BELL & HOWELL
20-007A1	H	150.00000	2.00	1.0	24.00	BELL & HOWELL
C-218B	H	0.00500	0.50	25.0	24.00	BELL & HOWELL
20-108B2	H	0.00500	3.00	50.0	24.00	BELL & HOWELL
C-228C	H	0.00500	25.00	50.0	24.00	BELL & HOWELL
SS5108AL	H	0.80000	0.20	1.0	24.95	PRECISION MONOLITHICS
HUA725A	M	100.00000	5.00	0.5	25.00	FAIRCHILD
HM1556AT	M	15.00000	1.50	15.0	25.00	RAYTHEON
725	M	30.00000	0.01	0.5	25.00	ADVANCED MICRO DEVICES
ZA801E1	H	0.01500	6.00	30.0	25.00	ZELTEX
ZA80101	H	0.01500	6.00	30.0	25.00	ZELTEX
27418H	H	0.02000	1.00	50.0	25.00	TELEDYNE SEMICONDUCTOR
LH0022H	H	0.00500	4.00	5.0	25.00	NATIONAL SEMICONDUCTOR
F-418H	H	0.00100	1.00	25.0	25.00	BELL & HOWELL
20-108B1	H	0.00500	3.00	25.0	25.00	BELL & HOWELL
20-00881	H	0.00500	3.00	25.0	25.00	BELL & HOWELL
MONOP-01L	M	18.00000	15.00	2.0	25.10	PRECISION MONOLITHICS
AD501A	H	0.00500	5.00	30.0	26.00	ANALOG DEVICES
ADP501A	H	0.00500	5.00	30.0	26.00	ANALOG DEVICES
L137AA	H	500.00000	0.40	50.0	26.25	SILICONIX
LH0020	H	60.00000	0.50	8.0	26.50	NATIONAL SEMICONDUCTOR
SS5747M	M	30.00000	0.70	3.0	26.80	PRECISION MONOLITHICS
MONOP-05Y	M	1.00000	0.25	0.3	26.95	PRECISION MONOLITHICS
1408-01	H	0.01000	5.00	15.0	27.00	TELEDYNE PHILBRICK
1408-11	H	0.01000	5.00	15.0	27.00	TELEDYNE PHILBRICK
LH0021K	H	30.00000	6.00	3.0	27.50	NATIONAL SEMICONDUCTOR
LH0032C	H	0.07500	700.00	20.0	28.00	NATIONAL SEMICONDUCTOR
LH0033	H	0.05000	1500.00	25.0	28.00	NATIONAL SEMICONDUCTOR
3521K	H	0.00500	0.80	1.2	28.00	BURR-BROWN
8500	M	0.00100	0.40	50.0	28.25	INTERMIL
8500	H	0.00010	0.50	100.0	28.25	INTERMIL
4250	M	5.00000	0.16	5.0	28.50	INTERMIL
20-24882	H	0.00500	6.00	50.0	29.00	BELL & HOWELL
F-418A	H	0.00100	1.00	10.0	29.00	BELL & HOWELL
C-218A	H	0.00500	0.50	10.0	29.00	BELL & HOWELL
20-247A2	H	100.00000	2.00	2.0	29.00	BELL & HOWELL
M-218H	H	0.00500	0.50	50.0	29.00	BELL & HOWELL
MONOP-08P	M	0.12000	0.01	2.0	29.25	PRECISION MONOLITHICS
SS5725P	M	30.00000	0.01	0.7	29.25	PRECISION MONOLITHICS
8500A	H	0.00001	0.50	40.0	29.75	INTERMIL
MONOP-05L	M	1.00000	0.25	0.3	29.95	PRECISION MONOLITHICS
LH0005A	H	25.00000	1.00	20.0	30.00	NATIONAL SEMICONDUCTOR
LH00524H	H	0.00030	3.00	2.0	30.00	NATIONAL SEMICONDUCTOR
LH0032H	H	0.00200	500.00	25.0	30.00	NATIONAL SEMICONDUCTOR
LH0043CH	H	0.00030	30.00	10.0	30.00	NATIONAL SEMICONDUCTOR
LH0032C	H	25.00000	1.00	20.0	30.00	NATIONAL SEMICONDUCTOR
3349/03	H	0.01000	3.00	6.0	30.00	BURR-BROWN
AD508L	H	6.00000	0.12	0.3	30.00	ANALOG DEVICES

Only Testline can give you true in-circuit analysis of ICs!

Testline instruments presents the Model 201 IC tester . . . the only instrument available today that can give you a complete profile of IC performance without removing circuits from the board.

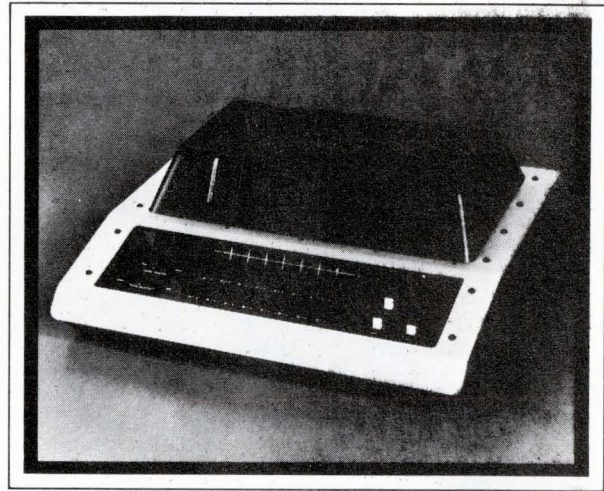

THE 201 IS UNIVERSAL — With this instrument, you can test all 14- and 16-pin DIPs, including TTL, DTL, and RTL. Complete functional analysis of sophisticated MSI circuits is readily accomplished. Component density of up to 200 ICs per board presents no problem.

THE 201 IS PRECISE — Take the guesswork completely out of IC testing. The 201 will isolate all shorts or opens within the IC under test; solder splashes or hardwire shorts etc. affecting the IC under test, and it will do all this with the IC still in-circuit.

THE 201 IS SELF-CONTAINED — All power, signal and monitoring functions are provided through a single IC clip. Special connectors, adapters, comparison ICs and additional test equipment are eliminated.

The instrumentation requires no calibration, no logic initiation, no modification for logic changes and no special programming. Therefore you can put it on line with a minimum of operator training.

THE 201 IS FOR YOU! — The Testline 201 . . . and **only** the Testline 201 can give you dependable in-circuit testing of ICs. Get the same efficiency in trouble shooting you get from the rest of your operation. Get technical details and arrange for a demonstration — write or call Testline today.



TESTLINE

P. O. Box 5671, Titusville, Fla. 32780
305/267-7212

Circle Reader Service #18

One part in 10 million from 0° to 55°C. Without an oven.

Unlike an oven oscillator, it's smaller, more reliable, uses less power, needs no warm-up time, and it's not as expensive. The K1098A TXCO has TTL compatible output, $\pm 1 \times 10^{-9}$ /sec. rms short term stability, operates from 5 and 12VDC. Prototype quantities available at 10MHz for immediate delivery. Full details from Motorola Component Products Dept., 4545 W. Augusta Blvd., Chicago, Ill. 60651.  **MOTOROLA**



Wanted: DIPs, dead or alive

Did you ever want to exert more effort designing systems than debating how they would actually be built? Ever have to scrap a design that was considered impractical because of a need for both "dead and alive" DIPs? Here's a dual-inline packaging system that partially alleviates these problems, by permitting the engineer to delay the final decision on soldering vs. plug-in until late in the design cycle.

This versatile system is comprised of panel boards, IC-carriers, adapter plugs, flat cable interfacing plugs, and IC-carrier crimping tools. Wire wrappable, this DIP system is a carrier for 14-, 16-, or 18-pin DIP ICs, and a PC board with offset pins.

Once the IC is mounted in the carrier, the carrier (which also acts as a protective holder during handling) is easily snapped into the panel. When using the plug-in method, the IC-carrier assembly is inserted with the IC leads down (alive). If you opt for wave soldering, the carrier goes on the board with the

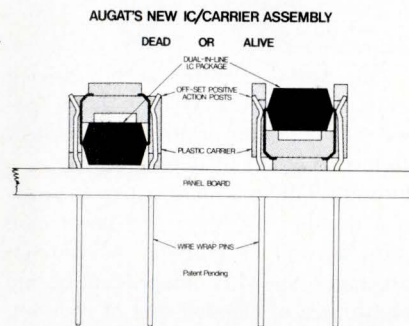

leads upright (dead). While in the dead position, the carrier assembly also serves as a reliable socket and can be tested and changed before soldering. Repetitive plugging of the carrier does not damage IC leads.

Of course, both methods (soldering

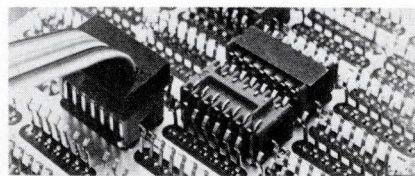

and plug-in) have advantages and disadvantages that must be considered. Weighing the pros and cons, Augat's Marketing VP Richard M. Grubb contends that the alive method offers greater flexibility, better field service, and eliminates heat damaging effects due to soldering. He adds, however, that "the dead method is ideal for extreme environments where soldering and conformal coating is required. The carrier in this position acts as a heat shield."

All contact pins are on 0.100-in. grid centers, which simplifies programming for automatic wrapping. Designated 8200, the panel series is offered in multiples of 30 patterns up to 180 patterns, and LSI configurations are provided. Supplied as Augat standards, the 8200 series can be designed, without additional time or expense, to adapt to the user's particular application.

Available within 4 to 8 weeks; \$0.45/pattern in production quantities. Augat, Inc., 33 Perry Ave., Attleboro, MA

Circle Reader Service #300

Data communication sub-systems handle all modes and formats

The P/SAT (Programmable Synchronous-Asynchronous Transmitter) and P/SAR (Receiver) combine to interface variable length parallel input data to one end of a serial channel and reconstruct the parallel characters at the other. Transmission code character lengths of 5, 6, 7 or 8 data bits plus parity span formats compatible with all standard synchronous, asynchronous, or isochronous data communication media. The 9-bit by 40-character FIFO (first in/first out) register interfaces at either the P/SAT input or the P/SAR output. The programmable transmitter and receiver sub-systems operate at a rate of 640 kb/s, programmably divisible by 16, 32 or 64. The transmitter is double-buffered with a fill (idle) character holding register and a transmitter holding register.

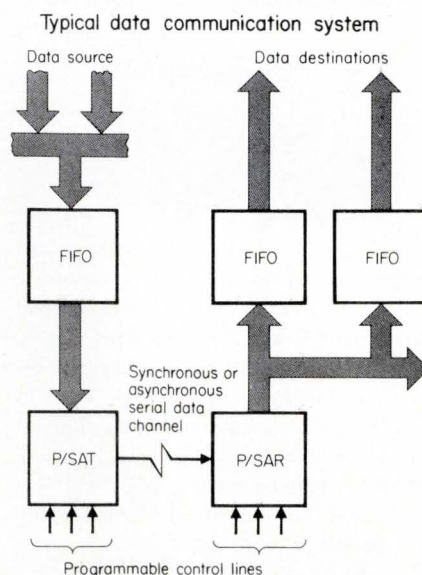

Other features include: data not available/underrun flag; data delimit/EOC flag; holding register empty; and programmable fill character with start and stop bit. The receiver has a match character holding register and also includes: tri-state data outputs; data received, parity, framing, and overrun error flags; and match detect. The FIFO is asynchronous and requires no special clocking. Its maximum data input/output rate is 1 MHz, with separate input and output enable. Register length can be expanded without external hardware. The 100 quantity prices are: PT1482 (P/SAT) 40-pin DIP, \$21.70; PR1472 (P/SAR) 40-pin DIP, \$26.05; FIFO 28-pin DIP, \$23.00. Western Digital, 19242 Red Hill, Newport Beach, CA 92663. (714) 557-3550.

Circle Reader Service #301

REVERSIBLE MOTORS

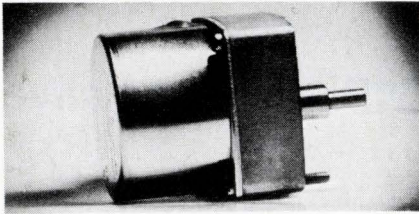

High torque synchronous motors provide 5.5 oz-in. torque at the rotor (600 rpm). Hardened steel gear trains provide a selection of speeds down to 10 rpm with proportionate increases in torque. Maximum gear train capacity is 200 oz-in. Motor design insures fast start/stop operation, eliminating the need for prestarts or clutching. The motor is built to NEMA type 2-11 configuration and is electrically reversible. Principal applications are instrument drives in medical and scientific apparatus, business machines, and computer peripherals. Available for 120 V ac, 60 Hz; also in 24 V ac or 230 V ac. Contact L. Torok, North American Philips Control Corp., Cheshire Industrial Park, Cheshire, CT 06410. (203) 272-0301.

Circle Reader Service #302

FILTER INDUCTORS



Protected by a flame-retardant, abrasion resistant vinyl coating, the "TD" line of toroidal filter inductors offers high Q and a wide selection of Q vs. frequency over a broad range of inductance values. Four models are being produced. TD-2 styles cover inductance ranges from .050 mH to 250 mH; TD-3 styles, from 50 μ H to 4 H; TD-4 styles, from 150 μ H to 7.5 H and TD-5 styles, from 1 mH to 20 H. Standard tolerance is $\pm 1\%$ for values above 2 mH, $\pm 2\%$ for lower values. All are available in a selection of temp. coeff. ranging from 0.25% to $\pm 1\%$. Typical price (100 mH TD4): \$1.90 each in medium quantity. Contact Dale Electronics, Inc., Box 180, Yankton, SD 57078. (605) 665-9301.

Circle Reader Service #303

COMPUTER PRINTER

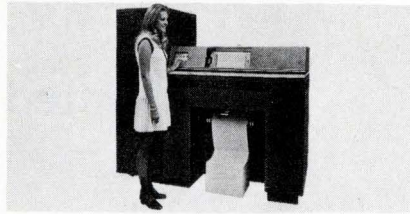

This new computer output device prints 8,000 lines/min. on ordinary paper. The EPI-100 printer uses an electrostatic method of depositing ink in a dot matrix directly onto paper. It prints in a number of upper and lower case fonts, as well as graphics and foreign languages. Speed is independent of line length, size of character set or code set. ElectroPrint, Inc., 10061 Bubb Rd., Cupertino, CA 95014.

Circle Reader Service #304

ONE-CHIP CALCULATOR

The C-500 is for the low-cost 8-digit personal calculator market. It features four function operation, constant in all four modes, chain operations, and power calculations. Entries are made in algebraic form with floating point entry and results. The circuit is in a 24-lead DIP and is easily interfaced with LEDs, gas discharge displays and fluorescent tubes. The unit contains its own keyboard bounce protection circuit. General Instrument Corp., Microelectronics Div., Box 800, 800 W. John St., Hicksville, NY 11802.

Circle Reader Service #305

FAST TUNING YIG FILTERS

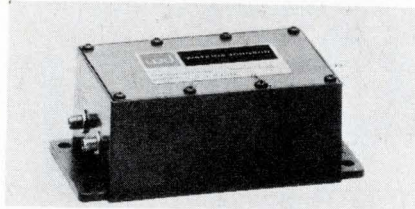

This series of filters, for applications requiring extremely fast step responses, covers the frequency range between 500 MHz and 4 GHz in standard bands. Designated the WJ-5170 Series, the filters can be tuned in 100-MHz steps in less than 35 μ s, and full band step response as low as 75 μ s can be provided. Watkins-Johnson Co., 3333 Hillview Ave., Stanford Industrial Pk., Palo Alto, CA 94304.

Circle Reader Service #306

DC TO DC CONVERTERS

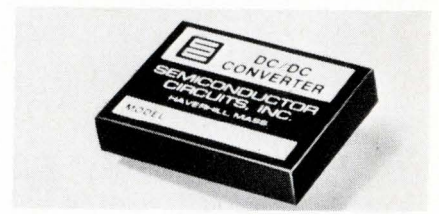

These single output dc to dc converters have floating outputs of 5, 12, 24, 28 and 30 V dc and 25, 40, 80, 100, 125, 200, 250 and 500 mA—up to 3 W with efficiencies of 50 and 55%. Regulation, line and load, is 0.02% max., except for 5-V and 500-mA models which have 0.05% max. The DD series converters are in two package sizes: 1.5 x 2.0 x 0.4 in. and 2 x 2 x 0.4 in. Prices (1-9) are \$46.00 for 25, 40, 80 and 200-mA units and \$76.00 for 100, 125, 250 and 500-mA supplies. Semiconductor Circuits, Inc., 306 River St., Haverhill, MA

Circle Reader Service #307

CERAMIC ACTS LIKE A THERMAL SWITCH

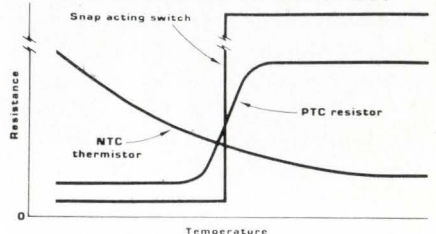

A new barium titanate ceramic material acts like a thermal switch: it can be formulated to change its conductivity abruptly from high to very low levels at a predetermined temperature anywhere from 60° to 180°C with repeatability within $\pm 2^\circ$ C. The material can be used in low-cost control devices to provide overheat protection, limit current, or to time and sequence electrical switches and relays. The PTC (positive temp. coeff.) ceramic devices can also be used as self-limiting, low-power heaters, going from a low-resistance, high-heat generating state at low temps. to a high-resistance keep-warm state when heated. Although a number of applications for the new material have been developed, potential applications are limitless. Current prices: under \$1/device. Texas Instruments Inc., Control Products Div., Attleboro, MA 02703. (617) 222-2800.

Circle Reader Service #308

SYSTEM PRODUCTS

BEAM-LEAD SCHOTTKY DIODE

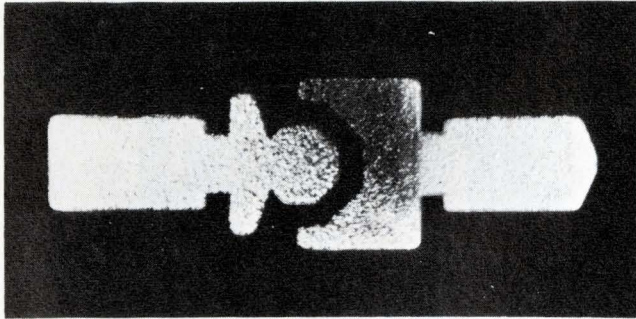

Model 5082-2837 is the beam-lead equivalent of HP's 5082-2800 Schottky diode. It features fast switching, high breakdown voltage and low turn-on voltage. Prices are 99¢ for small quantities, with lower prices for large volumes. The device has epitaxial, planar passivated construction making it mechanically rugged. Its leads are coplanar, gold-plated, and are 4 mils wide by 1/2 mil thick for easy mounting. Breakdown voltage is 70 V; reverse leakage current is 200 nA; capacitance is 2 pF; and its effective minority carrier is 100 ps maximum. Inquiries Manager, Hewlett-Packard Co., 1501 Page Mill Rd., Palo Alto, CA 94304.

Circle Reader Service #309

BACKPLANE TEST SYSTEM

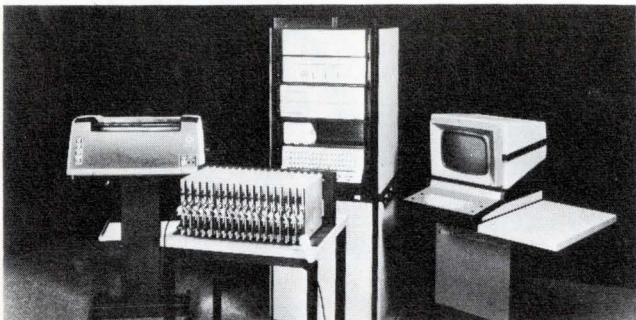

The N151 is a self-programming system which will record all shorts and opens, in your nomenclature, on either a CRT display or a printer. Pin electronics are on "fixture cards" designed to mate with the backplane being tested. With multiple sets of fixture cards, you can test one backplane while setting up or servicing others. In normal use, a prototype or backplane known to be good is connected to the system, which automatically "learns" the network. A "run list" may then be printed for comparison against engineering drawings. When production backplanes are tested, the system records all wiring errors instantly on the CRT display and you can also get hard copy. The N151, including computer, CRT display and keyboard, Printec line printer, magnetic tape unit, and software, is \$35,000, plus \$5 per point for fixture cards. An economy version, with a Teletype substituted for the CRT display and line printer, is \$25,000 plus \$5 per point. Delivery is 12 weeks. Teradyne, Inc., 183 Essex St., Boston, MA 02111.

Circle Reader Service #310

OUT OF THE ORDINARY PERIPHERALS...



call for MCD Custom Power Supplies for precise, dependable performance.

YOU CAN TAKE ADVANTAGE of Magnetic Components Divisions' 15 years of Control Data® "inside" computer experience. The talent that supplied CDC with unique power-supply packages—with MTBF's to 100,000 hours, sophisticated regulation techniques (ferroresonant, linear, hi-frequency switching, and phase controlled, for example), pure EDP design applications—**can engineer a custom power source for your own creative design!**

IT'S EASY TO DO—send today for the facts. See how you can build-in low cost-performance to the user over the life of your product!

MAGNETIC COMPONENTS DIVISION **CONTROL DATA CORPORATION**

7801 Computer Ave. So., Minneapolis, Minn. 55435
(612) 920-8600 TWX 910-576-2978

Circle Reader Service #20

SWITCH/INDICATORS

THE FIRST TRULY SUBMINIATURE LED SWITCH/INDICATOR

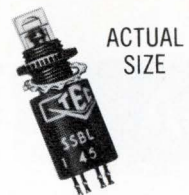

ACTUAL SIZE

Extremely compact TEC-LITE SSBL Series combines LED and SPST-NO-DB switch in a low cost, highly reliable unit for a variety of display and control functions... especially where space is limited. The .360 diameter, anodized aluminum body protrudes just 3/16" behind panel, including terminals. Mounts in 1/4" hole on 3/8" centers.

Red LED is mounted high in lens for maximum visibility. Replaces incandescent or neon lamps for low current, solid state applications. Internal resistor adapts unit for 5 or 6.3 VDC operation. Switch life is one million operations at 20 mA. In 3 lens colors. \$4.10 each in quantities of 100.

Matching Indicator. SSIL Series LED with resistor for 5-28 VDC operation. \$3.10 ea., 100 quantities.

Write: TEC Incorporated, 9800 N. Oracle Road, Tucson, Arizona 85704; or call (602) 297-1111.



Circle Reader Service #21

Why spend a bundle to automate, then fumble around with hand wiring?

You can automate right down the line, but when you get to the hand wiring you're back in the dark ages.

It's one of those costly things you always had to put up with, until Flexprint® Circuitry came along. Flexprint Circuitry saves you money on installation, and it fits into an automated system like a glove.

Recently for one customer, Flexprint Circuits saved up to \$4.02 on every \$6.24* wiring installation. Because Flexprint Circuits are so adaptable, no other design changes in his product were necessary. If you manufacture in quantity, the savings multiply. And there's no room for error, because the wiring design is built into every Flexprint Circuit design. You reduce repair costs, soldering costs and handling costs because Flexprint Circuitry is built to fit into your system. Consider Flexprint Circuitry while your new product is still in the concept stage. That way, you'll get maximum cost and design flexibility from the very beginning.

Call Mr. Tom Stewart at (603) 669-4615 (Ext. 417) or write to Grenier Field, Manchester, New Hampshire now, while your automation is still in the design stage. It can save you a bundle.

*Ask to see our 8-minute film presentation on Flexprint Circuitry cost savings.

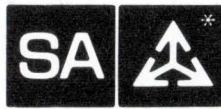

* T.M. SANDERS ASSOCIATES, INC.

SANDERS ASSOCIATES, INC.
FLEXPRINT DIVISION

Call your nearby Sanders rep, or write Sanders Flexprint Division,
Grenier Field, Manchester, New Hampshire 03103.

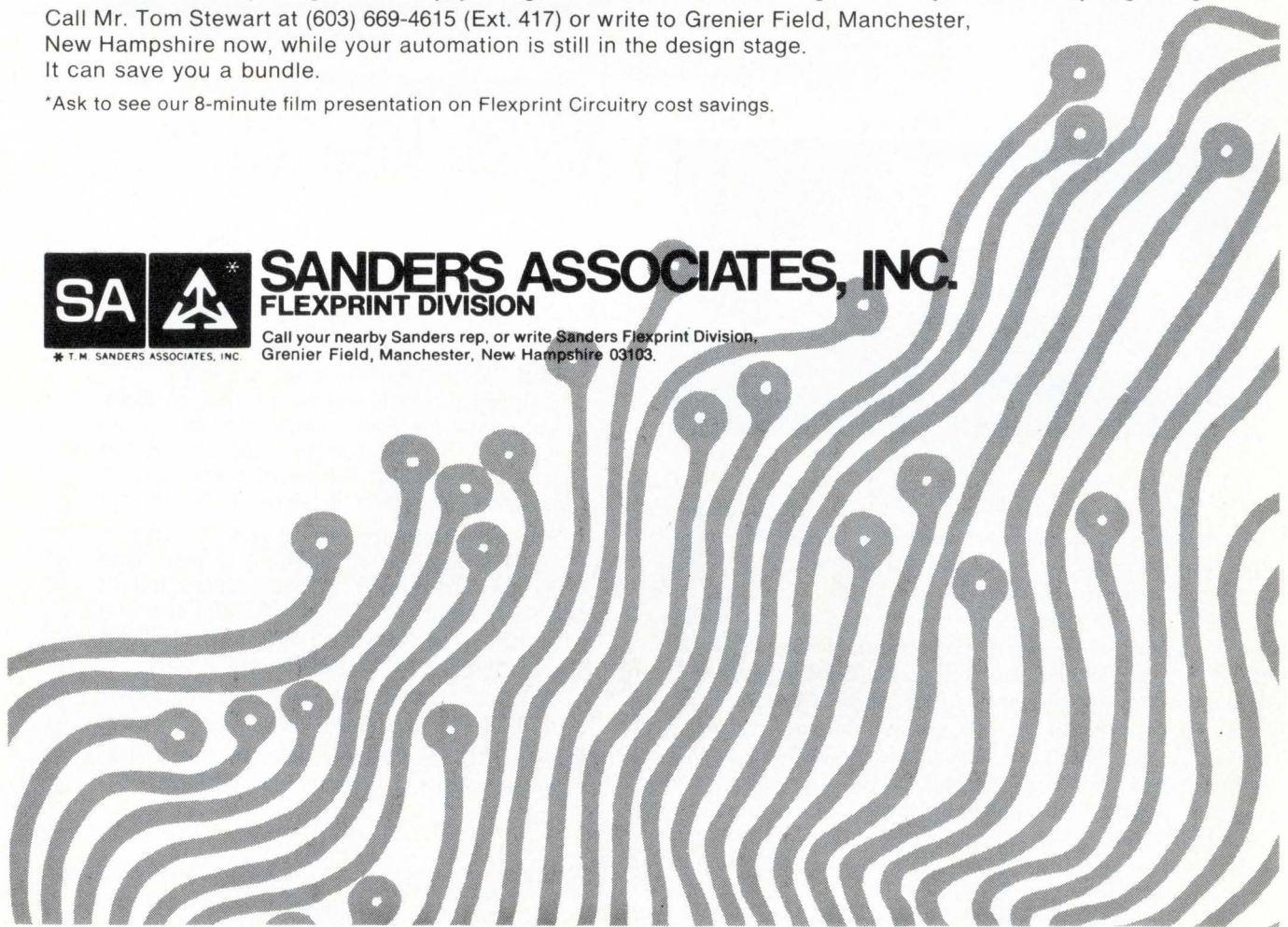

LINEARS IN MINIATURE PACKAGE



The "Pico Pak" is a silicone plastic package that measures 0.21 x 0.14 x 0.06 in., as compared to 0.73 x 0.27 x 0.18 for an 8-pin DIP, and 0.25 x 0.25 x 0.07 for a flatpack. Initially, three general purpose circuits are being offered in the new package. The 8007 FET-input op amp, with 6 V/ μ s slew rate and 2 pA input current, is \$5.00 for the commercial version and \$10.00 for military version in quantities of 100. The 8021 micropower op amp, with 20 μ W power consumption and 30 nA input bias current is \$2.75 (commercial) and \$10.00 (military). The 8001 precision low power comparator, with 30 mW power consumption, and less than 250 nA input current, is \$3.00 for commercial and \$9.00 for military. Intersil, 10900 N. Tantau Ave., Cupertino, CA 95014.

Circle Reader Service #312

OPTO-ISOLATORS

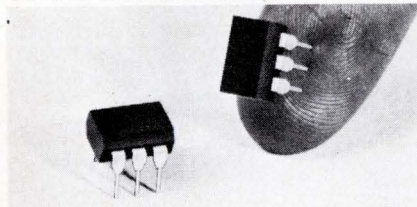

For the OEM who must electrically isolate low voltage logic circuits (DTL and TTL) from high voltage outputs, the 551 series Opto-Isolators eliminate the need for a common electrical ground while providing effective isolation. Both models, 551-0002 and 551-0003, consist of a GaAs LED and an npn silicon phototransistor mounted on a 6-lead frame encapsulated within an electrically non-conductive plastic compound. Maximum input-to-output voltage is ± 1.5 kV @ 25°C; max. continuous power dissipation is 100 mW for the LED, 150 mW for the phototransistor. Price from \$1.50 in 1000 quan. Availability: 2 to 3 weeks. Dialight Corp., 60 Stewart Ave., Brooklyn, NY 11237.

Circle Reader Service #313

SORT THOSE LEDs



Fast, accurate, luminous intensity (candela) measurements of all LEDs, including discretes, 7-segment, dot matrix, or multicharacter are done with this direct reading digital system. The W-11 Photometric Chamber contains a silicon photodetector and layered glass filter combination. Sensitivity is 1 μ candela over 5 ranges from 1 μ candela to 10 candela. Electrometer response is selectable 2 ms or 200 ms, and display is 3-digit LED. Options include BCD output, 10-bit binary output, 2-MHz freq. response, light binning, and automatic or semi-automatic handling. W-10 photometer and W-11 photometric chamber, \$1750; 2-4 weeks ARO. Western Electronics Labs, 2120 Ronald St., Santa Clara, CA 95052.

Circle Reader Service #314

CUSTOM HYBRID CIRCUITS

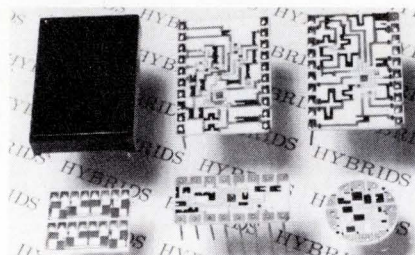

Starting from a circuit diagram, complete hybrid circuits in a wide variety of packages can be made. Circuits are printed on ceramic substrates with either chip and wire or discrete components. Resistor tolerances of under 1% with TCs of 50 ppm are available. Many popular digital or linear semiconductor chips can be specified. Packages available include DIPs, hermetically-sealed TO-8s, and conformally coated modules. Circuits are tested 100% electrically, and subjected to environmental tests. Typical delivery: six weeks. Contact Al Gomez, Airpax Electronics/Controls Div., 6801 W. Sunrise Blvd., Ft. Lauderdale, FL 33313. (305) 587-1100.

Circle Reader Service #315

Now the famous 829 has a "G" for good measure!



Calibrate or Measure with the

RFL Model 829G

RFL's famous 829, for 15 years the industry calibration standard, now gives way to the new 829G — still the industry calibration standard. But now it's twice as useful: When functioning as a calibration source, the 829-G delivers AC or DC voltages from 10mV to 1400V; current from 10 μ A to 14A; and 10 cardinal resistance values from 0.01 ohm to 10 megohms. AC calibration is internally generated and may be selected at 50, 60, 400 and 1000Hz. Direct read-out is by a 5-digit DPM. Many other features are available. Price \$3,600.00. □ Write for complete data today. RFL Industries, Inc., Instrumentation Division, Boonton, New Jersey 07005 Tel.: (201) 334-3100 / Twx: 710-987-8352 / Cable: RADAIRCO, N.J.



RFL Industries, Inc.

Circle Reader Service #23

Look close or you may miss the world's smallest shielded inductor.

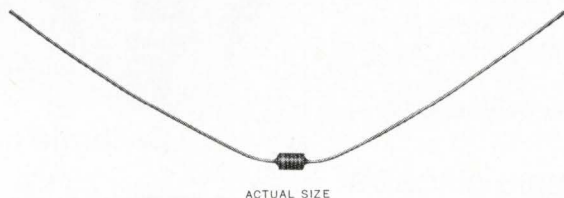

ACTUAL SIZE

New Pee-Wee Ductor 66% smaller than the previous smallest

Nytronics' new Pee-Wee Ductor for microminiature hybrid circuits is about an 1/8th of an inch from stem to stern . . . or about 1/3 rd the size of the previous world's smallest magnetically shielded inductor. Yet its electrical performance is big time. It offers higher L and Q (MIL-C-15305) in ratio to volume than its famous predecessors Wee-Wee and Super Wee-Wee. Values run from .10 to 1000 uH $\pm 10\%$, a low of .025 to a high of 10,000 uH on special order. Minimum Q ranges from 34 to 55 at RF frequencies, and current capability from 43 mA to a whopping 1.5 amps.

Write for additional specs and temperature curves.
Write small.



Nytronics, Inc.

THE QUALITY LINE OF STANDARD COMPONENTS

ORANGE STREET, DARLINGTON, S. C. 29532 • (803) 393-5421 • TWX 810-665-2182

SYSTEM PRODUCTS

DATA RECORDER



This digital cartridge recorder combines a 3M 1/4-in. tape cartridge with Kennedy's isoelastic drive system. Fully bi-directional drive at 25 ips normal speed results in data transfer rate of 40 kb/s at 1600 cpi recording density. Search modes and rewind speed are 90 ips. Total data capacity (gapless) with 300 ft. of 1-mil tape is 23×10^6 bits for 4-track operation. One, 2-, and 4-track versions equipped with dual gap read/write head for read-after-write operation are available. Model 330 meets proposed ANSI standard. Quantity prices range from \$200 (mechanics only) to \$750 (4-track write electronics). Kennedy Co., 540 W. Woodbury Rd., Altadena, CA 91001.

Circle Reader Service #316

PAPER TAPE READER

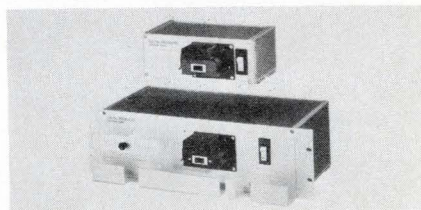

You can read 5- to 8-level tape at speeds up to 250 characters per second with this asynchronous high-speed paper tape reader. The DP-2001 Tape Reader is a photoelectric, solid-state reader with only one moving part. The reader is rack mountable with supply and take-up for fanfold and supply for rolled tape. Hardware and software compatible interfaces are available for OEM application without interface. The DP-2001 is also available as a portable unit complete with carrying case. A typical reader system, including interface, is priced at \$1200 in single quantities. Available 30 days ARO. Contact Thomas Paine, Digital Products, 9821 Katy Freeway, Houston, TX 77024.

Circle Reader Service #317

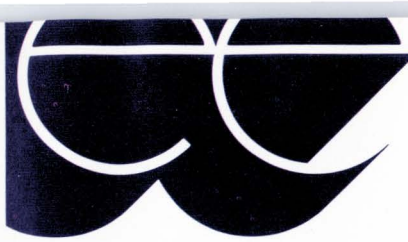

Twelve months of ideas for electronic systems.

In this issue, we're giving you just a *hint* of many exciting new ideas and new features that will appear in The Electronic Engineer.

We've been telling you about *systems*, and how important the systems concept is to you, for the past three years. In 1973, we're going to tell you more. And do it even better. *Why* we're doing it is explained in the editorial on page 7.

Because of this greater emphasis on systems, you'll also notice a modification of our name as we emphasize *systems engineering today*. We think it identifies us better to you, the technical leaders in the industry. *Below*, we tell you just a bit more about *how* we're going to make systems more meaningful to you beginning with next February's issue.

Systems: *To design them, you must know what components are available. From which suppliers. At what price. To build them, you must know who needs them. Which type of industries need them. For what application. EE/systems engineering today gives you information on the components, and on the systems your customers want, and on how to use the former to build the latter. It's vital information. For an important reader. The systems engineer.*

Cover story: *People, markets, technologies, and dollars. EE/systems engineering today brings to your desk the technical leaders who introduce to their industries the electronic systems that are going to save money; systems which are going to mean more dollars for electronic systems engineers. Look into these stories as through windows to new opportunities.*

The profit center: *Selection guides for specific types of products, components, and subsystems. The economic story of their applications to today's electronic systems and equipment. Pricing trends. What to buy, and what not to buy, as reported by readers of EE/systems engineering today who have bought those products in big volume. It's the kind of article that saves you money, or that triggers new ideas for new components.*

Systems technology: *Two serialized courses for systems designers this year. One on applications of minicomputers (February to October), the other on applications of phase-locked loops (Nov. '73 to January '74).*

Systems design: *Technical articles, written by experts from industry, on systems applications of integrated circuits, instruments, and other systems components.*

Managers behind the systems: *Interviews with executives who define for systems engineers the kind of performance they expect from the electronic systems they are going to buy.*

Product emphasis: *Each month, we will feature the types of products (power supplies, relays, etc.) which have proven to be most popular among our readers, plus the new ones recently introduced.*

Product feature: *The latest system component or instrument of wide application to electronic systems, reported exclusively in EE/systems engineering today.*

On the other side of this page is a month-to-month schedule of the major editorial features you will see beginning in January. The emphasis, of course, being on systems. Please be sure to look at it. We think you'll be delighted. Then, if you want to, remove the calendar for your own permanent reference throughout 1973.

editorial features for 1973

january

cover story:
The Electronic Markets.

profit center:
Special report on Complementary-MOS

systems technology:
Readouts course. Part 7. Plus exam.

product emphasis:
Most popular of 1972

february

cover story:
Automotive electronics; Chrysler Corp.

profit center:
Special report on keyboards & keyswitches

systems technology:
Course on the applications of minicomputers. Part 1. Systems considerations.

product emphasis:
Most popular power supplies.

march

cover story:
Peter Peterson, Secretary of Commerce.

profit center:
Special report on low-cost digital multimeters

systems technology:
Course on the applications of minicomputers. Part 2. Systems considerations.

product emphasis:
Most popular relays.

april

cover story:
Mainframe manufacturers look at memories.

special report:
Relays—coverage of the NARM conference.

systems technology:
Course on the applications of minicomputers. Part 3. Computers in today's market.

product emphasis:
Most popular op amps.

may

cover story:
Production testing

profit center:
Special report on readouts.

systems technology:
Course on the applications of minicomputers. Part 4. Systems considerations.

product emphasis:
Most popular connectors.

june

cover story:
Consumer electronics.

profit center:
Special report on digital ICs.

systems technology:
Course on the applications of minicomputers. Part 5. Peripherals in today's market.

product emphasis:
Most popular frequency analyzers, spectrum analyzers and frequency synthesizers.

july

cover story:
Data communications.

profit center:
Special report on trimmers.

systems technology:
Course on the applications of minicomputers. Part 6. Systems considerations.

product emphasis:
Most popular MOS circuits.

august

cover story:
Industrial control.

profit center:
Special report on capacitors.

systems technology:
Course on the applications of minicomputers. Part 7. Systems considerations.

product emphasis:
Most popular digital multimeters.

september

profit center:
Special report on lighted pushbutton switches.

systems technology:
Course on the applications of minicomputers. Part 8. Application packages on today's market.

product emphasis:
Most popular TTL circuits.

october

special report:
Connectors—The Electronic Connector Symposium.

systems technology:
Course on the applications of minicomputers. Part 9. Systems considerations. Plus exam.

product emphasis:
Most popular readouts.

november

profit center:
Power supplies.

systems technology:
Course on the applications of phase-locked loops. Part 1.

product emphasis:
Most popular keyboards.

december

profit center:
Special report on op amps and linear ICs.

systems technology:
Applications of phase-locked loops. Part 2.

product emphasis:
Most popular trimmers, pots and resistor networks.

For further information write or call: Art Boyle, MANAGING EDITOR (215) 687-8200

The Electronic Engineer/systems engineering today

201 King of Prussia Road, Radnor, Pa. 19087

**Want to know
what will happen
--in electronics--
ONE YEAR from
NOW?**

If you do, look over there at the left. That monthly Calendar of editorial features was created by our editors for you. It tells you—in advance—about the major articles that will appear in *EE/Systems Engineering Today*—throughout 1973. By checking the Calendar you can look for those features that are of very special interest to you as the months go by. Practical? You bet! Check our Calendar and see for yourself!

Idea. Why not tear it out and keep it on your desk? Or wall. Or wherever it is that you keep material for ready reference. We've even perforated the page to make its removal easy.

OH! OH! If the page we're talking about isn't there, it means the engineer who read this issue before you did, beat you to it. Now it's on his wall. But if you do want your own Editorial Calendar, it's still easy to get. Simply circle number 201 on the reader service card and a copy will come to you. Pronto!

We like to think that extra services like this make *EE/Systems Engineering Today* the most talked about magazine in the field today. We hope you think so too.



systems engineering today

SYSTEM PRODUCTS

PROGRAMMABLE DISTORTION ANALYZER



The Model 334A-H25 distortion analyzer/ac voltmeter has all the capabilities of the standard Model 334A plus complete programmability of all functions, ranges, and settings. As a distortion analyzer, the instrument measures total harmonic distortion from 0.1% to 100% full scale in seven ranges. The fundamental frequency range for distortion measurements is from 10 Hz to 100 kHz with harmonics indicated up to 1 MHz. Frequency resolution is 3 digits over the full frequency range. As an rms calibrated voltmeter, the unit measures input levels from 0.3 mV rms to 300 V rms full scale in thirteen meter ranges. The frequency range for voltage measurements is from 10 Hz to 1 MHz. \$3600. Inquiries Manager, Hewlett-Packard Co., 1501 Page Mill Rd., Palo Alto, CA 94304.

Circle Reader Service #318

SEMICONDUCTOR MEMORY FOR PDP-12

Users of the DEC PDP-12 laboratory computer system can now purchase solid-state, plug-compatible add-on memory. Buy 4k of expansion memory at \$2,850; 8k is priced at \$4,050. The add-on memory is expandable in 4k increments to a total of 28k. Signal Galaxies, Inc., 6955 Hayvenhurst Ave., Van Nuys, CA 91406. (213) 988-1570.

Circle Reader Service #319

TIME INTERVAL COUNTER

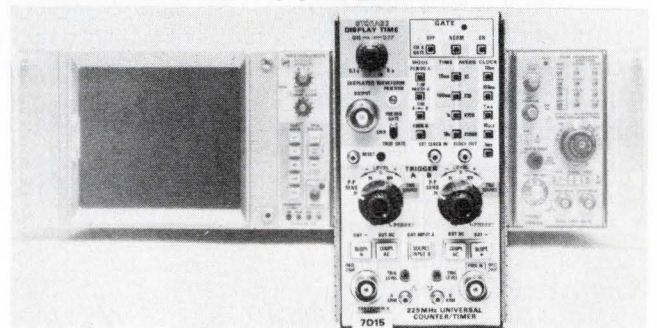

The 7D15 Universal Counter/Timer is a scope plug-in, which provides convenient counting and timing measurements with greater accuracy and confidence at a lower cost per measurement. Signals from the scope arm and control the counter/timer. The measured signal can be seen on the CRT along with the measurement interval and the counter Schmidt trigger signal. There are eight modes for this dc-to-225 MHz unit: time interval, time interval averaging, period, multi-period, frequency, frequency ratio, totalize, and manual stop watch. Resolution is 10 ns in single-shot time measurements, and is 100 ps in time interval averaging. Price is \$1475. Tektronix, Inc., Box 500, Beaverton, OR 97005.

Circle Reader Service #320

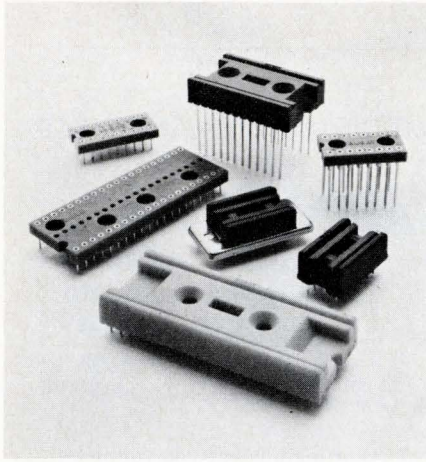

If you've got the circuit, we've got the socket.

We ought to.

After all, Augat conceived and pioneered the socket panel for dual-in-line IC's. So why wouldn't we make other sockets for printed circuit boards as well?

We do. Low profile types, ultra-low profile types, MSI and LSI types, even LED sockets. More important, Augat design and quality standards provide for longer life, better retention and greater reliability.

There's more to Augat than sockets. As the leader in electronic interconnection, we also offer a broad selection of accessories. For quick information on price and delivery, call us at (617) 222-2202. Or write for our catalog. Augat Inc., 33 Perry Ave., Attleboro, Mass. 02703. Our representation and distribution is nationwide and international.

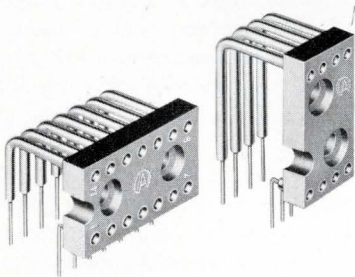

Plug into Augat®

Circle Reader Service #25

THIN-FILM RESISTORS

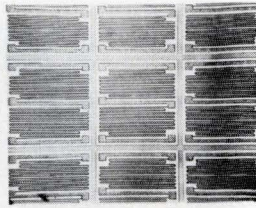

A series of "S" configuration, glass passivated, thin-film resistors offers standard temperature coefficients of less than ± 50 ppm/ $^{\circ}$ C and custom tempcos below ± 15 ppm/ $^{\circ}$ C tracking to ± 5 ppm. Standard RETMA resistance values have 1% tolerance from 10 Ω to 511 k Ω ; 5% from 10 Ω to 510 k Ω , and 10% from 10 Ω to 470 k Ω . Power dissipation rated at 250 mW. In 100-499 quantity, 10% units cost \$0.59; 5% units are \$0.68. Hybrex, Div. of Burr-Brown, International Airport Industrial Park, Tucson, AZ

Circle Reader Service #321

FAST CHARACTER GENERATOR

This 5,184-bit static character generator comes in a 64 x 9 x 9 organization for use in vertical or raster scan displays that use a 7 x 9 matrix, printer character generators, panel displays and billboards, micro-programming applications, and code conversion. Called Model 2526, this device has TTL compatible inputs and outputs, and requires +5-V and -12-V power supplies. Features include a 450-ns typical access time. Signetics Corp., 811 E. Arques Ave., Sunnyvale, Calif. 94086.

Circle Reader Service #322

SENSE AMP/LINE RECEIVER

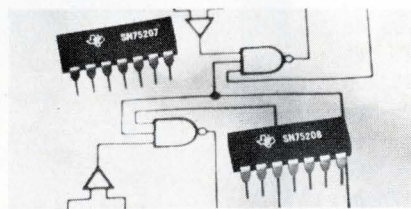

This dual mos sense amplifier and line receiver replaces the SN75107 and SN75108 and is particularly suited for 1103 MOS RAM applications. The sense amplifier is the SN75207 and the receiver the SN75208. Tight ± 10 mV input sensitivity makes these circuits well suited for mos memory sense amplifiers. Texas Instruments Inc., Inquiry Answering Service, Box 5012, M/S 308, Dallas, TX 75222.

Circle Reader Service #323

16 M-BIT STORAGE TUBE

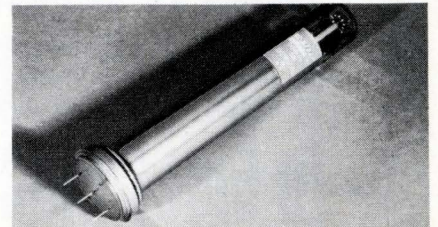

The TH9903 storage tube can store 16 million bits of digital information or the equivalent in tv gray scale form for better than 20 minutes of continuous readout. The 2-in. dia. silicon target permits a resolution of 2700 tv lines at 50% modulation level and a limiting resolution of 4300 tv lines per diameter. A special gun design permits fast erasing. Because the display function is separated from the storage system, the user can selectively edit the stored image or zoom in on any portion of the image. Tube operates with standard Vidicon hardware for such applications as buffer memory, high density data storage, or bandwidth compression. Contact Mme. J. Durand, Thomson. CSF, Groupment Tubes Electroniques, 8 rue Chasse-loup-Laubat, 75015 Paris, France.

Circle Reader Service #324

SEAL MOISTURE OUT

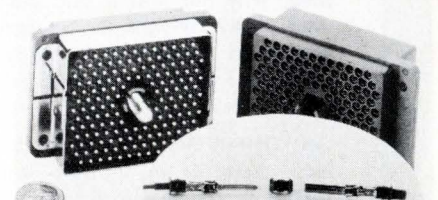

A new sealing technique provides environmental performance better than the most stringent military specs. Designed for equipment requiring ultra-reliable moisture seals, the C-21 connector uses individual pressure-sensitive seals attached to each contact—one at the rear where the wire is attached, and the other at the pin-socket interface. Pressure differentials improve the seal. Clamping pressure is not required to maintain seal integrity. The 158 rectangular connector is available for immediate delivery. Four other sizes, 52, 80, 104, and 212 to be introduced in next four months. Hughes Connecting Devices, 500 Superior, Newport Beach, Ca. 92663.

Circle Reader Service #325

CASSETTE DATA RECORDER

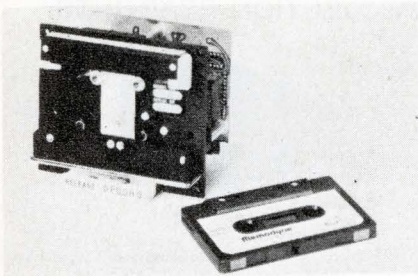

For portable or remote applications, the Series 201 high-density, low-power cassette recording system provides compact data logging and storage. Using a stepping motor drive, it provides incremental recording at a density of 615 b/in., yielding 2.214 million bits of storage on a single Phillips 300-ft. cassette tape. During recording the unit draws only 54 mA from the 12-V supply. Maximum write speed is 180 steps/s. Price: \$425.00. Availability: 2-4 weeks ARO. Contact Paul Nathan, Memodyne Corp., 369 Elliot St., Newton Upper Falls, MA 02164. (617) 527-6600.

Circle Reader Service #326

8-BIT SYNCHRO CONVERSION



This 8-bit (1.4°) synchro-to-binary conversion module offers an update rate of 5 ms and data transfer time of less than 100 ns from the output register included in the module. All inputs, including the reference, are transformer isolated. Mounted on a single PC card, the converter module occupies 5.7 in.³. Can be used in position monitoring systems, servo readouts, and data acquisition systems. Price: from \$295 (100 pieces). From stock. Contact Norman Wheatcroft, Astrosystems Inc., 6 Nevada Dr., Lake Success, NY 11040. (516) 328-1600.

Circle Reader Service #328

QUARTZ CRYSTAL OSCILLATORS

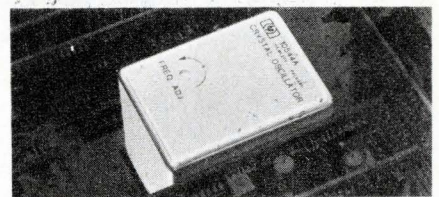

The aging rate is 5 parts in 10^{10} per day (less than 5/100 of a sec/yr), reached within 24 hours after being off for 24 hours. The Model 10543A, \$850, is sealed and ruggedized for field reliability and delivers more output, 1V into 50 ohms, instead of 1V into 1000 ohms. It is better suited for mobile, or airborne uses. The Model 10544A, \$450, has slightly degraded noise performance, down 125 dB, instead of down 145 dB, and will usually be chosen for fixed installations. Both available as 5 or 10 MHz units. Inquiries Manager, Hewlett-Packard, 1501 Page Mill Rd., Palo Alto, CA 94304.

Circle Reader Service #329

SOLID-STATE KEYBOARD



The five standard roll-over features of the Super Switch Keyboard are: N-key roll-over; N-key roll-over/two-key lock-out; N-key lockout/two-key roll-over; two-key roll-over; and mechanical simulator. The Super Switch Keyboard has magnetic core switching. Contactless solid-state switches can be connected to a PC board, yet contain no electronics in the switches themselves. Easily replaceable switches can be pulled straight out after desoldering. Keyboard measures only 0.666 in. from mounting surface to bottom of PC board. Low power consumption: 300 mA max., 150 mA typical drain. Contact John Pfeiffer, Licon, Div. Illinois Tool Works, Inc., 6615 W. Irving Pk. Rd., Chicago, IL 60634. (312) 282-4040.

Circle Reader Service #327

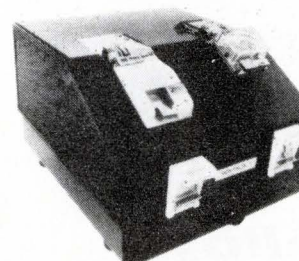
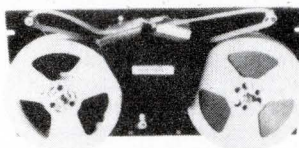
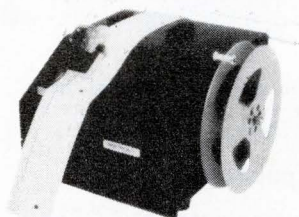

if you're going to use punched paper tape and edge punched cards... use

ROYTRON

the most reliable paper tape and edge punched card punches and readers in the industry for over a decade.

For more information call Frank Misiewicz
OEM Products
(201) 935-2200



OEM PRODUCTS DIVISION
LITTON ABS
Automated Business Systems
600 Washington Avenue, Carlstadt, N. J. 07072

Circle Reader Service #26

NEW COOL-PAX MODULAR COOLING SYSTEMS FOR Power Semiconductors

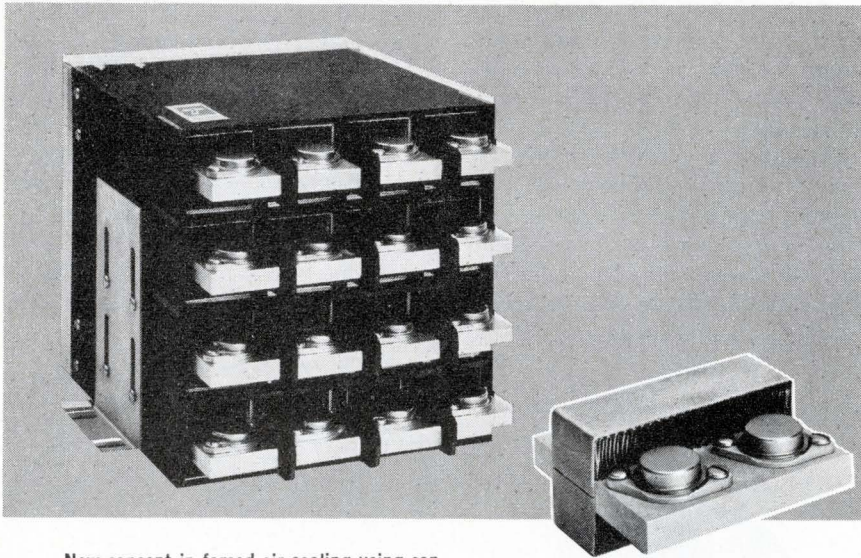

New concept in forced-air cooling using convoluted fin stock in modular assemblies accommodates any number of devices in case-common or single, isolated modules.

Modules are easily removed from system via a simple latching mechanism. Shown, a two-unit module.

Brazed aluminum compact cooling packages:

- Provide $.65^{\circ}\text{C/W}$ cooling for each transistor at 8 CFM
- Provide parallel air flow to all devices
- Greatly reduce volume and weight

The COOL-PAX Modular System is a new generation in electronic cooling. Its superior performance and greatly reduced volume and weight make the heavy extrusion obsolete. COOL-PAX systems improve packaging versatility and lower overall systems costs. Devices are easily accessible and wiring complexity is reduced.

COOL-PAX Systems are simple to specify, to analyze, and to predict performance. For technical applications data to analyze your own system, write for our new COOL-PAX Catalog 72-CP-7.

WRITE FOR FREE CATALOG



Thermalloy

P.O. BOX 34829
2021 W. VALLEY VIEW LANE
DALLAS, TEXAS 75234
(214) 243-4321 TWX 910-860-5542

SYSTEM
PRODUCTS

PROJECTION READOUTS

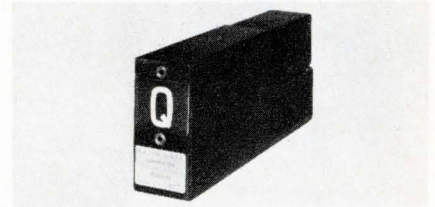

For visual displays in control systems, electronic equipment, vending machines, and instrumentation, the Major 16/32/64 readouts can display any standard or custom message that can be photographically placed on film. (Standard 64 message is ASCII code with capability of up to 120 characters per image frame.) Projected front panel image size ranges from 1.10 in. to 5 in. high, can be viewed at 75° at distances up to 20 ft. Larger images are possible ranging up to 10 in. high. Access time to messages is 70 ms. Readout is self-decoding and requires only a 6-bit input; the last selected message is retained without signal power. Price: from \$49.00 in production qty's. Delivery: stock to 4-weeks ARO. Contact Harold Sarkissian, Major Data Corp., 1796 Monrovia Ave., Costa Mesa, CA 92627. (714) 646-2455.

Circle Reader Service #366

LIQUID CRYSTAL READOUT



These three-digit liquid crystal readouts draw only $10\ \mu\text{A}$ at 30-40 V, 20 Hz to 10 kHz. Standard CMOS driving ICs are available from several semiconductor manufacturers. Standard units include 3-, $3\frac{1}{2}$ -, and 8-digit models. Each digit is separated by a decimal point. Specials are easily fabricated for particular applications. Price for a single three-digit evaluation unit: \$50.00, available immediately. OEM discounts for over 10,000 units. Radionics Laboratory Inc., Box 211, Kingston, NJ 08528.

Circle Reader Service #367

MINICOMPUTER ROMS

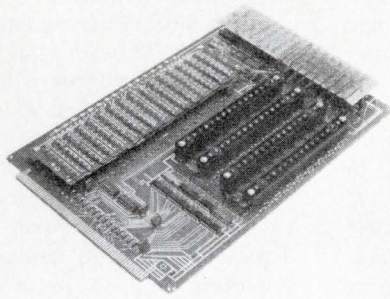

Model 401-30 "Q CORE" ROM comes in three configurations: 512 x 16, 1024 x 16, and 2048 x 16. It is plug-to-plug compatible with the Microdata 800 and features a 95-ns access time and a 220-ns cycle time. The 401-30 is packaged on one PC board, 12.5 x 8.575 x 1.5 in., and cost for the 2k x 16 model ranges from 2.5¢/bit to less than 2¢/bit. The Model 401-31 is designed for applications requiring large storage capacities and fast access and cycle speeds. It features a storage capacity of 8196 x 16 and is plug-to-plug compatible with the Interdata Model 70. Access time is to 200 ns and cycle time is 600 ns. Cost per bit ranges from 2.2¢/bit, to 0.8¢/bit. Quadri Corp., 2950 W. Fairmont, Phoenix, AZ 85017. (602) 263-9555.

Circle Reader Service #368

SS ABSOLUTE PRESSURE TRANSDUCER

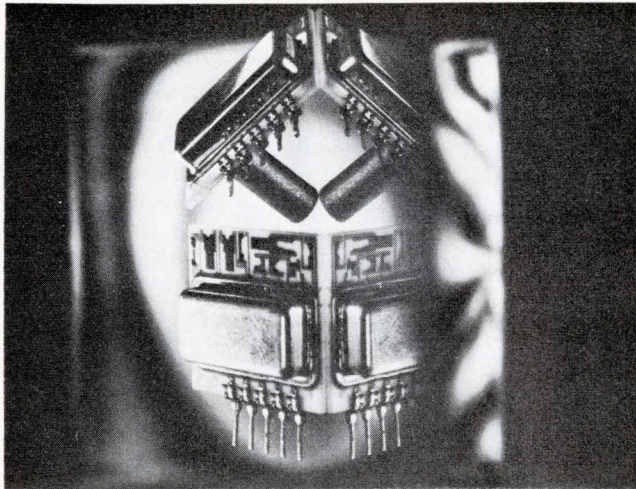

The LX1600A is a hybrid device that includes a diaphragm-vacuum reference, piezoresistive sensor, signal discriminator-conditioner and signal amplifier-processor. The output of each device is factory adjusted to meet the nominal values within specified tolerances. For each unit, the specified nominal output is the "best straight line actual" value, thus eliminating the need for user evaluation and calibration. The calibrated range is 6 to 15 psi and the device can be operated up to 27 psi. \$58 ea. (100 & up). National Semiconductor Corp., 2900 Semiconductor Dr., Santa Clara, CA 95051.

Now...the only one of its kind available! A Course in MOS integrated circuits

This 9 part course on MOS technology, applications and costs, originally published in *The Electronic Engineer*, is a definitive volume that provides all the background you need as a user or designer to master this new technology. It covers the processing of MOS circuits, applications of MOS circuits, complementary MOS, MOS memories (random access, read only, associative memories and cost) and the testing of complex MOS integrated circuits. The course, the only one of its kind available, costs just \$5.00 per copy. To get your copy of the only course available on the new MOS technology, send your order today with check or money order for \$5.00 to

THE ELECTRONIC ENGINEER
One Decker Square
Bala-Cynwyd, Pa. 19004
 Dept. E-12

CHANCES ARE YOU'RE PAYING MORE FOR YOUR ALPHAMERIC STRIP PRINTER RIGHT NOW

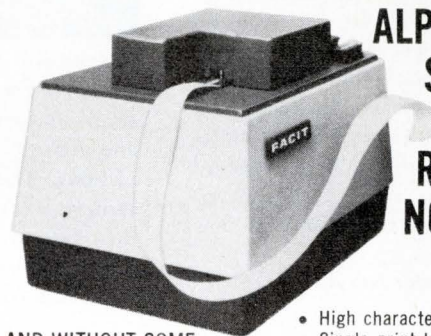

... AND WITHOUT SOME OF THESE FEATURES.

- Input US ASCII standard, character by character
- 15 CPS
- 5 x 7 dot matrix presentation of characters
- High character flexibility
- Single print hammer—fewer moving parts

Also available:
 4552/01 Signal Input Serial dot-by-dot in the matrix
 4552/02 Signal Input parallel column-by-column in the matrix
 • Immediate delivery from stock

Facit Odhner Inc.
 501 Winsor Drive
 Secaucus, N.J.
 Gentlemen:

EE-12

I am interested in receiving detailed data on your Alphameric Strip Printer



Name _____ Title _____
 Phone _____
 Company _____
 Address _____
 City _____ State _____ Zip _____

LITERATURE

Hybrid microcircuits design manual

If you're considering the use of thick-film hybrid ICs in your designs, you'll want a copy of this design guide from Airpax. The manual contains data on circuit partitioning, design rules, component characteristics, packaging, and

COMPARISON OF CUSTOM INTEGRATED CIRCUIT TECHNIQUES		
	HYBRID	MONOLITHIC
1. Initial set-up cost	\$400.00 - \$1,000.00	Greater than \$10,000.00
2. Unit cost	Low	Very low
3. Redesign	Possible at small cost	Expensive
4. Power dissipation	Can be relatively high	Relatively low
Component	High	Very high

the hybrid IC process. Still another section provides circuit diagrams for such ICs as quad power drivers, analog switches, gated high-power drivers, hybrid linear pulse-power amplifiers, and more. Airpax Electronics, 6801 W. Sunrise Blvd., Ft. Lauderdale, FL 33313.

Circle Reader Service #369

Short form connector catalog

A condensed version of their full product catalog outlines Elco's total connector capability in just 20 pages, yet covers everything from a simple solder receptacle to a completely terminated package. Covered, for example, are Elco's back panel packaging, Press-Fit system, Varipost™ connectors, card-edge connectors, sockets, rack-and-panel connectors, and more. Product write-ups include features such as standard materials, platings, and center spacings. Elco Corp., Willow Grove Div., Willow Grove, PA 19090.

Circle Reader Service #370

RCA's Databooks

It's time to order your 1973 edition of RCA's Solid State Databooks. For \$10 (\$12 after Dec. 31) you get complete technical data sheets and application notes for all RCA commercial solid-state devices as of Dec. 1972. This includes linear ICs and MOS devices, CMOS digital ICs, power transistors and power hybrid circuits, rf power devices, and thyristors, rectifiers, and triacs. Not only that, but you'll receive RCA's "What's new in solid state" newsletter throughout the year, keeping you posted on the latest developments. Order your set now from RCA Solid State Div., Box 3200, Somerville, NJ 08876.

Troubleshooting digital ICs

HP's logic probes, logic pulsers, logic clips, logic comparators, and accessories are all described in this 20-page brochure which discusses troubleshooting digital ICs while they're operating in-circuit. The function of each product in the technique is discussed, and there are details on a typical operation, available options, and accessories. Hewlett-Packard Co., 1501 Page Mill Rd., Palo Alto, CA 94304.

Circle Reader Service #371

Disc testing guide

With the total systems man in mind, this 24-page disc testing guide deals with the reasons for testing substrates, discs and packs, magnetic recording theory, disc characteristics, and magnetic recording techniques as well as

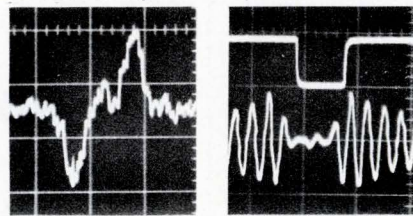

Extra Bit Signal

Missing Bit Signal

equipment selection and costing. It's all simplified with diagrams, illustrations and a glossary of test terms and abbreviations. There's also a cost estimate form so you can predict the cost of your own system requirements. Computest Corp., 3 Computer Dr., Cherry Hill, NJ

Circle Reader Service #372

Edmund's 1973 catalog

Everybody always looks forward to a new catalog from Edmund introducing hundreds of unusual and hard-to-find items for the engineer. This year's 164-page edition, in addition to thousands of surplus bargains, contains such items as a noise pollution meter, a portable 8-digit electronic calculator selling for \$149.50, a desk-top 14-digit display calculator for \$259, an underwater microphone, and an electronic thermometer! And, of course, optical items are always a specialty. Edmund Scientific Co., 380 Edscorp Bldg., Barrington, NJ 08007.

Circle Reader Service #373

Display buyer's guide

In the form of an eye chart, this display equipment buyer's guide compares the appearance of Sperry displays with LEDs and Nixie® tubes. The chart outlines the factors you should consider when selecting display equipment, then goes on to discuss applications, brightness, appearance, viewing angle and distance, size, and life expectancy. Copies of the chart are available from Sperry Information Displays, Box 3578, Scottsdale, AZ 85257.

Circle Reader Service #374

Toggle switch

Detailed in this data sheet is a new fast-action, 10-position, bi-directional toggle switch from Digitran. Photos and drawings illustrate the switch, and features and operation are explained. There are complete performance specs, dimensional drawings, and truth tables illustrating several of the 18 available standard output codes. The Digitran Co., 855 S. Arroyo Pkwy., Pasadena, CA

Circle Reader Service #375

Fairchild's MOS handbook

A must for all semiconductor libraries is this 300-page MOS handbook from Fairchild. With the cost and design goals of the system planner in mind, Fairchild takes a look at MOS product evaluation, design alternatives, and development costs and timing. Their handbook examines all these planning

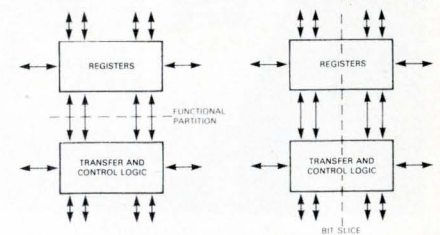

factors as they relate to MOS/LSI in general and, in particular, to OPTIMOS, a Fairchild acronym for optimum MOS in terms of capability and application, and their method of exercising all major MOS cost and design options. Write on company letterhead for your handbook to Fairchild Camera & Instrument Corp., 464 Ellis St., Mountain View, CA 94040.

Systems power supplies

Six series of power supplies for systems applications are reviewed in a 24-page catalog. In addition to product information you'll find data on accessories, variations, case sizes, options, and a complete line of voltage references with long term stabilities better than 10 ppm and temp. coefficients of 1 ppm/°C. Dynage Inc., 1331 Blue Hills Ave., Bloomfield, Conn. 06002.

Circle Reader Service #376

1973 A/D-D/A catalog

Datel's comprehensive 36-page catalog contains detailed electrical and mechanical information on a line of data conversion products that form the basic building blocks for many forms of data acquisition, data analysis, data reproducing and graphic display equipment.

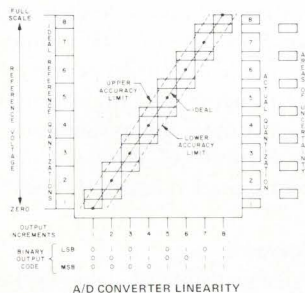

Diagrams and text fully cover ultraminiature A/D and D/A converters, accessory op amps, sample-and-hold amplifiers, analog multiplexers, miniature dc power supplies, and a line of modular and rack mount data acquisition systems. Datel Systems Inc., 1020 Turnpike St., Canton, MA 02021.

Circle Reader Service #377

Electronic packaging

Three different packaging techniques are described in this 8-page capabilities brochure. You'll read about SAE's plug-in packaging method using PC cards and cages, their planar system based on IC logic panels, and their Dipstik method, a self-contained plug-in modular package for ICs. You'll learn when to use which service, and how these services save you money. Get full details from Stanford Applied Engineering Inc., 340 Martin Ave., Santa Clara, CA 95050.

Circle Reader Service #378

Decision: Assume you need an alterable, non-volatile memory in your system, what choices do you have *right now*? And at what *true* and *complete* cost-per-bit?

Cores and plated wire—patchboards—diode arrays? Fine. Providing you need lots of memory—and you're not concerned about size, bulk and speed. Or power consumption. Or compatibility with existing and future logic forms. Or the additional cost of power-fail detection circuitry, or retrieval software and reload hardware—and the like.

Let's talk

Cost-per-Bit

Semiconductor memories? If you go with RAMs your bit cost per se may be lower. But you'll have to consider the extra cost of providing an uninterruptible power source. Or power-fail detection circuitry and battery back-up. Or retrieval software and reload hardware. Just to compensate for their inherent volatility.

If you consider ROMs—either the fixed or one-shot programmable variety—your cost-per-bit for memory alone could be even lower. Until you start adding up all the extra peripheral costs involved in trying to overcome their inherent unalterability. Simulation systems. Special masks and programmers. Surplus capacity for unused future options. Not to mention multiple spare parts inventories, field retrofits, obsolete stock, and spoilage due to errors.

So where do you go from there? *Take a good look at RMMs!*

AMORPHOUS RMM

ALTERABLE / NON-VOLATILE SEMICONDUCTOR MEMORIES

They're the only *inherently* non-volatile, *fully* electrically alterable semiconductor memories in production—*now!* You can use them just like any other hard-wired memory elements—but without having to buy and build a bunch of superfluous circuitry into your system just to protect stored data or correct program errors.

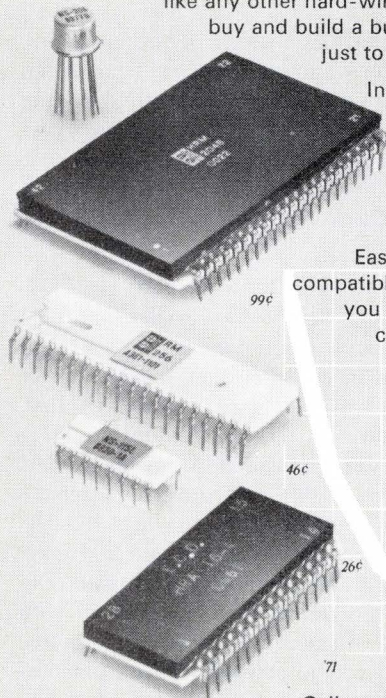

In fact, you can take Ovonic RMMs completely out of your system—for days, weeks, years at a time—without loss of data. And you can also change, up-date and re-alter stored information at will. Quickly, selectively and *repeatedly*—by simple electrical means.

Easy to apply, too. Standard packages. TTL/DTL compatible. Compatible with each other. Which means you can mix or intermix them any way you like to create flexible, expandable memory systems to meet present and future needs—*exactly!*

Cost-per-bit? Still a bit more than RAMs or ROMs on a straight device comparison basis. But considering the fact that bit cost is the *only cost* with RMMs, you'll find they're worth it! Important, too: RMM costs have dropped dramatically in the past 18 months and haven't reached bottom yet. So if you start using them now, your true bit costs will be a lot less by the time you hit volume production.

Call or write for complete information today!

Energy Conversion Devices, Inc.
1675 WEST MAPLE ROAD • TROY, MICHIGAN 48084
TELEPHONE 313/549-7300



Circle Reader Service #29

Rf capacitor handbook

The more than 200 pages of this rf capacitor handbook will help clarify the effects of capacitors on rf circuit performance. You'll find theoretical and empirical high-frequency circuit design equations, characteristics of capacitor dielectrics, especially at high rf power levels and frequencies, actual test data at frequencies from 100 MHz to 3 GHz,

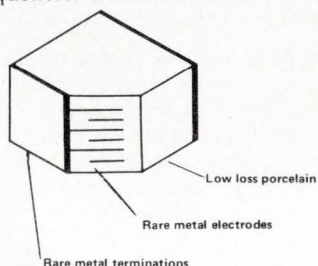

and practical design methods for increasing gain and power, dc to rf conversion efficiency, bandwidth, transistor lifetime, circuit MTBF, and low-noise performance. Get your copy of the Rf Capacitor Handbook from American Technical Ceramics, 1 Norden La., Huntington Sta., NY 11746.

Circle Reader Service #379

Socket cards

Socket cards holding up to 70 ICs and featuring test points, locking tabs, decoupling capacitors, and universal mounting strips are described in this bulletin. The cards listed include combinations for 14, 16, 24, and 36-pin ICs and both 2 and 3-level automatic wiring. Electronic Engineering Co. of Calif., 1441 E. Chestnut Ave., Santa Ana, Calif. 92701.

Circle Reader Service #380

Modem data

Capable of synchronous operation at 2400 b/s, this Bell 201B compatible modem offers automatic fast sync, clear to send delay, carrier detect, external/internal transmitter timing, and more. Included in this brochure are complete technical specs, theory of operation, an outline drawing of the PC card, a block diagram, a data mode timing diagram, and an illustration showing the transmitted signal frequency spectrum. Intel, 6 Vine Brook Park, Burlington, Mass. 01803.

Circle Reader Service #381

Printed circuit connectors

There are complete specs, application data, and dimensional drawings for nearly 1000 components in this 64-page catalog. Covered are two-piece connectors, card-edge connectors, single-lead connectors, flexible flat cable connectors, and others for PC applications. You'll also find explanations of complete packaging concepts such as modular interconnection systems and programmed wiring systems. AMP Inc., Harrisburg, PA 17105.

Circle Reader Service #382

Miniature lamps

Here are descriptions and specs for more than 470 miniature and subminiature incandescent and solid-state lamps. This 40-page catalog covers several incandescent types, line filament lamps, tungsten halogen types, in-

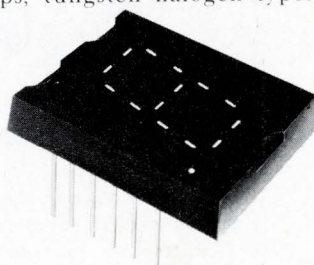

dicating/illuminating, solid-state lamps, and LED numeric displays. Your design selection is aided by complete operating parameters on each lamp, outline drawings, and all dimensions. Lamps Inc., 19220 S. Normandie Ave., Torrance, CA

Circle Reader Service #383

Image intensifier wall charts

Hang them on your wall or put them in a notebook, either way you'll want these image intensifier wall charts for reference. One contains data on first, second, and third generation electrostatically focused image intensifiers for low light level direct and remote viewing night vision applications. The other covers special purpose and magnetically focused image intensifiers. Details are provided in chart form with brief discussions of potting, modifications and unlisted variants, photocathode response, and gated image tubes. RCA, Electronic Components, 415 S. Fifth St., Harrison, NJ 07029.

Circle Reader Service #384

Digital readout systems handbook

Although written specifically for the DMS 500 2-axis, direct reading, digital readout system, this handbook may give you an insight into digital readout system considerations. You'll find helpful information in the section of application notes covering such topics as using digital position readout systems, choosing a location for a transducer, scale mounting techniques, and accuracy, resolution, and repeatability. Dynamics Research Corp., 50 Concord St., Wilmington, MA 01887.

Circle Reader Service #385

Flexible wiring standard

Established in this 14-page document are the qualification and acceptance requirements for multilayered flexible wiring that consists of three or more conductive layers on flexible insulating bases bonded to form a monolithic or solid mass. Tables and illustrations accompany data on applicable documents, four-layer drawings, quality assurance, quality conformance inspection requirements, test methods, and preparation for delivery. Copies are available for \$1 from the Institute of Printed Circuits, 1717 Howard St., Evanston, IL 60202.

Dual processor

This 4-page technical data sheet describes Microdata's Micro 1600D digital computer system consisting of two microprogrammable CPUs that can simultaneously execute independent programs while sharing a common main

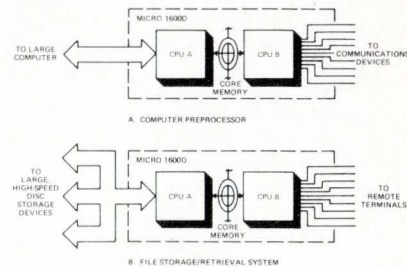

memory. Details are provided here, as are application data, a complete list of specs, and photos and diagrams illustrating functional characteristics, data flow, and the physical packaging of the system. Microdata Corp., 644 E. Young St., Santa Ana, CA 92705.

Circle Reader Service #386

Teleprocessing system

Data on a stored program communications control system is provided in a 6-page brochure. The system is suggested for such digital communications applications as data transmission controller, front end communications pre-processor, remote or local data concentration, data base access, and more. Details of the system components are provided as are block diagrams of several major configurations. Telefile Computer Products Inc., 17785 Sky Park Cir., Irvine, CA 92664.

Circle Reader Service #387

D/A converter applications

Digital-to-analog conversion using cos/mos-bipolar DACs is the subject of this application note. The note explains the use of a cos/mos dual complementary pair plus inverter as the D/A switch and op amp output stage for a low-power DAC. The resulting 9-bit DAC

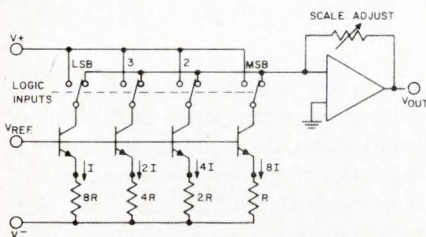

system combines in a simple single-supply system the concepts of multiple-switch cos/mos ICs, a ladder network of discrete metal-oxide film resistors, a cos/mos bipolar op amp voltage follower, and a monolithic regulator. RCA Solid State Div., Box 3200, Somerville, NJ

Circle Reader Service #388

Function modules

A 24-page catalog covers standard analog function modules for the design of control, monitoring, and computational systems. The modules, each of which performs a specific function, fall into five basic groups—input signal conversion, algebraic functions, dynamic response, logic functions, and output signal conversion. Several typical applications are illustrated in a supplement to the catalog. Bell & Howell, Control Products Div., 706 Bostwick Ave., Bridgeport, Conn. 06605.

Circle Reader Service #389

Electro-sensitive recording

The advantages of selecting the Dry Electro-sensitive Process around which to design a recorder, display, or printer are outlined in this 16-page booklet. It discusses operational aspects of the process, including data recording, stylus

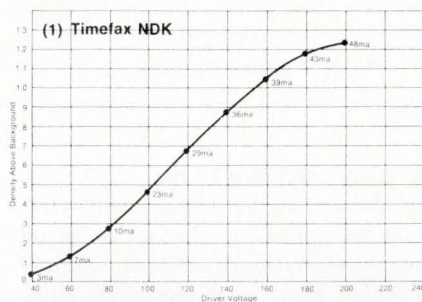

Reflection density as a function of driver voltage and paper grade

construction, the proper recording medium, required marking power, tonal response, and recording speed. There's also data on applications, and graphs illustrating various reflection density functions. Fitchburg CPI, Box 1106, Scranton, PA 18501.

Circle Reader Service #390

Radio Shack's 1973 catalog

Here's a 180-page catalog of home entertainment, audio, and communications equipment, parts and kits. There's everything from miniature electronic calculators, to stereo systems, to tape decks, and even electronic parts such as transistors, cables, tools, connectors, wires, and plugs. It's packed with all kinds of new and unusual items. Get your copy from Radio Shack, 2617 W. 7th St., Fort Worth, Tex. 76107.

Circle Reader Service #391

Switch catalog

There are 24 pages of detailed information in this catalog on subminiature toggle, rocker, and paddle handle switches, momentary pushbutton switches, and C&K's 360° rotary print-switch. You'll find photos, schematics, charts, and descriptions for all, as well as detailed data on available options. Prices are included in this comprehensive catalog from C&K Components Inc., 103 Morse St., Watertown, Mass. 02172.

Circle Reader Service #392

Whatever your tape handling needs...

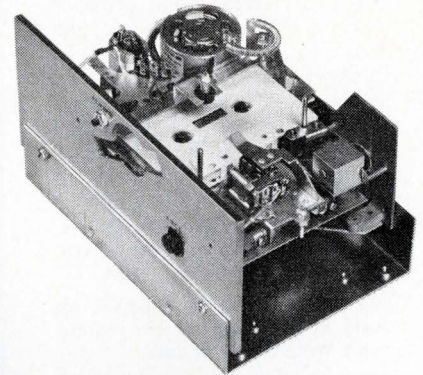

cassette...

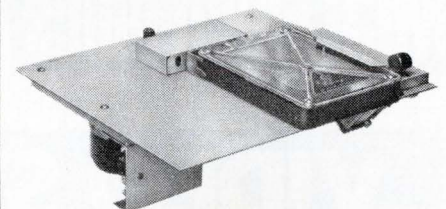

cartridge...

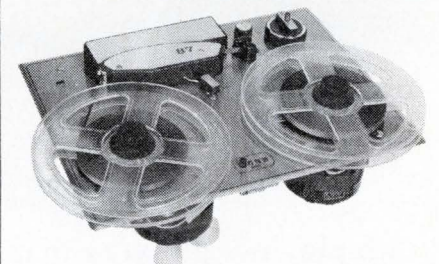

reel to reel...

Telex has an answer. Professional magnetic tape handling equipment, designed for heavy duty commercial and industrial use. Available with a wide choice of configurations, options and associated electronics. Write for free information.

PRODUCTS OF SOUND RESEARCH

TELEX®

COMMUNICATIONS DIVISION

9600 ALDRICH AVENUE SOUTH
MINNEAPOLIS, MINNESOTA 55420

CANADA: DOUBLE DIAMOND ELECTRONICS, LTD. Scarborough 4, Ontario
EUROPE: ROYAL SOUND COMPANY, INC., 408 North Main St., Freeport, N.Y. 11520 U.S.A.
INTL.: TELEX EXPORT DEPT., 9600 Aldrich Ave. So., Minneapolis, MN. 55420 U.S.A.

Circle Reader Service #30

Circuit Savers

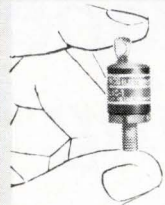

DC CROWBARS

Here's positive burnout protection for your ICs, transistors, power supplies and PC cards. LVC-1 DC Overvoltage Crowbar mounts in your equipment like any mini component, switches to short circuit when voltage on supply bus exceeds specified level, resets automatically when power source is removed. Trip levels 2.5 to 600V, current to 235A, reaction time less than 3 usec, MIL temperature range. For specs, application data, prices, request Bulletin 10A.

Full line of protection modules for every hi-lo voltage/current requirement. Write or call for data.

279 Skidmore Rd., Deer Park, N.Y. 11729
Telephone: 516-586-5125

MCG Electronics

Circle Reader Service #38

LITERATURE

Instant SOS kit

To introduce you to silicon-on-sapphire (sos) technology, Inselek is offering an instant sos kit that includes all the essentials necessary to fabricate the four most often used transistor types in thin silicon films. Details on the kit, including contents, cost, and instructions, are provided in this data sheet. Inselek Co., 743 Alexander Rd., Princeton, NJ

Circle Reader Service #393

Automatic reclosing relays

Described in this 16-page catalog are automatic reclosing relays for ac circuit breakers with ac and dc control schemes. There's complete application, construction, and operating information as well as internal wiring and circuit diagrams. Included also are a listing of relay characteristics and a contact position development chart. Westinghouse Electric Corp., Westinghouse Bldg., Pittsburgh, Pa. 15222.

Circle Reader Service #394

Plug-in reed relays

For applications in control and instrumentation, low-level switching, counting, high-speed sampling, computers, and associated peripheral equipment, Computer Components offers a series of dry reed and mercury wetted relays. This brochure gives you a CCI/IBM reed relay equivalency chart, mounting data, packaging/mounting dimensional diagrams, operating parameters, and contact rating charts. Computer Components Inc., 88-06 Van Wyck Expwy., Jamaica, N.Y. 11418.

Circle Reader Service #395

Terminal boards: data and design

First you read about standard terminal boards, fast connect circuit boards (solid-state components soldered in place), pc terminal boards, and terminal tabs. Then the design section tells you

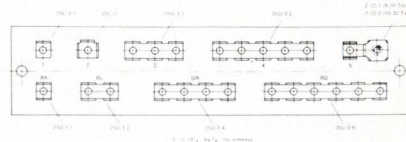

how to save with stock tooling, and provides pointers on paper base or epoxy board materials, printing and embossing, styles of terminals, and terminal arrangement. Doran Mfg. Co., 2851 Massachusetts Ave., Cincinnati, Ohio 45225.

Circle Reader Service #396

Power supply standards

For both producers and consumers of stabilized dc power supplies, this NEMA standard provides a means by which to judge compliance to the internationally accepted safety standards for electronic apparatus, a reference for test methods used to determine performance ratings, a synopsis of required nameplate data, international warning symbology, and a glossary of terms. This standard represents the United States' contribution to the International Electrotechnical Commission, a committee to draft standards specifically for power supplies, and including such other participating nations as the U.S.S.R., Germany, France, England, the Netherlands, Switzerland, Japan, Italy, Poland, Yugoslavia, and Sweden. Copies are available for \$9 from NEMA, 155 E. 44th St., New York, NY 10017.

VIDEO STORAGE



Simple, low cost way to give your displays stop-action and four other competitive advantages—all in one small package.

Introducing the Hughes Model 639 video storage unit. A complete electronic image memory system. With all the circuitry, power and controls built-in to make your displays versatile exhibitions.

It stores alphanumeric, graphic, and pictorial data. With high resolution, high-speed writing capability, selective updating and fast erasure. It converts slow-scan and x-y information to TV format.

It integrates signals (automatically enhancing weak or low light images). It speedily processes and

stores input signals for conversion into TV displays for the medical, management, law enforcement, and many other applications.

If you need close-up images, there's a zoom control, with a positioning joystick. And because it's flexible, it can be customized to star in any graphic display system.

Write for new brochure:
2020 Oceanside Blvd., Oceanside, CA 92054.

Or call:
(714)
757-1200.



Pin and socket connectors

Interconnecting devices for commercial or industrial applications are the subject of this 52-page catalog. Selection charts provide easy access to electrical, mechanical, and environmental specs, and there are line drawings and photos for each connector. There's also a section devoted to termination equipment, including crimping, insertion, and withdrawal tools for all connectors. Amphenol Industrial Div., 1830 S. 54th Ave., Chicago, IL 60650.

Circle Reader Service #397

Microwave digital radio primer

Written to provide a basic understanding of digital modulation of microwave radio, a 12-page primer explains the operation of an AvanteK radio in the 2-GHz common carrier bands and the 1850 to 1990-MHz PSIT band using T1 type PCM carriers for multiplexing.

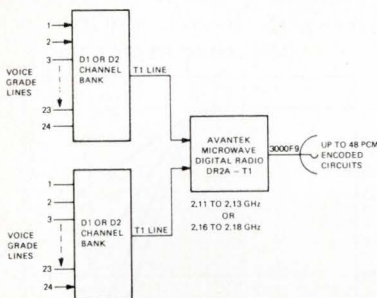

You'll find discussions on digital traffic and digital modulation, T-carrier on microwave radio, characteristics of digital microwave, a glossary of microwave digital radio terms, and an appendix on the switched telecommunications network. AvanteK Inc., 2981 Copper Rd., Santa Clara, CA 95051.

Circle Reader Service #398

Flat cable handbook

Flat cable is the subject of this 40-page handbook which covers distinguishing features, termination, connectors, wiring changes, cable assemblies, installation and support, and signal transmission lines. Also provided are a flat cable glossary and a series of charts and tables on such topics as dielectric properties, standard configurations, and cross sections. Copies are available for \$5 from the Institute of Printed Circuits, 1717 Howard St., Evanston, Ill. 60202.

Transformer buyer's guide

This 24-page booklet guides you in selecting and applying this series of dry-type transformers, including general purpose, buck-boost, and distribution transformers. Complete specs, dimensions, and wiring and connection diagrams are provided in each series' selection guide. An accompanying supplement provides prices. General Electric Co., Rm. 207, Building 6, Schenectady, N.Y. 12345.

Circle Reader Service #399

Solderless electrical terminals

AMP's revised catalog contains over 400 additional solderless wiring devices. In the 32-page catalog are descriptions, specs, and dimensional data for the entire Faston™ product line, including straight and right angle receptacles, tabs, insulating sleeves, quick disconnect splices, multi-position connectors, and special purpose items. AMP Inc., Harrisburg, Pa. 17105.

Circle Reader Service #400

WITH OUR CATALOG
YOU MAY NOT NEED
A CUSTOM

CAPACITOR

AND THE CATALOG
IS YOURS
FOR THE ASKING

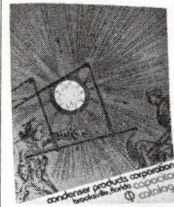

Picture a complete concise composite catalog of over 800 off-the-shelf capacitors, over 1200 variations including some weird and unusual units.

If what you need isn't there, then drop us a line, or give us a call, we'll custom design a capacitor for your circuit, and in most cases there is no charge for customizing. But check the catalog first, what you need may be there and ready for immediate shipment.

TO GET YOUR CATALOG,
JUST DROP US A LINE.

condenser
products
corporation

Box 997, Brooksville, Florida 33512
Phone (904) 796-3562

Circle Reader Service #32

How to be beautiful, strong and colorful, in 24 small sizes.

Bold design and quality construction are hallmarks of Optima Small Case enclosures. Mobile, versatile and rugged, these cases offer hundreds of two-color combinations in durable vinyl finishes, with useable inside space ranging from 133.6 to 1445.4 cubic inches. Get information on the complete Optima line. Write

Optima Enclosures, division of Scientific-Atlanta, Inc., 2166 Mountain Industrial Blvd., Tucker, Ga. 30084. Or call (404) 939-6340.

OPTIMA

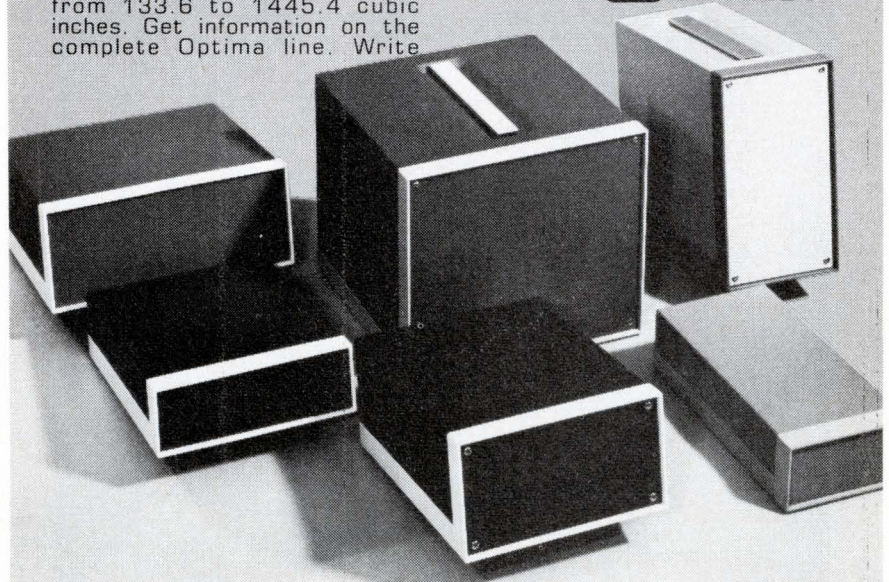

Circle Reader Service #33

Digital multimeter

Featuring a new logic scheme called SAINT, this DMM combines approximation logic (SA) and integration logic (INT) in one instrument. Details of the new 5-digit meter are covered in this 4-page brochure, including specs, standard functions, and available options. Lear Siegler Inc., Electronic Instrumentation Div., Cimron Instruments, Anaheim, CA 92803.

Circle Reader Service #401

Bridge rectifiers

Designed to help you select the AFI bridge rectifier best suited to your requirements, this 10-page catalog describes standard and custom devices to serve a variety of industrial and high power circuit design applications. Photos, maximum ratings, features, and electrical characteristics are provided for each product. Arthur Fallon Ind., 400 Warburton Pl. Long Branch, NJ 07740.

Circle Reader Service #402

Switch catalog

A recent edition of Arcoelectric's switch catalog illustrates a wide variety of toggle, pushbutton, snap-action, and rocker style switches. The 20-page catalog provides technical data for each switch, and additional sections cover neon indicator lights, lenses, and indicator lamp holders. Arcoelectric Switch Corp., 10523 Burbank Blvd., No. Hollywood, Calif. 91601.

Circle Reader Service #403

Portable laser holographic camera

Discussed in this literature is a completely portable laser holographic camera that enables interferometric and nondestructive testing in any environment. Applications suited to the laser's 20-ns exposure time are suggested for both reflective and transmissive holography. Union Carbide Corp., Korad Dept., 2520 Colorado Ave., Santa Monica, Calif. 90406.

Circle Reader Service #404

Power module

Abbott's new catalog describes a method that allows conversion of low frequency ac lines (47 to 440 Hz) to 50 W of regulated power in a package that measures only 4 x 6 x 2 1/4 in. Complete details are provided here, including output current, ripple, temp. coefficient, short circuit and transient protection, and available options. Remote error sensing and parallel operation are standard features. Abbott Transistor Laboratories Inc., 5200 W. Jefferson Blvd., Los Angeles, CA 90016.

Circle Reader Service #405

Catalog of active filters

Here's brief but effective coverage of the features of active filters. Following a chart outlining the electrical specs for standard filters is a section on the definition of filter responses for low-pass (Butterworth, Bessel, and Cheby-

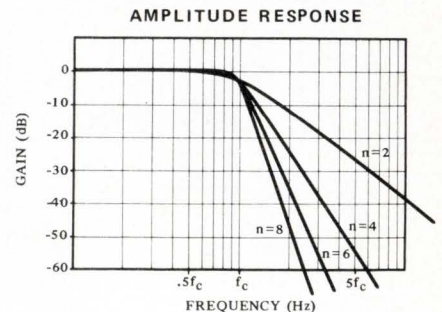

schew), band reject, and band-pass (single-tuned and stagger-tuned) filters. Dimensional and pin connection diagrams are provided also. Burr-Brown Research Corp., International Airport Industrial Park, Tuscon, AZ 85706.

Circle Reader Service #406

High-speed SCR

Described in this 10-page note is a 600-V, 235-A rms high-speed SCR for inverter service. Included are 34 curves depicting maximum energy per pulse and maximum on-state current for both sinusoidal and rectangular current waves at 10, 25, and 50% duty cycles. Other descriptive information provided includes specs and ratings, outline drawing and photo. International Rectifier Corp., Semiconductor Div., 233 Kansas St., El Segundo, Calif. 90245.

Circle Reader Service #407

think woven

for versatility

You name it. Any type of conductor. Any combination of functions, sizes, colors and insulation (unboundables included.) It's loom-made by Woven Electronics like nobody else can make it!

WOVEN ELECTRONICS
A DIVISION OF SOUTHERN WEAVING COMPANY
P.O. Box 189, Mauldin, S.C. 29662, (803) 288-4411

Circle Reader Service #34

Variable resistor catalog

Here are 20 pages of specs and details on single, tandem, multisection and vernier adjust types of commercial composition variable resistors. Graphs illustrate tapers while charts and diagrams illustrate electrical and mechanical characteristics and constructions. There's also a section on rotary, pull-push, and push-push power switches used with these resistors. CTS of Elkhart Inc., 1142 W. Beardsley Ave., Elkhart, Ind. 46514.

Circle Reader Service #408

Panel meter catalog

The Big Look® and Horizon Line® families of panel meters are the subject of this 28-page catalog. Features and specs are provided for voltmeters, ammeters, frequency meters, motor load indicators, current transformers, meter relays, shunts and leads, resistors, parts, accessories, and more. General Electric Co., 1 River Rd., Schenectady, N.Y.

Circle Reader Service #409

Miniature active filter

A hybrid ic, two-pole, audio-frequency filter that uses negative multi-loop feedback for stability is the subject of this 8-page application note. In addition to the equations needed for many applications, you'll find data on circuit operation and construction, complete

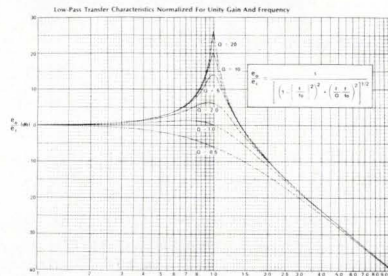

performance specs, a series of filter characteristic response curves, and details of a simplified tuning procedure that eliminates involved calculations. Beckman Instruments Inc., Helipot Div., 2500 Harbor Blvd., Fullerton, Calif. 92634.

Circle Reader Service #410

Reconditioned instruments

If you don't want to spend a lot of money, you might be interested in looking here for your instruments. In this 60-page catalog, you'll find instruments from such manufacturers as Digilin, Weston, Honeywell, Simpson, H-P, Tektronix, Triplett, and Dana, some new, some fully reconditioned, and all guaranteed. Leasametric, 822 Airport Blvd., Burlingame, Calif. 94010.

Circle Reader Service #411

Rack and panel standard

The EIA has issued a recommended standard for racks, panels, and associated equipment. Establishing dimensions critical to compatibility between racks, panels, and installed equipment, the standard covers three cabinet and rack widths to accommodate each of three standard panel widths (19, 24, and 30 in.). Copies are available for \$2.50 from Electronic Industries Assoc., 2001 Eye St. N.W., Washington, D.C. 20006.

It's time to order your 1973 RCA Solid State Databooks

Complete, up-to-the-minute data for RCA's IC's and discrete devices.

Get off to a fast start in 1973 with timely, comprehensive data from RCA, the company that specializes in complete, accurate data on all of its solid state devices. The 1972 DATABOOKS have been used in thousands of plants in the United States and around the world. And even more plants will be reached in 1973. This is your chance to be one of the new recipients.

The new DATABOOKS cover a great range of your requirements because RCA has some of the broadest lines in the industry: linear and COS/MOS ICs, MOS-FETs, power transistors, power hybrids, RF and microwave devices, thyristors, rectifiers, and diacs. 25% new or revised material. Complete commercial product data. Complete, current application notes. Easier-to-use quick-reference guides. New, comprehensive subject index. Cross-reference index of developmental to commercial type numbers.

Six 1973 DATABOOKS for only \$10 (optional list price: \$12), with monthly new products newsletter. See coupon for details. Send the coupon along with your check or money order (payable to RCA Corporation) or your company purchase order. Or call your RCA distributor. If the coupon is missing, write RCA, Solid State Division, Section 59L, Box 3200, Somerville, N.J. 08876.

RCA Corporation
Solid State Division
Section 59L, Box 3200
Somerville, New Jersey 08876

- Rush me the six 1973 DATABOOKS and put my name on newsletter mailing list. My cost, only \$10. Offer good only until December 31, 1972.
- Rush me prices for individual DATABOOKS and updating service.

NAME/TITLE _____
 COMPANY _____
 ADDRESS _____
 CITY/STATE/ZIP _____

I enclose payment by: Check Money Order Purchase Order
 Offer good only in U.S. and Canada. Direct other inquiries to RCA sales offices or distributors.

Circle Reader Service #35

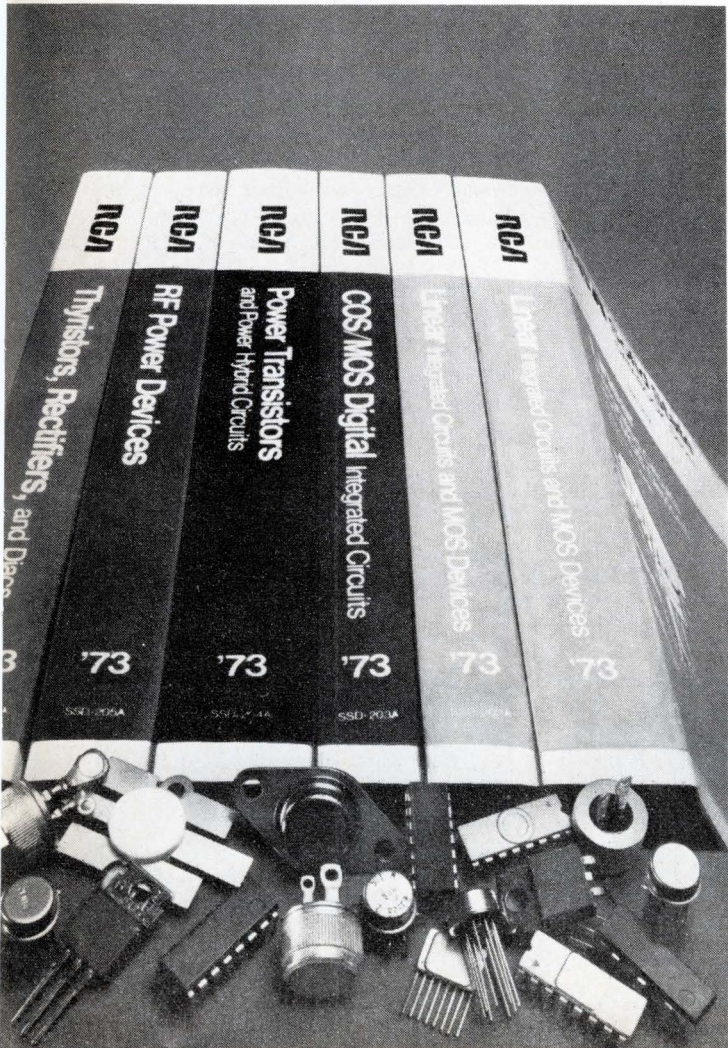

SAMPLES

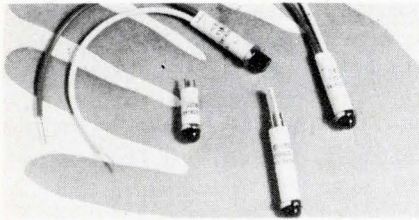

LED pilot light

If you missed our offer in September you'll want to ask now for a sample of this LED pilot light. A complete package ready to interface with your circuit, you'll find these solid-state lamps economical since they can be permanently wired into a circuit. Features include an LED for reliability and resistance to shock and vibration, a current limiting resistor for dc applications, and a rectifier diode for ac applications. Industrial Devices Inc., Edgewater, NJ 07020.

Circle Reader Service #412

Magnetic shielding material

Free samples of two magnetic shielding materials, Netic and Co-Netic, are offered to you here. For determining the shielding levels required for various electronic components, Netic serves medium attenuation, high intensity applications, and Co-Netic, high attenuation, low intensity applications. Ask for your samples from Perfection Mica Co., 740 Thomas Dr., Bensenville, IL 60106.

Circle Reader Service #413

Knobs

Recommended for light clamping and adjusting devices and as a thumb screw or nut is this knurled knob from Dimco. Also, the large contact area of the brass insert makes it suitable for terminal nut applications. Although black is the standard color, the injection molded knob is available in other colors with large production runs. You also have a choice of four sizes of tapped brass inserts. Get your free sample from Dimco-Gray Co., 207 E. 6th St., Dayton, OH 45402.

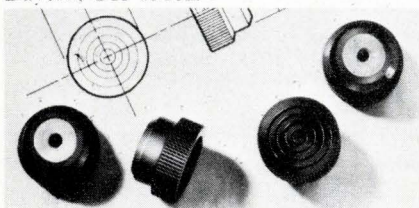

Circle Reader Service #414

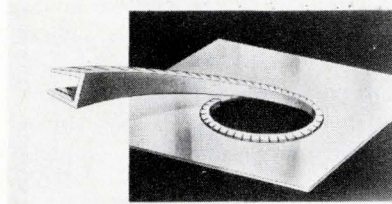

Serrated continuous grommet

For easier contouring around openings of any shape, try this new serrated grommet. You'll protect your wires, cables, and cords against damage from sharp panel edges. It's available in natural color polyethylene or nylon, and for five panel thicknesses from 0.036 to 0.250 in. Ask for a free sample from Richo Plastic Co., 5825 N. Tripp Ave., Chicago, IL 60646.

Circle Reader Service #415

Glass bubbles

Here's a lightweight glass bubble for use in syntactic foams where minimum density must be controlled precisely. In a foam, the bubbles can be used as an electrical potting compound because their low density and dielectric constants reduce the likelihood of harming semiconductors with excessive temperatures. Applications in the aircraft and space industry include tooling molds, radome applications, and ablative nose cones. 3M Co., 3M Center, St. Paul, Minn. 55101.

Circle Reader Service #416

Bridging clip

To save wire, time, and labor, try this new bridging clip for electrically interconnecting adjacent terminals in the same row of 66-type connecting blocks. It's made of stainless steel and eliminates tedious interconnection by wire since it easily slips over adjacent terminals. And it's just as easy to remove. Fastex, Div. Illinois Tool Works Inc., 195 Algonquin Rd., Des Plaines, IL

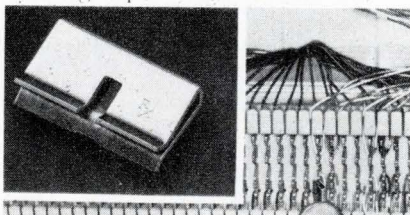

Circle Reader Service #417

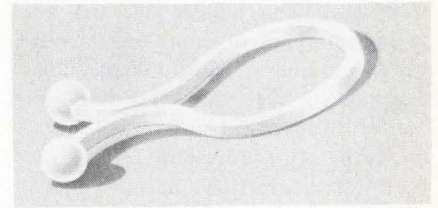

Nylon wire tie

Tying wires in a TV set or an automobile are only examples of the unlimited fastening applications suited to Purse Lock™ wire ties, designed for quick tying bundles of wires and other stranded materials. Both application and removal are fast and easy (no tools required) and ties may be color coordinated. Free samples, specs, and application data are available from Fastex, Div. Illinois Tool Works Inc., 195 Algonquin Rd., Des Plaines, IL 60016.

Circle Reader Service #418

Mini temperature recorder

The world's smallest 4-position temperature recorder indicates four different temperatures per recorder in ranges from 110°F to 450°F with an accuracy of ±1%. Complete specs and a free evaluation sample of the recorder, designed for such applications as testing miniature components and troubleshooting instruments, are available from William Wahl Corp., Temp-Plate Div., 12908 Panama St., Los Angeles, CA 90066.

Circle Reader Service #419

Gold-plated electrical contact

These gold-plated bellows contact springs are suitable for applications in all kinds of electronic equipment, including computers. Because the nickel bellows, which form the body of the contacts, retains its spring characteristics in most applications, permanent contact with the conductors is assured, no matter how small the conductor may be. They're available in a variety of diameters and lengths, and are offered to you by Servometer Corp., 82 Industrial East, Clifton, NJ 07012.

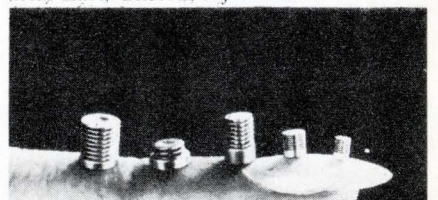

Circle Reader Service #420

THE ELECTRONIC ENGINEER

DISTRICT SALES MANAGERS

EDWARD G. SHAUD
BALA-CYNWYD, (Pa.) 19004
One Decker Square
(Area Code 215) SHERWOOD 8-2000

JACK RATTINGER
NEW YORK 10016-600 Third Ave.
(Area Code 212) OXFORD 7-3400

JOHN W. BERNHARDT
CHICAGO 60606-100 S. Wacker Drive
(Area Code 312) 782-1400

G. T. ALFANO
NEEDHAM HEIGHTS, MASS. 02194-
570 Hillside Ave.
(Area Code 617) 444-0010

TERRENCE D. BUCKLEY
THOMAS R. BORIS
LOS ANGELES 90020-3727 W.
Sixth St. # 202
(Area Code 213) DUNKIRK 7-1271

RALPH PETERSEN
JOHN SLY
LOS ALTOS (San Francisco) 94022
199 First St., Room 335
(Area Code 415) 941-6655

RICHARD DUTE
CLEVELAND 44114-601 Rockwell Ave.
(Area Code 216) SUPERIOR 1-2860

NEWTON B. COLLINSON
ATLANTA 30309-1776 Peachtree St.
N.W.
(Area Code 404) 872-4723

HAROLD E. MOTT
RICHARD HERRANEN
Houston 77027
4151 Southwest Freeway
Suite 735
(Area Code 713) 621-7550

INTERNATIONAL BUSINESS OFFICES

London, SW1Y 6PB
67 68 Jermyn St. St. James's
01-839 6318 9
Cables
Max F. Holsinger
Dir. European Sales
K. J. Hendry, S. K. Elliott
WHIP LONDON S W 1

Manchester M22 5RQ
Haletop, Wythenshawe Civic Centre
4 Dusseldorf-Nord
Eitelstrasse 32
Dusseldorf 652031-2
Cables
D. I. Goulden
061-437 3293
E. Hillerbrand
R. Schomburg, H. Haibt

75 Paris 8e
70 rue de Ponthieu
Paris 359 65-77
Cables
WHIP DUSSELDORF

75 Paris 8e
70 rue de Ponthieu
Paris 359 65-77
Cables
S. Brown-Joussard
J. C. Lamoine
UIIP, PARIS 8E

Tokyo
11-3-2 Chome, Shinbashi
Minato-ku, Tokyo, Japan
Clarence T. Sakaguchi
Tel: 591 6897

BUSINESS STAFF

BERNARD M. GITTELMAN

Publisher

DENNIS J. PERKINS

Promotion Manager

JOHN J. MEEHAN

Marketing Services Manager

KAREN A. CHRISTIAN

Production Mgr.

BEVERLY TATUM

Production Asst.

WILLIAM HOWAT

Circulation Director

DAVID ELY

Circulation Manager

JOSEPH P. BABCOCK

Reader Service Manager

JOHN H. KOFRON

Chilton Research Services

C. R. WILHIDE

Washington Vice-President

Advertisers—December 1972

No liability is assumed for errors or omissions.
This Index is published for a convenience.

AMP, INC.	21	MAGNECRAFT ELECTRIC CO.	1
Aitkin-Kynett Co., Inc.		Marktronics, Inc.	
ANALOG DEVICES	51	MAGNETIC COMPONENTS DIV. CDC	61
Schneider Parker Guy Inc.		Kent Dixon Advertising	
ANSLEY ELECTRONIC CORP.	29	MCG ELECTRONICS	74
Richard L. Renner		Dunwoodie Advertising	
AUGAT	66	MOTOROLA COMMUNICATIONS	
Creamer, Trowbridge, Case & Basford, Inc.		& ELECTRONICS	58
		Brand Advertising Inc.	
BUSSMANN	6	MOTOROLA SEMICONDUCTOR	
Henderson Advertising Company		PRODUCTS, INC.	bet. 32 & 33
		E. B. Lane & Associates, Inc.	
CONDENSER PRODUCTS CORP.	75	MOTOROLA SEMICONDUCTOR	
MacMahon Advertising Inc.		PRODUCTS, INC.	14, 15
		E. B. Lane & Associates, Inc.	
ELCO CORPORATION	17	NATIONAL SEMICONDUCTOR	52, 53
Mort Barish Associates, Inc.		Chiat/Day Inc.	
ENERGY CONVERSION DEVICES, INC.	71	NYTRONICS	64
Watkins-Rogers, Inc.			
FACIT-ODHNER, INC.	69	OPCOA, INC.	22
Kriegel/Feldman/Stern, Inc.			
FAIRCHILD MOD	37	RCA—Solid State Division	48, 77, BC
FAIRCHILD SYSTEMS TECHNOLOGY	45	Al Paul Lefton Company, Inc.	
Hall Butler Blatherwick, Inc.		RFL INDUSTRIES	63
		Josephson, Cuffari & Company	
GTE SYLVANIA	IFC	SANDERS ASSOCIATES—Microwave Div.	62
Allied Advertising Agency Inc.		Harold Cabot & Co., Inc.	
HUGHES AIRCRAFT COMPANY	74	SCIENTIFIC—ATLANTA, INC.	75
Foot, Cone & Belding		NOW	
INTERSIL	8, 9	SOLITRON DEVICES, INC.	30
Herrick & Associates, Inc.		William E. Haselmire Advertising	
KEPCO, INC.	4	SYSTRON DONNER	19
Weiss Advertising		Bonfield Associates	
LAMBDA ELECTRONICS	IBC	TEC, INCORPORATED	61
Michel Cather Inc.		Tec-Ad	
LITTON OEM PRODUCTS	67	TELEX COMMUNICATIONS DIVISION	73
GHB Advertising, Inc.		PAR Advertising, Inc.	
MAGNECRAFT ELECTRIC CO.	1	TERADYNE, INC.	2
Marktronics, Inc.		Quinn & Johnson, Inc.	
MAGNETIC COMPONENTS DIV. CDC	61	TESTLINE	57
Kent Dixon Advertising		THERMALLOY	68
MCG ELECTRONICS	74	Warren Guild	
Dunwoodie Advertising		U. S. CAPACITOR CORP.	5
MOTOROLA COMMUNICATIONS		S. Michelson Advertising	
& ELECTRONICS	58	UNITRODE CORPORATION	13
Brand Advertising Inc.		Impact Advertising Inc.	
MOTOROLA SEMICONDUCTOR		WATKINS-JOHNSON COMPANY	46
PRODUCTS, INC.	bet. 32 & 33	William C. Estler	
E. B. Lane & Associates, Inc.		WESTERN DIGITAL CORP.	11
MOTOROLA SEMICONDUCTOR		RHB Marketing Communications	
PRODUCTS, INC.	14, 15	WOVEN ELECTRONICS	76
E. B. Lane & Associates, Inc.		Prentiss Court	

Distributors—who needs them?

Sir:

In the excellent article "Distributors—who needs them?" (June, pp. 54-58) on distribution of electronic components, your basic theme is very indicative of the more important role played by the components distributor in today's electronic marketing process.

While we at Newark may be accused of hiding our light under a blanket, it might be illuminating to you and your readers to point out some very helpful programs and services we offer, which apparently missed your attention.

Newark Electronics is not a "mail order" house—our 18 existing branches are located for convenience of contract by our industrial customers. We have six semiconductor sales engineers and specialists on the staff to solve customer application or purchasing problems, and one branch on the East Coast specializing in MOS products. An exclusive program which we call ESP—Extra Service Procurement—has been introduced to solve the difficult procurement problems for short runs of hard-to-get special items, such as: testing, conditioning or selection of semiconductors, resistors and other components; custom assembly of switches, potentiometers, connectors; custom engraving of pilot lights, switches. In addition, there is the famous Newark catalog that offers the engineer an easy reference guide to a wide variety of components with primary parameters for comparison and pricing.

These services are designed to meet the progressively more complicated requirements of today's electronic engineers and the purchasing people who must procure these products to meet schedules.

Oliver Goold, VP
Newark Electronics
Chicago, IL

Kick the 608 habit!

Sir:

Your October 1972 issue has a very interesting article: "Kick the 608 habit" (P. 84). Unfortunately, our company and our products are not mentioned, al-

though Rohde and Schwarz has been, for many years, a leader in the field of vhf-uhf generators. As this article rightly states, the need for this new generation of very stable and noise free generators stems from requirements for narrow channel communications.

As you and your readers undoubtedly know, Rohde and Schwarz has introduced the first commercial synthesizer on the American market as far back as 1954. R & S was again the first to introduce the frequency locking system on its new generators. Types SMDA and SMDF, which are part of our Test Assembly for Radiotelephone Systems. This gives the signal generator frequency stability, accuracy, and resolution similar to that of the best synthesizers, by reducing noise and eliminating spurious frequencies which are inherent to the synthesis process. The tabulation below gives data similar to your tabulation.

R & S SMDA with frequency controller

Freq. range: 0.4-484 MHz

Readout: 10/100 Hz; 8/7 digits

Accuracy: 10/100 Hz

Rf output into 50Ω: 0.05 uV to 0.5 V

Freq. lock: Yes

Modulation: Int. Ext. am, fm and phase modulation; sweep

Simultaneous modulation: am/fm

Comments: With power adapter, all measurements on transmitter and receiver possible through 1 connection to antenna. Generator protected against overload.

Price: \$6200 for the generator, plus \$5200 for the frequency controller.

Rudolf Feldt, President
Rohde & Schwarz
111 Lexington Ave.
Passaic, NJ 07055

God is systems engineering

Sir:

I can't think of a less appropriate way to talk about systems engineering (Editorial, June 1972, page 5). I am sure that Christians will be offended by using our Creator's name in such a context. If God is systems engineering and you believe it, I suggest you start reading the Bible starting with Genesis.

K. V. Kratochvil
Bartlesville, OK

Scandal in Cupertino

That darling of the engineering set, the Hewlett-Packard Model 35 pocket calculator, does have one flaw, and HP is writing to all owners to tell them that they will get an incorrect answer (albeit by less than 2%) if they try to read e^x for $x = 0.7030975114$ or $x = 0.995033085E2$. (If you find other gremlins in the mini-wonder, please let us know.) A corrected version of the chip is now in production, and owners who won't be able to sleep until their calculators are corrected are advised to contact Ron Stevenson, Customer Service Manager, Hewlett-Packard Advanced Product Div., 11000 Wolfe Rd., Cupertino, CA 95014, or

Circle Reader Service #276

If you would like this magazine to publish the *correct* answers,

Circle Reader Service #277

If you aren't familiar with the HP-35, don't despair; read "Made in USA—finally," *The Electronic Engineer*, March 1972, pp. 18-22, and/or

Circle Reader Service #278

QUOTES OF THE MONTH

"Until ESP provides the answer to 'perfect' foxhole-to-headquarters information transfer, perfecting the digital (tactical communications) technique is the key planning factor for the next decade." (*Major General Harold A. Kissinger, Director, Joint Tactical Communications Office, Office of Secretary of Defense, in a presentation to Armed Forces Communications Electronics Association on Digitization—A New Dimension in Tactical Communications.*)

"A new layer of electronic distribution will emerge by 1980. Its genesis is in today's special-line distributor. On the one hand, this new superdistributor will perform many marketing functions that manufacturers do today, as well as certain repair services. On the other, the general-line distributors will become less loyal to brand names." (*Edward J. Walter, Publisher of Electronic Distributing and Marketing magazine, speaking to the Association of Electronic Manufacturers, Nov. 10, 1972.*)

Do you face a make or buy decision on power supplies?

BUY THE NEW LAMBDA LY SERIES

**>50% efficient, 20 KHz switching,
50mV P-P ripple, 0.1% line or load regulation**

SINGLE OUTPUT

\$300

**5 VOLTS 30 AMPS
WITH OVERVOLTAGE
PROTECTION BUILT-IN**

DUAL OUTPUT

\$380

**±15 TO ±12 VOLTS
8.5 AMPS EACH OUTPUT**

TRIPLE OUTPUT

\$395

**5 VOLTS 18 AMPS
DUAL ±15 TO ±12 VOLTS
2 AMPS EACH OUTPUT**

QUADRUPLE OUTPUT

\$450

**5 VOLTS 16 AMPS
DUAL ±15 TO ±12 VOLTS
1.5 AMPS EACH OUTPUT
24 TO 28 VOLTS 1.0 AMPS**

AC input: 105-132 VAC, 47-440 Hz
DC input: 145 VDC ±10%

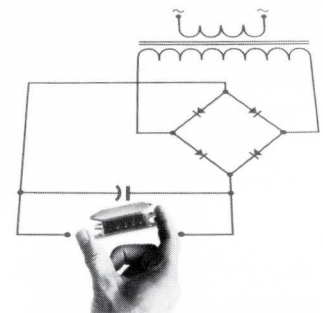
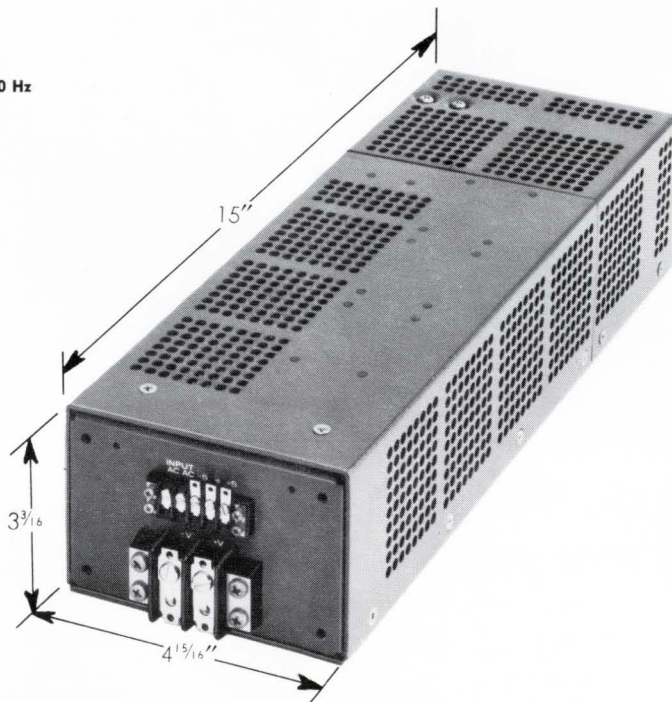

11 standard models in single, dual, triple or quadruple outputs in new "5" package. Triple and quadruple output models incorporate Lambda Power Hybrid Voltage Regulator.

**ALL CARRY LAMBDA'S 5-YEAR GUARANTEE.
ALL IN STOCK FOR 1-DAY DELIVERY.**

**△ LAMBDA
ELECTRONICS CORP.**
A **Veeco** Company

MELVILLE, NEW YORK 11746 515 Broad Hollow Road Tel. 516-694-4200 ARLINGTON HEIGHTS, (CHICAGO) ILL. 60005 2420 East Oakton St., Unit Q Tel. 312-593-2550
NORTH HOLLYWOOD, CALIF. 91605 7316 Varna Ave. Tel. 213-875-2744 MONTREAL, QUEBEC 100C Hymus Blvd., Pointe-Claire, Quebec-730 Tel. 514-697-6520

Circle Reader Service #36

Chip

off the old breadboard.

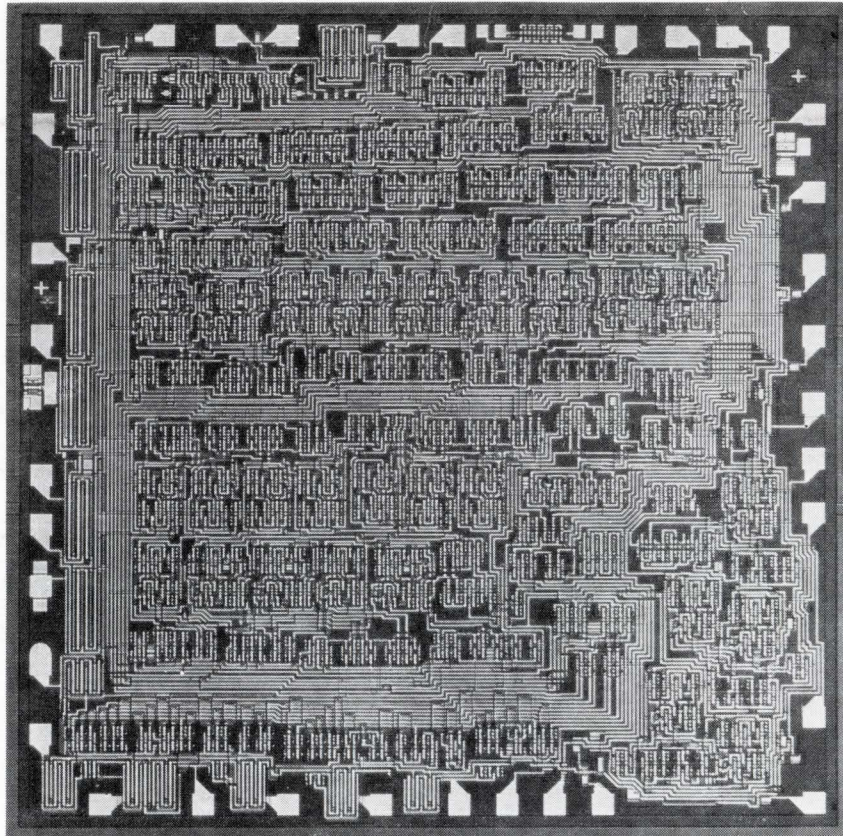

RCA put 1,238 devices on a 150 mil COS/MOS chip. What are your LSI requirements ?

The move is toward LSI. And RCA is ready now to develop custom COS/MOS circuits to your most demanding requirements.

For example, the 149 x 150 mil timing circuit above was integrated from a breadboard containing 1,238 discrete devices. Just one of many custom chips designed with RCA's unique silicon interconnect process to provide high packaging density.

RCA maintains a staff of systems engineers who are experienced in the

development of complex micropower arrays. They are backed by extensive facilities to speed the process of IC design and development.

These facilities consist of computers for logic simulation, artwork digitizer-plotter systems that can cut turn-around time by 33% in typical circuits, Mann Pattern Generator facilities to speed mask preparation, and Teradyne Model J-283 digital IC systems which functionally evaluate complex arrays.

Put RCA's COS/MOS team to

work to help reduce package count, cut assembly costs, and achieve excellent cost effectiveness in your systems.

When it comes to COS/MOS LSI, come to RCA.

Contact your local RCA Representative or RCA Distributor, or write RCA Solid State Division, Section 59L, Box 3200, Somerville, New Jersey 08876.

RCA Solid State
products that make products pay off

International: RCA, Sunbury-on-Thames, U. K., or Fuji Building, 7-4 Kasumigaseki, 3-Chome, Chiyoda-Ku, Tokyo, Japan. In Canada: RCA Limited, Ste. Anne de Bellevue 810, Canada.