

DISPLAY TERMINAL GUIDE

Pub. #515-30001

March, 1979

Rev. November, 1979

11/79

This is a preliminary version of the Display Terminal Guide, covering the use of the Regent® 20, 40 and 60 display terminals.

11/79

The current printing has added a section on the Regent® 25 as well as corrections on other sections.

The material contained in this document is furnished for customer reference only, and is subject to change. The techniques described are proprietary and should be treated accordingly.

©1979

Applied Digital Data Systems Inc.
Hauppauge, N.Y.

SECTION 1:
INTRODUCTION

A display terminal is an input/output device capable of transmitting data to and receiving data from a system to which it is connected. It provides a visible representation of data on a screen, which may be characters, symbols or drawings, in which images appear as a series of dots in a desired pattern. This principle of the dot matrix is used by many display terminals. However, the area covered by a character may vary.

A built-in cursor (location marker) indicates the place where the next character will be entered on the screen. This may be an underline or a block (blinking or steady). As the operator enters data, the cursor moves to the right automatically. When an entire line has been entered, the cursor may move to the left-most position of the same or the next line.

Some terminals also provide cursor control keys to allow the operator to move the cursor up, down, left, right and home.

Transmission to a host computer may be a character at a time, a line at a time or a full screen at a time, depending on the type of terminal, its mode, and the application.

The capabilities of the terminal can be used in the solution of problems relating to commercial, scientific and education applications, which require efficient data collection and retrieval.

Information entered at the keyboard may be displayed simultaneously on the screen. After the transmission of the displayed data to a host computer, the computer may send a response which is displayed on the screen. The screen may be re-used simply by depressing a key which causes the display to be cleared (erased).

A terminal operator can inquire on an account record and receive a response from the host computer. A record may be corrected directly on the display and it can be transmitted to update a master file.

The application program controlling the terminal can also present the operator with partial results or other computational output.

All the Regent® terminals are in attractive desk-top packages and combine operating simplicity with the latest in technological sophistication and microprocessor capability. The Regent® 20, 25, 40 and 60 are low-cost teletypewriter-compatible terminals which display a total of 1920 legible characters arranged on a display of 24 lines by 80 characters per line. Dark characters are presented on a light background (with the reverse selected by a switch).

The main section of the keyboard on all Regent® terminals is in a standard typewriter-like layout. The separate sections in this handbook give more detailed information on keyboards for specific terminals as well as switches and coding. The side-by-side photographs and specifications for all four terminals shown below and in Table 1.1 give an overview of one of the broadest lines of asynchronous terminals available.



Regent® 60



Regent® 40

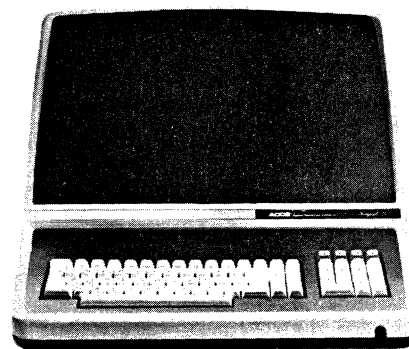

Regent® 25



Regent® 20

The Regent® 20 is used in applications which demand a conversational type terminal with an EIA RS232C interface, upper and lower case (128) character set, unidirectional auxiliary port, a 24 line by 80 character screen and cursor addressing. A current loop interface is optional.

The Regent® 25 combines all the features of the Regent® 20 with the convenience of separate numeric-entry keys. The Regent® 25's separate 18-key cluster greatly speeds numeric data entry and cursor movement. The 10-key numeric section can be altered by switch selection to become a function pad that transmits discrete code sequences.

The Regent® 40, has the capability of extensive visual effects, a 25th Status Line, function keys and a bidirectional auxiliary port. The typical user of a Regent® 40 has need for more extensive visual highlighting in screen formats such as reverse video, blinking, underline, and half and zero intensity. A line drawing set is standard on this conversational display terminal.

At the top of the Regent® series is the Regent® 60. This product has extensive visual highlighting ability, a 25th Status Line, function keys and a bidirectional auxiliary port with the additional features of buffered transmission, insert/delete character, print local, must tab and modified data transmission.

All four terminals feature a MONITOR Mode in which all characters received by the terminal, including control codes, can be displayed without being acted upon. This mode is extremely useful as an aid in application program development and communication debugging. By converting the terminal to a line monitor device, it allows full viewing of received data and non-buffered transmitted data. This increases accuracy in the analysis of problems, reduces programming time, and shortens diagnostic time by eliminating assumptions regarding transmission events.

Table 1.1. Comparative Specifications for Regent® Series

Feature	20	25	40	60
<u>Display</u>				
Non-Glare Screen	x	x	x	x
1920 Display Positions	x	x	x	x
12" Display Area	x	x	x	x
128 Displayable Characters	x	x	x	x
Reversible Video Display	x	x	x	x
Block or Underline Cursor	x	x	x	x
Blinking or Steady Cursor	x	x	x	x
Scroll/Non-Scroll	x	x	x	x
International Character Sets	x	x	opt	opt
Character Formation	5x8	5x8	7x8	7x8
Status Line			x	x
Visual Effects				
Half-Intensity			x	x
Reverse Video			x	x
Blinking			x	x
Zero Intensity			x	x
Underline			x	x
Line Drawing			x	x
Disable Status Line			x	x
Disable Screen			x	x
Protect Data from Keyboard Entry				x
<u>Keyboard</u>				
Number of Keys	59	77	91	104
Character Code Set	128	128	128	128
Character Repeat	x	x	x	x
Backspace Key	x	x	x	x
Alpha Lock Key	x	x	x	x
Break Key	x	x	x	x
Escape Key	x	x	x	x
Upper Case SHIFT Lower, Lower Case SHIFT Upper	x	x	x	x
Erase All Key	x	x	x	x
International Character Set Layouts	x	x	opt	opt
Cursor Control Keys				
U, D, L, R, H, LF	LF only	x	x	x
Numeric Pad		x	x	x
Print On/Off Key			x	x
Local Key			x	x
Tab Key				x
Print Local Key				x
Transmit Key				x
Insert/Delete Line Key				x
Reset Key				x
Erase to End of Line Key	x	x	x	x
Erase to End of Page Key			x	x
Erase Variable Key				x
Form-Page-Message-Conversational Mode Keys				x

Table 1.1. Comparative Specifications for
Regent® Series (continued)

Feature	20	25	40	60
<u>Functions</u>				
Cursor Address (Row or Column)	x	x	x	x
Cursor Address (ESC,Y,row,column)	x	x	x	x
Erase Screen	x	x	x	x
Auto Line Feed	x	x	x	x
Audible Alarm	x	x	x	x
Monitor Mode	x	x	x	x
Keyboard Lock/Unlock	x	x	x	x
Print Transparent	x	x	x	x
Printer Busy Code			x	x
Programmable Function Keys		x	x	x
Read Terminal Status			x	x
Self-Test			x	x
Insert/Delete Character in Line				x
Insert/Delete Character in Page				x
Auto Tab/Must Tab				x
<u>Transmission</u>				
9600 Baud Transmission	x	x	x	x
8 Switch-Selectable Speeds	x	x	x	x
EIA RS232C Interface	x	x	x	x
Current Loop Interface	opt	opt	x	x
Parity Selection	x	x	x	x
Parity Check	x	x	x	x
Conversational	x	x	x	x
Unidirectional AUX Port	x	x		
Bidirectional AUX Port			x	x
End of Line Character Selection			x	x
Reverse Channel			x	x
Page, Message, Form, Partial Page				x
Modified Data Transmit				x
Separate Speed for Aux Port				x
<u>Power Ratings</u>				
120 Volt: 60 Watts .50 amps	x	x		
240 Volt: 60 Watts .25 amps	x	x		
120 Volt: 85 Watts .70 amps			x	x
240 Volt: 85 Watts .35 amps			x	x
<u>Physical</u>				
Dimensions	15" (38cm) H x 18.5" (47cm) W x 23.25" (59cm) D			
Weight	approx. 38 lbs. (17 kg)			
Temperature				
Operating	10-40° C			
Storage	0-85° C			
Humidity	10 to 95% RH non-condensing			
Power	120V/60 Hz, 120V/50 Hz, 240V/50Hz			
Warranty	90 days, optional 2-year			

SECTION 3:
THE REGENT® 25

The Regent® 25 combines all the advanced features of the Regent® 20 with the convenience of a separate 18-key numeric pad.

The separate key cluster is intended to increase numeric data entry and cursor movement. It includes a 10-key numeric pad laid out to ANSI standards, five cursor control keys to move the cursor Up, Down, Left, Right, Home and an ENTER key and COMMA (,) key. The 10-key numeric section can be altered by an internal switch selection to become a function pad that transmits discrete ASCII code sequences.

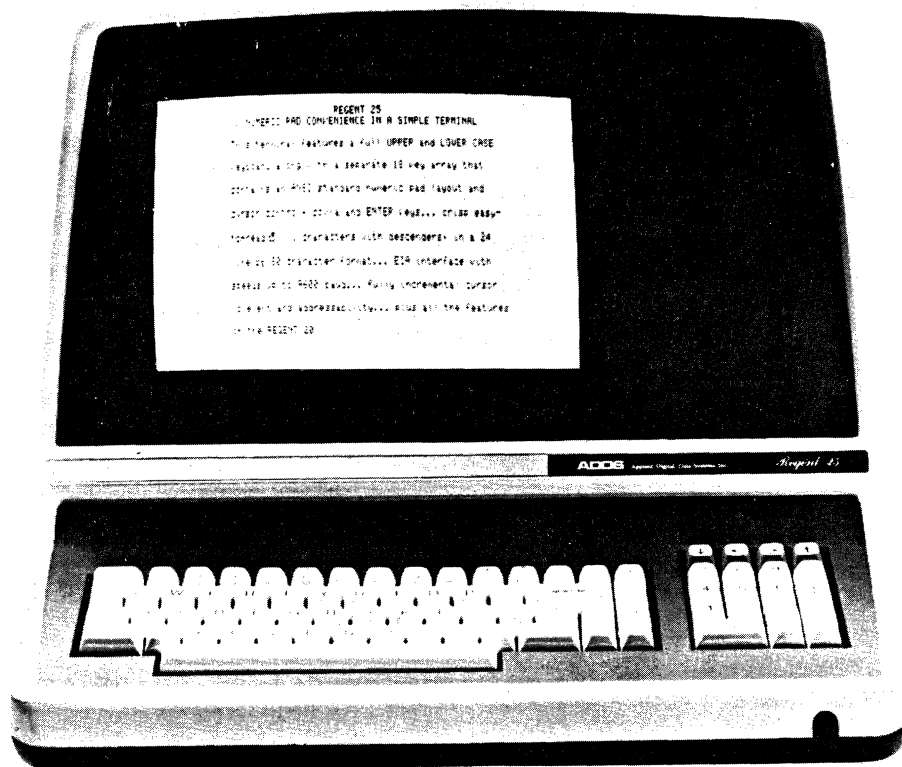

SPECIFICATIONS

Table 3.1. Regent® 25: Specifications

Feature	Description
Screen Format	24 lines by 80 characters per line
Alphanumeric Character Set	96 displayable ASCII codes, and 32 control codes, each formed by a 5 x 8 dot matrix.
Display Presentation	Dark characters on a light background (reversible through switch selection)
Screen Size	12" diagonal, non-glare screen
Refresh Rate	60 frames per second (50 for export model)
Operating Mode	Conversational (character at a time) transmission
Monitor Mode	Allows the terminal to display all received data including control codes. In this mode all encoded sequences are ignored.
Transmission	Half- or Full-Duplex, switch-selectable
Communications Interface	EIA RS232C/CCITT V.24 operates through the range of 110 to 9,600 bps, switch-selectable. (Current loop, optional)
Parity	Choice of even, odd, marking or spacing, switch-selectable.
Keyboard	Standard typewriter-like layout plus numeric pad and cursor control keys. Keyboard lock/unlock under computer control.
Addressable Cursor	Direct positioning by either incremental steps, absolute address or separate line and column address.
Cursor Selection	Allows hardware selection of cursor presentation; blinking or steady, block or underline
Auxiliary Port	Unidirectional, serial output.
Weight	Approximately 38 pounds (17 kg)
Power	120 Volts @ 60 Hz 60 Watts 0.50 Amp 240 Volts @ 50 Hz 60 Watts 0.25 Amp

Table 3.1. Regent® 25 Specifications (continued)

Feature	Description
Physical Dimensions	15" (38cm) H x 18.5" (47cm) W x 23.25" (59cm) D
Temperature	
Operating:	10° to 40° C
Storage:	0° to 85° C
Humidity	10 to 95% RH, non-condensing

MAJOR COMPONENTS

A block diagram of the major components in the Regent® 25 is shown in Figure 3-1 on the following page and described below.

Microprocessor

The heart of the Regent® 25 is an 8085A microprocessor with scratch pad memory (RAM) and program memory (ROM). The program memory of the device is 2K.

CRT Display and Display Buffer

The CRT display presentation is arranged in 24 lines of 80 characters per line (1920 characters total).

Keyboard

The keyboard is arranged in a typewriter-like layout. The keyboard can be locked and unlocked under computer control. A separate 18-key pad contains a numeric section (laid out according to ANSI standards), plus cursor control, ENTER and COMMA (,) keys.

Character Set

Upper/lower case with 96 displayable characters (space is displayed as a blank) is standard, as is display of control characters explicitly inserted into the display. International languages are accommodated by internal switch changes and key-cap changes; no new ROM is needed. Currently supplied character sets are USA, UK, French, German, Spanish, Danish/Norwegian and Swedish/Finnish. The appropriate key caps are optionally available.

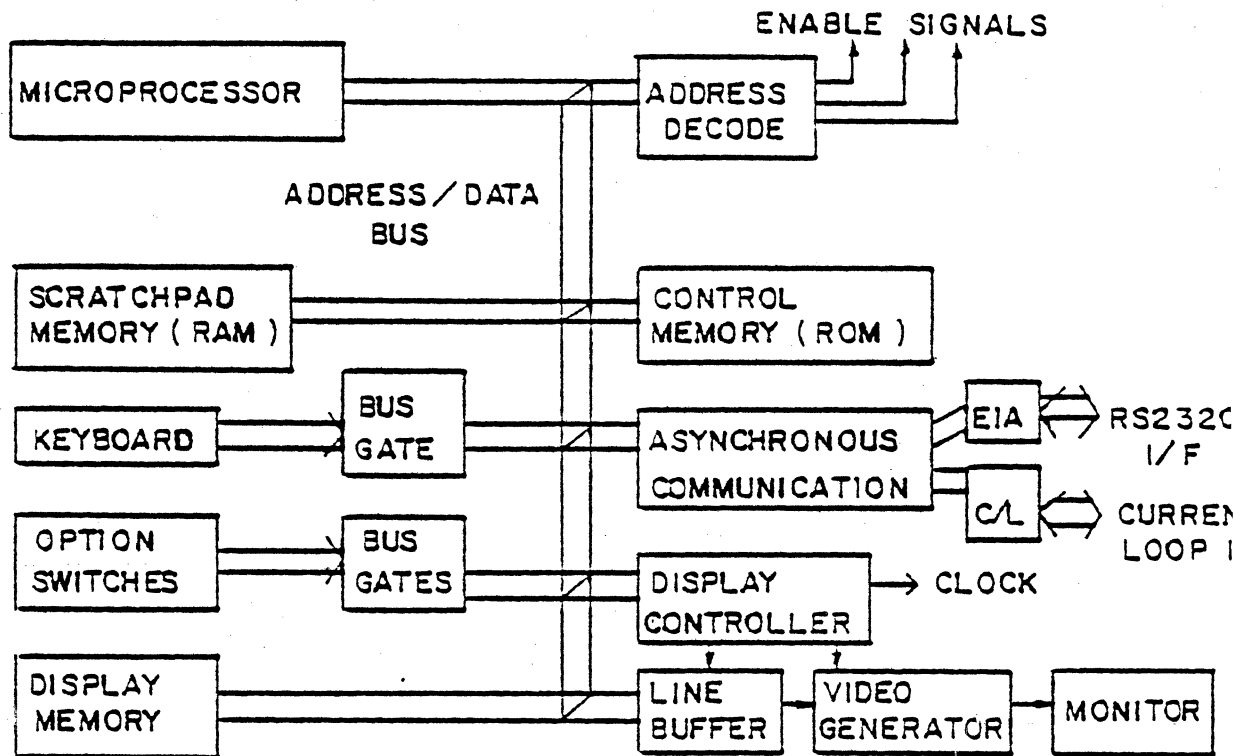

Figure 3-1. Regent® 25: Hardware Overview

Monitor Mode

All characters received by the terminal including control codes are displayed in the screen memory following the keyboard entry of CONTROL-1. The terminal will only display the data stream and will not act upon any of the control commands. Typing CONTROL- will terminate this mode. Figure 3-2 shows the 32 special symbols used for the control codes when displayed.

Communication Interface

The communication interface is EIA RS232C/CCITT V.24.

Transmission rates of 110, 150, 300, 1200, 1800, 2400, 4800 and 9600 baud are switch-selectable on the rear panel of the terminal (see Switch-Selectable Options, page 3-5).

20 mA Current Loop is available as an option.

\dot{N} NUL	A SOH	B STX	C ETX	D EOT	E ENQ
F ACK	G BEL	H BS	I HT	J LF	K VT
L FF	M CR	N SO	O SI	P DLE	Q DC1
R DC2	S DC3	T DC4	U NAK	V SYN	W ETB
X CAN	Y EM	Z SUB	[ESC	\ FS] GS
^ RS	<u> </u> US	 DEL			

Figure 3-2. Special Symbols for Displayed Control Codes

Auxiliary Port

A serial output port for a peripheral is standard. This port is unidirectional from the Regent® 25 to the peripheral, and consists of only serial output data. Upon command, the display can be made to ignore all data received by the terminal that is intended for the auxiliary port.

SWITCH-SELECTABLE OPTIONS

Operational parameters for the Regent® 25 terminal are conveniently located at the rear of the terminal and can be set by the user before connection to the system.

Figure 3-3 shows the location of the switch block on the rear panel through which the parameters are selected. The switches are clearly labeled 1 through 8. Each is a miniature rocker switch which is pushed down for the "1" state or pushed up for the "0" state. In addition, PC card switches control other parameters. All of these parameters are listed in alphabetical order in Table 3.2. The effects of the individual settings are described in the following pages.

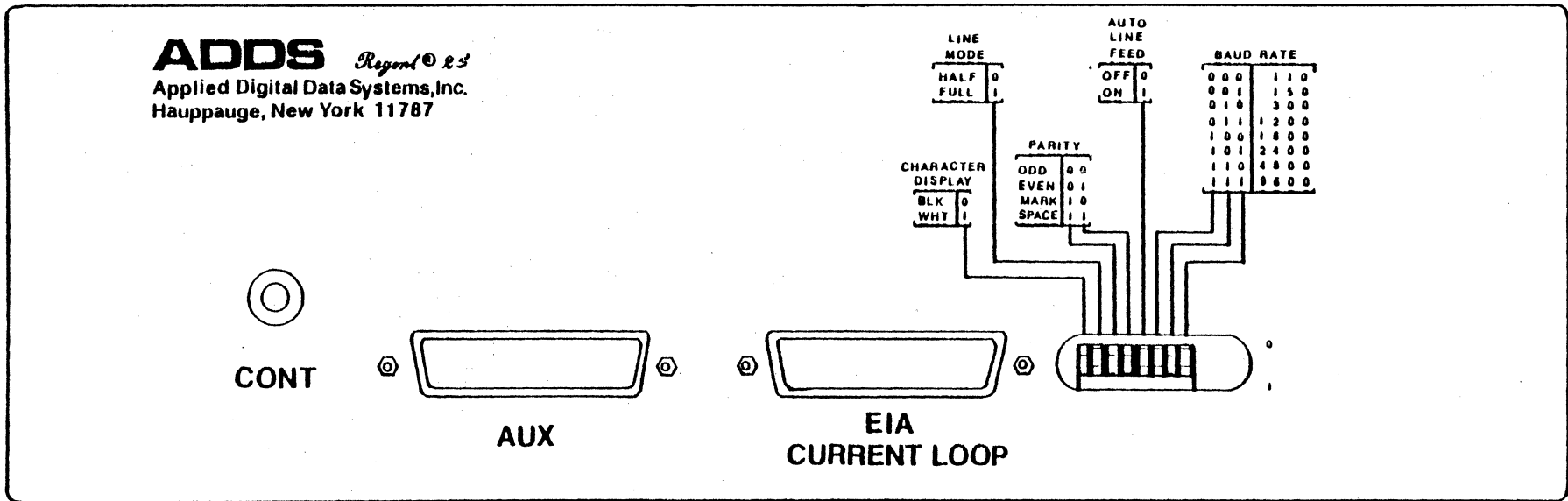

Figure 3-3. Regent® 25: Rear Panel

Table 3.2. Regent® 25: Alphabetic List of Parameter Settings/Locations

Parameter	Location/Switch	Setting	See Page																																			
Audible Key Feedback	PC Card Switch A5/3	OFF=no click ON =click	3-14																																			
Auto Line Feed	Rear Panel Switch 5	0=disabled 1=enabled	3-9																																			
Auto Scroll	PC Card Switch A5/1	OFF=disabled ON =enabled	3-12																																			
Baud Rate	Rear Panel Switches 6,7,8	<table border="1"> <tr><td>6</td><td>7</td><td>8</td></tr> <tr><td>110</td><td>0</td><td>0</td><td>0</td></tr> <tr><td>150</td><td>0</td><td>0</td><td>1</td></tr> <tr><td>300</td><td>0</td><td>1</td><td>0</td></tr> <tr><td>1200</td><td>0</td><td>1</td><td>1</td></tr> <tr><td>1800</td><td>1</td><td>0</td><td>0</td></tr> <tr><td>2400</td><td>1</td><td>0</td><td>1</td></tr> <tr><td>4800</td><td>1</td><td>1</td><td>0</td></tr> <tr><td>9600</td><td>1</td><td>1</td><td>1</td></tr> </table>	6	7	8	110	0	0	0	150	0	0	1	300	0	1	0	1200	0	1	1	1800	1	0	0	2400	1	0	1	4800	1	1	0	9600	1	1	1	3-9
6	7	8																																				
110	0	0	0																																			
150	0	0	1																																			
300	0	1	0																																			
1200	0	1	1																																			
1800	1	0	0																																			
2400	1	0	1																																			
4800	1	1	0																																			
9600	1	1	1																																			
Character Display	Rear Panel Switch 1	0=dark on light background 1=light on dark background	3-8																																			
Cursor Display	PC Card Switches A3/3, A5/4	<table border="1"> <tr><td>A3/3</td><td>A5/4</td></tr> <tr><td>Steady block</td><td>OFF OFF</td></tr> <tr><td>Steady Underl.</td><td>OFF ON</td></tr> <tr><td>Blinking block</td><td>ON OFF</td></tr> <tr><td>Blinking Underl.</td><td>ON ON</td></tr> </table>	A3/3	A5/4	Steady block	OFF OFF	Steady Underl.	OFF ON	Blinking block	ON OFF	Blinking Underl.	ON ON	3-11																									
A3/3	A5/4																																					
Steady block	OFF OFF																																					
Steady Underl.	OFF ON																																					
Blinking block	ON OFF																																					
Blinking Underl.	ON ON																																					
International Character Set	PC Card Switches A3/5,6,7	<table border="1"> <tr><td>5</td><td>6</td><td>7</td></tr> <tr><td>Dom(U.S.)</td><td>OFF</td><td>OFF</td><td>OFF</td></tr> <tr><td>Bel/Fr/AZERTY</td><td>OFF</td><td>OFF</td><td>ON</td></tr> <tr><td>UK/Netherlands</td><td>OFF</td><td>ON</td><td>OFF</td></tr> <tr><td>Ger/Switzer.</td><td>OFF</td><td>ON</td><td>ON</td></tr> <tr><td>Swed/Finland</td><td>ON</td><td>OFF</td><td>OFF</td></tr> <tr><td>Den/Norway</td><td>ON</td><td>OFF</td><td>ON</td></tr> <tr><td>Spain</td><td>ON</td><td>ON</td><td>OFF</td></tr> <tr><td>(Reserved)</td><td>ON</td><td>ON</td><td>ON</td></tr> </table>	5	6	7	Dom(U.S.)	OFF	OFF	OFF	Bel/Fr/AZERTY	OFF	OFF	ON	UK/Netherlands	OFF	ON	OFF	Ger/Switzer.	OFF	ON	ON	Swed/Finland	ON	OFF	OFF	Den/Norway	ON	OFF	ON	Spain	ON	ON	OFF	(Reserved)	ON	ON	ON	3-12
5	6	7																																				
Dom(U.S.)	OFF	OFF	OFF																																			
Bel/Fr/AZERTY	OFF	OFF	ON																																			
UK/Netherlands	OFF	ON	OFF																																			
Ger/Switzer.	OFF	ON	ON																																			
Swed/Finland	ON	OFF	OFF																																			
Den/Norway	ON	OFF	ON																																			
Spain	ON	ON	OFF																																			
(Reserved)	ON	ON	ON																																			
Full/Half-Duplex	Rear Panel Switch 2	0=Half 1=Full	3-8																																			
Keyboard Lock/Unlock	PC Card Switch A3/4	OFF=Normal Mode ON =ADDS Consul 580 Compatability	3-11																																			
Numeric Pad as Function Keys	PC Card Switches A3/1,4	<table border="1"> <tr><td>Emitted Codes</td><td>1</td><td>4</td></tr> <tr><td>STX, Key Code, CR</td><td>ON</td><td>OFF</td></tr> <tr><td>ESC, Key Code</td><td>ON</td><td>ON</td></tr> <tr><td>Key Codes</td><td>OFF</td><td></td></tr> </table>	Emitted Codes	1	4	STX, Key Code, CR	ON	OFF	ESC, Key Code	ON	ON	Key Codes	OFF		3-10																							
Emitted Codes	1	4																																				
STX, Key Code, CR	ON	OFF																																				
ESC, Key Code	ON	ON																																				
Key Codes	OFF																																					
Parity	Rear Panel Switches 3,4	<table border="1"> <tr><td>3</td><td>4</td></tr> <tr><td>Odd</td><td>0</td><td>0</td></tr> <tr><td>Even</td><td>0</td><td>1</td></tr> <tr><td>Marking</td><td>1</td><td>0</td></tr> <tr><td>Spacing</td><td>1</td><td>1</td></tr> </table>	3	4	Odd	0	0	Even	0	1	Marking	1	0	Spacing	1	1	3-8																					
3	4																																					
Odd	0	0																																				
Even	0	1																																				
Marking	1	0																																				
Spacing	1	1																																				
Parity Check	PC Card Switch A3/2	OFF=disable ON =enable	3-11																																			
Refresh Rate	PC Card Switch A5/2	OFF=60 Hz ON =50 Hz	3-14																																			
Upper/Lower Case	PC Card Switch A3/8	OFF=Upper,Shift lower ON =Lower,Shift Upper	3-12																																			

Rear Panel Switches

Character Display - Switch 1

Position of Switch	Description
0	Dark characters, light background
1	Light character, dark background

The standard video presentation of the terminal is dark characters on a light background (switch 1 = 0). This presentation can be reversed by setting this switch to 1.

Full or Half-Duplex - Switch 2

Position of Switch	Description
0	Half-Duplex
1	Full-Duplex

In the Full-Duplex Mode (switch 2 = 1), the keyboard acts simply as a code generator which sends data to the communication line. There is no direct connection from the keyboard to the display electronics. Incoming data from the communication line goes directly to the display electronics. Note that in Full-Duplex operating mode, the communication line must echo each character if the operator is to see the data entered from the keyboard.

In Half Duplex Mode (switch 2 = 0), keyed data is simultaneously displayed on the screen and transmitted to the communication line.

Parity - Switches 3 and 4

Position of Switch	Description	
3	4	
0	0	Odd
0	1	Even
1	0	Marking
1	1	Spacing

If either Even or Odd parity is selected, the terminal appends the proper parity bit (bit 8, in addition to the 7 ASCII bits) to outgoing data, and checks parity on all incoming data. Any error on incoming data (parity, framing, overrun, open line) causes an asterisk (*) to be displayed on the screen in place of the defective character if the parity check feature is enabled.

NOTE

A Break in Half-Duplex Mode or disconnecting the data lines may also cause the asterisk to be displayed, since such conditions cause a framing error or open-line error.

If the parity selected is Marking or Spacing, the parity bit on outgoing data is always 1 or always 0, respectively. Enabling parity check (see below) in these modes will display an asterisk in place of any character with the parity bit in the wrong state.

Auto Line Feed - Switch 5

Position of Switch	Description
0	Auto Line Feed Disabled
1	Auto Line Feed Enabled

In Auto Line Feed Mode (switch 5 = 1), an internal line feed is generated within the terminal logic whenever a Carriage Return code (CR) is received or the NEW LINE key is depressed. Since the effect of a CR code is to place the cursor to the beginning of the current line, the net effect of a CR when Auto Line Feed is enabled is to position the cursor to the beginning of the next line. Note also that a CR code will cause the display to scroll if the cursor is at the bottom line and both Auto Line Feed and Auto Scroll are enabled. An internal line feed is always performed when the cursor advances past the end of a line.

Baud Rate - Switches 6, 7, 8

The user may select from the following baud rates: 110, 150, 300, 1200, 1800, 2400, 4800, or 9600, as shown in Table 3.3 below.

Table 3.3. Regent® 25: Baud Rate Settings

Baud Rate	S W I T C H E S		
	6	7	8
110	0	0	0
150	0	0	1
300	0	1	0
1200	0	1	1
1800	1	0	0
2400	1	0	1
4800	1	1	0
9600	1	1	1

PC Card Switches

The following additional user-selectable parameters can be set using switches on the PC card, as shown in Figure 3-4.

Function Pad Enable - Switch Block A3, Switches 1,4

A3/1 Position	A3/4 Position	Description
ON	OFF	STX, key code, CR
ON	ON	ESC, key code
OFF	OFF	key code

The numeric pad can be changed into one of the two function pad arrays by setting two switches in Switch Block A3. When A3/1 is ON and A3/4 is OFF, the keys 0 through 9 plus the COMMA (,) and PERIOD (.) will transmit the three byte sequence:

STX code of the depressed key CR

When A3/1 and A3/4 are both set ON, the keys 0 through 9 plus the COMMA (,) and PERIOD (.) will transmit the two-byte sequence:

ESC code of the depressed key

The twelve numeric pad keys emit codes as shown in Table 3.4 below:

Table 3.4 Numeric Pad Key Codes

Key	A3/1 OFF	A3/1 ON, A3/4 OFF	A3/1 ON, A3/4 ON
0	0	STX 0 CR	ESC 0
1	1	STX 1 CR	ESC 1
2	2	STX 2 CR	ESC 2
3	3	STX 3 CR	ESC 3
4	4	STX 4 CR	ESC 4
5	5	STX 5 CR	ESC 5
6	6	STX 6 CR	ESC 6
7	7	STX 7 CR	ESC 7
8	8	STX 8 CR	ESC 8
9	9	STX 9 CR	ESC 9
.	.	STX . CR	ESC .
,	,	STX , CR	ESC ,

When A3/1 is ON, the function sequences sent;

- 1) are not displayed in Half-Duplex;
- 2) in Half-Duplex Mode, set RTS at start and drop RTS at end of sequence;
- 3) transmit regardless of keyboard lock status.

Parity Check - Switch Block A3, Switch 2

Position of A3/2	Description
OFF	Parity Check Disabled
ON	Parity Check Enabled

The parity check feature may be enabled or disabled using an internal switch. When switch 2 of Switch Block A3 is ON, the terminal displays detected parity errors as an asterisk (*) on the CRT. If OFF, parity errors are ignored, and data is displayed as received by the terminal without checking for parity.

Cursor Display - Switch Block A3, Switch 3 Switch Block A5, Switch 4

A3/3 Position	Description	A5/4 Position	Description
OFF	Steady Cursor	OFF	Rectangular Block
ON	Blinking Cursor	ON	Underline

The standard display uses a steady block cursor. Blinking cursor (at 2 Hz rate) is set through switch 3 on Switch Block A3; underline cursor is set through switch 4 of Switch Block A5. For example, both of these switches would be set ON for a blinking underline cursor.

Keyboard Lock - Switch Block A3, Switch 4

Position of A3/4	Description
OFF	Normal Mode
ON	ADDS Consul 580 Compatibility

Keyboard Lock (Normal Mode)

When switch A3/4 is OFF and the control code ESC,5 is received or generated at the keyboard, the keyboard locks and remains locked until an unlock command ESC,6 is received or generated at the keyboard. The unlock command is not transmitted to the CPU when generated from the locked keyboard and is strictly a local function that operates in either Half or Full-Duplex Mode. BREAK is the only key enabled to transmit during keyboard lock; it will not unlock the keyboard.

Note

If switch A3/1 is ON, the function pad sequences are also enabled to transmit.

Keyboard Lock (ADDS Consul 580 Compatibility)

When switch A3/4 is ON, the keyboard will lock upon receipt of an EOT code, and unlock on receipt of an STX code or the depression of the BREAK key on the keyboard.

International Character Sets - Switch Block A3, Switches 5, 6, 7

The user may change the character set by setting switches 5, 6 and 7 on Switch Block A3 as shown in Table 3.5 below.

Table 3.5. International Character Set Switch Settings

	A3/5	A3/6	A3/7
Domestic (U.S.)	OFF	OFF	OFF
Belgium/France/ AZERTY	OFF	OFF	ON
U.K./Netherlands	OFF	ON	OFF
Germany/ Switzerland	OFF	ON	ON
Sweden/Finland	ON	OFF	OFF
Denmark/Norway	ON	OFF	ON
Spain	ON	ON	OFF
(Reserved)	ON	ON	ON

Upper/Lower Case - Switch Block A3, Switch 8

Position of Switch	Description
OFF	Upper case, shift-lower
ON	Lower case, shift-upper

The terminal normally powers up in upper case-shift to lower mode. Setting switch 8 on Switch Block A3 ON will change this initial condition to lower-shift to upper.

Auto Scroll Mode - Switch Block A5, Switch 1

Position of Switch	Description
OFF	Auto Scroll Mode Disabled
ON	Auto Scroll Mode Enabled

When the Auto Scroll Mode is enabled, data scrolls upward if the cursor is in the bottom line (line 24) and a Line Feed (CONTROL-J) code is received by the display electronics or generated from the keyboard. Data will also scroll if the cursor is in the bottom line and a CR is received, or the NEW LINE key is depressed and Auto Line Feed is enabled. As a result of the upward scroll, all data on the screen moves up by one line, with data previously on the top line being lost from memory and a new blank line appearing at the bottom of the screen. This simulates the line feed action of a teletypewriter.

If the Auto Scroll option is disabled, the display does not scroll. A command which attempts to move the cursor down from the bottom line (Cursor Down or Line Feed) causes the cursor to appear in the top line, rather than causing the data to scroll. Thus, the non-Auto Scroll mode of operation corresponds to a "wraparound" action of the cursor in the vertical direction.

Switch Block A3

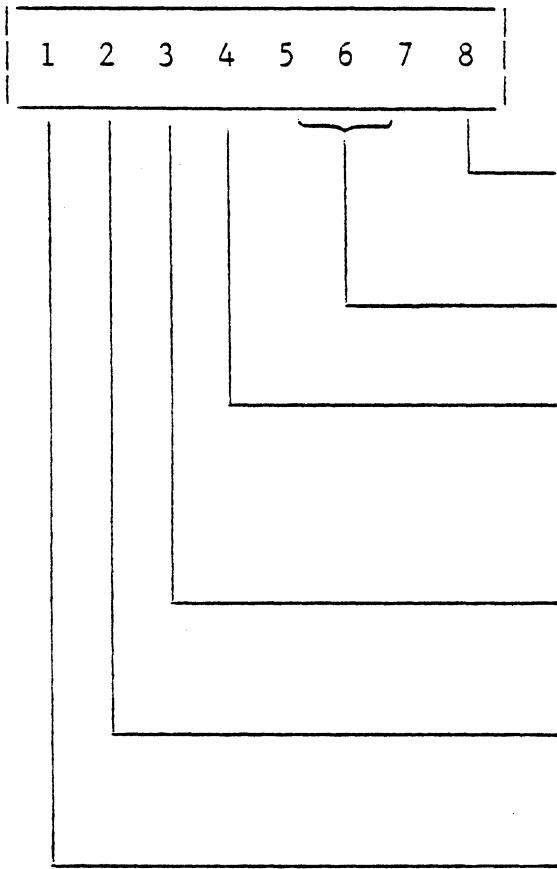

- Upper-Lower case
ON = lower, shift-upper
OFF= upper, shift-lower
- International character sets
(see Table 3.5)
- Keyboard Lock
OFF ESC,5 locks
ESC,6 unlocks
ON EOT locks
STX unlocks
- Cursor Blink (also see A5/4)
ON = blink
OFF= steady
- Parity Check
ON = enable
OFF= disable
- Numeric pad as function keys
(see Table 3.4)

Switch Block A5

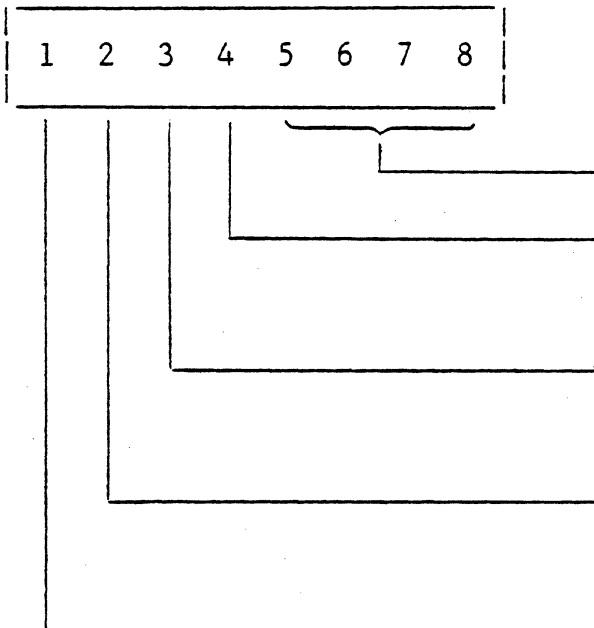

- Reserved
- Cursor Display (also see A3/3)
ON = underline
OFF= block
- Audible Key Feedback
ON = feedback
OFF= no feedback
- Screen Refresh Rate
ON = 50 Hz
OFF= 60 Hz
- Auto Scroll Mode
ON = enable
OFF= disable

Figure 3-4. Regent® 25: PC Card Switch Settings

Screen Refresh Rate - Switch Block A5, Switch 2

Position of A5/2	Description
OFF	60 Hz
ON	50 Hz

An internal switch controls the screen refresh rate. The screen is refreshed at 60 frames/second with switch 2 of Switch Block A5 OFF; to refresh at 50 frames/second, this switch should be set ON.

NOTE

Power wiring changes will be necessary to change between 120 VAC and 240 VAC operation.

Audible Key Feedback - Switch Block A5, Switch 3

Position of A5/3	Description
ON	Key Click
OFF	No Click

A short tone burst ("click") is heard each time a key emits a code when this switch is set ON.

DISPLAY PRESENTATION

Size

The non-glare screen is 12" diagonal. Standard presentation of the 24 x 80 data entry area is dark characters on a light background. A rear panel switch can reverse this presentation (see page 3-8).

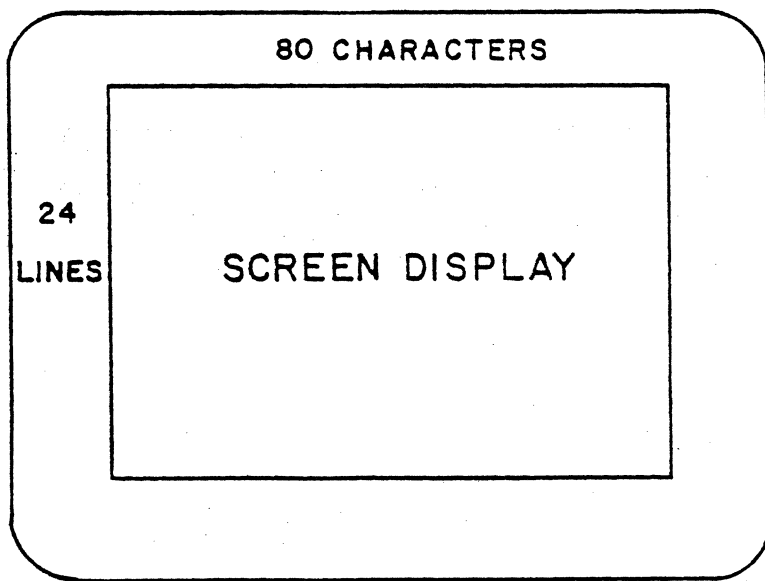

Figure 3-5. Regent® 25: CRT Screen

Matrix

Characters are formed as a 5 x 8 pattern within a 7 x 10 dot matrix.

KEYBOARD

The keyboard is designed for ease of operation and to minimize required training time for operators familiar with typewriters.

Typing Array

A group of 59 keys is arranged in the standard offset used for typewriters. All keys in this array generate ASCII codes, except for four unencoded keys:

- BREAK - Generates a 500 millisecond break ("spacing" condition) on the Transmitted Data output line (interlocked with CONTROL key).
- CONTROL - Used in conjunction with alphanumeric keys to effect the desired code. For example, the key labeled "J" generates different codes depending on whether or not the CONTROL key is held down when the J-key is depressed.
- SHIFT - Used in conjunction with alphanumeric keys to effect the desired code. For example, the non-shifted P-key generates the code for "P" but the shifted P-key generates the code for "p".

NOTE

The SHIFT and CONTROL Keys are independent; either key alone or both together may be used in conjunction with an alphanumeric key.

- CASE - Toggles the alphabetic portion of the keyboard through an "alpha lock" state. The keyboard will normally generate upper case and SHIFT will generate the lower case. Operation of the "CASE" key will cause the alphabetic portion of the keyboard to generate lower case and SHIFT will generate upper case.

For the domestic keyboard, "alphabetic" is A through Z. For international layouts, such special characters as Ñ, Å, Ø, Ü, Ä, Ö are also affected.

The keyboard's power-up state is upper case-shift lower. This is alterable to lower case-shift upper through the use of an internal switch (see page 3-12).

Separate Key Pad

In addition, there is a separate key pad which contains the ten numerics (0-9) plus the PERIOD (.), COMMA (,), ENTER, and control keys for cursor movement; i.e., up, down, left, right and home. Through the setting of internal switches, the 0 through 9 plus PERIOD and COMMA keys will transmit either a three-byte sequence comprised of STX, the depressed keys code and CR or a two-byte sequence of ESCape plus the depressed key's code.

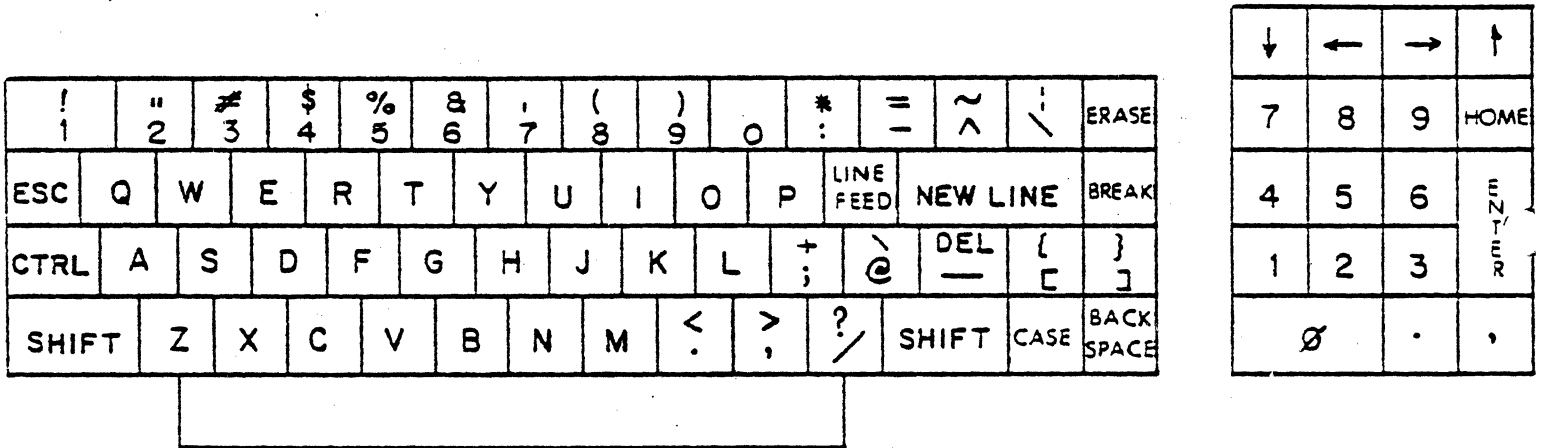

Figure 3-6. Regent® 25: Keyboard

All keys on the keyboard are typamatic except ERASE, NEW LINE, ENTER, HOME, ESCAPE, BREAK, SHIFT, CONTROL and CASE. Key functions automatically repeat at the rate of 15 per second if the key is held down for more than a full second.

TERMINAL COMMANDS

Commands which generate ASCII codes to affect the state of the terminal can be entered using ASCII Code Sequences. However, some commands can be obtained by using one of the display terminal's special function keys. For example, the Cursor Home Command may be generated by depressing the HOME key or the ASCII Code Sequence CTRL-A.

The Terminal Commands are described below and listed alphabetically in Table 3.6.

Cursor Control Codes

The cursor is shown in the inverse presentation of the display. It indicates where the next entered character will appear and can be moved to any position in the display without changing any of the displayed data. The following codes are used for moving the cursor.

Home

The SOH (CONTROL-A or HOME) code places the cursor in the Home position, that is, in the lower left in Auto Scroll Mode, and the upper left in non-Auto Scroll Mode.

Forward

The ACK (CONTROL-F or ->) code moves the cursor one position forward. If the cursor is at the end of a line, it advances to the beginning of the next line when ACK is received.

Back

The BS (CONTROL-H or BACKSPACE) or the NAK (CONTROL-U or <-) code moves the cursor back one position. If the cursor is at the beginning of a line, it goes to the end of the preceding line in response to BS or NAK. Note that BS or NAK causes a cursor wrap-around from the beginning of the top line to the end of the last line on the display.

Up

The SUB (CONTROL-Z or |) code moves the cursor up to the same relative position in the line above the current line. The upward cursor movement is wraparound from the top line to the bottom line in the display.

Down

The LF (CONTROL-J, ↓ or LINE FEED) code causes the cursor to move down one line from its current position. Cursor downward movement is wraparound from the bottom line to the top line if Auto Scroll Mode is disabled. If Auto Scroll is enabled, LF causes the display to scroll.

Carriage Return

The CR (CONTROL-M or NEW LINE) code places the cursor at the beginning of the same line in non-Auto Line Feed Mode, or at the beginning of the next line if Auto Line Feed is enabled.

Line Feed

The LF (CONTROL-J, ↑ or LINE FEED) code causes the cursor to move down one line from its current position. Cursor downward movement is wraparound from the bottom line to the top line if Auto Scroll is disabled; if Auto Scroll is enabled, LF causes the display to scroll.

Erase Codes

Erase All

When the FF (CONTROL-L or CONTROL-ERASE) code is received, the screen is erased (filled with "spaces") and the cursor is positioned at the upper left corner.

Erase to End of Line

The code sequence ESC, K or ERASE causes the data to be erased to the end of the line, with the cursor remaining in the current position.

Erase to End of Page

The code sequence ESC,k erases the data from the present cursor position to the end of the screen. The cursor remains in its present position.

Cursor Addressing Codes

Two forms of cursor addressing are available on the terminal. The first scheme allows for separate commands to either the vertical or horizontal address; both commands are absolute. The second address scheme allows a four-byte command to position the cursor both vertically and horizontally to the desired cursor position.

Vertical Cursor Addressing

The Vertical Address Command code is VT (CONTROL-K). The five least significant bits of the character following receipt of a VT code positions the cursor to the desired line by defining, in binary, one of the 24 lines (0-23).

Vertically positioning the cursor using the Vertical Address Command does not affect its horizontal position. For example, the sequence VT,K positions the cursor to line number 11 (the 12th line from the top) without affecting horizontal positioning of the cursor.

Horizontal Cursor Addressing

The Horizontal Address Command code is DLE (CONTROL-P). All seven bits of the character following receipt of a DLE define the desired horizontal position of the cursor. The most significant three bits are used to determine which group of ten positions is to be addressed (0-9, 10-19, ..., 70-79). The least significant four bits make up a BCD number (0-9) which selects which of the ten positions within any one group is to be selected.

For example, the ASCII Code for "8" is 38 (hexadecimal).

$$38 = \underbrace{011}_{\text{group}} \mid \underbrace{1000}_{\text{position in group}}$$

The cursor position can be determined from the tables below.

<u>Group</u>	<u>Most Significant Three Bits</u>
0-9	000
10-19	001
20-29	010
30-39	011
40-49	100
50-59	101
60-69	110
70-79	111

<u>Position in Group</u>	<u>Least Significant Four Bits</u>
0	0000
1	0001
2	0010
3	0011
4	0100
5	0101
6	0110
7	0111
8	1000
9	1001

The code sequence DLE (CONTROL-P), 8 positions the cursor to column 38, the 39th column on the screen counting from zero, without affecting the vertical positioning of the cursor.

Refer to Appendix A, Figure A-2, the Vertical and Horizontal Cursor Addressing Chart, for the recommended ASCII characters for horizontal positioning.

Absolute Cursor Addressing

The address scheme ESC,Y,r,c (where ESC is CONTROL-[) can position the cursor to any position on the screen, where r,c is the address of a position within the 1920-character data entry field. In this command, r represents the row and c represents the column. A chart of absolute screen addresses used with this command sequence is given on pages A-6 and A-7.

Print Transparent Mode

The Print Transparent Enable code sequence ESC,3 is a remote command from the computer which tells the CRT to ignore the entire data stream including all command codes which are directed to the peripheral (printer or other device). Likewise, the peripheral device may communicate directly with the CPU while in Transparent Mode. Generation of the code sequence ESC,4 disables this mode.

Audible Tone

An audible tone is sounded in the Regent® if the BEL (CONTROL-G) character is received. This is consistent with the bell control of teletypewriters.

Auxiliary Port

All incoming serial data following the code DC2 (CONTROL-R) is directly routed to the auxiliary port. Upon receipt of a DC4 (CONTROL-T, which is also sent to the AUX port), the port is disabled (held marking).

Receipt of the ESC,3 command will enable the AUX port and cause the display to ignore the entire data stream which is directed to the peripheral. Receipt of the sequence ESC,4 will reenable the display of the data stream. The AUX port will be returned to the state it was in before receipt of the ESC,3 and the ESC,4 ending Transparent Print Mode will have gone to the AUX port.

Table 3.6. Regent® 25: Alphabetical List of Terminal Commands

Command	ASCII Code	Generation from Keyboard
Address, Absolute	ESC,Y,r,c	ESC,Y,r,c
Address, Horizontal	DLE,x	CONTROL-P,x
Address, Vertical	VT,x	CONTROL-K,x
Audible Tone	BEL	CONTROL-G
AUX port OFF	DC4	CONTROL-T
AUX port ON	DC2	CONTROL-R
Backspace	BS	BACKSPACE or CONTROL-H
Cursor Back	NAK	CONTROL-U or ←
Cursor Down	LF	LINE FEED or CONTROL-J or ↓
Cursor Forward	ACK	CONTROL-F or →
Cursor Home	SOH	CONTROL-A or HOME
Cursor Up	SUB	CONTROL-Z or ↑
Erase All	FF	CONTROL-ERASE
Erase to End of Line	ESC,K	ERASE
Erase to End of Page	ESC,k	ESC,k
Keyboard Lock	ESC,5	ESC,5†
	EOT	CONTROL-D*
Keyboard Unlock	ESC,6	ESC,6†
	STX	CONTROL-B*
Line Feed	LF	LINE FEED or CONTROL-J
Monitor Mode Disable	--	CONTROL-2
Monitor Mode Enable	--	CONTROL-1
New Line	CR	NEW LINE or CONTROL-M
Store Control Character	ESC,Z	ESC,Z
Transparent Print OFF	ESC,4	ESC,4
Transparent Print ON	ESC,3	ESC,3

*-only when the keyboard lock option is enabled.

†-only when the keyboard lock option is disabled.

NOTE

Commas are shown between characters in a code sequence for readability in this text, but are not entered as part of the code sequence.

DATA ENTRY

In Half-Duplex Mode (or with echoed data in Full-Duplex Mode), when a displayable code is entered from the keyboard it causes the corresponding character to be entered at the current cursor location, and the cursor automatically advances one position. New data overwrites old data showing on the screen. When a character is entered at the end of a line, the cursor goes to the beginning of the next line. If the character was entered in the last position on the last line, the screen will scroll if Auto Scroll is enabled; otherwise, the cursor will be positioned to the first position on the first line.

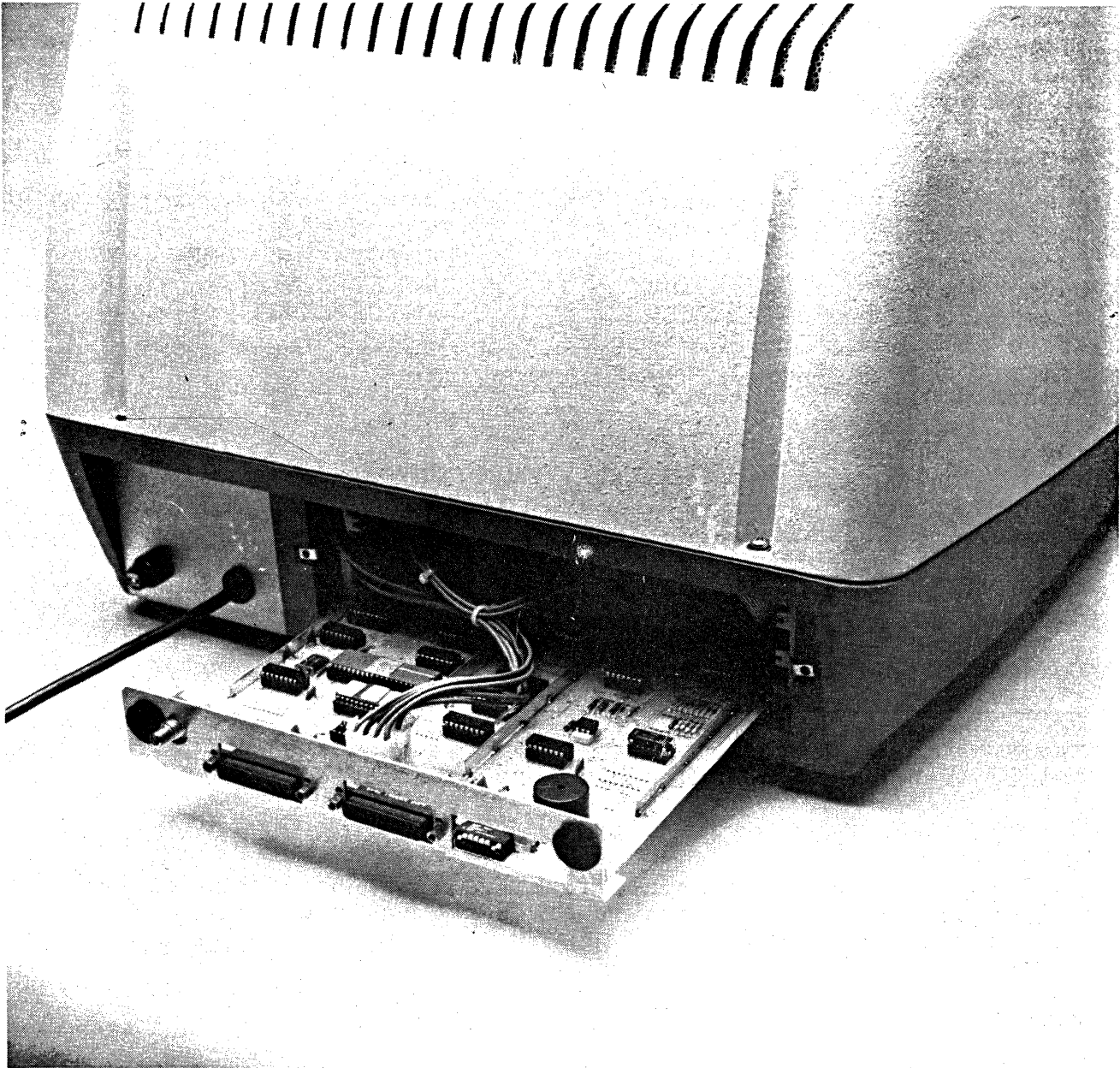

Figure 3-7 Location of PC Board in Regent® 25

DATA INTERFACE DESCRIPTION
AND CABLING

Interfaces available with the Regent® terminals are described in this section. Connector pin assignments, interface signal descriptions and recommended cable practice are presented in sufficient detail to enable the systems engineer to construct appropriate cables and to design interfaces to special equipment, if required.

CONNECTOR COMPLEMENT

Two connectors are located on the rear panel of the Regent®, a Data connector and an Auxiliary Connector.

Mating connectors (Cinch or Canon type DB-25P, or equivalent) are shipped with each terminal.

A 25-pin female connector (Cinch or Canon type DB-25S, or equivalent) is the data connector for both EIA signals and Current Loop signals. The same type of connector is used for the Auxiliary interface.

PIN ASSIGNMENTS

Those EIA signals which apply to this class of terminal (asynchronous data communication) are assigned to pins in accordance with EIA Specification RS232C for interfacing data communication equipment, with one exception as noted in Table 7.1. Both the standard EIA circuit name and the circuit name used in Europe (CCITT Specification V24) are shown in Table 7.1. Pins which are unassigned by RS232C for asynchronous data communication are used by the Regent® terminals for the Current Loop interface.

THE EIA DATA INTERFACE

Signal Definition and Description

All signals at this interface are not required for most applications. Signal descriptions are grouped from most commonly used to least frequently used.

1. Protective Ground and Signal Ground (AA and AB)

Pins 1 and 7 should be carried in a cable to a device such as a modem which is wired in accordance with RS232C. Internally in the Regent®, these signals are tied together at one point.

Table 7.1. Regent® Data Connector Pin Assignments

Pin No.	EIA	CCITT	Signal	Description
	RS232 Circuit	V24 Circuit		
1	AA	101	GND	Protective Ground
2	BA	103	EIAOUT	Transmitted Data
3	BB	104	EIAIN	Received Data
4	CA	105	RQSND	Request to Send
5	CB	106	CLSND	Clear to Send
6	CC		DSR	Data Set Ready
7	AB	102	GND	Signal Ground
8	CF	109	CARDET	Received Line Signal
11	*SCA/SA	120	SCA	Secondary Request to Send
12	*SCF/SB	122	SCR	Secondary Received Line Signal Detector
15	-	-	LBIAS2	Current Loop Bias (+)
17	-	-	LIN+	Current Loop Input (+)
18	-	-	LIN-	Current Loop Input (-)
20	CD	108.2	DATTRY	Data Terminal Ready
22	-	-	LBIAS1	Current Loop Bias (+)
23	-	-	CLEIAOUT	Current Loop Receiver's EIA Output (Regent® 20/25)
24	-	-	LOUT+	Current Loop Output (+)
25	-	-	LOUT-	Current Loop Output (-)

*For Regent® 40 and 60 only. There is a discrepancy between RS232C and standard assignments on a Bell System 202 modem, as shown below:

202		RS232C	
Name	Pin #	Name	Pin #
SA	11	SCA	19
SB	12	SCF	12

These terminals use RS232 signal names and a pin assignment for SCA/SA in accordance with Bell 202 modems.

2. Transmitted Data and Received Data (BA and BB)

The "primary channel" data lines (Pins 2 and 3) are the lines on which data goes to and from the terminal.

Data can be output on BA when Clear to Send (CB) is in the ON state. The 200-300 millisecond "long space" is forced on this line when the operator's CTRL-BREAK keys are depressed. (For the Regent® 20/25 the "long space" is 500 milliseconds.)

Data received on BB goes to the display electronics.

3. Request to Send and Clear to Send (CA and CB)

These control lines (Pins 4 and 5) are normally used in either of two situations:

a) when operating on a half-duplex channel such as a two-wire 202 modem, or

b) when hardwired to a computer which senses CA to determine when the terminal wants to transmit and controls CB to permit the terminal to transmit only at the CPU's discretion.

Signal CA is turned ON when the Regent® has data to transmit. In CONVERSATIONAL mode CA goes ON when the first character is typed and goes OFF when a NEW LINE function occurs in the Regent® 20, 40 and 60. In the Regent® 20 and 25, CA also goes OFF after a control character is sent.

CA goes ON when a Function key is depressed and goes OFF automatically about two bit times after the last bit of the line termination character sequence is transmitted.

CA goes ON when the XMIT key is activated and goes OFF when the line terminator is output at the end of a transmission in PAGE, MESSAGE, or FORMS mode (in the Regent® 60 only).

Data will not be transmitted until CB is ON. If CB is OFF the first character from the keyboard is buffered and then permitted to go out when CB goes to the ON state again.

CB is assumed ON if left open (disconnected) at the interface.

4. Data Set Ready (CC)

This signal from the MODEM is ON when the Data Set is conditioned to operate.

5. Received Line Signal Detector (CF)

If this signal on Pin 8 goes to the ON state, the CARRIER message appears in the Status Line (Regent® 40 and 60 only). If CF is left open (disconnected) the CARRIER message does not appear.

6. Secondary Request to Send and
Secondary Received Line Signal Detector (SCA and SCF)

These signals are normally of interest only to the users of a two-wire 202 modem equipped with the "Supervisory Channel" option. Pin assignments are 11 (SCA) and 12 (SCF).

SCA and SCF are used for circuit assurance and interrupt capability between the CPU and the terminal.

SCA is controlled by the terminal to inform the CPU of circuit assurance. It may also be used to interrupt the CPU. SCA is held ON when the Regent® is receiving data (is in Half-Duplex Mode and Request to Send is OFF), except that if the operator depresses the BREAK key, a 250-millisecond OFF condition occurs on the SCA.

SCF to the Regent® can force the terminal from a transmit state to a receive state and keep the Regent® in a receive state. If SCF is ON, the Regent® can transmit, but if SCF goes to the OFF state, the Regent® is forced to a receive state and cannot send data until SCF goes ON again.

NOTE

If SCF is open (not connected), it is assumed by the interface to be ON.

Refer to Section 6 for a detailed description of the various options available for reverse channel operation.

Voltage Conventions

Signal CD on Pin 20 (DATTRY) is held ON whenever power is on. The following signal levels apply:

For CA, CB, CF, and CD: ON = +3V to +15V
 OFF = -3V to -15V

For BA and BB: MARK = -3V to -15V = Logical 1
 SPACE = +3V to +15V = Logical 0

Circuit CB is assumed to be true if no signal is applied, e.g., open input.

Recommended EIA Cabling

The recommended method of constructing cables varies, depending on the baud rate and distances involved. The limitation on cable length is set by the capacitance of the cable. When a pulse which represents a bit is transmitted down a line, the edges of the pulse become less sharp (rise and fall time get longer) as the capacitance of the line increases.

Since line capacitance is a linear function of length, it follows that the probability of correctly detecting a bit will eventually deteriorate to an unacceptable value as the line length is increased. Table 7.2 below lists cable lengths which can be safely assumed.

Table 7.2. Recommended EIA Cabling Lengths

Baud Rate	Maximum Cable Length (feet)
300	4000 feet
1200	1000 feet
1800	650 feet
2400	500 feet
4800	250 feet
9600	125 feet

These figures are conservative in the sense that they might be exceeded by a factor of two and still provide an acceptable error rate. However, ADDS does not recommend going beyond those figures. The table is based on several assumptions. Readily available wire is used; that is, special low-capacitance cable was not utilized in deriving these numbers. In addition, no special line drive or receiver circuits were assumed and the terminal was not operating over telephone facilities.

Table 7.3 gives recommended cable construction for two cases: distances of less than 50 feet and transmission speed of 2400 baud or less, and distances of more than 50 feet and transmission speeds up to 9600 baud.

For the shorter distance and lower speed, only signals BA and BB (Transmitted Data and Received Data) need be carried as two twisted pairs, with a ground return in each pair. For the longer distance and higher speed, signals CA and CB (Request to Send and Clear to Send) should also be carried as twisted pairs with a ground return in each pair.

If one purchases off-the-shelf cable containing twisted pair, the cable usually consists of all twisted pairs with no other single conductors in the cable. The tables on the following page show the signals which must be carried as twisted pair and those which are carried in pairs as a matter of convenience is using readily available cable.

Table 7.3 EIA Cable Lengths

I. Distances less than 50 feet, speeds up to 2400 baud

PIN	SIGNAL	PAIR
2 1	BA-EIAOUT AA-GND	Pair
3 7	BB-EIAIN GND	Pair
4 8	CA-RQSND CF-CARDET	Pair or single
5 20	CB-CLSND* CD-DATTRY	Pair or single
6	DSR	Single

II. Distances greater than 50 feet, speeds more than 2400 baud

PIN	SIGNAL	PAIR
2 1	BA-EIAOUT AA-GND	Pair
3 1	BB-EIAIN GND	Pair
4 7	CA-RQSND GND	Pair
5 7	CB-CLSND* GND	Pair
8	CF-CARDET	Single
20	CD-DATTRY	Single
6	DSR	Single

*CLSND is true if the line is left open.

THE CURRENT LOOP INTERFACE

The Regent® Current Loop Interface is implemented by means of opto-isolators which can operate at any speed up to 9600 baud.

Cabling

As shown in Figure 7-1, two cases are possible, one where ADDS supplies the 20 Ma. current or the customer supplies it. Frequently one has to employ a hybrid of the two parts, e.g., the customer provides 20 Ma. to ADDS but expects a "contact closure" output from ADDS. (Most TTYs are strapped to accept a loop current and provide contact closure outputs.) **IMPORTANT:** The polarities shown in Figure 7-1 must be followed.

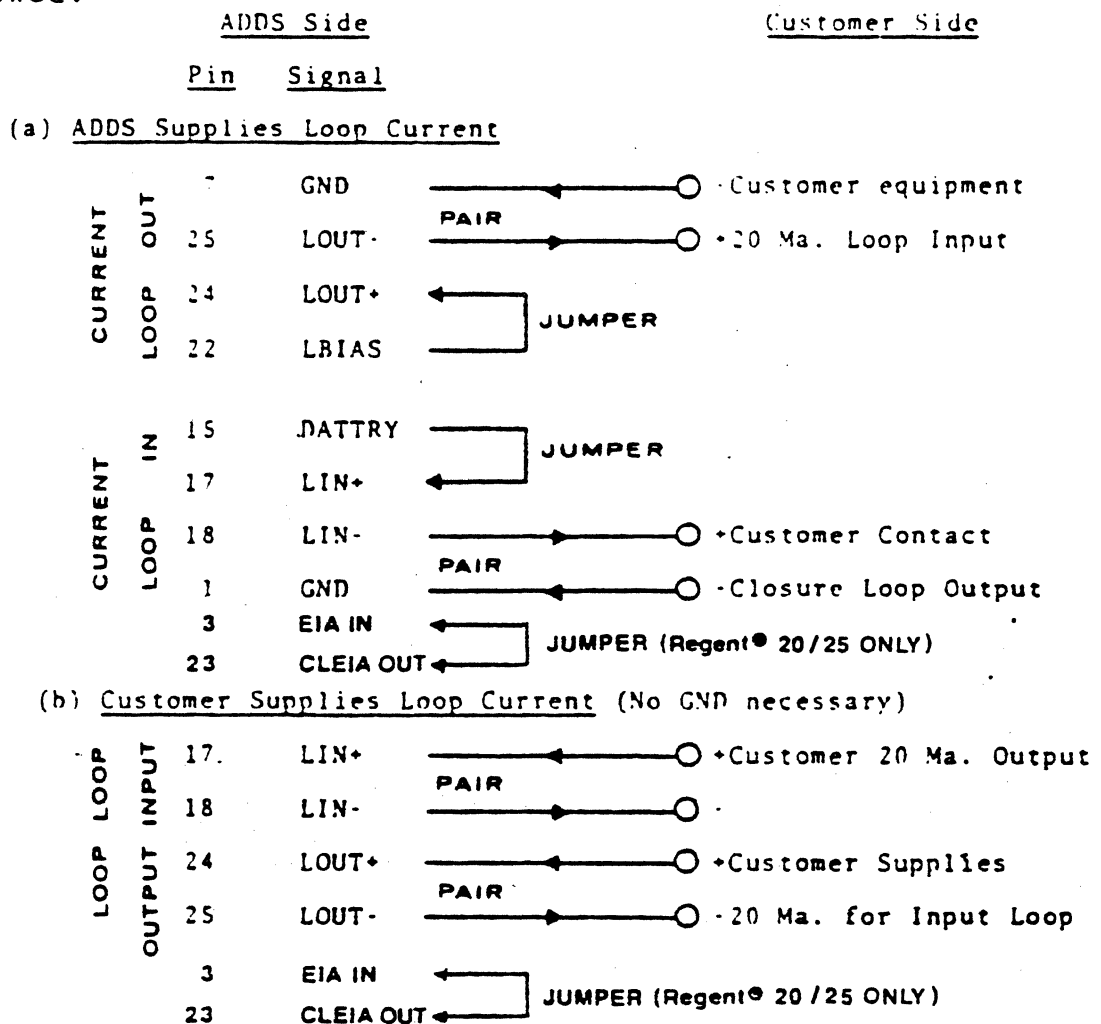

Figure 7-1. Current Loop Cabling

High Noise Environments

Since the current loop interface provides a true floating pair of input wires and a floating pair of output wires, the system designer may utilize this interface to achieve very high common mode noise rejection. A suggested technique is depicted in Figure 7-2.

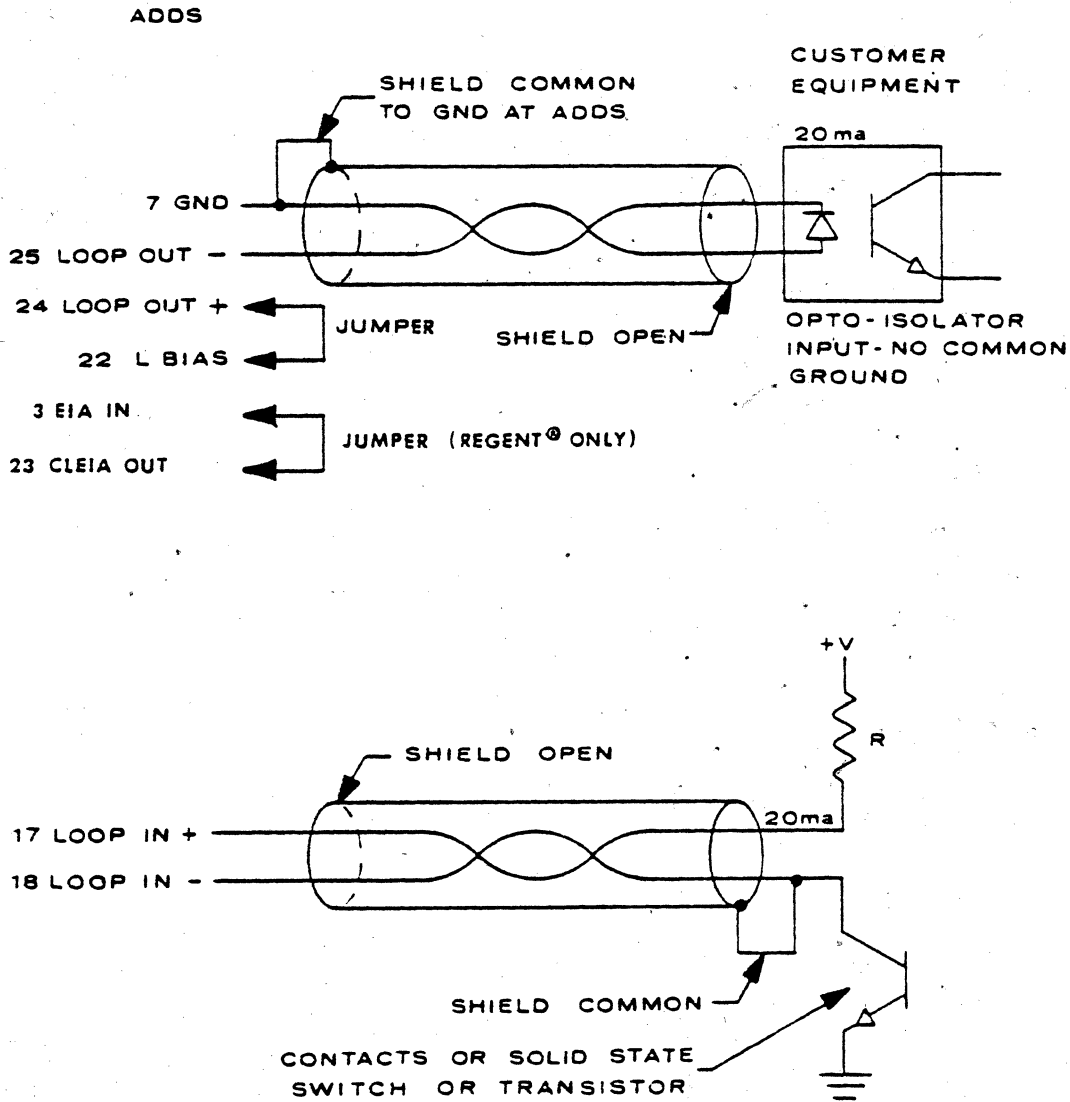

Figure 7-2. Current Loop in High Noise Environment