



ProFile[®]
Owner's Manual

Notice

Apple Computer Inc. reserves the right to make improvements in the product described in this manual at any time and without notice.

Disclaimer of All Warranties And Liabilities

Apple Computer Inc. makes no warranties, either express or implied, with respect to this manual or with respect to the software described in this manual, its quality, performance, merchantability, or fitness for any particular purpose. Apple Computer Inc. software is sold or licensed "as is." The entire risk as to its quality and performance is with the buyer. Should the programs prove defective following their purchase, the buyer (and not Apple Computer Inc., its distributor, or

its retailer) assumes the entire cost of all necessary servicing, repair, or correction and any incidental or consequential damages. In no event will Apple Computer Inc. be liable for direct, indirect, incidental, or consequential damages resulting from any defect in the software, even if Apple Computer Inc. has been advised of the possibility of such damages. Some states do not allow the exclusion or limitation of implied warranties or liability for incidental or consequential damages, so the above limitation or exclusion may not apply to you.

This manual is copyrighted. All rights are reserved. This document may not, in whole or part, be copied, photocopied, reproduced, translated or reduced to any electronic medium or machine readable form without prior consent, in writing, from Apple Computer Inc.

Warning

This equipment generates, uses and can radiate radio frequency energy and if not installed and used in accordance with the instructions manual, may cause interference to radio communications. As temporarily permitted by regulation it has not been tested for compliance with the limits for Class A computing devices pursuant to Subpart J of Part 15 of FCC Rules, which are designed to provide reasonable protection against such interference. Operation of this equipment in a residential area is likely to cause interference in which case the user at his own expense will be required to take whatever measures may be required to correct the interference.

030-0604-A

Contents

Preface

<i>Chapter 1</i>	<i>1 Introduction</i>
	<i>1 Getting Familiar</i>
	<i>1 Unpacking Your Drive</i>

<i>Chapter 2</i>	<i>5 Preparing to Use Your ProFile</i>
	<i>5 Getting Started</i>
	<i>6 Connecting the ProFile</i>
	<i>9 Turning On Your System</i>
	<i>9 Turning Off Your System</i>
	<i>9 Configuring Your System</i>
	<i>9 Operating Your Drive</i>
	<i>9 Backing Up Your Files</i>
	<i>10 Caring for Your ProFile</i>
	<i>10 If Your Drive Doesn't Work</i>

<i>Chapter 3</i>	<i>11 How the Drive Operates</i>
	<i>11 Basic Functions</i>
	<i>12 Spindle Rotation</i>
	<i>12 Head Positioning</i>
	<i>13 Read/Write Heads and Disks</i>
	<i>13 Air Filtration System</i>
	<i>14 Drive Electronics</i>
	<i>14 Controller Card</i>
	<i>15 Analog Card</i>
	<i>16 Motor Control Card</i>
	<i>16 Power Supply</i>

Appendix**17 Operating Specifications****17 Storage Characteristics****17 Drive Characteristics****17 Environmental Characteristics**

19 Index

Caution:

Your ProFile disk drive is a very delicate instrument.
Please handle it with care.

Preface

Your ProFile disk drive is a valuable addition to your Lisa computer. It is extremely reliable, quiet, and very easy to use. This manual describes the drive and explains how to unpack, install, operate, and care for it.

Before reading this manual or attempting to use your ProFile, you should first set up your Lisa following the instructions in the Lisa Setup Procedures located in the Lisa accessories box.

Chapter 1 introduces you to the ProFile and explains how to unpack it.

Chapter 2 gives step-by-step instructions for connecting the ProFile to Lisa. This chapter also explains how to turn on the ProFile and provides information that prepares you to operate the drive.

Chapter 3 provides technical information on the structure and operation of the ProFile. This is strictly an informative chapter for those who have experience with computers and want to learn more about the internal architecture and functional operations of a disk drive. If you are not really interested in understanding the inside of your drive, you can skip this chapter.

The Appendix lists your ProFile's operating specifications. An Index follows the Appendix.

Chapter 1

Introduction

Getting Familiar

Powerful computers, such as Lisa, need large amounts of data storage in a physically small package. They also require their data storage systems to be highly reliable. Your new ProFile disk drive, Figure 1-1, satisfies both of these requirements.

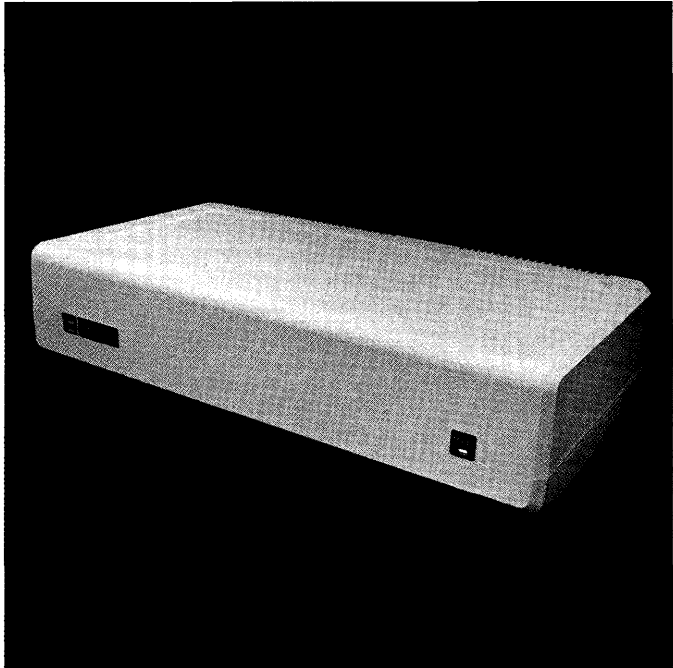

Figure 1-1. ProFile Disk Drive

Your ProFile is much different from the floppy disk drives built into your Lisa. For example, the ProFile stores information on rigid disks rather than floppy disks. Since the ProFile disks are protected by a sealed housing, they cannot be removed or interchanged and therefore cannot be damaged or lost as floppy disks can.

The main advantages ProFile has over a floppy disk drive are:

- Greater data storage capacity. ProFile can store nearly 5,000,000 bytes of data.
- Higher reliability.
- Improved performance.

Unpacking Your Drive

Your ProFile drive is packed in two shipping cartons. The larger of the two cartons contains your ProFile disk drive and unpacking instructions. The smaller, rectangular-shaped carton is your ProFile accessory kit. It contains this manual, a packing list, an interface cable, a power cable, and some important documents. Be sure to read the unpacking instructions entitled "How to Unpack the ProFile" before you start unpacking the drive. Then as you unpack the drive, check your packing list to make sure you have received all items listed.

The instructions that follow are similar to those outlined in "How to Unpack the ProFile." They are provided as a backup in case you lose the unpacking instructions.

Warning: Your ProFile drive is a delicate instrument. Be very careful when you remove it from the shipping carton. Extensive damage may result if the unit is accidentally jarred, bumped, dropped, or handled roughly.

To unpack your ProFile, first open the large shipping carton containing the drive. Then lift off the thick foam lid that protects the top of the drive. Notice that the drive is packaged in a small cardboard container with hand cutouts on each side. Reach down with both hands, grasp the container by the hand cutouts, and carefully pull it straight up and out of the shipping carton as shown in Figure 1-2.

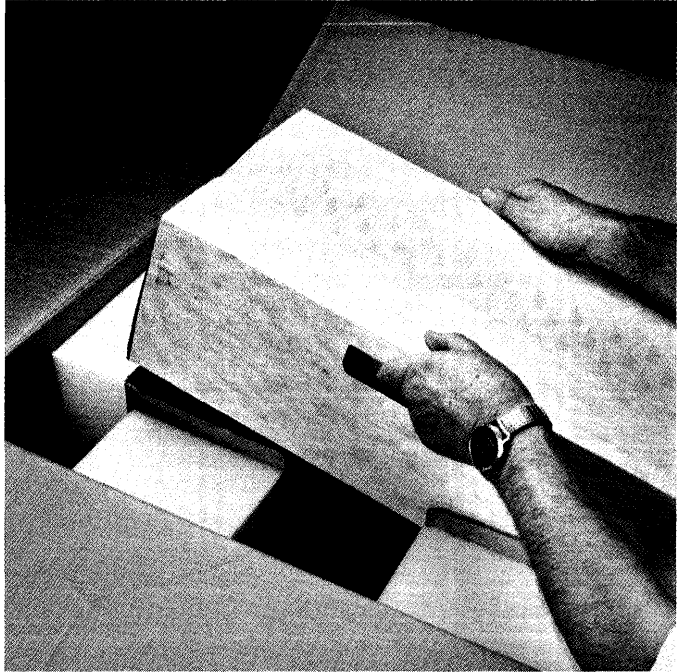

Figure 1-2. Removing the ProFile from the Shipping Carton

Open the container and remove the drive but do not remove the strapped-on foam end caps. Place the drive on a flat surface in the area where you intend to use it. See Figure 1-3.

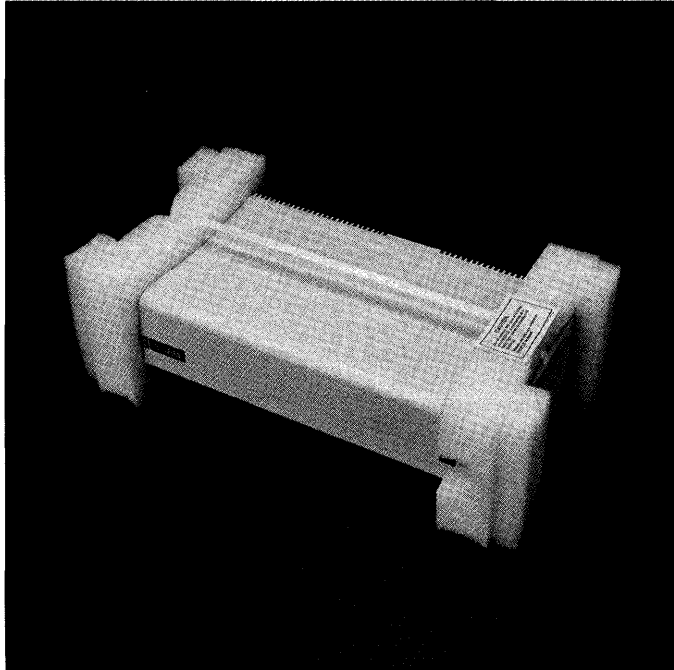

Figure 1-3. ProFile with End Caps Strapped On

As an added precaution against damage, you should leave the foam end caps strapped on until after you have turned on your drive for the first time. Then you can remove the foam end caps and set the drive on its feet. Be sure to save both the end caps and the carrying container. If you have to move your drive a short distance, for example from one building to another, you should strap on the end caps and carry the drive in the small carrying container.

Save the large carton and packing material in case you wish to ship your drive. Remember, if you attempt to ship the drive without proper packing, serious damage may result.

Chapter 2

Preparing to Use Your ProFile

Getting Started

Now that your ProFile is unpacked, you're probably eager to connect it to your Lisa to see how it works. However, before you remove the protective foam end caps and start hooking your ProFile up to Lisa, you should turn on the ProFile for the first time to make sure it starts up properly. Do this as follows:

1. Turn off the power switch on the back of the ProFile.

Warning: Your ProFile is equipped with a 3-wire power cord. As a safety feature, the plug is designed to fit only into a polarized, grounded, 3-hole outlet. If you are unable to insert the plug into the existing outlet, have a licensed electrician install a polarized, grounded 3-hole outlet (and a grounding conductor, if necessary). Do not defeat the purpose of the grounding-type plug.

2. Plug one end of the power cord into the recessed 3-pin connector on the back of the ProFile.
3. Plug the other end of the power cord into a wall outlet.
4. Turn on the power switch on the back of the ProFile.

Notice that the red Ready light on the front panel comes on for about 2 seconds and then goes off for about 20 seconds while the drive comes up to operating speed. Then the light starts to flash and continues to flash for about 40 seconds while the drive runs some internal tests on its disks. After that the light stays on continuously to indicate that the startup sequence is complete and the drive is ready for operation. Under certain conditions your drive could take up to 3 minutes to complete its startup sequence.

Failure of the Ready light to stay on after a maximum of 3 minutes indicates a possible drive malfunction. If this occurs, turn off your ProFile and contact your dealer for service.

Once the Ready light stays on, you are ready to connect your ProFile to Lisa. First turn off your drive and unplug the power cord from both the drive and the wall outlet. Next remove the foam end caps from the drive and place it on top of or as close as possible to Lisa.

Warning: Never, under any circumstance, enclose your ProFile or place it on a thick carpet or any other surface that might obstruct air flow through the vents on the bottom of the unit.

Connecting the Profile

Your ProFile accessory kit includes a power cord and an interface cable. You will use the interface cable, a flat, ribbon-like cable with identical D-shaped connectors on each end, to connect your ProFile to Lisa.

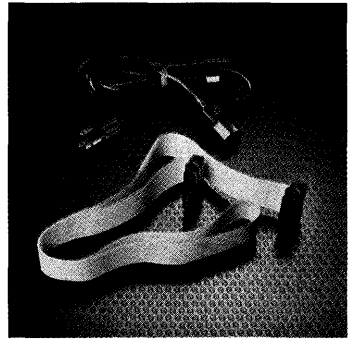

First locate the built-in parallel connector on the back of Lisa. You should connect your ProFile directly to this connector as described in the following steps.

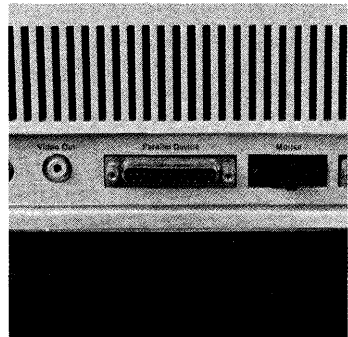

However, if you plan to connect another ProFile to your Lisa, you must first install a Parallel Interface board in Lisa and connect your additional ProFile to this board. Refer to the documentation that came with your board for directions on how to install it.

To connect your ProFile to Lisa:

1. Turn off Lisa by pressing the power button. Wait until all diskettes are released and the power light is off.



2. Turn off all peripherals. Unplug Lisa and all peripherals from the wall outlet.

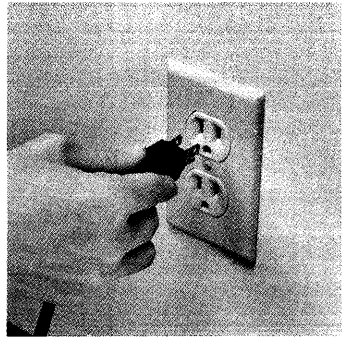

3. Turn Lisa so the back is facing you. Disconnect the power cord from the back of Lisa.

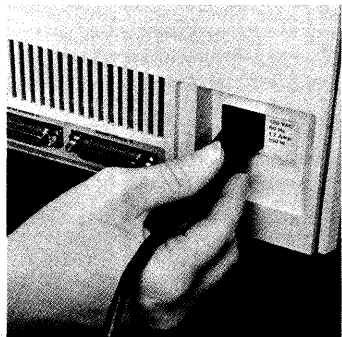

4. Make sure that the power switch on the ProFile is turned off.

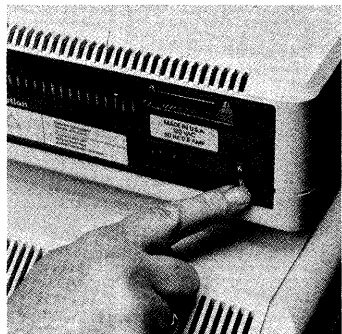

5. Plug one end of the interface cable into Lisa's built-in parallel connector. The connector can go on in only one way because of its shape.

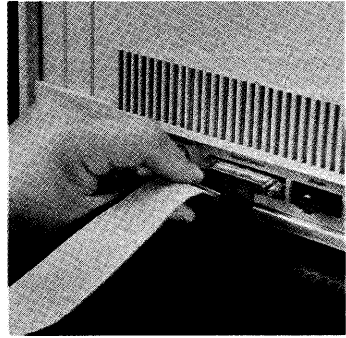

6. Plug the other end of the interface cable into the D-shaped mating connector on the back of the ProFile.

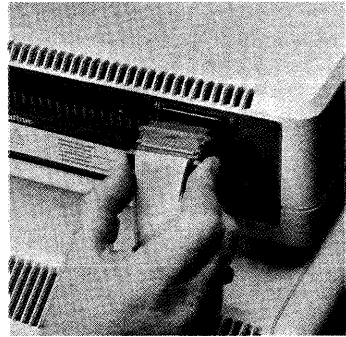

7. Plug one end of the power cord into the recessed 3-pin connector on the back of the ProFile.

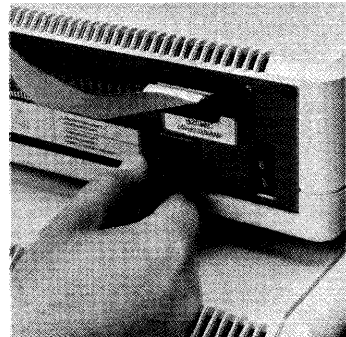

8. Plug the other end of the power cord into a wall outlet.

9. Plug Lisa into a wall outlet.

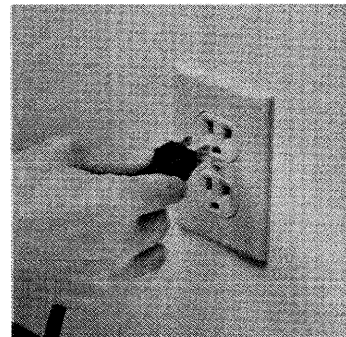

Turning on Your System

Reach around to the back of the ProFile and turn on the power switch. The red Ready light should start to flash but in approximately 1 minute it will remain on continuously to indicate that your ProFile is ready for operation. Once the Ready light is on continuously, you can turn on your Lisa.

The Ready light will also show activity by flashing rapidly whenever ProFile is communicating with Lisa.

Turning Off Your System

As a general rule, you should keep your ProFile on unless you do not plan to use it for an extended period of time. When you turn off your ProFile, observe the following precautions.

- Always turn off Lisa before you turn off the ProFile.
- Do not turn off your ProFile while it is active (Ready light flashing). If you do, the read/write heads will settle over a data area instead of returning to their home position outside of the data area.
- When the ProFile is no longer active, make sure the Ready light remains on continuously for at least 4 seconds before turning off power.

Configuring Your System

Before you can use your ProFile, you must configure it to your system. To do this, refer to Section D, Desktop Manager Reference Guide, of the *Lisa Owner's Guide* under Set Hard Disk Connection, or the System Manager section of the "Workshop User's Guide for the Lisa."

Operating Your Drive

With the exception of the AC power switch, the ProFile drive contains no operating controls. After initial startup, all drive operations are controlled by Lisa.

Backing Up Your Files

It is very important that you make a backup copy of the information you have stored on your ProFile in case you accidentally erase your data or lose it due to an equipment malfunction. To do this, refer to Section D, Desktop Manager Reference Guide, of the *Lisa Owner's Guide* under Copy. If you are using systems software, refer to the Filer Section in the "Workshop User's Guide for the Lisa."

Caring for Your Profile

The ProFile disk drive, unlike the computer, is a mechanical device, with motors and moving parts. Therefore it is somewhat more delicate than the computer. The ProFile drive is completely aligned and tested at the factory, and with proper care and handling, it should provide trouble-free operation. However, rough handling, such as dropping the drive, sharply jarring it, or allowing heavy objects to fall on it, could cause damage.

If Your Drive Doesn't Work

If your ProFile does not operate, reread this manual carefully to make sure that the cables are properly connected. This cures most problems.

This isn't likely, but if your drive received excessive rough handling during shipping or unpacking, one of the connectors inside of the ProFile cabinet may be loose. If you suspect this condition, contact your dealer, who will be glad to help you.

Do not attempt to open the ProFile cabinet as this could void your warranty.

Chapter 3

How the Drive Operates

Basic Functions

The ProFile disk storage system consists of a 5-1/4 inch disk drive, its controller card, and a power supply, all packaged in a compact cabinet, as shown in Figure 3-1.

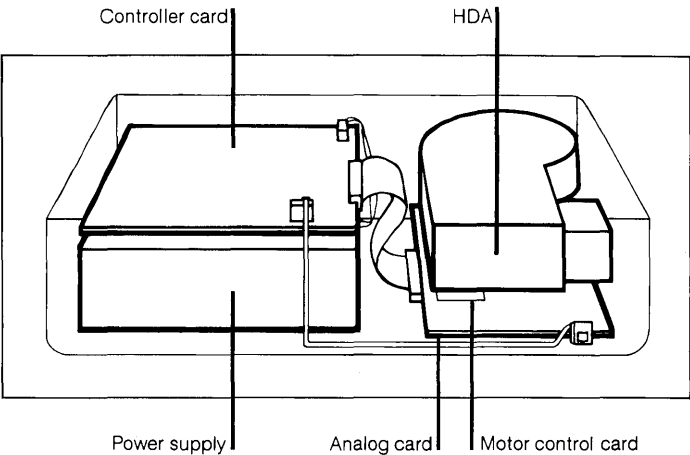

Figure 3-1. ProFile Disk Storage System

The ProFile disk drive is a fixed-media, rotating memory, storage device, consisting of two rigid 5-1/4 inch disks, four read/write heads, a spindle drive mechanism, a positioning mechanism, and a recirculating air-filtration system. All of these components are enclosed in an environmentally sealed, protective, nonremovable aluminum housing called an HDA (head disk assembly). Analog and motor control cards are mounted beneath the HDA.

The ProFile disk storage system does the following:

- Moves the read/write heads to the desired track.
- Reads and writes data.
- Provides a contamination-free environment.

Spindle Rotation

A brushless DC motor drives the spindle directly at a rotational speed of 3600 rpm (no belt or pulley is used). A mechanical brake ensures a fast stop of the spindle drive motor whenever you turn off the ProFile.

Head Positioning

An open loop stepper system moves the read/write heads. The heads are attached to a carriage that is driven and positioned by a band actuator connected to the capstan shaft of a stepper motor. See Figure 3-2. The heads are positioned by wrapping and unwrapping the band around the capstan.

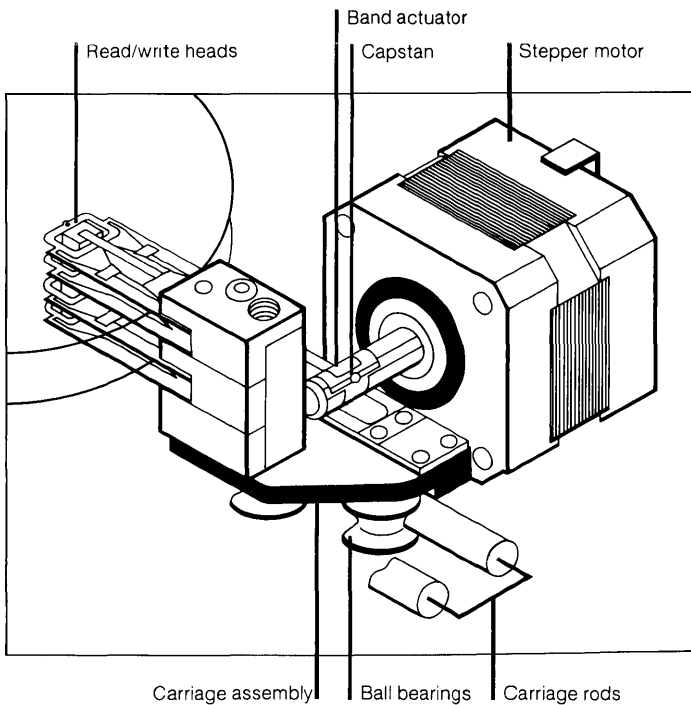

Figure 3-2. Positioning Mechanism

Read/Write Heads and Disks

The drive uses two nonremovable 5-1/4 inch disks as storage media. Each disk consists of an aluminum substrate covered on each side with a lubricated, thin, magnetic oxide coating. This coating formulation, together with the low load force/low mass of the Winchester-type heads, permits the heads to contact the disk surface during start/stop operations. Each of the four read/write heads (one per disk surface) accesses 152 data tracks. The total formatted capacity of the ProFile drive is approximately 5 megabytes.

Air Filtration System

An internal recirculating air system with an absolute filter maintains a clean environment within the HDA. Integral to the filter is a port that permits ambient air to equalize pressure without causing contamination. The filter never requires cleaning or replacement.

Drive Electronics

The ProFile electronics consist of a controller card, an analog card, a motor control card, and a power supply. These components are packaged, together with the HDA, in the ProFile cabinet. A 25-conductor interface cable connects the ProFile's controller card to Lisa. This cable contains eight bidirectional data lines and five control lines.

Controller Card

The controller card is mounted on top of the power supply in the ProFile cabinet. It has four main sections; a microprocessor, a random access memory (RAM), serializing/deserializing and error detection logic, and read/write control logic.

The controller :

- Communicates with Lisa.
- Selects the read/write head and moves it to the proper track.
- Provides signals to read and write serial data on the disk.
- Converts 8-bit parallel data from the computer into serial data for the drive during a write operation.
- Converts serial data from the drive into 8-bit parallel data for the computer during a read operation.
- Continuously monitors the ProFile for error conditions.

During the first 60 seconds after you turn on the ProFile, the controller performs a surface analysis, checks the data integrity of all sectors, and spares out any marginal sectors automatically. If a head positioning error is detected, the controller will automatically attempt to reposition the heads to the proper track location. If a read error occurs during operation, the controller retries the data and attempts to recover from the error automatically. If the error rate for a given sector is too high, the controller will automatically "spare" it (relocate the sector data to another area of the disk). The controller will attempt to spare a sector on a read operation only if valid data has not been recovered from the sector. If valid data cannot be recovered, the sector will be flagged as bad and a sparing attempt will be made on the next write or write/verify operation.

The microprocessor section supervises the controller hardware through signals on its input/output (I/O) ports and control information stored in the RAM. The microprocessor directly controls the two-phase stepper motor to move the actuator and heads from track to track, selects one of four read/write heads, and writes sector marks on the disk during the format operation (each track is divided into 16 sectors whose boundaries are defined by sector marks).

Under direction of the microprocessor, the controller's read/write control logic converts parallel data to serial data when writing and serial data to parallel data when reading, controls the transfer of data to and from the RAM, and controls the error detection logic. This logic detects errors in data read from the disk and outputs an error signal to the microprocessor. As a result, the controller tries again to read the data. Normally one or two retries will result in a successful read.

Analog Card

The analog card is the interface between the controller card and the HDA. It is mounted on the bottom of the HDA and is primarily dedicated to read/write functions. The analog card includes a write encoder, write driver, head select matrix, preamplifier, read detector, and sector detector.

The head select matrix selects one of the four read/write heads for a read or write operation.

During a write operation, the write circuit receives serialized digital data pulses from the controller and converts them into an encoded data stream of current reversals for the selected head. These current reversals are recorded on the disk surface as a series of polarity reversals (flux changes) having the same timing relationships as the encoded data.

During a read operation, the selected read/write head transforms the polarity reversals (flux changes) on the disk surface into an encoded data stream. The read circuit separates the encoded read data into streams of serialized digital clock and data pulses and sends them to the controller.

Motor Control Card

The motor control card is a small card mounted between the HDA and the analog card. Its function is to maintain spindle rotation speed at 3600 RPM, plus or minus 1 percent.

Power Supply

The power supply provides operating voltages of +5V, +12V, and -12V to the ProFile electronics.

Appendix

Operating Specifications

Storage Characteristics	Data capacity (formatted)	4,980,736 bytes
	Data surfaces	4
	Heads per surface	1
	Tracks per surface	152
	Track spacing	254 tracks per inch
	Bytes per block	512
	Blocks per track	16
	Blocks per surface	2432
	Total number of blocks	9728

Drive Characteristics	Seek time distribution	330 tracks per second
	Average seek time	180 milliseconds
	Data transfer rate	5 megabits/second
	Rotational speed	3600 RPM
	Rotational startup time	20 seconds
	Drive ready to operate	60 seconds

Environmental Characteristics	Operating temperature	10°C (50°F) to 40°C (104°F)
	Storage temperature	-22°C (-7.6°F) to 80°C (176°F)
	Operating humidity	8% to 80% (no condensation)
	Storage humidity	1% to 95%

Index

A

accessory kit 2, 6
advantages of ProFile 2
analog card 12, 14, 15

B

backing up files 9
basic functions 11

C

caring for the ProFile 10
configuring the system 9
connecting the ProFile 6-9
controller card 14, 15
controller functions 14

D

data tracks 13, 17
description, ProFile 1, 2, 12
drive problems 5, 10

E

electronics 14
error detection 14, 15

H

HDA (Head Disk Assembly) 12, 14, 15
head positioning 12
head select matrix 15

I

initial checkout 5, 6
instructions, unpacking 2-4
interface cable 6, 8

M

media 12, 13
microprocessor 15
motor control card 14, 16

O

operating the drive 9

P

parallel connector 6, 8
parallel interface card 6
power cord 5, 8
power supply 16
power switch 5, 7, 9

R

read operation 15
read/write control 15
read/write heads 12, 13
Ready light 5, 9
retries 15
rotational speed 16

S

sector sparing 14
specifications 17
spindle drive mechanism 12
startup sequence 5
storage capacity 2, 13, 17
surface analysis 14

T

turning off the system 9
turning on the system 9

U

unpacking 2-4

W

write operation 15

S

sector sparing 14
specifications 17
spindle drive mechanism 12
startup sequence 5
storage capacity 2, 13, 17
surface analysis 14

T

turning off the system 9
turning on the system 9

U

unpacking 2-4

W

write operation 15