



**NOS Version 2**  
**Operations Handbook**

**Reference Manual**



# **NOS Version 2**

## **Operations Handbook**

### **Reference Manual**

**This product is intended for use only as described in this document. Control Data cannot be responsible for the proper functioning of undescribed features and parameters.**

# Manual History

---

<b>Revision</b>	<b>System Version</b>	<b>PSR Level</b>	<b>Date</b>
A	2.0	562	April 1982
B	2.1	580	January 1983
C	2.2	596/597	October 1983
D	2.3	617	October 1984
E	2.4.1	630	March 1985
F	2.4.2	642	September 1985
G	2.5.1	664	September 1986
H	2.5.1	670	December 1986
J	2.5.2	678	April 1987
K	2.5.3	688	September 1987
L	2.6.1	700	April 1988
M	2.7.1	716	December 1988
N	2.7.1	739	December 1989
P	2.7.1	750	June 1990
R	2.7.2	774	June 1991
T	2.7.4	797	June 1992
U	2.8.2	826	December 1993
V	2.8.3	840	August 1994

Revision V of this manual, printed August 1994, reflects NOS 2.8.3 at PSR level 840.

This edition obsoletes all previous editions.

# Contents

---

<b>About This Manual</b> .....	<b>9</b>
Audience .....	9
Conventions .....	10
Submitting Comments .....	11
Customer Support Hotline .....	11
Related Publications .....	12
<b>Introduction</b> .....	<b>1-1</b>
Basic NOS Functions .....	1-1
Operator/System Communication .....	1-2
Special Characters .....	1-11
System Operation .....	1-12
Job Entries in System Tables .....	1-15
Preparing for Deadstart .....	1-16
Deadstart Classifications .....	1-16
Deadstart File .....	1-17
Deadstart Process .....	1-17
<b>Deadstart</b> .....	<b>2-1</b>
Warmstart Procedure Summary .....	2-1
Setting the Deadstart Program for a Warmstart .....	2-4
Setting Word 12 (CYBER 180-Class Mainframes) .....	2-8
Setting Word 13 .....	2-9
Selecting the Deadstart Level .....	2-9
Selecting the Deadstart Parameters .....	2-11
Selecting the CMRDECK .....	2-12
Warmstart Procedure for Models Without a Deadstart Panel .....	2-12
Initiating the Deadstart Process .....	2-16
Initial Options Display .....	2-17
Modifying the Deadstart Decks .....	2-19
Modifying the CMRDECK .....	2-20
Modifying the EQPDECK .....	2-21
Modifying the APRDECK .....	2-22
Modifying the IPRDECK .....	2-23
System Loading and Initiating .....	2-24
Preparing for System Restart .....	2-28
Deadstart Error Troubleshooting .....	2-32
<b>Operation under DSD Control</b> .....	<b>3-1</b>
System Control Commands .....	3-1
Subsystem Control Commands .....	3-9
Peripheral Equipment Control Commands .....	3-12
Printer Support Utility (PSU) Commands .....	3-21
Job Processing Control Commands .....	3-26
Dayfile Commands .....	3-29

<b>DSD Displays</b> .....	<b>4-1</b>
Display Selection .....	4-1
Display Screen Headers .....	4-3
Dayfile Displays (A) .....	4-4
System Status Displays (B,A. and B,O.) .....	4-13
Storage Displays (C, D, F, G, and M) .....	4-18
Equipment Status Displays (E) .....	4-23
Equipment Status Table Display (E,. or E,A.) .....	4-23
System and Local Files Display (H) .....	4-48
Central Programmable Display (K) .....	4-55
Transaction Facility (TAF) Displays (O) .....	4-56
PP Registers Display (P) .....	4-63
.....	4-65
Rollout Status Display (R) .....	4-68
System Control Display (S) .....	4-71
Interactive Status Display (T) .....	4-76
System Information Displays (W) .....	4-78
Monitor Functions Display (Y) .....	4-90
Directory Display (Z) .....	4-91
<b>L Displays</b> .....	<b>5-1</b>
How to Make L-Display Entries .....	5-1
SUBSYST L Display .....	5-2
<b>Operator Messages</b> .....	<b>A-1</b>
<b>Glossary</b> .....	<b>B-1</b>
<b>Multimainframe Operation</b> .....	<b>C-1</b>
<b>Peripheral Equipment Operation</b> .....	<b>D-1</b>
405 Card Reader Operation .....	D-1
415 Card Punch Operation .....	D-4
533/536 Printer Operation .....	D-5
537 Printer Operation .....	D-7
580 Line Printer Operation .....	D-10
585 Printer Operation .....	D-16
Magnetic Tape Units .....	D-17
819 Disk Storage Unit Operation .....	D-28
834/836 Disk Storage Unit Operation .....	D-29
844 Disk Storage Unit Operation .....	D-30
885 Disk Storage Unit Operation .....	D-31
887 Disk Storage Unit Operation .....	D-32
895 Disk Storage Unit Operation .....	D-35
9853 Disk Storage Subsystem Operation .....	D-37
CC545 Display Console Operation (CYBER 170 and CYBER 180 Computer Systems)	D-40
CC598B Display Console Operation (CYBER 180 Computer System) .....	D-41
CC634B Display Console Operation (CYBER 180-810 or 830 Mainframe) .....	D-42
6612 Dual Screen Display Console Operation (CYBER 70 and 6000 Computer Systems)	D-43
Procedure to Initialize Local 255x Network Processing Unit (NPU) .....	D-44

Procedures to Initialize Remote 255x Network Processing Unit (NPU) . . . . .	D-48
Mass Storage Extended Subsystem (MSE) . . . . .	D-50
5380-100 STORNET Subsystem . . . . .	D-52
Solving NOS Multimainframe Environment Problems . . . . .	D-54
Filter Maintenance . . . . .	D-55
<b>Error Detection . . . . .</b>	<b>E-1</b>
S/C Register Error Detection . . . . .	E-1
Maintenance Register Error Detection . . . . .	E-4
<b>Example of End-of-Operation Shutdown . . . . .</b>	<b>F-1</b>
<b>Index . . . . .</b>	<b>Index-1</b>

## **Figures**

---

1-1. CC545 Console Keyboard . . . . .	1-2
1-2. CC598B Console Keyboard . . . . .	1-3
1-3. CC634B Keyboard . . . . .	1-4
1-4. CC634B Help Screen . . . . .	1-6
1-5. CC598B Help Screen . . . . .	1-7
1-6. Input Queue Display (Q,IN.) . . . . .	1-13
1-7. System Status Display (B,O.) . . . . .	1-13
1-8. Rollout Status Display (R) . . . . .	1-14
1-9. Print Queue Display (Q,PR.) . . . . .	1-14
1-10. Deadstart Panel for Models 835, 840, 845, 850, 855, 860, 870, 990, and 995 . . .	1-18
1-11. Initial Deadstart Display for Models 815 and 825 . . . . .	1-19
1-12. Deadstart Options Display for Models 810, 830, 840A, 850A, 860A, 960, 990A, 994, and 995A . . . . .	1-20
1-13. CC598B Console Initial Deadstart Display for Models 960 and 994 . . . . .	1-20
1-14. Deadstart Panel for CYBER 170 Computer Systems (Except CYBER 180-Class Mainframes) . . . . .	1-21
1-15. Deadstart Panel for CYBER 70 and 6000 Computer Systems . . . . .	1-22
2-1. Typical Warmstart Sequence . . . . .	2-3
2-2. Deadstart Options Display . . . . .	2-13
2-3. Maintenance Options Display . . . . .	2-14
2-4. Initial Options Display . . . . .	2-17
2-5. Label Validation Display . . . . .	2-25
2-6. System Load Display . . . . .	2-25
2-7. Date Initialization Request . . . . .	2-26
2-8. Time Initialization Request . . . . .	2-26
2-9. Level 3 Deadstart Left Screen Display . . . . .	2-29
2-10. Level 3 Deadstart Right Screen Display . . . . .	2-30
3-1. NAM Display . . . . .	3-21
3-2. NAM STATUS Display . . . . .	3-22
3-3. PSU Display . . . . .	3-22
4-1. Left Screen Header . . . . .	4-3
4-2. Right Screen Header . . . . .	4-3
4-3. System Dayfile Display (A. or A,.) . . . . .	4-7
4-4. Account Dayfile Display (A,ACCOUNT FILE.) . . . . .	4-8



4-5.	Error Log Display (A,ERROR LOG.)	4-9
4-6.	Operator Action Display (A,OPERATOR.)	4-10
4-7.	System Status Display (B,A.)	4-13
4-8.	Alternate Data Fields of the System Status Display (B,A.)	4-15
4-9.	System Status Display (B,O.)	4-16
4-10.	Central Memory Display (C)	4-18
4-11.	Central Memory Display (F)	4-19
4-12.	Extended Memory Display (M)	4-20
4-13.	Equipment Status Display (E,. or E,A.)	4-24
4-14.	Disk Configuration Display (E,C.)	4-27
4-15.	Disk Errors Display (E,E.)	4-29
4-16.	Family Status Display (E,F.)	4-32
4-17.	Disk Thresholds Display (E,H.)	4-34
4-18.	Disk Status Display (E,M.)	4-36
4-19.	Optical Disk Requests Display (E,O.)	4-40
4-20.	Resource Requests Display (E,P.)	4-41
4-21.	Additional Data Fields of the Resource Requests Display (E,P.)	4-43
4-22.	Optical Disk Status Display (E,S.)	4-44
4-23.	Tape Status Display (E,T.)	4-45
4-24.	System Files Display (H,.)	4-49
4-25.	Local Files Display (H,jsn.)	4-49
4-26.	BIO Status Display (I)	4-51
4-27.	Job Status Display (J,jsn.)	4-53
4-28.	Subcontrol Point Status Display (O,SCP.)	4-57
4-29.	Task Library Directories Display (O,TLD.)	4-59
4-30.	Transaction Status Table Display (O,TST.)	4-61
4-31.	PP Registers Display (P)	4-63
4-32.	Queued File Table Display (Q,.)	4-65
4-33.	Print Queue Display (Q,PR.)	4-65
4-34.	Rollout Status Display (R)	4-68
4-35.	System Control Display (S)	4-71
4-36.	Interactive Status Display (T)	4-76
4-37.	Memory Allocation Display (W,A.)	4-78
4-38.	Channel Status Display (W,C.)	4-80
4-39.	Channel Status Display (W,C.) for CYBER 180-Class Mainframes	4-81
4-40.	Miscellaneous Parameters Display (W,M.)	4-83
4-41.	System Table Addresses Display (W,P.)	4-84
4-42.	System Queues Display (W,Q.)	4-86
4-43.	System Resources Display (W,R.)	4-88
4-44.	Monitor Functions Display (Y)	4-90
4-45.	Directory Display (Z)	4-91
5-1.	SUBSYST L Display	5-2
D-1.	Card Reader Switches	D-2
D-2.	415 Card Punch Switches	D-4
D-3.	533/536 Printer Switches and Indicators	D-5
D-4.	537 Printer Switches and Indicators	D-7
D-5.	580 Line Printer Switches	D-10
D-6.	Line Printer Format Tape Configuration for Short Paper	D-12
D-7.	Line Printer Format Tape Configuration for Long Paper	D-13
D-8.	639 Tape Unit Operator Control Panel	D-18
D-9.	667/669 Tape Unit Operator Control Panel	D-19
D-10.	677/679 Tape Unit Operator Control Panel	D-21
D-11.	698 Tape Unit Operator Control Panel	D-22

D-12. Tape Path	D-26
D-13. 834/836 Disk Storage Unit Operation	D-29
D-14. 885 Disk Storage Unit Switches and Indicators	D-31
D-15. Operator Control for 887 Disk Storage Unit	D-32
D-16. HSC Operator Control for an 895 Disk Storage Unit	D-35
D-17. SCU Operator Control for an 895 Disk Storage Unit	D-36
D-18. Operator Control for 9853 Disk Storage Subsystem	D-38
D-19. CC545 Console Panel	D-40
D-20. CC598B Monitor Control Panel	D-41
D-21. CC634B Console Panel	D-42
D-22. Display Controls	D-43
D-23. Loop Multiplexer Circuit Card PWR ON/OFF Switch Location	D-45
D-24. CLA Circuit Card ON/OFF Switch Locations	D-46
D-25. Maintenance Panel MASTER CLEAR Switch Location	D-47
D-26. Storage Module and Control Unit	D-50
D-27. Entry and Exit Trays	D-51
D-28. STORNET Configuration	D-52
D-29. Location of STORNET Switches and Controls	D-54
D-30. Location of Filters in STORNET Cabinet	D-56

## Tables

---

1-1. Left, Right, or Dual Screen Control Keys	1-5
1-2. Special Characters	1-11
2-1. CYBER 170 and CYBER 180 Computer Systems Program Settings for Warmstart from Channel with a PP	2-5
2-2. CYBER 70 and 6000 Computer Systems Panel Settings for Warmstart from Channel with a PP	2-5
2-3. Panel Settings for Warmstart from Channel with No PP	2-6
2-4. Deadstart Parameters Switch Settings	2-12
2-5. Moving from One Deadstart Deck to Another	2-24



# About This Manual

---

This manual explains how to operate the CONTROL DATA® Network Operating System Version 2 (NOS 2). The network capabilities of NOS allow interactive and transaction processing in addition to local and remote batch processing.

NOS 2 operates on the following computer systems:

CONTROL DATA CYBER 180 Computer Systems

Models 810, 830, 835, 840, 845, 850, 855, 860, 870, 960, 970, 990, 994, and 995

CONTROL DATA CYBER 170 Computer Systems

Models 171, 172, 173, 174, 175, 176, 720, 730, 740, 750, 760, 815, 825, 835, 845, 855, 865, and 875

CONTROL DATA CYBER 70 Computer Systems

Models 71, 72, 73, and 74

CONTROL DATA 6000 Computer Systems

## Audience

This manual is written for central site system operators who work in a normal production environment and are not involved in troubleshooting. A mix of conversational and reference formats is used to facilitate an introduction to NOS.

This manual assumes you are familiar with your computer system and with local site operating procedures.

Since operating requirements may vary from one installation to another, this manual is intended to be used in conjunction with the policies and procedures unique to each installation.

## Conventions

The following conventions are used for consistency in the presentation of information:

- Technical changes are indicated by a vertical bar in the margin.
- Bits for the deadstart panels are numbered right to left.
- The CONTROL DATA 18002-2 console is available as an option for certain CYBER 180-class machines. This product includes a 721-21 display terminal and an AV117A cable. This console is referred to throughout the manual as the CC634B console.

The CONTROL DATA 19003-3 console is available as an option for certain 180-class machines. This product includes a video monitor, keyboard, 40 Mbyte hard disk (Winchester) drive, 1.2 Mbyte 5-1/4 in. floppy disk drive, 640 Kbyte RAM memory, one parallel printer port, and nine RS-232-C serial ports. This console is referred to throughout this manual as the CC598B console.

- Carriage return refers to the CR key on the CC545 console, to the Enter/Return key on the CC598B console, and to the NEXT key on the CC634B console.
- The terms CYBER 180-class models and CYBER 180-class mainframes are used, when convenient, to refer collectively to CYBER 180 computer systems and those CYBER 170 models that share many of the CYBER 180 functional and architectural characteristics. The CYBER 170 models included in the CYBER 180-class are: 815, 825, 835, 845, and 855.
- Extended memory for the CYBER 180-class machines and models 865 and 875 is unified extended memory (UEM) and may also include extended core storage (ECS), extended semiconductor memory (ESM), or STORNET. Extended memory for model 176 is large central memory extended (LCME) and may include ECS, ESM, or STORNET. Extended memory for all other NOS computer systems is either ECS, ESM, or STORNET.

In this manual, ECS refers to ECS, ESM, and STORNET. Extended memory refers to all forms of extended memory unless otherwise noted. ECS, ESM, and STORNET are the only forms of extended memory that can be shared in an ECS multimainframe complex and can be accessed by a distributive data path (DDP) or low-speed port (LSP). For CYBER 180-class machines, only UEM may be accessed directly from CPU programs as extended field length; similarly on the model 176, only LCME may be accessed directly from CPU programs. The other forms of extended memory are supported only as mass storage devices on these machines.

## **Submitting Comments**

If you have comments concerning this manual, mail your comments to:

Control Data  
Information Services ARH219  
4201 Lexington Avenue N.  
St. Paul, MN 55126-6198

If you have access to SOLVER, an online facility for reporting problems, you can use it to submit comments about this manual. When entering your comments, use NS2 as the product identifier. Include the name and publication number of the manual.

If you have questions about the packaging and/or distribution of a printed manual, write to:

Control Data  
Literature Distribution Services ARHLDS  
4201 Lexington Avenue N.  
St. Paul, MN 55126-6198

You can also call (612) 482-3800 or 482-3801, or FAX your inquiry to (612) 482-3813.

## **Customer Support Hotline**

Control Data's Central Software Support maintains a hotline to assist you if you have difficulty using our products. If you need help not provided in the documentation, or find the product does not perform as described, call us at one of the following numbers. A support analyst will work with you.

From the USA and Canada: 1-800-345-6628

From other countries: 1-612-482-3434

## Related Publications

Control Data manuals are available through Control Data sales offices or Control Data Literature and Distribution Services (4201 Lexington Avenue N., St. Paul, MN 55126-6198).

The NOS System Information Manual is an online manual that includes brief descriptions of all NOS and NOS product manuals. To access this manual, log in to NOS and enter the command EXPLAIN.

<b>Control Data Publication</b>	<b>Publication Number</b>
CDCNET Network Operations and Analysis	60461520
Communications Control Program Version 3 Diagnostic Handbook	60471500
COMPASS Version 3 Reference Manual	60492600
CYBER Initialization Package (CIP) Reference Manual	60457180
CYBER Supermini Operations User's Guide	60459850
CYBER 70 Model 71 Computer System Hardware Reference Manual	60453300
CYBER 70 Model 72 Computer System Hardware Reference Manual	60347000
CYBER 170 Computer Systems Models 171 through 175 (Levels A, B, C) Model 176 (Level A, B, C) Hardware Reference Manual	60420000
CYBER 170 Computer Systems Models 720, 730, 740, 750, and 760 Model 176 (Level B/C) Hardware Reference Manual	60456100
CYBER 170 Computer Systems Models 815 and 825 Hardware Operator's Guide	60469370
CYBER 170 Computer Systems Models 815 and 825 Hardware Reference Manual	60469350
CYBER 170 Computer Systems Models 835, 845, and 855 CYBER 180 Computer Systems Models 835, 840, 845, 850, 855, 860, 970, and 990 CYBER 990E, 995E, and 994 Computer Systems CYBER 170 State Hardware Reference Manual	60469290

<b>Control Data Publication</b>	<b>Publication Number</b>
CYBER 170 Computer Systems Models 835, 845, and 855 CYBER 180 Computer Systems Models 835, 845, and 855 Hardware Operator's Guide	60458390
CYBER 170 Computer Systems Models 865 and 875 Hardware Reference Manual	60458920
CYBER 180 Models 810 and 830 Computer Systems Hardware Operator's Guide	60469440
CYBER 180 Models 810 and 830 Computer Systems Hardware Reference Manual	60469420
CYBER 840A, 850A, 860A, and 870A Computer Systems Hardware Reference Manual	60463560
CYBER 960 Computer System CYBER 170 State Hardware Reference Manual	60000127
CYBER 5380-100 STORNET Subsystem (SNSS) Hardware Reference Extended Core Storage Reference Manual	60000188 60347100
Extended Core Storage II and Distributive Data Path Reference Manual	60430000
Extended Semiconductor Memory Hardware Reference Manual	60455990
Message Control System Version 1 Reference Manual	60480300
Network Access Method Version 1 Host Application Programming Reference Manual	60499500
Network Access Method Version 1 Network Definition Language Reference Manual	60480000
Network Access Method Version 1/Communications Control Program Version 3 Terminal Interfaces Reference Manual	60480600
NOS Online Maintenance Software Reference Manual	60454200
NOS Version 2 Administration Handbook	60459840
NOS Version 2 Analysis Handbook	60459300
NOS Version 2 Diagnostic Index	60459390
NOS Version 2 Installation Handbook	60459320



<b>Control Data Publication</b>	<b>Publication Number</b>
NOS Version 2 Operations Handbook	60459310
NOS Version 2 Reference Set, Volume 1 Introduction to Interactive Usage	60459660
NOS Version 2 Reference Set, Volume 2, Guide to System Usage	60459670
NOS Version 2 Reference Set, Volume 3, System Commands	60459680
NOS Version 2 Reference Set, Volume 4, Program Interface	60459690
NOS Version 2 Security Administrator's Handbook	60460410
NOS Version 2 System Overview	60459270
NOS Version 2 Systems Programmer's Instant	60459370
Remote Batch Facility Version 1 Reference Manual	60499600
SCOPE Version 2.1 Operator's Guide	60455090
TAF Version 1 Reference Manual	60459500
TOTAL-CDC Version 2 Reference Manual	76070300
537 Band Printer Operator's Guide	60000208
585 Band Printer Operator's Manual	60000181
5830 Disk Array Subsystem Configuration Guide	60000494
5830 Disk Array Subsystem Controller Reference	60000551
5830 Disk Array Subsystem Reference	60000552
7155 Disk Storage Subsystem Operator Maintenance Guide	60456650
7155 Disk Storage Subsystem Reference Manual	60455860
19003-3 System Console CC598B Hardware Operation/Maintenance Guide	60463610

---

Basic NOS Functions	1-1
Operator/System Communication	1-2
Operating the Keyboard	1-4
Screen Control	1-4
Choosing a Left, Right, or Dual Screen Display	1-4
Hidden Screens	1-8
Additional Capabilities of the CC598B and CC634B Consoles	1-8
Error Messages	1-9
DSD/DIS Commands	1-9
DSD Command Syntax	1-9
DSD Command Entry	1-10
Display Screen Paging	1-10
Special Characters	1-11
System Operation	1-12
Job Tracking	1-12
Job Entries in System Tables	1-15
Job Sequence Name (JSN)	1-15
Queued File Table (QFT)	1-15
Executing Job Table (EJT)	1-16
Preparing for Deadstart	1-16
Deadstart Classifications	1-16
Deadstart File	1-17
Deadstart Process	1-17
Setting the Deadstart Panel	1-17



## Basic NOS Functions

The Network Operating System (NOS) is a collection of computer programs that execute in a Control Data computer to assist and control the execution of user programs. A program with the series of commands that directs its execution is called a job. Both user and system programs execute as jobs.

You start NOS executing through a process called deadstart. While NOS is executing, you can monitor, track, and direct the flow of user jobs and jobs created by NOS for users. This is done by watching console displays presented by the system and entering commands to the system from the console keyboard.

NOS requires a minimal amount of interaction. NOS automatically controls the scheduling, allotting, and assigning of time, access, and system resources to jobs as they enter, execute, and leave the system. This control is exercised automatically using limits and priorities set during the installation procedure.

NOS operates in either secured or unsecured mode, depending on how your site installed it. On an unsecured system, NOS enforces access controls based on user ownership of data and allows the use of the full range of operator console functions.

On a secured system, NOS enforces an additional set of mandatory access controls based on security access levels and categories. Access level is a number from 0 to 7 set up by the installation. 0 corresponds to the lowest access level and 7 corresponds to the highest access level. Every file has a security level and category set that describe the security sensitivity of the data. Users are validated to some range of security access levels and set of access categories, and their jobs must execute within this range. There are further system-wide constraints on user jobs and files based on the security level limits on peripheral equipment, terminals, types of jobs, and the overall system range. Your site should provide guidelines on the use of security levels and categories and on the system-wide security constraints to be used. To prevent security violations through use of the console, operator console functions are restricted.

NOS provides five types of user job processing. Each type of processing provides a different means of entering a job into the system. The five types are:

Deferred batch processing	Jobs are entered from an interactive terminal or another batch job to the batch queue for processing. Their output is sent to user-specified peripheral equipment or remote batch locations.
Interactive terminal processing	Jobs are entered from, and output is sent to, an interactive terminal.
Local batch processing	Jobs are entered and processed at the central site using only the central site peripheral equipment attached to the computer.

Remote batch processing

Jobs are entered from remotely located terminals such as the CDC 200 User Terminals, CDC 731-12/732-12/734 Remote Batch Terminals, or CDC CYBER 18-05 Remote Batch Terminals. The jobs are processed at the central site and output is sent back to the remote terminal.

Remote host processing

Jobs are transferred back and forth between local and remote host mainframes. The hosts may be linked by either the loosely coupled network (LCN) or network processing units (NPU's).

## Operator/System Communication

NOS and jobs executing under NOS control communicate with you by displaying information on the system console screen. You respond by typing instructions on the console keyboard. NOS supports three types of consoles: the CC545 console, the CC598B console (also known as the PC console), and the CC634B console (also known as the 721 console). Figures 1-1, 1-2, and 1-3 illustrate the console keyboards.

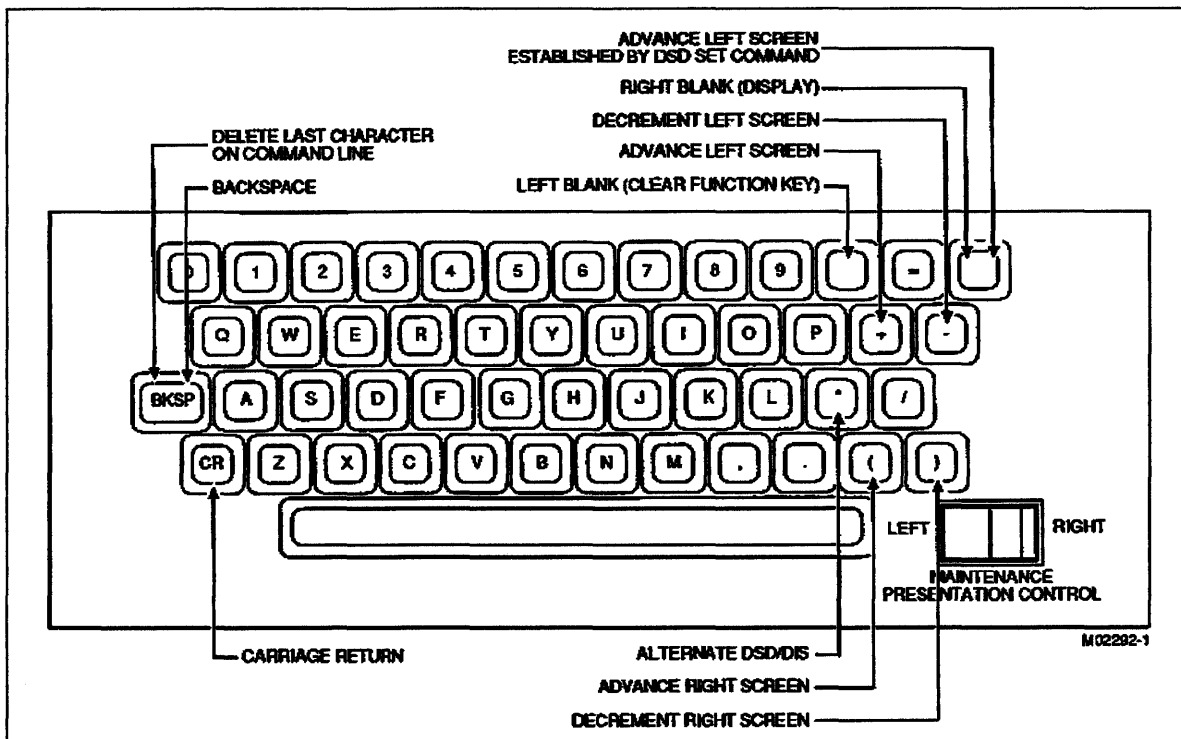

Figure 1-1. CC545 Console Keyboard

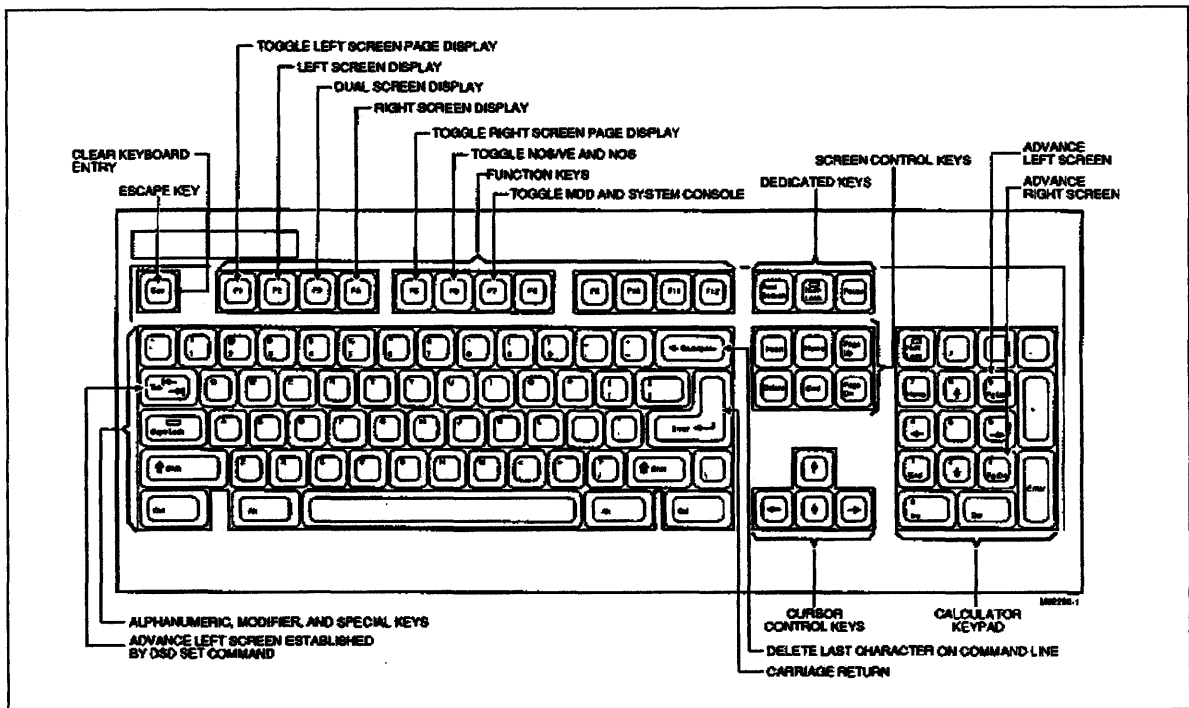

Figure 1-2. CC598B Console Keyboard



**Table 1-1. Left, Right, or Dual Screen Control Keys**

<b>Function</b>	<b>CC545</b>	<b>CC598B</b>	<b>CC634B</b>
Alternate display control between DSD and DIS.	*	*	F15 or *
Advance left screen display forward one page.	+	Down Arrow or + or Grey +	DOWN or +
Decrement left screen display back one page.	-	Up Arrow or - or Grey -	UP or -
Advance right screen display forward one page.	(	PgDn or (	FWD or (
Decrement right screen display back one page.	)	Pg Up or )	BKW or )
Process command.	CR	Enter	NEXT
Clear keyboard entry.	(left blank)	Esc	(left tab) or ERASE
Advance left screen display sequence set by DSD SET command.	(right blank)	Tab	(right tab)
Delete last character on command line.	BKSP	Back Space	(backspace)
Toggle top to bottom of page for left screen.	Not applicable	F1	F1
Select left screen display.	<sup>1</sup> PCS – left position	F2	F2
Select split screen display.	<sup>1</sup> PCS – middle position	F3	F3
Select right screen display.	<sup>1</sup> PCS – right position	F4	F4
Toggle top to bottom of page for right screen.	Not applicable	F5	F5
Toggle between NOS/VE and NOS operations.	Not applicable	F6	F6
Toggle between MDD and system console.	Not applicable	F7	F7
Present a menu of special keys.	Not applicable	Home	HELP

1. Presentation Control Switch.



**HELP SCREEN**

KEY	FUNCTION
F1	TOGGLES UPPER/LOWER LEFT SCREEN
F2	VIEW LEFT SCREEN ONLY
F3	VIEW LEFT AND RIGHT SCREENS
F4	VIEW RIGHT SCREEN ONLY
F5	TOGGLES UPPER/LOWER RIGHT SCREEN
DOWN	VIEW NEXT PAGE LEFT SCREEN
UP	VIEW PREVIOUS PAGE LEFT SCREEN
FWD	VIEW NEXT PAGE RIGHT SCREEN
BKW	VIEW PREVIOUS PAGE RIGHT SCREEN
→	ADVANCE DSD/DIS DISPLAY
F15	TOGGLE BETWEEN DSD - DIS
←	CLEAR INPUT LINE
CTRL I	REINSTALL CONTROLWARE

**CURRENT SCREEN STATUS**

LEFT  
UPPER

F1

LEFT

F2

DUAL  
YES

F3

RIGHT

F4

RIGHT  
UPPER

F5

PRESS ANY KEY TO EXIT HELP SCREEN

M02294

**Figure 1-4. CC634B Help Screen**

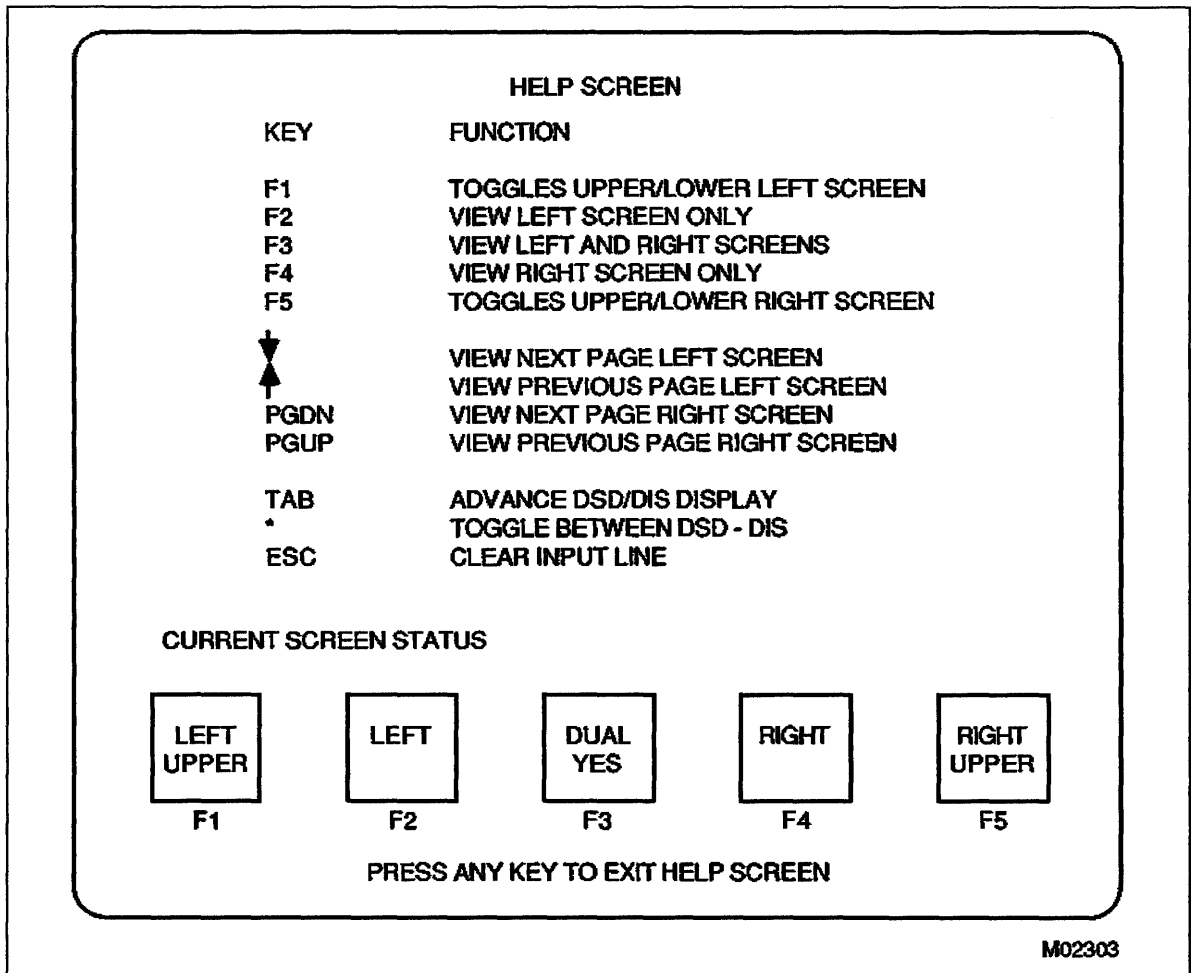

Figure 1-5. CC598B Help Screen

## **Hidden Screens**

The text of the displays is the same for all consoles. However, for long displays some portions of the page may not be visible on the CC598B and CC634B consoles. When a portion of the display is hidden, the message F1 FOR LOWER F1 FOR UPPER (left screen), or F5 FOR LOWER F5 FOR UPPER (right screen) is displayed on the appropriate display at the bottom of the screen. To view the hidden portion of the page, use function key F1 (for left display) or F5 (for right display).

## **Additional Capabilities of the CC598B and CC634B Consoles**

When NOS and NOS/VE are running simultaneously on the same machine in dual state and using the same console, pressing the F6 function key alternates the system displays from one operating system to the other. The CC598B and CC634B consoles can display screens on NOS or windows on NOS/VE, but not both simultaneously.

Pressing the F7 function key causes the system console driver (SCD) for either operating system (NOS or NOS/VE) to relinquish access to the port and allows either the monitor display driver (MDD) or remote diagnostic facility (RDF) to use the same port to access the console (if one or the other has been initiated to use the console port). If MDD or RDF does not acquire access to the port within two seconds, the SCD regains access to the port.

## Error Messages

After you enter a carriage return to indicate a command is complete, the command is processed and erased from the screen. If the system must wait for a resource to become available (such as a channel), or if the command is not acceptable, one of the following messages may appear above the command (refer to appendix A for a complete list of error messages).

INCORRECT ENTRY	Command not recognized. Correct or reenter command.
DISK BUSY	System waiting for program to be loaded from mass storage device before processing command.
PP BUSY	System waiting for peripheral processor (PP) to be assigned before processing command.
MTR BUSY	System waiting for PP monitor program to complete job before processing command.
COMMAND TOO LONG	Command has more than 60 characters.

If a message remains for more than a few seconds, clear the entry by pressing the clear function key or by repeatedly pressing the backspace key. Try the command again. If the message is preceded by LOG -, the command has been executed but not yet recorded in the system dayfile.

## DSD/DIS Commands

Two NOS programs, DSD and DIS, allow communication between you and the operating system. DSD and DIS maintain current displays of system and job status, and process commands you type at the keyboard. DSD is the system display program. It is the normal operating mode at the console. Information on the displays pertains to all jobs in the system. Under DSD, you can communicate with the system or any of the jobs under system control. Once a job begins execution, you can respond to job requests for equipment assignment (or other actions), modify system parameters, or stop execution permanently or temporarily. DIS is the job display program. It is used most often by site analysts. The DIS displays show data from a single job only. Refer to the NOS Version 2 Analysis Handbook for detailed procedures for using DIS.

## DSD Command Syntax

Each DSD keyboard entry is contained on a single line and ends with a period. Each command must be in all uppercase characters with no extra spaces. In most DSD commands, when there is more than one parameter, you must enter the parameters in the order shown. When a parameter is required, the DSD command is not acceptable to the system without the parameter. If you do not specify any values for the optional parameters, NOS supplies a value called a default.

Some DSD commands allow messages, parameters, or subcommands to appear after the period. For example, in K.CH=32,26 the DSD command is K. and the subcommand CH=32,26 appears after the period.

## **DSD Command Entry**

As you enter characters from the keyboard, DSD checks the accumulated entry for a match against the table of possible commands. When DSD receives enough characters to recognize the command, it automatically fills in the remaining portion of the command.

For example:

To request the system to display the error log dayfile on the left console screen, the appropriate DSD command is A,ERROR LOG. Begin by typing A. DSD checks this input but cannot recognize the command since other commands also begin with the letter A. Then enter the comma. Because other commands also begin with these characters, DSD still cannot recognize the command. However, when you enter E the command becomes unique and DSD fills in the remainder of the entry (RROR LOG.) on the display.

When you press the carriage return, the command is examined to see if it is valid. If the command is acceptable, the system processes the command and clears the keyboard entry. If the command is not acceptable, an error message appears above the entry. Enter either the clear function key to clear both the entry and the error message, or the backspace key to delete the last character displayed and the error message. Press the backspace key repeatedly to delete the entry to the position of the error and enter the correction.

## **Display Screen Paging**

Many DSD displays have more information to present than fits on one display screen. To display this information, DSD uses a concept called paging. Paging presents one screen of information and waits until you signal for more information.

When DSD presents a display with more information than fits on one screen, the first page is presented and the message

MORE

appears at the bottom of the screen.

The keyboard character used to advance to the next page (or reset to the previous or first page) depends on whether you called the display as a left screen display or a right screen display.

Refer to table 1-2 for further information on advancing screens.

## Special Characters

The keys listed in table 1-2 have special uses in DSD in addition to their uses within commands. This table provides a complete list of the special characters and the action they initiate.

**Table 1-2. Special Characters**

<b>Key Identifier CC545</b>	<b>Key Identifier CC598B</b>	<b>Key Identifier CC634B</b>	<b>Action Initiated</b>
*1	*1	□ <sup>1</sup>	Alternates display control between DSD and DIS each time the key is pressed.
+	Down Arrow or + or grey +	+	Advances the left screen display to the next screen of information when more than one screen of information is available. Reenables scrolling on the A display.
-	Up Arrow or - or grey -	-	Sets the left screen display back to the previous or first screen of information. Temporarily inhibits scrolling on the A display.
(	PgDn or (	FWD or (	Advances the right screen display as described for + (plus) character.
)	PgUp or )	BKW or )	Changes the right screen display as described for - (minus) character.
CR <sup>1</sup>	Enter/Return <sup>1</sup>	NEXT <sup>1</sup>	Initiates processing of a command. If carriage return is pressed before the entire command is entered, the message REPEAT ENTRY is displayed on the error message line of the left screen. The next command entered is processed but not erased. It is repeatedly processed each time carriage return is pressed. To exit the repeat entry mode, press the clear function key.
Left blank	Esc <sup>1</sup>	(back arrow) or ERASE	Clears current keyboard entry and any error messages.

1. If you enter additional characters after this key is entered but before input is completely processed, some of the additional characters may be lost.

*(Continued on next page)*

**Table 1-2. Special Characters**

<b>Key Identifier</b> CC545	<b>Key Identifier</b> CC598B	<b>Key Identifier</b> CC634B	<b>Action Initiated</b>
<i>(Continued from previous page)</i>			
Right blank <sup>1</sup>	Tab	(forward arrow) <sup>1</sup>	Advances the left screen display sequence established by the DSD SET command (refer to chapter 4).
BKSP	Back Space	(back arrow)	Deletes last character and clears any error message.
/	/	/	Advances the left screen display by the value specified for the C, D, F, G, or M display. Displays alternate data fields on the left screen for the B,A and H displays.
=	=	=	Advances the right screen display by the value specified for the C, D, F, G, or M display. Displays alternate data fields on the right screen for the B,A and H displays.

1. If you enter additional characters after this key is entered but before input is completely processed, some of the additional characters may be lost.

## System Operation

The NOS Version 2 operating system allows you to track a job wherever the job is in the system. NOS does this tracking using a unique identifier, two tables, and several DSD displays. The unique identifier is called a job sequence name (JSN). The tables used are the queued file table (QFT) and the executing job table (EJT). The DSD displays used are the job status, rollout, and active job queues displays.

### Job Tracking

Figures 1-6 through 1-9 show how you can track a local batch job as it moves through the system. Information in the displays relevant to the example is shown in bold type.

When a job starts executing, the system recognizes the job as a new job, assigns a JSN, and creates an entry in the QFT for the job. Its name is placed in a list that contains all jobs waiting to be processed, called the input queue. During the time the job is in the input queue, you can track it by looking at the Q,IN. display. Figure 1-6 shows how the job (named AADF) appears in the Q,IN. display.

Q, IN.		QUEUE STATUS.								
JSN	SC	QP	QT	FSI	LID	DS	ID	FC	EC	LEVEL
AAAE	S	7776	IN	2	MQE	BC				LVL0
AAAZ	S	7415	IN	1	MOG	BC		LF	A9	LVL0
<b>AADF</b>	<b>S</b>	<b>7343</b>	<b>IN</b>	<b>1</b>	<b>M42</b>	<b>BC</b>				<b>LVL0</b>

**Figure 1-6. Input Queue Display (Q,IN.)**

The job remains in the input queue until the system schedules it to central memory. As the job is moved to central memory, the system moves information and the JSN from the QFT to an entry in the EJT. The QFT entry is then cleared. When the job is scheduled to central memory, it is assigned to a control point. A control point is an area in central memory where the system maintains all the information needed to control a job during execution. The number of control points determines the number of jobs that can be in central memory at any moment. You can specify the number of control points allowed in your system when the system is deadstarted.

During the time the job is scheduled to central memory, you can track it by looking at the B,O display. Figure 1-7 shows how the job appears on the B,O display.

B,O. SYSTEM STATUS		
CP	JSN	STATUS
1	IAF	NETWORK CONNECTED.
2	AAAU	ROUTE COMPLETE. JSN IS AAUV
3		
4		
5	AAAR	CMU SMM V4.0-0.
6	AAAQ	MRG SMM V4.0-0.
7	AAAP	FS8 SMM V4.0-0.
10	AAAP	CU8 SMM V4.0-0.
11	AAAN	CT8 SMM V4.0-0.
<b>12</b>	<b>AADF</b>	<b>EDITING COMPLETE.</b>
13		
14	AABQ	ASSEMBLING TAF.
15	MAG	RECOVERY COMPLETE.
16	BIO	IDLE.
17		
20		
21		
22		
23		
24		

**Figure 1-7. System Status Display (B,O.)**



Periodically, as the job uses up its allotted time in central memory, the job is placed in a rolled out state. Normally, in this rolled out state the job is waiting its turn to be rescheduled back to central memory. During the time the job is rolled, you can track it by looking at the R display. Figure 1-8 shows how the job appears on the R display.

R. ROLLOUT STATUS.									
JSN	SC	EJT	ST LR	SCPR	FL	FLE	ACCESS LIMITS		
AAAY	S	6	EX				LVL0	LVL7	
AAAH	M	11	EX				LVL0	LVL7	
<b>AAAF</b>	<b>M</b>	<b>12</b>	<b>RO*</b>	<b>7</b>	<b>204</b>	<b>0</b>	<b>LVL0</b>	<b>LVL7</b>	
AADE	M	13	EX				LVL0	LVL7	

**Figure 1-8. Rollout Status Display (R)**

The process of central memory assignment and rollout continues until the job runs out of commands to process or the job is dropped. At this time the EJT entry is cleared, file OUTPUT (with a new JSN) is sent to the line printer queue, and the job is terminated. Figure 1-9 shows how file OUTPUT appears on the print queue display (Q,PR.).

Q, PR.										
JSN	SC	QP	QT	FSI	LID	DS	ID	FC	EC	LEVEL
AABX	T	212	PR	0	MQE	BC	2		A9	LVLO
AACG	T	172	PR	2	MQG	BC	3			
<b>AAAF</b>	<b>T</b>	<b>100</b>	<b>PR</b>	<b>1</b>	<b>M42</b>	<b>BC</b>	<b>4</b>	<b>AC</b>		

**Figure 1-9. Print Queue Display (Q,PR.)**

During the time the job is executing, or when it terminates, the job can create files. These files can be placed in various queues for printing on a line printer, punching on a card punch, or plotting on a plotter. As each file is placed in a queue, the queued file is assigned a new JSN and an entry is made for it in the QFT. These queued files created by the job can be tracked on the various active job queues displays.

There is no easy way to determine which new JSNs were created by the original job. As far as the system is concerned, each new QFT entry is a separate job. Refer to the NOS Version 2 Analysis Handbook for information on tracking new JSNs using the QFTLIST utility.

The QFT entries for files queued by your job remain until the appropriate subsystem selects them for processing. When the subsystem completes the processing of these files, the QFT entries are removed and your job and all jobs created by it are now gone from the system.

The previous example is for a local batch job. Jobs that enter the system by another method may or may not appear on the above displays. Every job, however, follows the same basic path through the system.

## Job Entries in System Tables

To better understand how the tracking works, a closer look at the job sequence name, the queued file table, and the executing job table is needed.

### Job Sequence Name (JSN)

The JSN is a three- or four-character identifier that allows you and the system to track the job as it is processed through the system.

Every job and every queued file has a JSN. The three-character JSNs are fixed in value and reserved for subsystems. The following list gives all of the defined three-character JSNs and the subsystems they designate.

JSN	Subsystem
BIO	Batch Input/Output
CDC	CYBER Database Control System (CDCS)
IAF	Interactive Facility
MAG	Magnetic Tape Subsystem
MAP	Matrix Array Processor
MCS	Message Control System
MSE	Mass Storage Extended Subsystem
NAM	Network Access Method
NVE	NOS/VE Subsystem
PLA	PLATO-NAM Interface Subsystem
RBF	Remote Batch Facility
RDF	Remote Diagnostic Facility
RHF	Remote Host Facility
SMF	Screen Management Facility
SSF	SCOPE 2 Station Facility
SYS	Operating system (CPUMTR)
TAF	Transaction Facility

The four-character JSNs are assigned sequentially by the system. Every time an operating system deadstart is performed, the JSN is set to AAAA. The first job is assigned this JSN, the second job is assigned AAAB, and so on to ZZZZ. The next JSN after ZZZZ is AAAA and the sequence repeats. There are 456976 possible names for jobs and queued files before a JSN repeats.

### Queued File Table (QFT)

The QFT is a table with an entry for every job in one of the following queues.

Queue	Description
Input	List of jobs waiting to start execution.
Plot	List of files waiting to be plotted on a line plotter.
Print	List of files waiting to be printed on a line printer.
Punch	List of files waiting to be punched on a card punch.
Wait	List of files waiting for user action.

Each entry contains system information needed to identify, locate, and provide characteristics about the job. All entries in the QFT are displayed on the Q, display (refer to chapter 4 for more information on this display).

## Executing Job Table (EJT)

The EJT is a table with an entry for every job that is in central memory or is rolled out (waiting for scheduling to central memory). Each entry contains system information needed to identify, locate, and provide characteristics about the job. This information comes from the QFT as the job first comes to central memory. A job remains in the EJT as long as it is scheduled to central memory or is rolled out. All jobs in the EJT are shown in the R display.

## Preparing for Deadstart

Deadstart is the process that makes the system (the mainframe, peripheral devices, and operating system software) ready to process jobs. Most of this process is automatic and does not require operator action. Most of your involvement is in preparing the system for deadstart. To do this, you must know your deadstart classification and how to start the deadstart process.

## Deadstart Classifications

There are several deadstart classifications. The most comprehensive are coldstart and warmstart. More limited deadstarts are the initial and recovery deadstarts. Deadstarts can also be classified by levels.

- Coldstart is the procedure used to deadstart the system when the tape and disk controllers do not have microcode loaded, or when you want to reload the microcode. Coldstarts are relatively infrequent. The CYBER Initialization Package (CIP) User's Handbook describes the coldstart procedures.
- Warmstart is the most common way to deadstart. A warmstart assumes the tape and disk controller controlware is loaded and executing correctly. All further discussion of deadstarting in this manual assumes a warmstart.
- Initial deadstarts recover only preserved files (permanent files, queued files, and the system dayfiles). They are usually performed periodically (such as every day, week, or month), or when the system halts because of an error condition and cannot correctly complete a recovery deadstart. An initial deadstart tests all of central memory (except on the CYBER 180-class mainframes), PP memory, and initializes hardware. This destroys all information stored in the system and requires that the operating system be reloaded.
- Recovery deadstarts recover preserved files and some portion of a previous operating environment. They are usually done when you bring the system back after some planned interruption or when the system halted due to an error condition without destroying the contents of central memory. Always attempt a recovery deadstart first when the system halts due to an error condition. Only when a recovery deadstart fails is an initial deadstart required.
- The most restrictive way to describe a deadstart is by its level. There are four levels of deadstart, numbered 0 through 3. Level 0 deadstarts are initial deadstarts. Levels 1, 2, and 3 are recovery deadstarts.

Levels 1 and 2 recovery deadstarts must be used with caution. They are usually for bringing back the system after maintenance or after a non-NOS operating system has been running in the mainframe. Attempt a level 1 or 2 deadstart only at the direction of an analyst. Do not attempt a level 1 or 2 deadstart to recover the system if a level 3 deadstart fails.

Unless otherwise noted, the terms initial deadstart and level 0 deadstart are identical. Similarly, the terms recovery deadstart and level 3 deadstart are identical.

## Deadstart File

Your site takes materials provided by Control Data and installs (builds) a deadstart file. The deadstart file contains the programs that make up the operating system and its products (COBOL, FORTRAN, COMPASS, and so forth). The deadstart file is a compiled and linked set of binary programs ready to be loaded into central memory. It can be either on a reel of magnetic tape or on a disk pack. The deadstart process loads the deadstart file.

## Deadstart Process

Deadstart is a two part process:

1. Prepare the equipment. This includes verifying that power is on in all the peripheral devices, mounting the deadstart file if it is on tape or a removable disk pack, and setting the deadstart panel program.
2. Initiate deadstart. This includes signaling the computer to begin execution of the deadstart panel, monitoring the deadstart, and intervening with any additional information requested by the system.

## Setting the Deadstart Panel

Each mainframe has a panel of switches arranged to represent bits in successive PP memory words. (Models 810, 815, 825, 830, 840A, 850A, 860A, 960, 990A, 994, and 995A do not have a physical panel but do have a logical equivalent in the initial display presented on the system console screen.)

Figure 1-10 shows the deadstart panel for models 835, 840, 845, 850, 855, 860, 870, 990, and 995.

Figure 1-11 shows the deadstart display for models 815 and 825.

Figure 1-12 shows the deadstart options display for models 810, 830, 840A, 850A, 860A, 960, 990A, 994, and 995A.

Figure 1-13 shows the initial deadstart display for models 960 and 994 when using the CC598B console.

Figure 1-14 shows the deadstart panel for CYBER 170 Computer Systems (except CYBER 180-class mainframes).

Figure 1-15 shows the deadstart panel for CYBER 70 and 6000 Computer Systems.

Each row of switches represents a 12-bit PP instruction. By setting these switches in a particular pattern you create the instructions necessary to deadstart. Each time you signal the system to begin deadstart, these instructions are copied into PP memory and executed.

These instructions load the first (bootstrap) program on the deadstart file. The bootstrap program loads the next program on the deadstart file, and so on until the entire operating system is loaded.

Control Data or someone at your site should supply you with the deadstart panel setting for your system. You must verify that the panel is set correctly before signaling deadstart to begin. The CIP User's Handbook describes the various deadstart panel settings.

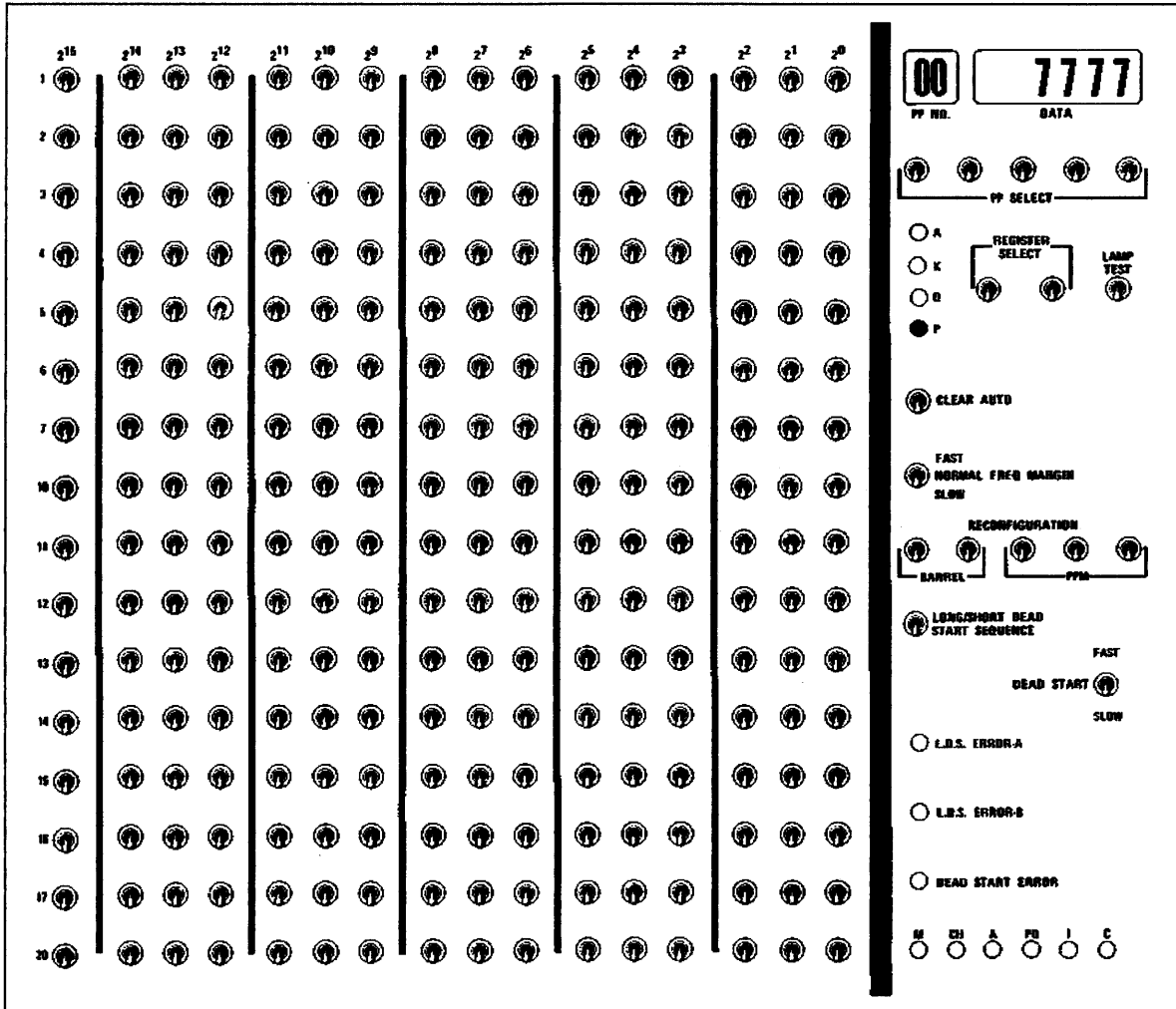

Figure 1-10. Deadstart Panel for Models 835, 840, 845, 850, 855, 860, 870, 990, and 995

DEADSTART - (REV 03)	
	PROGRAM 0
XX YYYYYY-CHANGE DS PRG	01 001402
XX+YYYYYY-CHANGE DS PRG INC	02 007303
S-SHORT DS	03 000017
L-LONG DS	04 007503
H-HELP	05 007703
	06 000301
	07 007403
PPM CONF = 00	10 007103
BRL CONF = 0	11 007301
DLY LOOP = 0	12 000710
LDS ADDR = 6000	13 000376
CLK FREQ = NORMAL	14 000000
	15 000000
	16 000000
	17 000000
	20 007112

**Figure 1-11. Initial Deadstart Display for Models 815 and 825**

The following screen entries in figure 1-11 are defined:

Program 0

The number of the most recently used deadstart program. The program contents are those most recently used to deadstart.

H-HELP

For an explanation of these entries, refer to the hardware operator's guides for models 815 and 825.

LDS.ADDR = 6000

CLK FREQ = NORMAL

PPM CONF = 00

Define PP configuration. Refer to the NOS Version 2 Analysis Handbook for information about reconfiguring PPs.

BRL CONF = 0

DLY LOOP = 0

```
DEADSTART OPTIONS

S - SYSTEM LOAD OPTIONS
M - MAINTENANCE OPTIONS

(CR) - SYSTEM LOAD OPTIONS

PROGRAM n SELECTED
```

**Figure 1-12. Deadstart Options Display for Models 810, 830, 840A, 850A, 860A, 960, 990A, 994, and 995A**

```
CONSOLE MAIN MENU

S - SYSTEM LOAD OPTIONS
M - MAINTENANCE OPTIONS
C - CONSOLE UTILITIES

(CR) - SYSTEM LOAD OPTIONS
PROGRAM 0 SELECTED

CONSOLE SOFTWARE
CC598B Level xxx
```

**Figure 1-13. CC598B Console Initial Deadstart Display for Models 960 and 994**

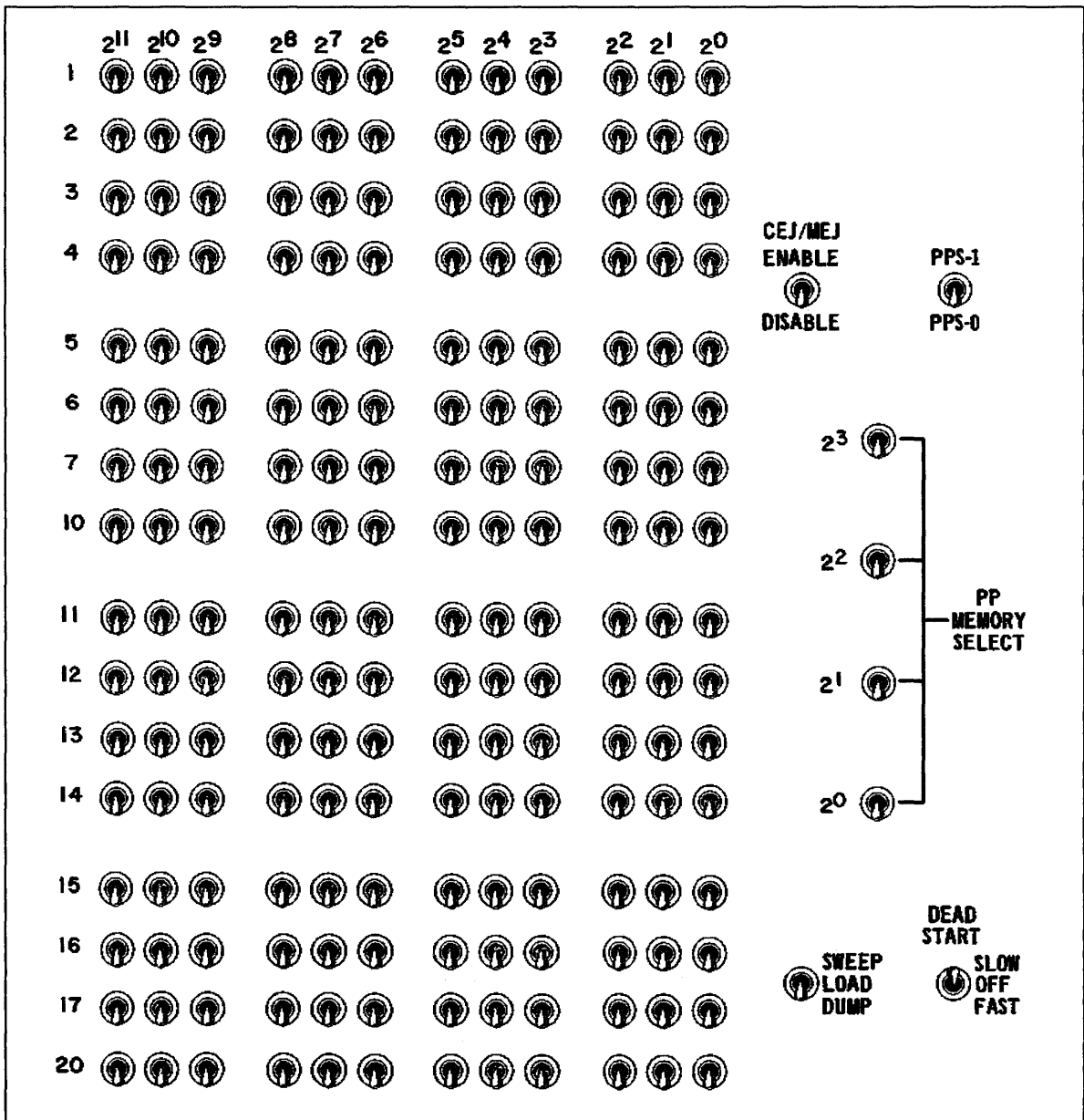

**Figure 1-14. Deadstart Panel for CYBER 170 Computer Systems (Except CYBER 180-Class Mainframes)**



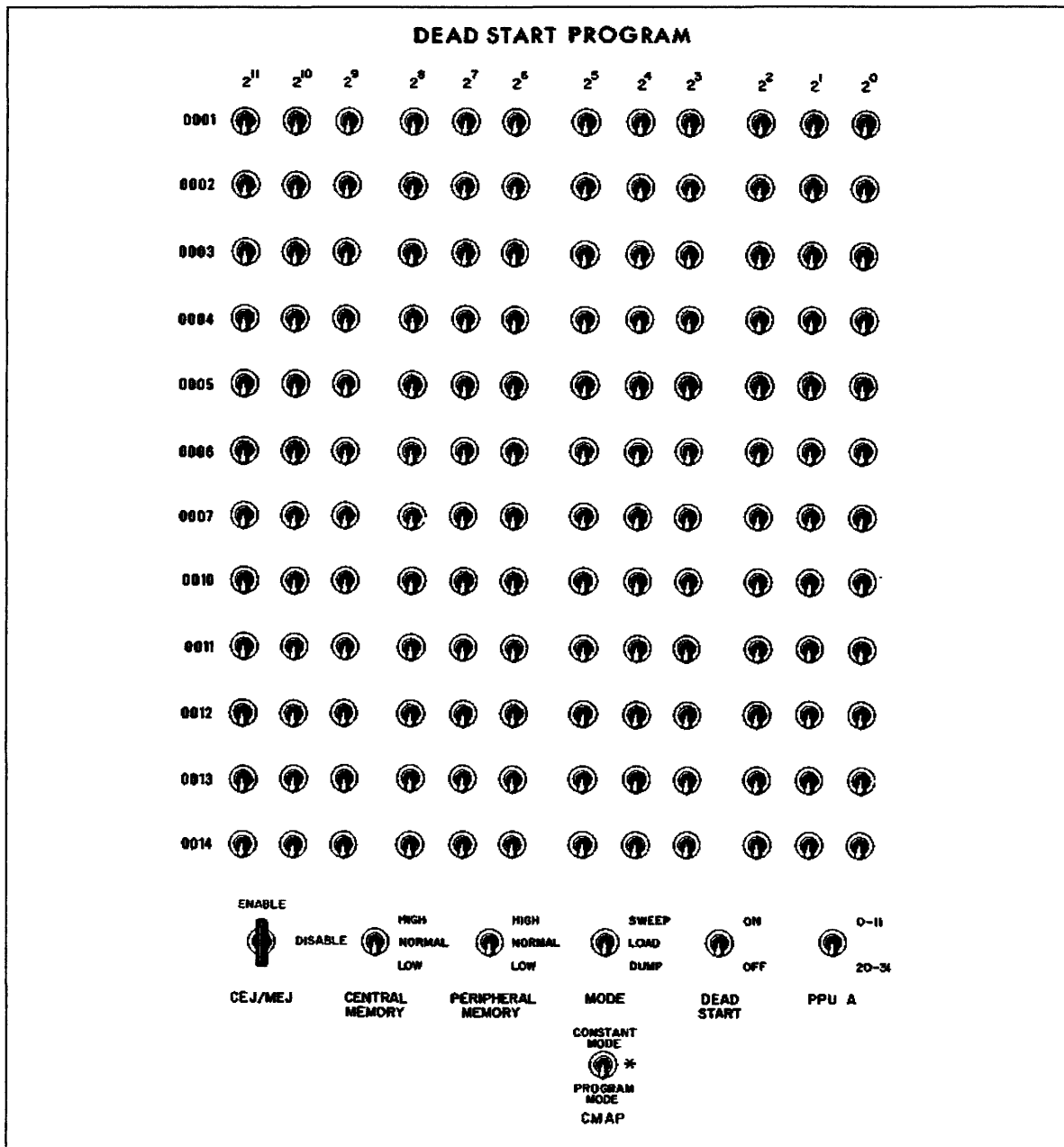

Figure 1-15. Deadstart Panel for CYBER 70 and 6000 Computer Systems

If you have verified that the deadstart panel settings are as documented, but have reason to think the settings are wrong, get advice from a knowledgeable person at your site or at Control Data before initiating the deadstart.

**NOTE**

---

On models 835, 840, 845, 850, 855, 860, 870, 990, and 995, the four leftmost switches in each row must be down. If any of these switches are up, the system will not operate properly.

On models 810, 815, 825, 830, 840A, 850A, 860A, 960, 990A, 994, and 995A, the first two digits in each row in the deadstart program must be zero. (Zero corresponds to the down position for the switches.)

---

You are now ready to initiate the deadstart, as described in chapter 2, next.



---

Warmstart Procedure Summary . . . . .	2-1
Setting the Deadstart Program for a Warmstart . . . . .	2-4
Setting Word 12 (CYBER 180-Class Mainframes) . . . . .	2-8
Setting Word 13 . . . . .	2-9
Selecting the Deadstart Level . . . . .	2-9
Selecting the Deadstart Parameters . . . . .	2-11
Selecting the CMRDECK . . . . .	2-12
Warmstart Procedure for Models Without a Deadstart Panel . . . . .	2-12
Initiating the Deadstart Process . . . . .	2-16
Initial Options Display . . . . .	2-17
Modifying the Deadstart Decks . . . . .	2-19
Modifying the CMRDECK . . . . .	2-20
Modifying the EQPDECK . . . . .	2-21
Modifying the APRDECK . . . . .	2-22
Modifying the IPRDECK . . . . .	2-23
System Loading and Initiating . . . . .	2-24
Mass Storage Label Validation . . . . .	2-24
Deadstart File Load/Recovery . . . . .	2-25
Entering the Date and Time . . . . .	2-26
Initiating Job Processing . . . . .	2-27
Preparing for System Restart . . . . .	2-28
Level 3 Recovery Deadstart . . . . .	2-28
Level 2 Recovery Deadstart . . . . .	2-31
Level 1 Recovery Deadstart . . . . .	2-31
Level 0 Initial Deadstart . . . . .	2-31
Deadstart Error Troubleshooting . . . . .	2-32



Deadstart is the process that makes the system operational. (Detailed information on all phases of the deadstart process is available in the CYBER Initialization Package (CIP) User's Handbook.) This manual assumes that a deadstart file exists and meets site configuration requirements. The deadstart file is on a reel of magnetic tape or a disk pack and contains the programs necessary to establish the operating system and its products (BASIC, FORTRAN, COMPASS, and so forth).

In general, the procedure most often used to deadstart is warmstart (described in the following sections). If warmstart is not used, the deadstart procedure is as follows.

After you complete the preparations described in chapter 1, you signal the system to initiate the deadstart:

On the CC545 console, press the deadstart button only once.

On the CC598B console, press the CTRL and F2 keys simultaneously only once.

On the CC634B console, enter the following sequence only once:

1. Press the CTRL and G keys simultaneously.
2. When the message

\*OPERATOR ACCESS ENABLED\*

appears on the screen, press the CTRL and R keys simultaneously.

This executes the PP program set on the deadstart panel.

## NOTE

---

The CC634B also has an optional deadstart button.

---

## CAUTION

---

Press the deadstart button only once on the CC545 console, or use the deadstart sequence only once on the CC598B or CC634B console. This sends one deadstart pulse at a time. This is important because multiple rapid deadstart signals can cause problems with certain tape and disk controllers.

---

For models 815 and 825, initiating the deadstart process brings the initial deadstart display to the console screen. For models 810, 830, 840A, 850A, 860A, 960, 990A, 994, and 995A, initiating the deadstart process brings the deadstart options display to the console screen. The deadstart program is then entered or retrieved.

## Warmstart Procedure Summary

Figure 2-1 illustrates the warmstart procedure. Warmstart from a disk unit or a CDC 639/667/669/698 Magnetic Tape Unit is possible after the disk controller or tape controller to be used is loaded with the proper functioning controlware. Warmstart is always possible from CDC 677/679 Magnetic Tape Units.

The following steps outline the procedures necessary to perform warmstart from a 66x/67x magnetic tape unit, an 834 disk unit, an 836 disk unit, an 844 disk unit, an 885-11/12 disk unit, or an 895 disk unit. Use this as a checklist during warmstart.

1. Ensure that required disk units are available and that they have packs mounted.
2. Mount the deadstart tape or pack (refer to appendix D if necessary).
3. If you are deadstarting a model without a deadstart panel, bring up the deadstart program display by entering the deadstart sequence and (except for models 815 and 825) entering M.
4. Set the deadstart panel for warmstart (refer to Setting the Deadstart Panel for a Warmstart in this chapter).
5. Initiate the deadstart process. If you are deadstarting a model without a deadstart panel, enter S followed by a carriage return; for other models, press the deadstart button. If you deadstart from a spun down 834 or 836 disk unit, a blank screen appears for about 30 seconds on a CC545 console before the next display appears. If you deadstart from a spun down 834 or 836 disk using a CC634B console, the message

SYSTEM INITIALIZATION IN PROGRESS

is displayed before the first CIP display appears.

6. Select the correct CIP options.
  - a. Select the correct deadstart level.
  - b. Select the correct CMRDECK.
7. Modify the deadstart decks if necessary. Help screens appear to aid you in the modifications. Refer to Modifying the Deadstart Decks later in this chapter for more information.
  - a. Modify the CMRDECK (if required and the correct bit is set on the deadstart panel). If there are no modifications to the EQPDECK, THE APRDECK, or the IPRDECK, type GO.
  - b. If EQPDECK changes are required, type NEXT. After modifying the EQPDECK and if there are no modifications to the APRDECK or the IPRDECK, type GO.
  - c. If APRDECK changes are required, type NEXT as many times as needed to locate the desired APRDECK. After modifying the APRDECK, type GO if there are no modifications to the IPRDECK.
  - d. If IPRDECK changes are required, type IPR. to proceed to the beginning of the IPRDECK. After modifying the IPRDECK, type GO to continue with the deadstart.
8. Enter the date and time, if the system does not display the current date and time automatically (refer to Entering the Date and Time in this chapter.)
9. Wait for file recovery and library directory generation to complete.
10. Initiate job processing (refer to Initiating Job Processing) by typing AUTO, MAINTENANCE, or SCHEDULE if job processing was not initiated automatically during IPRDECK processing.

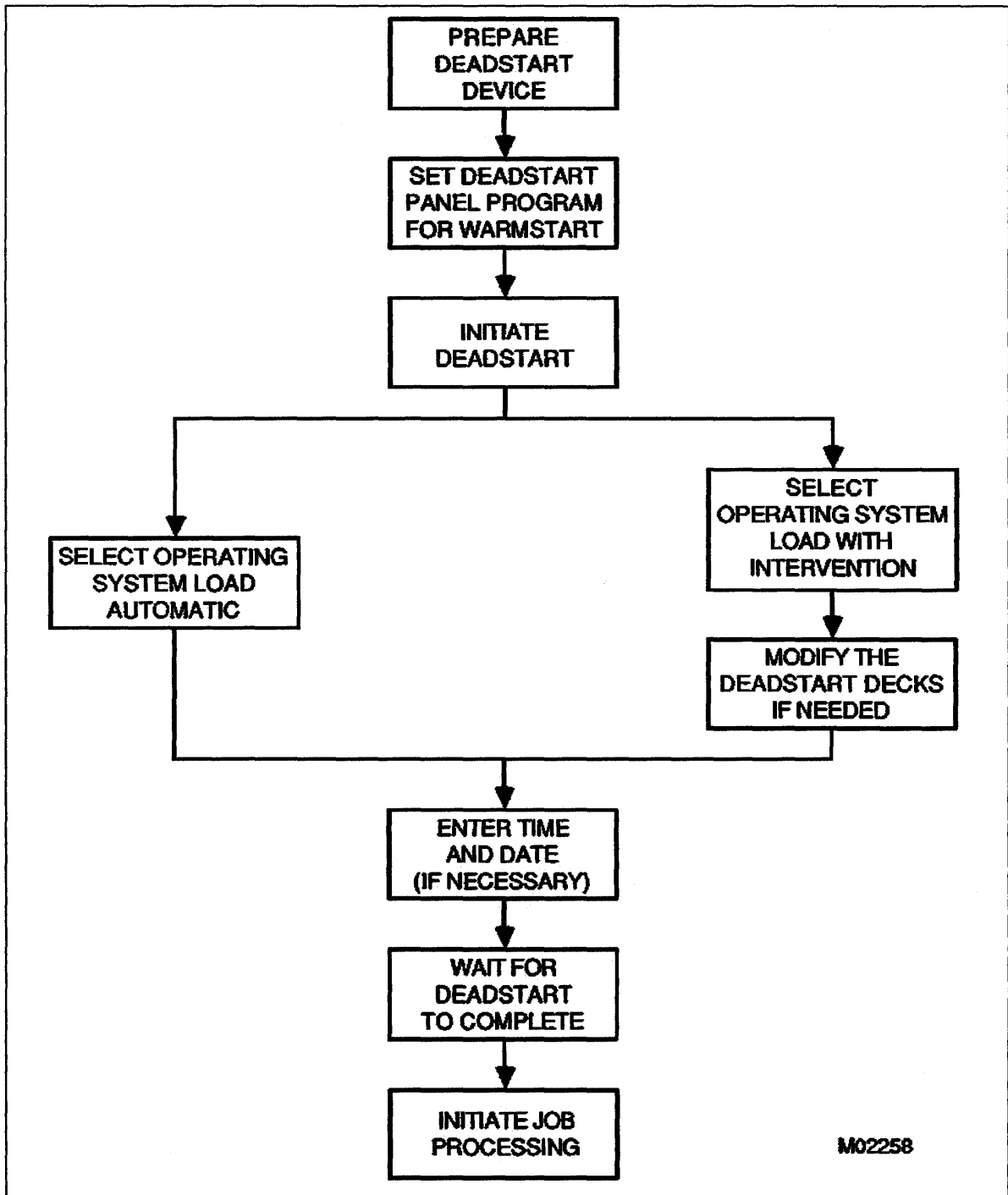

Figure 2-1. Typical Warmstart Sequence



## Setting the Deadstart Program for a Warmstart

The deadstart device (where the deadstart file resides), its associated controller, and the channel used to access this equipment are identified by setting the switches shown in the bold area of the deadstart programs shown in tables 2-1, 2-2, and 2-3.

There are two types of warmstart program settings: one for a deadstart device connected to a channel with a PP and the other for a deadstart device connected to a channel without a PP.

Each switch on the deadstart panel represents a binary number in the program (1 means the switch is set in the up position, 0 means the switch is set in the down position). Three switches grouped together form an octal digit (a number from 0 through 7). Four octal digits form a numeric code for a PP instruction to the computer. You set instructions on the deadstart panel by setting a row of switches that corresponds to that instruction.

For CYBER 180-class machines, you must set the four leftmost bit positions for each row to 0 (down). They are not shown in tables 2-1 and 2-3.

Refer to Setting Word 13 in this chapter for detailed information on word 12 (for CYBER 70 and 6000 Computer Systems) and word 13 parameters.

Someone from your site or Control Data will provide the actual settings for each row of switches on the deadstart panel. The following descriptions of the panel settings are provided only for information and to allow you to check the deadstart panel settings if you have deadstart problems.

**Table 2-1. CYBER 170 and CYBER 180 Computer Systems Program Settings for Warmstart from Channel with a PP**

Word	Binary				Octal
1	001	100	000	010	1402
2	111	011	0tt	ttt	73tt
3	000	000	001	111	0017
4	111	101	1tt	ttt	75tt
5	111	111	0tt	ttt	77tt
6	eee	ddd	ddd	ddd	eddd <sup>1</sup>
7	111	100	0tt	ttt	74tt
10	111	001	0tt	ttt	71tt
11	111	011	000	001	7301
12	000	000	000	000	0000
13	rrr	ppp	xxx	xxx	rp <sup>xx</sup> <sup>2</sup>
14	000	000	000	000	0000
15	000	000	000	000	0000
16	000	000	000	000	0000
17	000	000	000	000	0000
20	111	001	001	010	7112

1. eddd for tape deadstart; dddd for disk deadstart.

2. The instructions for setting the bits represented by these parameters are given in Setting Word 13.

**Table 2-2. CYBER 70 and 6000 Computer Systems Panel Settings for Warmstart from Channel with a PP**

Word	Binary				Octal
1	001	100	000	010	1402
2	111	011	0tt	ttt	73tt
3	000	000	001	011	0013
4	111	101	1tt	ttt	75tt
5	111	111	0tt	ttt	77tt
6	eee	ddd	ddd	ddd	eddd <sup>1</sup>
7	111	100	0tt	ttt	74tt
10	111	001	0tt	ttt	71tt
11	111	011	000	001	7301
12	rrr	ppp	xxx	xxx	rp <sup>xx</sup> <sup>2</sup>
13	000	000	000	000	0000
14	111	001	001	010	7112

1. eddd for tape deadstart; dddd for disk deadstart.

2. The instructions for setting the bits represented by these parameters are given in Setting Word 13.

**Table 2-3. Panel Settings for Warmstart from Channel with No PP**

<b>Word</b>	<b>Binary</b>				<b>Octal</b>
1	000	000	000	000	0000
2	000	000	000	000	0000 <sup>1</sup>
3	000	000	000	000	0000 <sup>1</sup>
4	111	101	1tt	ttt	75tt <sup>1</sup>
5	111	111	0tt	ttt	77tt
6	eee	ddd	ddd	ddd	eddd <sup>2</sup>
7	111	100	0tt	ttt	74tt
10	111	001	0tt	ttt	71tt
11	111	011	000	001	7301
12	000	000	000	000	0000
13	rrr	ppp	xxx	xxx	rpxx <sup>3</sup>
14	000	000	000	000	0000

1. If a 6681 data channel converter is the first equipment on the channel, or if it precedes the deadstart device controller, words 2, 3, and 4 must be set as shown below.

2. eddd for tape deadstart; dddd for disk deadstart.

3. The instructions for setting the bits represented by these parameters are given in Setting Word 13.

Set words 2, 3, and 4 (referred to in table 2-3) as follows:

<b>Word</b>	<b>Binary</b>				<b>Octal</b>
2	111	101	1tt	ttt	75tt
3	111	111	0tt	ttt	77tt
4	010	001	000	000	2100

Descriptions of the deadstart panel parameters follow.

<b>Notation</b>	<b>Description</b>																				
tt ttt	Channel number used to access the deadstart equipment.																				
eee	Controller number to which the deadstart tape unit is connected.																				
ddd ddd ddd	Tape deadstart function. Depends on device type as follows: <table border="0" style="margin-left: 2em;"> <tr> <td>001</td> <td>01u</td> <td>uuu</td> <td>639 tape units.</td> </tr> <tr> <td>010</td> <td>11u</td> <td>uuu</td> <td>66x tape units.</td> </tr> <tr> <td>001</td> <td>01u</td> <td>uuu</td> <td>677 tape units at 800 cpi, 679 tape units or 698 tape units.</td> </tr> <tr> <td>011</td> <td>01u</td> <td>uuu</td> <td>677 tape units at 556 cpi.</td> </tr> </table>	001	01u	uuu	639 tape units.	010	11u	uuu	66x tape units.	001	01u	uuu	677 tape units at 800 cpi, 679 tape units or 698 tape units.	011	01u	uuu	677 tape units at 556 cpi.				
001	01u	uuu	639 tape units.																		
010	11u	uuu	66x tape units.																		
001	01u	uuu	677 tape units at 800 cpi, 679 tape units or 698 tape units.																		
011	01u	uuu	677 tape units at 556 cpi.																		
ddd ddd ddd ddd	Disk deadstart function. Depends on the device type as follows: <table border="0" style="margin-left: 2em;"> <tr> <td>000</td> <td>011</td> <td>uuu</td> <td>uuu</td> <td>844, 885-11/12, or 895 disk units.</td> </tr> <tr> <td>000</td> <td>011</td> <td>ccc</td> <td>uuu</td> <td>834 or 836 disk units. Control module self-checking diagnostics are executed. The initial options display usually appears in 15 to 50 seconds.</td> </tr> <tr> <td>000</td> <td>101</td> <td>ccc</td> <td>uuu</td> <td>834 or 836 disk units. Control module self-checking diagnostics are not executed. The initial options display usually appears in 0 to 20 seconds.</td> </tr> <tr> <td>011</td> <td>011</td> <td>uuu</td> <td>uuu</td> <td>895 disk units.</td> </tr> </table> <p style="margin-left: 2em;">u uuu, uuu uuu, or uuu represents the physical unit number of the device on which the deadstart tape or disk pack is mounted. ccc represents the physical control module equipment number of the control module connected to the deadstart disk.</p>	000	011	uuu	uuu	844, 885-11/12, or 895 disk units.	000	011	ccc	uuu	834 or 836 disk units. Control module self-checking diagnostics are executed. The initial options display usually appears in 15 to 50 seconds.	000	101	ccc	uuu	834 or 836 disk units. Control module self-checking diagnostics are not executed. The initial options display usually appears in 0 to 20 seconds.	011	011	uuu	uuu	895 disk units.
000	011	uuu	uuu	844, 885-11/12, or 895 disk units.																	
000	011	ccc	uuu	834 or 836 disk units. Control module self-checking diagnostics are executed. The initial options display usually appears in 15 to 50 seconds.																	
000	101	ccc	uuu	834 or 836 disk units. Control module self-checking diagnostics are not executed. The initial options display usually appears in 0 to 20 seconds.																	
011	011	uuu	uuu	895 disk units.																	
rrr	Deadstart level.																				
ppp	Deadstart parameters.																				
xxx xxx	CMRDECK number.																				

## Setting Word 12 (CYBER 180-Class Mainframes)

For CYBER 180-class mainframes, two unique fields exist in word 12 of the deadstart program. They allow you to enter the model type that hardware initialization and verification sequence and maintenance software library (HIVS/MSL) 15x uses and to select extended deadstart testing. The switches that represent these fields are shown in the following illustration. For machines that do not have a deadstart panel (see chapter 1, Introduction), the values are entered from the console as octal numbers.



sss Specifies the model type as follows:

<b>Model Type</b>	<b>Mainframe</b>
001	810, 815, 825, or 830
010	835
011	840, 845, 850, 855, 860, 870, 990, or 995

You must set these bits correctly for HIVS/MSL 15x use. If you set the bits to any other configuration, the model type set is not valid and the following message appears.

ERROR - NOT ON LIBRARY

- a Reserved for maintenance use.
- f Specifies the extended deadstart sequence option. If you set this bit and have the LONG/SHORT DEADSTART SEQUENCE switch on the deadstart panel set to the up (long) position, the system loads and executes the extended deadstart sequence (EDS). If this bit is not set or if the LONG/SHORT DEADSTART SEQUENCE switch is set to the down (short) position, the extended deadstart sequence does not occur.

When this bit is set, parts of PP memories are destroyed. Refer to the description of the E option in the Utilities Display in the CIP User's Handbook for more information.

The rest of word 12 can be set for other maintenance purposes (refer to the applicable hardware operator's guide for more information).

## Setting Word 13

Three unique fields exist in word 13 (word 12 on CYBER 70 and 6000 Computer Systems) of the deadstart program allowing you to select the CMRDECK, the deadstart parameters, and the level of deadstart. The switches that represent these fields are shown in the following illustration. For machines that do not have a deadstart panel (see chapter 1, Introduction), the values are entered from the console as octal numbers.



- rrr        Specifies the level of deadstart.
- ppp        Specifies the deadstart parameters.
- xxx xxx    Specifies the CMRDECK number.

## Selecting the Deadstart Level

You can select one of four levels of deadstart by setting bits 11, 10, and 9 in word 13. The switches that represent this field of bits are shown in the shaded area:



**Value of rrr  
(Bits 11 - 9)**

**Description**

000

Indicates an initial or level 0 deadstart. The system is loaded from the deadstart file. This is not considered a recovery deadstart although permanent files, queued files, and system dayfiles are recovered automatically unless those file types are initialized by the EQPDECK entry, INITIALIZE (refer to Modifying the EQPDECK in the NOS Version 2 Analysis Handbook). These files are recovered on all levels of system deadstart.

Level 0 deadstart is normally specified under the following conditions.

- For the first deadstart following a period in which the system was either inoperative or used for purposes other than NOS operations.
- When a system malfunction occurred and other levels of system deadstart prove ineffective.

If it is necessary to redeadstart the system (for example, due to system malfunction), it is recommended that you attempt a level 3 recovery deadstart. If you select level 0, the system is reloaded from the deadstart file. All central memory (except on CYBER 180-class mainframes) and PP contents are destroyed by the memory confidence test.

**NOTE**

Central memory and extended memory are not destroyed on CYBER 180-class mainframes unless the I option is selected on the CIP Utilities display or the V option is selected from the Operator Intervention display.

001

Indicates a level 1 recovery deadstart, in which the operating system, all jobs, and all active files are recovered from checkpoint information on mass storage. Refer to the NOS Version 2 Analysis Handbook, for more information on level 1 deadstarts.

Value of rrr (Bits 11 - 9)	Description
010	Indicates a level 2 recovery deadstart, in which all jobs and active files are recovered from checkpoint information on mass storage. No attempt is made to recover the operating system. Refer to the NOS 2 Analysis Handbook for more information on level 2 deadstarts.
011	<p>Indicates a level 3 recovery deadstart in which all jobs, permanent files, active files, and the operating system, with the exception of the system library directory, are recovered from central memory tables. The system library directory is recovered from mass storage.</p> <p>A level 3 deadstart is the only level that preserves the contents of central memory. To avoid inadvertent destruction of central memory contents when a level 3 deadstart is intended, always select level 3 on the deadstart panel. If you need a deadstart level other than 3, you can specify the level using the *P* display (refer to the CIP User's Handbook for more information). You must issue a CHECK POINT SYSTEM command prior to deadstart to prevent loss of system library modification (SYSEDIT) information.</p> <p>Normally you perform level 3 recovery deadstart following an equipment malfunction (for example, channel or PP hung), provided that central memory and mass storage remain intact. Unless you can determine that central memory is no longer reliable, you should attempt a level 3 recovery following a malfunction. If level 3 recovery fails, you must perform a level 0 deadstart.</p>

**CAUTION**

Attempting a level 1 or 2 recovery deadstart after a level 3 deadstart fails does not correctly recover system activity and can endanger system and permanent file integrity. You must perform a level 0 deadstart.

For additional information concerning levels of deadstart, refer to Preparing for System Restart in this chapter and Preparing for Recovery Deadstart in the NOS 2 Version Analysis Handbook.

**Selecting the Deadstart Parameters**

You can select deadstart parameters to control miscellaneous deadstart functions by setting bits 8 through 6 in word 13. The switches that represent this field of bits are shown in the shaded area:



ppp Specifies miscellaneous deadstart functions. Refer to table 2-4.



**Table 2-4. Deadstart Parameters Switch Settings**

Bit Number	Switch Position	Description
8	Down	Reserved for future use.
7	Down	Reserved for future use.
6 = 0	Down	Indicates that the CMRDECK is not displayed during deadstart.
6 = 1	Up	Indicates that the CMRDECK is displayed during all levels of deadstart.

## Selecting the CMRDECK

The CMRDECK defines the table sizes and other information to be used for system operations. Up to 64 CMRDECKs (numbered 0 through 77<sub>8</sub>) can be included on the deadstart file.

### NOTE

You can select the CMRDECK only during a level 0 (initial) deadstart. For a level 1, 2, or 3 (recovery) deadstart, you must use the CMRDECK selected during the most recent level 0 deadstart. Refer to *Selecting the Deadstart Level* earlier in this chapter for information concerning the levels of deadstart.

The number of the selected CMRDECK is indicated by setting the switches (bits 5 through 0) shown in the shaded area:



xxx xxx Specifies the CMRDECK number (0 through 77<sub>8</sub>) to be used.

For example, if CMRDECK number 26<sub>8</sub> is selected, the corresponding switches on the deadstart panel are set as follows:

rrr ppp 010 110

0 indicates the switch is in the down position; 1 indicates the switch is in the up position. You can also specify the CMRDECK from the console keyboard by using the CIP \*P\* display (described in the CIP User's Handbook). Values entered from the CIP \*P\* display take precedence over those specified on the deadstart panel.

## Warmstart Procedure for Models Without a Deadstart Panel

The procedure to warmstart models without a deadstart panel (models 810, 815, 825, 830, 840A, 850A, 860A, 960, 990A, 994, and 995A) is similar to the procedure used for models that have a deadstart panel, except that the deadstart program settings are entered from the console keyboard as octal numbers. The actual programs used to warmstart models without a deadstart panel are identical to the programs used to warmstart other models, except where specifically noted.

Initiating the deadstart process brings up the deadstart display on model 815 or 825 (refer to figure 1-11). On other models without a deadstart panel, initiating the deadstart process brings up the Deadstart Options display (refer to figure 2-2).

```
DEADSTART OPTIONS

S - SYSTEM LOAD OPTIONS
M - MAINTENANCE OPTIONS

(CR) - SYSTEM LOAD OPTIONS

PROGRAM n SELECTED
```

**Figure 2-2. Deadstart Options Display**

Selecting option M on Deadstart Options display brings up the Maintenance Options display (refer to figure 2-3). If the warmstart program is already stored in the microprocessor, retrieve it by typing

```
GP n
```

where n is the number (0 through 3) of the stored program. You can change individual instructions in a program, such as unit number or other parameters, as described in the following paragraphs. These changes are not retained across deadstarts unless the new program is stored, as described later in this chapter.

MAINTENANCE OPTIONS (REV 03)	
	PROGRAM 0
XX YYYYYY-CHANGE DS PRG	01 001402
XX+YYYYYY-CHANGE DS PRG INC	02 007303
S-SHORT DS	03 000017
L-LONG DS	04 007503
H-HELP	05 007703
	06 000301
	07 007403
PPM CONF = 00	10 007103
BRL CONF = 0	11 007301
DLY LOOP = 0	12 000710
LDS ADDR = 6000	13 000376
CLK FREQ = NORMAL	14 000000
CM RECONF SW3 = C	15 000000
SW4 = C SW5 = C	16 000000
	17 000000
	20 007112

**Figure 2-3. Maintenance Options Display**

The following screen entries in figure 2-3 are defined:

**PROGRAM 0**

The number of the most recently used deadstart program. The program contents are those most recently used to deadstart.

**H-HELP**

**LDS ADDR = 6000**

**CLK FREQ = NORMAL**

For an explanation of these entries, refer to the hardware operator's guides for your machine.

**PPM CONF = 00**

**BRL CONF = 0**

**DLY LOOP = 0**

Define PP configuration. Refer to the NOS Version 2 Analysis Handbook for information about reconfiguring PPs.

**CM RECONF SW3 = C**

**SW4 = C SW5 = C**

Define CM configuration for models 810 and 830 with memory update option, the switches are numbered SW1, SW2, and SW3. SW1 is not used. Refer to the NOS Version 2 Analysis Handbook for information about reconfiguring CM.

If the correct warmstart program is not stored or a new program is to be entered and stored, the program must be entered as octal numbers equivalent to the switch settings on the deadstart panel of other mainframes.

Enter the warmstart program represented by the switch settings shown in the related deadstart panel figure for your configuration by typing

xx YYYYYY

where xx is the octal row number of the deadstart instruction and yyyyyy is the octal number equivalent of the actual instruction. When you enter a six-digit instruction, the first two digits of the instruction must be zeros. However, leading zeros in both the octal row number and the instruction need not be entered. For example, if the row number is 03 and the instruction is 000017 you could enter

3 17

and get the same setting as entering

03 000017.

If you want the system to automatically increment the octal row number, the entry after which the increment is to occur is

xx+YYYYYY

where the + character means the system automatically increments the octal row number. When the automatic increment is in effect, the system displays the next location after accepting the previous entry. Only the next instruction need be entered.

To cancel the automatic incrementing, press the erase key after the octal row number appears.

To store a new program or a modified program, type

SP n

where n is the number (0 through 3) of the program to be stored. If a program is already stored at the specified number, the new program replaces the old stored program.

After entering or retrieving the desired warmstart program, type

S

followed by a carriage return for a short deadstart sequence, or

L

followed by a carriage return for a long deadstart sequence.

When power is applied to a model 810, 815, 825, or 830 mainframe, the microprocessor automatically retrieves the warmstart program stored as program number 3 and initiates a long deadstart sequence. If you want this feature, store the warmstart program for your configuration (as in figure 2-3) as program number 3. If you do not want this feature, store the first word of program 3 as 000300. This instruction puts the program in PP0 into a loop. No deadstart activity occurs and no displays appear on the screen. You must initiate the deadstart process by bringing up the initial deadstart display on models 815 or 825. On models 810 or 830, initiate deadstart by bringing up the Deadstart Options display or the Initial Deadstart display. You can then retrieve or enter your warmstart program and select the short or long deadstart sequence.

## Initiating the Deadstart Process

To initiate the deadstart process, do the following:

On the CC545 console, press the deadstart button only once.

On the CC598B console, press the CTRL and F2 keys simultaneously only once.

On the CC634B console, enter the following sequence only once:

1. Press the CTRL and G keys simultaneously.
2. When the message

\*OPERATOR ACCESS ENABLED\*

appears on the screen, press the CTRL and R keys simultaneously.

This executes the PP program set on the deadstart panel.

### NOTE

---

The CC634B has an optional deadstart button.

---

### CAUTION

---

Press the deadstart button only once on the CC545 console, or use the deadstart sequence only once on the CC598B or CC634B console. This sends one deadstart pulse at a time. This is important because multiple rapid deadstart signals can cause problems with certain tape and disk controllers.

---

Deadstart proceeds automatically until you are required to initialize the system or until an error is encountered (refer to Initializing the System in this chapter).

You can monitor deadstart progress on the console display screens. If errors are encountered during deadstart, an error message is displayed on the right console screen, and deadstart halts. Refer to Deadstart Error Troubleshooting at the end of this chapter for more information and possible corrective actions.

If the left display screen is replaced by an error display, a fatal error occurred. Deadstart halts. Refer to appendix A for a description of the error messages and appropriate actions.

## Initial Options Display

The initial options display appears (except on models 810 and 830) after you initiate the deadstart process. On models 810 and 830, selecting S on the deadstart options display brings up the initial options display. From the initial options display, you instruct the system to proceed with automatic system deadstart or select additional options.

Figure 2-4 shows the initial options display.

```
          INITIAL OPTIONS

A      OS LOAD AUTOMATIC
O      OS LOAD WITH INTERVENTION
U      UTILITIES
M      OFFLINE MAINTENANCE
H      HELP

(CR) OS LOAD AUTOMATIC

ppp-mmm Llevel
```

**Figure 2-4. Initial Options Display**

<b>Option</b>	<b>Description</b>
(CR) or A	OS load automatic. Press carriage return to load the operating system with no intervention on your part. You cannot select additional options after this entry.
O	Deadstart with operator intervention. Select this option to display the Operator Intervention display (refer to the CIP User's Handbook for details).
U	Utilities. Select this option to display the utilities display (refer to the CIP User's Handbook for details).
M	Offline maintenance. Select this option to initiate the offline maintenance tests. For CYBER 180-class mainframes, refer to the appropriate hardware operator's guide for more information. For all other CYBER and 6000 Computer Systems, consult a customer engineer for more information. The offline maintenance display always appears when you deadstart from tape. When you deadstart from disk, this display appears only if the maintenance software library (MSL) is available at your site. Consult a customer engineer for more information.
H	Help for initial option selections.

The CIP level, ppp-mmm Llevel, is displayed at the bottom of the initial options display, where ppp is mainframe type, mmm is mainframe model number, and level is the CIP release level.

## Modifying the Deadstart Decks

The most important function of the deadstart text decks is to identify and group the peripheral devices used by the mainframe. These peripheral devices include disk drives, tape drives, line printers, controllers, network processing units, and so forth. The identification and grouping of these devices is defined in four types of files on the deadstart file: the CMRDECK, the EQPDECK, the APRDECKs, and the IPRDECK.

The CMRDECK, EQPDECK, APRDECKs, and IPRDECK files together define the system configuration and set the initial operating system limits and priorities. Refer to the NOS Version 2 Analysis Handbook for more information on the actual structure and function of each of these files.

Each of these files can exist in many versions on the deadstart file. You specify which CMRDECK and EQPDECK to use during a level 0 (initial) deadstart. (On level 3 deadstarts, the CMRDECK and EQPDECK specified during the last level 0 deadstart remains in effect.) Some entries in the EQPDECK require an APRDECK. Each entry in the EQPDECK requiring an APRDECK specifies which APRDECK it needs. If an APRDECK is not specified, a default APRDECK (usually APRD00) is supplied. One of the entries in the CMRDECK specifies which IPRDECK is required for this particular system configuration. Thus, by specifying a particular CMRDECK and EQPDECK, you can also select the unique combination of APRDECKs and IPRDECK needed to deadstart the system.

All of these files are prepared before or during installation. There is no need to interact with these files unless you want to change your system configuration (for example, because of malfunctioning hardware). You control when the CMRDECK is displayed during deadstart by setting bit 6 in word 13 of the deadstart panel (refer to Setting Word 13 earlier in this chapter).

If the display-CMRDECK switch is set in the up position, the system displays the CMRDECK after you complete the CIP activities. The CMRDECK, the EQPDECK, the APRDECKs, and the IPRDECK can be viewed and changed.

If the display-CMRDECK switch is set in the down position, the CMRDECK instructions are carried out as set up in the file, unless there is an error in the CMRDECK (or the EQPDECK or the APRDECK or the IPRDECK). If an error is discovered, the system halts until you enter a correction and tell the system to continue.

To modify deadstart decks, you must start by displaying the CMRDECK. To do this, either set the display-CMRDECK switch (bit 6 in word 13 of the deadstart panel) or select the D=Y option on the Parameters display (refer to CIP User's Handbook, for more information on this display).

After you set bit 6 (or select the D=y option) press the deadstart button and select the OS LOAD WITH INTERVENTION option on the Initial Options display. After the CIP test is completed, the system stops and presents an instruction display called CMRINST. When the CMRINST display is presented, you can view the CMRDECK, go to the EQPDECK, go to the APRDECKs, go directly to the IPRDECK, or continue the automatic system load. To continue with the automatic system load, type

GO .

and press carriage return.



## Modifying the CMRDECK

All valid CMRDECK entries are defined in the CMRINST display. Several of the entries listed are assigned system default values. These values are assumed if the entries do not appear in the CMRDECK being used. To view the contents of the CMRDECK being used, press the right blank key on the CC545 console, or the TAB key on the CC598B console, or the forward arrow key on the CC634B console. Use these same keys to toggle between the CMRINST and the CMRDECK displays. If either the CMRDECK or CMRINST overflows two screens, the display can be advanced by pressing the + key.

Modify the CMRDECK by entering the appropriate changes or additions from the console keyboard. These entries can be made while either CMRDECK or CMRINST is displayed. Each console entry supersedes the value currently specified in the CMRDECK (or default value in CMRINST).

Refer to the NOS Version 2 Analysis Handbook for complete information concerning all CMRDECK entries.

### NOTE

---

The modified CMRDECK remains in effect only until the next level 0 deadstart. Changes to the CMRDECK are not recovered for the next deadstart.

---

If it is necessary to modify a specific EQPDECK, APRDECK or the IPRDECK, refer to *Modifying the EQPDECK*, *Modifying the APRDECK*, or *Modifying the IPRDECK* in this chapter. Otherwise, to indicate that all modifications to the CMRDECK, the EQPDECK, the APRDECKs, and the IPRDECK are complete, type

GO .

and press carriage return.

## Modifying the EQPDECK

After modifying the CMRDECK, you can modify the default EQPDECK, the APRDECKs, or the IPRDECK being used. If no changes are needed to an EQPDECK, but you must modify the APRDECK or the IPRDECK, refer to *Modifying the APRDECK* or *Modifying the IPRDECK* in this chapter.

To modify an EQPDECK, type

NEXT.

and press carriage return while CMRDECK or CMRINST is displayed.

Modify the EQPDECK by entering the appropriate changes or additions from the console keyboard. These entries can be made while viewing any of these displays. The instruction display EQPINST appears on the console displays. All valid EQPDECK entries are defined in the EQPINST display.

To view the contents of the EQPDECK being used, press the right blank key on the CC545 console, or the TAB key on the CC598B console, or the forward arrow key on the CC634B console. These same keys can be used to select the EQPDECK display, EQPINST display, Equipment Status display, Mass Storage Status display, Mass Storage Initialization Status display, or Controlware Status display. Each console entry supersedes the value currently specified in the EQPDECK (or default value in EQPINST).

Refer to the NOS Version 2 Analysis Handbook for complete information on all EQPDECK entries and displays.

### NOTE

---

The modified EQPDECK remains in effect only until the next level 0 deadstart. Changes to the EQPDECK are not recovered for the next deadstart unless a new deadstart file is created to reflect those changes.

---

After all EQPDECK modifications are complete, and if there are no APRDECK or IPRDECK modifications, type

GO.

and press carriage return.

## Modifying the APRDECK

After modifying the EQPDECK, or if no EQPDECK modifications are needed, you can modify the default APRDECK, the APRDECK for a specific equipment, or the IPRDECK being used. If no changes are needed to an APRDECK, but you must modify the IPRDECK, refer to Modifying the IPRDECK in this chapter.

The APRDECK contains entries reserving areas of mass storage that are not usable (flaws). The APRDECK used can vary from equipment to equipment. One of the parameters specified when equipment is defined in the EQPDECK is the APRDECK number that applies to that equipment. The default (APRD00) is selected if this parameter is not specified.

To modify an APRDECK while the EQPDECK or EQPINST is displayed, type

NEXT.

and press carriage return. The APRINST display is presented if the device was initialized. It describes the acceptable APRDECK entries. Enter the changes or additions to the APRDECK from the console keyboard.

If there are no changes to the APRDECK displayed, type

NEXT.

and press carriage return to go to the next APRDECK. Repeat this process until you have changed all APRDECKs that need modifications.

After all APRDECK modifications are complete, you can skip to the IPRDECK (either the default IPRDECK defined during system installation or the IPRDECK specified by the IPD command in the CMRDECK) by typing

IPR.

and pressing carriage return. Refer to Modifying the IPRDECK in this chapter for more information. If there are no IPRDECK modifications, type

GO.

and press carriage return to indicate that changes to the CMRDECK, the EQPDECK, the APRDECKs, and/or the IPRDECK are complete.

## Modifying the IPRDECK

The IPRDECK contains installation parameters that describe the mode of system operation – for example, whether the system is in secured mode or unsecured mode. IPRDECK modification is seldom required during deadstart since nearly all IPRDECK commands are also valid DSD commands that make the same changes during normal system operation. Generally, installation parameters changed during normal operations (with DSD commands or by modifying the IPRDECK) are retained only across a level 3 recovery deadstart. All valid DSD commands used in a normal production environment are described in chapter 3.

After you modify the CMRDECK, EQPDECK, or APRDECK, or after you repeatedly type NEXT to step through all the APRDECKs, type

IPR.

and press carriage return. The instruction display IPRINST appears on the console screens. This display defines all valid IPRDECK entries. Most of these entries are also valid DSD commands. To view the contents of the IPRDECK being used, press the right blank key on the CC545 console, or the TAB key on the CC598B console, or the forward arrow key on the CC634B console.

The display alternates each time this key is pressed. If either the IPRDECK or IPRINST overflows two screens, you can advance the display by pressing the + key.

Enter the appropriate changes or additions from the console keyboard. These entries can be made while either IPRINST or the IPRDECK is displayed. A console entry supersedes the value currently specified in the IPRDECK.

### NOTE

---

Changes to the IPRDECK are retained only for a level 3 (recovery) deadstart.

---

To indicate that changes to the CMRDECK, the EQPDECK, the APRDECK and/or the IPRDECK are completed, type

GO.

and press carriage return. The automatic system loading continues with the system initialization displays.

Table 2-5 describes how to move from one deadstart deck to another. Refer to the column in the table with your current display. Then follow each step down the column until you reach the display you want.

**Table 2-5. Moving from One Deadstart Deck to Another**

<b>Desired Display</b>	<b>Current Display: CMRDECK</b>	<b>Current Display: EQPDECK</b>	<b>Current Display: APRDECK</b>	<b>Current Display: IPRDECK</b>
CMRDECK	—	—	—	—
EQPDECK	NEXT.	—	—	—
APRDECK	NEXT. NEXT.	NEXT.	—	—
IPRDECK	IPR.	IPR.	IPR.	—
Proceed with deadstart	GO.	GO.	GO.	GO.

## System Loading and Initiating

Once the system configuration is established, all mass storage device labels are validated, then the system library of programs is either loaded from the deadstart file or recovered from mass storage. Job processing is then initiated either automatically from information in the IPRDECK or manually when you enter the AUTO or MAINTENANCE command.

### Mass Storage Label Validation

Figure 2-5 shows a typical mass storage label validation display. While normally presented for only a few seconds, it could remain displayed much longer if there are 834, 836, 887, 9853 disks in the configuration that must be spun up automatically before their labels can be validated (but never more than two minutes unless there are problems). The message

```
SPINNING UP DRIVES
```

is displayed on the console while the 834, 836, 887, 9853 disks are spinning up.

```

NOW LOADING THE NOS SOFTWARE SYSTEM.
COPYRIGHT CONTROL DATA 1978, 198x

DEADSTART STATUS

RECOVERY, DQ121

```

**Figure 2-5. Label Validation Display**

## Deadstart File Load/Recovery

If you are performing a level 0 (initial) deadstart, the system library is automatically loaded from the deadstart file to one or more mass storage devices. The name of each system library program is also displayed on the right console screen as it is being loaded. This allows you to monitor deadstart progress. Figure 2-6 shows a typical system load display.

```

NOW LOADING THE NOS SOFTWARE SYSTEM.
COPYRIGHT CONTROL DATA 1978, 198x.

DEADSTART STATUS

LOADING 1MT

```

**Figure 2-6. System Load Display**

If you are performing a level 3 (recovery) deadstart, the system library is not reloaded. It is recovered from mass storage. Central memory tables such as the system file name table (system FNT), executing job table (EJT), queued file table (QFT), equipment status table (EST), and track reservation table (TRT) are recovered from central memory for level 3 deadstarts. Additional information may be recovered from the link device if you are part of an extended memory multimainframe configuration. For level 3 deadstarts, the deadstart file is rewound and is not accessed again until another deadstart operation is performed.

If a deadstart error occurs, a message appears on the right console screen and, depending upon the nature of the error, deadstart processing may halt. Refer to Deadstart Error Trouble Shooting later in this chapter for more information and possible corrective actions.

## Entering the Date and Time

The system uses the date and time (updated every second) for dayfile messages and for permanent file catalogs and directories for files being accessed. It is important to enter the correct date and time to accurately maintain these system records.

When the system loading (or recovery) phase of deadstart is about to begin, the system reads the date and time internally and displays the current date and time. If the system does not display the current date and time, the one-line message in figure 2-7 appears in the center of the left console screen and requests entry of the current date.

```
NOW LOADING THE NOS SOFTWARE SYSTEM.
COPYRIGHT CONTROL DATA 1978, 198x.

ENTER DATE YY/MM/DD.
```

**Figure 2-7. Date Initialization Request**

Type the current date, followed by carriage return, in the following format.

yy/mm/dd.

yy	Year: 00 through 99.
mm	Month: 01 through 12.
dd	Day: 01 through 31.

When the system accepts the date entry, it displays the request for entry of the current time, as shown in figure 2-8.

```
ENTER TIME HH.MM.SS.
```

**Figure 2-8. Time Initialization Request**

Type the current time, followed by carriage return in the following format.

hh.mm.ss.

hh	Hour: 00 through 23.
mm	Minute: 00 through 59.
ss	Second: 00 through 59.

If the deadstart file loading (or recovery) is not completed when the time is entered, the DSD commands listed in the IPRDECK are displayed on the lower portion of the left console screen. The commands are not executed, however, until the file is loaded and the system library directory is generated.

## Initiating Job Processing

If a level 3 (recovery) deadstart is being performed, the system recovers all jobs and active files and automatically resumes normal job processing.

If a level 0 (initial) deadstart is being performed, the system automatically initiates job processing only if the commands are in the IPRDECK. To initiate job processing when the automatic resumption is not in the IPRDECK, type either

AUTO.

or

MAINTENANCE.

or

SCHEDULE.

and press carriage return.

Following entry of the AUTO or MAINTENANCE or SCHEDULE command during a level 0 (initial) deadstart, the deadstart sequencing process begins. Deadstart sequencing suspends job processing until all system files in the default family are initiated.

Normal job processing begins after the deadstart sequencing job is complete. If you entered the AUTO command, the subsystems enabled in the IPRDECK are also automatically initiated and assigned to control points at this time.

The MAINTENANCE command performs the same function as the AUTO command. Additionally, it assigns several maintenance routines, according to mainframe type, to available control points and runs them as normal jobs. These are CPU or central memory test routines designed to detect hardware errors. The routines display error messages either in the status field on the B,O display (refer to chapter 4) or in the system error log.

To display the error log, type

A, ERROR LOG.

You should monitor these routines from time to time. If a maintenance routine displays an error message indicating a hardware malfunction, contact a customer engineer. It is recommended that these programs be run at all times. The maintenance programs have minimal effect on system performance. Descriptions of the maintenance routines are in the Online Maintenance Software Reference Manual.



## Preparing for System Restart

Sometimes during system operation an uncorrectable error occurs that prevents further system activity. Often the situation can be corrected by deadstarting the system and recovering prior activity. The success of such a recovery depends upon the severity of the problem and the extent to which system information is destroyed.

If you are deadstarting in a multimainframe environment, refer to appendix C, *Multimainframe Operation*.

During a level 0 (initial) deadstart, the system verifies the length of preserved files. If a length error is detected, the system reads the disk chain to determine the correct length of the file, issues a message to the B,O display, and stops recovery of the device. To alter the end-of-information (EOI) for the file and proceed with recovery, enter

```
GO, SYS.
```

To terminate recovery of the device, enter

```
PAUSE, SYS.
```

### NOTE

---

If this error occurs, inform a knowledgeable person at your site.

---

The following topics provide general information concerning each level of system deadstart and recommended steps of preparation.

### CAUTION

---

Before attempting any level of deadstart, examine the current status codes listed for each mass storage device in the disk status display (E,M.). Delay deadstart if status code C (checkpoint requested) appears for any device. When the system processes the request, status code C is cleared (within 30 seconds). Refer to chapter 4 for complete information concerning the disk status display (E,M.). Failure to observe this caution can result in the loss of permanent file information.

---

## Level 3 Recovery Deadstart

Usually you perform a level 3 recovery deadstart following an equipment malfunction (for example, channel or PP hangs), provided the system remains intact. However, unless you can determine that central memory is no longer intact, attempt a level 3 recovery deadstart before a level 0 deadstart. This is recommended because system activity, as it existed at the time of the malfunction, can best be recovered by performing a level 3 recovery deadstart. Only PP memory confidence testing occurs during a level 3 recovery deadstart. Central memory is not affected.

Requests for device checkpoint are retained over a level 3 recovery. Therefore, if a system malfunction prevents a device checkpoint from being done, the checkpoint is processed after level 3 recovery is successfully completed. If a level 3 recovery fails, you must determine if the device checkpoint requests completed successfully or not.

On a level 3 deadstart, the CMRDECK, the EQPDECK, the APRDECKs, and the IPRDECK cannot be viewed or changed. The CMRDECK, the EQPDECK, the APRDECKs, and the IPRDECK specified during the last level 0 (initial) deadstart remain in effect. If you set the CMRDECK switch (bit 6 in word 13 of the deadstart panel) or select the D=Y option on the CIP \*P\* display, the system halts and displays level 3 deadstart options. The options and their default values are displayed on the left screen (figure 2-9). Instructions are displayed on the right screen (figure 2-10).

Entering a command toggles the level 3 deadstart selections. The ABORT command checkpoints all the devices and aborts level 3 recovery. You should use this option if a previous level 3 deadstart failed to complete. Selecting the ABORT command automatically deselects the ABORT,B command. The ABORT,B command checkpoints all the nonbuffered devices and aborts level 3 recovery. You should use this option if a previous level 3 deadstart (where you specified the ABORT option) failed to complete because of a problem writing to the buffered disk devices. Selecting the ABORT,B command automatically deselects the ABORT command. The AUTOLOAD command toggles the selection of buffer controller autoloading. The GRENADE command toggles the selection of the grenade function. Refer to the NOS Version 2 Analysis Handbook for more information on AUTOLOAD and GRENADE commands. The AUTO command enables job scheduling and initiates any subsystem that is enabled.

When you have made all changes, type

GO.

to continue the deadstart recovery. If you choose not to display the level 3 options, the default values are used.

LEVEL 3 OPTIONS	
ABORT .	NO
ABORT , B .	NO
AUTOLOAD .	YES
GRENADE .	NO
AUTO .	YES

**Figure 2-9. Level 3 Deadstart Left Screen Display**

```
INSTRUCTIONS FOR SELECTING LEVEL 3 RECOVERY OPTIONS.
  ENTER COMMAND TO TOGGLE SELECTION
  ENTER GO. TO CONTINUE RECOVERY.

ABORT.
  CHECKPOINT ALL DEVICES AND ABORT LEVEL 3 RECOVERY.
  SELECTING *ABORT.* DESELECTS *ABORT,B.*

ABORT,B.
  CHECKPOINT ALL NONBUFFERED DEVICES AND ABORT LEVEL
  3 RECOVERY.  SELECTING *ABORT,B.* DESELECTS *ABORT.*.

AUTOLOAD.
  TOGGLE THE SELECTION OF BUFFER CONTROLLER AUTOLOADING.

GRENADE.
  TOGGLE THE SELECTION OF THE GRENADE FUNCTION.  THE
  GRENADE FUNCTION IS ISSUED ONCE THE CONTROLWARE IS
  LOADED, CAUSING UNIT RESERVATIONS TO BE CLEARED ON
  ALL 844 UNITS PHYSICALLY CONNECTED TO EACH CONTROLLER.

AUTO.
  TOGGLE THE SELECTION OF THE DSD AUTO COMMAND.
```

**Figure 2-10. Level 3 Deadstart Right Screen Display**

A level 3 recovery deadstart is impossible after:

- An attempted checkpoint recovery (level 1).
- An aborted level 0 (initial) deadstart.
- The MREC utility (refer to the NOS Version 2 Analysis Handbook) has been run for the machine to be deadstarted while in multimainframe mode.

It is recommended that you stop system activity prior to beginning the system deadstart procedure (that is, before initiating the deadstart). To accomplish this, enter the following DSD commands.

UNLOCK.	Necessary only if console is locked.
E,M.	Displays the E,M display.
CHECK POINT SYSTEM.	Allows termination of job processing and writing the contents of central memory tables to disk. For a complete description of this process, refer to the CHECK POINT SYSTEM command in chapter 3.
STEP.	Prevents the system from processing PP requests. This stops all central memory I/O operations. You should enter the STEP command after all device checkpoints are completed. Examine the disk status display (E,M.) to determine if all checkpoint status requests are complete.

## **Level 2 Recovery Deadstart**

Usually you perform level 2 recovery deadstart in system test situations. It is not recommended for the normal production environment. Refer to the NOS Version 2 Analysis Handbook for more information on level 2 recovery deadstarts.

## **Level 1 Recovery Deadstart**

Usually you perform a level 1 recovery deadstart to resume normal processing following maintenance procedures. The system, all jobs, and all active files are recovered from checkpoint information on mass storage. Refer to the NOS Version 2 Analysis Handbook for more information on level 1 recovery deadstarts.

## **Level 0 Initial Deadstart**

Use level 0 or initial deadstart when a recovery deadstart is not possible. This is a complete or initial load from the deadstart file. Only preserved files, which includes permanent files, queued files, and system dayfiles, are recovered. (Preserved files are recovered on all levels of system deadstart.) Because memory confidence testing destroys the contents of central memory (except on CYBER 180-class models) and PPs, you must complete all memory dumps before deadstart begins.

### **NOTE**

---

If the machine is the first machine deadstarted in a multimainframe environment, you must enter an EQPDECK PRESET entry. (Refer to the NOS Version 2 Analysis Handbook for description.)

---

## Deadstart Error Troubleshooting

If no display appears after you initiate the deadstart sequence, perform the following steps as needed. After each step, initiate the deadstart sequence to see if the problem is eliminated.

To deadstart from CC598B console, proceed through the following steps until deadstart occurs.

1. Press CTRL-F2 keys. If successful, the Deadstart Options display appears.
2. Press CTRL, ALT and DEL in sequence while simultaneously holding down each of the previous keys. This reboots the CC598B console software. If successful, the Control Data logo appears followed by the Deadstart Options display.
3. Power down the console, wait 5 seconds, then power it up again. If successful, the Deadstart Options display appears.
4. Execute hardware diagnostics by pressing CTRL, ALT and INS keys in sequence while simultaneously holding down each of the previous keys. If a hardware error is detected, contact your site engineer.
5. Reinstall the CC598B console software. If still unable to deadstart, contact CYBER Software Support.

To deadstart from CC634B console:

1. Verify that the terminal is connected to the cable, which is connected and coupled correctly to the 2-port multiplexer.
2. Verify that the 2-port multiplexer is set to the correct baud rate.
3. Verify that the terminal is set up correctly. Refer to CIP User's Handbook for terminal setup.

To deadstart from tape:

1. If the unit select switch on the deadstart tape unit is not on (tape does not move), check the channel, controller, and unit selections on the deadstart panel to ensure they are set correctly.
2. If the unit select switch is on, the correct unit was selected. However, check word 11 of the deadstart panel to verify that it is set correctly.
3. Verify that a 7-track tape is not mounted on a 9-track drive or vice versa. Also, verify that a deadstart tape with density of 6250 cpi is not mounted on a tape unit that does not support this density.
4. Verify that the deadstart tape is an I-format unlabeled tape.
5. Verify that the card reader and tape unit (667 or 669 only) are not on the same channel and that the card reader is not on a channel with a PP. Also, verify that two or more units do not have the same physical unit number.

6. Select an alternate channel, if desired, for deadstart.
7. If no display appears after activating the deadstart switch, contact CYBER Software Support. There might be a parity error on one of the first records of the deadstart tape, or the magnetic tape controller might have detected a channel parity error on a CYBER 170 or CYBER 180 Computer System.

To deadstart from disk:

1. For an 844 or 885 disk, verify that the disk is spinning, the READY light is on, and the SELECT light is on.

For an 834 or 836 disk, verify that the START button is pushed in and the power switch is on.

For an 895 disk, verify that the POWER-ON INDICATOR light is on.

2. Verify that the disk has the CTI module loaded (refer to CIP User's Handbook for more information). When deadstarting a CYBER 180-class mainframe, the CIP disk must be used.
3. Verify that the deadstart program is set correctly.
4. Select an alternate channel, if desired, for deadstart.
5. If no display appears after initiating the deadstart, contact CYBER Software Support. There might be a parity error on one of the first records of the deadstart file, or the disk controller might have detected a channel parity error on a CYBER 170 or CYBER 180 Computer System.

Because most of the errors that occur during deadstart involve disk devices, you should be familiar with their use in the system.

Each mass storage device has a label that describes its contents. For certain levels of recovery deadstart, this information must be consistent with corresponding information either contained in central memory or provided through deadstart procedures. Conflicts can cause the system to issue deadstart error messages. The system attempts to recover all disk devices defined in the EST during all levels of system deadstart. The specific recovery function performed depends on the level of deadstart selected.

Refer to appendix A for a list of deadstart messages.



# Operation under DSD Control

---

- System Control Commands ..... 3-1
- Subsystem Control Commands ..... 3-9
  - Initiation Commands ..... 3-9
  - Termination Commands ..... 3-11
- Peripheral Equipment Control Commands ..... 3-12
- Printer Support Utility (PSU) Commands ..... 3-21
- Job Processing Control Commands ..... 3-26
  - Scheduling Control Commands ..... 3-26
  - Job Communication Commands ..... 3-27
  - Interactive Job Control Commands ..... 3-28
- Dayfile Commands ..... 3-29





Although all DSD commands are generally available, many of them are used only by analysts for maintenance or debugging and are seldom used in a normal production environment. This chapter describes only the commands used in a normal production environment. (For a complete list of the DSD commands refer to the NOS Version 2 Analysis Handbook.)

After the system is deadstarted, the NOS routine DSD begins executing automatically. DSD displays system information at the system console. The DSD commands described in this chapter allow you to monitor and direct the system for optimum performance and reliability.

There are five general categories of DSD commands available.

System control	Maintains system integrity in a normal production environment.
Subsystem control	Initiates a subsystem or terminates a current subsystem.
Peripheral equipment control	Controls the peripheral equipment available to the system.
Job processing control	Provides added control over job scheduling and processing.
Dayfile control	Dumps the system, account, or error log dayfile to a specified device.

## CAUTION

---

When unusual problems arise, consult a knowledgeable person at your site or call CYBER Software Support. Misguided attempts to correct a system problem can often destroy information needed to correct the problem.

---

Since the commands that follow are arranged according to function rather than alphabetically, use the alphabetical command index at the back of this manual for a quick page reference.

## System Control Commands

The following DSD commands control the operating system as well as its subsystems. Several of these commands are typically used only by an analyst for debugging purposes when the system is in an abnormal state. You may use others frequently to maintain system integrity in a normal production environment.

## AUTO.

Calls enabled subsystems to control points, initiates job processing, and spins up any 834, 836, 887, or 9853 disk drive that is on and not unloaded. The IPRDECK used at deadstart time determines which subsystems are activated by default. You can disable any subsystem not currently assigned to a control point or enable others through the use of the SUBSYST L display utility (refer to chapter 5 for more information). You can also call or remove individual subsystems to or from a control point independent of the AUTO command by using the Subsystem Control Commands described later in this chapter. For additional information concerning the AUTO command, refer to Initiating Job Processing in chapter 2.

## CHECK POINT SYSTEM.

Terminates job processing and writes the contents of central memory tables to mass storage. You must unlock the console before entering this command (refer to UNLOCK command). This command is typically entered in preparation for recovery deadstart. If the recovery deadstart is to be made from a tape unit, at least one tape unit must be available (not assigned to a job) before you issue this command.

The following sequence of operations takes place:

1. A sense switch is automatically set that places all IAF subsystem users in detached job status. When all users are in detached job status, the IAF subsystem is dropped and the checkpoint continues.
2. All job scheduling is inhibited. (This has the same effect as if the IDLE command were entered.)
3. All user jobs are rolled out and later recovered on a level 1 or level 2 recovery.
4. The system moves the system dayfile buffers maintained in CMR to disk.
5. All subsystems except the magnetic tape subsystem (MAG) are terminated.
6. MAG is rolled out when no other jobs are active. Rolling out MAG allows recovery of all tape files associated with jobs rolled out if the tapes are not repositioned prior to the level 1 or level 2 recovery.
7. The system is left in an idle state. If SPINDOWN is enabled, all 834, 836, 887, or 9853 disk drives that are on and not unloaded are spun down. Normal processing may be continued with an AUTO command. If this is done, no attempt should be made to later perform a level 1 or level 2 recovery unless another checkpoint command is processed.

During processing of the checkpoint, the message

```
PROCESSING SYSTEM CHECKPOINT
```

is issued at the system control point.

When the checkpoint is finished, the message

```
SYSTEM CHECKPOINT COMPLETE
```

is displayed.

**NOTE**

---

Under certain circumstances, the checkpoint routine is not able to properly terminate a job (such as one that has NOEXIT selected and is a subsystem or special system job). If such a job continues processing after you enter the checkpoint command, you must terminate the job for the checkpoint to continue. It is better to make sure that jobs such as permanent file dumps are finished prior to the checkpoint.

---

DATE.yy/mm/dd.

Changes the current system date. Unlock the console before entering this command (refer to UNLOCK command).

yy        Year; 00 through 99.  
mm        Month; 01 through 12.  
dd        Day; 01 through 31.

DISABLE,option. or ENABLE,option.

Disables or enables option.

If you enter the ENABLE command and the specified option is currently enabled, the system ignores the command. The system also ignores the DISABLE command if you enter it and the specified option is already disabled. If you enter multiple commands for the same option, the last command entered is the valid command. The system ignores all previous commands.

option is one of the following:

<b>option</b>	<b>Description</b>
ACS TAPE PF STAGING	Enables or disables the staging of permanent files to disk from tapes residing within the Automated Cartridge Subsystem (ACS). If disabled, jobs attempting to access permanent files that reside only on ACS tapes are aborted. This option controls staging of files from ACS tapes, whereas the TAPE PF STAGING option controls staging of files from 9-track tapes and CTS tapes. ACS TAPE PF STAGING can be enabled and disabled independently from the TAPE PF STAGING attribute.
AUTO RESTART	Enables or disables the AUTORESTART installation parameter. If enabled, the system clears step mode (set during environmental shutdown) and initiates all jobs waiting in the input queue by processing the AUTO command described earlier in this chapter. This recovery process requires no operator interaction.

<b>option</b>	<b>Description</b>
<b>CARTRIDGE PF STAGING</b>	<p>Enables or disables the staging of permanent files to disk from cartridge alternate storage (MSE and/or optical disk).</p> <p>Enabling CARTRIDGE PF STAGING allows both MSE-resident files and/or optical disk-resident files to be staged to disk when accessed. If CARTRIDGE PF STAGING is disabled and a user attempts to access a file that has copies on both cartridge alternate storage and on tape alternate storage, the file is staged from tape, provided that TAPE PF STAGING is enabled. If CARTRIDGE PF STAGING is disabled and a user attempts to access a file that has a copy only on cartridge alternate storage, the user job is aborted. If both CARTRIDGE PF STAGING and TAPE PF STAGING are enabled, a file that has copies on both cartridge alternate storage and tape is staged from cartridge alternate storage.</p> <p>If the tape that contains the file resides within the Automated Cartridge Subsystem (ACS), the ACS TAPE PF STAGING attribute is checked instead of the TAPE PF STAGING attribute.</p>
<b>DDP ROLLOUT PATH</b>	Enables or disables the use of the distributive data path (DDP) for job rollout and rollin. If DDP equipment is not present, this entry has no effect.
<b>ENGR<sup>1</sup></b>	Enables or disables engineering mode. When engineering mode is set, the message ENGR appears in the header of the left screen display. Engineering mode allows PP/hardware diagnostics and FORMAT/FDP to be executed if the user has system origin privileges. Unlock the console before entering this command (refer to the UNLOCK command later in this section).
<b>FLEXIBLE PARTITIONS</b>	Enables or disables flexible memory partitioning. The job scheduler attempts to use memory space to the greatest extent possible when flexible partitions are enabled. Some service classes may be allotted more total memory space than memory partitioning constraints normally allow. If flexible partitions are disabled, total memory used by jobs of a given service class are never allowed to exceed the maximum specified on the SERVICE command.
<b>LOGGING</b>	Enables or disables logging of dayfile messages intended for systems analysts concerned with program efficiency.
<b>MASTER MSE</b>	Enables or disables master mainframe mode for MSE processing. When the MSE subsystem is initiated, the SSEEXEC program runs if master mainframe mode is enabled. The SSSLV program runs if master mainframe mode is disabled. This entry has no effect unless MSE processing is activated.

1. On a secured system, the console must be in security unlock status to accept this command (refer to the UNLOCK,username,password command in the NOS Version 2 Analysis Handbook).

<b>option</b>	<b>Description</b>
MS VALIDATION	Enables or disables automatic verification of mass storage tables. This command cannot be used unless the MS VALIDATION option is selected in the IPRDECK used at deadstart. The validation for each level of recovery deadstart is described in the NOS Version 2 Analysis Handbook.
PF VALIDATION	Enables or disables verification of BOI/EOI on preserved files. Selection of this option causes BOI/EOI information to be verified when a direct access file is attached or purged, and when an existing local file is defined as a direct access permanent file.
PRIVILEGED ANALYST MODE	Enables or disables PRIVILEGED ANALYST MODE operations. When enabled, a user validated with AW=CPAM is permitted to read system status information (such as the system dayfile, account file and error log) using a nonsystem origin type job. Unlock the console to enable or disable this option (refer to the UNLOCK command later in this section). This command is not accepted on a secured system.
REMOVABLE PACKS	Enables or disables automatic label checking for mass storage devices defined as removable. Examine the disk status display (E,M) (refer to chapter 4, DSD Displays) to determine which mass storage devices (if any) are defined as removable. If this option is disabled, all removable devices subsequently introduced into the system cannot be accessed. This option must be enabled to perform label verification before those devices can be accessed.
PRIVILEGED RDF	Enables or disables privileged mode of the Remote Diagnostic Facility (RDF).
RESIDENT RDF	Enables or disables resident mode of the RDF. When enabled, RDF remains active regardless of maintenance terminal activity. When disabled (the default condition), RDF becomes inactive if 15 minutes elapses with no maintenance terminal activity. If RDF becomes inactive, you must reactivate RDF with the RDFffff command (where ffff represents alphanumeric characters) to allow maintenance terminal activity to resume.
SECONDARY USER COMMANDS	Enables or disables the acceptance of more than one USER command in a job. If disabled, any USER command encountered after the first one causes the job to be aborted with no exit processing. An interactive origin type job that issues a USER command is logged off. Unlock the console (refer to the UNLOCK command later in this section) to enable or disable this option. This command is not accepted on a secured system.

<b>option</b>	<b>Description</b>
SPINDOWN	Enables or disables the spinning down of the 834, 836, 887, or 9853 disk storage device during a system checkpoint.
SYSTEM DEBUG	Places the system in system debug mode. In this state, the system is less tolerant of system errors and is more likely to hang when errors occur. When the system is not in system debug mode, it rates system errors as critical or noncritical. For critical errors, the system partially or totally interrupts normal system operation to tend to the errors. For noncritical errors, the system logs them into the binary maintenance log and as much as possible allows normal system operation to proceed. You can initiate the system debug mode with the DSD command ENABLE,SYSTEM DEBUG or the corresponding IPRDECK entry.
TAPE PF STAGING	<p>Enables or disables the staging of permanent files to disk from tapes that do not reside within the Automated Cartridge Subsystem (ACS). The media for tape alternate storage is 9-track tapes and CTS tapes.</p> <p>Enabling TAPE PF STAGING allows tape alternate storage-resident files to be staged to disk when accessed. If TAPE PF STAGING is disabled and a user attempts to access a file that has copies on both cartridge alternate storage (MSE or optical disk) and on tape alternate storage, the file is staged from cartridge alternate storage, provided that CARTRIDGE PF STAGING is enabled. If TAPE PF STAGING is disabled and a user attempts to access a file which only has a copy on tape, the user's job is aborted. If both CARTRIDGE PF STAGING and TAPE PF STAGING are enabled, a file that has copies on both cartridge alternate storage and tape is staged from cartridge alternate storage.</p> <p>If the tape that contains the file resides within the Automated Cartridge Subsystem (ACS), the system checks the ACS TAPE PF STAGING attribute instead of the TAPE PF STAGING attribute to determine if the file can be staged. These two attributes can be enabled and disabled independently.</p>
USER EXTENDED MEMORY	Enables or disables use of the user accessible area of extended memory. If disabled, no job can access the user area of extended memory and, other than subsystems, all jobs currently accessing the area are rolled out.

**IDLE.**

Prevents any new jobs from being scheduled to a control point but does not terminate the jobs currently assigned. If a job is rolled out while this command is in effect, it is not scheduled back to a control point until the AUTO or MAINTENANCE or SCHEDULE command is entered.

**K.messagetext.**

Allows entry of data **messagetext** in the user- or system-defined CPU buffer for control when the K display is active. Refer to the NOS Version 2 Analysis Handbook for more information concerning the K display.

**LOCK.**

Locks the console keyboard. This command prevents entry of the following restricted commands:

**CHECK POINT SYSTEM.**

**DATE.yy/mm/dd.**

**DISABLE,PRIVILEGED ANALYST MODE.<sup>2</sup>**

**DISABLE,SECONDARY USER COMMANDS.**

**DISABLE,SYSTEM DEBUG.**

**DROP,jsn,qt,ujn.**

**ENABLE,ENGR.<sup>3</sup>**

**ENABLE,PRIVILEGED ANALYST MODE.<sup>2</sup>**

**ENABLE,SECONDARY USER COMMANDS.**

**ENABLE,SYSTEM DEBUG.**

**OVERRIDE,jsn.**

**SPINDOWN,est.**

**STEP.**

**STEP,jsn,ff,b,v.**

**STOP,sub.**

**TIME.hh.mm.ss.<sup>3</sup>**

**UNLOAD,est.** (where **est** specifies a nonremovable shared mass storage device)

All other DSD commands can be entered when the console is locked. Always lock the console when the system is used in a production environment.

---

2. Not allowed on secured systems.

3. Refer to the NOS Version 2 Analysis Handbook for information on locking and unlocking the console keyboard on a secured system.



**MAINTENANCE.**

This command performs the same functions as the **AUTO** command but additionally starts several maintenance routines. Refer to **Initiating Job Processing** in chapter 2 for more information concerning this command.

**X.MDD(p).**

Initiates the monitor display driver (**MDD**), which is a remote maintenance tool. **MDD** is a PP program and is independent of the operating system. **MDD** should be initiated only if required by maintenance personnel. Refer to the **NOS Online Maintenance Software Reference Manual** for more information.

<b>Parameter</b>	<b>Description</b>
p	Port number of the multiplexer. If you enter 1, the first port is connected. If you enter 2, the second port is connected. If you do not specify any parameter, the second port is connected by default.

**OQSH=level.**

Specifies the output queue special handling (**OQSH**) level on a secured system. The **OQSH** level is set initially during deadstart by the **OQSH IPRDECK** entry. Refer to the **NOS Version 2 Analysis Handbook** for more information on **OQSH IPRDECK** entry. The **OQSH** command can be entered at any time from the system console to change the current level. The **OQSH** level can be examined using the **DSD S** display. Output files with an access level greater than or equal to the **OQSH** level specified in this command are not printed but remain in the queue until released by the operator (refer to **RELEASE** command). If level is set to the lowest access level, or no level is specified, no files are held in the queue. Refer to chapter 1 for more information about the access levels.

**RELEASE,jsn.**

Allows the operator to release a file from the output queue whose access level is equal to or above the **OQSH** level on a secured system. Output queue files and their access levels can be examined using the **DSD Q** display. The output file with job sequence name **jsn** is released from the output queue and processed by the batch input/output subsystem. The **RELEASE** command can be entered at any time. Restrictions set by your site, based on device access levels and file access levels, continue to apply.

**SCHEDULE.**

Enables job scheduling (reversing the effect of the **IDLE** command), but does not automatically start any subsystems or maintenance jobs.

**TIME.hh.mm.ss.**

Changes the current system time. Unlock the console before entering this command.

hh (hours):           00 through 23.  
mm (minutes):        00 through 59.  
ss (seconds):         00 through 59.

**UNLOCK.**

Unlocks the console keyboard. When this command is active, the message UNLOCKED appears in the header of the left screen display. When the console is unlocked you can enter any DSD command.

X.name. or X.name(parameters)

Calls a system program or utility specified by name to an available control point. If parameters are to be passed to the program, the second form of the command is used where (parameters) specifies the parameters. In both the first and second form of the command, the field length specified in the library for the command is used. If no field length is specified in the library, a value of 60000<sub>8</sub> is assumed. Only the first 58 characters following X. are used.

## Subsystem Control Commands

These commands control which subsystems are used. When you deadstart a system, parameters specified in the IPRDECK determine which subsystems are initially available. To schedule other subsystems to a control point and terminate a current subsystem, use the initiation and termination commands described next.

### Initiation Commands

These commands initiate previously enabled subsystems. The AUTO and MAINTENANCE commands also initiate previously enabled subsystems, but only those subsystems whose initiation files have default names (identical to the three-character subsystem names). Site personnel will inform you if you are to use a name other than the default subsystem name. The structure and naming of the initiation files are described in the NOS Version 2 Installation Handbook.

To initiate a subsystem, it must be enabled. The SUBSYST display shows the status of all subsystems (see chapter 5). If the subsystem needs enabling, enter

L.ENABLE, sub, cp.

where sub is the three-character subsystem name and cp is the control point where the subsystem is to run. At this point enter the initiation command:

subffff.

where subffff is an initiation file name for the subsystem. The suffix ffff is optional and site-defined. If required, installation personnel must supply the one to four alphanumeric characters to be used. The values for subffff follow:

<b>subffff</b>	<b>Associated Subsystem</b>
ATF. <sup>4</sup>	Automated Tape Facility
BIO.	Batch Input/Output Subsystem
CDCffff.	CYBER Database Control System
CYBffff.	CYBIS-NAM Interface
IAFffff.	Interactive Facility
MAGffff.	Magnetic Tape Subsystem
MAPffff.	Matrix Array Processor
MCSffff.	Message Control System
MSEffff.	Mass Storage Extended Subsystem
NAMffff.	Network Access Method
NVEffff.	NOS/VE Subsystem
RBF. <sup>4</sup>	Remote Batch Facility
RDFffff.	Remote Diagnostic Facility
RHFffff.	Remote Host Facility
SMFffff.	Screen Management Facility (Multiuser Full Screen Editor)
SSFffff.	SCOPE 2 Station Facility
STMffff.	Interactive Stimulator
TAFffff.	Transaction Facility

When a subsystem is scheduled to a specific control point, any job currently assigned to that control point is rolled out unless it is another subsystem or special system job. If the job cannot be rolled out, the command used to call the subsystem is not accepted. In this case, either terminate the job (if the subsystem requires that control point) or specify another control point for the subsystem using the SUBSYST L display utility (refer to chapter 5 for more information). Under normal circumstances, do not terminate the job unless you are instructed to do so.

<sup>4</sup>. This subsystem cannot be initiated directly by using a DSD command. It is initiated automatically by the NAM subsystem, if selected in the NAM startup file.

## Termination Commands

The following commands terminate any of the previously described subsystems.

**IDLE,subsystem.**

Sets idledown status for the specified subsystem. Any acceptable three-character subsystem name can be specified. The subsystem terminates when idledown conditions are met. MAG terminates when no tapes are assigned. MSE terminates when no requests are outstanding and no MSE utilities are connected. BIO terminates when no equipment remains active. RHF terminates when no applications or jobs are connected. NAM and TAF idledown require special handling (refer to the NOS Version 2 Analysis Handbook for more information). For all other subsystems, there are no idledown conditions – they terminate immediately. The system does not initiate new activity, such as assigning tapes and beginning print jobs, when idledown status is set. Use this command for terminating all subsystems.

**STOP,subsystem.**

Drops (terminates) the specified subsystem. Any acceptable three-character subsystem name can be specified. Unlock the console to enter this command. This command can cause termination errors in the subsystem being dropped. Use this command only when the IDLE,subsystem command is not appropriate.

Refer to the AUTO and MAINTENANCE commands in this chapter and the SUBSYST L display utility in chapter 5, for additional information concerning subsystem control.

## Peripheral Equipment Control Commands

The commands described in this section logically control the operation of the peripheral equipment available to the system. Appendix D describes the physical operation of the peripheral equipment, such as magnetic tape units, line printers, and disk storage units.

This section does not, however, include the commands that logically control CDC 533 and 536 printers. These printers are controlled by the Printer Support Utility (PSU) commands. The next section describes these commands.

To control peripheral equipment, you should become familiar with the following DSD displays:

Display	Display Call
Equipment Status Table	E,A
Disk Configuration	E,C
Disk Errors	E,E
Family Status	E,F
Disk Thresholds	E,H
Disk Status	E,M
Optical Disk Requests	E,O
Resource Requests	E,P
Optical Disk Status	E,S
Tape Status	E,T
BIO Status	I

A complete description of each of these displays is given in chapter 4. The peripheral equipment control commands are described next.

**ASSIGN,jsn,est.**

Assigns equipment defined by EST ordinal est (normally a tape unit) to the job with job sequence name jsn. This command is entered in response to a flashing REQUEST message. You do not normally use this command to assign a tape unit because tape assignment is automatic when a volume serial number (VSN) is specified in the job request. However, if a VSN is not specified in the job request for a labeled or unlabeled tape, the REQUEST message appears at the job's control point (on B,O display), and you must enter the ASSIGN command to assign a tape unit to the job.

**BKSP,est,rr.**

Backspaces rr<sub>8</sub> logical records on the print file for the BIO equipment defined by EST ordinal est. When rr is not specified, the default is one record.

**BKSPF,est,ff.**

Backspaces ff<sub>8</sub> files on the print file for the BIO equipment defined by EST ordinal est. When ff is not specified, the default is one file.

BKSPRU,est,ss.

Backspaces  $ss_8$  physical record units (PRUs) on the print file for the BIO equipment defined by EST ordinal est. The PRU count, ss, must be specified. There is no default setting. Printing resumes at the beginning of a line.

CONTINUE,est.

Resumes printing on BIO equipment defined by EST ordinal est.

END,est,rc.

Terminates current operation on BIO equipment defined by EST ordinal est. If est defines a line printer or card punch, BIO assigns the next available file to that equipment. If est defines a card reader that is actively reading cards when the END command is entered, the job terminates at the last card read. The next card is treated as the beginning of a new job. If another card deck follows the end-of-information card (multipunch 6/7/8/9), it is processed normally.

The rc parameter cancels a portion of the repeat count specified for that equipment by the REPEAT command. For example, if the current operation on equipment est is set to be repeated five times (operation performed six times), entering a value of 4 for rc permits the operation to be performed only twice. If the repeat count is zero, this command performs the END operation once.

FORM,est,fc.

Assigns a two-character forms code fc to the BIO line printer or card punch defined by EST ordinal est. Only those files in the output queue assigned the forms code fc are directed to equipment est. A user can assign a forms code to an output file using the ROUTE command. (For a description of the ROUTE command, refer to the NOS Version 2 Reference Set, Volume 3.) The value of the forms code can range from AA to 99. If a forms code is not present, the current forms code field is cleared (value is null).

GO,est.

Blank labels the tape on the tape unit defined by EST ordinal est for a TMS scratch tape request. This command is used only in response to one of the following E,P display error messages:

NEEDS LABEL	GO, EST TO BLANK
NO PERMIT	GO, EST TO BLANK
WRONG VSN	GO, EST TO BLANK

If the tape should not be blank labeled, enter STOP,est. to unload the tape.

HOLD,est.

Suspends printing on the BIO equipment defined by EST ordinal est.

ID,est,id.

Assigns a numeric identifier id to the card punch, card reader, or line printer defined by EST ordinal est. The value of the identifier can range from 00 to 67<sub>8</sub>. Only jobs or queued files with an identifier equal to id are directed to equipment est.

**MOUNT,est,P.**

Clears local unload (L) and global unload (N) status on the E,M display for a mass storage device and reactivates the device. If the device is a spun down 834, 836, or 887 drive, it is automatically spun up. The device is defined by EST ordinal est (examine the E,A display to determine the EST ordinal).

When you specify P in the MOUNT command for an independent shared device in a multimainframe environment, the system presets the device with EST ordinal est. The preset (P) option must not be specified unless this is the first mainframe to access the device.

If the device defined by EST ordinal is not a disk device, the MOUNT command is ignored and the following message appears on the left console screen.

```
INCORRECT EQUIPMENT.
```

If the device is shared in a multimainframe environment and another mainframe has an unsatisfied initialize request pending for that device, the MOUNT command is ignored and the following message appears at the system control point on the B,O display.

```
INITIALIZE PENDING ON THIS DEVICE.
```

**MOUNT,est,vsn.**

Allows an operator to mount cartridges on the Automated Cartridge Subsystem. The operator designates the EST ordinal for the subsystem to use. If a cartridge is mounted using the MOUNT command and has not been assigned to a job for an installation-defined period of time, the subsystem unloads and dismounts the cartridge.

**NEXTVSN,est,vsn.**

Specifies that the tape with VSN vsn is to follow the tape currently mounted on the magnetic tape unit defined by EST ordinal est. This command is allowed only in response to the following prompt on the E,P display:

```
NEXTVSN, EST, VSN TO CONTINUE
```

This message is posted when an end-of-reel condition occurs on a tape file and the user does not specify the VSN of the next reel. The EST ordinal of the affected tape unit is displayed under the UNIT header on the E,P display. After entry of the NEXTVSN command, a request to mount the specified VSN is posted on the E,P display.

**OFF,EQ=est.**

Logically turns off the line printer, card reader, or card punch defined by EST ordinal est. This command allows you to logically remove a device from the operating environment. Examine the E,A display to determine the EST ordinal and current status (ON, OFF, IDLE, or DOWN) of the device. Examine the E,E display to determine disk errors.

**CAUTION**

---

Verify that the correct EST ordinal is specified before entering this command. You usually enter this command for a line printer, card reader, or card punch. Serious performance problems may result if this command is entered for any other device.

---

ON,EQ=est.

Logically turns on the line printer, card reader, or card punch defined by EST ordinal est. This command allows you to activate a device currently having OFF status in the EST. If the device is a spun down 834, 836, or 887 drive, it is automatically spun up. Examine the E,A display to determine the EST ordinal and current status (ON, OFF, IDLE, or DOWN) of the device. Examine the E,E display to determine disk errors.

PRSIZE,est,ps.

Sets the paper status ps to short (S) or long (L) paper for the printer with EST ordinal est.

REPEAT,jsnn,rc.

Alters the repeat count for the queue file specified by job sequence name jsnn. If the file is still in the queue, the repeat count for the file is set to rc. If the file is already being processed by BIO, the remaining repeat count for the file is increased by rc. If the current BIO operation is being repeated, the system reinitializes the maximum line and card limits prior to printing or punching the file being processed. User control limits apply individually to each output file copy produced. The maximum value that can be entered for rc is 77<sub>8</sub>. The default value for rc is one.

REPRINT,est,pr.

Terminates current operation on the BIO printer equipment defined by EST ordinal est and reenters the job in the print queue with a queue priority specified by pr00 (service class minimum  $\leq$  pr00  $\leq$  service class maximum). If pr is not specified, the service class default priority is assigned. If the current BIO operation is being repeated, the system reinitializes the maximum line and card limits prior to printing or punching the file being processed. User control limits apply individually to each output file copy produced.

REPUNCH,est,pr.

Terminates current operation on the BIO card punch equipment defined by EST ordinal est and reenters the job in the punch queue with a queue priority specified by pr00 (service class minimum  $\leq$  pr00  $\leq$  service class maximum). If pr is not specified, the service class default priority is assigned. If the current BIO operation is being repeated, the system reinitializes the maximum line and card limits prior to printing or punching the file being processed. User control limits apply individually to each output file copy produced.

RETRY,est.

Reissues the tape operation on the magnetic tape unit defined by EST ordinal est that previously aborted with a load point error. The tape must be reloaded on the same tape unit before this command can be entered.

SCRATCH,est.

Declares the tape mounted on an unassigned magnetic tape unit, defined by EST ordinal est, to be a scratch tape. This command enables a tape to be available to satisfy scratch VSN requests and still be assigned by its original VSN. Thus, the VSN defined on the tape (in VOL1 label) is not redefined as scratch, although the VSN appears as SCRATCH on the tape status display (E,T).



Scratch status is retained for only one job assignment. This allows a tape to be used temporarily for scratch. For example, a job requests a tape that is mounted on the tape unit defined in this command by specifying the current VSN for that tape in the request. The tape is then assigned to the job as a scratch tape (the original VSN is retained and not made scratch). When that job releases the tape, SCRATCH status is cleared and, unless this command is entered again, that tape is not assigned as a scratch tape in future requests. To determine if SCRATCH status is in effect for a tape, monitor the E,T display.

SKIP,est,rr.

Skips forward rr<sub>g</sub> logical records on the print file for the BIO equipment defined by EST ordinal est. When rr is not specified, the default is one record.

SKIPF,est,ff.

Skips forward ff<sub>g</sub> files on the print file for the BIO equipment defined by EST ordinal est. When ff is not specified, the default is one file.

SKIPRU,est,ss.

Skips forward ss<sub>g</sub> PRUs on the print file for the BIO equipment defined by EST ordinal est. All parameters must be specified – there are no default settings. The PRU count, ss, is limited to 10<sub>g</sub> PRUs (current buffer size) plus the number of PRUs remaining in the buffer. If the buffer is empty, ss is limited to 20<sub>g</sub> PRUs.

SPINUP,est.

Spins up the 834, 836, 887, or 9853 disk storage device defined by EST ordinal est.

SPINDOWN,est.

Spins down the 834, 836, 887, or 9853 disk storage device defined by EST ordinal est. To enter this command, the console must be unlocked (refer to UNLOCK command).

### CAUTION

---

Spinning down an 834, 836, 887, or 9853 disk storage device that does not have global unload status (N) as specified on the E,M display can cause mass storage device status errors or permanent file errors when the device is spun up.

---

STOP,est.

Prevents the tape on the tape unit defined by EST ordinal est from being blank labeled. See the description of the GO,est. command for the conditions under which this command can be used. Execution of this command unloads the tape.

SUPPRESS,est.

Suppresses automatic printer carriage control on the BIO line printer defined by EST ordinal est. This command stops the page eject function on the line printer to provide a continuous listing for the current job.

TERMINATE,est.

Aborts a tape load point error recovery attempt where the load point error occurred on the magnetic tape unit defined by EST ordinal est.

TRAIN,est,t.

Assigns or changes print train identifier t of the line printer defined by EST ordinal est. This command can set the identification if it was not specified in the EQ entry of the EQPDECK, or change an identification previously included in the EQPDECK. An LR designation in the EQ entry indicates a 580-12 line printer, LS is a 580-16 line printer, LT is a 580-20 line printer, and LX is a 5870 printer. Print trains supported for the 580 printers are 595-1/596-1, 595-5/596-5, and 595-6/596-6. The print train supported for the 5870 printer is t=7. The t field specifies the print train.

t	Print Train
0	595-1/596-1 (CDC graphic 63/64-character set). Default.
1	595-1/596-1 (CDC graphic 63/64-character set).
2	Reserved for future use. (Value is allowed, but defaults to 596-1.)
3	Reserved for future use. (Value is allowed, but defaults to 596-1.)
4	595-6/596-6 (ASCII graphic 95-character set).
5	595-5/596-5 (ASCII graphic 63/64-character set).
6	595-6/596-6 (ASCII graphic 95-character set).
7	595-6/596-6 (ASCII graphic 63/64-character set or ASCII graphic 95-character set).

UNLOAD,est.

Physically unloads a tape or logically removes a removable mass storage device from the operating system. (Only removable devices can be physically removed by unloading.) The device to be unloaded is defined by EST ordinal est (examine the E,A display to determine the EST ordinal). Also, in a multimainframe environment, the UNLOAD command must be issued if another mainframe wants to initialize a shared mass storage device, whether the device is removable or nonremovable (refer to the INITIALIZE command in the NOS Version 2 Analysis Handbook).

*Magnetic tape units:* Examine the E,T display before entering the UNLOAD command to determine if the tape to be unloaded is currently assigned to a job. If the tape is not currently assigned, entering this command physically unloads the specified tape. If a tape is currently assigned to a job, it cannot be unloaded. If this is attempted, the UNLOAD command is ignored and the following message appears on the left console screen.

UNIT NOT AVAILABLE

*Mass storage devices:* The UNLOAD command is valid for initializing any shared mass storage device in a multimainframe environment. In other environments, the command is valid only for removable devices. If a nonremovable shared mass storage device is specified, the console must be unlocked (refer to UNLOCK command).

After entering the UNLOAD command, monitor the disk status display (E,M). A local unload (L) status appears in the STATUS field for that device. While L status is displayed, no new users are permitted to access files on the device. A user currently accessing files on the device can continue while at least one direct access file from the device is attached to the job. When the user count is zero and there are no checkpoint requests pending, one of the following two actions occurs.

- If the device is removable and the L status is set in all machines accessing the device, global unload (N) status is displayed. This indicates you can now physically dismount that device.
- If an initialize is pending on the device and all other machines accessing the device have the L status set, the initialization proceeds. However, initialization cannot take place if the device has been unloaded.

---

**NOTE**

If a multispindle family is mounted on a single spindle device, only the first device shows the global unload status. A device should be physically dismounted only if global unload status (N) is displayed on all machines accessing the device.

---

If a removable pack is dismounted before the N status is displayed, the following may occur.

- Mass storage device status errors.
- Permanent file errors when pack is remounted at some later date.
- If another pack is mounted, accesses made by a previously attached user may destroy information on the current pack, or the previous user may retrieve information from the new device that he or she is not privileged to access.

---

**NOTE**

If the Mass Storage Extended (MSE) subsystem is active, it must be idled before unloading a removable family pack that has MSE files. After dismounting the family pack, MSE can be initialized again.

---

*Optical disk units:* Examine the E,S display before entering the UNLOAD command to determine if the optical disk to be unloaded is assigned to a job. If the optical disk is not assigned, entering this command physically unloads the specified optical disk. If an optical disk is assigned to a job, it cannot be unloaded. If unloading is attempted, the UNLOAD command is ignored, and the following message appears on the left console screen:

UNIT NOT AVAILABLE

VSN,est.

Reverses the effect of a previous VSN,est,vsn command and forces the magnetic tape subsystem to read the label on the tape. This command is not allowed for ACS cartridge tape units.

VSN,est,.

Declares the tape mounted on an unassigned magnetic tape unit, defined by EST ordinal est, to be a scratch tape. This command is similar in function to the SCRATCH command in that it enables a tape to be available to satisfy scratch VSN requests. However, if the tape is labeled and a write function is performed, the VSN specified in the VOL1 label is rewritten as a scratch VSN, destroying the original VSN and making the tape available for future scratch VSN requests. The VSN also appears as \*\*\*est (est is the ordinal of the est) on the tape status display (E,T). Refer to the VSN,est,vsn command for a discussion of the INCORRECT ENTRY message that is also applicable to VSN,est,. This command is not allowed for ACS cartridge tape units.

VSN,est,vsn.

Assigns VSN vsn to an unassigned magnetic tape unit defined by EST ordinal est. This command allows you to specify a one- to six-character VSN for a mounted, unlabeled tape so it may be assigned and referenced automatically. For example, when a job specifies a VSN in the request for an unlabeled tape, an entry for that job appears in the resource requests display (E,P). This display indicates:

Job sequence name of the job

Type of tape unit – 7-track (MT), 9-track (HD, PE, or GE), or CTS Cartridge (CT) – on which tape is to be mounted

Required VSN

User name of the job

Required write ring status (IN or OUT).

If the correct tape is not currently mounted, mount the tape on an available unit (ensuring that track type and write ring status are correct), ready the unit, and enter this command. The system equates the VSN entered with that specified by the job and assigns the tape automatically upon demand. This command is not allowed for ACS cartridge tape units.

## NOTE

---

Special characters cannot be entered using this command. If a special character is encountered in vsn, the VSN entered is truncated at the character preceding the special character.

---

If the tape mounted on the tape unit defined by EST ordinal est is a labeled tape, or already has a VSN assigned by a console command, or has not yet been checked for a label by the magnetic tape subsystem, this command is ignored. The message

INCORRECT ENTRY

appears on the left console screen. To change a VSN previously assigned by this command, clear the first VSN by entering

VSN,est.

est            EST ordinal of the tape unit.

**The command**

```
VSN, est, vsn.
```

```
vsu      New VSN.
```

can then be entered.

If a job specifies a VSN in the request for a labeled tape, the VSN is assigned automatically, unless an incorrect tape is mounted. In this case, the system enters a description of the correct tape in the resource requests display (E,P).

When the correct tape is mounted and the tape unit is ready, the VSN is automatically assigned.

For multivolume files, automatic tape assignment occurs only if the tape units on which the tapes are mounted are the same and on the same channels. That is, if the first reel of the file is on a 669 tape unit on channels 13 and 33, all subsequent reels must be on a 669 unit on channels 13 and 33.

When assigning tapes, models 679-2, 679-3, and 679-4 drives (800/1600 cpi) are similar. Also models 679-5, 679-6, 679-7, 698-10, 698-11, 698-12, 698-20, 698-21, 698-22, 698-30, and 698-31 drives (1600/6250 cpi) are similar. All CTS cartridge tape units are similar, and all ACS cartridge tape units are similar.

If two or more unassigned tapes having identical VSNs are mounted on units of the same track type, the flashing message

```
REQUEST, dt, vsn
```

appears on the B display. The dt field is either a device type (MT or CT) or a density requirement (HD, PE, or GE). vsn is the VSN required.

You must assign one of the tapes using the ASSIGN command. If the duplicate VSNs are SCRATCH, the resource executive routine automatically assigns one.

**NOTE**

---

It is not possible to specify a VSN of SCRATCH with this command since only six characters may be used to define a VSN. To define a scratch tape (used to satisfy scratch VSN requests), refer to the description of the SCRATCH command.

---

## Printer Support Utility (PSU) Commands

Printer Support Utility (PSU) commands are valid only if your site has a 533, 536, 537, or 585 printer. You must enter PSU commands by way of the K display. Ensure that the STOP/START indicator on the printer is lit. All command entries must be prefixed by K. (K period). After pressing carriage return for the first command entry, everything but the K. is erased. This allows another command to be entered without entering K. first. All examples in this chapter show K., although you may not have to enter it.

To communicate with PSU, follow these steps:

1. Bring up the NAM display (figure 3-1) by typing this command:

K, NAM.

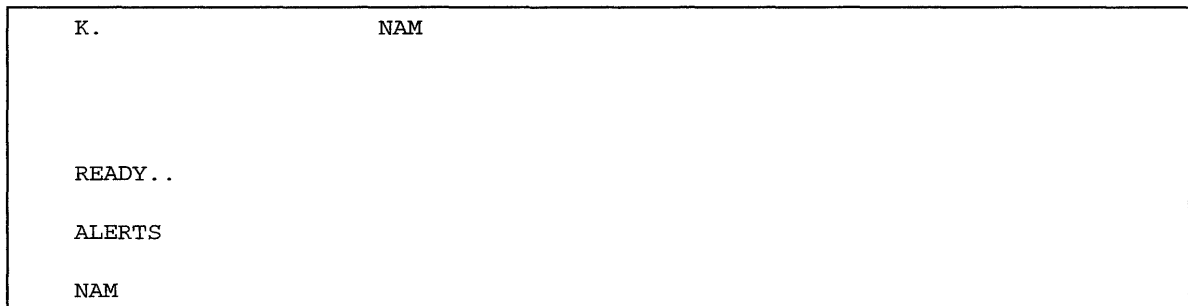

**Figure 3-1. NAM Display**

2. Bring up the NAM STATUS display (figure 3-2) by typing this command:

K.ST.

You may have to page through the display to get to PSU.

```

K.                NAM

NIN = 146 REG LVL = 3 NO OF APPLS = 6 MAX FL = 060000

APP   JSN   STATUS  I   NCN  AC   NSM  NDM  TIME UP
NVF   AAAX  100000  N   0   0   0   0   10.42.33
CS    AAAZ  100000  N   0   0   0   0   10.42.33
TVF   AABA  100000      0   0   0   0   10.42.33
NS    AAAY  100000  N   0   0   0   0   10.42.33
IAF   IAF   000000      0   0   0   0   10.42.37
PSU   AABE  600000      1   0   0   0   10.44.23

EST  HN   NSM  NHM   NLM   IVTSTAT  PRUSTAT  NPUREJ

ALERTS

NAM           ST
    
```

**Figure 3-2. NAM STATUS Display**

3. Type:

K,jsn.

where jsn is the JSN displayed for PSU on the NAM STATUS display.

The PSU display appears on the console (refer to figure 3-3). If you see the message:

JSN ROLLED

wait until PSU rolls in. When it rolls in, the PSU display appears on the console.

```

K.  PSU.                AABE

***  PRINTER SUPPORT UTILITY  ***

PRINTER  JSN  ID  FC  TR  REP  PCT  MAX  SZ  DE  BA  STATUS
PRINT01  AACZ      95  4  12      EL  6  1  ACTIVE
    
```

**Figure 3-3. PSU Display**

Each entry on the display has the following format:

```
printer jsn id fc tr rep pct max sz de ba status
```

printer	Name of printer. You may have up to 12 printers, numbered from PRINT01 through PRINT12.																
jsn	Job sequence name of file that is printing.																
id	Identification of printer.																
fc	Forms code.																
tr	Print train identifier.																
rep	Repeat count. Number of copies left to be printed.																
pct	Percentage of file already printed (except 585 printers).																
max	Maximum file size the printer can print.																
sz	Form size.																
de	Default density.																
ba	Number of banners to be printed on this printer.																
status	Status of the printer. One of the following: <table> <tr> <td>IDLE</td> <td>Printer is idle.</td> </tr> <tr> <td>WAIT</td> <td>Printer is starting or ending a job, or a 585 printer is waiting for STOP state prior to executing a command.</td> </tr> <tr> <td>ACTIVE</td> <td>Printer is printing.</td> </tr> <tr> <td>STOP</td> <td>Printer halted.</td> </tr> <tr> <td>OFF</td> <td>Printer is logged in and is off.</td> </tr> <tr> <td>HOLD</td> <td>Printer is in HOLD state. An explanation line immediately below the status line explains the reason for the HOLD state. No commands are accepted for a connection in the HOLD state. The only way to clear the connection is to break the connection external to the PSU.</td> </tr> <tr> <td>++</td> <td>Printer is not logged in and is on.</td> </tr> <tr> <td>-</td> <td>Printer is not logged in and is off.</td> </tr> </table>	IDLE	Printer is idle.	WAIT	Printer is starting or ending a job, or a 585 printer is waiting for STOP state prior to executing a command.	ACTIVE	Printer is printing.	STOP	Printer halted.	OFF	Printer is logged in and is off.	HOLD	Printer is in HOLD state. An explanation line immediately below the status line explains the reason for the HOLD state. No commands are accepted for a connection in the HOLD state. The only way to clear the connection is to break the connection external to the PSU.	++	Printer is not logged in and is on.	-	Printer is not logged in and is off.
IDLE	Printer is idle.																
WAIT	Printer is starting or ending a job, or a 585 printer is waiting for STOP state prior to executing a command.																
ACTIVE	Printer is printing.																
STOP	Printer halted.																
OFF	Printer is logged in and is off.																
HOLD	Printer is in HOLD state. An explanation line immediately below the status line explains the reason for the HOLD state. No commands are accepted for a connection in the HOLD state. The only way to clear the connection is to break the connection external to the PSU.																
++	Printer is not logged in and is on.																
-	Printer is not logged in and is off.																



4. Type:

KK.

The PSU HELP display appears on the right screen. PSU display remains on the left screen. You may enter more than one of the following commands.

**K.BANNERS,pn,nb.**

Sets the number of banners nb to be printed on the printer pn. You can specify a value of 0, 1, or 2.

**K.BKSPRU,pn,nn.**

Backspaces nn physical record units (PRUs) on the printer pn. If the printer is in STOP state when the command is entered, it returns to the ACTIVE state.

**K.CONTINU,pn.**

Resumes printing on the printer pn.

**K.DOWN,pn.**

Removes the printer pn from the K display. This command may be given only for printers that are not logged in (status ++ or -). A printer that is removed from the K display with a DOWN command may be returned to the K display with an ON or OFF command. The printer also returns to the K display if it is logged in (removal from the K display with the DOWN command does not prevent login).

**K.END,pn,nn.**

Terminates the current file printing on the printer pn. nn specifies the number of copies to drop. For example, if the file has a repeat count of 5 (meaning the file is printed six times), entering a value of 4 for nn drops four copies and permits the file to be printed only twice.

**K.FORM,pn,fc.**

Assigns the form code fc to the printer pn. If you specify \* for fc, the default form code is assumed (the one in effect when the last SAVE command was entered). If you specify NULL for fc, the form code is cleared (no form code in effect).

**K.ID,pn,id.**

Assigns logical identifier id to the printer pn. The range of allowable values for id is 0-67B. After this command is entered, the printer prints only those files routed with an identifier of id. You may, for example, use this command to distinguish two printers with different size paper or to distinguish PSU printers from batch input/output (BIO) printers.

**K.MAXIMUM,pn,nn.**

Ignores lengthy listings on the printer pn. nn specifies the maximum number of PRUs.

**K.OFF,pn.**

Turns the printer pn OFF. The file being printed continues to print. To terminate the current file, use the END command.

**K.ON,pn.**

Turns the printer pn ON.

**K.PRSIZE,pn,sd.**

Changes the form size and default density of the printer pn. PSU defaults to standard 11-inch paper. The default density is the system default density at your site. If your site uses mostly 12-inch or 8.5-inch paper, or if the type of paper or default density changes, use the PRSIZE command. The size and density parameter (sd) can be one of the following combinations:

<b>sd</b>	<b>Paper Size</b>	<b>Density</b>
EL6	12-inch	6 lines-per-inch
EL8	12-inch	8 lines-per-inch
L6	11-inch	6 lines-per-inch
L8	11-inch	8 lines-per-inch
S6	8.5-inch	6 lines-per-inch
S8	8.5-inch	8 lines-per-inch

**K.REPEAT,pn,nn.**

Repeats printing the file in progress on the printer pn. nn specifies the number of copies.

**K.REPRINT,pn.**

Reprints a file that is printing on the printer pn. The file being printed is terminated and returned to the queue. When printing resumes, PSU prints the smallest size file first.

**K.SAVE.**

Saves the current configuration of PSU. That is, specifications you give with the commands BANNERS, FORM, ID, MAXIMUM, OFF, ON, PRSIZE, and TRAIN are effective for all subsequent PSU startups. The current down status of all printers at the time the SAVE command is entered is preserved (refer to DOWN command).

**K.SELECT,pn,jsn.**

Selects the next job to be printed on the printer pn. If you select a second file before the first is printed, the second file overrides the first file selected. jsn is the job sequence name of the job.

**K.SKIPRU,pn,nn.**

Skips a portion of the file while the file is printing on the printer pn (state may be ACTIVE or STOP). nn specifies the number of PRUs to be skipped. If the state is STOP when this command is entered, it returns to ACTIVE.

**K.STOP,pn.**

Temporarily stops printing a file on the printer pn. Enter the CONTINU command to resume printing.

**K.SUPPRES,pn.**

Suppresses automatic printer carriage control on the printer pn. This command stops the page eject function on the printer to provide a continuous listing for the current job.

K.TRAIN,pn,tr.

Assigns or changes the print train identifier tr to the printer pn. This command sets a train of 64 or 95, which corresponds to the character band on the printer pn.

## Job Processing Control Commands

Under normal circumstances, the system automatically controls job processing. The following commands provide an added measure of control over job processing.

### Scheduling Control Commands

The following job control commands affect scheduling and execution of jobs in the system.

#### CAUTION

---

Do not enter these commands unless specifically directed to do so. Improper use of these commands can drastically hamper job flow as well as system performance. In certain cases, jobs may be lost.

---

DROP,jsn,qt,ujn.

Drops the job with job sequence name jsn from the queue qt where it currently resides. You can optionally specify a one- to seven-character user job name, ujn, after the queue type. If jsn and ujn are both specified, they must identify the same job. If only one is specified, that one determines which job is dropped.

If no jsn or ujn is specified, all jobs in the specified queue type are dropped. If the queue type is not specified, the default is ALL. The console must be unlocked if no jsn is specified (refer to UNLOCK command).

The DROP command cannot be used to terminate a subsystem, a nonsuspended interactive job, or an input file of origin type IAOT.

The queue type is one of the following.

qt	Queue Type
ALL	All jobs and queued files.
EX	Only jobs in the executing queue (including the rolled out jobs).
IN	Only jobs in the input queue.
PL	Only jobs in the plot queue.
PR	Only jobs in the print queue.
PU	Only jobs in the punch queue.
WT	Only jobs in the wait queue.

**KILL,jsn.**

Drops the job with job sequence name jsn from the executing job table (EJT) without exit processing. If you want the job to terminate with exit processing, use the DROP command. The KILL command cannot be used to drop a subsystem.

**NOTE**

---

Before pressing carriage return, verify that the correct job sequence name is specified.

In some cases, the KILL command is intercepted by a job's REPRIEVE processing. If the job does not terminate itself after finishing its reprieve processing, a second KILL terminates it.

---

**RERUN,jsn.**

Terminates the job with job sequence name jsn, then reruns the job from the beginning. The job must be in rerun status as set by the RERUN command or macro.

**ROLLIN,jsn,L.**

Allows the job defined by job sequence name jsn to be scheduled to an available control point. If L is entered, the job cannot be selected by the scheduler for roll out.

**ROLLOUT,jsn,sd.**

Removes the currently executing job with job sequence name jsn and makes it a rolled out job. A subsystem cannot be rolled out. sd is the number of scheduler intervals before the job can be scheduled again. The acceptable range for sd is between 0 and 777<sub>8</sub>. If sd is not present or is zero, the job is not scheduled back to a control point automatically. That is, action is required to return the job to a control point. This can be done using the ROLLIN command.

The time required for one job scheduler interval is initially set in the IPRDECK.

## Job Communication Commands

The following job communication commands are used to communicate with a job currently in the executing job table.

**CFO,jsn,message text.**

Sends a message message text (36 characters maximum) from the operator to the job with job sequence name jsn. The job to which the message is sent must be ready to receive the message. Contact an analyst for more information on preparing a job to receive a CFO command.

**COMMENT,jsn,message text**

Enters comment message text (48 characters maximum) in the dayfile for the job with job sequence name jsn.

**GO,jsn.**

Clears the pause bit of the job with job sequence name jsn. A job may set the pause bit if an error is encountered or if an operator response is required. If jsn is not specified, the command applies to the system control point.

OFFSW,*jsn,s<sub>1</sub>,s<sub>2</sub>,...,s<sub>6</sub>*.

Turns off sense switch  $s_i$  ( $1 \leq s_i \leq 6$ ) of the job with job sequence name *jsn*. Refer to Subsystem Control Commands in the NOS Version 2 Analysis Handbook, for a definition of sense switches that can be set for the BIO, IAF, and TAF subsystems.

ONSW,*jsn,s<sub>1</sub>,s<sub>2</sub>,...,s<sub>6</sub>*.

Turns on sense switch  $s_i$  ( $1 \leq s_i \leq 6$ ) of the job with job sequence name *jsn*. Refer to Subsystem Control Commands in the NOS Version 2 Analysis Handbook, for a definition of sense switches that can be set for the BIO, IAF, and TAF subsystems.

PAUSE,*jsn*.

Sets the pause bit of the job with job sequence name *jsn*. If *jsn* is not specified, the command applies to the system control point.

## Interactive Job Control Commands

The following job control commands apply only to online interactive jobs. The interactive facility subsystem must be active at control point 1.

DIAL,*jsn,messagetext*.

DIAL,*\*,messagetext*.

Sends message *messagetext* (48 characters maximum) to the terminal currently assigned to the job with job sequence name *jsn*. If *jsn=\**, the message is sent to all active terminals. Examine the T display (refer to chapter 4) to determine the appropriate job sequence name. The message is sent to the terminal immediately unless output is being sent to the terminal. In this case, the message follows the output data.

WARN,*messagetext*.

Sends message *messagetext* (48 characters maximum) to all terminals currently logged into IAF. The message is received at a terminal upon completion of the current command or at the end of a job step. Each subsequent terminal to log in also receives this message. This continues until either a new message is entered or the message is cleared (refer to the following WARN. command). In addition, the current message appears at the IAF subsystem control point on the B display.

When sent to an interactive terminal, the message *messagetext* is always preceded by the statement

```
hh.mm.ss WARNING
```

where *hh.mm.ss* is the time (hours, minutes, seconds) you entered the WARN command.

For example, if you enter

```
WARN,SYSTEM SHUTDOWN AT 1500.
```

the following information is transmitted to all interactive terminals.

```
hh.mm.ss WARNING
SYSTEM SHUTDOWN AT 1500.
```

This command is typically used to notify interactive users of an interruption in service or system shutdown.

WARN.

Clears message entered by the `WARN,messagetext.` command. If you do not enter this command, the existing message (if any) continues to be transmitted to each new terminal that logs into the system.

## Dayfile Commands

The system saves messages in five types of dayfiles.

Account dayfile.

Binary maintenance log.

Error log.

Job dayfile.

System dayfile.

The account dayfile keeps a record of all resources charged to a job. This dayfile can be used for customer billing and other accounting purposes. The binary maintenance log dayfile records the information used by Control Data for maintenance of your system. The error log records system error messages, such as disk errors. Job dayfiles keep entries for individual jobs. The system dayfile keeps a history of all commands for all jobs processed.

The following commands dump the account, error log, or system dayfile to a system-defined mass storage device. The resultant mass storage file is put in the output queue for printing. The system automatically prints the job dayfile at the end of the job's output.

### NOTE

---

These are very large files and require extensive printing resources. Consult with site personnel to determine if you should print these files.

---

### Command Description

---

<b>X.AFD.</b>	Requests that account dayfile be dumped to system-defined mass storage. The resultant mass storage file is put in the output queue for printing.
<b>X.DFD.</b>	Requests that system dayfile be dumped to system-defined mass storage. The resultant mass storage file is put in the output queue for printing.
<b>X.ELD.</b>	Requests that error log dayfile be dumped to system-defined mass storage. The resultant mass storage file is put in the output queue for printing.

Refer to the NOS Version 2 Analysis Handbook for more information on dayfile dumps.

The binary maintenance log is processed through an interpreter program; therefore, it is normally dumped to tape or disk.

Refer to chapter 4 for descriptions of dayfile displays.



---

Display Selection	4-1
Display Screen Headers	4-3
Dayfile Displays (A)	4-4
System Dayfile Display (A. or A.,)	4-7
Account Dayfile Display (A,ACCOUNT FILE.)	4-8
Error Log Display (A,ERROR LOG.)	4-9
Operator Action Display (A,OPERATOR.)	4-10
Job Dayfile Display (DAYFILE,jsn.)	4-12
System Status Displays (B,A. and B,O.)	4-13
Storage Displays (C, D, F, G, and M)	4-18
Equipment Status Displays (E)	4-23
Equipment Status Table Display (E,. or E,A.)	4-23
Disk Configuration Display (E,C.)	4-27
Disk Errors Display (E,E.)	4-29
Family Status Display (E,F.)	4-32
Disk Thresholds Display (E,H.)	4-34
Disk Status Display (E,M.)	4-36
Optical Disk Requests Display (E,O.)	4-40
Resource Requests Display (E,P.)	4-41
Optical Disk Status Display (E,S.)	4-44
Tape Status Display (E,T.)	4-45
System and Local Files Display (H)	4-48
BIO Status Display (I)	4-51
Job Status Display (J)	4-53
Central Programmable Display (K)	4-55
Transaction Facility (TAF) Displays (O)	4-56
Subcontrol Point Status Display (O,SCP.)	4-57
Task Library Directories Display (O,TLD.)	4-59
TAF Status Table Display (O,TST.)	4-61
PP Registers Display (P)	4-63
.....	4-65
Rollout Status Display (R)	4-68
System Control Display (S)	4-71
Interactive Status Display (T)	4-76
System Information Displays (W)	4-78
Memory Allocation Display (W,A.)	4-78
Channel Status Display (W,C.)	4-80



Miscellaneous Parameters Display (W,M.) . . . . .	4-83
System Table Addresses Display (W,P.) . . . . .	4-84
System Queues Display (W,Q.) . . . . .	4-86
System Resources Display (W,R.) . . . . .	4-88
Monitor Functions Display (Y) . . . . .	4-90
Directory Display (Z) . . . . .	4-91

You communicate with the system through the console keyboard. The system provides information about job and system status through displays on the console screens. Data entered from the keyboard is also displayed. You can request a permanent record, called a system dayfile, of all system and console communication.

There are two major display programs: DSD, which generates system-oriented displays, and DIS, which generates job-specific displays. The primary functions of DSD are:

- Maintain a current display of system status.
- Process keyboard entries from the operator.

At the console keyboard, you can:

- Assign equipment to the job.
- Control job scheduling and execution.
- Initiate utility programs through the L display.
- Select displays.

A DSD Display Index is provided at the back of this manual for quick reference. The NOS Version 2 Analysis Handbook describes DIS commands and displays.

## Display Selection

Select any of the DSD displays with the console command

`xy.`

where x and y represent the letter designation of the displays.

Display x appears on the left screen and display y appears on the right. If x and y are identical, both screens display the same information except for the B or P display. A single B display may use both screens on the CC598B and CC634B consoles. The P display uses both screens on the CC545, CC598B, and CC634B consoles.

You can specify a sequence of DSD displays to display on the left screen. To preselect the left screen display sequence, enter the DSD command

`SET,screen.`

where screen represents letters designating any four DSD displays.

Four display identifiers (see following list) must be specified. Usually you specify four different displays, although DSD accepts any four valid screen identifiers.

After entering this command, press the right blank key (CC545 console), or TAB key (CC598B console), or forward arrow key (CC634B console). The first display specified appears on the left console screen. Press the appropriate key for your console again to select the second display. Each time you press this key, the next display in the specified sequence appears on the left console screen.

The following displays are available under DSD.

<b>Display</b>	<b>Description</b>
----------------	--------------------

A	Dayfile. Chronological history of system operations. There are five subdisplays.
B	System status. Current status of all jobs assigned to control points. There are two subdisplays.
C,D	Central memory. Contents of central memory words (two or four selectable eight-word groups) in five columns of four octal digits with display code equivalents.
E	Equipment status. Status of peripheral devices. There are ten subdisplays.
F,G	Central memory. Contents of central memory words (two or four selectable eight-word groups) in four columns of five octal digits with display code equivalents.
H	System FNT. List of system FNT entries for all fast attach and system files in the system. H,jsn lists the local files for that jsn.
I	BIO status. Status of central site unit record devices.
J	Individual job status. Status of the specified job sequence name.
K	CPU programmable. Dynamic operator and CPU communication. Refer to the NOS Version 2 Analysis Handbook for further information.
L	CMR buffer interface programmable. System utility interface communication. Refer to chapter 5 for further information.
M	Extended memory. Contents of 60-bit words of extended memory (two or four selectable eight-word groups) in five columns of four octal digits with display code equivalents.
O	Transaction status. Status of the transaction subsystem. There are three subdisplays.
P	PP registers. Current contents of PP registers.
Q	Queue status. Status of active input and output queue in the queued file table. There are six subdisplays.
R	Rollout status. Status of all executing jobs.
S	System control information. Parameters used to control job flow.
T	IAF status. Status of interactive users.
V	PP Breakpoint Display. Refer to the NOS Version 2 Analysis Handbook for more information.
W	System information. Memory allocation, channel status, request queues, resource information, system table addresses, and miscellaneous parameters. There are six subdisplays.
Y	Monitor functions. List of all monitor mnemonics and codes.
Z	Directory. List of the letter designators and descriptions of all DSD displays.

## Display Screen Headers

The left and right screen displays have standard system headers, as shown in figure 4-1 and figure 4-2. Displays illustrated in this chapter are shown without these headers.

A.	SYSTEM DAYFILE.				
	STEP	SECURITY-UNLOCK	ENGR	DEBUG	99
	hh.mm.ss. yy/mm/dd.	CDC NETWORK OPERATING SYSTEM.			
	access limits	MID=06	NOS version		

**Figure 4-1. Left Screen Header**

B,O.	SYSTEM STATUS.	BIO. REQUEST *I* DISPLAY.
SEE *L* DISPLAY		MAG. CHECK *E,P* DISPLAY
SEE *A,OPERATOR*		IAF.REQUEST DISPLAY. (DIS)

**Figure 4-2. Right Screen Header**

The left screen header provides the following information.

- Display name.
- Monitor step mode (either STEP or blank).
- Console status (SECURITY-UNLOCK, UNLOCK, or blank). Refer to chapter 3 for a description of the LOCK and UNLOCK commands, and to the NOS Version 2 Analysis Handbook for a description of UNLOCK,username,password command.
- Engineering mode (either ENGR or blank).
- System modification status (either DEBUG or blank).
- Syntax loading status (99 if syntax loading is disabled, blank if enabled).
- Time and date (specified by the DSD TIME and DATE commands) in the form hh.mm.ss. and yy/mm/dd.
- System name (specified by the NAME entry in CMRDECK).
- Security access limits. These appear on a secured system only.
- A two-character machine identifier (MID) used to identify this mainframe in a multmainframe environment.
- System version.

The right screen header gives the display name and highlights up to four subsystems, or a system control point, with a short message that requires your attention.

In addition, the message

```
SEE *L* DISPLAY
```

or

```
SEE *A, OPERATOR*
```

may appear.

## Dayfile Displays (A)

The system saves five types of dayfiles and an operator action display. The system dayfile contains the system history. The account dayfile keeps the accounting record for further processing (for example, customer billing). The error log dayfile records system error messages, such as disk errors. Job dayfiles record the operations of each job. The binary maintenance log dayfile records information used by Control Data for maintenance. You cannot display the binary maintenance log. The operator action display lists system error conditions that require corrective action.

To display these dayfiles on the console screen, type one of the following:

<b>DSD Command</b>	<b>Dayfile</b>
A,. or A.	System
A,ACCOUNT FILE.	Account
A,ERROR LOG.	Error log
A,OPERATOR.	System to operator messages
DAYFILE,jsn.	Job dayfile

The system adds dayfile messages to one or more of the dayfiles when:

- The system processes a command or a system action occurs that is not a direct response to a command (such as an error message).
- The system detects an error.
- A user enters a comment either via a COMMENT command, \* command, an OPMSG command, or a MESSAGE macro.
- A user at an RDF terminal enters an MS= message command.
- You enter a message at the console.

When a job terminates, the system sends the messages to the account dayfile that contains a record of the resources charged to the job. In addition, job dayfile entries are printed at the end of a job's output. The system dayfile, which includes entries for all jobs processed, is a record of all action taken since deadstart. Although the A display shows only the most recent dayfile messages, you can obtain the entire contents by dumping the file to a printer, punch, or tape unit.

Messages on an A display appear in the following formats.

**System dayfile messages:**

```
time. jsn sc. message.
```

**Account dayfile messages:**

```
time. jsn sc. activity, additional information.
```

**Error log messages:**

```
time. jsn sc. message.
```

**Job dayfile messages:**

```
time. message.
```

**Operator action messages:**

```
error number message
```

**or**

```
JSN=jsn - message
```

**or**

```
RDF=jsn - message
```

where *jsn* is the job sequence name of the job where the message originated, and *sc* is a one-character code for the job's service class. The System Status Display (B,A) section of this chapter lists the acceptable service class codes.

The time is the time of day relative to that entered into the system at deadstart or by a TIME command to DSD. For example, if the system is deadstarted at 8:00 a.m. and the time is entered at deadstart, the time in 10 minutes is 08.10.00. If the time was not entered at deadstart, the time in 10 minutes is 00.10.00.

The time is followed by the three- or four-character job sequence name of the job associated with the message and the message itself. As a job is processed, messages are sent to the dayfile by PP programs or central memory programs. The job sequence name is followed by a one-character service class designator, *sc*. The job sequence name is a unique four-character alphabetic name or a three-character subsystem name assigned by the system when the job is entered in the queued file table (QFT). For remote batch jobs, this assignment occurs when the job enters the input queue. Files queued by jobs are assigned a job sequence name when they are queued.

Every time a level zero deadstart is performed, the job sequence name is set to AAAA. The first job after a level zero deadstart is assigned this name. The second job is assigned the name AAAB and so on to ZZZZ. The next job sequence name after ZZZZ is AAAA, and the sequence begins again. There are 456,976 possible names for jobs and queued files before a job sequence name repeats.

The activity in the account dayfile messages is a unique four-character identifier that defines a particular activity. The first character identifies the information group. The second character identifies the event that caused the message to be entered into the account dayfile. The third and fourth characters identify the activity being recorded. The purpose of this field and the additional information that follows it is to record system usage and provide a means of accurately billing users. Complete descriptions of account dayfile activity messages can be found in the NOS Version 2 Administration Handbook.

Each command executed, including the JOB command, is entered into the job dayfile. The dayfile is displayed as follows:

- On the CC545 console (A display), the file is scrolled up the screen as messages are generated. To inhibit scrolling for about 15-20 seconds, press the – key. To resume scrolling, press the + key.
- At the end of a job's printed output, all dayfile messages associated with that job are printed. However, interactive users must request the dayfile listing by using the dayfile terminal command.

To dump a dayfile to the output queue, type:

<b>DSD Command</b>	<b>Dayfile</b>
X.DFD.	System
X.AFD.	Account
X.ELD.	Error log

## System Dayfile Display (A. or A.,)

To bring the system dayfile to the console display, enter the following command.

A. or A.,

A. displays the system dayfile by starting the display from the start of the dayfile buffer (with scrolling). A., displays the system dayfile without starting the display from the start of the dayfile buffer.

Figure 4-3 illustrates the system dayfile display.

```

A.  SYSTEM DAYFILE.

09.56.57.  MAG X.   OUT(* /OP=E)
09.56.57.  MAG X.   DAYFILE(OUTPUT, JT=D)
09.56.57.  IAF X.   1TM - NO TPM AVAILABLE.
09.56.57.  IAF X.   NOS 23K2/10R3/9KT.
09.56.57.  RHF X.   RPV - PREVIOUS ERROR CONDITIONS RESET.
09.56.57.  RHF X.   OUT(* /OP=E)
09.56.57.  RHF X.   DAYFILE(OUTPUT, JT=D)
09.56.57.  MAG X.   USER DAYFILE PROCESSED.
09.56.57.  RHF X.   USER DAYFILE PROCESSED.
09.57.07.  IAF X.   WAITING FOR NETWORK.
09.58.09.  MAG X.   MAG.
09.58.09.  MAG X.   GET, MAG/NA.
09.58.10.  MAG X.   MAG.
09.58.10.  MAG X.   MAGNET.
09.58.10.  MAG X.   MT054, C13, TURNED OFF.
09.58.58.  AAABS.   DIS.
09.58.58.  AAABS.   MODE(0)
09.58.58.  AAABS.   SUI(0)
09.58.58.  AAABS.   RETURN(INPUT)
09.58.58.  AAABS.   NORERUN.
09.58.58.  AAABS.   RFL(060000)
09.58.58.  AAABS.   DIS.
10.00.00.  SYS S.   SYSTEM DATE    yy/mm/dd.

```

**Figure 4-3. System Dayfile Display (A. or A.,)**



**Account Dayfile Display (A,ACCOUNT FILE.)**

To bring the account dayfile to the console display, enter the following command.

```
A,ACCOUNT FILE.
```

Figure 4-4 illustrates the account dayfile display.

```

A. ACCOUNT DAYFILE.

10.07.45. SYS S. ABLQ, C2,      0.001KUNS, SS.
10.07.45. CMS X. AEQP, C1, CMS , 840514, 100745, IN.
10.08.50. SYS S. ABLQ, C1, CMS , 840514, 100850, IN.
10.08.50. SYS S. ABLQ, C2,      0.001KUNS, SS.
10.08.50. CMS X. AEQP, C1, CMS , 840514, 100850, IN.
10.09.55. SYS S. ABLQ, C1, CMS , 840514, 100955, IN.
10.09.55. SYS S. ABLQ, C2,      0.001KUNS, SS.
10.09.55. CMS X. AEQP, C1, CMS , 840514, 100955, IN.
10.12.33. SYS S. ABLQ, C1, CMS , 840514, 101233, IN.
10.12.33. SYS S. ABLQ, C2,      0.001KUNS, SS.
10.12.33. CMS X. AEQP, C1, CMS , 840514, 101233, IN.
10.13.36. SYS S. ABLQ, C1, CMS , 840514, 101336, IN.
10.13.36. SYS S. ABLQ, C2,      0.001KUNS, SS.
10.13.36. CMS X. AEQP, C1, CMS , 840514, 101336, IN.
10.14.39. SYS S. ABLQ, C1, CMS , 840514, 101439, IN.
10.14.39. SYS S. ABLQ, C2,      0.001KUNS, SS.
10.14.39. CMS X. AEQP, C1, CMS , 840514, 101439, IN.
10.15.42. SYS S. ABLQ, C1, CMS , 840514, 101542, IN.
10.15.42. SYS S. ABLQ, C2,      0.001KUNS, SS.
10.15.42. CMS X. AEQP, C1, CMS , 840514, 101542, IN.
10.16.45. SYS S. ABLQ, C1, CMS , 840514, 101645, IN.
10.16.45. SYS S. ABLQ, C2,      0.001KUNS, SS.
10.16.45. CMS X. AEQP, C1, CMS , 840514, 101645, IN.

```

**Figure 4-4. Account Dayfile Display (A,ACCOUNT FILE.)**



**Operator Action Display (A,OPERATOR.)**

Certain system errors cause the highlighted message

```
SEE *A, OPERATOR*
```

to appear in the right screen header. When you enter the command

```
A, OPERATOR.
```

the display in figure 4-6 appears:

```
A. OPERATOR DISPLAY.

NUMBER      MESSAGE TEXT

10 TRACK LIMIT
   ENTER *LOG,NUMBER.* WHEN PROBLEM HAS BEEN CORRECTED.

JSN = AAAG - WHAT TIME DOES THE SYSTEM GO DOWN
   ENTER *CFO,JSN.MESSAGE.* TO RESPOND.
```

**Figure 4-6. Operator Action Display (A,OPERATOR.)**

Each entry on this display has the following format:

```
number messagetext
```

where **number** and **messagetext** have one of the following values. The corrective actions prescribed for the following errors are, for the most part, discretionary. Consult with a knowledgeable person at your site to determine what action is appropriate for your site. Backing up files, terminating dayfiles, and other analyst actions described below are described in the NOS Version 2 Analysis Handbook.

<b>number</b>	<b>messagetext</b>	<b>Corrective action</b>
0	FAMILY ORDINAL TABLE FULL	Contact a knowledgeable person at your site.
1	SYSTEM FNT FULL	Contact a knowledgeable person at your site.
2	QUEUED FILE TABLE FULL	Too many files in the input/output queue. Check the operation of the system output devices. If the problem is an inoperable device, you can consider backing up the queue files and reloading them when the device is again operable.

<b>number</b>	<b>messagetext</b>	<b>Corrective action</b>
3	EXECUTING JOB TABLE FULL	Maximum number of jobs executing. The problem clears by itself.  <b>NOTE</b>  When the message EXECUTING JOB TABLE FULL appears, up to five executing job table entries (EJT=nn) may appear on the system resources display (W,R.). These EJT entries are reserved by the system.
4	DAYFILE LENGTH EXCEEDED	Length of a dayfile has exceeded a set length. Various system conditions could cause this situation. Query the system for inadvertent looping in some job, for some malfunctioning hardware, or for an unusually heavy system work load. If the system device is not approaching a track limit situation, you might choose to ignore this error message. Otherwise, someone at your site might consider terminating the dayfiles.
5	ERROR LOG LENGTH EXCEEDED	Refer to the message DAYFILE LENGTH EXCEEDED.
6	ACCOUNT FILE LENGTH EXCEEDED	Refer to the message DAYFILE LENGTH EXCEEDED.
7	MAINLOG LENGTH EXCEEDED	Refer to the message DAYFILE LENGTH EXCEEDED.
10	TRACK LIMIT	Not enough available tracks on the disk media. The following four actions are ways to create more available tracks: <ul style="list-style-type: none"> <li>• A WARN message to the users to purge or return unused files.</li> <li>• An archival backup of files.</li> <li>• Backing up dayfiles.</li> <li>• Backing up queue dayfiles.</li> </ul>
11	USER EXTENDED MEMORY DISABLED	Enable user extended memory using the ENABLE,USER ECS command.
12	CHANNEL DOWNED BY SYSTEM	NOS has detected a problem with a channel. Inform a knowledgeable person at your site.
13	ERRLOG ALERT	Indicates that a hardware error has been logged in the file ERRLOG. Examine the A,ERROR LOG display.

<b>number</b>	<b>messagetext</b>	<b>Corrective action</b>
14	LOW SPACE ON MASS STORAGE DEVICE	Available space on a mass storage device has fallen below the low space threshold.
15	CHECK TMSDIS,FAM	A TMS tape catalog file has run out of scratch tapes or has a catalog error. Examine the FAM display of the TMSDIS utility.
16	CHECK E,E DISPLAY	Indicates that an error condition exists on one or more mass storage devices. Examine the E,E display.

After you take corrective action, the right screen notification and the message are cleared by entering the following command.

```
LOG, number.
```

The variable number is the error number on the operator action (A,OPERATOR.) display.

If you attempt to clear the message (except for ERRLOG ALERT) before taking corrective action, the message reappears immediately. The ERRLOG ALERT message is cleared when you enter the command.

The Remote Diagnostic Facility allows customer engineers to send messages to you from a remote terminal. When they do, the system notifies you by displaying the highlighted message SEE A,OPERATOR in the upper right screen header. You will see one of the following user messages:

<b>user message</b>	<b>Description</b>
JSN=jsn - message	Appears on the A,OPERATOR display. Respond to the message by entering the following DSD command.  CFO, jsn.response message  Refer to the CFO command in chapter 3. This entry removes the highlighted message.
RDF=jsn - message	Appears on the A,OPERATOR display. Respond to the message by entering the following DSD command.  DIAL, jsn.response message  Refer to the DIAL command in chapter 3. This entry removes the highlighted message.

### **Job Dayfile Display (DAYFILE,jsn.)**

To bring the dayfile of the particular job to the console display, enter the following command.

```
DAYFILE, jsn.
```

where jsn is the job sequence name of the particular job you want to examine.

The job dayfile is displayed only if the job is at a control point.

## System Status Displays (B,A. and B,O.)

DSD displays the status of executing jobs. There are two subdisplays of the system status display: B,A and B,O. Figures 4-7, 4-8, and 4-9 illustrate the B,A and B,O displays. The B,A display is the default subdisplay. The number of control points is specified at deadstart time (34<sub>8</sub> maximum). The system adds one control point to the number specified and dedicates it to system use.

If the display screen is full and more entries remain to be displayed, the message

MORE

appears at the bottom of the display.

For the CC634B console, type:

BB.

to see all the control points on the left and right screen display.

If the display is on the right screen, entering the = key displays the alternate data fields of the B,A display. Similarly, entering the / key when the display is on the left screen displays the alternate data field of the B,A display.

B, A. SYSTEM STATUS.						
CP	JSN	SC	PR	FL	CPU	STATUS
1	IAF	X	76	414	X	WAITING FOR NETWORK.
2						
3	AAAG	S	30	24	X	REWIND, *.
4	AAAT	S	30	24	X	MRG SMM V4.0-0.
5	AAAN	S	75	32		DUMP COMPLETE.
6	AAAB	S	30	120	X	REQUEST DISPLAY. (DIS)
7	AAAM	M	2	100	W	MRG SMM V4.0-0.
10	AAAD	M	2	23	W	CU8 SMM V4.0-0.
11	AAAK	M	2	64	A	CSU SMM V4.0-0.
12	AAAL	M	2	23	W	FS8 SMM V4.0-0.
13	AAAI	M	2	200	W	CSU SMM V4.0-0.
14	AAAJ	M	2	200	W	CT8 SMM V4.0-0.
15	AAAH	M	2	21	W	ALX SMM V4.0-0.
16	AAAG	S	30	120		REQUEST DISPLAY. (DIS)
17	AAAR	S	30	120	X	CU8 SMM V4.0-0.
20	AAAU	S	30	120	X	CMU SMM V4.0-0.
21	AAAP	S	30	120	X	CSU SMM V4.0-0.
22	AAAS	S	30	120	X	FS8 SMM V4.0-0.
23	AAAQ	S	30	120	X	CT8 SMM V4.0-0.
24	AAAO	S	30	120	X	ALX SMM V4.0-0.
MORE						

Figure 4-7. System Status Display (B,A.)

Each entry on this display has the following format.

cp jsn sc pr fl cpu status

- cp Control point number. A job is assigned to a control point when it resides in central memory.
- jsn Job sequence name assigned by the system to uniquely identify the job. The job sequence name consists of a three- or four-character identifier.
- sc Service class. A one-character mnemonic for the service class of the job. Each mnemonic is described next.

sc	Description
B	Local batch.
C	Communications.
D	Detached interactive.
M	Maintenance.
N	Network supervisor.
R	Remote batch.
S	System.
T	Interactive.
X	Subsystem.
0	Installation-defined.
1	Installation-defined.
2	Installation-defined.
3	Installation-defined.

pr CPU priority (the job priority for the CPU).

fl Field length/100<sub>8</sub> of job being processed.

cpu CPU status:

- blank CPU not in use at this control point.
- A Job using CPU 0.
- B Job using CPU 1 (dual CPU systems only).
- I Job is in auto recall (waiting for completion of system request: tape I/O, and so forth).
- W Job waiting for CPU.
- X Job is in recall.

status Thirty characters from the message area for the job. Messages requiring your intervention, commands being processed, and error messages are displayed here.

B,A. SYSTEM STATUS.						
CP	JSN	EJT	SCPR	FLE	SS	STATUS
1	IAF	2	7776	0		WAITING FOR NETWORK.
2						
3	AAAG	10	7000	0		REWIND, *.
4	AAAT	6	2000	0		MRG SMM V4.0-0.
5	AAAN	3	7000	0		DUMP COMPLETE.
6	AAAB	17	10	0		REQUEST DISPLAY. (DIS)
7	AAAM	16	10	0		MRG SMM V4.0-0.
10	AAAD	9	10			CU8 SMM V4.0-0.
11	AAAK	14	10	0		CSU SMM V4.0-0.
12	AAAL	15	10	0		FS8 SMM V4.0-0.
13	AAAI	12	10	0		CSU SMM V4.0-0.
14	AAAJ	13	10	0		CT8 SMM V4.0-0.
15	AAAH	11	10	0		ALX SMM V4.0-0.
16	AAAG	6	10			REQUEST DISPLAY. (DIS)
17	AAAR	10	10	0		CU8 SMM V4.0-0.
20	AAAU	9	10	0		CMU SMM V4.0-0.
21	AAAP	14	10	0		CSU SMM V4.0-0.
22	AAAS	15	10	0		FS8 SMM V4.0-0.
23	AAAQ	11	10	0		CT8 SMM V4.0-0.
24	AAAO	12	10	0		ALX SMM V4.0-0.
MORE						

**Figure 4-8. Alternate Data Fields of the System Status Display (B,A.)**

Each entry on this display has the following format.

cp	jsn	ejt	scpr	file	ss	status
<b>cp</b>						Control point number. A job is assigned to a control point when it is residing in central memory.
<b>jsn</b>						Job sequence name assigned by the system to uniquely identify the job. The job sequence name consists of a three- or four-character identifier.
<b>ejt</b>						The executing job table (EJT) ordinal of the job. This ordinal uniquely identifies the job to the system.
<b>scpr</b>						Scheduling priority (an indication of the relative priority of the job).
<b>file</b>						Extended memory field length/1000 <sub>8</sub> assigned to job being processed.
<b>ss</b>						Special status:
					<b>I</b>	Subsystem idle flag is set.
					<b>L</b>	Job has been locked in at the control point with the ROLLIN,jsn,L command. The job is not rolled out until you enter the ROLLOUT command.
					<b>M</b>	Storage move control point.
					<b>R</b>	Rollout pending flag.
					<b>S</b>	Subcontrol point is active at this control point.

*(Continued on next page)*



*(Continued from previous page)*

**status**                    **Thirty characters from the message area for the job. Messages requiring your intervention, commands being processed, and error messages are displayed here.**

```

B,O.  SYSTEM STATUS.

CP   JSN           STATUS

  1   IAF   WAITING FOR NETWORK.
  2
  3   AAAG  REWIND, *.
  4   AAAT  MRG  SMM V4.0-0.
  5   AAAN  DUMP COMPLETE.
  6   AAAB  REQUEST DISPLAY.  (DIS)
  7   AAAM  MRG  SMM V4.0-0.
 10   AAAD  CU8  SMM V4.0-0.
 11   AAAK  CSU  SMM V4.0-0.
 12   AAAL  FS8  SMM V4.0-0.
 13   AAAI  CSU  SMM V4.0-0.
 14   AAAJ  CT8  SMM V4.0-0.
 15   AAAH  ALX  SMM V4.0-0.
 16   AAAG  REQUEST DISPLAY.  (DIS)
 17   AAAR  CU8  SMM V4.0-0.
 20   AAAU  CMU  SMM V4.0-0.
 21   AAAP  CSU  SMM V4.0-0.
 22   AAAS  FS8  SMM V4.0-0.
 23   AAAQ  CT8  SMM V4.0-0.
 24   AAAO  ALX  SMM V4.0-0.

      MORE
    
```

**Figure 4-9. System Status Display (B,O.)**

Each entry on this display has the following format.

```
cp   jsn   status
```

**cp**                    **Control point number. A job is assigned to a control point when it is residing in central memory.**

**jsn**                   **Job sequence name assigned by the system to uniquely identify the job. The job sequence name consists of a three- or four-character identifier.**

**status**                **Fifty characters from the message area for the job. Messages requiring your intervention, commands being processed, and error messages are displayed here.**

For dual state NOS/VE:

During periods of heavy interactive usage, the message

PASSON ABNORMAL message number

may flash. Unless related to a problem a user has reported, this message does not necessarily indicate an error condition. Refer to appendix A for a description of all PASSON messages.

When PASSON ABNORMAL appears on the system console screen, record the number of the message for possible use in debugging later. To clear the message from the screen, enter the following command:

GO, jsn.

where jsn is the job sequence name of the job where the message is flashing. If normal operations do not resume, contact a knowledgeable person at your site. If you are asked to examine the dayfile of the PASSON job, enter the following command:

DAYFILE, jsn.

where jsn is the job sequence name of the job where the message is flashing.

Examine the dayfile for a message of the following format:

HEX DATA FOR PASSON CONDITION=message number

The message is followed by one or more lines of hexadecimal data that you may be asked to record.

## Storage Displays (C, D, F, G, and M)

These displays show the contents of central memory (C, D, F, and G displays) and extended memory (M display). Each storage display consists of four (CC545 console) or two (CC598B console or CC634B console) groups of either central memory or extended memory words, with the groups numbered 0 through 3 from top to bottom.

Figure 4-10 illustrates the C and D central memory displays. Figure 4-11 illustrates the F and G central memory displays. Figure 4-12 illustrates the M extended memory display.

C. CENTRAL MEMORY.			DISPLAY CODE EQUIVALENT	
ADDRESS	MEMORY CONTENTS			
00000220	5001	0000 0000 0000 0001	/A	A
00000221	0174	0000 7776 0000 2021	A	PQ
00000222	0003	0000 1775 0713 6726	C	O GK V
00000223	0000	0000 0000 0000 0000		
00000224	0004	0000 0000 1315 0414	D	KMDL
00000225	0000	0000 0000 1311 4004 0414		KI5DDL
00000226	0000	0000 0000 0000 0160 0000		A
00000227	0000	0000 0000 0000 0000 6100		
00000230	5527	0111 2411 1607 5506	WAITING	F
00000231	1722	5516 0524 2717 2213	OR	NETWORK
00000232	5700	0000 0000 0000 0000	.	
00000233	5516	0524 1716 5522 0512	NETON	REJ
00000234	0503	2457 0000 0000 0000	ECT.	
00000235	0000	6711 2417 2247 4111	ITOR*6I	
00000236	2320	1401 3157 5555 5104	SPLAY.	(D
00000237	1123	5200 0000 0100 4646	IS)	A --
FIVE COLUMNS OF FOUR DIGITS				

**Figure 4-10. Central Memory Display (C)**

F. CENTRAL MEMORY.

ADDRESS	MEMORY CONTENTS	DISPLAY CODE EQUIVALENT
*		
00000020	00000 00000 00000 00000	
00000021	00000 00000 03010 10127	CAA AW
00000022	00000 20000 00000 14115	B A6M
00000023	00000 00000 00000 00000	
00000024	00000 00000 00000 01311	KI
00000025	00000 00000 00400 01311	5 KI
00000026	00000 00002 00016 00000	B A
00000027	00000 03017 50002 00004	XO/ P D
00000030	00000 00000 43373 43640	84135
00000031	00000 00016 05161 31725	NENKOU
00000032	55343 45734 40573 53457	11.15.21.
00000033	55433 75033 40503 43757	84/05/14.
00000034	51403 35255 03313 44233	(50) CY170
00000035	46433 54055 23164 13341	-825 SN606
00000036	57552 33123 24051 55505	. SYSTEM E
00000037	26011 45755 00000 00000	VAL.

FOUR COLUMNS  
OF FIVE DIGITS

**Figure 4-11. Central Memory Display (F)**

```

M. EXTENDED MEMORY.

FLAG REGISTER 000000

00000000 3777 0077 1401 0205 1400 4 LABEL
00000001 0002 0100 0003 3777 4003 BA C4 5C
00000002 0003 0076 0000 0000 0000 C
00000003 0000 0000 1401 0205 1400 LABEL
00000004 0000 0000 0000 0000 0000
00000005 0000 0000 0000 0000 0000
00000006 0000 0000 0000 0000 0000
00000007 0000 0000 0000 0000 0000

00000010 0000 0000 0000 0000 0000
00000011 0000 0000 0000 0000 0000
00000012 0000 0000 0000 0000 0000
00000013 0000 0000 0000 0000 0000
00000014 0015 0100 0000 0000 0000 MA
00000015 0000 0000 0000 0000 0000
00000016 0000 0000 0000 0000 0000
00000017 0000 0000 0000 0000 0000
    
```

**Figure 4-12. Extended Memory Display (M)**

**NOTE**

The extended memory flag register does not appear on CYBER 180-class models.

Each entry on the display has the following format:

address      memory contents      display code equivalent

**address**                      Central memory and extended memory can be displayed with absolute or relative addresses.

**memory contents**              The memory contents in the C, D, and M displays are shown in five columns of four octal digits. Memory contents in the F and G displays have four columns of five octal digits.

**display code equivalent**      The character equivalent to the display-coded octal digits appears to the right of the octal word. Blanks appear for any character with an octal display code above 57, as well as for display codes 00, 53, and 55.

The flag register field at the top of the M display shows the contents of the extended memory flag register as of the last status. (Status is taken once every second by the monitor.) Extended memory parity errors in words on the M display are denoted by intensifying the address and data of the words in error.

The central memory displays C and D, and F and G, are exactly the same.

To bring the C, D, F, G, and M displays to the screens, enter one of the following commands.

xy.

Brings the x and y displays to the left and right console screens, respectively (x and y are C, D, F, G, or M). Unless a memory display for a specific job is previously selected (refer to the following command), all words displayed represent absolute memory locations on an unsecured system. On a secured system, the memory display commands are accepted only when the security unlock status is set.

x,jsn.

Brings a memory display for the specified job to the left console screen. Either absolute addresses or those relative to a job sequence name can be displayed.

x            Display identifier (C, D, F, G, or M).

jsn          Job sequence name.

All words displayed are relative to the reference address (RA for central memory, RAE for extended memory) for the job specified by jsn. When addresses relative to a job's RA are displayed, the job sequence name appears next to the display identifier at the top of the screen (for example, D.CENTRAL MEMORY. AQBV). If jsn is not specified, absolute memory locations are displayed. When absolute memory locations are displayed, the display identifier appears alone at the top of the screen.

On a secured system, the memory display shows the message

```
***SECURED AREA***
```

The security administrator must set the security unlock status to bring the memory display for the specified job to the left console screen.

xz,addr.

Brings a specified memory display to the left console screen, if not currently selected, and provides display modification as follows:

x            Display identifier (C, D, F, G, or M).

z            Type of display modification:

z	Description
0-3	Changes the specified word group (0 through 3) to display the eight words beginning at memory location addr.
4	Changes the display so that all two or four eight-word groups are displayed as 16 or 32 contiguous memory locations beginning at location addr.
5	Advances the display by addr locations.
6	Decrements the display by addr locations.

addr        Location parameter (eight digits).

If a job sequence name appears with a memory display identifier (C, D, F, G, or M) at the top of the screen, the memory locations shown in the display are relative to that job's RA. If no job sequence name is indicated, all memory locations shown are absolute.

When a memory display is on the left screen, the address can be stepped forward or backward 20 or 40 octal locations by pressing the + or – key. The right screen is paged with the parenthesis keys or the PgUp/PgDn keys. (Refer to table 1-2 for specific console information.) The address can also be advanced by the value in the lower 18 bits of the first word by pressing the / key on the left screen or by pressing the = key on the right. Memory displays can also be set to advance or decrement by a specified constant by using the x5,addr and x6,addr entries. For example:

- Carriage return Causes the REPEAT ENTRY message to appear.
- C5,101. Increments present C display by 101<sub>8</sub>. Each successive carriage return increments the displays by 101<sub>8</sub>.

x6,addr is used in the same manner to decrement by the value specified.

The selection of a memory display for a specific job and/or the selection of addresses for any word group on a memory display remain in force even though the display is not on either screen. For instance, if the standard format of xy. is used to recall the C display to the screen, the job sequence name and/or the addresses shown are those specified by the last call in the format C,jsn. and/or Cz,addr. For example, if the A and B displays are on the left and right screens and you type in the following sequence, the displays change as follows:

- C,jsn. The A display on the left screen is replaced by the C display showing the words at locations 0 through 17 or 37 relative to the RA of the job with job sequence name jsn.
- C1,1234. The second group of words on the display changes from words at locations 10 through 17 to those at locations 1234 through 1243.
- AB. The B display remains on the right screen. The C display is replaced by the A display on the left screen.
- CB. The C display relative to the RA of the job previously specified by jsn is brought back to the left screen still showing the words at locations 0 through 7 (group 0), 1234 through 1243 (group 1), on the CC545 console, 20 through 27 (group 2), and 30 through 37 (group 3).

## Equipment Status Displays (E)

The E display lists the status of peripheral equipment. The type of information supplied varies according to the subdisplay specified.

<b>Command</b>	<b>Display</b>
E, or E,A.	Status of all equipment.
E,C.	Disk configuration.
E,E.	Disk errors.
E,F.	Family status.
E,H.	Disk thresholds.
E,M.	Disk status.
E,O.	Optical disk requests.
E,P.	Resource requests.
E,S.	Optical disk status.
E,T.	Tape status.

## Equipment Status Table Display (E, or E,A.)

The equipment status table display lists the status of all devices in the equipment status table (EST).

If the display screen is full and more equipment entries remain to be displayed, the message

MORE

appears at the bottom of the display.

Figure 4-13 illustrates the equipment status display.



E, A. EQUIPMENT STATUS.									
EST	TYPE	STATE	JSN	EQ	UN	CHANNELS		ACCESS LIMITS	
5	DE	OFF		0	0	0		LVL0	LVL7
6	EC	ON		1	0	C00A	C01B *	LVL0	LVL7
7	DN	ON		2	3	C02B	C03A	LVL0	LVL7
10	DJ-1	ON		0	0	1	24	LVL0	LVL7
23	LT	ON	ASDF	5	0	12		LVL0	LVL7
50	MT	ON		0	0	13 *	22	LVL0	LVL7
51	NT	ON		0	1	13 *	33	LVL0	LVL7
MORE									

**Figure 4-13. Equipment Status Display (E., or E,A.)**

Each entry on this display has the following format.

```
est   type   state   jsn   eq   un   channels   access limits
```

est            EST ordinal.

type            Device type. The following device types can appear in the second column of the equipment status display.

- AT            ACS Tape Unit; a 5682 cartridge tape unit attached to a 5744 Automated Cartridge Subsystem.
- CC            Satellite Coupler.
- CM            Control Module for an 834 or 836 Disk Storage Subsystem.
- CP            415 Card Punch.
- CR            405 Card Reader.
- CT            CTS Tape Unit; a standalone 5682 cartridge tape unit.
- DB-i          885-42 Disk Storage Subsystem (1 ≤ i ≤ 3).
- DC-i          895 Disk Storage Subsystem (1 ≤ i ≤ 2).
- DD-i          834 Disk Storage Subsystem (1 ≤ i ≤ 8).
- DE            Extended Memory.
- DF-i          887 Disk Storage Subsystem (1 ≤ i ≤ 3. 4K sector).
- DG-i          836 Disk Storage Subsystem (1 ≤ i ≤ 3).
- DH-i          887 Disk Storage Subsystem (1 ≤ i ≤ 2. 16K sector).
- DI-i          844-21 Disk Storage Subsystem (1 ≤ i ≤ 8. Half-track).
- DJ-i          844-41/44 Disk Storage Subsystem (1 ≤ i ≤ 8. Half-track).

type  
(Continued)

## Device type:

DK-i	844-21 Disk Storage Subsystem ( $1 \leq i \leq 8$ . Full-track).
DL-i	844-41/44 Disk Storage Subsystem ( $1 \leq i \leq 8$ . Full-track).
DM-i	885-11/12 Disk Storage Subsystem ( $1 \leq i \leq 3$ . Half-track).
DN	9853 Disk Storage Subsystem.
DP	Distributive data path to extended memory.
DQ-i	885-11/12 Disk Storage Subsystem ( $1 \leq i \leq 3$ . Full-track).
DS	Console Display.
DV	819 Disk Storage Subsystem (single-density).
DW	819 Disk Storage Subsystem (double-density).
EA-i	5830 Disk Array Subsystem; one 5832 SSD drive run in serial mode ( $1 \leq i \leq 8$ ).
EB-i	5830 Disk Array Subsystem; two 5832 SSD drives run in parallel mode ( $1 \leq i \leq 6$ ).
EC-i	5830 Disk Array Subsystem; one 5833 Sabre drive run in serial mode ( $1 \leq i \leq 2$ ).
ED-i	5830 Disk Array Subsystem; two 5833 Sabre drives: one for data and the other for parity ( $1 \leq i \leq 2$ ).
EE	5830 Disk Array Subsystem; two 5833 Sabre drives run in parallel mode.
EF	5830 Disk Array Subsystem; three 5833 Sabre drives: two for data and one for parity.
EG	5830 Disk Array Subsystem; one 5838 Elite drive.
EH	5830 Disk Array Subsystem; two 5838 Elite drives: one for data and one for parity.
LP	Any Line Printer.
LR	580-12 Line Printer.
LS	580-16 Line Printer.
LT	580-20 Line Printer.
LX	5870 Printer.
MP	MAP.
MT	Magnetic Tape Drive (7-track).
NC	380-170 Network Access Device.
ND	Mainframe Device Interface (MDI) or Mainframe Terminal Interface (MTI).

type (Continued)	Device type:	
	NP	255x Network Processing Unit.
	NT	Magnetic Tape Drive (9-track).
	OD	Optical Disk Drive.
	RM	2-Port Multiplexer (CYBER 180-class mainframes and models 865 and 875).
	SS	Mass Storage Extended Subsystem.
	TT	Internal Stimulation Device.

The system creates the following device types at deadstart for internal use. Physical hardware does not necessarily exist for this equipment. The device types appear in the second column of the equipment status display along with the real device types.

RD	Used for online reconfiguration of mass storage (EST ordinal 0).
DS	Console display (EST ordinal 1)
NE	Null equipment (EST ordinal 2).
TE	Tape assignment equipment (EST ordinal 3).
TT	Used for assignment of terminal files (EST ordinal 4).

state	Equipment status (ON, OFF, IDLE, or DOWN).
jsn	Job sequence name. A job sequence name precedes the equipment number in each entry if that piece of equipment is assigned to a job.
eq	Equipment (controller) number.
un	Unit number (serves as ID code for unit record devices). The identifier code (un parameter) provides a method of grouping peripheral devices when a site has several units. Output from a job read in through a card reader with identifier un can only be directed to a device with the same identifier. Changing the identifier code via the ROUTE command can direct program output to a special printer.
channels	Channels on which equipment is available. The prefix C indicates a concurrent (CIO) channel. An asterisk (*) following the channel number entry indicates that the channel is down. A hyphen (-) following the channel number entry indicates that the channel is idle. The port selection (A or B) follows the channel number. For example, C00A indicates that port A is selected for concurrent channel 0.
access limits	Access level limits of the equipment. This column appears on a secured system only.

### Disk Configuration Display (E,C.)

The disk configuration display shows the current configuration of disk devices in the system. Figure 4-14 illustrates the disk configuration display.

E,C. DISK CONFIGURATION.							
EST	TYPE	FM/PN	DN	CHANNELS	EQ	UNIT-NUMBERS	
6	DF	SYST08	1	C00B C01A	0	0	
7	DQ	SYST08	2	21 22	- 0	0	
10	DN	SYSFAM1	1	C02B	2	5	
11	EC	SYSFAM1	2	C03A* C04A	6	12	
14	DJ-8/8	SYSFAM2	2	22 - 21	0	40 41 42 43	
						44 45 46 47	
17	DK-3	PACKV22*	40	21 22	- 0	3	

Figure 4-14. Disk Configuration Display (E,C.)

Each entry on this display has the following format.

est type fm/pn dn channels eq unit-numbers

est EST ordinal.

type Device type:

- DB-i 885-42 Disk Storage Subsystem (1 ≤ i ≤ 3).
- DC-i 895 Disk Storage Subsystem (1 ≤ i ≤ 2).
- DD-i 834 Disk Storage Subsystem (1 ≤ i ≤ 8).
- DE Extended memory.
- DF-i 887 Disk Storage Subsystem (1 ≤ i ≤ 3. 4K sector).
- DG-i 836 Disk Storage Subsystem (1 ≤ i ≤ 3).
- DH-i 887 Disk Storage Subsystem (1 ≤ i ≤ 2. 16K sector).
- DI-i 844-21 Disk Storage Subsystem (1 ≤ i ≤ 8. Half-track).
- DJ-i 844-41/44 Disk Storage Subsystem (1 ≤ i ≤ 8. Half-track).

type (Continued)	Device type:
	DK-i 844-21 Disk Storage Subsystem ( $1 \leq i \leq 8$ . Full-track).
	DL-i 844-41/44 Disk Storage Subsystem ( $1 \leq i \leq 8$ . Full-track).
	DM-i 885-11/12 Disk Storage Subsystem ( $1 \leq i \leq 3$ . Half-track).
	DN 9853 Disk Storage Subsystem.
	DP Distributive data path to extended memory.
	DQ-i 885-11/12 Disk Storage Subsystem ( $1 \leq i \leq 3$ . Full-track).
	DV 819 Disk Storage Subsystem (single-density).
	DW 819 Disk Storage Subsystem (double-density).
	EA-i 5830 Disk Array Subsystem; one 5832 SSD drive run in serial mode ( $1 \leq i \leq 8$ ).
	EB-i 5830 Disk Array Subsystem; two 5832 SSD drives run in parallel mode ( $1 \leq i \leq 6$ ).
	EC-i 5830 Disk Array Subsystem; one 5833 Sabre drive run in serial mode ( $1 \leq i \leq 2$ ).
	ED-i 5830 Disk Array Subsystem; two 5833 Sabre drives: one for data and the other for parity ( $1 \leq i \leq 2$ ).
	EE 5830 Disk Array Subsystem; two 5833 Sabre drives run in parallel mode.
	EF 5830 Disk Array Subsystem; three 5833 Sabre drives: two for data and one for parity.
	EG 5830 Disk Array Subsystem; one 5838 Elite drive.
	EH 5830 Disk Array Subsystem; two 5838 Elite drives: one for data and one for parity.
fm/pn	Family name/packname-user name.
dn	Device number.
channels	Channels connecting this equipment to the mainframe. The prefix C indicates a concurrent (CIO) channel. An asterisk (*) following the channel number entry indicates that the channel is down. A hyphen (-) following the channel number entry indicates that the channel is idle. The port selection (A or B) follows the channel number. For example, C00A indicates that port A is selected for concurrent channel 0.
eq	Equipment (controller) number.
unit-numbers	List of unit numbers defined in the EQPDECK.

## Disk Errors Display (E,E.)

The disk errors display shows the abnormal conditions of the mass storage devices. Figure 4-15 illustrates the disk errors display.

E, E. DISK ERRORS.			
EST	TYPE	STATE	CONDITIONS
6	DQ-3	ON	ERROR CODE = NR.
15	DJ	ON	LOW SPACE. SUSPECT.
100	DJ-8	OFF	VERIFICATION FAILURE THRESHOLD. UNRECOVERED ERROR THRESHOLD.

**Figure 4-15. Disk Errors Display (E,E.)**

Each entry on this display has the following format.

est	type	state	conditions
est			EST ordinal.
type			Device type:
	DB-i		885-42 Disk Storage Subsystem (1 ≤ i ≤ 3).
	DC-i		895 Disk Storage Subsystem (1 ≤ i ≤ 2).
	DD-i		834 Disk Storage Subsystem (1 ≤ i ≤ 8).
	DE		Extended memory.
	DF-i		887 Disk Storage Subsystem (1 ≤ i ≤ 3. 4K sector).
	DG-i		836 Disk Storage Subsystem (1 ≤ i ≤ 3).
	DH-i		887 Disk Storage Subsystem (1 ≤ i ≤ 2. 16K sector).
	DI-i		844-21 Disk Storage Subsystem (1 ≤ i ≤ 8. Half-track).
	DJ-i		844-41/44 Disk Storage Subsystem (1 ≤ i ≤ 8. Half-track).
	DK-i		844-21 Disk Storage Subsystem (1 ≤ i ≤ 8. Full-track).
	DL-i		844-41/44 Disk Storage Subsystem (1 ≤ i ≤ 8. Full-track).
	DM-i		885-11/12 Disk Storage Subsystem (1 ≤ i ≤ 3. Half-track).

type  
(Continued)

Device type:

- DN 9853 Disk Storage Subsystem.
- DP Distributive data path to extended memory.
- DQ-i 885-11/12 Disk Storage Subsystem ( $1 \leq i \leq 3$ . Full-track).
- DV 819 Disk Subsystem (single-density).
- DW 819 Disk Subsystem (double-density).
- EA-i 5830 Disk Array Subsystem; one 5832 SSD drive run in serial mode ( $1 \leq i \leq 8$ ).
- EB-i 5830 Disk Array Subsystem; two 5832 SSD drives run in parallel mode ( $1 \leq i \leq 6$ ).
- EC-i 5830 Disk Array Subsystem; one 5833 Sabre drive run in serial mode ( $1 \leq i \leq 2$ ).
- ED-i 5830 Disk Array Subsystem; two 5833 Sabre drives: one for data and the other for parity ( $1 \leq i \leq 2$ ).
- EE 5830 Disk Array Subsystem; two 5833 Sabre drives run in parallel mode.
- EF 5830 Disk Array Subsystem; three 5833 Sabre drives: two for data and one for parity.
- EG 5830 Disk Array Subsystem; one 5838 Elite drive.
- EH 5830 Disk Array Subsystem; two 5838 Elite drives: one for data and one for parity.

state

Equipment status (ON, OFF, IDLE, or DOWN)

conditions

Conditions that may be displayed are as follows:

- ACTIVITY RESTRICTED** The amount of available space on the device is below the restricted activity threshold. This is an early warning that the available space on the device is getting low.
- CONTROLLER OVERTEMP.** The controller is overheated. Notify the customer engineer immediately.
- ERROR CODE = ec** For an expanded description of the error code, refer to the error code description for the E,M display. ec can be one of the following:
  - \*\*** Error code is not valid.
  - CA** Checkpoint aborted.
  - CE** Configuration error.
  - CS** PF catalog size error.

conditions  
(Continued)

ERROR CODE = ec (Continued)

DE	Device hardware error.
DN	Device number conflict.
EI	Error idle status.
LE	Label error.
FF	FOT full.
IL	Incorrect label
LK	PF linkage error.
NR	Not ready.
NV	Nonstandard device mounted.
PN	Duplicate packname.
SV	Security access level error.
TL	TRT length error.
UM	User mask conflict.
VA	Validation errors.
LOW SPACE	The amount of available space on the device is below the low space threshold. This is a warning that available space on the device is getting dangerously low and you should free more space on the pack.
PARITY PROTECTION LOST. UNIT=nn	Parity protection has been lost on this 5833 device, and physical unit nn has been turned off. Notify the customer engineer immediately.
PARITY PROTECTION RESTORE IN PROGRESS	Parity protection restore is in progress.
RECOVERED ERROR THRESHOLD	The recovered disk error threshold is exceeded.
SUSPECT	The state of the device between the time of a disk error and the completion of device verification.
UNRECOVERED FAILURE THRESHOLD	The unrecovered disk error threshold is exceeded.
VERIFICATION FAILURE EXCEEDED	The device verification failure threshold is exceeded.



## Family Status Display (E,F.)

The family status display shows the current configuration of each permanent file family. Figure 4-16 illustrates the family status display.

E, F. FAMILY STATUS.							
EST	TYPE	FM/PN	DN	FAMC	DAFC	IAM	DAM
5	DE	SYST06	1	0	0	0	0
6	DQ	SYST06	6	0	0	377	377
7	DQ	SYST06	2	0	0	0	0
10	DJ		0	0	0	0	0
11	DL	I4	40	0	0	377	377
12	DJ		0	0	0	0	0
13	DJ		0	0	0	0	0
14	DL	SYS606	40	20	4	377	377
15	DJ		0	0	0	0	0
16	DJ		0	0	0	0	0
17	DJ		0	0	0	0	0
20	DI		0	0	0	0	0
21	DJ		0	0	0	0	0
22	DJ		0	0	0	0	0
23	DJ		0	0	0	0	0

**Figure 4-16. Family Status Display (E,F.)**

Each entry on this display has the following format.

```
est  type  fm/pn  dn  famc  dafc  iam  dam
```

est            EST ordinal.

type           Device type:

- DB-i        885-42 Disk Storage Subsystem (1 ≤ i ≤ 3).
- DC-i        895 Disk Storage Subsystem (1 ≤ i ≤ 2).
- DD-i        834 Disk Storage Subsystem (1 ≤ i ≤ 8).
- DE           Extended memory.
- DF-i        887 Disk Storage Subsystem (1 ≤ i ≤ 3. 4K sector).
- DG-i        836 Disk Storage Subsystem (1 ≤ i ≤ 3).
- DH-i        887 Disk Storage Subsystem (1 ≤ i ≤ 2. 16K sector).
- DI-i        884-21 Disk Storage Subsystem (1 ≤ i ≤ 8. Half-track).

type  
(Continued)

## Device type:

DJ-i	844-41/44 Disk Storage Subsystem ( $1 \leq i \leq 8$ . Half-track).
DK-i	844-21 Disk Storage Subsystem ( $1 \leq i \leq 8$ . Full-track).
DL-i	844-41/44 Disk Storage Subsystem ( $1 \leq i \leq 8$ . Full-track).
DM-i	885-11/12 Disk Storage Subsystem ( $1 \leq i \leq 3$ . Half-track).
DN	9853 Disk Storage Subsystem.
DP	Distributive data path to extended memory.
DQ-i	885-11/12 Disk Storage Subsystem ( $1 \leq i \leq 3$ . Full-track).
DV	819 Disk Storage Subsystem (single-density).
DW	819 Disk Storage Subsystem (double-density).
EA-i	5830 Disk Array Subsystem; one 5832 SSD drive run in serial mode ( $1 \leq i \leq 8$ ).
EB-i	5830 Disk Array Subsystem; two 5832 SSD drives run in parallel mode ( $1 \leq i \leq 6$ ).
EC-i	5830 Disk Array Subsystem; one 5833 Sabre drive run in serial mode ( $1 \leq i \leq 2$ ).
ED-i	5830 Disk Array Subsystem; two 5833 Sabre drives: one for data and the other for parity ( $1 \leq i \leq 2$ ).
EE	5830 Disk Array Subsystem; two 5833 Sabre drives run in parallel mode.
EF	5830 Disk Array Subsystem; three 5833 Sabre drives: two for data and one for parity.
EG	5830 Disk Array Subsystem; one 5838 Elite drive.
EH	5830 Disk Array Subsystem; two 5838 Elite drives: one for data and one for parity.

fm/pn	Family name/pack name.
dn	Device number.
famc	Number of jobs in that device's family.
dafc	Number of direct access files attached.
iam	Indirect access file mask.
dam	Direct access file mask.

## Disk Thresholds Display (E,H.)

The disk thresholds display shows the current threshold information relating to mass storage devices. Threshold values appear on the same line as the EST ordinal. These values are site-definable. Below each threshold is the current count associated with that threshold. The count is highlighted when the count exceeds its threshold value. The disk errors display (E,E) shows the state of any device experiencing one of these error conditions. Figure 4-17 illustrates the disk thresholds display.

E, H. DISK THRESHOLDS.							
EST	TYPE	SIZE	VF	RA	LS	RE	UE
6	DL-3	3150	100	1000	400	100	1
			0	2076	2076	25	0

**Figure 4-17. Disk Thresholds Display (E,H.)**

Each entry on the display has the following format:

```
est  type  size  vf  ra  ls  re  ue
```

est            EST ordinal.

type          Device type:

- DB-i        855-42 Disk Storage Subsystem (1 ≤ i ≤ 3).
- DC-i        895 Disk Storage Subsystem (1 ≤ i ≤ 2).
- DD-i        834 Disk Storage Subsystem (1 ≤ i ≤ 8).
- DE          Extended memory.
- DF-i        887 Disk Storage Subsystem (1 ≤ i ≤ 3. 4K sector).
- DG-i        836 Disk Storage Subsystem (1 ≤ i ≤ 3).
- DH-i        887 Disk Storage Subsystem (1 ≤ i ≤ 2. 16K sector).
- DI-i        844-21 Disk Storage Subsystem (1 ≤ i ≤ 8. Half-track).
- DJ-i        844-41/44 Disk Storage Subsystem (1 ≤ i ≤ 8. Half-track).
- DK-i        844-21 Disk Storage Subsystem (1 ≤ i ≤ 8. Full-track).
- DL-i        844-41/44 Disk Storage Subsystem (1 ≤ i ≤ 8. Full-track).

type (Continued)	Device type:
	DM-i 885-11/12 Disk Storage Subsystem ( $1 \leq i \leq 3$ . Half-track).
	DN 9853 Disk Storage Subsystem.
	DP Distributive data path to extended memory.
	DQ-i 855-11/12 Disk Storage Subsystem ( $1 \leq i \leq 3$ . Full-track).
	DV 819 Disk Subsystem (single-density).
	DW 819 Disk Subsystem (double-density).
	EA-i 5830 Disk Array Subsystem; one 5832 SSD drive run in serial mode ( $1 \leq i \leq 8$ ).
	EB-i 5830 Disk Array Subsystem; two 5832 SSD drives run in parallel mode ( $1 \leq i \leq 6$ ).
	EC-i 5830 Disk Array Subsystem; one 5833 Sabre drive run in serial mode ( $1 \leq i \leq 2$ ).
	ED-i 5830 Disk Array Subsystem; two 5833 Sabre drives: one for data and the other for parity ( $1 \leq i \leq 2$ ).
	EE 5830 Disk Array Subsystem; two 5833 Sabre drives run in parallel mode.
	EF 5830 Disk Array Subsystem; three 5833 Sabre drives: two for data and one for parity.
	EG 5830 Disk Array Subsystem; one 5838 Elite drive.
	EH 5830 Disk Array Subsystem; two 5838 Elite drives: one for data and one for parity.
size	Total number of logical tracks on this type of device.
vf	Verification failures.
ra	Restricted activity.
ls	Low space.
re	Recovered errors.
ue	Unrecovered errors.

### Disk Status Display (E,M.)

The disk status display provides detailed status information about all mass storage devices. Figure 4-18 illustrates disk status display.

E,M. DISK STATUS.							
EST	TYPE	STATE	STATUS	FILES	TRACKS	RP	ERROR
5	DE	ON	-----A-----	S-----	600	10	
6	DQ	ON	S-----F-----G	-----T	2760		
7	DQ	OFF	S-----F-----	-----T	3007		
10	DJ	IDLE	--RUL-----	-----	3150		
11	DJ	IDLE	--RUL-----N--	-----	3150		OF
12	DL	IDLE	--RUL-----N--	-----	3150		DW
13	DL	ON	--R-----	-----	146		
14	DL	OFF	-----F-----	-----	3070		
15	DC	IDLE	--R-----XF-----	---D---	2725		
16	DC	IDLE	--R-----XF-O---	--L-----	0		
17	DC	IDLE	--RUL-----	-----	3140		
20	DJ	IDLE	--RUL-----	-----	3150		

**Figure 4-18. Disk Status Display (E,M.)**

Each entry on this display has the following format.

```
est type state status files tracks rp error
```

est EST ordinal.

type Device type:

- DB-i 885-42 Disk Storage Subsystem (1 ≤ i ≤ 3).
- DC-i 895 Disk Storage Subsystem (1 ≤ i ≤ 2).
- DD-i 834 Disk Storage Subsystem (1 ≤ i ≤ 8).
- DE Extended memory.
- DF-i 887 Disk Storage Subsystem (1 ≤ i ≤ 3. 4K sector).
- DG-i 836 Disk Storage Subsystem (1 ≤ i ≤ 3).
- DH-i 887 Disk Storage Subsystem (1 ≤ i ≤ 2. 16K sector).
- DI-i 844-21 Disk Storage Subsystem (1 ≤ i ≤ 8. Half-track).
- DJ-i 844-41/44 Disk Storage Subsystem (1 ≤ i ≤ 8. Half-track).
- DK-i 844-21 Disk Storage Subsystem (1 ≤ i ≤ 8. Full-track).
- DL-i 844-41/44 Disk Storage Subsystem (1 ≤ i ≤ 8. Full-track).
- DM-i 885-11/12 Disk Storage Subsystem (1 ≤ i ≤ 3. Half-track).
- DN 9853 Disk Storage Subsystem.
- DP Distributive data path to extended memory.
- DQ-i 885-11/12 Disk Storage Subsystem (1 ≤ i ≤ 3. Full-track).
- DV 819 Disk Subsystem (single-density).
- DW 819 Disk Subsystem (double-density).

type  
(Continued)

## Device type:

- EA-i 5830 Disk Array Subsystem; one 5832 SSD drive run in serial mode ( $1 \leq i \leq 8$ ).
- EB-i 5830 Disk Array Subsystem; two 5832 SSD drives run in parallel mode ( $1 \leq i \leq 6$ ).
- EC-i 5830 Disk Array Subsystem; one 5833 Sabre drive run in serial mode ( $1 \leq i \leq 2$ ).
- ED-i 5830 Disk Array Subsystem; two 5833 Sabre drives: one for data and the other for parity ( $1 \leq i \leq 2$ ).
- EE 5830 Disk Array Subsystem; two 5833 Sabre drives run in parallel mode.
- EF 5830 Disk Array Subsystem; three 5833 Sabre drives: two for data and one for parity.
- EG 5830 Disk Array Subsystem; one 5838 Elite drive.
- EH 5830 Disk Array Subsystem; two 5838 Elite drives: one for data and one for parity.

state

Equipment status (ON, OFF, IDLE, or DOWN).

status

Status conditions. Any combination of the following conditions can appear on the display. The following codes are listed in the order in which they appear on the display.

- S The operating system resides on this device.
- M Device is shared by more than one mainframe.
- R Device is removable.
- U Device is unavailable.
- L Device is in local unload status and, therefore, not available for permanent file access.
- C Checkpoint has been requested for this specific device. Ensure that C status is not present before dismounting a removable device, issuing an OFF command to logically remove a device, or attempting to perform deadstart.
- T This mainframe holds the interlock for this device. Status T is relevant only for an independent shared device. (Status T is displayed in place of status C, which is not relevant for independent shared devices).
- I Initialization requested or format is pending.
- A Alternate system device.
- F CTI is installed on the device.
- X Device is an auxiliary permanent file device.

status (Continued)	<p>Status conditions:</p> <p>O      Catalog track overflowed. If enough tracks are available on the device, no action is required. The system automatically starts another catalog track. The site analyst may want to allocate more catalog tracks. Refer to the NOS Version 2 Analysis Handbook for more information.</p> <p>D      System deadstart file is installed on the device.</p> <p>*      Reconfiguration is requested.</p> <p>N      Device is in global unload status (all machines sharing the device have it in local unload status). Do not physically remove a pack unless N status is displayed on all machines sharing the device.</p> <p>P      A permanent file utility is active.</p> <p>G      Device has been defined as a checkpoint file device.</p>
files	<p>Types of files allowed on this device. The following codes are listed in the order in which they appear on the display.</p> <p>S      Secondary rollout.</p> <p>B      LGO.</p> <p>L      Local.</p> <p>P      Primary.</p> <p>D      Job dayfile.</p> <p>R      Rollout.</p> <p>O      Output.</p> <p>I      Input.</p> <p>T      Temporary.</p>
tracks	<p>Number of tracks available on device.</p>
rp	<p>Number of I/O requests pending for device.</p>
error	<p>Error code. If an error is detected, the system displays (and highlights) an error code.</p> <p>The following errors can appear during normal production.</p> <p>**      Error code is not valid. The system has set an error code that is not defined.</p> <p>LE      Label error (unrecognizable label).</p> <p>NR      Not ready.</p> <p>PN      Duplicate pack name exists or a pack name/family name conflict exists.</p> <p>SV      Device has security access levels not allowed for the specified EST ordinal.</p>

error  
(Continued)

The following errors indicate more serious system or equipment errors.

CA	Checkpoint abort (unable to checkpoint device).
CE	Configuration error (active device has one of the packs mounted or defined incorrectly).
CS	The size of permanent file catalogs on the device is incorrect for the current system.
DE	Device hardware error has been detected by the system.
DN	Device number conflicts with that of another device in the family.
EI	Error idle status has been set for the device as a result of some error.
FF	Family ordinal table is full.
IL	Incorrect label (the label on an active device is incorrect).
IN	Initialize disk. An INITIALIZE command was entered to initialize a disk. This will disappear if the initialize completes without an error.
LK	Error in TRT linkage detected when recovering permanent files. No recovery possible. Can occur only when introducing removable devices after deadstart.
NV	Device contains a NOS/VE label.
TL	Length of device's TRT entry is in error; no recovery possible.
UM	Sum of the device masks for family does not equal $377_8$ .
VE	Error status set in MST because of failure during mass storage table validation.

---

#### NOTE

When a VE status error occurs, the device becomes interlocked. A PP program that attempts to access that device cannot complete until the interlock is cleared. Enter the DSD command VALIDATE to remove the VE error and interlock.

---



## Optical Disk Requests Display (E,O.)

The optical disk requests display identifies the optical disks needed to satisfy users' requests.

Figure 4-19 illustrates the optical disk requests display.

E,O. OPTICAL DISK REQUESTS.						
JSN	EQ	VSN	USERNAM	WT	STATUS	JBM=AAAQ
AABK	OD	LABEL12	DON	YES		
AAQI	OD	VV0002	3KSNN64			
AAAQ	JB	AA0077	SYSTEMX		(STAGE)	

**Figure 4-19. Optical Disk Requests Display (E,O.)**

Each entry on this display has the following format.

```
jsn  eq  vsn  usernam  wt  status  jbm=
```

- jsn** Job sequence name of the job to which the equipment is assigned.
- eq** Optical equipment type:
  - JB** Optical disk drives housed in a jukebox. A jukebox contains many optical disks assigned automatically when requested.
  - OD** Optical disk drive. Optical disk drives require an operator to mount requested optical disks.
- vsn** One- to twelve-character volume serial name corresponding to the volume identifier recorded in the volume label on the optical disk.
- usernam** User name of job.
- wt** Request is for write mode access.
- status** Operator message indicating an error condition. A status of (STAGE) indicates that this is a request for a disk containing files to be restored to mass storage from optical disk alternate storage.
- jbm=** If the system is equipped with an optical jukebox, shows the JSN of the Jukebox Manager job.

### NOTE

Pressing the = key for the right screen or pressing the / key for the left screen causes requests for equipment type JB not to appear on the screen. Usually, entries for equipment type JB do not require operator intervention. Pressing the key again returns the E,O display to the original format.

## Resource Requests Display (E,P.)

The resource requests display identifies tapes and disk packs that must be mounted to satisfy user requests. It also displays conditions that require operator intervention. You can select this display only when the magnetic tape subsystem (MAG) is executing.

You cannot see the entire resource requests display on one screen. Figure 4-20 illustrates the main resource requests screen. Figure 4-21 illustrates additional data fields not present on the main screen. When the resource requests display is on the left screen, pressing the / key displays the additional data fields. Similarly, when the display is on the right screen, pressing the = key displays the additional data fields.

E,P. RESOURCE REQUESTS.								
14.57.55 93/10/18.(31) CY180-860 SN302. NOS STANDALONE								
MID=32 NOS 826E1/32R4/3B.								
JSN	UNIT	RS	VSN/PN	MD	LEVEL	USER	FAMILY	ERR
AAAD	NT062	GE	RD0002	W			SYST32	WE
AAAG		DL1	MYPACK	-		TESTX	SYST32	
AAAH		GE	AA1234	-			SYST32	
AAAI		CT	CT0025	R			SYST32	
AAAJ		GE	AB2245	-		PCS3320	SYST32	

**Figure 4-20. Resource Requests Display (E,P.)**

Each entry on the main screen has the following format.

```
jsn    unit    rs    vsn/pn    md    level    user    family    err
```

**jsn**            Either the job sequence name of the job making the resource request or the job sequence name assigned to a tape unit requiring operator intervention.

**unit**           Equipment type and EST ordinal of a tape unit requiring operator intervention.

**rs**             Resource type:

**AT**            ACS Tape Unit; a 5682 cartridge tape unit attached to a 5744 Automated Cartridge Subsystem.

**CT**            CTS Tape Unit; a standalone 5682 cartridge tape unit.

**DB-i**          885-42 Disk Storage Subsystem (1 ≤ i ≤ 3).

**DC-i**          895 Disk Storage Subsystem (1 ≤ i ≤ 2).

**DD-i**          834 Disk Storage Subsystem (1 ≤ i ≤ 8).

**DF-i**          887 Disk Storage Subsystem (1 ≤ i ≤ 3. 4K sector).

**DG-i**          836 Disk Storage Subsystem (1 ≤ i ≤ 3).

**DH-i**          887 Disk Storage Subsystem (1 ≤ i ≤ 2. 16K sector).

**DI-i**          844-21 Disk Storage Subsystem (1 ≤ i ≤ 8. Half-track).

**DJ-i**          844-41/44 Disk Storage Subsystem (1 ≤ i ≤ 8. Half-track).

**DK-i**          844-21 Disk Storage Subsystem (1 ≤ i ≤ 8. Full-track).

rs (Continued)	Resource type:
	DL-i 844-41/44 Disk Storage Subsystem ( $1 \leq i \leq 8$ . Full-track).
	DM-i 885-11/12 Disk Storage Subsystem ( $1 \leq i \leq 3$ . Half-track).
	DN 9853 Disk Storage Subsystem.
	DQ-i 885-11/12 Disk Storage Subsystem ( $1 \leq i \leq 3$ . Full-track).
	EA-i 5830 Disk Array Subsystem; one 5832 SSD drive run in serial mode ( $1 \leq i \leq 8$ ).
	EB-i 5830 Disk Array Subsystem; two 5832 SSD drives run in parallel mode ( $1 \leq i \leq 6$ ).
	EC-i 5830 Disk Array Subsystem; one 5833 Sabre drive run in serial mode ( $1 \leq i \leq 2$ ).
	ED-i 5830 Disk Array Subsystem; two 5833 Sabre drives: one for data and the other for parity ( $1 \leq i \leq 2$ ).
	EE 5830 Disk Array Subsystem; two 5833 Sabre drives run in parallel mode.
	EF 5830 Disk Array Subsystem; three 5833 Sabre drives: two for data and one for parity.
	EG 5830 Disk Array Subsystem; one 5838 Elite drive.
	EH 5830 Disk Array Subsystem; two 5838 Elite drives: one for data and one for parity.
	GE Magnetic tape unit (6250-cpi, 9-track).
	HD Magnetic tape unit (800-cpi, 9-track).
	MT Magnetic tape unit (7-track).
	PE Magnetic tape unit (1600-cpi, 9-track).
vsn/pn	Either the external volume serial number of the required tape or pack name of the required pack. The external VSN of a tape is the legible VSN affixed to the tape reel or cartridge.
md	One character representing the access mode required on a tape request:
	R Read-only access.
	W Write access required.
	- No access mode specified in request.
level	Access level of the file being requested (tape only). The tape unit assigned must allow this access level. This field appears only on a secured system.
user	User name of job. A user name of (STAGE) specifies that this is a request for staging tape that is used to restore files to disk from tape alternate storage.
family	Family name of job.
err	Error code mnemonic. A corresponding error is displayed in the message field (see figure 4-21).

E, P. RESOURCE REQUESTS.					
14.58.49 93/10/18.(31) CY180-860 SN302. NOS STANDALONE					
MID=32 NOS 826E1/32R4/3B.					
JSN	UNIT	RS	IVSN/PN	FLG	
AAAD	NT062	GE	RD0002	-L	NEEDS WRITE ENABLE
AAAG		DL1	MYPACK	--	
AAAH		GE	AA1234	-L	
AAAI		CT	CT0025	-L	
AAAJ		GE	AB2245	-L	

**Figure 4-21. Additional Data Fields of the Resource Requests Display (E,P.)**

Each entry on this screen has the following format.

```
jsn  unit  rs  ivsn/pn  flg  message
```

<b>jsn</b>	Either the job sequence name of the job making the resource request or the job sequence name assigned to a tape unit requiring operator intervention.				
<b>unit</b>	Equipment type and EST ordinal of a tape unit requiring operator attention.				
<b>rs</b>	Resource type. For a description of resource types, see the description of the rs field in figure 4-20.				
<b>ivsn/pn</b>	Either the internal volume serial number of the required tape or packname of the required pack. The internal VSN of a tape is the value recorded in the tape label. The internal VSN can differ from the external VSN.				
<b>flg</b>	Flags represented as 1-character mnemonics. The possible values are: <table> <tr> <td><b>T</b></td> <td>Tape is under control of the NOS Tape Management System (TMS).</td> </tr> <tr> <td><b>L</b></td> <td>Labeled tape request.</td> </tr> </table>	<b>T</b>	Tape is under control of the NOS Tape Management System (TMS).	<b>L</b>	Labeled tape request.
<b>T</b>	Tape is under control of the NOS Tape Management System (TMS).				
<b>L</b>	Labeled tape request.				
<b>message</b>	Error message corresponding to the error mnemonic in the err file (see figure 4-20).				

## Optical Disk Status Display (E,S.)

The optical disk status display summarizes the status of all optical disk equipments in the system. If the display screen is full and more equipment entries remain to be displayed, the message

MORE

appears at the bottom of the display. Page through the display to view all equipment entries.

Figure 4-22 illustrates the optical disk status display.

E,S. OPTICAL DISK STATUS.					
EST	VSN	PARTITION	WT	STATUS	AFC
30	DON	DEFAULT	NO	READY	0
31*	LABEL12	PART01	YES	READY	12
32			YES	IDLE	2
33	3KSNN64	DEFAULT	YES	FAULT	10

**Figure 4-22. Optical Disk Status Display (E,S.)**

Each entry on this display has the following format.

est vsn partition wt status afc

- est Identifies the equipment being used. An asterisk following the ordinal indicates the equipment is assigned to a job.
- vsn Volume serial name of the optical disk currently mounted.
- partition Partition within the optical disk being used.
- wt Write mode status.
- status Status of the optical disk drive:
  - READY Unit is ready.
  - IDLE Unit is idle.
  - BUSY Unit is busy processing an operation.
  - NOTRDY Unit is not spinning or otherwise not ready.
  - ERROR Driver has detected a hardware error in the unit.
  - FAULT Driver has detected an operating fault in the unit.
  - ROLLED Job using unit is rolled out.
  - DOWN Unit has been logically removed from the operating environment by the DOWN command.
  - OFF Unit has been logically removed from the operating environment by the OFF command.
- afc Active file count. The number of files currently being read or written by jobs accessing the optical disk currently mounted.

## Tape Status Display (E,T.)

The tape status display summarizes the status of all magnetic tape units in the system. If the display screen is full and more equipment entries remain to be displayed, the message

MORE

appears at the bottom of the display. Page through the display to view all equipment entries.

Figure 4-23 illustrates the tape status display.

E, T. TAPE STATUS.								
EST	VSN	DEN	RING	FMT	JSN	STATUS	REEL	MODE
MT050						IDLE		
NT051	***051	1600		I	ABCD	MOUNT	1	AS
	UNLABELED.							
NT052	TEST2	1600	IN			IDLE	2	AS
NT053						IDLE		
MT054						DOWN		
NT055						OFF		
CT060	C00101	38000	IN	LI	ABJQ	READY	1	AS

**Figure 4-23. Tape Status Display (E,T.)**

Each entry on this display has the following format.

```
est vsn den ring fmt jsn status reel mode fileid
```

**est** Identifies the equipment being used:

**ATest** ACS tape unit. est is the EST ordinal.

**CTest** CTS tape unit. est is the EST ordinal.

**MTest** 7-track tape unit. est is the EST ordinal.

**NTest** 9-track tape unit. est is the EST ordinal.

**vsn** Volume serial number of the mounted tape. The E,T display shows a VSN of \*\*\*est when the tape does not contain a recognizable label. The est portion of the display is the EST ordinal.

<b>den</b>	<b>Density (cpi):</b>
	200          200 cpi (implies 7-track).
	556          556 cpi (implies 7-track).
	800          800 cpi (7- or 9-track).
	1600        1600 cpi (implies 9-track).
	6250        6250 cpi (implies 9-track).
	38000       38000 cpi (implies AT or CT device).
<b>ring</b>	<b>Ring status (IN if the write enable ring is in, blank if the ring is out).</b>
<b>fmt</b>	<b>Data format:</b>
	F          Foreign.
	I          Internal.
	L          Long block stranger.
	LI         Long block internal
	S          Stranger.
	SI         System internal (NOS/BE system default format).
<b>jsn</b>	<b>Job sequence name of the job to which the tape unit is assigned.</b>
<b>status</b>	<b>Status of the tape unit:</b>
	READY      Unit is ready.
	IDLE        Unit is idle.
	LOADPT     Tape is positioned at load point.
	ROLLED     Job using tape unit has been rolled out.
	DOWN       Unit has been logically removed from the operating environment by the DOWN command, or by the magnetic tape executive when it detects a hardware error in the unit.
	OFF         Unit has been logically removed from the operating system by the OFF command.
	NOTRDY     Unit is not ready or is rewinding.

status (Continued)	<p>Status of the tape unit:</p> <p><b>MOUNT</b> Indicates that next reel should be mounted. Reel to be mounted may be identified by VSN or, if tape is unlabeled, by reel number.</p> <p>All subsequent reels of a labeled multireel file must have the same characteristics as the first reel of the file; that is, they must be labeled (at the same density), they must be of the same track type, and they must have the same conversion mode.</p> <p><b>SUSPCT</b> Indicates an unrecoverable hardware or tape medium error occurred on this unit. To make the unit available again after it is checked by the customer engineer, you must take it down and then turn it back on using DSD commands.</p>
reel	Reel number currently in use or reel to be mounted if MOUNT status is set.
mode	<p>Conversion mode of mounted tape. If tape is not assigned, this is the conversion mode of labels. If the tape is assigned, this is the conversion mode of labels and coded data. Values for conversion mode are:</p> <p><b>Blank</b> No conversion (unlabeled and not assigned).</p> <p><b>BC</b> BCD (7-track).</p> <p><b>AS</b> ASCII (9-track).</p> <p><b>EB</b> EBCDIC (9-track).</p>
fileid	File identifier obtained from tape label. No column heading is displayed for this field. It is the first field in the second line of the entry and appears under the vsn field. UNLABELED is displayed if the tape does not contain a recognizable label. WRONG DENSITY is displayed if the tape is written in a density not handled by the tape drive.



## System and Local Files Display (H)

The H display is used to obtain information about a system file or about a local file attached to a job at a control point.

To bring the system files display (figure 4-22) to the console, enter

```
H, .
```

To bring the local files display (figure 4-23) to the console, enter

```
H, jsn.
```

where jsn is the job sequence name of the specific job you wish to examine. The jsn also appears on the display header.

If you specify a jsn of a job that is not at a control point (for example, the job is in the print queue), the message

```
JSN NOT FOUND
```

appears on the screen.

If the job is rolled out, the message

```
JSN ROLLED
```

appears on the screen.

If more than one page exists, the message

```
MORE
```

appears at the bottom of the display. Page through the display to view all system and local files.

Figure 4-24 illustrates the system files display.

H. SYSTEM FILES.					
FNT	NAME	TYPE	EST	TRACK	LENGTH
0	SYSTEM	LI	6	4005	217656
1	RSXD06	FA	14	4016	40
2	RSXV06	FA	14	4015	40
3	VALIDUS	FA	14	5652	22

**Figure 4-24. System Files Display (H,.)**

Figure 4-25 illustrates the local files display.

H. LOCAL FILES.		AAAT						
FNT	NAME	TYPE	EST	TRACK	FS	STATUS	POSITION	LENGTH
0	INPUT	IN*	12	4004	ND	5	1	7
5	INPUT	LO	4	4010		405	1	110
6	OUTPUT	LO	4	4213		405	40	271
7	PROCFIL	LO	7			401		
10	LIST	LO	6			703		

**Figure 4-25. Local Files Display (H,jsn.)**

Each entry on this display has the following format.

```
fnt  name  type  est  track  fs  status  position  length
```

**fnt** Unique number (FNT ordinal) that the system assigns to the system file when the file is created and that retains the file as long as it is in the system.

**name** Name of the system file or local file.

**type** File type – System Files display (an asterisk following the file type indicates a read-only file):

FA Fast-attach file.

LI Library file.

SY System file.

type (Continued)	File type – Local Files display (an asterisk following the file type indicates the file is locked):
	RO Rollout file.
	LI Library file.
	PT Primary terminal file.
	FA Direct-access permanent file.
	SY System file.
	LO Local file.
	IN Input file.
	QF Deferred routed queued file.
est	EST ordinal of the device on which the file resides.
track	Track number at which the file begins. (Applicable only with mass storage files.)
fs	File status of the local file.
	UP User file privacy.
	SS Special system job file.
	CB CB checkpoint file.
	CK CK checkpoint file.
	SO Special output file.
	AA Application accounting file.
	ND No-auto-drop file.
status	Byte 4 of the second word of the local File Name Table (FNT) entry. Refer to the NOS Version 2 System Programmer's Instant for more information.
position	Current position of the file. (Applicable only with mass storage files.) The value is displayed in octal.
length	File length in sectors. (Applicable only with mass storage files.) The value is displayed in octal.

**NOTE**

---

Pressing the = key for the right screen or the / key for the left screen causes the position and length fields not to appear on the screen. On a CC545 console, this stops the screen from flickering. Pressing the key again returns the H display to the original format.

---

## BIO Status Display (I)

The BIO status display shows the status of all the unit record devices (such as line printers, card readers, and card punches) except the 533/536 line printers.

Figure 4-26 illustrates the BIO status display.

I. BIO STATUS.									
EST	JSN	TR	PS	ID	FC	REP	SIZE	DONE	STATUS
LT022		0	L		E9				OFF.
LT023	AAAX	1	L	31		3	636	123	
CR024									NOT READY.
CP025									OFF - CHECK ERRLOG.

**Figure 4-26. BIO Status Display (I)**

Each entry on this display has the following format.

```
est  jsn  tr  ps  id  fc  rep  size  done  status
```

**est** Peripheral equipment (mnemonic and EST ordinal). For example:

CR011 Card reader, equipment 11.

CP012 Card punch, equipment 12.

LP020 Line printer, equipment 20.

Refer to the E,A display description for a list of all equipment mnemonics.

**jsn** Job sequence name of the job using the device. However, card reader names are of the form ZZest, where est is the EST ordinal of the card reader. \*IDLE\* if no job is using the equipment.

**tr** Print train on the specified printer ( $0 \leq tr \leq 7$ ).

**ps** Paper size. S specifies short paper and L specifies long paper.

**id** Equipment identification ( $0 \leq id \leq 67_8$ ).

**fc** Two-character alphanumeric forms code assigned to the line printer or card punch.

**rep** Repeat count (refer to the REPEAT command in chapter 3).

**size** Length of the file in PRUs being printed on the specified printer. The value is displayed in octal.

done	Amount of the file in PRUs already printed on the specified printer. The value is displayed in octal.
status	Equipment status (for example, NOT READY, which can be activated by pressing the STOP button on the device).

At the BIO control point (refer to the B,A display), a message appears whenever a device is active. The message appears as:

```
n  BUFFERS ACTIVE
```

where n is the number of buffers reserved in BIO's field length.

**NOTE**

---

The status of the printers running under PSU will not be available on this display. Refer to chapter 3 for more information on PSU.

---

## Job Status Display (J)

The job status display shows the status of a specific job executing at a control point. To bring the J display to the console screen, type

```
J,jsn.
```

where jsn is the job sequence name of the specific job you are to examine. If jsn is not specified, the screen is cleared.

If you specify a job sequence name of a job that is not at a control point (for example, a job in the print queue), the message

```
JSN NOT FOUND
```

appears on the left screen display.

If the job is rolled out, the message

```
JSN ROLLED
```

appears on the left screen display.

The heading for the J display is followed by the JSN of the specified job.

In addition to the status, any equipment assigned exclusively to the job is listed by EST ordinal, message 1 and message 2 from the control point area are displayed, and the current commands buffer is shown, allowing you to anticipate future job requirements.

Figure 4-27 illustrates the job status display.

```
J.  JOB STATUS.      AAAT

      JSN = AAAT          EJTO =      25          P =      1633
      UI = 377777        SRUA =      256          RA =      2107
      FM = MLSTEST       SRUL = 777777          FL =       23
      PN =                CS = BATCH           RAE =       160
      CPU = W            CN =                  FLE =        0
                        LV = LVL0             CPA =     1000

      EST =

      MS1 = MRG  SMM V4.0-0.
      MS2 =

      EXIT.
      DMP.
      DMP,002300.
      IF,EF.EQ.ODE,NOLIST.
      RETURN,OUTPUT.
      ENDIF,NOLIST.
```

**Figure 4-27. Job Status Display (J,jsn.)**

The status portion of the J display has the following format.

jsn	ejto	p
	srua	ra
ui	srul	fl
fm	cs	rae
pn	cn	fle
cpu	lv	cpa

jsn	Job sequence name of the job.
ejto	Executing job table ordinal.
p	P address.
srua	System resource units accumulator (estimated).
ra	Reference address/100 <sub>8</sub> .
ui	User index.
srul	Account block limit for system resource units.
fl	Central memory field length.
fm	Current family name.
cs	Connection status.
rae	Extended memory reference address.
pn	Current pack name.
cn	Connection number (interactive jobs only).
fle	Extended memory field length.
cpu	CPU status:
	blank CPU not in use at this control point.
	A Job using CPU 0.
	B Job using CPU 1 (dual CPU system only).
	I Job is in auto recall (waiting for completion of system request: tape I/O, and so forth).
	W Job waiting for CPU.
	X Job is in recall.
lv	Job access level on a secured system.
cpa	Control point area address.

## Central Programmable Display (K)

Using the K display, a job at a control point can place information on the console screen and receive information from the keyboard.

The K display is job-oriented. The job sequence name to which the K display is assigned appears at the top of the screen next to the display designator. Normally, these displays are used for utility programs.

The job first issues a request message on the B,O display, asking you to bring up the K display. You respond by typing

```
K,jsn.
```

where jsn is the job sequence name of the requesting job.

DSD then accepts information from the keyboard and passes it on to the job requesting the K display. Each piece of data entered at the keyboard must be in the following format:

```
K.commandstring.
```

where commandstring is any input (command, data, or parameter) that is defined by the job as valid input.

If more than 50 characters are entered in commandstring, the message

```
LINE TOO LONG.
```

appears on the screen. DSD does not accept the entry until commandstring is shortened.



## Transaction Facility (TAF) Displays (O)

The TAF displays give the status of the subcontrol points, the task library directory, or the transaction terminals, depending on the command entered.

<b>Command</b>	<b>Display</b>
O,SCP.	Subcontrol point status.
O,TLD.	Task library directories.
O,TST.	Transaction status table.

When the transaction subsystem has no transactions active or is rolled out, the words

NOT ACTIVE

appear in the upper left portion of each display. The rest of the display is blank.

### Subcontrol Point Status Display (O,SCP.)

The subcontrol point status display lists subcontrol points, tasks that are currently active at specific subcontrol points, and information about these tasks.

Figure 4-28 illustrates the subcontrol point status display.

O, SCP.		TAF SUBCONTROL PT.					
SCP	NAME	RA	FL	NT	USER	RA+1	STATUS
1	ITASK	142520	1000			SCTP	-----UC----
2	INDXC	143640	3000				-----UC----
3	KDIS	146760	500	1		CTI	-----U-----
4							
5							
6							
7							
10							
11							
12							
13							
14							
15							

**Figure 4-28. Subcontrol Point Status Display (O,SCP.)**

Each entry on this display has the following format.

```
  scp  name  ra  fl  nt  user  ra+1  status
```

**scp** Subcontrol point number.

**name** Task name if active. NEXT if inactive.

**ra** Reference address.

**fl** Field length.

**nt** Number of transactions queued to use this copy of the task.

**user** User name associated with the currently active transaction. Blank if none.

**ra+1** Address of last RA+1 request issued by the task.

**status** Subcontrol point status. The following codes are listed in the order as they appear on the display.

<b>Code</b>	<b>Description</b>
S	Storage move is not allowed.
F	Subcontrol point is available for release.
L	Task requested communication block.
M	Common memory manager currently controls the task program library.
B	Subcontrol point is occupied by data for processing a batch concurrency job.
U	Task is reusable.
C	Task is a central memory resident task.
E	Task is in recall condition.
A	Abort task.
T	Task is available for termination.
D	CDCS subsystem aborted.

## Task Library Directories Display (O,TLD.)

The task library directories display provides information on each task within a library directory. The system task library directory, TASKLIB, is shown first by default. Each individual task library directory, xxTASKL, is displayed by paging through the display.

Figure 4-29 illustrates a task library directories display.

```

O,TLD.      TAF TASK LIBRARY

LIBRARY = TASKLIB

NUMBER      NAME          CALLED      LOADED      FL          EFL         STATUS
-----
   1      BTASK             1           1           600         0          U-----
   2      CRMTASK          0           0          4300        0          U-----
   3      CTASK             1           1          2300        0          U-----
   4      ITASK            4           0          1000        0          U-----
   5      KDIS             1           1           500         0          U-----
   6      LOGT             0           0           400         0          U-----
   7      MSABT            0           0           700         0          U-----
  10      OFFTASK          0           0           400         0          U-----
  11      RCTASK           0           0           700         0          U-----
  12      RTASK            0           0          2500        0          U-----
  13      STSNSG           0           0           500         0          U-----
  14      XTASK            0           0           400         0          U-----

```

**Figure 4-29. Task Library Directories Display (O,TLD.)**

Each entry on this display has the following format.

```
number name called loaded fl efl status
```

**number** Line number on display.  
**name** Task name.  
**called** Number of times task was requested.  
**loaded** Number of times task was loaded into memory.  
**fl** Field length.  
**efl** Expandable field length.

status            Additional task information. The presence of a letter indicates it applies to the corresponding task.

<b>Code</b>	<b>Description</b>
C	Central memory resident.
D	Task is logically deleted.
E	Extended memory resident library copy of task.
O	Indicates task OFF.
Q	Queuing forced (refer to the TAF Reference Manual for more information on the Q parameter for the LIBTASK * Input directive).
R	Reduce field length for central memory resident task.
S	Solicited communication block load requested.
U	Reusable (disk resident).

## TAF Status Table Display (O,TST.)

The transaction status table display provides information about each active terminal. The number following TERMINALS in the title line indicates the number of transaction terminal lines currently in use.

Figure 4-30 illustrates the transaction status table display.

O, TST.		TAF TERMINALS.				
TERMINALS = 146.						
NUMBER	NAME	DB	STATUS	USER AREA	ACN	COUNT
1	JHE3247	TT	-----	0000000000	0	0
2	MSP2721	TT	-----	0000000000	0	0
3	IAF001	TT	-----	0000000000	0	0
4	IAF002	TT	-----	0000000000	0	0
5	IAF003	TT	-----	0000000000	0	0
6	IAF004	TT	-----	0000000000	0	0
7	IAF005	TT	-----	0000000000	0	0
10	IAF006	TT	-----	0000000000	0	0
11	IAF007	TT	-----	0000000000	0	0
12	IAF008	TT	-----	0000000000	0	0
13	IAF009	TT	-----	0000000000	0	0
14	IAF010	TT	-----	0000000000	0	0
15	IAF011	TT	-----	0000000000	0	0
16	IAF012	TT	-----	0000000000	0	0
17	IAF013	TT	-----	0000000000	0	0
20	IAF014	TT	-----	0000000000	0	0
21	IAF015	TT	-----	0000000000	0	0
22	IAF016	TT	-----	0000000000	0	0
MORE						

**Figure 4-30. Transaction Status Table Display (O,TST.)**

Each entry on this display has the following format.

```
number name db status user area acn count
```

**number**            Line number on display.

**name**             Terminal name.

**db**                Data base (two-character name).

**status**            The transaction terminal status. The status codes are listed in the order they appear on the display.

<b>Code</b>	<b>Description</b>
A	Terminal is active.
L	Terminal logged in.
C	Supervisory message CON/REG received.
R	Automatic recovery required.
T	A recoverable transaction is executing.
M	Multiple block input received.
I	Task is waiting for input.
F	Final message block sent for transaction.
P	Connection postponed.
D	CDCS subsystem aborted.

**user area**        User-accessible argument area.

**acn**                Application connection number.

**count**            Number of transactions submitted.

## PP Registers Display (P)

The PP registers display shows the status of all the PPs in the system.

Figure 4-31 illustrates the PP registers display for a CYBER 170 Computer System with an S/C register (for models 865 and 875, S/C registers are maintenance registers).

P. PP REGISTERS.										
PP	PGM	CP	JSN	CH	IA/FCN	INPUT/OUTPUT REGISTERS			ADDR	
0	MTR	11	AAAZ		5200	1524	2211	0000	0000	0000
						0000	4000	0000	0000	0000
1	DSD	24	SYS	*	5210	0423	0424	2027	0000	0000
						0000	5250	0000	0000	0000
2	1MS	2	NAM	*	5220	3415	2302	0000	0000	0137
						0000	0000	0000	0000	0000
3	TCS	17	AABH		5230	2403	2357	0004	0000	0070
					DSWM	0013	3206	0003	4000	3601
4	1MS	2	NAM		5240	3415	2302	0000	0000	0120
					DSWM	0013	3206	0004	4000	0401
5	1MS	7	AABF		5250	3415	2347	0000	0000	0120
					DSWM	0013	2635	0005	2424	1602
6	1DD	10	AABJ		5260	3404	0410	0000	0000	0000
					DSWM	0013	3206	0006	4000	2001
7	1MS	14	RBF		5270	3415	2314	0000	0000	1264
					DSWM	0013	2635	0007	2424	3002
10										
11	1MS	23	AABI		5310	3415	2323	0000	0000	3331
					DSWM	0013	3206	0011	4000	4601
MORE										

**Figure 4-31. PP Registers Display (P)**

### NOTE

The ADDR column does not appear on CYBER 180-class models.



Each entry on this display has the following format.

pp	pgm	cp	jsn	ch	ia/fcn	inreg/outreg	addr
pp							The logical PP number. PS is the CPUCIO pseudo PP and is always listed last. If a C prefixes the PP number, a concurrent PP is being referred to.
pgm							PP program name. If the field is ***, this PP has been logically turned off.
cp							The control point number to which the PP is assigned.
jsn							The job sequence name of the job to which the PP is assigned.
ch							An * appears in this field if channels are assigned. The W,C display shows which channels are assigned to the PP.
ia							The address of the 60-bit PP input register.
fcn							The current monitor function being called by the PP program.
inreg							The contents of the 60-bit PP input register are displayed in octal format.
outreg							The contents of the 60-bit PP output register are displayed in octal format.
addr							The P address of the PP (this value appears only on CYBER 70 and 700 series models, and on models 865 and 875).

If you enter the DSD command

P, jsn.

only those PPs assigned to the specified job sequence name jsn are displayed.

The queue status displays show the status of a specified queue or the entire queued file table. The appropriate Q display is called when you enter

Q,qt.

where qt is one of the following queue types.

qt	Display Called
blank	All entries in the queued file table.
IN	Input queued file entries.
PL	Plot queued file entries.
PR	Print queued file entries.
PU	Punch queued file entries.
WT	Terminal wait files or errors.

Figure 4-32 illustrates the queued file table display and figure 4-33 illustrates the print queue display.

Q, . QUEUE STATUS.												
QFT	JSN	SC	QP	QT	FSI	REP	LID	DS	ID	FC	EC	LEVEL
0	SYS	S	0	IN	0							LVL0
12	AAAE	S	7776	PR	2	3		BC	23			LVL0
1	AAAZ	S	7415	PR	1			BC		LF	A9	LVL0
4	AABA	S	7343	WT	1			BC				LVL0
5	AABB	S	7244	PU	1			BC			26	LVL0

**Figure 4-32. Queued File Table Display (Q,.)**

Q, PR.												
QFT	JSN	SC	QP	QT	FSI	REP	LID	DS	ID	FC	EC	LEVEL
1	AABX	T	212	PR	0		MQE	BC	2		A9	LVLO
4	AACG	T	172	PR	2	3	MQG	BC	3			
5	AADB	T	100	PR	1		M42	BC	4	AC		

**Figure 4-33. Print Queue Display (Q,PR.)**

If the display screen is full and more queued file table entries remain to be displayed, the message

MORE

appears at the bottom of the screen. The additional entries are brought to the screen by paging the display.

Each entry on this display has the following format.

qft jsn sc qp qt fsi rep lid ds id fc ec level

- qft Queued file table ordinal of the file in the queue.
- jsn Job sequence name of the file in the queue.
- sc Service class of the job. Refer to System Status Displays (B,A. and B,O.) earlier in this chapter for a list of the various service class mnemonics.
- qp Queue priority.
- qt Queue type (IN, PU, PR, PL, WT).
- fsi File size indicator shows the length of the file. It can have a value of 1 to 7. The length of the file associated with a particular value is as follows:

<b>Value</b>	<b>PRUs in octal</b>
1	1 to 500.
2	501 to 1000.
3	1001 to 2000.
4	2001 to 4000.
5	4001 to 10000.
6	10001 to 20000.
7	20001 to maximum.

- rep Repeat count.
- lid Logical identifier of the mainframe where the file is processed.
- ds Destination (output files only).
  - BC Local batch.
  - RB Remote batch.
- id File identification (output files only).
- fc Forms code (output files only).

ec

External characteristics (print and punch queue types only).

**Punch Code**

<b>Mnemonics</b>	<b>Description</b>
PH	System default. Set at installation time.
SB	System binary.
80	80 column.
26	O26.
29	O29.
AS	ASCII.

**Print Code**

<b>Mnemonics</b>	<b>Description</b>
A4	NOS/BE. Same as A6.
B4	NOS/BE. Same as B6.
A6	ASCII graphic 63/64-character set.
B6	CDC graphic 63/64-character set.
A9	ASCII graphic 95-character set.

**Plot Code**

<b>Mnemonics</b>	<b>Description</b>
T6	Transparent 6-bit plotter data.
T8	Transparent 8-bit plotter data.

level

Access level of the file. This column appears only on a secured system.

## Rollout Status Display (R)

The rollout status display shows the current status of the executing jobs and those that are rolled out for any reason.

Figure 4-34 illustrates the rollout status display.

```

R.  ROLLOUT STATUS.

      JSN   SC   EJT   ST LR   SCPR   FL   FLE   ACCESS LIMITS
      SYS   S    0   EX      0   1242           LVL0   LVL0
      MAG   X    1   EX   7776   34           LVL0   LVL7
      IAF   X    2   EX   7776   604          LVL0   LVL7
      AAAW  S    3   EX   4000   224          LVL0   LVL7
      AAAC  S    4   RS     64           LVL0   LVL7
      BIO   X    5   EX   7776    2    0   LVL0   LVL7
      AAAY  S    6   EX   2000   220    0   LVL0   LVL7
      AAAH  M   11   EX     1    23    0   LVL0   LVL7
      AAAI  M   12  RO*     7   204    0   LVL0   LVL7
      AAAJ  M   13   EX     1   200    0   LVL0   LVL7
      AAAK  M   14   EX     1    23    0   LVL0   LVL7
      AAAL  M   15   EX     1    27    0   LVL0   LVL7
      AAAM  M   16   EX     1   200    0   LVL0   LVL7
      AAAN  M   17   EX     1   200    0   LVL0   LVL7
      AAAO  M   20   EX     1    23    0   LVL0   LVL7
      AAAP  M   21   EX     1    27    0   LVL0   LVL7
      AAAQ  M   22   EX     1   100    0   LVL0   LVL7
      AAAR  M   23   EX     1   100    0   LVL0   LVL7
      AAAS  M   24   EX     1    23    0   LVL0   LVL7
      AAAT  M   25   EX     1   200    0   LVL0   LVL7
      MORE

```

**Figure 4-34. Rollout Status Display (R)**

If more entries remain to be displayed when the screen is full, the message

```
MORE
```

appears at the bottom of the screen. To view these entries, page through the display.

Each entry on this display has the following format.

```
jsn   sc   ejt   st   lr   scpr   fl   fle   access limits
```

**jsn** Job sequence name of the executing job table entry.

**sc** Service class of the executing job table entry.

**ejt** Executing job table ordinal of the executing job.

st

Job status. One of the following values is displayed.

<b>st</b>	<b>Description</b>
AS	Waiting for an account dayfile-size-exceeded condition to be detected.
BS	Waiting for a binary maintenance log-size-exceeded condition to be detected.
CD	Waiting for a channel to be downed by the system.
CI	Waiting for CPD initiation.
CT	Waiting for CPD termination.
DO	Disabled rollout. The job is waiting for a command.
DS	Waiting for a system dayfile-size-exceeded condition to be detected.
EJ	Waiting for an executing job table-full condition to be detected.
ER	I/O error on rollout.
ES	Waiting for an error log-size-exceeded condition to be detected.
EX	Job currently executing at a control point.
FN	Waiting for system file name table-full condition to be detected.
FO	Waiting for family ordinal table-full condition to be detected.
IN	The job has not started. Job is available to be scheduled to a control point for the first time.
IO	Interactive rollout. Job rolled to perform interactive input or output.
In	Installation event n ( $0 \leq n \leq 7$ ).
LD	Waiting for L display input.
MA	Waiting for MSE subsystem initiation.
MG	Waiting for MAG subsystem initiation.
PC	Pseudo-rollout. Job rolled to a pseudo-control point to make space for another job with higher scheduling or control-point priority.
PF	Waiting for permanent file.
QF	Waiting for queued file table-full condition to be detected.

st (Continued) Job status.

<b>st</b>	<b>Description</b>
RD	Waiting for DOWN tape drive to be turned ON.
RH	Waiting for RHF subsystem initiation.
RO	Scheduler rollout. Job was rolled to make space for another job of higher scheduling priority.
RS	Waiting for a resource. Job waiting for a tape or removable pack assignment.
SC	Waiting for the service class change.
SI	Rollin requested for this job by system control point request.
SO	Rollout for this job was caused by system control point request.
SS	Subsystem waiting for required control point.
SU	Detached job is suspended.
SW	Service limit wait status.
TC	Waiting for a problem on a TMS tape catalog file to be cleared.
TE	Extended time event.
TL	Waiting for track limit condition to be detected.
TM	Waiting for a TMS/MAGNET condition to be cleared.
TO	Timed or event rollout.
TU	Waiting for a TMS utility to complete execution.
TV	Waiting for a TMS VSN or for a TMS scratch tape.
UA	Utility active.
WI	Waiting for a mass storage device to become accessible.
WK	Waiting for Screen Management Facility (SMF) subsystem to return workfile to FSE.

lr Locked rollout. If an asterisk (\*) is present, the job was rolled out when you entered a ROLLOUT command. To clear this condition, use the ROLLIN command (refer to chapter 3 for more information).

<b>lr</b>	<b>Description</b>
scpr	Scheduling priority of the executing job.
fl	Rollin central memory field length divided by 100 <sub>8</sub> .
fle	Rollin extended memory field length divided by 1000 <sub>8</sub> .
access limits	Access limits of the job. This column appears on a secured system only.

## System Control Display (S)

The system control display shows the parameters used to control the job flow for the various service classes. For each service class, queue priorities and service limits are shown. To view additional screens of the S display information, page through the display.

Figure 4-35 illustrates the system control display.

S. SYSTEM CONTROL.												
SC	QU	QUEUE VALUES					SERVICE LIMITS					
		IL	LP	UP	WF	IP	CP	CT	CM	NJ	TD	
							FL	AM	TP	AJ	DT	
							EC	EM	DS	FC	CS	FS
							PR	SE	RS	US		
SY	IN		7770	7776		1	6770	10	200	7777		341
	EX	4000	2000	7000		1	7000	3777	77777	4004	2	DI
	OT		7000	7776		1		3777	7777			
							30	20		4	20	
BC	IN		10	4000		1	3770	20	200	7777		341
	EX	2000	1000	4004		1	2000	3777	77777	4004	2	DI
	OT		1	7000		1		3777	7777			
							30	20		4	20	
RB	IN		10	4000		1	3770	20	200	7777		341
	EX	2000	1000	4000		1	2000	3777	77777	4004	1	DI
	OT		1	7000		1		3777	7777			
							30	20		4	20	
SSTL = 3703 0020 0000 5674 0000 4C P ,												
INWL = 0000 0000 0000 0000 0000												

**Figure 4-35. System Control Display (S)**



Each entry on this display has the following format.

sc qu queue values service limits

sc Service class. Each field in the entry is described as follows:

sc	Service Class
BC	Local batch job.
CT	Communication task.
DI	Detached interactive job.
DS	Deadstart sequencing job.
In	Installation-defined class n ( $0 \leq n \leq 3$ ).
MA	Maintenance job.
NS	Network supervisor job.
RB	Remote batch job.
SS	Subsystem job.
SY	System job.
TS	Interactive job.

qu Queue type. One of each of the following for each job type:

qu	Job Type
IN	Input
EX	Executing
OT	Output

queue values Each entry appears in the following format:

il	lp	up	wf	ip
il	Initial low priority.			
lp	Lowest priority.			
up	Highest priority.			
wf	Weighting factor.			
ip	Initial priority.			

service limits      Each entry appears in the following format:

```

cp   ct   cm   nj   td
fl   am   tp   aj   dt
ec   em   ds   fc   cs   fs
pr   se   rs   us

```

cp      Control-point slice priority.

ct      Control-point time slice (seconds).

cm      Central memory time slice (seconds).

nj      Maximum number of jobs for this service class.

td      Timeout delay. This value is the number of seconds /10<sub>8</sub> before a suspended job is timed out.

fl      Maximum field length/100<sub>8</sub> for any individual job of the service class.

am      Maximum field length/100<sub>8</sub> for all jobs of the service class.

tp      Terminal priority. This is the priority assigned to an interactive job at the beginning of the job step or at completion of terminal I/O.

aj      Number of active jobs for this service class.

dt      Service class assigned when job is voluntarily detached.

ec      Maximum number of extended memory allocation units (UEBS) for any individual job of the service class.

em      Maximum number of extended memory allocation units (UEBS) for all jobs of the service class.

ds      Size in PRUs allowed for individual direct access permanent files for jobs of this service class.

fc      Number of permanent files allowed for jobs of this service class.

cs      Cumulative size in PRUs allowed for all indirect access permanent files for jobs of this service class.

fs      Size in PRUs allowed for individual indirect access permanent files for jobs of this service class.

pr      CPU priority.

se      CPU slice extension.

rs      Recall CPU slice.

us      Unextended CPU slice.

**NOTE**

---

The entry in each of the four fields (ds, fc, cs, and fs) is not the actual value but an index to a table of values. Refer to the SERVICE command in the NOS Version 2 Analysis Handbook and find the parameter that corresponds to the S display field (such as the FCfc parameter for the FC field). The table in the parameter description shows the actual value. If zero is used, the entry does not appear in the display.

---

Refer to the DSD commands QUEUE and SERVICE in the NOS Version 2 Analysis Handbook for more information about these parameters.

The system status control word (SSTL) and the system interlock word (INWL) appear at the bottom of the S display, each in five groups of four octal digits. The display code equivalent is shown at the right of each word.

The following bits may be set in the control word (SSTL). (The commands used to change these conditions are described in the NOS Version 2 Analysis Handbook.)

<b>SSTL Bit Set</b>	<b>Description</b>
59	Disable autorestart.
58	Disable memory clearing.
57	Console is in security unlock status.
56	Console is unlocked.
54	Disable cartridge PF staging.
53	Disable user extended memory.
52	Disable PF validation.
51-50	Disable MS validation.
49	Disable MSE executive master mode.
48	Disable spindown.
46	Disable forced formatting.
45	Disable ACS tape PF staging.
44	Disable hardware fault injection.
43	Disable tape PF staging.

<b>SSTL Bit Set</b>	<b>Description</b>
42	Disable removable device checking.
41	Disable disk validation.
40	Disable secondary USER commands.
39	Disable system control point (SCP) facility.
35	Disable subcontrol points.
30	Disable PROBE.
29	Disable TRAP/TRACE.
24	Disable TMS.
23	VE= entry not entered at deadstart.
22	Disable flexible memory partitioning.
21	Disable DDP rollout path.
20	Disable resident RDF.
19	Disable privileged RDF.
18	Disable privileged analyst mode.
17	Disable extended stack purging.
16	Disable analyst logging.
15	Disable simulated SCR.
14	Disable engineering mode.
13	Disable system debug mode.
12	System is in debug mode.
0-11	Reserved for installation use.

All other SSTL bits are reserved for future use by Control Data.

The following bits may be set in the interlock word (INWL).

<b>INWL Bit Set</b>	<b>Description</b>
13	Disable job scheduler.
0	SCP abort interlock is set.

## Interactive Status Display (T)

The interactive status display shows the status of interactive users. The display shows the number of successful logins since the IAF subsystem was activated and the number of currently active users.

Figure 4-36 illustrates the interactive status display.

```

T.    INTERACTIVE STATUS.

TOTAL USERS =   100D    ACTIVE USERS = 100D

CONN  USER      JSN  W   ST  TERM      CONN  USER      JSN  W   ST  TERM
-----
   3  BOBSIM1    AAEK      EX  BLNTA1F    25  BOBSIM4    AACV      EX  CLNTN17
   4  BOBSIM2    AACC      EX  BLNTA2F    26  BOBSIM5    AACT      EX  ALNTN07
   5  BOBSIM3    AACF      DO  BLNTA3F    27  BOBSIM1    AACS      EX  CLNTN10
   6  BOBSIM4    AACD *    EX  BLNTA1F    30  BOBSIM2    AACW      EX  CLNTN11
   7  BOBSIM5    AACE      EX  BLNTA2F    31  BOBSIM3    AACY      TE  ALNTN11
  10  BOBSIM1    AACH      IO  BLNTA3F    32  BOBSIM4    AACX      EX  CLNTN17
  11  BOBSIM2    AACG      EX  BLNTA4F    33  BOBSIM5    AACZ      EX  ALNTN07
  12  BOBSIM3    AACJ      EX  BLNTA2F    34  BOBSIM1    AADE      RO  CLNTN10
  13  BOBSIM4    AACI      IO  BLNTA1F    35  BOBSIM2    AADA      IO  CLNTN11
  14  BOBSIM5    AACK      EX  BLNTA2F    36  BOBSIM3    AADC      EX  ALNTN11
  15  BOBSIM1    AACN *    TE  BLNTA3F    37  BOBSIM4    AADB      EX  CLNTN17
  16  BOBSIM2    ACL *    EX  BLNTA1F    40  BOBSIM5    AADD      EX  ALNTN07
  17  BOBSIM3    AACP      EX  BLNTA2F    41  BOBSIM1    AADF      EX  CLNTN10
  20  BOBSIM4    AACQ      EX  BLNTA3F    42  BOBSIM2    AAHF      DO  CLNTN11
  21  BOBSIM5    AACO      EX  BLNTA4F    43  BOBSIM3    AADG      EX  ALNTN11
  22  BOBSIM1    AACM      TE  BLNTA5F    44  BOBSIM4    AADJ      EX  CLNTN17
  23  BOBSIM2    AACR      DO  BLNTA1F    45  BOBSIM5    AADK      EX  ALNTN07
  24  BOBSIM3    AACU      EX  BLNTA2F    46  BOBSIM1    AADI      TE  ALNTN17

```

**Figure 4-36. Interactive Status Display (T)**

Each entry on this display has the following format.

```
conn user jsn w st term
```

conn	Connection number.
user	User name.
jsn	Job sequence name assigned to this session.
w	If an asterisk (*) is present, the user has not received the last warning message (refer to WARN command in chapter 3).
st	Job status. One of the following values is displayed.
<b>st</b>	<b>Description</b>
DO	Disable rollout. The job is waiting for a command.
ER	I/O error on rollout.
EX	Job currently executing at a control point.
IN	The job has not started. Job is available to be scheduled to a control point for the first time.
IO	Interactive rollout. Job rolled out to perform interactive input or output.
PC	Pseudo-rollout. Job rolled out to a pseudo-control point to make space for another job with higher scheduling or control point priority.
RO	Scheduler rollout. Job was rolled out to make space for another job of higher scheduling priority.
SI	Rollin requested for this job by system control point request.
SO	Rollout for this job was caused by a system control point request.
SU	Detached job is suspended.
SW	Service limit wait status.
TE	Extended time event.
term	Network terminal name.

## System Information Displays (W)

The system information displays show system information that can be used to monitor memory allocation, channel status, system queue activity, available system resources, and miscellaneous parameters. The type of information supplied varies according to the subdisplay specified.

Command	Display
W,A.	Memory allocation.
W,C.	Channel status.
W,M.	Miscellaneous parameters.
W,P.	System table addresses.
W,Q.	System queues.
W,R.	System resources.

### Memory Allocation Display (W,A.)

The memory allocation display shows the amount of central memory and extended memory allocated at deadstart time. Central memory size is displayed as the number of words/100<sub>8</sub>.

Figure 4-37 illustrates the memory allocation display.

W, A. MEMORY ALLOCATION					
CENTRAL MEMORY					
100000					
EXTENDED MEMORY					
	USER EM	FILE SPACE	I/O BUFF SPACE	TRACK SIZE	USER EM BLOCK SIZE
UEM	1240		7700		1000
EQ 47		76		20	

**Figure 4-37. Memory Allocation Display (W,A.)**

Each entry on this display has the following format.

```

          file   i/o buff  track   user em
user em  space   space     size   block size

```

```

uem
eq

```

user em	Number of words/1000 <sub>8</sub> available for user-accessible extended memory.
file space	Number of words/1000 <sub>8</sub> available for files.
i/o buff space	Number of words/1000 <sub>8</sub> available for file buffers.
track size	Track size is the number of words/100 <sub>8</sub> .
user em block size	Number of words/1000 <sub>8</sub> available for each block of user-accessible extended memory.
uem	Unified extended memory (not allocated to specific equipment).
eq	Equipment number.



### Channel Status Display (W,C.)

The channel status display shows the status of all channels. The first line of the display contains the contents of the A register when a DSD channel control operation is active.

Figure 4-38 illustrates the channel status display for mainframes other than CYBER 180-class models. Figure 4-39 illustrates the Channel Status display for CYBER 180-class mainframes.

```

W,C. CHANNEL STATUS.

CHANNEL A REGISTER = 0000

CH   PP  PGM  STATUS           CH   PP  PGM  STATUS
-----
0
1
2
3
4
5
6
7

10   1   DSD  EMPTY           30
11
12
13
14           FULL           33           DOWN
15
16
17
    
```

**Figure 4-38. Channel Status Display (W,C.)**

```

W,C. CHANNEL STATUS.

CHANNEL A REGISTER = 0000

CH  PP  PGM  STATUS          CH  PP  PGM  STATUS          CCH  PP  PGM  STATUS
0           ---          20           ---          0           ---
1           D--          21           ---          1           ---
2           ---          22           ---          2           ---
3           ---          23           ---          3           ---
4           ---          24           ---          4           ---
5           ---          25           ---
6     2  1SJ  ---          26           ---
7           ---          27           ---

10    1  DSD  --F          30           ---
11           ---          31           ---
12           ---          32           ---
13           ---          33           ---
14           -CF
15           ---
16           ---
17           ---

```

**Figure 4-39. Channel Status Display (W,C.) for CYBER 180-Class Mainframes**

**NOTE**

The CCH, PP, and PGM columns on the right appear only if the mainframe has concurrent channels.

Each entry on this display has the following format.

```
ch  pp  pgm  status
```

**ch** Channel number ( $0 \leq \text{ch} \leq 33_8$ ).

**pp** PP number assigned to the specified channel. If a C prefixes the number, the channel is assigned to a concurrent PP.

**pgm** PP program name.

**status** Channel status.

<b>status</b>	<b>Description</b>
blank	Channel is not in use.
EMPTY	Channel is empty.
FULL	Channel is full.
DOWN	Channel is logically down.
DCx	CYBER 180-class mainframes only.
D	Channel is down.
C	Channel flag is set.
x	Can be one of the following:
F	Channel is full.
E	Channel is empty.

## Miscellaneous Parameters Display (W,M.)

The miscellaneous parameters display shows the delay parameters that can be altered by the DSD DELAY command. In addition, the W,M display shows various file threshold values. Refer to the NOS Version 2 Analysis Handbook for detailed information on the DELAY command and various file threshold values.

Figure 4-40 illustrates the miscellaneous parameters display.

W,M. MISC. PARAMETERS.	
SYSTEM DELAY PARAMETERS	
OPTION	DESCRIPTION
JQ = 2	INPUT FILE SCHEDULING INTERVAL (2**JQ SECONDS)
JS = 1	JOB SCHEDULER DELAY (SECONDS)
CR = 30	CPU PROGRAM RECALL (MILLISECONDS)
AR = 1750	PP AUTO RECALL (MILLISECONDS)
MP = 0	MEMORY PAD (BLOCKS)
FILE THRESHOLDS	
OPTION	DESCRIPTION
CPTT = 100	CPU TRANSFER THRESHOLD
SRST = 320	SECONDARY ROLLOUT SECTOR THRESHOLD
OQSH = LVL7	OUTPUT QUEUE SPECIAL HANDLING LEVEL

**Figure 4-40. Miscellaneous Parameters Display (W,M.)**

### System Table Addresses Display (W,P.)

The system table addresses display shows the first word address of many system tables.

Figure 4-41 illustrates the system table addresses display.

W, P. SYSTEM TABLE ADDRESSES.			
SYSTEM TABLES			
BIO = 43306	EPB = 31555	LDS = 15024	PRB = 130670
BKP = 63343	EPD = 126151	LID = 43105	PST = 123662
BNT = 104574	EST = 7734	MCT = 10134	QFT = 40005
CHT = 14270	EVT = 14523	MFS =	RCL = 122641
CLT = 43105	FNT = 33337	MSA = 15000	RPL = 104634
DDB = 17156	FOT = 33327	MTR = 54651	SAB = 14573
DFP = 7720	INB = 33307	PCP = 10270	SDA = 33307
EDB = 31511	JCB = 14620	PLD = 122646	SID = 14547
EJT = 33405	LBD = 130521	PPC = 7400	SSC = 14535
EMB = 14323			
BUFFERED I/O TABLES			
BST = 43323	CCT = 43365	FTT = 43435	CBT = 45041
PLT = 43327	PUT = 43375	HAT = 43441	IOS = 131755

**Figure 4-41. System Table Addresses Display (W,P.)**

The table identifiers are defined as follows:

<b>Identifier</b>	<b>Description</b>
BIO	Buffered I/O tables.
BKP	Breakpoint buffer.
BNT	Block name table.
CHT	Channel tables.
CLT	Common libraries table.
DDB	Dayfile dump buffer.
DFP	Dayfile FNT entries.
EDB	Extended Memory data buffer.
EJT	Executing job table.
EMB	Error message buffer.
EPB	Extended memory PP buffer.
EPD	Entry point directory.
EST	Equipment status table.
EVT	Event table.
FNT	File name table.
FOT	Family ordinal table.
INB	Installation buffer.
JCB	Job control blocks.
LBD	Library directory.
LDS	L display control buffer.
LID	Logical ID table.
MCT	Memory control table.
MFS	Mainframe status table.
MSA	Mass storage allocation area.
MTR	FWA of CPUMTR.
PCP	FWA of Pseudo-control point areas.
PLD	PP library directory.
PPC	PP communications area.
PRB	Probe data area.
PST	Program status table.
QFT	Queued file table.
RCL	Resident CPU library directory.
RPL	Resident PP library directory.
SAB	System attribute block.
SDA	Statistical data area.
SID	SECDED ID table.
SSC	Subsystem control table.
BST	Buffered I/O statistics table.
PLT	PP link table.
CCT	Channel control table.
PUT	Physical unit table.
FTT	Function timeout table.
HAT	Hash table.
CBT	Control buffer area.
IOS	I/O statistics.

A blank entry indicates the table is not present in the system.

## System Queues Display (W,Q.)

The system queues display shows the request queues for all jobs in the executing job table. This display can be used to monitor the request flow (and bottlenecks) and CPU scheduling.

Figure 4-42 illustrates the system queues display.

```

W,Q.  SYSTEM QUEUES.

      ---CPU---      -RECALL-      ---PP---      PSEUDO-PP      -BUFFER-
      CP   CPU      CP  TYPE      CP   PP      CP              CP   BUF
20                                32   CPU
23                                1   CPU
 7                                33   IIO
14                                35   END
 4
12
24
21
11
10
15
17
22
IDL   0
    
```

**Figure 4-42. System Queues Display (W,Q.)**

The header line shows the five types of requests that can be made.

Type	Request
CPU	WQRL
RECALL	RQRL
PP	PQRL
PSEUDO-PP	CQRL
BUFFER	BQRL

### NOTE

There is only one PSEUDO-PP type for NOS. Its function is to emulate the function of the CIO PP program (1MS). It is assigned to you when you are using buffered devices.

For the CPU (WQRL) requests, each entry has the following form.

cp   cpu

cp           The control point from which the request was made. The following special codes may also appear in this field:

<b>Code</b>	<b>Description</b>
FTN	CPUMTR program mode monitor function.
MVE	CPUMTR storage move.
FLV	CPUMTR field length verification.
PSP	CPUMTR buffered I/O (pseudo-PP).
IDL	Idle package.

cpu           If present, this is the CPU (0 or 1) to which the request is restricted.

For the RECALL (RQRL) requests, each entry has the following form.

cp   type

cp           The control point from which the request was made.

type           The name of the PP program making the request. CPU appears here if the job is waiting for a completion bit to be set or for a recall interval to expire.

For the PP (PQRL) requests, each entry has the following form.

cp   pp

cp           The control point from which the request was made.

pp           The name of the PP program making the request.

For the PSEUDO-PP (CQRL) requests, each entry is the control point from which the request was made.

For the BUFFER (BQRL) requests, each entry has the following form.

cp   buf

cp           The control point from which the request was made.

buf           The I/O buffer number for which the request was made.



## System Resources Display (W,R.)

The system resources display shows the available system resources.

Figure 4-43 illustrates the system resources display.

SYSTEM ACTIVITY			
JSN IN CPU 0	=	ASOF	NEXT JSN = ASST
JSN IN CPU 1	=	BIO	JOBS ROLLED = 37
AVAILABLE RESOURCES			
CM =	13647	UXM =	0
PP-S =	20	CPP-S =	7
CLD =	0	EJT =	1052
FNT =	145	FOT =	6
LID =	24	QFT =	612
CP-S =	13	PCP-S =	23

**Figure 4-43. System Resources Display (W,R.)**

The first part of the display shows the job sequence name to which the CPU(s) are assigned, the next job sequence name the system will assign to a job, and the number of jobs currently rolled out. When a CPU is assigned to CPUMTR running in program mode, one of the following special codes will be displayed in place of the JSN:

Special Code	Description
SYS FTN	Program mode monitor function.
SYS MVE	Storage move.
SYS FLV	Field length verification.
SYS PSP	Pseudo-PP.
SYS IDL	Idle package.

The second portion of the display shows the status of various system resources:

Resource	Description
CM	Amount of available central memory divided by 100 <sub>8</sub> .
PP-S	Number of peripheral processors (PPs) available for assignment.
CLD	Octal number of available common library table entries.
FNT	Octal number of available file name table entries.
LID	Octal number of available logical ID table entries.
CP-S	Number of control points available for assignment.

<b>Resource</b>	<b>Description</b>
UXM	Amount of available user extended memory divided by 1000 <sub>g</sub> .
CPP-S	Number of concurrent peripheral processors (CPPs) available for assignment.
EJT	Octal number of available executing job table entries. If the number is zero, the system cannot start a new job until an current job completes execution, freeing an executing job table entry.
FOT	Octal number of available family ordinal table entries.
QFT	Octal number of available queued file table entries.
PCP-S	Number of psuedo-control points available for assignment.

## Monitor Functions Display (Y)

The monitor functions display lists all monitor function mnemonics and their respective codes. Codes 1 through 20 represent PP monitor functions. Codes 21 and higher represent CPU monitor functions.

Figure 4-44 illustrates the monitor functions display.

Y. MONITOR FUNCTIONS.				
1. ASCM	21. CHGM	41. SMDM	61. EATM	101. SCDM
2. BOTM	22. HNGM	42. STBM	62. JACM	102. SCTM
3. CCHM	23. SCSM	43. VMSM	63. LDAM	103. SFEM
4. DCHM	24.	44.	64. LMSM	104. SJCM
5. DRCM	25. ACTM	45. SPLM	65. MTRM	105. TDAM
6. DSRM	26. AFAM	46. ABTM	66. PLFM	106. TGPM
7. RCXM	27. BFMM	47. BIOM	67. RCLM	107. TIOM
10. SFLM	30. CKSM	50. BMIM	70. RCPM	110. TRCM
11.	31. CSTM	51. CCAM	71. RECM	111. TSEM
12. CDBM	32. DLKM	52. CDAM	72. REQM	112. UADM
13. DSWM	33. DTKM	53. CEFM	73. RJSM	113. UTEM
14. HLTM	34. ECSM	54. CPRM	74. RLMM	114. VFLM
15. PRLM	35. ECXM	55. DCPM	75. ROCM	115. VFPM
16. RCHM	36. PIOM	56. DEQM	76. RPNM	116. VSAM
17. RSTM	37. RDCM	57. DFMM	77. RPPM	117.
20. SEQM	40. RTCM	60. DPPM	100. RSJM	

**Figure 4-44. Monitor Functions Display (Y)**

## Directory Display (Z)

The directory display lists all the displays available under DSD control.

Figure 4-45 illustrates the directory display.

Z.	DIRECTORY.
A	DAYFILES. (A. A,. A,OPERATOR. A,ERROR LOG. A,ACCOUNT FILE. DAYFILE,JSN.)
B	SYSTEM STATUS. (B,A. B,O.)
C,D	CENTRAL MEMORY. 5 GROUPS OF 4.
E	EQUIPMENT STATUS. (E,X. X = A, C, E, F, H, M, O, P, S, T.)
F,G	CENTRAL MEMORY. 4 GROUPS OF 5.
H	SYSTEM AND LOCAL FILES. (H., H,JSN.)
I	BIO STATUS.
J	JOB STATUS.
K	CPU PROGRAMMABLE.
L	CMR BUFFERS.
M	EXTENDED MEMORY.
O	TAF STATUS. (O,SCP. O,TLD. O,TST.)
P	PP REGISTERS.
Q	QUEUE STATUS. (Q,. Q,IN. Q,PL. Q,PR. Q,PU. Q,WT.)
R	ROLLOUT STATUS.
S	SYSTEM CONTROL.
T	INTERACTIVE STATUS.
U	INSTALLATION USE.
V	PP BREAKPOINT.
W	SYSTEM INFORMATION. (W,A. W,C. W,M. W,P. W,Q. W,R.)
Y	MONITOR FUNCTIONS.

**Figure 4-45. Directory Display (Z)**



# L Displays

---

How to Make L-Display Entries .....	5-1
SUBSYST L Display .....	5-2



This chapter describes only the SUBSYST L display. The other L displays are described in the NOS Version 2 Analysis Handbook.

NOS supports the following L-display utilities.

<b>Utility</b>	<b>Description</b>
FOTD	Displays the family ordinal table (FOT). Displays all the family names known to the system and the corresponding family ordinals.
LIDOU	Displays the table of logical identifiers (LIDs) of mainframes in your computer system. Allows you to add, delete, or modify entries in the LID table.
QDSPLAY	Displays the contents of a file in the queued file table (QFT).
SCTD	Displays the validated service classes for each origin type in the service class control table.
SDSPLAY	Displays system values used to control job flow.
SUBSYST	Displays information about all the subsystems supported by NOS.

## How to Make L-Display Entries

When you enter the name of the L-display utility, the system automatically assigns the L display to the utility. When the L display is ready for use, DSD assigns it to the left screen automatically.

All entries must be prefixed by L. (L period). However, after the first entry, when you press carriage return everything but the L. is erased. This allows you to enter another command without entering L. All examples in this section show L., although you may not have to type it. If you must enter a DSD command, simply erase the L., enter the command, then continue by typing L. and the entry.

After you call a specific utility, enter the first command in the following format.

```
L.commandstring.
```

commandstring is any input (command, data, or parameter) defined by the job as valid input.



## SUBSYST L Display

The SUBSYST L display utility displays information about all the subsystems supported by NOS. To begin the SUBSYST utility, enter one of the following commands.

SUBSYST, L=outfile, LO=option.

or

SUBSYST, outfile, option.

- outfile            Output file name. This parameter is valid only if a list option is specified. The default outfile is file OUTPUT.
- option            List option. Enter one or more of the following.
- D                Formats the data for the DSD L display. This is the default list option if the parameters outfile and option are not specified.
  - L                Formats the data for a line printer.

Figure 5-1 illustrates the SUBSYST L display.

L. SUBSYST				
SUBSYSTEMS				
NAME	REQUIRED CONTROL POINT	EJT ORDINAL	STATUS	
IAF	1		DISABLED	
RHF			DISABLED	
TAF			DISABLED	
MAP			DISABLED	
NAM			DISABLED	
NVE			DISABLED	
CDC			DISABLED	
MCS			DISABLED	
RDF	1		DISABLED	
RBF			DISABLED	
BIO	22	10	ENABLED	
MAG	21	11	ENABLED	
STM	23		DISABLED	
MORE				

**Figure 5-1. SUBSYST L Display**

Each entry in the SUBSYST L display has the following form.

name	req cp	ejto	status
name	Three-character subsystem name.		
req cp	Required control point (set by the ENABLE or DISABLE command).		
ejto	Executing job table (EJT) ordinal of the subsystem if it is currently active.		
status	Enabled or disabled status of the subsystem.		

Valid SUBSYST commands are:

Command	Description
L.END.	Terminates the utility.
L.OUT.	Routes a listing of the subsystem status information to the printer.
L.DISABLE,sub,cp. or L.ENABLE,sub,cp.	Enables or disables the subsystem sub. The ENABLE or DISABLE command does not initiate or drop a subsystem when you enter the command. Instead, it determines if the specified subsystem is to be assigned to a control point upon entry of the next AUTO or MAINTENANCE command. In addition, a currently active subsystem (assigned to a control point) is not dropped by entering the DISABLE command followed by AUTO or MAINTENANCE. You must enter the IDLE,subsystem command to drop an active subsystem.

sub is one of the following:

sub	Description
ATF <sup>1</sup>	Enables or disables the Automated Tape Facility.
BIO	Enables or disables the Batch Input/Output subsystem.
CDC	Enables or disables the system control point version of the CDCS Data Management subsystem.
CYB	Enables or disables the CYBIS-NAM Interface subsystem.
IAF	Enables or disables the Interactive Facility. IAF always runs at control point 1.
MAG	Enables or disables the Magnetic Tape subsystem.
MAP	Enables or disables the Matrix Array Processor.

*(Continued on next page)*

<sup>1</sup> This subsystem is not initiated directly by the AUTO or MAINTENANCE commands. If selected in the NAM startup file, it is initiated automatically by the NAM subsystem.

Command	Description
---------	-------------

(Continued from previous page)

sub	Description
MCS	Enables or disables the Message Control System.
MSE	Enables or disables the Mass Storage Extended subsystem.
NAM	Enables or disables the Network Access Method subsystem.
NVE	Enables or disables the NOS/VE subsystem.
RBF <sup>2</sup>	Enables or disables the Remote Batch Facility.
RDF	Enables or disables the Remote Diagnostic Facility. RDF always runs at control point 1. To help maintain access security to RDF, enable RDF only when needed. Refer to NOS Online Maintenance Software Reference Manual for more information. On a secured system, RDF can be enabled only when in security unlock status.
RHF	Enables or disables the Remote Host Facility.
SMF	Enables or disables the Screen Management Facility (Multiuse Full Screen Editor).
SSF	Enables or disables the SCOPE 2 Station Facility.
STM	Enables or disables the Interactive Stimulator.
TAF	Enables or disables the Transaction Facility.

cp is an optional control point assignment. If cp is specified for a subsystem, the control point assignment supersedes any IPRDECK control point assignment. If cp is not specified, whatever IPRDECK assignment was made remains in effect. If the format DISABLE,sub,0 or ENABLE,sub,0 is used, any IPRDECK control point assignment is cleared and any available control point is used for the subsystem when you enter the next AUTO or MAINTENANCE command.

#### NOTE

If you choose to specify a control point for any subsystem, it is recommended that you specify a unique control point for each subsystem. Otherwise, a subsystem may not be able to initiate successfully because its designated control point is already occupied by another subsystem. When this happens, the subsystem being initiated waits indefinitely for the other subsystem to give up the control point.

<sup>2</sup> This subsystem is not initiated directly by the AUTO or MAINTENANCE commands. If selected in the NAM startup file, it is initiated automatically by the NAM subsystem.





This appendix contains a sorted listing of all console messages and network messages of importance to the operator. Each message is followed by an explanation of the message and/or the circumstances causing it to be issued, the recommended operator action, and the routine that issued the message. Messages beginning with numbers follow the alphabetical list.

If you encounter a diagnostic or informative message that does not appear in this appendix, refer to the NOS Version 2 Diagnostic Index. The Index catalogs all messages produced by NOS and its products and specifies the manual or manuals in which each message is fully documented.

Lowercase letters are used within a message to identify variable fields. Messages beginning with lowercase (variable) fields are listed alphabetically according to the first nonvariable field.

The messages in this appendix may appear in a subsystem dayfile on the following DSD displays.

- System status display (B,A. or B,O.).
- System dayfile display (A. or A,.).
- System error log dayfile display (A,ERROR LOG.).
- Resource requests display (E,P.).
- Utility display (K).
- Console display during deadstart.

**type: element, NOT DEFINED.**

Description: An erroneous element name of the specified type entered on the command.

Issued by CS.

User Action: Reenter corrected command.

**type: element, NOT UNDER YOUR CONTROL.**

Description: An element name of the specified type was entered on the command and the element is not being controlled by operator.

Issued by CS.

User Action: Enter CONTROL, ON command and reenter command.

**rrn est,nn.**

Description: The operator requested a reprint or repunch of the file on BIO equipment with a repeat count of nn.

Issued by QAP.

User Action: None.

**A LOG FILE NAME MUST BE SPECIFIED ON A PURGE.**

Description: The PURGE command requires that a file name be specified.

Issued by NLTERM.

User Action: Set a file name with the NM command or position the cursor on the full screen display to the NM field and enter a name. Then reenter the PURGE command.

**A LOG FILE NAME MUST BE SPECIFIED ON A TERM.**

Description: The TERM command requires that a file name be specified.

Issued by NLTERM.

User Action: Set a file name with the NM command or position the cursor on the full screen display to the NM field and enter a name. Then reenter the TERM command.

**A PARAMETER VALUE MUST BE SPECIFIED.**

Description: A parameter value must be specified with the L or NM parameter.

Issued by NLTERM.

User Action: Change the L or NM parameter so that a value is specified and rerun the job.

**ABNORMAL TERMINATION.**

Description: The utility has terminated abnormally.

Issued by NLTERM.

User Action: Check the reason for the abnormal termination on the dayfile.

**ABORT OF CDCS DETECTED.**

Description: Self-explanatory.

Issued by TAF.

User Action: Refer to EQest,Uunit,PS=serialn.

**ABORT RUN DUE TO ERRORS.**

Description: The SSVAl run aborted because of errors on the command.

Issued by SSVAl.

User Action: Correct errors and retry.

### **jsn ABORTED - message.**

Description: Unauthorized or incorrect user program sent incorrect requests to SSEXEC; message can be any of the following.

- ALREADY CONNECTED
- CARTRIDGE ACTIVE
- INVALID ADDRESS
- INVALID REQUEST CODE
- INVALID REQUEST TYPE
- MULTIPLE REQUESTS
- MULTIPLE RUN
- NOT CONNECTED
- SSEXEC IS CLOSED

Issued by SSEXEC.

User Action: Ensure that only authorized versions of the utilities are used.

### **jsn ABORTED - UTILITY CONFLICT.**

Description: SSVAL, SSLABEL, and SSDEBUG are mutually exclusive utilities. Only one copy of SSMOVE per family can be run at a time.

Issued by SXUCP.

User Action: Rerun the aborted utility after the other one has terminated.

### **ACCESS LEVEL CONFLICT**

Description: The device on which the tape is mounted does not allow the access level of the requested tape file.

Issued by RESEX.

User Action: Mount the tape on a device that allows the access level of the requested file.

### **ACCESS LEVEL LIMITS OUT OF RANGE.**

Description: The access level limits specified in a QDUMP or QLOAD command are not within the system access level limits.

Issued by QDUMP.

User Action: Reenter the command with access level limits that are within the system access level limits.

### **ACCESS LEVEL OUT OF RANGE.**

Description: The access level limits you specified in a PFDUMP, PFLOAD, or PFCOPY command are not within the system access level limits.

Issued by PFS.

User Action: Reenter the command with access level limits that are within the system access level limits.

### **\*\*\*\*ACCESS LEVEL OUT OF RANGE.**

Description: K display message indicating the selected access level is not within system limits.

Issued by QFSP.

User Action: Correct and retry.



### **ACCESS NOT PERMITTED.**

Description: The user is not permitted to access the data on the mounted tape.

Issued by MAGNET.

User Action: Mount correct tape or drop job.

### **ACCOUNT DAYFILE PROCESSED.**

Description: The account dayfile dump is complete.

Issued by DAYFILE.

User Action: None.

### **ACCOUNT UNRECOVERABLE.**

Description: The account dayfile cannot be recovered.

Issued by REC.

User Action: Enter GO,SYS. at the system console: a new dayfile will be created.

### **ACN LOST - NVFCPUT.**

Description: For debug only. An ACN is not found in the ACN list. This message is generated by NVF procedure NVFCPUT.

Issued by NVF.

User Action: Contact CYBER Software Support.

### **ACPD ARGUMENT ERROR - xx.**

Description: The xx parameter in the ACPD command is either undefined or is an incorrect value.

Issued by ACPD.

User Action: Enter a correct value and retry.

### **ACPD COMPLETE.**

Description: ACPD analysis completed.

Issued by ACPD.

User Action: None.

### **ACPD/CPD VERSIONS MISMATCH.**

Description: The version of CPD that created the data file does not match the version of ACPD that is currently processing the data file.

Issued by ACPD.

User Action: Use the correct version of ACPD to process the data file.

### **ACTIVE.**

Description: Informative message indicating that the Mass Storage Subsystem is active at a control point.

Issued by SXMAIN.

User Action: None.

### **ACTIVE LOAD NOT ALLOWED.**

Description: The load is not allowed because the device selected to receive active queues is removable.

Issued by QLOAD.

User Action: Select another device and retry the load.

**ADDCUBE - ONLY 100 LOCATIONS PROCESSED.**

Description: At most 100 cubicles can be added. The coordinate pairs specified by the YI and ZI parameters encompass more than 100 cubicles.

Issued by SSLABEL.

User Action: Use multiple AB directives.

**ADDING FILE lfn TO DATABASE.**

Description: File pfn is being read; RECLAIM is adding information for this file to your database.

Issued by RECLAIM.

User Action: None.

**ADDING TAPE vsn TO DATABASE.**

Description: Tape with VSN vsn is being read; RECLAIM is adding information for this tape to your database.

Issued by RECLAIM.

User Action: None.

**ADDRESS OUT OF RANGE.**

Description: A parameter block address was passed to CVL that was not within the job's field length.

Issued by CVL.

User Action: Inform a site analyst.

**ADDRESS xxxx OUT OF RANGE**

Description: An input directive has specified an address value that was too large.

Issued by BINEDIT.

User Action: Correct input file and retry.

**ADL ASSIGNED PFN= filename UN= usernam.**

Description: Informative message indicating the file name and user name of the application definition language (ADL) file attached by MCS.

filename	File name
username	User name

Issued by MCS.

User Action: None.

**ADL CREATED yy/mm/dd. hh.mm.ss.**

Description: Informative message indicating the creation date and time of application definition language (ADL) file.

Issued by MCS.

User Action: None.

**ADL NOT AVAILABLE PFN=filename, UN=username.**

Description: The system could not attach the named application definition language (ADL) file.

filename	File name
username	User name

Issued by MCS.

User Action: Assign correct file.

### **ADV 1 CD RE-RD 3 CDS.**

Description: I-display message is indicating that the card reader has encountered an error.

Issued by DSD.

User Action: Advance the card deck by 1 card, then reread the last three cards.

### **ADV 1 CD RE-RD 3 CDS.**

Description: I-display message. The card reader has encountered a transmission parity error, an incomplete data transfer, or a binary checksum error.

Issued by 1CD.

User Action: In order to recover, the operator must advance the next card in the input hopper, and then re-read the last 3 cards in the output hopper.

### **AFD - ARGUMENT ERROR.**

Description: Keyword specified is not recognizable or command is not properly formatted.

Issued by DAYFILE.

User Action: Check keyword and command formats.

### **AFD - BUFFER TOO SMALL.**

Description: The buffer DAYFILE used to hold the central memory dayfile buffer is not large enough.

Issued by DAYFILE.

User Action: Either make the internal DAYFILE buffer larger or specify a smaller dayfile buffer during deadstart.

### **AFD - DATA LOST.**

Description: A data read error occurred while processing an active dayfile. Processing continues with the next readable message. Lost data is not recoverable.

Issued by DAYFILE.

User Action: Contact a customer engineer.

### **AFD - FR INCORRECT FOR THIS OPTION.**

Description: The FR=string parameter is not allowed with this utility.

Issued by DAYFILE.

User Action: Use an appropriate option or omit the FR=string parameter and retry.

### **AFD - INCORRECT PAGE SIZE FORMAT.**

Description: The page size value is nonnumeric.

Issued by DAYFILE.

User Action: Retry with a numeric value.

### **AFD - INCORRECT PRINT DENSITY.**

Description: The print density value is not 3, 4, 6, or 8.

Issued by DAYFILE.

User Action: Retry with a valid print density.

### **AFD - INCORRECT PRINT DENSITY FORMAT.**

Description: The print density value is nonnumeric. Print density must be 3, 4, 6, or 8.

Issued by DAYFILE.

User Action: Retry with a valid print density.

### **AFD - LOCAL DAYFILE PROCESSED.**

Description: DAYFILE has successfully completed processing a local file as input (as in a terminated dayfile).

Issued by DAYFILE.

User Action: None.

### **AFD - RECOVERY SECTOR ENCOUNTERED.**

Description: A level 0, 1, or 2 deadstart was performed at this point in the Binary Maintenance Log. If the utility detects a linkage error it discards any message fragment being processed.

Issued by DAYFILE.

User Action: If possible, always checkpoint the system before performing a level 0, 1, or 2 deadstart.

### **AFD - RESERVED FILE NAME.**

Description: The file name specified for the L=filename parameter is a reserved name.

Issued by DAYFILE.

User Action: Retry using a nonreserved name.

### **AFD - UNABLE TO ACCESS DAYFILE.**

Description: Dayfile message indicating that an unexpected error was encountered.

Issued by DAYFILE.

User Action: Contact a customer engineer.

### **AFD - UNEXPECTED EOF/EOI ENCOUNTERED.**

Description: An EOF or EOI was encountered before the PRU count was depleted on the input file. The dayfile is shorter than expected based on the PRU count.

Issued by DAYFILE.

User Action: Retry operation.

### **AFD - UNKNOWN \*OP\* FIELD.**

Description: The option specified is not valid.

Issued by DAYFILE.

User Action: Retry using a valid option.

### **AFTER IMAGE ACCUMULATION TABLE OVERFLOW.**

Description: When updating a file, the after image accumulation table was filled.

Issued by (AAI).

User Action: The size of the AAIT table in DMPEC must be increased. Inform the database administrator.

### **AIP LOAD ERROR.**

Description: During an attempt to load network AIP relocatable subroutines, a loader error was returned.

Issued by IAFEX.

User Action: Contact CYBER Software Support.

### **AIP TOO LARGE FOR LOADING.**

Description: A fatal error occurred causing TAF to abort.

Issued by TAF.

User Action: Inform site analyst. TFWA must be increased in deck TAF.

### **ALARM ON PORT nn LCN=num PKID=id CAUSE=cc DIAG=dd**

Description: CCP received an abnormal packet on a port serviced by the X.25 terminal interface program.

nn Port identifier  
num Logical connection number  
id Packet identifier  
cc Cause identifier (first byte after packet header)  
dd Diagnostic identifier (second byte after packet header)

Issued by CCP.

User Action: Inform network analyst.

### **ALL CPUS OFF, OS LOAD IMPOSSIBLE**

Description: Self-explanatory.

Issued by CTI.

User Action: At least one CPU must be turned on for the OS load to proceed.

### **ALL EQ-S CHECKPOINTED. RECOVERY ABORTED.**

Description: During a level 3 recovery, either the ABORT. CMRDECK command was entered, or the system has determined that recovery is not possible. All devices with pending checkpoints have been checkpointed.

Issued by 1CK.

User Action: Level 0 deadstart is required.

### **ALL NPUS ARE BEING CONTROLLED BY OTHER NOPS**

Description: A CONTROL,NPUS command was attempted but all NPUs are already being controlled by other NOPS.

Issued by CS.

User Action: Wait until control is released before attempting to gain control of the NPUs.

### **ALL 7990 CONTROLLERS OFF.**

Description: All EST entries for the 7990 equipment are off. No hardware actions will take place.

Issued by SSEXEC.

User Action: Idle SSEXEC. Turn on appropriate EST entries and reinitiate SSEXEC.

### **filenam ALLOCATED.**

Description: Informative message.

Issued by DMREC.

User Action: None.

### **ALLOW FL AND DU COMMAND ONLY**

Description: NAM is initializing or is in buffer regulation level 0 (maximum field length has been reached). Only an FL command to increase NAM's field length or a DU command to dump NAM's field length is allowed.

Issued by NIP.

User Action: None.

### **ALREADY IN DESIRED STATE.**

Description: This message is a response to an enable or disable line command.

Issued by CS.

User Action: None.

### **ALTERING FLAW MAP S/N=serialn**

Description: Console message indicating that the utility flaw map is undergoing modification. Here serialn is the actual pack serial number as read from the manufacturing data recorded in cylinder 6328 (or 1466B), track 0, sector 0.

Issued by FORMAT.

User Action: None.

### **ALTERNATE FILE ACTIVE.**

Description: Output file message indicating that the alternate file was already being processed when entry of the OUTPUT directive was attempted.

Issued by DSDI.

User Action: Wait until processing is complete to enter the OUTPUT directive.

### **ALTERNATE OUTPUT TO TERMINAL INCORRECT.**

Description: Output file message indicating that the file name OUTPUT was specified on the OUTPUT directive entered from a terminal. Alternate list output cannot be assigned to the terminal.

Issued by DSDI.

User Action: Specify a file name other than OUTPUT on the OUTPUT directive when it is entered from a terminal.

### **ALTERNATE STORAGE ERROR.**

Description: The disk space for the file cannot be released because a permanent error status is set for the alternate storage file copy.

Issued by PFM.

User Action: Write a PSR.

### **AN EQUAL SIGN MUST FOLLOW COMMAND.**

Description: The L and NM commands require an equal sign to follow the command.

Issued by NLTERM.

User Action: Change the command so that an equal sign follows it and reenter.

### **AN ILLEGAL COMMAND IS SPECIFIED.**

Description: The command specified does not match any of the valid commands.

Issued by NLTERM.

User Action: Change the command so that it is one of the valid commands and reenter it.

### **ANOTHER RBF ALREADY NETTED ON.**

Description: Another copy of RBF has entered the network.

Issued by RBF.

User Action: No action required. The second copy of RBF will be dropped automatically.

### **APP CDA ERROR.**

Description: An internal error exists in the deadstart sector.

Issued by REC.

User Action: Contact CYBER Software Support to determine nature of problem. All or parts of CIP may have to be re-installed.

### **APP DISK STATUS ERROR.**

Description: An I/O error occurred.

Issued by REC.

User Action: Contact customer engineer to run HPA to determine the nature of the error and take appropriate maintenance action.

### **APP REQUEST NOT FOUND.**

Description: None.

Issued by REC.

User Action: Contact CYBER Software Support.

### **APP SENT BLK ON BROKEN CONNECTION.**

Description: Informative message indicating that an application has sent a block on a broken connection.

Issued by NIP.

User Action: No action is required. NIP discards the block in question.

### **APP TIMEOUT.**

Description: APP is not responding.

Issued by REC.

User Action: Take a deadstart dump, write a PSR, and send the dump and PSR to CDC along with any support materials which will allow CDC to duplicate the problem.

### **APPL - applnam INITIALIZED.**

Description: Informative message indicating that named application was started and is now active.

applnam      Application name

Issued by MCS.

User Action: None.

### **APPL - applnam JOURNAL journal DISABLED.**

Description: Because of CIO errors or an incorrect owner name, the recording of messages in the journal was disabled.

applnam      Application name

journal      Journal file name

Issued by MCS.

User Action: Correct owner name if appropriate.

### **APPL - applnam MONITOR monitor DISABLED.**

Description: Because of CIO errors or an incorrect owner name, the monitor file was disabled.

applnam      Application name

monitor      Monitor file name

Issued by MCS.

User Action: Correct owner name if appropriate.

**APPL - applnam PROG proqram CONNECTED.**

Description: Informative message indicating that a test mode program has connected to MCS.

applnam      Application name  
proqram      Program name

Issued by MCS.

User Action: None.

**APPL - applnam PROG proqram DISCONNECT.**

Description: Informative message indicating that a test mode program has disconnected from MCS.

applnam      Application name  
proqram      Program name

Issued by MCS.

User Action: None.

**APPL - applnam PROG proqram REVOKED.**

Description: Informative message indicating that MCS aborted the named program.

applnam      Application name  
proqram      Program name

Issued by MCS.

User Action: None.

**APPL - applnam Q queuenam FLUSHED.**

Description: Informative message indicating that the named queue file has been moved to disk.

applnam      Application name  
queuenam      Queue file name

Issued by MCS.

User Action: None.

**APPL - applnam Q queuenam PURGED.**

Description: Informative message indicating that the named queue file was purged because it could not be verified upon recovery.

applnam      Application name  
queuenam      Queue file name

Issued by MCS.

User Action: None.

**APPL - applnam QUEUE queuenam IN CM.**

Description: Named disk queue file was moved to central memory because of an incorrect owner name.

applnam      Application name  
queuenam      Queue file name

Issued by MCS.

User Action: Correct owner name.



### **APPL - applnam RECOVERED FILE filenam.**

Description: Informative message that is displayed for each file when the application is initiated.

applnam     Application name  
filenam     Queue file name

Issued by MCS.

User Action: None.

### **APPL - applnam SHUTDOWN**

Description: Informative message indicating that the application was terminated successfully.

applnam     Application name

Issued by MCS.

User Action: None.

### **APPL - applnam START FAILED, FILE BUSY.**

Description: Named application file is busy. This causes application initiation to be aborted. This message is preceded by a message specifying the name of the busy file.

applnam     Application name

Issued by MCS.

User Action: Return the busy file and retry initiation.

### **APPL - applnam START FAILED, I/O ERROR.**

Description: Errors were encountered in trying to read application definition language (ADL) file for the named application.

applnam     Application name

Issued by MCS.

User Action: Recreate ADL file.

### **APPL - applnam START FAILED, NO MEMORY.**

Description: No memory is available to start the application.

applnam     Application name

Issued by MCS.

User Action: Retry later.

### **APPLICATION ALREADY RUNNING.**

Description: An attempt was made to start an application that was already active.

Issued by MCS.

User Action: None.

### **APPLICATION DISABLED FOR NETON**

Description: The requested application is disabled. RHF does not abort the application.

Issued by RHF.

User Action: Inform site operator to enable application and retry.

### **APPLICATION FAILED - application-name.**

Description: The specified application has failed. The application-name field contains the name of the failed application.

Issued by NVF.

User Action: The specified application should be reinitialized using NAMI.

### **APPLICATION NOT ALLOWED TO USE K-DISPLAY**

Description: AP=appnam was entered, where appnam is not defined in the local configuration file (LCF) to support the NAM display.

Issued by NIP.

User Action: Assign a different application or update the LCF.

### **APPLICATION NOT SUPPORTING NAM K-DISPLAY**

Description: AP=appname was entered for an application that does not support the NAM K display.

Issued by NIP.

User Action: None.

### **APPLICATION UNKNOWN**

Description: AP=appname was entered, and there is no application appname that had netted-on.

Issued by NIP.

User Action: None.

### **APRDECK NOT ON TAPE.**

Description: The specified text deck number is not contained on the deadstart tape being used.

Issued by SET.

User Action: Redeadstart and select the correct text deck.

### **\*APRD00 MUST BE EMPTY.**

Description: The first APRDECK on the deadstart tape (first record following APRINST) must be an empty record, containing only record name APRD00.

Issued by SET.

User Action: Rebuild deadstart tape to conform to requirements.

### **ARF BLOCK SIZE IS LARGER THAN THE BUFFER.**

Description: The maximum block length field in the header record for an ARF is larger than the maximum block length (installation parameter) allocated by TAF/CRM data manager.

Issued by TAF.

User Action: The file must be dumped using DMREC and preallocated.

### **ARF DUMP TAPE HEADER ERROR.**

Description: No header found on ARF tape.

Issued by DMREC.

User Action: Use alternate tape if available.

### **ARF ENTRY TABLE OVERFLOW.**

Description: Too many recoverable file names exist on this ARF.

Issued by DMREC.

User Action: Increase the size of the TLOG table with installation parameter TLOGL.

### **ARF ENTRY TABLE OVERFLOW.**

Description: Too many recoverable database file names exist on ARF.

Issued by DMREC.

User Action: Increase size of table (TLOG).

### **ARF FILE HEADER ERROR.**

Description: No header was found on the ARF file.

Issued by DMREC.

User Action: Down the database, dump the database, purge the old ARF, and create a new one.

### **ARF HEADER ERROR.**

Description: No ARF header on what is supposed to be an ARF.

Issued by DMREC.

User Action: Check ARF for validity, inform data base administrator.

### **ARF HEADER STATUS (3) POSSIBLE ERROR.**

Description: ARF header status shows a possible error condition.

Issued by DMREC.

User Action: Inform database administrator.

### **ARF ORDINAL MUST BE 01 OR 02.**

Description: ARFs can have only 01 or 02 as an ordinal.

Issued by DMREC.

User Action: Correct directive name (ARF/BRF).

### **ARGUMENT ERROR.**

Description: Dayfile message indicating that the parameter list on the ISF entry contained an incorrect parameter.

Issued by ISF.

User Action: Repeat the ISF entry with the correct parameter list.

### **ARGUMENT ERROR.**

Description: Error detected in ICPD command syntax.

Issued by ICPD.

User Action: Correct command and retry.

### **ARGUMENT ERROR.**

Description: JSN was not entered in the command call or more than one parameter was entered.

Issued by QDSPLAY.

User Action: Ensure proper command format.

### **ARGUMENT ERROR.**

Description: An incorrect parameter was entered on the command.

Issued by SCTD.

User Action: Correct and retry.

### **ARGUMENT ERROR.**

Description: One of the parameters is in error.

Issued by MST.

User Action: Repeat the MST entry with the correct parameter list.

### **ARGUMENT ERROR - arg.**

Description: The option arg or its associated value is not correct as specified on the call to SDSPLAY.

Issued by SDSPLAY.

User Action: Check option on SDSPLAY command and retry.

### **ARITHMETIC ERROR.**

Description: An arithmetic hardware error occurred.

Issued by RECLAIM.

User Action: Inform site analyst.

### **ASSIGNED FILE CONFLICT - SDF.**

Description: A local file named SDF is assigned at the control point. SDF is a reserved file name.

Issued by IIS.

User Action: Rename the local file.

### **ASSIGNED FOR DIAGNOSTICS, FILE filename AT address.**

Description: A MALET user attempted a CIO operation on a preassigned tape with file name filename and FET address.

Issued by IMS.

User Action: Enter only CIO operations that remove the file from the system tables (for example, RETURN or UNLOAD).

### **ASSIGNED TTYS GREATER THAN (NT).**

Description: Nonfatal K-display message indicating that the number of terminals assigned to sessions is greater than the number of terminals being stimulated.

Issued by STIMULA.

User Action: Reduce the number of terminals assigned by using the MX entry.

### **AST UPDATED**

**PFN=filename, FAMILY=familyname, UI=userindex.  
SUBCATALOG SM ID=id.**

Description: AST was updated after analyzing the FET.

Issued by SSEXEC.

User Action: None.

### **ATTACH ERROR - BUDT FILE BUSY.**

Description: File busy.

Issued by SSEXEC.

User Action: Analyze why the file is busy and retry.

### **ATTACH ERROR - BUDT FILE NOT FOUND.**

Description: File not found.

Issued by SSBLD.

User Action: None.

### **ATTACH ERROR ON - filename.**

Description: The transaction executive cannot attach the file filename under present conditions. This usually implies that the file does not exist or modify permission has not been given to the TAF user name.

Issued by TAF.

User Action: Correct error and reinitialize executive, or inform the database administrator.

### **ATTACH ERROR ON filename.**

Description: SSEXEC was unable to attach file filename.

Issued by SSDEBUG.

User Action: Ensure that the file is direct access and not in use, and then retry.

### **ATTACH ERROR ON PF xxxxxxxx.**

Description: When attempting to attach a permanent file xxxxxxxx, an error was encountered.

Issued by DMREC.

User Action: Check for valid directive file name and presence of a direct access permanent file by that name.

### **ATTACH ERROR ON SFM SMMAP. PFN=filename, FAMILY=familyname, UI=userindex.**

Description: System error.

Issued by SSEXEC.

User Action: Recover or create the missing SM map.

### **ATTACH ERROR ON SFM SUBFAMILY CATALOG.**

Description: Informative message indicating that the file could not be attached to the catalog.

Issued by SSEXEC.

User Action: Analyze what happened to the file and retry.

### **ATTACH ERROR ON SFM SUBFAMILY CATALOG PFN=filename, FAMILY=familyname, UI=userindex.**

Description: At least one but fewer than eight subfamily catalogs exist for the family familyname.

Issued by SSEXEC.

User Action: Recover the missing catalogs.

### **ATTACH MODE MUST BE W, M, R, OR RM.**

Description: The mode parameter on the CYBER Record Manager (CRM) statement must be one of the specified values.

Issued by TAF.

User Action: Correct the mode parameter on the CRM statement or inform the data administrator.

### **ATTEMPTING NETWORK NETON.**

Description: NLTERM is attempting to NETON to the network.

Issued by NLTERM.

User Action: None.

### **AUTO MODE.**

Description: DIS is in AUTO command processing.

Issued by DIS.

User Action: None.

### **AUTOMATIC NAME ASSIGNMENT IMPOSSIBLE.**

Description: DFTERM was unable to determine an available name for the terminated dayfile.

Issued by DFTERM.

User Action: Enter a valid name for the file using the K display. Use the NM directive to override automatic name assignment.

### **n.nnn AVERAGE ACTIVE SUBCONTROL POINTS.**

Description: n.nnn is the average number of simultaneously active subcontrol points when TAF is not rolled out. An active subcontrol point is one which is in recall, is waiting to use the CPU, or is currently assigned the CPU. The sampling rate is once per second.

Issued by TAF.

User Action: None.

### **n.nnn AVERAGE OUTSTANDING CDCS REQUESTS.**

Description: n.nnn is the average number of outstanding (uncompleted) CDCS requests per second. The sampling rate is once per second.

Issued by TAF.

User Action: None.

### **AWAITING UDT ALTERATION**

Description: SSEXEC initialization. SSEXEC has attached all the files it needs and loaded the Unit Device Table (UDT) into memory.

Issued by SSEXEC.

User Action: Any UDT changes by SSALTER should be done now, before SSEXEC connects to the 7990 equipment.

### **B PARAMETER NOT ALLOWED WITH DMB DUMP FILE.**

Description: Self-explanatory.

Issued by DSDI.

User Action: Correct and rerun.

### **B PARAMETER USED INCORRECTLY.**

Description: The small/large file boundary was specified on a directive other than AM or was greater than 1931.

Issued by SSLABEL.

User Action: Correct parameters and retry.

### **BACKUP DIRECTORY - xxxxxxxx HAS BEEN RECONSTRUCTED.**

Description: No directory file for the specified data base. A new directory was generated from the information on the xxJ file.

Issued by DMREC.

User Action: Inform database administrator.

### **BAD AN NET/ON SM RESPONSE FROM NVF.**

Description: Incorrect application number received on NETON response from NVF. NIP will abort if DEBUG is on.

Issued by NIP.

User Action: Supply dumps to site analyst.

### **BAD CATALOG/PERMIT SECTOR.**

Description: PFM has encountered a catalog or permit sector which does not have a valid sector length. This indicates corruption of system areas on disk.

Issued by PFM.

User Action: Inform site analyst. If many of these errors occur, the site analyst should perform a full PFDUMP, total INITIALIZE, and full PFLOAD on the device.

### **BAD DIRECTORY ON ADL.**

Description: An incorrect application definition language (ADL) file was encountered during MCS initiation.

Issued by MCS.

User Action: Recreate ADL file.

### **BAD DUMP FILE.**

Description: Dump cannot be written on the specified file.

Issued by QDUMP.

User Action: Request another dump file.

### **BAD LCF.**

Description: For debug only. The LCF in use is bad.

Issued by NVF.

User Action: Correct the LCF and restart the network.

### **BAD LFM REQUEST BY NETFM.**

Description: Bad LFM request was made by NETFMC.

Issued by NETFMC.

User Action: Inform site analyst.

### **BAD MINACN/MAXACN VALUE. JOBID = jobid.**

Description: Application used invalid MINACN and/or MAXACN on NETON request. NAM will abort the application.

Issued by NIP.

User Action: None.

### **BAD NCF.**

Description: The current NCF is bad.

Issued by CS.

User Action: Correct NCF and restart network.

### **BAD NCF READ.**

Description: The NCF read is bad.

Issued by CS.

User Action: Correct NCF and restart network.

### **BAD NLF FILE FORMAT**

Description: The alternate load file specified in the change NPU (network processing unit) load file command does not have a valid NPU load file format. No alternate load file will be assigned to the specified NPU.

Issued by NS.

User Action: Reenter command with valid format.

### **BAD PFM REQUEST BY NETFM.**

Description: Bad PFM request made by NETFM.

Issued by NETFMA.

User Action: Inform site analyst.

### **BAD SYSTEM POINTER.**

Description: Output file message indicating that a bad system pointer was detected in the EDD file during processing of an input directive.

Issued by DSDI.

User Action: Ensure that the dump file contains meaningful information (can use P option on DSDI to cause the use of CMR pointers running system) and rerun.

### **BAD VERIFICATION RECORD ON ADL.**

Description: An incorrect application definition language (ADL) file was encountered during MCS initiation.

Issued by MCS.

User Action: Recreate ADL file.

### **BATCH CONCURRENCY DISABLED.**

Description: TAF was brought up without BATCH concurrency enabled (CTBCON=Q).

Issued by BAAML.

User Action: Ask database administrator to bring up TAF with BATCH concurrency ENABLED.

### **BATCH RECOVERY ACTIVE ON DATA BASE.**

Description: Self-explanatory.

Issued by TAF.

User Action: Wait for the completion of batch recovery, then reinitialize the transaction subsystem.

### **BEGIN \*CRM\* TASK RECOVERY.**

Description: TAF/CRM has received a recovery indication from TAF.

Issued by AAMI.

User Action: None.

### **BIO BUSY.**

Description: BIO is currently busy and cannot process the BKSPF, BKSPRU, BKSP, CONTINUE, END, STOP, REPEAT, REPRINT, REPUNCH, SKIPF, SKIPRU, SKIP, or SUPPRESS command.

Issued by DSD.

User Action: Retry. If the message still appears, inform a site analyst.

### **BKF est, nn.**

Description: The operator requested a backspace of nn logical files on the print file on BIO equipment est.

Issued by QAP.



User Action: None.

### **BKP est, nn.**

Description: The operator requested a backspace of nn PRU's on the print file on BIO equipment est.

Issued by QAP.

User Action: Nonel

### **BKR est, nn.**

Description: The operator requested a backspace of nn logical records on the print file on BIO equipment est.

Issued by QAP.

User Action: None.

### **BLANK LABELS DO NOT VERIFY.**

Description: Flashing B display message. This message can occur only during blank labeling of a tape and indicates that the tape label read does not match the label written.

Issued by BLANK.

User Action: Enter GO,jsn to retry or DROP,jsn to terminate.

### **BLOCK BUFFER OVERFLOW.**

Description: When attempting a record load operation, the data block buffer was found to be too small.

Issued by DMREC.

User Action: Increase the length of the working buffer WBUF. Inform the database administrator.

### **BLOCK BUFFER TOO SMALL.**

Description: Tape block on ARF was too large for buffer.

Issued by DMREC.

User Action: Increase size of buffer and try again.

### **BLOCK LOAD ERROR.**

Description: Block load of a file failed because no header was found on the dump tape or the file name from the directory record does not match the file name on the tape.

Issued by DMREC.

User Action: Load from previous dump tape.

### **BLOCK LOST - tn.**

Description: An output message block was not acknowledged by the network.

Issued by IAFEX.

User Action: If this occurs, write a PSR and include the IAF trace for support. Specify terminal number tn and time of day.

### **BLOCK SEQUENCE ERROR.**

Description: For a specific block, the block number recorded on the tape did not match the block number expected by the system tape loader.

Issued by DIO.

User Action: Perform either of the following actions:

- Type GO. to continue deadstart. Further block checking is disabled and the information transferred from tape may not be valid.

- Redeadstart using a different tape unit or a different deadstart tape.

### **BLOCKAGE AMONG CM RESIDENT TASKS.**

Description: The sum of initial field lengths for the CM resident tasks exceeds the minimum size of total task area.

Issued by TAF.

User Action: Correct error.

### **BOTH FM AND PN SPECIFIED.**

Description: Family name and pack name cannot both be specified.

Issued by PFS.

User Action: Correct error and retry.

### **BT/BD NOT FOUND.**

Description: The beginning time and/or beginning date is greater than the time of the last record on the data file.

Issued by ACPD.

User Action: Correct BT/BD parameters and retry.

### **BTASK - TAF AUTOMATIC RECOVERY NOT INSTALLED.**

Description: A keyword specified in a TSTAT request requires TAF automatic recovery to be installed.

Issued by BTASK.

User Action: Inform the database administrator.

### **BTASK - TASK LOGICAL ERROR.**

Description: An unexpected error status was returned.

Issued by BTASK.

User Action: Inform the database administrator.

### **BTASK - xxxxxxxx TRANSACTION NOT RERUNNABLE NOW.**

Description: This occurs when an I/O error is detected and the database cannot be recovered for the user xxxxxxxx.

Issued by BTASK.

User Action: Inform the database administrator.

### **BTASK - USER NOT DEFINED IN NETWORK FILE.**

Description: The user is not defined in the NETWORK file on a TSTAT request.

Issued by BTASK.

User Action: Inform the database administrator.

### **BUDT CONTROLLER ENTRY COUNT EXCEEDED.**

Description: Informative message indicating that the number of the entry is larger than the table.

Issued by SSEXEC.

User Action: Correct the BUDT file or increase the table in SSEXEC.

### **BUDT CONTROLLER TABLE READ ERROR.**

Description: Informative message indicating that a read error has occurred.

Issued by SSEXEC.

User Action: Check the BUDT file.

### **BUDT READ ERROR.**

Description: Informative message indicating that a read error has occurred.

Issued by SSEXEC.

User Action: None.

### **BUDT SM ENTRY COUNT EXCEEDED.**

Description: Informative message indicating that the number of SM entries is larger than the table.

Issued by SSEXEC.

User Action: Correct the BUDT file or increase the table in SSEXEC.

### **BUDT SM TABLE READ ERROR.**

Description: Informative message indicating that a read error has occurred.

Issued by SSEXEC.

User Action: Check the BUDT file.

### **BUFFER ARGUMENT ERROR.**

Description: \*LOADBC\* LOAD FET contained incorrect buffer pointer.

Issued by LOADBC.

User Action: Write a PSR.

### **BUFFER CONTROL WORD ERROR.**

Description: Dayfile message indicating that the word count in the disk linkage is greater than 100B.

Issued by SLL.

User Action: Take a deadstart dump, write a PSR, and send the dump and PSR to CDC along with any support materials which will allow CDC to duplicate the problem.

### **BUFFERED I/O RECOVERY ERRORS.**

Description: This message is followed by one or more of the following messages:

- WRITE LIST LINKAGE ERROR.
- READ DATA OR WRITE LIST.
- INTERLOCKED BUFFER ON WRITE LIST.
- WRITE LIST BUFFER COUNT.
- NON - LINKED WRITE BUFFER.

A level 3 recovery detected one of the above listed errors during buffered I/O recovery.

Issued by REC.

User Action: Inform site analyst. If PF or QF file errors are detected, perform PF or QF dump reload.

### **BUFFERED I/O RECOVERY ERRORS EQest.**

Description: This message is followed by one or more of the following messages:

- I/O QUEUE SIZE ERROR.
- I/O QUEUE LINKAGE ERROR.
- I/O QUEUE PUT ORDINAL ERROR.

A level 3 recovery detected one of the above listed errors on the equipment with EST ordinal est.

Issued by REC.

User Action: Inform site analyst. A PF or QF dump load may be required if problems occur on EQest.

**nn BUFFERS ACTIVE.**

Description: Issued to DSD B and J displays, indicating the number of buffers currently in use by BIO.

Issued by IIO.

User Action: None.

**Ccc DOWNED.**

Description: Magnetic tape channel cc has been logically turned off by the system.

Issued by 1MT.

User Action: Inform site analyst.

**Ccc, MTS FIRMWARE LOAD ERRORS. or  
Ccc, FSC FIRMWARE LOAD ERRORS. or  
Ccc, 639 FIRMWARE LOAD ERRORS. or  
Ccc, 698 FIRMWARE LOAD ERRORS.**

Description: Unable to load magnetic tape controller firmware on channel cc.

Issued by 1MT.

User Action: Inform customer engineer.

**Ccc, Tt ATS CONVERSION TABLE LOAD ERRORS. or  
Ccc, Tt MTS CONVERSION TABLE LOAD ERRORS. or  
Ccc, Tt FSC CONVERSION TABLE LOAD ERRORS. or  
Ccc, Tt 639 CONVERSION TABLE LOAD ERRORS. or  
Ccc, Tt 698 CONVERSION TABLE LOAD ERRORS.**

Description: Errors occurred in loading of conversion table.

cc Channel number  
t Conversion table (one of the following).  
1 ASCII table  
2 EBCDIC table  
3 BCD table

Issued by 1MT.

User Action: Inform customer engineer.

**CAN-T STEP.**

Description: PP breakpoint message indicating a step command is not possible in this PP at this time.

Issued by DSD.

User Action: None.

**CANNOT ACCESS L-DISPLAY.**

Description: DSD detected an error condition when input was entered via the L-display.

Issued by QDSPLAY.

User Action: Check proper input procedure and retry.

**CANNOT ACCESS L-DISPLAY.**

Description: DSD detected an error condition when input was entered via the L-display.

Issued by SCTD.

User Action: Retry input.

### **CANNOT ACCESS ROLLOUT DEVICE.**

Description: A mass storage error has occurred on the rollout device.

Issued by DSD.

User Action: Inform site analyst.

### **CANNOT ALLOCATE DEVICE.**

Description: Cannot allocate a multipindle device for one of the following reasons:

- Not enough spare spindles available
- Spare spindles not up and allocatable
- An attempt was made to allocate a nonremovable device

Issued by MSI.

User Action: Perform one of the following:

- Decrease pack count  
and enter GO.
- Enter CLEAR to clear initialize status for the device.

### **\*\*\*\* CANNOT ALTER XD/XT OF \*CSAP\*.**

Description: You have security administrator privileges and you attempted to specify an expiration date or term for your interactive or batch password.

Issued by MODVAL.

User Action: None.

### **CANNOT ATTACH/GET FILE fffffff-FILE SKIPPED.**

Description: An error occurred when attempting to get or attach file fffffff. The file may have been attached or purged by another job.

Issued by RECLAIM.

User Action: Check your dayfile for a specific error message. If you do not find one, inform the site analyst. It's normal for this message to appear, referencing the RECLAIM database, during a DUMP operation.

### **CANNOT ATTACH \*IQFT\* FILE.**

Description: An attempt to attach the IQFT file on the destination device failed.

Issued by QLOAD.

User Action: Check for other utilities accessing the file. When the file is free, retry the load operation.

### **CANNOT BROADCAST TO HOST-HOST LOGICAL LINK.**

Description: A broadcast message command cannot be issued to a host-host logical link.

Issued by CS.

User Action: Select appropriate logical link and reenter command.

### **CANNOT CATLIST FAMILY/PACK-fampck.**

Description: DFTERM was unable to perform a CATLIST operation on the familyname/pack fampck.

Issued by DFTERM.

User Action: Ensure that catalogs exist on the familyname/packname and retry the operation.

**CANNOT DEFINE REFORMATTED FILE - filename.**

Description: A reformat of the TAF Communication Recovery File was necessary, but when attempting to DEFINE the reformatted file (ZZCRFAi), an error occurred.

Issued by TAFREC.

User Action: Purge the existing file indicated by filename.

**\*\*\*\* CANNOT DELETE \*CSAP\* PRIVILEGE.**

Description: You attempted to delete your security administrator privilege while executing MODVAL.

Issued by MODVAL.

User Action: None.

**\*\*\*\* CANNOT DELETE USER RUNNING MODVAL.**

Description: You attempted to delete your user name from the VALIDUS file while executing MODVAL.

Issued by MODVAL.

User Action: None.

**CANNOT FIX CSN FOR GOOD LABEL.**

Description: An entry for the cartridge specified in the FX directive to SSLABEL in the current map, or the family and subfamily specified, does not match the label.

Issued by SSLABEL.

User Action: Restore the cartridge to the SM or match the family and subfamily on the FX directive with those on the label.

**CARD READER ERROR.**

Description: Job was terminated without exit processing.

Issued by 1AJ.

User Action: Resubmit job.

**CARTRIDGE ALREADY IN CUBE.**

Description: The location for storing the cartridge is not empty.

Issued by SSLABEL.

User Action: Manually remove the cartridge and restore it.

**CARTRIDGE ALREADY IN USE.**

Description: The cartridge is currently being read or written and cannot be accessed.

Issued by SSLABEL.

User Action: Wait and try later.

**CARTRIDGE EJECTED**

Description: Cartridge was placed in the output tray.

Issued by SSEXEC.

User Action: Either reenter the cartridge into the storage module or remove it from the tray.

**CARTRIDGE LABEL ERROR.**

Description: The cartridge label is defective.

Issued by SSLABEL.

User Action: Fix or discard cartridge.

### **CARTRIDGE LABEL ERROR - SEE DAYFILE**

Description: The requested cartridge doesn't have a matching label. The requested label and received label are displayed in the dayfile. The dayfile messages show the format.

Issued by SSEXEC.

User Action: Check storage module and catalogs.

### **CARTRIDGE MISSING, Y=ya, Z=za**

Description: Cartridge was not found in the storage module matrices ya and za.

Issued by SSEXEC.

User Action: Check storage module for a missing cartridge.

### **CARTRIDGE NOT ASSIGNED AS EXPECTED.**

Description: One of the cartridges specified has a CSN that does not allow the assignment or removal specified by a directive to SSLABEL.

Issued by SSLABEL.

User Action: Correct directive to SSLABEL and retry.

### **CARTRIDGE NOT EMPTY.**

Description: The cartridge cannot be removed because it still contains file data.

Issued by SSLABEL.

User Action: Retry after doing release processing with PFDUMP and SSVAL.

### **CARTRIDGE NOT FOUND.**

Description: The cartridge is not in its assigned cubicle.

Issued by SSLABEL.

User Action: Locate and restore the missing cartridge or change the directive to SSLABEL or SSDEBUG to select a different cartridge.

### **CARTRIDGE NOT FOUND**

Description: Cartridge specified with CM and CN parameters does not exist in SFM catalog.

Issued by SSUSE.

User Action: Correct the CM and CN parameters.

### **CARTRIDGE PRESENT-LOST BIT SET.**

Description: The lost (LT) option was specified on the RM directive to SSLABEL, but the cartridge is physically present.

Issued by SSLABEL.

User Action: Clear the lost flag in the SFM catalog. Restoring the cartridge with SSLABEL will clear the flag.

### **CATALOG COMPLETE.**

Description: Informative message indicating that catalog processing is complete.

Issued by CATALOG.

User Action: None.

### **CATALOG FORMAT ERROR.**

Description: An attempt was made to catalog a permanent file device which was created on a system whose permanent file catalog format is different from that used by the currently running system.

Issued by PFCAT.

User Action: Dump and reload the affected device.

### **CATALOG FST CURRENT SECTOR .NE. ZERO.**

Description: PACKER internal logic error. Overflow processing requires catalog tracks to contain the full number of sectors per track.

Issued by PACKER.

User Action: Write a PSR.

### **CATALOG INDEX OUT OF RANGE.**

Description: Location of catalog entry is not in buffer range.

Issued by PFDUMP.

User Action: Write a PSR and include support material to allow CDC to duplicate the problem.

### **CATALOG LOST BIT MUST BE SET.**

Description: The lost (LT) option was specified on the RM directive to SSLABEL, but the cartridge is not known to be lost.

Issued by SSLABEL.

User Action: Run the RM directive, first without the lost (LT) option to set the lost bit.

### **CATALOG/MAP ATTACH PROBLEM.**

Description: A permanent file error was encountered on the SM map or the SFM catalog.

Issued by SSLABEL.

User Action: Recover the SM map or SFM catalog.

### **CATALOG/MAP FILE INTERLOCKED.**

Description: Another utility is using the SMMAP or SFMCAT required to process the directive to SSDEBUG or SSLABEL.

Issued by SSLABEL.

User Action: Rerun at a later time.

### **CATALOG/MAP INTERLOCKED.**

Description: Another utility is using the SM map or SFM catalog required to process the directive to SMMAP or SSLABEL.

Issued by SSDEBUG.

User Action: Rerun at a later time.

### **CATALOG/MAP NOT OPEN.**

Description: The SMMAP or SFMCAT was created after the last initialization of SSEXEC or was not present.

Issued by SSDEBUG.

User Action: Idle down and restart SSEXEC before rerunning the directive to SSDEBUG or SSLABEL.

### **CATALOGING filename userindex.**

Description: Informative K display message indicating which file and user index are being cataloged by PFATC or PFCAT.

Issued by PFATC.

User Action: None.



### **CATALOGING COMPLETED.**

Description: Informative message indicating that cataloging is complete.

Issued by PFCAT.

User Action: None.

### **CATALOGS MODIFIED.**

Description: Informative message indicating that SSVAl repaired the SFM catalogs.

Issued by SSVAl.

User Action: None.

### **CATALOGS NOT MODIFIED.**

Description: Informative message indicating that SSVAl did not repair any SFM catalogs.

Issued by SSVAl.

User Action: None.

### **CCC, CHxx. DCC - CHANNEL ACTIVE BEFORE FUNCTION.**

Description: Channel xx was already active when DCC tried to send a function code to the CCC.

Issued by DCC.

User Action: Have a customer engineer run the appropriate diagnostics.

### **CCC, CHxx. DCC - CHANNEL NOT AVAILABLE.**

Description: Channel xx was not available when DCC attempted to access it to dump the CCC.

Issued by DCC.

User Action: Retry later. If the problem persists, ascertain what NOS subsystem has control of the channel and drop the subsystem; then retry.

### **CCC, CHxx. DCC - CONSTANT CHANNEL FULL.**

Description: An attempt to clear the CCC on channel xx timed out with a channel full condition.

Issued by DCC.

User Action: Have a customer engineer run the appropriate diagnostics.

### **CCC, CHxx. DCC - FUNCTION nnnn REJECT.**

Description: There was a function timeout on an attempt to send a function code nnnn to the CCC on channel xx.

Issued by DCC.

User Action: Have a customer engineer run the appropriate diagnostics.

### **CCC, CHxx. DCC - INPUT INCOMPLETE.**

Description: DCC encountered an incomplete input on attempting to read data from the CCC on channel xx.

Issued by DCC.

User Action: Have a customer engineer run the appropriate diagnostics.

### **CCC, CHxx. DCC - LOAD ADDRESS ERROR.**

Description: There was a channel hang on a load address function attempt on the CCC on channel xx.

Issued by DCC.

User Action: Have a customer engineer run the appropriate diagnostics.

**CCC, CHxx, DCC - NO RESPONSE. CHECK CABLES.**

Description: There was a function timeout on the first attempt to send a function code nnnn to the CCC on channel xx.

Issued by DCC.

User Action: Ensure that you have selected the correct channel and retry. If the problem persists, have a customer engineer run the appropriate diagnostics.

**CCHxx, DCord, FORMAT FAILURE.  
HUNG BUSY - GS = zzzz.**

Description: The operation failed when attempted to format the indicated disk.

xx Channel number.  
ord EST ordinal of disk.  
zzzz General status.

Issued by 1XY.

User Action: Inform customer engineer.

**CCHcc, DCest, FORMAT FAILURE.  
HUNG BUSY - GS zzzz.**

Description: The operation failed while attempting to format the indicated disk.

cc Channel number.  
est EST ordinal of disk.  
zzzz General status.

Issued by 1XY.

User Action: Inform a customer engineer.

**CCL214- NOT ENOUGH FL - CHECK \*CCFL\*  
IN \*PPCOM\***

Description: There is insufficient field length to execute CCL when called by VALEX during prologue processing. This is caused by the symbol CCFL in PPCOM being set too low.

Issued by CCL.

User Action: Modify the value of CCFL to be greater than the FL required for the CCLBRWE overlay of CCL, reassemble NOSTEXT and VALEX, and rebuild the NOS system.

**CDCNET ENTRY ALREADY EXISTS.**

Description: Entry already exists for this CDCNET file name.

Issued by NETFMC.

User Action: Inform site analyst.

**CE DIAG TEST IN PROGRESS.**

Description: This message is a response to an enable line command.

Issued by CS.

User Action: Wait for test to complete and then reenter command.

**CEJ/MEJ NOT PRESENT OR DISABLED.**

Description: CEF/MEJ is either disabled on the deadstart panel or was logically turned off by the operator at CTI time. NOS no longer supports a non CEJ/MEJ mode of operation.

Issued by SET.

User Action: Rereadstart with CEJ/MEJ enabled.

### **CEJ/MEJ OPTION NOT ENABLED FOR CEJ/MEJ USAGE, ENABLE SWITCH ON DEADSTART PANEL AND DEADSTART (CR) FOR NON CEJ/MEJ USAGE**

Description: Indicates the CEJ/MEJ switch is physically set to the disable position on the deadstart panel and is not logically disabled via the hardware Reconfiguration display.

Issued by CTI.

User Action: Enable the switch on the deadstart panel and rereadstart to continue.

### **CEL DEVICE UNDEFINED.**

Description: A hardware error was detected by CTI during this deadstart or a previous deadstart. Information intended for analysis by HPA has been recorded on the deadstart disk but the alternate deadstart device option was selected and the CIP deadstart disk was not defined in the EST. The CIP disk device contains the critical error log and is not defined in the equipment status table (EST). CEL data has been logged in the Binary Maintenance Log, but the bit indicating this could not be cleared. Therefore, the same data will again be logged on the next level 0 deadstart.

Issued by REC.

User Action: If the site wishes to analyze the error information on the deadstart disk, rereadstart from that disk and define it in the EST. Enter GO,SYS. to clear the message. Define the CEL device in the EST on the next level 0 deadstart.

### **CELL FULL, Y=ya, Z=za**

Description: The 7990 was asked to place a cartridge in a cubicle that was already occupied.

Issued by SSEXEC.

User Action: Check the catalogs and maps. Enter K.1.GO. to continue.

### **CCH,cc.,MH427-D,vv.**

Description: Identifies the firmware revision number of the 5831 controller.

Issued by 1DA.

User Action: None required.

### **CHcc,ABORT,ALL DATA NOT TAKEN.**

Description: The controller did not accept all the data on an attempt to download controlware.

cc Channel on which controlware was loaded.

Issued by LOADBC.

User Action: Inform customer engineer.

### **CHcc,ABORT,Ffff.**

Description: Function ffff timed out while accessing the controller.

cc Channel on which controlware was loaded.

Issued by LOADBC.

User Action: Inform customer engineer.

### **CHcc,ABORT,NO GENERAL STATUS.**

Description: After a download of controlware completed, the controller did not return a general status word after a status function.

cc Channel on which controlware was loaded.

Issued by LOADBC.

User Action: Inform customer engineer.

### **CHcc,ABORT,Snnnn.**

Description: An error in the general status of the controller occurred after the controlware was loaded.

cc Channel on which controlware was loaded.  
nnnn General status of the controller.

Issued by LOADBC.

User Action: Inform customer engineer.

### **CHcc,Maaaa-Arr.**

Description: Informative message indicating the controlware name and revision number for a mass storage controller.

cc Channel number.  
aaaa Type of controlware.  
A401 7152/7154 controlware.  
A462 7255 controlware.  
A710 7054/7152/7154 controlware.  
A721 7155-1 controlware.  
A722 7155-401 controlware.  
rr Revision number in octal.

Issued by OCI.

User Action: None.

### **CHcc Maaaa-Drr.**

Description: Informative message indicating the controlware name and revision number for a control module.

cc Channel number.  
aaaa Type of controlware.  
rr Revision number.

Issued by 1XY.

User Action: None.

### **CHcc,Maaaa-Drr,CMn.**

Description: Informative message indicating the controlware name and revision number for a control module.

cc Channel number  
aaaa Type of controlware.  
H422 834 Control module controlware.  
H424 836 Control module controlware.  
rr Revision number in octal.  
n Control module equipment number.

Issued by OCI.

User Action: None.

### **CHcc Maaaa-Drr,CMn.**

Description: Informative message indicating the microcode name and revision number of a CM3 control module.

cc Channel number.  
aaaa Name of microcode.  
rr Revision number.  
n Control module number.

Issued by 1XD.

User Action: None.

### **CHcc,Maaaa-DRR.**

Description: Informative message indicating the controlware name and revision number for a control module.

cc Channel number.  
aaaa Type of controlware.  
A464 895 control module controlware.  
RR Revision number in octal.

Issued by 1XY.

User Action: None.

### **CHcc,MAttt-vvv,LOAD COMPLETE.**

Description: Informative message indicating that the controlware was successfully loaded.

cc Channel on which disk controlware was downloaded.  
ttt Controlware type (401, 710, or 721).  
vv Version number (12, 13, 14, ...).

Issued by LOADBC.

User Action: None.

### **CHcc, Unuu - Szzzz.**

Description: Operator message indicating the status zzzz of unit uu on deadstart channel cc. This message is significant only if the deadstart process halts.

Issued by DIO.

User Action: If hardware malfunction is suspected, inform customer engineer; otherwise, try a different deadstart tape or disk unit.

### **CHANGED TLD DETECTED - filename, username.**

Description: An unrecognizable library directory format was encountered during a library directory update attempt.

Issued by TAF.

User Action: Inform site analyst.

### **CHANNEL ACTIVE ERROR.**

Description: The channel associated with a logically off PP is active when it should be inactive.

Issued by EBL.

User Action: Redeadstart. If the condition persists, inform customer engineer or site analyst.

### **CHANNEL ERROR**

Description: An error occurred on a 7990 channel.

Issued by SSEXEC.

User Action: Inform site analyst.

### **CHANNEL INTERFACE ci OFF-LINE**

Description: No controller access is available through channel interface CI.

Issued by SSEXEC.

User Action: Check configuration file.

**CHANNEL cc PARITY ERROR.**

Description: A parity error was detected on channel cc.

Issued by SCE.

User Action: Inform site analyst and customer engineer.

**CHANNEL TEST ON xx est, CHANNEL ch FAILED.**

Description: The channel confidence test on the device with EST ordinal est on channel ch was not completed successfully.

xx Device mnemonic specified by the DT parameter.

Issued by INITMDI.

User Action: Inform site analyst.

**CHANNEL TURNED OFF**

Description: An error has caused SSEXEC to turn off a channel to an 7990 controller.

Issued by SSEXEC.

User Action: Try to re-initialize SSEXEC. Failing this,  
inform site analyst.

**CHANNEL yy UNIT xx NOT RESPONDING**

Description: Tape unit xx on channel yy is not responding to a read request.

Issued by CTI.

User Action: The unit either is not ready or does not exist.

**CHANNEL 15 DATA TRANSFER ERROR**

Description: Data transfer error (dual I4).

Issued by CTI.

User Action: Inform C.E.

**CHANNEL 36 NOT ACTIVE.**

Description: HFM was called to perform a function on S/C register channel 36 while the mainframe has only 1 S/C register.

Issued by HFM.

User Action: Write a PSR.

**\*\*\*\* CHARGE NUMBER ACTIVE.**

Description: The user has attempted to activate an already active charge number.

Issued by PROFILE.

User Action: Rerun using correct charge number or directive, if necessary.

**\*\*\*\* CHARGE NUMBER DOES NOT EXIST.**

Description: A directive for which the charge number must exist has made a reference to a charge number that does not exist.

Issued by PROFILE.

User Action: Rerun using the correct charge number.

#### **\*\*\*\* CHARGE NUMBER INACTIVE.**

Description: A directive for which the charge number must be active made a reference to a charge number that is inactive.

Issued by PROFILE.

User Action: Activate charge number and rerun, or rerun using correct charge number.

#### **CHECK DAYFILE FOR ERRORS.**

Description: Informative message indicating that you should check the dayfile for errors.

Issued by COPYB.

User Action: Examine error messages in dayfile.

#### **CHECK \*E,P\* DISPLAY**

Description: An error condition or request for operator action is currently being displayed on the E,P display. Operator action is required.

Issued by MAGNET.

User Action: Bring E,P display to console screen and perform necessary action. (See status field of E,P display, section 4.)

#### **CHECK OUTPUT FOR WARNING MESSAGES.**

Description: No directive errors were encountered, but certain input directives (on create or update) received warning messages.

Issued by MODVAL.

User Action: Check output listing.

#### **CHECKPOINT ABORTED.**

Description: The checkpoint operation was aborted by the operator, possibly by dropping the control point at which 1CK was executing or because of mass storage write errors.

Issued by 1CK.

User Action: Contact CYBER Software Support.

#### **CHECKPOINT COMPLETE.**

Description: Informative message indicating the checkpoint operation completed successfully.

Issued by 1CK.

User Action: None.

#### **CHECKPOINT DEVICE ERROR.**

Description: An error attempting to recover the system from a previous checkpoint has occurred.

Issued by REC.

User Action: Attempt a level 0 deadstart.

#### **CHECKPOINT DEVICE NOT FOUND**

Description: Level 1 or 2 deadstart aborted because no checkpoint device was found in EST.

Issued by MSM.

User Action: Go to the EQPINST and check the mass storage status display for checkpoint device status. Reconfigure if necessary.

#### **CIO ERROR ec DURING RETURN OF FILE nm.**

Description: CIO error ec occurred while returning the file nm.

Issued by NLTERM.

User Action: Refer to Volume 4 of the NOS 2 Reference Set for a description of the CIO error codes.

**CIO ERROR ec DURING WRITE ON FILE nm.**

Description: CIO error ec occurred writing to file nm during log file termination. The log file name has been changed but the termination is not complete.

Issued by NLTERM.

User Action: Refer to Volume 4 of the NOS 2 Reference Set for a description of the CIO error codes. After the error has been corrected, the TERM command can be used to complete the termination of the file.

**CIO ERROR ec DURING WRITE TO OUTPUT FILE nm.**

Description: CIO error ec occurred writing to the output file nm.

Issued by NLTERM.

User Action: Refer to Volume 4 of the NOS 2 Reference Set for a description of CIO error codes.

**CIO ERROR ec, EOI NOT FOUND ON FILE nm.**

Description: CIO error ec occurred on file nm because no EOI exists on this file. This indicates the file is a tape file or a problem exists with the disk file. The log file name is changed but the termination is not complete.

Issued by NLTERM.

User Action: If the file resides on tape, move it to disk. If a problem exists with the disk file, inform a knowledgeable person at your site. (Refer to Volume 4 of the NOS 2 Reference Set for a description of the CIO error codes and the SKIPEI macro.) After the error is corrected, the TERM command can be used to complete the termination of the file.

**CIO ERROR ON SFM SMMAP.**

Description: Informative message indicating that CIO cannot read the SFM or subfamily.

Issued by SSEXEC.

User Action: None.

**CIO ERROR ON SFM SUBFAMILY CATALOG**

Description: Informative message indicating that CIO cannot read the SFM or subfamily catalog.

Issued by SSEXEC.

User Action: None.

**CIP COMPONENT xxxx NOT FOUND**

Description: CTI cannot find CIP component xxxx in the common disk area.

Issued by CTI.

User Action: Reinstall CIP. If message persists, inform C.E.

**CLDT - A SEPARATOR MUST FOLLOW NLID OR NPID.  
ERROR IN THE FOLLOWING STATEMENT.  
(statement without a separator after the NPID or NLID)  
CLDT ABORT.**

Description: Self-explanatory.

Issued by CLDT.

User Action: Correct the directive with a separator and retry.



**CLDT - COMMAND ERROR.  
CLDT ABORT.**

Description: An argument error was encountered in the CLDT command.

Issued by CLDT.

User Action: Correct command and retry.

**CLDT COMPLETE.**

Description: Self-explanatory.

Issued by CLDT.

User Action: None.

**CLDT - DUPLICATE LID ON NLID STATEMENT.  
ERROR IN THE FOLLOWING STATEMENT.  
(statement containing duplicate LID name)  
STATEMENT IGNORED.**

Description: The same LID name was specified on a previous NLID directive.

Issued by CLDT.

User Action: Correct the error and retry.

**CLDT - DUPLICATE PID ON NPID STATEMENT.  
ERROR IN THE FOLLOWING STATEMENT.  
(statement containing duplicate PID name)  
CLDT ABORT.**

Description: The same PID name was specified on a previous NPID directive.

Issued by CLDT.

User Action: Correct the error and retry.

**CLDT - EXCEEDED MAXIMUM NUMBER OF LIDS/PID - xxx.**

Description: A LID entry specified in the LIDCMID file was ignored, since the PID to which it was being added already had as many LIDs as is allowed by the system. This limit is the value xxx. The ignored LID is listed in the dayfile following this message.

Issued by CLDT.

User Action: Reduce the number of LIDs for any PID which has too many.

**CLDT - FIRST STATEMENT NOT LIDCMid.  
CLDT ABORT.**

Description: The first statement of the LID CONFIGURATION FILE must be LIDCMid (Mid is the appropriate machine id).

Issued by CLDT.

User Action: Correct the file and retry.

**CLDT - IDLE SUBSYSTEMS RHF, NAM, AND SSF BEFORE  
ATTEMPTING CLDT.  
CLDT ABORT.**

Description: RHF, NAM, and/or SSF was active while attempting to execute CLDT. Because these subsystems may keep an internal copy of the LDT, it is imperative that these copies be kept synchronized with the LDT in CM.

Issued by CLDT.

User Action: Idle RHF, NAM, and SSF as appropriate, and then execute the CLDT command.

**CLDT - INCORRECT CHARACTER IN DIRECTIVE.  
ERROR IN THE FOLLOWING STATEMENT.  
(statement with a colon in the directive)  
CLDT ABORT.**

Description: Self-explanatory.

Issued by CLDT.

User Action: Correct the directive with a colon in it and retry.

**CLDT - INCORRECT HOST LID ATTRIBUTE.  
ERROR IN THE FOLLOWING STATEMENT.  
(statement containing incorrect attribute)  
STATEMENT IGNORED.**

Description: A store-and-forward attribute is not valid for a host LID.

Issued by CLDT.

User Action: Remove the STOREF attribute from the LID and retry.

**CLDT - INCORRECT LINKED LID ATTRIBUTE.  
ERROR IN THE FOLLOWING STATEMENT.  
(statement containing incorrect attribute)  
STATEMENT IGNORED.**

Description: A loopback attribute is not valid for a linked LID.

Issued by CLDT.

User Action: Remove the LOOPB attribute from the LID and retry.

**CLDT - LID KEYWORD NOT SPECIFIED.  
ERROR IN THE FOLLOWING STATEMENT.  
(statement of NLID where LID is not specified)  
STATEMENT IGNORED.**

Description: Self-explanatory.

Issued by CLDT.

User Action: Correct the NLID statement and retry.

**CLDT - MAXIMUM OF 7 CHARACTERS ALLOWED ON MFTYPE. ERROR IN THE  
FOLLOWING STATEMENT.  
(statement with bad mainframe descriptor)  
CLDT ABORT.**

Description: Self-explanatory.

Issued by CLDT.

User Action: Correct the error and retry.

**CLDT - = MUST FOLLOW KEYWORD.  
ERROR IN THE FOLLOWING STATEMENT.  
(NLID statement with erroneous separator)  
STATEMENT IGNORED.**

Description: Self-explanatory.

Issued by CLDT.

User Action: Correct the error and retry.

**CLDT - = MUST FOLLOW KEYWORD.  
ERROR IN THE FOLLOWING STATEMENT.  
(NPID statement with erroneous separator)  
CLDT ABORT.**

Description: Self-explanatory.

Issued by CLDT.

User Action: Correct the error and retry.

**CLDT - NETDIS IS INCORRECT FOR HOST PID.  
ERROR IN THE FOLLOWING STATEMENT.  
(statement containing erroneous directive)  
CLDT ABORT.**

Description: Self-explanatory.

Issued by CLDT.

User Action: Correct the error and retry.

**CLDT - NO LID TABLE CREATED.  
CLDT - BUFFER TOO SMALL.  
CLDT ABORT.**

Description: The length of the LDT was 0 CM words.

Issued by CLDT.

User Action: Do a level 0 deadstart and increase the size of the LDT entry in the CMR deck, if intending or needing to build the LDT. If this mainframe does not want or need the LDT, the message can be ignored.

**CLDT - NO LID TABLE CREATED.  
FILE LIDCMid NOT FOUND.  
CLDT ABORT.**

Description: File LIDCMid could not be found under user index 377777B on the system.

Issued by CLDT.

User Action: Ensure the file exists as an indirect access file before executing CLDT.

**CLDT - NO MFTYPE SPECIFIED ON NPID STATEMENT.  
ERROR IN THE FOLLOWING STATEMENT.  
(statement containing the NPID directive without a MFT keyword)  
CLDT - ABORT.**

Description: Self-explanatory.

Issued by CLDT.

User Action: Add the MFTYPE keyword to the NPID directive and retry.

**CLDT - NO PID SPECIFIED ON NPID STATEMENT.  
ERROR IN THE FOLLOWING STATEMENT.  
(statement containing missing PID)  
CLDT ABORT.**

Description: Self-explanatory.

Issued by CLDT.

User Action: Correct the error and retry.

**CLDT - NPID DIRECTIVE MUST BE PROCESSED BEFORE A  
NLID DIRECTIVE.**

**ERROR IN THE FOLLOWING STATEMENT.  
(statement containing the first NLID)  
CLDT ABORT.**

Description: Self-explanatory.

Issued by CLDT.

User Action: Add a NPID directive before the first NLID directive.

**CLDT - ONLY YES OR NO ALLOWED ON ENABLED  
KEYWORD. ERROR IN THE FOLLOWING STATEMENT.  
(statement containing erroneous keyword)  
CLDT ABORT.**

Description: Self-explanatory.

Issued by CLDT.

User Action: Correct the error and retry.

**CLDT - SPECIFY EXACTLY 3 ALPHANUMERIC CHARACTERS IN LID.  
ERROR IN THE FOLLOWING STATEMENT.  
(statement containing erroneous LID)  
STATEMENT IGNORED.**

Description: Self-explanatory.

Issued by CLDT.

User Action: Correct the error and retry.

**CLDT - SPECIFY EXACTLY 3 ALPHANUMERIC CHARACTERS IN PID.  
ERROR IN THE FOLLOWING STATEMENT.  
(statement containing erroneous PID)  
STATEMENT IGNORED.**

Description: Self-explanatory.

Issued by CLDT.

User Action: Correct the error and retry.

**CLDT - UNABLE TO GENERATE LID TABLE.  
NUMBER OF WORDS AVAILABLE FOR LID - xxx  
NUMBER OF WORDS NEEDED FOR LID - yyy.  
CLDT ABORT.**

Description: The size of the LDT CMR deck entry was xxx words, while the minimum number of CM words needed to generate the LDT is yyy.

Issued by CLDT.

User Action: Do a level 0 deadstart and increase the size of the LDT entry in the CMR deck.

**CLDT - UNRECOGNIZABLE DIRECTIVE.  
ERROR IN THE FOLLOWING STATEMENT.  
(statement containing unrecognized directive)  
CLDT ABORT.**

Description: Self-explanatory.

Issued by CLDT.

User Action: Correct or delete the directive and retry.

**CLDT - VALID KEYWORDS FOR NLID ARE LID,ENABLED, AND AT.  
ERROR IN THE FOLLOWING STATEMENT.  
(statement containing erroneous keyword)  
STATEMENT IGNORED.**

Description: Self-explanatory.

Issued by CLDT.

User Action: Correct the error and retry.

**CLDT - VALID KEYWORDS FOR NPID ARE PID,MFTYPE,ENABLED,AT,  
AND NETDIS.  
ERROR IN THE FOLLOWING STATEMENT.  
(statement containing erroneous keyword)**

Description: Self-explanatory.

Issued by CLDT.

User Action: Correct the error and retry.

**CLDT - VALID OPTION CAN ONLY BE SPECIFIED IF THE STOREF OPTION IS  
SPECIFIED.  
(statement containing valid option)  
STATEMENT IGNORED.**

Description: A valid option was specified on an \*AT\* keyword without the STOREF option.

Issued by CLDT.

User Action: Correct the error and retry.

**CLDT - VALID OPTIONS FOR \*AT\* ARE  
LOOPB/STOREF/VALID/NVALID/NLIST.  
ERROR IN THE FOLLOWING STATEMENT.  
(NLID statement containing erroneous keyword)  
STATEMENT IGNORED.**

Description: Self-explanatory.

Issued by CLDT.

User Action: Correct the error and retry.

**CLDT - VALID OPTIONS FOR \*AT\* ARE VALID/NVALID/NLIST.  
ERROR IN THE FOLLOWING STATEMENT.  
(NPID statement containing erroneous keyword)  
CLDT ABORT.**

Description: Self-explanatory.

Issued by CLDT.

User Action: Correct the error and retry.

**CLDT - VALID OPTIONS FOR NETDIS ARE SSF,RHF, AND NAM.  
ERROR IN THE FOLLOWING STATEMENT.  
(statement containing erroneous keyword)  
CLDT ABORT.**

Description: Self-explanatory.

Issued by CLDT.

User Action: Correct the error and retry.

### **CLEAR COMPLETE.**

Description: Indicates that the command list has been returned to the display.

Issued by NLTERM.

User Action: None.

### **CLEARING PF ACTIVITY COUNT.**

Description: PFDUMP or PFCAT is waiting for PFU to decrement the permanent file device activity count because catalog processing has been completed. This message should be displayed for a few seconds only.

Issued by PFCAT.

User Action: If message is displayed for an extended period of time, take a deadstart dump, write a PSR, and send the dump and PSR to CDC along with any support materials which will allow CDC to duplicate the problem.

### **CLEARING UTILITY INTERLOCK.**

Description: PFLOAD is waiting for PFU to clear the permanent file utility interlock on a device after it is loaded. This message should be displayed for a few seconds only.

Issued by PFLOAD.

User Action: If message is displayed for an extended period of time, take a deadstart dump, write a PSR, and send the dump and PSR to CDC along with any support materials which will allow CDC to duplicate the problem.

### **CLOCK UPDATE WARNING.**

Description: Indicates that NOS was locked out of the CPU for more than 10 seconds. If NOS/VE shutdown is in progress, enter GO,SYS. to ignore. Otherwise, a hardware error may be indicated.

Issued by CPUMTR.

User Action: Inform site analyst.

### **CM ADDRESS PARITY ERROR**

Description: S/C register error.

Issued by CTI.

User Action: Inform C.E.

### **CM ALLOCATION ERROR.**

Description: The system was unable to allocate sufficient central memory for the defined configuration.

Issued by SET.

User Action: Notify system configuration.

### **CMn BEING RESENT ON CCHcc.**

Description: The control module with equipment number n is being reset on concurrent channel cc.

Issued by 1XD.

User Action: None. This operation may take up to six minutes to complete.

### **CM NOT ACTIVE - LEVEL 3 REC**

Description: Memory initialization cannot be performed on a level 3 recovery.

Issued by CTI.

User Action: None.

### **CM RECORD NOT FOUND.**

Description: Dayfile and output file message indicating that the central memory record was not found in the EDD file.

Issued by DSDI.

User Action: Ensure that the dump file contains meaningful information and is positioned correctly.

### **CMn RESET FAILURE ON CCHcc.**

Description: A reset operation on the control module with equipment number n failed on concurrent channel cc.

Issued by 1XD.

User Action: Call a customer engineer.

### **CM UNAVAILABLE, (CR) TO RE-ENTER**

Description: Indicates that an address entered during a CM memory dump option is greater than the central memory size.

Issued by CTI.

User Action: Press the carriage return key and reenter the address.

### **CMC PARITY ERROR.**

Description: A central memory control (CMC) parity error has occurred.

Issued by SCE.

User Action: Inform site analyst and customer engineer.

### **\*CMM\* ERROR.**

Description: A \*CMM\* error occurred. Memory cannot be granted to load \*OPEN\* routine.

Issued by AAMI.

User Action: Inform database administrator.

### **CMR LENGTH CHANGED.**

Description: The MST address determined by SET or the first word address of the RPL (REC) has changed on a recovery level deadstart. Possible causes include the following:

- MST pointer in EST was destroyed.
- Condition of CM has changed (upgraded/ downgraded) since initial deadstart.

Issued by REC.

User Action: Retry recovery deadstart or perform an initial (level 0) deadstart.

### **CMR OVERFLOW.**

Description: CMR LENGTH is greater than 131K or greater than execution memory size if that value is less than 131K.

Issued by SET.

User Action: Reduce CMR length by removing mass storage entries from the EQPDECK or by reducing the amount of space reserved for control points, EJT, QFT, dayfile buffers, etc. If still unable to deadstart, then take a deadstart dump, write a PSR, and send the dump and PSR to CDC along with any support materials which will allow CDC to duplicate the problem.

### **CMR OVERFLOW.**

Description: During a SYSEDIT, the size of the central memory resident was found to exceed the maximum allowed.

Issued by SLL.

User Action: Remove routines from central memory and retry SYSEDIT.

### **CMRDECK NOT ON TAPE.**

Description: The specified text deck number is not contained on the deadstart tape being used.

Issued by SET.

User Action: Rereadstart and select the correct text deck.

### **CN,FO,OR YI OPTION VIOLATED.**

Description: The specified directive to SSDEBUG requires only one of the three parameters CN, FO, or Y to be specified.

Issued by SSDEBUG.

User Action: Correct directive and retry.

### **CN NOT SPECIFIED**

Description: OP=D was specified without a cartridge serial number.

Issued by SSUSE.

User Action: Specify CN.

### **COMMAND ABORTED.**

Description: The redefinition procedure for the equipment was terminated by the operator.

Issued by 1RM.

User Action: None.

### **COMMAND ARGUMENT ERROR.**

Description: Dayfile message indicating that incorrect command arguments have been encountered.

Issued by QFSP.

User Action: Correct and retry operation.

### **COMMAND BUFFER FULL.**

Description: The command buffer can not hold more commands at this time.

Issued by DIS.

User Action: None.

### **COMMAND ILLEGAL AFTER GO.**

Description: The command which was just entered is incorrect after the GO command has been entered.

Issued by MCS.

User Action: None.

### **COMMAND IS INAPPROPRIATE**

Description: A command was entered for a printer which was not in the proper state to receive the command.

Issued by PSU.

User Action: Enter the command when the printer is in the proper state.

### **COMMAND MISSING PARAMETER.**

Description: A needed parameter is missing.

Issued by NVF.

User Action: Attempt corrected command entry.



### **COMMAND OPTION MISMATCH.**

Description: OP parameter R or C was specified without a P parameter being specified.

Issued by PROBE.

User Action: Correct parameter and retry.

### **COMMAND PROCESSED.**

Description: The command entered was processed successfully.

Issued by LIDOU.

User Action: None.

### **COMMAND PROCESSED.**

Description: Indicates command is valid and the change has been made.

Issued by SUBSYST.

User Action: None.

### **COMMAND RESTRICTED TO NPU OPERATORS.**

Description: The host operator (HOP) attempted a superfluous command.

Issued by CS.

User Action: Command not necessary.

### **COMMAND SYNTAX ERROR.**

Description: The command did not meet the required syntax.

Issued by SSVAl.

User Action: Check syntax of the command.

### **COMMAND TOO LONG.**

Description: The command entered via the X. or the RSS command was longer than 50 characters.

Issued by DIS.

User Action: Shorten command if possible and reenter.

### **COMMAND TOO LONG.**

Description: An attempt to enter more than 60 characters has been made.

Issued by DSD.

User Action: Backspace and shorten the entry to 60 characters or less.

### **COMMAND UNDEFINED**

Description: Self-explanatory.

Issued by PSU.

User Action: Enter the correct command.

### **COMMANDS ON FILE.**

Description: Processing of the ELS command is not valid while DIS is processing a procedure call.

Issued by DIS.

User Action: None.

### **COMMON DISK AREA FULL**

Description: Insufficient space in the common disk area to perform an update build.

Issued by CTI.

User Action: Redeadstart using the CIP tape and initialize the CDA by selecting the Z option on the CAU Initial Options display.

### **COMMUNICATION FILE BUSY.**

Description: The communication file MVOCOM is busy.

Issued by SSMOVE.

User Action: Rerun SSMOVE when MVOCOM is no longer busy.

### **COMPARE ERROR.**

Description: I-display message indicating that the card reader has encountered an error.

Issued by DSD.

User Action: Compare error on card reader to previous error.

### **COMPARE ERROR.**

Description: I-display message. The card punch has a compare error.

Issued by 1CD.

User Action: Clear the punch feed path, reload the hopper and ready the punch.

### **COMPLETE BIT NOT SET.**

Description: Peripheral interface module (PIM) internal error. PIM did not set the complete bit in the INITMDI/PIM parameter block before returning control to INITMDI.

Issued by INITMDI.

User Action: Inform site analyst.

### **CON est.**

Description: The operator resumed printing on BIO equipment est.

Issued by QAP.

User Action: None.

### **CONFIG UTILITY COMPLETE.**

Description: All redefinition requested equipments have been processed.

Issued by CONFIG.

User Action: None.

### **CONNECT REJECT, filename AT address.**

Description: The system was unable to connect a peripheral device.

Issued by 1MT.

User Action: Inform site analyst.

### **CONNECT TO EXEC FAILED.**

Description: SSVAL is not running at full capacity because SSEXEC is not running. No MSE release processing or catalog repair processing is done but a validation report is produced.

Issued by SSVAL.

User Action: None.

### **CONSOLE TYPE CHANGED.**

Description: A level-3 deadstart was initiated from a console other than the type used during the previous level-0 deadstart.

Issued by SET.

User Action: Deadstart from the correct console.

### **CONTROL CARD ERROR.**

Description: Indicates that a command error has occurred.

Issued by NLTERM.

User Action: Correct the command problem and rerun the job.

### **CONTROL POINT NOT ALLOWED.**

Description: The specified subsystem does not allow the control point for its execution to be changed.

Issued by SUBSYST.

User Action: None.

### **CONTROL STATEMENT PARAMETER SYNTAX ERROR.**

Description: Command parameter separator is not equal sign or command parameter value is missing.

Issued by RBF.

User Action: Correct RBF2P0 command parameter.

### **CONTROLLER DID NOT TAKE ALL CONTROLWARE.**

Description: The controller did not accept all the data in the controlware record. The contents of a register did not equal zero after one of the OAM instructions in the PP.

Issued by LOADBC.

User Action: Inform customer engineer.

### **CONTROLLER DUMP COMPLETE.**

Description: Requested controller dump was successful.

Issued by LOADBC.

User Action: None.

### **CONTROLLER DUMP UNSUCCESSFUL.**

Description: 1LC was unable to dump 7155 controller memory due to function timeout or incorrect controller response.

Issued by LOADBC.

User Action: Contact customer engineer.

### **CONTROLLER ERROR**

Description: An error response has been received from the 7990 controller.

Issued by SSEXEC.

User Action: Inform site analyst.

### **CONTROLLER EST ENTRY est INITIALIZED.**

Description: Informative message indicating that est entry for the controller has completed the initialization.

Issued by SSEXEC.

User Action: None.

### **CONTROLWARE LOAD ABORT, C=cc.**

Description: First line of a two-line message indicating that controlware was not successfully loaded on channel cc. The second line of the message indicates the reason for the abort.

Issued by LOADBC.

User Action: Refer to the message given in the second line for information about the appropriate action to be taken.

### **CONTROLWARE LOAD ABORT, EQ=est.**

Description: First line of a two-line message indicating that controlware was not successfully loaded in the control module with EST ordinal est. The second line of the message indicates the reason for the abort.

Issued by LOADBC.

User Action: Refer to the message given in the second line for information about the appropriate action to be taken.

### **CONTROLWARE LOAD ALREADY IN PROGRESS.**

Description: Requested controlware load for specified channel was already being processed by another copy of LOADBC/ILC.

Issued by LOADBC.

User Action: Wait until other load completes and retry.

### **CONTROLWARE LOAD COMPLETE.**

**yyy FIRMWARE MAtt-vvv,CH=cc.**

Description: Informative message indicating that the controlware was successfully loaded.

yyy Controller type.  
ttt Controlware type.  
vvv Version number.  
cc Channel number.

Issued by LOADBC.

User Action: None.

### **CONTROLWARE NOT FOUND.**

Description: Either the file (system file by default or F=filename) does not contain the requested controlware or F=0 was specified.

Issued by LOADBC.

User Action: Check that the file being used contains the correct controlware.

### **CONVERSION ERROR.**

Description: The parameter given to SCRSIM contained one of the following errors:

- A character was detected after the postradix.
- An 8 or a 9 was detected when a postradix of B was specified.

Issued by SCRSIM.

User Action: Correct and reenter.

### **CONVERSION TO SOURCE COMPLETE.**

Description: Dayfile message indicating that source run successfully completed.

Issued by MODVAL.

User Action: None.

**COPY NOT ALLOWED OF RESERVED FILE NAME filename.**

Description: An attempt was made to make a local copy of a file with the same name as a RECLAIM scratch file, dump file, INPUT, or OUTPUT.

Issued by RECLAIM.

User Action: Retry using a different local file name.

**COPYING filename userindex.**

Description: Informative message indicating that file filename with user index userindex is being copied.

Issued by PFCOPY.

User Action: None.

**COPYING DUMP TO RANDOM FILE.**

Description: DSDI is creating a random dump file from the EDD tape during initialization.

Issued by DSDI.

User Action: None.

**COPYING SESSION DATA TO OUTPUT**

Description: DEMUX is copying the translated session output from the scratch file to the selected OUTPUT file.

Issued by DEMUX.

User Action: None.

**CPD - ALREADY ACTIVE.**

Description: An attempt to initiate CPD was made when CPD was already active.

Issued by CPD.

User Action: Do not attempt to initiate second copy of CPD before the first copy is terminated.

**\*CPD\* ALREADY ACTIVE.**

Description: You are attempting to initiate CPD, but CPD is already active.

Issued by ICPD.

User Action: If you want to start using a different sample file, issue ENDCPD followed by an ICPD. Otherwise, no action is required.

**CPD - FILE NOT FOUND.**

Description: CPD could not find the specified data file.

Issued by CPD.

User Action: Inform site analyst.

**CPD - FILE STATUS ERROR.**

Description: The specified system FNT ordinal was incorrect.

Issued by CPD.

User Action: Inform site analyst.

**CPD - INITIATED.**

Description: An informative message indicating that system monitoring has begun.

Issued by CPD.

User Action: None.

### **CPD NOT ACTIVE.**

Description: An informative message indicating that ENDCPD was called when CPD was not active.

Issued by ICPD.

User Action: None.

### **CPD NOT ACTIVE.**

Description: SFM was called to set the CPD drop flag when CPD was not active.

Issued by SFM.

User Action: None.

### **CPD - PARAMETER ERROR.**

Description: The specified parameter address was incorrect.

Issued by CPD.

User Action: Inform site analyst.

### **CPD SAMPLE FILE IN USE.**

Description: An error was encountered when attempting to enter the sample file in the system FNT.

Issued by ICPD.

User Action: Inform site analyst.

### **CPD - TERMINATED.**

Description: An informative message indicating that system monitoring is complete.

Issued by CPD.

User Action: None.

### **CPD - TRACK LIMIT.**

Description: An informative message indicating that a track limit has occurred on the CPD data file device.

Issued by CPD.

User Action: Take appropriate action to regain space on the device.

### **CPD - USER ACCESS NOT VALID.**

Description: The calling program did not have system origin privileges.

Issued by CPD.

User Action: None.

### **CPM - EPILOGUE AND SHELL CONFLICT.**

Description: A project epilogue and a no abort shell are defined.

Issued by CPM.

User Action: Delete the epilogue or shell, or change the shell control option.

### **CPM - MASS STORAGE ERROR.**

Description: A non-recoverable mass storage error is detected by CPM when attempting to access a mass storage device, or a recoverable mass storage error has occurred during a disk access attempt, causing the job to roll out and wait for the device to be repaired.

Issued by CPM.

User Action: Repair the device and retry.

### **CPP OVERLAY LOAD FAILED.**

Description: A concurrent PP failed to load a program overlay.

Issued by 1MA.

User Action: Take an Express Deadstart Dump and send it along with a PSR to Cyber Software Support.

### **CPU ABORT.**

Description: RECLAIM system error.

Issued by RECLAIM.

User Action: Check previous messages and the dayfile for the reason for the abort. If you find no other messages, inform the site analyst.

### **CPU ERROR EXIT.**

Description: Self-explanatory.

Issued by RECLAIM.

User Action: None.

### **CPU MODEL NOT FOUND.**

Description: The CPU model number, passed by CTI from the Hardware Descriptor Table, was not recognized by NOS.

Issued by SET.

User Action: Ensure the correct CIP is installed. Otherwise, inform CYBER Software Support.

### **CPU x NOT RESPONDING**

Description: CPU x did not respond to EI function request within 1-second time limit.

Issued by CTI.

User Action: Inform C.E.

### **CPU x P REGISTER PARITY ERROR.**

Description: A central processor P register parity error was detected on CPU x.

x CPU number (0 or 1)

Issued by SCE.

User Action: Inform site analyst and customer engineer.

**CPU SECONDS = xxx.**

**CPU PERCENT = xxx.**

**FL CHANGES = xxx.**

**MAXIMUM FL = xxx.**

**OVERLAY LOADS = xxx.**

**FILES DESTAGED = xxx.**

**FILES STAGED = xxx.**

**SSEXEC TERMINATING**

Description: Informative messages issued when SSEXEC terminates.

Issued by SSEXEC.

User Action: None.

### **CPU STATE CHANGE.**

Description: A level 3 recovery is being done and the state of the central processor(s) (on/off or up/down) on the machine has changed. NOS cannot continue with the deadstart.

Issued by SET.

User Action: Determine the cause of the processor state change and continue with a level 3 deadstart or do a level 0 deadstart.

### **CPUMTR ERROR EXIT.**

Description: Flashing message at the system control point on the B display and the right screen header. This indicates that CPUMTR has executed an error exit sequence. Either a hardware or a software problem could be the cause.

Issued by DSD.

User Action: The exit mode condition bits for the conditions causing CPUMTR to error exit are in location zero of CMR (DSD C display). Ask the customer engineer to examine the hardware maintenance registers (on CYBER 180-class machines) to determine if a hardware problem exists. You must redeadstart. If no hardware errors are indicated, write a PSR and send a deadstart dump to CDC along with any other support materials which will allow CDC to duplicate the problem.

### **CREATE EVFU LOAD FILE xxxxxxxx, THEN TYPE K.GO.**

Description: The EVFU load file is missing.

Issued by PSU.

User Action: Inform a knowledgeable person at your site to install the EVFU load file. Type K.GO. to continue processing.

### **CREATING username.**

Description: Message displayed at line 1 of control point indicating that the username is being created.

Issued by MODVAL.

User Action: None.

### **CREATING CATALOG IMAGE RECORD.**

Description: Informs operator that the catalog image record from the archive file is being copied to a scratch file.

Issued by PFLOAD.

User Action: None.

### **CREATION COMPLETE.**

Description: Dayfile message indicating that creation run successfully completed.

Issued by MODVAL.

User Action: None.

### **CRF HEADER ERROR - filename.**

Description: I/O errors or logical errors were encountered in the header record of the named CRF. The file is unusable.

filename	File name
----------	-----------

Issued by TAFREC.

User Action: Initialize the file using the K.INT initial K display command.

### **CRF RECOVERY/INITIALIZATION ABORTED.**

Description: Informative message.

Issued by TAFREC.

User Action: The action depends on the message preceding this one in the dayfile.



### **CRF RECOVERY/INITIALIZATION COMPLETE.**

Description: Informative message.

Issued by TAFREC.

User Action: None.

### **CRF RUN UNIT ERROR - filename.**

Description: I/O errors or logical errors were encountered in a run unit of the named CRF.

Issued by TAFREC.

User Action: Attempt to recover any good information using the K.ERO=YES initial K display command, or initialize the file using the K.INT initial K display command.

### **CRM(...parameter-list...)**

Description: This is a copy of a CRM statement that is in error. A subsequent message follows.

Issued by TAF.

User Action: Inform the database administrator.

### **CRM DATA MANAGER SUCCESSFULLY LOADED.**

Description: Self-explanatory.

Issued by TAF.

User Action: None.

### **CRM ERROR ENCOUNTERED.**

Description: A CRM error occurred while processing the directory. The CRM error is either an incorrect key or end of file when this is the only output message.

Issued by MREC.

User Action: Inform database administrator.

### **CRM ERROR IN ZZdbDIR (GET).**

Description: A CRM error was encountered when trying to retrieve a VSN record from the directory on a file load.

Issued by DMREC.

User Action: Inform database administrator.

### **\*CRM\* TASK RECOVERY IMPOSSIBLE.**

Description: Recovery is not possible when the recovery file structure is found to be inconsistent with TAF/CRM tables and parameters specified on xxJ files.

Issued by AAMI.

User Action: The last reported BRP must be corrected or reallocated.

### **CRMTASK - DATA BASE DOWNED BY OPERATOR.**

Description: DMREC notified TAF that the database was recovered, but AAMI was not able to access it because it had been downed by the operator.

Issued by CRMTASK.

User Action: Only an operator may up the database that he/she downed. It cannot be upped automatically.

### **CRMTASK - DATA BASE/FILE BEING IDLED.**

Description: AAMI will not process any requests on an idle database/file.

Issued by CRMTASK.

User Action: After the cause of the database/file being idle has been fixed, the operator must bring it up.

**CRMTASK - DATA BASE/FILE CANNOT BE UPPED.**

Description: AAMI was not able to bring up the data base or file.

Issued by CRMTASK.

User Action: Database administrator must investigate the cause of AAMI's inability to bring file/data base up.

**CRMTASK - DATA BASE/FILE NAME UNKNOWN.**

Description: DMREC request had an incorrect database or file name.

Issued by CRMTASK.

User Action: Call the database administrator to investigate the cause.

**CRMTASK - INCORRECT REQUEST.**

Description: CRMTASK was not called correctly by DMREC.

Issued by CRMTASK.

User Action: There may be a transaction in the system attempting to use functions reserved for DMREC.

**CRMTASK - INCORRECT REQUEST FORMAT.**

Description: AAMI rejected this request.

Issued by CRMTASK.

User Action: An analyst should investigate the reason for this rejection.

**CRMTASK - INCORRECT TT SEQUENCE NUMBER.**

Description: AAMI does not recognize the TT sequence number returned by DMREC.

Issued by CRMTASK.

User Action: Call the analyst to investigate the discrepancy between DMREC and TAF.

**CRMTASK - NOT ALL DATA BASE FILES UPPED.**

Description: DMREC recovered the database but AAMI was unable to attach/open all of database files.

Issued by CRMTASK.

User Action: Database administrator should investigate why only some of the data base files came up.

**CRMTASK TIMEOUT.**

Description: A terminal job timed out while waiting for the next command.

Issued by CRMTASK.

User Action: A valid command must be entered within the default time of 480 seconds.

**CRT - CIO ERROR.**

Description: A CIO error was generated when creating a log file.

Issued by DMREC.

User Action: Purge the log file and try again (check file name).

**CS=ssss.**

Description: A coupler status error has occurred.

ssss Status (four octal digits)

Issued by CDX.

User Action: Rereadstart. If message persists, inform site analyst.

### **CS ATTEMPTING NETON.**

Description: Self-explanatory.

Issued by CS.

User Action: None.

### **CS/CONTROL STATEMENT PARAMETER SYNTAX ERROR.**

Description: This CS command in the master file is formatted incorrectly.

Issued by CS.

User Action: Correct command in master file, restart the network.

### **CS DISABLED.**

Description: CS is disabled.

Issued by CS.

User Action: Inform site analyst.

### **CS/DUPLICATE CONTROL STATEMENT PARAMETER.**

Description: A duplicate parameter setting encountered on the CS command.

Issued by CS.

User Action: Correct command in master file, restart the network.

### **CS DUPLICATE NETON.**

Description: CS has already netted on. A subsequent neton is illegal.

Issued by CS.

User Action: Inform site analyst.

### **CS/ILLEGAL CONTROL STATEMENT PARAM VALUE.**

Description: An out-of-range value encountered for a CS command parameter.

Issued by CS.

User Action: Correct command in master file, restart the network.

### **CS/NCF yy/mm/dd, hh.mm.ss.**

Description: Informative. NCF (network configuration file) build date and time.

Issued by CS.

User Action: None.

### **CS/NCF title.**

Description: Informative. NCF (network configuration file) time table (limited to 50 characters).

Issued by CS.

User Action: None.

### **CS NETON SUCCESSFUL.**

Description: Self-explanatory.

Issued by CS.

User Action: None.

**CS/NIN IS NOT SPECIFIED.**

Description: The required NIN (network invocation number) value on the CS command is missing.

Issued by CS.

User Action: Correct command in master file, restart the network.

**CS SHUTDOWN INITIATED, PLEASE TERMINATE CONNECT.**

Description: Self-explanatory.

Issued by CS.

User Action: Network operator must terminate connection to CS.

**CS/UNRECOGNIZED CONTROL STATEMENT PARAMETER.**

Description: An undefined parameter was encountered on the CS command in the master file.

Issued by CS.

User Action: Correct command in master file, restart the network.

**CS/VER nnn-*nnn*.**

Description: Informative. CS version and level number.

Issued by CS.

User Action: None.

**CSDDNT - SM NOT ROUTED.**

Description: CS received an unexpected supervisory message.

Issued by CS.

User Action: Inform site analyst.

**CSM - INCORRECT COMMUNICATION FUNCTION.**

Description: An incorrect or unrecognizable request was received by the transaction executive from the CPU monitor.

Issued by TAF.

User Action: Inform site analyst.

**CSN ALREADY IN SMMAP.**

Description: A cartridge being added from the input drawer has a scratch or manufacturer's label and a VSN which is already assigned in the SM map. Because all cartridges have unique CSNs, the SM map entry is probably obsolete.

Issued by SSLABEL.

User Action: Remove incorrect SM map entry, using steps described in section 3: Removal of Faulty or Missing Cartridges.

**CSN NOT FOUND.**

Description: The CSN specified in the directive to SSDEBUG is not contained in the SMMAP.

Issued by SSDEBUG.

User Action: Correct CSN and retry.

**CSN NOT FOUND IN SMMAP.**

Description: The CSN specified in the RM directive to SSLABEL or in the label of the cartridge being restored is not contained in the SM map.

Issued by SSLABEL.

User Action: Correct directive and retry.

### **CSN OPTION VIOLATED.**

Description: One of the following occurred:

- CN=csn cannot be used with the directive specified.
- CN=csn was not specified but is required with the directive specified.
- CN=csn cannot be used with at least one of the other parameters specified.
- c alone cannot be used with a directive to SSDEBUG.

Issued by SSLABEL.

User Action: Correct error and retry.

### **CSN OR Y-Z NOT IN SUBFAMILY.**

Description: The specified csn or Y and Z coordinates correspond to a cubicle which is not assigned to a subfamily as required by this directive.

Issued by SSDEBUG.

User Action: Obtain the correct csn or Y and Z coordinates from an SSUSE report and retry the directive.

### **CSSANS - DUPLICATE SUP/IN FROM npuname.**

Description: For debug only. CS received a duplicated SUP/IN supervisory message from NPU npuname.

Issued by CS.

User Action: Inform site analyst.

### **CSSAST - INVALID CMD FORMAT.**

Description: A CS routed command is bad.

Issued by CS.

User Action: Inform site analyst.

### **CSSDRC - BAD COMMAND.**

Description: A bad command is entered. The message is issued by CS procedure CSSDRC.

Issued by CS.

User Action: Inform site analyst.

### **CSSTNS - NO NPUCB.**

Description: An NPUCB entry cannot be found.

Issued by CS.

User Action: Inform site analyst.

### **CSU x ADDRESS PARITY ERROR**

Description: S/C register error.

Issued by CTL.

User Action: Inform C.E.

### **CSU x FAULT**

Description: S/C register error.

Issued by CTI.

User Action: Inform C.E.

**CT, CN, OR OV KEYWORD NOT PRESENT**

Description: The COMPACT directive has been specified on the RECLAIM command; COMPACT requires either the CT, CN, or OV option, but none of these was specified.

Issued by RECLAIM.

User Action: Retry with the CT, CN, or OV option.

**CTASK - DATA BASE OR FILE DOWN.**

Description: The database, TAF/CRM, or file is down on an RSTDBI request.

Issued by CTASK.

User Action: Inform the database base administrator.

**CTASK - DATA BASE OR FILE IDLE.**

Description: The database, TAF/CRM, or file is idle on an RSTDBI request.

Issued by CTASK.

User Action: Inform the database administrator.

**CTASK - FILE IS NOT INSTALLED.**

Description: The database or file is not available in the xxJ file on a CRMSTAT request.

Issued by CTASK.

User Action: Inform the database administrator.

**CTASK - INCORRECT RECOVERY CASE.**

Description: The recovery case selected for processing was incorrect.

Issued by CTASK.

User Action: Inform the database administrator.

**CTASK - NO CRM RECOVERY FILES FOR DATA BASE.**

Description: There is no recovery file assigned to the database on an RSTDBI request.

Issued by CTASK.

User Action: Inform the database administrator.

**CTASK - SYSTEM IDENTIFIER UNKNOWN.**

Description: The old system identifier is unknown when issuing a TINVOKE request.

Issued by CTASK.

User Action: Inform the database administrator.

**CTASK - TABLE AREA NOT LARGE ENOUGH.**

Description: The table area supplied by CTASK for a CRMSTAT request is not large enough.

Issued by CTASK.

User Action: Inform the data administrator.

**CTASK - TASK LOGICAL ERROR.**

Description: An unexpected error status was returned.

Issued by CTASK.

User Action: Inform the database administrator.

### **CTASK - TRANSACTION NOT RERUNNABLE.**

Description: The TAF transaction was not rerunnable and a RERUN was attempted.

Issued by CTASK.

User Action: Inform the database administrator.

### **CTASK - TRMREC ERROR.**

Description: One of the following occurred:

- There was no outstanding DBEGIN request.
- An error was encountered on a database or recovery file.
- The database or TAF/CRM is down.

Issued by CTASK.

User Action: Inform the database administrator.

### **CTASK - USER NOT DEFINED IN NETWORK FILE.**

Description: The user specified on a TSTAT, WSTAT, or RERUN request is not defined in the NETWORK file.

Issued by CTASK.

User Action: Inform the database administrator.

### **CTI CYLINDER OVERFLOW**

Description: CTI overflowed the area reserved on cylinder.

Issued by ICD.

User Action: Redeadstart.

### **CTI CYLINDER OVERFLOW**

Description: Space available on the CTI cylinder was not enough to contain the entire CTI file. This problem may have been caused by disk errors.

Issued by CTI.

User Action: Reformatting the disk or changing packs may resolve the problem.

### **CTI PP~~xx~~ NOT RESPONDING DEADSTART ABORTED**

Description: CTI cannot communicate with the PP selected as the alternate PP.

Issued by CTI.

User Action: Inform C.E.

### **CUBE EMPTY - SMMAP ENTRY REMOVED.**

Description: Informative message indicating that the cubicle corresponding to the SMMAP entry being removed with an RC directive was empty.

Issued by SSDEBUG.

User Action: None.

### **CVL CALL ERROR.**

Description: The validation routine, CVL, encountered one of the following errors while processing the CEVAL macro.

- Recall bit was not set.

- Illegal function number was specified.
- Insufficient or improper combination of parameters was specified.
- The user supplied mnemonic does not match the preassigned tape mnemonic when CVL was called by preassignment.
- A tape was not preassigned when CVL was called by preassignment.
- The user attempted to load tape controlware when CVL was called by preassignment.
- A labeled tape was preassigned when CVL was called by preassignment.

Issued by CVL.

User Action: Correct error and resubmit program.

### **CYCLE NUMBER IS OUTSIDE LIMITS.**

Description: The specified cycle number is outside the limits set by the installation parameter (CYUCM).

Issued by DMREC.

User Action: Check the maximum cycle number and rerun.

### **CYCLE STILL PROCESSING.**

Description: Dayfile message indicating that a command other than END. was entered before the total time limit was reached.

Issued by SCRSIM.

User Action: Wait until processing is complete before entering commands other than END.

### **DATA AVAILABLE BIT NOT SET.**

Description: INITMDI tried to receive data from the MDI, but the general status data available bit was not set.

Issued by INITMDI.

User Action: Inform site analyst.

### **DATA BASE ERROR.**

Description: The system has detected an error in its validation file.

Issued by VALEX.

User Action: Contact installation personnel.

### **DATA BASE ERROR n - NOTIFY ANALYST.**

Description: System error dayfile message indicating that an abnormal situation exists. n is displayed for consideration by the analyst. The internal documentation, obtained by using the DOCUMENT command, contains an explanation of each error n for use by the analyst. (Refer to the NOS 2 Reference Set, Volume 3 for a description of DOCUMENT.)

Issued by PROFILE.

User Action: Inform site analyst.

### **DATA BASE/FILE ALREADY DOWN OR IDLE.**

Description: CRMTASK issued a DBDOWN request to AAMI, but the database or file name was already down or idle.

Issued by CRMTASK.

User Action: Inform database administrator.



### **DATA BASE/FILE CANNOT BE UPPEd.**

Description: CRMTASK issued a DBUP request but AAMI was not able to bring up the database or file name.

Issued by CRMTASK.

User Action: Inform database administrator.

### **DATA BASE/FILE NAME UNKNOWN.**

Description: CRMTASK issued a CRMSTAT, DBUP, or DBDOWN request but the database or file name was not found.

Issued by CRMTASK.

User Action: Inform database administrator.

### **DATA BASE NAME IN CRM FILE NAME DOES NOT MATCH xxJ.**

Description: The two-character database name from the file name on the CRM statement does not match the xxJ header.

Issued by DMREC.

User Action: Correct the CRM statement and try again.

### **DATA BASE NAME OR FILE NAME MISSING.**

Description: No file name or database name on directive.

Issued by DMREC.

User Action: Include file name or database name on directive.

### **DATA BASE NAME OR FILE NAME(S) BOTH SPECIFIED.**

Description: Self-explanatory.

Issued by DMREC.

User Action: Eliminate file name or database name from the directive.

### **DATA BASE NOT IN EDT.**

Description: Self-explanatory.

Issued by TAF.

User Action: Reinitialize the transaction executive, or inform the site analyst.

### **DATA BLOCK BUFFER OVERFLOW.**

Description: ARF tape block size is too large for buffer allocated for it.

Issued by DMREC.

User Action: Inform the database administrator and lengthen buffer WBUF.

### **DATA BLOCKS MISSING.**

Description: Expected data blocks following a header record were not found.

Issued by ACPD.

User Action: Regenerate the data file.

### **DATA FILE CONTENT ERROR.**

Description: Data file is not in the expected format.

Issued by ACPD.

User Action: Regenerate the data file.

**DATA FILE EMPTY.**

Description: Data file is empty.

Issued by ACPD.

User Action: Use nonempty data file.

**DATA FILE NOT AT BEGINNING OF FILE.**

Description: Data file was not initially positioned at the beginning of a file.

Issued by ACPD.

User Action: Reposition the data file.

**DATA FILE NOT FOUND - filename.**

Description: Data file filename was not local to the job at the time ACPD is running.

Issued by ACPD.

User Action: Make filename local before initiating ACPD

**DATA FILE NOT IN CHRONOLOGICAL ORDER.**

Description: A multi-file data file is not in the increasing order of time of the records. This error can only occur if a begin and/or end date and time are specified.

Issued by ACPD.

User Action: Do not use the N parameter with a begin and end date and time for the file.

**DATA FILE POSITIONED AT EOI.**

Description: Data file is initially positioned at end of information.

Issued by ACPD.

User Action: Reposition the data file.

**DATA LOST DRIVER - tn.**

Description: A mux driver has detected a hardware data lost condition for terminal number tn.

Issued by IAFEX.

User Action: Write a PSR. Include the user's dayfile and time of lost data.

**DATA LOST IAFEX - tn.**

Description: The presented input was not accepted from the terminal number tn because a driver reentry was waiting to be processed.

Issued by IAFEX.

User Action: Write a PSR. Include the user's dayfile and time of lost data.

**DATABASE CORRUPTED.**

Description: RECLAIM encountered a problem with the database; usually indicates that the database is empty or has been overwritten with something other than a database.

Issued by RECLAIM.

User Action: Check to ensure that your database is in correct RECLAIM format and that it is not empty.

**DATABASE NOT FOUND-DEFINING NEW ONE.**

Description: RECLAIM did not find the specified database in your catalog and is attempting to define a new one.

Issued by RECLAIM.

User Action: None.

### **DAYFILE - message.**

Description: Refer to explanation of AFD - message.

Issued by DAYFILE.

User Action: None.

### **DAYFILE BUSY.**

Description: The dayfile to be terminated is currently attached to another job.

Issued by DFTERM.

User Action: Retry operation.

### **DAYFILE STATUS INDEFINITE.**

Description: An error exit occurred which caused DFTERM to abort while it was terminating a dayfile. Status of the dayfile is unknown.

Issued by DFTERM.

User Action: Inform site analyst immediately.

### **DAYFILE TERMINATED.**

Description: Informative message issued to the terminated dayfile.

Issued by SFM.

User Action: None.

### **DAYFILE UNRECOVERABLE**

Description: The system dayfile cannot be recovered.

Issued by REC.

User Action: Enter GO,SYS. at the system console: a new dayfile will be created.

### **DB-NAME MUST NOT START WITH THE LETTER Z.**

Description: A database name was found which starts with the letter Z. These are reserved names.

Issued by TAFREC.

User Action: Change the database name to one not beginning with Z. If the name appears on an NCTF entry, contact the user and request a new identifier. If the name appears on the TCF, make the change on the applicable DMS statement or inform the database administrator.

### **DCord, Uuu,PS=ssssss.**

Description: Informative message indicating the pack serial number.

ord	EST ordinal of disk.
uu	Unit number.
ssssss	Pack serial number.

Issued by 1XY.

User Action: None.

### **DCest, Uuu,PS=ssssss.**

Description: Refer to EQest, Uuu,PS=ssssss.

Issued by 1XY.

User Action: None.

**DCC - CIRCULAR BUFFER ADDRESS ERROR.**

Description: One of the circular buffer pointers FIRST, IN, OUT or LAST points are outside the field length, LAST is not greater than FIRST, or IN or OUT is not within the buffer limits.

Issued by DCC.

User Action: Report the problem to your service representative.

**DCC - FWA .GE. LWA+1.**

Description: The specified CCC addresses are not in the correct relationship. They may be reversed.

Issued by DCC.

User Action: Report the problem to your service representative.

**DCC - INCOMPLETE \*CCC\* DUMP.**

Description: The CM buffer size in the calling program was not large enough to hold the entire CCC memory.

Issued by DCC.

User Action: Report the problem to your service representative.

**DCC - INCORRECT CCC CONTROLWARE TYPE.**

Description: The controlware type associated with the specified channel is not one that DCC is allowed to dump.

Issued by DCC.

User Action: Ensure that you have specified the correct channel.

**DCC - INCORRECT ORIGIN TYPE.**

Description: User must be system origin to use DCC and is not.

Issued by DCC.

User Action: Execute the program from the system console.

**DCC - INCORRECT REQUEST.**

Description: The request specified in the call to DCC is incorrect.

Issued by DCC.

User Action: Report the problem to your service representative.

**DCC INCORRECT REQUEST.**

Description: DCC was not called with RECALL.

Issued by DCC.

User Action: Report the problem to your service representative.

**DCC - INCORRECT USER ACCESS.**

Description: User is not validated for system origin privileges.

Issued by DCC.

User Action: Execute the program from the system console.

**DCC - LWA+1 OUT OF RANGE.**

Description: The CCC last word address specified in the call to DCC is beyond the CCC limit address.

Issued by DCC.

User Action: Report the problem to your service representative.

### **DCC - NOT CONTROLWARE CHANNEL.**

Description: The channel specified in the call to DCC is not a channel with controlware.

Issued by DCC.

User Action: Ensure that you have specified the correct channel.

### **DCC - PARAMETER ADDRESS ERROR.**

Description: The CCC addresses passed with the call to DCC are not in the valid address range.

Issued by DCC.

User Action: Report the problem to your service representative.

### **DDeee, Uuu,PS=ssssss.**

Description: Refer to EQeee, Uuu,PS=ssssss.

Issued by OPI.

User Action: None.

### **DEADSTART DEVICE UNDEFINED.**

Description: The deadstart device is not defined in the EQPDECK or the operator attempted to down the deadstart device.

Issued by SET.

User Action: Redeadstart and enter the equipment definition for the deadstart device at EQPDECK time.

### **DEADSTART FILE FORMAT ERROR.**

Description: An error was detected in the directory of the deadstart file.

Issued by INSTALL.

User Action: Check the contents and format of the deadstart file for errors.

### **DEADSTART OF CPP xx FAILED.**

Description: Concurrent PP xx could not be deadstarted by the system.

Issued by 1MA.

User Action: Take an Express Deadstart Dump and send it along with a PSR to Cyber Software Support.

### **DEADSTART SECTOR ERROR.**

Description: An I/O error occurred when attempting to read the deadstart sector.

Issued by REC.

User Action: Contact customer engineer to run HPA to determine the nature of the error and take appropriate maintenance action.

### **DEADSTART SEQUENCING FAILED.**

Description: The deadstart sequencing job could not be initiated because of an I/O error encountered on a mass storage device.

Issued by 1DS.

User Action: Inform site analyst. Check A,ERRORLOG; E,E; and E,H displays to display failing devices. Perform an express dump for later analysis. If the failure occurred during a level 3 recovery, restart the level 3 recovery and enter ABORT or ABORT,B to checkpoint the devices and abort. In all cases, redeadstart, turning off the failing devices. Inform customer engineer about the failing devices.

### **DEBUG LOG FILE RELEASE NOT AVAILABLE**

Description: Dayfile message indicating that due to the limitations within PSU, the K.LR=PSU NAM command cannot be actioned.

Issued by PSU.

User Action: None.

### **DEBUG MODE TURNED OFF**

Description: Dayfile message indicating PSU has turned off debug mode in response to a K.DE=PSU NAM command.

Issued by PSU.

User Action: None.

### **DEBUG MODE TURNED ON**

Description: Dayfile message indicating PSU has turned on debug mode in response to a K.DB=PSU NAM command.

Issued by PSU.

User Action: None.

### **DEBUG NOT TURNED ON.**

Description: The system was not in DEBUG mode when you entered the SCRSIM command.

Issued by HFM.

User Action: Put the system in DEBUG mode and reenter the job.

### **DEFAULT FAMILY USED.**

Description: You entered a FAMILY command with no parameter. The default family was used.

Issued by CONTROL.

User Action: None.

### **DEFINE ERROR ON FILE.**

Description: An error in defining PRU size or in trying to define the log file was encountered on a create directive.

Issued by DMREC.

User Action: Correct PRU length on create directive.

### **DEFINED DEVICE ALREADY EXISTS.**

Description: The device as defined during initialization already exists in the multimainframe environment.

Issued by MSI.

User Action: Remove the duplicate device from the complex or change the parameters for the device being initialized.

### **\*\*\*\* DELETE NON-EXISTENT USER NAME.**

Description: The user name to be deleted from the specified charge/project number entry does not exist. This message is not posted on the K display (DUN directive is ignored) and is not listed on the output file until all directives for the specified charge/project number have been processed.

Issued by PROFILE.

User Action: Check the user name and retry.

### **DELETING username.**

Description: Message displayed at line 1 of control point indicating that the user name is being deleted.

Issued by MODVAL.

User Action: None.

### **DELIMITER WAS NOT RECOGNIZED.**

Description: An incorrect delimiter or an unrecognizable delimiter was encountered on a directive.

Issued by DMREC.

User Action: Check directive format and rerun.

### **DEMUX ARGUMENT ERROR.**

Description: An incorrect argument was specified or an argument was equivalenced that cannot be equivalenced.

Issued by DEMUX.

User Action: Correct the argument format and retry.

### **DEMUX COMPLETE.**

Description: DEMUX normal termination.

Issued by DEMUX.

User Action: None.

### **DEMUX MEMORY OVERFLOW.**

Description: DEMUX required more field length than the maximum field length allowed.

Issued by DEMUX.

User Action: Recommended action is one of the following:

- Decrease the number of terminals (NT).
- Increase the maximum field length (MFL).
- Reassemble DEMUX and modify one or more assembly parameters (see listing).

### **DEMUX NT VALUE TOO LARGE.**

Description: DEMUX NT value is greater than 512 (decimal).

Issued by DEMUX.

User Action: Decrease the number of terminals (NT) value and retry.

### **DEMUX NUMERIC ARGUMENT CONVERSION ERROR.**

Description: An error was detected when converting the SL or NT argument.

Issued by DEMUX.

User Action: Ensure correct argument format and value and retry.

### **DEMUX SL VALUE TOO LARGE.**

Description: DEMUX SL value is greater than the NT value.

Issued by DEMUX.

User Action: Decrease the SL value or increase the NT value.

### **\*\*\* DESIRED PATTERN NOT FOUND \*\*\***

Description: The circular buffer does not contain the bit pattern used in the input directive.

Issued by NDA.

User Action: Check that the correct pattern was used.

### **DESTINATION DEVICE ERROR.**

Description: An unrecoverable error occurred while QLOAD was writing to the destination device.

Issued by QLOAD.

User Action: Check the output file for the files that were processed. Reload to a different device.

### **DESTINATION DEVICE REQUIRED.**

Description: An attempt was made to load inactive queues but the destination device was not selected correctly. Either the family name and device number or the pack name of the destination device must be specified.

Issued by QLOAD.

User Action: Enter correct parameters and retry load operation.

### **DESTINATION FAMILY NOT SPECIFIED.**

Description: K display message indicating that a GO command has been entered before the destination family (DF) or family name (FM) has been specified.

Issued by QFSP.

User Action: Enter the family name and type GO.

### **DESTINATION HOST IN BUFFER REGULATION LEVEL 0**

Description: SEND command cannot be processed because the destination host does not allow any network traffic.

Issued by NIP.

User Action: None.

### **DETACH FAILED, JSN=jsnm**

Description: An unrecoverable error occurred while a job was being detached.

Issued by IAFEX.

User Action: None.

### **DETACHING, JSN=jsn.**

Description: Informative message indicating that the interactive subsystem is detaching active users during termination processing.

jsn Job sequence name

Issued by IAFEX.

User Action: None.

### **DEVICE DOWN.**

Description: An attempt was made to MOUNT or INITIALIZE an allocatable device with a DOWN status set in the EST.

Issued by DSD.

User Action: Inform site analyst before attempting to change the DOWN status.

### **DEVICE ERROR - xx est, GS = gggg.**

Description: A hardware or interface error was detected by the peripheral interface module (PIM). The mainframe channel interface (MCI) general status is gggg (octal). The following instances will produce this message:

- Busy bit set in the MCI general status.
- Error while attempting to send or receive data to/from the MDI.
- Unrecognizable MCI command or general status.



xx Device mnemonic specified by the DT parameter.  
est EST ordinal of MDI.

Issued by INITMDI.

User Action: Inform site analyst.

### **DEVICE NOT AVAILABLE.**

Description: Permanent file device is not available.

Issued by NETFMA.

User Action: Inform site analyst.

### **DEVICE NOT FIRST IN CHAIN.**

Description: To prevent destroying the integrity of a chained multispindle device, initialization will take place only if the device is first in the chain.

Issued by MSI.

User Action: The only input accepted at this time is RERUN or CLEAR. Enter RERUN to update list (on K display) of devices with initialize status set. If first device in chain is not included in new list, enter CLEAR to clear initialize status for the current device.

### **DEVICE NOT FIRST IN CHAIN.**

Description: An equipment other than the first equipment in a linked device was entered to be reconfigured.

Issued by CONFIG.

User Action: Enter the CLEAR or RERUN command and redefine the first equipment in the linked device.

### **DEVICE NOT FOUND.**

Description: The device number (DN) specified to be cataloged was not defined in the system.

Issued by PFCAT.

User Action: Retry operation with device defined in the system.

### **DEVICE NOT REMOVABLE.**

Description: A nonremovable device was selected for chaining in a multispindle string. Before initialization and chaining can be performed, it is required that all physical units to be included in the multispindle string be defined as removable.

Issued by MSI.

User Action: Enter CLEAR to clear initialize status for nonremovable device.

### **DEVICE SPACE GOAL NOT MET.**

Description: Informative message indicating requested amount of disk space was not released.

Issued by SSMOVE.

User Action: None.

### **DEVICE TURNED OFF**

Description: The device listed has been turned off.

Issued by SSEXEC.

User Action: Inform site analyst.

### **DEVICE TYPE/NUMBER NOT FOUND.**

Description: An RL directive contained a device type or number that was not in the summary file. The directive is ignored.

Issued by GENPFD.

User Action: If incorrect, correct the device type or number and resubmit.

### **DEVICE UNAVAILABLE.**

Description: Message resulted from one of the following:

- A packname was specified for a pack that is not currently mounted.
- For a DIS job, no SUI or USER command has been entered.
- No permanent file device could be found for your user name.
- On a secure system, no permanent file device with the proper access level could be found for your user name.

Issued by PFM.

User Action: If a pack name was specified, try again with the WB or NA parameter to request that the pack be mounted. For other errors, inform site operator.

### **DEVICE UNAVAILABLE.**

Description: The device is removable and has been unloaded.

Issued by QFM.

User Action: Ignore the message or mount the device and repeat the request.

### **DEVICE UNAVAILABLE ON SFM CATALOG ACCESS.**

Description: SSEXEC received a device unavailable status from PFM while attempting a PFM request on an SFM catalog. The SFM catalog is closed.

Issued by SSEXEC.

User Action: Inform site analyst. When the condition which caused the device unavailable status has been cleared, MSE can be restarted to reopen the SFM catalog.

### **DFD - message.**

Description: Refer to explanation of AFD - message.

Issued by DAYFILE.

User Action: None.

### **DFT BUFFER TOO LARGE.**

Description: The size of the DFT buffer, as passed by CTI, is larger than 7777(8) words.

Issued by SET.

User Action: Ensure the correct CIP is installed. Otherwise, inform CYBER Software Support.

### **DFTERM ABORTED.**

Description: An error exit caused DFTERM to abort.

Issued by DFTERM.

User Action: Check the dayfile for more information.

### **Dleee, Uuu,PS=ssssss.**

Description: Refer to EQeee, Uuu,PS=ssssss.

Issued by OPI.

User Action: None.

### **DIRECT ACCESS FILE ERROR.**

Description: The system sector for the file contains incorrect data or cannot be read.

Issued by PFM.

User Action: Inform site analyst. If many of these errors occur, the site analyst should perform a full PFDUMP, total INITIALIZE, and full PFLOAD on the device.

### **DIRECT CPU INPUT.**

Description: DIS is in direct CPU input mode. All data entered from the keyboard will be passed directly to the job step.

Issued by DIS.

User Action: None.

### **number DIRECT FILES SKIPPED WITH ERRORS.**

### **number FILES WITH LENGTH ERRORS.**

### **number DIRECT ACCESS FILES DUMPED.**

### **number INDIRECT ACCESS FILES DUMPED.**

### **number DUMPED FILES PURGED.**

### **number DUMPED FILES NOT PURGED.**

Description: This listing of six messages gives the number of files of each type that were found and dumped.

Issued by PFDUMP.

User Action: None.

### **DIRECTIVE ARGUMENT ERROR.**

Description: RECLAIM detected a syntax error in an input directive.

Issued by RECLAIM.

User Action: Correct the syntax and retry.

### **DIRECTIVE ARGUMENT ERROR.**

Description: GENPFDD detected an error in an input directive. This could be a bad separator, an incorrect value, too many values, etc.

Issued by GENPFDD.

User Action: Correct the error and retry the GENPFDD run.

### **DIRECTIVE CONTAINS AN INCORRECT DATE/TIME.**

Description: A directive contains an unrecognizable date/time.

Issued by DMREC.

User Action: Correct the directive and rerun.

### **DIRECTIVE ERROR - REPORT ONLY.**

Description: Syntax error on SSMOVE input file. No file processing occurs.

Issued by SSMOVE.

User Action: Correct input directives.

### **DIRECTIVE ERRORS.**

Description: Dayfile message indicating that one or more input directives were in error.

Issued by MODIFY.

User Action: Examine output file to determine reason for error.

### **DIRECTIVE ERRORS.**

Description: Dayfile message indicating that one or more input directives were in error.

Issued by SYSEDIT.

User Action: Examine the output file to determine the reason for the error.

### **DIRECTIVE ERRORS.**

Description: Dayfile message indicating that one or more input directives were in error.

Issued by PROFILE.

User Action: Examine the output file to determine the reason for the error.

### **DIRECTIVE FILE ~~xxxxxxx~~ EMPTY.**

Description: The directive file specified as the default directive file via the I parameter is an empty file.

Issued by NDA.

User Action: Correct error and try again.

### **DIRECTIVE FORMAT ERROR.**

Description: Error in one or more directive parameter formats.

Issued by DMREC.

User Action: Correct directive and rerun.

### **DIRECTIVE KEYWORD NOT VALID.**

Description: The wrong delimiter on the directive parameter was used or the directive keyword is not valid.

Issued by DMREC.

User Action: Correct directive and rerun.

### **DIRECTIVE NOT ALLOWED.**

Description: A skip command was entered when \*SS\* or \*HELP\* data was displayed, or L-display format was in octal mode.

Issued by QDSPLAY.

User Action: Enter a different directive.

### **\*\*\*\* DIRECTIVE NOT AUTHORIZED.**

Description: The user must be either a special accounting user or from system origin to issue this directive.

Issued by PROFILE.

User Action: None.

### **DIRECTIVE NOT MEANINGFUL.**

Description: The ALLMEM, CB, CBW, MPP, or PMS directive for the DSDI command has no meaning for this dump.

Issued by DSDI.

User Action: Remove the directive.

### **DIRECTIVE NOT PRECEDED BY EDIT DIRECTIVE.**

Description: This directive must be preceded by an edit directive.

Issued by DMREC.

User Action: Include an edit directive.

### **DIRECTIVE PARAMETER ERROR.**

Description: Output file message indicating that an error was detected in a directive parameter.

Issued by DSDI.

User Action: Correct and rerun.

### **DIRECTIVE RESTRICTED TO PRINTER OUTPUT.**

Description: Output file message indicating that the directive entered produces output which cannot be listed at a terminal.

Issued by DSDI.

User Action: Assign the output to an alternate output file for later printing at a line printer (refer to the description of the OUTPUT directive).

### **DIRECTIVE RESTRICTED TO TERMINAL OUTPUT.**

Description: Output file message indicating that the directive entered produces output which must be listed at a terminal.

Issued by DSDI.

User Action: Use directive from terminal.

### **DIRECTIVE SHOULD HAVE NO PARAMETERS.**

Description: Output file message indicating that a directive entered with parameters should not have parameters.

Issued by DSDI.

User Action: Correct and rerun.

### **DIRECTIVE TRUNCATED**

Description: One of the directives on the input file was too long, and was truncated.

Issued by BINEDIT.

User Action: Correct input file and retry.

### **DIRECTORY FILE BUSY.**

Description: The desired directory file is currently in use.

Issued by NETFMA.

User Action: Inform site analyst.

### **DIRECTORY FILE ENTRY MISSING.**

Description: The permanent boot file in the -NETDIR- was not found.

Issued by NETFMA.

User Action: Inform site analyst.

### **DIRECTORY FILE IS BAD.**

Description: There is a problem with the contents of the directory file.

Issued by NETFMA.

User Action: Inform site analyst.

### **DIRECTORY FILE NOT FOUND.**

Description: The directory file was not found.

Issued by NETFMA.

User Action: Inform site analyst.

### **DIRECTORY HEADER FROM THE COPY.**

Description: Informative message.

Issued by DMREC.

User Action: None.

### **DIRECTORY NOT OPEN - NETFM ERROR.**

Description: NETDIR was not open due to an internal error.

Issued by NETFMA.

User Action: Inform site analyst.

### **DIRECTORY TABLE BAD.**

Description: Dayfile message indicating that an EOR or EOF was encountered while the random file directory, which was created by the D option, was being read.

Issued by DSDI.

User Action: Ensure that the dump file contains meaningful information.

### **DIRECTORY UNUSABLE**

Description: Attempt to reconstruct the directory failed.

Issued by DMREC.

User Action: Check the output for the detailed error message.

### **nnnn DISABLED ROLLOUT FILES RECOVERED.**

Description: nnnn jobs that were in a disabled job state have been recovered.

Issued by REC.

User Action: None.

### **DISK ADDRESS NOT ON CHAIN.**

Description: The track and sector specified in the catalog entry was not on the IAPF chain.

Issued by PACKER.

User Action: The IAPF chain on the device in question may have been corrupted. Either have an analyst repair the damage with DDF (if that is possible), or perform a full PFDUMP, deadstart INITIALIZE, and full PFLOAD.

### **DISK BUSY.**

Description: System activity prevents DIS from completing the command last entered.

Issued by DIS.

User Action: Retry.

### **DISK BUSY.**

Description: System device is busy. DSD cannot complete the loading of an overlay.

Issued by DSD.

User Action: None. If message persists, however, inform the site analyst.

### **DISK CONTROLLER RESERVED.**

Description: Disk controller currently busy, waiting to access controller.

Issued by CTI.

User Action: None.

### **DISK FILE ERROR.**

Description: SSEXEC encountered a write error on a file.

Issued by SSDEBUG.

User Action: Retry using a different file name.

### **DISK READ ERROR INFORM CE**

Description: The system was unable to read from a disk before the retry counter exceeded its limit.

Issued by CTI.

User Action: Inform site analyst.

### **DISK STATUS ERROR STATUS = xxxx**

Description: The general status word xxxx received from the disk indicates an error condition exists.

Issued by CTI.

User Action: Press the carriage return key to retry the operation.

### **DISK UNIT RESERVED.**

Description: Disk unit currently busy, waiting to access unit.

Issued by CTI.

User Action: None.

### **DISPLAY SPACE UNAVAILABLE FOR ADDITIONAL ERRORS**

Description: S/C or maintenance register error.

Issued by CTI.

User Action: Inform C.E.

### **DJeee, Uuu,PS=ssssss.**

Description: Refer to EQeee, Uuu,PS=ssssss.

Issued by OPI.

User Action: None.

### **DKeee, Uuu,PS=ssssss.**

Description: Refer to EQeee, Uuu,PS=ssssss.

Issued by OPI.

User Action: None.

### **DLest, NO FT CONTROLLER.**

Description: The equipment with EST ordinal est has been defined as a full track 844-41/44 disk but there is no 7154 full track controller present.

Issued by STL.

User Action: If a full track controller is not present, redefine the device as a half track device. If a full track controller is actually present but not detected, ensure the correct controlware is specified on the LBC CMRDECK entry.

### **DLeee, Uuu,PS=ssssss.**

Description: Refer to EQeee, Uuu,PS=ssssss.

Issued by OPI.

User Action: None.

**DMest, Uuu,PS=ssssss.**

Description: Refer to EQest, Uuu,PS=ssssss.

Issued by OPI.

User Action: None.

**DMB FILE FORMAT ERROR.**

Description: The file being analyzed with the DMB parameter present is not in the correct format.

Issued by DSDI.

User Action: Ensure that the dump file contains meaningful information.

**DMPNAD ABORTED - CHANNEL NUMBER INVALID OR MISSING**

Description: A NAD dump requires CH=nn where nn is an octal number (0-13 or 20-33).

Issued by DMPNAD.

User Action: Correct command and retry.

**DMPNAD ABORTED - CVL ERROR CODE = nnB.**

Description: CVL did not allow the calling program to access the specified NAD. nnB is the CVL response code explaining why access was not granted.

Issued by DMPNAD.

User Action: Wait a few seconds and retry. If the same error occurs, inform site analyst.

**DMPNAD ABORTED - EQUIVALENCE MISSING.**

Description: The AC, CH, LT, and ND parameters must be followed by an equivalence character.

Issued by DMPNAD.

User Action: Correct command and retry.

**DMPNAD ABORTED - FILE NAME CONFLICT.**

Description: The B, I, and L parameters must have unique file names when used at the same time.

Issued by DMPNAD.

User Action: Correct command and retry.

**DMPNAD ABORTED - ILLEGAL CHANNEL NUMBER.**

Description: Channel number must be 0 to 13B inclusive or 20B to 33B inclusive.

Issued by DMPNAD.

User Action: Correct channel number and retry.

**DMPNAD ABORTED - ILLEGAL DIRECTIVE NAME.**

Description: Only AC, B, CH, I, L, LT, and ND are valid parameters for DMPNAD.

Issued by DMPNAD.

User Action: Correct command and retry.

**DMPNAD ABORTED - INVALID ACCESS CODE.**

Description: Command contained an AC=aaaa, where aaaa was not a valid hexadecimal number.

Issued by DMPNAD.

User Action: Correct access code and retry.



### **DMPNAD ABORTED - INVALID NAD ADDRESS.**

Description: Command contained an ND=nn, where nn was not a valid hexadecimal number.

Issued by DMPNAD.

User Action: Correct NAD address and retry.

### **DMPNAD ABORTED - INVALID TRUNK ENABLES.**

Description: Command contained an LT=tttt, where tttt was not a valid binary number.

Issued by DMPNAD.

User Action: Correct command and retry.

### **DMPNAD ABORTED - MORE THAN 10 CHARACTERS IN NAME.**

Description: DMPNAD command parameters must not exceed ten characters.

Issued by DMPNAD.

User Action: Correct command and retry.

### **DMPNAD ABORTED - NAD ADDRESS INVALID OR MISSING**

Description: A remote NAD dump requires ND=nn where nn must be a hexadecimal number.

Issued by DMPNAD.

User Action: Correct command and retry.

### **DMPNAD ABORTED - NLD ERROR CODE = nnB.**

Description: NLD was unable to dump the specified NAD. nnB is the NLD response code explaining why the NAD was not dumped.

Issued by DMPNAD.

User Action: Make sure the command is correct. Inform site analyst if the correct NAD information had been entered.

### **DMPNAD ABORTED - NUMERIC FIELD MUST NOT BE BLANK.**

Description: DMPNAD expects a numeric value to follow the equivalence sign for the AC, CH, LT, and ND parameters.

Issued by DMPNAD.

User Action: Correct command and retry.

### **DMPNAD ABORTED - TRUNK ENABLES INVALID OR MISSING.**

Description: A remote NAD dump requires LT=tttt, where tttt must be a binary number (t = 0 or 1).

Issued by DMPNAD.

User Action: Correct command and retry.

### **DMPNAD ABORTED - 8/9 NOT ALLOWED IN OCTAL FIELD.**

Description: Self explanatory.

Issued by DMPNAD.

User Action: Correct command and retry.

### **DMPNAD COMPLETE.**

Description: Informative message indicating that DMPNAD was successful in dumping the requested NAD.

Issued by DMPNAD.

User Action: None.

### **DMPNAD DUMPING REMOTE NAD xx - GO/DROP.**

Description: Informative message indicating that NAD is about to be dumped.

Issued by DMPNAD.

User Action: If correct NAD, type GO,jsn to dump the NAD. If incorrect NAD, type DROP,jsn, correct the command and retry.

### **DMREC COMPLETE.**

Description: Informative message. The output file may contain other informative messages and should be reviewed.

Issued by DMREC.

User Action: None.

### **DMREC FAILED - xxxxxxxx zz.**

Description: The DMREC job submitted by TAF failed. xxxxxxxx is the directive being processed, and zz is the database name.

Issued by DMREC.

User Action: Notify the database administrator and correct as directed.

### **DMREC TAPE LABEL ERROR.**

Description: No tape header was found on ARF to be used for an update function.

Issued by DMREC.

User Action: Check for correct ARF tape. Use alternate ARF tape if available.

### **DN CANNOT BE ZERO.**

Description: DN=0 was entered to clear a duplicate device number error. The device number (DN) cannot be zero for a family type device.

Issued by MSI.

User Action: Enter a nonzero value to continue or enter GO to override the error.

### **DN = DD, FILE TRACK COUNT = NNNN.**

Description: For device DD, specified via an RL directive, files representing the equivalent of NNNN tracks were selected.

Issued by GENPFD.

User Action: None.

### **DNdn FM familyname FNT/QFT FULL.**

Description: The FNT or QFT was filled while recovering the specified device.

dn	Device number.
familyname	Family name.

Issued by QREC.

User Action: Retry at a later time when the system is not as busy.

### **DNdn FM familyname IGNORE - UNAVAILABLE.**

Description: The device is removable and has been unloaded.

Issued by QREC.

User Action: Ignore the message or mount the device and repeat the request.

### **DNdn, FM familyname IGNORED - ERROR IDLE.**

Description: Informative message indicating that queues on the specified device were not processed because the device had an error idle status.

dn                    Device number.  
familyname        Family name.

Issued by QREC.

User Action: None.

### **DNdn FM familyname IGNORED - REMOVABLE.**

Description: Informative message indicating that queues on the specified device were not processed because the device is removable.

dn                    Device number.  
familyname        Family name.

Issued by QREC.

User Action: None.

### **DNdn FM familyname INCORRECT ACCESS LEVEL.**

Description: The job doing the QREC is not validated for the access level of the device.

dn                    Device number.  
familyname        Family name.

Issued by QREC.

User Action: Run with matching access level.

### **DNdn FM familyname IQFT INTERLOCKED.**

Description: The track interlock on the IQFT file is set. It is possible IQFT is currently being used by another utility.

dn                    Device number.  
familyname        Family name.

Issued by QREC.

User Action: Retry at a later time.

### **DNdn FM familyname MS ERROR.**

Description: A mass storage error occurred while processing the IQFT file on the specified device.

dn                    Device number.  
familyname        Family name.

Issued by QREC.

User Action: Run HPA to obtain more information about the mass storage error.

### **DNdn FM familyname NO IQFT FILE.**

Description: Informative message indicating that no IQFT file exists for the specified device.

dn                    Device number.  
familyname        Family name.

Issued by QREC.

User Action: None.

### **DNdn FM familyname UNDEFINED ERROR.**

Description: System failure has occurred generating an erroneous error code.

dn                    Device number.  
familyname        Family name.

Issued by QREC.

User Action: Contact CYBER Software Support.

### **DNest, Uuu,PS=ssssss.**

Description: Refer to EQest, Uuu,PS=ssssss.

Issued by 1XD.

User Action: None.

### **DOWN.**

Description: BIO equipment is down.

Issued by 1IO.

User Action: None.

### **DOWN.**

Description: I-display message. Device is DOWN and OFF in the est.

Issued by 1CD.

User Action: Enter ON,EQ=xxx to turn the device on.

### **DOWNLINE BLOCK LIMIT (DBL) TOO SMALL**

Description: The message indicates that the DBL specified in the NDL source for a 533/536 printer is less than 2.

Issued by PSU.

User Action: Notify site analyst. Correct the NDL source and recompile.

### **DQest, Uuu,PS=ssssss.**

Description: Refer to EQest, Uuu,PS=ssssss.

Issued by OPI.

User Action: None.

### **DQest, 2X PPS REQUIRED.**

Description: The equipment with EST ordinal est requires 2X PPs but 2X PPs do not exist.

Issued by STL.

User Action: Redefine the device as a half track device.

### **DRD LOAD ERROR**

Description: The DRD will not load a cartridge.

Issued by SSEXEC.

User Action: Inform site analyst.

### **DRD UNLOAD ERROR**

Description: The DRD will not unload a cartridge.

Issued by SSEXEC.

User Action: Inform site analyst.

### **DRIVE TYPE CONFLICT.**

Description: A tape with 1600 cpi density is mounted on magnetic tape unit NTnnn but actual assignment of the tape to unit est would result in a resource deadlock for the job.

Issued by RESEX.

User Action: Unload the tape and mount it on a unit with opposite density (that is, if the tape is on an 800/1600 cpi unit, mount it on a 1600/6250 cpi unit).

### **DRIVER STACK OVERFLOW.**

Description: Space sufficient to allocate the required stack area was not available. An internal change to IAF is necessary.

Issued by IAFEX.

User Action: Contact CYBER Software Support.

### **DROP IGNORED.**

Description: K display message indicating that a K.DROP command was attempted but could not be performed because of one of the following:

- The task was in recall.
- The command was attempted during the initial load of the task.

Issued by TAF.

User Action: Reenter the K.DROP command. When recall operation, time-sharing request, or initial load is complete, the command will be accepted and the task will abort.

### **DROP PROCESSED.**

Description: A DROP command was entered via L-display. The file has been removed from the queue and the utility has terminated.

Issued by QDSPLAY.

User Action: None.

### **DSDI ARGUMENT ERROR.**

Description: Dayfile message indicating that an unknown keyword was encountered on the DSDI command.

Issued by DSDI.

User Action: Correct and rerun.

### **DSDI ERROR LIMIT EXCEEDED.**

Description: Dayfile message indicating that more than 50 errors were detected.

Issued by DSDI.

User Action: Examine output file for specific errors.

### **DT AND OP=P CONFLICT.**

Description: The DT (destage dump) option and the OP=P (purge after dump) option were both specified.

Issued by PFDUMP.

User Action: Specify DT or OP=P but not both.

### **DT AND OP=P CONFLICT.**

Description: The purge option cannot be used with the destage option.

Issued by PFS.

User Action: Correct and retry.

### **DT AND OP=Z CONFLICT.**

Description: The DT (destage dump) option and the OP=Z (zero alternate storage) option were both specified.

Issued by PFDUMP.

User Action: Specify DT or OP=Z but not both.

### **DT AND PN CONFLICT.**

Description: The destage option cannot be used with PN specified.

Issued by PFS.

User Action: Correct and retry.

### **DT = TTT, FILE TRACK COUNT = NNNN.**

Description: For device type TTT, specified via an RL directive, files representing the equivalent of NNNN tracks were selected.

Issued by GENPFD.

User Action: None.

### **DUAL RECORDED FILE *filenam* NOT ATTACHED.**

Description: The user has neglected to attach file *filenam*.

Issued by TAF.

User Action: Batch data manager users must attach all data files.

### ***npuname*, DUMP ABORTED - ABNORMAL RESPONSE.**

Description: NS aborted the dump of the NPU because it had received an error response from the SAM program while it was trying to load the dump bootstrap program into the NPU. The dump bootstrap program is a program which is loaded into the NPU after macromemory has been dumped. The program, whose function is to copy micromemory into macromemory so micromemory can be dumped, is executed after it is loaded. For the load of this program to fail, there was either a hardware problem with the NPU that was being dumped or an error in the network load file (NLF).

Issued by NS.

User Action: The NPU should be checked to make sure there is nothing wrong with the coupler or memory. (Refer to the CCP Diagnostic Handbook for information on how to run NPU diagnostics.) If the NPU is a remote NPU, then the trunk should also be checked. The NLF file should also be checked to make sure it was built correctly for this NPU.

### ***npuname*, DUMP ABORTED - BAD DPCB.**

Description: NS aborted the dump of the NPU because it had detected an error in the network load file (NLF). For each NPU that NS can dump, there is a dump procedure control block (DPCB) in the NLF. The DPCB for the NPU that NS is trying to dump had a bad header.

Issued by NS.

User Action: The NLF file should be checked to make sure that it was built correctly for the NPU that NS is trying to dump.

### ***npuname*, DUMP ABORTED - BAD LOAD MODULE.**

Description: NS aborted the dump of the NPU because it had detected an error in the network load file (NLF). For each NPU that NS can dump, there is a dump bootstrap program in the NLF. This program, whose function is to copy micromemory into macromemory so micromemory can be dumped, is read from the NLF and loaded into the NPU. NS detected an error while it was reading the dump bootstrap program for the NPU that was being dumped.

Issued by NS.

User Action: None.

### **npuname, DUMP ABORTED - BAD PICB DIRECTIVE.**

Description: NS aborted the dump of the NPU because it had detected an error in the network load file (NLF). For each NPU that NS can dump, there is a program initiation control block (PICB) in the NLF. This PICB contains directives for NS to follow. NS has found too many bad directives in the PICB for the NPU that was being dumped.

Issued by NS.

User Action: The NLF file should be checked to make sure that it was built correctly for the NPU that NS is trying to dump.

### **npuname, DUMP ABORTED - DUMP INDEX FULL.**

Description: NS aborted the dump of the NPU because it could not create a permanent file for saving the NPU dump. This is because NS has already dumped the NPUs connected to this host 256 times under the current network.

Issued by NS.

User Action: To allow more NPU dumps, some of the existing NPU dump files must be purged. These files have permanent file names with the naming convention NPxxxx where xx is a 2-character hexadecimal string ranging in value from 00 to FF, and yyy is the current NAM invocation number. The files will be under the user name NETOPS.

### **npuname, DUMP ABORTED - LOAD MOD NOT FOUND.**

Description: NS aborted the dump of the NPU because it had detected an error in the network load file (NLF). For each NPU that NS can dump, there is a dump bootstrap program in the NLF. This program, whose function is to copy micromemory into macromemory so micromemory can be dumped, is read from the NLF and loaded into the NPU. NS could not find the dump bootstrap program in the NLF for the NPU that was being dumped.

Issued by NS.

User Action: The NLF file should be checked to make sure that it was built correctly for the NPU that NS is trying to dump.

### **npuname, DUMP ABORTED - PREEMPTED.**

Description: NS aborted the dump of the NPU because it has received another initialization request from the SAM program or from PIP for the NPU that it was currently trying to dump. There was probably a hardware problem with the NPU that was being dumped.

Issued by NS.

User Action: If the NPU has two couplers, ensure that the SAM attribute is declared in the EST entry for at least one of the couplers. The NPU should be checked to make sure there is nothing wrong with the coupler or memory. (Refer to the CCP Diagnostic Handbook for information on how to run NPU diagnostics.) If the NPU is a remote NPU, then the trunk should also be checked.

### **npuname, DUMP ABORTED - RETRY LIMIT.**

Description: NS aborted the dump of the network dump control block (NDCB) or the dump of the entire NPU, because it was getting too many error responses from the SAM program. If the SAM program returns an error response to either the dump or start request, NS will reissue the request two more times. If after the third request, NS still gets an error response, then NS gives up trying to dump the NPU and this alert condition is issued. There was probably a hardware problem with the NPU that was being dumped.

Issued by NS.

User Action: The NPU should be checked to make sure there is nothing wrong with the coupler or memory. (Refer to the CCP Diagnostic Handbook for information on how to run NPU diagnostics.) If the NPU is a remote NPU, then the trunk should also be checked.

### **npuname, DUMP ABORTED - TIMEOUT.**

Description: NS aborted the dump of the network dump control block (NDCB) or the dump of the entire NPU because it had not received a response from the SAM program. If this response is not received by NS, then NS gives up trying to load the NPU and this alert condition is issued.

Issued by NS.

User Action: There is either a hardware problem with the NPU or with the SAM program that was loaded into the NPU. If SAM was loaded from cassette, the cassette tape and tape drive should be checked. If the SAM program was loaded by the host, then the network load file (NLF) should be checked to make sure it was built correctly. The NPU may also be checked to make sure there is nothing wrong with the coupler or memory. (Refer to the CCP Diagnostic Handbook for information on how to run NPU diagnostics.) If the NPU is a remote NPU, then the trunk should also be checked.

### **DUMP BUFFER ARGUMENT ERROR.**

Description: LOADBC DUMP FET contained incorrect buffer pointer.

Issued by LOADBC.

User Action: Write a PSR.

### **DUMP COMPLETE.**

Description: Informative message indicating the completion of the dump utility.

Issued by DMPCCC.

User Action: None.

### **DUMP COMPLETE - xx est, RC = rr, FN = ddddddd.**

Description: Device xx at EST ordinal est has been dumped. The reset code is equal to rr. Dump file name is ddddddd.

Issued by INITMDI.

User Action: None.

### **DUMP FILE CONTAINS 63 DUMPS. FILE IS FULL.**

Description: In response to a DUMP or COMPACT operation, RECLAIM has determined that the dump file already contains the maximum allowable number of dumps; this directive is ignored.

Issued by RECLAIM.

User Action: Compress the current dump file using the COMPACT directive or use a new tape.

### **DUMP FILE dumpfile EMPTY**

Description: The NPU dump file specified via the NDF parameter or the default NPU dump file NDF is an empty file.

Issued by NDA.

User Action: Correct error and try again.

### **DUMP FILE MALFUNCTION-EOI ENCOUNTERED.**

Description: An EOI was encountered before the specified dump file or record was found; the tape has probably been overwritten.

Issued by RECLAIM.

User Action: Check the contents of the dump file tape.

### **DUMP FILE MALFUNCTION-FILE NAME MISMATCH.**

Description: The specified file name does not match the file name found at the specified position on the dump tape; the tape has probably been overwritten.



Issued by RECLAIM.

User Action: Check the contents of the dump tape.

### **DUMP FILE MALFUNCTION-POSITION LOST.**

Description: RECLAIM system error.

Issued by RECLAIM.

User Action: Inform site analyst.

### **DUMP FILE MALFUNCTION-UNRECOGNIZABLE PFC.**

Description: The PFC for the dumped file is incorrect; either the tape is bad or has been overwritten.

Issued by RECLAIM.

User Action: Check the contents of the tape.

### **DUMP FILE MUST BE IN WRITE MODE**

Description: A DUMP or COMPACT was attempted using a mass storage dump file which was attached in some mode other than WRITE mode.

Issued by RECLAIM.

User Action: Attach the dump file in WRITE mode and retry.

### **DUMP FILE NOT FOUND**

Description: A LOAD or COPY was attempted and the mass storage dump file indicated by the data base could not be found. The file may have been purged or may never have been made permanent.

Issued by RECLAIM.

User Action: Check your options. If they are correct, you may have to load your files from an alternate source. Check with your site analyst.

### **DUMP MEMORY ERROR - xx est.**

Description: A memory error on the specified device caused a premature termination of the dump process. The dump file will contain data up to the data unit containing the error.

xx Device mnemonic specified by the DT parameter.

est EST ordinal of MDI.

Issued by INITMDI.

User Action: Inform site analyst.

### **DUMP NN COMPLETE.**

Description: Operator message indicating dump complete.

Issued by EDD.

User Action: None.

### **DUMP NN STOPPED.**

Description: The operator has chosen to terminate the dump process because an error has been encountered.

Issued by EDD.

User Action: None.

### **DUMP NOT ALLOWED OF RESERVED FILE NAME filename.**

Description: An attempt was made to dump a local file with the same name as a RECLAIM scratch file, dump file, INPUT, or OUTPUT.

Issued by RECLAIM.

User Action: Retry using a different local file name.

**DUMP TAPE ON CHII EQ JJ UN KK  
NOT READY (CR WHEN READY).**

Description: Operator message indicating the tape unit is not ready.

Issued by EDD.

User Action: Make the tape unit ready to continue.

**DUMP TAPE ON CHII EQ JJ UN KK  
NO WRITE RING (CR WHEN READY).**

Description: Operator message indicating there is no write ring on the tape.

Issued by EDD.

User Action: Insert a write ring onto the tape.

**DUMP TAPE SPECIFIES NON-STANDARD COMPRESSION.**

Description: When trying to reload a record formatted dump tape, the compression mode was nonstandard.

Issued by DMREC.

User Action: Try loading from a previous dump tape and inform the data base administrator.

**DUMP TAPE THRESHOLD NOT REACHED.**

Description: Too few files qualified for selection to fill a dump tape of the specified or default density to the minimum length as determined by the specified or default DT value.

Issued by GENPFD.

User Action: It is desirable to proceed even though the criteria specified cannot be met, reduce the DT value and retry the GENPFD run.

**nnnnnn DUMPED FILES DESTAGED.**

Description: The tape alternate storage pointers for the indicated number of dumped files were updated successfully.

Issued by PFDUMP.

User Action: None.

**nnnnnn DUMPED FILES NOT DESTAGED.**

Description: The tape alternate storage pointers for the indicated number of dumped files were not updated. This usually means that a user accessed the file in a mode that obsoleted the version of the file data dumped to tape.

Issued by PFDUMP.

User Action: None.

**DUMPING filename userindex.**

Description: Informative message indicating the name of the file being dumped and the user index under which the file is stored.

Issued by PFDUMP.

User Action: None.

**DUMPING CENTRAL MEMORY.**

Description: During IAF termination, the EJT table is written from central to the IAF dump file along with IAF's field length.

Issued by IAFEX.

User Action: None.

### **DUMPS LOST**

Description: K display message indicating that requests to dump the field length of the transaction facility have been ignored because the global task dump limit (GTDL) is not greater than zero.

Issued by TAF.

User Action: Refer to the TAF K.DUMPLIM command; this command should be used only under the direction of the central site TAF systems analyst.

### **DUPLICATE BITS IN MASK.**

Description: Device mask for the family has duplicate bits set. This destroys the integrity of the permanent file system by creating an ambiguous mapping of user indexes.

Issued by MSI.

User Action: Correct and enter GO or enter GO to override. This is the only input accepted at this time.

### **\*\*\*\* DUPLICATE CHARGE NUMBER.**

Description: An existing charge number was referenced on a create run.

Issued by PROFILE.

User Action: Rerun using correct charge number, if required.

### **DUPLICATE CLA ADDRESS.**

Description: Line number lineno has been found to have a CLA address in use by another line on the NPU.

Issued by CS.

User Action: Inform site analyst.

### **DUPLICATE CONTROL STATEMENT PARAMETER.**

Description: Command parameter was specified more than once.

Issued by RBF.

User Action: Correct RBF2P0 command to specify the parameter only once.

### **DUPLICATE DATA BASE IN TCF - xx.**

Description: Active database identifier xx in the TCF is not unique.

Issued by TAF.

User Action: Fix TCF so that xx appears only once among active (ON) DMS statements.

### **DUPLICATE DN.**

Description: Device number specified is the same as that specified for another device in the family.

Issued by MSI.

User Action: Correct and enter GO or enter GO to override. This is the only input accepted at this time.

### **DUPLICATE DUMP ENTRY ON ADD.**

Description: When trying to add a file dump entry to the directory with an add directive, a duplicate entry was found.

Issued by DMREC.

User Action: List the directory for visual check and try again.

### **DUPLICATE ENTRY ON ADD.**

Description: When trying to modify the directory, a duplicate of the entry was found.

Issued by DMREC.

User Action: List the directory and check for the needed entry.

### **DUPLICATE FILE NAME.**

Description: Dayfile message indicating that when QFM tried to attach an inactive queue file to the control point, a file by the same name was already assigned.

Issued by QFM.

User Action: Rename or return the file with the conflicting name.

### **DUPLICATE FILE NAME ERROR.**

Description: The files for input and output have the same name.

Issued by PROBE.

User Action: Change and retry.

### **DUPLICATE FILE NAME - FILE IGNORED.**

Description: QFM has detected a duplicate file name on the source device.

Issued by QDUMP.

User Action: Check device and change one file name, then retry.

### **DUPLICATE LFN `xxxx`**

Description: The same file name, `xxxx`, has been specified for more than one parameter.

Issued by BINEDIT.

User Action: Specify unique file names for each parameter.

### **DUPLICATE NETON REQUEST**

Description: Two NETON requests were made for the same application without an intervening NETOFF request.

Issued by RHF.

User Action: Remove the duplicate NETON or add a NETOFF request.

### **DUPLICATE OPTION.**

Description: The same report is indicated more than once on the OP parameter.

Issued by SSUSE.

User Action: Correct the OP parameter.

### **DUPLICATE PARAMETER.**

Description: A duplicate VSN or duplicate file name was detected on a single directive.

Issued by DMREC.

User Action: Correct directive and rerun.

### **DUPLICATE PARAMETER `xxxx`**

Description: Parameter `xxxx` has been specified more than once.

Issued by BINEDIT.

User Action: Correct and dretry.

## **DUPLICATE PN.**

Description: Another pack in the system has the same name.

Issued by MSI.

User Action: Change the pack name or remove the other device from the system.

## **\*\*\*\* DUPLICATE PROJECT NUMBER.**

Description: An existing project number was referenced on a create run.

Issued by PROFILE.

User Action: Rerun using correct project number, if required.

## **\*\*DUPLICATE SB SUBFAMILY.**

Description: The same subfamily is indicated more than once on the SB parameter.

Issued by SSUSE.

User Action: Correct the SB parameter.

## **DUPLICATE SM.**

Description: There was a duplicate SM parameter in a directive to SSDEDBUG.

Issued by SSUSE.

User Action: Correct SM parameter and retry.

## **\*\*DUPLICATE SM PARAMETER.**

Description: The same SM is indicated more than once on the SM parameter.

Issued by SSVAL.

User Action: Correct the SM parameter.

## **\*\*\*\* DUPLICATE USER NAME.**

Description: The user name has already been created by a previous directive in the same create run.

Issued by PROFILE.

User Action: Correct the input directives.

## **DUPLICATE VSN ENTRY ON ADD.**

Description: When trying to add a VSN entry to the directory with an add directive, a duplicate entry was found.

Issued by DMREC.

User Action: List the directory for visual check and try again.

## **DUPLICATED VCB REQUEST.**

Description: For debug only. Duplicate request to read a VCB (validation control block) entry. The message is issued by NVF procedure NVFVRVF.

Issued by NVF.

User Action: Contact CYBER Software Support.

## **DURATION TIME TERMINATE.**

Description: Time-sharing subsystem has aborted in less than 60 seconds after initialization or last recovery.

Issued by IAFEX.

User Action: Contact CYBER Software Support.

### **DXB CONVERSION ERROR - TRANSACTION SEQUENCE NUMBER.**

Description: An error occurred while converting the number in the table entry to binary.

Issued by DMREC.

User Action: Inform database administrator.

### **ECS ERROR.**

Description: An extended core storage (extended memory) hardware error has occurred.

Issued by SCE.

User Action: Inform site analyst and customer engineer.

### **\*ECSM\* ERROR CLEARING USER XM.**

Description: A hardware error occurred while attempting to clear extended memory.

Issued by REC.

User Action: Inform customer engineer.

### **ED, filename/userindex/length/code.**

Description: ED denotes MSE end of staging operation for file filename and user index userindex. The file length is specified in PRUs. The following return codes are valid:

Code	Description
0	No errors.
1	No space available
2	No storage module available
3	No cartridge or group available
4	File has a different alternate storage address (asa)
5	Permanent file error or destage abandoned
6	Catalog access error
7	Cartridge overflow not permitted
10	Group full
11	Disk read error
12	Cartridge lost
13	SSEXEC closed to destage

Issued by SSEXEC.

User Action: Self explanatory. If the problem persists, inform a knowledgeable person at your site.

### **EDITING COMPLETE.**

Description: Informative message.

Issued by DMREC.

User Action: None.

### **EI, nn yymmdd.**

Description: EI revision level nn loaded on lower 800 series mainframe. yymmdd is the year-month-date that EI was generated.

Issued by REC.

User Action: None.

### **EI MISMATCH, nn**

Description: EI that was loaded on a level 1, 2, or 3 deadstart does not compare with that loaded on the level 0 deadstart.

nn The 2-character EI name

Issued by REC.

User Action: Deadstart using EI nn.

### **EJT ENTRY BUSY.**

Description: The EJT entry specified on an ENPR command cannot be interlocked.

Issued by DSD.

User Action: Retry command. If message persists, inform the site analyst.

### **EJT SYSTEM REQUEST ERROR xxxx, JSN=jsn, TN=nn.**

Description: Attempt to detach job jsn during IAF termination failed due to error xxxx. The connection number was nn. The job will remain in the system until deadstart and will not be recoverable.

Issued by IAFEX.

User Action: Write a PSR and include this dayfile message and an express deadstart dump. The dump can be taken at the end of the day; the job will still be there.

### **ELBP OUT OF RANGE**

Description: The external bootstrap loader parameter (ELBP) that determines whether to load the OS, HIVS, or MSL (if present) is out of range.

Issued by CTI.

User Action: Inform site analyst.

### **ELD - message.**

Description: Refer to explanation of AFD - message.

Issued by DAYFILE.

User Action: None.

### **EMPTY FILE xxxx**

Description: The specified local file, xxxx, is empty.

Issued by BINEDIT.

User Action: Correct and retry.

### **EMPTY SESSION FILE.**

Description: Nonfatal K-display message indicating that the session file was empty.

Issued by STIMULA.

User Action: Resupply the correct file name or put data into the file.

### **END est, nn.**

Description: The operator ended batch equipment est for nn copies.

Issued by QAP.

User Action: None.

### **END FORMAT**

Description: Dayfile message indicating tht FORMAT terminated normally.

Issued by FORMAT.

User Action: None.

### **END MASS STORAGE TEST.**

Description: End of test.

Issued by MST.

User Action: None.

### **END OF DAT TRACK CHAIN.**

Description: An attempt to introduce a new shared device into the multimainframe environment failed. The machine which preset extended memory did not reserve enough tracks in the DAT chain. Configuration error status is set by CMS.

Issued by MSM.

User Action: Redeadstart removing some shared equipment from the configuration or preset extended memory to accommodate more shared devices.

### **END OF FILE REACHED.**

Description: Informative message.

Issued by DMREC.

User Action: None.

### **END PROCESSED.**

Description: An END command was entered via L-display. The file has been returned to the queue and the utility has terminated.

Issued by QDSPLAY.

User Action: None.

### **END PROCESSED**

Description: The END command was entered via the L-display and SDSPLAY successfully completed processing.

Issued by SDSPLAY.

User Action: None.

### **END SIMULATOR.**

Description: Dayfile message indicating that the system operator has entered STOP. to drop the simulator.

Issued by SCRSIM.

User Action: None.

### **ENDCPD COMPLETE.**

Description: Informative message indicating that ENDCPD is finished. Completion of ENDCPD does not mean that system monitoring by CPD has been terminated. It means that the CPD drop flag has been set and the next time CPD statuses this flag it will begin its termination process.

Issued by ICPD.

User Action: None.

### **ENDING NETWORK CONNECTION.**

Description: NLTERM is ending the network connection.

Issued by NLTERM.

User Action: None.

### **ENTER CFO COMMAND**

Description: NAMI is awaiting CFO input from the console operator.



Issued by NAMI.

User Action: Enter CFO input.

**ENTER E TO TERMINATE LOADING.  
L TO LIST REMAINING FILES.  
GO TO RESUME INCREMENTAL LOAD.**

Description: This message occurs as a result of a complete load of an archive file during incremental load operations. The message appears at the end of a reel during incremental loading to allow the operator to optionally load additional archive files. If something other than one of the three specified options is entered,

ILLEGAL - REENTER  
OPTION

is issued to the K display.

Issued by PFLOAD.

User Action: Enter E, L, or GO as indicated in the message.

**ENTERED PARAMETER NOT VALID.**

Description: Parameter is not correct for the utility being run.

Issued by PFS.

User Action: Enter correct parameter via the K display.

**ENTRY IGNORED - TABLE FULL.**

Description: No room in CM table for COMLIB entry.

Issued by SET.

User Action: Redeadstart and increase CLT entry value in CMRDECK.

**ENTRY OVERLAP tttt/ssss/o, tttt/ssss/o.**

Description: PACKER has detected an IAPF chain overlap between the two entries whose PFC locations are given (track/sector/PFC ordinal). Note - a value of 0000/0000/0 in the message indicates the IAPF chain EOI.

Issued by PACKER.

User Action: The IAPF chain on the device in question may have been corrupted. Either have an analyst repair the damage with DDF (if that is possible), or perform a full PFDUMP, deadstart INITIALIZE, and full PFLOAD.

**ENVIRONMENT WARNING.**

Description: DFT detected bit 63 in the status summary register for one of the mainframe elements. This bit indicates that there is an abnormal environmental condition present. Refer to appendix E for more information.

Issued by 1MB.

User Action: Verify that the system was able to complete checkpoint. Inform the customer engineer and site analyst.

**(xxx) ENVIRONMENT WARNING**

Description: A long warning condition has been detected in the maintenance resistors for any element.

xxx 701

Issued by 1MB.

User Action: Wait until the message is cleared.

### **EQest Atrack PF RECOVERY ERROR.**

Description: In the recovery of mass storage device est, an unidentified preserved file or preserved file with a system sector error was encountered.

est EST ordinal of device being recovered  
track First track of file

Issued by MSM.

User Action: No action required. You will continue to get the message until the disk pack is initialized or the track is flawed.

### **EQest, ACTIVE FILES, CANNOT INITIALIZE**

Description: Informative message indicating that mass storage device with EST ordinal est has initialize status set but cannot be initialized because permanent files are active on that device. The initialize request will be honored when the active file count reaches zero.

Issued by MSI.

User Action: When active file count reaches zero, REQUEST\*K\*DISPLAY message appears on B display and initialization of device can proceed.

### **EQest Atrack1 Ttrack2 Ssector LINKAGE ERROR.**

Description: A length or linkage error was detected while recovering preserved files on equipment est.

track1 First track of file  
track2 EOI track  
sector EOI sector

Issued by MSM.

User Action: To alter EOI of the file and proceed with recovery, enter  
GO,CMS.

To terminate recovery of the device, enter  
PAUSE,CMS.

If the problem occurs during deadstart, enter  
GO,SYS.

To terminate the device, enter  
PAUSE,SYS.

### **EQest BUSY ON MID=id.**

Description: An attempt has been made to initialize a shared device which is still being accessed by another machine.

est EST ordinal of device  
id Machine ID of mainframe on which device is still active

Issued by IMS.

User Action: Clear initialize request or unload device on mainframe id. If the initialize request is cleared, CMS must be dropped from the control point.

### **EQest,Ccc,link,sec,ann,Stttt,Fqqqq. or EQest,Ccc,link,sec,ann,Stttt,Uunit Cylinder, Strack, sector.**

Description: An error has been detected on mass storage device with EST ordinal EQest. Any of the following device types can appear in place of EQ: DI (half track 844-21 disk), DJ (half track 844-41/44 disk), DK (full

track 844-21 disk), DL (full track 844-41/44 disk), DM (half track 885-11/12 disk), or DQ (full track 885-11/12 disk). The nature of the error is determined by examining each parameter in the message.

est EST ordinal of the disk  
cc Channel number  
link Link code used to associate multiple lines of messages occurring for the same error  
s Error recovery status (one of the following):

blankStatus of error (recovered or unrecovered) has not been determined

R Error has been recovered  
U Error is irrecoverable

ec Error code (one of the following):

CH Channel parity error  
RA 7155 RAM parity error  
RO 7155 ROM error stop  
PE Parity error/checkword error  
AD Address error  
ST Device status error  
FT Function timed out with no response  
RS Device reserved  
CR Controller reserved  
NR Device not ready

a Type of operation (one of the following):

R Read  
W Write

nn Retry count; error is considered irrecoverable after the following number of retries:

CH 10  
RA 0  
RO 0  
PE 10  
AD 10  
ST 64  
FT 3  
RS 64  
CR 64  
NR indefinite

tttt Device status - implies there was an incomplete transfer if status does not indicate an error.  
qqqq Function which timed out  
unit Physical unit cylinder Physical cylinder  
track Physical track  
sector Physical sector

Issued by 1MD.

User Action: Dump error log dayfile to printer (refer to description of X.ELD. command), and make it available to the customer engineer and/or contact CYBER Software Support.

### **EQest CCC/NIP CONTROLWARE LOAD ERROR.**

Description: An error was encountered while trying to load the CCC equipment est.

Issued by 110.

User Action: Inform customer engineer.

**EQest CCC/NIP CONTROLWARE LOADED.**

Description: An informative message indicating that the CCC/NIP controlware has been loaded successfully.

Issued by 110.

User Action: None.

**EQest CCC/NIP CONTROLWARE NOT FOUND.**

Description: The CCC/NIP controlware was not found on the system file.

Issued by 110.

User Action: Inform customer engineer.

**EQest CCC/NIP STATUS ERROR.**

Description: A status of 5xxx was returned from the CCC connected to NIP printer est.

Issued by 110.

User Action: Inform customer engineer.

**EQest, CHcc CONTROLLER HUNG BUSY.**

Description: The specified controller did not drop BUSY status for card punch equipment est.

est EST ordinal of card punch  
cc Channel number

Issued by 110.

User Action: Inform customer engineer.

**EQest,CHcc, CONTROLLER RESERVED.**

Description: Equipment est could not be accessed because the controller was reserved.

est EST ordinal of device  
cc Channel number

Issued by MREC.

User Action: Refer to the NOS 2 Analysis Handbook for possible action. If these actions fail, contact a customer engineer.

**EQest, CHcc Fcode REJ  
Pdriver,Cconvert,Eequip.**

Description: Function reject or transmission parity error was detected on the specified card punch equipment est.

est EST ordinal of card punch  
cc Channel number  
code Function code  
driver Driver (1CD) address convert Converter status  
equip Equipment status

Issued by 110.

User Action: Inform customer engineer.

**EQest, CHcc PRINT ERROR LIMIT EXCEEDED.**

Description: Maximum number of consecutive print errors was detected on line printer.

est EST ordinal of line printer  
cc Channel number

Issued by QAP.

User Action: Inform customer engineer.

### **EQest, CHcc RESERVED.**

Description: The 415 card punch est is reserved and cannot be connected on channel cc.

Issued by IIO.

User Action: Inform customer engineer.

### **EQest, CHcc TURNED OFF BY SYSTEM.**

Description: The specified equipment est was logically turned off (OFF status set in EST). This message is preceded in the error log by a message for the same equipment which specifies the failing condition.

est EST ordinal of equipment.

Issued by IIO.

User Action: Inform customer engineer.

### **EQest CHANNEL PARITY ERROR.**

Description: BIO detected a parity error on the data channel to equipment est.

Issued by QAP.

User Action: Inform customer engineer.

### **EQest CHANNEL PARITY ERROR.**

Description: BIO detected a parity error on the data channel to equipment est.

Issued by 1CD.

User Action: Inform customer engineer.

### **EQxxx, CHECKPOINT ABORTED.**

Description: One of the following:

- A write error occurred while writing the disk label or the TRT sectors on the label track.
- There were not enough tracks allocated to checkpoint the system tables or UEM.
- There is insufficient space on the device to allocate the checkpoint file.

Issued by 1CK.

User Action: If write error, notify customer engineer; otherwise, free up space to allocate checkpoint file.

### **EQest, CLEARING MST INTERLOCKS.**

Description: This mainframe is in the process of clearing hardware and software interlocks held by the downed machine.

Issued by 1MR.

User Action: None.

### **EQest, COMPARE ERROR.**

Description: Compare error was detected on card reader with EST ordinal est.

Issued by QAP.

User Action: Reread deck.

**EQest, COMPARE ERROR.**

Description: BIO detected compare error on card punch with EST ordinal est.

Issued by QAP.

User Action: Job output must be repunched via DSD command REPUNCH.

**EQest COMPARE ERROR.**

Description: BIO detected an error on card punch equipment est.

Issued by 1CD.

User Action: Job output must be repunched via the DSD command REPUNCH,est.

**EQest CONTROLLER HUNG BUSY.**

Description: BIO detected that the controller for equipment est did not drop the busy status.

Issued by QAP.

User Action: Inform customer engineer.

**\*EQest CONTROLLER HUNG BUSY.**

Description: The specified controller did not drop BUSY status for equipment est.

Issued by 1IO.

User Action: Inform customer engineer.

**EQest CONTROLLER HUNG BUSY.**

Description: The specified controller did not drop BUSY status for equipment est.

Issued by 1CD.

User Action: Inform customer engineer.

**EQest, COUNTER MISMATCH IN LABEL n.**

Description: During label verification and repair a counter mismatch was encountered while attempting to read the nth copy of the label. This signifies that a problem occurred during a table update.

Issued by MSM.

User Action: If the label cannot be repaired and a label error (LE) error status appears in the E,M display, the device must be initialized and files must be reloaded. If a device error (DE) error status appears, take corrective action and retry the label repair.

**EQest,DAF INTERLOCKS NOT CLEARED.**

Description: A permanent file catalog size error condition exists on device with EST ordinal est causing interlocks in the system sectors of direct access files to not be cleared.

Issued by 1MR.

User Action: Contact CYBER Software Support.

**EQest,DATA ERROR AT -PHYSICAL POSITION-.**

**EQest,Rxxxxxxx,Tyyyy,Szzzz.**

Description: Data errors have been detected on a sector which was read.

Issued by MST.

User Action: Report hardware error to customer engineer.

**EQest,DATA EXP www,eeeeeeeeeeeeeeeeeeee**

**EQest,DATA READ www,rrrrrrrrrrrrrrrrrrrr**

### **EQest,DATA DIFF www,dddddddddddddddd**

Description: When a data error or device parity error is detected, the data on the sector is checked and the errors reported. If no errors are found, the message \*DATA OK.\* is issued.

www Word number in the sector.  
eee... Expected data.  
rrr... Data read.  
ddd... Difference.

Issued by MST.

User Action: Report hardware error to customer engineer.

### **EQest,DEV.-TYPE ERR-~~PHYSICAL POSITION~~. EQest,Rxxxxxx,Tyyyy,Szzzz.**

Description: CIO has detected one of the following errors which appear in the -TYPE ERR- position:

PARITY ER.	Parity error
ADDR. ERR.	Address error
STATUS ER.	Device status error
81 FNC REJ	6681 function reject
RESERVED	Device reserved
NOT READY	Device not ready

Issued by MST.

User Action: Report hardware error to customer engineering.

### **EQest, DEVICE ACCESS ERROR.**

Description: The access limits in the device label for a non-removable device were not found to be within the equipment access level limits from the device EST entry during a level 0 deadstart.

Issued by MSM.

User Action: Redeadstart after changing the access level limits in either the device label (by initializing the device) or the equipment status table (using the ACCESS EQPDECK entry).

### **EQord, DIAGNOSTIC RUNNING.**

Description: Informative message indicating that an 887 or 9853 disk is busy running diagnostics.

Issued by 1HY.

User Action: None.

### **EQord, DIAGNOSTIC RUNNING.**

Description: Informative message indicating that the disk with EST ordinal ord is busy running diagnostics.

Issued by 1HY.

User Action: None.

### **EQord, DIAGNOSTIC RUNNING.**

Description: Informative message indicating that the disk with EST ordinal ord is busy running diagnostics.

Issued by 1XD.

User Action: None.

### **EQest nnnn DIRECT ACCESS FILE ERRORS.**

Description: Number of direct access files on mass storage device with EST ordinal est that could not be recovered during mass storage device recovery (performed during deadstart or when a removable device is introduced into the system). The files in error are identified by PF LENGTH ERROR messages. In addition, the number of files in error (nnnn) should equal the number of PF LENGTH ERROR messages issued.

Issued by MSM.

User Action: Files should either be reloaded or redefined (refer to description of PF LENGTH ERROR message for additional information).

### **EQest nnnn DIRECT ACCESS FILES RECOVERED.**

Description: Informative message indicating the number (nnnn) of direct access files that were successfully recovered on mass storage device with EST ordinal est. Mass storage device recovery is performed during system deadstart or when a removable device is introduced into the system.

Issued by MSM.

User Action: None.

### **EQest,DNdn,message.**

Description: A form of PFM error message (issued to the system dayfile, error log, and sometimes the user dayfile) identifying the mass storage equipment on which the error occurred.

est EST ordinal of device  
dn Device number message PFM error message

Issued by PFM.

User Action: Refer to the significance and action of the message as given in this list of error messages.

### **EQest,DNdn,message.**

Description: A permanent file utility has encountered an error on equipment with EST ordinal est and device dn.

Issued by PFDUMP.

User Action: Refer to the explanation given for the message following the device number for further information. This is an abbreviated form of the message issued to the error log. The complete message is issued to the system dayfile and the control point dayfile.

### **EQest DOWNED BY SYSTEM.**

Description: A mass storage error was detected on device est. The system determined that data was being written or read incorrectly, although no error was detected by the controller.

Issued by 1MV.

User Action: Inform customer engineer.

### **EQest, ERROR IDLE SET.**

Description: This message follows the PF LENGTH ERROR or QF LENGTH ERROR message if error idle status was set by the system or the operator entered PAUSE.

Issued by MSM.

User Action: See the action for PF LENGTH ERROR or QF LENGTH ERROR.

### **EQest, ERROR IDLE SET.**

Description: PFM has set ERROR IDLE status on the indicated permanent file device.

Issued by PFM.

User Action: See the previous error message(s) for more information on the error.

### **EQest xx ERROR RETRY UNDERWAY.**

Description: An error has occurred while attempting to read data from, or write data to, a mass storage device; a recovery attempt is in progress.



est EST ordinal of the mass storage device in use when the error occurred.  
 xx Error type (one of the following):  
 CP Channel parity error  
 CS Controller stop error  
 RA Controller memory error  
 FT Function timeout error  
 AD Address error. A software error was encountered.  
 ST Device status error  
 RS Device reserved error. The device hardware interlock is held by another mainframe.  
 CR Controller reserved error. The controller hardware interlock is held by another mainframe.  
 NR Device not ready error. The device may have been spun down.  
 CF Channel failure error.  
 ID Data transfer error.  
 ME A track media error. A track or sector on the device could not be accessed.  
 LN Logical not ready error.

Issued by PPR.

User Action: Refer to individual error type. If the error reoccurs frequently, contact a site analyst or CYBER Software Support. If the channel has been downed by the operating system (OS), inform customer engineer. If the error is intermittent, no action is required.

### **EQord xx ERROR RETRY UNDERWAY.**

Description: Error processing is being performed by the mass storage driver.

ord EST ordinal of disk.  
 xx Error mnemonic.

Issued by 1XY.

User Action: Call C.E. if error goes unrecovered as indicated by messages in the error log.

### **EQord xx ERROR RETRY UNDERWAY.**

Description: Error processing is being performed by the mass storage driver.

ord EST ordinal of disk.  
 xx Error mnemonic.

Issued by 1HP.

User Action: Call C.E. if error goes unrecovered as indicated by messages in the error log.

### **EQest xx ERROR RETRY UNDERWAY.**

Description: Error processing is being performed by the mass storage driver.

est EST ordinal of disk.  
 xx Error mnemonic.

Issued by 1HP.

User Action: Call customer engineer if error goes unrecovered as indicated by messages in the ERRLOG.

### **EQest xx ERROR RETRY UNDERWAY.**

Description: Error processing is being performed by the mass storage driver.

est EST ordinal of disk.  
 xx Error mnemonic.

Issued by 1XM.

User Action: Call a customer engineer if error goes unrecovered as indicated by messages in the ERRLOG.

**EQest xx ERROR RETRY UNDERWAY.**

Description: Error processing is being performed by the mass storage driver.

est EST ordinal of disk.  
xx Error mnemonic.

Issued by 1XY.

User Action: Call customer engineer if error goes unrecovered as indicated by messages in the ERRLOG.

**EQest,EXP. POSITION -PHYSICAL POSITION-.**  
**EQest,Rxxxxxxx,Tyyyy,Szzzz.**

Description: When a position or device address error occurs, the expected position is given by this message.

Issued by MST.

User Action: Report hardware error to customer engineer.

**EQest, FEED FAILURE.**

Description: Card punch with EST ordinal est experiencing card feed failure.

Issued by QAP.

User Action: Inform customer engineer.

**EQest FEED FAILURE.**

Description: Card punch equipment est is experiencing a card feed failure.

Issued by 1CD.

User Action: Inform customer engineer.

**EQest, FILE ACTIVE - filename.**

Description: IMS was unable to initialize the dayfile filename on the device with EST ordinal est, because filename is a current active dayfile.

Issued by IMS.

User Action: Use DFTERM to move the current active dayfile to another device, and try again.

**EQest, FILE BUSY - filename.**

Description: IMS was unable to initialize the dayfile filename on the device with EST ordinal est, because the first track of the dayfile was currently interlocked.

Issued by IMS.

User Action: Wait until the other job which is accessing this file (probably a DFTERM job) releases the file, and then try again.

**EQest, FLAWING INCOMPLETE.**

Description: Flaw map could not be read during initialization. For multiunit 844 equipment, some flaws may not have been recorded.

est EST ordinal of device

Issued by IMS.

User Action: Reformat 881 or 883 packs.

**EQest nn FLAWS NOT PROCESSED.(list).**

Description: Informative message indicating the number of flaw entries not processed because the tracks specified (list) were in use.

est EST ordinal of device

Issued by IMS.

User Action: Reenter list of tracks to be flawed at a later time.

**EQest,FM=familyname,PF=filename,  
UI=userindex.**

Description: Additional line is written only in error log after one of the following messages:

- DATA TRANSFER ERROR.
- DIRECT ACCESS FILE ERROR.
- FILE LENGTH ERROR.
- FILE BOI/EOI/UI MISMATCH.
- MASS STORAGE ERROR.
- RANDOM INDEX ERROR.
- REPLACE ERROR.
- SYSTEM SECTOR ERROR.
- TRACK LIMIT.

est	EST ordinal of device.
familyname	Family name.
filename	Permanent file name.
userindex	User index.

Issued by PFM.

User Action: See action for associated message.

**EQest, FUNCTION TIMEOUT.**

Description: No response (inactive) was received after a function code was issued to the specified equipment est (converter and equipment status unavailable).

est EST ordinal of equipment.

Issued by QAP.

User Action: Inform customer engineer.

**EQest FUNCTION TIMEOUT.**

Description: A function timeout was detected on a converter or equipment function issued to equipment est.

Issued by IIO.

User Action: Inform customer engineer.

**EQest FUNCTION TIMEOUT.**

Description: A function timeout was detected on a converter or equipment function issued to equipment est.

Issued by 1CD.

User Action: Inform customer engineer.

### **EQest, HARDWARE RESERVE ERROR.**

Description: While reading the tables from the ISHARED device est, it was determined that another machine had released the device reserve before completely writing the tables. This should only occur if hardware errors occur during the write operation

Issued by 1RU.

User Action: If the write error processing successfully recovers from the hardware problem, the read operation should continue. If there is a hardware problem, it must be corrected.

### **EQest HAS DUPLICATE UNIT NUMBER.**

Description: More than one 834 or 836 disk EQPDECK entry has been made specifying the same unit number on the same control module.

Issued by SET.

User Action: Change the EQPDECK entry so that all unit numbers for the disks on the control module are unique.

### **EQest HAS NO DRIVE DEFINED.**

Description: A control module EST entry has been made but is not referenced by a drive EST entry.

Issued by SET.

User Action: Define an EQPDECK entry for at least one drive on each control module.

### **EQest, INCOMPLETE DATA TRANSFER.**

Description: An incomplete data transfer occurred involving equipment est.

est EST ordinal of equipment.

Issued by QAP.

User Action: Inform customer engineer.

### **EQest INCOMPLETE DATA TRANSFER.**

Description: All data being transmitted to or from equipment est was not accepted by the equipment or received by BIO.

Issued by IIO.

User Action: Inform customer engineer.

### **EQest INCOMPLETE DATA TRANSFER.**

Description: All data being transmitted to or from equipment est was not accepted by the equipment or received by BIO.

Issued by 1CD.

User Action: Inform customer engineer.

### **EQest, INCOMPLETE SECDED READ.**

Description: The read of the ESM or STORNET SECDED log data failed.

Issued by 1MB.

User Action: Contact a customer engineer.

### **EQest INITIALIZE BIT NOT SET.**

Description: Device with EST ordinal est is available and has a good label but cannot be linked to another device unless initialize status is set.

Issued by MSI.

User Action: One of the following:

- Enter INITIALIZE command to set initialize status for device and then enter RERUN to update list (on K display) of devices with initialize status set.
- Enter CLEAR to clear initialize status for current device.

### **EQest, INITIALIZED - filename.**

Description: Informative message. IMS has successfully initialized the dayfile filename on the device with EST ordinal est.

Issued by IMS.

User Action: None.

### **EQest, INTERLOCKED BY id.**

Description: The software reserve is being held by the mainframe whose machine identifier is id.

Issued by 1RU.

User Action: Check the device status in the E,M display on the mainframe that has the interlock. A device status of T indicates that a table update is pending on that device. (One and only one mainframe should have the status set.) It will be attempting to complete the table update and clear the reserve. It is probably detecting device errors. Check its A,ERRLOG display for error information. When the problem is corrected, activity will resume normally. If the corrective action will require a long time, the device should be OFFed on the other mainframe. Otherwise, you may want to deadstart the mainframe and run MREC on one of the other mainframes to clear the reserves and interlocks held by the mainframe. When the corrective action is complete, the downed mainframe will have to be recovered with a level 0 deadstart.

### **EQest, INTERLOCKED BY MID yy.**

Description: Informative message at control point B-display. IMS is waiting for the mainframe with MID yy to release the interlock on the independent shared device with EST ordinal est.

Issued by IMS.

User Action: If you do not want to wait for the other mainframe to release the interlock, clear the INITIALIZE and drop the job. If the mainframe with the interlock is no longer up, use MREC to clear the interlock.

### **EQest INTERNAL/EXTERNAL REJECT.**

Description: BIO detected an internal or external reject while communicating to equipment est.

Issued by QAP.

User Action: Inform customer engineer.

### **EQest INTERNAL/EXTERNAL REJECT.**

Description: BIO detected an internal or external reject while communicating to equipment est.

Issued by IIO.

User Action: Inform customer engineer.

### **EQest INTERNAL/EXTERNAL REJECT.**

Description: BIO detected an internal or external reject while communicating to equipment est.

Issued by 1CD.

User Action: Inform customer engineer.

### **EQest, LABEL CHECKSUM ERROR.**

Description: During the reading of the label sector, a checksum error is detected. Normally, a checksum error is due to a write error. The mainframe that was writing should attempt to rewrite the label sector, correcting the checksum error. Another, less frequent, cause of this error is an access path problem that went undetected by the hardware.

Issued by 1RU.

User Action: Check the device status in the E,M display on the other mainframes. A device status of T indicates that a table update is pending on that device. One and only one mainframe should have the status set. That mainframe will be attempting to rewrite the label to repair the checksum error. Check its A, ERRLOG display for error information. When the problem is corrected, activity will resume normally. If the corrective action will require a long time, the device should be OFFed on the other mainframes. Otherwise, you may want to deadstart the mainframe and run MREC on one of the other mainframes to clear any reserves and interlocks held by the mainframe that has T status. When the corrective action is complete, the downed mainframe will have to be recovered with a level 0 deadstart.

### **EQest, LABEL READ ERROR.**

Description: During the reading of the label track a hardware error is detected.

Issued by 1RU.

User Action: Same action as LABEL CHECKSUM ERROR.

### **EQest, LABEL READ ERROR.**

Description: IMS was unable to initialize the independent shared device with EST ordinal est, because it encountered a read error on the label sector when attempting to interlock the device.

Issued by IMS.

User Action: Deadstart all machines which access the device, PRESET the device and do a deadstart initialize.

### **EQest, LABEL WRITE ERROR.**

Description: During the writing of the label sector, a hardware error was detected. If a good access to the device can be found by 1MU, it will attempt to rewrite the label sector.

Issued by 1RU.

User Action: Same action as LABEL CHECKSUM ERROR.

### **EQest, LOCAL AREA SECTOR ERROR.**

Description: IMS was unable to initialize the device with EST ordinal est, because a read error was encountered when attempting to read the sector of local areas.

Issued by IMS.

User Action: Deadstart all machines which access the device, PRESET the device and do a deadstart initialize.

### **EQest, LOCAL AREA SECTOR RESET.**

Description: Informative message. IMS has reset the sector of local areas on the device with EST ordinal est.

Issued by IMS.

User Action: None.

### **EQest, LOCAL AREAS INITIALIZED.**

Description: Informative message. IMS has successfully initialized the sector of local areas on the device with EST ordinal est.

Issued by IMS.

User Action: None.

### **EQest, MACHINE NOT IN DIT.**

Description: This machines ID is not in the Device Information Table (DIT) in the label sector. The device has probably been preset from another mainframe.

Issued by 1RU.

User Action: Perform a level 0 deadstart on the machine displaying the error message.

### **EQest, MAINTENANCE CHANNEL ERROR.**

Description: 1MB was unable to access the ESM or STORNET maintenance channel while attempting to read error status or the SECDED log.

Issued by 1MB.

User Action: Contact a customer engineer.

### **EQest MRT PROCESSED BUT NOT REWRITTEN.**

Description: Unrecovered write error occurred when attempting to zero out the MRT FOR EQest.

Issued by 1MR.

User Action: Same action as CONTROLLER RESERVED.

### **EQest, NO INACTIVE DAYFILES FOUND.**

Description: Informative message. IMS did not encounter any inactive dayfiles while initializing the device with EST ordinal est.

Issued by IMS.

User Action: None.

### **EQest OFFED BY SYSTEM.**

Description: The mass storage device was turned off by the system due to a hardware error.

Issued by 1MV.

User Action: Inform customer engineer.

### **EQ OR DN INCORRECT.**

Description: Either the specified EST ordinal (EQ) is beyond the EST or does not define a mass storage device, or the device number specified (DN) is greater than the EST.

Issued by MSI.

User Action: Correct and enter GO.

### **EQest, PACK NAME ERROR = packnam-u**

Description: The pack name recorded in the label of the pack on equipment est is packnam. If u is displayed, it is the unit number of the pack in a multispindle set. These are not the values the system expects.

Issued by 1RU.

User Action: Check the E,F display for the pack name of the pack the system expects on the device, remove the current pack, and mount the correct one. If the pack that is mounted is the correct one, it has been initialized with a different pack name. It will have to be re-initialized before it can be used.

### **EQest, PF CATALOG SIZE ERROR.**

Description: The size of the permanent file catalogs on device with EST ordinal est is incorrect for the current system.

Issued by MSM.

User Action: Perform the following: full PFDUMP of the device, total initialize, then full PFLOAD.

### **EQest PF INITIALIZE COMPLETE.**

Description: Informative message indicating the permanent file initialization operation completed successfully.

est EST ordinal of device

Issued by IMS.

User Action: None.

**EQest PFC ERROR.**

Description: BIO encountered an error loading the PFC memory in printer est.

Issued by QAP.

User Action: Inform customer engineer.

**EQest PFC ERROR.**

Description: Error loading PFC memory.

Issued by 1CD.

User Action: Notify a customer engineer.

**EQxxx,POS. ERROR AT -PHYSICAL POSITION-  
EQxxx,Rxxxxxxxx,Tyyyy,Szzzz.**

Description: The sector which was read was not the correct sector. The position given is the position of the sector read.

Issued by MST.

User Action: Report hardware error to customer engineer.

**EQest nnnn PRESERVED FILE ERRORS.**

Description: Message indicating the number of preserved files encountered during mass storage device recovery which had system sector errors or could not be identified. Mass storage device recovery is performed during system deadstart or when a removable device is introduced into the system.

est EST ordinal of device  
nnnn Number of files in error

Issued by MSM.

User Action: Obtain dumps of dayfile and error log. Files that were in error (or the entire device) should be reloaded.

**EQxxx, PRESERVED FILE RECOVERY INITIATED.**

Description: Informative message indicating that the device with est ordinal xxx has started preserved file recovery.

Issued by MSM.

User Action: None.

**EQest PRINT ERROR LIMIT EXCEEDED.**

Description: Print error limit was exceeded.

Issued by 1CD.

User Action: Notify a customer engineer.

**EQest, nnnn PRINT ERRORS.**

Description: Print errors detected on line printer.

est EST ordinal of line printer  
nnnn Octal number of print errors

Issued by QAP.

User Action: Inform customer engineer.

**EQest nnnn PRINT ERRORS.**

Description: Equipment est had nnnn lines printed with print errors in them.



Issued by 1CD.

User Action: Inform customer engineer.

### **EQest PROCESSING ERROR.**

Description: An error has occurred processing interlocks on an ISHARED device.

Issued by 1RU.

User Action: Same action as for LABEL CHECKSUM ERROR.

### **EQest, PROTECTED QUEUES IGNORED.**

Description: Informative message. IMS encountered some protected queue files while performing a PF initialize on the device with EST ordinal est. These queue files were left intact.

Issued by IMS.

User Action: If you want to get rid of the queue files, perform a QF or AL initialize.

### **EQest nnnn QUEUED FILE ERRORS.**

Description: Message indicating the number (nnnn) of queue files which were found to have length errors or BOL/EOI mismatch.

Issued by MSM.

User Action: No action required. You will continue to get the message until the disk is initialized.

### **EQest nnnn QUEUED FILES IGNORED.**

Description: Informative message indicating the number (nnnn) of queue files ignored because of lack of space on equipment est in which to build the IQFT.

Issued by MSM.

User Action: None.

### **EQest nnnn QUEUED FILES RECOVERED.**

Description: Informative message indicating the number of queue files found on equipment est and added to the IQFT.

Issued by MSM.

User Action: None.

### **EQest, fname, dn, RECOVERED.**

Description: Recovery is complete on EST ordinal est with family name fname and device number dn.

Issued by MSM.

User Action: None.

### **EQest, pname RECOVERED.**

Description: Recovery is complete on EST ordinal est with packname pname.

Issued by MSM.

User Action: None.

### **EQest REDEFINITION COMPLETE.**

Description: The redefinition procedure for equipment est has completed successfully.

Issued by 1RM.

User Action: None.

### **EQest, SECURED DEVICE.**

Description: On an unsecured system, device's access limits in the device label were found not to be within the equipment access level limits from the device EST entry during an online recovery.

Issued by MSM.

User Action: Either terminate recovery of the device by entering PAUSE,CMS. at the console and remove the device from the system, or enter GO CMS. to complete recovery of the device.

### **EQest, SECURED DEVICE RECOVERED.**

Description: On an unsecured system, recovery of a device whose access limits in the device label were found not to be within the equipment access level limits from the device EST entry during an online recovery has been completed.

Issued by MSM.

User Action: None.

### **EQest, SIMULTANEOUS UPDATE.**

Description: An error has occurred in interlocking the access to an ISHARED device.

Issued by 1RU.

User Action: Perform a level 0 deadstart on the machine displaying the message.

### **EQord, SPIN UP PENDING.**

Description: Informative message indicating that an 887 or 9853 disk is being spun up.

Issued by 1HY.

User Action: None.

### **EQord, SPIN UP PENDING.**

Description: Informative message indicating that the disk with EST ordinal ord is being spun up.

Issued by 1HY.

User Action: None.

### **EQord, SPIN UP PENDING.**

Description: Informative message indicating that the disk with EST ordinal ord is being spun up

Issued by 1XD.

User Action: None.

### **EQest SYSTEM USAGE OF DEVICE SUSPENDED.**

Description: Device usage has been suspended as requested (the device appears to be not ready).

Issued by 1RM.

User Action: None.

### **EQest TABLE WRITE ERROR.**

Description: An error has occurred writing tables to an ISHARED device.

Issued by 1RU.

User Action: Same action as for LABEL CHECKSUM ERROR.

### **EQest,TKtrac, INCORRECT LOCAL FILE.**

Description: The MRT bit was set for track trac on device with EST ordinal est but the track did not have a legal system sector for a local file. The track was not dropped.

Issued by 1MR.

User Action: Contact CYBER Software support.

**EQest,TKnnnn, MEDIA DEFECT ENCOUNTERED.**

Description: A disk media error was detected for the logical track specified.

Issued by 1XM,1XY.

User Action: Report error to customer engineer.

**EQord,TKnnnn, MEDIA DEFECT ENCOUNTERED.**

Description: Media defect has been encountered by the mass storage driver.

ord EST ordinal of 887 disk.  
nnnn Logical track containing media error.

Issued by 1HY.

User Action: None

**EQord,TKnnnn, MEDIA DEFECT ENCOUNTERED.**

Description: Media defect has been encountered by the mass storage driver.

ord EST ordinal of 9853 disk.  
nnnn Logical track containing media error.

Issued by 1HY.

User Action: None

**EQest,TKnnnn, MEDIA DEFECT ENCOUNTERED.**

Description: A media defect has been encountered by the mass storage driver.

est EST ordinal of disk.  
nnnn Logical track number containing media error.

Issued by 1HP.

User Action: None.

**EQest,TKnnnn, MEDIA DEFECT ENCOUNTERED.**

Description: A media defect has been encountered by the mass storage driver.

est EST ordinal of disk.  
nnnn Logical track number containing media error.

Issued by 1HY.

User Action: None.

**EQest,TKnnnn, MEDIA DEFECT ENCOUNTERED.**

Description: A media defect has been encountered by the mass storage driver.

est EST ordinal of disk.  
nnnn Logical track number containing media erro

Issued by 1XD.

User Action: None.

**EQest,TKnnnn, MEDIA DEFECT ENCOUNTERED.**

Description: A media defect has been encountered by the mass storage driver.

est EST ordinal of disk.  
nnnn Logical track number containing media error.

Issued by 1XD.

User Action: None.

**EQest,TKnnnn, MEDIA DEFECT ENCOUNTERED.**

Description: A media defect has been encountered by the mass storage driver.

est EST ordinal of disk.  
nnnn Logical track number containing media error.

Issued by 1XY.

User Action: None.

**EQest, TKnnnn, MEDIA DEFECT FLAWED.**

Description: The system has marked track nnnn of the indicated mass storage device as flawed.

Issued by 1MV.

User Action: None.

**EQest,TK=track,SC=sector.**

Description: Additional message written only in error log after the message

BAD CATALOG/PERMIT SECTOR.

est EST ordinal of device.  
track Track number of bad sector.  
sector Sector number of bad sector.

Issued by PFM.

User Action: See action for associated message.

**EQest, TKyyyy, SYSTEM SECTOR ERROR.**

Description: Informative message. While initializing the device with EST ordinal est, IMS encountered a read error or an incorrect system sector when attempting to read the system sector of preserved track yyyy. The track chain beginning with track yyyy was left intact.

Issued by IMS.

User Action: If you want to get rid of the track chain beginning with track yyyy, perform a deadstart initialize.

**EQest, TKnnnn - TRACK FLAWED BY IMS.**

Description: Flawed track found on equipment with EST ordinal est and logical track tttt.

Issued by IMS.

User Action: Hardware error. Inform customer engineer.

**EQest, TKyyyy - VERIFICATION ERRORS.**

Description: Informative message. When allocating a catalog track or a permit track on the device with EST ordinal est, IMS encountered an error in track yyyy. The track was flawed, and a different track was allocated for the catalog and permit track.

Issued by IMS.

User Action: If many such errors occur, have the customer engineers check the hardware for the device in question.

### **jsn EQest TRACK tttt LENGTH ERROR.**

Description: The queue file with JSN jsn on track tttt of equipment est had a length error at recovery time.

est EST ordinal of the equipment.

Issued by QDUMP.

User Action: Contact CYBER Software Support.

### **EQest TRACK LIMIT.**

Description: There is insufficient space to allocate a catalog, permit, or indirect file chain needed to initialize device with EST ordinal est.

Issued by MSI.

User Action: If attempting to initialize a device online, monitor the E,A. display and wait for tracks to become available. Then enter K.RERUN. If attempting to initialize a device during deadstart, redeadstart and check device usage.

### **EQest TRACK LIMIT.**

Description: Mass storage device with EST ordinal est has no allocatable tracks left and a program is waiting for a track in order to continue processing of a file. Additional space must be made available on the device.

Issued by PFU.

User Action: Drop utility or purge unneeded files.

### **EQest, TRACK LIMIT.**

Description: Mass storage device with EST ordinal est has no allocatable tracks left. IMS cannot finish processing until space is available.

Issued by IMS.

User Action: None; job will purge unnecessary files. If problem persists, contact CYBER Software Support.

### **EQxx TRACK LIMIT ON IQFT.**

Description: There is not enough space on equipment est to build the inactive queue file table (IQFT). Queue files remain inactive.

Issued by MSM.

User Action: Inform site analyst, if present. If not, contact CYBER Software Support.

### **EQest nn TRACKS FLAWED.**

Description: Informative message indicating the number of tracks that were successfully flawed.

est EST ordinal of device

Issued by IMS.

User Action: None.

### **EQest TRANSMISSION PARITY ERROR.**

Description: BIO detected a transmission parity error from the data channel converter on equipment est.

Issued by QAP.

User Action: Inform customer engineer.

### **EQest TRANSMISSION PARITY ERROR.**

Description: BIO detected a transmission parity error from the data channel converter for equipment est.

Issued by IIO.

User Action: Inform customer engineer.

**EQest TRANSMISSION PARITY ERROR.**

Description: A transmission parity error was detected.

Issued by 1CD.

User Action: Notify a customer engineer.

**EQest TURNED OFF BY SYSTEM.**

Description: The equipment specified by est was logically turned off (OFF status set in EST). This message is preceded in the error log by a message for the same equipment which specifies the failing condition.

Issued by IIO.

User Action: Inform customer engineer.

**EQest TURNED OFF BY SYSTEM.**

Description: Faulty equipment was turned off by the system.

Issued by 1CD.

User Action: Notify a customer engineer.

**EQest, Uunit, PS=serialn.**

Description: Informative message indicating the pack serial number of the pack mounted on the device defined by EST ordinal est. Any of the following device types can appear in place of EQ: DI (half track 844-21 disk), DJ (half track 844-41/44 disk), DK (full track 844-21 disk), DL (full track 844-41/44 disk), DM (half track 885-11/12 disk), or DQ (full track 885-11/12 disk).

est	EST ordinal of the disk.
unit	Physical unit number on which the pack is mounted.
serialn	Pack serial number.

Issued by 6DI.

User Action: None.

**EQest, Uuu,PS=ssssss.**

Description: Informative message indicating the pack serial number (ssssss) of the disk pack mounted on unit uu of the device defined as EST ordinal est. Any of the following device types can appear in place of EQ:

DB	885-42, full track
DD	834, full track
DI	844-21, half track
DJ	844-41/44, half track
DK	844-21, full track
DL	844-41/44, full track
DM	855-11/12, half track
DQ	855-11/12, half track

Issued by 0PI.

User Action: None.

**EQest,UNuu, CHECKING RESERVE.**

Description: Informative message indicating that controller and unit reservations are being processed for logical unit uu on equipment est.

Issued by 1MR.

User Action: None.

### **EQest,UNuu, UNIT RESERVED.**

Description: Logical unit uu on equipment est could not be accessed due to physical unit reservation.

Issued by MREC.

User Action: Refer to the NOS 2 Analysis Handbook for possible action. If these actions fail, contact a customer engineer.

### **EQest UNAVAILABLE.**

Description: The mass storage device indicated is not available. The system will automatically retry the request.

Issued by 1MV.

User Action: If the device remains unavailable, inform customer engineer.

### **EQest UNIT DEFINED ON WRONG \*CM\*.**

Description: One of the drives (834 or 836) is defined on the wrong type of control module.

Issued by SET.

User Action: DD drives must be defined on control module CMI and DG drives must be defined on control modules CMII. Define the drives correctly and retry.

### **EQest UNITS SPAN DIFFERENT CHANNELS**

Description: A multi-unit 834/836 device has been defined in which at least one of its control modules specifies a channel different than the other CMs. All control modules in the same multi-unit device must have the same channel number.

Issued by SET.

User Action: Change the configuration so that all control modules in a multi-unit device have the same channel numbers.

### **EQest, VALIDATION ERROR ec.**

Description: An error was detected on equipment est during mass storage table validation.

- ec Error code; may be any one or a sum of the following:
- 1 Error in track count
- 2 Error in preserved file count
- 4 Error in permits chain
- 10 Error in catalog chain
- 20 Error in indirect chain

PP programs that attempt to access equipment est must wait until the validation error is corrected and the device is revalidated.

Issued by 5ME.

User Action: Take a deadstart dump, write a PSR, and send the dump and PSR to CDC along with any support materials which will allow CDC to duplicate the problem.

### **EQest VERIFICATION FAILURE.**

Description: The system has detected a failure on a mass storage device and the verification algorithm confirms the failure.

Issued by 1MV.

User Action: Inform customer engineer.

### **EQ<ord>,TK<ttt>,MEDIA DEFECT ENCOUNTERED**

Description: The 5830 detected a media defect and automatically issued a request to the system to flaw the track.

Issued by 1DA.

User Action: Copy the equipment and track location of the flaw and enter this information in the APRDECK. This ensures that the flaw information is retained when the equipment is reinitialized.

**EQord XX ERROR RETRY UNDERWAY.**

Description: Error processing is being performed by the mass storage driver.

ord EST ordinal of the disk.  
xx Error mnemonic.

Issued by 1XM.

User Action: Call C.E. if error goes unrecovered as indicated by messages in the error log.

**EQest, 1FA ERROR, m, filename.**

Description: An error occurred during an attempt to fast-attach a file.

est est ordinal of the equipment  
m One of the following:  
R Read mode  
W Write mode  
filename Name of fast-attach file

Issued by PPR.

User Action: Contact CYBER Software Support.

**EQUIPMENT xx AT EST est ALREADY RESERVED.**

Description: The EST ordinal entry est was reserved when INITMDI tried to assign it.

xx Device mnemonic specified by the DT parameter.  
est EST ordinal of MDI.

Issued by INITMDI.

User Action: If NAM is present, the initialization process will automatically reoccur. If not present, reenter the INITMDI command.

**EQUIPMENT xx NOT FOUND AT EST est.**

Description: A mismatch of parameters EST and DT was entered on the INITMDI command.

xx Device mnemonic specified by the DT parameter.  
est EST ordinal of MDI.

Issued by INITMDI.

User Action: Alter the INITMDI command to include the correct EST ordinal est and device type xx.

**EQUIPMENT xx OFF AT EST est.**

Description: The EST ordinal entry est is in OFF status.

xx Device mnemonic specified by the DT parameter.  
est EST ordinal of MDI.

Issued by INITMDI.

User Action: Turn the equipment ON.

**EQUIPMENT STATUS INCORRECT.**

Description: The equipment being redefined is not unloaded and the number of units cannot be changed.

Issued by CONFIG.

User Action: Correct K display input and retry.



### **EQUIVALENCE MISSING.**

Description: A syntax error was encountered with the command. The command parameter was not separated from its value by an equals sign.

Issued by DMPCCC.

User Action: Correct the syntax error and retry.

### **EQest1 EQest2 CONFLICTING DN.**

Description: Two devices in the same family have the same device number and the system library resides on one of them. est1 and est2 are the EST ordinals of these devices. Recovery is impossible. This message is preceded by the message

RECOVERY, EQest1.

which indicates the equipment that is in error.

Issued by MSM.

User Action: Recommended action is one of the following:

- Remove one of the specified devices and reeadstart.
- Reeadstart and logically turn off one of the specified devices (via CMRDECK entry).

If problems, contact CYBER Software Support.

### **EQest1 EQest2 CONFLICTING PN.**

Description: Two auxiliary devices have the same pack name and the system library resides on one of them. est1 and est2 are the EST ordinals of these devices. Recovery is impossible. This message is preceded by the message

RECOVERY, EQest1.

which indicates the equipment that is in error.

Issued by MSM.

User Action: Recommended action is one of the following:

- Remove one of the specified devices and reeadstart.
- Reeadstart and logically turn off one of the specified devices (via CMRDECK entry).

If problems, contact CYBER Software Support.

### **EQest1 EQest2 CONFLICTING UM.**

Description: Two devices in the same family have the same bits set in the device mask and the system library resides on one of them. est1 and est2 are the EST ordinals of these devices. Recovery is impossible. This message is preceded by the message

RECOVERY, EQest1.

which indicates the equipment that is in error.

Issued by MSM.

User Action: Recommended action is one of the following:

- Remove one of the specified devices and reeadstart.
- Reeadstart and logically turn off one of the specified devices (via CMRDECK entry).

If problems, contact CYBER Software Support.

### **ERR/LGL RECEIVED FROM NAM - RC=xx.**

Description: NAM sent TAF a message out of order or an unrecognizable message.

xx NAM reason code

Issued by TAF.

User Action: Contact CYBER Software Support.

### **hh.mm.ss. ERR=Demmxxx**

Description: A mainframe failure has been detected by DFT. hh.mm.ss is the time the error was detected, unless DFT was unable to access the wall clock chip; in this case, it is the time the failure was logged by 1MB. The element where the error occurred is denoted by Demmxxx, with the following values:

e Element

C Processor 0

D Processor 1

I IOU 0

J IOU 1

M Memory

mm denotes the model number of the element specified by e. xxx represents the DFT analysis code for the error in question.

Issued by 1MB.

User Action: Refer to appendix E for more information on mainframe failures and solutions.

### **ERRLOG UNRECOVERABLE**

Description: The errorlog cannot be recovered.

Issued by REC.

User Action: Enter GO,SYS. at the system console: a new dayfile will be created.

### **divname-mmm ERROR AND nn WARNING MESSAGES ISSUED.**

Description: If mmm is not zero, the indicated number of fatal diagnostic message errors are described in the error summary listing produced by the NDL processor as part of the listing output file. A nonzero value for mmm indicates that any configuration file created by the job from the named division does not contain a verification record. If nn is not zero, the indicated number of nonfatal diagnostic message errors are described in the error summary listing. A nonzero value for nn does not affect the verification record of any network definition file created by the job.

Issued by DAYYES.

User Action: Correct the NDL statements input and rerun the job if mmm is not zero.

### **ERROR ec DURING ROUTE OF FILE nm.**

Description: Error ec occurred routing the output file nm to the printer.

Issued by NLTERM.

User Action: Refer to Volume 4 of the NOS 2 Reference Set for a description of the ROUTE macro and its error codes.

### **ERROR FILE LIMIT.**

Description: One of the following occurred:

- An unrecoverable error occurred during an attempt to create the error file.
- The number of error files created has exceeded the upper limit allowed.

Issued by QLOAD.

User Action: Check the output file for files processed. Retry load, skipping the files in error.

### **ERROR FLAG NOT SET IN SMMAP.**

Description: The RC directive to SSDEBUG did not remove the SM map entry because the error flag was not set in the SM map entry.

Issued by SSDEBUG.

User Action: Correct the CS, XI, and YI parameters and retry.

### **ERROR IN libdeck.**

Description: An error was detected in the specified LIBDECK while processing the SYSEDIT command.

Issued by SYSEDIT.

User Action: Correct the error in the LIBDECK and retry.

### **\*\*\*\*ERROR IN ACCESS LEVEL.**

Description: K display message indicating no access is specified or an invalid separator is specified.

Issued by QFSP.

User Action: Correct and retry.

### **ERROR IN ADD/DELETE VSN.**

Description: The number of added or deleted entries does not match the number of active files.

Issued by DMREC.

User Action: Check edit directives and list the directory for a visual check.

### **ERROR IN ALPHANUMERIC DATA.**

Description: No data is present or an incorrect separator follows the data.

Issued by QFSP.

User Action: Correct and reenter K display input.

### **\*\*\*\* ERROR IN ALPHANUMERIC DATA.**

Description: Output file message indicating any of the following:

- No data was present.
- The data accompanying the \*AW\* input identifier was unrecognizable.
- The number of characters exceeded the maximum allowed.

If entered from the K display, the line of input on which the error occurred is disregarded; otherwise, that particular user name is disregarded.

Issued by MODVAL.

User Action: Rerun the corrected job or correct the new validation file, if necessary.

### **ERROR IN ATTACHING USER DATABASE.**

Description: RECLAIM system error.

Issued by RECLAIM.

User Action: Check the dayfile for a more specific error message. If there is no message in the dayfile, inform the site analyst.

### **ERROR IN ATTRIBUTE.**

Description: An attribute was specified twice or an incorrect combination was specified.

Issued by LIDOU.

User Action: Reenter L display input with correct attributes.

### **ERROR IN BUILDING DIRECTORY ENTRIES.**

Description: An error was encountered when DMREC attempted to add or update a directory record.

Issued by DMREC.

User Action: Inform database administrator, correct as directed and rerun.

### **ERROR IN BUILDING RECOVERY TABLES.**

Description: An error was encountered while attempting to retrieve a record from the directory file.

Issued by DMREC.

User Action: Try an update from an earlier file and inform the database administrator.

### **ERROR IN CHANNEL NUMBER.**

Description: Indicates one of the following:

- If system has 10 PPs or less, channel number was not in the range of 0 to 13B.
- If system has more than 10 PPs, channel number was not in the range of 0 to 13B or 20B to 33B.
- A channel with a DOWN status was specified during an attempt to REDEFINE a MSM device.

Issued by CONFIG.

User Action: Correct K display input and retry.

### **ERROR IN CHECKSUM DETECTED.**

Description: INITMDI detected an error in the checksum.

Issued by INITMDI.

User Action: Inform site analyst.

### **\*\*\* ERROR IN COLUMN nn, MUST BE BLANK OR COMMA.**

Description: The character in the indicated column is located where a separator is expected.

Issued by NDA.

User Action: Check the syntax.

### **ERROR IN CRM -PUT- (RECORD LOAD).**

Description: An error was encountered while attempting to execute a CRM PUT onto the data file.

Issued by DMREC.

User Action: Try to load from previous dump tape.

### **ERROR IN CRM STATEMENT ARGUMENTS.**

Description: The CRM statement in the xxJ file is in error.

Issued by DMREC.

User Action: Correct the CRM statement and try again.

### **ERROR IN DATE.**

Description: K display message indicating any of the following:

- The date entry is not in the correct format.
- An incorrect separator follows the date.

- The date entry is prior to 70/01/01.
- The date entry is not a valid date (e.g. 76/04/44).

Issued by QFSP.

User Action: Correct and reenter K display input.

### **ERROR IN DEVICE NUMBER.**

Description: K display message indicating one of the following:

- No family name has been specified.
- The device number is not in the specified family name.
- An incorrect separator follows the device number.

Issued by QFSP.

User Action: Correct and reenter K display input.

### **ERROR IN EDIT PROCESSING.**

Description: Editing processor has encountered an error in trying to execute the directive.

Issued by DMREC.

User Action: Check the edit directive parameters and inform database administrator.

### **ERROR IN EST ORDINAL.**

Description: Indicates one of the following:

- Equipment is not a mass storage device.
- Equipment is not a 844 or 885 disk drive.

Issued by CONFIG.

User Action: Correct K display input and retry.

### **ERROR IN FAMILY NAME.**

Description: K display message indicating that either the specified family name cannot be found or an incorrect separator follows the family name.

Issued by QFSP.

User Action: Correct and reenter K display input.

### **\*\*\* ERROR IN FIELD (xxxxx), MUST BE 5 HEX. DIGITS.**

Description: The contents of the field shown as xxxxx might be misplaced. If the field contains a hexadecimal number, be sure the first digit is a zero.

Issued by NDA.

User Action: Check that comments are not in a required numeric field.

### **ERROR IN FILE SIZE RANGE.**

Description: K display message indicating one of the following:

- File size is nonnumeric.
- File size range is not within the range 0 through 77777B.
- An incorrect separator follows the last size.

Issued by QFSP.

User Action: Correct and reenter K display input.

### **ERROR IN FILENAME LIST.**

Description: A syntax error was found in the list of file names entered using the PF=\* option.

Issued by RECLAIM.

User Action: Correct the file name list and retry.

### **ERROR IN IAFEX ARGUMENTS.**

Description: An error was encountered on the IAFEX command.

Issued by IAFEX.

User Action: Correct error in IAF procedure and retry.

### **ERROR IN IAFEX PARAMETER - T.**

Description: The value assigned to the T parameter on the IAFEX command is not valid.

Issued by IAFEX.

User Action: Correct T parameter in IAF procedure and retry.

### **ERROR IN ID RANGE.**

Description: K display message indicating one of the following:

- ID is not within the range 0 through 77B.
- Incorrect separator between or after ID data.
- Minimum ID is greater than the maximum ID.
- Identifier number is nonnumeric.

Issued by QFSP.

User Action: Correct and reenter K display input.

### **ERROR IN IDENTIFIER.**

Description: K display message indicating that an incorrect directive or command has been entered, or a directive is incorrect for the selected utility.

Issued by QFSP.

User Action: Correct and reenter K display input.

### **\*\*\*\* ERROR IN IDENTIFIER.**

Description: Output file message indicating that an incorrect parameter identifier was encountered. If entered from the K display, that line of input is disregarded; otherwise, that particular user name is disregarded.

Issued by MODVAL.

User Action: Rerun the corrected job or correct the new validation file, if necessary.

### **\*\*\* ERROR IN INPUT DIRECTIVE COLUMN 1 \*\*\***

Description: Column 1 does not contain a recognized rule description character.

Issued by NDA.

User Action: Check for a typographical error.

### **ERROR IN IXN STATEMENT ARGUMENTS.**

Description: The IXN statement in the xxJ file is in error.

Issued by DMREC.

User Action: Correct the IXN statement and try again.

### **ERROR IN LCF – SUMMARY SUPPRESSED.**

Description: NDLP attempted to list a file and found either the file was not in LCF format or the NDLP run was flagged unsuccessful.

Issued by NDLP.

User Action: Correct errors and rerun NDLP.

### **ERROR IN LIST PROCESSING.**

Description: Errors in generating list as described on directive.

Issued by DMREC.

User Action: Check list directive for accuracy and retry.

### **ERROR IN \*LO\* SPECIFICATION.**

Description: The list option parameter has an incorrect option specified.

Issued by PROBE.

User Action: Correct and retry.

### **ERROR IN LOADING AAMI.**

Description: The loader encountered errors while loading the TAF CRM AAM interface (AAMI).

Issued by TAF.

User Action: The site analyst should consult the CYBER Loader Reference Manual.

### **ERROR IN LOADING HASH CODE `filenam`.**

Description: The loader encountered errors while loading the hashing routine code that is on file `filenam`.

Issued by TAF.

User Action: The site analyst should consult the CYBER Loader Reference Manual.

### **ERROR IN LOADING TOTAL.**

Description: The loader encountered errors while loading Total and the database descriptor modules (DBMODs).

Issued by TAF.

User Action: The site analyst should consult the CYBER Loader Reference Manual.

### **ERROR IN NCF – SUMMARY SUPPRESSED.**

Description: NDLP attempted to list a file and found either the file was not in NCF format or the NDLP run was flagged unsuccessful.

Issued by NVF.

User Action: Correct error and rerun NDLP.

### **ERROR IN NUMERIC DATA.**

Description: K display message indicating one of the following:

- No data is present.
- Nonnumeric data was entered where numeric data was required.
- Numeric data exceeds maximum value.

Issued by QFSP.

User Action: Correct and reenter K display input.

**\*\*\*\* ERROR IN NUMERIC DATA.**

Description: Output file message indicating any of the following:

- The data entered was non-numeric and numeric data was required.
- Numeric data exceeded the maximum allowed.
- No data was present.

If entered from the K display, the line of input on which the error occurred is disregarded; otherwise, that particular user name is disregarded.

Issued by MODVAL.

User Action: Rerun the corrected job. Correct the new validation file, if necessary.

**ERROR IN \*OP\* SPECIFICATION.**

Description: The OP parameter has an incorrect option specified.

Issued by PROBE.

User Action: Correct and retry.

**ERROR IN PARAMETERS.**

Description: There is an error in the channel parameter (C=cc) on the LOADBC command or in the other required parameters if attempting to load NAD controlware.

Issued by LOADBC.

User Action: Correct parameter and retry.

**ERROR IN PERFORMING SERVO CHECK ON UNITxx.**

Description: The servo adjustment procedure has encountered a disk error condition on unit xx.

Issued by 1RM.

User Action: Contact CYBER Software Support.

**ERROR IN PROFILE ARGUMENTS.**

Description: Dayfile message indicating there was an error on the PROFILE command.

Issued by PROFILE.

User Action: Correct command and rerun.

**ERROR IN RATE PARAMETER.**

Description: The rate entered in the alternate format of the SMP call was incorrect.

Issued by SMP.

User Action: Correct the rate parameter and retry.

**ERROR IN READING TASK LIBRARY - filename.**

Description: Error occurred during transaction executive initialization or extended memory-resident task loading. File specified as task library was incorrectly formatted; therefore, it could not be read or loaded into extended memory correctly.

Issued by TAF.

User Action: Inform site analyst.

**ERROR IN RECORD DUMP.**

Description: During a record dump, DMREC is unable to recognize the first record on the dump file as an FSTT.



Issued by DMREC.

User Action: Check structure of file to be dumped for IS, DA or AK type and try again.

### **ERROR IN RETRIEVING VSN.**

Description: No VSN has been found in the directory that satisfies the directive.

Issued by DMREC.

User Action: Check directive parameters. If correct, inform data base administrator.

### **ERROR IN ROUTE FCN. EC=error**

Description: DSP has encountered an error of the type error in the attempt to route a job record to the INPUT queue.

error      Error code

Issued by NAMI.

User Action: Check the NOS 2 Reference Manual, Vol. 3, for the error codes. Contact CYBER Software Support.

### **ERROR IN SECOND PPS.**

Description: An error in the second peripheral processor subsystem (PPS) has occurred.

Issued by SCE.

User Action: Inform site analyst and customer engineer.

### **ERROR IN SELECTED FILE TYPE.**

Description: The file type or queue type selected cannot be recognized or an incorrect separator follows the file type or queue type.

Issued by QFSP.

User Action: Correct and reenter K display input.

### **ERROR IN SPECIAL ACCOUNT NUMBER.**

Description: The stimulation was aborted because an error in the scripts was encountered while processing the special account number flags.

Issued by 1TS.

User Action: inform site analyst.

### **ERROR IN STIMULATOR ARGUMENTS.**

Description: Fatal dayfile message indicating that a parameter other than the I parameter is present or the parameter is in the wrong format.

Issued by STIMULA.

User Action: Correct and rerun.

### **ERROR IN UNIT LIST.**

Description: Indicates one of the following:

- A unit number was duplicated in the unit list.
- More than three units are specified for an 885 disk drive.

Issued by CONFIG.

User Action: Correct K display input and retry.

### **ERROR IN USER INDEX RANGE.**

Description: K display message indicating one of the following:

- User index is nonnumeric data.
- User index is not within the range 0 through 377777B.
- An incorrect separator follows the last user index.

Issued by QFSP.

User Action: Correct and reenter K display input.

### **\*\*\*\* ERROR IN USER NAME.**

Description: Output file message indicating that incorrect data was encountered where the user name was expected. MODVAL disregards the incorrect data and goes to the next user entry.

Issued by MODVAL.

User Action: Rerun the job or correct the new validation file, if necessary.

### **ERROR IN USER STATEMENT ARGUMENT.**

Description: The charge or user statement in the xxJ file is in error.

Issued by DMREC.

User Action: Correct the charge/user statement and try again.

### **ERROR LOADING -DIO-.**

Description: The record on the deadstart file immediately following OSB is not DIO.

Issued by OSB.

User Action: Select a different tape or disk from which to deadstart.

### **ERROR LOG PROCESSED.**

Description: The error log dump is complete.

Issued by DAYFILE.

User Action: None.

### **ERROR ON ACTIVE DEVICES.**

Description: Label checking has detected error on device with active files. Message indicates abnormal condition that should be corrected immediately (for example, wrong pack removed when interchanging devices).

Issued by MSM.

User Action: Check the E,M display to determine which device has the error. If it is an ISHARED device, check the device status in the E,M display on all the mainframes. A device status of T indicates that a table update is pending on that device. One and only one mainframe should have the status set. That mainframe will be attempting to rewrite the label. Check its E,E display for error information. When the problem is corrected, activity will resume normally. If the corrective action will require a long time, the device should be OFFed on the other mainframes. Otherwise, you may want to deadstart the mainframes and rerun MREC on one of the other mainframes to clear any reserves and interlocks held by the mainframe that has T status. When the corrective action is complete, the downed mainframe will have to be recovered with a level 0 deadstart.

### **ERROR ON DEVICE WITH ACTIVE FILES.**

Description: This message is issued during level 1 or 2 recovery deadstart if the label on mass storage device cannot be verified and active files are on the device. Recovery is impossible. This message is preceded by the message RECOVERY, EQest, which indicates the equipment that is in error.

Issued by MSM.

User Action: Attempt another deadstart with no recovery (level 0).

### **ERROR ON FILE - PROFILa.**

Description: Either the profile file cannot be found or there is a bad profile file level-3 block random address.

Issued by CPM.

User Action: Inform site analyst.

### **ERROR ON xxJ FILE ARGUMENTS.**

Description: The xxJ file contains statements in error, which causes the transaction subsystem to abort.

Issued by TAF.

User Action: Examine xxJ file. Inform TAF database administrator.

### **ERROR ON LINK DEVICE.**

Description: An unrecoverable error occurred while reading the link device.

Issued by IMS.

User Action: Inform customer engineer; error should be logged in error log.

### **ERROR ON LINK DEVICE.**

Description: An unrecoverable read error was encountered while reading the extended memory label track.

Issued by 1RM.

User Action: Contact CYBER Software Support. Deadstart may be required.

### **ERROR ON OUTPUT FILE.**

Description: K display message indicating that the OUT command was entered when no output file existed.

Issued by QREC.

User Action: None.

### **ERROR ON SYSTEM DEVICE.**

Description: A label error was encountered while attempting to recover a device with system status.

Issued by MSM.

User Action: Redeadstart and initialize the device.

### **ERROR ec OPENING PANEL pan.**

Description: Screen Formatting error ec occurred opening the panel pan.

Issued by NLTERM.

User Action: Refer to the Screen Formatting Reference Manual for a description of the SFOPEN routine and its error codes. An error could occur if the PANELIB is not a local or system library, or if the panel is not on PANELIB.

### **ERROR READING \*PFC\*.**

Description: The PFC entries for the family name are either missing or have a bad sector error.

Issued by SSVAL.

User Action: Reload the permanent files.

### **ERROR STATUS nnn ON BACKUP DIRECTORY.**

Description: CRM error has occurred on directory file.

Issued by DMREC.

User Action: Inform site analyst.

### **ERROR - TERMINATED DAYFILE ON LOCAL FILE ZZZDAYF.**

Description: An error occurred while defining the permanent file for the terminated dayfile which remains on the local file ZZZDAYF.

Issued by DFTERM.

User Action: Dispose of ZZZDAYF as desired. Examine dayfile to determine PFM error.

### **ERRORED FILE PARTIALLY DUMPED - filename.**

Description: Informative message indicating that an unrecoverable read error was encountered on file filename while the option to dump files in error was disabled. The backspace on the dump file hit the beginning of the tape reel, leaving filename partially dumped on the previous reel. This file will not be loaded if the option to load files in error is disabled.

Issued by QDUMP.

User Action: None.

### **filename - xxx ERRORS AND yy WARNINGS.**

Description: Indicates count of errors or warning messages encountered. Files created with fatal errors do not contain verification records and are not usable by the network.

Issued by NDLP.

User Action: Correct errors and rerun NDLP.

### **ERROR(S) ENCOUNTERED IN DMREC PROCESSING.**

Description: Fatal errors were encountered during processing.

Issued by DMREC.

User Action: Check the output file for the detailed error message.

### **ERRORS OCCURRED DURING CENTRAL MEMORY INITIALIZATION.**

Description: This display is presented at the conclusion of the writing or scanning function if errors were encountered.

Issued by CTI.

User Action: Inform site analyst.

### **ES, filename/userindex/length/code.**

Description: ES denotes MSE end of staging operation for file filename and user index userindex. The file length is specified in PRUs. The following return codes are valid:

Code	Description
0	No errors.
1	No errors, but the alternate storage address (ASA) is cleared
2	Temporary cartridge busy
3	SETAF failed
4	SETDA or UREPLAC failed
5	Permanent file data error.
6	Permanent file linkage error
7	AU out of range
10	PFC entry obsolete
11	File length error
12	PP detected data problem
13	Obsolete catalog
14	Disk full
15	Disk write error
16	Cartridge lost

- 17 Storage module off
- 20 Unknown hardware problem
- 21 7990 catalog not online
- 22 7990 catalog input or output error
- 23 Access level unavailable

Issued by SSEXEC.

User Action: Self explanatory. If the problem persists, inform a knowledgeable person at your site.

### **ESM ERROR - BUFFERED I/O.**

Description: Hardware error has occurred during buffered device request processing.

Issued by CPUMTR.

User Action: Inform customer engineer and site analyst. Redeadstart.

### **ESTest**

Description: Gives the location in the Equipment Status Table.

Issued by SSEXEC.

User Action: None

### **EST est - BAD NBSTTP TRIGER FROM NETWK.**

Description: Informative message indicating that NIP has received a block for an existing network connection from the front end with EST ordinal est that NIP considers to be in error. NIP discards such blocks. The dayfile message is followed by an octal/hex dump of the block that was discarded.

Issued by NIP.

User Action: The error is not serious enough to bring down the network. If the error occurs consistently, bring down the network.

### **EST est - BAD NETWORK BLOCK DISCARDED.**

Description: Informative message indicating that NIP has received a block from the front end with EST ordinal est that it cannot recognize. NIP discards such blocks. The dayfile message is followed by an octal/hex dump of the block that was discarded.

Issued by NIP.

User Action: The error is not serious enough to bring down the network. If the error occurs consistently, bring down the network.

### **EST est - BAD NODE NUMBER IN UPLINE MSG.**

Description: Alert message indicating that the front end with EST ordinal est was configured with a node number that is different than the one defined in the EST. NAM will not be able to communicate with the front end until the problem is corrected. The dayfile message is followed by an octal/hex dump of the upline block with the bad node number.

Issued by NIP.

User Action: Inform site analyst.

### **ESTest,CHch or ESTest,CHch,SMdn or ESTest,CHch,SMdn,DRDdrd**

Description: The first describes a controller location, the second describes a storage module location, and the third describes a DRD location on a storage module.

- est EST ordinal
- ch Channel number
- dn Device number
- drd DRD offset ordinal

Issued by SSEXEC.

User Action: None.

### **EST est - FRONT END INTERFACE ERROR ee**

Description: Alert message indicating that PIP has detected error ee in the interface to the front end with EST ordinal est.

est	EST ordinal
ee	Explanation
1	Channel active before function.
2	Channel active after function.
3	Channel active before activate.
4	Channel inactive after activate.
5	Channel active after disconnect.
6	Channel inactive during output.
7	Channel hung full during output.
8	Channel inactive during input.
9	Channel hung empty during input.
10	Channel hung full after input.
11-15	Reserved.
16	NPU memory protect error.
17-19	Reserved.
20	Unable to obtain MDI status.
21	Reserved.
22	MDI inoperative.
23	Unable to reset MDI interface.
24	MDI header format error.

Issued by NIP.

User Action: If the problem persists, inform a customer engineer.

### **EST est - MDI ERROR STATUS MESSAGE.**

Description: Informative message indicating that PIP has detected an error condition in the MCI board that is part of the MDI with EST ordinal est. The dayfile message is followed by an octal/hex dump of detailed information from the MCI board about the error condition.

Issued by NIP.

User Action: Inform site analyst.

### **EST est - NIP/REGLL DN=ddd,SN=sss,RL=y.**

Description: Informative message indicating that NIP has received a logical link regulation (REG/LL) supervisory message from the front end with EST ordinal est. ddd is the destination node (host node) of the logical link, sss is the source node (terminal node) of the logical link, and y is the new regulation level of the logical link.

Issued by NIP.

User Action: None.

### **EST ORDINAL est - NO UDT ENTRY.**

Description: Informative message indicating that there is no entry in the controller BUDT.

Issued by SSEXEC.

User Action: This is a warning message.

### **EST ORDINAL est OUT OF RANGE.**

Description: The EST ordinal est entered on the INITMDI command is not within the limits of valid EST ordinals.

est EST ordinal of MDI.

Issued by INITMDI.

User Action: Alter the INITMDI command to include a valid EST ordinal est.

### **EST est - PRU BLOCK PROTOCOL ERROR.**

Description: Informative message indicating that PIP has received a block for a PRU connection from the front end with EST ordinal est that PIP considers to be in error. PIP discards such blocks. The dayfile message is followed by an octal/hex dump of the worklist sent to NIP.

Issued by NIP.

User Action: The error is not serious enough to bring down the network. If the error occurs consistently, bring down the network.

### **EST READ ERROR**

Description: SSEXEC could not read the EST entries.

Issued by SSEXEC.

User Action: System problem.

### **EST/UDT CHANNEL MISMATCH.**

Description: Informative message indicating that the channel in the BU DT est entries do not match.

Issued by SSEXEC.

User Action: Check the BU DT and EST.

### **EST est - UNSUPPORTED CHANNEL PROTOCOL.**

Description: Alert message indicating that the CDCNET front end with EST ordinal est is using a version of the MCI channel protocol that is not supported by NAM running in this host. NAM will not be able to communicate with the front end until the problem is corrected. The dayfile message is followed by an octal/hex dump of the worklist sent to NIP to log the error condition.

Issued by NIP.

User Action: Inform site analyst to reload the CDCNET front end with the correct software.

### **EVFU PROBLEM - SEE CDCNET NETWORK LOG FILE**

Description: This message indicates that a problem exists with a 585 EVFU load file.

Issued by PSU.

User Action: Refer to the CDCNET network log file for details.

### **EXCESS PARAMETERS.**

Description: A second parameter was specified on a command which was not a skip command.

Issued by QDSPLAY.

User Action: Delete one of the parameters and retry the command.

### **EXCESS PARAMETERS.**

Description: You specified one or more extra parameters on the command.

Issued by SDSPLAY.

User Action: Correct parameter and retry.

### **EXCESS PARAMETERS.**

Description: Too many parameters were specified on the command. See list of available commands.

Issued by LIDOU.

User Action: Correct command and retry.

### **EXCESSIVE PARITY ERRORS.**

Description: Excessive recovered parity errors due to a faulty DRD or cartridge were encountered while the cartridge label was being written.

Issued by SSLABEL.

User Action: Retry after cleaning or repairing the DRD, or discard the cartridge.

### **EXEC ABNORMAL,xxxxx.**

Description: Informative message.

Issued by SSEXEC.

User Action: Analyze the SSEXEC dump and take the appropriate action.

### **EXEC IN SINGLE MAINFRAME MODE**

Description: Informative message indicating that the SSEXEC program is running in a single mainframe configuration.

Issued by SSEXEC.

User Action: None.

### **EXEC MMF INITIALIZATION FAILED - message.**

Description: SSEXEC failed to establish communication with any of the slave machines in a multimainframe environment; message indicates the reason and can be one of the following:

- ALL SLAVES OMITTED.
- ATTACH MTOS FAILED.
- DEFINE MTOS FAILED.
- MTOS FILE BUSY.
- SETPPF PROBLEM.

Issued by SSEXEC.

User Action: Inform site analyst.

### **EXEC - SLAVE i xxxxx.**

Description: SSEXEC is ready to communicate with SSSLV on mainframe i or that the status of SSSLV on mainframe i has changed. The current status of SSSLV is indicated by xxxxx can be ACTIVE or INACTIVE.

Issued by SSEXEC.

User Action: None.

### **EXEC - SLAVE i OMITTED - message.**

Description: SSEXEC was unable to establish or maintain access to a communication file with SSSLV on mainframe i; message indicates the reason and can be one of the following:

- STOM FILE LENGTH PROB.
- NO \*STOM\* FILE.

SSEXEC will continue to operate, but will not attempt to receive requests from SSSLV on mainframe i.

Issued by SSEXEC.

User Action: If SSSLV is to be run on mainframe i and the message is NO \*STOM\* FILE; idle SSEXEC, purge the STOM file, initiate SSSLV, and then initiate SSEXEC. If the message is STOM FILE LENGTH PROB, purge the existing STOM file, and reinstall SSEXEC and SSSLV using identical values for NUMRB, MAXSLV, and NUMSLV in common deck COMEIPR and for RBSIZE in common deck COMBFAS.



### **EXEC SMF MODE - ALL SLAVES OMITTED.**

Description: SSEXEC has lost access to all of the SSSLVs and is now running in single mainframe mode.

Issued by SSEXEC.

User Action: Inform site analyst.

### **nnnn EXECUTING JOB FILES RECOVERED.**

Description: nnnn jobs at control points have been recovered.

Issued by REC.

User Action: None.

### **EXPECTING PERIOD.**

Description: A command string was not terminated properly.

Issued by NVF.

User Action: Attempt corrected command entry.

### **EXPECTING PERIOD OR COMMA.**

Description: A command string is missing comma or period.

Issued by NVF.

User Action: Attempt corrected command entry.

### **EXPRESS DUMP COMPLETE (FL USED xxxxxxB).**

Description: Dayfile message indicating that the dump was completed normally. The amount of field length used was xxxxxx octal words.

Issued by DSDI.

User Action: None.

### **EXTENDED MEMORY ERROR.**

Description: An extended memory hardware error occurred during a transfer between CM and extended memory.

Issued by CPUMTR.

User Action: Inform site analyst and customer engineer.

### **EXTENDED MEMORY ERROR - STORAGE MOVE.**

Description: An extended memory hardware error occurred during a storage move through extended memory. Storage move is to be done through registers or the Compare/Move Unit (CMU).

Issued by CPUMTR.

User Action: Inform site analyst and customer engineer.

### **EXTENDED MEMORY LABEL TRACK NOT FOUND.**

Description: Operator message indicating that the CPUMTR preset routine was unable to find a valid label track in extended memory. Recovery is impossible.

Issued by CPUMTR.

User Action: It is necessary to deadstart with INITIALIZE and PRESET. Inform site analyst, if present. If not, contact CYBER Software Support.

### **EXTENDED MEMORY NOT AVAILABLE.**

Description: The FL requested on the ENFLE, nnnn. command is not available.

Issued by DIS.

User Action: Wait until FL becomes available or hit the left blank to clear command.

### **EXTENDED MEMORY PARITY ERROR.**

Description: Hardware error.

Issued by RECLAIM.

User Action: Inform site analyst.

### **EXTENDED MEMORY READ ERROR.**

Description: Self-explanatory.

Issued by TAF.

User Action: Inform customer engineer.

### **EXTENDED MEMORY READ/WRITE PARITY ERRORS.**

Description: Operator message indicating that error exit was taken during execution of RE/WE instructions in CPUMTR preset. Recovery is impossible.

Issued by CPUMTR.

User Action: Inform customer engineer.

### **EXTENDED MEMORY RECORD NOT FOUND.**

Description: Output file message indicating that the extended memory record was not found in the EDD file.

Issued by DSDI.

User Action: Re-run DSDI with the FULL option. If the message still appears, the dump extended memory option in EDD was probably not selected.

### **EXTENDED MEMORY TASK tasknam NOW MS RESIDENT.**

Description: Task tasknam could not be loaded into extended memory because of insufficient storage. It is loaded into mass storage.

Issued by TAF.

User Action: If task must be resident in extended memory, more extended memory space must be allocated for the TAF user name.

### **EXTENDED MEMORY WRITE PARITY ERROR ENCOUNTERED.**

Description: Self-explanatory.

Issued by TAF.

User Action: Inform customer engineer.

### **FAMILY FILES ACTIVE.**

Description: Dayfile message indicating that the direct access file count is greater than the number of fast attach files.

Issued by ISF.

User Action: Use IDLEFAMILY and wait for the direct access file count to decrease until it equals the number of fast attach files.

### **FAMILY FOR TERMINAL MUST BE ENTERED.**

Description: The operator attempted to enter a destination user index before entering a destination family name for the terminal.

Issued by QFSP.

User Action: Enter a destination family name for the terminal and reenter a destination user index.

### **FAMILY MASK NOT EQUAL TO 377.**

Description: The device mask for the family name does not equal 377B.

Issued by MSI.

User Action: Correct and enter GO or enter GO to override. This is the only input accepted at this time.

### **FAMILY NAME MUST BE ENTERED.**

Description: K display message indicating that the operator attempted to enter a specific device number before entering a specific family name.

Issued by QFSP.

User Action: Enter the missing family name and type GO.

### **FAMILY NOT FOUND.**

Description: The family name specified by the FM parameter on the SSLABEL, SSMOVE, SSUSE, or SSDEBUG command does not exist or is not online.

Issued by SSMOVE.

User Action: Specify an existing online family name and retry.

### **FAMILY NOT FOUND.**

Description: The family device requested did not exist, or was an auxiliary device.

Issued by PACKER.

User Action: Check parameters and retry.

### **FAMILY NOT FOUND IN SYSTEM.**

Description: The family name specified by the FM parameter on the SSVAL command or the family name in the RDF header was not found in the system family name packs.

Issued by SSVAL.

User Action: Correct the parameter or add the family name to the system.

### **FAMILY/PACK NOT FOUND.**

Description: Family name or pack name specified is not defined in the permanent file system.

Issued by PFS.

User Action: Reenter parameters and specify correct pack name or family name, or mount the correct family or pack into the system if not currently present.

### **FAST-ATTACH ALTERNATE FILE NOT ALLOWED.**

Description: The file specified by the P option cannot be a fast-attach file.

Issued by PROFILE.

User Action: Use the ISF command R parameter to release the file from fast-attach status or change name.

### **FAST ATTACH FILES ON DEVICE.**

Description: An attempt was made to initialize a mass storage device on which one or more fast-attach files are currently active. This message also appears in the comment field of the system control point in the system status display (B,O).

Issued by 1DS.

User Action: Inform site analyst; the fast-attach files have to be released via ISF function before the device can be initialized. The recommended procedure is as follows.

- Examine the FNT (H) display to determine the names of the fast-attach files on the device (typically, VALIDUS, PROFILC, or RSXDid).

- Release those files via ISF entries in the following format X.ISF,R=filename. If fast-attach files are to be reloaded after the device is initialized, those files must be initialized via the entry X.ISF.

**nnnn FAST ATTACH FILES RECOVERED.**

Description: nnnn fast attach files have been recovered.

Issued by REC.

User Action: None.

**FAST-ATTACH PROFILE FILE INCORRECT.**

Description: Dayfile message indicating that the project file cannot be in fast-attach status on a reformat run.

Issued by PROFILE.

User Action: Use the ISF command with the R option to release the project file from fast-attach status or change name.

**FATAL CIO ERROR STATUS.**

Description: A TAF CIO operation returned a fatal error status which aborted TAF.

Issued by TAF.

User Action: Inform site analyst.

**(xxx) FATAL CM ERROR**

Description: DFT detected an uncorrected fatal memory error. Check the Binary Maintenance Log for further information.

xxx 105, 11E, 21E

Issued by 1MB.

User Action: Inform customer engineer and site analyst.

**(xxx) FATAL CPU ERROR**

Description: A job has been aborted with a fatal processor error. Check the binary maintenance log for further information.

xxx 204

Issued by 1MB.

User Action: Inform customer engineer and site analyst.

**(xxx) FATAL ERROR**

Description: DFT has detected a fatal error condition. The analysis code is indicated by xxx.

Issued by 1MB.

User Action: Inform customer engineer.

**FATAL INITIALIZATION ERROR.  
OPERATOR IDLE OF EXEC.**

Description: Fatal error.

Issued by SSEXEC.

User Action: Analyze and take the appropriate action.

**(xxx) FATAL IOU ERROR**

Description: DFT detected a fatal IOU error which caused the PP that received the error to halt. Check the Binary Maintenance Log for further information.

xxx 006 or 008

Issued by 1MB.

User Action: Inform customer engineer and site analyst.

### **(xxx) FATAL MCH ERROR**

Description: The maintenance channel timed out while 1MB was attempting to build the long instructions.

xxx 215

Issued by 1MB.

User Action: Inform customer engineer.

### **FCT ORDINAL OUT OF RANGE.**

Description: The FCT ordinal specified by the FO parameter in a directive to SSDEBUG is out of range.

Issued by SSDEBUG.

User Action: Correct the FO parameter and retry.

### **FDP ABORT - USER VALIDATION ERROR.**

Description: Dayfile message indicating that ENGINEERING mode has not been set at the system console.

Issued by FDP.

User Action: Set ENGINEERING mode at the system console.

### **FEED FAILURE.**

Description: I-display message indicating that the card reader has encountered an error.

Issued by DSD.

User Action: Check specified equipment.

### **FEED FAILURE.**

Description: I-display message. The card punch has a card feed problem.

Issued by 1CD.

User Action: Clear the punch feed path, reload the hopper and ready the punch.

### **FEET OF DUMP TAPE REQUIRED = NNNN.**

Description: Files specified by the utility directives generated by GENPFD will fill NNNN feet of tape at the specified or default density.

Issued by GENPFD.

User Action: None.

### **FET ADDRESS OUT OF RANGE.**

Description: One of the FET pointers is outside the caller's field length.

Issued by 1LC.

User Action: Examine program to determine error.

### **FETCHING FLAW DATA S/N=serialn**

Description: Console message indicating that the factory recorded data is being retrieved from cylinder 632B (or 1466B), track 0, sectors 0, 1, and 2. Here, serialn is the actual pack serial number read.

Issued by FORMAT.

User Action: None.

### **FIELD LENGTH DUMPED**

Description: Dayfile message indicating PSU has dumped its field length in response to a K.DU=PSU NAM command.

Issued by PSU.

User Action: None.

### **FIELD LENGTH EXCEEDED FOR CMM.**

Description: TAF does not have enough field length to allocate the space potentially required by CMM.

Issued by TAF.

User Action: Increase TAF initialization field length.

### **FIELD LENGTH EXCEEDED FOR LOCKS.**

Description: TAF does not have enough initialization field length for allocating lock tables.

Issued by TAF.

User Action: Decrease the locks parameter on the CRM statement, increase the TAF initialization field length, or inform site analyst.

### **FIELD LENGTH EXCEEDED FOR RECORD.**

Description: TAF does not have enough field length to allocate the space for the record buffer.

Issued by TAF.

User Action: Decrease the record size specified in the xxJ file or increase the TAF initialization field length.

### **FIELD LENGTH EXCEEDED FOR USERS.**

Description: TAF does not have enough initialization field length for allocating file control tables.

Issued by TAF.

User Action: Decrease the users parameter on the CRM statement, increase the TAF initialization field length, or inform site analyst.

### **FILE ALREADY INTERLOCKED.**

Description: The track interlock for an IQFT file is currently interlocked.

Issued by QFM.

User Action: Contact CYBER Software Support.

### **FILE ATTACH/DEFINE ERROR.**

Description: An error was detected in attaching or defining an ARF or BRF.

Issued by TAF.

User Action: Check the ARFs and the BRFs for attach mode and processing mode and correct if necessary.

### **FILE BUSY PFN= filename UN= username.**

Description: Informative message indicating that MCS attempted to attach the named file.

filename	File name
username	User name

Issued by MCS.

User Action: None.

### **FILE EQUIVALENCE MAY NOT BE 0**

Description: Dayfile message indicating that either the input or the standard output file has been declared empty (that is, set equal to 0).

Issued by FORMAT.

User Action: Correct and rerun.

### **FILE ERROR.**

Description: K-display message indicating that the change file specified could not be attached.

Issued by STIMULA.

User Action: Verify that the change file is an indirect file.

### **FILE/JOB NOT FOUND.**

Description: The specified file or job was not found in the system.

Issued by CONTROL.

User Action: Use the ENQUIRE command to ensure the job is still in the system.

### **FILE LENGTH ERROR.**

Description: The length of a file does not equal the length specified in the catalog. This indicates that the file has been destroyed.

Issued by PFM.

User Action: Inform site analyst. If many of these errors occur, the site analyst should perform a full PFDUMP, total INITIALIZE, and full PFLOAD on the device.

### **FILE LENGTH ERROR tttt/ssss/o.**

Description: During a file copy, the amount of data read does not match the file length in the PFC. tttt/ssss/o is the track/sector/PFC ordinal of the file's PFC entry.

Issued by PACKER.

User Action: The IAPF chain on the device in question may have been corrupted. Either have an analyst repair the damage with DDF (if that is possible), or perform a full PFDUMP, deadstart INITIALIZE, and full PFLOAD.

### **FILE NAME CONFLICT.**

Description: The same file cannot be used for both applications without conflict.

Issued by MODIFY.

User Action: Use a different file name for one of the applications.

### **FILE NAME CONFLICT.**

Description: The file names specified by the I and L directives are identical or a reserved file name was specified. Reserved file names include IQF, MIQFT, NIQFT, and SCR.

Issued by QFSP.

User Action: Change the incorrect file names and reenter directives.

### **FILE NAME CONFLICT.**

Description: The file to receive output cannot be named IQF or NIQFT.

Issued by QREC.

User Action: Change output file name and enter new directive.

### **FILE NAME CONFLICT.**

Description: The input file name specified on the KTSMDMP command is the same as the output file name specified.

Issued by KTSMDMP.

User Action: Correct error and rerun.

**FILE NAME CONFLICT.**

Description: The names of the output, load, and IQFT files conflict.

Issued by QLOAD.

User Action: Change the name of the output or load file and retry the operation.

**FILE NAME CONFLICT - filename.**

Description: The named file was specified on more than one parameter of a PF utility program.

Issued by PFS.

User Action: Correct and retry.

**FILE NAME CONFLICT.**

Description: The old file, replacement file, and the new file were not all specified by unique file names.

Issued by COPYL.

User Action: Specify unique file names.

**FILE NAME CONFLICT - filename.**

Description: File filename was used for more than one purpose.

Issued by MODVAL.

User Action: Correct call parameters and retry.

**FILE NAME CONFLICT - FILE filename.**

Description: The names of the output, dump, and IQFT files conflict.

Issued by QDUMP.

User Action: Change the name of the output or dump file and retry the operation.

**FILE NAME MISMATCH ON TAPE HEADER RECORD.**

Description: File name on ARF tape and attached ARF don't match.

Issued by DMREC.

User Action: Check file name on ARF tape being used.

**FILE NAME MUST BE 2-7 CHARACTERS.**

Description: The xxpfn parameter on the CRM statement must be two to seven characters, the first two (xx) being the database name.

Issued by TAF.

User Action: Correct the xxpfn parameter on the CRM statement or inform database administrator.

**FILE NAME -NETDIR- RESERVED.**

Description: This message is issued when NETDIR is used as a local file name on an ATTACH directive. NETDIR is reserved as the local file name for attaching the directory file itself.

Issued by NETFMA.

User Action: Reenter the directive. Specify a different local file name.

**FILE NAME NOT SET.**

Description: Nonfatal K-display message indicating that a GO was entered, and the file name was not set.



Issued by STIMULA.

User Action: Set the file name.

### **FILE NOT ALLOWED ON EQUIPMENT**

Description: The requested equipment's access level did not match the file.

Issued by QFM.

User Action: Select a different equipment.

### **FILE NOT ALLOWED ON EQUIPMENT.**

Description: The requested equipment did not have the required access level for the queued file.

Issued by QLOAD.

User Action: Load the file to a different device.

### **FILE NOT DISK RESIDENT.**

Description: Access to a file which does not reside on disk is not permitted with the requesting function.

Issued by PFM.

User Action: Write a PSR.

### **FILE hash NOT FOUND.**

Description: The indirect file named hash containing the binary code of the hashing routine was not found under the username parameter on the USER statement in the xxJ file or a PFM error occurred.

Issued by TAF.

User Action: Ensure that file hash is saved under the username parameter or inform database administrator. Consult the CYBER Loader Reference Manual.

### **FILE NOT FOUND.**

Description: Requested file could not be found.

Issued by LFM.

User Action: Verify that the file exists and retry.

### **FILE lfn NOT FOUND.**

Description: Fatal error if DEBUG is on. File NRF1 or NRF2 does not exist at NAM's control point as a local file. JOBNIP of the NAM start-up master file must contain the job records NRF1 and NRF2.

Issued by NIP.

User Action: Reinitialize NAM. Run collector job. Save COLLECT tape and contact CYBER Software Support or a site analyst.

### **FILE NOT FOUND.**

Description: An error was encountered while attempting to define the sample file, possibly because an inaccessible device was encountered.

Issued by ICPD.

User Action: Check status of family devices.

### **FILE NOT FOUND OR FAILED CRITERIA - filename**

Description: RECLAIM did not process the named file because it could not find the file on the dump tape or file (for a LOAD or COPY operation); it could not find a local or permanent file by that name (for a DUMP operation); or it found the file, but failed to meet other criteria. the file

filename            A file name you specified in a RECLAIM PF or FN option

Issued by RECLAIM.

User Action: Check to see that a file exists with the specified file name.

**FILE NOT IN ALTERNATE FAMILY.**

Description: The file specified via the R parameter is a default family name file, but an alternate family name was specified via the FM parameter.

Issued by ISF.

User Action: Verify which family name and file you want to return. Repeat the ISF entry with the correct combination of parameters.

**FILE ORGANIZATION IS NOT IS, DA OR AK.**

Description: The file organization parameter on the CRM statement was not specified as either IS, DA, or AK.

Issued by DMREC.

User Action: Correct the CRM statement and try again.

**FILE OVERLAP tttt/ssss/o, tttt/ssss/o.**

Description: The file length from the catalog entry overlaps the next file/hole. The two PFC locations are given (track/sector/PFC ordinal).

Issued by PACKER.

User Action: The IAPF chain on the device in question may have been corrupted. Either have an analyst repair the damage with DDF (if that is possible), or perform a full PFDUMP, deadstart INITIALIZE, and full PFLOAD.

**FILE PROBLEM, RESET UP.**

Description: SSEXEC has aborted. It couldn't attach the file RELCOM under the default family, user index 377760B, during an SSVAL run.

Issued by SSEXEC.

User Action: Correct the attach problem for file RELCOM.

**FILE TCF NOT FOUND.**

Description: The TCF was not found under the user name of the Transaction Facility.

Issued by TAFREC.

User Action: Create a TCF file under the TAF user name.

**FILE TYPE MUST BE AK, DA, OR IS.**

Description: The type parameter on the CRM statement must be AK (actual key), IS (indexed sequential) or DA (direct access).

Issued by TAF.

User Action: Correct the type parameter on the CRM statement or inform the database administrator.

**FILE TYPE NOT ARF OR BRf.**

Description: On a create function, a file name was used that does not conform to the ARF/BRF naming conventions.

Issued by DMREC.

User Action: Check file name on create directive.

**nnnn FILES ACTIVATED DNdn FM familyname.**

Description: Informative message indicating the number of queued files that have been activated on the specified device.

nnnn	Number of files.
dn	Device number.
familyname	Family name.

Issued by QREC.

User Action: None.

**nnnn FILES DEQUEUED DNdn FM familyname.**

Description: Informative message indicating the number of files that have been dequeued on the specified device.

nnnn	Number of files.
dn	Device number.
familyname	Family name.

Issued by QREC.

User Action: None.

**nnnn FILES DUMPED (A) DNdn FM familyname.**

Description: Informative message indicating the number of active queued files which have been dumped and remained active on the specified device.

nnnn	Number of files.
dn	Device number.
familyname	Family name.

Issued by QDUMP.

User Action: None.

**nnnn FILES DUMPED (I) DNdn FM familyname.**

Description: Informative message indicating the number of inactive queued files which have been dumped and remained inactive on the specified device.

nnnn	Number of files.
dn	Device number.
familyname	Family name.

Issued by QDUMP.

User Action: None.

**nnnn FILES IGNORED DNdn FM familyname.**

Description: Informative message indicating the number of queued files which have been ignored on the specified device during a queue operation.

nnnn	Number of files.
dn	Device number.
familyname	Family name.

Issued by QREC.

User Action: None.

**nnnn FILES MOVED (A) DNdn FM familyname.**

Description: Informative message indicating the number of active queued files that have been moved and remained active on the specified device.

nnnn	Number of files.
dn	Device number.
familyname	Family name.

Issued by QMOVE.

User Action: None.

**nnnn FILES MOVED (I) DNdn FM familyname.**

Description: Informative message indicating the number of inactive queued files that have been moved and remained inactive on the specified device.

nnnn	Number of files.
dn	Device number.
familyname	Family name.

Issued by QMOVE.

User Action: None.

**FILES MOVED nnnnnn, ssssss PRUS.**

Description: PACKER statistics reflecting the condition of the portion of the IAPF chain which PACKER has processed.

nnnnnn	Number of files moved.
ssssss	Total number of sectors moved.

Issued by PACKER.

User Action: None.

**nnnn FILES PURGED DNdn FM familyname.**

Description: Informative message indicating the number of queued files which have been purged on the specified device.

nnnn	Number of files.
dn	Device number.
familyname	Family name.

Issued by QREC.

User Action: None.

**nnnnn FILES RELEASED.**

Description: nnnnn files were released by PFREL.

Issued by PFREL.

User Action: None.

**FILES SELECTED FOR DESTAGE = NNNN.**

Description: GENPFD wrote utility directives for NNNN files to the UD file for a destage operation.

Issued by GENPFD.

User Action: None

**FILES SELECTED FOR RELEASE = NNNN.**

Description: GENPFD wrote utility directives for NNNN files to the UD file for a release operation.

Issued by GENPFD.

User Action: None.

**number FILES WITH ERRORS.  
number DIRECT ACCESS FILES LOADED.**

**number INDIRECT ACCESS FILES LOADED.**

Description: This listing of three messages gives the number of files of each type that were found and loaded.

Issued by PFLOAD.

User Action: None.

**FILL MOVES nnnnnn, ssssss PRUS.**

Description: PACKER statistics reflecting the condition of the portion of the IAPF chain which PACKER has processed.

nnnnnn Number of files moved into holes via the fill move procedure.

ssssss Total number of sectors moved via this procedure.

Issued by PACKER.

User Action: None.

**FIP - ACN acn NOT WITHIN RANGE.**

Description: A data transfer error has occurred. The system has halted the file transfer.

acn Application connection number (octal)

Issued by FIP.

User Action: Inform site analyst.

**FIP - CONNECTION BROKEN ON ACN acn.**

Description: The network connection has been broken unexpectedly. The system has halted the file transfer.

acn Application connection number (octal)

Issued by FIP.

User Action: Rerun your job. Inform site analyst.

**FIP - CONVERT MODE N/A FOR filename.**

Description: The application timed out waiting for resources to become available.

filename The affected file

Issued by FIP.

User Action: Try again. If problem persists, inform site analyst.

**FIP - DISABLE WARNING RECEIVED.**

Description: The system has halted the file transfer because the network is shutting down immediately.

Issued by FIP.

User Action: Retry the file transfer after the network is reactivated.

**FIP - GT 4 FILE TRANSFERS INITIATED.**

Description: The system is attempting too many file transfers simultaneously. The system has not initiated the file transfer you are requesting.

Issued by FIP.

User Action: Inform site analyst.

**FIP - INITIATING XFR OF filename.**

Description: The system has initiated the transfer of file filename.

Issued by FIP.

User Action: None.

**FIP - NETOFF DURING FILE TRANSFER.**

Description: An internal error occurred during your file transfer. The file transfer was not completed successfully.

Issued by FIP.

User Action: Inform site analyst.

**FIP - filename ON INVALID DEVICE.**

Description: File filename is assigned to an inaccessible device. The system has halted the file transfer.

filename            File being transferred

Issued by FIP.

User Action: Reassign file filename to an accessible device and rerun job. Inform site analyst if the problem persists.

**FIP - OUTPUT BLOCK NOT DEL ON ACN acn.**

Description: The remote system did not receive the network message or data block before the time-out period elapsed. The system has halted the file transfer.

acn    Application connection number (octal)

Issued by FIP.

User Action: Retry the file transfer. Inform site analyst if the problem persists.

**FIP - PREMATURE TERMINATION RCVD ON acn.**

Description: The system detected an error during a file transfer and halted the file transfer.

acn    Application connection number (octal)

Issued by FIP.

User Action: Retry file transfer. Inform site analyst if the problem persists.

**FIP - PROTOCOL ERROR DETECTED.**

Description: An unrecognized or unexpected network message has been received. The file transfer is ended.

Issued by FIP.

User Action: Retry file transfer. Inform system analyst if problem persists.

**FIP - SECOND FILE XFR ON ACN acn.**

Description: The system attempted a file transfer on a connection that already has a file transfer in progress. The system halted the second file transfer.

acn    Application connection number (octal)

Issued by FIP.

User Action: Inform site analyst.

**FIP - TIMED OUT WAITING FOR NETWORK.**

Description: The network failed to respond before the time-out period elapsed. The system halted the file transfer.

Issued by FIP.

User Action: Ensure that the network and remote system are active and retry the file transfer. Inform site analyst if the problem persists.

### **FIP - TRANSFER OF filename COMPLETE.**

Description: Self explanatory.

filename File being transferred

Issued by FIP.

User Action: None.

### **FIP - TRANSFER OF filename IN PROGRESS.**

Description: Self explanatory.

filename File being transferred

Issued by FIP.

User Action: None.

### **FIP - XFR TERM WITH ERR, IDLEDOWN.**

Description: The network is shutting down and your file transfer ended unsuccessfully.

Issued by FIP.

User Action: Retry the file transfer when the network becomes active.

### **FIRST SELECTION FILE COUNT = NNNN.**

Description: NNNN files were qualified by selected user index/file name, selected archive vsn, or preferred residence and release device residence to be prioritized for final selection.

Issued by GENPFD.

User Action: None.

### **FIX EVFU LOAD FILE xxxxxxxx, THEN TYPE K.GO.**

Description: The information on EVFU load file is incorrect.

Issued by PSU.

User Action: Inform a knowledgeable person at your site to fix EVFU load file. Type K.GO. to continue processing.

### **FL OPTION VIOLATED.**

Description: The FL parameter was used with a directive which prohibits it, omitted with a directive which requires it, or used to specify an incorrect flag name.

Issued by SSDEBUG.

User Action: Correct the directive and retry.

### **FL REQUEST BEYOND MFL (CM)**

Description: A central memory field length request exceeds the maximum allowed field length.

Issued by 1MA.

User Action: Increase central memory field length.

### **FL TOO LARGE- nnnnnnB, taskname, tasklibrary.**

Description: The initial load field length, nnnnnnB, for task taskname on task library tasklibrary exceeds the minimum size of the transient task area (potential space available to contain transient tasks). Thus a situation could arise in which it would not be possible to load the task.

Issued by TAF.

User Action: Correct error.

### **FL TOO SHORT FOR SAMPLES.**

Description: The field length of the job step is too small to allow SMP to execute.

Issued by SMP.

User Action: Rerun job with larger field length assigned.

### **FLAW SPACE nnnnnn, ssssss PRUS.**

Description: PACKER statistics reflecting the condition of the portion of the IAPF chain which PACKER has processed.

nnnnnn Number of IAPF flaw files encountered.

ssssss Sectors occupied by IAPF flaw files.

IAPF flaws are files with UI=IFUI(377775B). They may reside on any IAPF device regardless of the device mask.

Issued by PACKER.

User Action: None.

### **FM NOT LEGAL FAMILY.**

Description: Dayfile message indicating that an incorrect family name was specified with the FM parameter.

Issued by PROFILE.

User Action: Correct FM parameter and retry.

### **FM OR PN MUST BE SPECIFIED.**

Description: Family name or pack name must be entered to initialize device.

Issued by MSI.

User Action: Enter the required family name or pack name, and then enter GO.

### **FO NOT SPECIFIED CORRECTLY.**

Description: One of the following conditions occurred:

OP=RF and FO was not specified

OP=RP and FO was not specified

OP=RL and FO was not specified

FO is less than 16 (the minimum value) or  
greater than 320 (the maximum value).

Issued by SSDEBUG.

User Action: Specify the FO parameter correctly and retry.

### **FORCED NETWORK SHUTDOWN.**

Description: The network is going down immediately. Users will probably not have time to logoff, but their jobs will be detached.

Issued by IAFEX.

User Action: Recover jobs as soon as the network comes up.

### **FORCED SHUTDOWN REQUESTED.**

Description: RBF has stopped communications with the network and is performing clean-up operations.

Issued by RBF.

User Action: No action required. RBF will be dropped automatically when clean-up operations are complete.

### **FORMAT ABORTED.**

Description: Dayfile message indicating that FORMAT aborted.



Issued by FORMAT.

User Action: Refer to other messages in the dayfile and the output file for more information.

### **FORMAT ERROR.**

Description: An error exists in the syntax of the command or the values of the parameters.

Issued by DDF.

User Action: Correct the command or parameters and retry operation.

### **\*\*\*\*\* FORMAT ERROR xxxx \*\*\*\*\***

Description: Dayfile message indicating that a channel malfunction has occurred, causing FDP to abort the control point.

xxxx One of the following errors.

- 0001 The coupler was reserved from the opposite access.
- 0004 The disk drive was hung busy.
- 0010 An uncorrectable error has occurred.
- 0014 Status was expected, but none was received.
- 0015 An uncorrectable error on the channel connection occurred.
- 0024 An output failure occurred on the FORMAT parameter array.
- 0026 A read abort occurred.
- 0027 A detailed status abort occurred.
- 0032 An uncorrectable error occurred during formatting.

Issued by FDP.

User Action: Correct and retry.

### **FORMAT ERROR IN NETWORK FILE - filename.**

Description: During transaction executive initialization, one or more errors were found to exist in the network description file.

Issued by TAFREC.

User Action: Inform site analyst.

### **FORMAT ERROR IN TIME PARAMETER.**

Description: The values specified for the loop operation times do not conform to standard numeric format (digits 0-9 with optional post-radix D or B). Default base is decimal.

Issued by ICPD.

User Action: Correct and retry.

### **FOT FULL.**

Description: The Family Ordinal Table (FOT) is not large enough to accommodate all family devices.

Issued by MSM.

User Action: Redeadstart and specify a larger FOT.

### **FOT FULL - FILES IGNORED.**

Description: The queued files were not processed because there was no FOT entry for the creation and/or destination family name and the table was full.

Issued by QLOAD.

User Action: A level 0 deadstart is required to create some space in the FOT.

### **FOT FULL - FILES IGNORED**

Description: Some files were ignored because the FOT did not contain an entry for the files family.

Issued by QREC.

User Action: Create a FOT entry for the family and rerun.

### **FOT IS FULL.**

Description: Not all files could be requested because of a full FOT.

Issued by QFM.

User Action: Level 0 deadstart to increase FOT size.

### **FREE CARTRIDGE FLAG SET.**

Description: Informative message indicating that the free cartridge flags were set in the PFCs of permanent files which are archived to a cartridge whose free cartridge flag was set.

Issued by SSVAl.

User Action: None.

### **FREE CHAIN ERROR.**

Description: NIP internal error issued if DEBUG defined (BFSC defined). This indicates a problem with the free buffer chain pointers. NAM takes an internal dump and terminates.

Issued by NIP.

User Action: Reinitialize NAM. Run collector job. Save COLLECT tape and contact CYBER Software Support.

### **FREE FILES NOT RELEASED.**

Description: Informative message indicating that SSVAl did not release the SFM space allocated to trouble-free orphans, because the last release date was after the date on the RDF file header.

Issued by SSVAl.

User Action: Retry with the correct RDF file.

### **FREE FILES RELEASED.**

Description: Informative message indicating that SSVAl released the SFM space allocated to trouble-free orphans.

Issued by SSVAl.

User Action: None.

### **FROM-npname: BUFFER THRESHOLD EXCEEDED**

Description: Informative message. This is an NPU statistics monitoring message indicating that currently the amount of available buffers has gone below the threshold specified by the ALERT command.

npname      Name of the NPU (network processing unit)

Issued by CS.

User Action: Inform site analyst. To suppress the message, change the threshold value with the ALERT command.

### **FROM npname ALARM ON PORT pn LCN = lcn PKID = pkid CAUSE = cc DIAG = dc**

Description: The X.25 TIP (terminal interface program) received an abnormal packet.

npname      Name of NPU (network processing unit).

pn            Port number.

lcn          Logical channel number.

pkid         Packet identification.

cc Cause code.  
dc Diagnostic code

Issued by CS.

User Action: Check CAUSE and DIAG fields in the relevant CCITT (International Consultation Committee for Telephone and Telegraph) manual for symptom.

### **FROM npuname LINK RESET ON PORT = pn**

Description: The X.25 TIP (terminal interface program) encountered an irrecoverable line error.

npuname Name of the NPU (network processing unit).  
pn Port number.

Issued by CS.

User Action: Contact PSN (Packet Switching Network) vendor.

### **FROM npuname MAINTENANCE ALARM COUPLER cn, ERROR=ec**

Description: Too many recent errors on this coupler.

npuname Name of the NPU (network processing unit).  
cn Coupler number.  
ec Error code.

Issued by CS.

User Action: Check coupler hardware.

### **FROM npuname MAINTENANCE ALARM DUPLICATE CLA DETECTED PORT=pn**

Description: More than one CLA (communication line adapter) address set to the same value.

npuname Name of NPU (network processing unit).  
pn Port number.

Issued by CS.

User Action: Find CLAs with duplicate addresses and change to unique addresses.

### **FROM npuname MAINTENANCE ALARM MLIA, ERROR=ec**

Description: Too many recent errors in Mux subsystem.

npuname Name of the NPU (network processing unit).  
ec Error code.

Issued by CS.

User Action: Check MLIA, Loop Mux, and CLA (communication line adapter) hardware.

### **FROM npuname MAINTENANCE ALARM MUST ENABLE TERM TO PREVENT LINE DISC/DISABLE**

Description: All terminals on a line have been disabled.

npuname Name of NPU (network processing unit).

Issued by CS.

User Action: Enable a terminal on the line or let CCP (communication control program) disable/disconnect the line.

**FROM npuname MAINTENANCE ALARM OUT OF RANGE  
CLA TURNED ON PORT=pn**

Description: CLA (communication line adapter) address set greater than the maximum number of links defined.

npuname Name of NPU (network processing unit).  
pn Port number.

Issued by CS.

User Action: Find CLA with the out of range address and change to a valid address.

**FROM npuname MAINTENANCE ALARM PORT=pn,  
ERROR=ec**

Description: Too many recent errors on this line (port).

npuname Name of the NPU (network processing unit).  
pn Part number.  
ec Error code.

Issued by CS.

User Action: Check CLA (communication line adapter) and modem for the specified port. Refer to CCP Diagnostic Handbook for more information on error code.

**FROM NOP.**

Description: This is the header of the message from network operator.

Issued by CS.

User Action: None.

**FROM OPERATOR: termnam**

Description: A header message which is included with text that is sent from another operator. It indicates the name of the terminal termnam from which the text was sent.

Issued by CS.

User Action: None.

**FROM npuname UNKNOWN VALUE OF LCN = lcn,  
PACKET IGNORED**

Description: X.25 LCN (logical channel number) out of range.

npuname Name of the NPU (network processing unit).  
lcn Logical channel number.

Issued by CS.

User Action: Contact CYBER Software Support.

**FROM npuname X.25 NETWORK (PSN) DOWN ON  
PORT = pn**

Description: The X.25 TIP (terminal interface program) could not establish link. Probable cause was a failure to get responses from DCE.

npuname Name of the NPU (network processing unit).  
pn Port number.

Issued by CS.

User Action: Contact PSN (Packet Switching Network) vendor.

### **FROZEN CHAIN.**

Description: While trying to read a file, SSDEBUG encountered the frozen chain flag set in the stream chain.

Issued by SSDEBUG.

User Action: Run SSVAL to identify the problem AU on the chain, and then read each stream separately using the RS directive to SSDEBUG.

### **FSTT READ ERROR.**

Description: No FSTT found on a record load dump tape.

Issued by DMREC.

User Action: Load from previous tape.

### **FULL INITIALIZE REQUIRED.**

Description: Operator message indicating an error was encountered and a total initialize is required on the pending device.

Issued by MSI.

User Action: Specify AL initialization option (total initialize) on the INITIALIZE command.

### **FUNCTION REJECT, filename AT address.**

Description: Function was rejected (possible hardware problem).

Issued by 1MT.

User Action: Inform site analyst.

### **FUNCTION TIMED OUT=nnnn.**

Description: 1LC timed out in the function routine while accessing the controller.

nnnn Function code.

Issued by LOADBC.

User Action: Inform customer engineer.

### **FWA .GE. LWA+1.**

Description: There is a logical error in the structure of the input file which implies that the first word address is greater than or equal to the last word address plus one.

Issued by KTSMDP.

User Action: Inform database administrator.

### **GENERAL STATUS = nnnn.**

Description: The controlware load was not successful and the general status of the controller (nnnn) is not zero.

Issued by LOADBC.

User Action: Inform customer engineer.

### **GENERATING CATALOG IMAGE.**

Description: Informative K display message indicating that catalog image record (CIR) is currently being written to the archive file.

Issued by PFDUMP.

User Action: None.

### **GENPFD ABORTED.**

Description: GENPFD detected an error or the user has initiated an abort.

Issued by GENPFD.

User Action: The specific error encountered will have been noted by an earlier dayfile message. Proceed as indicated under the conditions indicated by that message.

**GENPFD ARGUMENT ERROR.**

Description: An incorrect argument was detected on the GENPFD command.

Issued by GENPFD.

User Action: Correct the error and retry the GENPFD run.

**GENPFD COMPLETE.**

Description: Normal completion of GENPFD.

Issued by GENPFD.

User Action: None.

**GET ERROR ON PF xxxxxxxx.**

Description: No indirect access permanent file, for use as an own code file, has been found.

Issued by DMREC.

User Action: Check for the presence of the file and try again.

**GETLOG - message.**

Description: Refer to explanation of AFD - message.

Issued by DAYFILE.

User Action: None.

**GETLOG PROCESSED.**

Description: The error log and maintenance log dump is complete.

Issued by DAYFILE.

User Action: None.

**GLOBAL TASK DUMP LIMIT EXHAUSTED.**

Description: A task issued a K.DUMP request when the global task dump limit (GTDL) is zero. No dump of the transaction facility occurred. No dumps of the transaction facility will occur from tasks until the GTDL is set to a value greater than zero.

Issued by TAF.

User Action: Refer to the TAF K.DUMPLIM command; this command should be used only under the direction of the central site TAF systems analyst.

**GO ALREADY RECEIVED.**

Description: Informative message.

Issued by MCS.

User Action: None.

**GO RECEIVED.**

Description: Informative message.

Issued by MCS.

User Action: None.

### **GR PARAMETER OUT OF RANGE.**

Description: The group parameter specified was not a number from 1 to 10.

Issued by SSLABEL.

User Action: Correct parameter and retry.

### **GR PARAMETER USED INCORRECTLY.**

Description: The group parameter was used with a directive other than AM or RM on the SSLABEL command.

Issued by SSLABEL.

User Action: Correct parameters and retry.

### **GS=ssss.**

Description: A general status error has occurred.

ssss Status (four octal digits)

Issued by CDX.

User Action: Redeadstart. If message persists, inform site analyst.

### **HARDWARE REGISTERS NOT FOUND.**

Description: Output file message indicating that the hardware register record was not found in the EDD file.

Issued by DSDI.

User Action: Ensure that the dump file contains meaningful information.

### **HARDWARE VERIFICATION IS UNAVAILABLE WITH A LEVEL 3 DEADSTART (BS) PREVIOUS DISPLAY**

Description: HIVS can only be executed on a level 2 or less recovery.

Issued by CTI.

User Action: None.

### **termnam HAS AUTO CONTROL STATUS**

Description: An attempt to gain auto control status was made, but the NPU operator at a terminal named termnam already maintains auto status.

Issued by CS.

User Action: Wait until auto status has been relinquished and then reenter command.

### **HASH TABLE OVERFLOW.**

Description: Operator message indicating that the computed address of the end of the buffered I/O tables is not less than 100000B.

Issued by SET.

User Action: Contact CYBER Software support.

### **HELLO, YOU ARE NOW A DIAGNOSTIC OPERATOR.**

Description: Self-explanatory.

Issued by CS.

User Action: None.

### **HELLO, YOU ARE NOW AN NPU OPERATOR.**

Description: Self-explanatory.

Issued by CS.

User Action: None.

### **HFM ARGUMENT ERROR.**

Description: Invalid function code was encountered or a parameter-word address was out of range.

Issued by HFM.

User Action: Write a PSR.

### **HFM ILLEGAL REQUEST.**

Description: HFM was called by job that did not contain one of the following:

- SSJ=.
- a RECALL setting.
- not system origin with user not validated for system privileges.
- not CYBER 70 or CYBER 170 mainframe.

Issued by HFM.

User Action: Write a PSR.

### **HIP NOT PRESENT.**

Description: Additional coupler status information when HIP is not configured in target NPU.

Issued by CS.

User Action: None.

### **HLD est.**

Description: The operator stopped printing on BIO equipment est

Issued by QAP.

User Action: None.

### **HOLD.**

Description: I-display message. Device is skipping or has been placed in hold.

Issued by ICD.

User Action: Enter CONTINUE,est when you are ready to proceed.

### **HOLES FREED nnnnnn, ssssss PRUS.**

Description: PACKER statistics reflecting the condition of the portion of the IAPF chain which PACKER has processed.

nnnnnn    Number of catalog entries freed.  
ssssss    Sectors removed from the IAPF chain. This is the number of sectors gained when viewing the IAPF chain as a sequence of sectors, ignoring the effects of track boundaries.

Issued by PACKER.

User Action: None.

### **HOLES LEFT nnnnnn, ssssss PRUS.**

Description: PACKER statistics reflecting the condition of the portion of the IAPF chain which PACKER has processed.

nnnnnn    Number of holes with catalog entries.  
ssssss    Total sectors with catalog hole entries.



Issued by PACKER.

User Action: None.

### **HOST IDLE DOWN IN PROGRESS.**

Description: Self-explanatory.

Issued by CS.

User Action: None.

### **HOST SHUTDOWN COMPLETE.**

Description: Informative message issued during network shutdown procedures after all the supervisors have terminated. NIP will terminate normally.

Issued by NIP.

User Action: None.

### **HUNG PP-xxx**

Description: An incorrect function has been attempted. The PP becomes hung because MTR does not clear the output register.

xxx PP program name.

Issued by MTR.

User Action: The recommended procedure is as follows.

1. Perform a full dump to tape.
2. Attempt to redeadstart the system.
3. Retain dump tape to be examined by the site analyst.

### **nnnn I/A ROLLOUT FILES RECOVERED.**

Description: nnnn jobs that were in an interactive rollout job state have been recovered.

Issued by REC.

User Action: None.

### **I DISPLAY MESSAGE 1IO DOWN.**

Description: BIO message indicating that the equipment is down in the EST.

Issued by 1IO.

User Action: None.

### **I DISPLAY MESSAGE 1IO INTERVENTION REQUIRED.**

Description: The 5870/5970 requires operator intervention.

Issued by 1IO.

User Action: Determine what action is required by the 5870/5970 and perform the required operation.

### **I DISPLAY MESSAGE 1IO NOT READY.**

Description: A message indicating that for BIO the equipment is not ready. This is normal for card readers, for all other equipment it indicates a possible problem.

Issued by 1IO.

User Action: Examine equipment to determine the cause of the not ready condition. Inform customer engineer if cause cannot be determined.

### **I DISPLAY MESSAGE IIO OFF.**

Description: BIO message indicating that the equipment is off in the EST.

Issued by IIO.

User Action: None. Turn equipment on when needed.

### **I DISPLAY MESSAGE IIO OFF - CHECK ERRLOG.**

Description: BIO message indicating that the equipment has been turned off in the EST due to a hardware problem.

Issued by IIO.

User Action: Examine ERRLOG to determine reason equipment was OFFed. Inform customer engineer.

### **I/O ERROR xxxx IN fffffff**

Description: The temporary file, fffffff, contains error indicated by the code xxxx; the code has the following meaning:

1	Parity error, operation completed.
2	Address error, operation complete.
3	Detailed status error, operation completed.
13	Buffer full, partial record read.
21	End of record on a coded file, read successful.
23	End of record, read successful.
31	End of file on a coded file, no record read.
33	End of file, no record read.
70	Not a SUPPIO file.
71	Bad record ident or a duplicate.
72	Incorrect index pointer.
73	Index area too small.
74	Random request on a sequential file.
75	Sequential request on a random file.
1031	End of information on a coded file, no record read.
1033	End of information, no record read.
4001	Parity error.
4001	Address error.
4003	Detailed status error.
4007	Track limit.

Issued by NDA.

User Action: Try the job again. If the message occurs again, follow site-defined procedures for reporting software problems.

### **I/O ERROR xxxx IN fffffff.**

Description: I/O error (error code xxxx) in file fffffff.

Issued by NDA.

User Action: Correct error and try again.

### **I/O LIMITS EXCEEDED.**

Description: Your validated job I/O limits have been exceeded during the current RECLAIM session.

Issued by RECLAIM.

User Action: Log in and retry the operation. If it fails again, check your validated I/O limits for tape mounts to ensure that you have not exceeded your limits.

### **Incorrect SM NUMBER.**

Description: The SM parameter in a directive to SSLABEL was not a letter from A through H.

Issued by SSLABEL.

User Action: Correct SM parameter and retry.

### **IAF ABORT.**

Description: The stimulation was aborted because IAF was not communicating with the stimulator.

Issued by 1TS.

User Action: Inform site analyst.

### **IAF NOT ACTIVE.**

Description: Fatal dayfile message indicating that the time-sharing subsystem is not at a control point.

Issued by 1TS.

User Action: Bring the time-sharing subsystem to one control point before running the stimulator.

### **IAF NOT ACTIVE.**

Description: Informative message for interactive message commands.

Issued by DSD.

User Action: None.

### **IAF REPRIEVED.**

Description: IAF has detected termination and is beginning its reprieve processing.

Issued by IAFEX.

User Action: None.

### **IAF TERMINATED.**

Description: IAF's termination process has completed.

Issued by IAFEX.

User Action: None.

### **IAFEX ABNORMAL - xxx nnnnnn.**

Description: IAF has encountered an abnormal situation. If sense switch 3 is set, IAF will abort, dump its FL, and reload automatically.

xxx IAF routine requesting the abort  
nnnnnn Contents of the B2 register (usually contains a terminal number)

Issued by IAFEX.

User Action: Write a PSR and send the IAF field length dump as support material.

### **IAFEX INITIALIZATION ABORT.**

Description: IAF could not be initialized properly. An additional dayfile message describing this error in more detail precedes this message.

Issued by IAFEX.

User Action: Contact CYBER Software Support.

### **IAPF CHAIN OVERLAP.**

Description: PACKER has detected entry overlaps on the IAPF chain before any changes have been made. PACKER will not attempt to pack a corrupt IAPF chain.

Issued by PACKER.

User Action: The IAPF chain on the device in question may have been corrupted. Either have an analyst repair the damage with DDF (if that is possible), or perform a full PFDUMP, deadstart INITIALIZE, and full PFLOAD.

### **ICPD COMPLETE.**

Description: Informative message indicating system monitoring by CPD has been terminated.

Issued by ICPD.

User Action: None.

### **IDLE.**

Description: Issued to the DSD B and J displays, the BIO subsystem is idle (no I/O buffers in use).

Issued by IIO.

User Action: None.

### **IF xx DOWN ENTER \*DOWN,MID=xx\***

Description: The machine is running in a multimainframe mode and is suspected of being down.

xx Machine ID

Issued by MTE.

User Action: Check the machine. If the machine is down, enter DOWN,MID=xx. If the machine is not down, enter GO,SYs.

### **IGNORE TABLE OVERFLOW.**

Description: Ignore table TTIG is too small.

Issued by DMREC.

User Action: Inform site analyst to enlarge TTIG table.

### **ILLEGAL APPLICATION.**

Description: Application name in application command is not defined.

Issued by NVF.

User Action: Attempt new command entry.

### **ILLEGAL CHARACTER FOUND IN COMMAND.**

Description: The command must be composed of alphabetic characters.

Issued by NLTERM.

User Action: Correct the command and reenter.

### **ILLEGAL CHARACTER FOUND IN FILE NAME.**

Description: The file name specified must be composed of alphanumeric characters.

Issued by NLTERM.

User Action: Correct the file name and reenter it.

### **ILLEGAL COMMAND**

Description: Informative message indicating that the network/local operator entered an incorrect command.

Issued by MCS.

User Action: Enter correct command.

### **ILLEGAL CONTROL STATEMENT PARAMETER VALUE.**

Description: Command value is too large or contains invalid characters.

Issued by RBF.

User Action: Correct RBF2P0 command parameter value.

### **ILLEGAL DESTINATION NODE NUMBER**

Description: Destination host node number entered in the NAM SEND command is illegal. It must be a decimal value less than 256.

Issued by NIP.

User Action: Correct the command and retry.

### **ILLEGAL EOF DETECTED.**

Description: An EOF was detected before the last sector on the file.

Issued by MST.

User Action: Correct EOF and rerun.

### **ILLEGAL EQUIPMENT.**

Description: The equipment which was assigned in response to the display request is not recognized as being a device upon which the test may be run.

Issued by MST.

User Action: Specify valid equipment entry and reenter display request input.

### **ILLEGAL EQUIPMENT.**

Description: The equipment specified in a VALIDATE command is incorrect or not available.

Issued by DSD.

User Action: Check equipment number and retry command.

### **ILLEGAL FILE NAME - filename**

Description: Dayfile message indicating that a file has been given an incorrect or duplicate name filename.

Issued by FORMAT.

User Action: Correct and rerun.

### **ILLEGAL FL VALUE**

Description: Field length specified in the FL command is illegal. It must be an octal value greater than NAM's current field length by at least 1000B words and less than the maximum field length allowed for NAM 360000B.

Issued by NIP.

User Action: None.

### **ILLEGAL KEY-WORD**

Description: The opcode entered is not valid.

Issued by NIP.

User Action: Enter correct keyword.

### **ILLEGAL KEYWORD = keyword.**

Description: An illegal keyword was entered on a CFO command.

Issued by NAMI.

User Action: Reenter the CFO command specifying the correct keyword.

### **ILLEGAL NDA CALL PARAMETER xxxxxxxx PARAMETER VALUE ILLEGAL FOR xxxxxxxx**

**VALUE NEEDED FOR PARAMETER xxxxxxxx  
INVALID CHARACTER AFTER ITEM xxxxxxxx.**

Description: Parameter xxxxxxxx in NDA call is incorrect or has incorrect items associated with it. Processing is aborted with any of these errors.

Issued by NDA.

User Action: Correct errors and try again.

**ILLEGAL PARAMETER**

Description: Indicates the HOP command string contains an illegal parameter.

Issued by NS.

User Action: Reenter the command with the correct parameter.

**ILLEGAL PRINT DENSITY SELECTION.**

Description: Output file message indicating a print density other than 3, 4, 6 or 8 lines per inch was specified or that no room would remain on the page after printing the header at the specified print density because the system value for lines per page is too small.

Issued by DSDI.

User Action: Specify valid print density and rerun, or increase print density and/or request site analyst to increase system value for lines per page.

**ILLEGAL SL.**

Description: The SL parameter in a directive to SSDEBUG was not a number from 1 through 1931 or was greater than the SU parameter.

Issued by SSDEBUG.

User Action: Correct the SL parameter and retry.

**ILLEGAL SM.**

Description: The SM parameter in a directive to SSDEBUG was not a letter from A through H.

Issued by SSDEBUG.

User Action: Correct the SM parameter and retry.

**ILLEGAL SU.**

Description: The SU parameter in a directive to SSDEBUG was not a number from 1 through 1931 or was less than the SL parameter.

Issued by SSDEBUG.

User Action: Correct the SU parameter and retry.

**ILLEGAL SUBFAMILY.**

Description: The SB parameter on the SSUSE command or in a directive to SSLABEL or SSDEBUG was not a number from 0 through 7.

Issued by SSLABEL.

User Action: Correct the SB parameter and retry.

**ILLEGAL VCB ORDINAL = vcb NVFUFVO.**

Description: For debug only. VCB (validation control block) ordinal vcb is illegal, so it cannot be freed up. The message is issued by NVF procedure NVFUFVO.

Issued by NVF.

User Action: Contact CYBER Software Support.

### **ILLEGAL VCB ORDINAL = vcb NVFUMVD.**

Description: For debug only. VCB (validation control block) ordinal vcb is illegal, it cannot be marked. The message is issued by NVF procedure NVFUMVD.

Issued by NVF.

User Action: Contact CYBER Software Support.

### **IMPROPER NUMERIC PARAMETER.**

Description: Nonfatal K-display message indicating that the field was too large, too small, or alphabetic.

Issued by STIMULA.

User Action: Reenter the correct data.

### **IMS ABORTED.**

Description: Additional dayfile message issued whenever IMS aborts. This message is always preceded by a message describing the specific reason for the abort.

Issued by IMS.

User Action: See the significance and action for the message which precedes this message in the dayfile.

### **\*IN\* AND \*IC\* PARAMETER CONFLICT.**

Description: Both the IN and IC parameters were specified.

Issued by ACPD.

User Action: Do not specify the IN and IC parameters simultaneously.

### **\*IN\* LESS THAN FILE WRITE TIME.**

Description: Report interval length (IN) is less than the file write time of the data file. The file write time is specified by the FW parameter of the ICPD command.

Issued by ACPD.

User Action: Correct the IN parameter of ACPD.

### **INACTIVE DAYFILE NOT FOUND ON DEVICE.**

Description: An inactive dayfile of the specified type was not found on the specified device.

Issued by DFTERM.

User Action: Enter the correct family name and device number using the K display. Use DFTERM to see where dayfiles reside.

### **INACTIVE DAYFILE ON DEVICE.**

Description: An inactive dayfile already exists on the device on which a new active dayfile is to be created.

Issued by DFTERM.

User Action: Enter another device using the K-display.

### **INACTIVE LOAD NOT ALLOWED.**

Description: The load is not allowed because the device selected to receive inactive queues is removable.

Issued by QLOAD.

User Action: Select another device and retry the load.

### **INCOMPLETE BANNER PAGE.**

Description: BIO was unable to print the entire banner page. NOTE: This message isn't issued by the standard system; the error is probably caused by local code in BIO.

Issued by QAP.

User Action: The CM buffers in BIO's field length must be increased in size or the size of the banner page must be reduced.

### **INCOMPLETE DESTINATION FAMILY/USER.**

Description: Either the DF or UN parameter was entered without the other.

Issued by QFTLIST.

User Action: Specify both parameters and rerun utility.

### **INCOMPLETE PARAMETER.**

Description: A parameter on a DMREC directive was not completed correctly.

Issued by DMREC.

User Action: Correct the parameter on the faulty directive.

### **INCORRECT ACCESS LEVEL - FILE IGNORED.**

Description: The specified file cannot be moved, because the specified destination device does not support the correct access level.

Issued by QMOVE.

User Action: Retry, specifying a different destination device.

### **INCORRECT ACCESS LEVEL FOR EQUIPMENT.**

Description: You have specified a level outside of the equipment access level limits.

Issued by RESEX.

User Action: Use access level within required equipment's access level limits or use equipment with access level required.

### **INCORRECT APPLICATION ACCOUNTING REQUEST.**

Description: The application program that issued this message attempted to initiate application accounting incorrectly.

Issued by CPM.

User Action: Inform database administrator.

### **INCORRECT ARGUMENT.**

Description: Error in command parameter.

Issued by PACKER.

User Action: Correct parameters and retry.

### **INCORRECT ARGUMENT VALUE.**

Description: A value entry on a directive is not valid for that directive. This could be a name longer than seven characters, an alphabetic string when a number is expected, etc.

Issued by GENPFD.

User Action: Correct the error and retry the GENPFD run.

### **INCORRECT ARGUMENT VALUE.**

Description: A directive keyword was equated to an incorrect value such as a file name longer than seven characters or an alphabetic character in a numeric string.

Issued by RECLAIM.

User Action: Correct the value and retry.



### **INCORRECT ATTRIBUTE.**

Description: An attribute entered was not recognized as a valid attribute.

Issued by LIDOU.

User Action: Reenter L display input with valid attributes.

### **INCORRECT BIT NUMBER.**

Description: Dayfile message indicating that the bit number specified was greater than 203.

Issued by SCRSIM.

User Action: Correct and reenter.

### **INCORRECT BYTE NUMBER.**

Description: Dayfile message indicating that the byte number specified was greater than 16.

Issued by SCRSIM.

User Action: Correct and reenter.

### **INCORRECT CATALOG UPDATE.**

Description: Verification of the PFC entry prohibits the setting of a new alternate storage address when a current alternate storage address exists and is not labeled obsolete. Also, an existing valid disk address cannot be replaced in the PFC entry.

Issued by PFM.

User Action: Write a PSR.

### **INCORRECT CEVAL REQUEST PARAMETERS.**

Description: An attempt was made to call routine CVL with an undefined function code.

Issued by CVL.

User Action: Inform site analyst.

### **INCORRECT CHANNEL NUMBER.**

Description: The channel number specified by the C=cc parameter on the LOADBC command is incorrect.

Issued by LOADBC.

User Action: Correct channel number and retry.

### **INCORRECT CHANNEL NUMBER.**

Description: The specified channel number was not in the range 0 - 13B or 20B - 33B.

Issued by DMPCCC.

User Action: Correct the syntax error and retry.

### **INCORRECT CHARACTER.**

Description: Dayfile message indicating that an alphabetic character other than B or D was entered as a postradix on a decimal value, an alphabetic character, 8, or 9 found in octal value argument, or a character with a display code of 60B or above was entered.

Issued by SCRSIM.

User Action: Correct and reenter.

### **INCORRECT CMS CALL.**

Description: Calling job does not have deadstart sequencing or mass storage subsystem ID. Calling job has been aborted.

Issued by MSM.

User Action: None.

**INCORRECT COMMAND.**

Description: MAGNET was called from a non-system origin job. MAGNET is only used for MAGNET clean-up (MAGNET originating from console).

Issued by MAGNET.

User Action: None.

**INCORRECT COMMAND.**

Description: Dayfile message indicating that the command entered was not a legitimate SCRSIM command.

Issued by SCRSIM.

User Action: Correct and reenter.

**INCORRECT COMMAND.**

Description: DIS was called to a job that did not have the correct user validation.

Issued by DIS.

User Action: None.

**INCORRECT COMMAND.**

Description: One of the following errors occurred:

- A command was entered other than what was on the menu.
- A terminal CRMSTAT request did not request its own database.
- A terminal origin job tried to request the menu.
- Unpack errors on the terminal message.

Issued by CRMTASK.

User Action: Ensure that the command is correct. If problem persists, inform the site analyst.

**INCORRECT COMMAND.**

Description: BIO was called from a non-system origin job.

Issued by BATCHIO.

User Action: Contact the system operator to bring up BATCHIO.

**INCORRECT COMMAND.**

Description: The command entered was not recognized as one of the available commands.

Issued by SUBSYST.

User Action: Reenter L-display input with valid command.

**INCORRECT COMMAND.**

Description: The command entered was not recognized as one of the available commands.

Issued by LIDOU.

User Action: Reenter L display input with valid command.

**INCORRECT COMMAND.**

Description: Arguments were entered on the command call to CONFIG.

Issued by CONFIG.

User Action: Reenter command without arguments.

### **INCORRECT COMMAND FORMAT.**

Description: An incorrect separator or extra parameters were entered for the command.

Issued by SUBSYST.

User Action: Reenter the command with valid parameter format.

### **INCORRECT CONTROL POINT.**

Description: The control point number entered on the ENABLE or DISABLE command is not a valid control point number for the system.

Issued by SUBSYST.

User Action: Reenter the command with a valid control point number.

### **INCORRECT CONTROL POINT NUMBER.**

Description: The control point number specified was greater than the system control point number or was not in a recognized numeric format.

Issued by DSDI.

User Action: Correct and rerun.

### **INCORRECT CSN.**

Description: The CSN specified on an FX directive contains incorrect characters; or the cartridge label for the current directive has an incorrect CSN.

Issued by SSLABEL.

User Action: Retry specifying a valid CSN; or use FX directive to relabel the cartridge.

### **INCORRECT DATA.**

Description: Nonfatal K-display message indicating that the data contains an incorrect display character.

Issued by STIMULA.

User Action: Correct data and retry.

### **INCORRECT DATA BASE IN xxJ FILE.**

Description: One of the statements in the xxJ file specifies an incorrect xx parameter and causes the transaction subsystem to abort.

Issued by TAF.

User Action: Examine xxJ files. Inform the TAF data base administrator.

### **INCORRECT DATA BASE NAME ON DMS STATEMENT.**

Description: A database name associated with TAF, CRM, or OTHER exceeds two characters.

Issued by TAF.

User Action: Correct the DMS statement on TCF file.

### **INCORRECT DEVICE ACCESS LEVEL.**

Description: The job doing the Q move is not validated for the access levels of the device.

Issued by QMOVE.

User Action: Correct and retry.

### **INCORRECT DEVICE/FAMILY.**

Description: The device specified by the DN and the FM/PN parameters could not be found or was OFF, unloaded or a PF Utility was active on the device.

Issued by PACKER.

User Action: Check parameters and device and retry when available.

### **INCORRECT DEVICE INDEX.**

Description: Device index not recognized by SSMOVE.

Issued by SSMOVE.

User Action: Examine PFC for error.

### **INCORRECT DEVICE TYPE.**

Description: Operator message indicating that a mass storage device type specified in the EQPDECK was not found in the table of legal device types.

Issued by SET.

User Action: Rereadstart and correct the EQPDECK entry.

### **\*\*\*\* INCORRECT DIRECTIVE.**

Description: Output file message indicating one of the following:

- The system encountered an unrecognizable identifier.
- An equal sign does not separate the identifier and a value.
- The system encountered a DCN, DPN, or DUN directive when OP=C was specified.

Issued by PROFILE.

User Action: Rerun using correct directives.

### **INCORRECT DIRECTIVE.**

Description: The directive specified is not a valid directive to SSLABEL or SSDEBUG.

Issued by SSLABEL.

User Action: Correct directive and retry.

### **INCORRECT DIRECTIVE NAME.**

Description: An unrecognized parameter has been specified on the command.

Issued by DMPCCC.

User Action: Correct the syntax error and retry.

### **INCORRECT DISK BUFFER NUMBER.**

Description: The disk buffer number on the directive was greater than that of the last disk buffer with the specified machine id.

Issued by DSDI.

User Action: Correct and rerun.

### **INCORRECT DUMP REQUESTED.**

Description: One of the following conditions has been detected prior to a queue file dump:

- The device specified to receive the dump is not a mass storage device.
- The device specified to receive the dump is removable and the type specified is A (active) or ALL.

Issued by QDUMP.

User Action: Enter the correct parameters and retry the operation.

### **INCORRECT ENTRY.**

Description: The DIS command last entered was incorrect.

Issued by DIS.

User Action: Correct command if possible and reenter.

### **INCORRECT ENTRY.**

Description: The command just entered is incorrect.

Issued by DSD.

User Action: Correct command and retry.

### **INCORRECT ENTRY.**

Description: One of the following:

- A keyword was not found.
- Too many digits were entered as a parameter.
- A nondigit character was found in a parameter.
- A character was found after the postradix.
- An 8 or 9 was found with a B postradix.

Issued by CONFIG.

User Action: Correct K display input and retry.

### **INCORRECT ENTRY.**

Description: A BIO buffer point request from DSD is referencing an incorrect Buffer Point.

Issued by 1DS.

User Action: If the device is still active, retry the command making sure the EST ordinal is correct.

### **INCORRECT ENTRY.**

Description: K display message indicating that the processor could not recognize the specified utility parameter.

Issued by QFSP.

User Action: Correct and reenter K display input.

### **INCORRECT ENTRY.**

Description: Self-explanatory.

Issued by DDF.

User Action: Clear message and try a valid entry.

### **INCORRECT ENTRY.**

Description: Invalid device numbers specified.

Issued by SET.

User Action: Correct SCKP, EQest=TY, ST=OFF, or REMOVE entry in EQPDECK.

### **INCORRECT ENTRY - EQest.**

Description: Incorrect equipment with EST ordinal est was specified.



User Action: Correct and rerun.

### **INCORRECT FILE NAME.**

Description: Dayfile message indicating that the file name specified in the ISF entry (file to be initialized) was not available to the system. Valid file names include VALIDUs, PROFILa, RSXDId, and RSXVId.

Issued by ISF.

User Action: Repeat the ISF entry with the correct file name.

### **INCORRECT FILE NUMBER.**

Description: Nonfatal K-display message indicating that the file number is greater than 18 bits.

Issued by STIMULA.

User Action: Reenter the correct decimal file number.

### **INCORRECT FL REQUEST.**

Description: Either USER extended memory is not present, the CM field length is less than MCMX or the extended memory FL requested is larger than 3777B when processing the ENFLE,nnn. command.

Issued by DIS.

User Action: Correct error and retry.

### **INCORRECT FL REQUEST.**

Description: The FL value entered on the ENFL, nnnn. command is greater than 131K.

Issued by DIS.

User Action: Enter correct value.

### **INCORRECT FORMAT FOR EQ ENTRY.**

Description: K display message indicating that a syntax error was made when entering parameters for the EQ keyword.

Issued by MREC.

User Action: Correct and reenter K display input.

### **INCORRECT FORMAT FOR MID.**

Description: K display message indicating the machine ID entered is either not two characters or not alphanumeric.

Issued by MREC.

User Action: Correct and reenter K display input.

### **INCORRECT FX PARAMETER.**

Description: The FX parameter on the SSVAL command was not a number.

Issued by SSVAL.

User Action: Correct FX parameter and retry.

### **INCORRECT IMS REQUEST.**

Description: Incorrect function code or nonsystem origin caller detected in call to IMS (could be caused by hardware parity error or logic error in program).

Issued by IMS.

User Action: Take a deadstart dump, write a PSR, and send the dump and PSR to CDC along with any support materials which will allow CDC to duplicate the problem.

### **INCORRECT JSN.**

Description: The JSN (job sequence name) was greater than four characters or less than three characters.

Issued by QDSPLAY.

User Action: Specify a valid JSN and retry.

### **INCORRECT LIBTASK ATTEMPT - filename, username.**

Description: The transaction executive validates all dynamic attempts to change the task library by comparing the user name of the requester against the list of database user names. If it does not match or if the library file is not attached by TAF, the transaction executive issues this dayfile message, where username is the user name of the incorrect attempt.

Issued by TAF.

User Action: Correct and reinitialize transaction executive.

### **INCORRECT LID.**

Description: The LID specified was not a three-character alphanumeric LID.

Issued by LIDOU.

User Action: Reenter L display input with valid LID.

### **INCORRECT LINE NUMBER.**

Description: Dayfile message indicating that the line number entered was not 0, 1, 2, or 3.

Issued by SCRSIM.

User Action: Correct and reenter.

### **INCORRECT MACHINE ID.**

Description: The machine id used to search the I/O buffer definition table in extended memory was not found.

Issued by DSDI.

User Action: Ensure that the dump file contains meaningful information.

### **INCORRECT MAINFRAME.**

Description: A mainframe descriptor of length zero or greater than seven characters was specified.

Issued by LIDOU.

User Action: Correct descriptor and retry.

### **INCORRECT MOVE REQUESTED.**

Description: One of the following occurred:

- Device specified is not mass storage.
- Device specified is removable; the queue file type to be moved is A (active) or ALL.
- Destination device is removable; destination disposition option is A (files remain active).
- Destination device is a shared device, QPROTECT is disabled, and destination disposition option is I (files remain inactive).

Issued by QMOVE.

User Action: Enter the correct parameters and retry move operation.

### **INCORRECT N.**

Description: The N parameter in a directive to SSLABEL was not a number from 1 through 100.



Issued by SSLABEL.

User Action: Correct N parameter and retry.

### **INCORRECT NETWORK.**

Description: The network specified was not \*RHF\*, \*NAM\*, \*SSF\*, or \*ALL\*.

Issued by LIDOU.

User Action: Correct network and retry.

### **INCORRECT NUMBER FOR LOCKS.**

Description: The locks parameter on the CYBER Record Manager (CRM) statement is in error. One of the following format conditions exists:

- A nonnumeric character.
- A character after a postradix of B or D.
- An 8 or 9 with a postradix of B.

Issued by TAF.

User Action: Correct the locks parameter on the CRM statement or inform the analyst.

### **INCORRECT NUMBER FOR USERS.**

Description: The user's parameter on the CRM statement is in error. One of the following format conditions exists:

- A nonnumeric character.
- A character after a postradix of B or D.
- An 8 or 9 with a postradix of B.

Issued by TAF.

User Action: Correct the user's parameter on the CRM statement or inform the database administrator.

### **INCORRECT NUMERIC PARAMETER FOR kw.**

Description: The entered value for the keyword kw was not in the allowable range for that keyword.

Issued by SDSPLAY.

User Action: Check entered value for kw and retry.

### **INCORRECT OPTION.**

Description: K-display message indicating that an incorrect OP parameter option was entered.

Issued by STIMULA.

User Action: Reenter the correct option.

### **INCORRECT OPTION - SEE RIGHT SCREEN.**

Description: The operator response to a previous message was incorrect.

Issued by PFDUMP.

User Action: Enter valid response.

### **INCORRECT ORIGIN TYPE.**

Description: MREC was run from a nonsystem origin job.

Issued by MREC.

User Action: Rerun from system origin.

**\*\*\*\* INCORRECT ORIGIN TYPE**

Description: Output file message indicting that the origin type entered on the MODVAL uc directive is incorrect.

Issued by MODVAL.

User Action: Rerun the job or correct the new validation file, if necessary.

**INCORRECT PARAMETER.**

Description: The parameter in the entry was invalid or too long.

Issued by DDF.

User Action: Correct the parameter and retry.

**\*\*\*\* INCORRECT PASSWORD**

Description: In the MODVAL command (for a create or update run) the password for a new user contained fewer characters than the minimum length required by the site. If entered from a K display, the line of input is ignored; otherwise, that particular user name is disregarded.

Issued by MODVAL.

User Action: Rerun the job or correct the new validation file, if necessary.

**\*\*\*\* INCORRECT PASSWORD.**

Description: The password specified was either too long, too short or contained incorrect characters.

Issued by MODVAL.

User Action: Correct error and retry.

**\*\*\*\* INCORRECT PASSWORD IGNORED.**

Description: Output file message indicating that the password encountered during an update run was less than the minimum length required by the site. The update of the user name proceeds without the password change.

Issued by MODVAL.

User Action: Choose a correct password and update VALIDUs via PASSWOR or rerun MODVAL, if desired.

**INCORRECT PFC ADDRESS.**

Description: The device number, track, and sector specified as the PFC address are incorrect.

Issued by PFM.

User Action: Write a PSR.

**INCORRECT POSITION IN THE DIRECTORY.**

Description: The directory structure is inconsistent or positioning is incorrect.

Issued by DMREC.

User Action: Inform database administrator.

**INCORRECT PRINT OPTION SELECTION.**

Description: Output file message indicating that an incorrect list option was specified in a directive.

Issued by DSDI.

User Action: Correct and rerun.

**INCORRECT PRIORITY.**

Description: The CPU priority entered with the ENPR, nn. command is incorrect.

Issued by DIS.

User Action: Enter valid priority.

### **INCORRECT REPORT OPTION.**

Description: The OP parameter on the SSUSE command was not a letter from A through D.

Issued by SSUSE.

User Action: Correct OP the parameter and retry.

### **INCORRECT - RF AND AM PARAMETERS.**

Description: AM cannot be specified if RF is specified. Both AM and RF were specified on the SSVAl command.

Issued by SSVAl.

User Action: Specify either AM or RF, or neither AM nor RF, but not both.

### **INCORRECT - RF FAND FM PARAMETER.**

Description: FM cannot be specified if RF is specified. Both FM and RF were specified on the SSVAl command.

Issued by SSVAl.

User Action: Specify either FM or RF or neither, but not both.

### **INCORRECT - RL AND NO RF PARAMETER.**

Description: RL can be specified only if RF is also specified. RF was not specified, but RL was specified on the SSVAl command.

Issued by SSVAl.

User Action: Either specify both RF and RL or neither.

### **INCORRECT ROLLOUT REQUEST.**

Description: SYSEdit and routine SLL can not be rolled out during execution.

Issued by SLL.

User Action: None.

### **INCORRECT RUBOUT COUNT.**

Description: Rubout parameter must be less than 31.

Issued by IAFEX.

User Action: Correct command and reenter.

### **INCORRECT SAMPLE RATE.**

Description: The user specified a sample rate in the SMP call request or command call that was less than 1 or greater than 50 octal.

Issued by SMP.

User Action: Correct the SMP call and retry.

### **INCORRECT SB PARAMETER.**

Description: The SB parameter on the SSVAl command was not a numeric character string specifying some of the subfamilies from 0 through 7.

Issued by SSVAl.

User Action: Correct SB parameter and retry.

### **INCORRECT SDF DEVICE.**

Description: The equipment selected to receive a deadstart file does not meet the requirements of an MSM deadstart device.

Issued by IIS.

User Action: Ensure accuracy of command or select another device.

### **INCORRECT SEPARATOR.**

Description: An = separator was found following a parameter value or command in the input string.

Issued by CONFIG.

User Action: Correct K display input and retry.

### **INCORRECT SEPARATOR.**

Description: The separator used was not a comma or an equal sign as required by the command syntax.

Issued by LIDOU.

User Action: Correct separator and retry.

### **xxxx INCORRECT SERVICE CLASS.**

Description: An incorrect service class was entered on the MODVAL UC or UM directive.

Issued by MODVAL.

User Action: Rerun the job or correct the new validation file, if necessary.

### **INCORRECT SERVICE CLASS FOR \*DT\*.**

Description: You specified an incorrect service class for the DT parameter.

Issued by SDSPLAY.

User Action: Correct parameter and retry.

### **INCORRECT SKIP COUNT.**

Description: An asterisk was present on a SKIP LINE, SKIP PAGE, or SKIP RECORD BACKWARD command or the skip count was greater than 377777B or the skip count was not numeric.

Issued by QDSPLAY.

User Action: Determine the error and correct it before retrying the command.

### **INCORRECT SLL REQUEST.**

Description: Dayfile message indicating an SLL with an undefined function code.

Issued by SLL.

User Action: Take a deadstart dump, write a PSR, and send the dump and PSR to CDC along with any support materials which will allow CDC to duplicate the problem.

### **INCORRECT SM PARAMETER.**

Description: The SM parameter on the SSVAL command was not an alphabetic character string specifying some of the characters from A through H.

Issued by SSVAL.

User Action: Correct SM parameter and retry.

### **INCORRECT SMP REQUEST.**

Description: SMP was not called with auto recall.

Issued by SMP.

User Action: Correct the SMP call and retry.

### **INCORRECT SSC STATUS RECEIVED.**

Description: IAF received unknown status from SMFEX subsystem.

Issued by IAFEX.

User Action: Contact CYBER Software Support.

### **INCORRECT ST PARAMETER.**

Description: The ST parameter on the SSVAl command parameter was not a number.

Issued by SSVAl.

User Action: Correct ST parameter and retry.

### **INCORRECT STATUS.**

Description: The status specified was not \*E\*, (ENABLE) or \*D\* (DISABLE).

Issued by LIDOU.

User Action: Correct status and retry.

### **INCORRECT SYSTEM SECTOR.**

Description: An error occurred while the system sector was being read.

Issued by QFM.

User Action: Contact CYBER Software Support.

### **INCORRECT TAPE DENSITY.**

Description: An incorrect NOS tape density has been requested for the dump option.

Issued by RECLAIM.

User Action: Correct the tape specification and reenter.

### **INCORRECT TAPE FORMAT.**

Description: An incorrect NOS tape format has been requested for the dump option.

Issued by RECLAIM.

User Action: Correct the tape specification and reenter.

### **INCORRECT TASK PERCENTAGE.**

Description: The task percentage specified exceeds 100.

Issued by STIMULA.

User Action: Correct task percentage in the task definition in the session file.

### **INCORRECT TCF ENTRY.**

Description: The previous dayfile message is the statement in TCF which is incorrect.

Issued by TAFREC.

User Action: Correct that statement in the TCF.

### **INCORRECT TERMINAL REQUEST.**

Description: Informative message indicating that an unidentified request was encountered or auto recall was not requested by the calling job.

Issued by TLX.

User Action: Correct erroneous request or rewrite program to use recall.

### **INCORRECT TERMINAL TYPE.**

Description: Parameter on TERM command is not a valid terminal type.

Issued by IAFEX.

User Action: Ensure accuracy of command.

**INCORRECT TRANSACTION DIRECTORY HEADER - filename.**

Description: The transaction directory (TRD) header word is not TRD.

Issued by TAF.

User Action: Inform TAF site analyst.

**INCORRECT USER ACCESS.**

Description: Calling job was not system origin.

Issued by SCTD.

User Action: Correct and retry.

**INCORRECT USER ACCESS.**

Description: The calling job was not system origin.

Issued by LIDOU.

User Action: Ensure system origin.

**INCORRECT USER ACCESS.**

Description: An attempt was made to call DDF on a secured system when SECURITY UNLOCK status was not set.

Issued by DDF.

User Action: If you are a security administrator, enter UNLOCK,username,password from DSD. Then reenter DDF command.

**INCORRECT USER INDEX.**

Description: Nonfatal K-display message indicating that the user index is greater than 18 bits.

Issued by STIMULA.

User Action: Enter the correct user index.

**\*\*\*\* INCORRECT VALUE.**

Description: The value specified by a directive does not convert to binary or is not within limits for the parameter specified.

Issued by PROFILE.

User Action: Rerun using correct value.

**INCORRECT 1LC DUMP RESPONSE CODE.**

Description: 1LC returned an incorrect response code to LOADBC.

Issued by LOADBC.

User Action: Write a PSR.

**INCORRECT 1MR FUNCTION.**

Description: An incorrect function was issued to 1MR.

Issued by 1MR.

User Action: Write a PSR and include support material to allow CDC to duplicate the problem.

**INDEX BUFFER LIMIT.**

Description: The limit for user indexes on a catalog track has been reached.

Issued by PFCAT.

User Action: Increase index buffer length (INDBL).

**xxest, INITIALIZATION FAILURE.  
SEE LOG FILE IIIIII FOR DETAILS.**

Description: The dump and/or load process has failed for the specified number of times. The device has been turned OFF. The second line will be sent to the NAM K-display only.

xx	Device mnemonic specified by the DT parameter.
est	EST ordinal of MDI.
IIIIII	Log file name (L file).

Issued by INITMDI.

User Action: Check the log file for the failure reason. Turn the device ON if another attempt at initialization is desired.

**INITIALIZATION OPTIONS.**

Description: This message precedes messages indicating the values of the initial K display options either during initialization or recovery.

Issued by TAFREC.

User Action: None.

**INITIALIZATION PROBLEMS -  
NO FAMILIES WITH 8 CATALOGS FOUND.**

Description: 7990 catalogs are missing.

Issued by SSEXEC.

User Action: Recover or recreate the missing 7990 catalogs.

**INITIALIZATION PROBLEMS.**

Description: The BUDT entries for the MSE facility equipment are incorrect.

Issued by SSEXEC.

User Action: Correct the BUDT.

**INITIALIZATION PROBLEMS -  
NO SMMAP FOUND.**

Description: SM maps are missing.

Issued by SSEXEC.

User Action: Recover or recreate the missing SM maps.

**INITIALIZATION PROBLEMS - NO SMMAP FOUND.**

Description: Informative message indicating that no map was found for the subfamilies.

Issued by SSEXEC.

User Action: Analyze and take the appropriate action.

**INITIALIZE OF LINK DEVICE REQUIRES PRESET.**

Description: A full initialize was specified for the link device which, if allowed to continue, would destroy extended memory resident multimainframe tables. These tables are assumed to be intact in the absence of a PRESET command.

Issued by SET.

User Action: Rereadstart without initializing the link device if other machines are operating in a multiframe mode; otherwise, clear message with left blank key and specify PRESET in conjunction with the INITIALIZE command.

### **INITIALIZE PENDING.**

Description: The equipment entered in a UNLOAD,eq. command has an initialize pending.

Issued by DSD.

User Action: Retry the command when the initialize clears.

### **INITMDI COMMAND PARAMETER ERROR.**

Description: This message is one of the following occurred:

- No parameters were supplied on the INITMDI command.
- An unrecognized separator or terminator appeared on the INITMDI command.
- An unrecognized value was entered for a parameter.

Issued by INITMDI.

User Action: Check the validity of the INITMDI command.

### **INITMDI DATA OVERFLOW.**

Description: INITMDI/PIM internal error. PIM sent more data to INITMDI than INITMDI's internal buffer could contain.

Issued by INITMDI.

User Action: Inform site analyst.

### **INITMDI ERROR ON WRITE.**

Description: INITMDI internal error. INITMDI tried to send data to the MDI, but had formatted no data in its internal buffer.

Issued by INITMDI.

User Action: Inform site analyst.

### **INITMDI INCORRECT KEYWORD.**

Description: An unrecognized keyword was entered.

Issued by INITMDI.

User Action: Check validity of INITMDI command.

### **INITMDI INCORRECT USER ACCESS.**

Description: The calling job was not SYOT.

Issued by INITMDI.

User Action: Ensure INITMDI was called using a system origin job.

### **INITMDI REPRIEVED - POSSIBLE FILE ERROR FOR xx est.**

Description: INITMDI encountered an uncorrected error while writing or reading the file.

- xx Device mnemonic specified by the DT parameter.
- est EST ordinal of MDI.

Issued by INITMDI.

User Action: Inform site analyst.



### **INITMDI REQUIRED PARAMETER MISSING.**

Description: The DT parameter was not found on the INITMDI command.

Issued by INITMDI.

User Action: Include the DT parameter on the INITMDI command.

### **INPUT FILE EMPTY.**

Description: There is no information in the input file.

Issued by NDLP.

User Action: Rerun NDLP with NDL input.

### **nnnn INPUT FILES RECOVERED.**

Description: nnnn files in the input queue have been recovered.

Issued by REC.

User Action: None.

### **INPUT MESSAGE TOO LONG.**

Description: An entered command exceeds the maximum allowed length.

Issued by NVF.

User Action: Attempt corrected command entry.

### **INPUT REQUESTED PAST END OF SCRIPT - nnnn.**

Description: An input request was received even though the end of script had been reached on terminal nnnn.

Issued by ITS.

User Action: inform site analyst.

### **INPUT TRAY EMPTY**

Description: The picker failed to find a cartridge in the input tray.

Issued by SSEXEC.

User Action: Check input tray and retry.

### **INQUIRING username.**

Description: Message displayed at line 1 of control point indicating that the user name is being inquired.

Issued by MODVAL.

User Action: None.

### **INQUIRY COMPLETE.**

Description: Dayfile message indicating that the inquiry is completed.

Issued by MODVAL.

User Action: None.

### **INSTALL ABORTED.**

Description: The install job was aborted by the operator.

Issued by IIS.

User Action: None.

**INSTALL ABORTED DUE TO DEVICE ERROR  
INFORM CE (CR) TO PROCESS DIFFERENT DEVICE**

Description: Self-explanatory.

Issued by CTI.

User Action: Enter a carriage return to select a new device or press deadstart button to exit. Inform site analyst if the message persists.

**INSTALL - ARGUMENT ERROR.**

Description: The INSTALL command is syntactically incorrect.

Issued by INSTALL.

User Action: Check parameters on INSTALL command.

**INSTALL FILE NOT FOUND.**

Description: The file to be installed as a deadstart file was not found (is not assigned to the job control point).

Issued by IIS.

User Action: Assign the file to be installed to the job control point before calling INSTALL.

**INSTALL FILE NOT MASS STORAGE.**

Description: The file to be installed as a deadstart file does not reside on mass storage.

Issued by IIS.

User Action: If the file to be installed is a tape file, copy it to mass storage.

**INSUFFICIENT CUBES. NUMBER PROCESSED = n.**

Description: The number of cubicles to be added to the subfamily is more than the number of unassigned cubicles contained in the SM. However, n cubicles were added.

Issued by SSLABEL.

User Action: Reassign empty cubicles presently assigned to another subfamily or the pool, or acquire an additional SM.

**INSUFFICIENT DUMP BUFFER SPACE.**

Description: LOADBC DUMP FET BUFFER SPACE was insufficient for controller memory dump.

Issued by LOADBC.

User Action: Write a PSR.

**INSUFFICIENT FIELD LENGTH.**

Description: The NDL processor requires additional central memory to completely process all input statements that cause table generation. Excessive use of the DEFINE statement can cause the processor to need additional table space.

Issued by STORDEF.

User Action: Remove as many NDL DEFINE statements as possible from the input file or add an RFL statement to the command portion of the job. Rerun the job.

**INSUFFICIENT FIELD LENGTH.**

Description: There is insufficient CM to process the command entered.

Issued by DIS.

User Action: Correct entry and retry.

### **INSUFFICIENT FIELD LENGTH FOR THIS COMMAND.**

Description: CRMTASK issued a CRMSTAT request but AAMI was not able to complete it because the table area supplied by the user was not large enough.

Issued by CRMTASK.

User Action: Inform database administrator.

### **INSUFFICIENT LOGICALLY ON PPS DEADSTART ABORTED.**

Description: Too few peripheral processors are logically on to permit a successful deadstart.

Issued by CTI.

User Action: Inform site analyst or customer engineer.

### **INSUFFICIENT MEMORY FOR CM RECOVERY.**

Description: During a level 3 recovery, not enough free memory (central memory not assigned to subsystem jobs) is available as is required for label MSTs. Recovery is impossible.

Issued by MSM.

User Action: Redeadstart using a level 0 deadstart.

### **INSUFFICIENT NFL SPACE.**

Description: The negative field length for the control point being dumped is less than the default value.

Issued by DSDI.

User Action: Ensure that the dump file contains meaningful information. Check that the correct control point is being dumped.

### **INTERLOCKING, EQest.**

Description: Informative message indicating IMR is waiting for the PF utility interlock on EQest.

Issued by IMR.

User Action: None.

### **INTERLOCKING IQFT, EQest.**

Description: MREC is waiting for the IQFT interlock on equipment est.

Issued by IMR.

User Action: If no queue utilities are active, inform site personnel.

### **INTERMEDIATE IGNORE TABLE OVERFLOW.**

Description: Intermediate ignore table FTAB is too small. Too many potentially recoverable files have been encountered when reading ARFs.

Issued by DMREC.

User Action: Inform site analyst to enlarge table FTAB.

### **INTERNAL ERROR - rn.**

Description: The utility has detected an internal error condition in the routine rn.

Issued by NLTERM.

User Action: Follow the site defined procedures for reporting software problems.

### **INTERNAL ERROR, details.**

Description: PACKER has encountered a condition which it cannot handle. This may be due to an internal error, or due to external problems. The detailed message details gives more reasons for the error.

Issued by PACKER.

User Action: Take a dump and write a PSR. Examine the device to see if it has been corrupted; if the device has been corrupted, perform a full PFDUMP, deadstart INITIALIZE, and full PFLOAD.

### **INTERNAL ERROR IN MSI.**

Description: MSI encountered an internal condition which could destroy permanent files.

Issued by MSI.

User Action: Take a deadstart dump, write a PSR, and send the dump and PSR to CDC along with any support materials which will allow CDC to duplicate the problem.

### **INTERVENTION NEEDED.**

Description: I-display message indicating a problem with the specified device.

Issued by DSD.

User Action: Check device for problem.

### **INTERVENTION NEEDED.**

Description: I-display message. The 5870/5970 requires operator intervention.

Issued by 1CD.

User Action: Check the 5870/5970 console and take indicated action.

### **INTRODUCED UNIT IN USE.**

Description: A unit being introduced to an equipment is defined on another equipment.

Issued by CONFIG.

User Action: Correct K display input and retry.

### **INVALID APPLICATION NAME ON NETON**

Description: RHF does not recognize the application name in the NETON request. RHF aborts the application.

Issued by RHF.

User Action: Retry and specify a valid application name.

### **INVALID CN ON ICN/TE/R.**

Description: CCP error. An incorrect connection number received on ICN/TE/R. NAM will dump the NPU. (This message is issued on debug NAM only.)

Issued by NIP.

User Action: Supply NPU dump to CYBER Software Support.

### **INVALID COMBINATION OF PARAMETERS.**

Description: A command contains an incorrect combination of parameter selections.

Issued by NVF.

User Action: Attempt corrected command entry.

### **INVALID CONTROL STATEMENT OPTION.**

Description: An unrecognizable option was specified on the NDLP command.

Issued by NDLP.

User Action: Rerun NDLP with valid command parameters.

### **INVALID DATA IN INPUT STREAM**

Description: Dayfile message indicating that the input file contains data that is incorrect.

Issued by FORMAT.

User Action: Refer to the listing of the input stream for statements in error.

### **INVALID DEVICE SPECIFIED**

Description: Dayfile message indicating that the device specified is in an improper state for the selected operation to proceed.

Issued by FORMAT.

User Action: Correct and rerun.

### **INVALID DEVICE SPECIFIED.**

Description: The specified device cannot be found, or cannot be used for dayfiles.

Issued by DFTERM.

User Action: Specify a new device.

### **INVALID DEVICE TYPE.**

Description: Error in residence of the file to attach.

Issued by NETFMA.

User Action: Inform site analyst.

### **INVALID DIRECTIVE**

Description: One of the specified directives was not valid.

Issued by BINEDIT.

User Action: Correct and retry.

### **INVALID LFN xxxx**

Description: The specified local file name, xxxx, was not a valid file name.

Issued by BINEDIT.

User Action: Correct file name and retry.

### **INVALID LINK.**

Description: An out of range alternate storage address from a PFC has caused SSVAl to abort.

Issued by SSVAl.

User Action: Inform site analyst.

### **INVALID MINACN/MAXACN ON NETON**

Description: The value of the minimum or maximum ACN in the NETON request is outside the range specified for the application. RHF aborts the application.

Issued by RHF.

User Action: Correct the value for the minimum or maximum ACN.

### **INVALID NFN/PFN IN PARAM BLOCK.**

Description: The NFN/PFN specification in PFPARAM is improperly specified.

Issued by NETFMA.

User Action: Inform site analyst.

### **INVALID OPTION.**

Description: Self-explanatory.

Issued by CTI.

User Action: Clear message and try a valid entry.

### **INVALID OPTIONAL THINK TIME.**

Description: The stimulation was aborted because of an invalid think time specification in the scripts.

Issued by ITS.

User Action: Correct scripts and retry.

### **INVALID PAGING ATTEMPT.**

Description: K display message indicating that the page advancing command (+) was entered before a LIST command or after a GO command.

Issued by QREC.

User Action: None.

### **INVALID PARAMETER xxxx**

Description: Parameter xxxx is not a valid parameter.

Issued by BINEDIT.

User Action: Correct and retry.

### **INVALID PARAMETER ON PROGRAM CALL CARD**

Description: Dayfile message indicating that at least one unrecognizable parameter was found on the FORMAT command.

Issued by FORMAT.

User Action: Correct and rerun.

### **INVALID PARAMETER VALUE.**

Description: Self-explanatory.

Issued by CS.

User Action: Reenter command.

### **INVALID PARAMETER(S) IN JOB STATEMENT.**

Description: An invalid parameter (example: more than seven characters) was found in a job statement in the parameter record. The job statement in error is shown.

Issued by NAMI.

User Action: Correct the error in the job statement.

### **INVALID PROGRAM NUMBER.**

Description: The CTI module has requested the loading of an undefined module.

Issued by DHE.

User Action: Rereadstart. If the message persists, inform customer engineer.

### **INVALID RC FROM CR/RCN.**

Description: For debug only. NVE received a CR/RCN with valid reason code.

Issued by NVF.

User Action: Contact CYBER Software Support.

### **INVALID SB PARAMETER.**

Description: The SB parameter on the SSVAL command was not a numeric character string specifying some of the subfamilies from 0 through 7.

Issued by SSVAL.

User Action: Correct SB parameter and retry.

### **INVALID SELECTION**

Description: A non-existent parameter record has been selected by the author.

Issued by NAMI.

User Action: None.

### **INVALID TRIGGER NUMBER - xxSTTP.**

Description: NIP internal error. Invalid trigger number encountered in NIP state table. NIP aborts.

xx First two characters of the name of the state table.

Issued by NIP.

User Action: Reinitialize NAM. Run collector job. Save COLLECT tape and contact CYBER Software Support.

### **IO ERROR ec ON filename.**

Description: CIO error ec was encountered on file filename.

Issued by MCS.

User Action: Refer to the message following this message for the disposition of the file.

### **IO ERROR ec ON ROLLOUT.**

Description: Because of IO errors, the MCS subsystem could not roll out.

ec CIO error code (refer to the NOS Reference Set, Volume 3)

Issued by MCS.

User Action: None.

### **IOU MARGINS SELECTED (CR) TO CONTINUE.**

Description: A deadstart was performed with the IOU margin switch not in the neutral position.

Issued by CTI.

User Action: Enter carriage return to proceed, or return the IOU margin switch to the neutral position and deadstart.

### **IOU MARGINS SELECTED DEADSTART ABORTED**

Description: IOU frequency margin status selected the maintenance registers.

Issued by CTI.

User Action: Inform site analyst or customer engineer.

### **IPL NOT FOUND**

Description: First record was read from the deadstart device and its name was not IPL.

Issued by ICD.

User Action: Redeadstart.

### **IQFT FILE ERROR DN dn FAMILY familyname.**

Description: An error was encountered during an attach or read of the IQFT file. The message which follows this message in the dayfile describes the error.

dn                    Device number.  
familyname          Family name.

Issued by QDUMP.

User Action: Contact CYBER Software Support.

### **IQFT NOT FOUND.**

Description: Mass storage devices require an IQFT file, but the selected device did not have one.

Issued by QLOAD.

User Action: Initialize the device and retry.

### **o IS AN ILLEGAL OR DUPLICATE OPTION.**

Description: The option o is incorrect or has already been specified.

Issued by NLTERM.

User Action: Correct or remove the option from the command and rerun the job.

### **p IS AN ILLEGAL OR DUPLICATE PARAMETER.**

Description: The parameter p is incorrect or has already been specified.

Issued by NLTERM.

User Action: Correct or remove the parameter from the command and rerun the job.

### **npuname IS CONTROLLING NOP.**

Description: A CONTROL,ON command attempted while control currently assigned to another NOP.

npuname          Name of the NPU (network processing unit)

Issued by CS.

User Action: Wait for control to be released, reenter command.

### **ISF COMPLETE.**

Description: Dayfile message indicating that ISF operation is complete.

Issued by ISF.

User Action: None.

### **ITF, ACN acn, APPLICATION LINKAGE ACCEPTED BY HOST pid.**

Description: Has accepted the application connection number acn.

Issued by ITF.

User Action: None.

### **ITF, ACN acn, APPLICATION LINKAGE ERROR WITH HOST pid. CN acn, REASON CODE = nn - xxxx.**

Description: The host physical identifier pid has detected one of the following anomalies on the application connection number acn:

nn    xxxx



- 01 UNRECOGNIZED COMMAND.
- 02 INVALID QUALIFIER.
- 03 INVALID ATTRIBUTE.
- 04 REQUIRED ATTRIBUTE MISSING.
- 05 CONNECTION TIMED OUT.
- 06 FC/BRK RECEIVED.
- 07 FC/NAK RETRY COUNT EXCEEDED.
- 08 BLOCKS OUT OF SEQUENCE.
- 09 UNEXPECTED COMMAND.

Issued by ITF.

User Action: Inform site analyst.

**ITF, ACN acn, APPLICATION LINKAGE REJECTED BY HOST pid.**

Description: Message indicates ITFS application on remote host physical identifier has rejected linkage request.

- acn Application connection number
- pid Physical identifier

Issued by ITF.

User Action: If problem persists, inform site analyst.

**ITF, ACN acn, CONNECTION TO HOST pid ESTABLISHED.**

Description: Connection to remote host physical identifier pid has been established as application connection number acn.

Issued by ITF.

User Action: None.

**ITF, ACN c, CONNECTION TO HOST pid BROKEN.**

Description: Failure of the connection numbered c to host pid.

Issued by ITF.

User Action: If problem persists, inform site analyst.

**ITF, ACN acn, CONNECTION TO HOST pid ENDED.**

Description: The application connection numbered acn to remote host physical identifier pid has ended.

Issued by ITF.

User Action: None.

**ITF, ACN acn, MESSAGE FROM HOST pid - ITF, ACN acn, xxxx**

Description: Message text xxxx received from the remote host pid with the connection number acn.

Issued by ITF.

User Action: None.

**ITF, ACN acn, RETRANSMITTING TO HOST pid.**

Description: The RHF subsystem has repeatedly rejected the transmission of a network block by ITF.

- acn Application connection number
- pid Physical identifier

Issued by ITF.

User Action: If problem persists, inform site analyst.

**ITF, ACN acn, TRANSMISSION RESUMED TO HOST pid.**

Description: ITF has successfully transmitted a network block which had been previously rejected by the RHF subsystem.

acn Application connection number

pid Physical identifier

Issued by ITF.

User Action: None.

**ITF, COULD NOT CONNECT TO HOST pid.  
ITF, REASON CODE = nn - xxxx.**

Description: ITF was not able to establish an RHF connection to remote host pid due to one of the following conditions:

nn xxxx

01 LID UNKNOWN TO SUBSYSTEM.  
02 REJECTED BY HOST.  
03 NETWORK RESOURCE LIMIT.  
04 SERVICER UNAVAILABLE.  
05 PATH DISABLED OR DOWN.  
06 HOST NOT RESPONDING.  
other CONNECTION REJECT.

Issued by ITF.

User Action: If problem persists, contact your local operator to ensure RHF subsystem and the LCN are operational, and/or operator for remote host pid to ensure RHF subsystem and the ITF servicer application are operational.

**ITF, COULD NOT CONNECT TO NAM SUBSYSTEM.  
ITF, REASON CODE = nn - xxxx.**

Description: ITF was not able to establish communications with the NAM subsystem due to one of the following conditions:

nn xxxx

01 SUBSYSTEM UNAVAILABLE  
02 ITF UNAVAILABLE.  
03 ITF DISABLED.  
other NETON FAILURE.

Issued by ITF.

User Action: If SUBSYSTEM UNAVAILABLE, initiate NAM. If ITF DISABLED, use the HOP ENABLE command to enable ITF. Otherwise, inform site analyst.

**ITF, COULD NOT CONNECT TO RHF SUBSYSTEM.  
ITF, REASON CODE = nn - xxxx.**

Description: ITF was not able to establish communications with the RHF subsystem due to one of the following conditions:

nn xxxx

01 SUBSYSTEM UNAVAILABLE.  
02 ITF UNAVAILABLE.  
03 ITF DISABLED.  
other NETON FAILURE.

Issued by ITF.

User Action: If SUBSYSTEM UNAVAILABLE, initiate RHF. If ITF DISABLED, use the RHF ENABLE command to enable ITF. Otherwise, inform site analyst.

#### **ITF, INVALID APPLICATION NAME (MA).**

Description: The mandatory application name specified by the MA parameter must be one to seven alphanumeric characters; may not be ITF.

Issued by ITF.

User Action: Correct the command.

#### **ITF, INVALID DEFAULT LID (DL).**

Description: The default logical identifier specified by the DL parameter must be three alphanumeric characters.

Issued by ITF.

User Action: Correct the command.

#### **ITF, INVALID MANDATORY LTD (ML).**

Description: The mandatory logical identifier specified by the ML parameter must be three alphanumeric characters.

Issued by ITF.

User Action: Correct the command.

#### **ITF, INVALID USER ACCESS.**

Description: The calling job was not system origin.

Issued by ITF.

User Action: Ensure system origin.

#### **ITF, NAM DETECTED LOGICAL ERROR. ITF, REASON CODE = nn.**

Description: ITF received an ERR/LGL/R supervisory message with reason code nn from NAM. Refer to the NAM/CCP Host Application Programming Reference Manual.

Issued by ITF.

User Action: Inform site analyst.

#### **ITF, NAM NETWORK IDLEDOWN IN PROGRESS.**

Description: The operator has initiated subsystem idledown. ITF will not accept any new connections.

Issued by ITF.

User Action: None.

#### **ITF, NAM NETWORK SHUTDOWN.**

Description: The subsystem is terminating immediately. All connections are aborted.

Issued by ITF.

User Action: None.

#### **ITF, REPRIEVED FROM ERROR CODE nn.**

Description: ITF has been reprieved by the system. See REPRIEVE macro description in the NOS 2 Reference Set, Volume 4 for listing of error codes nn.

Issued by ITF.

User Action: Inform site analyst if problem persists.

**ITF, RHF DETECTED LOGICAL ERROR.  
ITF, REASON CODE = nn.**

Description: ITF received an ERR/LGL/R supervisory message with reason code nn from RHF.

Issued by ITF.

User Action: Inform site analyst.

**ITF, RHF INPUT BLOCK ERROR DETECTED.  
ITF, REASON CODE = nn - xxxx.**

Description: One of the following anomalies was detected in a block received from RHF:

nn    xxxx

- 01 UNKNOWN BLOCK TYPE.
- 02 INVALID ACN.
- 03 ACN NOT IN USE.
- 04 INCORRECT CHARACTER TYPE.
- 05 BLOCK UNDELIVERABLE.
- 06 UNKNOWN SUPERVISORY MESSAGE.

Issued by ITF.

User Action: Inform site analyst.

**ITF, RHF NETWORK IDLEDOWN IN PROGRESS.**

Description: The operator has initiated subsystem idledown. ITF will not accept any new connections.

Issued by ITF.

User Action: None.

**ITF, RHF NETWORK SHUTDOWN.**

Description: The subsystem is terminating immediately. All connections are aborted.

Issued by ITF.

User Action: None.

**ITF, Tnnnn, ASSIGNED TO ACN c/TCN yy.**

Description: Assignment of terminal connection nnnn to the RHF connection c was made. yy is the virtual connection number.

Issued by ITF.

User Action: None.

**ITF, Tnnnn, CONNECTION BROKEN.**

Description: Indicates state of connection nnnn.

Issued by ITF.

User Action: None.

**ITF, Tnnnn, CONNECTION FROM xxxxxxxx  
ACCEPTED.**

Description: Indicates state of connection nnnn to terminal xxxxxxxx.

Issued by ITF.

User Action: None.

**ITF, Tnnnn, CONNECTION FROM xxxxxxxx ENDED.**

Description: Indicates state of connection nnnn to terminal xxxxxxxx.

Issued by ITF.

User Action: None.

**ITF, Tnnnn, SECURITY CONFLICT ON HOST pid.**

Description: Remote host has indicated a security conflict has occurred. The security count of the user will be decremented and the user logged out.

Issued by ITF.

User Action: None.

**ITF, Tnnnn, TERMINAL CONNECTION ABORTED BY HOST pid.**

Description: Message indicates state of terminal connection.

Issued by ITF.

User Action: None.

**ITF, Tnnnn, TERMINAL CONNECTION ABORTED TO HOST pid.**

Description: Message indicates state of terminal connection.

Issued by ITF.

User Action: None.

**ITF, Tnnnn, TERMINAL CONNECTION ACCEPTED BY HOST pid.**

Description: Indicates state of terminal connection nnnn to host pid.

Issued by ITF.

User Action: None.

**ITF, Tnnnn, TERMINAL CONNECTION ENDED BY HOST pid.**

Description: Message indicates state of terminal connection.

Issued by ITF.

User Action: None.

**ITF, Tnnnn, TERMINAL CONNECTION ENDED TO HOST pid.**

Description: Message indicates state of terminal connection.

Issued by ITF.

User Action: None.

**ITF, Tnnnn, TERMINAL CONNECTION REJECTED BY HOST pid.**

Description: Message indicates state of terminal connection.

Issued by ITF.

User Action: None.

**ITF, Tnnnn, TERMINAL TIMEOUT.**

Description: Indicates connection nnnn is being ended due to lack of activity.

Issued by ITF.

User Action: None.

**ITF, TERMINATED.**

Description: You terminated IAF.

Issued by ITF.

User Action: None.

**ITF, UNDEFINED DEFAULT LID (DL=xxx).**

Description: The specified logical identifier is not defined in the system LID table.

Issued by ITF.

User Action: Ensure that xxx is the correct LID.

**ITF, UNDEFINED MANDATORY LID (ML=xxx).**

Description: The specified logical identifier is not defined in the system LID table.

Issued by ITF.

User Action: Ensure that xxx is the correct LID.

**xxJ FILE NOT FOUND.**

Description: Transaction subsystem aborts. Data base in TCF file has no xxJ file or a PFM error occurred.

Issued by TAF.

User Action: Inform TAF database administrator or site analyst.

**xxJ FILE NOT FOUND.**

Description: When using the TAF's user name and password, an xxJ file for this database was not found.

Issued by DMREC.

User Action: Ensure xxJ file exists for this database and try again.

**JOB ABORTED.**

Description: Abnormal termination of MST.

Issued by MST.

User Action: Check dayfile for additional error information.

**JOB ACTIVE.**

Description: The DIS command last entered cannot be processed because a job step is active.

Issued by DIS.

User Action: Wait until the job step completes and reenter.

**JOB HUNG IN AUTO RECALL.**

Description: System error.

Issued by RECLAIM.

User Action: Inform site analyst.

### **JOB NOT RERUN.**

Description: The system was unable to successfully rerun a job because of a mass storage read error or because the QFT is full.

Issued by 1AJ.

User Action: Resubmit the job to the system.

### **JOB/PARAM RECORD COUNT EXCEEDS 200.**

Description: This message is issued during NAMI's preloading processing if the maximum of 200 job and/or parameter records permitted in any one master file is exceeded.

Issued by NAMI.

User Action: Self-explanatory.

### **JOB RERUN.**

Description: The job has been terminated and requeued for input.

Issued by 1AJ.

User Action: None.

### **JOB STATEMENTS IN PARAM RECORD EXCEED 200.**

Description: Issued if any selected parameter record contains more than 200 job statements.

Issued by NAMI.

User Action: None.

### **JOB STEP ABORT.**

Description: Job step aborted due to a system problem such as a rollout file was corrupted due to a mass storage failure.

Issued by 1AJ.

User Action: Retry the job step. If the problem recurs, inform site analyst.

### **JOURNAL TYPE DOES NOT MATCH xxJ FILE.**

Description: TAF journal file entries in the xxJ file do not match the files themselves. This causes the transaction subsystem to abort.

Issued by TAF.

User Action: Inform TAF database administrator. Examine xxJ file for the TAF journal file entries.

### **JSN LIST FULL.**

Description: K display message indicating that the job sequence name list does not have room for the specified job sequence name. The job sequence name list may have up to five job sequence names entered.

Issued by QFSP.

User Action: None.

### **JSN xxxx NOT FOUND.**

Description: JSN xxxx was not found in input, print, plot, terminal wait, or punch queue.

Issued by QDSPLAY.

User Action: Specify an appropriate JSN and retry.

### **JSN NOT FOUND.**

Description: Either the jsn you specified on a DAYFILE,jsn or other command is incorrect, or the job has terminated.

Issued by DSD.

User Action: Make sure the jsn is correct.

**K.BFL=nnnnnnnB.**  
**K.CMB=nn.**  
**K.ECS=nnnK.**  
**K.ERO=CRF,xxx.**  
**K.INT=CRF,xxxxxxx.**  
**K.INT=CRM,xxxx.**  
**K.MFL=nnnnnnnB.**  
**K.REC=xxx.**  
**K.SCP=nn.**  
**K.TLF=xxxxxxx.**

Description: Values of the initial K display options at either initialization or recovery. Initial K-display provides more information.

n integer  
x character

Issued by TAFREC.

User Action: None.

#### **K. COMMAND NOT VALID.**

Description: A K. command in the TCF file is improperly formatted.

Issued by TAFREC.

User Action: Correct the statement in the TCF or inform the TAF analyst.

#### **K.MAXFL,nnnnnnnB.**

Description: The run-time K display command K.MAXFL was entered with the indicated value.

Issued by TAF.

User Action: None.

#### **K.MAXFL REJECTED.**

Description: A value was entered which caused potential blocked tasks to be detected.

Issued by TAF.

User Action: Reenter K.MAXFL with a larger value.

#### **KEYWORD IS INCORRECT FOR THIS FUNCTION.**

Description: A keyword was used that is incorrect for the selected directive.

Issued by DMREC.

User Action: Check format of directive and valid key words for that directive.

#### **KEYWORD/VALUE COUNT IN PARAM RECORD EXCEEDS 200.**

Description: The NAMI allows a maximum of 200 replacement pairs in the parameter record; this count must include 21 pairs which are internal to NAMI.

Issued by NAMI.

User Action: None.



### **n.nnn KILO CDCS REQUEST REJECTS FOR BUSY.**

Description: Total number of SSC rejects for busy when less than seven outstanding CDCS SSC requests existed at the time of the current request.

Issued by TAF.

User Action: None.

### **n.nnn KILO CDCS REQUEST REJECTS FOR MAXR.**

Description: Total number of SSC attempts when there were seven (MAXR) outstanding CDCS SSC requests.

Issued by TAF.

User Action: None.

### **n.nnn KILO CDCS REQUESTS FROM TASKS.**

Description: Total number of CDCS SSC requests issued by tasks. The number does not include terminate requests which are blocked by TAF.

Issued by TAF.

User Action: None.

### **n.nnn KILO TRANSACTION ABORTS.**

Description: Upon transaction termination, this message indicates how many transaction tasks have aborted.

Issued by TAF.

User Action: Data base administrator may have to correct data base to account for transactions.

### **n.nnn KILO TRANSACTIONS PROCESSED.**

Description: Upon TAF termination, this message indicates the number of TAF transactions processed.

Issued by TAF.

User Action: None.

### **KL PARAMETER ON CRM STATEMENT NOT SPECIFIED PROPERLY.**

Description: The KL parameter on the CRM statement was specified improperly or specified as zero length.

Issued by DMREC.

User Action: Correct the CRM statement and try again.

### **L DISPLAY NOT ACTIVE.**

Description: No data was available to be displayed when the L display was requested at the console.

Issued by DSD.

User Action: None.

### **L DISPLAY NOT ASSIGNED.**

Description: No L display utility was active when input was entered at the console.

Issued by DSD.

User Action: Ensure an L display utility has been initiated.

### **L DISPLAY NOT AVAILABLE.**

Description: The L display is currently assigned.

Issued by DSD.

User Action: Retry command when the L display is available.

### **LA AND UA BOTH REQUIRED.**

Description: You specified a lower access level limit or an upper access level limit, but not both.

Issued by PFS.

User Action: Reenter the command with both lower and upper access level limits specified.

### **\*\*\*\*LA AND UA BOTH REQUIRED.**

Description: K display message indicating both LA (lower access) and UA (upper level) must be specified when selecting access levels.

Issued by QFSP.

User Action: Correct and retry.

### **LA GREATER THAN UA.**

Description: The lower access level limit specified for a device during online initialization is greater than the upper access level limit specified for that device.

Issued by MSI.

User Action: Select appropriate access level limits for the device.

### **LA NOT WITHIN LIMIT.**

Description: The device lower access level limit specified during online initialization is not within the device's access limits from the EST.

Issued by MSI.

User Action: Select a lower access level limit within the device's EST access limits.

### **LA VALUE LARGER THAN UA.**

Description: The lower access limit you specified is greater than the upper access limit you specified.

Issued by PFS.

User Action: Enter appropriate access level limits.

### **\*\*\*\*LA VALUE LARGER THAN UA.**

Description: K display message indicating the value associated with the lower access level (LA) must be less than or equal to the value of the upper access level (UA).

Issued by QFSP.

User Action: Correct and retry.

### **LABEL TRACK CONFLICT.**

Description: While attempting to initialize a device at deadstart time, it has been determined that the track reserved via CPUMTR is not the first available track in the TRT or a track was not available for the label. Recovery is impossible.

Issued by MSM.

User Action: Contact CYBER Software Support. The TRT (and possibly a dump of MSM) must be investigated to determine the conflict. A level 0 deadstart may be necessary to allow deadstart initialization of the device.

### **LABEL TRACK CONFLICT.**

Description: IMS is unable to initialize the device. The first nonflawed track in the TRT for the device is not the label track.

Issued by IMS.

User Action: Perform a deadstart initialize on the device.

### **LACKING MEMORY FOR CM RECOVERY.**

Description: The system is unable to complete the deadstart because an insufficient amount of memory is available for system use during the deadstart.

Issued by SET.

User Action: Perform a level 0 deadstart after attempting a level 3 deadstart with the abort option.

### **LBL - CIO ERROR.**

Description: A CIO error was encountered because no trailer record was found on a block load.

Issued by DMREC.

User Action: Load from previous dump tape.

### **LCF DOES NOT EXIST.**

Description: For debug only. An LCF is not included in the network run.

Issued by NVF.

User Action: Restart the network with an LCF.

### **LDLIST OPERATION COMPLETE.**

Description: Informative message indicating completion of QLOAD.

Issued by QLOAD.

User Action: None.

### **ttt LENGTH CONFLICT.**

Description: The length of table ttt does not agree with the information from the system table file. Recovery is aborted.

Issued by REC.

User Action: Level 0 deadstart is required.

### **LENGTH IN 52 TABLE .NE. FET.**

Description: The controlware record length in the 52 table did not equal the controlware record length specified in the FET after the controlware was read into the LOADBC field length.

Issued by LOADBC.

User Action: Check system controlware records.

### **LEVEL-0 DATA BASE ERROR.**

Description: Dayfile message indicating that a level 0 block on the VALIDUs file was not present or was incorrect.

Issued by MODVAL.

User Action: Ensure that the file is local and contains valid level 0 and level 1 blocks (at least one user entry) and rerun.

### **LEVEL-1 INDEX BLOCKS LINKED.**

Description: Informative dayfile message indicating that index blocks are linked.

Issued by MODVAL.

User Action: None, although if the validation file can be reformatted to eliminate block linkage, searches will be faster for user names residing in linked blocks and for nonexistent user names which would have resided in linked blocks.

### **LEVEL-2 DATA BASE ERROR.**

Description: Dayfile message indicating that a VALIDUs structure error in the level 2 block was detected.

Issued by MODVAL.

User Action: Inform site analyst immediately.

**LEVEL 3 RECOVERY NOT POSSIBLE. or  
CENTRAL MEMORY INITIALIZATION HAS BEEN  
SELECTED BY THE OPERATOR, or  
AUTOMATICALLY SET BY THE HARDWARE. or  
DEADSTART AND SELECT DIFFERENT RECOVERY LEVEL, or  
DO NOT SELECT MAINFRAME INITIALIZATION.**

Description: A level 3 recovery is not possible when power on initialization is selected. On I4 IOUs, power on initialization will be set automatically by CTI following a system power up, or when the current deadstart immediately follows an MSL load.

Issued by CTI.

User Action: Change the deadstart level to less than 3.

**LFG COMPLETE.**

Description: Indicates normal LFG termination.

Issued by LFG.

User Action: None.

**LFG ERRORS.**

Description: Indicates abnormal LFG termination. Consult LFG summary listing for detailed error descriptions.

Issued by LFG.

User Action: Correct error and try again.

**LI LENGTH ERROR filename.**

Description: The EOI sector of the library file as specified by the TRT is not an EOI sector. The EOI sector was adjusted if possible.

Issued by MSM.

User Action: Inspect the file to ensure that the data is correct. Some data may be missing if the system could not correctly adjust the EOI sector.

**LIBRARY DIRECTORY EMPTY - filename.**

Description: The task library file indicated does not contain a directory.

Issued by TAF.

User Action: Inform site analyst.

**LIBRARY DIRECTORY ERROR - filename.**

Description: The task library file indicated contains a nonrecognizable directory.

Issued by TAF.

User Action: Inform site analyst.

**LIBRARY DIRECTORY TOO LONG - filename.**

Description: The directory record on the task library file indicated exceeds the maximum length allowed by the transaction executive (TLDMS words).

Issued by TAF.

User Action: Delete tasks from the task library or reassemble LIBTASK and TAF increasing the value of the installation parameter TLDMT.

### **LIBRARY TABLE ERROR.**

Description: Dayfile message indicating that an error was encountered while building the system library. Blank entry was not found in the library table or in the directory within the field length at the deadstart control point.

Issued by SLL.

User Action: Attempt another deadstart. If the problem persists, contact CYBER Software Support.

### **LID NOT ADDED - FILES IGNORED.**

Description: Some of the queued files were not processed because there was no LID table entry for the LID associated with the files, and the LID could not be added because all of the LID slots for the host PID were already occupied by other LIDs.

Issued by QLOAD.

User Action: Redeadstart, defining a larger LID table.

### **LID NOT ALTERED.**

Description: Informative message indicating an attempt to change a LID to its current attributes.

Issued by LIDOU.

User Action: None.

### **LID NOT DELETED.**

Description: An attempt to delete a LID was rejected by \*SFM\*.

Issued by LIDOU.

User Action: None.

### **LID NOT FOUND.**

Description: An attempt was made to delete a LID that was not in the LID table.

Issued by LIDOU.

User Action: Reenter L display input with correct LID to be deleted.

### **LID NOT IN TABLE.**

Description: An NLD (New Destination Logical Identifier) was specified that was not in the LID table.

Issued by QFSP.

User Action: Correct and reenter K display input or use the LID operator utility to add the LID to the table.

### **LID TABLE EMPTY.**

Description: The LID table read from central memory was empty (program terminated).

Issued by LIDOU.

User Action: Contact site analyst.

### **LIDOU UTILITY COMPLETE.**

Description: Informative message indicating normal termination.

Issued by LIDOU.

User Action: None.

### **LINE: linenam,st,lt,npuname,port.**

Description: Status of line linenam. It indicates the current status (st), the line type (lt), the supporting NPU (npuname) and the line's port number (port).

Issued by CS.

User Action: None.

**LINE: xxxxxxxx, DUPLICATE CLA ADDRESS.**

Description: Line xxxxxxxx has been found to have a CLA address that is in use by another line on the same NPU.

Issued by CS.

User Action: Change the CLA address to have a unique address or turn off the CLA. Turning off the CLA will cause the line to be disabled.

**LINE: xxxxxxxx, TIP NOT CONFIGURED.**

Description: Line xxxxxxxx has been defined in the network configuration file (NCF) and the corresponding terminal interface program (TIP) is not resident in the NPU to support the line.

Issued by CS.

User Action: Rebuild the variant for the NPU with the TIP module included.

**LINE MODE IS NOT SUPPORTED, USE SCREEN MODE.**

Description: NLTERM is being run on a terminal that is not in screen mode or does not support screen mode.

Issued by NLTERM.

User Action: If the terminal model is one that is supported by the NOS Screen command, refer to Volume 3 of the NOS 2 Reference Set and use that information to make the terminal model known to the system. If the terminal is not supported by the Screen command or it does not support screen mode, then use the K display for interactive processing, or set OP=A and/or run NLTERM from a batch job for single function processing.

**LINE TOO LONG.**

Description: Operator attempted to enter a line over 50 characters long as input to a K or L display. DSD does not accept the entry.

Issued by DSD.

User Action: Backspace and shorten entry to 50 characters or less.

**LINE TOO LONG.**

Description: The CMR command buffer was not long enough to contain all the characters entered at the keyboard.

Issued by DSD.

User Action: Enter fewer characters for L display input requests.

**LINK DEVICE CANNOT BE ALTERED.**

Description: Informative message indicating that an incorrect attempt was made to change the characteristics of the link device using an online initialize.

Issued by MSI.

User Action: None.

**LINK DEVICE INCORRECTLY DEFINED.**

Description: The equipment defined as the link device in a multi-mainframe configuration is not extended memory or is OFF or DOWN.

Issued by SET.

User Action: Correct the link device EST entry.

**LINK DEVICE LABEL TRACK ERROR.**

Description: An attempt to locate a free track for link device label information within predetermined limits was unsuccessful, possibly because a large block of extended memory was flawed initially.

Issued by SET.

User Action: Remove need for flawing of the device.

### **LINK DEVICE READ ERROR.**

Description: An unrecoverable error occurred while attempting to read the link device.

Issued by MREC.

User Action: Contact CYBER Software Support. The only K display entries allowed are K.RERUN. and K.STOP.

### **LINK DEVICE WRITE ERROR.**

Description: An unrecoverable error occurred while attempting to write the link device.

Issued by MREC.

User Action: Contact CYBER Software Support. The only K display entries allowed are K.RERUN. and K.STOP.

### **LINK RESET ON PORT nn.**

Description: An irrecoverable line error has occurred on port nn serviced by the CCP X.25 terminal interface program. Following the error, CCP automatically performed a link reset. The reset can cause packet level errors to occur. Repeated occurrences of this message may indicate software problems or poor transmission characteristics of the line.

Issued by CCP.

User Action: None. Inform network analyst if this occurs frequently.

### **LIST COMPLETE.**

Description: Informative message.

Issued by DMREC.

User Action: None.

### **LIST COMPLETE.**

Description: Informative message on the K display indicating that the LIST command has completed.

Issued by QREC.

User Action: None.

### **LIST WRITTEN TO OUTPUT FILE nm.**

Description: Indicates that the LIST command is complete and the list has been successfully written to the list file nm.

Issued by NLTERM.

User Action: None.

### **LISTING REMAINING FILES.**

Description: Informative message indicating that the remaining catalog image files are being listed.

Issued by PFLOAD.

User Action: None.

### **LISTPPM - ARGUMENT ERROR.**

Description: Dayfile message indicating that an incorrect parameter or an undefined parameter was encountered.

Issued by LISTPPM.

User Action: Correct error and retry.

### **LISTPPM COMPLETE.**

Description: Dayfile message indicating that the LISTPPM run was completed successfully.

Issued by LISTPPM.

User Action: None.

### **LISTPPM - INVALID DUMP FILE.**

Description: Dayfile message indicating that the PIP-PP memory dump was formatted incorrectly.

Issued by LISTPPM.

User Action: Contact CYBER Software Support.

### **LLINK: llname, MESSAGE NOT SENT.**

Description: Broadcast message not delivered to terminals on logical link llname.

Issued by CS.

User Action: Reenter command.

### **LLINK: llname,RL-r,typ,nn1/tn1,nn2/tn2.**

Description: Status of logical link llname. It indicates the regulation level (r), whether the link is host to host or host to NPU (typ), NPU node i.e. and terminal node id 1 (nn1/tn1), and NPU node id and terminal node id 2 (nn2/tn2).

Issued by CS.

User Action: None.

### **npuname, LOAD ABORTED - ABNORMAL RESPONSE.**

Description: NS aborted the load of the NPU because it had received an error response from the SAM program while it was trying to load CCP into the NPU. Either there was a hardware problem with the NPU that was being loaded or there was an error in the network load file (NLF).

Issued by NS.

User Action: The NPU should be checked to make sure there is nothing wrong with the coupler or memory. (Refer to the CCP Diagnostic Handbook for information on how to run NPU diagnostics.) If the NPU is a remote NPU, then the trunk should also be checked. The NLF file should likewise be checked to make sure it was built correctly for this NPU.

### **npuname, LOAD ABORTED - BAD LOAD MODULE.**

Description: NS aborted the load of the NPU because it had detected an error in the network load file (NLF). NS detected the error while it was reading the CCP load modules from the NLF for the NPU that was being loaded.

Issued by NS.

User Action: The NLF file should be checked to make sure that it was built correctly for the NPU that NS is trying to load.

### **npuname, LOAD ABORTED - BAD LPCB.**

Description: NS aborted the load of the NPU because it had detected an error in the network load file (NLF). For each NPU that NS can dump, there is a load procedure control block (LPCB) in the NLF. The LPCB for the NPU that NS was trying to load had a bad header.

Issued by NS.

User Action: The NLF file should be checked to make sure that it was built correctly for the NPU that NS is trying to load.

### **npuname, LOAD ABORTED - BAD NCB SIZE.**

Description: NS aborted the load of the NPU because it could not load the network configuration Block (NCB) into the NPU. For each NPU that NS will load, there is an NCB in the network configuration file (NCF) and a load



procedure control block (LPCB) in the network load file (NLF). In the LPCB is a directive for loading the NCB into the NPU which specifies the maximum size of the NCB. For this error condition to occur, the size of the NCB in the NCF was larger than the maximum size specified in the LPCB for the NPU that was being loaded.

Issued by NS.

User Action: The NLF and NCF files should be checked to determine which one has the incorrect information and the erroneous file should be rebuilt.

#### **npuname, LOAD ABORTED - BAD PICB.**

Description: NS aborted the load of the NPU because it had detected an error in the network load file (NLF). For each NPU that NS can load, there is a program initiation control block (PICB) in the NLF. The PICB for the NPU that NS was trying to load had a bad header.

Issued by NS.

User Action: The variant specified in the network configuration file (NCF) should be checked to see if it matches the variant specified in the NLF. If the two variants do not match, change one to match the other.

#### **npuname, LOAD ABORTED - BAD PICB DIRECTIVE.**

Description: NS aborted the load of the NPU because it had detected an error in the network load file (NLF). For each NPU that NS can load, there is a program initiation control block (PICB) in the NLF. This PICB contains directives for NS to follow. NS had found too many bad directives in the PICB for the NPU that was being loaded.

Issued by NS.

User Action: The NLF file should be checked to make sure that it was built correctly for the NPU that NS is trying to load.

#### **npuname, LOAD ABORTED - LOAD MOD NOT FOUND.**

Description: NS aborted its attempt to load the NPU because it had detected an error in the network load file (NLF). For each NPU that NS will load, there are supposed to be CCP load modules in the NLF. NS could not find a CCP load module for the NPU that was being loaded.

Issued by NS.

User Action: The NLF file should be checked to make sure that it was built correctly for the NPU that NS is trying to load.

#### **npuname, LOAD ABORTED - PICB NOT FOUND.**

Description: NS aborted the load of the NPU because it has detected an error in the network load file (NLF). For each NPU that NS can load, there is a program initiation control block (PICB) in the NLF. The PICB for the NPU that NS was trying to load was missing.

Issued by NS.

User Action: The NLF file should be checked to make sure that it was built correctly for the NPU that NS is trying to load.

#### **npuname, LOAD ABORTED - PREEMPTED.**

Description: NS aborted the load of the NPU because it had received another initialization request from the SAM program or from PIP while it was currently trying to load CCP into the NPU. There was probably a hardware problem with the NPU that was being loaded.

Issued by NS.

User Action: If the NPU has two couplers, ensure that the SAM attribute is declared in the EST entry for at least one of the couplers. The NPU should be checked to make sure there is nothing wrong with the coupler or memory. (Refer to the CCP Diagnostic Handbook for information on how to run NPU diagnostics.) If the NPU is a remote NPU, then the trunk should also be checked.

#### **npuname, LOAD ABORTED - RETRY LIMIT.**

Description: NS aborted the load of the NPU because it was getting error responses from the SAM project when NS was sending the START function to the SAM program. The START function is sent after NS has

completed loading micromemory into the NPU. The SAM program is supposed to send back a normal response. If the SAM program returns an error response, NS will reissue the request two more times. If after the third request, NS still gets an error response, it gives up trying to load the NPU and this alert condition is issued. There was probably a hardware problem with the NPU that was being loaded.

Issued by NS.

User Action: The NPU should be checked to make sure there is nothing wrong with the coupler or memory. (Refer to the CCP Diagnostic Handbook for information on how to run NPU diagnostics.) If the NPU is a remote NPU, then the trunk should also be checked.

### **npuname, LOAD ABORTED - TIMEOUT.**

Description: NS aborted the load of the NPU because it had not received a response from the SAM program. There was either a hardware problem with the NPU or with the SAM program that was loaded into the NPU.

Issued by NS.

User Action: If SAM was loaded from cassette, the cassette tape and tape drive should be checked. If the SAM program was loaded by the host, then the network load file (NLF) should be checked to make sure it was built correctly. The NPU may also be checked to make sure there is nothing wrong with the coupler of memory. (Refer to the CCP Diagnostic Handbook for information on how to run NPU diagnostics.) If the NPU is a remote NPU, then the trunk should be checked also.

### **LOAD COMPLETE FOR xx AT EST est, RESET CODE = rr.**

Description: Device xx at EST ordinal est has been loaded. The reset code is rr.

Issued by INITMDI.

User Action: None.

### **LOAD ERROR DEADSTART ABORTED**

Description: An attempt to load a module from the Maintenance Software Library or the CTI/MSL Disk Area failed.

Issued by CTI.

User Action: Inform site analyst or customer engineer.

### **LOAD ERROR IN HASHING ROUTINE.**

Description: When attempting to load the hashing routine on a record load operation, a load error or no entry point in the hashing routine was found.

Issued by DMREC.

User Action: Check for valid hashing routine, inform analyst.

### **LOAD FILE bbbbbbb FOR xx est IS EMPTY.**

Description: INITMDI found no data on load file bbbbbbb.

xx Device mnemonic specified by the DT parameter.  
est EST ordinal of MDI.

Issued by INITMDI.

User Action: Ensure a load file is present.

### **LOAD FILE MISPOSITIONED.**

Description: One of the following situations has occurred:

- A file position function indicated an attempt to position beyond EOI.
- During a file read function, the control word read was not the expected control word.

Issued by QLOAD.

User Action: Rewind the load file and retry the operation.

### **LOAD FILE POSITION LOST.**

Description: Position on the load file was lost during the write error recovery sequence.

Issued by QLOAD.

User Action: Retry or contact CYBER Software Support.

### **LOAD INTERLOCK ON xx est NOT SET.**

Description: The load interlock at EST ordinal est is not set.

xx Device mnemonic specified by the DT parameter.  
est EST ordinal of MDI.

Issued by INITMDI.

User Action: If NAM is present, inform the site analyst as an error internal to PIP occurred. If NAM is not present, set the load interlock.

### **LOAD RECORD FORMAT IN ERROR.**

Description: The file data may not be intact, since a load record format error was encountered when the file was loaded. The file is skipped, unless error processing is selected.

Issued by QLOAD.

User Action: None.

### **LOADBC ABORT - BAD INITIATION PARAMETERS.**

Description: The actual NAD memory size is smaller than the specified LOADBC default memory size.

Issued by LOADBC.

User Action: Verify if installation parameters in LOADBC are correct. If so, contact a customer engineer.

### **LOADBC ABORT - xxx ERROR CODE = yyy.**

Description: PP program xxx (either CVL or NLD) returned response code yyy when validating the NAD or when loading NAD controlware.

Issued by LOADBC.

User Action: Verify LOADBC parameters are correct and that the job has the proper origin type. If so, contact a customer engineer.

### **LOADBC REMOTE NAD LOAD - GO OR DROP.**

Description: Flashing B display message indicating that CVL could not determine the status of the NAD.

Issued by LOADBC.

User Action: Operator must determine status of the NAD. If NAD is not in use by remote mainframe or by customer engineers, enter GO.jsn. Otherwise, enter DROP.jsn.

### **LOADING filename userindex.**

Description: Informative message indicating the name of the file currently being loaded and the user index under which the file is stored.

Issued by PFLOAD.

User Action: None.

### **LOADING filename**

Description: This message is issued when NAMI routine processes each job record which is to be routed to the input queue.

Issued by NAMI.

User Action: None.

### **LOADING Ccc,xxxx AUTOLOAD FAILURE, STyyyy.**

Description: Following the autoloading of controlware record xxxx to the buffer controller on channel cc, controller status indicated an error.

yyyy Controller status. If status is 5020, the wrong controlware was loaded. If zero, the channel was disconnected without status being received. If not zero, a channel parity error or controlware checksum error occurred for the autoloading.

Issued by STL.

User Action: Ensure the correct controlware is specified in the CMRDECK. To retry the autoloading, type GO. If several retries continue to produce this message, check controlware record for validity. If the controlware record is known to be good, inform customer engineer to check the controller and channel.

### **LOADING Ccn, cwrecord CONTROLLER RESERVED.**

Description: Controller reserved when trying to load controlware record cwrecord on channel number cn.

Issued by STL.

User Action: Clear reserve by deadstart of machine on other access or clearing controller.

### **LOADING Ccc,xxxx FUNCTION nnnn TIME OUT.**

Description: The controller on channel cc is not responding to an autoloading function nnnn.

Issued by STL.

User Action: Inform customer engineer.

### **LOADING Ccc,HCD TO FLPP**

Description: Informative status message indicating that the 819 driver, HCD, is being loaded to the FLPP channel cc. If the deadstart stops with this message displayed, a hardware problem in the LFLPP or MUX is indicated.

Issued by STL.

User Action: If the EQPDECK and driver record are known to be good, inform customer engineer to check the channel or FLPP.

### **LOADING Ccc,xxxx TO CENTRAL MEMORY.**

Description: Informative status message indicating that controlware record xxxx is being loaded to central memory in preparation for autoloading the buffer controller on channel cc. If deadstart stops with this message displayed, there is insufficient central memory available to contain the controlware record rcdname.

Issued by STL.

User Action: If a level 3 deadstart was in progress, attempt another level of deadstart. If other than a level 3 deadstart was in progress, the controlware record xxxx is bad.

### **LOADING Ccc,xxx TO CONTROL MODULE.**

Description: This is an informative message indicating that the controlware record xxx is being autoloading to a control module on channel cc. If deadstart stops with this message, the autoloading program has hung due to one of the following conditions:

- Another machine had the control module reserved.
- An incorrect EQPDECK equipment definition has been entered.
- A controller or channel malfunction has occurred.
- The controlware record xxx is bad.

Issued by STL.

User Action: None, unless deadstart stops with this message. In that case, determine the cause from the above possibilities and correct it. If the EQPDECK and controlware record are known to be good, inform the customer engineer so the controllers and channel can be checked.

### **LOADING Ccc,xxxx TO CONTROLLER.**

Description: Informative status message indicating that controlware record xxxx is being autoloading to the buffer controller on channel cc. If deadstart stops with this message displayed, the autoloading program has hung due to one of the following conditions:

- An incorrect EQPDECK equipment definition has been entered.
- A controller or channel malfunction has occurred.
- The controlware record xxxx is bad.

Issued by STL.

User Action: If the EQPDECK and controlware record are known to be good, inform customer engineer to check the controller and channel.

### **LOADING EXTENDED MEMORY TASK - taskname.**

Description: Informative message. The transaction subsystem is loading task taskname.

Issued by TAF.

User Action: None.

### **LOCAL AREA OVERFLOW.**

Description: The local area sector has filled.

Issued by 1CK.

User Action: Perform a level 0 deadstart and initialize the device.

### **LOCAL AREA SECTOR ERROR.**

Description: An error was encountered while reading the sector of local areas on the label track.

Issued by MSM.

User Action: Redeadstart and initialize the device.

### **LOCAL AREA SECTOR ERROR.**

Description: An error was encountered while reading the sector of local areas on the label track.

Issued by 1CK.

User Action: Perform a level 0 deadstart and initialize the device.

### **LOG,nn.**

Description: Operator executed command. Refer to the A,OPERATOR. command.

Issued by DSD.

User Action: None.

### **LOG FILE nm HAS BEEN TERMINATED.**

Description: Indicates that the GO command has completed the termination of the file nm.

Issued by NLTERM.

User Action: None.

**LOG FILE nm IS PURGED FROM THE CATALOG.**

Description: Indicates the completion of the PURGE command.

Issued by NLTERM.

User Action: None.

**LOG FILE NAME nm CONTAINS AN ILLEGAL CHARACTER.**

Description: The log file name nm contains a non- alphanumeric character.

Issued by NLTERM.

User Action: Change the file name so that it only contains alphanumeric characters.

**LOG FILE NAME MUST BE 1-5 CHARACTERS IN LENGTH.**

Description: The log file name specified must be 1 to 5 characters in length.

Issued by NLTERM.

User Action: Change the log file name so that it is 1 to 5 characters in length and reenter it.

**LOG FILE NAME MUST BE 5 CHARACTERS OR LESS.**

Description: The log file name specified by the NM parameter must be 1 to 5 characters in length.

Issued by NLTERM.

User Action: Change the log file name so that it is 1 to 5 characters in length and rerun the job.

**LOG FILE NAME SET TO nm.**

Description: The NM command has set the file name (to be used by the GO or TERM commands) to nm.

Issued by NLTERM.

User Action: None.

**LOG - MTR BUSY.**

Description: DSD is waiting for MTR to process a request.

Issued by DSD.

User Action: Erase command and retry. Inform site analyst if the problem persists.

**LOG - PPU BUSY.**

Description: DSD cannot assign a PP to process an entry at this time.

Issued by DSD.

User Action: Erase command and retry. Inform site analyst if the problem persists.

**LOGGING MAINTENANCE REGISTERS.**

Description: CTI is writing the contents of the maintenance registers to the MSL dayfile.

Issued by CTI.

User Action: None.

**LOGICAL ERROR - xxxx.**

Description: A supervisory message that was issued with PFC/SFC of xxxx (hexadecimal) caused a logical protocol error with NAM.

Issued by CS.

User Action: Contact site analyst.

### **LOGICAL ERROR xx.**

Description: Unrecognizable block sent to NAM, where xx is the type of error.

Issued by IAFEX.

User Action: Write a PSR including network trace, IAF dump, and time of occurrence.

### **LOGICAL ERROR, PFC/SFC = pfcsfc.**

Description: This message will appear only if a non-debug version of NVF is running. (If the error condition that causes this message happens in a debug system, NVF will abort.) NVF received an ERR/LGL supervisory message from NIP. The pfcsfc field contains the PFC/SFC of the supervisory message that is in error. This could be a sign of a serious internal problem in NVF and may cause further unpredictable actions by NVF or NIP.

Issued by NVF.

User Action: If the network starts behaving in an unusual or unpredictable manner, NAM should be stopped. Save the dumps and write a PSR. Since this type of problem is difficult to fix without trace turned on, build and install a debug version of the network with trace turned on.

### **xxxx LOST OUTPUT MESSAGE.**

Description: Job with jsn xxxx lost an output message because the maximum number of output messages was reached.

Issued by IAFEX.

User Action: Write a PSR including a copy of the file that was currently being output.

### **LOST SPACE nnnnnn, ssssss PRUS.**

Description: PACKER statistics reflecting the condition of the portion of the IAPF chain which PACKER has processed. This message indicates the amount of lost space which PACKER was unable to reclaim. It remains unknown to PFM. It may be reclaimed on a future PACKER run after production has changed the makeup of the IAPF chain.

nnnnnn     Number of holes without catalog entries.  
ssssss     Total sectors without catalog hole entries.

Issued by PACKER.

User Action: None.

### **LOST STIMOUT DATA.**

Description: Nonfatal output file message indicating that the buffer has overrun, since CIO is not servicing the stimulator output buffer fast enough.

Issued by 1TS.

User Action: Reassemble STIMULA with a larger output buffer, reduce line speed or input speed, or increase think time for stimulation.

### **LOWER BOUND IS .GE. UPPER BOUND FOR CLASS xx.**

Description: During GO processing, a lower bound was encountered which exceeded the associated upper bound for the service class xx.

Issued by SDSPLAY.

User Action: Bring up the appropriate CLASS display for the service class and check all lower bounds against all upper bounds.

### **LPest, CHcc Account INCOMPLETE TRANSFER. LPest, CHcc CONTROLLER HUNG BUSY.**

**LPest, CHcc Fcode FUNCTION TIMEOUT.  
LPest, CHcc Fcode REJ Pdriver,Cconvert,Eequip.  
LPest, CHcc TURNED OFF.**

Description: Line printer messages. Refer to EQest...

Issued by IIO.

User Action: Inform customer engineer.

**LPest, CHcc RESERVED.**

Description: The line printer is reserved and cannot be connected on channel cc.

est EST ordinal of line printer  
cc Channel number

Issued by IIO.

User Action: Inform customer engineer.

**LRest, CHcc Acount INCOMPLETE TRANSFER.  
LRest, CHcc CONTROLLER HUNG BUSY.  
LRest, CHcc Fcode FUNCTION TIMEOUT. or  
LRest, CHcc Fcode REJ  
Pdriver,Cconvert,Eequip. or  
LRest, CHcc TURNED OFF.**

Description: 580-12 line printer messages. Refer to EQest...

Issued by IIO.

User Action: Inform customer engineer.

**LRest, CHcc Emmmm PFC ERROR**

Description: Detected PFC error on the specified local batch equipment.

LR 580-12 line printer  
LS 580-16 line printer  
LT 580-20 line printer  
est EST ordinal of local batch equipment

Issued by IIO.

User Action: Inform customer engineer.

**LRest, CHcc RESERVED.**

Description: The 580-12 line printer is reserved and cannot be connected on channel cc.

est EST ordinal of line printer  
cc Channel number.

Issued by IIO.

User Action: Inform customer engineer.

**LSest, CHcc Acount INCOMPLETE TRANSFER.  
LSest, CHcc CONTROLLER HUNG BUSY.  
LSest, CHcc Fcode FUNCTION TIMEOUT.  
LSest, CHcc Fcode REJ  
Pdriver,Cconvert,Eequip.  
LSest, CHcc TURNED OFF.**

Description: 580-16 line printer messages. Refer to EQest...



Issued by IIO.

User Action: Inform customer engineer.

**LSest, CHcc Emmmm PFC ERROR.**

Description: 580-16 line printer message. Refer to EQest...

Issued by IIO.

User Action: Inform customer engineer.

**LSest, CHcc RESERVED.**

Description: The 580-16 line printer is reserved and cannot be connected to channel cc.

est EST ordinal of line printer  
cc Channel number

Issued by IIO.

User Action: Inform customer engineer.

**LS VALUE LARGER THAN US.**

Description: The lower file size limit is greater than the upper file size limit.

Issued by PFDUMP.

User Action: Change the LS or US parameter value.

**LS VALUE LARGER THAN US.**

Description: The lower file size limit is larger than the upper file size limit.

Issued by PFS.

User Action: Correct and retry.

**LTest, CHcc Acount INCOMPLETE TRANSFER.**

**LTest, CHcc CONTROLLER HUNG BUSY.**

**LTest, CHcc Fcode FUNCTION TIMEOUT.**

**LTest, CHcc Fcode REJ**

**Pdriver,Cconvert,Eequip.**

**LTest, CHcc TURNED OFF.**

Description: 580-20 line printer messages. Refer to EQest...

Issued by IIO.

User Action: Inform customer engineer.

**LTest, CHcc Eequip PFC ERROR.**

Description: 580-20 line printer message. Refer to EQest...

Issued by IIO.

User Action: Inform customer engineer.

**LTest, CHcc RESERVED.**

Description: The 580-20 line printer is reserved and cannot be connected to channel cc.

est EST ordinal of line printer  
cc Channel number

Issued by IIO.

User Action: Inform customer engineer.

**LT OPTION NOT SPECIFIED CORRECTLY.**

Description: The LT option is valid only with the RM directive; LT was specified in another directive to SSLABEL.

Issued by SSLABEL.

User Action: Correct directive and retry.

**MAG NOT ACTIVE.**

Description: Informative message for MOUNT or UNLOAD commands.

Issued by DSD.

User Action: None.

**MAGNET DROPPED DURING RECOVERY.**

Description: Informative message indicating the routine MAGNET was dropped while attempting clean-up or recovery of the magnetic tape subsystem.

Issued by MAGNET.

User Action: None.

**MAGNET TERMINATION/NO TAPE JOBS.**

Description: Informative message indicating the magnetic tape subsystem was dropped or aborted with no tapes assigned.

Issued by MAGNET.

User Action: None.

**MAINFRAME NOT SET.**

Description: An attempt to alter a mainframe descriptor was rejected by \*SFM\*.

Issued by LIDOU.

User Action: None.

**MAINLOG - message.**

Description: Refer to the explanation of AFD - message.

Issued by DAYFILE.

User Action: None.

**MAINLOG - \*BML\* FORMAT INCORRECT.**

Description: An incorrect recovery sector word was detected while processing the Binary Maintenance Log (BML).

Issued by DAYFILE.

User Action: Check format of BML file to determine what failed.

**MAINLOG - \*FR\* TIME VALUE INCORRECT.**

Description: The time specified via the FR option cannot be converted to a packed time for searching the Binary Maintenance Log.

Issued by DAYFILE.

User Action: Retry with a valid time specified.

**MAINLOG - INTERACTIVE BINARY OUT-FILE NOT ALLOWED.**

Description: The Binary Maintenance Log cannot be written to a terminal (TT) device type.

Issued by DAYFILE.

User Action: Specify a non-TT destination file.

### **MAINLOG - \*OP\* OPTION INCORRECT.**

Description: The specified option is not valid when dumping the Binary Maintenance Log.

Issued by DAYFILE.

User Action: Retry with a valid option.

### **MAINLOG UNRECOVERABLE**

Description: The binary maintenance log cannot be recovered.

Issued by REC.

User Action: Enter GO,SYS. at the system console: a new dayfile will be created.

### **MAINS POWER FAILURE.**

Description: Bit 36 of the status/control register (bit 0 of the interlock register) is set, indicating a main power failure. This message is preceded in the error log by the letters SR hh.mm.ss. (CYBER 170 machine) or IR hh.mm.ss. (CYBER 70 machine) where hh.mm.ss. is the time at which the condition was detected.

Issued by SCE.

User Action: Inform site analyst and customer engineer. (For further explanation and procedures, refer to S/C Register Error Detection Detection, appendix E.)

### **MAINTENANCE CHANNEL TIMEOUT DEADSTART ABORTED. INFORM CE**

Description: The maintenance channel did not respond during an attempt to function or transfer data to a mainframe element.

Issued by CTI.

User Action: Inform site analyst or customer engineer.

### **MAINTENANCE LOG PROCESSED.**

Description: The Binary Maintenance Log dump is complete.

Issued by DAYFILE.

User Action: None.

### **MAINTENANCE REGISTER ERROR.**

Description: A channel error is preventing access to the maintenance register on CYBER 180-class models.

Issued by STL.

User Action: Inform customer engineer.

### **MAINTENANCE REGISTER RECORD NOT FOUND.**

Description: Output file message indicting that a maintenance record was not found in the EDD file.

Issued by DSDI.

User Action: Ensure tha the dump file contains meaningful information.

### **MAJPTR FOUND BAD BLK ID.**

Description: NIP encountered a bad block in garbage collection processing. NIP aborts if debug is on.

Issued by NIP.

User Action: Reinitialize NAM. Run collector job. Save COLLECT tape and contact CYBER Software Support.

### **MANUFACTURING DATA INVALID**

Description: Dayfile message indicating that one of the factory-recorded sectors, containing either manufacturing or flaw data, is either unreadable or not present.

Issued by FORMAT.

User Action: Refer to the output listing for a detailed status report indicating the actual problem. If the factory-recorded data cannot be read, the pack cannot be processed using this utility. Customer engineering must be contacted to add this format information off-line.

### **MASS STORAGE ERROR.**

Description: An error was encountered in reading a portion of the permanent file catalog or permit information (error log and dayfile message). This indicates a hardware problem with a disk pack or disk drive.

Issued by PFM.

User Action: Inform site analyst. If many of these errors occur, the site analyst should perform a full PFDUMP, total INITIALIZE, and full PFLOAD on the device.

### **MASS STORAGE ERROR DURING DUMP.**

Description: The file data may not be intact, since a mass storage error was encountered when the file was dumped. The file is skipped, unless error processing is selected.

Issued by QLOAD.

User Action: None.

### **MASS STORAGE LIMIT.**

Description: You have exceeded your mass storage validation limits.

Issued by RECLAIM.

User Action: Return all unneeded files and try again. If the message occurs again, your validation limit is too low to allow the operation you are attempting.

### **MASS STORAGE TABLE OVERFLOW.**

Description: Operator message indicating that the computed address of a mass storage table (MST) is not less than 100000B.

Issued by SET.

User Action: Contact CYBER Software Support.

### **MASTER FILE NOT PRESENT.**

Description: The specified master file (MFN/UN) was not found.

Issued by NAMI.

User Action: A different MFN/UN pair should be specified.

### **MASTER USER NAME REQUIRED.**

Description: Dayfile message indicating that the job did not enter a user name (via USER command). This is needed for a master user list run and for a master user inquire run.

Issued by PROFILE.

User Action: Rerun job with USER command.

### **MAX FL REACHED.**

Description: NIP has reached the maximum field length allowed by the installation.

Issued by NIP.

User Action: Increase maximum field length using K display command.

### **\*MAXDEV\* TOO SMALL.**

Description: Number of devices exceeds maximum allowed by SSMOVE.

Issued by SSMOVE.

User Action: Increase MAXDEV.

### **MAXIMUM NUMBER MIDS ACTIVE.**

Description: The table in extended memory resident which contains machine ids of the mainframes which have been active is full. Recovery is impossible.

Issued by CPUMTR.

User Action: Redeadstart with the correct machine id.

### **MAXIMUM NUMBER OF ARGUMENTS.**

Description: Dayfile message indicating that only the first 30 bit numbers were accepted on a SET or a CLEAR command.

Issued by SCRSIM.

User Action: Correct and reenter.

### **MAXIMUM TERMINALS EXCEEDED.**

Description: More than IPTST transaction terminals have been defined in the Network Files.

Issued by TAFREC.

User Action: Reduce the number of terminal definition statements or increase IPTST and reassemble TAFREC.

### **MAXIMUM TOTAL FEET OF TAPE = NNNN.**

Description: Files qualifying for final selection would occupy NNNN feet of tape at the specified or default density if they all survived the final selection.

Issued by GENPFD.

User Action: None.

### **MCS DISABLED BY NETWORK.**

Description: MCS cannot NETON to NAM.

Issued by MCS.

User Action: Enter the LOP command to enable MCS in the network.

### **MCS IDLE DOWN STARTED.**

Description: Informative message indicating that the CFO.IDLE command is being processed.

Issued by MCS.

User Action: None.

### **MCS INITIATED INCORRECTLY - TRY N.MCS.**

Description: n.MCS was entered instead of MCS.

Issued by MCS.

User Action: Enter MCS.

### **MCS NETON COMPLETE.**

Description: Informative message.

Issued by MCS.

User Action: None.

### **MCS REPRIEVE.**

Description: A fatal error was encountered by MCS.

Issued by MCS.

User Action: Contact MCS administrator.

**MCS SHUTDOWN COMPLETE.**

Description: Informative message.

Issued by MCS.

User Action: None.

**MDD - ALREADY ACTIVE.**

Description: MDD is already operating. Only one copy can be present at a time.

Issued by MDD.

User Action: None.

**MDD - BYE COMMAND EXECUTED.**

Description: The MDD operator has entered the BYE command and directed the PP to drop.

Issued by MDD.

User Action: None.

**MDD - CONSOLE MUST BE UNLOCKED.**

Description: An attempt was made to bring MDD up when your console was in a locked state. MDD will drop.

Issued by MDD.

User Action: Unlock the console.

**MDD - IMPROPER ACCESS ATTEMPT.**

Description: MDD was not initiated with the proper validation. MDD will drop.

Issued by MDD.

User Action: None.

**MDD - MR ERROR.**

Description: A maintenance register error was detected at initialization time. MDD will drop.

Issued by MDD.

User Action: If no PPs are hung, try to bring the MDD up again.

**MDD - MUST BE INITIATED FROM NOS/VE.**

Description: An attempt to initiate MDD from the NOS side of a dual state system was made.

Issued by MDD.

User Action: MDD must be initiated from NOS/VE to operate.

**MDD - NOT ALLOWED ON THIS MAINFRAME.**

Description: MDD can be run only on CYBER 180-class mainframes. An attempt was made to bring up MDD on a mainframe other than CYBER 180-class mainframe. MDD will drop.

Issued by MDD.

User Action: None.

**MDD - SCI NOT FOUND IN CIP DIRECTORY.**

Description: MDD has searched the central memory CIP directory and did not find the resident version of SCI. MDD will drop.

Issued by MDD.

User Action: Use correct level of CIP and NOS.

### **MDD - VALIDATED.**

Description: MDD has successfully validated itself and begun operation.

Issued by MDD.

User Action: None.

### **MDI ERROR STATUS RECEIVED.**

**Status word 0**

**Status word 1**

**Status word 2**

**Status word 3**

**Status word 4**

**Status word 5**

**Status word 6**

Description: Informative message indicating that PIP has detected an error condition in the MCI board of an MDI. This dayfile message is followed by a seven-word hexadecimal dump of detailed information from the MCI board about the error condition.

Status word 0:

Bits	Description
59-52	Host node number of MDI.
51-44	Terminal node number of MDI.
43-36	Connection number; zero if detailed status is not related to a data message.
35-28	PIP error code; always 19.
27-20	PIP reason code; always 02.
19-12	PIP work list operation code; always 05.
11-0	Always 000.

Status word 1:

Bits	Description
59-52	Reserved.
51-44	MCI board slot number
43-28	MCI software version number.
27-0	Upper 28 bits of system identification.

Status word 2:

Bits	Description
59-40	Lower 20 bits of system identification.

- 39-32 Last I/O operation.
- 0 Unknown
  - 1 Read
  - 2 Write
- 31-24 Last transparent function.
- 1 Detailed status
  - 2 Shutdown
  - 3 Read error
  - 4 Interface reset
  - 5 Start regulation
  - 6 Stop regulation
  - 7 Request diagnostics
- 23-8 Last function.
- 100 Master clear
  - 108 Send status
  - 110 Write data
  - 118 Read data
  - 120 Set packing mode
  - 140 Unknown
- 7-0 Upper 8 bits of next-to-last function.

Status word 3:

- | Bits  | Description                            |
|-------|--|
| 59-52 | Lower 8 bits of next-to-last function. |
| 51-36 | Error word 1; reserved.                |
| 35-28 | ICB status register 1.                 |
| Bit 7 | ITB error                              |
| Bit 6 | ITB parity error                       |
| Bit 5 | Channel timeout                        |
| Bit 4 | Input data truncated                   |
| Bit 3 | PP overrun                             |
| Bit 2 | Channel parity error                   |
| Bit 1 | Not used; always 0                     |
| Bit 0 | PP master clear                        |

---

*(Continued on next page)*



*(Continued from previous page)*

27-20 ICB status register 3.

Bit 7	Channel active
Bit 6	Packing code: 0=Bit packing code; 1=Byte packing code
Bit 5	BU full
Bit 4	BL full
Bit 3	Odd/Even
Bit 2	Chaining
Bit 1	Write
Bit 0	Read

19-4 Error word 2. Bits 19-5 are reserved. Bit 4 indicates a write-length error was detected.

3-0 Upper 4 bits of error word 3; reserved.

Status word 4:

Bits	Description
------	-------------

59-48	Lower 12 bits of error word 3; reserved.
-------	--

47-32	Error word 4; reserved.
-------	-------------------------

31-0	Unused.
------	---------

Status words 5 and 6 are unused.

Issued by NIP.

User Action: Inform site analyst.

### **MEMORY FILE REPLACED**

Description: After the message VERSION MISMATCH ON MEMORY FILE is displayed, the memory file is updated and replaced, and then this message is displayed.

Issued by NAMI.

User Action: None.

### **MEMORY MARGINS SELECTED (CR) TO CONTINUE**

Description: A deadstart was performed with the central memory margin switch not in the neutral position.

Issued by CTI.

User Action: Enter carriage return to proceed, or return the central memory margin switch to the neutral position and deadstart again.

### **MEMORY MARGINS SELECTED DEADSTART ABORTED.**

Description: Central memory margin status selected the maintenance registers.

Issued by CTI.

User Action: Inform site analyst or customer engineer.

### **MEMORY OVERFLOW.**

Description: There is no more space left in memory for SYSEEDIT internal tables.

Issued by SYSEEDIT.

User Action: Reduce the number of programs to SYSEEDIT and retry.

### **MEMORY OVERFLOW DURING INITIALIZATION.**

Description: TAF aborted because its field length for initialization was insufficient.

Issued by TAF.

User Action: Inform site analyst. IFL= in deck TAF should be increased. Increasing the central memory field length parameter on the RFL command in the TAF initialization procedure file (ffff) does not correct this problem.

### **MEMORY REQUEST ERROR.**

Description: Fatal dayfile message indicating that STIMULATOR and 1TS disagree on the correct field length.

Issued by 1TS.

User Action: Rerun job; this could be caused by a system failure.

### **MERGING STIMOUT DATA.**

Description: STIMULA is copying the task data to the STIMOUT file.

Issued by STIMULA.

User Action: None.

### **MESSAGE NOT ALLOWED FOR THIS APPLICATION.**

Description: A HOP/DU, LE, RS, LB, or LR is not allowed for non-supervisory applications.

Issued by NIP.

User Action: Self-explanatory.

### **npuname MESSAGE SENT.**

Description: Indicates that a host broadcast to NPU npuname has completed.

Issued by CS.

User Action: None.

### **MESSAGE STATUS TABLE OVERFLOW.**

Description: Space sufficient to allocate the required table during IAF initialization was not available. An internal change to IAF is necessary.

Issued by IAFEX.

User Action: Contact CYBER Software Support.

### **MFL TOO LARGE - nnnnnnB, taskname, tasklibrary.**

Description: The MFL (initial field length plus expandable field length) of the non-CM resident task (taskname) on task library (tasklibrary) exceeds the minimum size of the transient task area (potential space available to contain transient tasks). Thus a situation could arise making it impossible to finish processing this task.

Issued by TAF.

User Action: Reduce the task FL or EF or increase the TAF FL.

### **MFLINK - APPLICATION CONNECTION BROKEN.**

Description: The connection with the remote host was broken by the network or remote host.

Issued by MFLINK.

User Action: Inform site analyst. MFLINK retries unless unless EP specified.

### **MFLINK - APPLICATION CONNECTION TIMEOUT.**

Description: The remote host did not respond in the allotted time.

Issued by MFLINK.

User Action: Inform site analyst. MFLINK retries unless EP specified.

### **MFLINK - APPLICATION DISABLED.**

Description: The operator has disabled PTF for the network subsystem (RHF or NAM).

Issued by MFLINK.

User Action: Contact site operator. MFLINK retries unless RT specified.

### **MFLINK - BLOCK TOO LARGE.**

Description: The remote host or the network sent a block or message that was too large.

Issued by MFLINK.

User Action: Inform site analyst.

### **MFLINK - CANNOT READ FROM filename.**

Description: The file filename does not have read permission. The file type is not supported by MFLINK or the file does not exist.

Issued by MFLINK.

User Action: Correct and resubmit.

### **MFLINK - CANNOT WRITE ON filename.**

Description: The file filename does not have write permission or the file type is not supported by MFLINK.

Issued by MFLINK.

User Action: Correct and resubmit.

### **MFLINK - CONNECT REJECT = nn.**

Description: The network subsystem (RHF or NAM) rejected the connection with unexpected reject code.

Issued by MFLINK.

User Action: Inform site analyst.

### **MFLINK - CONNECTING TO lid.**

Description: Informative message. You are being connected to the remote host you specified.

Issued by MFLINK.

User Action: None.

### **MFLINK - CONNECTION REJECTED BY xxx. REASON CODE = nnn -**

Description: Subsystem xxx (RHF or NAM) has rejected the remote connection for the reason indicated by nnn and further explained by a second dayfile message which is one of the following: nnn Second Message

- 1 MFLINK - LID UNKNOWN TO SUBSYSTEM
- 2 MFLINK - CONNECTION REJECTED BY REMOTE HOST
- 3 MFLINK - LOCAL NETWORK RESOURCE LIMIT
- 4 MFLINK - REMOTE SUBSYSTEM RESOURCE LIMIT
- 5 MFLINK - LID CURRENTLY UNAVAILABLE
- 6 MFLINK - REMOTE SUBSYSTEM NOT RESPONDING
- n MFLINK - CONNECT REJECT = nnn.

Issued by MFLINK.

User Action: Refer to the description of the second dayfile message. If nnn is greater than 6, refer to the Network Access Method Host Application Programming Reference Manual for more detailed information.

**MFLINK - CONNECTION REJECTED BY REMOTE HOST.**

Description: The remote host you specified has rejected the connection.

Issued by MFLINK.

User Action: Inform remote analyst.

**MFLINK - CONTINUATION BLOCK DID NOT FOLLOW.**

Description: The continuation block did not follow.

Issued by MFLINK.

User Action: Inform site analyst.

**MFLINK - ERR/LGL RECEIVED FROM SUBSYSTEM.**

Description: The network subsystem (RHF or NAM) detected a logic error in communication.

Issued by MFLINK.

User Action: Inform site analyst.

**MFLINK - FC/BRK RECEIVED RC=rc.**

Description: The remote host has sent a break with reason code rc.

Issued by MFLINK.

User Action: Inform site analyst.

**MFLINK - FC/NAK RETRY LIMIT.**

Description: MFLINK was unable to transmit a block after a system-defined number of attempts. Each attempt was rejected by the network subsystem (RHF or NAM).

Issued by MFLINK.

User Action: Inform site analyst.

**MFLINK - FILE RETRANSMIT REQUESTED.**

Description: The remote host has requested that the host retransmit the file.

Issued by MFLINK.

User Action: None.

**MFLINK - FILE TRANSFER IN PROGRESS.**

Description: The file requested to be transferred is in progress.

Issued by MFLINK.

User Action: None.

**MFLINK - INCORRECT LID.**

Description: No mainframe in the network has the specified logical identifier (LID), or the LID specified contains an illegal character or is not three characters long.

Issued by MFLINK.

User Action: Use the LISTLID command to select the proper LID.

**MFLINK - INVALID ACCESS VALIDATION.**

Description: Your user name does not have the required validation to access the remote mainframe.

Issued by MFLINK.

User Action: Contact your site administrator to get the authorization.

### **MFLINK - INVALID COMMAND cmd.**

Description: The system received an invalid command (cmd) from the remote host or received a command out of sequence.

Issued by MFLINK.

User Action: Inform site analyst.

### **MFLINK - INVALID CONTROL STATEMENT.**

Description: You specified an incorrect parameter or value on the MFLINK command.

Issued by MFLINK.

User Action: Correct the MFLINK command and retry.

### **MFLINK - INVALID DATA DECLARATION.**

Description: You specified an incorrect DD=dd parameter on the MFLINK command.

Issued by MFLINK.

User Action: Correct the MFLINK command and retry.

### **MFLINK - INVALID FILE NAME.**

Description: The file name you specified on the MFLINK command is incorrect.

Issued by MFLINK.

User Action: Correct the MFLINK command and retry.

### **MFLINK - INVALID FILE TYPE.**

Description: The file you attempted to transfer to a remote host does not have a local file type.

Issued by MFLINK.

User Action: Ensure that the file has the correct type and retry.

### **MFLINK - INVALID SUPERVISORY MESSAGE.**

Description: The remote host or the network sent an incorrect or unsupported supervisory message.

Issued by MFLINK.

User Action: Inform site analyst.

### **MFLINK - LID CURRENTLY UNAVAILABLE.**

Description: The network subsystem (RHF or NAM) is unable to complete the connection to the remote host.

Issued by MFLINK.

User Action: Contact site operator. MFLINK retries unless RT specified.

### **MFLINK - LID DISABLED.**

Description: The mainframe with the specified logical identifier (LID) has been disabled by the system.

Issued by MFLINK.

User Action: Contact site operator. MFLINK retries unless RT specified.

### **MFLINK - LID UNKNOWN TO SUBSYSTEM.**

Description: The network subsystem (RHF or NAM) has rejected a connection request to the specified LID even though the system LID table indicates a network path is available.

Issued by MFLINK.

User Action: If the problem persists, inform site analyst.

**MFLINK - LOCAL NETWORK RESOURCE LIMIT.**

Description: The network subsystem (RHF or NAM) is temporarily unable to complete the connection to the requested remote host.

Issued by MFLINK.

User Action: If the problem persists, inform site analyst. MFLINK retries unless RT specified.

**MFLINK - NETWORK SEQUENCE ERROR.**

Description: A network message block was found for the connection before the connection was completed.

Issued by MFLINK.

User Action: Inform site analyst.

**MFLINK - NETWORK SHUTDOWN.**

Description: The operator has disabled the PTF application in the network subsystem (RHF or NAM). MFLINK terminates the network connection.

Issued by MFLINK.

User Action: Contact site operator.

**MFLINK - NETXFR STATUS = 0.**

Description: A system or network error occurred.

Issued by MFLINK.

User Action: Inform site analyst.

**MFLINK - NO LID SPECIFIED.**

Description: You failed to specify the ST=lid parameter on the first MFLINK command of the MFLINK session.

Issued by MFLINK.

User Action: Correct the MFLINK command and retry.

**MFLINK - RECOVERING ST lid.**

Description: An informative message. The system is recovering the files for the mainframe specified by lid.

Issued by MFLINK.

User Action: None.

**MFLINK - REMOTE SUBSYSTEM NOT RESPONDING.**

Description: The network subsystem (RHF or NAM) cannot establish communication with the remote host.

Issued by MFLINK.

User Action: Contact site operator. MFLINK retries unless RT is specified.

**MFLINK - REMOTE SUBSYSTEM RESOURCE LIMIT.**

Description: The network subsystem (RHF or NAM) on the remote host is temporarily unable to complete the connection.

Issued by MFLINK.

User Action: Retry. If message persists, contact site operator.

**MFLINK - SUBSYSTEM FULL.**

Description: The network subsystem (RHF or NAM) is temporarily too busy to process your request.

Issued by MFLINK.

User Action: Contact site operator. MFLINK retries unless RT is specified.

### **MFLINK - SUBSYSTEM UNAVAILABLE.**

Description: The network subsystem is temporarily too busy to process your request.

Issued by MFLINK.

User Action: Contact site operator. MFLINK retries unless RT is specified.

### **MFLINK - TERMINATING CONNECTION.**

Description: The application is terminating its connection to the network.

Issued by MFLINK.

User Action: None.

### **MFLINK - UNKNOWN NETWORK INTERFACE TYPE.**

Description: An internal error was detected by MFLINK.

Issued by MFLINK.

User Action: Inform site analyst.

### **MFLINK - USER REQUEST SENT.**

Description: The user request for file transfer has been sent to the network.

Issued by MFLINK.

User Action: None.

### **MFLINK - WRONG APPLICATION LEVEL.**

### **MFLINK - TRANSFER IMPOSSIBLE TO ST lid.**

Description: Files cannot be transferred because MFLINK's protocol version or level is incompatible with the remote server's protocol version or level on ST lid.

Issued by MFLINK.

User Action: Inform site analyst.

### **MFQUEUE - COMPLETE.**

### **jsn = ROUTED FILE NAME.**

Description: Job jsn was successfully routed.

Issued by MFQUEUE.

User Action: None.

### **MFQUEUE - CONTROL STATEMENT ERROR.**

Description: MFQUEUE was unable to process the command. Usually an invalid character or successive separators is the cause of this problem.

Issued by MFQUEUE.

User Action: Correct the command.

### **MFQUEUE - DUPLICATE PARAMETER.**

Description: Multiple occurrences are not allowed for any of the MFQUEUE parameters.

Issued by MFQUEUE.

User Action: Correct the command.

### **MFQUEUE - FIRST PARAMETER NOT VALID LFN.**

Description: The first parameter must be a valid file name.

Issued by MFQUEUE.

User Action: Correct the command.

**MFQUEUE - ILLEGAL DD VALUE SPECIFIED.**

Description: Your DD=dd specification is not supported.

Issued by MFQUEUE.

User Action: Correct the command.

**MFQUEUE - ILLEGAL ST VALUE SPECIFIED.**

Description: The logical identifier (LID) you specified in the ST=lid parameter is not three alphanumeric characters.

Issued by MFQUEUE.

User Action: Correct the command.

**MFQUEUE - INVALID DIRECTIVE NAME.**

Description: The directive file name must be a valid file name.

Issued by MFQUEUE.

User Action: Correct the command.

**MFQUEUE - INVALID PARAMETER.**

Description: You specified a parameter that is not allowed on the MFQUEUE command.

Issued by MFQUEUE.

User Action: Correct the command.

**MFQUEUE - NO REMOTE DIRECTIVES FOUND.**

Description: The directive file was empty or you did not supply remote directives via the PC parameter.

Issued by MFQUEUE.

User Action: Fix the job so that the directive file is not empty.

**MFQUEUE - ST PARAMETER MUST BE SPECIFIED.**

Description: The ST parameter is not optional. It must appear on each MFQUEUE command.

Issued by MFQUEUE.

User Action: Correct the command.

**MGETC/MAXFL REACHED.**

Description: NIP internal error in buffer management.

Issued by NIP.

User Action: Reinitialize NAM. Run collector job. Save COLLECT tape and contact CYBER Software Support.

**MHF, ABORTED**

Description: Fatal Error. Consult the MHF job dayfile to determine the error.

Issued by MHF.

User Action: Correct the problem and enable MHF in the RHF application display.

**MHF, BUFFER FOR NLD TOO SMALL, LOCAL NAD CH=xx**

Description: A fault in MHF prevents automatic loading or dumping of the local NAD on channel xx.

Issued by MHF.

User Action: Correct MHF and restart RHF.



**MHF, CONNECT BROKEN, RNAD yy, LOCAL NAD CH=xx**

Description: The connection between the local NAD on channel xx and remote NAD yy (hexadecimal) was broken because of a configuration error.

Issued by MHF.

User Action: Correct RHF network configuration and/or NAD hardware switches.

**MHF, CONNECT REJECT, RNAD yy, LOCAL NAD CH=xx**

Description: The connection between the local NAD on channel xx and remote NAD yy (hexadecimal) was rejected because of a network or remote NAD failure.

Issued by MHF.

User Action: None.

**MHF, DEVICE ENABLE SWITCH OFF, LOCAL NAD CH=xx**

Description: The device enable switch of the local NAD on channel xx is turned off, disabling the NAD.

Issued by MHF.

User Action: Turn on device enable switch.

**MHF, ERROR IN ROUTINE xxxxxxxx**

Description: Fatal error. Fault in MHF routine xxxxxxxx.

Issued by MHF.

User Action: Correct MHF and restart RHF.

**MHF, EST/CHANNEL UNAVAILABLE, LOCAL NAD CH=xx.**

Description: The error response from NLD indicates that the local NAD's EST entry or channel xx is in an improper state for NAD memory dumping or microcode loading, or has been in use too long by another job.

Issued by MHF.

User Action: Inform site analyst if error persists.

**MHF, EST ENTRY UP OR NOT RESERVED, NAD CH=xx**

Description: A CVL error response indicates that the EST entry of the local NAD on channel xx is not in the proper state for NAD memory dumping or controlware loading.

Issued by MHF.

User Action: Inform site analyst.

**MHF, FILE = NDFMxx DATE = yy/mm/dd**

Description: This message follows "MHF, NAD ON CHANNEL xx DUMPED" to indicate the name of the NAD dump permanent file and the date the dump record was added. xx is the host mainframe identifier.

Issued by MHF.

User Action: None.

**MHF, INIT PARAMETER BAD IN RECORD xxxxxxxx.**

Description: MHF found a faulty memory-size or system- buffer-count value in the controlware initialization parameter record xxxxxxxx on the RHF configuration file. The NAD is not loaded.

Issued by MHF.

User Action: Correct the faulty initialization parameter record on the RHF configuration file.

**MHF, INIT PARAMETER RECORD MISSING xxxxxxxx**

Description: MHF did not find record xxxxxxxx on the RHF configuration file. A subsequent message will indicate that the load succeeded with default parameters.

Issued by MHF.

User Action: Correct RHF configuration file.

**MHF, INVALID NLD RESPONSE yyB, LOCAL NAD CH=xx**

Description: MHF received an unexpected response code (yy) when trying to communicate with the local NAD on channel xx.

Issued by MHF.

User Action: Inform site analyst.

**MHF, INVALID STATUS IN EST ENTRY, NAD CH=xx**

Description: An error response from NLD indicates that the EST entry of the local NAD on channel xx is not in the proper state for NAD memory dumping or controlware loading.

Issued by MHF.

User Action: Inform site analyst.

**MHF, LOCAL NAD FAULT, LOCAL NAD CH=xx.**

Description: The error response from NLD indicates a NAD microcode status error in the local NAD on channel xx, preventing access to a remote NAD.

Issued by MHF.

User Action: Inform site analyst if error persists.

**MHF, LOGGING LOCAL NAD (LOCAL CH=xx).**

Description: Informative message. MHF is transmitting error log entries from the local NAD on channel xx to the Binary Maintenance Log (BML).

Issued by MHF.

User Action: None.

**MHF, LOGGING ND=yy NAD (LOCAL CH=xx).**

Description: Informative message. MHF is transmitting error log entries from remote NAD yy (via the local NAD on channel xx) to the Binary Maintenance Log (BML).

Issued by MHF.

User Action: None.

**MHF, NAD ACCESS ERROR (NLD ERROR 4) NAD CH=xx**

Description: MHF could not dump or load the local NAD on channel xx because of a fault detected by NLD. MHF will retry the dump or load.

Issued by MHF.

User Action: Inform site analyst if message persists.

**MHF, NAD C/W FAULTY - xxxxxxxx.**

Description: MHF found a fault in controlware record xxxxxxxx on the system: no 77-table, 52-table, or incorrect length. The NAD is not loaded.

Issued by MHF.

User Action: Correct the controlware record and restart RHF.

**MHF, NAD C/W MISSING - xxxxxxxx.**

Description: MHF did not find controlware record xxxxxxxx on the system when attempting to load a NAD.

Issued by MHF.

User Action: Add controlware record to system and restart RHF.

**MHF, NAD DUMP FILE BAD - xxxxxxxx**

Description: MHF could not automatically dump NAD memory because permanent file xxxxxxxx was faulty.

Issued by MHF.

User Action: Rename or purge the permanent file and turn on NAD in EST.

**MHF, NAD DUMP FILE IN USE, NDFxxxx.**

Description: MHF is waiting for exclusive access to the NAD dump permanent file, NDFxxxx. After three attempts fail, MHF stops trying to dump the NAD and proceeds with microcode reloading.

Issued by MHF.

User Action: Inform site analyst if no other job is using the permanent file.

**MHF, NAD DUMP RECORD NAME = NDMPLch**

Description: This message follows "MHF, NAD ON CHANNEL xx DUMPED" to indicate the name of the NAD binary dump record written to the NAD dump permanent file. ch is the channel number of the local NAD.

Issued by MHF.

User Action: None.

**MHF, NAD MAINTENANCE ACCESS DENIED, CH=xx**

Description: MHF was unexpectedly denied maintenance access to the local NAD on channel xx.

Issued by MHF.

User Action: Inform site analyst.

**MHF, NAD ON CHANNEL xx DISABLED**

Description: MHF has abandoned further attempts to dump or load the local NAD on channel xx. Consult the preceding dayfile messages to determine the error.

Issued by MHF.

User Action: Correct the problem and restart RHF.

**MHF, NAD ON CHANNEL xx DUMPED**

Description: The memory of the local NAD on channel xx has been copied to a permanent file. Subsequent dayfile messages indicate the permanent file name, dump record name and number, time, and date:

MHF, NAD DUMP RECORD NAME = NDMPLch

MHF, RECORD            TIME = hh.mm.ss  
NO.0000

MHF, FILE = NDFMxx    DATE = yy/mm/dd

Issued by MHF.

User Action: Use DMPNAD to print the NAD dump record.

**MHF, NAD ON CHANNEL xx LOADED**

Description: MHF has loaded controlware into the local NAD on channel xx.

Issued by MHF.

User Action: None.

**MHF, NAD PROCESSOR STOPPED (DC=yyyy), NAD CH=xx**

Description: The local NAD on channel xx stopped unexpectedly, with dead code yyyy (hexadecimal).

Issued by MHF.

User Action: None.

### **MHF, NDT LENGTH CHANGED.**

Description: Fatal error. MHF received a copy of the network description table from RHF, but found the length different from the previous copy.

Issued by MHF.

User Action: Restart MHF and inform site analyst.

### **MHF, NDT NOT AVAILABLE FROM RHF.**

Description: Fatal error. MHF could not obtain the Network Description Table from RHF.

Issued by MHF.

User Action: Correct MHF or RHF and restart RHF.

### **MHF, NETON REJECT - reason**

Description: Fatal error. MHF failed to connect (NETON) with RHF for one of the following reasons:

1. RHF UNAVAILABLE
2. MHF ALREADY ACTIVE
3. MHF DISABLED
4. MHF UNKNOWN TO RHF
5. MHF UNAUTHORIZED
6. INVALID VALUE FOR ACN
7. MHF NETTED ON ALREADY
8. UNRECOGNIZED ERROR

Issued by MHF.

User Action:

1. Start RHF. Inform site analyst if message persists.
2. Inform site analyst if no other copy of MHF is active.
3. Enable MHF in RHF's tables.
4. Add MHF to the RHF configuration file and restart RHF.
5. Inform site analyst if no other copy of MHF is active.
6. Correct MHF.
7. Correct MHF.
8. Correct MHF or RHF.

### **MHF, NO ERROR LOG, LOCAL NAD CH=xx**

Description: The error log of the local NAD on channel xx was unavailable.

Issued by MHF.

User Action: None.

### **MHF, NO ERROR LOG, RNAD yy, LOCAL NAD CH= xx**

Description: The error log of remote NAD yy (hexadecimal) was unavailable when MHF tried to obtain it by way of the local NAD on channel xx.

Issued by MHF.

User Action: None.

**MHF, NO EST ENTRY DEFINED, LOCAL NAD  
CH=xx**

Description: MHF found no EST entry for a local NAD on channel xx.

Issued by MHF.

User Action: Correct RHF configuration file or EST.

**MHF, RECORD NO.xxxx TIME = hh.mm.ss**

Description: This message follows "MHF, NAD ON CHANNEL xx DUMPED" to indicate the position xxxx (decimal) of the dump record on the NAD dump permanent file, and the time of dump.

Issued by MHF.

User Action: None.

**MHF, STARTED**

Description: Informative message.

Issued by MHF.

User Action: None.

**MHF, STOPPED**

Description: Informative message.

Issued by MHF.

User Action: None.

**MHF, WAIT FOR NAD DUMP FILE - xxxxxxxx**

Description: MHF is waiting for exclusive access to file xxxxxxxx in order to dump NAD memory.

Issued by MHF.

User Action: Inform site analyst if the message persists.

**MHF, WAITING FOR ACCESS TO LOCAL NAD,  
Ch=xx**

Description: MHF is waiting for maintenance access to the local NAD on channel xx.

Issued by MHF.

User Action: Inform site analyst if the message persists.

**MICROCODE/EI MISMATCH - MAY CAUSE SYSTEM HANG.**

Description: The microcode or EI (environment interface) entries specified on the IPRDECK entries do not match those that were loaded. This can cause a system hang.

Issued by SET.

User Action: Load the correct microcode or EI.

**MICROCODE INITIALIZATION ERROR DEADSTART  
ABORTED. INFORM CE**

Description: Processor microcode failed to complete its initialization in the prescribed time limit.

Issued by CTI.

User Action: Inform site analyst or customer engineer.

**MICROCODE MISMATCH microname.**

Description: Microcode that was loaded on a level 1, 2, or 3 deadstart does not compare with that loaded on the level 0 deadstart.

microname        The 6-character microcode name

Issued by REC.

User Action: Deadstart using microcode microname.

**MICROCODE, microname, yymmdd NL.**

Description: Microcode microname was loaded in a lower 800 series mainframe. yymmdd is the year-month-day that the microcode/EI was generated.

Issued by REC.

User Action: None.

**MID CURRENTLY ACTIVE.**

Description: Extended memory resident indicates that the machine id specified in the CMRDECK is in use by another mainframe. Recovery is impossible.

Issued by CPUMTR.

User Action: Change machine id.

**MID NOT SPECIFIED.**

Description: K display message indicating that the machine ID of the machine on which to perform recovery processing was not entered.

Issued by MREC.

User Action: Enter machine ID and type K.GO.

**MID SPECIFIED NOT DOWN.**

Description: K display message indicating that the machine with the specified machine ID was determined to be not down.

Issued by MREC.

User Action: Correct machine ID and reenter or type K.STOP.

**MID SPECIFIED NOT FOUND.**

Description: K display message indicating that the machine with the specified machine ID was not found in the multimainframe complex.

Issued by MREC.

User Action: Correct machine ID and reenter.

**MID UNDEFINED IN EXTENDED MEMORY.**

Description: CPUMTR preset routine failed to find a copy of low core MMFL word in extended memory resident. This message implies that machine id has changed and/or MMFL link tables have been destroyed. Recovery is impossible.

Issued by CPUMTR.

User Action: Change machine id or perform a level 0 deadstart.

**MIN CONFIGURATION NOT AVAILABLE**

Description: The operator attempted to load microcode, EI, or both without the required minimum system elements. CTI also displays the count of each system element.

Issued by CTI.

User Action: Reconfigure hardware to at least the minimum configuration.

**MINIMUM TAF MFL NEEDED = nnnnnnB.**

Description: Potentially blocked tasks were detected at one of the following times:

- TAF initialization
- Attempted task library update
- Attempt to change TAF maximum FL via K.MAXFL command

The above operation did not complete normally. The maximum FL of TAF must be at least nnnnnnB. If nnnnnnB exceeds the largest field length possible for TAF (377700B), then other corrective action is needed.

Issued by TAF.

User Action: Correct error.

### **MISSING AIP ENTRY POINT.**

Description: No entry point for a required AIP subroutine was returned by the loader.

Issued by IAFEX.

User Action: Contact CYBER Software Support.

### **MISSING HEADER WORD ON xxJ FILE.**

Description: The first statement on the xxJ file is in error, causing the transaction subsystem to abort.

Issued by TAF.

User Action: Examine xxJ files for header xxJ. Inform the TAF database administrator.

### **MISSING HEADER WORD ON xxJ FILE.**

Description: No header word on xxJ was found.

Issued by DMREC.

User Action: Correct xxJ file and rerun.

### **MISSING NCF RECORD.**

Description: A required record in the NCF is missing.

Issued by CS.

User Action: Correct NCF and restart network.

### **\*\*\*\* MISSING VALUE.**

Description: Output file message indicating that the user has specified a directive identifier without a value.

Issued by PROFILE.

User Action: Correct and rerun.

### **MMF DEVICE ACCESS ERROR.**

Description: Verification of this machine's access to a given mass storage device failed during a level 3 recovery. Possible causes are the following:

- The CMR copy of the MST has been destroyed (specifically, the DAT index in MDGL).
- MREC was inadvertently run on another mainframe.

Recovery is impossible. This message is preceded by the message RECOVERY, EQest.

which indicates the equipment that is in error.

Issued by MSM.

User Action: Perform a level 0 deadstart.

**MMFLINK DEVICE ERROR.**

Description: A hardware error has occurred.

Issued by MTE.

User Action: Inform customer engineer.

**MODIFICATION DIRECTIVE EXPECTED**

Description: BINEDIT encountered a different directive when it expected a modification directive.

Issued by BINEDIT.

User Action: Correct input file and retry.

**MODULE NOT ON LIBRARY DEADSTART ABORTED**

Description: An attempt to find a module on the Maintenance Software Library failed.

Issued by CTI.

User Action: Inform site analyst or customer engineer.

**MODVAL ABORTED.**

Description: Dayfile message indicating that a control point error flag has been set.

Issued by MODVAL.

User Action: Consult the dayfile listing for reason.

**MONITOR CONDITION REGISTER =xxxx**

Description: During central memory initialization, a nonzero monitor condition register appeared in the job exchange package after reverting to monitor mode.

Issued by CTI.

User Action: Inform site analyst or customer engineer.

**MORE CHANNELS THAN MSG FETS.**

Description: Informative message indicating that not enough message FETS have been created in the SSEXEC.

Issued by SSEXEC.

User Action: Create sufficient number of message FETS, or check EST/BUDT entries.

**MORE THAN ONE ARF SPECIFIED.**

Description: More than one ARF was specified on the DUMP directive.

Issued by DMREC.

User Action: Correct the directive and rerun.

**MORE THAN 4 TAPE CHANNELS.**

Description: More than four channels are currently defined in the system for magnetic tape equipment.

Issued by 1MT.

User Action: Inform site analyst.

**MOVE PACK FROM UNIT xx TO UNIT yy AND SPIN UP.**

Description: Operator message indicating the that pack can be moved.

Issued by 1RM.

User Action: Move physical pack and activate unit xx.



### **MPF - ADDRESS OUT OF RANGE.**

Description: PACKER internal error. The specified address was not within PACKER's field length.

Issued by MPF.

User Action: Write a PSR.

### **MPF - BUFFER ARGUMENT ERROR.**

Description: PACKER internal error. Buffer arguments (FIRST/IN/OUT/LIMIT) are incorrect.

Issued by MPF.

User Action: Write a PSR.

### **MPF - CATALOG REWRITE LINK BYTE ERROR.**

Description: PACKER internal error. An incorrect link byte was read from the catalog track.

Issued by MPF.

User Action: Write a PSR.

### **MPF - DEVICE ERROR IDLE SET.**

Description: A device error idle was set as the result of a mass storage error on a catalog sector write.

Issued by MPF.

User Action: The catalogs on the device in question may have been corrupted. Either have an analyst repair the damage with DDF (if that is possible), or perform a full PFDUMP, deadstart INITIALIZE, and full PFLOAD.

### **MPF - EQxx TKyyyy SCzzzz.**

Description: The est ordinal, track and sector location of the incorrect sector write.

Issued by MPF.

User Action: See action for MPF - DEVICE ERROR IDLE SET.

### **MPF - FET COMPLETE BIT SET.**

Description: PACKER internal error. The FET complete bit was set on entry for FN=7.

Issued by MPF.

User Action: Write a PSR.

### **MPF - FET TOO SHORT.**

Description: PACKER internal error. The FET was too short for FN=7.

Issued by MPF.

User Action: Write a PSR.

### **MPF - FILE NOT FOUND.**

Description: PACKER internal error. The local file specified in the FET was not found.

Issued by MPF.

User Action: Write a PSR.

### **MPF - FM DN fffffff nn.**

Description: The family name (ffffff) and device number (nn) of the device on which an error idle was set.

Issued by MPF.

User Action: See action for MPF - DEVICE ERROR IDLE SET.

**MPF - I/O SEQUENCE ERROR.**

Description: PACKER internal error. The FST entry for the rewrite EOI function was busy.

Issued by MPF.

User Action: Write a PSR.

**MPF - INACCESSIBLE DEVICE.**

Description: The device status returned by the SETMS macro indicates that the device is not accessible.

Issued by MPF.

User Action: Check status of device. Retry when device is accessible.

**MPF - INCORRECT CALL.**

Description: Caller was not SSJ= program or MPF was not called with auto recall.

Issued by MPF.

User Action: None.

**MPF - INCORRECT CATALOG REWRITE REQUEST.**

Description: PACKER internal error. One or more of the parameters on a catalog rewrite request was incorrect.

Issued by MPF.

User Action: Write a PSR.

**MPF - INCORRECT CIO CODE IN CATALOG REWRITE.**

Description: PACKER internal error. The CIO code set in the FET on a catalog rewrite request was incorrect.

Issued by MPF.

User Action: Write a PSR.

**MPF - INCORRECT FUNCTION.**

Description: Function number not recognized.

Issued by MPF.

User Action: None.

**MPF - INCORRECT LINK BYTE IN CATALOG SCAN.**

Description: The control bytes in the sector at end of a track were not link bytes, the link byte pointed to an unreserved track, or the link byte pointed to a track which was not on the track chain which started with the label track.

Issued by MPF.

User Action: The catalogs on the device in question may have been corrupted. Either have an analyst repair the damage with DDF (if that is possible), or perform a full PFDUMP, deadstart INITIALIZE, and full PFLOAD.

**MPF - INCORRECT OVERFLOW FST REQUEST.**

Description: PACKER internal error. The parameter block for FN=6 was incorrect.

Issued by MPF.

User Action: Write a PSR.

**MPF - INCORRECT SECTOR READ IN CATALOG REWRITE.**

Description: An unrecovered mass storage error was encountered on a sector read.

Issued by MPF.

User Action: Have the engineers check the device.

### **MPF - INCORRECT SECTOR READ IN CATALOG SCAN.**

Description: An unrecovered mass storage error was encountered on a catalog track.

Issued by MPF.

User Action: Have the engineers check the device.

### **MPF - INCORRECT SYSTEM SECTOR.**

Description: PACKER internal error. The linkage bytes in the buffer were not correct for the write system sector function.

Issued by MPF.

User Action: Write a PSR.

### **MPF - INCORRECT WORD COUNT IN CATALOG REWRITE.**

Description: PACKER internal error. The word count in the CIO buffer is greater than 100B.

Issued by MPF.

User Action: Write a PSR.

### **MPF - INCORRECT WRITE IN CATALOG REWRITE.**

Description: An unrecovered mass storage error was encountered on a sector write. This error will set error idle on the device.

Issued by MPF.

User Action: The catalogs on the device in question may have been corrupted. Either have an analyst repair the damage with DDF (if that is possible), or perform a full PFDUMP, deadstart INITIALIZE, and full PFLOAD.

### **MPF - RANDOM ADDRESS NOT ON IAPF CHAIN.**

Description: The specified random address was not found on the IAPF chain.

Issued by MPF.

User Action: The catalogs on the device in question may have been corrupted. Either have an analyst repair the damage with DDF (if that is possible), or perform a full PFDUMP, deadstart INITIALIZE, and full PFLOAD.

### **MPF - SYSTEM SECTOR ERROR.**

Description: A mass storage error was encountered when reading or writing a system sector.

Issued by MPF.

User Action: None.

### **MPF - WRITE LOCK-OUT ON CATALOG FILE.**

Description: PACKER internal error. The catalog file was not in write mode.

Issued by MPF.

User Action: Write a PSR.

### **MR ERROR**

Description: The maintenance channel hung full while attempting to read a maintenance register.

Issued by 1XD.

User Action: Call a customer engineer.

### **MR ERROR**

Description: The maintenance channel hung full while attempting to read a maintenance register.

Issued by 1HY.

User Action: Call a customer engineer.

### **MR ERROR.**

Description: The maintenance channel hung full while attempting to read a maintenance register.

Issued by 1HY.

User Action: Call a customer engineer.

### **MR ERROR.**

Description: The maintenance channel hung full while attempting to read a maintenance register.

Issued by 1XD.

User Action: Call a customer engineer.

### **MREC ABNORMAL TERMINATION.**

Description: An error condition occurred which caused MREC to abort.

Issued by MREC.

User Action: Take a deadstart dump, write a PSR, and send the dump and PSR to CDC along with any support materials which will enable CDC to duplicate the the problem.

### **MRL PARAMETER ON CRM STATEMENT NOT SPECIFIED PROPERLY.**

Description: The MRL parameter on the CRM statement was specified improperly or specified as zero length.

Issued by DMREC.

User Action: Correct the CRM statement and try again.

### **MS ERROR ON DEADSTART FILE.**

Description: A mass storage error was encountered while the deadstart file was being written.

Issued by 1IS.

User Action: Use FORMAT to reserve the bad sector.

### **MS LIMIT EXCEEDED.**

Description: More than MSMX (release value = 200) mass storage devices have been defined in the EQPDECK.

Issued by SET.

User Action: Rereadstart using another EQPDECK, or remove some of the existing mass storage devices from this EQPDECK.

### **MS REDUCTION INCORRECT - filename.**

Description: The maximum message size, specified via the MS parameter on the RECOVER directive, was less than the actual message record size on the named CRF.

Issued by TAFREC.

User Action: Correct the RECOVER directive or select initialization of the named CRF via the K.INT initial K display command if reducing the message size is actually required. (Note that K.INT will destroy the current recovery information).

### **MSI ABORT.**

Description: Message at system control point indicating that MSI aborted. A message explaining the reason for the MSI abort should be present in either the system dayfile or the error log. The DAT interlock for this device was not cleared. If the error occurred during deadstart sequencing, job scheduling will remain disabled.

Issued by IMS.

User Action: If job scheduling is disabled, rereadstart. If the device being initialized is a shared device, it may be necessary to deadstart all mainframes accessing the device, PRESET the device, and do a deadstart initialize.

See the significance and action for the error message which explains the reason for the MSI abort for more information.

### **MSI ABORTED INITIALIZE MAY NOT BE COMPLETE.**

Description: Initialization of mass storage device did not complete due to hardware/software failure.

Issued by MSI.

User Action: Contact CYBER Software Support.

### **MST ERROR - GO/DROP.**

Description: MST has detected an irrecoverable READ error.

Issued by MST.

User Action: Enter GO,jsn. or DROP,jsn command for the job sequence name at which the message appears.

### **MST POINTER ERROR.**

Description: The system is unable to complete a level 3 deadstart because of a MST pointer error.

Issued by SET.

User Action: Perform a level 0 deadstart.

### **MT,Ccc,Eec,Hhhhhhhh, BCR.**

Description: Magnetic tape controller controlware restarted. BCR identifies B.C. RESTART.

Issued by 1MT.

User Action: None.

### **MT,Ccc,Eec,Hhhhhhhh, BTL.**

Description: Data block is at least one byte longer than length bbbb shown in third line of message. Refer to BLOCK TOO LARGE message.

Issued by 1MT.

User Action: None.

### **MT,Ccc,Eec,Hhhhhhhh, BUSY.**

Description: Unit was still busy after one second.

Issued by 1MT.

User Action: Inform customer engineer.

### **MT,Ccc,Eec,Hhhhhhhh, CMF.**

Description: Channel is not accepting function for status requests properly. Refer to CHANNEL MALFUNCTION message.

Issued by 1MT.

User Action: Inform customer engineer.

### **MT,Ccc,Eec,Hhhhhhhh, CON. REJ. OFF.**

Description: Connect reject; unable to connect to unit. Unit turned off.

Issued by 1MT.

User Action: Inform site analyst.

### **MT,Ccc,Eec,Hhhhhhhh, ERA.**

Description: Refer to the ERASE LIMIT message.

Issued by 1MT.

User Action: None.

**MT,Ccc,Eec,Hhhhhhhh, FNfff,Pyyyy.**

Description: Function ffff was rejected by the controller; yyyy is the address in 1MT where the function was initiated.

Issued by 1MT.

User Action: Inform site analyst.

**MT,Ccc,Eec,Hhhhhhhh, Lbbbb,Bnnnnnn.**

Description: The length (bbbb) and block number (nnnnnn) read from trailer bytes in block did not match the actual length or the block number read given in previous message line.

Issued by 1MT.

User Action: None.

**MT,Ccc,Eec,Hhhhhhhh, LCH.**

Description: Load sequence failed on the unit. LCH identifies LOAD CHECK.

Issued by 1MT.

User Action: Push CLEAR button and reload tape, or inform site analyst.

**MT,Ccc,Eec,Hhhhhhhh, MDW.**

Description: Indicates controller failure. Channel has been logically turned off and maintenance is required. MDW identifies MARGINAL, DOWN.

Issued by 1MT.

User Action: Inform customer engineer.

**MT,Ccc,Eec,Hhhhhhhh, MOF.**

Description: Unit has been logically turned off because of read/write failure. This occurred when a special function to check the read/write path to a unit failed during initial label scan. Maintenance is required. MOF identifies MARGINAL, OFF.

Issued by 1MT.

User Action: Inform customer engineer.

**MT,Ccc,Eec,Hhhhhhhh, NBE.**

Description: A noise block was skipped on the tape. NBE identifies NOISE.

Issued by 1MT.

User Action: None.

**MT,Ccc,Eec,Hhhhhhhh, NO EOP.**

Description: No end-of-operation detected from unit within 1 second.

Issued by 1MT.

User Action: Inform customer engineer.

**MT,Ccc,Eec,Hhhhhhhh, NOT READY.**

Description: Tape unit dropped ready status.

Issued by 1MT.

User Action: Make unit ready.

**MT,Ccc,Eec,Hhhhhhhhh, OPA.**

Description: Tape was written in parity opposite that being read. OPA identifies WRONG PARITY.

Issued by 1MT.

User Action: None.

**MT,Ccc,Eec,Hhhhhhhhh, OTF.**

Description: Error was corrected as the data was read. OTF identifies ON THE FLY.

Issued by 1MT.

User Action: None.

**MT,Ccc,Eec,Hhhhhhhhh, PLO.**

Description: The last good block written cannot be found during write recovery. PLO identifies POSITION LOST.

Issued by 1MT.

User Action: None.

**MT,Ccc,Eec,Hhhhhhhhh, REC.**

Description: Previously reported error has been successfully recovered. REC identifies RECOVERED.

Issued by 1MT.

User Action: None.

**MT,Ccc,Eec,Hhhhhhhhh, STE.**

Description: Error type cannot be determined so actual controller status is returned. STE identifies STATUS.

Issued by 1MT.

User Action: Inform site analyst.

**MT,Ccc-e-uu,vsn,rw,est,Ss,GSggggggggg**

**MT,Ccc,Dddd...d.**

**MT,Ccc,Uuu...u,Tttt.**

**MT,Ccc,Aaaaaaaaa.**

**MT,Ccc,Fff,Iii,Bnnnnnn,Lbbbb,Ppppppppp.**

**MT,Ccc,Eec,Hhhhhhhhh,type. or**

**MT,Ccc-e-uu,vsn,rw,est,Ss,GSggggggggg.**

**MT,Ccc,Dddd...d.**

**MT,Ccc,Aaaaaaaaa.**

**MT,Ccc,Fff,Iii,Bnnnnnn,Lbbbb,Ppppppppp.**

**MT,Ccc,Eec,Hhhhhhhhh,type. or**

**MT,Ccc,-e-uu,vsn,rw,est,Ss,GSggggggggg.**

**MT,Ccc,Dddd...d.**

**MT,Ccc,Fff,Iii,Bnnnnnn,Lbbbb,Ppppppppp.**

**MT,Ccc,Eec,Hhhhhhhhh,type. or**

**MT,Ccc-e-uu,vsn,rw,est,Ss,GSggggggggg.**

**MT,Ccc,Dddd...d.**

**MT,Ccc,Uuu...u,Tttt.**

**MT,Ccc,Fff,Iii,Bnnnnnn,Lbbbb,Ppppppppp.**

**MT,Ccc,Eec,Hhhhhhhhh,type.**

Description: Four, five, or six-line message describing a magnetic tape hardware malfunction on a 66x or 67x tape unit. Message as illustrated indicates 7-track, model 667 or 677 unit. If NT appears in place of MT, message indicates 9-track, model 669 or 679 unit. Message is issued to error log and optionally issued to dayfile. The first line of each message provides the following information.

cc-e-uu Channel, equipment (tape controller), and physical unit number of tape unit on which error was encountered.

vsn Volume serial number associated with tape on the specified unit.

rw Read (RD) or write (WR) operation; any operation not involving an actual read or write is listed as a read.

est EST ordinal of the unit on which the tape was last labeled. This is provided only for labeled tapes generated under NOS; otherwise, the field is blank. This field does not represent the EST ordinal of the tape unit that the tape is currently mounted on.

s Channel status.

ggggggg General status of magnetic tape unit. Last byte is block ID. Refer to the tape drive's hardware reference manual for general status information.

The MT,Ccc,Dddd...d line of the message provides the following information.

cc Channel number; the channel number is repeated to allow the analyst to associate this message with the first message if errors are occurring on more than one tape channel at the same time.

ddd...d Detailed status of magnetic tape unit. Refer to the tape drive's hardware reference manual for general status information.

The MT,Ccc,Uuu...u,Tttt line of the message provides the following information.

cc Channel number; repeated to associate this message with the previous message.

uu...u Detailed unit status. Refer to the tape drive's hardware reference manual for general status information.

ttt Third byte of the tape unit format parameters (refer to the Magnetic Tape Subsystem Reference Manual for descriptions of unit format parameter fields).

The MT,Ccc,Aaaaaaaaa line (for FSC only) contains the additional sense byte status not placed in the detailed status or unit status fields.

cc Channel number.

aaaaaaaa Sense byte.

The MT,Ccc,FFf,...,Pppppppp line of the message provides the following information.

cc Channel number; repeated to associate this message with the previous message.

ff Software function on which the error occurred.

ii Error iteration; number of times error has been encountered on this unit without successful recovery.

nnnnnn Block number on which error occurred.

bbbb Length of block on which error occurred in octal bytes.

ppppppp 1MT internal error parameters.

The last line of each message provides the following information.

cc Channel number; repeated to associate this message with the previous message

ec Octal error code value.

hhhhhhh Parameters passed to the tape unit for the format function (refer to the tape drive's hardware reference manual for descriptions of the unit format parameter fields).

type Additional description of the error. Refer to individual listing of the last line message.



Issued by 1MT.

User Action: Refer to the separate listing of the last line message (MT,...,type.) for the appropriate action.

### **MTest, Ccc, TURNED OFF.**

Description: A 7-track magnetic tape unit xx has been logically turned off due to function reject. If NT appears in place of MT, the message indicates a 9-track tape unit.

est EST ordinal of magnetic tape unit  
cc Channel number

Issued by 1MT.

User Action: Inform customer engineer.

### **MTR HUNG**

Description: PP routine MTR has detected a system problem such as an overlap in CM storage assigned to two control points.

Issued by MTR.

User Action: Take a deadstart dump, write a PSR, and send the dump and PSR to CDC along with any support materials which will allow CDC to duplicate the problem. Make sure PP0 is included in the dump (barrel reconfiguration is required).

### **MTS FIRMWARE LOAD, PART NO.- 12345678. or FSC FIRMWARE LOAD, PART NO.- 12345678. or 639 FIRMWARE LOAD, PART NO.- 12345678. or 698 FIRMWARE LOAD, PART NO.- 12345678.**

Description: Informative error log message indicating part number of firmware loaded.

Issued by 1MT.

User Action: None.

### **MTS FIRMWARE NOT FOUND. or FSC FIRMWARE NOT FOUND. or 639 FIRMWARE NOT FOUND. or 698 FIRMWARE NOT FOUND.**

Description: Magnetic tape controller controlware is not in the system.

Issued by 1MT.

User Action: Inform site analyst.

### **No EOF detected on last read.**

Description: No EOF on the last sector.

Issued by MST.

User Action: Add EOF and rerun.

### **\*N\* EXCEEDS NUMBER OF FILES.**

Description: Informative message indicating that EOI was encountered on the data file before the number of files specified on the N parameter were processed.

Issued by ACPD.

User Action: None.

### **NAKY PARAMETER ON IXN STATEMENT NOT SPECIFIED PROPERLY.**

Description: The NAKY parameter is not specified properly or equals zero.

Issued by DMREC.

User Action: Correct the IXN statement and try again.

**NAM ERROR - ILLOGICAL ABT.**

Description: The application block type (ABT) sent to TAF by NAM is unrecognizable.

Issued by TAF.

User Action: Contact CYBER Software Support.

**NAM ERROR - INCORRECT ABH.**

Description: The application block header (ABH) sent to TAF by NAM is unrecognizable.

Issued by TAF.

User Action: Contact CYBER Software Support.

**NAM FUNCTION NOT FOUND.**

Description: TAF received a supervisory message from NAM which had an unrecognizable primary or secondary function code.

Issued by TAF.

User Action: Contact CYBER Software Support.

**NAM NOT AVAILABLE.**

Description: Informative message indicating that TAF is currently at a control point but NAM is not. TAF transactions can be initiated from batch only or TAF-CRM databases may be accessed from batch or interactive jobs.

Issued by TAF.

User Action: Bring NAM to a control point, if desired.

**NAM REG LEVEL reglvl.**

Description: NIP initialization is complete.

reglvl Regulation level (decimal).

Issued by NIP.

User Action: None.

**NAM VER x.x - nnnn.**

Description: Informative message indicating that NIP has initialized successfully and is ready to process applications (including the supervisors).

nnnn Current integration or PSR level

x.x Version of NAM

Issued by NIP.

User Action: None.

**NAMI ILLEGAL KEYWORD/VALUE.**

Description: An invalid keyword or value was specified on the NAMI call statement.

Issued by NAMI.

User Action: Correct the NAMI call statement.

**NAMI VERSION n.nnnnnn.**

Description: NAMI version identification message issued when NAMI is initiated.

n.nnnnnn    Version identification number.

Issued by NAMI.

User Action: None.

### **NC EXCEEDS 200B TRACKS.**

Description: The number of catalog tracks specified for device exceeds the limit allowed.

Issued by MSI.

User Action: Correct and enter GO.

### **NC IS NOT A POWER OF 2.**

Description: The number of catalog tracks specified must be a power of two.

Issued by MSI.

User Action: Correct and enter GO.

### **NDLP COMPLETE.**

Description: NDLP has finished processing.

Issued by NVF.

User Action: None.

### **NDR - ADDRESS ERROR.**

Description: The calling program specified an invalid address.

Issued by NDR.

User Action: Inform site analyst.

### **NDR - ILLEGAL CALLER.**

Description: Only RHF is allowed to call NDR.

Issued by NDR.

User Action: Inform site analyst.

### **NDR - ILLEGAL FUNCTION.**

Description: RHF specified an invalid function.

Issued by NDR.

User Action: Inform site analyst.

### **NDR - INVALID CONNECT REQUEST.**

Description: A NAD sent an invalid reply to a system connect request.

Issued by NDR.

User Action: Inform site analyst.

### **NEED AT LEAST xx SUBCONTROL POINTS.**

Description: There are more CM resident tasks defined than subcontrol points. If non-CM resident tasks exist, there must be at least one more subcontrol point than there are CM resident tasks.

Issued by TAF.

User Action: Reinitialize the transaction executive and assign more subcontrol points, or reduce the number of CM resident tasks.

### **NEEDS LABEL**

Description: Mounted tape unit is unlabeled and the job requires a labeled tape. On labeled multireel files, all subsequent reels must be labeled.

Issued by MAGNET.

User Action: Mount correct tape.

### **NEEDS LABEL GO,est TO BLANK.**

Description: Mounted tape is unlabeled and the job requires a labeled tape allocated from the scratch pool of the NOS Tape Management System (TMS).

Issued by MAGNET.

User Action: Verify that the correct reel is mounted and enter the GO,est. DSD command to write blank labels on the reel. If the correct reel is not mounted, enter the STOP,est. DSD command to unload the reel. Mount the correct reel.

### **NEEDS WRITE ENABLE.**

Description: Mounted tape is not write-enabled and the job requested the tape with write-enabled.

Issued by MAGNET.

User Action: Remount the tape with write enabled.

### **NETBDF-BUILD DIRECTORY FILE.**

Description: Informative message indicating that the directory file build utility has been initiated.

Issued by NETBDF.

User Action: None.

### **NETBDF-CANNOT DEFINE NEW DIRECTORY-filename.**

Description: An error was encountered while attempting to define the new directory file filename. A PFM error code is reported.

Issued by NETBDF.

User Action: Inform site analyst. Correct condition causing PFM error.

### **NETBDF - CONTROL STATEMENT ERROR-JOB ABORTED.**

Description: Informative message indicating that an error was encountered while processing the command parameters.

Issued by NETBDF.

User Action: Correct the relevant errors.

### **NETBDF-CPU USAGE SECS. MS.**

Description: Informative message indicating the CPU usage of the program.

Issued by NETBDF.

User Action: Informative message indicating the CPU usage of the program.

### **NETBDF-DEFINING DIRECTORY FILE-filename.**

Description: Informative message indicating that filename is the NOS permanent file name of the new directory.

Issued by NETBDF.

User Action: None.

### **NETBDF-DIRECTORY GENERATION COMPLETE.**

Description: Informative message indicating successful completion of the utility.

Issued by NETBDF.

User Action: None.

**NETBDF-DUPLICATE CONTROL STATEMENT  
PARAMETER-xxxxxxx.**

Description: User specified the same parameter name more than once on the command.

Issued by NETBDF.

User Action: Correct the command.

**NETBDF-DUPLICATE FILE NAME-xxxxxxx.**

Description: A duplicate file name was detected on the command (more than one parameter had the same file name value).

Issued by NETBDF.

User Action: Supply unique file names on the command.

**NETBDF-ILLEGAL CONTROL STATEMENT PARAMETER  
VALUE-xxxxxxx.**

Description: The value specified was incorrect for the associate parameter.

Issued by NETBDF.

User Action: Specify a value that conforms to the parameter specifications.

**NETBDF-ILLEGAL FILE NAME-filename.**

Description: File name specified contained characters other than A through Z and 0 through 9.

Issued by NETBDF.

User Action: Correct the invalid file name on the command.

**NETBDF-ILLEGAL SEPARATOR-\*x\*.**

Description: The user supplied the invalid separator x on the command invocation.

Issued by NETBDF.

User Action: Supply a correct separator.

**NETBDF-PFM ERROR-xxx(10)**

Description: PFM error xxx was encountered while attempting to issue permits for user names contained on the input file or while attempting to define the new directory file.

Issued by NETBDF.

User Action: Inform site analyst. Correct condition causing PFM error.

**NETBDF-PURGED PERMANENT FILE-pfn.**

Description: Informative message indicating that pfn is the NOS permanent file that was purged.

Issued by NETBDF.

User Action: None.

**NETBDF-REQUIRED PARAMETER MISSING-param.**

Description: A required parameter param was not supplied on the command.

Issued by NETBDF.

User Action: Supply the missing parameter.

**NETBDF-UNRECOGNIZED CONTROL STATEMENT  
PARAMETER-param.**

Description: An unrecognized parameter param was supplied on the command.

Issued by NETBDF.

User Action: Remove unrecognized parameter.

**NETBDF-VALUE NOT SPECIFIED FOR  
PARAMETER-param.**

Description: You did not supply a value param for a parameter that requires a value.

Issued by NETBDF.

User Action: Supply missing value.

**NETBDF-VALUE SUPPLIED FOR KEYWORD-xxxxxxx.**

Description: You supplied a value xxxxxx for a parameter that is valid only as a keyword.

Issued by NETBDF.

User Action: Remove the value supplied with the keyword.

**NETFM-ADD FAILED PF = pfn NF = nfn.**

Description: This is an informative message only. The attempt to create a directory entry for permanent file pfn failed.

Issued by NETFM.

User Action: None.

**NETFM-ADDED PF = pfn NF = nfn.**

Description: This is an informative message only. The directory entry for permanent file pfn was created.

Issued by NETFM.

User Action: None.

**NETFM-BAD DIRECTORY FILE.**

Description: This dayfile message is issued if NETFM detects that the verification words in the header entry of the directory are not correct. NETFM will abort and not process any directive records.

Issued by NETFM.

User Action: Replace the file NETDIR with a backup copy of the directory file. If one does not exist, use the utility NETBDF to create one.

**NETFM-BAD LFM REQUEST BY NETFM.**

Description: This dayfile message is output when an invalid LFM request is issued by NETFM. NETFM will abort and not process any directive records.

Issued by NETFM.

User Action: Inform site analyst.

**NETFM-BAD PFM REQUEST BY NETFM.**

Description: This dayfile message is output when an invalid PFM request is issued by NETFM. NETFM will abort and not process any directive records.

Issued by NETFM.

User Action: Inform site analyst.

### **NETFM-CONTROL STATEMENT ERROR-JOB ABORTED.**

Description: Informative message indicating that an error was encountered while processing the command parameters.

Issued by NETFM.

User Action: Correct the relevant errors.

### **NETFM-CPU USAGE SECS. MS.**

Description: Informative message indicating the CPU usage of the program.

Issued by NETFM.

User Action: Informative message indicating the CPU usage of the program.

### **NETFM-DELETE FAILED PF = pfn NF = nfn.**

Description: This is an informative message only. The attempt to delete a directory entry for permanent file pfn failed.

Issued by NETFM.

User Action: None.

### **NETFM-DELETED PF = pfn NF = nfn.**

Description: This is an informative message only. The directory entry for permanent file pfn was deleted.

Issued by NETFM.

User Action: None.

### **NETFM-DIRECTORY FILE NOT FOUND.**

Description: This dayfile message is issued if NETFM is unable to attach the file NETDIR. NETFM will abort and not process any directive records.

Issued by NETFM.

User Action: Check to see if the file NETDIR exists and the user name under which NETFM is running is allowed to access the directory file.

### **NETFM-DIRECTORY NOT OPEN.**

Description: NETFM issued a request to access the directory and the directory was not open. NETFM aborted and did not process any directive records.

Issued by NETFM.

User Action: Inform site analyst.

### **NETFM-DIRECTORY RESTRUCTURE NEEDED.**

Description: Informative message indicating that the number of entries in the CDCNET directory has exceeded the optimum performance threshold.

Issued by NETFM.

User Action: Inform site analyst. The restructure utility NETRDF should be run to enlarge the directory and improve access efficiency.

### **NETFM-DUPLICATE CONTROL STATEMENT PARAMETER-xxxxxxx.**

Description: User specified the same parameter name more than once on the command.

Issued by NETFM.

User Action: Correct the command.

**NETFM-DUPLICATE FILE NAME-xxxxxxx.**

Description: A duplicate file name was detected on the command (more than one parameter had the same file name value).

Issued by NETFM.

User Action: Supply unique file names on the command.

**NETFM ERROR = nn**

Description: This is the general error message to handle any response codes that do not currently exist. nn is the response code (octal).

Issued by NETFMA.

User Action: Inform site analyst.

**NETFM-ILLEGAL CONTROL STATEMENT PARAMETER VALUE-xxxxxxx.**

Description: The value specified was incorrect for the associate parameter.

Issued by NETFM.

User Action: Specify a value that conforms to the parameter specifications.

**NETFM-ILLEGAL FILE NAME-xxxxxxx.**

Description: File name specified contained characters other than A through Z and 0 through 9.

Issued by NETFM.

User Action: Correct invalid file name on the command.

**NETFM-ILLEGAL SEPARATOR-\*x\*.**

Description: The user supplied the invalid separator x on the command invocation.

Issued by NETFM.

User Action: Supply a correct separator.

**NETFM-INTERNAL I/O ERROR**

Description: A CIO error has been encountered by NETFM. NETFM will abort and not process any directive records.

Issued by NETFM.

User Action: Inform site analyst.

**NETFM INTERNAL I/O ERROR.**

Description: NETFM had an internal I/O error and was unable to proceed.

Issued by NETFMA.

User Action: Inform site analyst.

**NETFM-NETFM COMPLETE.**

Description: NETFM has completed processing all of the directive records or has aborted.

Issued by NETFM.

User Action: Informative message.

**NETFM-NON-FATAL ERROR(S) ENCOUNTERED.**

Description: This dayfile message is issued when nonfatal errors are encountered.

Issued by NETFM.



User Action: Check the output file for further information on the errors encountered.

**NETFM-action PF = pfn NF = nfn.**

Description: Specify the necessary action:

action	Meaning
PURGED	Permanent file purged and directory entry deleted
DELETED	Directory entry deleted
ADDED	Directory entry created
UPDATED	Directory entry updated
PURGE FAILED	Attempt to purge permanent file failed
DELETE FAILED	Attempt to delete directory entry failed
ADD FAILED	Attempt to create directory entry failed
UPDATE FAILED	Attempt to update directory entry failed

Issued by NETFM.

User Action: Informative dayfile message.

**NETFM-PURGE FAILED PF = pfn NF = nfn.**

Description: This is an informative message only. The attempt to purge permanent file pfn failed.

Issued by NETFM.

User Action: None.

**NETFM-PURGED PF = pfn NF = nfn.**

Description: This is an informative message only. The permanent file pfn was purged and its directory entry deleted.

Issued by NETFM.

User Action: None.

**NETFM-REQUIRED PARAMETER MISSING-param.**

Description: A required parameter param was not supplied on the command.

Issued by NETFM.

User Action: Supply the missing parameter.

**NETFM-UNRECOGNIZED CONTROL STATEMENT  
PARAMETER-param.**

Description: An unrecognized parameter param was supplied on the command.

Issued by NETFM.

User Action: Remove unrecognized parameter.

**NETFM-UPDATE FAILED PF = pfn NF = nfn.**

Description: This is an informative message only. The attempt to update a directory entry for permanent file pfn failed.

Issued by NETFM.

User Action: None.

**NETFM-UPDATED PF = pfn NF = nfn.**

Description: This is an informative message only. The directory entry for permanent file pfn was updated.

Issued by NETFM.

User Action: None.

**NETFM-VALUE NOT SPECIFIED FOR  
PARAMETER-param.**

Description: You did not supply a value param for a parameter that requires a value.

Issued by NETFM.

User Action: Supply missing value.

**NETFM-VALUE SUPPLIED FOR KEYWORD-xxxxxxx.**

Description: You supplied a value xxxxxx for a parameter that is valid only as a keyword.

Issued by NETFM.

User Action: Remove the value supplied with the keyword.

**NETFS - ABNORMAL TERMINATION COMPLETE.**

Description: Informative message indicting that NETFS is terminating abnormally.

Issued by NETFS.

User Action: Check previous messages for cause of abnormal termination.

**NETFS - ATTEMPTING NETON.**

Description: Informative message indicating that NETFS is attempting to establish communication with the network.

Issued by NETFS.

User Action: None.

**NETFS - BAD CONTROL CARD PARAMETER FORMAT.**

Description: The NETFS command in the master file is formatted incorrectly.

Issued by NETFS.

User Action: Correct the NETFS command in the master file.

**NETFS - BAD CONTROL CARD PARAMETER VALUE.**

Description: An out-of-range value is specified for a NETFS command parameter.

Issued by NETFS.

User Action: Correct the NETFS command in the master file.

**NETFS - BUILT YY/MM/DD. HH.MM.SS.**

Description: Informative message indicating the installation date and time of the current level of NETFS.

Issued by NETFS.

User Action: None.

**NETFS-CIO READ ERROR ENCOUNTERED.**

**CIO ERROR CODE =ccode**  
**PERMANENT FILE NAME =pfn**  
**NETWORK FILE NAME =nfn**

Description: NETFS received an error status other than end-of-device from CIO while trying to read from a CDCNET permanent file.

ccodeCIO detailed error code (refer to the NOS 2 Reference Manual, Volume 4, for a description of CIO error codes.)

pfm NOS permanent file name.

nfn CDCNET file name.

Issued by NETFS.

User Action: Inform site analyst.

**NETFS-CIO WRITE ERROR ENCOUNTERED.**

**CIO ERROR CODE =ccode**

**PERMANENT FILE NAME =pfm**

**NETWORK FILE NAME =nfn**

Description: NETFS received an error status other than end-of-device from CIO while trying to write to a CDCNET permanent file.

ccodeCIO detailed error code (refer to the NOS 2 Reference Manual, Volume 4, for a description of CIO error codes.)

pfm NOS permanent file name.

nfn CDCNET file name.

Issued by NETFS.

User Action: Inform site analyst.

**NETFS-DIRECTORY ENTRY CREATED.**

**PERMANENT FILE NAME =pfm**

**NETWORK FILE NAME =nfn**

Description: Informative message indicating that NETFS has created an entry in the CDCNET directory corresponding to a permanent file that it has created.

pfm NOS permanent file name.

nfn CDCNET file name.

Issued by NETFS.

User Action: None.

**NETFS-DIRECTORY ENTRY DELETED.**

**PERMANENT FILE NAME =pfm**

**NETWORK FILE NAME =nfn**

Description: Informative message indicating that NETFS has deleted the CDCNET directory entry corresponding to a permanent file that it has purged.

pfm NOS permanent file name.

nfn CDCNET file name.

Issued by NETFS.

User Action: None.

**NETFS-DIRECTORY ENTRY NOT CREATED.**

**NETFM ERROR CODE =fcode**

**PERMANENT FILE NAME =pfm**

**NETWORK FILE NAME =nfn**

Description: NETFS is unable to create an entry in the CDCNET directory for a permanent file that it has created because it received an unexpected error from NETFM.

fcode NETFM error code.  
pfn NOS permanent file name.  
nfn CDCNET file name.

Issued by NETFS.

User Action: Inform site analyst. The permanent file created by NETFS should be purged.

**NETFS-DIRECTORY ENTRY NOT DELETED.  
NETFM ERROR CODE =fcode  
PERMANENT FILE NAME =pfn  
NETWORK FILE NAME =nfn**

Description: NETFS is unable to delete the entry in the CDCNET directory for a permanent file that it purged because it received an unexpected error from NETFM.

fcode NETFM error code.  
pfn NOS permanent file name.  
nfn CDCNET file name.

Issued by NETFS.

User Action: Inform site analyst. The CDCNET directory entry should be deleted using the NETFM DELETE command.

**NETFS-DIRECTORY ENTRY NOT UPDATED.  
NETFM ERROR CODE =fcode  
PERMANENT FILE NAME =pfn  
NETWORK FILE NAME =nfn**

Description: NETFS is unable to update the entry in the CDCNET directory for a permanent file that it modified because it received an unexpected error from NETFM.

fcode NETFM error code.  
pfn NOS permanent file name.  
nfn CDCNET file name.

Issued by NETFS.

User Action: Inform site analyst. The CDCNET directory entry should be updated using the NETFM UPDATE command.

**NETFS-DIRECTORY ENTRY UPDATED.  
PERMANENT FILE NAME =pfn  
NETWORK FILE NAME =nfn**

Description: Informative message indicating that NETFS has updated the CDCNET directory entry corresponding to a permanent file that it has modified.

pfn NOS permanent file name.  
nfn CDCNET file name.

Issued by NETFS.

User Action: None.

**NETFS-DIRECTORY ERROR ENCOUNTERED.  
NETFM ERROR CODE =fcode**

Description: NETFS received an unexpected error from NETFM while trying to attach or release the CDCNET directory file

fcode NETFM error code.

Issued by NETFS.

User Action: Inform site analyst.

### **NETFS-DIRECTORY FILE NOT FOUND.**

Description: NETFS tried to attach the CDCNET directory file and one of the following occurred:

- The CDCNET directory file could not be found.
- NETFS is not allowed to access the CDCNET directory file in the requested mode.

Issued by NETFS.

User Action: Inform site analyst. Verify that the CDCNET directory file exists with the correct file name and user name, and that the user name specified in the NETFS job is allowed to access the file in MODIFY mode.

### **NETFS-DIRECTORY IMPROPERLY FORMATTED.**

Description: The CDCNET directory file accessed by NETFS is not a valid directory file.

Issued by NETFS.

User Action: Inform site analyst. The CDCNET directory file must be recreated or restored.

### **NETFS-DIRECTORY RESTRUCTURE NEEDED.**

Description: Informative message indicating that the number of entries in CDCNET directory has exceeded the optimum performance threshold.

Issued by NETFS.

User Action: Inform site analyst. The NETFM restructure utility NETRDF should be run to enlarge the directory and improve access efficiency.

### **NETFS-DISABLED.**

Description: NETFS is not able to establish communication with the network because NETFS has been disabled.

Issued by NETFS.

User Action: Enable NETFS using NVF's enable application commands.

### **NETFS-DUPLICATE CONTROL CARD PARAMETER.**

Description: A NETFS command parameter is specified more than once.

Issued by NETFS.

User Action: Correct the NETFS command in the master file.

### **NETFS - DUPLICATE NETON.**

Description: A second copy of NETFS tried to establish communication with the network while a previous copy is still active.

Issued by NETFS.

User Action: Inform site analyst.

### **NETFS-FILE SIZE IN BYTES MISMATCH.**

**PERMANENT FILE NAME =pfn**

**NETWORK FILE NAME =nfn**

Description: NETFS detected an inconsistency between the actual size of the permanent file and the file size in bytes specified in the corresponding CDCNET directory entry. NETFS continues processing the file, using the smallest of the two size specifications.

pfn NOS permanent file name.

nfn CDCNET file name.

Issued by NETFS.

User Action: Inform site analyst. The CDCNET directory entry should be updated using the NPTFM UPDATE command.

**NETFS - ILLEGAL CONTROL CARD PARAMETER.**

Description: NETFS detected an invalid value assigned to a NETFS command parameter.

Issued by NETFS.

User Action: Correct the NETFS command in the master file.

**NETFS - IMMEDIATE SHUTDOWN REQUESTED.**

Description: NETFS received a forced network shutdown request.

Issued by NETFS.

User Action: None.

**NETFS - INVALID CONNECTION REQUEST.**

Description: NETFS received and rejected an invalid connection request.

Issued by NETFS.

User Action: If problem persists, inform site analyst.

**NETFS - INVALID SUPERVISORY MESSAGE.**

Description: NETFS received an unexpected supervisory message from NAM.

Issued by NETFS.

User Action: Inform site analyst.

**NETFS-MAXIMUM FIELD LENGTH EXCEEDED.**

Description: NETFS has exceeded the maximum field length allowed by the installation.

Issued by NETFS.

User Action: Inform site analyst.

**NETFS - MDI NODE *mnode* CONNECTION ACCEPTED.**

Description: Informative message indicating that NETFS has accepted a connection request from the specified MDI node.

*mnode* MDI node number

Issued by NETFS.

User Action: None.

**NETFS - MDI NODE *mnode* CONNECTION ACTIVATED.**

Description: Informative message indicating the connection with the specified MDI node is ready for normal operation.

*mnode* MDI node number

Issued by NETFS.

User Action: None.

**NETFS - MDI NODE *mnode* CONNECTION BROKEN.**

Description: Informative message indicating that the connection with the specified MDI node has been broken.

*mnode* MDI node number

Issued by NETFS.

User Action: None.

### **NETFS - MDI NODE mnode CONNECTION ENDED.**

Description: Informative message indicating that NETFS has ended the connection with the specified MDI node.

mnode MDI node number

Issued by NETFS.

User Action: None.

### **NETFS - MDI NODE mnode CONNECTION REJECTED.**

Description: Informative message indicating that NETFS has rejected a connection request from the specified MDI node.

mnode MDI node number

Issued by NETFS.

User Action: If problem persists, inform site analyst.

### **NETFS - MDI NODE mnode PROTOCOL ERROR ecode.**

Description: NETFS has detected a protocol error with the specified MDI node.

mnode	MDI node number
ecode	Protocol error number
01	Null or BLK block received
02	Incorrect protocol identifier
03	Bad block
04	Missing File-Ident request block
05	Duplicate File-Ident request block
06	Invalid function code received

Issued by NETFS.

User Action: None.

### **NETFS - NETON SUCCESSFUL.**

Description: Informative message indicating that NETFS has successfully established communication with the network.

Issued by NETFS.

User Action: None.

### **NETFS - NETWORK PROTOCOL ERROR ecode.**

Description: NETFS has detected a protocol error with the network.

ecode	Protocol error number
01	Error logical received
02	Block not delivered
03	Unexpected connection broken
04	Unexpected connection ended
05	Unexpected connection request
06	Unexpected block delivered
07	Unexpected connection initialized
08	Unexpected data block received

Issued by NETFS.

User Action: Inform site analyst.

**NETFS - NETWORK SHUTDOWN REQUESTED.**

Description: NETFS received an idle network shutdown request.

Issued by NETFS.

User Action: None.

**NETFS - NIN IS NOT SPECIFIED.**

Description: The required NIN (network invocation number) value on the NETFS command is not specified.

Issued by NETFS.

User Action: Correct the NETFS command in the master file.

**NETFS-NO CONNECTIONS REMAINING.**

Description: Informative message indicating that NETFS has no connections with MDIs.

Issued by NETFS.

User Action: None.

**NETFS-NORMAL TERMINATION COMPLETE.**

Description: Informative message indicating that NETFS is terminating normally.

Issued by NETFS.

User Action: None.

**NETFS-PERMANENT FILE NOT FOUND.**

**PERMANENT FILE NAME =pfn**

**NETWORK FILE NAME =nfn**

Description: NETFS tried to access the CDCNET permanent file and one of the following occurred:

- The permanent file could not be found.
- NETFS is not allowed to access the permanent file in the requested mode.

pfn NOS permanent file name.

nfn CDCNET file name.

Issued by NETFS.

User Action: Inform site analyst. Verify that the CDCNET permanent file exists, that the permanent file is correctly described in the CDCNET directory, and that the user name specified in the NETFS job is allowed to access the file in the requested mode.

**NETFS-UNKNOWN ENTRY POINT NAME.**

**ENTRY POINT NAME =epname**

**PERMANENT FILE NAME =pfn**

**NETWORK FILE NAME =nfn**

Description: NETFS is unable to locate the entry point name specified on the OPEN request for a library file.

epname Entry point name

pfn NOS permanent file name

nfn CDCNET file name

Issued by NETFS.

User Action: Inform site analyst. Verify that the entry point name is valid.

**NETLS-ABNORMAL TERMINATION COMPLETE.**

Description: Informative message indicating that NETLS is terminating.



Issued by NETLS.

User Action: Check previous messages for cause of abnormal termination.

### **NETLS-ATTEMPTING NETON.**

Description: Informative message indicating that NETLS is attempting to establish communication with the network.

Issued by NETLS.

User Action: None.

### **NETLS - BAD CONTROL CARD PARAMETER FORMAT.**

Description: The NETLS command file in the master file is formatted incorrectly.

Issued by NETLS.

User Action: Correct the NETLS command in the master file.

### **NETLS - BAD CONTROL CARD PARAMETER VALUE.**

Description: An out-of-range value is specified for a NETLS command parameter.

Issued by NETLS.

User Action: Correct the NETLS command in the master file.

### **NETLS-BUILT YY/MM/DD.HH.MM.SS.**

Description: Informative message indicating the installation date and time of the current level of NETLS.

Issued by NETLS.

User Action: None.

### **NETLS-CONTROL STATEMENT ERROR-JOB ABORTED.**

Description: Informative message indicating that an error was encountered while processing the NETLS command.

Issued by NETLS.

User Action: Correct the NETLS command in the master file.

### **NETLS-DISABLED.**

Description: NETLS is not able to establish communication with the network because NETLS has been disabled.

Issued by NETLS.

User Action: Enable NETLS using NVF's enable application commands.

### **NETLS-DUPLICATE CONTROL STATEMENT PARAMETER\_XXXXXXXX.**

Description: A NETLS command parameter was specified more than once.

xxxxxxx Parameter

Issued by NETLS.

User Action: Correct the NETLS command in the master file.

### **NETLS-DUPLICATE NETON.**

Description: A second copy of NETLS tried to establish communication with the network while a previous copy is still active.

Issued by NETLS.

User Action: None.

### **NETLS-ERROR code IN ACCESSING LOG FILE.**

Description: NETLS encountered a CIO error while accessing the current log file.

code CIO detailed error code (refer to the NOS 2 Reference Set, Volume 3, for a description of CIO error codes).

Issued by NETLS.

User Action: Inform site analyst.

### **NETLS-ERROR code IN ATTACHING LOG FILE.**

Description: NETLS encountered a PFM error while attaching the current log file.

code PFM detailed error code (refer to the NOS 2 Reference Set, Volume 3, for a description of PFM error codes).

Issued by NETLS.

User Action: Inform site analyst.

### **NETLS-ERROR code IN DEFINING LOG FILE.**

Description: NETLS encountered a PFM error while defining the current log file.

code PFM detailed error code (refer to the NOS 2 Reference Set, Volume 3, for a description of PFM error codes).

Issued by NETLS.

User Action: Inform site analyst.

### **NETLS-ERROR code IN PERMITTING ACCESS TO LOG FILE.**

Description: NETLS encountered a PFM error while permitting access to the current log file.

code PFM detailed error code (refer to the NOS 2 Reference Set, Volume 3, for a description of PFM error codes).

Issued by NETLS.

User Action: Inform site analyst.

### **NETLS-ERROR code IN REATTACHING LOG FILE.**

Description: NETLS encountered a PFM error while reattaching the current log file.

code PFM detailed error code (refer to the NOS 2 Reference Set, Volume 3, for a description of PFM error codes).

Issued by NETLS.

User Action: Inform site analyst.

### **NETLS-ERROR code IN SKIPPING LOG FILE.**

Description: NETLS encountered a PFM error while skipping the current log file.

code CIO detailed error code (refer to the NOS 2 Reference Set, Volume 3, for a description of CIO error codes).

Issued by NETLS.

User Action: Inform site analyst.

### **NETLS-EXISTING LOG FILE ATTACHED.**

Description: NETLS has attached an existing log file to be the current log file.

Issued by NETLS.

User Action: None.

### **NETLS-ILLEGAL CONTROL STATEMENT PARAMETER.**

Description: NETLS detected an invalid value assigned to a NETLS command parameter.

Issued by NETLS.

User Action: Correct the NETLS command in the master file.

### **NETLS-ILLEGAL SEPARATOR-x.**

Description: An illegal parameter separator was detected in the NETLS command.

x Parameter separator

Issued by NETLS.

User Action: Correct the NETLS command in the master file.

### **NETLS-ILLEGAL VALUE-vvvvvvvv FOR PARAMETER-xxxxxxx.**

Description: An illegal value was specified for a parameter in the NETLS command.

vvvvvvv Incorrect value

xxxxxxx Parameter value

Issued by NETLS.

User Action: Correct the NETLS command in the master file.

### **NETLS-IMMEDIATE SHUTDOWN REQUESTED.**

Description: NETLS received a forced network shutdown request.

Issued by NETLS.

User Action: None.

### **NETLS-INVALID CONNECTION REQUEST.**

Description: NETLS received and rejected an invalid connection request.

Issued by NETLS.

User Action: If problem persists, inform site analyst.

### **NETLS-INVALID SUPERVISORY MESSAGE.**

Description: NETLS received an unexpected supervisory message from NAM.

Issued by NETLS.

User Action: Inform site analyst.

### **NETLS-LOG FILE TERMINATION COMPLETE.**

Description: NETLS completed a request to terminate the current log file.

Issued by NETLS.

User Action: None.

### **NETLS-LOG FILE TERMINATION REJECTED.**

Description: NETLS rejected a request to terminate the current log file.

Issued by NETLS.

User Action: Inform site analyst.

**NETLS-MAXIMUM FIELD LENGTH EXCEEDED.**

Description: NETLS has exceeded the maximum field length allowed by the installation.

Issued by NETLS.

User Action: Inform site analyst.

**NETLS-MDI NODE *mnode* CONNECTION ACCEPTED.**

Description: Informative message indicating that NETLS has accepted a connection request from the specified MDI node.

*mnode* MDI node number

Issued by NETLS.

User Action: None.

**NETLS-MDI NODE *mnode* CONNECTION ACTIVE.**

Description: Informative message indicating that the connection with the specified MDI node is ready for normal operation.

*mnode* MDI node number

Issued by NETLS.

User Action: None.

**NETLS-MDI NODE *mnode* CONNECTION BROKEN.**

Description: Informative message indicating that the connection with the specified MDI node has been broken.

*mnode* MDI node number

Issued by NETLS.

User Action: None.

**NETLS-MDI NODE *mnode* CONNECTION ENDED.**

Description: Informative message indicating that NETLS has ended the connection with specified MDI node.

*mnode* MDI node number

Issued by NETLS.

User Action: None.

**NETLS-MDI NODE *mnode* CONNECTION INACTIVE.**

Description: Informative message indicating that normal operation of the connection with the specified MDI node is complete.

*mnode* MDI node number

Issued by NETLS.

User Action: None.

**NETLS-MDI NODE *mnode* CONNECTION REJECTED.**

Description: Informative message indicating that NETLS has rejected a connection request from the specified MDI node.

mnode MDI node number

Issued by NETLS.

User Action: If problem persists, inform site analyst.

### **NETLS-MDI NODE mnode PROTOCOL ERROR ecode.**

Description: NETLS has detected a protocol error with the specified MDI node.

mnode	MDI node number
ecode	Protocol error number
01	NULL or BLK block received.
02	Incorrect protocol identifier
03	Bad block length
04	Missing Log-Connect-Req block
05	Duplicate Log-Connect-Req block
06	Invalid function code received
07	Invalid data format detected
08	Log-Disconnect-Req timeout
09	Incorrect unique identifier

Issued by NETLS.

User Action: Inform site analyst.

### **NETLS-NETLS JOB IS NOT SYSTEM ORIGIN.**

Description: The job which invoked NETLS was not system origin.

Issued by NETLS.

User Action: Inform site analyst.

### **NETLS-NETON SUCCESSFUL.**

Description: Informative message indicating that NETLS has successfully established communication with the network.

Issued by NETLS.

User Action: Inform site analyst.

### **NETLS-NETWORK PROTOCOL ERROR ecode.**

Description: NETLS has detected a protocol error with the network.

ecode	Protocol error number
01	Error logical received
02	Block not delivered
03	Unexpected connection broken
04	Unexpected connection ended
05	Unexpected connection request
06	Unexpected block delivered
07	Unexpected connection initialized
08	Unexpected data block received

Issued by NETLS.

User Action: Inform site analyst.

### **NETLS-NETWORK SHUTDOWN REQUESTED.**

Description: NETLS received an idle network shutdown request.

Issued by NETLS.

User Action: None.

**NETLS-NEW LOG FILE CREATED.**

Description: NETLS has defined a new log file to be the current log file, as opposed to using an existing log file.

Issued by NETLS.

User Action: None.

**NETLS - NIN IS NOT SPECIFIED.**

Description: The required NIN (network invocation number) value on the NETLS command is not specified.

Issued by NETLS.

User Action: Correct the NETLS command in the master file.

**NETLS-NO CONNECTIONS REMAINING.**

Description: Informative message indicating that NETLS has no connections with MDIs.

Issued by NETLS.

User Action: None.

**NETLS-NORMAL TERMINATION COMPLETE.**

Description: Informative message indicating that NETLS is terminating normally.

Issued by NETLS.

User Action: None.

**NETLS NOT AVAILABLE, NETWORK CONNECTION REJECTED.**

Description: The network has rejected the connection because the log server is not active. Log file termination continues.

Issued by NLTERM.

User Action: None.

**NETLS-REQUIRED PARAMETER MISSING-xxxxxxx.**

Description: A required parameter was not encountered in the NETLS command.

xxxxxxx      Parameter name

Issued by NETLS.

User Action: Correct the NETLS command in the master file.

**NETLS-UNRECOGNIZED CONTROL STATEMENT  
PARAMETER-xxxxxxx.**

Description: An unrecognized parameter was encountered in the NETLS command.

xxxxxxx      Parameter name.

Issued by NETLS.

User Action: Correct the NETLS command in the master file.

**NETLS-VALUE NOT SPECIFIED FOR PARAMETER-xxxxxxx.**

Description: A required value was not specified for a parameter in the NETLS command.

xxxxxxx      Parameter name

Issued by NETLS.

User Action: Correct the NETLS command in the master file.

**NETLS-VALUE OUTSIDE OF RANGE FOR  
PARAMETER-xxxxxxx.**

Description: A value outside the acceptable range was specified for a parameter xxxxxxx in the NETLS command.

Issued by NETLS.

User Action: Correct the NETLS command in the master file.

**NETMDF-BAD GET ON DIRECTORY-filename.**

Description: An internal error occurred while attempting to read an entry from the source directory file filename.

Issued by NETMDF.

User Action: Inform site analyst.

**NETMDF-BAD OPEN ON DIRECTORY-xxxxxxx.**

Description: A bad verification record was found in the directory file.

Issued by NETMDF.

User Action: Inform site analyst. The directory does not have the proper internal verification record. Either restore a valid directory file from a PFU dump tape or rebuild the directory via the NETBDF utility. In the latter case, all CDCNET directory entries must be recreated in the directory via NETFM.

**NETMDF-CANNOT ATTACH DESTINATION DIRECTORY-filename.**

Description: NETMDF could not attach the named directory file filename. A PFM error code is reported.

Issued by NETMDF.

User Action: Create directory file under the current user name (where NETMDF is being run) with the utility NETBDF.

**NETMDF-CANNOT ATTACH SOURCE DIRECTORY-filename,UN=username.**

Description: NETMDF could not access the source directory file filename under user name username.

Issued by NETMDF.

User Action: The user name under which NETMDF is executing must have read access to the source directory on the alternate user name.

**NETMDF - CONTROL STATEMENT ERROR-JOB ABORTED.**

Description: Informative message indicating that an error was encountered while processing the command parameters.

Issued by NETMDF.

User Action: Correct the relevant errors.

**NETMDF-CPU USAGE SECS. MS.**

Description: Informative message indicating the CPU usage of the program.

Issued by NETMDF.

User Action: Informative message indicating the CPU usage of the program.

**NETMDF-DESTINATION DIRECTORY-filename, UN=username.**

Description: Informative message indicating that the destination directory is on file filename under user name username.

Issued by NETMDF.

User Action: None.

**NETMDF-DIRECTORY MERGE COMPLETE.**

Description: Informative message indicating the successful completion of the utility.

Issued by NETMDF.

User Action: None.

**NETMDF-DUPLICATE CONTROL STATEMENT PARAMETER-xxxxxxx.**

Description: User specified the same parameter name more than once on the command.

Issued by NETMDF.

User Action: Correct the command.

**NETMDF-DUPLICATE FILE NAME-xxxxxxx.**

Description: A duplicate file name was detected on the command (more than one parameter had the same file name value).

Issued by NETMDF.

User Action: Supply unique file names on the command.

**NETMDF-ENTRY ALREADY EXISTS IN THE DIRECTORY. NFN =**

Description: Informative message indicating that an entry already exists in the directory for this file name.

Issued by NETMDF.

User Action: User may manually delete old entry and add new entry with NETFM. To have NETMDF automatically replace duplicate entries, specify REPLACE parameter on the command and re-execute utility. Exercise caution in the use of the REPLACE option since it will cause all duplicate entries to be overwritten by the utility. If MOVE option is also specified, duplicate permanent file names in entries will cause repeated overwrites of replaced permanent files.

**NETMDF-FILE ALREADY EXISTS IN DIRECTORY.  
NETWORK FILE NAME =**

Description: Informative message indicating that an entry already exists in the directory for this file name.

Issued by NETMDF.

User Action: You may manually delete old entry and add new entry with NETFM. To have NETMDF automatically replace duplicate entries, specify REPLACE parameter on command and re-execute utility. Warning: Use of the REPLACE option will cause all duplicate entries to be over-written by the utility.

**NETMDF-FILE COULD NOT BE MOVED DUE TO A PFM ERROR.  
NETMDF-PFN=filename, NFN -**

Description: A PFM error occurred while attempting to move the NOS permanent file filename. The network file name is listed along with the PFM error code.

Issued by NETMDF.

User Action: Correct condition causing PFM error.

**NETMDF-FILE filename NOT CATLISTABLE. FILE  
CHARACTERISTICVS NETMDF-MAY BE DIFFERENT  
FOR THE FILE MOVED TO THIS INDEX.**

Description: Informative message indicating that even though the file was moved to this index, the file characteristics may differ from the original file.

Issued by NETMDF.

User Action: None.

**NETMDF-ILLEGAL CONTROL STATEMENT PARAMETER VALUE-xxxxxxx.**

Description: The value specified was incorrect for the associate parameter.

Issued by NETMDF.



User Action: Specify a value that conforms to the parameter specifications.

**NETMDF-ILLEGAL FILE NAME-filename.**

Description: File name specified contained characters other than A through Z and 0 through 9.

Issued by NETMDF.

User Action: Correct the invalid file name on the command.

**NETMDF-ILLEGAL SEPARATOR-x.**

Description: You supplied the invalid separator x on the command invocation.

Issued by NETMDF.

User Action: Supply a correct separator.

**NETMDF-MERGE DIRECTORY FILES.**

Description: Informative message indicating the utility has been invoked.

Issued by NETMDF.

User Action: None.

**NETMDF-NFA ERROR OCCURRED. ERROR CODE=ec.**

Description: Internal error ec occurred while attempting to write an entry to the destination directory file.

Issued by NETMDF.

User Action: Inform site analyst.

**NETMDF-NUMBER OF ENTRIES ADDED TO DESTINATION- n.**

Description: Informative message indicating that n entries have been added to the destination directory.

Issued by NETMDF.

User Action: None.

**NETMDF-NUMBER OF ENTRIES IN DESTINATION DIRECTORY- n.**

Description: Informative message indicating that there are currently n entries in the destination directory.

Issued by NETMDF.

User Action: None.

**NETMDF-NUMBER OF ENTRIES IN SOURCE DIRECTORY- n.**

Description: Informative message indicating that there are currently n entries in the source directory.

Issued by NETMDF.

User Action: None.

**NETMDF-NUMBER OF ENTRIES REPLACED IN DESTINATION- n.**

Description: Informative message indicating that n entries have been replaced in the destination directory.

Issued by NETMDF.

User Action: None.

**NETMDF-NUMBER OF FILES ADDED TO DESTINATION- n.**

Description: Informative message indicating that there are n files for which entries have been added to the destination directory.

Issued by NETMDF.

User Action: None.

**NETMDF-NUMBER OF FILES IN DESTINATION DIRECTORY- n.**

Description: Informative message indicating that there are currently n files for which entries exist in the destination directory.

Issued by NETMDF.

User Action: None.

**NETMDF-NUMBER OF FILES IN SOURCE DIRECTORY- n.**

Description: Informative message indicating that there are currently n files for which entries exist in the source directory.

Issued by NETMDF.

User Action: None.

**NETMDF-NUMBER OF FILES MOVED TO DESTINATION- n.**

Description: Informative message indicating that n files have been moved from the source user to the destination user.

Issued by NETMDF.

User Action: None.

**NETMDF-NUMBER OF FILES REPLACED IN DESTINATION- n.**

Description: Informative message indicating that there are n files for which entries have been replaced in the destination directory.

Issued by NETMDF.

User Action: None.

**NETMDF-PERCENTAGE OF NEW DIRECTORY USED-xxx.**

Description: Informative message indicating the percentage of the online directory that is used following the addition of the file entries from the alternate directory.

Issued by NETMDF.

User Action: None.

**NETMDF-PFM ERROR-xxx(10).**

Description: PFM error code xxx was encountered while attempting to attach either the alternate directory or the online directory, or while trying to move a NOS permanent file.

Issued by NETMDF.

User Action: Inform site analyst. Correct condition causing PFM error.

**NETMDF-REQUIRED PARAMETER MISSING-param.**

Description: A required parameter param was not supplied on the command.

Issued by NETMDF.

User Action: Supply the missing parameter.

**NETMDF-SOURCE DIRECTORY-filename, UN=username.**

Description: Informative message indicating the source directory is on file filename under user name username.

Issued by NETMDF.

User Action: None.

**NETMDF-UNRECOGNIZED CONTROL STATEMENT PARAMETER-param.**

Description: An unrecognized parameter param was supplied on the command.

Issued by NETMDF.

User Action: Remove unrecognized parameter.

**NETMDF-VALUE NOT SPECIFIED FOR PARAMETER-param.**

Description: You did not supply a value param for a parameter that requires a value.

Issued by NETMDF.

User Action: Supply missing value.

**NETMDF-VALUE SUPPLIED FOR KEYWORD-xxxxxxx.**

Description: You supplied a value xxxxxx for a parameter that is valid only as a keyword.

Issued by NETMDF.

User Action: Remove the value supplied with the keyword.

**NETOFF COMPLETE.**

Description: Informative message indicating that TAF is no longer communicating with NAM. NAM initiated shutdown procedures prior to loss of communications.

Issued by TAF.

User Action: When NAM is available, the central site console operator command K.NAMON can be used to resume communications between TAF and NAM.

**NETON ACCEPTED.**

Description: Informative message indicating that RBF entered the network successfully.

Issued by RBF.

User Action: None.

**NETON COMPLETE.**

Description: Informative message indicating that TAF is communicating with NAM.

Issued by TAF.

User Action: None.

**NETON REJECT.**

Description: IAF was unable to connect to NAM.

Issued by IAFEX.

User Action: Take dump of network and submit PSR.

**NETON REJECTED, TVF ALREADY PRESENT.**

Description: The NETON was aborted. Routine TVF was already present when the NETON was attempted.

Issued by TVF.

User Action: None.

**NETON SECURITY VIOLATION**

Description: The application is not validated to do a NETON request. RHF aborts the application.

Issued by RHF.

User Action: None.

### **NETON WITH NIN = xxx**

Description: Informative message telling the application's owner the NIN of NIP to which it netted on.

Issued by AIP.

User Action: None.

### **NETPLM-ADDFILE EMPTY.**

Description: Informative message indicating that the Addfile appeared to be empty. This could have been caused by incorrect file positioning. NETPLM does not rewind the Addfile.

Issued by NETPLM.

User Action: Check the content and positioning of the Addfile.

### **NETPLM-CIO ERROR yyy(8) DURING READ.**

Description: CIO error code yyy was encountered during a READ operation.

Issued by NETPLM.

User Action: Inform the site analyst. Correct the condition causing the CIO error. (Refer to NOS 2 Reference Set, Vol. 4 for CIO errors.)

### **NETPLM-CIO ERROR yyy(8) DURING SKIP.**

Description: CIO error code yyy was encountered during a SKIP operation.

Issued by NETPLM.

User Action: Inform the site analyst. Correct the condition causing the CIO error. (Refer to NOS 2 Reference Set, Vol. 4 for CIO errors.)

### **NETPLM-CIO ERROR yyy(8) DURING WRITE.**

Description: CIO error code yyy was encountered during a WRITE operation.

Issued by NETPLM.

User Action: Inform the site analyst. Correct the condition causing the CIO error. (Refer to NOS 2 Reference Set, Vol. 4 for CIO errors.)

### **NETPLM-CONTROL STATEMENT ERROR-JOB ABORTED.**

Description: Informative message indicating that an error was encountered while processing the command.

Issued by NETPLM.

User Action: Correct appropriate errors.

### **NETPLM-CPU USAGE- ssssssss SECS, mmm MS.**

Description: Informative message indicating the CPU usage of the program.

Issued by NETPLM.

User Action: None.

### **NETPLM-DIRECTIVE ERROR(S).**

Description: An invalid directive was found in the directive (I) file.

Issued by NETPLM.

User Action: See the list (L) file to identify the directive errors. Correct the errors and rerun NETPLM.

### **NETPLM-DIRECTIVE FILE EMPTY.**

Description: Informative message indicating that the directive file appeared to be empty. This could have been caused by incorrect file positioning. NETPLM does not rewind the directive file.

Issued by NETPLM.

User Action: Check the content and positioning of the directive file.

### **NETPLM-DIRECTORY FILE BUSY**

Description: The network directory is busy.

Issued by NETPLM.

User Action: Wait until the file is no longer busy (NETPLM will automatically proceed as soon as the file is available) or terminate NETPLM with a User Break 2.

### **NETPLM-DUPLICATE CONTROL STATEMENT PARAMETER-xxxxxxx.**

Description: User specified the same parameter name more than once on the command.

Issued by NETPLM.

User Action: Correct the command.

### **NETPLM-ERROR(S) IN ADD FILE.**

Description: A format error was found in a procedure in the addfile (A).

Issued by NETPLM.

User Action: See the list (L) file to identify the procedure errors. Correct the errors and rerun NETPLM.

### **NETPLM-ILLEGAL FILE NAME-filename.**

Description: File name specified contained characters other than A through Z and 0 through 9.

Issued by NETPLM.

User Action: Correct incorrect file name on command.

### **NETPLM-INCORRECTLY FORMATTED PREVIOUS LIBRARY**

Description: The PL specified file is not of the correct library format.

Issued by NETPLM.

User Action: Verify the PL specified file is the correct library file.

### **NETPLM-INTERRUPT RECEIVED.**

Description: Message indicating that an interrupt was received while NETPLM was processing secure code (uninterruptible code which copies the temporary new library into the operational library).

Issued by NETPLM.

User Action: None.

### **NETPLM-LFM ERROR yyy(8) WHILE RETURNING FILE filename**

Description: LFM error code yyy was encountered during a RETURN operation on file filename.

Issued by NETPLM.

User Action: Inform the site analyst. Correct the condition causing the LFM error. (Refer to NOS 2 Reference Set, Vol. 4 for LFM errors.)

### **NETPLM-LIBRARY filename BUSY.**

Description: The operational CDCNET library's entry was found in the network directory, but the file filename could not be attached because it was busy. The file may be busy because another NETPLM is already modifying it or NETFS is accessing the library.

Issued by NETPLM.

User Action: Wait until the file is no longer busy (NETPLM will automatically proceed as soon as the file is available). If the situation persists, coordinate your activities with other NETPLM users or wait until NETFS activity subsides.

### **NETPLM-LIBRARY FILE filename NOT FOUND ON UN=username**

Description: The operational CDCNET library's entry was found in the network directory, but the library file filename could not be found on user name username.

Issued by NETPLM.

User Action: Check if the library exists and if the current user name is permitted to access the file. Ask the site administrator to correct the situation.

### **NETPLM-LIBRARY NOT FOUND IN NETWORK DIRECTORY.**

Description: The operational CDCNET library's entry could not be found in the network directory, and thus could not be accessed.

Issued by NETPLM.

User Action: Create the proper file entry in the CDCNET network directory to reference an existing library file (or build a new library if none exists).

### **NETPLM-NETFM ERROR rc ON FILE ATTACH.**

Description: NETFM reason code rc was encountered during a NETFMA operation.

Issued by NETPLM.

User Action: Inform the site analyst. Correct the condition causing the NETFM error.

### **NETPLM-NETWORK DIRECTORY NOT FOUND ON UN=username**

Description: NETPLM is unable to attach the network directory on the specified user name username. NETPLM will abort and not process the library.

Issued by NETPLM.

User Action: Check that the network directory exists and the directory file is permitted to the user name under which NETPLM is running.

### **NETPLM-NETWORK DIRECTORY NOT FOUND ON THE CURRENT USERNAME.**

Description: NETPLM is unable to attach the network directory on the current user name. NETPLM will abort and not process the library.

Issued by NETPLM.

User Action: Check that the network directory exists.

### **NETPLM-NEW LIBRARY WRITTEN ON FILE filename.**

Description: Informative message indicating the library update was completed and the resulting new library was written onto local file filename.

Issued by NETPLM.

User Action: None.

### **NETPLM-NEW LIBRARY WRITTEN ONTO CDCNET LIBRARY.**

Description: Informative message indicating the library update was completed and the resulting new library was written onto the operational CDCNET library.

Issued by NETPLM.

User Action: None.

### **NETPLM-NEW PROCEDURE LIBRARY NOT WRITTEN**

Description: Check dayfile and listing error messages to determine why NETPLM could not complete the library update.

Issued by NETPLM.

User Action: Correct any problems and rerun NETPLM.

### **NETPLM-PFM ERROR yyy(8) WHILE ATTACHING FILE filename.**

Description: PFM error code yyy was encountered during an ATTACH operation on file filename.

Issued by NETPLM.

User Action: Inform the site analyst. Correct the condition causing the PFM error. (Refer to NOS 2 Reference Set, Vol. 4 for PFM errors.)

### **NETPLM-PFM ERROR yyy(8) WHILE GETTING FILE filename**

Description: PFM error code yyy was encountered during a GET operation on file filename.

Issued by NETPLM.

User Action: Inform the site analyst. Correct the condition causing the PFM error. (Refer to NOS 2 Reference Set, Vol. 4 for PFM errors.)

### **NETPLM-PFM ERROR yyy(8) WHILE REPLACING FILE filename**

Description: PFM error code yyy was encountered during a REPLACE operation on file filename.

Issued by NETPLM.

User Action: Inform the site analyst. Correct the condition causing the PFM error. (Refer to NOS 2 Reference Set, Vol. 4 for PFM errors.)

### **NETPLM-PREVIOUS LIBRARY NOT OF THE CORRECT TYPE, ACTUAL TYPE- 'tttttt'**

Description: The library specified by the PL parameter (type tttttt) does not match that specified by the PT parameter.

Issued by NETPLM.

User Action: Verify the PL specified library file is the correct library and the PT parameter was specified correctly.

### **NETPLM-PROGRAM INTERRUPTED.**

Description: NETPLM was interrupted while processing secure code (uninterruptible code which copies the temporary new library into the operational library). The new library copy was completed and then the interrupt was processed.

Issued by NETPLM.

User Action: None.

### **NETPLM-REQUIRED PARAMETER MISSING-xxxxxxx.**

Description: A parameter that is required was not supplied on the command.

Issued by NETPLM.

User Action: Supply missing parameter.

### **NETPLM-UNKNOWN PROCEDURE TYPE - tttttt**

Description: An unknown procedure type tttttt was specified by the PT parameter.

Issued by NETPLM.

User Action: Correct the PT parameter to specify one of the valid procedure types.

### **NETPLM-UNRECOGNIZED CONTROL STATEMENT PARAMETER-xxxxxxx.**

Description: An unrecognized parameter was supplied on the command.

Issued by NETPLM.

User Action: Remove unrecognized parameter.

### **NETPLM-UPDATED LIBRARY ON FILE ZZZZZNL.**

Description: The operational procedure library was busy and could not be rewritten (the user terminated NETPLM at that point). Local file ZZZZZNL contains the new library.

Issued by NETPLM.

User Action: File ZZZZZNL may be used to manually update the operational procedure library or NETPLM may be rerun when the library is less busy. If the library is continually busy, inform the site administrator.

Caution- check that no other NETPLM update of the operational library has occurred since your NETPLM run was terminated. If another update took place, a manual update using your ZZZZZNL library will destroy those more recent updates. To avoid this, run NETPLM again (with the original changes).

### **NETPLM-VALUE NOT SPECIFIED FOR PARAMETER-xxxxxxx.**

Description: The user did not supply a value for a parameter that requires a value.

Issued by NETPLM.

User Action: Supply missing value.

### **NETRDF-BAD \*GET\* ON DIRECTORY filename.**

Description: An error occurred while attempting to read an entry from the old directory file filename.

Issued by NETRDF.

User Action: Internal error. Inform site analyst.

### **NETRDF-BAD \*OPEN\* ON DIRECTORY-filename.**

Description: A bad verification record was found in the directory file filename.

Issued by NETRDF.

User Action: Inform site analyst. The directory does not have the proper internal verification record. Either restore the permanent file from a PFU dump tape or rebuild the directory via the NETBDF utility. In the latter case, all CDCNET file entries must be recreated in the directory via NETFM.

### **NETRDF-BAD \*PUT\* ON DIRECTORY-filename.**

Description: An error occurred while attempting to write an entry to the new directory file filename.

Issued by NETRDF.

User Action: Internal error. Inform site analyst.

### **NETRDF-CANNOT ATTACH OLD DIRECTORY-filename.**

Description: An error occurred while trying to attach the old directory file filename. A PFM error code is returned.

Issued by NETRDF.

User Action: Inform site analyst. Correct condition causing PFM error.

### **NETRDF-CANNOT DEFINE NEW DIRECTORY-filename.**

Description: An error occurred while trying to define the new directory file filename. A PFM error code is reported.

Issued by NETRDF.

User Action: Inform site analyst. Correct condition causing PFM error.

### **NETRDF - CONTROL STATEMENT ERROR-JOB ABORTED.**

Description: Informative message indicating that an error was encountered while processing the command parameters.

Issued by NETMDF.

User Action: Correct the relevant errors.



### **NETRDF-CPU USAGE SECS. MS.**

Description: Informative message indicating the CPU usage of the program.

Issued by NETRDF.

User Action: Informative message indicating the CPU usage of the program.

### **NETRDF-DIRECTORY filename NOT FOUND.**

Description: The directory file filename could not be found in your NOS permanent file catalog.

Issued by NETRDF.

User Action: Inform site analyst. Execute the utility under the user name where the directory file resides.

### **NETRDF-DIRECTORY PERFORMANCE DECREASES WHEN NETRDF-SIZE EXCEEDS 80 PERCENT. A DEFAULT NETRDF-NF WILL SET DIRECTORY SIZE TO NETRDF-50 PERCENT UTILIZATION.**

Description: Informative message indicating how the utility derives the optimum size to be used in restructuring the directory.

Issued by NETRDF.

User Action: None.

### **NETRDF-DIRECTORY RESTRUCTURE COMPLETE.**

Description: Informative message indicating the successful completion of the utility.

Issued by NETRDF.

User Action: None.

### **NETRDF-DUPLICATE CONTROL STATEMENT PARAMETER-xxxxxxx.**

Description: User specified the same parameter name more than once on the command.

Issued by NETRDF.

User Action: Correct the command.

### **NETRDF-DUPLICATE FILE NAME-xxxxxxx.**

Description: A duplicate file name was detected on the command (more than one parameter had the same file name value).

Issued by NETRDF.

User Action: Supply unique file names on the command.

### **NETRDF-ILLEGAL CONTROL STATEMENT PARAMETER VALUE-xxxxxxx.**

Description: The value specified was incorrect for the associate parameter.

Issued by NETRDF.

User Action: Specify a value that conforms to the parameter specifications.

### **NETRDF-ILLEGAL FILE NAME-filename.**

Description: File name specified contained characters other than A through Z and 0 through 9.

Issued by NETRDF.

User Action: Correct the invalid file name on the command.

**NETRDF-ILLEGAL SEPARATOR-\*x\*.**

Description: The user supplied the invalid separator x on the command invocation.

Issued by NETRDF.

User Action: Supply a correct separator.

**NETRDF-NUMBER OF ENTRIES IN DIRECTORY- n.**

Description: Informative message indicating that there are currently n entries existing in the directory.

Issued by NETRDF.

User Action: None.

**NETRDF-NUMBER OF FILES IN DIRECTORY.**

Description: Informative message indicating that there are currently files for which entries exist in the directory.

Issued by NETRDF.

User Action: None.

**NETRDF-PERCENTAGE OF NEW DIRECTORY USED-xxx.**

Description: Informative message indicating the percentage of the new directory that is used.

Issued by NETRDF.

User Action: None.

**NETRDF-PERCENTAGE OF OLD DIRECTORY USED-xxx.**

Description: Informative message indicating the percentage of the old directory that is used.

Issued by NETRDF.

User Action: None.

**NETRDF-PFM ERROR-xxx(10), FILE-filename.**

Description: PFM error code xxx was encountered during an ATTACH, DEFINE, or CHANGE command on file filename.

Issued by NETRDF.

User Action: Inform site analyst. Correct condition causing PFM error.

**NETRDF-REQUIRED PARAMETER MISSING-param.**

Description: A required parameter param was not supplied on the command.

Issued by NETRDF.

User Action: Supply the missing parameter.

**NETRDF-RESTRUCTURE DIRECTORY FILE.**

Description: Informative message indicating the utility has been invoked.

Issued by NETRDF.

User Action: None.

**NETRDF-UNRECOGNIZED CONTROL STATEMENT  
PARAMETER-param.**

Description: An unrecognized parameter param was supplied on the command.

Issued by NETRDF.

User Action: Remove unrecognized

parameter.

**NETRDF-VALUE NOT SPECIFIED FOR  
PARAMETER-param.**

Description: You did not supply a value param for a parameter that requires a value.

Issued by NETRDF.

User Action: Supply missing value.

**NETRDF-VALUE SUPPLIED FOR KEYWORD-xxxxxxx.**

Description: You supplied a value xxxxxxx for a parameter that is valid only as a keyword.

Issued by NETRDF.

User Action: Remove the value supplied with the keyword.

**NETWORK ACTIVITY TABLE OVERFLOW.**

Description: Space sufficient to allocate the required table during IAF initialization was not available. An internal change to IAF is necessary.

Issued by IAFEX.

User Action: Contact CYBER Software Support.

**NETWORK CONNECTION ACCEPTED.**

Description: NLTERM has accepted the connection from the network.

Issued by NETLS.

User Action: None.

**NETWORK CONNECTION ENDED.**

Description: The connection with the network is now ended.

Issued by NLTERM.

User Action: None.

**NETWORK CONNECTION ENDED BY NETLS.**

Description: The log server is in the process of returning the log file. The function of the connection with NLTERM is complete and the connection is ended by the log server.

Issued by NLTERM.

User Action: None.

**NETWORK CONNECTION INITIALIZED.**

Description: NLTERM has initialized the connection to the network.

Issued by NLTERM.

User Action: None.

**NETWORK CONNECTION LOST.**

Description: Incomplete status received from network.

Issued by IAFEX.

User Action: Take dump of network and submit PSR.

**NETWORK CONNECTION TO NETLS TERMINATED PREMATURELY.**

Description: The connection being established by NLTERM to the log server was terminated before the connection was initialized. This could mean that the log server is no longer executing. Log file termination continues.

Issued by NLTERM.

User Action: None, unless the log server terminated abnormally.

### **NETWORK DIRECTORY BUSY, WAITING FOR ACCESS**

Description: The network directory is busy.

Issued by NETPLM.

User Action: Wait until the file is no longer busy (NETPLM will automatically proceed as soon as the file is available) or terminate NETPLM with a User Break 2.

### **NETWORK FILE NOT FOUND - filename.**

Description: The network description file, NCTFi, could not be found.

Issued by TAFREC.

User Action: Check that correct parameters were specified on the NETWORK directive corresponding to filename.

### **NETWORK IDLE DOWN IN PROGRESS.**

Description: The network is in the process of shutting down. The network connection will be ended but log file termination continues.

Issued by NLTERM.

User Action: None.

### **NETWORK INVOCATION NUMBER nin**

Description: Issued each time the NIN (network invocation number) nin is changed. This number changes when first read from the memory file.

Issued by NAMI.

User Action: None.

### **NETWORK NETON ERROR, APPLICATION DISABLED.**

Description: NLTERM has been disabled by the network operator. NLTERM terminates abnormally.

Issued by NLTERM.

User Action: The name of the currently active log file has been changed and will need to be terminated using the TERM command.

### **NETWORK NETON ERROR, DUPLICATE NETON.**

Description: Two copies of NLTERM are executing at the same time and both are trying to terminate the currently active log file. NLTERM terminates abnormally.

Issued by NLTERM.

User Action: The new log file name that the log server created (as a result of the other copy of NLTERM terminating the log file) has been changed and will need to be terminated using the TERM command.

### **NETWORK NETON SUCCESSFUL.**

Description: NLTERM has successfully signed on to the network.

Issued by NLTERM.

User Action: None.

### **NETWORK NETON UNSUCCESSFUL, NAM IS UNAVAILABLE.**

Description: During log file termination processing, NLTERM is unable to NETON to the network to communicate to the log server to release the currently active log file. Termination will still be attempted.

Issued by NLTERM.

User Action: None, unless termination of the file is unsuccessful. Then the TERM command can be used to complete the termination of this file.

### **NETWORK NETON UNSUCCESSFUL, NAM IS BUSY.**

Description: NLTERM is unable to NETON to the network to communicate to the log server to release the currently active log file that is to be terminated. Termination will still be attempted.

Issued by NLTERM.

User Action: None, unless termination of the file is unsuccessful. Then the TERM command can be used to complete the termination of this file.

### **NETWORK PROTOCOL ERROR, REASON CODE IS rc.**

Description: A protocol error occurred (with reason code rc) during communication with the network. NLTERM terminates abnormally.

Issued by NLTERM.

User Action: The name of the currently active log file has been changed and will need to be terminated using the TERM command. Consult the site analyst regarding the protocol error.

### **NETWORK REQUESTED IMMEDIATE SHUTDOWN.**

Description: The network is shutting down immediately. NLTERM terminates abnormally.

Issued by NLTERM.

User Action: The name of the currently active log file has been changed and will need to be terminated using the TERM command.

### **NETWORK SHUT DOWN DETECTED.**

Description: Self-explanatory.

Issued by TAF.

User Action: None.

### **NETWORK SHUTDOWN COMPLETE.**

Description: All network users have been detached.

Issued by IAFEX.

User Action: None.

### **NETWORK SHUTDOWN - PLEASE LOGOUT.**

Description: NAM is going to be going down.

Issued by IAFEX.

User Action: Log off.

### **NETWORK TYPE DOES NOT SUPPORT ATTRIBUTE COMMAND.**

Description: You are attempting to enter NAM/CDCNET commands from a NAM/CCP connection.

Issued by TRMDEF.

User Action: Ensure that the attributes you are trying to change can be changed in your network by TRMDEF.

### **NEW CHECKSUM MISMATCH**

Description: The checksum of the deck after modification did not match the expected checksum.

Issued by BINEDIT.

User Action: Verify that the changes requested were correct.

### **NEW DESTINATION USER/FAMILY INVALID.**

Description: K display message indicating that the user name specified by NUN is not on the VALIDUs file in the family specified by NDF.

Issued by QFTLIST.

User Action: Ensure accuracy of NUN and NDF parameters and rerun.

### **NEXTVSN,EST,VSN TO CONTINUE.**

Description: A job encountered an end-of-reel condition on a tape file, but the user did not specify the VSN of the next reel. This message appears on the DSD E,P display.

Issued by MAGNET.

User Action: Enter the DSD command NEXTVSN,est,vsn to specify the VSN of the tape on which to continue operations.

### **NIP DUMP TAKEN.**

Description: NIP detected potential operating system problem (that is, bad reason code from operating system). NIP will take an internal dump.

Issued by NIP.

User Action: None.

### **NIP DUMP TAKEN - nnn.**

Description: An internal NAM dump with a dump index of nnn was taken.

Issued by NIP.

User Action: None.

### **NIP FATAL ERROR PROC = name.**

Description: NIP has detected a fatal error and will abort after taking a dump. This message usually indicates an internal problem within NIP or the operating system.

name First 4 characters of the NIP procedure from which the message was issued

Issued by NIP.

User Action: Reinitialize NAM. Run collector job. Save COLLECT tape and contact CYBER Software Support.

### **NIP/HGETNWL - BAD NWL BUFFER.**

Description: Buffer reserved for incoming network worklist is inoperative.

Issued by NIP.

User Action: Reinitialize NAM. Run collector job. Save COLLECT tape and contact CYBER Software Support.

### **NIP INTERNAL ERROR - rname.**

Description: NIP internal error in routine rname. If DEBUG is on, NIP aborts.

Issued by NIP.

User Action: Reinitialize NAM. Run collector job. Save COLLECT tape and contact CYBER Software Support.

### **NIP/NETWORK PROTOCOL VIOLATION.**

Description: NIP received NPI/DD from another NIP. In debug, NIP will abort.

Issued by NIP.

User Action: Reinitialize NAM. Run collector job. Save COLLECT tape and contact CYBER Software Support.

## **NIP RECEIVED BAD BSN.**

Description: Informative message indicating that the block sequence number that NAM expected and what it actually received were different. If compiled with DEBUG on, NIP aborts; otherwise, NIP continues.

Issued by NIP.

User Action: None.

## **NIP RECEIVED DBG/STOP.**

Description: DBG/STOP sent to NIP indicates a NAM problem. NIP will abort if DEBUG is on.

Issued by NIP.

User Action: Supply dumps to site analyst.

## **NIP/REGLL DN=xx SN=yy RL=z**

Description: Dayfile message indicating the level of the available buffer space in the NPU or DI. This message is generated whenever the host receives a REGLL supervisory message from an NPU or DI.

xx Destination node number in the REGLL message.

yy Source node number in the REGLL message.

If the REGLL message is from a NPU, the regulation level z is one of the following:

- 0 Logical link is down.
- 1 Number of buffers available < 30. Only supervisory messages allowed.
- 2 Number of buffers available < 40. Only supervisory messages and high priority data allowed.
- 3 Number of buffers available > 50. Normal case.

If the REGLL message is from a DI, the regulation level z is one of the following:

- 0 Logical link is down.
- 1 Buffer space is almost full.
- 2 Only 20% buffer space is available.
- 3 Buffer space is normal and about 40% space is still available.

Issued by NIP.

User Action: None.

## **NIP/SCP ERROR RC=ec JOBID=jobid.**

Description: Informative message indicating that NIP has received an error response with code ec from the operating system as the result of a system control point call. NIP takes a dump; if DEBUG is on and the error was fatal, NIP aborts. Fatal error codes usually indicate an internal problem within NIP or the operating system.

ec Error code which caused response

- 41 Invalid job identifier; fatal.
- 42 Bad NIP address; fatal.
- 43 Application passed bad address to NIP; fatal for application.
- 44 Application rolled out; nonfatal.
- 45 Specified application is not found in system; nonfatal.
- 57 Long term connection already exists between NIP and application; fatal.
- 60 Long term connection request rejected; fatal.
- 61 Long term connection does not exist between NIP and application; fatal.
- 62 Number of words transferred between subsystem and application is over allowed limit; fatal.
- 63 Short term connection does not exist between NIP and application; fatal or nonfatal.
- 64 NIP is not established with application; fatal.
- 65 NIP attempted to set incorrect error flag; fatal.
- 66 NIP attempted to set incorrect dayfile processing flag; fatal.
- jobid Job identifier passed to NIP from the operating system

Issued by NIP.

User Action: Supply dumps to site analyst.

**NIP/SST RC=ec, JOBID=jobid.**

Description: NIP received an error response with code ec from the operating system as a result of issuing a SST call to transfer a file to or from the application's control point. If the returned error code indicates a NIP error or an operating system error, NIP aborts; otherwise NIP continues.

ec	Error code.
1	The file FNT entry was busy. If the request was to transfer a file from the application's control point, the error is nonfatal. If the request was to transfer a file to the application's control point, the error is fatal.
2	The application was swapped out; nonfatal error.
3	The file FNT entry was an invalid file type. If the request was to transfer a file from the application's control point, the error is nonfatal. If the request was to transfer a file to the application's control point, the error is fatal.
4	The specified application was not found in the system; nonfatal error.
5	The application's FNT space was filled; nonfatal error.
6	The control point's assigned file limit was reached; nonfatal error.
7	The specified file FNT entry was not found in the system; fatal error.
jobid	The job identifier of the application to or from which a file is to be transferred.

Issued by NIP.

User Action: Reinitialize NAM. Rerun collector job. Supply dumps or collector tape to analyst.

**NIP/hcSTTP ERR AN=app, CN=cn, tn,state.**

Description: NIP Internal error in the state table. NIP aborts.

hc	Name of the host state table (HC/HB)
app	Application number.
cn	Connection number.
tn	Trigger number.
state	State of the connection.

Issued by NIP.

User Action: Reinitialize NAM. Run collector job. Save COLLECT tape and contact CYBER Software Support.

**NIP/ncSTTP ERR HN=hnode, TN=tnode,  
ncn,tn,state.**

Description: NIP internal error in the state table. NIP aborts.

nc	Name of the network state table (NC/NB).
hnode	Host node.
tnode	Terminal node.
ncn	Network connection number.
tn	Trigger number.
state	State of the connection.

Issued by NIP.

User Action: Reinitialize NAM. Run collector job. Save COLLECT tape and contact CYBER Software Support.



### **NIP UNABLE TO FIND FAILED APP jobid.**

Description: Informative message indicating the operating system informed NIP that an application failed but NIP is unable to locate the application specified. NIP assumes the application is not on the network or has already terminated.

jobid Job identifier passed to NIP  
from the operating system

Issued by NIP.

User Action: None.

### **NLD01 - FET ADDRESS ERROR.**

Description: The calling program specified a FET pointer that was not within the calling program's field length.

Issued by NLD.

User Action: Inform site analyst.

### **NLD02 - NOT CALLED FROM SYSTEM LIBRARY.**

Description: The calling program did not have system origin privileges.

Issued by NLD.

User Action: Inform site analyst.

### **NLD03 - INVALID FUNCTION CODE.**

Description: The calling program specified a function code that does not exist.

Issued by NLD.

User Action: Inform site analyst.

### **NLD05 - BUFFER ARGUMENT ERROR.**

Description: The calling program specified a FET buffer pointer that was not valid.

Issued by NLD.

User Action: Inform site analyst.

### **NLD06 - ABORTED BY SYSTEM.**

Description: One of the error flags in the calling program's control point area was set.

Issued by NLD.

User Action: None.

### **NLF IS NOT AVAILABLE.**

Description: The alternate load file specified in the change NPU (network processing unit) load file command is not available. The alternate load file must exist as a direct access file in the permanent file catalog.

Issued by NS.

User Action: None.

### **NLF IS NOT SPECIFIED.**

Description: The NLF parameter is missing in the change NPU (network processing unit) load file command.

Issued by NS.

User Action: Reenter the command with correct parameter.

### **NM=filename.**

Description: File filename is not found on deadstart device.

Issued by CDX.

User Action: Redeadstart. If message persists, inform site analyst.

### **NM REDUCTION INCORRECT - filename.**

Description: The maximum number of user messages, specified by the NM parameter on the RECOVER directive, was less than the actual number of user messages on the named CRF.

Issued by TAFREC.

User Action: Correct the RECOVER directive or select initialization of the named CRF via the K.INT initial K display command if reducing the number of user messages is actually required. (Note that K.INT will destroy the current recovery information).

### **NO ACTIVE DAYFILE FOUND.**

Description: An active dayfile of the specified type was not found in the QFSP equipment table.

Issued by DFTERM.

User Action: Stop this DFTERM run, start another DFTERM run, and retry the operation. If the error still exists, check system for loss of dayfile.

### **NO ACTIVE DISK BUFFERS.**

Description: No disk buffers in extended memory have nonzero activity counts in their corresponding control buffer table entries.

Issued by DSDI.

User Action: None.

### **NO ACTIVE DRIVERS REMAINING.**

Description: All available drivers, network and multiplexor, have dropped. This can be the result of a hardware failure or because a driver never becomes active after initialization, and the other drivers do not have terminals defined (nonexistent or off EST entry).

Issued by IAFEX.

User Action: Check driver EST entries to ensure they are on. If the problem still persists, contact CYBER Software Support.

### **NO ACTIVITY ON NETWORK CONNECTION.**

Description: NLTERM has not received any supervisory messages in a length of time determined in NLTERM. NLTERM terminates abnormally.

Issued by NLTERM.

User Action: This may indicate an internal error in NLTERM. Consult the site analyst to see if other applications are communicating with the network or if something is wrong with the system.

### **NO ALTERNATE KEY SPECIFIED ON IXN CARD.**

Description: Self-explanatory.

Issued by DMREC.

User Action: Correct the IXN statement and try again.

### **NO ALTERNATE STORAGE COPY OF FILE.**

Description: The disk space for the file cannot be released because the alternate storage image is labeled obsolete or the alternate storage address is not specified in the permanent file catalog.

Issued by PFM.

User Action: None.

### **NO APPLICATION ALERT PENDING.**

Description: AP or IG was entered without an application name while there is no application in alert status.

Issued by NIP.

User Action: None.

### **NO APPLICATION IN ALERT Q.**

Description: AP or IG was entered without an application name. There is no application in ALERT status.

Issued by NIP.

User Action: Enter the application name.

### **NO ARF DUMP ENTRIES - DUMP IGNORED.**

Description: When trying to build directory entries for an ARF dump function, no ARF file was found.

Issued by DMREC.

User Action: Include ARF file name on dump.

### **NO ARF DUMP ENTRIES IN DIRECTORY.**

Description: A search of the directory for the targeted VSNs of ARF tapes was unsuccessful.

Issued by DMREC.

User Action: Check time and data or VSN used to delineate update.

### **NO BITS SPECIFIED.**

Description: Dayfile message indicating that no bit numbers were specified on a SET or a CLEAR command.

Issued by SCRSIM.

User Action: Correct and reenter.

### **NO BUFFERED DEVICES DEFINED.**

Description: Disk buffers are not defined on the dump file.

Issued by DSDI.

User Action: Ensure that the dump file contains meaningful information.

### **NO C. B. AVAILABLE TO SCHEDULE CTASK.**

Description: Communication block not available to schedule CTASK.

Issued by TAF.

User Action: Increase the number of communication blocks at initialization time using the K.MCB= command.

### **NO CHANNEL LOAD REQUEST**

Description: Channel was not specified on the LOADBC command and channel controlware load request was not found in the channel table.

Issued by LOADBC.

User Action: Correct and retry.

### **\*\*\*\* NO CHARGE NUMBER IN EFFECT.**

Description: Output file message indicating that a charge number must be in effect before any charge value or project directives can be processed.

Issued by PROFILE.

User Action: Enter a correct charge number directive before proceeding.

### **NO CONTROLWARE ON CHANNEL.**

Description: The channel controlware table indicates that no controlware exists on the requested channel.

Issued by LOADBC.

User Action: Check the C=cc parameter on the LOADBC command and retry.

### **NO CPP AVAILABLE.**

Description: STL could not find a concurrent PP to load the 895 driver.

Issued by STL.

User Action: Check hardware configuration.

### **NO CRM STATEMENT FOUND IN xxJ FILE.**

Description: Self-explanatory.

Issued by DMREC.

User Action: Correct the CRM statement and try again.

### **NO DATA BASE ID FOR DATA MANAGER.**

Description: At least one database identifier must be specified on each active (ON) DMS statement.

Issued by TAF.

User Action: Add database identifier to DMS statements or specify status as OFF.

### **NO DATA BASE NAME IN xxJ FOR TOTAL.**

Description: Self-explanatory.

Issued by TAF.

User Action: Add database name to xxJ file.

### **NO DATA FOUND FOR USER NAME.**

Description: RECLAIM could not find the calling user in the directory of the database.

Issued by RECLAIM.

User Action: Check for correct database file specification.

### **NO DAYFILE FOUND.**

Description: Dayfile for job does not exist.

Issued by QDSPLAY.

User Action: None.

### **NO DEVICES IN THE FAMILY.**

Description: The family specified by the FM parameter on the SSMOVE command has no devices on line.

Issued by SSMOVE.

User Action: Bring the devices on line or specify a different family.

### **NO DIRECTIVES PROCESSED.**

Description: No directives were specified on the DSDI command.

Issued by DSDI.

User Action: Reenter command with directives specified.

### **NO DUMP FILE FOR xx est IS AVAILABLE.**

Description: All file names for the dump file prefix and network invocation number specified on the INITMDI command are in use. A load will be attempted if requested.

xx Device mnemonic specified by the DT parameter.  
est EST ordinal of MDI.

Issued by INITMDI.

User Action: Purge any dump file not specifically needed or inform the site analyst.

### **NO DUMP RECORD WITH SPECIFIED VSN.**

Description: DMREC could not locate a dump record with the specified VSN.

Issued by DMREC.

User Action: Check directory with list directive for proper VSN.

### **NO EMPTY CARTRIDGES IN GROUP.**

Description: There are no empty cartridges in the specified group.

Issued by SSLABEL.

User Action: Let the group parameter default by not specifying it or specify another group and retry.

### **NO EMPTY CUBE IN FAMILY/POOL.**

Description: Empty cubicles assigned to the family/pool are needed so that the directive to SSLABEL can be processed.

Issued by SSLABEL.

User Action: Assign more cubicles to the family/pool or change the directive.

### **NO EMPTY CUBES. NUMBER PROCESSED=n.**

Description: There are no more empty cubicles in the family/pool/reserved area. The RB directive to SSLABEL could remove only n cubicles.

Issued by SSLABEL.

User Action: None.

### **NO ENTRIES FOUND.**

Description: No entries found (PF and NF not specified).

Issued by NETFMA.

User Action: Inform site analyst.

### **NO EQUIPMENT AVAILABLE.**

Description: BIO determined that no equipment (card reader, card punch, and/or line printer) is defined in system.

Issued by IIO.

User Action: System must be deadstarted to define equipment in EST.

### **divnam-NO ERRORS ENCOUNTERED.**

Description: A properly verified network and/or local configuration file has been created or listed from the indicated division by the NDL processor.

Issued by DAYNNO.

User Action: None.

### **filename - NO ERRORS ENCOUNTERED.**

Description: There were no errors in this division and the configuration file which was created is valid.

Issued by NDLP.

User Action: None.

### **NO ERRORS REPORTED IN MAINTENANCE REGISTERS.**

Description: No BML messages were written to the Binary Maintenance Log (BML) register file because no errors were reported in the status summary registers.

Issued by DSDI.

User Action: None.

### **NO FILE NAME SPECIFIED ON CRM CARD.**

Description: A CRM statement in the xxJ file did not contain a file name.

Issued by DMREC.

User Action: Correct the xxJ file and try again.

### **NO FILE NAME SPECIFIED ON IXN CARD.**

Description: The xxJ file has an IXN statement that does not contain a file name.

Issued by DMREC.

User Action: Correct IXN statement on xxJ file and rerun.

### **NO FILES FOUND FOR SPECIFIED DUMP FILE.**

Description: For a COPY, LOAD, or LIST directive, no entries were found in the database for the dump tape or file specified. RECLAIM may try to read the dump file and enter it into the database.

Issued by RECLAIM.

User Action: Check your database file specification.

### **NO FILES PROCESSED.**

Description: Informative message indicating that no files have been cataloged during the utility run.

Issued by PFCAT.

User Action: None.

### **NO FILES SELECTED FOR DESTAGE.**

Description: Either no files met the selection criteria or none of the selected files can be dumped without exceeding the maximum specified by the DL option.

Issued by GENPFD.

User Action: If it is desirable to proceed even though the criteria specified cannot be met, it will be necessary to change the criteria sufficiently to allow action.

### **NO FILES SELECTED FOR RELEASE.**

Description: Either no files met the selection criteria or none of the selected files can be dumped without exceeding the maximum specified by the DL option.

Issued by GENPFD.

User Action: If it desirable to proceed even though the criteria specified cannot be met, it will be necessary to change the criteria sufficiently to allow action.

### **NO FILES TO DUMP.**

Description: No files have been specified on a dump directive.

Issued by DMREC.

User Action: Include file name on directive.

### **NO GENERAL STATUS RECEIVED.**

Description: After the function was performed, no status word was received.

Issued by LOADBC.

User Action: Inform customer engineer.

### **NO H-H LOGICAL LINK TO DESTINATION.**

Description: SEND command cannot be processed because there is not host-host logical link to the destination host.

Issued by NIP.

User Action: None.

### **NO I/O BUFFERS DEFINED.**

Description: No I/O buffers are allocated on the XM EQPDECK entry.

Issued by SET.

User Action: Correct the XM EQPDECK entry.

### **NO INACTIVE QUEUED FILES PRESENT.**

Description: No inactive queues were found during the processing of a LIST command.

Issued by QREC.

User Action: None.

### **NO INACTIVE QUEUES ON DEVICE.**

Description: Informative message indicating that the LIST command failed to find any inactive queued files on the device specified on the K display by the FM/DN parameter.

Issued by QREC.

User Action: None.

### **NO INITIALIZE REQUESTS SET FOR MSI.**

Description: MSI was called by some means other than the INITIALIZE command (for example, X.MSI.), and initialize status is not currently set for any mass storage devices.

Issued by MSI.

User Action: None.

### **NO INPUT FILE SPACE AVAILABLE**

Description: The system was unable to find a TEMP device with enough space to create an input file (all TEMP devices are at TRACK LIMIT).

Issued by IDS.

User Action: Try to free TRACK LIMIT condition by dropping jobs. A level 0 deadstart may be required.

### **NO INTERLOCK.**

Description: PIP did not acknowledge a NIP interlock request within two seconds.

Issued by NIP.

User Action: Contact CYBER Software Support.

### **NO KEY LENGTH SPECIFIED ON CRM CARD.**

Description: The KL parameter on the CRM statement was not specified.

Issued by DMREC.

User Action: Correct the CRM statement and try again.

### **NO LINK DEVICE DEFINED.**

Description: A link device (extended memory) was not identified in EQPDECK during an attempt to deadstart into a multimainframe environment or extended memory was DOWNed while in multimainframe mode.

Issued by SET.

User Action: Redeadstart and identify the link device (define extended memory).

### **NO LOG FILE EXISTS TO BE TERMINATED.**

Description: There is currently no active network log file to be terminated.

Issued by NLTERM.

User Action: Wait for a log file to become active.

### **NO MANUFACTURER OR SCRATCH LABEL.**

Description: The cartridge to be added has a label of unknown type.

Issued by SSLABEL.

User Action: Discard the cartridge or use the FX directive to SSLABEL to restore the label.

### **NO MATCH ON FAMILY/SUBFAMILY.**

Description: The family name or subfamily name in the cartridge label does not agree with the values specified in the directive to SSLABEL.

Issued by SSLABEL.

User Action: Try restoring the cartridge or use correct family name and subfamily name.

### **NO MAXIMUM RECORD LENGTH SPECIFIED ON CRM CARD.**

Description: The MRL parameter on the CRM statement was not specified.

Issued by DMREC.

User Action: Correct the CRM statement and try again.

### **\*\*\* NO MEANINGFUL DATA IN BUFFER \*\*\***

Description: The file 1 register flag indicated that the selected buffer contains no meaningful data.

Issued by NDA.

User Action: None.

### **NO MONITOR RESPONSE.**

Description: A software or hardware failure has occurred. If the system has stopped running, there is a communication failure with CPU or PP monitor.

Issued by DSD.

User Action: Inform site analyst. If system processing has stopped, deadstart is necessary. If the system continues to run, possible causes (such as PP saturation) should be investigated.

### **NO MORE SPACE FOR NETON**

Description: All allowable applications with the requested application name are netted on.

Issued by RHF.

User Action: Retry the NETON request later.



### **NO NAME DIRECTIVE**

Description: A NAME directive must appear before the CHKSUM, REPLACE, and modification directives.

Issued by BINEDIT.

User Action: Ensure that a NAME directive precedes the other directives and retry.

### **NO NPUS ARE BEING SUPERVISED.**

Description: A CONTROL,NPUS or CONTROL,AUTO was entered as a command and CS does not currently supervise any NPUs.

Issued by CS.

User Action: None.

### **NO NPUS UNDER YOUR CONTROL.**

Description: An attempt was made to release all NPUs under the control of the operator, but no NPUs are currently being controlled by him/her.

Issued by CS.

User Action: None.

### **NO ONLINE DIAGNOSTICS PRESENT.**

Description: An online diagnostic test request command was entered for NPU without online diagnostic test capability.

Issued by CS.

User Action: None.

### **NO OUTPUT FILE EXISTING.**

Description: K-display message indicating that no output file was created before the OUT command was entered.

Issued by DFTERM.

User Action: None.

### **NO OUTPUT FILE EXISTS.**

Description: K display message indicating that no output file was created before the OUT command was entered.

Issued by QDUMP.

User Action: None.

### **NO OUTPUT FILE PRESENT.**

Description: The OUT command was entered but QLOAD could not find an output file to release.

Issued by QLOAD.

User Action: Create an output file and retry operation.

### **NO OUTPUT FILE PRESENT.**

Description: Informative message to dayfile.

Issued by QREC.

User Action: None.

### **NO PAPER.**

Description: I-display message indicating printer is out of paper.

Issued by DSD.

User Action: Check printer.

**NO PAPER.**

Description: I-display message. The printer has a paper out condition.

Issued by 1CD.

User Action: Replenish the paper supply and ready the printer.

**NO PERMANENT DAYFILES.**

Description: Informative message indicating that no permanent dayfiles exist on any permanent file device.

Issued by DFTERM.

User Action: None.

**NO PERMIT GO,est TO BLANK.**

Description: User is not permitted to access the data on the mounted tape, which was allocated from the scratch pool of the NOS Tape Management System (TMS).

Issued by: MAGNET

User Action: To write blank labels on the reel so that the tape can be accessed by the job, enter GO,est. To unload the reel and prevent access by the job, enter STOP,est.

**NO \*PROBE\* DATA AVAILABLE.**

Description: The system failed to return any data. No report will be generated, nor will a file be created.

Issued by PROBE.

User Action: Ensure that PROBE was enabled at deadstart time.

**NO \*PROBE\* DATA ON FILE.**

Description: The file specified by the B option on the command has no PROBE data.

Issued by PROBE.

User Action: Check file for correctness.

**\*\*\*\* NO PROJECT NUMBER IN EFFECT.**

Description: Output file message indicating that a project number must be in effect before any project value directives can be processed.

Issued by PROFILE.

User Action: Enter a project number directive before proceeding.

**NO QUEUED FILES FOUND.**

Description: No queued files meet the specified selection criteria.

Issued by QFTLIST.

User Action: Ensure that correct selection criteria were entered and rerun.

**NO RECORD FOUND FOR GIVEN VSN - DATE/TIME.**

Description: The file specified or implied on the load cannot be found on the directory.

Issued by DMREC.

User Action: Check load directive for correct file loading parameters.

**NO REPLACE DIRECTIVE**

Description: The user must specify a REPLACE directive.

Issued by BINEDIT.

User Action: Specify a REPLACE directive and retry.

### **NO REPORT GENERATED.**

Description: The L option on the command was set to 0.

Issued by PROBE.

User Action: None.

### **NO SCR ON MAINFRAME.**

Description: The user entered SCRSIM on a mainframe that does not support a status/control register or a status/control register simulator.

Issued by SCRSIM.

User Action: None.

### **NO SHARED DEVICES FOR THIS MACHINE.**

Description: The machine on which MREC is being run is not in multimainframe mode; therefore, it cannot access any devices on an inoperative machine.

Issued by MREC.

User Action: None.

### **NO SPACE AVAILABLE.**

Description: No room exists in the LID table to add a LID for the specified PID.

Issued by LIDOU.

User Action: Contact the site analyst to arrange for a larger LID table or delete some LIDs from the table.

### **NO SPACE FOR ARF/BRF BUFFER.**

Description: No space was available for an ARF or BRF buffer.

Issued by DMREC.

User Action: Increase field length of DMREC.

### **NO SPACE IN DIT.**

Description: More than sixteen mainframes are trying to access this independent shared device.

Issued by MSM.

User Action: Contact CYBER Software Support.

### **NO STATISTICAL AREA DATA ON FILE.**

Description: The file specified by the B option on the command has no statistical data area data.

Issued by PROBE.

User Action: Check file for correctness.

### **NO SUCH APPLICATION ON HOST NOW.**

Description: AP=appnam was entered and there is not an application appname netted-on.

Issued by NIP.

User Action: None.

### **NO SUCH SMMAP OR SUBCATALOG.**

Description: The SM specified by the SM parameter is not assigned to the subfamily name specified by the SB parameter.

Issued by SSLABEL.

User Action: Correct the SM and/or SB parameter on the SSLABEL command.

### **NO SUCH SUBCATALOG.**

Description: The SM specified by the SM parameter is not assigned to the subfamilyname specified by the SB parameter.

Issued by SSDEBUG.

User Action: Correct the SM and/or SB parameter.

### **NO SYSTEM DEVICE DEFINED.**

Description: Operator message indicating that the mass storage device on which the system is to reside has not been identified.

Issued by SET.

User Action: Define the system device with the SYSTEM=n. command.

### **NO TAPE EQUIPMENT.**

Description: There is no magnetic tape equipment currently defined in the system.

Issued by 1MT.

User Action: Inform site analyst.

### **NO TAPE FILES RECOVERED**

Description: See nn tape files recovered.

Issued by MAGNET.

User Action: None.

### **NO TERM UNDER THIS USER.**

Description: Host operator entered a command to get the status of all terminals that this user is logged into, but there is no terminal under this user.

Issued by NVF.

User Action: Select another user and reenter command.

### **NO TERM/USER CONNECTED TO THIS APPLICATION.**

Description: Host operator entered a command to get the status of all terminals/users connected to a specific application, but there is no terminal/user connected to this application.

Issued by NVF.

User Action: Select another application and reenter the command.

### **NO TERMINALS DEFINED.**

Description: A terminal count of zero was determined during IAF initialization.

Issued by IAFEX.

User Action: Check which devices are on in the EST; at least one TT device or NP device or ND device must be on.

### **NO TERMINALS IN NETWORK FILE - filename.**

Description: A valid network file was found but no transaction terminals were defined in it.

Issued by TAFREC.

User Action: Ensure the network file is correctly named. The network file is NCTFi (i=id specified on the network directive in the TCF).

### **NO TERMINATOR**

Description: The last word of each modification directive must terminate with a nonblank separator in or before column 72. If this is the last modification line, the terminator must be a period. If it is a continuation line, the terminator must be a nonblank separator other than a period.

Issued by BINEDIT.

User Action: Ensure that all modification directives have proper terminators and retry.

### **NO TTYS ASSIGNED.**

Description: There are no terminals assigned to the sessions.

Issued by STIMULA.

User Action: Enter assigned terminals using the MX directive.

### **\*\*\*\* NO USER INDICES AVAILABLE.**

Description: Output file message indicating that no more user indices are available for automatic assignment. If entered from the K display, the line of input on which the error occurred is disregarded; otherwise, that particular user name is disregarded.

Issued by MODVAL.

User Action: Rerun the corrected job or correct the new validation file using the FUI directive (force user index to be inserted or changed) to specify user indices.

### **NO USER STATEMENT IN xxJ FILE.**

Description: The USER statement in the xxJ file is not present, causing the transaction subsystem to abort.

Issued by TAF.

User Action: Add USER statement in xxJ file. Inform the TAF database administrator.

### **NO USER STATEMENT IN xxJ FILE.**

Description: No user statement exists on the xxJ file.

Issued by DMREC.

User Action: Correct the xxJ file and rerun.

### **NO VALID DUMP FOUND ON DUMP FILE.**

Description: For a COPY, LOAD, or LIST operation, RECLAIM determined that the file was not a RECLAIM dump file; the directive that caused this message is ignored.

Issued by RECLAIM.

User Action: None.

### **NO VERSION DATA ON FILE.**

Description: The file specified by the B option on the command has no version data.

Issued by PROBE.

User Action: Check file for correctness.

### **NO 52 TABLE IN CONTROLWARE RECORD.**

Description: The controlware read from the specified file (system file by default or F=filename) did not contain a 52 table entry.

Issued by LOADBC.

User Action: Check the controlware file being used.

### **NO 77 TABLE IN CONTROLWARE RECORD.**

Description: The controlware read from the specified file (system file by default or F=filename) did not contain a 77 prefix table entry.

Issued by LOADBC.

User Action: Check the controlware file being used.

**NON-BUFFERED EQ-S CHECKPOINTED.  
RECOVERY ABORTED.**

Description: During a level 3 recovery either the ABORT,B. CMRDECK command was entered or the system determined that the buffered devices could not be recovered. All non-buffered devices with checkpoints pending have been checkpointed.

Issued by 1CK.

User Action: Perform level 0 deadstart.

**NON-585 PRINTER DIRECTIVE FOR 585 CONNECTION**

Description: This message indicates that the printer type specified in the EVFU file did not match that in the login message from the network.

Issued by PSU.

User Action: Notify site analyst. Correct the EVFU file, NDL source, and/or CDCNET 585 configuration information.

**NONSHARED DEVICE ACTIVE IN DAT.**

Description: A nonshared device accessed by another mainframe (as determined by MID/machine index) is described in the device access table with the same family name and device number as the device being recovered. Recovery is impossible. This message is preceded by the message

RECOVERY, EQest.

which indicates the equipment in error.

Issued by MSM.

User Action: Redeadstart with correct configuration for equipment in error.

**NOP: termname, ASSIGNED CONTROL OF npuname.**

Description: Network operation at terminal termname is assigned control of NPU npuname being supervised by CS.

Issued by CS.

User Action: None.

**NOP: termname, CONTROL RELEASED OF npuname.**

Description: Network operator has released control of NPU npuname being supervised by CS.

Issued by CS.

User Action: None.

**(xxx) NOS/VE IOU ERROR.**

Description: DFT detected a fatal IOU error that caused the PP receiving the error to halt. This PP is currently used by NOS/VE. Check the Binary Maintenance Log for further information.

xxx 004 or 009

Issued by 1MB.

User Action: Examine the DFT maintenance register buffers. If there is a hardware error, inform customer engineer. If there is a software error, write a PSR. Type GO,SYS to clear the message.

**NOT A MASTER DEVICE.**

Description: The device requested did not contain pf catalogs (device mask = 0).

Issued by PACKER.

User Action: Correct parameters and retry.

### **NOT ALL DATA BASE FILES UPPED.**

Description: CRMTASK issued a DBUP request but AAMI was unable to attach/open all database files.

Issued by CRMTASK.

User Action: Inform database administrator.

### **NOT ALLOWED.**

Description: The NEXTREEL, est command can only be entered in response to the E,P display CHECK AND MOUNT message or if a ring conflict has occurred on the first reel of an unlabeled multi-reel request.

Issued by DSD.

User Action: None.

### **NOT AT BREAK.**

Description: The PP selected on the V display is not at a breakpoint.

Issued by DSD.

User Action: None.

### **NOT AUXILIARY PACK.**

Description: An attempt was made to define a nonauxiliary device as a private pack.

Issued by MSI.

User Action: Correct and enter GO.

### **NOT AVAILABLE.**

Description: Equipment specified in the ASSIGN,jsn,eq. command is currently unavailable.

Issued by DSD.

User Action: Retry command when equipment becomes available.

### **NOT CONTROL MODULE EST ORDINAL.**

Description: The EST ordinal specified by the EQ=est parameter on the LOADBC command does not correspond to a control module.

Issued by LOADBC.

User Action: Correct EST ordinal and retry.

### **NOT CORRECT CONTROLLER TYPE FOR DUMP.**

Description: Informative message indicating that the user attempted to dump controlware from a controller other than one of those supported.

Issued by LOADBC.

User Action: None.

### **NOT ENOUGH ARGUMENTS.**

Description: Dayfile message indicating that before the correct number of arguments was specified, a terminator was encountered.

Issued by SCRSIM.

User Action: Correct and reenter.

### **NOT ENOUGH MASS STORAGE.**

Description: Not enough mass storage exists on the specified device to enable creation of a new active dayfile.

Issued by DFTERM.

User Action: Enter new device using the K-display.

**NOT ENOUGH PP-S FOR DEADSTART.**

Description: Too many PPs have been logically turned off through CTI. NOS requires at least 4 pool PPs to be available.

Issued by SET.

User Action: Redeadstart with more PPs logically on.

**xxxxxxx NOT FOUND IN DIRECTORY.**

Description: Specified file is not found in the directory.

Issued by DMREC.

User Action: Check the file name and the list directory.

**xxx NOT FOUND ON DEVICE.  
ENTER ALTERNATE DEVICE LOCATION.**

Description: The deadstart file does not contain the maintenance system or the HVS module.

xxx Significance  
DSB HVS module  
MSB Maintenance

Issued by CTI.

User Action: Entry of alternate device location is not supported for NOS. Install the Maintenance or HVS module on the device and redeadstart.

**xxxxxxx NOT IN DIRECTORY.**

Description: The task or named TAF transaction unit, xxxxxxx, was specified in the TN parameter but was not found on the task library or transaction unit directory.

Issued by LIBTASK.

User Action: Ensure the correct task or transaction name was specified with the TN parameter. Check task or transaction listing for presence of specified unit.

**xxx NOT IN PP LIB.**

Description: Dayfile message indicating that PP package xxx was not found in PP libraries.

Issued by SFP.

User Action: Ensure that the correct PP package name was specified.

**xxx NOT IN PP LIB. CALLED BY yyy.**

Description: Dayfile message indicating that PP package xxx, which was called by package yyy, was not found in the PP libraries.

Issued by SFP.

User Action: Ensure that the correct PP package name was specified or write a PSR.

**xxxxxxx NOT INITIALIZED BY TOTAL.  
STATUS IS yyyy.**

Description: An error was encountered on the TOTAL data base.

Issued by TAF.

User Action: Regenerate TOTAL data base. Refer to TOTAL Reference Manual for status.



### **NOT LOADED - xx est.**

Description: This message is issued if INITMDI is not loaded because no load file was specified on the INITMDI command.

xx Device mnemonic specified by the DT parameter.  
est EST ordinal of MDI.

Issued by INITMDI.

User Action: If a load is desired, alter the INITMDI command to include the load file name.

### **\*\*\*\* NOT MASTER USER.**

Description: Output file message indicating that the user is neither a master user of a specified charge number, a special accounting user, nor from system origin, as is required for the directive entered.

Issued by PROFILE.

User Action: None.

### **NOT READY.**

Description: I-display message indicating unit not ready .

Issued by DSD.

User Action: None.

### **NOT READY**

Description: I-display message. The device is not ready.

Issued by LCD.

User Action: Ready the device.

### **type element NOT SUPERVISED.**

Description: An element name of the specified type entered on the command is not supervised by this NPU.

Issued by CS.

User Action: Reenter corrected command.

### **NOT VALIDATED FOR REQUESTED ACCESS LEVEL.**

Description: User has specified an access level outside the user's access level validation.

Issued by RESEX.

User Action: Use a validated access level or site must validate user for additional access level.

### **NOT VALIDATED FOR WRITING UNLABELED TAPES.**

Description: User has not been validated for writing on unlabeled tapes.

Issued by RESEX.

User Action: Either use a labeled tape or site must validate user for SAV=CULT MODVAL privilege.

### **NOT VALIDATED TO CHANGE ACCESS LEVEL.**

Description: The user must have security administrator privileges to change the access level of a queued file.

Issued by QFTLIST.

User Action: Inform CYBER Software Support.

### **yyyy NOT WITHIN ALLOWABLE RANGE FOR CLASS xx.**

Description: The parameter yyyy (either EXID, EXIP, or EXTP) is not within the execution queue priority range (FXLP to FXUP) for service class xx.

Issued by SDSPLAY.

User Action: Adjust one of the parameters so that yyyy is within the allowable range.

**NOTE FAILURE, THEN TYPE IN CFO,JSN.GO.**

Description: An error has occurred that the database administrator needs to know about.

Issued by DMREC.

User Action: The operator should log the failure and inform the database administrator.

**NOTICE\*\*\* DATA READ ERROR.**

Description: Read error caused loss of words in the dayfile.

Issued by DAYFILE.

User Action: None.

**NOTICE\*\*\* RECOVERY BOUNDARY.**

Description: Messages were lost due to crossing a deadstart recovery boundary.

Issued by DAYFILE.

User Action: None.

**NP GREATER THAN 8.**

Description: Number of packs specified for multispindle device cannot exceed eight.

Issued by MSI.

User Action: Enter correct number of packs and then enter GO.

**NP NOT ALLOWED.**

Description: The NP parameter (number of packs) was specified and the device to be initialized is not a pack type device.

Issued by MSI.

User Action: Correct and enter GO.

**NPU: npuname, status, node  
GO IS REQUIRED.**

Description: GO is required on an NPU in order to start the terminal interface packages.

npuname	Name of the NPU.
status	Status. Always ACTIVE for an NPU.
node	Node number of NPU.

Issued by CS.

User Action: Enter GO command.

**NPU: npuname, status, node.  
CONNECTION BROKEN, SUPERVISION LOST.**

Description: Supervisory connection to an NPU has been broken because the NPU has either switched supervision or has gone down or has been turned off.

npuname	Name of the NPU
status	Status. Always ACTIVE for an NPU.
node	Node number of NPU.

Issued by CS.

User Action: Look at NAM's dayfile for the reason the connection was broken. If the NPU has switched supervision, no action is necessary. If the NPU has gone down, it will be automatically restarted and supervision will be gained again. Save the NPU dumps that will be generated by NS and write a PSR. If the NPU has been accidentally turned off, turn it on again.

**NPU: npuname, status, node.  
NCF MISMATCH/CCP NCF VERSION: ver,  
LEVEL: lev, VARIANT: var**

Description: An NPU with a different version than CS has requested supervision.

npuname	Name of the NPU
status	Status. Always active for an NPU.
node	Node number of NPU.
ver	Version.
lev	Level.
var	Variant.

The last three refer to the CCP currently running in the NPU.

Issued by CS.

User Action: Inform site analyst.

**NPU: npunanme, status, node.  
SUPERVISION GAINED.  
CCP VERSION: ver, LEVEL: lev,  
VARIANT: var,  
PREVIOUS CS NODE: pcn,  
PREVIOUS NS NODE: pnn.**

Description: Supervision of an NPU was gained.

npuname	Name of the NPU.
status	Status. Always active for an NPU.
node	Node number of NPU.
ver	Version.
lev	Level.

The last three refer to the CCP currently running in the NPU.

Issued by CS.

User Action: None.

**NPU: npuname, DUMP OPTION CHANGED.**

Description: Self-explanatory.

Issued by CS.

User Action: None.

**NPU: npuname, nl LINES DISABLED.**

Description: Indicates that number of lines nl supported by NPU npuname are disabled.

Issued by CS.

User Action: None.

**NPU: npuname, nll LOGICAL LINKS DISABLED.**

Description: Indicates that number of logical links nll supported by NPU npuname are disabled.

Issued by CS.

User Action: None.

**NPU: npuname, nnn, MESSAGE MAY HAVE BEEN LOST.**

Description: The broadcast message sent to an NPU may have been lost.

npuname Name of the NPU.  
nnn NPU node number.

Issued by CS.

User Action: Pause. Reenter command.

**NPU: npuname, MESSAGE NOT SENT.**

Description: Broadcast message was not sent to terminals on NPU npuname.

Issued by CS.

User Action: None.

**NPU: npuname, status, node, NEEDGO, dump.**

Description: Indicates NPU npuname with status stat, and node number node needs operator go flag, and dump flag. The NEEDGO keyword is present when a GO is required.

dump NPU dump flag (ON or OFF).

Issued by CS.

User Action: None.

**NPU: npuname, nt TERMINALS DISABLED.**

Description: Indicates that number of terminals nt supported by NPU npuname are disabled.

Issued by CS.

User Action: None.

**NPU: npuname, nt TERMINALS DISABLED ON  
LINE: line.**

Description: Indicates that number of terminals nt on the specified line supported by NPU npuname are disabled.

Issued by CS.

User Action: None.

**NPU: npuname, ntr TRUNKS DISABLED.**

Description: Indicates that number of trunks ntr supported by NPU npuname are disabled.

Issued by CS.

User Action: None.

**NPU: UNKNOWN,status,node  
SUPERVISION REQUEST FROM UNKNOWN NPU**

Description: A supervision request from an NPU that is not defined in the NCF has been detected.

status Status. In the case of an NPU, the status is always ACTIVE.  
node Node number of NPU.

Issued by CS.

User Action: Reload NPU or inform site analyst.

### **NPU IS ACTIVE, TRY LATER.**

Description: The NPU specified in the change NPU load file command is being dumped or loaded when the HOP command is entered. NS (network supervisor) cannot process the change NPU load file command unless the NPU is in idle state (no ongoing dump/load activity).

Issued by NS.

User Action: Retry later.

### **NPU IS NOT CONFIGURED.**

Description: The NPU specified in the HOP command is not known in the current network configuration.

Issued by NS.

User Action: None.

### **NPU IS NOT SPECIFIED.**

Description: An NPU name must be specified in the HOP command.

Issued by NS.

User Action: Reenter the command with an NPU name.

### **NPU npuname, NCF VERSION MISMATCH.**

Description: NPU npuname has requested supervision from CS but the NPU was configured from an NCF built with a different version of NDLP than the one used to build the NCF available to CS.

Issued by CS.

User Action: Reload NPU or inform site analyst.

### **NS/ BAD NCF DIRECTORY RECORD.**

Description: The directory record of the network configuration file is not valid.

Issued by NS.

User Action: Assign a valid network configuration file.

### **NS/ BAD NCF NPU XREF RECORD.**

Description: NS detected an error on the NPU cross reference table of the network configuration file.

Issued by NS.

User Action: Assign a valid network configuration file.

### **NS/ BAD NCF PHYLINK RECORD.**

Description: NS detected an error on the physical link cross reference table of the network configuration file.

Issued by NS.

User Action: Assign a valid network configuration file.

### **NS/ BAD NLF DIRECTORY RECORD.**

Description: The directory record of the network load file is not valid.

Issued by NS.

User Action: Assign a valid network load file.

### **NS/ CONTROL STATEMENT PARAMETER SYNTAX ERROR.**

Description: NS detected syntax errors in the NS command.

Issued by NS.

User Action: Correct the NS command.

### **NS DISABLED.**

Description: The NETON request was not successful because NS has been disabled.

Issued by NS.

User Action: Enable NS using NVF's enable application commands.

### **NS/ npuname, DUMP/LOAD xxxxxx REQUESTED.**

Description: NS received a load request from the NPU.

npuname Name of the NPU.

xxxxxx NPU variant assigned to the NPU in the network. configuration file.

Issued by NS.

User Action: None.

### **NS/ npuname, DUMP NPyxxxx COMPLETED.**

Description: Dumping of the NPU to the direct access permanent file NPyxxxx was successfully completed.

npuname Name of the NPU.

yy Unique dump number (hexadecimal).

xxx Network invocation number (decimal).

Issued by NS.

User Action: None.

### **NS/ npuname, DUMP NPyxxxx SAVED.**

Description: Dumping of the NPU was prematurely terminated and the partial NPU dump file NPyxxxx was saved as a direct access permanent file.

npuname Name of the NPU.

yy Unique dump number (hexadecimal).

xxx Network invocation number (decimal).

Issued by NS.

User Action: None.

### **NS/ npuname, DUMP STARTED.**

Description: Dumping of the NPU has started.

npuname Name of the NPU.

Issued by NS.

User Action: None.

### **NS/ DUPLICATE CONTROL STATEMENT PARAMETER.**

Description: An NS command parameter is specified more than once.

Issued by NS.

User Action: Correct the NS command.

### **NS DUPLICATE NETON.**

Description: The NETON request was not successful because a second copy of NS tried to NETON.

Issued by NS.

User Action: None.

### **NS/ GRADUAL SHUTDOWN REQUESTED.**

Description: NS received an idle network shutdown request.

Issued by NS.

User Action: None.

### **NS/ npuname, HALT code AT address.**

Description: The NPU has halted.

npuname	Name of the NPU.
code	CCP halt code (hexadecimal).
address	NPU P-register address.

Issued by NS.

User Action: None.

### **NS/ ILLEGAL CONTROL STATEMENT PARAMETER VALUE.**

Description: NS detected an illegal value assigned to an NS command parameter.

Issued by NS.

User Action: Correct the NS command.

### **NS/ npuname, ILLEGAL xpcb DIRECTIVE.**

Description: NS detected an illegal directive in the program initiation control block while it was dumping or loading the NPU.

npuname	Name of the NPU.
xpcb	Directive.
DPCB	Dump procedure control block.
LPCB	Load procedure control block.
SPCB	SAM load procedure control block.

Issued by NS.

User Action: Assign a valid network load file.

### **NS/ ILLEGAL USER ACCESS.**

Description: NS does not have a system job origin type.

Issued by NS.

User Action: Assign a system job origin type to NS.

### **NS/ IMMEDIATE SHUTDOWN REQUESTED.**

Description: NS received a forced network shutdown request.

Issued by NS.

User Action: None.

### **NS/ npuname, LOAD COMPLETED.**

Description: Loading of CCP software into the NPU was completed successfully.

npuname	Name of the NPU.
---------	------------------

Issued by NS.

User Action: None.

### **NS/ npuname, LOADING loadname.**

Description: A CCP load module is being loaded into the NPU.

npuname        Name of the NPU.  
loadname        CCP load module name (display code).

Issued by NS.

User Action: None.

### **NS/ LOGICAL ERROR RC=rc.**

Description: Indicates NIP has detected a logical error on a supervisory message. This message is immediately followed by the two-word text of the ERR/LGL supervisory message. The host operator is alerted by the alert line on the NAM K display. If DEBUG is on, NS is aborted.

rc        Reason code (refer to NAM/CCP Reference Manual for further information).

Issued by NS.

User Action: Write a PSR and include support materials to allow CDC to analyze the problem.

### **NS/ NCB ENTRY NOT FOUND IN NCF.**

Description: NS cannot locate the NPU configuration block of all the NPUs specified in the NPU cross reference table of the network configuration file.

Issued by NS.

User Action: Assign a valid network configuration file.

### **NS/ NCF - yy/mm/dd, hh.mm.ss.**

Description: Indicates the creation date and time of the current network configuration file.

Issued by NS.

User Action: None.

### **NS/ NCF NOT AVAILABLE.**

Description: The network configuration file is not at NS control point. NS expects the network configuration file to be available as local file NCF.

Issued by NS.

User Action: Assign the network configuration file to NS as local file NCF.

### **NS/ NDLP VERSION n.n, LEVEL mln.**

Description: Indicates version and modification level number of the network definition language program that creates the current network configuration file.

n.n        Version level.  
mln        Modification level number.

Issued by NS.

User Action: None.

### **NS/ NIN IS NOT SPECIFIED.**

Description: The network invocation number is not specified in the NS command.

Issued by NS.

User Action: Correct the NS command.

### **NS/ NLF - yy/mm/dd, hh.mm.ss.**

Description: Indicates the creation date and time of the current network load file.

Issued by NS.



User Action: None.

### **NS/ NLF NOT AVAILABLE.**

Description: The network load file is not at NS control point. NS expects the network load file to be available as local file NLF.

Issued by NS.

User Action: Assign network load file to NS as local file NLF.

### **NS NOT RESPONDING TO NPU INIT REQUEST.**

Description: Network supervisor (NS) is not netted on yet. Issued every 30 seconds if NS does not respond to NPU load request.

Issued by NIP.

User Action: None.

### **NS/ PROTOCOL ERROR - NP=xx, NB=yy, SM=hhhh, STATE=pss.**

Description: NS received an unexpected supervisory message from an NPU. The host operator is alerted by the alert line on the NAM K display.

xx	Node number (hexadecimal) of the NPU.
yy	Node number (hexadecimal) of the source node.
hhhh	Primary function code/secondary function code (hexadecimal) of the unexpected supervisory message.
pss	Current state of the NPU.
p	Primary State
1	Loading SAM
2	Dumping NPU
3	Loading NPU
4	Dumping network dump control block
ss	Secondary state
10	Waiting for load response
20	Waiting for dump response
30	Waiting for start response
40	Waiting for load network dump control block response

Issued by NS.

User Action: Check to see that NPU is running versions of CCP and SAM that are supported by the version of NS running. If this is a supported combination, write a PSR and include support materials to allow CDC to analyze the problem.

### **NS/ npuname, RECEIVED NPU/DT/A code RC=rc.**

Description: NS received an abnormal response from an NPU while the NPU was being dumped or loaded.

npuname	Name of the NPU that sends the abnormal response.
code	Code value.
0	Dump response.
1	Load response.
2	Start response.
rc	Reason code.
1	Invalid NPU macromemory address specified on the dump/load command.

- 2           Checksum error on load data.
- 3           NPU not equipped with 8K micromemory.
- 4           Load batch count mismatch, load data may be lost.

Issued by NS.

User Action: Assign a valid CCP load file or inform customer engineer.

**NS/ npuname, SAM LOAD COMPLETED.**

Description: The system autostart module was successfully loaded into the NPU.

npuname     Name of the NPU.

Issued by NS.

User Action: None.

**NS/ npuname, SAM LOAD STARTED.**

Description: Loading of the system autostart module into the NPU has started.

npuname     Name of the NPU.

Issued by NS.

User Action: None.

**NS/ SHUTDOWN COMPLETED.**

Description: Indicates the shutdown processing has completed.

Issued by NS.

User Action: None.

**NS/ SM ABH ERROR.**

Description: NS received an invalid application block header from NAM. This message is immediately followed by the application block header plus up to four words of the text. The host operator is alerted by the alert line on the NAM K display.

Issued by NS.

User Action: Write a PSR and include support materials to allow CDC to analyze the problem.

**NS/ SM NETWORK ABH ERROR.**

Description: NS received a supervisory message with a bad network header from an NPU. This message is immediately followed by the application block header plus up to four words of the supervisory message text. The host operator is alerted by the alert line on the NAM K display.

Issued by NS.

User Action: Write a PSR and include support materials to allow CDC to analyze the problem.

**NS/ SM NETWORK ADDRESS ERROR.**

Description: NS received from an NPU a supervisory message with bad NPU addressing information. NS cannot locate a configured NPU with the information contained in the supervisory message. This message is immediately followed by the application block header plus up to four words of the supervisory message text. The host operator is alerted by the alert line on the NAM K display.

Issued by NS.

User Action: Write a PSR and include support materials to allow CDC to analyze the problem.

### **NS/SM NETWORK DUMP RESPONSE ERROR.**

Description: NS received a bad dump response supervisory message from an NPU during the NPU dump sequence. This message is immediately followed by the application block header plus up to four words of the supervisory message text. The host operator is alerted by the alert line on the NAM K display.

Issued by NS.

User Action: Contact CYBER Software Support.

### **NS/ SM NETWORK PFC/SFC/LT/CC ERROR.**

Description: NS received a bad supervisory message from a NPU during the NPU dump/load sequence. This message is immediately followed by the application block header plus up to four words of the supervisory message text. The host operator is alerted by the alert line on the NAM K display.

Issued by NS.

User Action: Contact CYBER Software Support.

### **NS/ SM PFC/SFC ERROR.**

Description: NS received a supervisory message with an invalid primary function code/secondary function code from NAM. This message is immediately followed by the application block header plus up to four words of the supervisory message text. The host operator is alerted by the alert line on the NAM K display.

Issued by NS.

User Action: Contact CYBER Software Support.

### **NS TRYING NETON.**

Description: NS is initiating a NETON request.

Issued by NS.

User Action: None.

### **NS/ UNRECOGNIZED CONTROL STATEMENT PARAMETER.**

Description: NS detected an unrecognized parameter in the NS command.

Issued by NS.

User Action: Correct the NS command.

### **NT,text**

Description: See MT,text. where text = rest of message.

Issued by 1MT.

User Action: None.

### **NTest, Ccn, 200 IPS GCR DRIVE ON 1X PPS.**

Description: A 679 magnetic tape unit capable of 6250 cpi is configured on a system with 1X PPU speed. 6250 cpi operations may not be valid.

est EST ordinal of tape unit  
cn Tape unit channel

Issued by 1MT.

User Action: Inform site analyst.

### **NULL DESCRIPTION FILE.**

Description: Self-explanatory.

Issued by TAFREC.

User Action: Create a description file NCTFi where i is the machine identifier specified on the network statement in the TCF.

**NUMBER OF BITS TOO LARGE.**

Description: Dayfile message indicating that the number of bits entered on the AREA. command was larger than the number of bits from the starting bit to the end of the register.

Issued by SCRSIM.

User Action: Correct and reenter.

**NUMBER OF CYCLES TOO LARGE.**

Description: Dayfile message indicating that the number of cycles specified on the CYCLE. command was greater than 4095.

Issued by SCRSIM.

User Action: Correct and reenter.

**NUMBER OF LINE REGULATIONS = nnnnnnnn.**

Description: Informative dayfile message indicating the number of time line regulations (REPEAT..) that were encountered.

Issued by STIMULA.

User Action: To reduce the number of line regulations, reduce the stimulator load by reducing the number of terminals or by increasing the think time or think time increment.

**NUMERIC FIELD MUST NOT BE BLANK.**

Description: No channel value was specified with the CH parameter.

Issued by DMPCCC.

User Action: Correct the syntax error and retry.

**NV/CONTROL STATEMENT PARAMETER SYNTAX ERROR.**

Description: The NVF command in the master file is formatted incorrectly.

Issued by NVF.

User Action: Examine command in master file, correct problem, revise master file, and attempt to restart network.

**NV/DUPLICATE CONTROL STATEMENT PARAMETER.**

Description: A duplicate parameter setting encountered on the NVF command.

Issued by NVF.

User Action: Examine command in master file, correct problem, revise master file, and attempt to restart network.

**NV/INVALID CONTROL STATEMENT PARAM VALUE.**

Description: An out-of-range value encountered for an NVF command parameter.

Issued by NVF.

User Action: Examine command in master file, correct problem, revise master file, and attempt to restart network.

**NV/LCF yy/mm/dd, hh.mm.ss.**

Description: Informative. LCF build data and time.

Issued by NVF.

User Action: None.

**NV/LCF title.**

Description: Informative. LCF title (limited to 50 characters).

Issued by NVF.

User Action: None.

### **NV/NIN IS NOT SPECIFIED.**

Description: A required NIN value for the NIN parameter on the NVF command is missing.

Issued by NVF.

User Action: Examine command in master file, correct problem, revise master file, and attempt to restart network.

### **NV/UNRECOGNIZED CONTROL STATEMENT PARAMETER.**

Description: An undefined parameter encountered on the NVF command in the master file.

Issued by NVF.

User Action: Examine command in master file, correct problem, revise master file, and attempt to restart network.

### **NV/VER nnn-~~nnn~~.**

Description: Informative. NVF version and level number.

Issued by NVF.

User Action: None.

### **NVF ATTEMPTING NETON.**

Description: Self-explanatory.

Issued by NVF.

User Action: None.

### **NVF FAILURE.**

Description: The Network Validation Facility (NVF) has aborted. NAM takes an internal dump and terminates.

Issued by NIP.

User Action: Reinitialize NAM. Rerun collector job. Supply dumps or collector tape to CYBER Software Support.

### **NVF NETON ATTEMPT FAILED.**

Description: NVF unable to successfully NETON to NAM.

Issued by NVF.

User Action: Contact CYBER Software Support.

### **NVF NETON SUCCESSFUL.**

Description: Self-explanatory.

Issued by NVF.

User Action: None.

### **NVFAPVD - NO AST ENTRY**

Description: For debug only. No application status table entry was found for an application.

Issued by NVF.

User Action: Contact CYBER Software Support.

### **NVFDDNT - UNEXPECTED ABHABT**

Description: For debug only. NVF has received an unknown type of message.

Issued by NVF.

User Action: Contact CYBER Software Support.

**NVFDDNT - UNEXPECTED SM**

Description: For debug only. NVF has received an unknown service message.

Issued by NVF.

User Action: Contact CYBER Software Support.

**NVFOROC - PARAMETER LIST TOO SHORT.**

Description: For debug only. The parameter list array for the parameterized host operator command is too short. This message is generated by NVF procedure NVFOROC.

Issued by NVF.

User Action: Contact CYBER Software Support.

**NVFTACC - CANNOT FIND PDCT ENTRY FOR termname.**

Description: For debug only. A PDCT entry for terminal termname cannot be found. The message is generated by NVF procedure NVFTACC.

Issued by NVF.

User Action: Contact CYBER Software Support.

**NVFTACC - CANNOT FIND PTAC ENTRY FOR termname.**

Description: For debug only. A PTAC entry for terminal termname cannot be found. The message is generated by NVF procedure NVFTACC.

Issued by NVF.

User Action: Contact CYBER Software Support.

**NVFTETC - CANNOT FIND PDCT ENTRY FOR termname.**

Description: For debug only. A PDCT entry for terminal termname cannot be found. The message is generated by NVF procedure NVFTETC.

Issued by NVF.

User Action: Contact CYBER Software Support.

**NVFTITE - CANNOT FIND PDCT ENTRY FOR termnam.**

Description: For debug only. A PDCT entry for terminal termnam cannot be found. The message is generated by procedure NVFTITE.

Issued by NVF.

User Action: Contact CYBER Software Support.

**NVFTPVD - CANNOT FIND AST ENTRY FOR termname.**

Description: An AST entry for terminal name termname cannot be found. The message is generated by NVF procedure NVFTPVD.

Issued by NVF.

User Action: Contact CYBER Software Support.

**NVFTURT - CANNOT FIND PTAC ENTRY.**

Description: A PTAC entry cannot be found. The message is generated by NVF procedure NVFTURT.

Issued by NVF.

User Action: Contact CYBER Software Support.

### **NVFTURT - CANNOT FIND RAU ENTRY.**

Description: For debug only. A RAU entry cannot be found. The message is generated by NVF procedure NVFTURT.

Issued by NVF.

User Action: Contact CYBER Software Support.

### **NVFTVVD - CANNOT FIND PTAC ENTRY.**

Description: For debug only. A PTAC entry cannot be found. The message is generated by procedure NVFTVVD.

Issued by NVF.

User Action: Contact CYBER Software Support.

### **NVFDVCD - ERRONEOUS READLS CALL.**

Description: Attempt to reissue CIO READLS call, while the complete list is read. The message is issued by NVF procedure NVFDVCD.

Issued by NVF.

User Action: Contact CYBER Software Support.

### **NW01, nnn,eeppbbssssssss.**

Description: CCP has detected an error on a port in the network.

Issued by CS.

User Action: Refer to the Communication Control Program Version 3 Diagnostic Handbook for documentation of the error message.

### **NW01, nnn,FFee, ccc .**

Description: PIP has detected an error in the interface to the front end with coupler node number nnn. The cc field is the 12-bit coupler status register contents for the NPU case and the MCI general status for the MDI case.

ee Explanation

- 1 Channel active before function.
- 2 Channel active after function.
- 3 Channel active before activate.
- 4 Channel inactive after activate.
- 5 Channel active after disconnect.
- 6 Channel inactive during output.
- 7 Channel hung full during output.
- 8 Channel inactive during input.
- 9 Channel hung empty during input.
- 0A Channel hung full after input. 0B-0F Reserved.
- 10 NPU memory protect error. 11-13 Reserved.
- 14 Unable to obtain MDI status.
- 15 Reserved.
- 16 MDI inoperative.
- 17 Unable to reset MDI interface.
- 18 MDI header format error.

Issued by NIP.

User Action: Inform site analyst or customer engineer.

### **\*\*\*\* OBSOLETE DIRECTIVE IGNORED.**

Description: The input directive entered is no longer meaningful and was ignored.

Issued by MODVAL.

User Action: None.

**OFF.**

Description: I-display message. The device is idle and OFF in the est.

Issued by 1CD.

User Action: Enter ON,EQ=xxx to turn the device on.

**OFF-CHECK ERRLOG.**

Description: The BIO equipment has been turned off due to a hardware error.

Issued by DSD.

User Action: Check the errlog and inform a site analyst.

**OFF - CHECK ERRLOG.**

Description: I-display message. The device has been turned off due to a hardware problem.

Issued by 1CD.

User Action: Check the ERRLOG for the details and correct the problem or notify a customer engineer.

**OFF TASK taskname - LIBRARY libraryname.**

Description: Task taskname in task library libraryname could not be loaded from extended memory or recovered and loaded from mass storage. Task was turned off. TAF transactions using tasks will abort.

Issued by TAF.

User Action: Inform site analyst. Library must be recreated.

**OFFLINE MAINTENANCE NOT AVAILABLE.**

Description: The operator unsuccessfully tried to initiate the off-line maintenance system during deadstart.

Issued by CTI.

User Action: Inform site analyst or customer engineer.

**npuname/OLD: ALREADY INITIATED.**

Description: A request to run NPU diagnostics has already been made by the operator. No need to make a second request.

npuname      Name of the NPU.

Issued by CS.

User Action: None.

**npuname/OLD: REQUEST INITIATED.**

Description: A request to run NPU diagnostics has been made by the operator.

npuname      Name of the NPU.

Issued by CS.

User Action: None.

**npuname/OLD: TST - NO PRIOR REQUEST COMMAND.**

Description: A TST drop or data command was attempted before OLD request command entered.

npuname      Name of the NPU.

Issued by CS.



User Action: Attempt TST request command, retry command.

### **OLD CHECKSUM MISMATCH**

Description: The expected checksum specified on the NAME directive does not match the calculated checksum of the unmodified record read from the old record file. Refer to the contents of OLD CHECKSUM in the preceding CHECKSUM CHANGED line of the output report. BINEDIT aborts only if the A parameter appears in the BINEDIT command.

Issued by BINEDIT.

User Action: If the job aborted, ensure that the two checksums match and rerun the job; otherwise, no action is required.

### **ON, OF NOT SPECIFIED CORRECTLY.**

Description: ON and OF are valid only with the IB or FC directive; ON or OF was specified on another directive to SSLABEL.

Issued by SSLABEL.

User Action: Correct directive and retry.

### **ON,OF OPTION VIOLATED.**

Description: The ON and OF parameters were omitted or both specified for a directive which requires that only one be present, or the ON and OF parameters were specified for a directive which prohibits their use.

Issued by SSDEBUG.

User Action: Correct the directive and retry.

### **ONE OPTION MUST BE SPECIFIED WHEN OP IS SPECIFIED.**

Description: A parameter value must be specified with the OP parameter.

Issued by NLTERM.

User Action: Change the OP parameter so that one parameter value is specified and rerun the job.

### **ONLY \*BLOCK\* or \*RECORD\* CAN FOLLOW FILE NAME.**

Description: Self-explanatory.

Issued by DMREC.

User Action: Correct error and rerun.

### **ONSET FILES nnnnnn, ssssss PRUS.**

Description: PACKER statistics reflecting the condition of the portion of the IAPF chain which PACKER has processed.

nnnnnn Number of files at PACKER onset.

ssssss Total sectors occupied by files at PACKER files at PACKER onset.

Issued by PACKER.

User Action: None.

### **ONSET HOLES nnnnnn, ssssss PRUS.**

Description: PACKER statistics reflecting the condition of the portion of the IAPF chain which PACKER has processed.

nnnnnn Number of holes at PACKER onset.

ssssss Total sectors occupied by holes at PACKER holes at PACKER onset.

Issued by PACKER.

User Action: None.

### **OPEN ERROR ON COPY OF THE DIRECTORY.**

Description: An open error was generated when trying to access the directory file.

Issued by DMREC.

User Action: Inform database administrator.

### **OPERATIONAL LIBRARY FILE BUSY, WAITING FOR ACCESS**

Description: The specified operational library is busy.

Issued by NETPLM.

User Action: Wait until the library file is no longer busy (NETPLM will automatically proceed as soon as the file is available) or terminate NETPLM with a User Break 2.

### **OPERATIONAL STATE NOT REACHED.**

Description: All the load data was sent to the MDI, but the MCI state did not become operational within 15 seconds.

Issued by INITMDI.

User Action: Inform site analyst.

### **OPERATOR DROP.**

Description: Informative message indicating that the operator dropped the job.

Issued by 1AJ.

User Action: None.

### **OPERATOR DROP.**

Description: The system operator dropped RECLAIM.

Issued by RECLAIM.

User Action: Inform site analyst.

### **OPERATOR IDLEDOWN.**

Description: The operator has entered an IDLE command to terminate a subsystem job.

Issued by 1AJ.

User Action: None.

### **OPERATOR IMPL REQUIRED.**

Description: The 7990 must be manually reset and reloaded by the the physical IMPL switch on the 7990 controller.

Issued by SSEXEC.

User Action: Have the operator do the resetting and reloading.

### **OPERATOR KILL.**

Description: The operator entered a KILL command to drop the job. This disallows exit processing unless the job has extended reprieve. A job with extended reprieve processing is reprieved once. Exit processing is allowed.

Issued by RECLAIM.

User Action: Correct job as needed and rerun.

### **OPERATOR OVERRIDE.**

Description: Operator has overridden TAF.

Issued by TAF.

User Action: None.

### **OPERATOR RERUN.**

Description: The system operator restarted the job.

Issued by RECLAIM.

User Action: None.

### **OPERATOR TERMINATION.**

Description: Operator typed in K.STOP in the K display command.

Issued by TAFREC.

User Action: None.

### **OSB NOT FOUND ON DEVICE. DEADSTART ABORTED.**

Description: The deadstart tape does not contain the operating system.

Issued by EBL.

User Action: Verify that the operating system is on the deadstart device and rereadstart. If message persists, inform site analyst.

### **OT, IF SPECIFIED, MUST BE SY OR BC.**

Description: The only value allowed in the OT field is SY or BC. The job statement in error is shown.

Issued by NAMI.

User Action: Correct the OT field or leave blank.

### **OUT OF RANGE.**

Description: The address entered on a BKP command was out of the job's FL, or the M. command was entered and the job DIS is assigned to has no field length.

Issued by DIS.

User Action: Enter a correct address.

### **OUT OF SYNCH.**

Description: The stimulation was aborted because 1TS was out of synch with IAF.

Issued by 1TS.

User Action: Inform site analyst.

### **OUTPUT BUSY.**

Description: Informative message for interactive message commands.

Issued by DSD.

User Action: None.

### **OUTPUT FILE NAME CONFLICT.**

Description: The specified output file name conflicts with a name already in use.

Issued by QMOVE.

User Action: Change the output file name and retry operation.

### **OUTPUT FILE NAME MUST BE 1-7 CHARACTERS IN LENGTH.**

Description: The output file name must be 1 to 7 characters in length.

Issued by NLTERM.

User Action: Change the output file name so that it is 1 to 7 characters in length and reenter it.

**OUTPUT FILE NAME SET TO nm.**

Description: The L command has set the file name, which is to be used by the LIST command, to nm.

Issued by NLTERM.

User Action: None.

**OUTPUT FILE RELEASED.**

Description: Informative message on K-display indicating that the output file was released to the printer.

Issued by DFTERM.

User Action: None.

**OUTPUT FILE nm ROUTED TO THE PRINTER.**

Description: Indicates the completion of the OUT command.

Issued by NLTERM.

User Action: None.

**OUTPUT TRAY FULL.**

Description: The picker tried to place a cartridge in the output tray, but found it full.

Issued by SSEXEC.

User Action: Remove cartridge from output tray and retry.

**ovlnam OVERLAY LOAD ERROR.**

Description: The MCS overlay could not be loaded so MCS aborted.

ovlnam      Overlay name

Issued by MCS.

User Action: Contact MCS administrator.

**overlay OVERLAY NOT FOUND.**

Description: CS program tried to load a CS overlay, but it could not be found.

Issued by CS.

User Action: Inform site analyst.

**overlay OVERLAY NOT FOUND.**

Description: The specified NVF overlay was not found.

Issued by NVF.

User Action: Contact CYBER Software Support.

**P.F. DEVICE dn DUMPED.**

Description: Informative message indicating that dumping of permanent files from device with device number dn is complete.

Issued by PFDUMP.

User Action: None.

### **P.F. DEVICE dn LOADED.**

Description: Informative message indicating that loading of permanent files from device with device number dn is complete.

Issued by PFLOAD.

User Action: None.

### **xxx Ppppp SYSTEM ERROR.**

Description: A software error has occurred and some alternative action was taken to avoid hanging up the system.

xxx PP program name that detected the error.

pppp Program address in PP where the error occurred.

Issued by 1AJ.

User Action: Contact CYBER Software Support.

### **PACK packname LOADED.**

Description: Informative message indicating that the auxiliary device, identified by packname, has been loaded.

Issued by PFLOAD.

User Action: None.

### **PACKED DATE/TIME CONVERSION ERROR.**

Description: An error was generated when converting the directive date/time to a packed date/time.

Issued by DMREC.

User Action: Check the date and time used on directive and rerun.

### **PACKER ABORTED.**

Description: PACKER terminated abnormally.

Issued by PACKER.

User Action: Check dayfile for other error messages.

### **PACKER COMPLETE.**

Description: PACKER terminated normally.

Issued by PACKER.

User Action: None.

### **PACKET COMMUNICATION ERROR**

Description: An error was encountered when CTI attempted to send a packet to the intelligent console.

Issued by CTI.

User Action: None.

### **PACKET TRANSFER ERROR TO IOU1 ERROR CODE - XX**

Description: The following is a list of the error codes available:

- 1 CHECKSUM ERROR
- 2 ILLEGAL FUNCTION CODE
- 3 PACKET TOO LONG
- 4 DATA TRANSMISSION ERROR
- 7 PP ERROR
- C DATA ERROR

- 10 CTRL-G EXCHANGE ABORTED
- 11 NO START BYE
- 12 PACKET ERROR
- 13 TIMEOUT ERROR
- 14 BUSY

Issued by CTL.

User Action: None.

**PACKNAME packname DUMPED.**

Description: Informative message indicating that the auxiliary device, identified by packname, has been dumped.

Issued by PFDUMP.

User Action: None.

**PACKNAME NOT FOUND.**

Description: The pack requested did not exist, or was a family device.

Issued by PACKER.

User Action: Correct parameters and retry.

**PAGE DESCRIPTOR ENTRY NOT FOUND.**

Description: A page table was not found when using the I directive.

Issued by DSDI.

User Action: Ensure that the dump file contains meaningful information.

**PAGE TABLE AREA VERIFY ERROR DEADSTART ABORTED.  
INFORM CE**

Description: A data error occurred during a ones/zeros page check of the central memory area in which the page table will be built.

Issued by CTL.

User Action: Inform site analyst or customer engineer.

**PAGING COMPLETE.**

Description: Informative message on the K display indicating that page advancing command (+) has completed.

Issued by QREC.

User Action: None.

**PAPER FAULT.**

Description: The paper on the line printer is not aligned correctly.

Issued by IIO.

User Action: Check paper alignment (refer to 580 line printer programmable control initialization in appendix D).

**PAPER FAULT.**

Description: I-display message indicating a printer problem.

Issued by DSD.

User Action: Correct printer paper flow.

**PAPER FAULT.**

Description: I-display message. Paper has jammed or otherwise failed to feed in the printer.

Issued by 1CD.

User Action: Correct paper alignment, if necessary, then enter CONTINUE,est.from DSD.

### **PARAM STATEMENTS IN PARAM RECORD EXCEED 40**

Description: The routine NAMI supports only 40 PARAM statements in any given parameter record. If this error is encountered, it may help to put more parameter keyword/values on each PARAM statement, thus reducing the number of necessary PARAM statements.

Issued by NAMI.

User Action: Self-explanatory.

### **PARAMETER ADDRESS ERROR.**

Description: The parameter address specified in the SMP monitor request call is not within the job's field length.

Issued by SMP.

User Action: Correct the SMP call and retry.

### **PARAMETER xx ARGUMENT ERROR.**

Description: Error in the specification of parameter xx.

Issued by PACKER.

User Action: Correct parameters and retry.

### **PARAMETER CHARACTER COUNT EXCEEDED.**

Description: A parameter has more than 10 characters in a DSDI command.

Issued by DSDI.

User Action: Correct parameter in DSDI command and rerun.

### **PARAMETER ERROR**

Description: Self-explanatory.

Issued by PSU.

User Action: Reenter the command with the correct parameter.

### **PARAMETER FIRST IS GREATER THAN LAST IN DIRECTIVE.**

Description: The 3 directive first and last values are not logical.

Issued by NDA.

User Action: Check both values. Change the incorrect one.

### **PARAMETER FORMAT ERROR.**

Description: The input directive contains an incorrect file name - too many characters or non-alphanumeric characters.

Issued by DMREC.

User Action: Correct directive and rerun.

### **PARAMETER FTCB/NTCB MUST BE LESS THAN LCBL/TCBL IN DIRECTIVE.**

Description: One of the A directive values is out of range. FTCB must be less than LCBL, and NTCB must be less than TCBL.

Issued by NDA.

User Action: Check both values. Change the incorrect one.

### **PARAMETER MISSING**

Description: This message indicates that a parameter was missing on the command that you just entered.

Issued by PSU.

User Action: Reenter the command with the correct parameter.

**p PARAMETER MUST BE FOLLOWED BY AN EQUAL SIGN.**

Description: The parameter p must be followed by an equal sign.

Issued by NLTERM.

User Action: Correct the parameter specification and rerun the job.

**PARAMETER OLDEST MUST BE BETWEEN FWA AND LWA OF CIO BUFFER.**

Description: The 4 directive OLDEST value is out of range.

Issued by NDA.

User Action: Change the value.

**PARAMETER TOO LONG.**

Description: A command parameter value exceeded maximum length.

Issued by NVF.

User Action: Attempt corrected command entry.

**PARAMETER TRUNCATED xxxx**

Description: An optional parameter contains too many characters. xxxx is the parameter in truncated form. BINEDIT aborts only if the A parameter appears in the BINEDIT command.

Issued by BINEDIT.

User Action: If the job aborted, ensure that the parameter in question has a proper character length and rerun the job; otherwise, no action is required.

**PARAMETER VALUE NOT SPECIFIED.**

Description: cmd= was entered. This is a syntax error.

Issued by NIP.

User Action: None.

**PARITY ERROR IN CATALOG IMAGE dm ct.**

Description: A parity error was encountered while PFLOAD read catalog image information for catalog track ct for the master device with device mask dm.

Issued by PFLOAD.

User Action: Enter K.GO to skip the affected catalog track while processing others. Enter anything else to abort the load.

**PARITY ERROR ON DATA RCVD FROM EXT CHANNEL.**

Description: A parity error was detected on data received from an external channel.

Issued by SCE.

User Action: Inform site analyst and customer engineer.

**PARITY ERROR ON DATA XMTD FROM EXTERNAL PP.**

Description: A parity error was detected on data transmitted from a PP.

Issued by SCE.

User Action: Inform site analyst and customer engineer.



**\*\*\*\* PASSWORD REQUIRED.**

Description: A password was not encountered for the user name being created. If MODVAL is being run from batch, the user name is not created.

Issued by MODVAL.

User Action: Specify a password if at K display or correct and rerun if from batch.

**PATH TURNED OFF - SEE MPA OUTPUT**

Description: The 7990 subsystem has turned a path off.

Issued by SSEXEC.

User Action: Examine the maintenance report to see why the path was turned off.

**PCPcp CPA/MOVING.**

Description: Control point or pseudo control point cp has a bad RA or was moving or rolling out when a level 3 deadstart was initiated. Recovery is aborted.

Issued by REC.

User Action: Level 0 deadstart is required.

**nnnn PER CENT CPU USAGE.**

Description: Summary message indicating CPU usage by the transaction subsystem.

Issued by TAF.

User Action: None.

**nnnnnn.nnn PERCENT CPU UTILIZATION.**

Description: Summary message indicating CPU utilization by the magnetic tape subsystem.

Issued by MAGNET.

User Action: None.

**PERCENT PARAMETER NOT SPECIFIED PROPERLY.**

Description: The percent parameter was not of the correct format or was specified greater than 100.

Issued by DMREC.

User Action: Correct directive and rerun.

**PERMANENT DAYFILE DEFINED AS filename.**

Description: Informative message indicating that the dayfile has been terminated and defined under the name filename.

Issued by DFTERM.

User Action: None.

**PERMANENT DAYFILE LIST COMPLETE.**

Description: K-display message for DFTERM or output file message for DFTERM indicating that the permanent dayfile list is complete.

Issued by DFTERM.

User Action: None.

**PERMANENT FILE BUSY.**

Description: The permanent boot file in NETDIR was already attached.

Issued by NETFMA.

User Action: Inform site analyst.

**PERMANENT FILE NOT FOUND.**

Description: The specified permanent file was not found.

Issued by NETFMA.

User Action: Inform site analyst.

**PERMIT RI RANGE ERR filename userindex.**

Description: Random index of the permit information for file filename is not within the legal range. Dumping continues with the file data.

Issued by PFDUMP.

User Action: Write a PSR and include support materials to allow CDC to duplicate the problem.

**PF LENGTH ERROR userindex filename.**

Description: The EOI sector of the direct access permanent file, as specified by the TRT, is not actually an EOI sector.

Issued by MSM.

User Action: Enter PAUSE,SYS to abort recovery of the device. Error IDLE status will be set. Enter GO,SYS to continue recovery of the device. The EOI sector will be found by reading the disk and the TRT will be adjusted accordingly. An 'error in file length' status will be set in the system sector. This will cause PFM to issue an EOI CHANGED BY RECOVERY error message when the file is attached. The error status can be removed with the CE parameter on the CHANGE command or macro.

**PF LINKAGE ERROR.**

Description: Operator message indicating that an error was encountered while recovering a preserved file during a level 0 deadstart. This message is preceded by the message

RECOVERY, EQest

which indicates the equipment in error.

est EST ordinal

Issued by MSM.

User Action: Redeadstart and initialize device. Preserved files on device are lost and must be reloaded.

**PF xxxxxxxx - NOT ON xxJ FILE.**

Description: The xxJ file does not have the specified CRM data file defined.

Issued by DMREC.

User Action: Make necessary xxJ file entry (CRM statement).

**PF xxxxxxxx - READ ONLY.**

Description: An attempt has been made to write on a file defined in the xxJ file as read only.

Issued by DMREC.

User Action: Change the xxJ file access mode.

**PF SPECIFIED BUT NOT UI/UN.**

Description: User index or user name associated with permanent file name specified is required but was not entered.

Issued by PFS.

User Action: Reenter parameters and specify both file name and user index or user name.

### **PF UTILITY ABORTED.**

Description: The utility has aborted because of an error detected in the parameter processing.

Issued by PFS.

User Action: Correct and retry.

### **PF UTILITY ACTIVE**

Description: Dayfile message indicating that a PF utility was active at the time SAVE command was entered.

Issued by PSU.

User Action: Reenter the SAVE command when the PF utility is not active.

### **PF UTILITY INPUT FILE EMPTY.**

Description: The file specified with the I parameter does not contain input directives or is positioned at EOI.

Issued by PFS.

User Action: Correct and retry.

### **PFATC ABORTED.**

Description: A fatal error occurred causing PFATC to abort. Issued by PFATC.

User Action: Check dayfile for other error messages to aid in determining the cause of this error.

### **PFATC - ARCHIVE FILE PARITY ERROR, FN=filename, UI=userindex.**

Description: Parity error was encountered on the archive file while cataloging file filename on user index userindex; file is skipped.

Issued by PFATC.

User Action: Retry or use backup archive file.

### **PFATC - ARCHIVE FILE PARITY ERROR.**

Description: Parity error was encountered on archive file. Archive file is skipped to next EOR mark. This message is similar to the PFATC - ARCHIVE FILE PARITY ERROR message with file name and user index except that the file name and user index are not known. This will occur when the error is in reading control information rather than file data.

Issued by PFATC.

User Action: Retry or use backup archive file.

### **PFATC COMPLETE.**

Description: Informative message indicating that PFATC is complete.

Issued by PFATC.

User Action: None.

### **PFATC - NO FILES PROCESSED.**

Description: Informative message indicating that no files meeting the specified selection criteria were found.

Issued by PFATC.

User Action: None.

### **PFATC - PREMATURE EOF DETECTED.**

Description: During archive file processing, an EOF was detected before the end of dump control word.

Issued by PFATC.

User Action: The format of the archive file should be investigated.

### **PFC VERIFICATION ERROR.**

Description: The creation date and time, user index, or alternate storage address does not agree with the current PFC contents.

Issued by PFM.

User Action: Write a PSR.

### **PFCAT ABORTED.**

Description: A fatal error occurred causing PFCAT to abort.

Issued by PFCAT.

User Action: Check dayfile for other error messages to aid in determining the cause of the abort.

### **PFCAT COMPLETE.**

Description: Informative message indicating that the catalog of the permanent file device is complete.

Issued by PFCAT.

User Action: None.

### **PFCAT LO AND S CONFLICT.**

Description: Both an output file and a summary file were specified for PFCAT.

Issued by PFS.

User Action: Correct and retry.

### **PFCAT - UNKNOWN DEVICE NUMBER filename userindex.**

Description: The device number specified in the catalog entry for file filename with user index userindex is the number of an alternate device that cannot be found.

Issued by PFCAT.

User Action: Mount the missing device and retry the operation.

### **PFCOPY ABORTED.**

Description: A fatal error occurred causing PFCOPY to abort.

Issued by PFCOPY.

User Action: Check dayfile for other error messages to aid in determining the cause of this error.

### **PFCOPY - ARCHIVE FILE PARITY ERROR, FN=filename,UI=userindex.**

Description: A parity error was encountered on tape while PFCOPY copied file filename on user index userindex; the file is skipped.

Issued by PFCOPY.

User Action: Retry or use backup archive file.

### **PFCOPY - ARCHIVE FILE PARITY ERROR.**

Description: A parity error was encountered on archive file. The archive file is skipped to next archive file mark. This message is similar to the PFCOPY - ARCHIVE FILE PARITY ERROR message with file name and user index except that the file name and user index are not known. This will occur when the error is in reading control information rather than file data.

Issued by PFCOPY.

User Action: Retry or use backup archive file.

### **PFCOPY - CATALOG CONTROL WORD MISSING.**

Description: During archive file processing, a catalog control word was expected but not found.

Issued by PFCOPY.

User Action: The format of the archive file should be investigated.

### **PFCOPY COMPLETE.**

Description: Informative message indicating that PFCOPY is complete.

Issued by PFCOPY.

User Action: None.

### **PFCOPY - DATA CONTROL WORD ERROR.**

Description: A data control word was expected on the archive file but was not found.

Issued by PFCOPY.

User Action: Retry or use backup archive file.

### **PFCOPY - FILE NAME CHANGED TO ZZZZZLF.**

Description: The name of the file being copied was the same as the specified output file. The local file name was changed to prevent a conflict.

Issued by PFCOPY.

User Action: None.

### **PFCOPY - FILE NAME CHANGED TO ZZZZZSF.**

Description: The name of the file being copied was the same as the specified summary file. The local file name was changed to prevent a conflict.

Issued by PFCOPY.

User Action: None.

### **PFCOPY - FILE NAME CHANGED TO ZZZZZTF.**

Description: The name of the file being copied was the same as the specified archive file. The local file name was changed to prevent a conflict.

Issued by PFCOPY.

User Action: None.

### **PFCOPY - NO DEVICE FOR FILE, FN=filename, UI=userindex.**

Description: No mass storage device whose access level limits include the access level of file filename is available.

Issued by PFCOPY.

User Action: None.

### **PFCOPY - NO FILES PROCESSED.**

Description: Informative message indicating that no files have been copied during the utility run.

Issued by PFCOPY.

User Action: None.

### **PFCOPY - PREMATURE EOF DETECTED.**

Description: During archive file processing, an EOF was detected before the end of dump control word.

Issued by PFCOPY.

User Action: The format of the archive file should be investigated.

**PFCOPY - SYSTEM SECTOR TOO LONG.**

Description: The word count for a system sector exceeds the standard system sector length; probable cause is that two parts of different split system sectors were joined. The affected file is skipped. Processing continues with the next file.

Issued by PFCOPY.

User Action: Retry or use backup archive file.

**PFCOPY - SYSTEM SECTOR TRUNCATED.**

Description: The word count for a system sector is less than the standard system sector length; probable cause is that part of a split system sector is missing. The affected file is skipped. Processing continues with the next file.

Issued by PFCOPY.

User Action: Retry or use backup archive file.

**PFDUMP - ABORT REPRIEVE BEGUN.**

Description: Marks the start of PFDUMP's abort processing.

Issued by PFDUMP.

User Action: None.

**PFDUMP - ABORT REPRIEVE COMPLETED.**

Description: Marks the completion of PFDUMP's abort processing. No further PFDUMP processing occurs after this message is issued.

Issued by PFDUMP.

User Action: None.

**PFDUMP ABORTED.**

Description: A fatal error occurred causing PFDUMP to abort.

Issued by PFDUMP.

User Action: Refer to accompanying error message to aid in determining the cause of the abort.

**PFDUMP - ACCESS LEVEL LIMITS OUT OF RANGE.**

Description: The access level limits for the devices to be dumped are not within the system access level limits or, if the LA and UA parameters were specified, the values specified for these parameters are not within the system access level limits.

Issued by PFDUMP.

User Action: Change the system access level limits or specify different values for the LA and UA parameters.

**PFDUMP - ACCESS LEVELS NOT ALLOWED ON ARCHIVE FILE EQUIPMENT.**

Description: The access level limits for the devices to be dumped or, if specified the LA and UA parameters, are not within the access level limits for the equipment assigned to the ARCHIVE and VERIFY files.

Issued by PFDUMP.

User Action: Assign different equipment to the ARCHIVE and VERIFY files.

**PFDUMP - BAD SYSTEM SECTOR, FN=filename, UI=userindex.**

Description: Error was encountered in the system sector of file filename during dump to archive tape. Dumping continues with the next file. Error idle status is set for the device.

Issued by PFDUMP.

User Action: Dump files, initialize device, and reload files.

**PFDUMP - CATALOG READ ERROR, FM=familyname,  
DNdn, CTct, EQest, Tttt, Sssss.**

Description: A mass storage error occurred while PFDUMP read catalog information on the specified family, device number, logical catalog track, EST ordinal, logical track, and logical sector. Files cataloged in the bad sector are not dumped. If possible, dumping continues with the next sector of the affected catalog track. Otherwise, dumping continues with the next catalog track or device as appropriate for the dump type. Error idle status is set for the device.

Issued by PFDUMP.

User Action: Analyze error and retry. If error persists, assume cause is hardware malfunction.

**PFDUMP - CATALOG READ ERROR, FN=filename,  
UI=userindex.**

Description: File filename for the specified user index was not dumped because a catalog read error affected the sector on which the file was cataloged. Error idle status is set for the device.

Issued by PFDUMP.

User Action: Analyze error and retry.

**PFDUMP - CATALOG READ ERROR, PN=packname,  
EQest, Tttt, Sssss.**

Description: A mass storage error occurred while PFDUMP read catalog information on the specified auxiliary pack. The EST ordinal, logical track, and logical sector are given. Files cataloged in the bad sector are not dumped. If possible, dumping continues with the next sector of the affected catalog track. Otherwise, dumping continues with the next catalog track or device as appropriate for the dump type. Error idle status is set for the device.

Issued by PFDUMP.

User Action: Analyze error and retry. If error persists, assume cause is hardware malfunction.

**PFDUMP COMPLETE.**

Description: Marks normal termination of PFDUMP. No further processing occurs after this message is issued.

Issued by PFDUMP.

User Action: None.

**PFDUMP - DAPF BUSY, FN=filename, UI=userindex.**

Description: Direct access file filename with user index userindex cannot be dumped because it is attached in a writable mode. Dumping continues with the next file.

Issued by PFDUMP.

User Action: Retry PFDUMP operation after user has released the file.

**PFDUMP - DAPF READ ERROR, FM=familyname,  
DNdn, EQest, Tttt, Sssss.**

Description: A mass storage error occurred while PFDUMP read a direct access file on the specified family, device number, EST ordinal, logical track, and logical sector. The dump continues with the next record, unless suppressed by the error option.

Issued by PFDUMP.

User Action: Analyze error and retry.

**PFDUMP - DAPF READ ERROR, FN=filename,  
UI=userindex, PRU=pru.**

Description: A mass storage error occurred while PFDUMP read direct access file filename for user index userindex at relative PRU pru. The dump continues at the next record, unless suppressed by the error option.

Issued by PFDUMP.

User Action: Analyze error and retry.

**PFDUMP - DAPF READ ERROR, PN=packname, EQest, Ttttt, Sssss.**

Description: A mass storage error occurred while PFDUMP read a direct access file on the specified auxiliary pack, EST ordinal, logical track, and logical sector. The dump continues with the next record, unless suppressed by the error option.

Issued by PFDUMP.

User Action: Analyze error and retry.

**PFDUMP - DAPF TOO LONG, FM=familyname, DNdn, EQest, Ttttt, Sssss.**

Description: A direct access file was truncated at the specified family, device, EST ordinal, logical track, and sector when the number of sectors read for the file exceeded the length determined from the TRT. Dumping continues with the next file. Error idle status is set for the device.

Issued by PFDUMP.

User Action: Dump files, initialize device, and reload files.

**PFDUMP - DAPF TOO LONG, FN=filename, UI=userindex, PRU=pru.**

Description: Direct access file filename for user index userindex was truncated at the specified relative PRU address when the number of sectors read for the file exceeded the length determined from the TRT. Dumping continues with the next file. Error idle status is set for the device.

Issued by PFDUMP.

User Action: Dump files, initialize device, and reload files.

**PFDUMP - DAPF TOO LONG, PN=packname, EQest, Ttttt, Sssss.**

Description: A direct access file on the specified auxiliary pack was truncated at the specified EST ordinal, logical track, and logical sector when the number of sectors read for the file exceeded the length determined from the TRT. Dumping continues with the next file. Error idle status is set for the device.

Issued by PFDUMP.

User Action: Dump files, initialize device, and reload files.

**PFDUMP - DAPF TOO SHORT, FM=familyname, DNdn, EQest, Ttttt, Sssss.**

Description: The number of sectors dumped for a direct access file on the specified family, device, EST ordinal, logical track, and sector was less than the length determined by the TRT. Dumping continues with the next file. Error idle status is set for the device.

Issued by PFDUMP.

User Action: Dump files, initialize device, and reload files.

**PFDUMP - DAPF TOO SHORT, FN=filename, UI=userindex, PRU=pru.**

Description: The number of sectors dumped for the specified direct access file was less than the length determined from the TRT. Dumping continues with the next file. Error idle status is set for the device.

Issued by PFDUMP.

User Action: Dump files, initialize device, and reload files.



**PFDUMP - DAPF TOO SHORT, PN=packname, EQest, Tttt, Sssss.**

Description: The number of sectors dumped for a direct access file on the specified auxiliary pack, EST ordinal, logical track, and sector was less than the length determined from the TRT. Dumping continues with the next file. Error idle status is set for the device.

Issued by PFDUMP.

User Action: Dump files, initialize device, and reload files.

**PFDUMP - DAPF TRUNCATED, FN=filename, UI=userindex, PRU=pru.**

Description: Direct access file filename was truncated when a mass storage error occurred preventing further dumping of the file. PRU=pru gives the number of PRUs truncated. Dumping continues with the next file.

Issued by PFDUMP.

User Action: Analyze error and retry.

**PFDUMP - DEVICE ERROR IDLE SET, FM=familyname, DNdn, EQest, Tttt, Sssss.**

Description: PFDUMP has set an error idle status on device dn with EST ordinal est for the reason given in the previous message.

Issued by PFDUMP.

User Action: Dump files, initialize device, and reload files.

**PFDUMP - DEVICE ERROR IDLE SET, PN=packname, EQest, Tttt, Sssss.**

Description: PFDUMP has set an error idle status on pack packname and EST ordinal est for the reason given in the previous message.

Issued by PFDUMP.

User Action: Dump files, initialize device, and reload files.

**PFDUMP DEVICE dn FAMILY familyname.**

Description: Informative message identifying the device being dumped and the family name associated with that device.

dn	Device number.
familyname	Family name.

Issued by PFDUMP.

User Action: None.

**PFDUMP DEVICE MASK dm.**

Description: Informative message indicating device mask (dm) of device currently being dumped.

Issued by PFDUMP.

User Action: None.

**PFDUMP - DEVICE NOT FOUND, FN=filename, UI=userindex, DNdn.**

Description: The device dn containing file filename for user index userindex was not found. Dumping continues with the next file.

Issued by PFDUMP.

User Action: Retry operation with device defined in the system.

**PFDUMP DEVICE dn PACK packname.**

Description: Informative message identifying the pack name of the auxiliary device currently being dumped.

dn                Device number.  
packname        Pack name.

Issued by PFDUMP.

User Action: None.

**PFDUMP - IAPF READ ERROR, FM=familyname,  
DNdn, EQest, Tttt, Sssss.**

Description: A mass storage error occurred while PFDUMP read an indirect access file on the specified family, device number, EST ordinal, logical track, and logical sector. Dumping continues with the next record, unless suppressed by the error option.

Issued by PFDUMP.

User Action: Analyze error and retry.

**PFDUMP - IAPF READ ERROR, FN=filename,  
UI=userindex, PRU=pru.**

Description: A mass storage error occurred while PFDUMP read indirect access file filename for user index at relative PRU pru. Dumping continues with the next record, unless suppressed by the error option.

Issued by PFDUMP.

User Action: Analyze error and retry.

**PFDUMP - IAPF READ ERROR, PN=packname,  
EQest, Tttt, Sssss.**

Description: A mass storage error occurred while PFDUMP read an indirect access file on the specified auxiliary pack, EST ordinal, logical track, and logical sector. Dumping continues with the next record, unless suppressed by the error option.

Issued by PFDUMP.

User Action: Analyze error and retry.

**PFDUMP - IAPF TOO LONG, FM=familyname,  
DNdn, EQest, Tttt, Sssss.**

Description: An indirect access file was truncated at the specified family, device, EST ordinal, logical track, and sector when the number of sectors read for the file exceeded the length determined from the TRT. Dumping continues with the next file. Error idle status is set for the device.

Issued by PFDUMP.

User Action: Dump files, initialize device, and reload files.

**PFDUMP - IAPF TOO LONG, FN=filename,  
UI=userindex, PRU=pru.**

Description: An indirect access file filename for user index userindex was truncated at the specified relative PRU address when the number of sectors read for the file exceeded the length determined from the TRT. Dumping continues with the next file. Error idle status is set for the device.

Issued by PFDUMP.

User Action: Dump files, initialize device, and reload files.

**PFDUMP - IAPF TOO LONG, PN=packname, EQest, Tttt, Sssss.**

Description: An indirect access file on the specified auxiliary pack was truncated at the specified EST ordinal, logical track, and logical sector when the number of sectors read for the file exceeded the length determined from the TRT. Dumping continues with the next file. Error idle status is set for the device.

Issued by PFDUMP.

User Action: Dump files, initialize device, and reload files.

**PFDUMP - IAPF TOO SHORT, FM=familyname,  
DNdn,EQest, Tttt, Sssss.**

Description: The number of sectors dumped for an indirect access file on the specified family device at the specified EST ordinal, logical track and sector was less than the length determined by the TRT. Dumping continues with the next file. Error idle status is set for the device.

Issued by PFDUMP.

User Action: Dump files, initialize device, and reload files.

**PFDUMP - IAPF TOO SHORT, FN=filename,  
UI=userindex, PRU=pru.**

Description: The number of sectors dumped for the specified indirect access file was less than the length determined from the TRT. Dumping continues with the next file. Error idle status is set for the device.

Issued by PFDUMP.

User Action: Dump files, initialize device, and reload files.

**PFDUMP - IAPF TOO SHORT, PN=packname, EQest,  
Tttt, Sssss.**

Description: The number of sectors dumped for an indirect access file on the specified auxiliary pack, EST ordinal, logical track, and sector was less than the length determined from the TRT. Dumping continues with the next file. Error idle status is set for the device.

Issued by PFDUMP.

User Action: Dump files, initialize device, and reload files.

**PFDUMP - IAPF TRUNCATED, FN=filename,  
UI=userindex, PRU=pru.**

Description: Indirect access file filename for user index was truncated when a mass storage error occurred preventing further dumping of the file. PRU=pru gives the number of PRUs truncated. Dumping continues with the next file.

Issued by PFDUMP.

User Action: Analyze error and retry.

**PFDUMP - INTERNAL ERROR ON FILE ZZZZZOD.**

Description: The contents of the job's optical disk control file (ZZZZZOD) is incorrect. It may have been returned or overwritten by the job.

Issued by PFDUMP.

User Action: Make sure that the job does not return or overwrite the ZZZZZOD file. If you are sure that the file has not been compromised, notify the site analyst.

**PFDUMP - NO FILES PROCESSED.**

Description: Informative message indicating that no files have been dumped.

Issued by PFDUMP.

User Action: Check file selection parameters and rerun if necessary.

**PFDUMP - NO FILES SELECTED.**

Description: The specified file selection parameters for the dump were such that the files could not exist on the system.

Issued by PFDUMP.

User Action: Change file selection parameters and restart dump.

**PFDUMP - NT/CT/AT TAPE OR OD REQUIRED FOR DESTAGE.**

Description: The file specified for either the archive file or the verify file on a destage dump was neither an NT, CT, or AT tape nor an OD optical disk device.

Issued by PFDUMP.

User Action: Assign correct files for the archive, verify files, and retry.

**PFDUMP - OPERATOR DISABLED filename.**

Description: The PFDUMP archive or verify file named was disabled by operator action. The dump continues on the remaining file.

Issued by PFDUMP.

User Action: None.

**PFDUMP - OPTICAL DISK LABEL NOT VALID FOR DESTAGE.**

Description: The recorded file name, file owner name, and/or group owner name on the optical disk requested for destaging purposes are not those required for destage processing.

Issued by PFDUMP.

User Action: Ensure that the optical disks are labeled correctly for destage processing.

**PFDUMP - ORPHAN PFC ENCOUNTERED,  
FN=filename, UI=userindex.**

Description: File filename does not have an image on disk or on alternate storage. Error idle status is set for the device. Dumping continues with the next file.

Issued by PFDUMP.

User Action: Analyze error and then purge the affected file.

**PFDUMP - PARTITION NOT VALID FOR DESTAGE.**

Description: The partition name on the optical disk requested for destaging purposes is not the partition name required for destage processing.

Issued by PFDUMP.

User Action: Ensure that the optical disks are correctly labeled and partitioned for destage processing.

**PFDUMP - PERMIT FORMAT ERROR, FN=filename,  
UI=userindex.**

Description: The permit entries for the specified file were not dumped because the user index of the file did not match the user index in the permit entry. Dumping continues with the file data. Error idle status is set for the device.

Issued by PFDUMP.

User Action: Recreate the permit entries for the file.

**PFDUMP - PERMIT READ ERROR, FM=familyname,  
DNdn, EQest, Tttt, Sssss.**

Description: A mass storage error occurred while PFDUMP read permit information on the specified family, device number, EST ordinal, logical track, and logical sector. The bad sector and any following sectors of permit information for the affected file are truncated. Dumping continues with the file data. Error idle status is set for the device.

Issued by PFDUMP.

User Action: Analyze error and retry.

**PFDUMP - PERMIT READ ERROR, FN=filename,  
UI=userindex.**

Description: A mass storage error occurred while PFDUMP read the permit information of file filename for user index userindex. The bad sector and any following sectors of permit information for file filename are truncated. Dumping continues with the file data. Error idle status is set for the device.

Issued by PFDUMP.

User Action: Analyze error and retry.

**PFDUMP - PERMIT READ ERROR, PN=packname, EQest, Ttttt, Sssss.**

Description: A mass storage error occurred while PFDUMP read permit information on the specified auxiliary pack, EST ordinal, logical track and logical sector. The bad sector and any following sectors of permit information for the affected file are truncated. Dumping continues with the file data. Error idle status is set for the device.

Issued by PFDUMP.

User Action: Analyze error and retry.

**PFDUMP - RD/WT ERROR ON CTSL UPDATE,  
FN=filename, UI=userindex.**

Description: During destage dump, an unrecoverable read/write error occurred when PFU attempted to set the TFLOK destage interlock in the PFC entry for file filename. The tape alternate storage pointers will not be updated in the PFC entry of the file.

Issued by PFDUMP.

User Action: None.

**PFDUMP - RD/WT ERROR ON UCDT UPDATE,  
FN=filename, UI=userindex.**

Description: An unrecoverable read/write error occurred while PFDUMP attempted to update the utility control date and time field in the PFC entry for file filename. Error idle status is set for the device. Dumping continues with the next file.

Issued by PFDUMP.

User Action: Dump the affected device and reload its files. PFLOAD will flaw the affected catalog track.

**PFDUMP - READ ERROR ON REQS-ABORT.**

Description: There is an unrecoverable read error on the staging request file REQS. Thus, PFDUMP is not able to report the files not dumped because the operator suspended the rescan of a given catalog track for alternate storage files staged to disk.

Issued by PFDUMP.

User Action: Analyze error and retry.

**PFDUMP - READ ERROR ON RESS - ABORT.**

Description: There is an unrecoverable read error on the rescan screen file RESS. Thus, PFDUMP was not able to search for alternate storage files it has requested to be staged to disk.

Issued by PFDUMP.

User Action: Analyze error and retry.

**PFDUMP - STAGED FILE RESCAN KILLED,  
FN=filename, UI=userindex.**

Description: The operator discontinued the rescan of a given catalog track for files staged to disk. Probable cause of the operator's action is a malfunction of the alternate storage executive and/or its auxiliaries. This message is issued for each file not dumped because of the operator's action. After all such files are listed, dumping continues with the next catalog track.

Issued by PFDUMP.

User Action: Analyze reason for operator's action and retry.

### **PFDUMP - TAPE FORMAT OR LABEL NOT VALID FOR DESTAGE.**

Description: The archive file or verify file tape is either not I format, is unlabeled, or has a non-standard label for a destage dump.

Issued by PFDUMP.

User Action: Ensure that the tapes are labeled correctly for destage processing.

### **PFDUMP - TAPE NOT AT BOI FOR DESTAGE.**

Description: The archive file or the verify file tape was not positioned at beginning of information (BOI) for a destage dump.

Issued by PFDUMP.

User Action: Ensure that the archive file and verify file tapes are positioned at BOI when a destage dump is performed.

### **PFDUMP - UNABLE TO STAGE FILE, FN=filename, UI=userindex.**

Description: File filename on user index userindex could not be staged to disk from either MSE or tape alternate storage because of an error flag or error flags set in the file's PFC entry. Only the file's PFC entry and permits will be dumped unless a destage dump is being performed. If a destage dump is being performed, the file will be skipped.

Issued by PFDUMP.

User Action: None.

### **PFDUMP - VERIFY ERROR ON CTSL UPDATE, FN=filename, UI=userindex.**

Description: During a destage dump, PFU rejected the request to set the TFLOK destage interlock in the PFC entry for file filename. The tape alternate storage pointers will not be updated for the affected file.

Issued by PFDUMP.

User Action: None.

### **PFDUMP - VERIFY ERROR ON UCDD UPDATE, FN=filename, UI=userindex.**

Description: PFU has rejected the request to update the utility control date and time field in the PFC entry for file filename. The catalog entry found at the indicated catalog track location did not agree with the supplied verification information. Error idle status is set for the device. Dumping continues with the next file.

Issued by PFDUMP.

User Action: Write a PSR and include support materials to allow CDC to duplicate the problem.

### **PFDUMP - VERSION NUMBER EXCEEDED FOR DESTAGE.**

Description: The version number of the optical disk requested for destaging purposes exceeds 4095.

Issued by PFDUMP.

User Action: Ensure that the optical disks are correctly prepared for destage processing.

### **PFDUMP - VSN NOT VALID FOR DESTAGE.**

Description: The VSN of the archive file tape, verify file tape, or optical disk is not in the correct format for a destage dump, or the archive and verify file tapes or optical disks do not have corresponding VSN formats and device types.

Issued by PFDUMP.

User Action: Ensure that the VSNs are in the correct format.

**PFDUMP - ZERO LENGTH FILE, FN=filename, UI=userindex.**

Description: File filename is empty and thus cannot be dumped. Error idle status is set for the device. Dumping continues with the next file.

Issued by PFDUMP.

User Action: None.

**PFLOAD ABORTED.**

Description: A fatal error occurred causing PFLOAD to abort.

Issued by PFLOAD.

User Action: Check dayfile for other error messages to aid in determining the cause of the abort.

**PFLOAD - ALTERNATE DEVICE NOT FOUND, FN=filename, UI=userindex.**

Description: The device on which a direct access file formerly resided is not available in the system and an alternate device was not specified. Loading continues with the next file.

Issued by PFLOAD.

User Action: To load the skipped file, rerun the utility and specify an alternate device (DD parameter) or specify OP=L to load the file to the device with the most space.

**PFLOAD - ARCHIVE FILE FORMAT ERROR.**

Description: Information not recognizable by PFLOAD was detected on the archive file. Loading continues with the next file.

Issued by PFLOAD.

User Action: Ensure correct tape is in use and/or retry operation.

**PFLOAD - ASSIGN TAPE.**

Description: Informs the operator that assignment of an archive file is required.

Issued by PFLOAD.

User Action: Assign archive file.

**PFLOAD - CATALOG IMAGE FORMAT ERROR.**

Description: A catalog image record was found on the archive file in a format unrecognizable by PFLOAD.

Issued by PFLOAD.

User Action: The bad archive file can be used in a normal load by specifying the omit option (OP=O) to skip the catalog image record.

**PFLOAD - CATALOG READ ERROR, FM=familyname, DNdn, CTct, EQest, Tttt, Ssss.**

Description: A mass storage error occurred while PFLOAD read catalog information on the specified family, device number, logical catalog track, EST ordinal, logical track, and logical sector. Error idle status is set for the device.

Issued by PFLOAD.

User Action: Analyze error and retry.

**PFLOAD - CATALOG READ ERROR, FN=filename,  
UI=userindex.**

Description: File filename was cataloged in a sector affected by a mass storage error. Error idle status is set for the master device.

Issued by PFLOAD.

User Action: Analyze error and retry.

**PFLOAD - CATALOG READ ERROR, PN=packname,  
EQest, Ttttt, Sssss.**

Description: A mass storage error occurred while PFLOAD read catalog information on the specified auxiliary pack, EST ordinal, logical track, and logical sector. Error idle status is set for the device.

Issued by PFLOAD.

User Action: Analyze error and retry.

**PFLOAD - CATALOG WRITE ERROR, FM=familyname,  
DNdn, CTct, EQest, Ttttt, Sssss.**

Description: A mass storage error occurred while PFLOAD wrote catalog information on the specified family, device number, logical catalog track, EST ordinal, logical track, and logical sector. Error idle status is set for the device.

Issued by PFLOAD.

User Action: Analyze error and retry.

**PFLOAD - CATALOG WRITE ERROR, FN=filename,  
UI=userindex.**

Description: The catalog information for file filename could not be written because of a mass storage write error. Error idle status is set for the master device.

Issued by PFLOAD.

User Action: Analyze error and retry.

**PFLOAD - CATALOG WRITE ERROR, PN=packname,  
EQest, Ttttt, Sssss.**

Description: A mass storage error occurred while writing catalog information on the specified auxiliary pack, EST ordinal, logical track, and logical sector. Error idle status is set for the device.

Issued by PFLOAD.

User Action: Analyze error and retry.

**PFLOAD - DAPF WRITE ERROR, FM=familyname,  
DNdn, EQest, Ttttt, Sssss.**

Description: A mass storage error occurred while PFLOAD wrote a direct access file on the specified family, device number, EST ordinal, logical track, and logical sector. Mass storage space for the affected file is dropped and the bad track is flawed. A catalog entry is not created for the file. Loading continues with the next file.

Issued by PFLOAD.

User Action: Analyze error and retry.

**PFLOAD - DAPF WRITE ERROR, FN=filename,  
UI=userindex.**

Description: A mass storage error occurred while PFLOAD wrote direct access file filename for user index. Mass storage space for the affected file is dropped and the bad track is flawed. A catalog entry is not created for the file. Loading continues with the next file. Issued by PFLOAD.

User Action: Analyze error and retry.



**PFLOAD - DAPF WRITE ERROR, PN=packname, EQest, Ttttt, Sssss.**

Description: A mass storage error occurred while PFLOAD wrote a direct access file on the specified auxiliary pack, EST ordinal, logical track, and logical sector. Mass storage space for the affected file is dropped and the bad track is flawed. A catalog entry is not created for the file. Loading continues with the next file.

Issued by PFLOAD.

User Action: Analyze error and retry.

**PFLOAD DEVICE dn FAMILY familyname.**

Description: Informative message identifying the device being loaded and the family name associated with that device.

dn	Device number
familyname	Family name

Issued by PFLOAD.

User Action: None.

**PFLOAD - DEVICE dn NOT FOUND.**

Description: The specified device was not found.

Issued by PFLOAD.

User Action: Retry operation with device defined in the system.

**PFLOAD DEVICE dn PACK packname.**

Description: Informative message identifying the pack name of the auxiliary device being loaded The device number will always be zero.

dn	Device number
packname	Pack name

Issued by PFLOAD.

User Action: None.

**PFLOAD - ERROR IDLE DETECTED, FM=familyname, DNdn, EQest, Ttttt, Sssss.**

Description: An error idle status was detected on the specified device. The EST ordinal, logical track, and logical sector are given.

Issued by PFLOAD.

User Action: Correct error idle condition and then rerun the load.

**PFLOAD - ERROR IDLE DETECTED, FN=filename, UI=userindex.**

Description: An error idle status was detected on the device being loaded. The file filename is the first file that could not be loaded.

Issued by PFLOAD.

User Action: Correct error idle condition and then rerun the load.

**PFLOAD - ERROR IDLE DETECTED, PN=packname, EQest, Ttttt, Sssss.**

Description: An error idle status was detected on the specified auxiliary device. The EST ordinal, logical track, and logical sector are given.

Issued by PFLOAD.

User Action: Correct error idle condition and then rerun the load.

**PFLOAD - ERROR IDLE SET, FM=familyname, DNdn, EQest, Tttt, Sssss.**

Description: PFLOAD has set an error idle status on device dn, EST ordinal est for the reason given in the previous message.

Issued by PFLOAD.

User Action: Analyze error and retry.

**PFLOAD - ERROR IDLE SET, PN=packname, EQest, Tttt, Sssss.**

Description: PFLOAD has set an error idle status on the specified auxiliary device for the reason given in the previous message.

Issued by PFLOAD.

User Action: Analyze error and retry.

**PFLOAD - ERROR ON FILE PURGE, FN=filename, UI=userindex.**

Description: PFLOAD was unable to purge the file to allow loading of the replacement file from the archive file. This is usually caused by a PFM error or by a user recreating the file immediately after a successful purge.

Issued by PFLOAD.

User Action: Check the file that could not be purged and retry the load.

**PFLOAD - EXCESSIVE PARITY ERRORS.**

Description: PFLOAD has encountered 100B consecutive read parity errors on the archive file. The load is aborted.

Issued by PFLOAD.

User Action: Retry or use backup tape.

**PFLOAD - EXTRACT OPTION REQUIRES CIR.**

Description: The extract option was specified for the load when the archive file did not contain a catalog image record (CIR).

Issued by PFLOAD.

User Action: Retry without extract option.

**PFLOAD-FILE TRUNCATED, FN=filename, UI=userindex.**

Description: The data for the file on the archive tape is shorter than the length indicated in the catalog entry for the file. The file is truncated and the length in the catalog is updated to reflect the smaller size. Loading continues with the next file.

Issued by PFLOAD.

User Action: Load the file from a backup tape if desired.

**PFLOAD - IAPF WRITE ERROR, FM=familyname, DNdn, EQest, Tttt, Sssss.**

Description: A mass storage error occurred while PFLOAD wrote an indirect access file on the specified family name, device number, EST ordinal, logical track, and logical sector. A catalog entry with a special write error user index is created for that portion of the file up to and including the bad sector. Loading continues with the next file.

Issued by PFLOAD.

User Action: Analyze error and retry.

**PFLOAD - IAPF WRITE ERROR, FN=filename, UI=userindex.**

Description: A mass storage error occurred while PFLOAD wrote indirect access file filename for user index userindex. A catalog entry with a special write error user index is created for that portion of the file up to and including the bad sector. Loading continues with the next file.

Issued by PFLOAD.

User Action: Analyze error and retry.

**PFLOAD - IAPF WRITE ERROR, PN=packname, EQest, Tttt, Sssss.**

Description: A mass storage error occurred while PFLOAD wrote an indirect access file on the specified auxiliary pack, EST ordinal, logical track, and logical sector. A catalog entry with a special write error user index is created for that portion of the file up to and including the bad sector. Loading continues with the next file.

Issued by PFLOAD.

User Action: Analyze error and retry.

**PFLOAD - INCORRECT NAME/INDEX, 00000000000000000000.**

Description: A file with an incorrect name and/or user index was encountered and skipped. The 42-bit file name and 18-bit user index are shown in octal. Loading continues with the next file.

Issued by PFLOAD.

User Action: Analyze error and retry.

**PFLOAD - LABEL BAD, ASSIGN NEW TAPE.**

Description: Informs the operator that the archive file did not contain a correct dump label.

Issued by PFLOAD.

User Action: Assign a new archive file.

**PFLOAD-MISSING EOR, FN=filename,UI=userindex.**

Description: Logical EOR is missing on the file being loaded (incorrect data). The file is truncated and the length of the file is updated in the PFC. This message is followed by the message

PFLOAD - TAPE ERROR, FN=filename, UI=  
userindex.

to identify the file.

Issued by PFLOAD.

User Action: Retry or use backup tape.

**PFLOAD - NO DEVICE FOR FILE, FN=filename, UI=userindex.**

Description: No permanent file device whose access level limits include the access level of file filename is available.

Issued by PFLOAD.

User Action: None.

**PFLOAD - NO EOI FOR FILE, FN=filename, UI=userindex.**

Description: The next catalog (or other control word type that logically precedes the previous DATA control word) was found before EOI was detected for the current file. The file length is updated in the catalog entry. Loading continues with the next file. The message is followed by the message

PFLOAD - TAPE ERROR, FN= filename, UI=  
userindex.

to identify the file.

Issued by PFLOAD.

User Action: Retry or use backup tape.

**PFLOAD - NO FILES SELECTED.**

Description: The file selection parameters for the load were such that the specified files could not exist in the system.

Issued by PFLOAD.

User Action: Correct selection parameters and restart load.

**PFLOAD - NO SPACE FOR FILE, FN=filename, UI=userindex.**

Description: The length of the named direct access file is greater than the amount of space available on the selected device. Loading is continued with the next file.

Issued by PFLOAD.

User Action: If the OP=L option was specified, there is no room for the file on any device; space must be made available by purging other files. If OP=L was not specified, it can be used to select the device with the most space.

**PFLOAD - PARITY ERROR, FN=filename, UI=userindex.**

Description: A parity error was encountered on the archive tape while PFLOAD loaded file filename. Loading continues with the next file.

Issued by PFLOAD.

User Action: Retry or use backup tape.

**PFLOAD - PERMIT WRITE ERROR, FM=familyname, DNdn, EQest, Tttt, Sssss.**

Description: A mass storage error occurred while PFLOAD wrote permit information on the specified family, device number, EST ordinal, logical track, and logical sector. The bad sector and any following sectors of permit information for the affected file are truncated. Error idle status is set for the device.

Issued by PFLOAD.

User Action: Analyze error and retry.

**PFLOAD - PERMIT WRITE ERROR, FN=filename, UI=userindex.**

Description: A mass storage error occurred while PFLOAD wrote the permit information of file filename for user index userindex. The bad sector and any following sectors of permit information for file filename are truncated. Error idle status is set for the device.

Issued by PFLOAD.

User Action: Analyze error and retry.

**PFLOAD - PERMIT WRITE ERROR, PN=packname, EQest, Tttt, Sssss.**

Description: A mass storage error occurred while PFLOAD wrote permit information on the specified auxiliary pack, EST ordinal, logical track and logical sector. The bad sector and any following sectors of permit information for the affected file are truncated. Error idle status is set for the device.

Issued by PFLOAD.

User Action: Analyze error and retry.

**PFLOAD - PERMITS MISSING, FN=filename, UI=userindex.**

Description: Permit information on the archive tape is missing or incomplete. Loading continues with the next file. This message is followed by the message

PFLOAD - TAPE ERROR, FN=filename,  
UI=userindex.

to identify the file.

Issued by PFLOAD.

User Action: Retry or use backup tape.

**PFLOAD - PERMITS PRESENT THAT SHOULD NOT BE, FN=filename, UI=userindex.**

Description: A permit block was found on tape but no permit random index was found in the catalog entry of the file. Loading continues with the next file. This message is followed by the message

PFLOAD - TAPE ERROR, FN=filename,  
UI=userindex.

to identify the file.

Issued by PFLOAD.

User Action: Retry or use backup tape.

**PFLOAD - PFC INCONSISTENT WITH ARCHIVE CONTENTS, FN=filename, UI=userindex.**

Description: The archive file is inconsistent in that a PFC only was expected and data for the file was also encountered, or data was expected and not found. Loading continues with the next file. This message is followed by

PFLOAD - TAPE ERROR FN=filename,  
UI=userindex.

to identify the file.

Issued by PFLOAD.

User Action: Retry or use backup tape.

**PFLOAD - SELECTED FILES NOT ON ARCHIVE FILE.**

Description: The archive file dump label showed that the selected files are not on the archive file.

Issued by PFLOAD.

User Action: Ensure correct archive tape is being used and that correct PFLOAD parameters are specified and retry operation.

**PFLOAD - SYSTEM SECTOR TOO LONG, FN=filename, UI=userindex.**

Description: The word count for the system sector encountered for file filename exceeds the standard length; probable cause is that two parts of different split system sectors were joined. Loading continues with the next file.

Issued by PFLOAD.

User Action: Analyze error and retry, or use backup tape.

**PFLOAD - SYSTEM SECTOR TRUNCATED, FN=filename, UI=userindex.**

Description: The word count for the system sector encountered for file filename is less than the standard length; probable cause is that part of a split system sector is missing. Loading continues with the next file.

Issued by PFLOAD.

User Action: Analyze error and retry.

**PFLOAD - TAPE ERROR, FN=filename,  
UI=userindex.**

Description: Error was encountered on tape while PFLOAD loaded file filename. Loading continues with the next file. This message identifies the file that PFLOAD was attempting to load when the error occurred. The error is described in the previously issued message.

Issued by PFLOAD.

User Action: Try backup tape.

**PFLOAD - TRACK LIMIT, FM=familyname, DNdn,  
EQest, Tttt, Sssss.**

Description: A track limit condition was encountered on the specified familyn device. The EST ordinal, logical track, and logical sector are given.

Issued by PFLOAD.

User Action: Free up space on the device and then rerun the load.

**PFLOAD - TRACK LIMIT, FN=filename,  
UI=userindex.**

Description: A track limit condition was encountered on the permanent file device being loaded. The file filename is the first file that could not be loaded.

Issued by PFLOAD.

User Action: Free up space on the device and then rerun the load.

**PFLOAD - TRACK LIMIT, PN=packname, EQest,  
Tttt, Sssss.**

Description: A track limit condition was encountered on the specified auxiliary device. The EST ordinal, logical track, and logical sector are given.

Issued by PFLOAD.

User Action: Free up space on the device and then rerun the load.

**PFM ERROR ec ATTACHING FILE nm.**

Description: PFM error ec occurred trying to attach the file nm during log file termination.

Issued by NLTERM.

User Action: Refer to the applicable permanent file error diagnostic in Volume 4 of the NOS 2 Reference Set. The name of the file is changed, but the file has not terminated. The log server must release the file before the TERM command can complete termination of this file.

**PFM ERROR ec DURING CHANGE TO FILE nm.**

Description: PFM error ec occurred during the change of the currently active log file to file nm. The change occurs during log file termination.

Issued by NLTERM.

User Action: Refer to the applicable permanent file error diagnostic in Volume 4 of the NOS 2 Reference Set.

**PFM ERROR ec DURING INTERNAL CATLIST.**

Description: PFM error ec occurred during an internal catlist.

Issued by NLTERM.

User Action: Refer to the applicable permanent file error diagnostic in Volume 4 of the NOS 2 Reference Set.

**PFM ERROR ec DURING PURGE OF FILE nm.**

Description: PFM error ec occurred during the PURGE of file nm from the catalog.

Issued by NLTERM.

User Action: Refer to the applicable permanent file error diagnostic in Volume 4 of the NOS 2 Reference Set.

**PFM ERROR ec PFN= filename UN= username.**

Description: MCS could not attach indicated file.

ec	PFM error code
filename	File name
username	User name

Issued by MCS.

User Action: Refer to the NOS Reference Set, Volume 4 for a list of the error codes.

**PFN=filename, FAMILY=familyname  
UI=userindex - DEFINE ERROR.**

Description: SSDEF cannot define a SMMAP or SFMCAT file.

Issued by SSDEF.

User Action: Submit a PSR and include support materials.

**PFN=filename, FAMILY=familyname,  
UI=userindex - ALREADY PERMANENT.**

Description: One or more of the SMMAP and/or SFMCAT files to be created already exist.

Issued by SSDEF.

User Action: Correct the parameters on the SSDEF command and retry, or purge the existing SFMCAT and/or SMMAP files and retry.

**PFN=filename, FAMILY=familyname,  
UI=userindex - FAMILY NOT FOUND.**

Description: The familyname specified by the FM parameter on the SSDEF command does not exist.

Issued by SSDEF.

User Action: Specify an existing familyname and retry.

**PFN=filename, FAMILY=familyname,  
UI=userindex - CIO ERROR.**

Description: A write error was encountered on the SMMAP or the SFMCAT files.

Issued by SSDEF.

User Action: Purge the file affected SMMAP or SFMCAT and use SSDEF to create a new one.

**PFREL ABORTED.**

Description: PFREL has aborted.

Issued by PFREL.

User Action: Check dayfile for more information.

**PFREL - CATALOG READ ERROR, FM=familyname, DN=dd, CTccc, EQest, Tttt,  
Sssss.**

Description: A mass storage read error occurred when reading catalog information from device number dd on family familyname. The error occurred on catalog track ordinal ccc, EST ordinal est, track tttt, sector sssss.

Issued by PFREL.

User Action: None.

**PFREL - CATALOG READ ERROR, FN=filename, UI=userindex.**

Description: File filename under user index userindex was cataloged in a sector affected by a mass storage error.

Issued by PFREL.

User Action: None.

**PFREL - CATALOG READ ERROR, PN=packname, EQest, Tttt, Sssss.**

Description: A mass storage read error occurred when reading catalog information from auxiliary device packname. The error occurred on EST ordinal est, track tttt, sector ssss.

Issued by PFREL.

User Action: None.

**PFREL COMPLETE.**

Description: PFREL has completed normally.

Issued by PFREL.

User Action: None.

**PFREL - DEVICE NOT FOUND, FN=filename, UI=userindex, DNdd.**

Description: File filename cataloged under user index userindex was selected for disk release but device dd on which the file resides could not be found in the system.

Issued by PFREL.

User Action: Check the status of the missing device.

**PFRES ABORTED.**

Description: PFRES aborted.

Issued by PFRES.

User Action: Check dayfile for more information.

**PFRES - ARCHIVE FILE PARITY ERROR, FN=filename, UI=userindex, FM=family.**

Description: A parity error was encountered on tape while PFRES staged the specified file; the file is skipped.

Issued by PFRES.

User Action: Retry or use backup archive file.

**PFRES - ARCHIVE FILE PARITY ERROR.**

Description: A parity error was encountered on the tape. The tape is skipped to the end of the record. This error is similar to the PFRES - ARCHIVE FILE PARITY ERROR message with file name, user index and family, except that the identity of the file is not known. This will occur when the error is encountered in reading control information rather than file data.

Issued by PFRES.

User Action: Retry or use backup archive file.

**PFRES - CATALOG CONTROL WORD MISSING.**

Description: An error was detected in the staging tape format.

Issued by PFRES.

User Action: Check the staging tape.

**PFRES COMPLETE.**

Description: PFRES completed.



Issued by PFRES.

User Action: None.

### **PFRES - DATA CONTROL WORD ERROR.**

Description: An error was detected in the staging tape format.

Issued by PFRES.

User Action: Check the staging tape.

### **PFRES - FILE VERIFICATION ERROR, FN=filename, UI=userindex, FM=family.**

Description: The information on the staging tape is inconsistent with the information in the PFC entry of the file being staged.

Issued by PFRES.

User Action: Check the staging tape.

### **PFRES - INCORRECT CATALOG SIZE.**

Description: The archive tape which was assigned to PFRES as a staging tape was dumped on a system with 8-word PFCs.

Issued by PFRES.

User Action: The wrong tape is mounted. Correct and retry.

### **PFRES - NO DEVICE FOR FILE, FN=filename, UI=userindex, FM=family.**

Description: No device was available with the correct security access level to contain file filename on user index userindex of family family.

Issued by PFRES.

User Action: Configuration problem. Contact security administrator.

### **PFRES - NO FILES TO RESTORE.**

Description: PFRES was initiated, but no stage requests were pending.

Issued by PFRES.

User Action: None.

### **PFRES - PFM ERROR ENCOUNTERED, FN=filename, UI=userindex, FM=family.**

Description: An error was encountered when attempting to restore a file to disk residence.

Issued by PFRES.

User Action: Check status of file.

### **PFRES - PREMATURE EOF DETECTED.**

Description: During archive file processing, an EOF was detected before the end of dump control word.

Issued by PFRES.

User Action: The format of the archive file should be investigated.

### **PFRES - STAGE ABANDONED, FN=filename, UI=userindex, FM=family.**

Description: The stage request for the specified file has been abandoned, because it had been retried unsuccessfully the maximum number of times.

Issued by PFRES.

User Action: Check the archive tape. Retry on a different tape unit, or use the backup archive tape.

**PFRES - STAGING TAPE ASSIGNED. VSN=vsn.**

Description: A staging tape has been assigned normally.

Issued by PFRES.

User Action: None.

**PFRES - STAGING TAPE NOT ASSIGNED.**

Description: A file other than a tape was assigned to PFRES as a staging tape.

Issued by PFRES.

User Action: None.

**PFRES - STAGING TAPE VSN ERROR, VSN=vsn.**

Description: The vsn of the tape assigned is not correct for a staging tape.

Issued by PFRES.

User Action: Check the staging tape.

**PFRES - SYSTEM SECTOR TOO LONG.**

Description: The word count for a system sector exceeds the standard system sector length; probable cause is that two parts of different split system sectors were joined. The affected file is skipped; processing continues with the next file.

Issued by PFRES.

User Action: Retry or use backup archive file.

**PFRES - SYSTEM SECTOR TRUNCATED.**

Description: The word count for a system sector is less than the standard system sector length; probable cause is that part of a split system sector is missing. The affected file is skipped; processing continues with the next file. Issued by PFRES.

User Action: Retry or use backup archive file.

**PFU - ALTERNATE DEVICE NOT FOUND.**

Description: PFU is unable to locate the alternate device for a direct access file which does not reside on a master device.

Issued by PFU.

User Action: Make device available and retry.

**PFU - BUFFER ARGUMENT ERROR ON filename AT address.**

Description: The circular buffer pointers for file filename did not satisfy the following conditions:

- FIRST .LE. IN .LT. LIMIT
- FIRST .LE. OUT .LT. LIMIT
- LIMIT .LE. FL

filename      File being processed  
address      FET address of the file

Issued by PFU.

User Action: Write a PSR and include support materials to allow CDC to duplicate the problem.

**PFU - BUFFER CTL WORD ERROR ON filename AT address.**

Description: The word count of a disk sector to be read from a central memory buffer exceeds the word count limit of a sector (100B).

filename     File being processed  
address     FET address of the file

Issued by PFU.

User Action: Write a PSR and include support materials to allow CDC to duplicate the problem.

### **PFU - CATALOG TRACK NOT FOUND.**

Description: No permanent file catalog track could be found for the user index being processed.

Issued by PFU.

User Action: Write a PSR and include support materials to allow CDC to duplicate the problem.

### **PFU - CONTROL POINT ERROR FLAG DETECTED ffff.**

Description: Error flag ffff was detected at PFU control point; PFU aborts. If no operator action has been taken to drop the control point, other messages indicating the probable cause of the error flag should be present.

Issued by PFU.

User Action: Analyze error and retry.

### **PFU - DUPLICATE FILE, filename AT address.**

Description: There is a file at the control point whose name, filename, is the same as one of the files used by the permanent file utility that is currently active.

filename     File being processed  
address     FET address of the file

Issued by PFU.

User Action: Write a PSR and include support materials to allow CDC to duplicate the problem.

### **PFU - FILE NOT FOUND, filename AT address.**

Description: An entry for the file filename was not found in the file name table (FNT).

filename     File being processed  
address     FET address of the file

Issued by PFU.

User Action: Write a PSR and include support materials to allow CDC to duplicate the problem.

### **PFU - I/O SEQUENCE ERROR ON filename AT address.**

Description: An operation was requested on a file before the previous operation completed.

filename     File being processed  
address     FET address of file

Issued by PFU.

User Action: Write a PSR and include support materials to allow CDC to duplicate the problem.

### **PFU - NO DEVICE SPECIFIED.**

Description: No device number was specified with the PFU read list function.

Issued by PFU.

User Action: Write a PSR and include support materials to allow CDC to duplicate the problem.

### **PFU - NOT SPECIAL SYSTEM JOB.**

Description: The calling program does not have an SSJ= special entry point defined.

Issued by PFU.

User Action: None.

### **PFU - PARAMETER ERROR.**

Description: The program calling PFU has an error in the calling parameters. This should not occur unless there is an error in the utility or a nonutility program is calling PFU. Nonutility programs call PFU at their own risk.

Issued by PFU.

User Action: Write a PSR and include support materials to allow CDC to duplicate the problem.

### **PFU - ROLLOUT FLAG DETECTED.**

Description: During a PFLOAD, the rollout flag was detected at the control point. This will normally be due to PFLOAD being aborted with a user break from an interactive job.

Issued by PFU.

User Action: None.

### **PFU - TRACK INTERLOCK CLEAR ON filename AT address.**

Description: When PFU was called to clear the track interlock on a file, the FST entry for that file showed that the interlock was already clear.

filename	File being processed
address	FET address of the file

Issued by PFU.

User Action: Write a PSR and include support materials to allow CDC to duplicate the problem.

### **PFU - TRACK INTERLOCK SET ON filename AT address.**

Description: When PFU was called to set the track interlock on a file, the FST entry for that file showed that the interlock was already set.

filename	File being processed
address	FET address of the file

Issued by PFU.

User Action: Write a PSR and include support materials to allow CDC to duplicate the problem.

### **PID NOT ALTERED.**

Description: An attempt to alter a PID was rejected by \*SFM\*.

Issued by LIDOU.

User Action: None.

### **PID NOT FOUND.**

Description: The PID specified could not be found in the LID table.

Issued by LIDOU.

User Action: Reenter L-display input with correct PID to be deleted.

### **PIM - ARGUMENT ERROR.**

Description: The peripheral interface module (PIM) encountered an invalid RA+1 request, a parameter block not within FL, or an invalid function code.

Issued by PIM.

User Action: Inform site analyst.

### **PIP - INCORRECT REQUEST.**

Description: The peripheral interface module (PIM) was not called by an SSJ= or SYOT job.

Issued by PIM.

User Action: Inform site analyst.

### **PIP x ISSUED THE FOLLOWING MESSAGE.**

Description: Informative message indicating that PIP x has detected an error and issued the dayfile message that follows this one. x is the PIP ordinal defined in EST.

Issued by NIP.

User Action: Inform site analyst about message which follows this one.

### **PIP x REJECTED DOWNLINE MSG.**

Description: Informative message indicating that PIP x has rejected a downline message that NIP sent. x is the PIP ordinal defined in the EST. The dayfile message is followed by an octal/hex dump of the message that PIP rejected.

Issued by NIP.

User Action: Inform site analyst about message which follows this one.

### **PIP x SENT MSG WITH BAD BLOCK TYPE.**

Description: Fatal message indicating that NIP aborted the network because it received an upline message with an unknown block type from PIP x. x is the PIP ordinal defined in EST. The dayfile message is followed by an octal/hex dump of the upline message with the bad block type.

Issued by NIP.

User Action: Reinitialize NAM. Rerun collector job. Supply dumps or collector tape to CYBER Software Support or site analyst.

### **PIP x SENT PRU WORKLIST FOR NONPRU CON.**

Description: Fatal message indicating that NIP aborted the network because it received a PRU worklist for a nonPRU connection from PIP x. x is the PIP ordinal defined in EST. The dayfile message is followed by an octal/hex dump of the PRU worklist with the bad connection number.

Issued by NIP.

User Action: Reinitialize NAM. Rerun collector job. Supply dumps or collector tape to CYBER Software Support or site analyst.

### **PIP x SENT PRU WORKLIST WITH BAD ADDR.**

Description: Fatal message indicating that NIP aborted the network because it received a PRU worklist with an unknown network connection number from PIP x. x is the PIP ordinal defined in EST. The dayfile message is followed by an octal/hex dump of the PRU worklist with the bad connection number.

Issued by NIP.

User Action: Reinitialize NAM. Rerun collector job. Supply dumps or collector tape to CYBER Software Support or site analyst.

### **PIP x SENT PRU WORKLIST WITH BAD LENGTH.**

Description: Fatal message indicating that NIP aborted the network because it received a PRU worklist from PIP x with a text length of zero or a length greater than the maximum text length allowed. x is the PIP ordinal defined in EST. The dayfile message is followed by an octal/hex dump of the PRU worklist with the bad text length.

Issued by NIP.

User Action: Reinitialize NAM. Rerun collector job. Supply dumps or collector tape to CYBER Software Support or site analyst.

### **PIP x SENT PRU WORKLIST WITH BAD SM.**

Description: Fatal message indicating that NIP aborted the network because it received a PRU worklist with an unknown supervisory message from PIP x. x is the PIP ordinal defined in EST. The dayfile message is followed by an octal/hex dump of the PRU worklist with the bad supervisory message.

Issued by NIP.

User Action: Reinitialize NAM. Rerun collector job. Supply dumps or collector tape to CYBER Software Support or site analyst.

### **PIP x SENT REL WORKLIST WITH BAD LEVEL.**

Description: Fatal message indicating that NIP aborted the network because it received a release worklist request from PIP x with a bad level number. x is the PIP ordinal defined in EST. The dayfile message is followed by an octal/hex dump of the release worklist with the bad level number.

Issued by NIP.

User Action: Reinitialize NAM. Rerun collector job. Supply dumps or collector tape to CYBER Software Support or site analyst.

### **PIP x SENT TERM WORKLIST WITH BAD RC.**

Description: Fatal message indicating that NIP aborted the network because it received a terminate PRU connection worklist from PIP x with an unknown return code. x is the PIP ordinal defined in EST. The dayfile message is followed by an octal/hex dump of the terminate PRU connection worklist with the unknown return code.

Issued by NIP.

User Action: Reinitialize NAM. Rerun collector job. Supply dumps or collector tape to CYBER Software Support or site analyst.

### **PIP x SENT UNEXPECTED RELEASE WORKLIST.**

Description: Fatal message indicating that NIP aborted the network because it received a release worklist request from PIP x for a worklist that does not exist. x is the PIP ordinal defined in EST. The dayfile message is followed by an octal/hex dump of the unexpected release worklist.

Issued by NIP.

User Action: Reinitialize NAM. Rerun collector job. Supply dumps or collector tape to CYBER Software Support or site analyst.

### **PIP x SENT WORKLIST WITH BAD OPCODE.**

Description: Fatal message indicating that NIP aborted the network because it received a worklist with a bad opcode from PIP x. x is the PIP ordinal defined in EST. The dayfile message is followed by an octal/hex dump of the worklist with the bad opcode.

Issued by NIP.

User Action: Reinitialize NAM. Rerun collector job. Supply dumps or collector tape to CYBER Software Support or site analyst.

### **PK, PT OPTION VIOLATED.**

Description: One of the following occurred:

- The PK or PT option cannot be used with the directive specified.
- The PK or PT option has not been specified correctly.
- The PK or PT option cannot be used with one of the other parameters specified.

Issued by SSLABEL.

User Action: Correct error and retry.

### **nnnn PLOT FILES RECOVERED.**

Description: nnnn files in the plot queue have been recovered.

Issued by REC.

User Action: None.

### **PLT INCREASE NOT POSSIBLE.**

Description: The plot link table is at its maximum possible length when more entries were requested due to current activity. A temporary slowdown in response time may be noticed by terminal users. The NAMIF IPRDECK entry may not reflect the actual number of interactive users.

Issued by IAFEX.

User Action: None, unless this message is seen many times. It is re-logged each time the maximum is reached, in which case, increase the NAMIAF entry when a level zero deadstart is done.

### **PM MESSAGE.**

Description: I-display message indicating a printer message.

Issued by DSD.

User Action: Check printer for special instructions. The operator should enter CONTINUE,est. to restart the printer.

est EST ordinal of device

### **PM MESSAGE.**

Description: I-display message. Printer is waiting for operator action.

Issued by ICD.

User Action: Check PM message and take requested action; then enter CONTINUE,est.from DSD.

### **POINTER ERROR.**

Description: The time-sharing subsystem has encountered incorrect internal pointers during recovery. These pointers could be the terminal table pointer or the plot pointer. Recovery terminates and reloading is attempted.

Issued by IAFEX.

User Action: Restart the time-sharing subsystem.

### **ttt POINTER WORD ERROR.**

Description: The number of assigned entries in managed table ttt pointer word does not agree with what is in the table. Recovery is aborted.

Issued by REC.

User Action: Level 0 deadstart is required.

### **PORT PRESET FAILED ON MMF LINK.**

Description: A bad channel has been defined for the port or a hardware problem has occurred with the port.

Issued by MTE.

User Action: Fix the EQPDECK entry to correct the channel. If the problem persists, contact customer engineer.

### **POSSIBLE BLOCKAGE AMONG CM RESIDENT TASKS.**

Description: The sum of the maximum field lengths (MFLs) for the CM resident tasks exceeds the minimum size of the total task area (potential space available to contain tasks). Thus one or more CM resident tasks could be blocked from completing.

Issued by TAF.

User Action: Correct error.

### **POT LINK TABLE OVERFLOW.**

Description: Space sufficient to allocate the required table during IAF initialization was not available. An internal change to IAF is necessary.

Issued by IAFEX.

User Action: Contact CYBER Software Support.

### **POTENTIALLY BLOCKED TASKS DETECTED.**

Description: During TAF initialization potentially blocked tasks were detected. Preceding error messages contain additional details.

Issued by TAF.

User Action: Correct error.

### **POWER DOWN.**

Description: Bits 36 and 37 of the status/control register are set, indicating detection of a power failure and abnormal environmental condition. This message is preceded in the error log by the characters SR hh.mm.ss. where hh.mm.ss is the time when the condition was detected.

Issued by 1MB.

User Action: Contact CYBER Software Support and customer engineer. (For further explanation and procedures, refer to S/C Register Error Detection, appendix E.)

### **POWER/ENVIRONMENT NORMAL.**

Description: Bits 36 and 37 of the status/control register (bit 0 of the interlock register) are clear after one or both were set. This message is preceded in the error log by the letters SR hh.mm.ss (CYBER 170 machine) or IR hh.mm.ss. (CYBER 70 machine) where hh.mm.ss is the time when the condition was detected. Also DFT has detected that either bit 59 of the processor status summary register or bit 63 of the processor, memory, or input/output unit status summary register was cleared.

Issued by 1MB.

User Action: Ensure that all equipment is ready. With the site analyst's approval, enter the commands:

99. UNSTEP. 99.

Refer to appendix E for further information.

### **POWER FAILURE.**

Description: DFT detected the short power warning bit (bit 59) in the processor status summary register. Refer to appendix E for more information.

Issued by 1MB.

User Action: Inform site analyst and customer engineer.

### **(xxx) POWER WARNING**

Description: For xxx=702: A long warning condition has been detected in the maintenance registers. Since battery backup is present and in use, the system has 60 seconds to react. For xxx=703: A short warning condition has been detected in the processor maintenance registers.

Issued by 1MB.

User Action: Wait until the message is cleared.

### **PP ABORT.**

Description: System error in PPU.

Issued by RECLAIM.



User Action: Examine the job dayfile to determine the cause.

### **PP BUSY.**

Description: System activity prevents DIS from completing the command last entered.

Issued by DIS.

User Action: Retry.

### **PP CALL ERROR.**

Description: Error detected in PP call due to hardware or RECLAIM error.

Issued by RECLAIM.

User Action: Inform site analyst.

### **PP HUNG-xxx**

Description: One or more PPs have attempted to perform an incorrect operation. The PP becomes hung because CPUMTR does not clear the output register. xxx = PP program name.

Issued by CPUMTR.

User Action: The recommended procedure is as follows.

1. Perform an express deadstart dump.
2. Attempt level 3 deadstart; if not successful, try level 0.
3. Retain dump tape for site analyst.

### **PPpp NOT RESPONDING -FATAL ERROR- DEADSTART ABORTED.**

Description: Communication with the PP was lost during initialization. pp is the number of the PP.

Issued by CTI.

User Action: Redeadstart. Select H option on O display and turn off the specified PP.

### **PP pp STOPPED ON PARITY ERROR - PPM.**

Description: Peripheral processor pp has stopped because of a memory parity error.

Issued by SCE.

User Action: Inform site analyst and customer engineer. (For further explanation and procedures, refer to S/C Register Error Detection, appendix E.)

### **PPN Pyyyy SYSTEM ERROR.**

Description: A hardware or software error occurred at address yyyy in PP routine xxx.

Issued by CPUMTR.

User Action: If the problem occurs frequently, enter ENABLE, SYSTEM DEBUG command to hang the PP when the problem occurs. When the PP hangs, obtain a total express dump, including all controlware. Analyze the dump for cause or submit the dump with a PSR to CYBER Software Support.

### **PPR LOAD ERROR.**

Description: An I/O error occurred when attempting to read PPR from the peripheral library.

Issued by REC.

User Action: Contact customer engineer to run HPA to determine the nature of the error and take appropriate maintenance action.

### **PPU ERROR.**

Description: A hardware error was detected in a PPU.

Issued by SCE.

User Action: Inform site analyst and customer engineer.

**PPU NOT FOUND.**

Description: Output file message indicating that the requested PP record was not found in the EDD file.

Issued by DSDI.

User Action: Ensure that the dump file contains meaningful information.

**nnnn PRE-INITIAL JOB FILES RECOVERED.**

Description: nnnn jobs that were in a preinitial job state have been recovered.

Issued by REC.

User Action: None.

**PREMATURE END OF FILE ON dumpfile.**

Description: Unexpected EOR or EOF encountered while processing NPU dump file dumpfile.

Issued by NDA.

User Action: Possible bad NPU dump file. Contact CYBER Software Support.

**PREMATURE EOF.**

Description: A premature EOF was detected while copying the EDD file to a random file during initialization.

Issued by DSDI.

User Action: Ensure that the dump file contains meaningful information.

**PREMATURE \*EOF\* ENCOUNTERED.**

Description: During processing of the load file, an EOF was encountered before it was expected.

Issued by QLOAD.

User Action: Inform site analyst. Format of the load tape should be investigated.

**PRESET NOT ALLOWED.**

Description: This is not the first machine being deadstarted in a multimainframe environment and the PRESET command is not needed.

Issued by MSM.

User Action: Attempt another deadstart without entering the PRESET command.

**PREVIOUS COMMAND INCOMPLETE, TRY AGAIN.**

Description: Host Operator entered a command before previous command completed.

Issued by NVF.

User Action: Wait for command completion, reenter command.

**PRINT ERROR.**

Description: I-display message indicating a printer error.

Issued by DSD.

User Action: Correct the printer error. The operator should enter CONTINUE,est. to restart the printer.

est EST ordinal of device

**PRINT ERROR.**

Description: I-display message. A printer error has occurred.

Issued by 1CD.

User Action: Correct printer error then enter CONTINUE,EST.\* FROM \*DSD\*. If failure recurs, notify a customer engineer.

### **nnnn PRINT FILES RECOVERED.**

Description: nnnn files in the print queue have been recovered.

Issued by REC.

User Action: None.

### **PRINTER NOT LOGGED IN**

Description: This message indicates that a command was entered for a printer which was not active.

Issued by PSU.

User Action: Correct printer name in command or bring up desired printer.

### **PRIVATE PACK/PERMIT UN CONFLICT.**

Description: User name of the private pack is not the same as the user name specified for permits. In this case, no new active dayfiles may be started on the private pack.

Issued by DFTERM.

User Action: Select a different device for the new dayfile.

### **\*PROBE\* COMMAND ERROR.**

Description: An error has been detected in the PROBE command.

Issued by PROBE.

User Action: Correct command and retry.

### **PROBE NOT ENABLED.**

Description: PROBE was not enabled on the system prior to the creation of the EDD tape.

Issued by DSDI.

User Action: Ensure that the dump file contains meaningful information.

### **\*PROBE\* REPORT COMPLETE.**

Description: Informative message.

Issued by PROBE.

User Action: None.

### **PROBE TABLE NOT AVAILABLE.**

Description: The PROBE tables were not found on the dump file.

Issued by DSDI.

User Action: Ensure that the dump file contains meaningful information.

### **PROBE VERSION MISMATCH.**

Description: The version under which the data was built is not the current PROBE version.

Issued by PROBE.

User Action: Use correct version of PROBE to generate report.

### **PROCESSING COMPLETE.**

Description: Informative message.

Issued by MREC.

User Action: None.

**PROCESSING COMPLETE ON NPxxxxx.**

Description: This message is output for each NPU dump record processed.

Issued by NDA.

User Action: None.

**PROCESSING DUMP FILE.**

**dmp yy/mm/dd. hh.mm.ss.**

Description: Informative message indicating which dump is currently being processed and the date and time.

This message is issued when the dump header field is encountered. In cases where file positioning requests position the file beyond this point, the message will not appear.

Issued by QLOAD.

User Action: None.

**PROCESSING INPUT DIRECTIVES.**

Description: DSDI initialization is complete and directives are being processed.

Issued by DSDI.

User Action: None.

**PROCESSOR FAULT STATUS ERROR DEADSTART  
ABORTED. INFORM CE**

Description: A fault status error occurred during processor initialization.

Issued by CTI.

User Action: Inform site analyst or customer engineer.

**PROCESSOR NOT ACCESSIBLE**

Description: A processor element is not accessible on the maintenance channel.

Issued by CTI.

User Action: None.

**PROCESSOR NOT RESPONDING - FATAL ERROR -  
DEADSTART ABORT. INFORM CE**

Description: A peripheral processor will not accept idle loop package or a processor (CP or PP) has not completed execution within a predefined time period.

Issued by CTI.

User Action: Inform site analyst or customer engineer.

**PROFILE ABORTED.**

Description: Dayfile message indicating that an error flag has been set at the control point.

Issued by PROFILE.

User Action: Consult dayfile listing for reason (operator drop, for example).

**PROFILE FILE CREATE COMPLETE.**

Description: Dayfile message indicating that the creation run is complete.

Issued by PROFILE.

User Action: None.

### **PROFILE FILE DATA BASE ERROR.**

Description: Dayfile message indicating that the project file does not contain both a level 0 and level 1 block.

Issued by PROFILE.

User Action: Ensure that the project file is local and contains a level 0 and level 1 block (at least one charge entry) and rerun.

### **PROFILE FILE INQUIRY COMPLETE.**

Description: Dayfile message indicating that the inquire run is complete.

Issued by PROFILE.

User Action: None.

### **PROFILE FILE INTERLOCKED**

Description: Message displayed at line 1 of the control point indicating that the PROFILE file is interlocked for modification during update run.

Issued by PROFILE.

User Action: None.

### **PROFILE FILE LIST COMPLETE.**

Description: Dayfile message indicating that the list of PROFILE is complete.

Issued by PROFILE.

User Action: None.

### **PROFILE FILE REFORMAT COMPLETE.**

Description: Dayfile message indicating that the reformat run is complete.

Issued by PROFILE.

User Action: None.

### **PROFILE FILE RELEASED.**

Description: Message displayed at line 1 of the control point indicating that the PROFILE file has been released during update run to allow other system updates.

Issued by PROFILE.

User Action: None.

### **PROFILE FILE SOURCE COMPLETE.**

Description: Dayfile message indicating that the source run is complete.

Issued by PROFILE.

User Action: None.

### **PROFILE FILE UPDATE COMPLETE.**

Description: Dayfile message indicating that the update run is complete.

Issued by PROFILE.

User Action: None.

### **PROGRAM ABNORMAL, xxx.**

Description: There is a catalog access internal error in module xxx.

Issued by SSEXEC.

User Action: Inform site analyst.

#### **PROGRAM NOT ON TAPE - xxxx**

Description: The program binary, whose 4-character binary mnemonic is xxxx, is not on the tape that is being read.

Issued by CTI.

User Action: Verify program mnemonic and check to see that the correct tape is mounted.

#### **\*\*\*\* PROJECT COUNT LIMIT EXCEEDED.**

Description: The user has tried to create more active projects under this charge number than allowed.

Issued by PROFILE.

User Action: None.

#### **\*\*\*\* PROJECT NUMBER ACTIVE.**

Description: The user has attempted to activate an already active project number.

Issued by PROFILE.

User Action: Rerun using correct project number, if necessary.

#### **\*\*\*\* PROJECT NUMBER DOES NOT EXIST.**

Description: A directive for which a project number must exist made reference to a project number that does not exist.

Issued by PROFILE.

User Action: Correct and rerun using existing project number.

#### **\*\*\*\* PROJECT NUMBER INACTIVE.**

Description: The user has made a reference to a project number that is inactive with a directive for which the project number must be active.

Issued by PROFILE.

User Action: Activate project number and rerun or rerun using correct project number.

#### **PROTOCOL VIOLATION, NPU DUMP REQUEST SENT**

Description: Informative message indicating NIP has detected a protocol error on an upline network block. The NPU which sent the bad block will be stopped to allow an NPU dump to be taken.

Issued by NIP.

User Action: Contact CYBER Software Support.

#### **PSU ALREADY NETTED ON - GO/DROP**

Description: Dayfile and flashing B-display message indicating PSU has already netted on to the network. When this message is issued, PSU goes into a pause state. This is caused by giving the system command X.NAMI(RS=PR) while PSU is netted on to the network.

Issued by PSU.

User Action: If the network (NAM) is not up, enter the system command DROP,jsn where jsn is the JSN for PSU. If the network is up, check the NAM status display. If the JSN for the PSU netted on is older than that for NVF, drop the PSU that is netted on, then give the system command GO,jsn for the PSU in pause. If the JSN for the PSU netted on is not older than that for NVF, give the system command DROP,jsn for the PSU in pause state. In any case, review operating procedures. If condition continues to reoccur, notify site analyst.

#### **PSU - COMMENCING IDLE-DOWN**

Description: Dayfile message indicating PSU is responding to an idle-down request from the network.

Issued by PSU.

User Action: None.

## **PSU DISABLED IN NVF - GO/DROP**

Description: Dayfile and flashing B-display message indicating PSU is disabled in NVF. PSU will go into a pause state when this message is issued.

Issued by PSU.

User Action: Enable PSU in NVF and then enter the system command GO,JSN where jsn is the JSN of PSU. If you do not need PSU, enter the system command DROP,jsn where jsn is the JSN of PSU.

## **PSU - FATAL ERROR nn**

Description: Dayfile message indicating that PSU aborted because it detected fatal error number nn.

nn Significance

- 1 Non-new connection supervisory message received for a connection with state equal to 0.
- 2 New connection supervisory message received for a connection with state not equal to 0.
- 3 585 new connection supervisory message received for a non-585 device type.
- 4 Non-585 new connection supervisory message received for a 585 device type.
- 5 Unexpected supervisory message received on a non-585 connection.
- 6 Invalid state found on a 585 connection by the state processor.
- 7 Invalid state found on a non-585 connection.
- 8 Unexpected return code from QTENDT, non-585 connection.
- 9 Unexpected supervisory message received on a 585 connection.
- 10 Invalid state found on a 585 connection by the supervisory message processor.
- 11 Unexpected supervisory message received for state on 585 connection.
- 12 File name in OFC/EOO or OFC/ABORT/N does not match that in FET.
- 13 Unexpected sub-return code in OFC/STPD.
- 14 Invalid command for delayed command processor (state 103).
- 15 Unexpected return code from QTENDT on 585 connection.
- 16 Invalid command ordinal returned by command cracker.
- 17 Unexpected return code from QTCMD (9).
- 18 Unexpected return code from QTCMD (10).
- 19 Unexpected return code from QTCMD (11).
- 20 Unexpected return code from QTCMD (12).
- 21 Invalid device type from connection-established supervisory message.
- 22 Unexpected return code from QTTIP in state 1.
- 23 Unexpected return code from QTPUT in state 2.
- 24 Unexpected return code from QTPUT in state 4.
- 25 Unexpected return code from QTSUP/SETFILE in PRSMAC3.
- 26 Unexpected return code from QTSUP/OFCDATA in PRSMAC3.
- 27 Unexpected return code from QTSUP/OFCABORT in PRSMAC3.
- 28 Unexpected return code from QTSUP/OFCABORT for command RERUN in state 103.
- 29 Unexpected return code from QTSUP/RSTRSM for command END in state 103.
- 30 Unexpected return code from QTSUP/OFCABORT for command END in state 103.
- 31 Unexpected return code from QTSUP/RSTRSM for command BKSP in state 103.
- 32 Unexpected return code from QTSUP/RSTRSM for command SKIP in state 103.
- 33 Unexpected return code from QTSUP/SETFILE (spacing code and file limit) in state 102.
- 34 Unexpected return code from QTSUP/SETFILE (code set of queue file) in state 102.
- 35 Unexpected return code from QTSUP/OFCSTRT in state 102.
- 36 Unexpected return code from QTSUP/SETFILE in MSG subroutine.
- 37 Unexpected return code from QTSUP/OFCDATA in MSG subroutine.
- 38 Unexpected return code from QTPUT/prelist text in state 3.
- 39 Unexpected return code from QTPUT/queue empty text in state 3.
- 40 Unexpected return code from QTPUT/end-of-list text in state 10.
- 41 Unexpected return code from QTPUT/end-of-list text in state 11.
- 42 Logical error return code from network.
- 43 ACN from network greater than NC.
- 44 Unexpected return code from QTSUP/RSTRSM for command CONTINU in state 103.

- 45 Unexpected return code from QTPUT for LOADVFU primary.
- 46 Unexpected return code from QTPUT in GLP flush for QRST.
- 47 Unexpected return code from QTPUT in GLP for send QRST.
- 48 Unexpected return code from QTSUP/SETDEV in state 102.
- 49 Unexpected return code from QTSUP/SETFILE in command SUPPRES.
- 50 Unexpected return code from QTPUT in MSG subroutine.
- 51 Unexpected return code from QTSUP/OFCSTP for command RERUN.
- 52 Unexpected return code from QTSUP/OFCSTP for command END.
- 53 Unexpected return code from QTSUP/OFCSTP for command BKSP.
- 54 Unexpected return code from QTSUP/OFCSTP for command SKIP.
- 55 Unexpected return code from QTCMD (13).
- 56 Unexpected return code from QTSUP/SETFILE (banner) in state 102.
- 57 Unexpected return code from QTSUP/OFCDATA (banner) in state 102.
- 58 Unexpected secondary return code on QTOPEN reject.

Issued by PSU.

User Action: PSU will be reinitiated automatically up to two more times. Inform site analyst of failure.

### **PSU - IDLE-DOWN COMPLETE**

Description: Dayfile message indicating idle-down processing is complete. PSU terminates.

Issued by PSU.

User Action: None.

### **PSU- IDLE-DOWN IN PROGRESS**

Description: B-display message indicating PSU is responding to an idle-down request from the network.

Issued by PSU.

User Action: None.

### **PSU REPRIEVED**

Description: Dayfile message indicating PSU has entered reprieve processing.

Issued by PSU.

User Action: None.

### **PSU - REQUEST \*K\* DISPLAY**

Description: Flashing B-display message requesting the K-display be assigned to PSU.

Issued by PSU.

User Action: Assign the K-display to PSU.

### **PSU - WAITING FOR NETWORK**

Description: Dayfile and B-display message indicating PSU cannot neton to the network.

Issued by PSU.

User Action: Indicates PSU attempted to neton before NAM completed initialization, in which case PSU will complete its neton process when NAM is fully initialized. If the condition is due to an attempt to restart PSU while the network (NAM) is not up, drop PSU before bringing the network back up. If the condition persists, notify site analyst.

### **PTFS - APPLICATION CONNECTION BROKEN.**

Description: The host or the network ended the MFLINK session.

Issued by PTFS.

User Action: None.



### **PTFS - APPLICATION CONNECTION TIMEOUT.**

Description: The remote host did not respond in the allotted time.

Issued by PTFS.

User Action: None.

### **PTFS - APPLICATION DISABLED.**

Description: PTFS was unable to NETON to the network subsystem (RHF or NAM).

Issued by PTFS.

User Action: None.

### **PTFS - BLOCK TOO LARGE.**

Description: The remote host or network sent a block that was too large.

Issued by PTFS.

User Action: Inform site analyst.

### **PTFS - CHARGE REQUIRED.**

Description: You must specify a CHARGE directive and you did not do so.

Issued by PTFS.

User Action: Restart your session and include a CHARGE directive.

### **PTFS - CHARGE RESTRICTED TO DEFAULT.**

Description: On a CHARGE command, you specified a charge and project number which was not the default that you were validated for and your validation restricts you to that default.

Issued by PTFS.

User Action: Use CHARGE(\*) rather than specifying a charge and project number.

### **PTFS - CONTINUATION BLOCK DID NOT FOLLOW.**

Description: The continuation block did not follow.

Issued by PTFS.

User Action: Inform site analyst.

### **PTFS - ERR/LGL RECEIVED FROM SUBSYSTEM.**

Description: The network subsystem (RHF or NAM) detected a logic error in communication.

Issued by PTFS.

User Action: Inform site analyst.

### **PTFS - EXECUTE ONLY FILE.**

Description: You attempted to transfer an execute-only file.

Issued by PTFS.

User Action: Change permanent file access to allow read permission.

### **PTFS - FC/BRK RECEIVED RC=rc.**

Description: The host sent the remote host a break with reason code rc.

Issued by PTFS.

User Action: Inform site analyst.

**PTFS - FC/NAK RETRY LIMIT.**

Description: PTFS was unable to transmit a block after a system-defined number of attempts. Each attempt was rejected by the network subsystem (RHF or NAM).

Issued by PTFS.

User Action: Inform site analyst.

**PTFS - FILE ALREADY PERMANENT.**

Description: You attempted to save a file that is already permanent.

Issued by PTFS.

User Action: Purge the file and retry.

**PTFS - FILE IS DIRECT ACCESS.**

Description: You attempted to alter a direct access file with a REPLACE or APPEND directive. This is not allowed.

Issued by PTFS.

User Action: Change directive and retry.

**PTFS - FL TOO SHORT FOR PROGRAM.**

Description: There is a system error in the remote host.

Issued by PTFS.

User Action: Inform site analyst.

**PTFS - HOST NOT SPECIFIED TYPE.**

Description: Your job assumes a non-NOS remote host and you have been linked to a NOS remote host.

Issued by PTFS.

User Action: Inform site analyst.

**PTFS - INCOMPLETE CONTINUED DIRECTIVE.**

Description: The remote host expected the text string to be a continuation of the previous string and it was not.

Issued by PTFS.

User Action: Correct the syntax of your directives record with emphasis on the continuation lines.

**PTFS - INVALID ACCESS VALIDATION.**

Description: Your USER directive has an incorrect user name or the specified user name does not have job processing privileges on the remote host.

Issued by PTFS.

User Action: Ensure that the user name is correct and retry. Inform site analyst if the problem persists.

**PTFS - INVALID BACKUP/RESIDENCE REQUIREMENT.**

Description: You specified an incorrect BR=br or PR=pr parameter on one of your directives.

Issued by PTFS.

User Action: Correct the parameter and retry.

**PTFS - INVALID COMMAND cmd.**

Description: The remote host received an incorrect command (cmd) from the host or received a command out of sequence.

Issued by PTFS.

User Action: Inform site analyst.

### **PTFS - INVALID COMMAND.**

Description: You entered PTFS as a command and PTFS is not a system command.

Issued by PTFS.

User Action: Enter a system command.

### **PTFS - INVALID DATA DECLARATION TYPE.**

Description: You specified an incorrect DD=dd parameter.

Issued by PTFS.

User Action: Correct the DD=dd parameter and retry.

### **PTFS - INVALID DEVICE SPECIFICATION.**

Description: You specified an incorrect R=r parameter on your directive.

Issued by PTFS.

User Action: Correct and retry.

### **PTFS - INVALID DIRECTIVE.**

Description: The remote host does not recognize the directive you specified.

Issued by PTFS.

User Action: Ensure that the syntax of the directive is correct and retry.

### **PTFS - INVALID MODE/CATEGORY.**

Description: The mode or category you specified for the file are not defined.

Issued by PTFS.

User Action: Correct and retry.

### **PTFS - INVALID xxxxxx=NO VALUE.**

Description: Argument xxxxxx was entered without a value.

Issued by PTFS.

User Action: Correct remote directive and retry.

### **PTFS - INVALID SUPERVISORY MESSAGE.**

Description: PTFS did not recognize a supervisory message received from the network subsystem (RHF or NAM).

Issued by PTFS.

User Action: Inform site analyst.

### **PTFS - LID UNAVAILABLE.**

Description: The requested LID is not a host LID, is disabled, or is a store-forward LID.

Issued by PTFS.

User Action: Inform site analyst.

### **PTFS - MISSING CHARGE/PROJECT.**

Description: The CHARGE directive did not have the required charge and project number.

Issued by PTFS.

User Action: Correct and retry.

**PTFS - MISSING USER NAME.**

Description: The USER directive did not contain the required user name.

Issued by PTFS.

User Action: Correct and retry.

**PTFS - MULTIPLE FILE TRANSFERS REQUESTED.**

Description: You have more than one file transfer directive in a given directive record.

This is not allowed.

Issued by PTFS.

User Action: Place the file transfer directives in separate records, one file transfer directive per record.

**PTFS - NETON REJECT = rc.**

Description: A system or network error occurred.

rc Reason code

Issued by PTFS.

User Action: Inform site analyst if problem persists.

**PTFS - NETWORK SEQUENCE ERROR.**

Description: A network message block was received out-of-order.

Issued by PTFS.

User Action: Inform site analyst.

**PTFS - NETWORK SHUTDOWN.**

Description: An immediate local network shutdown is in progress. The application cannot send or receive blocks on any existing connection and no additional connections can be established.

Issued by PTFS.

User Action: None.

**PTFS - NETXFR ERROR rc - rejmess**

Description: An error occurred during file transfer.

rc Reason code.  
rejmess Reject message.

rc rejmess

- 03 CONNECTION BROKEN.
- 04 PROTOCOL ERROR.
- 05 TIMEOUT EXPIRED.
- 06 BLOCK NOT SENT.
- 07 TOO MANY TRANSFERS.
- 08 ACN OUT-OF-RANGE.
- 09 CIO ERROR.
- 13 IDLEDOWN ERROR.
- 14 SHUTDOWN.
- 15 RHF I/O ERROR.
- 16 INCORRECT DEVICE.
- 17 CODE CONV N/A. (not available)
- 18 CONTROL WORD ERROR.
- 19 INCORRECT DEVICE.

- 20 EMPTY FILE.
- 21 NAM INTERFACE ERR.
- 22 BLK NUM MISCOMPARE.
- 23 INCORRECT BLK SIZE.
- 25 BLOCK SEQUENCE ERR.
- 26 PRU BOUNDS ERROR.
- 27 INTRA-HOST PRU XFR.
- 28 ERROR DURING XFR.
- 29 ABL OUT OF RANGE.
- 30 APPL NOT VALIDATED.
- 31 FILE TYPE ERROR.
- 32 JOB ORIGIN ERROR.

Issued by PTFS.

User Action: Inform site analyst if problem persists.

### **PTFS - NO CONNECTION RECEIVED.**

Description: PTFS did not receive a connection request from a remote host before the connection delay time (CD=nn) expired.

Issued by PTFS.

User Action: None.

### **PTFS - PF NAME REQUIRED.**

Description: You did not specify the permanent file to be processed.

Issued by PTFS.

User Action: Correct and retry.

### **PTFS - PF REQUEST COMPLETE.**

Description: The remote host successfully processed your permanent file request.

Issued by PTFS.

User Action: None.

### **PTFS - PROTOCOL ERROR IN nn.**

Description: PTFS received an incorrect value for the parameter xx.

Issued by PTFS.

User Action: Inform site analyst.

### **PTFS - RECOVERY DIRECTIVE AFTER FILE TRANSFER.**

Description: Your MFLINK directives are not in the proper sequence. The USER, CHARGE, or PACKNAM directive must precede the file transfer directive.

Issued by PTFS.

User Action: Resequence your directives and retry.

### **PTFS - RHF I/O ERROR.**

Description: The file transfer was terminated because an I/O error was detected by RHF. See dayfile for further information.

Issued by PTFS.

User Action: Inform site analyst.

### **PTFS - SECONDARY USER DIRECTIVES DISABLED.**

Description: You are not authorized to specify secondary USER directives.

Issued by PTFS.

User Action: Get site personnel to authorize you or do not attempt to use secondary USER directives.

**PTFS - SUBSYSTEM FULL.**

Description: PTFS was unable to NETON to the network subsystem (RHF or NAM).

Issued by PTFS.

User Action: None.

**PTFS - SUBSYSTEM UNAVAILABLE.**

Description: PTFS was unable to NETON to the network subsystem (RHF or NAM).

Issued by PTFS.

User Action: None.

**PTFS - UNKNOWN NETWORK INTERFACE TYPE.**

Description: An internal error was detected by PTFS.

Issued by PTFS.

User Action: Inform site analyst.

**PTFS - USER DIRECTIVE REQUIRED FIRST.**

Description: You must first specify a USER directive to access permanent files on remote NOS hosts.

Issued by PTFS.

User Action: Correct and retry.

**n\*\*\* PUNCH FILES RECOVERED.**

Description: n\*\*\* files in the punch queue have been recovered.

Issued by REC.

User Action: None.

**PURGING filename userindex.**

Description: Informative message indicating that file filename is being purged after being dumped as directed by the OP=P option.

Issued by PFDUMP.

User Action: None.

**PVA WITH RING = 0.**

Description: A CM address for a CYBER 170-8xx has an incorrect ring value. The value must be in the range of 1 to 15.

Issued by DSDI.

User Action: Correct address and rerun.

**PWL RECEIVED FROM PIP WITH HN=hn, TN=tn, CN=cn.**

Description: Informative message indicating that a worklist has been sent to NIP from PIP from host node hn, terminal node tn, and connection number cn.

Issued by NGIGO.

User Action: None.

### **QAC ERROR ENCOUNTERED.**

Description: Explanatory dayfile message indicating why QFTLIST or QALTER aborted. QAC returned an unexpected error code.

Issued by QFTLIST.

User Action: Write a PSR and include support materials to allow CDC to duplicate the problem.

### **QALTER COMPLETE.**

Description: Informative message indicating that QALTER operation is finished.

Issued by QFTLIST.

User Action: None.

### **QAP - BUFFER ARGUMENT ERROR.**

Description: One of the following conditions occurred:

- The buffer did not contain all the data required by the calling function.
- One or more of the buffer pointers (FIRST, IN, OUT, or LIMIT) is out of the acceptable range.

Issued by QAP.

User Action: Inform CYBER Software Support.

### **QAP - INCORRECT REQUEST.**

Description: Bad parameter in QAP call.

Issued by QAP.

User Action: Inform CYBER Software Support.

### **QDUMP ABORTED.**

Description: An error has been detected which is not processed by QDUMP error processing. Attempts to correct the situation have been made, but discretion should be used in continuing use of QDUMP.

Issued by QDUMP.

User Action: Contact CYBER Software Support. Check the dayfile for other error messages to determine the cause of the abort.

### **QDUMP COMPLETE.**

Description: Informative message indicating the specified operation has been completed.

Issued by QDUMP.

User Action: None.

### **QF LENGTH ERROR filename.**

Description: The EOR sector of the queued file as specified by the TRT is not an EOI sector. The EOI sector was adjusted if possible.

Issued by QFM.

User Action: Contact CYBER Software Support.

### **QF LENGTH ERROR filename.**

Description: Interlock data in system sector of queued file indicates that the last sector of the file (specified by TRT) was not an EOI sector. The EOI sector was adjusted, if possible.

filename            Name of file on which error was encountered

Issued by MSM.

User Action: Inspect the file to insure that data is correct. Some data may be missing if the system could not correctly adjust the EOI sector.

**QFM BUFFER TOO SMALL.**

Description: The buffer for reading the system sector is fewer than 100B words long.

Issued by QFM.

User Action: Increase buffer size and retry.

**QFM EOI BAD ON ATTACHED FILE.**

Description: The EOI sector cannot be found on the specified file.

Issued by QFM.

User Action: Inform site analyst.

**\*QFM\* ERROR ON ERRNNN FILE.**

Description: While getting the file, QFM detected an error and converted the file to locked common file ERRNNN.

Issued by QLOAD.

User Action: Check file, cleanup, and retry.

**QFM FILE ALREADY ATTACHED.**

Description: The specified file is already attached to the job.

Issued by QFM.

User Action: None.

**QFM - FILE IGNORED filename.**

Description: The file was ignored either because it had an incorrect origin or type code (this could indicate a bad IQFT file), or because its system sector could not be read.

Issued by QFM.

User Action: Verify that valid origin or file type code is being used.

**QFM FOT FULL.**

Description: Family cannot be defined in the system since the family ordinal table is full.

Issued by QFM.

User Action: A level 0 deadstart is required to create space in the FOT.

**QFM I/O SEQUENCE ERROR.**

Description: Action was requested on a busy file.

Issued by QFM.

User Action: Wait until file is not busy and retry.

**QFM INCORRECT REQUEST.**

Description: One of the following occurred:

- Specified function was incorrect or undefined.
- Job did not have SSJ= entry point.
- Auto recall bit was not set.

Issued by QFM.

User Action: Verify that a valid QFM request is being made.



### **QFM INTERLOCK ERROR.**

Description: Track interlock could not be set because of conflict.

Issued by QFM.

User Action: Contact CYBER Software Support.

### **QFM IQFT INTERLOCK ABORT.**

Description: The utility aborted while trying to set a new IQFT file on the device.

Issued by QFM.

User Action: Contact CYBER Software Support.

### **QFM NO IQFT TRACK AVAILABLE.**

Description: Space is not available to create an IQFT file while initializing the device.

Issued by QFM.

User Action: Contact CYBER Software Support.

### **QFM SYSTEM SECTOR ERROR.**

Description: An error occurred while the system sector was being read.

Issued by QFM.

User Action: Contact CYBER Software Support.

### **QFM TRACK MISMATCH.**

Description: The file about to be purged is not the same file that was previously attached. The first track in the FST does not equal the one from the DULL word.

Issued by QFM.

User Action: Contact CYBER Software Support.

### **QFM USER ACCESS NOT VALID.**

Description: The user tried to perform an operation for which he is not validated (for example, attempting to run a system origin job from nonsystem origin).

Issued by QFM.

User Action: Ensure accuracy of command or macro or determine proper validation requirements.

### **QFT FULL.**

Description: DSP cannot route the file since there are no available entries in the QFT.

Issued by DSP.

User Action: Retry when space is available in the QFT.

### **QFT FULL DETECTED BY QFM.**

Description: When called to assign a file to mass storage, QFM returned status indicating that the QFT was full.

Issued by QLOAD.

User Action: Check output file to determine which files were not loaded. Retry when system is not as busy.

### **QFT LIMIT ON LOAD.**

Description: The calculated QFT threshold has been reached.

Issued by QLOAD.

User Action: Check listing to determine which files were not loaded. Retry when the system is not as busy.

### **QFT/LOCAL FNT IS FULL.**

Description: Either the QFT became full during processing of the requeue function and not all files could be requeued or the IQFT could not be attached because the local FNT was full.

Issued by QFM.

User Action: If the QFT is full, either wait for some queue files to be processed by the system, or remove some files from the queue with QDUMP and/or QREC. You could also do a level 0 deadstart to increase your QFT size. If your local FNT is full, return some files and retry.

### **QFT THRESHOLD - FILE IGNORED.**

Description: The QFT has reached the limit allocated for queued files. The specified file cannot be activated until some QFT entries are released.

Issued by QMOVE.

User Action: Retry when the system is not as busy.

### **QFT THRESHOLD LIMIT.**

Description: The QFT has reached the limit allocated for queued files. No more queued files can be activated until some of these files are released.

Issued by QREC.

User Action: Retry when system is not as busy.

### **QFTLIST/QALTER ABORTED.**

Description: The system aborted QFTLIST or QALTER.

Issued by QFTLIST.

User Action: Inform site analyst.

### **QLOAD ABORTED.**

Description: Job was dropped by operator or aborted because of a system error.

Issued by QLOAD.

User Action: Check the dayfile for other error messages to determine the cause of the abort.

### **QLOAD - nnnn ACTIVE FILES LOADED.**

Description: Informative message indicating the number of active files loaded.

Issued by QLOAD.

User Action: None.

### **QLOAD - nnnn ERRxxx FILES CREATED.**

Description: Informative message indicating the number of queued files that could not be processed because of write parity errors on mass storage. The files in error have been renamed to the file ERRxxx and will remain assigned to the control point as locked common files.

Issued by QLOAD.

User Action: Inform site analyst to locate and flaw the tracks in error.

### **QLOAD - nnnn FILES IGNORED.**

Description: Informative message indicating the number of files ignored during the load operation.

Issued by QLOAD.

User Action: None.

### **QLOAD - nnnn FILES LISTED.**

Description: Informative message indicating the number of files listed.

Issued by QLOAD.

User Action: None.

### **QLOAD - nnnn INACTIVE FILES LOADED.**

Description: Informative message indicating the number of inactive files loaded.

Issued by QLOAD.

User Action: None.

### **QLOAD OPERATION COMPLETE.**

Description: Informative message indicating completion of QLOAD.

Issued by QLOAD.

User Action: None.

### **QLOAD TERMINATED.**

Description: QLOAD aborted and the abort processing was terminated either by the operator or because of a system error.

Issued by QLOAD.

User Action: Check dayfile for the cause.

### **QMOVE ABORTED.**

Description: An error has been detected which is not processed by QMOVE error processing. Attempts to correct the situation have been made, but discretion should be used in continuing use of QMOVE.

Issued by QMOVE.

User Action: Check the dayfile for other error messages to determine the cause of the abort.

### **QMOVE COMPLETE.**

Description: Informative message indicating completion of QMOVE.

Issued by QMOVE.

User Action: None.

### **QREC COMPLETE.**

Description: K display message indicating completion of QREC.

Issued by QREC.

User Action: None.

### **QREC/QLIST ABORTED.**

Description: This message occurs if QREC aborts for any reason.

Issued by QREC.

User Action: A level 0 deadstart may be needed to recover lost queued files.

### **QTF, ABORT - RESTART ATTEMPTED.**

Description: QTF aborted for an undetermined reason. The QTF procedure attempts to restart QTF by submitting a new copy to the batch queue.

Issued by QTF.

User Action: None.

**QTF, -n- qfn ACQUIRED, DC=dc, ST=did, DO=sid.**

Description: The system has acquired local queue file qfn on connection number n from the local queue with disposition code dc for transfer to destination LID did with source LID sid.

Issued by QTF.

User Action: None.

**QTF, -n- qfn ASSIGNED TO CONNECTION NUMBER p.**

Description: Informative message indicating connection number assigned by system is different from the current QTF file table index for this file. All subsequent messages for this file will reflect the assigned connection number p.

qfn Queued file name

Issued by QTF.

User Action: None.

**QTF, ASTERISK NOT VALID HERE.**

Description: In a QTF operator command, an asterisk may only appear as a single character value.

Issued by QTF.

User Action: Correct the command.

**QTF, -n- qfn CONNECTING TO pid.**

Description: The system is attempting to establish communications with remote host pid.

n QTF connection number  
qfn Queued file name  
pid Physical identifier

Issued by QTF.

User Action: None.

**QTF, -n- qfn CONNECTION REJECTED, REASON CODE = xxx.**

Description: The system was unable to establish a connection to the remote host.

n QTF connection number  
qfn Queued file name  
xxx Reason code (decimal)

(For more details about reason codes, refer to the descriptions of Application Connection Reject Messages in the Supervisory Messages chapters of the Network Access Method Reference Manual (60499500) and the RHF Access Method Reference Manual (60459990).)

Issued by QTF.

User Action: If problem persists, contact remote operator to ensure remote subsystem and QTFS are operational; otherwise contact site analyst.

**QTF, END OF INCLUDE FILE.**

Description: QTF has stopped processing commands from an INCLUDE file or initial directives file because a file boundary condition was reached.

Issued by QTF.

User Action: None.

### **QTF, -n- qfn EVICTED.**

Description: The system evicted the local queue file qfn to connection number n from the local queue.

Issued by QTF.

User Action: None.

### **QTF, nnnn FILES TRANSFERRED.**

Description: Informative message issued at end of QTF session. nnnn is the number of files successfully transferred.

Issued by QTF.

User Action: None.

### **QTF, FROM source - xxx**

Description: The source parameter indicates the source of an operator command that QTF is processing. The source is either DSD K-display entry or the file name associated with an INCLUDE command. The text of that command is xxx.

Issued by QTF.

User Action: None.

### **QTF, INCLUDE FILE filename NOT FOUND.**

Description: The field filename is the name of a file specified on an INCLUDE command. QTF could not find a file by that name either as a local file or a permanent file under the user name SYSTEMX.

Issued by QTF.

User Action: Correct the command.

### **QTF, INCORRECT CHARACTER.**

Description: A QTF operator command contains a character other than a letter, digit, space, +, -, =, (, ), comma, or period.

Issued by QTF.

User Action: Correct the command.

### **QTF, INCORRECT COMMAND.**

Description: QTF detected an error in an operator command. The K-display command buffer points to the incorrect entry.

Issued by QTF.

User Action: Correct the command.

### **QTF, INCORRECT PARAMETER.**

Description: A QTF operator command has an incorrect keyword or keyword value. The K-display command buffer points to the parameter in error.

Issued by QTF.

User Action: Consult the HELP display for possible keywords. Correct the command.

### **QTF, INCORRECT RANGE VALUE.**

Description: In a QTF operator command, a range construct (i..j, where i and j are integers) may appear only as a value parameter.

Issued by QTF.

User Action: Correct the command.

### **QTF, INCORRECT SELECTION CLASS.**

Description: A selection class must be a single letter in the range A through L.

Issued by QTF.

User Action: Correct the command.

### **QTF, INCORRECT SEPARATOR.**

Description: On a QTF operator command, use either a comma or one or more spaces to separate a parameter from the command verb or other parameters.

Issued by QTF.

User Action: Correct the command.

### **QTF, INCORRECT VERB.**

Description: On a QTF operator command, the command verb is not recognized. You have tried to use a non-unique abbreviation. The IDLE and STOP commands may not be abbreviated.

Issued by QTF.

User Action: Consult the HELP display for possible verbs. Correct the command.

### **QTF, -n- qfn INVALID QUALIFIER OR PARAMETER.**

Description: The system received an invalid network message from the remote host.

n QTF connection number

qfn Queued file name

Issued by QTF.

User Action: Inform site analyst.

### **QTF, -n- qfn INVALID USER ACCESS.**

Description: The creator of the file qfn is not validated to send files with QTF.

qfn Queued file name

Issued by QTF.

User Action: Contact site administrator to obtain proper validation.

### **QTF, -n- qfn LOG FILE NOT SENT - DSP ERROR CODE = nnnB.**

Description: QTF was unable to return error log file for rejected file to originator because DSP returned error code nnn.

qfn Queued file name

Issued by QTF.

User Action: None. If error persists, inform site analyst.

### **QTF, \*=\* NOT VALID HERE.**

Description: On a QTF operator command, an equal sign should be used only to separate a keyword and value.

Issued by QTF.

User Action: Correct the command.

### **QTF, \*.\* NOT VALID HERE.**

Description: On a QTF operator command, an ellipsis (two periods) should be used only as part of a range value.

Issued by QTF.

User Action: Correct the command.

**QTF, PID NOT DEFINED.**

Description: The physical identifier specified on a QTF ENABLE or DISABLE operator command is unknown.

Issued by QTF.

User Action: Consult the STATUS,PID display for defined PIDs. Correct the command.

**QTF, -n- qfn QUEUED AS xxxxxxxx ON pid.**

Description: File has been successfully queued on remote host pid with name xxxxxxxx.

qfn Queued file name  
pid Physical identifier

Issued by QTF.

User Action: None.

**QTF, -n- qfn xxxxx REJECTED BY REMOTE HOST.**

**QTF, -n- qfn VALUE = (yyyy).**

Description: The remote host QTFs has rejected the file transfer due to an unacceptable attribute value on the request file transfer message. yyyy is the value of the attribute and xxxx is the attribute name which may be one of the following:

FILE NAME, DISPOSITION CODE, JOB NAME,  
DESTINATION LID, SOURCE LID, HOST PID, FILE  
SIZE, DATA DECLARATION, ROUTING DIRECTIVE,  
IMPLICIT TEXT, SYSTEM TEXT, ATTRIBUTE nn.

n QTF connection number  
qfn Queued file name

Issued by QTF.

User Action: File is evicted and QTF log file returned to originator. If ROUTING DIRECTIVE, correct MFQUEUE routing directive and retry. If other attribute, correct ROUTE or MFQUEUE command, if possible; otherwise, inform site analyst.

**QTF, -n- qfn REQUEUED.**

Description: The system returned a file to the local queue after a transfer failed.

qfn Queued file name

Issued by QTF.

User Action: None.

**QTF, -n- qfn REQUIRED PARAMETER MISSING.**

Description: The remote host failed to send a required parameter on a network message.

n QTF connection number  
qfn Queued file name

Issued by QTF.

User Action: Inform site analyst.

**QTF, -n- qfn SENT TO PID xxx, PID yyy RESPONDING.**

Description: The subsystem network description table does not agree with the remote host PID returned by the remote host QTFs. The file transfer may complete.

n QTF connection number  
qfn Queued file name  
xxx Expected physical identifier  
yyy Actual physical identifier

Issued by QTF.

User Action: Inform site analyst.

### **QTF, -n- qfn TRANSFER REJECTED BY REMOTE HOST.**

Description: The remote host QTFs has rejected the file transfer.

n QTF connection number  
qfn Queued file name

Issued by QTF.

User Action: File is evicted and QTF log file returned to originator.

### **QTF, -n- qfn UNEXPECTED ACQUIRE ERROR CODE = nnnB.**

Description: A system error.

n QTF connection number  
qfn Queued file name

Issued by QTF.

User Action: Inform site analyst.

### **QTF, -n- qfn UNRECOGNIZED DISPOSITION CODE.**

Description: The system has acquired a file from the local queue with an unrecognized disposition code. See previous message for disposition code value.

n QTF connection number  
qfn Queued file name

Issued by QTF.

User Action: None.

### **QTF, WAITING FOR NAM.**

Description: Indicates that QTF is attempting to establish communications with the NAM subsystem and has not yet received a response. QTF rolls out for ten seconds and retries.

Issued by QTF.

User Action: If NAM is available and the message persists, use the DROP command to abort and restart QTF and submit a PSR with supporting material. If NAM is not available, use the DSD KILL command to terminate this copy of QTF.

### **QTF, -n- qfn WRONG APPLICATION LEVEL.**

Description: The queue file cannot be transferred because QTF's protocol version or level is incompatible with the remote server's version or level.

qfn Queued file name

Issued by QTF.

User Action: Inform site analyst.

### **QTF, -n- qfn WRONG REMOTE APPLICATION LEVEL.**

Description: QTF is unable to complete the transfer of the file assigned to connection slot n because the remote host QTFs is using an incompatible protocol level. The transfer will be retried.



qfn Queued file name

Issued by QTF.

User Action: Contact CYBER Software Support.

**\*QTFPROC ABORT - DELAY OUT OF RANGE.**

Description: Fatal error. The delay parameter on the QTF procedure call is defective (outside the range of 1 to 2048).

Issued by QTF.

User Action: Correct the QTF procedure call. If error persists after entering corrected RHF command ENABLE, notify system analyst.

**\*QTFPROC ABORT - INVALID DELAY.**

Description: Fatal error. The delay parameter on the QTF procedure call is defective (outside the range 1 to 2048).

Issued by QTF.

User Action: Correct the QTF procedure call. If error persists after entering corrected RHF command ENABLE, notify system analyst.

**QTFPROC ENDED - JOB NOT BATCH ORIGIN,  
CANNOT USE SEQUENCER FOR RERUN.**

Description: Informative message. The QTF job must be batch origin to be rerun.

Issued by QTF.

User Action: None.

**QTFPROC ENDED - NETON RETRY LIMIT.**

Description: The subsystem is no longer available or accessible.

Issued by QTFPROC.

User Action: Inform site analyst.

**QTF(S), -n- qfn CONNECTION BROKEN.**

Description: The remote host partner or the remote subsystem broke the network connection usually due to an involuntary termination or failing network hardware.

n QTF connection number

qfn Queued file name

Issued by QTF.

User Action: If error persists, inform site analyst and customer engineer.

**QTF(S), -n- qfn CONNECTION ESTABLISHED.**

Description: Indicates state of connection to remote host partner.

n QTF connection number

qfn Queued file name

Issued by QTF.

User Action: None.

**QTF(S), CONNECTION NUMBER NOT IN SUPERVISORY MESSAGE.**

Description: The connection number is missing from the supervisory message received from the subsystem.

Issued by QTF.

User Action: Inform site analyst.

**QTF(S), -n- qfn CONNECTION TIMED OUT.**

Description: Remote host partner did not respond within the allowed time span. Transfer will be retried.

n QTF connection number  
qfn Queued file name

Issued by QTF.

User Action: If error persists, inform site analyst and disable remote host pid in subsystem ID table.

**QTF(S), -n- qfn CONNECTION TO pid ABORTED.**

Description: Indicates state of connection to remote host partner.

n QTF connection number  
qfn Queued file name  
pid Physical identifier

Issued by QTF.

User Action: None.

**QTF(S), -n- qfn CONNECTION TO pid ENDED.**

Description: Indicates state of connection to remote host partner.

n QTF connection number  
qfn Queued file name  
pid Physical identifier

Issued by QTF.

User Action: None.

**QTF(S), -n- qfn ERROR IN FILE TRANSFER.**

Description: Transfer of file qfn was unsuccessful.

n QTF connection number  
qfn Queued file name

Issued by QTF.

User Action: If error persists, inform site analyst.

**QTF(S), FATAL LFM ERROR = nnB.**

Description: Error code nn was returned on a call to LFM.

Issued by QTF.

User Action: Inform site analyst.

**QTF(S), -n- qfn FC/BRK RECEIVED.**

Description: The remote host partner broke the network connection. Usual cause is detection of an unrecoverable protocol anomaly.

n QTF connection number  
qfn Queued file name

Issued by QTF.

User Action: If error persists, inform site analyst.

**QTF(S), -n- qfn FC/NAK RETRY COUNT EXCEEDED.**

Description: The subsystem was unable to deliver a network message.

n QTF connection number  
qfn Queued file name

Issued by QTF.

User Action: Inform site analyst.

**QTF(S) -n- qfn FIRST KEYWORD IS NOT \*ROUTE\*.**

Description: The MFQUEUE routing directive must begin with the keyword ROUTE.

n QTF connection number  
qfn Queued file name

Issued by QTF.

User Action: Correct the MFQUEUE routing directive.

**QTF(S) -n- qfn INCORRECT EC FOR THIS QUEUE TYPE.**

Description: The external characteristics (EC) value specified on a MFQUEUE routing directive does not match the disposition code of the file.

n QTF connection number  
qfn Queued file name

Issued by QTF.

User Action: Correct the MFQUEUE routing directive using a print-type EC value if the file is a print file, or a punch-type EC value if the file is to be punched.

**QTF(S) -n- qfn INCORRECT VALUE (xxx).**

Description: You specified an incorrect keyword xxx on an MFQUEUE routing directive.

n QTF connection number  
qfn Queued file name

Issued by QTF.

User Action: Correct the MFQUEUE routing directive.

**QTF(S) -n- qfn INCORRECT VALUE (xxx=yyy).**

Description: You specified an incorrect value yyy for keyword xxx on an MFQUEUE routing directive.

n QTF connection number  
qfn Queued file name

Issued by QTF.

User Action: Correct the MFQUEUE routing directive.

**QTF(S), INITIATED.**

Description: Indicates QTF or QTFS has successfully established communication with the RHF or NAM subsystem.

Issued by QTF.

User Action: None.

**QTFS, -n- qfn INVALID ATTRIBUTE IGNORED.**

Description: QTFS received a network message from the remote host QTF with an unrecognized parameter. Transfer may complete.

n QTF connection number  
qfn Queued file name

Issued by QTFS.

User Action: Inform site analyst.

**QTF(S), -n- qfn INVALID SEQUENCE RECEIVED.**

Description: A network message from the remote host partner was received that was not in sequence.

n QTF connection number  
qfn Queued file name

Issued by QTF.

User Action: Inform site analyst.

**QTF(S), JOB ORIGIN ERROR.**

Description: QTF or QTFS was improperly initiated by user command.

Issued by QTF.

User Action: None.

**QTF(S), -n- qfn MESSAGE FROM REMOTE HOST -  
QTF(S), -n- qfn xxx.**

Description: xxx is the text of a message received from the remote host partner.

n QTF connection number  
qfn Queued file name

Issued by QTF.

User Action: None.

**QTF(S), NETON REJECT, CODE nn - xxxx.**

Description: QTF or QTFS was unable to establish communications with the RHF subsystem due to one of the following conditions:

nn xxxx

01 SUBSYSTEM UNAVAILABLE.  
02 SUBSYSTEM FULL.  
03 APPLICATION DISABLED.  
04 APPLICATION NAME UNKNOWN.  
05 ILLEGAL NETON.  
06 INVALID ACN VALUE.  
07 ALREADY NETTED ON.  
other (UNRECOGNIZED CODE).

Issued by QTF.

User Action: If SUBSYSTEM UNAVAILABLE, initiate subsystem. If APPLICATION DISABLED, enable application in subsystem application table. Otherwise, inform site analyst.

**QTF(S), -n- qfn NETWORK BLOCKS OUT OF SEQUENCE.**

Description: A network message from the remote host partner was received that was not in sequence.

n QTF connection number  
qfn Queued file name

Issued by QTF.

User Action: Inform site analyst.

### **QTF(S), NETWORK IDLEDOWN IN PROGRESS.**

Description: The operator has initiated subsystem idledown. QTF will not initiate any new transfers and will terminate upon completion of any transfers in progress.

Issued by QTF.

User Action: None.

### **QTF(S), NETWORK MESSAGE BLOCK SIZE ERROR.**

Description: QTF/QTFs was unable to receive a network message due to its size.

Issued by QTF.

User Action: Inform site analyst.

### **QTF(S), NETWORK SHUTDOWN.**

Description: The subsystem is terminating immediately. All transfers are aborted and QTF will requeue any files in progress.

Issued by QTF.

User Action: None.

### **QTF(S), -n- qfn NETXFR ERROR rc - rejmess**

Description: An error occurred during file transfer.

n	QTF connection number
qfn	Queued file name
rc	Reason code
rejmess	Reject message

rc rejmess

03	CONNECTION BROKEN.
04	PROTOCOL ERROR.
05	TIMEOUT EXPIRED.
06	BLOCK NOT SENT.
07	TOO MANY TRANSFERS.
08	ACN OUT-OF-RANGE.
09	CIO ERROR.
13	IDLEDOWN ERROR.
14	SHUTDOWN.
15	RHF I/O ERROR.
16	INCORRECT DEVICE.
17	CODE CONV N/A. (not avail)
18	CONTROL WORD ERROR.
19	INCORRECT DEVICE.
20	EMPTY FILE.
21	NAM INTERFACE ERR.
22	BLK NUM MISCOMPARE.
23	INCORRECT BLK SIZE.
25	BLOCK SEQUENCE ERR.
26	PRU BOUNDS ERROR.
27	INTRA-HOST PRU XFR.
28	ERROR DURING XFR.
29	ABL OUT OF RANGE.
30	APPL NOT VALIDATED.
31	FILE TYPE ERROR.
32	JOB ORIGIN ERROR.

Issued by QTF.

User Action: Inform site analyst if problem persists.

**QTF(S) -n- qfn NO USERNAME FOR \*DC=WT/TT\* FILE.**

Description: QTF(S) is unable to accept a file for the wait queue because no user name exists with which to associate the file.

n QTF connection number

Issued by QTF.

User Action: Specify UN=username parameter on MFQUEUE routing directive.

**QTF(S) -n- qfn QUEUED AS xxxx FROM pid.**

Description: File qfn on connection number n has been successfully queued locally with name xxxx.

qfn Queued file name

Issued by QTF(S).

User Action: None.

**QTF(S) -n- qfn RECEIVING, DC=dc, ST=did, DO=sid.**

Description: QTF(S) is receiving file qfn on connection number n from the remote host QTF with disposition code dc, destination lid did, and source lid sid.

Issued by QTF(S).

User Action: None.

**QTF(S) -n- qfn ROUTE ERROR nnB-xxxx.**

Description: QTF(S) was unable to queue the queued file (qfn) due to one of the reasons in the following list. nn is the DSP error code, and xxxx is the reason.

INVALID DISPOSITION CODE.  
INVALID ST OR DO LID.  
INVALID TERMINAL ID.  
INVALID FORMS CODE.  
INVALID JOB COMMAND.  
INVALID DATA DECLARATION.  
INVALID INTERNAL CHAR.  
INVALID EXTERNAL CHAR.  
INVALID SPACING CODE.  
TOO MANY DEFERRED JOBS.  
INVALID USER ACCESS.  
INVALID USER COMMAND.  
QFT FULL (RETRY LATER).  
DISK FULL (RETRY LATER).  
INVALID OWNER USER.  
INVALID CREATION USER.  
FILE IS EMPTY.

Refer to section 10 of Volume 4 of the NOS Version 2 Reference Set for DSP error codes and descriptions.

Issued by QTF.

User Action: If REPLY LATER, no action is required; QTF will periodically retry to transfer the file until the temporary condition clears. For all other reasons, the file is evicted and the log file is returned to originator. Correct the ROUTE command or MFQUEUE routing directive, if possible; otherwise inform site analyst.

**QTF(S), -n- qfn TRANSFER xxxxxxxxxxxx BY REMOTE HOST.  
QTF(S), -n- qfn REASON CODE = nnnnnn. or**

## **QTF(S), -n- qfn REASON CODE = nnnnnn - yyy.**

Description: QTF or QTFS has been informed by its remote host partner that the current file transfer cannot be initiated or completed. xxxxxxxxxx may be either REJECTED, TERMINATED, or ABORTED. n is the QTF connection number, nnnnnn is the reason code, and yyy is one of the following reasons. A description follows each yyy entry.

(CONTACT SITE ANALYST).

An unexpected reason code was received.

PROTOCOL ERROR.

The remote host partner detected a protocol anomaly.

TIME-OUT MATURED.

Remote host partner did not receive message within the allowed time span.

SENDER PROBLEMS.

Unspecified problems were encountered on the sending (QTF) side.

RECEIVER PROBLEMS.

Unspecified problems were encountered on the receiving (QTFS) side.

FILE SIZE TOO BIG.

The file is too large to be accommodated on the remote host or not enough space was preallocated.

INVALID USERNAME/ACCOUNT.

An invalid or missing account or username was detected by the remote host partner.

UNSPECIFIC TRANSFER

Insufficient information was received by the remote host partner to allow the transfer to continue.

QUEUE TYPE UNAVAILABLE.

The disposition code requested on the ROUTE command or MFQUEUE routing directive could not be processed on the remote host. For example, a print file was attempted to be transferred to a CYBER 200 remote host.

UNACCEPTABLE ATTRIBUTES.

An invalid attribute value was received by the remote host partner.

Issued by QTF.

User Action: If fatal transfer error, file is evicted and QTF log file returned to originator. In all other cases, transfer will be retried. If error persists, inform site analyst.

## **QTF(S), nn TRANSFERS ACTIVE (xxx).**

Description: Indicates the number of currently active connection slots. xxx is either RHF or NAM. \*IDLEDOWN\* appears if QTF is attempting to idledown as a result of the IDLE QTF operator command or due to subsystem idledown.

Issued by QTF.

User Action: None.

**QTF(S), -n- qfn UNKNOWN STATE-OF-TRANSFER  
SENT BY REMOTE HOST.  
QTF(S), -n- qfn REASON CODE = nnnnnn -  
(CONTACT SITE ANALYST).**

Description: An unrecognized value, nnnnnn, for the state-of-transfer attribute was received on a network message from the remote host partner.

n QTF connection number  
qfn Queued file name

Issued by QTF.

User Action: Inform site analyst.

**QTF(S), -n- qfn UNRECOGNIZED COMMAND RECEIVED xx.**

Description: The command sent by the remote host partner is not recognized.

n QTF connection number  
qfn Queued file name  
xx Command number received

Issued by QTF.

User Action: Inform site analyst.

**QTF(S), -n- qfn UNRECOGNIZED MESSAGE RECEIVED.**

Description: The network message received from the subsystem is not recognized.

n QTF connection number  
qfn Queued file name

Issued by QTF.

User Action: Inform site analyst.

**QUEUE FILE ASSIGN ERROR.**

Description: Attempt to force a device assignment for the queued file being loaded resulted in the file being assigned to the wrong equipment.

Issued by QLOAD.

User Action: Check output for files processed.

**QUEUE FILE UTILITY COMPLETE.**

Description: Informative message indicating the utility has completed.

Issued by QFSP.

User Action: None.

**nnnn QUEUE FILES INTERLOCKED.**

Description: Informative message indicating the number (nnnn) of interlocked files created on the destination device because of unrecoverable write errors which occurred on that device. The names of these files are of the form ERRxxx, where xxx is a three-digit sequence number from 001 through 999.

Issued by QMOVE.

User Action: None.

**QUEUE STATUS INDEFINITE.**

Description: QREC, QDUMP, or QMOVE has not been able to finish necessary file processing after an error or error exit. The status of IQFT's and queued files is unknown.



Issued by QREC.

User Action: Contact CYBER Software Support. A level 0 (initial) deadstart is recommended.

### **QUEUES UNRECOVERABLE THIS DEVICE.**

Description: This message is issued in conjunction with the following message.

DNdn FM familyname MS ERROR. (for QREC)  
or IQFT FILE ERROR DN dn FAMILY  
familyname. (for QDUMP/QMOVE)

Refer to the appropriate message for device information.

Issued by QREC.

User Action: None.

### **QUIESCE DATA UNIT SENT.**

Description: INITMDI detected an error and tried to restart the initialization process by causing a return to the MCI reset state.

Issued by INITMDI.

User Action: Inform site analyst.

### **RANDOM ADDRESS ERROR.**

Description: Dayfile message indicating that an error was encountered while building the system library. The random address is not on file.

Issued by SLL.

User Action: Attempt another deadstart. If the error persists and the system has worked previously, inform customer engineer and test memory and MSM.

### **RANDOM INDEX ERROR.**

Description: The random disk address of the permit sector is in error (error log and dayfile message). This may be a problem with

your program.

Issued by PFM.

User Action: Check your program. If it does not use the CATLIST macro, inform site analyst.

### **RANDOM READ.**

Description: This test section is being executed.

Issued by MST.

User Action: None.

### **RANDOM WRITE.**

Description: This test section is being executed.

Issued by MST.

User Action: None.

### **RBF DISK ERROR, CANNOT REDUCE SIZE.**

Description: Because of a disk error, RBF cannot perform periodic field length reduction. RBF processing is unaffected, but CM usage is higher than normal.

Issued by RBF.

User Action: To lower CM usage by RBF, idle down RBF and restart.

**RBF ENDED.**

Description: Informative message indicating that RBF has terminated.

Issued by RBF.

User Action: None.

**RBF NOT ENABLED.**

Description: RBF attempted to enter the network but was rejected because it was disabled by the local operator.

Issued by RBF.

User Action: Enable RBF and retry the operation.

**RBF NOT STARTED PROPERLY.**

Description: An attempt was made to initiate RBF incorrectly, such as with an X.RBF command.

Issued by RBF.

User Action: Initiate RBF with the the RBF command. The copy of RBF started incorrectly is dropped automatically.

**RD AND UI/UN NOT ALLOWED.**

Description: The RD and UI/UN parameters in the PFDUMP command are mutually exclusive.

Issued by PFS.

User Action: Correct and retry.

**RDF CARRIER LOST.**

Description: Indicates that the carrier has dropped on an active terminal. The terminal is immediately logged out when this occurs.

Issued by 1TM.

User Action: No action.

**RDF DATE BEFORE PURGE DATE.**

Description: Release processing was not performed because the RDF file was created before the last purge date.

Issued by SSVAL.

User Action: Create a new RDF file and retry.

**RDF FILE ERROR - BAD RECORD LENGTH.**

Description: The RF parameter specifies an existing but incorrect file or there is an internal error in SSVAL or PFDUMP. The run is aborted.

Issued by SSVAL.

User Action: Correct RF parameter and retry, or rerun PFDUMP to produce new RDF file.

**RDF FILE ERROR - MISSING HEADER.**

Description: The RF parameter specifies an existing but incorrect file or there is an internal error in SSVAL or PFDUMP. The run is aborted.

Issued by SSVAL.

User Action: Correct RF parameter and retry, or rerun PFDUMP to produce a new RDF file.

**RDF INITIATED.**

Description: Issued when terminal initiates login.

Issued by 1TM.

User Action: None.

### **RDF TERMINATED**

Description: RDF is not enabled. 1TM will issue this message, then drop after signalling driver drop to RDF.

Issued by 1TM.

User Action: 1TM may be restarted by enabling RDF and by entering the console command to restart 1TM.  
Otherwise, no action.

### **RDF TIME-OUT.**

Description: This message accompanies the 1TM - RDF TIME-OUT. dayfile message and indicates that no terminal activity has occurred for 15 minutes (assembly parameter) and that RDF is not in dedicated mode. 1TM has dropped from the PPU without recall and has signalled driver-drop to RDF.

Issued by 1TM.

User Action: None.

### **RDPFC, ERROR IDLE, DN dv.**

Description: RDPFC skipped device dv because of an error idle on the device.

Issued by MAC2.

User Action: Correct the error idle and rerun job.

### **RDPFC, PF UTILITY ACTIVE, DN dv.**

Description: RDPFC skipped device dv because a permanent file utility was active on it.

Issued by MAC2.

User Action: Rerun job after the utility is done.

### **RE-RD CD COMPARE ERR.**

Description: I-display message is indicating that the card reader has encountered an error.

Issued by DSD.

User Action: Reread the last card and check the error.

### **RE-RD CD COMPARE ERR.**

Description: I-display message. The card reader has a card compare error.

Issued by 1CD.

User Action: Operator should re-read the last card in the output hopper.

### **READ ERROR - FILE IGNORED.**

Description: During a mass storage read, an error occurred with no error processing indicated; the file was ignored.

Issued by QDUMP.

User Action: Check file and correct. If problem persist, inform customer engineer.

### **READ ERROR - FILE MOVED.**

Description: During a mass storage read, an error occurred with error processing indicated; the file is moved.

Issued by QDUMP.

User Action: Contact CYBER Software Support and check file for accuracy.

### **READ ERROR ON TAPE.**

Description: Error in attempting to read an after image dump tape.

Issued by DMREC.

User Action: Inform the database administrator.

### **READ ID BURST FAILURE**

Description: This message occurs if either condition is true:

- The tape is assigned to a control point in PE (1600 cpi) mode and the drive is unable to read the ID burst at load point.
- The tape is assigned to a control point in GE (6250 cpi) mode and one of the following has occurred:
  - a. The drive is unable to read the ID burst at load point.
  - b. The drive is unable to set the automatic gain control using the automatic read amplitude (ARA) burst.

This error occurs only when a tape is assigned to a job. If the drive is unable to read the label during scanning, the tape is considered an unlabeled tape. MAGNET automatically unloads the tape.

Issued by MAGNET.

User Action: Clean the tape drive, reload the tape, and type the DSD command `RETRY,est` where `est` is the EST ordinal of the tape drive. If the message reappears, request the customer engineer to repair the drive, then reload the tape and ready the drive. Enter the DSD command `RETRY,est`. If the failure cannot be repaired at this time, enter the DSD command `TERMINATE,est`. If this problem occurs with other tapes on this same drive, stop using the tape drive and inform the customer engineer.

### **READ ID BURST FAILURE, filename AT address.**

Description: This message occurs if either of the following is true:

- The tape is assigned to a control point in PE (1600 cpi) mode and the drive is unable to read the ID burst at load point.
- The tape is assigned to a control point in GE (6250 cpi) mode and one of the following has occurred:
  - The drive is unable to read the ID burst at load point.
  - The drive is unable to set the automatic gain control using the automatic read amplitude (ARA) burst.

Issued by MAGNET.

User Action: Load the tape on another drive or use a different tape.

### **READ PARITY ERROR ON LOAD FILE.**

Description: The file data may not be intact, since a read parity error was encountered when the file was loaded. The file is skipped, unless error processing is selected.

Issued by QLOAD.

User Action: None.

### **READ PYRAMID PARITY ERROR.**

Description: A parity error was detected in a read pyramid.

Issued by SCE.

User Action: Inform site analyst and customer engineer.

### **READ/WRITE ERROR ON TAPE.**

Description: A tape error has been encountered. If possible, use another tape.

Issued by DMREC.

User Action: On all dumps, use another tape; on other DMREC functions, inform database administrator.

### **READING TRACK-xxxx.**

Description: Informative message at job B-display. IMS is reading the track xxxx.

Issued by IMS.

User Action: None.

### **REAL TIME DURATION TERMINATION.**

Description: The maximum real time allowed for PACKER to execute has been exceeded.

Issued by PACKER.

User Action: None.

### **REASSIGN ADL.**

Description: Informative message.

Issued by MCS.

User Action: Enter the CFO<sub>jsn</sub>.ADL command.

### **RECLAIM ABORTED.**

Description: RECLAIM has been aborted due to an error or user intervention.

Issued by RECLAIM.

User Action: Check the previous message for a description of the error.

### **RECLAIM ARGUMENT ERROR.**

Description: An invalid argument was detected in the RECLAIM command.

Issued by RECLAIM.

User Action: Check the RECLAIM command for correct parameters, values, etc.

### **RECLAIM COMPLETE.**

Description: Normal completion.

Issued by RECLAIM.

User Action: None.

### **RECORD NOT FOUND rtype/rname**

Description: The system could not find on the old record file a record matching the name (rname) and type (rtype) defined in the NAME directive.

Issued by BINEDIT.

User Action: Ensure that the name and type of records defined in the NAME directive match those of the records in the old record file and retry.

### **RECORD NOT FOUND.**

Description: Output file message indicating that the record name specified in a READ directive was not found in the specified file, or that the buffer controller record specified in the BCDUMP directive was not found on the dump file.

Issued by DSDI.

User Action: Recheck READ directive, or re-run DSDI with the FULL option.

### **RECORD NOT FOUND.**

Description: Error was encountered during the building of the system library. An attempt was made to place a nonexistent routine on an alternate system device. Deadstart processing halts when this error is detected.

Issued by SYSEDIT.

User Action: Attempt another deadstart. If the error persists, contact CYBER Software Support.

### **RECORD NOT FOUND**

Description: A requested job record (in the parameter record) was not found in the master file.

Issued by NAMI.

User Action: None.

### **RECORD NUMBER ERROR.**

Description: No header or an incorrect header or a missing header has been found on an ARF when updating a file.

Issued by DMREC.

User Action: Inform database administrator.

### **RECOVER, EQest, Atrack1, Track2.**

Description: Recovering preserved file on EST ordinal est. First track is track1 and track currently being read is track2.

Issued by MSM.

User Action: None.

### **RECOVERABLE RUN UNIT DELETED - username.**

Description: The recoverable run unit for username which appeared on the CRF has been deleted because username did not appear in the corresponding NCTFi file.

Issued by TAFREC.

User Action: None.

### **RECOVERING PF.EQest, TRK track.**

Description: Informative message indicating that preserved files on the specified logical track of device xx are being recovered.

est	EST ordinal of device
track	Logical track number

Issued by 1MR.

User Action: None.

### **RECOVERY COMPLETE.**

Description: Informative message indicating that a level 3 recovery deadstart was successful and the magnetic tape subsystem was recovered.

Issued by MAGNET.

User Action: None.

### **RECOVERY COMPLETE.**

Description: Informative message issued during deadstart; indicates end of REC processing and start of system loading, or recovery, depending upon level of deadstart selected.

Issued by REC.

User Action: None.

### **RECOVERY COMPLETE.**

Description: The interactive subsystem has successfully completed recovery.

Issued by TAF.

User Action: None.

### **RECOVERY COMPLETE.**

Description: An informative message indicating that BIO has successfully recovered.

Issued by IIO.

User Action: None.

### **RECOVERY, EQest.**

Description: Informative message indicating mass storage device being recovered during system deadstart.

est EST ordinal of device

Issued by MSM.

User Action: None.

### **RECOVERY FILE INITIALIZATION ERROR.**

Description: An error has occurred during initialization because of the ARF or BRf file.

Issued by AAMI.

User Action: Refer to the error message following this one for the error condition description.

### **RECOVERY IMPOSSIBLE.**

Description: The magnetic tape subsystem was dropped or aborted, or a level 3 recovery deadstart was not successful.

Issued by MAGNET.

User Action: Call magnetic tape subsystem to a control point if desired. Previous tape assignments are not recovered.

### **RECOVERY IMPOSSIBLE.**

Description: IAF recovery is impossible due to pointer errors. Jobs will not be detached.

Issued by IAFEX.

User Action: Submit a PSR.

### **RECOVERY IN PROGRESS.**

Description: Informative message indicating that the routine MAGNET is performing clean-up or recovery procedures for the magnetic tape subsystem. Issued by MAGNET.

User Action: None.

### **RECOVERY, WAITING MMF DEADSTART IN PROGRESS.**

Description: The device access table in extended memory resident is currently interlocked by another machine, indicating that machine is deadstarting.

Issued by MSM.

User Action: Verify that another machine is deadstarting. If not, contact CYBER Software Support.

### **REENTRY TABLE OVERFLOW.**

Description: Space sufficient to allocate the required table during IAF initialization was not available. An internal change to IAF is necessary.

Issued by IAFEX.

User Action: Contact CYBER Software Support.

**REFORMAT COMPLETE.**

Description: Dayfile message indicating reformat run successfully completed.

Issued by MODVAL.

User Action: None.

**REMOVABLE DEVICE CONFLICT.**

Description: Removable/nonremovable status of a shared device as specified in the CMRDECK conflicts with the status determined by the mainframe which originally recovered the device. If detected by CMS, configuration error status is set. Recovery is impossible.

Issued by MSM.

User Action: Retry after determining the correct removable/ nonremovable status.

**REMOVABLE DEVICE/NO ACTIVE DAYFILES.**

Description: The device specified by K-display parameters is a removable device and the option selected is termination of an active dayfile. Active dayfiles are not allowed to reside on removable devices.

Issued by DFTERM.

User Action: Enter new device using the K-display.

**REP est, nn.**

Description: The operator requested a repeat count of nn on the print file on BIO equipment est.

Issued by QAP.

User Action: None.

**REPEAT ENTRY.**

Description: Informative message.

Issued by DIS.

User Action: None.

**REPEAT ENTRY.**

Description: Informative message.

Issued by DSD.

User Action: None.

**REPLACE ERROR.**

Description: The same file was found twice during a catalog search. This error can occur for APPEND or REPLACE commands or macros after a file is found and purged and the catalog search is continued (error log and dayfile message).

Issued by PFM.

User Action: Inform site analyst. If many of these errors occur, the site analyst should perform a full PFDUMP, total INITIALIZE, and full PFLOAD on the device.

**\*REPLACE\* ERROR - STATUS = xyzB**

Description: Dayfile message indicating that a PF error was encountered while attempting to replace the file containing the PSU environment during a SAVE command.

Issued by PSU.

User Action: Notify site analyst.

**REPRIEVE PROCESSING BEGUN.**

Description: PACKER has begun reprieve processing.



Issued by PACKER.

User Action: See dayfile for other error messages.

### **REPRIEVE PROCESSING COMPLETE**

Description: Dayfile message indicating PSU completed its reprieve processing.

Issued by PSU.

User Action: None.

### **REPRIEVE PROCESSING COMPLETE.**

Description: PACKER has completed reprieve processing.

Issued by PACKER.

User Action: None.

### **REQUEST filename, eq.**

Description: Issued to DSD B and J displays for job, requesting that equipment type eq be assigned to file filename.

Issued by LFM.

User Action: Assign equipment to job using ASSIGN operator command.

### **REQUEST COMPLETE.**

Description: The terminal origin CRMTASK request is complete.

Issued by CRMTASK.

User Action: None.

### **REQUEST DISPLAY. (xxx)**

Description: Program xxx is waiting for the display to be assigned. This message appears in the comment field of the control point at which the program is active on the job status (B) display.

name Program name  
O26 File editor  
DIS Job display routine

Issued by DIS.

User Action: Enter DSD command ASSIGN,jsn,est.

jsn Job sequence name requesting assignment  
est EST ordinal of the display console

### **REQUEST EXCEEDS MAXIMUM FLE.**

Description: You specified an extended memory request on an ENFLE command that exceeds the maximum extended memory FL size.

Issued by DIS.

User Action: Correct entry and retry.

### **REQUEST \*I\* DISPLAY.**

Description: BIO has detected an abnormal condition on an assigned unit record device and has issued the message to the DSD B and J displays.

Issued by 1CD.

User Action: Check the status field of the I display for more specific information. The message remains until the condition is corrected.

### **REQUEST \*I\* DISPLAY.**

Description: BIO has detected an abnormal condition on an assigned unit record device and has issued the message to the DSD B and J displays.

Issued by IIO.

User Action: Check the status field of the I-display for more specific information. The message remains until the condition is corrected.

### **REQUEST \*K\* DISPLAY.**

#### **Issued by function 5 (Set Console Display**

Description: Register) to DSD B and J displays when operator action is requested.

Issued by CPM.

User Action: Refer to DSD K display.

### **REQUESTED EXTENDED MEMORY NOT AVAILABLE.**

Description: The amount of extended memory requested was not available in a contiguous block.

Issued by TAF.

User Action: Reinitialize with less extended memory requested.

### **REQUESTED MEMORY NOT FOUND.**

Description: Output file message indicating that the EPB directive was entered and no extended memory/PP buffer was found in the EDD file.

Issued by DSDI.

User Action: Ensure that the dump file contains meaningful information.

### **REQUESTED RESTORATION NOT FOUND.**

Description: The SYSEEDIT value specified by the R parameter is greater than the current level.

Issued by SYSEEDIT.

User Action: Correct the value specified by the R parameter to a value less than the current SYSEEDIT change level.

### **REQUESTING DUMP FILE.**

Description: RECLAIM is requesting the dump file specified by the TN or DN option. RECLAIM will try to read it and rebuild the database entries for this dump file.

Issued by RECLAIM.

User Action: Wait for RECLAIM to finish the request and issue another message.

### **jsn REQUEUED**

Description: Dayfile message indicating that file jsn was requeued during PSU reprieve processing.

Issued by PSU.

User Action: None.

### **REQUIRED FL EXCEEDS JOB MAX.**

Description: SSVAl needs more field length than allowed to complete processing.

Issued by SSVAl.

User Action: Increase the maximum field length for the job.

### **xx REQUIRES DE/DP WITH CPU PORT.**

Description: A device of type xx is defined that requires a CPU access to extended memory, but there is no entry for extended memory in the EQPDECK (or extended memory is defined to have no CPU access).

Issued by SET.

User Action: Correct the EQPDECK entries.

### **RESET STATE ENCOUNTERED.**

Description: The MCI general status was set to the reset state.

Issued by INITMDI.

User Action: Inform site analyst.

### **RESIDENT CENTRAL LIBRARY EMPTY.**

Description: No resident central library was found in the EDD file.

Issued by DSDI.

User Action: None.

### **RESTORING filename userindex**

Description: PFRES is restoring file filename and user index userindex to disk residence.

Issued by PFRES.

User Action: None.

### **RESTORING ADDRESSES S/N=serialn**

Description: Console message indicating that the pack is currently undergoing restoration of the address fields. Here, serialn is the actual pack serial number read.

Issued by FORMAT.

User Action: Do not drop the control point while this message is displayed.

### **RETRY DETACHES.**

Description: Informative message indicating that the interactive subsystem was unable to detach one or more users during termination processing. IAF will try to detach jobs a maximum of three times.

Issued by IAFEX.

User Action: If this message appears three times along with the JSN of a job unable to be detached, take an express deadstart dump and write a PSR.

### **RHF, jobn ACNacn ACCOUNTING OVERFLOW-ADD 32767 TO message**

Description: Application connection number acn of the application with job name or job sequence name jobn has had an accounting overflow. 32767 must be added to the appropriate field of the accounting message that is issued when a connection is terminated. message is one of the following:

- BLOCKS SENT
- BLOCKS RECEIVED
- ACKS SENT
- ACKS RECEIVED

This message is issued every time an overflow occurs.

Issued by RHF.

User Action: None.

**RHF, jobn ACNacn DISCONNECT BLOCKS  
SENT=bssss RECEIVED=brrrr  
RHF, jobn ACKS SENT=kssss, ACKS RECD=krrrr,**

## **PATH ID=id, CH=cc**

Description: The application with job name or job sequence name jobn terminated its application connection number acn. The connection had path-id id and used the NAD on channel cc.

acn      Application connection number in octal.  
bssss    Number of blocks sent by the application to RHF for transport across the LCN.  
brrrr    Number of blocks received by the application from RHF.  
kssss    Number of acknowledgements sent by RHF for blocks sent by the remote application (and later received by the local application).  
  
krrrr    Number of acknowledgements received by RHF for blocks sent by the application.  
id        Connection path identifier in hexadecimal.  
cc        Channel number in octal.

Issued by RHF.

User Action: None.

## **RHF, APPLICATION DISABLED FOR NETON**

Description: The requested application is disabled. RHF does not abort the application.

Issued by RHF.

User Action: None.

## **RHF, jobn APPLICATION IS NOT NETTED ON**

Description: The application with job name or job sequence name jobn requested an RHF function before requesting a NETON to RHF. RHF aborts the application.

Issued by RHF.

User Action: None.

## **RHF, APPLICATION NOT VALIDATED FOR CTRL/INFO/R.**

Description: The application issuing a CTRL/INFO/R supervisory request is not system origin and is aborted. All CTRL/INFO/R requests, except the request for logical identifier to physical identifier mapping, require the application to be system origin.

Issued by RHF.

User Action: Make the application a system origin job.

## **RHF, jobn APPLICATION NOT VALIDATED FOR CTRL/INFO/R.**

Description: The application with job name or job sequence name jobn issued a CTRL/INFO/R supervisory request without the required system origin privileges.

Issued by RHF.

User Action: Inform site analyst.

## **RHF, BAD TCU ON PATH id, PATH TURNED OFF.**

Description: Informative message to operator that the connection path identifier is turned off.

id      Path ordinal corresponding to the path assigned to the connection by RHF.

Issued by RHF.

User Action: Inform customer engineer and site analyst. Verify that the LT, RT and NAD address parameters for the identified path are correct.

### **RHF, jobn BUFFER ADDRESS ERROR IN CTRL/INFO/R.**

Description: The buffer specified in the CTRL/INFO/R supervisory request for the network description table is outside the requesting application's field length. RHF aborts the application.

Issued by RHF.

User Action: None.

### **RHF, BUFFER ADDRESS ERROR IN CTRL/INFO/R.**

Description: The buffer specified in the CTRL/INFO/R supervisory request for the network description table is outside of the application's field length. RHF aborts the application.

Issued by RHF.

User Action: Correct error in application.

### **RHF, jobn CONNECTED TO applnam LID=lid PID=pid ACN=acn PATH ID=id CH=cc.**

Description: RHF accepted connection request to application applnam.

jobn Job name or job sequence name. applnam Name of application requested.  
lid Logical identifier of the remote mainframe.  
pid Physical identifier of the remote mainframe.  
acn Application connection number in octal.  
id Connection path identifier in hexadecimal.  
cc Channel number in octal.

Issued by RHF.

User Action: None.

### **RHF, jsn COULD NOT BE ABORTED.**

Description: The application with job sequence name jsn has been aborted by RHF for committing a fatal error, and has now committed a second fatal error. RHF forces a NETOFF of the application.

Issued by RHF.

User Action: Inform site analyst.

### **RHF, DUPLICATE NETON REQUEST.**

Description: Two NETON requests were made for the same application without an intervening NETOFF request. RHF aborts the application.

Issued by RHF.

User Action: Remove the second NETON request or add the missing NETOFF request.

### **RHF, jsn FATAL SSF ERROR. FC = fc, RC = rc.**

Description: The application with job sequence name jsn has been aborted by RHF after RHF received an SSF error rc on an SSF request fc.

fc Function code  
rc Reason code

Issued by RHF.

User Action: Inform site analyst.

### **RHF, FATAL SSF ERROR. FC = fc, RC = rc.**

Description: RHF has aborted itself or the offending application upon receiving a fatal reason code rc from an SSF request fc.

fc    Function code  
rc    Reason code

Issued by RHF.

User Action: Inform site analyst.

### **RHF, FET PRAM. FET = address.**

Description: RHF has aborted an application with job sequence name jsn for issuing a request to RHF that included a FET address or FET buffer pointer from a NETXFR request that was not within the application's field length.

address        The actual address that RHF found to be invalid. For FET buffer pointer errors, the address is the FED address.

Issued by RHF.

User Action: Inform site analyst.

### **RHF, INVALID APPLICATION CALL TO RHF.**

Description: An application issued an invalid RHF call. The call may contain an incorrect RHF function, a request (other than NETON) from an application with an end-of-job connect status, or an incorrect word count in the RHF call. RHF aborts the application.

Issued by RHF.

User Action: Correct error in application and retry.

### **RHF, jobn INVALID APPLICATION CALL TO RHF.**

Description: The application with job name or job sequence name jobn issued an invalid RHF call. The call may contain an incorrect RHF function, an invalid word count, or the calling application may have an end-of-job connect status. RHF aborts the application.

Issued by RHF.

User Action: None.

### **RHF, INVALID APPLICATION NAME ON NETON.**

Description: An application issued a NETON request using an application name that was not in RHF's configuration or that contained incorrect characters. RHF aborts the application.

Issued by RHF.

User Action: Correct name in the application NETON call or add the application name to RHF's configuration.

### **RHF, jobn INVALID APPLICATION TABLE ADDRESS.**

Description: In an RHF call, the application with job name or job sequence name jobn used an incorrect application table address. The address may be out of range or may point to another application table. RHF aborts the application.

Issued by RHF.

User Action: Correct error in application.

### **RHF, INVALID APPLICATION TABLE ADDRESS.**

Description: In an RHF call, an application used an incorrect application table address. The address may be out of range or may point to another application table. RHF aborts the application.

Issued by RHF.

User Action: Correct error in application.

## **RHF, INVALID CONTROL MESSAGE FOR applnam ON ACN acn RECEIVED.**

Description: An incoming control message for application applnam on application connection number acn is not a valid control message.

applnam      Name of application requested.  
acn            Application connection number in octal.

Issued by RHF.

User Action: Inform site analyst.

## **RHF, INVALID FET PRAM. FET = address.**

Description: RHF has aborted this application for issuing a request to RHF that included a FET address or FET buffer pointer from a NETXFR request that was not within the application's field length.

address      The actual address that RHF found to be invalid. For FET buffer pointer errors, the address is the FET address.

Issued by RHF.

User Action: Inform site analyst.

## **RHF, jsn INVALID HEADER ADDRESS address.**

Description: RHF has aborted an application with job sequence name jsn for issuing a request to RHF that included a header address from a NETGET or NETPUT request that was not within the application's field length.

address      The actual address that RHF found to be invalid.

Issued by RHF.

User Action: Inform site analyst.

## **RHF, INVALID HEADER ADDRESS address.**

Description: RHF has aborted this application for issuing a request to RHF that included a header address from a NETGET or NETPUT request that was not within the application's field length.

address      The actual address that RHF found to be invalid.

Issued by RHF.

User Action: Inform site analyst.

## **RHF, INVALID MINACN/MAXACN ON NETON.**

Description: The value for the minimum or maximum ACN in the NETON request is outside the range specified for the application. RHF aborts the application.

Issued by RHF.

User Action: Correct the minimum or maximum ACN in the application's NETON request.

## **RHF, INVALID PASSWORD ppppppp**

Description: Self explanatory.

pppppp      Password

Issued by RHF.

User Action: Inform site analyst.

**RHF, jsn INVALID SSF UCP ADDRESS address.**

Description: RHF has aborted an application with job sequence name jsn for issuing a request to RHF that included an SSF UCP address from any address given in an application request which RHF uses in an SSF request that was not within the application's field length.

address        The actual address that RHF found to be invalid.

Issued by RHF.

User Action: Inform site analyst.

**RHF, INVALID SSF UCP ADDRESS address.**

Description: RHF has aborted this application for issuing a request to RHF that included an SSF UCP address from any address given in an application request which RHF uses in an SSF request that was not within the application's field length.

address        The actual address that RHF found to be invalid.

Issued by RHF.

User Action: Inform site analyst.

**RHF, jsn INVALID TEXT ADDRESS address.**

Description: RHF has aborted an application with job sequence name jsn for issuing a request to RHF that included a text address (ta or ta + tmax) from a NETGET or NETPUT request that was not within the application's field length.

address        The actual address that RHF found to be invalid.

Issued by RHF.

User Action: Inform site analyst.

**RHF, INVALID TEXT ADDRESS address.**

Description: RHF has aborted this application for issuing a request to RHF that included a text address (ta or ta + tmax) from a NETGET or NETPUT request that was not within the application's field length.

address        The actual address that RHF found to be invalid.

Issued by RHF.

User Action: Inform site analyst.

**RHF, LID TABLE EMPTY.**

Description: The NOS central memory LID table is empty.

Issued by RHF.

User Action: Inform site analyst.

**RHF, MHF APPLICATION DISABLED.**

Description: Application MHF is disabled in RHF's tables, preventing automatic dumping and loading of a NAD that has stopped.

Issued by RHF.

User Action: Use APPL display ENABLE command to enable MHF application.

**RHF, MHF APPLICATION NOT DEFINED.**

Description: Application MHF is not defined in RHF's tables, preventing initial loading of local NADs and automatic dumping and reloading of a NAD that has stopped.

Issued by RHF.



User Action: Correct the RHF configuration file by defining application MHF and restart RHF.

**RHF, NAD CODE CONVERSION ENABLED  
(EST=est,NB=yy,NP=zz).**

Description: Informative message.

est EST ordinal of the NAD (octal).  
yy Number of convert mode buffers (hexadecimal).  
zz Number of convert mode paths (hexadecimal).

Issued by RHF.

User Action: None.

**RHF, NAD CODE CONVERSION NOT AVAILABLE  
(EST=est).**

Description: RHF unsuccessfully attempted to enable code conversion in the NAD on EST ordinal est.

Issued by RHF.

User Action: Inform site analyst.

**RHF, NAD on ESTest HAS BEEN TURNED OFF.**

Description: Informative message to operator that the NAD on EST ordinal est is turned off.

est EST entry for NAD in octal

Issued by RHF.

User Action: Inform a customer engineer and a site analyst. If AUTODUMP and AUTOLOAD are enabled, MHF will attempt to dump and load the NAD.

**RHF, jobn NETOFF AS applnam.**

Description: Informative message indicating application applnam with job name or job sequence name jobn ended access to RHF.

Issued by RHF.

User Action: None.

**RHF, jobn NETON AS applnam ACCEPTED  
ACN=mina/maxa.**

Description: Informative RHF message indicating successful NETON of the application with job name or job sequence name jobn and application name applnam. The minimum and maximum ACN values specified in the NETON request were mina and maxa, respectively.

Issued by RHF.

User Action: None.

**RHF, jobn NETON AS applnam REJECTED ACN - mina/maxa.  
RHF, jobn - rejmess.**

Description: The application with job name or job sequence name jobn made a NETON request with application name applnam and minimum and maximum ACN values of mina and maxa, respectively. RHF rejected the NETON request for the reason given in the reject message rejmess.

Issued by RHF.

User Action: Refer to the separate listing of the last line message (RHF, jobn - rejmess) for the appropriate action.

**RHF, NETON SECURITY VIOLATION**

Description: An application is not validated to do a NETON request. RHF aborts the application.

Issued by RHF.

User Action: None.

### **RHF, NO APPLICATION ADDRESS IN RHF CALL-EXTRA CHARGE**

Description: Informative message indicating an application issued an RHF request (other than NETON) without specifying an application table address in the RHF call. The application is charged less if it specifies its application table address in each RHF call.

Issued by RHF.

User Action: None.

### **RHF, jobn NO APPLICATION ADDRESS IN RHF CALL-EXTRA CHARGE**

Description: Informative RHF message indicating the application with job name or job sequence name jobn issued an RHF request (other than NETON) without specifying an application table address in the RHF call. The application is charged less if it specifies an application table address in each RHF call. This informative message is issued only once after the first RHF call from the application with no application table address.

Issued by RHF.

User Action: None.

### **RHF, NO MORE aname SPACE FOR NETON**

Description: The NETON is rejected because all allowable applications with the requested application name aname are currently netted on. RHF does not abort the application.

Issued by RHF.

User Action: Retry the NETON request later.

### **RHF, NO MORE TABLE SPACE FOR NETON**

Description: RHF rejects NETON because there is no more table space available. RHF does not abort the application.

Issued by RHF.

User Action: Retry the NETON request later.

### **RHF, jsn NOT IN RHF\*S TABLES.**

Description: The job sequence name jsn that RHF used in an invalid SSF request does not exist in RHF's tables.

Issued by RHF.

User Action: Inform site analyst.

### **RHF, PATH OR NAD UNAVAILABLE**

Description: One of the following is not in the RHF configuration or is disabled.

- Remote NAD.
- Local NAD.
- Path between the remote and local NADs.

This message may also be issued if no TCU enables in the RHF configuration for this path are in common with the TCU enables specified by the requesting NAD.

Issued by RHF.

User Action: If appropriate, enable corresponding elements in RHF configuration, or correct TCU enables in RHF configuration.

## **RHF, PID/LID NOT AVAILABLE**

Description: Either the PID of the requestor is not in the RHF configuration or the PID is disabled or the LID requested is not in the LID table.

Issued by RHF.

User Action: If appropriate, enable PID or LID in RHF configuration or add LID to LID table.

## **RHF, QUEUED MESSAGE LIMIT EXCEEDED**

Description: An application exceeded the maximum number of supervisory messages that are queued in RHF. RHF aborts the application.

Issued by RHF.

User Action: Modify the application to issue more frequent NETGETs for the supervisory messages queued in RHF.

## **RHF, jobn QUEUED MESSAGE LIMIT EXCEEDED**

Description: The application with job name or job sequence name jobn is aborted if the number of supervisory messages queued in RHF exceeds the limit.

Issued by RHF.

User Action: None.

## **RHF, REJECTED CONTROL MESSAGE FOR applnam ON ACNacn RECEIVED**

Description: The NAD rejected a control message sent by application applnam on application connection number acn.

applnam      Application name of requestor  
acn            Application connection number in octal

Issued by RHF.

User Action: Inform a customer engineer and a site analyst.

## **RHF, REMOTE CONNECT REQUEST FROM aplname ON pid TO applnam LID=lid RHF, NAD=nn, CH=cc, BUFF=b, TCU=nnnn, DEST=d, PATH ID=id, ACC=cccc RHF, REQUEST ACCEPTED.**

Description: Informative message indicating a connection request from a remote host has been accepted by RHF.

aplname      Application name of requestor.  
pid            Physical identifier of remote mainframe where request initiated.  
applnam      Name of application requested.  
lid            Logical identifier requested (valid lid for remote mainframe pid).  
nn            Address of NAD issuing request in hexadecimal.  
cc            Channel number of receiving NAD in octal.  
b            Buffer size of the allocation request in octal.  
0            516 bytes  
1            2064 bytes  
2            4128 bytes  
nnnn        Binary bit pattern which indicates trunks that may be used to communicate back to the requesting NAD.  
  
d            Destination device physical address in hexadecimal.  
id            Connection path identifier in hexadecimal. The NAD gives this id to the connection path.  
cccc        Access code in hexadecimal.

Issued by RHF.

User Action: None.

**RHF, REMOTE CONNECT REQUEST FROM aplname ON  
pid TO applnam LID=lid  
RHF, NAD=nn, CH=cc, BUFF=b, TCU=nnnn,  
DEST=d, PATH ID=id, ACC=cccc  
RHF, REQUEST REJECTED - rejmess.**

Description: Informative message indicating rejection by RHF of a remote host's connection request for the reason given in the reject message rejmess.

aplname	Application name of requestor.
pid	Physical identifier of remote mainframe where request initiated.
applnam	Name of application requested.
lid	Logical identifier requested.
nn	Address of NAD issuing request in hexadecimal.
cc	Channel number of receiving NAD in octal.
b	Buffer size of the allocation request in octal.
0	516 bytes
1	2064 bytes
2	4128 bytes
nnnn	Binary bit pattern which indicates trunks that may be used to communicate back to the requesting NAD.
d	Destination device physical address in hexadecimal.
id	Connection path identifier in hexadecimal. The NAD gives this id to the connection path.
cccc	Access code in hexadecimal.

Issued by RHF.

User Action: Refer to the separate listing of the last line message (RHF, REQUEST REJECTED - rejmess) for the appropriate action.

**RHF, REQUESTED APPLICATION UNAVAILABLE**

Description: Requested remote application is invalid, not running, disabled, no additional connections are allowed to the running application, or no new applications could be started on the remote mainframe.

Issued by RHF.

User Action: Take corrective action and retry.

**RHF, RHF SHUTDOWN IN PROGRESS**

Description: New connections are not made during the RHF shutdown process.

Issued by RHF.

User Action: None.

**RHF, SSF ERROR, jsn NOT IN SYSTEM.**

Description: RHF issued an SSF request that referenced an application, with job sequence name jsn, that is not currently known to the system.

Issued by RHF.

User Action: Inform site analyst.

**RHF, THE FOLLOWING CONTROL MESS. IS FOR AN UNKNOWN PATH.  
RHF, xx...xx**

Description: A control message for which no active path could be found in any application connection table entry was received by RHF from a local NAD. xx...xx is the contents of the control message in hexadecimal.

Issued by RHF.

User Action: Inform site analyst if problem persists.

**RHF, THE FOLLOWING CONTROL MESS. IS NOT SUPPORTED.  
RHF, xx...xx**

Description: A control message which could not be recognized by RHF was received from a local NAD. xx...xx is the contents of the control message in hexadecimal.

Issued by RHF.

User Action: Inform site analyst if problem persists.

**RHF, THE FOLLOWING CONTROL MESS. WAS REJECTED BY THE NAD.  
RHF, xx...xx**

Description: A control message issued by RHF could not be delivered by a local NAD and was returned as a rejected control message. xx...xx is the contents of the control message in hexadecimal.

Issued by RHF.

User Action: Inform site analyst if problem persists.

**RHH01 - INVALID FUNCTION CODE.**

Description: The calling program specified an invalid function code.

Issued by RHH.

User Action: Inform site analyst.

**RHH02 - INVALID PARAMETER BUFFER ADDRESS.**

Description: The calling program specified a parameter block address that was either zero or not within the caller's field length.

Issued by RHH.

User Action: Inform site analyst.

**RHH03 - USER NOT SYSTEM ORIGIN.**

Description: The calling program does not have a subsystem job entry point.

Issued by RHH.

User Action: Inform site analyst.

**RHH04 - CALLED FROM CP 0.**

Description: This routine cannot be called from control point 0.

Issued by RHH.

User Action: Inform site analyst.

**RHH05 - NOT CALLED BY SUBSYSTEM CONTROL POINT.**

Description: A program specified a function that can be used only by RHF.

Issued by RHH.

User Action: Inform site analyst.

**RHH10 - NO LOCAL NADS.**

Description: RHF does not have any local NADs in the local NAD table.

Issued by RHH.

User Action: Inform site analyst. The RCFILE for RHF must be corrected.

**RHH11 - NAD TABLE OUT OF RANGE.**

Description: The address of the local NAD table was not within RHF's field length.

Issued by RHH.

User Action: Inform site analyst.

**RHH12 - CHANNEL NOT FOUND  
ERROR IN LNT ORDINAL ord.**

Description: Informative message that indicates which LNT entries in RHF do not have a corresponding EST entry.

Issued by RHH.

User Action: None.

**RHH13 - CONFIGURATION ERROR.**

Description: The equipment status table (EST) contains more than one NAD entry with the same channel.

Issued by RHH.

User Action: Inform site analyst. The CMRDECK must be changed.

**RHH21 - MORE THAN ONE LNT WITH SAME CHANNEL.**

Description: The local NAD table (LNT) in RHF has more than one local NAD entry with the same channel specified.

Issued by RHH.

User Action: Inform site analyst. RCFILE for RHF must be changed to avoid duplicate channel entries.

**RHH22 - INVALID EST ORDINAL.**

Description: The calling program asked to update an equipment status table (EST) entry that does not exist.

Issued by RHH.

User Action: Inform site analyst.

**RHH23 - EST IS NOT A NAD.**

Description: The calling program asked to update an equipment status table (EST) entry that was not for a NAD.

Issued by RHH.

User Action: Inform site analyst.

**RING PORT TABLE OVERFLOW.**

Description: The address of the memory assigned as ring port tables (RPT) has overflowed the address storage field. RPT addresses should be less than 20000 (octal).

Issued by SET.

User Action: Inform site analyst.

**RMeee Cxx Pnn Fyyyy REJECT.**

Description: Two-port multiplexer, equipment number est, channel number cn, port number pn, has rejected function ffff.

Issued by 1TM.

User Action: Contact CYBER Software Support.

**ROLLED.**

Description: Informative message indicating that the job requested by a DAYFILE.jsn or other command has been rolled out.

Issued by DSD.

User Action: None.

**nnnn ROLLOUT ERROR FILES RECOVERED.**

Description: nnnn jobs in an error state have been recovered.

Issued by REC.

User Action: None.

**nnnn ROLLOUT FILES RECOVERED.**

Description: nnnn jobs that were in a scheduler rollout state have been recovered.

Issued by REC.

User Action: None.

**filename ROUTED, JOB NAME - jobname.**

Description: The job record filename has been routed to the INPUT queue and the system has assigned a job name jobname to the job.

Issued by NAMI.

User Action: None.

**RRN est, nn.**

Description: The operator requested a reprint or repunch of the file on BIO equipment est with a repeat of nn.

Issued by QAP.

User Action: None.

**RSA NOT ON CHAIN.**

Description: The random address in a catalog entry is not in the IAPF chain.

Issued by PACKER.

User Action: The IAPF chain on the device in question may have been corrupted. Either have an analyst repair the damage with DDF (if that is possible), or perform a full PFDUMP, deadstart INITIALIZE, and full PFLoad.

**S/N MISMATCH - serialn JOB ABORTED**

Description: Console message indicating that FORMAT was terminated due to a mismatch between the serial number specified by the P parameter of the FORMAT command and the serial number recorded on the pack. Here, serialn is the serial number read from the pack.

Issued by FORMAT.

User Action: Enter correct serial number with the P parameter of the FORMAT command.

**npuname, SAM LOAD ABORTED - ABNORMAL RESPONSE.**

Description: NS aborted its attempt to load the SAM program into the NPU because it had received an error response from PIP. Either there was a hardware problem with the NPU that was being loaded or there was an error in the network load file (NLF).

Issued by NS.

User Action: The NPU should be checked to make sure there is nothing wrong with the coupler or memory. (Refer to the CCP Diagnostic Handbook for information on how to run NPU diagnostics.) The NLF file should also be checked to make sure it was built correctly for the NPU into which NS is trying to load the SAM program.

**npuname, SAM LOAD ABORTED - BAD LOAD MODULE.**

Description: NS aborted its attempt to load the SAM program into the NPU because it detected an error in the network load file (NLF). For each NPU that NS will load the SAM program, there is a SAM load module in the NLF. NS detected an error while it was reading the SAM load module for this NPU.

Issued by NS.

User Action: The NLF file should be checked to make sure that it was built correctly for the NPU into which NS is trying to load the SAM program.

**npuname, SAM LOAD ABORTED - BAD PICB.**

Description: NS aborted its attempt to load the SAM program into the NPU because it detected an error in the network load file (NLF). For each NPU that NS will load the SAM program into, there is a program initiation control block (PICB) in the NLF. The PICB for the NPU that NS was trying to load SAM into had a bad header.

Issued by NS.

User Action: The NLF file should be checked to make sure that it was built correctly for the NPU into which NS is trying to load the SAM program.

**npuname, SAM LOAD ABORTED - BAD PICB DIRECTIVE.**

Description: NS aborted its attempt to load the SAM program into the NPU because it detected an error in the network load file (NLF). For each NPU that NS can load SAM, there is a SAM load procedure control block (SPCB) in the NLF. This SPCB contains directives for NS to follow. NS found too many bad directives in the SPCB in the NLF for the NPU that SAM was being loaded.

Issued by NS.

User Action: The NLF file should be checked to make sure that it was built correctly for the NPU into which NS is trying to load the SAM program.

**npuname, SAM LOAD ABORTED - BAD SPCB.**

Description: NS aborted its attempt to load the SAM program into the NPU because it had detected an error in the network load file (NLF). For each NPU that NS can dump, there is a SAM load procedure control block (SPCB) in the NLF. The SPCB for the NPU that NS was trying to load SAM into a bad header.

Issued by NS.

User Action: The NLF file should be checked to make sure that it was built correctly for the NPU into which NS is trying to load the SAM program.

**npuname, SAM LOAD ABORTED - LOAD MOD NOT FOUND.**

Description: NS aborted its attempt to load the SAM program into the NPU because it had detected an error in the network load file (NLF). For each NPU that NS will load the SAM program, there should be a SAM load module in the NLF. NS could not find a SAM load module for the NPU that SAM was to be loaded.

Issued by NS.

User Action: The NLF file should be checked to make sure that it was built correctly for the NPU that NS is trying to load the SAM program.

**npuname, SAM LOAD ABORTED - PICB NOT FOUND.**

Description: NS aborted its attempt to load the SAM program into the NPU because it had detected an error in the network load file (NLF). For each NPU that NS will load the SAM program, there should be a program initiation control block (PICB) in the NLF. NS could not find the PICB in the NLF for the NPU that SAM was being loaded.

Issued by NS.

User Action: The NLF file should be checked to make sure that it was built correctly for the NPU that NS is trying to load the SAM program.



### **npuname, SAM LOAD ABORTED - PREEMPTED.**

Description: NS aborted its attempt to load the SAM program into the NPU because it had received another initialization request from PIP while it is currently trying to load the SAM program into the NPU. There was probably a hardware problem with the NPU that was being loaded.

Issued by NS.

User Action: If the NPU has two couplers, ensure that the SAM attribute is declared in the EST entry for at least one of the couplers. The NPU should be checked to make sure there is nothing wrong with the coupler or memory. (Refer to the CCP Diagnostic Handbook for information on how to run NPU diagnostics.) If the NPU is a remote NPU, then the trunk should also be checked.

### **npuname, SAM LOAD ABORTED - TIMEOUT.**

Description: NS aborted its attempt to load the SAM program into the NPU because it had not received a response from PIP. There was probably a software problem in the network that prevented PIP from responding to NS.

Issued by NS.

User Action: If the problem has not gone away, the network should be taken down if possible and reinitialized.

### **SAMPLE FWA .GE. LWA.**

Description: The first word address and last word address of the sample range were entered incorrectly.

Issued by SMP.

User Action: Correct the SMP call and retry.

### **SC, IF SPECIFIED, MUST BE BC IF OT=BC.**

Description: If the OT field is specified as BC, the only value allowed in the SC field is BC. The job statement in error is shown.

Issued by NAMI.

User Action: Correct the SC field, or leave blank.

### **SC, IF SPECIFIED, MUST BE SY, NS, OR BC.**

Description: The only value allowed in the SC field is SY, NS, or BC. The job statement in error is shown.

Issued by NAMI.

User Action: Correct the SC field, or leave blank.

### **SCANNING MEMORY.**

Description: Each available word of central memory is read to check the integrity of the data. The duration of the message is a function of central memory size.

Issued by CTI.

User Action: None.

### **SCANNING RESOURCE DEMAND FILE.**

Description: Informative message indicating the routine MAGNET is attempting clean-up procedures on the resource demand file.

Issued by MAGNET.

User Action: None.

### **SCLI,node,C1,port,blckst.**

### **SCLI,node,C2, charst.**

### **SCLI,node,C3,blocksrt,padrjct,acrjct.**

Description: Denotes the number of blocks and characters transmitted and received on the trunk connected to the indicated port number port of the NPU with node number node. The port number is hexadecimal; all other values are decimal.

blkst Two contiguous six-digit fields tttttrrrrrr: ttttt - Blocks transmitted; rrrrrr - Blocks received  
 charst Two contiguous six-digit fields ssssscccc: ssssss - Characters transmitted/32; ccccc - Characters received/32  
 blocksrt Number of bad blocks retransmitted.  
 padrjct Number of X.25 PAD call requests rejected due to insufficient number of enabled circuits.  
 acrjct Number of X.25 application to application call requests rejected due to insufficient number of enabled circuits.

Issued by CS.

User Action: None.

**SCNQ,node,C1,statistics1.**  
**SCNQ,node,C2,statistics2.**  
**SCNQ,node,C3,statistics3.**  
**SCNQ,node,C4,statistics4.**

Description: Indicates various statistics about the NPU with node number node. All values are decimal. Fields consist of contiguous six-digit numbers as follows:

statistics 1	cccccdllllll	
statistics 2	qqqqrrrrrsss	
statistics 3	ppppplllllddd	
statistics 4	wwwww	
cccc		CPU utilization percentage in tenths of a percent
dddd		Average number of data buffers
llll		Lowest regulation level reached
qqqqq		Number of inputs rejected due to NPU regulation
rrrrr		Average characters per second sent to host
sssss		Number of active batch output devices
lllll		Number of active batch input devices
dddd		Number of console devices connected
wwwww		Average number of worklists per second

Issued by CS.

User Action: None.

**SCP PROBLEM - TAKE DEADSTART DUMP.**

Description: Operating system problem.

Issued by NIP.

User Action: Inform site analyst to take a deadstart dump.

**nmmn SCP ROLLIN FILES RECOVERED.**

Description: nmmn jobs that were in an SCP rollin job state have been recovered.

Issued by REC.

User Action: None.

**nmmn SCP ROLLOUT FILES RECOVERED.**

Description: nmmn jobs that were in a SCP rollout job state have been recovered.

Issued by REC.

User Action: None.

## **SCP TERMINATION PROCESSING.**

Description: This message appears only in the message field of the affected control point on the Job Status (B) display. It indicates the system is executing termination processing for the system control point job that was at the affected control point. All connected user jobs that are also system control point jobs are informed of the termination. All other connected user jobs are aborted.

Issued by OST.

User Action: None.

## **SCRIPTS CANNOT FOLLOW TASK DEFINITIONS.**

Description: K-display message indicating that the format of the session file is incorrect; tasks must follow sessions.

Issued by STIMULA.

User Action: Put task definitions after session records.

## **SCTD UTILITY COMPLETE.**

Description: Informative message indicating processing is complete.

Issued by SCTD.

User Action: None.

## **SCTU,node,C1,port,blkst.**

## **SCTU,node,C2,charst.**

## **SCTU,node,C3,blocksrt.**

Description: Denotes the number of blocks and characters transmitted and received on the trunk connected to the indicated port number port of the NPU with node number node. The port number is hexadecimal; all other values are decimal.

blkst	Two contiguous six-digit fields tttttrrrrrr: tttttt - Blocks transmitted; rrrrrr - Blocks received
charst	Two contiguous six-digit fields sssssccccc: ssssss - Characters transmitted/32; ccccc - Characters received/32
blocksrt	Number of bad blocks retransmitted.

Issued by CS.

User Action: None.

## **SDF INSTALLATION COMPLETE.**

Description: Informative message indicating that system deadstart file installation is complete.

Issued by INSTALL.

User Action: None.

## **SDSPLAY UTILITY COMPLETE.**

Description: Processing of the SDSPLAY utility has been ended.

Issued by SDSPLAY.

User Action: None.

## **xxxxxx.xxx SEC. 1TS CYCLE TIME.**

Description: Informative message indicating the maximum cycle time for 1TS.

Issued by 1TS.

User Action: None.

### **SECURE MEMORY, DUMP DISABLED.**

Description: You either attempted to dump memory protected by the system or entered a memory dump request after a protected command or from a terminal.

Issued by 1AJ.

User Action: Refer to Security Control in NOS Reference Set, Volume 3 or user Field Length Dump Request in Volume 4. To obtain memory dumps from an interactive job, include the dump command in a procedure or in an ENTER command.

### **SECURITY CONFLICT.**

Description: An attempted operation within the job would have resulted in a violation of security access levels or categories. The cause is described in the immediately preceding dayfile message.

Issued by 1AJ.

User Action: Correct and retry.

### **SECURITY MODE CHANGED.**

Description: The current system is not in the same security mode as the system being recovered.

Issued by REC.

User Action: Perform a level 0 deadstart.

### **SECURITY UNLOCK REQUIRED.**

Description: In a secured system, security unlock status is required to enable RDF.

Issued by SUBSYST.

User Action: Contact site administration.

### **SECURITY VIOLATION APP jobid.**

Description: Informative message indicating that NIP has detected a security violation (for example, an application attempting to perform operations reserved for a supervisor or privileged application).

jobid Job identifier passed to NIP from the operating system.

Issued by NIP.

User Action: None.

### **SEE DAYFILE-UNABLE TO LOAD pfn.**

Description: RECLAIM is unable to load file pfn due to bad tape, database in error, the file is already permanent, or some other problem as indicated in the dayfile.

Issued by RECLAIM.

User Action: Check the dayfile for the specific error. Check your permanent file catalog to ensure that the specified file is not already in the catalog. If the file is not already permanent, check the database file and dump tape.

### **SEE JOB DAYFILE.**

Description: An error occurred during DMREC processing that requires the operator to check the dayfile.

Issued by DMREC.

User Action: Check the job's dayfile for required information and instructions.

### **SEGMENT MISSING.**

Description: The segment ID part of a CYBER 170-8xx address is incorrect or the segment cannot be found in the segment table.

Issued by DSDI.

User Action: Correct address and rerun.

**SELECTED CUBE NOT ASSIGNED AS EXPECTED.  
NUMBER PROCESSED = n.**

Description: One of the cubicles is not available for the assignment specified by a directive to SSLABEL.  
However, n cubicles were assigned.

Issued by SSLABEL.

User Action: Correct directive to SSLABEL and retry.

**SELECTED CUBE NOT EMPTY.  
NUMBER PROCESSED = n.**

Description: One of the cubicles to be removed by the RB directive to SSLABEL is not empty. However, n cubicles were removed.

Issued by SSLABEL.

User Action: Specify a different cubicle and retry.

**SELECTED CUBE NOT UNASSIGNED.  
NUMBER PROCESSED = n.**

Description: One of the cubicles to be added by the AB directive to SSLABEL is already assigned. However, n cubicles were added.

Issued by SSLABEL.

User Action: Specify a different cubicle and retry.

**SELECTED DEVICE NOT MASS STORAGE.**

Description: The EST ordinal specified on the MST directive was not that of a mass storage device.

Issued by DSDI.

User Action: Correct and rerun.

**SELECTED ENTRY BEYOND TABLE BOUNDARY.**

Description: The entry number selected to be dumped from the desired buffered device table was greater than that of the last table entry.

Issued by DSDI.

User Action: Correct entry and rerun.

**SELECTION FILE DEVICE NUMBER ERROR.**

Description: Program error - a device number not in the catalog device table was found in a record during final selection.

Issued by GENPFD.

User Action: Report this problem to CYBER Software Support.

**SEND DATA BIT NOT SET.**

Description: INITMDI wished to send data to the MDI, but the general status send data bit was not set.

Issued by INITMDI.

User Action: Inform site analyst.

**SENSE SWITCH ONE TERMINATION.**

Description: PACKER has detected a termination request via sense switch one.

Issued by PACKER.

User Action: None.

### **SEQUENCE NUMBER OUT OF ORDER - dudd.**

Description: INITMDI detected an out-of-order sequence number on dump data unit dudd.

Issued by INITMDI.

User Action: Inform site analyst.

### **SEQUENCE NUMBER OUT OF ORDER - dutd.**

Description: INITMDI detected an out-of-order sequence number on terminate dump data unit dutd.

Issued by INITMDI.

User Action: Inform site analyst.

### **SEQUENTIAL POSITIONING.**

Description: This test section is being executed.

Issued by MST.

User Action: None.

### **SEQUENTIAL READ.**

Description: This test section is being executed.

Issued by MST.

User Action: None.

### **SEQUENTIAL WRITE.**

Description: This test section is being executed.

Issued by MST.

User Action: None.

### **SETTING PF ACTIVITY COUNT.**

Description: PFDUMP or PFCAT is waiting for PFU to increment the permanent file device activity count before starting catalog processing. This message should be displayed for a few seconds only.

Issued by PFDUMP.

User Action: If message is displayed for an extended period of time, take a dead- start dump, write a PSR, and send the dump and PSR to CDC along with any support materials which will allow CDC to duplicate the problem.

### **SETTING UTILITY INTERLOCK.**

Description: PFLOAD is waiting for PFU to set the permanent file utility interlock on a device before loading it. When no other utility (such as PFLOAD or MSI) is active on the device and permanent file activity on the device ceases, PFLOAD continues automatically.

Issued by PFLOAD.

User Action: Wait for other utility to complete.

### **SFM CATALOG INTERLOCKED DESTAGE DELAYED, FM=familyname, SF=subfamily.**

Description: A file destage operation was delayed because the SFM catalog for the family and subfamily indicated is being accessed. The destage will resume when the SFM catalog becomes available.

Issued by SSEXEC.

User Action: None.

**SFM CATALOG INTERLOCKED  
STAGING DELAY, FM=familyname, UI=userindex.**

Description: Staging is delayed because PFDUMP or SSVAL is accessing the SFM catalog. Staging will resume automatically when the interlock is no longer needed.

Issued by SSEXEC.

User Action: None.

**SFM CATALOG NOT ONLINE  
DESTAGE ABANDONED,  
FM=familyname, SF=subfamily.**

Description: A file destaging operation was abandoned because the SFM catalog for the family and subfamily indicated was not on line. The next SSMOVE run for this subfamily will reselect these files for destaging.

Issued by SSEXEC.

User Action: None.

**SFM CATALOG NOT ONLINE.  
filename FOR jsn NOT STAGED.**

Description: The staging of file filename for job jsn was abandoned because the SFM catalog was not on line. This condition exists when a removable family is mounted after SSEXEC was initiated or when an I/O error occurred on the SFM catalog.

Issued by SSEXEC.

User Action: A site analyst should ensure that the SFM catalog is on line and recover from the I/O error, if necessary. Then restart SSEXEC.

**SFM CATALOG REPLACE ERROR.**

Description: An error was encountered during an attempt to add, extend, or remove a subcatalog. The SFM catalog is closed.

Issued by SSEXEC.

User Action: Inform site analyst. It may be necessary to restore the SFM catalog from the temporary catalog SFM.

**SFM FAMILY STILL ACTIVE.**

Description: An attempt was made to release fast attach files for a family name which was still in use.

Issued by SFM.

User Action: Enter DSD command IDLEFAM to prevent new jobs from being scheduled to that family name while allowing the operations in progress to complete.

**SFM FILE NOT FOUND.**

Description: Requested file could not be found.

Issued by SFM.

User Action: Verify that the file exists and retry.

**SFM GLOBAL FAST ATTACH LIMIT.**

Description: A request has been made to enter a file in global fast attach mode and there is insufficient space in the FAT table. A maximum of 77B global fast-attach files can exist at one time.

Issued by SFM.

User Action: Inform site analyst; a sufficient number of files must be returned from fast-attach status, via the ISF function, to make room for the files being put into fast-attach status.

### **SFM LID TABLE TOO LONG FOR BUFFER.**

Description: An attempt was made to get a copy of the LID table but the LIDT was larger than the caller's buffer.

Issued by SFM.

User Action: Make the buffer larger and rerun.

### **SFM LINK FAST ATTACH FILE NOT FOUND.**

Description: An attempt to fast-attach a file already in the fast-attach table (FAT) has been unsuccessful. The file is currently busy in a status other than fast-attach.

Issued by SFM.

User Action: Locate the job to which the desired file is attached and return the file. Retry the function (usually through ISF).

### **SFM SYSTEM SECTOR ERROR.**

Description: When entering or deleting a fast-attach file, SFM was unable to read the file's system sector.

Issued by SFM.

User Action: The fast-attach file should be copied to another area and the unreadable space flawed.

### **SFM UNRECOVERABLE LINK DEVICE ERROR.**

Description: An unrecoverable error was encountered while trying to process an SFM request involving DAT or FAT tables on the link device.

Issued by SFM.

User Action: The error information logged in the error log should be referred to a customer engineer. If the error cannot be fixed, the area in error should be flawed before attempting to proceed. A level 0 deadstart may be necessary.

### **SFMCATn FOR FAMILY familyname CLOSED.**

Description: The SFM catalog SFMCATn is closed. A preceding message indicates why the SFM catalog is closed.

Issued by SSEXEC.

User Action: Inform site analyst.

### **SFMCATALOG PARITY ERROR.**

Description: There is a read parity error on the SFM catalog.

Issued by SSUSE.

User Action: Recover the SFM catalog from a backup copy and retry.

### **SH/ISD ON NON-EXISTENT AN.**

Description: NVF error. Shutdown requested for nonexistent application number.

Issued by NIP.

User Action: Contact a customer engineer.

### **SHARED DEVICE ACTIVE IN DAT.**

Description: A shared device is described in the device access table with the same family and device number as the nonshared device being recovered. Recovery is impossible. Preceded by message RECOVERY, EQest. which indicates the equipment in error.

Issued by MSM.

User Action: Rereadstart with correct configuration for equipment in error.



## **SHUTDOWN IMMINENT.**

Description: Bit 37 of the status/control register is set, indicating an abnormal environmental condition has been detected. When entered in the error log, the message is preceded by SR. This is an operator and error log message.

Issued by 1MB.

User Action: Inform site analyst and customer engineer. (For further information and procedures, refer to S/C Register Error Detection, appendix E.)

## **SHUTDOWN WARNING.**

Description: The network will be going down.

Issued by IAFEX.

User Action: Log off as soon as possible.

## **\*\*\* SIZE EXCEED CIO BUFFER LIMIT. \*\*\***

Description: The 4 directive SIZE parameter is too big.

Issued by NDA.

User Action: Specify a smaller size.

## **SKF est,nn.**

Description: The operator requested a skip forward of nn logical files on the print file on BIO equipment est.

Issued by QAP.

User Action: None.

## **SKIPPING filename userindex.**

Description: Informative message indicating name of the file that is currently being skipped on the archive tape and the user index under which the file is stored.

Issued by PFLOAD.

User Action: None.

## **SKP est,nn.**

Description: The operator requested a skip forward of nn sectors (PRUs) on the print file on BIO equipment est.

Issued by QAP.

User Action: None.

## **SKR est,nn.**

Description: The operator requested a skip forward of nn logical records on the print file on BIO equipment est.

Issued by QAP.

User Action: None.

## **SLIDE MOVES nnnnnn, ssssss PRUS.**

Description: PACKER statistics reflecting the condition of the portion of the IAPF chain which PACKER has processed.

nnnnnn Number of files moved into holes via the slide move procedure.

ssssss Total number of sectors moved via this procedure.

Issued by PACKER.

User Action: None.

## **SLL ARGUMENT ERROR.**

Description: One of the following conditions occurred:

- An incorrect function code was passed to routine SLL.
- The parameter address passed to routine SLL was out of range.
- The request word address passed to routine SLL was out of range.

Issued by SLL.

User Action: Take a deadstart dump, write a PSR, and send the dump and PSR to CDC along with any support materials which will allow CDC to duplicate the problem.

## **SLL - LOCAL FILE LIMIT**

Description: Files required to run SYSEDIT cannot be created because they would exceed the user's local file limit.

Issued by SLL.

User Action: Return local files and rerun SYSEDIT.

## **/SLVi ABNORMAL - xxx.**

Description: SSSLV on mainframe i has encountered an abnormal error condition in routine xxx.

Issued by SXSLV.

User Action: Inform site analyst.

## **SLVi ACTIVE, EXEC xxxxx.**

Description: The current status of SSEXEC according to SSSLV on mainframe i, where xxxxx is ACTIVE, IDLE, or INACTIVE.

Issued by SXSLV.

User Action: None.

## **SLVi - ERROR TERMINATION (1).**

Description: While SSSLV on mainframe i was reading the master-to-slave communications file MTBSPFN, an I/O error occurred which prevented further SSSLV processing.

Issued by SXSLV.

User Action: Purge file MTBSPFN and reinitialize SSEXEC and all SSSLV programs.

## **SLVi - IDLED DOWN.**

Description: Informative message indicating that SSSLV on mainframe i terminated normally in response to an operator IDLE command.

Issued by SXSLV.

User Action: None.

## **SLVi, MTBSPFN xxxxx.**

Description: SSSLV on mainframe i attempted to attach or read the master-to-slave communication file MTBSPFN. xxxxx is the status of the attempt and is one of the following:

- OK.
- ATTACH PROBLEM.
- LENGTH PROBLEM.
- NO MID MATCH.

Issued by SXSLV.

User Action: If xxxx is OK, no action is required. If xxxx is LENGTH PROBLEM, purge MTBSPFN and reinstall SSSLV and SSEXEC using identical values for NUMRB, MAXSLV, and NUMSLV in common deck COMEIPR and for RBSIZE in common deck COMBFAS.

### **SLVi, STOMNOi xxxx.**

Description: SSSSLV on mainframe i attempted to establish access to the slave-to-master communication file STOMNOi. The status of this attempt is indicated by xxxx, which can be one of the following:

- OK.
- ATTACH PROBLEM.
- BUSY.
- DEFINE PROBLEM.

Issued by EXSLV.

User Action: If xxxx is not OK, analyze error and try again. Ensure that the link device is configured as a direct access permanent file device.

### **SMF IS ALREADY CONNECTED TO IAF**

Description: SMF attempted to form a user control point (UCP) connection with the interactive facility (IAF) when there was already a connection established.

Issued by IAFEX.

User Action: Inform site analyst.

### **SMMAP ERROR FLAG NOT SET IN FCT.**

Description: The RL directive to SSDEBUG did not remove the FCT entry in the SFMCAT because the SMMAP error flag was not set in the FCT entry.

Issued by SSDEBUG.

User Action: Correct the FCT ordinal and the SB and SM parameters and retry.

### **SMMAP OPEN ERROR.**

Description: The SM map does not exist or is incorrect for the specified SM on the default family name.

Issued by SSVAL.

User Action: Correct the SM parameter on the SSVAL command or reload/recreate the SM map.

### **SMMAP PARITY ERROR.**

Description: There is a read parity error on the SM map.

Issued by SSUSE.

User Action: Recover the SM map from a backup copy and retry.

### **SMMAP READ ERROR.**

Description: A parity error was encountered on the SM map.

Issued by SSVAL.

User Action: Recover the SM map from a back copy and retry.

### **SMP - ABORTED DUE TO ROLLOUT REQUEST.**

Description: The rollout request flag is set in the job's control point area. This may happen as a result of terminal I/O or DIS dropping while SMP is running.

Issued by SMP.

User Action: None.

**SMP ERR xxxxxxxxxxxxxxxxxxxxxxxx.**

Description: An incorrect supervisory message was received from the network. xxx...x is the octal representation of the message. This is an informative message.

Issued by IAFEX.

User Action: None.

**nnnn SPECIAL FILES RECOVERED.**

Description: nnnn files in an installation defined special file queue have been recovered.

Issued by REC.

User Action: None.

**SPECIFIED CHANNEL IS IN USE.**

Description: The user tried to load controlware on a channel that was down and assigned to a maintenance user.

Issued by LOADBC.

User Action: Retry the LOADBC command after the maintenance user has finished and has released the channel.

**SPIN DOWN UNIT xx.**

Description: Unit xx should be deactivated prior to a physical pack switch.

Issued by 1RM.

User Action: Deactivate unit xx.

**SR-m-2 yyyy yyyy yyyy yyyy yyyy.**

**SR-m-1 yyyy yyyy yyyy yyyy yyyy yyyy.**

**SR-m-0 yyyy yyyy yyyy yyyy yyyy yyyy.**

Description: A status/control register error has been detected. This is an error log message.

m Channel register 0 Channel 16 register 1 Channel 36 register (if 20 PPU's are being used; in this case the contents of both registers are given)

yyy...yyy Contents in octal of words 16 through 0 as specified below. SR-m-2 words 16-12 (bits 203144) SR-m-1 words 11-6 (bits 143-72) SR-m-0 words 5-0 (bits 71-0)

Issued by 1MB.

User Action: Inform customer engineer.

**SSEXEC SEEKING FL INCREASE.**

Description: Informative message indicating that SSEXEC is waiting for the field length increase from the system.

Issued by SSEXEC.

User Action: None.

**SSEXEC SEEKING FL INCREASE.**

Description: SSEXEC needs space for its tables before it can be initialized.

Issued by SSEXEC.

User Action: Take action to make additional memory available.

**SSF FUNCTION nn RECEIVED ERROR mm FOR zzzz.**

Description: TAF received error code mm (octal) while issuing SSF function code nn (octal) for job zzzz.

Issued by TAF.

User Action: Inform TAF site analyst.

**SSUSE ABNORMAL, xxx.**

Description: There is an SSUSE internal error in module xxx.

Issued by SSUSE.

User Action: Inform site analyst.

**SSUSE - ARGUMENT ERROR.**

Description: The SSUSE command is syntactically incorrect.

Issued by SSUSE.

User Action: Correct command and retry.

**SSUSE COMPLETE.**

Description: Informative message indicating that SSUSE completed normally.

Issued by SSUSE.

User Action: None.

**SSUSE - MUST BE SYSTEM ORIGIN.**

Description: An attempt was made to call SSUSE from other than system origin.

Issued by SSUSE.

User Action: Retry the call from system origin.

**SSVAL - MUST BE SYSTEM ORIGIN.**

Description: The calling program did not have system origin privileges.

Issued by SSVAL.

User Action: Rerun from console.

**ST NOT SPECIFIED CORRECTLY.**

Description: The ST parameter was specified outside the valid range in a directive to SSDEBUG.

Issued by SSDEBUG.

User Action: Correct the ST parameter and retry.

**STATISTICS FLUSH NOT AVAILABLE**

Description: Dayfile message indicating that due to limitations within PSU, the K.RS=PSU NAM command cannot be actioned.

Issued by PSU.

User Action: None.

**STATISTICS MAY NOT BE ACCURATE.**

Description: PACKER is issuing statistical messages during reprieve or error recovery processing. Since normal processing has been interrupted, the information may not be accurate.

Issued by PACKER.

User Action: None.

**STATUS/CONTROL REGISTERS NOT FOUND.**

Description: Output file message indicating that the S/C register record was not found in the EDD file.

Issued by DSDI.

User Action: Ensure that the dump file contains meaningful information.

**STIMULATION COMPLETE.**

Description: Informative dayfile message indicating that stimulation is complete.

Issued by STIMULA.

User Action: None.

**STIMULATION INITIATED.**

Description: Informative message indicating that the stimulation has started.

Issued by ITS.

User Action: None.

**\*STM\* MUST BE AT LAST CP.**

Description: You enabled STIMULA to run at a control point other than the last control point.

Issued by ITS.

User Action: Change the control point assignment for STM using the ENABLE,STM,-1. command in the SUBSYST L display utility.

**STORAGE MODULE ERROR.**

Description: Error on a 7990 storage module.

Issued by SSEXEC.

User Action: Inform site analyst.

**STORAGE MODULE IS TURNED OFF.**

Description: The specified storage module is off line.

Issued by SSLABEL.

User Action: Put the SM on line or specify another SM and retry.

**STORAGE NOT AVAILABLE.**

Description: The FL requested on the ENFL,nnnn. command is not available.

Issued by DIS.

User Action: Wait until FL becomes available or bit the left blank to clear command.

**STRING TOO LONG.**

Description: CFO command contains a string longer than seven characters.

Issued by MCS.

User Action: Reenter the command.

**SUB ALREADY DEFINED.**

Description: The specified subfamily has already been added for this family.

Issued by SSLABEL.

User Action: None.

**SUBSYST UTILITY COMPLETE.**

Description: Indicates normal completion.

Issued by SUBSYST.

User Action: None.

### **SUBSYSTEM ABORTED.**

Description: Your job was connected (either long term connection or wait response set) to a subsystem which aborted.

Issued by 1AJ.

User Action: Retry later.

### **SUBSYSTEM NOT FOUND.**

Description: Output file message indicating that the requested subsystem was not found in the EDD file.

Issued by DSDI.

User Action: Ensure that the dump file contains meaningful information.

### **SUFFICIENT TRACKS ALREADY AVAILABLE.**

Description: The number of tracks specified as the goal on the RL directive is already available on the designated device(s).

Issued by GENPFD.

User Action: If it is desirable to proceed even though the goal is already achieved, it will be necessary to increase the RL directive goal value and retry the GENPFD run.

### **SUMMARY FILE IS EMPTY OR MISPOSITIONED.**

Description: End of file or end of record was detected on the first read of the summary file presented as input to GENPFD. Either no summary file is present or it is incorrectly positioned.

Issued by GENPFD.

User Action: Check to see if a summary file was produced. If not, correct the PF Utility run that should have produced it. Otherwise, make sure that the file is properly positioned, for example by issuing a REWIND command. Then retry the GENPFD run.

### **SUMMARY FILE PREFIX TABLE ERROR.**

Description: The summary file presented as input to GENPFD contained no prefix table record. The wrong file may have been presented as input to GENPFD, or it may have been incorrectly positioned.

Issued by GENPFD.

User Action: Check to see if the wrong file has been presented to GENPFD as a summary file, and correct the error if so. Otherwise, make sure that the file is properly positioned, for example by issuing a REWIND command. Then retry the GENPFD run.

### **SUP est.**

Description: The operator requested automatic printer carriage control suppression on BIO equipment est.

Issued by QAP.

User Action: None.

### **nnnn SUSPENDED ROLLOUT FILES RECOVERED.**

Description: nnnn jobs that were in a suspended job state have been recovered.

Issued by REC.

User Action: None.

### **SVC: svcname,EN=enum,DI=dinum,stip.**

Description: Status of a switched virtual circuit. It included the name (svcname), number of circuits enabled (enum), number of circuits disabled (dinum), and the sub-tiotype (stip).

Issued by CS.

User Action: None.

### **SYNCHRONIZE LOAD RECEIVED.**

Description: A synchronize load data unit was sent to INITMDI from the MDI. The MDI sends this unit when an error is detected.

Issued by INITMDI.

User Action: Inform site analyst.

### **SYNTAX ERROR.**

Description: Indicates a syntax error in the HOP command.

Issued by NS.

User Action: Reenter the correct command.

### **SYNTAX ERROR IN DIRECTIVE.**

Description: One of the directives to SSDEBUG is syntactically incorrect.

Issued by SSDEBUG.

User Action: Correct directive and retry.

### **SYNTAX ERROR IN LID.**

Description: An incorrect separator was present, no parameter was specified, or there were not three characters specified.

Issued by QFSP.

User Action: Correct and reenter K display input.

### **SYNTAX ERROR, SSDEBUG ABORT.**

Description: The SSDEBUG command or directive is syntactically incorrect.

Issued by SSDEBUG.

User Action: Correct the command or directive and retry.

### **SYNTAX ERROR - SSLABEL ABORT.**

Description: The SSLABEL command or directive is syntactically incorrect.

Issued by SSLABEL.

User Action: Correct the command or directive and retry.

### **SYSEDT ARGUMENT ERROR.**

Description: An error was detected on the SYSEDT command.

Issued by SYSEDT.

User Action: Correct error and retry.

### **SYSTEM ABORT.**

Description: A system error was encountered.

Issued by QDSPLAY.

User Action: None.

### **SYSTEM ABORT.**

Description: Flashing message at system control point on B display and the right screen header. This indicates that the IDLE exchange package has terminated.

Issued by CPUMTR.



User Action: Ask the customer engineer to examine the hardware maintenance registers (on CYBER 180-class machines) to determine if a hardware problem exists. A redeadstart is necessary. If no hardware errors are indicated, write a PSR and send a deadstart dump to CDC along with any other support materials which will allow CDC to duplicate the problem.

### **SYSTEM ACTIVITY PROHIBITS LIBRARY CHANGE.**

Description: Dayfile message indicating that an error occurred because the job at control point 1 cannot be moved in order to perform the SYSEDIT.

Issued by SLL.

User Action: Either drop activity at control point 1 or reduce size of CMR resident to allow building of tables within the allocated field length.

### **SYSTEM BUILT WITH LIBDnn. or SYSTEM BUILT WITH LIBDnn. (UNDEFINED)**

Description: Informative message following a level 0 (initial) or level 2 (recovery) deadstart to indicate the LIBDECK with which the system was generated. The second form of the message is issued if the specified deck was not found. This can seriously affect system performance because often used routines which normally reside in CM or the alternate system device (ASD) must be accessed from the system disk instead.

nn LIBDECK number

Issued by SYSEDIT.

User Action: Redeadstart if necessary to rebuild system using a known LIBDECK.

### **SYSTEM BUSY.**

Description: A previous L-display command or utility is being processed. At job initiation time, the L-display is already interlocked.

Issued by DSD.

User Action: Wait until the current command entered at console is processed, wait until the current L display utility terminates and try again.

### **SYSTEM CHECKPOINT ABORT.**

Description: A subsystem has aborted due to a CHECK POINT SYSTEM request initiated by the operator.

Issued by 1CK.

User Action: None.

### **SYSTEM CONTROL POINT FAILURE.**

Description: One of the programs connected to IAF through a system control point has gone down. In most cases, this is NAM and all network jobs will be detached.

Issued by IAFEX.

User Action: Recover job as soon as NAM comes back up.

### **SYSTEM DAYFILE PROCESSED.**

Description: The system dayfile dump is complete.

Issued by DAYFILE.

User Action: None.

### **SYSTEM DEVICE DOWN.**

Description: One of the system devices is down.

Issued by SLL.

User Action: Attempt to set device on. If this is not possible because of a hardware problem, redeadstart the system without that system device.

### **SYSTEM DEVICE ERROR.**

Description: An unrecovered write error occurred on a system device.

Issued by SLL.

User Action: Retry SYSEDIT or redeadstart without system device.

### **SYSTEM EDIT COMPLETE - CHANGE n.**

Description: Informative message indicating the change level and completion of SYSEDIT.

Issued by SYSEDIT.

User Action: None.

### **SYSTEM ERROR.**

Description: A software or hardware system error occurred. This message follows a more specific message in the dayfile.

Issued by PFM.

User Action: Refer to action for the associated message.

### **SYSTEM FILE DESTROYED.**

Description: Dayfile message indicating that the system sector of the system file is bad.

Issued by SLL.

User Action: Take a deadstart dump, write a PSR, and send the dump and PSR to CDC along with any support materials which will allow CDC to duplicate the problem. Redeadstart is necessary.

### **SYSTEM FILE ERROR IN CLD.**

Description: Error was encountered during the building of the system library. A disk resident overlay (OVL) or absolute (ABS) program is not formatted correctly. Deadstart processing halts when this error is detected.

Issued by SYSEDIT.

User Action: Redeadstart at a different tape density, use another tape unit or a different deadstart tape. If the error persists, contact CYBER Software Support.

### **SYSTEM FILE ERROR IN DIRECTORY.**

Description: System file error occurred during the building of the system library. Start of the system library was not found. Deadstart processing halts when this error is detected.

Issued by SYSEDIT.

User Action: Redeadstart at a different tape density, use another tape unit or a different deadstart tape. If the error persists, contact CYBER Software Support.

### **SYSTEM FILE ERROR IN PLD.**

Description: System file error occurred during the building of the system library. A disk resident PP program or central memory resident PP program is not formatted correctly. Deadstart processing halts when this error is detected.

Issued by SYSEDIT.

User Action: Redeadstart at a different tape density, use another tape unit or a different deadstart tape. If the error persists, contact CYBER Software Support.

### **SYSTEM FILE ERROR IN RCL.**

Description: Error was encountered during the building of the system library. A central memory resident overlay (OVL) or absolute (ABS) program is not formatted correctly. Deadstart processing halts when this error is detected.

Issued by SYSEDIT.

User Action: Rereadstart at a different tape density, use another tape unit or a different deadstart tape. If the error persists, contact CYBER Software Support.

### **SYSTEM FILE ERROR IN RPL.**

Description: Error was encountered during the building of the system library. A central memory resident overlay (OVL) or absolute (ABS) program is not formatted correctly. Deadstart processing halts when this error is detected.

Issued by SYSEDIT.

User Action: Rereadstart at a different tape density, use another tape unit or a different deadstart tape. If the error persists, contact CYBER Software Support.

### **SYSTEM FILE FORMAT ERROR.**

Description: Operator message indicating that the system file directory has been destroyed.

Issued by SYSEDIT.

User Action: Rereadstart using a different deadstart tape. If the error persists, contact CYBER Software Support.

### **SYSTEM FILE RESERVED.**

Description: Dayfile message indicating that the system file is currently in use, possibly by another copy of SYSEDIT.

Issued by SLL.

User Action: Wait until SYSEDIT activity has completed and retry.

### **SYSTEM LIBRARY CHANGE INCORRECT.**

Description: Informative dayfile message indicating that the caller does not have permission to modify the system. You attempted to change the system library on a secured system without having security administrator privileges.

Issued by SLL.

User Action: None.

### **SYSTEM NOT IN ENGR MODE.**

Description: The system must be in engineering mode when the LOADBC command is entered.

Issued by LOADBC.

User Action: Enter the ENGR command to place the system in engineering mode.

### **SYSTEM SECTOR ERROR.**

Description: The system sector of an indirect access permanent file contains an error (error log and dayfile message). This indicates that the file has been destroyed.

Issued by PFM.

User Action: Inform site analyst. If many of these errors occur, the site analyst should perform a full PFDUMP, total INITIALIZE, and full PFLOAD on the device.

### **SYSTEM SECTOR ERROR - FILE IGNORED.**

Description: QFM returned an error in the system sector.

Issued by QDUMP.

User Action: Contact CYBER Software Support.

### **SYSTEM TAPE PARITY ERROR.**

Description: Parity error occurred while reading the deadstart tape.

Issued by DIO.

User Action: Perform one of the following:

- To continue, type GO (information transferred may not be valid).
- Rereadstart and specify a different tape density, or use another tape unit or a different deadstart tape. Ensure that the deadstart tape is an unlabeled I-mode tape and that the tape unit on which it is mounted is the correct type (7- or 9-track).

### **SYSTEM TASK LIBRARY MISSING TASK, taskname.**

Description: Taskname is not on system library or not enough communication blocks are allocated.

Issued by TAF.

User Action: Add taskname to system library or increase number of communication blocks.

### **SYSTEM TOO BIG FOR MASS STORAGE.**

Description: Error encountered during the building of the system library. Storage required not available on mass storage device specified for system library. Preserved files on the system device may cause insufficient local file space to be available. If multiple copies of the system are specified, these preserved files may prevent allocation of matching track chains.

Issued by SLL.

User Action: Attempt another deadstart using a larger system mass storage device or use a deadstart tape that generates a smaller system library. Ensure deadstart sector is initialized by releasing CMSE space if it is not to be present on system devices.

### **nnnn T/E ROLLOUT FILES RECOVERED.**

Description: nnnn jobs that were in a timed/event job state have been recovered.

Issued by REC.

User Action: None.

### **TABLE ADDRESS ERROR**

Description: The system is unable to complete level 3 recovery deadstart because of a table address error or a table length error.

Issued by SET.

User Action: Perform a level 0 deadstart after attempting a level 3 deadstart with the abort option.

### **TABLE OVERFLOW ON INPUT**

Description: Dayfile message indicating that too many flaw entries were available in the input stream; the flaw limit is 157 flaws.

Issued by FORMAT.

User Action: Correct and rerun.

### **TABLE OVERFLOW, UNABLE TO OBTAIN REQUIRED MEMORY.**

Description: The table overflow processor was unable to obtain enough memory to build the required tables.

Issued by PACKER.

User Action: Make sure that the job has unlimited CM validation and retry PACKER command.

### **TAF COMM. RECOVERY FILE NOT FOUND - filename.**

Description: The TAF Communication Recovery File could not be found.

Issued by TAFREC.

User Action:

- Check that the correct family name and user name were specified on the NETWORK statement.
- Check if TRFi should be initialized via the K.INT initial K display command.

### **TAF/CRM DATA MANAGER NOT LOADED IN TAF.**

Description: This message is returned to the dayfile of a batch concurrency job that attempted to access a CRM file while CRM was not loaded in TAF.

Issued by BAAML.

User Action: Ask the database administrator to bring up TAF with CRM. Rerun job when TAF/CRM is available.

### **TAF/CRM RECOVERY FILE INCONSISTENT.**

Description: The ARF or BRF table header information does not match the buffer header information.

Issued by TAF.

User Action: Dump the database associated with the inconsistent ARF or BRF using DMREC. Re-create the ARF or BRF using DMREC and reinitialize the transaction subsystem.

### **TAF DATA NOT WITHIN UCP FL.**

Description: TAF cannot access data from user program because the address specified is outside the user control point field length.

Issued by BAAML.

User Action: Correct program.

### **TAF ERROR CODE NOT DEFINED.**

Description: TAF or TAF/CRM has returned an error code that the routine RQS was not programmed to handle.

Issued by BAAML.

User Action: Inform responsible individual for maintaining system.

### **TAF FIELD LENGTH DUMP RELEASED.**

Description: A dump of the transaction facility has occurred. The dump has been routed to a printer with an ID of zero.

Issued by TAF.

User Action: The output may contain secure information and should be given to the central site TAF systems analyst only. A header page follows the banner page for identification.

### **TAF FUNCTION CODE NOT VALID.**

Description: TAF cannot process the request issued because it is an unrecognizable function code. This is an internal error.

Issued by BAAML.

User Action: Inform database administrator.

### **TAF FUNCTION CODE NOT VALID.**

Description: TAF cannot process the request issued because it is an unrecognizable function code. This is an internal error.

Issued by BAAML.

User Action: Inform database administrator.

### **TAF IDLE (GO OR DROP).**

Description: Access to TAF denied because it is idling down.

Issued by BAAML.

User Action: Operator: Type GO.jsn. or drop job with DROP.jsn. Others: Informative message only.

### **TAF INTERNAL ERROR.**

Description: TAF has found internal data to be inconsistent.

Issued by TAF.

User Action: Perform a dump of TAF or inform site analyst.

### **TAF NOT PRESENT (GO OR DROP).**

Description: The TAF subsystem was not present when a batch job tried to connect to it.

Issued by BAAML.

User Action: Operator: Bring up TAF and type GO.jsn. or drop job with DROP.jsn. Others: Informative message only.

### **TAF RECOVERY REQUEST ERROR.**

Description: TAF cannot recover a batch user because of an internal TSTAT error.

Issued by BAAML.

User Action: Inform database  
administrator.

### **TAF SUBSYSTEM BUSY.**

Description: TAF was busy and couldn't accept the batch request.

Issued by BAAML.

User Action: None. Job will automatically retry request.

### **TAF SUBSYSTEM NOT DEFINED AS A SCP.**

Description: TAF was not defined as a system control point when it was brought up.

Issued by BAAML.

User Action: Inform database administrator.

### **TAF TAPE REQUEST DB=db DUMP.**

Description: A tape request is being made for a TAF submitted job that dumps the database db after image recovery files.

Issued by DMREC.

User Action: Enter CFO.jsn.GO. where jsn is the job sequence name of the job making the tape request.

### **TAF TRANSACTION NOT RERUNNABLE.**

Description: There was an attempt to rerun a transaction and an error occurred.

Issued by RTASK.

User Action: Inform the database administrator. The administrator may check the TAF dayfile for the possible cause of the error.

### **TAF TWO OUTSTANDING REQUESTS.**

Description: TAF received another request from a user program before the previous request was satisfied. This is an internal error.

Issued by BAAML.

User Action: Inform database administrator.

### **TAF USER NAME ACTIVE.**

Description: Another batch or terminal job is currently accessing TAF/CRM under this user name.

Issued by BAAML.

User Action: Resubmit job at a later time.

### **TAF USER NOT VALID FOR \*TAF\* ACCESS.**

Description: The batch job tried to access TAF (via a BTRAN) and the user name under which the job was run was not validated in the network file of TAF.

Issued by BAAML.

User Action: Inform TAF database administrator to enter the user name in the network file of TAF.

### **TAPE CLEANER FAULT.**

Description: The tape is assigned to a job and the tape cleaner failed to return to its original position after a tape load operation or a high speed rewind operation. MAGNET automatically unloads the tape.

Issued by MAGNET.

User Action: Ensure the tape cleaner moves smoothly. Reload the tape and ready the drive. Enter the DSD command `RETRY,est` where `est` is the EST ordinal of the tape drive. If the fault did not clear, request a customer engineer to repair the problem. After repairing the drive, reload the tape and ready the drive. Enter the DSD command `RETRY,est`. If repair is not feasible at this time, enter the DSD command `TERMINATE,est`. Stop using the tape drive and inform the customer engineer of the problem.

### **TAPE CLEANER FAULT, filename AT address.**

Description: Recovery from tape CLEANER FAULT error failed and `TERMINATE,est` was entered; or the tape is not assigned to a job and the tape cleaner did not return to the parked or stowed position after tape loading or high speed rewinding. Magnet automatically unloads tape and turns off the drive.

Issued by 1MT.

User Action: Mount the tape on a different tape drive.

### **TAPE ERR STAT status.**

Description: Tape drive error of type status occurred during the attempted copy. Printed on the preceding line is the name of the current program or command buffer name.

Issued by CTI.

User Action: Press space bar to continue the copy. There may be errors in the copy and another copy may have to be made.

### **TAPE ERROR - GO,JSN/DROP,JSN.**

Description: An error was encountered while QDUMP was writing to the dump tape.

Issued by QDUMP.

User Action: To continue job, enter `GO,jsn`. To terminate dump, enter `DROP,jsn`. Mount another tape and retry QDUMP.

### **nn TAPE FILES RECOVERED.**

Description: Informative message indicating the number of tape assignments (nn) recovered by a level 3 recovery deadstart.

Issued by MAGNET.

User Action: None.

### **TAPE FUNC REJ function.**

Description: Tape drive rejected the attempted function. Printed on the preceding line is the name of the current program or command buffer.

Issued by CTI.

User Action: Press the space bar to retry the function.

### **TAPE MUST BE REQUESTED AS LABELED.**

Description: An EDD dump tape was requested as an unlabeled tape.

Issued by DSDI.

User Action: Return the tape and request it again as a labeled tape. Enter LB=KL in the LABEL command.

### **TAPE NOT READABLE.**

Description: On a record load of a file, the dump tape was found incomplete - no trailer record.

Issued by DMREC.

User Action: Load from previous dump.

### **TAPE NUMBER FILE EMPTY.**

Description: Error in RECLAIM scratch file.

Issued by RECLAIM.

User Action: Inform site analyst.

### **TAPE READ/WRITE ERROR (BLANK).**

Description: Flashing B display message. The blank label operation was unable to complete successfully.

Issued by BLANK.

User Action: Enter GO,jsn to retry or DROP,jsn to terminate.

### **TAPE STATUS ERROR STATUS = xxxx**

Description: The tape controller indicates an error condition. The status word xxxx indicates the type of error.

Issued by CTI.

User Action: Press CR to retry. If the condition persists, contact site analyst or customer engineer.

### **TAPES ASSIGNED AT MAGNET TERMINATION.**

Description: The magnetic tape subsystem was dropped or aborted while tapes were assigned. These tape assignments are lost and associated user jobs will abort if subsequent I/O is attempted.

Issued by MAGNET.

User Action: Rerun jobs which abort following attempted I/O. (Only jobs with lost tapes will be affected.)

### **TASK LIBRARY DIRECTORY EMPTY.**

Description: The file specified as the task library contains no recognizable directory or is empty.

Issued by LIBTASK.

User Action: Ensure that the correct file has been specified; if so, the library must be recreated. Inform site analyst.



### **TASK LIBRARY DIRECTORY ERROR.**

Description: The first word of the last record on the library file does not contain the directory header.

Issued by LIBTASK.

User Action: Inform site analyst. Task library must be corrected.

### **TASK LIBRARY DIRECTORY TOO LONG.**

Description: The length of the indicated task library directory exceeds the limit specified by COMKTLD symbol TLDMT.

Issued by LIBTASK.

User Action: TAF and LIBTASK must be reassembled with installation parameter TLDMT increased.

### **TASK NOT VALIDATED FOR REQUEST**

Description: One of the following actions has occurred:

- The terminal operator initiated a TAF transaction which tried to perform an action associated with a database for which the terminal was not validated.
- A NEWTRAN request was issued by a task not in the system task library (TASKLIB).

Issued by MSABT.

User Action: Perform the appropriate action.

- Inform the database administrator. Set up the terminal name in the network file to use the data base. The system database (SY) may be used.
- Put the task on TASKLIB.

### **TASK PERCENTAGE UNEQUAL TO 100.**

Description: K-display message indicating that the total task percentages for all tasks defined do not add up to 100.

Issued by STIMULA.

User Action: Correct task definitions in the session file.

### **taskname - TASK RECOVERY FAILED.**

Description: The specified task recovery attempt has failed.

Issued by AAMI.

User Action: Inform database administrator.

### **nnn TASK(S) NOT LOADED INTO EXTENDED MEMORY.**

Description: An insufficient amount of extended memory was available to load all tasks. The nnn field is the number of tasks not loaded.

Issued by TAF.

User Action: Check extended memory requested and reinitialize with more extended memory if appropriate.

### **TCB CHAINS EXCEED MAXIMUM NUMBER OF TCBS PER LCB.**

Description: The end of the TCB chains cannot be found.

Issued by NDA.

User Action: None.

### **TCF FILE EMPTY.**

Description: An empty TCF exists under the TAF user name.

Issued by TAFREC.

User Action: Place the necessary information on TCF.

### **TERM: termnam,un,ltime,aname,acn/ctime,dt.**

Description: Current status of the terminal.

termnam	Terminal name.
un	User number.
ltime	Login time.
aname	Name of application to which it is connected.
acn	Terminal connection number.
ctime	Time it was connected to the application.
dt	Device type.

Issued by NVF.

User Action: None.

### **TERM: term, UNACTIONED COMMAND.**

Description: An enable or disable terminal term command was not actioned. Terminal may already be in desired state or not configured.

Issued by CS.

User Action: None.

### **TERM: trmname,st,dt/tc,hnid,linenam/a1/a2.**

Description: Status of a terminal. It includes the terminal name (trmname), status (st), device type and terminal class (dt/tc), host node id that the terminal is currently connected to (hnid), the name of the line that supports the terminal (linenam), and address one and two of the terminal (a1/a2).

Issued by CS.

User Action: None.

### **TERMINAL INPUT NOT VALID. USE \*I\* OR \*Z\* OPTION.**

Description: SYSEEDIT was called from an interactive terminal and attempted to read input directives from the terminal.

Issued by SYSEEDIT.

User Action: Retry, specifying either the I or Z parameter on the SYSEEDIT command.

### **TERMINAL INTERRUPT.**

Description: RECLAIM processing was terminated due to a terminal user break.

Issued by RECLAIM.

User Action: None.

### **TERMINAL NAME TABLE OVERFLOW.**

Description: Space sufficient to allocate the required table during IAF initialization was not available. An internal change to IAF is necessary.

Issued by IAFEX.

User Action: Contact CYBER Software Support.

### **TERMINAL NODE OF LLINK llname, NOT SUPERVISED.**

Description: A command has been entered that would result in a command SM (supervisory message) being sent to an unsupervised NPU.

llname Logical link name

Issued by CS.

User Action: Target NPU must be supervised. Contact site analyst.

### **TERMINAL NOT VALIDATED FOR PSU**

Description: This message indicates that the user name under which the printer is logged in as specified in the NDL did not match with the one in the EVFU file.

Issued by PSU.

User Action: Notify site analyst. Correct the NDL source and recompile and/or change the EVFU file.

### **TERMINAL TABLE OVERFLOW.**

Description: Space sufficient to allocate the required table during IAF initialization was not available. An internal change to IAF is necessary.

Issued by IAFEX.

User Action: Contact CYBER Software Support.

### **TERMINALS CANNOT CONNECT ON HOST-HOST LOGICAL LINK.**

Description: A status command of terminals on a host-host logical link is not allowed.

Issued by CS.

User Action: Correct command.

### **xxxxxx TERMINATED.**

Description: Dayfile xxxxxx has been terminated (issued to system and control point dayfiles).

Issued by SFM.

User Action: None.

### **TERMINATION IN PROGRESS.**

Description: The interactive subsystem has begun dump/disconnect/recovery procedures due to an abort or termination condition.

Issued by IAFEX.

User Action: None.

### **TEST MODE, NETWORK NOT USED.**

Description: Informative message indicating that MCS was started in global test mode.

Issued by MCS.

User Action: None.

### **TFHL TABLE DEACTIVATED.**

Description: The TFHL table was deactivated due to memory constraints. The fill move technique is not used when the TFHL table is inactive. The processing time of PACKER may increase when the TFHL table is inactive.

Issued by PACKER.

User Action: Make sure that the job has unlimited CM validation and retry PACKER command.

### **THIS TERM IS NOT CONNECTED.**

Description: Host operator entered a command to get the status of a specific terminal, but the terminal is not connected.

Issued by NVF.

User Action: Select another terminal and reenter command.

### **TIME LIMIT.**

Description: The job has reached its CPU time limit.

Issued by RECLAIM.

User Action: Increase your job's time limit.

### **TIME LIMIT UP.**

Description: Dayfile message indicating that the total time limit on the CYCLE. command has passed.

Issued by SCRSIM.

User Action: Input can again be accepted by the simulator.

### **TIP NOT CONFIGURED.**

Description: The terminal interface program (TIP) was not present to support line lineno.

Issued by CS.

User Action: None.

### **TN OR DN MUST BE SPECIFIED.**

Description: A RECLAIM operation was attempted which required a dump file name or tape number, but neither was specified.

Issued by RECLAIM.

User Action: Retry after specifying the file name or tape number.

### **TOO MANY BITS SPECIFIED.**

Description: Dayfile message indicating that more bits were specified than can be held in the area, line, or byte given.

Issued by SCRSIM.

User Action: Correct and reenter.

### **\*\*\*\* TOO MANY CHARACTERS IN VALUE.**

Description: Output file message indicating that the value for a directive consists of too many characters.

Issued by PROFILE.

User Action: Rerun using legal value.

### **TOO MANY DATA BASE NAMES.**

Description: The number of database names associated with one data manager via DMS statements exceeds the value of MAXDB.

Issued by TAF.

User Action: Decrease the number of database names associated with the data manager.

### **TOO MANY -DD- UNITS DEFINED.**

Description: More than eight drives have been defined.

Issued by SET.

User Action: Reduce the number of drives.

### **TOO MANY -DD- UNITS DEFINED**

Description: More than eight 834 drive units have been defined.

Issued by SET.

User Action: Eliminate the EQPDECK entries for all but eight drive units.

### **TOO MANY DEVICE SELECTION (RL) ENTRIES.**

Description: The size of an internal table was exceeded while processing an RL directive. You have selected too many devices or device types on RL directives. The released maximum is 80.

Issued by GENPFDD.

User Action: Reduce the number of RL directives. If this is not possible, the size of table TSDV in GENPFDD must be increased to accommodate the requirement, and GENPFDD must then be reassembled.

### **TOO MANY FILE NAME AND/OR VSN ENTRIES.**

Description: The size of an internal table was exceeded during processing of an SF or SV directive. This is caused by an excessive number of file name or VSN entries.

Issued by GENPFDD.

User Action: Reduce the number of file names and/or VSNs specified by SF and/or SV directives. If this is not possible, the size of table TSFV in GENPFDD must be increased to accommodate the number required and GENPFDD must then be reassembled.

### **TOO MANY FILE NAMES OR VSN-S SPECIFIED.**

Description: The VSN or file name limit was exceeded on a directive.

Issued by DMREC.

User Action: Check the installation parameters TVSNL and TDFNL for maximums.

### **TOO MANY FILE/VSN SELECTION (SF SV XF) ENTRIES.**

Description: The size of an internal table was exceeded while processing an SF, SV, or XF directive. This is caused by a combination of too many directives and/or too many file names and VSNs. The released maximum is 1000.

Issued by GENPFDD.

User Action: Reduce the number of entries specified by SF, SV, and XF directives. Each of these directives counts as an entry, whether or not it contains a file name or VSN. Each file name or VSN beyond the first on each of these directives counts as an additional entry. If it is not possible to reduce the number of entries sufficiently, the size of table TSFV in GENPFDD must be increased to accommodate the number required, and GENPFDD must then be reassembled.

### **TOO MANY FILENAMES IN LIST.**

Description: The number of filenames listed after a PF=\* parameter exceeded 999. The directive was ignored.

Issued by RECLAIM.

User Action: Reduce the number of files specified and retry.

### **TOO MANY FILES IN TOTAL DATA BASE.**

Description: Self-explanatory.

Issued by TAF.

User Action: Reduce the number of entries in the TCF file or increase TMAXFIL.

### **TOO MANY LOCAL FILES.**

Description: A RECLAIM attempt to create a local file exceeded your site-determined limit on the allowable number of local files. (RECLAIM uses six local files as internal scratch files.)

Issued by RECLAIM.

User Action: Reduce the number of files to your job or reduce the number of files to be processed by RECLAIM.

### **TOO MANY MUX PORTS.**

Description: More than 512 ports have been defined in the multiplexer entries of the equipment status table (EST).

Issued by 1TN.

User Action: IAF issues this message. Check with the project for the exact routine.

### **TOO MANY OPTIONS ARE SPECIFIED.**

Description: Only one option can be specified.

Issued by NLTERM.

User Action: Correct the options parameter so that only one option is specified and rerun the job.

### **TOO MANY OVERFLOW CATALOG TRACKS.**

Description: The field width allotted for the catalog track index in the TFRI table entries has been exceeded. PACKER is unable to process the device.

Issued by PACKER.

User Action: Perform a full PFDUMP, deadstart INITIALIZE, and full PFLOAD of the device in question. Specify more catalog tracks on the PF entry when initializing the device.

### **TOO MANY PRIORITY GROUP (PG) ENTRIES.**

Description: There were more parameters on the PG directive than there are defined preferred residence types.

Issued by GENPFD.

User Action: Correct the PG directive and retry.

### **TOO MANY TAF JOURNAL FILES IN xxJ FILE.**

Description: More than three TAF journal files per data base were specified, causing the transaction subsystem to abort.

Issued by TAF.

User Action: Examine xxJ file for xxJOR entries. Inform the TAF data base administrator.

### **TOO MANY TERMINALS.**

Description: The total number of terminals defined in the EST and/or the network description files exceeds the maximum defined by the assembly variable MAXTT. Issued by IAFEX.

User Action: Reduce the number of devices in the EST which are on.

### **TOO MANY TERMINATED LOG FILES EXIST, PROVIDE NAME**

Description: Log file termination was attempted using a name generated by the NLTERM. NLTERM can only generate 36 names for each day. This number has been reached for this day.

Issued by NLTERM.

User Action: Assign a name or purge all the log files that have been assigned for this day.

### **TOTAL DATA MANAGER SUCCESSFULLY LOADED.**

Description: Self-explanatory.

Issued by TAF.

User Action: None.

**TOTAL DID NOT RECOVER PROPERLY  
STATUS IS yyyy.**

Description: An error status yyyy was returned on a TOTAL FINAL call. Refer to Diagnostics in the TOTAL Reference Manual for yyyy.

Issued by TAF.

User Action: Correct error and reinitialize transaction executive.

**TOTAL VALIDATION ERRORS = n.**

Description: Informative message indicating that SSVAl found n validation errors.

Issued by SSVAl.

User Action: None. However, n can be used as the FX parameter on subsequent SSVAl runs if catalog repair processing is desired.

**TRACK ALREADY ASSIGNED.**

Description: The track byte for the IQFT file in the DULL word in the MST is already assigned.

Issued by QFM.

User Action: Inform CYBER Software Support.

**TRACK LIMIT.**

Description: No allocatable tracks remain on your permanent file equipment (error log and dayfile message).

Issued by PFM.

User Action: None; job will continue as tracks become available. If problem persists, contact CYBER Software Support.

**TRACK LIMIT.**

Description: All mass storage devices available for temporary files are full. The system cannot finish processing until space is available on one of the devices.

Issued by IMS.

User Action: Retry when space becomes available.

**TRACK LIMIT.**

Description: BIO cannot assign mass storage space to an input file. BIO will continue to attempt to assign space until the space is actually assigned or BIO is dropped.

Issued by QAP.

User Action: None.

**TRACK LIMIT.**

Description: QFM is unable to process because it cannot get a track.

Issued by QFM.

User Action: Try to free up some tracks on the device.

**TRACK LIMIT - FILE IGNORED.**

Description: When returning a queued file to the source device a track limit was encountered.

Issued by QDUMP.

User Action: Inform CYBER Software Support.

### **TRACK LIMIT ON SDF DEVICE.**

Description: The device selected to be a deadstart device does not have enough space to accommodate the deadstart file.

Issued by IIS.

User Action: Use another device.

### **TRACKS FREED nnnnnn, ssssss PRUS.**

Description: PACKER statistics reflecting the condition of the portion of the IAPF chain which PACKER has processed.

nnnnnn Number of tracks delinked or dropped.

ssssss Sectors returned to the system via track delinks or drops.

Issued by PACKER.

User Action: None.

### **TRANSLATING SESSION FILE.**

Description: STIMULA is converting the scripts into an internal format.

Issued by STIMULA.

User Action: None.

### **TRANSLATING STIMULATOR OUTPUT.**

Description: DEMUX is translating the stimulator output and copying it to a scratch file.

Issued by DEMUX.

User Action: None.

### **TRT ADDRESS ERROR.**

Description: The system is unable to complete a level 3 recovery deadstart because of a TRT address error.

Issued by SET.

User Action: Perform a level 0 deadstart.

### **TRT LENGTH ERROR.**

Description: Operator message indicating that an error was encountered while reading the track reservation table (TRT) during a level 0 deadstart. Preceded by message RECOVERY, EQest, which indicates the equipment in error.

est EST ordinal

Issued by MSM.

User Action: Rdeadstart and initialize device. Preserved files on device are lost and must be reloaded.

### **TRUNK: trunk, CE DIAG TEST IN PROGRESS.**

Description: An enable trunk command on the trunk was attempted while the diagnostic test was in progress.

Issued by CS.

User Action: Pause. Reenter command after the test is completed.

### **TRUNK: trunk, DUPLICATE CLA ADDRESS.**

Description: The trunk is dialed to an address already in use on the NPU.

Issued by CS.

User Action: Change the CLA address to a unique value or turn off the CLA.



**TRUNK: trunk, IN DESIRED STATE ALREADY.**

Description: An enable or disable command on trunk was attempted when trunk was already in state.

Issued by CS.

User Action: None.

**TRUNK: trunk, LAST PATH TO CS.**

Description: A disable trunk command was attempted on trunk and this trunk represents the only supervisory path for NPU to CS.

Issued by CS.

User Action: None.

**TRUNK: trunk LIP NOT CONFIGURED.**

Description: A trunk has been defined to an NPU and the link interface program is not resident in the NPU to support the trunk.

Issued by CS.

User Action: Rebuild the variant for for the NPU with the LIP module included.

**TRUNK: trkname,st,lt,npunam1/p1,npunam2/p2.**

Description: Status of a trunk. It includes the trunk name (trkname), status (st), line type (lt), name of NPU one and the number of the port that supports the trunk (npunam1/p1), and the name of NPU two and the number of the port that supports the trunk (npunam2/p2).

Issued by CS.

User Action: None.

**TTtest, FNf, FUNCTION TIMEOUT.**

Description: The driver routine issued a function to the multiplexer and did not receive an inactive signal within four major cycles. This error causes the subsystem to abort.

est EST ordinal of multiplexer  
f Function

Issued by 1TN.

User Action: Contact CYBER Software Support.

**TT OPTION REQUIRES USER NAME.**

Description: When updating a task library online (TT option is specified on LIBTASK command), the user name must be specified prior to the LIBTASK command so the library associated with that user name can be found.

Issued by LIBTASK.

User Action: Specify user name via USER or CHARGE command before LIBTASK command and rerun job.

**TVF ATTEMPTING NETON.**

Description: Informative message indicating that TVF has been called and is attempting to enter the network.

Issued by TVF.

User Action: None.

**TVF ERMSMG, ABT=nn, ADR=address, TEXT=aaaa,  
TERMINAL=termname.**

Description: TVF has received a message with out-of-range values or erroneous values.

nn	Application block type from message header
address	Addressing information from message header
aaaa	First 4 characters of text
termname	Terminal name associated with the message

Issued by TVF.

User Action: None.

### **TVF NETOFF, NAM NOT PRESENT.**

Description: A NETON was attempted when NAM was not present.

Issued by TVF.

User Action: Bring NAM up. Routine TVF automatically attempts a NETON.

### **TVF NETON SUCCESSFUL.**

Description: Informative message indicating that TVF has successfully entered the network.

Issued by TVF.

User Action: None.

### **TVF RC=ec, ABT=nn, ADR=addr, TEXT=aaaa, TERMINAL=termnam.**

Description: TVF has received ERR/LGL/SM (TVF probably issued an erroneous message).

ec	Error code from ERR/LGL/SM
nn	Application block type from message header
addr	Addressing information from header of message that caused ERR/LGL/SM
aaaa	First 4 characters of text of message that caused ERR/LGL/SM
termnam	Terminal name associated with address

Issued by TVF.

User Action: None.

### **TWO CONTROLLER TYPES ON SAME CHANNEL.**

Description: EST entries indicate a conflict in tape channels and controller types. Only one tape controller type is allowed per channel.

Issued by 1MT.

User Action: Inform site analyst.

### **TY NOT ALLOWED.**

Description: Value specified for TY parameter was not valid (legal values are F or X).

Issued by MSI.

User Action: Correct and enter GO.

### **TYPEAHEAD OVERFLOW, REENTER INPUT.**

Description: IAF has reached maximum number of typeahead commands.

Issued by IAFEX.

User Action: Reenter input.

### **<eq><ord>,U<uu>,PARITY PROTECTION DISABLED.**

Description: Unit uu in the parity protected device of type eq defined by EST ordinal ord has been set off-line, and there is no longer parity protection for the device.

Issued by 1DA.

User Action: Consult site customer engineer.

**<eq><ord>,U<uu>,PARITY PROTECTION RESTORED.**

Description: Unit uu in the parity protected device of type eq defined by EST ordinal ord is no longer off-line, and parity protection for the device is restored.

Issued by 1DA.

User Action: None.

**<eq><ord>,U<uu>,PS=<pppppp>.**

Description: Identifies the pack serial number of unit.

Issued by 1DA.

User Action: None.

**UA NOT WITHIN LIMIT.**

Description: The device upper access level limit specified during online initialization is not within the device's access limits from the EST.

Issued by MSI.

User Action: Select an upper access level limit within the device's EST access limits.

**UCCR, mi, est, xxxxxx.xxxKCDS.**

Description: Denotes the number of cards (in kilocards) read into the system for a job on the equipment with machine identifier mi (MID entry in CMRDECK) and EST ordinal est.

Issued by 1AJ.

User Action: None.

**UCLP, mi, est, xxxxxx.xxxKLNS.**

Description: Denotes the number of lines (in kilolines) printed for a job on equipment with machine identifier mi (MID entry in CMRDECK) and EST ordinal est.

Issued by QAP.

User Action: None.

**UCLV, mi, est, xxxxxx.xxxKLNS.**

Description: Denotes the number of lines (in kilolines) printed for a job in which the V carriage control character was used on the equipment with machine identifier mi (MID entry in CMRDECK) and EST ordinal est.

Issued by QAP.

User Action: None.

**UCP CALL ERROR.**

Description: There is an SSVAL or SSEXEC internal error. Detail status is the UCP response code.

Issued by SSVAL.

User Action: Inform site analyst.

**UCP TERMINATION PROCESSING.**

Description: This message appears only in the message field of the Job Status (B) display. It indicates the system is executing termination processing for the user job at the control point. System control point jobs connected to the user job are informed and must disconnect before termination processing can complete.

Issued by OST.

User Action: None.

**UCPC, mi, est, xxxxxx.xxxKCDS.**

Description: Denotes the number of cards (in kilocards) punched for a job on equipment with machine identifier mi (MID entry in CMRDECK) and EST ordinal est.

Issued by QAP.

User Action: None.

**UN MUST BE SPECIFIED.**

Description: Auxiliary device is defined as private. Thus, user name must be specified or the device must be redefined as public.

Issued by MSI.

User Action: Specify user name or enter UN=NULL to indicate that private device is being made public.

**UN=username NOT VALID ON FM=family.**

Description: Username on the specified family is not valid. The user name or family name may not be defined or are incorrect in the xxJ file.

Issued by TAF.

User Action: Inform site analyst.

**UNABLE TO ACCESS DISK (CR) TO PROCESS DIFFERENT DEVICE.**

Description: Self-explanatory.

Issued by CTI.

User Action: Enter a carriage return to select a different device or press deadstart button to exit. Inform site analyst if the message persists.

**UNABLE TO ATTACH COMMUNICATION FILE.**

Description: SSMOVE cannot attach MVOCOM after destaging has completed.

Issued by SSMOVE.

User Action: Possible SSEXEC problem. Dump SSEXEC.

**UNABLE TO ATTACH MRF, FM=familyname.**

Description: File MOVCOM could not be attached.

Issued by SSEXEC.

User Action: Purge MOVCOM and rerun SSMOVE to create a new file.

**UNABLE TO ATTACH MRF, MF=familyname.**

Description: File MVOCOM could not be attached.

Issued by SSEXEC.

User Action: Purge MVOCOM and rerun SSMOVE to create a new file.

**UNABLE TO ATTACH SAMPLE FILE.**

Description: An error was encountered while attempting to access the sample file, possibly because an inaccessible device was encountered or because the file is busy.

Issued by ICPD.

User Action: Check for other jobs having the file attached and check the status of the family devices.

**UNABLE TO ATTACH TOTAL BINARIES.**

Description: File of TOTAL binaries is not under the user index of the transaction subsystem or a PFM error occurred.

Issued by TAF.

User Action: Correct error and reinitialize transaction executive, or inform site analyst.

**UNABLE TO ATTACH TOTAL DBMOD BINARIES.**

Description: One or more of the DBMOD files listed on the TOTAL DMS statement in the TCF file could not be attached under the user name of the transaction subsystem or a PFM error occurred.

Issued by TAF.

User Action: Correct error and reinitialize transaction executive, or inform site analyst.

**UNABLE TO CONNECT WITH EXEC.**

Description: SSEXEC is not running at this time.

Issued by SSMOVE.

User Action: Rerun the utility when SSEXEC is running.

**UNABLE TO DEFINE COMMUNICATION FILE.**

Description: File MVOCOM does not exist and cannot be defined by SSMOVE.

Issued by SSMOVE.

User Action: Submit a PSR with supporting material.

**UNABLE TO EXECUTE COMMON DISK AREA REQUEST.  
CDA HAS NOT BEEN INITIALIZED.  
DEADSTART REQUIRED.**

Description: With the release of CIP V006, an initial install is required before any CDA utility can be executed.

Issued by CTI.

User Action: Subsequent CIP releases do not require this initial build.

**UNABLE TO EXECUTE COMMON DISK AREA REQUEST.  
CDA HAS NOT BEEN INITIALIZED.  
(CR) FOR OPTION DISPLAY**

Description: With the release of CIP V006, an initial install is required before any CDA utility can be executed.

Issued by CTI.

User Action: Subsequent CIP release do not require this initial build.

**UNABLE TO INSTALL CIP READ ONLY SWITCH ACTIVE**

Description: In an attempt to install CTI to a model 885 (FMD) disk drive, CTI found the drive in read-only mode.

Issued by CTI.

User Action: Toggle the read-only button on the disk drive and try again.

**UNABLE TO LOAD MDD.  
THE INTEGRITY OF CENTRAL MEMORY HAS BEEN COMPROMISED.**

Description: MDD checksum failed.

Issued by CTI.

User Action: None.

**UNABLE TO OPEN CATALOG.**

Description: The SFM catalog does not exist or is busy.

Issued by SSUSE.

User Action: Correct the command or wait until the SFM catalog is not busy.

**UNABLE TO OPEN SMMAP.**

Description: The SM map does not exist or is busy.

Issued by SSUSE.

User Action: Correct the command or wait until the SM map is not busy.

**UNABLE TO PERFORM -UPDATE- INSTALL.  
COMMON DISK AREA NOT INITIALIZED.  
DEADSTART AND SELECT AN -INITIAL-  
CIP INSTALLATION.**

Description: With the release of CIP V006, an initial install is required before any other build can be executed.

Issued by CTI.

User Action: Subsequent CIP releases do not require this initial build.

**UNABLE TO READ COMMUNICATION FILE.**

Description: SSMOVE is unable to read file MVOCOM after destaging has completed.

Issued by SSMOVE.

User Action: Possible SSEXEC error. Dump SSEXEC.

**UNABLE TO READ MRF, FM=familyname.**

Description: A read error was encountered on the move request file, MVOCOM.

Issued by SSEXEC.

User Action: Purge MVOCOM and rerun SSMOVE to create a new file

**UNABLE TO REATTACH SFM CATALOG.**

Description: An error was encountered during an attempt to reattach an SFM catalog. The SFM catalog is closed.

Issued by SSEXEC.

User Action: Inform site analyst.

**UNABLE TO REATTACH SM MAP.**

Description: An error was encountered during an attempt to reattach an SM map. The SM map is closed.

Issued by SSEXEC.

User Action: Inform site analyst.

**UNACTIONED COMMAND.**

Description: An enable or disable command was not actioned by CCP. This message is followed by an explanatory element status line.

Issued by CS.

User Action: None.

**UNAVAILABLE.**

Description: The selected value exceeds available physical memory.

Issued by CTI.

User Action: Clear message with left blank key and try another entry.

**UNCORRECTABLE MSM ERROR.**

Description: An irrecoverable rotating mass storage error was detected during an I/O operation.

Issued by QFM.

User Action: Inform customer engineer.

### **UNCORRECTABLE RMS ERROR.**

Description: An error was detected when reading the EOI.

Issued by DFTERM.

User Action: Retry operation.

### **(xxx) UNCORRECTED IOU ERROR**

Description: A PP has encountered an uncorrected error. (PP halt).

xxx 004 or 009

Issued by 1MB.

User Action: Inform customer engineer and site analyst.

### **UNCORRECTED PROCESSOR ERROR THRESHOLD EXCEEDED.**

Description: Processor error threshold has been exceeded.

Issued by 1MD.

User Action: Inform customer engineer.

### **UNDEFINED ORIGIN TYPE.**

Description: The two character origin type entered on the CHVAL command is not defined.

Issued by MODVAL.

User Action: Correct and retry.

### **UNDEFINED SERVICE CLASS.**

Description: The two character service class entered on the CHVAL command is not defined.

Issued by MODVAL.

User Action: Correct and retry.

### **UNEXPECTED DATA UNIT RECEIVED.**

Description: An unrecognizable or out-of-sequence initialization data unit was received by INITMDI.

Issued by INITMDI.

User Action: Inform site analyst.

### **UNEXPECTED INTRAHOST MSG DISCARDED.**

Description: Informative message indicating that NIP has received a message from an application program on an intrahost application-to-application connection that has been broken. NIP discards such blocks. The dayfile message is followed by an octal/hex dump of the discarded intrahost message.

Issued by NIP.

User Action: The error is not serious enough to bring down the network. If the error occurs consistently, bring down the network.

### **UNEXPECTED SM, Y, Z, FAMILY OR SUBFAM.**

Description: The acquired cartridge's label is not what was expected.

Issued by SSLABEL.

User Action: Inform site analyst.

### **UNEXPECTED STATE ENCOUNTERED.**

Description: The mainframe channel interface (MCI) general status returned from the MDI contained an unrecognized or out-of- sequence state code. This indicates an MDI device error. Issued by INITMDI.

User Action: Inform site analyst.

### **UNIDENTIFIED DATA UNIT ID.**

Description: INITMDI internal error. INITMDI incorrectly formatted a data unit to be sent to the MDI.

Issued by INITMDI.

User Action: Inform site analyst.

### **UNIT xx CHyy LABEL READ ERROR.**

Description: A mass storage read error was encountered while attempting to verify the pack label.

Issued by 1RM.

User Action: Enter RECHECK on all machines to continue the replacement of the physical packs or ABORT to end the reconfiguration.

### **UNIT xx CHyy LABEL VERIFICATION ERROR.**

Description: The label being verified did not match the expected values.

Issued by 1RM.

User Action: In single mainframe mode or if all machines in multimainframe mode received the message, deactivate the replacement unit and ensure that the correct pack has been mounted. If the correct pack was mounted or if not all machines in multimainframe mode received the message, enter RECHECK on all machines to continue the replacement of physical packs or ABORT to end the reconfiguration.

### **UNIT xx,CHyy WRITE/READ VERIFY ERROR.**

Description: A read/write test performed before returning the equipment for system use has failed.

Issued by 1RM.

User Action: Enter ABORT to discontinue processing, RECHECK to retry; or IGNORE to ignore processing on this device.

### **UNIT NOT AVAILABLE.**

Description: The magnetic tape unit specified in an UNLOAD command is not available.

Issued by DSD.

User Action: Change magnetic tape unit and retry the command.

### **UNIT NOT FOUND.**

Description: You specified an incorrect tape unit on a tape request.

Issued by DSD.

User Action: Correct tape unit number.

### **UNIT NOT READY.**

Description: The tape unit is not ready.

Issued by DSD.

User Action: Press the ready button on the tape drive.



**UNIT est SERVO TIMING = nnn. ACCEPTABLE RANGE IS 325 TO 345.**

Description: Unit xx had servo timing check of nnn. If the timing check was within the specified range, 1RM proceeds with the reconfiguration process. If the timing check was not in the specified range, 1RM rechecks the timing every 15 seconds until the timing check is in the correct range or the run is aborted.

Issued by 1RM.

User Action: If the timing is not in the acceptable range, the CE must perform an adjustment on the unit.

**UNIT xx SERVO TIMING IN PROGRESS.**

Description: Informative message stating that a servo timing is being taken on unit xx.

Issued by 1RM.

User Action: None.

**UNKNOWN ACCESS LEVEL NAME.**

Description: The job specified an undefined access level name.

Issued by MLSEXEC.

User Action: Reenter the command with the correct access level name.

**\*\*\*\*UNKNOWN ACCESS LEVEL NAME.**

Description: K display indicating the access level name selected is not a defined name.

Issued by QFSP.

User Action: Correct and retry.

**UNKNOWN APPLICATION ATTEMPTING TERMINATION.**

Description: For debug only. The application name in the supervisory message is unknown to NVF.

Issued by NVF.

User Action: Contact CYBER Software Support.

**UNKNOWN DUMP FILE WILL BE OVERWRITTEN.**

Description: When preparing to do an incremental (EI-type) dump, RECLAIM determined that the specified dump file does not contain valid dump information. The file is either empty or contains information other than RECLAIM dump information. If the user is executing interactively, RECLAIM will also issue the prompt " IS THIS OK (YES OR NO)?", and will wait for a response.

Issued by RECLAIM.

User Action: If interactive, respond by entering Y to overwrite the file or N to abort the operation.

**UNKNOWN FILE FORMAT.**

Description: There is a logical error in the structure of the input file. It does not conform to the established format rules.

Issued by KTSNDMP.

User Action: None.

**UNKNOWN PARAMETER - kw.**

Description: An unknown keyword parameter kw was entered.

Issued by SDSPLAY.

User Action: Correct parameter and reenter command.

**UNKNOWN SEPARATOR - kw.**

Description: The separator for the keyword kw was not an "=".

Issued by SDSPLAY.

User Action: Correct command syntax and reenter command.

#### **UNKNOWN SERVICE CLASS.**

Description: The specific service class on a CLASS command was incorrect.

Issued by SDSPLAY.

User Action: Check service class on command and retry.

#### **UNKNOWN SUBSYSTEM.**

Description: The subsystem name entered on the ENABLE or DISABLE command is not one of the defined subsystem names.

Issued by SUBSYST.

User Action: Reenter the command with a valid subsystem name.

#### **UNKNOWN SUBSYSTEM.**

Description: Self-explanatory.

Issued by SUBSYST.

User Action: Reenter command with valid subsystem.

#### **UNMATCHED SYSTEM DEVICES.**

Description: Multiple system devices are defined which are unlike in equipment mnemonic/sector limit.

Issued by MSM.

User Action: Rereadstart with correct system device definition.

#### **UNREADABLE OPTICAL LABEL.**

Description: An ACS tape cannot be mounted by the ACS robotic tape system because the optical bar code on the tape cartridge could not be verified.

Issued by: MAGNET.

User Action: Eject the tape cartridge from the ACS storage module (LSM). If possible, repair the optical label and reenter the cartridge in the LSM.

#### **UNRECOGNIZABLE DIRECTIVE.**

Description: Incorrect command was entered via L-display.

Issued by QDSPLAY.

User Action: Try a different command or ensure proper format of the previous command.

#### **UNRECOGNIZABLE DIRECTIVE.**

Description: Output file message indicating that the directive entered was not a valid DSDI input directive.

Issued by DSDI.

User Action: Correct and rerun.

#### **UNRECOGNIZABLE DIRECTIVE.**

Description: A command was entered via the L-display which was not one of the valid SDSPLAY commands.

Issued by SDSPLAY.

User Action: Check command and retry.

#### **UNRECOGNIZABLE HEADER TYPE.**

Description: When interpreting ARF after image header types, one has been found incorrect.

Issued by DMREC.

User Action: Inform database administrator.

### **UNRECOGNIZABLE LABEL.**

Description: The cartridge label to be repaired is of an unknown type.

Issued by SSLABEL.

User Action: Retry the FX directive to SSLABEL without specifying the FM parameter or use SSDEBUG to read the AUs from the cartridge in order to analyze the label.

### **UNRECOGNIZED COMMAND.**

Description: An incorrect command was entered.

Issued by NVF.

User Action: Attempt corrected command entry.

### **UNRECOGNIZED COMMAND.**

Description: Indicates the HOP command is not one of the valid commands supported by NS.

Issued by NS.

User Action: None.

### **UNRECOGNIZED COMMAND.**

Description: An incorrect command was entered.

Issued by NIP.

User Action: Check syntax of command that was entered.

### **UNRECOGNIZED CONTROL STATEMENT PARAMETER.**

Description: Command parameter is incorrect.

Issued by RBF.

User Action: Correct RBF2P0 command parameter.

### **UNRECOGNIZED FILE NAME.**

Description: An error was encountered while assembling the file name.

Issued by DMPCCC.

User Action: Correct the file name and retry.

### **UNRECOGNIZED SM - xxxx.**

Description: A supervisory message with PFC/SFC of xxxx (hexadecimal) was received and not recognized as a valid SM.

Issued by CS.

User Action: Contact site analyst.

### **UNRECOGNIZED SM. PFC/SFC = pfcsrc.**

Description: This message will appear only if a non-debug version of NVF is running. (If the error condition that causes this message happens in a debug system, NVF will abort.) NVF received a supervisory message that it does not recognize. The pfcsrc field contains the first sixteen bits of the unrecognized message or the PFC/SFC field. This could be a sign of a serious internal problem and may cause further unpredictable actions by the network.

Issued by NVF.

User Action: If the network starts behaving in an unusual or unpredictable manner, NAM should be stopped. Save the dumps and write a PSR. Since this type of problem is difficult to fix without trace turned on, build and install a debug version of the network with trace turned on.

### **UNRECOGNIZED UCP ABORTED BY IAF**

Description: User control point attempted to connect to IAF.

Issued by IAFEX.

User Action: None.

### **filename UNRECOVERABLE**

Description: The dayfile specified by filename is not recoverable.

Issued by REC.

User Action: Initialize the dayfile and redeadstart.

### **UNRECOVERABLE DISK ERROR - jsn**

Description: Dayfile message indicating an unrecoverable disk error occurred during output of print file jsn. File was aborted at point of error. The unrecoverable disk error can occur on 585 connections.

Issued by PSU.

User Action: None.

### **UNRECOVERABLE ERROR CONDITION OCCURRED**

Description: Dayfile message indicating that operation was terminated due to a nonrecoverable error.

Issued by FORMAT.

User Action: Refer to the general and detailed status described in the output listing for the specific error condition. If this condition occurs, it is extremely probable that the pack and/or disk drive is unusable in its present condition.

### **UNRECOVERABLE READ.**

Description: An unrecoverable read error has occurred on a cartridge and the DRD has been turned off.

Issued by SSEXEC.

User Action: The DRD should be turned back on when the read starts on the second DRD. If there is a hardware problem, inform site analyst.

### **UNRECOVERABLE READ ERROR.**

Description: The cartridge label cannot be read because of a faulty DRD or cartridge.

Issued by SSLABEL.

User Action: Retry after cleaning or repairing the DRD, relabel the cartridge, or discard the cartridge.

### **UNRECOVERABLE WRITE.**

Description: An unrecoverable write error has occurred on a cartridge.

Issued by SSEXEC.

User Action: None.

### **UNRECOVERABLE WRITE ERROR.**

Description: The cartridge label cannot be read because of a faulty DRD or cartridge.

Issued by SSLABEL.

User Action: Retry after cleaning or repairing the DRD, or discard the cartridge.

## **UNRECOVERED ERROR**

Description: An unrecovered I/O error has occurred on the tape unit with EST ordinal est.

Issued by 1MT.

User Action: The customer engineer should check the unit or tape and correct the error. The unit can be restored to service by entering a DOWN,EQ=est. followed by a ON,EQ=est. command. Note that if the tape is still assigned to the job, it is not addressable until it is returned by the job or the user logs out. The JSN on the E,P display will show "SYS" when the unit is released from the job.

## **UNRECOVERED PARITY ERROR - filename ENTER K.GO - CONTINUE ON NEW REEL. K.END - ABORT DUMP. K.DISABLE - CONTINUE ON ONE FILE.**

Description: An irrecoverable parity error was encountered on archive tape during PFDUMP operations. If GO is selected, the system will attempt to logically complete the current tape reel and request the next reel to continue on. If this is not possible, PFDUMP will abort just as if END was entered. The DISABLE option is displayed only if both the archive and verify files are active. If selected by the operator, the dump will continue on the remaining good file.

Issued by PFDUMP.

User Action: Described in message. The GO option is not recommended. It is possible that the current tape reel will be successfully completed but still be unusable by PFLOAD.

## **UNSUPPORTED ATTRIBUTE - xx.**

Description: The value of the attribute is recognized but not supported by TRMDEF.

xx Attribute mnemonic

Issued by TRMDEF.

User Action: None.

## **UPDATE COMPLETE.**

Description: Dayfile message indicating update run successfully completed.

Issued by MODVAL.

User Action: None.

## **\*\*\*\* UPDATE NOT ALLOWED BY INQUIRE.**

Description: Entry of update directives is rejected during K display inquire of a user name.

Issued by MODVAL.

User Action: Request K display update of user name if update is desired.

## **UPDATING username.**

Description: Message displayed at line 1 of control point indicating that the user name is being updated.

Issued by MODVAL.

User Action: None.

## **USER: un,termnam,ltime,aname/acn,ctime,dt.**

Description: Current status of a user.

un	User number.
termnam	Terminal name.
ltime	Login time.
aname	Name of application to which it is connected.

acn	Terminal connection number.
ctime	Time it was connected to the application.
dt	Device type.

Issued by NVF.

User Action: None.

### **USER ACCESS NOT VALID.**

Description: SMP was not called from a SYOT job or system privileges plus DEBUG.

Issued by SMP.

User Action: Rerun with DEBUG or under DIS.

### **USER ACCESS NOT VALID.**

Description: You tried to perform an operation for which you are not authorized. Possible causes include attempts to access a file or equipment which you are not authorized to access.

Issued by LFM.

User Action: Ensure accuracy of command or determine proper validation requirements via LIMITS command.

### **USER ACCESS NOT VALID.**

Description: You tried to perform an operation for which you are not authorized. Possible causes include attempts to do the following:

- Run a system origin job from non-system origin.
- Access a restricted subsystem without proper validation.
- Use the V carriage control character without validation.

Issued by IAFEX.

User Action: Ensure accuracy of command or macro, or determine proper validation requirements via LIMITS command.

### **USER ACCESS NOT VALID.**

Description: You attempted to run MODVAL in a mode that would access the system validation file (FA parameter or K display input) without being system origin or without having security administrator privileges.

Issued by MODVAL.

User Action: None.

### **USER ACCESS NOT VALID.**

Description: The permanent file utilities were called by a non-system origin user without proper validation.

Issued by PFS.

User Action: Ensure proper validation.

### **USER ACCESS NOT VALID.**

Description: CONFIG was called from a nonsystem origin job or without mass storage subsystem priority.

Issued by CONFIG.

User Action: None.

### **USER ACCESS NOT VALID.**

Description: Calling job was not system origin.

Issued by QDSPLAY.

User Action: Correct the error and retry.

### **USER ACCESS NOT VALID.**

Description: Calling job does not have mass storage subsystem identifier.

Issued by 1RM.

User Action: Contact CYBER Software Support.

### **USER ACCESS NOT VALID.**

Description: The calling job must be system origin and have an SSJ= entry point to invoke SDSPLAY.

Issued by SDSPLAY.

User Action: Check for SSJ= entry point and/or rerun the job from the operator console or as system origin.

### **USER ACCESS NOT VALID.**

Description: One of the following occurred:

- You are not authorized to create direct access or indirect access files.
- You are not authorized to access auxiliary devices.
- Your job made a CATLIST request for permit information on a file that has a higher access level than that of your job.

Issued by PFM.

User Action: Contact your site administration about obtaining the necessary validations. For CATLIST request, resubmit the request after raising your job's access level.

### **USER CONDITION REGISTER =xxxx.**

Description: During central memory initialization, a nonzero user condition register appeared in the job exchange package after reverting to monitor mode.

Issued by CTI.

User Action: Inform site analyst or customer engineer.

### **USER DATABASE MISSING.**

Description: The specified database file was not found and could not be constructed.

Issued by RECLAIM.

User Action: None.

### **USER ECS DISABLED.**

Description: Jobs that assign user extended memory are no longer being scheduled because of unrecovered extended memory errors.

Issued by REC.

User Action: Reenable user extended memory scheduling after extended memory errors have been corrected.

### **USER EM SPACE UNAVAILABLE.**

Description: The UEC parameter for the XM EQPDECK entry specified an amount of extended memory larger than the available extended memory.

Issued by REC.

User Action: Redeadstart and correct the UEC parameter for the XM EQPDECK entry.

### **USER EXTENDED MEMORY IMPROPERLY ALLOCATED.**

Description: The amount of extended memory specified on the UEC parameter for the XM EQPDECK entry does not match the amount defined previously in the system sector of the user extended memory chain.

Issued by REC.

User Action: Rereadstart and correct the UEC parameter for the XM EQPDECK entry.

### **USER EXTENDED MEMORY NOT DEFINED**

Description: No user extended memory space was defined in the CMR word ECRL.

Issued by DSDI.

User Action: Ensure that the dump file contains meaningful information.

### **USER EXTENDED MEMORY NOT DEFINED.**

Description: Output file message indicating that User Extended Memory (UEM) was not defined on the system when dumped.

Issued by DSDI.

User Action: None.

### **USER EXTENDED MEMORY SYSTEM SECTOR ERROR.**

Description: The system sector of the user extended memory chain is in error and cannot be read.

Issued by REC.

User Action: Deadstart and initialize extended memory to reallocate the extended memory area.

### **USER INDEX userindex B PURGED.**

Description: Output file message indicating that the files under user index userindex were purged during a REFORMAT run.

Issued by MODVAL.

User Action: None.

### **USER INDEX NOT ON DEVICE.**

Description: Permanent files for the user index specified, do not reside on the device being cataloged.

Issued by PFCAT.

User Action: Retry utility and specify the correct combination of user index and device number.

### **USER INDEX OUT OF RANGE.**

Description: The user index entered for the UI or DI parameter is too large. The maximum value is 377777B.

Issued by PFS..

User Action: Enter correct user index.

### **USER INDEX OUT OF RANGE.**

Description: The user index specified on the UI or DI parameter is larger than 377777B.

Issued by PFS.

User Action: Correct and retry.

### **\*\*\*\* USER INDEX PREVIOUSLY DEFINED.**

Description: More than one user name has been assigned to a user index with the UI identifier. MODVAL disregards this user name entirely unless the SI parameter has been selected on a create (OP=C) run. In that case, the duplication is flagged on the output file and processing continues normally.



Issued by MODVAL.

User Action: Rerun the job or correct the new validation file so that only one user name is assigned to any user index.

### **nnn USER INDICES PURGED.**

Description: Dayfile message indicating that all files under nnn user indices were purged via the reformat option. This can occur only with a system origin job.

Issued by MODVAL.

User Action: None.

### **\*\*\*\* USER NAME ALREADY EXISTS.**

Description: You attempted to create a user name that already exists. Your line of input is disregarded.

Issued by MODVAL.

User Action: None.

### **USER NAME INCORRECT.**

Description: User name cannot be converted to user index correctly.

Issued by PFS.

User Action: Reenter parameters and specify correct user name or site analyst must create a new user name.

### **\*\*\*\* USER NAME LIMIT.**

Description: An attempt was made to validate more than 4095 user names for the specified charge and project number entry.

Issued by PROFILE.

User Action: Rerun with a maximum of 4095 user names under one charge/project entry.

### **USER NAME NOT FOUND.**

Description: Output file message indicating that an attempt was made to delete (or inquire or update from the K display) a nonexistent user name. If entered from the K display, the line of input on which the error occurred is disregarded; otherwise, that particular user name is disregarded.

Issued by MODVAL.

User Action: Correct input directives and rerun job, or correct new validation file, if necessary.

### **USER NOT ACTIVE.**

Description: Informative message for interactive message commands.

Issued by DSD.

User Action: None.

### **USER NOT SYSTEM ORIGIN.**

Description: The user who entered the LOADBC command did not have system origin privileges.

Issued by LOADBC.

User Action: Enter the LOADBC command from the console.

### **USER PROLOGUE NOT FOUND.**

Description: Although a user prologue was defined, it could not be accessed.

Issued by VALEX.

User Action: The user should either delete the prologue definition or create a prologue file.

### **USER SECURITY COUNT EXHAUSTED.**

Description: User has reached a security count of zero.

Issued by IAFEX.

User Action: Have site administrator increase user's security count if appropriate.

### **users USERS tasks TASKS.**

Description: Informative message indicating how many IAF users are connected to the screen management facility (SMF) subsystem, and how many tasks are active within SMF.

users	Number of users
tasks	Number of tasks

Issued by SMFEX.

User Action: None.

### **UTILITY COMPLETE.**

Description: This is an informative message indicating that an END command was processed.

Issued by SUBSYST.

User Action: None.

### **VALID LO OPTIONS ARE LO, LO=A, LO=T or LO=X.**

Description: The LO parameter was specified on the LIBTASK command with an incorrect list option.

Issued by LIBTASK.

User Action: Specify one of the following valid list options LO, LO=A, LO=T or LO=X.

### **VALID ONLY FOR HELP DISPLAY.**

Description: The L. - directive is valid only for the L. HELP display.

Issued by QDSPLAY.

User Action: Correct directive and retry.

### **VALIDATING SB=subfamily SM=id.**

Description: Informative message indicating that SSVAl is validating the SFM catalog for the specified subfamily and the SM map for SM id.

Issued by SSVAl.

User Action: None.

### **VALIDATION DENIED - DEVICE NOT FOUND.**

Description: CVL returned a response indicating that a NAD on the specified channel could not be found in the EST.

Issued by LOADBC.

User Action: Correct channel parameter and retry.

### **VALIDATION DENIED - DEVICE ON OR IN USE.**

Description: CVL returned a response indicating that the NAD controlware could not be loaded because the NAD was turned on or was being used by a maintenance user.

Issued by LOADBC.

User Action: Either turn off the NAD, or wait until the maintenance user has returned the NAD. Retry.

### **VEJ - BUFFER ARGUMENT ERROR.**

Description: Dayfile message indicating that FET buffer pointers are incorrect. (FWA<LWA<FL) was not true or TID (terminal id) with complement address was not within the field length.

Issued by VEJ.

User Action: Write a PSR and include support materials to allow CDC to duplicate the problem.

### **VEJ - INCORRECT REQUEST.**

Description: Dayfile message indicating that one of the following conditions has occurred:

- VEJ was not called by a subsystem.
- The FET address was out of range.
- The system sector buffer address was out of range.
- The caller was not validated to call VEJ.

Issued by VEJ.

User Action: Write a PSR and include support materials to allow CDC to duplicate the problem.

### **VER n.n - min.**

Description: Indicates the version and modification level number of NS.

n.n Version level.

mln Modification level number.

Issued by NS.

User Action: None.

### **VERIFY CM DATA ERROR**

Description: Indicates CTI encountered errors when verifying EI data written to central memory.

Issued by CTI.

User Action: Inform C.E.

### **VERIFY ERROR ON EST ENTRY est.**

Description: Informative message indicating that the EST entry est did not match the one on the BUDT file.

Issued by SSEXEC.

User Action: Check EST est or BUDT file and retry.

### **VERIFYING ADDRESSES S/N=serialn**

Description: Console message indicating that a read-only pass is being made across the pack. This message is displayed after successfully fetching the factory-recorded data and flaw maps or after successfully restoring the address fields, if the V (verify) option was specified on the FORMAT command. Here, serialn is the actual pack serial number read.

Issued by FORMAT.

User Action: None.

### **VERSION MISMATCH ON MEMORY FILE.**

Description: The memory file already on the system contains a version number different from the version number in NAMI. The memory file will automatically be changed to reflect the current NAMI version number.

Issued by NAMI.

User Action: None.

**VOLUME LABEL ERROR.**

Description: Error on the volume header.

Issued by SSEXEC.

User Action: The DRD should be turned back on when the read starts on the second DRD. If there is a hardware problem, inform site analyst.

**VOLUME NOT IN ACS.**

Description: The requested ACS tape is not in the ACS system storage module.

Issued by:MAGNET.

User Action: Enter the requested tape cartridge into the storage module.

**VSN ALREADY EXISTS.**

Description: When attempting to use the edit/add directives, the VSN specified was found to already exist on the directory.

Issued by DMREC.

User Action: Continue processing.

**VSN - ~~xxxxxxx~~ ALREADY IN DIRECTORY.**

Description: The VSN supplied for this operation was found to already exist on the directory.

Issued by DMREC.

User Action: Try another VSN.

**VSN AND DATE/TIME CANNOT CO-EXIST ON LOAD DIRECTIVE.**

Description: On a load directive, the date/time keywords cannot be used with VSN keyword.

Issued by DMREC.

User Action: Correct the directive and rerun.

**VSN ASSIGNED DOES NOT MATCH VSN REQUESTED.**

Description: The VSN assigned as a result of a DMREC ADD subdirective does not agree with the VSN specified on the subdirective.

Issued by DMREC.

User Action: Correct the VSN conflict.

**VSN DOES NOT EXIST.**

Description: When attempting to access a directory, the specified VSN was not found on the directory.

Issued by DMREC.

User Action: List the directory for further information.

**VSN IS NOT FIRST REEL.**

Description: When attempting to modify a directory, the specified VSN was not the first reel of the set.

Issued by DMREC.

User Action: Specify the first reel of the multireel set.

**VSN OR DATE/TIME NOT SPECIFIED.**

Description: When attempting to delete directory entries, no VSN or date/time was specified.

Issued by DMREC.

User Action: Specify VSN or date/time and rerun.

### **VSN STORED OFFSITE.**

Description: Informative message from the NOS Tape Management System indicating the requested tape is stored offsite.

Issued by MAGNET.

User Action: Mount tape if available, otherwise drop the job.

### **VSN TABLE OVERFLOW.**

Description: Too many VSN entries were encountered for this directive.

Issued by DMREC.

User Action: Check directive and increase TVSN size if necessary.

### **VSN TOO LONG**

Description: The PVSN value is longer than 6 characters.

Issued by PFDUMP.

User Action: Shorten the value of the PFDUMP parameter PVSN to 6 characters or less.

### **VWBT EMPTY - FALSE INVOKE OF NVFVWVF.**

Description: For debug only. Worklist procedure NVFVWVF is erroneously invoked.

Issued by NVF.

User Action: Contact CYBER Software Support.

### **WAIT DEMAND FILE ATTACH.**

Description: The MAGNET routine is waiting for the resource demand file to become available so clean-up processing can be done.

Issued by MAGNET.

User Action: If the message is displayed for an extended period of time, drop the job which has the demand file attached or drop the magnetic tape subsystem.

### **WAIT FNT SPACE.**

Description: OBF (begin file routine) is waiting for additional NFL to create a local file.

Issued by OBF.

User Action: None.

### **WAIT FOR CATALOG INTERLOCK.**

Description: Informative message indicating that permanent file requests are currently active. PFDUMP will automatically continue when the interlock on the catalog track is successfully obtained.

Issued by PFDUMP.

User Action: None.

### **WAIT FOR FILE STAGING.**

Description: PFDUMP is waiting for the alternate storage executive to link any staged files to their respective catalog entries.

Issued by PFDUMP.

User Action: None.

### **WAIT FOR PF UTILITY ON est.**

Description: PFDUMP or PFCAT is waiting for a permanent file utility (such as PFLOAD or MSI) to complete processing on equipment with EST ordinal est. The waiting utility continues automatically when the other utility completes.

Issued by PFDUMP.

User Action: Wait for utility to complete.

**nnnn WAIT QUEUE FILES RECOVERED.**

Description: nnnn files in the wait queue have been recovered.

Issued by REC.

User Action: None.

**WAIT 1MV COMPLETE.**

Description: ISF is waiting for suspect to clear on all mass storage devices.

Issued by ISF.

User Action: None.

**WAITING FOR BUSY DAYFILE.**

Description: The dayfile you are attempting to terminate is busy. DFTERM is waiting for it to become free.

Issued by DFTERM.

User Action: If the message persists, inform the site analyst. If you wish to abandon the DFTERM operation, drop the job.

**WAITING FOR CFO.GO.**

Description: MCS processing is suspended until you enter the CFO,jsn.GO command.

Issued by MCS.

User Action: Enter CFO,jsn.GO command.

**WAITING FOR CHcc SLAVE PP.**

Description: Informative message indicating that 1XM is waiting on 2XM to load and initialize.

cc Channel number.

Issued by 1XM.

User Action: None.

**WAITING FOR CHcc SLAVE PP.**

Description: Informative message indicating that 1XM on channel cc is waiting on 2XM to load and initialize.

Issued by 1XM.

User Action: None.

**WAITING FOR \*CMS\* TO FINISH.**

Description: MREC'S helper, 1MR, will not run when CMS is active.

Issued by 1MR.

User Action: Wait for CMS to finish or drop MREC.

**WAITING FOR DATABASE NON-BUSY.**

Description: The specified database is busy (for example, it may be attached in write mode to another job).

RECLAIM continues to attempt to attach the file at ten second intervals until the file becomes available or you interrupt RECLAIM.

Issued by RECLAIM.

User Action: Wait for the specified database to become available or terminate RECLAIM processing.

### **WAITING FOR EXEC.**

Description: SSEXEC is temporarily delaying the processing of SSVAL requests.

Issued by SSVAL.

User Action: None.

### **WAITING FOR EXTENDED MEMORY.**

Description: The FL requested on the ENFLE,nnnn. command has not been assigned to the control point yet.

Issued by DIS.

User Action: Wait until FL is assigned or hit the left blank to clear command.

### **WAITING FOR FILE filename.**

Description: Informative message indicating that SSVAL is waiting for SSEXEC to return a SM map or an SFM catalog.

Issued by SSVAL.

User Action: None.

### **WAITING FOR xxxI INTERLOCK.**

Description: 1MR is waiting for flag register interlock xxxI.

xxx One of the following:

DAT Device access table interlock

FAT Fast attach table interlock

Issued by 1MR.

User Action: None.

### **WAITING FOR INTERLOCK.**

Description: Another machine has the software reserve on this independent shared device.

Issued by MSM.

User Action: If the other machine is running, no action is necessary. If the specified mainframe is not running, clear the software reserve with the MREC utility or by presetting the device.

### **WAITING FOR MACHINE ID=XX.**

Description: Informative message stating that reconfiguration cannot occur until the operator on the mainframe with ID = xx either enters the same reconfiguration parameters or enters K.IGNORE.

Issued by 1RM.

User Action: None.

### **WAITING FOR MAGNET.**

Description: The job is waiting for the magnetic tape subsystem to be activated.

Issued by RESEX.

User Action: Wait for the operator to activate MAGNET or terminate the job.

### **WAITING FOR NETWORK.**

Description: NAM was not active when MCS tried to NETON.

Issued by MCS.

User Action: Bring NAM up.

### **WAITING FOR PN=packname, type.**

Description: The job is waiting for the operator to mount pack packname on device type type.

Issued by RESEX.

User Action: Wait until the operator mounts the requested pack or terminate the job.

### **WAITING FOR RESOURCE FILE.**

Description: The job is waiting for the resource demand file or VSN file to become available.

Issued by RESEX.

User Action: Wait until resource file becomes available or terminate the job. To operator: If job is not rolled out and this message persists, inform site analyst or drop the job. If the operator decides to override an interrupted job at this point, the preview data in the demand file is not cleared and the E,P display continues to show the VSN request associated with the job until you log off or issue a subsequent request for tape or pack.

### **WAITING FOR RESOURCES.**

Description: The job is waiting for sufficient resources to allow assignment of the tape/pack without causing a system deadlock.

Issued by RESEX.

User Action: Wait until the resources become available or terminate the job.

### **WAITING FOR STORAGE.**

Description: The FL requested on the ENFL,nnnn. command has not been assigned to the control point yet.

Issued by DIS.

User Action: Wait until FL is assigned or clear the command.

### **WAITING FOR STORAGE.**

Description: Issued to DSD B and J displays. BIO is waiting to increase its field length or for a buffer to become available.

Issued by 110.

User Action: None.

### **WAITING FOR TVF TO BE ENABLED.**

Description: TVF is not enabled.

Issued by TVF.

User Action: Enable TVF.

### **WAITING FOR VSN= vsn, type.**

Description: The job is waiting for the operator to mount the tape with VSN vsn on the specified type (MT, HD, PE, or GE). VSN= SCRATCH indicates that any scratch tape is acceptable.

Issued by RESEX.

User Action: Wait for the operator to mount the tape or terminate the job.

### **WAITING - GLOBAL INTERLOCK.**

Description: Informative message indicating that another deadstart file installation is in progress on the selected device.

Issued by 11S.

User Action: None.



### **WAITING ON TRACK LIMIT.**

Description: The job is waiting for additional tracks on the family device containing the resource demand and VSN files.

Issued by RESEX.

User Action: Wait for the additional tracks or terminate the job.

### **WAITING - RECOVERY INTERLOCK.**

Description: Informative message. In order to recover a device online, it is necessary to load the device access table out of extended memory. However, the flag register interlock is currently unavailable, possibly because another machine is deadstarting.

Issued by MSM.

User Action: None.

### **WAITING - RECOVERY INTERLOCK.**

Description: Informative message at job B-display. IMS is waiting for another mainframe to finish recovering this device.

Issued by IMS.

User Action: Wait for other mainframe to finish recovering the device. If the other mainframe is not up, use MREC to clear the interlock.

### **WARNING - INCOMPLETE DUMP FILE.**

Description: Informative message indicating an unexpected EOF was encountered while copying the dump file to disk. Processing will continue with the data copied so far.

Issued by DSDI.

User Action: None.

### **WORD ADDRESS NOT FOUND.**

Description: Output file message indicating that a word address requested was not found in the specified record in the EDD file.

Issued by DSDI.

User Action: Ensure that the dump file contains meaningful information. If the directive was issued to dump NOS/VE memory, re-run DSDI with the FULL option specified on the command.

### **WPE UNRECOVERED - ABORT.**

Description: Operator has aborted PFDUMP operation by entering K.END in response to UNRECOVERED PARITY ERROR message or PFDUMP was unable to continue after the operator entered K.GO.

Issued by PFDUMP.

User Action: Retry PFDUMP operation using a different tape.

### **WRITE FUNCTION NOT COMPLETE.**

Description: INITMDI was unable to send data to the MDI because of one of the following:

- The general status available bit was set, forcing INITMDI to read data from the MDI.
- The general status send data bit was clear.
- The data unit count was not clear upon return, implying that data was not accepted by the MDI.

Issued by INITMDI.

User Action: Inform site analyst.

### **WRITE ID BURST FAILURE.**

Description: The tape driver is unable to correctly write the PE (1600 cpi) or GE (6250 cpi) identification tracks or the automatic read amplitude (ARA) burst at load point. MAGNET automatically unloads the tape.

Issued by MAGNET.

User Action: Clean the tape drive, then load and ready the drive. Enter the DSD command `RETRY,est`, where `est` is the EST ordinal of the tape drive. If the message reappears, cut off the tape at load point and put on a new load point marker or use a new tape (move any external labels to the new tape). Then reload the tape on the same drive and make it ready. Enter the DSD command `RETRY,est`. If the message reappears, request the customer engineer to repair the drive's port, then reload the tape and ready the drive. Enter the DSD command `RETRY, est`. If the failure cannot be repaired at this time, enter the DSD command `TERMINATE,est`. If a new tape is used and the tape operation does not recover, stop using the tape drive and inform the customer engineer.

### **WRITE ID BURST FAILURE, filename AT address.**

Description: The tape driver is unable to correctly write the PE (1600 cpi) or GE (6250 cpi) identification tracks or the automatic read amplitude (ARA) burst at load point.

Issued by 1MT.

User Action: Load the tape on another drive or use a different tape.

### **WRITING MEMORY.**

Description: Each available word of central memory is written with two patterns, checking for errors on each pass. The duration of the message is a function of central memory size.

Issued by CTI.

User Action: None.

### **WRITING SUMMARY.**

Description: Informative K display message indicating that the summary report is being generated.

Issued by PFCAT.

User Action: None.

### **WRONG ENTRY WHILE READING VSN ENTRIES.**

Description: The VSN record read from the directory has an incorrect format.

Issued by DMREC.

User Action: Inform database administrator.

### **WRONG VSN**

Description: Mounted tape does not have the volume serial number (VSN) requested by the job.

Issued by MAGNET.

User Action: Mount tape with correct VSN as shown on the resource requests display (E,P).

### **WRONG VSN GO,est. TO BLANK.**

Description: Mounted tape does not have the volume serial number (VSN) allocated by the NOS Tape Management System (TMS) from the TMS scratch pool.

Issued by MAGNET.

User Action: Enter the DSD command `GO,est` to blank label the tape with the requested VSN. Enter the DSD command `STOP,est` to unload the tape if the wrong reel was mounted.

### **WRONG VSN USED.**

Description: Either the wrong VSN was used or no header was found on ARF.

Issued by DMREC.

User Action: Make sure the correct ARF is being used and retry.

### **XM ALLOCATION ERROR.**

Description: The system was unable to allocate sufficient extended memory for the defined configuration.

Issued by SET.

User Action: Modify system configuration.

### **XM ENTRY NEEDED.**

Description: No extended memory is defined for I/O buffers.

Issued by SET.

User Action: Enter an XM entry with I/O buffers defined.

### **Y,Z OPTION VIOLATED.**

Description: An incorrect Y,Z combination was specified by the YI and ZI parameters in a directive to SSLABEL.

Issued by SSLABEL.

User Action: Correct YI and ZI parameters and retry.

### **YOU ARE NOT THE CONTROLLING NOP.**

Description: An attempt was made by the operator to release control of an NPU that is not currently under his/her control.

Issued by CS.

User Action: None.

### **YOU NOW HAVE AUTO CONTROL STATUS.**

Description: A CONTROL,AUTO command has been successfully initiated by the operator.

Issued by CS.

User Action: None.

### **ZZdbDIR UNREADABLE.**

Description: When trying to expand a data file, an attempt to read the directory file failed.

Issued by DMREC.

User Action: Inform database administrator.

### **1DA - UNAUTHORIZED CALL.**

Description: A 5830 driver has received an unauthorized call.

Issued by 1DA.

User Action: None.

### **1DD ABT.**

Description: This message is displayed when one of the following conditions occurs:

- Unrecoverable write error on a dayfile dump.
- No mass storage space available on which to write the dayfile.
- Enough dayfile messages (usually error log) were generated during the deadstart process to necessitate a dump of the buffer. However, the deadstart process had not advanced far enough to properly dump the buffer.

In each of the above cases, the buffer is set empty. A portion of the dayfile is lost and messages may be incomplete.

Issued by PPR.

User Action: The system should be idled (refer to IDLE command) immediately and the appropriate step taken as follows:

- Correct write errors.
- Free space on the full device.
- During deadstart, this message usually indicates a bad pack or disk drive. Use another pack or take the drive offline.

### **1HP - TOO MANY UNITS ON CHANNEL.**

Description: More than 16 DEMA drives were defined on one channel.

Issued by 1HP.

User Action: Rereadstart and reduce the number of drives defined on the channel. Get C.E's to reconfigure the extra drives onto another channel.

### **1HP - TOO MANY UNITS ON CHANNEL.**

Description: More than 16 drives were defined on one channel.

Issued by 1HP.

User Action: Rereadstart and reduce the number of drives defined on the channel. Get customer engineers to reconfigure extra drives onto another channel.

### **1HP - UNAUTHORIZED CALL.**

Description: 1HP was called from a control point other than the system control point.

Issued by 1HP.

User Action: None.

### **1HP - UNAUTHORIZED CALL.**

Description: 1HP was called from a control point other than the system control point.

Issued by 1HP.

User Action: Inform site administrator if repeated attempts are made to access the mass storage driver.

### **1HY - UNAUTHORIZED CALL.**

Description: 1HY was called from a control point other than the system control point.

Issued by 1HY.

User Action: Inform site administrator if repeated attempts are made to access the mass storage driver.

### **1HY - UNAUTHORIZED CALL.**

Description: 1HY was called from a point other than the system control point.

Issued by 1HY.

User Action: Inform site administrator if repeated attempts are made to access the mass storage driver.

### **1IS - INCORRECT REQUEST.**

Description: 1IS was called with an incorrect function request.

Issued by 1IS.

User Action: None.

### **1MA - FATAL MAINTENANCE REGISTER ERROR.**

Description: An error was detected in the maintenance registers.

Issued by 1MA.

User Action: Inform site analyst.

### **1MB CALL ERROR.**

Description: 1MB was called with an invalid function code.

Issued by 1MB.

User Action: Inform CYBER Software Support.

### **1MB ESM CHANNEL HANG**

Description: The ESM maintenance channel hung active while attempting to read the ESM secded log.

Issued by 1MB.

User Action: Contact a customer engineer.

### **1MB INCOMPLETE ESM SECDED READ.**

Description: The read of the ESM secded data failed.

Issued by 1MB.

User Action: Contact a customer engineer.

### **1MD - MESSAGES LOST.**

Description: 1MD was unable to flush the error buffer fast enough to keep up with the generation of error messages by the drivers.

Issued by 1MD.

User Action: Inform customer engineer.

### **1MR ERROR FLAG TERMINATION.**

Description: An error flag was set at 1MR's control point.

Issued by 1MR.

User Action: None.

### **1MT PROBABLY LOST.**

Description: Informative message indicating the routine MAGNET was dropped while waiting for 1MT to complete.

Issued by MAGNET.

User Action: None.

### **1RM INCORRECT REQUEST.**

Description: Incorrect function code or status word address out of range.

Issued by 1RM.

User Action: Take a deadstart dump, write a PSR, and send the dump and PSR to CDC along with any support materials which will allow CDC to duplicate the problem.

### **1TM - NO TPM AVAILABLE.**

Description: Either there is no two-port multiplexer available in the equipment status table, or the multiplexer channel is not available.

Issued by 1TM.

User Action: Contact CYBER Software Support.

**1TM - RDF CANNOT BE RUN ON MAINFRAME.**

Description: The mainframe does not have the necessary hardware to support usage of RDF.

Issued by 1TM.

User Action: None.

**1TM - RDF TERMINATED.**

Description: RDF is not enabled. 1TM will issue this message, then drop after signalling driver drop to RDF.

Issued by 1TM.

User Action: 1TM may be restarted by enabling RDF and by entering the console command to restart 1TM. Otherwise, no action.

**1TM - RDF TIME-OUT.**

Description: No terminal activity has occurred for 15 minutes (assembly parameter) and that RDF is not in dedicated mode. 1TM has dropped from the PPU without recall and has signalled driver-drop to RAF.

Issued by 1TM.

User Action: No action.

**1TM - RMest Ccn Ppn Ffff REJECT.**

Description: Two-port multiplexer, equipment number est, channel number cn, port number pn, has rejected function ffff.

Issued by 1TM.

User Action: Contact CYBER Software Support.

**1TO ABORT nn, pppp.**

Description: An internal error was found in an IAF call.

nn Error number  
pppp Pot pointer

Issued by 1TO.

User Action: Contact CYBER Software Support.

**1XD - UNAUTHORIZED CALL.**

Description: 1HY was called from a point other than the system control point.

Issued by 1XD.

User Action: Inform site administrator if repeated attempts are made to access the mass storage driver.

**1XD - UNAUTHORIZED CALL.**

Description: 1XD was called from a control point other than the system control point.

Issued by 1XD.

User Action: Inform site administrator if repeated attempts are made to access the mass storage driver.

**1XM - TOO MANY UNITS ON CHANNEL.**

Description: More than 16 895 drives were defined on one channel.

Issued by 1XM.

User Action: Rereadstart and reduce the number of drives on the channel - Get C.E.'s to reconfigure the extra drives onto another channel.

### **1XM - TOO MANY UNITS ON CHANNEL.**

Description: More than 16 drives were defined on one channel.

Issued by 1XM.

User Action: Redeadstart and reduce the number of drives defined on the channel. Get the customer engineers to reconfigure the extra drives onto another channel.

### **1XM - UNAUTHORIZED CALL.**

Description: 1XM was called from a control point other than the system control point.

Issued by 1XM.

User Action: Contact CYBER Software Support.

### **1XM - UNAUTHORIZED CALL.**

Description: 1XM was called from a control point other than the system control point.

Issued by 1XM.

User Action: Inform site administrator if repeated attempts are made to access the mass storage driver.

### **1XY - TOO MANY UNITS ON CHANNEL.**

Description: More than 16 895 drives were defined on one concurrent channel.

Issued by 1XY.

User Action: Redeadstart and reduce the number of drives on the channel. Get C.E's to reconfigure the extra drives onto another concurrent channel.

### **1XY - TOO MANY UNITS ON CHANNEL.**

Description: More than 16 drives were defined on one channel.

Issued by 1XY.

User Action: Redeadstart and reduce the number of drives defined on the channel. Get the customer engineers to reconfigure the extra drives onto another channel.

### **1XY - UNAUTHORIZED CALL.**

Description: 1XY was called from a control point other than the system control point.

Issued by 1XY.

User Action: Contact CYBER Software Support.

### **1XY - UNAUTHORIZED CALL.**

Description: 1XY was called from a control point other than the system control point.

Issued by 1XY.

User Action: Inform site administrator if repeated attempts are made to access the mass storage driver.

### **5ME, EQest, CATALOG CHAIN.**

Description: During mass storage table validation, an error was encountered in the catalog chain on equipment est. The error was caused by one or more of the following:

- Label track was not linked to first catalog track.
- Number of catalog tracks was not a power of 2.
- Catalog chain was not reserved.
- Length of catalog chain was incorrect.

- Catalog chain was noncontiguous.

Issued by MSM.

User Action: Take a deadstart dump, write a PSR, and send the dump and PSR to CDC along with any support materials which will allow CDC to duplicate the problem.

### **5ME, EQest, INDIRECT CHAIN.**

Description: The first track of the indirect chain on equipment est is not reserved or set as a preserved file in the TRT.

Issued by MSM.

User Action: Take a deadstart dump, write a PSR and send the dump and PSR to CDC along with any support materials which will allow CDC to duplicate the problem.

### **5ME, EQest, PERMITS CHAIN.**

Description: The first track of the permits chain on equipment est is not reserved or set as a preserved file in the TRT.

Issued by MSM.

User Action: Take a deadstart dump, write a PSR, and send the dump and PSR to CDC along with any support materials which will allow CDC to duplicate the problem.

### **5ME, EQest PF COUNT.**

Description: During mass storage table validation, the number of preserved files indicated in the TRT for equipment est did not match the number in word ACGL of the MST.

Issued by MSM.

User Action: Take a deadstart dump, write a PSR, and send the dump and PSR to CDC along with any support materials which will allow CDC to duplicate the problem.

### **5ME, EQest, TRACK COUNT.**

Description: During mass storage table validation, the number of available tracks (word TDGL in the MST) for equipment est was found to be incorrect.

Issued by MSM.

User Action: Take a deadstart dump, write a PSR and send the dump and PSR to CDC along with any support materials which will allow CDC to duplicate the problem.

### **667x MALFUNCTION.**

Description: Either a function was not accepted or no multiplexer is on the channel.

Issued by 1TN.

User Action: Inform customer engineer.

### **8/9 NOT ALLOWED ON OCTAL FIELD.**

Description: The specified channel number was specified with a post suffix of B and an 8 or 9 was specified.

Issued by DMPCCC.

User Action: Correct the syntax error and retry.

### **x25 NETWORK (PSN) DOWN ON PORT xx.**

Description: CCP is not receiving a response from the packet switched network (PSN) on port xx. Indicates cable/modem problems or the PSN is down.

Issued by CCP.

User Action: Contact PSN vendor.



## **585 PRINTER DIRECTIVE FOR NON-585 CONNECTION**

Description: This message indicates that the printer type specified in the EVFU file did not match that in the login message from the network.

Issued by PSU.

User Action: Notify site analyst. Correct the EVFU file, NDL source, and/or CDCNET 585 configuration information.

## **819 ABT**

Description: Informative message.

Issued by CPUMTR.

User Action: Enter GO,SYS. If the message does not clear, inform customer engineer.

## **819 NRDY**

Description: Informative message. The disk is not ready.

Issued by CPUMTR.

User Action: Enter GO,SYS. If the message does not clear, inform customer engineer.

## **819 PRTY**

Description: Informative message. The disk has experienced a parity error.

Issued by CPUMTR.

User Action: Enter GO,SYS. If the message does not clear, inform customer engineer.

## **667X FUNCTION REJECT.**

Description: 1TN issued a function to the multiplexer which was not accepted by the equipment.

Issued by 1TN.

User Action: Contact CYBER Software Support.

## **7990 CATALOG OPEN ERROR.**

Description: The SFM catalog does not exist or is incorrect for the specified family name and subfamily.

Issued by SSVAL.

User Action: Correct the SB parameter on the SSVAL command or reload/recreate the SFM catalog.

## **7990 CATALOG READ ERROR.**

Description: A read error occurred on the specified SFM catalog.

Issued by SSVAL.

User Action: Recover the catalog from a backup copy and retry.

## **7990 HARDWARE PROBLEM.**

Description: The directive to SSLABEL or SSDEBUG cannot be processed at this time because of an MSE hardware failure.

Issued by SSLABEL.

User Action: Rerun after a repair has been made.

## **7990 INITIALIZATION COMPLETE.**

Description: Informative message indicating that the 7990 hardware initialization is complete.

Issued by SSEXEC.

User Action: None.





## A

### **Abort**

To terminate a program, job or job step when an error condition (hardware or software) exists from which the program or computer cannot recover.

### **Account Dayfile**

The account dayfile provides a history of system usage over the life of the account dayfile. It provides information necessary for accurate billing and system usage analysis.

### **ACS**

Refer to the Automated Cartridge System.

### **Address**

The location of a word in memory. The location is designated by number or symbolic name.

### **Alternate Storage**

The storage of permanent file data on external media other than mass storage such as tape alternate storage or MSE. When a file resides on alternate storage, the file's permanent file catalog (PFC) entry and permit data still reside on disk, but the disk space occupied by the file data can be released.

### **ANSI**

American National Standards Institute. An organization that establishes standards for the benefit of its member organizations.

### **Application Program**

A program resident in a host computer that provides an information storage, retrieval, and/or processing service to a remote user via the data communication network and the Network Access Method. Application programs use the system control point feature of NOS to communicate with the Network Access Method.

In the context of network software, an application program is not an interactive job, but rather a terminal servicing facility. A terminal servicing facility provides terminal users with a specific processing capability such as remote job entry from batch terminals, transaction processing, entry and execution of interactive jobs, and so forth. For example, the standard Control Data interactive facility IAF makes terminal input and output appear the same to an executing program as file input and output. IAF is a network application program, but the executing program using IAF is an interactive job.

### **ASCII**

American National Standard Code for Information Interchange. The standard character set and code used for information interchange between systems.

ATF

## **ATF**

Refer to the Automated Tape Facility.

## **Automated Cartridge Subsystem (ACS)**

The 5744 Automated Cartridge Subsystem consists of hardware and software that allows reading and writing of ACS tapes (IBM 3480-compatible cartridge tapes). The ACS hardware includes a robot that automatically loads and unloads the cartridge tapes. Contrast with Cartridge Tape Subsystem.

## **Automated Tape Facility (ATF)**

The Automated Tape Facility (ATF) is a NAM application that enables communication between the ACS library server (Sun Workstation) software and NOS. ATF must be active before users can access the Automated Cartridge Subsystem.

## **Auxiliary Device**

Mass storage device that is not part of a permanent file family. Auxiliary devices can contain direct or indirect access permanent files.

## **B**

### **Buffer**

An intermediate storage area used to compensate for a difference in rates of data flow, or times of event occurrence, when transmitting data between central memory and an external device during input/output operations.

## **C**

### **Cartridge**

Component of MSE. The cartridge consists of a plastic housing that encloses a strip of magnetic tape on which data is stored under program control.

### **Cartridge Alternate Storage**

MSE or optical disk used as an alternate storage medium for permanent files. See also Alternate Storage.

### **Cartridge Tape Subsystem (CTS)**

The 5680 Cartridge Tape Subsystem (CTS) consists of hardware and software that allows reading and writing of IBM 3480-compatible cartridge tapes. Cartridge tapes must be manually loaded and unloaded by the operator. Contrast with Automated Cartridge Subsystem.

### **Cassette**

The magnetic tape device in an NPU used for bootstrap loading of offline diagnostics and (in remote NPUs) the bootstrap load/dump operation.

**Central Memory (CM)**

The main storage device whose storage cells (words) can be addressed by a computer program and from which instructions and data can be loaded directly into registers from which the instructions can be executed or from which data can be manipulated.

**Central Processor Unit (CPU)**

The high-speed arithmetic unit that performs the addition, subtraction, multiplication, division, incrementing, logical operations, and branching instructions needed to execute programs.

**Channel Number**

The number of the data channel on which a peripheral device controller can be accessed.

**Character**

Unless otherwise specified, references to characters in this manual are to 7-bit ASCII code.

**Checkpoint**

The process of writing to a magnetic tape or mass storage file a copy of your job's central memory, the system information used for job control, and the names and contents of all assigned files that are identified in a CHECKPT request.

**CIP**

Refer to CYBER Initialization Package.

**CMRDECK**

The central memory configuration description deck used during deadstart to define the existence and size of various tables in central memory resident. The CMRDECK also defines which EQPDECK, IPRDECK, and LIBDECK are to be used.

**Coldstart**

Procedure used to deadstart if the tape or disk controller has not yet been loaded with controlware or the controlware is not running.

**Command**

A sequence of words and characters that call a system routine to perform a job step. The command must conform to format specifications and end with either a period or a right parenthesis. A command is sometimes called a control statement.

**Connection Number**

A number assigned to an IAF terminal by the system when the terminal is logged in and an entry is made for the job in the executing job table.

**Connection Status**

A job attribute kept in the job's executing job table (EJT) entry. The system uses it to determine the job's relationship with IAF.

### **Control Point Number**

The number of the control point to which a job is assigned, while the job resides in central memory. The actual number of control points is an installation parameter. Before the job can execute, each central processor program must be assigned to a control point.

### **Control Statement**

Refer to Command.

### **Controller**

Hardware device that connects channels to peripheral devices. For example, a tape controller might connect up to eight tape units to one channel.

### **Controlware**

Refer to Peripheral Microcode.

### **CTS**

Refer to Cartridge Tape Subsystem.

### **CYBER Database Control System (CDCS)**

The DMS-170 controlling module that provides the interface between an application and a data base.

### **CYBER Initialization Package (CIP)**

A release mechanism that provides CTI, HIVS/MSL, EI, and microcode on a single tape.

## **D**

### **DAS**

Refer to Disk Array Subsystem.

### **Data Channel**

One of the nine to 24 channels (12-bit) by which information passes between the peripheral processors and peripheral devices. Refer to Channel Number.

### **Dayfile**

A chronological file created during job execution that forms a permanent accounting and job history record. Dayfile messages are generated by operator action or when certain commands are processed. A copy of the dayfile is printed with the output for each job. You must explicitly request it in an interactive job.

### **Deadstart**

The process of initializing the system by loading the operating system library programs and any of the product set from magnetic tape or disk. Deadstart recovery is reinitialized after system failure.

**Deadstart Sequencing**

The execution of a selected set of commands before normal system job scheduling is enabled.

**Default Value**

A fixed value supplied by the system for a missing parameter.

**Detached Job**

An interactive service class job which is no longer connected to an interactive terminal. It may or may not continue to execute, depending on the presence of commands in the command buffer or an active job step. Control is regained by recovering the EJT entry for the job.

**Device Interface (DI)**

A collective term that can refer to either a Mainframe Device Interface (MDI) or a Mainframe Terminal Interface (MTI).

**Direct Access File**

A NOS permanent mass storage file that can be attached to your job. All changes to this file are made on the file itself rather than a temporary copy of the file. Compare with Indirect Access File.

**DIS (Job Display)**

A system peripheral processor program similar to system display (DSD) that provides communication between a job in central memory and the operator at the console, and permits the operator to control execution of the program through the console keyboard.

**Disabled Job**

An interactive service class job temporarily rolled out due to user break processing or encountering the end of its command stream. The job scheduler ignores disabled jobs.

**Disk**

A unit composed of one or more flat, circular plates with magnetic material on both sides that is used to store large amounts of data or programs.

**Disk Array Subsystem**

A disk storage subsystem. The 5830 Disk Array Subsystem allows the configuration of multiple disks combined into a single logical device.

**Disk Pack**

A group of disks with magnetically encoded information. Disk packs can be removed from the system with the stored information intact.

**Display**

One or more screens used to display system and job information, operator messages, and contents of central memory. Through the console keyboard, the operator can control the operation of the system. The displays are identified by alphabetic characters. Some



frequently used displays are: system status (B,O.), system files (H), and dayfile messages (A).

### **Display Code**

A 6-bit character code set used to represent alphanumeric and special characters.

### **Disposition Code**

A two-character mnemonic indicating destination queue and format for processing a file named on a ROUTE function.

### **Downline**

The direction of output flow, from host to terminal.

### **DSD (System Display)**

The operating system program that provides communication between the operator and the system by accepting control information typed on the console keyboard and by displaying to the operator information pertinent to all jobs known to the system. DSD is permanently assigned to peripheral processor 1.

## **E**

### **ECS**

Extended Core Storage. Refer to Extended Memory.

### **EJT Ordinal (EJTO)**

An index into the executing job table (EJT). It uniquely identifies an EJT entry. The acceptable range is from 1 through 4095. EJTO is reserved for the system.

### **EQPDECK**

The equipment description deck used during deadstart to define the system equipment configuration.

### **Equipment Number**

A number from 0 to 7 that identifies the setting on a peripheral device controller.

### **Equipment Status Table (EST)**

A central memory resident table listing all the defined equipments, parameters affecting their operation, and the status of the equipments.

### **EST Ordinal**

The number designating the position of an entry within the equipment status table (EST) established at each installation. Devices are identified in operator commands by EST ordinals. The EST ordinal is sometimes referred to as the equipment number.

### **Executing Job**

When a job is assigned an EJT entry, it is considered an executing job. An executing job can be rolled out or at a control point.

**Executing Job Table (EJT)**

A central memory resident table that contains a four-word entry for all executing jobs including interactive service class jobs.

**Extended Core Storage (ECS)**

Optional additional memory. ECS contains 60-bit words. It has a large amount of storage and fast transfer rates. ECS can be used only for program and data storage, not for program execution. Special hardware instructions exist for transferring data between central memory and ECS.

**Extended Memory**

An extension to central memory that is physically located outside of the machine. Formerly referred to as Extended Core Storage (ECS) or Large Central Memory Extended (LCME).

**F****Family Device**

Mass storage permanent file device associated with a specific system. A family may consist of one to 63 logical devices. Normally, a system runs with one family of permanent file devices available. However, additional families may be introduced during normal operation. This enables users associated with the additional families to access their permanent files via the alternate family.

**Family Name**

A designation that the installation may give to a group of permanent file devices.

**Family Ordinal (FO)**

An index into the FOT. The family ordinal is used to identify a unique family.

**Family Ordinal Table (FOT)**

A central memory resident table used to map family names to family ordinals, and family ordinals to family names.

**Field Length**

The area in central memory allocated to a particular job; the only part of central memory that a job can directly access.

**Field Length Extended (FLE)**

Amount of extended memory assigned to an executing job.

**File**

1. A set of information that begins at beginning-of-information (BOI), ends at end-of-information (EOI), and is referenced by a local file name. (This definition refers to NOS commands requiring a parameter that is a file name.)
2. That portion of a multfile file terminated by an end-of-file (EOF). (This definition refers to commands requiring a parameter that specifies the number of files.)

3. Data recorded on a magnetic tape beginning after an HDR1 label and ending before an EOF1 label. (This definition applies only to labeled magnetic tapes.)

### **First Level Peripheral Processor (FLPP)**

The processor that is connected directly to the CYBER 170 Model 176 mainframe and operates synchronously with the mainframe.

### **Flag**

A character or bit that signals the occurrence or presence of a particular condition.

### **Forms Code**

An attribute of output files and output devices. The user can specify special forms required for output. You can mount the special forms and use the FORM command to let the system process the user's output.

## **H**

### **Hang**

A system stop that may be caused by hardware failure or by an error in a system program. An error in a user program could cause that program to hang (go into a loop or abort), but no user program error should cause a system hang.

## **I**

### **Indirect Access File**

A NOS permanent file that you access by making a temporary copy of the file (GET or OLD command). You create or alter it by saving or substituting the contents of an existing temporary file (REPLACE or SAVE command). Compare with Direct Access File.

### **Interactive Facility (IAF)**

An application that provides a terminal operator with interactive processing capability. The interactive facility makes terminal input/output and file input/output appear the same to an executing program.

### **Interactive Job**

A job initiated from an interactive (time-sharing) terminal.

## **IOU**

Input/output unit (CYBER 180-class mainframes and models 865 and 875). An IOU is a collection of all PPs, PP channels, and related hardware.

## **J**

### **Job Sequence Name (JSN)**

The unique, system-defined name assigned to every executing job or queued file. The JSN is a string of four alphabetic characters.

**Job Status**

A job attribute kept in the job's executing job table (EJT) entry. It is used by the system to determine if a job is rolled in or rolled out. If the job is rolled out, job status indicates why it was rolled out.

**L****Load Point**

Metallic strip marking the beginning of the recordable portion of a magnetic tape. Data, including labels, is written after the load point. A rewind positions a single file volume to the load point.

**Local Batch Job**

A batch job submitted at the central computer site through a card reader.

**Logical Identifier (LID)**

A three-character alphanumeric string used to identify a particular mainframe in a loosely coupled network. LIDs are identified by your site.

**M****Machine Identification (MID)**

Identifier used to associate a specific machine with its access to a shared device.

**MAG**

Magnetic tape subsystem.

**Mainframe Device Interface (MDI)**

The collection of hardware and software that is used to relay information within and between networks.

**Mainframe Terminal Interface (MTI)**

The collection of hardware and software that is used to connect terminals to the network.

**Maintenance Registers**

Hardware registers used in error detection, logging and recovery procedures for CYBER 180-class mainframes and models 865 and 875 only.

**Mass Storage**

The equipment used to hold temporary and permanent files within the system.

**Mass Storage Device**

An extended memory (ECS) or disk unit with defined logical attributes such as family, file residency, and so on.

### **Mass Storage Extended Subsystem (MSE)**

MSE consists of the 7990 hardware, the channel interface, the diagnostics, and the operational software. MSE stores data on the 7990 and moves it to disk upon request for access by an authorized user.

### **Mass Storage Table (MST)**

Table that contains an entry for each logical device in the configuration of mass storage devices currently available to the system.

### **MDD**

Refer to Monitor Display Driver.

### **MDI**

Refer to Mainframe Device Interface.

### **Monitor Display Driver**

A program that monitors maintenance registers during operating system operation.

### **MSE**

Refer to Mass Storage Extended Subsystem.

### **MTI**

Refer to Mainframe Terminal Interface.

### **Multimainframe System**

Network of physically and logically connected computer systems.

### **Multispindle Device**

A logical mass storage device that includes two to eight disk units.

## **N**

### **Network Access Device (NAD)**

The primary element in a loosely coupled network. Each NAD connects a computer system to the network.

### **Network Access Method (NAM)**

A software package that provides a generalized method of using a communications network for switching, buffering, queuing, and transmitting data. NAM is a set of interface routines used by a terminal servicing facility for shared access to a network of terminals and other applications, so that the facility program does not need to support the physical structures and protocols of a private communication network.

### **Network Processing Unit (NPU)**

The collection of hardware and software that switches, buffers, and transmits data between terminals and host computers.

## O

### **Online Job**

A job that has a logical connection between an interactive device and a job in the system.

### **Order-Dependent**

Used to describe items that must appear in a specific order.

### **Order-Independent**

Used to describe items that need not appear in a specific order. Parameters, particularly those with keywords, may be order-independent.

### **Origin Type**

A job attribute that indicates how a job entered the system. The four origin types are interactive origin, batch origin, remote batch origin, and system origin.

### **Output File**

The system-defined file that contains all the output from job processing. It is also known as the print or punch file.

## P

### **Paging (Screen)**

The process of filling a CRT display with data, and holding additional data for subsequent displays. Changing the page display is an operator-controlled function if the page wait option is selected.

### **Parity**

In writing data, an extra bit is either set or cleared in each byte so that every byte has either an odd number of set bits (odd parity) or an even number of set bits (even parity). Parity is checked on a read for error detection and possible recovery.

### **Peripheral Microcode**

Special type of software that resides in a peripheral controller. The peripheral microcode defines the functional characteristics of the controller.

### **Peripheral Processor (PP)**

The hardware unit within the host computer that performs physical input and output through the computer's data channels.

### **Peripheral Processor Unit (PPU)**

First level peripheral processor. A PPU is contained in the mainframe in a multimainframe environment and operates synchronously with the mainframe. Sometimes referred to as FLPP.

## **Permanent File**

A mass storage file cataloged by the system so its location and identification are always known to the system. Permanent files cannot be destroyed accidentally during normal system operation. They are protected from unauthorized access according to privacy controls specified when they are created.

## **Permanent File Transfer Facility Service (PTFS)**

PTFS is an application program servicer started by RHF or NAM when requested by a PTF on another host. The PTFS application assists the PTF application in completing the file transfer by performing those permanent file functions requested by the user and then transferring the file between PTF and PTFS.

## **Physical Identifier (PID)**

The unique three-character identifier of a specific host.

## **Physical Record Unit (PRU)**

The amount of information transmitted by a single physical operation of a specified device. For mass storage files, a PRU is 64 central memory words (640 characters). For magnetic tape files, the size of the PRU depends upon the tape format. A PRU that is not full of user data is called a short PRU. A PRU that has a level terminator but no user data is called a zero-length PRU.

## **Preserved File**

A mass storage file that is recovered on all levels of system deadstart. This includes permanent files, queued files, and system dayfiles.

## **Programmable Format Control**

Spacing and format control for 580 line printers provided by the use of software and a microprocessor instead of a carriage control format tape.

## **PRU**

Refer to Physical Record Unit.

## **Pseudo A Register**

A software register used by DSD to function channels and to manipulate peripheral hardware devices from the operator's console.

## **Pseudo PP**

A pseudo PP emulates the CIO PP program. It is assigned when using buffered devices.

## **Q**

## **Queue File Transfer Facility (QTF)**

QTF is an application program initiator that periodically scans the I/O queues searching for files to transfer. When it finds a file to transfer, it initiates and completes the queue file transfer with the help of its servicing application, QTFS on another host.

**Queue File Transfer Facility Servicer (QTFS)**

QTFS is an application program servicer started by RHF or NAM when requested by a QTF on another host. The QTFS application assists the QTF application in completing the transfer by receiving the queue file and placing it in the I/O queue.

**Queue Priority**

An attribute associated with input and output files. If all other factors are equal, queue priority is used to select the best file for processing.

**Queue Transfer Facility Initiator (QTFI)**

Refer to Queue File Transfer Facility.

**Queued File**

An input, print, plot, or punch file that has an entry in the QFT, is not assigned to an EJT entry, and is waiting to be selected for processing.

**Queued File Table (QFT)**

A central memory resident table containing a four word entry for all active input and output queue files.

**R****Recoverable Job**

A job currently in a detached state that is recoverable from an interactive terminal.

**Remote Batch Job**

A job submitted from a remote batch terminal.

**Remote Host Facility (RHF)**

A central processor program that executes at a system control point. It performs data buffering and switching, and is the intermediary between application programs and the network.

**Rollout**

The removal of jobs from central memory to mass storage before execution is complete, so the control point and central memory can be assigned to another job. A job is rolled out when it is waiting for an external event, when its control point and/or central memory is needed by a higher priority job, or when it exceeds its central memory time slice.

**Rollout File**

A file containing a job (and system information) that is temporarily removed from the main processing area of the system.

**S****SABRE**

A disk unit that may be configured as part of the Disk Array Subsystem (DAS). It has a formatted capacity of 1039 megabytes.



## **Scheduling Priority**

An attribute associated with an executing job available for job scheduling. Scheduling priority is used to select the best executing service class job for processing.

## **SCOPE 2 Station Facility (SSF)**

A NOS subsystem that allows a NOS user to submit a batch (including batch jobs that require interactive I/O) job to a linked SCOPE 2 system. The submitted job uses standard SCOPE 2 control statement but can access NOS files stored on the originating NOS system.

## **Screen Management Facility (SMF)**

A subsystem that alters the performance characteristics of the Full Screen Editor (FSE) by using a single multiuser editor rather than multiple copies of the single user editor. The absence or presence of SMF is not directly detectable by the user of FSE. Performance can be optimized by disabling SMF for small mainframes with heavy interactive workloads and by enabling SMF for large configurations.

## **Service Class (SC)**

An attribute associated with a queued file or executing job. Service class determines how the system services the job.

## **Solid State Disk**

A disk unit that may be configured as part of the Disk Array Subsystem. It has a formatted capacity of 165 megabytes.

## **SSD**

Refer to Solid State Disk.

## **Status**

Information relating to the current state of a device, line, and so forth. Service messages are the principal carriers of status information. Statistics are a special subclass of status.

## **Status/Control (S/C) Register**

Hardware register used in error detection, logging, and recovery procedures for CYBER 170, 700 series.

## **Step Mode**

A protected or debugging mode for the operating system monitor. The keyboard spacebar must be pressed to process each PP request.

## **Stimulator**

A collection of central memory and peripheral processor programs that enters a hypothetical work load into the system to analyze the effects of such a load on response time and system reliability.

## **Suspended Job**

An interactive job placed in an inactive state. Processing is stopped immediately and recovery information is copied to the rollout file. Processing is resumed as if no interruption took place, if the job's EJT entry is recovered.

**System Debug**

A system in the system debug mode is less tolerant than normal of system errors; that is, it is more likely to hang upon experiencing errors.

**System Job**

A job brought to a control point by the operator.

**System Origin Job**

A job entered at the system console.

**System Resource Unit (SRU)**

A unit of measurement of system usage. The number of SRUs includes the central processor time, memory usage, and input/output resources used for a given job.

**T****Time-Sharing Job**

See Interactive Job.

**Timed/Event Rollout**

A condition in which an executing a job is temporarily removed from central memory, and is rolled back into central memory only when a specified event occurs (for example, a file is no longer busy) or a specified time period elapses.

**Track Reservation Table (TRT)**

Table that describes the physical layout of data on a device and is the key to allocating information on the device.

**Transaction Facility (TAF)**

The network host product application that supports transactional terminal operation.

Transactional refers to a terminal operation that is used to conduct a single, simple data base access or retrieval procedure, such as a business transaction. A transactional terminal is distinctive in that the operator is aware of only the transaction being conducted.

**U****UEBS**

User-accessible extended memory block size. Refer to the NOS Version 2 Analysis Handbook for more information.

**Unit Number**

The setting of a hardware device. Used when more than one hardware unit can be connected to a controller.

Unload

## **Unload**

To remove a tape from ready status, and from computer control, by rewinding beyond the load point.

## **Upline**

The direction of input flow from terminal to host.

## **User Job Name (UJN)**

A one- to seven-character alphanumeric name you specify to replace the system defined JSN for a queued file or executing job.

## **V**

### **Volume Serial Number (VSN)**

A one- to six-character identifier that identifies the volume of magnetic tape to the system. \*

## **W**

### **Warmstart**

Procedure used to deadstart if the tape or disk controller is loaded and the controlware is running.

### **Write Ring**

Circular device inserted into tape reel indicating to the tape unit that it can write on that reel. NOS checks for presence of a write ring upon request.

## **7990**

A large-capacity hardware product for online mass storage. A cost-effective extension of the disk file storage system and an alternative to conventional magnetic tape storage.

### **7990 Catalog**

A disk-resident direct access permanent file that describes which allocation units (AUs) of each cartridge assigned to a particular subfamily are allocated to 7990 files and which AUs are available for allocation.





The following are basic rules and recommendations for operating a multimainframe system.

- Do not mount packs with duplicate labels.
- Verify that shared removable devices are mounted on an active machine before deadstarting a second machine that will access these devices. Check the E,M display on the active machine to determine if the devices are mounted. None can have global unload (N) status set.
- Physically dismount a device only if the global unload (N) status is displayed on the E,M display for that device.
- If a level 3 recovery deadstart is required, press the DEADSTART switch but do not begin recovery until all remaining active machines display the message

\*MACHINE DOWN\*

at the respective system control points.

- If a level 3 recovery deadstart is not possible, or if you attempted a level 3 deadstart and were not successful, MREC must be run on all machines sharing disks with the down machine, followed by a level 0 deadstart on the down machine.
- If you are deadstarting the first machine (no machine is currently operating), you must use the PRESET EQPDECK entry (refer to the NOS Version 2 Analysis Handbook for a description of PRESET).
- If a magnetic tape unit is accessible from more than one mainframe, concurrent use must be disabled by one of the following methods:
  1. Set the access switches on the tape controller such that only one mainframe can access the unit at any time.
  2. Verify that the EST entry for each shared unit is defined as ON in only one of the mainframes.

Refer to the NOS Version 2 Analysis Handbook for more detailed information on multimainframe operation.



# Peripheral Equipment Operation

# D

405 Card Reader Operation . . . . .	D-1
415 Card Punch Operation . . . . .	D-4
533/536 Printer Operation . . . . .	D-5
Switches and Indicators . . . . .	D-5
Setting the Top of the Form . . . . .	D-7
537 Printer Operation . . . . .	D-7
Setting the Top of the Form . . . . .	D-9
580 Line Printer Operation . . . . .	D-10
Format (Carriage Control) Tape Loading . . . . .	D-11
Paper Loading . . . . .	D-14
Ribbon Change . . . . .	D-15
580 Line Printer Programmable Format Control Initialization . . . . .	D-15
585 Printer Operation . . . . .	D-16
Magnetic Tape Units . . . . .	D-17
639 Tape Unit . . . . .	D-17
667 and 669 Tape Units . . . . .	D-19
677 and 679 Tape Units . . . . .	D-21
698 Tape Unit . . . . .	D-22
Tape Unit Operation . . . . .	D-24
Reel Installation . . . . .	D-24
Standard (Noncartridge) Reel . . . . .	D-24
Cartridge-Loaded Reel . . . . .	D-25
Cartridge-Loaded Reel (639 Tape Unit) . . . . .	D-25
Load/Thread . . . . .	D-25
Load/Thread (639 Tape Unit) . . . . .	D-26
Ready Status . . . . .	D-26
Rewind . . . . .	D-27
Unload and Reel Removal . . . . .	D-27
Emergency Stop . . . . .	D-27
Reflective Markers . . . . .	D-27
819 Disk Storage Unit Operation . . . . .	D-28
834/836 Disk Storage Unit Operation . . . . .	D-29
844 Disk Storage Unit Operation . . . . .	D-30
885 Disk Storage Unit Operation . . . . .	D-31
887 Disk Storage Unit Operation . . . . .	D-32
Operating Instructions . . . . .	D-33
895 Disk Storage Unit Operation . . . . .	D-35
9853 Disk Storage Subsystem Operation . . . . .	D-37
Operating Instructions . . . . .	D-39



Power On Procedure .....	D-39
Power Off Procedure .....	D-39
CC545 Display Console Operation (CYBER 170 and CYBER 180 Computer Systems)	D-40
CC598B Display Console Operation (CYBER 180 Computer System) .....	D-41
CC634B Display Console Operation (CYBER 180-810 or 830 Mainframe) .....	D-42
6612 Dual Screen Display Console Operation (CYBER 70 and 6000 Computer Systems)	D-43
Procedure to Initialize Local 255x Network Processing Unit (NPU) .....	D-44
Procedures to Initialize Remote 255x Network Processing Unit (NPU) .....	D-48
Generating SAM-D .....	D-48
Duplicating SAM-P .....	D-49
Mass Storage Extended Subsystem (MSE) .....	D-50
Adding Cartridges .....	D-51
Removing Cartridges .....	D-51
5380-100 STORNET Subsystem .....	D-52
Operator Controls and Indicators* .....	D-52
Power Control .....	D-52
Warning Control .....	D-53
Air Flow Sensor Test Switch .....	D-53
Solving NOS Multimainframe Environment Problems .....	D-54
Recommended Actions .....	D-55
Filter Maintenance .....	D-55
Main Filter .....	D-55
Small Filter .....	D-55

All online peripheral equipment runs under the control of NOS. To determine the EST ordinal and current status (ON or OFF) of a device, examine the EST display. A device must be logically ON before it can be used by NOS. Refer to the description of the ON command in chapter 3 to logically turn on a device.

The 533, 536, 537, and 585 printers operate under the control of the Printer Support Utility (PSU). Refer to chapter 3 for information on PSU commands.

## 405 Card Reader Operation

Once the MAIN POWER switch on the card reader is lit, load and start the reader as follows:

1. Set guide edge of input feed hopper and output stacker for length of card. The narrow half of each tray may be removed, turned end-for-end, and reassembled as necessary.
2. Load cards into hopper, placing column 1 at right as cards face entrance of read station.
3. Check input wall of secondary and main output stackers. If standard cards are used, hinged card-stopping blocks should be positioned to form a flush surface at each input wall. If short cards are used, hinged block assemblies must be pivoted to protrude from wall surfaces of each stacker.
4. At feed hopper, set card-stopping pin to protrude from faceplate if short cards are used. Turn pin in clockwise direction to form flush wall if long cards are used.
5. If short cards are to be read, press 51 COLUMN switch until it lights.
6. To check operation:
  - a. If MAN is not lighted on AUTO/MAN switch, press switch to place equipment in manual mode.
  - b. If STOP is not lighted on RUN/STOP switch, press switch so that STOP lights.
  - c. Press MOTOR POWER switch. Light should turn on and input hopper should begin vibrating.
  - d. Press READY switch until it lights.
  - e. Press SINGLE PICK switch to cause first card to be read and transferred to output stacker. No light exists. If card does not move properly, check read station for an obstruction.
  - f. Press MOTOR POWER to stop vibrators and replace card in input hopper.
7. To allow cards to be read:
  - a. Press RUN/STOP so that RUN lights, if necessary.
  - b. Press AUTO/MAN so that AUTO lights.
  - c. Press MOTOR POWER so that it lights.
  - d. Press RELOAD MEMORY. It does not light.
  - e. Press READY until it lights.

The switches and indicators on the reader (figure D-1) are explained in the following paragraph. They differ slightly depending upon the type of controller (3649 or 3447). The controllers are an integral part of the card reader equipment.

**MAIN POWER**

Controls all primary power and turns on the photocell light source. It is lit when power is on. It must be on before subsequent operations are effective.

**MOTOR POWER**

Controls power to the drive motors, the vacuum-pressure system, and the hopper-stacker vibrators. It must be on before the READY status is effective. It is lit when on.

**AUTO/MAN**

Selects manual or program controlled modes of operation. The switch must be in the AUTO position when the reader is to be controlled by the system. Change switch position to MAN to disable system control and allow you to cycle cards manually.

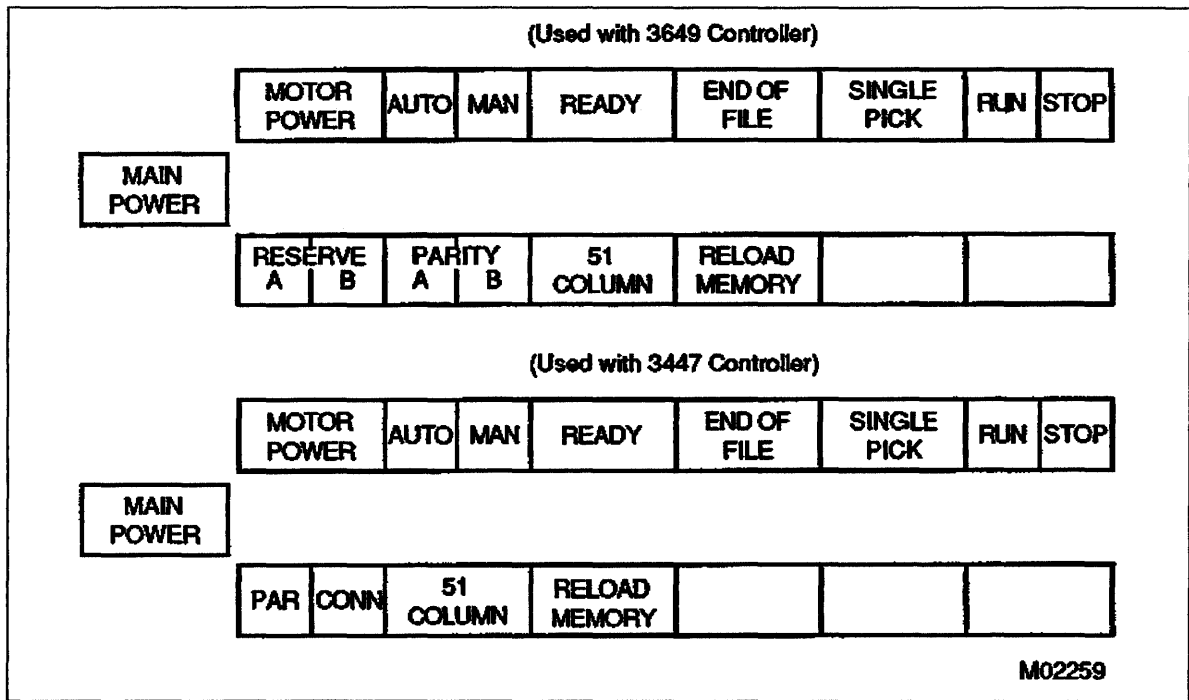

**Figure D-1. Card Reader Switches**

**READY**

The switch lights to indicate the ready condition. When the switch is pressed, the first card is read into buffer memory. Thereafter, the reader is under system control. If the input hopper is empty, error conditions exist on the device, the output stacker is not closed or it is full, a not ready condition exists.

**END OF FILE**

Causes the reader to generate an end-of-file status bit after the last card in the input tray is read. It lights when set. If the last card in the input tray is not the last card in the file being read into the system, this switch should be off. Currently not used by NOS. Included for compatibility with previous systems.

**SINGLE PICK**

Cycles a single card through the reader when the AUTO/MAN switch is in MAN position. It does not light.

**RUN/STOP**

The card feed may be controlled manually when the AUTO/MAN switch is in MAN position. The set side is lit.

**RESERVE A/B (3649 Controller only)**

One side lights as one of the two converters attached to the controller reserves reader access.

**PARITY A/B (3649 Controller only)**

This light appears only when a parity error occurs during the transmission of a connect or function code. An error message will appear on the console screen.

**PAR/CONN (3447 Controller only)**

Similar to the RESERVE and PARITY switches of the 3649 Controller in that one side lights for a parity error and the other when the reader is connected to the controller channel.

**51 COLUMN**

Allows short (51-column) cards to be read. It is lit when set.

**RELOAD MEMORY**

Feeds data from a new card into card reader memory buffer when pressed, providing AUTO/MAN is in AUTO. It does not light. It should be pressed prior to each READY.

Inside the right front door are several lights that indicate malfunction. If FEED/FAIL is lighted, a card is not acceptable or a card jam exists. Lifting the read station panel will expose the card guides. The PRE-READ and COMPARE lights indicate that the preread and read stations do not interpret a card identically. If the card reader stops during operation, examine the BIO (I) display to determine the action to take. The action can involve rereading one or several cards. If the card reader stops at the end of a batch job, check the I display to ensure that there were no errors on the last card.

## 415 Card Punch Operation

The 415-30 card punch contains the 3446 controller in the same cabinet. The controller for the 415 card punch, 3644 or 3446, is in a separate cabinet. It has the equipment number switch that establishes the equipment number for the punch in the EST display. With the exception of the lights mentioned in the following paragraph, controller switches are the responsibility of the customer engineer.

Once the MAIN POWER and MOTOR POWER switches on the card punch are lit, operation is initiated as follows:

1. Place cards face down in input hopper with row 9 toward rear.
2. Check that chip box and output stacker are not full.
3. Advance two cards into the punch and read stations by pressing the SINGLE PICK switch twice.
4. Check the controller equipment. If either the NOT READY or FAIL TO FEED light is on, cards have not advanced into the punch and read stations.

The card punch is then ready for operation.

Switches on the card punch (figure D-2) have the following functions.

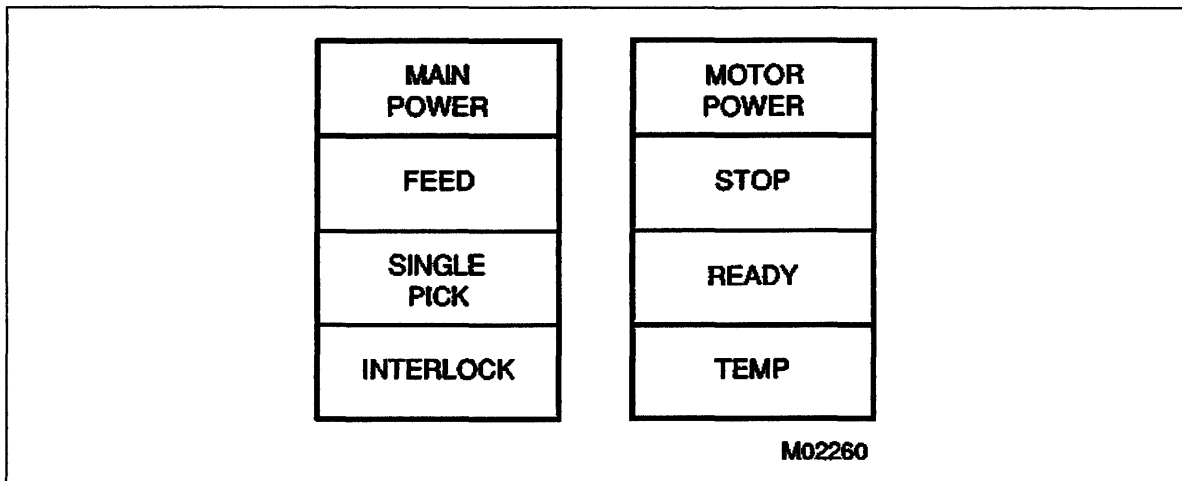

**Figure D-2. 415 Card Punch Switches**

### MAIN POWER

This switch applies power to the cooling fans and the power supplies. It is lit when power is on.

### MOTOR POWER

This switch applies power to the punch motor. It is lit when power is on.

### FEED

This indicator is lit when a card jam exists. A message CPuu NOT READY appears at the console. Call a customer engineer to remove the jammed card.

**STOP**

This switch causes the punch to become not ready. It lights when pressed to stop system control.

**SINGLE PICK**

This switch advances cards one station in the input hopper-punch-read-output cycle. It lights until the advance is complete.

**READY**

This switch clears punch logic and puts it in automatic mode for system control. It lights when the punch is in a ready condition. If it does not light when pressed, conditions such as feed failure and full output stack should be examined and corrected.

**INTERLOCK**

This switch lights if the head panel, hood panel, or right door is open. All should be closed during operation.

**TEMP**

If this light is on, the temperature of the punch exceeds operation requirements. Consult a customer engineer.

A toggle switch at the top of the output stacker automatically turns off the card punch when the stacker is full. Reset the switch when cards are removed from the stacker.

## 533/536 Printer Operation

The 533 or 536 printer includes a set of instruction cards. The instruction cards are attached to the top of the printer just under the plastic lid.

### Switches and Indicators

Figure D-3 shows configuration of the 533 or 536 printer switches. The switches and indicators on the printer (figure D-3) have the following functions.

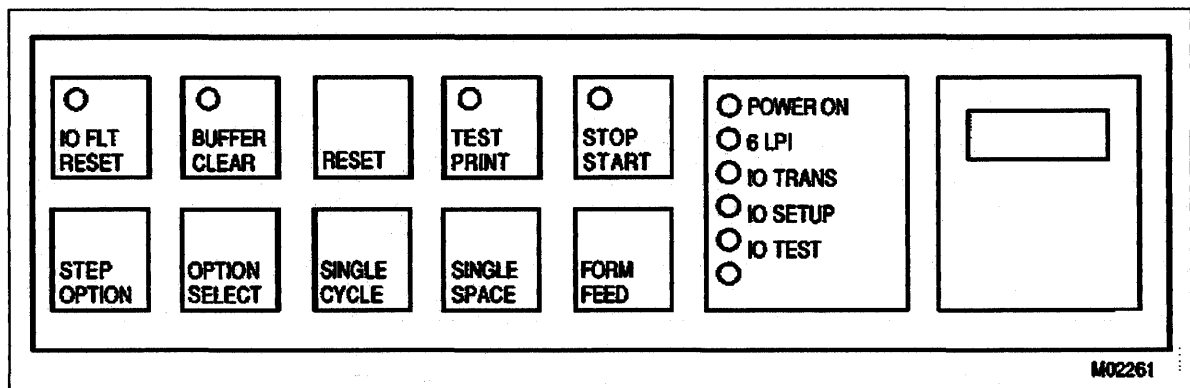

**Figure D-3. 533/536 Printer Switches and Indicators**

**IO FLT RESET**

This indicator lights when an I/O fault is detected.

### **BUFFER CLEAR**

This indicator lights when unprocessed data is in the I/O buffer. When the switch is pressed, the I/O buffer memory is cleared of all data.

### **RESET switch**

This switch removes the code on STATUS DISPLAY when pressed after the fault condition has been corrected. It also turns off the alarm beeper after a media fault has been corrected.

### **TEST PRINT**

This switch prints a test pattern.

### **STOP/START**

This is both an indicator and a switch. The indicator is off when the printer is in the STOP mode. When the switch is pressed, the indicator lights and the printer is in START mode. When in START mode, the printer can accept the print data from the data source.

### **POWER ON**

This indicator lights when POWER ON/OFF switch is ON.

### **6 LPI**

This indicator lights when vertical line spacing is one-sixth inch. If not lit, the vertical spacing is one-eighth inch.

### **IO TRANS**

This indicator lights when characters are received or transmitted across the interface lines.

### **IO SETUP**

This indicator lights when switches are set for your (or customer engineer) option setup.

### **IO TEST**

This indicator lights when switches are set and internal, local, or remote loopback tests are in progress.

### **STEP OPTION**

This switch allows you to view all possible option numbers in the two leftmost digits on the control panel's STATUS DISPLAY. This switch functions only when switches are set on the control panel. Refer to card 4 for switch setup and description of option numbers.

### **OPTION SELECT**

This switch allows you to choose options once they are accessed by the STEP OPTION switch. The option number appears in the two leftmost displays. Pressing the STEP OPTION switch sets the option. Refer to card 4 for more information.

### **SINGLE CYCLE**

This switch activates the printer to receive and print one line of data each time the switch is pressed.

### SINGLE SPACE

This switch advances the paper one line. Holding the switch down advances the paper continuously one line at a time until released.

### FORM FEED

This switch advances the paper to the top of the next form.

## Setting the Top of the Form

To set the top of the form, follow these steps:

1. Set power switch to ON position. (Switch is under the right side of the printer.)
2. Turn the paper roller so the top perforation line on the form lines up with the top of the ribbon.
3. Set power switch to OFF position.
4. Set power switch again to ON position. This sets the top of the form. When you press the FORM FEED switch, the paper will advance to the same relative position on the next form.
5. Press the STOP/START switch, which turns on the indicator light and puts the printer in the START mode.

## 537 Printer Operation

Figure D-4 shows configuration of the 537 printer switches. The switches and indicators have the following functions.

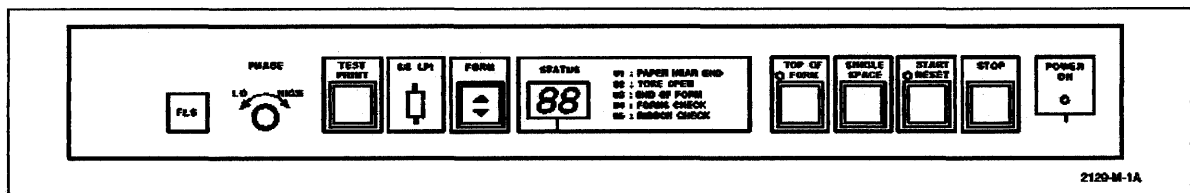

**Figure D-4. 537 Printer Switches and Indicators**

### FLS

This switch is enabled in the offline mode. Pressing this switch validates the form length set (FLS).

### PHASE

This control knob sets the position of the characters to be printed. Turning the knob clockwise shifts the printed characters to the right and turning the knob counterclockwise shifts the printed characters to the left.



### TEST PRINT

- Pressing this switch causes the printer to print sliding ripple patterns in all columns. Pressing it again stops this print.
- Pressing this switch while pressing the STOP switch causes the printer to print the character H in all columns. Pressing it again stops this print.

### 6/8 LPI

This switch sets the vertical line density to 6 lines/inch or 8 lines/inch, respectively. The printer accepts the setting only when the printer is in the offline mode and the TOP OF FORM indicator is on.

### FORM

This switch is enabled in the offline mode and is used for fine adjustment of the vertical print position. Pressing this switch advances the forms slightly. Pressing this switch while pressing the STOP switch reverses the forms slightly.

### STATUS

This indicator displays the two-digit error status code.

### TOP OF FORM

This switch is enabled in the offline mode. Pressing this switch advances the forms to the next top-of-form position. The indicator goes on when form feeding is completed.

### SINGLE SPACE

This switch is enabled in the offline mode. Pressing this switch advances the forms one at a time.

### START/RESET

This switch puts the printer in the online mode if the printer has no error. The indicator remains on while the printer is in the online mode. If the printer has an error, press this switch to clear the error status.

### STOP

This switch puts the printer in the offline mode.

### POWER ON indicator

This indicator lights when power is on.

## Setting the Top of the Form

To set the top of the form, follow these steps:

1. Press the STOP switch.
2. Press the FLS switch.
3. The existing form length is shown on the STATUS display in number of lines.
4. To increase the form length:
  - Push the FORM switch once to increase the form length by one line.
  - Push the TOP OF FORM switch to increase the form length by 10 lines.
5. To decrease the form length:
  - Hold the STOP switch and push the FORM switch once to decrease the form length by one line.
  - Hold the STOP switch and push the TOP OF FORM switch to decrease the form length by 10 lines.
6. At the desired form length, push the FLS switch again to enter the value. This sets the top of the form. When you press the TOP OF FORM switch, the paper advances to the same relative position on the next form.

---

### NOTE

- The form length returns to the default value when the printer is powered off.
- If the form length is over 100 lines, the display shows the number of lines with a decimal point. To determine the actual number of lines, drop the decimal and add 100.

For example:

$$3.2 = 32 \text{ plus } 100 = 132 \text{ (over 100 lines)}$$

$$32 = 32 \text{ (under 100 lines)}$$

$$2.5 = 25 \text{ plus } 100 = 125 \text{ (over 100 lines)}$$

$$25 = 25 \text{ (under 100 lines)}$$

- Maximum form length is 192 lines.
- 

For operating information including procedures, troubleshooting, and preventive maintenance, refer to the CDC 537 Band Printer Operator Guide.

## 580 Line Printer Operation

The 580 line printer includes both the printer and controller in one cabinet. Operator manual controls on the back duplicate three switches on the front to facilitate removing paper. Figure D-5 shows configuration of the 580 Line Printer switches. (For more information on 580 line printer format control, refer to the NOS Version 2 Analysis Handbook.)

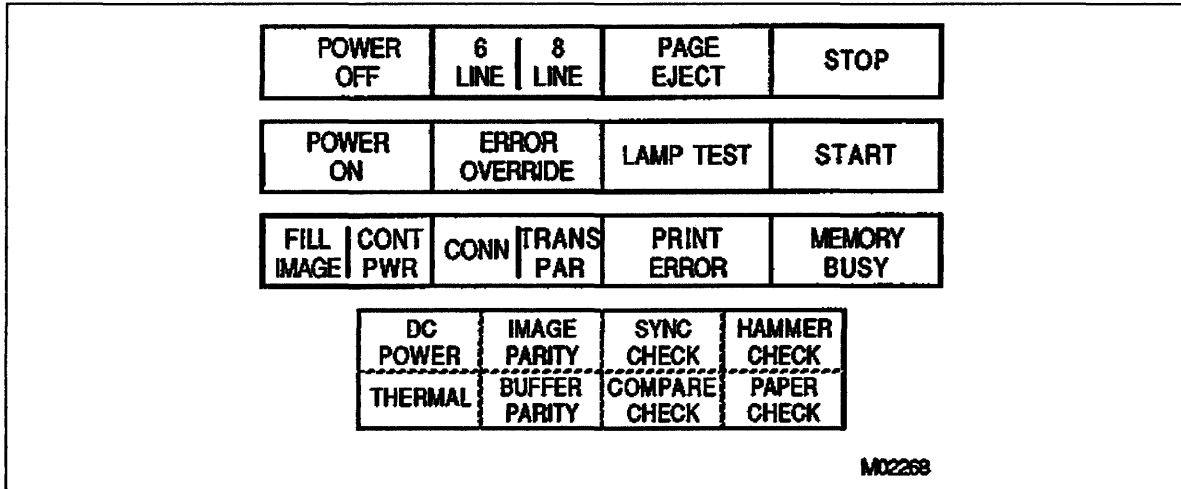

**Figure D-5. 580 Line Printer Switches**

When the POWER ON switch lights, control the printer's operation with the following switches.

### POWER OFF

This switch turns off power supply.

### 6 LINE / 8 LINE

This switch alternates between 6 and 8 line-per-inch spacing. One-half of the indicator is lit, depending on which spacing mode is selected.

### PAGE EJECT

Under manual control, this switch advances paper to top of form as determined by format loop control.

### STOP

This switch stops printer control.

### LAMP TEST

This switch causes all lamp indicators on the control panels to light.

### START

This switch prepares printer (lights when selected).

The remaining indicators light when the condition specified occurs.

## **Format (Carriage Control) Tape Loading**

1. Press the POWER HOOD switch to raise hood.
2. Loosen the tape spool and slide it toward the drive hub.
3. Place the format tape on the drive hub in the space between the reader and the lamp housing. The coincidence lines on the format tape must align with the scribe lines on the drive hub. The arrows on the tape must point to the back of the printer.
4. Place the format tape over the tape spool, slide the tape spool down the slot until there is 1/8-inch slack in the format tape loop.
5. Tighten the tape spool.

Standard format tape configurations for short and long paper for the 580 Line Printer are given in figure D-6 and figure D-7.

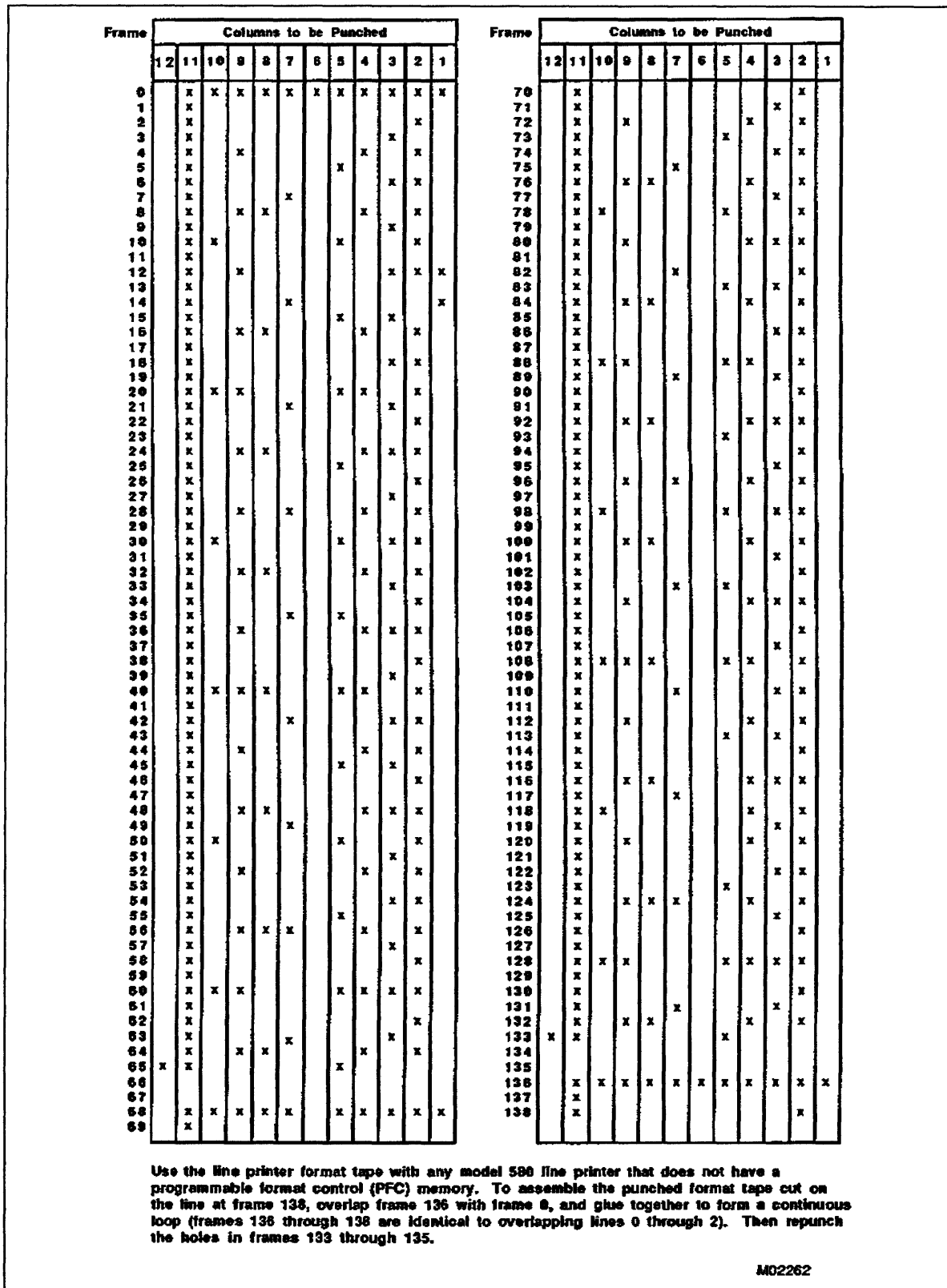

Figure D-6. Line Printer Format Tape Configuration for Short Paper

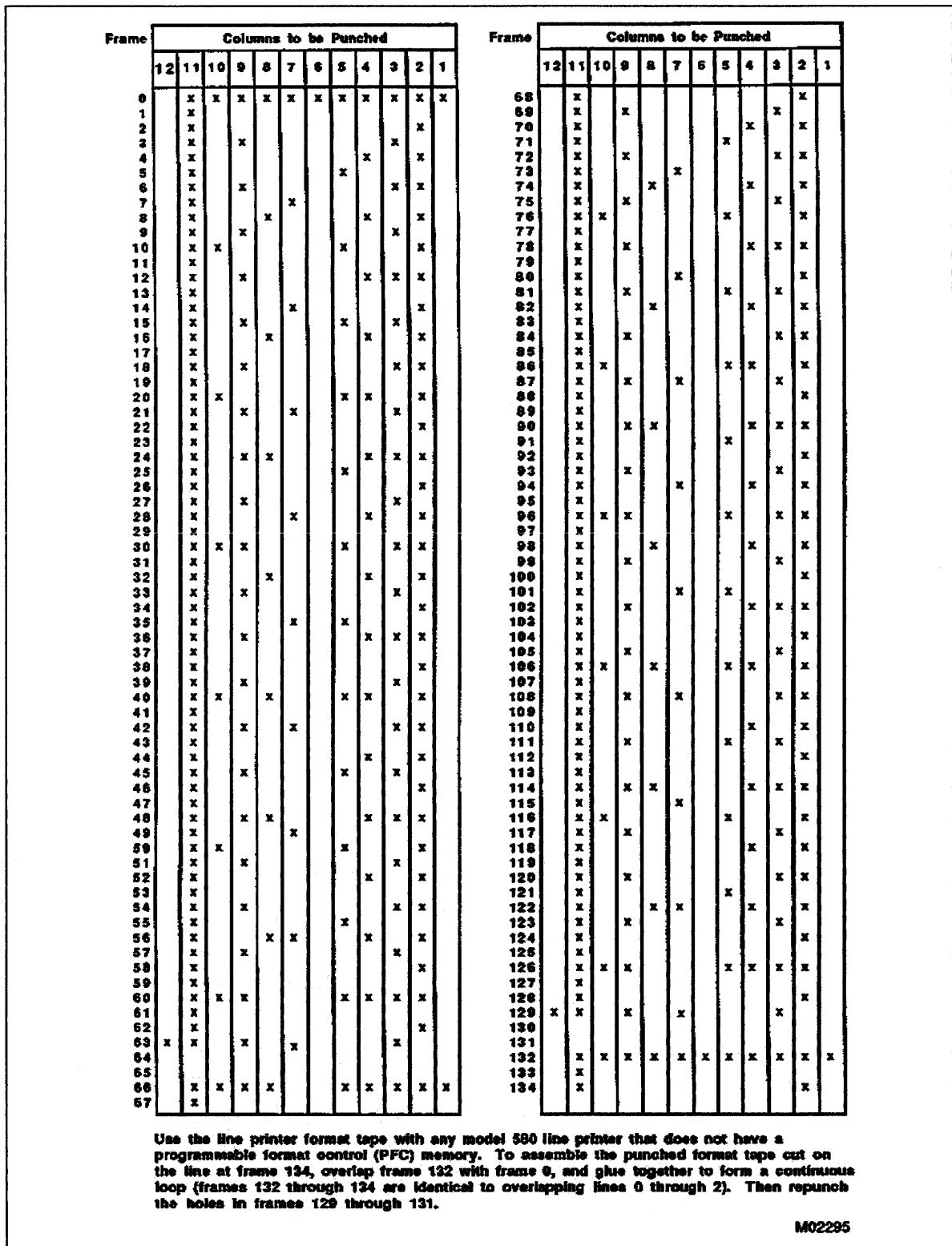

Figure D-7. Line Printer Format Tape Configuration for Long Paper

## **Paper Loading**

To load paper into the 580 printer:

1. Press POWER HOOD switch on left side of cabinet to raise hood.
2. Remove old paper supply with PAGE EJECT switch.
3. Open front printer gate.
4. Open pressure plate on upper and lower left and right tractors.
5. Raise paper vertically from supply box and place into upper and lower paper tractors. Ensure that header page will always be an inner page (that is, page is visible when output is laid flat) by placing inner fold at front edge of printer's paper bail assembly. Close all four pressure plates.
6. Close front panel securely.
7. Press PAGE EJECT four times and manually feed the forms over the paper bail and into the stacker exit rollers.
8. In back of printer, press PLATFORM DOWN switch to lower forms platform.
9. Press PAGE EJECT to observe that forms fold properly and are correctly aligned.
10. Press PLATFORM UP switch and observe that forms fold and fit properly as platform rises.

To load forms of a different width or thickness:

1. Move tractors to approximate position by loosening the tractor locking knob and sliding tractors until aligned. Tighten locking knob.
2. Place forms in upper left paper tractor and close tractor door.
3. Place forms in lower left paper tractor and close tractor door.
4. Place forms in upper right paper tractor and close tractor door.
5. Place forms in lower right paper tractor and close tractor door.
6. Slide the two right tractors to adjust the horizontal paper tension. Forms should not buckle (too loose) and the tractor pins should not deform the holes (too tight). Tighten the tractor locking knobs on the right hand tractors.
7. Close the forms alignment scale against the paper. The scale indicates print column location and the top of the ribbon shield indicates the bottom of the next line of print.
8. Adjust the horizontal position control to align the forms with the proper print columns.
9. Place the forms lock control in the manual position and adjust the manual forms advance control to align forms vertically to the top of forms position.
10. Place the forms lock control in the auto position, relatch the forms alignment scale to the print gate, and the print gate to the print head.
11. Press PAGE EJECT three times and manually feed the forms over the paper bail and into the stacker exit rollers.

12. In back of printer, press PLATFORM DOWN switch to lower forms platform.
13. Press PAGE EJECT to observe that forms fold as originally folded, that multipart forms do not separate, and that the forms are properly aligned to the forms scales.

### **Ribbon Change**

1. Press the POWER HOOD switch on left side of cabinet to raise hood.
2. Press POWER OFF switch.
3. Unlatch print gate and swing away from the print head.
4. Unlatch ribbon cover and swing away from the print gate.
5. Unlatch line finder and swing away from the print gate.
6. Grasp the ribbon rolls with the left hand on the upper roll and the right hand on the lower roll.
7. Push the rolls toward the hinged end of the print gate. Lift the upper roll up and off the spool and the lower roll down and off the spool.
8. Pass the left hand over, behind, and then under the print gate and remove the ribbon.
9. After the new ribbon is unwrapped, grasp one roll in the left hand and the other roll in the right hand.
10. Approaching print gate from the latch end, hold right hand in front of lower ribbon spools. Pass ribbon roll in left hand under, behind, and over the print gate bringing it to the upper ribbon spools.
11. Press ribbon roll in left hand against the upper ribbon spool on the hinged end of the print gate and press the roll in right hand against lower ribbon spool.
12. Ease the ribbon rolls into place against the ribbon spools on the latch end of the print gate ensuring that the drive keys on the ribbon spools fit into the slots in the ribbon rolls.
13. Rotate upper ribbon roll to take up slack.
14. Latch line finder and ribbon cover to print gate and close print gate.
15. Press POWER ON switch.

### **580 Line Printer Programmable Format Control Initialization**

1. Press POWER ON switch.
2. Press PAGE EJECT switch. The printer controller advances to the next 6/8 lines per inch (LPI) coincident point. The tractors advance accordingly.
3. Press POWER HOOD switch on left side of cabinet to raise hood.
4. Open front printer gate.
5. Open pressure plate on upper and lower left and right tractors.



6. Raise paper vertically from supply box and place into upper and lower paper tractors. Close all four pressure plates.
7. Close front panel securely.
8. Align paper to top of form by pressing the PAGE EJECT switch, causing the paper to advance to subsequent 6/8 LPI coincidence points as required. Paper thus positioned will be at top of form when the system loads a PFC array before a job is printed.
9. Close the forms alignment scale against the paper. The scale indicates print column location and the top of the ribbon shield indicates the bottom of the next line of print.
10. Adjust the horizontal position control to align the forms with the proper print columns.
11. Place the forms lock control in the manual position and adjust the manual forms advance control to align forms vertically to the top of forms position.
12. Place the forms lock control in the auto position, relatch the forms alignment scale to the print gate, and the print gate to the print head.
13. Press START switch.

**NOTE**

---

This initialization procedure assumes that the first code loaded into the PFC buffer will be top of forms (format level 1).

---

BIO loads the PFC buffers at the start of each print file. Prior to loading a PFC array, pressing the PAGE EJECT switch advances the paper to the next 6/8 LPI coincident point. After a PFC array has been loaded into the printer, pressing PAGE EJECT causes an entire form to be ejected.

## **585 Printer Operation**

The operator control panel on the 585 printer has, in addition to the usual controls, a display that shows the print band position. This indicates whether the print band needs adjusting. The display also shows error conditions that cause the printer to go to a not ready state. For complete operating information, including procedures, troubleshooting, and preventive maintenance, refer to the CDC 585 Band Printer Operator's Manual.

## Magnetic Tape Units

NOS supports unit models 667 and 677 for 1/2-inch, 7-track magnetic tape and models 639, 669, 679, and 698 for 1/2-inch, 9-track tape.

All models except 639 show a unit identification number at the top of the cabinet (right side of the controls on a 667 or 669 unit, left side of the controls on a 677 or 679 unit) that ranges from 0 to 17. The unit number of a 667 or 669 tape unit is set using the UNIT NO/HOLD REL select switch next to the unit number display. Each unit that is on should have a unique number, but once this switch is set, it can be ignored during operation. It is not possible to change unit numbers on 677, 679, or 698 tape units.

### NOTE

---

Do not change unit numbers on 667, 669, or 698 tape units when the magnetic tape subsystem is being used.

---

The system and the operator identify a unit by its EST ordinal as shown in the E display. Installations usually configure the system so the last digit of an ordinal for a tape drive is the same as the unit select switch setting, making it easier to equate the two.

Online operation of tape units except 639 is controlled and synchronized with system demands by an associated tape control unit. Power up and autothread/autoload operations are facilitated by front panel controls and indicators located at the top front of the tape unit. Controls for 667/669, 677/679, and 698 tape units differ slightly, as described later in this chapter.

If a magnetic tape unit is currently assigned to a job, it cannot be unloaded. Examine the tape status (E,T.) display to determine if the magnetic tape unit is currently assigned to a job. If it is not, entering the UNLOAD command causes the tape to unload. Refer to the description of UNLOAD in chapter 3.

### 639 Tape Unit

The functions of the membrane switches and indicators on the 639 tape unit (figure D-8) are described next. Switches with alternate actions are described in terms of first (1) and second (2) action.

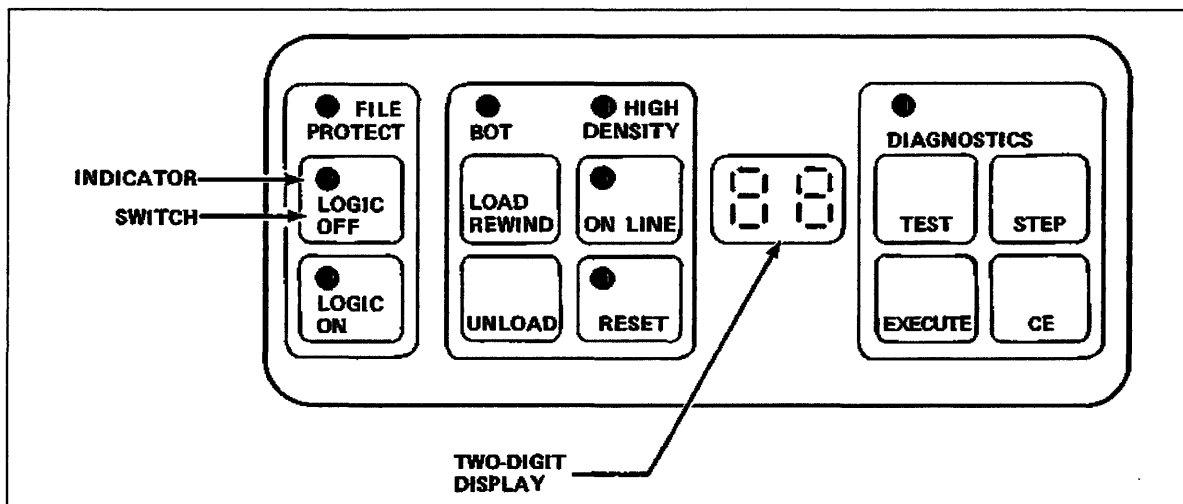

**Figure D-8. 639 Tape Unit Operator Control Panel**

#### FILE PROTECT

No switch function. When illuminated, it indicates absence of a write ring in the tape reel. Disables the write circuitry and conditions the unit to accept only read functions.

#### LOGIC OFF

This switch deactivates power circuits, places tape unit in power-down status, and lights indicator.

#### LOGIC ON

This switch activates power circuits, places tape unit in power-up status, and lights indicator.

#### BOT

No switch function. Illuminates when loadpoint marker is detected.

#### LOAD/REWIND

- (1) Initiates load operation (reel-to-reel contact, thread and set loops).
- (2) When unit is loaded but not ready, initiates rewind to load point operation.

#### UNLOAD

If the unit is loaded but not ready, the tape is rewound to BOT and the tape unit is unloaded.

#### HIGH DENSITY

No switch function. Illuminates when unit is in GCR mode.

#### ONLINE

This switch places tape unit under system control via tape control unit. Light indicates unit is in ready status awaiting system activity.

**RESET**

This switch lights when error condition exists, or at the completion of a diagnostic test. To clear error condition follow logic-off or logic-on sequence.

**TWO-DIGIT DISPLAY**

This switch lights when tape unit is in offline diagnostic or test mode.

**DIAGNOSTICS**

No switch function. Lights when tape unit is in diagnostic or test mode.

**TEST**

This switch places the tape unit in diagnostic or test mode.

**EXECUTE**

This switch executes the two-digit diagnostic or test display.

**STEP**

This switch sequences the diagnostic test numbers.

**CE**

This switch initiates special diagnostics to aid customer engineer.

**667 and 669 Tape Units**

The functions of the switches and indicators on the 667/669 tape unit (figure D-9) are described below. Switches with alternate actions are described in terms of first (1) and second (2) action.

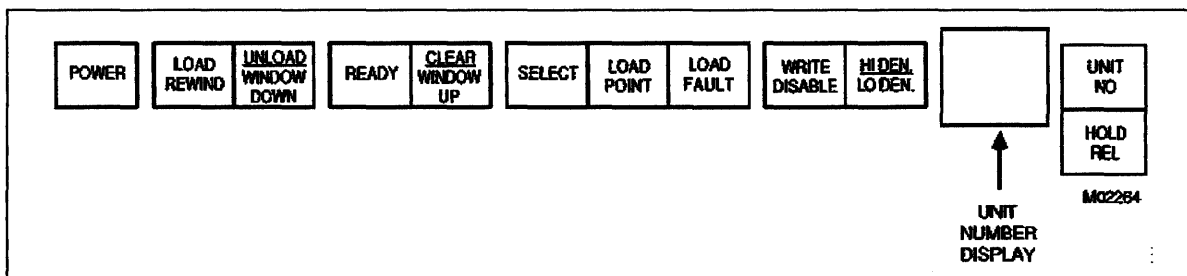

**Figure D-9. 667/669 Tape Unit Operator Control Panel**

**POWER**

- (1) Activates power circuits, places tape unit in a power-up status, and lights indicator.
- (2) Deactivates power circuits, places tape unit in a power-down status, and turns off indicator light.

**LOAD REWIND**

- (1) Initiates load operation (reel-to-reel contact, thread and set loops).
- (2) When unit is offline, initiates rewind to loadpoint operation.

### UNLOAD/WINDOW DOWN

This switch initiates unload operation by rewinding leader length onto right reel.

### READY

This switch places tape unit under system control via tape control unit. Light indicates unit is in ready status awaiting system activity. Light extinguishes when a fault condition is detected.

### CLEAR/WINDOW UP

When tape unit is online, negates READY condition and stops tape motion. When unit is offline, stops tape motion and clears fault condition. Light comes on when loop fault is detected.

### NOTE

---

Do not use this control during system operation.

---

### SELECT

No switch function. Light comes on when tape unit is selected by tape control unit.

### LOAD POINT

No switch function. Illuminates when loadpoint marker or end of tape marker is detected, depending upon tape motion direction.

### LOAD FAULT

No switch function. Indicates a fault occurred during load procedure.

### WRITE DISABLE

No switch function. Illuminated, it indicates the absence of a write enable ring in the right tape reel. Disables the write circuitry and conditions the tape unit to accept only read functions.

### HI DEN/LO DEN

No switch function. HI DEN illuminates in phase mode for 9-track tapes or in 800-cpi NRZI mode for 7-track tapes. LO DEN illuminates in 800-cpi NRZI mode for either 9- or 7-track tapes or for 556-cpi NRZI mode for 7-track tapes.

### Unit Number Display

This switch shows tape unit number in octal numbers, 00 to 17.

### UNIT NO/HOLD REL

Two-position rocker switch used to assign tape unit number. Pressing UNIT NO causes that portion of the switch to light, indicating that a hold status is being sent to the tape controller unit. Numbers shown on the unit number display advance until UNIT NO is released. Pressing HOLD REL removes the hold status on the tape unit; the indicator light turns off.

## 677 and 679 Tape Units

The functions of the switches and indicators on the 677/679 tape unit (figure D-10) are described below. Switches with alternate actions are described in terms of first (1) and second (2) action.

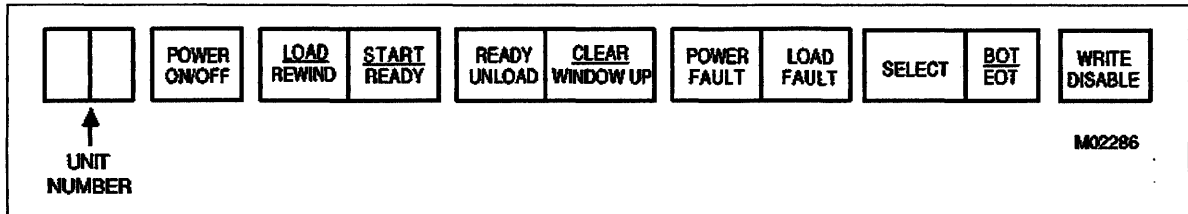

**Figure D-10. 677/679 Tape Unit Operator Control Panel**

### POWER ON/OFF

- (1) Activates power circuits, places tape unit in power-up status, and lights indicator.
- (2) Deactivates power circuits, places tape unit in a power-down status, and turns off indicator light.

### LOAD/REWIND

- (1) Initiates load operation (reel-to-reel contact, thread and set loops).
- (2) When unit is loaded but not ready, initiates rewind to loadpoint operation.

### START/READY

This switch places tape unit under system control via tape control unit. Light indicates unit is in ready status awaiting system activity. Light extinguishes when a fault condition is detected.

### REWIND UNLOAD

If the unit is loaded but not ready, the tape is rewound to BOT and the tape unit is unloaded. If present, the cartridge closes. The reel latch and window open.

If the unit is not loaded or a fault has been detected, the window lowers.

### CLEAR/WINDOW UP

When tape unit is online, pressing this switch negates READY condition and stops tape motion. If the tape unit is offline and the window is down, pressing this switch raises the window. Load check is reset if applicable.

### NOTE

---

Do not use this control during system operation.

---

### POWER FAULT/LOAD FAULT

No switch function. Indicates a power fault occurred or a fault occurred during the load procedure.

### SELECT

No switch function. Light comes on when tape unit is selected by tape control unit.

**BOT/EOT**

No switch function. Illuminates when loadpoint marker or end of tape marker is detected, depending upon tape motion direction.

**WRITE DISABLE**

No switch function. Illuminated, it indicates the absence of a write enable ring in the right tape reel. Disables the write circuitry and conditions the tape unit to accept only read functions.

**698 Tape Unit**

The functions of the switches and indicators on the 698 tape unit (figure D-11) are described next.

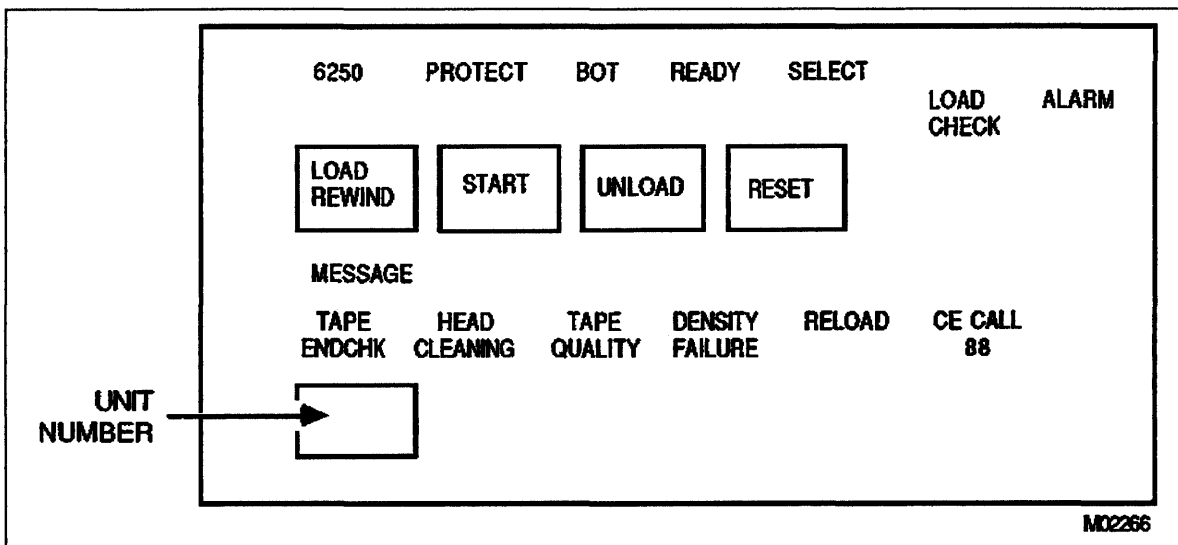

**Figure D-11. 698 Tape Unit Operator Control Panel**

**6250**

No switch function. Lights when processing 6250 cpi (GCR) mode.

**PROTECT**

No switch function. Lights to indicate the absence of a write enable ring in the supply tape reel. Disables the write circuitry and conditions the tape unit to accept only the read function.

**BOT**

No switch function. Lights when loadpoint marker is detected.

**READY**

No switch function. Lights to indicate unit is ready for system activity.

**SELECT**

No switch function. Lights to indicate tape unit is selected by tape control unit.

**LOAD CHECK**

No switch function. Indicates a fault occurred during the load procedure.

**ALARM**

No switch function. Indicates a power fault occurred.

**LOAD/REWIND**

Alternates between two actions:

1. Initiates load operation (reel-to-reel contact, thread and set loops).
2. Initiates rewind to loadpoint operation when unit is loaded but not ready.

**START**

This switch places tape unit under system control via tape control unit. Ready light comes on when unit is ready for system activity. Ready light goes off when a fault condition is detected.

**UNLOAD**

This switch rewinds the tape to BOT and unloads the tape unit if the unit is loaded but not ready. The cartridge closes, if present. The reel latch and window open.

If the unit is not loaded, or a fault has been detected, the window lowers.

**RESET**

This switch negates ready condition and stops tape motion when tape unit is online.

If the tape unit is offline and the window is down, pressing this switch raises the window. Load check is reset if applicable.

**NOTE**

---

Do not use this control during system operation.

---

**MESSAGE**

No switch function. A message is displayed when one of the following conditions occurs.

**TAPE END CHK**

This switch indicates the tape end is damaged. Fix the tape and reload.

**HEAD CLEANING**

This switch indicates the tape head needs cleaning. Clean the tape head and reload.

**TAPE QUALITY**

This switch indicates the tape is damaged, old, or dirty. Replace the tape and reload.

**DENSITY FAILURE**

This switch indicates wrong tape density. This display disappears when the next write command is executed.



### RELOAD

This switch indicates tape must be reloaded.

### CE CALL

Record the two-digit display and call customer engineer.

### TWO-DIGIT DISPLAY

This switch is lit when an abnormal device condition or error exists.

## Tape Unit Operation

All tape units except 639 can handle cartridge-contained tape reels or standard 10-1/2-inch supply reels. Smaller noncartridge reels can be used, but they must be threaded manually. The take-up reel on left side is a vacuum hub assembly permanently attached to the tape unit.

When a load sequence is initiated, the tape reel in the cartridge programs the tape unit to thread tape and load loops into the vacuum columns automatically. Internal delays control the timing of the load/thread operation. If a fault is detected during a load attempt or if a successful load is not achieved, one automatic retry is executed. At the end of the automatic load attempt, the tape unit automatically stops and lowers the power window. When standard reels are used, the automatic retry is inhibited, requiring operator action.

The power window of the tape unit is activated by control logic circuits and is raised or lowered in response to LOAD and UNLOAD commands initiated by you. Initially, when the POWER switch is pressed, the window lowers, allowing access to the tape deck. An interlock protection switch prevents power window operation when the front access door is open.

## Reel Installation

Prior to operating the tape unit, review thoroughly the description of control switches and indicators. The following operating instructions apply to all 667/669 and 677/679 tape units unless specifically noted.

### Standard (Noncartridge) Reel

1. Press POWER switch to power up unit. POWER light comes on and window lowers.
2. Install write-enable ring within inner surface cutout of reel if write operation is to be performed. The write-enable ring is to be installed only if a write operation is to be performed. Valuable data stored on the tape must be protected by removing the write ring when read only operation is to be performed.
3. Place reel onto right hub. Ensure that reel is fully seated against hub face.
4. Manually rotate reel hub clockwise until several inches of tape leader extend along inner surface of tape chute.

**Cartridge-Loaded Reel**

1. Perform steps 1 and 2 as for standard reel.
2. Orient cartridge reel on hub so that locating notches in cartridge retainer and chute assembly align with keys on outer rim of cartridge. Ensure that actuator rod fits into recess of cartridge latch.
3. Press cartridge into place on hub. Seat firmly against hub face.

**Cartridge-Loaded Reel (639 Tape Unit)**

1. Press the LOGIC OFF switch and open the dust cover.
2. Press the LOGIC ON switch. The FILE PRO and HIGH DENSITY indicators light.
3. Install the write-enable ring within the inner surface cutout of the reel if a write operation is to be performed. The write-enable ring is to be installed only if a write operation is to be performed. Valuable data stored on the tape must be protected by removing the write ring when a read-only operation is to be performed.
4. Press the inner button on the face of the right hub. Ensure that the reel is against the rear flange and the curb face is secured against the latch reel.

**Load/Thread**

Operator action, such as pressing LOAD/REWIND switch, initiates a load/thread operation. The cartridge actuator rotates clockwise until the cartridge is brought to the full open position. Observe the following points for either cartridge or standard reels except 639 tape unit.

1. Tape proceeds along tape feed path and enters the left vacuum reel enclosure.
2. Left reel rotates clockwise until load point marker is detected. Reel motion then ceases.
3. Tape is drawn immediately into loop columns and drops below AR and AL sensors.
4. Motion stops when load point marker is correctly positioned.

### Load/Thread (639 Tape Unit)

1. Thread the magnetic tape over the tape path as shown in figure D-12.
2. Wrap the tape onto the bottom reel for several turns.

#### CAUTION

To prevent tape damage, be sure the tape is positioned correctly over all tape path components.

3. Close the dust cover door and press the LOAD/REWIND switch. The pneumatics pump motor starts. After a one-second delay, forward motion is established. Motion stops when the beginning of tape (BOT) reflective marker is detected. If BOT marker was positioned after the sensor, when the tape was threaded, then forward motion continues for approximately 40 feet. The transport then initiates reverse motion until the reflective marker is detected. Motion stops and the BOT indicator lights.

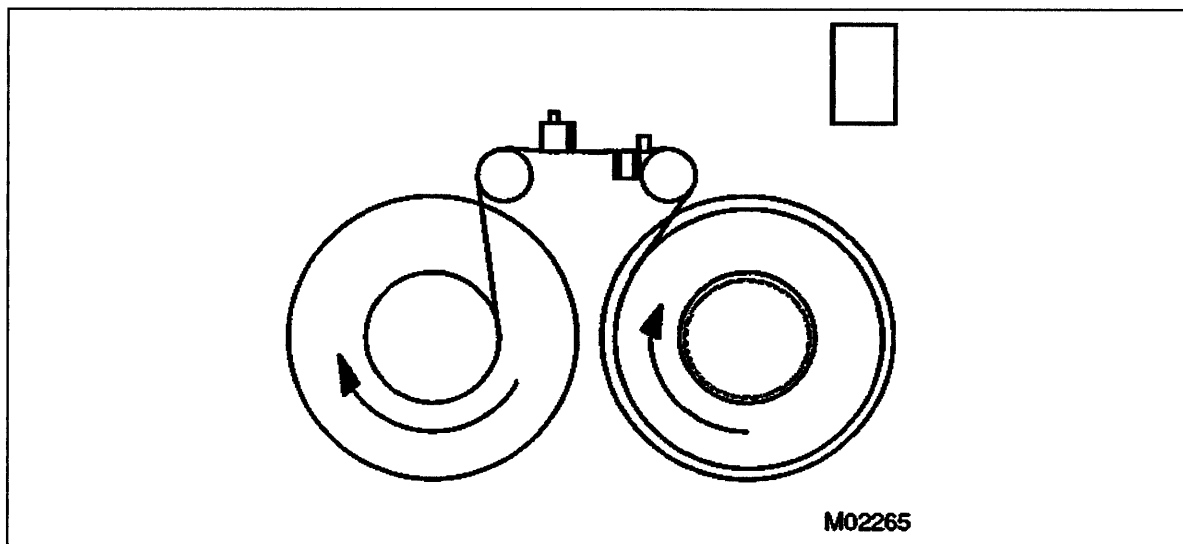

Figure D-12. Tape Path

### Ready Status

At completion of load/thread sequence, the tape unit is placed in ready status if the ONLINE (639), READY (667/669) or START READY (677/679) switch on the front panel of the tape unit has been pressed. The indicator illuminates, followed by the SELECT light or FILE PRO and HIGH DENSITY (639) switch or switches, indicating receipt of an online callup by the system.

## **Rewind**

The LOAD/REWIND (all modes) or RESET followed by the UNLOAD (639) switch rewinds a tape to load point when the tape unit is offline. It is not necessary to use this switch during normal operation, since the operating system controls tape movements.

## **Unload and Reel Removal**

The REWIND/UNLOAD or RESET followed by the UNLOAD (639) switch rewinds and unloads a tape when the tape unit is offline. It is not necessary to use this switch during normal operation, since the operating system controls tape movements. The operator command UNLOAD,est logically unloads a tape that is physically loaded but not in use.

After unload is initiated, the tape rewinds at high speed until the load point marker is detected. A downshift to normal operating speed occurs at load point detection. The leader length unwinds completely from the left onto the right reel and simultaneously, the cartridge closes and the power window lowers (except 639). The automatic hub, if applicable, releases the right tape reel for removal from the tape deck area. For a 639 tape unit, open the dust cover and press the center button face of the right hub. The hub unlatches and the supply reel is removed.

## **Emergency Stop**

Activating of the CLEAR switch terminates the operation in progress in either offline or online mode. Pressing the CLEAR switch once while in rewind mode causes the unit to downshift to normal tape speed: 200, 150, or 100 inches per second. A second activation terminates the rewind operation and stops the tape movement.

## **Reflective Markers**

The load point and end-of-tape markers are placed near the beginning and end of the tape to enable sensing of the usable portion of the tape by the photocells. Adhesive material on one side of reflective material secures the markers to the tape. Vaporized aluminum deposited on the material creates a highly reflective surface.

The markers, approximately 1.2 inches long and 0.2 inches wide, are placed on the uncoated side of the tape. The uncoated side is the underside of the tape when mounted on the tape deck. The end-of-tape marker is placed on the edge of the tape nearest the tape deck. The load point is placed on the outer edge of the tape. The 667/669 tape unit can load tapes with load point markers located up to 40 feet from the beginning of the tape. The 677/679 tape unit can load tapes with load point markers located up to 26 feet from the beginning of the tape. Recommended distance is 10 to 18 feet.

## 819 Disk Storage Unit Operation

The functions of the six switches and indicators on the 819 Disk Storage Unit are described as follows. Switches with alternate actions are described in terms of first (1) and second (2) action.

### START

- (1) Starts the spindle rotating and loads heads. Indicator light comes on.
- (2) Stops the spindle rotation and unloads the heads. Indicator light turns off.

### READY

This indicator light comes on when the disk unit is ready for operation.

### FAULT

This indicator light comes on when the disk unit detects a unit fault.

### MAINTENANCE

This indicator light comes on when the disk unit is in maintenance mode (offline).

### TEMP

This indicator light comes on when the temperature in the unit exceeds the safe operating temperature.

### 1/0

The 1 lights when the disk unit is reserved by the controller on access 1. The 0 lights when the disk unit is reserved by the controller on access 0.

Besides these switches and indicators, there are the following lockout channel toggle switches (lower right inside rear door).

### LOCKOUT CHAN 0

In the up position, this switch disables the controller/disk unit interface designated as 0.

### LOCKOUT CHAN 1

In the up position, this switch disables the controller/disk unit interface designated as 1.

Toggling these switches clears the controller/disk unit reservation.

## 834/836 Disk Storage Unit Operation

The functions of the switches and indicators on an 834/836 Disk Storage Unit (figure D-13) are described next. Switches with alternate actions are described in terms of first (1) and second (2) actions.

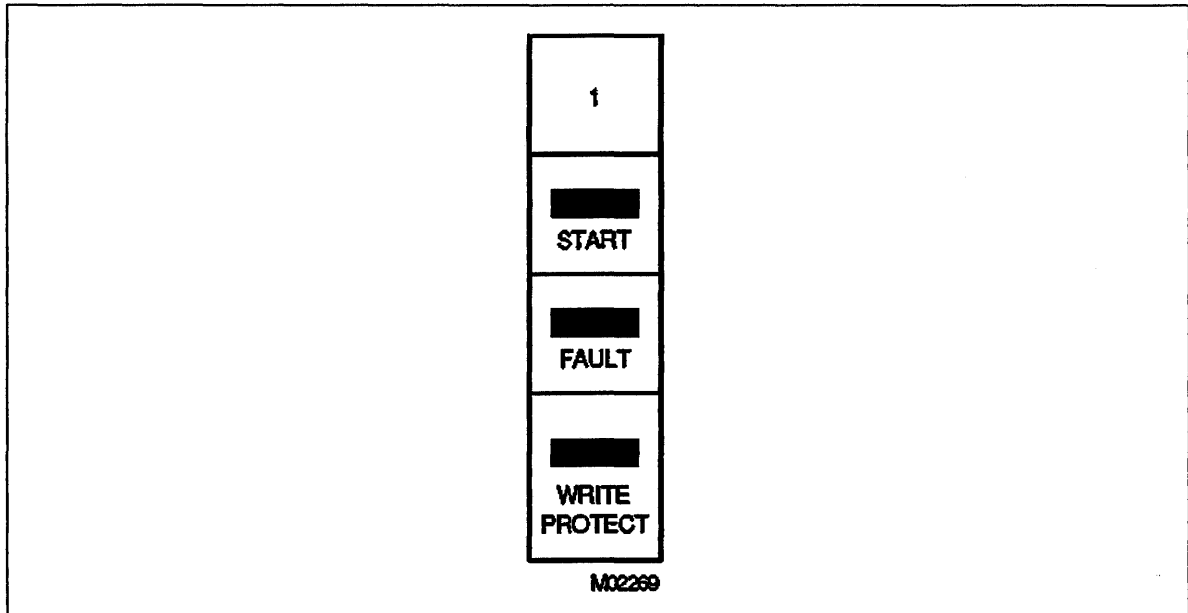

**Figure D-13. 834/836 Disk Storage Unit Operation**

**1**

Interchangeable plug specifying the disk physical unit number (0, 1, 2, or 3).

### START

(1) Enables communication between the drive and the control module attached to the drive. Spins up the drive. Turns the indicator light on.

(2) Disables communication between the drive and the control module attached to the drive. Spins down the drive. Turns the indicator light off.

### NOTE

---

The START switch does not spin up the drive the first time it is used after applying power to the 834/836 Disk Storage Subsystem. Drives must be spun up initially through the operating system by either deadstarting or entering a SPINUP command.

---

### FAULT

Indicator light comes on in the event of a drive error. Push the switch and release. It clears the error and the light goes out.

### WRITE PROTECT

(1) Disables write logic within drive and turns the indicator light on.

(2) Enables write logic within drive and turns the indicator light off.

## 844 Disk Storage Unit Operation

To ready an 881 or 883 disk pack on the 844 Disk Storage Unit:

1. Press the main cover latch and lift the main cover of the unit. Remove the base of the pack container so that the pack is held only by its cover.
2. Using its cover as a handle, place the disk pack slowly over the spindle until it engages the spindle drive unit. Turn the disk pack cover clockwise to a full stop position. At this point, the cover is released from the pack and can be lifted off.
3. Close the main cover making sure that it latches. If the cover is not securely latched, the dust cover interlock remains open and prevents power application.
4. Press the **START** switch to apply power to the unit. When the disk pack is at operating speed, the **READY** indicator lights. The disk storage unit is now ready for operation.

Before unloading an 881 or 883 disk pack from the 844 Disk Storage Unit, examine the mass storage status display (E,M.). A disk pack can be physically unloaded only if the global unload status (N) is displayed on all machines accessing the disk pack. Refer to the description of **UNLOAD** in chapter 3.

To unload:

1. Press **START** switch to turn off indicator light and stop unit.
2. When disk pack has stopped spinning, press main cover latch and lift main cover.
3. Place a disk pack cover over loaded disk pack so that it engages spindle. Turn counterclockwise until spindle clicks, and lift cover and disk pack from unit. Replace base of pack container.

## 885 Disk Storage Unit Operation

The functions of the switches and indicators on the 885 Disk Storage Unit (figure D-14) are described next. Switches with alternate actions are described in terms of first (1) and second (2) actions.

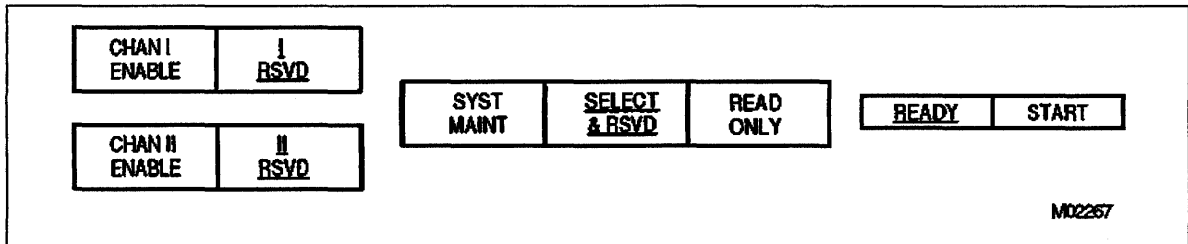

**Figure D-14. 885 Disk Storage Unit Switches and Indicators**

### CHAN I ENABLE or CHAN II ENABLE

(1) Enables communication between drive and controller attached to associated drive channel. Lights indicator.

(2) Disables communication between drive and controller attached to associated drive channel. Turns off indicator light.

### I RSVD or II RSVD

No switch function. Lights when controller reserves associated drive channel.

### SYST MAINT

(1) Enables fault checking and manual seek tests. Lights indicator.

(2) Disables fault checking and manual seek tests. Turns off indicator light. This switch is used only for maintenance.

### SELECT & RSVD

No switch function. Lights when reserved drive channel is active.

### READ ONLY

(1) Disables write logic within drive and lights indicator.

(2) Enables write logic within drive and turns indicator light off.

### READY

No switch function. Lights when disk pack reaches operating speed and drive is on track.

### START

(1) Applies power to drive motor and lights indicator.

(2) Removes power from drive motor and turns indicator light off.

For additional information, refer to the 7155 Disk Storage Subsystem Customer Troubleshooting Guide.



## 887 Disk Storage Unit Operation

The functions of the switches and indicators on the 887 Disk Storage Unit (see figure D-15) are described next. The 887 disk storage unit supports dual state access.

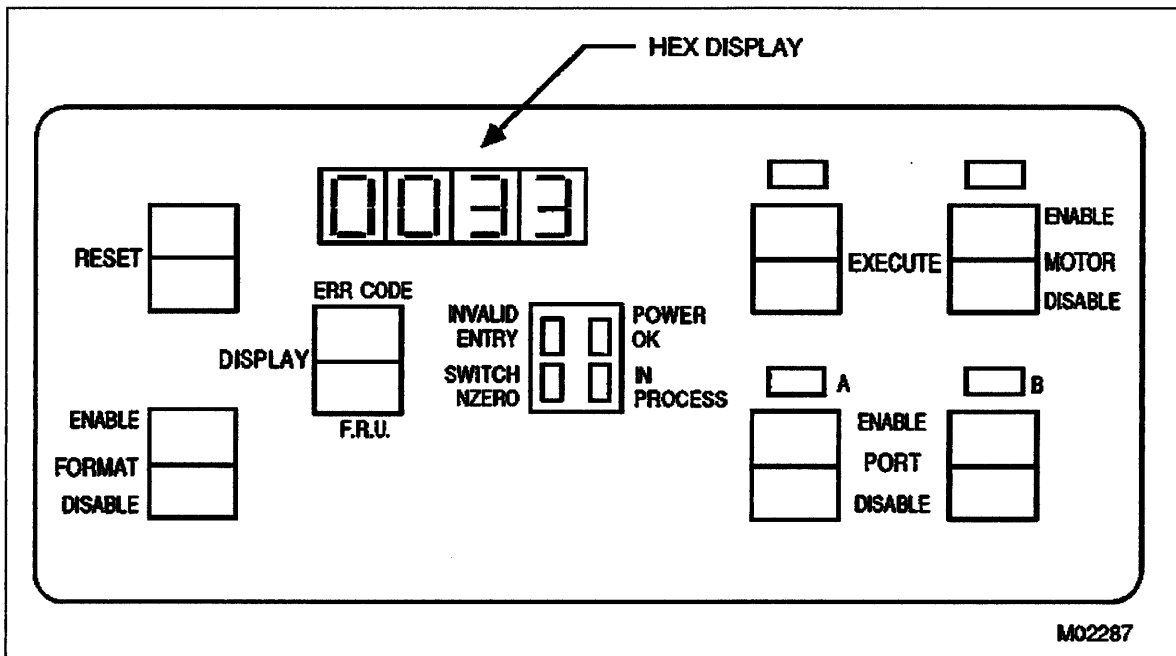

**Figure D-15. Operator Control for 887 Disk Storage Unit**

### RESET

Pressing this switch halts all current 887 disk activity and begins execution of the Level 1 diagnostic tests. This switch is active only if the PORT A and B switches are in the DISABLE position.

### FORMAT

Activate the DISABLE mode. The disk is initially formatted by the customer engineer.

### CAUTION

If the ENABLE mode is activated at any time, the disk is reformatted and all the data is lost.

### FOUR DIGIT HEX DISPLAY

The four-digit hex display can display four hexadecimal digits (0 – 9 and A – F). The information displayed depends on the setting of the DISPLAY switch.

### DISPLAY

The position of this switch determines the type of message displayed on the four-digit hex display. In the ERR CODE position, the four-digit hex display indicates the last four bits of the diagnostic test number, the subtest number, and the specific diagnostic error code. In the FRU position, the display indicates the four most probable causes for a detected fault condition.

## STATUS INDICATORS

The four status indicators provide information about conditions within the 887 disk.

### INVALID ENTRY

When lit, contact customer engineer.

### POWER OK

When lit, indicates the operating voltages in the 887 disk are within required ranges. This light turns off if any voltage varies from specified ranges.

### IN PROCESS

When lit, contact customer engineer.

### SWITCH NZERO

When lit, contact customer engineer.

### EXECUTE

This switch tells the 887 disk that a diagnostic command and its parameters have been selected and the command can be executed. The EXECUTE indicator goes on when the switch is pressed and goes off when the 887 disk begins acting on the command.

### PORT

There are two switches that enable or disable the 887 disk interface, one for port A and one for port B. In the ENABLE position, the indicator above the switch is on and the selected port is enabled to communicate with the operating system. In the DISABLE position, the selected port is disconnected from the operating system and the indicator above the switch is off.

### MOTOR

This switch controls the drive motor circuits in the 887 disk. To start the drive motor, the switch must be in the ENABLE position, then the SPINUP command must be entered. When the drive motor is running, the SPINDOWN command must be entered to stop the drive motor.

If this switch is in the DISABLE position, the SPINUP command cannot start the motor.

The indicator above the switch is off when the 887 disk drive motor is off. The indicator is on when the disk is operating at its specified speed.

## Operating Instructions

Except for the power-on and power-off operations, the operating system controls the normal operation of 887 disk. Use the following procedures to operate the 887 disk from the operator control panel.

### Power On Procedure

1. Ensure maintenance is not being performed on the 887 disk or the system to which it is attached.
2. Observe that the POWER OK status indicator is on. Also verify that the INVALID ENTRY, SWITCH NZERO, and IN PROCESS status indicators are off.
3. Place the MOTOR switch in the ENABLE position.
4. If a port is used, place the PORT switch for the port, or ports, desired (A and/or B) in the ENABLE position. The indicator above each selected PORT switch lights when the ENABLE mode is activated.
5. Place the FORMAT switch in the DISABLE position.
6. Place the DISPLAY switch in either the F.R.U. or ERR CODE position.
7. Enter the SPINUP command to start the disk drive motor. The indicator above the MOTOR switch lights when the disk reaches operating speed.

The 887 disk is now ready for normal operation.

### Power Off Procedure

The 887 disk is not routinely turned on and off. The operating system controls the starting and stopping of the drive motor. However, if the host or channel does not need the 887 disk for an extended period, issue the SPINDOWN command to stop the drive motor. The power supplies and other circuits inside the 887 disk remain active so the 887 disk can respond to a SPINUP command.

### **NOTE**

---

Do not put the MOTOR switch in the DISABLE position.

---

## 895 Disk Storage Unit Operation

An 895 Disk Storage unit has two operator control panels: one on the Head-of-String Controller (HSC) and one on the Storage Control Unit (SCU). The switches on the HSC panel (figure D-16) and on the SCU panel (figure D-17) are described next.

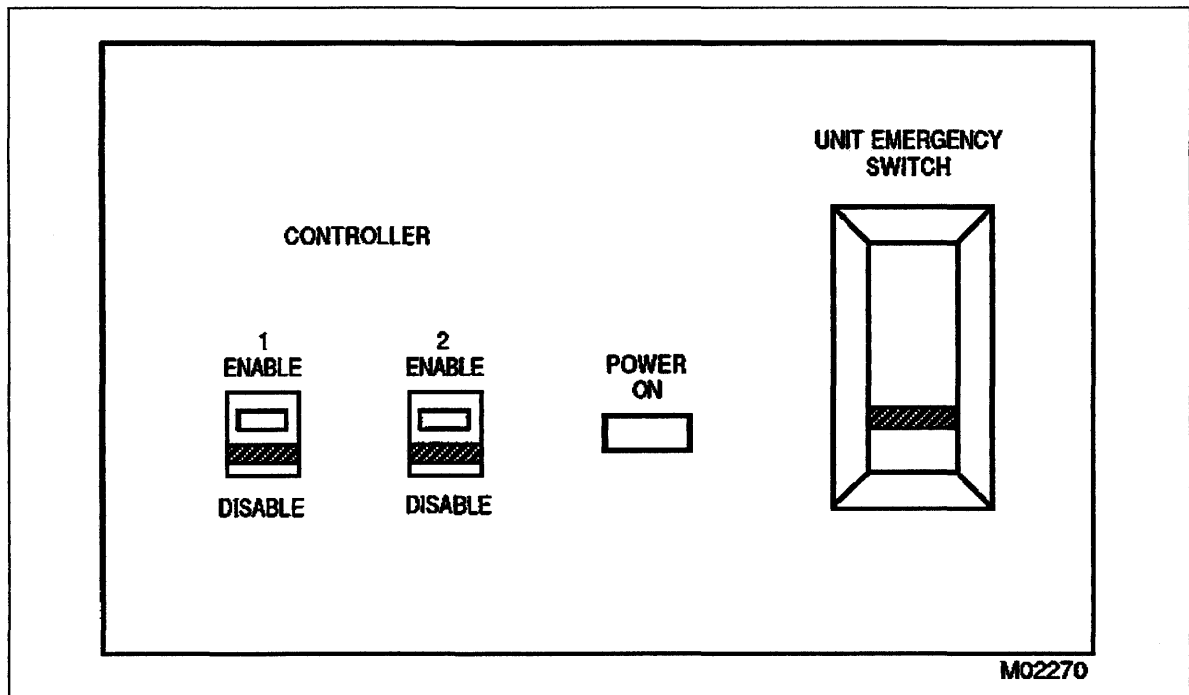

**Figure D-16. HSC Operator Control for an 895 Disk Storage Unit**

### POWER ON

The indicator is lit whenever power is applied to the HSC.

### UNIT EMERGENCY SWITCH

This switch allows an immediate power down of the drives in the event of an emergency.

### CAUTION

---

To avoid damaging drives, do not use this switch to power up or down the drives except for life-threatening emergencies.

---

### ENABLE 1/ENABLE 2

When an ENABLE switch is placed in the ENABLE (up) position, the HSC enables that storage director (SD) interface and the associated indicator is lit.

When an ENABLE switch is placed in the DISABLE (down) position, the HSC disables that SD interface and the associated indicator is turned off.

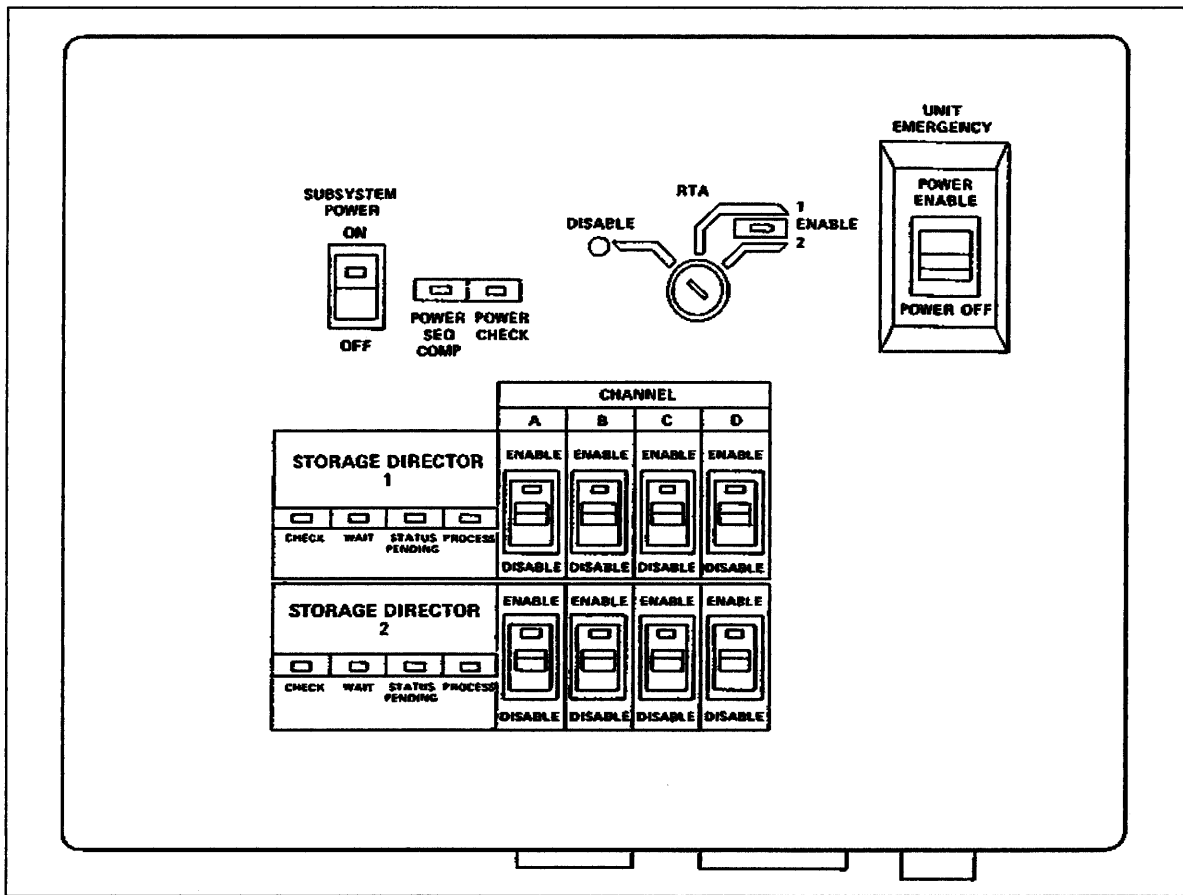

**Figure D-17. SCU Operator Control for an 895 Disk Storage Unit**

**SUBSYSTEM POWER ON/OFF**

The SUBSYSTEM POWER ON/OFF switch provides manual control of subsystem power.

The indicator is lit when power is applied to the SCU.

The OFF position deactivates the SUBSYSTEM POWER ON indicator light.

**POWER SEQ COMP**

The indicator is lit when the power-up sequence for the subsystem is completed.

**POWER CHECK**

The indicator is lit when a malfunction is detected in the SCU power circuitry.

**CHECK**

The indicator is lit when a malfunction is detected in the associated SD.

**WAIT**

The indicator is lit when the associated SD is in the wait state and is not processing any information.

**STATUS PENDING**

The indicator is lit when the associated SD has status pending.

## PROCESS

The indicator is lit when the associated SD is processing information.

## ENABLE/DISABLE

The ENABLE/DISABLE switches allow the associated SD to be disabled or enabled to/from the indicated CPU channel. The appropriate switch must be in the ENABLE position before the associated SD is available to the channel. Figure D-17 illustrates a four-channel (A through D) configuration.

## RTA Subsystem Security switch

This key-operated switch prevents the unauthorized execution of various diagnostics. Only Control Data authorized personnel should operate this switch.

## UNIT EMERGENCY

This switch allows control of subsystem power in the event of an emergency. When this switch is in the OFF position all the other switches on the SCU power panel are bypassed.

## CAUTION

---

The UNIT EMERGENCY switch should be used with extreme caution. Data can be lost.

---

## 9853 Disk Storage Subsystem Operation

An operator control panel for the 9853 Disk Storage Subsystem is located in both a main cabinet and an auxiliary cabinet. The auxiliary cabinet control panel, however, contains only PHASE indicators. The functions of the switches and indicators on the 9853 Disk Storage Subsystem operator control panel (see figure D-18) are described next. The 9853 Disk Storage Subsystem supports dual state access.

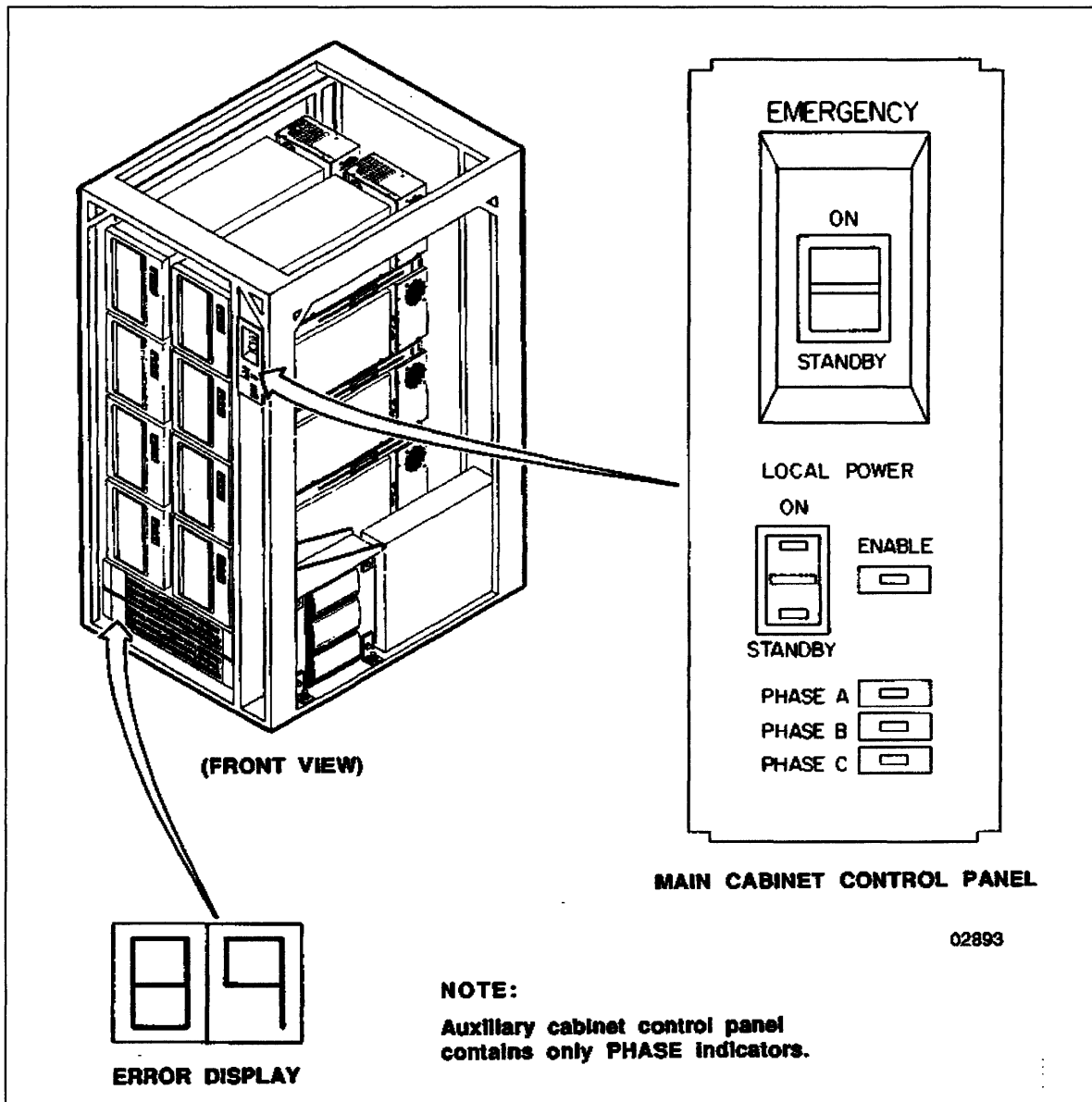

**Figure D-18. Operator Control for 9853 Disk Storage Subsystem**

**EMERGENCY**

This switch is normally in the ON position. When set to the STANDBY position, this switch removes all ac power from all units within the main cabinet (and auxiliary cabinet, if used).

**LOCAL POWER**

When the ENABLE switch/indicator lights, subsystem power can be turned on and off. The ON/STANDBY switch turns on subsystem power when set to the ON position. Setting the switch to the STANDBY position turns off subsystem power.

**PHASE A/B/C**

Each indicator verifies that the corresponding ac input power phase is being applied to the units within the cabinet. A power system failure exists if all three indicators are not on or off at the same time.

## TWO-DIGIT ERROR DISPLAY

This two-digit hexadecimal display indicates controller status. (See figure D-18.1) for location within the cabinet.) If the display is 00 or 40, the unit is ready for operation. Any other display indicates that the controller is performing power-on diagnostics or that an error condition exists.

## Operating Instructions

Except of the power-on and power-off operations, the operating system controls the normal operation of the 9853 disk. Use the following procedures to operate the 9853 disk from the operator control panel.

### Power On Procedure

1. If the LOCAL POWER ENABLE indicator is lit, set the LOCAL POWER switch to the ON position. If the LOCAL POWER ENABLE indicator is not lit, the host central processing unit controls power-on.
2. Verify that the PHASE A, PHASE B, and PHASE C indicators are lit. If they are not, make sure the EMERGENCY switch is set to the ON position.
3. If problems still exist, contact a customer engineer. Otherwise, the 9853 disk is ready for normal operation.

### Power Off Procedure

If the LOCAL POWER ENABLE indicator is lit, set the LOCAL POWER switch to the STANDBY position. This immediately removes all power from all units within the cabinet.

### NOTE

---

Before setting the LOCAL POWER switch to the STANDBY position, ensure that the subsystem is not performing any input/output operations with the host central processing unit. Failure to do so could destroy data.

---

If the LOCAL POWER ENABLE indicator is not lit, the disk power-off operation is under the control of the host central processing unit.



## CC545 Display Console Operation (CYBER 170 and CYBER 180 Computer Systems)

The console panel (figure D-19) contains the DEAD START button and controls affecting the appearance of displayed information.

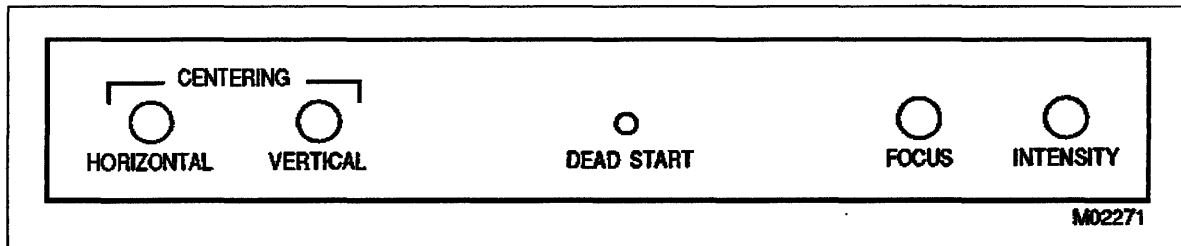

**Figure D-19. CC545 Console Panel**

The following controls allow you to change the characteristics of displayed characters.

### CENTERING

Varies horizontal and vertical position of display.

### FOCUS

Changes clarity in center areas of display.

### INTENSITY

Varies brightness of display.

On the lower right side of the console keyboard is the PRESENTATION CONTROL rocker switch. It is labeled LEFT, RIGHT, and MAINTENANCE to allow you to specify a single left screen display (LEFT), a single right screen display (RIGHT), or the normal setting, a split screen display containing a left and a right display (MAINTENANCE).

## CC598B Display Console Operation (CYBER 180 Computer System)

The following controls (figure D-20) allow the operator to change the characteristics of displayed characters.

### CONTRAST

Varies contrast between screen image and screen background.

### BRIGHTNESS

Varies brightness of screen background.

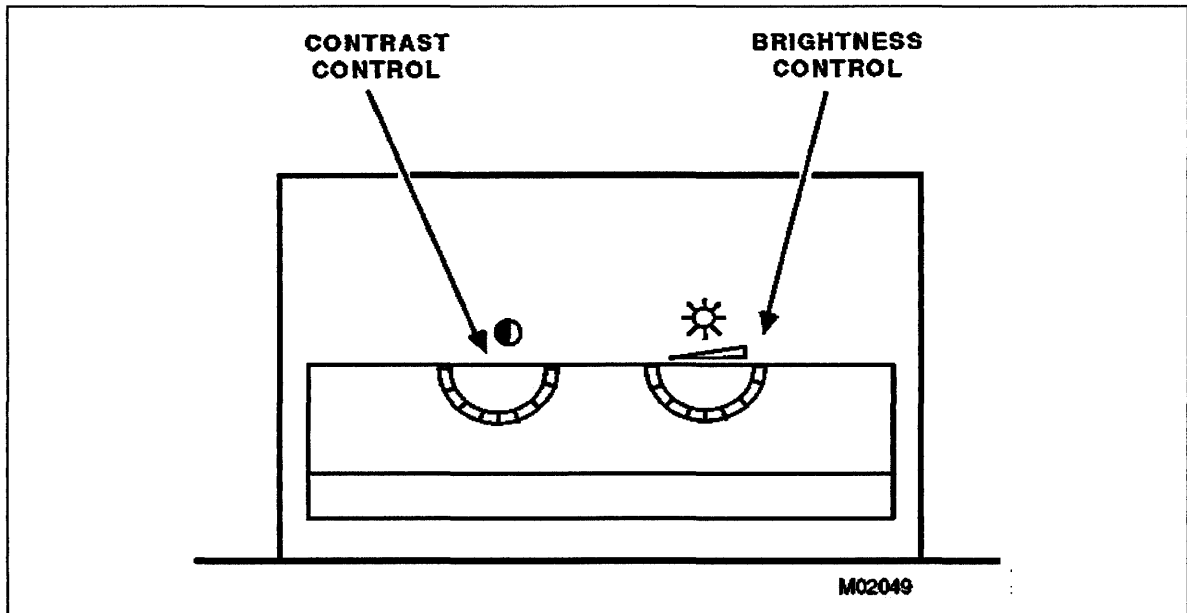

**Figure D-20. CC598B Monitor Control Panel**

There are two power switches on the CC598B display console. One is on the back of the display monitor, and the other is on the back of the CC598B PC case.

On the top of the keyboard is a set of function keys. (Refer to figure 1-2 for the CC598B console keyboard.) The keys labeled F2 through F4 allow you to specify a single left screen display (F2), a split screen display containing a left and a right display (F3), or a single right screen display (F4). The function keys F1 and F5 allow you to toggle from top of page to bottom of page for the left (F1) and the right (F5) screens.

## CC634B Display Console Operation (CYBER 180-810 or 830 Mainframe)

The console panel (figure D-21) contains the POWER switch, the RESET switch and the controls affecting the appearance of display information.

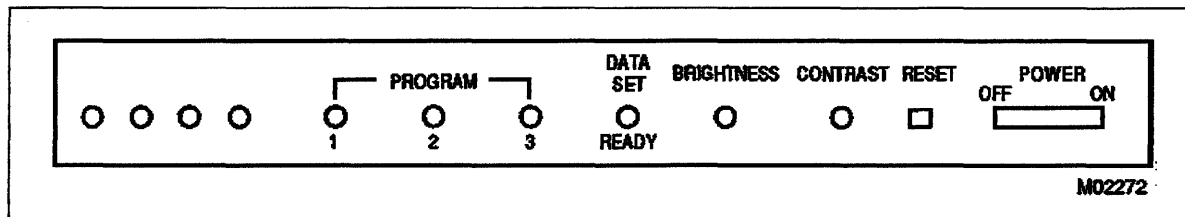

**Figure D-21. CC634B Console Panel**

The following controls allow the operator to change the characteristics of displayed characters.

### CONTRAST

Varies contrast between image on screen and background.

### BRIGHTNESS

Varies brightness of image on screen.

The data set ready light indicates a connection has been made between the terminal and the two-port mux.

Program lights 1 and 2 must both be on for the function key F6 to alternate displays between NOS and NOS/VE as described in chapter 1. Refer to the additional capabilities of the CC634B console in chapter 1 for more information.

On the top row of the keyboard is a set of function keys. The keys labeled F2 through F4 allow you to specify a single left screen display (F2), a split screen display containing a left and a right display (F3), or a single right screen display (F4). The function keys F1 and F5 allow you to toggle from top of page to bottom of page for the left (F1) and the right (F5) screens.

## 6612 Dual Screen Display Console Operation (CYBER 70 and 6000 Computer Systems)

Controls on a panel below the display screens (figure D-22) allow you to change the characteristics of displayed characters.

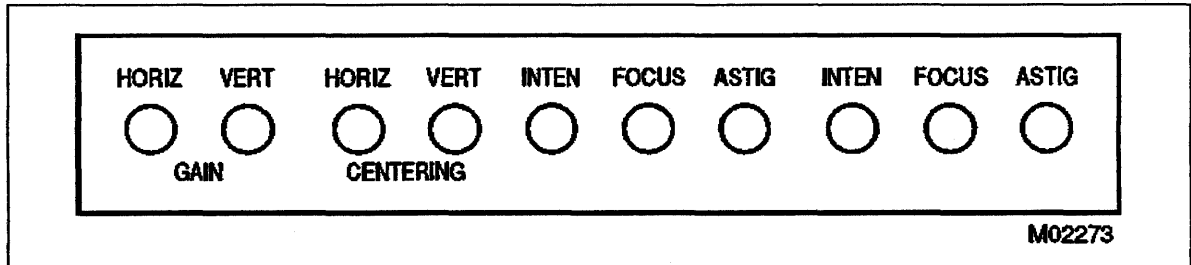

**Figure D-22. Display Controls**

Controls to the left affect both screens:

### GAIN

Varies width (HORIZ) or height (VERT) or area of display.

### CENTERING

Varies horizontal and vertical position of display.

The sets of three knobs affect the right and left screens individually.

### INTEN

Varies brightness of display.

### FOCUS

Changes clarity in center areas of display.

### ASTIG

Changes clarity at edges of display.

## **Procedure to Initialize Local 255x Network Processing Unit (NPU)**

Following a failure of the network processing unit (NPU), you can downline load the local NPU with the communications control program (CCP) operating system. The following procedure assumes the system autostart module-cassette is not available on the local NPU. If the cassette exists, the procedure for downline loading the local NPU is the same as described in the next section (on initializing a remote NPU).

1. Set the ports (CLA addresses) to the correct settings.
2. Set power switch (PWR) to ON (figure D-23) on the loop multiplexer circuit card.
3. Set the CLA ON/OFF switches to CLA ON (figure D-24) on the CLA circuit card.
4. Verify that the local console (if present) is in the normal ON state.
5. Press the MASTER CLEAR switch on the maintenance panel to stop the NPU (figure D-25).

Once the host detects the NPU has stopped, it starts to dump and to reload the NPU. The host is notified when the downline load is successfully completed. The host then configures the NPU terminals and system operation begins.

If the downline load is unsuccessful, the host requests and receives a dump of the NPU memory, page registers, and file 1 registers. After the dump, the host attempts to reload the NPU.

This discussion applies to manually loading the local NPU. You can initialize both a local and a remote NPU automatically by first loading the SAM-C cassette and then setting the ENABLE/DISABLE switch on the SAM-C cassette tape equipment to ENABLE.

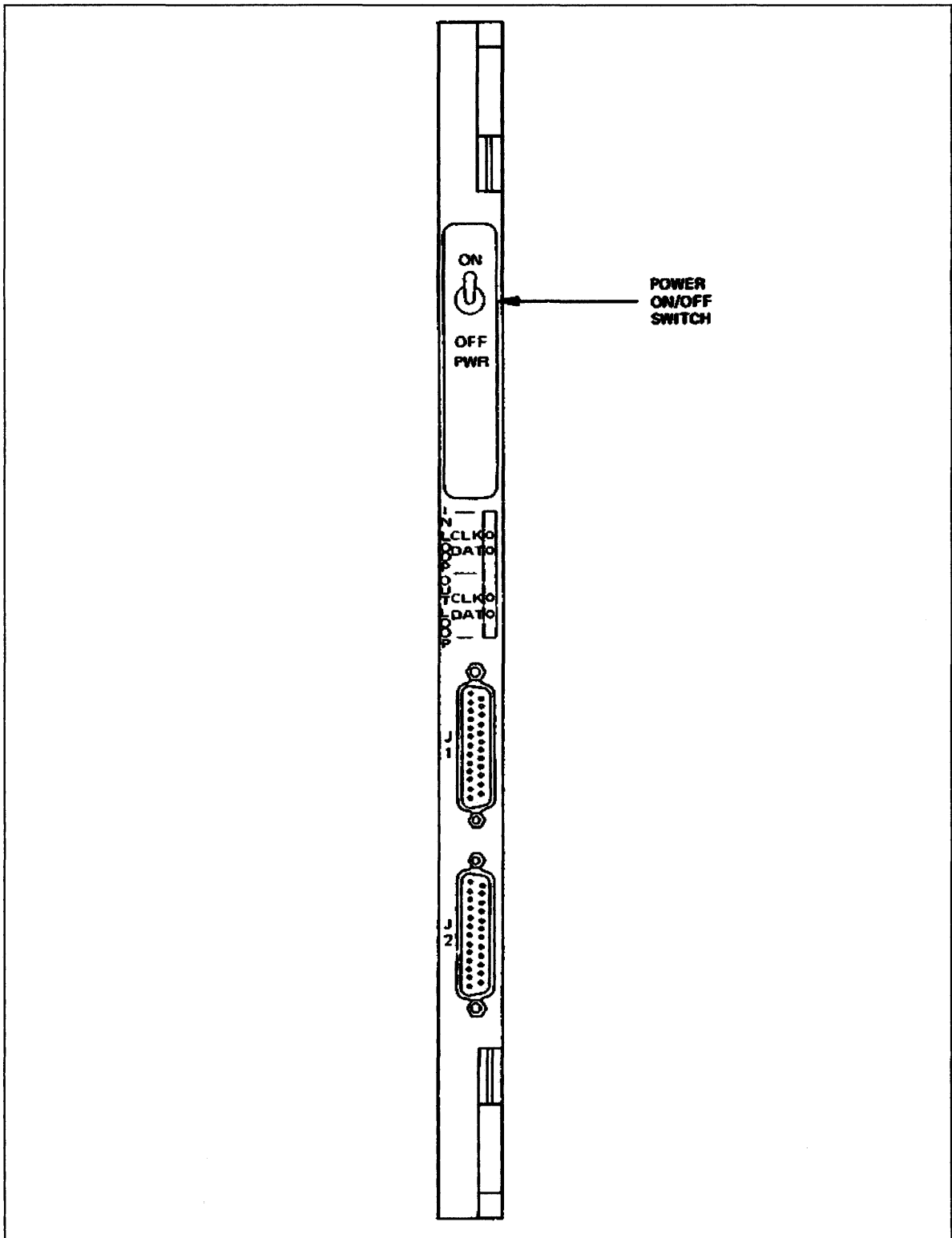

**Figure D-23. Loop Multiplexer Circuit Card PWR ON/OFF Switch Location**

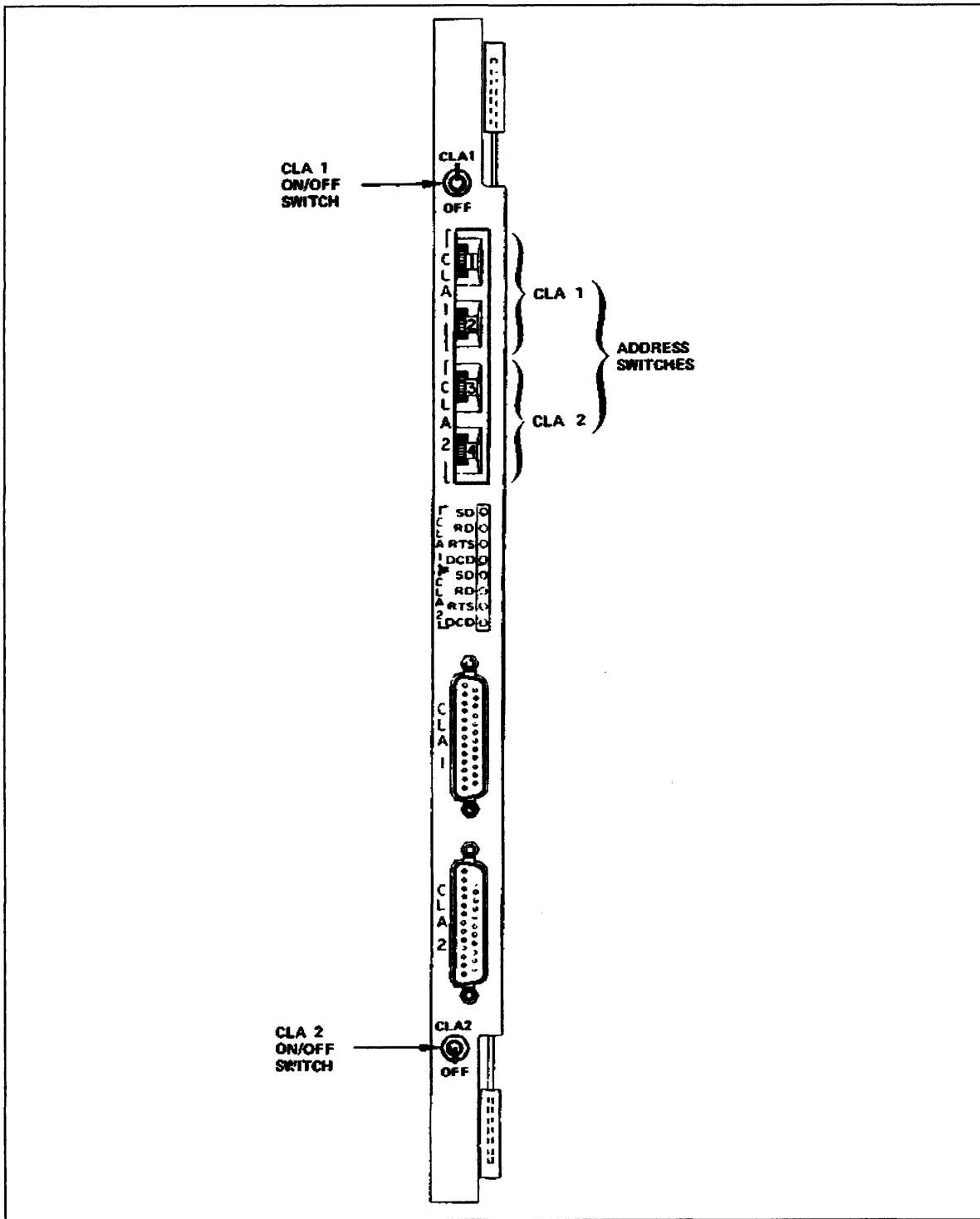

Figure D-24. CLA Circuit Card ON/OFF Switch Locations

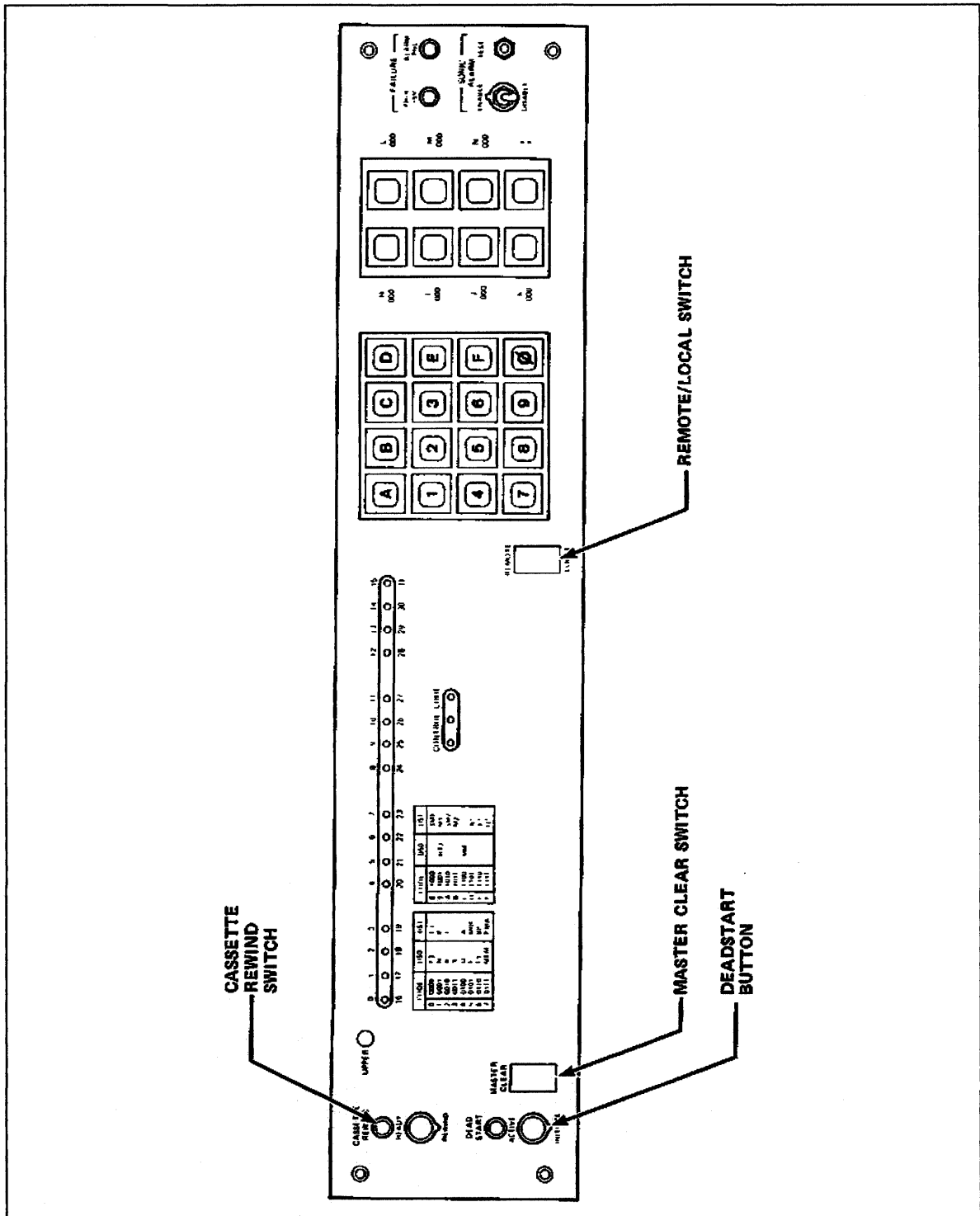

Figure D-25. Maintenance Panel MASTER CLEAR Switch Location



## Procedures to Initialize Remote 255x Network Processing Unit (NPU)

The remote 255x network processing unit (NPU) is downline loaded from the local 255x NPU with the communications control program (CCP) operating system. Use the following procedure on the remote 255x NPU:

1. Check bootstrap load (SAM-C) tape equipment mounted on NPU cabinet door. The SAM-C tape cassette should be loaded and the ENABLE/DISABLE switch on the SAM-C cassette tape equipment should be set to ENABLE.
2. Place system autostart module-cassette (SAM-C) containing system autostart module-program (SAM-P) in cassette deck.
3. Press MASTER clear switch on the maintenance panel.
4. Set REMOTE/LOCAL switch on the maintenance panel to REMOTE.
5. Press CASSETTE REWIND switch on the maintenance panel.
6. Press DEADSTART button.

After a short timeout, the remote NPU reads the cassette and begins the loading process.

This discussion applies to manually loading the remote NPU. You can initialize both a local and a remote NPU automatically by first loading the SAM-C cassette and then setting the ENABLE/DISABLE switch to ENABLE.

Do not remove the SAM-P cassette. It must remain in place and enabled to automatically dump and reload the NPU in case of a failure. Power to the cassette deck is turned off when the remote NPU is not operating.

### Generating SAM-D

SAM-D can be generated using a local 255x NPU equipped with a cassette controller and cassette tape unit as part of an NPU load.

Use the following procedure to create a SAM-D.

1. Place a blank cassette into the cassette tape unit in write mode (the tab should be positioned away from the center of the tape for write mode).
2. Press the MASTER CLEAR button on the maintenance panel.
3. Proceed to load CCP in the normal way. The cassette tape rewinds and positions itself at load point. SAM-D is written to the tape. The tape rewinds and stops. If a parity error is encountered, the tape rewinds and tries to write SAM-D again. If this procedure is repeated more than fourteen times, SAM-D is not generated and CCP is loaded. If a parity error occurs four or five times, go to step 1.
4. Remove the cassette tape.

## Duplicating SAM-P

SAM-P can be duplicated for the 255x NPU using the cassette controller and cassette tape unit. SAM-D is the utility program which duplicates copies of SAM-P.

### WARNING

---

Make sure there are no connections to a host or a neighboring NPU when you build a SAM-P tape. This avoids problems when you do a MASTER CLEAR.

---

Use the following procedure to duplicate a SAM-P.

1. Set toggle switch to DISABLE (down) position on the cassette tape unit.
2. Place SAM-D cassette tape into the cassette tape unit in read mode (the tab should be positioned towards the center of the tape for read mode). The tape should rewind and position itself to the load point. If the tape does not rewind, lift and close the lid to rewind.
3. Perform the following steps at the maintenance panel:
  - a. Select REMOTE mode.
  - b. Press the MASTER CLEAR button.
  - c. Press the INITIATE button.
4. The SAM-P bootstrap and program are loaded into the NPU. At the end of the load, the SAM-D cassette stops. If the cassette starts to rewind, remove the SAM-D cassette tape as soon as possible or SAM-D cassette will be written over.
5. Remove the SAM-D cassette tape.
6. Place a blank cassette tape into the unit in write mode (the tab should be positioned away from the center of the tape for write mode). The cassette tape rewinds and positions itself at load point. The SAM-P bootstrap and program is written to the tape, and the tape rewinds and stops. If a parity error is encountered, the tape rewinds and tries to write to SAM-P again. If this procedure is tried more than fourteen times, SAM-P is destroyed. If a parity error occurs four or five times, remove the cassette tape while it is rewinding and replace it with another cassette tape. SAM-P is then written on the new cassette tape. Remove the (new) cassette tape. Repeat step 5 to generate another copy, if desired.
7. At the maintenance panel, press the MASTER CLEAR button. This terminates the SAM-D program.

## Mass Storage Extended Subsystem (MSE)

The Mass Storage Extended subsystem (MSE) consists of one or more of each of the following two hardware components:

- 7990 control unit (CU)
- 7991 storage module (SM)

The MSE operation proceeds under computer control, but your action is required to add cartridges to or remove cartridges from the storage module. Figure D-26 illustrates a SM and CU and figure D-27 illustrates the entry and exist trays for insertion or removal of cartridges.

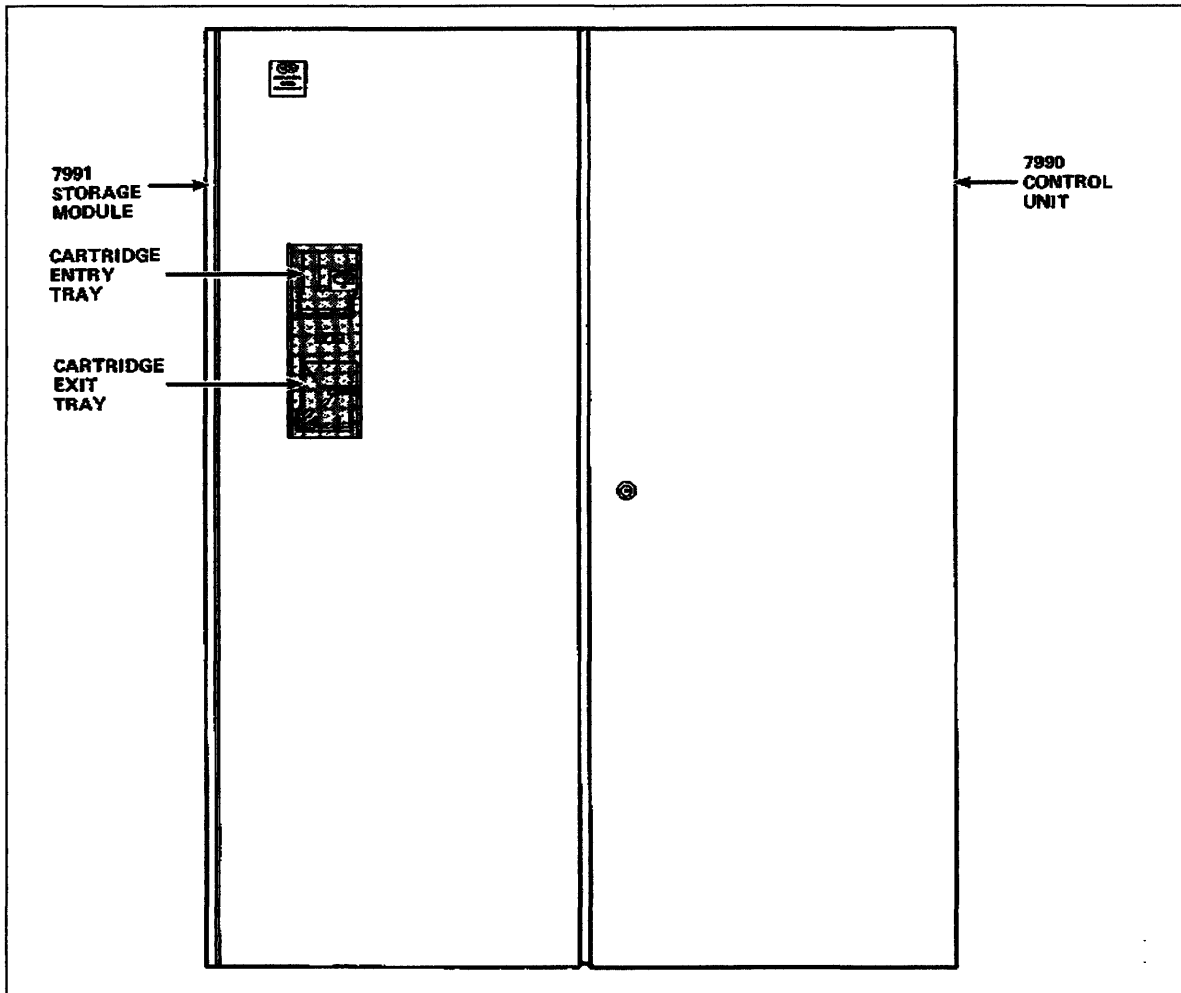

**Figure D-26. Storage Module and Control Unit**

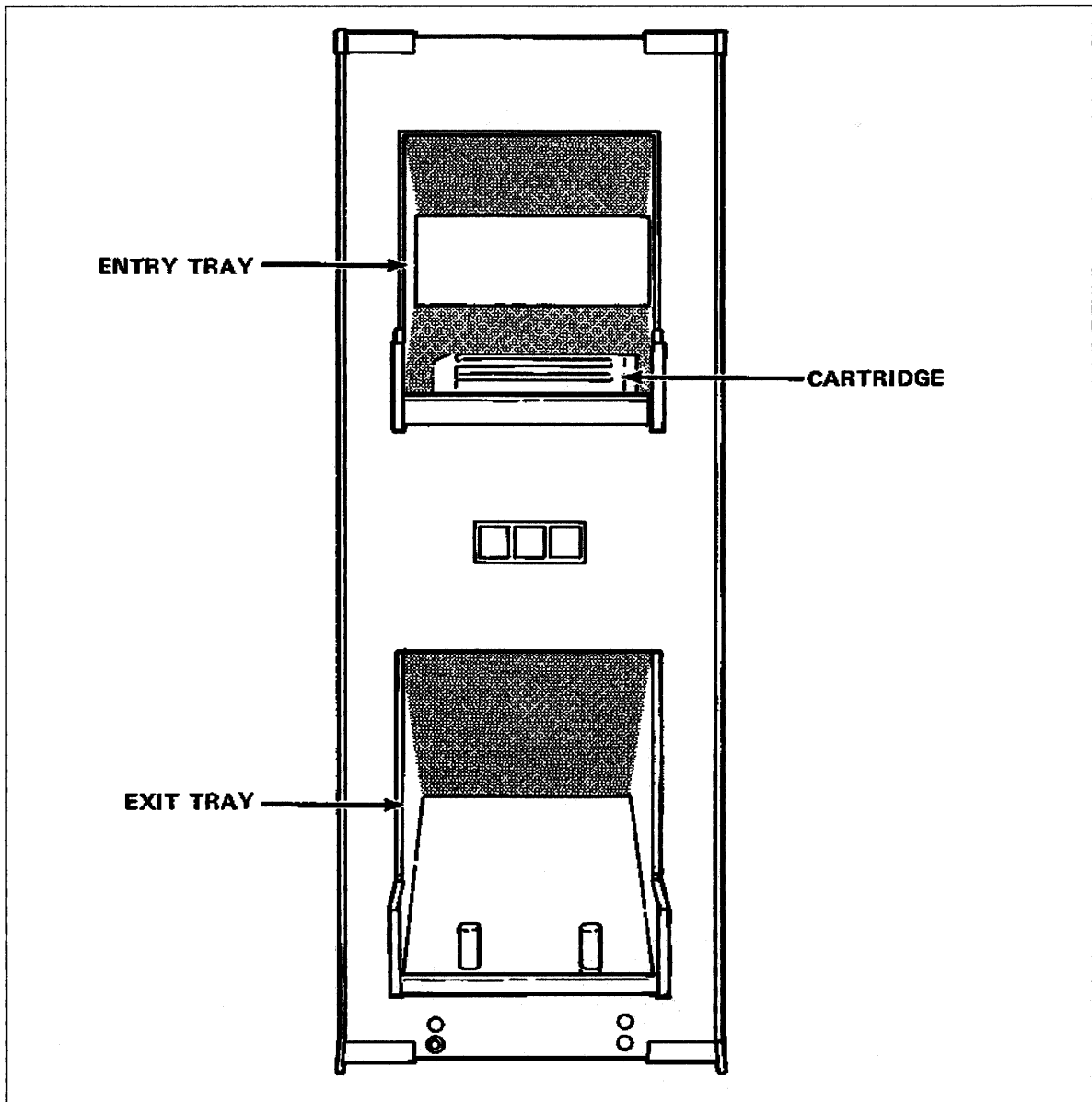

Figure D-27. Entry and Exit Trays

### Adding Cartridges

The entry tray of the SM is a gravity feed station, capable of holding up to five cartridges at a time. The cartridges are inserted into the SM under control of the MSE software.

### Removing Cartridges

The exit tray of the SM is also a gravity feed station capable of holding up to five cartridges at a time. The cartridges are removed from the SM under control of the MSE software.

## 5380-100 STORNET Subsystem

The 5380-100 STORNET Subsystem (SNSS) is a link device for disk drives used in multimainframe application with CYBER 170 or 180 mainframes.

The minimum STORNET configuration contains two low speed ports, one side door port, one 4M memory bank, associated control logic, and power supplies. Up to six 5380-170 Low Speed Port options can be field-installed on the 5380-100 SNSS. A maximum STORNET contains a side door maintenance port that also connects to a standard CYBER 170 channel. The low speed ports connect directly to a standard CYBER 170 channel, the CYBER 170 direct memory access (DMA) channel. STORNET also operates with the CYBER 930 Computer System. Figure D-28 shows a typical STORNET configuration.

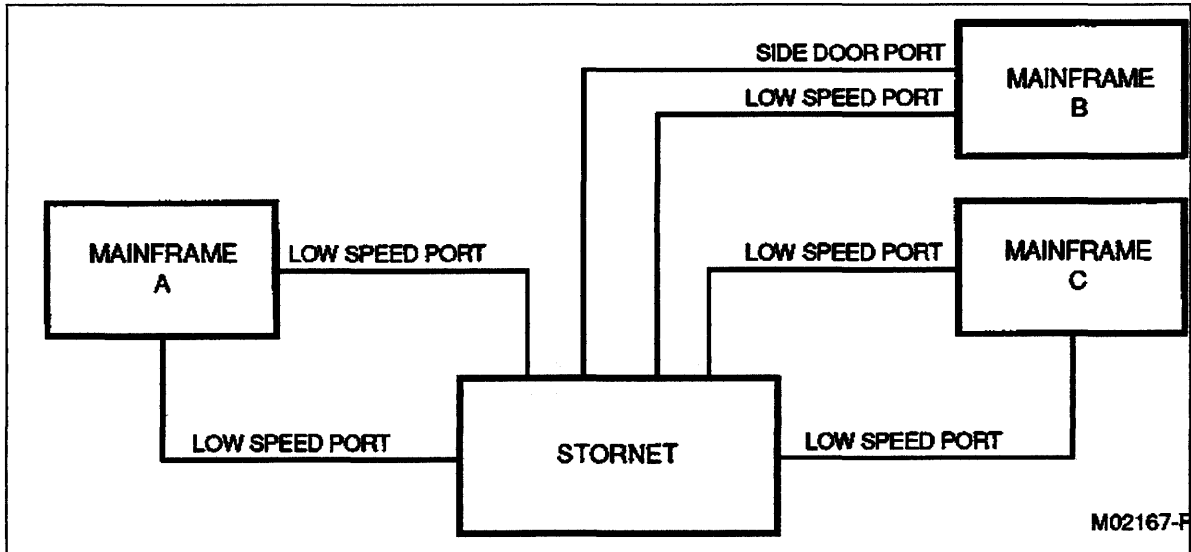

Figure D-28. STORNET Configuration

### Operator Controls and Indicators\*

The following power and warning controls are located on the 50/60 Hz Power Panel (inside the front cabinet door). Refer to figure D-29.

#### Power Control

The 50/60 Hz DISCONNECT toggle switch at the bottom of the 50/60 Hz Power Panel operates the cabinet blowers..

To power off, press the CABINET POWER OFF switch. To power on, press the CABINET POWER ON switch.

**Warning Control**

The 50/60 Hz Power Panel has the following fault indicators (LEDs). If a fault occurs, the corresponding LED lights up until the FAULTS RESET switch is pushed.

- C.B. OFF (Circuit Breaker Off)
- CABLE PROTECTION
- HIGH TEMP HEAT SINK
- LOW AIRFLOW
- HIGH TEMP AIR OUT/AIR IN

The fault indicator remains on after the fault condition is removed. The FAULTS RESET switch must be pushed to reset the display circuit.

If the fault condition persists, notify customer engineering (CE) for maintenance assistance.

**Air Flow Sensor Test Switch**

The AIR FLOW SENSOR TEST switch is a momentary switch. When it is held on, the power to the blowers is removed. After approximately two minutes, the LOW AIRFLOW indicator (LED) energizes, indicating the sensor is working properly.

If the sensor fails the test, notify customer engineering (CE) for maintenance assistance.

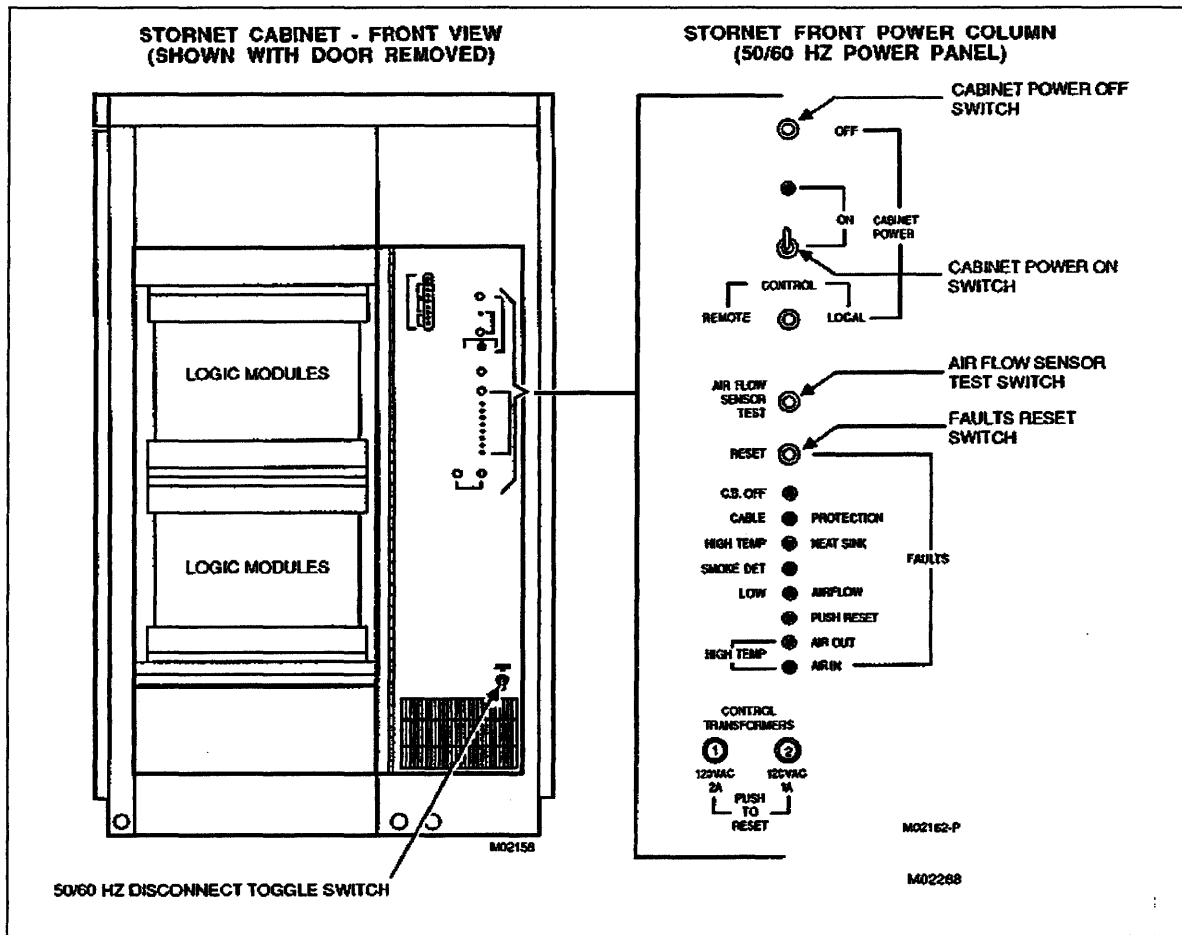

Figure D-29. Location of STORNET Switches and Controls

## Solving NOS Multiframe Environment Problems

Do not continue to use any mainframe that encounters unrecovered errors with STORNET. Other mainframes sharing STORNET may also be affected.

If corrective maintenance is required, there will be one or two interruptions. One interruption occurs if the operator takes STORNET off-line and calls for maintenance intervention, or if the entire system is turned over to a CE. Two interruptions occur if STORNET is removed from the configuration, repaired and reinstated at a later time.

During repair, NOS can run in ISHARE mode. The first deadstart occurs when switching to ISHARE; the second occurs when switching back to STORNET after the repair.

When NOS is in ISHARE mode, only on-line diagnostics can be run and STORNET can be repaired concurrently with ISHARE operation. Any STORNET errors available via the side door port are also available via HPA on the mainframe to which the side door port is connected.

## Recommended Actions

If a STORNET error occurs, a site may take one of the following actions:

1. Ignore the error and continue. This may require a system dump and a deadstart to resume normal operations.
2. Delay repair by degrading (removing) the failing mainframe from the STORNET configuration. This requires:
  - a. Terminating file server access.
  - b. Shutting down NOS. The system can be deadstarted to remove STORNET and come up again in ISHARE mode.
3. Repair STORNET immediately. This requires:
  - a. Removing all operating system activity.
  - b. Terminating the file server.
  - c. Deadstarting NOS.

## Filter Maintenance

There are two air filters in the STORNET cabinet (figure D-30). They should be cleaned at least every six months.

### Main Filter

The large main filter lies horizontally under the logic modules. To remove this filter, proceed as follows:

1. Remove the two Phillips screws and metal retainer (figure D-30) and lift out the filter.
2. Wash the filter in warm running water. Remove excess water by tapping the filter gently on a cloth.
3. Replace the filter and associated hardware.

### Small Filter

The small filter is on the inside bottom of the front door (figure D-30). To remove it, proceed as follows:

1. Open the door and slide the filter to the right and out.
2. Wash the filter in warm running water. Remove excess water by tapping the filter gently on a cloth.
3. Replace the filter by sliding it back into place.



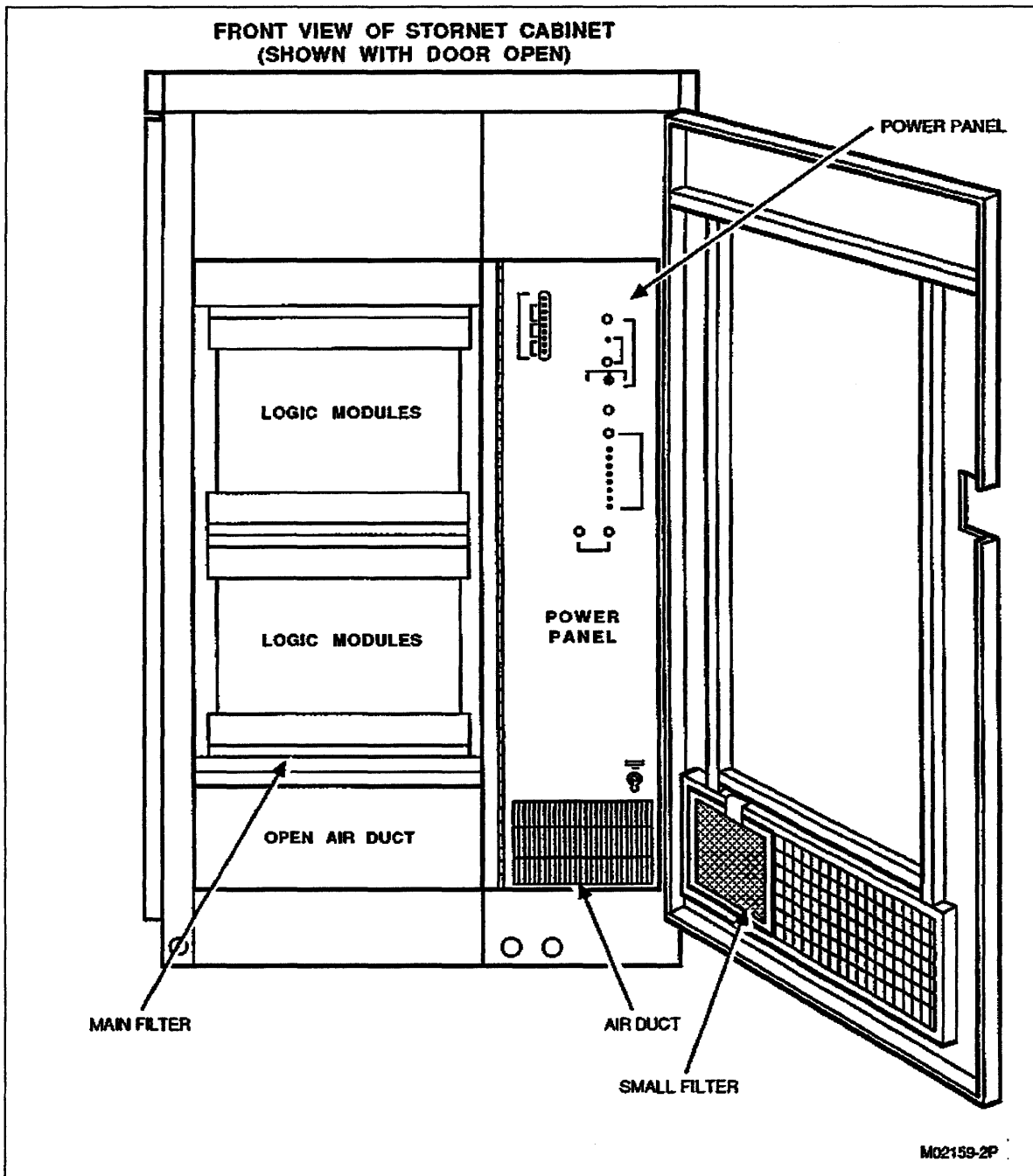

**Figure D-30. Location of Filters in STORNET Cabinet**

# Error Detection

# E

---

S/C Register Error Detection . . . . .	E-1
Power and Environmental Failure . . . . .	E-1
Power Failure . . . . .	E-1
Abnormal Environmental Conditions . . . . .	E-2
Bits 36 and 37 Set Simultaneously . . . . .	E-2
Clearing Abnormal Conditions . . . . .	E-2
Fatal Mainframe Errors . . . . .	E-3
Maintenance Register Error Detection . . . . .	E-4
Power and Environmental Failure . . . . .	E-4
Power Failure . . . . .	E-4
Abnormal Environmental Conditions . . . . .	E-5
Clearing Abnormal Conditions . . . . .	E-5
Autorestart After Environmental Shutdown . . . . .	E-6
Fatal Mainframe Errors . . . . .	E-6



NOS has three ways to indicate errors on CYBER mainframes. For CYBER 180-class mainframes and models 865 and 875, NOS uses the maintenance registers. For all other CYBER 170 Computer Systems, NOS uses the status/control (S/C) registers. For the CYBER 70 Computer Systems, NOS uses the interlock register. Refer to Maintenance Register Error Detection for error processing information. Refer to S/C Register Error Detection for all other CYBER error processing information.

## NOTE

In all references in this chapter to S/C registers, for models 865 and 875, S/C registers are maintenance registers.

## S/C Register Error Detection

After the system is loaded, NOS monitors certain bits of the CYBER 170 Computer Systems (except CYBER 180-class models) status/control (S/C) register and the CYBER 70 Computer Systems interlock register to detect abnormal conditions and possible fatal errors. When one or more bits are set in the S/C register, the system automatically takes steps to prevent further damage to the system and attempts to preserve the system in a state as near as possible to that before the condition was detected.

## Power and Environmental Failure

Bit 36 of the S/C register and bit 0 of the interlock register indicate a main power supply failure. Bit 37 of the S/C register (no comparable interlock register bit exists) indicates an unusual, potentially damaging environmental condition. When one or more of the warning bits are set, from two seconds to two minutes of processing time remain to prepare the system for a power loss.

### Power Failure

If the main power source supplying the computer system is lost for more than one-half cycle (8.3 milliseconds for 60 Hz; 10.0 milliseconds for 50 Hz), the system automatically sets bit 36 of the S/C register (bit 0 of the interlock register on a CYBER 70 Computer Systems machine). The CPU and other equipment powered by 400 Hz remains available for processing approximately two seconds. However, all peripheral equipment powered directly from the main power supply will probably fail.

When the S/C register bit 36 (interlock register bit 0) is set, the system immediately assumes step mode. Refer to STEP command, chapter 3. Actually, the system steps on monitor function DPPM (drop PP).

The message

```
POWER FAILURE
```

appears at the system control point on the system status display (B,O.).

## Abnormal Environmental Conditions

If the system detects an environmental condition that could lead to power failure, it automatically sets bit 37 of the S/C register (no comparable interlock register bit exists). Bit 37 is set in any of the following situations:

- The main power source supplying the system is lost for at least 100 milliseconds. Power will probably not return to normal within the time required.
- An environmental condition (including dew point and chassis temperature warnings) is abnormal and approaching an emergency power shutdown.
- An environmental condition is about to cause a controlled shutdown.
- A critical system device is down due to environmental conditions. This indication exists only if the system has monitoring provisions for the device.

If bit 37 is set but bit 36 is not, the system immediately initiates a system checkpoint. The message

```
SHUTDOWN IMMINENT.
```

appears at the system control point on B,O display. This message and the contents of the S/C register are entered in the error log. When the checkpoint is complete, the system assumes step mode.

### Bits 36 and 37 Set Simultaneously

If a power failure and abnormal environmental condition are detected, it is possible for bits 36 and 37 to be set at the same time. This can happen if an unusual environmental condition is found (bit 37 set) and is not remedied within the required time (approximately two minutes). Upon removal of power, a power failure (bit 36 set) is detected. With bits 36 and 37 set, the system immediately assumes step mode. The message

```
POWER DOWN.
```

appears at the system control point on the B,O display. Recovery is unlikely. Deadstart is necessary.

### Clearing Abnormal Conditions

When bit 36 and/or bit 37 of the S/C register (bit 0 of the interlock register) are set and cleared, the message

```
POWER/ENVIRONMENT NORMAL.
```

appears at the system control point on the B,O display. Verify that all equipment is ready. With the approval of an analyst, enter the following commands:

```
99 .  
UNSTEP.  
99 .
```

At this point, messages indicating the time of the power failure or power shutdown, the contents of the S/C register, and the time of the return to normal condition are entered in the error log. Processing may then be restarted.

## Fatal Mainframe Errors

A fatal mainframe error is a hardware error that usually causes a serious system malfunction and disrupts current user job processing. Many of these errors are reported in the S/C registers of a CYBER 170 Computer Systems mainframe. The steps taken by the system in response to a fatal mainframe error depend on the type of error detected.

Fatal errors can be divided into two groups: general errors and specific job errors. The system sets one or more bits in the S/C registers when an error is detected. Check these registers to determine the type of error. (Some of these bits may not be active on your mainframe. Refer to the appropriate hardware reference manual for detailed information.)

For a model 176 mainframe, the system sets S/C register bits when a general error is detected. There is no way to determine a specific job error. One or more of the following bits can be set:

S/C register bits set for general errors:

3/183, 4, 11/196, 14, 15, 16, 17, 18, 19, 20, 21, 22, or 23 (For bits 3/183 and 11/196, the system detects a fatal error only if both bits are set.)

For a model 171, 172, 173, 174, 175, 720, 730, 750, or 760 mainframe, the following bits can be set for each error group.

S/C register bits set for general errors:

0, 1, 2, 3/183, 8, 9, 14, 15, 16, 17, 18, 19, 20, 21, 22, or 23 (For bit 3/183, the system detects a fatal error only if both bits are set.)

S/C register bits set for specific job errors:

3/183 or 5 (For bit 3/183, the system detects a fatal error only if both bits are set. The error is a specific job error if the system completes a checkpoint.)

If the error detected is a specific job error, the system takes the following steps.

1. The system is checkpointed.
2. The job containing the error is aborted without exit processing or a dump.
3. The contents of the S/C register is entered in the error log.

The following action is the same regardless of the type of error detected. The system assumes step mode. Actually, the system steps on monitor function DPPM (drop PP). This allows current requests, including device checkpoints in progress to complete execution. The message

```
FATAL MAINFRAME ERROR.
```

appears at the system control point on the B,O display.

When the system displays the fatal mainframe error message you should:

1. Perform a level 3 recovery deadstart to display the S/C register display. For each S/C register bit set, a descriptive message appears on the screen. The system clears each fatal error bit automatically when you activate the deadstart switch.
2. Determine the type of error (refer to the errors and corresponding bits listed previously).
3. If desired, reconfigure central memory. Refer to NOS Version 2 Analysis Handbook.
4. If the error is of a general type, perform a level 0 initial deadstart.

If the error is of a specific job type, perform a level 1 recovery deadstart. The system resumes operation from the point of the malfunction. If the level 1 recovery deadstart fails, perform a level 0 initial deadstart.

## Maintenance Register Error Detection

After the system is loaded, NOS monitors the status summary registers of all CYBER 180-class mainframes to detect abnormal conditions and possible fatal errors. When one or more bits are set in a status summary register, the system automatically takes steps to prevent further damage to the system and attempts to preserve the system in a state as near as possible to that before the condition was detected.

## Power and Environmental Failure

Bit 59 (short warning) of the processor status summary register indicates a main power supply failure. Bit 63 (long warning) of the processor, memory, or input/output unit status summary register indicates an unusual, potentially damaging environmental condition. Bit 31 of the input/output status register indicates that the power supply is switched to the backup battery. When one or more of the warning bits are set, from two seconds to two minutes of processing time remain to prepare the system for a power loss.

### Power Failure

If the main power source supplying the computer system is lost for more than one-half cycle (8.3 milliseconds for 60 Hz; 10.0 milliseconds for 50 Hz), the system automatically sets bit 59 of the processor status summary register. The CPU and other equipment powered by 400 Hz remains available for processing approximately two seconds. However, all peripheral equipment powered directly from the main power supply will probably fail.

Models 810 and 830 may be backed up by a battery. In this situation, the mainframe and 834/ 836 disk drives will be operational for an additional 55 seconds after the power failure.

When bit 59 is set and the backup battery option is not installed, the system immediately assumes step mode. Actually, the system steps on monitor function DPPM (drop PP). Refer to STEP command, in NOS Version 2 Analysis Handbook. This allows current I/O requests, including device checkpoints in progress, to complete execution. The message

```
hh.mm.ss. ERR = Demm 703
```

appears at the system control point on the B,O display.

If the battery is installed, and all mass storage devices are 834/836 devices, a full system checkpoint is attempted. The message

```
hh.mm.ss ERR=Demm 702
```

appears at the system control point on the B,O display.

A message is issued to the Binary Maintenance Log. When the checkpoint is completed, the system assumes step-mode.

### **Abnormal Environmental Conditions**

If the system detects an environmental condition that can lead to removal of power, it automatically sets bit 63 of the processor, memory, or input/output unit status summary register. Bit 63 is set in any of the following situations:

- The main power source supplying the system is lost for at least 100 milliseconds. Power will probably not return to normal within the time required.
- An environmental condition (including dew point and chassis temperature warnings) is abnormal and approaching an emergency power shutdown.
- An environmental condition is about to cause a controlled shutdown.
- A critical system device is down due to environmental conditions. This indication exists only if the system has monitoring provisions for the device.

If bit 63 is set but bit 59 is not, the system immediately initiates a system checkpoint. The message

```
hh.mm.ss ERR=Demm 701
```

appears at the system control point on the B,O display.

A message is issued to the Binary Maintenance Log. When the checkpoint is completed, the system assumes step mode.

### **Clearing Abnormal Conditions**

When bit 59 of the processor status summary register and/or bit 63 of the processor, memory, or input/output unit status summary register is set and cleared, the message

```
POWER/ENVIRONMENT NORMAL.
```

appears at the system control point on the B,O display. Verify that all equipment is ready. With the approval of an analyst, enter the following commands:

```
99 .
UNSTEP .
99 .
```

At this point, messages indicating the type of failure and the time of return to normal condition are entered in the Binary Maintenance Log. Processing may then be restarted.



## Autorestart After Environmental Shutdown

If environmental shutdown conditions occur and are subsequently cleared, and if the installation parameter AUTORESTART is enabled either through the IPRDECK entry or the DSD command:

```
ENABLE, AUTORESTART.
```

the system will UNSTEP itself and restart normal processing by initiating all jobs in the input queue.

## Fatal Mainframe Errors

A fatal mainframe error is a hardware error that, if undetected, usually causes a serious system malfunction and disrupts current user job processing. Many of these errors are detected and reported in the status summary registers of CYBER 180-class mainframes. The steps taken by the system in response to a fatal mainframe error depend on the type of error detected.

There are three types of fatal mainframe errors: central processor, central memory, and input/output.

If a job is aborted with a central processor fatal error, the system takes the following steps:

1. The system is checkpointed.
2. The system displays the following message at the system control point in the B,O display:

```
(204) FATAL CPU ERROR.
```

3. The system places itself in emergency step mode, but allows current input/output requests, including device checkpoints in progress, to complete execution.

If a central memory fatal error occurs, the system takes the following steps:

1. The system displays the following message at the system control point in the B,O display:

```
hh.mm.ss ERR=Demmxxx (xxx=105, 11E, 21E)
```

2. The system places itself in emergency step mode, but allows current input/output requests, including device checkpoints in progress, to complete execution.

If an input/output fatal error occurs, the system takes the following steps:

1. The system displays the following message at the system control point in the B,O display:

```
hh.mm.ss ERR=DIImmxxx (xxx=004, 006, 008, 009)
```

2. The system checkpoints the mass storage devices.
3. The system places itself in emergency step mode, but allows current input/output requests, including device checkpoints in progress, to complete execution.

**NOTE**

---

Fatal mainframe error messages are defined as follows:

hh.mm.ss = Time the error was detected.  
e = Element for which the error occurred.  
= C for CPU 0  
= D for CPU 1  
= I for IOU  
= M for CM  
mm = Model number for the element specified by e.

---

You cannot reverse the steps the system takes after a fatal mainframe error. Notify the customer engineer that the system requires diagnostics and repair maintenance. After maintenance is complete, you must deadstart to restart the system.



**Example of End-of-Operation Shutdown      **F****



# Example of End-of-Operation Shutdown **F**

---

Because the method used to terminate system operations depends on site requirements, the actual procedure for shutdown may differ among sites. The following procedure is only an example of orderly termination of processing.

## **CAUTION**

---

Do not confuse this procedure with the shutdown procedures used in preparing for a recovery deadstart. (Refer to Preparing for Recovery Deadstart in chapter 2.)

---

1. Use the DSD system status display (B,A.) to monitor control point activity.
2. If NAM is active, provide advance notice of shutdown time to active users by entering the SEND command. (Refer to the NOS Version 2 Analysis Handbook for further information.) For example:

```
SEND,NPUS,MSG = SYSTEM SHUTDOWN AT 1500, PLEASE LOG OFF.
```

If IAF is active but NAM is not active, provide advance notice of shutdown time to active interactive users by entering the DSD command WARN. For example:

```
WARN,SYSTEM SHUTDOWN AT 1500,  
PLEASE LOG OFF.
```

3. Prevent new users from logging into the system by entering the following NVF control command.

```
IDLE,HOST.
```

4. If the IAF subsystem is active, examine the T display to determine if there are still active users. To send a message to an active user, enter the DIAL command. For example:

```
DIAL,jsn,SYSTEM CLOSED,CALL X492 IF MORE TIME NEEDED.
```

This message is sent to the terminal assigned the job sequence name jsn following output data, if any.

When there are no longer active interactive users indicated on the T display, drop the IAF subsystem by typing

```
IDLE,IAF.
```

5. Drop NAM, if active, by typing the following sequence of commands.

```
K,NAM.  
K.K.  
K.*.  
K.APPL=NVF.  
K.IDLE,HOST.  
K.DISABLE,HOST.
```

6. Drop TAF, if active, by typing

```
IDLE,TAF.
```

7. If MSE is active, and if jobs that need files to be staged from MSE are to be aborted, type

DISABLE, CARTRIDGE PF STAGING.

Drop MSE by typing

IDLE, MSE.

MSE becomes idle after it completes all stage requests currently in process. Examine the output drawer for any cartridges and save them for subsequent recovery processing (refer to the NOS Version 2 Analysis Handbook).

8. Drop BIO by typing

IDLE, BIO.

BIO drops when processing of all active devices is complete. Files being printed or punched, as well as cards being read, will complete execution. No new files will be printed or punched.

9. Prevent any new jobs in the input queue (refer to the Q displays in chapter 4) from being scheduled to a control point by dumping the input queue. This is accomplished with the QDUMP system utility (refer to the NOS Version 2 Analysis Handbook). Doing this allows jobs currently scheduled to control points to run to completion. In addition, rolled out jobs (refer to the R display in chapter 4) are scheduled back to a control point and allowed to complete execution.
10. Monitor job activity on the B,O display. Wait for all jobs to run to completion and then dump the output queues (print and punch queues). This is also accomplished with the QDUMP system utility (refer to the NOS Version 2 Analysis Handbook).
11. If permanent files are to be dumped, bring up BIO to print output reports by entering the following DSD command.

BIO.

Refer to the description of the PFDUMP permanent file utility in the NOS Version 2 Analysis Handbook for procedures to dump permanent files.

12. Drop BIO again by typing

IDLE, BIO.

13. Terminate dayfiles and retain as direct access permanent files. This is accomplished with the DFTERM system utility (refer to the NOS Version 2 Analysis Handbook). This preserves dayfile information held in the central memory buffers.
14. If the system is not to be used after shutdown, proceed to step 15. However, if the system is to be used for reasons other than normal NOS processing, perform the following steps.
  - a. Examine the disk status display (E,M.) to determine if status code C (checkpoint requested) is set for any disk device. Wait until the checkpoint operation completes execution before proceeding (C status cleared).
  - b. Dismount the deadstart tape (if currently mounted), and initiate the deadstart process. The display screens should become blank, indicating the system hardware is idle. The system is now ready for other use.

- c. Prevent subsequent users of the system from accessing mass storage permanent file devices by dismounting disk packs (844 only) or making the devices unavailable (not ready) for system access.
15. If the system is not to be used after NOS operations end, use the SUBSYST L display to disable the following subsystems.

BIO

CDC

IAF

MAG

MAP

MCS

MSE

NAM

PLA

RBF

RDF

RHF

SMF

SSF

STM

TAF

This disables all subsystems. It is recommended that the display screen intensity be turned down before leaving the system.





# Index

---

- 255x Network Processing Unit (NPU)
    - Local . . . . . D-44
    - Remote . . . . . D-48
  - 405 Card Reader operation . . . . . D-1
  - 415 Card Punch operation . . . . . D-4
  - 533/536 Printer operation . . . . . D-5
  - 537 Printer operation . . . . . D-7
  - 5380-100 STORNET subsystem . . . . . D-52
  - 580 Printer operation . . . . . D-10
  - 585 Printer operation . . . . . D-16
  - 639 Tape Unit . . . . . D-17
  - 667 and 669 Tape Units . . . . . D-19
  - 677 and 679 Tape Units . . . . . D-21
  - 698 Tape Unit . . . . . D-22
  - 819 Disk operation . . . . . D-28
  - 834/836 Disk operation . . . . . D-29
  - 844 Disk operation . . . . . D-30
  - 885 Disk operation . . . . . D-31
  - 887 Disk operation . . . . . D-32
  - 895 Disk operation . . . . . D-35
  - 9853 Disk Subsystem operation . . . . . D-37
- A**
- APRDECK, modifying . . . . . 2-22
- C**
- Card Punch operation . . . . . D-4
  - Card Reader operation . . . . . D-1
  - Central programmable display (K) . . . . . 4-55
  - CMRDECK, modifying . . . . . 2-20
- D**
- Dayfile commands . . . . . 3-29
  - Dayfile displays (A) . . . . . 4-4
  - Deadstart
    - Deadstart classifications . . . . . 1-16
    - Deadstart file . . . . . 1-17
    - Deadstart process . . . . . 1-17
    - Error troubleshooting . . . . . 2-32
    - Initiating deadstart process . . . . . 2-16
    - Modifying deadstart decks . . . . . 2-19
    - Preparing for deadstart . . . . . 1-16
    - Selecting CMRDECK . . . . . 2-12
    - Selecting level . . . . . 2-9
    - Selecting parameters . . . . . 2-11
    - Setting the deadstart panel . . . . . 1-17
    - Setting the deadstart program for a warmstart . . . . . 2-4
    - Warmstart procedure summary . . . . . 2-1
  - Directory display (Z) . . . . . 4-91
  - Disk storage unit
    - 819 Disk operation . . . . . D-28
    - 834/836 Disk operation . . . . . D-29
    - 844 Disk operation . . . . . D-30
    - 885 Disk operation . . . . . D-31
    - 887 Disk operation . . . . . D-32
    - 895 Disk operation . . . . . D-35
    - 9853 Disk Subsystem operation . . . . . D-37
  - Display console operation
    - 6612 Dual Screen Console (CYBER 70 and 6000 Computer Systems) . . . . . D-43
    - CC545 Console (CYBER 170 and CYBER 180 Computer Systems) . . . . . D-40
    - CC598B Console (CYBER 180 Computer System) . . . . . D-41
    - CC634B Console (CYBER 180-810 or 830 Mainframe) . . . . . D-42
  - Display screen headers . . . . . 4-3
  - Display selection . . . . . 4-1
  - Displays
    - Initial Options . . . . . 2-17
  - Documentation
    - Audience . . . . . 9
    - Conventions . . . . . 10
    - Customer support hotline . . . . . 11
    - Related publications . . . . . 12
    - Submitting comments . . . . . 11
  - DSD commands
    - A,. . . . . 4-4, 4-7
    - A,ACCOUNT FILE. . . . . 4-4, 4-8
    - A,ERROR LOG. . . . . 4-4, 4-9
    - A,OPERATOR. . . . . 4-4, 4-10
    - A. . . . . 4-4, 4-7
    - ASSIGN. . . . . 3-12
    - AUTO. . . . . 3-2
    - B,A. . . . . 4-13
    - B,O. . . . . 4-13

BANNERS.	3-24	K.	3-21
BIO.	3-10	K.messagetext.	3-7
BKSP.	3-12	KILL.	3-27
BKSPF.	3-12	L.	5-1
BKSPRU.	3-13, 3-24	L.DISABLE.	5-3
C,jsn.	4-21	L.ENABLE.	5-3
CDCffff.	3-10	L.END.	5-3
CFO.	3-27	L.OUT.	5-3
CHECK POINT SYSTEM.	3-2	LIDOU.	5-1
COMMENT.	3-27	LOCK.	3-7
CONTINU.	3-24	M,jsn.	4-21
CONTINUE.	3-13	MAGffff.	3-10
CYBffff.	3-10	MAINTENANCE.	3-8
D,jsn.	4-21	MAPffff.	3-10
DATE.	3-3	MAXIMUM.	3-24
DAYFILE.	4-4, 4-12	MCSffff.	3-10
DIAL.	3-28	MOUNT.	3-14
DISABLE.	3-3	MSEffff.	3-10
DOWN.	3-24	NAMffff.	3-10
DROP.	3-26	NEXTVSN.	3-14
E,.	4-23	NVEffff.	3-10
E,A.	4-23	O,SCP.	4-57
E,C.	4-27	O,TLD.	4-59
E,E.	4-29	O,TST.	4-61
E,F.	4-32	OFF.	3-14, 3-24
E,H.	4-34	OFFSW.	3-28
E,M.	4-36	ON.	3-15, 3-25
E,O.	4-40	ONSW.	3-28
E,P.	4-41	OQSH.	3-8
E,S.	4-44	P.	4-63
E,T.	4-45	PAUSE.	3-28
ENABLE.	3-3	PRSIZE.	3-15, 3-25
END.	3-13, 3-24	Q,.	4-65
F,jsn.	4-21	Q,IN.	4-65
FORM.	3-13, 3-24	Q,PL.	4-65
G,jsn.	4-21	Q,PR.	4-65
GO,est.	3-13	Q,PU.	4-65
GO,jsn.	3-27	Q,WT.	4-65
H,.	4-49	QDSPLAY.	5-1
H,jsn.	4-49	R.	4-68
HOLD.	3-13	RDFffff.	3-10
I	4-51	RELEASE.	3-8
IAFffff.	3-10	REPEAT.	3-15, 3-25
ID.	3-13, 3-24	REPRINT.	3-15, 3-25
IDLE.	3-6, 3-11	REPUNCH.	3-15
J,jsn.	4-53	RERUN.	3-27
K,jsn.	4-55		

RETRY.	3-15	A,ACCOUNT FILE. (Account Dayfile)	4-8
RHFfff.	3-10	A,ERROR LOG. (Error Log Dayfile)	4-9
ROLLIN.	3-27	A,OPERATOR. (Operator Action)	4-10
ROLLOUT.	3-27	A. or A,. (System Dayfile)	4-7
S.	4-71	B,A. (System Status)	4-13
SAVE.	3-25	B,O. (System Status)	4-16
SCHEDULE.	3-8	C (Central Memory)	4-18
SCRATCH.	3-15	D (Central Memory)	4-18
SCTD.	5-1	DAYFILE,jsn. (Job Dayfile)	4-12
SDSPLAY.	5-1	E,. or E,A. (Equipment Status Table)	4-23
SELECT.	3-25	E,C. (Disk Configuration)	4-27
SET,screen.	4-1	E,E. (Disk Errors)	4-29
SKIP.	3-16	E,F. (Family Status)	4-32
SKIPF.	3-16	E,H. (Disk Thresholds)	4-34
SKIPRU.	3-16, 3-25	E,M. (Disk Status)	4-36
SMFfff.	3-10	E,O. (Optical Disk Requests)	4-40
SPINDOWN.	3-16	E,P. (Resource Requests)	4-41
SPINUP.	3-16	E,S. (Optical Disk Status)	4-44
SSFfff.	3-10	E,T. (Tape Status)	4-45
STMfff.	3-10	F (Central Memory)	4-19
STOP.	3-11, 3-16, 3-25	G (Central Memory)	4-19
SUBSYST.	5-2	H,. (System Files)	4-49
SUPPRES.	3-25	H,jsn. (Local Files)	4-49
SUPPRESS.	3-16	I (BIO Status)	4-51
T.	4-76	J,jsn. (Job Status)	4-53
TAFfff.	3-10	K,jsn. (CPU Programmable)	4-55
TERMINATE.	3-17	M (Extended Memory)	4-20
TIME.	3-8	O,SCP. (Subcontrol Point Status)	4-57
TRAIN.	3-17, 3-26	O,TL.D. (Task Library Directories)	4-59
UNLOAD.	3-17	O,TST. (Transaction Status Table)	4-61
UNLOCK.	3-9	P. (PP Registers)	4-63
VSN.	3-19	Q,. (Queued File Table)	4-65
W,A.	4-78	Q,PR. (Print Queue Status)	4-65
W,C.	4-80	R. (Rollout Status)	4-68
W,M.	4-83	S. (System Control)	4-71
W,P.	4-84	T. (Interactive Status)	4-76
W,Q.	4-86	W,A. (Memory Allocation)	4-78
W,R.	4-88	W,C. (Channel Status)	4-80
WARN.	3-28	W,M. (Miscellaneous Parameters)	4-83
X.AFD.	3-29	W,P. (System Table Addresses)	4-84
X.DFD.	3-29	W,Q. (System Queues)	4-86
X.ELD.	3-29	W,R. (System Resources)	4-88
X.MDD.	3-8	Y. (Monitor Functions)	4-90
X.name.	3-9	Z. (Directory)	4-91
Y.	4-90		
Z.	4-91		
DSD displays		<b>E</b>	
		End-of-operation shutdown	F-1

EQPDECK, modifying . . . . . 2-21  
 Equipment status displays (E) . . . . 4-23

**F**

Filter maintenance . . . . . D-55

**I**

Initial deadstart  
   Level 0 . . . . . 2-31  
 Initial Options display . . . . . 2-17  
 Initiating deadstart process . . . . . 2-16  
 Interactive status display (T) . . . . . 4-76  
 IPRDECK, modifying . . . . . 2-23

**J**

Job entries in system tables  
   Executing job table (EJT) . . . . . 1-16  
   Job sequence name (JSN) . . . . . 1-15  
   Queued file table (QFT) . . . . . 1-15  
 Job processing control commands  
   Interactive job control . . . . . 3-28  
   Job communication . . . . . 3-27  
   Scheduling control . . . . . 3-26

**L**

L-Display  
   Entries . . . . . 5-1  
   SUBSYST . . . . . 5-2  
 Level 0 initial deadstart . . . . . 2-31  
 Level 1 recovery deadstart . . . . . 2-31  
 Level 2 recovery deadstart . . . . . 2-31  
 Level 3 recovery deadstart . . . . . 2-28  
 Local 255x Network Processing Unit  
 (NPU), Initializing . . . . . D-44

**M**

Magnetic tape unit . . . . . D-17  
   639 Tape Unit . . . . . D-17  
   667 and 669 Tape Units . . . . . D-19  
   677 and 679 Tape Units . . . . . D-21  
   698 Tape Unit . . . . . D-22  
   Emergency stop . . . . . D-27  
   Load/thread . . . . . D-25  
   Operation . . . . . D-24  
   Ready status . . . . . D-26

Reel installation . . . . . D-24  
 Reflective markers . . . . . D-27  
 Rewind . . . . . D-27  
 Unload and reel removal . . . . . D-27

Maintenance register error detection E-4  
   Autorestart after environmental  
   shutdown . . . . . E-6  
   Clearing abnormal conditions . . . . E-5  
   Fatal mainframe errors . . . . . E-6  
   Power and environmental failure . . . E-4

Mass Storage Extended subsystem  
 (MSE) . . . . . D-50

Modifying deadstart decks  
   APRDECK . . . . . 2-22  
   CMRDECK . . . . . 2-20  
   EQPDECK . . . . . 2-21  
   IPRDECK . . . . . 2-23

Monitor functions display (Y) . . . . . 4-90

Multimainframe environment problems  
 D-54

Multimainframe operation . . . . . C-1

**N**

NEXTVSN DSD command . . . . . 3-14  
 NOS functions . . . . . 1-1

**O**

Operator messages . . . . . A-1  
 Operator/system communication . . . . 1-2  
   CC598B and CC634B consoles  
   capabilities . . . . . 1-8  
   Display screen paging . . . . . 1-10  
   DSD command entry . . . . . 1-10  
   DSD command syntax . . . . . 1-9  
   DSD/DIS commands . . . . . 1-9  
   Error messages . . . . . 1-9  
   Hidden screens . . . . . 1-8  
   Left, right, or dual screen display . 1-4  
   Operating the keyboard . . . . . 1-4  
   Screen control . . . . . 1-4

**P**

Peripheral equipment control commands  
 3-12  
 Preparing for system restart . . . . . 2-28  
 Printer operation





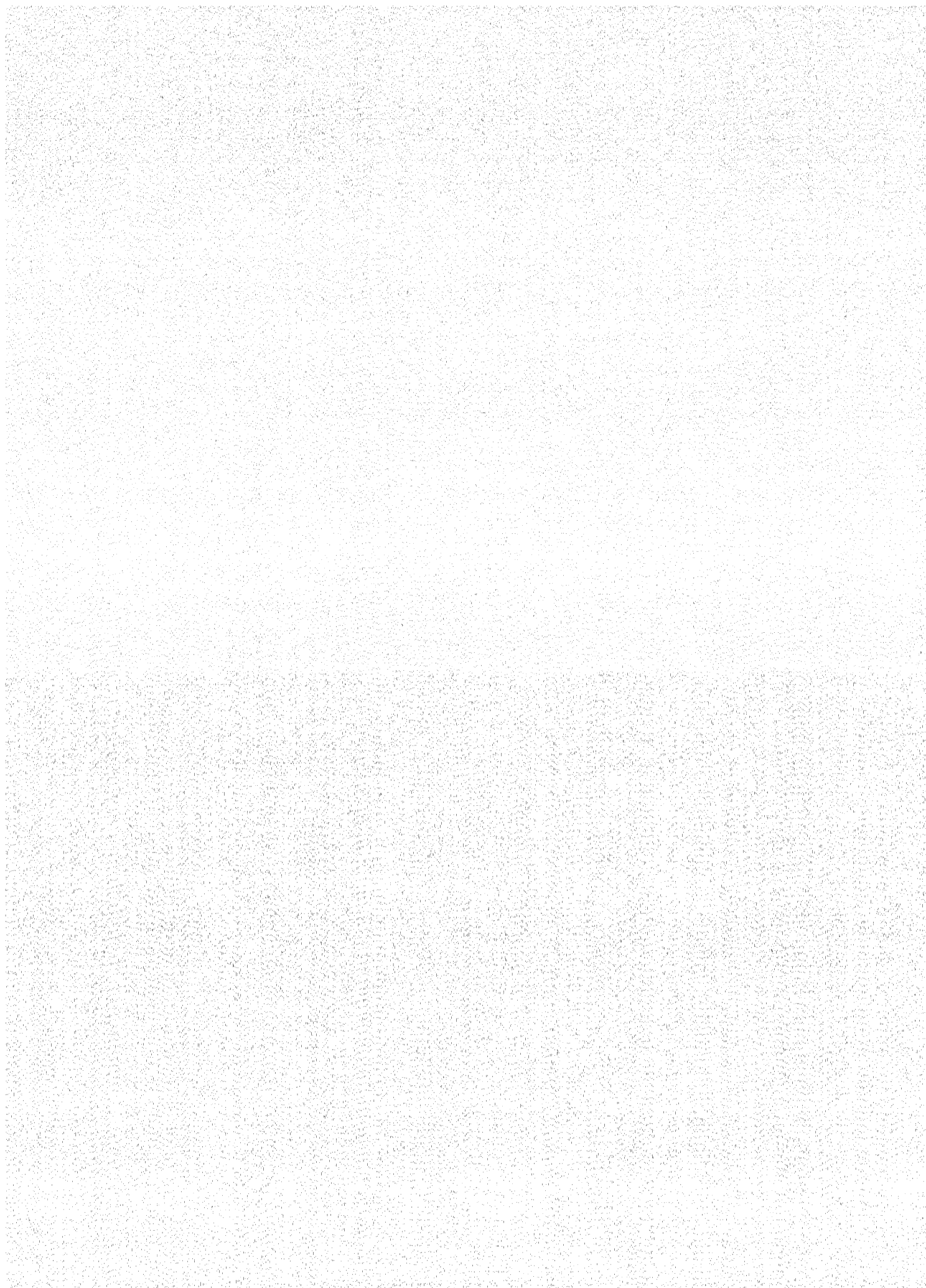







Control Data Systems, Inc.  
ARH215  
4201 Lexington Avenue N.  
St. Paul, Minnesota 55126-6198

**Note**

If you need a binder for this manual, you can order  
binder no. 60086230 from:

Control Data Systems, Inc.  
Literature Distribution Services  
ARHLDS  
4201 Lexington Avenue N.  
St. Paul, Minnesota 55126-6198

NOS Version 2 Operations Handbook  
60459310 V