

HORIZON H136A

USERS MANUAL

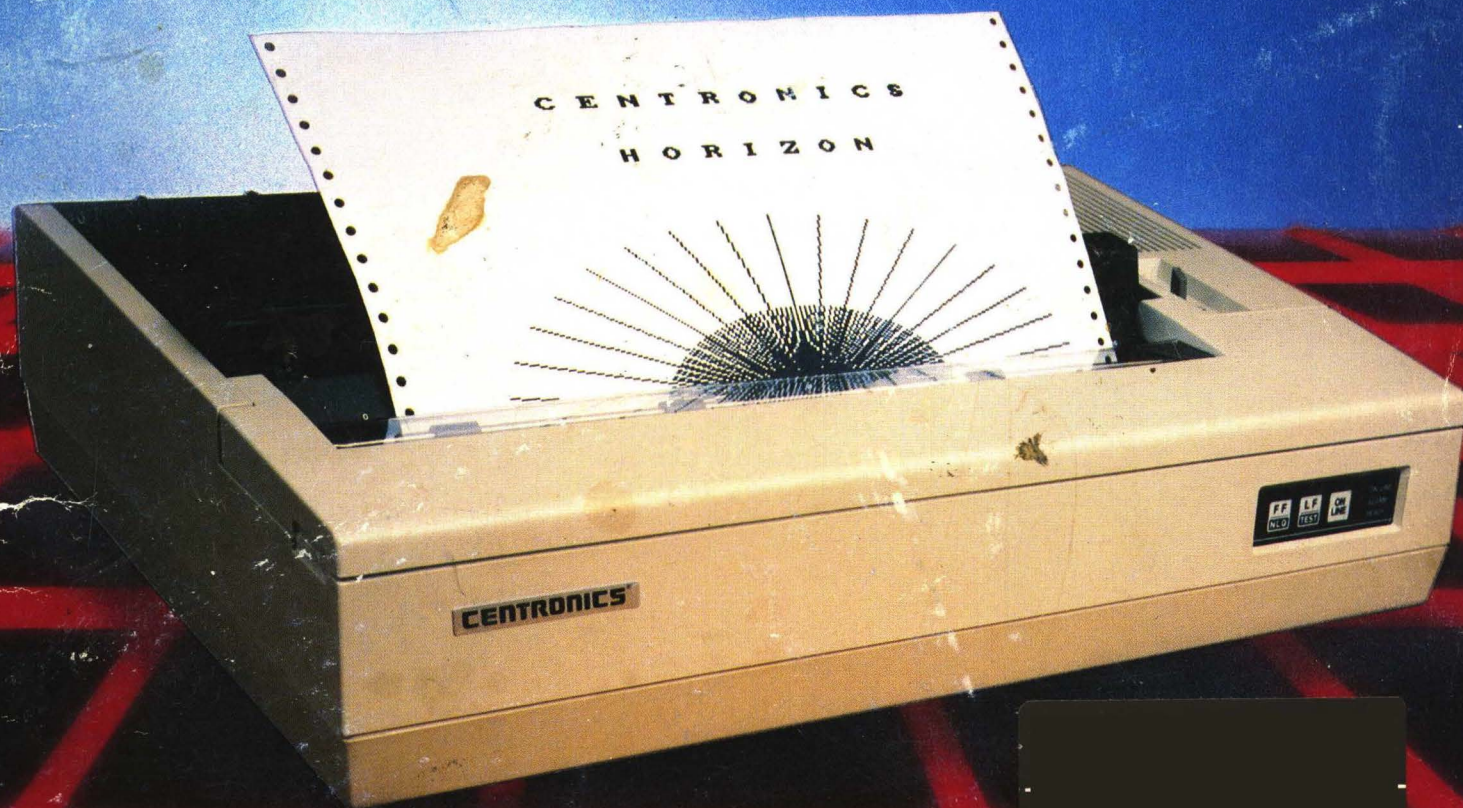

P/N 37401361-9A00 REV. A.

CENTRONICS®

CENTRONICS SALES & SERVICE
SERVICE INFORMATION FOR YOUR PRINTER MAY BE
OBTAINED BY CALLING THE NUMBERS LISTED BELOW.
(ASK FOR FIELD ENGINEERING)

CENTRONICS®

Centronics Data Computer Corp.
Hudson, New Hampshire 03051
Tel. (603) 883-0111, TWX. (710) 228-6505, TLX. 94-3404
Field Engineering Headquarters (603) 883-0111

Regional Sales Offices

Mid-Atlantic Region (NJ):	Tel. (609) 234-8266, TWX. 710-897-1975
Southern Region (TX):	Tel. (817) 461-5711, TWX. 910-890-4916
Western Region (CA):	Tel. (714) 979-6650, TWX. 910-595-1925
Northwest Region (CA):	Tel. (408) 744-1244, TWX. 910-339-9324

District Field Engineering Offices

Northeast District:	Tel. (516) 496-3506
Mid-Atlantic District:	Tel. (609) 234-8194
Midwest District:	Tel. (312) 956-6141
Southern District:	Tel. (817) 461-7121
Western District:	Tel. (714) 957-1944

International Offices

Centronics Data Computer (Canada) Ltd.
Mississauga, Ontario
Tel. (416) 625-0770, TWX. 610-492-4382

Centronics Data Computer—
European Headquarters
London SW73HA, United Kingdom
Tel. 441-581-1001, TLX. 8951373

Centronics Data Computer (France)
71-73 Rue Desnouettes, 75015 Paris, France
Tel. 828-4051, TLX. 202686

Centronics Data Computer (Germany), GmbH
6000 Frankfurt am Main 71
Tel. 666-6748, TLX. 841-413224

Centronics (Italia) S.P.A.
Archielle Grandi 10
Cologno Monzese, Milano, Italy
Tel. 02-253-7841

Centronics Ireland B.V.
Industrial Estate
Donore Road
Drogheda, Co. Louth
Republic of Ireland
Tel: 011-353-41-8991/31243/31244/31081/31082
Tlx: 31866 CENT EI

Centronics Sales and Service Walk-In Service Centers

6649 Peachtree Industrial Blvd.
Suite J
Norcross, GA 30092
Tel. (404) 447-6530

16359 N.W. 57th Avenue
Miami Lakes, FL 33014
Tel. (305) 621-0125

1 Wall Street
Hudson, NH 03051
(603) 883-0111, Ext. 4227

North Shore Atrium
231-04 Robbins Lane
Syosset, NY 11791
Tel. (516) 931-8620

137 Galthier Drive, Suite D
Mt. Laurel, NJ 08054
Tel. (609) 234-8194

738 W. Algonquin Road
Arlington Heights, IL 60005
Tel. (312) 956-6141

1900 East Randol Mill Road
Suite 103
Arlington, TX 76011
Tel. (817) 461-7121

17881 Skypark Circle
Suite H
Irvine, CA 92714
Tel. (714) 261-9444

554 Weddell Avenue, Suite 5
Sunnyvale, CA 94086
Tel. (408) 745-7040

**MODEL H136A
PRINTER**

37401361-9A00

REV A

SEPTEMBER 1984

USERS MANUAL

WARNING

This equipment generates and uses radio frequency energy and if not installed and used properly, that is, in strict accordance with the manufacturer's instructions, may cause interference to radio and television reception. It has been type tested and found to comply with the limits for a Class B computing device in accordance with the specifications in Subpart J of Part 15 of FCC rules, which are designed to provide reasonable protection against such interference in a residential installation. However, there is no guarantee that interference will not occur in a particular installation. If this equipment does cause interference to radio or television reception, which can be determined by turning the equipment off and on, the user is encouraged to try to correct the interference by one or more of the following measures:

- reorient the receiving antenna
- relocate the computer with respect to the receiver
- move the computer away from the receiver
- plug the computer into a different outlet so that computer and receiver are on different branch circuits.

If necessary, the user should consult the dealer or an experienced radio/television technician for additional suggestions. The user may find the following booklet prepared by the Federal Communications Commission helpful: "How to Identify and Resolve Radio-TV Interference Problems." This booklet is available from the U.S. Government Printing Office, Washington, D.C. 20402, Stock No. 004-000-00345-4.

JANUARY 1, 1981

APPROVED, CLASS B

PREFACE

Horizon H136A Printer

The following describes briefly the basic character of the Centronics Model H136A dot-matrix printer. Some of the highlights of this versatile printer are summarized below.

QUALITY—The Centronics Model H136A is a high-quality printer, designed for operation with popular computer software and word processors.

RELIABILITY—This newly-designed printer has a reputation for very high reliability among those who have tested and used it extensively. It is ruggedly built and runs cool hour after hour. MTBF is conservatively rated at 2000 hours.

HIGH SPEED—The fast, smooth paper feed system increases the overall (throughput) speed, which equals and exceeds that of competitive printers.

EPSON COMPATIBILITY—The Model H136A is Epson FX-100 control sequence compatible. The parallel interface communicates through a 36-pin Amphenol connector using the Centronics data transfer format.

NLQ CHARACTERS—The near-letter quality character set prints correspondence-quality “typed” materials without interruption such as replacing a font wheel for style changes on a daisy-wheel printer. Pica Italic NLQ is available as an option as well as Orator, Courier, and Gothic. With the option installed, two NLQ sets are available in the printer.

EASY PAPER HANDLING—This printer uses two standard styles of paper (sheet and fanfold) with self-contained hardware. Paper loading is fast, easy and positive.

TABLE OF CONTENTS

SECTION 1—PRINTER SETUP

1.1	PURPOSE	1-1
1.2	UNPACKING	1-1
1.3	SITE SELECTION, GENERAL	1-2
1.4	PRINTER PLACEMENT	1-2
1.5	ELECTRICAL SUPPLY	1-2
1.6	DIP SWITCH SETTINGS (Refer to paragraph 2.9)	1-2
1.7	INTERFACE TO COMPUTER	1-2
1.8	OPERATING INSTRUCTIONS	1-2

SECTION 2—PRINTER OPERATION

2.1	BEFORE YOU OPERATE THE PRINTER	2-1
2.2	CONTROLS, SWITCHES AND INDICATORS	2-1
2.3	INTERNAL CONTROLS	2-2
2.4	RIBBON INSTALLATION	2-4
2.5	LOADING SHEET PAPER	2-5
2.6	LOADING FANFOLD PAPER	2-6
2.7	PRINTER SELF-TEST	2-7
2.8	COMPUTER-PRINTER COMMUNICATION TEST	2-8
2.9	DIP SWITCH SETTINGS	2-9
2.10	HELPFUL HINTS ON OPERATION	2-11

SECTION 3—PROGRAMMER'S REFERENCE

3.1	PURPOSE OF THIS SECTION	3-1
3.2	COMPUTERS USED TO GENERATE THE PROGRAMS	3-1
3.3	DIP SWITCH SETTINGS (Refer to paragraph 2.9)	3-1
3.4	DECIMAL AND HEXADECIMAL NUMBERS	3-1
3.5	ASCII CODES AND CHARACTERS	3-1
3.6	CONTROL CODES AND ESCAPE SEQUENCES	3-1
	• CONTROL CODE SUMMARY	3-2
	• PROGRAMS	3-4 to 3-63

SECTION 4—PREVENTIVE MAINTENANCE	
4.1 GENERAL	4-1
4.2 CLEANING THE EXTERIOR	4-1
4.3 CLEANING THE PLATEN (RUBBER ROLLER)	4-1
4.4 LUBRICATION	4-1
SECTION 5—PRINT HEAD REPLACEMENT	
5.1 PURPOSE	5-1
5.2 PRINT HEAD REPLACEMENT	5-1
5.3 PRINTER REPAIR/MAINTENANCE	5-1
APPENDIX A—GENERAL SPECIFICATIONS	A-1
APPENDIX B—INTERFACE SPECIFICATIONS	
B.1 PARALLEL INTERFACE	B-1
B.2 INTERFACE SIGNAL DESCRIPTIONS	B-2
APPENDIX C—DATA TABLES	
C.1 DECIMAL TO HEXADECIMAL CONVERSION	C-1
C.2 ASCII CODE CONVERSION CHART	C-2
APPENDIX D—CHARACTER SETS	
D.1 GENERAL	D-1
D.2 STANDARD 11×9 MATRIX	D-1
D.3 NEAR LETTER QUALITY 23×16 MATRIX	D-2
D.4 CHARACTER STYLE COMBINATIONS	D-3
D.5 STANDARD CHARACTER MATRICES (11×9)	D-4
D.6 ITALIC CHARACTER MATRICES (11×9)	D-6
D.7 NLQ CHARACTER MATRICES (23×16)	D-8
D.8 STANDARD 11×9 PROPORTIONAL SPACING TABLE	D-10
D.9 NLQ PROPORTIONAL SPACING DATA	D-13

SECTION 1

PRINTER SETUP

1.1 PURPOSE

This section provides instructions for preparing the printer for operation. Please follow the guidelines in this section to ensure a successful installation.

CAUTION

Do not attempt to operate the printer without first removing the print head restraint (and shipping screws). To do so may cause damage to the printer and void the warranty.

1.2 UNPACKING

1. Carefully remove the printer (with foam endcaps) from the carton.
2. Remove the foam end-caps from the printer and place the printer (in its plastic bag) on a safe surface, such as a rug or table top.
3. Remove the printer from the plastic bag and place upside down on a rug or newspaper to prevent scratching.
4. Refer to Figure 1-1. Remove (2) phillips-head screws from the bottom front of the printer. These are shipping screws. The printer runs quieter with these screws removed.
5. Place the printer upright in the normal position and open the front hinged cover.
6. Refer to Figure 1-2. Remove the elastic band restraining the print head.

—RESTRAINT REMOVAL IS COMPLETE—

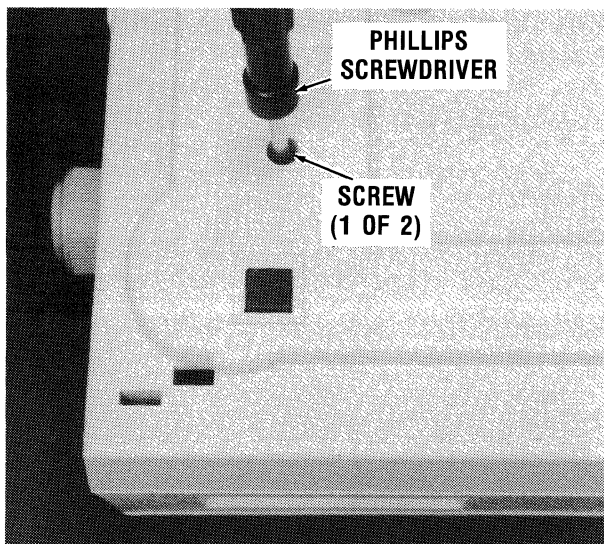

Figure 1-1 Remove Bottom Screws (2)

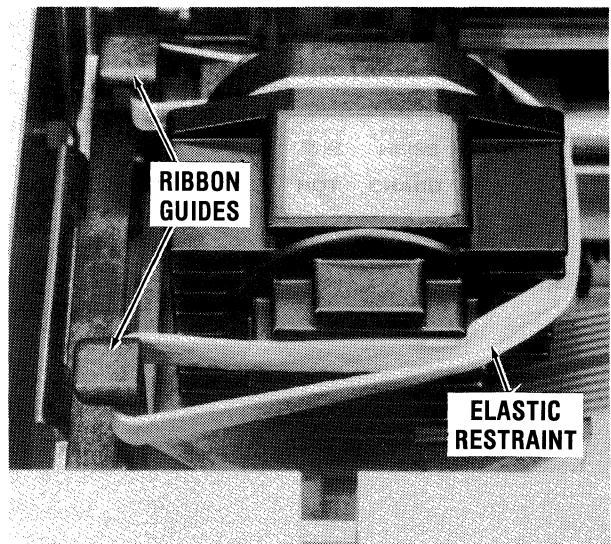

Figure 1-2 Remove Head Restraint

1.3 SITE SELECTION, GENERAL

Computer-operated equipment such as this printer should be installed in a clean, relatively cool environment (normal room temperature is suitable). The electrical service should be free of electrical noise spikes that are caused by industrial equipment, refrigerators, air conditioners, etc. Computer equipment operates most reliably on its own separate outlet, isolated from other noise-generating lines. For most reliable operation, connect printer to ground (Figure 1-3).

1.4 PRINTER PLACEMENT

The printer should be stationed on a safe, flat surface, preferably on a typewriter pad to ensure quietest operation. If operating with fan-fold paper, locate the supply and the catch basket (if used) for smooth paper feed.

1.5 ELECTRICAL SUPPLY

This printer should be plugged into the following electrical supply:

- Model H136-1 (domestic, standard unit) 115 VAC, 60 Hz
- Model H136-2 (overseas unit) 230 VAC, 50 Hz

Printer power consumed is 120 watts maximum for either model.

CAUTION

Check the electrical supply to ensure that it is proper for the printer model described above. Improper electrical power may cause damage to the printer.

1.6 DIP SWITCH SETTINGS

Some special functions of the printer are enabled by setting switches before placing the printer into service. Once the switches are set, they are normally left in that position. Refer to paragraph 2.9 for details.

1.7 INTERFACE TO COMPUTER

The printer uses a 36-pin Amphenol #57-40360 female connector. Make connection to computer with power OFF at the computer and printer. Close wire clamps on connector for reliable connection. Refer to Appendix B for Interface Specifications and signal descriptions.

1.8 OPERATING INSTRUCTIONS

Instructions on use of control panel switches, ribbon loading, paper loading, and setting of DIP switches (for special functions) are contained in Section 2 Printer Operation.

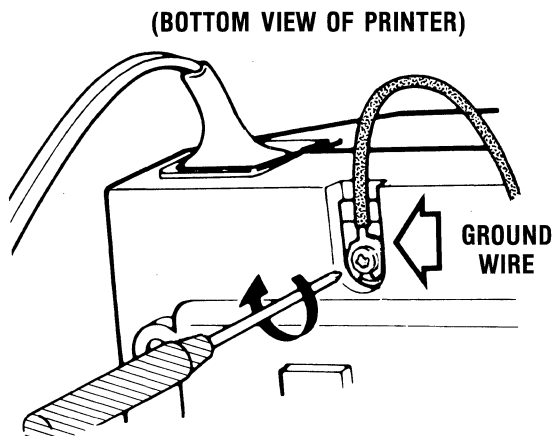
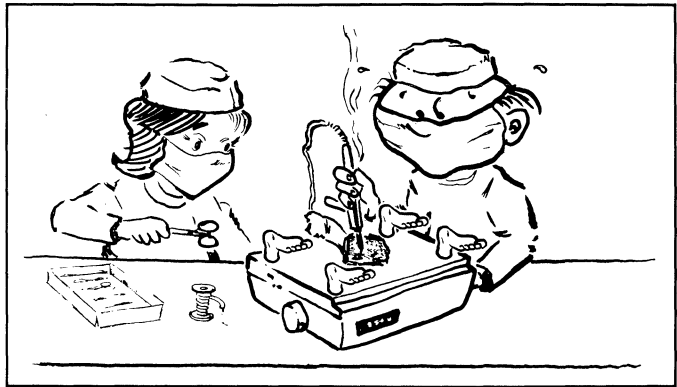

Figure 1-3 Ground Connection

SECTION 2 PRINTER OPERATION

(SERIOUS STUFF BELOW)



2.1 BEFORE YOU OPERATE THE PRINTER

Please be certain that you have prepared the printer as outlined in Section 1 before you operate it. This could prevent damage to the mechanism and avoid operating problems.

CAUTION

No attempt should be made to operate the printer without first removing the mechanism restraint (used for shipping) and taking other preparatory action. Refer to Section 1 for directions.

2.2 CONTROLS, SWITCHES AND INDICATORS

Figure 2-1 shows the main external controls and indicators which are numbered and described as follows:

1. **POWER SWITCH** (behind platen knob)—The Power Switch is a rocker type that turns the electrical power ON and OFF as indicated by the READY lamp.
2. **PLATEN KNOB**—This knob turns the platen (rubber roller) which feeds the paper manually.
3. **CONTROL LEVER**—This 3-position lever works as follows:
 - **PAPER SET**—The bail is moved toward the front of the printer to allow the paper to be moved up and around the front of the platen.
 - **FRICTION**—Cut sheet paper is pressed against the platen for positive paper feed.
 - **PIN FEED**—The pressure is released from the platen for fanfold (pinfeed) paper and the tractors drive the paper. The alarm is enabled for the paper-out condition.

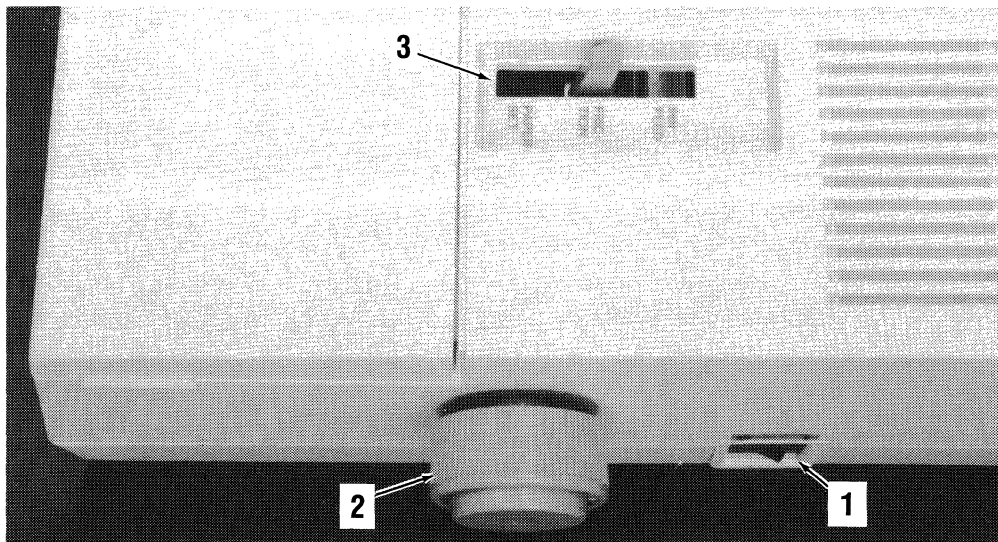

Figure 2-1A Main External Controls

4. FF (Form Feed) Switch—This button advances the paper to the next top of form when the printer is OFF LINE. If held in when power is turned on, enables Near Letter Quality print.
5. LF Switch—When the printer is OFF LINE, this button advances the paper by one line if pressed momentarily, and feeds paper continuously if held when the printer is OFF LINE. If held in when power is turned on, starts self-test.
6. ON LINE Switch—This button controls the interface connection to the computer. When power is turned ON, the printer goes ON LINE automatically (ready to receive data). Pressing this button places the printer OFF LINE, allowing local paper control (LF & FF). Pressing it once more places the printer ON LINE again.
7. ON LINE Lamp—This light indicates that the printer is ready to receive data. It is controlled by the ON LINE switch.
8. ALARM Lamp—This light indicates that the paper supply is exhausted when the control lever is in the “FRICTION” position for fanfold paper. The beeper alarm may also sound depending on DIP Switch settings.
9. READY Lamp—This light indicates that power is applied to the printer and the POWER switch is on.

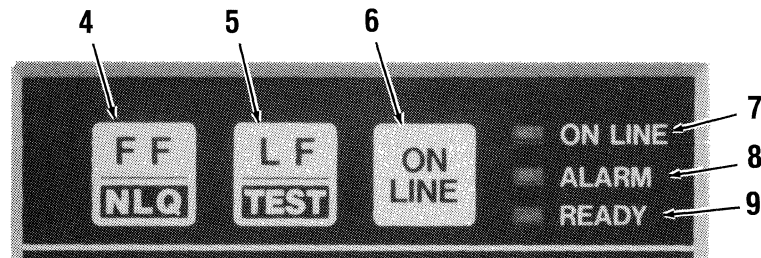

Figure 2-1B Control Panel Switches and Indicators

2.3 INTERNAL CONTROLS (Refer to Figure 2-2)

The Control Lever (3) is shown in the PAPER SET position thus the bail (10) is moved forward to allow paper to be fed around to the front of the platen. When the Control Lever is moved to FRICTION, the bail springs back onto the platen.

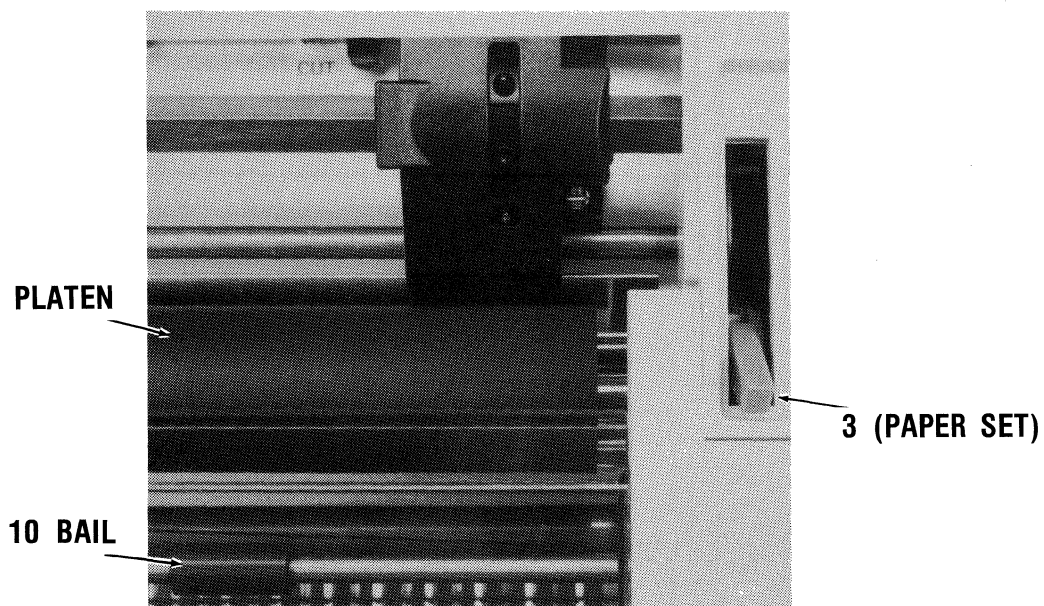

Figure 2-2A Internal Controls

PRINT HEAD POSITION—The five-position lever (Figure 2-2B) moves the print head forward and backward to accommodate single or multipart forms. The #2 position is for single sheet and the #4 position is for multipart forms of one original and up to two copies. Place this switch in the position that produces best printing.

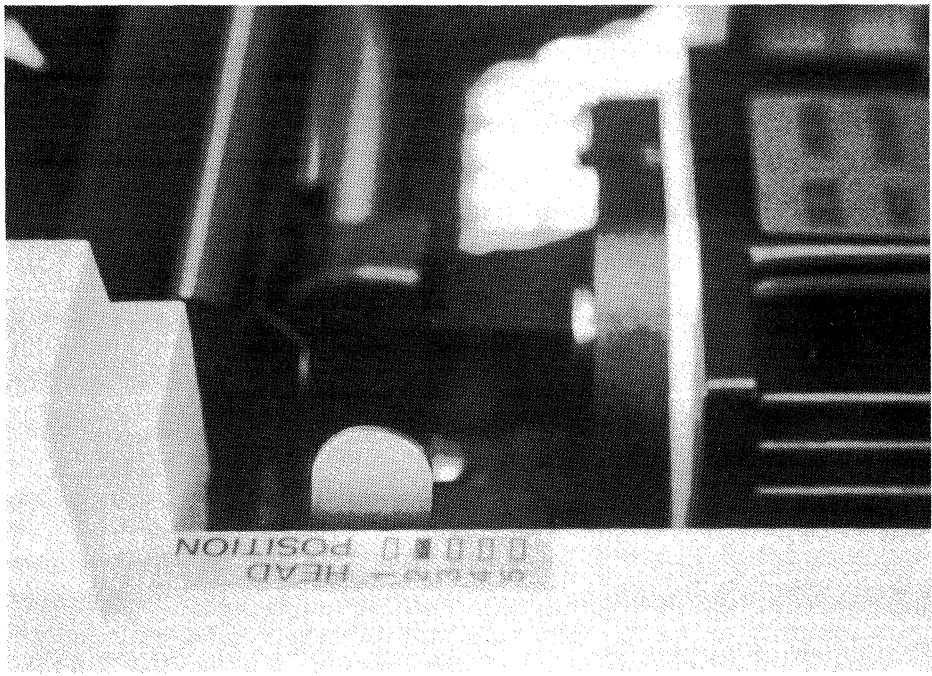

Figure 2-2B Print Head Position Lever
(Shown in position #2; normal position for single sheets)

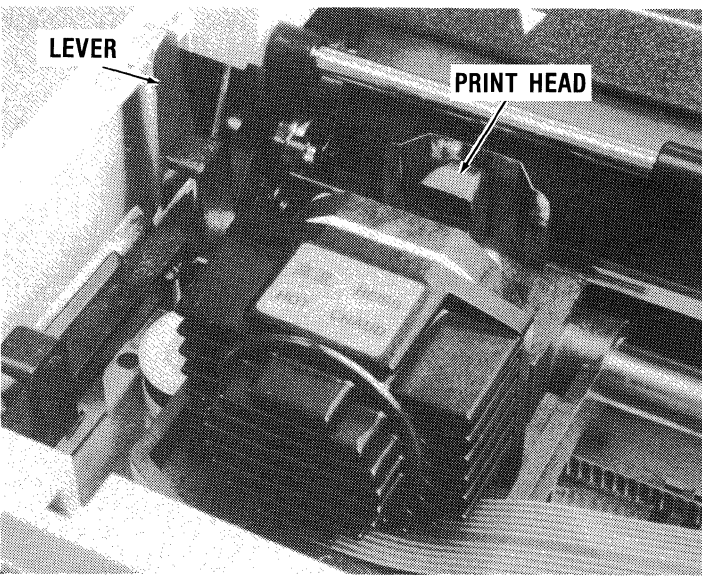

Figure 2-2C Lever and Print Head

2.4 RIBBON INSTALLATION (Clean Hands Technique)

The following procedure allows the operator to install (or change) the ribbon without soiling the hands. However, using the pencil (Figure 2-3C) may be omitted if desired. Refer to Figures 2-3A, B, C, D.

1. With power OFF, lift the front, hinged cover and move the print head to the middle of the carriage.
2. Holding the ribbon cassette by the ridge as shown in Figure 2-3A, loop the ribbon onto the two left ribbon guides.
3. Draw the cassette to the right end of the printer and seat the right end of the cassette as shown in Figure 2-3B.
4. Now press the cassette downward and seat the left end of the cassette. It should snap into place.

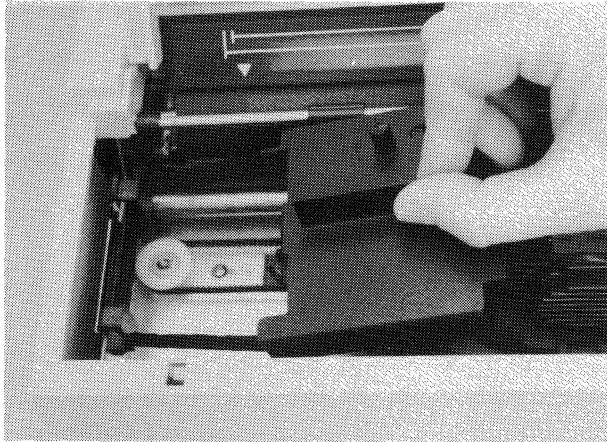

Figure 2-3A Looping the Ribbon onto the Left Ribbon Guides

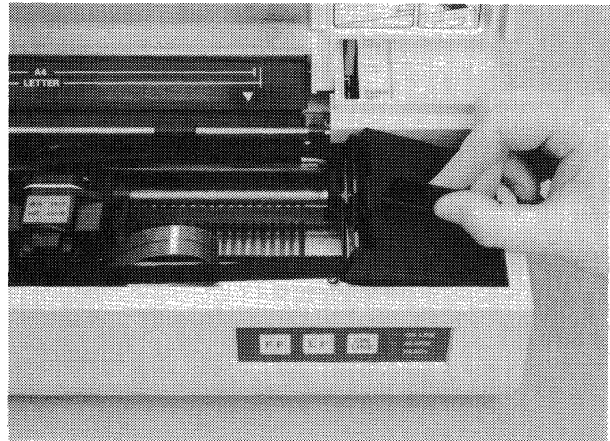

Figure 2-3B Seating the Ribbon Cassette into the Right End of the Printer

5. Using a pencil as shown in Figure 2-3C, place the ribbon between the print head and the shiny ribbon guide. The ribbon should **NOT** be on the platen side of the guide.
6. Return the print head to the left side of the printer, then tighten the ribbon by turning the small knob on the cassette (Figure 2-3D).

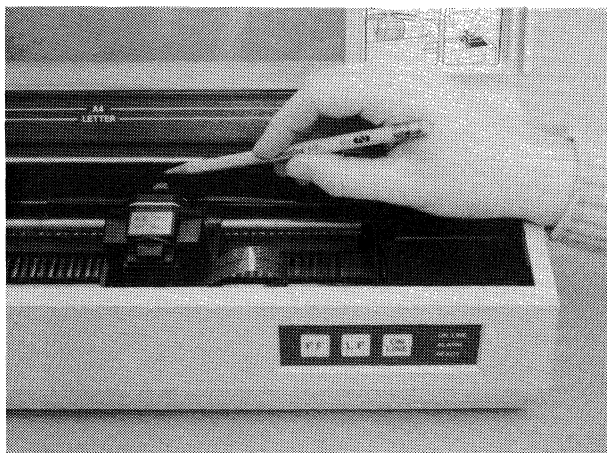

Figure 2-3C Inserting Ribbon at Print Head

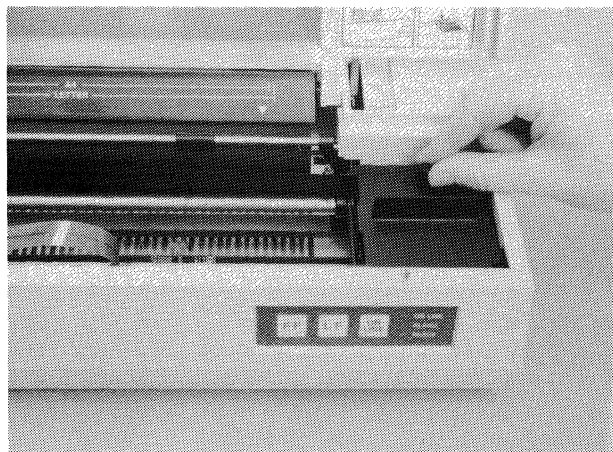

Figure 2-3D Tightening the Ribbon (Knob)

2.5 LOADING SHEET PAPER

Single sheets of paper are loaded into the printer exactly as loading a typewriter.

1. Place the control lever in the PAPER SET position (Figure 2-4A).
2. Insert the sheet paper into the paper slot (Figure 2-4B). Standard 8½ × 11" paper should line up with the 80 marker as shown.
3. Guide the paper downward until it seats squarely on the platen, then advance the paper up to the front of the platen, using the platen knob.

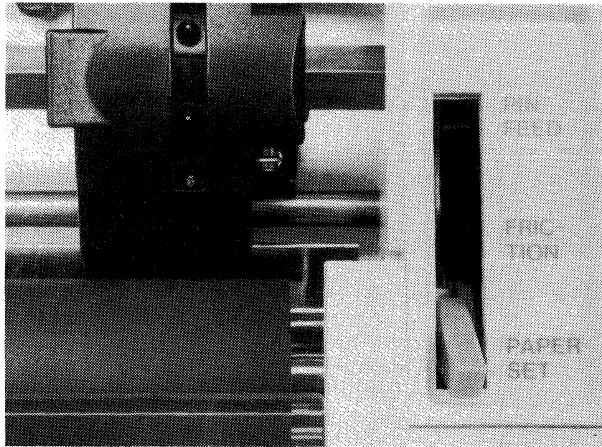

Figure 2-4A Paper Set Position

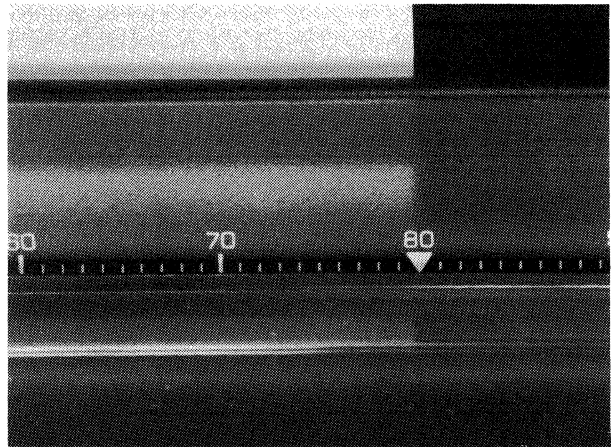

Figure 2-4B Inserting Sheet Paper

4. Move the control lever to FRICTION (Figure 2-4C). The bail should press the paper against the platen.
5. Advance the paper with the platen knob until both ends of the paper meet, then square the sides of the paper.
6. Move the leading edge of the paper down to the clear plastic tear-off edge (Figure 2-4D). This is the normal top of form position.

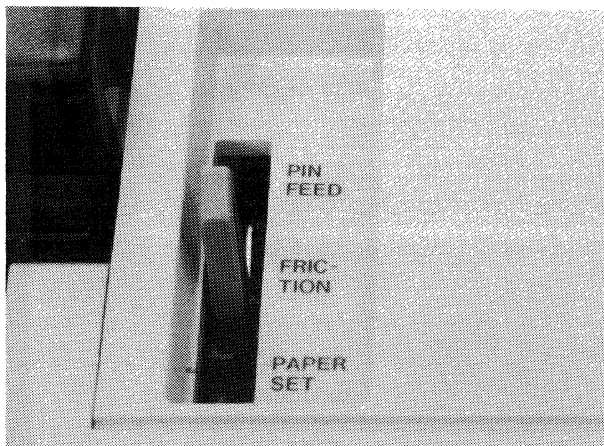

Figure 2-4C Lever to Friction Position

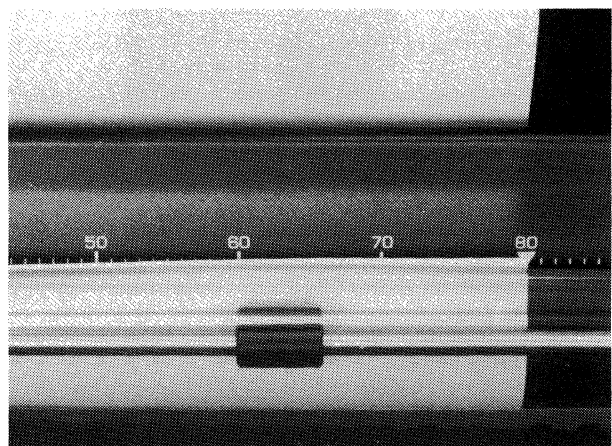

Figure 2-4D Paper at Top of Form

2.6 LOADING FANFOLD PAPER

Fanfold paper has pinfeed holes on each side that engage with the tractor sprocket (pins). Fanfold paper is loaded as follows:

1. Place the control lever in the PAPER SET position (see Figure 2-4A).
2. Open the paper cover and unlock the left tractor by pushing the lever rearward (Figure 2-5A). Note the Paper End switch.
3. Align the sprocket pins with the full-headed arrow (Figure 2-5B). Lock the tractor lever.

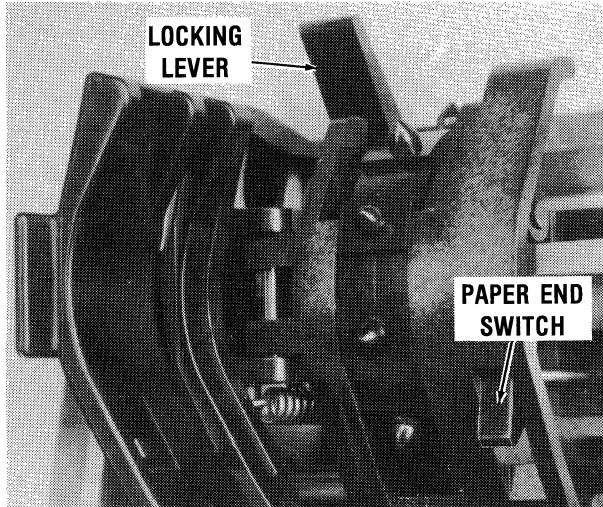

Figure 2-5A Left Tractor Controls

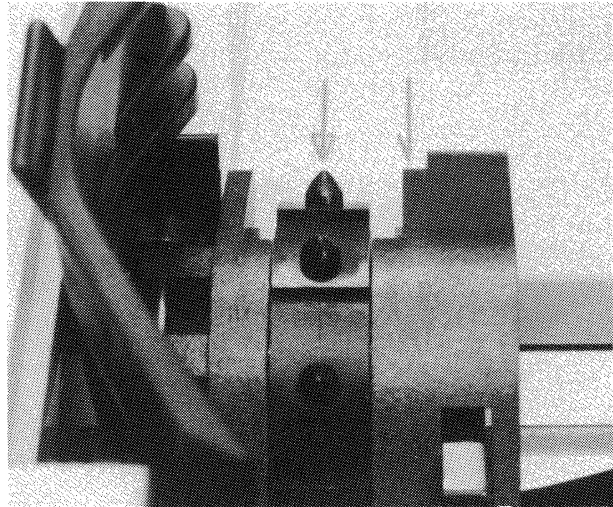

Figure 2-5B Left Tractor Alignment

4. Feed the fanfold paper through the rear slot and engage two or three holes in the sprocket (Figure 2-5C) then close the tractor.
5. Similarly, engage the fanfold paper with the right sprocket pins. Use the locking lever to position the sprocket for a snug fit, but do not elongate the holes.
6. Move the paper around to the platen with the platen knob and place the control lever in the PIN FEED position (Figure 2-5D).

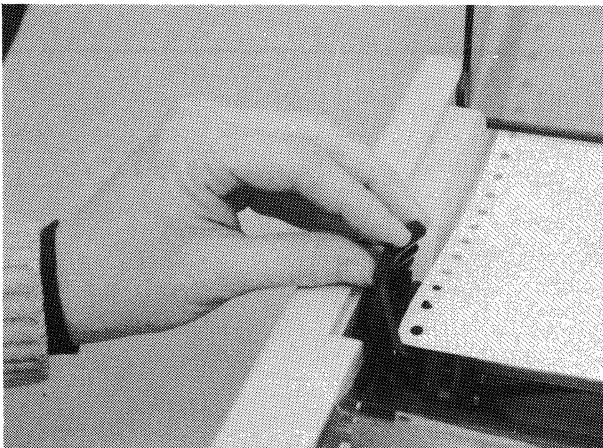

Figure 2-5C Engaging Left Sprocket

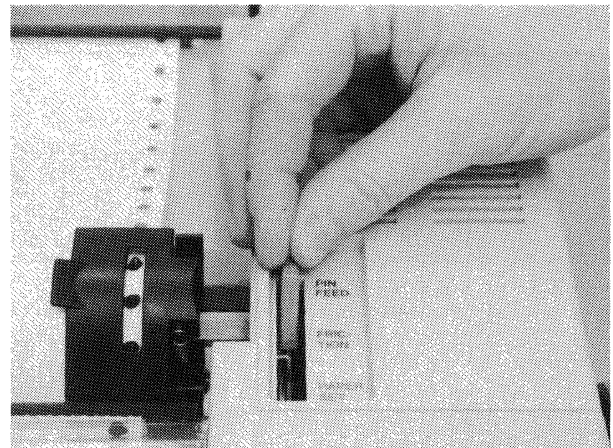

Figure 2-5D Lever To PIN FEED Position

2.7 PRINTER SELF-TEST

PURPOSE—Self-test exercises all electrical and mechanical functions of the printer. The only area not tested is the communication with the computer. Thus, self-test verifies correct printer operation with a high degree of certainty.

DESCRIPTION—The self test printout is a “rolling ASCII”, beginning with the SPACE character (20 Hex, 32 Decimal), continuing in ascending ASCII order (!”#%&) etc. Each new line printed omits the first character of the previous line, thus the pattern appears to “roll”.

On the 1st line, the character in column 96 is normally an italic, accented, “a”, and each new line includes additional italic characters. Eventually, every printable character is printed in 10 cpi (pica) monospaced and then the pattern repeats itself. There are two different fonts in this italic area, determined by DIP switch settings (see note).

NOTE

If graphic blocks appear beginning near the end of the 1st line, this means that DIP switch SW1-7 is OFF. If italic printing is desired when using the printer, SW1-7 must be ON. Refer to paragraph 2.9 for DIP switch settings.

SELF-TEST PROCEDURE—The self-test is activated as follows:

1. Make certain that ribbon and paper are installed as detailed in this section.
2. If sheet paper is used, the control lever must be in the FRICTION position.
3. (POWER OFF)—Press the LF switch on the control panel and hold it in for a few seconds after the power switch is turned ON.

The self-test should start, printing bidirectionally at maximum speed. The test continues until power is turned OFF or when paper runs out (with lever in the PINFEED position).

NOTE

Self-test will print in the style selected by DIP switch SW2. Refer to paragraph 2.9. Normally, all switches on SW2 are OFF, thus Pica 10 cpi is the active style when power is turned ON.

Ver2.04E AM

```
!"#$%&'()*+,-./0123456789:;<=>?@ABC abcdef' yz{|}~`àèùòì /"#$%&'(
!"#$%&'()*+,-./0123456789:;<=>?@ABC abcdef' yz{|}~`àèùòì /"#$%&'(
!"#$%&'()*+,-./0123456789:;<=>?@ABC abcdef' yz{|}~`àèùòì /"#$%&'()*
#$%&'()*+,-./0123456789:;<=>?@ABC abcdef' yz{|}~`àèùòì /"#$%&'()*+
%&'()*+,-./0123456789:;<=>?@ABC abcdef' yz{|}~`àèùòì /"#$%&'()*+,-
&'()*+,-./0123456789:;<=>?@ABC abcdef' yz{|}~`àèùòì /"#$%&'()*+,-.
'()*+,-./0123456789:;<=>?@ABC abcdef' yz{|}~`àèùòì /"#$%&'()*+,-./
()*+,-./0123456789:;<=>?@ABC abcdef' yz{|}~`àèùòì /"#$%&'()*+,-./0
)*+,-./0123456789:;<=>?@ABC abcdef' yz{|}~`àèùòì /"#$%&'()*+,-./01
*+,-./0123456789:;<=>?@ABC abcdef' yz{|}~`àèùòì /"#$%&'()*+,-./012
+,-./0123456789:;<=>?@ABC abcdef' yz{|}~`àèùòì /"#$%&'()*+,-./0123
,-./0123456789:;<=>?@ABC abcdef' yz{|}~`àèùòì /"#$%&'()*+,-./01234
-./0123456789:;<=>?@ABC abcdef' yz{|}~`àèùòì /"#$%&'()*+,-./012345
./0123456789:;<=>?@ABC abcdef' yz{|}~`àèùòì /"#$%&'()*+,-./0123456
```

Figure 2-6 Self-Test Sample

2.8 COMPUTER-PRINTER COMMUNICATION TEST

PURPOSE—The following program (in Microsoft BASIC) tests some of the commands from the computer to the printer. It may be keyed into the computer and saved on disk for future use. This program contains “download” commands which allow the computer to change printer operation (in addition to sending text).

NOTE

For this test, it is assumed that all switches are OFF except SW1-7, which should be ON for italic characters. However, the test should verify that the printer is responding to the computer's commands regardless of DIP switch settings.

PREPARATION—Load ribbon and paper as required. With power OFF at the printer and computer, make proper connections with the interface cable as detailed in Section 1. Next, turn power ON to the computer, then the printer. The printer will go ON LINE automatically.

CAUTION

Always remove power from the computer and printer before making connections with the interface cable. In this manner, electrical damage to the equipment is avoided.

Assuming that the program below is keyed in and accepted as proper syntax by the computer, key RUN then hit ENTER (or RETURN as appropriate). The printer should respond per “RESULT”.

PROGRAM:

```
10 LPRINT CHR$(27);"@";:REM PRINTER INITIALIZE
20 LPRINT "This is Pica 10 cpi Monospaced"
30 LPRINT CHR$(27);"("; "Near Letter Quality Characters"
40 LPRINT CHR$(27);"P";:REM CANCEL NLO, TURN ON PICA
50 LPRINT CHR$(27);"4"; "Let's Print Italic Characters"
60 LPRINT CHR$(27);"5"; "Now We Have Pica 10 cpi Again"
70 LPRINT CHR$(27);CHR$(15);:REM TURN ON CONDENSED
80 LPRINT "This is Condensed (17.14 Characters/inch)"
90 LPRINT CHR$(27);"!";CHR$(32);"ENLARGED TYPE"
100 LPRINT CHR$(27);"!";CHR$(0);:REM TURN ON PICA
110 LPRINT "Back to Pica 10 cpi Monospaced"
```

RESULT:

```
This is Pica 10 cpi Monospaced
Near Letter Quality Characters
Let's Print Italic Characters
Now We Have Pica 10 cpi Again
This is Condensed (17.14 Characters/inch)
ENLARGED TYPE
Back to Pica 10 cpi Monospaced
```

2.9 DIP SWITCH SETTINGS

Three DIP (Dual Inline Package) switches on the logic PCB control some of the characteristics of the printer. Normally, once the mode of operation is set, the switches remain in the positions set initially. The functions controlled by these switches become active when power is turned ON. Refer to Figures 2-8, 2-9 and 2-10 (see CAUTION).

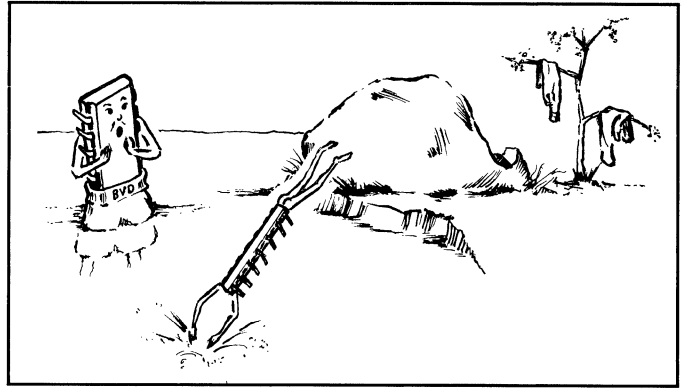

Figure 2-7 Skinny DIP

CAUTION

The top cover must be removed in order to set the switches. This must be performed by a qualified service person, with power removed from the printer. Take care not to damage front control panel.

INSTRUCTIONS FOR COVER REMOVAL

1. Remove power plug from outlet.
2. Lift the front hinged cover and remove ribbon cassette.
3. Remove platen knob by pulling straight outward. Note flat keyway for shaft.
4. Loosen 3 screws at rear of printer (Figures 2-8, 2-9).
5. Lift top cover at rear of printer, then carefully continue until front latching tabs disengage (they will make a snapping sound).
6. Set switches according to functions desired (Figure 2-10; Tables 2-1 and 2-2).
7. Reinstall cover, starting at rear. Align and index the power plug spacer and serial I/F spacer as covers are fit together. Finally, press downward at the front until the latching tabs engage. Fasten rear screws.
8. Replace platen knob and ribbon cassette, indexing it properly and pressing down firmly. Take up slack with small cassette knob.

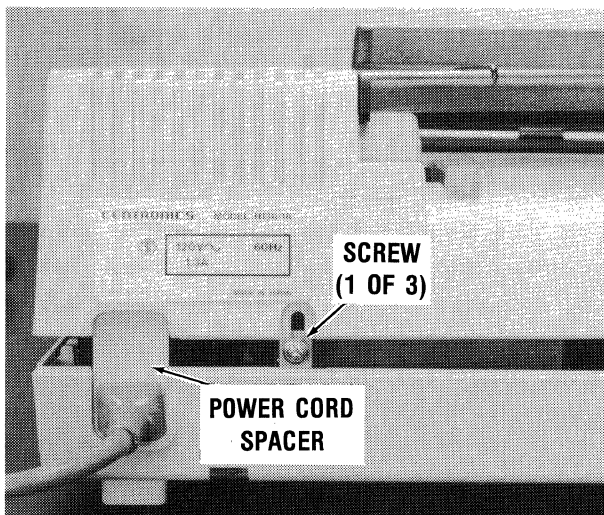

Figure 2-8 Left Rear View of Printer

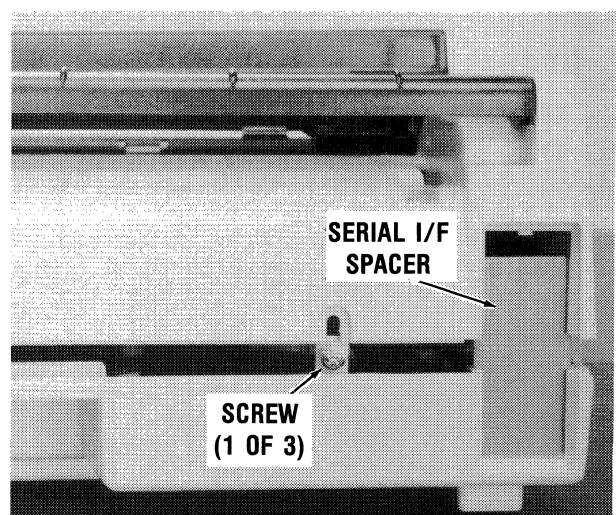
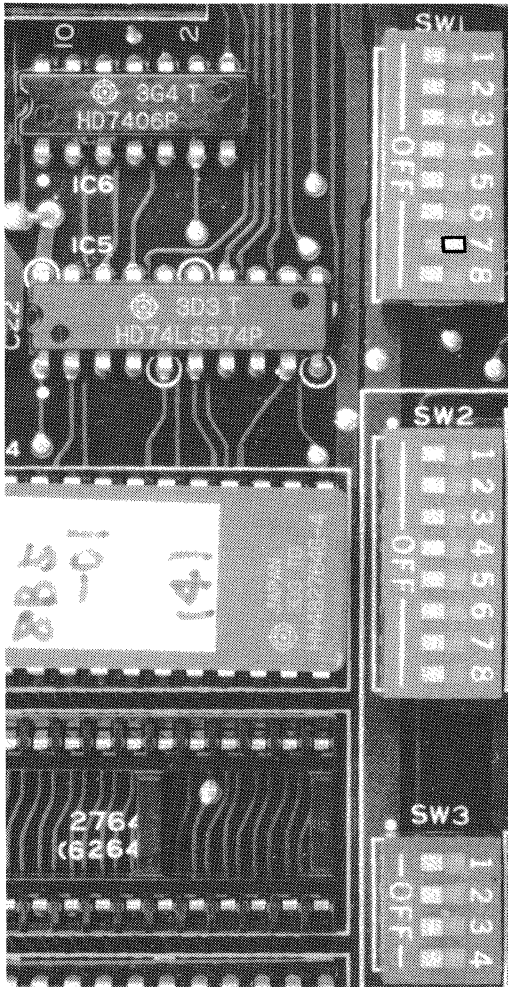

Figure 2-9 Right Rear View of Printer

LOGIC BOARD

ON 



DIP SW1

- 1] POWER-ON
- 2] INTERNATIONAL
- 3] CHARACTER SETS
- 4] (SEE SW1 TABLE)
- 5 8K ROM/RAM OPTION (ON = ACTIVE)
- 6 ZERO MARKER (ON = SLASHED ZERO)
- 7 ON = *ITALICS*, OFF = BLOCK GRAPHICS
- 8 (NOT USED)

DIP SW2

- 1 ON = BYPASS PAPER END DESELECT
- 2 PRINTER ALARM (OFF = ACTIVE)
- 3 OFF = DOWNLOAD CG, ON = INBUF (3K)
- 4] POWER-ON
- 5] PRINT
- 6] STYLE
- 7] (SEE SW2 TABLE)
- 8 RT MARGIN (OFF = 156 COL, ON = 136)

DIP SW3

- 1 SLCT IN (OFF = SELECT/DESELECT)
- 2 FORM LENGTH (OFF = 11", ON = 12")
- 3 PERF SKIP (ON = ACTIVE, 1" SKIP)
- 4 AUTO LINEFEED (ON = LF AFTER CR)

Figure 2-10 DIP Switch Settings on Logic Board

Table 2-1 Country Settings

COUNTRY	SW 1			
	1	2	3	4
USA	OFF	OFF	OFF	OFF
FRANCE	ON	OFF	OFF	OFF
GERMANY	OFF	ON	OFF	OFF
U.K.	ON	ON	OFF	OFF
DENMARK	OFF	OFF	ON	OFF
SWEDEN	ON	OFF	ON	OFF
ITALY	OFF	ON	ON	OFF
SPAIN	ON	ON	ON	OFF
JAPAN	ON	ON	ON	ON

Table 2-2 Type Styles (Power ON)

STYLE	SW2			
	4	5	6	7
PICA (10 CPI)	OFF	OFF	OFF	OFF
PICA ENLARG	OFF	OFF	OFF	ON
CONDENSED	ON	OFF	OFF	OFF
COND-ENLARG	ON	OFF	OFF	ON
PICA-EMPH	OFF	ON	OFF	OFF
ENLARG-EMPH	OFF	ON	OFF	ON
NLQ	ON	ON	OFF	OFF
ENLARG-NLQ	ON	ON	OFF	ON
ELITE (12 CPI)	OFF	OFF	ON	OFF
ELITE-ENLARG	OFF	OFF	ON	ON

2.10 HELPFUL HINTS ON OPERATION

PURPOSE—This paragraph provides helpful hints in the operation of the printer.

- Place a typewriter pad under the printer to reduce vibration and provide quieter operation.
- When power is turned ON, the print head jogs back and forth twice to find the left margin, then it goes ON LINE and beeps once.
- NLQ (Near Letter Quality) characters are selected by holding the FF button while turning printer power ON.
- Normal DIP switch settings are: all switches OFF except SW1-7 ON (for italics). Switches can be set by qualified service personnel (see Figure 2-10).
- DIP switch settings become active as power is turned ON.
- Printer will self-test in the style selected by DIP switch SW2.
- Printer must be ON LINE to receive data from the computer.
- Printer will NOT go ON LINE when in the alarm condition. This occurs when paper supply is exhausted with lever in PINFEED position.
- Paper End alarm is 5 beeps (about .1 second each).
- Paper End alarm is disabled with lever in FRICTION position.
- DIP switch SW3-4 ON causes a line feed (LF) after a carriage return (CR). Most computers and word processors provide a LF after CR; thus, to prevent a double line feed, DIP switch SW3-4 should be OFF. Refer to helpful hint illustrations below for Carriage Return and Line Feed.
- Some Centronics parallel interfaces may force pin 14 to ground, causing a fixed condition of AUTO LF (Automatic Line Feed). In this case, the cable would require modification to disconnect the wire at pin 14 (see Appendix B.1).
- When printing on fanfold paper, the specification is that no printing should be performed within ½" before and after the perforation.
- Section 3 contains reference data and programs for the Programmer. With this information, the Programmer will be able to control all the special functions of the printer using download commands.

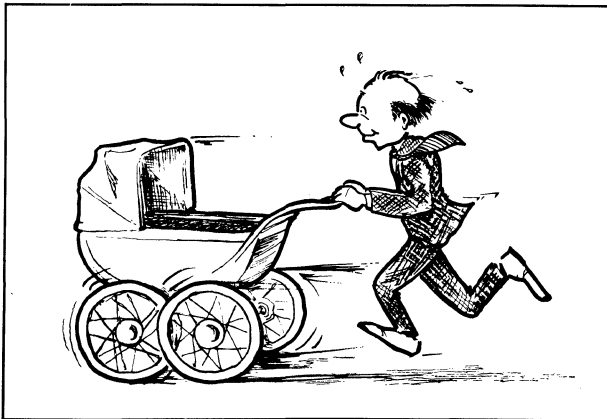

Figure 2-11 Carriage Return

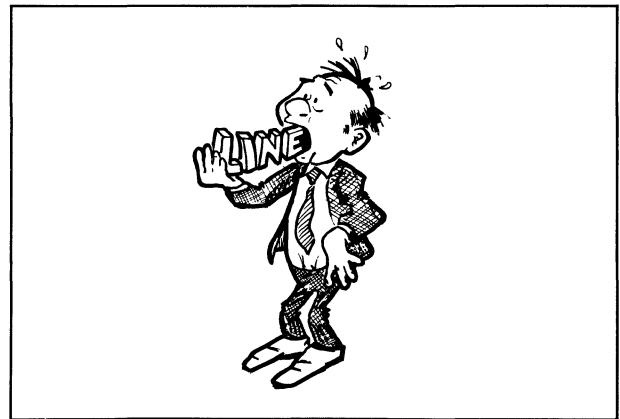

Figure 2-12 Line Feed

SECTION 3

PROGRAMMER'S REFERENCE

3.1 PURPOSE OF THIS SECTION

This section provides samples of actual BASIC programs that exercise the functions of the printer. There are control codes and sequences that change character styles, spacing, tabbing, etc. These commands normally originate at the keyboard and are sent from the computer to the printer.

IMPORTANT

In order to control all of the functions of this powerful printer, your computer or word processor must be able to generate and send the 8th bit (128 decimal). However, most important functions do NOT require bit 8. For example, all character styles can be programmed with any computer that operates in BASIC.

3.2 COMPUTERS USED TO GENERATE THE PROGRAMS

The programs in this section were generated using an Apple® IIe, IBM PC and a COMPAQ™ Portable computer. Those programs with PRINT statements were generated on the Apple® IIe. Those with LPRINT statements (and those requiring bit 8) were generated on the IBM PC and COMPAQ™ Portable. Refer to your computer's reference documentation to determine whether your computer sends bit 8 to the printer, or try the program below.

SIMPLE CHECK FOR BIT 8—Run this program to see if bit 8 is being sent to the printer. Note that DIP switch SW1-7 must be ON to get the italic, accented character *ı*.

```
10 REM CHECK FOR BIT 8
20 LPRINT CHR$(27);"ı";CHR$(1);
30 LPRINT CHR$(132);:LPRINT:END
```

The printer should respond with an *ı*, accented letter *ı* (*ı*). If the *ı* is not *ı*, the printer did not receive the 8th bit.

3.3 DIP SWITCH SETTINGS

Some printer functions are affected by the setting of DIP switches on the logic board. Look for the NOTE included with the programs for any DIP switch settings required. The functions of the DIP switches are described in Section 2.

3.4 DECIMAL AND HEXADECIMAL NUMBERS

The programs listed in this section are written in BASIC (Beginner's All-purpose Symbolic Instruction Code), and the number system is the familiar decimal (0-9). For the programmer's convenience, the control sequence is also expressed in hexadecimal (0-9 + ABCDEF) for each function.

3.5 ASCII CODES AND CHARACTERS

ASCII (American Standard Code for Information Interchange) control codes and characters are assigned numbers 0 (NUL) thru 127 (DEL) decimal. Printable characters are codes 33 thru 126. A complete ASCII table (including numerical cross-reference) is included in the Appendix.

3.6 CONTROL CODES AND ESCAPE SEQUENCES

The control codes and ESC sequences are summarized on the next two pages. The summary is listed in ascending ASCII code sequence as a general rule. Following the summary, programs are listed for each function where appropriate and the result is included for comparison.

CONTROL CODE SUMMARY

ASCII	FUNCTION	PAGE
N/A	Self-Test Function: (hold LF button, turn power ON)	3-4
N/A	Hex Code Dump Function: (hold FF + LF buttons, turn power ON)	3-4
BEL	Sound Printer Alarm (beep!)—DIP Switch SW2-2 OFF	3-5
BS	Backspace Width of One Character	3-5
HT	Horizontal Tab Execution (used with ESC D)	3-6
LF	Line Feed Execution (value set by ESC 0, 1, 2, 3, A)	3-6
VT	Vertical Tab Execution (positions set by ESC B, ESC b)	3-7
FF	Form Feed Execution (values set by ESC C, ESC C 0)	3-8
CR	Carriage Return (automatic LF if DIP Switch SW3-4 is ON)	3-8
SO	Select Enlarged Characters (one line; cancelled by LF)	3-9
SI	Select Condensed Characters (effective until cancelled by DC2)	3-9
DC1	Remote Printer Select (DIP Switch SW3-1 OFF)	3-10
DC2	Cancel Condensed Characters	3-10
DC3	Remote Printer Deselect (DIP Switch SW3-1 OFF)	3-11
DC4	Cancel Enlarged Characters	3-11
CAN	Cancel Printer Buffer Data (on same line as CAN code)	3-12
DEL	Delete Last Character in Printer Buffer	3-12
ESC SO	Select Enlarged Characters (cancelled by LF)	3-13
ESC SI	Select Condensed Characters (cancelled by DC2)	3-13
ESC !	Select Print Mode (Modes 0-63)	3-14
ESC #	Cancel MSB Sequence (cancel bit 8 being forced to 1 or 0)	3-16
ESC % 0	Select Internal CG (Character Generator) ROM	3-17
ESC % 1	Select Download Character RAM/ROM	3-17
ESC &	Define Download Character (ASCII code, attribute)	3-18
ESC (Select NLQ (Near Letter Quality) Characters	3-21
ESC *	Selectable Density Graphics Mode	3-22
ESC -	Print Underline Function (1 = ON, 0 = OFF)	3-24
ESC /	Select VFU (Vertical Format Unit) Channel 0 to 7	3-25
ESC 0	1/8 Inch Line Spacing (8 lines per inch)	3-27
ESC 1	8 Pin Graphics (7/72") Line Spacing	3-27
ESC 2	1/6 Inch Line Spacing (6 lines per inch)	3-28
ESC 3	N/216" Line Spacing (1/3 Dot Diameter)	3-28
ESC 4	Select Alternate Character Set (italics)	3-29
ESC 5	Cancel Alternate Character Set (italics)	3-29
ESC 6	Printable Area Code Expansion (International Characters)	3-30
ESC 7	Cancel Printable Area Code Expansion	3-30
ESC 8	Disable Paper Out—Remote	3-31
ESC 9	Enable Paper Out—Remote	3-31

table 4 (horizon1) 1-19-84

(Continued on next page)

CONTROL CODE SUMMARY (CONT.)

ASCII	FUNCTION	PAGE
ESC :	Copy ROM CG to Download CG	3-32
ESC <	Left-to-Right Printing (home print head)	3-33
ESC =	Set MSB to 0 (force bit 8 to 0, cancelled by ESC #)	3-34
ESC >	Set MSB to 1 (force bit 8 to 1, cancelled by ESC #)	3-34
ESC ?	Multiple Function Graphics (Mode)	3-35
ESC @	Printer Initialization Command—Remote	3-37
ESC A	N/72" Line Spacing (1 dot diameter)	3-37
ESC B	Vertical Tab Setting, 16 Positions	3-38
ESC C	Set Form Length, # of Lines (n = 1 to 127)	3-39
ESC C 0	Set Form Length, # of Inches (n = 1 to 22)	3-39
ESC D	Horizontal Tab Setting, 32 Positions	3-40
ESC E	Select Emphasized Print	3-41
ESC F	Cancel Emphasized Print	3-41
ESC G	Select Double Strike Print Mode	3-42
ESC H	Cancel Double Strike Print Mode	3-42
ESC I	Enable Printable Control Codes (1 = ON, 0 = OFF)	3-43
ESC J	N/216" Paper Feed (1/3 Dot Increment)	3-44
ESC K	Normal Density Graphic Mode	3-45
ESC L	Double Density Graphic Mode	3-47
ESC M	Select Elite Characters (12 characters per inch)	3-48
ESC N	Enable Skip-Over Perforation (DIP switch 3-3 OFF)	3-49
ESC O	Disable Skip-Over Perforation	3-49
ESC P	Select Pica Characters (10 characters per inch)	3-48
ESC Q	Right Margin Setting (n = 1 to 255)	3-50
ESC R	Select International Character Set Mode (n = 0 to 8)	3-51
ESC S 0	Select Superscript Character Set (cancelled by ESC T)	3-53
ESC S 1	Select Subscript Character Set (cancelled by ESC T)	3-53
ESC T	Cancel Subscript, Superscript Character Sets	3-54
ESC U	Select Unidirectional Print Mode (1 = ON, 0 = OFF)	3-33
ESC W	Select Enlarged Print Mode (1 = ON, 0 = OFF)	3-54
ESC Y	Double Speed, Dual Density Graphics Mode	3-55
ESC Z	Quadruple Density Graphics Mode	3-56
ESC ^	Select 9-Bit & 16-Bit Graphics Mode	3-57
ESC b	VFU Tab Position Setting (8 channels, 16 positions)	3-61
ESC i	Incremental Typewriter Mode	3-62
ESC j	N/216" Reverse Paper Feed (1/3 Dot Increment)	3-44
ESC l	Left Margin Setting (n = 0 to 255)	3-50
ESC p	Proportional Spacing Mode (1 = ON, 0 = OFF)	3-63
ESC s	Half-Speed (quiet) Print Mode (1 = ON, 0 = OFF)	3-63

table4 (horizon1) 1-19-84

BS**(Backspace one character width)****BS**

BASIC: CHR\$(8);**HEX:** 08**NAME:** BS (Backspace)

FUNCTION: When BS is received, all codes in the printer buffer are printed, then the next print position is moved to the left (in the same line) by the width of one character. Multiple BS commands move the position one character width for each BS command. Subsequent characters will then be printed starting at the new position. In enlarged print mode, the new position is two character widths for each BS.

NOTE

BS function is most accurate in unidirectional print mode (ESC "U"). Also, BS is active only on the same line, thus characters following BS must be entered on the same line as previous characters.

PROGRAM:

```
10 REM BACKSPACE 10
20 PRINT CHR$(27);"U"; CHR$(1);
30 PRINT "12345678901234567890";
40 FOR X = 1 TO 10
50 PRINT CHR$(8);
60 NEXT X
70 PRINT "123456789/BACKSPACE"
80 END
```

RESULT:

```
JRUN
12345678901234567890BACKSPACE
```

HT**(Horizontal Tab Execution)****HT**

BASIC: CHR\$(9);**HEX:** 09**NAME:** HT (Horizontal Tab)

FUNCTION: Executes Horizontal Tab function. Values of horizontal tab position are determined by ESC D (N₁) (N₂) . . . (N_k) ; otherwise, tabs are automatically set every 8 characters when power is turned on. In enlarged mode, HT executes the tabs in twice the normal width value.

NOTE

Some Microsoft BASIC programs cannot use CHR\$(9). In this case, use CHR\$(137). This is established by 9 + 128 = 137.

```
PROGRAM:      5  REM HTAB POWER UP (8)
                10 PRINT "0123456789012345678901
                  234567890"
                20  FOR X = 1 TO 3
                25  PRINT CHR$ (9); "TAB";
                30  NEXT
```

```
RESULT:      0123456789012345678901234567890
                TAB      TAB      TAB
```

LF**(Line Feed Execution)****LF**

BASIC: CHR\$(10);**HEX:** 0A**NAME:** LF (Line Feed)

FUNCTION: Receipt of LF causes the printing of all data in printer buffer, then paper is moved the effective line feed value. At power ON, line feed value is 1/6" (six lines per inch). Other values are established by ESC "A", ESC 0, ESC 1, ESC 3.

NOTE

When in OFF LINE mode, the LF button executes paper movement by the value established at power ON (six lines per inch) or by the above codes.

```
PROGRAM:      10  REM LINE FEED 3
                12  PRINT "*****";
                15  FOR X = 1 TO 3
                20  PRINT CHR$ (10);: REM LF
                25  NEXT
                30  PRINT "*****"
```

```
RESULT:      *****
```

```
*****
```

BASIC: (CHR\$(11));**HEX:** 0B**NAME:** Vertical Tab Execution

FUNCTION: Receipt of VT causes the printing of all data in the print buffer, then a line feed to the position established by ESC B or ESC b. VT cancels enlarged characters set by SO. If no vertical tab has been set, VT simply performs a line feed.

PROGRAM:

```
10 REM ESC B VERT TAB
20 FOR X=0 TO 11
30 LPRINT X:NEXT
40 LPRINT CHR$(27);"B";CHR$(2);
45 LPRINT CHR$(6);CHR$(10);CHR$(0);
50 FOR I = 1 TO 2
60 LPRINT CHR$(27);"j";CHR$(216);
70 NEXT
80 FOR Z = 1 TO 3
90 LPRINT CHR$(11);" VTAB";:NEXT
95 LPRINT:END
```

RESULT:

```
0
1
2 VTAB
3
4
5
6 VTAB
7
8
9
10 VTAB
11
```

FF**(Form Feed Execution)****FF**

BASIC: CHR\$(12);

HEX: 0C

NAME: FF (Form Feed)

FUNCTION: When the FF code is received, all data in the printer buffer is printed, then paper is fed the number of lines or inches in effect, established by ESC C, ESC C 0 or by SW3-2. The normal Form Feed is 11 inches (SW3-2 OFF).

NOTE

Top of form is established by the position of the paper prior to execution of any line feeds. Whenever FF is received, (or when FF button is pressed when OFF LINE) the paper is advanced the appropriate amount relative to the top of form position.

PROGRAM:

```
10 REM FF 3 LINES=1/2"
20 PRINT "*****";
30 PRINT CHR$ (27);"C"; CHR$ (3);
40 PRINT CHR$ (12);: REM FF
50 PRINT "*****"
```

RESULT: *****

CR**(Carriage Return)****CR**

BASIC: CHR\$(13);

HEX: 0D

NAME: CR (Carriage Return)

FUNCTION: When the CR code is received, all data in the printer buffer is printed. If Auto Linefeed is active (SW3-4 ON) paper will be fed one line automatically; otherwise the next print position is at the first character on the same line.

NOTE

Some word processing programs and interfaces force a linefeed after a CR. In this case CR without a linefeed is not functional unless the program/interface can be modified to not issue the linefeed.

PROGRAM:

```
10 REM CR OVERPRINT
15 PRINT CHR$ (27);"U"; CHR$ (1);
20 PRINT "0000000000";
30 PRINT CHR$ (13);: REM CR
40 PRINT "//////////"
```

RESULT: 0000000000

SO**(Select Enlarged Characters)****SO**

BASIC: CHR\$(14);**HEX:** 0E**NAME:** SO (Shift Out)**FUNCTION:** When SO code is received, all subsequent characters and spaces are printed double-width on the same line. This function is cancelled by a linefeed, DC4, ESC ! or ESC W.**NOTE**

All character styles can be enlarged, and this function can be mixed within a line. ESC SO is functionally identical to SO. However, ESC W 1 selects enlarged characters until cancelled by ESC W 0.

```
PROGRAM:      10 REM ENLARGED
                20 PRINT "JACK SPRAT COULD EAT NO ";
                30 PRINT CHR$ (14);"FAT"
```

RESULT: JACK SPRAT COULD EAT NO FAT

SI**(Select Condensed Characters)****SI**

BASIC: CHR\$(15);**HEX:** 0F**NAME:** SI (Shift In)**FUNCTION:** When SI code is received, all data in the printer buffer is printed, then all subsequent characters will be condensed until cancelled by the DC2 code.**NOTE**

The Elite and NLQ character styles cannot be condensed. Also, ESC SI is functionally identical to SI.

```
PROGRAM:      10 REM CONDENSED
                20 PRINT "HIS WIFE COULD EAT NO";
                30 PRINT CHR$ (15);"LEAN"
                40 PRINT CHR$ (18);: REM DC2
                50 PRINT "AND SO BETWEEN THE TWO
                   OF THEM"
                60 PRINT "THEY LICKED THE PLATTER CLEAN"
```

RESULT: HIS WIFE COULD EAT NO LEAN
 AND SO BETWEEN THE TWO OF THEM
 THEY LICKED THE PLATTER CLEAN

DC1

(Remote Printer Select)

DC1

BASIC: CHR\$(17);

HEX: 11

NAME: DC1 (Device Control 1)

FUNCTION: The DC1 code selects the printer, enabling data reception. DC1 is normally used to cancel DC3, which de-selects the printer.

NOTE

In order for DC1 to function as described here, the printer must be ON LINE and DIP switch SW3-1 must be OFF. If the DC1 code is received along with data, all data stored in the printer buffer before DC1 will be ignored (not printed).

PROGRAM:

```
10 REM PRINTER SELECT
20 PRINT "$$$$$$$$$$$$$$$$$"
30 PRINT CHR$ (19);
40 PRINT "#####"
50 PRINT CHR$ (17);
60 PRINT "$$$$$$$$$$$$$$$$$"
```

RESULT:

```
$$$$$$$$$$$$$$$$
$$$$$$$$$$$$$$$$
```

DC2

(Cancel Condensed Mode)

DC2

BASIC: CHR\$(18);

HEX: 12

NAME: DC2 (Device Control 2)

FUNCTION: The DC2 code is used to cancel condensed characters as selected by SI or ESC SI.

NOTE

The condensed character mode is not affected by linefeed as with SO and ESC SO (enlarged). Elite and NLQ characters cannot be condensed.

PROGRAM:

```
10 REM DC2 CANCEL CONDENSED
20 PRINT "NORMAL "; CHR$ (15);
30 PRINT "CONDENSED";
40 PRINT CHR$ (18); " NORMAL"
```

RESULT:

```
NORMAL CONDENSED NORMAL
```

DC3

(Remote Printer Deselect)

DC3

BASIC: CHR\$(19);

HEX: 13

NAME: DC3 (Device Control 3)

FUNCTION: The DC3 code de-selects the printer, inhibiting data reception. DC3 is used to cancel DC1, which selects the printer.

NOTE

In order for DC3 to function as described here, the printer must be ON LINE and DIP switch SW3-1 must be OFF.

PROGRAM:

```
10 REM PRINTER DE-SELECT
20 PRINT "PRINT THIS LINE"
30 PRINT CHR$ (19);
40 PRINT "IGNORE THIS LINE"
50 PRINT CHR$ (17);
60 PRINT "SELECTED ONCE AGAIN"
```

RESULT:

```
PRINT THIS LINE
SELECTED ONCE AGAIN
```

DC4

(Cancel Enlarged Characters)

DC4

BASIC: CHR\$(20);

HEX: 14

NAME: DC4 (Device Control 4)

FUNCTION: The DC4 code is used to cancel enlarged characters selected by SO and ESC SO.

NOTE

Enlarged characters selected by ESC W1 or ESC! are not affected by the DC4 code.

PROGRAM:

```
10 REM CANCEL ENLARGED
20 PRINT "ACROSS THE "; CHR$ (14);
30 PRINT "WIDE"; CHR$ (20);: REM
   DC4
40 PRINT " MISSOURI"
```

RESULT:

```
ACROSS THE WIDE MISSOURI
```

CAN

(Cancel Printer Buffer Data)

CAN

BASIC: CHR\$(24);

HEX: 18

NAME: CAN (Cancel)

FUNCTION: When the CAN code is received, all prior data stored in the printer buffer on the same line is cancelled (not printed).

NOTE

The DEL (Delete) code performs a similar function, but affects only the last character stored in the printer buffer.

PROGRAM:

```
10 REM CANCEL CHR$(24)
20 PRINT "THAT"
30 PRINT "@#!*##!!"; CHR$ (24); "
   CAT!"
```

RESULT:

```
THAT
CAT!
```

DEL

(Delete Last Printer Buffer Character)

DEL

BASIC: CHR\$(127);

HEX: 7F

NAME: DEL (Delete)

FUNCTION: When the DEL code is received, the last character in the printer buffer on the same line is deleted (not printed).

NOTE

The CAN (Cancel) code performs a similar function, but it affects all prior data on the same line.

PROGRAM:

```
10 REM DEL LAST CHAR
20 PRINT "BEAUTY IS ONLY SKINY";
30 PRINT CHR$ (127); " DEEP"
```

RESULT:

```
BEAUTY IS ONLY SKIN DEEP
```

ESC SO

(Select Enlarged Characters)

ESC SO

BASIC: CHR\$(27);CHR\$(14);

HEX: 1B 0E

NAME: ESC SO (Escape Shift Out)

FUNCTION: Same as SO. When ESC SO code is received, all subsequent characters and spaces are printed double-width on the same line. This function is cancelled by a linefeed, DC4, ESC ! or ESC W.

NOTE

All character styles can be enlarged and mixed within a line. Note that ESC W 1 selects enlarged characters until cancelled by ESC W 0.

```
PROGRAM:      10  REM ENLARGED ESC SO
                20  PRINT "UNDER THE ";
                30  PRINT CHR$(27); CHR$(14);
                40  PRINT "BIG"; CHR$(20);" TOP!"
```

RESULT: UNDER THE **BIG** TOP!

ESC SI

(Select Condensed Characters)

ESC SI

BASIC: CHR\$(27);CHR\$(15);

HEX: 1B 0F

NAME: ESC SI (Escape Shift In)

FUNCTION: Same as SI. When ESC SI code is received, all subsequent characters will be condensed until cancelled by the DC2 code.

NOTE

The Elite and NLQ character styles cannot be condensed.

```
PROGRAM:      10  REM CONDENSED ESC SI
                20  PRINT "FOR ONLY ONE ";
                30  PRINT CHR$(27); CHR$(15);"
                   THIN"; CHR$(18);" DIME!"
```

RESULT: FOR ONLY ONE THIN DIME!

ESC !**(Print Mode 0-63 Select)****ESC !**

BASIC: CHR\$(27);"!";CHR\$(n);

HEX: 1B 21 (n)

NAME: Print Mode (n = 0 to 63)

FUNCTION: Print Mode selects one of 16 different print styles/combinations. The ESC !(n) sequence takes precedence over any prior print style command such as SO, SI etc. See Table D-1 in Appendix D for typestyle combinations that are possible.

NOTE

Whenever leaving Print Mode to select NLQ (near letter quality) characters, always send ESC ! 0 to cancel Print Mode styles in effect, otherwise, NLQ could be enlarged or other styles could be affected. **IMPORTANT**—If proportional (ESC p 1) is set when entering an ESC ! (n) to obtain a condensed style, the ESC ! (n) for condensed is ignored because proportional is emphasized and cannot be condensed. Also, the elite style cannot be emphasized nor condensed.

PROGRAM:**(TYPICAL)**

```
20 PRINT "MODE 24 ";
30 PRINT CHR$ (27);"!"; CHR$ (24);
40 PRINT "ABCabc123"
```

RESULT:**(TYPICAL)**

```
MODE 0  ABCabc123
MODE 1  ABCabc123
MODE 4  ABCabc123
MODE 8  ABCabc123
MODE 16 ABCabc123
MODE 17 ABCabc123
MODE 20 ABCabc123
MODE 24 ABCabc123
MODE 32 ABCabc123
MODE 33 ABCabc123
MODE 36 ABCabc123
MODE 40 ABCabc123
MODE 48 ABCabc123
MODE 49 ABCabc123
MODE 52 ABCabc123
MODE 56 ABCabc123
```

NOTE: Refer to table for Print Modes 0 to 63

PRINT MODE BYTE (n=0-63)

n	ENLG	DBLS	EMPH	COND	ELIT
0*					
1					●
2*					
3					●
4				●	
5					●
6				●	
7					●
8			●		
9					●
10			●		
11					●
12			●		
13					●
14			●		
15					●
16		●			
17		●			●
18		●			
19		●			●
20		●		●	
21		●			●
22		●		●	
23		●			●
24		●	●		
25		●			●
26		●	●		
27		●			●
28		●	●		
29		●			●
30		●	●		
31		●			●

n	ENLG	DBLS	EMPH	COND	ELIT
32	●				
33	●				●
34	●				
35	●				●
36	●			●	
37	●				●
38	●			●	
39	●				●
40	●		●		
41	●				●
42	●		●		
43	●				●
44	●		●		
45	●				●
46	●		●		
47	●				●
48	●	●			
49	●	●			●
50	●	●			
51	●	●			●
52	●	●		●	
53	●	●			●
54	●	●		●	
55	●	●			●
56	●	●	●		
57	●	●			●
58	●	●	●		
59	●	●			●
60	●	●	●		
61	●	●			●
62	●	●	●		
63	●	●			●

*Modes 0 and 2 are Pica 10 cpi

ENLG=Enlarged; DBLS=Double Strike; EMPH=Emphasized; COND=Condensed; ELIT=Elite (12 cpi)

ESC #**(Cancel MSB Sequence)****ESC#**

BASIC: CHR\$(27)“#”;**HEX:** 1B 23**NAME:** Cancel MSB Sequence (MSB=0, MSB=1)**FUNCTION:** ESC # cancels control of MSB (8th bit) as set by ESC = (MSB=0) and ESC > (MSB=1). Thus, ESC # releases the 8th bit from forced condition and allows it to change with data.

PROGRAM:

```
10 REM ESC # CANCEL MSB SEQUENCE
15 LPRINT "          (NORMAL)"
20 LPRINT "If you wish to go nowhere..."
25 LPRINT "Any road will take you there!"
30 LPRINT:LPRINT CHR$(27);">";
35 LPRINT "          (ITALIC)"
40 LPRINT "When in Rome do as the Italics do"
45 LPRINT:LPRINT CHR$(27);"#";:REM CANCEL MSB
50 LPRINT "          (NORMAL)"
55 LPRINT "Doe... a deer, a female deer..."
```

RESULT:

```
          (NORMAL)
If you wish to go nowhere...
Any road will take you there!

          (ITALIC)
When in Rome do as the Italics do

          (NORMAL)
Doe... a deer, a female deer...
```

ESC % 0**(Select Internal CG ROM)****ESC % 0**

BASIC: CHR\$(27);"%";CHR\$(0);CHR\$(0);**HEX:** 1B 25 00 00**NAME:** ROM Character Generator selection**FUNCTION:** This code sequence selects the character generator in the Internal ROM and is normally used to cancel the Download CG as selected by ESC % 1.**PROGRAM:** (See example in ESC &)

ESC % 1**(Select Download CG RAM/ROM)****ESC % 1**

BASIC: CHR\$(27);"%";CHR\$(1);CHR\$(0);**HEX:** 1B 25 01 00**NAME:** Download Character Generator Selection**FUNCTION:** This code sequence selects the Download Character set previously defined by ESC & code (see Note 1). If an optional NLQ character ROM or 8K RAM is installed, this sequence selects that RAM/ROM (see Note 2).**NOTE 1 STANDARD**

DIP switch SW2-3 must be OFF to enable 3K Download Buffer for this function (standard 11 × 9 matrix download characters).

NOTE 2 OPTION

To access optional 8K RAM or optional NLQ ROM, DIP switch SW1-5 must be ON. Also, ESC“(” must be sent to select NLQ before sending ESC%1.

PROGRAM: (See example in ESC &)

ESC &

(Define Download Character)

ESC &

BASIC: CHR\$(27);"&";CHR\$(0);CHR\$(n);CHR\$(n);CHR\$(a);CHR\$(p₁)...CHR\$(p₁₁); **HEX:** 1B 26

NAME: Define Download Character

FUNCTION: ESC & (etc.) defines the dot pattern of a download character, assigns an ASCII code to it so it can be accessed (CHR\$(n)) and defines an attribute (CHR\$(a)) that contains starting and ending column data, plus descender information (if MSB = 1, no descender). In the example below, ESC & defines the Greek letter omega and assigns the ASCII character "#" to it.

NOTE

DIP switch SW2-3 must be OFF in order for this function to work properly.

```

PROGRAM:  10 REM # = OMEGA
          20 LPRINT CHR$(27); "&"; CHR$(0); "##";
          30 LPRINT CHR$(139); : REM ATTRIBUTE
          32 LPRINT CHR$(50); CHR$(72); CHR$(6); CHR$(64);
          33 LPRINT CHR$(0); CHR$(64); CHR$(6); CHR$(72);
          34 LPRINT CHR$(50); CHR$(0); CHR$(0);
          45 LPRINT "#####"
          47 LPRINT "The resistance = 7";
          50 LPRINT CHR$(27); "%"; CHR$(1); CHR$(0);
          55 LPRINT "#"
          70 LPRINT "#####"
          85 LPRINT CHR$(27); "%"; CHR$(0); CHR$(0);
          90 LPRINT "#####"
          95 LPRINT:END

```

```

RESULT:  #####
         The resistance = 7Ω
         Ω Ω Ω Ω Ω Ω Ω Ω Ω Ω
         #####

```

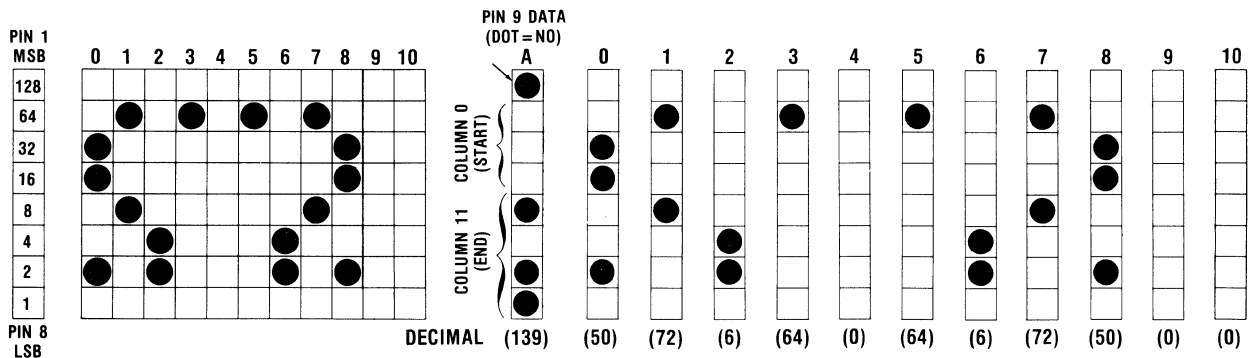

(Continued on next page)

(ESC & continued)

ADJACENT PINS—When defining a half-dot column pattern for a download character, be certain **NOT** to define adjacent dots; that is, if a pin is fired, it cannot be fired again in the next half-dot column. To do so could cause damage to the printhead or associated circuitry (See illustration).

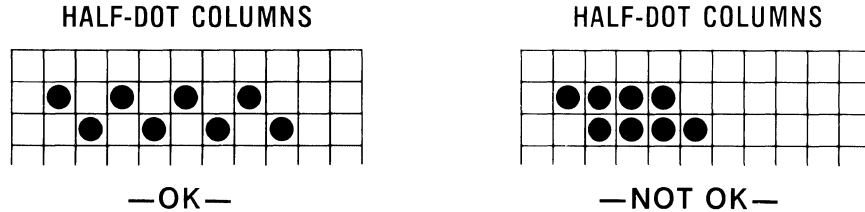

DESCENDER—The attribute (A) defines descender data (for pin 9). If the MSB is zero (no dot), there is a descender (A = 11 decimal). Refer to the illustration of lower case letter “g”. The character is defined in the standard 11 × 8 pattern, attribute (A) shifts the pattern down one dot and it is printed with a descender.

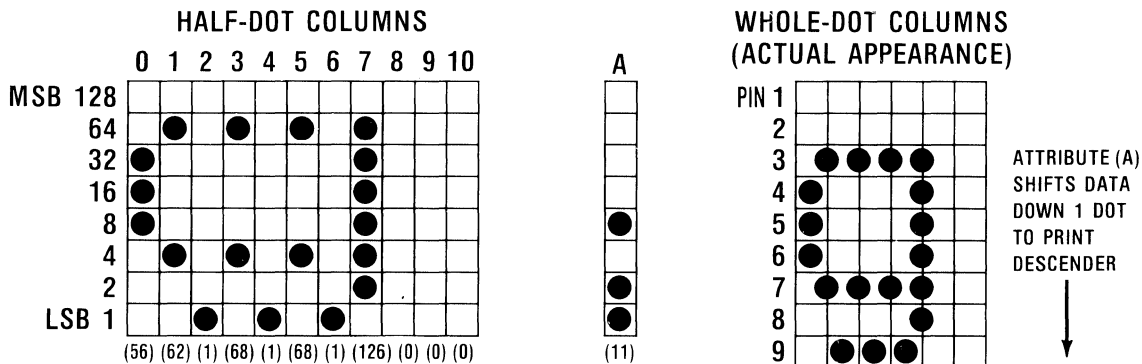

```

PROGRAM: 10 REM ESC & (* = LOWER CASE g)
          15 LPRINT CHR$(27); ":"; CHR$(0); CHR$(0); CHR$(0);
          20 LPRINT CHR$(27); "&"; CHR$(0); "*"";
          30 LPRINT CHR$(11); : REM ATTRIBUTE FOR DESCENDER
          35 REM HERE COMES LOWER CASE "G" DATA
          40 LPRINT CHR$(56); CHR$(68); CHR$(1); CHR$(68);
          45 LPRINT CHR$(1); CHR$(68); CHR$(1); CHR$(126);
          50 LPRINT CHR$(0); CHR$(0); CHR$(0);
          55 LPRINT "*" * 11
          60 LPRINT CHR$(27); "%"; CHR$(1); CHR$(0);
          65 LPRINT "U*U*U*U*U*U*U*U*U*U*U"
          70 LPRINT CHR$(27); "%"; CHR$(0); CHR$(0);
          75 LPRINT "*" * 11
          80 END
    
```

RESULT:

```

* * * * *
UgUgUgUgUgUgUgUgUgU
* * * * *
    
```

(Continued on next page)

(ESC & Continued)

PROPORTIONAL: Attribute (A) defines the start and end columns of the character. If the attribute is 11 decimal (descender) or 139 decimal (no descender) for all characters, the character set is monospaced at 10 cpi. However, if the end column is less than those values, the character has a proportional attribute and this will be evident in the Proportional Spacing Mode (ESC p). If ESC p is not active, the attribute defaults to monospace. A program for a simple proportional character is provided below.

NOTE

Proportional characters are printed in Emphasized Mode. In this mode, all dots are fired twice in the horizontal plane. If space is desired between characters, the end column should be defined as at least two half-dot columns greater than the last data column (dots) of the character. Trailing non-data columns must be filled with zeroes so that eleven (11) columns are defined.

PROGRAM:

```
10 REM ESC & PROPORTIONAL SPACING
15 LPRINT CHR$(27);": ";CHR$(0);CHR$(0);CHR$(0);
20 LPRINT CHR$(27);"&";CHR$(0);"***";
25 LPRINT CHR$(132);:REM PROPORTIONAL ATTRIBUTE
30 REM HERE DEFINE SIMPLE DOWNLOAD CHARACTER
35 LPRINT CHR$(254);CHR$(0);CHR$(0);CHR$(0);
40 LPRINT CHR$(0);CHR$(0);CHR$(0);CHR$(0);
45 LPRINT CHR$(0);CHR$(0);CHR$(0);
50 GOSUB 70
55 LPRINT CHR$(27);"p";CHR$(1);:REM PROPORTIONAL
60 GOSUB 70
65 LPRINT CHR$(27);"p";CHR$(0);:END
70 LPRINT "* * * * * * * * * * * * *"
75 LPRINT CHR$(27);"%";CHR$(1);CHR$(0);
80 LPRINT "U*U*U*U*U*U*U*U*U*U"
85 LPRINT CHR$(27);"%";CHR$(0);CHR$(0);
90 RETURN
```

RESULT:

```
* * * * * * * * * * * *
U U U U U U U U U U U
* * * * * * * * * * * *
UUUUUUUUUUUUUUUUUU
```

ESC (**(Select NLQ Characters)****ESC (**

BASIC: CHR\$(27);"(";**HEX:** IB 28**NAME:** NLQ (Near Letter Quality)**FUNCTION:** When ESC "(" is received, all subsequent characters will be printed in near-letter quality. NLQ is produced by two passes of the print head.**NOTE**

NLQ is automatically selected by holding the FF button as power is turned ON. Also, NLQ is selected at power ON using DIP switch SW2 settings. Refer to power-up Print Mode chart below.

Also, NLQ characters can be set to proportional spacing by ESC p and enlarged by SO and ESC W codes. However, NLQ cannot be condensed or italicized.

PROGRAM:

```
10 REM SELECT NLQ
20 PRINT CHR$ (27);"(";
30 PRINT "THIS IS NLQ (Near Lett
   er Quality)"
40 PRINT "ABCDEFGHIJKLMNQPQRSTU
   VWXYZ"
50 PRINT "abcdefghijklmnopqrstuv
   wxyz"
60 PRINT "1234567890!@#%&^*()_+
   {}<>"
70 PRINT CHR$ (27);"P";: REM P
   ICA
```

RESULT:

```
THIS IS NLQ (Near Letter Quality)
ABCDEFGHIJKLMNQPQRSTUVWXYZ
abcdefghijklmnopqrstuvwxyz
1234567890!@#%&^*()_{}<>
```

Power-On NLQ Character Selection

DIP Switch SW2	7	6	5	4
NLQ (10 cpi)	OFF	OFF	ON	ON
Enlarged NLQ	ON	OFF	ON	ON

ESC ***(Selectable Density Graphics Mode)****ESC ***

BASIC: CHR\$(27);“*” ;CHR\$(M);CHR\$(n1);CHR\$(n2);**HEX:** 1B 2A**NAME:** Selectable Density Graphics Mode
(M = 0 to 6) (n1 = remainder) (n2 = # ÷ 256)**FUNCTION:** This code sequence selects 1 of 7 graphics densities based on the value of M (M = 0 to 6) and is defined below. Values n1 and n2 specify the number of graphic characters to be printed.

n1 and n2 are calculated as follows:

- n2 is an integer (whole number) = # of characters to print ÷ 256
- n1 is the remainder of the division in n2

Example: # of characters to print = 680
n2 = 680 ÷ 256 = 2
n1 = 680 – (2 × 256) = 168

Thus, to print 680 graphic characters, the BASIC code sequence is:

CHR\$(27);“*” ;CHR\$(M);CHR\$(168);CHR\$(2);

MODE SELECTIONS

MODE (M)	DENSITY	SAME AS	DESCRIPTION
0	SINGLE	ESC K	60 DOTS/INCH; 936 CHARACTERS/LINE
1	LO-SPEED DOUBLE	ESC L	120 DOTS/INCH; 1872 CHARACTER/LINE.
2	HI-SPEED DOUBLE	ESC Y	SAME AS 1, BUT FASTER. CONSECUTIVE DOTS IN SAME ROW NOT PRINTED.
3	QUADRUPLE	ESC Z	240 DOTS/INCH; 3744 CHARACTER/LINE. CONSECUTIVE DOTS IN SAME ROW NOT PRINTED.
4	N/A	N/A	80 DOTS/INCH; 1248 CHARACTERS/LINE.
5	1 TO 1 RATIO	N/A	72 DOTS/INCH; 1123 CHARACTERS/LINE.
6	N/A	N/A	90 DOTS/INCH; 1104 CHARACTERS/LINE.

(Continued on the next page)

ESC –**(Print Underline)****ESC –**

BASIC: CHR\$(27);"–";CHR\$(1);**HEX:** 1B 2D 01**NAME:** Print Underline

FUNCTION: When ESC – 1 is received, subsequent characters and spaces are underlined by the 9th pin at the "10th" pin position as one continuous underline. Underline continues line to line until cancelled by ESC – 0. Individual words or characters may be underlined, as the underline can be turned on and off anywhere in a line.

NOTE

The underline is printed as a separate, continuous line after the text is completed. However, if character styles are changed, the underline is drawn after each change. To draw the underline, paper is moved up one dot width to clear descenders.

PROGRAM:

```
10 REM UNDERLINE
20 PRINT "Let's underline an entire
   line!"
25 PRINT
30 PRINT CHR$ (27);"-"; CHR$ (1);
40 PRINT "An entire line!"
50 PRINT CHR$ (27);"-"; CHR$ (0);
60 PRINT : PRINT "No underline here"
70 PRINT : PRINT "Let's underline ";
80 PRINT CHR$ (27);"-"; CHR$ (1);
   "one";
90 PRINT CHR$ (27);"-"; CHR$ (0);
   "word"
```

RESULT:

```
Let's underline an entire line!
An entire line!
No underline here

Let's underline one word
```

ESC /**(Select VFU Channel 0—7)****ESC /**

BASIC: CHR\$(27);"/";CHR\$(n);**HEX:** 1B 2F (n)**NAME:** Select VFU Channel (n = 0 to 7)

FUNCTION: ESC / (n) selects one of eight channels for vertical tab format (called VFU; Vertical Format Unit). This function is used with ESC b, which establishes the vertical tab stops within each channel. The basic purpose of this function is to divide a page into two or more channels with independent tab stops and independent Top of Form.

PROGRAM:

```
10 REM ESC / VFU CHANNEL 0-7
15 LPRINT CHR$(27);"C";CHR$(10);:REM FORM LENGTH 10
20 FOR Z = 0 TO 47: LPRINT Z:NEXT
25 FOR X = 1 TO 8: LPRINT CHR$(27);"j";CHR$(216);
30 NEXT X: LPRINT " <--- TOP OF FORM #1"
35 LPRINT CHR$(27);"b";CHR$(1);:REM CHANNEL 1
40 LPRINT CHR$(2);CHR$(6);CHR$(9);CHR$(0);:REM CH1 TABS
45 LPRINT CHR$(27);"/";CHR$(1);:REM SELECT CH1
50 LPRINT CHR$(12);:REM TOP OF FORM COMMAND
55 LPRINT " <--- VFU 1 TOP OF FORM"
60 FOR Y = 1 TO 3: LPRINT CHR$(11);:REM VERT TAB
65 LPRINT " <--- VFU 1; TAB ";Y:NEXT Y
70 LPRINT CHR$(27);"b";CHR$(2);:REM CHANNEL 2
75 LPRINT CHR$(3);CHR$(5);CHR$(8);CHR$(0);:REM CH2 TABS
80 LPRINT CHR$(27);"/";CHR$(2);:REM SELECT CH2
85 LPRINT CHR$(12);:REM TOP OF FORM COMMAND
90 LPRINT " <--- VFU 2 TOP OF FORM"
95 FOR N = 1 TO 3: LPRINT CHR$(11);:REM VERT TAB
100 LPRINT " <--- VFU 2; TAB ";N:NEXT
105 END
```

RESULT: (See result of program on next page)

(ESC / continued)

0 <--- TOP OF FORM #1
1
2
3
4
5
6
7
8
9
10 <--- VFU 1 TOP OF FORM
11
12 <--- VFU 1; TAB 1
13
14
15
16 <--- VFU 1; TAB 2
17
18
19 <--- VFU 1; TAB 3
20
21
22
23
24
25
26
27
28
29
30 <--- VFU 2 TOP OF FORM
31
32
33 <--- VFU 2; TAB 1
34
35 <--- VFU 2; TAB 2
36
37
38 <--- VFU 2; TAB 3
39
40
41
42
43
44
45
46
47

(program on previous page)

ESC 0

(1/8-Inch Line Spacing)

ESC 0

BASIC: CHR\$(27);"0";

HEX: 1B 30

NAME: 1/8-Inch Line Spacing (8 lpi)

FUNCTION: When ESC 0 is received, line spacing is set at 1/8 inch. This spacing corresponds with 8 lines per inch. This spacing is in effect until cancelled by ESC 2 (normal 1/6 inch spacing) or by ESC A, ESC 1, ESC 2, or ESC 3. ESC J is in effect for one line only, so does not cancel ESC 0.

PROGRAM:

```
10 REM 1/8 INCH LINE SPACE
20 PRINT CHR$ (27);"0";
30 FOR X = 1 TO 4
40 PRINT "-----": NEXT
50 PRINT CHR$ (27);"2";
60 FOR Z = 1 TO 4
70 PRINT "-----": NEXT
```

RESULT:

```
-----
-----
-----
-----
-----
-----
-----
-----
```

ESC 1

(8-Pin Graphics Line Spacing 7/72")

ESC 1

BASIC: CHR\$(27);"1";

HEX: 1B 31

NAME: 8-Pin Graphics Line Spacing (7/72")

FUNCTION: When ESC 1 is received, the line-spacing value is set at 7/72". This is the spacing normally used between 8-pin graphic lines. This spacing is cancelled by ESC A, ESC 0, ESC 2 or ESC 3. ESC J is in effect for only line only, so does not cancel ESC 1.

PROGRAM:

```
10 REM 8-PIN GRAF 7/72
20 PRINT CHR$ (27);"1";
30 FOR X = 1 TO 4
40 PRINT "-----": NEXT
50 PRINT CHR$ (27);"2";
60 FOR Z = 1 TO 4
70 PRINT "-----": NEXT
```

RESULT:

```
-----
-----
-----
-----
-----
-----
-----
-----
```

ESC 2

(1/6-Inch Line Spacing)

ESC 2

BASIC: CHR\$(27);"2";

HEX: 1B 32

NAME: Normal (1/6 Inch) Line Spacing

FUNCTION: ESC 2 sets the normal line spacing (6 lpi) and is normally used to cancel special line spacing functions such as ESC A, ESC 0, ESC 1, and ESC 3.

PROGRAM:

```
10 REM 1/6 INCH LF
20 PRINT CHR$ (27);"A"; CHR$ (5);
30 FOR X = 1 TO 6
40 PRINT "-----": NEXT
50 PRINT CHR$ (27);"2";: REM 1/6"
60 FOR Z = 1 TO 4
70 PRINT "-----": NEXT
```

RESULT:

```
-----
-----
-----
-----
-----
-----
-----
-----
-----
```

ESC 3

(N/216-Inch Line Spacing)

ESC 3

BASIC: CHR\$(27);"3";CHR\$(n);

HEX: 1B 33 (n)

NAME: N/216-Inch Line Spacing (n = 1 to 216)

FUNCTION: This function allows the setting of line spacing in increments of 1/3 dot diameter. This function is in effect until cancelled by ESC A, ESC 0, ESC 1 or ESC 2.

NOTE

ESC J is similar in function to ESC 3 but is effective for one line only.

PROGRAM:

```
10 REM ESC 3 - 1/3 DOT LINE SPACING
20 LPRINT CHR$ (27);"3";CHR$ (72);
30 FOR X = 1 TO 4
40 LPRINT "-----":NEXT X
50 LPRINT CHR$ (27);"2";:REM 1/6" LINE SPACE
```

RESULT:

```
-----
-----
-----
-----
```

ESC 4

(Select Alternate *Italic* Characters)

ESC 4

BASIC: CHR\$(27);"4";

HEX 1B 34

NAME: Select Alternate (Italic) Characters

FUNCTION: When ESC 4 is received, subsequent characters are italicized until cancelled by ESC 5.

NOTE

All characters styles except NLQ (Near Letter Quality) can be italicized. Also, DIP switch SW1-7 must be ON to enable italics.

PROGRAM:

```
10 REM ITALICS
20 PRINT "This is Normal"
30 PRINT CHR$ (27);"4";
40 PRINT "This is Italic"
50 PRINT CHR$ (27);"5";
60 PRINT "Back to Normal"
```

RESULT:

```
This is Normal
This is Italic
Back to Normal
```

ESC 5

(Cancel Alternate *Italic* Characters)

ESC 5

BASIC: CHR\$(27);"5";

HEX: 1B 35

NAME: Cancel Alternate (Italic) Characters

FUNCTION: When ESC 5 is received, italicized characters are cancelled and subsequent characters are printed in the normal style.

PROGRAM: (see above)

ESC 6

(Printable Area Code Expansion)

ESC 6

BASIC: CHR\$(27);"6";

HEX: 1B 36

NAME: Printable Area Code Expansion

FUNCTION: ESC 6 enables the printer to print international characters in the code area of 128 to 159 (plus 255). ESC 6 is cancelled by ESC 7.

PROGRAM:

```
10 REM ESC 6 PRINT AREA EXPANSION
20 LPRINT CHR$(27);"6";CHR$(27);"(";
30 FOR Z= 128 TO 159
40 LPRINT CHR$(Z);" ";:NEXT
50 LPRINT CHR$(255);: LPRINT
60 LPRINT CHR$(27);"7";:REM CANCEL
70 LPRINT CHR$(128);:REM WON'T PRINT
```

RESULT:

à è ù ò ì ° £ ì ï Ñ ñ ð Pt Å å ç Š B Æ æ Ø ø " Ä Ö Ü ä ö u É é ¥ Ø

NOTE: Characters are italicized when in Pica style per this sample.

à è ù ò ì ° £ ì ï Ñ ñ ð Pt Å å ç Š B Æ æ Ø ø " Ä Ö Ü ä ö u É é ¥ Ø

CODE CHART (DECIMAL)

128	129	130	131	132	133	134	135	136	137	138
<i>à</i>	<i>è</i>	<i>ù</i>	<i>ò</i>	<i>ì</i>	<i>°</i>	<i>£</i>	<i>ì</i>	<i>ï</i>	<i>Ñ</i>	<i>ñ</i>
139	140	141	142	143	144	145	146	147	148	149
<i>ð</i>	<i>Pt</i>	<i>Å</i>	<i>å</i>	<i>ç</i>	<i>Š</i>	<i>B</i>	<i>Æ</i>	<i>æ</i>	<i>Ø</i>	<i>ø</i>
150	151	152	153	154	155	156	157	158	159	255
<i>"</i>	<i>Ä</i>	<i>Ö</i>	<i>Ü</i>	<i>ä</i>	<i>ö</i>	<i>u</i>	<i>É</i>	<i>é</i>	<i>¥</i>	<i>Ø</i>

ESC 7

(Cancel Printable Area Code Expansion)

ESC 7

BASIC: CHR\$(27);"7";

HEX: 1B 37

NAME: Cancel Printable Area Code Expansion

FUNCTION: ESC 7 cancels the printing of codes in the 128 to 159 area (plus 255). Control codes such as BEL (7 + 128 = 135) will respond, but not as printable characters.

PROGRAM: (see above)

ESC 8

(Disable Paper Out—Remote)

ESC 8

BASIC: CHR\$(27);"8";

HEX: 1B 38

NAME: Disable Paper Out Function (Remote)

FUNCTION: When ESC 8 is received, the Paper End condition does not result in the printer going OFF LINE as in the normal case. In this manner, printing can continue to within the last few lines of a form. This function is cancelled by ESC 9. A CR code must follow ESC 8 for the function to work (or omit semicolon at end of CHR\$(27);"8").

PROGRAM: LPRINT CHR\$(27);"8";
LPRINT CHR\$(13);

RESULT: Paper End alarm (beep) and OFF LINE condition are bypassed. ALARM light goes ON when paper is out to alert operator.

ESC 9

(Enable Paper Out—Remote)

ESC 9

BASIC: CHR\$(27);"9";

HEX: 1B 39

NAME: Enable Paper Out Function (Remote)

FUNCTION: ESC 9 cancels the bypass of the Paper End condition set by ESC 8. In this manner, the Paper End switch functions normally, setting the printer OFF LINE and sounding the alarm when the paper supply is exhausted. A CR code must follow ESC 9 for the function to work (or omit semicolon at end of CHR\$(27);"9").

PROGRAM: LPRINT CHR\$(27);"9";
LPRINT CHR\$(13);

RESULT: Paper End alarm (beep) and OFF LINE condition return to normal function.

ESC : (Copy ROM CG to Download CG)**ESC :**

BASIC: CHR\$(27);“:”;CHR\$(0);CHR\$(0);CHR\$(0);

HEX: 1B 3A 00 00 00

NAME: Copy ROM CG to Download CG Set

FUNCTION: ESC : 0 0 0 causes the fonts in the standard ROM Character Generator to be copied into the download area. The basic purpose of this function is to provide most of the standard characters for use with special characters defined by ESC &, which would replace some of the standard characters.

In the program example below, the character “!” is replaced by the Greek letter omega, the symbol for ohms in electronics.

PROGRAM:

```
10 REM ESC : COPY CG ROM TO DOWNLOAD AREA
15 LPRINT CHR$(27);":";CHR$(0);CHR$(0);CHR$(0);
20 REM NOW DEFINE OMEGA AS "!"
25 LPRINT CHR$(27);"&";CHR$(0);"!";:REM ! = OMEGA
30 LPRINT CHR$(139);:REM ATTRIBUTE FOR OMEGA
35 REM HERE COMES OMEGA
40 LPRINT CHR$(50);CHR$(72);CHR$(6);CHR$(64);
45 LPRINT CHR$(0);CHR$(64);CHR$(6);CHR$(72);
50 LPRINT CHR$(50);CHR$(0);CHR$(0);
55 REM NOW SELECT DOWNLOAD CG
60 LPRINT CHR$(27);"%";CHR$(1);CHR$(0);
65 FOR X = 33 TO 57
70 LPRINT CHR$(X);: NEXT X: LPRINT
75 REM NOW SELECT ROM CG
80 LPRINT CHR$(27);"%";CHR$(0);CHR$(0);
85 FOR X = 33 TO 57
90 LPRINT CHR$(X);: NEXT X: LPRINT
95 END
```

RESULT:

```
Ω"##$%&'()*+,-./0123456789
!"##$%&'()*+,-./0123456789
```

NOTE

For details on the definition of download characters, their attributes etc. refer to ESC &.

ESC <**(Unidirectional Print, One Line)****ESC <**

BASIC: CHR\$(27);"<";**HEX:** 1B 3C**NAME:** Unidirectional Print, one line only**FUNCTION:** Receipt of ESC < moves the print head to the left-most position and prints subsequent characters left to right for one line, then resumes bi-directional printing.**NOTE**

Unidirectional printing is used when positional accuracy is more important than speed. The line to line positional indexing is best in unidirectional print mode. See ESC U.

```
PROGRAM:      10 REM UNIDIRECTIONAL 1 LINE
                20 PRINT CHR$ (27); "<";
                30 PRINT "UNIDIRECTIONAL -->"
                35 PRINT CHR$ (27); "<";
                40 PRINT "UNIDIRECTIONAL -->"
                50 PRINT "BI-DIRECTIONAL <--"
                60 PRINT "BI-DIRECTIONAL -->"
```

```
RESULT:      UNIDIRECTIONAL -->
                UNIDIRECTIONAL -->
                BI-DIRECTIONAL <--
                BI-DIRECTIONAL -->
```

ESC U**(Unidirectional Print Mode)****ESC U**

BASIC: CHR\$(27);"U";CHR\$(1);**HEX:** 1B 55 01**NAME:** Unidirectional Print Mode**FUNCTION:** Receipt of ESC U 1 moves the print head to the leftmost position and prints subsequent characters left to right, line after line until cancelled by ESC U 0. See note above.

```
PROGRAM:      10 REM UNIDIRECTIONAL MODE
                20 PRINT CHR$ (27); "U"; CHR$ (1);
                30 PRINT "UNIDIRECTIONAL -->"
                40 PRINT "UNIDIRECTIONAL -->"
                50 PRINT CHR$ (27); "U"; CHR$ (0);
                60 PRINT "BI-DIRECTIONAL <--"
                70 PRINT "BI-DIRECTIONAL -->"
```

```
RESULT:      UNIDIRECTIONAL -->
                UNIDIRECTIONAL -->
                BI-DIRECTIONAL <--
                BI-DIRECTIONAL -->
```

ESC =**(Set MSB to 0)****ESC =**

BASIC: CHR\$(27);"="";**HEX:** 1B 3D**NAME:** Set MSB to 0 (force 8th bit to zero)**FUNCTION:** ESC = forces the MSB to a 'zero' condition, thus codes 128 and above are not accessible (do not print). ESC = is changed by ESC > (MSB = 1) or cancelled by ESC #.**NOTE**

DIP switch SW1-7 must be ON to enable italics.

PROGRAM:

```
10 REM ESC = SET MSB TO 0
20 LPRINT CHR$(27);">";:REM MSB = 1
25 LPRINT "This is italic (MSB = 1)"
30 LPRINT CHR$(27);"="";:REM MSB = 0
35 LPRINT "This is normal (MSB = 0)"
40 LPRINT CHR$(27);"#";:REM CANCEL
```

RESULT:

```
This is italic (MSB = 1)
This is normal (MSB = 0)
```

ESC >**(Set MSB to 1)****ESC >**

BASIC: CHR\$(27);">";**HEX:** 1B 3E**NAME:** Set MSB to 1 (force 8th bit to one)**FUNCTION:** ESC > forces the MSB to a 'one' condition, thus codes lower than 128 are not accessible (do not print). ESC > is changed by ESC = (MSB = 0) or cancelled by ESC #.**NOTE**

DIP switch SW1-7 must be ON to enable italics.

PROGRAM:

```
10 REM ESC > SET MSB TO 1
20 LPRINT "These are Standard Characters"
40 LPRINT CHR$(27);">";:REM MSB = 1
50 LPRINT "These are Alternate Characters"
60 LPRINT CHR$(27);"#";:REM CANCEL MSB = 1
70 LPRINT "Standard Characters Again!"
```

RESULT:

```
These are Standard Characters
These are Alternate Characters
Standard Characters Again!
```

ESC ?**(Multiple Function Graphics Mode)****ESC ?**

BASIC: CHR\$(27);"?";"n";CHR\$(M);**HEX:** 1B 3F**NAME:** Multiple Function Graphics (n = K, L, Y or Z)(M = 0 to 6)**FUNCTION:** This special code sequence allows the changing of pitch (density) to 1 of 6 other pitches without changing the current program. In addition, this code sequence allows sequences ESC K, ESC L, ESC Y or ESC Z to function as any of the following:

MODE	DENSITY	TOTAL (MAXIMUM) 8" LINE
0	• 60 DOTS/INCH	936 GRAPHIC CHAR/LINE
1	• 120 DOTS/INCH	1872 GRAPHIC CHAR/LINE
2	• 60 DOTS/INCH	1872 GRAPHIC CHAR/LINE
3	• 240 DOTS/INCH	3744 GRAPHIC CHAR/LINE
4	• 80 DOTS/INCH	1248 GRAPHIC CHAR/LINE
5	• 72 DOTS/INCH	1123 GRAPHIC CHAR/LINE
6	• 90 DOTS/INCH	1404 GRAPHIC CHAR/LINE

PROGRAM:

```
10 REM CHANGING PITCH OF GRAPHICS MODE
15 WIDTH "LPT1:",255
20 A = 1 : B = 480 : J = 1
30 IF J = 1 THEN LPRINT "SINGLE DENSITY GRAPHICS MODE" : C$="K"
40 IF J = 2 THEN LPRINT "DOUBLE DENSITY GRAPHICS MODE" : C$="L"
50 IF J = 3 THEN LPRINT "DOUBLE DENSITY, DOUBLE SPEED GRAPHICS MODE" : C$="Y"
60 IF J = 4 THEN LPRINT "QUADRUPLE DENSITY GRAPHICS MODE" : C$="Z"
70 FOR M = 0 TO 6
75 LPRINT CHR$(27);"?";C$;CHR$(M);
80 LPRINT CHR$(27);C$;CHR$(B MOD 256);CHR$(INT(B/256));
90 FOR K = 1 TO B
100 LPRINT CHR$(&H99);
110 NEXT K
120 LPRINT
125 LPRINT CHR$(27);C$;CHR$(B MOD 256);CHR$(INT(B/256));
130 FOR K = 1 TO B
140 LPRINT CHR$(A);
150 A = A + 1
155 IF A > 128 THEN A = 1
160 NEXT K
170 LPRINT
180 A = 1
190 NEXT M
195 J = J + 1
200 IF J < 5 THEN GOTO 30 ELSE LPRINT CHR$(12); : END
```

(Continued on the next page)

(ESC ? continued)

RESULT:

SINGLE DENSITY GRAPHICS MODE

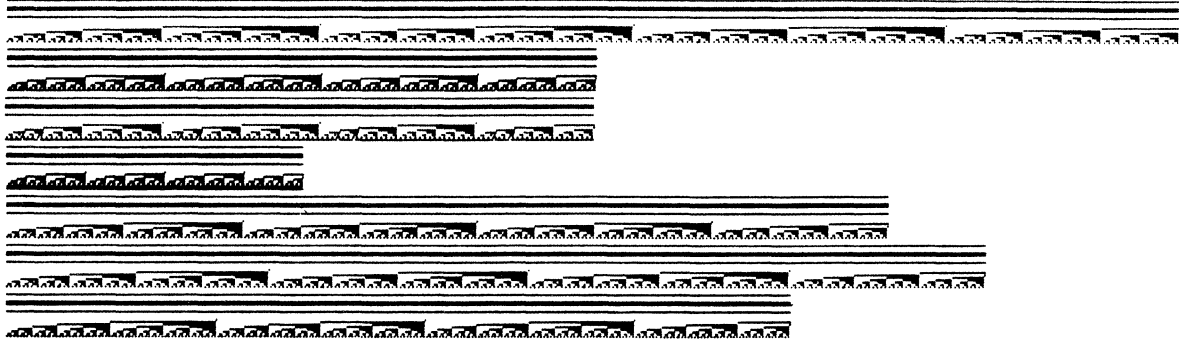

DOUBLE DENSITY GRAPHICS MODE

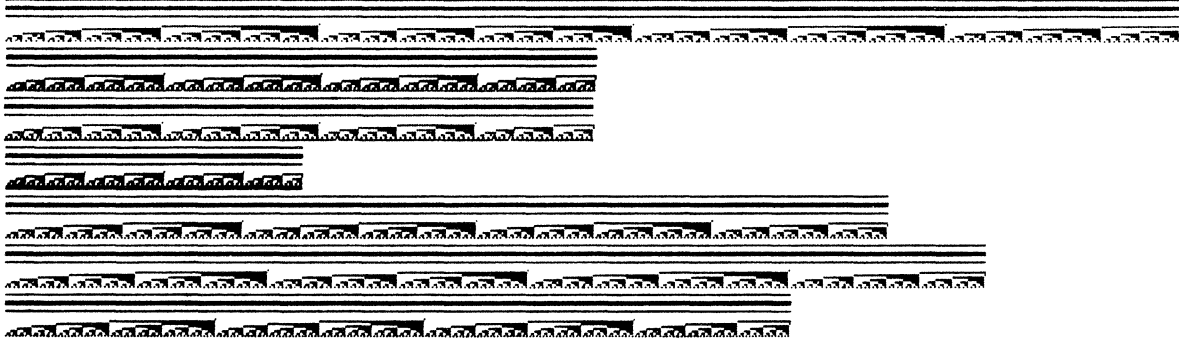

DOUBLE DENSITY, DOUBLE SPEED GRAPHICS MODE

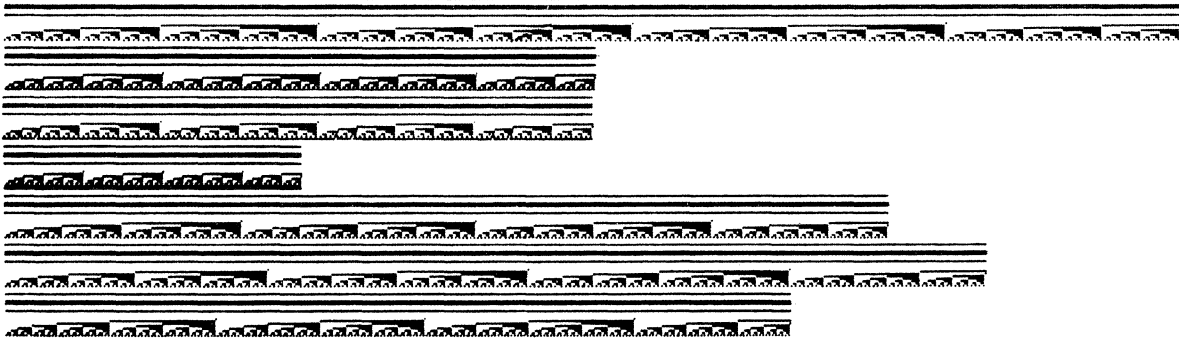

QUADRUPLE DENSITY GRAPHICS MODE

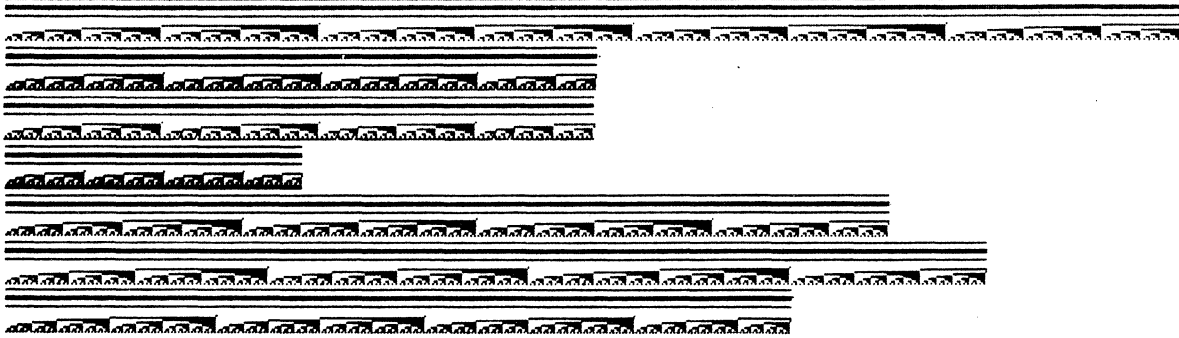

NOTE: Ink reproduction may not show actual density.

ESC @**(Printer Initialization)****ESC @**

BASIC: CHR\$(27);"@";

HEX: 1B 40

NAME: Printer Initialization**FUNCTION:** ESC @ initializes the printer, clears data in the print buffer and cancels any special print style, line spacing, etc.

```
PROGRAM:      10 REM PRINTER INITIALIZATION
                 20 PRINT CHR$ (27);"!"; CHR$ (32);
                 30 PRINT "A STITCH IN TIME"
                 40 PRINT "SAVES NINE";
                 50 PRINT "A ROLLING STONE";
                 60 PRINT CHR$ (27);"@";
                 70 PRINT CHR$ (27);"!"; CHR$ (32);
                 80 PRINT "GATHERS NO MOSS!"
```

RESULT: A STITCH IN TIME
 GATHERS NO MOSS!

ESC A**(1 Dot Line Spacing)****ESC A**

BASIC: CHR\$(27);"A";CHR\$(n);

HEX: 1B 41 (n)

NAME: One Dot Line Spacing (n = 1 to 72)**FUNCTION:** ESC A (n) establishes the line feed value in one dot increments for fine control of line spacing.**NOTE**

The line spacing value established by this function will also be executed when the LF button is pressed while OFF LINE.

```
PROGRAM:      10 REM N/72 LINE SPACING
                 20 FOR X = 2 TO 12 STEP 2
                 30 PRINT CHR$ (27);"A"; CHR$ (X);
                 40 PRINT "-----"
                 50 NEXT X
                 60 PRINT "-----"
```

RESULT: =====

NOTE

1 dot = 1/72"

ESC B**(Vertical Tab Setting, 16 Positions)****ESC B**

BASIC: CHR\$(27);"B";CHR\$(n₁)...CHR\$(n₁₆);CHR\$(0);**HEX:** 1B 42 (n) 00**NAME:** Vertical Tab Setting (up to 16 positions)

FUNCTION: ESC B establishes the vertical tab stops that are executed sequentially with each VT code received. The tab settings are terminated by CHR\$(0). This function will track the original top of form and tab stops even if the line spacing is changed between stops, as the original line measure is stored and executed with VT.

NOTE

Tab positions in ESC B must be entered in numerical ascending order and terminated with CHR\$(0). Also, if no tab positions are established, VT performs a line feed. The maximum tab value is 66 for normal (1/6") line spacing. Larger values default to 66. The largest number accepted is 254.

PROGRAM:

```
10 REM ESC B VERTICAL TAB
15 FOR Z = 0 TO 17
20 LPRINT Z: NEXT
25 FOR X = 1 TO 3
30 LPRINT CHR$(27); "j"; CHR$(216); : NEXT
35 LPRINT CHR$(27); "B"; CHR$(1); CHR$(6);
40 LPRINT CHR$(11); CHR$(17); CHR$(0);
45 LPRINT CHR$(11); " <--VTAB @ 1"
50 LPRINT CHR$(27); "A"; CHR$(5);
55 FOR I = 1 TO 3
60 LPRINT " -----": NEXT
65 LPRINT CHR$(11); " <--VTAB @ 6"
70 LPRINT CHR$(11); " <--VTAB @ 11"
75 LPRINT CHR$(11); " <--VTAB @ 17"
80 LPRINT CHR$(27); "A"; CHR$(10);
```

RESULT:

```
0
1 <--VTAB @ 1
2 =====
3 =====
4
5
6 <--VTAB @ 6
7
8
9
10
11 <--VTAB @ 11
12
13
14
15
16
17 <--VTAB @ 17
```

ESC C**(Set Form Length # of Lines)****ESC C**

BASIC: CHR\$(27);"C";CHR\$(n);**HEX:** 1B 43 (n)**NAME:** Set Form Length by # of lines (n = 1 to 127)

FUNCTION: ESC C (n) sets the absolute number of lines that will be fed when a FF (Form Feed) code is received. If the line spacing is the normal 1/6", then 66 lines would be standard Form Length (11"). If the line spacing value is changed by ESC A (n) etc. a FF will still result in feeding paper the **number of lines** established by ESC C (n).

PROGRAM:

```
10 REM ESC C FORM # LINES
20 PRINT CHR$ (27);"C"; CHR$ (6);
30 PRINT "*****";
40 PRINT CHR$ (12);: REM FF
50 PRINT "SIX LINES FORM FEED"
```

RESULT: *****

SIX LINES FORM FEED

ESC C 0**(Set Form Length # of Inches)****ESC C 0**

BASIC: CHR\$(27);"C";CHR\$(0);CHR\$(n);**HEX:** 1B 43 00 (n)**NAME:** Set Form Length by # of inches (n = 1 to 22)

FUNCTION: ESC C 0 (n) sets the number of inches that will be fed when a FF (Form Feed) code is received. 11 inches is a standard Form Length.

PROGRAM:

```
10 REM ESC C 0 FORM # INCHES
20 PRINT CHR$ (27);"C"; CHR$ (0
); CHR$ (1);
30 PRINT "*****";
40 PRINT CHR$ (12);: REM FF
50 PRINT "ONE INCH FORM FEED"
```

RESULT: *****

ONE INCH FORM FEED

ESC D (Horizontal Tab Setting, 32 Positions)

ESC D

BASIC: CHR\$(27);"D";CHR\$(n)...CHR\$(n₃₂);CHR\$(0);

HEX: 1B 44 (n) 00

NAME: Horizontal Tab Setting (32 positions maximum)

FUNCTION: ESC D establishes the horizontal tab stops that are executed with each HT code received. Tab settings are entered in ascending numerical order and are terminated with CHR\$(0). Tab stops can be specified to 80 columns in 10 cpi and to 132 columns in condensed mode.

NOTE

The tab stops are established by the character width at time of tab entry. This function stores these positions and executes proper positioning regardless of type style changes. Tab stops greater than the effective column width are executed at tab position zero on the next line.

PROGRAM:

```
10 REM ESC D HORIZONTAL TAB SETTING @ PICA 10 CPI
15 LPRINT "0123456789012345678901234567890123456789"
20 LPRINT CHR$(27);"D";CHR$(5);CHR$(15);CHR$(25);
25 LPRINT CHR$(30);CHR$(35);CHR$(0);:REM END TABS
30 LPRINT CHR$(27);"W";CHR$(1);:REM ENLARGED
35 FOR Z = 1 TO 2: LPRINT CHR$(9);"TAB";:NEXT Z
40 LPRINT CHR$(27);"W";CHR$(0);:REM CANCEL ENLARGED
45 LPRINT CHR$(15);:REM CONDENSED CHARACTERS
50 LPRINT CHR$(9);"TAB";
55 LPRINT CHR$(18);:REM CANCEL CONDENSED
60 LPRINT CHR$(27);"M";:REM ELITE 12 CPI CHARACTERS
65 LPRINT CHR$(9);"TAB";
70 LPRINT CHR$(27);"P";:REM BACK TO PICA 10 CPI
75 LPRINT CHR$(9);"TAB";:LPRINT :END
```

RESULT:

```
0123456789012345678901234567890123456789
  TAB   TAB   TAB   TAB   TAB
```

ESC E**(Select Emphasized Print)****ESC E**

BASIC: CHR\$(27);"E";

HEX: 1B 45

NAME: Select Emphasized Print

FUNCTION: When ESC E is received, all subsequent characters are emphasized by firing adjacent pins in one pass of the printhead. Emphasized characters are printed at reduced speed. This function is cancelled by ESC F or ESC I.

PROGRAM:

```
10 REM EMPHASIZED
20 PRINT "(NORMAL) LOOK JANE LOOK!!!"
30 PRINT
40 PRINT "(EMPHASIZED) ";
50 PRINT CHR$ (27);"E";
60 PRINT "SEE SPOT RUN!!!"
70 PRINT : PRINT CHR$ (27);"F";
80 PRINT "(NORMAL) RUN DICK RUN!!!"
```

RESULT:

```
(NORMAL) LOOK JANE LOOK!!!

(EMPHASIZED) SEE SPOT RUN!!!

(NORMAL) RUN DICK RUN!!!
```

ESC F**(Cancel Emphasized Print)****ESC F**

BASIC: CHR\$(27);"F";

HEX: 1B 46

NAME: Cancel Emphasized Print

FUNCTION: When ESC F is received, emphasized print is cancelled.

PROGRAM: (see above)

ESC G**(Double Strike Print Mode)****ESC G**

BASIC: CHR\$(27);"G";**HEX:** 1B 47**NAME:** Double Strike Print Mode

FUNCTION: When ESC G is received, all subsequent characters are printed in double strike. This print style is printed in two passes of the print head, the second pass a fraction of a dot lower. This fills the vertical strokes of the characters to improve quality. This function is cancelled by ESC H.

PROGRAM:

```
10 REM ESC G DOUBLE STRIKE
20 PRINT CHR$ (27); "G";
30 PRINT "DOUBLE STRIKE!"
40 PRINT CHR$ (27); "H";
50 PRINT
60 PRINT "WHILE THE IRON IS HOT"
```

RESULT:

```
DOUBLE STRIKE!
WHILE THE IRON IS HOT
```

ESC H**(Cancel Double Strike Mode)****ESC H**

BASIC: CHR\$(27);"H";**HEX:** 1B 48**NAME:** Cancel Double Strike Mode

FUNCTION: Receipt of ESC H cancels the Double Strike print mode.

PROGRAM: (see above)

ESC I

(Enable Printable Control Codes)

ESC I

BASIC: CHR\$(27);"I";CHR\$(1);

HEX: 1B 49 01

NAME: Enable Printable Control Codes

FUNCTION: ESC I 1 enables the printer to print characters using ASCII codes in the control code area (ASCII 0 to 31 and 128 to 159). Note that standard control codes such as BEL (7 decimal) and CR (13 decimal) do not produce characters, but continue to function as normal. This function is cancelled by ESC I 0.

```

PROGRAM: 10 REM ESC I PRINTABLE CONTROL CODES
            20 LPRINT CHR$(0);CHR$(1);CHR$(128);CHR$(129);
            30 LPRINT "LINE 20 UNPRINTABLE CONTROL CODES"
            40 LPRINT CHR$(27);"I";CHR$(1);:REM OK TO PRINT
            50 LPRINT CHR$(0);CHR$(1);CHR$(128);CHR$(129);
            60 LPRINT " <-- LINE 50 PRINTABLE CONTROL CODES"
            70 LPRINT CHR$(27);"I";CHR$(0);:REM CANCEL
            80 LPRINT CHR$(0);CHR$(1);CHR$(128);CHR$(129);
            90 LPRINT "LINE 80 UNPRINTABLE CONTROL CODES"
            95 END

```

```

RESULT: LINE 20 UNPRINTABLE CONTROL CODES
           àèàè <-- LINE 50 PRINTABLE CONTROL CODES
           LINE 80 UNPRINTABLE CONTROL CODES

```

PRINTABLE CODES WITHIN CONTROL CODE AREA

DEC/CHAR	DEC/CHAR	DEC/CHAR	DEC/CHAR	DEC/CHAR	DEC/CHAR	DEC/CHAR	DEC/CHAR
0 à	8 BS	16 Š	24	128 à	136 BS	144 Š	152 ö
1 è	9 HT	17 ß	25 ù	129 è	137 HT	145 ß	153 ù
2 ù	10 LF	18 DC2	26 à	130 ù	138 LF	146 DC2	154 à
3 ò	11 VT	19 DC3	27 ESC	131 ò	139 VT	147 DC3	155 ESC
4 ì	12 FF	20 DC4	28 ù	132 ð	140 FF	148 DC4	156 ù
5 º	13 CR	21 ø	29 é	133 º	141 CR	149 ø	157 é
6 ₣	14 SO	22 ``	30 é	134 ₣	142 SO	150 ``	158 é
7 BEL	15 SI	23 Å	31 ¥	135 BEL	143 SI	151 Å	159 ¥

ESC J**(Paper Feed, 1/3 Dot Increment)****ESC J**

BASIC: CHR\$(27);"J";CHR\$(n);**HEX:** 1B 4A (n)**NAME:** Paper Feed Execution, 1/3 dot increment (n = 1 to 216)**FUNCTION:** ESC J (n) causes all data in the print buffer to be printed, then paper is fed the amount indicated by (n). ESC J (n) is cancelled by a line feed.

PROGRAM:

```
10 REM ESC J PAPER FEED 1/3 DOT
20 LPRINT "-----"
30 FOR X = 1 TO 20
40 LPRINT CHR$(8);: NEXT
50 LPRINT CHR$(27);"J";CHR$(216);
60 LPRINT "-----"
70 LPRINT "-----"
```

RESULT: -----

NOTE

1 dot is equal to 1/72".
1/3 dot is equal to 1/216".

ESC j**(Reverse Paper Feed, 1/3 Dot Increment)****ESC j**

BASIC: (CHR\$(27);"j";CHR\$(n);**HEX:** 1B 6A (n)**NAME:** Reverse Paper Feed Execution, 1/3 dot increment (n = 1 to 216)**FUNCTION:** ESC j (n) causes all data in the print buffer to be printed, then paper is fed (in reverse) the amount indicated by (n). ESC j (n) is cancelled by a line feed.

PROGRAM:

```
10 REM ESC j REVERSE PAPER
20 FOR X = 6 TO 1 STEP -1
40 LPRINT X:NEXT X
45 LPRINT " 0 (REF)";
50 LPRINT CHR$(27);"j";CHR$(216);
60 LPRINT "<----"
```

RESULT:

```
6      <----
5
4
3
2
1
0 (REF)
```

NOTE

To perform one standard (1/6") linefeed in reverse,
n = 36.

ESC K

(Graphics Mode—Single Density)

ESC K

BASIC: CHR\$(27);"K";CHR\$(N1);CHR\$(N2);

HEX: 1B 4B

NAME: Graphics Mode—Single Density

FUNCTION: When the above code sequence is received, the printer is placed into Single Density Graphics Mode and waits to receive the total number of graphic characters in the line designated by (N1) and (N2).

(N1) and (N2) are defined as follows:

(N2) is a whole number = total number of graphic characters ÷ 256

(N1) is the remainder of the above equation

Example: total number of graphic characters = 750

$$N2 = 750 \div 256 = 2$$

$$N1 = 750 - (256 \times N2) = 238$$

In Single Density Graphics the maximum number of graphic characters that can be printed per line is 960 (60 dots/inch). If the number of graphic characters exceeds this maximum, the excess graphic characters are ignored.

Graphic Character—A graphic character corresponds on a one-to-one basis with the print head wires as illustrated. This relationship is sometimes referred to as "bit image" graphics.

The ninth print head wire is used for underline and nine pin graphics only.

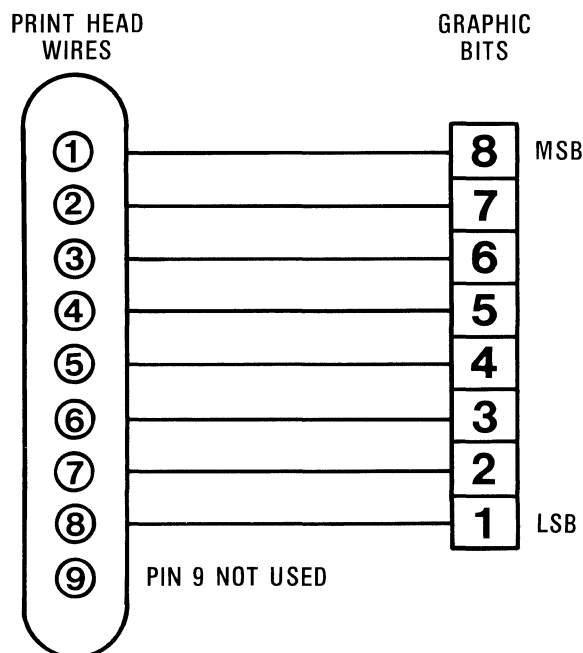

(Continued on the next page)

(ESC K continued)

The following are examples:

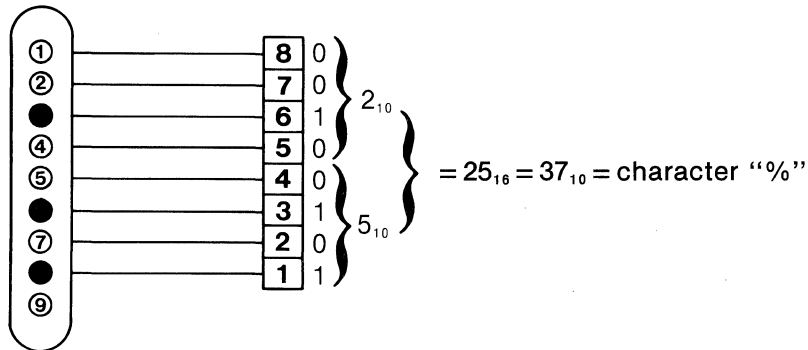
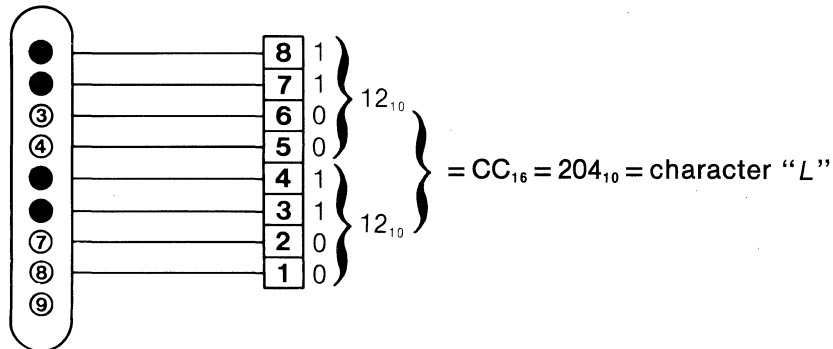

PROGRAM:

```

10 REM SINGLE DENSITY GRAPHICS MODE
15 WIDTH "LPT1:",255
20 A = 1 : B = 320
30 FOR I = 1 TO 8
40 LPRINT "START";
50 LPRINT CHR$(27);"K";CHR$(B MOD 256);CHR$(INT(B/256));
60 FOR J = 1 TO B
70 LPRINT CHR$(A);
80 NEXT J
90 A = A * 2
100 LPRINT "END"
110 NEXT I
120 LPRINT CHR$(12); : END

```

RESULT:

START		END
START		END
START		END
START		END
START		END
START		END
START		END
START		END

NOTE: Ink reproduction may not show actual density.

ESC M

(Select Elite Characters)

ESC M

BASIC: CHR\$(27);"M";

HEX: 1B 4D

NAME: Select Elite (12 cpi) Characters

FUNCTION: ESC M selects elite characters which are 12 characters per inch. This function is cancelled by ESC P, ESC ! and ESC (.

PROGRAM:

```
10 REM ESC M ELITE CHARACTERS
20 PRINT "PICA 10 CPI-20 H'S"
30 PRINT "HHHHHHHHHHHHHHHHHHHHHHHH"
40 PRINT CHR$(27);"M";
50 PRINT "ELITE 12 CPI-20 H'S"
60 PRINT "HHHHHHHHHHHHHHHHHHHHHHHH"
70 PRINT CHR$(27);"P";
80 PRINT "PICA 10 CPI-20 H'S"
90 PRINT "HHHHHHHHHHHHHHHHHHHHHHHH"
```

RESULT:

```
PICA 10 CPI-20 H'S
HHHHHHHHHHHHHHHHHHHHHHHH
ELITE 12 CPI-20 H'S
HHHHHHHHHHHHHHHHHHHHHHHH
PICA 10 CPI-20 H'S
HHHHHHHHHHHHHHHHHHHHHHHH
```

ESC P

(Select Pica Characters)

ESC P

BASIC: CHR\$(27);"P";

HEX: 1B 50

NAME: Select Pica (10 cpi) characters

FUNCTION: ESC P selects standard pica characters, which are 10 characters per inch. ESC P can be used to cancel Elite, NLQ, and Condensed characters.

PROGRAM: (see above)

ESC N**(Enable Skip-Over Perforation Setting)****ESC N**

BASIC: CHR\$(27);"N";CHR\$(n);**HEX:** 1B 4E (n)**NAME:** Enable Skip-Over Perforation Setting (n = 1 to 127)

FUNCTION: ESC N (n) specifies the number of lines to be skipped at the bottom of the fanfold page. In this example, the form length is set at 8 lines by ESC C (8) and the skip-over is set at 3 lines by ESC N (3). Thus, the skip-over begins after line 5 (8 - 3 = 5). This function is in effect for each form length until cancelled by ESC O. Note that if DIP switch 3-3 is ON, the skip-over will always be 1 inch (6 lines at 1/6 inch) for a standard form length (11" or 12") with DIP switch 3-3 ON.

PROGRAM:

```
10 REM ESC N SKIP OVER PERF
20 FOR X= 1 TO 18: LPRINT X:NEXT
30 FOR Z = 1 TO 3
40 LPRINT CHR$(27);"j";CHR$(216);:NEXT
50 LPRINT CHR$(27);"C"CHR$(8);:REM FORM LENGTH
60 LPRINT CHR$(27);"N";CHR$(3);:REM SKIP 3
70 FOR Z = 1 TO 6
80 LPRINT "    SKIP OVER ";Z:NEXT
90 LPRINT CHR$(27);"O";:REM CANCEL SKIP OVER
100 FOR I = 1 TO 9
110 LPRINT "    NO SKIP OVER ";I:NEXT
```

RESULT:

```
1  SKIP OVER  1
2  SKIP OVER  2
3  SKIP OVER  3
4  SKIP OVER  4
5  SKIP OVER  5
6
7
8
9  SKIP OVER  6
10 NO SKIP OVER  1
11 NO SKIP OVER  2
12 NO SKIP OVER  3
13 NO SKIP OVER  4
14 NO SKIP OVER  5
15 NO SKIP OVER  6
16 NO SKIP OVER  7
17 NO SKIP OVER  8
18 NO SKIP OVER  9
```

ESC O**(Cancel Skip-Over Perforation Setting)****ESC O**

BASIC: CHR\$(27);"O";**HEX:** 1B 4F**FUNCTION:** ESC O cancels the skip-over perforation setting established by ESC N (n).**PROGRAM:** (see above)

ESC ℓ**(Left Margin Setting)****ESC ℓ**

BASIC: CHR\$(27);"ℓ";CHR\$(n);**HEX:** 1B 6C (n)**NAME:** Left Margin Setting (n = 0 to 255)

FUNCTION: ESC ℓ (n) establishes the column setting for the left margin, and is entered before any characters for that line. The character size in effect at the time establishes the left margin column position. Column zero (0) is the normal first column, thus ESC ℓ 0 cancels this function.

PROGRAM:

```
10 REM ESC ℓ LEFT MARGIN SETTING
15 LPRINT "0123456789"
20 FOR Z = 1 TO 5
30 LPRINT CHR$(27);"1";CHR$(Z);"MOVE -->"
40 NEXT Z: LPRINT CHR$(27);"1";CHR$(0);
```

RESULT:

```
0123456789
MOVE -->
MOVE -->
MOVE -->
MOVE -->
MOVE -->
MOVE -->
```

ESC Q**(Right Margin Setting)****ESC Q**

BASIC: CHR\$(27);"Q";CHR\$(n);**HEX:** 1B 51 (n)**NAME:** Right Margin Setting (n = 1 to 255)

FUNCTION: ESC Q (n) establishes the column setting for the right margin, and is entered before any characters for that line. Excessive value for (n) is ignored and previous setting is in effect. The right margin setting must be greater than the left margin setting.

PROGRAM:

```
10 REM ESC Q RIGHT MARGIN SETTING
20 LPRINT "1234567890123456789012345678901234567890"
30 LPRINT CHR$(27);"Q";CHR$(20);
40 LPRINT "1234567890123456789012345678901234567890"
50 LPRINT CHR$(27);"Q";CHR$(40);
60 LPRINT "1234567890123456789012345678901234567890"
```

RESULT:

```
1234567890123456789012345678901234567890
12345678901234567890
12345678901234567890
1234567890123456789012345678901234567890
```

ESC R

(International Character Set Mode)

ESC R

BASIC: CHR\$(27);"R";CHR\$(n);

HEX: 1B 52 (n)

NAME: International Character Set Mode (n = 0 to 8)

FUNCTION: ESC R (n) selects one of nine international character sets. Refer to table on next page for decimal codes.

PROGRAM:

```
10 REM ESC R INTERNATIONAL CHARACTERS
15 LPRINT CHR$(27);"(";
20 X = 0:REM USA
25 LPRINT CHR$(27);"R";CHR$(X);
30 LPRINT "MODE ";X;" ";
35 X = X + 1
40 FOR Z = 33 TO 79:LPRINT CHR$(Z);
45 NEXT Z:LPRINT
50 LPRINT "          ";
55 FOR J = 80 TO 126: LPRINT CHR$(J);
60 NEXT J:LPRINT : LPRINT
65 IF X = 9 THEN END
70 GOTO 25
```

RESULTS:

MODE 0	!"#\$%&'()*+,-./0123456789:;<=>?@ABCDEFGHIJKLMNO PQRSTUVWXYZ[\]^_`abcdefghijklmnopqrstuvwxy{ }~
MODE 1	!"#\$%&'()*+,-./0123456789:;<=>?àABCDEFGHIJKLMNO PQRSTUVWXYZ"ç\$^_`abcdefghijklmnopqrstuvwxyzéùè"
MODE 2	!"#\$%&'()*+,-./0123456789:;<=>?§ABCDEFGHIJKLMNO PQRSTUVWXYZÄÖÜ^_`abcdefghijklmnopqrstuvwxyzáöüß
MODE 3	!"£\$%&'()*+,-./0123456789:;<=>?@ABCDEFGHIJKLMNO PQRSTUVWXYZ[\]^_`abcdefghijklmnopqrstuvwxy{ }~
MODE 4	!"#\$%&'()*+,-./0123456789:;<=>?@ABCDEFGHIJKLMNO PQRSTUVWXYZÆØÅ^_`abcdefghijklmnopqrstuvwxyzaøå~
MODE 5	!"#¤%&'()*+,-./0123456789:;<=>?ÉABCDEFGHIJKLMNO PQRSTUVWXYZÄÖÅÜ_éabcdefghijklmnopqrstuvwxyzáöåü
MODE 6	!"#\$%&'()*+,-./0123456789:;<=>?@ABCDEFGHIJKLMNO PQRSTUVWXYZ"è^_`abcdefghijklmnopqrstuvwxyzáèèì
MODE 7	!"r\$%&'()*+,-./0123456789:;<=>?@ABCDEFGHIJKLMNO PQRSTUVWXYZ;Ñ¿^_`abcdefghijklmnopqrstuvwxyznñ~
MODE 8	!"#\$%&'()*+,-./0123456789:;<=>?@ABCDEFGHIJKLMNO PQRSTUVWXYZ[¥]^_`abcdefghijklmnopqrstuvwxy{ }~

(See chart, next page)

(ESC R continued)

INTERNATIONAL CHARACTERS

	0	1	2	3	4	5	6	7	8
DEC	U.S.A.	FRANCE	GERMANY	U.K.	DENMARK	SWEDEN	ITALY	SPAIN	JAPAN
35	#	#	#	£	#	#	#	Pt	#
36	\$	\$	\$	\$	\$	¤	\$	\$	\$
64	@	@	§	@	@	É	@	@	@
91	[°	À	[Æ	Ä	°	¡	[
92	/	ø	Ö	/	Ø	Ö	/	Ñ	¥
93]	§	Ü]	À	Ä	É	¿]
94	^	^	^	^	^	Ü	^	^	^
96	'	'	'	'	'	É	À	'	'
123	{	é	ä	{	æ	ä	@	¨	{
124	:	à	ö	:	ø	ö	ò	ñ	:
125	}	è	ü	}	â	ä	ê	}	}
126	~	¨	ß	~	~	ü	ï	~	~

ESC S 0 (Select Superscript Characters)

ESC S 0

BASIC: CHR\$(27);"S";CHR\$(0);

HEX: 1B 53 00

NAME: Select Superscript Characters

FUNCTION: ESC S 0 selects superscript characters, which are half-size and printed in two passes of the print head. This function is cancelled by ESC T.

PROGRAM:

```
10 REM ESC S0 SUPERSCRIP
20 PRINT "HERE IS SUPERSCRIP";
30 PRINT CHR$ (27);"S"; CHR$ (0);
40 PRINT "1234567890"
50 PRINT : PRINT CHR$ (27);"T";
60 PRINT "EINSTEIN'S FAMOUS FORM
   ULA: ";
70 PRINT "E=MC";
80 PRINT CHR$ (27);"S"; CHR$ (0);
90 PRINT "2";: REM SUPERSCRIP
95 PRINT CHR$ (27);"T";
```

RESULT: HERE IS SUPERSCRIP¹²³⁴⁵⁶⁷⁸⁹⁰
EINSTEIN'S FAMOUS FORMULA: E=MC²

ESC S 1 (Select Subscript Characters)

ESC S 1

BASIC: CHR\$(27);"S";CHR\$(1);

HEX: 1B 53 01

NAME: Select Subscript Characters

FUNCTION: ESC S 1 selects subscript characters, which are half-size and printed in two passes of the print head. This function is cancelled by ESC T.

PROGRAM:

```
10 REM ESC S1 SUBSCRIPT
20 PRINT "HERE IS SUBSCRIPT";
30 PRINT CHR$ (27);"S"; CHR$ (1);
40 PRINT "1234567890"
50 PRINT : PRINT CHR$ (27);"T";
60 PRINT "FORMULA FOR WATER = H";
70 PRINT CHR$ (27);"S"; CHR$ (1);
80 PRINT "2"; CHR$ (27);"T";"0"
```

RESULT: HERE IS SUBSCRIPT₁₂₃₄₅₆₇₈₉₀
FORMULA FOR WATER = H₂O

ESC T**(Cancel Super/Sub Script)****ESC T**

BASIC: CHR\$(27);"T";

HEX: 1B 54

NAME: Cancel Superscript/Subscript**FUNCTION:** ESC T cancels superscript (ESC S 0) and subscript (ESC S 1) characters.

PROGRAM:

```
10 REM ESC T CANCEL SUPER/SUBSCRIPT
20 LPRINT "THIS IS SUPER";
30 LPRINT CHR$(27);"S";CHR$(0);
40 LPRINT "SCRIPT";CHR$(27);"T"
50 LPRINT "NORMAL PICA STYLE"
60 LPRINT "THIS IS SUB";
70 LPRINT CHR$(27);"S";CHR$(1);
80 LPRINT "SCRIPT";CHR$(27);"T"
90 LPRINT "NORMAL PICA STYLE"
```

RESULT:

```
THIS IS SUPERSSCRIPT
NORMAL PICA STYLE
THIS IS SUBSCRIPT
NORMAL PICA STYLE
```

ESC W**(Enlarged Character Mode)****ESC W**

BASIC: CHR\$(27);"W";CHR\$(1);

HEX: 1B 57 01

NAME: Enlarged Character Mode**FUNCTION:** ESC W 1 causes any print style to be enlarged and is in effect until cancelled by ESC W 0 or ESC !.

PROGRAM:

```
10 REM ESC W ENLARGED PRINT MODE
20 LPRINT CHR$(27);"(";:REM NLQ
30 LPRINT CHR$(27);"W";CHR$(1);
40 LPRINT "THIS IS ENLARGED NLQ"
50 LPRINT "AND SO IS THIS LINE!"
60 LPRINT CHR$(27);"W";CHR$(0);
70 LPRINT "NOW WE ARE PRINTING NLQ AT 10 CPI"
```

RESULT:

```
THIS IS ENLARGED NLQ
AND SO IS THIS LINE!
NOW WE ARE PRINTING NLQ AT 10 CPI
```

ESC Z (Graphics Mode—Quadruple Density)

ESC Z

BASIC: CHR\$(27);"Z";CHR\$(N1);CHR\$(N2);

HEX: 1B 5A

NAME: Graphics Mode—Quadruple Density

FUNCTION: When the above code sequence is received, the printer is placed into Quadruple Density Graphics Mode and waits to receive the total number of graphics characters for the line designated by (N1) and (N2). (Refer to ESC K for definition of (N1) and (N2) values).

In Quadruple Density Graphics Mode the maximum number of graphic characters per line is 3744 (240 Dots/in). If the number of graphic characters to be received exceeds this maximum, the excess is ignored.

Graphic Characters (Refer to ESC K)

PROGRAM:

```
10 REM QUADRUPLE DENSITY GRAPHICS MODE
15 WIDTH "LPT1:",255
20 A = 1 : B = 700
30 FOR J = 1 TO 4
40 IF J = 1 THEN LPRINT "SINGLE DENSITY GRAPHICS MODE" : C$="K"
50 IF J = 2 THEN LPRINT "DOUBLE DENSITY GRAPHICS MODE" : C$="L"
60 IF J = 3 THEN LPRINT "DOUBLE DENSITY, DOUBLE SPEED GRAPHICS MODE" : C$="Y"
70 IF J = 4 THEN LPRINT "QUADRUPLE DENSITY GRAPHICS MODE" : C$="Z"
80 LPRINT CHR$(27);C$;CHR$(B MOD 256);CHR$(INT(B/256));
90 FOR K = 1 TO B
100 LPRINT CHR$(&H99);
110 NEXT K
120 LPRINT
125 LPRINT CHR$(27);C$;CHR$(B MOD 256);CHR$(INT(B/256));
130 FOR K = 1 TO B
140 LPRINT CHR$(A);
150 A = A + 1
155 IF A > 128 THEN A = 1
160 NEXT K
170 LPRINT
180 A = 1
190 NEXT J
200 LPRINT CHR$(12); : END
```

RESULT:

SINGLE DENSITY GRAPHICS MODE

DOUBLE DENSITY GRAPHICS MODE

DOUBLE DENSITY, DOUBLE SPEED GRAPHICS MODE

QUADRUPLE DENSITY GRAPHICS MODE

NOTE: Ink reproduction may not show actual density.

ESC ^ (Graphics Mode—9 Dot and 16 Dot)

ESC ^

BASIC: CHR\$(27);“^”;CHR\$(M);CHR\$(N1);CHR\$(N2);

HEX: 1B 5E

NAME: Graphic Mode (9 Dot and 16 Dot Graphics)

FUNCTION: When the above code sequence is received, the printer enters 9 dot or 16 dot graphic mode and waits to receive the total number of graphic characters for the line designated by (N1) and (N2). Refer to ESC K for the definition of (N1) and (N2) values. The value of (M) is defined as follows.

M	MODE
0	9 Dot Graphics, 936 Dots/Line, Single Density
1	9 Dot Graphics, 1872 Dots/Line, Double Density
17	16 Dot Graphics, 1872 Dots/Line, Double Density

If the number of graphic characters exceeds the above maximum, the excess graphic characters are ignored.

Data Byte Structure—In 9 Dot and 16 Dot Graphic Modes, each graphic character consists of two 8-bit data bytes as illustrated.

9 Dot Graphics—Pin to Data Bit Relationship

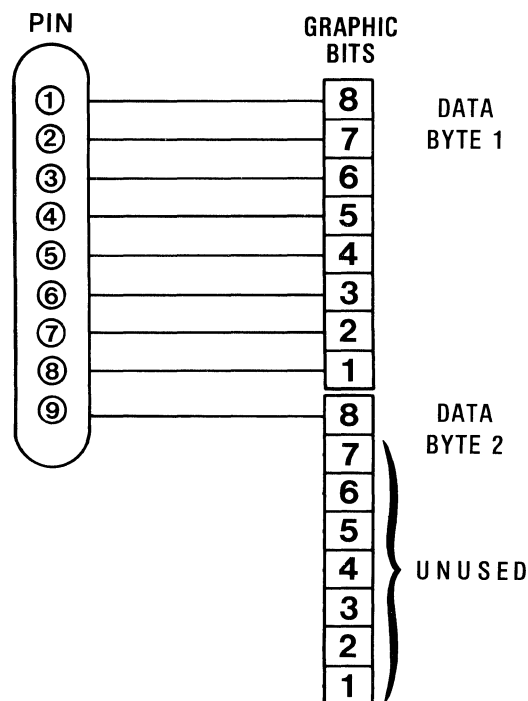

(Continued on the next page)

(ESC ^ continued)

Example:

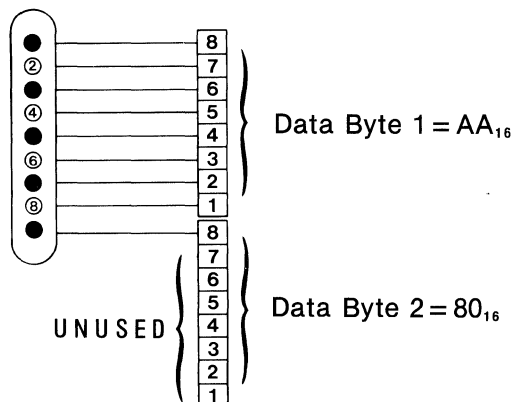

PROGRAM:

```
10 REM 9-DOT GRAPHICS MODE
20 A = 0 : B = 400
25 LPRINT "9-DOT GRAPHICS, SINGLE DENSITY"
30 FOR J = 1 TO 4
40 LPRINT "START";
50 LPRINT CHR$(27);"^";CHR$(A);CHR$(B MOD 256);CHR$(INT(B/256));
60 FOR I = 1 TO B
70 LPRINT CHR$(&HAA);CHR$(&H80);
80 NEXT I
81 LPRINT "END"
85 LPRINT : NEXT J
90 IF A = 1 THEN LPRINT CHR$(12); : END
100 A = 1 : B = 700
110 LPRINT "9-DOT GRAPHICS, DOUBLE DENSITY"
120 GOTO 30
```

RESULT:

```
9-DOT GRAPHICS, SINGLE DENSITY
START=====END
START=====END
START=====END
START=====END
9-DOT GRAPHICS, DOUBLE DENSITY
START=====END
START=====END
START=====END
START=====END
```

NOTE: Ink reproduction may not show actual density.

(Continued on the next page)

(ESC ^ continued)

16 Dot Graphics Pin to Data Bit Relationship

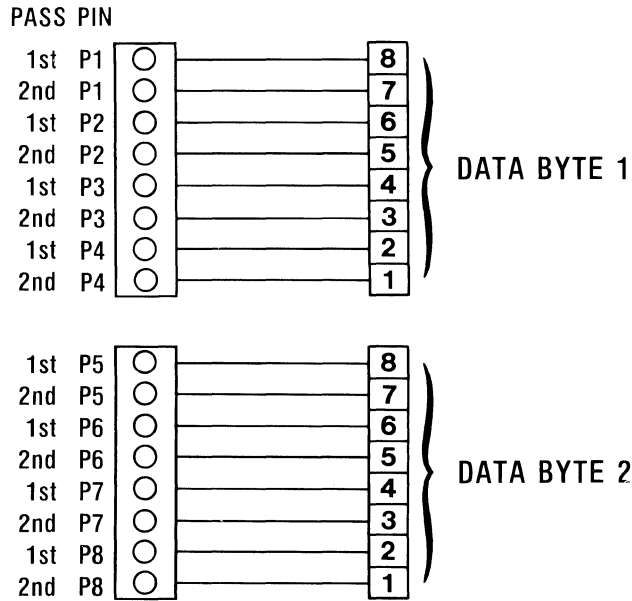

Note—16 Dot Graphics is a two-pass function with pin firing as shown above. Between first and second pass there is a 1/3 dot line feed then a 1/3 dot reverse line feed after the second pass.

Example:

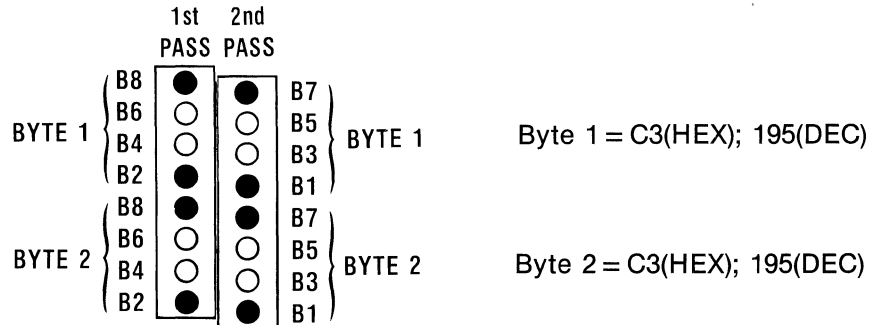

(Continued on the next page)

(ESC ^ continued)

PROGRAM:

```
10 REM 9-DOT GRAPHICS MODE
20 A = 0 : B = 400
25 LPRINT "9-DOT GRAPHICS, SINGLE DENSITY
30 FOR J = 1 TO 4
40 LPRINT "START";
50 LPRINT CHR$(27);"^";CHR$(A);CHR$(B MOD 256);CHR$(INT(B/256));
60 FOR I = 1 TO B
70 LPRINT CHR$(&HAA);CHR$(&H80);
80 NEXT I
81 LPRINT "END"
85 LPRINT : NEXT J
90 IF A = 1 THEN GOTO 130
100 A = 1 : B = 700
110 LPRINT "9-DOT GRAPHICS, DOUBLE DENSITY"
120 GOTO 30
130 A = 17 : B = 800
140 LPRINT "16-DOT GRAPHICS, DOUBLE DENSITY"
150 FOR J = 1 TO 4
160 LPRINT "START";
170 LPRINT CHR$(27);"^";CHR$(A);CHR$(B MOD 256);CHR$(INT(B/256));
180 FOR I = 1 TO B
190 LPRINT CHR$(&H90);CHR$(&H9);
200 NEXT I
210 LPRINT "END"
220 LPRINT : NEXT J
230 LPRINT CHR$(12); : END
```

RESULT:

```
9-DOT GRAPHICS, SINGLE DENSITY
START=====END
START=====END
START=====END
START=====END

9-DOT GRAPHICS, DOUBLE DENSITY
START=====END
START=====END
START=====END
START=====END

16-DOT GRAPHICS, DOUBLE DENSITY
START=====END
START=====END
START=====END
START=====END
```

NOTE: Ink reproduction may not show actual density.

ESC b

(VFU Tab Position Setting)

ESC b

BASIC: CHR\$(27);"b";CHR\$(n);CHR\$(m₁);...CHR\$(m₁₆);CHR\$(0)

HEX: 1B 62

NAME: VFU Tab Position Setting (n = 0 to 7) (m = 1 to 16)

FUNCTION: ESC b (n) (m) specifies the vertical tab stops (m₁ to m₁₆) within one of eight channels (n₀ to n₇). ESC / (n) selects the channel and VT activates the tab stops in sequence. See ESC / for additional programming.

PROGRAM:

```
10 REM ESC b VFU POSITION SETTING
15 LPRINT CHR$(27);"C";CHR$(10);:REM FORM LENGTH 10
20 FOR Z = 0 TO 23: LPRINT Z:NEXT
25 FOR X = 1 TO 4: LPRINT CHR$(27);"j";CHR$(216);
30 NEXT X: LPRINT " <--- TOP OF FORM
35 LPRINT CHR$(27);"b";CHR$(3);:REM CHANNEL 3
40 LPRINT CHR$(3);CHR$(7);CHR$(9);CHR$(0);:REM CH3 TABS
45 LPRINT CHR$(27);"/";CHR$(3);:REM SELECT CH3
50 LPRINT CHR$(12);:REM TOP OF FORM COMMAND
55 LPRINT " <--- CHAN 3 TOP OF FORM"
60 FOR Y = 1 TO 3: LPRINT CHR$(11);:REM VERT TAB
65 LPRINT " <--- CHAN 3; TAB ";Y:NEXT Y
70 END
```

RESULT:

```
0 <--- TOP OF FORM
1
2
3
4
5
6
7
8
9
10 <--- CHAN 3 TOP OF FORM
11
12
13 <--- CHAN 3; TAB 1
14
15
16
17 <--- CHAN 3; TAB 2
18
19 <--- CHAN 3; TAB 3
20
21
22
23
```

ESC i

(Incremental Typewriter Mode)

ESC i

BASIC: CHR\$(27);"i";CHR\$(1);

HEX: 1B 69 01

NAME: Incremental (Typewriter) Mode

FUNCTION: ESC i 1 sets the typewriter mode. The function is similar to the old tele-type printer where a view of the printed character is provided by reverse-feeding the paper after printing. The program below requires that a CR (Carriage Return) be sent whenever printing and viewing is desired. To exit the program, send "XXX (CR)". This mode is cancelled by ESC i 0.

NOTE

Some computers ignore trailing spaces and lone spaces sent in this mode. If a space is to be recognized, there must be a character before and after the space prior to the CR.

PROGRAM:

```
10 REM ESC i TYPEWRITER MODE
20 LPRINT CHR$(27);"i";CHR$(1);
30 INPUT A$:IF A$= "XXX" THEN 50
40 LPRINT A$;:GOTO 30
50 LPRINT CHR$(27);"i";CHR$(0);:END
```

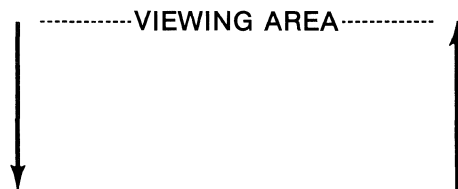

RESULT:

THIS IS TYPEWRITER MODE.

ESC p**(Proportional Spacing Mode)****ESC p**

BASIC: CHR\$(27);"p";CHR\$(1)

HEX: 1B 70 01

NAME: Proportional Spacing Print Mode

FUNCTION: ESC p 1 causes subsequent printing to be spaced in proportion to the width of the characters; that is, they are not monospaced at 10 cpi. This results in more characters per line. Also, proportional printing is always emphasized to improve the quality of print. Proportional spacing is cancelled by ESC p 0. The BS and DEL functions are not valid with this function.

PROGRAM:

```
10 REM ESC p PROPORTIONAL PRINT
20 LPRINT "NORMAL PRINT"
30 LPRINT "ABCDEFGHIJKLMNOPQRSTUVWXYZ"
40 LPRINT "abcdefghijklmnopqrstuvwxyz"
50 LPRINT CHR$(27);"p";CHR$(1);
60 LPRINT : LPRINT "PROPORTIONAL"
70 LPRINT "ABCDEFGHIJKLMNOPQRSTUVWXYZ"
80 LPRINT "abcdefghijklmnopqrstuvwxyz"
90 LPRINT CHR$(27);"p";CHR$(0);
```

RESULT:

```
NORMAL PRINT
ABCDEFGHIJKLMNOPQRSTUVWXYZ
abcdefghijklmnopqrstuvwxyz

PROPORTIONAL
ABCDEFGHIJKLMNOPQRSTUVWXYZ
abcdefghijklmnopqrstuvwxyz
```

ESC s**(Half Speed Print Mode)****ESC s**

BASIC: CHR\$(27);"s";CHR\$(1);

HEX: 1B 73 01

NAME: Half-Speed (Quiet) Print Mode

FUNCTION: ESC s 1 causes the printer to operate at half normal speed, resulting in quieter operation. This function is cancelled by ESC s 0.

PROGRAM:

```
10 REM ESC s HALF SPEED MODE
20 LPRINT "THIS IS NORMAL SPEED"
30 LPRINT CHR$(27);"s";CHR$(1);
40 LPRINT "THIS IS HALF SPEED"
50 LPRINT CHR$(27);"s";CHR$(0);
60 LPRINT "BACK TO NORMAL SPEED"
```

RESULT:

```
THIS IS NORMAL SPEED
THIS IS HALF SPEED
BACK TO NORMAL SPEED
```

SECTION 4 PREVENTIVE MAINTENANCE

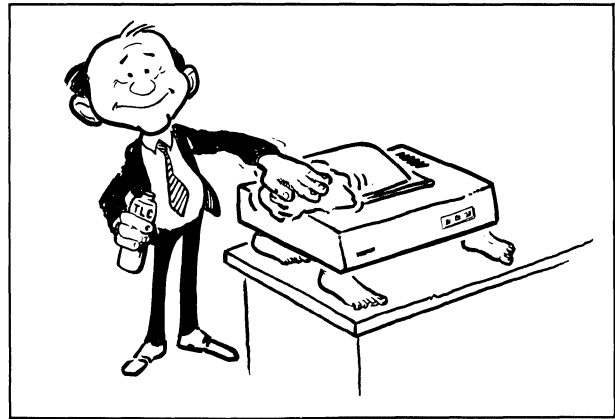

4.1 GENERAL

Preventive maintenance can be performed by the operator. This printer requires very little attention except for cleaning when necessary. Follow the safety guidelines below.

WARNING

Always remove power plug from outlet before performing preventive maintenance. Liquid cleaners should NOT be used on any appliance that is plugged into the outlet.

4.2 CLEANING THE EXTERIOR

The external surfaces of the printer may be cleaned using a cotton cloth or industrial wiper dampened with a mild detergent solution. Limit the amount of liquid used; do not allow to drip inside cabinet. Dry the surfaces with an industrial wiper before restoring power.

CAUTION

Do not use solvents to clean any part of the printer, as these fluids may attack and permanently mar the plastic finish. Use a mild detergent solution as described above.

4.3 CLEANING THE PLATEN (RUBBER ROLLER)

The platen may become soiled with ink or bits of paper after extended use. Remove the power plug from the outlet and clean the platen with mild detergent and cotton cloth turning the platen as required. Let platen dry before restoring power.

4.4 LUBRICATION

This printer is lubricated for extended service. If the carriage rods become dry after lengthy service, remove the power plug, remove the ribbon cassette and wipe the carriage rods with a clean cotton cloth, then rub a thin film of light grease on the (2) carriage rods. Move the print head back and forth along the full length of travel, then remove any excess grease. Allow a thin film of grease to remain on carriage rods.

NOTE

For a more complete maintenance program refer to the Service Manual.

SECTION 5

PRINT HEAD REPLACEMENT

5.1 PURPOSE

This section provides instructions for replacement of the print head by a handy operator or technician in the event it fails to perform properly after extended operation.

NOTE

Before considering replacing the print head, make certain that the head position lever (Figure 2-3C) is toward the platen. A worn ribbon also results in light print. It is not likely that the print head would need replacement except after very extensive operation (100 million characters). Note that sometimes the 8th and 9th pins produce light dots because they are seldom used. This can be remedied by sending lines of lower case "y" (8th pin descender) and lower case "g" (9th pin descender) until dots are darker.

5.2 PRINT HEAD REPLACEMENT

The print head may be replaced in a few minutes by a handy person as follows:

1. Remove power plug from power outlet. Lift front cover and remove ribbon cassette (see Figure 2-3).
2. Loosen 2 phillips-head screws on print head mounting bracket (Figure 5-1). No need to remove the screws completely.
3. Pull the print head out, toward the front of the printer (stop to avoid tension on the flex cable shown in Figure 5-2).
4. Unplug the flex cable from the connector by pulling the tab to the right.
5. Plug the new ribbon cable into the black connector. The tab goes under the ribbon cable. Hold the ribbon and tab together to get more stiffness if required (Figure 5-2).
6. Install the new print head, slipping the mounting bracket under the screws. Wiggle the print head to make certain that it seats properly.
7. Tighten the 2 screws and replace the ribbon cassette.

5.3 PRINTER REPAIR / MAINTENANCE

If the printer needs repair or replacement parts, contact the company that supplied the printer. The Service Manual contains procedures for replacement.

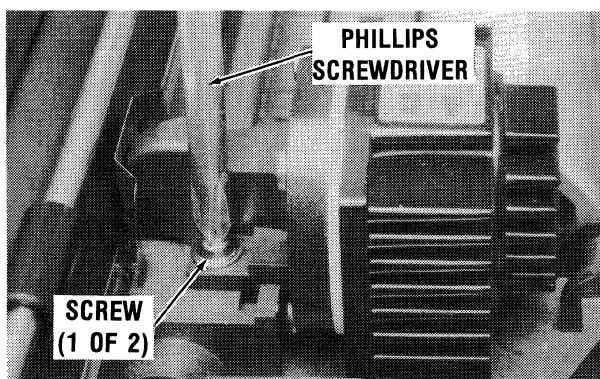

Figure 5-1 Print Head Mounting Screws (2)

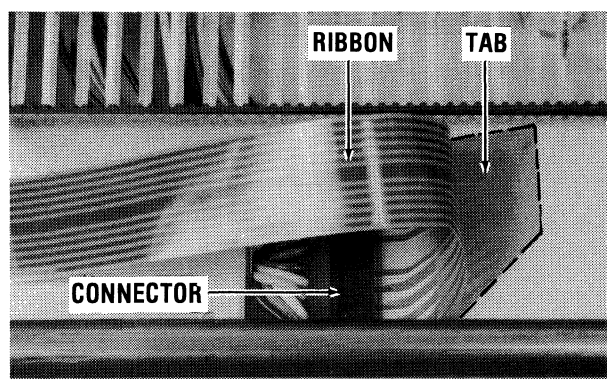

Figure 5-2 Flexible Ribbon Connector

APPENDIX A

GENERAL SPECIFICATIONS

PRINTING

- 160 CPS, Bidirectional, Logic-Seeking
- Unidirectional; NLQ, Super/Subscript, Graphics
- 9-Pin, Impact, Dot-Matrix Printhead
- Printhead Life: 100 Million Characters
- 8-Pin, 9-Pin, 16-Pin Graphics
- Matrix: 11 × 9 Standard; 23 × 16 NLQ (2 passes)
- Noise Level: 60 dbA

CHARACTER SETS

- Standard; 96 ASCII Characters (Hex 20-7F)
- Italic; 96 ASCII Characters (Hex A0-FF)
- Proportional; 96 Characters (Hex 20-7F)
- NLQ; 96 ASCII Characters (Hex 20-7F)
- Download 11 × 9 Capability
- Optional Download NLQ 23 × 16 (8K RAM)
- Character Widths: 5, 6, 8.57, 10, 12, 17.14 cpi
- NLQ Character Width: 5 cpi Enlarged; 10 cpi Normal

COLUMN WIDTH

- Pica Size—156
- Enlarged—78
- Condensed—265
- Condensed Enlarged—132
- Elite—187
- Elite Enlarged—93

PAPER HANDLING (All Hardware Self-Contained)

- Cut-Sheet, Fanfold
- Copies: One Original, Two Carbons
- Width: Adjustable to 17 inches (43.2 cm)

PHYSICAL

- Size: 24.6"W, 13.8"D, 5.6"H (62.5 × 35 × 14.2 cm)
- Weight: 26.4 lbs (12 kg) approximately

ELECTRICAL

- Voltage: H136-1, 115V@60Hz; H136-2, 230V@50Hz
- Power Consumption: 120 Watts Maximum

APPENDIX B INTERFACE SPECIFICATIONS

B.1 PARALLEL INTERFACE

The Models H136-1A and H136-2A interface to the computer through a 36-pin female connector (Amphenol 57-40360 or equivalent). The data transfer is 8 bits parallel with strobe in the Centronics configuration. The 36-pin connector pin-out is summarized in the table below.

Parallel Interface Connector Pin-out

PIN NO.	SIGNAL NAME	PIN NO.	SIGNAL NAME
1	$\overline{\text{STB}}$	19	$\overline{\text{STB RET}}$
2	DATA 1	20	DATA 1 RET
3	DATA 2	21	DATA 2 RET
4	DATA 3	22	DATA 3 RET
5	DATA 4	23	DATA 4 RET
6	DATA 5	24	DATA 5 RET
7	DATA 6	25	DATA 6 RET
8	DATA 7	26	DATA 7 RET
9	DATA 8	27	DATA 8 RET
10	$\overline{\text{ACKNLG}}$	28	$\overline{\text{ACKNLG RET}}$
11	BUSY	29	BUSY RET
12	PE (Paper End)	30	PE RET
13	SLCT	31	$\overline{\text{INPRM}}$
14	$\overline{\text{AUTO LF}}$	32	$\overline{\text{FAULT}}$
15	(NC)	33	GND
16	GND (0V)	34	(NC)
17	FG (Protective Ground)	35	+5V
18	(NC)	36	$\overline{\text{SLCT IN}}$

*Connector is female Amphenol #57-40360; 36 Pin

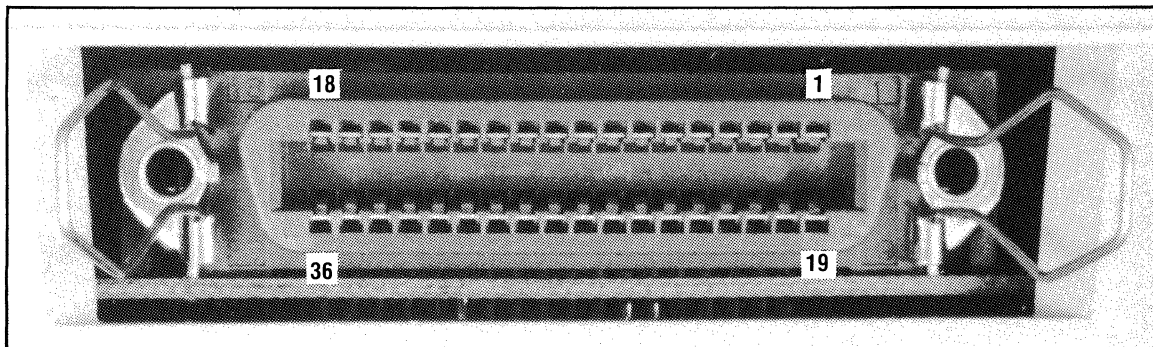

Figure B-1 36-Pin Female Connector (Centronics P/N 31310012-1016)

B.2 INTERFACE SIGNAL DESCRIPTIONS

DATA 1-DATA 8 (Host Generated) [PINS 2-9]

Data lines 1 thru 8 carry ASCII character and control code information, plus graphic image data. Data is true when high (logic 1).

DATA STROBE ($\overline{\text{STB}}$) (Host Generated) [PIN 1]

This negative-going pulse transfers data (from the host) into the electronics of the printer. Pulse duration of the strobe must be 0.5 microseconds, minimum.

ACKNOWLEDGE ($\overline{\text{ACKNLG}}$) (Printer Generated) [PIN 10]

This negative-going pulse (18 microseconds) indicates that the printer has processed the latest byte of data. Also, Acknowledge is sent to the host under these conditions: after power-up and ON LINE; after Input Prime input. Next Strobe from host must be held until Acknowledge times out.

BUSY (Printer Generated) [PIN 11]

This positive-going signal indicates that the printer cannot accept new data. Busy is active under these conditions: Printer deselected (OFF LINE); leading edge of Input Prime signal; buffer full condition.

SELECT (SLCT) (Printer Generated) [PIN 13]

This line is always high.

PAPER END (PE) (Printer Generated) [PIN 12]

This positive-going signal indicates an out-of-paper condition which deselects the printer (unless switch is in CUT-SHEET position). After replenishing paper, the printer must be selected by pressing ON LINE.

FAULT ($\overline{\text{FAULT}}$) (Printer Generated) [PIN 32]

This is a negative-going signal which indicates printer OFF LINE or out of paper (PE).

SELECT IN ($\overline{\text{SLCT IN}}$) (Host Generated) [PIN 36]

This low level (with DIP SW3-1 OFF) allows remote select and deselect of the printer by DC1 and DC3 codes. With DIP SW3-1 ON, remote select and deselect is disabled.

AUTO LINE FEED ($\overline{\text{AUTO LF}}$) (Host Generated) [PIN 14]

This low level (with DIP SW3-4 ON) causes an automatic line feed after each CR (carriage return). Note that most computers and word processors force an LF after a CR; thus DIP SW3-4 is normally left OFF; otherwise, double linespacing may occur.

INPUT PRIME ($\overline{\text{INPRM}}$) (Host Generated) [PIN 31]

This negative-going signal (50 microseconds) resets (initializes) the printer circuitry and clears the print buffer.

APPENDIX C

DATA TABLES

C.1 DECIMAL TO HEXADECIMAL CONVERSION

The table below may be used by the programmer to convert from decimal (0-9) to hexadecimal (0-9 plus A, B, C, D, E, F).

Decimal to Hexadecimal Conversion Chart

DE = HX	DE = HX	DE = HX	DE = HX	DE = HX	DE = HX	DE = HX	DE = HX
0 = 00	32 = 20	64 = 40	96 = 60	128 = 80	160 = A0	192 = C0	224 = E0
1 = 01	33 = 21	65 = 41	97 = 61	129 = 81	161 = A1	193 = C1	225 = E1
2 = 02	34 = 22	66 = 42	98 = 62	130 = 82	162 = A2	194 = C2	226 = E2
3 = 03	35 = 23	67 = 43	99 = 63	131 = 83	163 = A3	195 = C3	227 = E3
4 = 04	36 = 24	68 = 44	100 = 64	132 = 84	164 = A4	196 = C4	228 = E4
5 = 05	37 = 25	69 = 45	101 = 65	133 = 85	165 = A5	197 = C5	229 = E5
6 = 06	38 = 26	70 = 46	102 = 66	134 = 86	166 = A6	198 = C6	230 = E6
7 = 07	39 = 27	71 = 47	103 = 67	135 = 87	167 = A7	199 = C7	231 = E7
8 = 08	40 = 28	72 = 48	104 = 68	136 = 88	168 = A8	200 = C8	232 = E8
9 = 09	41 = 29	73 = 49	105 = 69	137 = 89	169 = A9	201 = C9	233 = E9
10 = 0A	42 = 2A	74 = 4A	106 = 6A	138 = 8A	170 = AA	202 = CA	234 = EA
11 = 0B	43 = 2B	75 = 4B	107 = 6B	139 = 8B	171 = AB	203 = CB	235 = EB
12 = 0C	44 = 2C	76 = 4C	108 = 6C	140 = 8C	172 = AC	204 = CC	236 = EC
13 = 0D	45 = 2D	77 = 4D	109 = 6D	141 = 8D	173 = AD	205 = CD	237 = ED
14 = 0E	46 = 2E	78 = 4E	110 = 6E	142 = 8E	174 = AE	206 = CE	238 = EE
15 = 0F	47 = 2F	79 = 4F	111 = 6F	143 = 8F	175 = AF	207 = CF	239 = EF
16 = 10	48 = 30	80 = 50	112 = 70	144 = 90	176 = B0	208 = D0	240 = F0
17 = 11	49 = 31	81 = 51	113 = 71	145 = 91	177 = B1	209 = D1	241 = F1
18 = 12	50 = 32	82 = 52	114 = 72	146 = 92	178 = B2	210 = D2	242 = F2
19 = 13	51 = 33	83 = 53	115 = 73	147 = 93	179 = B3	211 = D3	243 = F3
20 = 14	52 = 34	84 = 54	116 = 74	148 = 94	180 = B4	212 = D4	244 = F4
21 = 15	53 = 35	85 = 55	117 = 75	149 = 95	181 = B5	213 = D5	245 = F5
22 = 16	54 = 36	86 = 56	118 = 76	150 = 96	182 = B6	214 = D6	246 = F6
23 = 17	55 = 37	87 = 57	119 = 77	151 = 97	183 = B7	215 = D7	247 = F7
24 = 18	56 = 38	88 = 58	120 = 78	152 = 98	184 = B8	216 = D8	248 = F8
25 = 19	57 = 39	89 = 59	121 = 79	153 = 99	185 = B9	217 = D9	249 = F9
26 = 1A	58 = 3A	90 = 5A	122 = 7A	154 = 9A	186 = BA	218 = DA	250 = FA
27 = 1B	59 = 3B	91 = 5B	123 = 7B	155 = 9B	187 = BB	219 = DB	251 = FB
28 = 1C	60 = 3C	92 = 5C	124 = 7C	156 = 9C	188 = BC	220 = DC	252 = FC
29 = 1D	61 = 3D	93 = 5D	125 = 7D	157 = 9D	189 = BD	221 = DD	253 = FD
30 = 1E	62 = 3E	94 = 5E	126 = 7E	158 = 9E	190 = BE	222 = DE	254 = FE
31 = 1F	63 = 3F	95 = 5F	127 = 7F	159 = 9F	191 = BF	223 = DF	255 = FF

C.2 ASCII CODE CONVERSION CHART

This chart provides a numeric cross-reference of the 128 ASCII codes. ASCII is the American Standard Code for Information Interchange. The basic ASCII characters are included. Note that some characters will vary, depending on the printer or country character sets. Refer to other tables as appropriate for specific characters.

HX	DEC	OCT	BINARY	ASCII	HX	DEC	OCT	BINARY	ASCII	HX	DEC	OCT	BINARY	ASCII
00	0	000	0000000	NULL	2B	43	053	0101011	+ plus	56	86	126	1010110	V (UC)
01	1	001	0000001	SOH	2C	44	054	0101100	, comma	57	87	127	1010111	W (UC)
02	2	002	0000010	STX	2D	45	055	0101101	- minus	58	88	130	1011000	X (UC)
03	3	003	0000011	ETX	2E	46	056	0101110	. period	59	89	131	1011001	Y (UC)
04	4	004	0000100	EOT	2F	47	057	0101111	/ slash	5A	90	132	1011010	Z (UC)
05	5	005	0000101	ENQ	30	48	060	0110000	0 zero	5B	91	133	1011011	[open brkt
06	6	006	0000110	ACK	31	49	061	0110001	1 one	5C	92	134	1011100	\ left slash
07	7	007	0000111	BEL	32	50	062	0110010	2 two	5D	93	135	1011101] close brkt
08	8	010	0001000	BS	33	51	063	0110011	3 three	5E	94	136	1011110	^ circumflex
09	9	011	0001001	HT	34	52	064	0110100	4 four	5F	95	137	1011111	_ underline
0A	10	012	0001010	LF	35	53	065	0110101	5 five	60	96	140	1100000	` grave
0B	11	013	0001011	VT	36	54	066	0110110	6 six	61	97	141	1100001	a (lc)
0C	12	014	0001100	FF	37	55	067	0110111	7 seven	62	98	142	1100010	b (lc)
0D	13	015	0001101	CR	38	56	070	0111000	8 eight	63	99	143	1100011	c (lc)
0E	14	016	0001110	SO	39	57	071	0111001	9 nine	64	100	144	1100100	d (lc)
0F	15	017	0001111	SI	3A	58	072	0111010	: colon	65	101	145	1100101	e (lc)
10	16	020	0010000	DLE	3B	59	073	0111011	; semicolon	66	102	146	1100110	f (lc)
11	17	021	0010001	DC1	3C	60	074	0111100	< less than	67	103	147	1100111	g (lc)
12	18	022	0010010	DC2	3D	61	075	0111101	= equals	68	104	150	1101000	h (lc)
13	19	023	0010011	DC3	3E	62	076	0111110	> gr than	69	105	151	1101001	i (lc)
14	20	024	0010100	DC4	3F	63	077	0111111	? question	6A	106	152	1101010	j (lc)
15	21	025	0010101	NAK	40	64	100	1000000	@ at sign	6B	107	153	1101011	k (lc)
16	22	026	0010110	SYN	41	65	101	1000001	A (UC)	6C	108	154	1101100	l (lc)
17	23	027	0010111	ETB	42	66	102	1000010	B (UC)	6D	109	155	1101101	m (lc)
18	24	030	0011000	CAN	43	67	103	1000011	C (UC)	6E	110	156	1101110	n (lc)
19	25	031	0011001	EM	44	68	104	1000100	D (UC)	6F	111	157	1101111	o (lc)
1A	26	032	0011010	SUB	45	69	105	1000101	E (UC)	70	112	160	1110000	p (lc)
1B	27	033	0011011	ESC	46	70	106	1000110	F (UC)	71	113	161	1110001	q (lc)
1C	28	034	0011100	FS	47	71	107	1000111	G (UC)	72	114	162	1110010	r (lc)
1D	29	035	0011101	GS	48	72	110	1001000	H (UC)	73	115	163	1110011	s (lc)
1E	30	036	0011110	RS	49	73	111	1001001	I (UC)	74	116	164	1110100	t (lc)
1F	31	037	0011111	US	4A	74	112	1001010	J (UC)	75	117	165	1110101	u (lc)
20	32	040	0100000	SP space	4B	75	113	1001011	K (UC)	76	118	166	1110110	v (lc)
21	33	041	0100001	! exclam	4C	76	114	1001100	L (UC)	77	119	167	1110111	w (lc)
22	34	042	0100010	" quotes	4D	77	115	1001101	M (UC)	78	120	170	1111000	x (lc)
23	35	043	0100011	# number	4E	78	116	1001110	N (UC)	79	121	171	1111001	y (lc)
24	36	044	0100100	\$ dollar	4F	79	117	1001111	O (UC)	7A	122	172	1111010	z (lc)
25	37	045	0100101	% percent	50	80	120	1010000	P (UC)	7B	123	173	1111011	{ op brace
26	38	046	0100110	& amprsnd	51	81	121	1010001	Q (UC)	7C	124	174	1111100	vert rule
27	39	047	0100111	' acute	52	82	122	1010010	R (UC)	7D	125	175	1111101	} cl brace
28	40	050	0101000	(op paren	53	83	123	1010011	S (UC)	7E	126	176	1111110	— overscore
29	41	051	0101001) cl paren	54	84	124	1010100	T (UC)	7F	127	177	1111111	DEL
2A	42	052	0101010	* asterisk	55	85	125	1010101	U (UC)					
HX	DEC	OCT	BINARY	ASCII	HX	DEC	OCT	BINARY	ASCII	HX	DEC	OCT	BINARY	ASCII

APPENDIX D

CHARACTER SETS

D.1 GENERAL

This printer produces the various character styles from three different dot-matrix formats:

- STANDARD 11 (horizontal) × 9 (vertical)
- ITALICS 11 (horizontal) × 9 (vertical)
- NLQ 23 (horizontal) × 16 (vertical)

D.2 STANDARD 11 × 9 MATRIX

In the 11 × 9 matrix, the “11” in the horizontal plane consists of six whole-dot positions and five half-dot positions between. This results in 11 half-dot positions in which pin firing is possible (see illustration). Note that adjacent half-dot pin positions cannot be fired due to the speed of the print head in the draft (pica 10 cpi) mode.

The 11 × 9 matrix is the basis for the high-speed draft set pica (10 cpi), elite (12 cpi), condensed (17.14 cpi), enlarged (5 cpi), emphasized (10 cpi), double-strike two pass (10 cpi), super/subscript, plus combinations of the above.

The various widths (xx cpi) are generated using the standard matrix data and changing print head speed and pin fire timing in the horizontal plane. The super/subscript set is created in two passes, each one using one-half the pin data, resulting in characters one-half normal height, but normal width. The second pass is printed 1/3 dot lower than the first pass. This set can be condensed to 17.14 cpi for the smallest set available.

ITALICS—The italic characters exist as a separate 11 × 9 matrix character set. It is not the standard set manipulated. These italic characters are accessible with DIP switch SW1-7 ON and with ESC 4 active. The character codes are the standard ASCII codes plus 128 (equivalent to bit 8 set).

97 DEC 61 HEX

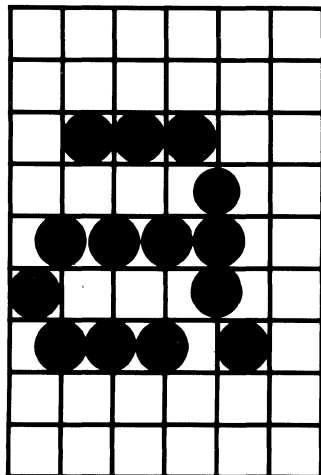

Figure D-1 Normal Appearance, “a”

1 2 3 4 5 6 7 8 9 10 11

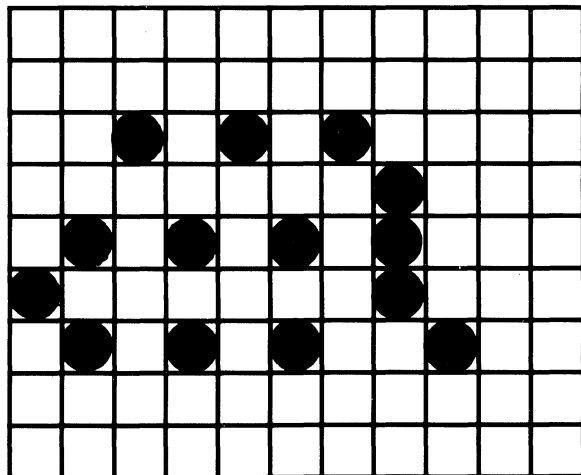

Figure D-2 Letter “a”, Half-Dot Matrix

D.3 NEAR LETTER QUALITY 23×16 MATRIX

The NLQ 23 × 16 matrix provides near-letter quality characters in 10 cpi and 5 cpi (enlarged). NLQ cannot be italicized nor condensed, and does not produce super/subscript (NLQ italics is an option). If commands such as these are received, they are simply ignored in NLQ mode.

NLQ is created in two passes of the print head, filling in gaps between dots, thus forming a high-quality character. The second pass is 1/3 dot lower than the first pass. Since the print head is slowed down for NLQ, dots can be fired on 1/4-dot centers for increased resolution in the horizontal plane. Adjacent 1/4-dot positions cannot be fired, but adjacent 1/2-dot positions can. The horizontal plane for one character consists of twelve 1/2-dot positions with eleven 1/4-dot positions between (23 total).

RESIDENT NLQ SET — Refer to Figure D-3. The vertical printing consists of two passes of eight pins each, the total vertical size being 8 1/3 dots maximum. There are no descender data for this set, thus the 9th pin is not used to print NLQ characters. The 9th pin is used only to underline in a separate (3rd) pass. This underline clears the (8th-pin) descenders, because there is a one-dot paper feed followed by the underline printed in the “10th” pin position.

Figure D-3 shows each dot isolated from the others for clarity. The actual printed character is much more fully-formed than the illustration. In the horizontal plane, dots shown adjacent to each other actually overlap at 1/2-dot centers. In the vertical plane, dots in the second pass actually are only 1/3 dot lower than the first pass rather than a whole dot as shown.

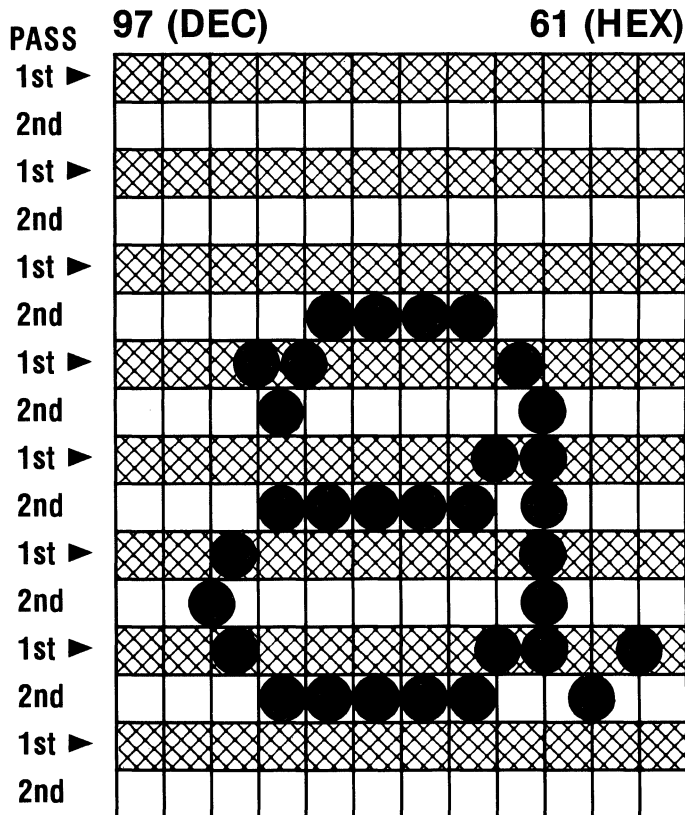

Figure D-3 NLQ Character “a”

D.4 CHARACTER STYLE COMBINATIONS

There are many combinations of character styles that are available to the programmer. Table D-1 summarizes the combinations possible in the standard printer model.

ITALICS—Every combination of styles in the standard printer model can be italicized except NLQ. Italics is turned on by ESC 4, or in BASIC, PRINT CHR\$(27);“4”.

PRINT MODE COMBINATIONS—The Print Mode is turned on by ESC ! (n) or in BASIC, PRINT CHR\$(27);“!”;CHR\$(0-63);. Refer to page 3-14 for a summary of character styles in this mode. Not included in the styles selected by the Print Mode are NLQ (ESC () and superscript (ESC S 0). These are included in Table D-1.

SUPERSCRIPT—Although not intended as a separate character set for text, superscript is excellent for footnotes and can be totally modified (italics, condensed, enlarged, double-struck, emphasized). Elite superscript is a fine small character set. The smallest set possible is pica (10 cpi) superscript condensed. Line feed values can be reduced by ESC 1 (8 lpi) and ESC 3 (n) to accommodate the small sets.

NLQ—Near Letter Quality can be enlarged or set to proportional spacing with ESC p 1 or in BASIC, LPRINT CHR\$(27); “p”; CHR\$ (1);. The top line of the sample below is proportionally spaced.

```

ABCDEF GHIJKLMNOPQRSTUVWXYZ[\]^_`abcdefghijklmnopqrstu vwxyz{ }~
ABCDEF GHIJKLMNOPQRSTUVWXYZ[\]^_`abcdefghijklmnopqrstu vwxyz{ }~
  
```

Table D-1 Typestyle Combinations (● = YES)

CHARACTER STYLE	ENABLE CODE	CANCEL CODE	ENABLE BY ►	ESC 4	ESC SI	ESC W 1	ESC S 0	ESC E	ESC G	# OF COMB (2 ⁿ)
			CANCEL BY ►	ESC 5	DC1	ESC W 0	ESC T	ESC F	ESC H	
			MODIFIER ►	ITAL	COND	ENLG	SUPER	EMPH	DBLSTRK	
NEAR LETTER QUALITY (NLQ)	ESC (ESC P				●				2
PICA 10 CPI	ESC P	ESC M		●	●	●	●	●	●	64
ELITE 12 CPI	ESC M	ESC P		●		●	●		●	16
CONDENSED 17.14 CPI	ESC SI	DC2		●		●	●		●	16
SUPERSCRIP T 10 CPI	ESC S 0	ESC T		●	●	●		●	●	32
PROPORTIONAL (EMPHASIZED)	ESC p 1	ESC p 0		●		●	●		●	16

D.5 STANDARD CHARACTER MATRICES (11×9)

The following samples comprise the standard 11 × 9 set which produces pica (10 cpi), elite (12 cpi), condensed (17.14 cpi), enlarged (5 cpi), and super/subscript. Proportional spacing is the standard set with unused spaces omitted from the rightmost columns. Refer to paragraph D.2 for format.

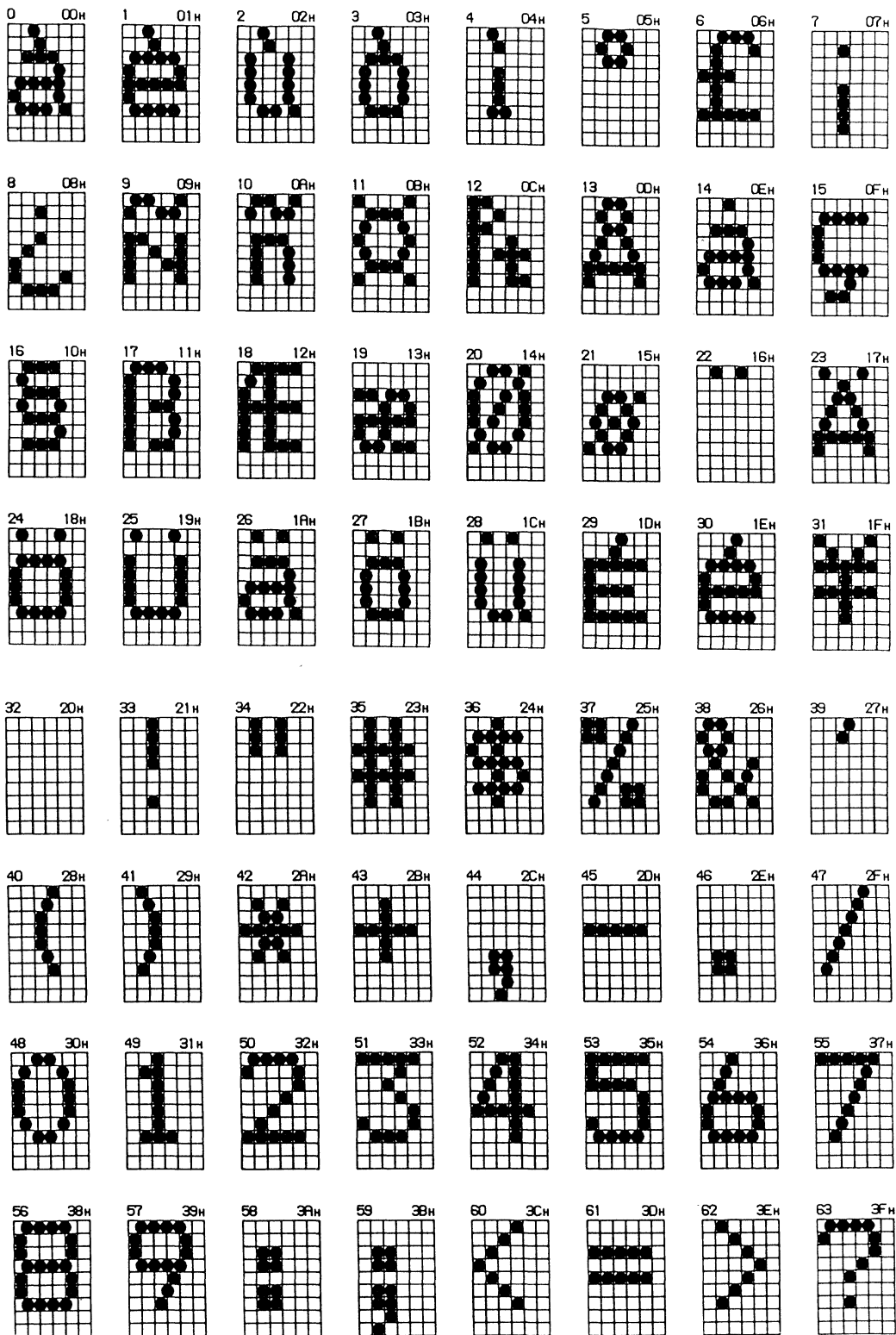

STANDARD CHARACTER MATRICES (11 × 9) (Continued)

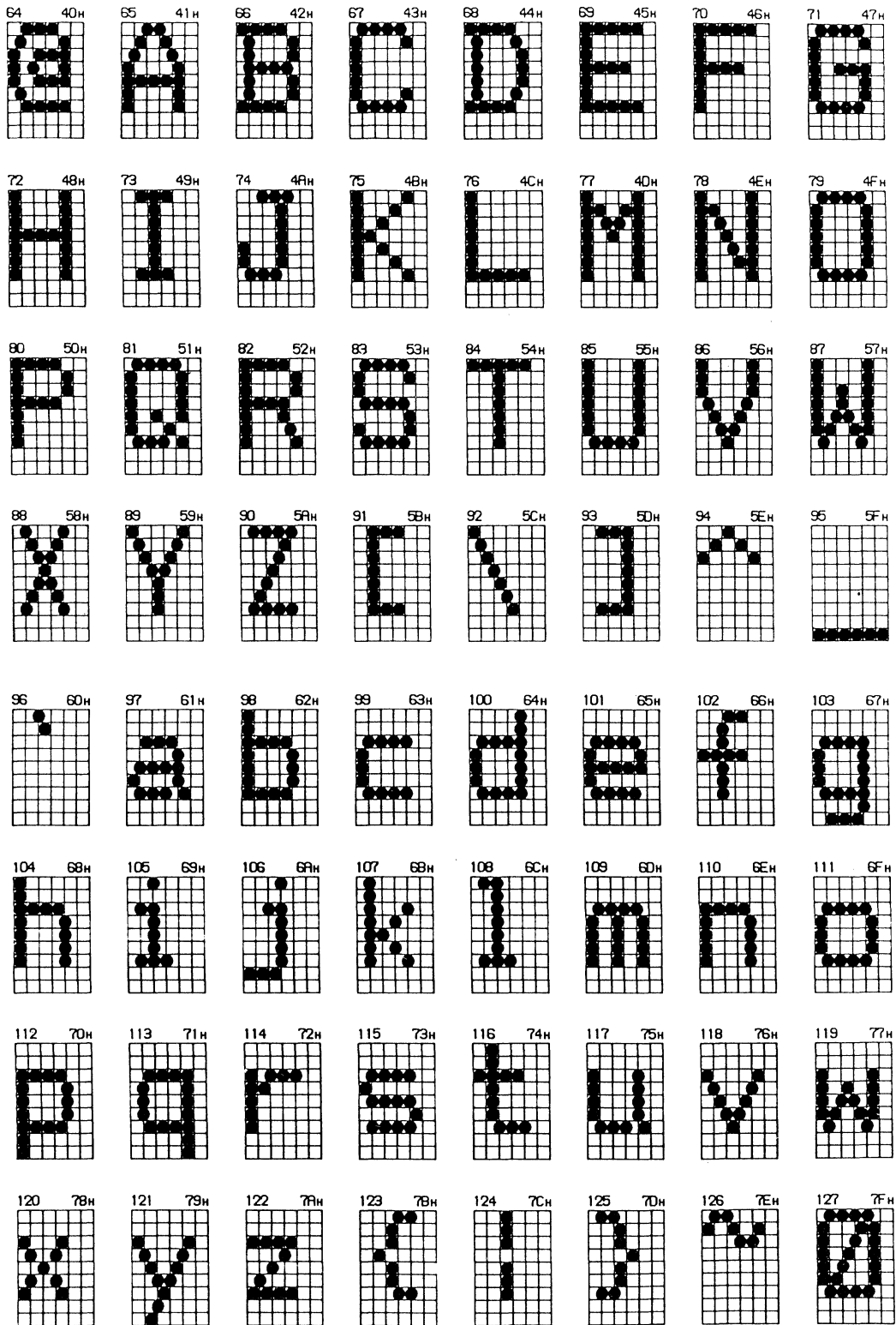

D.6 ITALIC CHARACTER MATRICES (11 × 9)

The following samples comprise the alternate (italic) 11 × 9 set which produces the italicized versions of pica (10 cpi), elite (12 cpi), condensed (17.14 cpi), enlarged (5 cpi), and super/subscript. Italicized proportional spacing is the alternate set with unused spaces omitted from the rightmost columns. Refer to paragraph D.2 for format.

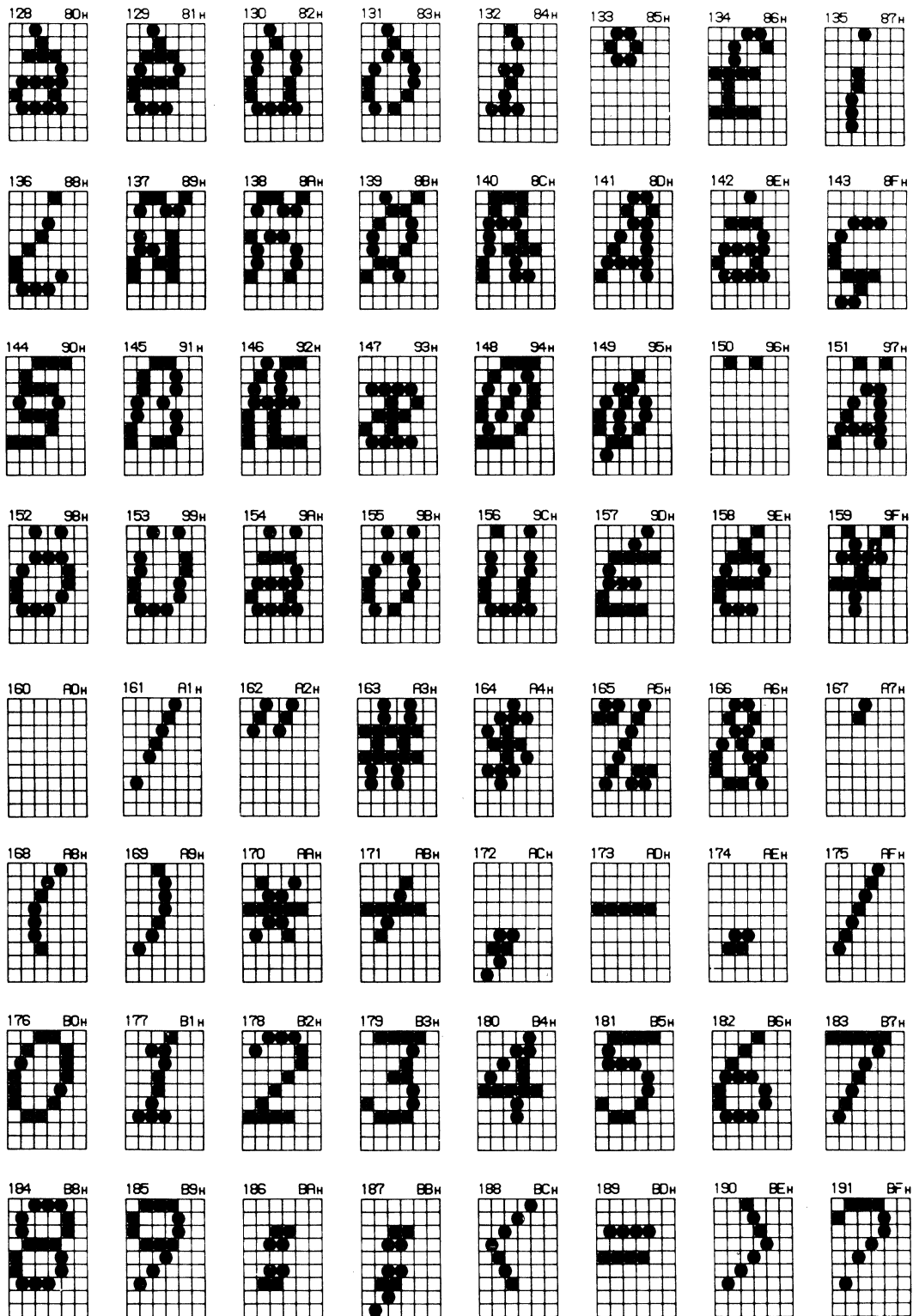

ITALIC CHARACTER MATRICES (11 × 9) (Continued)

192 C0H	193 C1H	194 C2H	195 C3H	196 C4H	197 C5H	198 C6H	199 C7H
200 C8H	201 C9H	202 CAH	203 CBH	204 CCH	205 CDH	206 CEH	207 CFH
208 D0H	209 D1H	210 D2H	211 D3H	212 D4H	213 D5H	214 D6H	215 D7H
216 D8H	217 D9H	218 DAH	219 DBH	220 DCH	221 DDH	222 DEH	223 DFH
224 E0H	225 E1H	226 E2H	227 E3H	228 E4H	229 E5H	230 E6H	231 E7H
232 E8H	233 E9H	234 EAH	235 EBH	236 ECH	237 EDH	238 EEH	239 EFH
240 F0H	241 F1H	242 F2H	243 F3H	244 F4H	245 F5H	246 F6H	247 F7H
248 F8H	249 F9H	250 FAH	251 FBH	252 FCH	253 FDH	254 FEH	255 FFH

D.7 NLQ CHARACTER MATRICES (23×16)

The following samples comprise the Near Letter Quality 23×16 set which is 10 cpi (normal) and 5 cpi (enlarged). Refer to paragraph D.3 for NLQ format.

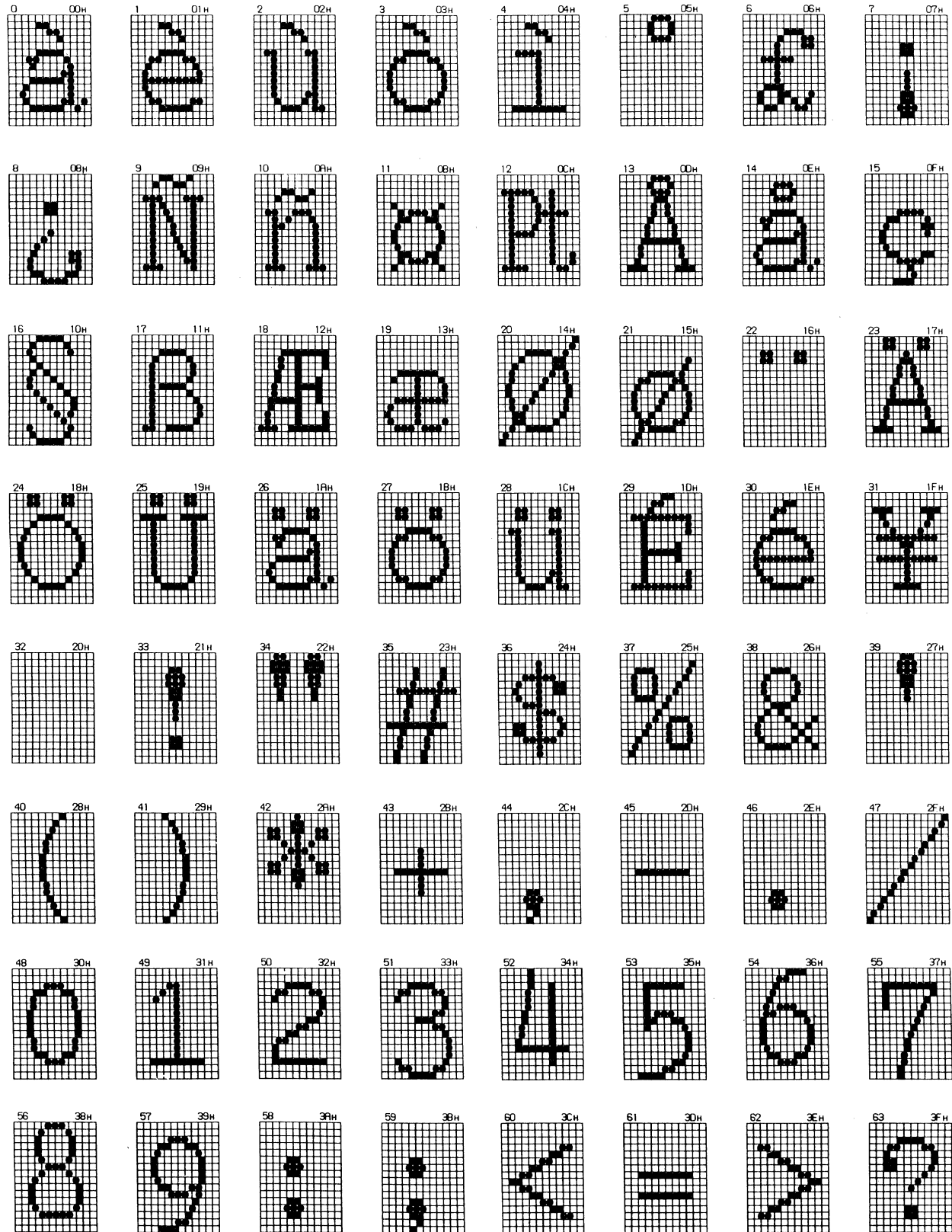

NLQ CHARACTER MATRICES (23 × 16) (Continued)

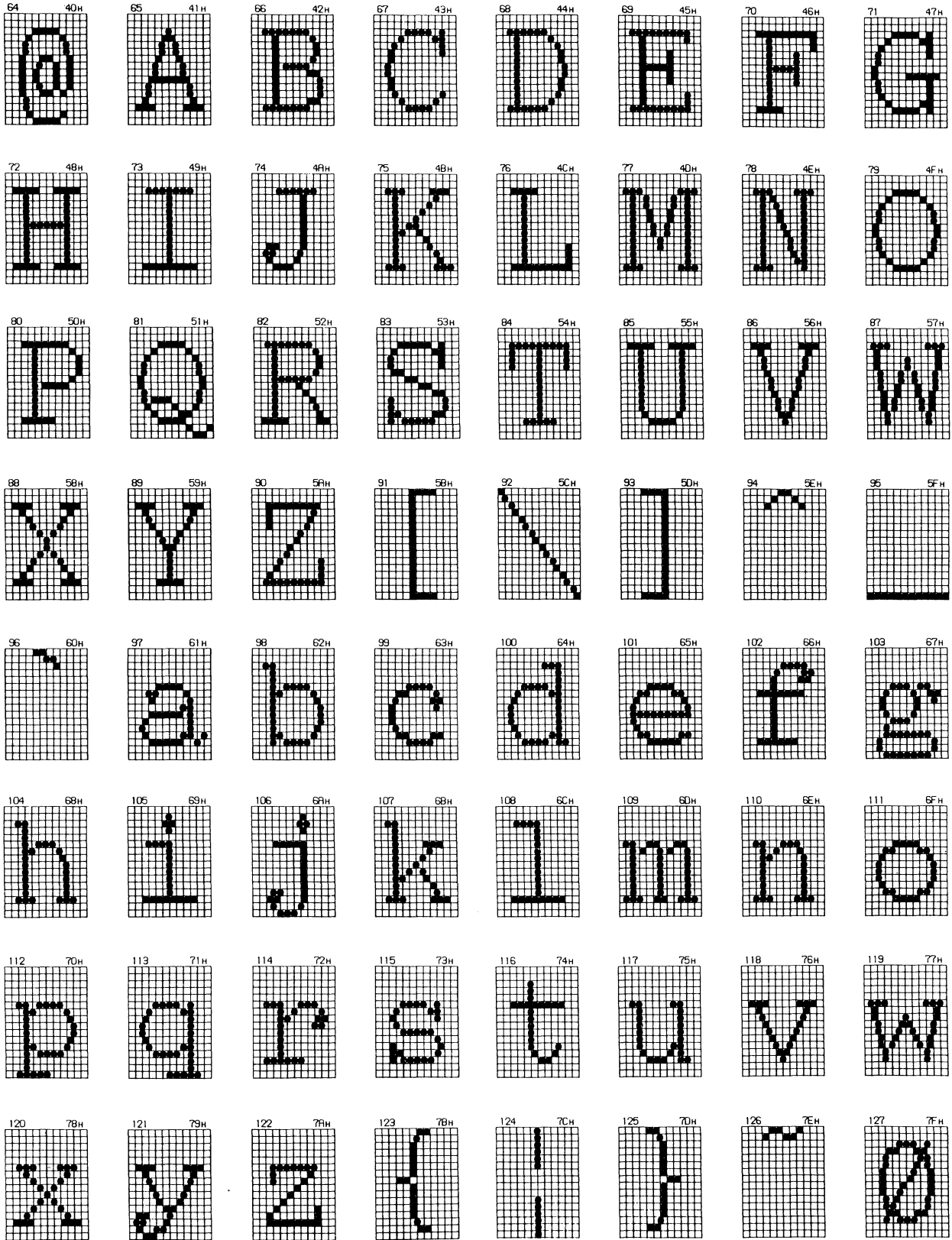

D.8 STANDARD 11×9 PROPORTIONAL SPACING TABLE

Table D-2 contains proportional spacing data for the standard 11×9 matrix character set.

Table D-2 Proportional Data—Standard Characters

CODE (HEX)	ATRIBUT. DATA (HEX)	DSCNDR DATA	START POS.	END POS.	WIDTH (1/2 DOT)
00	8B	1	0	11	12
01	8B	1	0	11	12
02	9B	1	1	11	11
03	9A	1	1	10	10
04	98	1	1	8	8
05	A9	1	2	9	8
06	8B	1	0	11	12
07	C8	1	4	8	5
08	8B	1	0	11	12
09	8B	1	0	11	12
0A	9B	1	1	11	11
0B	8B	1	0	11	12
0C	8B	1	0	11	12
0D	8B	1	0	11	12
0E	8B	1	0	11	12
0F	0A	0	0	10	11
10	9A	1	1	10	10
11	8A	1	0	10	11
12	8B	1	0	11	12
13	8B	1	0	11	12
14	8B	1	0	11	12
15	8B	1	0	11	12
16	A9	1	2	9	8
17	8B	1	0	11	12
18	8B	1	0	11	12
19	8B	1	0	11	12
1A	8B	1	0	11	12
1B	9A	1	1	10	10
1C	9B	1	1	11	11
1D	8B	1	0	11	12
1E	8B	1	0	11	12
1F	8B	1	0	11	12
20	8B	1	0	11	12
21	C8	1	4	8	5
22	A9	1	2	9	8
23	8B	1	0	11	12
24	8B	1	0	11	12
25	8B	1	0	11	12
26	8B	1	0	11	12
27	C8	1	4	8	5
28	C9	1	4	9	6
29	A7	1	2	7	6
2A	8B	1	0	11	12
2B	8B	1	0	11	12
2C	27	0	2	7	6
2D	8B	1	0	11	12
2E	A7	1	2	7	6
2F	9A	1	1	10	10
30	8B	1	0	11	12
31	A9	1	2	9	8
32	8B	1	0	11	12
33	8B	1	0	11	12
34	8B	1	0	11	12
35	8B	1	0	11	12
36	8B	1	0	11	12
37	8B	1	0	11	12
38	8B	1	0	11	12
39	8B	1	0	11	12
3A	A7	1	2	7	6
3B	27	0	2	7	6
3C	89	1	0	9	10
3D	8B	1	0	11	12
3E	AB	1	2	11	10
3F	8B	1	0	11	12
40	8B	1	0	11	12
41	8B	1	0	11	12
42	8B	1	0	11	12
43	8B	1	0	11	12
44	8B	1	0	11	12
45	8B	1	0	11	12
46	8B	1	0	11	12
47	8B	1	0	11	12
48	8B	1	0	11	12
49	A9	1	2	9	8
4A	8A	1	0	10	11
4B	8B	1	0	11	12
4C	8B	1	0	11	12
4D	8B	1	0	11	12
4E	8B	1	0	11	12
4F	8B	1	0	11	12
50	8B	1	0	11	12
51	8B	1	0	11	12
52	8B	1	0	11	12
53	8B	1	0	11	12
54	8B	1	0	11	12
55	8B	1	0	11	12
56	8B	1	0	11	12
57	8B	1	0	11	12
58	9A	1	1	10	10
59	8B	1	0	11	12
5A	9A	1	1	10	10
5B	A9	1	2	9	8
5C	89	1	0	9	10
5D	A9	1	2	9	8
5E	8B	1	0	11	12
5F	0B	0	0	11	12

Table D-2 Proportional Data—Standard Characters (Cont.)

CODE (HEX)	ATRIBUT. DATA (HEX)	DSCNDR DATA	START POS.	END POS.	WIDTH (½ DOT)
60	B7	1	3	7	5
61	8B	1	0	11	12
62	8A	1	0	10	11
63	8A	1	0	10	11
64	8A	1	0	10	11
65	8B	1	0	11	12
66	89	1	0	9	10
67	0A	0	0	10	11
68	8A	1	0	10	11
69	98	1	1	8	8
6A	88	1	0	8	9
6B	9A	1	1	10	10
6C	98	1	1	8	8
6D	8B	1	0	11	12
6E	8A	1	0	10	11
6F	8B	1	0	11	12
70	0A	0	0	10	11
71	1B	0	1	11	11
72	8A	1	0	10	11
73	8B	1	0	11	12
74	8A	1	0	10	11
75	8B	1	0	11	12
76	8B	1	0	11	12
77	8B	1	0	11	10
78	89	1	0	9	10
79	0B	0	0	11	12
7A	89	1	0	9	10
7B	AA	1	2	10	9
7C	C8	1	4	8	5
7D	99	1	1	9	9
7E	8B	1	0	11	12
7F	8B	1	0	11	12
80	8B	1	0	11	12
81	8B	1	0	11	12
82	8B	1	0	11	12
83	8B	1	0	11	12
84	8B	1	0	11	12
85	8B	1	0	11	12
86	8B	1	0	11	12
87	8B	1	0	11	12
88	8B	1	0	11	12
89	8B	1	0	11	12
8A	8B	1	0	11	12
8B	8B	1	0	11	12
8C	8B	1	0	11	12
8D	8B	1	0	11	12
8E	8B	1	0	11	12
8F	8B	1	0	11	12

CODE (HEX)	ATRIBUT. DATA (HEX)	DSCNDR DATA	START POS.	END POS.	WIDTH (½ DOT)
90	8B	1	0	11	12
91	8B	1	0	11	12
92	8B	1	0	11	12
93	8B	1	0	11	12
94	8B	1	0	11	12
95	8B	1	0	11	12
96	8B	1	0	11	12
97	8B	1	0	11	12
98	8B	1	0	11	12
99	8B	1	0	11	12
9A	8B	1	0	11	12
9B	8B	1	0	11	12
9C	8B	1	0	11	12
9D	8B	1	0	11	12
9E	8B	1	0	11	12
9F	8B	1	0	11	12
A0	8B	1	0	11	12
A1	87	1	0	7	8
A2	CB	1	4	11	8
A3	87	1	0	7	8
A4	86	1	0	6	7
A5	B8	1	3	8	6
A6	8B	1	0	11	12
A7	89	1	0	9	10
A8	89	1	0	9	10
A9	89	1	0	9	10
AA	89	1	0	9	10
AB	89	1	0	9	10
AC	89	1	0	9	10
AD	89	1	0	9	10
AE	89	1	0	9	10
AF	89	1	0	9	10
B0	8B	1	0	11	12
B1	8B	1	0	11	12
B2	8A	1	0	10	11
B3	8A	1	0	10	11
BA	8B	1	0	11	12
B5	8B	1	0	11	12
B6	8B	1	0	11	12
B7	8B	1	0	11	12
B8	8B	1	0	11	12
B9	8B	1	0	11	12
BA	8B	1	0	11	12
BB	8B	1	0	11	12
BC	8B	1	0	11	12
BD	8B	1	0	11	12
BE	8B	1	0	11	12
BF	8B	1	0	11	12

Table D-2 Proportional Data—Standard Characters (Cont.)

CODE (HEX)	ATRIBUT. DATA (HEX)	DSCNDR DATA	START POS.	END POS.	WIDTH (½ DOT)	CODE (HEX)	ATRIBUT. DATA (HEX)	DSCNDR DATA	START POS.	END POS.	WIDTH (½ DOT)
C0	8B	1	0	11	12	F0	8B	1	0	11	12
C1	8B	1	0	11	12	F1	8B	1	0	11	12
C2	8B	1	0	11	12	F2	8B	1	0	11	12
C3	8B	1	0	11	12	F3	8B	1	0	11	12
C4	AA	1	2	10	9	F4	8B	1	0	11	12
C5	8B	1	0	11	12	F5	8B	1	0	11	12
C6	8B	1	0	11	12	F6	8B	1	0	11	12
C7	8B	1	0	11	12	F7	8B	1	0	11	12
C8	8B	1	0	11	12	F8	8B	1	0	11	12
C9	8A	1	0	10	11	F9	8B	1	0	11	12
CA	8B	1	0	11	12	FA	8B	1	0	11	12
CB	8B	1	0	11	12	FB	8B	1	0	11	12
CC	8B	1	0	11	12	FC	8B	1	0	11	12
CD	8B	1	0	11	12	FD	8B	1	0	11	12
CE	8B	1	0	11	12	FE	8B	1	0	11	12
CF	8B	1	0	11	12	FF	8B	1	0	11	12
D0	8A	1	0	10	11						
D1	8B	1	0	11	12						
D2	8A	1	0	10	11						
D3	8B	1	0	11	12						
D4	8B	1	0	11	12						
D5	8B	1	0	11	12						
D6	8B	1	0	11	12						
D7	8B	1	0	11	12						
D8	9A	1	1	10	10						
D9	8B	1	0	11	12						
DA	9B	1	1	11	11						
DB	8B	1	0	11	12						
DC	8B	1	0	11	12						
DD	8B	1	0	11	12						
DE	87	1	0	7	8						
DF	87	1	0	7	8						
E0	8B	1	0	11	12						
E1	8B	1	0	11	12						
E2	8B	1	0	11	12						
E3	8B	1	0	11	12						
E4	8B	1	0	11	12						
E5	8B	1	0	11	12						
E6	8B	1	0	11	12						
E7	8B	1	0	11	12						
E8	8B	1	0	11	12						
E9	8B	1	0	11	12						
EA	8B	1	0	11	12						
EB	8B	1	0	11	12						
EC	8B	1	0	11	12						
ED	8B	1	0	11	12						
EE	8B	1	0	11	12						
EF	8B	1	0	11	12						

D.9 NLQ PROPORTIONAL SPACING DATA

The proportional spacing data for the NLQ 23 × 16 matrix character set consists of two bytes of attribute data. The attribute contains descenders information plus start and stop column information. Refer to the sample below:

Example: ATTRIBUTE DATA=8017 (HEX)

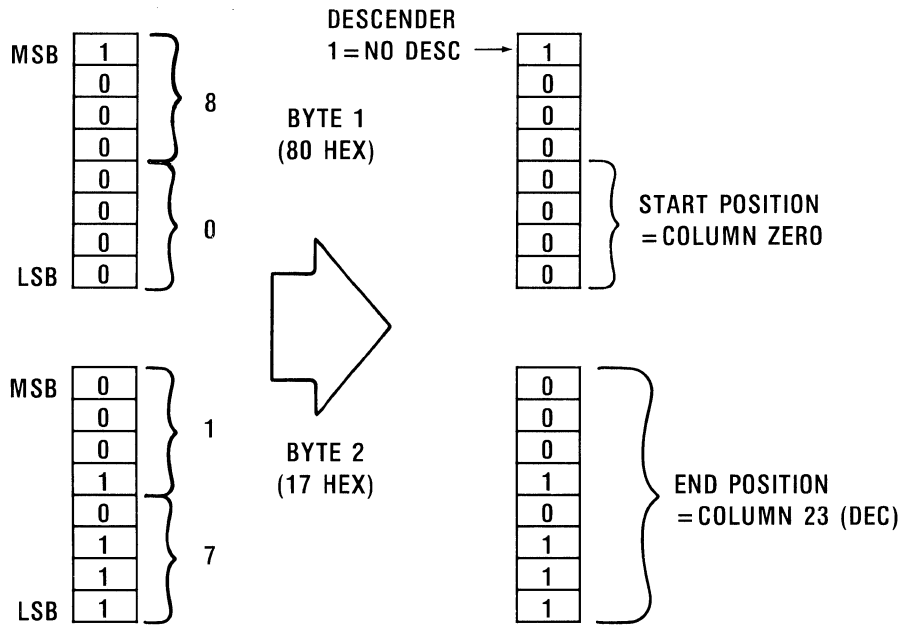
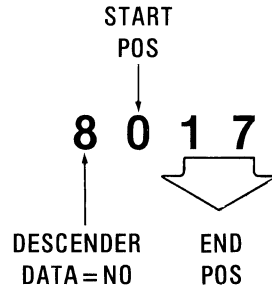

D.10 NLQ PROPORTIONAL SPACING TABLES

Table D-3 contains the data for the resident NLQ character set in proportional mode (ESC p 1). Note that the space character (20 HEX) is assigned a proportional width of 20 quarter dots.

Table D-3 Proportional Data Table for NLQ Characters

CHAR	CODE (HEX)	ATRIBUT (HEX)	DSCNDR DATA	START POS	END POS	WIDTH (¼ DOT)	CHAR	CODE (HEX)	ATRIBUT (HEX)	DSCNDR DATA	START POS	END POS	WIDTH (¼ DOT)
à	00	8117	1	1	23	23	0	30	8215	1	2	21	20
è	01	8116	1	1	22	22	1	31	8215	1	2	21	20
ù	02	8116	1	1	22	22	2	32	8215	1	2	21	20
ò	03	8116	1	1	22	22	3	33	8215	1	2	21	20
ï	04	8215	1	2	21	20	4	34	8215	1	2	21	20
°	05	8611	1	6	17	12	5	35	8215	1	2	21	20
£	06	8216	1	2	22	21	6	36	8215	1	2	21	20
;	07	8710	1	7	16	10	7	37	8215	1	2	21	20
;	08	8316	1	3	22	20	8	38	8215	1	2	21	20
Ñ	09	8116	1	1	22	22	9	39	8215	1	2	21	20
ñ	0A	8116	1	1	22	22	:	3A	850E	1	5	14	10
æ	0B	8215	1	2	21	20	;	3B	850E	1	5	14	10
Æ	0C	8017	1	0	23	24	<	3C	8016	1	0	22	23
À	0D	8017	1	0	23	24	=	3D	8215	1	2	21	20
à	0E	8117	1	1	23	23	>	3E	8117	1	1	23	23
ç	0F	8215	1	2	21	20	?	3F	8215	1	2	21	20
ç	10	8315	1	3	21	19	@	40	8215	1	2	21	20
B	11	8116	1	1	22	22	A	41	8017	1	0	23	24
Æ	12	8017	1	0	23	24	B	42	8116	1	1	22	22
æ	13	8016	1	0	22	23	C	43	8116	1	1	22	22
Ø	14	8017	1	0	23	24	D	44	8116	1	1	22	22
ø	15	8116	1	1	22	22	E	45	8116	1	1	22	22
·	16	8314	1	3	20	18	F	46	8217	1	2	23	22
Ä	17	8017	1	0	23	24	G	47	8017	1	0	23	24
Ö	18	8017	1	0	23	24	H	48	8017	1	0	23	24
Ü	19	8017	1	0	23	24	I	49	8215	1	2	21	20
ä	1A	8117	1	1	23	23	J	4A	8114	1	1	20	20
ö	1B	8116	1	1	22	22	K	4B	8117	1	1	23	23
ü	1C	8116	1	1	22	22	L	4C	8217	1	2	23	22
É	1D	8116	1	1	22	22	M	4D	8017	1	0	23	24
é	1E	8116	1	1	22	22	N	4E	8116	1	1	22	22
¥	1F	8017	1	0	23	24	O	4F	8017	1	0	23	24
!	20	8215	1	2	21	20	P	50	8217	1	2	23	22
!"	21	8710	1	7	16	10	Q	51	8017	1	0	23	24
"	22	8215	1	2	21	20	R	52	8017	1	0	23	24
#	23	8017	1	0	23	24	S	53	8116	1	1	22	22
\$	24	8215	1	2	21	20	T	54	8116	1	1	22	22
%	25	8017	1	0	23	24	U	55	8017	1	0	23	24
&	26	8117	1	1	23	23	V	56	8017	1	0	23	24
'	27	8710	1	7	16	10	W	57	8017	1	0	23	24
(28	8611	1	6	17	12	X	58	8017	1	0	23	24
)	29	8611	1	6	17	12	Y	59	8017	1	0	23	24
*	2A	8116	1	1	22	22	Z	5A	8116	1	1	22	22
+	2B	8215	1	2	21	20	[5B	8813	1	8	19	12
,	2C	850E	1	5	14	10	\	5C	8017	1	0	23	24
-	2D	8215	1	2	21	20	/	5D	840F	1	4	15	12
.	2E	850E	1	5	14	10	^	5E	8413	1	4	19	16
/	2F	8017	1	0	23	24	_	5F	8017	1	0	23	24

Table D-3 Proportional Data Table for NLQ Characters (cont'd)

CHAR	CODE (HEX)	ATRIBUT (HEX)	DSCNDR DATA	START POS	END POS	WIDTH (¼ DOT)
`	60	8611	1	6	17	12
a	61	8117	1	1	23	23
b	62	8116	1	1	22	22
c	63	8215	1	2	21	20
d	64	8116	1	1	22	22
e	65	8116	1	1	22	22
f	66	8216	1	2	22	21
g	67	8117	1	1	23	23
h	68	8116	1	1	22	22
i	69	8215	1	2	21	20
j	6A	8212	1	2	18	17
k	6B	8117	1	1	23	23
l	6C	8215	1	2	21	20
m	6D	8017	1	0	23	24
n	6E	8116	1	1	22	22
o	6F	8116	1	1	22	22
p	70	8116	1	1	22	22
q	71	8116	1	1	22	22
r	72	8117	1	1	23	23
s	73	8215	1	2	21	20
t	74	8215	1	2	21	20
u	75	8116	1	1	22	22
v	76	8017	1	0	23	24
w	77	8017	1	0	23	24
x	78	8017	1	0	23	24
y	79	8017	1	0	23	24
z	7A	8215	1	2	21	20
{	7B	8411	1	4	17	14
	7C	890E	1	9	14	6
}	7D	8613	1	6	19	14
~	7E	8413	1	4	19	16
Ø	7F	8215	1	2	21	20



NO POSTAGE
NECESSARY
IF MAILED
IN THE
UNITED STATES

BUSINESS REPLY CARD
FIRST CLASS PERMIT NO. 31 HUDSON, N.H. 03051

Postage will be paid by addressee:

CENTRONICS®

Centronics Data Computer Corp.
1 Wall Street
Hudson, New Hampshire 03051

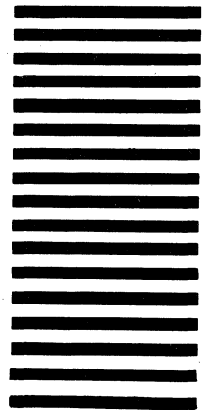

Attn: Technical Publications



Centronics Data Computer Corp.
1 Wall Street
Hudson, New Hampshire 03051
Tel. (603) 883-0111
An affiliate of Control Data Corporation