**Series 540
Cartridge Tape Drive
Product Specification**

QIC-02 Interface

cipher[®]

TABLE OF CONTENTS

SECTION 1 - GENERAL DESCRIPTION

INTRODUCTION	1
Microprocessor Supervisory Control	1
Host Interface and Sequencer	1
Write Logic and Sequencer	2
Read Logic and Sequencer	2
Data Buffer	2
Basic Drive Interface	2

SECTION 2 - QIC-02 INTERFACING

INTRODUCTION	3
ELECTRICAL INTERFACE	3
DC Power Interface	3
Interface Signal Levels	4
Functional Interface	6
540 INSTRUCTION SET	7
QIC-02 Command Set	7
Select Command (0000-NNNN)	8
Select Drive/Lock Cartridge Command (0001-NNNN)	8
Select Lock Command (1101-NNNN)	8
Read Status Command (1100-0000)	13
Read Extended Status Command (1110-0000)	16
Write Data Command (0100-0000)	20
Write Without Underruns Command (0100-0001)	22
Write File Mark Command (0110-0000)	22
Write N File Marks Command (0111-NNNN)	22
Write Filemark On the Fly (62)	24
Read Data Command (1000-0000)	24
Read File Mark Command (1010-0000)	28
Read On The Fly (82)	28
Read N File Marks Command (1011-NNNN)	28
Read Quarterback Format Command (0100-1001)	28
Rewind Command (0010-0001)	33
Erase Tape Command (0010-0010)	33
Retension Command (0010-0100)	33
Backspace (89)	33
Seek End of Recorded Data Command (1010-0011)	33
Block Search Command (AD)	33
Run Self Test 1 (C2)	35
Run Self Test II (CA)	35

SECTION 3 - ERROR PROCESSING & RECOVERY

INTRODUCTION	41
WRITE BUFFER UNDERRUN	43
Read-After-Write Errors	43
READ BUFFER UNDERRUN	44

Read Data Errors	44
Read Sequence Errors	45
READ OR WRITE ABORT ERRORS	45
NO DATA DETECTED ERRORS	45

SECTION 4 - REPOSITION TIMING

INTRODUCTION	47
WRITE BUFFER CRITICAL TIMING	49
Write Reposition	49
JUMPER CONFIGURATION	50

LIST OF FIGURES

Figure 1. Host/Formatter Logical Interface	3
Figure 2. Line Driver/Receiver Termination	4
Figure 3. Read Status Timing Diagram	9
Figure 4. Reset Timing Diagram	10
Figure 5. Select Formatter Timing Diagram	11
Figure 6. Select Lock Timing Diagram	12
Figure 7. Read Status Timing Diagram	13
Figure 8. Read Extended Status Timing Diagram	17
Figure 9. Write Data Timing Diagram	21
Figure 10. Write File Mark Timing Diagram	23
Figure 11. Write N File Marks Timing Diagram	25
Figure 12. Write Filemark on the Fly (WFOTF)	26
Figure 13. Read Data Timing Diagram	27
Figure 14. Read Filemark Timing Diagram	29
Figure 15. Read On The Fly (ROTF)(1 of 2)	30
Figure 15. Read On The Fly (ROTF)(2 of 2)	31
Figure 16. Read N File Marks Timing Diagram	32
Figure 17. BOT, Erase & Retension Timing Diagram	34
Figure 18. Block Search Command	36
Figure 19. Run Self Test I & II	37
Figure 20. Write Buffer Underrun Events	47
Figure 21. Write Buffer Underrun Flowchart	48
Figure 22. Critical Write Timing Elements.	49
Figure 23. Reposition Timing Sequence	49

LIST OF TABLES

Table 1. Signal Levels	5
Table 2. Input/Output Pin Assignments	5
Table 3. Read Status Byte Summary	14
Table 4. Read Extended Status III Format.	18
Table 5. Exception Status Bytes.	41

SECTION 1

GENERAL DESCRIPTION

INTRODUCTION

The optional integral QIC-02 formatter supplied by Cipher for the 540 drive provides the intelligence for tape formatting and QIC-02 interface control. The formatter board can be logically partitioned into 6 major functional blocks. They are:

- 1) Microprocessor supervisory control
- 2) Host interface and sequencer
- 3) Write logic and sequencer
- 4) Read logic and sequencer
- 5) Data buffering
- 6) Basic drive interface

A general overview of the interrelationship of these 6 components is as follows.

Microprocessor Supervisory Control

At the heart of the QIC-02 formatter is the 8051 microprocessor and 8K of drive ROM (firmware). The 8051 is responsible for:

- 1) Interpreting QIC-02 commands and responses
- 2) Assigning one of four, 512-byte pages of data buffering to one of three sequencers (Host, Write, Read)
- 3) Enabling the appropriate sequencer at the correct time
- 4) Monitoring the sequencers for completion status
- 5) Controlling tape motion and position

Host Interface and Sequencer

The host interface is composed of an 8-bit bi-directional bus that is used to transmit commands, status, and data to or from the host. In addition there are eight control lines that are used to facilitate communication between the host system and the Cipher QIC-02 tape drive. Their names and specific uses are covered in the "Interfacing" section of this manual module. The sequencer associated with the host interface has the responsibility of transferring 512-byte data blocks to or from the host via the 8-bit bus to or from the microprocessor assigned 512-byte page of buffering.

Write Logic and Sequencer

The write logic under the control of its sequencer is responsible for:

- 1) Sequencing 512-byte user data blocks from the assigned buffer page to the basic drive
- 2) Dynamically performing a 4-bit to 5-bit GCR translation on the data, microprocessor supplied 4-byte block address and the 2 byte CRC field generated against the entire "logic block".

Read Logic and Sequencer

The read logic under the control of its sequencer is responsible for:

- 1) Sequencing 512-byte user data blocks from the basic drive to the assigned buffer page
- 2) Dynamically performing a 5-bit to 4-bit translation on the data, four byte block address and 2 bytes of CRC.

Data Buffer

The data buffer is comprised of a 16384 by 1 RAM chip that is partitioned into four 4096-bit (512-byte) pages. Any page under 8051 control can be connected to any of the three sequencers. This feature provides for optimal buffer usage and assists in streaming.

Basic Drive Interface

The Basic Drive Interface is composed of latches that are utilized to communicate between the formatter board and basic drive board.

SECTION 2

QIC-02 INTERFACING

INTRODUCTION

Data commands and status are transferred to or from the 540 on an 8-bit bi-directional data bus, using asynchronous handshaking techniques to eliminate tight timing constraints. The interface is compatible with the standard QIC-02, Revision D. The logical interface between the host and the formatter in the 540 is illustrated in Figure 1.

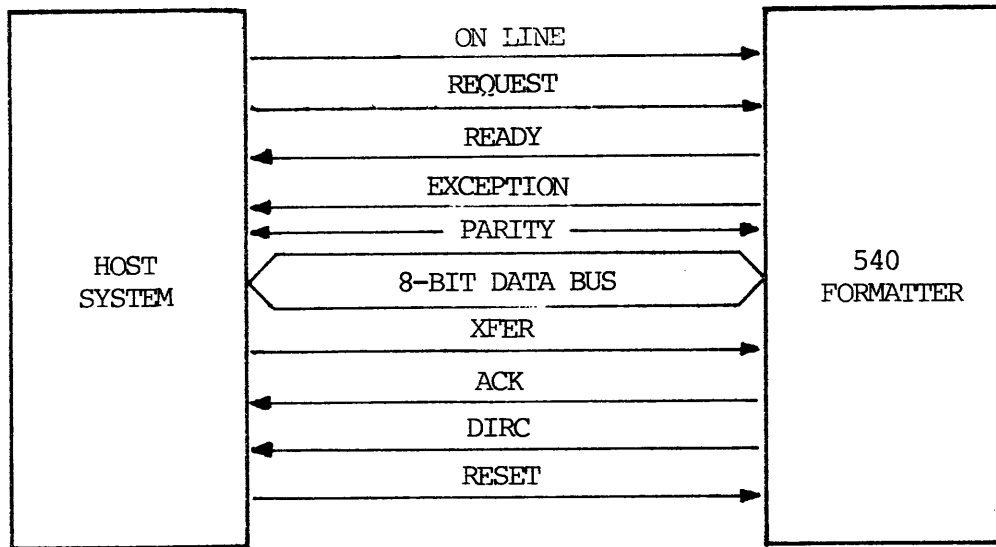

Figure 1. Host/Formatter Logical Interface.

ELECTRICAL INTERFACE

The signals are connected through a 50-conductor edge connector. The mating connector is a 3M 3415-0001, or equivalent. The signal cable is a 50-conductor flat ribbon cable, such as the 3M 3365/50. The maximum cable length supported by the interface is 9.84 feet (3 meters).

DC Power Interface

The standard termination is 220 ohms to +5 VDC and 330 ohms to ground, or the Thevenin equivalent. The bi-directional data bus and the four control signals from the host are terminated at the drive. The bus and four control signals from the drive are terminated at the host. A typical driver/receiver termination configuration is illustrated in Figure 2.

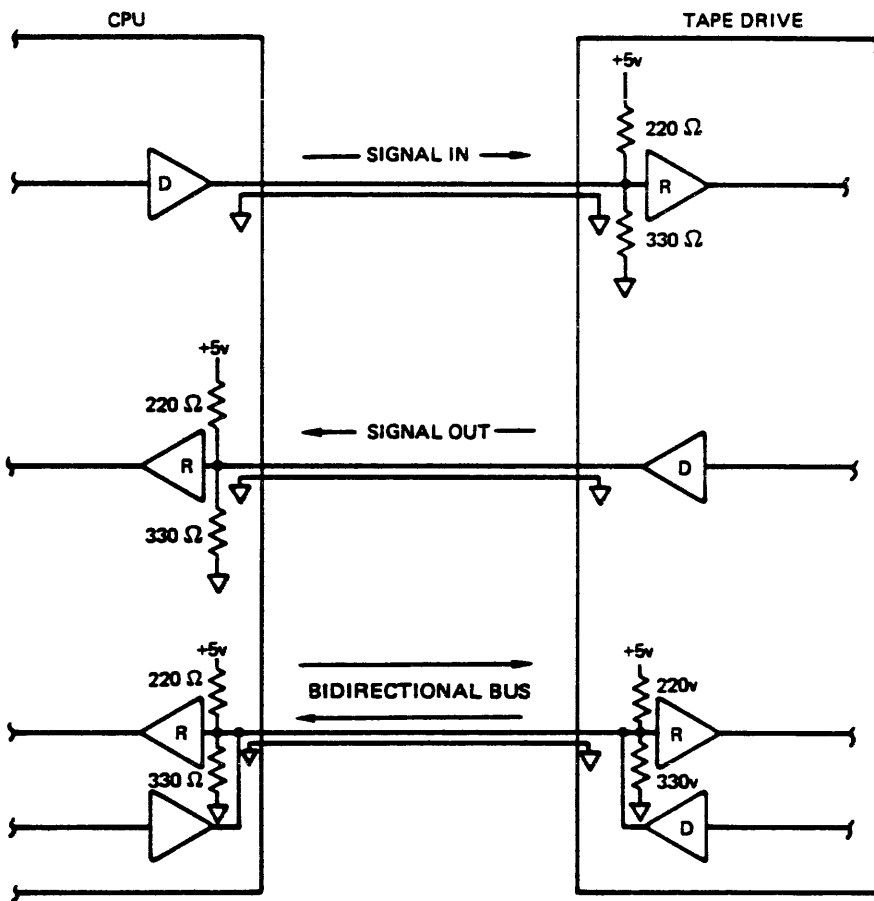

Figure 2. Line Driver/Receiver Termination.

Signals loaded by the drive, or the host, onto the interface are no more than 2.0 mA, plus required terminations.

Interface Signal Levels

All signals to the host or to the drive use standard Transistor-Transistor Logic (TTL), as provided in Table 1.

The odd numbered pins are connected to signal ground (gnd). The assignments for the even numbered pins are listed in Table 2. In the "To" column in this table, X means unused, B means bi-directional, D means drive, and H means host.

Table 1. Signal Levels.

Direction	Logic	0/1	Voltage (VDC)
Drive---->Host	False	0(high)	2.4 - 5.25
	True	1(low)	0 - 0.55
Host---->Drive	False	0(high)	2.0 - 5.25
	True	1(low)	0 - 0.8

Table 2. Input/Output Pin Assignments.

Pin #	Name	To	Description
02	N/U-	X	Not Used (N/U) - unconnected signal line
04	N/U-	X	
06	N/U-	X	
08	N/U-	X	
10	HBP-	B	Host Bus odd parity - optional
12	HB7-	B	Host Bus bit 7 - MSB on 8-bit bus
14	HB6-	B	Host Bus bit 6
16	HB5-	B	Host Bus bit 5
18	HB4-	B	Host Bus bit 4
20	HB3-	B	Host Bus bit 3
22	HB2-	B	Host Bus bit 2
24	HB1-	B	Host Bus bit 1
26	HB0-	B	Host Bus bit 0 -LSB on data bus
28	ONL-	D	On Line - Host activates signal before transferring or terminating a Read or Write.
30	REQ-	D	Request - Host activates signal to indicate that, in Command mode, command data has been placed on the data bus. Also used in Status Input mode to indicate status has been taken from the bus. REQ- is used only when RDY or EXC is asserted by the drive.
32	RST-	D	Reset - Initialize the drive and the EXC signal is asserted.
34	XFR-	D	Transfer - Host generates signal to indicate, in Write mode, that data has been placed on the data bus. In Read mode, it indicates that data has been taken from the bus.
36	ACK-	H	Acknowledge - Drive generates signal to indicate, in Write mode, data has been taken from the bus or, in Read mode, placed on the bus.
38	RDY-	H	Ready - Drive generates signal to indicate one of the following: 1. - In Command Transfer mode, data has

Table 2. Input/Output Pin Assignments continued.

Pin #	Name	To	Description
			<p>been taken from the data bus or, in Status Input mode, data has been placed on the bus.</p> <ol style="list-style-type: none"> 2. - A BOT, Cartridge Initialization, or Erase command has been completed. 3. - Drive is ready to receive the next block or, in Write mode, to receive a Write, Write File Mark, or Write N File Marks, from host. 4. - In Write File Mark mode, a Write File Mark, or Write N Files Marks is completed. 5. - Drive is ready to send next block or, in Read mode, receive a Read, Read N File Marks, or Read File Marks command from the host. 6. - Drive is ready to receive a new command.
40	EXC-	H	Exception - Drive generates this signal when an exception condition exists in the drive. Host must issue a Status command or perform a Status input to determine the cause and clear the exception.
42	DIR-	H	Direction - Drive generates the signal that, when false, causes the host data bus drivers to assert their data bus levels and drive data bus drivers to assume a high impedance state. If true, the host assumes the high impedance state and the drive asserts its bus level.
44	RES	X	Reserved - Kept for test I/O.
46	RES	X	
48	RES	X	
50	N/U-	X	Not Used - Unconnected signal line.

Functional Interface

The interface signals ONL-, REQ-, and RST- can be easily generated by the host program, and output to the interface adapter register latches and drivers. Similarly, the drive formatter generated RDY- and EXC- should be input, through receivers, to the host.

Commands are transferred by simply loading each command into a register that is connected, through drivers, to the bi-directional data bus and implanting the required control signal protocol with the host program. Status input is similarly implemented by the host. In order to avoid prolonged waits by the host for the formatter to complete a command, the RDY- and EXC- lines are necessary. However, the bi-directional bus control signal DIR- should only be used by the host interface adaptor to enable the host's bus drivers.

540 INSTRUCTION SET

QIC-02 Command Set

The following is a summary of QIC-02 commands supported by the Cipher 540 tape drive. An in-depth description for each command and its associated timing can be found on the page listed with each command.

OPCODE (HEX)	Command Name	Page #	Command Type
System Type Commands			
0M	Formatter Select, LED off	8	S
1M	Formatter Select, LED on	8	O
DM	Formatter Select, Hold Position	8	V
C0	Read Status	13	S
C4	Read Extended Status 1	16	O
E0	Read Extended Status 3	16	O
Write Type Commands			
40	Write Data	20	S
41	Write Without Underrun	22	O
60	Write File Mark	22	S
7M	Write M File Marks	22	O
62	Write File Mark on the Fly	24	V
Read Type Commands			
80	Read Data	24	S
A0	Read File Mark	28	S
82	Read File Mark on the Fly	28	V
BM	Read M File Marks	28	O
49	Read QIC-11 Format	28	V
Position Type Commands			
21	Rewind Tape	33	S
22	Erase Tape	33	S
24	Retension Tape	33	S
89	Backspace 1 Block	33	O
A3	Seek End of Recorded Data	33	O
AD	Locate Block N	33	V
C2	Run Self Test	35	O
Note:	M = Modifier Nibble Field S = Standard QIC-02 Command O = Optional QIC-02 Command V = Vendor Unique to Cipher Command		

The host and 540 formatter communicate through the 8-bit bi-directional data bus. All transfers are asynchronous and eight bits wide.

The Power On/Reset sequence provides the host with the device-oriented power-on procedure. It also provides a convenient method of initializing the drive during hardware or software debugging of the host's interface.

When the power-on Reset times out or the RES- pulse terminates the operating parameters of the 540 initialize. The parameters default to the drive and the QIC-24 format for subsequent commands. Then, the drive becomes active, asserting EXC-, which makes the host issue a Read Status command. The drive responds with six status bytes, following the Request/Ready handshake illustrated in Figure 3. Bit 0 of byte 1 is set to indicate power-up or reset.

Following the Reset, the physical drive recalibrates the Read/Write head positioner to Track 0, which causes a delay of approximately three seconds before the execution of any motion command. Read/Write commands, following the reset, begin execution from BOT. Timing for the Reset sequence is illustrated in Figure 4.

Select Command (0000-NNNN)

This command allows the host to select one of up to four available drives, uniquely numbered from 1 to 4 as shown below. When the Select command is initiated, the formatter saves the tape drive address, selects the addressed drive, and alerts the host at the completion of the command sequence. A LED on the front panel of the selected 540 is illuminated during command execution. The drive remains selected until another Select command is initiated. Unit select jumpers W6 and W7 are provided on the formatter. The timing diagram for the Select command is provided in Figure 5.

NNNN	W6	W7	Select
0001	In	In	Drive 0
0010	Out	In	Drive 1
0100	In	Out	Drive 2
1000	Out	Out	Drive 3

Select Drive/Lock Cartridge Command (0001-NNNN)

This optional command performs the functions of a Select command, except the LED is illuminated and remains on until a standard Select command is issued or the drive is reset. The timing for this command is the same as for a standard Select command. (See Figure 5.)

Select Lock Command (1101-NNNN)

This optional command is used with daisy chained formatted drives. It performs the functions of a Select command, except the tapes in both the selected and deselected drives are not rewound to BOT. Because these tapes stay at the current position, one 540 can copy from another 540 without rewinding to BOT or seeking the end-of-data position. The timing for this command is illustrated in Figure 6.

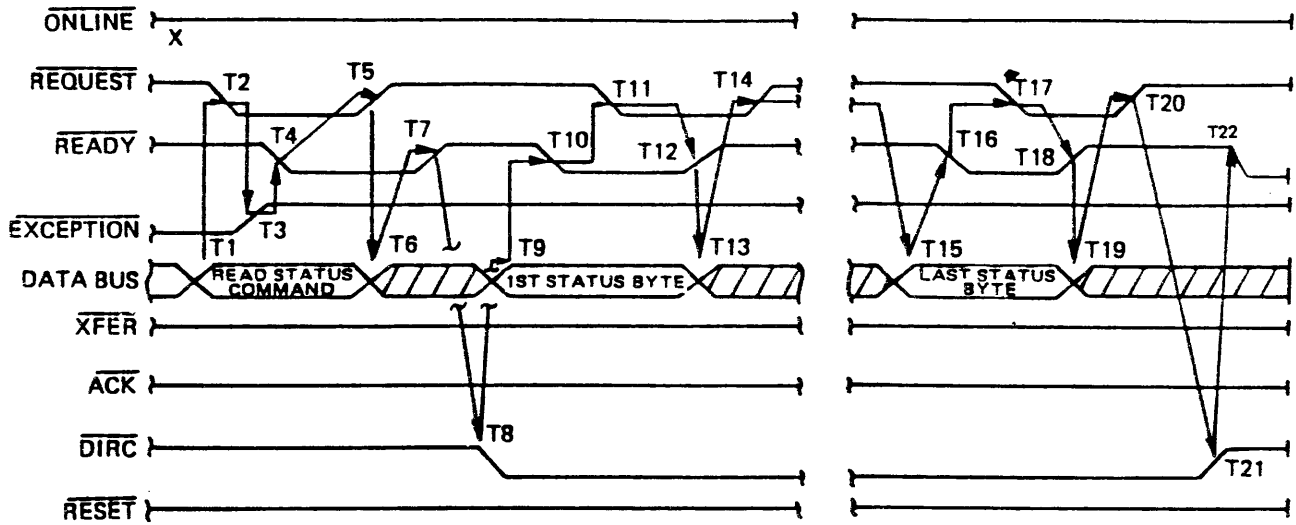

Activity

- T1-Host command to bus
- T2-Host sets REQUEST
- T3-Controller resets EXCEPTION
- T4-Controller sets READY
- T5-Hosts resets REQUEST
- T6-Bus data invalid
- T7-Controller resets READY
- T8-Controller changes bus DIRC
- T9-First status byte to bus
- T10-Controller sets READY
- T11-Host sets REQUEST
- T12-Controller resets READY
- T13-Bus data invalid
- T14-Host resets REQUEST
- T15-Last status byte to bus
- T16-Same as T10
- T17-Same as T11
- T18-Same as T12
- T19-Same as T13
- T20-Same as T14
- T21-Controller changes bus DIRC
- T22-Controller sets READY
- X-Don't Care

Critical Timing

- N/A
- $T1 \rightarrow T2 > 0 \text{ uS}$
- $T3 \rightarrow T4 > 10 \text{ uS}$
- $T2 \rightarrow T4 > 20 \text{ uS}$ (500 uS nom.)
- $T4 \rightarrow T5 > 0 \text{ uS}$
- $T4 \rightarrow T6 > 0 \text{ uS}$
- $20 < T5 \rightarrow T7 < 100 \text{ uS}$
- N/A
- N/A
- $T7 \rightarrow T10 > 20 \text{ uS}$
- N/A
- $T11 \rightarrow T12 < 1 \text{ uS}$
- $T11 \rightarrow T13 > 0 \text{ uS}$
- $T11 \rightarrow T14 > 20 \text{ uS}$
- N/A
- Same as T10
- Same as T11
- Same as T12
- Same as T13
- Same as T14
- N/A
- $T20 \rightarrow T21 > 0 \text{ uS}$
- $T21 \rightarrow T22 > 0 \text{ uS}$

Figure 3. Read Status Timing Diagram.

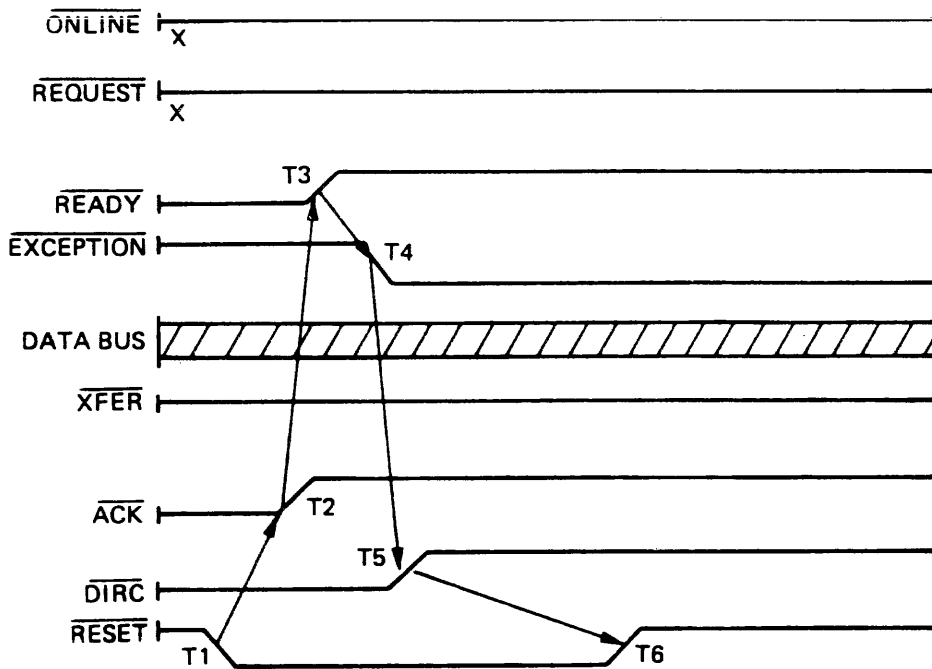

Activity

- T1-Host asserts RESET
- T2-Controller disables ACK
- T3-Controller disables READY
- T4-Controller asserts EXCEPTION
- T5-Controller disables DIRC
- T6-Host disables RESET

Critical Timing

- N/A
- $T2 < T6 + 100 \text{ NSec}$
- $T1 \rightarrow T3 < 1 \text{ uS}$
- $T1 \rightarrow T4 < 10 \text{ uS}$
- $T1 \rightarrow T5 < 10 \text{ uS}$
- $T1 \rightarrow T6 > 25 \text{ uS}$

NOTE: The drive may assert ACK when reset is asserted.

X-Don't Care

Figure 4. Reset Timing Diagram.

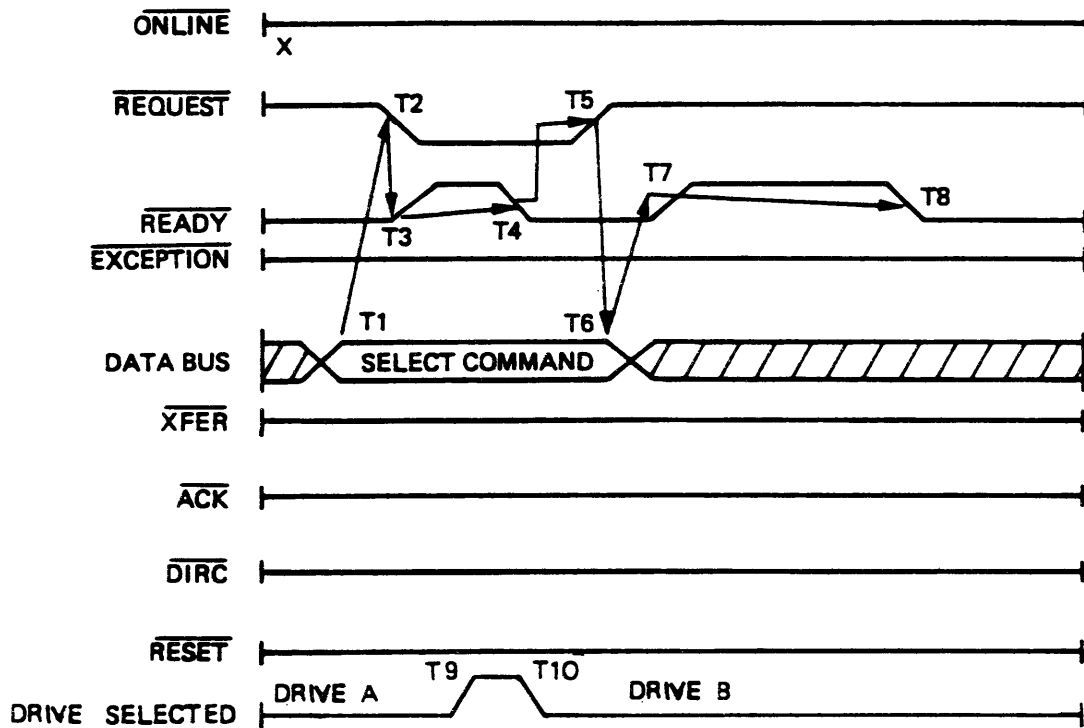

Activity

- T1-Host command to bus
- T2-Host sets REQUEST
- T3-Controller resets READY
- T4-Controller sets READY
- T5-Host resets REQUEST
- T6-Bus data invalid
- T7-Controller resets READY
- T8-Controller sets READY
- T9-Drive A Deselected
- T10-Drive B Selected

Critical Timing

- N/A
- $T1 \rightarrow T2 > 0 \text{ uS}$
- $T2 \rightarrow T3 < 1 \text{ uS}$
- $T3 \rightarrow T4 > 20 \text{ uS}$ (500 uS nominal)
- $T4 \rightarrow T5 > 0 \text{ uS}$
- $T4 \rightarrow T6 > 0 \text{ uS}$
- $20 < T5 \rightarrow T7 < 100 \text{ uS}$
- $T7 \rightarrow T8 > 20 \text{ uS}$
- $T2 \rightarrow T9 < 170 \text{ uS}$
- $T9 \rightarrow T10 > 20 \text{ uS}$

X-Don't Care

*If more than one drive is daisy chained, Drive A is the previously selected drive and Drive B is the drive addressed in the new Select command.

Figure 5. Select Formatter Timing Diagram.

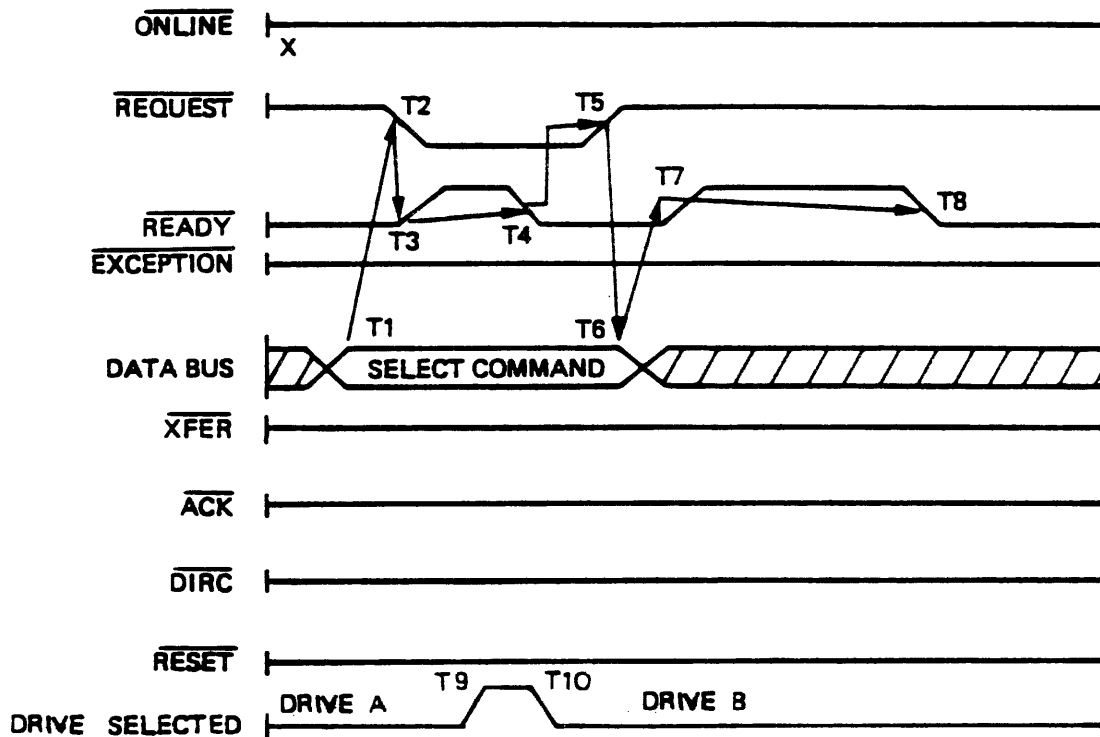

Activity

- T1-Host command to bus
- T2-Host sets REQUEST
- T3-Controller resets READY
- T4-Controller sets READY
- T5-Host resets REQUEST
- T6-Bus data invalid
- T7-Controller resets READY
- T8-Controller sets READY
- T9-Drive A De-Selected
- T10-Drive B Selected

Critical Timing

- N/A
- $T1 \rightarrow T2 > 0 \text{ uS}$
- $T2 \rightarrow T3 < 1 \text{ uS}$
- $50 < T3 \rightarrow T4 < 500 \text{ uS}$
- $T4 \rightarrow T5 > 0 \text{ uS}$
- $T3 \rightarrow T6 > 0 \text{ uS}$
- $20 < T5 \rightarrow T7 < 100 \text{ uS}$
- $T7 \rightarrow T8 > 20 \text{ uS}$
- $T2 \rightarrow T9 < 170 \text{ uS}$
- $T9 \rightarrow T10 < 20 \text{ uS}$

X-Don't care

*If more than one formatted drive is daisy chained, Drive A is the previously selected drive, and Drive B is the drive addressed in the new Select command.

Figure 6. Select Lock Timing Diagram.

Read Status Command (1100-0000)

This command, originated by the host, provides the host with information about the selected drive. This information is transferred from the drive in the standard QIC-02 six status bytes. The timing diagram is provided in Figure 7.

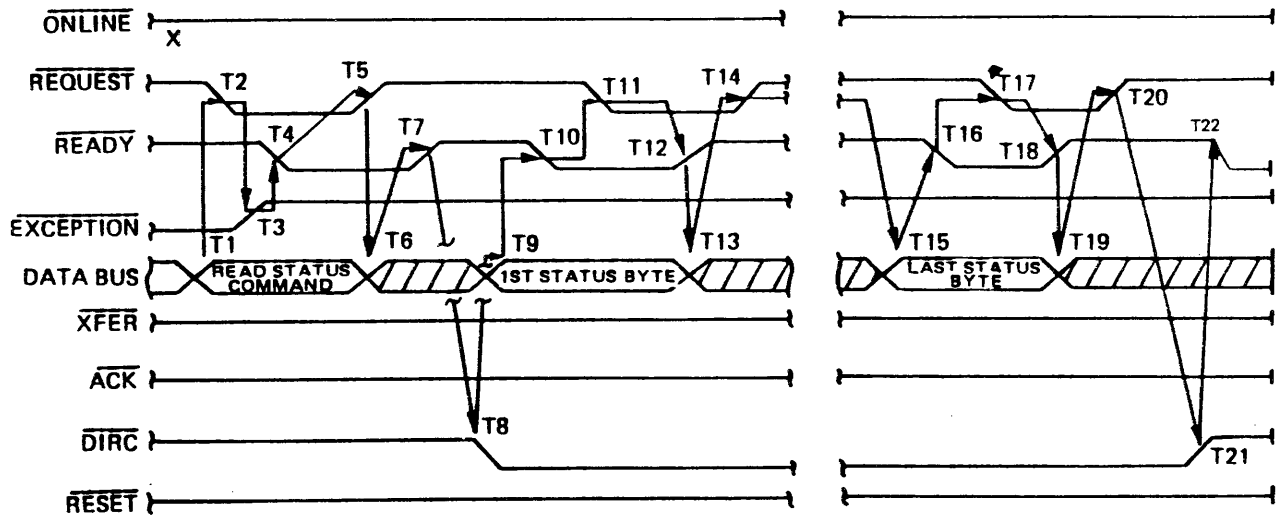

Activity

T1-Host command to bus
 T2-Host sets REQUEST
 T3-Controller resets EXCEPTION
 T4-Controller sets READY
 T5-Hosts resets REQUEST
 T6-Bus data invalid
 T7-Controller resets READY
 T8-Controller changes bus DIRC
 T9-First status byte to bus
 T10-Controller sets READY
 T11-Host sets REQUEST
 T12-Controller resets READY
 T13-Bus data invalid
 T14-Host resets REQUEST
 T15-Last status byte to bus
 T16-Same as T10
 T17-Same as T11
 T18-Same as T12
 T19-Same as T13
 T20-Same as T14
 T21-Controller changes bus DIRC
 T22-Controller sets READY
 X-Don't Care

Critical Timing

N/A
 $T1 \rightarrow T2 > 0 \text{ uS}$
 $T3 \rightarrow T4 > 10 \text{ uS}$
 $T2 \rightarrow T4 > 20 \text{ uS}$ (500 uS nom.)
 $T4 \rightarrow T5 > 0 \text{ uS}$
 $T4 \rightarrow T6 > 0 \text{ uS}$
 $20 < T5 \rightarrow T7 < 100 \text{ uS}$
 N/A
 N/A
 $T7 - T10 > 20 \text{ uS}$
 N/A
 $T11 \rightarrow T12 < 1 \text{ uS}$
 $T11 \rightarrow T13 > 0 \text{ uS}$
 $T11 \rightarrow T14 > 20 \text{ uS}$
 N/A
 Same as T10
 Same as T11
 Same as T12
 Same as T13
 Same as T14
 N/A
 $T20 \rightarrow T21 > 0 \text{ uS}$
 $T21 \rightarrow T22 > 0 \text{ uS}$

Figure 7. Read Status Timing Diagram.

Table 3. Read Status Byte Summary.

0 (MSB)	7	(STO) Set, if any other bit in Byte 0 is set. If Bit 7 is set Exception may be set.
	6	(CNI) Cartridge Not In. Exception set if cartridge removed, and (1) drive selected by select drive with Lock Cartridge command; (2) motion command is issued; or (3) tape moved previously from BOT.
	5	(DFF) Device Fault Flag. DFF sets Exception. Must be followed by a Read Status sequence to clear Exception. (Read Extended Status III contains information in Byte 25 to determine cause of fault.) DFF set when formatter detects 540 condition which prohibits further command execution. For example: <ol style="list-style-type: none"> 1. No tape motion (jammed cartridge) 2. Failure to recognize or exit area between BOT/load point, or early warning/EOT. 3. No tach pulses from capstan motor. 4. Failure to complete command function in specified internal time. For example: not completing rewind once formatter initiates command. DFF indicates an unrecoverable 540 or cartridge error to user.
	4	(WRP) Write Protected cartridge. Set if cartridge write protect mechanism on safe. Remains set until cartridge is write enabled. Exception set if any Write or Erase command is issued when cartridge is write protected.
	3	(EOM) End of Media. Set when early warning hole detected on last track in write mode. Remains set while tape is at logical end of media. Not reset by Read Status. When set, Exception is set.
	2	(UDE) Unrecoverable Data Error. Set for unrecoverable data error during read or write operation. If set, Exception is set. Reset by Read Status.
	1	(BNL) Bad Block Not Located. Set to indicate drive not able to locate correct block on tape. If set, Exception is set. When set with (UDE), drive transfers filler data block or data from a different block to keep correct total block count. BNL reset by Read Status.

Table 3. Read Status Byte Summary continued.

Byte No.	Bit No.	Definition
	(LSB) 0	(FMD) File Mark Detected. Set when filemark block is read. Exception set and FMD reset by Read Status.
1	(MSB) 7	(STI) Set, if any other bit in Byte 1 is set. If set, Exception may be set.
	6	(ILL) Illegal command. Exceptions and Bit 6 set under these conditions: <ol style="list-style-type: none"> 1. On line not asserted when read or write type command attempted or in process. 2. Non-implemented command is issued. 3. Non-read type command issued without proper termination of write sequence. 4. Non-write type command issued without proper termination of write sequence. ILL reset by Read Status.
	5	(NDT) No data detected. Set when drive determines no data is recorded on tape. If set, Exception is set. NDT reset by Read Status.
	4	(MBD) Marginal Block Detected. Set at detection of marginal data block. Enhanced track offset read recovery uses MBD to alert host if +4-mil or +8-mil offset required to read recorded cartridge. Exception set only if Exception and filemark read status are indicated. A set MBD indicates track position offset, when filemark was read. This status indicates to host a marginally recorded cartridge. Host may determine to write append tape, or recover data and rewrite cartridge.
	3	(BOM) Beginning of Medium. Bit set when drive is logically at BOT, Track 0. If set, Exception is set. Bit not reset by Read Status, but reset when tape moved away from logical BOT.
	2	(BPE) Bus Parity Error. Bit set when drive detects odd parity error on bus during data transfer to drive. If set, Exception is set. Odd parity is an odd number of active bits on bus. Parity

Table 3. Read Status Byte Summary continued.

Byte No.	Bit No.	Definition
	1	<p>enabled by W8, W9, W10 jumper configuration on 540 formatter. Only data is checked for parity.</p> <p>(ERM) End of Recorded Media. Bit set when drive detects end of recorded media, or following a Seek End of Data command. If set, Exception is set.</p>
(LSB)	0	<p>(POR) Power On/Reset occurred set. Bit set following power on to drive or a reset from host. If set, Exception is set. Bit reset by a Read Status.</p>

Read Extended Status Command (1110-0000)

This optional command, issued by the host, provides the host with information for fault isolation of the selected drive. This information is provided by the drive in 64 bytes of vendor unique status data. The timing diagram for this command is provided in Figure 8.

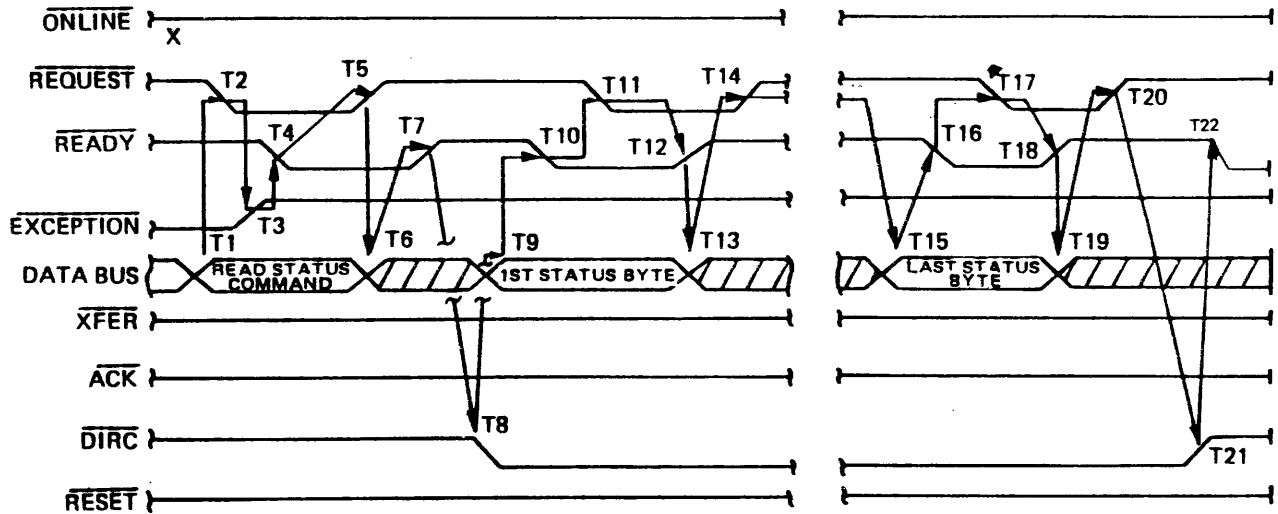

Activity

- T1-Host command to bus
- T2-Host sets REQUEST
- T3-Controller resets EXCEPTION
- T4-Controller sets READY
- T5-Hosts resets REQUEST
- T6-Bus data invalid
- T7-Controller resets READY
- T8-Controller changes bus DIRC
- T9-First status byte to bus
- T10-Controller sets READY
- T11-Host sets REQUEST
- T12-Controller resets READY
- T13-Bus data invalid
- T14-Host resets REQUEST
- T15-Last status byte to bus
- T16-Same as T10
- T17-Same as T11
- T18-Same as T12
- T19-Same as T13
- T20-Same as T14
- T21-Controller changes bus DIRC
- T22-Controller sets READY
- X-Don't Care

Critical Timing

- N/A
- $T1 \rightarrow T2 > 0 \text{ uS}$
- $T3 \rightarrow T4 > 10 \text{ uS}$
- $T2 \rightarrow T4 > 20 \text{ uS}$ (500 uS nom.)
- $T4 \rightarrow T5 > 0 \text{ uS}$
- $T4 \rightarrow T6 > 0 \text{ uS}$
- $20 < T5 \rightarrow T7 < 100 \text{ uS}$
- N/A
- N/A
- $T7 \rightarrow T10 > 20 \text{ uS}$
- N/A
- $T11 \rightarrow T12 < 1 \text{ uS}$
- $T11 \rightarrow T13 > 0 \text{ uS}$
- $T11 \rightarrow T14 > 20 \text{ uS}$
- N/A
- Same as T10
- Same as T11
- Same as T12
- Same as T13
- Same as T14
- N/A
- $T20 \rightarrow T21 > 0 \text{ uS}$
- $T21 \rightarrow T22 > 0 \text{ uS}$

Figure 8. Read Extended Status Timing Diagram.

Table 4. Read Extended Status III Format.

Byte (Hex)	Byte & Bit Description
00 (00)	Basic Drive Control Register (bit map) 7 - Reserved 6 - Write Enable 5 - Erase Enable 4 - Reverse Enable 3 - Go Enable 2 - 0 Reserved
01 (01)	Current Track/Lock Register 7 thru 4 Bit On Current Track (MSB=7, LSB=4) 3 thru Lock Bit Set By Host If(In) Select Cmd.Used 2 thru 0 Reserved
02 (02)	Last Status (bit map) 7 - CRC Error 6 - Filemark 5 - Gap Detected 4 - 3 Reserved 2 - Write Complete 1 - Read Complete 0 - Host Complete
03 (03) thru 12 (0C)	Reserved
13 (0D)	Command Register 7 thru 0 - Reserved
4 (0E)	Status Byte 0
15 (0F)	Status Byte 1
16 (10)	Status Byte 2, Data Error Counter
17 (11)	Status Byte 3, Data Error Counter
18 (12)	Status Byte 4, Underrun Counter
19 (13)	Status Byte 5, Underrun Counter
20 (14) thru 23 (17)	Reserved
24 (18)	Format Type (bit map) 7 - 0 6 - 0

Table 4. Read Extended Status continued.

Byte (Hex)	Byte & Bit Description
	5 - 0
	4 - 0
	3 - 0
	2 - 0
	1 - X (0 = QIC-11)
	0 - X (3 = QIC-24)
25 (19)	Position Error Map for Device Fault Flag
	01 = CMD = Rev. + Go + Delay Error = Still at EOT
	02 = Drive in Zone With Go ON. Error = Unable to Reach EOT or BOT Within 1 Second
	03 = Error = No Tach. Pulses Motor Running less than 30IPS
	04 = CMD = Rev. + Go + Delay. Error = No BOT Within 1.5 Minutes
	05 = Unable to Find Load Point or Early. Warning After Go From BOT or EOT + Timeout
	06 = Unable To Exit Zone Area After Go Issued + Delay
	07 = Speed Error
	08 = Speed Error At Zone
	09 = Acceleration Error
	OA = Speed 10 Percent
	OB = Speed Deviation 10 Percent
	OC = Motor Run Away
	OD = Main Board Is Busy Following Wait Timeout. Device Ready Line From Main To Formatter Board Did Not Go Ready
	OE
	OF
	10 Motor Not Moving When It Should Be
	11 Running
	12
	13
	14 = Fake Zone Indication False Early Warning or Load Point Detected
	17 = Consecutive Write Errors in Excess
	18 = Unable To Write The Target Block
	19 = Unable To Locate Elongated Gap For an Append
26 (1A) thru 29 (1D)	Reserved
30 (1E)	Last Block Address (LSB)
31 (1F)	Last Block Address
32 (20)	Last Block Address
33 (21)	Last Block Address (MSB)
34 (22)	File Mark Count (usually set to 0)
35 (23)	

Table 4. Read Extended Status continued.

Byte (Hex)	Byte & Bit Description
thru	Reserved
46 (2E)	
47 (2F)	Offset Status
48 (30)	Reserved
49 (31)	Append Up Count
50 (32)	Append Down Count
51 (33)	Reserved
52 (34)	Reserved
53 (35)	Number of Blocks Recovered at Current Position
54 (36)	Number os Blocks Recovered at Last Offset Position
55 (37)	Reserved
56 (38)	Reserved
57 (39)	Vendor I.D. Cipher = 01
58 (3A)	Firmware Revision Level
59 (3B)	Select
60 (3C)	Previous Track Offset Bit Map
61 (3D)	Previous Track Offset Bit Map
62 (3E)	Previous Track Offset Bit Map
63 (3F)	Previous Track Offset Bit Map

Write Data Command (0100-0000)

The Write command can only be issued by the host after ONL- is asserted. When the drive is ready for a data block transfer, the RDY- line is activated. However, if the host asserts a XFER- between blocks before RDY- has been asserted, the Ready line may not be asserted.

When Ready has been asserted to indicate a data block boundary, the host can terminate the Write command by issuing a Write File Mark or Write N File Mark command. Either command will stop tape motion and the drive will maintain the present tape position until another command is issued. When RDY- is active, the host can terminate the Write command by de-activating ONL-. This action will write a file mark and rewind the tape to BOT.

If the Write command is issued after the insertion of a cartridge, or a RST-pulse, writing starts at BOT. Otherwise, writing begins at the current tape position.

If the drive unsuccessfully attempts to write a data block 16 times, the Write-command is terminated, EXC- is set, and the tape is rewound.

When the drive detects the Early Warning hole on the last track, the drive stops accepting data blocks from the host, terminates the Write command, and uses an EXC- and Read status sequence to report an End-Of-Media condition. Then, if another Write command is issued, a final data transfer of 1,024 bytes can be made. A timing diagram for the Write command is provided in Figure 9.

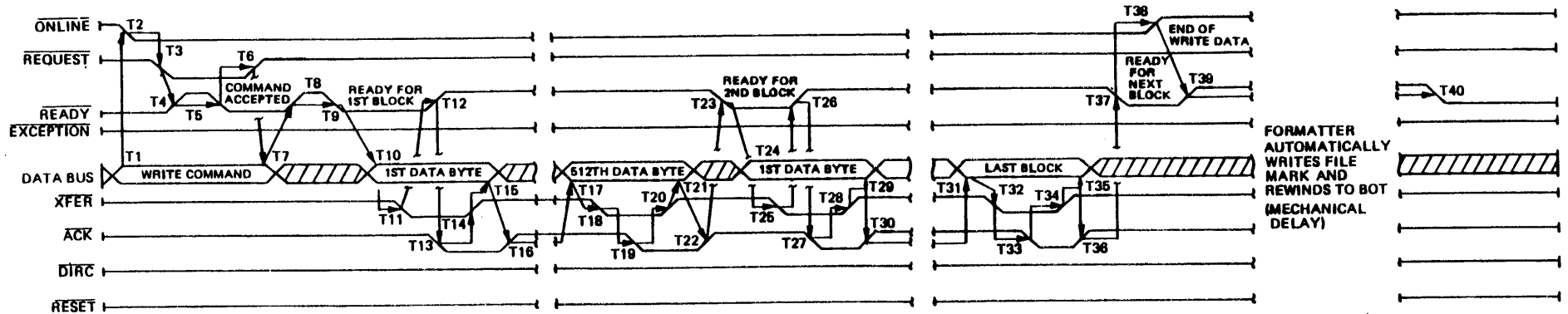

Figure 9. Write Data Timing Diagram.

Activity

- T1-Host command to bus
- T2-Host sets ONLINE
- T3-Host sets REQUEST
- T4-Controller resets READY
- T5-Controller sets READY
- T6-Host resets REQUEST
- T7-Bus data invalid
- T8-Controller resets READY
- T9-Controller sets READY
- T10-Host data to bus
- T11-Host sets XFER
- T12-Controller resets READY
- T13-Controller sets ACK
- T14-Host rests XFER
- T15-Bus data invalid
- T16-Formatter resets ACK
- T17-Host data to bus
- T18-Same as T11*
- T19-Same as T13
- T20-Same as T14

Critical Timing

- N/A
- N/A
- $T2 \rightarrow T3 > 0 \text{ uS}$
- $T3 \rightarrow T4 < 1 \text{ uS}$
- $T4 \rightarrow T5 > 20 \text{ uS}$ (500 uS nominal)
- $T5 \rightarrow T6 > 0 \text{ uS}$
- $T5 \rightarrow T7 > 0 \text{ uS}$
- $20 < T6 \rightarrow T8 < 100 \text{ uS}$
- $T8 \rightarrow T9 > 20 \text{ uS}$
- N/A
- $T10 \rightarrow T11 > -40 \text{ nS}^*$
- $T11 \rightarrow T12 = 1 \text{ uS}$
- $0.5 < T11 \rightarrow T13 < 100 \text{ uS}$
- $T11 \rightarrow T14 > 0 \text{ uS}$
- $T13 \rightarrow T15 > 0 \text{ uS}$
- $0 < T14 \rightarrow T16 < 3 \text{ uS}$
- N/A
- Same as T11
- Same as T13
- Same as T14

Activity

- T21-Same as T15
- T22-Same as T16
- T23-Controller sets READY
- T24-Host data to bus
- T25-Host sets XFER
- T26-Controller resets READY
- T27-Controller sets ACK
- T28-Host resets XFER
- T29-Bus data invalid
- T30-Controller resets ACK
- T31-Host data to bus
- T32-Host sets XFER
- T33-Controller sets ACK
- T34-Host resets XFER
- T35-Bus data invalid
- T36-Controller resets ACK
- T37-Controller sets READY
- T38-Host resets ONLINE
- T39-Controller resets READY
- T40-Controller set READY

Critical Timing

- Same as T15
- Same as T16
- $T22 \rightarrow T23 > 100 \text{ uS}$
- N/A
- Same as T11*
- Same as T12
- Same as T13
- Same as T14
- Same as T15
- Same as T16
- N/A
- Same as T18
- Same as T19
- Same as T20
- N/A
- Same as T22
- Same as T23
- N/A
- N/A
- N/A

* T11 may precede T10 by up to 40 nS

Write Mode Option

An optional bus parity check can be enabled by installing jumper W6 on the formatter pcb with this option:

- o Data bytes, not commands, are checked for parity.
- o Up to 50 nanoseconds are allowed between XFR- and HBP- valid.
- o EXC- is set to parity error detected, and a data block with a parity error is not written to tape.
- o Valid data buffers are written to tape and the buffer in error is cleared.
- o Recovery from a parity error is accomplished by the host reading status, then issuing another Write command. If this is not done, it causes a re-wind abort with illegal command status.

Write Without Underruns Command (0100-0001)

This optional command keeps the tape running when there is no data available in the Write mode. This is accomplished by writing an elongated preamble and/or redundant blocks until data becomes available or the end of the tape is reached. The timing for this command is the same as for a standard Write command. (See Figure 9).

The Write Without Underrun Function (repetitively writing the last transferred block) may be terminated by the host system in one of three ways. They are:

- o Issue next data block
- o Issue write filemark type command
- o Taking On Line signal false

If the host system supplies the "next" data block ($N + 1$) the formatter will repetitively write $N + 1$ until the host supplies $N + 2$ etc. Severe host underruns after issuing WWU command will impact overall capacity. The formatter itself will "time out" the WWU command whenever it encounters the physical end of the track.

Write File Mark Command (0110-0000)

This command writes a file mark on the tape in the selected drive. A Write File Mark (WFM) command, following a cartridge insertion or RST- pulsed, writes the mark at the BOT. Otherwise, the mark is written at the current tape position. The timing diagram for the WFM command is illustrated in Figure 10.

Write N File Marks Command (0111-NNNN)

This optional command is identical to the WFM, except the number of file marks to be written is specified by the binary value of NNNN. If NNNN is made equal to

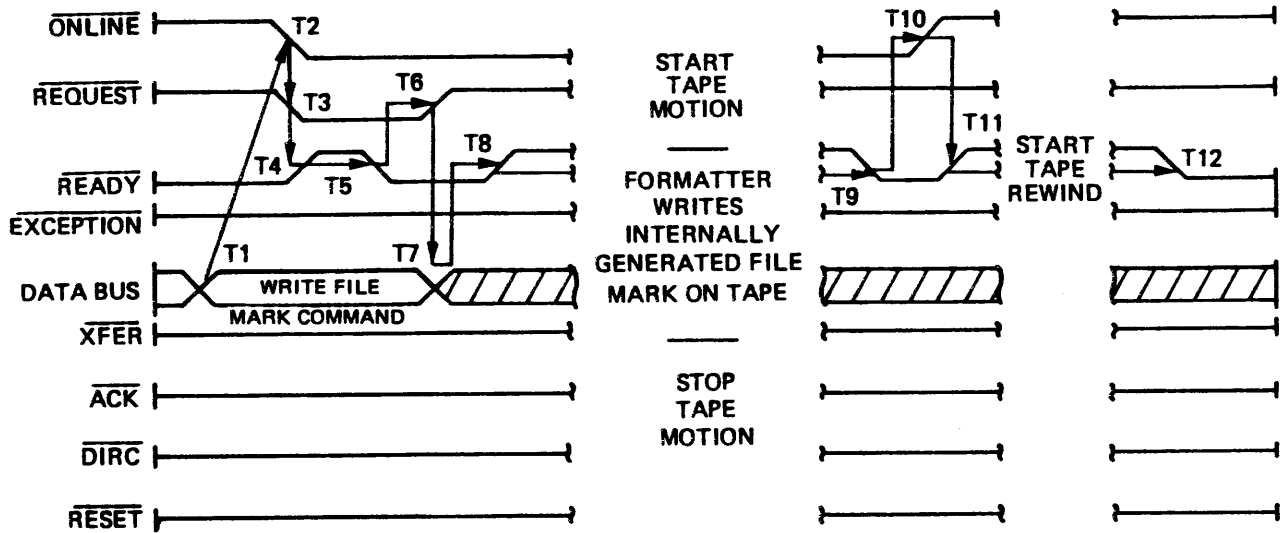

Activity

- T1-Host command to bus
- T2-Host sets ONLINE
- T3-Host sets REQUEST
- T4-Controller resets READY
- T5-Controller sets READY
- T6-Host resets REQUEST
- T7-Bus data invalid
- T8-Controller resets READY
- T9-Controller sets READY
- T10-Host resets ONLINE
- T11-Controller resets READY
- T12-Controller sets READY (at BOT)

Critical Timing

- N/A
- $T1 \rightarrow T2 > 0 \text{ uS}$
- $T2 \rightarrow T3 > 0 \text{ us}$
- $T3 \rightarrow T4 < 1 \text{ uS}$
- $T4 \rightarrow T5 > 20 \text{ uS}$ (500 uS nominal)
- $T5 \rightarrow T6 > 0 \text{ uS}$
- $T5 \rightarrow T7 > 0 \text{ uS}$
- $T20 < T6 \rightarrow T8 < 100 \text{ uS}$
- N/A
- $T9 \rightarrow T10 > 0 \text{ uS}$
- N/A
- N/A

Figure 10. Write File Mark Timing Diagram.

0, the operation is not performed. The timing diagram for this command is illustrated in Figure 11.

Write Filemark On the Fly (62)

The WFOTF command has all the attributes of a Write Filemark command, except tape motion is not terminated immediately after writing the filemark. Instead, the 540 writes an elongated postamble, waiting for the host to respond with a new Write command. If the host fails to respond with a new Write command within 7.0 msec., the 540 terminates the Write command and stops tape motion. If the host reinstructs the 540 with a new Write command within the allowed 7.0 msec., then an additional 3.5 msec. is allowed to complete the data block transfer from the host to the 540. If the 540 is reinstructed within the 7.0 msec., but a 512 byte data block is not transferred within the 10.5 msec. time allowed, the 540 will perform a write underrun sequence and stop tape motion. If the data block transfer is completed after the underrun, the 540 will reposition and continue writing as if following a normal underrun.

Proper termination of a Write command can be accomplished in one of two ways. First, after issuing a WFTOFF, the host can force a write underrun condition. In this case, tape motion is terminated and the 540 exits the write mode. Second, the host can inactivate On-line. In this case, a file mark is written and the tape is rewound. (Timing for WFOTF is shown in Figure 12.)

Read Data Command (1000-0000)

The Read command can only be issued by the host after an ONL- is asserted. When the drive is ready for a data block transfer, the RDY-line is asserted. However if the host begins transferring between blocks by asserting ACK-before RDY- is asserted, the RDY line may not be asserted.

When a file mark is read, the Read command is terminated by the drive. This action stops the tape, and asserts EXC-. Then, the host must issue a Read Status command to clear the exception.

The Read command can also be terminated by issuing a Read File mark or Read N File Mark command when RDY- is asserted. With either of these commands, the drive reads to the designated file mark, sets EXZC- and stops tape motion.

The Read command can be terminated by de-activating ONL-, when Ready has been asserted. This sequence rewinds the tape to BOT.

If the drive is unable to read a data block after 16 attempts, EXC- is asserted and the drive stops at the present tape position.

A Read command following a cartridge insertion, or RST-pulse, starts at BOT. Otherwise, the Read starts at the current tape position. The timing diagram for the Read command is illustrated in Figure 13.

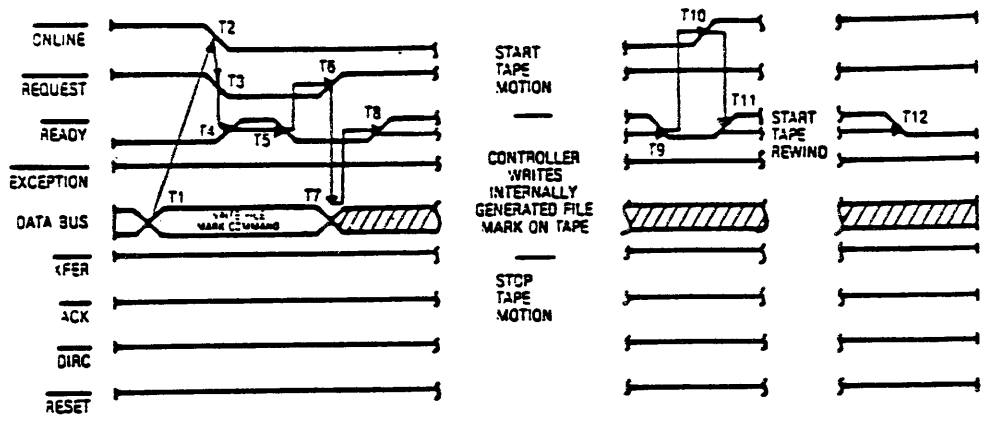

Activity

- T1-Host command to bus
- T2-Host sets ONLINE
- T3-Host sets REQUEST
- T4-Controller resets READY
- T5-Controller sets READY
- T6-Host resets REQUEST
- T7-Bus data invalid
- T8-Controller resets READY
- T9-Controller sets READY
- T10-Host resets ONLINE
- T11-Controller resets READY
- T12-Controller sets READY (at BOT)

Critical Timing

- N/A
- $T1 \rightarrow T2 > 0 \text{ uS}$
- $T2 \rightarrow T3 > 0 \text{ uS}$
- $T3 \rightarrow T4 < 1 \text{ uS}$
- $T4 \rightarrow T5 > 20 \text{ uS}$ (500 uS nom.)
- $T5 \rightarrow T6 > 0 \text{ uS}$
- $T5 \rightarrow T7 > 0 \text{ uS}$
- $20 < T6 \rightarrow T8 < 100 \text{ uS}$
- N/A
- $T9 \rightarrow T10 > 0 \text{ uS}$
- N/A
- N/A

Figure 11. Write N File Marks Timing Diagram.

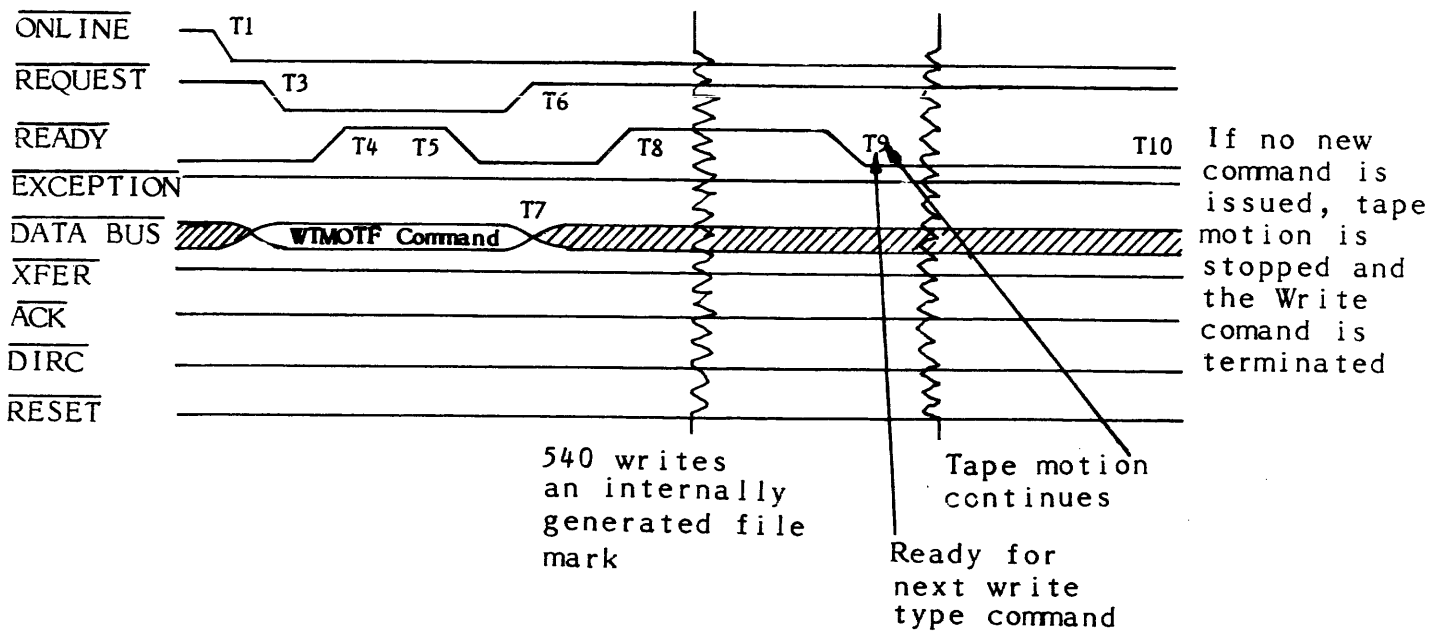

Write Filemark on the Fly

	<u>ACTIVITY</u>	<u>TIMING</u>
T1	Host sets ONLINE	N/A
T2	Host command to bus	T1 → T2 > 0 uS
T3	Host sets REQUEST	T2 → T3 > 0 uS
T4	Controller resets READY	T3 → T4 < 1 uS
T5	Controller sets READY	T4 → T5 > 20 uS (500 uS nom.)
T6	Host resets REQUEST	T5 → T6 > 0 uS
T7	Bus data invalid	T5 → T7 > 0 uS
T8	Controller resets READY	20 uS < T6 - T8 < 100 uS
T9	Controller sets READY	N/A
T10	No command issued Write terminated	T9 → T10 > 7 mS

Figure 12. Write Filemark on the Fly (WFOTF).

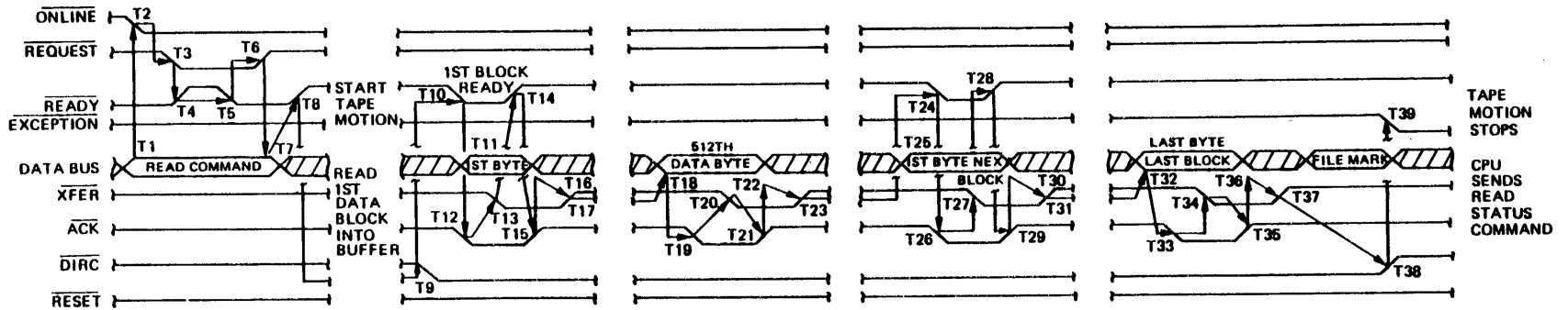

Figure 13. Read Data Timing Diagram.

Activity

- T1-Host command to bus
- T2-Host sets ONLINE
- T3-Host sets REQUEST
- T4-Controller resets READY
- T5-Controller sets READY
- T6-Host resets REQUEST
- T7-Bus data invalid
- T8-Controller resets READY
- T9-Controller changes DIRC
- T10-First data byte to bus
- T11-Controller sets READY
- T12-Controller sets ACK
- T13-Host sets XFER
- T14-Controller resets READY
- T15-Formatter resets ACK
- T16-Host data to bus
- T17-Host resets XFER
- T18-Bus data valid
- T19-Formatter sets ACK
- T20-Host sets XFER

Critical Timing

- N/A
- N/A
- $T2 \rightarrow T3 > 0 \text{ uS}$
- $T3 \rightarrow T4 < 1 \text{ uS}$
- $T4 \rightarrow T5 > 20 \text{ uS}$ (500 uS nominal)
- $T5 \rightarrow T6 > 0 \text{ uS}$
- $T5 \rightarrow T7 > 0 \text{ uS}$
- $20 < T6 \rightarrow T8 < 100 \text{ uS}$
- N/A
- N/A
- N/A
- $T11 \rightarrow T12 > -40 \text{ nS}^*$
- $T12 \rightarrow T13 > 0 \text{ uS}$
- $T13 \rightarrow T14 < 1 \text{ uS}$
- $0.5 < T13 \rightarrow T15 < 3 \text{ uS}$
- $T13 \rightarrow T16 > 0 \text{ uS}$
- $T15 \rightarrow T17 > 0 \text{ uS}$
- N/A
- Same as T12*
- Same as T13

* T12 may precede T11 by up to 40 nS

Activity

- T21-Controller resets ACK
- T22-Bus data invalid
- T23-Host resets XFER
- T24-Controller sets READY
- T25-First byte to bus
- T26-Controller sets ACK
- T27-Host sets XFER
- T28-Controller resets XFER
- T29-Controller resets ACK
- T30-Bus data invalid
- T31-Host resets XFER
- T32-Last byte to bus
- T33-Controller sets ACK
- T34-Host sets XFER
- T35-Controller resets ACK
- T36-Bus data invalid
- T37-Host resets XFER
- T38-Controller sets EXCEPTION
- T39-Change bus direction

Critical Timing

- Same as T15
- Same as T16
- Same as T17
- N/A
- N/A
- Same as T12*
- Same as T13
- Same as T14
- Same as T15
- Same as T16
- Same as T17
- N/A
- Same as T12*
- Same as T13
- Same as T15
- Same as T16
- Same as T17
- N/A
- N/A

Read Mode Option

A Parity option enables the bus parity generator by installing jumper W6 on the formatter pcb. With this option:

- o The 540 generates the parity bit with 50 nanoseconds maximum delay from ACK- to HBP- valid.
- o The 540 accepts a backspace command while in a Read sequence to recover from a Read parity error. Any other command will cause a rewind abort with illegal command status.

Read File Mark Command (1010-0000)

This command moves the tape on the selected drive to the next file mark. A Read File Mark (RFM) command, following a cartridge insertion or RST- pulse, starts reading at the BOT. Otherwise, reading starts at the current tape position. The timing diagram for the RFM command is illustrated in Figure 14.

Read On The Fly (82)

The ROTF command has all the attributes of a Read command, except tape motion is not terminated immediately after reading the file mark. This allows the host to maintain streaming, when reading cartridges written with a large number of short files.

When the host issues a ROTF command, the 540 starts reading. If a filemark is detected, the 540 will set an Exception. To maintain streaming, the host must issue a read Status command, complete a read status sequence, and reinstruct the 540 with a new ROTF command within 8 msec. If the host is unable to meet these requirements, a read overrun will occur, tape motion will be stopped, and the read will be terminated. (Timing for ROTF is shown in Figure 15.)

Read N File Marks Command (1011-NNNN)

This optional command is identical to the RFM, except the number of file marks to be read is specified by the binary value of NNNN. If NNNN is made equal to 0, the operation is not performed. The timing diagram for this command is illustrated in Figure 16.

Read Quarterback Format Command (0100-1001)

This vendor-unique command changes the 540 parameter logic to read the format of the Cipher QuarterbackTM 4-track tape. All 540 commands, except the Write operations, may be used in this mode. A Power-On or RST-pulse restores the drive to the QIC-24 configuration.

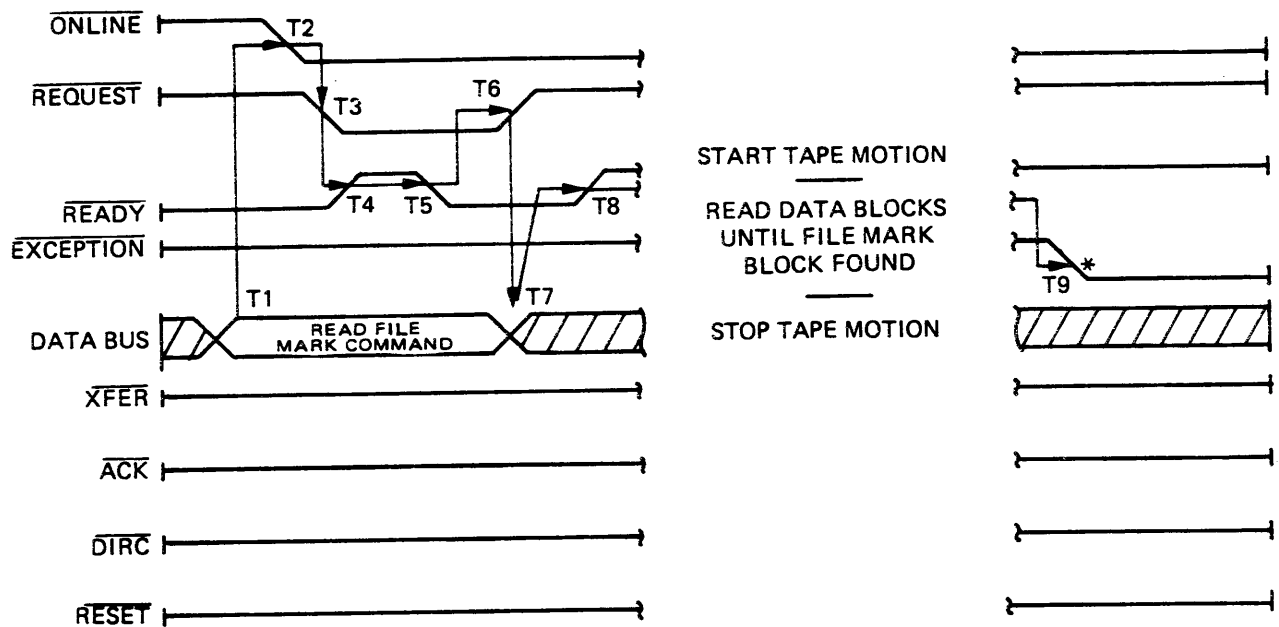

Activity

- T1-Host command to bus
- T2-Host sets ONLINE
- T3-Host sets REQUEST
- T4-Controller resets READY
- T5-Controller sets READY
- T6-Host resets REQUEST
- T7-Bus data invalid
- T8-Controller resets READY
- T9-Controller sets EXCEPTION

* System must issue READ STATUS command

Critical Timing

- N/A
- $T1 \rightarrow T2 > 0 \mu\text{S}$
- $T2 \rightarrow T3 > 0 \mu\text{S}$
- $T3 \rightarrow T4 < 1 \mu\text{S}$
- $T4 \rightarrow T5 > 20 \mu\text{S}$ (500 μS nominal)
- $T5 \rightarrow T6 > 0 \mu\text{S}$
- $T4 \rightarrow T7 > 0 \mu\text{S}$
- $20 < T6 \rightarrow T8 < 100 \mu\text{S}$
- N/A

Figure 14. Read Filemark Timing Diagram.

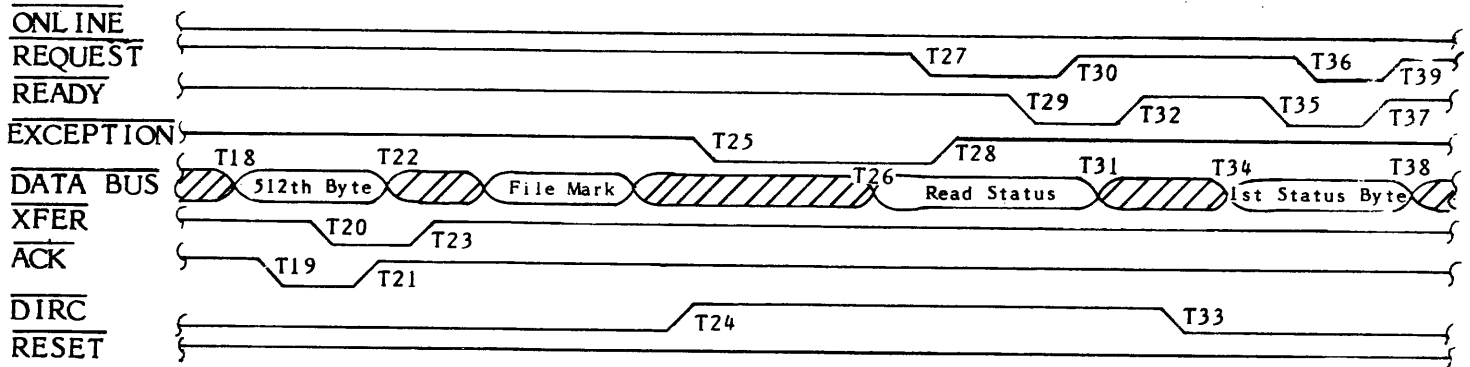
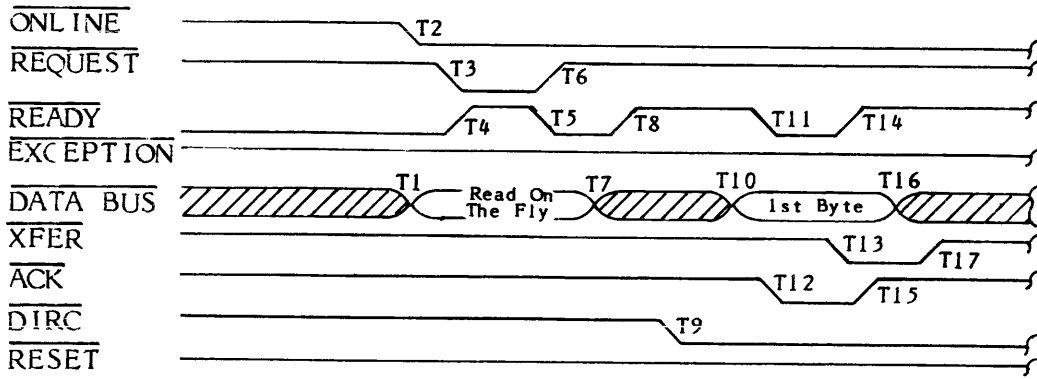

T1	CPU command to bus	N/A
T2	CPU sets ONLINE	N/A
T3	CPU set REQUEST	T2→T3>0 uS
T4	Formatter resets READY	T3→T4<1 uS
T5	Formatter sets READY	T4→T5>20 uS (500 uS nom.)
T6	CPU resets REQUEST	T5→T6>0 uS
T7	Bus data invalid	T5→T7>0 uS
T8	Formatter resets READY	20 uS<T6-T8<100 uS
T9	Formatter changes DIRC	N/A
T10	Data byte to bus	N/A
T11	Formatter sets READY	N/A
T12	Formatter sets ACK	T11-T12>-40 nS
T13	CPU sets XFER	T12→T13>0 uS
T14	Formatter resets READY	T13-T14<1 uS
T15	Formatter reset ACK	0.5 uS<T13-T15<3 uS
T16	Bus data invalid	T13→T16>0 uS
T17	CPU resets XFER	T15→T17>0 uS
T18	Data to bus	N/A
T19	Formatter sets ACK	T18-T19>0 uS
T20	CPU sets XFER	T19-T20>0 uS
T21	Formatter resets ACK	0.5 uS<T20-T21<3 uS
T22	Bus data invalid	T20-T22 0 uS
T23	CPU resets XFER	T21-T23 0 uS
T24	Changes bus DIRC	T23→T24 0 uS
T25	Formatter sets exception	T24→T25 0 uS
T26	CPU command to bus	N/A
T27	CPU sets REQUEST	T26→T27>0 uS
T28	Formatter resets exception	T27→T28>0 uS
T29	Formatter sets READY	T27→T29>20 uS (500 uS nom.)
T30	CPU resets REQUEST	T29→T30>0 uS
T31	Bus data invalid	T29→T31>0 uS
T32	Formatter resets READY	20 uS<T30-T32<100 uS
T33	Formatter changes bus DIRC	N/A
T34	First status byte to bus	N/A
T35	Formatter sets ready	T32→T35>20 uS
T36	CPU sets REQUEST	N/A
T37	Formatter resets READY	T36→T37<2 uS
T38	Bus data invalid	T36→T38>0 uS
T39	CPU resets REQUEST	T36→T39>20 uS

Figure 15. Read On The Fly (ROTF)(1 of 2).

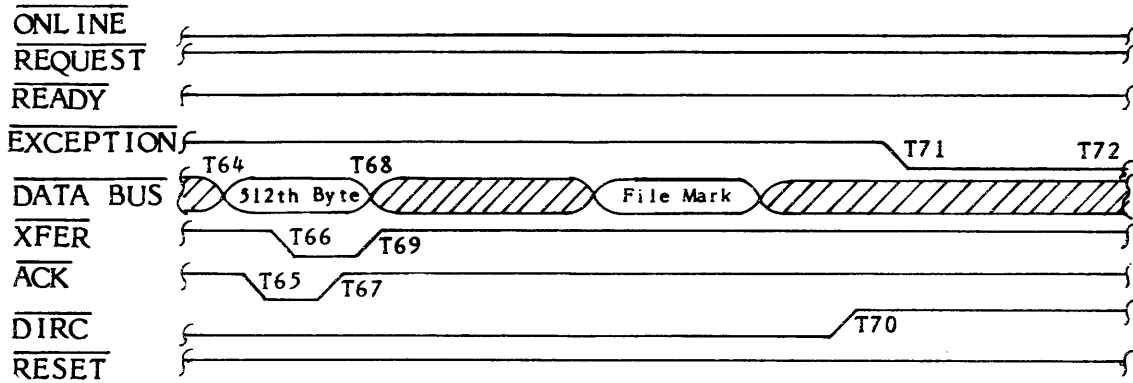
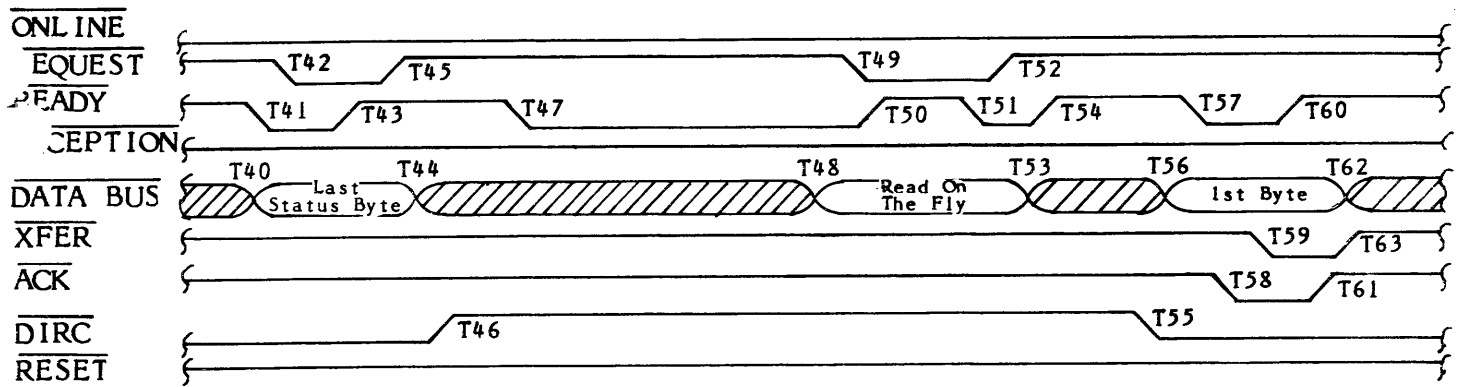

	ACTIVITY	TIMING
T40	Last status byte to bus	N/A
T41	Formatter sets READY	Same as T35
T42	CPU sets request	Same as T36
T43	Formatter resets READY	Same as T37
T44	Bus data invalid	Same as T38
T45	CPU resets REQUEST	Same as T39
T46	Formatter changes bus DIRC	$T45 \rightarrow T46 > 0 \text{ uS}$
T47	Formatter sets READY	$T46 \rightarrow T47 > 0 \text{ uS}$
T48	CPU command to bus	N/A
T49	CPU sets REQUEST	N/A
T50	Formatter resets READY	$T49 \rightarrow T50 < 1 \text{ uS}$
T51	Formatter sets READY	$T50 \rightarrow T51 > 20 \text{ uS}$ (500 uS nom.)
T52	CPU resets REQUEST	$T25 \rightarrow T52 < 8 \text{ mS}$
T53	Bus data invalid	$T51 \rightarrow T53 = 0 \text{ uS}$
T54	Formatter resets READY	$20 \text{ uS} < T52 \rightarrow T54 < 200 \text{ uS}$
T55	Formatter changes DIRC	N/A
T56	Data byte to bus	N/A
T57	Formatter sets READY	N/A
T58	Formatter sets ACK	$T57 \rightarrow T58 > -40 \text{ nS}$
T59	CPU sets XFER	$T58 \rightarrow T59 > 0 \text{ uS}$
T60	Formatter resets READY	$T59 \rightarrow T60 < 1 \text{ uS}$
T61	Formatter resets ACK	$0.5 \text{ uS} < T59 \rightarrow T61 < 3 \text{ uS}$
T62	Bus data invalid	$T59 \rightarrow T62 > 0 \text{ uS}$
T63	CPU resets XFER	$T61 \rightarrow T63 > 0 \text{ uS}$
T64	Data to bus	N/A
T65	Formatter sets ACK	$T64 \rightarrow T65 > 0 \text{ uS}$
T66	CPU sets XFER	$T65 \rightarrow T66 > 0 \text{ uS}$
T67	Formatter resets ACK	$0.5 \text{ uS} < T66 \rightarrow T67 < 3 \text{ uS}$
T68	Bus data invalid	$T66 \rightarrow T68 > 0 \text{ uS}$
T69	CPU resets XFER	$T67 \rightarrow T69 > 0 \text{ uS}$
T70	Changes bus DIRC	$T69 \rightarrow T70 > 0 \text{ uS}$
T71	Formatter sets exception	$T70 \rightarrow T71 > 0 \text{ uS}$
T72	Read terminated	$T71 \rightarrow T72 > 8 \text{ mS}$

Figure 15. Read On The Fly (ROTF)(2 of 2).

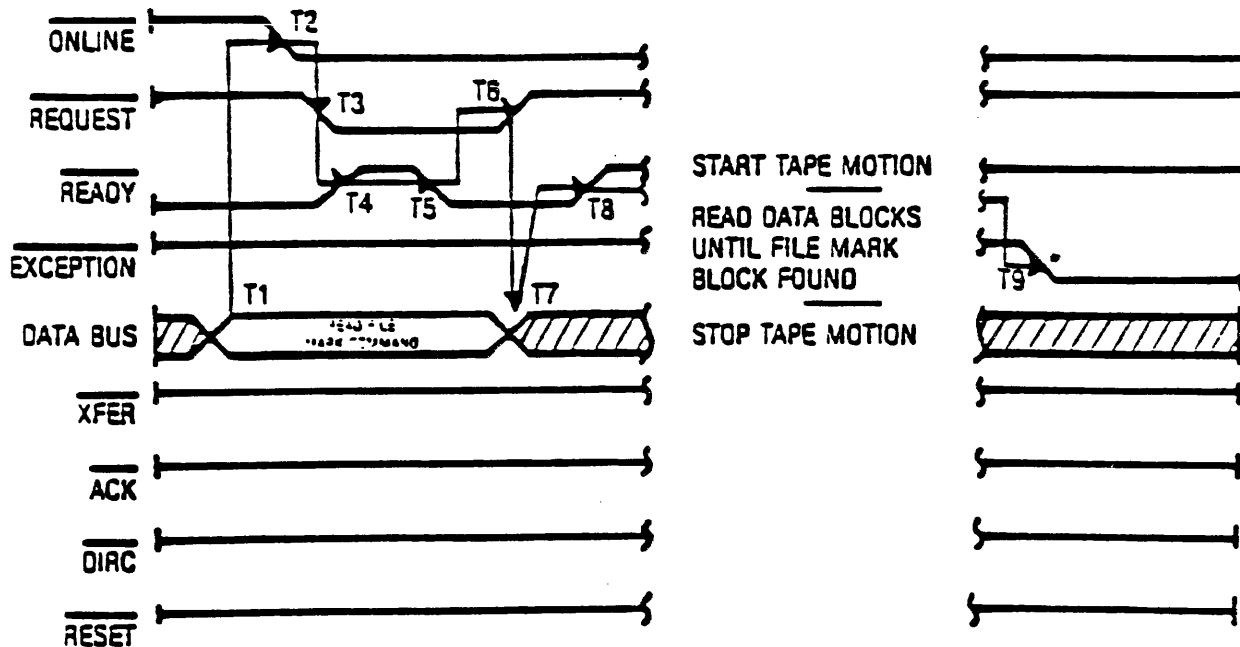

Activity

- T1-Host command to bus
- T2-Host sets ONLINE
- T3-Host sets REQUEST
- T4-Controller resets READY
- T5-Controller sets READY
- T6-Host resets REQUEST
- T7-Bus data invalid
- T8-Controller resets READY
- T9-Controller sets EXCEPTION

*System must issue READ STATUS command

Critical Timing

- N/A
- $T1 \rightarrow T2 > 0 \text{ uS}$
- $T2 \rightarrow T3 > 0 \text{ uS}$
- $T3 \rightarrow T4 < 1 \text{ uS}$
- $T4 \rightarrow T5 > 20 \text{ uS}$ (500 uS nom.)
- $T5 \rightarrow T6 > 0 \text{ uS}$
- $T4 \rightarrow T7 > 0 \text{ uS}$
- $20 < T6 \rightarrow T8 < 100 \text{ uS}$
- N/A

Figure 16. Read N File Marks Timing Diagram.

Rewind Command (0010-0001)

This command positions the tape in the selected drive to the Beginning Of Tape (BOT). The timing diagram for this command is illustrated in Figure 17.

Erase Tape Command (0010-0010)

This command erases all the tape tracks from BOT to EOT, then deactivates the Erase bar and returns to BOT. This command fulfills the requirements of initialization. Timing for Erase Tape is the same as for the BOT command. (See Figure 17)

Retension Command (0010-0100)

This Command retensions the tape by returning to BOT; going from BOT to EOT; then returning to BOT. This command also fulfills the requirements of initialization. Timing for Retension is the same as for the BOT command. (See Figure 17)

Backspace (89)

When nested in a read sequence, it is actually a Backspace Read which physically repositions and rereads the previous data block. Once the data block is read, the command returns the tape to the original position. If the data block is not read by the host, multiple nested backspaces will position tape reverse a block at a time.

The 540 presents the first data byte of the previous data block command to the bus, and maintains the read sequence. This is a particularly useful way to recover from a read parity error. The read sequence is terminated if a filemark is read, and the 540 must be reinstructed with a new Read command to continue reading.

The Backspace command can also be a stand-alone instruction. In this case, it positions the tape, but does not present data to the bus. Multiple commands will position tape reverse a block at a time.

A Backspace command issued at BOT results in an Exception.

Seek End of Recorded Data Command (1010-0011)

This optional command instructs the drive to find the end of the recorded data. Once found, new data may be appended by another Write command. The timing for this command is essentially the same as for a Read File Mark command. (See Figure 14.) No data is transferred, and the completion of the command is indicated by an Exception signal and the End of Recorded Media status bit.

Block Search Command (AD)

This command allows the host to search for a specific block on tape without streaming sequentially through the entire tape. The sequence for this command is:

1. The host issues the Block Search command followed by a 4-byte block,

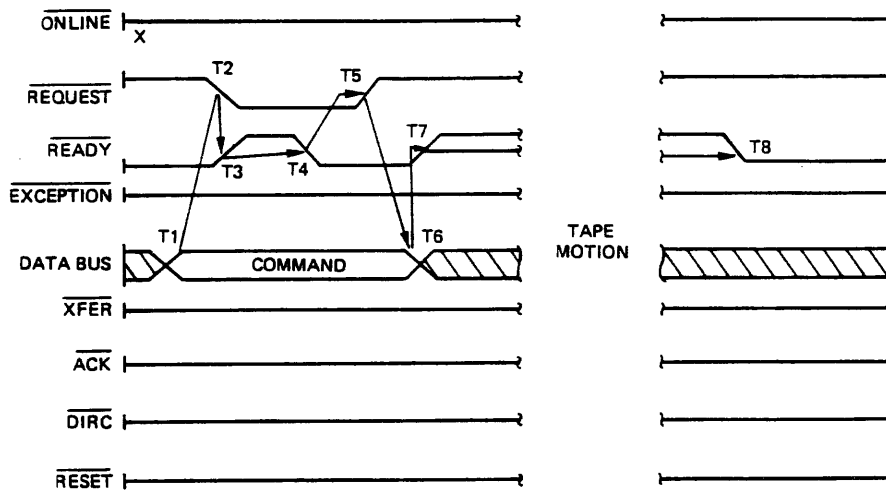

Activity

- T1-Host command to bus
- T2-Host sets REQUEST
- T3-Controller resets READY
- T4-Controller sets READY
- T5-Host resets REQUEST
- T6-Bus data invalid
- T7-Controller resets READY
- T8-Controller sets READY

X-Don't Care

Critical Timing

- N/A
- $T1 \rightarrow T2 > 0 \text{ uS}$
- $T2 \rightarrow T3 < 1 \text{ uS}$
- $T3 \rightarrow T4 > 20 \text{ uS}$ (500 uS nominal)
- $T4 \rightarrow T5 > 0 \text{ uS}$
- $T4 \rightarrow T6 > 0 \text{ uS}$
- $20 < T5 \rightarrow T7 < 100 \text{ uS}$
- $T7 \rightarrow T8 > 20 \text{ uS}$

Figure 17. BOT, Erase & Retention Timing Diagram.

using the request/ready handshake. The most significant block address byte is issued first.

2. The 540 calculates a track position and determines motor direction.
3. The 540 enables the capstan motor, and updates the track position.
4. The 540 searches for the target block, minus one.
5. When found, the 540 enables Ready.
6. If the block search was nested in a Read command, the host may resume reading. If not, tape motion stops, the 540 terminates the search and waits for another command.
7. If the 540 fails to locate the target block, it will reposition and try again. If the 540 again fails to locate the target block, the tape is rewound, Exception is set, and the command aborted. Following an abort, the following read status will show in Status Bytes 0 and 1, indicating an unrecoverable data error and BOT:

Byte 0	Byte 1
100X0100	10001000

Before using the Search command, it is necessary to know how many data blocks are recorded on a cartridge. Tape block addresses are sequential and the first block address convenient method of identifying block addresses is to write a label block in the data field as either the first or last block in a file. This block can then be used as a reference, prior to using the Search command. (Timing for Block Search command is shown in Figure 18.)

Run Self Test 1 (C2)

The command performs a check sum test. Following completion, a Read Status Command should be issued to verify results in Status Byte 3, as shown below. Command timing is illustrated in Figure 19.

Status Byte 3:

- 00 = Self Test not performed
- 11 = Self Test Complete. No error.
- 24 = Self Test failed. Check sum error.

Run Self Test II (CA)

This command performs the following sequential tests and reports status in Bytes 3, 4 and 5. After each test has passed, the next test is automatically run. Following completion, a Read Status Command should be issued to verify results. Command timing is illustrated in Figure 19.

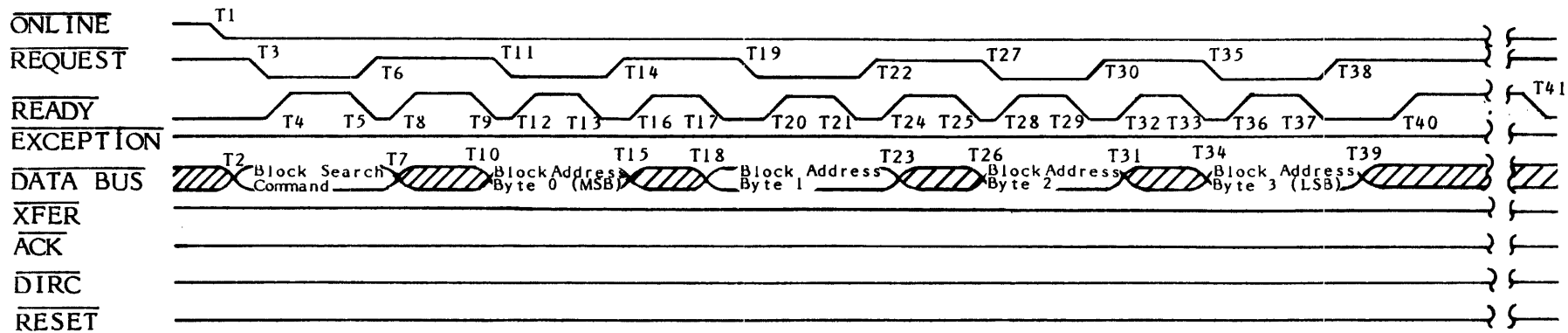
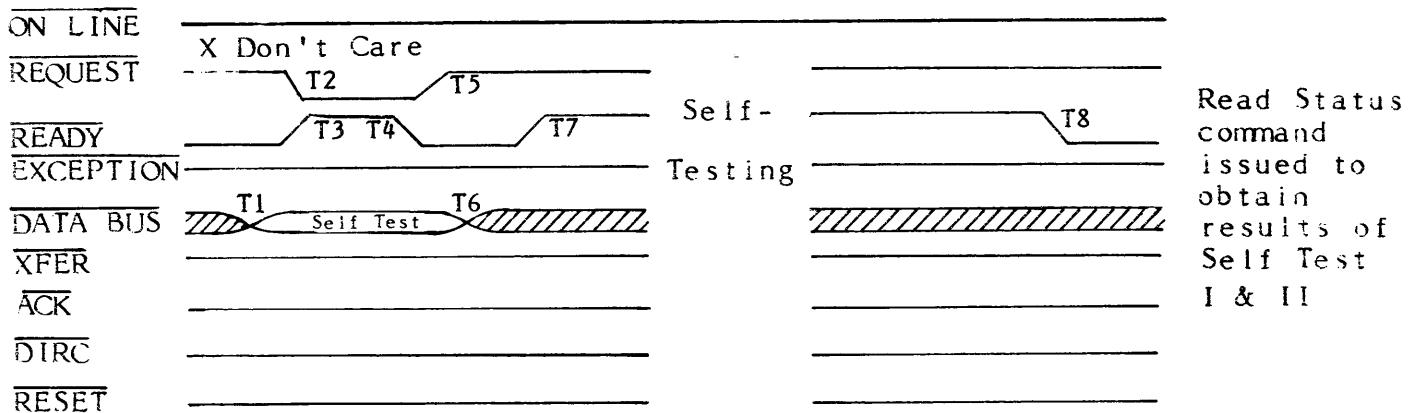

Figure 18. Block Search Command.

ACTIVITY	TIMING	ACTIVITY	TIMING
T1	Host sets ONLINE	N/A	
T2	Host command to bus	N/A	
T3	Host sets REQUEST	T2→T3>0 uS	
T4	Controller resets READY	T3→T4<1 uS	
T5	Controller sets READY	T4→T5>20 uS (500 uS nom.)	
T6	Host resets REQUEST	T5→T6>0 uS	
T7	Bus data invalid	T5→T7>0 uS	
T8	Controller resets READY	20 T6→T8 100 uS	
T9	Controller sets READY	20<T8→T9<100 uS	
T10	Bus data valid byte 0 (MSB)	N/A	
T11	Host sets REQUEST	T9→T11>0 uS	
T12	Controller resets READY	T11→T12<1 uS	
T13	Controller sets READY	T12→T13>20 uS (500 uS nom.)	
T14	Host resets REQUEST	T13→T14>0 uS	
T15	Bus data invalid	T13→T15>0 uS	
T16	Controller resets READY	20<T14→T16<100 uS	
T17	Controller sets READY	20<T16→T17<100 uS	
T18	Bus data valid byte 1	N/A	
T19	Host sets REQUEST	T17→T19>0 uS	
T20	Controller resets READY	T19→T20<1 uS	
T21	Controller sets READY	T20→T21>20 uS (500 nom.)	
T22	Host resets REQUEST	T21→T22>0 uS	
T23	Bus data invalid	T21→T23>0 uS	
T24	Controller resets READY	20<T22→T24<100 uS	
T25	Controller sets READY	20<T24→T25<100 uS	
T26	Bus data valid byte 2	N/A	
T27	Host sets REQUEST	T25→T27>0 uS	
T28	Controller resets READY	T27→T28<1 uS	
T29	Controller sets READY	T28→T29>20 uS (500 nom.)	
T30	Host resets REQUEST	T29→T30>0 uS	
T31	Bus data invalid	N/A	
T32	Controller resets READY	20<T30→T32<100 uS	
T33	Controller sets READY	20<T32→T33<100 uS	
T34	Bus data valid byte 3 (LSB)	N/A	
T35	Host sets REQUEST	T33→T35>0 uS	
T36	Controller resets READY	T35→T36<1 uS	
T37	Controller sets READY	T36→T37>20 uS (500 nom.)	
T38	Host resets REQUEST	T37→T38>0 uS	
T39	Bus data invalid	T37→T39>0 uS	
T40	Controller resets READY	20<T38→T40<100 uS	
T41	Controller sets READY, search complete, target block found	T40→T41 (5-90 sec.)	



ACTIVITY

- T1 Host command to bus
- T2 Host sets REQUEST
- T3 Controller resets READY
- T4 Controller sets READY
- T5 Host resets REQUEST
- T6 Bus data invalid
- T7 Controller resets READY
- T8 Controller sets READY

TIMING

- N/A
- T1→T2 > 0 uS
- T2→T3 < 1 uS
- T3→T4 > 20 uS (500 uS nom.)
- T4→T5 > 0 uS
- T4→T6 > 0 uS
- 20 uS < T5→T7 < 100 uS
- T7→T8 > 20 uS

Figure 19. Run Self Test I & II.

CAUTION

Self test II writes to the cartridge. Ensure that only a scratch tape cartridge has been installed.

1. Speed Test - Monitors tachometer pulses to verify tape speed.
Fail = Status Byte 3 = 23 = Speed error.
= Status Byte 4 = 01 = Test 01.
2. Sensor Test - Rewind the tape, detects BOT, and moves forward to ensure that the sensors detect when the load point is passed.
Fail = Status Byte 3 = 23 = Sensor error.
= Status Byte 4 = 02 = Test 02.
3. Write Test - This test writes 16 data blocks followed by 16 filemarks, and verifies internal write completion for each block.
Fail = Status Byte 3 = 22 = Write/Read error.
= Status Byte 4 = 03 = Test 03.
= Status Byte 5 = 01 = Speed or sensor error.
= 03 = Write timeout error.
4. Read Test - This test verifies read data, read filemark, and gap detect.
Fail = Status Byte 3 = 22 = Read error.
= Status Byte 4 = 04 = Test 04.
= Status Byte 5 = 01 = Sensor or speed error.
= 02 = Overrun detector error.
= 03 = Read timeout*.
= 04 = Unable to read*.
= 05 = Unable to read filemark.
= 06 = Gap detect failure.
* If write protected cartridge is used with Self Test II, Test 4 will fail here, and status Byte 0 will indicate write protect status.
5. Erase Test - This test erases a portion of tape from BOT, and verifies that it is erased.
Fail = Status Byte 3 = 22 = Write/Read error.
= Status Byte 4 = 05 = Test 05.
= Status Byte 5 = 01 = Speed or sensor error.
= 03 = Erase error.
6. Write Test - This test verifies single block write function.
Fail = Status Byte 3 = 22 = Write/Read error.
= Status Byte 4 = 06 = Test 06.
= Status Byte 5 = 01 = Speed or sensor error.
= 03 = Write timeout.

7. CRC Test - This test verifies the CRC check function, and performs a positioning test.

Fail	= Status Byte 3	= 22 = Write/Read error.	
	= Status Byte 4	= 07 = Test 07.	
	= Status Byte 5	= 01 = Speed or sensor error.	
		= 02 = Position error.	
		= 03 = CRC failed.	
Pass	= Status Byte 3	= 11 = Self Test complete.	No error.
	= Status Byte 4	= 07 = Test 07.	
	= Status Byte 5	= 00	

This concludes Self Test II. If all the tests are passed, the tape is erased and rewound to BOT, and the Self Test complete status can be found by issuing a Read Status command. If an error occurred, the test is stopped at that point, and the error status defined, as shown above.

Self Test II is a functional verification of the 540, and may be used as an incoming test or as an isolation test of a specific drive failure. It allows the system to verify quickly that the 540 drive is functioning.

SECTION 3

ERROR PROCESSING & RECOVERY

INTRODUCTION

The 540 formatter provides extensive error processing and recovery sequences which greatly reduce the software effort required to interface the formatter with the host. The information in this Section is only intended to be an introduction to the basic principles of error processing and error recovery for the 540.

The formatter provides statistical information on the number of errors it has automatically processed. When determining system performance, during the evaluation phase, these statistics can be very useful. Table 5 summarizes the Exception Status bytes provided by the formatter in accordance with QIC-02.

Table 5. Exception Status Bytes.

Byte 0	Byte 1	Status	Description	Result
110X0000	00000000	No Cartridge	Drive selected has no cartridge when BOT, RET, Erase, Write, WFM, Read or RFM was issued or cartridge was removed while selected.	Fatal
11110000	00000000	No Drive	Tape drive selected not present when BOT, RET, Erase, Write, WFM Read, or RFM was issued.	Fatal
10010000	X000X000	Write Protected	Tape drive selected contains safe (write protected) cartridge when Erase, Write, or WFM was issued.	Fatal
10001000	00000000	End of Media	Tape passed early warning hole of last track during Write command.	Continuable
100X0100	10001000	Read or Write Abort	Same block rewritten 16 times during Write or WFM command, or unrecoverable reposition error occurred during Write, WFM, Read or RFM command.	Fatal

Table 5. Exception Status Bytes.

Byte 0	Byte 1	Status	Description Tape returns to BOT.	Result
100X0100	00000000	Read Error Bad Block Transfer	Same block retried 16 times to recover block without CRC error; last transfer contained data from erroneous data block for off-line reconstruction.	Continuable
100X0110	00000000	Read Error Filler Block	Same block with 16 retries failed to recover block without CRC error; last block transferred contained filler data to keep total block count correct.	Continuable
100X0110	10100000	Read, Error, No Data	No recorded data detected on the tape.	Continuable
100X1110	10100000	Read Error No Data & EOM	No recorded data detected on the tape; logical EOT holes on last track encountered.	Continuable
100X0110	00000000	Read Error No Data & BOM	No data detected; failed to recover next or subsequent blocks; during reverse reposition, BOT holes in first track encountered.	Continuable
100X0001	00000000	File Mark	File Mark block is read during Read or RFM command.	Continuable
XXXX0000	1100X000	Illegal Command	One of six attempts were made: a. To select multiple drives b. To change Drive select during a Read/Write with tape not at BOT c. To request BOT,	Fatal

Table 5. Exception Status Bytes.

Byte 0	Byte 1	Status	Description	Result
			Retention, or Erase simultaneously. d. To request Write, WFM, Read, or RFM with On-line off. e. To issue command, other than Write or WFM during Write command. f. To issue command, other than Read or RFM during Read command. g. To issue any non-implemented command.	
XXXX0000	1000X001	Power	Power On Reset or a Reset by host occurred.	Fatal

NOTE

Bytes 2 and 3 (DEC) are the data error counter. Bytes 4 and 5 (URC) are the underrun counter.

WRITE BUFFER UNDERRUN

A Write buffer underrun should be avoided because it lowers the data storage capacity of the tape and because it terminates the tape motion, resulting in a tape reposition delay before writing can resume.

Tape streaming implies continuing tape motion with small gaps between data blocks. Therefore, the host must maintain an uninterrupted transfer of data blocks to the 540 formatter. If a full Write buffer is not available to the Write channel when it is required by the formatter, a Write buffer underrun condition occurs and is logged in the statistical counters of the formatter. The formatter then initiates a last block sequence by rewriting the last data block. If a full Write Buffer is not available before the Read data channel finishes checking the last data block the last block sequence is completed, tape motion is stopped, and a write Reposition is initiated.

A complete last block sequence requires 0.528-inches to rewrite the last block, plus 0.300-inches for the extended gap. The data throughput decrease that results from a Write buffer underrun at 90 ips is 0.98-inch per 1.76 blocks.

Read-After-Write Errors

It requires a density of 10,000 flux changes per inch (fci) to provide the 540 with its high-capacity storage. With this density it would be ideal for all recording conditions to be perfect. However, this state is seldom achieved. Therefore, the

540 formatter is designed to accommodate occasional data errors. To ensure that data is written correctly, a Read-After-Write check is made on each block of data immediately after it is written. If an error is found, the block is rewritten. In order to support this Read-After-Write check, the three Write data buffers are allocated in this sequence:

- o Buffer one stores the block that is being written.
- o Buffer two stores the block being checked by the Read-After-Write, so data remains available for rewriting.
- o Buffer three stores the next data block transferred by the host.

To perform Read-After-Write checking, the tape drive head is designed with two gaps, one for writing and one for reading. These gaps are separated by a distance of 0.3-inch. For tape streaming, the inter-record gap length is only 0.013-inch; therefore, the formatter must begin writing the next record before the previous record has been completely verified by the Read-After-Write.

Read-After-Write error recovery is automatically processed by the formatter. Because this process is invisible to the host, a statistical counter is provided to inform the host of the number of blocks automatically rewritten by the formatter. Each rewritten block subtracts one block from the total capacity of the tape. Because each Error Recovery sequence normally rewrites two data blocks, the statistical counter normally contains an even number which usually represents one half the number of soft errors.

READ BUFFER UNDERRUN

In normal Read operations, the formatter locates a block of data, transfers it to the buffer memory in the formatter, and performs a CRCX check for errors. If no error occurs, the block of data is transferred to the host. The formatter contains three buffer memories. One is allocated to the Read Channel, one to the host, and one is held in reserve to be used if the host system temporarily gets behind the transfer throughput rate of the Read channel. This buffer memory configuration provides a 1-block buffer that allows short-term host system contentions before the Read operation overruns the buffer memories in the formatter.

If the host system, with the three buffer memories, fails to stay ahead of the Read channel, a Read buffer underrun occurs. This condition arises when the Read channel has located the next block of data and none of the three buffer memories in the formatter are available for data storage. To prevent the loss of that block, the formatter must stop the tape. The formatter then performs a Read reposition sequence and then resumes the normal read operation sequence. A statistical counter is provided in the formatter to keep track of the number of Read buffer underrun occurrences.

Read Data Errors

The formatter verifies Write data with a Read-After-Write check, because there are a large number of variables associated with reading data that can result in temporary

Read data errors. The error recovery process internal to the formatter rereads the Block-In-Error(BIE) up to 20 times during error recovery before informing the host that an unrecoverable Read error has been detected. The process of rereading a BIE is referred to as Soft Error Retry (SER) sequence. This process stops the tape, performs a Read reposition sequence, then continues the normal Read sequence.

If the error is a BIE and is not recovered after 20 tries, the formatter transfers the BIE, if it can be located, terminates the Read operation, and alerts the host that the transferred BIE has an unrecoverable Read error. Unless aborted, an available data block is always transferred. If another block, rather than the BIE is transferred, the host is alerted to this fact.

Each SER sequence increments, by one, a statistical counter in the formatter. During a Read operation, data blocks with CRC errors that were rewritten during the Write operation are ignored.

Read Sequence Errors

The formatter appends a block address byte to each data block written on the tape. Blocks rewritten because of a Read-After-Write detected error, alter the normal sequence of the blocks written on tape.

During Read operations, a block sequence error can be caused by encountering a block that was read from tape without a CRC error, but with an unexpected address. Block sequence errors cause the formatter to perform an SER sequence. The SER sequence for a Read sequence error is the same as for a Read data error. If the limit of 20 SER sequences is exceeded without re-establishing the proper block address, the formatter transfers the BIE, if it can be located; terminates the Read operation; and alerts the host that the transferred BIE has an unrecoverable read error. Unless aborted, an available data block is always transferred. If another block, rather than the BIE is transferred, the host is alerted to this fact.

READ OR WRITE ABORT ERRORS

A Read abort or Write abort prevents a Read or Write sequence from being completed. An abort is done when, after 16 rewrites of the same block, there is an unrecoverable reposition error.

NO DATA DETECTED ERRORS

The formatter searches a length of tape, equal to approximately 32 block times, for a specific block on the Read channel. If the block is not found, the formatter performs a Read reposition sequence and repeats the search up to 20 times. If the block is still lost, the formatter alerts the host that there is an unrecoverable data error due to no data being detected, and does not transfer a block of data.

SECTION 4

REPOSITION TIMING

INTRODUCTION

There are two types of Write buffer underruns. Type 1 allows continuation of the streaming mode. Type 2 is followed by a reposition operation, which is conducted by a Write buffer underrun handling routine. A normal Write operation and the two types of Write buffer underrun conditions are shown and described in Figure 20. A flow chart of a Write buffer underrun routine is shown in Figure 21.

Type 1. Write Buffer Underrun Event Sequence

- a. Host system fails to fill buffer in one block time.
- b. Last Block (N) is rewritten.
- c. Host fills buffer with block N + 1 while block N is being rewritten.
- d. Tape keeps streaming and writing is continued with block N + 1.

Type 2. Write Buffer Underrun Event Sequence

- a. Host system fails to fill buffer in one block time.
- b. Block N is rewritten, but host system has not yet transferred block N + 1 to buffer.
- c. Formatter writes 0.3-inch gap.
- d. Tape motion ramps down and stops.
- e. Formatter waits for host system to load buffer.
- f. When host system has filled buffer, tape motion begins in opposite direction and tape is run back approximately 10 blocks.
- g. Tape motion stops briefly, then is reversed to original direction of tape motion during Write operation.
- h. Formatter scans incoming bit stream from Read logic for block address of last block written.
- i. When block address is found, formatter searches for extended gap.
- j. When extended gap is found, formatter appends another 1 ms of gap, followed by standard 528.5-byte block format (512 user data bytes), which contains block N + 1.

Figure 20. Write Buffer Underrun Events.

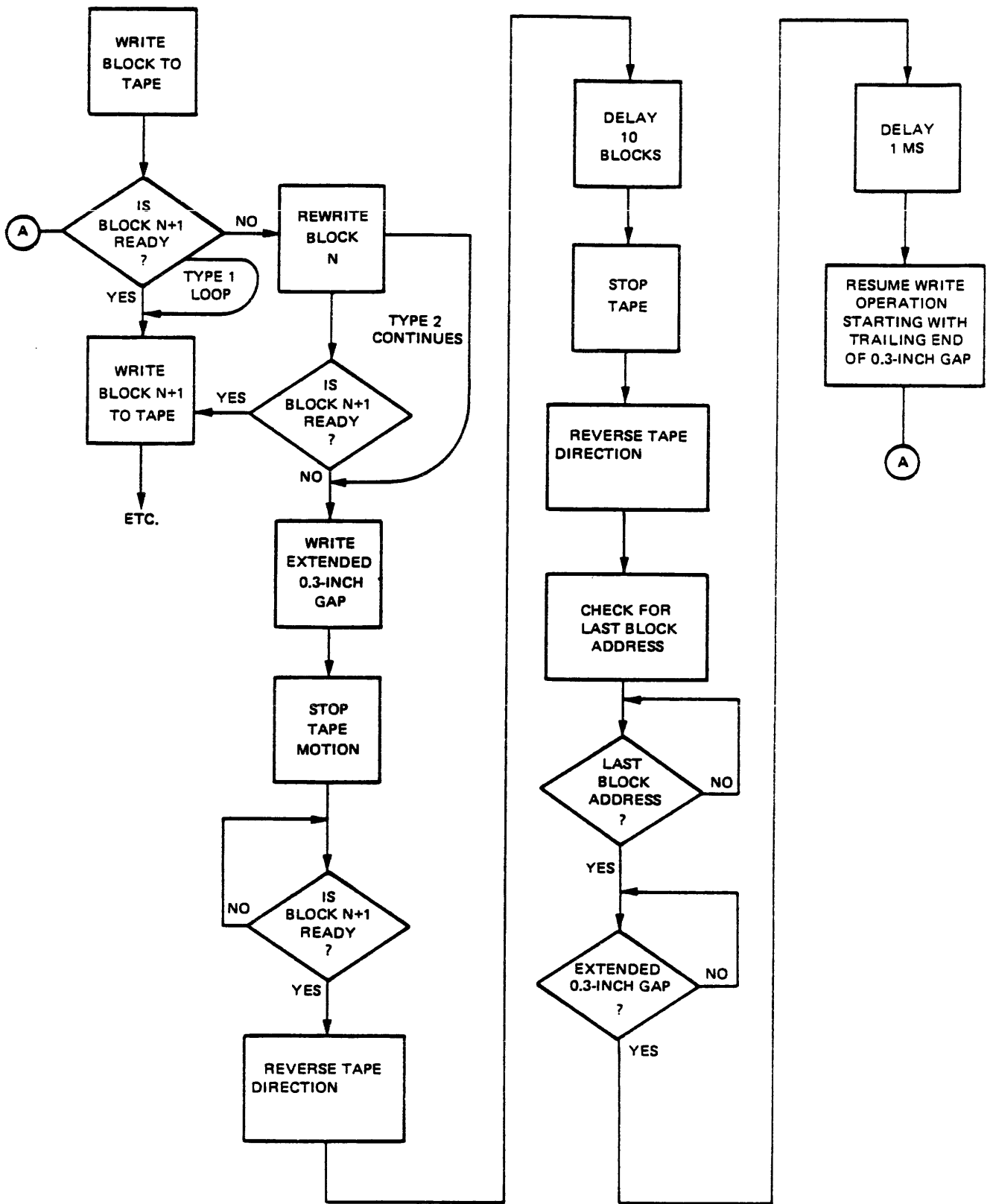

Figure 21. Write Buffer Underrun Flowchart.

WRITE BUFFER CRITICAL TIMING

To maintain tape drive operation in a streaming mode without logging a Write buffer underrun on the statistical counter, a complete 512-byte transfer of user data must be accomplished with 5.8 ms.

If the host fails to respond within one block time, the formatter rewrites the last block from the host. The host then has an additional block of Write time to fill a Write buffer, before the formatter drops out of the streaming mode. The critical time elements are shown in Figure 22.

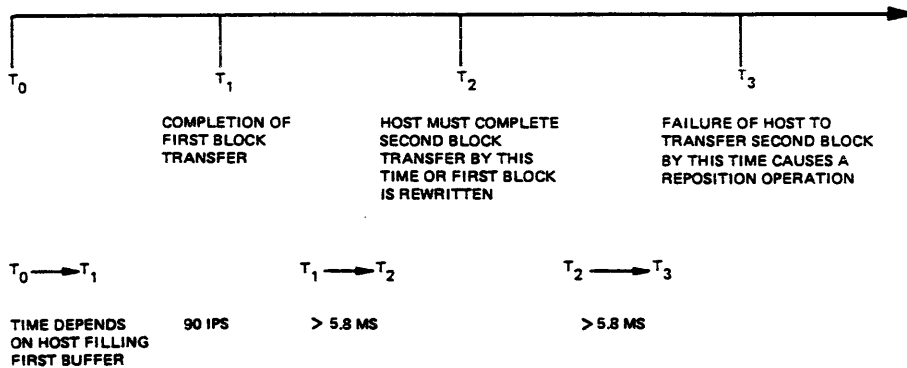

Figure 22. Critical Write Timing Elements.

Write Reposition

The timing sequence of a Reposition is shown in Figure 23.

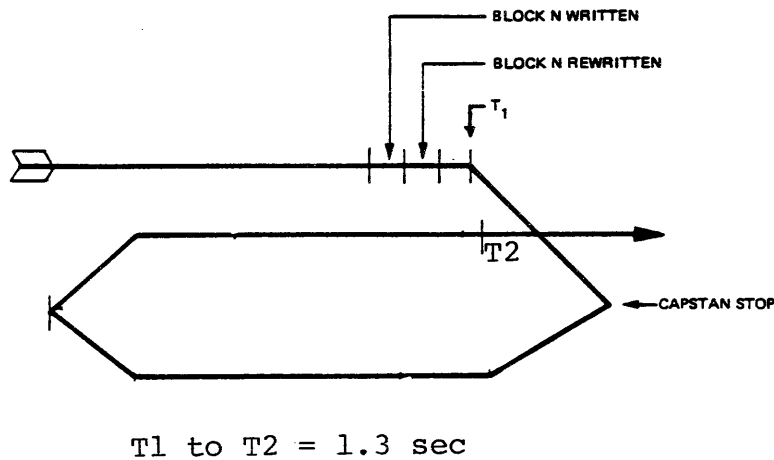

Figure 23. Reposition Timing Sequence.

SECTION 5

CONFIGURE OPTIONS

JUMPER CONFIGURATION

The select drive jumper configuration with enhanced formatter board (P/N 940524) is shown below:

NNNN	W6/W7	Select
0001	In/In	Drive 0
0010	Out/In	Drive 1
0100	In/Out	Drive 2
1000	Out/Out	Drive 3

The parity jumper configuration with enhanced formatter board is shown below:

W8	W9	W10	Parity
In	Out	In	Enabled
Out	In	N/A	Disabled

cipher[®]

P.O. Box 85170
San Diego, California 92138
Telephone: 1-800-4-CIPHER
TWX: 910-335-1251