

# Altergo Products Inc SHADOW II Teleprocessing Monitor

## ■ PROFILE

**Function** • multithreaded, multitasking TP monitor.

**Computers/Operating Systems Supported** • all IBM DPD and plug-compatible computer systems; DOS, DOS/VS, DOS/VSE, OS, OS/VS1, OS/VS2(SVS), and OS/VS2(MVS).

**Networks & Protocols** • SNA/SDLC, BSC 1/2/3, and asynchronous.

**Language Interface** • COBOL, PL/1, and IBM assembler.

**DBMS/Interfaces** • DL/1 DOS/VS (standard and entry) and most major commercial DBMS.

**Native Languages** • optional CPG.

**TP & File Access Methods** • BTAM, TCAM, VTAM, and SHADOW II STAM; SAM, ISAM, BDAM, VSAM, and SHADOW II USAM (proprietary).

**Terminals** • most standard IBM devices including 3790 Mod 5; Systems 32/34 and Series/1 through BSC; EMI TC 500; OLIVETTI TC349B1; all Teletype models.

**Security** • basic named sign-on; passwords and security keys available as kernel options.

**Logging/Accounting** • kernel-optional transaction accounting system.

**Failure Recovery** • kernel-optional automatic pre-/post-update journaling with warm restart.

**Current Version** • 3.1.

**Installations** • approximately 700 worldwide.

**Comparable Systems** • all full-function multithreaded TP monitors targeted for non-IMS IBM users.

**Vendor** • Altergo Products Inc; 400 West Cummings Park, Woburn, MA 01801 • 617-938-8811.

## ■ ANALYSIS

SHADOW II is one of the few remaining independent mainframe TP monitors still being actively marketed against IBM's dominant CICS/VS. It is a product that has undergone a series of ownerships unrivaled by any other product of its type. Initially developed and marketed here in the United States by Altergo Software, the American arm of the Altergo Ltd, England-based owner, the product

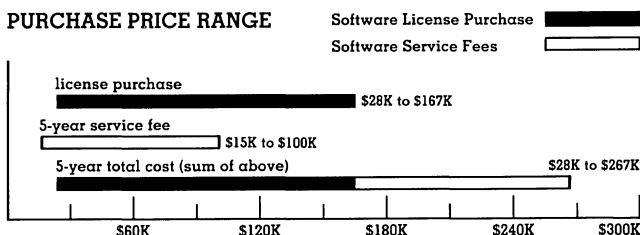

**ALTERGO PRODUCTS SHADOW II PRICING** • solid bar shows typical min/max configuration price range; open bar shows the corresponding service range for a 5-year period, but the fees are computed for 54 months because the first 6 months of service are included in license purchase price • **MINIMUM CONFIGURATION** is a DOS/VS(E)-level local terminal support system with no options • **MAXIMUM CONFIGURATION** is the OS/MVS version with all allowable options, including online mapping, automatic logging/recovery, DBMS interface support, VTAM Interface, System Predictor, FQS query facility, and CPG language.

became so popular that Altergo expanded rapidly throughout the country, establishing branch offices in most major cities. A few years later, an agreement was reached with Insac, an entity receiving significant support from the British government, whereby SHADOW II would be marketed and supported from their Atlanta, Georgia, headquarters. Not too long after this acquisition, Insac was, in turn, acquired by Britton-Lee, who proceeded to belly-up Insac. Realizing the importance of maintaining the satisfaction of the existing SHADOW II user base, Altergo Ltd set up its own stateside office in Massachusetts, and called it Altergo Products Inc. In the latest move, Altergo Ltd, the parent organization, was acquired by Thorn-EMI, a large conglomerate which controls such European software outlets as Software Sciences. Altergo Products Inc is now part of the Thorn-EMI(USA) empire, falling under their Information Technology Division. EMI may be best known for their film productions and their industrial electrical and electronic products. Hopefully, Altergo Products can now settle down and define the marketplace for their product line, which now includes an imported database management system called Data-Man II, a product originally marketed almost exclusively in Canada. Part of the commitment being made by the new ownership is the enhanced support of its product line, and an expansion of their user base into companion products such as FQS, a user-friendly query language for use with SHADOW II or CICS/VS. Original plans for expansion of the Altergo support office posture have been shelved for the time being, but will be reevaluated at a later time.

It is only fair to point out that SHADOW II ranks as one of the better commercial TP monitors on the market. Many strong claims are made for SHADOW II, such as the claim that it uses 25% less real storage than some other, more popular TP monitor (which we believe is referring to IBM's CICS), and that it uses 30% less virtual storage, 10% less library space, runs twice as fast, and can be installed and ready to operate in about 1 hour. These claims are hard to substantiate when measured against such independent offerings such as Software AG's COM-LETE and Mathematica's MPGSWIFT. Although extremely competitive, there does not seem to be any overwhelming competitive edges.

One of SHADOW II's most important assets, independent of the direct capabilities of the system, is a strong supporting cast of related products from Altergo. We treat this subject here because it is a corporate strength rather than a product strength. A directly related product (really a SHADOW II option) is an RPG II-like TP language called CPG (Communications Program Generator). A more distantly related product is QUOTA II, an interactive program development/maintenance package that can also operate in a standalone mode under a subset of SHADOW II. FQS is the newest addition to the product line. This query system allows SHADOW II or CICS/VS users to directly interrogate associative databases.

Taken altogether, SHADOW II with its closely and distantly related Altergo sibling products provides one of the better TP-related productivity enhancement package assemblies currently available from any vendor. Hopefully, the ownership of the product line has finally been resolved.

## □ Strengths

SHADOW II is fully multithreaded and multitasking, as befits a good TP monitor, but it seems to accomplish these somewhat difficult tasks in a relatively straightforward, uncomplicated way. Briefly, SHADOW II identifies every component (terminal, line, known program, etc) in the system as a task and gathers the task identities into a central table that drives a recycling multiplexer. The basic cycle time varies, as only tasks that are ready to run

## Altergo Products Inc SHADOW II Teleprocessing Monitor

are scanned. However, selected tasks can be prioritized in the scheduling chains. Each task execution is also monitored for internal wait points (e.g., I/O calls) to control asynchronous advances to the next task in the queue. Each task is, in effect, part of a continuous thread, and tasks can be easily added or deleted without having to do a new sysgen to reconfigure the system. This simple but effective scheme is selected to illustrate the underlying design strength that generally characterizes SHADOW II's structure.

**Limitations**

SHADOW II is intended primarily to interface with DOS/VS DL/1 and secondarily with the more popular commercial DBMSs. It cannot interface with IMS. Its range of use is thus restricted to DOS (VS and VSE) users and to non-IMS OS installations. Altergo claims that IMS is simply too complex to accommodate (however, FQS is available to both DL/1 and IMS users) and, for similar reasons, does not intend to produce a SHADOW II version that will run under the CMS component of VM/370 in the near future. Altergo also has no immediate plans to implement a SQL/DS interface. These decisions could cause the generally high quality of SHADOW II and related Altergo products to be inaccessible to a substantial body of IBM users and sharply restrict the IBM upgrade path for current SHADOW II users.

**OVERVIEW**

**Terms & Support**

**Terms** • SHADOW II and related software product licenses may be acquired on a permanent or rental basis; rental terms are 2, 3, or 4 years; respective monthly rates are a function of purchase price: 5.5%, 4.75%, and 4% • a separate charge is levied for installation and education.

**Support** • maintenance is included for the first 6 months of a permanent license; maintenance and license renewal is then billed annually at 12% of the prevailing license purchase price; maintenance is bundled into all rental contracts.

**Product Definition**

The basic SHADOW II kernel is offered in 5 operating-system-dependent versions. Kernel facilities can be extended through an extensive range of related options. Related products consist of CPG, an RPG-like TP monitor language; QUOTA II, a program development/maintenance aid; and FQS, an online, end-user query facility. Please refer to Native Languages section of this report for a discussion of CPG, and to Program Development and Special Facilities for discussions of QUOTA II and FQS.

**SHADOW II Kernel:**

DOS/VS(E) Version • Local Terminal Support:	<u>\$28,000 lcns</u>	<u>\$1,330 mo</u>	<u>\$3,360 serv</u>
DOS/VS(E) Version • Local/Remote Terminal Support:	<u>32,500</u>	<u>1,544</u>	<u>3,900</u>
OS (MFT/MVT) Version:	<u>50,000</u>	<u>2,375</u>	<u>6,000</u>
OS/VS1 & OS/VS2(SVS) Version:	<u>55,000</u>	<u>2,613</u>	<u>6,600</u>
OS/VS2(MVS) Version:	<u>70,000</u>	<u>3,325</u>	<u>8,400</u>
<b>Kernel Options:</b>			
On-Line Screen Mapping • DOS/VS(E) Version:	<u>9,200</u>	<u>437</u>	<u>1,104</u>
On-Line Screen Mapping • OS/VS Version:	<u>11,000</u>	<u>523</u>	<u>1,320</u>
Automatic Logging & Recovery • DOS/VS(E) Version:	<u>9,000</u>	<u>428</u>	<u>1,080</u>

Automatic Logging & Recovery • OS/VS Version:	<u>11,000</u>	<u>523</u>	<u>1,320</u>
DBMS Interface • DOS/VS(E) Version:	<u>4,500</u>	<u>214</u>	<u>540</u>
DBMS Interface • OS/VS Version:	<u>5,000</u>	<u>238</u>	<u>600</u>
System Predictor • DOS/VS(E) Version:	<u>4,100</u>	<u>195</u>	<u>492</u>
System Predictor • OS/VS Version:	<u>5,100</u>	<u>243</u>	<u>612</u>
Transaction Accounting • DOS/VS(E) Version:	<u>3,500</u>	<u>166</u>	<u>420</u>
VTAM Interface • DOS/VS(E) Version:	<u>6,000</u>	<u>285</u>	<u>720</u>
VTAM Interface • OS/VS Version:	<u>6,000</u>	<u>285</u>	<u>720</u>
Systems Programmers & Operators Transaction (SPOT) • DOS/VS(E) Version only:	<u>4,900</u>	<u>233</u>	<u>588</u>

**FUNCTIONAL FACILITIES**

**Computers/Operating Systems Supported**

SHADOW II runs on all IBM and plug-compatible mainframe computer systems under all OS and DOS operating systems. It does not currently run under the CMS component of VM/370.

**Minimum Operating Requirements**

Minimum main, or real, and virtual storage requirements are 2K and 60K bytes, respectively. Disk storage requirements for source statement and relocatable code are 203K and 339K bytes, respectively. These minimums apply to a small configuration operating under DOS. Operating requirements for OS-based systems are substantially higher.

**Protocols & Network Access Methods**

SHADOW II is provided with its own reentrant terminal access method, called STAM, which can handle most of the standard IBM terminals. It can also accommodate BTAM, TCAM, and VTAM/SDLC access methods. BSC1/2/3 support is provided to connect with certain smaller computer systems such as Series/1 and Systems 32/34. SHADOW II is wholly compatible with SNA.

**File/DBMS Interface**

Fully supported file access methods are SAM, ISAM, BDAM, and VSAM. Sequential data sets are accommodated through BSAM or QSAM. Multiple concurrent positioning and access techniques for disk resident data are provided by a special SHADOW II method called USAM. BDAM data sets can be handled in keyed and nonkeyed formats. VSAM data sets are supported in entry sequenced, key sequenced, or relative record formats.

Most of the major IBM and commercial DBMS products support interfaces to SHADOW II. Significant commercial systems are Software AG ADABAS, Cullinet IDMS, Mathematica RAMIS II, and Cincom TOTAL. All versions of IBM DOS/VS DL/1, with the exception of IMS, are accommodated in full multitasking/multi-partitioned operating modes with complete logging and recovery facilities.

*LCNS: one-time license purchase price, which includes first 6 months of service. MO: monthly charge for 3-year lease/rental plan, which includes maintenance. SERV: annual charge for ongoing service after first 6 months of the license purchase. Prices effective as of August 1984.*

# Altergo Products Inc SHADOW II Teleprocessing Monitor

**Multithreading Support**

Multithread operation is supported through 3 memory tiers, which provide basic buffer/spooling facilities through a simple traffic-volume-dependent queueing facility. The first memory tier consists of a 3-part static storage. One part is effectively a dictionary that contains globally accessible data about all system tasks. The second part is an address vector table used by nonresident programs to locate address constants and other nucleus-resident information. The third part is a task-related control block that supplies, for example, information about a preceding conversation.

The second memory tier is essentially the spooling area and consists of fixed and variable buffer storage. The fixed portion provides the basis for queue management; the variable area is allocated as required during each task execution.

The third tier provides temporary storage facilities in main storage and scratchpad facilities on disk.

Tasks can be queued in main or disk storage areas. Each queued-task execution sequence (thread) is monitored and logged, and automatic facilities are provided for warm restart of abending threads. Task processing can also be event driven for asynchronous queueing.

**Message-Switching Facilities**

Messages of up to 72 characters can be switched among all terminals (including system console) in a SHADOW II-controlled system.

**USER INTERFACES**

**Languages Supported**

COBOL, PL/1, and IBM assembler are fully supported by SHADOW II. Terminal-oriented functions are handled as language extensions that are intercepted by SHADOW II to activate macros for PL/1 and assembler and preprocessed commands for COBOL. COBOL working storage may optionally be multithreaded, allowing a trade-off between performance and a natural batch-like COBOL coding style.

**Native Languages**

**CPG** • a high-level RPG II-like terminal programming language intended as a productivity enhancement feature to replace or to be used with COBOL or PL/1; file independence, and thus substantial portability, is achieved through a file specification library designated the CPG Dataset Processor; TP-dependent functions are consolidated in a separate Central Routine Library; specifically intended to simplify transaction processing chores, CPG also supports interactive program testing, online screen editing/formatting, and maskless screen mapping. CPG can be integrated with DOS/VS DL/1 or with Cullinet's IDMS database management systems.

**CPG • DOS/VS(E) Version:**

\$29,000 lcns	\$1,378 mo	\$3,480 serv
---------------	------------	--------------

**CPG • OS/VS and IDMS Version:**

35,000	1,663	4,200
--------	-------	-------

**Host Operating System Interface**

**Batch Processing**

SHADOW II is wholly transaction oriented in the sense that a "transaction" in the TP environment can be equivalent to a "batch" in the operating system. However, a batch program can consist of multiple transactions and is thus best defined from the operating system perspective.

In addition to the customary high-level language programming interface for batch operations, the SHADOW II kernel contains an auxiliary utility that supports batch simulation for program testing. Full reporting and other statistical facilities can be applied to all test runs.

**Transaction Processing**

Full facilities for transaction management are integrated into the SHADOW II kernel. Transactions are coordinated through a simple transaction control table that identifies the initiating key and the program targeted for control transfer. The type of transaction is then identified, and the transaction is processed. Each transaction consists of one or more modules, which can be further subdivided into units of work. Each transaction can thus be logically segmented to support operational multiplexing (multithreading). The entire transaction process is overlaid by a "tasking" structure that allocates an identity to every connectable terminal, line, batch program, etc. The task identities are gathered into a control block and the block is continually sequenced to provide task dispatching control. The general task dispatching sequence is cyclic by priority, where the total cycle time is dependent on the number of tasks within a completed event. Each task is monitored for internal "wait" points, such as I/O calls, to support asynchronous intrapartition task switching. Multipartition switching support is provided for DOS/VS DL/1 users.

**Program Development & Special Facilities**

**QUOTA II** • program development and source program maintenance package; operates in batch and online modes; supports JCL procedural set-ups; develops test data and provides full documentation; permits modules to be submitted to POWER/VS with wrapped-around JCL; provides full views of input/output batch spool queues with selected views of batch data; supports full- and split-screen editing with forward and backward paging; hierarchical HELP screen facility is provided for operator assistance; security integrity controls can be graded through 4 levels of status flags plus passwords; protection can be applied across partitions; module activity history can be traced through audit trails; archiving and backup support can be applied selectively to the module level with automatic or controlled restore; can function as a stand-alone package (non-TP) operating under a subset of SHADOW II, in conjunction with SHADOW II in a full TP environment, or as a single transaction within a CICS partition; QUOTA II can operate in batch-only mode, if required, to maintain operations during a TP system failure • not available for OS/VS2(SVS) and (MVS) systems.

**QUOTA II • DOS/VS(E) Version:**

\$19,000 lcns	\$902 mo	\$1,260 serv
---------------	----------	--------------

**FQS (Friendly Query System)** • an online query facility designed for end-user ad hoc inquiries; enables users to make queries on existing files using standard IBM access methods, including DAM and VSAM, as well as Altergo's SHADOW II USAM; provides user option of hard copy or CRT display; supports all versions of the IBM 3270 display unit • consists of 4 main functions: query, file definition, user definition, and printer definition; the query facility is a menu-driven, user-prompted facility that displays a list of authorized access files; selection criteria may consist of compound conditions which FQS tests automatically; the user definition is maintained for each authorized user and includes authorization to make queries on specific files; a file definition is maintained for each file on which queries will be made, including field formats for those files which are available for display or test during a query; printer definitions contain a default option if most terminals are using the same printer • FQS provides users with the option of saving a query specification so that it may be rerun without having to be respecified; a user exit is provided for access to nonstandard files or DBMSs.

**Friendly Query System (FQS) • DOS/VS(E) Version:**

20,000	950	2,400
--------	-----	-------

**Friendly Query System (FQS) • OS/VS Version:**

24,000	1,140	2,880
--------	-------	-------

**Security Facilities**

Basic security is handled through a named sign-on. More elaborate optional security facilities include passwords and single/multiple table-controlled security keys.

## Altergo Products Inc SHADOW II Teleprocessing Monitor

---

### Failure Recovery Methods

Logging is provided automatically to support both recovery and backout procedures. The recovery journal retains after-images of all updated records. The backout journal retains pre-update images of all records selected for update. The logging facilities automatically support warm restart for selected transactions and provide detailed information to the operator when manual intervention is required.

### USER REFERENCE LIST

The following users can be contacted directly by Data Decisions subscribers for firsthand opinions and advice about the product covered in this report:

- Mr. David J. Hayes  
Vice President of Data Processing  
Purity Supreme  
312 Boston Road  
Billerica, MA 01862  
Tel: 617-288-8030 Ext 260
- Mr. Ronald A. Flink  
Corporate Director, Mgmt Information Services  
Handy & Harmon  
850 Third Avenue  
New York, NY 10022  
Tel: 212-752-3400 Ext 263

- Mr. Charles Davis  
Systems and Programming Manager  
Dade Savings & Loan  
101 East Flagler Street  
Miami, FL 33131  
Tel: 305-376-5216
- Mr. Robert J. Vint  
Vice President, Systems & Data Processing  
Sundt Corp  
4101 East Irvington Road  
Tucson, AZ 85726  
Tel: 602-748-7555 Ext 210
- Mr. Walter C. McDaniel  
Data Processing Manager  
California Almond Growers  
1802 C Street  
P.O. Box 1768  
Sacramento, CA 95808  
Tel: 916-446-8351

---

● END



# Amdahl 2211 T1 Multiplexer

## Models 2211-01 & 2211-03

### ■ PROFILE

**Function** • bit-interleaved TDM designed for T1 carrier facilities • point-to-point and multinode applications; down-line loading of remote multiplexer • handles asynchronous and synchronous input data • trunk speeds to 1.544M bps.

**Communications/Networks** • supports asynchronous and synchronous data channels in any combination up to 96 channels; up to 42 voice channels • asynchronous speeds of 110 bps to 19.2K bps; synchronous speeds of 300 bps to 460.8K bps • trunk interfaces consist of RS-232C/CCITT V.24, CCITT V.35, AT&T 301/303, MIL-Std-188-114 unbalanced, MIL-Std-188C unbalanced, and T1 bipolar (DSI) • single composite link (trunk) standard; secondary composite link with optional redundant facilities • point-to-point and multinode applications; supports cascaded multiplexers.

**First Delivery** • 1983.

**Systems Delivered** • approximately 70 pairs.

**Comparable Systems** • Avanti Ultra Mux, Bayly Omniplexer, Codex 6240, Datatel DCP9100, DCA Netlink, General DataComm Megamux 1258, Infotron T Mux, Paradyne DCX-T1, and Timeplex Link/1.

**Vendor** • Amdahl Corporation, Communications Systems Division; 2500 Walnut Avenue, Marina Del Rey, CA 90291 • 213-822-3202.

**Distribution** • worldwide through local Amdahl sales offices.

### ■ ANALYSIS

The Amdahl Model 2211 represents a commercial breed of multiplexer designed specifically to combine a wide range of asynchronous and synchronous data paths on a single link referred to as a **T1 carrier**. The term T1 carrier is telco nomenclature for a digital line with a bandwidth of 1.544M bps within the United States, Canada, and Japan, and 2.048M bps elsewhere.

The T1 carrier service has been used by the telephone company for many years to carry digitized voice and data. Until early 1983, however, T1 was unavailable as a tariffed service to private users; those who required it had to subscribe to independent carriers, or had to install their own microwave links. Users can now order the service under AT&T Communications' Accunet T1.5 service.

T1 offers the end user a high-volume communication facility at

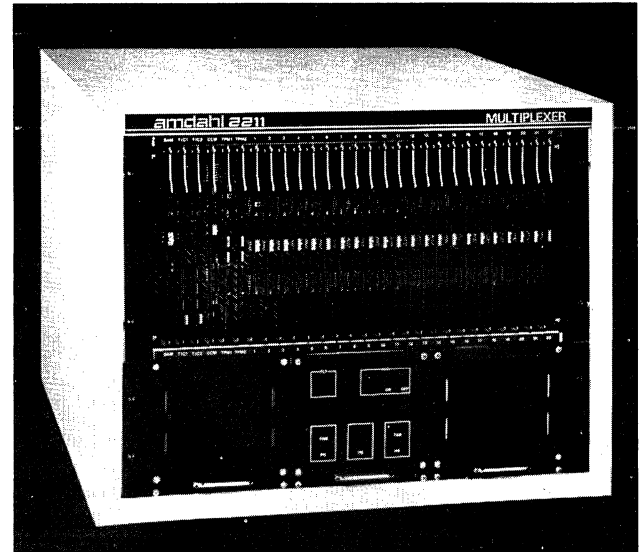

low cost. For example, a single 1.544M-bps link can support up to 24 64K-bps channels and the transmission quality of the service is also superior. AT&T guarantees a point-to-point, full-duplex link with an error rate of **no more than 1 bit in 1 million over a 1 day period**. The current cost for service between points served within a central office is \$450 per month.

The T1 bandwidth is ideal for combining a large number of communication links (paths) such as may be the requirements of office automation. For example, such applications as digital voice requires 32K to 64K bps, mainframe-to-mainframe file transfers need 64K bps, and compressed video must have at least 450K bps. A T1 multiplexer can accommodate these requirements.

The Amdahl Model 2211 is offered in 2 versions: the 2211-01 and the 2211-03. Both handle asynchronous and synchronous data and voice channels directly, and both can be configured with central logic redundancy. They differ in that the 2211-03 has redundant common logic and accommodates more channels. The facility to handle asynchronous data directly is a strong advantage. Some Amdahl competitors offer products which accommodate synchronous channels only. To interface asynchronous data, users must purchase separate multiplexer pairs; 1 multiplexes the channel data and converts it to a synchronous data stream which in turn is fed to the T1 multiplexer; the other demuxes the data and reconverts it to an asynchronous stream.

The 2211 is an easy product to use. All channel parameter configurations are soft-configured from a terminal with the user prompted in English. All configuration parameters are retained in EAROM, making them impervious to power failures. Many other multiplexers employ RAM for configurations, and require battery backing to ensure data integrity in case of power failure. To further safeguard the configuration parameters, Amdahl has added storage to each channel card. Thus a central logic failure will not require a complete reconfiguration of the multiplexer.

Both the 2211-01 and 2211-03 are offered as single-rack units with 1 optional expansion shelf. Both basic racks accommodate

### PURCHASE PRICE RANGE

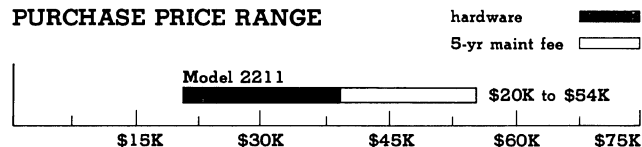

**AMDAHL 2211 SERIES PURCHASE PRICING** bar graph covers price ranges between "small" and "large" configurations and associated 5-year maintenance • **SMALL 2211** consists of 2211-01 base unit accommodating 44 I/O channels, common central logic, 5 synchronous (RS-232C) and 5 synchronous (CCITT V.35) channel cards, 10 asynchronous channel cards, a trunk interface converter, an equipment channel interface converter, a network console printer, and a power supply • **LARGE 2211** consists of 2211-03 base unit accommodating 44 I/O channels, redundant common control logic, 10 synchronous (RS-232C) and 10 synchronous (CCITT V.35) channel cards, 20 asynchronous channel cards, a channel expansion shelf, a network console video terminal, an equipment channel interface, a trunk interface converter, and 2 power supplies.

## Amdahl 2211 T1 Multiplexer

### Models 2211-01 & 2211-03

up to 44 channels; the expansion shelf allows an additional 52 channels bringing the total to 96. If the expansion shelf is supporting redundancy, only 92 channels are supported.

In summary, the Amdahl product is one of the more attractive T1 multiplexers on the market. It supports a wide range of channel parameters, is easy to expand, and is a **proven performer**. Prior to Amdahl acquiring the product, a version of it built and sold by the Tran Corporation had established an impressive performance record as part of the Canadian Telephone Company's Dataroute service. The 2211 is still produced by Tran, which ensures the high quality of the product.

#### □ Strengths

The principal strengths of the 2211 are its configuration flexibility, ease of expansion, redundancy, ease of use, and overall efficiency. As was mentioned under Analysis, both versions of the 2211 directly accept asynchronous, synchronous, and voice channels. While this might seem like a minor point, it isn't. Vendors that handle synchronous data only require users to employ additional multiplexers to interface asynchronous channels to their T1 multiplexers. This adds additional expense in the initial purchase of auxiliary multiplexers, plus the ongoing cost of maintenance. And, of course, any time another component is introduced, the risk of failure increases.

Like a number of vendors, Amdahl reduces the risk of a system failure by offering redundant central logic. Since this, along with the power supply, are most vulnerable to failure in any multiplexer, redundancy in both areas substantially reduces the risk of failure.

With the 2211, all channel configurations are entered from a control terminal and are maintained in EAROM in central logic. Thus a power failure will not cause the loss of configuration parameters. For further redundancy, each channel card contains storage which retains its configuration parameters. Consequently, a failure in central logic will not result in the loss of the channel configuration parameters.

The redundant facilities also provide **alternate path routing** should the primary link fail. In this case, the link switchover is automatic with **no interruption** in service.

The soft-configured nature of the 2211 is another strong asset. As mentioned, users enter configuration parameters from a terminal keyboard. If the terminal employs a CRT, the user can also review the configurations. By contrast, some vendors employ panel-mounted rotary switches to set channel parameters, which severely limit operating flexibility and ease of use.

The 2211's method for handling channel and link data also adds to its overall efficiency. The time slot assigned to synchronous data channels is exactly the same as the channel data rate. For asynchronous data, the smallest time slot is 110 bps. Thus, very little of the available bandwidth is wasted. Some vendors assign a fixed-sized time slot which means that data rates above that figure require more time slots while rates below waste capacity.

The 2211 message train format conforms to the specifications established by AT&T for T1 service. Under that specification, any 24-bit interval must have at least 3 "ones" and no more than 15 consecutive "zeros." This is done to keep the carrier timing aligned. If a multiplexer conforms, 99.4 percent of the bandwidth is available for data. If the multiplexer does not conform, the phone company requires the use of a Model 306 modem to establish compatibility. Besides the extra cost of the modem, the 306 reduces available bandwidth by 12.5 percent. This is equivalent to 1.34M bps using 306 versus 1.53M bps for a multiplexer that conforms.

For users with remote terminals or controllers, Amdahl offers 2 simple facilities for interfacing with the 2211. The first is called Synchronous Loop Access Module (SLAM) which allows a terminal or controller located up to 32 miles from the multiplexer to directly interface with it via a 4-wire loop. The second facility, called Multipoint Synchronous Loop Access Method (MSLAM), multiplexes 4 remote terminals and/or controllers on a 4-wire cable, and directly interfaces to a multiplexer. Again, the remote site can be located up to 32 miles away.

The key word with both facilities is "directly." The SLAM module fits into a 2211 card slot and contains a **built-in** data set. Thus, users save the cost of that product at the multiplexer site. The MSLAM module also resides in a card slot and contains both a time-division multiplexer facility and a data set, saving the user the cost of both devices. To interface with SLAM and MSLAM, however, remote users must employ an Amdahl-type line driver or multipoint data set for additional expense (\$1,500 for a Model 984 used with MSLAM).

#### □ Limitations

The prospective user should consider that while the product does support multinode and cascading multiplexers, it does not permit a drop-and-insert network. Such a facility is extremely useful in environments where many user end points are involved that pick up and drop data. Organizations such as large banks and companies with large regional centers are typical candidates for this type of operating arrangement. Of the multiplexers on the market that actually work, only Bayly's Omnplexer and Coastcom D/I Mux support this service.

The Amdahl voice cards employ CVSD as the quantization technique for converting analog voice to digital data. CVSD divides the 4-Hz voice into 8-bit words and samples each bit at 32,000 times a second. Only the change (delta) in the slope between the current and previous sampling is transmitted. As a result, a CVSD channel only requires 32K bps to produce the digitized voice output. The other popular digitizing technique, Pulse Code Modulation (PCM), needs 64K bps.

CVSD is normally an advantage since it permits 2 voice channels to occupy a 64K-bps channel. However, if you're planning to employ AT&T switching facilities as part of your T1 network, CVSD is unacceptable. Amdahl does not provide a PCM option. Thus, voice facility is limited to private facilities.

#### ■ HARDWARE

##### □ Terms & Support

**Terms** • all standard components and options are offered on a purchase basis only • volume discounts are available.

**Support** • all products are offered with a monthly maintenance contract • support is provided by Amdahl personnel through local sales office/service centers.

##### □ Overview

The Amdahl 2211 is a bit-interleaved time-division multiplexer. The unit is intended for point-to-point applications over T1 carrier facilities, and can be configured as a multinode network. Cascaded multiplexers are also supported. The 2211 handles asynchronous, synchronous, and voice channels directly, and provides a single high-speed data link capable of operating at speeds up to 1.544M bps.

The 2211 is offered in 2 models: 2211-01 and 2211-03. Both units provide identical data handling/multiplexing services. Both support up to 44 channels, and both support an expansion shelf (rack) that accommodates an additional 52 channels. The major difference is that the 2211-03 comes with redundant central logic and still provides 44 channels. The 2211-01 can be fitted with optional redundant central logic, but at the cost of 2 card slots. Redundant units also support primary and secondary composite links, with automatic switchover in the event of primary link failure.

Both multiplexers permit intermixing asynchronous, synchronous, and voice channel cards in any combination. The asynchronous cards are single channel only, while the synchronous and voice cards contain dual channels. The channel parameters are entered (soft-configured) via a control terminal keyboard, and the parameters reside in EAROM within central logic. For the remote-end multiplexer, system configuration parameters are down-line loaded. If the optional network console video terminal (F4404-22) is used, one operator can configure, monitor, and manage up to 27 pairs of 2211s.

Asynchronous channels accept data speeds ranging from 110 bps to 19.2K bps. Both RS-232C and MIL-Std-188-114 interfaces

## Amdahl 2211 T1 Multiplexer Models 2211-01 & 2211-03

are supported. Synchronous channels accommodate speeds of 300 bps to 460.8K bps, and RS-232C, CCITT V.35, AT&T 301/303, and MIL-Std-188-114 and MIL-Std-188C interfaces. Voice channels employ 4-wire E&M signaling.

The diagnostics facility tests local/remote central logic and I/O channels. Loopback tests can be conducted on low-speed channels and high-speed links. All tests can be initiated from the control console. In addition, a disable switch on each channel card isolates a particular channel to assist in the diagnostic process.

### □ Amdahl 2211 Multiplexers

#### 2211-01 Central Control

**Central Control** • chassis and common logic for multiplexing up to 96 data channels or up to 42 voice channels over single high-speed data link • common logic consists of Common Control Module (F2211-75), Switch and Alarm Module (F2211-8X), and Trunk Processor Module (F2211-70) • single channel asynchronous and dual channel synchronous data channels intermixed in any combination • multiplexers soft-configured with channel configurations held in EAROM • remote multiplexer configurations down-line loaded • optional features consist of power supply, channel adapter cards, trunk interface converter module, trunk interface converter module with synthesizer and satellite buffer, multiplexer-channel expansion shelf, cabinet assembly, network console video terminal, network console printer, and equipment channel interface converter:

\$3,550 prch \$25 maint

#### 2211-03 Central Control

**Central Control** • chassis and redundant common logic for multiplexing up to 22 single- or dual-channel I/O modules over single high-speed trunk • common logic consists of a Common Control Module (F2211-75), 2 Trunk Processor Modules (F2211-70), and a Switch and Alarm Module (F2211-80) • all other features and options same as 2211-01:

\$5,550 prch \$40 maint

#### 2211-01/-03 Central Control—Common Components

**F2211-05 Multiplexer Expansion Shelf** • contains mounting facilities for 27 individual single- or dual-channel I/O modules • supports same asynchronous and dual-channel synchronous and voice I/O modules as 2211-01 and 2211-03; expands the capacity of those multiplexers by an additional 52 channels • requires 0151 Power Pack:

\$2,000 prch \$14 maint

**F2211-75 Common Control Module** • microprocessor (8-bit) controlled • initializes, configures, and monitors all plug-in logic modules • accepts commands from and reports alarms to network console video terminal • contains EAROM for storing channel configurations; EPROM for program storage; and static RAM for working memory • remote multiplexer links control via network management channel • inband (primary channel) control and diagnostic signals • fault-detection circuits check for problems in high-speed data stream, system clock, message frame, other system modules, and system microprocessor • occupies single card slot in 2211-01 or 2211-03 card cage • standard item included in package price:

NC NC

**F2211-81 Switch & Alarm Modules** • detects and discriminates between major and minor alarm conditions • major condition affects more than 1 channel; minor condition affects only 1 channel and/or will not directly interrupt multiplexer service • detects power failures or voltage variations • performance indicator lights signal fault condition; audible alarm • occupies single card slot in 2211-01 or 2211-03 card cage • standard item included in package price:

NC NC

**F2211-70 Trunk Processor Module** • provides all multiplexing support logic • manages data stream, generates system clock and frame, synchronizes trunk, and interfaces external clock • uses bit-interleaved multiplexing • on-board channel clock generator

provides all low-speed clocks for channel I/O modules • employs 3 buses to compare received data and ensure data integrity • handles test data from Common Control Module; performs loopback tests on composite link or selected channel • occupies single card slot in 2211-01 or 2211-03 card cage • standard item included in package price:

NC NC

**F2211-80 Switch & Alarm Module** • redundant version of F2211-81 • provides automatic switching between primary and secondary composite link (trunk) logic paths in redundant systems; link service uninterrupted by switching operations • occupies single card slot in 2211-01 or 2211-03 card cage • standard item included in package price:

NC NC

#### 0127 Cabinet Assembly

Rackmount facilities for housing 1, 2, and up to 6 2211-01 or 2211-03 multiplexers. All enclosures measure 19 inches wide x 24.5 inches deep. All cabinets have optional front and rear doors, fixed panel rails at front and rear, and standard EIA spacing for easy installation of later additions to multiplexer equipment.

**0127-01 1-Chassis Cabinet** • houses single 2211-01 or single 2211-03 with up to 22 I/O modules (44 channels) and single 0151 Power Pack:

\$350 prch \$2 maint

**0127-02 2-Chassis Cabinet** • houses 2 2211-01 or 2211-03 multiplexers, or a multiplexer with single 2211-05 expansion shelf • supports up to 48 I/O modules (96 channels) and single 0151 Power Pack:

400 3

**0127-03 6-Chassis Cabinet** • houses up to 6 2211-01 or 2211-03 multiplexers, or 3 multiplexers plus 3 2211-05 expansion shelves • supports up to 144 I/O modules (288 channels) and 3 0151 Power Packs:

1,900 7

**0151 Power Pack** • power supply required by 2211-01 and 2211-03 multiplexers, plus F2211-05 multiplexer expansion shelf and 0127 cabinet assembly:

1,500 10

#### F1306 Network Console Printer

**F1306** • keyboard printer provides operator interface to configure, monitor, and manage pairs of 2211 multiplexers • operator can add, delete, or change channel configuration; initiate test loops on both channels and composite links (trunks) • operating status and error conditions printed out on 30-cps printer • operates in asynchronous mode and provides an RS-232C interface • requires 2230 Equipment Channel Interface:

\$1,850 prch \$15 maint

#### F4404-22 Network Console Video

**F4404-22** • provides same capabilities and services as the F1306 Network Console Printer • data relating to monitored multiplexers displayed on 12-inch CRT screen with 25-line x 80-column capacity • 60-key keyboard with 12 function/control keys • accepts data rates of 300/1200/2400/4800 bps, full-or half-duplex; RS-232C interface:

\$1,500 prch \$12 maint

#### 2230 Equipment Channel Interface Converter

**2230** • used in conjunction with F4404-22 Network Console to provide centralized management of local or remote multiplexer networks • bus-contention logic permits up to 9 daisy-chained multiplexers and the remote ends to pass alarm messages and status information • asynchronous access to management

*PRCH: purchase price. MAINT: monthly maintenance charge for purchased product. NC: no charge. Prices effective as of August 1984. All prices single-quantity purchase; discounts available.*

## Amdahl 2211 T1 Multiplexer Models 2211-01 & 2211-03

channels of each multiplexer • built-in loopback test facility • RS-422A equipment channel interface; RS-232C DTE/DCE interface:

          \$350 prch   \$2 maint

### 2211-01/-03 Channels

The 2211-01 and 2211-03 multiplexers accommodate any combination of single-channel asynchronous and dual-channel synchronous I/O and voice channel modules up to the limit of 44 channels. For additional channel capacity, an expansion shelf is required which facilitates 26 additional I/O modules, raising the total channel capacity for either multiplexer to 96 data channels or 42 voice channels. Asynchronous, synchronous, and voice channels can be intermixed.

Channel parameters for each channel are **soft-configured** through either a network console printer or network console video terminal. Both devices allow the operator to add, delete, or change channel parameters by entering commands and responding to prompting messages, and both allow testing each channel and the composite link (trunk). While the configuration for each channel is retained in the common control module's EAROM, each channel also stores a mirror of the configuration parameters. This ensures channel integrity even with common equipment failure.

**F2211-2X 2-Channel Synchronous I/O Module** • provides channel logic for 2 synchronous data channels • onboard storage of channel parameters • full- or half-duplex mode • channel data rates of 300/600 bps plus 1.2/2.4/3.6/4.8/7.2/9.6/14.4/16/19.2/32/38.4/40.8/48/50/64/112/115.2/128/230.4/256/460.8K bps • transmits up to 4 interface control signals (DTR,RTS, CTS, BO, DSR, CO, RI) in either direction • can be configured to interface with either DTE or DCE equipment • manual channel disable.

F2211-21 EIA RS-232C/CCITT V.24 Interface • supports data rates of 300 bps to 19.2K bps:

          \$700 prch   \$5 maint

F2211-22 CCITT V.35 Interface • supports data rates of 300 bps to 460.8K bps:

          950           7

F2211-23 AT&T 301/303 Interfaces • supports data rates of 300 bps to 460.8K bps:

          900           6

F2211-24 MIL-Std-188-114 Interface • supports data rates of 300 bps to 64K bps:

          900           6

**F2211-4X Asynchronous I/O Module** • provides channel logic for single asynchronous data channel • no onboard storage of channel parameters • full- or half-duplex mode • channel data rates of 110/300/600 bps plus 1.2/1.8/2.4/3.6/4.8/7.2/9.6/19.2K bps • ASCII or EBCDIC data formats; 6, 7, or 8 data bits with 1 start and 1 or 2 stop bits • transmits up to 4 interface control signals (DTR, RTS, CTS, BO, DSR, CO, RI) in either direction • can be configured to interface with either DTE or DCE equipment • can be installed in any available channel slot • manual channel disable.

F2211-41 EIA RS-232C/CCITT V.24 Interface • supports data rates of 110 bps to 19.2K bps:

          400           3

F2211-44 MIL-Std-188-114 Interface • supports data rates of 110 bps to 19.2K bps:

          420           3

**F2211-45 Voice I/O Module** • provides 2 voice channels • employs CVSD to produce 16K-, 32K-, 48K-, or 64K-bps outputs; DCE interface for 4800-/9600-bps modem inputs • 4-wire E&M signaling:

          1,600        NA

**F2211-31/-32 Synchronous Loop Access Module** • interfaces remote synchronous device transmitting over a 4-wire loop to the multiplexer • contains integrated limited distance modem for data rates from 1200 to 19.2K bps:

          890           6

**F2211-34 Multipoint Synchronous Loop Access Module** • interfaces 4 remote synchronous devices multiplexed on a single 4-wire loop to the multiplexer • employs time-division multiplexing with aggregate data rate to 19.2K bps • integral limited-distance modem • requires Model 984 multipoint data set at remote site:

          1,300        9

**Model 984 Multipoint Data Set** • multiplexes up to 4 synchronous channels on 4-wire cable • employs TDM; 19.2K-bps aggregate:

          1,500        9

### 2211-01/-03 Composite Link

The 2211-01 and 2211-03 each contain a single composite link as standard. In redundant versions of either multiplexer, a primary and secondary data link can be established.

The composite link between the multiplexer and high-speed trunk is established through the trunk interface converter module. Data rates from 9600 bps to 1.544M bps are supported. Trunk interface can be RS-232C/CCITT V.24, CCITT V.35, AT&T 301/303, MIL-Std-188C or MIL-Std-188-114. For satellite links, a trunk interface module with an 4K-bit buffer is available to compensate for the diurnal delay variations in satellite orbits.

**F2211-10 Trunk Interface Converter Module** • provides logic and electrical circuitry for interfacing multiplexer with high-speed trunk • switch-selectable trunk data rates of 9.6/19.2/40.8/48/50/56/64/115.2/128/230.4/256/460.8/921.6K bps and 1.344/1.544 bps • trunk interface RS-232C, CCITT V.35, AT&T 301/303, MIL-Std-188-114 unbalanced, or MIL-Std-188C unbalanced, T1 bipolar (DSI) • master clocking via internal crystal oscillator; slave clocking phase and frequency locked to trunk; external clocking accepted at trunk rate • indicators show loopback testing being performed; fault condition within modules; multiplexer not synchronized • occupies single card slot; 2 card slots when used in redundant configuration:

          \$650 prch   \$5 maint

**F2211-11 Trunk Interface Converter Module & Satellite Buffer** • provides all services/features of F2211-10 plus a 4K-bit center-biased data buffer for handling diurnal delay variations in satellite orbits • occupies single card slot; 2 card slots when used in redundant configuration:

          850           6

• END

# Amdahl 3400 Series Data Switching System

## ■ PROFILE

**Function** • TDM circuit-switching processor composed of integrated set of components supporting a single-node or multinode digital network • performs TDM and STDM multiplexing functions, switching management, and diagnostics • interconnects wide range of synchronous and asynchronous terminals and computers in interactive environments.

**Associated Systems/Networks** • broad variety of synchronous/asynchronous terminals and computers; also supports facsimile, low-speed digitized voice, and encrypted digital signals • supports IBM, Sperry, DEC, Burroughs, and Honeywell networks.

**Communications/Networks** • single node supports up to 1,000 terminations (terminals/computers); up to 16 nodes on a network • Network Processor (NP) on each node can support up to 30 trunks with aggregate throughput up to either 350K bps or 650K bps • synchronous data rates in TDM up to 19.2K bps and asynchronous up to 9.6K bps over full-duplex dedicated or switched lines; other communication facilities include Dataphone Service and private lines or microwave • asynchronous STDM transmissions with data rates up to 9600 bps • PACUIT-EXECUIT transmissions over TDM • satellite transmissions.

**Operating System** • DSOS resides in each Network Processor (NP) to handle call routines, node switching functions, reconfiguring • online diagnostics in background mode.

**Language/Program Development** • turnkey system programmed by Amdahl; separately loaded programs on NP diskettes for off-line diagnostics • system initialization and parameters in PROM in Network Access Controller (NAC); RAM in NAC is downline loaded from NP via DSOS.

**Processor** • Network Processor (NP) is 16-bit minicomputer supporting 208K-byte ECC memory • Network Access Controller (NAC) is composed of 2 microprocessors; 1 with PROM; 1 with RAM downline loaded from NP (DSOS).

**First Delivery** • June 1982.

**Systems Delivered** • 16 networks worldwide.

**Comparable Systems** • the Codex 6000 Series Intelligent Network and Distributed Communication Processor offer similar performance as flexible statistical multiplexers and network concentrators in a multinode environment; largest Codex 6000 Series configuration (Model 6050 DCP) supports up to 32 composite links and addresses up to 127 nodes; terminal support capacity limited to node throughput requirements; no X.25 public network interface currently, but Codex plans to announce X.25 (PAD) gateway soon.

**Vendor** • Amdahl Corp, Communications Systems Division;

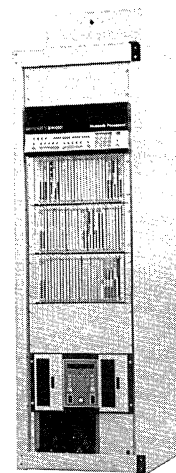

2500 Walnut Avenue, Marina del Rey, CA 90291 • 213-822-3202.

**Distribution** • turnkey • direct sales through Communications Systems Division of Amdahl at Marina Del Rey, CA • international distribution through subsidiaries in United Kingdom, Italy, South Africa, and Canada.

## ■ ANALYSIS

The Amdahl 3400 Data Switching System was developed in 1981 as an upgrade and replacement for the 3200 Series Processors, which were marketed from the Trans Telecommunication headquarters at Marina del Rey. No longer a Trans product, the 3400 System was introduced as a hybrid circuit-/packet-switching system offering enhanced features over its predecessor. The DSOS operating system, for example, can support higher session rates: 5000 local sessions per hour (to the former 3500) and 1500 remote sessions per hour (to the former 900). The Network Processor (NP) supports more terminals and computers: 1000 terminations (to the former 500 terminal/computer support). And while memory capacity remains at 208K bytes, the new system's memory includes Error Correcting Circuitry (ECC). Also, the new system can handle satellite transmissions more efficiently.

In addition to the internal protocol PACUIT, Amdahl added the EXECUIT protocol on a separate band on the TDM backbone. Thereby, the new 3400 System provides 2 distinct bands, 1 for user traffic (PACUIT) and 1 for system management traffic (EXECUIT). Consequently, more efficient band allocation can improve satellite transmissions by accommodating the 1-second delay inherent in satellite communication. Another attractive capability is the ACK-NACK (acknowledgement) at the local level per user requirement.

The 3400 System also offers more effective statistics reporting and system diagnostics. Especially attractive for system security was the capability of each component to monitor its own internal operations, providing time and data on status reports in case of communication failure.

At the time the enhanced 3400 System was introduced to supersede the 3200 Series, Amdahl did not provide the new

### PURCHASE PRICE RANGE hardware & software

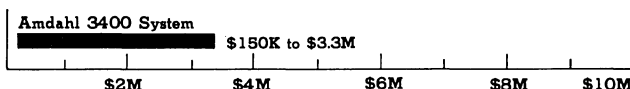

**AMDAHL 3400 SERIES PURCHASE PRICING** bar graph illustrates approximate price range for small- to large-scale configurations • solid bar represents hardware and software (bundled purchase price); no maintenance prices are available (NA) • small system is a basic configuration including an NP, a single NAC, a console, and trunk cards • large system is a 5-node network including 5 NPs, 100 NACs, an NCC, an NBS, 10 consoles, 10 printers, and 200 trunk cards (2 for each NAC).

## Amdahl 3400 Series Data Switching System

system with the X.25 support of its predecessor. Users requiring the X.25 capability to access public packet-switched networks were offered a separate product, the 4410 XPRO Packet Processor. Users were, in a sense, put into either of 2 camps: those who do and those who don't use X.25 access capability. There is no upgrade path from a 3400 system to the 4410 XPRO. This situation remains unchanged. Amdahl, however, is planning the next generation of 3400 Systems and purports to be alert to RPOs (requests per quotes).

The 3400 Data Switching has been installed in large-network configurations at approximately 16 various user locations worldwide—including England, Africa, and the United States. It is a system primarily aimed at low-speed asynchronous terminal users requiring resource selection, and for users who find the cost-saving dial-in/dial-out capability and the systems flexibility via the code/protocol transparency feature attractive. For example, while Amdahl does not digitize voice transmissions, it can support the user's digitized voice product via the System 3400's protocol transparency.

### Modes of Operation

The Amdahl 3400 System operates as a passive switch for transmitting data among computers and terminals. It offers many enhancements to make communication efficient, error free, and secure: TDM and STDM multiplexing, facility testing and monitoring, and password and hunt group access confinement.

### Ease of Use

The 3400 System offers mnemonic addressing for multiple-user environments wanting access to the same host, resource, or group of resource. The Echo and Echoplex features provide tests to maintain communication integrity between terminal and NP, and between host computer and NP. The asynchronous autobaud facility is useful for switched or multispeed terminal applications. And the asynchronous dial-in/dial-out capability allows asynchronous 1200-bps transmission to connect to the DDD network through an AT&T 801C ACU.

### Strengths

The Amdahl 3400 System provides wide support of synchronous and asynchronous transport of digital information in a protocol/code transparent mode. It provides Time Division Multiplexing for both synchronous and asynchronous terminals as well as for satellite transmissions, and Statistical Time Division Multiplexing and data concentration for asynchronous transmissions. The improved operating system DSOS extends the maximum number of sessions per hour for both local and remote environments; and double the number of terminals and computers can be supported by a single node or NP (1,000 terminations). The system supports terminations (terminals/computers) from IBM, Sperry, DEC, Burroughs, and Honeywell with communication support.

### Limitations

While the 3400 System does not provide an X.25 interface to public switched networks, Amdahl does assign this important function to another product like the System 4410. Users, therefore, have that choice. The 3400, however, does lack this expanded capability; and with no upgrade path to the System 4410, a serious system limitation that should be considered.

## ■ SOFTWARE

### Terms & Support

**Terms** • bundled in hardware costs

**Support** • Amdahl arranges contracts for monthly or yearly maintenance charges • Amdahl provides maintenance and service at over 95 Amdahl Service Centers throughout the U.S. in addition to worldwide locations.

### Operating System

**Data Switching Operating System (DSOS)** • resides in each Network Processor (NP) • supports switching functions of NP; provides console operator with network commands to handle

operating decisions, utility information, and reconfiguring instructions for adding lines or resources • offers security feature through user identification: access to network by user is by access group, a logical partition that identifies each terminal or computer; all network terminations belong to at least one access group; through intergroup privileges users can access at least 13 terminals and computers; a connect protocol (security password) separate from the termination identification is required for access to network • resource access is provided through hunt group (type of service) as well as by a contention access scheme that includes camp-on-priority queuing • mnemonic addressing feature • integral diagnostics run in background mode provide constant surveillance and online system integrity of communication paths, system I/O, and transmission trunk integrity; internal memory, power and cooling systems are monitored; all major modules within the system maintain status of their internal operations for error reporting; automatic looptesting on all inactive channels.

**Communications/Networks** • protocol/code transparent • various industry-standard protocols supported: BSC (Binary Synchronous Communications), HDLC (High Level Data Link Control), SDLC (Synchronous Data Link Control), ADCCP (Advanced Data Communications Control Procedures), as well as non-standard protocols, including encryption, facsimile, and low-speed digitized voice signals • supports IBM, Sperry, Burroughs, Honeywell terminals/computers with communication capability.

**Program Development** • turnkey system • 2 programs separate from DSOS are loaded on diskettes on NP for off-line diagnostics of hardware and logic • on-demand tests for the operator or service personnel are initiated at master console or NCC to usable or disable various background diagnostics, selective loop testing of channels, and selective reprogramming or disabling of malfunctioning hardware modules • NAC programs; 1 in each of the 2 microprocessors; 1 in PROM for system initialization and basic logic; and 1 downline loaded from the NP via DSOS to the NAC's RAM for control of I/O and communication.

## ■ HARDWARE

### Terms & Support

**Terms** • direct sales from Amdahl Communications Systems Division at Marina del Rey, California • Amdahl does not lease or rent the 3400 • the Communications Systems Division will not release equipment prices for publication because installations are application dependent; the purchase prices listed in this report are rounded figures and approximate costs.

**Support** • Amdahl provides monthly and yearly maintenance plans • Amdahl provides maintenance and service at over 95 Amdahl Service Centers throughout the U.S. in addition to worldwide locations.

### System Overview

A full-capacity bus-oriented 3400 System is composed of 4 integrated components. The Network Processor (NP) runs the DSOS operating system to perform local switching control and management functions for the NP/NAC cluster. The Network Access Concentrator (NAC) provides multiplexing and computer/terminal access to the NP. The optional Network Control Center (NCC) provides centralized network control for a multinode environment. The Optional Network Billing System (NBS), provides a central billing information collection facility. A node consists of an NP and at least 1 associated NAC; a basic configuration can consist of an NP supporting 3 NACs. Up to 27 NAC trunks per network processor can be supported; each NAC can accommodate 3 trunks. The number of NACs supported by a single NP in a node is determined by the overall system throughput requirements and the maximum node support of 1000 terminals and computers. The networks expand by adding NP-based nodes. Theoretically, a system can support up to 8 nodes; typically the Amdahl 3400 System supports an 8-node network. A multinode network, however, can require the optional Network Control Center (NCC) and/or the Network Billing System (NBS) for consolidated network management/diagnostics and billing functions.

## Amdahl 3400 Series Data Switching System

**Network Processor (NP)** • basic component of network node that contains the DSOS operating system; 208K bytes of ECC RAM • serves as source, destination, or local processor and performs local switching controls and manages interfacing functions • each NP can have up to 3 master control consoles (MCCs) for operator input to NP and output from NP • connects up to 27 Network Access Concentrators (NACs), accommodating up to 3 trunks per NAC for user I/O; supports up to 4 internodal trunks • 2 configurations: 1 supports up to 350K-bps aggregate transmission rates; the other supports up to 650K-bps aggregate transmission rates.

**3400-01** • NP with minimum configuration: supports up to 3 NACs that include interface and I/O cards • provides up to 350K-bps aggregate data rates:

\$114,000 prch

**3400-02** • NP with maximum configuration: supports up to 30 NACs that include interface and I/O cards • provides up to 650K-bps aggregate data rates:

154,000

**Network Access Controller (NAC)** • basic component of network node composed of 1 microprocessor with both PROM and RAM memory • performs multiplexing and data concentration functions and provides user interface to NP; processes errors and alarms and reports to NP • each NAC handles up to 100 synchronous/asynchronous channels • each NAC will support up to 124 I/O cards and 3 trunk lines—1 required to connect to NP for downline loading; others to connect other NACs • prices reflected below do not include trunk interfaces • trunk cards are offered in 3 models according to user application requirements; purchase prices are \$1,000, \$1,500, or \$6,000 per trunk card, depending on application.

**3412-00** • NAC • tabletop configuration • single chassis:

9,350

**3412-13** • NAC tabletop configuration • single chassis to insert 13 I/O cards and 3 trunk cards:

15,500

**3412-32** • NAC dual chassis to insert 32 I/O cards and 3 trunks • 6-foot standalone cabinet:

26,400

**Network Control Center (NCC)** • supports up to 8-node network; provides centralized controls and monitors system-wide performance; provides on-demand tests and message reporting • requires a master console and a serial interface matrix printer; supports up to 10 additional consoles/printers.

**3420-XX** • NCC; consoles/printers provided by user or by Amdahl:

21,000

Consoles/Printers:

1,850

**Network Billing System (NBS)** • minicomputer-driven standalone system used to consolidate bill collecting/

management function; supports up to 8 nodes • stores information on industry-standard magnetic tape • attaches to 3400 System via dedicated asynchronous channel attached to NP via a NAC • typical 4-node network requires 2 tape units; 8-node network requires 4 tape units • standard 9-track magnetic tape (up to 10.4-inch reels), 1600 bpi.

**3410-XX** • NBS includes 2 industry-standard 9-track, 1600-bpi tape drives:

58,000

### □ I/O & Communications

Terminals/computers interface to the 3400 Data Switching Network through a NAC over dedicated or switched lines operating in full-duplex mode.

Synchronous data rates up to 19.2K bps; EIA RS-232/CCITT V.24 interface. A synchronous remote terminal interface unit provides multiple resource addressing for synchronous devices without keyboards. Asynchronous data rates up to 9.6K bps; supports EIA RS-232/CCITT V.24 and Teletype 20-/60-mA current-loop interfaces. The 3400 features asynchronous auto-baud for dial-up terminals or multispeed terminals; it also has an asynchronous dial-in/dial-out capability, that interfaces a AT&T 801C Automatic Calling Unit (ACU). Any asynchronous terminal or host computer that transmits at 1200 bps can connect to the 3400 either directly or via the DDD network, and request a special dial-out module as the resource.

Local communication between an NP and its associated Network Access Controllers (NACs), as well as communication between NPs and between NACs, is performed over dedicated common carrier lines at data rates up to 64K bps. The NP supports a local connect rate of up to 5000 sessions per hour; remote connect rate is at 1500 sessions per hour. An NP can support 30 NAC trunks. A NAC supports 3 trunks; one connects to its associated NP and the remaining 2 trunks can connect to other NACs.

Aggregate maximum throughput is 192K bps per 3-trunk NAC and 350K/650K bps per NP.

NACs provide multiplexing through TDM or STDM channels. The TDM (Time Division Multiplexing) channels support synchronous communication at 1200 to 19.2K bps through RS-232/CCITT V.24 interface and asynchronous communication at 110 to 9600 bps through an RS-232C/CCITT V.24 or 20-/60-mA current-loop interfaces or through a Directran limited-distance modem. The STDM (Statistical Time Division Multiplexing) channel supports only asynchronous communication at 110 to 9600 bps; through an RS-232C/CCITT V.24 interface.

Satellite transmission is supported by the 3400 System. Amdahl has made an adjustment in the internal protocol by adding EXECUIT along with PACUIT, creating 2 distinct bands on the TDM backbone network, 1 for user traffic using PACUIT protocol and 1 for system management traffic using the EXECUIT protocol. This adjustment provides for the approximate 1-second delay inherent in satellite transmissions. Satellite transmission, however, can depend on user throughput requirement. It provides no problem, for example, in a typical timesharing environment or in many standard ASCII applications. More complex applications may require adjustment from the user in order to take advantage of satellite transmission capability.

• END

*PRCH: approximate purchase price. Prices effective as of July 1984.*





# Amdahl 4400 Series

## Model 4440, 4450, 4460 & 4470 Network Concentrators and 4404E Network Administrator

### ■ PROFILE

**Function** • network concentrators (NCs) and network administrator (NA) • NCs perform protocol conversion to provide access to X.25 public and private packet-switched networks by nonpacket-switched terminals and hosts; offer PAD and remote polling functions • NA provides centralized network management and billing system, status reports, and network diagnostics; downline loads software to NCs.

**Associated Systems/Networks** • asynchronous and bisynchronous and SNA 3270-compatible devices; 3270 BSC with Display System Protocol (DSP) and 3270 SNA with LLC (Logical Link Control) • NCs can be used with Amdahl 4410 Network Processor to structure private X.25 network • public X.25 networks: Datapac (Canada), Saponet, Telenet, Tymnet, Uninet, and Accunet X.25.

**Communications/Network** • 8 maximum X.25 links on NC with data rates up to 19.2K bps; 4 maximum X.25 links on NA with data rates up to 19.2K bps; aggregate throughput 100K bps maximum (NC) and 70K bps maximum (NA) • Model 4440 NC supports up to 39 asynchronous device lines; Model 4450 supports up to 15 3270 BSC device lines; Model 4460 supports up to 39 device lines for both asynchronous and 3270 BSC communications; and Model 4470 supports up to 7 SNA 3270 device links.

**Operating System** • NA programmed to provide centralized network control, billing, and diagnostics • downline loads software to configuration-dependent NCs.

**Languages/Program Development** • configuration/reconfiguration functions and software downline loaded from NA to 4400 Series NCs.

**Processor** • Basic Processor Module (BPM) combines Intel 8086 microprocessor and 2 IOPs; 8086 supports 256K-word (512K-byte) main memory and 256K-word (128K-byte) shared memory; each IOP based on Z80 microprocessor that supports a 12K-byte RAM and 4 I/O ports • 4404E NA multiprocessor supports 512K-byte memory, 8-inch double-sided 1M-byte diskette, a 40M-byte disk, a network display console, and 2 line printers.

**First Delivery** • first quarter 1983.

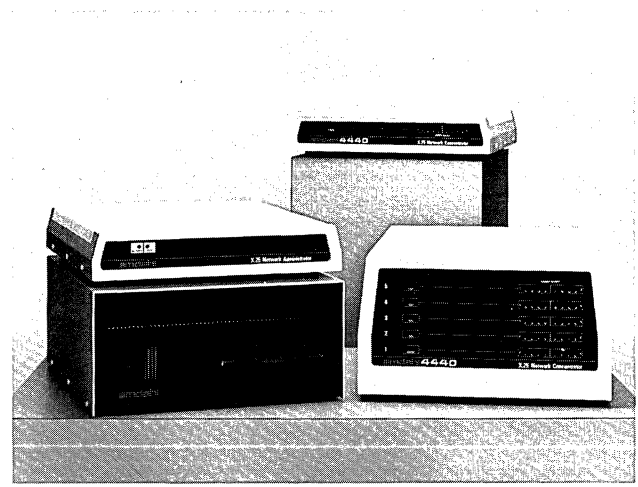

**Systems Delivered** • several thousand.

**Comparable Systems** • GTE Telenet TP2000, TP3010, and TP4000 Series Network Interface Processors (NIPs) are comparable to the Amdahl 4400 Series Network Concentrators • GTE 5000 Network Control Processor Series comparable to Amdahl 4404 for centralized control of terminal networks.

**Vendor** • Amdahl Corporation, Communications Systems Division; 2500 Walnut Avenue, Marina Del Rey, CA 90291 • 213-822-3202.

**Distribution** • nationwide and worldwide through Amdahl's Communications Systems Division sales force.

### ■ ANALYSIS

With the growing importance of X.25 packet-switching networks, products such as the Amdahl 4400 Series serve a very useful function. They allow a user's asynchronous or 3270 BSC/SNA terminal to communicate with remote hosts over X.25 packet-switching networks. The 4400 Series provides the PAD (packet assembly/disassembly) function as well as concentration and code conversion if needed. In addition, the Amdahl 4404E Network Administrator can control a network of up to 10,000 terminals using 250 4400 Series Network Concentrators connecting up to 40 user terminals each. A 40-port configuration provides the PAD function and X.25 network connection for about \$350 per terminal.

In addition, the 4400 Series can be configured to perform a straightforward concentration function using 2 4400 systems to connect multiple terminal ports to multiple host ports.

#### □ Strengths

Amdahl Corporation is a major mainframe computer vendor branching out into the communications market. The 4705 Communication Processor has been a very successful product popular with IBM as well as Amdahl mainframe customers.

The 4400 Series systems are natural extensions to Amdahl's network processors in the communication market and useful to

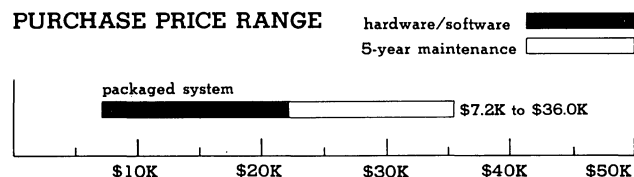

**AMDAHL 4400 SERIES NETWORK CONCENTRATOR (NC) PURCHASE PRICING** bar graph illustrates price ranges for "small" to "large" system, with solid bars reflecting hardware/software purchase pricing; open bars reflect 5-year maintenance cost associated with hardware/software of large system only; the NCs are configuration dependent and require the 4404 Network Administrator, which downloads software to each NC (purchase price, including 5-year maintenance, is \$48,000) • **SMALL** system pricing is based on Model 4440-88 NC package, which includes 1-board enclosure and supports 8-port configuration • **LARGE** system is based on Model 4460-00 NC package and includes a 5-board enclosure which supports 40-port configuration • **4404E Network Administrator** adds \$50,000 minimum to purchase price plus \$30,000 for 5-year maintenance for terminal network.

## Amdahl 4400 Series

### Model 4440, 4450, 4460 & 4470 Network Concentrators and 4404E Network Administrator

Amdahl mainframe customers.

The 4400 Series provides an inexpensive alternative to a user developing the X.25 interfaces, not a trivial task. Amdahl also provides centralized control for networks of terminals at a cost as small as about \$4 per terminal on a 20,000-terminal network.

#### Limitations

Until last year, the 4400 Series Network Concentrators were limited to port connections for asynchronous and 3270 BSC terminals. The new 4470 supports 3270 SNA connections, so this is no longer a limitation.

#### ■ SOFTWARE

##### Terms & Support

**Terms** • software modules bundled with hardware.

**Support** • monthly maintenance fees for software are charged for each 4400 Series system: \$15 for the 4440 Network Concentrator (NC); \$30 for the 4450/4460 NCs; and \$250 for the 4404 Network Administrator.

##### Software Overview

The 4400 Series features the 4404 Network Administrator (NA), which provides centralized network management and control for up to 250 attached 4400 Series Network Concentrators (NCs). The 4404E NA collects comprehensive usage statistics and network traffic information to evaluate network performance and provide billing information, as well as statistical and system status reporting and network diagnostics. It can configure/reconfigure network components and downline load configurations and software to each 4400 Series NC.

Implementing the CCITT X.25 standard PAD functions, the 4400 Series NCs also provide protocol conversion to and from devices' native-mode protocol and the CCITT X.25 network access protocol. All, except 4470 models in the 4400 Series of Network Concentrators provide asynchronous, bisynchronous, or mixed protocol support, and either Terminal Network Concentrator (TNC) or Host Network Concentrator (HNC) functions. In back-to-back TNC-to-HNC configurations, the NCs support line concentration in nonpacket-switched environments. The 4450/4460/4470 NCs, in addition to their packet assembly/disassembly functions, perform remote polling. The 4470 provides up to 3270 SNA lines for device connections to up to 7 X.25 links.

##### Communications/Networks

All 4400 Series NC models support the 1980 version of CCITT X.25 Recommendation using LAPB with HDLC framing; all models support load balancing across multiple X.25 links and terminal contention for access to host ports. In addition, the NC provides hunt group definitions, station-to-station addressing, and menu-driven features.

Model 4440 supports X.25 with X.3, X.28, X.29 protocols; Model 4450 supports X.25 with Display System Protocol (DSP for 3270 bisynchronous); and Model 4460 supports X.25 with X.3, X.28, X.29, and DSP protocols. The 4470 supports IBM's LLC-2 protocol and is fully compatible with IBM's NPSI software in the IBM 3705/3725 communications controller.

**1980 CCITT Recommendation X.3, X.28, X.29** • supports standard X.3 PAD parameters plus some configurable and negotiable Interactive Terminal Interface (ITI) PAD parameters • supports dynamic flow control provided by Recommendation X.3; allows user selection of flow control character values • packet forwarding can be initiated by receipt of a user-defined termination character or characters, or by expiration of a user-selected interval timer • supports dial-in and optional automatic call organization with asynchronous DTE connection; ABD (Automatic Band Detection) on dial-in ports for 110, 150, 300, 1200, 1800, and 2400 bps.

**3270 Display Systems Protocol (3270 DSP)** • de facto standard bisynchronous protocol for 3270 devices in

packet-switched networks • maximizes resource utilization: allows each CRT or printer attached to 3270 cluster control unit (CCU) to initiate an individual virtual circuit to any destination application program in network; eliminates need for polling across network; 3270 CCUs are polled by local 4460 or 4450 TNC; only user data and X.25 control packets are transmitted through packet network • in addition to 1980 X.25 "D" bit, which provides NC-to-NC conformation, DSP supports additional assurance of user-data delivery; user can optionally withhold acknowledgement of final message frame until entire message is received by destination device • optional pipelining feature improves response time and increases line utilization for large messages; packets are transmitted as soon as a package of data is received from originating device without waiting for the end of the message.

**Program Development** • program: downline loading of configuration/reconfiguration and software from 4404 NA to 4400 Series NCs attached to the NA.

#### ■ HARDWARE

##### Terms & Support

**Terms** • purchase only; no leasing plan is available at this time • installation charges: \$400 for an 8-port 4440-88 Network Concentrator; \$840 for a 40-port 4440-00 Model; \$645 for an 8-port 4450-88 Network Concentrator; \$1,328 for a 40-port 4460-00 Network Concentrator; \$1,800 for a 4404 Network Administrator.

**Support** • customer has option of self maintenance or full maintenance • under self-maintenance, the customer assumes responsibility for problem diagnosis and shipment of nonfunctioning units to Amdahl Center • under full-maintenance, problem diagnosis and resolution can be performed by Amdahl field personnel.

##### System Overview

The Amdahl 4400 Series consists of 4 models of Network Concentrators (NCs) and a Network Administrator (NA). The NCs support either or both asynchronous and 3270 bisynchronous transmission modes and provide protocol conversion for non-packet mode terminals and host processors and access to X.25 public or private packet-switched networks. The Network Administrator supports up to 250 NCs, providing centralized network management and billing, network diagnostics, and downline loading of software to the NCs.

The 4400 Series NCs can be configured to operate as either Terminal Network Concentrators (TNCs) or Host Network Concentrators (HNCs). In back-to-back TNC-to-HNC configurations over dedicated lines, the 4400 NC can function as a concentrator in nonpacket-switched environments. The NCs can be used with the Amdahl 4410 Network Processor to structure a private X.25 network.

The 4400 Series hardware is built around a dual-bus multiprocessor architecture using the Basic Processor Module (BPM) and dual Input/Output Processors (IOPs). The system supports 8 X.25 links on the NCs and up to 4 X.25 links on the NA. The X.25 links can be directly connected to a private or public packet-switched network or directly to a 4400 HNC when NC pairs are used on dedicated lines as concentrators. The system supports asynchronous/3270 BSC device lines attached to the NC ports or peripherals attached to the NA ports. A basic 8-port/-line NC configuration can be extended by adding up to 4 Passive Processing Modules (PPMs), each PPM connects to 8 additional device lines for a maximum 40-line configuration. The PPMs run under the control of the IOP. The second IOP on an NA is used to support peripherals: disk subsystem, console, and up to 2 printers.

Two standard packaging options are offered for the NC. A single-board enclosure houses a single BPM for a basic 8-port configuration or with a single PPM for a 16-port configuration. A 5-board enclosure houses 1 BPM and up to 4 PPMs. The 5-board

## Amdahl 4400 Series

### Model 4440, 4450, 4460 & 4470 Network Concentrators and 4404E Network Administrator

unit is field-upgradeable if ordered with less than 4 PPMs. The NA is housed in a single-board enclosure.

**Processors**

**4440 Network Concentrator** • supports up to 39 ports for interfacing asynchronous ASCII devices to up to 8 X.25 trunk links • supports up to 40 virtual circuits with setup rate of 2 per second • provides packets of 64, 128, 256 bytes with packet-level facilities that include reverse charging, user-negotiated packet size, and user-negotiated window size • features include automatic dial-in ports; global/selective flow control and DTE flow control using XON/XOFF; station-to-station, hunt group, and abbreviated addressing; and parity detection/generation (odd, even, or none).

**4440-88 Network Concentrator** • 8-port configuration; single-board enclosure:

<u>\$7,200 prch</u>	<u>\$70 maint</u>
---------------------	-------------------

**4440-00 Network Concentrator** • 8-port configuration in 5-board enclosure:

<u>8,500</u>	<u>80</u>
--------------	-----------

16-Port Configuration:

<u>9,600</u>	<u>90</u>
--------------	-----------

24-Port Configuration:

<u>12,000</u>	<u>110</u>
---------------	------------

32-Port Configuration:

<u>13,500</u>	<u>130</u>
---------------	------------

40-Port Configuration:

<u>15,000</u>	<u>140</u>
---------------	------------

**4450 Network Concentrator** • supports up to 15 ports for connecting to 3270 BSC devices to up to 8 X.25 links; provides ASCII and EBCDIC code support and ASCII to EBCDIC protocol conversion • supports over 100 virtual circuits with setup rates up to 2 per second • packet size can be 64, 128, or 256 bytes; packet-level facilities similar to 4440 Model • features include global/end-to-end flow control; synchronous clocking from DCE or DTE (internal or external); station-to-station, hunt groups, or menu addressing; VRC/LRC parity detection/generation; error-correction capability; menu-driven 3270 access to application selection; automatic 3270 session recovery; limited conversational mode supported on 3270 BSC terminals; remote polling (weighted and slow poll) for BSC terminals.

**4450-88 Network Concentrator** • 8-port configuration; single-board enclosure:

<u>11,500</u>	<u>110</u>
---------------	------------

**4460 Network Concentrator** • supports up to 39 ports for interfacing both asynchronous and 3270-BSC devices to up to 8 X.25 links; handles ASCII and EBCDIC (3270) codes; ASCII to EBCDIC protocol conversion • supports over 100 virtual circuits with setup rate of 2 per second • packet size can be 64, 128, 256 bytes; packet-level facilities similar to 4440 Model • features are similar to those on Model 4450; plus parity detection for asynchronous (odd, even, none); abbreviated synchronous addressing.

**4460-88 Network Concentrator** • supports mixed asynchronous and 3270 BSC devices • 8-port configuration; single-board enclosure:

<u>15,000</u>	<u>130</u>
---------------	------------

**4460-08 Network Concentrator** • supports mixed asynchronous and 3270 BSC devices; 8-port configuration; 5-board enclosure:

<u>15,000</u>	<u>140</u>
---------------	------------

16-Port Configuration:

<u>16,000</u>	<u>150</u>
---------------	------------

24-Port Configuration:

<u>18,000</u>	<u>170</u>
---------------	------------

32-Port Configuration:

<u>21,000</u>	<u>195</u>
---------------	------------

40-Port Configuration:

<u>24,000</u>	<u>200</u>
---------------	------------

**4470 Network Concentrator** • supports up to 8 ports for SNA 3270 devices to up to 7 X.25 links; supports up to 15 SNA 3270 cluster control units (point-to-point or multidrop) on up to 7 SDLC lines; supports over 100 virtual circuits with setup rates up to 2 per second; packet size can be 64, 128, or 256 bytes; packet level facilities similar to 4440 model • directly compatible with IBM's NCP Packet Switching Interface (NPSI) in the SNA Front-End Processor • features include global/end-to-end flow control; synchronous clocking from DCE to DTE (internal or external); error correction capability; host selection on a cluster-by-cluster basis as well as application selection and remote polling (weighted and slow poll) for SNA/SDLC terminals:

<u>12,500</u>	<u>130</u>
---------------	------------

**4404 Network Administrator** • supports up to 250 configuration-dependent NCs and up to 10,000 application-dependent logical devices • provides up to 4 X.25 network links • peripherals include diskette, hard disk drive, network display console, and 2 printers • features downline loading of configurations and software to NCs; upline dumping of software from NCs for dump analysis • supports redundant NA with automatic backup • performs centralized management and control, centralized billing, complete online diagnostics control to port level, real-time status reporting, archiving, and file maintenance.

**4404E Network Administrator** • includes processor, 40M-byte disk drive, 1M-byte diskette, 2 printers, and a display/keyboard:

<u>50,000</u>	<u>500</u>
---------------	------------

**CPU & Memory**

**4400 Series Network Concentrator**

The programmable Basic Processor Module (BPM) uses a dual-bus architecture with the 8086 microprocessor and 2 Input/Output Processors (IOPs). The 8086 microprocessor includes 128K-byte main (private) memory with 80K-byte EPROM and 64K-byte shared (public) memory for system operations and tasks; the 8086 communicates with the dual bus through main memory shared by the 2 IOPs. Each IOP is based on a Z80 microprocessor that supports 12K-byte RAM memory and 4 I/O ports.

**4404E Network Administrator**

The BPM supports 1M-byte memory, 1M-byte 8-inch double-sided diskette, a 40M-byte Winchester disk, a network display console, and 2 line printers. Redundant NA configuration provides automatic takeover in event of prime NA system's malfunction.

**Communication Lines**

The 4400 Series Network Concentrators (NCs) based on a dual-bus architecture support from 8 to 40 asynchronous and/or 3270 bisynchronous lines with data rates from 110 to 19.2K bps and with aggregate half-duplex throughput rates from 80K to 100K bps. The NC's device line support is expandable via 4 Passive Processing Modules (PPMs), each provides 8 additional lines. Packet throughput is 40 packets per second on all models. The NCs support up to 8 X.25 links and the NA supports from up to 4 X.25 links to 1 or more networks to provide access to public data networks such as Datapac, Saponet, Telenet, Tymnet, Uninet, and Accunet X.25 network. Each IOP in the BPM attaches to one of the dual buses to provide the processing for asynchronous, bisynchronous, or HDLC (X.25) lines. The NCs connect X.25 links

*PRCH: purchase price; MAINT: monthly maintenance charge under Amdahl full-maintenance plan. Prices effective as of September 1984.*

## Amdahl 4400 Series

### Model 4440, 4450, 4460 & 4470 Network Concentrators and 4404E Network Administrator

to public/private data networks or directly to 4400 HNC when the 4400 NC pairs are used on dedicated lines as concentrators. The NCs feature load balancing on multiple X.25 links, terminal contention for access to host ports, and hunt group definitions.

#### 4440 Network Concentrator

Network Concentrator supports up to 40 asynchronous device lines with data rates of 110 to 19.2K bps; aggregate half-duplex throughput over 80K bps. Supports up to 8 X.25 network links; fully compatible with 1980 CCITT Recommendations X.3, X.28, X.29; LAPB link access protocol; in addition to X.3 PAD, supports some configurable and negotiable Interactive Terminal Interface (ITI) PAD parameters. Supports up to 40 virtual circuits with setup rate at 2 per second. Automatic Baud Detection (ABD) on device lines for speeds of 110, 150, 300, 600, 1200, 1800, and 2400 bps. Physical interface support includes 2-wire direct-connect, dedicated connection (with or without data set), dial-in (optional disconnect when call cleared), and dial-in emulator.

#### 4450 Network Concentrator

Network Concentrator supports up to 16 BSC device lines for 3270-type devices communicating at data rates from 110 to 19.2K bps; aggregate half-duplex throughput at 100K bps. Supports up to 8 X.25 network links; EIA RS-232C, CCITT V.24 line interface standard; fully compatible with CCITT 1980 Recommendations X.3, X.28, X.29; ASCII/EBCDIC code LAPB link access protocol; Display System Protocols (DSP) support for BSC 3270 devices. Supports over 100 virtual circuits with setup rates up to 2 per second. Physical interface includes 2-wire connect, dedicated connection, and 3270 multipoint.

#### 4460 Network Concentrator

Network Concentrator supports up to 40 lines for both asynchronous and 3270 BSC communication at data rates from 110 to 19.2K bps; aggregate half-duplex throughput at 100K bps. Supports up to 8 X.25 network links; EIA RS-232C, CCITT V.24 line interface standards; fully compatible with CCITT 1980 X.3,

X.28, X.29; LAPB link access protocol; DSP for 3270 BSC. Supports over 100 virtual circuits with setup rate of 2 per second. Physical interface includes 2-wire direct-connect, dedicated connection, dial-in (asynchronous), dial-in emulation (asynchronous), and multipoint (3270).

#### 4470 Network Concentrator

Network Concentrator supports up to 8 lines for both X.25 and SNA 3270 communications at data rates up to 9600 bps; aggregate half-duplex throughput at 90K bps. Supports up to 7 X.25 network links; EIA RS-232C, CCITT V.24 line interface standard; fully compatible with CCITT 1980 Recommendation X.25, LAPB link access protocol; LLC-2 with PSH (Physical Services Header) for SNA/SDLC 3270. Supports over 100 virtual circuits with setup rate of 2 per second. Physical interface includes direct connect single point or multipoint (3270).

#### 4404E Network Administrator

Network Administrator supports up to 4 X.25 network lines at data rates up to 19.2K bps; aggregate half-duplex transmission at over 70K bps.

#### Disk

**4404E Network Administrator Diskette/Disk Storage • 1** 1M-byte diskette (8-inch, double sided) for removal of collected data; 1 40M-byte Winchester disk drive for primary storage.

#### Consoles & Printers

**4404E Network Administrator Display Console •** alters and verifies system configuration; monitors network operations; initiates diagnostics, requests status and statistical reports.

**4404E Network Administrator Printers •** supports 2 printers (150 cps) for logging network activities and status reporting.

• END

# Amdahl 4705 Series Communication Processors

## 4705 Models 4705E & 4705T

### ■ PROFILE

**Function** • SNA-compatible front-end processor/remote communication processor • runs all IBM 3705 software.

**Associated Systems/Networks** • replaces IBM 270X, 3704, and 3705 processors; supports IBM S/370, 303X, 3081, and 4300, single/multiprocessor SNA networks as well as Amdahl and other IBM S/370-compatible PCM hosts.

**Communications/Networks** • support up to 352 half-duplex communication lines at speeds up to 64K bps • support up to 6 channel-attached hosts simultaneously; other hosts attached through remote 4705E/Ts • 4705T also supports up to 90 communications lines, including voice line, with aggregate data rate of 2.048M bps, including T1 service (1.544M bps).

**Operating System** • generated on and loaded from host • runs IBM ACF/NCP Versions 1, 2, and 3 and all previous releases including EP Releases; Version 2 for 3705 • Amdahl provides built-in, IBM-independent diagnostic facility including a probe display panel and a diagnostic floppy disk reader.

**Languages/Program Development** • via same SSPs at host



### PURCHASE PRICE RANGE

hardware & software   
5-yr maint/serv fee

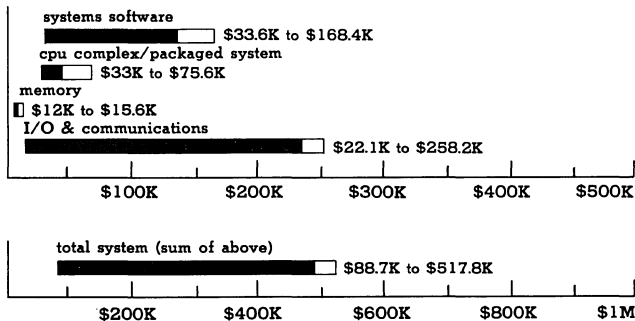

**AMDAHL 4705E/T PURCHASE PRICING** bar graphs cover price ranges between small and large configurations for software and hardware products (solid bars), and for associated 5-year period maintenance/service fees; software prices are for the IBM 3705-II software packages that run on the 4705E/T • **SMALL SYSTEM** is based on the 4705E packaged system with 256K-byte memory • optional features include 256K-byte memory; SS2E Single Communications Scanner Attachment Base, Type 2 • 3 LIB1E Line Interface Bases; 5 HD1LE Line Sets (connect 20 half-duplex, asynchronous lines with data rates up to 2400 bps) 2 FD1LE Line Sets (connect 4 full-duplex, synchronous lines that operate at data rates up to 19.2K bps), and 1 CA4E 1 Channel Adapter; software includes ACF/NCP/VS 3.0 for 3705-II and ACF/SSP 2.2 for program development on IBM S/370-compatible host • **LARGE SYSTEM** includes 4705T packaged system with 256K-byte memory and console • optional features include three 256K-byte memory modules for 1M bytes of memory; 6 CA4E Channel Adapters to connect to host computers; 2 TCSE 2-channel switches for connection of 2 channel adapters to 4 host byte- or block-multiplexer channels; 4 CS2E communication scanners, Type 2 (connect up to 245 LIBs); 15 LIBE Line Interface Bases (support up to 60 asynchronous or synchronous Line Sets to connect RS-232C lines with data rates up to 2400 bps async and 19.2K bps sync); 58 HD1LE Line Sets (support up to 232 half-duplex asynchronous lines at data rates up to 2400 bps); 10 FD1LE Lines (support up to 20 full-duplex synchronous lines at data rates up to 19.2K bps); 1 HS20 Sync I/O module (provides 2 data channels with data rates from 300 to 512K bps); and 10 HS45 Voice I/O modules (provides 20 voice channels) • IBM 3705-II support software includes ACF/NCP 3.0, ACF/SSP 2.2, EP for 3705, NTO 1.2, and Network Routing Facility (NRF) 1.5.

facilities as with IBM 3705-II; SSPs provide control program macro language, assembler, and load/dump utilities • current SSP version is ACF/SSP V2 R1.1 and will support V2 R2 when available.

**Processor** • 256K- to 1M-byte memory; diskette for Amdahl diagnostics loading.

**First Delivery** • November 1980 (4705); second quarter 1983 (4705E); first quarter 1985 (4705T).

**Systems Delivered** • over 1,000 worldwide.

**Comparable Systems** • provides the only software-compatible alternative to the IBM 3705/3725 family Communications Controllers; competes with interface-compatible (but not software-compatible) offerings of Computer Communications Inc, and NCR/Comten.

**Vendor** • Amdahl Corporation; 1250 East Arques Avenue, P.O. Box 3470, Sunnyvale, CA 94088-3470 • 408-746-6000.

**Canada** • Amdahl Limited; One First Canadian Place, Suite 3940, P.O. Box 123, Toronto, ON M5X 1A4 • 416-862-7479.

**Distribution** • direct sales offices in the U.S., Canada, Belgium, Denmark, France, Germany, Italy, the Netherlands, Norway, Sweden, Switzerland, and the United Kingdom; Amdahl Diagnostic Assistance Centers (AMDAC) in Sunnyvale, CA; Columbia, MD; London, England; Toronto, Canada; Australia, Singapore, and Hong Kong.

### ■ ANALYSIS

The Amdahl 4705E/4705T represent a natural evolution for the firm that pioneered IBM software-compatible large-scale mainframes utilizing advanced technology and offering dramatic improvements in price/performance. Amdahl tests show the 4705E/T offers 2.4 times the performance of the 3705-II. The IBM 3725 offers about 2 times the performance of the 3705-II at a 12%

## Amdahl 4705 Series Communication Processors

### 4705 Models 4705E & 4705T

to 15% lower price for comparable configurations. When replacing an existing 3705, the Amdahl 4705E/T requires no change to either the host or front-end software; and the operating procedures remain the same.

The Amdahl front end has several features that make it preferable to the IBM 3705, such as a faster internal cycle time and an instruction look-ahead. These features increase throughput over a comparably configured 3705. Amdahl, however, does not support some of the features that IBM does, such as the high-speed 230.4K-bps IBM line adapter or some of the low-speed terminal IBM line adapters. Amdahl supports the popular transmission range of 2400 bps to 64K bps. With the new 4705T, Amdahl has added support for high-speed T1 data rates and voice channels.

Both the IBM 3705 and the Amdahl 4705 support the same physical attachability. Consequently, Amdahl has installed 4705s not only in locations with Amdahl mainframes but also in locations with exclusively IBM mainframes.

The 4705 has been popular with Amdahl users. Amdahl customers are not "locked into" IBM hardware for communication processing. Although other IBM-compatible front ends are available, these offerings require changing from IBM software and converting to the non-IBM vendor's developed packages. For emulation-based networks, which are relatively stable, this action has been done with successful experiences. For SNA-based networks, however, the non-IBM software vendors are finding it increasingly difficult to replicate the latest SNA enhancements due to their frequency and the complexity of IBM's added functionalities.

The 4705E/T extended the performance level and memory size of the older 4705 Series to be competitive with that of the IBM 3725 Communications Controller. IBM claims the 3725 performance is about twice that of the 3705-II and Amdahl tests show the 4705E is 2.4 times that of the 3705-II. Thus, the 4705E/T performance is about 1.2 times that of the 3725. The 4705E/T supports 1M bytes of memory; the 3725, 2M bytes. The 4705E/T supports 6 host connections as compared to 8 on the IBM 3725.

The 4705E/T, however, cannot run the ACF/NCP Versions for the 3725 because the 4705E/T does not include the Maintenance and Operator Subsystem (MOSS) integral to the 3725. The 4705E/T can run the compatible ACF/NCP Versions that run on the 3705-II. Amdahl will need a 4705 model with a MOSS-type unit to be truly competitive with the IBM 3725. The MOSS unit allows unloading more host functions onto the 3725, a direction many experts had predicted for a new IBM front end although IBM has not yet done so.

Amdahl claims that the 4705E/T supports all of the network functionality of the 3725. Furthermore, the firm provides support for stabilized software. Amdahl has announced to its users that a 4705E/T follow-on product will support 3725 Code once the 3725 Code is stabilized.

With the introduction of the 4705T, Amdahl has increased the functionality of the 4705 over both the 3705-II and 3725. The 4705T incorporates in one unit the 4705E and the facilities of its 2211 T1 multiplexer with I/O voice module from the Amdahl Communications Systems Division. It offers the big mainframe customer opportunities to use high-speed data links and combine voice and data communications.

The 4705E/T communication processor represents a continuing effort by Amdahl to be a single-source supplier of IBM-compatible hardware. Amdahl has expanded into the peripheral and communications markets. The Company's Communications Systems Division offers networking products that provide concentrated (economical) access to X.25-based networks and nodal processors that perform data switching using the X.25-based packet-switching techniques.

#### □ Ease of Use Features

Programs for the 4705E/4705T as with IBM's 3705-II/3725 are generated on the S/370-compatible host using a macro language to specify system parameters, configuration, number of connections to hosts, number of hosts, type of lines used, number of lines, speed of lines, etc. The same IBM source code generates

the access method (VTAM or TCAM) in the host so that the 2 programs work compatibly.

#### □ Modes of Operation

The Amdahl 4705E/4705T runs the IBM 3705-II/3725 software. As a result, the 4705E/4705T can be employed in any capacity that is supported by the 3705/3725, including emulation mode, partitioned emulation mode, and network control program (NCP) mode. In emulation mode, the 4705E/4705T appear to the host as IBM 270X hardwired communication controllers. Many terminal devices are supported in this mode: those using asynchronous and synchronous protocols including BSC, SDLC, and X.25.

In partitioned emulation mode (PEP), the 4705E/4705T run both as a 270X controller and as an SNA-supporting 3705/3725. Attached devices, however, are dedicated to one partition or the other. PEP is designed to offer users a migration path for systematically converting from non-SNA to SNA operation. Devices can be replaced one at a time and switched over from the emulation realm to the NCP realm.

When running in the NCP mode, the 4705E/4705T functions as a keystone of an SNA network. A number of software versions have now been issued by IBM, including NCP, NCP/VS, and ACF/NCP/VS (the latest of which is Version 3 for 3705-II, and 4 for 3725). Later versions are compatible with earlier versions and offer enhanced networking capabilities. For more detailed descriptions of IBM's NCP software products, refer to the individual reports on IBM Systems Network Architecture (SNA) and the IBM 3705-II/3725 Communications Controllers. The 4705E/T runs the 3705-II software versions, not the 3725 versions.

#### □ Strengths

The 4705E/4705T features both cost and performance advantages over the IBM 3705-II/3725. Based on comparable configurations, Amdahl 4705 offers 2.4 times more throughput with pricing over 25 percent less than the 3705-II, depending on the purchase or lease arrangement. The smallest cost differential is with purchased systems; the biggest difference is realized with the long-term lease. Amdahl offers both 2- and 4-year lease plans. The 4705E offers about 20% higher performance than IBM 3725 at from 12% to 15% less cost. The 4705E price/performance advantage is most pronounced for large configurations with over 200 lines.

In typical configurations, the 4705E/4705T offers more throughput than the 3705-II/3725. The degree of improved performance varies significantly depending on configuration (number of terminals, line speeds, mix of protocols, and so on). Contributing factors are a 145-nanosecond access time on the 4705E/T (versus 900-nanosecond on 3705-II) and the instruction look-ahead capability of the 4705E/T, which essentially permits one CPU operation to begin before the last one is completed.

The Amdahl processors feature a touch-sensitive operator control panel with LED displays and hexadecimal read-outs, which make it easier to use as well as reduce operator errors when compared to the IBM manual-switch panel with rotary switches and binary read-outs.

Amdahl also offers high-speed asynchronous support up to 9600 bps, internally clocked. IBM's internally clocked asynchronous is currently limited to 1200 bps.

Amdahl offers an integrated line switch for 4705E/4705T, unavailable on 3705-II/3725, that switches line interface units to a back-up communications processor in case of failure. This arrangement is considerably less expensive than a fully redundant system.

The 4705T offers facilities unavailable on the 3705-II/3725. The 3725 can connect to a high-speed line, 512K to 1.544M (T1) bps via RPQ but does not offer the support provided by Amdahl for its high-speed T1 facility. The High-Speed Voice Data Attachment module in the 4705T can support up to 44 (90 with options) voice and/or data lines. Some lines can interface to the 4705E unit in the 4705T, others can interface to a PBX, and others can interface to another 4705E. The 4705T gives the user considerable flexibility in using a T1 data link facility.

## Amdahl 4705 Series Communication Processors

### 4705 Models 4705E & 4705T

#### □ Limitations

Older IBM communications software, including the emulation program (EP) and the partitioned emulation program (PEP) are available from Amdahl, along with software maintenance. However, currently licensed IBM front-end software, including ACF/NCP, must still be obtained from and supported by IBM. This is not a significant limitation, however, because users of Amdahl mainframes are also generally using IBM licensed software.

Apart from the inconvenience of retaining IBM as a software source with someone else's hardware, there are no apparent limitations to the 4705E/4705T. Users of plug-compatible devices, however, should keep in mind that as new IBM operating software is released, there may be some delay before the PCM will support the new versions. This is because of small internal differences between the processors, which also permit the 4705E/4705T to offer improved performance. IBM has exhibited a trend towards microcoding an increasing portion of its operating software. While this has not yet affected the 3705-II front end, the new 3725 front-end hardware implements a processor-based MOSS subsystem for network control and maintenance thus the Amdahl 4705E/4705T cannot run the ACF/NCP for the 3725. They can, however, run the ACF/NCP Version 3 for the 3705-II, which is compatible with the Version 3 for the 3725. The ACF/NCP for the 3705-II has been frozen at the ACF/NCP Version 3 level. No new releases will be made for the 3705-II. The ACF/NCP is at Version 4 for the IBM 3725.

#### ■ SOFTWARE

Software for the 4705E/4705T consists of software developed for the IBM 3705. Some of the IBM operating software is in the public domain and available to anyone who asks for it. The 4705E/4705T customers will typically receive public-domain software, including early versions of the emulation program (EP), the partitioned emulation program (PEP), and the network control program (NCP), directly from Amdahl. Most current IBM software versions, however, including ACF/NCP/VS, are obtained by the customer directly from IBM.

#### □ Terms & Support

**Terms** • Amdahl-supplied software consists of software in the public domain, plus Amdahl-developed licensed software and utilities; for the 4705E/4705T, this consists only of diagnostic and maintenance routines which run in off-line and online 4705E/4705T without any host involvement • licensed IBM program products must be ordered from IBM.

**Support** • public-domain software provided by Amdahl is supported by Amdahl as part of 4705E/4705T system • software support services for IBM licensed software is available from IBM (see IBM 3705-II Report No 950-1048-3705, for licensed software charges and support fees).

#### □ Operating Systems

Host operating system, and in particular the communication access method, will determine the role of the 4705E/4705T communications processors. All IBM host operating systems are supported by the 4705E/4705T, although there are restrictions on which front-end software loads are supported by which operating systems. For example, TCAM, Release 10 or later, or VTAM is required as the host telecommunications access method before the front end (4705E/4705T or IBM 3705/3725) can run in network control (NCP) mode—a prerequisite to operating an SNA network. (For a more detailed discussion of compatible access methods, operating systems, and front-end software loads, see IBM Systems Network Architecture, Report No 950-1048-0000.)

#### □ Network/Communications

The software products which operate with the Amdahl 4705E/4705T are the same as those for the IBM 3705-II. The 4705E/T cannot run the IBM 3725 software. (See IBM 3705-II, Report No 950-1048-3705, for details on specific software products.)

#### □ Program Development

The software for the 4705E/4705T (as with the IBM 3705-II/3725) is generated on the host processor and then downloaded into the front end. Whether an IBM, Amdahl, or compatible host processor is utilized, IBM licensed system support programs (SSPs) are required. SSPs include support programs for generating the control program, an assembler, and loader and dump facilities. Latest version is ACF/SSP 2.2 for the 3705/3725 3.0.

As with the 3705/3725, the 4705E/4705T are also capable of being located remotely from the host processor, primarily as a remote concentration/switching node. This requires a special remote IPL option, analogous to a similar option available with the 3705-II/3725. (See IBM 3705-II Report No 950-1048-3705, for additional program-generation information.)

#### □ Other Program Modules

Other utilities available from IBM for the 3705/3725, including support modules which execute on the host, are generally supported by the 4705E/4705T. In addition, a set of diskette-based diagnostic and maintenance routines is provided by Amdahl for execution on the 4705E/4705T when it is off-line. These routines are supplied as part of the 4705E/4705T system, along with the integrated diskette drive.

#### ■ HARDWARE

#### □ Terms & Support

**Terms** • available for purchase or lease under 2- or 4-year agreements • lease can be renewed on 12-month basis after initial agreement expires • for the purchase of leased equipment, up to 55 percent of lease payments may be applied towards purchase price.

**Support** • standard maintenance agreement offers on-call service 24 hours per day, 7 days per week.

#### □ Overview

Basic to the 4705E/4705T models is the central control unit, which performs all processing and controls the line scanners, channel adapters, and line sets. The control unit is configured with a minimum of 256K bytes of main memory, expandable to 1M bytes in 256K-byte increments. Channel adapters provide for the attachment of the 4705E/4705T to the host processor(s). Up to 6 different hosts, or 6 channel attachments to the same host, are supported simultaneously. One channel adapter model is available. The channel adapters attach to either the byte or block multiplexer channels of the host with connector cables provided by Amdahl.

Two models of the 4705E/4705T are available. The 4705 requires an expansion cabinet for configurations with more than 160 communication lines.

Up to 3 communication line scanners can be used depending on the type and mix of lines. Line interface bases attach to the scanners and perform character-level communication processing. Amdahl's line interface base supports a variety of communication line sets. Different line speeds and protocols can be handled by the same line interface base.

Line sets, supporting from 1 to 4 individual communication lines depending on type and speed of line, attach directly to the line interface base. Generally, the available line sets support 4 half-duplex voice-grade lines or 2 full-duplex voice-grade lines. Wideband line sets support either 1 full-duplex communication line or 2 half-duplex facilities. Wideband support to 64K bps is available. Line sets to support digital transmissions are also available. Interfaces for external modems are EIA RS-232C or CCITT V.35. Automatic dialing units are also supported.

The 4705T includes a 4705E unit as well as a modified version of a 2211 T1 multiplexer with a High-Speed Voice and Data Attachment Unit. The basic system can attach up to 44 voice and/or data lines that can be multiplexed over a high speed data link of 2.048M bps (including T1 service of 1.544M bps). Lines can be terminated in the 4705E portion of the communications processor, in a PBX, or in another 4705E.



## Amdahl 4705 Series Communication Processors

### 4705 Models 4705E & 4705T

Amdahl provides high-speed features to support the High-Speed Voice Data attachment unit: synchronous and asynchronous interfaces, integrated limited distance data sets, and additional voice I/O modules. The 4705T can support up to 90 voice/data lines in addition to the 352 half-duplex data communication lines supported by 4705E.

#### □ CPU & Memory

The 4705E/4705T include 1 model each with 256K bytes of memory expandable in 256K-byte increments to 1M bytes.

#### 4705 Models

Each model includes central control, basic cabinet and, if applicable, extension cabinets, power supplies, operator control panel, and internal diagnostic routine diskette and loader.

Both 4705E and T can attach up to 352 half-duplex lines at speeds up to 64K bps. Both can attach to up to 6 hosts through channel adapters. Up to 2 channel adapters can be connected through 2-way switches to 2 byte or block multiplexer channels on 1 or 2 hosts. The switch is manually set to attach the adapter to one of the 2 channels.

The 4705T also includes a 4705E plus the High-Speed Voice and Data Attachment module, which allows the 4705T to connect to 90 voice and/or data lines multiplexed over a trunk transmission facility at rates up to 2M bps including T1 service of 1.544M bps. Data lines can operate at speeds of 4800 to 168K bps.

Throughput of the 4705E is limited to about the equivalent of ten 56K bps lines or 560K bps, thus the High-Speed Voice and Data Attachment module can supply more data than the 4705E can use. Generally, part of the bandwidth will be used for voice lines or it can be used for connection to an alternate 4705E.

**4705E** • basic unit includes 256K-byte memory; supports 2 scanners to connect up to 160 communication lines; requires expansion unit to support 2 additional scanners to connect 192 more lines:

\$1,225/\$730 mo	\$27,000 prch	\$330 maint
------------------	---------------	-------------

**4705T** • includes same base unit as 4705E plus High-Speed Voice and Data Attachment with redundant multiplexer, high-speed expansion cabinet, redundant power supplies, 3 synchronous I/O modules, redundant trunk interface modules, network console with asynchronous interface and associated cables; requires specification of trunk and line interfaces, cable connections; basic system provides up to 44 voice and/or data lines and support equipment • additional voice I/O module can support up to 46 additional voice and/or data lines • \$1,000 • one-time installation fee charged:

1,905/1,135	42,000	430
-------------	--------	-----

**4705T Network Console** • standard feature of 4705T; provides operator interface to configure, monitor, and manage the High-Speed Voice and Data Attachment for the 4705T; controlled by a program in the High-Speed Voice and Data Attachment • operates in 2 modes; Multimaster Mode where every 4705T connected to console reports status and alarm conditions and Session Mode where operator can use console to monitor, configure, or diagnose any local or remote channel linked to the console • operator interface through interactive dialogue using English commands and responses • 12-inch display and typewriter-style electronic keyboard; supports data rates from 300 to 4800 bps; console can be located 4,000 feet from local 4705T:

NC/NC	NC	NC
-------	----	----

**4705E to 4705T Upgrade** • requires \$1,000 one-time installation charge:

725/430	16,000	NA
---------	--------	----

**EXPE Expansion Unit** • required for configurations supporting more than 160 lines; can support up to 96 communications lines; maximum of 2 per system:

545/320	12,000	50
---------	--------	----

#### Memory Modules

Can be expanded in 256K-byte increments to maximum of 1M bytes.

**MS3E Memory Module** • 256K-byte memory increment • for 4705E and 4705T:

\$270/\$160 mo	\$6,000 prch	\$30 maint
----------------	--------------	------------

#### □ I/O Channels

A single channel adapter is available for the 4705E and 4705T. It can attach to a byte or block multiplexer channel and can support a 2-channel switch to connect to 2 host channels. Up to 6 channel adapters can be configured per 4705E/4705T.

#### Channel Adapters

**CA4E Channel Adapter** • connects 4705E/4705T to a host byte of block multiplexer channel • up to 6 can connect to a 4705E/T system:

\$180/\$105 mo	\$4,000 prch	\$15 maint
----------------	--------------	------------

**TCSE 2-Channel Switch** • used with CA4E to connect 1 adapter to 2 byte or block multiplexer channels attached to 1 or 2 hosts:

80/45	1,750	15
-------	-------	----

#### I/O Modules for 4705T Only

**HS20 Synchronous I/O Module** • provides channel logic to attach 2 low-speed synchronous data channels; can be configured in field to interface to DTE or DCE devices; channels operate in full- or half-duplex mode and support data rates from 300 to 512K bps depending on interface selected; each channel can operate at its own data rate • can interface to standard communication interfaces, low-speed channel of another multiplexer, the trunk of another multiplexer in a cascaded configuration, the trunk or port of a network concentrator or synchronous DCE/DTE devices • supports the following interfaces: F2211-21 EIA RS-232C/CCITT V.24, at data rates of 300 to 19.2K bps; F2211-22 CCITT V.35, at data rates of 300 to 512K bps; F2211-23 AT&T 301/303 at 300 to 512K bps; and F2211-24 MIL-STD-188-114 (unbalanced) at 300 to 64K bps • channel data rates include 300, 600, 1200, 2400, 3600, 4800, 7200, 9600, 14.4K, 16.0K, 19.2K, 32.0K, 38.4K, 40.8K, 48.0K, 50.0K, 56.0K, 64.0K, 112.0K, 115.2K, 128.0K, 230.4K, 256.0K, 512.0K bps • channel parameters are software configured from operator console:

\$50/\$25 mo	\$1,000 prch	NC maint
--------------	--------------	----------

**HS30 Integrated Limited—Distance Data Set** • plug-in module in 4705T High-Speed Expansion Cabinet • interfaces one synchronous data channel on a 4-wire loop • loop is terminated at remote end by Amdahl 982 Synchronous Data Set which can be located up to 32 miles away depending on data rate and wire gauge; module operates in half or full duplex mode at 1200 to 9600 bps; loop access cable length is 20 feet • module meets AT&T PUB 43401 specifications for connection to 4-wire private lines • provides built-in fault detection and alarm reporting, manual or remote channel disable/enable, and automatic Equalization and Automatic Line Buildout (ALBO) to ensure distortion free transmissions • provides soft configuration and setting channel parameters from Network Console; channel transmits 4 inband (DEC to DTE) and 3 outbound (DTE to DCE) control signals:

40/25	880	NC
-------	-----	----

**HS34 Integrated Multiport Limited Distance Data Set** • similar to HS30 except provides logic to interface up to 4 channels on one 4-wire loop terminated at remote end up to 28 miles away by an Amdahl 984 Multiport Synchronous Data Set; occupies 2 contiguous slots in the chassis in the High-Speed Expansion Cabinet of 4705T • supports data rates from 600 to 9600 bps per channel with aggregate data rate of 19.2K bps • operates in full-duplex mode; provides full end-to-end diagnostics; conforms AT&T DUB 4301 specifications • channels soft to configured from Network Console:

65/35	1,300	NC
-------	-------	----

*MO: monthly 2-year/4-year lease charge including maintenance. PRCH: single-unit purchase price. MAINT: monthly maintenance charge for purchased units. NC: no charge. NA: not available. Prices effective as of March 1985.*



## Amdahl 4705 Series Communication Processors

### 4705 Models 4705E & 4705T

**HS40 Asynchronous I/O Module** • provides channel logic to interface 1 low-speed asynchronous channel at data rates from 300 to 19.2K bps; provides RS-232C/V.24 and MIL-STD-188-114 (unbalanced) interfaces cable length can be up to 50 feet • data formats include ASCII or EBCDIC with 1 start bit, 6/7/8 data bits, 1/2 stop bits, and parity (transparent) • full or half duplex with CTS turnaround in response to RTS or half duplex with remote CTS origin:

30/15	680	NC
-------	-----	----

**HS45 Voice I/O Module** • 2-channel, plug-in module provides a standard E&M (Type 1) voice interface; uses the Amdahl Enhanced Continuously Variable Slope Delta (AECVSD) modulation technique to allow the user to vary the multiplexer bandwidth to select the voice channel quality • can be terminated directly on a PBX tie-trunk terminal to allow PBX-to-PBX communication without tie trunk or long distance leased line • can be extended for facsimile transmission, business machine intercommunication, or automatic hot-line operation • supports up to 46 voice channels or combination of voice and data channels over 1 trunk; software-controlled diagnostics and input/output level settings from Network Console and software-controlled sampling/channel rates of 16K/32K/48K/64K Hz • full support of analog modems up to 9600 bps • mounts in the High-Speed Expansion Cabinet of 4705T • voice channels can be patched through nodal sites using standard 4705T Synchronous Data I/O Module without voice quality degradation:

70/50	1,430	NC
-------	-------	----

**Communication Lines**

Communication line attachments require at least 1 line scanner, a line interface base, and a communication line set.

**Communications Scanners**

Up to 4 communication scanners can be configured with the 4705E/4705T, with at least 1 scanner required. All scanners are housed in the basic 4705 cabinet.

The Communications Scanner Type 2 (CS2E) supports up to 6 line interface bases or a maximum of 96 communication lines. The CS2E supports a mixture of asynchronous and synchronous lines. The Communications Scanner Type 3 (CS3E) supports up to 4 line interface bases, or a maximum of 64 communications lines. The first scanner used in a 4705 (whether a CS2E or CS3) can attach a maximum of 64 lines.

The 4705E/4705T requires a single scanner attachment base when only 1 scanner is configured with the system.

**CS2E Communications Scanner Type 2** • functionally equivalent to IBM 1642 Type 2 scanner • assembles/disassembles characters automatically and provides character buffering for each line • interrupts control program only when entire character is available and allows program to perform line control, control character recognition, and code translation and recovery functions • supports up to 6 line interface bases (LIBs) and mix of asynchronous/synchronous lines:

\$270/\$160 mo	\$6,000 prch	\$30 maint
----------------	--------------	------------

**SS2E Single Scanner Attachment Base Type 2** • required only if 4705E/4705T is configured with single scanner; used in place of CS2E:

225/135	5,000	NC
---------	-------	----

**CS3 Communications Scanner Type 3** • functionally equivalent to IBM 1643 Type 3 scanner • interrupts control program on multibyte, cycle steal basis for data transfers between memory and line sets • provides control character recognition for BSC and SDLC line controls; provides ASCII-to-EBCDIC and EBCDIC-to-ASCII code translation for BSC operation; provides for auto-dial operation • supports up to 4 line interface bases (LIBs), and synchronous lines only:

725/430	16,000	70
---------	--------	----

**SS3E Single Scanner Attachment Base Type 3** • required only if 4705E/4705T is configured with single scanner; used in place of CS3E:

360/215	8,000	NC
---------	-------	----

**Line Interface Base (LIB)**

**LIB1E Line Interface Base (LIB)** • functionally equivalent to IBM 4701 Type 1 LIB • allows attachment of line sets that interface to external modems, auto-call units, or directly attached terminals • supports up to 4 HD1E, HD1LE, FD1E, FD1LE and LA1CE line sets; up to 2 HD2E or FD2E line sets alone or in combination with one another • requires CS2, CS3, SS2E, or SS3E communication line scanner:

\$45/\$25 mo	\$1,000 prch	NC maint
--------------	--------------	----------

**LIB2E Line Interface Base** • for high-speed asynchronous line speeds up to 9600 bps:

90/50	2,000	NC
-------	-------	----

**Line Sets**

Line sets attach to the 4705E/4705T via line interface bases (LIBs), and support from 1 to 4 communication lines or terminal attachments dependent on line speed, duplex mode, and synchronization. Some models support IBM's Link Problem Determination Aid (LPDA).

**HD1E Line Set** • supports attachment of 4 half-duplex lines at data rates to 2400 bps asynchronous or 19.2K bps synchronous • RS-232C interface • maximum of 4 line sets (16 lines) per LIB; cannot be used with C3 scanner:

\$110/\$65 mo	\$2,400 prch	NC maint
---------------	--------------	----------

**HD1LE Line Set** • analog, half-duplex, V.24 interface; provides 4 lines; LPDA compatible:

115/70	2,500	NC
--------	-------	----

**FD1E Line Set** • functionally equivalent to IBM 3704 4718 Type 1H line set • supports attachment of 2 full-duplex lines at data rates to 19.2K bps synchronous • RS-232C (V.24) interface • maximum 4 line sets (8 lines) per LIB:

45/30	1,200	NC
-------	-------	----

**FD1LE Line Set** • same as FD1E but supports LPDA:

50/35	1,300	NC
-------	-------	----

**HD1GE Line Set** • functionally equivalent to IBM 4717 Type 1G line set • supports attachment of 2 half-duplex wideband lines (Bell 303) or terminals at data rates to 50K bps synchronous:

180/105	4,000	NC
---------	-------	----

**FD1TE Line Set** • functionally equivalent to IBM 1T line set • supports attachment of a full-duplex wideband line (Bell 303) at data rates to 50K bps:

90/50	2,000	NC
-------	-------	----

**HD2E Line Set** • functionally equivalent to IBM 4720 Type 1S line set • supports attachment of 2 half-duplex lines at data rates to 56K bps synchronous • CCITT V.35 interface • maximum 2 line sets (4 lines) per LIB:

225/135	5,000	NC
---------	-------	----

**FD2E Line Set** • functionally equivalent to IBM 4726 Type 1U line set • supports attachment of 1 full-duplex line at data rates to 64K bps synchronous • CCITT V.35 interface • maximum 2 line sets (2 lines) per LIB:

135/80	3,000	NC
--------	-------	----

**FD4E Line Set** • provides full-duplex X.21 interface for 2 lines; supports data rates up to 19.2K bps:

45/30	1,200	NC
-------	-------	----

**FD5E Line** • provides full-duplex X.21 interface for 1 line; supports data rates up to 64K bps:

110/75	2,900	NC
--------	-------	----

**LA1CE Line Set** • functionally equivalent to IBM 3704 4713 Type 1C line set • supports attachment of 4 half-duplex local lines or terminals at distances to 200 feet and data rates to 2400 bps asynchronous • maximum 4 line sets (16 lines) per LIB; cannot be used with C3 scanner:

100/65	2,400	NC
--------	-------	----

**NC1E Automatic Dialing Unit Adapter** • supports attachment of 2 auto dialing units and 2 half-duplex communications lines;

## Amdahl 4705 Series Communication Processors

### 4705 Models 4705E & 4705T

supports asynchronous transmission at up to 2400 bps or synchronous transmission at up to 19.2K bps; interfaces are RS-232C and RS-366 for auto-dial units • requires HD1 line set:

55/30	1,200	NC
-------	-------	----

**ILSE Integrated Line Switch Unit** • switches line interface units between 2 hosts for backup • also allows line sets to be shared in fully redundant systems:

180/105	4,000	NC
---------	-------	----

**Other Units**

**Remote Integral Program Load Extended (RIPLE)** • similar to option available with IBM 3705-II/3725 used when 4705E/T is configured remotely to host; takes the place of 1 channel adapter; permits 4705E/T to be IPL'ed remotely:

\$90/\$50 mo	\$2,000 prch	NC maint
--------------	--------------	----------

• END

# American Satellite

## Domestic Communication Services

### ■ PROFILE

**Function** • voice-grade and wideband, shared and dedicated channel, carrier network services.

**Facilities** • satellite, microwave, and landline network comprising American Satellite-owned satellite city earth stations as well as earth stations at customer sites • extension channels provide access to major metropolitan areas.

**Services** • shared and leased network services for teleprinter, data, facsimile, and voice communication • specialized government services • satellite transponder leasing services • customer-owned earth stations • video teleconferencing.

**Access** • direct from customer locations via on-site earth stations • voice-grade leased channel access via Central Offices in 12 major cities • shared station-to-station voice exchange access in 5 major cities • shared voice foreign exchange access in 17 major cities • wideband digital channel access in 17 city-pair combinations • service extensions provide access to other metropolitan areas.

**First Available** • 1974.

**Number of Users** • over 450 customers.

**Comparable Services** • RCA Americom, Satellite Business Systems, and Western Union for on-site dedicated channels.

**Vendor** • American Satellite Company; 1801 Research Boulevard, Rockville, MD 20850 • 301-251-8399.

**Canada** • none.

### ■ ANALYSIS

Under its National Network Services, American Satellite (ASC) offers customers leased voice-grade channels, 56K-bps digital data channels, and video teleconferencing services under the name **Flex Stream**. Like its competitors, RCA Americom and Western Union Satellite, ASC offers voice-grade channels suitable for voice, data, records, facsimile, or alternate voice/data applications. These channels are available on a full-period (7 days per week, 24 hours per day) basis for a minimum period of one month. Reduced monthly channel charges 19 to 25 percent below monthly charges are applied to long term service for a minimum of 12 months. Monthly channel charges apply to city-pairs serviced by ASC earth stations and vary according to city-pair distances. Monthly charges also include a nominal local facilities charge for each full-duplex channel connection at either end. Customer Termination Package charges and Echo Cancellation charges are included in channel charges under a 30-day or 1-year rate, but are charged separately under a 2-year rate. Over the past year, voice-grade channel charges have been increased by about 9 to 10 percent.

ASC offers a shared voice-grade channel service under its Satellite Voice Exchange. This service is for low volume traffic because city-pair channels are shared among many subscribers. Channels are shared between CO's only. However, their service limits customer calls to calls placed between New York and Chicago, Dallas, Los Angeles, or San Francisco only.

American Satellite has substantially expanded its network over the past few years to include **170 earth stations** located throughout the Continental U.S., Hawaii, Guam, and Puerto Rico. Satellite city-pairs have been increased to 47 from just 26 in 1982, an 81 percent increase. American Satellite central offices (CO's) are now located in most major U.S. cities and are accessible to customers in surrounding vicinities via dedicated telephone lines. The latest addition to ASC's network is its Seattle facility which became operational in November 1984. This facility

### AMERICAN SATELLITE LEASED VOICE-GRADE CHANNEL MINIMUM USAGE COSTS

**Configuration** • single leased voice-grade channel customer stations (2) located in Chicago and Dallas, respectively • long term service (12 months) • no special extension facilities, echo cancellation or other equipment.

**Minimum Start-Up Costs** • \$220.00 total • consists of \$140.00 for installation of local facilities in Chicago and Dallas (2x\$70.00) and \$80.00 for installation of the channel.

**Minimum Monthly Operating Costs** • \$725.00 per month total • consists of \$625.00 per month channel charge for 12-month period; \$100.00 per month for local facilities (2x\$50.00).

serves the business community in the Pacific Northwest. ASC plans to continue the expansion of its national network and will make significant strides throughout this decade.

The principal appeal of the ASC service is a raw economic one—made possible by the technology of free space. On long high-volume routes, where the capital equipment costs of terrestrially bound facilities quickly assert themselves, a private line satellite circuit can be a very attractive proposition. Buttressing this cost advantage are a host of other innovative ASC services. For the budget-conscious user willing to forego the exclusivity of a private line, the Shared Voice Exchange (SVX) service offers additional cost savings. Where the traffic volume and geographic location warrants, the ASC Satellite Data Exchange (SDX) service, with its on-site earth stations is a feasible approach. The very high-volume user with on-site earth stations in place acquires a gateway to other potential offerings including teleconferencing, high-speed facsimile and electronic mail, in addition to a measure of independence from terrestrial facilities.

Only a decade old, ASC has carved itself a comfortable niche in the burgeoning market for dedicated satellite communication channels. Backed by the considerable resources of Fairchild Industries and Continental Telephone Corporation, the fourth largest telephone corporation in the United States, ASC reported a profit for the first time in 1982 and has since been profitable. In 1982 and 1983, ASC reported profits of \$1.9 and \$3.2 million on revenues of \$44 and \$54 million, respectively. The company now has over 450 customers. For the foreseeable future, it has contractual access to ample satellite transponder capacity from Western Union. Over the longer term, ASC is planning to launch its own series of satellite spacecraft. Besides the public access facilities of its National Network Service, American Satellite is a key supplier of data transmission services to the Federal Government; its Satellite Data Exchange service is in heavy use by major corporations.

### □ Strengths

For the high data volume user with long distance sites in reasonably close proximity to the local distribution areas served by ASC, this service can be a very attractive bargain; for private, voice-grade line, long term leases, the monthly savings on many routes can exceed 50 percent compared with equivalent AT&T private line services. If the data volume is high enough, even a remotely located user can justify the satellite service via on-site earth stations. Over a three-year period, one Western banking

## American Satellite Domestic Communication Services

organization, with a daily satellite circuit volume of 40 million bits of information, expects to save nearly one million dollars. And, of course, a strong suit of the satellite circuit is its remarkable clarity and freedom from the error-producing disturbances of land circuits.

### □ Limitations

Corporations with small, low traffic sites, located at considerable distances from ASC satellite cities, would probably be hard pressed to justify a satellite network or, for that matter, any form of private line network. The cost of linking each site, via common carrier extensions, to an ASC Central Office, could prove exorbitant. In addition, while sophisticated compensation delay units have dramatically improved the throughput of satellite data circuits, the "tunnel voice" effect caused by propagation delay can prove annoying to speakers who frequently interrupt each other.

### ■ NETWORK

#### □ Terms & Conditions

**Billing Criteria** • customers pay for leased voice-grade services based typically on factors associated with city-pair access, local facility channels, termination packages, and extension channels • private line shared voice-grade (SVX) channel service charges are based on city-pair access • wideband 56K-bps data channel charges require payment of a monthly access charge for a fixed term • contractual charges for transponder service involve monthly rentals for a minimum term.

**Billing Conditions** • leased voice-grade service is full-duplex, 2-point, 7 days per week, 24 hours per day • minimum period of service is 1 month for leased voice-grade service; reduced rate offered in specified city-pairs for rental periods of 12 or more months • customer must specify number of voice-grade channels, city-pair interconnect combinations, station functions, and period of service, as well as echo cancellation and channel conditioning required • ASC will provide or arrange end-to-end connection • recurring charges payable in advance; nonrecurring charges normally payable when service is established; at discretion of ASC, advance payments may be required • proportionate billing for fractional charges incurred when service start or stop does not coincide with billing period • customer responsible for payment of all local business line charges incurred in conjunction with SVX foreign exchange service • customer may participate in a shared use group to obtain ASC services and facilities • 30-day advance notice required for service termination.

**Other Conditions** • services shall not be used for any unlawful purpose • resale and shared use arrangements must be made known to ASC prior to such use • ASC furnished facilities and services may be resold by other common carriers • customer may provide his own earth stations, terminal equipment, or communication systems • customer responsible for all arrangements for inter-connection of customer-provided equipment to ASC facilities • customer may be required to use suitable interfaces to protect common carrier facilities • ASC undertakes to maintain and repair facilities and equipment which it furnishes • ASC not liable for any act or omission of other common carriers or companies furnishing a channel, facility, or service interconnected with or provided in conjunction with ASC's channels or facilities.

#### □ Overview

Over the past year, ASC entered into several large contractual agreements. In March, ASC received a 3-year contract from Hambrecht & Quist for a private, 3-city voice and video teleconferencing network among locations in San Francisco, New York, and Boston. In May, ASC signed a \$15 million contract with STARNET, a communication carrier, for bulk satellite capacity which STARNET will use to provide its long-distance voice and data communication services to its residential and business users. ASC also received a \$6.5 million contract from United Technologies for a private satellite network for video teleconferencing, voice, and data. And in September, ASC signed a multimillion dollar contract with Sears Communications for a private voice, data, and video communications network

connecting Sears corporate and subsidiary offices in 26 U.S. cities. Also, in October, ASC signed a 3-year contract with Xerox Corporation for a 3-city video teleconferencing network.

In operation since 1974, American Satellite Company (ASC) has achieved a leading position in direct facility-to-facility data transmission, including distributed data processing and voice communications. ASC provides private-line and specialized network services to more than 450 commercial and government customers through 170 earth stations in the United States. In mid-1979, Fairchild Industries, the corporate parent of ASC, entered into an agreement with Continental Telephone Corporation, to share ownership and operation of ASC as a partnership.

Toward year-end 1979, American Satellite, Fairchild, and Continental entered into agreements with Western Union to acquire ownership of satellite capacity. Under one agreement, ASC contracted to purchase a 20 percent interest in the current Westar satellite system including the Westar V. In the second agreement, Fairchild and Continental each agreed to acquire a 25 percent interest in Western Union Space Communications, Inc (SPACECOM), a Western Union subsidiary established to construct and operate NASA's Tracking and Data Relay Satellite System (TDRSS) as well as to service Western Union's Advanced Westar satellite program. Under this agreement, half the commercial capacity provided by TDRSS will be available to American Satellite through the early 1990's.

In January 1985, ASC announced the sale and lease back of Westar V satellite transponders. This \$35 million leveraged lease transaction provided through CitiCorp Multilease (SEF), Inc, represents an attractive low-cost method to finance the company's future growth.

American Satellite filed an application with the FCC in 1981 to acquire and launch 2 wholly owned commercial communication satellites. The FCC approved ASC's application in April 1983. ASC had awarded RCA Astro with a contract for the construction of the 2 spacecrafts in March 1983. Designated ASC 1 and 2, the 2 hybrid (dual frequency) satellites have been assigned orbital locations at 81 degrees and 128 degrees west longitude. Each satellite includes 12 36-MHz C-band, 6 72-MHz C-band, and 6 72-MHz Ku-band transponders. Launch dates for the ASC satellites are scheduled for August 1985 and 1986 on NASA's Space Shuttle.

Most of American Satellite's customers are served by private-line voice and data circuits provided by the company's National Network Service facilities. Customers lease fixed-price voice-grade circuits that can be used 7 days a week, 24 hours a day. The circuits (channels) are suitable for voice, record, data, or alternate voice/data transmission at speeds up to 9600 bps in either half-duplex or full-duplex mode. This service is provided to 47 city-pairs via a network of earth stations and Central Offices in major metropolitan areas.

Communication signals are combined at the Central Offices for transmission via an earth station to a satellite. Conversely, signals received at the Central Offices are distributed to the various customers. The transmission link between the earth station and the Central Office is usually a microwave radio channel. Each Central Office consists of transmission and switching equipment, digitizing equipment, high-speed data modems, echo suppressors, echo cancellers, traffic analysis equipment, and emergency power sources for use in the event of commercial power failures.

ASC's National Network Services network was completely converted to an all-digital operation in 1981. The all-digital communication system, using Time Division Multiple Access (TDMA) technology supports data transmission at speeds up to 64M bps. The upgraded earth stations permit the user to add high-speed data, facsimile, and video teleconferencing to private-line voice service. Intermixing of voice and digital inputs is performed at the ASC Central Offices.

A reduced rate voice-grade service, called Satellite Voice Exchange (SVX), entails the establishment of direct communication lines between city-pairs via shared voice channels terminated in the requisite channel terminating equipment in ASC's Central Offices. By nature of the use of

## American Satellite Domestic Communication Services

shared trunking facilities and in order to maintain a satisfactory grade of service for all users, customer communications are intended to be of short duration. Station-to-Station service includes the local access lines to connect a customer's station at each end to the ASC serving Central Office. Foreign Exchange service includes the local access lines to connect a customer's station to the ASC serving Central Office on one end and a termination in a Bell Central Office for interconnection with a local business line on the other end. Also included in each of these service arrangements, wherever applicable, is a standard telephone handset or connection to customer provided communications equipment. Access lines and foreign exchange terminations are only provided as part of the basic service arrangements when they are within the local distribution areas of a satellite serving city. If a customer's premises or termination is located outside any of these local distribution areas, the customer may be connected to the service via an extension service facility.

Customer-dedicated commercial networks, using antennas half the size of those used previously, were first installed by ASC in 1978. Called Satellite Data Exchange service or SDX, these networks allow simultaneous transmission of digitized voice, data from entry devices to remote computers, direct transfer of data between computers, cross-country document transmission, video teleconferencing and transmission of video images of people, objects, and charts. All information is exchanged directly between earth stations located on the customer's premises or through a nearby shared earth station. The smallest such stations currently authorized by the FCC for transmit and receive applications have dish antennas 5 meters (16 feet) in diameter. Depending on the volume of data to be transmitted, the 5-meter SDX stations can communicate with installations using larger (10-meter or 7-meter) dish antennas or the General Services earth stations.

ASC proprietary equipments used in the SDX service include a Satellite Delay Compensation Unit (SDCU), a cryptographic device called Cryptoline, and a Digital Communications Controller (DCC). The Satellite Delay Compensation Unit virtually eliminates signal transmission delay in satellite communication, thus at least doubling the normal efficiency of computer-to-computer data relay via satellite. This device also increases the data transfer efficiency (transfer speed) of conventional ground-based communication links.

To ensure communication privacy, an important consideration in the transmission of financial data, American Satellite offers an encryption unit called CryptoLine, which can handle various data formats in a direct computer-to-computer link-up over a satellite channel. The CryptoLine security system is based on the data encryption algorithm published by the National Bureau of Standards. CryptoLine can also provide transmission privacy to other forms of communication such as digitized voice, facsimile, and digitized video.

The Digital Communications Controller automatically allocates portions of a 56K-bps data channel to various types of simultaneous communication fed to it for transmission. The equipment performs its functions according to a stored program, or can be set manually.

The DCC can receive input from as many as 15 different peripheral devices. For example, 15 slow-speed synchronous Remote Job Entry (RJE) devices could work into one Controller, or the Controller could process one 56K-bps data input for transmission at data transfer efficiencies much higher than now possible over conventional ground-based channels.

ASC also leases satellite transponders, provided 56K-bps wideband service between specified city-pairs, leases quantities of voice-grade channels for resale by other common carriers, and leases optional customer on-site equipment.

**Access Charges**

**Leased Voice-Grade Channel Charges**

Access charges typically include monthly charges for a channel between a satellite city-pair in addition to monthly charges for local facilities and customer termination packages in each satellite serving city. Extension facility, channel conditioning, and

ENFIA service arrangement charges may also be applicable. Service is available 24 hours per day, 7 days per week for a minimum period of one month. For many satellite city-pairs, ASC offers a reduced monthly channel charge for long term service of 12 or more months. Channels offered have an approximate bandwidth of 300 to 3000 Hz and are suitable for half- or full-duplex voice, record, data, facsimile, or alternate voice/data transmission.

**Channel Charges** • rental for each voice-grade channel • monthly rental for one-month service/monthly rental for 12 or more months long-term service • includes customer, termination package, and echo canceller charges.

Atlanta—Chicago Satellite City-Pair:	<b>\$825/\$625 mo</b>
Atlanta—Dallas Satellite City-Pair:	<b>825/625</b>
Atlanta—Denver Satellite City-Pair:	<b>900/700</b>
Atlanta—Houston Satellite City-Pair:	<b>825/625</b>
Atlanta—New York Satellite City-Pair:	<b>825/625</b>
Atlanta—Washington, D.C. Satellite City-Pair:	<b>825/625</b>
Atlanta—Los Angeles Satellite City-Pair:	<b>1,100/900</b>
Atlanta—San Francisco Satellite City-Pair:	<b>1,100/900</b>
Chicago—Dallas Satellite City-Pair:	<b>825/625</b>
Chicago—Denver Satellite City-Pair:	<b>825/625</b>
Chicago—Houston Satellite City-Pair:	<b>825/625</b>
Chicago—New York Satellite City-Pair:	<b>825/625</b>
Chicago—Los Angeles Satellite City-Pair:	<b>900/700</b>
Chicago—San Francisco Satellite City-Pair:	<b>900/700</b>
Chicago—Seattle Satellite City-Pair:	<b>900/700</b>
Dallas—Los Angeles Satellite City-Pair:	<b>900/700</b>
Dallas—New York Satellite City-Pair:	<b>900/700</b>
Dallas—San Francisco Satellite City-Pair:	<b>900/700</b>
Dallas—Seattle Satellite City-Pair:	<b>900/700</b>
Dallas—Washington, D.C. Satellite City-Pair:	<b>900/700</b>
Denver—Houston Satellite City-Pair:	<b>825/625</b>

*DIEM: daily charge rate. HR: hourly charge for service. INSTAL: installation charge associated with specific network feature or option. MO: monthly charge for service. ORD: charge per order. OTC: one-time charge. Prices current as of March 1984.*

## American Satellite Domestic Communication Services

Denver—Los Angeles Satellite City-Pair:	825/625
Denver—San Francisco Satellite City-Pair:	825/625
Denver—New York Satellite City-Pair:	900/700
Denver—Seattle Satellite City-Pair:	900/700
Denver—Washington, D.C. Satellite City-Pair:	900/700
Houston—Los Angeles Satellite City-Pair:	900/700
Houston—New York Satellite City-Pair:	900/700
Houston—San Francisco Satellite City-Pair:	900/700
Houston—Seattle Satellite City-Pair:	900/700
Houston—Washington, D.C. Satellite City-Pair:	900/700
Los Angeles—New York Satellite City-Pair:	1,100/900
Los Angeles—Philadelphia Satellite City-Pair:	1,100/900
Los Angeles—San Antonio Satellite City-Pair:	975/775
Los Angeles—San Francisco Satellite City-Pair:	NA/525
Los Angeles—Seattle Satellite City-Pair:	825/625
Los Angeles—Washington, D.C. Satellite City-Pair:	1,100/900
New York—San Francisco Satellite City-Pair:	1,100/900
New York—Seattle Satellite City-Pair:	1,100/900
Philadelphia—San Francisco Satellite City-Pair:	1,100/900
Philadelphia—Seattle Satellite City-Pair:	1,100/900
Puerto Rico—New York Satellite City-Pair:	1,800/NA
Puerto Rico—Chicago Satellite City-Pair:	1,800/NA
San Antonio—San Francisco Satellite City-Pair:	975/775
San Francisco—Seattle Satellite City-Pair:	825/625
San Francisco—Washington, D.C. Satellite City-Pair:	1,100/900
Seattle—Washington, D.C. Satellite City-Pair:	1,100/925

**Voice-Grade Local Facility Charges** • one-time installation charge plus a monthly recurring charge for each full-duplex local facility used to connect a voice-grade channel from the ASC Central Office to the premises of a customer or to the Central Office of another common carrier in a satellite city • local facility not required when channel is terminated in a satellite city solely

for the purpose of forming a through channel:

\$70 instal	\$50 mo
-------------	---------

**Customer Termination Package Charges** • only applies to channels leased for 2-year period • one-time installation charge plus a monthly recurring charge for each termination package required to terminate a local facility at the customer site • for any order involving 60 or more channels, the one-time installation charge per termination package is one-half the rate shown • dependent on service requirements, the package may consist of echo suppression, line amplification, in-band signaling, telephone handset, and a transfer key:

49	30
----	----

Echo Cancellation Option • may be used with a termination package in lieu of an echo suppressor • one-time installation charge only applies when substitution is made subsequent to initial installation of termination:

NC	30
----	----

### Leased Voice-Grade Channels For Other Common Carriers

Quantities of voice-grade channels may be leased by other common carriers for a one-year minimum service period. Channels are available on a distributed basis between ASC Central Offices in Chicago, Dallas, Denver, Los Angeles, New York, and San Francisco. There is a 600 channel minimum requirement. Charges are based on the period of service.

**Service Period I** • Dec 1, 1983 through Nov 30, 1984 • installation charge and monthly rental per channel:

\$25 instal	\$460 mo
-------------	----------

**Service Period II** • Dec 1, 1984 through Nov 30, 1985 • installation charge and monthly rental per channel:

25	470
----	-----

### Satellite Voice Exchange (SVX) Service Charges

Access charges for the SVX shared voice-grade channel service include an all-encompassing installation charge and a monthly recurring charge for each service arrangement on a shared voice channel. For service outside the local distribution area of a satellite city designated for SVX service, extra-cost extension facilities, obtained from other common carriers, are required. ASC reserves the right to limit each customer call on this shared voice-grade service to five minutes.

**Station-To-Station SVX Service** • charges include local facilities to connect customer stations within local distribution areas of each satellite city-pair with the ASC Central Office, and where applicable, a telephone handset or connection to customer-provided communications equipment • installation charge covers all service arrangements installed at one time in both satellite cities • ASC offers a reduced monthly rental, per service arrangement, if the customer has 30 or more installed.

Between Chicago & New York:

\$220 instal	\$400/\$375 mo
--------------	----------------

Between Dallas & New York:

220	425/400
-----	---------

Between Los Angeles & New York:

220	525/500
-----	---------

Between San Francisco & New York:

220	525/500
-----	---------

**Foreign Exchange SVX Service** • charges include local facilities to connect a customer station, within the local distribution area of a satellite city, with the ASC Central Office, and a termination in a local distribution Bell Central Office in the other satellite city for interconnection with a local business line • where applicable, also includes a telephone handset or connection to customer provided communication equipment • installation charge covers all service arrangements and Bell Central Office terminations installed at one time in both satellite cities • ASC offers a reduced monthly rental, per service arrangement, if the customer has 30 or more installed • customer is responsible for all local business line telephone charges.

## American Satellite Domestic Communication Services

Between Chicago & New York:	220	400/375
Between Dallas & New York:	220	450/425
Between Los Angeles & San Francisco:	300	375/350
Between San Francisco & New York:	220	525/500

**SVX Master Station Handset** • available in lieu of a standard telephone handset • charges include capability of adding up to 5 extension stations • installation and monthly rental per master station:

	25	5
SVX Extension Stations • up to a maximum of 5 within same building as master station handset • charges include telephone handset and intrabuilding extension facilities • installation and monthly rental per extension station:	25	10

### Digital Data Channel Charges

**Wideband Digital Data Channel Charges** • full-duplex wideband 56K-bps data channels are available between ASC Central Offices in designated satellite cities • minimum service period of 12 months • charges include one-time fee which covers installation in both cities, and a recurring monthly charge per wideband channel.

Chicago—Dallas Satellite City-Pair:	\$2,000 instal	\$2,500 mo
Chicago—Los Angeles Satellite City-Pair:	2,000	3,500
Chicago—New York Satellite City-Pair:	2,000	2,500
Chicago—San Francisco Satellite City-Pair:	2,000	3,500
Chicago—Seattle Satellite City-Pair:	2,000	3,500
Dallas—Los Angeles Satellite City-Pair:	2,000	3,500
Dallas—New York Satellite City-Pair:	2,000	3,500
Dallas—San Francisco Satellite City-Pair:	2,000	3,500
Denver—Chicago Satellite City-Pair:	2,000	2,500
Denver—Los Angeles Satellite City-Pair:	2,000	2,500
New York—Los Angeles Satellite City-Pair:	2,000	4,500
New York—San Francisco Satellite City-Pair:	2,000	4,500
Puerto Rico—Chicago Satellite City-Pair:	2,000	8,000
Puerto Rico—New York Satellite City-Pair:	2,000	8,000
Seattle—Los Angeles Satellite City-Pair:	2,000	2,500
Seattle—San Francisco Satellite City-Pair:	2,000	2,500

**Digital Data Local Facility Charges** • where required, ASC provides local facility digital data channels between the ASC Central Office in a satellite city and a customer's site via

arrangements made with another common carrier • applicable charges are directly passed through to the customer.

### Channel Conditioning Charges

ASC makes arrangements with other common carriers to provide Type C1, C2, C4, or D1 conditioning as requested by customer • applicable charges are directly passed through to customer.

### Extension Facility Charges

Leased voice-grade channels may be extended beyond the local distribution area of a satellite city via published tariff or special arrangement with other common carriers.

### ENFIA Service Arrangement Charge

A one-time order processing fee and a monthly charge for recurrent trouble-shooting and testing are levied when an ENFIA facility is terminated in an ASC Central Office on behalf of another common carrier. Billing for this charge is assigned to the other common carrier:

	\$70 ord	\$37 mo
--	----------	---------

### Satellite Transponder Service

Fixed term transponder service is available on a 24-hour-per-day, 7-day-per-week basis. Execution of renewal options is contingent on the remaining life of the satellite on which the transponder is provided. Ninety-day written notice of renewal required prior to expiration of initial term.

**One-Year Fixed Term** • protected transponder service • customer has option to extend contract term for an additional one-year period • one-time charge plus monthly rental per transponder:

	\$150,000 otc	\$149,666.66 mo
--	---------------	-----------------

**Two-Year Fixed Term** • protected transponder service • customer has option to extend contract term for an additional two-year period • monthly rental charge per transponder:

	160,000
--	---------

**Limited Term** • preemptible transponder service • minimum service period of 3 months • renewal month-to-month on 15 days written notice • monthly rental charge per transponder:

	70,000
--	--------

### Optional Equipment Charges

Charges for ASC-supplied optional equipment typically include a one-time installation charge and a monthly rental fee. These charges represent currently tariffed rates and are subject to change.

**Alternate Voice/Data Equipment** • basic equipment provides simultaneous voice channel plus 2 300-bps data channels:

	\$255 instal	\$140 mo
--	--------------	----------

**Additional Data Channels** • 2 maximum • installation and monthly charge for each; installation charge not applicable if initially ordered with basic equipment:

	29	17
--	----	----

**Bridging Arrangement** • used with voice coordination network:

	100	30
--	-----	----

**Bridging Arrangement** • single station:

	58	29
--	----	----

Two Added Stations:

	58	23
--	----	----

**Speech Plus Data-Coherent Type Arrangement** • provides up to 4 low-speed data channels on 1 voice-grade channel:

	175	245
--	-----	-----

**Speech Plus Data-Coherent Type Arrangement** • provides up to 6 low-speed data channels on 1 voice-grade channel:

	175	265
--	-----	-----

**Voice Connection Arrangement** • master location:

	NA	350
--	----	-----

## American Satellite Domestic Communication Services

<b>Voice Connection Arrangement</b> • each remote location:	250	85
<b>Call Director</b> • 10 line:	175	63
<b>Code Select Signaling Arrangement</b> • enables either of 2 stations in 1 termination city to connect with 1 station in another or vice versa:	175	115
<b>COM II Failsafe Arrangement</b> • restores a customer's trunking facilities as individual circuits, per trunk destination:	58	44
<b>Data Bipler</b> • provides full-duplex data transmission up to 19.2K-bps over 2 voice-grade channels • one-year minimum service period:	58	290
<b>Data Coupler</b> • Type 1001:	58	14.50
<b>Data Modem</b> • dual frequency; 0-300 bps:	25	24
<b>Data Modem</b> • 1200 bps:	54	55
<b>Data Modem</b> • 2400 bps:	75	75
<b>Data Modem</b> • 4800 bps:	150	150
<b>Data Modem</b> • 9600 bps:	200	225
<b>Digital Line Buffer</b> • Type V.35:	115	120
<b>Digital Line Drivers</b> • per local facility:	115	190
<b>Line Switch</b> • Type 805:	17	13.50
<b>Loopback Key</b> • isolates customer-provided termination equipment:	17	1.75
<b>Loudspeaker</b> • Type 107A:	11.50	5
High Impedance Matching Device • for loudspeaker:	11.50	7.25
<b>Loudspeaker &amp; Control Arrangement</b> • includes 2 bridging arrangements, 2 additional telephone sets, and 3 loudspeakers:	330	143
<b>Microphone</b> • Type 877L; push-to-talk, desk-type, stand model:	11.50	6.25
<b>Microphone</b> • Type 450; push-to-talk, desk-type, stand model:	11.50	10.50
<b>Customer Termination Package Modification</b> • permits connection of 2 private lines to form through connection • installation charge not applicable if initially ordered with customer termination package:	58	35
<b>Customer Termination Package Modification</b> • provides code select signaling • installation charge not applicable if initially ordered with customer termination package:	46	17
<b>Customer Termination Package Modification</b> • provides toll restriction at open end of foreign exchange channel:	29	13.25
<b>Multiplexer Buffer Unit</b> • for use with 2400-bps and 4800-bps data modems:	145	140

<b>Noise Suppressor</b> • for telephone handset • installation charge not applicable initially if ordered with telephone handset:	27	1.50
<b>Extension Service Unit</b> • off-premises:	29	5.25
<b>PAX Switching Arrangement</b> • 14-line capacity:	330	86
<b>Remote Circuit Monitoring Unit</b> • dial select; trunk status display panel; 20-line capacity • also includes two local facility and customer termination packages associated with remote access:	500	240
<b>Satellite Delay Compensation Termination</b> • basic termination inclusive of customer termination package • per termination:	50	86
<b>Satellite Delay Compensation Termination</b> • basic termination inclusive of customer termination package • reduced installation charge applicable if equivalent termination/modem previously installed • per termination with 2400-bps data modem:	125	161
<b>Satellite Delay Compensation Termination</b> • basic termination inclusive of customer termination package • reduced installation charge applicable if equivalent termination/modem previously installed • per termination with 4800-bps data modem:	200	236
<b>Satellite Delay Compensation Termination</b> • basic termination inclusive of customer termination package • reduced installation charge applicable if equivalent termination/modem previously installed • per termination with 9600-bps data modem:	250	311
<b>Additional Satellite Delay Compensation Options</b> • Bisynchronous/HASP:	29	29
Rackmounting Arrangement:	110	NA
Protocol Reprogramming • to accept other than Bisynchronous or HASP • per hour charge at customer premises; per diem charge at ASC headquarters:	52 hr	415 diem
<b>Speaker Amplifier:</b>	11.50 instal	10 mo
<b>Speakerphone Arrangement</b> • transmitter, loudspeaker, transformer, telset, and adapter:	58	20
<b>Special Telephone Handsets</b>		
Amplified Handset:	\$23 instal	\$5 mo
Color Telephone Deskset:	5.75	1.50
Color Telephone Wallset:	5.75	1.50
Push-To-Listen Handset • with amplifier control:	17	2.50
Six-Button Handset • with loudspeaker:	52	15.25
Amplified Handset • with volume control:	11.50	7.75
<b>Split Stream Multiplex Unit</b> • provides simultaneous transmission of single 2400-bps and 7200-bps data streams, or 2 4800-bps data streams through a 9600-bps data modem:	115	110
<b>Switch Arrangement</b> • to alternately connect voice-grade		



## American Satellite Domestic Communication Services

private line or foreign exchange line to a single circuit, or to permit customer to alternately use a channel for voice or data transmission:

NA	18
----	----

**Manual Switch** • to connect an intercity circuit for tie line or foreign exchange line usage at predetermined intervals:

29	9.25
----	------

**Manual Switch** • to enable use of customer-provided data modem on either of 2 circuits:

17	2
----	---

**Manual Switch** • to enable customer-provided equipment to be used on either of 2 circuits or off-line:

17	3.25
----	------

**TDM Multiplex Unit** • basic unit with 2400-bps data modem • capable of deriving a quantity of low-speed data channels with an aggregate data rate that does not exceed 2400 bps:

520	460
-----	-----

Four-Channel Card • pricing for each card; minimum of 1 required with TDM unit • installation charge not applicable if initially ordered with TDM unit:

17	13.75
----	-------

**Teleprinter** • ASR with 4K-byte memory.

Model 315S:

115	205
-----	-----

Model 315SWL:

115	190
-----	-----

Touchtone Intercom Arrangement:

58	39
----	----

**Handset Visual Indicator** • per lamp; installation charge not applicable if initially ordered with handset:

5.75	1.25
------	------

**Voice Shout-Down Arrangement** • with automatic speaker cutout control during transmission.

Control Location:

115	86
-----	----

Other Locations:

115	63
-----	----

**Additional Equipment** • for voice shout-down arrangement.

Loudspeaker • with volume control:

5.75	4
------	---

Microphone • desk-type with stand:

5.75	5
------	---

Auxiliary Equipment • cabinet-mounted amplifiers, relays, mixer, and power supply:

	109
--	-----

**Access**

**Locations For Leased Voice-Grade Channel Service**

ACS provides a leased channel connection service for various communities within the local distribution access areas of its satellite serving cities. For service outside these areas, ACS will provide extension channel access arranged via other common carrier(s).

**Atlanta Area** • Atlanta; Austell; Chamblee; Clarkston; Fairburn; Jonesboro; Marietta; Panola; Powder Springs; Roswell; Smyrna; Stockbridge.

**Chicago Area** • Bellwood; Berwyn; Brookfield; Chicago; Chicago-Newcastle; Chicago-O'Hare; Cicero; Des Plaines; Evanston; Forest; Franklin Park; Glenview; La Grange; Maywood; Oak Park; Oak Lawn; Park Ridge; Riverside; Skokie; Summit; Western Springs; Willow Springs; Willmette.

**Dallas Area** • Addison; Aledo; Arlington; Benbrook; Berleson;

Cedar Hill; Crowley; Dallas; Danieldale; De Soto; Duncanville; Eagle Mountain Lake; Edgecliff; Euless; Farmers Branch; Fort Worth; Grand Prairie; Hasket; Hutchins; Kennedale; Lake Worth; Lancaster; Lawson; Mansfield; Mesquite; North Mesquite; North Richland Hills; Renner; Richardson; Roanoke; Rylie; Saginaw; Seagoville; Silver Creek; Sunnyvale; Wedgewood; Westland; Wheatland; White Settlement.

**Denver Area** • Arvada; Aurora; Commerce City; Denver; Englewood; Greenwood Village; Lakewood; Littleton; Morrison; Thornton; Westminster; Wheat Ridge.

**Houston Area** • Airline; Aldine; Alief; Apollo; Bammel; Barker; Blue Ridge; Buffalo; Channelview; Deer Park; East Houston; Ellington; Friendswood; Houston; Lake Houston; Langham Creek; La Porte; Manvel; Pearland; Satsuma; Seabrook; Sheldon; Westfield.

**Los Angeles Area** • Agoura; Alhambra; Anaheim; Arcadia; Beverly Hills; Burbank; Canoga Park; Compton; Costa Mesa; Covina; Culver City; Downey; El Monte; El Segundo; Fullerton; Garden Grove; Glendale; Hawthorne; Inglewood; Irvine; LaCrescenta; Lomita; Long Beach; Los Angeles; Malibu; Monrovia; Montebello; Mount Wilson; Newport Beach; North Hollywood; Norwalk; Orange; Pasadena; Redondo; Reseda; San Fernando; San Pedro; Santa Ana; Santa Monica; Sierra Madre; Sunland-Tujunga; Torrance; Van Nuys; West Los Angeles; Whittier.

**New York Area** • Bronx; Brooklyn; Manhattan; Queens; Staten Island.

**Philadelphia Area** • Ambler; Bristol; Broomall; Bryn Mawr; Chester; Conshohocken; Bala Cynwyd; Darby; Eddington; Hatboro; Havertown; Jenkintown; Langhorne; Levittown; Media; Norristown; Paoli-Malvern-Berwyn; Philadelphia; Swarthmore; Upper Darby; Valley Forge; Wayne; Willow Grove.

**San Antonio Area** • Babcock; Bracken; Buena Vista; Culebra; Elm Creek; Elmendorf; Foster; Fratt; Geronimo Creek; Helotes; Indian Creek; Jarratt; Lackland; Leon Springs.

**San Francisco Area** • Millbrae; Oakland; Palo Alto; Redwood City; San Carlos; San Francisco; San Mateo; South San Francisco.

**Washington, D.C. Area** • District of Columbia: Washington • Maryland: Berwyn; Bethesda; Bowie-Glen Dale; Capital Heights; Clinton; Hyattsville; Kensington; Layhill; Marlboro; Oxon Hill; Rockville; Silver Spring • Virginia: Alexandria; Daleview; Elmwood; Fairfax; Falls Church; Oxford; Vienna.

**Locations For Leased Channel Service For Other Common Carriers**

**Chicago Satellite City-Pairs** • Dallas; Denver; Los Angeles; New York; San Francisco.

**Dallas Satellite City-Pairs** • Los Angeles; New York; San Francisco.

**Denver Satellite City-Pairs** • Chicago; Dallas; Los Angeles; New York; San Francisco.

**New York Satellite City-Pairs** • Dallas; Los Angeles; San Francisco.

**Los Angeles Satellite City-Pairs** • Dallas; New York; San Francisco.

**San Francisco Satellite City-Pairs** • Dallas; Los Angeles; New York.

**Locations For Satellite Voice Exchange Service**

Exchange area zones, where shown, are as designated in AT&T tariff F.C.C. No. 274.

**Chicago** • exchange area zones 1 through 11.

**Dallas** • Dallas.

**Los Angeles** • exchange area zones 1 through 14.

**New York** • exchange area zones 1 through 3.

**San Francisco** • exchange area zones 1 through 3.

## American Satellite Domestic Communication Services

---

### Other Network Services

---

#### **Dedicated Government Services**

---

American Satellite Company provides high-speed (wideband) data transmission services to government agencies including digitally secure voice channels. User-dedicated earth stations, using 10-meter diameter antennas, serve the Air Force, Navy, Army, Department of Defense, NASA, and the Department of Energy. Satellite communication channels are used to transmit such diverse information as global weather maps, space shuttle developmental and operational support data, and nuclear research data. To serve international transmission requirements, ASC has built two earth stations for Western Union International. These stations now provide service to the NASA space shuttle program. The stations are located adjacent to existing stations in Etam, West Virginia and Andover, Maine to gain access to the INTELSAT network.

#### **INFOSAT Service**

---

INFOSAT is a joint ASC/Tandem Computer service offering, which was announced in March 1982. Under the agreement, Tandem will provide the computer network hardware and software while American Satellite will transmit the data simultaneously over two 56K-bps transmission paths to provide the same high level of reliability inherent in the design of Tandem computers. INFOSAT is constantly monitored in 2 ways. The Tandem computer system is designed for early detection and correction of potential problems through a series of diagnostic programs. And the satellite communication link is monitored 24 hours a day by American Satellite from the Network Operations Control Center at Vernon Valley, New Jersey.

#### **Video Teleconferencing**

---

ASC's Flex Stream transmission service integrates voice, data,

and compressed digital video over a single T1 (1.544M bps) satellite channel. The service incorporates a video digitizer which compresses full-motion video to half the bandwidth of a T1 channel. Through multiplexing, the remaining channel bandwidth can be used for voice and data communication. Flex Stream users can reduce the cost of video teleconferencing by as much as 75 percent over previously available systems. Flex Stream is available to users on their own site under a long term contract, and includes on-premise customer equipment. ASC does not offer "walk-in" teleconferencing services. In a multipoint customer installation, ASC's Network Controller switches communication among network sites during a meeting without interruption.

#### **Transportable Earth Stations**

---

For transmission of data from remote work locations, ASC provides a transportable earth station system. One version packaged in permanent shipping containers, can be assembled in approximately 12 hours. A second version trailer-mounts the antenna and electronics and can be set-up in four hours. The transportable station features a single channel 56K-bps data rate capacity which is expandable to 115K bps. It is compatible with readily available multiplexers, voice digitizers, teleprinters, delay compensation units and crypto devices.

#### **Network Management**

---

In addition to installing and operating satellite communication systems, ASC also offers network management services. These services range from managing a customer's global communication network to operating a group-user voice channel concentrator service between metropolitan areas, to designing value-added services.

• END

# Anderson Jacobson Modems

## AT&T 103/113, 202 & 212A Compatible; Vadic 3400 Compatible; & AJ 4800 Models

### ■ PROFILE

**Function** • low- and medium-speed, AT&T-compatible and non-AT&T-compatible modems and acoustic couplers.

**Communications/Networks** • 300-/450-bps AT&T 103/113 compatible for the DDD network • asynchronous 1200-bps AT&T 202 compatible for the DDD network • asynchronous 300/450/1200-bps or synchronous 1200-bps AT&T 212A and/or Vadic 3400 compatible for the DDD network • asynchronous or synchronous 4800 bps for the DDD network; point-to-point over unconditioned 2-wire dedicated Type 3002 facility.

**First Delivery** • 1980/1981 (most current models) • 1983 (AJ 1211, AJ 1233, AJ 1259, AJ 4048).

**Units Delivered** • 150,000.

**Comparable Systems** • principal competition from AT&T 103, 113, 202, and 212A; Hayes Smartmodem; General DataComm 103J, 202S, and 212A; Penril 300/1200 and 1800 DED; Prentice P103/P113, P212A/C, and P202A; Racal-Vadic VA300, VA212, VA1200, and VA3400 Series; Rixon T103J, T108, and T113C; Universal Data Systems 103 and 202 Series; Ventel MD103, MD202, and MD212 • no compatible competition for the AJ 1233, AJ 1235, or AJ 4048.

**Vendor** • Anderson Jacobson Inc; 521 Charcot Avenue, San Jose, CA 95131 • 408-263-8520.

**Distribution** • direct through Anderson Jacobson sales offices throughout the U.S., Canada, France, and the U.K.; distributors throughout Europe.

### ■ ANALYSIS

Anderson Jacobson recently introduced 4 new AT&T 212A-compatible modems, including a plug-in unit for the IBM PC/XT (the AJ CONNECTION) and a security modem with 2-level password protection and auto-logout support (the AJ

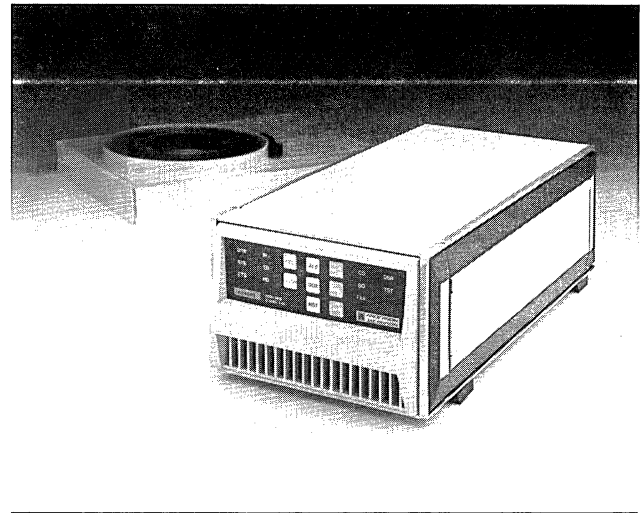

1212-AD2). Although the vendor is well-known as a modem lessor, lease pricing was not available for new models at press time; purchase pricing is included. The AJ CONNECTION, however, will be available through retail dealers only on a purchase basis. Last March, Anderson Jacobson also introduced an error control option for the 4800-bps AJ 4048 that reportedly delivers 99.9 percent error-free, full-duplex data communication over dial-up lines. The vendor will enter the high-speed modem market when it introduces a 9600-bps, CCITT V.29-compatible modem at the National Computer Conference (NCC) in July, dubbed the AJ 9601. The AJ 9601 supports an optional integral dial backup unit, as well. In addition, Anderson Jacobson is now marketing the BLAST (Blocked Asynchronous Transmission) file transfer protocol for personal computer users, a product of Communications Research Group, Inc of Baton Rouge, LA. Packaged with an AJ-written operator manual, BLAST will sell for \$250 in single quantities.

Anderson Jacobson is a highly innovative and successful manufacturer of low-to-medium speed modems and acoustic couplers. Most models focus on the low-end AT&T-compatible or Vadic-compatible replacement market, providing users with significant benefits in terms of cost and features. The company pioneered acoustic couplers, and presently manufacturers the only AT&T 212A-compatible acoustic couplers in the industry. Several years ago AJ traded its acoustic-coupler technology to competitor Racal-Vadic for rights to the VA3400 (1200 bps full-duplex) standard, and now caters to a large Vadic-compatible user base as well. Other innovations include the industry's first 4800-bps, 2-wire full-duplex modem, and direct connect modems that double as acoustic couplers when standard telephone wall-jacks are not available.

Anderson Jacobson modems support data rates up to 300/450 bps, 1200 bps, and 4800 bps. Dual and triple models provide compatibility with AT&T 103/113, 212A, and/or VA3400 standards, giving users the flexibility to communicate at 300 bps or 1200 bps and eliminating the cost for 2 or 3 modems, extra cables, and a switch. AT&T 103-compatible models supporting data rates to 450 bps can provide increased throughput over their

### PURCHASE PRICE RANGE

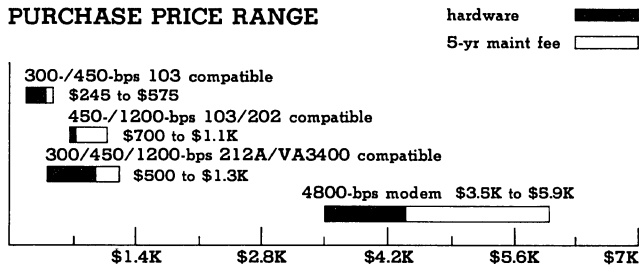

**ANDERSON JACOBSON MODEM PURCHASE PRICING** bar graphs cover ranges between "small" and "large" configuration for hardware products (solid bar), and for associated 5-year maintenance fees (open bar) • **AT&T 103-compatible small** configuration consists of 450-bps AJ 245 direct-connect modem; **large** of 450-bps AJ 347 acoustic coupler/modem • **AT&T 103-/202-compatible small/large** configuration consists of 450-/1200-bps AJ 1245 acoustic coupler/modem • **AT&T 212A and VA 3400-compatible small** configuration consists of 300-/1200-bps AJ 1212-ST direct-connect modem; **large** of 300-/1200-bps AJ 1233 acoustic coupler/modem • **4800-bps small** configuration consists of 4800-bps AJ 4048 modem; **large** of AJ 4048 modem with integral eye-pattern generator, error controller option, and rackmount option.

## Anderson Jacobson Modems

### AT&T 103/113, 202 & 212A Compatible; Vadic 3400 Compatible; & AJ 4800 Models

AT&T counterparts, with qualifications: users require terminal equipment supporting the odd data rate (they are scarce), along with an AJ modem at both ends of transmission (AT&T 103 supports data rates to 300 bps only).

The unique AT&T 212A-compatible acoustic coupler/modems, Models AJ 1232, AJ 1233, and AJ 1235 fill an important niche in low-end modem applications. The 212A standard is exploding in popularity, and the acoustic coupler permits its use where direct connection is impossible; e.g., in a hard-wired PBX environment, or with portable terminals/microcomputers.

The AJ 4048 represented a major breakthrough in modem technology. Until recently, full-duplex data transmission over the switched telephone network was limited to 1200 bps. Just as other modem vendors were breaking this speed barrier with 2400-bps full-duplex models, AJ introduced the 4048 which is twice as fast at 4800 bps. This modem also operates in a full-duplex mode over 2-wire circuits with 2400-bps fallback data rate. AJ engineers achieved the feat by using a frequency-division multiplexing technique with 2 slightly overlapping transmit/receive bandwidths, dealing with the resulting echo by incorporating a combination of filters and echo cancellers. Applications for the AJ 4048 range from using full-duplex protocols over 2-wire/switched lines, to dial-backup for high-speed dedicated lines and dial-up replacements for lightly used dedicated lines.

Anderson Jacobson supports its modem products through a nationwide sales/service network with locations in several large metropolitan areas. Most modems, including low-speed variants, are available on a lease basis; in fact over half of all AJ modem revenues are obtained through leasing. The company also manufactures a successful line of ASCII terminals, and will soon have a third-generation digital PABX out on the market.

#### □ Strengths

Anderson Jacobson provides modem solutions not available from any other vendor. These include the first AT&T 212A-compatible acoustic coupler; a 4800-bps full-duplex, 2-wire modem; and AT&T 103-compatible modems with data rates up to 450 bps. Specifically, it offers solutions to user needs unsatisfied by AT&T, providing extensive operating flexibility while retaining AT&T compatibility for unrestricted communication with AT&T modem users. AJ modems are priced considerably below AT&T equivalent models, and are reliable and technically sophisticated units. Anderson Jacobson also supports a nationwide service organization and convenient lease terms which are often unavailable from competing vendors.

The AJ CONNECTION is a 300-/1200-bps plug-in modem for IBM PC/XT and IBM bus-compatible computers. It is comprised of a 212 modem and communication circuitry on one card, and can be purchased with an RS-232C port for serial printer attachment also on the same card. This packaging saves the expense and wasted space of buying a separate communications adapter and external modem, and also supplies the popular CROSSTALK communication software which is compatible with several major personal computer communication programs.

The AJ 1212-AD2 Auto Dial Logon Modem prevents unauthorized users from accessing a user's computer system. It incorporates a 2-level password security procedure, requiring one password for dialing numbers into the modem and a different password to enter the modem's memory. The AJ 1212-AD2 can also logon automatically to host computer systems upon receipt of proper password.

#### □ Limitations

Although Anderson Jacobson modems now on the market are technically sound, they cater mainly to low-speed switched network users—a problem for larger users with wide-ranging modem requirements. The company is not, therefore, a single source for all datacomm requirements. It does not provide AT&T 201, 208, or other high-speed type modems, although a 9600-bps CCITT V.29-compatible modem is waiting in the wings. Other equipment such as an 801-type automatic calling unit, modem

sharing devices and switches, and short-haul modems are also unavailable.

The CCITT, along with prominent modem vendors like AT&T, is working on 4800- and 9600-bps full-duplex, 2-wire modem standards. When established, these standards will not be compatible with Anderson Jacobson's AJ 4048, and will probably include advanced features not incorporated into the AJ modem. AJ 4048 users may one day wake up to find their modems obsolete, and unable to communicate with a majority of business users who will, by then, have CCITT-compatible/full-duplex/high-speed/switched-network modems.

#### ■ HARDWARE

##### □ Terms & Support

**Terms** • available for purchase, monthly rental, or lease on a 1-, 2-, or 3-year term • purchase conversion option allows 40 percent of monthly rental to be applied; rental credits cannot exceed 50 percent of purchase price • separate maintenance contract available for purchased units; included with lease agreements • 1-year warranty • quantity discounts available.

**Support** • installed by Anderson Jacobson or the user • installation charge is \$35 for low-speed modems; \$50 for 1200-bps modems; and \$90 for the AJ 4048; lower installation charges for multiple units • modems under warranty returned to appropriate service centers equipped to handle such equipment; AJ will repair modems on-site under first 30 days of warranty for AJ-installed units • on-site repairs available within 25 miles (Zone 1) or 50 miles (Zone 2) of an AJ service center • AJ normal service/maintenance hours are 8:00 A.M. to 5:00 P.M., Monday through Friday • service beyond normal hours is billed at \$74 per hour; Sundays and holidays billed at \$127 per hour • service center locations in San Jose and Carson, CA; Englewood, CO; Rosemont, IL; Indianapolis and Jefferson, IN; Oak Park, MI; Kansas City and Maryland Heights, MO; Cincinnati, Akron, Columbus, Middleburg Heights, and Dayton, OH; Sharpsburgh and Jefferson, PA; Dallas and Houston, TX; West Allis, WI; Homewood, AL; East Hartford, CT; Altamonte Springs, FL; and Norcross, GA.

##### □ Overview

Anderson Jacobson modems are divided among applications for acoustic couplers, direct-connect modems for the DDD network, and combination acoustic coupler/direct-connect modems. Included in these are models for low-to-medium-speed AT&T- and Vadic-compatible markets, and a unique 4800-bps full-duplex 2-wire (switched network) modem. Some models are dual 212A-/103-compatible or triple VA3400/212A/103-compatible units, allowing users to communicate with several different modem types as well as providing significant advantages in cost and features over their AT&T counterparts. AJ Models 1232, 1233, and 1235 are the only AT&T 212-compatible acoustic couplers in the world; other AJ models provide low-speed operation up to 450-bps, providing increased throughput for users with the facilities to take advantage of it. Acoustic coupler/modems provide users the choice of connecting to the DDD network through a telephone handset, or directly via modular telephone jack for application flexibility.

All AJ modems are designed to operate over the DDD network; only the AJ 4048 can be readily adapted for leased-line applications. It is possible to adapt other AJ direct-connect modems for dedicated line use, but they then require solder-strap adjustments as well as other internal modifications. Most models are packaged for standalone environments. Models AJ 1211 and AJ 1259 are optionally packaged as plug-in PC boards for central-site placement; the AJ 4048 can be shelf-mounted in empty rack space.

The AJ CONNECTION is a cost-effective alternative communication tool for IBM PC/XT users. It combines an AT&T 212A-compatible modem, serial communication adapter, and optional serial printer port on a single plug-in card; communication software (Microstuff CROSSTALK XVI) supplied

## Anderson Jacobson Modems

### AT&T 103/113, 202 & 212A Compatible; Vadic 3400 Compatible; & AJ 4800 Models

on diskette is also included in the basic price. The AJ CONNECTION requires an IBM PC, XT, or bus-compatible computer with at least 64K bytes of RAM memory, PC-DOS or MS-DOS, at least 1 diskette drive, and an 80-column CRT display.

**AT&T 103-/113-Compatible Models** • AT&T 103-/113-compatible direct-connect modems and acoustic couplers with data rates up to 450 bps.

**AT&T 103/113/202-Compatible Model** • AT&T 103/113/202-compatible direct-connect modem/acoustic coupler with data rates up to 450/1200 bps.

**AT&T 103-/212A-Compatible & VA3400-Compatible Models** • AT&T 103-compatible, AT&T 212A-compatible, and VA3400-compatible acoustic couplers and acoustic coupler/direct-connect modems • single, dual, and triple mode compatibility • data rates up to 300/1200 bps and 450/1200 bps.

**4800-bps Model** • point-to-point 2-wire modem for the DDD or dedicated networks with data rates at 4800 bps and 2400 bps, fallback.

**☐ Packaged Modems**

Standalone packaging standard for most models; Models AJ 1211 and AJ 1259 available in a modem card, rackmount version for central-site card nesting • central-site card nest fits standard 19-inch equipment rack.

**AT&T 103-/113-Compatible Modems**

**A 242-A Acoustic Coupler** • standard 450-bps acoustic coupler; manual originate only mode:

NA/NA mo	\$295 prch	\$2.50 maint	
----------	------------	--------------	--

**AJ 243 Acoustic Coupler** • same as A 242-A except with TTL interface only:

NA/NA	250	2.50	
-------	-----	------	--

**AJ 243 for Teletype Model 43** • same as AJ 243 except includes interface I/O board for installation on rear of Model 43 teletypewriter:

NA/NA	265	2.50	
-------	-----	------	--

**AJ 243 for LA36 DecWriter II** • same as AJ 243 except includes special cable for connection to LA36 teleprinter:

NA/NA	265	2.50	
-------	-----	------	--

**AJ 245 Modem** • standard DDD direct-connect 450-bps modem with manual originate mode • standalone:

NA/NA	245	2.50	
-------	-----	------	--

**AJ 247 Acoustic Coupler/Modem** • standard 450-bps DDD direct-connect modem or acoustic coupler with manual originate mode:

21/19	295	3.00	
-------	-----	------	--

**AJ 347 Acoustic Coupler/Modem** • same as AJ 247 except with originate/answer/automatic answer mode:

25/23	365	3.50	
-------	-----	------	--

**AT&T 103/113/202-Compatible Modems**

**AJ 1245 Acoustic Coupler/Modem** • standard AT&T 103/113/202-compatible DDD direct-connect modem or acoustic coupler; 5-bps secondary channel (AT&T 202 mode) • 450/1200 bps • originate only mode:

\$42/\$39 mo	\$695 prch	\$7.00 maint	
--------------	------------	--------------	--

**AT&T 103-/212A-Compatible & VA3400-Compatible Modems**

**AJ 1211 Modem** • standard AT&T 103-/212A-compatible standalone modem; 300/1200 bps over DDD direct connection; originate/answer/automatic answer mode:

NA/NA mo	\$625 prch	\$7.00 maint	
----------	------------	--------------	--

**AJ 1211-AD Modem** • same as AJ 1211 except with integral automatic dialer:

NA/NA	675	7.00	
-------	-----	------	--

**AJ 1211-RM Modem** • same as AJ 1211 except contained on single PC card for rackmounting • fits AJ Series 8 Multiple Modem System enclosure:

37/35	645	7.00	
-------	-----	------	--

**AJ 1212-AD1 Modem** • standard AT&T 103-/212A-compatible standalone modem; 300/1200 bps over DDD direct connection; manual automatic originate and manual/automatic answer mode:

NA/NA	595	8.00	
-------	-----	------	--

**AJ 1212-AD2 Modem** • same as AJ 1212 except with computer log-on sequence and 2-level password protection:

NA/NA	695	8.00	
-------	-----	------	--

**AJ 1212-ST Modem** • standard AT&T 103-/212A-compatible standalone modem; 300/1200 bps over DDD direct connection; manual originate and manual/automatic answer mode:

NA/NA	495	8.00	
-------	-----	------	--

**AJ 1232 Acoustic Coupler/Modem** • standard AT&T 103-/212A-compatible DDD direct-connect modem or acoustic coupler • 300/1200 bps • originate only mode:

NA/NA	795	7.00	
-------	-----	------	--

**AJ 1233 Acoustic Coupler/Modem** • standard AT&T 103-/212A- and Vadic 3400-compatible DDD direct-connect modem or acoustic coupler • 300/1200 bps • originate only mode:

55/52	845	7.00	
-------	-----	------	--

**AJ 1234-A Acoustic Coupler/Modem** • standard Vadic 3400-compatible DDD direct-connect modem or acoustic coupler • 300/600/1200 bps • originate only mode:

47/44	695	7.00	
-------	-----	------	--

**AJ 1235 Acoustic Coupler/Modem** • standard AT&T 103-/212A- and Vadic 3400-compatible DDD direct-connect modem or acoustic coupler • 450/1200 bps • originate only mode:

47/44	795	7.00	
-------	-----	------	--

**AJ 1256 Modem** • standard Vadic 3400-compatible standalone modem; 1200 bps over DDD direct connection; originate/automatic answer modes:

47/44	625	7.00	
-------	-----	------	--

**AJ 1259 Modem** • standard AT&T 103-/212A- and Vadic 3400-compatible standalone modem; 450/1200 bps over DDD direct connection; originate/automatic answer modes:

55/52	695	7.00	
-------	-----	------	--

**AJ 1259-AD Modem** • same as AJ 1259 except with integral automatic dialer:

55/52	775	7.00	
-------	-----	------	--

**AJ 1259-RM Modem** • same as AJ 1259 except contained on 2 PC cards for rackmounting:

37/35	695	7.00	
-------	-----	------	--

**AJ CONNECTION Modem** • standard DDD direct-connect 300-/1200-bps modem with CROSSTALK XVI communication software (on diskette) for the IBM Personal Computer • automatic originate and manual/automatic answer modes • inserts into the IBM PC/XT backplane:

NA/NA	495	NA	
-------	-----	----	--

**AJ CONNECTION/2B02** • same as AJ CONNECTION but includes an independent RS-232C for bidirectional printer

*MO: single-unit monthly 1-year/2-year lease charge, including maintenance; month-to-month rental averages 10% higher than 1-year lease charge. PRCH: single-unit purchase price. MAINT: monthly maintenance charge for purchased units. NA: not applicable/not available. NC: no-cost item. Prices effective as of July 1984.*

## Anderson Jacobson Modems

### AT&T 103/113, 202 & 212A Compatible; Vadic 3400 Compatible; & AJ 4800 Models

operation • supports simultaneous print and modem communication:

NA/NA	545	NA
-------	-----	----

#### 4800-bps Modem

**AJ 4048** • standard DDD direct-connect or 2-wire dedicated 4800-bps standalone modem • originate/answer/automatic answer modes:

\$156/\$144 mo	\$3,495 prch	\$24.00 maint
----------------	--------------	---------------

#### Modem Enclosures

**Series 8 Multiple Modem System** • 8-slot card nest; accommodates 8 dual-card AJ 1211-RM or AJ 1259-RM modems • requires 1 or 2 S1 power supplies • requires cooling fan under abnormally hot conditions only • fits standard 19-inch equipment cabinet:

\$16/\$15 mo	\$380 prch	NA maint
--------------	------------	----------

S1 Power Supply • power supply supports 4 rackmount modems; 2 power supplies required for full card nest:

12/11	160	NA
-------	-----	----

FAN-1 Blower Assembly • cooling fan required when temperature immediately surrounding modems is at or above 122 degrees F (50 degrees C) • other cooling measures may be substituted:

NA/NA	295	NA
-------	-----	----

**AJ 4048 Rackmount Adapter** • rackmount shelf mounts single AJ 4048 or pair of AJ 4048 modems in a standard 19-inch equipment cabinet:

10/3	98	NA
------	----	----

#### Application

##### AT&T 103-/113-Compatible Modems

**All Models** • designed for operation over the DDD network.

##### AT&T 103/113/202-Compatible Modems

**AJ 1245** • designed for operation over the DDD network.

##### AT&T 103-/212A-Compatible & VA3400-Compatible Modems

**All Models** • designed for operation over the DDD network.

#### 4800-bps Modem

**AJ 4048** • point-to-point communication over unconditioned 2-wire dedicated Type 3002 voice channel, or over the DDD network • training time (CTS) delay at 833 microseconds.

#### Operating Parameters

##### AT&T 103-/113-Compatible Modems

**All Models** • asynchronous full-duplex at rates up to 450 bps • FSK modulation.

##### AT&T 103/113/202-Compatible Modems

**AJ 1245** • asynchronous full-duplex at rates up to 450 bps, AT&T 103/113 mode; asynchronous half-duplex at rates up to 1200 bps, AT&T 202 mode • FSK modulation.

##### AT&T 103/212A-Compatible & VA3400-Compatible Modems

**AJ 1211, AJ 1212-AD1, AJ 1212-AD2, AJ 1212-ST, AJ CONNECTION & AJ 1232** • asynchronous full-duplex at rates up to 300 bps, AT&T 103 mode; FSK modulation • asynchronous or synchronous full-duplex at 1200 bps, AT&T 212A mode; QAM modulation (4-level PSK) • switch-selectable 9- or 10-bit character code at 1200 bps.

**AJ 1233** • asynchronous full-duplex at rates up to 300 bps, AT&T 103 mode; FSK modulation • asynchronous or synchronous full-duplex at 1200 bps, AT&T 212A mode (async only, AJ CONNECTION); QAM modulation (4-level PSK) • asynchronous or synchronous full-duplex at 1200 bps, VA3400 mode; QAM

modulation • switch-selectable 9- or 10-bit character code at 1200 bps, AT&T 212A mode; 8-, 9-, 10-, 11-bit character code at 1200 bps, VA3400 mode.

**AJ 1235 & AJ 1259** • asynchronous full-duplex at rates up to 450 bps, AT&T 103 mode; FSK modulation • asynchronous or synchronous full-duplex at 1200 bps, AT&T 212A mode; QAM modulation (4-level PSK) • asynchronous or synchronous full-duplex at 1200 bps or 1220 bps, VA 3400 mode; QAM modulation • switch-selectable 9- or 10-bit character code at 1200 bps, AT&T 212A mode; 8-, 9-, 10-, 11-bit character code at 1200 bps, VA3400 mode.

**AJ 1256 & AJ 1234-A** • asynchronous or synchronous full-duplex at 300 and 1200 bps or 0 to 150 and 600 bps, or synchronous full-duplex at 1200 bps, VA3400 mode; QAM modulation • switch-selectable 8-, 9-, 10-, 11-bit character code at 1200 bps.

#### 4800-bps Modems

**AJ 4048** • asynchronous or synchronous full-duplex at 4800/2400 bps; fallback rate established from modem front panel of via EIA signal from DTE • QAM modulation; 16 vector, 1200 baud • switch-selectable 8-, 9-, 10-, 11-bit character code for asynchronous operation • continuous automatic adaptive equalization; echo suppression.

#### Channel Functions

**5-bps Secondary Channel** • 0- to 5-bps half-duplex, amplitude-modulated channel • provides control path for supervisory control or line turnaround commands • standard feature on Model AJ 1245 only:

NC/NC mo	NC prch	NC maint
----------	---------	----------

**Local Copy** • Models A 242-A, AJ 245, AJ 247, AJ 347, and AJ 1245 include integral local copy option; echoes data back to DTE for local printout • standard feature included in package price:

NC/NC	NC	NC
-------	----	----

**Digital Interface** • EIA RS-232C, all models except AJ 243; 25-pin electrical connector • 20-mA current-loop interface, Models AJ 242-A; AJ 245; AJ 247 • TTL interface, Model AJ 243.

#### Control Functions

**FCC-Registered Modems** • all Anderson Jacobson direct-connect modems are FCC registered under FCC Rules Part 68; does not require a separate Data Access Arrangement (DAA) • standard feature included in modem pricing:

NC/NC mo	NC prch	NC maint
----------	---------	----------

**Alternate Voice/Data** • all direct-connect and leased-line modems can be equipped for alternate voice/data by attaching standard TelCo 502/2502 telephones or Anderson Jacobson standard telephones • modems include voice/data switch; do not require exclusion-key telephones.

1255-RTA/RTM • Anderson Jacobson standard rotary-dial telephone for auto-answer or automatic answer applications:

NA/NA	50	NA
-------	----	----

**Automatic Mode Adaptation** • Models AJ 1211, AJ 1212-AD1, AJ 1212-AD2, AJ 1212-ST, and AJ 1259 with dual and triple modem compatibility (AT&T 103, AT&T 212A, VA3400) can recognize calling modems and automatically adjust to the correct mode • does not require operator intervention • standard feature:

NC/NC	NC	NC
-------	----	----

**AJ 4048 EDR Option** • Error Detection and Retransmission (EDR) option board provides end-to-end error control by inserting an HDLC-like synchronous protocol and frame-check sequence with asynchronous user data • removes asynchronous overhead bits; formats data into frames and checks for calculated errors • ARQ command automatically retransmits errored frames; supports up to 15 outstanding frames before requiring acknowledgement:

NA/NA	495	NA
-------	-----	----

**Auto-Answer (Automatic Answer)** • Models AJ 347, AJ 1211,

## Anderson Jacobson Modems

### AT&T 103/113, 202 & 212A Compatible; Vadic 3400 Compatible; & AJ 4800 Models

AJ 1256, and AJ 1259 include integral automatic answer function • standard feature:

NC/NC	NC	NC
-------	----	----

**Auto-Dial (Automatic Originate)** • rackmounted versions of Models AJ 1211 and AJ 1259, and the AJ 4048 can be equipped with third party automatic calling units (ACUs) for CPU-originated automatic dialing • standalone Models AJ 1211-AD, AJ 1212-AD1, AJ 1212-AD2, and AJ 1259-AD are equipped with an integral auto-dialer.

AJ 1211 AD/AJ 1259-AD Auto-Dial • stores up to 10 9-digit telephone numbers • pulse dial • single-keystroke dialing; continuous redial up to 9 times • supports tandem dialing • terminal screen menu; help file; operator messages • single-entry edit without re-entering entire directory • standard feature, Models AJ 1211-AD and AJ 1259-AD only:

NC/NC	NC	NC
-------	----	----

AJ 1212-AD1/AJ 1212-AD2 Auto-Dial • stores up to 16 37-digit telephone numbers; asynchronous data only • pulse dial or tone dial • single-keystroke dialing; automatic redial of a failed call • supports tandem dialing with programmable pause and auto-dial tone detection • automatic linking of alternate number • single-entry edit without re-entering entire directory • nonvolatile memory • AJ 1212-AD2 supports up to two 19-digit logon numbers for speed-dialing from internal memory to carrier networks; can dial a number upon receipt of code name; remote modem control and memory download; requires second-level password for modem memory access • standard features, Models AJ 1212-AD1 and AJ 1212-AD2 only:

NC/NC	NC	NC
-------	----	----

**Echo Suppression Disable** • Model AJ 1245 AT&T 202-compatible modem includes integral switch-selectable option that inserts a 2025-Hz tone at end of answer tone; disables TelCo echo suppressors • required for AT&T 202 operation if echo suppression disabling is not supported at the remote site • standard feature, Model AJ 1245:

NC/NC	NC	NC
-------	----	----

**Clock Slaved Timing** • integral switch-selectable option on some synchronous full-duplex models locks received clock signal in phase with outgoing signal; slaves modem tail circuit timing to that of high-speed modem or multiplexer • standard feature on Models AJ 1211, AJ 1233, AJ 1234, AJ 1256, and AJ 1259:

NC/NC	NC	NC
-------	----	----

**Automatic Disconnects** • AJ modems designed for the DDD network contain integral abort timers that will automatically disconnect a call after no carrier detected on the network • dual

and triple modems include several levels of switch-selectable automatic disconnects, including loss of carrier and long space • standard feature:

NC/NC	NC	NC
-------	----	----

**No Option Mode** • integral strap-selectable option on Models AJ 1211 and AJ 1259 programs modem for factory-specified "standard configuration," disabling all other strap and switch options • ease-of-use feature for end users with standard configuration requirements; any deviation to the standard configuration necessitates manual setting of over 40 straps and switches • standard feature, Models AJ 1211 and AJ 1259:

NC/NC	NC	NC
-------	----	----

#### □ Diagnostic & Status Indicators

Loopback diagnostics isolate failures in local or remote modems, dedicated line, or data terminal equipment (DTE), depending on the modem • manual control of diagnostics through modem front panel; some loopback testing initiated from remote modem • visual indication of operating conditions; visual warning of abnormal conditions, Model AJ 1211 and up • low-speed models do not support loopback diagnostics.

**Loopback Tests** • local analog and local/remote digital loopback, all models except low-speed types (A 242-A, AJ 243, AJ 245, AJ 247, AJ 347) • end-to-end digital/analog loopback, AJ 4048:

NC/NC mo	NC prch	NC maint
----------	---------	----------

**Test Pattern Generation** • integral bit pattern generator and error detector performs bit error rate tests • integral feature on models supporting loopback diagnostics:

NC/NC	NC	NC
-------	----	----

**AJ 4048 Signal Display Board** • optional internally mounted PC board provides signal eye-pattern generation for display on an externally attached oscilloscope • detects poor S/N ratio, phase jitter, and signal level variations • extra-cost option, Model AJ 4048 only:

11/6	345	NA
------	-----	----

**Status Indicators** • modem power and carrier detect, A 242-A, AJ 245, AJ 247, AJ 347, AJ 1245; carrier detect only, AJ 243 • modem power and key EIA interface signal activity for 1200 bps and dual/triple modems • key EIA interface signal activity, fallback speed, test mode, loopback modes, remote loopback mode, fail test, and signal quality (indicates possible/probable error condition), AJ 4048.

• END





# Anderson Jacobson Display Terminals

## Models 510 & 520

### ■ PROFILE

**Function** • general-purpose, nonprogrammable, interactive keyboard-display ASCII terminals.

**Architectures Supported** • any architecture supporting an ASCII terminal; local/remote attachment • 510 compatible with IBM 2741; 520 compatible with DEC VT100/52.

**Communications** • half-/full-duplex, asynchronous; 110 to 9600 bps (Model 510); 50 to 19,200 bps (Model 520) • point-to-point • character, line, and block transmission modes • RS-232C interface.

**Operating System** • none.

**Database Management** • no database management facility; does allow local storage of information which can be retrieved via keywords.

**Transaction Processing Management** • none; only in association with host facilities.

**Support Software** • none; only in association with host facilities.

**Processor** • Z80 • display-oriented control and communications logic • local/remote initiated printing.

**Terminals/Workstations** • single keyboard, 1920-character display (Model 510); 1920-/3168-character display (Model 520) • RS-232C interface for local printer attachment (option on Model 520).

**First Delivery** • 1979.

**Systems Delivered** • unknown.

**Competitive Systems** • competitive with a number of general-purpose ASCII display terminals; typically DEC VT100, Teletype 4420/4430, Hazeltine Exec 80, Datamedia Excel, IBM 3101, ADDS Regent 60, Televideo 900 Series, Lear Siegler ADM, Beehive DM.

**Vendor** • Anderson Jacobson Inc; 521 Charcot Avenue, San Jose, CA 95131 • 408-263-8520.

**Canadian Distribution** • Anderson Jacobson Limited; 205 Torbay Road, Unit 2, Markham, ON L3R 1H1 • 416-475-5510.

**Distribution** • direct through Anderson Jacobson sales offices throughout the U.S., Canada, France, and the U.K.; distributors throughout Europe.

**GSA Schedule** • listed.

### ■ ANALYSIS

Anderson Jacobson AJ 510 and 520 terminals represent mature

#### PURCHASE PRICE RANGE

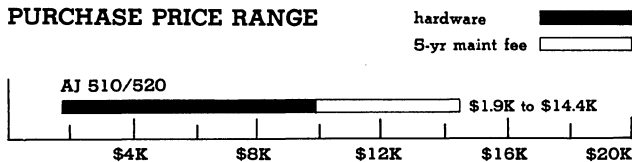

**ANDERSON JACOBSON 510 & 520 PURCHASE PRICING** bar graph covers price range between "small" and "large" configurations for hardware products (solid bar), and for associated 5-year maintenance fees (open bar) • **SMALL AJ 510** consists of a standalone keyboard-display with no options • **LARGE AJ 520** consists of a standalone keyboard-display with standard enhanced video feature and expanded data memory and optional printer port, a 204K-character diskette subsystem, and a 45-cps keyboard printer.

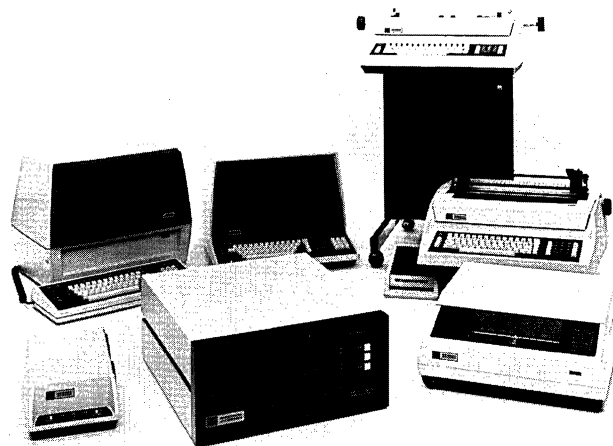

The AJ 510 and 520 are general-purpose ASCII display terminals that support 1920-character displays, an auxiliary printer, and a diskette subsystem; AJ 520 also offers a 3168-character display and 16K-byte RAM expansion.

products that have experienced no major changes over the past few years. Over this past year, Anderson Jacobson has reacted to a declining price trend that has affected the terminal marketplace by slashing its own 510 prices from 23 to 26 percent. Pricing for Model 520 didn't change even though enhanced video and 16K-byte RAM expansion options are now being incorporated as standard features. Anderson Jacobson has also reduced the purchase price of its 460 Diskette system by approximately 20 percent.

The AJ 510 and 520 are solid products with above average editing/formatting features and competitive price positioning. However, the vendor has indicated that there will be no continuing effort to significantly enhance or add to the product family. Instead, Anderson Jacobson appears to be focusing its development energies on producing PC networking products such as its PC Multinet, and on expanding its current lineup of low- and medium-speed modems.

The AJ 510 and 520 are typical ASCII terminals with standard editing and formatting features. They also support 1920-character displays and accommodate an auxiliary printer. But there are some key differences that offset these terminals from the others. Specifically, both terminals accommodate a diskette drive; the 520 offers a 3168-character display arranged in a 132-column x 24-line arrangement. Also, the 510 supports an APL keyboard and firmware to support interactive communication with hosts using the APL language.

In the marketplace, these terminals compete well with prominent models such as the IBM 3101, DEC VT100, Lear Siegler ADM, Teletype 4420/4430, Datagraphix 132, Tab 132/15, and others. The AJ models offer some benefits missing with other models. For example, the 510 and 520 as compared with the IBM 3101 offer increased transmission flexibility. AJ provides character, line, and block mode transmission versus character only on the IBM 3101 Models 10, 12, 13, and character/block on the Models 20, 22, and 23. And besides, the AJ models provide editing and

## Anderson Jacobson Display Terminals Models 510 & 520

formatting not available with the IBM models. IBM's products are priced below the AJ models, however. Against DEC's VT100 and VT101, both terminals are superior with respect to full data editing and formatting, which is not available for the DEC products, and, except for monthly contract maintenance, they are priced below the DEC products on a purchase basis. However, both DEC terminals offer a 132-character line option, while the 510 does not. Newer DEC VT200 Series terminals are also more competitive. Compared with the Teletype 4420/30, the AJ 510 is about equal in performance, but is priced substantially below. The AJ 510 compared with the Tab 132/15 is about equal in both price and performance.

The AJ 520 with the advanced video option competes favorably against the Datagraphix 132 Series, the DEC VT100, and the Tab 132/15. The AJ 520 as compared with the Datagraphix 132A is slightly limited with respect to displayable characters (3960 for Datagraphix versus 3168 for AJ) and buffer capacity (8K for Datagraphix versus 5K for AJ), but the AJ 520 has program function keys (12 versus none on Datagraphix 132 Series) and a lower purchase price. As compared with the DEC VT131, both AJ's 520 and DEC's VT131 display 3168 characters, but the 520 offers 12 program function keys versus 4, and is priced slightly lower than the VT131. As compared with the Tab 132/15, the 520 provides equal performance.

Before selecting a terminal, keep in mind the total cost of owning the device over a typical 3- to 5-year period; the monthly maintenance costs are substantial.

### Strengths

The major benefits of the AJ 510 and 520 lie with reasonably good editing/formatting features, and price positioning of the product within the ASCII terminal market. The soft-configuring aspect of the 520 and the option for adding a 132-character line to its display are especially noteworthy attributes.

Another strong user benefit offered by both terminals is the capability for the host CPU to directly address and transmit data to the attached printer without rendering the terminal unusable for transmitting data. This bypass feature, usually called screen bypass, is offered on few terminals of this type and provides a significant performance boost.

### Limitations

Compared with ASCII terminals in general, both terminals are solid products with no significant limitations. There are only a few deficiencies that might be considered as restrictions for some applications. The 510 is not equipped with function keys, and the 520 user must employ escape routines to perform character/line insert/delete and partial-line erase functions.

The AJ terminals are somewhat dated and the vendor's decision to not add further models or enhancements considerably lessens the life expectancy of this product line. The AJ 520 does support DEC VT100/52 compatibility but DEC VT200 compatibility is lacking, which will cause Anderson Jacobson to lose competitive positioning. Several other terminal manufacturers, including Televideo and Visual Technology, have entered the VT200-compatible arena by offering products that extend VT100 capabilities with the additional benefits of color and ReGIS and Tektronix 4010/4014 graphics.

## ■ COMMUNICATIONS FACILITIES OVERVIEW

The Models 510 and 520 operate as general-purpose, half-/full-duplex, asynchronous ASCII display terminals in a point-to-point communication environment. The 510 transmits data at rates of 110 to 9600 bps, while the 520 ranges from 50 to 19.2K bps. Character, line, and block transmission modes are provided. The terminals are equipped with an RS-232C interface.

## ■ SOFTWARE

The 510 and 520 follow ANSI programming standards. In addition, the 510 is compatible with the IBM 2741 using either EBCDIC or Correspondence code; the 520 is compatible with the DEC VT100/52.

### Operating System

No operating system is provided for either terminal. Firmware supports normal keyboard-display functions. Transmission parameters are established via DIP switches on the 510 and via the keyboard on the 520.

### Data Management

Neither terminal offers a database management system. However, through use of an optional diskette storage system, users can build and retrieve text data. Data retrieval can be performed via a keyword or a string of 3 keywords.

### Communications/Networks

Both terminals communicate point-to-point over switched or dedicated lines. Maximum speed for the 510 is 9600 bps; maximum speed for the 520 is 19.2K bps. Both terminals communicate with any host that supports an ASCII terminal.

### Applications Development Aids

None are provided.

## ■ HARDWARE

### Terms & Support

**Terms** • for purchase or lease on a 1-, 2-, or 3-year term • purchase conversion option allows 40% of monthly rental to be applied; rental credits cannot exceed 50% of purchase price • quantity discounts available.

**Support** • AJ normal service/maintenance hours are 8:00 AM to 5:00 PM Monday through Friday • service beyond normal hours is billed at \$74 per hour; Sunday and holiday service is billed at \$127 per hour • an installation charge of \$15 per unit is charged for sites within a 25-mile radius of an AJ service center, and \$30 beyond 25 and up to 50 miles.

### Overview

The AJ 510 and 520 are ASCII keyboard-display terminals for general-purpose applications. Both terminals communicate point-to-point over switched or dedicated lines at rates up to 9600 bps (510) or 19.2K bps (520), and both accommodate a local printer.

The 510 is the more rudimentary terminal. It employs a standard typewriter keyboard with separate numeric and control keypads; offers what has become standard editing and formatting features; and displays 1920 characters in a conventional 80-character x 24-line format. A somewhat unusual feature is an 81st character position that displays system status. The 510 is also compatible with the IBM 2741 and runs in EBCDIC and Correspondence modes.

The 520 is also equipped with a standard typewriter keyboard with separate numeric and control keypads, but unlike the 510, the keyboard is detachable. The 520 displays data in 1920- or 3168-character screen arrangements; the latter is arranged in a 132-character x 24-line format. A 25th line provides status information. The 520 also differs from the 510 in that it is soft configured (parameters are established via the keyboard) while the 510 is configured by DIP switches. The 520 displays a menu of operating parameters in English and the user reconfigures the terminal from the keyboard. The 520 is software compatible with the DEC VT100/52; it runs under software written for those terminals.

The 510 and 520 offer an APL option and accommodate an optional diskette drive. The APL option consists of a separate keyboard and firmware, and provides 76 valid overstrike characters plus 20 synonyms. Editing is permitted.

The diskette option comprises a 5.25-inch diskette drive with 2048K-character capacity. This unit can be used for formatting data off-line via its own keyboard, formatting can be performed online under terminal-keyboard control. An unusual feature of this diskette drive is its capability to retrieve data by a single keyword or a string of 3 words.

## Anderson Jacobson Display Terminals Models 510 & 520

### Model Packages

**510 Display Terminal** • keyboard-display unit with 15-inch horizontal CRT • 9x12 dot matrix • displays 1920 characters at 24 lines x 80 characters per line • 128-character ASCII set • 41 graphic characters • 2K RAM buffer • 94-key attached typewriter-style keyboard with separate 11-key numeric keypad; no program function keys • half-/full-duplex operation • 110/300/440/600/1200/2400/4800/9600-bps transmission speeds • character/line/block transmission mode • RS-232C interface:

\_\_\_\_\_ \$110/\$89 mo    \$1,995 prch    \$27 maint

**510-02 Display Terminal** • same as 510, but with APL software and keyboard:

\_\_\_\_\_ 118/100            1,675            27

**510-03 Display Terminal** • same as basic Model 510 but compatible with IBM 2741:

\_\_\_\_\_ 130/112            1,850            27

**510 APL Keyboard** • provides APL character set with strikeover:

\_\_\_\_\_ 12/12            200            40

**510-201 2741 Upgrade** • upgrades ASCII terminal for 2741 operation; for 510 only:

\_\_\_\_\_ 15/15            520            NC

**510-202 2741 Upgrade (APL)** • upgrades APL-compatible terminal for 2741 operation:

\_\_\_\_\_ 15/15            520            NC

**510-300 Rev 4 Enhancement Kit** • adds APL software capability to 510:

\_\_\_\_\_ 12/10            200            NC

**520-01 Display Terminal** • keyboard-display unit with 15-inch horizontal CRT • 7x10 dot matrix • displays 1920 characters at 24 lines x 80 characters per line standard; 3168 characters at 24 lines x 132 characters per line standard • 25th status line • 128-character ASCII set • 41 graphic characters • 5K RAM buffer standard; 16K-byte additional RAM standard • 94-key detachable keyboard with separate 11-key numeric keypad and 12 program function keys • half-/full-duplex operation • 50/75/110/134.5/150/300/600/1200/1800/2000/2400/3600/4800/9600/19,200-bps transmission speed • character/line/block mode • RS-232C interface • DEC VT100/VT52 compatible:

\_\_\_\_\_ 135/104            1,995            31

**520-3A Display Terminal** • same as basic Model 520, but with APL software and keyboard:

\_\_\_\_\_ 149/117            2,095            34

### I/O & Communications

The 510 and 520 support point-to-point asynchronous ASCII communication at rates ranging from 110 to 9600 bps (Model 510) and 50 to 19.2K bps (Model 520). All models communicate over switched or dedicated facilities, provide half-/full-duplex modes, and support echoplexing. Transmission parity is selectable for odd, even, or none. Character length is selectable at 7 or 8 data bits, and 1 or 2 stop bits (2 stop bits at 110 bps only). Both terminals transmit in character, line, and block modes.

The 510 is a DIP switch-configurable terminal; the 520 is soft configured. The 520 provides a menu which displays the operating parameters in English, and allows the user to alter the parameters (reconfigure the terminal) from the keyboard.

Both terminals are equipped with an RS-232C interface. An RS-232C serial interface is also provided for attaching a local printer to the terminal. This interface is standard on the 510 and optional on the 520.

Both terminals can also accommodate a Model 460 floppy diskette. This unit offers 2048K characters of storage and a separate keyboard for controlling the unit. The 460 interfaces with the terminal via the RS-232C modem interface. When the terminal is used in the online mode, received information can be recorded on the diskette or bypass it.

**520-602 Printer Port** • RS-232C port for attaching local service character printer:

\_\_\_\_\_ \$12/\$12 mo    \$200 prch    NC maint

### Disk

The vendor offers a 5.25-inch diskette drive which can attach to the 510 and 520. The Model 460 is a double-density, single-sided unit with a capacity of 2048K characters. Information can be recorded in packed or unpacked form. The 460 attaches to the terminal via the RS-232C modem interface and may receive data at 9600 bps. In the online mode, the diskette does not interfere with data communications. The 460 can be controlled by its own keyboard or by the terminal.

**460 Diskette System** • 5.25-inch diskette drive with 2048K-character capacity • single-sided, double-density; packed or unpacked format • direct/random line addressing:

\_\_\_\_\_ \$115/\$93 mo    \$1,595 prch    \$16 maint

### Terminals/Workstations

Aside from the data editing/formatting capabilities, the 510 and 520 are quite different. The 520 provides a detached keyboard and 3-position tiltable screen; an 80- or 132-character display mode; up to 6 pages of scrolling buffer; and 12 program function keys. In addition, the 520 is a soft-configured terminal and is DEC VT100/52 compatible. The 510, by comparison, has an integrated keyboard; a nonadjustable screen; an 80-character line; a 1-page buffer; and no program function keys. It is IBM 2741 compatible.

**Configuration** • tabletop keyboard-display with separate numeric and cursor clusters • RS-232C communications interface • RS-232C printer interface (standard on 510).

**Display** • 15-inch horizontal CRT • 9x12 dot matrix on 510; 7x10 dot matrix on 520 • 510 displays 1920 characters; 520 displays 1920 or 3168 characters • 25th status line on 520; 81st column for status on 510 • 128 ASCII character set • 41 graphic characters • APL character set optional • blinking cursor • line intensity, underline, and reverse video • n-key repeat.

**Edit & Format** • cursor up, down, left, right, home • cursor program addressable • clear line/clear screen • character/line insert or delete • scroll; bidirectional scroll (520 only) • tab, backtab, backspace • protected fields • local print.

**Peripherals** • auxiliary RS-232C interface supports local printer attachment for terminal-initiated/host-initiated printing • 5.25-inch diskette drive attaches via RS-232C modem interface.

### Printers

The vendor offers 5 printers, any of which attach to the 510 and 520 via a serial RS-232C interface. In addition, the Models 832, 833, and 880 are send/receive terminals which interface with the host directly via a modem and communication line.

**832 Keyboard Printer** • pedestal-mounted, bidirectional daisywheel printer • 30 cps • 10/12 cpi (switch selectable) • 96 ASCII character set • 68-key keyboard • 256-character buffer • friction feed:

\_\_\_\_\_ \$155/\$123 mo    \$2,450 prch    \$29 maint

**833 Keyboard Printer** • pedestal-mounted, bidirectional daisywheel printer with print lookahead buffer • automatic line centering and automatic right margin • 45 cps • 10/12 cpi (switch selectable) • 96 ASCII character set • 68-key keyboard with 7 program function keys • 2K-character buffer • friction feed:

\_\_\_\_\_ 160/125            3,530            38

**864 Keyboard Printer** • tabletop matrix impact printer; bidirectional with print lookahead buffer • 9x12 matrix • 180 cps • 10/12 and 15/17 cpi • 96 ASCII character set • 68-key keyboard with 7 program function keys • 16K-character,

*MO: 1-year/3-year monthly lease charge including maintenance. PRCH: single-unit purchase price. MAINT: monthly maintenance charge for purchased units. NC: no charge. Prices current as of June 1985.*

## Anderson Jacobson Display Terminals Models 510 & 520

nonvolatile, extended buffer • optional print/plot • tractor feed 2 to 14.9 inches:

160/128	2,500	29
---------	-------	----

**880 Keyboard Printer** • tabletop matrix impact printer; bidirectional with print lookahead buffer • 9x7 matrix • 10 or 30 cps (switch selectable) • 10/12 cpi • 96 ASCII character set • 68-key keyboard with 7 program function keys • tractor feed:

80/60	1,295	18
-------	-------	----

**650 Ink-Jet Printer** • pedestal-mounted bidirectional printer with print lookahead buffer • 180 cps (80 columns) or 210 cps (132 columns):

219/177	1,495	40
---------	-------	----

**832 Buffer Option** • adds 2K-character buffer to 832:

5/5	100	50
-----	-----	----

**IBM 2741 Compatibility Option** • provides IBM 2741 EBCDIC and Correspondence compatibility for 864:

135/105	188	NC
---------	-----	----

**Numeric Keypad** • 16-key numeric keypad for 880:

6/6	100	NC
-----	-----	----

**Editing Buffer** • 16K-character editing buffer for 880:

56/43	995	5
-------	-----	---

• END

# Applied Data Research (ADR) ROSCOE

## Interactive Time-Sharing System

### ■ PROFILE

**Function** • terminal-oriented conversational monitor; remote job stream entry; production monitoring.

**Computers/Operating Systems Supported** • any IBM System/370 (Model 145 and up), 3000, 4300, or compatible computer; OS/VS1, or OS/VS2(MVS); supports JES, JES2, and JES3.

**Networks & Protocols** • SNA, bisync; all standard IBM protocols.

**Languages Supported** • COBOL, FORTRAN, PL/1, BAL.

**DBMS Interfaces** • available from DBMS vendors; Software AG ADABAS, Informatics MARK IV, Mathematica RAMIS II, Information Builders FOCUS.

**TP & File Access Methods** • BTAM, VTAM; BDAM, SAM, VSAM.

**Terminals** • 3270, 3767, TTY, and equivalents.

**Special Features** • extended timesharing capability.

**Security** • sign-on key file; password to member level; security exits called during sign-on and command execution; RACF, ACF/2, SECURE, and TOP SECRET interfaces.

**Logging/Accounting** • accounting file for session and user statistics.

**Current Version** • 5.3A.

**Installations** • approximately 1,500.

**Comparable Systems** • IBM TSO/ISPF.

**Vendor** • Applied Data Research, Inc; Route 206 & Orchard Road, Princeton, NJ 08540; 201-874-9000 • ADR Applied Data Research, Canada, Ltd; 718 12th Avenue SW, Suite 101, Calgary, AB T2R 0H7; 403-269-2680 • 2055 Rue Peel, Suite 1100, Montreal, PQ H3A 3B8; 514-845-2134 • 505 Consumers Road, Suite 401, Toronto, ON M2J 4V8; 416-497-4424.

### ■ ANALYSIS

ADR/ROSCOE is a total interactive system development tool for use by application programmers, system programmers, operations personnel, end user personnel, and management. In the past 12 years ROSCOE has traveled a long way from its humble beginnings as a simplified remote job entry system. It now serves the needs of almost every person involved in data processing, either directly or indirectly. In addition to simplifying the task of preparing and submitting jobs into a system, ROSCOE can be used effectively to monitor system performance, to enhance data entry, to track resource utilization, and to permit interactive time-

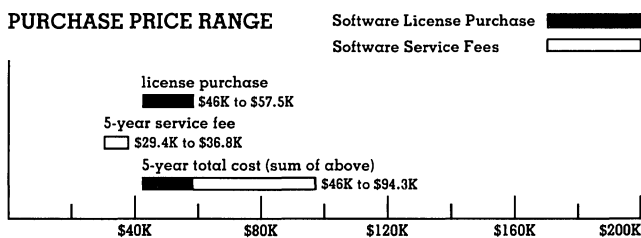

**ADR ROSCOE PRICING** • solid bar shows typical min/max configuration price range; open bar shows corresponding service fee range for 5-year period, but fees are computed for 4 years (48 mos) because first-year service is included in license purchase price • **MINIMUM CONFIGURATION** is ROSCOE for non-MVS systems • **MAXIMUM CONFIGURATION** is ROSCOE for MVS systems.

sharing operations. It also provides syntax checkers and debugging aids for program preparation, and a nonprocedural language facility that helps users perform many of the routine daily house-keeping tasks.

### □ Strengths

ROSCOE is truly a user-oriented product. It is easy to use and easy to learn. It competes effectively with IBM's TSO/ISPF, normally requiring less resources and providing greater overall system support in the form of more terminals supported for the amount of resources used. The RPF (ROSCOE Programming Facility) simplifies the preparation of prompting screens. The system command language is small but powerful. ROSCOE is very stingy when it comes to space utilization for its libraries. It not only compresses blanks out of library data sets, but it also reuses free space from data sets that have been deleted or updated without having to go through a file reorganization. ROSCOE employs an effective hierarchical index structure of library members for rapid access and retrieval. The Extended Time Sharing Option (ETSO) enables programmers to execute their applications in an interactive environment. For nonprogrammers, ETSO provides the means of converting applications into ROSCOE.

Much of ROSCOE's popularity has to stem from the excellent support provided by ADR. Since its introduction 12 years ago, ADR has constantly solicited and implemented enhancements from their user base. In fact, most of the enhancements included in the latest release are directly attributable to their more than 1,500 customers worldwide. Such things as SKETCH, new line commands, and the enhancements to ETSO are just some examples of ADR's responsiveness to its constantly expanding user base.

### □ Limitations

ROSCOE manages system resources more efficiently than IBM's TSO/ISPF, but its "efficiency" is strictly comparative, not absolute. An average ROSCOE installation requires approximately 1M byte of virtual memory for a 10-terminal configuration. Also, the recommended disk storage configuration calls for the use of 3 to 5 different drives. For example, the vendor recommends placing the AWS (Active Work Sets) files, which can be as many as 16, on different disk units to realize maximum performance benefits. The AWS pointer file requires still another DASD device. The vendor further recommends that the work files be positioned on the packs in places where "minimal contention" can be realized. It certainly appears that users would greatly benefit by performing a full disk activity analysis to identify the "minimal contention" point. Further, the file allocation and preformatting function takes place at installation time, and the AWS files must be allocated contiguously on cylinder boundaries with no secondary extents. The bottom line is that users must do some in-depth preinstallation planning to provide sufficient file space without having to reconfigure ROSCOE as the files grow larger. If laid out properly, the system can grow with very little maintenance.

### ■ OVERVIEW

#### □ Terms & Support

**Terms** • license can be acquired on purchase monthly rental, 3-year lease, or 5-year lease terms, all with bundled first-year maintenance; term maintenance available on rental and lease plans; multiple-copy discounts are 20% for second through fifth copy, and 30% for 6 or more copies.

**Support** • no charge for first-year maintenance on all acquisition plans; ongoing annual maintenance fee is 15% of the then-current

## Applied Data Research (ADR) ROSCOE Interactive Time-Sharing System

permanent license fee; 2-, 3-, and 4-year maintenance plans are available at reduced annual rates of 12% to 14%; no charge for installation planning and assistance.

### Component Summary

ROSCOE consists of a coordinated set of discrete tasks. The tasks are invoked asynchronously by a primary telecommunications task that resides in a region or partition for the term of the ROSCOE operation period and that is normally assigned the highest job priority to assure optimum response times. All terminal-entered data is placed in a user library in ROSCOE. Editing is handled in temporary storage areas called AWS files. ROSCOE provides COBOL, FORTRAN, and PL/1 syntax checkers and a JCL verification facility. RPF (ROSCOE Programming Facility) is a structured programming language that can be used to manipulate data, to control operations, to provide screen masks for data entry operations, and to design prompting sessions for nonprogrammer end-user personnel.

Other integral components of the basic ROSCOE system include support for IBM's System Management Facility (SMF), resource utilization/user accounting statistics-gathering facilities, session-to-session operational reports, and security routines that prevent unauthorized access to library files. The security facilities also include a sophisticated password protection scheme.

For the MVS user, an Extended Time Sharing Option (ETSO) permits interactive high-level language programs to be integrated into the ROSCOE environment. Associated application files are dynamically allocated and then linked with ROSCOE's external data sets, Active Work Space (AWS), ROSCOE library members, and the terminal. ETSO also monitors the application programs to ensure that they do not interfere with other ROSCOE users.

A major enhancement to ROSCOE, in Release 5.3A, is the addition of a system that simplifies the creation and maintenance of panels used by CICS application programs. ADR has named the new system SKETCH, and used the ROSCOE Programming Facility (RPF) for implementation. By following system prompts, the SKETCH user "paints" panels and defines fields in panels. Once the user is satisfied with the panel(s), SKETCH automatically generates the appropriate CICS Basic Mapping Support (BMS) macros.

SKETCH is fully integrated with ROSCOE. It also accepts existing RPF panels and converts them into BMS format. With SKETCH, users can prototype entire applications, verifying not only individual panels, but the flow of the application.

Other ADR products, such as LIBRARIAN, ETC, EMAIL, LOOK, and Empire can be interfaced with ROSCOE to form applications-oriented operating environments. For example, the ROSCOE/ETC configuration provides an effective online word processing system.

### Host Computers & Operating Systems

ROSCOE can be installed on any IBM System/370 Model 145 and up, the 3000 and 4300 series processors, and any compatible computer capable of running under OS/VS1 or MVS. The JES/JES2/JES3 automatic job scheduling subsystems are supported under ROSCOE. Any operator console can be used as the ROSCOE control terminal, and any terminal or disk unit on the system can be supported under ROSCOE.

### Minimum Operational Configuration

The minimum region size for the ROSCOE environment is 1M bytes of main memory. BTAM and/or VTAM access methods must be implemented in the system, along with BDAM for file construction. A modification is available to permit a VS/1 system to transfer a job directly to the VS/1 job queue without staging the data sets.

### File Interfaces

All standard IBM files are supported under ROSCOE, and almost any file with up to 255-character records can be accepted. ROSCOE provides a complete set of facilities to interface with OS and VSAM data sets. Data set and catalog management is provided for sequential and partitioned files. All editing operations take

place in the AWS, so all data sets must be transferred into an AWS file. After editing, the file is restored to its original data set location. In an MVS environment, external files are accessed via dynamic allocation. Interactive VSAM file management is provided through the IDCAMS (Access Method Services) interface. All IDCAMS commands can be entered from a ROSCOE terminal.

### REMOTE JOB ENTRY/TIMESHARING FACILITIES

ROSCOE is a command-oriented telecommunications task that resides in an operating system region or partition during a user-defined operational session. Its primary purpose is to coordinate data transfer activities among user terminals, libraries, and work files. ROSCOE synchronizes its operational processing with batch and spooling activities in other partitions/regions. The operator console is also the ROSCOE control console from which the operator can control, through the command vocabulary, all the data management and performance monitoring functions available with ROSCOE. The ROSCOE supports interactive operations with job submission and output scanning. All of these activities are handled in a single mode of operation. The 3270-type console allows the user to do all necessary editing and command operations and then scroll through the output to preformat the desired printed output. All ROSCOE files are handled through temporary work files called Active Work Sets (AWS). The AWSs appear to the terminal user as an extension to the terminal operational capabilities. Data from a terminal enters the AWS where it is manipulated and sent on to an output file, to a job queue, or to the ROSCOE library file for future use. The physical structure of the AWS consists of a pool of space in several disk files with a series of control buffers for each user residing in memory. AWS data is saved automatically from session to session.

### Job Entry Facilities

ROSCOE supports a job entry subsystem interface that allows jobs to be verified and accessed by the OS reader/interpreter for spooling onto the OS job queue. When ROSCOE is running with JES, JES2, or JES3, jobs are verified and transferred directly into the scheduling queues.

### User Libraries

ROSCOE user libraries are a set of BDAM files, all of which have identical characteristics and differ only in space allocation. One of the 99 allowable online library files is an index file, which contains the control information on the location of the user library members within the system. All library files must have the same block size. The minimum size is 240 bytes, and the maximum is the track size of the device used to store the file. Multiple ROSCOE systems can access a common user library system. Each user appears to have a separate library within the file system.

### Screen Facilities

The ROSCOE screen is divided into three areas: the command area, which is reserved for entering ROSCOE commands and verifying correct usage; the system control area, which contains response information and system performance information; and the execution area, where data is created and modified. All PA (Program Attention) and PF (Program Function) keys on the 3270 are used to perform procedural operations.

The sign-on procedure is the first phase of an intricate security/integrity capability built into ROSCOE. Users must submit a sign-on key that must match a predefined key in the ROSCOE authorization file. These keys, along with passwords, are assigned by the site management and can be altered dynamically. After sign-on, the system prompts for the correct password to access specific library files. The system must accept the sign-on key and the password before a terminal operator can participate in the ROSCOE session. ROSCOE provides a HELP screen for users not familiar with the functions or features of the system, with RPF, or with any of the terminal commands.

Most of ROSCOE's facilities are accessible to terminal users, including the ability to modify, insert, rearrange, and edit data. Library members can be updated, and line numbers within programs can be deleted or renumbered. A full complement of utility programs is provided to support tasks such as copying data sets

## Applied Data Research (ADR) ROSCOE Interactive Time-Sharing System

and allocating new data sets on disk. ROSCOE keeps track of resource usage with built-in accounting operations. A file containing CPU usage time, terminal I/O time, disk I/O time, terminal connect time, and library space used for a session or for any time period is created, and data from the file can be extracted to prepare management reports at various detail levels. A user exit permits the resource usage data to be submitted to the system SMF file.

### Language Facilities

The most sophisticated element of ROSCOE is the RPF. This interactive, structured programming language can be used to develop programs that can control operator activities via prompting messages, can generate JCL, can schedule production jobs, and can provide screen masks for data entry operations. RPF programs are stored as members in the ROSCOE library system and can be executed by remote terminal operations. RPF programs can call other RPF programs with arguments and return variables used for communication. An RPF program consists of several RPF-only commands that support line-by-line or full-screen operations. Regular ROSCOE commands can be embedded in an RPF program, so that the full range of ROSCOE facilities is available to the RPF programmer. JCL syntax checker commands can be integrated into the RPF program string, and ROSCOE also provides syntax checkers for COBOL that adheres to 1974 ANSI COBOL standards (or earlier) FORTRAN, and PL/I.

ROSCOE • for non-MVS systems:

\$46,000 lcms	\$2,555/\$3,194 mo	\$7,360 serv
---------------	--------------------	--------------

ROSCOE • for MVS systems:

57,500	3,194/3,993	9,200
--------	-------------	-------

### Applications Programming Aid

**ETSO** • an interactive program execution facility for application developers using COBOL, PL/I, FORTRAN, and other high-level languages; manages the timesharing environment by monitoring an application's CPU consumption; adjusts dispatching priorities according to usage; controls total CPU usage through limits preset by site management; provides memory acquisition protection

*LCNS: permanent license fee with 1 year of maintenance included at no extra cost. MO: first figure is monthly rental license fee; second figure is monthly fee for 3-year lease with term maintenance. SERV: ongoing annual maintenance fee based on 15% of the permanent license fee. Prices effective as of October 1, 1984.*

whereby only management can set the total amount of storage to be acquired by an application and set the amount of storage that is to be allocated for any one request • allows application programs to communicate with ROSCOE terminals by using IBM TSO's TPUT and TGET macros, as well as BSAM and QSAM access methods; maintains site security and accounting; controls access through exit routines and an Eligible Program list maintained by site management; and with release 5.3A, ETSO now supports concatenated data sets, sysout files, and programs that use authorized system functions • site management monitors and controls usage through special ETSO facilities available to the ROSCOE control account; usage is logged by the ROSCOE accounting system • ETSO is only available to MVS sites.

### USER REFERENCE LIST

The following users can be contacted directly by Data Decisions subscribers for firsthand advice and opinions about the products covered in this report:

- Mr. John Walker  
Manager of Systems Support  
Alco Standard Products  
825 Dupor Tail Road, Chesterbrook  
Valley Forge, PA 19482  
Tel: 215-296-8400
- Mr. William Hart  
Senior Telecommunications Analyst  
Kobacker Company  
6606 Tussing Road  
P.O. Box 16751  
Columbus, OH 43216  
Tel: 614-863-7385
- Mr. Greg Grimes  
Systems Programmer  
Intel Systems  
12675 Research Boulevard  
Austin, TX 78766  
Tel: 512-258-5171
- Mr. Gary Malone  
Senior Systems Engineer  
Endata Incorporated  
230A Cumberland Bend Drive  
Nashville, TN 37228  
Tel: 615-255-5353

• END





# Applied Data Research (ADR) VOLLIE Online Program Development System

## ■ PROFILE

**Function** • online source statement and procedure library maintenance system.

**Computers/Operating Systems Supported** • any IBM System/370, 3000, 4300, or compatible computer; DOS/VS, DOS/VSE, and SSX/VSE with POWER/VS(E).

**Languages Supported** • most IBM-supported high-level language source programs; syntax checkers for COBOL and IBM JCL/JECL.

**Communications Interfaces** • IBM CICS/DOS/VS.

**TP & File Access Methods** • supports all standard IBM file access methods.

**Terminals** • 3270-type.

**Special Features** • VOICE (VOLLIE Interactive Command Executor); VOLLIE/IPO/E (Installation Productivity Option/Extended Facility); SAFE (Security Account File); VIP (VOLLIE Interface Program).

**Security** • SAFE authorization system; sign-on ID code; password; privilege table in program area.

**Logging/Accounting** • system and command usage statistics; user-established backup logs; modification and date logging provided.

**Failure/Recovery** • internal restart feature provided; backup files for restart are defined by user.

**Current Version** • 3.3.

**Installations** • approximately 2,200.

**Comparable Systems** • Westinghouse SCEPTER; Pansophic PANVALET/On-Line and O-W-L.

**Vendor** • Applied Data Research, Inc; Route 206 & Orchard Road, CN-8, Princeton, NJ 08540; 201-874-9000 • ADR Applied Data Research, Canada, Ltd; 718 12th Avenue SW, Suite 101, Calgary, AB T2R 0H7; 403-269-2680 • 2055 Rue Peel, Suite 1100, Montreal, PQ H3A 3B8; 514-845-2134 • 505 Consumers Road, Suite 401, Toronto, ON M2J 4V8; 416-497-4424.

## ■ ANALYSIS

Online programming development systems are all the rage in today's data processing world, but VOLLIE, a DOS/VS(E)-based product, has been quietly acquiring its satisfied user base since 1978. The number of users selecting this highly proclaimed development tool has been growing on the average of at least 300

new converts a year. The attractiveness of being able to create, modify, and stream source statement and procedure modules for execution directly from an interactive terminal has captured the fancy of many DOS/VS(E)-oriented installations.

Among the many advantages that VOLLIE offers is the ability to interface the programming tool with many of the other popular ADR products to configure a tightly knit environment for improving ease of use, processing effectiveness, and general resource savings. Much of this flexibility is provided through the use of the Online Library (OLL) facility that permits data to be accessed by VOLLIE to be stored in the form of partitioned members. Added access protection is achieved through the use of directories, which control who can get at what data. In fact, security of VOLLIE data elements is one of the key design points of the product, and the internal security and integrity facilities can be further augmented by a separate security system called SAFE, which allows the user to tailor the security needs for each installation's authority scheme.

There are VOLLIE features which permit the IBM DOS user to make the transition from the IBM-provided development environment to VOLLIE with minimal, or no extra effort. In most cases, the conversion to the faster and more efficient ADR product can be achieved with a simple file conversion task. And, if the user desires, interfaces to other ADR products, such as The LIBRARIAN and LOOK, can be implemented at any time. The combination of VOLLIE and The LIBRARIAN gives users a total library maintenance and productivity system. The incorporation of LOOK provides the user with that ability to recognize and take steps to eliminate production bottlenecks at any time. The combination of these ADR systems is also attractively priced in a single package.

## □ Strengths

VOLLIE is a macro-generated, command-oriented, online development tool that is easily learned and mastered by technical and nontechnical personnel. The command structure is very flexible and offers many options, especially in the area of security where over 50 different levels of access and authority can be tailored by the user. The partitioned structure of the OLLs and the fact that an unlimited number of OLLs can be implemented in VOLLIE generate significant savings in access and retrieval time. The PF (Program Function) and PA (Program Attention) keys on connected 3270-type terminals also are used to speed up VOLLIE operations by giving users the ability to automate frequently used procedures. VOICE, the VOLLIE interactive programming language, enables users to create procedures and macros that further reduce repetitive operations. It also allows users to write specialized programs that address any unique operating situations. All VOLLIE commands can be included in the VOICE command program with no special handling. Access to VOICE programming capabilities must be authorized, lending even further security to the already security-minded system.

The VOLLIE IPF facility gives VOLLIE users the same functions offered by the IBM ICCF/IPF option, but it does the operations faster and uses less system resources. These improvements are the result of the OLL design. VOLLIE provides users with 2 very effective syntax checkers to verify all changes and/or modifications performed on members of the OLL libraries. The syntax checkers are for COBOL source programs and JCL/JECL control statements.

For LIBRARIAN users, VOLLIE permits source programs to be extracted directly from the master file, and modified in the OLL. The updated source program can be submitted directly to The LIBRARIAN's LIBAUDIT facility before it is returned to the master file. VOLLIE also allows users to extract modules from the source statement library. An Internal Reader facility, using the POWER/

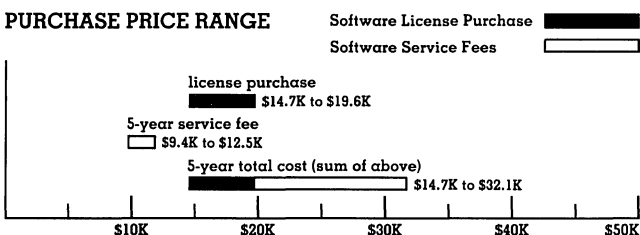

**ADR VOLLIE PRICING** • solid bar shows typical min/max price range; open bar shows the corresponding service fee range for 5-year period, but the fees are computed for 4 years (48 mos) because first-year service is included in license purchase • **MINIMUM CONFIGURATION** is a version of VOLLIE for use with CICS/VS or DATACOM/DC running on an IBM 4321 small system • **MAXIMUM CONFIGURATION** is the version of VOLLIE for mainframes larger than the System/370 Model 135.

## Anderson Jacobson Display Terminals Models 510 & 520

520 provides equal performance.

Before selecting a terminal, keep in mind the total cost of owning the device over a typical 3- to 5-year period; the monthly maintenance costs are substantial.

### □ Strengths

The major benefits of the AJ 510 and 520 lie with reasonably good editing/formatting features, and price positioning of the product within the ASCII terminal market. The soft-configuring aspect of the 520 and the option for adding a 132-character line to its display are especially noteworthy attributes.

Another strong user benefit offered by both terminals is the capability for the host CPU to directly address and transmit data to the attached printer without rendering the terminal unusable for transmitting data. This bypass feature, usually called screen bypass, is offered on few terminals of this type and provides a significant performance boost.

### □ Limitations

Compared with ASCII terminals in general, both terminals are solid products with no significant limitations. There are only a few deficiencies that might be considered as restrictions for some applications. The 510 is not equipped with function keys, and the 520 user must employ escape routines to perform character/line insert/delete and partial-line erase functions.

### ■ COMMUNICATIONS FACILITIES OVERVIEW

The Models 510 and 520 operate as general-purpose half-/full-duplex asynchronous ASCII display terminals in a point-to-point communication environment. The 510 transmits data at rates of 110 to 9600 bps, while the 520 ranges from 50 to 19.2K bps. Character, line, and block transmission modes are provided. The terminals are equipped with an RS-232C interface.

### ■ SOFTWARE

The 510 and 520 follow ANSI programming standards. In addition, the 510 is compatible with the IBM 2741 using either EBCDIC or Correspondence code; the 520 is compatible with the DEC VT100/52.

### □ Operating System

No operating system is provided for either terminal. Firmware supports normal keyboard-display functions. Transmission parameters are established via DIP switches on the 510 and via the keyboard on the 520.

### □ Data Management

Neither terminal offers a database management system. However, through use of an optional diskette storage system, users can build and retrieve text data. Data retrieval can be performed via a keyword or a string of 3 keywords.

### □ Communications/Networks

Both terminals communicate point-to-point over switched or dedicated lines. Maximum speed for the 510 is 9600 bps; maximum speed for the 520 is 19.2K bps. Both terminals communicate with any host that supports an ASCII terminal.

### □ Applications Development Aids

None are provided.

### ■ HARDWARE

### □ Terms & Support

**Terms** • for purchase or lease on a 1-, 2-, or 3-year term • purchase conversion option allows 40% of monthly rental to be applied; rental credits cannot exceed 50% of purchase price • quantity discounts available.

**Support** • AJ normal service/maintenance hours are 8:00 AM to 5:00 PM Monday through Friday • service beyond normal hours is billed at \$74 per hour; Sunday and holiday service is billed at \$127 per hour • an installation charge of \$15 per unit is charged for sites within a 25-mile radius of an AJ service center, and \$30

beyond 25 and up to 50 miles.

### □ Overview

The AJ 510 and 520 are ASCII keyboard-display terminals for general-purpose applications. Both terminals communicate point-to-point over switched or dedicated lines at rates up to 9600 bps (510) or 19.2K bps (520), and both accommodate a local printer.

The 510 is the more rudimentary terminal. It employs a standard typewriter keyboard with separate numeric and control keypads; offers what has become standard editing and formatting features; and displays 1920 characters in a conventional 80-character by 24-line format. A somewhat unusual feature is an 81st character position that displays system status. The 510 is also compatible with the IBM 2741 and runs in EBCDIC and Correspondence modes.

The 520 is also equipped with a standard typewriter keyboard with separate numeric and control keypads, but unlike the 510, the keyboard is detachable. The 520 displays data in 1920- or 3168-character screen arrangements; the latter is arranged in a 132-character by 24-line format. A 25th line provides status information. The 520 also differs from the 510 in that it is soft configured (parameters are established via the keyboard) while the 510 is configured by DIP switches. The 520 displays a menu of operating parameters in English and the user reconfigures the terminal from the keyboard. The 520 is software compatible with the DEC VT100/52; it runs under software written for those terminals.

The 510 and 520 offer an APL option and accommodate an optional diskette drive. The APL option consists of a separate keyboard and firmware, and provides 76 valid overstrike characters plus 20 synonyms. Editing is permitted.

The diskette option is comprised of a 5.25-inch diskette drive with 2048K-character capacity. This unit can be used for formatting data off-line via its own keyboard, formatting can be performed online under terminal-keyboard control. An unusual feature of this diskette drive is its capability to retrieve data by a single keyword or a string of 3 words.

### Model Packages

**510 Display Terminal** • keyboard-display unit with 15-inch horizontal CRT • 9x12 dot matrix • displays 1920 characters at 24 lines x 80 characters per line • 128-character ASCII set • 41 graphic characters • 2K RAM buffer • 94-key attached typewriter-style keyboard with separate 11-key numeric keypad; no program function keys • half-/full-duplex operation • 110/300/440/600/1200/2400/4800/9600-bps transmission speeds • character/line/block transmission mode • RS-232C interface:

	\$100/\$89 mo	\$1,995 prch	\$37 maint
--	---------------	--------------	------------

**510-02 Display Terminal** • same as 510, but with APL software and keyboard:

	118/100	2,195	37
--	---------	-------	----

**510-03 Display Terminal** • same as basic Model 510 but compatible with IBM 2741:

	123/105	2,515	37
--	---------	-------	----

**510 APL Keyboard** • provides APL character set with strikeover:

	12/12	200	40
--	-------	-----	----

**510-201 2741 Upgrade** • upgrades ASCII terminal for 2741 operation; for 510 only:

	15/15	200	NC
--	-------	-----	----

**510-202 2741 Upgrade (APL)** • upgrades APL-compatible terminal for 2741 operation:

	15/15	520	NC
--	-------	-----	----

*MO: 1-year/3-year monthly lease charge including maintenance. PRCH: single-unit purchase price. MAINT: monthly maintenance charge for purchased units. NC: no charge. NA: not available or applicable. Prices effective as of May 1984.*

## Applied Data Research (ADR) VOLLIE Online Program Development System

The library control directory, which is maintained in ascending sequence, maintains information describing the member, the date it was added, the date of last update, the number of records in the member, the number of library blocks occupied, and the position of the line numbers.

VOLLIE • under CICS for small systems (IBM 4321 through 370/135):

\$14,700 lcns	\$766/\$552 mo	\$2,350 serv
---------------	----------------	--------------

VOLLIE • under CICS for all other IBM mainframes:

19,600	1,021/737	3,135
--------	-----------	-------

**Remote Job Entry/Output** • requires presence of POWER/VS(E) in the system configuration; uses the SUBMIT command to enter OLL members and/or LIBRARIAN modules directly to the Internal Reader queue; a number of members can be concatenated, the limit is only the length of the command field on the terminal; leading and trailing JCL must be present to complete the job stream; JCL can be in a shareable OLL member; all members and JCL are concatenated to form job stream • QUEUE command prints, punches, and/or displays individual queues; enables users to delete entry in queue, to retain the entry for operator intervention, or to retain entry after processing is completed • OUTPUT command dictates punching or listing of output data; segmented output can be displayed; page number fields can be modified • all queue status can be displayed or listed; output can be directed to an OLL.

**VOLLIE Online Interactive Command Executor (VOICE)** • high-level interpretive terminal-oriented language provides full-screen editing; handles all terminal and I/O processing; performs arithmetic calculations using addition, subtraction, multiplication, and division operations; provides string manipulation capabilities, including use of comparators (e.g., AND/OR, EQ, NE, etc); enables users to develop internal and external subroutines and macros • all VOLLIE commands can be interspersed in VOICE procedure; all procedures can be cataloged to OLL; debugging procedures are provided, including trace and snap facilities.

**Security Account File (SAFE)** • maintained on an OLL; automatically link-edited into VOLLIE system upon initialization; SAFE Maintenance Program specifies the control statements that define the privileges allowed in the system; default options are provided for each authorization element; most options are YES/NO choices when generating the environment; control statements and keywords (with or without values) control profiles; a control statement is required for each user receiving access authority or several users can be profiled after a single user; authorities can be added, deleted, or modified through the use of SAFE commands; almost 50 different keywords make up the maintenance program; some of the authorities that can be designated include authority to execute the VOLLIE Batch Utility program, authority to access private online libraries other than one's own, and authority to display jobs in the queues.

*LCNS: license purchase fee with first year of maintenance included. MO: first figure is cost on a monthly rental plan; second figure is the monthly cost based on a 5-year lease plan; both fees include maintenance. SERV: maintenance costs on a one-year plan for a license purchase. Prices effective as of October 1984.*

**VOLLIE IPO/E (Installation Productivity Option/Extended) Facility** • replaces IBM IPF component controlling ICCF (Interactive Communications Control Facility)/IPF (Installation Productivity Facility); maintains operating system and program product data sets through the use of IPF panels; VOLLIE IPO/E can directly execute IPF from a VOLLIE terminal; utilizes all standard IPF prompts and commands; a program is available to convert members from an ICCF library to an OLL; IPF panels and data must reside on one OLL on either a BDAM or VSAM file; use of IPF function can be restricted by entries in the SAFE file or the Privilege Table • any modification made by IBM to program products that run under IPF will be fully supported by VOLLIE.

### ■ USER INTERFACES

**VIP (VOLLIE Interface Program)** • allows user-written programs to retrieve and manipulate data from an OLL; both batch and online versions are available • VIP consists of 5 data manipulation routines: OPEN makes OLL available, FIND locates an index entry of a specified member, REC retrieves next record, POS positions screen to retrieve specific record, and CLOSE terminates program.

**VOLLIE Batch Utility** • can be used to generate SAFE modules; can access members on an OLL; can manipulate entries in the OLL; can assign attributes to OLL members; can be used to construct backup and restore operations • Console Reader facility allows the operator console to be used as a pseudo card reader device in an Internal Reader environment.

### ■ USER REFERENCE LIST

The following users can be contacted directly by Data Decisions subscribers for firsthand advice and opinions about the products covered in this report:

- Mr. Stuart Masson  
VP/Data Processing  
TAXX  
3228 6th Street  
Metairie, LA  
Tel: 504-838-8299
- Mr. Ed Reardon  
Manager of Systems & Programming  
Massachusetts State Lottery  
15 Lockdale Avenue  
Braintree, MA 02125  
Tel: 617-848-7755
- Mr. Raoul Henri  
System Prog/Mgr Tech Support  
City of Burbank  
275 East Olive Avenue  
Burbank, CA 91510  
Tel: 818-953-9696
- Mr. James A. Carter  
Manager of Technical Support  
Community College of Rhode Island  
400 East Avenue  
Warwick, RI 02886  
Tel: 401-825-2135

• END



# ADDS Viewpoint Series Display Terminals

## Models A1, A2, 3A Plus, Viewpoint, Plus, 60 Plus, 60, Color, G, 60G, 78, 78 Color & 90

### ■ PROFILE

**Function** • general-purpose, nonprogrammable ASCII keyboard display • interactive-/block-mode operation • business graphics; vector graphics • split-screen operation on Viewpoint/90 • ADDS Regent Series terminals compatibility; no ANSI mode operation • Lear Siegler ADM 3 compatible; Model 3A Plus.

**Architecture Supported** • any architecture supporting asynchronous ASCII protocol.

**Communications** • half-/full-duplex, asynchronous, 110 to 19.2K bps, point-to-point • character and block transmission • RS-232C interface standard; RS-449 and current-loop optional for some models.

**Operating System** • none.

**Database Management** • none; only in conjunction with host facilities.

**Transaction Processing Management** • none; only in association with host facilities.

**Support Software** • Models G and 60G support popular graphics software package from Tektronix and ISSCO; no other support available.

**Processor** • display-oriented control and communication logic.

**Terminals/Workstations** • single-terminal, 1920-character keyboard display; 3168 characters optional on Viewpoint/90 • auxiliary printer port.

**First Delivery** • 1981 (Viewpoint/A1, /A2, and 3A Plus); 1982 (/60, /90); 1983 (/Color, /78, 78 Color); 1984 (Viewpoint, /Plus, /60 Plus).

**Systems Delivered** • unknown.

**Comparable Systems** • comparable with a host of ASCII terminals, especially DEC VT100, Datagraphics 132 Series, IBM 3101, Hazeltine Exec 80 and Esprit, Beehive, Televideo 900 Series, Datamedia Excel, and Visual 100.

**Vendor** • Applied Digital Data Systems, Inc, a subsidiary of NCR Corporation; 100 Marcus Boulevard, Hauppauge, NY 11788 • 516-231-5400.

**Distribution** • direct sales through nationwide ADDS sales offices.

### ■ ANALYSIS

ADDS introduced three new members to its Viewpoint family of terminals at the 1984 NCC. These include the Viewpoint, a

### PURCHASE PRICE RANGE

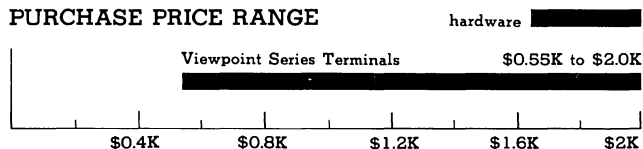

**VIEWPOINT SERIES PURCHASE PRICING** bar graphs cover price ranges between "low-end" and "high-end" terminals • maintenance is performed entirely through a third party and must be negotiated • low-end terminals include the Viewpoint, /Plus, and /60 Plus • high-end terminals include graphics models Viewpoint/G and /60G, and color models Viewpoint/78 and /78 Color.



bare-bones, low-cost model; Viewpoint/Plus, which emulates the older Viewpoint/A1, /2, and /3A Plus; and Viewpoint/60 Plus, a low-priced smart terminal. Physically identical, the terminals feature ergonomic design (tilt-and-swivel monitor and low-profile keyboard) for operating convenience, menu-selectable operating parameters for ease of use, and selection of black/white, green, amber, or smooth white screens. ADDS will undoubtedly phase out production of its Viewpoint/A1, /A2, and /3A Plus with the availability of its new lower-priced Viewpoint/Plus. The Viewpoint/60 Plus supports an optional second page, allowing the user to alternate between two independent 24-line screens or a single 48-line page, which the user can view at 24 lines at a time by moving the window to view the desired data.

The Viewpoint/G and /60G graphics terminals, announced last year, were not delivered and will be introduced at this year's COMDEX trade show.

ADDS manufactures and markets general-purpose ASCII terminals, which can be categorized as either **dumb** or **smart**, smart meaning the addition of local editing features such as character/line inserts and erasures. The company eliminated the Regent family of display terminals from its product line, leaving the Viewpoint series to support this market segment. These terminals offer commonplace display, editing, and formatting features; data communication facilities are ordinary. Pricing on the Viewpoint series is very competitive, however, and newer models provide a very inexpensive means to add color CRTs or vector graphics to a data network.

The Viewpoint/90 is a terminal that, through options, can compete with the likes of the DEC VT100. It allows users to configure operating parameters directly from the keyboard, and permits 132 characters per line—an optional feature. The /90 cannot operate with DEC formats, however, and in fact only one

## ADDS Viewpoint Series Display Terminals

### Models A1, A2, 3A Plus, Viewpoint, Plus, 60 Plus, 60, Color, G, 60G, 78, 78 Color & 90

model (the Viewpoint/3A Plus) is compatible with another terminal or standard. ADDS **has not** chosen to follow the ANSI X3.64 terminal formatting standard, as other terminal vendors are now doing, which would allow different makes and models to intercommunicate.

Overall, however, the ADDS products are competitive in their respective classes. They provide competitive data editing and formatting, and their prices are attractive. Newer models support sophisticated business graphics and color screens with average resolution; the Viewpoint/78 and /78 Color are part of an industry trend to offer users inexpensive ASCII terminals to replace IBM 3270 products, with the addition of a protocol converter (ASCII/BSC or ASCII/SDLC).

#### Strengths

All terminals without options are on par technically with most competitive terminals in the dumb and smart class. As for price, they are among the most inexpensive units on the market.

The Viewpoint/90 with its optional 4K-RAM Paging Buffer puts it into a class with the Tab 132/15 and DEC VT100. With the paging buffer, ADDS provides the capability of displaying a 132-character line. Such a capability, in turn, permits a typical 132-character computer printout line to be displayed as it would appear in line print copy. With the Viewpoint/90's local print feature, such a line can be printed locally without reformatting.

The Viewpoint/Color is a color terminal on a par with many monochrome smart terminals in the same price range. The addition of color may improve operator productivity by highlighting screen areas so that the operator can easily differentiate between different types of information. In a similar vein, the Viewpoint/G and /60G support advanced business graphics (as opposed to forms or simple line-drawing graphics) that can display numerical data in the form of charts or graphs, generally considered a better way to convey information.

Models Viewpoint/78 and /78 Color are an inexpensive alternative to IBM 3278 displays. Both include a 3278-lookalike keyboard, making the transition from the IBM terminal less painful for operators. At a price savings of from \$1,000 to \$2,000 per terminal, depending on the model and excluding the price of protocol converters, the price may be worth the transition.

Newer models in the Viewpoint stable (/Color, /G, /60G, /78, and /78 Color) are built with operator comfort as a high priority. Ergonomic features such as tilt-and-swivel displays and low-profile keyboards are standard.

#### Limitations

All terminals suffer from 3 significant limitations: they are not ANSI compatible; they cannot be used to send/receive data while the attached printer is receiving data from the host; and none have a smooth scrolling compatibility.

The fact that neither terminal is ANSI compatible means that it cannot generate/respond to coded sequences per ANSI standards X3.41-1974 and X3.64-1977. This, in turn, limits its compatibility with other terminals. (In a multivendor shop, such incompatibility could be a significant drawback.) Most Viewpoint models are compatible with each other and with the ADDS Regent line.

The second limitation concerns host-initiated printing. With a Viewpoint terminal operating in **print transparency mode**, data can be directed to the optional terminal printer without passing through the screen (this is called screen bypass). While this is a definite advantage in that the microprocessor isn't burdened with character generation and screen scanning, it interrupts terminal communication during printing. Viewpoint terminals, incidentally, are not alone with this limitation. A good number of terminals—including DEC and Tab—have the same problem.

The lack of smooth scrolling means that the user has no control over how quickly data lines are displayed on the screen, other than slowing down the communication speed. Some operators find fast screen scanning to be an irritant; others aren't bothered by it at all. You'd be wise to poll your operators in advance to see

which category they fall into before you accept or reject either of these terminals.

The newer "G" type graphics terminals are not designed to support sophisticated applications. Screen images cannot be rotated or translated to another part of the screen, and the unit will not perform quantitative conversions.

#### Communications Facilities Overview

All models operate as general-purpose half-/full-duplex ASCII terminals in point-to-point applications. Transmit and receive data rates are user selectable and range from 110 to 19.2K bps. Transmission is standard Teletype emulation. Transmit/receive speeds need not be the same.

#### SOFTWARE

Models Viewpoint/G and Viewpoint/60G support the following graphics software: Tektronix's 4010, 4012, and PLOT 10; ISSCO's DISSPLA and TELLGRAF.

#### Operating Systems

No operating system is supported. Firmware controls keyboard-display functions, data communication, and printing activities.

#### HARDWARE

##### Terms & Support

**Terms** • purchase-only basis with separate monthly maintenance charge; on-site, third-party (NCR) maintenance; depot service available • volume discounts available.

**Support** • on-site service provided by NCR; users must negotiate terms • ADDS warrants its products for 90 days; extended warranty plans offered • ADDS service provided through depots.

##### Overview

The ADDS Viewpoint family consists of 13 general-purpose ASCII keyboard-display terminals designed for a variety of applications. At the low end, Models /A1, /A2, and /3A Plus are all basically **dumb** terminals with little or no local editing capability. Although the /A2 is priced the same as the /A1, it contains a couple of **extras** in the form of XY cursor addressing and a controllable auxiliary port that allows host data to be transferred to an attached printer. The /3A Plus emulates the Lear Siegler ADM 3A dumb terminal.

The Viewpoint/60 and /90 are general-purpose **smart** terminals that provide fairly standard editing facilities. Both terminals operate in local/remote modes, and allow transmission of variable data, modified data only, and forms data. In forms mode, certain fields can be specified to contain only alpha or numeric data. In addition, the Viewpoint/90 contains a row of 15 function keys programmable by the user; the /90 can be modified to perform in particular host environments, and software can be downline loaded from the host to the terminal.

The Viewpoint/G and /60G are general-purpose terminals that provide vector graphics applications. Both units support popular graphics software from Tektronix and ISSCO for creating graphs, bar charts, pie charts, scattergrams, maps, and diagrams. The /60G has many of the editing capabilities of the Viewpoint/60, while the /G is basically a dumb terminal.

The Viewpoint/Color is an inexpensive color terminal designed to replace monochrome CRTs, with increased operator productivity and ease of viewing graphic information in mind. Also based on the Viewpoint/60, the /Color contains many local editing features and provides a choice of 8 foreground and 8 background colors that can be used to highlight information presented in a graphic format.

The Viewpoint/78 and /78 Color are both ASCII terminals intended for IBM 3270 environments. Both feature a 3278-2 lookalike keyboard and are designed to be coupled with a protocol converter; pricing is considerably below their IBM

## ADDS Viewpoint Series Display Terminals

### Models A1, A2, 3A Plus, Viewpoint, Plus, 60 Plus, 60, Color, G, 60G, 78, 78 Color & 90

counterpart. The /78 also provides 4 colors displayed on a black background.

Another notable difference between the Viewpoint/90 and the other models is the display capacity and format. All models display 1920 characters in a 24-line x 80-character format, but the Viewpoint/90 can **optionally** be expanded to accommodate 3168 characters in a 24-line x 132-character format. More expensive models include a 128-character ASCII character set; the bottom 3 models each have a 96-character ASCII set. All support data rates from 110 to 19.2K bps in a point-to-point environments, and optional RS-422 or current-loop interfaces are available for most models; all support an RS-232C auxiliary interface for attaching a local printer. The Viewpoint/90 and /Color are the **only** models which can provide the user with an extra buffered page of scrollable screen memory.

#### Model Packages

**Viewpoint** • keyboard-display terminal with 1920-character display configured 24 lines x 80 characters; 96 ASCII character set • RS-232C DTE/DCE interface:

\$549 prch

**Viewpoint Plus** • keyboard-display terminal with 1920-character display configured 24 lines x 80 characters; 96 ASCII character set • emulates Viewpoint/A1, /A2, and /3A Plus and Televideo • bidirectional auxiliary RS-232C interface:

595

**Viewpoint/60 Plus** • keyboard-display terminal with 1920-character display configured 24 lines x 80 characters; 96 ASCII character set • optional second page alternates between 2 24-line screens or single 48-line screen • bidirectional auxiliary RS-232C interface:

749

**Viewpoint/A1** • keyboard-display terminal with 1920-character capacity display configured 24 lines x 80 characters; 96 ASCII character set • supports absolute cursor addressing • RS-232C interface for DTE/DCE and auxiliary printer:

650

**Viewpoint/A2** • keyboard-display terminal with 1920-character capacity display configured 24 lines x 80 characters; 96 ASCII character set • supports absolute cursor and XY cursor addressing • controllable auxiliary port • RS-232C interface for DTE/DCE and auxiliary printer:

650

**Viewpoint/3A Plus** • keyboard-display terminal with 1920-character capacity display configured 24 lines x 80 characters; 96 ASCII character set • emulates Lear Siegler ADM 3A display terminal • RS-232C interface for DTE/DCE and auxiliary printer:

650

**Viewpoint/60** • keyboard-display terminal with 1920-character capacity display configured 24 lines by 80 characters plus status line; 128 ASCII character set; fine line business graphics • editing • RS-232C interface for DTE/DCE and auxiliary printer:

895

**Viewpoint/Color** • keyboard-display terminal with 1920-character capacity display configured 24 lines x 80 characters plus status line; 128 ASCII character set • detached, low-profile keyboard meets DIN standard • up to 8 foreground and 8 background colors; terminal operating parameters and color selection configured from keyboard • fine line business graphics • 110- to 19.2K-bps asynchronous operation • RS-232C interface for DTE/DCE and auxiliary printer:

1,095

**Viewpoint/G** • keyboard-display terminal with 1920-character capacity display configured 24 lines x 80 characters plus status line; 128 ASCII character set • 512x256 pixels bit-mapped (vector) graphics • 110- to 19.2K-bps asynchronous operation • RS-232C interface for DTE/DCE and auxiliary printer:

1,750

**Viewpoint/60G** • keyboard-display terminal with 1920-character capacity display configured 24 lines x 80 characters plus status line; 128 ASCII character set • 512x256 pixels bit-mapped (vector) graphics • 110- to 19.2K-bps asynchronous operation • character or block (line or page) transmission modes • RS-232C interface for DTE/DCE and auxiliary printer:

1,950

**Viewpoint/78** • keyboard-display terminal with 1920-character capacity display configured 24 lines x 80 characters plus status line • IBM 3278-2-compatible detached, low-profile keyboard meets DIN standard • 128 ASCII character set • fine line business graphics • 110- to 19.2K-bps asynchronous operation • RS-232C interface for DTE/DCE and auxiliary printer:

1,095

**Viewpoint/78 Color** • identical to Viewpoint/78 but provides 4 foreground colors on a black background, and screen attribute combinations can be truncated if required:

1,095

**Viewpoint/90** • keyboard-display terminal with 1920-character capacity display configured 24 lines x 80 characters plus status line; 128 ASCII character set • 256 custom graphics characters • editing • RS-232C interface for DTE/DCE:

1,195

**European Character Set** • PROM-resident German, French, UK, Spanish, Swedish, or Danish character set, all models except Viewpoint/G (with German, French, UK only); includes keycaps:

25

**Extended Video** • provides 3168 characters at 24-line x 132-character capability for Viewpoint/90 • part of the 4K RAM Paging Buffer Option:

NA

#### CPU & Memory

All editing terminals operate under microprocessor control and employ RAM and ROM for handling system functions, paging (Viewpoint/90 and Viewpoint/Color only), and buffering. The Viewpoint/60, /60 Plus, /Color, /78, and /78 Color employ an Intel Model 8051 microprocessor; the Viewpoint/90 employs an Intel Model 8085; and the Viewpoint/G and /60G employ twin Motorola 6803 microprocessors. All use a 96- or 129-character ROM for character font and 2K RAM for screen buffering; the Viewpoint/Color includes a 4K RAM for 2 pages of scrollable memory, each page scrolls independently of the other; the Viewpoint/90 supports an optional 4K-RAM buffer scrollable through 2 pages. All other models support scrolling from the host only (destructive scrolling). Models Viewpoint/G and /60G provide an input buffer for storing graphic data in a dot-addressable 512x256 format.

The optional 4K RAM paging buffer for the Viewpoint/90 allows the user to establish a single 48-line page or 2 24-line pages. Each page can be called up separately. It also permits a 132-character display line.

**4K RAM Paging Buffer** • provides for 1 contiguous 48-line page or 2 separate 24-line pages:

\$30 prch

#### I/O & Communications

All terminals support point-to-point asynchronous half-/full-duplex ASCII communication at switch-selectable (keyboard-selectable on /90, /78, /78 Color, and Viewpoint, Viewpoint/Plus, /60 Plus, /Color) speeds of 110/300/1200/1800/2400/4800/9600/19,200 bps. RS-232C is the standard interface; RS-422 and current-loop interfaces are optional for all models except the /A1, /A2, /3A Plus, and /G.

A 7- or 8-bit character length is permitted, with 1 or 2 stop bits; even/odd/mark/space/none parity. XON/XOFF controls data

*PRCH: purchase price. NC: no charge. Prices effective as of September 1984.*

## ADDS Viewpoint Series Display Terminals

### Models A1, A2, 3A Plus, Viewpoint, Plus, 60 Plus, 60, Color, G, 60G, 78, 78 Color & 90

flow from host; the /G supports flow control in graphics mode only; flow control for the Viewpoint/90 is also user programmable. Local attachment can be half- or full-duplex. In full-duplex mode, host echo-back is supported. In half-duplex mode, local echo-back is provided. Data transmitted can be variable data, modified data only, or all data.

Transmission modes vary among the different models. The Viewpoint, Viewpoint/A1, /A2, /3A Plus, /60, /G, /78, and /78 Color support conversational (character-by-character) transmission mode only. The Viewpoint/Plus, /60 Plus, /90, /Color, and /60G support conversational and page (block) modes; the /90 and /60G support line transmission modes, and the /90 also supports a partial line mode as well. Besides conversation mode, the Viewpoint/Plus and /60 Plus operate in message mode.

The Viewpoint/90 can emulate different vendor products by accepting code and keyboard functions downloaded from the host. User programs can be downloaded to the /90 as well.

All models provide an RS-232C unidirectional auxiliary port for attaching a user-supplied serial printer. The auxiliary port supports printing from a host computer (except the Viewpoint/A1) in a fashion transparent to the terminal; however, the terminal keyboard **must be locked** during such an operation and cannot be used while the screen is being bypassed. Data rate for the auxiliary port can be selected independently from the communication interface. All Viewpoint models except the /G can print a local copy of the terminal screen contents through the auxiliary port.

Current-Loop Interface: \$30 prch

RS-422 Interface: 25

**Disk**

No disk/diskette is supported.

**Terminals/Workstations**

Display, editing, and format features differ greatly among members of the Viewpoint family. Viewpoint models Viewpoint, Viewpoint/Plus, Viewpoint/A1, /A2, /3A Plus, /78, /78 Color, and /G are essentially **dumb** terminals with little or no editing capability. The Viewpoint/60 is a **low-end smart** terminal with basic editing features; the Viewpoint/90 is a smart terminal that can be user-programmed to fit a wide variety of operator environments. Newer models feature color monitors, vector graphics, and IBM compatibility. The Viewpoint, /Plus, and /60 Plus provide menu-selectable operating parameters. The Viewpoint/Plus emulates the Viewpoint/A1, /A2, /3A, and /3A Plus via menu-selectable modes.

The Viewpoint/G and /60G contain a 512x256 pixel bit-mapped, monochrome graphics display. Graphic information is communicated by vector drawing endpoint coordinates (line segments) or by single points plotted for each X,Y coordinate pair. In addition, an Alpha Mode allows ASCII characters to be entered into graphics memory; a Cursor Mode provides a cross-hair cursor that does not occupy space in memory; and a Basic Mode permits operation as a basic terminal without the graphics features. A Print Mode also allows output to an appropriate graphics terminal that can operate in a dot-address mode, such as the Epson FX 80 and other popular dot-matrix printers. The Viewpoint/G is compatible with the Viewpoint/A2 and the ADDS Regent 25, while the Viewpoint/60G is compatible with the Viewpoint/60, /60 Plus, and Regent 60 and 40 (the Regent Series is no longer marketed). Other Viewpoint terminals, beginning with the Viewpoint/60, support "fine-line" business graphics for forms generation or simple line drawings.

Models Viewpoint/78 and /78 Color are designed for IBM 3278

display station users who want the economy of an ASCII terminal. Both contain a detachable keyboard similar to that of the IBM 3278-2, including function keys and other special keys indigenous to the 3278. Both are ASCII terminals, however, and require any pair of 3270/ASCII protocol converters now on the market. The /78 Color—as its name implies—is identical to the /78 except that it provides 4 foreground colors (green, red, blue, and white) displayable on a black background; attribute combinations can also be truncated if required.

The Viewpoint/Color is also a color terminal based on the Viewpoint/60. It provides 8 foreground colors selectable on 8 background colors and can be programmed during forms mode so that the user can evaluate the effects of different color combinations.

All Viewpoint terminals are equipped with detached keyboards, and newer models include other advanced ergonomic features. Screen displays for the Viewpoint/Plus, /60 Plus, /Color, /G, /60G, /78, and /78 Color tilt and swivel; keyboards have a low profile and meet DIN standards. All screens are anti-glare, and display light characters on a dark background, or the reverse. The Viewpoint, Viewpoint/Plus, and /60 Plus are also available with green or optional amber or smooth white screens.

**Configuration** • tabletop keyboard-display with detachable keyboard • 82-to 104-key alphanumeric typewriter-style keyboard, depending on model • 14-key pad includes numerics, cursor control, and 3 programmable function keys shiftable to 6 PF functions on Viewpoint/Plus • 22-key pad includes numerics, cursor control, and 8 programmable function keys shiftable to 16 PF functions on Viewpoint/60 Plus • 14-key cursor-control/calculator-style numeric keypad and 16 program function and 8 function keys for Viewpoint/60 • 18-key cursor-control/calculator-style numeric keypad with 16 program function and 8 function keys; separate insert/delete line/character editing keys for Viewpoint/90.

**Display** • tilt/swivel 12-inch diagonal; 13-inch, Viewpoint/Color only • 5x8, 7x8, or 7x9 dot matrix, depending on model • 1920-character at 24-line x 80-character display with 25th status line for models beginning with the /60; 3168-character at 24-line x 132-character display with 25th status line optional on Viewpoint/90 • 96- or 128-character ASCII set; switch-selectable European character set optional • 256 custom symbols optional on Viewpoint/90 • block or underline cursor, blinking or steady, visible or invisible • 6 international character sets (U.K., Germany/Switzerland, Denmark/Norway, Spain/Portugal, France/Belgium, and Sweden/Finland available for Viewpoint/Plus and /60 Plus.

**Edit & Format Features** • blink or steady, block or underline cursor; cursor up, down, left, right, home • absolute cursor addressing, all models; XY cursor addressing, Model Viewpoint/A2 and above • auto-repeat (typamatic) keys • monitor mode • erase to EOL, end of screen, erase full screen (erase to EOL only, Viewpoint/G) • insert/delete character/line, all models above 3A Plus except the /G • video attributes including blink, underline, reverse video, full/half/zero intensity or combination • forms mode, Viewpoint/60 Plus, /60, /90, /Color, and /60G; line-lock, Viewpoint/90 • scrolling, all models; nondestructive scrolling, Viewpoint/90 and /Color • split screen on Viewpoint/60 Plus and /90 • protected fields, Viewpoint/60 Plus, /90, and /60G • double-high, double-wide characters, Viewpoint/90.

**Peripherals** • auxiliary serial RS-232C interface supports printer.

**Printers**

No printers are supplied by the vendor. Each terminal provides a serial RS-232C interface for connecting a local printer.

• END



# AST Research Protocol Converters

## Models AST-SNA, -BSC, -PCOX, -3780 & AST-5251-12

■ **PROFILE**

**Function** • IBM terminal/cluster-controller emulator • SNA emulates 3274-51C/3276-12 controllers and 3278-2, 3279-2A, 3287 printers • BSC emulates 3274-51C, 3278-2, 3279-2A, 3287 printer • PCOX emulates 3278-2, -3, -4, 3279-2A and 3A • 3780 emulates 2780/2770/3741/3780 • 5251-12 emulates 5251-12 and 5256 printers • substitutes IBM personal computer/printers for IBM units • performs terminal management and control • bidirectional file transfers permitted with PCOX, 3780, 5251-12 (optional); unidirectional (download), print file transfers with SNA and BSC.

**Packaging** • printed-circuit card plugs into IBM PC card cage.

**Communications** • dedicated or dial-up single link to host front-end processor (270X or 370X) or communications adapter used with the IBM S/360, 370, 30XX, and 43XX processors; communications adapter on IBM S/34, 36, or 38 for 5251-12 and 3780 • IBM System 1 and DEC System 20, PDP-10, PDP-11, and VAX systems supported by 3780 • DTE/DCE interfaces provided by all AST emulators • 1200 to 9600 bps (BSC, 3780, 5251); 2400 to 9600 bps (SNA); 2.35M bps PCOX coax connection to IBM 3274 cluster controller • RS-232C interface on all except PCOX which employs the RG-62U coaxial interface.

**First Delivery** • 1983 (SNA, BSC, PCOX) and 1984 (3780 and 5251).

**Systems Delivered** • 1,200 (SNA), 4,000 (BSC), 2,500 (PCOX), 5,000 (3780), 3,000 (5251).

**Comparable Systems** • ABM Computer Systems SC-Series, Avatar PA100 and PA100 Turbo, CXI Inc CXI 3278/3279, Forte Data Systems FORTEPI/3270-PC, DCA Irma, Micro-Integration Coax/Micro/BIS family, Pathway Design PC Path, Persyst Products Coax/3278 and PC/3270/3280/HASP, Techland Systems Blueynx Series, and Winterhalter DataTalker/PC/PC+/II/Coax Series.

**Vendor** • AST Research Inc; 2121 Alton Avenue, Irvine, CA 92714 • 714-863-1333.

**Canadian Headquarters** • same as U.S. distribution.

**GSA Schedule** • unlisted.

■ **ANALYSIS**

The AST family, officially classified as "protocol converters" allow

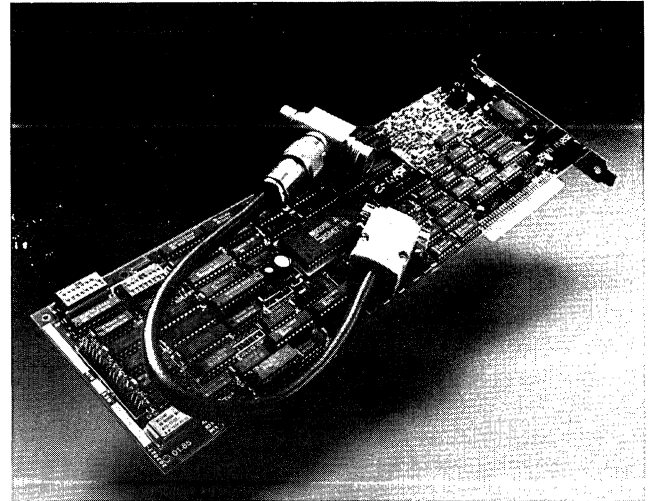

The AST family consists of a printed circuit card and diskette-resident software which allows an IBM PC to emulate the IBM 3270, 2780/3780 or 5251. Versions are available for SNA/SDLC and BSC applications.

incompatible terminals and printers to communicate with IBM mainframes. Like so many products in this growing marketplace, the AST units are actually emulators that make the IBM PC and its printer appear to be IBM cluster controllers, terminals, and/or printers. In addition to emulator services, many of the AST products support file transfers between the PC and mainframe (and vice-versa).

The AST product line includes the AST-SNA, -BSC, -PCOX, -3780, and -5251-12 emulators. All are printed circuit cards which plug into the personal computer's card cage, and use the PC's diskette to hold the emulation software. The AST-SNA and -BSC emulate the IBM 3274-51C cluster controller plus 3278-2, 3279-2A, and 3287 terminals and printers. In addition, the SNA version also can emulate the 3276-12 terminal-controller. The PCOX simply emulates the 3278-2, -3, or -4 terminals plus the 3279-2A or -3A base (4-color) terminals. This AST product has no communications capability; rather it requires the PC to plug directly into an IBM 3274-51C. The AST-3780 and -5251-12 are remote job-entry units, emulating the IBM 2780/3780/2770/3741 (AST-378) and IBM 5251-12 and 5256 (AST 5251-12).

Except for the PCOX, the AST lines are standalone products providing emulation, file transfer, and communication services only for its host personal computer. For those requiring a clustered terminal capability, AST has recently begun marketing SNA and BSC cluster systems which allow up to 4 IBM PC/XT/AT or asynchronous terminals to be controlled by a PC emulating an IBM 3274/51C. According to Advanced Information, the cluster system emulates IBM 3278/3279 terminals and the 3287 graphics printer. In addition, users can also use standard ASCII terminals like the IBM 3101 and DEC VT100 (and lookalikes) in lieu of personal computers. Unfortunately, insufficient technical information was available at press time to allow an analysis of the cluster system. As a marketing move, however, it's a smart one since it not only provides a multiple terminal handling facility

**PURCHASE PRICE RANGE**

hardware/software ■■■■■

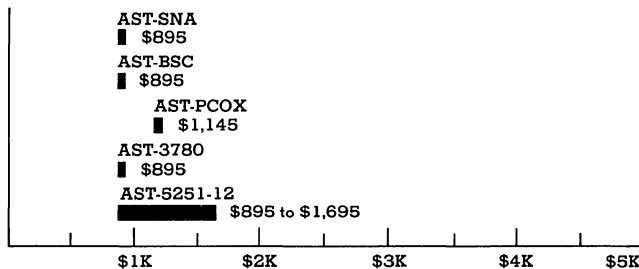

AST SERIES PURCHASE PRICING bar graphs cover price ranges between "small" and "large" configurations • AST-SNA, AST-BSC, AST-PCOX, and AST-3780 are basic systems • AST-5251-12 small configuration is for basic system; large adds file-transfer utility to interface with IBM S/38 • all prices are single-quantity purchase • maintenance is negotiable.

## AST Research Protocol Converters

### Models AST-SNA, -BSC, -PCOX, -3780 & AST-5251-12

but allows organization with ASCII terminals to run them as part of an IBM 3270 system. Also, by handling ASCII terminals AST can now compete in the same markets as Datastream, ICOT, PCI, etc. The AST products, however, will have the advantages of providing a bidirectional file transfer facility. The list prices for the SNA and BSC Cluster systems are \$2,190 and \$1,990, respectively.

Those purchasing the noncluster AST-SNA and -BSC versions—the products evaluated in this report—are not provided with a bidirectional file transfer facility. In fact, the only file transfer permitted are downloaded **print-file** operations which are transferred from the host to the PC's diskette. This data is formatted and intended for off-line printing, not real-time file manipulation.

The AST-3780's file transfer facilities are bidirectional and perform file uploading and downloading, as in ASCII-to-EBCDIC data conversion. Data can be transmitted in the PC's display, diskette, or directly to an ASCII printer. The 3780 (both IBM and AST) is an RJE product, however, and its file transfer is intended for large batch transfers where the receiving device is a printer (or printer substitute) or card punch. Thus the data is not immediately available to the end user. The 5251-12 is also an RJE terminal, so the same limitations apply. With the 5251-12, the file transfer facility is an extra-cost option. According to the vendor, it is developing a routine to format the data for real-time use. The vendor also states that independent packages are now available that will run on the AST products and reformat the file data.

Probably the best file transfer for end users is provided with the PCOX. It uploads and downloads files and automatically converts EBCDIC to ASCII, and the reverse. The PCOX, however, only emulates the IBM 3278/3279 terminals and requires an IBM 3274 controller for communication services. This restriction diminishes the attractiveness of the PCOX.

The method employed for implementing emulation functions is worth noting. All AST products, except the PCOX, employ the same expansion board (CC-432); the emulation functions reside on diskette and are loaded into the PC's RAM for execution. To change protocol emulators, only the diskette need be changed—not the AST board.

In summary, the AST products are really nothing special if only emulation is required. In fact, products from Datastream, ICOT, PCI, and Local Data (to name a few) can do the same job and support multiple terminals and printers (see survey report 737 for details). Most of those products are standalone units, which require space on already crowded desk tops. But they are only device emulation and do not support file transfer, which is the principal advantage of AST's products.

AST products would be even more beneficial if they offered file transfer facilities for SNA and BSC systems. A standalone 3270 capability is a popular application for remote users who need file transfer facilities. However, PCOX's file transfer could be improved. It currently uses the host's TSO/CMS editor to upload data which can be very slow (see Limitations).

#### Strengths

The principal strength of the AST product line is the ability to emulate the control function of the device in addition to the terminal/printer characteristics. The file-transfer facilities provide a further degree of operating autonomy and flexibility not available with native-mode IBM units.

There are numerous products that emulate only the terminals/printers of the IBM 3270. For controller services they rely only on 3271/3274/3275/3276 (or compatible) products, which costs anywhere from \$4,885 for an IBM 3274-51C to \$5,535 for a 3276-12. While some IBM replacement products are priced slightly lower, their prices are still in the same ballpark. The AST-SNA and -BSC provide both controller and terminal/printer emulation, and with a price of \$895 each is an excellent buy—provided you don't need a file transfer capability.

The AST-3780 and 5251-12 are also standalone units, but both support bidirectional file transfers. Unfortunately, they both emulate terminals (like IBM 2780/3780 and 5251) batch-oriented RJE, which means that downloaded files are not immediately

usable by the PC operator.

The AST products also employ diskette-resident software to execute emulation. While this approach is probably slightly slower than a total firmware approach, it is far more flexible. For example, firmware generally requires PROM chips that must be physically swapped to change emulation modes or implement updates. Our experience has shown that nontechnical users are quite reluctant to even change a cable, let alone a chip. However, none will resist swapping a diskette. Of course, software emulation does use the personal computer's RAM—typically at least 64K to 128K bytes with the AST products—but given the flexibility it's probably worth it. AST could make this approach even more attractive if it provided perhaps 64K bytes of RAM on its board to off-load some responsibilities from the PC's main storage.

The print-spooling facility available on the SNA and BSC systems is also a strong benefit. By downline loading print files to diskette, users needn't tie up the personal computer during long print runs.

#### Limitations

The AST line has 2 major drawbacks and several minor ones. The major limitations are the file-transfer techniques employed with the PCOX, 3780, and 5251-12. Of course, the lack of a file transfer capability for the AST-SNA and -BSC is a major limitation, but we've already discussed that.

The PCOX uploads and downloads files, but operates with the services provided by IBM TSO/CMS software redundant in the communication processor. The limitation with this arrangement is that the TSO's editor must verify each line of data sent to the host. The verification process causes the personal computer to wait between lines, thus slowing the entire file-transfer process. Some vendors (Forte, DCS, and Winterhalter) have eliminated this problem by bypassing the editor. AST should also consider this technique.

The file-transfer problems associated with the 3780/5251 are not so much AST's as they are the nature of the terminals emulated. The IBM 3780 and 5251, as mentioned previously, are remote batch units (RJE workstations) designed to transfer large blocks of data. Further, it makes the personal computer appear to be a card-image reader or printer. Batch file transfers such as these do not allow the data to be used in real-time, unless a routine links batch execution with data destination. While AST does not furnish this routine, it can be written by a systems programmer or acquired commercially since it is available.

The PCOX is a flexible product that can emulate the IBM 3278 Models 2, 3, or 4 and 3279 Models 2A or 3A. While this is a significant user advantage, emulation mode switching is not easily performed by the user. To change the configuration, users must reload the emulation program and reboot the microprocessor. While this operation is not complex, it would be far simpler to execute by single-key depression.

Other minor drawbacks of the entire product line are: lack of multiple windowing facilities and the display format is limited to 80 columns. The multiwindowing facility would allow several jobs to be displayed concurrently like the way IBM's 3270 PC handles it. A 132-column display format would allow applications such as spreadsheets to be easily handled. AST is looking at both as future enhancements.

#### SOFTWARE

##### Terms & Support

**Terms** • emulation software applications offered on purchase basis only • firmware bundled into basic system price.

**Support** • provided by the vendor and/or seller • telephone consulting free-of-charge.

##### Utilities

AST offers several utilities that provide device and protocol emulation of IBM 3270 components operating under SNA/SDLC and BSC, as will an IBM 3780 and 5251-12 terminal emulators operating in a BSC or SNA/SDLC environment. All emulators

## AST Research Protocol Converters

### Models AST-SNA, -BSC, -PCOX, -3780 & AST-5251-12

are diskette resident and operate in conjunction with AST boards and IBM PC and PC/XT (and compatible) devices.

The device emulators are bundled into the price of the product. The only extra-cost utility noted is a file-transfer program which allows the AST 5251-12 to bidirectionally transfer data between the PC and an IBM System/34/36/38.

**5251-12 File Transfer Utility** • diskette-resident package running on IBM PC, PC/XT, and compatible systems • interfaces via AST 5251-12 to IBM mainframe • transmits/receives formatted print file data.

**5251-12-to-System/34** • links AST 5251-12 to S/34:  

	\$400 prch	NA maint
--	------------	----------

**5251-12-to-System/36** • links AST 5251-12 to S/36:  

	500	NA
--	-----	----

**5251-12-to-System/38** • links AST 5251-12 to S/38:  

	800	NA
--	-----	----

#### ■ HARDWARE

##### Terms & Support

**Terms** • offered on a purchase basis only; discounts available in large-quantity purchases.

**Support** • 12-month parts and labor warranty • factory repair; service also available from third-party sellers.

##### Overview

The AST family consists of 5 different hardware/software products which permit the IBM personal computer operating under PC-DOS or MS-DOS to emulate some of IBM's most popular terminal devices. The AST-SNA and BSC products both emulate the 3274-51C or 3276-12 controllers and the 3278-2 or 3279-2A terminals, plus the 3287 printer. The AST-PCOX unit simply emulates the 3278-2, -3, or -4 monochrome terminals or the 3279-2A or 3A basic color terminals. The PCOX plugs into a 3274C cluster controller and relies on that device for all communication support. The AST-3780 is a Remote Job Entry (RJE) station emulator that allows the PC to appear as an IBM 2770/2780/3742/3780 RJE terminal. The AST-5251-12 emulates the IBM 5251-12 remote workstation, and permits the PC's printer to function as a 5256. All AST units are intended for remote attachment to the IBM 27XX or 37XX communications processor (front-ends) or integrated communications adapters employed with the S/360, S/370, 30XX, and 43XX processor, as well as the S/1, S/34, S/36, and S/38 hosts.

In evaluating this product line, we found that the same expansion board (CC-432) is used by the SNA, BSC, 3780 and 5251-12. Thus the user should be able to switch protocol converter services by merely expecting different emulation programs.

The AST products, except the PCOX, are standalone units that interface the PC directly to the host processor. All operate over switched or dedicated lines at speeds up to 9600 bps. While the emulators are designed primarily for remote attachment to the host, all can be configured as either DTE or DCE terminals. With DCE, the emulator itself provides clocking normally furnished by a modem or modem eliminator. Thus local PCs with AST emulators can directly attach to the host's front-end or communications adapter **without** the expense of a modem.

Like most products of this ilk, the software to perform the emulation resides on diskette and is loaded into the PC's main memory for execution. Depending on the PC's operating system, main memory requirements are either 64K or 128K of RAM with 1 or 2 diskettes needed for auxiliary storage (see Converters/Emulators). Since the software needed to perform emulation resides on diskette, users can switch terminal operating modes without changing cards.

The AST-3780 emulates the remote job IBM 2780/3780 terminals, as well as the 2770 and 3741. The workstation can operate in attended or unattended modes; the latter is used for batch transfer of large files, while the former is a menu-driven interactive operation. The file transfer operation is bidirectional with the

AST-3780 automatically translating between ASCII and EBCDIC codes. File transfers can be made at speeds up to 9600 bps and data is automatically checked for errors and corrected. Data can be transmitted to the PC's display, diskette, or ASCII printer with forms control functions provided by the emulator.

The remainder of the AST product line does not possess the same level of power for handling file transfers as is available with the 3780. The SNA and BSC modes, for example, do not support uploading files from the PC to the host. A form of downloading is supported by transferring formatted print files to disk or diskette, but this facility is intended primarily for printing operations. The data cannot be used for real-time data manipulation and/or file updating.

The AST 5251-12 has no file transfer facility, but AST offers an optional file transfer utility that does. This, coupled with the 5251-12's keystroke compiler which converts files from ASCII to EBCDIC, should provide adequate file-transfer facilities.

The AST-PCOX comes with a Professional Workstation Facility that allows the user to transfer files between the PC and host via TSO or VM/CMS. Part of this file transfer software resides on the host mainframe, but that portion is uploaded from the PC.

##### Converters/Emulators

The AST products consists of an expansion board that fits into an available card slot in the IBM PC or PC/XT (or compatible) and emulation software that resides on the PC's disk or diskette. The hardware/software combination permits the PC to emulate the characteristics of an IBM 3274-51C cluster controller with attached 3278/3279/3287 terminals and printers (AST SNA and BSC); the IBM 3278/3279 terminals (PCOX); the IBM 5251-12 workstation and 5256 printer (AST 5251-12) or the IBM 2780/3780/2770/3741 remote job entry workstation (AST-3780). All emulators will run under PC-DOS 1.1 or higher; the 3780 also runs under MS-DOS. With the exception of the PCOX, all provide communication facilities and operate on point-to-point or multipoint lines at speeds up to 9600 bps. The PCOX attaches to an IBM 3274 controller and transmits data via a coaxial interface at 2.35M bps.

File uploading/downloading is standard on the PCOX and 3780, optional on the 5251-12, and not available on the AST-SNA and BSC. The PCOX's Professional Workstation Facilities provides the file transfer and ASCII to EBCDIC conversion, and interfaces with the host's TSO/CMS facilities. The "bridging" software between the PC and the CMS/TSO is uploaded to the host from the PC.

The 3780 provides a bidirectional file facility and also converts ASCII to EBCDIC. File transfers can be accomplished in either interactive or batch modes. In interactive mode, a menu of operations and device selections plus automatic line and exception status indicators are provided. In batch mode, the user must set up a command file to direct the transfer operation. Downloaded files can be displayed on the console, output directly to the printer (serial or parallel), or output to a disk or diskette. Uploaded files can be transmitted from a disk/diskette or directly from the console.

The 5251-12 contains a keystroke compiler which converts ASCII to EBCDIC, but does not provide a standard file transfer facility. AST, however, offers an optional file transfer utility that supports file uploading/downloading.

All of the evaluated AST products only support a single terminal. For those requiring multiple terminal handling, AST has just introduced an SNA and BSC cluster unit which allows a PC to emulate 3274-51C or 3276-12 with up to 4 PC's or ASCII terminals attached. Data transmission speeds are 1200 to 9600 bps under BSC or SNA/SDLC. No details were available at this writing, but the SNA version reportedly costs \$2,190 while the BSC is quoted at \$1,990.

**AST-SNA** • emulates IBM 3274-51C or 3276-12 with 3278-2, 3279-2A, 3287 terminals/printer attached • RS-232C DTE/DCE

*PRCH: single-unit purchase price. MAINT: monthly maintenance charge. NA: not applicable. Prices current as of April 1985.*

## AST Research Protocol Converters

### Models AST-SNA, -BSC, -PCOX, -3780 & AST-5251-12

interfaces; 2400- to 9600-bps transmit speed; SNA/SDLC protocol  
 • runs under PC-DOS 1.1 or higher; requires at least 128K bytes of RAM and a diskette:

          \$895 prch  NA maint

**AST-BSC** • emulates an IBM 3274-51C • all other features same as AST-SNA except runs under BSC protocol:

          895      NA

**AST-PCOX** • emulates an IBM 3278-2, -3, or -4 and 3279-2A or 2B in BSC or SNA/SDLC modes • attaches to IBM 3274 cluster controller via RG-62U coaxial connector • runs under PC-DOS 1.1 or higher and PC-DOS 2.0; requires at least 64K bytes of RAM with PC-DOS 1.1 or 128K with PC-DOS 2.0; both require at least 1 diskette for emulation software • Professional Workstation Facility requires 128K bytes of RAM for PC-DOS 1.1 and 192K bytes for PC-DOS 2.0:

          1,145  NA

**AST-3780** • emulates IBM 2780/3780/2770/3741 remote job terminals • RS-232C DTE/DCE interface; 1200- to 9600-bps transmit speed; BSC protocol • runs under PC-DOS and MS-DOS; requires at least 64K bytes of RAM and a diskette:

          895      NA

**AST-5251-12** • emulates IBM 5251-12 workstation and 5256 printer • RS-232C DTE/DCE interface • 1200- to 9600-bps transmit speed; SNA/SDLC protocol • runs under PC-DOS 1.1 or higher and PC-DOS; requires at least 64K bytes of RAM for PC-DOS 1.1 and 128K bytes for PC-DOS; both require a diskette (double-sided):

          895      NA

**Terminals/Printers**

The AST product line operates with the IBM PC, PC/XT, and

*PRCH: single-unit purchase price. MAINT: monthly maintenance charge. NA: not applicable. Prices current as of April 1985.*

compatible products, and provides the emulation services needed to interact with IBM mainframes. To accomplish this, the products emulate IBM 3274-51C or 3276-12 cluster controllers and IBM 3278/3279/3780/5251-12 terminals and 3287/5256 printers (see Converters/Emulators). The AST emulators allow substituting any ASCII printer compatible with the IBM PC for IBM units. RS-232C interfaces connect terminals, printers, and modems. The PCOX attaches to an IBM 3274 cluster controller via an RG-62U coaxial interface.

The emulators handle ASCII to EBCDIC conversion, as well as file-transfer operations for selected products. The supported screen capacity is equivalent to 3278-2, 3279-2A and -3A (i.e., 1920 characters) for the SNA and BSC versions; PCOX emulates the 3278 Models 2, 3, or 4 and 3279 Models 2A or 3A. Keyboard emulation in 3270 mode is for a 75- or 87-key EBCDIC typewriter-style model.

**Communications**

Except for the PCOX which attaches to an IBM 3274, all AST units emulate the IBM 3274-51C or 3276-12 remote controllers or 2780/3780/2770/3741/5251-12 workstations, and attach to the IBM System/370, 30Xx, or 43XX mainframe via 3705/3725 communication processor on integrated communications adapter. The 2780/3780/2770/3741 emulators attach to the IBM System/34/36/38, as well as System 1, S/370, 4300, and DEC System 20, PDP-10, PDP-11, or VAX systems. The 5251-12 versions run on the System/34/36/38.

All AST units except PCOX operate in half-/full-duplex mode over point-to-point or multipoint lines at data rates of 1200- to 9600-bps. BSC and SNA/SDLC protocols are supported. In addition, all versions except PCOX can be configured at a DTE or DCE, allow interface to the host communications facility without use of a modem. Standard communications interface is RS-232C. PCOX attaches to IBM 3274 controller via an RG-62U coaxial interface.

• END

# AT&T Communications WATS & 800 Service

## ■ PROFILE

**Function** • interstate, low-speed, voice-grade, switched common carrier network services.

**Facilities** • AT&T network, consisting of land lines, microwave, and satellite links using both analog and digital techniques.

**Services** • long-distance dial-up connections at bulk rates • voice or data connection • customer-supplied standard modems for data transmission.

**Access** • separate access line from customer site to nearby local exchange carrier central office • Interstate WATS provides connections to all of the contiguous states in United States, plus Alaska, Hawaii, Puerto Rico, and U.S. Virgin Islands.

**First Available** • AT&T WATS, 1961; AT&T 800 service, 1967.

**Number of Users** • AT&T WATS, 65,000; AT&T 800 service, 50,000.

**Comparable Services** • MCI Telecommunication WATS, Satellite Business System Message Service-1 and Skyline Service, and GTE Direct Sprint for voice service; PACNET, GTE Telenet, and Tymnet for low-speed data services.

**Vendor** • AT&T Communications; 295 North Maple Avenue, Basking Ridge, NJ 07920 • 201-221-2000.

## ■ ANALYSIS

WATS offers significant cost savings over normal long-distance dialing for large-volume users. WATS savings are so significant that the FCC has periodically investigated the tariff since the service's inception. Normal long-distance calls and WATS calls use most of the same facilities; however, WATS users are high-volume users who receive a discount. The FCC has expressed concern that WATS users may end up utilizing a higher percentage of the network at lower costs than normal long-distance callers. In its most recent investigation, the Commission went so far as to declare that normal long-distance services and WATS are like services, and asked AT&T to justify the price differential. However, in June of 1982, the U.S. Court of Appeals for the District of Columbia disagreed with the FCC, sending the issue back for further proceedings. Furthermore, the court has pushed the FCC for a timely and final resolution of the WATS issue; however, to date, there is no final FCC disposition WATS.

As long as WATS pricing remains attractive, it will be a popular service with high-volume, long-distance users. Meanwhile, more and more long-distance alternatives are becoming available. These alternatives vary from comparable long-distance services such as GTE's Direct Sprint, SBS's MS-1 and Skyline Service, and MCI's WATS to data-only networks such as the all-digital PACNET, and packet-switched Telenet, Tymnet, and Uninet.

## □ Strengths

WATS offers significant cost savings to customers handling large amounts of long-distance calls. The WATS service uses the existing AT&T network; therefore, WATS is available just about anywhere in the United States. Most competitive long-distance services are currently available only in major metropolitan areas.

WATS is well integrated into the rest of the AT&T network. There is no need to learn a new set of prefixes or additional access codes, and there is no requirement for a touch-tone telephone as in some competitive offerings.

The AT&T 800 Service is a strong offering which is currently not available from other long-distance carriers. The "Toll Free 800

## AT&T WATS Minimum Usage Costs

**Configuration** • WATS communication from a home state to one or more states within a service area for Rate Step 1 (for example, from Connecticut to Massachusetts, New Hampshire, New Jersey, New York-North, New York-South, Pennsylvania-East, Rhode Island, and Vermont) • assumed 15 hours of use per month during the Business Day period.

**Minimum Start-Up Costs** • \$175.60 total; consists of \$51.80 service order charge, and an installation connection charge of \$123.80 for one access line to local carrier central office.

**Minimum Monthly Operating Costs** • \$31.65 per month for use of an access line.

Number" has become a significant marketing tool for sales and service oriented businesses throughout the United States. AT&T has capitalized on this lead and enhanced the service to make it more attractive to large corporations with multiple facilities nationwide.

Data communication users whose applications require long-distance calls at low data rates also find AT&T WATS & AT&T 800 Service cost savings attractive. The AT&T 800 Service can be particularly useful when many remote nodes must call a central site to process short transactions such as credit verifications.

AT&T has extended its toll-free dialing service to Canada. Called AT&T 800 Service-Canada, the service allows Canadian customers to reach 11 U.S. states, including Alabama, Illinois, Iowa, Kentucky, Louisiana, Minnesota, Nebraska, North Dakota, and Tennessee. Service pricing is based on geographic area, hours of use, time of day, and the number of access lines required by the customer. In addition, the customer pays an installation fee plus a \$36.80 monthly charge per access line.

AT&T Communications launched its international toll-free service on November 1. Initially, the 800 service will allow customers in France to place toll-free international calls to companies in the U.S. France's telecommunications administration is offering a similar service called Numero Vert International that offers toll-free dialing from France to the U.S. The AT&T Communications international 800 service carries a usage charge of \$96 per hour for each line, billable in 6-minute increments, plus a charge of \$36.80 per month for each domestic access line; a minimum of 2 lines is required. Existing domestic 800 Service customers also will pay a monthly charge of \$25 per line for country access capability, plus a one-time service order fee of \$108.

Last and perhaps most significant, WATS is backed by AT&T, which is the best known, most experienced communication company with a proven commitment to service and support. AT&T's resources include almost 7,000 exchanges with an average of almost 20,000 phones per exchange.

## □ Limitations

By design, the WATS marketplace is limited to users who handle large amounts of long-distance calls. AT&T customers without sufficient volume to justify WATS service might possibly be able to lower their costs by using competitive long-distance services offered by organizations such as MCI or GTE. These two companies also offer direct competitive services to AT&T WATS:

## AT&T Communications WATS & 800 Service

MCI's WATS and GTE's Direct Sprint. Another competitive service to AT&T WATS is also being offered by Satellite Business System's (SBS) Message Service-1 (MS-1) and Skyline Service.

WATS is somewhat limited as a data communication network. The maximum data rate is 4800 bps since the service uses only switched, voice-grade lines. This factor makes the service unattractive to users wanting to do large file transfers. Also, the analog technology of the voice network makes it more noise sensitive than digital services.

### ■ NETWORK

#### □ Terms & Conditions

**Billing Criteria** • service costs are based on monthly charge for accumulated per hour of use per rate period per access line for each service area • accumulated per hour use is based on either 60 calls per hour or on actual hours of use, whichever is greater • for 60 calls per hour, if average duration per call in any rate period during each billing cycle is less than one minute, billing is based on an average duration on one minute per call • 1 to 6 service areas may be selected for each access line • service to a higher-numbered service area includes service to all lower-numbered areas.

**Billing Conditions** • usage charges are billed at end of billing cycle; all other charges are billed monthly in advance • applicants who have no account with the Telephone Company or whose financial responsibility is not a matter of general record may be required to pay, at time of application, an amount equal to installation charges if applicable and at least the estimated charge for 1-month service • any customer or applicant may be required to deposit a sum equal to twice the estimated average monthly usage charge • minimum contract period is 1 day • charges for fractional part of month are based on each month being considered to have 30 days.

#### □ Overview

AT&T offers 2 long-distance dial-up services: AT&T Long Distance Service and AT&T Wide Area Telephone Service (WATS). MTS is the standard long-distance service available to customers in their homes and offices. WATS is an alternative for high-volume long-distance customers. Both intrastate and interstate WATS are available.

AT&T Long Distance costs are calculated on a per call basis. The call's duration, distance, and time of day are used to determine the price of each call. AT&T Long Distance is accessed via the customer's normal local loop telephone connection. WATS costs, on the other hand, are calculated at bulk rates. The entire United States is divided into 6 wide service areas, and the customer pays a monthly fee for access to all or a subset of these service areas. The monthly fee is based on the service areas accessed, the number of hours used per service area, and the time of day the service is used. There is a minimum charge of one minute per call. A separate WATS access line must be connected between the customer's site and a nearby local carrier central office when the service is first contracted.

There are 2 types of WATS service: Outward WATS and 800 Service (Inward WATS). AT&T WATS allows the customer to use a WATS access line to originate calls to locations in the service areas. The 800 Service allows the customer to use a AT&T WATS access line to terminate calls originated out in the service areas. The caller does not pay any charges for 800 Service; i.e., all telephone numbers prefaced by 800 are toll-free numbers. AT&T WATS and 800 Service cannot share the same access lines. In fact, when contracting for 800 Service, at least 2 separate 800 access lines must be installed.

To define the service areas, AT&T divides the contiguous United States into a set of subdivisions called WATS states. In general, a WATS state is a geographical state. Some of the larger states are divided into multiple WATS states. To define the service areas for a specific WATS state, called the home rate state, all the remaining states are grouped in a series of 5 bands. Each band or service area is a set of WATS states approximately equidistant from the home rate state. Lower number service areas are those closest to the home rate state. Higher numbered areas are those

farthest away. A sixth service area for all home rate states is Alaska and Hawaii. Puerto Rico and the U.S. Virgin Islands are always in Service Area 5. Alaska, Hawaii, Puerto Rico, and the U.S. Virgin Islands cannot be home rate states; therefore, they cannot be the originator of Outward WATS or the destination of 800 Service calls. When a customer contracts for service to a particular service area, access to all lower-numbered areas is automatically included.

AT&T recently added Expanded 800 Service to WATS. Expanded 800 gives the customer new options on the destination of 800 calls. There are 3 basic capabilities: Single Number Service, Customized Call Routing, and Variable Call Routing.

Single Number Service allows customers to have intrastate WATS and multiple locations all serviced by the same 800 number. The destination of the call is based on the service area in which the call originates.

Customized Call Routing increases the customer's control over the destination of the call. With this feature, the destination of the call is based on the area code of the caller, and the customer can define which calling area codes are to be received by which destination.

Variable Call Routing is customized call routing with the further refinement of varying the destination with the time of day and day of the week.

Data communication users can attach Bell System modems or other FCC-registered modems to WATS access lines. Both 2-wire and 4-wire arrangements are available.

#### □ Traffic Charges

Traffic charges for AT&T WATS and AT&T 800 Service are determined by amount of hourly usage accumulated per access line per month for each rate period to each service area. Rate periods consist of Business Day period, Evening period, and Night/Weekend period. Business Day period covers 8:00 AM to 5:00 PM, Monday through Friday. Evening period extends from 5:00 PM to 11:00 AM, Sunday through Friday. Night/Weekend period includes 11:00 PM to 8:00 AM all days, 8:00 AM to 11:00 PM Saturday, and 8:00 AM to 5:00 PM Sunday. The states within each service area and the associated hourly charges for calls per rate period are determined by the applicable rate step.

Traffic charges are based on time-of-day, or nontime of day for temporary usage until usage data is recorded by the Telephone Company. Time-of-day charges are determined by the total number of calls completed at the access line for each rate period in each service group. The total number of calls completed in each rate period is divided by 60 and compared with the total number of hours used. The largest of the 2 totals is used as the chargeable hours for each rate period. This total is divided by the number of access lines in each service group in service during the month to obtain the total number of hours of usage per access line. Then the usage charge per each rate period in each service group corresponding to the applicable rate step, is multiplied by both the total number of hours of usage per access line, and by the number of access lines in each service area, to obtain the total usage for each rate period. The total usage for all rate periods, in turn, is obtained by adding together the total usage charges for each rate period.

#### AT&T Traffic Charges Per Rate Step

There are 22 rate steps for AT&T WATS. The charges corresponding to each rate step per hour of usage for Business Day and Evening periods, and for Night/Weekend hours follow. These rate step hourly usage charges can be related to home state service areas by referring to the section on Access, Tables 3 and 4.

#### AT&T 800 Service Charges Per Rate Step

There are 22 rate steps for AT&T 800 Service. The charges corresponding to each rate step per hour of usage for Business Day and Evening periods, and for Night/Weekend hours follow. These rate step hourly usage charges can be related to home state service areas by referring to the following section on Access, Tables 3 and 4.

## AT&T Communications WATS & 800 Service

**TABLE 1 • AT&T WATS Rate Steps - Hourly Usage Charges Per Access Line \***

AT&T WATS Rate Steps	First 15 Hours		Next 25 Hours		Next 40 Hours		Over 80 Hours		All Hours Night/ Weekend
	Business Day	Evening	Business Day	Evening	Business Day	Evening	Business Day	Evening	
1	\$16.35	\$10.62	\$14.54	\$9.46	\$12.73	\$8.27	\$10.78	\$7.00	\$5.68
2	17.17	11.17	15.30	9.94	13.40	8.72	11.34	7.38	5.97
3	17.58	11.43	15.65	10.18	13.72	8.92	11.60	7.53	6.11
4	17.90	11.63	15.93	10.36	13.97	9.07	11.81	7.67	6.22
5	18.17	11.81	16.17	10.51	14.17	9.22	11.99	7.80	6.30
6	18.40	11.96	16.39	10.66	14.37	9.34	12.15	7.90	6.39
7	18.70	12.16	16.66	10.82	14.60	9.49	12.35	8.03	6.50
8	19.05	12.39	16.95	11.01	14.85	9.66	12.57	8.17	6.62
9	19.33	12.57	17.21	11.19	15.09	9.80	12.77	8.30	6.71
10	19.59	12.73	17.45	11.34	15.29	9.94	12.93	8.40	6.82
11	19.81	12.87	17.63	11.46	15.47	10.06	13.08	8.51	6.88
12	20.02	13.01	17.81	11.59	15.61	10.15	13.20	8.58	6.95
13	20.20	13.14	17.97	11.69	15.76	10.24	13.33	8.66	7.01
14	20.40	13.27	18.16	11.81	15.93	10.35	13.47	8.76	7.09
15	20.61	13.40	18.37	11.93	16.09	10.47	13.61	8.85	7.16
16	20.86	13.56	18.56	12.07	16.26	10.57	13.77	8.95	7.24
17	21.09	13.70	18.77	12.21	16.45	10.70	13.92	9.05	7.32
18	21.50	13.98	19.13	12.43	16.77	10.90	14.18	9.22	7.47
19	22.50	14.62	20.02	13.01	17.55	11.41	14.85	9.65	7.88
20	24.24	15.76	21.58	14.03	18.91	12.29	16.00	10.40	8.49
21	25.32	16.45	22.53	14.64	19.75	12.84	16.70	10.85	8.86
22	27.27	17.73	24.27	15.78	21.27	13.82	18.00	11.70	9.54

\* Effective May 25, 1984.

**TABLE 2 • AT&T 800 Service Rate Steps - Hourly Usage Charges Per Access Line \***

AT&T 800 Service Rate Steps	First 15 Hours		Next 25 Hours		Next 40 Hours		Over 80 Hours		All Hours Night/ Weekend
	Business Day	Evening	Business Day	Evening	Business Day	Evening	Business Day	Evening	
1	\$16.32	\$11.75	\$14.89	\$10.72	\$13.49	\$9.71	\$11.94	\$8.60	\$7.78
2	16.84	12.12	15.36	11.07	13.92	10.02	12.33	8.87	8.02
3	17.07	12.29	15.59	11.22	14.11	10.17	12.49	9.00	8.13
4	17.26	12.43	15.76	11.34	14.27	10.27	12.64	9.09	8.22
5	17.42	12.55	15.92	11.46	14.40	10.38	12.74	9.17	8.30
6	17.57	12.65	16.04	11.54	14.52	10.46	12.85	9.26	8.37
7	17.73	12.77	16.21	11.66	14.68	10.56	12.99	9.35	8.44
8	17.93	12.92	16.39	11.79	14.84	10.69	13.14	9.47	8.55
9	18.11	13.04	16.55	11.92	14.99	10.79	13.27	9.55	8.63
10	18.25	13.15	16.67	12.00	15.09	10.87	13.36	9.62	8.70
11	18.39	13.24	16.79	12.10	15.21	10.95	13.46	9.69	8.75
12	18.50	13.32	16.89	12.16	15.30	11.01	13.55	9.76	8.82
13	18.60	13.39	16.99	12.24	15.39	11.07	13.61	9.79	8.85
14	18.70	13.47	17.10	12.32	15.47	11.15	13.70	9.87	8.91
15	18.84	13.57	17.21	12.40	15.57	11.21	13.79	9.93	8.98
16	18.98	13.66	17.32	12.47	15.70	11.30	13.89	10.00	9.04
17	19.11	13.77	17.46	12.57	15.79	11.38	13.99	10.07	9.11
18	19.33	13.92	17.66	12.71	15.98	11.51	14.16	10.20	9.22
19	20.24	14.57	18.42	13.27	16.80	12.09	14.78	10.64	9.72
20	21.82	15.71	19.86	14.30	18.11	13.04	15.93	11.47	10.48
21	22.78	16.40	20.73	14.93	18.91	13.62	16.63	11.97	10.94
22	24.55	17.67	22.34	16.09	20.38	14.67	17.92	12.90	11.78

\* Effective May 25, 1984.



## AT&T Communications WATS & 800 Service

### Access Charges

Access lines are only furnished within the contiguous United States. Each access line is utilized either for AT&T WATS or AT&T 800 Service. Service requires a minimum of 2 access lines for each service group for the completion of a call. Monthly charges for each WATS access line or extension line includes a standard USOC RJ11C jack termination. Each access line may be connected at local carrier's central office. At the customer's premises, the line may be connected to terminal equipment, multiline terminating system (e.g., PBX, Centrex, or ACD), or a communication system. At the central office, the line may be connected to Telephone Company switching equipment or to another common carrier communication system using a WATS central office connecting facility. AT&T 800 Service cannot be terminated as a dial station in a multiline terminating system. Where a customer provides terminal equipment, multiline terminating system, or a communication system, the customer is responsible for installing, operating, and maintaining that equipment.

#### **AT&T WATS Access Line Charges**

**Basic Charge** • charge for each access line for AT&T WATS; consists of a nonrecurring service order charge, an installation connection charge, and a monthly fee for each access line:

\$51.80 ord	\$123.80 instal	\$31.65 mo
-------------	-----------------	------------

**Charge For Access Line Extension** • charge for each additional AT&T WATS access line extension located in same building and on same service as first extension or access line; consists of a nonrecurring service order charge, an installation connection charge, and a monthly fee for each extension:

80.50	20.70	7.45
-------	-------	------

**Charge For Access Line Extension In Different Building** • charge for first AT&T WATS extension access line in a building different from building in which access line in same service is located; consists of a nonrecurring service order charge, an installation connection charge, and a monthly fee for each extension:

80.50	131.00	25.25
-------	--------	-------

#### **AT&T 800 Service Access Line Charges**

**Basic Charge** • charge for each access line for AT&T 800 Service; consists of a nonrecurring service order charge, an installation connection charge, and a monthly fee for each access line:

\$60.95 ord	\$153.00 instal	\$36.80 mo
-------------	-----------------	------------

**Charge For Access Line Extension** • charge for each additional AT&T 800 Service access line extension located in same building and on same service as first extension or access line; consists of a nonrecurring service order charge, an installation connection charge, and a monthly fee for each extension:

80.50	20.70	7.45
-------	-------	------

**Charge For Access Line Extension In Different Building** • charge for first AT&T 800 Service extension access line in a building different from building in which access line in same service area is located; consists of a nonrecurring service order charge, an installation connection charge, and a monthly fee for each extension:

80.50	131.00	25.25
-------	--------	-------

#### **AT&T WATS & 800 Service Access Line Move Charge**

Charge for moving an access line for AT&T WATS and AT&T 800 Service are the same. This charge for a move within same building; consists of a nonrecurring service order charge, and a charge for installing each line or extension:

\$101.00 ord	\$21.85 instal
--------------	----------------

#### **AT&T WATS & 800 Service Access Line 4-Wire Termination Charge**

This nonrecurring termination charge is in addition to access line nonrecurring charges and it is the same for AT&T WATS and AT&T 800 Service:

\$54.10 term
--------------

### Conversion & Associated Charges

#### **Conversion of Service Area to Different Area**

**Charge For Conversion—AT&T WATS** • nonrecurring charge consists of a service ordering charge and a connection charge for each line:

\$98.95 ord	\$27.60 cnt
-------------	-------------

**Charge For Conversion—AT&T 800 Service** • nonrecurring charge consists of a service ordering charge and a connection charge for each line:

108.00	36.80
--------	-------

#### **Charge For Separate AT&T 800 Service Hunting Group**

Nonrecurring charge for separation of existing AT&T 800 Service Group into 2 or more hunting arrangements consists of a service ordering charge and a connection charge for each line:

\$120.00 ord	\$36.80 cnt
--------------	-------------

#### **Charge For Combined AT&T 800 Service Hunting**

Charge for combining 2 or more AT&T 800 Service hunting arrangements; consists of a service ordering charge and a combination charge for each line:

\$98.95 ord	\$13.80 comb
-------------	--------------

#### **Advanced AT&T 800 Service Charges—Nonoriginal Order**

**Single Number Service Charge** • charge for each grouping of intrastate WATS with multiple locations served by the same AT&T 800 number; consists of a nonrecurring network charge for each installation or rearrangement, and a monthly fee for each grouping:

\$35.00 instal	\$300.00 mo
----------------	-------------

**Customized Call Routing Charge** • charge for each grouping of customer-defined area codes to destination; consists of a nonrecurring network charge for each installation or rearrangement, and a monthly fee for each grouping:

44.00	100.00
-------	--------

**Variable Call Routing Charge** • charge for each variation of the customized call routing option according to time of day and day of week; consists of a nonrecurring network charge for each installation or rearrangement, and a monthly fee for each grouping:

120.00	34.62/shift
--------	-------------

**Call Attempt Profile** • collects data and measures calling to 800 telephone numbers. Compiles a sample of the number of times an 800 number is dialed in a 24-hour period and separates the data by area code and time of day • consists of a monthly fee and charge per attempt:

200.00 mo	0.01/attempt
-----------	--------------

**Routing Control Service** • allows a business to immediately change its 800 routing configurations using its own terminals instead of placing service orders through AT&T • each additional connect minute over 60 minutes charged at \$1.00:

120.00 instal	500.00 mo
---------------	-----------

### Access

#### **WATS & 800 Service States For Home State Service Areas**

WATS and 800 Service states, including multiple WATS and 800 Service states, along with the corresponding rate step for each service area accessed from a home state, are listed in Tables 3 and 4. Charges for each listed rate step may be determined by

*INSTAL: installation charge associated with specific network feature or option. ORD: nonrecurring service order charge. MO: monthly service charge. CNT: connection charge for specific service. COMB: charge for combining 2 or more 800 service hunting arrangements. Pricing effective as of May 1984.*



## AT&T Communications WATS & 800 Service

**TABLE 3 • AT&T WATS & AT&T 800 Service - Rate Step Table**

Home Rate		Rate Step					Home Rate		Rate Step				
State	SA1	SA2	SA3	SA4	SA5	SA6	State	SA1	SA2	SA3	SA4	SA5	SA6
Alabama	4	7	9	11	17	22	Nevada	5	8	13	16	18	20
Arizona	6	9	12	15	18	20	New Hampshire	2	7	11	15	18	22
Arkansas	4	7	9	11	15	21	New Jersey	1	5	9	13	18	22
California-N	8	12	15	17	18	20	New Mexico	6	8	10	13	17	21
California-S	7	11	15	17	18	20	New York-NE	3	7	10	14	18	22
Colorado	7	8	10	12	16	21	New York-SE	1	7	10	14	18	22
Connecticut	1	7	10	14	18	22	New York-W	3	5	10	14	18	22
Delaware	1	5	9	13	18	22	North Carolina	4	7	8	12	18	22
Dist of Columbia	1	4	8	12	18	22	North Dakota	6	9	11	14	15	21
Florida	7	10	12	13	18	22	Ohio-N	3	5	7	10	17	22
Georgia	4	7	10	12	18	22	Ohio-S	3	5	8	10	17	22
Idaho	5	9	13	15	18	22	Oklahoma	5	7	9	12	15	21
Illinois-N	3	6	8	10	15	21	Oregon	5	9	15	17	18	19
Illinois-S	3	6	8	10	15	21	Pennsylvania-E	1	5	8	12	18	22
Indiana	3	6	8	10	16	21	Pennsylvania-W	3	5	8	12	18	22
Iowa	4	7	9	11	14	21	Rhode Island	1	6	11	14	18	22
Kansas	5	7	9	12	14	21	South Carolina	4	7	9	12	18	22
Kentucky	3	5	8	10	17	22	South Dakota	5	8	10	12	15	21
Louisiana	5	8	10	13	16	21	Tennessee	5	6	8	10	17	22
Maine	6	9	12	16	18	22	Texas-E	6	9	11	14	16	21
Maryland	2	5	9	12	18	22	Texas-S	8	11	12	14	16	21
Massachusetts	2	7	11	14	18	22	Texas-W	7	9	11	14	16	21
Michigan-N	5	8	9	12	17	21	Utah	6	7	11	14	18	20
Michigan-S	4	7	9	12	17	21	Vermont	2	7	11	14	18	22
Minnesota	6	8	10	12	15	21	Virginia	3	5	8	11	18	22
Mississippi	5	7	9	11	16	22	Washington	8	11	15	17	18	19
Missouri	5	7	8	10	15	21	West Virginia	2	5	7	11	18	22
Montana	7	10	12	14	17	20	Wisconsin	3	7	9	11	16	21
Nebraska	5	8	9	12	14	21	Wyoming	5	9	10	13	16	21

**TABLE 4 • AT&T WATS & AT&T 800 Service - Home State Service Areas**

Home State	Rate Step					
	SA1	SA2	SA3	SA4	SA5	SA6
AL	FL,GA,KY,LA,MS,SC,TN	AR,IL-S,IN,MO,NC,OH-S	DC,IL-N,LA,MD,OH-N,OK,TX,VA,WV	CT,DE,KS,MI,MN,NE,NJ,NY,PA,RI,WI	AZ,CA,CO,ID,ME,MA,MT,NV,NH,NM,OR,PR,SD,UT,VI,WA,WY	AK,HI
AZ	CA-S,CO,NV,NM,UT	CA-N,ID,TX-W,WY	AR,KS,MT,NE,ND,OK,OR,SD,TX-E,TX-S,WA	AL,IL,IN,LA,MN,MO,MS,TN,WI	CT,DE,DC,FL,GA,ME,MD,MA,MT,NH,NJ,NY,NC,OH,PA,PR,RI,SC,VT,VA,VI,WV	AK,HI
AR	LA,MS,MO,OK,TN,TX-E	AL,IL,KS,KY	FL,GA,IN,NE,NC,OH,SC,TX-S,TX-W,WV,WI	CO,DE,DC,MD,MI,MN,ND,PA,SD,VA,WY	AZ,CA,CT,ID,MA,ME,MT,NV,NH,NJ,OR,PR,RI,UT,VI,WA	AK,HI
CA-N	AR,ID,NV,OR,UT,WA	CO,MT,NE,NM,WY	IA,KS,MN,MO,ND,OK,SD,TX	AL,AR,IL,KY,LA,MI,MS,TN,WI	CT,DE,DC,FL,GA,ME,MD,MA,NH,NJ,NY,NC,OH,PA,PR,RI,SC,VT,VA,VI,WV	AK,HI
CA-S	AZ,NV,NM,OR,UT	CO,MT,NE,NM,WY	IA,KS,MO,MN,MT,NE,ND,OK,SD,TX-E,TX-S	AL,AR,IL,IN,KY,LA,MI,MN,MO,MS,TN,WI	CT,DE,DC,FL,GA,ME,MD,MA,NH,NJ,NC,OH,PA,PR,RI,SC,VT,VI,WV	AK,HI
CO	AZ,KS,NE,NM,OK,UT,WY	ID,MT,NV,SD,TX-W	AR,CA,IA,MN,MO,ND,TX-E	IL,IN,LA,MI,MS,OR,TN,TX-S,WA,WI	AL,CT,DE,DC,FL,GA,KY,ME,MD,MA,NH,NJ,NY,NC,OH,PA,PR,RI,SC,VT,VA,VI,WV	AK,HI
CT	MA,NH,NJ,NY-N,NY-S,PA-E,RI,VT	DE,DC,MD,ME,NY-W,OH,PA,VA,WV	AL,GA,IL,IN,KY,MI,NC,SC,TN,WI	AR,FL,IA,KS,LA,MN,MO,MS,NE,ND,OK,SD	AZ,CA,CO,ID,MT,NV,NM,OR,PR,TX,UT,VI,WA,WY	AK,HI
DE	DC,MD,NJ,NY-S,PA-E	CT,MA,NH,NY-N,NY-S,OH-S,PA-W,RI,VT,WV	AL,FL,GA,IL,IN,KY,ME,MI,OH-N,SC,TN	AR,IA,KS,LA,MN,MO,MS,OK,ND,NE,WI	AZ,CA,CO,ID,MT,NV,NM,OR,PR,TX,UT,VI,WA,WY	AK,HI
DC	DE,MD,NJ,PA,VA,WV	CT,NY,NC,OH,RI	AL,FL,GA,IL,IN,KY,ME,MA,MI,NH,SC,TN,VT	AR,IA,KS,LA,MN,MO,MS,NE,ND,SD,WI	AZ,CA,CO,ID,MT,NV,NM,OR,PR,TX,UT,VI,WA,WY	AK,HI
FL	AL,GA,LA,MS,NC,SC,TN	AR,DC,DE,IN,KY,MD,OH-N,OK,PA,TX	IL,MO,NJ,OH-N,OK,PA,TX	CT,IA,KS,MA,MI,NE,NH,NY,PR,RI,VT,VI,WI	AZ,CA,CO,ID,MT,NV,NM,ND,OR,SD,UT,WA,WY	AK,HI

## AT&T Communications WATS & 800 Service

**TABLE 4 • AT&T WATS & AT&T 800 Service - Home State Service Areas**

Home State	Rate Step					
	SA1	SA2	SA3	SA4	SA5	SA6
GA	AL,FL,KY,MS,NC,SC,TN	AR,IL-S,IN,LA,OH-S,VA,WV	DE,DC,IL-N,MD,MI,MO,NJ,NY,OH-N,PA	CT,IA,KS,MA,NE,NH,OK,RI,TX,VT,WI	AZ,CA,CO,ID,ME,MN,MT,NV,NM,ND,OR,PR,SD,UT,VI,WA,WY	AK,HI
ID	MT,NV,OR,UT,WA,WY	CA,CO	AZ,IA,KS,MN,MO,NE,NM,ND,OK,SD,WI	AR,IL,IN,KY,LA,MI,MS,TX	AL,CT,DE,DC,FL,GA,ME,MD,MA,NH,NJ,NY,NC,OH,PA,PR,RI,SC,TN,VT,VA,VI,WV	AK,HI
IL-N	IN,IA,MI-S,MO,WI	AR,KY,MI-N,MN,OH,TN,WV	AL,GA,KS,LA,MS,NE,NC,OK,PA,SC,VA	CO,DE,DC,MD,NJ,NY,ND,SD,TX	AZ,CA,CT,FL,ID,ME,MA,MT,NV,NH,NM,OR,PR,RI,UT,VT,VI,WA,WY	AK,HI
IN	IL,KY,MI-S,OH	IA,MO,PA-W,TN,WI,WV	AL,AR,DE,DC,GA,MD,MI-N,MN,MS,NY,NC,PA-E,SC,VA	CT,FL,KS,LA,MA,ND,NE,NH,NJ,NY,OK,RI,SD,VT	AZ,CA,CO,ID,ME,MT,NV,NM,OR,PR,TX,UT,VI,WA,WY	AK,HI
IA	IL,MN,MO,NE,SD,WI	IN,KS,MI,OK	AL,AR,CO,KY,LA,MS,ND,OH,TN,WV,WY	DC,GA,MD,MT,NM,NC,PA,SC,TX,VA	AZ,CA,CT,DE,FL,ID,ME,MA,NV,NH,NJ,NY,OR,PR,RI,UT,VT,VI,WA	AK,HI
KS	CO,IA,MO,NE,OK,SD	AR,IL-S,NM,SD,TX-E,TX-W	AL,IL-N,IN,KY,LA,MN,MS,ND,TN,TX-S,UT,WI,WY	AZ,GA,ID,MI,MT,NV,NC,OH,SC,VA,WV	CA,CT,DE,DC,FL,ME,MD,MA,NH,NJ,NY,OR,PA,PR,RI,VT,VI,WA	AK,HI
KY	IL-S,IN,MO,OH-S,TN,VA,WV	AL,GA,IL-N,NC,SC	AR,DE,DC,IA,LA,MD,MI,MS,NJ,PA,WI	CT,FL,KS,MA,MN,NE,NH,NY,OK,RI,TX,VT	AZ,CA,CO,ID,ME,MT,NV,NM,ND,OR,PR,SD,UT,VI,WA,WY	AK,HI
LA	AL,AR,MS,OK,TX-E,TX-S	GA,IL-S,KY,MO,TN,TX-W	FL,IL-N,IA,KS,NE,NM,NC,OH,SC,WV	CO,DE,DC,MD,MI,MN,NJ,PA,SD,VA,WI	AZ,CA,CT,ID,ME,MA,MT,NV,NH,NY,ND,OR,PR,RI,UT,VT,VI,WA,WY	AK,HI
ME	CT,MA,NH,NJ,NY-N,NY-S,RI,VT	DE,DC,MD,NY-W,OH-N,PA,VA,WV	GA,IL,IN,KY,MI,MN,NC,OH-S,SC,TN,WI	AL,AR,FL,IA,KS,LA,MO,MS,NE,ND,OK,SD	AZ,CA,CO,ID,MT,NV,NM,OR,PR,TX,UT,VI,WA,WY	AK,HI
MD	DE,DC,NJ,NY-S,PA,VA,WV	CT,MA,NC,NY-N,NY-W,OH,RI	AL,FL,GA,IL,IN,KY,ME,MI,NH,SC,TN,VT	AR,IA,KS,LA,MN,MO,MS,NE,ND,OK,SD,WI	AZ,CA,CO,ID,MT,NV,NM,OR,PR,TX,UT,VI,WA,WY	AK,HI
MA	CT,ME,NH,NJ,NY-N,NY-S,PA-E,RI,VT	DE,DC,MD,NY-W,OH,PA-W,VA,WV	AL,GA,IL,IN,IA,KY,MI,NC,SC,TN,WI	AR,FL,KS,LA,MN,MO,MS,NE,ND,OK,SD	AR,CA,CO,ID,MT,NV,NM,OR,PR,TX,UT,VI,WA,WY	AK,HI
MI-N	IL-N,IA,MN,OH-N,WI	IL-S,IN,KY,MO,NY-W,ND,OH-S,PA-W	CT,DE,DC,MA,MD,NH,NJ,NY,NC,PA-E,RI,SD,TN,VT,VA,WV	AL,AR,CO,FL,GA,KS,LA,ME,MS,NE,OK,SC	AZ,CA,ID,MT,NV,NM,OR,PR,TX,UT,VI,WA,WY	AK,HI
MI-S	IL-N,IN,NY-W,OH,WI	DC,IL-S,IA,KY,NY-N,PA,WV	CT,DE,MD,MA,MN,MO,NH,NJ,NY-S,NC,RI,SD,TN,VT,VA	AL,AR,CO,FL,GA,KS,LA,ME,MS,NE,ND,OK,SC	AZ,CA,ID,MT,NV,NM,OR,PR,TX,UT,VI,WA,WY	AK,HI
MN	IL-N,IA,MI-N,NE,ND,SD,WI	IL-S,IN,KS,MI-S,MO	AR,CO,KY,MT,OH,OK,PA,TN,WV,WY	AL,DC,ID,LA,MD,MS,NM,NY,TX,UT,VA	AZ,CA,CT,DE,FL,GA,ME,MA,NV,NH,NJ,NC,OR,PR,RI,SC,VT,VI,WA	AK,HI
MS	AL,AR,GA,LA,TN,TX-E	FL,IL-S,KY,MO,OK,SC	IL-N,IN,IA,KS,NC,OH,TX-S,TX-W,VA	CO,DE,DC,MD,MI,MN,NE,NJ,NM,PA,SD	AZ,CA,CT,ID,ME,MA,MT,NV,NH,NY,ND,OR,PR,RI,UT,VT,VI,WA,WY	AK,HI
MO	AR,IL-N,IL-S,KS,KY,NE,OK,TN	ID,LA,MS,WI	AL,GA,MI,MN,OH,SD,TX,WV	CO,DE,DC,FL,MD,NM,NC,ND,PA,SC,VA,WY	AZ,CA,CT,ID,ME,MA,MT,NV,NH,NJ,NY,OR,PR,UT,VI,WA	AK,HI
MT	ID,ND,OR,SD,UT,WA,WY	CA-N,CO,MN,NE,NV	AZ,CA-S,IA,KS,MO,NM,OK,WI	AR,IL,IN,KY,MI,OH,TX	AL,CT,DE,DC,FL,GA,LA,ME,MD,MA,MS,NH,NJ,NY,NC,PA,PR,RI,SC,TN,VT,VA,VI,WV	AL,HI
NE	CO,IA,KS,MO,SD,KY	IL-N,MN,ND,OK,WI	AR,ID,IL-S,IN,MI,MT,NM,TX,UT	AL,AZ,GA,KY,LA,MS,NV,OH,OR,TN,WV	CA,CT,DE,DC,FL,ME,MD,MA,NH,NJ,NY,NC,PA,PR,RI,SC,VT,VA,VI,WA	AK,HI
NH	CT,ME,MA,NJ,NY-N,NY-S,RI,VT	DE,DC,MD,NY-W,OH-N,OH-S,PA-E,PA-W,VA,WV	GA,IL,IN,IA,KY,MI,NC,SC,TN,WI	AL,AR,FL,KS,LA,MN,MS,MO,NE,ND,OK,SD	AZ,CA,CO,ID,MT,NV,NM,OR,PR,TX,UT,VI,WA,WY	AK,HI
NJ	CT,DE,DC,MD,MA,NY-S,PA-E,RI	NH,NY-N,NY-W,NC,OH-N,OH-S,PA-W,VT,VA,WV	AL,GA,IL,IN,KY,ME,MI,SC,TN,WI	AR,FL,IA,KS,LA,MN,MS,MO,NE,ND,OK,SD	AZ,CA,CO,ID,MT,NV,NM,OR,PR,TX,UT,VI,WA,WY	AK,HI
NM	AZ,CO,OK,TX-W,UT	KS,NE,NV,TX-E,TX-S,WY	AR,CA,ID,IA,LA,MO,MT,SD	AL,IL,IN,KY,MN,MS,ND,OR,TN,WA,WI	CT,DE,DC,FL,GA,ME,MD,MA,MI,NH,NJ,NY,NC,OH,PA,PR,RI,SC,VT,VI,VA,WV	AK,HI
NY-N	CT,DE,MD,MA,NH,NJ,PA-E,PA-W,RI,VT	DC,ME,MI-S,OH-N,OH-S,VA,WV	AL,GA,IL,IN,IA,KY,MI-N,MO,NC,SC,TN,WI	AR,FL,KS,LA,MN,MS,NE,ND,OK,SD	AZ,CA,CO,ID,MT,NV,NM,OR,PR,TX,UT,VI,WA,WY	AK,HI
NY-S	CT,DE,DC,MD,MA,NH,NJ,PA-E,RI,VT	ME,NC,OH-N,OH-S,PA-W,VA,WV	AL,GA,IL,IN,IA,KY,MI,MO,SC,TN,WI	AR,FL,KS,LA,MN,MS,NE,ND,OK,SD	AZ,CA,CO,ID,MT,NV,NM,OR,PR,TX,UT,VI,WA,WY	AK,HI
NY-W	DE,DC,MD,NJ,OH-N,PA-E,PA-W,WV	CT,ME,MA,MI-S,NH,OH-S,RI,VT,VA	AL,GA,IL,IN,IA,KY,MI-N,MO,NC,SC,TN,WI	AR,FL,KS,LA,MN,MS,NE,ND,OK,SD	AZ,CA,CO,ID,MT,NV,NM,OR,PR,TX,UT,VI,WA,WY	AK,HI

## AT&T Communications WATS & 800 Service

**TABLE 4 • AT&T WATS & AT&T 800 Service - Home State Service Areas**

Home State	Rate Step					
	SA1	SA2	SA3	SA4	SA5	SA6
NC	DE,DC,GA,MD,OH-S, SC,TN,VA,WV	AL,KY,NJ,OH-N, PA-E,PA-W	CT,FL,IL,MA,MI, MS,NY,RI,IV	AR,IA,KS,LA,ME,MN,MO, NE,NH,OK,TX,WI	AZ,CA,CO,ID,MT,NV,NM, ND,OR,PR,SD,UT,VI,WA, WY	AK,HI
ND	IA,MN,MT,NE,SD, WY	CO,IL,IL-N,KS, MI-N,WI	AR,IL-S,IN,MI-S, MO,NV,NM,OK,UT,WA	AZ,CA,KY,MS,OH,TN,TX WV	AL,CT,DE,DC,FL,GA,LA, ME,MD,MA,NH,NJ,NY,NC, PA,PR,RI,SC,VT,VI,WA	AK,HI
OH-N	IN,KY,MI-S,NY-W, PA-W,VA,WV	DE,DC,IL-N,IL-S, MD,PA-E,TN	AL,CT,GA,IA,MA, MI-N,MO,NJ,NY-N, NY-S,NC,SC,VT,WI	AR,FL,KS,LA,ME,MN, MS,NE,NH,ND,OK,RI,SD	AZ,CA,CO,ID,MT,NV,NM, OR,PR,TX,UT,VI,WA,WY	AK,HI
OH-S	IN,KY,MI-S,NY-W, PA-W,VA,WV	DC,IL-N,IL-S,MD, NC,PA-E,TN	AL,CT,DE,IA,MA, MI-N,MO,NJ,NY-N, NY-S,SC,VT,WI	AR,FL,KS,LA,ME,MN, MS,NE,NH,ND,OK,RI,SD	AZ,CA,CO,ID,MT,NV,NM, OR,PR,TX,UT,VI,WA,WY	AK,HI
OK	AR,CO,KS,MO,NM, TX-E,TX-W	LA,NS,ME,TX-S	AL,IL,IN,IA,KY, MN,SD,TN,UT,WI,WY	AZ,FL,GA,MI,MT,NC,ND, OH,SC,VA,WV	CA,CT,DE,DC,ID,ME,MD, MA,NV,NH,NJ,NY,OR,PR, PA,RI,VT,VI,WA	AK,HI
PA-E	CT,DE,DC,MD,NJ, NY-N,NY-S	MA,NH,NC,OH-N, OH-S,RI,VT,VA,WV	AL,GA,IL,IN,KY, ME,MI,MO,SC,TN,WI	AR,FL,IA,KS,LA,MN, MS,NE,ND,OK,SD	AZ,CA,CO,ID,MT,NV,NM, OR,PR,TX,UT,VI,WA,WY	AK,HI
PA-W	DE,DC,MD,NY-N, NY-W,OH-N,OH-S, VA,WV	CT,MA,MI-S,NJ, NY-S,NC	AL,GA,IN,KY,ME, MI-N,MO,NH,RI,SC, TN,VT,WI	AR,FL,IA,KS,LA,MN, MS,NE,ND,OK,SD	AZ,CA,CO,ID,MT,NV,NM, OR,PR,TX,UT,VI,WA,WY	AK,HI
RI	CT,MA,NH,NJ,NY-N, NY-S,VT	DE,DC,ME,MD,NY-W, OH-N,PA-E,PA-W, VA,WV	AL,GA,IL,IN,KY,MI, NC,OH-S,SC,TN,WI	AR,FL,IA,KS,LA,MN, MS,MO,NE,ND,OK,PR, SD,VI	AZ,CA,CO,ID,MT,NV,NM, OR,TX,UT,VA,WY	AK,HI
SC	AL,GA,KY,NC,TN, VA,WV	DE,DC,FL,IN,MD, OH-N,OH-S,PA-W	AR,CT,IL,LA,MS,MO, NJ,NY,PA-E	IA,KS,ME,MA,MI,NH,OK, RI,TX,VT,WI	AZ,CA,CO,ID,NM,MT,NE, NV,NM,ND,OR,PR,SD,UT, VI,WA,WY	AK,HI
SD	IA,MN,MT,NE,ND, WY	CO,IL-N,KS,MO, WI	AR,ID,IL-S,IN,MI, NM,OK,TX,UT	AL,AZ,KY,LA,MS,NV,OH, OR,TN,VA,WV	CA,CT,DE,DC,FL,GA,ME, MD,MA,NH,NJ,NY,NC,PA, PR,RI,SC,VT,VI,VA	AK,HI
TN	AL,AR,GA,KY,MS, MO,NC,VA	IL-N,IL-S,IN, OH-N,OH-S,SC, WV	DC,FL,IA,LA,MD,MI, OK,PA,WI	CT,DE,KS,MN,NE,NJ,NY, RI,TX	AZ,CA,CO,ID,ME,MA,MT, NV,NH,NM,ND,OR,PR,SD, UT,VT,VA,WY	AK,HI
TX-E	AR,KS,LA,MS,MO, OK	AL,CO,IL-S,NE, NM,TN	AZ,FL,GA,IL-N,IN, IA,KY,SD,UT,WY	ID,MI,MN,MT,NV,NC,ND, OH,SC,WV,WI	CA,CT,DE,DC,ME,MD,MA, NH,NJ,NY,OR,PA,PR,RI, VT,VI,VA,WA	AK,HI
TX-S	AR,KS,LA,MS,NM, OK	AL,AR,CO,MO,TN	FL,GA,IL,IN,IA, KY,NE,SD,UT,WI,WY	ID,MI,MN,MT,NV,NC,ND, OH,SC,WV	CA,CT,DE,DC,ME,MD,MA, NH,NJ,NY,OR,PA,PR,RI, VT,VI,VA,WA	AK,HI
TX-W	AR,CO,KS,NM,OK	AZ,LA,MS,MO,NE, UT	AL,FL,GA,IL,IN, IA,KY,SD,TN,WY	ID,MI,MN,MT,NV,NC,ND, OH,SC,WV,WI	CA,CT,DE,DC,ME,MD,MA, NH,NJ,NY,OR,PA,PR,RI, VT,VI,VA,WA	AK,HI
UT	AZ,CO,ID,NV,NM, WY	CA-N,CA-S,MT	IA,KS,NE,ND,OK, OR,SD,TX,WA	AR,IL,IN,LA,MI,MN,MS, MO,TN,WI	AL,CT,DE,DC,FL,GA,KY, ME,MD,MA,NH,NJ,NY,NC, OH,PA,PR,RI,SC,VT,VI, VA,WV	AK,HI
VT	CT,ME,MA,NH,NJ, NY-N,NY-S,RI	DE,DC,MD,NY-W, OH-N,OH-S,PA-E, PA-W,VA,WV	GA,IL,IN,IA,KY, MI,NC,SC,TN,WI	AL,AR,FL,KS,LA,MN,MS, MO,NE,ND,OK,SD	AZ,CA,CO,ID,MT,NV,NM, OR,PR,TX,UT,VI,WA,WY	AK,HI
VA	DE,DC,KY,MD,NC, OH-S,PA-W,TN,WV	NJ,NY-S,NY-W, OH-W,PA-S,SC	AL,CT,FL,GA,IL, IN,MA,MI,MS,NH, NY-N,RI,VT	AR,IA,KS,LA,ME,MN,MO, NE,OK,SD,WI	AZ,CA,CO,ID,MT,NV,NM, ND,OR,PR,TX,UT,VI,WA, WY	AK,HI
WA	CA-N,ID,MT,NV, OR	CA-S,ND,UT,WY	AZ,CO,IA,KS,NM, MO,NE,NM,OK,SD, WI	AR,IL,MI,TX	AL,CT,DE,DC,FL,GA,IN, KY,LA,ME,MD,MA,MS,NH, NJ,NY,NC,OH,PA,PR,RI, SC,TN,VT,VI,VA,WV	AK,HI
WV	DC,KY,MD,NC, OH-N,OH-S,PA-W, VA	DE,IN,NJ,NY-W, PA-E,SC,TN	AL,CT,GA,IL,MA, MI,MO,NH,NY-N, NY-S,RI,VT,WI	AR,FL,IA,KS,ME,MN,MS, NE,OK,SD	AZ,CA,CO,ID,MT,NV,NM, ND,OR,PR,TX,UT,VI,WA, WY	AK,HI
WI	IL-N,IA,MI-N, MI-S,MN	IL-S,IN,MO, OH-N,OH-S,SD	AR,DC,KS,KY,MD, NY,ND,OK,PA,TN, VA,WV	AL,CO,CT,DE,GA,LA,MA, MS,MT,NH,NJ,NC,RI,SC, VT,WY	AZ,CA,FL,ID,ME,NV,NM, OR,PR,TX,UT,VI,WA	AK,HI
WY	CO,ID,MT,NE, SD,UT	AZ,KS,NV,NM, ND,OR	CA,IA,MN,MO,OK, WA,WI	AR,IL,IN,KY,LA,MI,MS, TX	AL,CT,DE,DC,GA,ME,MD, MA,NH,NJ,NY,NC,OH,PA, PR,RI,SC,TN,VT,VI,VA,WV	AK,HI

referring to Tables 1 and 2 of the previous section on traffic charges for either AT&T WATS or AT&T 800 Service. In some instances, highly populated states are divided into North (N), South (S), and/or East (E), West (W) service areas for a particular home state. For example, Ohio may occasionally be found to be

subdivided into Ohio-North (OH-N) and Ohio-South (OH-S). Rate steps for each service area are outlined in Table 3, with corresponding states in each home state outlined in Table 4.

• END



# AT&T-IS DATAPHONE II Network Control & Management Systems

## Levels I, II, III & IV

### ■ PROFILE

**Function** • network control systems (Levels I and II) and network control and management reporting system (Levels III and IV).

**Communications/Networks** • Level I supports DATAPHONE II modems on single point-to-point or multipoint 4-wire Type 3002 lines; Levels II and III support DATAPHONE II modems on up to 256 Type 3002 lines; Level IV supports DATAPHONE II modems on up to 8 networks of 256 Type 3002 lines each • Level I addresses 200 drops (modem addresses) maximum; Level II and III address 192,000 drops maximum, 750 drops per line maximum; Level IV addresses up to 411,648 modem addresses maximum, 200 drops per line maximum • does not support other vendors' modems • 110-bps secondary channel supports network control functions.

**First Delivery** • 1980 (Levels I/II/III); 1984 (Level IV).

**Systems Delivered** • over 75,000 DATAPHONE II modems; figures for Level II/III/IV systems unavailable.

**Comparable Systems** • principal competition from Codex DNCS 200, 300, and 400; General DataComm Netcon 6; IBM 3860 Series modems with NPDA software product; Infinet EMS-One and Series 90; Paradyne Analysis Series 550 and 5500; Racal Milgo CMS 185 and 2000 Systems.

**Vendor** • AT&T Information Systems; 100 Southgate Parkway, P.O. Box 1955, Morristown, NJ 07960; 201-898-8000 • National Sales Center, 111 Westwood Place, Suite 300, Brentwood, TN 37027; 800-247-1212.

**Distribution** • nationwide through AT&T Information Systems • also available from Bell Operating companies as long as predivestiture stock lasts.

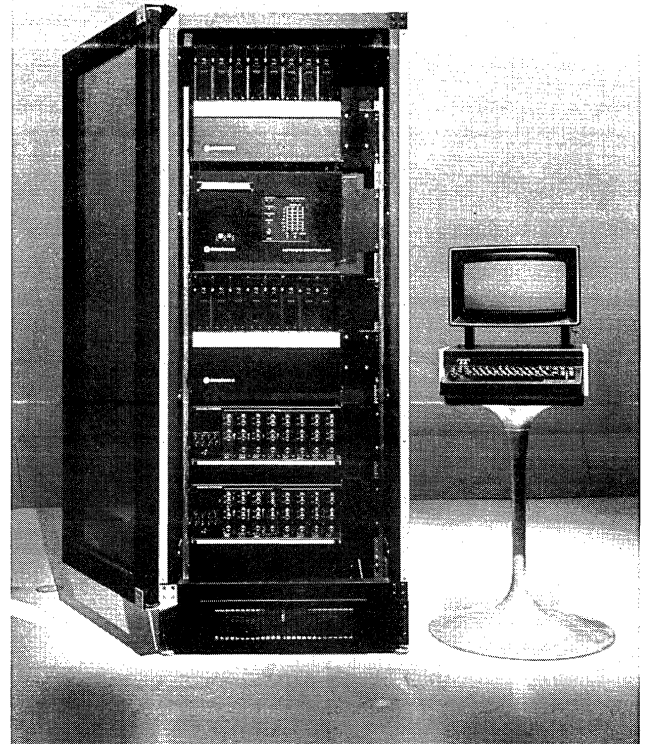

### PURCHASE PRICE RANGE

hardware ██████████

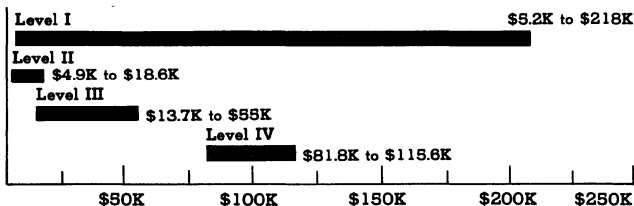

**AT&T-IS DATAPHONE II SYSTEM PURCHASE PRICING** bar graphs cover purchase price ranges between "small" and "large" configurations for hardware, including maintenance for the first year after purchase; installation not included • Level I bar graph represents modem pricing for a single network line; Levels II through IV control multiple lines of DATAPHONE II modems; thus, modem pricing is excluded from Levels II through IV bar graphs • Level I small configuration consists of single point-to-point line with 2 2024A modems; large of single point-to-point backbone circuit with 2 2096A modems support 4 tail circuits with 20 multidropped 2024A modems • Level II small configuration consists of a single Diagnostic Console; large consists of 4 diagnostic consoles • Level II small configuration consists of a single Network Controller with a single operator terminal and system printer; large of 4 Network Controllers, 4 operator terminals, and 4 system printers • Level IV small configuration consists of a System Controller with 4 control ports, a single operator terminal, and system printer; large of a System Controller with 4 operator terminals, 2 system printers, 8 control ports, and 1M-byte main memory upgrade.

### ■ ANALYSIS

AT&T-IS announced DATAPHONE II Level IV during March 1984. An evolutionary step in the progression of AT&T sidechannel network management systems, Level IV provides a greater degree of control over large multitier networks while maintaining compatibility with existing levels. Level IV gives users a better-defined migration path from single-line supervision to the complex task of managing multiple, database-intensive networks. AT&T was beta testing Level IV at selected user locations as this report update went to press.

DATAPHONE II Service is a modular network control system that addresses network supervision of dedicated networks through continuous surveillance for line or component failures and degradation, remedial recovery procedures to eliminate excessive downtime, and diagnostic testing to insure network integrity and isolate failures. The service is comprised of 4 upward-compatible levels to satisfy the needs of small-, medium-, and large-scale networks. Level I, an entry-level service for small-scale networks, consists of DATAPHONE II diagnostic and control modems only. Level II provides centralized control of all modems and extends test and command functions. Level III also provides centralized control through 1 to 4 operator consoles and

## AT&T-IS DATAPHONE II Network Control & Management Systems Levels I, II, III & IV

accommodates the requirements for large-scale networks. Level III service is available with an administrative option designated as the Performance Analysis System. The option produces management reports on network utilization and failure statistics, and tracks network problems through trouble ticket reports. Level IV includes management reporting as a standard feature, and can accommodate larger networks than preceding levels while providing secure access for a greater number of network operators. User-friendliness was a major design criterion for Level IV; simplified menu operation, network map graphics, and other enhancements make it easier to supervise multilevel networks.

DATAPHONE II Systems serve point-to-point or multipoint dedicated lines and are implemented through an out-of-band secondary channel. Levels III and IV accommodate networks with multiple tail circuits and multiplexer concentrator nodes, up to 3 and 4 network tiers, respectively. However, the secondary channel cannot pass through multiplexer or concentrator nodes and must circumvent these nodes through the digital interface of the colocated modems.

The service is designed for DATAPHONE II modems only. Some other AT&T modems can be used in a network with DATAPHONE II modems, but with limited diagnostic capabilities.

Polling and selection is performed by control modems over the secondary channel on a hierarchical basis. For example, where tail circuits extend from backbone circuits through a multiplexer or concentrator node, modems on each tail circuit are polled for operating status by the head-end tail circuit modem. These modems respond to a poll by transferring their operating status to the head-end modem. In turn, each head-end modem is polled for its operating status and that of its own tail circuit modems by the remote backbone circuit modem. The status of all tail circuit modems is then transferred to the backbone circuit modem, which responds to polling from the control modem at the head end of the backbone circuit with its own status plus that of all tail circuit modems. Conversely, the selection process is performed in the same manner beginning with the controlling backbone modem.

DATAPHONE II was a relative latecomer to the network control market. It was introduced at Info 79 and tariffed on April 11, 1980 with first installations starting service in 1980. It may not surprise anyone, though, to learn of the prominent position DATAPHONE II presently holds in the marketplace, with double the diagnostic modem installations of its nearest competitor. If Level IV performs as announced, it will help keep AT&T competitive in network management markets. Level IV addresses many shortcomings inherent to Levels I through III, providing a more flexible and more user-friendly interface for managing large networks. AT&T has the resources to make DATAPHONE II an even better system, and is known to be working on a DATAPHONE multiplexer interface for Level IV at the present time.

### □ Strengths

Ease of use, configuration flexibility, and ease of expansion to meet existing and future user requirements are the principal advantages of DATAPHONE II Systems. The user can easily upgrade the system according to needs from Level I to Level II to Level III or IV since each is an enhancement to the lesser and does not require equipment replacement or elimination. The service is configuration flexible to accommodate networks as small as a single point-to-point line to large complex networks with up to 2,000 multiterminal lines and several thousand modem drops. Users do not pay for unused equipment since the service is expandable on a line-by-line, drop-by-drop basis.

The Automatic Trouble Reporting option available with Level III and IV is a very useful feature. With the simple addition of a dial-up modem, users can have equipment and line problems automatically forwarded to an AT&T Maintenance Operational Control Center (Data MOCC) to expedite rapid repair procedures. Test center personnel can also access DATAPHONE II systems over dial lines to conduct diagnostic tests of their own on the AT&T equipment.

Operator console and printer support with Levels II and III is also flexible to satisfy network requirements. Consoles and printers can be added as they are needed and where they are needed;

they don't have to be located at the central site. The user can locate them where they are most effective, and can have as many as 4 remote locations serviced by a dedicated line. The service protects against unauthorized use through password protection.

Ease of operation by relatively unskilled personnel is another key consideration. Highly skilled technicians are not necessary to use DATAPHONE II Systems. Little training is required because operation is simplified through displayed menus and status information.

DATAPHONE II is a modular system which lends itself easily to upgrades. Small users can start out with just the diagnostic modems, and later add a centralized console at nominal extra cost to obtain Level II performance for growing networks. Level III or IV can be obtained by swapping the Level II console for a more sophisticated workstation, or by keeping the console and adding the workstation to another point in the network for distributed control. All levels tie into DATAPHONE II modems which contain command and test procedures in their firmware. If a Level II, III, or IV diagnostic control device malfunctions, control reverts back to Level I (or another lower level) whereby individual lines can still be monitored and tested at each central-site control modem. Although it may be difficult to manage a large DATAPHONE II network from individual modems, the capability still exists. In many competing systems, when centralized control is lost the diagnostic/monitor function is down until the control unit can be brought back up again. Furthermore, DATAPHONE II modems themselves can be considered "user friendly," featuring a front panel menu-driven display and controls for simplified operation.

The Performance Analysis System (PAS), another modular component that can be added to Level III, is designed to provide management with reports on network performance and utilization. Feature Group A, the present software release for PAS, will print trouble tickets and arrange fault data into various management reports. Management reporting facilitates the administrative chores of managing a network, and is a real boon for large networks.

The new Level IV provides several enhanced features currently in vogue among network management vendors and users. These include an integral database management system and management reporting; network map graphics and color operator terminals; unattended diagnostics with user-definable test routines; multiuser access under a password/logon security access system; and other enhanced ease-of-use features. In addition, Level IV can address larger networks and store many more fault conditions than can previous levels.

### □ Limitations

Like other secondary channel network control/management systems, DATAPHONE II cannot be used over all-digital transmission facilities that cannot support sideband diagnostics; i.e., AT&T's current DATAPHONE Digital Service or satellite facilities. Hybrid or wide-area network users can only employ DATAPHONE II over that portion of their networks traversing dedicated voice-grade circuits. Therefore, DATAPHONE II represents only a partial solution to comprehensive network management for the increasingly interconnected networks of today. AT&T has disclosed specifications for DDS service with integral sideband channel, however, and will surely address centralized DDS diagnostics in the near future.

DATAPHONE II Systems perform the essential functions of network control, but there are other limitations that deserve strong consideration. DATAPHONE II Service does not support modems produced by other vendors, nor does it support DATAPHONE II diagnostic or control functions for AT&T modems other than DATAPHONE II. Although AT&T 201C and 208A modems can share a multidrop line with DATAPHONE II modems, the DATAPHONE II modems cannot monitor their self-status and circuit quality; however, they can still perform diagnostic testing. Networks consisting of other vendor's modems would have to convert to DATAPHONE II modems at considerable cost, whereas users of Codex DNCS, General DataComm's Netcon 5, or Infinet's EMS-One can employ a "wraparound" option to accommodate other-vendor modems (wraparound diagnostic and control functions, however, may not be as comprehensive as those provided by Codex/GDC/Infinet diagnostic modems).

## AT&T-IS DATAPHONE II Network Control & Management Systems Levels I, II, III & IV

Analog line parameters monitored by DATAPHONE II Systems are by no means comprehensive. DATAPHONE II Service monitors signal level and quality only. By comparison, Codex' DNCS and Paradyne's ANALYSIS monitor a number of additional analog parameters such as phase jitter and hits, harmonic distortion, impulse noise, etc, and also monitor user-defined parameters. It is important for a user to know when a line is not within TelCo-defined specifications and to be able to disclose the out-of-spec parameter and its value to TelCo personnel so that the condition can be quickly remedied before failure occurs.

The user **cannot** establish alarm thresholds for monitored parameters except for the terminal streaming condition. Nor can thresholds be set differently on a per-site basis except for terminal streaming. Users can establish different alarm thresholds for a terminal streaming condition, which may differ among sites. Other conditions may be interpreted as abnormal (alarm) or normal operation conditions depending on operation, but it is not possible for the DATAPHONE II user to differentiate among these. The Codex DNCS System does allow users to establish alarm thresholds according to specific operating conditions on a per-site basis.

The user cannot mask specific operating parameters to be ignored by network surveillance to prevent alarms from known conditions. However, a user can disable a site and remove it from surveillance.

Dial backup and hot-spare modem recovery procedures are not an integral part of DATAPHONE II Systems. Dial backup is available separately to users who need uninterrupted service, but hot-spare modem switching is not available, and would have to be furnished through a different source.

There are still other DATAPHONE II system limitations that make it less attractive than competitive offerings. It does not provide an auxiliary secondary channel, which could be used to transfer customer-specific data such as building maintenance or security commands. There are no DATAPHONE II modems to support data rates higher than 9600 bps such as the 14.4K-bps and 16K-bps modems offered by Codex, Paradyne, and Racal-Milgo; IBM 3600 Loop systems are also not supported. DATAPHONE II also does not support network performance monitoring/measurement, as offered or under development by competitors Infinet and Paradyne. Measuring parameters such as network response times, time-to-poll, and transaction counts can alert users to emergency conditions (such as network bottlenecks) and aid network planning/expansion.

### ■ SOFTWARE

#### □ Terms & Support

**Terms** • all software, except for the Performance Analysis System, is bundled with Levels I/II/III hardware component pricing • Performance Analysis System software available by monthly rental only; terms and support identical to hardware • Level IV software is unbundled, available for a one-time license fee.

**Support** • software support automatically included in monthly rental, and is identical to hardware; listed under HARDWARE section.

#### □ Operating System

All levels run under proprietary AT&T operating systems. All systems and applications software is contained in firmware modules in Levels I and II components; Level III contains system/application software in both firmware and magnetic tape storage. The Performance Analysis System uses its own diskette-resident systems software. The Control Program is bundled with basic system pricing.

**Level IV** • all Level IV software, including systems and applications software, is unbundled and available for a one-time right-to-use fee • resides on tape cartridges:

**\$25,000 lcn\$**

#### □ Network Control Program

#### System Control

**Level I** • system control for Level I configurations is performed

through the front panel of DATAPHONE II modems at the modem site • each modem on a point-to-point or multipoint line must have its configuration options manually set from the individual modem front panel, although most diagnostic testing can be performed from a control modem at the central site for all remote modems on a data link • modem commands and diagnostic tests are defined in Level I Configuration, and since DATAPHONE II modems are integral components of Level II and Level III networks these functions apply to those Levels also • commands and tests are generally categorized as being disruptive or nondisruptive of normal network activity, with testing procedures further defined as timed or nontimed (continuous) • differences or added capabilities for Levels II and III are described as follows.

**Level II** • all commands available for DATAPHONE II modems under Level I can be performed from a central location • all modems can have their individual configuration options established from the central location, and multipoint configurations for all Models 2096A can be established from there as well • all diagnostic testing can be performed from the central location for both control and remote-site modems, except for 4 tests which cannot reach remote-site modems: automatic network test, remote digital test, end-to-end test, and circuit loss • can enable or disable a modem site from network surveillance • manual tests and commands can still be initiated from individual modems in Level II; manual control reverts back to Level I manual procedures upon inadvertent loss of centralized control.

**Level III** • includes all of the control capabilities of Levels I/II • includes Network Controller Commands which can create or modify entries in system activity files • includes Diagnostic and Maintenance Routine commands which create, schedule, and manipulate diagnostic routines and queues.

**Level IV** • includes all control capabilities of Levels I/II/III • includes System Controller commands for creating up to 30 customized diagnostic test routines, trouble ticketing, and management reporting.

#### Network Surveillance

Network surveillance is performed continuously during active communication periods without interfering with network activity. Digital modem EIA interface signal parameters and analog line levels are continuously monitored for change of state (fault) conditions by each modem, and control modems poll the remote units for a fault response. In Level II and Level III, central-site diagnostic units poll the control modems (on command) to collect fault information on remote modems and the control modems themselves. In Level I, faults are automatically displayed on the modem front panel. In Level II, up to 50 network faults are stored and the latest fault displayed on the Diagnostic Console panel. In Level III, up to 100 faults can be stored and the last 5 displayed on the operator display terminal; an optional system printer will automatically log each fault. Corrected faults are deleted from the displayed active faults list on the printed fault log. In Level IV, up to 2,000 active faults and up to 20,000 historical faults are stored in a database, and can be listed or arranged in up to 7 different fault reports.

#### System Activity Files

Levels I and II components contain activity files to log faults and configuration parameters. Levels III and IV contain a more sophisticated set of activity files which can be accessed, created, modified, or deleted through the operator terminal and printed for hard copy via an optional printer attached to the terminal. Level III files include the following:

**Modem Profile** • contains a list of network modems and addresses, including modem type, circuit number, location, site contact person, telephone number, and pertinent remarks • can be accessed to display a directory of all modem addresses or individual modem profiles.

*MO: monthly charge for 2-year lease; includes on-call maintenance. PRCH: single-unit purchase price; includes on-call maintenance for the first year after purchase. INSTAL: installation charge. LCNS: one-time license fee. NC: no charge. NA: not available. Prices effective as of July 1984.*

# AT&T-IS DATAPHONE II Network Control & Management Systems

## Levels I, II, III & IV

**Network Controller Options** • contains a list of Network Controller interface activity (excluding the control channel), indicating the status, channel speed, and communication facility (DDD or dedicated line) relating to the 5 optional NC ports.

**Poll List** • contains a list of network modems to be polled during normal network surveillance.

**Routine Directory** • contains a list of timed testing procedures performed on part or all of the network; schedules testing for specific modem addresses based on time and test name • for Level IV, each user can create up to 30 customized routines, each consisting of up to 25 tests/commands/report criteria • Level IV routines can be scheduled or routed according to user-defined timetables • additionally, 60 general-purpose routines are available to all Level IV users.

**Auto-Trouble Report File** • when the automatic trouble reporting option is activated, provides fault information to the Data MOCC, Levels III and IV only • includes company (customer name), company contact, telephone number, and Network Controller phone number • when a system printer is installed, 2 fault reports are logged: once when the fault is first detected, and once when it is reported to the test center.

### Diagnostic Tests

Diagnostic test procedures isolate and identify failures or degradation in network lines or modems. Specific tests are executed at the control modem, remote modem or at both ends for Level I configurations; performed from the Diagnostic or Network Controller or from the modems in Level II and Level III networks. Tests are categorized as disruptive or nondisruptive of normal network communication. Disruptive tests include loopbacks, test tones, and circuit-loss tests; nondisruptive tests include signal-level and quality tests. Tests are described in DATAPHONE II Service—Level I under HARDWARE.

### Remedial Recovery

Remedial recovery procedures restore communication interrupted by line outages or degradation, or terminal or modem streaming conditions until faulty condition is corrected. Recovery procedures conducted through the modem front panel, or via diagnostic control devices in Levels II and III (for modem fallback switching only). Any network modem will disconnect itself from the network when Request-To-Send (RS) has been on continuously for a prolonged period of time. Dial backup performed through separate equipment.

**Dial Backup** • switches modem at remote (attended or unattended) site between 4-wire dedicated line and 2 dial-up lines to restore communication interrupted by line failure or degradation; remote dial backup unit automatically answers call on DDD lines and switches modem from dedicated to dial-up lines.

**Modem Fallback/Reconfiguration** • switches modem data rate to fallback rate to compensate for line degradation; integral feature for DATAPHONE II Models 2096A and 2096C only • reconfigures Model 2096A main channel from 9600 bps to 4800 bps, or reconfigures multipoint configurations to 2400 bps for the first 2 data channels • Model 2096C main channel can be reconfigured from 9600 bps to 7200 or 4800 bps.

**Streaming Recovery** • disables streaming modem (or terminal) by disconnecting the main channel at the modem interface.

### Management Reports

Management reporting is available for DATAPHONE II networks beginning with Level III. Called the Performance Analysis System, it consists of hardware in the form of a dual diskette unit and optional display terminal, operating system software, and application software currently comprised of Feature Group A. Management reporting is a standard feature of Level IV. The ability to produce management reports makes it easier to handle administrative information and to track network performance. Management reports can help pinpoint chronic network problems and establish relationships between diversified groups of data, supplying management with timely information needed to supervise a complex data network.

**Level III System Management Diskette** • operating system software for Performance Analysis System (purchase only):

NC mo	\$85 prch	NC instal
-------	-----------	-----------

**Level III Feature Group A** • stores fault indication data and test result information recorded by the network controller; contains a master file describing network components • system menus produce up to 36 different management reports; prints initial trouble tickets and tracks open trouble conditions • fault reports in 3 formats: detailed, frequency/duration, and chronological • displays test results over a period of time, showing marginally passed tests and deterioration trends • master file expands Network Controller capabilities; provides additional space for user-related data • nonvolatile storage of all fault indicators • trouble ticket log prepares initial trouble tickets for both DATAPHONE II Systems and other vendor problems:

200	5,200	NC
-----	-------	----

**Level IV Management Reports** • prints initial trouble tickets and tracks open trouble conditions with database reporting capability • 3 types of management reports: Device Profile Listing, Fault Reports, and Trend Report • Device Profile Listing supplies inventory of network components • Fault Reports provided in 7 different formats including detailed, daily summary, or summary faults sorted by fault type, control channel, network, or device; tabular or graphic (bar chart) output configured by user-definable criteria • Trend Report determined from any standard diagnostic test repeated at user-defined intervals; results displayed in tabular or graphic format.

### HARDWARE

#### Terms & Support

**Terms** • available for monthly rental, 2- or 4-year lease, or purchase • available while stock lasts from Bell Operating Companies on monthly rental basis only.

**Support** • installed by AT&T Information Systems or Bell Operating Companies under monthly lease or rental contracts; installation charges extra • purchase systems installed by user, or by AT&T Information Systems at normal installation charges • on-call maintenance included in monthly rental or lease pricing • optional dial-out automatic network fault reporting to the nearest AT&T Data Maintenance Operations Control Center (Data MOCC), Levels III and IV only; vendor will respond to fault reports by initiating dial-in diagnostics and/or by dispatching maintenance personnel under customized contract • 16 Data MOCCs located nationwide • purchased systems include 1 year of on-call maintenance; after 1 year, maintenance contract available.

#### Overview

AT&T DATAPHONE II Systems provide from 1 to 4 levels of network supervision for small to large networks performed through network surveillance, diagnostic testing, and to some extent remedial failure recovery. Supervision is performed on all levels through a narrowband secondary channel attached to the primary communication channel; digital modem parameters and analog line levels are continuously monitored for change-of-state conditions according to AT&T-established operating thresholds. Visual alarms alert the network operator to fault conditions, and a printed fault log is optional in Level III systems.

Level I is an entry-level system and upward growth path for small network users with only a limited need for network control. It consists of DATAPHONE II modems with integral diagnostic and control functions performed on point-to-point and multipoint lines. Control is not centralized; each line in a network must be individually monitored and tested from the corresponding central-site control modem. The major functions implemented at the control modem include monitoring circuit transmission integrity and remote-site modem status, and performing loopback and line-level tests. A menu-driven LED alphanumeric display provides the means to manually view and command appropriate measures.

DATAPHONE II modem models span the medium- to high-speed communication range at 2400, 4800, and 9600 bps. Except for



# AT&T-IS DATAPHONE II Network Control & Management Systems

## Levels I, II, III & IV

Model 2048C and 2096A, all models can be configured in 1 of 4 modem roles: point-to-point control, point-to-point tributary (remote), multipoint control, and multipoint remote. The 2048C is a control modem only, and features a fast receiver training time to facilitate high-volume polling of 2048A remote sites on a multipoint line. Model 2096A is a point-to-point model only and contains an integral time-division multiplexer which, when activated, provides up to 4 data channels with combinations of 2400/4800/7200-bps data rates. Model 2096C is a multipoint, quick start-up model with the same data rates as the 2096A. DATAPHONE II modems also afford some measure of remedial recovery from line failure or degradation: Models 2096A and 2096C can fall back to a lower, less error-prone data rate, and external dial backup equipment can be installed to provide an alternate data route in case of private line outages. Level I modems are also integral components of Levels I, II, and III networks, enabling smooth upward growth through both upper levels.

Level II contains all of the features of Level I, plus centralized control from the Diagnostic Console. At one location, a network operator can monitor and run tests on all network lines. In addition, central- and remote-site modem parameters can be established from the console, alleviating the need for remote-site personnel. Level II networks can include up to 4 Diagnostic Consoles for distributed control; the consoles can also be incorporated into Level III or IV networks in a distributed control environment.

Level III contains all of the features of the preceding levels with supervision for up to 3 network tiers and enhanced features for network management. Its Network Controller can store larger amounts of fault information, and all interaction is performed from a display terminal with possibilities for additional peripherals added on to the system. Diagnostic tests can also be stored, queued, and scheduled for execution, and activity files and fault information can be displayed or optionally printed for management. Level III also accommodates optional software and hardware which makes up the Performance Analysis System, a management report generator for manipulating fault data and producing trouble tickets. A maximum of 4 Network Controllers can comprise a Level III network, along with 1 or 2 display terminals and a local printer for each.

Level IV contains all key features of preceding levels but includes expanded network supervision, enhanced diagnostics and reporting, and improved ease-of-use for very large networks of up to 4 tiers. It accommodates up to 40 users accessing the system through several color operator terminals and/or printers, and includes integral network map graphics and database management and reporting. A multilevel security access system prevents unauthorized network tampering. Level IV communicates with DATAPHONE II modems like other DATAPHONE levels, and will also accommodate Level II and Level III components within the same network.

**Level I Configuration** • Level I configurations consist of DATAPHONE II modems on point-to-point or multipoint dedicated Type 3002 lines.

Model 2024A • standalone or rackmount, point-to-point or multipoint modem with fixed 2400-bps data rate • secondary channel for DATAPHONE II network control.

Model 2048A • standalone or rackmount, point-to-point or multipoint modem with fixed 4800-bps data rate • secondary channel for DATAPHONE II network control.

Model 2048C • standalone or rackmount, Quick Start-Up multipoint control modem with fixed 4800-bps data rate • secondary channel for DATAPHONE II network control.

Model 2096A • standalone or rackmount, point-to-point modem with data rates at 9600/4800 bps • 2-, 3-, or 4-channel TDM multiplexer • secondary channel for DATAPHONE II network control.

Model 2096C • standalone or rackmount, Quick Start-Up multipoint modem with data rates at 9600/7200/4800 bps • secondary channel for DATAPHONE II network control.

**Level II Configuration** • consists of DATAPHONE II modems and from 1 to 4 central-site Diagnostic Consoles • Diagnostic

Console(s) support up to 256 secondary channels originating from 256 control modems in single-line increments • each secondary channel supports a single backbone circuit and up to 15 individual 4-wire dedicated Type 3002 lines in multiplexed, multipoint, and tail circuit arrangements with a maximum of 750 modem drops per secondary channel.

**Level III Configuration** • consists of DATAPHONE II modems and from 1 to 4 central-site Network Controllers, or combinations of up to 4 Network Controllers and Diagnostic Consoles • each Network Controller supports 2 operator display terminals and a printer • supports line and modem configurations similar to Level II, but extends out to 3 network tiers.

**Level IV Configuration** • consists of DATAPHONE II modems and a System Controller with 1 to 8 operator consoles and/or system printers; 4 or 8 control channels supporting up to 256 control modems each with associated tributary modems; and optional automatic alarm reporting device and centralized maintenance access port • supports line and modem configurations similar to Level III, but can extend to 4 network tiers.

### □ DATAPHONE II System—Level I

Level I is comprised of DATAPHONE II data sets (modems) only and is also called the primary data transmission system. The primary data transmission system can operate by itself, or with the appropriate diagnostic control device it is the nucleus of Levels II and III; i.e., Levels II and III require DATAPHONE II modems to function. These modems provide the necessary secondary channel for passing control, monitoring, and reconfiguration information (Levels II and III only) between a designated control modem at the central site and its tributary (remote) modems on a point-to-point or multipoint line. Control modems monitor remote modems for their internal status and associated circuit quality by polling them over the secondary channel, and can address 1 tier of tributary modems (1 point-to-point or one multipoint line). Status checking and also diagnostic testing are performed from the front panel of a control modem at the head end of each and every point-to-point and multipoint line for Level I control. Any DATAPHONE II model can be configured as a control modem; Model 2048C cannot be used in a remote-site capacity.

AT&T 201C or 208A modems can be used on the same line with DATAPHONE II modems, but they do not incorporate DATAPHONE II control or diagnostic capabilities. On such a mixed-modem circuit, DATAPHONE II modems are also deprived of the ability to monitor their self-status and circuit quality, although diagnostic testing can still be performed.

### Packaged Modems

Standalone or rackmount packaging standard for all models • rackmount versions contained in equal-sized modules for all models; all fit 1 slot in 64A2 Data Mounting enclosure • 64A2 provided with brackets to fit standard 19-inch or 23-inch equipment racks.

### Standalone Packaging

**Model 2024A** • standard 2400-bps modem with DATAPHONE II network control • AT&T 201C compatible:

<b>\$101 mo</b>	<b>\$2,595 prch</b>	<b>\$225 instal</b>
-----------------	---------------------	---------------------

**Model 2048A** • standard 4800-bps modem with DATAPHONE II network control • AT&T 208A compatible:

<b>136</b>	<b>3,520</b>	<b>225</b>
------------	--------------	------------

**Model 2048C** • standard 4800-bps Quick Start-Up modem with DATAPHONE II network control • AT&T 208A compatible (without quick start-up mode):

<b>146</b>	<b>3,820</b>	<b>225</b>
------------	--------------	------------

*MO: monthly charge for 2-year lease; includes on-call maintenance. PRCH: single-unit purchase price; includes on-call maintenance for the first year after purchase. INSTAL: installation charge. NC: no charge. NA: not available. Prices effective as of July 1984.*

# AT&T-IS DATAPHONE II Network Control & Management Systems

## Levels I, II, III & IV

**Model 2096A** • standard 9600-bps modem with DATAPHONE II network control and integral 4-channel multiplexer:

196	5,120	250
-----	-------	-----

**Model 2096C** • standard 9600-bps Quick Start-Up modem with DATAPHONE II network control:

196	5,120	250
-----	-------	-----

**Rackmount Packaging**

**Model 2024A** • central-site 2400-bps modem module equivalent to Model 2024A standalone • requires slot in Model 64A2 enclosure:

\$85 mo	\$2,175 prch	\$100 instal
---------	--------------	--------------

**Model 2048A** • central-site 4800-bps modem module equivalent to Model 2048A standalone • requires slot in Model 64A2 enclosure:

120	3,100	100
-----	-------	-----

**Model 2048C** • central-site 4800-bps modem module equivalent to Model 2048C standalone • requires slot in Model 64A2 enclosure:

130	3,400	100
-----	-------	-----

**Model 2096A** • central-site 9600-bps modem module equivalent to Model 2096A standalone • requires slot in Model 64A2 enclosure:

180	4,700	125
-----	-------	-----

**Model 2096C** • central-site 9600-bps modem module equivalent to Model 2096C standalone • requires slot in Model 64A2 enclosure:

180	4,700	125
-----	-------	-----

**Model 64A2 Data Mounting** • 8-slot central-site enclosure accommodates up to 8 DATAPHONE II rackmount modems in any model combination • includes power supply and cooling fans • fits standard 19-inch or 23-inch equipment racks:

NA	NA	NA
----	----	----

**Application**

**Model 2024A** • point-to-point or multipoint communication over unconditioned 4-wire dedicated Type 3002 voice channel • 8-millisecond training time delay.

**Model 2048A** • point-to-point or multipoint communication over unconditioned 4-wire dedicated Type 3002 voice channel • 50-millisecond receiver/transmitter training time delay; 20-millisecond transmitter training time delay for quick start at remote sites with Model 2048C as the control modem.

**Model 2048C** • central-site control modem for multipoint communication over unconditioned 4-wire dedicated Type 3002 voice channel • 50-millisecond transmitter training time delay; 20-millisecond receiver training time delay.

**Model 2096A** • single port or multipoint, point-to-point communication over 4-wire dedicated Type 3002 voice channel; D1 conditioning required • 147-millisecond training time delay.

**Model 2096C** • multipoint communication over 4-wire dedicated Type 3002 voice channel; D5 conditioning recommended • 30-millisecond training time delay.

**Operating Parameters**

**Model 2024A** • synchronous full-duplex at 2400 bps • DPSK modulation • fixed compromise (statistical) equalization.

**Models 2048A & 2048C** • synchronous full-duplex at 4800 bps • DPSK modulation • automatic adaptive equalization.

**Model 2096A** • synchronous full-duplex at 9600/4800 bps • QAM modulation • automatic adaptive equalization.

**Model 2096C** • synchronous full-duplex at 9600/7200/4800 bps • QAM modulation • automatic adaptive equalization.

**Channel Functions**

**Multipoint** • Model 2096A contains an integral 4-channel TDM multiplexer that, when activated, provides any mix of data rates at

2400/4800/7200 bps • fall-back data rates to 2400 bps for the first 2 channels; other multiplexed channels in multipoint configurations (if any) are lost when modem switched to fall-back mode • channels accommodate any mix of colocated terminals in tail circuits • Level II and Level III control from Diagnostic Console or Network Controller, respectively; Level I control from individual 2096A modem front panel:

NC mo	NC prch	NC instal
-------	---------	-----------

**Secondary Channel** • all DATAPHONE II modems contain a full-duplex, FSK modulated narrowband secondary channel; FDM multiplexed with the primary data channel • provides the transmission path for passing control, monitoring, and configuration information between control and remote-site modems in Level I networks, and between the diagnostic console/network controller and associated modems in Level II/Level III networks:

NC	NC	NC
----	----	----

**Digital Interface** • EIA RS-449/CCITT V.10 (RS-423 unbalanced) all ports; downward compatible with RS-232C/CCITT V.24/V.28 • 37-pin electrical connector; includes adapter for 25-pin (RS-232C) conversion • DTE/DCE cable distance guaranteed up to 200 feet, longer distances for tailored applications.

**Control Functions**

**Alternate Voice/Data** • standalone telephone handset with pushbuttons equips DATAPHONE II and other dedicated modems with alternate voice/data communication over 4-wire leased lines:

NA mo	NA prch	NA instal
-------	---------	-----------

**Failure Recovery—Dial Backup Feature** • provides immediate recovery from line failures on point-to-point lines • switches modems at attended (Level I) or unattended (Levels II and III) sites between 4-wire dedicated line and 2 dial-up lines to restore communication interrupted by line failure/degradation • Level I manual operation from the modem front panel or through the terminal interface; automatic remote control from the Diagnostic Console or Network Controller, Levels II and III.

**Single Station Arrangement** • standalone unit switches unattended or attended-site modem between 4-wire dedicated line and 2 DDD line pairs • FCC certified • manual or automatic control at the remote site • single unit required at central and at remote model locations:

27	885	70
----	-----	----

**Multiple Station Arrangement** • rackmounted unit with power supply and logic accommodates Dial-Backup Features and Switching Arrangements for switching unattended- or attended-site modems between 4-wire dedicated line and 2 DDD line pairs • provides dial backup for up to 23 colocated modems • FCC certified • requires at least 1 dial-backup feature and 1 switching arrangement:

27	860	150
----	-----	-----

**Attended or Unattended Dial-Backup Feature** • plug-in module provides connection for 2 DDD backup lines • accommodates single modem • auto-answer; FCC certified • requires slot in Multiple Station Arrangement:

12	390	50
----	-----	----

**Switching Arrangement** • plug-in module provides physical switching for up to 4 modems; switches 4-wire dedicated line to 2 dial backup lines • FCC certified • requires slot in Multiple Station Arrangement:

9	28	16
---	----	----

**Anti-Stream Timer** • selectable feature turns primary data channel off and alerts control modem or console after RS (Request-To-Send) signal on RS-449 interface has been on continuously for 3, 9, or 27 seconds (user selectable) • standard feature all models:

NC	NC	NC
----	----	----

**Automatic Retraining Feature** • provides automatic retraining of modem automatic adaptive equalizer on received carrier signal, upon signal interference or signal interruptions that

# AT&T-IS DATAPHONE II Network Control & Management Systems

## Levels I, II, III & IV

exceed 1 second • retrains in approximately 2 to 3 seconds • notifies DTE and RD (Receive Data) signal may be invalid; alerts modem or console operator of error condition • standard feature on Models 2048A and 2096A only:

NC                      NC                      NC

### Command Functions

Menu-driven commands change modem operating parameters; commands entered through modem front-panel controls • menu displays a scrolled list of parameters via 4-digit alphanumeric display • commands include:

**Modem Check** • displays addresses of remote-site modems that are disabled, or in maintenance or test mode.

**Disable** • disables a modem from primary data channel by putting itself into analog loopback.

**Maintenance Mode** • augments and enhances diagnostic testing and commands during maintenance periods.

**Display Options** • displays the options installed for a particular modem.

**Clear Options** • erases previously selected options for a particular modem.

**Change Options** • displays the available options for a particular modem, shows which options are installed or not installed; allows option additions or deletions.

**Change Mux Option** • changes multiplexer configuration; Model 2096A only.

**Add To Poll List** • allows remote-site modem to be added to control modem poll list.

**Port Select Command** • allows 2096A multipoint models to change the port (ports 1 through 4) over which poll list commands are intended.

**Display Poll List** • allows user to scroll through modem addresses contained in control modem's poll list.

**Acquire Poll List** • commands control modem to poll all modems on a multipoint line and establish a list for them.

**Change Poll List** • allows user to manually add or delete modem addresses from a control modem's poll list.

**Display Software Version** • commands modem to display the software version(s) for its resident microprocessor(s).

**Display Network Address** • displays modem network address.

**Change Network Address** • changes modem network address.

**Display Local Address** • displays modem local mounting slot address.

### Diagnostic & Status Indicators

Comprehensive diagnostics isolate failures in local or remote modems or dedicated line • manual implementation of diagnostic tests conducted from front panel of individual Level I modems; remote implementation of testing from diagnostic console or network controller in Levels II and III • visual indication of operating conditions; visual warning of deteriorating or abnormal conditions.

**Loopback Tests** • timed or continuous local analog loopback; local analog loopback mode for external test equipment • local and remote digital loopback; digital loopback for AT&T 201C and 208A modems • end-to-end test; local- and remote-site modems check the performance of the other:

NC mo                      NC prch                      NC instal

**Test Pattern Generation** • integral 511-bit pseudorandom generator/comparator for digital loopback testing • 15-bit pseudorandom pattern, Model 2024A, and steady mark pattern, Models 2048A and 2048C to test AT&T 201C and 208A modems • Automatic Network Test sends test message from a control modem to every remote drop on a multipoint line; each remote unit sends back a good copy of the message with an error indication (ACK or NAK):

NC                      NC                      NC

**Test Tone Generation** • timed 1004-Hz tone transmitted/received by pair of DATAPHONE II modems to measure transmit or receive loss of signal strength; attended operation at modem initiating or requesting test required • continuous 1004-Hz tone transmitted from a DATAPHONE II modem and received by either a DATAPHONE II or non-DATAPHONE II modem requires attended operation at both modem sites:

NC                      NC                      NC

**Signal Level Test** • measures the approximate level of received signal in decibels for switched carrier communication • control modems can measure their own receive levels and those of associated remote modems:

NC                      NC                      NC

**Signal Quality Test** • measures quality of received signal for switched carrier communication, expressed as a dimensionless number from 0 to 9 where the lowest number is the best:

NC                      NC                      NC

**Status Indicators** • front panel 4-character (digital) alphanumeric display indicates option selections, test results, faults, addresses, and multiplexer mode (Model 2096A) • LED status lamps indicate key EIA signal status, test condition, successful message relay over secondary channel, and equalizer retrain condition.

### □ DATAPHONE II System—Level II

Level II service consists of DATAPHONE II modems coupled with the Diagnostic Console (DC). It allows the same inherent control, monitoring, and diagnostics from Level I to be performed for an entire network from 1 central location. The DC can support up to 256 secondary channels, each one originating from a central-site control modem. Each secondary channel, in turn, can support up to 15 individual 4-wire Type 3002 circuits in multiplexed/tail circuit arrangements, excluding the "backbone" link from the control modem to the first remote-site modem (which can also be a control modem for more remote locations). Each one of these 15 circuits can support up to 50 multipoint modem drops, and all under control of the primary control modem at the central site. This yields a maximum number of 750 possible drops for each secondary channel in the network, with a total network maximum of 192,000 drops for a 256-line/secondary channel configuration. In addition, Level II adds certain capabilities that are not available in Level I. Secondary channel control, for instance, can bypass standalone multiplexers in the user's network to reach all modems. Remote modems can have their options set from the DC, an impossible task for control modems under Level I. Furthermore, some timed loopback tests can be extended for longer durations. Complete DATAPHONE II modem characteristics, which apply to Level II also, are detailed in Level I service.

The Diagnostic Console polls all control modems at the "top" of a hierarchical pyramid of network modems. Control modems return fault information to the DC covering failures in their own circuitry; they also return fault information for remote modems and circuits further down the pyramid, which they have previously polled. The DC does not have a direct link to remote-site units. The console itself can be located with the central-site control modems, or remotely from them. A local or remote DC communicates with the central-site modems via a 1200-bps control channel; a remote DC requires a dial or private line extension of the control channel, using a pair of AT&T-compatible 212AR or 202T modems, respectively. Central-site control modems or 64A1 multiple mounting enclosures must be daisy-chained with the control channel and located no more than 200 feet from each other. Up to 4 DCs can be linked to the control channel in a Level II network providing greater access and flexibility; they can also be attached to the control channel in a Level III network with Network Controllers for a total of 4 such devices in any combination.

**Diagnostic Console (DC)** • rackmountable or desktop console panel; displays modem parameters and allows test and control functions to be performed for all network modems • panel face divided into 6 logical areas to display status information and modem addresses and to run test and diagnostic procedures • address and nature of network faults appear on a 10-digit LED display, aided by several switches and 3 additional 2-digit

# AT&T-IS DATAPHONE II Network Control & Management Systems

## Levels I, II, III & IV

displays to scroll through and count the various modem faults • 8 LED indicator lamps display key EIA signal activity for any selected network modem • 2 LED lamps indicate normal or fault condition for the Diagnostic Console itself • 10-digit LED display (with switch) selects the address of the modem to receive tests or commands • 16-button keypad enters addresses of network modems and supports test/command functions • Test/Command section includes 2 12-digit displays and several switches to select tests and commands and display the results; also includes a row of pushbuttons for quick access to 5 often-used procedures • 4-digit access code (password) entered into console keypad provides system security • 2 10-pin (EIA RS-449/RS-423) and 1 25-pin (EIA RS-232C) interfaces provide local or remote connection to the control channel:

\$183 mo	\$4,850 prch	\$250 instal
----------	--------------	--------------

### □ DATAPHONE II System—Level III

Level III consists of DATAPHONE II modems coupled with the Network Controller (NC). It affords the same centralized control of DATAPHONE II modems as the Diagnostic Console in Level II, supporting a maximum of 256 secondary channels with a maximum of 192,000 modem drops. Over and above this, however, the NC provides users with several enhancements: the ability to more accurately define and store up to 100 network faults; network addressing for up to 3 tiers; automatic queueing of multiple (timed) tests and commands; storage and scheduling of test routines and/or sequences for 1 time of repeated use; the ability to enter a test while another is in progress, for subsequent execution; the ability to automatically report faults to a AT&T Information Systems test center; and the option to generate management reports via the optional Performance Analysis System.

The NC requires at least 1 keyboard display terminal, such as the Dataspeed 40/2 or equivalent, for an operator to enter commands and interact with the system. An optional receive-only printer will automatically log network faults.

Level III users can also add multiple control devices for added flexibility and distributed control, including up to 2 terminals per NC (2 local or 1 local and 1 remote) and up to 3 additional NCs or Diagnostic Consoles (DCs) in any combination. As in Level II, a 1200-bps control channel interconnects control devices and central-site modems. Additional NCs or DCs can be remoted from each other by extending the control channel with dial or private line facilities, using AT&T 212A- or 202T-compatible modems, respectively; however, password security is lost when using 212A modems over the DD network. DATAPHONE II modem characteristics and DC functions, which apply to Level III, are detailed in Level I Service and in Level II service.

**Network Controller (NC)** • rackmountable unit with integral cartridge tape drive and system logic for program execution; stores up to 50 network faults in buffer memory, up to 100 inactive or active faults on tape • contains 6 interfaces for accessing control modems, peripherals, and other diagnostic units, or for outside access to diagnose NC internal circuitry • 2 10-pin connectors provide the EIA RS-449/RS-423 interface for local/remote connection of the NC to a 1200-bps control channel • 2 37-pin RS-449/RS-423 interfaces provide connection for the mandatory local terminal at 300 or 1200 bps, and for 1 optional RO printer at 300 bps • 3 25-pin RS-232C interfaces provide connections for an optional local or remote terminal at 1200 bps, and 2 diagnostic entry points at 1200 bps for TelCo or service personnel to troubleshoot NC internal circuitry or network performance (without the real-time capabilities of the NC itself); connection to a TelCo test center requires 1 212A dial-up modem plus a 1-number dialer • front panel LED indicators monitor cartridge tape drive and interface status • requires 1 Dataspeed 40/2 or equivalent display terminal • fits standard 19- or 23-inch equipment rack:

\$285 mo	\$7,300 prch	\$400 instal
----------	--------------	--------------

**Dataspeed 4420** • asynchronous ASCII keyboard display terminal required for system operation • screen size 80 columns x 24 lines, with 72 lines (3 pages) stored in buffer memory • 2 screen partitions divided horizontally • top partition displays 5 most recent network faults in real-time including time of day, network location, and fault type; older faults displayed on

command • fault types include modem failure, line impairment, streaming terminal, or no response on a diagnostic channel • bottom partition contains interactive working field for entering diagnostic and test commands • can accommodate a Teletype Model 40 keyboard receive-only printer (or equivalent) for page printing from the Dataspeed 4420 screen • other vendor ASCII terminals can be used in place of the 4420, but not all read ASCII control characters in the same fashion and will not display screen information properly • extra-cost item:

220	4,760	100
-----	-------	-----

**Teletype Model 43 Teleprinter** • optional hard-copy terminal prints network faults as they occur • ASCII characters with 16K-character buffer • attaches to Network Controller printer port:

68	1,680	115
----	-------	-----

**Comm-Stor II Communications Storage Unit** • optional dual-diskette storage unit manufactured by Sykes Datatronics, Inc; provides menu-driven retrieval of fault data for management reports under the Performance Analysis System • can accommodate a Dataspeed 4420 or equivalent terminal for program generation of management reports, recommended to offload the tasks of the primary system terminal • attaches to Network Controller printer port; an optional Model 43 teleprinter can subsequently be attached to the Comm-Stor II to function as the system fault-logger and print trouble tickets and reports:

400	9,800	200
-----	-------	-----

### □ DATAPHONE II System—Level IV

Level IV provides the same functionality found in Levels I, II, and III, with expanded network supervision, enhanced diagnostics and reporting, and improved ease-of-use. It employs DATAPHONE II modems, as do the other levels, and can support Level II Diagnostic Consoles and Level III Network Controllers within the same network. Level IV supports up to 8 control channels, each of which supports up to 256 control modems (secondary channels), and can stretch over 2,000 individual circuits. Each control modem can address up to 200 tributary (remote) modems, but can only accumulate fault records for a maximum of 50 remote addresses. The integral database stores up to 3,000 modem/device profiles; up to 2,000 active fault records; and up to 20,000 historical fault records. In addition, Level IV can address up to 4 network tiers with multipoint networks located behind multipoint networks.

Physically, Level IV consists of an AT&T AP16 minicomputer, called the System Controller (SC), with up to 8 operator terminals and/or system printers and 4 or 8 controller channels daisy-chained to a maximum of 2,048 control modems. Other optional peripherals can include a screen printer attached to each operator terminal; an alarm reporting device for reporting SC malfunctions; and an AT&T 801 Automatic Calling Unit (ACU) plus attached modem for sending Automatic Trouble Reports (ATRs) to an AT&T Data MOCC or for distributing network test results to user-specified locations.

Level IV incorporates numerous enhancements over previous levels. Up to 40 users can access the System Controller under supervision of a multilevel password/logon security hierarchy. Diagnostic testing can be scheduled for unattended operation by hour/day/week/month; test results can be routed to one or many destinations, including a temporary storage queue. Users can filter faults for transmission to user devices or to an AT&T Data MOCC, selectable by control channel and/or fault type. Level IV also includes standard trouble ticket generation and updating with database reporting capability. Management reports include a device profile listing, 7 different fault reports, and a trend report, sortable on length or fault type. For more customized reporting, users can attach a 9600-bps asynchronous (ASCII) host link to one of the user ports, providing access to user-specific applications programs.

User-friendliness is improved with network map graphics, providing visually enhanced network testing and fault isolation. Color graphics is standard for both operator terminals and system printers. The menu-driven operator interface also features improved prompting and special function keys to aid system access.

## AT&T-IS DATAPHONE II Network Control & Management Systems Levels I, II, III & IV

**Level IV Kernel System** • minimum configuration includes AP16 processor with 2M bytes of main memory; 40M-byte hard disk drive with tape cartridge backup; 4-port EIA interface card and accompanying terminal controller (each port supports up to 256 control modems/secondary channels); 8 user ports for attaching system terminals/printers; one color system display terminal; and one system printer • software pricing unbundled; see SOFTWARE • supports up to 6 additional system terminals and/or system printers; 4 additional control ports; optional AP16 alarm transmitter; and optional centralized maintenance access port • kernel system price:

\$2,190 mo	\$86,775 prch	\$1,685 instal
------------	---------------	----------------

**Terminal Controller** • supports 4-port EIA interface (controller) card • single terminal controller included in kernel price; 1 optional (2 maximum):

60	1,585	55
----	-------	----

**EIA Interface Card** • provides 4 control ports; each port supports up to 256 control modems/secondary channels • single interface card included in kernel system price; 1 optional (8 control ports maximum):

30	785	30
----	-----	----

**System Display Terminal** • color keyboard-display terminal provides primary operator-system interface • attached locally or remotely via dial-up or dedicated modem coupled with protocol converter • accommodates optional AT&T Model 475 local printer for screen hardcopy (not to be confused with System Printer) • single display terminal included in kernel system price;

unused user ports support additional terminals:

195	4,615	105
-----	-------	-----

**System Printer** • 250-cps dot-matrix printer provides hardcopy reports, profile printouts, and other System Controller output • 2-color operation (red and black) • attached locally or remotely • single printer included in kernel system price; unused user ports support additional System Printers:

280	6,700	115
-----	-------	-----

**Model 801CR ACU** • optional automatic calling unit sends automatic trouble report (ATR) to an AT&T Data MOCC • sends network test results to an optional remote printer • requires AT&T 212A or compatible modem • attaches to user port:

19	610	55
----	-----	----

**Silent Knight Automatic Alarm Transmitter** • allows AP16 processor to report internal processor alarm conditions to a remote location:

NA	NA	NA
----	----	----

**Centralized Maintenance Access Port** • allows AT&T personnel to dial into System Controller to conduct remote diagnostics:

NA	NA	NA
----	----	----

**Main Memory Upgrade** • provides 1M bytes of additional memory for the AP16 processor, 3M bytes total:

400	11,000	360
-----	--------	-----

• END



# AT&T-IS ISN

## Packet Switched Local Area Network

### ■ PROFILE

**Architecture** • Information Systems Network (ISN) local area network.

**Type** • baseband hierarchical star network with nodal concentrators grouped around centralized packet controller; connections between devices made through interface modules connected to centralized bus in packet controller.

**Transmission Speed** • 8.64M bps over central bus between nodal concentrator and packet controller, and between host computer and concentrator or packet controller; up to 19.2K bps asynchronous interfaces.

**Cable Length** • 2.2 kilometers (7,200 feet) for fiber optic link between nodal Concentrator and packet controller and between ISNs; up to 250 feet for 4-wire copper cable between asynchronous devices and concentrator; Asynchronous Data Unit (ADU) at each end of link extends distance to 2,000 feet at 19.2K bps and up to 6,000 feet at 4800 bps between asynchronous device and concentrator; covers radius of 3,624 feet (without ADU) or 9,274 feet using ADUs • 200 feet between IBM 3270 terminal and ISN.

**Applications** • automated office and distributed processing environments within departments, single buildings, campuses, or nationwide locations.

**Configuration** • consists of Model 100 Packet Controller that acts as a switch and management center and concentrators that connect to Packet Controller through fiber optic links up to 2.2 kilometers; devices can connect to ISN through 4-wire copper cable to a Concentrator or the Packet Controller through 4- or 8-port Asynchronous Interface Modules (AIMs) through synchronous terminal interface, or through BSC/SDLC interface; IBM and AT&T Personal Computers connected to STARLAN can access

ISN through STARLAN interface; devices on Ethernet can access ISN through an Ethernet bridge • Model 100 Packet Controller supports a maximum of 1920 ports using concentrators • provides protocol conversion for attachment of ASCII terminals to IBM SNA hosts and for attachment of devices on ISN to DEC hosts running UNIX V; protocol converters connect to ISN through ports on AIMs; DEC hosts connect to concentrator or packet controller through fiber optic link • System 75/85 can also connect to ISN through ports on AIMs • ISNs can interconnect with each other through fiber optic trunks at 8.64M bps and over interpremises trunks at speeds up to 2.048M bps using DDS or DS-1 digital facilities (T1 lines) • see **Figure 1**.

**Interface** • asynchronous devices interface to ISN through RS-232C interface on 4-/8-port Asynchronous Interface Modules (AIMs) in the packet controller or the concentrator; DEC hosts connect to a fiber optic link to the concentrator or packet controller through a DEC Unibus Host Interface (DUB/HI) board in a KMC-11 front-end processor of a DEC computer • IBM hosts interface to concentrator or packet controller through a synchronous or packet communication link to a protocol converter connected to AIM ports of ISN or through BSC or SNA/SDLC interface; IBM 3270 terminals interface to ISN through synchronous terminal interface • Ethernet bridge allows devices connected to Ethernet to access ISN, and STARLAN interface allows devices connected to STARLAN to access ISN • ISN can also interface to other ISNs and to System 75/85 • packet controller accommodates a system control console and system control printer • AT&T 3B20 interfaces to ISN through special fiber interface module.

**Gateways** • DEC Unibus Host Interface (DUB/HI) connect DEC UNIX V hosts • protocol converters connect ASCII terminals to IBM SNA hosts • connection to outside world through DDD Dial-in/Dial-out facilities and to DIMENSION System 85 Distributed Communication through AIM Port • connection to other ISNs, STARLAN, and Ethernet.

**Support of Foreign Devices** • ASCII terminals through protocol converters • RS-232C ports on Asynchronous Interface Modules are vendor independent • IBM 3270 terminals and cluster controllers; IBM PCs on STARLAN, devices on Ethernet • DEC UNIX System V hosts and AT&T 3B20 hosts.

**Security** • System Control Console is password protected • Access Security feature allows manager to require users to logon before accessing user resources • closed user group provides control over who uses what on ISN.

**Communications Management** • through system control console; connects to packet controller or to any port on Asynchronous Interface Module • executes network reconfiguration including expansion, device rearrangement, and module addition/deletion without disrupting network service; automatically alerts operator to network failures; and failure location; provides secure, nonvolatile storage of configuration and fault data with automatic system recovery after power failure • provides dual simultaneous sessions from terminals, both asynchronous and synchronous • provides customer defined call progress messages and help facility.

**Protocols** • AT&T-IS proprietary collision-free contention scheme, see Specifications section.

**Distributed Functions** • implementation of access protocols and routing functions are in concentrators as well as in packet controller.

**First Delivery** • June 1984; general availability, December 1984 • major additions announced May 1985, available second quarter 1986.

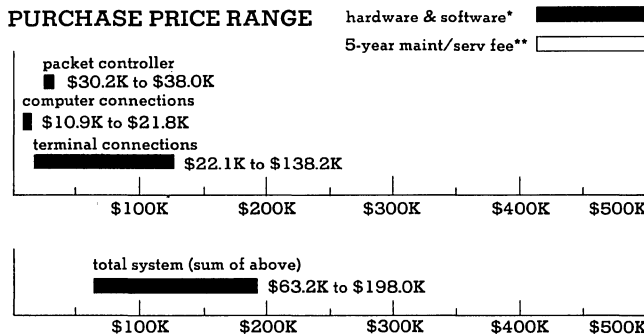

**AT&T-IS ISN PURCHASE PRICING** bar graph covers range between small and large configurations for hardware and software products (solid bar) • small system interconnects 100 terminals with 2 DEChost systems; requires Model 100 Packet Controller in 70-inch cabinet, 1 IIC, AC Power Distribution, Battery Backup, System Control Console with Keyboard, System Control Printer, 2 FIMs (to connect hosts), 2 DUB/HIs (at host sites), 12 AIM 8s and 1 AIM 4 • large system interconnects 500 terminals with 4 hosts; includes Model 100 Packet Controller in 70-inch cabinet, 3 IICs, AC Power Distribution, Battery Backup, System Control Console with Keyboard, System Control Printer, 10 FIMs (4 connect hosts and 6 connect concentrators), 4 DUB/HIs (at host sites), 6 concentrators, 6 concentrator Wall Mountings, 62 AIM 8s (30 in concentrators and 32 in Model 100) and single AIM 4 (in Model 100) • neither system includes the Distribution System (wiring). \* AT&T-IS software is bundled with hardware \*\* AT&T-IS has supplied no maintenance figures although the company does charge maintenance charges on a per-item basis.

## AT&T-IS ISN Packet Switched Local Area Network

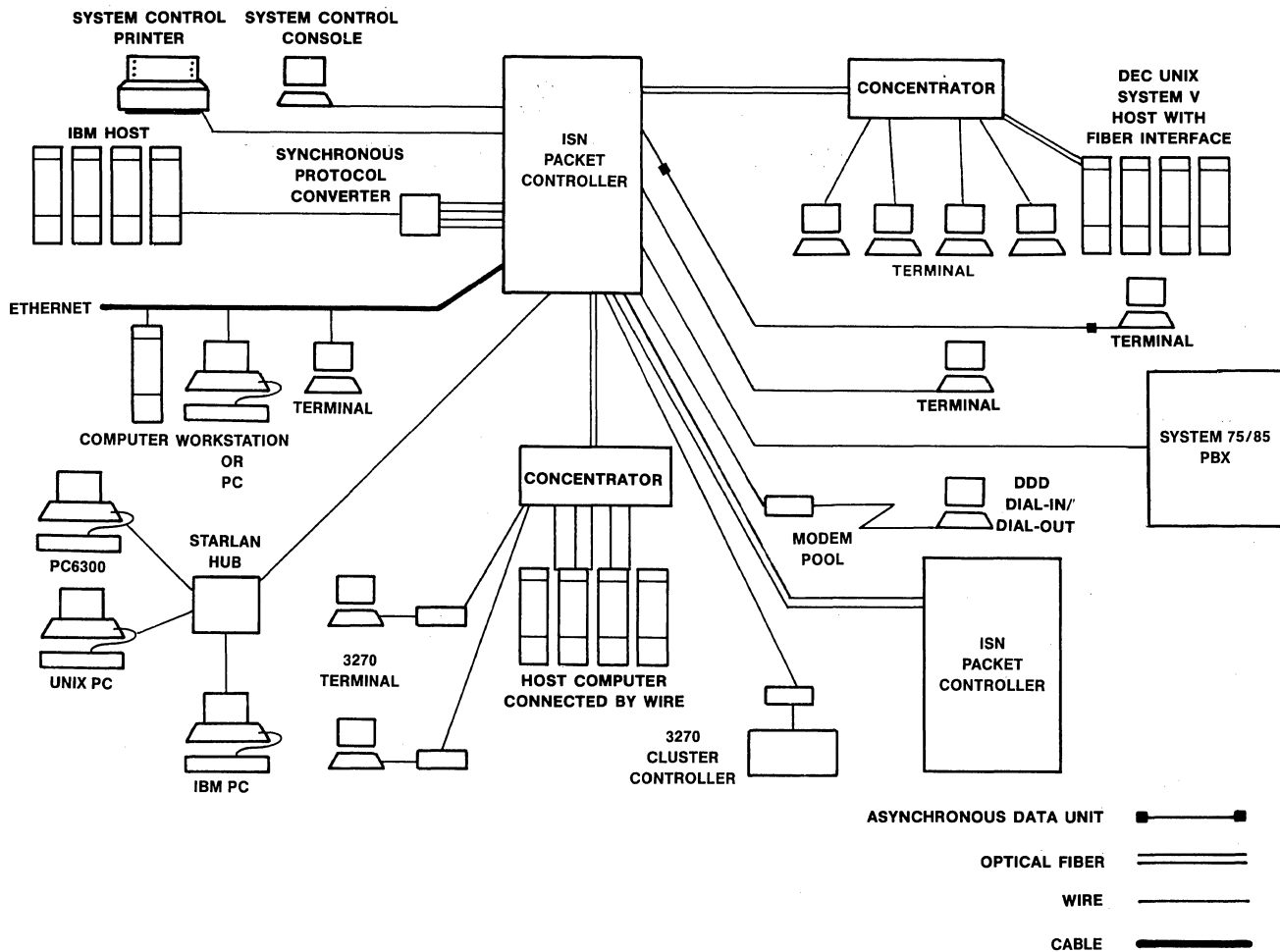

Figure 1 • ISN components.

**Systems Delivered** • 150 (rumored); unconfirmed by AT&T.

**Comparable Systems** • most comparable system is INSTANET/PLUS from Micom/Interlan; combines INSTANET Data PBX with Interlan's NET/PLUS Ethernet LAN • other local networks, such as Net/One from Ungermann Bass and HYPERbus from Network Systems, perform same network functions, but use bus topology.

**Vendor** • AT&T Information Systems; 100 Southgate Parkway, Morristown, NJ 07960 • 201-898-8000 • National Sales Center 1-800-247-1212 (toll free).

**Distribution** • nationwide through AT&T Information Systems sales offices.

**Canadian Distribution** • AT&T Canada, Inc; 1500 Don Mills Road, Suite 500, Don Mills, ON M3B 3K4 • 416-449-4300.

**GSA Schedule** • listed (70B).

### ■ ANALYSIS

The ISN is a product that many data communication consultants considered a solution to the needs of the integrated office because it combines the facilities of a PBX with those of a LAN. ISN is only a data network, but its packet controller is very similar to AT&T-IS's System 75 PBX and AT&T Technologies Datakit.

AT&T-IS has integrated the ISN into the data switching facilities of its System 85. Both systems can be administered from a single

station, providing reports from both ISN and System 85 to the same terminal. Users on ISN have access to Applications Processor or other devices on System 85, and System 85 users have access to ISN's network and facilities.

Initially, AT&T offered a limited set of components for ISN: packet controller; concentrator; asynchronous communication interfaces; an interface to access a DEC Host running UNIX V; protocol converters to access IBM SNA (ASCII to SNA/SDLC and ASCII to BSC 3271), and fiber optic links (between Concentrator and Packet Controller and between DEC Host and Concentrator or Packet Controller). In May 1985, AT&T-IS made an announcement of substantial enhancements to ISN. The company was vague (as usual) about specific details of the products and no prices other than average price per port: \$350 to \$550 per asynchronous device; \$500 to \$750 per device port for STARLAN applications and Ethernet/IEEE 802.3 bridge services; and \$1,000 to \$1,300 per BSC or SDLC port. What the company announced were functional descriptions of features that will be firmed up into products with model numbers and pricing for ordering fourth quarter 1985. The products are scheduled for delivery in second and third quarters 1986. The Trunk Interface Module (TIM) may be a little earlier.

The announcement included STARLAN, a 1M-bps LAN for interconnection of PCs via ordinary telephone wire. STARLAN is based on the CSMA/CD access protocol; it supports up to 128 simultaneous virtual circuits. STARLAN can interface to ISN



## AT&T-IS ISN

### Packet Switched Local Area Network

through a plug-in interface module in the ISN packet controller or concentrator. STARLAN and ISN use a common addressing scheme.

AT&T-IS announced an IBM 3270 terminal switching scheme for connecting synchronous IBM 3270 terminals to any number of cluster controllers attached to different host computers.

Two modules are available, one connects the terminals to ISN and the other attaches the cluster controller to ISN. Both the terminal and cluster controller modules include 2 ports. Two sessions can be set up per terminal, thus it can be switched between 2 applications.

AT&T-IS also announced a BSC and SNA/SDLC interface to ISN: it provides 2 ports for direct connection of cluster controllers and front-end processors to ISN using either BSC or SNA/SDLC protocols. The ports are independent of each other and can implement the same or different protocols.

A Trunk Interface Module allows ISNs to be interconnected over fiber trunks up to 2.2 kilometers (7,200 feet) long at 8.64M bps. Interpremises ISNs can also be interconnected over telephone facilities using RS-232C and V.35 interfaces at data rates of 9600, 56K, 64K, and T1 speeds of 1.544M/2.048M bps. The ISN can share T1 links with System 75/85 data/voice traffic.

Currently, ISN can interconnect with System 75/85 only through the RS-232C interfaces in the AIMS. The System 75/85 can be located up to 2.2 kilometers away from the ISN packet controller, however, by essentially incorporating a concentrator in the System 75/85 and connecting it through a fiber link to the packet controller.

The Ethernet Bridge interfaces ISN to an IEEE 802.3 or Ethernet LAN. The data rate through the gateway is 10M bps. The connection includes only layer 1 (physical) and layer 2 (data link) of the ISO model. It performs no protocol conversion. TCP/IP and XNS devices are supported.

AT&T-IS redesigned its Data Control Unit (DCU) to include a fixed hard disk (10M bytes) with floppy disk (0.78M bytes) in place of the high-capacity mini-recorder magnetic tape unit. The redesign with some logic repartitioning left more space in the chassis so it can now house 10 half-width slots for plug-in modules. Thus the Model 100 packet controller is now available in a small 21-inch version that can provide up to 40 ports in a single cabinet and up to 400 ports using concentrators. The hard disk is used to store configurations, parameters, and performance data. The floppy disk is used to load software.

The memory provided for the control processor has been increased to 4M bytes. The larger memory increases the Model 100's capacity from 1200 to 2500 virtual circuits.

Software has been added to support additional user features on ISN. Access security provides authorization for users to access system resources, and closed user groups provide for partitioned subnetwork restrictions with multiple restricted access levels. Help sessions allow end users to receive Help instructions on dialing and administering parameters. Default routing is provided. Customized call progress messages can be provided.

A 3B20 fiber host multiplexed interface connects the 3B20 to ISN. The same facilities provided for the DEC VAX-11/750 and 11/780 are now provided for the 3B20.

Future directions of development include interconnection with System 75/85 over fiber optic links, half-width AIM-8 modules to increase packet controller capacity, and interface to X.25 packet network.

With these announcements, AT&T-IS has made ISN a very comprehensive, general-purpose, local area network, which the company is integrating with its System 75/85 Dimension PBXs. The company now provides most of the facilities needed for the automated office environment. It supports the IBM 3270 networks and provides the added feature of switching among processors. It supports PCs on STARLAN as well as minicomputers and terminals on Ethernet. It allows terminals on ISN to access Application Processors (APs) on System 75/85 with a single call. The APs can implement many services such as electronic mail, message center, call detail recording, and directories.

ISNs can interconnect with each other in the campus environment as well as over telephone facilities to remote sites. All in all, AT&T-IS now has the most comprehensive LAN networking facilities offered by any vendor today. It is also a network that fits in with AT&T's expertise: wiring buildings and providing telephone facilities.

The comprehensiveness of ISN makes it a powerful competitor for IBM with its Cabling System and long-delayed Token Ring network. AT&T-IS has moved quickly and is going to be quite entrenched when the IBM Token Ring network arrives. It is doubtful IBM can come out with a better product. AT&T-IS is offering the facilities users have been asking for in their LANs: the integration of the LAN with other office products. The biggest plus factor of ISN has to be its integration with the System 75/85 PBX products.

#### □ Strengths

The ISN begins with a strong advantage because of its introduction by AT&T-IS and its integration with other AT&T-IS Systems 75 and 85.

It is a solution to the needs of many users, the integration of data and voice communication. Currently, it is only through a common network management facility for ISN and System 85 and through the RS-232C interface in the AIMS. ISN is **currently only** a data network.

ISN has a considerable potential for expansion. Communication between Concentrator and Packet Controller and between host and Concentrator or Packet Controller is over fiber optic cable. The transmission rate is currently 8.64M bps, but that is primarily limited to the data rate of the switching bus on the packet controller.

The data rate of 8.64M bps on the Packet Controller bus is sustainable because contention is resolved using a separate bus. This method eliminates wasted or delayed packets due to collisions or token passing.

The architecture is open ended. The network can be extended to almost any extent through interconnection of Packet Controllers and through connection to System 75/85.

As announced, ISN is a very comprehensive general-purpose LAN that will be fully integrated with System 75/85 PBXs. It supports PCs through STARLAN, minicomputers and terminals on Ethernet, IBM 3270 terminals, IBM front-ends and cluster controllers, and asynchronous devices. ISNs can be interconnected through local and long-distance telephone facilities to extend the areas they cover. If AT&T-IS can deliver the products as announced on schedule, ISN will be a very competitive LAN offering.

#### □ Limitations

Documentation is limited and AT&T-IS has not disclosed general pricing. Thus, it is difficult to judge how competitive AT&T facilities are. Apparently, potential customers are expected to rely on AT&T-IS to provide them with the lowest cost solutions to their problem.

ISN has no interface to X.25 packet-switched networks, and connections to System 75/85 are only through AIMS.

#### ■ NETWORK SUMMARY

The ISN is a local area network using a Packet Controller to interconnect network devices. Asynchronous devices connect to the network through 4-port or 8-port Asynchronous Interface Modules (AIMs) that plug into the Packet Controller or a Concentrator. The Concentrators connect to the Packet Controller through a fiber optic cable up to 2.2 kilometers long. Asynchronous devices connect to the interface modules through 4-wire copper cables up to 250 feet long. Cable length can be extended up to 2,000 feet at 19.2K bps or up to 6,000 feet at 4800 bps using Asynchronous Data Units (ADUs).

Fiber Interface Modules (FIMs) connect devices to the Concentrator or Packet Controller through fiber optic cable. So far, only DEC hosts, 3B20 hosts, and concentrators can connect to the

## AT&T-IS ISN Packet Switched Local Area Network

Packet Controller through fiber cable. Packet Controllers can also interconnect through fiber optic cable.

**Figure 2** illustrates a data path on ISN between 2 devices through AIMs and FIMs Concentrators, fiber optic cable, and Packet Controller.

The network manager controls the network through a System Control Console that connects to an integrated interface on the Packet Controller. AT&T-IS uses the 513 BCT as the System Control Console. An integrated printer interface accommodates a System Control Printer. Any asynchronous ASCII terminal can be used in place of the System Control Console.

AT&T supplies a bridge to Ethernet to allow ISN to operate as a backbone network for separate Ethernet/IEEE 802.3 baseband networks. The bridge relieves the length restriction inherent in Ethernet. It is transparent to devices connected to the different Ethernets; the devices operate as if they were connected to one large Ethernet. The bridge operates at 10M bps.

ISN also interfaces to the new AT&T STARLAN 1M-bps personal computer network that uses standard twisted-pair wiring. STARLAN uses the IEEE 802.3 protocols. It supports IBM as well as AT&T personal computers. ISN and STARLAN use a common addressing scheme, thus PCs on STARLAN can use ISN resources.

AT&T-IS also supplies support for synchronous IBM 3270 terminals and cluster controllers, and BSC and SNA/SDLC interfaces to connect IBM front-ends. ISNs can interconnect through fiber cable as 8.64M bps or through interpremises telephone facilities using RS-232C and V.35 interfaces for speeds up to T1 rates of 1.544/2.08M bps.

The DEC Unibus Host Interface (DUB/HI), another network component, implements high-speed multiplexed communication

between a Fiber Interface Module (FIM) in a Concentrator or Packet Controller for the DEC VAX 11/750 and 11/780 computers. A similar facility, the 3B20 Fiber Interface Module (3B-FIM) in a concentrator or packet controller, connects 3B20 hosts to ISN.

Other network units include 2 protocol converters to support SNA/SDLC communication with IBM hosts. The 4276 Protocol Converter converts asynchronous ASCII data to SNA/SDLC synchronous protocol. The 4271 Protocol Converter converts asynchronous ASCII data and converts it to 3271 controller BSC protocol. Both the 4271 and 4276 are available in 3-port or 7-port versions.

Modem pooling is implemented by attaching modems to ports on the AIMs and assigning their addresses to the same hunt group.

Throughput on the network is 8.64M bps, the speed of the internal bus of the Packet Controller.

The Packet Controller functions as the switch and management center. All messages between sending and receiving devices pass over an internal high-speed bus in the Packet Controller. The internal bus consists of a Receive Bus, a Transmit Bus, and a Contention Bus. The Contention Bus determines which interface module in the Packet Controller gains control of the next time slot on the Transmit Bus. The contention scheme is on a first-come, first-served basis. Each time a contending module fails to gain access to the bus, its priority increases above that of the next module seeking to gain access to the network. The concentrator functions similar to the Packet Controller. It remotely collects data from attached devices and formats that data into packets/messages and sends them to the Packet Controller. The Concentrator supports up to 40 asynchronous ports. It uses a contention scheme similar to the Packet Controller to determine

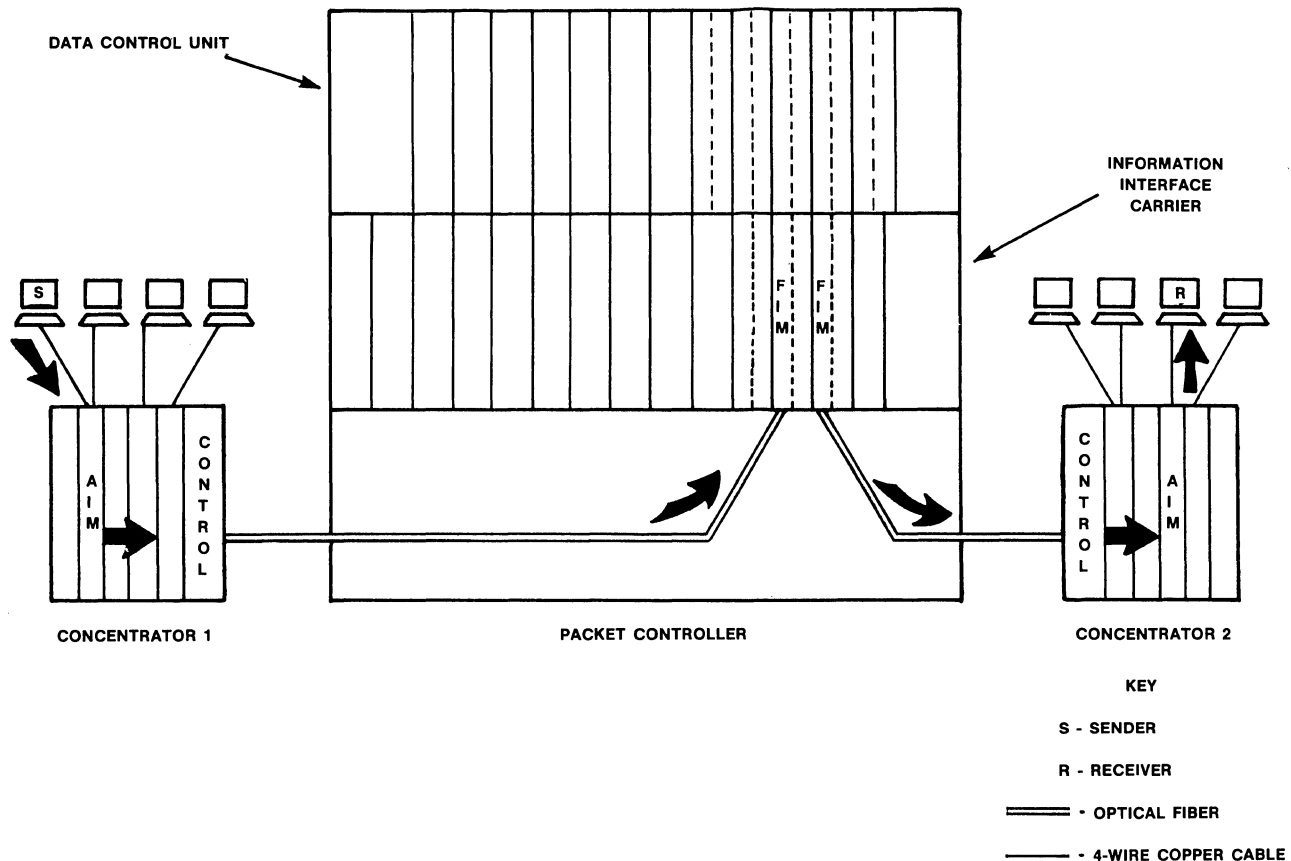

**Figure 2** • a data path through ISN.

## AT&T-IS ISN

### Packet Switched Local Area Network

which module gains control of the link between the Concentrator and Packet Controllers. Messages/packets are 180 bits long and consist of 18 10-bit characters.

ISN management provides facilities to reconfigure (add/delete/rearrange) network devices without disrupting the network as a whole. It senses and logs abnormal conditions, alerts supervisory personnel, and isolates failures to the replaceable module level. Configuration and fault data are stored on magnetic tape to restore the system after a power failure.

Access security features provide secured passwords for users to access network resources. A closed user group feature defines who can access which end user or host port. End users can customize Call Progress Messages; they can also use a Help feature for assistance in configuring port parameters. The user can control access to modem pools, protocol converters, and hosts.

The system manager can establish "hunt groups" so that multiple ports on a host or a modem pool can be used to accept a "call" (message). The manager can also set up permanent virtual circuits so that users need not reestablish and disconnect them as they are needed.

The manager can initiate tests and receive reports on system status, endpoint addresses, network configuration, translation data (between mnemonic and numeric addresses), traffic, performance, and traffic activity. The system automatically performs many self-tests and alerts the manager of faults through the System Control Console and Printer. The System Control Console is password protected from unauthorized use.

#### ■ SOFTWARE

All software is currently bundled with the ISN. The system is **not** user programmable. It is programmed to support all system modules, the network access contention scheme, and network management. AT&T-IS will charge for the internetworking software separately when it is available.

The network manager controls the network from the System Control Console through system management commands using English words and simple syntax. The System Control Console is password protected. The manager can also assign ports to "hunt" groups so that multiple ports on a host or in a modem pool can service a call.

The network manager can also establish permanent virtual circuits so users need not reestablish them each time they are used.

The system generates management reports that are displayed and/or printed. These reports include endpoint addresses, network configuration, translation data between mnemonic addresses, physical module and port location addresses, network traffic status and performance data, fault activity, and system status.

The system provides facilities that automatically check the hardware and software for abnormal conditions. It sends an alarm message to the System Control Console and to the printer when tests detect faults. Regularly performed tests include status poll; self-health tests on control processors, dedicated system control ports, and interface with nonvolatile storage; and memory checks.

The system manager can also initiate these tests as well as a loopback test to check link circuits.

When a system with the battery backup option unit fails, the system management is stored on hard disk. When power is restored, the system automatically reboots with the management data retrieved from the disk system. Battery backup maintains power for 10 minutes.

#### ■ HARDWARE

##### □ Terms & Support

**Terms** • systems are available for lease or purchase • AT&T-IS generally performs a site study and develops a network plan based on customer needs; AT&T-IS then bids on the total system including the components and distribution (wiring) system • AT&T-IS has released purchase prices only on selected components, but has not yet disclosed wiring charges.

**Support** • AT&T-IS provides a 1-year warranty on all ISN parts and 1 year's free maintenance; after that, maintenance is on a component-by-component basis, but AT&T-IS has not released these prices.

#### Packet Controller

The Packet Controller is the nucleus of an ISN system. It establishes the virtual connections between all devices connected to ISN, and it provides all the network management and control functions. Currently, AT&T offers only 1 model of the Packet Controller, Model 100.

Model 100 can be housed in a 70-inch, 42-inch, or 21-inch cabinet. See **Figure 3**. Model 100 consists of the Data Control Unit (DCU); it can also include 1 or more (up to 3) Information Interface Carriers (IICs). The DCU contains the common logic circuitry and storage for Model 100 and 10 half-width plug-in slots. The IIC provides additional slots for plug-in modules to configure a specific ISN system. The 21-inch cabinet includes no IICs, the 42-inch cabinet 1 IIC, and the 72-inch cabinets up to 3 IICs. All 3 cabinets provide space for up to 9 plug-in modems that can be pooled. The modems are wired to ports on Asynchronous Interface Modules (AIMs) in an IIC or the DCU. Pooled modems can also be standalone units connected to AIM ports.

The bottom shelf on both the 42- and 72-inch cabinets houses the battery backup option, which maintains power for 10 minutes once external power is disrupted. Battery backup maintains all circuit connections for 2 minutes, thus if power is restored during that interval, no disruption in service occurs. After 2 minutes, the system has 8 minutes to powerdown and store system status on disk so the system can be automatically restored once power returns. AT&T-IS indicates that future releases will allow for a duplicate DCU in either cabinet. Battery backup must be housed in a separate cabinet for the 21-inch model.

The Data Control Unit (DCU) contains all the common logic and storage facilities of the Model 100. It includes an integral hard disk (10M bytes) with floppy disk (0.78M-byte) unit (HD/FD), Maintenance Module (MAINT), Control Processor (PROC), 2M bytes of RAM (which can be expanded to 4M bytes), Clock Module (CLK), Channel Address Translator (CAT), Control Processor Disk Interface Module (CPDIM), Power Supply Control, memory, and 10 slots for addition of interface modules. See **Figure 4**.

The PROC is a 16-bit microprocessor that establishes and terminates connections. After receiving addressing information, it establishes the route from the sender to receiver, until the receiving device disconnects. Automatically, the PROC initiates periodic status polls of modules in the IICs and Concentrators and sends failure warnings to the System Control Console. The PROC also processes administrative and maintenance procedures.

The RAM contains software to run ISN. It stores network configuration information, including routing tables used by PROC to establish connections between devices.

A fixed hard disk with floppy disk unit replaces the HCM-R magnetic tape unit in earlier models. The hard disk provides nonvolatile memory backup in case of power failure, retains the system configuration data for automatic restart after a power outage and stores network performance data for network management. The floppy disk is used to load the network control software into RAM. The disk interfaces to the processor through the CPDIM.

The Maintenance Module passes data between the System Control Console and the PROC to bypass the switch with network management and maintenance messages. It links the PROC directly to the System Control Console and the System Control Printer.

The Clock Module (CLK) generates all timing signals for the system and synchronizes packets passing through the Channel Address Translator (CAT). Through Repeater modules in the IICs, the CLK transfers some transmission timing signals on the Transmit and Receive buses that run behind the interface modules in the IICs.

The Channel Address Translator (CAT), a hardware-based packet switch, stores (in RAM), tables of the virtual circuits established

## AT&T-IS ISN Packet Switched Local Area Network

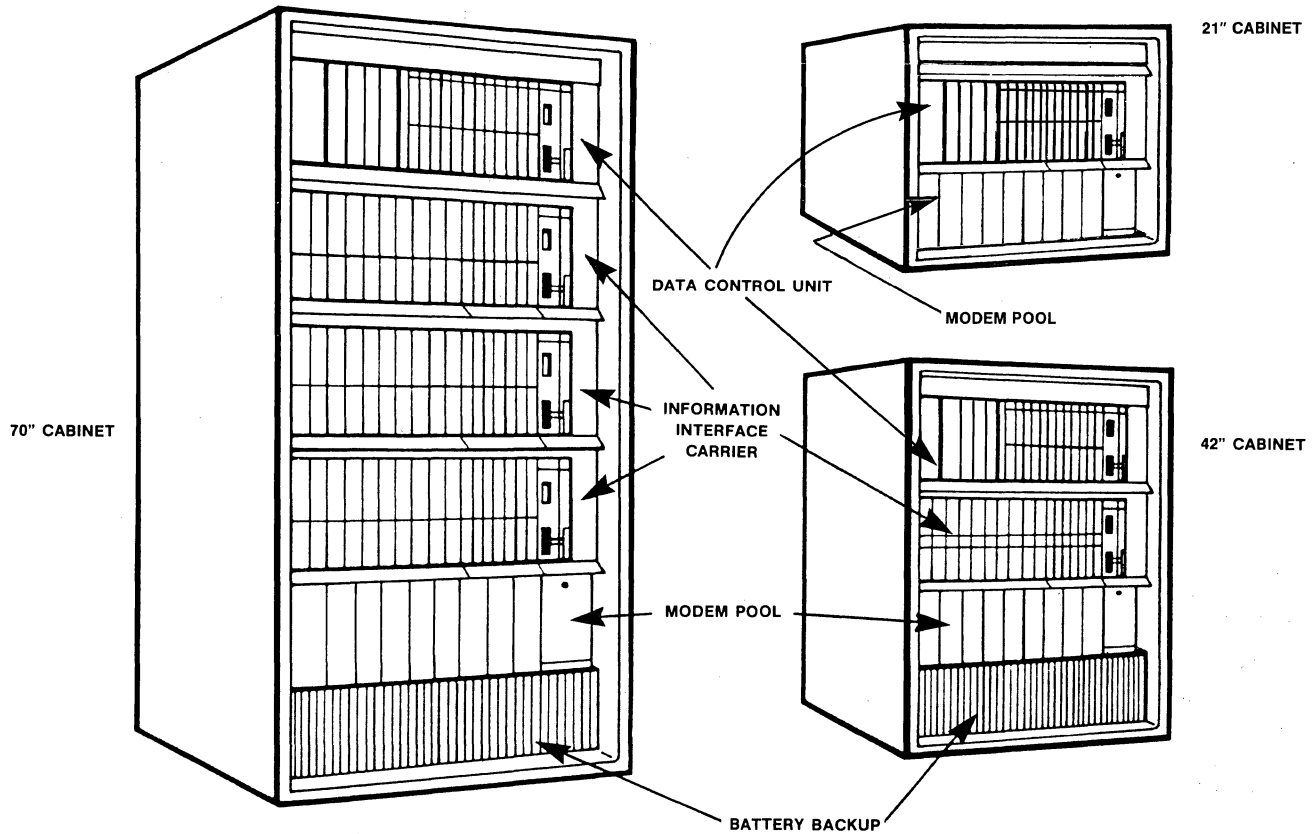

**Figure 3** • mounting arrangements of the ISN packet controller.

by the PROC. It replaces the incoming address with the destination address read from the virtual circuit table. The virtual circuit remains until the PROC changes it.

The Control Processor Disk Interface Module (CPDIM) provides an interface between PROC and the disk. The PROC interfaces to the Control Interface Module (CIM) which takes the data from PROC and formats it for transmission in the Transmit Bus. The CIM also accepts data from the Receive Bus and passes it to PROC.

The Information Interface Carrier (IIC) includes a Power Supply, Repeater, and slots to plug in interface modules, such as Asynchronous Interface Modules (AIMs) and Fiber Interface Modules (FIMs). The Repeater Modules synchronize bus transmissions throughout the Packet Controller by repeating the timing signals generated by the CLK in the DCU.

The IIC can accommodate up to 16 interface modules, including 13 AIMs or 16 FIMs or a combination of both types. As shown in Figure 4, a FIM requires a narrow slot while an AIM requires a wide slot, which accounts for the difference in number of modules accommodated. AIMs are available with 4 or 8 ports. With the 8-port version, an IIC can provide connections for up to 104 asynchronous devices.

Without using any concentrators, a Model 100 in a 70-inch cabinet can support up to 3 IICs. Each IIC can attach 104 devices, thus a fully loaded Model 100 can provide connections for up to 312 asynchronous devices. Using concentrators, a Model 100 can support up to 1,920 asynchronous devices on the ISN. It can support up to 2,500 simultaneous full-duplex virtual circuits.

The Model 100 in a 42-inch cabinet can support only 1 IIC. Using concentrators, this system can provide from 40 to 1600 asynchronous ports. A Model 100 in a 21-inch cabinet can support no

IICs. With concentrators, this system can provide from 40 to 400 asynchronous ports. The number of ports varies according to the interface modules configured.

The Packet Controller resolves contention for access to the internal bus using an algorithm that basically operates on a first-come, first-serve basis. See Specifications section.

See Table 1 for the maximum number of Interface Modules that can be plugged into DCU, IIC, and concentrator.

**6910-004 Model 100 Packet Controller** • includes Data Control Unit (DCU) only; throughput is 8.64M bps; provides 10 half-width slots for plug-in interface boards:

	NA mo	\$18,260 prch	NA maint
69009 Cabinet • 70-inch:	NA	1,975	NA
Cabinet • 42-inch:	NA	NA	NA
Cabinet • 21-inch:	NA	NA	NA
2M-Byte Memory Option • additional memory for DCU for maximum of 4M bytes; requires 1 half-width slot in DCU:	NA	NA	NA

69001 Information Interface Carrier (IIC) • houses modules that

*NA MO: monthly lease charge including maintenance not available. PRCH: single-unit purchase price. NA MAINT: monthly maintenance charge for purchased units not available. Prices current as of June 1985.*

## AT&T-IS ISN Packet Switched Local Area Network

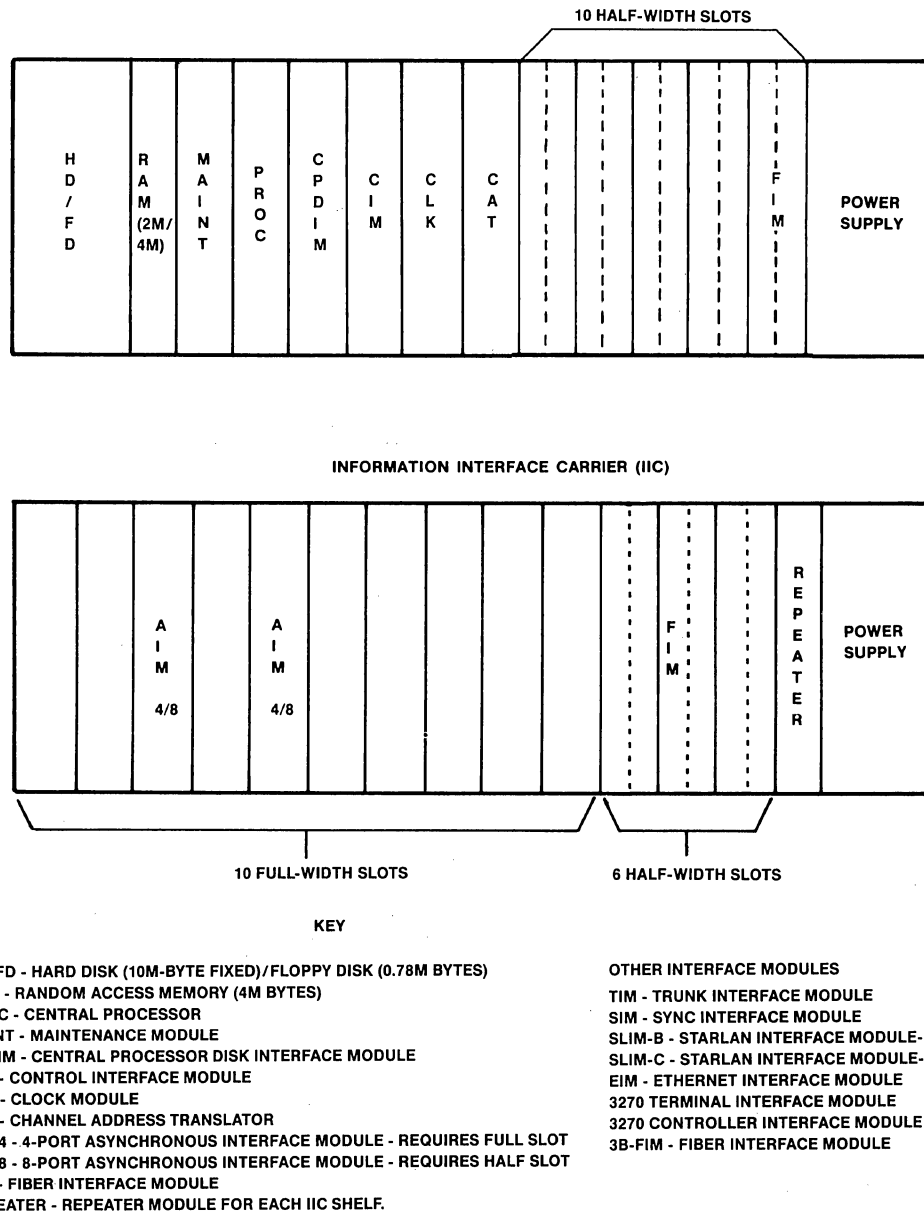

**Figure 4** • allocation of slots in packet controller.

provide interface between user devices and the network switch; provides row of slots for up to 16 FIMs or 13 AIMs or combination of 2 with other interface modules, Power Supply and Repeater; includes a backplane with a passive bus structure to connect all modules to each other, to Power Supply, and to all other modules in the cabinet; includes Repeater and Power Supply:

69005 AC Power Distribution • for 6910-004:	NA	3,895	NA
	NA	575	NA
69006 Battery Backup • maintains system power for 10 minutes when external power removed:	NA	2,720	NA

2250-513 Administration Console • based on 513 Business Communication Terminal (BCT); used as System Control Console:

NA	1,775	NA
38089 Keyboard • for Administration Console:	NA	270
	NA	NA

3330-475 Administration Printer • for use as System Control Printer:

NA	745	NA
----	-----	----

**69010 Concentrator** • similar to Packet Controller in architecture; includes Control Module, Power Supply, and slots for up to 5 Device Interface Modules for a maximum of 40 asynchronous devices; uses the same AIMs, FIMs, and other interface

## AT&T-IS ISN Packet Switched Local Area Network

**TABLE 1: MAXIMUM NUMBER OF INTERFACE MODULES SUPPORTED ON ISN**

Chassis Interface Module	Data Control Unit (DCU)	Information Carrier (IIC)	Concentrator
AIM 4/8 (Async Interface Module)	5	13	5
FIM (Fiber Interface Module)	10	16	1
TIM (Trunk Interface Module)	10	13	1
SIM (Sync Interface Module)	10	16	1
SLIM-B (STARLAN Interface Module-Bridge)	5	13	5
SLIM-C (STARLAN Interface Module-Connection)	10	13	5
EIM (Ethernet Interface Module)	5	13	5
3270 Terminal Interface Module	5	13	5
3270 Controller Interface Module	5	13	5
3B-FIM (Fiber Interface Module)	10	16	1

modules as the Packet Controller but it can support only 1 FIM • connects to Packet Controller through fiber-optic cable up to 2.2 kilometers long at 8.64M bps • a Packet Controller can attach up to 48 Concentrators, see **Figure 5**; price includes the FIM required on the Packet Controller:

NA      5,000      NA

69011 Concentrator Wall Mounting:

NA      100      NA

### Device Interface Modules

Several types of Device Interface Modules (DIMs) are available and include Asynchronous Interface Modules (AIMs), Fiber Interface Modules (FIMs) Synchronous Terminal Interfaces, and BSC or SNA/SDLC interfaces. AIMs and FIMs provide a multiplexed interface to the Packet Controller or Concentrator. AIMs are available in both 4-port and 8-port models, while FIMs are single-ported but multiplex up to 64 virtual channels. AIMs interface asynchronous devices including terminals, protocol converters, System 75/85, and modems. FIMs interface host systems to a Concentrator or Packet Controller.

**69002 Asynchronous Interface Module (AIM)** • 4-port version; asynchronous, full-duplex ports each contain an RS-232C interface with 9 leads; data rates up to 19.2K bps • device can be located 250 feet from the AIM; with ADU, distance can be increased to 2,000 feet at 19.2K bps or 6,000 feet at 4800 bps • provides hardware and software flow control; includes two 8-bit microprocessors with on-board nonvolatile memory for terminal configuration data • assembles data from asynchronous device into packets, implements protocols, and retains data in buffers until it gains control of the switch • collects data from switch, stores it in buffers, separates packet string, and sends data to its destination • manager or end user can set/change operating parameters for each port including data rate, autobaud detection, capability, number of stop bits, parity standard, flow control method, and auto-answering:

NA mo    \$1,560 prch    NA maint

**69003 Asynchronous Interface Module (AIM)** • same as 69002 except it contains 8 RS-232C ports with 6 leads each and

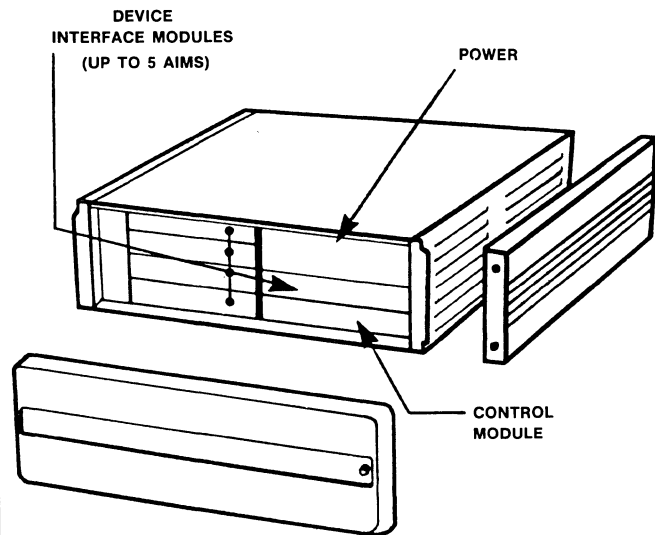

**Figure 5 • ISN concentrator.**

supports optional (XON/XOFF) flow control:

NA      1,710      NA

2169-003 Asynchronous Data Unit (ADU) • paired with 2169-004 to transmit signals over wire at distances up to 2,000 feet and 19.2K bps and 6,000 feet at 4800 bps • used to extend range of asynchronous devices beyond 250 and to use spare pairs in cables carrying analog voice signals • used as hardware end:

NA      115      NA

2169-004 Asynchronous Data Unit (ADU) • paired with 2169-003 • same as 2169-003 but used at terminal end of wire:

NA      115      NA

**69004 Fiber Interface Module (FIM)** • contains single high-speed port supporting multiple virtual circuits; acts as transmitter and receiver of data transmitted over optical fiber between host and concentrator Packet Controller and between Concentrator and Packet Controller • codes and decodes data in Manchester format for transmission of 8.64M bps on optical fiber:

NA      2,150      NA

**3270 Terminal Interface Module** • provides 2 ports for connection of IBM 3270 terminals—IBM 3278, 3279, 3178, and 3179; does not support models with light pen and magnetic strip reader accessories or with programmable symbol options • supports Type A coax at 2.358M bps • terminals use standard AT&T keyboard dialing to access any cluster controller connected to ISN; the user can establish 2 sessions per terminal allowing the terminal to switch between 2 applications; ISN provides access security for applications:

NA      NA      NA

**3270-Controller Interface Module** • emulates 3274 controller for 3270 terminals connected to ISN; provides 2 ports for connection to IBM 3274 controller:

NA      NA      NA

**Synchronous Interface Module (SIM)** • BSC and SNA/SDLC Interface • supports both BSC and SNA/SDLC devices such as cluster controllers and front-ends: for BSC, half-duplex communications at speeds up to 9600 bps; for SNA/SDLC, half- or full-duplex communications at 19.2K bps • permanent virtual circuits are established for synchronous transport service:

NA      NA      NA

### Host Communications

Currently, AT&T provides 2 types of devices to allow host computers to communicate with devices on ISN: Multiplexed Host

## AT&T-IS ISN

### Packet Switched Local Area Network

Interface for DEC and 3B20 hosts and protocol converters for IBM hosts.

**69013 DEC Unibus Host Interface (DUB/HI)** • a module inserted in a KMC-11 front-end processor of a DEC computer running UNIX System V; connects via an optical fiber up to 1 kilometer long to a FIM in a Packet Controller or Concentrator; statistically multiplexes up to 64 logical channels on the fiber cable; maximum aggregate data rate over the fiber cable is 8.64M bps:

<u>NA mo</u>	<u>\$3,310 prch</u>	<u>NA maint</u>
--------------	---------------------	-----------------

**3B20 Host Multiplexed Interface** • a module inserted into a 6N-144 front-end processor on a 3B20 that connects to an optical fiber cable and a 3B-FIM in a concentrator or packet controller; statistically multiplexes up to 128 logical channels on the fiber cable—5 for control and maintenance and 123 for data; maximum aggregate data rate is 8M bps for compatibility with 3B20:

<u>NA</u>	<u>NA</u>	<u>NA</u>
-----------	-----------	-----------

**3B-Fiber Interface Module (FIM)** • plug-in module in the concentrator or packet controller to interface 3B20 to ISN; maximum aggregate data rate of 8M bps:

<u>NA</u>	<u>NA</u>	<u>NA</u>
-----------	-----------	-----------

**4276 Protocol Converter** • translates between ASCII protocol from asynchronous terminal and synchronous SNA/SDLC protocol for transmission to IBM host • each 4276 asynchronous port attaches to ports on an AIM in a Packet Controller or Concentrator.

3-Port Model • with 3 asynchronous input ports and single synchronous output port:

<u>NA</u>	<u>2,900</u>	<u>NA</u>
-----------	--------------	-----------

7-Port Model • with 7 asynchronous input ports and single synchronous output port:

<u>NA</u>	<u>4,300</u>	<u>NA</u>
-----------	--------------	-----------

**4271 Protocol Converter** • emulates a 3271 controller • translates between asynchronous ASCII, protocol, and synchronous BSC protocol for connection to IBM host; each asynchronous port connects to a port on an AIM in the Packet Controller or a Concentrator.

3-Port Model • with 3 asynchronous input ports and single synchronous output port:

<u>NA</u>	<u>2,900</u>	<u>NA</u>
-----------	--------------	-----------

7-Port Model • with 7 asynchronous input ports and single synchronous output port:

<u>NA</u>	<u>4,300</u>	<u>NA</u>
-----------	--------------	-----------

#### Gateways

AT&T-IS provide gateways to STARLAN and to Ethernet/IEEE 802.3 LANs. For STARLAN, AT&T-IS provides 2 interface modules: a bridge (B) version operates as if ISN were an extension of STARLAN and a connection (C) version allows users on STARLAN to dial services on ISN, such as remote files, print servers, and electronic mail. STARLAN supports up to 128 virtual circuits that allows windowing and other services requiring multiple logical channels. STARLAN provides a 1M-bps data link for interconnection of PCs. STARLAN and ISN use a common addressing phone.

**STARLAN Interface Module-Bridge (SLIM-B)** • provides a bridge between STARLAN and ISN; any number of STARLANs up to maximums as shown in Table 1 can connect to ISN; data rate of 1M bps over the interface • allows ISN to operate as an extension to STARLAN • available second or third quarter of 1986:

<u>NA mo</u>	<u>NA prch</u>	<u>NA maint</u>
--------------	----------------	-----------------

**STARLAN Interface Module-Connection (SLIM-C)** • allows user on STARLAN to dial any of the services on ISN • available second or third quarter 1986:

<u>NA</u>	<u>NA</u>	<u>NA</u>
-----------	-----------	-----------

**Ethernet Interface Module (EIM)** • a bridge that allows ISN to extend the range of an Ethernet or IEEE 802.3 network; interfaces only the physical and data link layers of the ISO models

• the bridge provides no protocol conversions but devices that implement XNS and TCP/IP standard products can communicate with each other over the EIM bridge • bridge carries only the Ethernet intersegment traffic; uses "blank delete" bit compression technique to use bandwidth of ISN more effectively • a 512K-byte buffer in the bridge is dynamically allocated to handle the difference in speeds and packet sizes between IEEE 802.3/Ethernet LANs and ISN: IEEE 802.3/Ethernet packets can be up to 1,526 bytes long; ISN packets are 180 bits long; data rate is 10M bps for IEEE 802.3/Ethernet and 8.64M bps for ISN • available second or third quarter 1986:

<u>NA</u>	<u>NA</u>	<u>NA</u>
-----------	-----------	-----------

**Trunk Interface Module (TIM)** • provides bridge between 2 ISNs over fiber optic cable; software to support TIM will be charged for separately • provides up to 512 logical circuits; supports 2 queues: 1 for low priority traffic and 1 for high priority traffic; low priority queue buffer size is 64K bytes while high priority queue buffer size is 4K bytes • available second or third quarter 1986:

<u>NA</u>	<u>NA</u>	<u>NA</u>
-----------	-----------	-----------

#### Other Communications

**Modem Pooling** • requires no additional hardware other than the full-duplex modems; each modem is connected to a port on an AIM; the AT&T software allows assignment of modems in a pool to a hunt group • provides dial-in, dial-out access between network and remote terminals or hosts • modems are accessed as needed; no modem is dedicated to a particular device • modem data rates of 300 to 2400 bps.

**System 75/85 Connection** • through port(s) on an AIM; requires no special hardware or software.

#### Distribution System

AT&T uses optical fiber, wire cable, and various cross-connect units to implement ISN.

**Wire Cable** • general-purpose No. 26-gauge (AWG) or larger twisted pair; connects devices to EIA RS-232C ports on AIMS; 250 feet maximum length • wires carrying EIA signals must be isolated from wires carrying analog voice signals to prevent interference • Asynchronous Data Units (ADUs) can extend distance to up to 6,000 feet.

**Optical Fiber Cable** • dual fiber with core/cladding diameter of 62.5/125 microns • transmits Manchester coded digital information at 8.64M bps for distances up to 1 kilometer without degrading signal; has potential for data transmission at much higher rates • connects concentrators to Packet Controller and DEC hosts to concentrator or Packet Controller.

**Wire Cross-Connects** • modular hardware using snap-on patch cords to reconfigure cable connections; located in satellite closets and equipment rooms • provides administration points for wire distribution system.

**Optical Cross-Connect Units (OCUs)** • modular hardware using fiber jumpers to reconfigure fiber cable connections • provides administration point for fiber distribution system.

**Optical Interconnection Units (OIUs)** • modular hardware; provides points for joining optical fiber cables near the Concentrators.

#### ■ SPECIFICATION

AT&T uses its access protocol based on a first-come, first-served algorithm.

#### Packet Format

Transmissions between devices are based on a 180-bit packet, consisting of 18 10-bit characters; 1 control bit, 1 parity bit, and 8 ASCII data bits. Two of the 10-bit characters contain the address of the device sending the packet. The first character is that of the interface module and the second is of the device connected to the module. The Channel Address Translator (CAT) in the Packet Controller maintains a record of all the virtual circuits established by the Control Processor. When a packet is received, the CAT

## AT&T-IS ISN Packet Switched Local Area Network

strips off the source address and replaces it with the destination address from the virtual circuit table. The virtual circuit remains in effect until the Control processor removes it from the virtual circuit cable.

When setting up a virtual circuit, the device initiating a transmission (setting up a call) enters a user-defined control sequence or hits the Break key. After receiving a "Dial" prompt, the user enters the call address. The DCU processor in the Packet Controller notifies the receiver of the sender's intention to call. If receiver is busy, the PCU returns a "Busy" signal to sender. If receiver is idle, the DCU enters a record of the virtual circuit in the virtual circuit table of the switch and sends an "Answered" message to the sender. The sender then transmits its message and the receiving device receives it. At the end of the message exchange, either the sender or receiver can request that the call be disconnected. The DCU then removes the virtual circuit from the switch's virtual circuit table.

The ISN uses short addresses to transmit messages within a node. The user or end-point or mnemonic call address can be up to 16 alphanumeric characters long. A device's end-point address remains the same even if that device is moved to another location in ISM. A physical address on ISN includes 2 digits to identify the packet controller, 2 digits to identify the concentrator, 3 digits to identify the slot module, and 3 digits to identify the port on a module.

The DCU, when setting up the virtual circuit, translates the 10-digit into the 2-digit address in the message packet.

### Transmission Characteristics

**Channel Encoding** • Manchester code.

**Data Rate** • 8.64M bps.

**Carrier** • none.

**Topology** • a hierarchical star with a centralized short bus (5 meters) in the Packet Controllers; Concentrators are center of star cluster of up to 40 asynchronous devices; up to 48 concentrators can connect to a Packet Controller through fiber optic links up to 1 kilometer long.

### Control Procedures

The ISN is organized around a short central bus, which actually consists of 3 buses: Transmit Bus, Receive Bus, and Contention Bus. All modules in the Packet Controller connect to all 3 buses. All modules send data to the switch (Channel Address Translator) over the Transmit Bus and receive data from the switch over the Receive Bus. The Contention Bus determines which module gains

access to the Transmit Bus, thus to the switch, see **Figure 6**.

The Contention Bus is synchronized with the Transmit Bus. The Contention Bus carries the 18-bit contention code of the module granted access to the Transmit Bus for the next time slot to transmit a data packet.

Packets of data transmitted over the Transmit Bus are 180 bits long, 18 units (envelopes), 10 bits each. Data rate on the Contention bus is 864K bps, one-tenth that of the data rate of the Transmit Bus. The packet size on the Contention Bus is also one-tenth that of the Transmit Bus (18 bits versus 180 bits), thus the time it takes to pass a packet over either bus is the same, 48 milliseconds, see **Figure 7**.

The current contention scheme is based on a first-come, first-served basis except when 2 modules with the same priority seek access simultaneously. Then, the one with the higher address gains access.

The contention code consists of a 9-bit priority number (most significant bits) and a 9-bit module address (least significant bits). Currently, a module's priority is zero when it first seeks access to the Transmit Bus. (AT&T-IS intends to allow the Network Manager to set priorities in future releases of ISN.) If it loses access to the bus to a module with a higher priority or with the same priority but a higher address, its priority is increased by 1. Each time the module is denied bus access, a "round robin" algorithm increases its priority until it does gain bus access and transmits its data.

**Figure 8** illustrates the ISN contention scheme. Each module seeking Transmit Bus Access transmits its contention code onto the Contention Bus. (The resultant code on the bus is essentially an OR function of all the bits transmitted). Simultaneously, each module compares the code on the bus with its own code. When a module perceives that the bus code is larger than its own, it realizes it has been outbid and stops transmitting, increases its priority by one, and waits for the next bus time slot. The final or winning contention code for the next Transmit Bus time slot contains the priority and address of the winning module. That module then places its packet of data on the Transmit Bus during the next time slot.

### Transmission Medium

ISN uses both copper wire and fiber optic cable. Devices connect to Asynchronous Interface Modules (AIMs) in Packet Controller or Concentrator through twisted pairs. Hosts connect to concentrators or the Packet Controller and concentrators connect to Packet Controller through optical fiber cable. When internet-

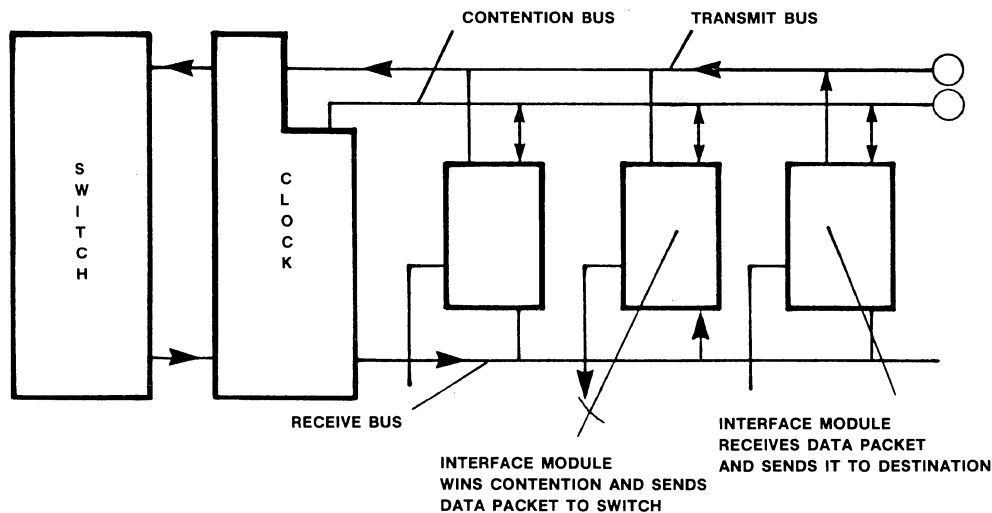

**Figure 6** • ISN bus design.



## AT&T-IS ISN Packet Switched Local Area Network

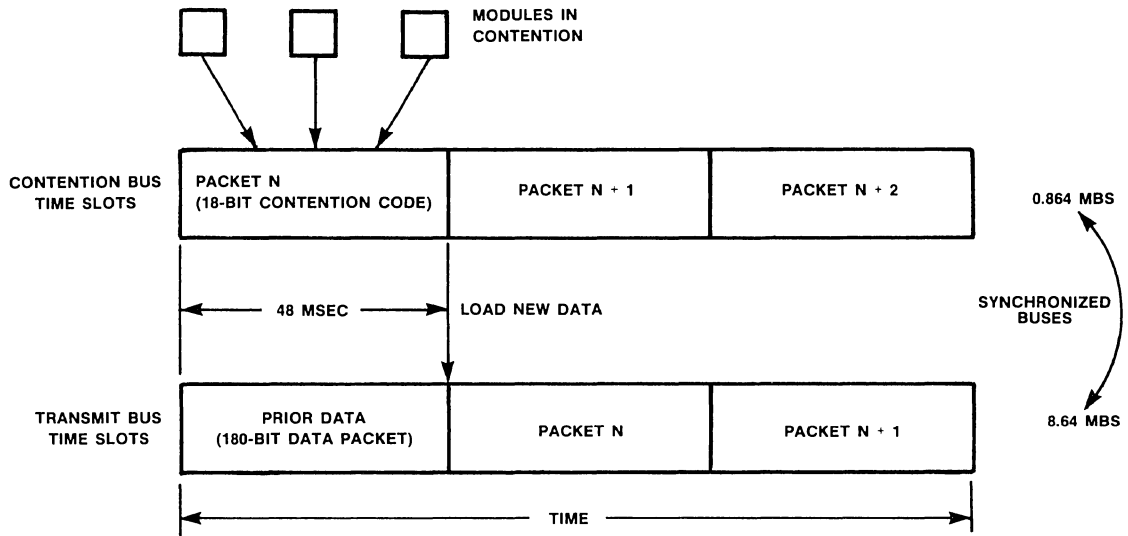

Figure 7 • ISN bus time slots.

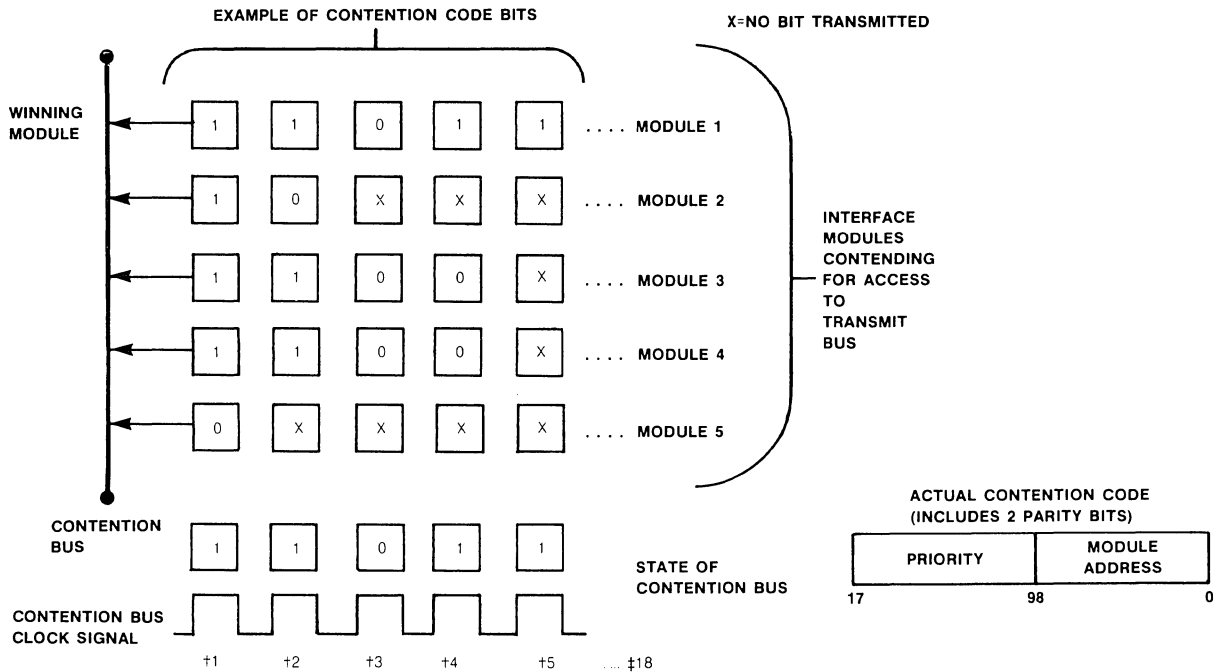

Figure 8 • example of ISN contention scheme.

working becomes available, Packet controllers will interconnect using fiber optic cable.

**Use**

ISN is a major product for AT&T to gain a share of the Local Area Network Market. It is a product for office automation and distributed processing environments. One Beta test site was at

Johns Hopkins University, connecting 10 university sites together with using fiber optic cable. This ISN was installed with an AT&T-IS System 85 so the wiring for both systems was installed at the same time.

• END



# AT&T-IS Net 1000 Service

## Intelligent Data Network

### ■ PROFILE

**Function** • intelligent data communication network services.

**Facilities** • interstate common carrier packet organized links connecting processing nodes • access via local common carrier to nationally distributed service points.

**Services** • data/message voice-prompted touch-tone data entry • error detection/correction, protocol/speed/code conversion, alternate routing, customer program execution and data storage facilities, interactive/noninteractive communications processing.

**Access** • public and dedicated dial-up to 4800 bps; private lines to 9600 bps • 25 service points in major metropolitan centers; additional service points added as needed • access to service points via local common carrier facilities • 21 Access Points plus nationwide 800 dial up service.

**First Available** • end of third quarter 1983.

**Number of Users** • not available.

**Comparable Services** • IBM Information Network; Telenet value-added packet-switched services; Tymnet value-added packet-switched services; Uninet value-added packet-switched services.

**Vendor** • AT&T Information Systems; 100 Southgate Parkway, Morristown, NJ 07960 • 201-898-2000.

### ■ ANALYSIS

Net 1000 is an atypical value added network (VAN). It is designed to be a total solution to users' distributed processing and communication needs. AT&T-IS defines Net 1000 as a shared, distributed, customer-programmable, nationwide data communication network, and claims that it is an integral part of an overall systems architecture in the AT&T-IS product family. Net 1000 supports bidirectional full-duplex interactive communication between incompatible end-point devices. It also supports communication between devices and programs within the network and between programs within the network, and it provides a store and forward message service for the distribution of messages, or transport or distribution of large files. But its storage and processing facilities distinguish it from conventional VANs such as Tymnet, Telenet, and Uninet. Net 1000 users can store data and/or application programs throughout the network and process entered data via their own stored application programs, those provided by AT&T-IS, or a third party. AT&T-IS protects Net 1000 users from unauthorized access of stored data and programs through a security scheme that screens all requests for access to programs and files.

Net 1000 has been under development for a decade, initially as the Bell Data Network using star topology (1975), which was scrapped and replaced by nodal topology in 1978 and called Advanced Communications Service (ACS). It was the initial offering of AT&T's unregulated subsidiary American Bell in 1982 which introduced it as Net 1000. Now over 2 years since its introduction, Net 1000 is still in development and its customers are few.

The network was a tremendous undertaking, especially in software development. It is estimated that AT&T has spent upwards of \$500 million in development costs and has received little in return on its investment. Though its architecture is long established, Net 1000 is an infant as compared with GTE Telenet and Tymnet, both giants in value added networks (VANs).

Vital to Net 1000's survival is its rapid expansion of network access points and processing modes, and accelerated development of application software. Currently, Net 1000

### Net 1000 Network Minimum Usage Costs

**Configuration** • 2 customer sites located within local telephone exchange areas of Net 1000 service points in continental U.S. • public dial-up ports • devices operate at 1200 bps • 80-hour-per-month total connect time to network • 4,000 128-character packet traffic load • Call Service • excludes processing and network storage costs for which estimating algorithms are not available at this time • also excludes costs associated with basic or message unit charges of local telephone company for dial-up link; user terminal equipment; and user-site modem or ACU.

**Minimum Start-Up Costs** • \$2.00 total • consists of basic charges associated with establishing 2 Network Standard Addresses (NSA).

**Minimum Monthly Operating Costs** • \$344.00 per month total • consists of \$1.00 per month for billing identity; \$336 per month for use of a public dial-up port interface; and \$7.00 per month for traffic of 4 kilopackets.

provides 12 processing nodes, 21 Access Points, and 25 Service Points. AT&T-IS has committed itself to 200 Access Points by early 1985. Tymnet alone has over 1,500 nodes, local access in at least 500 cities; and supports a daily traffic average of 400,000 sessions.

There has been an acute lack of application software for the network, which with the Access Point limitation, has discouraged prospective customers. AT&T-IS originally expected Net 1000 customers to develop their own application software. But it has since learned that users want available software; they do not want the added cost, time, and effort associated with producing their own. So AT&T-IS has reestablished its objectives and is actively producing applications. It has also commissioned several software firms to produce application software. The first of these is AGS Computers, Inc, which has developed customized software to make Dow Jones News/Retrieval available to Net 1000 users. According to an AT&T-IS spokesman, the company is developing applications for production, distribution, and delivery environments. It is taking a vertical market approach to software development, and has targeted the financial and other deregulated industries. The first of these packages is a mortgage service application which provides originators and brokers with immediate information on current mortgage rates and quotes for their borrowers, prequalifies them, and sends in loan applications for approval. A second package, AT&T Interchange Services, supports host-to-host and terminal-to-host electronic data exchange. It allows users to send or receive large volumes of purchase orders, invoices, freight bills, and other documents through the network. In consistency with its vertical market approach, AT&T-IS is also pursuing the use of joint ventures and/or cooperative marketing arrangements with companies that understand the applications but need Net 1000 technology.

Customer programmability is one of the key features (originally considered as an advantage) that distinguishes Net 1000 from other value added networks. Customers may develop their own applications using COBOL with assistance available from AT&T-IS. One of these customers, an AT&T-IS beta test site, is Norwest Mortgage, the nation's second largest mortgage company. AT&T-IS has assisted Norwest in the development of mortgage applications for its in-house network, Nornet.

Another Net 1000 customer, Ford Motor Company, has been

## AT&T-IS Net 1000 Service

### Intelligent Data Network

evaluating Net 1000 at its beta test site using the AT&T-IS Data Locator application program. The program locates out-of-stock parts for Ford's dealers. After a 6-month beta test, Ford terminated the evaluation with the decision not to subscribe to Net 1000. The apparent reason for Ford's decision was that Net 1000 did not have an adequate number of nodes to satisfy Ford's needs. The loss of Ford was a painful blow to AT&T-IS, which considered it one of its "hub" clients that would create "spokes" to other clients.

Information security is another threat to the survival of Net 1000. DP managers are reluctant to relinquish control of the corporate database, allowing it to reside in a public data network. Fortune 500 corporations are actively developing their own private networks to satisfy corporate communication needs that emphasize security.

Despite AT&T-IS' enthusiasm for Net 1000 and its continuation of network expansion and application development, industry pundits as well as many analysts believe the demise of Net 1000 is inevitable. The service represents a gigantic loss for AT&T, which it cannot allow to continue. But according to an AT&T-IS spokesman, Net 1000 will not be abandoned. According to the spokesman, Net 1000 has a considerable advantage over conventional VANs because it offers a "total communications and processing solution."

#### Strengths

Unlike other value added networks, Net 1000 offers users a total solution to their communication and processing needs. User information can be stored throughout the network, retrieved at demand, and processed under the direction of user-entered programs or AT&T-IS-provided programs residing in the network. Users can tailor programs to suit their needs. Users can intercommunicate between incompatible devices located at network end points.

Net 1000 is easily accessed through a number of commonly available facilities. The network can be accessed through the public switched telephone network, dedicated or private lines, WATS, MTS, FX channels, or via DDS at rates up to 9600 bps.

Net 1000 also provides store and forward facilities to accommodate message, document and file transmittals. Users can confirm transmittals and establish priorities.

Net 1000 protects users against unauthorized access of user information and/or programs through 3 or 4 levels of customer identification. Additional protection is available at the user's option through passwords.

Net 1000 also offers the customer's network administrator the means to control and administer the network. Should the network administrator encounter problems or need help or information, an AT&T-IS telecommunication consultant is available in addition to the availability of a complete operations center to diagnose trouble and aid network managers in need of support.

#### Limitations

Net 1000 suffers from a severe lack of application software and a limited number of processing nodes and Access/Service points. The Access Point/Service Point limitation is a severe bottleneck that restricts network usage to a few users at a time, with other users contending for network access. Also, users who are geographically remote from Access/Service Points must pay extra usage charges for the service they use to connect into the Net 1000 network; e.g., public telephone network, leased lines, etc. This could be a substantial extra monthly charge depending on usage and distance from Access/Service points.

Besides the Access/Service Point limitation, Net 1000 still does not support terminals and hosts operating in the IBM SNA/SDLC environment, which means there are a large number of users operating in this environment who cannot use Net 1000. AT&T-IS has promised support for IBM SNA/SDLC once beta testing was completed, but so far there is no assurance that this support will be provided. AT&T-IS has committed itself to expanding the network and claims it will have 200 Access Points by early 1985. It is also actively developing application software for vertical markets, and it has also commissioned software firms to develop applications. Although AT&T-IS is acutely aware of these Net

1000 limitations and is making a strong attempt to eliminate them, the long-term viability of Net 1000 is uncertain. Large and well established VANs such as GTE Telenet, Tymnet, and Uninet, have long ago achieved market penetration and virtually dominate the public data network market. What's more, large Fortune 500 companies are actively building their own private networks prompted by the divestiture of the BOCs. Even though AT&T is an industry giant with the resources to capture market share, it is bucking the tide with Net 1000; and even if it is successful in eliminating Net 1000's acute limitations, it is dubious whether Net 1000 will ever gain substantial market penetration to make it a strong contender.

#### NETWORK

##### Terms & Conditions

**Billing Criteria** • customers pay for Net 1000 services based on a variety of factors associated with access arrangements, traffic volume and priority, processing, and data storage • as with most interstate offerings, billing can get quite complex; perhaps even more so in the case of Net 1000 because user-supplied COBOL software may be resident in the network • low-volume users would typically access Net 1000 via public dial port interfaces • medium-volume users would typically access Net 1000 via dedicated dial port interfaces or via private line analog or digital port interfaces • high-volume users would typically access Net 1000 via multiple private line analog or digital port interfaces.

**Billing Conditions** • user arranges for local common carrier connection to the service point; all charges for this connection billed separately by local common carrier • customer obtains compatible modem and/or digital interface equipment for his premises • services involving user programming and applications on Net 1000 invariably incur processing and data storage charges.

**Other Conditions** • Net 1000 assumes responsibility for all network facilities up to and including the interface port at the service point.

##### Overview

An initial perusal of AT&T Information Systems' first enhanced service offering might suggest that it is simply another conventional packet switching network. Further probing, however, quickly dispels that notion and Net 1000 emerges as a system of much wider scope. Net 1000 is an intelligent network; its specifications certainly support this appellation. Besides having a data transmission capability which can support the far-flung elements of a corporate empire, Net 1000 offers many other appealing features. Hitherto incompatible terminals are able to talk to each other; intercompany data communication can become a practical reality. Advanced concepts involving customer-generated application software and data files resident at network nodes imply that AT&T has set its sights on the burgeoning intelligent network market. And the network management thrust of this new service may prove attractive to large organizations increasingly encumbered and disenchanting with the administrative/cost woes implicit in private networks.

Net 1000 is an enhanced packet-switched network. High throughput nodal processors are connected by 56K-bps channels routed over the Accunet Packet Service, formerly called Basic Packet Switching Service (BPSS). Within the network, the nodal processors use the X.25 protocol (finalized in 1980 by the CCITT) as the standard transmission control procedure. X.25 contains an error-checking system that ensures that the message sent by one node is identical to the one received by the adjacent node. The network is designed to be self-monitoring to minimize customer involvement in trouble reporting. According to AT&T, major network components will be duplicated to minimize system malfunctions.

Although the chosen equipment complement may change as the network evolves, current nodal hardware includes a DEC VAX-11/780 running on VMS to handle code processing, database assignments, and call routing. IBM Series/1 computers are utilized for protocol conversion and customer terminal interfacing.

## AT&T-IS Net 1000 Service Intelligent Data Network

Customers, using the facilities of a local common carrier, access Net 1000 through port interfaces at nationally distributed access points which currently number 21. By year end, 1984 or early 1985, there will be approximately 200 access points. Contingent on network design economics, a service point may, or may not, be a network node. The port interfaces are available in a variety of types and speeds; up to 9600 bps for private line analog and digital ports, and up to 4800 bps for dedicated and public dial ports.

Net 1000 supports an array of terminal and host interfaces. These interfaces include: asynchronous contention (AT&T Teletype 5420); synchronous contention (IBM 2780/3780/3275), and synchronous polled (IBM 3271, 3274 BSC, and 3276 BSC). Host plug-compatible interfaces include asynchronous contention, synchronous contention (IBM 2780/3780), and host synchronous polled (IBM 3271 BSC). Within the network, Common Mode operation provides compatibility between unlike devices by defining least common denominator formats TTY amenable to both endpoints. The Class-Specific Mode provides for transmission of data which supports the standard features of defined terminal stations. Net 1000 also offers a Transparent Mode of operation which does not translate data. Interrupt and disconnect are the only format features supported in this mode. Two forms of data transmission service are available on Net 1000; a Call Service provides for 2-way, session-oriented (inquiry/response) transmission; a 1-way Message Service provides 3 grades of transmission (priority, standard, and delayed) and 2 delivery options (delivery confirmation and earliest delivery time). Although it is probably not a major customer cost factor, traffic volume is a component in the continental U.S. pricing structure for the Call and Message Services.

As alluded to earlier, Net 1000 is much more than just a packet-switching system. It is a shared, expandable, user-programmable, and user-controlled data communication network. Besides providing communication interchange between previously incompatible terminals and host computers, Net 1000 can, for example, be used in distributed communications processing systems to perform the preprocessing and postprocessing tasks inherent in many business applications. Users may store and execute COBOL application programs, and their attendant data files, a feature which suggests an imminent Net 1000 foray into the distributed processing, database inquiry, front-end processing, and network management fields.

Users customize their own network applications at a "customization environment," a special service point (on AT&T premises) where—with AT&T assistance—users can install applications programs anywhere on the Net 1000 network; i.e., users instruct the network where application programs will reside, and the code is downline loaded to the appropriate node(s) and/or site(s). This environment provides facilities for code creation, editing, compilation, and linking. Various debugging tools are also available, including a program trace that prints out a program during execution; and a symbolic memory dump that names the values of various program variables. In addition, an initial software package—UTS/TSO—is available that executes on IBM's TSO teleprocessing monitor. User testing of Net 1000-resident programs can be accomplished using host facilities linked to Net 1000; an off-network customization environment is planned by AT&T for future implementation.

Two languages are provided for customer programming. The first is a subset of ANSI X3.23-1974 COBOL equipped with enhancements to facilitate its use in the network processing environment. The second language is used for forms definition to specify form/screen terminal formats. In Net 1000, privacy is protected by authorization screening within the system software. The screening procedures determine the rights of a program to cause another program to execute. The screening system also determines the access rights an application program has regarding a data file. The Net 1000 customer programming language can be used by customers to obtain additional integrity and security.

### □ Traffic Charges

Net 1000 charges are based on traffic volume forwarded over the network, type of service, and customer-specified transmission

priorities and delivery options in addition to charges for a service point port interface, computer resources used, program storage, and data storage facilities allocated. Network Standard Address (NSA) is an identity assigned by Net 1000 to customer components including terminals, hosts, and application program load modules. Non-Recurring Charge (NRC) is a one-time fee levied for the automatic dialing feature and for a port interface. An AIS Resource Unit (ARU) is a billing measure of Net 1000 computer processing used by the customer.

### Call Service

The Net 1000 Call Service provides 2-way, session-oriented, inquiry/response transmission. Charges are assessed per 1,000 packets of 128 characters each; charge per kilopacket:

**\$1.75 Kp**

### Message Service

Message Service provides 3 grades of 1-way transmission via the store and forward facility of Net 1000: Priority Service messages are moved before Standard Service messages; Standard Service messages are moved before Deferred Service messages. Customer can select from 2 delivery options; with Confirmed Delivery, a confirmation response is sent back over the network to the message originator; the Timed Delivery option guarantees that the message will arrive at a specific date and time. The NSA charge is levied against each NSA recipient of a message.

**Priority Service Messages • charge per 100,000 characters plus NSA:**

**\$1.25      \$0.05 NSA**

**Standard Service Messages • charge per 100,000 characters plus NSA:**

**1.15      0.01**

**Deferred Service Messages • charge per 100,000 characters plus NSA:**

**0.75      0.01**

### Confirmed Delivery Option:

Priority:

**0.15**

Standard/Deferred:

**0.02**

### □ Access Charges

Net 1000 access charges are imposed in the form of interface port charges at the service point in addition to traffic volume charges (see previous section). User must obtain site modems and/or digital interfaces and arrange for connection to the service point via a local common carrier. Dial ports may require automatic dialing. For private port interfaces, the monthly NSA charge is levied against every NSA (drop) on the private line.

### Billing Identifier

A Net 1000 customer accounting system which provides a flexible assortment of functions for reporting and billing of Net 1000 users; minimum function charge:

**\$1 BID mo**

### Remote Dial Network Access

Additional To Port Charge:

**\$0.33 min**

*NSA: Network Standard Address charge. NRC: Non-Recurring Charge. BID: Billing Identifier customer accounting charge. ARU: Application Resource Unit processing charge. MO: monthly charge. MIN: charge per minute. HR: hourly charge. KP: charge per 1,000 128-character packets. Prices are current as of December 1984.*

## AT&T-IS Net 1000 Service

### Intelligent Data Network

**Port Interfaces-Terminal**

**Public Dial Ports**

Data Rates to 1200 bps • async:	\$0.07 min
Data Rates to 2400 bps • sync (BSC 3275)	0.25

**Automatic Dialing Option**

A dial port function which translates network standard addresses into equivalent telephone numbers and establishes the line connection:

	\$75 mo	\$150 NRC
--	---------	-----------

**Dedicated Dial Ports**

Data Rates to 1200 bps • async:	\$275 mo	\$450 NRC
Data Rates to 1200 bps • sync (BSC 3275):	525	450
Data Rates to 2400 bps • sync (BSC 3275):	525	450
Data Rates to 4800 bps • sync (BSC 3275):	600	450

**Private Line Analog Ports**

Port charge is sum of monthly charge plus NSA monthly charge plus one-time NRC.

Data Rates to 1200 bps • async:	\$275 mo	\$10 NSA mo	\$450 NRC
Data Rates to 2400 bps • sync (BSC 3270):	525	10	450
Data Rates to 4800 bps • sync (BSC 3270):	600	10	450
Data Rates to 9600 bps • sync (BSC 3270):	800	10	450

**Private Line Digital Ports**

Port charge is sum of monthly charge plus NSA monthly charge plus one-time NRC.

Data Rates to 2400 bps • sync (BSC 3270):	\$450 mo	\$10 NSA mo	\$300 NRC
Data Rates to 4800 bps • sync (BSC 3270):	550	10	300
Data Rates to 9600 bps • sync (BSC 3270):	700	10	300

**Port Interfaces-Host & Remote Job Entry Terminal**

**Public Dial Ports**

Data Rates to 4800 bps • sync (BSC 3780):	\$0.29 min
-------------------------------------------	------------

**Dedicated Dial Ports**

Data Rates to 1200 bps • async:	\$350 mo	\$600 NRC
Data Rates to 1200 bps • sync:	450	600
Data Rates to 2400 bps • sync (BSC 3780):	675	600
Data Rates to 4800 bps • sync (BSC 3780):	775	150

**Private Line Analog Ports**

Port charge is sum of monthly charge plus NSA monthly charge plus one-time NRC.

Data Rates to 1200 bps • async:	\$350 mo	\$10 NSA mo	\$600 NRC
Data Rates to 2400 bps • sync (BSC 3270/3780):	675	10	600
Data Rates to 4800 bps • sync (BSC 3270/3780):	775	10	600
Data Rates to 9600 bps • sync (BSC 3270/3780):	1,000	10	600

**Private Line Digital Ports**

Port charge is sum of monthly charge plus NSA monthly charge plus one-time NRC.

Data Rates to 2400 bps • sync (BSC 3270/3780):	\$575 mo	\$10 NSA mo	\$400 NRC
Data Rates to 4800 bps • sync (BSC 3270/3780):	700	10	400
Data Rates to 9600 bps • sync (BSC 3270/3780):	800/900	10	400

**Automatic Dialing Option**

A dial port function which translates network standard addresses into equivalent telephone numbers and establishes the line connection.

Port Interfaces Terminal:	\$75 mo	\$150 NRC
Host & Remote Job Entry:	100	150

**Processing Charges**

Interactive processing on Net 1000 is a high-priority foreground form of computer processing. Noninteractive processing refers to low-priority background computer processing.

Interactive Processing:	\$0.02 ARU
Noninteractive/Customization Processing:	0.005

**Storage Charges**

Charges are levied for 2 forms of storage used by the customer: program storage is always reserved storage and is used exclusively to store application program executable load modules (ELMs); data storage is either reserved or demand storage, required for execution of application programs and storage of data and information files. Demand storage is also available as timed delivery.

Reserved Program Storage • charge per 100 kilobytes per month:	\$20 mo
Reserved Data Storage • charge per 100 kilobytes per month:	10
Demand Storage • charge per 50 kilobytes per hour:	0.50 hr
Timed Delivery Demand Storage • charge per 1,000 characters per hour per service point:	0.01

**Program NSA Reservation**

Charge for Network Standard Address (NSA) assigned to each customer application program (load module):

	\$1.00 NSA mo
--	---------------

# AT&T-IS Net 1000 Service

## Intelligent Data Network

### □ Account Team Support Service Charges

Hourly charge for the services of Net 1000 Account Team specialists typically in the areas of functional design, physical design, implementation planning, customized programming, and program debugging:

\$125.00 hr

### User-Site Interface Equipment

Net 1000 will support various user-site modems and digital interfaces, terminal interfaces, and host interfaces as defined in this section or their compatible equivalents.

**Modems & Digital Interfaces** • modems and digital interfaces listed and supported by Net 1000 are supplied by AT&T; compatible equivalents are acceptable • 103JR, 113CR, 113DR, 113AR • 212AR-L1A • 201CR • 208BR • 108F • 202T • 201C-L1D • 208A-L1B • 500A and B DSU (2.4, 4.8, 9.6) • 801CR-L1 • 2024A, 2048A, 2048C, 2096A (no external channels, no multiplexing) • 2096A (multiplexing) • external channels using 2024A or 2048A • see also Survey Report 731-01 on Modems.

**Terminal Interfaces** • Net 1000 supports terminal interfaces listed or their compatible equivalents • asynchronous contention (AT&T Teletype Model 5420) • synchronous contention (IBM 2780/3780 and IBM 3275) • terminal synchronous polled (IBM 3271/3274 BSC/3276 BSC) • SDLC unsupported.

**Host Interfaces** • Net 1000 supports host interfaces listed or their compatible equivalents • asynchronous contention (ASCII asynchronous host emulation) • synchronous contention (IBM 2780/3780 host emulation) • host synchronous polled (IBM 3271/3274/3276 binary synchronous host emulation) • SNA/SDLC unsupported.

**PBX Interfaces** • Net 1000 includes packages compatible with AT&T's electronic document communications feature available for Dimension System 85 • allows users to take advantage of capabilities of both systems.

### □ Access

**U.S. Locations** • Net 1000 provides access at locations throughout the country • dial-up access limited to 4800 bps • users at or near these metropolitan access points use local phone service, others may use inward WATS.

Net 1000 Service Points:

**California** • Los Angeles; San Francisco.

**Colorado** • Denver.

**District of Columbia** • Washington.

**Florida** • Orlando.

**Georgia** • Atlanta.

**Idaho** • Des Moines.

**Illinois** • Chicago.

**Massachusetts** • Boston.

**Michigan** • Detroit.

**Minnesota** • Minneapolis.

**Missouri** • Kansas City, St. Louis.

**New Jersey** • Camden, Morristown, Somerset.

**New York** • New York.

**North Carolina** • Greensboro.

**Ohio** • Cleveland.

**Pennsylvania** • Philadelphia; Pittsburgh.

**Texas** • Dallas; Houston.

**Utah** • Salt Lake City.

**Washington** • Seattle.

Net 1000 Access Points:

**Alabama** • Mobile.

**California** • Garden Grove, Oakland, San Bernadino.

**Florida** • Tampa.

**Georgia** • Columbus, Savannah.

**Indiana** • Gary.

**Kentucky** • Bowling Green, Louisville.

**Maine** • Portland.

**Massachusetts** • Lowell.

**New Jersey** • Trenton.

**Ohio** • Cincinnati.

**Pennsylvania** • Allentown.

**Rhode Island** • Providence.

**Tennessee** • Nashville.

**Texas** • Fort Worth, Galveston.

**West Virginia** • Huntington.

**Wisconsin** Green Bay.

Net 1000 Nodes:

**California** • Los Angeles.

**Illinois** • Chicago.

**New Jersey** • Camden.

**New York** • New York.

**Utah** • Salt Lake City.

### □ Other Network Services

#### Standard Application Software

The following software packages are available to the user at no extra charge except for related storage and processing costs.

**Standard Logon Application (LAP)** • logon functions for public dial-in ports and optionally any dedicated ports • provides layer of authorization for individual users • establishes billing entry once logon completed.

**Standard Customer Control Package (SCCP)** • permits users to manage their Net 1000 resources through defined (authorized) control terminals • user execution of control commands to initialize, monitor, maintain, and change network resource utilization • unsolicited reports sent to SCCP files for customer examination of their network resources status.

**Standard Hunt Group Package (SHGP)** • routing to 1 of several stations based on call to 1 Net 1000 address for efficient load distribution and "busy" reduction • collects usage statistics.

**Standard Station Parameter Handling Package (SPHP)** • terminal operator can display and set station parameters • automatic negotiation of station parameters between call end points.

**Standard Software Support Package (SSSP)** • provides customer programmers with interface to application program development environment of Net 1000.

**On-Line Documentation** • retrieves data stored in Net 1000 for terminal operator assistance.

**Net 1000 Editor** • creates and updates files • creates and modifies text/correspondence (word processing) • accessed through MAP or SCCP.

**Net 1000 Command Language** • high-level language used to exercise functional capabilities of Standard Application Packages.

**Format Translator** • drives asynchronous terminal devices and permits them to access IBM 3270 host programs.

#### Network Management

Net 1000 is a self-monitoring network equipped with duplicate or standby major equipment components and a high degree of

## AT&T-IS Net 1000 Service Intelligent Data Network

---

automated trouble detection and isolation to minimize customer trouble reporting. A Customer Network Manager (CNM) serves as the single point of contact for customer trouble reporting. The CNM is responsible for having trouble report verified, isolated, and referred to appropriate Net 1000 repair force. Through use of

customer control facilities (e.g., SCCP) customer can define and control own private subnetwork management and authorization.

---

• **END**



# AT&T-IS Dataspeed 4400 Series Display Terminals

## Models 4410 & 4425

### ■ PROFILE

**Function** • general-purpose nonprogrammable interactive keyboard-display terminals.

**Architectures Supported** • any architecture supporting asynchronous ASCII protocol.

**Communications** • half-/full-duplex, asynchronous, 300- to 19.2K-bps, point-to-point character (both models) and block (4425) mode transmission • RS-232C or 20-/60-mA loop interfaces.

**Operating System** • none.

**Database Management** • none; only in association with host facilities.

**Transaction Processing Management** • none; only in association with host facilities.

**Support Software** • none; only in association with host facilities.

**Processor** • display-oriented control and communication logic • host-initiated print operation on Model 4410; local/remote print operation on Model 4425.

**Terminals/Workstations** • single keyboard 1920-/3168-character display • auxiliary printer port for local printer attachment.

**First Delivery** • 1983 (4410), 1984 (4425).

**Systems Delivered** • unknown.

**Comparable Systems** • competitive with a number of general-purpose ASCII display terminals; most notable are ADDS Regent, Lear Siegler ADM, Beehive DM, IBM 3101, DEC VT100, TeleVideo 900 Series, AJ 510/520.

**Vendor** • AT&T Information Systems (subsidiary of AT&T); 100 Southgate Parkway, P.O. Box 1955, Morristown, NJ 07960 • 201-898-8000.

**Canadian Distribution** • AT&T Canada, Inc; 1500 Don Mills Road, Suite 500, Don Mills, ON M3B 3K4 • 416-449-4300.

**Distribution** • nationwide through AT&T Information Systems sales offices.

**GSA Schedule** • listed.

### ■ ANALYSIS

Within recent months, AT&T Teletype Corporation has become a wholly owned subsidiary of the Computer Systems Division of AT&T Information Systems. As a result of the acquisition, all

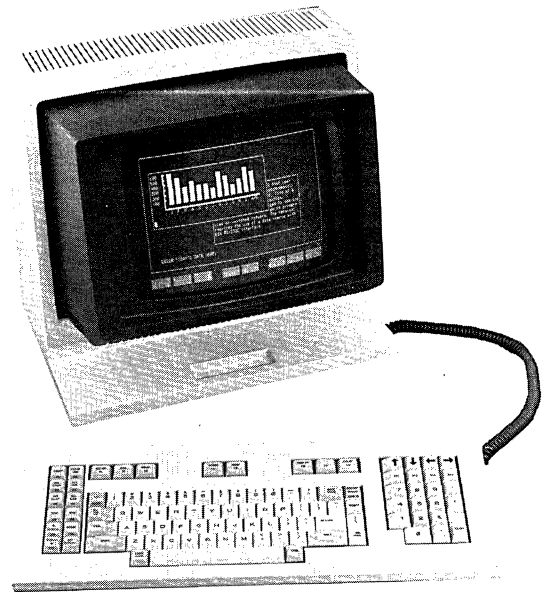

Dataspeed Model 4425 is a buffered display terminal with standard 24x80/132 display format, 38 downloadable function keys, and multiwindowing capability.

Teletype sales and marketing operations are being relocated to AT&T-IS headquarters in Morristown, New Jersey. Teletype Corporation, based in Skokie, Illinois, will remain the manufacturing arm for the production of AT&T-IS Dataspeed general-purpose and 3270-compatible terminals. Therefore, the AT&T Teletype 5400 Series of display terminals will now be marketed under the AT&T-IS Dataspeed 4400 Series designation. The older Teletype 4400 Series (formerly AT&T-IS Dataspeed Models 4420 and 4430) have been withdrawn from manufacturing. The revised Dataspeed 4400 Series is now composed of general-purpose Models 4410 (formerly Teletype 5410) and 4425 (replacement product for Teletype 5420).

The Dataspeed Model 4425 has joined the product lineup over the past year as an enhanced version of the AT&T-IS Dataspeed 4415 terminal. A buffered display terminal, the 4425 builds upon the capabilities included on the older 4415 with the addition of full-screen windowing, DEC VT102 compatibility, 38 downloadable function keys, and an alternate DEC VT52 keypad and cursor key modes. Full-screen windowing allows the user to view the 9600-character buffer with a maximum window size of 3168 characters. Also, 2 additional windows can be opened and can vary both in length and width. When full-screen windowing is not employed, the screen can be divided into 4 independent windows.

In addition to its windowing capabilities, the 4425 terminal supports a 78-line display memory with 80 characters per line, or a 54-line display memory with 132 characters per line. Eight user-programmable function keys and 8 host-defined

### PURCHASE PRICE RANGE

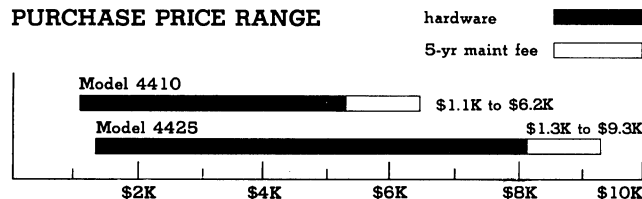

AT&T-IS DATASPEED 4400 SERIES PURCHASE PRICING bar graphs cover price ranges between "small" and "large" configurations for hardware (solid bar) and associated 5-year maintenance (open bar) • **SMALL 4410** consists of standard keyboard display unit; **LARGE** configuration adds optional integral modem/dialer and an 80-column printer • **SMALL 4425** consists of standard keyboard display unit; **LARGE** configuration adds optional integral modem/dialer and a 132-column friction-feed line printer.

## AT&T-IS Dataspeed 4400 Series Display Terminals Models 4410 & 4425

programmable function keys are offered with each function key capable of holding 80 characters. Also, an additional 11 shiftable keys are available, each of which can be downloaded with 2 sequences of up to 16 characters. Other features include character, line, block, and page modes; plain-language set-up menu; and optional integral modem/dialer.

The Dataspeed 4410 is a low-priced, character-mode terminal designed for applications that require extensive interaction with the host such as software development, timesharing, inquiry/response, and database entry. Among its attributes are user-selectable 80- or 132-column screen formats, 8 user- or host-programmable function keys, line graphics, line speeds up to 19.2K bps, and an optional integral AT&T 212A-compatible modem.

At the present moment, a new 4418 3270-replacement terminal is waiting in the wings pending a formal announcement from AT&T-IS. Designed to operate in conjunction with a protocol converter or an AT&T 3B computer system, the 4418 is essentially an asynchronous terminal with a synchronous 3278-style keyboard. The 4418 incorporates an assortment of 4400 Series features including 24x80/132 screen format, plain-language set-up menu, and optional integral modem/dialer. Targeted at 3270 environments, the 4418's 3278 keyboard represents a beneficial addition and reduces the overhead and turnaround time often associated with the keyboard mapping overlays included with most protocol converters.

In the general marketplace, the 4420/4430 Series will compete against the likes of the IBM 3101 or the very popular DEC VT100 display terminal. For the most part, Teletype displays should certainly more than hold their own technically. But when price is considered, they come at a premium. Both models are higher priced than conventional display terminals offered by other vendors.

### □ Strengths

Ease of use and operating flexibility emerge as the foremost advantages of the Dataspeed 4400 Series. Ergonomic design considerations have remained a top vendor priority represented by standard tilt/swivel displays; low-profile, DIN standard, detachable keyboards; a CRT Saver feature that prevents image burn-in on unattended terminals; and a choice of amber or green phosphors. To facilitate operational ease of use, 4400 Series terminals employ a plain-language set-up menu for establishing operating parameters.

An array of standard features that are often extra-cost options on competitive systems provide users with additional benefits. For instance, the standard 80-/132-column line display feature offers users a selectable display format. Users can choose between 80- and 132-column screen formats for spreadsheet applications as well as for displaying 132-column information as it is printed.

Aside from a 132-column line, the 4425 terminal offers up to 3 pages of storage that allow the user to build multiple screens of data and store them locally. In addition to enhancing operational flexibility, local storage cuts communication costs by eliminating the need to store and retrieve such data at the host. The stored pages can be either 80 or 132 columns wide. While a variety of AT&T-IS competitors provide a multipage local storage facility, the majority do not support the storage of 132-column pages. Furthermore, the 4425 can display 1 full-screen 132-column window or up to 4 independent windows of information, which can be overlapped. Window parameters are user-selectable. Split-screen operation, another 4410 and 4425 advantage, is suitable for applications that require a fixed heading and scrollable text, or 2 fixed and independent screen segments.

Further advantages can be derived from the utilization of the 26th and 27th display lines for depicting programmable function key labels. This feature eliminates the need for various templates that explain the programmable functions and will attract users with frequently changing application requirements.

Other benefits include an optional 212-compatible integral modem for both models, line drawing and selectable character sets, and selectable isochronous transmission on the 4425 for supporting the use of synchronous modems.

The final strong point of the 4425 is the bidirectional auxiliary printer port. This port allows the host to directly transmit data to the printer without interfering with terminal activity. Users can also continue to enter data from the keyboard while the received data is printed.

Other benefits include an optional 212-compatible integral modem for the 4410 and 4425, a choice of amber, green, or white on black screens for the 4410 and 4425, line drawing graphics and selectable character sets for the 4410 and 4425, and selectable isochronous transmission for the 4425 to allow the use of synchronous modems.

### □ Limitations

The 4410 is strictly an asynchronous interactive conversation terminal limited to character mode transmission in a point-to-point arrangement. It does not support extensive editing nor does it provide printing flexibility.

The 4415 supports text editing, but it does not support formatted data entry. It is limited to a single typewriter-style keyboard and it cannot be used in a multipoint communication environment.

The user should also consider that neither terminal offers smooth scrolling. This feature enables the user to vary the speed at which data is displayed on the screen. Some operators find the "normal" rate too fast to read comfortably, others do not. The user should be encouraged to poll prospective operators in advance to discern which category they fall into before accepting or rejecting these terminals.

At the present time, the AT&T-IS 4400 Series of display terminals lacks a color display model. Chief competitors, including DEC and ADDS, have incorporated models with selectable color displays into their product families. Furthermore, AT&T-IS terminals do not support sophisticated graphics. DEC VT200 series terminals, on the other hand, offer full bit-map graphics generation in both Tektronix 4010/4014 and ReGIS protocol mode.

## ■ COMMUNICATIONS FACILITIES OVERVIEW

Both terminals operate as general-purpose half-/full-duplex asynchronous ASCII display units at rates of 300 bps to 19.2K bps. Online operating modes are point-to-point; keyboard-to-line/display; line-to-display; line-to-printer. Model 4425 buffers all incoming printer-bound data. Buffering of 2K to the display, 2K to the printer, and 1K from the line is available on the 4425. Both terminals support echoplexing; Model 4425 provides local echo. Transmission mode is character/line/block/page. An optional integral modem/dialer is available for both models. RS-232C and 20-/60-mA current-loop interfaces are included.

### ■ HARDWARE

#### □ Terms & Support

**Terms** • AT&T-IS offers the Dataspeed terminals for purchase or on a monthly rental or 2-year or 4-year lease basis • AT&T-IS requires that all Dataspeed products be installed by its service personnel, and levies a charge for the service • the typical installation charge for a 4420/4430 keyboard-display is \$80; \$50 for the 4410 and 4415 • discounts are 10 percent (25 to 49 units); 15 percent (50 to 99); 20 percent (100 to 199); and 25 percent (200+).

**Support** • all units are serviced by AT&T-IS field personnel • maintenance contracts are quoted on a yearly basis; prices shown in this report show those figures divided by 12 to indicate monthly maintenance charges.

### ■ OVERVIEW

The Dataspeed 4410 and 4425 are standalone terminals with a 12-inch diagonal monochrome display and detached low-profile keyboard. The keyboard includes a separate numeric cluster and editing keys; all alphanumeric keys are repeatable. The screen displays 24 data lines, a status line, and 2 lines for screen labels. The user or host can initiate the selection of an 80- or 132-column display format. The 4410 contains a single page of display memory while the 4425 offers a 9600-character display memory. The 4410 transmits a character per keystroke; the buffered 4425

## AT&T-IS Dataspeed 4400 Series Display Terminals

### Models 4410 & 4425

can operate in character/line/block/page modes.

Both 4400 Series offerings feature split-screen operation. This capability permits the screen to be divided horizontally for providing a scrollable segment and a static segment or 2 static segments. In addition, the 4425 provides a page mode along with full-screen and multiwindowing capabilities. Page mode allows up to 3 discrete screens of display memory with different programmable function designations and editing for each. Windowing allows the user to divide the 9600-character buffer into as many as 4 segments; segment size is user-specified and windows can be overlapped.

Full-screen windowing allows the user to execute existing software without modification and permits 2 additional windows to be opened. Upwards and downwards destructive scrolling is available on both the 4410 and 4425.

The 4410 and 4425 each contain 8 user-programmable function keys; however, the 4425 offers an additional 8 host-defined programmable function keys. A string of up to 50 (4410) or 80 (4425) characters can be stored per key; PF key character storage is nonvolatile and is retained after power is removed. PF characters can be entered from the keyboard or received from the host. Displayed screen labels identify the function of each PF key and screen labels can be downloaded from the host or entered via the keyboard. In addition, the 4425 supports an additional 11 downloadable function keys (shiftable to 22) for a total of 38 functions.

The 4410 contains an unbuffered serial printer port; however, the 4425 contains a bidirectional buffered (2K) serial printer port. The printer port operates in 3 modes: local print (prints displayed data), log text (prints received data displayed on the screen), and media copy (prints data received directly from the line). Overflow control (DC3/DC1) is provided.

**Model Packages**

**Model 4410 Display Terminal** • keyboard-display terminal with tilt/swivel 12-inch diagonal CRT • displays 1920/3168 characters at 24 lines x 80/132 characters; 25th status line, 26th and 27th keyboard label lines • 7x9 dot matrix with descenders for 80-column format; 5x7 dot matrix with descenders for 132-column format • 128 ASCII characters with 5 character sets including US, UK, line drawing, securities, and mosaic • detachable, low-profile typewriter-style keyboard with separate numeric key cluster; 8 user-programmable function keys • auxiliary RS-232C printer port • half-/full-duplex operation • 300 bps to 19.2K bps operation; character transmission mode • ANSI X3.64 compatible:

\$52/\$70 mo    \$1,145 prch    \$15 maint

Integrated Modem/Dialer • AT&T 212 compatible with firmware Auto-Dial (3 preprogrammed phone numbers) and Auto-Logon features • 300/1200 bps:

35/26                      575                      8

**Model 4425 Buffered Display Terminal** • keyboard-display terminal with tilt/swivel 12-inch diagonal CRT • displays 1920/3168 characters at 24 lines x 80/132 characters; 25th status line; 26th and 27th keyboard label lines • 78-line display (scroll buffer) memory with 80-character-per-line display format, or 54-line display memory with 132-character-per-line display format • 7x9 dot matrix with descenders for 80-column format; 5x7 dot matrix with descenders for 132-column format • 9600-character display memory, 2K-byte send/receive buffer; 2K-byte print buffer; 2K-byte options/label buffer • 128 ASCII characters with 5 character sets including US, UK, line-drawing, securities, and mosaics • detachable, low-profile, typewriter-style keyboard with separate numeric key cluster; 8 user-programmable function keys, 8 host-programmable function keys, 11 downloadable (shiftable to 22) keys • integral answerback and auto-dial • auxiliary RS-232C bidirectional printer port • character/line/page/block mode transmission • DEC VT52/102 and ANSI X3.64 compatible:

NA/NA                      1,265                      NA

**Integrated Modem/Dialer** • AT&T 212-compatible modem with firmware Auto-Dial (5 preprogrammed phone numbers) and

Auto-Logon features • 300-/1200-bps operation:

35/26                      575                      8

**Buffer Memory**

The 4410 is unbuffered. The 4425 contains a 32K-byte RAM and 32K-byte ROM. RAM is divided into 2K buffer segments for print buffer, send/receive line buffers, and options/screen label buffer; 10K bytes for display and the remainder is for data.

**I/O & Communications**

The 4410 and 4425 are both equipped with an RS-232C modem port and RS-232C serial printer port. The terminals operate at half-/full-duplex asynchronous or isochronous (4415 only) rates to 19.2K bps over 7 selectable rates. The 4410 transmits a character per keystroke, while the 4425 transmits in character/line/page/block mode. Both terminals are ANSI 3.64 protocol compatible. In addition, Model 4425 supports DEC VT52/102 compatibility. The 4425 is also equipped with answerback.

**Disk**

No disk/diskette is supported.

**Terminals/Workstations**

**4410 & 4415**

**Configuration** • tabletop keyboard display with detachable keyboard • typewriter-style keyboard with numeric cluster and edit keys • 8 user-programmable function keys available on Model 4410; 8 user-programmable and 8 host-defined function keys offered on Model 4425 in addition to 11 downloadable function keys (shiftable to 22) offered on Model 4425 for a total of 38 functions • swivel-and-tilt display screen.

**Display** • 12-inch diagonal, white/green/amber phosphorous screen • 1920 characters at 24x80 characters; 3168 characters at 24x132 characters; 25th through 27th lines for status (1 line) and screen labels for PF keys • 7x9 dot matrix in 9x13 field (80 characters per line); 5x7 dot matrix in 7x13 field (132 characters per line).

**Edit & Format Features** • auto-repeat keys • cursor up, down, left, right, home up, home down, tab, cursor address read/write, save/recall • 4410 only—cursor wraparound, erase all data, erase to EOL/EOS, and transparent mode • character insert/delete; line insert/delete • split-screen with scrolling and static region or 2 static regions on 4410; destructive scrolling on 4410 • scroll up/down; destructive scrolling; next/previous page on 4425 • full-/half-intensity, reverse video, blink, and underline display attributes • 4425 print functions include print line from cursor up/down, print screen, print online, and print media copy.

**Printers**

AT&T-IS offers both matrix and impact printers for attachment to the 4410/4415/4420/4430. All printers listed below can attach to either terminal.

**3320-102 Belt-Impact Printer** • tabletop 300-lpm full-character belt-impact • 64 or 128 ASCII set • 80 columns • function-feed • horizontal tab • vertical format control:

\$195/\$145 mo    \$3,580 prch    NA maint

**3300-154 Belt-Impact Printer** • same as 300-102 except employs tractor-feed:

175/130                      3,180                      NA

**3300-202 Belt-Impact Printer** • same as 300-154 except provides 132-column format:

225/170                      4,160                      NA

*MO: monthly charge for 4-year/month-to-month lease; includes maintenance. PRCH: purchase price. MAINT: monthly maintenance charge. NA: prices not available. Prices are current as of August 1984. Revised pricing has not been firmly established as of June 1985.*

## AT&T-IS Dataspeed 4400 Series Display Terminals

### Models 4410 & 4425

**3330-204 Belt-Impact Printer** • floor-console 300-lpm full-impact character belt-impact • 64 or 128 ASCII set • 80 or 132 columns • friction or tractor feed • horizontal tab • vertical format control:

<u>380/260</u>	<u>6,475</u>	<u>NA</u>
----------------	--------------	-----------

**3330-201 Matrix Printer** • tabletop 340-cps bidirectional

matrix printer • tractor feed • 7x7 half-space matrix • 5, 10, or 16.7 cpi; 6/8 lpi:

<u>210/160</u>	<u>3,920</u>	<u>NA</u>
----------------	--------------	-----------

• END

# AT&T-IS Dataspeed 4400 Series Display Terminals

## Models 4410, 4415, 4420 & 4430

### ■ PROFILE

**Function** • general-purpose nonprogrammable interactive keyboard-display terminals.

**Architectures Supported** • any architecture supporting asynchronous ASCII protocol.

**Communications** • half-/full-duplex, asynchronous, 50- to 19.2K-bps, point-to-point character (4410 and 4415) and block (4415) mode transmission • half-/full-duplex, asynchronous, 50- to 9600-bps, point-to-point character/block mode transmission • half-/full-duplex, asynchronous, 50- to 4800-bps, multipoint block mode (4430) • RS-232C or 20-/60-mA loop interfaces.

**Operating System** • none.

**Database Management** • none; only in association with host facilities.

**Transaction Processing Management** • none; only in association with host facilities.

**Support Software** • none; only in association with host facilities.

**Processor** • display-oriented control and communications logic • 5760-character (72-line) display memory • 2K display, 2K printer, and 1K-line buffer; 32K I/O and display/print buffer (4430).

**Terminals/Workstations** • single keyboard 1920-/3168-character display with modem and printer ports (4410 and 4415) • single keyboard 1920-character display with dual auxiliary ports for local printers (4420); or for local printer, paper tape, diskette, and slave keyboard-display or keyboard-printer devices (4430).

**First Delivery** • 1980 (4420); 1981 (4430); 1983 (4410 and 4415).

**Systems Delivered** • unknown.

**Comparable Systems** • competitive with a number of general-purpose ASCII display terminals; most notable are ADDS Regent, Lear Siegler ADM, Beehive DM, IBM 3101, DEC VT100, Televideo 900 Series, AJ 510/520, and AT&T Teletype 4420/4430.

**Vendor** • AT&T Information Systems (Subsidiary of AT&T); 100

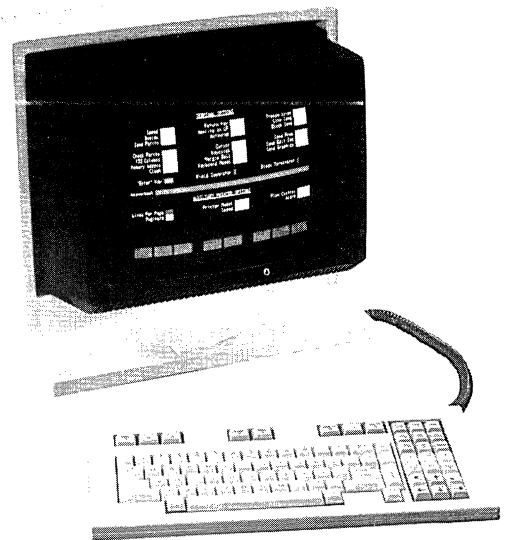

Southgate Parkway, P.O. Box 1955, Morristown, NJ 07960 • 201-898-8000.

**Distribution** • nationwide through AT&T Information Systems sales offices.

### ■ ANALYSIS

AT&T-IS Dataspeed 4400 Series is a family of ANSI 364-compatible asynchronous ASCII terminals produced by AT&T's subsidiary, AT&T Teletype. Except for the AT&T nameplate, these products are essentially the same as those marketed by AT&T Teletype. The family is divided into older models (4420 and 4430) and newer models (4410 and 4415). The latter 2 models are in reality the Teletype 5410 and 5420; which supercede the older, more expensive models.

The 4410 (AT&T Teletype 5410) is a low-priced, character-mode terminal designed for applications that require extensive interaction with the host, such as software development, timesharing, inquiry/response, and database entry. Among its attributes are user-selectable 80- or 132-column screen formats, 8 user or host programmable function (PF) keys for associated stored program commands in memory, screen labels that identify PF key programmed functions, line graphics, line speeds up to 19.2K bps, and an optional integral AT&T 212-compatible modem.

The 4415 (AT&T Teletype 5420) is essentially a buffered 4410, which enables entered data to be edited before it is transmitted. Besides character mode operation, the 4415 transmits in line, page, and block modes. It also provides windowing (up to 4 windows) for applications that require more than one operation at a time or several reference sources. The 4415's print buffer allows substantial printing flexibility. The user can elect to print data received from the line as it is displayed or bypass the display; locally entered data can also be printed. Also, the 4415 can operate isochronously, which means a synchronous modem can be used where clocked high-speed transmission is required.

### PURCHASE PRICE RANGE

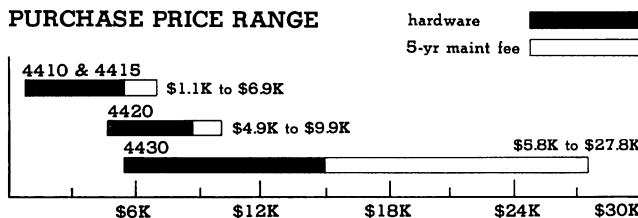

**AT&T-IS DATASPEED 4400 SERIES PURCHASE PRICING** bar graphs cover price ranges between "small" and "large" configurations for hardware (solid bars) and associated 5-year maintenance (open bars) • **SMALL 4410** consists of standard keyboard display unit; **LARGE 4415** consists of standard keyboard display unit and an 80-column friction-feed line printer • **SMALL 4420** consists of standard keyboard-display and features group; **LARGE** system adds an 80-column friction-feed line printer • **SMALL 4430** consists of standard keyboard-display and feature group; **LARGE** system adds an 80-column friction-feed line printer and 256K-byte diskette subsystem • **NOTE:** no maintenance fees for the printer were available at this writing; prices therefore are on the low side.

## AT&T-IS Dataspeed 4400 Series Display Terminals

### Models 4410, 4415, 4420 & 4430

The Dataspeed 4420 is primarily intended as a replacement for the old Dataspeed 40/2, although AT&T-IS has also targeted new applications requiring a point-to-point terminal that operates on private line or the DDD. The Dataspeed 4430 provides upward migration for customers currently using the older Models 28, 35, 40/3, and 43 BSC. The primary market for this multipoint terminal should be the 40/3, with some 6000 such terminals installed.

Across the board, the 4420 and 4430 are superior to the older 40 Series units. Such features as microprocessor control, buffering, programmable function keys, cursor addressing, and more advanced formatting/editing features are standard on the new models, and almost nonexistent on the 40 family. The older 40 units were also limited to a top 4800-bps transmission rate; 4420 operates at up to 9600 bps.

These AT&T-IS products are not identical to AT&T Teletype's offerings. For example, the Dataspeed 4430 contains a 32K-byte RAM buffer while the Teletype product has 14K bytes of RAM standard and 18K bytes optional. In addition, the 20-/60-mA current-loop interfaces that are optional on the Teletype line are standard on the Dataspeed. In adopting the Teletype product line, AT&T chose not to include the Model 4424. As a result, neither Dataspeed terminal offers split-screen formatting, line graphics, reverse video, half-intensity characters, and underline cursor.

In the general marketplace, the 4420/4430 Series will compete against the likes of the IBM 3101 or the very popular DEC VT100 display terminal. For the most part, Teletype displays should certainly more than hold their own technically. But when price is considered, they come at a premium. Both models are higher priced than conventional display terminals offered by other vendors.

#### □ Strengths

Ease of use and operating flexibility are the principal advantages of the Dataspeed 4400 Series. User friendliness is a virtue of the terminals, especially with the newer 4410 and 4415. Displayed menus simplify the establishment of operating parameters via keyboard selection. Changeable screen labels identify programmable function key functions on the 4410 and 4415. Programmable function keys transmit a string of characters at one keystroke. The 4410 and 4415 provide 8 and 16 programmable functions, respectively; the 4420 and 4430 provide 10.

A strong user benefit is the selectable format feature on the 4410 and 4415. Users can select between 80- and 132-column screen formats for spreadsheet applications, as well as to display 132-column information as it is printed.

Also, the 4415 can display up to 4 windows of information, which can be overlapped. Window parameters are user selectable. Split-screen operation benefits applications that require a fixed heading and scrollable text, or two fixed and independent screen segments.

Other benefits include an optional 212-compatible integral modem for the 4410, a choice of amber, green, or white on black screens for the 4410 and 4415, line drawing graphics and selectable character sets for the 4410 and 4415, and selectable isochronous transmission for the 4415 to allow the use of synchronous modems.

Both the 4420 and 4430 have their own strong points. The 4420 provides transmission options of character-at-a-time, line-at-a-time, or block/page modes at asynchronous rates to 9600 bps point-to-point. The 4430 offers block/page mode transmission at rates to 4800 bps multipoint.

By far the "glamor" terminal in the series has to be the 4430. This top-of-the-line model has 32K bytes of dynamically shared RAM, allowing the attachment of tape or diskette peripherals as well as a local printer. Through such facilities, the 4430 may operate with completely independent auxiliary port send and receive buffers, display send and receive buffers, and printer receive buffer. Such capability allows communication modes of send block/page from display and auxiliary port buffers; and of receive block/page to display, auxiliary port, and printer buffers. This capability also allows local modes of display-to-printer, display-to-auxiliary port, auxiliary port-to-display, and auxiliary port-to-printer.

The 4420 and 4430 incorporate the logic and buffering to support directly addressing the attached printers or auxiliary devices by the host CPU without interfering with terminal operation. Many competitive products employ a shared buffer and common transmit/receive logic, which prevents simultaneous screen preparation and printer message reception. As a result, terminal operators must wait for the print operation to end before resuming screen activity. The bypass feature is a beneficial feature for Teletype users and could be a factor in overlooking the terminals less than competitive prices.

#### □ Limitations

The 4410 is strictly an asynchronous interactive conversation terminal limited to character mode transmission in a point-to-point arrangement. It does not support extensive editing nor does it provide printing flexibility.

The 4415 supports text editing, but it does not support formatted data entry. It is limited to a single typewriter-style keyboard and it cannot be used in a multipoint communication environment.

The 4420 and 4430 support text editing and formatted data entry; however, format storage is not provided. These terminals do not support split-screen operation, line graphics, or highlighting attributes such as reverse video or half intensity which alert operators to important information and distinguishes different types of data. The 4420 cannot be used in a multipoint environment.

According to a user study by Data Decisions, more and more applications in the future will involve graphics and personal computing. AT&T does not provide an upward mobility path to convert the terminals to personal computers. DEC has offered this facility for years with its UT100. IBM added that capability to the 3270 in March 1983.

#### ■ COMMUNICATIONS FACILITIES OVERVIEW

Operation as general-purpose half-/full-duplex asynchronous ASCII display terminal at point-to-point rates to 19.2K bps over 7 selectable rates (4410 and 4415), 9600 bps (4420), or multipoint rates to 4800 bps (4430). Character mode only (4410), character/line/block mode (4415 and 4420), or block mode only (4430) transmission.

The 4410 is unbuffered. The 4415 contains a 32K-byte RAM and 32K-byte ROM. RAM is divided into the print buffer (2K), send/receive line buffers (2K each), options/screen label buffer (2K), and display buffer (10K); the remainder is for data storage. Both 4410 and 4415 contain an RS-232C modem interface. An integral 300- to 1200-bps integral modem is optional.

Buffering of 2K to the display, 2K to the printer, and 1K from the line is available on 4420, allowing keyboard-to-line/display, line-to-display, display-to-printer, and line-to-printer operations. Line-to-printer and keyboard-to-display operations may occur concurrently.

Dynamic buffering of 32K bytes on 4430 allows keyboard-to-line/display, keyboard-to-display/printer, keyboard-to-display/auxiliary device, line-to-display, line-to-printer, line-to-auxiliary device, and auxiliary device-to-printer operations. Line-to-printer, line-to-auxiliary device, or auxiliary device-to-printer operations may occur concurrently with keyboard-to-display operations. Each model has a dual auxiliary device port for local attachment of up to 2 printers (4420), or of printer, paper tape unit, diskette unit, or slave keyboard-display or keyboard-printer devices (4430). RS-232C and 20-/60-mA current-loop interfaces are included.

#### ■ HARDWARE

##### □ Terms & Support

**Terms** • AT&T-IS offers the Dataspeed terminals for purchase or on a monthly rental or 2-year or 4-year lease basis • AT&T-IS requires that all Dataspeed products be installed by its service personnel, and levies a charge for the service • the typical installation charge for a 4420/4430 keyboard-display is \$80; \$50 for the 4410 and 4415 • discounts are 10 percent (25 to 49 units);

## AT&T-IS Dataspeed 4400 Series Display Terminals

### Models 4410, 4415, 4420 & 4430

15 percent (50 to 99); 20 percent (100 to 199); and 25 percent (200+).

**Support** • all units are serviced by AT&T-IS field personnel • maintenance contracts are quoted on a yearly basis; prices shown in this report show that figures divided by 12 to indicate monthly maintenance charges.

#### ■ OVERVIEW

The Dataspeed 4410 and 4415 are standalone terminals with a 12-inch (diagonal) monochrome display and detached, low profile, typewriter-style keyboard. The keyboard includes separate numeric cluster and editing keys; all alphanumeric keys are repeatable. The screen displays 24 data lines, a status line, and two lines for screen labels. The user or host can select an 80- or 132-column display format. The 4410 contains a single page display memory while the 4415 has a 9600-character memory.

The 4410 transmits a character per keystroke; in addition, the buffered 4415 can operate in line, page, or block modes.

The 4410 and 4415 feature split-screen operation. The screen is divided horizontally to provide a scrollable segment and a static segment or two static segments. The 4415, in addition, provides page mode and windowing. Page mode allows up to 3 discrete screens of display memory with different PF designations and editing for each. Windowing allows the user to divide the 9600-byte RAM memory into as many as 4 segments; segment size is user-specified and windows can be overlapped. Upwards and downwards destructive scrolling is selectable on the 4410.

The 4410 and 4415 each contain 8 PF keys; however, the 4415 effectively has 16. A string of up to 50 (4410) or 80 (4415) characters can be stored per key; PF key character storage is nonvolatile and is retained after power is removed. PF characters can be entered from the keyboard or received from the host. Each of the PF keys on the 4415 can be associated with character strings established by the host and the operator, effectively providing 16 keys. Displayed screen labels identify the function of each PF key. Screen labels can be downloaded from the host or entered via the keyboard.

The 4410 contains an unbuffered serial printer port; however, the 4415 contains a bidirectional buffered (2K) serial printer port. The printer port operates in 3 modes: local print (prints displayed data), log text (prints received data displayed on screen), and media copy (prints data received directly from line). Overflow control (DC3/DC1) is provided.

The Dataspeed 4420 and 4430 are general-purpose keyboard-display buffered terminals aimed at inquiry/update and data entry applications. Both employ a 13-inch diagonal CRT with a display capacity of 1920 characters. The 4420 is intended for point-to-point communication and operates in character/line/block modes at asynchronous data rates up to 9600 bps. The 4430 is designed for multipoint communication, and is compatible with 8-level multipoint protocols. This terminal can also be used with the AT&T-IS Message Switching Information System (MSIS) because it can communicate directly through the 8A1 protocol.

The 4420/4430 each contain a 72-line (5760 character) display buffer, but differ in system RAM capacity. The 4420 has 5K bytes while the 4430 has 32K. Of the 32K, about 5K is reserved for the display buffer, and the remainder is pool-shared in 256K-byte blocks among the display send/receive and printer/auxiliary device ports.

Both units can accommodate a complement of character and line printers. The 4430 can also accommodate a diskette unit to perform data entry, batching and buffering from the terminal and/or host line.

#### □ Model Packages

##### 4410

3344-102 DS 4410 Display Terminal • unbuffered character mode terminal with 27-line x 80- or 132-character display format; single page display memory • 7x9 matrix in 9x13 field (80-character format); 5x7 matrix in 7x13 field (132-character format) • 128 ASCII character set plus 96 graphic symbols •

RS-232C unbuffered serial printer port • detached typewriter keyboard with numeric cluster and edit keys and 8 PF keys:

\$52/\$70 mo	\$1,145 prch	\$15 maint
--------------	--------------	------------

34413 Integrated Modem • AT&T 212 compatible with firmware Auto-Dial (3 preprogrammed phone numbers) and Auto Log-on features • 300/1200 bps:

35/26	575	8
-------	-----	---

##### 4415

3344-150 DS 4415 Display Terminal • buffered character/line/page/block mode terminal with 27 line x 80- or 132-character display format; 9600-character display memory, 2K send/receive buffer, 2K print buffer, 2K options/label buffer • 7x9 matrix in 9x13 field (80-character format); 5x7 matrix in 7x13 field (132-character format) • 128 ASCII character set plus 96 graphic symbols • RS-232C serial bidirectional printer port • detached typewriter-style keyboard with numeric cluster and edit keys and 8 (effectively 16) PF keys • integral answerback:

\$85/\$114 mo	\$1,895 prch	\$23 maint
---------------	--------------	------------

##### 4420

3344-440 DS 4420 Display Terminal • buffered, character/block mode terminal with 1920-character 24-line x 80-character display capacity; 5760-character (72-line) display memory • 7x9 matrix • 128 ASCII character set • 40-character answerback • requires keyboard and controller:

\$190/\$145 mo	\$3,440 prch	\$13 maint
----------------	--------------	------------

34409-4420 Typewriter-Style Keyboard • standard typewriter-style keyboard with 10 program function keys:

55/40	1,020	6
-------	-------	---

34410-4420 Numeric Keyboard • same as 34409 except has separate numeric keypad:

65/50	1,150	7
-------	-------	---

34411-4420 Feature Group • controller which adapts terminal for point-to-point transmission:

20/13	300	3
-------	-----	---

##### 4430

3344-440 DS 4430 Display Terminal • buffered, block-mode terminal with 1920-character 24-line x 80-character display capacity; 5760-character (72-line) display memory; 32K character buffer • 7x9 dot matrix • 128 ASCII characters • requires keyboard and controller:

\$190/\$145 mo	\$3,440 prch	\$13 maint
----------------	--------------	------------

34409-4400 Typewriter Keyboard • same as 34409:

55/40	1,020	6
-------	-------	---

34408-4430 Feature Group • controller which adapts terminal for multipoint transmission using 8A1 protocol:

55/40	1,290	45
-------	-------	----

34408-4430 Feature Group • semiconductor chip adapts the terminal to multipoint communication:

55/40	1,290	3
-------	-------	---

**Display** • buffered, character/line/block mode terminal with 1920-character 24-line x 80-character capacity; 5760-character (72-line) display memory • 7x9 matrix • 128 ASCII character set • 40-character answerback.

#### □ Buffer Memory

The 4410 is unbuffered. The 4415 contains a 32K-byte RAM and 32K-byte ROM. RAM is divided into 2K buffer segments for print buffer, send/receive line buffers, and options/screen label buffer; 10K bytes for display and the remainder is for data.

*MO: monthly charge for 4-year/month-to-month lease; includes maintenance. PRCH: purchase price. MAINT: monthly maintenance charge. NA: prices not available. Prices effective as of August 1984.*



## AT&T-IS Dataspeed 4400 Series Display Terminals

### Models 4410, 4415, 4420 & 4430

The 4420 terminal contains 5K of RAM buffer of which 2K is assigned to the display, 2K to the local attached printer, and 1K to the line. The 4420 also has display screen memory for up to 72 lines (5760 characters).

The 4430 has 32K of RAM buffering as a standard feature. From this buffer, up to 72 lines (5760 characters) are assigned as display memory. The remainder is pool-shared in 256-byte blocks among the display send/receive and printer/auxiliary device ports.

Memory is also available to store screen menus of display format, keying and communication setup options; programmable key function definitions; answerback messages; and terminal self-diagnostics.

#### □ I/O & Communications

The 4410 and 4415 are both equipped with an RS-232C modem port and RS-232C serial printer port. Both terminals operate at half-/full-duplex asynchronous or isochronous (4415 only) rates to 19.2K bps over 7 selectable rates. The 4410 transmits a character per keystroke, while the 4415 transmits in character/line/page/block mode. Both terminals are ANSI 3.64 protocol compatible. The 4415 is equipped with answerback.

In addition to a communication interface, both the 4420 and 4430 display terminals are equipped with dual port interfaces for the attachment of local printers (4420); or printer, paper tape, diskette, slave keyboard-display, or slave keyboard-printer peripherals. The SSI (Standard Serial Interface) auxiliary port is used to attach Model 40 line printers. The other local auxiliary port, an RS-232C interface, supports printers on all models, or tape unit, diskette unit, and slave terminals on the 4430.

The 4420 operates at synchronous half-/full-duplex rates to 9600 bps on a point-to-point basis, and can transmit a character-at-a-time, line-at-a-time, or block/page-at-a-time. The 4420 offers an integrated manual/auto answerback of up to 40 characters; odd/even/mark/space parity and 8-level ASCII code are employed.

The 4430 provides for multipoint operations. Block mode transmissions are at half-/full-duplex asynchronous rates to 4800 bps. Protocol complies with ANSI 3.28 subcategories 1.1, 2.4 to 2.8, A1, A3, and A4; 85A poll/select with LRC, 8A1 contention features. The 4430 provides for roll-call polling with status replies; with message transfer check employing auto retransmit, controlled retransmit, and LRC checking; and with termination transmit checking roll call with status replies. Odd/even/mark/space parity and 8-level ASCII code are also employed.

The 4420/4430 is equipped with an RS-232C interface for communication line/modem connection. A 20-/60-mA current-loop interface is also provided for local connections to host processor.

#### □ Disk

AT&T-IS offers the Sykes Datatronics Com-Stor II Model 8120 for use with the Model 4430. The 256K/512K single-/dual-drive Com-Stor II connects to the terminal's auxiliary interface and allows the 4430 to perform diskette-based data entry, batching, or buffering from terminal and/or host line.

3610-1SS • single-drive unit  

<u>\$320/\$240 mo</u>	<u>\$5,640 prch</u>	<u>\$150 maint</u>
-----------------------	---------------------	--------------------

3610-2DS • dual-drive unit  

<u>420/310</u>	<u>7,400</u>	<u>180</u>
----------------	--------------	------------

#### □ Terminals/Workstations

##### 4410 & 4415

**Configuration** • tabletop keyboard display with detached

keyboard • typewriter-style keyboard with numeric cluster, edit keys, and 8 PF keys • swivel-and-tilt display screen.

**Display** • 12-inch diagonal, white/green/amber phosphorous screen • 1920 characters at 24x80 characters; 3168 characters at 24x132 characters; 25th through 27th lines for status (1 line) and screen labels for PF keys • 7x9 dot matrix in 9x13 field (80 characters per line); 5x7 dot matrix in 7x13 field (132 characters per line).

**Edit & Format Features** • auto-repeat keys • cursor up, down, left, right, home up, home down, tab, cursor address read/write, save/recall • 4410 only—cursor wraparound, erase all data, erase to EOL/EOS, and transparent mode • character insert/delete; line insert/delete • split-screen with scrolling and static region or 2 static regions on 4410; destructive scrolling on 4410 • scroll up/down; destructive scrolling; next/previous page on 4415 • full-/half-intensity, reverse video, blink, and underline display attributes • 4415 print functions include print line from cursor up/down, print screen, print online, and print media copy.

##### 4420 & 4430

**Configuration** • tabletop keyboard-display with modular keyboard • typewriter-style keyboard with cursor or cursor and numeric keypad cluster • 10 program function keys • swivel-and-tilt display screen.

**Display** • 13-inch diagonal • 7x9 dot matrix • 1920 characters as 24 lines x 80 characters with 25th status line • 5760-character (72-line) display memory • 128 ASCII characters.

**Edit & Format Features** • auto-repeat keys • cursor up, down, left, right, home; tab, backtab, auto tab; return, return line feed, line feed; page advance, scroll up, scroll down • cursor address read/write • erase to EOL/EOF/EOP; character insert and delete; line insert and delete • protected fields • underscore • send, print local, print online, form enter, form transfer (all models); auxiliary print, auxiliary send, auxiliary receive, auxiliary local, auxiliary write (4430).

#### □ Printers

AT&T-IS offers both matrix and impact printers for attachment to the 4410/4415/4420/4430. All printers listed below can attach to either terminal.

**3320-102 Belt-Impact Printer** • tabletop 300-lpm full-character belt-impact • 64 or 128 ASCII set • 80 columns • function-feed • horizontal tab • vertical format control:  

<u>\$195/\$145 mo</u>	<u>\$3,580 prch</u>	<u>NA maint</u>
-----------------------	---------------------	-----------------

**3300-154 Belt-Impact Printer** • same as 300-102 except employs tractor-feed:  

<u>175/130</u>	<u>3,180</u>	<u>NA</u>
----------------	--------------	-----------

**3300-202 Belt-Impact Printer** • same as 300-154 except provides 132-column format:  

<u>225/170</u>	<u>4,160</u>	<u>NA</u>
----------------	--------------	-----------

**3330-204 Belt-Impact Printer** • floor-console 300-lpm full-impact character belt-impact • 64 or 128 ASCII set • 80 or 132 columns • friction or tractor feed • horizontal tab • vertical format control:  

<u>350/260</u>	<u>6,475</u>	<u>NA</u>
----------------	--------------	-----------

**3330-201 Matrix Printer** • tabletop 340-cps bidirectional matrix printer • tractor feed • 7x7 half-space matrix • 5, 10, or 16.7 cpi; 6/8 lpi:  

<u>210/160</u>	<u>3,920</u>	<u>NA</u>
----------------	--------------	-----------

• END



# AT&T-IS Dataspeed 4540 Series Display Terminals/Cluster Controllers

## ■ PROFILE

**Function** • standalone and cluster display terminal system employed in inquiry/update, data entry, and data retrieval applications • all processing and database services handled by host computer • replacement for IBM 3270 Information Display Systems.

**Architectures Supported** • used with IBM S/360, S/370, 3030, 3081, 4300, and S/3 processors • S/360, S/370, 4300 and S/3 operate under BSC • local attach via I/O channels • remote attach by non-switched private facilities in BSC/SDLC half-duplex at rates up to 9600 bps for BSC and SDLC.

**Communications** • CICS/VS under ACF/VTAM, ACF/VTAME, ACF/TCAM for OS/VS and DOS/VS • IMS/VS under BTAM and ACF/VTAM • single line • 1200/2400/3600/4800/7200/9600 bps • half-duplex BSC (4541-1) and SDLC • ASCII/EBCDIC codes • point-to-point/multipoint configurations • RS-232C interface.

**Operating System** • service through host processor under DOS, DOS/VS, DOS/VSE, OS, OS/VS, VM/370.

**Database Management** • none; only in association with host IMS/VS and CICS/VS facilities.

**Transaction Processing Management** • primarily through CICS or IMS which acts as terminal-oriented transaction monitor with file processing facilities • supports send/receive batch and inquiry tasks.

**Support Software** • supported by and employs software and program facilities of host processor • no local independent (from host) off-line programming/processing capabilities • system diagnostics checks DTE and DCE.

**Terminals/Workstations** • up to 32 CRTs; up to 8 printers.

**First Delivery** • 1983.

**Systems Delivered** • unknown.

**Comparable Systems** • IBM 3270, Harris 8100/9200, ITT Courier 2700, Memorex 1370/2070, Teletype 4540 Series, Telex



Terminal Communications 270, and Trivex Plus 70.

**Vendor** • AT&T Information Systems (Subsidiary of AT&T); 100 Southgate Parkway, Morristown, NJ 07960 • 201-898-8000.

**Distribution** • nationwide through AT&T Information Systems sales offices.

## ■ ANALYSIS

There have been no changes to the 4540 Series product line over the year, and except for a 10 percent decrease in maintenance prices, there have been no price changes.

The Dataspeed 4540 Series, for the most part, are reskinned versions of Teletype's competent but aging 4541 and 4543. These 3270-like products have been on the market for a number of years, and have done fairly well in competition against IBM's 3271/3272/3274/3275/3276 systems.

AT&T-IS has taken a different approach to packaging and marketing with its version of these systems. For example, while Teletype offers separate remote cluster controllers to handle BSC and SDLC protocols, AT&T-IS offers a single controller which handles both. On the other hand, while Teletype allows users to field upgrade the number of I/O ports handled by its controller, AT&T-IS does not. Such upgrades require the replacement of the entire controller. More about this later when we discuss other product limitations.

The AT&T-IS 4540 Series consists of a single remote cluster controller (4540), a local cluster controller (4540-LCC), and a standalone terminal that accommodates a printer (4540-SDS). The remote 4540 and 4540-LCC replace the IBM 3271, 3272, and 3274, while the 4540-SDS replaces the 3275/3276. Like IBM's large-scale cluster controllers, the AT&T-IS versions also support the attachment of 8, 16, or 32 terminals/printers. The remote version runs under BSC and an SDLC-like protocol called

## PURCHASE PRICE RANGE

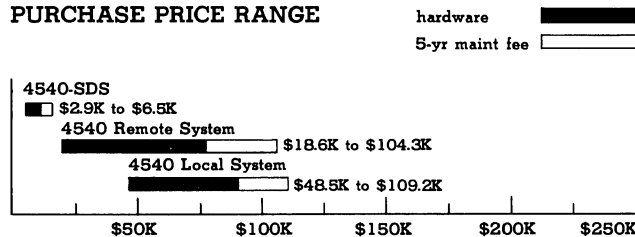

**AT&T-IS DATASPEED 4540 SERIES PURCHASE PRICING** bar graphs cover price range between "small" and "large" configurations for hardware products (solid bars) and associated 5-year maintenance (open bars) • **SMALL 4540 SDS** consists of standalone terminal-controller and associated keyboard; **LARGE SYSTEM** adds 1 30-cps matrix printer • **SMALL 4540 REMOTE SYSTEM** consists of a cluster controller with 8 I/O ports, 4 displays with associated typewriter-like keyboards, and 2 300-/220-lpm belt printers; **LARGE SYSTEM** consists of 32-port cluster controller with 16 displays and associated wide typewriter-style keyboards, 6 300-/220-lpm belt printers, and 4 30-cps matrix printers • **SMALL 4540 LOCAL SYSTEM** consists of a 16-port cluster controller, 8 displays with associated typewriter-style keyboards, and 4 300-/220-lpm printers; **LARGE SYSTEMS** consists of 32-port cluster controller with 16 displays and associated wide typewriter-style keyboards, 4 300-/220-lpm printers, and 4 30-cps matrix printers.

## AT&T-IS Dataspeed 4540 Series Display Terminals/Cluster Controllers

ADCCP (Advanced Data Communications Control Procedures). The local version attaches directly to the host and runs in 3270 mode, while the standard 4540-SDS runs under SDLC.

The 4540 is software compatible with the 3270, and therefore, can take advantage of some of the better software IBM furnishes for its terminals such as IMS, IMS/VS, CICS/VS, DL/1, SQL/Data Systems, and Stairs/VS.

The 4540 is a good alternative as a comparable 3270, provided no local processing is required. IBM supports this capability by attaching its personal computer through a 3278-2 terminal; AT&T-IS has no such upgrade. The absence of local processing means that all processing and service functions (e.g., changing screen formats) must be handled through the host. Aside from making poor use of the communication facility, such action can also cause delays—and a drop in operator productivity—in a heavily loaded or busy system.

### □ Strengths

The 4540 clustered systems are technically comparable with the old and discontinued 3271/3272 controllers, and offer virtually the same facilities as the newer 3274 control units. Likewise, the 4540-SDS standalone terminal is in the same league as the discontinued 3275, and can be used in place of the 3276 provided support for 1 printer is sufficient. (The 3276 supports up to 8 terminals/printers). If this is what you're looking for, the AT&T-IS offerings are attractively priced.

Another strength of the 4540 remote controller is that it can accommodate both BSC and SDLC protocols. While this is certainly notable, it is not unique.

IBM and many of the other plug-compatible products have the same facility.

### □ Limitations

The 4540 suffers from the same limitations that plague the 3270: no peer-to-peer addressability, no print spooling, and no multipoint communication support. In addition, the AT&T-IS product lacks data security.

AT&T-IS, unlike IBM, also does not offer data encryption. The lack of this facility could make the 4540 an unacceptable product in environments where sensitive data is transmitted over remote communication facilities.

AT&T-IS, like IBM, also lacks a data compression and print spooling capability. The lack of these beneficial features increases the load on the communication facility, which can result in significant delays when servicing users, as well as escalating communication costs. For example, when there are up to 32 devices operating online, every bit of available bandwidth is needed to maximize efficiency. Data compression provides such a service by eliminating unnecessary data such as zeros, blanks, and redundant characters.

Print spooling is another facility which would also increase overall efficiency. Print spooling is a technique whereby information bound for a relatively slow device like a printer is placed on an auxiliary device (usually a disk). This allows the printer to operate at its normal speed and suffer its normal problems without inhibiting the overall data communication function. The 4540 has no spooler, and it could certainly benefit from one.

## ■ COMMUNICATIONS FACILITIES OVERVIEW

### □ Distributed Communications

The 4540 operates in a remote/local clustered or standalone environment and communicates with the host computer as an IBM 3270. The protocols supported by remote controller include BSC and ADCCP (Advanced Data Communications Control Procedures). The latter is equivalent to IBM's SDLC used with its 3270, and conforms to ANSI X3.66-1979-UN. The BSC line protocol is the standard version which conforms to ANSI X.28-1971 and the sub 2.4 and B2 plus RVI and WACK.

A single remote cluster controller is available which runs under BSC or ADCCP, and supports ASCII and EBCDIC codes. To the

host, this unit looks like an IBM 3271-2 or 3271-12.

In addition to the cluster controller, AT&T-IS offers the 4540-SDS standalone terminal which accommodates a single local printer. This unit, which consists of a keyboard-display with an integrated controller runs under ADCCP, supports only EBCDIC, and looks like a 3271-12 to the host. Access methods supported are TCAM, ACF/TCAM, VTAM, ACF/VTAM, ACF/VTAME, and EXTM.

The remote clusters run on the IBM S/360 Models 25, 30, 40, 50, 65, 67 (65-mode), 75, 85, and 195; any S/370 including 3030 and 3081; any 4300; and S/3 Models 4, 8, 10, 12, 15, and 15D. Terminal access methods supported are BTAM, BTAM-ES (BSC only), TCAM, ACF/TCAM, VTAM, ACF/VTAM, ACF/VTAME, and EXTM.

The 4540-LCC local controller connects to the host's block, byte multiplexer, or selector channel, and supports only EBCDIC. The controller emulates the IBM 3272-2 or 3274-1B, and is compatible with the IBM S/360, 370, 303X, or 4300 Series.

The remotely connected systems communicate in half-duplex mode in a point-to-point or multipoint arrangement via 4-wire, leased/private lines and the DDS at speeds up to 9600 bps. Interface between DTE and DCE is RS-232C. The modem can be located up to 50 feet from the controller.

Both general and specific polling is supported. In a general poll, the highest numbered device transmits first, followed by the next highest. In a specific poll, only the polled device can transmit.

### □ Distributed Configurations

The 4540 consists of 2 cluster controllers and 1 standalone terminal system. The remote cluster controller is offered in 8- and 16-I/O port versions, while the local cluster controller is offered with 16 ports. Both cluster controllers may add 16 I/O ports through an optional expansion module, bringing the total number of attachable terminals/printers to 32 devices. The standalone terminal, on the other hand, may attach 1 local printer. The standard display used with the 4540 is a 13-inch diagonal CRT with an 80-column x 24-row capacity. Both EBCDIC and ASCII characters are accommodated.

A choice of 4 keyboards are offered: a typewriter-style keyboard; a typewriter-style keyboard with internal numeric cluster; a typewriter-style keyboard with an external numeric keyboard; and a typewriter-style keyboard with external numeric keyboard and magnetic stripe badge reader.

The printers include belt printers, which operate at 300 or 220 lpm, and matrix printers with speeds of 30/340 cps. Any combination can be attached to the cluster controller, and any one can be interfaced with the standalone 4543-2 terminal.

The cluster controllers support any combination of keyboard-displays and printers. At least 1 keyboard-display must be included in each configuration, and no more than 8 printers per configuration can be used.

Control of locally attached terminals and printers is handled by the Cluster Control Unit. This device is microprocessor controlled and contains 64K bytes of RAM and ROM. Cluster operating parameters—i.e., station and cluster addresses, EBCDIC/ASCII operating codes, etc—are keyed into tables. All display and keyboard characteristics are defined from the keyboard of the first device on the cluster controller, and then downline loaded to each terminal.

The attached devices can be any combination of display/keyboards and printers, provided that at least 1 device be a display/keyboard and no more than 8 printers are included in the cluster. The terminals/printers attach to the Cluster Control Unit via 2 twisted-pair or coaxial cables. Keyboard-displays can be located 5,000 feet from the controller, line printers can be located 2,000 feet away, and matrix printers can be located up to 5,000 feet away. The 4540 interfaces with the DCE via an RS-232C interface; modems can be 50 feet from the controller.

**4540 Cluster Systems** • clusters up to 32 keyboard-displays/printers • RS-232C interface • compatible with 3271-2, supports ASCII/EBCDIC character sets; compatible with an IBM 3271-12 and runs under SDLC and supports EBCDIC character set;

## AT&T-IS Dataspeed 4540 Series Display Terminals/Cluster Controllers

half-duplex mode • point-to-point/multipoint configurations • maximum transmission speed is 9600 bps.

**4540-LCC Cluster System** • clusters up to 32 keyboard-displays/printers • local connect to IBM S/360, 370, 303X, or 4300 block, byte multiplexer or selector channels • emulates IBM 3272-2 or 3274-B • supports EBCDIC character set.

**4540-SDS Standalone Terminal** • single keyboard-display with integral controller • accommodates a single character/line printer • RS-232C interface • looks like an IBM 3271-12, runs under ADCCP protocol, and supports EBCDIC character set; half-duplex mode • point-to-point/multipoint configuration • maximum transmit speed is 9600 bps.

### Distributed Utilities

AT&T-IS offers no distributed utilities with the 4540, but users can employ those packages developed for the IBM 3270. Such packages include:

**DEMF (Display Exception Monitoring Facility)** • provides for network problem determination and isolation in BSC mode under OS/VS.

**DIDOCS (Device Independent Display Operator Console Support)** • provides uniform services for all displays on OS and OS/VS systems • DIDOCS establishes linkage between displays and systems allowing displays to function as operator consoles; provides for processing and routing of messages from operating system or application program to console in multiconsole environments; and extends such support to 3270 printers operating as output-only hardcopy consoles.

**NPDA (Network Problem Determination Application)** • provides for network problem definition and isolation in BSC/SDLC modes under VTAM or TCAM.

**SDS (Status Display Support)** • provides system status display services for both display and nondisplay consoles.

**IIS (Interactive Instruction System)** • provides interactive online training capabilities for 3270 database/communications systems users under IMS/CICS/TCAM.

### SOFTWARE

The 4540 operates under control of local/remote host processor software; the following briefly summarizes software support under such host-controlled environments.

#### Operating System

##### **IBM S/360, S/370, 3030, 3081 & 4300 Processors**

The 4540 operates under OS, DOS, OS/VS1, OS/VS2(SVS), OS/VS2 (MVS, MVS/SE, MVS/SP), DOS/VS, DOS/VSE, and VM/370 (VM, VME, VM/BSE, VM/SP) in conjunction with other systems software and programs.

**TSO (Time Sharing Option)** • provides for local/remote timeshared operation under all OS/DOS or communications/OS/DOS facilities.

##### **IBM S/3 Processors**

The 4540 operates under 570-SC (Systems Control) series software in conjunction with other program facilities.

#### Database Management

##### **IBM S/360, S/370, 3030, 3081 & 4300 Processors**

**ATMS-II (Advanced Text Management System II)** • provides conversational text processing capabilities, allowing the terminal to enter, edit, store, format, proof, and present textual material.

**ACP (Airline Control Program)** • special-purpose standalone combination operating system and database management system for airlines • provides for real-time (under 3 seconds) transaction processing in inquiry/update mode with large centralized database.

**CICS/VS (Customer Information Control System/VS)** • general-purpose communications/database system that provides

an interface between operating system, access methods, and applications programs • has facilities for file inquiry, browsing, order entry and distribution, data entry and collection, and message switching/broadcasting in local/remote environments • usually operates in conjunction with DL/1, but IMS version also available.

**IBM & IMS/VS (Information Management System)** • IMS is program product supported by OS/BTAM allowing user to define message formats and associated screen image formats, and for message transmission between terminal and application program without regard for device characteristics • IMS/VS communications/database program product supports user-written batch processing and teleprocessing tasks; provides database and communications management for multiple applications employing common database.

**DL/1** • stripped-down compatible version of IMS/VS designed to run under DOS/VS or DOS/VSE in conjunction with CICS/VS.

**SQL/Data System** • limited function relational database system designed to complement DL/1 under DOS/VSE; includes extract feature which enables users to copy portions of DL/1 into an SQL/DS table.

**STAIRS/VS (Storage & Information Retrieval System)** • provides for terminal-oriented, multiuser storage/retrieval operations and for batch processing under OS/VS; previous queries made under STAIRS/VS may be referred to or extended, and take the form of simple language statements to extended Boolean logic.

#### Communications/Networks

##### **IBM S/360, S/370, 3030, 3081 & 4300 Processors**

**BTAM & BTAM-ES (Basic Telecommunications Access Method & BTAM Extended Support)** • provides control for data transfer between processor storage and remote BSC terminals • provides application/problem program with macros assembled into routines, inline instructions and linkages, and control blocks and table defining lines, terminals, and other devices to be used • support tended to 4540 includes generation of channel programs, starting I/O operations, handling attentions and line interruptions, and performing error recovery, counting and posting • allows display to write data into display/printer buffer; to erase buffer and write data; to erase all unprotected fields in buffer; to read data from buffer or specified buffer location; and to read modified fields from buffer or specified buffer location • macro support provided to local 4540 (3272-type) attachments under virtual memory OS/VS and DOS/VS; local attachment under real memory versions of OS and DOS; all buffer sizes accommodated for remote BSC attachment • BTAM-ES extends support to DOS/VSE environments, and to 4300 Series processors.

**TCAM & ACF/TCAM (Telecommunications Access Method & Advanced Communications Function TCAM)** • supports 4540 in either local or BSC/SDLC remote environments for data transfer between processor storage and display terminals • TCAM macros construct control program that governs messages between local/remote terminals and applications programs • ACF/TCAM add facilities for multisystem networking as well as expanding TCAM functions • TCAM macros define equipment configuration at facility and buffers necessary for message processing; functional macros select TCAM modules that route and edit messages, and check for message errors • support tended to 4540 by TCAM control systems includes auto-insert/-delete of line control characters; assignment, use, and release of buffers during program execution; incoming/outgoing message edit; message error handling; and message traffic statistics maintenance • allows device scheduling under control program on general or specific polling basis • online test capability allows diagnostic testing on 1 control unit while other units continue processing.

**VTAM, ACF/VTAM & ACF/VTAME (Virtual Telecommunications Access Method, Advanced Communications Function VTAM & VCF/VTAM Entry)** • supports local or BSC/SDLC remote environments for data transfer between

## AT&T-IS Dataspeed 4540 Series Display Terminals/Cluster Controllers

terminals and applications programs • VTAM operates with 3704/3705 communications controllers, eliminating considerations of communications lines and controllers in application program coding • services provided include access control between device and applications programs; data transfer between device and program; allowing programs to share lines, controllers, and devices; and allowing network monitoring and alteration • ACF/VTAM extends support by allocating main storage for buffer pools according to message traffic loads and availability of storage facilities; accumulating and displaying data on network status and resources; allowing data flow through multicontroller network without recourse to host system; and providing program-to-program communications facilities • VTAM operates under OS/VS and DOS/VS; ACF/VTAM is supported by OS/VS, DOS/VS, and DOS/VSE; ACF/VTAME works with DOS/VSE.

### IBM S/3 Processors

4540 Display Control Feature of S/3 RPG II provide local/remote BSC communications facilities for up to 15 3270-type displays • program feature automatically linked into RPG II application program via SPECIAL file exit capability • features include RPG access to displays attached by Local Communications Adapter, Local Display Adapter, Integrated Communications Adapter, or BSC Adapter of S/3; auto-buffering and queuing of terminal data; display formatting interface for 3270 RPG II coding; and line control.

#### □ Applications Development Aids

### IBM S/360, S/370, 3030 & 4300 Processors

**VM/CMS (Conversational Monitor System)** • CMS is a VM/370 component that provides general-purpose conversational facility for program development and problem solving in remote timesharing modes.

**DMS/VS (Display Management System)** • under CICS/VS will simplify establishment of online use of DMS/VS forms upon which users define data files, display images, and batch utility operations required.

**GIS/VS (Generalized Information System)** • allows non-EDP professionals to maintain and access information from database systems.

**SPF (Structured Program Facility)** • provides program development aid for VS2/TSO users.

**VSPC (Virtual Storage Personal Computing)** • operating under OS/VS and DOS/VS allows remote terminal users to perform problem-solving and personal computing tasks, or develop programs.

**VS/APL** • supported under VM/370 3270 Data Analysis and APL/Text features.

**SCRIPT** • supported under VM/370 3270 Text feature.

**VIDEO/370 (Visual Data Entry Online)** • under OS, DOS, OS/VS, DOS/VS, or CICS provides for data entry via local/remote displays • user may define image formats, application records, and data field to be checked for errors; both OS and DOS versions are to be dropped from IBM support between December 1981 and June 1982.

**GDDM & PGF (Graphical Data Display Manager & Presentation Graphics Feature)** • allows display of graphic or alphanumeric-graphic formats • PGF via GDDM generates business charts in conjunction with user application program or interactively with the user with no application program requirements • GDDM and PGF operate under CICS/VS, TSO and ACF/TCAM or ACF/VTAM, or VM/370 CMS.

### ■ HARDWARE

#### □ Terms & Support

**Terms** • major components of the 4540 are available for purchase, or on a monthly, 2- or 4-year lease basis • lease prices include maintenance.

**Support** • rendered by AT&T-IS personnel through local field

offices • maintenance contracts offered on a yearly fee basis; monthly maintenance prices shown in this report represent a yearly fee divided by 12.

### ■ OVERVIEW

The Dataspeed 4540 is an interactive display-based system compatible with IBM 3270 host software. It can be configured in clustered or standalone configurations, and used for data entry, data retrieval, and inquiry/response applications.

The 4540 consists of 3 discrete configurations: a remote cluster controller (4540) which supports up to 32 terminals/printers and operates under BSC and ADCCP; a local cluster controller (4540-LCC) which also supports up to 32 terminals/printers and operates in 3272 mode; and a standalone terminal (4540-SDS) which attaches 1 printer and operates under SDLC.

The configuration rules of the 4540 are straightforward. Any combination of keyboard-displays and printers can be attached to the cluster controller, provided that at least 1 device be a keyboard-display and no more than 8 printers be used. The 4540-SDS can accommodate a single character or line printer.

The 4540 communicates with the host in a point-to-point or multipoint network over 4-wire dedicated lines at speeds up to 9600 bps. Only half-duplex transmission is supported, however.

#### □ Model Packages

##### 4540 Remote Clusters

Offered in 8- or 16-I/O port versions with a 16-port expansion module for attaching local terminals/printers. All support BSC and ADCCP (SDLC-like) protocols and EBCDIC and ASCII codes.

**4540 8-Port Remote Controller** • I/O ports accommodate up to 8 local terminals/printers:

\$150/\$110 mo	\$3,690 prch	\$21.00 maint
----------------	--------------	---------------

**4540 16-Port Remote Controller** • I/O ports accommodate up to 16 local terminals/printers:

260/195	6,430	31.00
---------	-------	-------

**4540 16-Port Expansion Module** • adds 16 I/O ports to remote cluster controller:

95/70	2,330	13.50
-------	-------	-------

##### 4540-LCC Local Clusters

Offered in 16-I/O port version with 16-I/O port expansion module for attaching local terminals/printers. Controller is connected directly to a local host CPU via a block or byte multiplexer channel or a selector channel, and employ EBCDIC code and the same protocols used for 3272-2 or 3274-B controllers.

**4540-LCC 16-Port Local Controller** • I/O ports accommodate up to 16 local terminals/printers:

\$530/\$410 mo	\$11,400 prch	\$68.00 maint
----------------	---------------	---------------

**4540-LCC 16-Port Expansion Module** • adds 16 I/O ports to local controller:

95/70	2,330	13.50
-------	-------	-------

##### 4540 Cluster Monitor & Keyboards

**Display** • 13-inch diagonal • 1920 characters (24 lines x 80 characters per line) format 96-character ASCII/EBCDIC set • 7x9 matrix • 16K-byte memory • 60-Hz power supply:

NA/NA mo	\$2,000 prch	\$11.75 maint
----------	--------------	---------------

**Typewriter Keyboard** • 96-character EBCDIC/ASCII • 24 program function keys; 2 program attention keys • separate cursor-control cluster • local send/receive keys:

28/21	680	3.75
-------	-----	------

*MO: monthly charge under monthly/4-year lease; includes maintenance. PRCH: purchase price. MAINT: monthly maintenance charge for purchased units. NA: not available. Prices effective as of August 1984.*

## AT&T-IS Dataspeed 4540 Series Display Terminals/Cluster Controllers

**Typewriter Keyboard (Narrow) & External Numeric Cluster** • 96-character EBCDIC/ASCII • 24 program function keys; 2 program attention keys • separate cursor-control and numeric clusters:

31/23	765	4.50
-------	-----	------

**Typewriter Keyboard (Wide) & External Numeric Cluster** • 96-character EBCDIC/ASCII • 24 program function keys; 2 program attention keys • local send/receive keys • attachable to 4507 tables:

32/24	800	4.50
-------	-----	------

**Typewriter Keyboard (Wide), External Numeric Cluster & Magnetic Stripe Card Reader** • 96-character EBCDIC/ASCII • 24 program function keys; 2 program attention keys • local send/receive keys:

37/28	930	5.25
-------	-----	------

### 4540-SDS Standalone Terminal

The 4540-SDS is a standalone keyboard-display terminal with an integrated controller. This unit supports SDLC protocol and EBCDIC character code. The terminal accommodates 1 local printer. The printer and terminal addresses are different, allowing the host to directly address the printer without interfering with the data preparation or online use of the display. The terminal also has a special feature called cursor-select which allows the operator to pick 1 or more fields on the screen and have them transmitted with the depression of a single key.

In an IBM SNA environment, the 4540-SDS looks like a 3271-12 and functions as Physical Unit Type 1, Logical Type 0, and FID Type 3. Its Functional Management Profile is 2 and the Transmission Services Profile is also 2.

**4543-1DOO Standalone Keyboard-Display** • 13-inch diagonal • 1920 characters (24 lines x 80 characters per line) format • 68-character EBCDIC set • 7x9 matrix • SDLC protocol • 4501-1DOO terminal keyboard • 60-Hz power supply:

\$115/\$90 mo	\$2,900 prch	\$16.50 maint
---------------	--------------	---------------

#### Buffer Memory

Each terminal contains 16K bytes of memory of which 2K bytes are reserved for buffering. Each of the 1920 characters in the buffer can be directly addressed.

#### I/O & Communications

All terminals/printers attach to cluster controller via 2 twisted-pair or coaxial cables using coax adapters. Keyboard-displays can be located up to 5,000 feet from the controller, printers can be 2,000 feet away, and matrix printers 5,000 feet away. Local-cluster configuration 4540-LCC connects to local host via a byte or block multiplexer, or selector channel.

The remote clusters communicate half-duplex over point-to-point or multipoint 4-wire leased/private lines and the DDS at speeds up to 9600 bps. RS-232C interface between DTE and DCE. Modem can be located up to 50 feet from the controller.

**Keyboard-Display-to-Controller Cable** • 12-foot cable with connector to attach keyboard-display to cluster controller:

NA/NA mo	NA prch	NA maint
----------	---------	----------

**Keyboard-Display-to-Controller Cable** • 25-foot version:

NA/NA	NA	NA
-------	----	----

**Keyboard-Display-to-Controller Cable** • 50-foot version:

NA/NA	NA	NA
-------	----	----

**Data-Set Extension Cable** • 12-foot cable for connecting modem to cluster controller:

NA/NA	NA	NA
-------	----	----

**Data-Set Extension Cable** • 25-foot version:

NA/NA	NA	NA
-------	----	----

**Data-Set Extension Cable** • 50-foot version:

NA/NA	NA	NA
-------	----	----

**Printer-to-Controller Cable** • 12-foot cable for connecting local printer to cluster controller:

NA/NA	NA	NA
-------	----	----

**Printer-to-Controller Cable** • 25-foot version:

NA/NA	NA	NA
-------	----	----

**Printer-to-Controller Cable** • 50-foot version:

NA/NA	NA	NA
-------	----	----

**Printer-to-Single-Display Cable** • 10-foot cable for connecting local printer to terminal:

NA/NA	NA	NA
-------	----	----

#### Disk

No disk or diskette storage is offered with the 4540.

#### Terminals/Workstations

The 4540 can be configured as a standalone or clustered terminal system. The standalone configuration employs a keyboard-display with integrated controller, while the clustered configuration is comprised of a control unit, displays, and keyboards. The display and keyboard characteristics are defined by the supervisor terminal (i.e., the first terminal connected to the cluster controller) and downline loaded to the other terminals.

The common characteristics of the display/keyboards are:

**Configuration** • tabletop interactive terminal with detachable keyboard • typewriter-style keyboard with integral/external numeric clusters; 24 program function keys; 2 or 3 program attention keys; swivel and tilt display screen.

**Display** • 13-inch diagonal, 7x9 matrix, 1920 characters, 24 lines x 80 characters format; 25th status line; 96-character ASCII/EBCDIC set; 64 EBCDIC monospace character on the 4540-SDS, intensified or blinked characters.

**Edit & Format Features** • auto-repeat keys, cursor up, down, left, right, home; cursor insert/select, tab, backtab, auto-tab, protected fields, read all/modified, write, erase-write, copy, erase all unprotected, erase all unprotected to address, erase EOF, start field, set buffer address, repeat address, sense, test I/O, sense ID, select (4540-LCC only).

**Communications** • see Communications Section for particulars.

**Peripherals** • 1 printer directly attached to 4540-SDS.

#### Printers

AT&T-IS offers a series of belt and matrix printers that can connect directly to the cluster controller or to the standalone terminal. The belt printers are full-impact types employing 80 or 132 print hammers operating on multiple character-set typecarrier belt. Print density is 10-cpi word or 6 lpi, adjustable for double-line feed. Both friction feed and tractor feed units are available. The former feeds on standard 8.5-inch single-ply rolled paper. The tractor feed version prints up to 6-part fanfold forms and is adjustable for forms 4 to 9.5 inches or 15 inches wide; form length may be 3.67, 5.5, or 11 inches. The feedout for both friction and tractor printers is 2, 16, or 35 lines to tear off last printed line. The form feedout for tractor printers is 16 lines.

The matrix printers are offered in 30-cps and 340-cps versions. The 30-cps unit prints 15, 25, and 45 lpm at 132, 72, or 40 characters per line. The print head is a mini-wire unit which produces a 4x7 dot matrix with a 7x9 definition. Print density is 10 cpi and 6 lpi. The printer handles up to 6-part fanfold forms, and is adjustable for forms 3 to 15 inches wide and 11 inches long.

The 340-cps unit prints 125, 200, and 300 lpm at 132, 72, and 40 characters per line. It uses a 2-column 14-wire print head which produces a 4x7 dot matrix with a 7x7 definition. Printing is bidirectional. Print density is 5, 10, or 16.7 cpi; 6 or 8 lpi. Up to 6-part fanfold forms are acceptable; form may be 3 to 16 inches wide and 3, 3.5, 4, 5.5, 6, 7, 8, 8.5, 11, 12, or 14 inches long. The printer feeds multiple lines at 10 ips.

**Belt Printer** • 300 or 220 lpm • EBCDIC • 80 columns:

\$210/\$160 mo	\$3,920 prch	\$24.00 maint
----------------	--------------	---------------

## AT&T-IS Dataspeed 4540 Series Display Terminals/Cluster Controllers

**Belt Printer** • tabletop, 300 or 220 lpm • EBCDIC • 80 columns •  
friction feed:

210/160	3,920	24.00
---------	-------	-------

**Belt Printer** • tabletop, 300 or 220 lpm • ASCII • 80 columns •  
friction feed:

210/160	3,920	24.00
---------	-------	-------

**Matrix Printer** • tabletop, unidirectional, 30/47.5 cps •  
EBCDIC/ASCII • 132 columns • tractor feed • ribbon re-inker:

105/80	1,935	12.00
--------	-------	-------

• END

# AT&T-NS Datakit Virtual Circuit Switch (VCS)

## Models 500 & 2000

### ■ PROFILE

**Architecture** • Datakit local area network.

**Type** • baseband star network with devices grouped around VCS centralized packet controller node; connections between devices made through interface modules connected to centralized bus in VCS; fiber optic cables connect nodes together for internodal communications • see Figure 1.

**Transmission Speed** • 8M bps over central bus over CPM-HS computer port module for 3B computers and between VCS nodes • up to 19.2K bps on asynchronous interface ports; up to 56K bps on synchronous module interface ports and on DDS trunk module; and up to 320K bps over CPM-422 computer port module.

**Cable Length** • 1 kilometer (3,274 feet) for fiber optic link between VCS nodes; up to 250 feet for 4-wire copper cable between asynchronous/synchronous devices and VCS; and up to 500 feet between CPM-422 and VCS and up to 3 kilometers (9,822 feet) from computer to CPM-HS module in VCS.

**Applications** • automated office and distributed processing environments.

**Configuration** • consists of Models 500 and 2000 that act as switch and management centers for standalone networks: Model 500 can provide up to 132 ports for interconnection of AT&T 3B and DEC PDP-11/70 or VAX-11 computers, asynchronous/synchronous terminals, and trunks to other nodes or to DDS network; Model 2000 can provide from 132 to 1,392 ports • AT&T-NS provides 6- or 12-port asynchronous interface modules, 6-port synchronous interface modules, 2 computer port modules, 2 trunk modules, and 2 modules specifically for interfacing to equipment used by the Bell Operating Companies • Models 500 and 2000 can interconnect with other Model 500/2000 VCSs as well as with the DDS wide area network • area covered by single

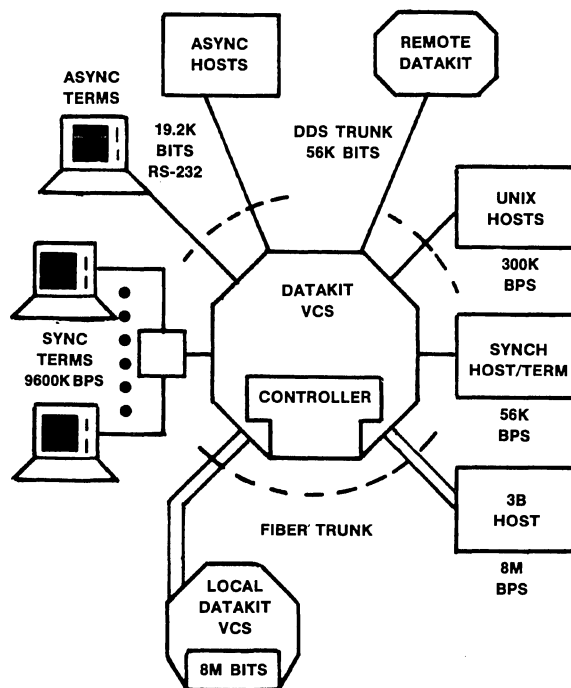
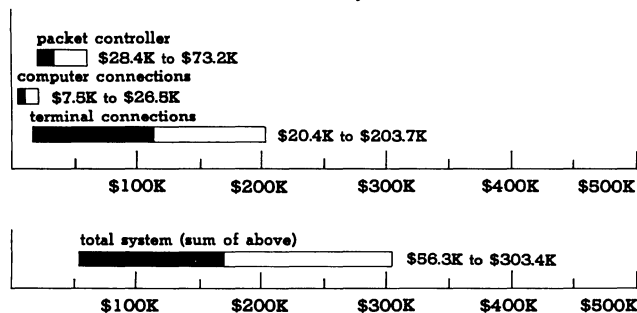

Figure 1 • Datakit VCS baseband hierarchical star network.

**PURCHASE PRICE RANGE** hardware & software   
5-year maint/serv fee



**BELL ATLANTICOM DATAKIT VCS PURCHASE PRICING** bar graph covers range between small and large configurations for hardware and software products (solid bar); purchase price for Model 500 has not been established so the price is based on small and large configuration using Model 2000 • **SMALL SYSTEM** interconnects 2 host computers and 100 terminals; includes Model 2000 Basic Unit, 1 Second/Fourth Shelf, TTY 5410 console, 8 TY 12 Asynchronous Interface Modules, 1 Sync Module, and 2 CPM-422 Computer Port Module • **LARGE SYSTEM** interconnects 4 host computers and 500 terminals; includes Model 2000 Basic Unit, 2 Second/Fourth Shelves, 5410 console, 5310 console printer, 2 CPM-422 and 2 CPM-HS Computer Printer Ports, 2 Sync Modules, and 41 TY 12 Asynchronous Interface Modules • software is bundled in the Model 2000 Basic Unit • neither configuration includes wiring.

Model 500/2000 LAN is limited to 1-kilometer radius; and almost unlimited when Model 500/2000 VCSs are interconnected.

**Interface** • asynchronous devices interface to Datakit through RS-232C interface on 12-port TY-6/TY-12 asynchronous interface modules in the VCS • DEC hosts connect to VCS through CPM-422 port (RS-422 interface); cable length limited to 500 feet • AT&T 3B hosts interface to VCS through CPM-HS module over fiber optic link at 8M bps • synchronous terminals connect to an RS-232C sync module providing 6 ports at 9600 bps or 1 port at 56K bps • nodes interconnect through trunk modules and fiber optic links up to 3 kilometers long at data rate of 8M bps • Model 500/2000 VCS can connect to the AT&T DDS network through a trunk module that provides a V.35 interface; data rate can be 56K bps, 19.2K bps, or 9600 bps • VCS requires a system control console and system control printer.

**Gateways** • none; provides interface to AT&T DDS wide area network; also interfaces to DEC PDP-11/70 and VAX-11 computers.

**Support of Foreign Devices** • RS-232C ports on TY-6 and TY-12 asynchronous interface units on sync modules are vendor independent.

**Security** • through terminal user passwords, closed user group security, and auto-connect feature which provides permanent virtual circuit connections.

**Communications Management** • through system control console; connects to interface module in basic VCS or to any port on an asynchronous interface module, AT&T uses TTY



## AT&T-NS Datakit Virtual Circuit Switch (VCS) Models 500 & 2000

5410/5420; can attach TTY 53 printer • provides for network reconfiguration including expansion, device rearrangement, and module addition/deletion without disrupting network service; automatically alerts operator to network failures and failure location; provides secure, nonvolatile storage of configuration and fault data with automatic system recovery after power failure.

**Protocols** • AT&T-NS proprietary collision-free contention scheme, see Specifications Section.

**Distributed Functions** • implementation of access protocols and routing functions are in VCS nodes only.

**First Delivery** • January 1984 for initial Datakit VCS version; Model 2000, October 1984; Model 500 ready to order December 10, 1984, general availability June 1985.

**Systems Delivered** • 150 to 200 VCRs as of third quarter 1984.

**Comparable Systems** • most comparable system is ISN from AT&T-IS; both are built around the same packet-switch controlled LAN developed by Bell Laboratories; AT&T-IS and AT&T-NS have developed different LANs although they are similar: AT&T-IS has developed ISN to complement its end-user PBX systems; AT&T-NS has developed Datakit to complement the Bell Operating Companies' (BOCs) equipment • AXIS (Advanced Exchange Information System) from Ztel, Inc; AXIS integrates PBX and baseband network using twisted-pair wire or fiber optic cable • other local networks, such as Net/One from Ungermann Bass and HYPERbus from Network Systems, perform same network functions, but use bus topology.

**Vendor** • developed and sold OEM to Bell Operating Companies and other distributors by AT&T Network Systems (NS) • 475 South Street, Morristown, NJ 07960; 201-631-6526 • purchase prices in this report are those for Bell Atlanticcom Systems, Inc; 105 Carnegie Center, Princeton, NJ 08540 • 609-890-7000.

### ■ ANALYSIS

Datakit is a product that many data communication consultants considered a solution to the needs of the integrated office because it combines the facilities of a packet switch with those of a LAN. Datakit is only a data network, but its VCS packet controller is very similar to AT&T-IS's System 75 PBX and AT&T-IS ISN.

Both Datakit and ISN are based on a switch-controlled LAN developed by Bell Laboratories. According to guidelines governing the split-up of Bell, the same division that sells equipment to the regional Bell Operating Companies (BOCs) cannot sell equipment to end users. Thus, AT&T organized the company into a number of divisions including AT&T-Information Systems (IS) and AT&T-Network Systems (NS). AT&T-IS sells its equipment to end users and AT&T-NS sells its equipment OEM to the BOCs and to other authorized distributors. Currently, the main emphasis is on selling to the BOCs, but AT&T-NS expects to sign agreements with other distributors.

When the 2 divisions developed their LAN products, they turned out to be similar in many ways because of their common origin and different in other ways because of their different applications. ISN, from AT&T-IS, is designed to operate with the System 75, and System 85, and other PBXs offered by AT&T-IS. Datakit, on the other hand, is designed to operate with the BOC telephone exchange equipment. The access protocol addressing scheme; and basic system design used by both LANs are the same. The interface modules are similar but somewhat different. ISN interfaces 3 internal buses to its backplane and Datakit interfaces only 2. Most surprisingly, the transmission speed through the switch is slightly different: ISN data rate is 8.6M bps, while Datakit data rate is 8M bps. ISN offers a concentrator and 1 packet controller model. Datakit includes a small model and a large model but no concentrator. The small Datakit model cannot be used like a concentrator because it is a standalone system with its own control console. The concentrator is controlled from the attached packet controller. This arrangement makes the concentrator cheaper than the small Datakit as a satellite. Because of the AT&T-NS charter, end users cannot buy Datakit VCS systems from AT&T-NS but must buy them from one of the BOCs that sells it. Currently, all BOCs have installed at least 1 Datakit. Bell Atlanticcom is probably the BOC most actively selling Datakit.

Currently, AT&T-NS offers a limited set of components for Datakit: 2 VCS models, 2 asynchronous communication interfaces; an interface to access a DEC host running UNIX V, a high speed interface for an AT&T 3B computer, fiber optic links between VCS nodes and between VCS and 3B computer, and an interface to DDS network. AT&T-NS is working on other components for release in 1985, one of which is probably a concentrator similar to the one offered for ISN.

### □ Strengths

The Datakit begins with a strong advantage because of its introduction by AT&T-NS and its integration with the Bell Operating Companies' equipment.

It is a solution to the needs of many users, the integration of data and voice communication, although Datakit is **currently only** a data network.

Datakit has a considerable potential for expansion. Communication between VCS nodes and 3B host and VCS is over fiber optic cable. The transmission rate is currently 8M bps, but that is primarily limited by the data rate of the switching bus on the packet controller.

The data rate of 8M bps on the VCS bus is sustainable because contention is resolved using the contention bus. This method eliminates wasted or delayed packets due to collisions or token passing. Overall, throughput is 44,000 packets per second.

The architecture is open ended. The network can be extended almost indefinitely through interconnection of VCS nodes and through connection to the wide area DDS network.

### □ Limitations

Datakit facilities are currently limited. No gateways are provided. Hosts are limited to DEC UNIX V and AT&T 3B hosts. Documentation is limited and general pricing data is unavailable.

These limitations will gradually disappear as AT&T-NS introduces its planned facilities. AT&T-NS has released only price-per-port prices. End-user prices in this report are from Bell Atlanticcom. AT&T-NS is currently developing documentation such as reference manuals and product bulletins. Hopefully, they will be available soon.

### ■ NETWORK SUMMARY

Datakit is a local area network using a Virtual Circuit Switch (VCS) to interconnect network devices. Asynchronous devices connect to the network through 6- or 12-port asynchronous interface modules that plug into the VCS. Asynchronous devices connect to the interface modules through 4-wire copper cables up to 250 feet long. Synchronous devices connect to VCS through a 6-port sync module.

The network manager controls the network through a System Control Console that connects to an integrated interface on the VCS. AT&T-NS uses the TTY 5410/5420 as the System Control Console. An integrated printer interface accommodates a System Control Printer. Any asynchronous ASCII terminal can be used in place of the System Control Console.

The CPM-422 computer port module implements multiplexed communication between a VCR and a DEC PDP-11/70 or VAX-11 host. Data rate is 320K bytes per second. An HS-CPM Computer Port Module interfaces AT&T 3B hosts to VCS through fiber optic cable. Data rate is 8M bps.

Models 500 and 2000, Datakit VCS systems, are designed to operate as standalone units, but they can interconnect through a fiber optic trunk module in each VCS. The Trunk Modules connect to each other through a fiber optic cable up to 3 kilometers (9,822 feet) long. Data rate is 8M bps.

Models 500 and 2000, Datakit VCS systems, connect to the wide area DDS network through the V.35 interface in the DDS Trunk Module. Data rate is 56K, 19.2K, or 9600 bps.

Both computer port modules and both trunk modules provide 512 channels or virtual circuits across the interface.

AT&T-NS provides 2 other modules that support the BOC exchanges: E2A and SLM modules. E2A Module offers E2A



## AT&T-NS Datakit Virtual Circuit Switch (VCS) Models 500 & 2000

telemetry service for the Switching Control Center System (SCCS). The SCCS uses a DEC or 3B host to control, administer, and maintain the stored program control systems from remote control sites. The SLM Module handles the BX25 protocol, a modified X.25 protocol used within the AT&T system.

Modem pooling is implemented by attaching modems to ports on the asynchronous interface modules and assigning their addresses to the same hunt group.

Throughput on the network is 8M bps, the speed of the internal bus of the VCS, equivalent to 44,000 Datakit packets per second.

The VCS functions as the switch and management center. All messages between sending and receiving devices pass over an internal high-speed bus in the VCS. The internal bus consists of a Broadcast Bus and a Contention Bus. The Contention Bus determines which interface module in the VCS gains control of the next time slot on the Broadcast Bus. The contention scheme is on a first-come, first-served basis. Each time a contending module fails to gain access to the bus, its priority increases above that of the next module seeking to gain access to the network. The contention scheme architecture prevents a high-priority module from gaining control of the Broadcast Bus more often than every other time slot. Messages/packets are 180 bits long and consist of 18 10-bit characters.

Datakit management provides facilities to reconfigure (add/delete/rearrange) network devices without disrupting the network as a whole. It senses and logs abnormal conditions, alerts supervisory personnel, and isolates failures to the replaceable module level. Configuration and fault data are stored on a Winchester disk integral to the control processor.

The system manager can establish "hunt groups" so that multiple ports on a host or a modem pool can be used to accept a "call" (message). The manager can also set up permanent virtual circuits so that users need not reestablish and disconnect them as they are needed. Datakit also provides for user password protection, closed user groups, and automatic fixed virtual circuit feature.

Routing is performed during call set-up processing. Once established, switch memory retains the circuit chosen for the call. Thus, the only routing table is a name translation table that translates a logical name to a destination address and virtual circuit number.

The manager can initiate tests and receive reports on system status, endpoint addresses, network configuration, translation data (between mnemonic and numeric addresses), traffic, performance, and traffic activity. The system automatically performs many self-tests and alerts the manager of faults through the System Control Console and Printer.

Datakit does not provide a battery backup facility but it does have a "bridged" power supply feature on the Model 2000. Each 4-shelf cabinet includes 2 power supplies plus a bridged power supply. One power supply provides power to the first and second shelves, the second power supply provides power for the third and fourth shelves. The bridged power supply can back up either of the other 2 power supplies if a failure occurs.

### ■ SOFTWARE

Software for the control computer integrated in the VCS is currently bundled with Datakit. The system is **not** user programmable. It is programmed to support all system modules, the network access contention scheme, and network administration and configuration.

The network manager controls the network from the System Control Console through system management commands using a user-friendly interface. The manager can also assign ports to "hunt" groups so that multiple ports on a host or in a modem pool can service a call.

The network manager can establish permanent virtual circuits so users need not reestablish them each time they are used. The manager can also change system parameters, such as data rates, security, and destination on existing channels or modules. Channels and modules can be added/deleted to/from service.

The system generates management reports that are displayed

and/or printed. These reports include hourly reports on system status and port activity.

The system provides facilities that automatically check the hardware and software for abnormal conditions. It sends an alarm message to the System Control Console and to the printer when tests detect faults. Regularly performed tests include status poll and self-health tests on control processors and components. The system manager can also initiate these tests as well as a loopback test to check link circuits.

Currently, each Datakit VCS system requires its own control console even if multiple systems are networked together. AT&T-NS is working on a package that will run on a UNIX V system to control a network with multiple VCS nodes from a central control console.

### ■ HARDWARE

#### □ Terms & Support

**Terms** • Datakit VCS models are available for lease or purchase from regional Bell Operating Companies or other distributors with end-user sales organizations; they are not available to end-users from AT&T-NS • the BOC would generally perform a site study and develop a network plan based on customer needs; the BOC then bids on the total system including the components and distribution (wiring) system • Bell Atlanticom has released purchase prices only on selected components, but has not yet disclosed wiring charges.

**Support** • AT&T-NS provides a 1-year warranty on all Datakit parts to the BOCs • the BOCs are responsible for the maintenance for the end user; the BOC can, in fact, subcontract for the maintenance with AT&T-NS • Bell Atlanticom gives the user the choice of maintenance from AT&T-NS or from Bell Atlanticom; Bell Atlanticom maintenance prices are about 1 percent of total purchase price per month.

#### Virtual Circuit Switch (VCS)

The VCS is the nucleus of Datakit system. It establishes the virtual connections between all devices connected to the network, and it provides all the network management and control functions. Currently, AT&T-NS offers Datakit VCS Models 500 and 2000. Both models are built around a Motorola 68000-based control computer.

Model 500 is designed as a standalone unit for small businesses; it can also function as a remote satellite to a Model 2000 or provide local facilities within a large organization. It is housed in a small 18-slot cabinet, 15x25x22 inches: 10 slots are used by the switch and 8 slots are available for expansion modules.

Model 2000 is designed as a standalone unit for large networking applications. It can also function as a node in a multinode network of Model 500s and 2000s. The basic unit is housed in a 63-slot, 4-shelf unit: 10 slots are used by the switch leaving up to 53 slots for expansion units. A second 4-shelf cabinet can be added to provide 15 slots per shelf or 60 slots. Thus, the maximum configuration provides up to 113 slots to attach expansion units or system features. Some units require 2 slots, such as a second Winchester disk for the switch or the synch module to attach up to 6 synchronous devices.

Model 500 and 2000 systems can interconnect with other Model 500 and 2000 systems in a multinode network using fiber optic cable trunks for local installations or V.35 interfaces to the wide area DDS network.

The basic VCS unit includes the switch, a control computer (based on the Motorola 68000), a clock, a Winchester disk drive and controller, and interfaces for the control console and console printer. All the modules connect to both the Contention Bus and the Broadcast Bus, see Figure 2.

All systems also include a power supply. For Model 2000, 1 power supply is for each set of 2 shelves in a cabinet. A bridged power supply for backup is supplied for a 4-shelf cabinet. It can replace either of the other 2 power supplies.

**Datakit VCS Model 500** • standalone control unit for LAN;

## AT&T-NS Datalink Virtual Circuit Switch (VCS) Models 500 & 2000

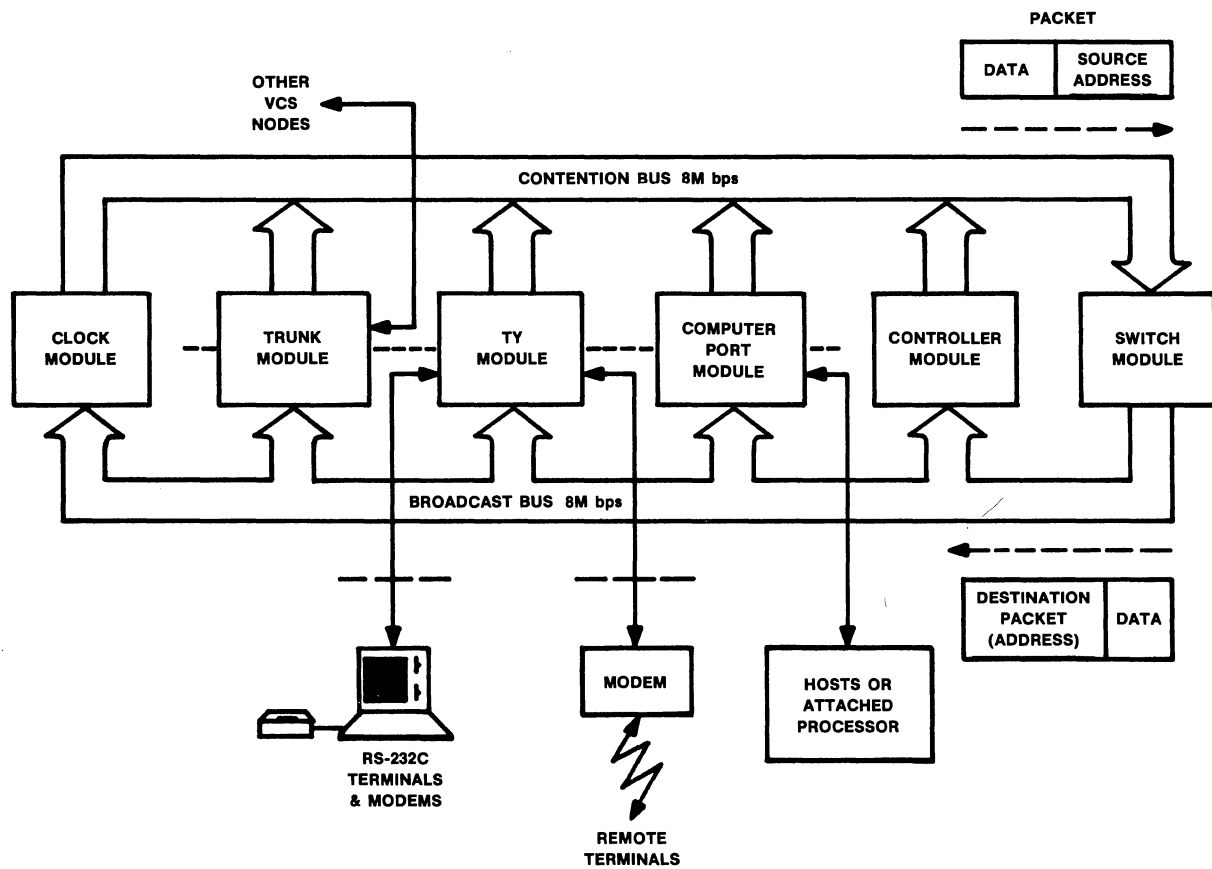

Note: controller module includes Control computer, Winchester disk subsystem, control console, and printer interfaces.

Figure 2 • DATALINK configuration; all modules connect to both Contention and Broadcast Buses.

includes control software that runs on the control computer; includes 11 slots for addition of interface modules to connect host computers, terminals, or trunks to other VCS units:

NA prch

**Datalink VCS Model 2000** • standalone control unit for LAN; includes electronics and power supply plus control software that runs on the control computer; includes 4-shelf cabinet but only 1 shelf implemented in basic unit; provides 8 slots for addition of interface modules to connect host computers, terminals, or trunks to other VCS units:

21,950

Second or Fourth Shelf for Model 2000 • for basic unit and second cabinet; does not include power supply; uses power supply in first or third shelf • provides repeater for resynchronization with other shelves and 15 slots for system expansion:

5,500

Third Shelf for Model 2000 • for basic unit and second cabinet; includes power supply for 2 shelves, repeater for resynchronization, and 15 slots for system expansion:

7,250

Second 4-Shelf Cabinet • includes electronics and power supply for 2 shelves but only 1 shelf with 15 slots for system expansion:

19,950

Bridged Power Supply • can backup either of 2 power supplies required for a 4-shelf cabinet:

1,950

Control Console • TTY 5410 ASCII Display Terminal:

995

Control Console • TTY 5420 Buffered Display Terminal:

1,495

Control Console Printer • TTY 5310:

1,350

**Failsafe Model 2000** • for total backup of complete system; available but requires some engineering for specific configuration:

NA

### Device Interface Modules

**TY 6 Asynchronous Interface Module** • 6-port RS-232 interface for asynchronous computers or terminals; each port supports data rate of 75 to 19.2K bps; device can be located up to 250 feet from interface module • requires 1 slot:

\$1,950 prch

**TY 12 Asynchronous Interface Module** • 12-port RS-232 interface for asynchronous computers or terminals; each port supports 300 to 19.2K bps data rate; device can be located up to 250 feet from interface module • requires 1 slot:

2,550

*PRCH: purchase price. NA: not available/not applicable. Prices are current as of December 1984.*

# AT&T-NS Datakit Virtual Circuit Switch (VCS)

## Models 500 & 2000

**Sync Module** • provides up to 6 ports with RS-232 synchronous interface supporting data rate of 9600 bps or 1 port at 56K bps; device can be located up to 250 feet from the interface module • 2-board module that requires 2 ports:

6,950

### Host Computer Interface Modules

**CPM-HS Computer Port Module** • serial interface to AT&T 3B computer running UNIX V over fiber optic cable up to 1 kilometer (3,274 feet) long at data rate of 8M bps; supports 512 channels (virtual circuits) • requires 1 slot:

\$3,950 prch

**CPM-422 Computer Port Module** • RS-422 interface to DEC PDP-11/70 or VAX-11 computer running UNIX V over flat ribbon or cable that conforms to RS-422 standard; computer can be located up to 500 feet from the CPM; supports 512 channels (virtual circuits) • requires 1 slot:

3,750

### Trunk Interface Modules

**Trunk Module (Fiber)** • interface to fiber optic cable up to 3 kilometers (9,822 feet) long to other Datakit VCS 500 or 2000 systems; data rate is 8M bps; provides 512 channels (virtual circuits) • requires 1 slot:

\$6,750 prch

**Trunk Module (DDS)** • V.35 interface to wide area DDS network; data rate of 9600, 19.2K, or 56K bps; provides 512 channels (virtual circuits) • requires 1 slot:

6,750

### Other Modules

AT&T-NS offers the E2A and SLM modules specifically to interface to the equipment of the Bell Operating Companies.

**E2A Module** • offers interface to E2A telemetry service switching control center system (SCCS) for BOCs; DEC computers and AT&T 3B processors provide facilities to control, administer, and maintain stored program control systems from remote control systems • requires 1 slot:

NA prch

**SLM** handles BX25 protocol, a modified X.25 protocol used within AT&T:

NA

### Other Communications

**Modem Pooling** • requires no additional hardware other than the full-duplex modems; each modem is connected to a port on TY Asynchronous interface module; the AT&T-NS software allows assignment of modems in a pool to a hunt group • provides dial-in, dial-out access between network and remote terminals or hosts • modems are accessed as needed; no modem is dedicated to a particular device.

### Distribution System

AT&T uses optical fiber, wire cable, and various cross-connect units to implement Datakit.

**Wire Cable** • general-purpose No. 26-gauge (AWG) or larger twisted pair; connects devices to EIA RS-232C ports on asynchronous modules; 250 feet maximum length • wires carrying EIA signals must be isolated from wires carrying analog voice signals to prevent interference.

**Optical Fiber Cable** • dual fiber with core/cladding diameter of 62.5/125 microns • transmits Manchester coded digital information at 8M bps for distances up to 1 kilometer without degrading signal; has potential for data transmission at much higher rates.

**Wire Cross-Connects** • modular hardware using snap-on patch cords to reconfigure cable connections; located in satellite closets and equipment rooms • provides administration points for wire distribution system.

**Optical Cross-Connect Units (OCUs)** • modular hardware

using fiber jumpers to reconfigure fiber cable connections • provides administration point for fiber distribution system.

**Optical Interconnection Units (OIUs)** • modular hardware; provides points for joining optical fiber cables.

### SPECIFICATION

AT&T-NS uses a prioritized access protocol based on the address of the module seeking access.

### Packet Format

Transmissions between devices are based on a 180-bit packet, consisting of 18 10-bit words; a word with 1 control bit, 1 parity bit, and 8-bit byte is called an envelope. The first 2 envelopes in a packet contain the address of the device sending the packet. The other 16 envelopes contain either data or control bytes. The first 7-bits of the address indicate 1 of 127 backplane slots. The second 11 bits of the address select 1 of 2,048 virtual circuits available in a single interface module. The Translation or virtual circuit table in the switch maintains a record of all the virtual circuits established by the Control Computer. When a packet is received, the switch strips off the source address and replaces it with the destination address from the virtual circuit table. The virtual circuit remains in effect until the Control computer removes it from the virtual circuit table.

When setting up a virtual circuit, the user initiating a transmission (setting up a call) turns on the terminal. After receiving a "Destination" prompt, the user "dials" (types in) the appropriate host-computer logical name. The switch module receives the request and sends it on to the Control Computer for processing. The Control Computer translates the "Destination" into an address and sends it back to the switch. The switch strips off the the terminals' source address and replaces it with the host-computer address supplied by the Control Computer.

The routing function is performed only when the call is set up. Once the call is established, the switch memory is updated to reflect the circuit chosen. For the duration of that call, the switch performs circuit switching based on the module and channel number mapped in its memory.

The only routing table information maintained in a single node is the name translation table. The Datakit console operator establishes and maintains the name translation table as part of the network configuration facility. The Datakit VCS allows up to 1,000 entries or service names in the name translation table. It provides for mapping a logical name (service name) into a physical Datakit address (module and channel/virtual circuit number).

### Transmission Characteristics

**Channel Encoding** • Manchester code.

### Access Method

The Contention Bus is synchronized with the Broadcast Bus. The Contention Bus is used to resolve contention among the modules waiting to gain access to the switch to transmit data. It is also used to transmit data to the switch. Each module, wishing to access the switch, transmits its address bit-by-bit onto the Contention Bus during each bus time slot. At the same time, it reads the ORed address bit; if the ORed bit is "1" when the module's address contains a "0," the module stops transmitting its address and drops out of contention for that time slot. After all address bits have been transmitted, the module with the same address as the ORed address bits is the only module still in contention. It transmits its data following the address to the switch. Thus, a module's priority for access to the switch is established when it is assigned an address.

The switch uses the source address to look up the virtual circuit in its translation table; attaches the destination address in place of the source address and puts the packet onto the Broadcast Bus. All modules listen to the Broadcast Bus for their addresses. When a module recognizes its address, it receives the data packet.

**Data Rate** • 8M bps.

**Carrier** • none.

**Topology** • a star with a centralized short bus (5 meters) in the

## AT&T-NS Datakit Virtual Circuit Switch (VCS) Models 500 & 2000

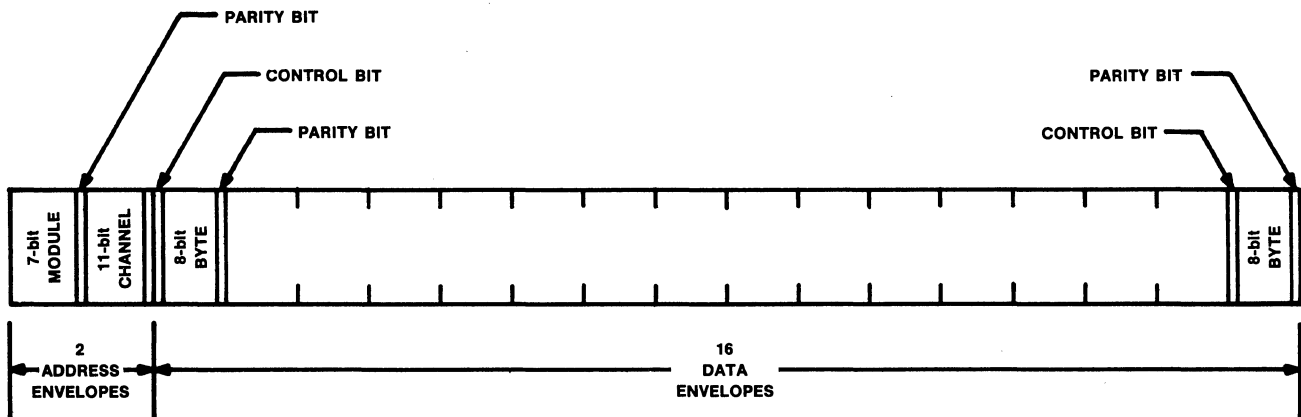

**Figure 3** • Packet composition; each packet contains 18 envelopes; each envelope contains a control bit, an 8-bit byte, and parity bit.

Virtual Circuit Switch (VCS); a number of VCS systems can be interconnected into a multiple node local or wide area network.

### Control Procedures

The Datakit VCS is organized around a short central bus, which actually consists of 2 buses: Broadcast Bus and Contention Bus. All modules in the Packet Controller connect to both buses. All modules send data to the switch over the Contention Bus and receive data from the switch over the Broadcast Bus. The Contention Bus determines which module gains access to the switch.

### Transmission Medium

Datakit VCS uses both copper wire and fiber optic cable. Devices

connect to TY asynchronous interface modules and synchronous modules in a VCS through twisted pairs. AT&T 3B hosts connect to VCS through optic fiber cable. DEC hosts connect to VCS through a flat ribbon cable or cable that conforms to RS-422 interface. VCS systems interconnect using fiber optic trunks.

### Use

Datakit VCS is a major product for AT&T-NS to gain a share of the Local Area Network Market. It is a product for office automation and distributed processing environments. It will be distributed by the Bell Operating Companies and other designated distributors.

• END

# AT&T Technologies 3BNET

## Baseband Local Area Network

### ■ PROFILE

**Architecture** • 3BNET Local Area Network (LAN).

**Type** • baseband packet switching LAN using CSMA/CD access protocol according to Ethernet Specification 1.0 of 1980; protocol has been extended to 3BNET, a higher level Ethernet protocol that increases maximum data field in the packet from 1500 bytes to 4096 bytes and provides 2 CRC fields (see packet format).

**Transmission Speed** • 10M bps.

**Cable Length** • 500 meters (1640 feet) of coaxial cable; drop cables length can be up to 50 meters (162 feet) for maximum node-to-node distance of 600 meters (1950 feet).

**Applications** • designed specifically for computer-to-computer transmission for file transfers.

**Configurations** • up to 100 transceivers per network, transceiver connects one Ethernet-compatible computer node to 3BNET; Ethernet-compatible computer can be a 3B or non-3B family product running UNIX System V Release 2; provides UNIX user level file transfer facility • all 3B computers operate as host nodes but only the 3B5 or 3B20S/A computer can be user-assigned as a master or backup computer node; master node operates as

network administrator, maintaining network configuration and status information; backup node continually monitors master node so it can take over in case of failure • all computers run under UNIX System V Release 2 operating system; other UNIX systems must be either upgraded to System V Release 2 or user must program the networking software • AT&T plans to interface Ethernet-compatible servers and gateways to 3BNET.

**Interface** • 3B computers connect to the network through a network interface, which in turn connects through a drop cable to a baseband Ethernet transceiver, (see Figure 1); AT&T does **not** recommend a piercing, tap transceiver; instead, the company recommends a 3COM transceiver that terminates the cable and provides direct coupling to the cable • the network interface for the 3B5 and 3B20 computers is a 3-board interface; the networking interface feature for the 3B2/300 is a single board; both interfaces are based on the WE32000 microsystem • AT&T is developing an interface to 3BNET for the 3B20/D computer.

**Gateways** • none except through attached host processors such as the AT&T Datakit; AT&T has gateways under development.

**Support of Foreign Devices** • Ethernet-compatible Unix-based computers can connect to 3BNET; require changes to software to support networking and file transfer services on 3BNET if UNIX System V Release 2 is not used.

**Communications Management** • through host system that has been designated the network administration master; supported by an administration software package that provides network configuration table and administration command language to query network and to collect data from all network nodes (including local node) • also provides for backup of master node if master becomes unavailable.

**Protocols** • uses CSMA/CD for network access • Ethernet protocol and 3BNET protocol; 3BNET protocol extends data field from 1500 bytes (Ethernet) to maximum of 4096 bytes and provides 2 CRC fields: one for data field only and the other for address, type, and data fields.

**Distributed Functions** • host-to-host file transfers.

**Support Software** • UNIX System V Release 2 operating system running on 3B20, 3B5, and 3B2/300 • Administration package running on network master computer • security package that runs on master • UNIX operating system utilities, compilers, and program development aids.

**First Delivery** • announced March 27, 1984; delivered to Bell Regional Holding Companies.

**Systems Delivered** • undisclosed.

**Comparable Systems** • comparable to most Ethernet-based networks, although limited to computers running under UNIX System V Release 2 • Ungermann-Bass Net/One baseband and Interlan Net/Plus similar but more flexible than 3BNET.

**Vendor** • AT&T Technologies; 222 Broadway, New York, NY 10038; 212-669-2584 • AT&T Information Systems; 100 Southgate Parkway, P.O. Box 1955, Morristown, NJ 07960; 201-898-8000; National Sales Center 1-800-247-1212 (toll free).

**Distribution** • AT&T Technologies direct to OEMs, technical VARs (Value Added Resellers), Regional Bell Holding Companies (RHCs), and Federal Government • AT&T Information Systems will sell to office system VARs and Fortune 500 end users.

### ■ ANALYSIS

The 3BNET local area network, primarily important because the vendor is AT&T, was designed to interconnect AT&T's 3B2 computers through local area networks. Before introduction to the

### PURCHASE PRICE RANGE

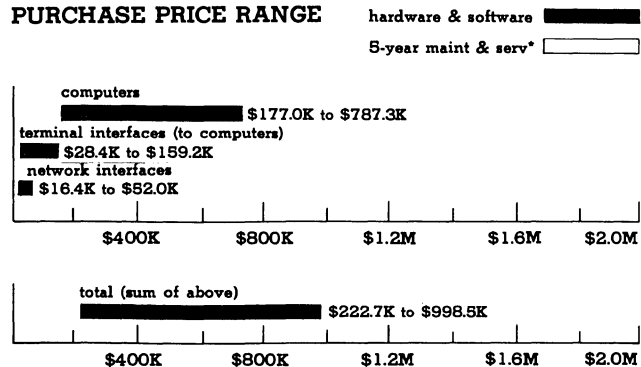

**AT&T 3BNET PURCHASE PRICING • SMALL SYSTEM** interconnects 2 host computers and 100 terminals • these can be configured many different ways but this small 3BNET includes a 3B2/300 computer with 12 terminals attached and 2 3B5 computers; one 3B5 has 56 terminals attached and the other has 32 terminals attached; the 3B5 with 32 terminals attached also acts as the master node on the network • components include 3B2/300 Package B (1M-byte memory, 32M-byte Winchester disk, and I/O expansion card) plus 1M-byte memory module, 2 I/O expansion cards, and networking interface feature; 3B5/100 (1M-byte memory, 48M-byte disk drive, and 8 RS-232C ports) plus 3M bytes memory, 3 ADLI boards, (8 ports each) and network interface; and 3B5/200 (2M-byte memory, 4M-byte disk, and 8 RS-232C ports) plus 4M-byte memory, 6 ADLI boards (8 ports each) and network interface • **LARGE SYSTEM** interconnects 4 host computers and 500 terminals • this network can be configured many different ways but this large 3BNET includes 10 3B2/300 computers with 16 terminals each, three 3B5 computers with 60 terminals each, and a 3B20/A with 160 terminals; one of the 3B5 host computers acts as the master network node • components include 10 3B2/300 Package B Systems (with 1M-byte memory, 32M-byte Winchester disk, and I/O expansion Card) plus 1M-byte memory, 3 I/O expansion cards, and networking interface feature; three 3B5/200 (2M-byte memory, 48M-byte Winchester disk, and 8 RS-232C ports) plus 4M bytes of memory, 7 ADLI boards, (8 ports each) and network interface; and 3B20/A (3B20S with 2M-byte memory, attached processor with 2M bytes of memory, 300M-byte disk, 8 asynchronous I/O ports, TTY controller, diagnostic processor, and 1600-bpi tape drive) plus 4M bytes of memory, 19 8-port asynchronous I/O options, and network interface • software for all systems is bundled with the hardware. \*AT&T has not disclosed maintenance and service prices.

## AT&T Technologies 3BNET Baseband Local Area Network

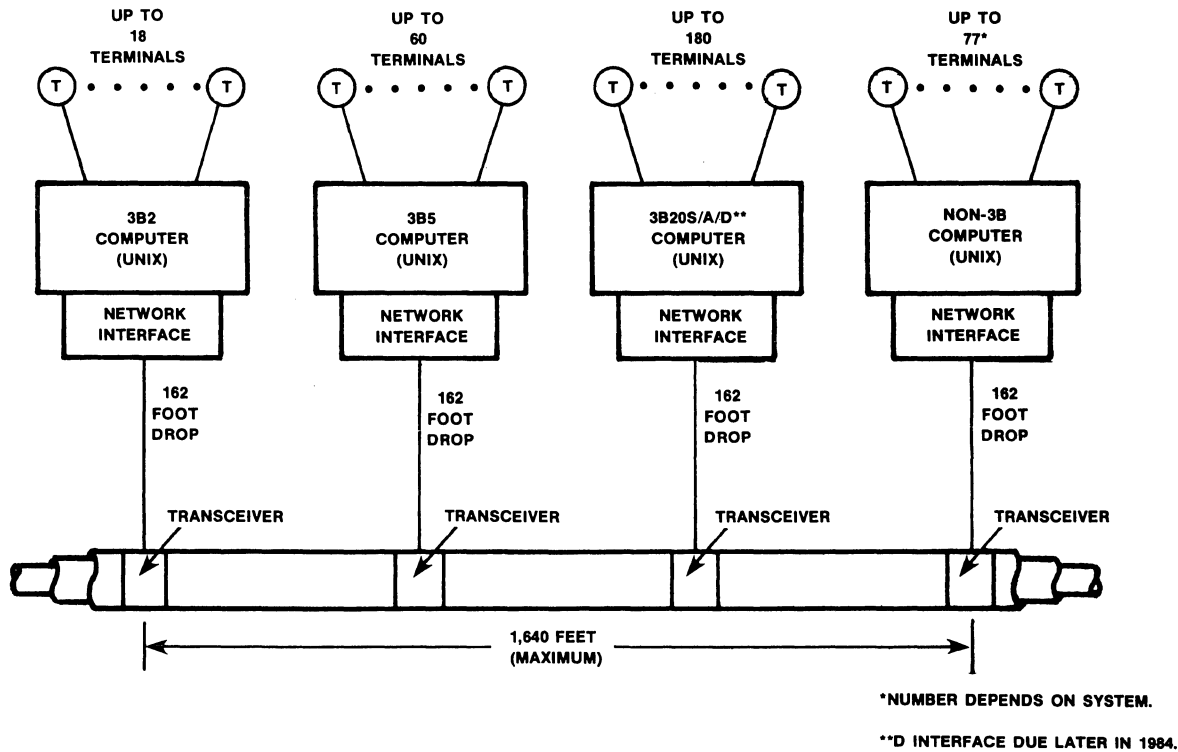

Figure 1 • Typical 3BNET Network.

general marketplace, 3BNET and the 3B computers were sold to the Regional Holding Companies (RHCs), thus many have been installed. Initially, the systems are being sold to OEMs and VARs; end-user deliveries began at the end of 1984.

Actually, AT&T announced 2 networks; one is a PC network that uses the 3B2/300 as a master; the other is 3BNET which is Ethernet-compatible. The PC network is not yet available; 3BNET is available now.

The 3BNET protocol is actually a **superset of the Ethernet protocol**; it increases the frame size for a larger data field and two CRC check fields. The larger data field will increase network performance for applications where large files are transmitted between computers. Of course, it does nothing for applications where short messages are transmitted between computers. The networking software for the 3B computers support both the Ethernet and 3BNET protocols. When 3B computers intercommunicate, they use the 3BNET protocol; when they intercommunicate with Ethernet-compatible computers, they use the Ethernet protocol.

All the 3B computers on 3BNET run under UNIX System 5 Version 2 operating system. Current UNIX users that are Ethernet-compatible will have to upgrade to the System 5 Version 2 to connect to 3BNET. Currently, the 3B20D cannot connect to 3BNET although such a connection is under development.

The initial product line for 3BNET is very limited. No gateways. No bridges to older UNIX systems. The marketing information on just what products AT&T is selling is also thin. Options for the 3B computers have not been priced. Liaisons between AT&T and the public do not know what networking products AT&T will sell. Will it sell transceivers, for example? The company does not recommend transceivers with pressure taps, however, but instead recommends that the cable be terminated and twisted through the transceiver. Will it sell cables, connectors, terminators, and so on? What are the functional characteristics of the printers and disks available with the 3B computers? What is the price of the

Administration package that runs on the Master Node to control the network? When will the Security package be available? What is its price? Eventually, AT&T should be able to answer these questions.

With the prices on its 3B computers high, its technology old, and 3BNET offerings limited, AT&T will need a superb marketing and service organization to compete successfully with other, more prominent vendors who have significant market penetration. Apparently maintenance arrangements have not yet been clarified for the 3B computers and 3BNET. So far, AT&T has produced no evidence to show that its marketing acumen will be up to its task.

### □ Strengths

The greatest strength of 3BNET is its vendor. AT&T is expected to become a major force in the computer industry, and 3BNET, along with the 3B computers it interconnects, represents the company's first major entry in the computer marketplace. The system is based on the popular UNIX operating system, one of the computer industry's de facto standards. The UNIX user community is growing rapidly; a single-user version, for example, is offered by IBM for its PC and PC/XT personal computers.

The network facilities include network management, security, and flow control. Network services include file transfer between computers by a single command.

### □ Limitations

The 3BNET is **not** a general-purpose network. It is designed primarily to network the 3B computers. The interface units are designed to offload the network processing from the attached computer system. The network interface contains the WE32000 microsystem, the same systems used as the base computing engine in the 3B5 and the 3B2/300. The network interface contains a substantial piece of logic and it is expensive. This is

## AT&T Technologies 3BNET Baseband Local Area Network

also true for the Ethernet interface, however: it is also substantial and expensive.

Terminals can attach to the network only through a 3B computer, which in turn requires the network interface. The 3B computers support from 18 terminals on the 3B2/300 to 180 terminals on the 3B/20A.

AT&T documentation is unclear on the difficulty of integrating non-3B computers in a 3BNET network. Obviously, Ethernet-compatible systems cannot operate on the network in 3BNET mode. It appears that Ethernet-compatible systems will have to run under UNIX System V Release 2.

### ■ NETWORK SUMMARY

AT&T offers a network system to interconnect its UNIX-based 3B computers. The network can operate in 2 modes: in Ethernet protocol mode or in 3BNET protocol mode. The 3BNET protocol is a higher-level protocol than the Ethernet protocol and constructs and processes packet header information for packet data fields of 64 to 4096 bytes as compared to 46 to 1500 bytes for Ethernet.

The network is structured around master and host nodes. The host nodes are 3B5 or 3B20S/A computer. A set of administration programs can be loaded into a host node computer, making it a network master. Currently, the 3B2/300 can operate only as a host node; it cannot be a master on 3BNET.

The network master implements a set of network administration commands to allow a user or manager to query the network and collect data from all the network nodes including the master node. The administration package also provides facilities to generate and keep a network configuration table that lists all the nodes on the network and the status of all 3B5 and 3B20/S/A computer nodes.

The network cable can be 500 meters (1640 feet) long with up to 100 nodes per network. The drop cables between the network computer and the network bus tap can be 50 meters, (162 feet) thus the maximum node-to-node distance can range up to 600 meters (1964 feet). The largest 3B computer that can connect to 3BNET can support up to 180 terminals, making a maximum network able to support up to 18,000 terminals.

Transmission rate on the cable is 10M bps. Packet size is 72 to 1526 bytes in Ethernet mode and 92 to 4124 bytes in 3BNET mode with 20 bytes being used for the header in either mode. Network interface addresses are 48 bits long. Each network interface can maintain 64 addresses: one physical maintenance channel address, one universal broadcast address, and 62 logical addresses. The logical addresses provide interface to software modules running on the host node.

Devices connect to the network through a 3B computer, which contains a network interface that offloads the communications housekeeping details from the computer. The network interface connects by drop cable to a baseband transceiver that connects directly to the network coaxial cable. The drop cable can be up to 50 meters (162 feet) long.

The network interface is implemented using the WE32000 microsystem which is also the CPU for the 3B5 and 3B2/300 computers. The network interface implements the CSMA/CD access method, Ethernet and 3BNET protocols, flow control, and maintenance. Two versions are provided: one to interface the 3B5 and 3B20 computers to the networks and another to interface the 3B2/300 to the network.

A Security package is available to run at the master node to control user access to the network facilities.

Network software running at each host node provides a UNIX-level file transfer facility.

The computer nodes on 3BNET run under the UNIX System V Release 2 which offers support for networking as well as other new facilities. In addition, the 3B5 and 3B2/300 computers are object-code compatible. Both use the IS25 instruction set of the WE32000 with identical bit layouts on the instructions. The 3B5 and 3B2/300 are source-code compatible through the C language with the 3B20A/S.

UNIX System 5 Release 2 provides new commands,

improvements, and up to 10 percent greater performance over Release 1.

Non-3B Ethernet-compatible computers can connect to 3BNET. To be completely compatible, the systems will have to run the UNIX System V Release 2 operating system.

### ■ SOFTWARE

#### □ Terms & Support

**Terms** • UNIX System V Release 2 is bundled with computer systems; some packages are unbundled and available.

**Support** • two levels provided: consultation and full maintenance • consultation provides newsletter, installation assistance, software and documentation updates, and problem reporting; software service includes problem/isolation and remote remedial assistance via toll-free number.

#### □ 3BNET Software Components

Software networking software for the 3BNET is based on the UNIX System V Release 2 operating system. The network file transfer facility is a UNIX-level facility. In addition, an administration package runs under UNIX on a 3B5 or 3B20S/A computer to provide centralized network management on a master host node. An optional Security package also runs on the master host node to provide access security for network facilities.

Software among all 3B computers is source code (C language) compatible and, between 3B2/300 and 3B5 computers, is object code compatible.

**UNIX System V Release 2** • general-purpose timesharing operating system for the 3B computers; allows multiple users to access system interactively and to manipulate input/output of files and commands; utilizes a hierarchical file structure; commands can be entered from any terminal on the system or from any file and output can be directed to a file or peripheral device; commands can be pipelined to program specialized functions for an application • program development and text processing facilities include C and FORTRAN compilers, and a user interface (shell), which is also a programming language • Release 2 provides a number of new facilities over Release 1 as well as a performance improvement of up to 10 percent; the "shell" overall performance has been improved by 25 percent; user-definable shell procedures can be retained in main memory; the shell can collect accounting information and support multiple mail files • 3 new commands are added: **mailx** provides new ways to handle mail; **pg** displays file contents one screen at a time; and **trenter** allows users and administrators to send trouble reports to the UNIX System Support Center • other commands include new options or features • **cron** command can schedule and execute both user and system jobs • **curses** is a subroutine package to manage terminal screens; **terminfo** is a database of hardware features and escape sequences for different terminals; **curses/terminfo** package allows users to unite terminal-independent applications • standard disk and tape names have been adopted; an accounting package can generate prime-time versus nonprime-time usage.

**Administration Package** • runs on host node making it the master node; provides users and a network manager access to centralized administration data • administration command language provides facilities to query all network nodes and collect operational data; master node maintains a network configuration table of the network with status of the various nodes.

**Security Package** • runs on the master node • name service facility; repository for making passwords available; keeps track of virtual circuits established; maps virtual circuits into addresses; tells what it accepts.

**Networking Software** • integrated into UNIX System V Release 2 operating system.

### ■ HARDWARE

#### □ Terms & Support

**Terms** • available for purchase only • quantity discounts are available; up to 38% for 100 to 150 3B20s, 200 to 300 3B5/100s

## AT&T Technologies 3BNET Baseband Local Area Network

and 200s, and up to 35% for 500 to 800 3B2/300s.

**Support** • hardware consultation, newsletter, update list, hot-line, and remote remedial assistance • full maintenance support 5 days per week, 9 hours per day except holidays; for all 3Bs except 3B2 support extended to 12 hours per day, 6 days per week, up to 24 hours per day, 7 days per week • response time of 4 hours for systems located within 100 miles of the 150 service centers.

### □ Ethernet & 3BNET Hardware

The 3BNET interconnects 3B computers together using an Ethernet coaxial cable, (see Figure 2). Network components include the 3B5, 3B20S/A, and 3B2/300 computers, two Network Interfaces, transceiver, coaxial cable, and drop cables. The network interfaces are implemented on boards that plug directly into slots on the computer backplane. All 3B computers operate as host nodes on the network. The user can select one 3B5 or 3B20 host node to operate as a master node and another to operate as the backup for the master. The 3B2/300 can function only as a host node.

### 3B5 Computers

These computers are aimed at office automation, software development, and CAD/CAM application, and are identified by AT&T as modular, mid-range, virtual memory, 32-bit superminis. They support up to 4 disk drives and 4 tape drives; disk drives include 48M-byte and 160M-byte models; tape drive is a streaming tape rated at 1600 bpi • all peripherals are handled by intelligent I/O processors, called by AT&T I/O accelerators (IOAs); disk file controllers are integrated; self diagnostics are a standard feature • 3B5's basic cabinet is 30x31x31 inches; additional disk drives over the basic configuration are housed in cabinet that may be placed atop the CPU cabinet.

**3B5/100** • accommodates up to 40 users and is rated at 0.63 MIPS; central control option increases performance by 30% • basic 64K-bit chip memory ranges from 1M bytes to 8M bytes; memory is error correcting with a 500-nanosecond access time; an 8K-byte cache is standard; WE32000 used in the 3B5/100 is rated at 7.2 MHz • basic package includes a 48M-byte disk drive, 8 RS-232C ports, and 5 slots expandable to 14; includes UNIX System V Release 2:

\$57,000 prch

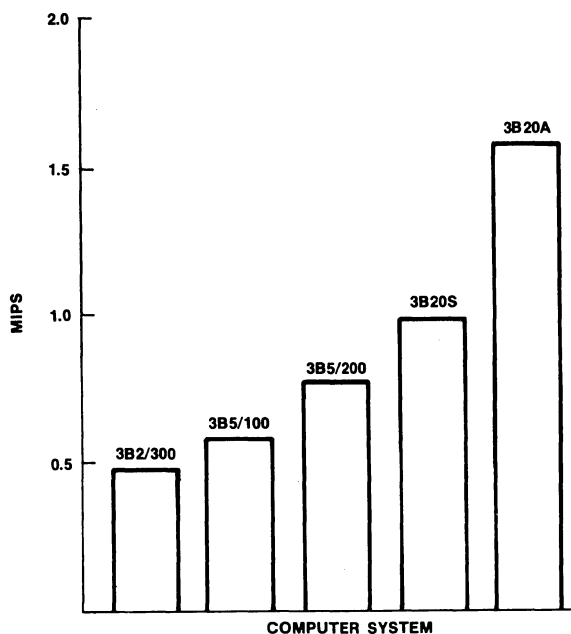

Figure 2 • estimate of 3B computer performance.

**3B5/200** • accommodates up to 60 users and is rated at 0.8 MIPS; uses the same 64K-bit memory as the 3B5/100 but ranges from 2M bytes to 8M bytes; also uses same cache as found in the model 3B5/100; WE32000 used in the 3B5/200 is rated at 10 MHz • basic package includes a 48M-byte disk drive, 8 RS-232C ports, and 14 slots expandable to 27; includes UNIX System V Release 2:

73,000

Memory • upgrades for the 3B5s are in 1M-byte increments:

4,900

**ADLI Board** • an 8-port asynchronous RS-232C interface board:

2,200

3B5/100 Upgrade • to the 3B5/200:

27,400

**Disk Drives** • the 160M-byte (134M bytes formatted) disk drive has nonremovable media; transfer rate is 1.2M bytes per second with an average seek time of 30 milliseconds; rotational delay is 8.33 milliseconds • the 48M-byte (40M bytes formatted) disk drive has a 24M-byte removable cartridge; transfer rate is 1.2M bytes per second with average seek time of 35 milliseconds; rotational delay is 8.55 milliseconds.

**Tape** • streaming tape drive is 9 track, 1600 bpi with a 24K-bps data transfer rate.

**I/O Hardware Support** • in addition to the previously mentioned ADLI, includes an automatic call unit interface with 2 RS-366 ports (1 per ADLI), synchronous data link interface (SDLI) with RJE link and 8 synchronous RS-232C/RS-449 ports, and Teletype Teletypewriter Terminal Interface with 16 standard serial interface ports • coming soon will be a 3BNET-based network interface and Ethernet standard interface • an AI/O accelerator can be added to either the 3B5/100 or 3B5/200.

### 3B20 Computers

The AT&T 3B20s are the top-of-the-line superminicomputers competitive with the DEC VAX product line; 32-bit architecture, based on AMD2901 bit slice technology; standard features include error correcting memory, intelligent I/O processors (uses WE32000 microcomputer) with DMA; addressing by word, half word, or byte; battery backup supports system operation for 10 minutes; and self checking logic for error detection and correction.

**3B20S (Simplex) Computer** • single-processor system rated at 1 MIPS accommodates up to 100 users; system has bus/parallel processing architecture; memory varies from 2M to 12M bytes; 8K-byte cache is standard, providing effective memory access time of 400 nanoseconds; 8K-byte ROM provides 64-bit word microcode instructions • system can handle up to 2 DMA controllers with 2 DMA channels per controller; each DMA channel provides 16 dual serial channels; all disk drives are supported with user specified choice of either 300M-byte or 675M-byte drives • 300M-byte disk drive has removable disk pack; average seek time is 30 milliseconds; rotational delay is 8.3 milliseconds with a DMA transfer rate of 1.2M bytes per second • 675M-byte drive utilizes fixed media; average seek time is 25 milliseconds; rotational delay is 8.3 milliseconds with a transfer rate of 1.2M bytes per second • two 9-track tape drives provide 1600-bpi density with a data transfer rate of 72K bytes per second or 6250-bpi density with a data transfer rate of 425K bytes per second • printed output is via 300- or 600-lpm dot-matrix or 600, 900-, or 1200-lpm band printers • asynchronous communication supported up to 9600 bps, with up to 8 RS-232 links • synchronous communication supported by 2 different boards • one provides X.25 level 2 link up to 56K bps with CCITT V.35 interface or up to 9600 bps with RS-232C interface; the other provides X.25 level 2 full-duplex RS-232C/RS-449 interface with 2 links up to 4800 bps and 1 link up to 9600 bps or bisynchronous communication with up to 4 RS-232C links at up

*PRCH: purchase price. AT&T has not announced its maintenance prices. Prices are current as of December 1984.*



## AT&T Technologies 3BNET Baseband Local Area Network

to 9600 bps and a single CCITT V.35 link at up to 56K bps • an auto-call unit provides up to 8 RS-366 channels controlling up to 96 modems with a sharing arrangement • basic configuration includes a processor with 2M bytes of memory and 8K-byte cache, 300K-byte disk drive, 1600-bpi tape drive, 8 I/O ports, system console, and printer:

\$230,000 prch

Add-In Memory • 1M-byte increment:

4,900

I/O Sharing Option • for high availability or load sharing, allows two 3B20S systems to share access to peripheral controllers; switching through operator-initiated switch:

NA

**3B20A Computer** • an attached processor complex rated at 1.8 MIPS designed for transaction processing applications • both the 3B20S and the attached processor perform operating system calls; both execute scheduling routines from a single job queue; the 3B20S performs all I/O • the bundled version of UNIX employed has been modified to handle 2 CPUs • the 3B20S and 3B20A are object-code compatible; if the attached processor should fail, the system can be reconfigured to a single processor with performance of about 90 percent of a 3B20S • available peripherals and communication are the same as for the 3B20S basic system package; includes a 3B20S with 2M bytes of memory, an attached processor with 2M bytes of memory, a DMA controller with 300M-byte disk, I/O processor, a maintenance (Teletype) controller, diagnostic processor, and 1600-bpi tape drive:

330,000

3B20S Upgrade • to 3B20A; includes processor and 2M bytes of memory:

120,000

### **3B2/300 Computer**

A desktop unit built around the proprietary WE32000 full 32-bit CMOS microprocessor. High-end versions of this system use 256K-bit chips in main memory, which is expandable from 512K bytes to 2M bytes; all memory boards for the 3B2/300 are dual-ported with the CPU connecting to 1 port and I/O bus to the other; self diagnostics and bootstrapping are provided via a 32K-byte ROM. The basic system contains 4 RS-232C I/O expansion ports; an I/O expansion card provides additional 4 RS-232C ports rated at 9600 bps each and a parallel centronics port; a card provides access to AT&T 3BNET LAN. The 3B2/300 is designed for an office environment and housed in a 22-inch-wide, 17-inch-deep, and 3.6-inch-high tabletop cabinet. The 4 available configurations of the 3B2/300 are bundled with UNIX System V, Release 2, administration utilities, backup copy of core UNIX software, user and system documentation, cabinet, and cables. All configurations also include a 720K-byte formatted 5.25-inch minifloppy disk drive for software loading and file system backup and 2 RS-232C serial, asynchronous, full-duplex ports (9600 bps).

**Standard Package A** • includes standard features plus 512K bytes of memory (2 256K-byte cards) and 10M-byte Winchester fixed disk:

\$9,950 prch

**Package B** • includes standard features plus 1M bytes of memory, 32M-byte Winchester fixed disk, and I/O expansion card:

15,510

**Package C** • includes standard feature plus 512K bytes of memory, 10M-byte Winchester, and 5410 Conversational Teletype Terminal:

12,650

**Package D** • includes standard features plus 512K bytes of memory, 10M-byte Winchester fixed disk, and 5620 Dot Mapped Display Terminal with mouse and windowing capability; 5620 requires the DMD core utility package:

16,000

Memory Module • 1M bytes:

2,200

DMD Core Utility Package • required by 5620:

160

I/O Expansion Card • provides 4 RS-232C serial I/O expansion ports (9600 bps) and 1 parallel Centronics printer port:

660

3BNET Interface • networking feature package:

2,400

3BNET Interface for 3B5 & 3B20 Computers • 3-board implementation: one provides Ethernet logic; another provides buffering for maintaining multiple virtual circuits through the interface; and the third is an intelligent interface to provide the software interface to the host transfer logic:

7,000

**Transceiver** • AT&T recommends a 3COM transceiver that terminates the cable and provides direct coupling to the cable; it does not recommend the pressure tap used by some Ethernet-compatible vendors.

**Cable** • standard Ethernet cable.

### ■ SPECIFICATION

The 3BNET is based on the Ethernet specification Version 1.0, published September 30, 1980 as defined by Xerox, Intel, and Digital Equipment Corporation; available from Xerox.

#### **Packet Format**

Packets vary in size from 76 to 1530 bytes in Ethernet mode and from 94 to 5126 bytes in 3BNET mode.

**Format** • dual frame format supported on 3BNET; all 3B host computers support both formats; 3B computers use 3BNET format when communicating with each other and Ethernet when communicating with non-3B Ethernet-compatible processors • 8-byte preamble, 6-byte destination address, 6-byte source address, 2-byte type field, N-byte data field with 46 (Ethernet mode) or 64 (3BNET mode) less than or equal to N less than or equal to 1,500 (Ethernet mode) or 4,096 (3BNET mode), and one 4-byte CRC (Ethernet mode) or 2 4-byte CRCs (3BNET mode) • preamble used for synchronization contains alternate 1s and 0s ending in 2 1s (see Figure 3) • destination and source addresses are long to provide unique addresses when a local Ethernet network functions as a subnetwork in a larger global distributed network; type field also included for use in a larger network, not used by Ethernet • minimum data field ensures that valid packets can be distinguished from collisions • 1 CRC (cyclic redundancy check) is calculated on the data field only and the other calculated on the destination and source address, type, and data fields • minimum spacing between packets is 9.6 microseconds • any sequence of bits shorter than minimum packet size is discarded as collision fragment.

#### **Transmission Characteristics**

**Channel Encoding** • uses Manchester encoding to ensure a transition for every bit position; transmits complement of the bit value in first half of bit time and true value in second half.

**Data Rate** • 10M bps equals 100 nanoseconds per bit on 3BNET.

**Carrier** • signaled by presence of transitions on the cable; if no transition within 75 to 125 nanoseconds after last transition, the carrier is lost, meaning the cable is free for another transmission.

#### **Control Procedures**

Control procedures follow the CSMA/CD scheme to control accesses to the channel from the 1024 stations (3BNET limited to 100) that can be connected to the cable. Only 1 station can transmit at a time, thus before transmission a station must determine if the channel is free. This is done by sensing the carrier on the line. During carrier absence, the station can transmit after waiting the minimum time between packets.

If a station starts to transmit, its data may collide with data from

# AT&T Technologies 3BNET

## Baseband Local Area Network

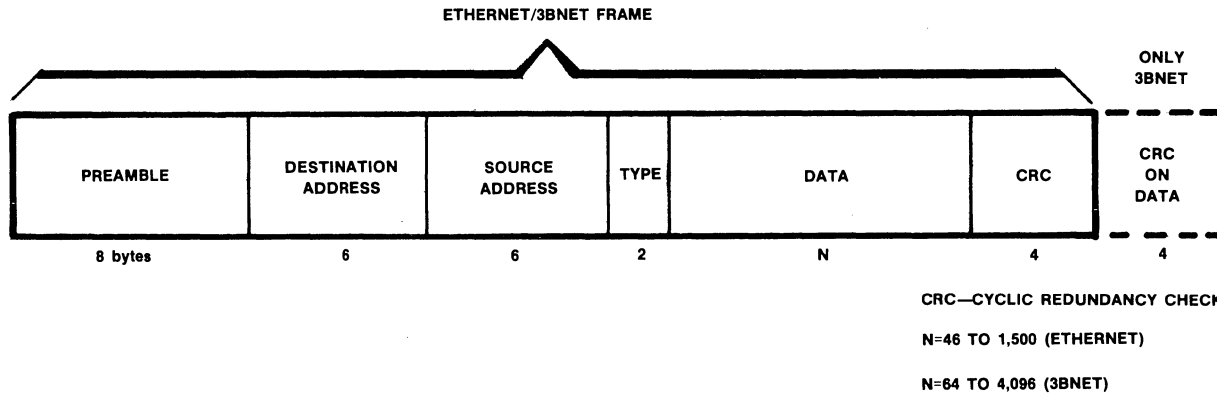

**Figure 3 •** Ethernet/3BNET frame formats.

another station that also listened, determined no carrier was present, waited, then transmitted data. When this occurs, the collision is detected and each transmission is aborted. A jam of 4-6 bytes of arbitrary data is transmitted to make sure all stations detect the collision.

Each station then backs off and waits for a random retransmission time interval calculated using a backoff algorithm before trying to transmit again. A station will attempt to transmit its data 16 times. Further attempts are dependent on software control. The remote possibility of continued collisions that prevent delivery of a message makes Ethernet a datagram service.

**Defer** • a station defers transmission until 9.6 microseconds after carrier is dropped.

**Transmit** • when not deferring, a station can transmit until its message is complete or until it detects a collision.

**Abort** • when collision is detected, the transmission is aborted and a jam sequence transmitted.

**Retransmit** • after an abort, the station waits for a random length of time, then attempts to retransmit • random number lies in range from 0 to 1023.

**Backoff** • retransmission delay calculated using Truncated Binary Exponential Backoff Algorithm; calculates random number in range from 0 to 2 raised to the nth power minus 1 for n less than or equal to 10 where n is the retransmission attempt number; for attempts 11 to 15, 2 raised to the nth power is truncated to 1023 • time interval before retransmission is 51.2 microseconds times random number generated.

### Transmission Medium

The 3BNET baseband uses Ethernet coaxial cable with terminators at each end of the transmission medium. Impedance is 50 ohms. Cable segments can be up to 500 meters (1,500 feet) long. All stations interface to cable through transceivers. Up to 255 transceivers can connect to 1 cable segment. Transceivers must be at least 2.5 meters apart. The network interface provides an intelligent connection to 3BNET.

### Use

3BNET was designed to operate in the fault tolerant and transaction processing environment. A backup is provided to monitor the master node and take over if the master node fails.

3BNET can interconnect 3B and non-3B Ethernet-compatible computers. The 3B computers all run under the same operating system and are all source code compatible. Application programs are portable from one system to another on the network. Furthermore, the 3B2/300 and 3B5 computers are object-code compatible so object modules for these systems are portable.

Non-3B computers must also run under the UNIX System V Release 2 operating system or the user must provide the networking software.

AT&T plans to provide facilities to interface Ethernet servers (file, print, and communication) to 3BNET.

• END

# AT&T Teletype 4400 Series Display Terminals

## Models 4420, 4424 & 4430

### ■ PROFILE

**Function** • general-purpose non-programmable interactive keyboard-display terminals.

**Architectures Supported** • any architecture supporting asynchronous ASCII protocol.

**Communications** • half-/full-duplex, asynchronous, 50- to 9600-bps, point-to-point character/block (4420) or character-only (4424) mode transmission • half-/full-duplex, asynchronous, 50- to 4800-bps, multipoint block mode (4430) • RS-232C or 20-/60-mA loop interfaces.

**Operating System** • none.

**Database Management** • none; only in association with host facilities.

**Transaction Processing Management** • none; only in association with host facilities.

**Support Software** • none; only in association with host facilities.

**Processor** • display-oriented control and communications logic • 5760-character (72-line) display memory (4420/4430); 3840-character (48-line) display memory (4424) • 2K display, 2K printer, and 1K-line buffer (4420/4424); 14K to 30K I/O and display/print buffer (4430).

**Terminals/Workstations** • single keyboard 1920-character display with dual auxiliary ports for local printers (4420/4424); or for local printer, paper tape, diskette, and slave keyboard-display or keyboard-printer devices (4430).

**First Delivery** • 1980 (4420); 1981 (4424/4430).

**Systems Delivered** • unknown.

**Comparable Systems** • competitive with number of general-purpose ASCII display terminals; most notable are ADDS Regent, Hazeltine Exec 10 and Esprit, Lear Siegler ADM, Beehive DM, IBM 3101, DEC VT100, Televideo 900 Series, and AJ 510/520.

**Vendor** • AT&T Teletype Corporation (Subsidiary of AT&T Technologies); 5555 Touhy Avenue, Skokie, IL 60077 • 312-982-2000.

**Distribution** • nationwide through Teletype sales offices • end-user sales handled by third parties only • also offered by AT&T-IS as Dataspeed 4400 (report 910-A428-4400).

### ■ ANALYSIS

The 4400 Series family of interactive display terminals were designed to replace older Teletype (AT&T Dataspeed) 40 Series models. The 4420 and 4424 replace the 40/1 and 40/2, while the 4430 replaces the 40/3. Only the Model 40/4—the synchronous 4800-bps member of the Teletype 40 Series—is still



actively marketed. Pricing for all models has been reduced by approximately \$300 per model in recent months; all other features remain the same since this report was first published.

Across the board, the 4400 Series is superior to the older 40 Series units. Such features as microprocessor control, buffering, programmable function keys, cursor addressing, and more advanced formatting/editing features are standard on 4400 models, and almost non-existent on the 40 family. The older 40 units were also limited to a top 4800-bps transmission rate; 4420/4424 operate at up to 9600 bps.

In the general marketplace, the 4400 Series will compete against the likes of the IBM 3101 or the very popular DEC VT100 display terminal. For the most part, Teletype displays should certainly more than hold their own technically. But when price is considered, they come at a premium. All models of the 4400 Series are higher priced than conventional display terminals offered by other vendors. Members of the 4400 family offer features which are unavailable on most competitive products. The bypass facility, discussed under Strengths, is one such feature.

Users can no longer purchase a 4400 terminal directly from Teletype but must order through a third-party source. This isn't necessarily a disadvantage from the buyer's point of view, since third parties often discount due to competition pressures. The manufacturers' suggested purchase prices are presented in this report and can be used as a reference to determine the margin of discount from a third party. Teletype will still maintain the terminals, so the reported maintenance prices are exact.

#### Strengths

Each of the different models of the 4400 Series has its own individual set of strengths. The 4420 provides transmission options of character-at-a-time, line-at-a-time, or block/page modes at asynchronous rates to 9600 bps point-to-point; the 4424 offers character-only transmission at the same rates. The 4430 offers block/page mode transmission at rates to 4800 bps multipoint.

By far the "glamor" terminal in the series has to be the 4430. This top-of-the-line model has from 14K to 32K of dynamically shared

#### PURCHASE PRICE RANGE

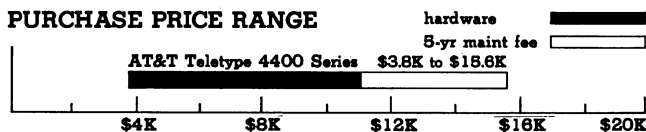

**AT&T TELETYPE 4400 SERIES PURCHASE PRICING** bar graphs cover price ranges between "small" and "large" configurations for hardware (solid bar), and for associated 5-year maintenance (open bar) • **SMALL 4400** configuration consists of 4420 keyboard-display terminal model • **LARGE 4400** configuration consists of 4430 keyboard-display terminal with 300-lpm, 132-column printer, 30-cps paper tape punch/read module, and 32K-byte buffer.

## AT&T Teletype 4400 Series Display Terminals

### Models 4420, 4424 & 4430

RAM, allowing the attachment of tape or diskette peripherals as well as a local printer. Through such facilities, the 4430 may operate with completely independent auxiliary port send and receive buffers, display send and receive buffers, and printer receive buffer. Such capability allows communications modes of send block/page from display and auxiliary port buffers; and of receive block/page to display, auxiliary port, and printer buffers. This capability also allows local modes of display-to-printer, display-to-auxiliary port, auxiliary port-to-display, and auxiliary port-to-printer.

The 4420 and 4430 incorporate the logic and buffering to support direct addressing of attached printers or auxiliary devices by the host CPU without interfering with terminal operation. Many competitive products employ a shared buffer and common transmit/receive logic, which prevents simultaneous screen preparation and printer message reception. As a result, terminal operators must wait for the print operation to end before resuming screen activity. The bypass feature is a beneficial feature for Teletype users and could be a factor in overlooking 4400's less than competitive prices.

#### □ Limitations

Lack of upgrade mobility within the 4400 Series can be viewed as a minor limitation. Thus, the terminal user is not able to start with a 4420 and then field (or otherwise) upgrade it to a 4424 or 4430. Another potential upgrade problem relates to building true computer intelligence into the 4400 such as available with the DEC VT100. DEC now provides a CP/M-compatible microprocessor enhancement for its VT100.

#### ■ COMMUNICATIONS FACILITIES OVERVIEW

Operation as general-purpose half-/full-duplex asynchronous ASCII display terminal at point-to-point rates to 9600 bps (4420/4424) or multipoint rates to 4800 bps (4430). Character/line/block mode (4420), character mode only (4424), or block mode only (4430) transmission is offered.

Buffering of 2K to the display, 2K to the printer, and 1K from the line is available on 4420/4424, allowing keyboard-to-line/display, line-to-display, display-to-printer, and line-to-printer operations. Line-to-printer and keyboard-to-display operations may occur concurrently.

Dynamic buffering of up to 30K on 4430 allows keyboard-to-line/display, keyboard-to-display/printer, keyboard-to-display/auxiliary device, line-to-display, line-to-printer, line-to-auxiliary device, and auxiliary device-to-printer operations. Line-to-printer, line-to-auxiliary device, or auxiliary device-to-printer operations may occur concurrently with keyboard-to-display operations.

RS-232C or optional 20-/60-mA loop interfacing is available on all 4400 models. In addition, each model has a dual auxiliary device port for local attachment of up to 2 printers (4420/4424), or of printer, paper tape unit, diskette unit, or slave keyboard-display or keyboard-printer devices (4430).

#### ■ HARDWARE

##### □ Terms & Support

**Terms** • Teletype sells to OEM and third-party vendors only • prices shown in following descriptions are manufacturers' suggested prices.

**Support** • on-site or in-shop maintenance provided from over 90 AT&T Teletype field-service facilities located nationwide • monthly maintenance contracts available, negotiable by the level of service provided and distance from field-service facility • monthly maintenance prices quoted in this report reflect suggested prices for full on-site maintenance for preferred customers located within 50 miles of field-service facility.

#### ■ OVERVIEW

The Teletype 4400 Series consists of 3 ASCII keyboard-display buffered terminals designed for general-purpose operations. Each member of the series is based on a central 13-inch diagonal, 1920-character display module with cable-attached modular keyboard. Differences between members relate to display memory capacity, buffer size, character/block, character-only, or

block-only transmission modes; maximum data rate; and certain display format or communication capabilities. The 4420 and 4424 are designed for data entry/retrieval applications on a point-to-point basis. The 4430 is designed for multipoint communication applications.

#### □ Model Packages

##### 4420 & 4424

Major features in common with both models are character/block transmission mode at rates up to 9600 bps point-to-point asynchronous; buffering of 2K to display, 2K to local printer, and 1K from line; RS-232C interface; and auxiliary EIA and SSI local device interfaces.

**4420-10FA1 Keyboard-Display** • buffered, character/block mode terminal with 1920-character 24-line by 80-character capacity; 5760-character (72-line) display memory • 7x9 matrix 128 ASCII character set • 40-character answerback • 10 program function keys; cursor keypad:

\$3,836 prch \$20 maint

**4420-10FB1 Keyboard-Display** • same as above with numeric keypad:

3,938 20

**4424-10AB1 Keyboard-Display** • buffered, character-only mode terminal with 1920-character 24-line by 80-character capacity; 3840-character (48-line) display memory • 7x9 matrix 128 ASCII plus 32 graphics character set • split-screen capability • reverse video, underline, blink, and half-intensity characters • 16 program function keys; numeric keypad • 80-character answerback:

3,938 20

##### 4430

The 4430 is a multipoint private-line terminal. It offers dynamic buffering of up to 32K characters.

**4431-2FFA Keyboard-Display** • buffered, block mode terminal with 1920-character 24-line by 80-character capacity; 5760-character (72-line) display memory • 16K buffer • 7x9 matrix 128 ASCII character set • cursor keypad:

\$3,968 prch \$20 maint

#### □ Buffer Memory

Both 4420 and 4424 terminal models contain 5K of RAM buffer of which 2K is assigned to the display, 2K to the local attached printer, and 1K to the line. The 4420 also has display screen memory for up to 72 lines (5760 characters); the 4424 has up to 48 lines (3840 characters) of display memory.

The 4430 has 16K of RAM buffering as a standard feature; this may be increased with optional RAM to up to 32K. From this buffer, up to 72 lines (5760 characters) are assigned as display memory. The remainder is pool-shared in 256-byte blocks among the display send/receive and printer/auxiliary device ports.

Memory is also available on all 4400 Series models to store screen menus of display format, keying and communication setup options; programmable key function definitions; answerback messages; and terminal self-diagnostics.

**410168 RAM Storage** • 16K-byte RAM increment for 4430 terminal, bringing total buffer size to 32K:

\$261 prch NC maint

#### □ I/O & Communications

In addition to a communication interface, all 4400 Series display terminals come equipped with dual port interfaces for the attachment of local printers (4420/4424); or printer, paper tape, diskette, slave keyboard-display, or slave keyboard-printer

**PRCH:** purchase price. **MAINT:** monthly maintenance charge for full on-site service within 50 miles of AT&T Teletype service center. **NC:** no charge. Prices effective as of February 1984.

## AT&T Teletype 4400 Series Display Terminals

### Models 4420, 4424 & 4430

peripherals. The SSI (Standard Serial Interface) auxiliary port is used to attach Teletype Model 40 line printers on the 4420/4424 or Model 40 printers on the 4430. The other local auxiliary port, an RS-232C interface, supports Model 40/43 printers on all models, or tape unit, diskette unit, and slave terminals on the 4430.

Transmission speeds and communication modes vary with each model. The 4420 operates at synchronous half-/full-duplex rates to 9600 bps on a point-to-point basis, and can transmit a character-at-a-time, line-at-a-time, or block/page-at-a-time. The 4424 operates at the same rates but only offers character-at-a-time transmission. The 4420 offers an integrated manual/auto-answerback of up to 40 characters; the 4424 offers answerback of up to 80 characters. Both models offer odd/even/mark/space parity and employ 8-level ASCII code.

The 4430 is the only member of the series to provide for multipoint operations. Block mode transmissions are at half-/full-duplex asynchronous rates to 4800 bps. Protocol complies with ANSI 3.28 subcategories 1.1, 2.4 to 2.8, A1, A3, and A4; 85A poll/select with LRC, 8A1 contention features. The 4430 provides for roll-call polling with status replies; with message transfer check employing auto-retransmit, controlled retransmit, and LRC checking; and with termination transmit checking roll call with status replies. Odd/even/mark/space parity and 8-level ASCII code are also employed.

All 4400 Series models come equipped with an RS-232C interface as standard for communication line/modem connections; a 20-/60-mA current-loop interface is also available as an extra-cost option.

**403103 Adapter** • 20-/60-mA current-loop interface for all 4400 Series terminals: \$307 prch NC maint

#### □ Disk

Teletype offers no diskette storage module to attach to its 4430 terminal. However, the auxiliary interface on the terminal can support a floppy disk unit offered by the local AT&T operating company (the Sykes Datatronics Com-Stor II Model 8120), allowing the 4430 to perform diskette-based data entry, batching or buffering from the terminal and/or host line. The 256K/512K single/dual Com-Stor II diskette drive and controller module may be rented from AT&T offices at prices from \$130 to \$180 per month, or purchased directly from Sykes for \$3,300 to \$6,000.

#### □ Terminals/Workstations

**Configuration** • tabletop keyboard-display with modular keyboard • typewriter-style keyboard with cursor or cursor and numeric keypad cluster • 1/10/16 (4430/4420/4424) program function keys • swivel and tilt display screen.

**Display** • 13-inch diagonal • 7x9 (4420/4430) or 8x14 (4424) matrix • 1920 characters at 24 lines by 80 characters with 25th status indicator line; 72-line 5760-character (4420/4430) or 48-line 3840-character (4424) display buffer • 128 ASCII upper/lower (4420/4430) or 128 ASCII upper/lower plus 32 graphics (4424) character set • split-screen (4424) • block cursor.

**Edit & Format Features** • auto-repeat keys • cursor up, down, left, right, home; tab, backtab, auto-tab; return, return line feed, line feed; page advance, scroll up, scroll down • cursor address read/write • erase to EOL/EOF/EOP; character insert and delete; line insert and delete • protected fields • underscore, reverse video, blink, intensity attributes • send, print local, print online, form enter, form transfer (all models); auxiliary print, auxiliary send, auxiliary receive, auxiliary local, auxiliary write (4430).

#### □ Printers

**Model 40 Printer** • 300-lpm full-character belt-impact printer • 64 or 128 ASCII set • 80 columns or 132 columns at 10 cpi • 6/3 lpi • friction or tractor feed • horizontal tab • vertical format control • floor console or tabletop.

4010-1AON Model 40 ROP • 1920-character buffer • 64 ASCII set • 80 columns • tractor feed • floor console • connects to 4430 display terminal via auxiliary RS-232C interface: \$7,488 prch \$28 maint

4010-1DON Model 40 ROP • 1920-character buffer • 128 ASCII set • 80 columns • tractor feed • floor console • connects to 4430 display terminal via auxiliary RS-232C interface: 7,488 28

4010-1COO Model 40 ROP • 1920-character buffer • 64 ASCII set • 80 columns • friction feed • tabletop • connects to 4430 display terminal via auxiliary RS-232C interface: 6,777 28

4010-1FOO Model 40 ROP • 1920-character buffer • 128 ASCII set • 80 columns • friction feed • tabletop • connects to 4430 display terminal via auxiliary RS-232C interface: 6,777 28

4010-1HOO Model 40 ROP • 1920-character buffer • 64 ASCII set • 80 columns • tractor feed • tabletop • connects to 4430 display terminal via auxiliary RS-232C interface: 6,942 28

4010-1KOO Model 40 ROP • 1920-character buffer • 128 ASCII set • 80 columns • tractor feed • tabletop • connects to 4430 display terminal via auxiliary RS-232C interface: 6,942 28

4010-1LOO Model 40 ROP • 1920-character buffer • 64 ASCII set • 132 columns • tractor feed • tabletop • connects to 4430 display terminal via auxiliary RS-232C interface: 7,902 30

4010-1MOO Model 40 ROP • 1920-character buffer • 128 ASCII set • 132 columns • tractor feed • tabletop • connects to 4430 display terminal via auxiliary RS-232C interface: 7,902 30

4011-1AON Model 40 EIA • 64 ASCII set • 80 columns • tractor feed • floor console • connects to 4430 display terminal via auxiliary RS-232C interface: 4,725 28

4011-1DON Model 40 EIA • 128 ASCII set • 80 columns • tractor feed • floor console • connects to 4430 display terminal via auxiliary RS-232C interface: 4,725 28

4011-1BOO Model 40 EIA • 64 ASCII set • 80 columns • friction feed • tabletop • connects to 4430 display terminal via auxiliary RS-232C interface: 4,163 28

4011-1EOO Model 40 EIA • 128 ASCII set • 80 columns • friction feed • tabletop • connects to 4430 display terminal via auxiliary RS-232C interface: 4,163 28

4011-1GOO Model 40 EIA • 64 ASCII set • 80 columns • tractor feed • tabletop • connects to 4430 display terminal via auxiliary RS-232C interface: 4,177 28

4011-1JOO Model 40 EIA • 128 ASCII set • 80 columns • tractor feed • tabletop • connects to 4430 display terminal via auxiliary RS-232C interface: 4,177 28

4011-1LOO Model 40 EIA • 64 ASCII set • 132 columns • tractor feed • tabletop • connects to 4430 display terminal via auxiliary RS-232C interface: 5,133 30

4011-1MOO Model 40 EIA • 128 ASCII set • 132 columns • tractor feed • tabletop • connects to 4430 display terminal via auxiliary RS-232C interface: 5,133 30

4011-3BOO Model 40 SSI • 64 ASCII set • 80 columns • friction feed • tabletop • connects to 4430 display terminal via auxiliary SSI interface: 3,973 28

4011-3EOO Model 40 SSI • 128 ASCII set • 80 columns • friction feed • tabletop • connects to 4430 display terminal via auxiliary SSI interface: 3,973 28

## AT&T Teletype 4400 Series Display Terminals

### Models 4420, 4424 & 4430

4011-4GOO Model 40 SSI • 64 ASCII set • 80 columns • tractor feed • tabletop • connects to 4430 display terminal via auxiliary SSI interface:

4,208      28

4011-4IOO Model 40 SSI • 128 ASCII set • 80 columns • tractor feed • tabletop • connects to 4420/4424/4430 display terminals via auxiliary SSI interface:

4,208      28

4011-4MOO Model 40 SSI • 128 ASCII set • 132 columns • tractor feed • tabletop • connects to 4420/4424 display terminals via auxiliary SSI interface:

5,170      30

45AP201AAA Auxiliary Printer • 340 cps, 7x7 half-space matrix • tractor feed • 5, 10, or 16.7 cpi; 6/8 lpi • connects to 4420, 4424, or 4430 • SSI or RS-232C interface:

3,888      32

**Model 43 Teleprinter** • RO/KSR • 10-/30-cps 7x9 matrix impact printer • 94 ASCII set • 80 columns at 10 cpi, 100 columns at 10 cpi or 132 columns at 13 cpi • 6/3 lpi • friction, pin, or tractor feed • tabletop.

4310AAG Model 43 RO • 132 columns • pin feed • connects to 4420/4424/4430 display terminals via auxiliary RS-232C interface:

1,388      17

4310AAH Model 43 RO • 80 columns • friction feed • connects to 4420/4424/4430 display terminals via auxiliary RS-232C interface:

1,423      17

4340BBL Model 43 BSR • buffered 132 columns • pin feed • connects to 4430 display terminal via auxiliary RS-232C interface:

3,142      17

4340BBM Model 43 BSR • buffered 80 columns • friction feed • connects to 4430 display terminal via auxiliary RS-232C interface:

3,085      17

4340BBN Model 43 BSR • buffered 100 columns • tractor feed • connects to 4430 display terminal via auxiliary RS-232C interface:

3,278      17

**Other Peripherals**

**Model 4350 TSR** • 30-cps paper tape reader/punch send/receive module • connects to 4430 display terminal via auxiliary RS-232C interface:

\$1,513 *prch*    \$28 *maint*

• END

# AT&T Teletype 4540 Series Display Terminal Systems

## Models 4541-1, 4541-2, 4541-3 & 4543-2

### ■ PROFILE

**Function** • standalone and cluster display terminal system employed in inquiry/update, data entry, and data retrieval applications • all processing and database services handled by host computer • replacement for IBM 3270 Information Display Systems.

**Architectures Supported** • used with IBM S/360, S/370, 3030, 3081, 4300, and S/3 processors • S/360, S/370, 4300, and S/3 operate under BSC • local attach via I/O channels • remote attach by nonswitched private facilities in BSC/SDLC half-duplex at rates up to 9600 bps for BSC and SDLC.

**Communications** • CICS/VS under ACF/VTAM, ACF/VTAME, ACF/TCAM for OS/VS and DOS/VS • IMS/VS under BTAM and ACF/VTAM • single line • 1200/2400/3600/4800/7200/9600 bps • half-duplex BSC (4541-1) and SDLC • ASCII/EBCDIC codes • point-to-point/multipoint configurations • RS-232C interface.

**Operating System** • service through host processor under DOS, DOS/VS, DOS/VSE, OS, OS/VS, VM/370.

**Database Management** • none; only in association with host IMS/VS and CICS/VS facilities.

**Transaction Processing Management** • primarily through CICS or IMS which acts as terminal-oriented transaction monitor with file processing facilities • supports send/receive batch and inquiry tasks.

**Support Software** • supported by and employs software and program facilities of host processor • no local independent (from host) off-line programming/processing capabilities • system diagnostics checks DTE and DCE.

**Terminals/Workstations** • up to 32 CRTs; up to 8 printers.

**First Delivery** • 1979.

**Systems Delivered** • about 100,000 units.

**Comparable Systems** • IBM 3270, Harris 8100/9200, ITT Courier 2700, Memorex 1370/2070, Telex Terminal Communications 270, and Trivex Plus 70.

**Vendor** • AT&T Teletype Corporation; 5555 Touhy Avenue, Skokie, IL 60077 • 312-982-2000.

**Distribution** • worldwide through local AT&T Teletype sales/service offices; also offered by AT&T-IS as part of its Dataspeed 4540 services.



### ■ ANALYSIS

AT&T Teletype has done little to the 4540 Series over the past year. The only addition is a new IBM-style keyboard for the 4541-3 Local Cluster, which features an enlarged set of program function keys. Pricing for the entire Series remains unchanged.

In the past few years, a number of IBM 3270 lookalikes have appeared with the sole purpose of cashing-in on one of the largest and most lucrative markets in data processing. Some of the new products are designed to replace IBM's 3275 Standalone Terminal, while others are targeted at the clustered 3271, 3272, 3274, and 3276 systems.

With the 4540, AT&T Teletype is aiming at the 3271, 3272, 3274, and 3275 markets. And, it definitely has the products to be a viable competitor. The 4541-1 and -2 are remote clustered systems which, like IBM, support up to 32 attached devices. The 4541-1 runs under BSC, while the 4541-2 is an SDLC product. AT&T Teletype also markets the 4541-3, which competes against the 3272/2 and 3274/1B and 21B and supports up to 32 devices. AT&T Teletype is one of the few IBM competitors to offer a local cluster with this level of terminal/printer support. For standalone markets, AT&T Teletype offers the 4543-2, an SDLC terminal that accommodates a printer.

The 4540 is software compatible with the 3270, and therefore, can take advantage of some of the better software IBM furnishes for its terminals. This includes software products such as IMS, IMS/VS, CICS/VS, DL/1, SQL/Data Systems, and Stairs/VS.

The technical capabilities of the 4540 are certainly in the same league as the 3270s; but when it comes to price, AT&T Teletype has an edge. Since IBM has withdrawn the 3271/3272 from marketing, potential customers must (1) forget it; (2) wait for a

### PURCHASE PRICE RANGE

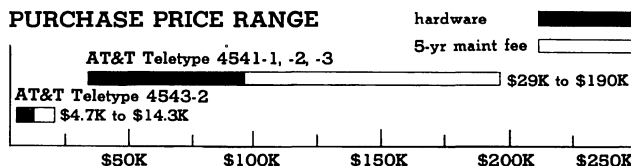

AT&T TELETYPE 4540 SERIES PURCHASE PRICING bar graphs cover price ranges between "small" and "large" configurations for hardware products (solid bars) and for associated 5-year maintenance fees (open bars) • AT&T Teletype 4541-1, -2, and -3 small configurations consist of 4505-4AAO cluster controller supporting six keyboard-displays, and two 300-lpm printers • large configuration consists of 4505-4BCO cluster controller supporting 24 keyboard-displays, four 300-lpm printers, four 300-cps matrix printers.



## AT&T Teletype 4540 Series Display Terminal Systems

### Models 4541-1, 4541-2, 4541-3 & 4543-2

recycled 3271/3272; (3) move up to a 3274; or (4) buy a compatible. Since the 3274 lists for more than double the price of a comparable 4540, the choice shouldn't be too difficult.

Overall, the 4540 is an excellent alternative to the 3270. Whether or not one should use a 4540 or 3270 in a distributed network is a decision which should result from careful analysis of current and future processing requirements. Remember, both products must rely entirely on the host for all processing services. Something as simple as changing a screen format must be done remotely, which causes processing delays, particularly on a loaded system, and makes poor use of the communications facility. With intelligent terminals, terminal clusters, and their associated floppy and hard disks becoming less expensive, and the demand for more local processing on the rise, products like the 3270 and 4540 are becoming less attractive.

#### □ Strengths

The 4540 possesses most of the strengths of the 3270. For example, the wide variety of controllers allows users to begin small and expand as their needs change; and upward compatibility among products protects the user's investment. The 4540 also supports broadcast and selective polling, effective in a distributed environment.

Users of the 4543-2 will also appreciate the screen bypass facility of this terminal. The attached printer can be directly addressed by the host and receive data without first passing through the terminal's screen. Thus, the terminal remains available to the user to perform useful work.

#### □ Limitations

In a distributed environment, the 4540 is limited with respect to data compression and encryption; peer-to-peer addressability; print spooling; and multipoint communication. With the exception of data encryption, the 3270 also does not support these beneficial features. IBM offers data encryption with its 3274 and 3276 systems.

The lack of these beneficial features increases the load on the communication facility, which can result in significant delays when servicing users, as well as escalating communication costs. For example, when there are up to 32 devices operating online, every bit of available bandwidth is needed to maximize efficiency. Data compression provides such a service by eliminating unnecessary data such as zeros, blanks, and redundant characters.

Print spooling is another facility which would also increase overall efficiency.

Print spooling is a technique whereby information bound for a relatively slow device like a printer is placed on an auxiliary device (usually a disk). This allows the printer to operate at its normal speed and suffer its normal problems without inhibiting the overall data communication function. The 4540 has no spooler, and it could certainly benefit from one.

### ■ COMMUNICATIONS FACILITIES OVERVIEW

#### □ Distributed Communications

The 4540 operates in a clustered or standalone environment and communicates with the host computer as an IBM 3270. The protocols supported include BSC and ADCCP (Advanced Data Communications Control Procedures). The latter is equivalent to IBM's SDLC **used with its 3270**, and conforms to ANSI X3.66-1979-UN. The BSC line protocol is the standard version which conforms to ANSI X.28-1971 and the sub 2.4 and B2 plus RVI and WACK.

The remote clustered configurations supported by the 4540 are designated 4541-1 and 4541-2. A local cluster, called the 4541-3, is also supported. The 4541-1 runs under BSC and operates in a manner similar to the IBM 3271-2. Both EBCDIC and ASCII codes are supported. The 4541-2 runs under ADCCP and supports EBCDIC only. To the host, 4541-2 looks like a 3271-12, but is technically similar to 3274/3276.

Both clusters run on the IBM S/360 Models 25, 30, 40, 50, 65, 67

(65-mode), 75, 85, and 195; any S/370 including 3030 and 3081; any 4300; and S/3 Models 4, 8, 10, 12, 15, and 15D. Terminal access methods supported are BTAM, BTAM-ES (BSC only), TCAM, ACF/TCAM, VTAM, ACF/VTAM, ACF/VTAME, and EXTM.

The remaining remotely connected product is the 4543-2, a standalone keyboard-display terminal with an integrated controller. This unit also runs under ADCCP, supports only EBCDIC, and looks like a 3271-12 to the host. This terminal runs on the same machines and supports TCAM, ACF/TCAM, VTAM, ACF/VTAM, ACF/VTAME, and EXTM.

The 4540 also supports local clusters via the 4541-3 local cluster system. This system uses the same terminals and printers as the 4541-1 and -2, and is connected to the local host's block, byte multiplexer, or selector channel. Only EBCDIC character set is supported. The cluster controller of the 4541-3 emulates the IBM 3272-2 or 3274-1B station controllers, and is compatible with the IBM S/360, 370, 303X, or 4300 series.

The remotely connected systems communicate in half-duplex mode in a point-to-point or multipoint arrangement via four-wire, leased/private lines and the DDS at speeds up to 9600 bps. Interface between DTE and DCE is RS-232C. The modem can be located up to 50 feet from the controller.

Both general and specific polling is supported. In a general poll, the highest numbered device transmits first, followed by the next highest. In a specific poll, only the polled device can transmit.

#### □ Distributed Configurations

The 4540 is built around a cluster controller, a display, a detachable keyboard, and matrix/line printers. Three cluster controllers are available that accommodate 8, 16, or 32 attached terminals/printers. The standard display for all members of the 4540 family is a 13-inch diagonal CRT which displays 1920 characters using a 7x9 matrix. Both EBCDIC and ASCII characters are accommodated.

A choice of six keyboards is offered: a typewriter-style keyboard; a typewriter-style with internal numeric cluster; two typewriter-style keyboards with an external numeric keyboard; a typewriter-style keyboard with external numeric keyboard and magnetic stripe badge reader; and a new typewriter-style keyboard featuring 24 programmable function keys and an IBM-compatible layout.

The printers include belt printers, which operate at 300 or 220 lpm, and matrix printers with speeds of 30/340 cps. Any combination can be attached to the cluster controller, and any one can be interfaced with the standalone 4543-2 terminal.

The cluster controllers support any combination of keyboard-displays and printers. At least one keyboard-display must be included in each configuration, and no more than eight printers per configuration can be used.

The clustered configurations of the 4540 are designated 4541-1, 4541-2, and 4541-3. The 4541-1 and -2 differ only in the protocols supported. The 4541-1 operates under BSC, while the other runs under ADCCP, an SDLC-like protocol. The 4541-3 supports the same configurations as the other two, but uses a local-connect protocol. The final member of the 4540 is the 4543-2, a standalone terminal that also runs under SDLC.

Control of locally attached terminals and printers is handled by the Model 4505 Cluster Control Unit. This device is microprocessor controlled and contains 64K bytes of RAM and ROM. Cluster operating parameters—i.e., station and cluster addresses, EBCDIC/ASCII operating codes, etc.—are keyed into tables. All display and keyboard characteristics are defined from the keyboard of the first device on the cluster controller, and then downline loaded to each terminal.

Three different versions of the controller are offered: Model 4BA0 accommodates 8 devices; Model 4BB0 handles 16 devices; and Model 4BC0 attaches 32 devices. The attached devices can be any combination of 4503 display/keyboards and 4504 printers, provided that at least one device be a display/keyboard and no more than eight printers are included in the cluster. The terminals/printers attach to the 4505 via two twisted-pair or



# AT&T Teletype 4540 Series Display Terminal Systems

## Models 4541-1, 4541-2, 4541-3 & 4543-2

coaxial cables. Keyboard-displays can be located 5,000 feet from the controller, line printers can be located 2,000 feet away, and matrix printers can be located up to 5,000 feet away. The 4505 interfaces with the DCE via an RS-232C interface; modems can be 50 feet from the controller.

**4541-1 & -2 Cluster Systems** • clusters up to 32 keyboard-displays/printers • RS-232C interface • 4541-1 is compatible with 3271-2 which runs under BSC and supports ASCII/EBCDIC character sets; 4541-2 is compatible with an IBM 3271-12 and runs under SDLC and supports EBCDIC character set; half-duplex mode • point-to-point/multipoint configurations • maximum transmission speed is 9600 bps.

**4541-3 Cluster System** • clusters up to 32 keyboard-displays/printers • local connect to IBM S/360, 370, 303X, or 4300 block, byte multiplexer, or selector channels • emulates IBM 3272-2 or 3274-B • supports EBCDIC character set.

**4543-2 Standalone Terminal** • single keyboard-display with integral controller • accommodates a single character/line printer • RS-232C interface • looks like an IBM 3271-12, runs under ADCCP protocol, and supports EBCDIC character set; half-duplex mode • point-to-point/multipoint configuration • maximum transmit speed is 9600 bps.

### □ Distributed Utilities

AT&T Teletype offers no distributed utilities with the 4540, but users can employ those packages developed for the IBM 3270. Such packages include:

**DEMF (Display Exception Monitoring Facility)** • provides for network problem determination and isolation in BSC mode under OS/VS.

**DIDOCS (Device Independent Display Operator Console Support)** • provides uniform services for all displays on OS and OS/VS systems • DIDOCS establishes linkage between displays and systems allowing displays to function as operator consoles; provides for processing and routing of messages from operating system or application program to console in multiconsole environments; and extends such support to 3270 printers operating as output-only hardcopy consoles.

**NPDA (Network Problem Determination Application)** • provides for network problem definition and isolation in BSC/SDLC modes under VTAM or TCAM.

**SDS (Status Display Support)** • provides system status display services for both display and non-display consoles.

**IIS (Interactive Instruction System)** • provides interactive online training capabilities for 3270 database/communications systems users under IMS/CICS/TCAM.

### ■ SOFTWARE

The 4540 operates under control of local/remote host processor software; the following briefly summarizes software support under such host controlled environments.

#### □ Operating System

##### IBM S/360, S/370, 3030, 3081 & 4300 Processors

The 4540 operates under OS, DOS, OS/VS1, OS/VS2(SVS), OS/VS2(MVS), MVS/SE, MVS/SP, DOS/VS, DOS/VSE, and VM/370 (VM, VME, VM/BSE, VM/SP) in conjunction with other systems software and programs.

**TSO (Time Sharing Option)** • provides for local/remote timeshared operation under all OS/DOS or communications/OS/DOS facilities.

##### IBM S/3 Processors

The 4540 operates under 570-SC (Systems Control) series software in conjunction with other program facilities.

#### □ Database Management

##### IBM S/360, S/370, 3030, 3081 & 4300 Processors

**ATMS-II (Advanced Text Management System II)** • provides

conversational text processing capabilities, allowing the terminal to enter, edit, store, format, proof, and present textual material.

**ACP (Airline Control Program)** • special-purpose standalone combination operating system and database management system for airlines • provides for real-time (under 3 seconds) transaction processing in inquiry/update mode with large centralized database.

**CICS/VS (Customer Information Control System/VS)** • general-purpose communications/database system that provides an interface between operating system, access methods, and applications programs • has facilities for file inquiry, browsing, order entry and distribution, data entry and collection, and message switching/broadcasting in local/remote environments • usually operates in conjunction with DL/1, but IMS version also available.

**IBM & IMS/VS (Information Management System)** • IMS is program product supported by OS/BTAM allowing user to define message formats and associated screen image formats, and for message transmission between terminal and application program without regard for device characteristics • IMS/VS communications/database program product supports user-written batch processing and teleprocessing tasks; provides database and communications management for multiple applications employing common database.

**DL/1** • stripped-down compatible version of IMS/VS designed to run under DOS/VS or DOS/VSE in conjunction with CICS/VS.

**SQL/Data System** • limited function relational database system designed to complement DL/1 under DOS/VSE; includes extract feature which enables users to copy portions of DL/1 into an SQL/DS table.

**STAIRS/VS (Storage & Information Retrieval System)** • provides for terminal-oriented, multiuser storage/retrieval operations and for batch processing under OS/VS; previous queries made under STAIRS/VS may be referred to or extended, and take the form of simple language statements to extended Boolean logic.

#### □ Communications/Networks

##### IBM S/360, S/370, 3030, 3081 & 4300 Processors

**BTAM & BTAM-ES (Basic Telecommunications Access Method & BTAM Extended Support)** • provides control for data transfer between processor storage and remote BSC terminals • provides application/problem program with macros assembled into routines, inline instructions and linkages, and control blocks and table defining lines, terminals, and other devices to be used • support tended to 4540 includes generation of channel programs, starting I/O operations, handling attentions and line interruptions, and performing error recovery, counting and posting • allows display to write data into display/printer buffer; to erase buffer and write data; to erase all unprotected fields in buffer; to read data from buffer or specified buffer location; and to read modified fields from buffer or specified buffer location • macro support provided to local 4540 (3272-type) attachments under virtual memory OS/VS and DOS/VS; local attachment under real memory versions of OS and DOS; all buffer sizes accommodated for remote BSC attachment • BTAM-ES extends support to DOS/VSE environments, and to 4300 series processors.

**TCAM & ACF/TCAM (Telecommunications Access Method & Advanced Communications Function TCAM)** • supports 4540 in either local or BSC/SDLC remote environments for data transfer between processor storage and display terminals • TCAM macros construct control program that governs messages between local/remote terminals and applications programs • ACF/TCAM add facilities for multisystem networking as well as expanding TCAM functions • TCAM macros define equipment configuration at facility and buffers necessary for message processing; functional macros select TCAM modules that route and edit messages, and check for message errors • support extended to 4540 by TCAM control systems includes auto insert/delete of line control characters; assignment, use and release of buffers during program execution; incoming/outgoing

## AT&T Teletype 4540 Series Display Terminal Systems

### Models 4541-1, 4541-2, 4541-3 & 4543-2

message edit; message error handling; and message traffic statistics maintenance • allows device scheduling under control program on general or specific polling basis • online test capability allows diagnostic testing on one control unit while other units continue processing.

**VTAM, ACF/VTAM & ACF/VTAME (Virtual Telecommunications Access Method, Advanced Communications Function VTAM & VCF/VTAM Entry)** • supports local or BSC/SDLC remote environments for data transfer between terminals and applications programs • VTAM operates with 3704/3705 communications controllers, eliminating considerations of communications lines and controllers in application program coding • services provided include access control between device and applications programs; data transfer between device and program; allowing programs to share lines, controllers, and devices; and allowing network monitoring and alteration • ACF/VTAM extends support by allocating main storage for buffer pools according to message traffic loads and availability of storage facilities; accumulating and displaying data on network status and resources; allowing data flow through multicontroller network without recourse to host system; and providing program-to-program communications facilities • VTAM operates under OS/VS and DOS/VS; ACF/VTAM is supported by OS/VS, DOS/VS, and DOS/VSE; ACF/VTAME works with DOS/VSE.

#### IBM S/3 Processors

4540 Display Control Feature of S/3 RPG II provide local/remote BSC communications facilities for up to 15 3270-type displays • program feature automatically linked into RPG II application program via SPECIAL file exit capability • features include RPG access to displays attached by Local Communications Adapter, Local Display Adapter, Integrated Communications Adapter, or BSC Adapter of S/3; auto-buffering and queuing of terminal data; display formatting interface for 3270 RPG II coding; and line control.

#### □ Applications Development Aids

#### IBM S/360, S/370, 3030 & 4300 Processors

**VM/CMS (Conversational Monitor System)** • CMS is a VM/370 component that provides general-purpose conversational facility for program development and problem solving in remote timesharing modes.

**DMS/VS (Display Management System)** • under CICS/VS will simplify establishment of online use of DMS/VS forms upon which users define data files, display images, and batch utility operations required.

**GIS/VS (Generalized Information System)** • allows non-EDP professionals to maintain and access information from database systems.

**SPF (Structured Program Facility)** • provides program development aid for VS2/TSO users.

**VSPC (Virtual Storage Personal Computing)** • operating under OS/VS and DOS/VS allows remote terminal users to perform problem-solving and personal computing tasks, or develop programs.

**VS/APL** • supported under VM/370 3270 Data Analysis and APL/Text features.

**SCRIPT** • supported under VM/370 3270 Text feature.

**VIDEO/370 (Visual Data Entry Online)** • under OS, DOS, OS/VS, DOS/VS, or CICS provides for data entry via local/remote displays • user may define image formats, application records, and data field to be checked for errors; both OS and DOS versions are to be dropped from IBM support between December 1981 and June 1982.

**GDDM & PGF (Graphical Data Display Manager & Presentation Graphics Feature)** • allows display of graphic or alphanumeric-graphic formats • PGF via GDDM generates business charts in conjunction with user application program or interactively with the user with no application program requirements • GDDM and PGF operate under CICS/VS, TSO

and ACF/TCAM or ACF/VTAM, or VM/370 CMS.

#### ■ HARDWARE

##### □ Terms & Support

**Terms** • purchase-only basis from AT&T Teletype with leasing available from AT&T or independent third-party vendors • OEM plans available • maintenance available and billed monthly from AT&T Teletype.

**Support** • rendered from AT&T Teletype field offices at varying monthly rates based on user location • rates shown in this report are maximum maintenance costs.

#### ■ OVERVIEW

The 4540 is an interactive display-based system compatible with IBM 3270 host software. It can be configured in clustered or standalone configurations, and used for data entry, data retrieval and inquiry/response applications.

The 4540 consists of four discrete configurations: 4541-1, 4541-2, 4541-3, and 4543-2. The 4541-1 and -2 are clustered configurations that accommodate 8, 16, or 32 terminal/printer arrangements, and communicate with remote host CPUs. The 4541-3 supports the same configurations, and is local channel connected. The 4543-2 is a standalone terminal-controller that accommodates one local printer.

The principal difference between the 4541-1 and the 4541-2 rests with the protocol supported. The 4541-1 runs under BSC, while the other runs under SDLC. The standalone 4543-2 also runs under SDLC.

The configuration rules of the 4540 are straightforward. Any combination of keyboard-displays and printers can be attached to the cluster controller, provided that at least one device be a keyboard-display and no more than eight printers be used. The 4543-2 can accommodate a single character or line printer.

The 4540 communicates with the host in a point-to-point or multipoint network over 4-wire dedicated lines at speeds up to 9600 bps. Only half-duplex transmission is supported, however.

#### □ Model Packages

##### 4541-1 & 4541-2 Remote Clusters

These two versions of the 4540 employ the same cluster controller and use the same keyboard-displays and printers. Both permit identical configurations. The difference is in the protocols and character codes supported. The 4541-1 is identified as an IBM 3271-2, runs under BSC, and supports EBCDIC and ASCII codes. The 4541-2 is identified as a 3271-12, runs under SDLC, and supports EBCDIC.

##### 4541-3 Local Cluster

The 4541-3 uses the same terminals and printers as the 4541-1 and -2, but a different controller. It also can be directly connected to a local host CPU. The 4541-3 is controlled via the same protocol used for the IBM 3272-2 station controller with 3277-2 keyboard-displays and IBM 3284-2, 3286-2, or 3282-2 printers; or IBM 3274-1B station controller with 3278-2 keyboard-displays and 3287/3289 printers. The 4541-3 supports EBCDIC and connects to a block or byte multiplexer channel, or a selector channel.

**4505-4AAO Cluster Controller** • up to 8 attached peripherals • EBCDIC • SDLC protocol:

\$4,543 prch    \$38 maint

**4505-4ABO Cluster Controller** • same as 4540-4AAO except accommodates up to 16 peripherals:

5,315            40

*PRCH: purchase price. MAINT: monthly maintenance charge for purchased units. NC: no charge. Prices effective as of December 1983.*

# AT&T Teletype 4540 Series Display Terminal Systems

## Models 4541-1, 4541-2, 4541-3 & 4543-2

**4505-4ACO Cluster Controller** • same as 4505-4AAO except accommodates up to 32 peripherals:

6,682      48

**4505-4BAO Cluster Controller** • up to 8 attached peripherals • EBCDIC/ASCII • BSC protocol:

4,543      38

**4505-4BBO Cluster Controller** • same as 4505-5BAO except accommodates up to 16 peripherals:

5,315      40

**4505-4BCO Cluster Controller** • same as 4505-4BAO except accommodates up to 32 peripherals:

6,682      48

**4503-10AO Display** • 13-inch diagonal • 1920-character (24 lines by 80 characters per line) format; 96-character ASCII/EBCDIC set • 7x9 matrix • 16K-byte memory • 60-Hz power supply:

1,952      31

**4503-10QO Display** • same as 4503-10AO but with 50-/60-Hz power supply:

2,333      31

**4501-1DOO Typewriter Keyboard** • 96-character EBCDIC/ASCII • 12 or 24 program function keys; 2 program attention keys • separate cursor-control cluster • local send/receive keys:

675      NC

**4501-1DUO Typewriter-Style Keyboard** • 96-character EBCDIC/ASCII • 24 programmable function keys with IBM keytop layout:

561      NC

**4501-2DOO Typewriter Keyboard & Internal Numeric Cluster** • 64-character EBCDIC • 5 program function keys; 3 program attention keys • reset/enter keys • separate cursor-control cluster • numeric/alphanumeric keylocks:

675      NC

**4501-3NOO Typewriter Keyboard (Narrow) & External Numeric Cluster** • 96-character EBCDIC/ASCII • 12 or 24 program function keys; 2 program attention keys • separate cursor-control and numeric clusters:

813      NC

**4501-3A0O Typewriter Keyboard (Wide) & External Numeric Cluster** • 96-character EBCDIC/ASCII • 12 or 24 program function keys; 2 program attention keys • local send/receive keys • attachable to 4507 tables:

770      NC

**4501-3DOO Typewriter Keyboard (Wide) & External Numeric Cluster** • same as 4501-A0O except cannot be attached to 4507 tables:

835      NC

**4501-4A0O Typewriter (Wide) & External Numeric Cluster** • same as 4501-3A0O except has magnetic-stripe badge reader:

905      NC

**4501-4DOO Typewriter Keyboard (Wide) & External Numeric Cluster** • same as 4501-3DOO except has magnetic-stripe badge reader:

970      NC

**403141 Program Function Keys** • adds PF 13 through 24 keys to the 4501-4A0O keyboard used with the 4541-3 or 4543-2:

6      NC

**403158 Program Function Keys** • adds PF 13 through 24 keys to the 4501-1DOO or 4501-3NOO keyboards used with the 4541-3:

6      NC

**4507-2AAO Table** • accommodates keyboard and display • 36 inches wide:

322      NC

**4507-2ABO Table** • accommodates cluster controller and keyboard-display • 45 inches wide:

347      NC

**4507-2BOO Table** • accommodates cluster controller • 20 inches wide:

252      NC

### 4543-2 Standalone Terminal

The 4543-2 is a standalone keyboard-display terminal with an integrated controller. This unit supports SDLC protocol and EBCDIC character code. The 4543-2 accommodates one local Model 4011 or 45 printer. The printer and terminal addresses are different, allowing the host to directly address the printer without interfering with the data preparation or online use of the display. The 4543-2 also has a special feature called cursor-select which allows the operator to pick one or more fields on the screen and have them transmitted with the depression of a single key.

In an IBM SNA environment, the 4543-2 looks like a 3271-12 and functions as Physical Unit Type 1, Logical Type 0, and FID Type 3. Its Functional Management profile is 2, and the Transmission Services Profile is also 2.

**4543-1DOO Standalone Keyboard-Display** • 13-inch diagonal • 1920-character (24-line by 80-character-per-line) format • 68-character EBCDIC set • 7x9 matrix • SDLC protocol • 4501-1DOO terminal keyboard • 60-Hz power supply:

\$4,745 prch    \$31 maint

**4543-1DQO Standalone Keyboard-Display** • same as 4543-1DOO except has 50-/60-Hz power supply:

5,127      31

**4543-2DOO Standalone Keyboard-Display** • same as 4543-1DOO but with 4501-2DOO Typewriter Keyboard:

4,745      31

**4543-2DQO Standalone Keyboard-Display** • same as 4543-2DOO but with 50-/60-Hz power supply:

5,127      31

**4543-3NOO Standalone Keyboard-Display** • same as 4543-1DOO but with 4501-3NOO Typewriter Keyboard:

4,883      31

**4543-3NQO Standalone Keyboard-Display** • same as 4543-3NOO but with 50-/60-Hz power supply:

5,265      31

**4543-3A0O Standalone Keyboard-Display** • same as 4543-1DOO but with 4501-3A0O Wide Typewriter Keyboard; attachable to 4507 tables:

4,840      31

**4543-3AQO Standalone Keyboard-Display** • same as 4543-3A0O but with 50-/60-Hz power supply:

5,222      31

**4543-3DOO Standalone Keyboard-Display** • same as 4543-3DOO but cannot be attached to 4507 tables:

4,905      31

**4543-3DQO Standalone Keyboard-Display** • same as 4543-3AQO but cannot be attached to 4507 tables:

5,287      31

**4543-4A0O Standalone Keyboard-Display** • same as 4543-3DOO but with 4543-3DOO Typewriter Keyboard; can be attached to 4507 tables:

4,975      31

**4543-4AQO Standalone Keyboard-Display** • same as 4543-4A0O but with 50-/60-Hz power supply:

5,357      31

**4543-4DOO Standalone Keyboard-Display** • same as 4543-1DOO but with 4501-4DOO Typewriter Keyboard:

5,040      31

**4543-4DQO Standalone Keyboard-Display** • same as

## AT&T Teletype 4540 Series Display Terminal Systems

### Models 4541-1, 4541-2, 4541-3 & 4543-2

4543-4DOO but with 50-/60-Hz power supply:  
5,422      31

**Buffer Memory**

Each terminal contains 16K bytes of memory of which 2K bytes are reserved for buffering. Each of the 1920 characters in the buffer can be directly addressed.

**I/O & Communications**

All terminals/printers attach to cluster controller via two twisted-pair or coaxial cables using coax adapters. Keyboard-displays can be located up to 5,000 feet from the controller, printers can be 2,000 feet away, and matrix printers 5,000 feet away. Local-cluster configuration Model 4541-3 connects to local host via a byte or block multiplexer, or selector channel.

The 4541-1, 4541-2, and 4543-2 communicate half-duplex over point-to-point or multipoint four-wire leased/private lines and the DDS at speeds up to 9600 bps. RS-232C interface between DTE and DCE. Modem can be located up to 50 feet from the controller.

**452223 Keyboard-Display-to-Controller Cable** • 12-foot cable with connector to attach keyboard-display to cluster controller:  
\$23 prch    NC maint

**452224 Keyboard-Display-to-Controller Cable** • 25-foot version of 452223:  
29            NC

**452225 Keyboard-Display-to-Controller Cable** • 50-foot version of 452223:  
41            NC

**408066 Data-Set Extension Cable** • 12-foot cable for connecting modem to cluster controller or 4543-2 terminal:  
47            NC

**408067 Data-Set Extension Cable** • 25-foot version of 408066:  
66            NC

**408068 Data-Set Extension Cable** • 50-foot version of 408066:  
101           NC

**452226 Printer-to-Controller Cable** • 12-foot cable for connecting local printer to cluster controller:  
23            NC

**452227 Printer-to-Controller Cable** • 25-foot version of 452226:  
29            NC

**452228 Printer-to-Controller Cable** • 50-foot version of 452226:  
41            NC

**348138 Printer-to-Single-Display Cable** • 10-foot cable for connecting local printer to 4543-2 terminal:  
12            NC

**Disk**

No disk or diskette storage is offered with the 4540.

**Terminals/Workstations**

The 4540 can be configured as a standalone or clustered terminal system. The standalone configuration employs a Model 4543 keyboard-display with integrated controller, while the clustered configuration is comprised of a 4505 control unit, 4503 displays, and 4501 keyboards. The display and keyboard characteristics are defined by the supervisor terminal (i.e., the first terminal connected to the cluster controller) and downline loaded to the other terminals.

The common characteristics of the 4543 and 4503 displays with 4501 keyboards are:

**Configuration** • tabletop interactive terminal with detachable keyboard • typewriter-style keyboard with integral/external numeric clusters; up to 24 program function keys; 2 or 3 program attention keys; swivel-and-tilt display screen.

**Display** • 13-inch diagonal, 7x9 matrix, 1920-character, 24-line x 80-character format; 25th status line; 96-character ASCII/EBCDIC set; 64 EBCDIC monospace characters on the 4543, intensified or blinked characters.

**Edit & Format Features** • auto-repeat keys, cursor up, down, left, right, home; cursor insert/select, tab, backtab, auto-tab, protected fields, read all/modified, write, erase-write, copy, erase all unprotected, erase all unprotected to address, erase EOF, start field, set buffer address, repeat address, sense, test I/O, sense ID, select (4541-3 only).

**Communications** • see Communications Section for particulars.

**Peripherals** • one printer directly attached to 4543-2.

**Printers**

AT&T Teletype offers a series of belt and matrix printers that can connect directly to the cluster controller or to the 4543-2 standalone terminal. The belt printers are full-impact types employing 80 or 132 print hammers operating on multiple character-set typecarrier belt. Print density is 10 cpi word or 6 lpi, adjustable for double-line feed. Both friction-feed and tractor-feed units are available. The former feeds on standard 8.5-inch single-ply rolled paper. The tractor-feed version prints up to six-part fan-fold forms and is adjustable for forms 4 to 9.5 inches or 15 inches wide; form length may be 3.67, 5.5, or 11 inches. The feedout for both friction and tractor printers is 2, 16, or 35 lines to tear off last printed line. The form feedout for tractor printers is 16 lines.

The matrix printers are offered in 30-cps and 340-cps versions. The 30-cps unit prints 15, 25, and 45 lpm at 132, 72, or 40 characters per line. The print head is a mini-wire unit which produces a 4x7 dot matrix with a 7x9 definition. Print density is 10 cpi and 6 lpi. The printer handles up to six-part fan-fold forms, and is adjustable for forms 3 to 15 inches wide and 11 inches long.

The 340-cps unit prints 125, 200, and 300 lpm at 132, 72, and 40 characters per line. It uses a 2-column 14-wire print head which produces a 4x7 dot matrix with a 7x7 definition. Printing is bidirectional. Print density is 5, 10, or 16.7 cpi; 6 or 8 lpi. Up to six-part fan-fold forms are acceptable; form may be 3 to 16 inches wide and 3, 3.5, 4, 5.5, 6, 7, 8, 8.5, 11, 12, or 14 inches long. The printer feeds multiple lines at 10 ips.

**4011-3BXO Belt Printer** • 300 or 220 lpm • EBCDIC • 80 columns:  
\$3,820 prch    \$64 maint

**4011-3BXO Belt Printer** • tabletop, 300 or 220 lpm • EBCDIC • 80 columns • friction feed:  
3,820            64

**4011-4GXO Belt Printer** • same as 4011-3BXO but employs tractor feed:  
4,043            64

**4011-4AXN Belt Printer** • same as 4011-GXO but is floorstanding unit with forms access:  
4,612            64

**4011-4LXO Belt Printer** • tabletop, 300 or 220 lpm • EBCDIC • 132 columns • tractor feed:  
5,170            68

**4011-4LYO Belt Printer** • tabletop, 300 or 200 lpm • ASCII • 132 columns • tractor feed:  
5,170            68

**4504-1CAF Belt Printer** • floorstanding, 300 or 220 lpm • ASCII • 132 columns • tractor feed • ribbon re-inker • paper jam preventor:  
5,595            68

**4504-ICEF Belt Printer** • floorstanding, 300 or 220 lpm • EBCDIC • 132 columns • ribbon re-inker • paper jam preventor:  
5,595            68

**4011-3BYO Belt Printer** • tabletop, 300 or 220 lpm • ASCII • 80 columns, friction feed:  
3,820            64

## AT&T Teletype 4540 Series Display Terminal Systems

Models 4541-1, 4541-2, 4541-3 & 4543-2

**4011-4GYO Belt Printer** • same as 4011-3BYO except employs tractor feed:

4,043      64

**4011-4AYN Belt Printer** • same as 4011-4GYO but is floorstanding unit with forms access:

4,612      64

**45AP104 AAA Matrix Printer** • tabletop, unidirectional, 30/47.5 cps • EBCDIC/ASCII • 132 columns • tractor feed • ribbon re-inker:

2,202      68

**45AP102 AAA Matrix Printer** • same as 45AP104 AAA except floorstanding unit:

2,498      68

**45AP201 AAA Matrix Printer** • tabletop, bidirectional, 125/200/300 cps at 132/72/40 characters per line • EBCDIC/ASCII • 132 columns • tractor feed:

3,868      68

• END



# AT&T Teletype 5400 Series Display Terminals

## Models 5410 & 5420

### ■ PROFILE

**Function** • general-purpose, nonprogrammable, interactive keyboard-display ASCII terminals • ANSI 3.64 compatible.

**Architecture Supported** • any architecture supporting an ASCII terminal; local/remote attachment.

**Communications** • half-/full-duplex, asynchronous, 300 bps to 19.2K bps • point-to-point • character-only transmission mode on Model 5410; character/line/page/block modes on Model 5420 • RS-232C communication/printer port interfaces.

**Operating System** • none.

**Database Management** • none; only in association with host facilities.

**Transaction Processing Management** • none; only in association with host facilities.

**Support Software** • none; only in association with host facilities.

**Processor** • display-oriented control and communication logic • host-initiated print operation on Model 5410; local/remote print operation on Model 5420.

**Terminals/Workstations** • single keyboard 1920-/3168-character display • auxiliary printer port for local printer attachment.

**First Delivery** • 1983.

**Systems Delivered** • unknown.

**Comparable Systems** • competitive with a number of ASCII display terminals, typically DEC VT100, Anderson-Jacobson 510/520, Beehive DM Series, Datagraphic 132, DEC VT100, Hazeltine Esprit and Exec 80, Lear Siegler ADM Series, ADDS Viewpoint Series and Model 25, IBM 3101, Televideo 900 Series, Teleray Models 7, 16, and 100.

**Vendor** • AT&T Teletype Corporation; 5555 Touhy Avenue, Skokie, IL 60077 • 312-982-2000.

**Distribution** • nationwide through AT&T Teletype sales offices.

### ■ ANALYSIS

Within the past few years, a new class of ASCII display terminal has appeared under the name "buffered display/editing terminals." Essentially, these products allow the user to build screens of data—called pages—and store them locally in a RAM buffer. Thus, when users wish to recall a page, it can be done with no host intervention and no associated communications cost. These same terminals also allow the local editing of screen data, relieving the host of this chore.

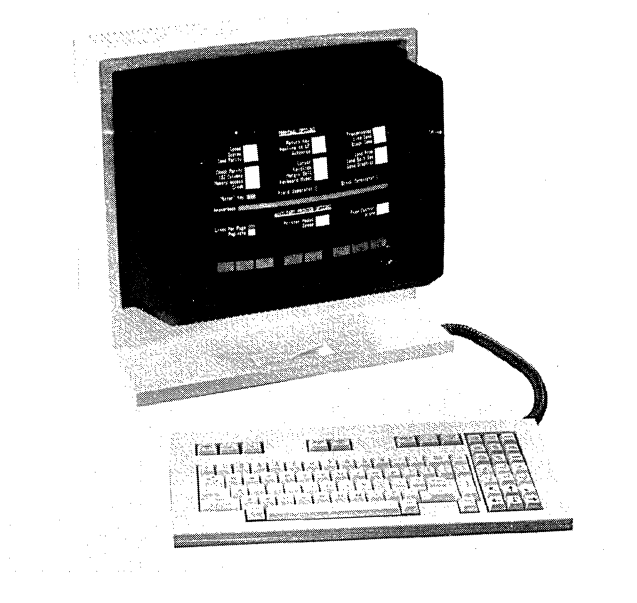

The AT&T Teletype 5420 is this class of terminal. It can store up to 3 pages of **80- or 132-column** by 24-line screens, and operates in character/line/page/block communication modes. It even has a bidirectional printer port that allows concurrent printing and keyboard operations. This is quite an advantage, as we'll discuss later under Strengths.

The 5410, the other member of the 5400 series, is pretty much your standard character-mode only, ANSI 3.64-compatible keyboard-display terminal. While it offers no local page storage or bidirectional printer port, it does share the 5420's facility for handling 80- or 132-column lines.

Both terminals are in one of the most crowded, highly competitive segments of the communications marketplace where price unfortunately is one of the most important factors in the selection process while there are currently over 100 ASCII keyboard-displays available (see report 722), the principal players are Televideo, ADDS, Beehive, DEC, Lear Siegler, Visual, and Esprit. For the most part, the offerings from these companies (except DEC) are priced **below** comparable 5410 and 5420. The price spreads, however, aren't that great and the 5410 and 5420 are very nice products.

### □ Strengths

The strongest feature of the 5410 lies with its 80-/132-column line display capability. The 132-column (characters) display can be used for displaying spreadsheet data or large inventory forms more conveniently. In addition, it permits users to view a standard printed line as it appears when printed.

The 5420 is the more powerful of the 2 products. Aside from a 132-column line, this terminal provides up to 3 pages of storage which allows users to build multiple screens of data and store them locally. Aside from being a convenience factor, local storage cuts communication costs by eliminating the need to store and retrieve such data at the host. Note that the stored pages can be 80 or 132 columns wide. While some of AT&T Teletype's

### PURCHASE PRICE RANGE

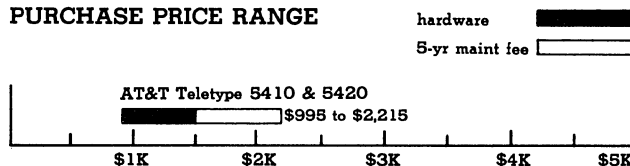

AT&T TELETYPE 5410 & 5420 PURCHASE PRICING bar graph covers price range between "small" and "large" configurations for hardware (solid bar) and for associated 5-year maintenance (open bar) • **SMALL Model 5410** consists of keyboard-display terminal with auxiliary printer port • **LARGE Model 5420** consists of keyboard-display terminal with 3 pages of display memory and bidirectional printer port.

## AT&T Teletype 5400 Series Display Terminals

### Models 5410 & 5420

competitors do offer a multipage local storage facility, none to our knowledge allow storing 132-column pages.

The final strong point of the 5420 is its bidirectional auxiliary printer port. This port allows the host to directly transmit data to the printer without interfering with terminal activity. Users can continue to enter data from the keyboard while the received data is printed. The bidirectional port is an uncommon feature, available only with the Televideo and Beehive DM5B terminals.

#### □ Limitations

The most severe limitations of both terminals are the lack of powerful graphics, and an intelligent terminal upgrade. While AT&T Teletype does offer a 96-symbol line-drawing and special graphics PROM set for both terminals, no sophisticated graphic sets are available as yet.

The lack of an intelligent option, such as offered by DEC on its VT100, could prove to be a drawback to those installations planning to implement distributed processing networks. Such an environment variable will involve local processing, and any terminal which cannot be upgraded will likely be at a disadvantage.

The user should also consider that neither AT&T Teletype terminal offers a smooth scrolling capability. This facility allows the user to vary the speed at which data from the host is displayed on the screen. Some operators find the "normal" rate too quick to read comfortably, others do not. You might survey yours before selecting or rejecting the AT&T Teletype offerings.

#### ■ COMMUNICATIONS FACILITIES OVERVIEW

Both terminals operate as general-purpose, half-/full-duplex asynchronous ASCII display units at rates of 300 bps to 19.2K bps. Online operating modes are point-to-point; keyboard-to-line/display; line-to-display; line-to-printer. On Model 5420, incoming printer-bound data is buffered. Both terminals support echoplexing; Model 5420 provide local echo. The DTE/DCE electrical interface as RS-232C.

#### ■ SOFTWARE

No software support is furnished.

#### □ Operating System

None; firmware controls all terminal functions. Programmable key functions may be downline loaded from host or established locally, and held in nonvolatile storage.

#### ■ HARDWARE

**Terms** • terminals offered on purchase basis only; quantity discounts have not been announced as yet.

**Support** • rendered from AT&T Teletype field offices at varying monthly rates depending on location of customer from field office • Zone 1 service covers greater metropolitan area, is typical monthly charge, and the one shown in this report.

#### ■ OVERVIEW

AT&T Teletype Models 5410 and 5420 are general-purpose ASCII terminals which operate point-to-point at speeds up to 19.2K bps. Both support 128 ASCII characters, or can be ordered with 96 line-drawing and special graphic characters.

Both terminals are quite similar in basic operation and facilities provided (see Model packages). For example, each support an 80-/132-character display line, split-screen formatting, scrolling, and limited data editing. Both are also soft-configured via a menu, and have hardware/software self-checking facilities. The major differences include local storage of displayed pages, nondistinctive scrolling, memory windowing, and buffered printer port—all features of the Model 5420.

#### Model Packages

**Model 5410 Display Terminal** • keyboard-display terminal with 7-tilt position CRT; displays 1920/3162 characters at 24 lines x 80/132 characters; 25th status line • 7x9 dot matrix with decender for 80-character format; 5x7 dot matrix with decender

for 132-character format • 128 ASCII character set of 96 line-drawing and special graphic characters • detachable typewriter format keyboard with separate numeric keypad; 8 programmable function keys • auxiliary RS-232C printer port • half-/full-duplex operation • 50-cps to 19.2K-bps transmission rate • ANSI 3.64 compatible • character mode transmission:

\$995 prch \$10 maint

**Model 5420 Buffered Display Terminal** • same as Model 5410 except has 78-line display (scroll buffer) memory with 80-character-per-line display format, or 54-line display memory with 132-character-per-line display format; 8 user-programmable and 8 host-definable keys; 2K-character buffered printer port; character/line/page/block mode transmission:

1,495 12

#### □ CPU & Memory

Both terminals are microprocessor controlled. The controller uses 32K bytes of RAM, and up to 32K bytes of ROM for software-driven functions. Some 2K bytes of RAM in battery-backed CMOS is employed for programmable function key strings.

Model 5420 provides a 9600-character buffer which allows users to store data locally. This buffer can be used to access and manipulate data in 4 different ways: scroll mode, page mode, horizontal split screen, and windowing. In scroll mode, the operator can scroll through 72 80-character lines; for 132-character lines, 48 lines can be scrolled. In page mode, the memory is divided into 3 distinct pages, each of which can have its own set of screen labels for system-defined function keys.

The horizontal split-screen feature allows the screen to be divided into a scrolling region and 1 or 2 fixed regions. The defined scrolling region must contain at least 2 lines. Split screening operation can be used in scroll or page modes. Windowing allows the 9600-character memory to be divided into as many as 4 workspaces of varying length and width. Each workspace can have its position location defined on the screen, and displayed workspaces can be overlapped. Maximum size of the workspace is 1782 characters; its length cannot exceed 24 lines.

#### □ I/O & Communications

Both terminals support point-to-point asynchronous ASCII communication at rates of 300 bps to 19.2K bps. Both communicate over switched or dedicated lines in half-/full-duplex modes and support echoplexing. Odd or even character parity or mark or space are selectable. Parity detection is also selectable.

Terminal operating parameters are user selected from a menu. Such factors as transmission speed, protocol, send/detect parity, size of display column, etc are displayed as labels, and the user keys-in the parameter. User-programmable function key assignments are also established from the keyboard—up to 50 characters can be assigned to each key; labels associated with each key are displayed on the 26th and 27th lines of the display. The user-programmable/host-programmable function key values and user-configured operating parameters are held in CMOS RAM.

Both terminals are equipped for RS-232C interfaces for DTE/DCE connection, and for connecting the auxiliary printer to the terminal. The printer can be addressed directly by the host, and can receive data without it displayed on the screen. The Model 5420's interface is buffered and bidirectional which means that while the printer is receiving, the operator can continue keying data for transmissions. A locally initiated print operation is available only on the Model 5420.

All incoming data is processed through a 2000-character line buffer which passes the characters to the display and/or printer. When the buffer is filled to within 1000 characters of its capacity, the terminal transmits a DC3 character to request the host to stop sending data. A DC1 character requests transmission resumption.

**PRCH:** purchase price. **MAINT:** monthly maintenance charge for local service. Prices effective as of June 1984. All prices single quantity.



## AT&T Teletype 5400 Series Display Terminals

### Models 5410 & 5420

#### Disk

No disk/diskette is supported.

#### Terminals/Workstations

Models 5410 and 5420 are basically the same terminal. The 5420 is the more powerful of the two, with its extended editing and formatting capabilities, character/line/page/block mode transmission, 3 pages of display memory, and buffered printer port.

Both terminals provide a split-screen function which divides the screen into 2 fixed regions and 1 variable region. While both terminals support scrolling, only the 5420's is nondestructive as a result of the display memory buffer design. Both terminals also support automatic character wraparound (called autowrap), whereby a line is automatically advanced when the character reaches the right margin.

A particularly useful feature available on both terminals is the 80-/132-character line format. Such a feature, until recently, was rare on any terminal. It is still an exceptional feature in low-cost terminals.

**Configuration** • tabletop keyboard-display with detached typewriter-style keyboard and separate numeric keypad • 3 pages of display buffer on Model 5420 • both terminals accommodate a local serial printer.

**Display** • 12-inch diagonal CRT • displays 1920 characters at 24 lines x 80 characters or 3168 characters at 24 lines x 132 characters; 25th status line; 26th and 27th lines for programmable function key labels • 128 ASCII character set and 96 line drawing and special graphic characters.

**Edit & Format Features** • cursor up, down, left, right, home, save, and restore • solid or blinking cursor • scroll up and down • cursor wraparound • clear line, screen, all • character/line insert/delete • split screen • revise index • Model 5420 only: protected fields, tab, delete word, nondestructive scrolling, active memory/workspace positioning, and next/previous page.

**Peripherals** • RS-232C interface supports local printer attachment • input from terminal (Model 5420) or host.

#### Printers

Both terminals will accommodate any serial printer with an RS-232C interface. The interface employed with the Model 5410 is unidirectional, while the 5420 employs a buffered bidirectional interface. The bidirectional feature bypasses data transmitted from the host around the screen so that users can continue to key data for transmission during a print operation. This is quite a performance boost, as was mentioned under Strengths.

• END



# AT&T Teletype 5540 Series Cluster Display Terminal Systems

## ■ PROFILE

**Function** • remote terminal-cluster system replacement for IBM 3274 C-Series and 3276 • employed for interactive inquiry/update, data entry, and program development • all processing and database services handled by host computer.

**Architectures Supported** • used with IBM S/360, S/370, 3030, 3081, and 4300 processors, and with 3790 communication systems • S/370 and 4300 function under SNA/SDLC • S/360, S/370, and 4300 operate under BSC.

**Communications** • CICS/VS under ACF/VTAM, ACF/VTAME, ACF/TCAM for OS/VS and DOS/VS • IMS/VS under BTAM and ACF/VTAM • single line, switched or nonswitched at speeds of 200 to 9600 bps, half-/full-duplex • BSC/SDLC • ASCII/EBCDIC codes • RS-232C interface.

**Operating System** • local proprietary control software handles terminal-cluster interaction • remote service through processor under DOS, DOS/VS, DOS/VSE, OS/VS, OS, VM/370.

**Database Management** • none; only in association with host IMS/VS and CICS/VS facilities.

**Transaction Processing Management** • primarily through CICS or IMS, which acts as terminal-oriented transaction monitor with file processing facilities • supports send/receive batch and inquiry tasks.

**Support Software** • supported by and employs software and program facilities of host processor • no local independent (from host) off-line programming/processing facilities • system diagnostics check DTE and DCE.

**Processor** • 16-bit microprocessor for system and communications control • 384K-byte RAM for 5546; 640K-byte RAM for 5544.

**Terminals/Workstations** • 6/12/24/32 CRT and printer cluster-controller models • maximum of 8 printers may be attached.

**First Delivery** • 1983.

**Systems Delivered** • unknown.

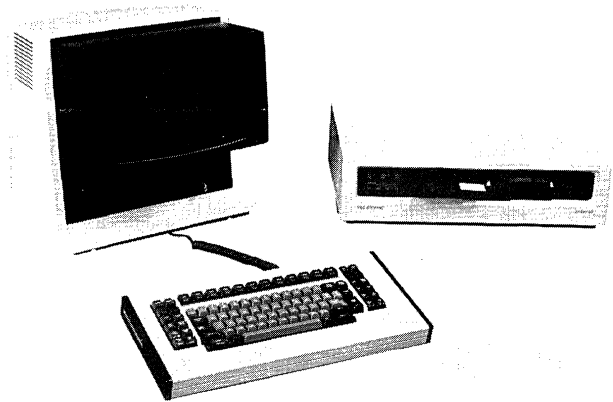

**Comparable Systems** • IBM 3274 C-Models and 3276, Lee Data System 300/400, Harris 8100/9200, ITT Courier 270, Memorex 2070, Racal-Milgo 4270/4276, and Davox Series 1000.

**Vendor** • AT&T Teletype Corporation; 5555 Touhy Avenue, Skokie, IL 60077 • 312-982-2000.

**Distribution** • worldwide through local AT&T Teletype sales/service offices.

## ■ ANALYSIS

The 5540, introduced last year, consists of a family of cluster controllers, keyboard-displays and printers all aimed at the IBM 3274C/3276 market. With the 5540 and older 4540 series, AT&T Teletype has a complete product line which competes across the board with IBM's 3271/72/74B/75/76 family of products.

The 5540's controllers consist of a tabletop unit, Model 5546, and a floorstanding unit, Model 5544. The 5544 is offered in 2 versions, one handling 6 displays/printers and the other, 12. The 5546 is also available in 2 versions, one handling 16 displays/printers and the other, 32. AT&T Teletype sells upgrade kits which allow the smaller controller within a class to be field upgraded.

Both controllers support BSC and SNA/SDLC. The 4541-1 and 4541-2 remote controllers, on the other hand, supported BSC or SNA/SDLC but not both. The flexibility of the 5544/5546 stems from their soft-configurable design. All software, including protocols and system configuration, are resident on diskette and loaded at the time of operation. A shift from BSC to SNA/SDLC protocol involves only interchanging diskettes. (Principal competitors like IBM, Lee Data, Telex, Racal-Milgo, etc also offer similar products.)

AT&T Teletype offers 3 ergonomically designed terminals which compete with the older IBM 3178 and 3278-2 through -5 models, as well as the recently announced 3180 Model 1. That device allows users to select the number of displayable characters and formats, and essentially provides the base functions of 3278-2 through -5. AT&T Teletype has a similar product called the 5548-25TF, which allows a display format of 24/27 lines x 80/132 columns.

The printers offered with the 5540 are the same time-proven units

## PURCHASE PRICE RANGE

hardware & software   
5-yr maint/serv fee

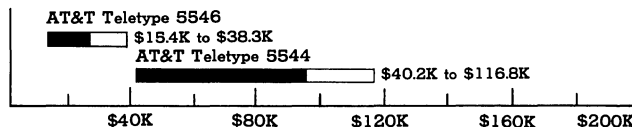

**AT&T TELETYPE 5540 SERIES PURCHASE PRICING** bar graphs cover price ranges between "small" and "large" configurations for hardware products (solid bars) and for associated 5-year period maintenance (open bars) • **5546-31 SA** small system consists of a 6-port cluster controller with 4 Model 5548-12TA displays, low-profile keyboards, and 2 Model 45AP104AAA 30-cps dot-matrix printers; **5546-31 SB** large system consists of 12-port cluster controller with 8 Model 5548-12TA displays, low-profile keyboards, and 4 Model 45AP104AAA 30-cps dot-matrix printers • **5544-31SA** small system consists of a 16-port cluster controller with 5 Model 5548-22TF displays with low-profile keyboards, 7 Model 5548-12TF displays with low-profile keyboards, and 2 Model 4011-4LXO 220-/300-lpm printers; **5544-31SB** large system consists of a 32-port cluster controller with 10 Model 5548-22TF displays with low-profile keyboards, 15 Model 5548-12TF displays with low-profile keyboards, 5 Model 5548-25TF displays with low-profile keyboards, 2 Model 4011-4LXO 220-/300-lpm printers, and 2 Model 45AP104AAA 30-cps dot-matrix printers. All prices are single-quantity purchase.

## AT&T Teletype 5540 Series Cluster Display Terminal Systems

available with the 4540. Users can choose from 220- or 300-lpm belt printers, or 30- or 340-cps, dot-matrix, character printers. The AT&T Teletype printers are comparable in print speed with the IBM 3287 and 3289 units, but slower than the 3262.

Overall, AT&T Teletype offers products which are functionally equivalent to the 3270 components they are designed to replace. However, Teletype prices its products below their IBM counterparts, which makes them extremely attractive. The 5544 and 5546 cluster controllers compete with the IBM 3274 Models 21C, 31C, 41C, 51C, and the 61C. AT&T Teletype also provides a nondisplay controller compatible with the IBM 3276. The IBM 3274 controllers support up to 32 Category A terminals (e.g., 3270 displays and 3287/3289 printers). Models 51C and 61C accommodate 12 and 16 Category A terminals, respectively. The IBM 3276 only supports up to 8 displays/printers.

Price comparisons between AT&T Teletype and IBM are subtle because the 3270 is sold in **basic** and **standard** versions. The basic version of a 3274 controller contains 8 terminal/prINTER adapters, except the 41C and 61C, which are delivered with 32 and 16 adapters, respectively. Additional terminal/prINTER adapters are offered as options to extend the total number of devices handled to 32. The standard versions of the 3274-21 and 31 contain 24 adapters. According to IBM, the standard versions are composed of those features most often ordered by the end user. IBM produces these standard versions in quantity in anticipation of sales, and thus can be delivered in time frames much shorter than "custom systems." The price of a 3274-31C standard model is \$13,800. A basic 3274-31C with 8 adapters is \$12,420; additional adapters are sold in an 8-adapter cluster at a cost of \$918. Thus, a 31C with full 32 terminal/prINTER support would cost \$15,174. An AT&T Teletype 5544 with 32 adapters costs \$11,500. (For more IBM 3270 prices, see report 950-1048-3270).

The 3274-51C includes 8 Category A ports, upgradable to 12 ports. Again, AT&T Teletype offers no 8-port version, but a 5546 with 12 ports costs \$4,742 versus \$5,871 for a similarly equipped 51C. The 3274-61C is shipped with 16 ports at a price of \$7,600. An AT&T Teletype 5544 with an equivalent number of ports costs \$7,150.

In the keyboard-display terminal area, AT&T Teletype receives very strong competition from IBM's 3178 and newly announced 3180 Model 1. The 3178 replaces the old and soon-to-be-discontinued 3278-2 and sells for \$1,720 including keyboard. A comparable AT&T terminal costs \$1,633 or \$1,817; the price difference reflects the type of keyboard selected. As was previously mentioned, the 3180 Model 1 provides all of the display characteristics of the old 3278-2 through 5—another group slated for discontinuance. The 3180, including keyboard, costs \$2,295. The AT&T model, called the 5548-25, costs between \$2,817 and \$3,000. Again, the price spread reflects the keyboard type selected.

Low printer prices are also strong points for AT&T Teletype. The top-rated 3278-12 character printer with a 120-cps print speed begins at \$5,210. An AT&T Teletype 45AP202AAA, which prints at 125, 200, 300, and 340 cps, sells for \$4,038. Line printer pricing is similarly lower. An IBM 3289 Model 2 and 3 with print speeds of 160, 230, 300, and 400 lpm sells for \$13,140. The most expensive comparable model from AT&T runs \$5,595.

Obviously, price position is the key to success for the 5540 series. Its controllers are priced below comparable IBM units, and in most cases are even better than the leading competitors. Its terminals, however, should receive a good deal of price pressure from many of the principal players.

While the 5540 is very competitive with IBM, it does fall short in product breadth when compared with Lee Data, Telex, Harris, and Davox. All of those companies offer products not available from AT&T Teletype. For example, Lee Data, Telex, and Harris have a multihost communications facility at the controller level, and all 4 principal competitors plus IBM have personal computer facilities. All, except Davox, offer color terminals. These shortcomings and others are discussed under Limitations.

### □ Strengths

Since AT&T Teletype did not significantly enhance the 5540 over

the past year, its strengths remain low price and flexibility. The overall flexibility of the product rests with its 5548-25 omniterminal and soft configurability of the system.

The 5548-25 encompasses all features of IBM 3278 Models 2 through 5, allowing users to display 80- or 132-column lines and display up to 27 lines (3564 characters per screen). However, while the 5548-25 wins hands down over the 3278 in price and performance, it does not fair well against the IBM 3180 Model 1. That unit has the same display characteristics as the 5548-25 but costs less—\$2,295 versus \$2,817 and \$3,000 for the AT&T Teletype product.

The 5540 is a soft-configurable system, allowing users to enter device assignments and operating parameters directly from the keyboard for ease of operation. The entered parameters are maintained on the system diskettes and are easily altered. While this facility is not unique to AT&T Teletype, it is a strong point because it makes the system more flexible and easier to use.

### □ Limitations

While the 5540 was introduced only last year, AT&T Teletype is already far behind IBM and principal competitors such as Lee Data, Telex, and Harris in terms of advanced features. All, for example, offer personal computers and color terminals for attachment to the controller, and Lee Data, Harris, and Telex offer controllers with a multihost communications facility. With the Lee Data and Harris controller, one host can be local and one remote, or both can be remote. With Telex, both must be remote.

The lack of multihost addressing could present a crippling limitation for those considering distributed processing. The ability to exchange data is extremely important in that environment and having a multihost facility is a definite benefit. Under AT&T's architecture, the host must perform switching operations. If the host is some distance from the target 5540, the user incurs increased communication costs as well. A dual-mode cluster controller that handles local and remote hosts would also be a strong user benefit. This facility would permit users to configure a local host for the more commonly used applications, while also allowing access to a remote host for specialized services. Both the Harris 9220 and Lee Data 321 and 421 offer a local/remote capability; AT&T Teletype does not.

The lack of a personal computer facility will not inhibit 3270-like applications on the 5540, but it could make the product unattractive to those that need a local processing. IBM embraced this concept with the 5150 personal computer option for the 3278-2. It endorsed it completely with the 3270 personal computer released last Fall. That unit also emulates most functions of the 3278 and 3279 color terminal, and can switch operating modes directly from the keyboard.

A strong user benefit, especially for minicomputer networks, is the ability to handle asynchronous ASCII/Teletype terminals. This, of course, can be done through protocol converters, but those devices are costly add-ons. In addition, if the site currently does not have asynchronous terminals but needs to interact with a minicomputer, users must incur the cost of the terminal and software to control it. Lee Data allows this with its Model 1220 terminal, a device that emulates an ASCII/TTY terminal and permits users to switch from 3278 mode to ASCII mode from the keyboard. Davox, a relative newcomer to the 3270-compatible marketplace, offers a similar capability with its workstation Models 911, 921, 1911, and 1921 employed with its Series 1000 controllers. Those units emulate the 3274 Models 21C, 31C, 41C, 51C, or 61C.

A beneficial product missing from the AT&T Teletype family is a terminal multiplexer. A terminal multiplexer is a cost-saving device which allows multiple on-site terminals to share a single coaxial cable to the cluster controller. Thus users needn't bear the expense of buying and pulling cables from each terminal to the controller. The cost-savings in coaxial cable alone should easily pay for this device, since even something as simple as an 8-port multiplexer will save the cost of 7 separate coaxial runs. An added benefit from a terminal multiplexer is that it generally extends the distance between the terminal and cluster controller beyond the normal 5,000 feet imposed by the coaxial cable. Since the multiplexer contains a driver facility, distances can

## AT&T Teletype 5540 Series Cluster Display Terminal Systems

generally be increased an additional 2,500 feet. IBM, Lee Data, and Davox offer such multiplexers.

Other beneficial facilities which everyone including IBM lacks are remote dial-in, data compression, and print spooling. A dial-in facility, whereby a remote terminal can connect to the cluster controller over the public telephone network, is not difficult or expensive to implement. Many protocol converter vendors offer this with their 3274-like cluster controllers, and we are aware of no problems in using that method.

When you have up to 32 devices operating online, as the 5540 permits, you want every bit of the available bandwidth to count. A data compression facility provides such a service by eliminating unnecessary data such as zeros, blanks, and redundant characters. AT&T should consider this facility.

Print spooling is a technique whereby information bound for a relatively slow device like a printer is placed on an auxiliary device (usually a disk). This allows the printer to operate at its normal speed and suffer its normal problems without effecting the overall data communication activity. Currently no vendor, including IBM, has this facility.

IBM is ahead of everyone when it comes to data security. Through an encryption/decryption facility, data transmitted between 3270s are encoded via a combination of hardware and software. The encryption technique itself is an IBM implementation of the Federal Data Encryption Standard (DES). The lack of security measures is a severe limitation of all 3270 replacement manufacturers.

### ■ COMMUNICATIONS FACILITY OVERVIEW

#### □ Distributed Communications

The AT&T Teletype 5544 and 5546 controllers communicate in half-/full-duplex modes in point-to-point or multipoint environments over switched or dedicated lines at speeds up to 9600 bps. Both ASCII and EBCDIC transmission codes are supported. NRZ and NRZI line control is employed.

Communication control of the cluster controllers rests with the IBM host terminal access methods supported. For the IBM S/360, S/370, 3030, 3081, and 4300 hosts, these include IBM BTAM, BTAM-ES, TCAM, ACF/TCAM, VTAM, ACF/VTAM, ACF/VTAME, and EXTEM. For a description of these access methods, see report 950-I048-3270.

#### □ Distributed Configurations

The AT&T Teletype 5540 system consists of 2 cluster controllers (5544 and 5546), 3 display stations (5548-12, -22, and -25), and 2 classes of printers (4011 and 45XX). The 5544 cluster controller is available in 2 versions: one accommodates up to 16 displays/printers and the other up to 32. The 5546 cluster controller is designed for smaller applications. Again, 2 versions are offered: one supports up to 6 displays/printers and the other up to 12. With the 5544, no more than 8 printers and at least 1 display can be attached. The 5546 accommodates up to 3 printers and requires at least 1 display terminal.

#### □ Distributed Utilities

AT&T Teletype provides utilities which allow the user to configure the system software from the terminal keyboard to meet operational requirements; to create backup copies of the system diskette; to incorporate software modifications or updates; and to initialize diskettes for use in copy operations. In addition to the vendor-supplied utilities, users may also avail themselves of a host of IBM software designed for 3270. See report 950-I048-3270 for a description of these utilities.

**AT&T Teletype Configuration Utility** • allows users to specify hardware/software configurations • allows definition of displays/printers, operating modes, and restrictions • multiple copies made through Copy Utility.

**AT&T Teletype Copy Utility** • provides for reproducing entire system diskette to create backup copies; or copies with other operating configurations.

**AT&T Teletype Diskette Initialize Utility** • provides for

preparing new diskettes for use as a destination diskette during a Copy Utility operation.

### ■ SOFTWARE

The 5540 operates under control of remote IBM host processor software. The following briefly summarizes the software support provided by IBM hosts.

#### □ Operating System

#### IBM S/360, S/370, 3030, 3081 & 4300 Processors

The 5544/5546 operate under IBM OS, DOS, OS/VS1, OS/VS2(SVS), OS/VS2 (MVS, MVS/SE, MVS/SP), DOS/VS, DOS/VSE, and VM/370 (VM, VME, VM/BSE, VM/SP) in conjunction with other systems software and programs.

**IBM TSO (Time Sharing Option)** • provides for timeshared option under all OS/DOS or communications/OS/DOS facilities.

#### □ Database Management

The product line can employ any of the following IBM software: Advanced Text Management System II; Airline Control Program; Customer Information Control System/VS; Information Management System/VS; Data Language/1 (DL/1); and Storage and Information Retrieval system (STAIRS). These database managers are described in report 950-I048-3270.

#### □ Communications/Networks

As previously mentioned, the controllers run under BTAM, BTAM-ES, TCAM, ACF/TCAM, VTAM, ACF/VTAM, and ACF/VTAME. In addition, the system may also make use of IBM's Conversational Monitor System; Display Information System; Generalized Information System; Structured Information Facility; and Virtual Storage Personal Computing. See report 950-I048-3270 for a description of these packages.

#### □ Application Development Aids

The vendor offers no application development aids; users, however, may employ IBM's Processors Disclose Mode; Script; Visual Data Entry Online routines; and the Graphical Data Display Manager and Presentation Graphics Feature.

#### □ Other Facilities

#### IBM S/360, S/370, 3030, 3081 & 4300 Processors

Again, users may employ any of the following IBM facilities: Display Exception Monitoring; Device Independent Display Operator Console Support; Network Problem Determination Application; and Interactive Instruction system. These are also described in report 950-I048-3270.

### ■ HARDWARE

#### □ Terms & Support

**Terms** • purchase-only basis from AT&T Teletype with leasing available through independent third-party vendors • OEM plans available • maintenance available and billed monthly from AT&T Teletype.

**Support** • rendered from AT&T Teletype field offices at varying monthly rates based on user location • rates shown in this report are maximum maintenance costs.

#### □ Packaged Components/Overview

The AT&T Teletype 5540 system is comprised of 2 models of cluster controllers, 3 models of display terminals, and 3 models of printers. All are IBM 3270 compatible.

The cluster controllers consist of the 5544 and 5546, both of which are IBM 3274 (C-Type) and 3276 compatible. The AT&T Teletype units, like their IBM counterparts, support BSC and SNA/SDLC protocols. The 5544 is a floorstanding unit. Available in 2 models, one accommodates up to 16 displays/printers; the other supports 32. Unlike IBM, however, these controllers do not allow any mix of displays and printers. The 5544 supports a maximum of 8 printers.

## AT&T Teletype 5540 Series Cluster Display Terminal Systems

The 5546 is a tabletop controller supporting up to 12 devices. This unit, too, is available in 2 versions: one attaching 6 displays/printers and the other, 12. These controllers are limited to 3 printers.

Both controllers operate under the direction of software stored on 5.25-inch dual diskettes. System configuration, attached device addresses, and controller poll/select addresses are maintained on diskette and can be modified from the keyboard. The communication protocol is also contained on the diskette, making the shift from BSC to SNA/SDLC communication as simple as changing the diskette.

The 3 display terminals are also IBM 3270 compatible and replace the 3278. Models 5548-12 and 5548-25 are IBM 3278-2 compatible. Model 5548-12 differs from the 5548-22 only in display screen size: 12-inch diagonal versus 7 or 13 inches for the 5548-22. The third terminal is the 5548-25, which replaces the 3278-2 through -5. This terminal can display 1920 or 3564 characters formatted at 24 or 27 lines by 80 or 132 columns.

While 3 classes of terminals exist, AT&T Teletype offers 6 different versions. The difference lies in the keyboard style selected by the users. Two keyboard styles are available; both employ a typewriter-style layout. One, however, is a low-profile unit (30 mm) while the other at 70 mm is a high-profile model.

In addition to these new keyboard-display units, AT&T Teletype also offers 4540-class displays for the 5540. While these displays provide only a 1920-character screen capacity, they are available with 5 different keyboards with different key layouts and features (such as a magnetic badge reader) not available with 5548 displays.

Two classes of printers are offered for the 5540: character and line. The line printers are full-character belt printers with print speeds of 220 or 300 lpm. Both 80- and 132-column versions are offered. The character printers are wire matrix printers offered in 30-cps and 200-/340-cps versions. Both printers use tractor feed and print 132 columns.

All displays and printers connect directly to the cluster controllers. The displays and character printers may be located up to 5,000 feet away, while the line printers are limited to 2,000 feet. The cluster controllers interface with the host processors via switched or dedicated lines at speeds up to 9600 bps. Both BSC and SNA/SDLC protocols and ASCII/EBCDIC codes are supported. The DTE/DCE interface is RS-232C.

### □ Controllers

AT&T Teletype provides a floorstanding controller (Model 5544) and a tabletop controller (Model 5546), the equivalent of IBM 3276 and 3274 C-type remote cluster controllers. The 5544 is offered in versions that accommodate 16 or 32 displays/printers; the 5546 is also available in 2 versions, one supports 6 displays/printers and the other, 12. AT&T Teletype permits the smaller units within a class to be field upgraded to the larger units. All terminals and printers are attached via 4-wire twisted pairs, coaxial cable or both, and can be mixed within the same cluster. Display and character printers can be positioned up to 5,000 feet from the controller; line printers up to 2,000 feet.

Both controllers are remote units and support SNA/SDLC and BSC protocols. Protocol handling and support software are stored on a 5.25-inch dual diskette. To switch protocols, the user need only interchange diskettes. Internal processing operations are supported by multiple 16-bit microprocessors. Device addresses, operating configurations, and a printer authorization matrix are also on the diskette and are easily altered.

**5546-31A Cluster Controller** • tabletop control unit accommodates 6 displays/printers; 3 printers maximum, single display minimum • 16-bit microprocessor for internal processing and communication • 348K-byte RAM • SNA/SDLC and BSC protocols • 2000- to 9600-bps transmission rates:

<b>\$4,500 prch</b>	<b>\$30 maint</b>
---------------------	-------------------

**5546-31 SB Cluster Controller** • same as 5546-31A except supports 12 displays/printers with same limitations:

<b>4,742</b>	<b>31</b>
--------------	-----------

**5544-31 SA Cluster Controller** • floorstanding control unit

accommodates 16 displays/printers; 8 printers maximum, single display minimum • 16-bit microprocessor for internal processing and communication • 348K-byte RAM for basic microprocessor operations; up to 256K-byte RAM for device handling • SNA/SDLC and BSC protocols • 2000- to 9600-bps transmission rates:

<b>7,150</b>	<b>33</b>
--------------	-----------

**5544-31 SB Cluster Controller** • same as 5544-31 SA except supports 32 displays/printers with same limitations:

<b>11,500</b>	<b>34</b>
---------------	-----------

### □ I/O Channels

#### 5544/5546-to-Processor Attachment

Both cluster controllers attach to the remote host processor via communication facilities to channel-connected control units/adapters. On the S/360, S/370, 3030, and 4300 processors the attachment is via the 2701 Data Adapter Unit, 2703 Transmission Control, or 3704/3705. On the S/370 Models 115, 125, 135, and 138 connection is via the Integrated Communications Adapter; the Communications Adapter is used on the 4331.

#### 5544/5546-to-Terminal Device Attachment

Display stations and printers attach directly to the controllers via terminal adapters. AT&T Teletype offers controllers with fixed numbers of adapters (see Controllers). Additional adapters can be added in the field. Both controllers allow the display stations and character printers to be located up to 5,000 feet from the controller; the line printers can be located 2,000 feet from the controller.

### □ Communication

The 5544 and 5546 cluster controllers communicate with the remote host processor via half-/full-duplex data transmission over point-to-point or multipoint, switched or dedicated lines at speeds up to 9600 bps. Protocols are BSC or SNA/SDLC. An RS-232C interface connects the cluster controller to DCE. Host processors and interfaces are: S/360, S/370, 3030, 3081, and 4300 via a channel-attached 2701, 2703, 3704, or 3705 communication processor or front end; S/370 Models 115, 125, 135, 138 via integrated adapters. A single host processor can be attached.

Data transmission is bit serial ASCII (BSC only) and EBCDIC (BSC, SDLC). Communication parameters are established via keyboard commands from the display console and stored on the controller diskette. In an SNA environment, the controllers are FID Type 2; PU Type 2; LU Type 1, 2, 3; Function Management (FM) Profile 0, 3; and Transmission Subsystem (TS) Profile 1, 3.

### □ Diskette

Both controllers employ an integrated dual diskette which stores system configuration tables and utility software. Each diskette has a capacity of 410K bytes, for a total capacity of 820K bytes per drive. Users can modify the contents of the diskette from the display station keyboard, and can create duplicate copies of the configuration or develop multiple configurations which can be loaded into the cluster controller as the processing needs dictate. The diskette cannot be used for any other function, such as local storage for housing applications.

AT&T Teletype permits the user to copy the system configuration table from one diskette to another. And, since the system contains 2 diskettes, copying can be done without alternately loading and unloading diskettes, as is the case with single-diskette systems like Lee Data's 300/400 and Racal-Milgo's 4270/4276.

### □ Terminals/Workstations

AT&T Teletype offers 3 different terminals for attachment to either controller. Models 5548-12 and -22 are direct replacements for

**PRCH:** purchase price. **MAINT:** monthly maintenance charge for local service. **NC:** no charge item. *Prices effective as of June 1984. All prices are single quantity purchase.*

## AT&T Teletype 5540 Series Cluster Display Terminal Systems

the IBM 3278-2, and differ only in screen size. Model 5548-12 contains a 12-inch diagonal screen, while Model 5548-22 is available with a 7- or 13-inch screen. Physically, the 5548-12 is slightly smaller, measuring 15.63x16.75x13.25 (HxWxD) versus 16x16.63x14.67 inches for the 5548-22. Model 5548-25 with its 1920-/3564-character display formatted at 80/132 columns x 24/27 lines can replace the IBM 3278-2 through -5 display stations. All terminals can be located up to 5,000 feet from the controller and can attach to the controller either through 4-wire twisted pair or coaxial cable.

In addition to the above terminals, AT&T Teletype keyboard-display units for the Model 4540 can also be attached. Those terminals are 3278-2 types that display 1920 characters and can be ordered with any of the 5 keyboards available for the 4540.

### Model 5548-12, -22 & -25 Displays

**Configuration** • microprocessor-controlled, tabletop displays with modular detached keyboard and monochrome screen • cluster-display stations employed with Teletype 5544/5546 controller • interface to cluster controller • 12-foot modem cable.

**Display** • 12-inch (Model 5548-12) and 7-/13-inch diagonal (Models 5548-22 and -25) • 7x9 dot matrix; 5x7 dot matrix with 132-column lines • 96 EBCDIC/ASCII character set • 1920 characters with 24-line x 80-character format (Models 5548-12 and -22); 3564 characters with 27-line x 132-character format (Model 5548-25).

**Edit & Format Features** • cursor up, down, left, right, home; block, underline, and blink/nonblink cursor • erase input/screen/EOF/unprotected fields • tab forward/backward; program tab • backspace • protected/numeric fields • cursor address write • character insert/delete • highlighted (intensified) character • nondisplayed data • n-key rollover • selector light pen field select • 24 programmable functions (12 shiftable keys); 2 program attention keys.

**Communications** • via controller; see Communications section for details.

**Peripherals** • selector light pen • printer; attached via controller.

**T5 High-Profile Keyboard** • 87-key typewriter-style keyboard with 24 programmable functions • 12-degree stepped key-row profile (70 mm) • included in Models 5548-12TA, -22TA, -25TA.

**T5 Low-Profile Keyboard** • 87-key typewriter-style keyboard with 24 programmable functions • 5-degree stepped keyrow (30 mm) • included on Models 5548-12TF, -22TF, -25TF.

**5548-12TA Keyboard-Display** • 12-inch CRT • 1920-character display capacity • low-profile keyboard:  
\$1,633 prch \$12 maint

**5548-12TF Keyboard-Display** • 12-inch CRT • 1920-character display capacity • high-profile keyboard:  
1,817 12

**5548-22TA Keyboard-Display** • 7- or 13-inch CRT • 1920-character display capacity • low-profile keyboard:  
2,067 12

**5548-22TF Keyboard-Display** • 7- or 13-inch CRT • 1920-character display capacity • high-profile keyboard:  
2,250 12

**5548-25TA Keyboard-Display** • 7- or 13-inch CRT • 1920-/3564-character display capacity • low-profile keyboard:  
2,817 12

**5548-25TF Keyboard-Display** • 7- or 13-inch CRT • 1920-/3564-character display capacity • high-profile keyboard:  
3,000 12

**Selector Light Pen** • field selects from displayed data; available on all keyboard displays:  
NC NC

### Printers

Character and line printers can be attached to either controller. Printers utilize the AT&T Teletype Standard Serial Interface (SSI)

signaling method for communication with the controllers, and operate with data streams in IBM 3270 Data Stream Compatibility (DSC) format, Logical Unit Type 3, or SNA Character String (SCS) format, LU Type 1. The printers connected to the 5544 controllers interface with host software supporting IBM 3287/3289 printers. Individual line printers can be located up to 2,000 feet from the controller; character printers up to 5,000 feet.

Printers can be configured to operate in local mode, system mode, and shared mode. In local mode, the printer can be used for off-line print functions only. Data is transferred from the display station to the printer. In system mode, the printer is entirely under control of the host processor and cannot be used by the local operator. In shared mode, the printer can be addressed by the host or the local operator, but obviously not at the same time.

The line printers are full-character, impact belt printers which print 10 cpi and 6 lpi. Forms handled can be from 4 to 9.5 or 15 inches wide and 3.75, 5.5, or 11 inches long. The low-speed matrix character printer prints 10 cpi and 6 lpi, and handles forms 3 to 15 inches wide and 11 inches long. The high-speed matrix character printer prints 5, 10, or 16.7 cpi and 6/8 lpi. Forms handled are 3 to 16 inches wide, and 3, 3.5, 4, 5.5, 6, 7, 8, 8.5, 11, 12, or 14 inches long.

**4011-3BXO Full-Character Belt Printer** • 220- or 300-lpm tabletop printer • monospace EBCDIC • 80-column friction feed:  
\$3,973 prch \$28 maint

**4011-4GXO Full-Character Belt Printer** • same as 4011-3BXO except employs tractor feed:  
4,208 28

**4011-4AXN Full-Character Belt Printer** • 220- or 300-lpm floorstanding printer • monospace EBCDIC • 80-column tractor feed • forms access:  
4,785 28

**4011-4LXO Full-Character Belt Printer** • 220- or 300-lpm tabletop printer • monospace EBCDIC • 132-column tractor feed:  
5,170 30

**4504-1CEF Full-Character Belt Printer** • 220- or 300-lpm floorstanding printer • monospace EBCDIC • 132-column tractor feed • ribbon re-inker • paper-jam preventor:  
5,595 30

**4011-3EXO Full-Character Belt Printer** • 220- or 300-lpm tabletop printer • upper-/lowercase EBCDIC • 80-column friction feed:  
3,973 28

**4011-4JXO Full-Character Belt Printer** • same as 4011-3EXO except has tractor feed:  
4,208 28

**4011-4DXN Full-Character Belt Printer** • same as 4011-4JXO except is floorstanding and has forms access:  
4,785 28

**4011-4MXO Full-Character Belt Printer** • 220- or 300-lpm tabletop printer • upper-/lowercase EBCDIC • 132-column tractor feed:  
5,170 30

**4504-1CFF Full-Character Belt Printer** • 220- or 300-lpm floorstanding printer • upper-/lowercase EBCDIC • 132-column tractor feed • ribbon re-inker • paper-jam preventor:  
5,595 30

**45AP201AAA Matrix Printer** • 200- or 340-cps tabletop, bidirectional 4x7 dot-matrix printer • upper-/lowercase EBCDIC • 132-column tractor feed:  
3,868 32

**45AP102AAA Matrix Printer** • 30-cps floorstanding, bidirectional 4x7 dot-matrix printer • upper-/lowercase EBCDIC • 132-column tractor feed • ribbon re-inker:  
2,498 17

• END





# Bayly Omniplexer

## Drop & Insert T1 Multiplexer

■ **PROFILE**

**Function** • bit-interleaved TDM designed for T1 carrier facilities (1.544M bps), T1C (3.152M bps), T2 (6.312M bps), or CCITT/CEPT (2.048M bps); compatible with D1D, D2, and D3 frame formats • point-to-point or drop/insert applications • handles asynchronous, isochronous, and synchronous data, and voice inputs.

**Communications** • supports low-speed data from 150 to 19.2K bps, and 56K bps • channels handle asynchronous, isochronous, and synchronous transmission • single composite link per channel shelf • RS-232C or RS-422 interface for asynchronous data; RS-449 or CCITT V.35 interface for synchronous data • cascaded multiplexers handled on channel side.

**First Delivery** • 1980.

**Systems Delivered** • 200 multiplexers.

**Comparable Systems** • Amdahl Model 2211, Avanti Ultra Mux, Coastcom Di Mux, Codex 6240, Datatel DCP9100, DCA Netlink, General DataComm Megamux, Infotron Systems TMux, Paradyne DCX-T1, Scitek BSPT1, and Timeplex Link/1.

**Vendor** • Bayly Engineering Limited; 167 Hunt Street, Ajax, ON L1S 1P6 • 416-683-8200.

**Distribution** • in North America through direct sales and manufacturers, representatives.

■ **ANALYSIS**

The Bayly Omniplexer is a specialized bit-interleaved time-division multiplexer (TDM) designed specifically to combine a wide range of asynchronous/synchronous data and voice channels on a single broadband digital link referred to as T1 carrier. The T1 carrier has been used by the telephone company since the early 1960s to carry digitized voice/data between central offices. Until early in 1983, T1 was unavailable as a tariffed service to private users; those requiring it had to subscribe to independent carriers or had to install their own microwave links. Users can now order T1 facilities through AT&T Communications via its Accunet T1.5 Service, or from independents such as SBS, MCI, etc.

T1 offers the end user a high-volume communication facility at low cost. For example, a single 1.544M-bps link can support up to

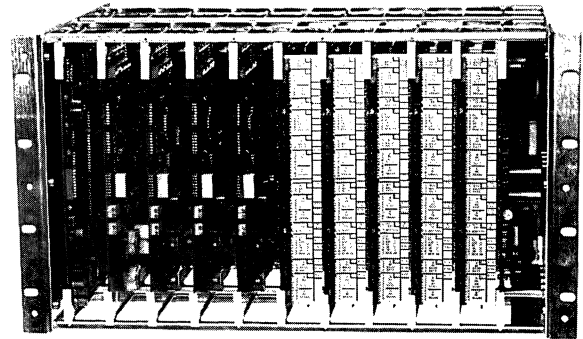

24 64K-bps channels, and the transmission quality is superior: 95 percent error-free seconds over a 24-hour period.

A version of the Omniplexer can be configured to handle conventional TDM multiplexing applications whereby n-channels communicate with a like number of channels on a point-to-point basis; or another version can handle **drop-and-insert** applications. With drop/insert, certain channels originating at one multiplexer can be dropped at an intermediate multiplexer, while the remaining channels continue on to their ultimate destination. With data insert, channel data can be inserted into the message train at the same intermediate multiplexer where data is dropped. A more detailed description of drop/insert is contained under the Overview portion of this report.

Drop/insert is ideally suited for companies with distributed processing applications. Organizations such as large banks and companies with sizeable regional centers are typical candidates for this type of service.

The Omniplexer is designed around channel shelves (chassis) that employ their own control logic, channels, composite link, and power supplies. Each shelf has 9 channel slots that accommodate any mix of data/voice cards. The data cards employed with the drop and insert version are dual-channel units, and the voice card provides a single channel. The point-to-point End Terminal version of the Omniplexer also offers a 4-channel data card, in addition to these cards.

The Omniplexer's control logic incorporates a T1 driver. Therefore, each channel shelf can have its own independent T1 link. (This is the same technique employed by the Avanti Ultra Mux, which is also the Codex 6240.) While this certainly adds to the overall operating flexibility of the product, it devotes an **entire** T1 link to **just** 18 channels on the drop and insert version and 36 channels on the End Terminal model, a fairly expensive proposition. Users can, however, increase the total number of channels serviced by employing external multiplexers to combine the channels from several terminals into a single Omniplexer channel. A maximum of 12 channels operating at speeds up to 2400 bps can fit into each 64K-bps channel slot. With 24 such slots available, the device can service 288 channels within this speed range.

While the Omniplexer has a number of notable features, it lags behind a number of its competitors with respect to ease of use, advanced voice-handling, system integrity (on the drop/insert version), and channel flexibility. These are all discussed in detail under Limitations.

**PURCHASE PRICE RANGE**

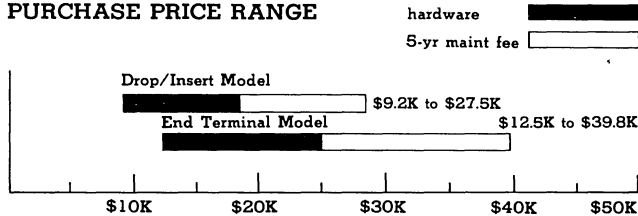

**BAYLY OMNIPLEXER PURCHASE PRICING** bar graph covers price range between "small" and "large" configurations for hardware (solid bars) and 5-year maintenance fees (open bars) • **small drop/insert model** consists of chassis with DC/DC converter, 3 low-speed channel cards, 3 high-speed channel cards, 3 voice-channel cards, RS-232C and CCITT V.35 interfaces and 1 control logic/T1 driver set; **large configuration** consists of 2 identically configured drop/insert units • **small End Terminal model** consists of chassis unit with redundant AC power supply, 6 quad-channel low-speed data cards, 3 voice-channel cards, RS-232C and CCITT V.35 interfaces, 1 set transmit control logic/T1 driver, 1 set receive logic/T1 driver; **large** consists of 2 identically configured End Terminals • all prices are single-quantity purchase.

## Bayly Omniplexer Drop & Insert T1 Multiplexer

### □ Strengths

Omniplexer's strengths rest with its drop/insert capability; the ability of its data channel cards to handle asynchronous, isochronous, and synchronous inputs; and its submultiplexing scheme that expands the total number of channels handled.

With drop/insert, users can designate certain data/voice channels originating from one multiplexer to be dropped/inserted at intermediate destinations (via Omniplexer) within a network. As discussed under Overview, such a facility should be invaluable to large organizations with sizeable dispersed regional offices.

The data channel cards' facility for accepting asynchronous, isochronous, and synchronous data is unique and invaluable. Customers need only buy one type of card and then change modes by merely resetting a few rocker switches. To our knowledge, Bayly is the only vendor offering a **universal** card like this, and it's a strong advantage for both the company and its customers.

While the Omniplexer only supports between 18 to 36 physical channels for each T1 link, each of these channels can be programmed to accommodate the combined channels from external multiplexers to increase the overall number of channels that can be serviced. Bayly accomplishes this by **subslotting** each of the 24 64K-bps channels associated with each T1 line into different data addresses assigned to the incoming multiplexed data. Subslotting is performed by the Omniplexer clock generator, which assigns data addresses according to the data rate settings on the card. (Note that all channels interfacing with the Omniplexer via external multiplexers must transmit data at the **same speed**.) Under this scheme, each of the 24 T1 channels can accommodate up to 12 channels operating at between 150 to 2400 bps; 6 channels at 4800 bps; 3 channels at 9600 bps; and 2 channels at 19.2K bps. Simple arithmetic indicates that a large chunk of each channel's total capacity is wasted using this scheme (e.g.,  $12 \times 2400 = 28.8K$  bps used out of 64K bps available). However, the overhead associated with signaling, error detection, alarms, etc are inherent in T1 multiplexers operating on AT&T Communications Accunet T1.5 service; and each Omniplexer low-speed data channel alone needs 28K bytes for error checks, controls, etc.

### □ Limitations

The Omniplexer is one of the older T1 multiplexers on the marketplace, and therefore, has some dated facilities. For example, the product is configured principally through hardware. Channel speeds and other parameters are established via switches and jumper cables; even the drop/insert channel designation is strapped. Such techniques are no longer popular with installations requiring an easy-to-use central control facility. These people want to configure and control the system from a terminal, now state-of-the-art technology.

The voice channels still employ Pulse Code Modulation (PCM) to encode voice inputs into a digital data stream. PCM requires 64K bps for quantization, thus occupying a full T1 time slot for each voice channel configured. Thus with the Omniplexer, only 24 voice channels can be accommodated. By contrast, most vendors have switched to the Continuously Variable Slope Delta (CVSD) technique for quantizing analog voice, which requires only 32K bps to produce toll-quality reproduction, allowing 2 voice channels to share a 64K-bps time slot. This same 24-channel limitation carries over to synchronous data cards as well. With synchronous inputs above 64K bps, however, time slots are used in multiples (e.g., 128K requires two time slots). According to the vendor, a channel employ Adaptive Delta PCM is under development which employs 32K bps per channel. This will be offered instead of CVSD.

Unlike the End Terminal version, the drop and insert version of the Omniplexer cannot accommodate redundant control logic and power supplies. Thus, a failure of either one of these key components renders the entire multiplexer inoperative, which of course, interrupts communication over that portion of the network. However, should a power or logic failure occur, an Omniplexer equipped with an optional PCM Generator within the affected multiplexer will automatically bridge the unit on the

T1 span, bypassing the failed unit. While this scheme will prevent a total network shut down, it does not help those users who are cut off from processing services. This problem can be eliminated with redundant power/central logic that automatically switches in should a failure occur.

Another significant drawback is the maximum data-handling capacity of the channel cards. At 56K bps, it's too slow to handle such applications as full-motion video, which needs at least 700K bps, and barely accommodates mainframe-to-mainframe data transfers. Every T1 multiplexer vendor we've evaluated supports higher data rates, making their products more appealing (and applicable) for a greater range of applications.

The Omniplexer supports multiple T1 links by supplying each channel shelf with its own T1 driver. However, this arrangement restricts channel/terminal communication to only the end point(s) associated with the attached multiplexer. To route a channel/terminal to another end point, the channel cards or terminal connections would have to be **physically** moved to another multiplexer. Currently, some multiplexer vendors are advertising a multitrunk facility that allows switching channels between different end points via terminal and/or program control. If this becomes a reality, the Bayly product will be at a real disadvantage.

### ■ HARDWARE

#### □ Terms & Support

**Terms** • all components are available for purchase only • discounts on multiple purchases are offered.

**Support** • components are warranted for 12 months • on-site service is available through a third-party maintenance organization within the United States • factory service and technical assistance are also offered.

#### □ Overview

The Omniplexer is a bit-interleaved TDM multiplexer compatible with AT&T Communications D1D, D2, and D3 frame formats, and can be terminated into digital switches or conventional D3 and D4 channel banks. Two versions of the Omniplexer are offered: the End Terminal model for conventional point-to-point transmission and a drop and insert model that allows selected channels to be dropped and inserted along intermediate data paths within a communication network. Both versions handle voice and data channels and both conform to the message format established by AT&T Communications for connection to its Accunet T1.5 (1.55M-bps) service.

The D3 and D4 channel banks (along with the older D1 and D2) are AT&T standards for framing. D2 and D3 call for 24 VF channels employing an 8-bit encoding scheme and a signal bit; a pseudo-random sample sequence is employed, and multiplexing produces a 1.544M-bps composite link rate. D4 calls for 48 VF channels, 8-bit voice encoding scheme, and a signal bit; alternate bit interleaving is employed, producing a 3.152M-bps multiplexed output. D4 also uses T1C repeated lines.

The DS1 format applies to voice and data, and specifies that any 24-bit interval must have at least 3 "ones" and no more than 15 consecutive "zeros." This is necessary to maintain carrier timing. Early next year, AT&T plans to implement a new scheme called framed DS1 extended frame format Fe. The new format imposes on the output data a predefined pattern every 193rd bit position. AT&T will use the pattern for framing, error detection, and network control information. The D/I Mux should have no trouble implementing the new frame format since it now employs a standard D3 frame of 24 channels with 8-bit words in each channel plus a framing bit ( $24 \times 8 = 192$  bits plus a framing bit = 193 bits).

The Omniplexer data-channel cards handle asynchronous, isochronous, and synchronous channels. Two different data cards are offered; one handles data rates up to 19.2K bps, the other accommodates data at a fixed rate of 56K bps. Both versions pass a full complement of control signals, and both provide 2 I/O channels. A third data card, offered only with the End Terminal version, provides 4 I/O channels but supports no control signals. That card also accepts data rates to 19.2K bps.

## Bayly Omniplexer Drop & Insert T1 Multiplexer

The data cards are offered with RS-232C or RS-422 interfaces for asynchronous data, and RS-449 or CCITT V.35 for synchronous data. All cards can be designated as data terminal equipment (DTE) or data communication circuit equipment (DCE).

The voice channels (VF) employ Pulse Code Modulation to quantize analog voice channels and produce a 64K-bps digitized channel. Voice channels are available in 4-wire E&M signaling. The voice channel can also be configured for conference calls, whereby multiple users can listen and speak at the same time. To enable the conference call facility, the voice card is assigned a particular time slot (say slot 10), and everyone else using that time slot can join in on the call.

While the drop and insert version does not provide a redundant control logic and power supply facility, it can bypass an intermediate station that fails. For example, if the middle station (node) in a 3-station network fails due to a control logic or power supply problem, that station's PCM Generator (see Composite Link) bridges the failed unit to prevent interruption of communication between operating stations.

The diagnostic facilities include local and remote channel loopbacks, all initiated from the channel card. An error condition is also indicated if the T1 circuit is lost, transmission rate settings are incorrect, or the digital facility fails. Conditions such as data overflow/underflow are also signalled. According to vendor specifications, Omniplexer can accommodate plus or minus 50-bps over-/underflow.

### Drop/Insert

The Omniplexer is offered in a version that supports bidirectional drop/insert of selected channels. Under this scheme, drop and insert sections are programmed identically; i.e., if a channel receives drop information from time slot 5 in the East/West direction, it must insert information in time slot 5 in the West/East direction.

Two channel-select matrices control the drop/insert of information. The first matrix controls channel drop and insertion in the East/West direction, while the second controls it in the West/East. Up to 18 channels per shelf can be programmed for drop/insert.

### □ Omniplexer

### Central Control

The Omniplexer is offered in a version that supports bidirectional drop/insert of selected channels. Under this scheme, drop and insert sections are programmed identically; i.e., if a channel provides the same basic facilities as the older drop/insert model; it furnishes 9 channel slots per card cage (chassis), it supports data and voice channels, and it contains a T1 driver **per card cage**. The End Terminal model differs in that it can be configured with **redundant** control logic and power supplies that operate as hot spares. The End Terminal model can also handle a quad-channel card that contains 4 low-speed data channels with no support for control signals.

Each card cage or chassis contains channel interfaces and provides slots for 9 uni-bidirectional channel cards. It supports up to 18 drops/channels in each direction on drop/insert model, and up to 36 channels on unidirectional point-to-point model. Common logic and T1 driver occupies single card slot. DC/DC converter occupies single card slot. Each card cage requires its own T1 driver.

**039985 Common Equipment Housing/End Terminal** • chassis with 9 card slots; requires 48VDC/DC Converter (037745) or AC power supply: \$735 prch    \$7.35 maint

**039986 Common Equipment Housing/Drop/Insert** • chassis with 9 card slots; requires 48VDC/DC Converter (037745) or AC power supply: 735            7.35

**037745 -48VDC/DC Converter** • provides +18, -18, +5, -5 volts DC • power single card shelf; one required per shelf • mutually exclusive with AC power supply: 675            6.75

**AC Power Supply (Nonredundant)** • standard 110V power supply for both versions of Omniplexer • powers single card shelf; one required per shelf • mutually exclusive with 48VDC/DC converter (037745): 1,050            10.50

**AC Power Supply (Redundant)** • provides hot-spare redundant power for End Terminal version only • powers single card shelf: 1,950            19.50

### Channels

The Omniplexer is unique with respect that its data channel cards accept asynchronous, isochronous, or synchronous data. Users merely specify the data format at configuration time. The voice channel card, on the other hand, employs conventional PCM to quantize analog channels.

Data-channel cards support bidirectional communication on the drop/insert model, and unidirectional on the point-to-point version. Two bidirectional cards, one supporting channel rates from 150 to 19.2K bps and the other supporting a channel rate of 56K bps, are offered for the drop/insert model. Both cards are dual-channel units and pass control signals. The point-to-point model also supports these cards in a unidirectional mode, but adds a third card that can be used only with this model. That card also operates at speeds between 150 and 19.2K bps, but provides 4 I/O channels; however, it passes no controls. All channel speeds must be identical.

The data cards access each of the 64K-bps time slots on a multiplexed basis. Thus, external multiplexers can be used to increase the total number of channels supported through submultiplexing. The total number of channels that will fit into each time slot depends on the speed of the transmitting device.

The following are system limits:

Terminal Speed	Max Channels/Slot
150 to 2400 bps	12
4800 bps	6
9600 bps	3
19.2K bps	2
56K bps	1

The remaining bandwidth between the aggregate channel rate and the 64K-bps channel bandwidth is consumed by error control, control signals, and the 8K-byte overhead associated with T1 operation.

Data channel inputs/outputs can support asynchronous, isochronous, or synchronous transmission, and different modes and speeds can be mixed in the same time slot. In addition, data channels destined for different drop/insert locations can share the same slot.

The voice-handling channel card employs the 64K-bps PCM quantization technique and requires an entire time slot. Thus, a maximum of 24 voice channel cards are accommodated by the Omniplexer. The voice card is also bidirectional and employs 4-wire E&M signaling.

The standard data-channel interfaces are RS-232C and CCITT V.35. RS-422, 423, and 449 interfaces are available on special order.

**037293 Dual Card/Controls** • provides channel logic for 2 data-channel I/Os • passes DSR, DTR, CD, CTS, and RTS control signals • DTE/DCE port 32-bit elastic buffer • accepts asynchronous, isochronous, and synchronous data channels at speeds of 150 to 19.2K bps • requires single card slot: \$750 prch    \$7.50 maint

*PRCH: single-unit purchase price. MAINT: monthly maintenance charge. Prices effective as of September 1984.*

## Bayly Omnplexer Drop & Insert T1 Multiplexer

**037386 Dual High-Speed Card/Controls** • provides channel logic for 2 synchronous data-channel I/Os • passes DTR, RTS, CD, DSR, CTS, RD, and TD control signals • 32-bit elastic buffer • DTE/DCE port • fixed data rate of 56K bps • requires single card slot:

775	7.75
-----	------

**039308 Dual Card/Controls** • same as 037293, except used on point-to-point model only • requires single card slot:

710	7.10
-----	------

**040347 Dual High-Speed Card/Controls** • same as 037386, except used on point-to-point model only • requires single card slot:

645	6.45
-----	------

**039308-1 Quad Channel Card/No Controls** • provides channel logic for 4 data-channel I/Os • passes no control signals • DTE/DCE port • accepts asynchronous, isochronous, and synchronous data inputs at speeds of 150 to 19.2K bps • all channel speeds must be the same data rate:

1,050	10.50
-------	-------

**033269 Voice-Channel Card** • provides channel logic for single voice channel • employs PCM • 4-wire E&M signaling • requires single card slot:

785	7.85
-----	------

**Low-Speed Channel Card Interface** • provides RS-232C interface connector for 037293, 039308, and 039308-1:

10	NC
----	----

**High-Speed Channel Card Interface** • provides CCITT V.35 interface connector for 037386:

12	NC
----	----

### Composite Link

The Omnplexer supports a single composite link per card shelf at a speed of 1.544M bps (T1), 3.152M bps (T1C), 6.312M bps (T2),

or 2.048M bps (CCITT). Transmission is bipolar, NRZ, full-duplex. The point-to-point model requires separate transmit and receive T1 driver modules, while the T1 module for drop/insert incorporates both functions.

The T1 driver module also incorporates the control logic functions for the multiplexer. In the point-to-point model, these facilities can be configured with redundant control logic and drivers.

The Omnplexer is available with a failure bypass unit that ensures that a failure of an intermediate multiplexer in a drop/insert configuration will not disrupt service to other multiplexers in the chain. Called the PCM Generator, it provides a DS1 standalone capability to maintain downstream service in the event of an upstream failure. The unit generates all timing signals normally received from the incoming bit stream needed for correct drop/insert operation for both voice and data channels.

**039325 T1 Transmit Driver** • provides T1 driver transmit facilities and control logic for point-to-point systems • requires single card slot; 1 required per card shelf:

\$545 prch	\$5.45 maint
------------	--------------

**039323 T1 Receive Driver** • provides T1 driver receive facilities and control logic for point-to-point systems • requires single card slot; 1 required per card shelf:

515	5.15
-----	------

**037402 T1 Driver** • provides T1 transmit and receive facilities plus control logic for drop/insert systems • requires single card slot; 1 required per card shelf:

755	7.50
-----	------

**031503 PCM Generator** • provides T1 timing and control to bypass failed nodes in drop/insert systems • requires single card slot:

250	2.50
-----	------

• END

# Beehive Display Terminals

## Models BASIC, STANDARD, PLUS, ATL-004, ATL-008, ATL-078 & ATL-083

### ■ PROFILE

**Function** • general-purpose, nonprogrammable interactive keyboard-display ASCII terminals • ANSI and DEC VT100 compatible (ATL Series); Burroughs TD830/MT983 compatible (ATL-083).

**Architectures Supported** • any architecture supporting an ASCII terminal; local/remote attachment • local/remote attachment to DEC or Burroughs hosts.

**Communications** • half-/full-duplex, asynchronous; isochronous, DM83/ATL Series; and synchronous, ATL-083 • 50 bps to 19.2K bps • point-to-point; multipoint, Model ATL-083 • character, line, and page transmission modes • RS-232C, RS-422A, and 20-mA current-loop interfaces.

**Operating System** • none.

**Database Management** • none; only in association with host facilities.

**Transaction Processing Management** • none; only in association with host facilities.

**Support Software** • none; only in association with host processor.

**Processor** • display-oriented control and communication logic, microprocessor controlled • local/remote initiated printing.

**Terminals/Workstations** • single keyboard 1920-character display (BASIC, STANDARD, PLUS, ATL-078, ATL-083); 1920-/3168-character display (ATL-004, ATL-008) • auxiliary printer port for local printer option.

**First Delivery** • 1981 (ADM Series); 1983 (ATL Series).

**Systems Delivered** • 100,000.

**Comparable Systems** • competitive with a number of ASCII display terminals, including ADDS Regent and Viewpoint Series; Anderson Jacobson 510/520; DEC VT100; Lear Siegler ADM Series; and Televideo 900 Series.

**Vendor** • Beehive International; 4910 Amelia Earhart Drive, P.O. Box 25668, Salt Lake City, UT 84125 • 801-355-6000.

**Distribution** • sold through original equipment manufacturers (OEMs); through 17 direct sales offices in 11 U.S. locations; and through distributors worldwide • European sales and service through Beehive International, Ltd, Ascot, Berkshire, England; Beehive Europe, Inc, Amsterdam, The Netherlands; and Beehive Ireland Limited, Fermoy, County Cork, Ireland.

### PURCHASE PRICE RANGE

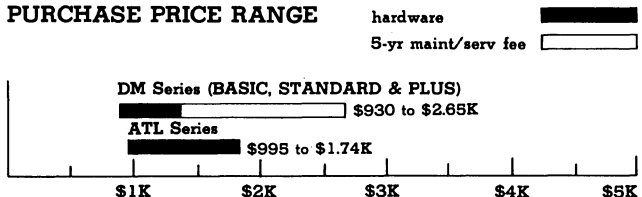

**BEEHIVE DM SERIES & ATL SERIES PURCHASE PRICING** bar graph covers price range between "small" and "large" configuration for hardware products (solid bars) and associated maintenance fees (open bars); maintenance fees were unavailable for the ATL Series • small DM consists of BASIC keyboard display terminal; large of PLUS keyboard display terminal • small ATL consists of ATL-004 keyboard display terminal; large of ATL-008 with 128K-byte page buffer and 2K-byte soft-key memory.

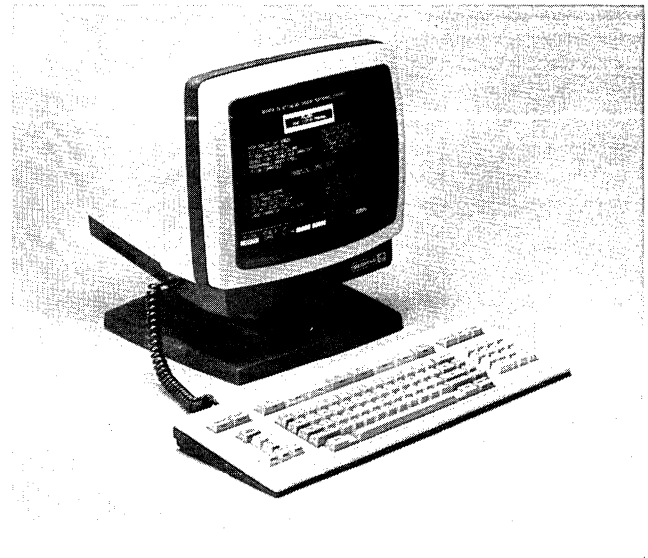

### ■ ANALYSIS

In recent months, Beehive has trimmed its ASCII terminal line and upgraded two models with new features. Model DM310, an IBM 3101 replacement, was dropped from production (IBM dropped the 3101 last year). Models DM78 and DM83 were incorporated into the ATL Series and are now named the ATL-078 and ATL-083, respectively. These terminals now include a larger display screen that tilts and swivels, along with a low-profile keyboard. Data rates and interface selections are keyboard-selectable now, as well, instead of the older method of setting internal switches. Model ATL-083 also features new power-down relays between main and chain ports, which allows downstream terminals in a daisy chain to continue receiving data when upstream units lose power.

Beehive has been in the interactive terminal marketplace since 1968, but until recently targeted the largest segment of its products at OEMs. The marketplace is changing, however, with a shifting emphasis towards end-user sales. Thus, Beehive has shifted its marketing direction to meet the new demand, and now provides a respectable stable of end-user terminals with increasingly sought-after features, including "smart" editing capabilities and block-mode transmission. The newer ATL Series accentuates an ergonomic design and increased functionality, and will supplant older Beehive models to carry the company through the mid-1980s.

The DM Series models BASIC, STANDARD, and PLUS are essentially warmed-over versions of an older product. The ATL-078 is an ASCII replacement for the IBM 3278 display (when used with a protocol converter); the ATL-083 is a Burroughs TD830-/MT983-compatible replacement.

The ATL Series, an abbreviation for Advanced Terminal Line, was announced at the Comdex Show in November 1982. The initial 2 models were aimed more at distributors than at end users, but specific end-user models for IBM, DEC, and Burroughs users have been introduced. Another model in the wings, the ATL-108, will include an I/O bus for the attachment of integral board-modems and/or other peripherals. Other future ATL

## Beehive Display Terminals

Models BASIC, STANDARD, PLUS, ATL-004, ATL-008, ATL-078 & ATL-083

models will feature bit-map graphics and 15-inch color CRTs. The ATL family provides a new low-profile keyboard, tiltable and swiveling CRT, and includes a wider variety of edit and display features not available on the DM Series.

Models BASIC, STANDARD, and PLUS compete with over 100 general-purpose ASCII terminals. Although basically sound, these units are hard-pressed to match the price/performance of some competitive products. Televideo's Model 925, for instance, compares very favorably with Beehive's Model PLUS, but retails for \$350 less. The 925 features a detached keyboard and split-screen operation, as does the PLUS, yet also affords an optional second page of display memory not available on the Beehive model. Entry-level terminals from Televideo, Lear Siegler, and others—selling in the \$500 to \$700 range—typically include a printer port, but Beehive's entry-level Model BASIC, priced at \$930, does not; nor does it provide split-screen operation, a feature often associated with competitive terminals in the BASIC's price range.

Beehive also markets an intelligent terminal for IBM 3270 networks, the ATL-3270; an IBM 3178 lookalike, the ATL-178; and a desktop computer with communication capability, called TOPPER. Beehive intends to increase its design and marketing efforts in this area of intelligent/programmable terminals, although the ATL Series of smart terminals should satisfy traditional interactive terminal customers for the foreseeable future. Another product, the CC76 ASCII/3270 protocol converter, is licensed from another manufacturer and modified by Beehive to accommodate its own terminals. An 8-port device, the CC76 is also available in a 4-port version.

### Strengths

Beehive terminals have an advertised MTBF (mean time between failures) of over 15,000 hours, which equates to almost 2 years of continuous operation without failing; the company's products are generally known for their quality. Beehive provides its own field service in several major metropolitan areas, and offers an impressive array of maintenance packages, both contractual and noncontractual.

Several Beehive terminals provide increased operating performance and reduced price over major industry models they replace. Model ATL-078 is part of a trend, for instance, providing inexpensive ASCII terminals as replacements for IBM 3270 devices. The ATL-078 has a 3278-lookalike keyboard and 3278 status line emulation, making the transition from the IBM terminal less painful for operators. At a price savings of around \$700 per terminal over an IBM 3278 Model 2, the transition may be worth it.

The ATL-083 is a Burroughs-compatible terminal which is priced about \$1,000 below the TD830 it is meant to replace. It can be used in a Burroughs multipoint environment, and includes advanced display, configuration, edit, and test procedures. The ATL-083 supports Burroughs' unique polling protocols as well as synchronous and isochronous transmission modes, and thus does not require a protocol converter.

### Limitations

A serious limitation of current Beehive terminals is their lack of upgradeability. Although Beehive terminals span a wide variety of applications, users cannot, for instance, purchase a smart terminal and add a personal computing option later on, an option offered by DEC for its VT100 family. The newer ATL Series may be upgradeable within the series by swapping-out logic boards, but this option has not been firmly established by the vendor. More users should be basing purchasing decisions on the flexibility and expandability of a product to protect their investment, especially with rapid change being the status quo in the industry.

Model ATL-083 is a replacement product for Burroughs terminal Models TD830 and MT983. The Burroughs terminals support IBM BSC communication; the Beehive model does not. This limitation is a serious one for Burroughs shops with requirements for IBM communication, or for those who may need to upgrade to BSC at a future date.

### SOFTWARE

No software support is furnished.

### HARDWARE

#### Terms & Support

**Terms** • terminal models are available for purchase, or under 1-, 2-, 3-, or 5-year lease (leasing from participating distributors) • lease/purchase credit available • separate maintenance contract available for leased or purchased units • 90-day warranty • discounts available for quantities over 100/500; contact vendor for quotation.

**Support** • maintenance provided by Beehive from 18 U.S. service depot locations, or by third party (Western Union) from over 400 U.S. locations • contractual and noncontractual service agreements available; contractual agreements include on-site, factory exchange, service center carry-in, and time-and-materials contracts; noncontractual arrangements include on-site time and materials, factory exchange, service center carry-in, subassembly exchange, and small parts purchase • on-site contractual and non-contractual maintenance performed Monday through Friday from 8:00 AM to 5:00 PM, with higher rates after normal hours and on weekends; non-contractual, on-site labor charges range from \$75 to \$150 per hour, mileage and material extra • contract on-site charges based on mileage zones I/II/III spaced at 25/75/125 miles from the nearest service center; monthly charges vary by terminal model (see maintenance pricing under Model Packages) • depot and carry-in service provides maintenance at reduced cost, ranging from \$70 to \$175 per repair, depending on the part • on-site contract maintenance guarantees 24-hour response time, 8-hour response average, and takes precedence over other repairs; includes toll-free service telephone number • factory repairs average 72 hours from receipt to return shipment; carry-ins repaired (normally) within 8 working hours • Beehive service depots, for factory parts exchange and carry-ins, located at Costa Mesa and Sunnyvale, CA; Salt Lake City, UT; Independence, MO; Dallas, TX; Chicago, IL; Woburn, MA; Colonia, NJ; Falls Church, VA; and Miami, FL • factory repairs performed in Salt Lake City.

#### Overview

The Beehive DM and ATL models covered in this report consist of 7 ASCII keyboard-display terminals designed to operate at speeds of 110 to 19.2K bps (BASIC, STANDARD, PLUS, ATL-078), and 50 to 19.2K bps (ATL-083, ATL-004, ATL-008). Although not programmable, the Beehive terminals covered in this report contain various levels of "smart" edit and display features, including character or line inserting/deleting, split-screen formatting with line lock, multipage memories, programmable function keys, and screen visual attributes. All models can be equipped with foreign character sets such as U.K., German, French, French Lower Level, Spanish, Swedish, Danish, Norwegian, and Finnish; these character sets are standard equipment for the newer ATL-004 and ATL-008.

Model ATL-078 is intended for IBM 3270 environments. The ATL-078 is a low-cost ASCII terminal with an IBM 3278 lookalike keyboard, and is designed to be coupled with a protocol converter for use in IBM 3270 networks. Model ATL-083 is a Burroughs TD830-/MT983-compatible terminal, and supports Burroughs polling protocols for use in multipoint networks. Models ATL-004 and ATL-008 can support DEC VT100 and VT100/VT131 applications, respectively, and also conform with the international ANSI X3.64 terminal standard. The ATL Series is a product line featuring enhanced display and edit capabilities, and advanced ergonomic design for operator comfort.

Operating parameters are established via DIP switches for Models BASIC, STANDARD, PLUS, and ATL-078. The ATL-083, ATL-004, and ATL-008, however, are soft configured from the terminal's keyboard. Moreover, the ATL-008 setup procedures are assisted by extensive English language menus.

Models BASIC, STANDARD, PLUS, and ATL-004 perform a basic self-test of display memory and terminal operation upon power-up. A status/error message is displayed on the status line. Model ATL-078 performs start-up tests on RAM, ROM, and

## Beehive Display Terminals

Models BASIC, STANDARD, PLUS, ATL-004, ATL-008, ATL-078 & ATL-083

keyboard, and will print an error message for each failed component. Models ATL-083 and ATL-008 perform an extensive array of tests, and can pinpoint errors to one of several discrete components; the ATL-008 includes an English menu for test selection.

### Model Packages

**BASIC** • keyboard-display ASCII terminal with 12-inch CRT; displays 1920 characters at 24 lines x 80 characters; 25th status line • 5x7 dot matrix • detached, typewriter-style keyboard; 75 keys, including choice of 14-key numeric keypad or special function/edit keys • standard business graphics • foreign character sets available • switch-selectable 110-bps to 19.2K-bps EIA interface; 110-bps to 9600K-bps current-loop interface • character or block (line or page) transmission mode • RS-232C or 20-mA current-loop communication interface • options including white or green phosphor screen; foreign keycaps/character generators:

\$930 prch    \$17.95 maint

**STANDARD** • keyboard-display ASCII terminal with 12-inch CRT; displays 1920 characters at 24 lines x 80 characters; 25th status line • 5x7 dot matrix • split-screen with line lock • detached, typewriter-style keyboard; choice of 87 keys with 16 alternate shift keys, editing keys and 12-key numeric pad, or 95 keys with 12 single-action function keys, editing keys and 14-key numeric pad • standard business graphics • foreign character sets available • switch-selectable 110-bps to 19.2K-bps EIA interface; 110-bps to 9600-bps current-loop interface • character or block (line or page) transmission mode • RS-232C or 20-mA current-loop communication interface; RS-232C bidirectional auxiliary interface • options including white or green phosphor screen; foreign keycaps/character generators:

1,145            19.95

**PLUS** • keyboard-display ASCII terminal with 12-inch CRT; displays 1920 characters at 24 lines x 80 characters; 25th status line • 5x7 dot matrix • split-screen with line lock • forms mode • detached, typewriter-style keyboard; choice of 87 keys with 16 alternate shift keys, editing keys and 12-key numeric pad, or 115-key keyboard with 16 single-action function keys, 14-key numeric pad, and specialized function/edit keys • standard business graphics • foreign character sets available • switch-selectable 110-bps to 19.2K-bps EIA interface; 110-bps to 9600-bps current-loop interface • character or block (line or page) transmission mode • RS-232C or RS-422A communication interface; RS-232C bidirectional, buffered, auxiliary interface • options including white or green phosphor screen; foreign keycaps/character generators:

1,345            21.95

**ATL-078** • keyboard-display ASCII terminal with 14-inch tilt-and-swivel CRT; displays 1920 characters at 24 lines x 80 characters; 25th status line • 5x7 dot matrix • detached, IBM 3278-style keyboard; 87 keys, including 12-key numeric pad • standard business graphics • switch-selectable 110-bps to 19.2K-bps operation • character transmission mode • 2 communication interfaces: RS-232C and 20-mA current-loop, or RS-232C and RS-422A • RS-232C bidirectional, buffered (both send and receive), auxiliary interface • optional 15-inch CRT:

1,195            21.95

**ATL-083** • keyboard-display ASCII terminal with 14-inch tilt-and-swivel CRT; displays 1920 characters at 24 lines x 80 characters; 25th status line • Burroughs TD830/MT983 compatible • 7x9 dot matrix • detached, low-profile typewriter-style keyboard; 110 keys with separate numeric keypad, including 16 user-definable function keys • 16K-byte RAM memory stores function key codes; additional 16K bytes optional • terminal operating parameters configured from the keyboard via 25th status line • standard business graphics • 9-page display memory, from 4 to 120 lines of 80 characters per page • 50-bps to 19.2K-bps asynchronous, synchronous, or isochronous operation • supports major Burroughs polling protocols, including poll/select, fast select, group poll, and multipoint contention • strap-selectable Burroughs TDI or RS-232C communication interface; RS-232C auxiliary port; RS-232C chain port (for daisy-chaining terminals) • options

include memory expansion for user-programmable function keys:

1,495            28.95

**ATL-004** • keyboard-display ASCII terminal with 14-inch tilt-and-swivel CRT; displays 1920/3168 characters at 24 lines x 80/132 characters; 26th and 27th function and status lines • DEC VT100 compatible; ANSI X3.64 compatible • 7x9 dot matrix • detached, low-profile typewriter-style keyboard with separate numeric keypad and cursor controls; meets DIN standards; includes 16 pre-programmed function keys and 8 user-programmable "soft" function keys • terminal operating parameters configured from the keyboard via 26th and 27th lines • standard business graphics • 9 resident foreign character sets • single-page display memory • 50-bps to 19.2K-bps operation, asynchronous or isochronous • character or block (line or page) transmission mode • RS-232C, RS-422A, or 20-mA current-loop communication interface; RS-232C bidirectional, buffered auxiliary interface:

995            NA

**ATL-008** • keyboard-display ASCII terminal with 14-inch tilt-and-swivel CRT; displays 1920/3168 characters at 24 lines x 80/132 characters; 26th and 27th function and status lines • DEC VT100/VT131 compatible; ANSI X3.64 compatible • 7x9 dot matrix • split-screen with line/memory lock • detached, low-profile typewriter-style keyboard with separate numeric keypad and cursor controls; meets DIN standards; includes 16 pre-programmed function keys and 8 user-programmable "soft" function keys • terminal operating parameters configured from the keyboard via full-screen menus • standard business graphics • 9 resident foreign character sets • 32K-byte page memory (16 pages maximum, user-definable page size); page memory expandable to 128K bytes • 50-bps to 19.2K-bps operation, asynchronous or isochronous • character or block (line or page) transmission mode • RS-232C, RS-422A, or 20-mA current-loop communication interface; RS-232C bidirectional, buffered auxiliary interface • options include 128K RAM screen buffer expansion; 2K nonvolatile RAM (2K maximum) for programmable function keys; P4 white screen phosphor:

1,495            NA

### □ CPU & Memory

All terminals are microprocessor controlled (Intel 8085; ATL-008 employs Motorola MC68008). RAM is employed for page scrolling, printer buffering, and terminal operating parameters for those models supporting these features. Firmware controls terminal functions.

**ATL-083 Memory Expansion** • adds 20K bytes of additional RAM memory (36K bytes total) for user programming of 16 function keys:

\$195 prch    NA maint

**ATL-008 Page Buffer Expansion** • provides 128K bytes of RAM memory for increased page buffer size:

200            NA

**ATL-008 Memory Expansion** • provides 2048 bytes of RAM memory for user programming of 8 soft keys:

50            NA

### □ I/O & Communications

All members of the Beehive terminal families support point-to-point asynchronous ASCII communication. The ATL Series also supports isochronous communication, while the ATL-083 can operate in a Burroughs multipoint environment and supports major Burroughs polling protocols as well as isochronous and synchronous communication. Transmission rates are 110 to 19.2K bps for Models BASIC, STANDARD, PLUS, and ATL-078; and 50 to 19.2K bps for Models ATL-083, ATL-004,

*PRCH: single-unit purchase price. MAINT: monthly on-site, contract maintenance charge for leased and purchased units. NA: pricing not announced to date. Monthly lease pricing available from independent distributors. Prices effective as of July 1984.*



## Beehive Display Terminals

### Models BASIC, STANDARD, PLUS, ATL-004, ATL-008, ATL-078 & ATL-083

and ATL-008. Incoming data is buffered by all models in a small receive (input) RAM memory, and XON/XOFF flow control procedures provide start/stop transmission in relation to space available in the buffer.

All models communicate over switched or dedicated lines in half-/full-duplex mode and support local echo (echoplex) in character mode. Transmission character parity is selectable for odd, even, mark, or space. The character is composed of 7 data bits with 1 start bit and 1 or 2 stop bits.

Operating parameters for Models BASIC, STANDARD, PLUS, and ATL-078 are established via DIP switches. Model ATL-078 and the ATL Series are soft configured via display menus; all parameter changes to operating configuration are established from the terminal's keyboard (or host), assisted by English menu prompts in the ATL-008. The ATL Series displays a blank 25th line, with 26th and 27th lines used for operating status and soft-key labeling, respectively.

Operating modes are fairly consistent among the different models. All can communicate in interactive (character) mode or block mode, except for the ATL-078, which operates in character mode only. Block mode communication supports line and page transmission. All models can operate in local mode, whereby data is keyed to the screen but does not pass through the communication facility.

Most models can be equipped with an RS-232C or 20-mA current-loop communication interface. Models PLUS, ATL-078, ATL-004, and ATL-008 can optionally support an RS-422A communication interface. The ATL-078 contains 2 communication interfaces for transmission between 2 hosts. The ATL-083 is equipped with an RS-232C main port that can double as a Burroughs TDI interface. TDI is a 2-wire, direct-connect interface designed for multiterminal applications, and uses only 3 conductors (signal, chassis ground, and signal ground). Up to 9 TDI-equipped ATL-083s can be attached to 1 line, with a maximum cable distance of 1,000 feet. ATL-083s can also be concatenated via an RS-232C "chain" interface, also standard equipment, by connecting the head terminal's chain port to the communication port of the following terminal. Using this method, the number of concatenated terminals is limited only by practical considerations such as poll response times or the number of terminal addresses available.

All terminals—excluding the BASIC—are equipped with an RS-232C auxiliary port, which is bidirectional (2-way) for all models and which is usually used to attach a serial printer. The DM310 can also be provided with an RS-422A auxiliary interface for IBM 3101 Model 23 emulation. The auxiliary ports for the ATL Series include a 1920-character buffer, allowing 2 terminals to share the same printer, or an operator to key-in data simultaneously while a host transmits to the terminal printer (screen bypass). Older models follow EIA control procedures, including XON/XOFF, DTR, ETX, ACK/NAK, and pins 11/9 (Busy or Ready). The ATL Series will support multiple handshaking protocols, according to the vendor.

Beehive also manufactures an IBM 3270 (SDLC/BSC) to ASCII protocol converter called the CC76. The CC76 is a standalone unit that provides 2 synchronous host connections for 8 terminals, or 2 synchronous and 1 asynchronous host connections for 7 terminals. It is designed to support specific status line functions and programmable function keys for the ATL-078 and operates in local or remote, switched or dedicated environments (remote dedicated BSC lines only).

**CC76** • IBM 3270/ASCII protocol converter • operates with terminal model ATL-078:

\$3,995	prch	\$53.50	maint
---------	------	---------	-------

**CC74** • 4-port version of Model CC76:

2,995	NA
-------	----

**Disk**

No disk/diskette is supported.

**Terminals/Workstations**

Display, editing, and format features are similar for the entire line.

Notable differences are forms mode (data entry) support starting with Model PLUS; split-screen operation, starting with Model STANDARD; and buffered/scrollable multiple screen displays for Models ATL-083, ATL-004, and ATL-008.

Models ATL-004 and ATL-008 are the newest members of the Beehive terminal line, and provide enhanced features and ergonomics over earlier models. These include larger, tiltable/swiveling CRT screens; low-profile, detached keyboards with separate, T-pattern cursor pad; N-key rollover for fast typists; and compatibility with the international ANSI terminal standard. All models in the Beehive families have a choice of white or green screens; all are anti-glare, with ATL Series employing a nylon mesh.

The split-screen function divides the screen into 2 separate regions, useful for comparing data. Line lock allows the user to lock 1 line on the screen and scroll data under it; memory lock allows all lines above the cursor to remain stationary. Other convenience features available on the ATL-008 include vertical as well as horizontal scrolling, with smooth or jump scroll in a vertical direction; "windowing," which allows up to N pages to be displayed on the screen at one time; and nonembedded visual attributes, meaning that screen characters and field effects do not take up space on the display.

The ATL-078 is designed for IBM 3278 display station users who desire the price/performance of Beehive terminals. The ATL-078 keyboard is similar to that of the 3278, but with a 12-key numeric pad and "high speed" right/left cursor keys. The ATL-078 operates in ASCII mode, however, and must be used in tandem with a pair of 3270/ASCII protocol converters, or with Beehive's own CC76 protocol converter. It provides several enhanced features over its IBM counterpart (see Analysis), including selective shift of alphabetic characters only (allowing normal numeric keying).

**Configuration** • tabletop keyboard-display with typewriter-style keyboard • separate numeric keypad, all models • keyboards range in size from 75 keys (BASIC) to 110 keys (ATL-083) • detached keyboard, all models • each terminal supports a local serial printer, excluding the BASIC which does not support a printer.

**Display** • 12 inches standard, DM Series; 14 inches standard, ATL Series • displays 1920 characters at 24 lines x 80 characters, all models; 3168 characters also selectable on ATL-004/ATL-008 • 128 ASCII characters, Models BASIC, STANDARD, PLUS, ATL-083, and ATL-004; 256 displayable ASCII characters for Model ATL-078, including displayable EBCDIC characters and graphic symbols for simulation of 3278-style status line; 256 ASCII characters, Model ATL-008 • business (line) graphics, including mathematical symbols, for simple line drawings and business forms, all models • choice of 9 foreign character sets, including UK, German, French, French Lower Level, Spanish, Swedish, Danish, Norwegian, and Finnish, factory-installed; machine-resident foreign character sets, Models ATL-004 and ATL-008.

**Edit & Format Features** • common features for all terminals include cursor left, right, up, down, home; addressable cursor for row and column • automatic character wraparound • return, line feed • typematic (auto-repeat) keys • scrolling • caps key lock • programmable tab • backtab for PLUS and ATL Series • insert/delete character for PLUS, ATL-078, ATL-083, ATL-004, ATL-008; insert/delete line for PLUS, ATL-083, ATL-008; insert/delete page for ATL-083 • erase to EOP/EOL for ATL-083, ATL-004, ATL-008 • erase to EOF for ATL-078, ATL-083 • erase from beginning of line/page for ATL-008 • erase protected field for PLUS • erase entry/unprotected entries for ATL-004, ATL-008 • clear variable data for ATL-083 • clear screen for ATL-083, ATL-078, ATL-004, ATL-008 • device cancel for ATL-078 • programmable editing extents for ATL-008 • character overwrite for PLUS, ATL-078, ATL-083 • logical attributes for PLUS, ATL-083, ATL-004, ATL-008 • reverse, blink, underline, half/bright intensity, security fields for BASIC, STANDARD, PLUS, ATL-078, ATL-083, ATL-004, ATL-008 • double-high/-wide characters, double-high and double-wide characters for ATL-004, ATL-008 • dark or light background for ATL-004, ATL-008.



## Beehive Display Terminals

Models BASIC, STANDARD, PLUS, ATL-004, ATL-008, ATL-078 & ATL-083

---

**Peripherals** • RS-232C interface supports local printer attachment for all models except BASIC • input from terminal or host processor.

**Printers**

---

Beehive does not offer a printer for any member of its terminal

families, but does provide a serial auxiliary interface for printer attachment on all models except the BASIC. Model ATL-078 provides 2 serial interfaces for printer attachment. See I/O & Communications for auxiliary/printer port characteristics.

---

• **END**



# Burroughs Facsimile Transceivers

## Express 2000, dex 3200, 3500, 3600 & 3700 Series

### ■ PROFILE

**Function** • high-performance transceivers using digital and analog image transmission • unattended operation through auto-dialer.

**Type** • tabletop transceivers.

**CCITT Compatibility** • Groups 2 and 3 on all models • Group 1 on dex 3200, 3600, and 3700 • dex mode on 3500.

**Maximum Scanning Width** • 10 inches (dex 3200, 3600, 3700); 8.5 inches (dex 3500); 8.2 inches (dex 2000).

**Feeder** • auto-feed, 30 sheets for all models except Express 2000 which is 10 sheets.

**Image Resolution** • 203x196 lpi fine; 203x98 lpi normal for all models • 203x64 lpi except on dex 3500; 101x98 lpi except for Model 3600 operating in proprietary mode • 98x98 lpi in Group 1 and 2 for Models 3200, 3606, and 3700; 96x96 lpi under Group 2 for Model 3500.

**Half-Tone Support** • none.

**Communications** • dedicated line or public switched network • transmit/receive speeds up to 9600 bps on dex 3500, 3603, 3604, and 3700; up to 4800 bps on dex 3200, 3601, 3602, and 2000 • Group 1 transmission 6 minutes at 98 lpi; 4 minutes at 65 lpi (3606 only) • Group 2 transmission 3 minutes • dex proprietary-mode transmission 3 minutes.

**First Delivery** • 1983.

**Units Installed** • unavailable.

**Comparable Systems** • Canon Fax 601; 3M EMT 9136/9140/9160/2346/1000B/VRC II; Muirhead K-442, 6400; Nippon (NEC) System 11/110/System III; Panafax MV 300/1200; Pitney Bowes 8100 and 8900; Ricoh 3100/3300; Telautograph Omnifax; and Xerox 200/400/410/455.

**Vendor** • Burroughs Corp, Imaging Systems Division; Corporate Drive, Commerce Park, Danbury, CT 06810 • 203-796-5400.

**Distribution** • nationwide through Burroughs sales offices.

### ■ ANALYSIS

The dex 3200, 3500, and 3600 Series first appeared last year, and have been fairly successful for Burroughs and for good reason, since the entire line is attractively priced, it offers very good

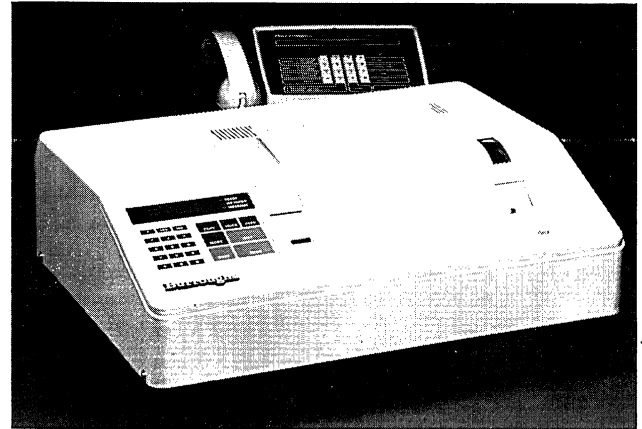

image scan resolutions (203x196/98 lpi), is CCITT Group 3 and 2 compatible, and features roll-feed printing. Two units, Models 3200 and 3600, auto-reduce oversized input documents and perform modified Huffman encoding—both very sophisticated features for transceivers of this type. Both also are Group 1 compatible.

To this family, Burroughs has recently added the dex Express 2000 and the dex 3700. The 2000 is clearly aimed at users requiring a low-cost, low-capacity machine with good image scan resolution and the ability to be polled. For that market segment, the 2000 is more than adequate. With a scan resolution of 203 (horizontal) x 196 (vertical) lpi, it provides a facility equal to many floor-console models. It is also CCITT Group 3 and 2 compatible, and has modified Huffman data compression. Priced at \$2,595, it's quite a bargain.

The dex 3700 has just about all of the facilities offered by the top of the line dex 3606, one of the more attractive cost-performance transceivers on the market. The new 3700, however, differs in 2 ways. First, it does not have the automatically adjustable scan image resolution feature (see Strengths); and second, the 3700 can function as a printer for word processors and personal computers. The latter is accomplished by software that accepts data from a local or remote host processor, and formats it to meet printing requirements. The interface to the host is a RS-232C connector. The only transceiver that comes close to this facility is Ricoh's 5000 transceivers with the Intelligent I option.

While the dex family provides top performance within its target markets, Burroughs has yet to respond to the challenge from facsimile transceivers with store-and-forward capabilities. Ricoh (formerly Rapicon) was the first to offer it with the SAF-PAK option on the R-5000, and now NEC, Pitney Bowes (Model 8900), and Panafax (Model PX-200) are offering similar products. While the techniques used for store-and-forward differ among vendors, the end result is that those machines can store pages in memory and selectively route them to other facsimile machines. Products with this capability are priced around \$10,000, which is far beyond the upper limit of anything in the dex family. We are not citing this deficiency to fault the dex line. Considering its price range, that would be ludicrous. What we are saying is that if your present or future needs call for store-and-forward, it is **not available** even as an option.

Burroughs attempts to blunt this deficiency via its dex controller.

### PURCHASE PRICE RANGE

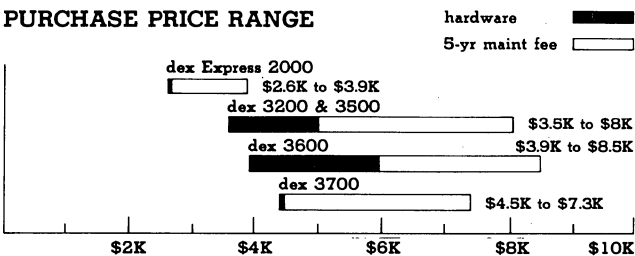

**BURROUGHS DEX SERIES TRANSCIVER PRICING** • bar graphs show purchase price range (solid bars) and associated 5-year maintenance fees (open bars) for product line • dex Express 2000 shows price of basic system • dex 3200 and dex 3500 low end shows price of basic dex 3200; high-end dex 3500 with dex Controller • dex 3600 Series low end shows price of dex 3601; high end of dex 3606 with dex Controller • dex 3700 shows price for basic system. All prices are single quantity purchase.

## Burroughs Facsimile Transceivers

### Express 2000, dex 3200, 3500, 3600 & 3700 Series

That unit is basically an intelligent auto-dialer that stores up to 50 phone numbers divided into 5 groups of 10 numbers each. The dex controller can be programmed to send a transaction to selected locations at designated times of the day. Working with the 30-document auto-feed facility of the dex transceivers, the controller could broadcast these pages to the selected locations. The principal problem with this scheme is that no provision exists for handling a document jam at the sending unit. Thus, attended operation is a must.

#### Strengths

For tabletop units, the dex Series provides some amazing facilities. The scan image resolution of 203x196/98 lpi is in the same class as larger, more expensive floor models, and the CCITT compatibility allows them to function with non-Burroughs units. The modified Huffman and modified Read encoding provides data compression which, in turn, reduces the overall volume of data communicated, speeding transmission and cutting costs.

The top products in this group, the dex 3600 Series, offer some extremely advanced features. Most notable is the auto-scan adjustment facility which automatically adjusts to the quality of the scanned document. Called Automatic Line Density Control, it switches between 203x198 lpi and 203x98 lpi according to the quality of the document. Very few transceivers have this capability. The advantage of auto-adjustment is that the user needn't set the scan rate for worst case conditions of the document. Such compromises generally result in longer transmit times when the scanning rate is set for fine or light print, even though most of the document could get by with normal scan rates. Other notable features are auto-reduction, modified Huffman, and 2-dimensional modified READ. They even poll.

#### Limitations

The only common limitation of all 3 transceivers is the absence of support for handling photographs. Since these units are clearly targeted at business applications, the absence of this facility could be a strong limitation to some users.

The only other weakness worth noting is the limited transmission speed of the dex 3200, 3601, and 3602. With a top transmit rate of 4800 bps, a standard page will require about 40 seconds. While this isn't slow when compared with the 3- and 6-minute speeds of the analog units, it's half the rate of 9600-bps machines.

#### HARDWARE

##### Terms & Support

**Terms** • all transceivers are available for purchase with lease agreements negotiable • volume discounts are available.

**Support** • on-site, vendor support is available in all major metropolitan cities • third-party service is offered at other locations.

##### Overview

The Burroughs' dex family consists of 9 tabletop transceivers and an auto-dialer; all are designed for general-purpose applications. All models are CCITT Group 3 compatible, and support scan resolutions of 203 (horizontal) x 196 (vertical) lpi. The members differ principally in the document-handling capabilities, protocols supported, communication speeds, and transmission reporting.

The dex Express 2000, a relatively new product, is an entry-level transceiver aimed at users with limited facsimile needs. This unit accepts an input document up to 8.54 inches wide with unlimited length; 10 documents can be stacked and auto-fed. As a receiver, however, the unit employs a roll of 8.5-inch x 164-foot paper. Printing is thermal and consists of 1664 individual print elements for a horizontal resolution of 203 lpi. The Express 2000 supports CCITT Groups 2 and 3, and has a data transmission rate of 4800 bps for Group 3 with automatic fallback to 2400 bps. Polling is also supported. The 2000 even features modified Huffman encoding, an unusual facility for an entry-level unit. Another unusual facility is the detailed reporting provided (see Express 2000 description for details).

The dex 3200 handles documents up to 11 inches wide, and reduces the image to the size acceptable to the receiver. The unit

is CCITT Groups 1, 2, and 3 compatible, provides modified Huffman encoding, and automatically adjusts for varying background colors. The dex 3200, however, only transmits digital data at speeds to 4800 bps; about 40 seconds are required to transmit an 8.5x11-inch page.

The dex 3500 lacks the auto-reduction, Huffman encoding, and background color adjustment features of the dex 3200, but does provide 203x64-lpi express scanning. The 3500 transmits data at 9600 bps, halving the time required by the dex 3200 to transmit a page. The 3500 is CCITT Group 2 and 3 compatible, but it does not support Group 1. Instead it offers proprietary dex-mode support with a scan resolution of 100x88 lpi and page transmit time of 3 minutes.

The dex 3600 Series consists of models 3601, 3602, 3603, 3604, and 3606. These are extremely sophisticated units that feature auto-reduction of oversized documents, automatic scan rate adjustment (to compensate for varying quality of the input document), modified Huffman and modified 2-dimensional READ data compression, and polling. Differences among models rate with the data transmission rates, CCITT support, and activity reporting. The latter facility, called Activity Reporting System, imprints each received document with the sender's name, date, and time. It also generates a send report on each transmission and prints detailed summary journals after 29 transactions, or on command.

The dex 3700 has the same facsimile features as the dex 3606 (i.e., CCITT Groups 1, 2, and 3 compatible and an integral 9600-bps modem), with the exception that automatic scan rate adjustment is not offered with the 3700. What sets the 3700 apart from the other dex units is that it can be used as a printer for information generated by the host computer. Burroughs indicates that this facility is well suited to handle print requirements associated with word processor and/or personal computers. The dex 3700-to-host interface is RS-232C; the transceiver can be connected to telephone lines or directly attached to a local host.

All dex transceivers except the Express 2000 can be combined with a new dex Controller, an intelligent dialer which automatically polls and sends commands at preprogrammed times of day. The Controller contains up to 50 phone numbers; busy transceivers are redialed 3 times.

##### Express 2000 Transceiver

Tabletop unit measuring 14.5 (W) x 25 (D) x 7.6 (H) inches; 36 lbs • accommodates input document from 5.04 to 8.54 inches wide with unlimited length; auto-feed, 10-sheet capacity • roll-feed output 8.5 inches wide; 164-foot roll • flatbed, charged coupled decode (CCD) scanning • switch-selectable resolution at 203x196 lpi (fine) or 203x98 lpi (regular) for Group 3; 203x98 lpi for Group 2 • modified Huffman coding • transmission time for 8.5x11-inch document at 4800 bps under Group 3 is below 1 minute; Group 2 is 3 minutes • issues transmit receipt message; prints sending terminal name, date, time, and page number heading on received documents; prints detailed send and receive summary journals • 8.2-inch maximum scanning width • thermal printing • no half-time support:

\$2,595 prch \$23 maint

##### dex 3200 Transceiver

Tabletop unit measuring 21.3(W) x 16.1(D) x 7.3(H) inches; 47 lbs • accommodates input document up to 11 inches wide and auto-reduces it to size acceptable to receiver; auto-feed, 30-document capacity • roll-fed output 8.5 inches wide; 328-foot roll • flatbed, charged coupled diode (CCD) scanning • switch-selectable resolution at 203x196 lpi (fine) or 203x98 lpi (normal) for Group 3; 98 lpi for Groups 1 and 2 • transmission time for 8.5x11-inch document at 4800 bps is subminute; Group 2 is 3 minutes; Group 1 is 6 minutes • issues transmit receipt message • 10-inch maximum scanning width • thermal printing •

**PRCH: purchase price. MAINT: monthly maintenance charge (one-twelfth annual fee). NA: not available. All prices single quantity purchase. Prices effective as of November 1984.**

## Burroughs Facsimile Transceivers

### Express 2000, dex 3200, 3500, 3600 & 3700 Series

CCITT compatible at all levels; modified Huffman encoding • no half-time support • adjusts for background color:

**\$3,995 prch \$47 maint**

#### dex 3500 Transceiver

Tabletop unit measuring 11.5(W) x 20.5(D) x 11.5(H) inches; 84 lbs • accommodates input document up to 8.5 inches wide; auto-feed, 30-document capacity • roll-fed output 8.5 inches wide; 328 foot roll • flatbed, charged coupled diode (CCD) scanning • switch-selectable resolution at 203x196 lpi (fine); 203x98 lpi (normal), 203x64 lpi (express) for Group 3; 96x96 lpi for Group 2; 100x88 lpi for dex mode • transmission time is 20 seconds for an 8.5x11-inch page at 9600 bps; Group 2 and dex mode both are 3 minutes per page • 8.5-inch maximum scanning width • thermal printing • no half-tone support:

**\$3,595 prch \$47 maint**

#### dex 3601 Transceiver

Tabletop unit measuring 23.2(W) x 19.7(D) x 10.2(H) inches; 79 lbs • accommodates input documents up to 11.7 inches wide • auto-feed, 30-document capacity • roll-fed output 8.5 inches wide; auto-reduction of oversized documents • flatbed, charged coupled diode (CCD) scanning • switch-selectable or automatically adjustable scan resolution at 203x196 lpi for Group 3; 203x98 or 101x98 lpi in dex 3600 mode; 98x98 lpi Group 2 mode • 4800-bps transmission rate • transmission time is 40 seconds for 8.5x11-inch document at 4800 bps; Group 2 is 3 minutes per page; 8.5-inch maximum scanning width • thermal printing • CCITT Group 3 and 2 compatibility • modified Huffman and 2-dimensional modified Read encoding • no half-tone support • polling:

**\$3,995 prch \$47 maint**

#### dex 3602 Transceiver

Same as dex 3601 except has automatic reporting system:

**\$4,195 prch \$47 maint**

#### dex 3603 Transceiver

Same as dex 3601 except transmits at 9600 bps:

**\$4,395 prch \$47 maint**

#### dex 3604 Transceiver

Same as dex 3601 except transmits at 9600 bps and has automatic reporting system:

**\$4,595 prch \$47 maint**

#### dex 3606 Transceiver

Same as dex 3604, except is CCITT Group 1, 2, and 3 compatible:

**\$4,795 prch \$47 maint**

#### dex 3700 Transceiver

Tabletop unit measuring 21.3 (W) x 16.1 (D) x 7.3 (H) inches; 47 lbs • accommodates input document of 4.7 to 11 inches wide and 3.9 inches to 9.8 feet long; auto-feed, 30-document capacity • roll fed output 8.5 inches wide; 328-foot roll • flatbed, charged coupled diode (CCD) scanning • switch-selectable resolution at 203x196 lpi (fine) or 203x98 lpi (normal) for Group 3; 98 lpi for Groups 1 and 2 • modified Huffman and READ • transmission time for 8.5 x 11-inch document is subminute for Group 3; 3 minutes for Group 2; and 6 minutes for Group 1 • prints sending terminal name, date, time, and page number heading or received documents; prints detailed send and receive summary journal; issues transmit receipt message • 10-inch maximum scanning width • thermal printing • no half-time support • polling:

**\$4,495 prch \$47 maint**

#### dex Controller

The dex controller is an intelligent auto-dialer for the dex facsimile product line (except Express 2000). It automatically performs multiple poll and send commands at preprogrammed times of the day. Busy numbers are automatically redialed for a total of 3 times at 5-minute intervals. The dex Controller also doubles as an office telephone with 2-digit speed dialing of up to 50 memory-stored numbers. Each telephone number can be 32 digits.

The 50 telephone-number memory locations are divided into 5 groups consisting of 10 telephone numbers each. Each group is automatically dialed by simply entering a 1-digit group number. The dex Controller can be programmed for individual or multiple send transactions. This enables the user to program a send transaction to selected locations at designated times of the day. An unsuccessfully executed command is indicated as an incomplete command on the display panel. These commands can be examined and reprogrammed.

**dex Controller** • auto-dialer with 50 telephone-number capacity:

**\$825 prch NA maint**

#### Communications

All models communicate over dedicated or switched voice-grade lines, and contain an FCC-approved coupler. The dex Models 3500, 3603, 3604, 3606, and 3700 operate at 9600/7200/4800/2400 bps; the dex 2000, 3200, 3601, and 3602 operate at 4800/2400 bps. All units support polling.

**• END**



# Burroughs CP 3682 Communication Processors

## Models CP 3682 & CP 3682-01

### ■ PROFILE

**Function** • CP 3682 front end supports a mix of up to 4 Burroughs B 2000/3000/4000 medium range processors; available as single processor; with CP 3682-01 as "Hot Standby" redundant processor, operates and manages online network.

**Associated Systems & Networks** • Burroughs networks • supports Burroughs Poll-Select/RJE/Point-to-Point protocols • access to IBM SNA via IBM Bisynchronous Point-to-Point 2780/3780; IBM Bisynchronous Multi-Point (3270); and IBM Inverse Bisynchronous (online IBM host communications) • access to NCR networks through support of NCR protocols; NCR 270 Variants; NCR 796 Variants; NCR Transparent Bisynchronous • supports Lear-Siegler ADM-2, AT&T Teletype TTY, TWX, and AT&T VU-SET.

**Communications** • can handle communications for up to 4 hosts simultaneously; transfer rate up to 200K bytes per second • provides 2 microprocessor-based data communications interfaces; 8-line asynchronous adapter and 2-line asynchronous/synchronous adapter; each adapter supports maximum aggregate data rate of 64K bps and requires one port • direct connect interface unit connects one device line • supports up to 41 system I/O ports; up to 36 I/O ports can be used for data communications interfaces • maximum 288 asynchronous multidrop communications lines; up to 72 synchronous multidrop lines • maximum aggregate throughput is 320K bps or 20 messages per second.

### PURCHASE PRICE RANGE

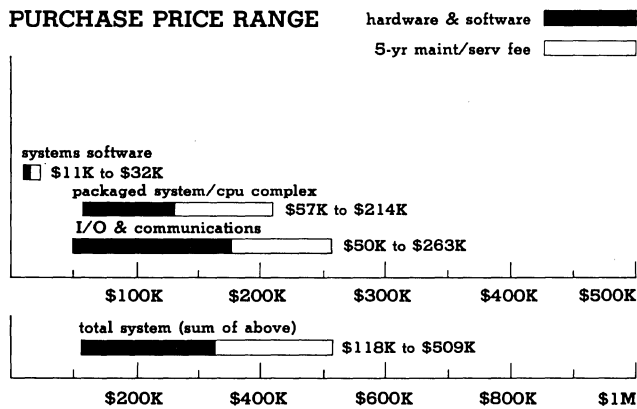

**BURROUGHS CP 3682 DATA COMMUNICATION SYSTEM** bar graphs illustrate price range for small to large systems • solid bars reflect software/hardware purchase prices; open bars reflect 5-year service/maintenance cost for large systems • **SMALL SYSTEM** is based on single CP 3682 packaged system with 512K-byte memory, 14 I/O port interfaces, 20M-byte disk subsystem and interfaces, real-time clock, dual-channel port controller, firmware set, system console interface, system cabinet, diagnostic adapter for remote, diagnostics, and diagnostic modem; options added include system console, 1 host interface, adapters for 64 communication lines, and CP 3600 DCS software • **LARGE SYSTEM** is based on CP 3682 packaged system plus CP 3682-1 packaged system with 512K-byte memory, 20M-byte disk subsystem and interface, real-time clock, dual-channel port controller, firmware set, system cabinet, CP 3643-1 Dual Port Interface Unit, CP 3644-1 Dual System I/O Interface Unit, CP 3645-1 Expansion Unit Cabinet with CP 3646-1 I/O Port Extender and diagnostic adapter; options include additional 512K-byte memory module per processor, system console, 4 host interfaces, adapters for 200 communications lines, 3 direct-connect interfaces, I/O extender unit with CP 3646-1 I/O port extender, dual system I/O interface, automatic calling unit, and DCS/SCS software.

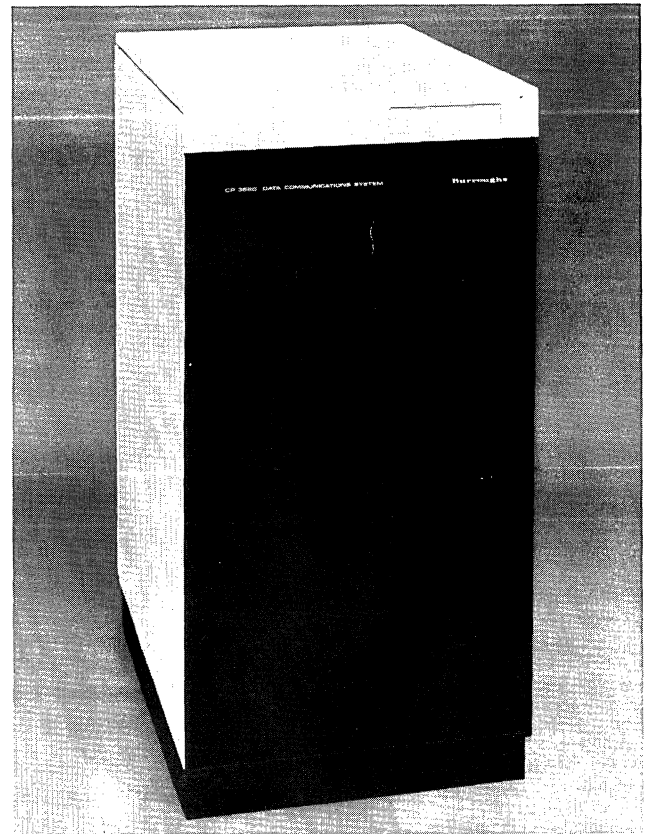

**Operating System** • CP 3600 Data Communications Software (DCS) runs on CP 3682 • standard Communications Software (SCS) runs on CP 3682-01 Standby System.

**Languages/Program Development** • completely menu-driven using series of menus and parameters.

**Processor** • single or redundant processor configurations • 512K-byte error-correcting memory is standard; 2 512K-byte increments optional to maximum of 1.5M bytes • 20M-byte disk storage capacity.

**First Delivery** • first quarter 1982.

**Systems Delivered** • over 250.

**Comparable Systems** • Amdahl 4705 Communication Processor; IBM 3705-80 • unlike these systems, however, the 3680 supports disk storage and can also run in a fully redundant hot standby mode.

**Vendor** • Burroughs Corporation; Burroughs Place, Detroit, MI 48232 • 313-972-7000.

**Canada** • Burroughs Canada; 801 York Mills Road, Don Mills, ON M3B 1X8 • 416-445-4030.

## Burroughs CP 3682 Communication Processors

### Models CP 3682 & CP 3682-01

**Distribution** • worldwide through Burroughs local sales/service offices.

**GSA Schedule** • yes.

#### ■ ANALYSIS

The CP 3682/3682-01 Data Communication Systems are designed specifically as front-end processors for the Burroughs B 2000/B 3000/B 4000 medium-scale host systems. They offer higher performance than earlier models but are application-compatible with the older B 874 Communication Processors, and revisions are not required for host software. Burroughs has long insulated application software from the network environment. Network configurations and terminal types can change with no effect on application programs.

Also, Burroughs implements its message control systems (MCSs) in all of its host products, and the CP 3682/3682-01 is no exception. MCS functions are integral to the communication software and run simultaneously with applications.

The CP 3682/3682-01 off-load the host processor by managing large online communication networks. The system includes a 20M-byte disk that can be used to store messages in queues if lines to a destination become temporarily overloaded.

Also, the CP 3682/3682-01 combination functions as a totally redundant system when the CP 3682-01 is used as a "hot standby" for a malfunctioning CP 3682. Both systems share all system I/O, port I/O interfaces, and the system console. The disk subsystem is duplicated for the "hot standby."

Also, the CP 3600 DCS and CP 3600 SCS operating systems do not require user programming.

#### □ Ease of Use Features

The most important attribute that makes Burroughs communication processors easy to use is its separation of the network environment from application programs. Changing network configuration or terminal types has no effect on application programs running in the host.

#### □ Modes of Operation

The CP 3682/3682-01 systems can function only as front-end processors to manage the communication network.

#### □ Strengths

The major strengths of the CP 3682/3682-01 systems are high performance, operating flexibility, and system redundancy. The systems support a maximum of 4 Burroughs medium-scale host processors and as many as 288 multidrop asynchronous or 72 multidrop synchronous lines.

Maximum aggregate throughput, expressed as 320K bps, 40K cps, or 20 messages per second, is quite high. The system can accommodate 1,200 terminals and handle 2,000 transaction types. It can identify 9,999 user codes and 9,999 forms. This kind of versatility undoubtedly results from the large volume of disk storage (20M bytes) integrated into the basic packaged system.

The message control system integrated into the communication control software package provides 5-level message security, dynamic and fixed routing, application data save areas, and forms service.

The "hot standby" feature is supported by both hardware and software so a user can develop a network with the confidence that communication will be maintained.

Another significant aspect is that the CP 3682/3682-01 can upgrade communication processing from older B 874 systems without recompiling the application software.

The systems support a large number of protocols. They also provide online statistics and remote diagnostics for network monitoring and control.

#### □ Limitations

Burroughs has been slow to develop its Burroughs Network Architecture (BNA), but BNA products are now available. Burroughs has indicated it will implement BNA on the CP 3682.

#### ■ SOFTWARE

##### □ Terms & Support

**Terms** • software separately priced; some systems software modules available separately from operating system • unlimited or 3-year limited time plans; unlimited time plan incurs a one-time initial charge or 12 monthly payments, plus an annual service charge; 3-year limited time plan includes service • pricing given in the text involves monthly charge for 3-year limited term license including service, the one-time initial charge, and the annual service charge associated with the unlimited time plan.

**Support** • local or field support is generally provided on a time-and-materials basis • software is classified according to its support from Burroughs; highest classification involves systems software with updates and enhancements; lower classification applies to mature products and those without updates or enhancements.

##### □ Operating System

The Burroughs CP 3600 DCS Data Communication Software on the CP 3682 and the CP 3600 SCS Standby Communication Software on the CP 3682-01 are modular task-based operating systems that off-load network operating and management functions with "hot standby" assurance for up to 4 Burroughs 2000/3000/4000 hosts. Medium system users with B 874 Communication Processors can add the CP 3682 front end with minimal or no change to their existing application software, because the CP 3682 off-loads standard NDLC online processing. Furthermore, the NDLC applications can be run independently or simultaneously with the CP 3682 Message Control System integral in the operating system software.

**CP 3600 Data Communications Software (DCS)** • runs on CP 3682 • performs online network control and management functions; supports from 9 to 41 communication lines • includes integrated, table-driven Message Control System with 5-level message security, dynamic or fixed message routing, application save areas, and forms service; can run simultaneously with standard NDLC applications • offers control character mapping for device-independent application programs • supports variety of protocols, including Burroughs Poll-Select/RJE/Point-to-Point (with batch, contention, and conversational modes for Point-to-Point); AT&T VU-Set; IBM Bisynchronous Point-to-Point (2780/3780), Bisynchronous Multipoint (3270), Inverse Bisynchronous (for online IBM host communication); Lear-Siegler ADM-2; NCR 270 Variants/796 Variants; NCR Transparent Bisynchronous; AT&T Teletype; TWX • supports online protocol generation utility • provides real-time statistical system information and online generated query for user-defined parameters.

**3360-5254 CP 3600 Data Communication Software (DCS)** • required for CP 3682:

\$330 mo	\$11,000 initl	\$2,090 serv
----------	----------------	--------------

**CP 3600 Standby Communication Software (SCS)** • runs on CP 3682-01 Standby System • logically attaches all data communication and host interfaces; and maintains same network services as the DCS running on CP 3682.

**3360-5262-SCS** • required for CP 3682-01 for redundant CP 3682/CP 3682-01 configuration:

165	5,500	1,045
-----	-------	-------

##### □ Communications/Networks

Networks are generated and controlled online, independent of application programs, through the CP 3600 DCS operating system. Redundant operations require the CP 3600 SCS on the CP 3682-01 Standby System. Communication lines are divided into protocol classes, a category of protocols with common

*MO: monthly charge for 3-year Limited Term license, including service. INITL: initial license fee. SERV: annual service fee associated with permanent license. Prices current as of February 1985.*



## Burroughs CP 3682 Communication Processors

### Models CP 3682 & CP 3682-01

characteristics. Each 8-line asynchronous adapter or 2-line asynchronous/synchronous adapter supports a single protocol class. All lines on the 8-line adapter must use the same data rate; 2-line adapter supports split data rates. There are 6 protocol classes, Class 1 is general poll and select; includes Burroughs POLL-SELECT, Lear Siegler ADM-2, and NCR 270/796 variants. Class 2 is Burroughs Point-to-Point; includes Batch Point-to-Point, Burroughs RJE Point-to-Point with variants. Class 3 is BSC contention; includes IBM 2780/3780. Class 4 is BSC polled; includes IBM 3270, 3600, and inverse 3270. Class 5 is Teletype protocol for AT&T VU-SET, TTY variants, and TWX. Class 6 is BSC contention high speed; supports only BSC contention protocols.

**Program Development** • uses series of menus and parameters.

#### ■ HARDWARE

##### □ Terms & Support

**Terms** • available for lease or purchase from local sales/service offices worldwide; 1-, 3-, and 5-year plans are available; one-time installation charges on some products • pricing quoted in the text includes 1-, 3-, and 5-year monthly lease rates that include maintenance, purchase price, and monthly maintenance charge for purchased systems.

**Support** • round-the-clock maintenance 7 days per week is available • maintenance charges quoted in the text are based on 8-hour, 5-day-week plan • time-and-material plans available • extensive customer education programs provided.

##### □ Overview

The CP 3682 is available in single and dual redundant "Hot Standby" configurations (CP 3682/CP 3682-01). A single 512K-byte front-end processor can simultaneously support a mix of up to 4 medium-range Burroughs host systems, such as the B 2000/B 3000/B 4000. The processor interfaces the host systems through host transfer Data Link Processors (DLPs). System options include a remote diagnostic unit.

The system provides 2 types of microprocessor-based data communication interfaces: an 8-line asynchronous line adapter and a 2-line asynchronous/synchronous adapter. A single system can support up to 36 adapters for a maximum support of 288 asynchronous and 72 synchronous multipoint communication lines to accommodate up to 1,200 terminal stations and up to 2,000 transaction types. Each line adapter occupies 1 of 9 ports in a basic system. Port capacity can be extended by using 1 or 2 Port Extenders, each providing an additional 16 ports for a total 41-port capacity.

In a redundant configuration, the system console and all I/O to the terminal network and to the host processors are shared by both the 3682 and 3682-01. The system is equipped with 17 ports, of which 16 are configurable and one is reserved for the system console that serves both systems. The System I/O port, vacated by the CP 3641-01 system console, is used by the CP 3643-01 Dual Processor Interface Unit, which is included with the CP 3682-01. By using a single 3646-01 Port Extender and a 3644-01 Dual System I/O Interface Unit, an additional 17 ports are provided for a total System I/O capacity of 33 I/O ports. For a redundant system, the total number of line adapters is 28.

##### □ CPU & Memory

**CP 3682 Data Communication System** • includes Communication Processor, 512K-byte error-correcting memory, 14 I/O port interfaces (5 reserved), 20M-byte disk subsystem, real-time clock, dual-channel port controller, firmware, CP 3641-X2 system console adapter, CP 3651-01 diagnostic adapter, CP 3640-02 diagnostic modem, and system cabinet:

**\$2,789/\$2,377/\$2,239 mo \$53,822 prch \$648.00 maint**

**CP 3682-01 Redundant Data Communication Subsystem** • includes communication processor, 512K-byte error-correcting memory module, 14 I/O port interfaces, 20M-byte disk subsystem with interfaces, real-time clock, dual-channel port controller (DCPC), firmware, system cabinet, CP 3643-01 Dual Port Interface Unit with cable, CP 3644-01 Dual System I/O Interface Unit with cable, CP 3645-01 I/O Expansion Unit

Cabinet, CP 3646-01 I/O Port Extender, and CP 3651-01 Diagnostic Adapter • requires CP 3682:

**2,789/2,377/2,239 52,225 566.00**

**CP 3641-1 System Console** • required on basic CP 3682:

**119/108/98 3,151 31.20**

**CP 3641-02 Console Adapter** • for connection of console to 3682-01:

**74/63/60 1,588 8.40**

**3643-1 Dual Port Interface** • with cables:

**114/103/93 2,941 31.20**

**CP 3640-2 Diagnostic Modem** • for CP 3682/3682-01 • includes modem:

**32/28/26 688 5.00**

**CP 3651-01 Diagnostic Adapter:**

**74/63/60 1,588 8.40**

**Memory** • the CP 3682 includes 512K bytes of error-correcting memory.

**CP 3610-04 Memory** • 512K-byte high-speed error correcting add-on memory module; maximum 2 per system for total of 1.5M bytes:

**511/436/410 11,115 67.20**

##### I/O Channels

The CP 3682 requires one host interface unit for each processor to which it is connected. It can connect up to 4 hosts and service all of them simultaneously.

Devices, communications lines, direct connect terminals, and host interface units connect to the CP 3682 through I/O ports on Dual Channel Port Controllers (DCPC).

The basic CP 3682 includes 9 system I/O ports and can be expanded to 41 I/O ports, 36 of which can be used for data communication interfaces.

When CP 3682 is combined with the CP 3682-01 redundant system, the 2 systems share all I/O host interfaces and all I/O port interfaces. The 9 system I/O ports in the CP 3682 are unused. The 2 systems share the 16 interfaces in the CP 3654-01 I/O Expansion unit. A CP 3646-1 I/O Port Extender with DCP C can be added to increase the I/O capacity by 17 ports for a system total of 33 I/O ports.

**CP 3620-1 Host Interface Unit** • connects 1 B 2000/B 3000/B 4000 host processor • supports transfer rate up to 800K bps • 1 required for each host processor; maximum of 4 per system:

**\$118/\$107/\$97 mo \$2,626 prch \$18.70 maint**

**CP 3644-1 Dual System I/O Interface** • couples CP 3682 and CP 3682-01 to share I/O on 3646 I/O Port Extender:

**145/129/119 3,833 35.00**

**CP 3645-1 I/O Port Expansion Unit** • cabinet, includes CP 3646-1 I/O Port Extender:

**830/720/646 21,001 198.00**

**CP 3646-1 I/O Port Extender with DCPC** • adds 16/17 I/O ports to CP 3682/3682-01; Port 17 cannot be used on single system:

**688/625/562 18,271 182.00**

##### □ Communications Lines

The CP 3682 supports 2 microprocessor-based communication interfaces. Each supports a variety of protocols and network configurations. One is an 8-line asynchronous adapter; the other, a 2-line asynchronous/synchronous adapter. Each adapter requires a single I/O port and supports aggregate data rates to

**MO: first figure is monthly charge for one-year lease; second figure is for 3-year lease; third figure is for 5-year lease; includes maintenance. PRCH: single-unit purchase price. MAINT: monthly maintenance charge for purchased systems. NC: no charge. Prices current as of February 1985.**

## Burroughs CP 3682 Communication Processors

### Models CP 3682 & CP 3682-01

64K bps. A single system accommodates a maximum of 36 adapters for a total of 288 asynchronous and 72 synchronous multipoint lines at an aggregate rate of 320K bps. The redundant CP 3682/3682-01 system supports 28 adapters for a total of 224 asynchronous or 56 synchronous lines. Each line adapter is equipped with RS-232C ports and includes a 25-foot modem cable. The adapter connects to a modem or direct-connect interface unit.

The 8-line asynchronous adapter is used with 4-wire dedicated modems or direct connect only; all lines must run at common data rate and are restricted to a single protocol class (see Communications in Software). The 2-line asynchronous/synchronous adapter supports dedicated, dial-up, and direct connection; each line can operate at an independent data rate. The only restriction is that each adapter can be used with only 1 protocol class. To run Burroughs Direct Connect Line (TDI), a Direct Connect Interface Unit is required for each direct connect line.

A line using an AT&T 801C Auto-Call Unit requires the CP 3633-01 Automatic Calling Unit and must be connected to the CP 3631-01 2-line asynchronous/synchronous adapter.

Each host interfaced to the CP 3682 requires one CP 3620 host interface.

**CP 3630-1 Asynchronous Adapter** • 8-line • microprocessor-based • maximum 36 adapters per single CP 3682 system • maximum aggregate data rate is 8000 cps (64K bps):  

\$250/\$214/\$201 mo	\$5,408 prch	\$37.40 maint
----------------------	--------------	---------------

**CP 3631-1 Asynchronous/Synchronous Adapter** • 2-line •

microprocessor-based • maximum 36 adapters per single CP 3682 system • maximum aggregate data rate is 8000 cps (64K bps):

112/96/90	2,416	22.50
-----------	-------	-------

**CP 3631-02 Synchronous Adapter** • for single line; microprocessor-based with RS-422 cable:

126/108/102	2,706	24.50
-------------	-------	-------

**CP 3631-03 Synchronous Adapter** • for single line; microprocessor-based with V.35 cable:

144/123/116	3,104	24.50
-------------	-------	-------

**CP 3632-01 Direct Connect Interface Unit** • maximum 11 per processor:

19/16/11	368	2.40
----------	-----	------

**CP 3633-1 Automatic Calling Unit Adapter** • for CP 3682/3682-01:

49/44/38	1,260	8.70
----------	-------	------

**CP 3634-02 RS-422 Cable** • 50 feet, for upgrade from CP 3631-1 to 02:

15/13/12	327	NC
----------	-----	----

**CP 3634-03 V.35 Cable** • 50 feet, for upgrade from CP 3631-1 to 03:

36/31/29	794	NC
----------	-----	----

• END

# Burroughs CP 9500 Communication Processors

## Models CP 9558-1, CP 9572, CP 9582 & CP 9585

### ■ PROFILE

**Function** • programmable communication processor, remote concentrator, distributed processor, nodal processor, and standalone local data processor.

**Associated Systems/Networks** • all Burroughs processors and mainframes; IBM 360/370, 303X, 308X, and 43XX utilizing an IBM SNA Interface that emulates a cluster controller; provides X.25 gateway • Burroughs Network Architecture (BNA) networks.

**Communications/Networks** • support synchronous/asynchronous, half-/full-duplex communication through data communication processors (DCPs) • single DCP accommodates up to 12 lines expandable through Line Expansion Module (LEM) to 32 lines; maximum transmission rate per line is 1800 bps asynchronous, modem connect; 9600 bps synchronous or bisynchronous, and 38.4K bps direct connect • 2 MHz-DCP used in CP 9558 and CP 9572 supports aggregate data rate of 10K cps; 3 MHz-DCP used in CP 9582 and CP 9585 supports aggregate data rate of 15K cps; synchronous characters usually 8 bits and asynchronous characters 10 bits • CP 9558 supports 2 DCPs (2 MHz) for aggregate data rate of 20K cps and up to 32 lines; CP 9572 supports 3 DCPs (2 MHz) for aggregate data rate of 30K cps and up to 47 lines; CP 9582/CP 9585 supports up to 4 DCPs (3 MHz) for aggregate data rate of 60K cps and up to 128 lines.

**Operating System** • Master Control Program (MCP), included in Computer Management System (CMS) package with Network Definition Language (NDL), Message Processing Language (MPL II), either Generalized Message Control System (GEMCOS) or

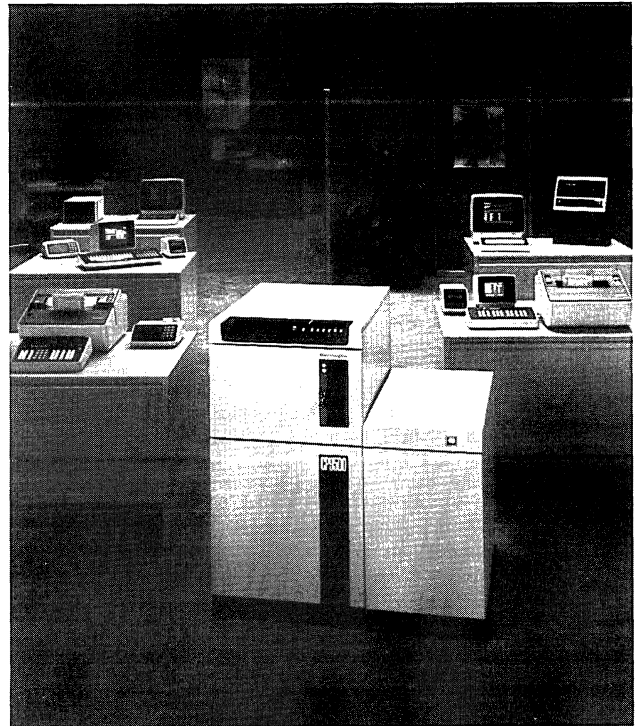

### PURCHASE PRICE RANGE

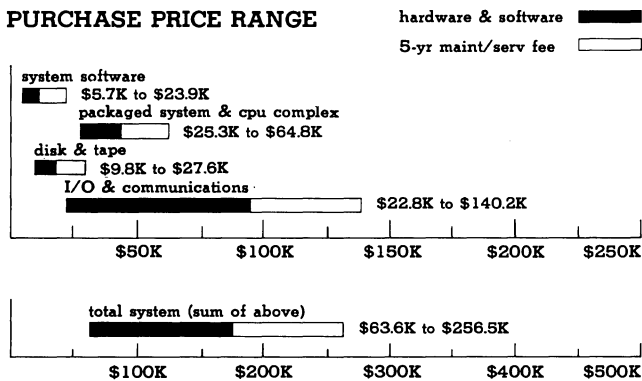

**BURROUGHS CP 9500 PURCHASE PRICING** bar graph illustrates price ranges for small to large systems, with solid bars reflecting software/hardware purchase pricing and open bars reflecting 5-year service and maintenance fees associated with large system • **SMALL SYSTEM** is based on CP 9582 System (includes cabinet with power supply and clock, 4 3-MHz processors, 2 with 64K-byte memory, 2 with 512K-byte memory), 1M-byte minidisk, 19M-byte fixed disk, disk loader, operator display terminal and control, 600-lpm printer and control, 10 line adapters, and 10 data set/direct connect interfaces • software includes CMS package, full GEMCOS and RSC • **LARGE SYSTEM** is based on CP 9585 System (includes cabinet with 64K-byte memory and power supply, 4 3-MHz processors, 64K-byte memory module, 1 512K-byte memory module, and extended backplane with the following optional features: 4 additional 3-MHz processors, 2 64K-byte memory modules, 2 256K-byte memory modules, disk file cache control, operator console and control, 38.7M-byte fixed-disk drive with control, 243K-byte ICMD drive with control, 50 dual line adapters, 100 modem direct/connect interfaces, 600-lpm printer with control; software same as for small system plus X.25 interface IBM SNA interface, IBM 3270 Protocol, X.25 station group, RNS, and COBOL compiler.

Transaction Distribution System (TDS), Utilities, and Data Communication Installation Tool (DCIT).

**Languages/Program Development** • CMS COBOL, a subset of ANSI 74 COBOL, MPL-II, RPG-II, and BASIC; compilers use interpreters in microcode developed specifically for each compiler.

**Processor** • consists of 4 to 6 (CP 9558-1), 5 to 8 (CP 9572), or 4 to 8 (CP 9582/9585) Basic Data Systems (BDS); 2-MHz microprocessors, each with a memory set of 32K/64K/128K/256K bytes for a total of 1.2M bytes (CP 9558-1) or 1.5M bytes (CP 9572); 3-MHz microprocessors, each with a memory set of 64K-, 256K-, or 512K-byte modules for a total 3.4M bytes (CP 9582/9585).

**First Delivery** • January 1981 (CP 9558/9572); August 1982 (CP 9582); April 1984 (CP 9585).

**Systems Delivered** • over 1,500 CP 9500 systems.

**Vendor** • Burroughs Corporation; Burroughs Place, Detroit, MI 48232 • 313-972-7000.

**Canada** • Burroughs Canada; 801 York Mills Road, Don Mills, ON M3B 1X8 • 416-445-4030.

**Distribution** • direct through worldwide Burroughs sales and service offices.

**Comparable Systems** • as a distributed processor/communication processor comparable to IBM 8100, Series/1,

## Burroughs CP 9500 Communication Processors

### Models CP 9558-1, CP 9572, CP 9582 & CP 9585

and S/34 systems; CP 9500 can also function as routing node on BNA, while none of the IBM systems can perform same function for SNA; also comparable to Hewlett-Packard HP 300, Sperry S/80, and Honeywell DPS 6.

**GSA Schedule** • listed.

#### ■ ANALYSIS

The CP 9558, CP 9572, CP 9582, and CP 9585 are versatile multiprocessor systems that function primarily in communication environments. They are based on the B 900 architecture and, so far, run the same software as the B 900 Business Systems. Only 2 hardware features are currently offered for the CP 9500 that are not available for the B 900 is the expansion feature that allows each DCP on a CP 9500 to support 32 rather than 12 communication lines and for a system to support 32 (9558-1), 47 (9572), or 128 (9582/9585) communication lines. Maximum capacity on the B 900 is 12 communication lines. Thus, Burroughs will generally use the CP 9500 in a network environment and the B 900 for a standalone data processing environment. Secondly, the CP 9582/9585 can support the Inter Systems Control facility that provides a high-speed direct connection of the CPs to Burroughs host computers.

Burroughs uses a distributed processor philosophy for its Burroughs Network Architecture (BNA) with peer-to-peer control. Thus, all processors on the network run the same BNA control software and all processors can operate as intermediate nodes and perform routing functions when data for remote devices is passed through the node. The BNA software was available for CP 9500 in 1984.

The CP 9500 can also interface to IBM communication networks, BSC, and SNA. In BSC environments, it can function as a HASP workstation, RJE terminal, or IBM 3270 Display Terminal controller. In SNA environments, it can operate as a Physical Unit Type 2 (PU.2) and appear as a cluster controller with devices attached.

The CP 9500 can also provide a gateway to X.25 packet-switched networks through an X.25 interface.

The CP 9500 family is a logical extension of the CP 9400 although the CP 9400 is based on the B 800 and the CP 9500 on the B 900 multiprocessor architecture. Both operate under the Computer Management System (CMS), software, which includes the Master Control Program (MCP) operating system. Different MCPs are used on the CP 9400 and CP 9500; the MCP for the CP 9500 supports multiprocessing, but otherwise both MCPs perform the same functions. All CP 9400 programs except NDL will run on the CP 9500 without recompilation. NDL requires some changes as well as recompilation.

The first members of the CP 9500 family were the CP 9551, CP 9555, and CP 9556. The CP 9558 and CP 9572 introduced January 1981 are gradually being phased out; the CP 9582 and CP 9585 are the only actively marketed systems in the series; they operate 50 percent faster than the older models. The CP 9500 systems contain a number of autonomous simultaneously operating processors, each dedicated to a processing function. The smallest system has 4 processors: 1 runs the operating system, 1 manages data files, 1 handles data communication, and 1 executes user application programs. Additional microprocessors can be added to a system for communication or application processing to a maximum of 6 for CP 9558-1 and 8 for CP 9572/CP 9582/CP 9585. The CP 9558-1 can be configured with up to 2 communication processors, the 9572 with up to 3, and the 9582 systems/9585 with up to 4. Processors not used for communication can be used for applications.

Burroughs has made an Inter Systems Control (ISC) Hub available on both the CP 9582 and CP 9585 to provide a full-duplex connection to Burroughs hosts. Burroughs hosts can provide up to 16 ports for ISC connections. The ports can be used to interconnect Burroughs hosts with each other as well as with the CP 9582 and 9585. Transmission is full-duplex as data rate of 1M bps.

The architecture and software make the CP 9500 Series especially applicable for distributed processing networks.

#### □ Ease of Use Features

The CP 9500 has a number of software tools which make it convenient for the user to utilize the system. The CMS Software features both COBOL (ANSI 74 COBOL subset) and RPG (Report Program Generation) for developing application software. The Network Definition Language (NDL), a high-level programming language, is used to define the system's data communication network.

Because the CP 9500 is a logical variation of B 900 business computers that replace the B 800 line, the CP 9500 inherits a wealth of applications development software under the broad title of Computer Management Distributed Information System Software (CMDIS).

The Message Processing Language (MPL-II) is available to develop message control programs. It enables the NDL to generate network control programs that interface with application programs. CANDE, a high-level command language, can update source and data files. ODESYS is a data entry system used to collect data in batches on disk for submission for local or remote applications.

#### □ Modes of Operation

The CP 9500, fully configured with CRT, printer, and disk, can function as an independent standalone data processor. In the BNA environment, it can function as a host processor, front-end processor, nodal processor, distributed processor, or remote concentrator, controlling attached devices, interlinking these devices to remote hosts. In the SNA environment, it can function as a Type 2 Cluster Controller.

The CP 9500 can appear as an IBM 2780 or IBM 3780 Data Transmission Terminal. This capability makes it possible to interlink other non-IBM networks with hosts that support IBM 2780/3780 emulation. It can also function as a HASP workstation and as a gateway to X.25 packet-switched network.

Furthermore, its microprocessor architecture, making it a multiprogrammable system, allows it to perform all these functions simultaneously.

#### □ Strengths

The CP 9500 system architecture makes it a good distributed processor as well as a concentrator. Each processor with its own memory "set" performs a parallel operation for high throughput. Up to 5 application processors can support user programs and up to 4 communication processors support communication lines. The total number of processors is limited to 8, thus, the more application processors, the less communication processors and vice versa. Stored microcode (Interpreters) also serve to speed execution of user programs.

The high-performance CP 9582/9585 use a faster 3-MHz cycle time as compared to the 2 "older" members (2 MHz on the CP 9558 and CP 9572). The CP 9582/9585 also provide increased memory capacity with a maximum 3.4M bytes of storage, 3 times greater than that on the CP 9572. Also, the CP 9582/9585 support ISC Hub so they can directly connect to Burroughs hosts through a high-speed data link.

The CP 9500 can reside as a distributed processor on BNA networks and function as an intermediate node, running the full complement of BNA host and network services software.

Compatibility with the rest of the B 900 line of computers gives the CP 9500 Series software the flexibility to implement many applications in a distributed processor environment. It can also interface to IBM SNA and X.25 networks. Emulation software also allows it to look like IBM workstations and RJE terminals.

#### □ Limitations

The CP 9500 Communication Processors serve very well as distributed processors on BNA networks. As front-end processors, however, they have no channel connections to non-Burroughs hosts but connect through 9600-bps synchronous, and 1800-bps asynchronous communication lines.

## Burroughs CP 9500 Communication Processors

### Models CP 9558-1, CP 9572, CP 9582 & CP 9585

Also, it should be noted that the MCP on the no longer manufactured CP 9400 Series is not the same MCP as the one running on the CP 9500 Series. The CP 9400 application programs, however, can run on the CP 9500 without recompilation. Only NDL programs must be recompiled.

#### ■ SOFTWARE

##### □ Terms & Support

**Terms** • unbundled • basic operating software contains the following modules in CMS packages: MCP, Utilities, Data Communication Installation Tool, Message Processing Language Compiler, Network Definition Language Compiler, and either the Transaction Distribution System or the Generalized Message Control System (Basic Module) • other modules priced separately • unlimited and limited 3-year time plan for licensing • monthly charges apply to a limited 3-year lease; unlimited term calls for 1 initial payment with annual license fee; both plans include service; initial payment can be spread over 12 months • multiple copy/multiple site discounts apply to all program products: multiple copy discounts range from 12% for second copy at 1 site to 44% for 20 copies at 1 site; multiple sites reduce multiple copy discounts by 2% for each additional site.

**Support** • by Burroughs throughout the software product line: periodic updates and enhancements are part of the licensing and service support agreement for category A products; category B products are provided limited support with no enhancements; category C for mature products provided with no updates, no enhancements; all CP 9500 software is in support category A • system software support includes local service as well as access to remote service center • applications software support provided under Product Service Agreement (PSA) categories 1, 2, and 3: Category 1 provides access to remote support center and centralized releases; Category 2 adds local services on time-and-material basis; Category 3 includes local support.

##### □ Operating Systems

The Computer Management System (CMS) Software is used to control the CP 9500 Systems. It is a disk-based interpretive system, which consists of an integrated set of operating and control software to support the user in distributed processing environments and the communication functionality of the CP 9500. CMS includes the Master Control Program (MCP), the comprehensive operating system for the CP 9500 systems.

**CM 9500 TC 1 Computer Management Transaction Control System 1** • CMS basic software; includes the Master Control Program, utilities, Message Processing Language Compiler, Network Definition Language Compiler, and the choice of either the Transaction Distribution System or the Generalized Message Control System (GEMCOS) Basic Module:

\$100 mo	\$2,850/\$274 lcms	\$205 serv
----------	--------------------	------------

**Master Control Program (MCP)** • disk-based operating system with large system features such as multiprocessing, multiprogramming, virtual memory, reentrant code, dynamic resource allocation, and I/O control • divided into modules: operator interface, data access, job management, processor interface, monitor, activity management, and data communication activity • operator interface is communication interface between the system operator and the operating processors; collects information, formats, messages, sorts messages, checks syntax, etc • data access module is logical/physical interface for I/O devices • job management tracks and maintains user job status • processor interface is processor-to-processor communication link that must be maintained between the 4 to 8 microprocessors that make up the CP 9500 • monitor records, analyzes, and reports system events • activity management module coordinates events and resources, allowing MCP to control modules • data communication activity consists of 4 principal sub-modules: data communication handler, data communication loader, results function, and end-of-job function • system loader and data file disks controlled by dedicated disk file management processor; disk data loaded directly to/from MCP buffer memory, accessible by user programs executing on task processors • data file buffer fixed partition assigned to operating system dedicated memory: 128K-byte total partition recommended; 40K bytes for data

communication; 88K bytes for file buffers (up to 512K bytes available); programs dynamically open files within fixed buffer partition • allows concurrent multiple update program access to same file or groups of files; applies to both indexed and sequential files; supported by COBOL, RPG, BASIC, and MPL programs • allows individual fixed disk units to be handled as one large contiguous disk; user does not control physical disk file allocation allowing software optimization of file distribution • provides/accepts files on industry-standard diskette as means of information exchange among disparate systems • diskette drive controlled by operating system processor.

**Utilities** • system initialization and program development aids; allow conventional and indexed sequential files to be sorted, merged, removed, copied, printed; facilities provided for copy-to-disk, printer backup, and spooling to disk for later printing.

##### □ Networks/Communications

Burroughs offers products for various communication environments including data entry and transaction processing between remote Burroughs terminals and hosts, between Burroughs terminals and remote IBM hosts in both SNA and BSC networks, and among many Burroughs terminals and hosts on Burroughs Network Architecture (BNA) networks. The CP 9500 can also interface to X.25 packet-switched networks.

A primary product for developing any communication environment is Network Definition Language (NDL). In the distributed processing environment, Burroughs offers a host of products under the broad classification of Computer Management Distributed Information System (CMDIS) software. CMDIS products provide for transaction processing; message control, online data entry; command edit; direct online maintenance; status reporting; Burroughs RJE, communication and BNA; interfacing to IBM networks and host; interfacing to X.25; and remote supervisory consoles.

**Network Definition Language (NDL)** • used to describe the data communication environment; mainly table-driven; NDL description produces tables used to control data communication network • consists of "constructs" that comprise a programming language: user programs (describes) the line discipline routines through which the subsystem communicates with remote devices • post compiler generates a microcode file loaded into the DCP by MCP using the Data Comm Loader (DCL) • included in CMS.

##### Computer Management Distributed Information System (CMDIS) Software

CMDIS consists, collectively, of the products Burroughs offers for building distributed processing communication networks.

**Transaction Distribution System (TDS)** • interfaces user application programs to communication network; preceded GEMCOS and now replaced by GEMCOS except for users with older Burroughs equipment; required only if GEMCOS not used; and if required, included in CMS basic package.

**Generalized Message Control System (GEMCOS)** • high-level, parameter-driven language provides the user with a message control system capability; provides link between the communication network and application program • generates a user-defined MCS that can provide security, auditing, recovery, transaction routing, alternate routing, and message formatting • generated MCS program with the NDL-generated Network Controller and MCP operating system insulate the application programmer from the network • generally has replaced TDS; required if TDS not used.

*MO: complete monthly charge for 3-year Limited Term license, including service. LCNS: first figure is one-time permanent license fee (unlimited time); second figure is alternate permanent license fee paid in 12 monthly installments. SERV: annual service fee associated with permanent license. NA: not available. NC: no charge. Prices current as of February 1985.*

## Burroughs CP 9500 Communication Processors

### Models CP 9558-1, CP 9572, CP 9582 & CP 9585

CM9500 GMB • GEMCOS Basic Module; included in basic CMS package price if chosen over TDS:

\$33 mo	\$700/\$68 lcns	\$306 serv
---------	-----------------	------------

CM9500 GMT • GEMCOS Transaction Control Language (TCL) compiler:

36	750/72	32
----	--------	----

CM9500 GMF • GEMCOS Formatting Module:

24	500/48	21
----	--------	----

CM9500 GMC • GEMCOS Complete System:

115	2,500/240	105
-----	-----------	-----

**CM9500 CDE Command AND Edit Language (CANDE)** • provides means to create and update source and data files; used when an MPL II, COBOL, RPG, NDL, data, or sequential file must be modified; provides such features as edit, delete, find, insert, and merge; used online interactively through easy-to-use command set; syntax and semantics of edit commands based on Burroughs B 7000/B 1000 CANDE Systems • remote user can also issue strings of commands to the CP 9500 System through CANDE, included with basic system.

**CM9500 DES MT Data Entry System** • data entry subsystem:

83	2,200/213	95
----	-----------	----

**CM9500 DE2 Online Data Entry System (ODESY)** • produces batches of data for application program input • features include: screen formatted data entry; data checking and verification; interactive indexed files existence checking; master file data retrieval, output data reformatting; statistical reporting; and optional formatted journal listing:

21	594/57	113
----	--------	-----

**CM9500 DOM DOMAIN** • inquiry and file maintenance program • features include: disk file record inquiry; disk file creation; and addition, deletion, and maintenance of disk file records:

87	1,782/171	339
----	-----------	-----

**CM9500 INQ Inquiry** • provides file inquiry capability:

30	825/80	157
----	--------	-----

**CM9500 RPO Online REPORTER** • selectively retrieves and prints data from a file; data selection based on record type, range of records, conditions, and runtime supplied data • features report formatting, computation, and statistical and summary information:

99	2,376/228	451
----	-----------	-----

**CM9500 RJE Burroughs RJE Package** • implements batch-oriented standard Burroughs Remote Job Entry line protocol • allows CP 9500 to function as RJE satellite to a Burroughs host system:

22	605/59	115
----	--------	-----

**CM9500 SYC Systems Communications Package (SYCOM)** • expands Burroughs standard RJE package to provide additional system-to-system communication • allows terminal or program on one system to communicate with program on another system; facilitates intersystem file transfers:

30	825/80	157
----	--------	-----

**CM9500 RNS Remote Network Services** • includes BDLC Station Group, basic network services and host services for BNA:

110	NA/NA	634
-----	-------	-----

**CM9500 B 25 X.25 Station Group** • requires CM9500 RNS; interfaces BNA to public data networks:

55	NA/NA	315
----	-------	-----

**CM9500 SJE IBM SNA RJE Package** • provides access to batch application programs in an IBM host from a remote CP 9500; SJE provides batches of data to the host site for processing and receives batches of data back as local output or as input to further processing • includes 4 modules: RJE control program, initialization utility, SNA off-line utility, and SNA NDL utility • SNA RJE establishes and maintains the interface with the SNA IBM host; services multiple input/output job streams and formats data to/from I/O devices • SNA initialization program sets up definition of physical and logical environments • SNA Utility off-line utility can be used to pre- or post-process data such as

compression/decompression • SNA NDL utility implements the SDLC data link control protocol • SNA SJE runs under GEMCOS on the CP 9500 • similar to the IBM 8100 running DPPX/RJE or the IBM 3770; each copy of SNA/RJE looks like a separate physical unit, type 2 to SNA network:

66	1,375/NA	261
----	----------	-----

**CM9500 HSP IBM 360/20 HASP RJE** • supports CP 9500 as HASP workstation:

33	908/88	173
----	--------	-----

**CM9500 R37 IBM 2780/3780 Look-Alike** • provides direct link to IBM S/370-compatible hosts running DOS or DOS/VS running POWER or POWER/VS RJE:

33	908/88	173
----	--------	-----

**CM9500 R32 IBM 3270 Protocol** • emulates IBM 3270 line protocol; to host, CP 9500 looks like an IBM 3271 control unit with cluster of attached terminals; supports Burroughs TD830 Display Terminals • communicates with host operating over leased lines using BSC protocol and EBCDIC transmission code:

33	908/88	173
----	--------	-----

**CM9500 SNA IBM SNA Interface** • allows CP 9500 to function as Physical Unit Type 2 (PU.2); a 3601 cluster controller or IBM 3791 on SNA network:

77	2,145/206	408
----	-----------	-----

**CM9500 SNA Adapter** • SNA Adapter/Interface allows CP 9500 to look like a Physical Unit Type 2 to SNA network • SNA adapter provides NCCF/NPDA support in SNA network; option of operating in SNA/X.25 environment, and interprogram communication facility of BNA for connection of application program in BNA host to application program in SNA host.

**CMS SNA PT.3270** • SNA 3270 PassThrough Module enables 3270 BSC terminals and CMS application programs to communicate with most system applications within IBM SNA networks; the Burroughs CP 9500 looks like a cluster of 3270s with associated controllers to the SNA network • executes as a CMS application program communicating with an SNA host via the CMS SNA Adapter program and with other BSC 3270 devices or CMS applications • requires CMS to SNA Adapter, GEMCOS, NDL, CANDE, and language computers.

**CM9500 X.25/X.29 Interface Module** • allows terminals attached to CP 9500 to communicate with applications in other systems through X.25 Packet networks; certified by Telenet and Tymnet in USA and other public packet switched networks outside USA • Datapac and Infoswitch in Canada, DDX in Japan, Datanet-1 in Netherlands, PSS in Great Britain, RETD-2 in Spain, Telepac in Switzerland, Transpac in France, Auspac in Australia, and Saponet in South Africa • acts as interface between CP 9500 and PDNs • includes X.25 Services in MCS that performs all line control procedure functions, contains line, terminal, station modem, DCP, and file definitions; X.25 Local allows user to change message output to the local language of the user; X.25 Subscribe provides network configuration, remote site directory, X.29 terminal and application styles, and user application information organized into 2 disk files for X.25 Servicer; X.25 Listlog prints contents of log file created by X.25 Servicer; X.25 servicer interfaces with MCS (GEMCOS):

33	908/88	173
----	--------	-----

**CP 9500 BNA X.25 Terminal Gateway** • allows CP 9500 operating in a BNA environment to communicate with terminals connected to PDN and meeting X.25 specifications; uses X.21 bis physical interface; supports up to 100 logical channels but a maximum of 5 physical connections are supported • implemented with BNA X.25 and BNA BDLC Message Control Systems (MCSs) to support the X.25 station and its BDLC (Burroughs Data Link Control) procedures; a Gateway program is an MCS to route messages between BNA X.25/BNA BDLC and the data communication application programs; a master MCS handles nontime critical functions and a slave utility starts the MCS; a list utility lists the network services log file; other programs provide ODT status, station transfer, and logical I/O • requires MCP and MPL II on the CP 9500 and the X.25 Service program and utilities.

**CM9500 RSC Remote Supervisory Console** • provides facility



# Burroughs CP 9500 Communication Processors

## Models CP 9558-1, CP 9572, CP 9582 & CP 9585

to use Burroughs TD830 Display Terminal as Remote Supervisory Console (RSC) for the CP 9500; connection can be by direct cable or through a modem:

13	330/32	76
----	--------	----

### □ Program Development

CMS supports COBOL and RPG, MPL-II, and BASIC. The CMS COBOL is a subset of ANSI '74 COBOL but includes Burroughs added extensions. It can be used for both communication and batch-oriented user programs. MPL-II is used to develop programs including message control system (MCS) programs. BASIC is general-purpose language to develop and execute programs. RPG is used to develop off-line batch programs. COBOL communication applications programs are network language dependent. CMS language compilers produce code that can be executed on any properly configured CMS designated system. Burroughs provides variable micrologic interpreters to support its compilers.

**CM9500 COB** • COBOL compiler:  

\$72 mo	\$2,008/\$193 lens	\$382 serv
---------	--------------------	------------

**CM9500 RPG** • RPG-II compiler:  

54	1,513/146	287
----	-----------	-----

### □ Other Facilities

Burroughs provides office automation software for the CP 9500 as well as a package for shop floor communication in a manufacturing environment. These products fall under support category B.

**CP 9500 WMS Word Management System** • multiuser system provides general-purpose entry, editing, formatting, and printing capabilities • up to 8 interactive operations; automatic merging of up to 3 documents; line, console, or letter-quality output printers • data processing interface merges data with form letters and statistical documents:  

\$127 mo	\$3,355/\$322 lens	\$235 serv
----------	--------------------	------------

**Office Automation System** • contains 4 modules: shared resource, electronic mail, productivity tools, and DP interface • offered as application program products.

**CP 9500 OSR** • shared resource module • for sharing files and printers:  

63	1,650/159	231
----	-----------	-----

**CP 9500 OEM** • electronic mail module:  

125	3,300/317	462
-----	-----------	-----

**CP 9500 OPT** • productivity tools module • includes calendar, conference schedules, reminders, distribution lists, and personal filing:  

125	3,300/317	462
-----	-----------	-----

**CP 9500 ODP** • DP interface module:  

32	825/80	116
----	--------	-----

**CP 9500 PDD Shop Floor Data Communication** • for manufacturing environment:  

268	7,500/NA	675
-----	----------	-----

## ■ HARDWARE

### □ Terms & Support

**Terms** • Burroughs CP 9500 Communication Processor systems are available for purchase or lease under 1-year, 3-year, and 5-year lease plans, which include maintenance; separate maintenance is available for purchased systems • some items can be upgraded in the field, for a one-time field installation charge • a portion of the lease can be used to pay for purchased equipment, but lease purchase must be declared at contract signing; typically 50% of the first 36 months lease price under a 5-year plan can be applied but it cannot exceed 50% of established purchase price.

**Support** • Burroughs maintenance is standard; available 24 hours per day, 7 days per week; basic contract covers Monday through Friday, 9:00 AM to 5:00 PM for unscheduled

maintenance calls; includes monthly scheduled preventive maintenance; after business hours and weekends, premium rates apply; monthly maintenance includes parts and labor • Burroughs also provides extensive customer education program.

### □ Overview

The Burroughs CP 9500 is a multiprocessor communication system in which each processor is assigned a specific function and operates independently of the other processors.

Each processor has its own memory and is connected to a common interface bus to exchange information. Each processor in the system is a basic Burroughs Data System (BDS) microprocessor with an operating speed of 2 MHz or 3 MHz. The memory modules are MOS integrated circuit memories, with the exception of the File Management Processor (32K bytes), memory modules are available in 64K, 128K, 256K, and 512K bytes with total system capacity at 1.2/1.5M bytes on CP 9558/CP 9572; 64K-, 256K-, and 512K-byte memory modules with a total system capacity at 3.4M bytes on CP 9582/CP 9585. The Data Communication Processor (DCP) requires a 64K-byte memory module as a minimum, while the others utilize a 128K/256K/524K-byte memory module. Each processor operates in a semiautonomous manner executing instructions from its own memory set.

A CP 9558 can include from 4 to 6 2-MHz processors, while a CP 9572 can contain from 5 to 8 2-MHz processors, and a CP 9582/9585 can contain from 4 to 8 3-MHz processors. A system supports up to 7 I/O controls on the CP 9558 and 8 I/O controls on the CP 9572 and CP 9582/CP 9585, excluding data communication adapters. In a typical system, 1 processor with 256K-byte memory executes the Master Control Program (MCP). A second processor with 32K-/64K-byte memory provides direct access to attached disk devices. A third processor with 128K-/512K-byte memory provides direct interface to communication lines and executes the network control code generated by the NDL data communication language. A fourth processor with 128K-/512K-byte memory is an application processor; it executes user application programs and utilities. The CP 9558 can support 2 additional processors; 1 can be a DCP and the other an application processor or both can be application processors. The CP 9572 supports 3 additional processors, 2 of which can be DCPs and the remaining application processors.

The CP 9582/9585 supports 4 additional processors; 3 can be used as DCPs or application processors, and the fourth can be used only as an application processor. Through the use of the I/O Select Module (IOSM), the CP 9572 can provide system backup with 1 of the application processors.

Restart, however is not automatic because operator intervention is required.

The IOSM option significantly extends operating flexibility. Peripherals include Operator Display, Console, Fixed Disk Drives, Disk Cartridge Drives, Burroughs Super Mini-Disk I and II, Industry Compatible Mini-Disk Drives and 5.25-inch inbuilt disk (CP 9585). Each DCP supports up to 12 lines operating in half- or full-duplex mode. Through use of line expansion modules (LEMs), line support of a DCP can be expanded to 32 lines. A fully expanded CP 9558 supports 32 lines, a CP 9572 47 lines, and a CP 9582/CP 9585 up to 128 lines, using the LEM to expand 4 DCPs. A single line can be multidropped with multiple concatenated terminals.

**Configuration** • a basic CP 9558 is configured with 4 processors, a 64K-byte memory module, 4 128K-byte memory modules, a 32K-byte memory module, 2M-byte BSMD Disk Drive, BSMD Controller, a 19M-byte Fixed Disk, Disk Loader, 2 Line Adapters Type II, and 2 Direct Control kits. This system can be configured with either 2 additional microprocessors, 1 of which can be a DCP. These processors require 2 128K-byte memory modules.

The CP 9572 is configured with 5 to 8 microprocessors. It includes the same processor modules as the 9558, but up to 5 can be application processors and up to 3 can be DCPs within the maximum limit of 8. Two application processors can be designated as backup processors for the operating system and file processors.

## Burroughs CP 9500 Communication Processors

### Models CP 9558-1, CP 9572, CP 9582 & CP 9585

The CP 9582/CP 9585, the most recent additions to the CP 9500 family, are configured with from 4 to 8 microprocessors with memory available in 64K-, 256K-, or 512K-byte modules. The system can support up to 4 communication processors (128 lines) with 64K- or 256K-byte memory. The operating system processor as well as the application processor supports 512K-byte memory; the file processor supports from 64K- to 256K-byte memory. Two application processors are used to backup both the operating system and file processors via IQSM feature. The CP 9582/CP 9585 support up to 1.7G bytes of disk storage and magnetic tape with up to 160K-byte-per-second transfer rate.

The CP 9500 systems can be configured with dual cartridge disk drives, industry-compatible mini-disk drives, Burroughs super mini-disk, Burroughs super mini-disk II or fixed disk with up to 2 printers or 1 printer and 4 magnetic tape drives or a card reader. CP 9585 will support up to 102M bytes on inbuilt disk.

The CP 9500 can be configured to support from up to 128 lines, depending upon user requirements and CP model.

#### Packaged Systems

**CP 9558-1 System** • includes CP 9558P Processor Cabinet with PWR supply and clock, 4 CP 9502 2-MHz Processors, CP 9511-1 64K-byte Memory Module, 4 CP 9511-2 128K-byte Memory Modules, CP 9511-3 32K-byte Memory, B 9489-1 1M-byte BSMD Disk Drive with CP 9527-1 BSMD Control, B 9493-20 19M-byte Fixed Disk Drive with CP 9526-1 Disk Control, CP 9543-11 Disk Loader Module A, 2 CP 9532-1 Line Adapter Type IIs, and 2 CP 9531-17 LA-11-Direct Connect Kits • requires software and Operator Console:

\$1,191/\$1,033/\$955 mo	\$22,000 prch	\$200.00 maint
--------------------------	---------------	----------------

**CP 9572 System** • includes CP 9572P Processor Cabinet with power supply and clock, 5 CP 9502 2-MHz Processors, CP 9511-1 64K-byte Memory Module, 4 CP 9511-2 128K-byte Memory Modules, and 1 CP 9511-3 32K-byte Memory Module; requires software and Operator Console:

857/729/685	19,000	75.30
-------------	--------	-------

**CP 9502 Processor 2 MHz** • additional microprocessor module; requires memory:

57/51/47	1,576	20.50
----------	-------	-------

**CP 9582/CP 9585 System** • includes Processor Cabinet with 64K-byte memory and power supply, 4 CP 9502-3 3-MHz Processors, CP 9503-11 DCP CSC Card, 1 CP 9512-1 64K-byte Memory Module, 2 CP 9512-4 512K-byte Memory Modules, and CP 9504-1 Extended Backplane • systems differ only in that the CP 9585 can support 5.25-inch inbuilt flexible and fixed disk; flexible disk capacity is 0.7M, 3M, or 6M bytes; fixed disk capacity is 14.4M to 43.2M bytes:

1,125/965/900	23,228	93.00
---------------	--------	-------

**CP 9585 System** • includes CP 9685P Processor cabinet with 64K-byte memory power supply, a CP 9512-1 64K-byte memory module, and a CP 9512-3 256K-byte memory module:

1,009/841/NA	23,228	NA
--------------	--------	----

**CP 9502-3 Processor 3 MHz** • additional microprocessor module for 9582 and 9585; requires memory:

73/63/59	1,750	18.00
----------	-------	-------

#### CPU & Memory

**CP 9558/CP 9572 System** • 2-MHz processor • operating system processor configured with 256K-byte memory; file management processor with 32K-byte memory; application processor with 128K-byte memory; the first data communication processor with 64K-byte memory • additional processors support 128K-/256K-byte memory.

**CP 9582/CP 9585 System** • 3-MHz processor • operating system configured with 512K-byte memory • file management processor supports 64K-byte memory with additional 16K-byte ROM attached to processor to provide load functions; optional disk file cache module can include 256K- or 512K-byte memory • application processor with either 256K- or 512K-byte memory • data communication processor configured with either 64K- or 256K-byte memory • includes 1 file management processor, 1

operating system processor, 1 to 5 application processors, and 1 to 4 communication processors, up to a maximum of 8 processors.

CP 9511-1 Memory Module, 64K Bytes • for CP 9558-1 or CP 9572:

\$29/\$26/\$24 mo	\$788 prch	\$11.10 maint
-------------------	------------	---------------

CP 9511-2 Memory Module, 128K Bytes • for CP 9558-1 or CP 9572:

57/51/47	1,576	20.90
----------	-------	-------

B9468-2 Disk File Cache Memory, 256K Bytes • stores most frequently accessed disk records • for 9572:

346/323/329	8,000	32.40
-------------	-------	-------

CP 9512-1 Memory Module, 64K Bytes • for CP 9582 and 9585 only:

33/29/27	750	10.60
----------	-----	-------

CP 9512-3 Memory Module, 256K Bytes • for CP 9582 and 9585 only:

77/67/63	1,750	24.70
----------	-------	-------

CP 9512-4 Memory Module, 512K Bytes • for CP 9582 and 9585 only:

131/114/106	3,000	42.40
-------------	-------	-------

CP 9505-1 Disk File Cache Control • for CP 9582/9585 only; requires CP 9512-3/-4 memory:

136/119/111	3,250	17.30
-------------	-------	-------

#### Processor Options

**Processor Redundancy** • the CP 9572 can support a processor redundancy feature that allows a backup application processor to run MCP and control the system; on CP 9582/CP 9585, application processor can provide backup for file processor also • requires operator to set a switch on the front panel and the system must include the appropriate I/O Select Module for the type of disk used as the system disk • CP 9530 LEM connects to 2 CP 9572/9582 processors.

CP 9503-1 I/O Select Module • for CP 9572 systems with 1M-byte or cartridge loader disk:

\$89/\$76/\$72 mo	\$1,576 prch	\$15.80 maint
-------------------	--------------	---------------

CP 9503-2 I/O Select Module • for CP 9572 systems with 3M-/6M-byte loader disk:

89/76/72	1,576	15.80
----------	-------	-------

CP 9503-3 I/O Select Module • for CP 9572 systems with 1M-byte loader and disk pack:

89/75/71	1,576	15.80
----------	-------	-------

CP 9503-13 I/O Select Module • redundancy option for CP 9585:

73/63/NA	1,750	NA
----------	-------	----

**Additional DCPs** • used for system upgrades.

CP 9503-5 DCP Kit • second DCP in CP 9588 or CP 9572 system:

10/9/9	226	2.80
--------	-----	------

CP 9503-6 DCP Kit • third DCP in CP 9588 or CP 9572 system:

16/15/14	379	2.60
----------	-----	------

CP 9503-7 DCP Kit • additional unit for CP 9588 or CP 9572:

26/22/21	630	5.80
----------	-----	------

CP 9503-10 Additional DCP Kit • for 9582 only:

22/19/18	475	4.20
----------	-----	------

CP 9531-26 Additional DCP Kit • for 9585 only:

31/26/NA	725	NA
----------	-----	----

*MO: first figure is monthly charge for 1-year lease; second figure is for 3-year lease; both include maintenance. PRCH: purchase price. MAINT: monthly maintenance charge for purchased products. NA: not available. NC: no charge. Prices current as of February 1985.*



## Burroughs CP 9500 Communication Processors

### Models CP 9558-1, CP 9572, CP 9582 & CP 9585

CP 9504-2 Extended Back Plane • for CP 9585, only:			
	55/58/NA	1,272	NA
CP 9505-2 Disk File Cache Module • for CP 9585 only:			
	136/117/NA	3,250	NA
CP 9506-2 Performance Package • for 9585 only; includes CP 9505-2 Disk File Cache and CP 9503-13 I/O Select Module:			
	248/215/NA	4,000	NA

#### ☐ Communications

The CP 9558 can be configured with 12 communication lines for a single DCP; with Line Expansion Modules this can go to 32. A single DCP is limited to an aggregate of 10K cps. A CP 9572 can be configured with 1 to 3 DCPs for a maximum of 47 lines, and a CP 9582/9585 can be configured with up to 4 DCPs for a maximum of 120 lines via line expansion modules.

#### Line Adapters & Cables

CP 9531-1 Line Adapter (Type I) • for CP 9558-1 and 9572:			
	\$27/\$23/\$22 mo	\$788 prch	\$7.00 maint
CP 9532-1 Line Adapter (Type II) • replaces Type I, for DCP 9558-1, 9572, and 9582:			
	27/23/22	788	7.00
CP 9532-3 (Dual) Link Adapter III • for CP 9582/9585 only:			
	42/36/NA	1,000	10.00
CP 9532-4 SNA NRZ/NRZI Adapter • for CP 9585 only:			
	27/26/NA	788	5.92
CP 9503-9 Line Adapter Type II Retrofit Kit • 1 per DCP for design Level 3 and 4:			
	11/10/9	284	3.60
CP 9503-11 DCP CSC Card for CP 9582:			
	11/9/8	250	2.00
CP 9531-5 Data Set Connect Kit • 50-foot:			
	6/6/6	158	NC
CP 9531-6 Data Set Connect Kit • 25-foot:			
	5/5/5	132	NC
CP 9531-7 BDLC Line Adapter • Type I; for CP 9558-1 and 9572 only:			
	35/30/28	1,045	5.50
CP 9531-8/9/10/12 DC I/O Extender Cable • for CP 9558-1 and 9572 only:			
	3/3/3	70	NC
CP 9531-11 Direct Connect Kit (TDI) • for Line Adapter Type I:			
	3/3/3	53	NC
CP 9531-13 ACU Interface Kit • 50-foot:			
	8/7/7	211	NC
CP 9531-14 ACU Interface Kit • 25-foot:			
	6/5/5	147	NC
CP 9531-17 Direct Connect Kit (TDI) • for Line Adapter Type II:			
	3/3/3	53	NC
<b>Line Expansion Components</b>			
CP 9503-8 LEU Interface Kit • for DCP:			
	\$20/\$18/\$17 mo	\$484 prch	\$3.80 maint
CP 9530 Line Expansion Module (LEM):			
	191/167/153	5,697	33.00
CP 9530-1 Line Expansion Unit (LEU):			
	140/120/113	3,886	16.50
CP 9530-2 LEU Dual Host Option:			
	18/16/15	457	3.80

CP 9530-3 Line Expansion Unit (LEU) • for CP 9582/CP 9585 only:

	140/120/NA	3,886	16.50
CP 9531-15 LEU-DCP Cable • 50-foot:			
	17/15/14	499	NC
CP 9531-16 LEU-DCP Cable • 25-foot:			
	14/13/12	379	NC
CP 9531-21 TDI/DSI Interface • with 25-foot cable:			
	12/10/NA	185	NC
CP 9531-22 TDI/DSI Interface • with 50-foot cable:			
	15/13/NA	210	NC
CP 9531-23 DSI/DSI Interface • with 25-foot cable:			
	17/15/NA	225	NC
CP 9531-24 DSI/DSI Interface • with 50-foot cable:			
	22/20/NA	300	NC
CP 9531-25 TDI/TDI Interface • up to 38.4K-bps transmission speed:			
	6/6/NA	100	NC
CP 9540-1 Inter Systems Control (ISC) Remote Hub • allows interconnection of CP 9582/CP 9585 with Burroughs host systems for full-duplex transmission at data rate of 1M bps; can also be used for CP to CP communications:			
	80/68/NA	1,490	10.00
CP 9540-2 Inter Systems Control (ISC) Inbuilt Hub • same as 9540-1 except inbuilt in CP 9582/CP 9585 cabinet:			
	148/126/NA	2,200	15.00
CP 9542-1 CP to CP Cable • 25 feet:			
	17/14/NA	355	NC
CP 9542-2 CP to CP Cable • 50 feet:			
	21/18/NA	455	NC
CP 9542-3 CP to CP Cable • 100 feet:			
	28/24/NA	610	NC
CP 9542-4 CP to Host Cable • 25 feet:			
	17/14/NA	355	NC
CP 9542-5 CP to Host Cable • 50 feet:			
	21/18/NA	455	NC
CP 9542-6 CP to Host Cable • 100 feet:			
	28/24/NA	610	NC
CP 9542-7 ISC Adapter Cable:			
	13/11/NA	280	NC
<b>☐ I/O Devices</b>			
<b>Disk</b>			
Disk storage is available as diskette, fixed-disk, removable disk pack, and disk cartridge subsystems that require control and loader module to interface to the system. The CP 9585 can support 0.7M/3M/6M-byte inbuilt floppy or 14.4M to 43.2M bytes of inbuilt fixed disk storage.			
CP 9526-1 Control for B 9493-20/40/80 Fixed-Disk Storage Subsystem • for CP 9558-1, 9572, and 9582:			
	\$33/\$29/\$28 mo	\$918 prch	\$10.80 maint
B 9493-20 Fixed-Disk Drive • 19.3M-byte storage:			
	486/430/430	10,000	80.00
B 9493-40 Fixed-Disk Drive • with 38.7M-byte storage:			
	609/541/541	13,600	108.00
B 9493-80 Fixed-Disk Drive • with 77.4M-byte storage:			
	608/602/602	16,225	128.00
CP 9526-2 Control for B 9493-9/18/37 Fixed-Disk Storage Subsystems • for CP 9558-1, 9572, and 9582:			
	33/29/28	918	8.00

## Burroughs CP 9500 Communication Processors

### Models CP 9558-1, CP 9572, CP 9582 & CP 9585

**CP 9526-3 Fixed Disk Control for B 9493-9/18/37 Fixed Disk Storage Subsystems** • for CP 9585 only:

31/27/NA	918	7.50
----------	-----	------

**B 9493-18 Fixed-Disk Drive** • with 18.9M-byte storage:

327/291/281	5,775	102.00
-------------	-------	--------

**CP 9527-1 Control for B 9489-1/-11** • Burroughs Super Mini-Disk Drive • for CP 9558-1 or CP 9572:

31/27/26	918	7.60
----------	-----	------

**CP 9527-2 Control for B 9489-21/-23 Super Mini-Disk (BSMD) II** • for CP 9558-1 or CP 9572:

31/27/26	918	9.40
----------	-----	------

**CP 9527-3 Control for B 9489-17 Diskette** • for CP 9558-1, 9572, and 9582:

33/29/28	918	10.80
----------	-----	-------

**CP 9527-4 Control for B 9489-1/-11** • Burroughs Super Mini-Disk Drive (BSMD) • for CP 9582:

54/47/44	1,250	8.40
----------	-------	------

**B 9489-1 Burroughs Super Mini-Disk (BSMD)** • 1M-byte storage capacity; integral unit:

41/36/36	956	34.80
----------	-----	-------

**B 9489-11 BSMD** • freestanding unit; single drive • 1M-byte capacity:

113/98/98	2,626	34.00
-----------	-------	-------

**CP 9527-5 Control for B 9489-21 Diskette** • for CP 9582 only:

54/47/44	1,250	8.40
----------	-------	------

**CP 9527-6 BSMD-1 Control** • for CP 9585 only:

31/27/NA	918	7.50
----------	-----	------

**B 9489-21 BSMD** • 3-/6M-byte storage capacity; integral unit:

246/211/198	3,150	52.70
-------------	-------	-------

**B 9489-17 Industry-Compatible Mini-Disk Drive** • 243K-byte storage capacity; 30-inch cabinet • subject to availability:

118/105/105	2,100	37.40
-------------	-------	-------

**CP 9528-1 Control for B 9480-12/-22 or B 9481-12 Disk Cartridge Subsystem** • for CP 9558/9572/9582:

31/27/26	918	10.20
----------	-----	-------

**B 9480-22 Dual Disk Cartridge Drive** • 4.6M-byte storage; 155-millisecond average access time:

230/206/209	4,000	127.00
-------------	-------	--------

**B 9481-12 Dual Disk Cartridge Drive** • 9.2M-byte capacity; 100-millisecond average access time:

459/411/418	7,500	191.00
-------------	-------	--------

**CP 9528-2 Control for B 9387-11/12/41 Disk Pack Drives** • for 9558-1, 9572, and 9582:

41/36/34	1,155	9.10
----------	-------	------

**B 9387-11 Disk Pack Drive** • with 65.2M-byte storage; 25-millisecond average access time:

1,360/1,279/1,279	42,000	178.00
-------------------	--------	--------

**CP 9543-11/12/13/14 Disk Loader Module A, B, E, or F** • required for disk storage for CP 9558/9572:

32/28/26	893	10.80
----------	-----	-------

#### Tape

**CP 9529-1 Magtape Control for B 9491-4** • PE Tape for 9558-1, 9572, and 9582:

\$81/\$70/\$66 mo	\$2,410 prch	\$18.40 maint
-------------------	--------------	---------------

**B 9491-4 Tape Drive** • 25 ips, 9-channel PE, 40K-byte-per-second transfer rate • subject to availability:

560/470/456	12,000	96.90
-------------	--------	-------

**CP 9529-2 Magtape Control for B 9498 PE Tape** • for 9558-1, 9572, and 9582:

91/77/73	1,360	6.30
----------	-------	------

**B 9498 Magnetic Tape Streamer:**

308/272/272	7,875	46.40
-------------	-------	-------

#### Printers

CP 9558 supports single printer; CP 9572 and CP 9582 support 2.

**CP 9523-1 Control for B 9249-1/2/3/4/30/50 Printer** • for 9558-1:

\$28/\$18/\$17 mo	\$635 prch	\$10.20 maint
-------------------	------------	---------------

**CP 9523-2 Control for B 9349-1/2/3/4, B 9249-375, B 9246-3/6/13, or B 9251** • for CP 9572/9582:

24/20/19	635	5.60
----------	-----	------

**B 9523-3 Control for B 9247-14/-15** • for CP 9558/9572/9582:

25/22/21	635	10.80
----------	-----	-------

**CP 9523-4 Printer Control for B 9247-14/-15** • for CP 9585 only:

22/18/NA	635	3.92
----------	-----	------

**B 9249-375 Printer** • 500-/375-lpm chain printer with 48-/64-character set:

422/365/365	8,915	112.00
-------------	-------	--------

**B 9246 Band/Train Line Printer** • 650, 1250, or 2000 lpm; 64-character EBCDIC standard; 48-character ASCII, 64-character ASCII, 64-character OCR-A, 64-character OCR-B, or 96-character OCR-B available on train types; 61/96/128 ASCII character sets available on band type; 132 print positions; 10-cpi horizontal spacing; 6- or 8-lpi vertical spacing, operator settable; 15-ips forms skip speed; full-line print buffer; electronic forms control buffer loaded from standard 12-channel format tape; operator removable print band and ribbon cartridge; out-of-paper and paper movement detectors • each printer requires B X246-9X DLP.

**B 9246-6 Printer** • 650-/600-lpm band printer with 48-/64-character set:

559/483/483	14,700	186.00
-------------	--------	--------

B 9246-13 Band Printer • 1250 lpm with 61-character set • for CP 9582 only:

1,600/1,435/1,325	42,500	399.00
-------------------	--------	--------

**B 9247 Series Train Line Printer** • 1100 or 1500 lpm; 132 print positions, standard 48-character horizontal train module; 16-, 64-, or 96-character set trains available; forms control through standard VEU or through Burroughs self-align system with codes preprinted on the forms; 20-ips forms skip speed.

B 9247-14 Train Printer • 1100 lpm with 48-character set • subject to availability:

1,693/1,523/1,379	25,000	579.00
-------------------	--------	--------

B 9247-15 Train Printer • 1500 lpm with 48-character set; includes powered forms stacker • subject to availability:

2,266/2,051/1,856	33,000	663.00
-------------------	--------	--------

B 9942-10 • additional Train Module for B 9247-14 or -15:

159/144/134	3,408	54.10
-------------	-------	-------

#### Operator Console

**CP 9521-2 Operator Display Terminal (ODT) Control** • for CP 9558-1, 9572, and 9582:

\$22/\$19/\$19 mo	\$630 prch	\$3.90 maint
-------------------	------------	--------------

**CP 9521-4 ODT Control** • for CP 9585 only:

22/19/NA	630	2.92
----------	-----	------

**B 9361-1 Operator Display Terminal** • with O15 keyboard (TD 850):

61/52/49	1,471	38.20
----------	-------	-------

**B 9361-2 Operator Display Terminal** • with O15 keyboard (MT 983):

131/126/123	2,095	22.00
-------------	-------	-------

## Burroughs CP 9500 Communication Processors

### Models CP 9558-1, CP 9572, CP 9582 & CP 9585

**Card Readers**

**CP 9522-1 Card Reader Controller** • for B 9115/B 9116; supported on CP 9558-1, 9572, and 9582:  
          \$25/\$22/\$21 mo                  \$630 prch          \$10.80 maint

**80-Column Card Readers** • column-by-column serial read at 300, 600, and 800 cpm; EBCDIC or BCD format; 1 input hopper and 1 output stacker with 1000-card capacity each; photoelectric

read technique.

B 9115 Card Reader • 300 cpm:	<u>353/314/276</u>	8,608	77.80
B 9116 Card Reader • 600 cpm:	<u>472/421/369</u>	11,372	109.00

• END

