

ECMA

EUROPEAN COMPUTER MANUFACTURERS ASSOCIATION

STANDARD ECMA-45
FOR
DATA INTERCHANGE
ON MAGNETIC 12-DISK PACKS
(100 MEGABYTES)

September 1975

Free copies of this ECMA standard are available from
ECMA European Computer Manufacturers Association
114 Rue du Rhône — 1204 Geneva (Switzerland)

ECMA

EUROPEAN COMPUTER MANUFACTURERS ASSOCIATION

STANDARD ECMA-45
FOR
DATA INTERCHANGE
ON MAGNETIC 12 - DISK PACKS
(100 MEGABYTES)

September 1975

C O N T E N T S

	<u>Page</u>
SECTION I - GENERAL DESCRIPTION	1
1. GENERAL DESCRIPTION	2
1.1 General Figures	2
1.2 Main Elements	2
1.3 Direction of Rotation	2
1.4 Pack Capacity	2
SECTION II - MECHANICAL AND PHYSICAL CHARACTERISTICS	3
2. GENERAL REQUIREMENTS	4
2.1 Operation and Storage Environment	4
2.1.1 Operation	4
2.1.2 Storage	4
2.2 Test Conditions	4
2.3 Shock and Vibration	4
2.4 Material	5
3. DIMENSIONAL CHARACTERISTICS	5
3.1 Reference Plane	5
3.2 Overall External Dimensions	5
3.3 Top Cover	5
3.4 Hub	5
3.4.1 Diameter of the flexture pads	5
3.4.2 Height of the flexture pads	6
3.4.3 Finish of the flexture pads	6
3.4.4 Relief of the flexture pads	6
3.4.5 Height of flexture pads from the Reference Plane	6
3.4.6 Radial compliance of flexture pads	6
3.4.7 Rest Buttons	6
3.5 Spindle Lock	7
3.5.1 Thread of the spindle lock	7
3.5.2 Diameter of the lower part of the spindle lock	7
3.5.3 Minimum full thread length	7
3.5.4 Chamfer	7
3.5.5 Location of the shoulder of the spindle lock	7
3.5.6 Length of the lower part of the spindle lock	7
3.5.7 Maximum diameter of the lower part of the spindle lock	7
3.5.8 Location of the safety balls	8
3.5.9 Hole for the penetration of the lockshaft pin	8
3.5.10 Depth of penetration of the lockshaft pin	8
3.5.11 Removal of the top cover	8

	<u>Page</u>
3.6 Bottom Protective Disk	8
3.7 Disk Supports	8
3.8 Recording Disks	8
3.9 Top Protective Disk	9
3.10 Location of the Disks	9
3.11 Location of the Lowest Element	10
3.12 Height without covers	10
3.13 Hub/Disk Relationship	10
3.13.1 Axial position limits of disk surfaces	10
3.13.2 Axial runout of disks	10
3.13.3 Acceleration of axial runout	10
3.13.4 Horizontal runout of disks	10
3.13.5 Angular shift between disks and hub	11
3.14 Location of Magnetic Surfaces	11
4. PHYSICAL CHARACTERISTICS	11
4.1 Moment of Inertia	11
4.2 Balance	11
4.3 Maximum Speed	11
4.4 Locking Pull	11
4.5 Ambient Air	11
4.5.1 Filtered air	11
4.5.2 Pressure	11
4.6 Thermal Time Constant	11
4.7 Electrical Earthing	12
4.8 Physical Characteristics of Magnetic Surfaces	12
4.8.1 Surface roughness	12
4.8.2 Durability of magnetic surfaces	12
SECTION III - MAGNETIC CHARACTERISTICS	13
5. TRACK AND RECORDING INFORMATION - DATA SURFACES	14
5.1 General Geometry, Surfaces and Heads	14
5.2 Track Geometry	14
5.2.1 Number of tracks	14
5.2.2 Width of tracks	14
5.2.3 Track location	14
5.2.4 Location of the lines of access	14
5.2.5 Recording offset angle	14
5.2.6 Identification of data tracks	14
6. TEST CONDITIONS AND EQUIPMENT - DATA SURFACES	15
6.1 General Conditions	15
6.1.1 Rotational speed	15
6.1.2 Temperature	15

	<u>Page</u>
6.1.3 Relative humidity	15
6.1.4 Conditioning	15
6.2 Standard Reference Data Surface	15
6.2.1 Characteristics	15
6.2.2 Secondary Standard Reference Data Surface	16
6.3 Data Test Head	16
6.4 Conditions for data test head measurements	17
6.4.1 Write current	17
6.4.2 DC-erase current	18
6.5 Read channel	18
6.5.1 Input impedance	18
6.5.2 Frequency and phase characteristics	18
6.5.3 Transfer characteristics	19
6.6 Automatic Gain Controlled Amplifier	19
6.7 Track Average Amplitude	19
6.8 Test signals	19
6.9 DC Erasure	19
7. FUNCTIONAL TESTING- DATA SURFACES	19
7.1 Surface Tests	19
7.1.1 Amplitude Test	19
7.1.2 Resolution Test	20
7.1.3 Overwrite Test	20
7.1.4 Residual Noise Test	20
7.2 Track Quality Test	21
7.2.1 Positive modulation test	21
7.2.2 Negative modulation test	21
7.2.3 Missing pulse test	21
7.2.4 Extra pulse test	21
8. ACCEPTANCE CRITERIA FOR DATA SURFACES	22
8.1 Surface Test Criteria	22
8.2 Track Quality Criteria	22
8.2.1 Modulation criteria	22
8.2.2 Data Errors	22
8.2.2.1 Single error	22
8.2.2.2 Correctable error	22
8.2.2.3 Uncorrectable error	22
8.2.2.4 Error criteria	22

	<u>Page</u>
9. SERVO SURFACE	22
9.1 General Description	22
9.1.1 Location	22
9.1.2 The servo surface and its task	23
9.1.3 Rotational speed	23
9.1.4 Recorded servo tracks	23
9.1.4.1 2-byte interval	23
9.1.4.2 Dibit	23
9.1.4.3 Plus-odd servo track	23
9.1.4.4 Minus-even servo track	23
9.1.4.5 Polarity of the servo read signal	23
9.1.4.6 Direction of magnetization	24
9.1.5 Servo head positions and servo track geometry	24
9.1.5.1 Line of access and alignment of servo head	24
9.1.5.2 Servo tracking centreline	24
9.1.5.3 Co-ordinates of reference track	24
9.1.5.4 Servo track spacing	24
9.1.5.5 Servo track numbering	24
9.1.5.6 Servo zone	25
9.1.5.7 Guard zones	25
9.1.5.8 Head loading zone	25
9.1.6 Index	25
9.2 Measurement Conditions	26
9.2.1 Rotational speed	26
9.2.2 Environmental conditions	26
9.2.3 Requirements for the measurement spindle	26
9.2.4 Servo test head and read channel	27
9.2.5 Servo track average amplitude V_{STA}	27
9.3 Standard Reference Servo Surface	27
9.3.1 Characteristics	27
9.3.2 Secondary Standard Reference Servo Surface	27
9.4 Servo Test Head	28
9.5 Servo Surface Signal Requirements	29
9.5.1 Servo signal timing	29
9.5.1.1 Time intervals	29
9.5.1.2 Cumulative timing errors	30
9.5.1.3 Guard zones timing	30
9.5.2 Servo signal amplitude requirements	30
9.5.2.1 Average amplitude in servo zones	30
9.5.2.2 Average amplitude in guard zones	30

	<u>Page</u>
9.5.2.3 Leading pulse amplitude	30
9.5.2.4 Missing dibits	30
9.5.3 Servo surface noise	31
9.5.3.1 Noise limits for two-byte intervals	31
9.5.3.2 Noise limits for the index pattern	31
9.5.3.3 Noise limits for head loading zone	31
9.6 Servo Surface Track Location	31
9.6.1 Spacing of servo tracking centrelines	31
9.6.2 Co-ordinates of the reference track	32
9.6.3 Position of data tracks # 000 and # 410	32
9.6.4 Runout of the servo tracking centrelines	32
9.6.5 Index pattern location	32
SECTION IV - PRE-INITIALIZATION	33
10. DATA TRACK PRE-INITIALIZATION	34
10.1 General Requirements	34
10.1.1 Data write clock	34
10.1.2 Mode of recording	34
10.1.3 Index	34
10.1.4 Byte	34
10.1.5 Hexadecimal notation	35
10.1.6 Error correcting code (ECC)	35
10.1.6.1 Correctable errors	35
10.1.6.2 Uncorrectable errors	35
10.2 Track Layout of an Initialized Data Track	36
10.2.1 Gap	36
10.2.2 Home Address (HA)	36
10.2.3 Record Zero	36
10.3 Detailed Description of an Initialized Data Track	36
10.3.1 Index Gap (G_1)	36
10.3.2 Home Address	36
10.3.3 Intermediate gap (G_2)	39
10.3.4 Record 0	39
10.3.4.1 Count of Record 0 (CR)	39
10.3.4.2 Intermediate gap (G_2)	40
10.3.4.3 Data Block of Record 0	40
10.3.5 Remainder of the track	41
10.3.6 Summary of pre-initialized Data Track	41

FIGURES

Fig. 1	Exploded view	42
Fig. 2	Cross Section	43
Fig. 3	Cover/Bottom protective cover	43
Fig. 4	Cross Section	44
Fig. 5	Spindle lock	44
Fig. 6	Enlarged view	45
Fig. 7	Disk surfaces and head numeration	45
Fig. 8	Write current characteristics	46
Fig. 9	AGC output characteristics	46
Fig. 10	Average read amplitude	47
Fig. 11	Modulation test	47
Fig. 12	Minus-even and plus-odd tracks	48
Fig. 13	Servo track geometry	48
Fig. 14	Signal from servo head at data track centreline	49
Fig. 15	Head positioning on Data Track centreline	49
Fig. 16	Servo surface zones and servo track numbering	50
Fig. 17	Index pattern	51
Fig. 18	Timing and amplitude diagram of servo signal	51
Fig. 19	Noise requirements for index pattern	51

APPENDICES

Appendix I	Air cleanliness Class 100	52
Appendix II	Measurement of track width	54
Appendix III	ECC Implementation	55
Appendix IV	General track format	57

SECTION I

GENERAL DESCRIPTION

1. GENERAL DESCRIPTION

1.1 General Figures

A typical 12-disk pack is represented in Fig. 1-6 of the drawings.

Fig. 1 shows an exploded view,

Fig. 2 shows a vertical cross-section,

Fig. 3 shows at an enlarged scale the relationship between top cover and bottom protective disk,

Fig. 4 shows a schematic cross-section of part of the disk pack,

Fig. 5 shows a schematic cross-section of the spindle lock,

Fig. 6 shows an enlarged view of the edge of a disk.

1.2 Main Elements

The main elements of this 12-disk pack are :

- the top cover
- the hub
- the spindle lock
- the protective disks
- the recording disks
- the servo surface
- the bottom cover

Other elements shown in the drawings are for better understanding of the figures only and are no part of the standard.

1.3 Direction of Rotation

The disk pack shall rotate counter-clockwise when seen from above.

1.4 Pack Capacity

A gross information capacity of 100 million 8-bit bytes is achieved in this 12-disk pack by the use of 19 data disk surfaces. Data is recorded on 404 tracks per data surface. The track spacing gives approximately 8 tracks per mm, each containing a maximum of 13030 8-bit bytes of information. The recording density varies between outer and inner track and reaches a maximum of 159 bpmm on the innermost track.

SECTION II

MECHANICAL AND PHYSICAL CHARACTERISTICS

2. GENERAL REQUIREMENTS

2.1 Operation and Storage Environment

2.1.1 Operation

The operating temperature - measured within the disk pack area of the drive - shall be within the range 15 °C to 57 °C at a relative humidity of 8 % to 80 %. The wet bulb reading shall not exceed 26 °C. Before a disk pack is placed into operation, it shall be conditioned within its covers for a minimum of 2 hours in the same environment as that in which the disk drive is operating.

The time of acclimatization is dependent on the difference between the disk pack temperature and the environmental temperature of the disk drive. The minimum time may be calculated using a temperature gradient of 10 °C per hour.

The above specified range does not necessarily apply to the disk drive.

2.1.2 Storage

The storage temperature shall be within the range -40 °C to 65 °C, the wet bulb reading not exceeding 30 °C. For wet bulb temperatures between 0,5 °C and 30 °C the disk pack shall be able to withstand a relative humidity of 8 % to 80 %.

Storage under the extreme conditions of the above range is not recommended. A temperature gradient of more than 10 °C per hour should be avoided.

The ambient stray magnetic field intensity shall not exceed 4000 A/m.

2.2 Test Conditions

Unless otherwise stated, measurements shall be carried out at $(23 \pm 3)^\circ\text{C}$, 40 % to 60 % RH after 24 hours of acclimatization. Tests shall be carried out with the disk pack in the upright position, unless otherwise stated.

2.3 Shock and Vibration

The disk pack should withstand exposure to shock and/or vibration during normal operator usage and still meet all dimensional and functional specifications of this Standard. Protection against shock and vibration during transportation and storage shall be subject to agreement between supplier and user.

2.4 Material

Unless otherwise stated, the disk pack may be constructed from any suitable material so long as the dimensional, inertial and other functional requirements of this Standard are maintained. The coefficient of thermal expansion of all the recording disks shall be the same.

3. DIMENSIONAL CHARACTERISTICS

3.1 Reference Plane

All dimensions are referred to a Reference Plane. It is the surface, perpendicular to the axis of the pack, on which the pack rests with its three rest buttons.

3.2 Overall External Dimensions

3.2.1 Overall height (Fig. 2)

The overall height of the disk pack with top and bottom cover shall be:

$$h_1 = 180 \text{ mm max.}$$

3.2.2 Overall diameter (Fig. 2)

The overall diameter of the disk pack with top and bottom cover shall be:

$$d_1 = 381 \text{ mm max.}$$

3.3 Top Cover (Fig. 3)

3.3.1 Outside radius, Pack-Centreline relationship

When measured with reference to the hub centreline the outside radius of the top cover shall be :

$$183,65 \text{ mm} < r_1 < 185,42 \text{ mm}$$

3.3.2 Vertical distance

The vertical distance of the lower edge of the top cover below the Reference Plane shall be:

$$h_2 = 3,56 \text{ mm} \pm 1,47 \text{ mm}$$

3.4 Hub (Fig. 4)

3.4.1 Diameter of the flexture pads

The diameter of the three hub flexture pads shall be:

$$d_2 = 44,432 \text{ mm} \pm 0,005 \text{ mm}$$

measured at $20,0 \text{ }^\circ\text{C} \pm 0,5 \text{ }^\circ\text{C}$.

3.4.2 Height of the flexture pads

The height of the hub flexture pads shall be:

$$h_3 = 1,91 \text{ mm} \pm 0,13 \text{ mm}$$

3.4.3 Finish of the flexture pads

The finish shall be of Class N 5 (0,4 um arithmetical mean deviation, see ISO R 1302).

3.4.4 Relief of the flexture pads

The hub flexture pad shall be relieved to:

$$d_3 = 44,478 \text{ mm} \pm 0,015 \text{ mm}$$

measured at $20,0 \text{ }^\circ\text{C} \pm 0,5 \text{ }^\circ\text{C}$.

3.4.5 Height of flexture pads from the Reference Plane

The height of the flexture pads from the Reference Plane shall be:

$$h_4 = 1,40 \text{ mm} \pm 0,30 \text{ mm}$$

3.4.6 Radial compliance of flexture pads

The radial compliance of each flexture pad shall be $1,0 \text{ } \mu\text{m} \pm 0,2 \text{ } \mu\text{m}$ per 4,5 N radial force located at the collet flexture pad with d_2 expanded to $44,4500 \text{ mm} \pm 0,0025 \text{ mm}$.

3.4.7 Rest Buttons

3.4.7.1 Location

The three rest buttons shall be equally spaced on a circle of diameter :

$$d_4 = 139,70 \text{ mm} \pm 0,13 \text{ mm}.$$

3.4.7.2 Diameter and shape

The diameter of the rest buttons shall be :

$$d_5 = 11 \text{ mm} \pm 1 \text{ mm}.$$

Their surface shall be spherical with a radius :

$$r_2 = 110 \text{ mm} \pm 15 \text{ mm}.$$

3.4.7.3 Roughness and hardness

The finish of the rest surfaces shall be of Class N4 (0,2 um arithmetical mean deviation, see ISO R 1302). The hardness shall be 55 to 60 (Rockwell Scale C).

3.5 Spindle Lock (Fig. 5)

3.5.1 Thread of the spindle lock

The thread of the spindle lock shall be a double lead thread of type 24 UNF-2A.

3.5.2 Diameter of the lower part of the spindle lock

The diameter of the lower part of the spindle lock shall be

$$d_6 = 9,37 \text{ mm} \pm 0,13 \text{ mm}$$

3.5.3 Minimum full thread length

The full thread length of the spindle lock shall be:

$$h_5 = 7,14 \text{ mm min.}$$

3.5.4 Chamfer

The lower end of the spindle lock shall be chamfered from an inner diameter of:

$$d_7 = 8,00 \text{ mm} \pm 0,13 \text{ mm}$$

and an angle:

$$\gamma = 45^\circ \pm 2^\circ$$

3.5.5 Location of the shoulder of the spindle lock

The shoulder of the spindle lock shall be at a distance from the Reference Plane of:

$$h_6 = 13,51 \text{ mm} \begin{matrix} + 0,23 \\ - 0,30 \end{matrix} \text{ mm}$$

3.5.6 Length of the lower part of the spindle lock

The length of the lower part of the spindle lock shall be:

$$h_7 = 19,15 \text{ mm} \pm 0,076 \text{ mm}$$

3.5.7 Maximum diameter of the lower part of the spindle lock

The diameter of the lower part of the spindle lock with the safety balls expanded shall be:

$$d_8 = 10,7 \text{ mm} \pm 0,1 \text{ mm}$$

The safety balls shall not extend before the lockshaft pin is at a distance of:

$$h_8 = 16,97 \text{ mm max.}$$

from the shoulder of the spindle lock. The safety balls shall cease to expand when the lockshaft pin is at a distance of:

$$h_9 = 14,65 \text{ mm min.}$$

from the shoulder of the spindle lock. The diameter with relaxed balls shall be:

$$d_9 = 9,53 \text{ mm max.}$$

3.5.8 Location of the safety balls

The centres of the safety balls shall be located with regard to the spindle lock shoulder at a distance of:

$$h_{10} = 9,04 \text{ mm} \pm 0,23 \text{ mm}$$

3.5.9 Hole for the penetration of the lockshaft pin

The diameter of the hole for the penetration of the drive spindle lockshaft pin into the spindle lock shall be:

$$d_{10} = 3,18 \text{ mm} \pm 0,13 \text{ mm}$$

3.5.10 Depth of penetration of the lockshaft pin

The clearance for the penetration of the drive spindle lockshaft pin into the spindle lock shall be at a distance from the shoulder of:

$$h_{11} = 13,84 \text{ mm max.}$$

3.5.11 Removal of the top cover

It shall be possible to remove the top cover when the lockshaft has penetrated into the spindle lock to a distance from the shoulder of:

$$h_{12} = 14,44 \text{ mm} \pm 0,21 \text{ mm}$$

3.6 Bottom Protective Disk (Fig. 4)

3.6.1 Diameter

The diameter of the bottom protective disk shall be:

$$d_{11} = 360,37 \text{ mm} \pm 0,25 \text{ mm}$$

3.6.2 Thickness

The thickness of the bottom protective disk shall be:

$$e_1 = 1,30 \text{ mm} \pm 0,08 \text{ mm}$$

3.7 Disk Supports (Fig. 4)

The radius of all disk supports shall be:

$$r_3 = 90,9 \text{ mm max.}$$

3.8 Recording Disks (Fig. 4)

3.8.1 Diameter

The diameter of all recording disks shall be:

$$d_{12} = 356,25 \text{ mm} \pm 0,15 \text{ mm}$$

3.8.2 Thickness

The thickness of all recording disks shall be:

$$e_2 = 1,905 \text{ mm} \pm 0,025 \text{ mm}$$

3.8.3 Disk edge chamfer (Fig. 6)

For a distance

$$b = 1,3 \text{ mm max.}$$

from the outside edge of the disk, the disk contour shall be relieved within the extended boundaries of the disk surfaces.

3.9 Top Protective Disk (Fig. 4)

3.9.1 Diameter

The diameter of the top protective disk shall be :

$$d_{13} = 356,25 \text{ mm} \pm 0,15 \text{ mm}$$

3.9.2 Thickness

The thickness of the top protective disk shall be :

$$e_4 = 1,27 \text{ mm} \pm 0,05 \text{ mm}$$

3.10. Location of the Disks (Fig. 4)

The disks shall be located with regard to the Reference Plane as follows :

3.10.1 Bottom protective disk : The distance between the Reference Plane and the lower surface of the bottom protective disk shall be :

$$0,56 \text{ mm} \leq h_{13} \leq 1,41 \text{ mm}$$

3.10.2 Recording disks: The distances above the Reference Plane to the recording disks shall be:

$$h_{14} = 10,478 \text{ mm} \pm 0,203 \text{ mm}$$

$$h_{15} = 20,003 \text{ mm} \pm 0,203 \text{ mm}$$

$$h_{16} = 29,528 \text{ mm} \pm 0,203 \text{ mm}$$

$$h_{17} = 39,053 \text{ mm} \pm 0,203 \text{ mm}$$

$$h_{18} = 48,578 \text{ mm} \pm 0,203 \text{ mm}$$

$$h_{19} = 58,103 \text{ mm} \pm 0,203 \text{ mm}$$

$$h_{20} = 67,628 \text{ mm} \pm 0,203 \text{ mm}$$

$$h_{21} = 77,153 \text{ mm} \pm 0,203 \text{ mm}$$

$$h_{22} = 86,678 \text{ mm} \pm 0,203 \text{ mm}$$

$$h_{23} = 96,203 \text{ mm} \pm 0,203 \text{ mm}$$

3.10.3 Top protective disk: The distance between the Reference Plane and the lower surface of the top protective disk shall be :

$$h_{24} = 105,982 \text{ mm} \pm 0,432 \text{ mm}$$

3.11 Location of the Lowest Element

The lowest element of the disk pack shall not extend outside an annular space defined by

$$h_{25} = 7,6 \text{ mm max.}$$

and two radii:

$$r_4 = 78,0 \text{ mm}$$

$$r_5 = 96,5 \text{ mm}$$

3.12 Height Without Covers

The overall height of the disk pack, without covers, above the Reference Plane shall be :

$$h_{26} = 123,0 \text{ mm max.}$$

3.13 Hub/Disk Relationship

3.13.1 Axial position limits of disk surfaces

With the disk pack revolving at any speed in the range 2500 rpm to 3700 rpm, the axial runout of the recording disks and the top and bottom protective disks (defined by stacking dimension h_{13} through h_{24} in Fig. 4) shall remain within the axial position limits defined for each surface by the plus and minus tolerance around the datum dimension expressed as a dimension from the Reference Plane for that surface (dimensions h_{13} through h_{24}). This requirement shall apply to the area of all disk surfaces between a radius of 175,08 mm min. and a radius of 98,42 mm max.

3.13.2 Axial runout of disks

The axial runout of any disk at any speed up to the maximum allowable speed (see 4.3) shall not exceed :

for the recording disks 0,15 mm

for the protective disks 0,51 mm

total indicator reading.

3.13.3 Acceleration of axial runout

With the disk pack revolving at (3600 ± 72) rpm, the acceleration of axial runout of the recording disk surfaces (measured with a high frequency cutoff defined by the point of intersection of the flat response and high frequency asymptote at 2200 Hz and a high frequency attenuation rate of 18 dB per octave) in the area between a radius of 175,08 mm min. and a radius of 98,42 mm max. shall not exceed a peak acceleration from the base line of $\pm 76 \text{ m/s}^2$.

3.13.4 Horizontal runout of disks

The horizontal runout (i.e. the total indicator reading) shall not exceed 0,25 mm for the recording disks, and 0,51 mm for the top and bottom protective disks as referenced to the centreline of the disk pack hub.

3.13.5 Angular shift between disks and hub

After the disk pack has experienced a positive or negative acceleration up to 3000 rad/s^2 , the angular shift between disks and hub must remain equal to zero when measured with a device capable of detecting a shift of 3 seconds.

3.14 Location of Magnetic Surfaces

The area of the magnetic surface of the recording disks shall extend from an inside diameter of 190,5 mm max. to an outside diameter of 352,0 mm min.

4. PHYSICAL CHARACTERISTICS

4.1 Moment of Inertia

The moment of inertia of the disk pack without covers shall not exceed 107 g.m^2 .

4.2 Balance

The disk pack shall be dynamically balanced within 100 g.mm when measured at 3600 rpm in each of two planes parallel to the disk surface at $5,84 \text{ mm} \pm 1,3 \text{ mm}$ above the upper surface of the top protective disk and below the lower surface of the bottom protective disk respectively.

4.3 Maximum Speed

The disk pack shall be capable of withstanding the effect of stress at a speed of 3700 rpm counterclockwise as seen from above.

4.4 Locking Pull

The disk pack shall be held to the disk drive spindle by a force within the range 1100 N to 2000 N, exerted by the downward pull of the disk drive lockshaft on the disk pack spindle lock.

4.5 Ambient Air

4.5.1 Filtered air

The filtered air in the immediate area of the disk pack shall be equivalent to a Class 100 clean room (see: App. I).

4.5.2 Pressure

The static pressure in the immediate area of the disk pack shall be 0,25 mbar min. above the environment of the drive.

4.6 Thermal Time Constant

The thermal time constant is the time required to reduce an initial temperature difference between the pack and the drive by $2/3$. The disk pack thermal time constant shall not exceed one minute when measured with the disk pack rotating at $3600 \pm 72 \text{ rpm}$ and within the specified operating environment and conditions.

4.7 Electrical Earthing

The disk pack shall provide a discharge path from the magnetic media to the drive spindle through the hub mechanism.

4.8 Physical Characteristics of Magnetic Surfaces

4.8.1 Surface roughness

The finished magnetic surfaces shall have a surface roughness less than 0,05 um, arithmetic average, with a maximum deviation in height of 0,38 um from the average, when measured with a 2,5 um stylus and a 750 um cutoff range.

4.8.2 Durability of magnetic surfaces

4.8.2.1 Resistance to chemical cleaning fluid

The magnetic surface of recording disks shall not be adversely affected by a 91 % solution of isopropyl alcohol (made from reagent grade isopropyl alcohol mixed with 9 % distilled or deionized water by volume) when used for cleaning.

4.8.2.2 Coating adhesion

The nature of the coating shall be such as to assure wear resistance under operating conditions and maintenance of adhesion and abrasive wear resistance.

4.8.2.3 Abrasive wear resistance

The coating shall be able to withstand operational wear.

SECTION III

MAGNETIC CHARACTERISTICS

5. TRACK AND RECORDING INFORMATION - DATA SURFACES

5.1 General Geometry, Surfaces and Heads

Head and surface details shall be as in Fig. 7 and 13.

Track locations shall be referred to a Cartesian coordinate system, axes X and Y, with its origin on the axis of rotation of the disk pack.

5.2 Track Geometry

5.2.1 Number of tracks

There shall be 411 discrete concentric tracks per data surface.

5.2.2 Width of tracks

The recorded track width on the data surfaces shall be:

$$0,109 \text{ mm} \pm 0,005 \text{ mm}$$

A suggested method of measuring the track width is contained in Appendix II.

5.2.3 Track location

The centreline of any track shall lie within $\pm 0,005$ mm of its corresponding data track centreline as defined in 9.1.5.3.

The incremental head movement and its tolerance are defined by the servo track information and shall correspond to the servo track spacing (see 9.1.5.4).

5.2.4 Location of the lines of access

There shall be two groups of heads each having a line of access A and B respectively. These lines of access shall be parallel to the X axis and shall have the ordinate

$$Y_A = + 7,772 \text{ mm}$$

$$Y_B = - 7,772 \text{ mm}$$

5.2.5 Recording offset angle

At the instant of writing or reading a magnetic transition, the transition may have an angle of $\pm 30'$ maximum with the line of access.

5.2.6 Identification of data tracks

For the purposes of testing data tracks the following identifying system is used.

5.2.6.1 Data track identification

Data track identification shall be a three-digit decimal number (000 to 410) which numbers data tracks consecutively starting at the outermost data track of each data surface.

5.2.6.2 Data surface identification

The data surfaces shall be numbered from 00 to 18 corresponding with the head numbers (see Fig. 7).

5.2.6.3 Cylinder

A cylinder is a set comprising all data tracks on the data surfaces having the same data track identification.

5.2.6.4 Data track address

A five-digit decimal number is used for data track address with the three most significant digits defining the cylinder address and the remaining two digits defining the data surface address.

6. TEST CONDITIONS AND EQUIPMENT - DATA SURFACES

6.1 General Conditions

6.1.1 Rotational speed

The rotational speed shall be (3600 ± 72) rpm in any test period. Rotation shall be counterclockwise when viewed from above.

6.1.2 Temperature

The temperature of the air entering the disk pack area shall be $(27 \pm 2)^{\circ}\text{C}$.

6.1.3 Relative humidity

The relative humidity of the air entering the disk pack shall be between 30% and 70%.

6.1.4 Conditioning

Before starting measurements the disk pack shall be conditioned for 24 hours in the same environment as that in which the test equipment is operating.

6.2 Standard Reference Data Surface

6.2.1 Characteristics

The Standard Reference Data Surface shall be characterized at the innermost and outermost track. When recorded at 1F (see 6.8), using a data test head, the track average amplitude (see 6.7) shall be :

3,75 mV at track # 000

1,9 mV at track # 410

When recorded at 2F (see 6.8), using a data test head, the track average amplitude (see 6.7) shall be :

2,7 mV at track # 000

1,3 mV at track # 410

6.2.2 Secondary Standard Reference Data Surface

This is a surface whose output is related to the Standard Reference Data Surface via the calibration factors C_{D1} (for 1F) and C_{D2} (for 2F).

These calibration factors C_D are defined as

$$C_D = \frac{\text{Standard Reference Data Surface Output}}{\text{Secondary Standard Reference Data Surface Output}}$$

To qualify as a Secondary Standard Reference Data Surface, the calibration factors C_D for such disks shall satisfy $0,90 \leq C_D \leq 1,10$ at the measured tracks for both frequencies.

6.3 Data Test Head

6.3.1 Description

This measurement shall be taken with a suitable test head. The test head shall be calibrated to the Standard Reference Data Surface, and used for amplitude and data testing of the data surfaces.

NOTE: A suitable test head is for example the 4040-19 test head of Information Magnetics Corp., 5743 Thorwood Drive, Goleta (Cal. 93017).

6.3.2 Gap width

The width of the recording gap (measured optically) shall be $0,1090 \text{ mm} \pm 0,0025 \text{ mm}$.

6.3.3 Gap length

The length of the recording gap shall be $2,54 \text{ um} \pm 0,63 \text{ um}$.

6.3.4 Offset angle

The angle between the read gap in the ferrite core and the line of access shall be $0^\circ \pm 30'$.

6.3.5 Flying height

When flying over track # 410, the test head shall have a flying height at the gap of $1,14 \text{ um} \pm 0,05 \text{ um}$.

6.3.6 Inductance

The total head inductance shall be $9,4 \text{ uH} \pm 0,2 \text{ uH}$ measured in air at 1 MHz. One leg shall have an inductance of $2,70 \text{ uH} \pm 0,05 \text{ uH}$, the other leg shall have an inductance of $2,85 \text{ uH} \pm 0,05 \text{ uH}$.

6.3.7 Resonant frequency

As measured at the head cable connector, the resonant frequency of the total read/write coil of the head shall be $19,5 \text{ MHz} \pm 0,5 \text{ MHz}$.

6.3.8 Resolution

The test head shall have a resolution of $(72 \pm 7) \%$ at track # 000 and $(68 \pm 7) \%$ at track # 410. Resolution is defined as:

$$\frac{2F \text{ Amplitude}}{1F \text{ Amplitude}} \quad 100 \%$$

6.3.9 Head loading force

The net head loading force shall be such as to achieve the flying height (6.3.5) and shall be within the limits $3,4 \text{ N} \pm 0,4 \text{ N}$.

6.3.10 Calibration factor

All measurements shall be taken with a suitable data test head. To qualify as a data test head its calibration factors C_{H1} , C_{H2} shall satisfy $0,90 \leq C_{Hi} \leq 1,10$.

C_H is defined by:

$$C_H = \frac{\text{Standard Reference Data Surface Output}}{\text{Actual head voltage measured}}$$

when measured on a Standard Reference Data Surface, or by

$$C_H = \frac{\text{Standard Reference Data Surface Output}}{(\text{Actual head voltage measured}) \cdot C_D}$$

when measured on a Secondary Standard Reference Data Surface.

6.3.11 Overwrite capability

The overwrite capability of the head shall meet the following requirement.

Write with 1F at track # 000 of a Standard Reference Data Surface and measure the average amplitude of the 1F-signal with a frequency-selective voltmeter. Without DC erase, overwrite once at 2F, measure the average amplitude of the residual 1F-signal.

The ratio:

$$\frac{\text{Average Amplitude of measured 1F-Signal after overwrite with 2F}}{\text{Average Amplitude of measured 1F-Signal before overwrite with 2F}}$$

shall be $0,0037 \pm 0,0019$ ($-50 \text{ dB} \pm 5 \text{ dB}$).

6.4 Conditions for data test head measurements

6.4.1 Write current

The 2F write current shall conform to Fig. 8. The current amplitude measured at the head termination connector shall be varied in 7 levels as presented below :

<u>Data Tracks</u>	<u>Write current ($I_{W+} + I_{W-}$) in mA</u>
0 - 63	180
64 - 127	173
128 - 191	166
192 - 255	160

Tolerance : $\pm 1 \%$

<u>Data Tracks</u>	<u>Write current ($I_{W+} + I_{W-}$) in mA</u>
	Tolerance : $\pm 1 \%$
256 - 319	153
320 - 383	147
384 - 410	140

The differences between the positive and negative amplitudes of the write current $| I_{W+} - I_{W-} |$ shall be less than 2 mA.

$T_R = 46 \text{ ns} \pm 3 \text{ ns}$

$T_F = 46 \text{ ns} \pm 3 \text{ ns}$

Overshoot : $(6,5 \pm 0,5) \%$ of $I_W = 0,5 (I_{W+} + I_{W-})$

Two consecutive half periods τ_1, τ_2 shall not differ

from $\frac{\tau_1 + \tau_2}{2}$ by more than 1 %.

6.4.2 DC-erase current

The DC-erase current supplied to one of the two read/write coils when DC-erase is specified shall be :

<u>Data Tracks</u>	<u>mA</u>
	Tolerance: $\pm 1 \%$
0 - 63	90,0
64 - 127	86,5
128 - 191	83,0
192 - 255	80,0
256 - 319	76,5
320 - 383	73,5
384 - 410	70,0

6.5 Read channel

6.5.1 Input impedance

The differential input impedance of the read channel shall be 900 Ohm ± 45 Ohm in parallel with 25 pF ± 2 pF, including the preamplifier input impedance and all other distributed and lumped impedance measured at the head termination connector.

6.5.2 Frequency and phase characteristics

The frequency and phase characteristics are defined by the following :

- The frequency response shall be flat within $\pm 0,25$ dB from 0,1 MHz to 6,45 MHz (0,06 F to 4 F).
- The -3 dB roll-off point shall be at 9,675 MHz (6 F).
- The attenuation above 9,675 MHz shall not be less than that given by a line drawn through zero dB at 9,675 MHz with a slope of -60 dB/decade.
- The phase shift shall be less than $\pm 5^{\circ}$ between 0,1 MHz and 6,45 MHz (0,06 F and 4 F).

6.5.3 Transfer characteristics

For inputs between 0,3 mV and 10,0 mV the transfer characteristic shall be linear within $\pm 3 \%$, or 50 uV, whichever is larger.

6.6 Automatic Gain Controlled Amplifier

The AGC-amplifier shall produce an output voltage V_{AGC} constant within $\pm 1 \%$ for input voltages from $V_{inmin} = 0,3$ mV to $V_{inmax} = 10,0$ mV (see Fig. 9).

Its response time shall be 3,4 us. All frequencies below 10 KHz shall be attenuated at a rate of 20 dB/decade.

6.7 Track Average Amplitude (V_{TA})

The track average amplitude (V_{TA}) is the average of the peak-to-peak values of the signals over one revolution of the disk, measured at the output of the Data Test Head when electrically loaded as in 6.5.

6.8 Test Signals

The recording frequencies specified as 1F and 2F shall be :

$$1F = (3225 \pm 3,225) \cdot 10^3 \text{ transitions/s}$$

$$2F = (6450 \pm 6,450) \cdot 10^3 \text{ transitions/s}$$

6.9 DC Erasure

Unless otherwise specified all write operations shall be preceded by a DC erase operation.

7. FUNCTIONAL TESTING - DATA SURFACES

7.1 Surface Tests

7.1.1. Amplitude test

7.1.1.1 Procedure

Write on any part of the data surface at 2F read back and measure the V_{TA} .

7.1.1.2 Result

The upper limit for the data track average amplitude of the corrected data test head output shall be 1,8 mV peak-to-peak at data cylinder 410 and shall increase linearly to a value of 3,6 mV peak-to-peak at data cylinder 000. The lower limit for the data track average amplitude shall be 0,95 mV peak-to-peak at data cylinder 410 and shall increase linearly to a value of 1,8 mV peak-to-peak at data cylinder 000 (see Fig. 10).

7.1.2 Resolution test

7.1.2.1 Procedure

On any part of the data surface write at 1F, read back and measure the V_{TA} . Then DC-erase, write at the same position at 2F, read back and again, measure the V_{TA} .

7.1.2.2 Result

In all cases the ratio:

$$\frac{\text{Average Track Amplitude of 2F Signal}}{\text{Average Track Amplitude of 1F Signal}}$$

shall be $0,70 \pm 0,20$.

7.1.3 Overwrite test

7.1.3.1 Procedure

Write at 1F on track # 000 and measure the average amplitude of the 1F-signal with a frequency-selective voltmeter. Without DC erase, overwrite once at 2F, measure the average amplitude of the residual 1F-signal with the frequency-selective voltmeter.

7.1.3.2 Result

The ratio:

$$\frac{\text{Average Amplitude of 1F-signal after overwrite}}{\text{Average Amplitude of 1F-signal before overwrite}}$$

shall be less than 0,01.

7.1.4 Residual noise test

7.1.4.1 Procedure

Write on data track # 410 at 2F, read back and measure the V_{TA} . Then DC erase once and read back over one revolution.

7.1.4.2 Result

Residual noise occurs if any of the following conditions is met :

<u>The number of noise pulses exceeding</u>	<u>is greater than</u>
---	------------------------

16 % of 0,5 V_{TA}	1700
18 % " " "	400
20 % " " "	90
22 % " " "	20
24 % " " "	5

Residual noise is not permitted.

7.2 Track Quality Test

7.2.1 Positive modulation test

7.2.1.1 Procedure

Write on each track at 2F, read back and measure the V_{TA} . With a delay of $t_d = 1,55 \text{ us} \pm 0,15 \text{ us}$ after detecting a read pulse exceeding 125 % of $0,5 V_{TA}$, count all further such read pulses during a time period $t_{pm} = 3,10 \text{ us} \pm 0,15 \text{ us}$ (see Fig. 11).

7.2.1.2 Result

Positive amplitude modulation occurs if the number of counted pulses exceeds 16.

7.2.2 Negative modulation test

7.2.2.1 Procedure

Write on each track at 2F, read back and measure the V_{TA} . With a delay of $t_d = 1,55 \text{ us} \pm 0,15 \text{ us}$ after detecting a read pulse not reaching 75 % of $0,5 V_{TA}$, count all further such read pulses during a time period $t_{nm} = 60 \text{ us} \pm 1 \text{ us}$ (see Fig. 11).

7.2.2.2 Result

Negative amplitude modulation occurs if the number of counted pulses exceeds 256.

7.2.3 Missing pulse test

7.2.3.1 Procedure

Write on each track at 2F and read back using the AGC-amplifier.

7.2.3.2 Result

A missing pulse is any read pulse whose amplitude is less than 55 % of the AGC output voltage (V_{AGC}).

7.2.4 Extra pulse test

7.2.4.1 Procedure

Write on each track at 2F, read back and measure the V_{TA} . Then DC-erase once and read back over one revolution.

7.2.4.2 Result

An extra pulse is any spurious read pulse exceeding 40 % of $0,5 V_{TA}$.

8. ACCEPTANCE CRITERIA FOR DATA SURFACES

8.1 Surface Test Criteria

The disk pack shall meet the requirements of all tests specified in 7.1.

8.2 Track Quality Criteria

8.2.1 Modulation criteria

Positive or negative amplitude modulation as defined in 7.2 shall not occur in any track.

8.2.2 Data Errors

8.2.2.1 Single error

A single error is the occurrence of a missing pulse (7.2.3) or of an extra pulse (7.2.4).

8.2.2.2 Correctable error

A correctable error occurs if the interval between the first single error and the last single error of a data track is equal to or less than 10 bit periods (see 10.1.1).

8.2.2.3 Uncorrectable error

An uncorrectable error occurs if the interval between the first single error and the last single error of a data track is greater than 10 bit periods (see 10.1.1).

8.2.2.4 Error criteria

There shall be neither correctable nor uncorrectable errors in tracks # 00 and # 01 within cylinder 000. There shall be no uncorrectable errors in each track from 93 us to 233,12 us following the Index. For the purposes of data interchange there shall be no uncorrectable errors on at least 7676 data tracks. (If more data tracks without uncorrectable errors are required, this is subject to agreement between supplier and user.)

9. SERVO SURFACE

9.1 General Description

9.1.1 Location

The servo surface shall be the upper surface of the 6th recording disk from the top. It shall be located between data surface # 10 and data surface # 9 (see Fig. 7).

9.1.2 The servo surface and its task

The servo surface shall be used as a geometrical and timing reference for all other surfaces of the disk pack. The servo surface shall provide the means to implement the following features:

- Head positioning and track following
- Write timing (write clock)
- Index sensing
- Rotational position sensing

9.1.3 Rotational speed

For the following dibit timing relationships a nominal rotational speed of 3600 rpm is assumed.

9.1.4 Recorded servo tracks

9.1.4.1 2-byte interval

Each recorded servo track shall be divided into 6720 equal intervals, called 2-byte intervals (or dual intervals). Each 2-byte interval shall correspond in time t_1 to two data bytes on any data surface.

$$t_1 = 2480 \text{ ns nominal}$$

9.1.4.2 Dibit

The read signal of a recorded servo track shall consist of pairs of pulses called dibits. Each dibit consists of a pulse of one polarity followed closely by a pulse of the opposite polarity. The time interval t_2 between these 2 pulses must be small compared with $0,5 t_1$ (Fig.12) and its value shall be :

$$t_2 = 330 \text{ ns nominal}$$

measured at the point of the leading edge of the pulse amplitude which equals 50% of the AGC reference amplitude.

9.1.4.3 Plus-odd servo track

A plus-odd servo track shall be recorded so that its read signal consists of plus-dibits occurring in the first half of the 2-byte intervals. A plus-dibit consists of a positive pulse followed by a negative pulse (Fig. 12).

9.1.4.4 Minus-even servo track

A minus-even servo track shall be recorded so that its read signal shall consist of minus-dibits occurring in the second half of the 2-byte intervals. A minus-dibit shall consist of a negative pulse followed by a positive pulse (Fig. 12).

9.1.4.5 Polarity of the servo read signal

The polarity of the read signal of a recorded servo track is defined by the condition that the outermost

recorded servo track (track -12,5; outer guard zone, 9.1.5.7) is a plus-odd servo track (9.1.4.3).

9.1.4.6 Direction of magnetization

Fig. 12 shows the relationship between direction of magnetization of the disk and the polarity of the two types of dibits.

9.1.5 Servo head positions and servo track geometry

9.1.5.1 Line of access and alignment of servo head

The read-gap of the servo head shall move along the line of access A (see 5.2.4 and Fig. 13). The centre-line of the servo head gap shall coincide with the line of access to the accuracy given in 5.2.5.

9.1.5.2 Servo tracking centreline

The servo tracking centreline for each cylinder is given by the centre of the servo head gap, with the servo head positioned on the line of access, when the read signal contains equal amplitudes of the leading peaks of plus-dibits and minus-dibits. This read signal (see figure 14) is produced by adjacent plus-odd and minus-even servo tracks (see also figure 15).

The centrelines of the written data tracks of each cylinder are determined by the corresponding servo tracking centreline and the accuracy of alignment of data heads with respect of the servo head.

9.1.5.3 Coordinates of reference track

The nominal locations of all data track centrelines and of all servo track edges shall be calculated from the nominal coordinates of the centreline of data track # 245 :

$$X_{245} = 129,487 \text{ mm}$$

$$Y = 7,772 \text{ mm}$$

9.1.5.4 Servo track spacing

The nominal spacing S between the centrelines of the servo tracks along the line of access shall be:

$$S = 132,08 \text{ um}$$

This spacing S is also the nominal spacing between the data track centrelines along the line of access.

9.1.5.5 Servo track numbering (Fig. 16)

The servo tracks are consecutively numbered starting at the outermost track:

$$-12,5; -11,5; \dots -0,5; +0,5; \dots +428,5$$

This numbering system has been chosen because the centre-lines of the servo tracks + 0,5 to 409,5 shall be spaced nominally half-way between the data track centrelines of track # 000 to track # 410.

9.1.5.6 Servo zone (Fig. 16)

The servo zone shall contain 412 servo tracks alternating between plus-odd and minus-even, from servo track -0,5 to 410,5.

9.1.5.7 Guard zones (Fig. 16)

The outer guard zone shall consist of 12 plus-odd servo tracks, from servo track -12,5 to -1,5. The inner guard zone shall consist of 18 minus-even servo tracks, from servo track 411,5 to 428,5. The nominal radii (see Fig. 13) calculated from the figures given in 9.1.5.3 and 9.1.5.4 shall be:

$$\begin{aligned} R_{-13} &= 163,748 \text{ mm} \\ R_{-1} &= 162,165 \text{ mm} \\ R_{+411} &= 107,842 \text{ mm} \\ R_{+429} &= 105,470 \text{ mm} \end{aligned}$$

9.1.5.8 Head loading zone (Fig. 13, 16)

The head loading zone shall extend from:

$$R_{HL} = 169,545 \text{ mm to } R_{-13} = 163,748 \text{ mm}$$

It shall be erased. AC or DC erase may be used.

9.1.6 Index

9.1.6.1 Definition

The index is the point which defines the beginning and the end of a track. At the instant of having detected the index pattern (see 9.1.6.2), the index for each data track is under the corresponding read/write gap on its line of access.

9.1.6.2 Index pattern

The index pattern is the pulse sequence :

d d d d o d o d o d

In the servo zone "d" is a pair of dibits and "o" is an omitted pair of dibits (see Fig. 17). In the guard zones "d" is a single dibit and "o" is a single omitted dibit.

9.1.6.3 Index geometry

The index pattern shall be recorded on all servo tracks from -12,5 to 428,5. All corresponding dibits shall coincide in the X-direction on the line of access (Fig. 13).

9.2 Measurement Conditions

9.2.1 Rotational speed

The rotational speed shall be (3600 ± 72) rpm. For the timing measurements (see 9.3.1) a rotational speed of (3600 ± 36) rpm is required.

9.2.2 Environmental conditions

Before measurements commence, the disk pack shall be conditioned for 24 hours in the same environment as that in which the test equipment is operating and shall be run on the drive used for measurements for at least 15 minutes.

The testing shall be conducted under following conditions:

Input air flow : $(6 \pm 1)\text{m}^3$ per minute

Air cleanliness : Class 100

RH : 40 % to 60 %

The pack input air temperature shall be $20\text{ }^{\circ}\text{C} \pm 3\text{ }^{\circ}\text{C}$. For the measurement of servo track locations, however, the air temperature (measured between disk surfaces # 9 and # 10, Fig. 7) shall be $20\text{ }^{\circ}\text{C} \pm 0,25\text{ }^{\circ}\text{C}$.

9.2.3 Requirements for the measurement spindle

The following measurements shall be taken with the disk pack measurement drive spindle revolving at (3600 ± 36) rpm. The measurements in 9.2.3.3 and 9.2.3.4 are made with a high frequency cutoff defined by the point of intersection of the flat response and high frequency asymptote at 2200 Hz and a high frequency attenuation rate of 18 dB per octave.

9.2.3.1 Radial runout

The total indicated radial runout measured where the spindle contacts the hub flexure shall not exceed 0,635 μm .

9.2.3.2 Axial runout

The total indicated axial runout shall not exceed 1,27 μm .

9.2.3.3 Acceleration of radial runout

The acceleration of radial runout shall not exceed $\pm 12,7\text{ m/s}^2$.

9.2.3.4 Acceleration of axial runout

The acceleration of axial runout shall not exceed $\pm 12,7\text{ m/s}^2$.

9.2.4 Servo test head and read channel

The electrical termination of the servo test head shall be $480 \text{ Ohm} \pm 24 \text{ Ohm}$ in parallel with $90 \text{ pF} \pm 5 \text{ pF}$, including the pre-amplifier input impedance and all other stray and external impedances.

The read channel shall have a frequency response flat within $\pm 3 \text{ dB}$ and a phase shift within $\pm 7,5 \text{ degree}$ from 250 kHz to 600 kHz .

The servo AGC-amplifier shall produce an output voltage constant within $\pm 1 \%$ for input voltages from $0,3 \text{ mV}$ to $10,0 \text{ mV}$. The response time of the AGC-amplifier shall be 300 us . The gain to produce the AGC reference level V_{SAGC} shall be based upon the average of the preceding 250 2-byte intervals.

9.2.5 Servo track average amplitude V_{STA}

The track average amplitude V_{STA} is the average of the peak-to-peak values of the signals over one revolution of the disk measured at the output of the servo test head when electrically loaded as in 9.2.4.

9.3 Standard Reference Servo Surface

9.3.1 Characteristics

The standard reference servo surface shall be characterized at the innermost and outermost servo tracking positions as well as at the inner and outer guard zones.

When recorded with the servo pattern shown in Fig. 14 and Fig. 18 using a servo test head, the V_{STA} shall be :

3,3 mV at track # 000
2,1 mV at track # 410
6,6 mV at track # -006 (outer guard zone)
4,2 mV at track # 416 (inner guard zone)

The time interval between the 50% V_{SAGC} levels of the two pulses of one dibit (T_1 to T_2 and T_3 to T_0 in figure 18) shall be 330 ns .

9.3.2 Secondary Standard Reference Servo Surface

This is a surface whose output is related to the Standard Reference Servo Surface via a calibration factor C_{SD} .

The calibration factor C_{SD} is defined as

$$C_{SD} = \frac{\text{Standard Reference Servo Surface output}}{\text{Secondary Standard Reference Servo Surface output}}$$

To qualify as a Secondary Standard Reference Servo Surface :

- the calibration factor C_{SD} for such disks shall satisfy
 $0,90 \leq C_{SD} \leq 1,10$ at the measured tracks,
- the dibit pulse width (T_1 to T_2 and T_3 to T_0 in figure 18) shall be 330 ± 20 ns.

9.4 Servo Test Head

9.4.1 Description

Disk measurements shall be taken with a suitable test head. The test head shall be calibrated to the Standard Reference Servo Surface.

9.4.2 Calibration factor

The calibration factor C_{SH} shall satisfy $0,90 \leq C_{SH} \leq 1,10$.

C_{SH} is defined by

$$C_{SH} = \frac{\text{Standard Reference Servo Surface output}}{\text{Servo test head output}}$$

when measured on a Standard Reference Servo Surface, or by

$$C_{SH} = \frac{\text{Standard Reference Servo Surface output}}{(\text{Servo test head output}) \cdot C_{SD}}$$

when measured on a Secondary Standard Reference Servo Surface.

9.4.3 Dibit pulse width

The time interval between the 50 % V_{SAGC} levels or the two pulses of one dibit (T_1 to T_2 and T_3 to T_0 in figure 18) shall be 330 ± 40 ns when measured on a Standard Reference Servo Surface.

9.4.4 Test circuit

The servo test head amplitude calibration and dibit pulse width tests shall be conducted using the read channel described in 9.2.4.

9.4.5 Gap width

The width of the read gap (measured optically) shall be
130 um \pm 2,5 um.

9.4.6 Gap length

The length of the read gap shall be
2,54 um \pm 0,63 um.

9.4.7 Offset angle

The offset angle between the read gap and the line of
access shall be $0^{\circ} \pm 30'$.

9.4.8 Flying height

When flying over track # 410, the test head shall have a
flying height at the gap of
1,14 um \pm 0,05 um.

9.4.9 Inductance

The total head inductance shall be 9,5 uH \pm 0,02 uH
measured in air at 1 MHz.

9.4.10 Resonant frequency

When measured at the head cable connector, the resonant
frequency of the head shall be 12,5 MHz \pm 0,5 MHz.

9.5 Servo Surface Signal Requirements

9.5.1 Servo signal timing

Fig. 18 shows the servo signal with the servo head in the
servo tracking centreline position. All measurements shall
be made at 50 % of the VSAGC.

9.5.1.1 Time intervals

The time of each 2-byte interval shall be :

time interval : T_1 to next T_1 = 2480 ns \pm 80 ns.

The time of each byte interval shall be :

time interval : T_1 to T_3 = 1240 ns \pm 80 ns

and

time interval : T_3 to T_1 = 1240 ns \pm 80 ns.

The time between the 2 pulses of one dibit shall be :

time interval : T_1 to T_2 = 330 ns \pm 80 ns

and

time interval : T_3 to T_0 = 330 ns \pm 80 ns.

9.5.1.2 Cumulative timing errors

Eight consecutive dibits shall be such that the algebraic sum of the timing differences between their actual positions (T_1 , T_3) and their predicted positions does not exceed 100 ns. The predicted positions shall be based on the average of 100 intervals immediately preceding the eight dibits being examined.

9.5.1.3 Guard zones timing

The dibits of two adjacent servo tracks within the guard zones shall coincide with each other within 150 ns.

9.5.2 Servo signal amplitude requirements

9.5.2.1 Average amplitude in servo zones

The maximum V_{STA} corrected by C_{SH} measured at the servo test head shall be 4,6 mV at track # 000 and 3,0 mV at track # 410.

The corresponding minimum amplitude shall be 2,0 mV at track # 000 and 1,2 mV at track # 410.

9.5.2.2 Average amplitude in guard zones

The V_{STA} corrected by C_{SH} measured at the servo test head shall be between 2,4 mV and 6,0 mV in the inner guard zone and between 4,0 mV and 9,2 mV in the outer guard zone.

However, these limits may be violated per periods up to 25 us. Such periods must be separated by at least 1 ms.

9.5.2.3 Leading pulse amplitude

The amplitude of the leading pulses of the dibits in a servo zone shall not exceed 125 % of V_{SAGC} . The amplitudes shall be measured after the servo AGC-amplifier.

9.5.2.4 Missing dibits

If the leading pulse amplitude of a dibit in the servo zone is less than 80 % of V_{SAGC} , this dibit is considered missing. Missing dibits shall not occur :

- i) in consecutive 2-byte intervals,
- ii) in the index pattern (see figure 17),
- iii) in more than 4 non-consecutive 2-byte intervals per servo tracking centreline.

9.5.3 Servo surface noise

9.5.3.1 Noise limits for two-byte intervals

Between the positive going pulses of the dibit pattern, read in the servo tracking centreline, no positive signal shall exceed 25 % of VSAGC for a time of $t_3 = 330$ ns and $t_4 = 930$ ns. (See fig. 18).

Between the negative going pulses of the dibit pattern, read in the servo tracking centreline, no negative signal shall exceed 25 % of VSAGC for a time of $t_5 = 930$ ns and $t_6 = 330$ ns. (See fig. 18).

Failure of any or all of the above testing during a 2-byte interval shall be considered one count of noise. On any servo tracking centreline the maximum allowed count is 4.

In any pair of consecutive 2-byte intervals the noise count shall not exceed 1.

9.5.3.2 Noise limits for the index pattern

Between the positive going pulses of the dibits adjacent to the omitted dibits of the index pattern no positive signal shall exceed 25 % of VSAGC for a time $t_7 = 3410$ ns. (See fig. 19).

Between the negative going pulses of the dibits adjacent to the omitted dibits of the index pattern no negative signal shall exceed 25 % of VSAGC for a time $t_8 = 2810$ ns. (See fig. 19).

9.5.3.3 Noise limits for head loading zone

Continuous noise shall not exceed 0,1 mV base-to-peak measured at the servo test head. Bursts of noise exceeding the continuous noise threshold shall have a maximum duration of 100 us and be separated from each other by at least 2 ms.

9.6 Servo Surface Track Locations

9.6.1 Spacing of servo tracking centrelines

The spacing between any two adjacent servo tracking centrelines (see 9.1.5.2) when measured along the line of access and averaged over one revolution at $20\text{ }^{\circ}\text{C} \pm 0,25\text{ }^{\circ}\text{C}$ shall be :

$$132,1\text{ }\mu\text{m} \pm 1,0\text{ }\mu\text{m}$$

9.6.2 Co-ordinates of the reference track

The co-ordinates of the centreline of data track # 245 at 20 °C shall be :

$$X_{245} = 129,487 \text{ mm} \pm 0,025 \text{ mm}$$

$$Y = 7,772 \text{ mm} \pm 0,051 \text{ mm}$$

9.6.3 Position of data tracks # 000 and # 410

The distance of the centrelines of data track # 000 and data track # 410 from that of data track # 245, measured along the line of access at 20 °C shall be :

$$X_0 - X_{245} = 32,360 \text{ mm} \pm 0,051 \text{ mm}$$

$$X_{245} - X_{410} = 21,793 \text{ mm} \pm 0,025 \text{ mm}$$

9.6.4 Runout of the servo tracking centrelines

The runout of the servo tracking centrelines shall not exceed 7,6 um (total indicator reading).

9.6.5 Index pattern location

The corresponding dibits of the index patterns of all servo tracks shall pass the line of access within ± 80 ns.

SECTION IV

PRE-INITIALIZATION

10. DATA TRACK PRE-INITIALIZATION

10.1 General Requirements

10.1.1 Data write clock

The Data Write Clock shall be derived from the servo information prerecorded on the servo surface of the disk pack (see also 9), so that speed variation does not cause variation in bit recording density.

The nominal bit period shall be 155 ns, which is 0,125 of the nominal byte interval (see 9.5.1.1).

10.1.2 Mode of recording

The mode of recording shall be Modified Frequency Modulation (MFM), where only one magnetic flux reversal is written for one data bit. Consequently 159 flux reversals per mm can produce 159 bpmm. For a bit pattern consisting of 00000, every bit cell starts with a clock transition. This clock transition is only written between two consecutive ZERO data bits. If a ZERO data bit follows a ONE data bit, the clock transition is missing. For a bit pattern consisting of 11111, only one data transition is written in the middle of every bit cell. Therefore the highest frequency of recording occurs for 11111 - only data transitions - or for 00000 - only clock transitions. All the other bit-combinations occur at lower frequencies. For a bit pattern consisting of 10101, only data transitions are written with half frequency of the nominal data write clock since the clock transitions for the ZERO bits are missing.

10.1.3 Index

The Index is the point which defines the beginning and the end of a track (see also 9.1.6).

10.1.4 Byte

A byte is a group of eight bit-positions along a track numbered B1 to B8 in order of recording.



Direction of recording: →

Direction of movement : ←

The bit in each bit-position is a ZERO or a ONE.

10.1.5 Hexadecimal notation

Hexadecimal notation is used to denote a number of bytes :

(00) for (B8 to B1) = 0000 0000

(01) for (B8 to B1) = 0000 0001

(08) for (B8 to B1) = 0000 1000

(12) for (B8 to B1) = 0001 0010

(19) for (B8 to B1) = 0001 1001

(FF) for (B8 to B1) = 1111 1111

10.1.6 Error correcting code (ECC)

This data checking method is capable of detecting single bursts of all errors up to 22 bits in length and correcting single bursts of errors up to 11 bits in length. The 7 ECC-bytes are hardware generated by shifting serially the relevant bits, specified later through a 56-bit shift register described by the generator polynomial :

$$X^{56} + X^{55} + X^{49} + X^{45} + X^{41} + X^{39} + X^{38} + X^{37} + X^{36} + X^{31} + X^{22} + X^{19} + X^{17} + X^{16} + X^{15} + X^{14} + X^{12} + X^{11} + X^9 + X^5 + X^1 + 1$$

They are appended to each part of the track (i.e. Home Address, Count and Data Block of Record 0) written on the disk pack (Appendix III).

10.1.6.1 Correctable errors

An error is correctable, when the detected erroneous bits are within a part of the track subjected to ECC checking (10.3) (i.e. Home Address, Count and Data Block of Record 0) and when the error extends over at most 11 consecutive bits.

10.1.6.2 Uncorrectable errors

An error is uncorrectable, when the detected erroneous bits are within a part of the track not subjected to ECC checking (10.3) or when the error extends over more than 11 consecutive bits.

10.2 Track Layout of an Initialized Data Track

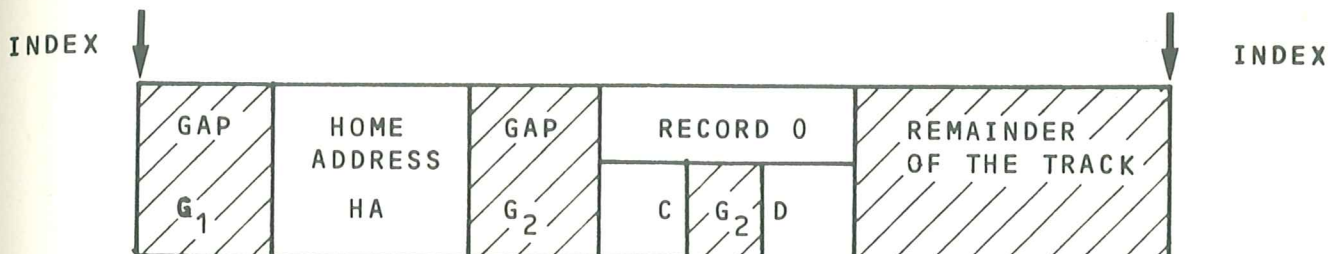

The different parts of this layout are:

10.2.1 Gap

A Gap is the space between the different fields of the track.

10.2.2 Home Address (HA)

The Home Address shall contain information which defines the physical location and characteristics of a track.

10.2.3 Record Zero

Record 0 shall be the only record on the track. On cylinders 000 to 403 it shall contain information to allocate alternative tracks, if any. On cylinders 404 to 410 it shall contain information to allocate the corresponding defective tracks, if any.

10.3 Detailed Description of an Initialized Data Track

10.3.1 Index Gap (G₁)

This is a gap preceding the Home Address. At writing, 83 (00)-bytes shall be recorded with no tolerance from Index up to the start of the Home Address.

10.3.2 Home Address

The Home Address shall comprise 24 bytes. As a result of interchange the start of the Home Address shall be located 83 ± 2 bytes from the Index when reading, due to alignment tolerances of the read-write heads with regard to the servo head.

The structure of the Home Address shall be:

SYNCHRONIZATION		PA	F	C	H	ECC	END
7 Bytes (00)	2 Bytes (19)	2 Bytes	1 Byte	2 Bytes	2 Bytes	7 Bytes	1 Byte (FF)

10.3.2.1 Synchronization

This field shall comprise:

- 7 (00)-bytes
- 2 (19)-bytes

These two (19)-bytes serve to recognize the start of the actual information.

10.3.2.2 Physical Address (PA)

This field shall comprise 2 bytes, it defines the physical address of the track. The significance of the bits in the bytes shall be:

The 1st byte indicates the low order cylinder address, i.e. it represents the numbers 0 to 255 in binary notation.

In the 2nd byte:

the bit in pos. B8 is always ZERO

the bit in pos. B7 indicates the high order cylinder address 256

the bit in pos. B6 is always ZERO

the bits in pos. B5 to B1 indicate the head addresses 0 to 18 in binary notation, the bit in pos. B5 being the most significant bit.

10.3.2.3 Flag (F)

This field shall comprise one single byte, it indicates defective and alternative tracks:

- the bits in pos. B8 to B3 are always ZERO
- the two-bit combinations in pos. B2, B1 have the following significance:

B2, B1	Cylinders	Meaning
00	000 - 403	Good original track
	404 - 410	Good unassigned alternative track
01	000 - 403	Shall not occur in these cylinders
	404 - 410	Good assigned alternative track
10	000 - 403	Defective original track, a good alternative track being assigned in one of cylinders 404 - 410
	404 - 410	Shall not occur in these cylinders
11	000 - 403	Shall not occur in these cylinders
	404 - 410	Defective track, no alternative track allocated

10.3.2.4 Cylinder (C)

This field shall comprise 2 bytes which specify in binary notation the address of the cylinder. The 1st byte shall contain the high order cylinder address 256. The bits in pos. B8 to B2 shall be ZERO. The bit in pos. B1 can be ZERO or ONE.

If the 1st byte is a (00)-byte, the 2nd byte represents in binary notation a value in the range 0 to 255. If the 1st byte is a (01)-byte the 2nd byte represents in binary notation a value in the range 0 to 154.

10.3.2.5 Head (H)

This field shall comprise two bytes, they specify the address of a track within a cylinder.

- the 1st byte is always a (00)-byte
- the 2nd byte represents in binary notation a value in the range 0 to 18.

10.3.2.6 Error correcting code (ECC)

These bytes shall be generated as defined in 10.1.6, using the bytes of HA beginning with the 2nd (19)-byte of the Synchronization field (10.3.2.1) and ending with the 2nd byte of the Head Address.

10.3.2.7 End of Home Address

The Home Address shall end with one (FF)-byte.

10.3.3 Intermediate gap (G₂)

A gap G₂ of 39 (00)-bytes shall be recorded between the Home Address and the start of the 1st field of Record 0.

10.3.4 Record 0

This field shall comprise three parts:

- the Count of Record 0
- a gap
- the Data Block of Record 0.

10.3.4.1 Count of Record 0 (CR)

This field shall comprise 28 bytes. It contains information which defines the physical location and characteristics of Record 0 or, for a defective track, the physical location of an allocated alternative track. For an alternative track, if assigned, this field contains the information defining the physical location of the defective track to which this alternative track is assigned.

SYNCHRONIZATION		PA	F	C and H	R	KL	DL	ECC	END
7 Bytes (00)	2 Bytes (19)	2 Bytes	1 Byte	4 Bytes	1 Byte (00)	1 Byte (00)	2 Bytes (00)(08)	7 Bytes	1 Byte (FF)

10.3.4.1.1 Synchronization

This part shall comprise the 9 bytes described in 10.3.2.1.

10.3.4.1.2 Physical address

This part shall comprise the 2 bytes described in 10.3.2.2.

10.3.4.1.3 Flag

This part shall comprise the byte described in 10.3.2.3.

10.3.4.1.4 Cylinder and Head

This part shall comprise the 4 bytes described in 10.3.2.4 and 10.3.2.5, but when appearing on defective or assigned alternative tracks:

- On a defective track in cylinders 000 to 403, C and H contain cylinder and head number of the alternative track which replaces it.
- On an assigned alternative track in cylinders 404 to 410, C and H contain cylinder and head number of the defective track which it replaces.

10.3.4.1.5 Record (R)

This part shall comprise one single (00)-byte. It identifies records on the track.

10.3.4.1.6 Key Length (KL)

This part shall comprise one single (00)-byte.

10.3.4.1.7 Data Length (DL)

This part shall specify the number of information bytes in the Data Block. It shall comprise two bytes, a (00)-byte and a (08)-byte.

10.3.4.1.8 Error correcting code (ECC)

This part shall comprise 7 bytes generated as defined in 10.1.6, using all the bytes of the Count of Record 0, beginning with the 2nd (19)-byte of the Synchronization field (10.3.4.1.1) and ending with the 2nd DL byte (10.3.4.1.7).

10.3.4.1.9 End of count

The Count of Record 0 shall end with one (FF)-byte.

10.3.4.2 Intermediate Gap (G₂)

A gap of 39 (00)-bytes shall be recorded between the end of the Count and the start of Data Block.

10.3.4.3 Data Block of Record 0

The Data Block comprises 25 bytes:

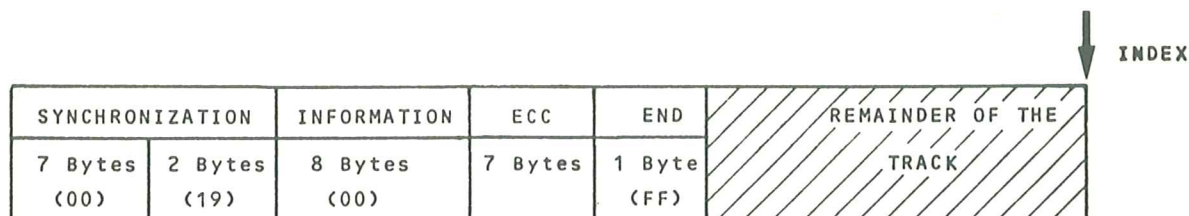

10.3.4.3.1 Synchronization

This part shall comprise the 9 bytes described in 10.3.2.1.

10.3.4.3.2 Information

This part shall comprise 8 (00)-bytes as specified in the DL part of the Count (10.3.4.1.7).

10.3.4.3.3 Error correcting code (ECC)

This part shall comprise 7 bytes generated as described in 10.1.6, using bytes of the Data Block starting with the 2nd (19)-byte of the Synchronization field (10.3.4.3.1) and ending with the last byte of the Information field (10.3.4.3.2).

10.3.4.3.4 End of the Data Block

The Data Block shall end with one (FF)-byte.

10.3.5 Remainder of the track

The remainder of the track up to the index shall be filled with approximately 13200 (00)-bytes.

10.3.6 Summary of pre-initialized Data Track

The above clauses can be summarized by the following drawing:

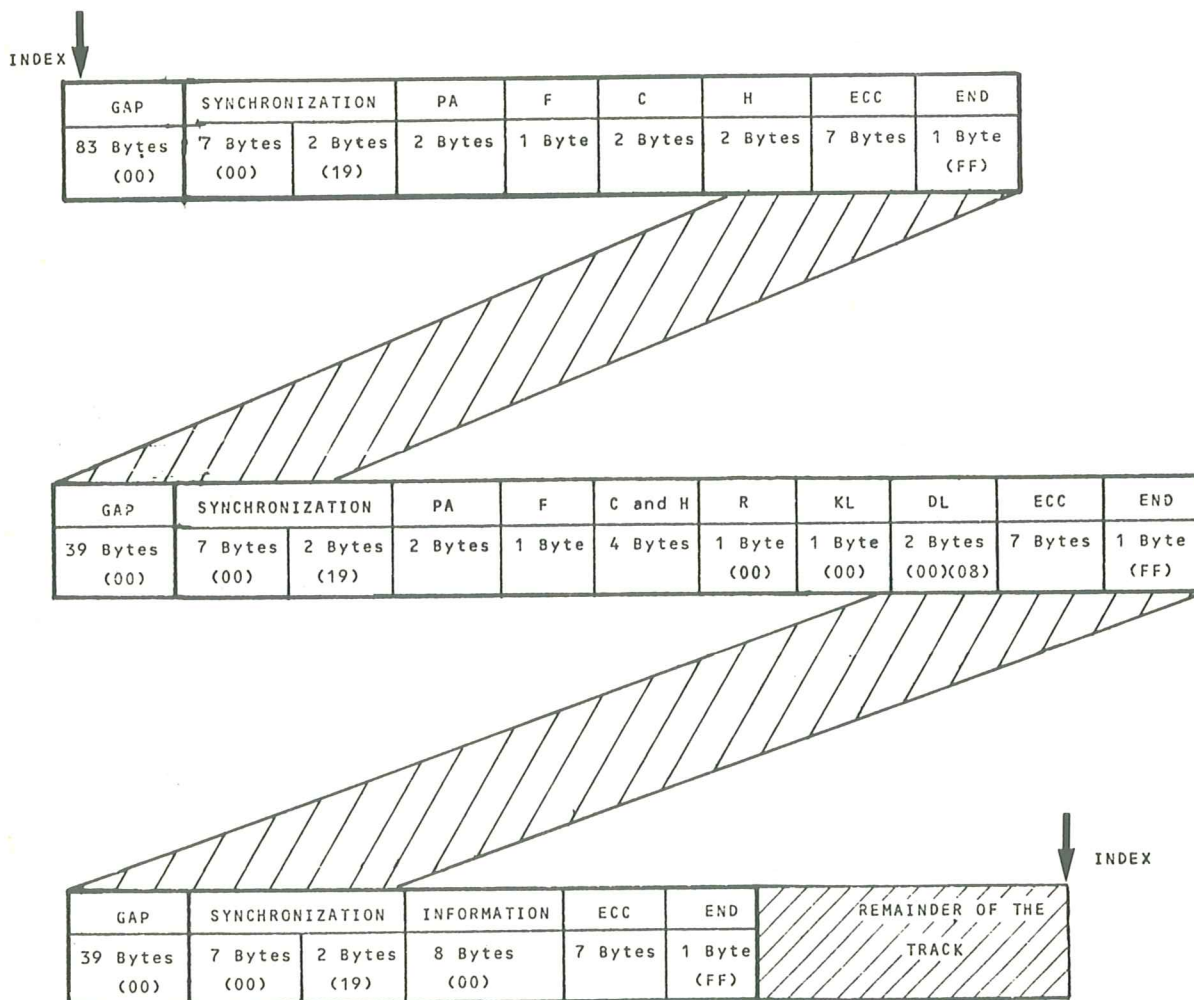

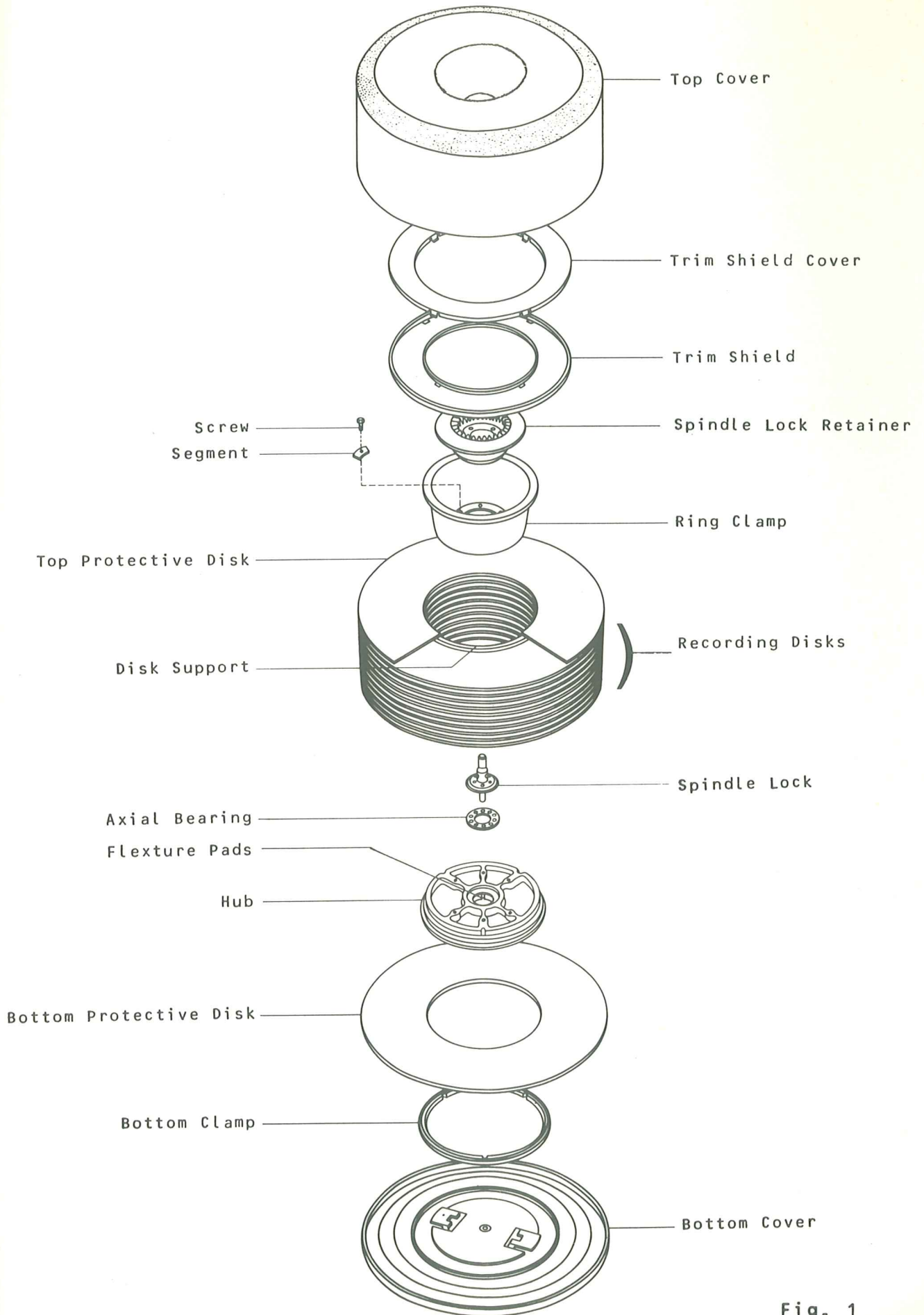

Fig. 1

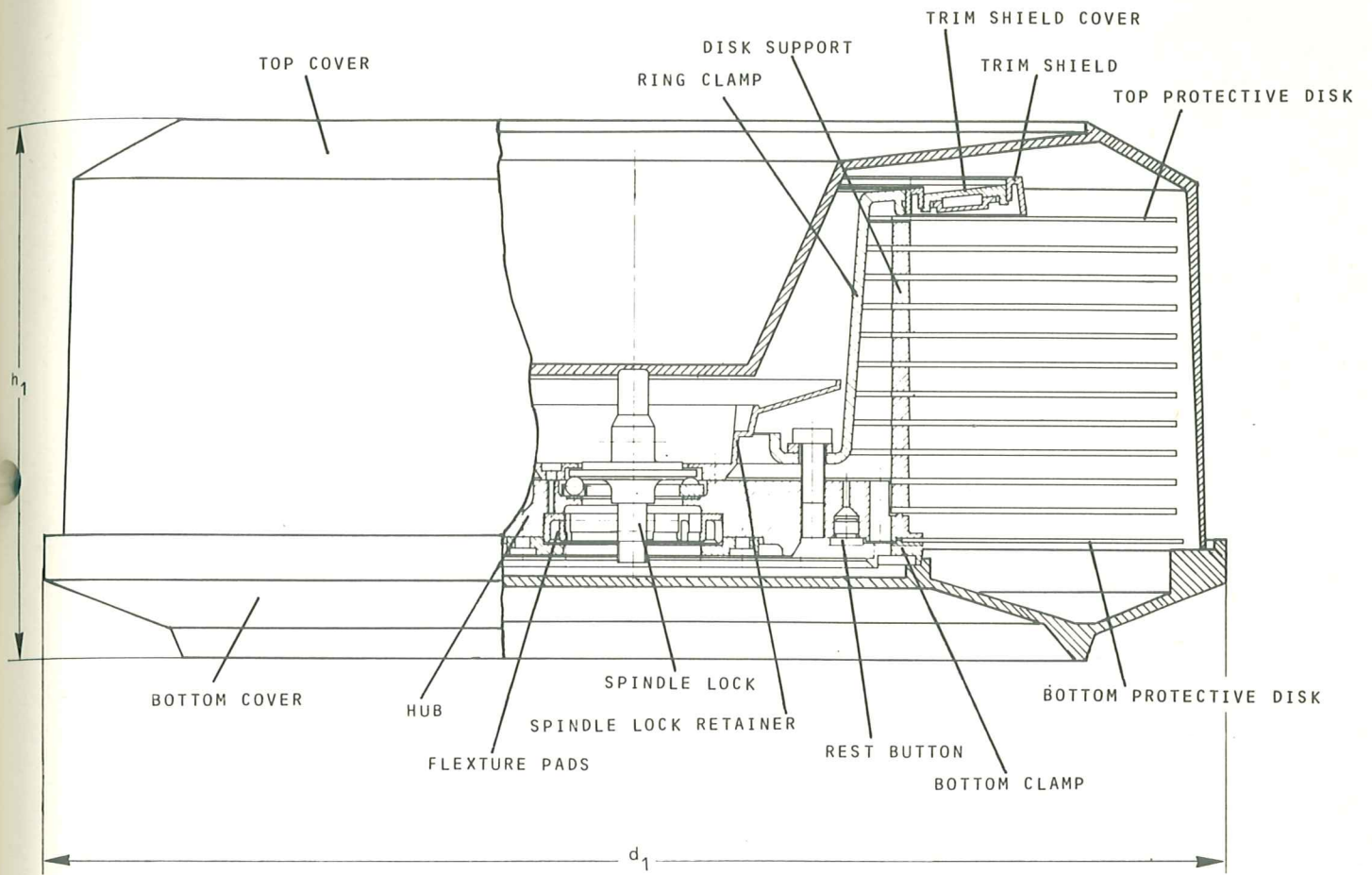

Fig. 2

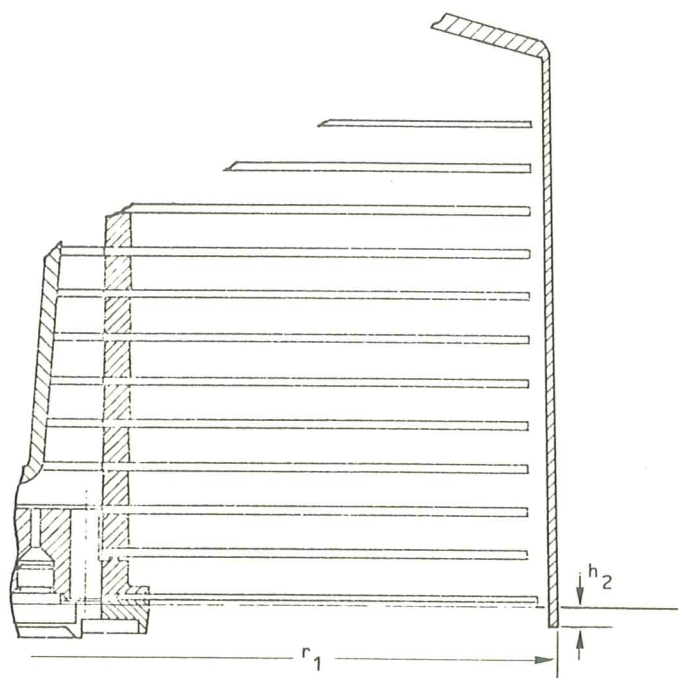

Fig. 3

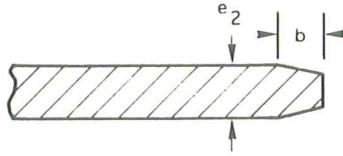

Fig. 6

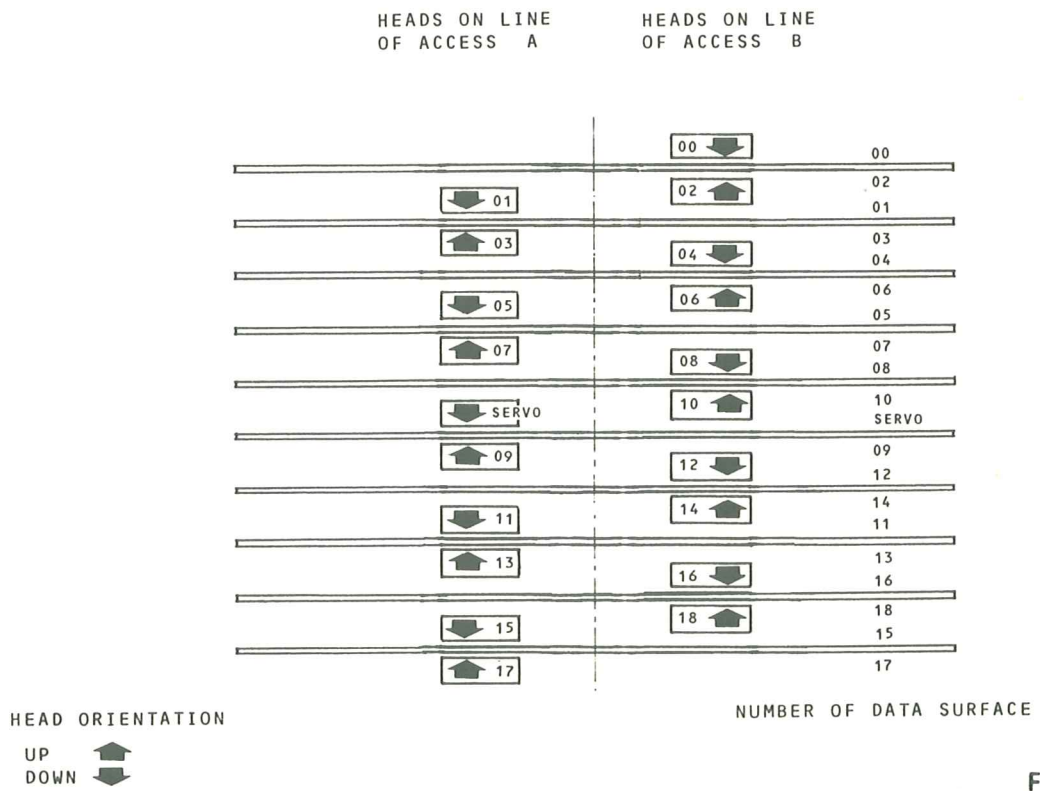

Fig. 7

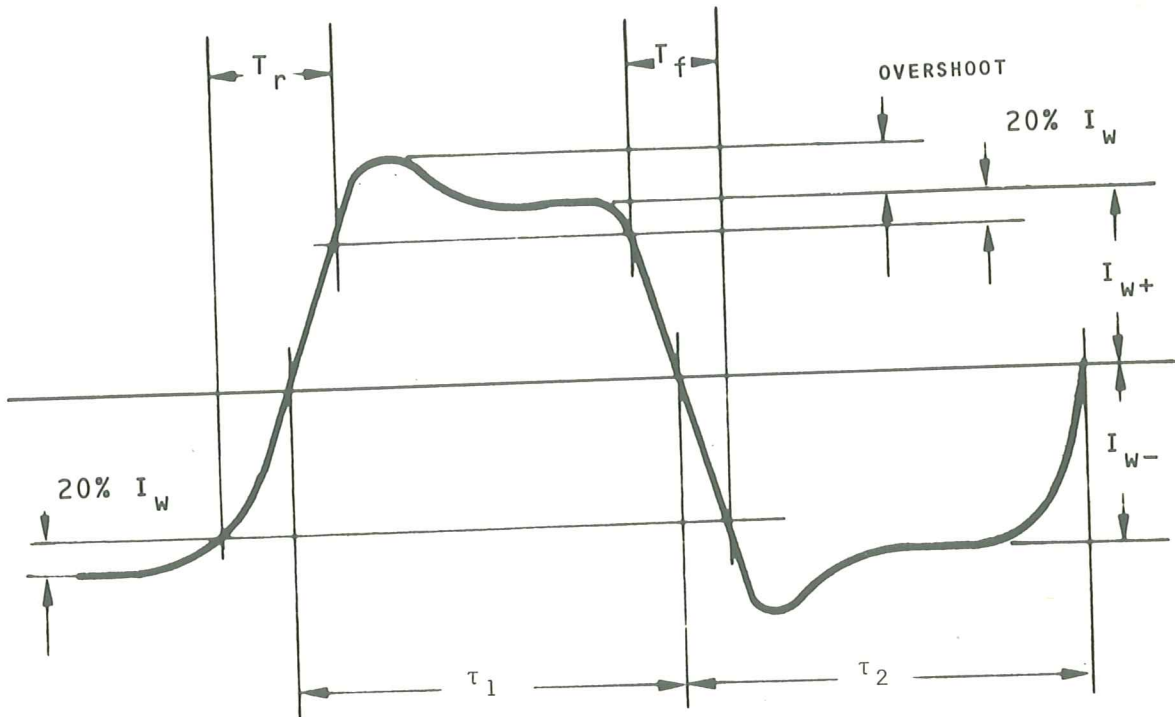

Fig. 8

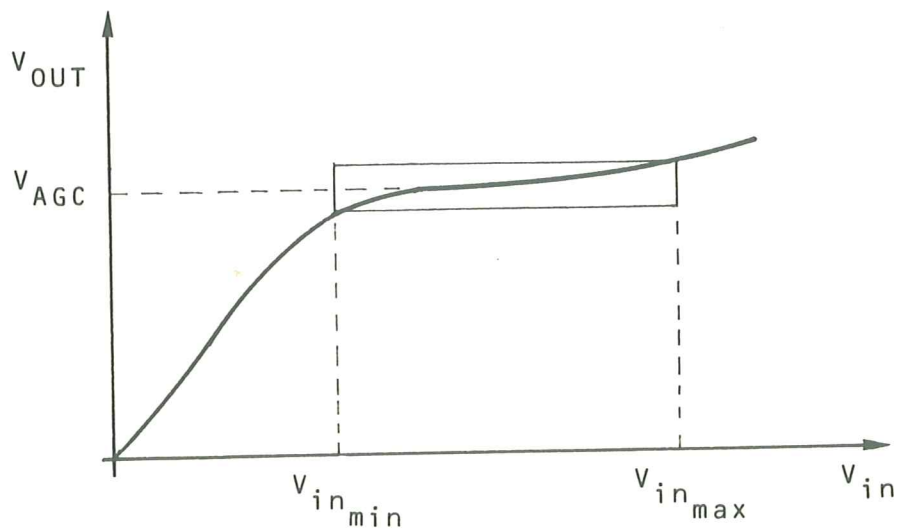

Fig. 9

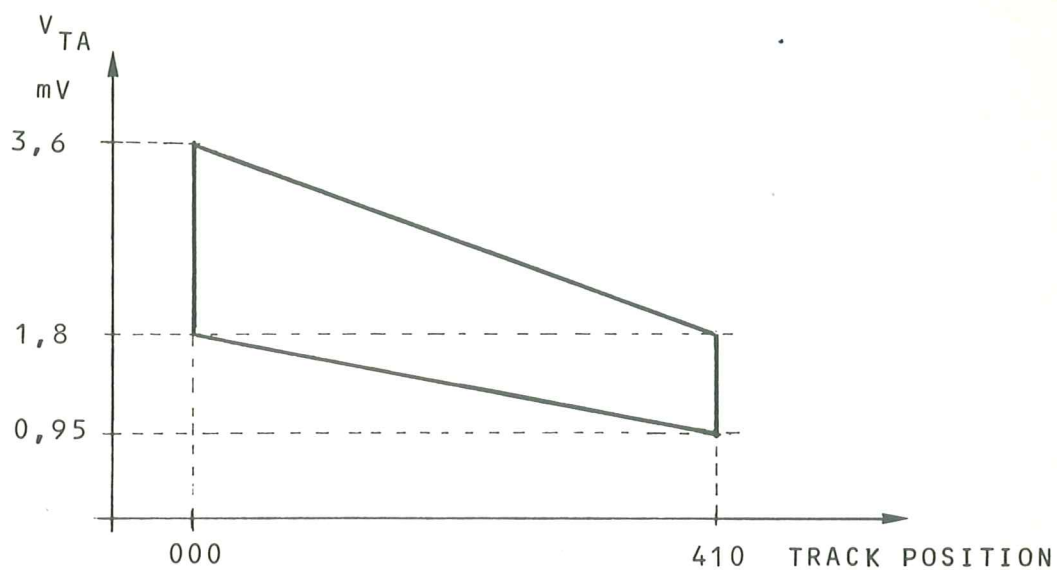

Fig. 10

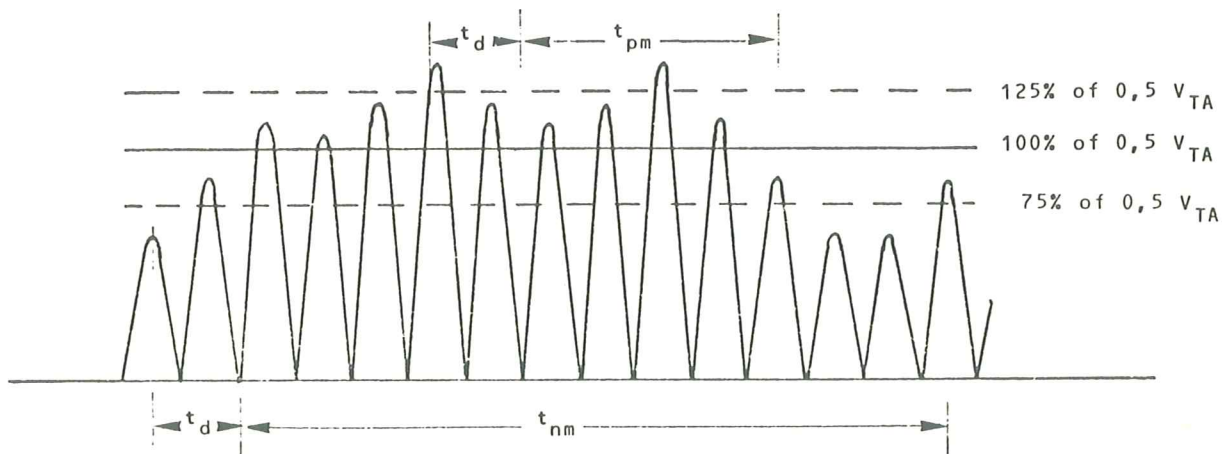

Fig. 11

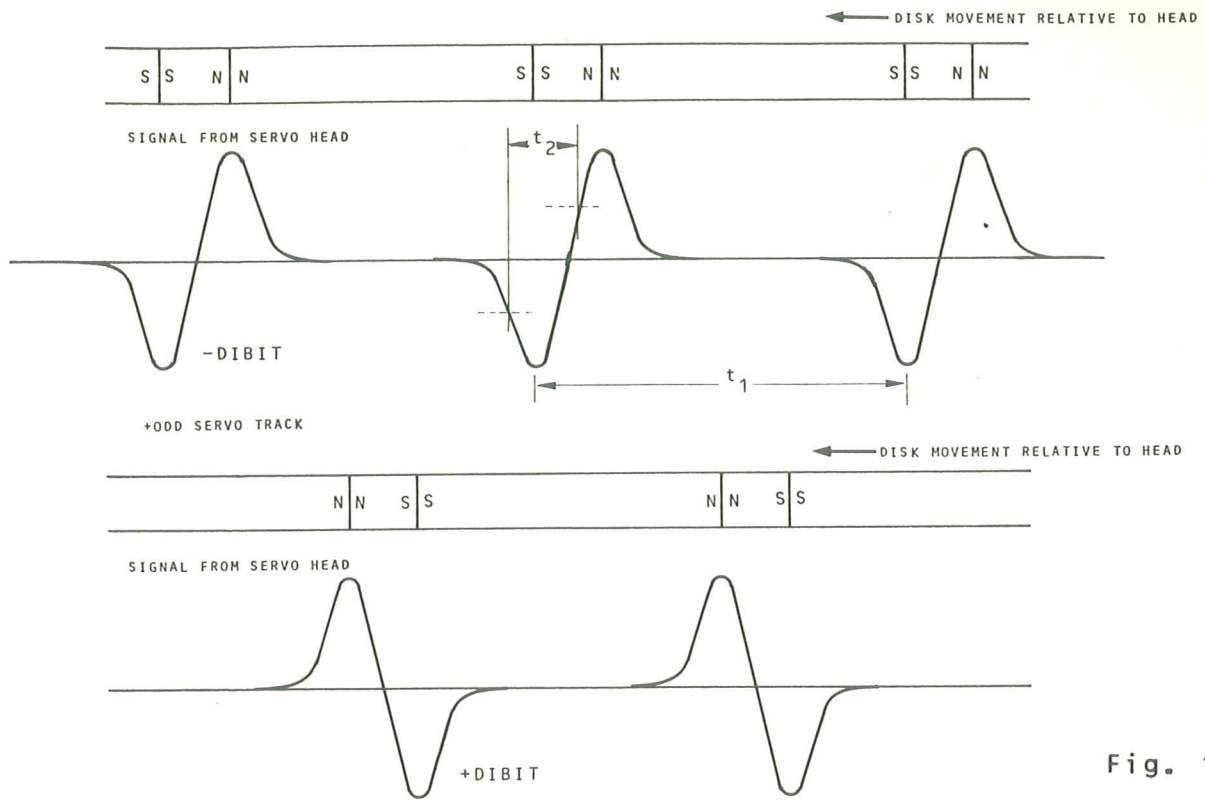

Fig. 12

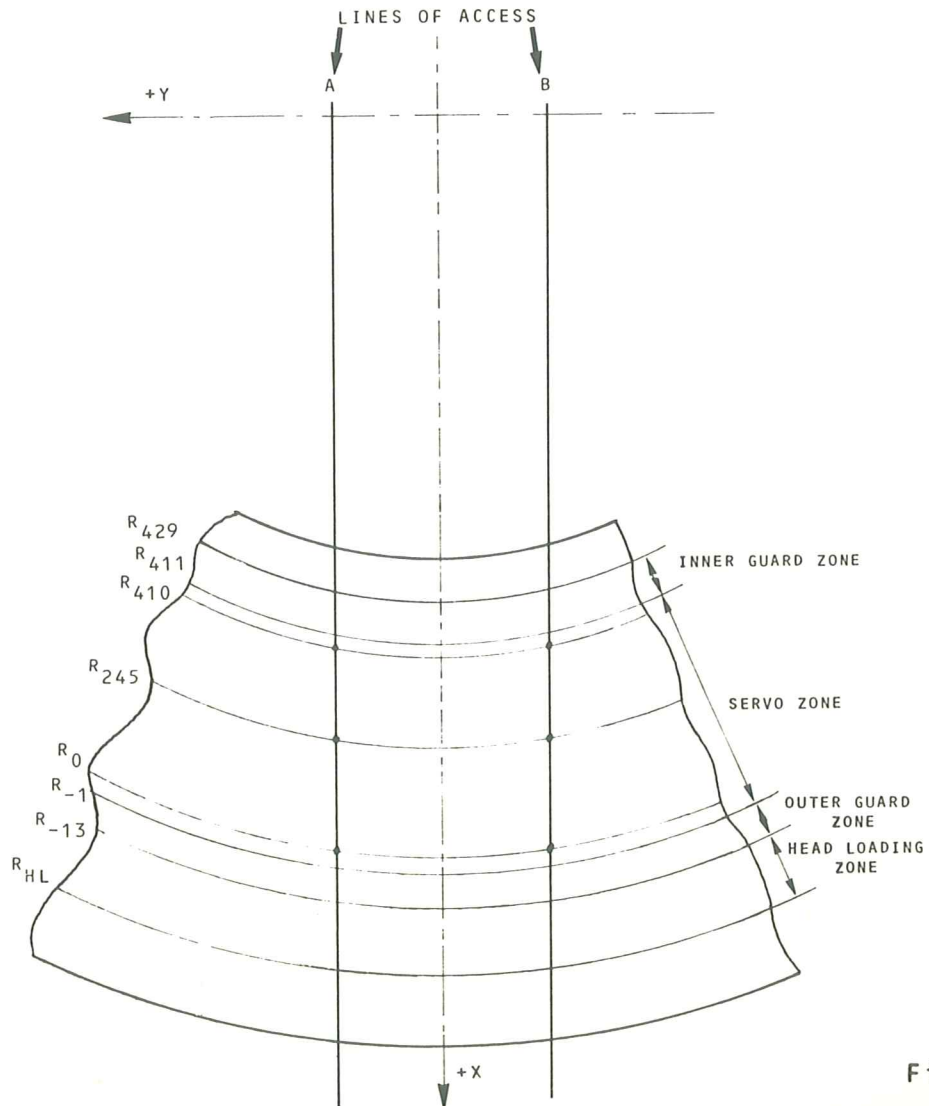

Fig. 13

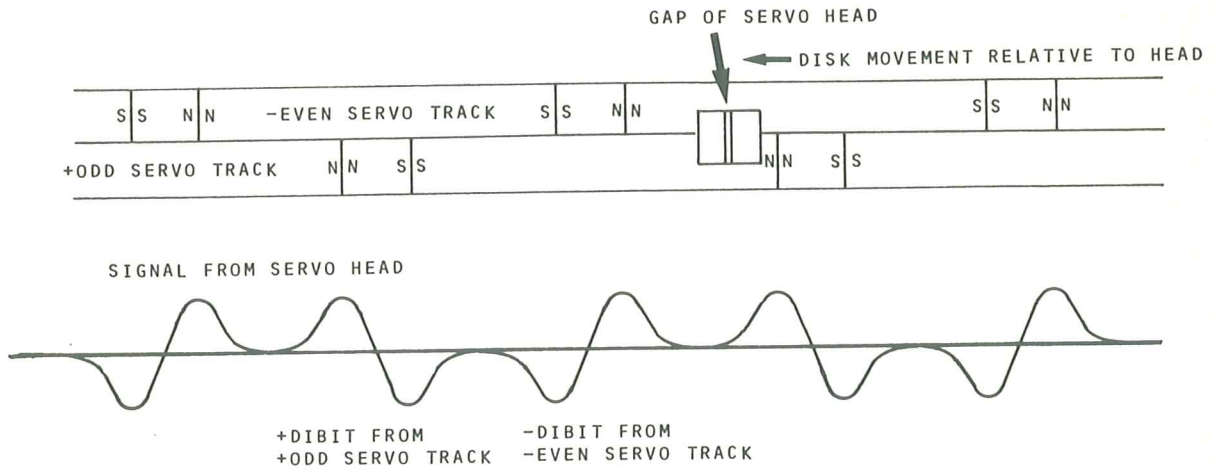

Fig. 14

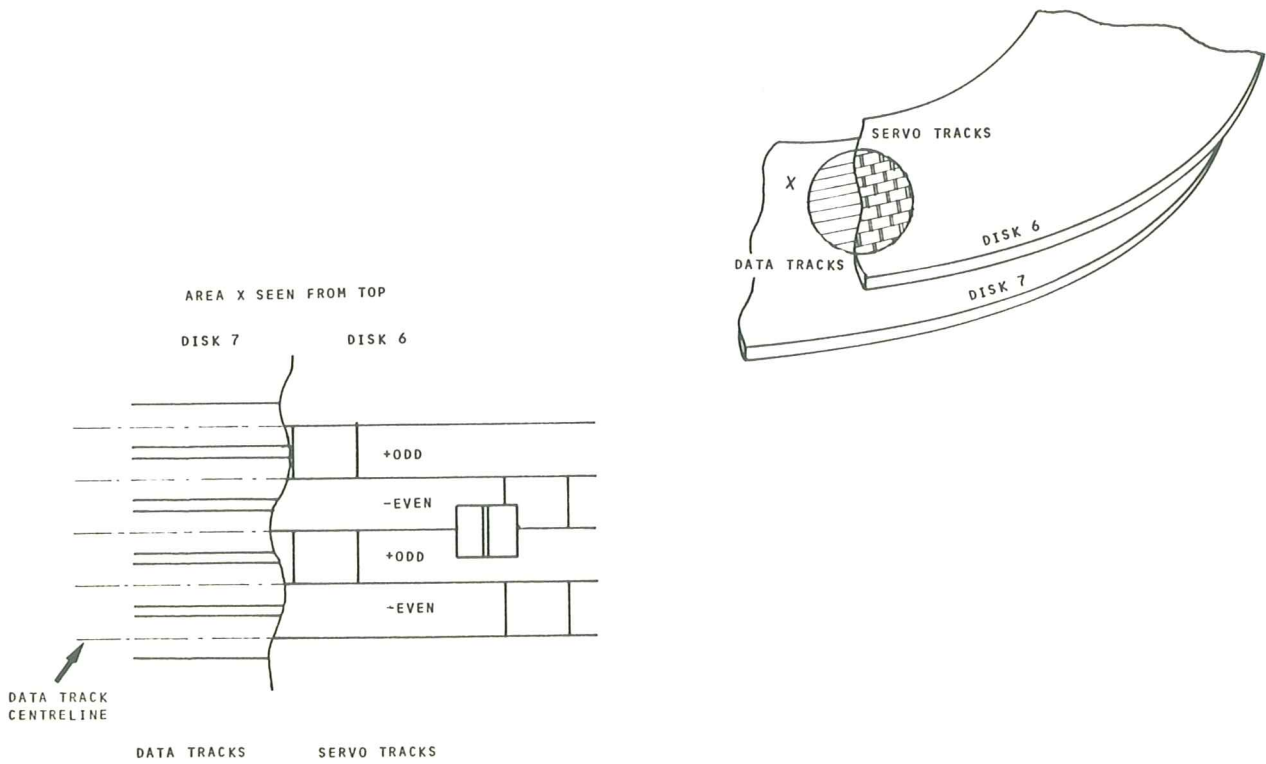

Fig. 15

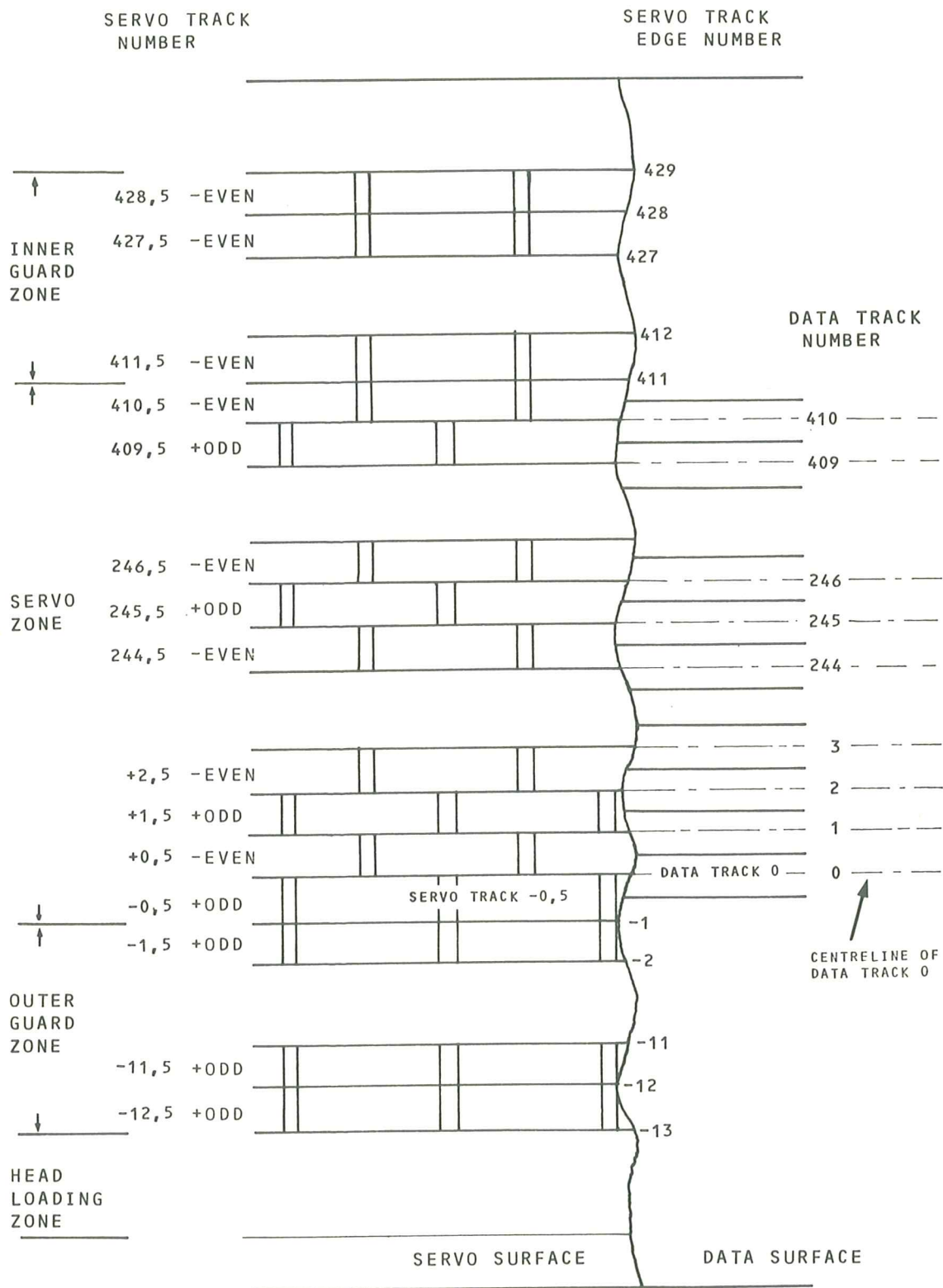

Fig. 16

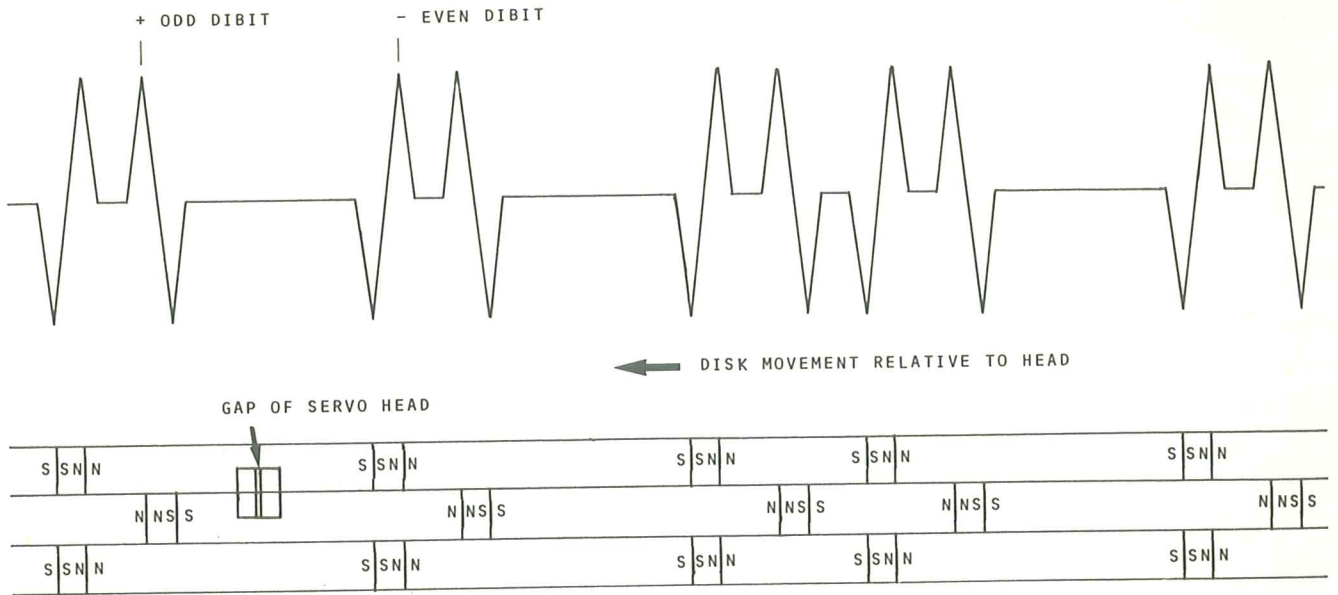

Fig. 17

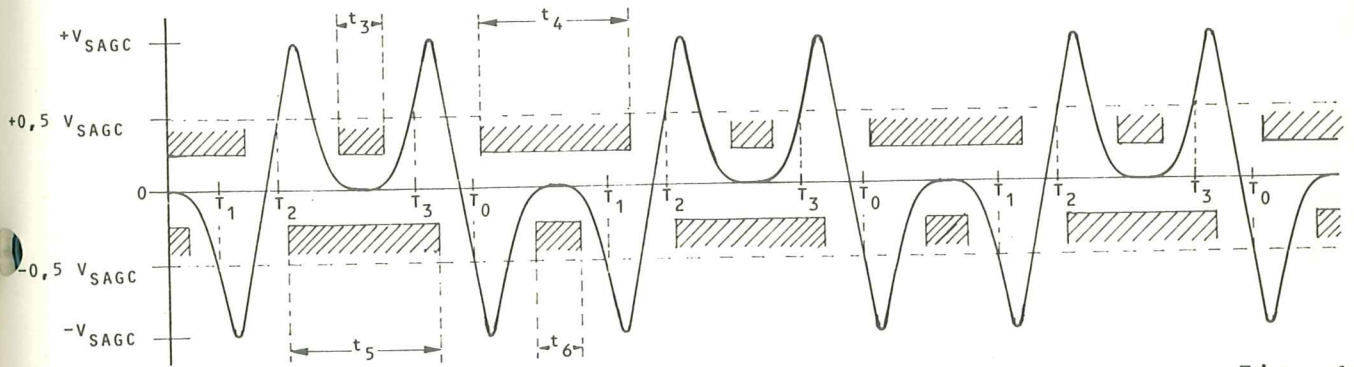

Fig. 18

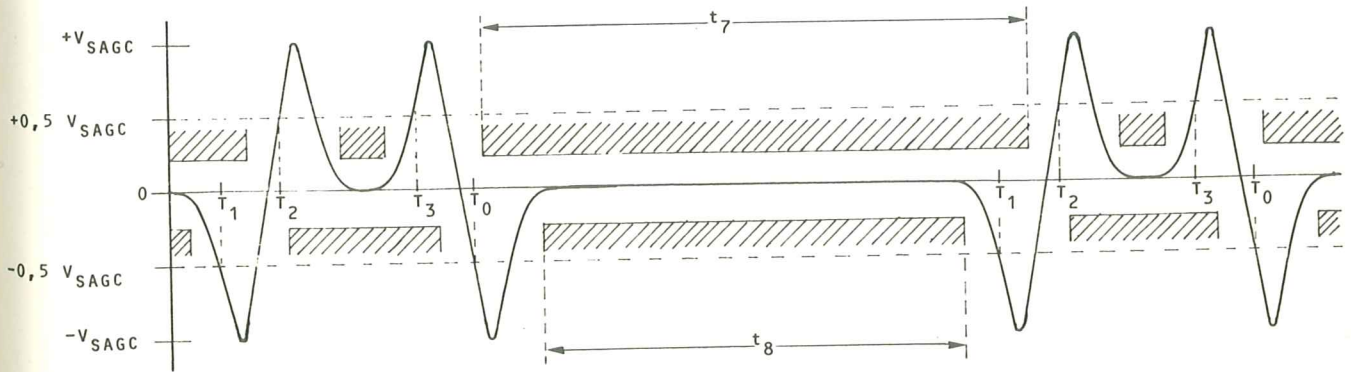

Fig. 19

APPENDIX I

AIR CLEANLINESS CLASS 100

Classification of air cleanliness is based on particle count with a maximum allowable number of specified minimum sized particles per unit volume and on statistical average particle size distribution.

Definition of Class 100 *

The particle count shall not exceed a total of 3,5 particles of size 0,5 um or larger per liter.

The statistical average particle size distribution is represented below. Class 100 means that 3,5 particles per liter of a size 0,5 um are allowed, but only 0,035 particles per liter of a size 4,0 um.

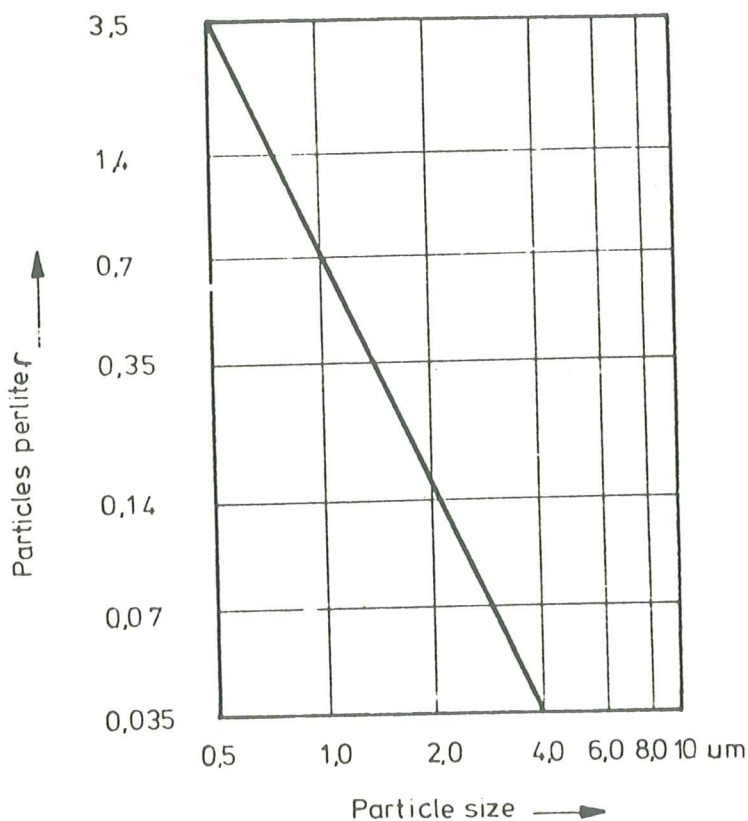

*) USA Federal Standard Fed. Std. No. 209 B, available from the General Services Administration, Specifications Activity, Printed Materials Supply Division, Building 197, Naval Weapons Plant, Washington, DC 20407, USA

It should be recognized that single sample distribution may deviate from this curve because of local or temporary conditions. Counts below 0,35 particles per liter are unreliable except when a large number of samplings is taken.

Test Method **)

For particles in the 0,5 to 5,0 μm size range, equipment employing light-scattering principles shall be used. The air in the controlled environment is sampled at a known flow rate. Particles contained in the sampled air are passed through an illuminated sensing zone in the optical chamber of the instrument. Light scattered by individual particles is received by a photodetector which converts the light pulses into electrical current pulses. An electronic system relates the pulse height to particle size and counts the pulses such that the number of particles in relation to particle size is registered or displayed.

**) American Society for Testing and Materials,
Standard ASTM F 50, 1916 Race St.,
Philadelphia, Pa 19103, USA

APPENDIX II

MEASUREMENT OF TRACK WIDTH

DC erase a 7-track wide band with track 400 in the centre of the band and write with 1F frequency in track 400 using the head to be tested, then read back.

The read back signal amplitude in this position is called 100 %. Then move the head along its line of access over the disk in increments not greater than 0,010 mm to the left or to the right of track 400 until the read back signal becomes zero. Determine the read back signal amplitude at each incremental move and plot the relative amplitude (Y axis) versus the displacement (X axis).

See diagram for reading track width.

The fringing of the curve at the low level end of the curve shall be ignored for determining the track width.

Relative Output

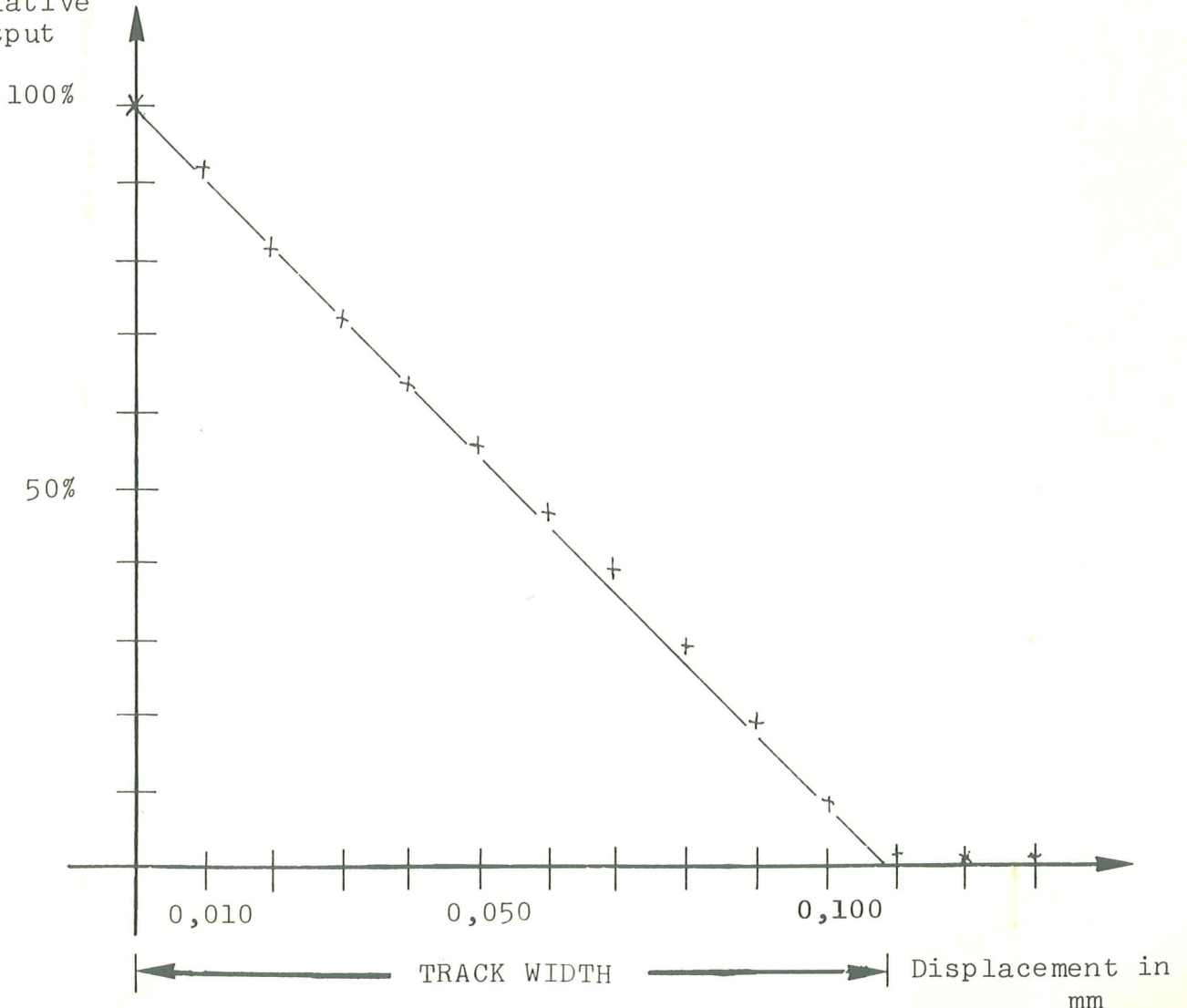

APPENDIX III

ECC IMPLEMENTATION

The following diagram shows the feedback connections of a 56-position shift register which may be used to generate the ECC bytes.

Prior to the operation, the shift register is set to ZERO. Input data is added (exclusive OR) to the contents of position 55 of the register to form a feedback.

This feedback is in its turn added (exclusive OR) to the contents of positions 0, 4, 8, 10, 11, 13, 14, 15, 16, 18, 21, 30, 35, 36, 37, 38, 40, 44, 48, 54.

On shifting, the outputs of the exclusive OR gates are entered respectively into positions 0, 4, 8 etc.

After the last data bit has been added the register is shifted once more as specified above.

The register then contains the ECC bytes.

If further shifting is to take place during the writing of the ECC bytes the control signal inhibits exclusive OR operations. To check for errors when reading, the data bits are entered into the shift register in exactly the same manner as they were during writing. After the data, the ECC bytes are also entered into the shift register as if they were data. After this operation the shift register contents will be all ZERO if the record does not contain errors.

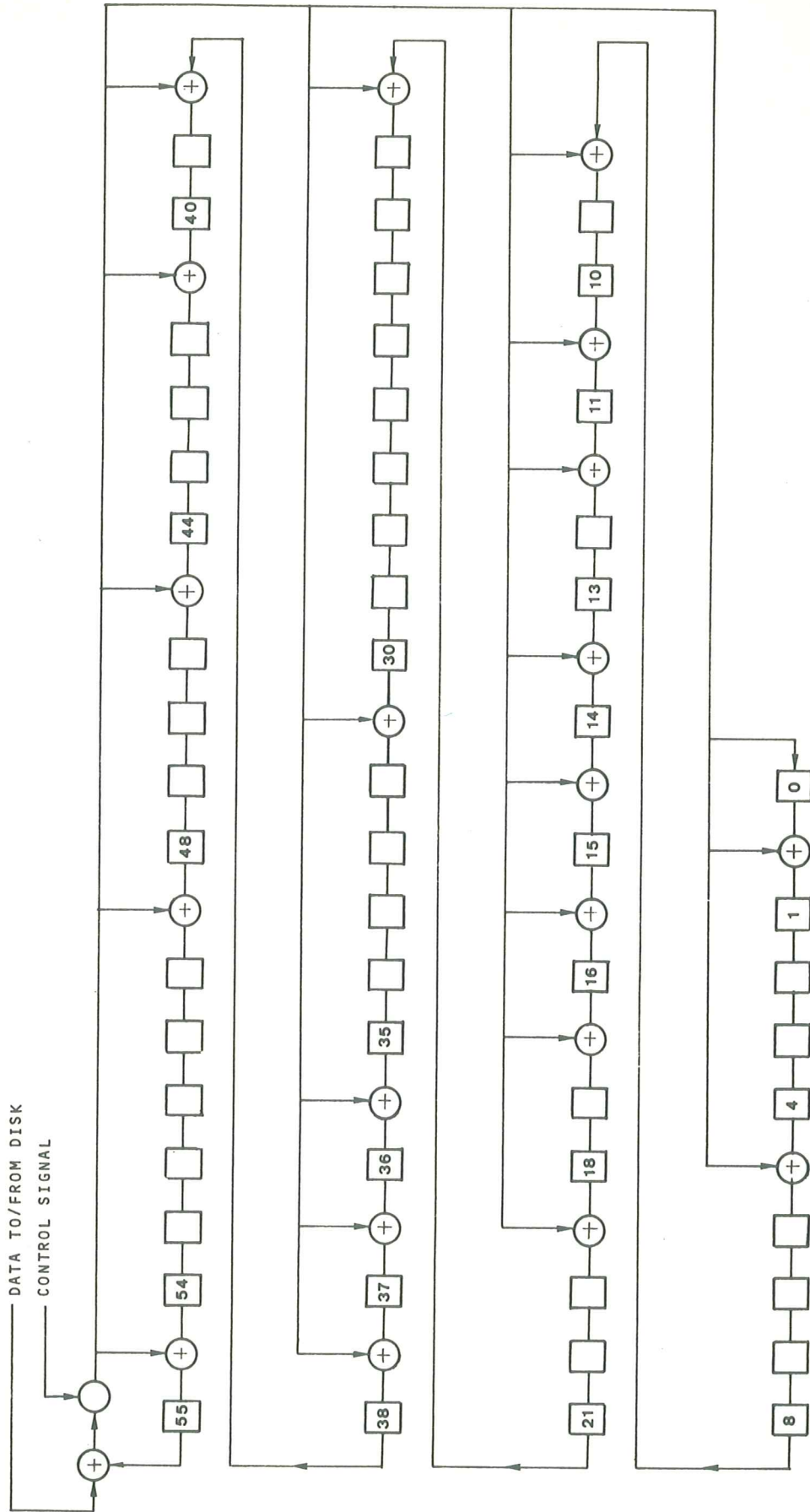

APPENDIX IV

GENERAL TRACK FORMAT

1. Scope

This Appendix defines the track format of a recorded disk pack used for data interchange purposes. Only the track format for a pre-initialized disk pack, as defined in Section IV of the Standard, is mandatory.

2. Representation of Characters

In the information fields of the records the characters shall be represented by means of the 7-bit Coded Character Set (Standard ECMA-6) and, where required, by its 7-bit or 8-bit extensions (Standard ECMA-35).

- 2.1 Each 7-bit coded character is recorded in bit positions B1 to B7 of a byte; bit position B8 is recorded with value ZERO.

The relationship is as follows :

Bits of the 7-bit combination	0	b ₇	b ₆	b ₅	b ₄	b ₃	b ₂	b ₁
Bit position in the byte	B8	B7	B6	B5	B4	B3	B2	B1

- 2.2 Each 8-bit coded character is recorded in bit positions B1 to B8 of a byte.

The relationship is as follows :

Bits of the 8-bit combination	b ₈	b ₇	b ₆	b ₅	b ₄	b ₃	b ₂	b ₁
Bit position in the byte	B8	B7	B6	B5	B4	B3	B2	B1

3. Error Correction

3.1 Error correcting code (ECC)

This data checking method is capable of detecting single bursts of all errors up to 22 bits in length and correcting single bursts of errors up to 11 bits in length. The 7 ECC-bytes are hardware generated by shifting serially the relevant bits, specified later for each part of the track through a 56-bit shift register described by the generator polynomial :

$$\begin{aligned}
 & X^{56} + X^{55} + X^{49} + X^{45} + X^{41} + X^{39} + X^{38} + X^{37} + X^{36} + X^{31} + \\
 & X^{22} + X^{19} + X^{17} + X^{16} + X^{15} + X^{14} + X^{12} + X^{11} + X^9 + X^5 + \\
 & X^1 + 1
 \end{aligned}$$

3.2 Correctable errors

An error is correctable, when the detected erroneous bits are within a part of the track subjected to ECC checking and when the error extends over at most 11 consecutive bits.

3.3 Uncorrectable errors

An error is uncorrectable, when the detected erroneous bits are within a part of the track not subjected to ECC checking or when the error extends over more than 11 consecutive bits.

4. Track Layout of a Recorded Disk Pack

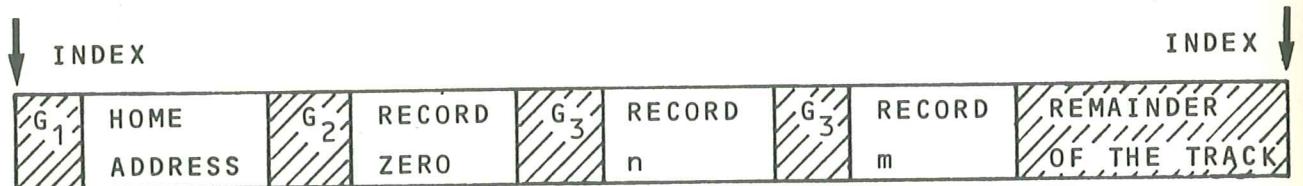

The different parts of this layout are :

4.1 The Pre-Initialization Part

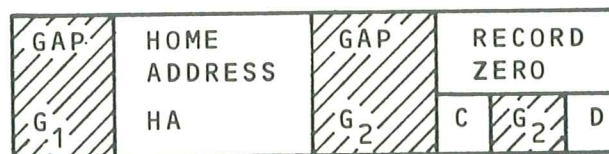

This part is described in Section IV of the Standard. However, when using the disk pack the following fields of the pre-initialization may be modified.

4.1.1 End-byte of the Home Address

This field is described in 10.3.2.7 of Section IV. Instead of (FF) it may take any value. It can be used to identify the disk drive on which the Home Address has been modified, e.g. in order to flag a defective track.

4.1.2 Data Length of Count of Record Zero

This field is described in 10.3.4.1.7 of Section IV of the Standard. It may take values other than (00) and (08) to accomodate other lengths of the Data Block.

4.1.3 End-byte of Count of Record Zero

This field is described in 10.3.4.1.9 of Section IV. Instead of (FF) it may take any value. It can be used to identify the disk drive on which the count of Record Zero has been modified.

4.1.4 Information of Data Block of Record Zero

This field is described in 10.3.4.3.2 of Section IV of the Standard. It shall comprise the number of bytes specified in the DL part of the Count (10.3.4.1.7 of Section IV). The data shall be coded according to 2. of this Appendix.

4.1.5 End-byte of Data Block of Record Zero

This field is described in 10.3.4.3.4 of Section IV. Instead of (FF) it may take any value. It can be used to identify the disk drive on which the Data Block of Record Zero has been modified.

4.2 Gap G₃

Before each record, but Record Zero, a gap G₃ of 41 (00)-bytes shall be written. It shall precede the Count (4.3.1) of each record.

These bytes may be subsequently become ill-defined due to the overwriting process.

4.3 Record n



The different parts of this layout are :

4.3.1 Count of Record n

AM	SYNCHRONIZATION	PA	F	C	H	R	KL	DL	ECC	END	
3 Bytes	12 Bytes (00)	2 Bytes (19)	2 Bytes	1 Byte	2 Bytes	2 Bytes	1 Byte	1 Byte	2 Bytes	7 Bytes	1 Byte

4.3.1.1 Address Mark (AM)

This field shall comprise 3 bytes of erased track (minimum 20 bit time-intervals).

4.3.1.2 Synchronization (SYN)

This field shall comprise :

- 12 (00)-bytes, to allow the data decoding system to synchronize onto known data,
- 2 (19)-bytes.

4.3.1.3 Physical Address (PA)

This field shall comprise 2 bytes, it defines the physical address of the track. The significance of the bits in the bytes shall be :

The 1st byte indicates the low order cylinder address, i.e. it represents the numbers 0 to 255 in binary notation.

In the 2nd byte :

- the bit in pos. B₈ is always ZERO
- the bit in pos. B₇ indicates the high order cylinder address 256
- the bit in pos. B₆ is always ZERO
- the bits in pos. B₅ to B₁ indicate the head addresses 0 to 18 in binary notation, the bit in pos. B₅ being the most significant bit.

4.3.1.4 Flag (F)

This field shall comprise one single byte, it indicates the track overflow and defective and alternative tracks :

- the bits in pos. B₃ and B₈ to B₅ are always ZERO,
- the bit in pos. B₄ shall be :

ONE, if the Information field of the record is extended onto the Data Block of the record immediately following Record Zero of the next track of the same cylinder,

ZERO, in all other cases.

- the two-bit combinations in pos. B₂ and B₁ shall have the following significance :

B2, B1	Cylinder	Meaning
00	000 - 403	Good original track
	404 - 410	Good unassigned alternative track
01	000 - 403	Shall not occur in these cylinders
	404 - 410	Good assigned alternative track

The combinations 10 and 11 shall not occur.

4.3.1.5 Cylinder (C)

This field shall comprise 2 bytes which specify in binary notation the address of the cylinder. The 1st byte shall contain the high order cylinder address 256. The bits in pos. B8 to B2 shall be ZERO. The bit in pos. B1 can be ZERO or ONE.

If the 1st byte is a (00)-byte, the 2nd byte represents in binary notation a value in the range 0 to 255. If the 1st byte is a (01)-byte the 2nd byte represents in binary notation a value in the range 0 to 154.

4.3.1.6 Head (H)

This field shall comprise two bytes, they specify the address of a track within a cylinder.

- the 1st byte is always a (00)-byte
- the 2nd byte represents in binary notation a value in the range 0 to 18.

4.3.1.7 Record (R)

This field shall comprise one single byte which is a binary number identifying each record on the track.

4.3.1.8 Key Length (KL)

This field shall comprise one single byte giving the length of the Information field (4.3.3.2) of the Key Block (4.3.3).

4.3.1.9 Data Length (DL)

This field shall comprise two bytes giving the number of bytes of the Information field (4.3.5.2) of the Data Block (4.3.5).

4.3.1.10 Error Correcting Code (ECC)

This field comprises 7 bytes described in 3.1, using bytes of the Count of Record n beginning with the second (19)-byte of the Synchronization field and ending with the 2nd DL byte.

4.3.1.11 End of Count

This field shall comprise one single byte. It may be used to identify the disk drive writing the record.

4.3.2 Intermediate Gap G2 after the Count

An intermediate gap G2 of 39 (00)-bytes shall be recorded after the End-byte of the Count. It precedes the Key Block if this field is present. (See also 4.3.3). If there is no Key Block, it precedes then the Data Block.

These bytes may subsequently become ill-defined due to the overwriting process.

4.3.3 Key Block

This field is present if and only if the byte in KL (4.3.1.8) is not a (00)-byte. A Key Block shall have the following layout:

SYNCHRONIZATION		INFORMATION	ECC	END
7 Bytes	2 Bytes	255 Bytes	7 Bytes	1 Byte
(00)	(19)	max.		

4.3.3.1 Synchronization

This field shall comprise 9 bytes as described in 4.3.1.2.

4.3.3.2 Information

This field shall comprise a number of information bytes equal to that indicated by KL (4.3.1.8), but at most 255 bytes. The data shall be coded according to 2. of this Appendix.

4.3.3.3 Error Correcting Code (ECC)

This field comprises 7 bytes as described in 3.1 using bytes of the Key Block starting with the second (19)-byte of the Synchronization field and ending with the last byte of the Information field.

4.3.3.4 End of Key Block (END)

This field shall comprise one single byte. It may be used to identify the disk drive used for writing the record.

4.3.4 Intermediate Gap G2 between Key Block and Data Block

When the byte in KL (4.3.1.8) is not a (00)-byte a further gap G2 of 39 (00)-bytes shall be recorded between the Key Block and the Data Block (4.3.5).

These bytes may subsequently become ill-defined due to the overwriting process.

4.3.5 Data Block

This field shall have the following layout :

SYNCHRONIZATION		INFORMATION	ECC	END
7 Bytes (00)	2 Bytes (19)		7 Bytes	1 Byte

4.3.5.1 Synchronization

This field shall comprise 9 bytes as described in 4.3.1.2.

4.3.5.2 Information

This field shall comprise a number of information bytes equal to the number indicated by DL (4.3.1.9). The data shall be coded according to 2. of this Appendix.

If DL comprises two (00)-bytes, then one single (00)-byte shall be written in this field. It then indicates the end of the file.

4.3.5.3 Error Correcting Code (ECC)

This field shall comprise 7 bytes as described in 3.1 using the bytes of the Data Block starting with the 2nd (19)-byte of Synchronization and ending with the last byte of the Information field.

4.3.5.4 End of Data Block (END)

This field shall comprise one single byte. It may be used to identify the disk drive used for writing the record.

4.4 Subsequent Record (Record n)

If - besides the pre-initialization - the track comprises more than one record (Record n) a gap G3 (4.2) shall be written between the End byte (4.3.5.4) of Record n and the Address Mark (AM) of the Count of the next record (Record m).

It should be noted that n and m need not to be consecutive numbers.

4.5 Remainder of the track

When no further records are to be written the remainder of the track shall be overwritten with (00)-bytes to the Index.

5. Summary of the complete track format

The above clauses can be summarized by the following drawing :

