

SC12/LX
(RL01/RL02 COMPATIBLE)
DISK CONTROLLER
TECHNICAL MANUAL



EMULEX

3545 Harbor Boulevard
Costa Mesa, California 92626
(714) 662-5600 TWX 910-595-2521

SC1251003 Rev A
July, 1985

Copyright (C) 1982 Emulex Corporation

The information in this manual is for information purposes and is subject to change without notice.

Emulex Corporation assumes no responsibility for any errors which may appear in the manual.

Printed in U.S.A.

TABLE OF CONTENTS

Section	Title	Page
ONE	INTRODUCTION	
1.1	OVERVIEW	1-1
1.2	CONTROLLER OVERVIEW	1-1
1.2.1	General Description	1-1
1.2.2	SC12/LX Emulation of RL01 and RL02	1-1
1.3	FEATURES	1-1
1.3.1	Microprocessor Design	1-1
1.3.2	Packaging	1-2
1.3.3	Self-Test	1-2
1.3.4	Buffering	1-2
1.3.5	Error Correction	1-2
1.3.6	Option and Configuration Switches	1-2
1.4	FUNCTIONAL COMPATIBILITY	1-3
1.4.1	Media Compatibility	1-3
1.4.2	Disk Mapping	1-3
1.4.3	Diagnostic	1-3
1.4.4	Operating Systems	1-3
TWO	GENERAL DESCRIPTION	
2.1	CONTROLLER ORGANIZATION	2-1
2.2	PHYSICAL DESCRIPTION	2-1
2.2.1	Connectors	2-4
2.2.1.1	A Cable Connector	2-4
2.2.1.2	B Cable Connector	2-4
2.2.1.3	Test Connector	2-4
2.2.2	Switches	2-4
2.2.3	LED Indicator	2-4
2.2.4	Firmware PROMs	2-5
2.2.5	Bootstrap PROMs	2-5
2.3	INTERFACES	2-5
2.3.1	Disk Interface	2-5
2.3.1.1	A Cable	2-5
2.3.1.2	B Cable	2-7
2.3.2	Unibus Interface	2-7
2.3.2.1	Interrupt Priority Level	2-7
2.3.2.2	Register Address	2-9
2.3.2.3	DOCK and INIT Signals	2-9
2.4	LOGICAL DISK FORMAT	2-9
2.4.1	Sector Format	2-9
2.4.1.1	Header Field	2-9
2.5	PHYSICAL DISK FORMAT	2-9
2.5.1	Disk Pack Organization	2-9
2.5.2	Mapping	2-10
2.5.3	Sector Format	2-11
2.5.3.1	Header Field	2-11
2.5.3.2	Data Field	2-12

TABLE OF CONTENTS (continued)

Section	Title	Page
2.5.3.3	Postambles	2-12
2.5.3.4	Recovery Area	2-12
2.6	REPLACED TRACKS	2-12
2.7	GENERAL PROGRAMMING INFORMATION	2-14
2.7.1	Interrupts	2-14
2.7.2	Seek Operations	2-14
2.7.3	Overlapped Seeks	2-14
2.7.4	Data Transfer	2-14
2.7.5	Recovery of Data with Bad Headers	2-15
2.7.6	Error Correction	2-15
2.7.7	Deleted Commands	2-15
2.7.8	Extended Commands	2-15
THREE	INSTALLATION	
3.1	INSPECTION	3-1
3.2	DISK DRIVE PREPARATION	3-1
3.2.1	Drive Placement	3-1
3.2.2	Local/Remote	3-1
3.2.3	Sectoring	3-2
3.2.3	Unit Numbering	3-2
3.3	SYSTEM PREPARATION	3-2
3.3.1	Powering Down the System	3-2
3.4	CONTROLLER SETUP	3-2
3.4.1	Controller Address Selection	3-2
3.4.2	Interrupt Vector Selection	3-4
3.4.3	Drive Configuration Selection	3-4
3.4.4	Option Installation	3-4
3.4.4.1	Unibus Terminator Option	3-4
3.4.4.2	Boot Strap Option	3-5
3.4.4.3	22-Bit Memory Addressing	3-5
3.4.4.4	Line Clock Option	3-6
3.5	PHYSICAL INSTALLATION	3-6
3.5.1	Slot Selection	3-6
3.5.2	Mounting	3-6
3.6	CABLING	3-6
3.6.1	A Cable	3-6
3.6.2	B Cable	3-7
3.6.3	Grounding	3-7
3.7	TESTING	3-8
3.7.1	Self-Test	3-8
3.7.2	Register Examination	3-8
3.7.3	Hardware Formatting the Disk	3-8
3.7.4	Diagnostics	3-9
FOUR	CONTROLLER REGISTERS	
4.1	CONTROLLER STATUS REGISTER (CSR)	4-1
4.1.1	CSR Normal Functions	4-1
4.1.2	CSR Extended Functions	4-3
4.2	BUS ADDRESS REGISTER (BAR)	4-4
4.3	DISK ADDRESS REGISTER (DAR)	4-4

TABLE OF CONTENTS (continued)

Section	Title	Page
4.3.1	DAR During a Seek Command	4-4
4.3.2	DAR During a Read or Write Data Command	4-5
4.3.3	DAR During a Get Status Command	4-5
4.3.4	DAR During a Write Header Command	4-6
4.4	MULTIPURPOSE REGISTER (MPR)	4-6
4.4.1	MPR After a Get Status Command	4-6
4.4.2	MPR After a Read Header Command	4-7
4.4.3	MPR During a Read/Write Data Command	4-8
4.4.4	MPR During a Multipurpose Command	4-9
4.4.5	MPR During a Write Header Command	4-9
4.5	BUS ADDRESS EXTENSION (BAE) REGISTER	4-10
4.5.1	BAE During Read or Write Data Commands	4-10
4.5.2	BAE During Write Header Commands	4-10
4.6	REGISTER 5	4-10
4.7	REGISTER 6	4-11
FIVE	COMMANDS	
5.1	STANDARD FUNCTIONS	5-1
5.1.1	Write Check (1)	5-1
5.1.2	Get Status (2)	5-1
5.1.3	Seek (3)	5-1
5.1.4	Read Header (4)	5-2
5.1.5	Write Data (5)	5-2
5.1.6	Read Data (6)	5-2
5.1.7	Read Data Without Header Check (7)	5-3
5.2	EXTENDED COMMANDS	5-3
5.2.1	Hardware Format (4)	5-3
5.2.2	Multipurpose Command (0)	5-3
A	CONFIGURATION AND OPTION SELECT	
A.1	INTRODUCTION	A-1
A.2	CONTROLLER CONFIGURATION	A-1
A.2.1	Single Drive Installations	A-1
A.2.2	Multi Drive Installations (same type)	A-2
A.2.3	Multi Drive Installations (different type)	A-3
A.3	USER SELECTABLE OPTIONS	A-6

LIST OF TABLES

Table	Title	Page
1-1	RL11/RL12/RL01/RL02 Disk Subsystems Characteristics	1-3
1-2	General Specification	1-4
2-1	Disk Drive Connections	2-6
2-2	Unibus Connections	2-8
2-3	Bootstrap Routines	2-17
A-1	Drives Supported	A-4
A-2	Drive Configuration	A-4
A-3	Option Switch Settings	A-6
A-4	Configuration Switch Settings	A-7
A-5	Address Switch Settings	A-7

LIST OF FIGURES

Figure	Title	Page
2-1	SC12/LX Block Diagram	2-2
2-2	SC12/LX Controller	2-3
2-3	Logical Header Format	2-10
2-4	Sector Format	2-10
2-5	Physical Header Format	2-11
2-6	Replaced Track Header Format	2-13
3-1	SC12/LX Assembly Drawing	3-3
3-2	NPG Signal Jumper Removal	3-6
3-3	Cabling Schematic	3-7

EMULEX PRODUCT WARRANTY

CONTROLLER WARRANTY: Emulex warrants for a period of twelve (12) months from the date of shipment that each Emulex controller product supplied shall be free from defects in material and workmanship.

CABLE WARRANTY: All Emulex provided cables are warranted for ninety (90) days from the time of shipment.

The above warranties shall not apply to expendable components such as fuses, bulbs, and the like, nor to connectors, adaptors, and other items not a part of the basic product. Emulex shall have no obligation to make repairs or to cause replacement required through normal wear and tear or necessitated in whole or in part by catastrophe, fault or negligence of the user, improper or unauthorized use of the product, or use of the product in such a manner for which it was not designed, or by causes external to the product, such as but not limited to, power failure or air conditioning. Emulex's sole obligation hereunder shall be to repair or replace any defective product, and, unless otherwise stated, pay return transportation cost for such replacement.

Purchaser shall provide labor for removal of the defective product, shipping charges for return to Emulex and installation of its replacement. THE EXPRESSED WARRANTIES SET FORTH IN THIS AGREEMENT ARE IN LIEU OF ALL OTHER WARRANTIES, EXPRESSED OR IMPLIED, INCLUDING WITHOUT LIMITATION, ANY WARRANTIES OF MERCHANTABILITY OR FITNESS FOR A PARTICULAR PURPOSE, AND ALL OTHER WARRANTIES ARE HEREBY DISCLAIMED AND EXCLUDED BY EMULEX. THE STATED EXPRESS WARRANTIES ARE IN LIEU OF ALL OBLIGATIONS OR LIABILITIES ON THE PART OF EMULEX FOR DAMAGES, INCLUDING BUT NOT LIMITED TO SPECIAL, INDIRECT, OR CONSEQUENTIAL DAMAGES ARISING OUT OF, OR IN CONNECTION WITH THE USE OR PERFORMANCE OF THE PRODUCT.

RETURNED MATERIAL: Warranty claims must be received by Emulex within the applicable warranty period. A replaced product, or part thereof, shall become the property of Emulex and shall be returned to Emulex at Purchaser's expense. All returned material must be accompanied by a RETURN MATERIALS AUTHORIZATION (RMA) number assigned by Emulex.

BLANK

1.1 OVERVIEW

This manual provides information related to the capabilities, design, installation, and use of the Emulex SC12/LX Disk Controller. In addition, this manual provides diagnostics and application information. The contents of the five sections and one appendix are described briefly below:

- Section 1 **Introduction:** This section contains an overview of the SC12/LX SMD Disk Controller.
- Section 2 **General Description:** This section describes the physical organization of the SC12/LX and gives general programming information.
- Section 3 **Installation:** This section contains the information needed to physically set up and install the controller.
- Section 4 **Controller Registers:** This section contains a description of the controller's Unibus registers.
- Section 5 **Commands:** This section describes the commands used to control the disk drive functions.
- Appendix A **Configuration and Option Selection:** This appendix contains drive configuration information and option switch selection tables.

1.2 CONTROLLER OVERVIEW

1.2.1 GENERAL DESCRIPTION

The SC12/LX Disk Controller is a one board, imbedded controller for PDP-11 and VAX-11 computers manufactured by Digital Equipment Corporation (DEC). This controller can be used to interface with any large disk having a Storage Module Drive (SMD) interface. The SC12/LX controller emulates the RL11/RL12 disk controller manufactured by DEC for use with RL01 and RL02 disk drives. On VAX-11 systems, only the larger capacity RL02 is supported.

1.2.2 SC12/LX EMULATION OF RL01 AND RL02

The RL11/RL12 provides a convenient controller architecture for a wide variety of modern technology type disks. It is supported by all DEC operating systems and is easy to program.

The SC12/LX controller can handle two disk drives. The drives need not be of the same type or manufacture. The controller configures

Features

each drive from the information in a configuration PROM. This technique permits up to 64 different switch selectable combinations of disk drive arrangements.

1.3 FEATURES

1.3.1 MICROPROCESSOR DESIGN

The SC12/LX design incorporates a unique 8-bit bipolar microprocessor to perform all controller functions. The microprocessor approach provides for a reduced component count, high reliability, easy maintainability, and most importantly, the ability to adapt a single set of hardware to a wide range of emulation capabilities through the use of microprogramming. Emulex controllers achieve functional capability beyond that of the DEC controllers they emulate by providing enhancement features such as built-in self-test during power-up, built-in disk formatting, and the ability to work with disk drives of various sizes.

1.3.2 PACKAGING

The SC12/LX is constructed on a single, quad-size, multi-layer PC board which plugs directly into the PDP-11 or VAX-11 chassis. No cabling is required between the computer and the disk controller. The controller obtains its power from the chassis in which it is mounted.

1.3.3 SELF-TEST

The controller incorporates an internal self-test routine which is executed upon power-up. This test exercises all parts of the microprocessor, buffer and disk data logic. Although this test does not completely test all controller circuitry, successful execution indicates a very high probability that the controller is operational. If the controller fails the self-test, it leaves the LED on and the controller cannot be addressed from the CPU.

1.3.4 BUFFERING

The controller contains a 1K x 8 high-speed RAM buffer. It is used to store the device registers of the controller plus a full 512 byte data sector. This buffering permits multiple sector reads with a 3-to-1 sector interleave format. Buffer operations eliminate the possibility of a data late condition and permit the controller to be operated at low bus priorities.

1.3.5 ERROR CORRECTION

The controller incorporates a 32-bit error correcting code (ECC) capable of correcting single error bursts of up to 11 bits in length

and detecting bursts of longer length. The controller determines the location of the error and the pattern so that the software may correct the data after it is transferred to memory. A 32-bit CRC is employed with the header of every sector.

1.3.6 OPTION AND CONFIGURATION SWITCHES

DIP switches are used to configure the controller for various disk sizes, Unibus addresses and options. It is possible to select from a large number of combinations of disk characteristics for the two drives which can be handled by the controller, including mixtures of disk sizes.

1.3.7 DUAL PORT CAPABILITY

The SC12/LX controller does not support programmable dual port capability. Disk drives that have dual port hardware may be used in a dual port configuration only if the port select switch is in the Channel I only or Channel II only position. The middle (programmable) position creates errors if two controllers access the drive at the same time.

1.4 FUNCTIONAL COMPATIBILITY

1.4.1 MEDIA COMPATIBILITY

In all cases, the headers written on the drives are not standard RL01/RL02 headers. In addition, a three-to-one or two-to-one sector interleave is generated by the hardware formatter. Packs may be formatted by utilizing the hardware formatting capability of the extended command set. Disk packs formatted with an SC12/LX controller are media compatible with packs formatted by the Emulex SC02/L and SC04/L controllers but not with DEC RL01/RL02 packs.

1.4.2 DISK MAPPING

Depending upon the type and size of the disk drive, one to four logical units may be mapped on it. Various mapping organizations are used, most of which do not leave direct 1:1 correlation between the logical and physical addresses.

1.4.3 DIAGNOSTICS

The SC12/LX will run the following DEC diagnostics on the PDP-11 without modification:

- o ZRLKB1 Performance Exerciser
- o ZRLMB0 Bad Sector File Tool

Functional Compatibility

The SC12/LX will run the following DEC diagnostic on the VAX-11 without modification:

- EVRFA

1.4.4 OPERATING SYSTEMS

The SC12/LX is compatible with all DEC operating systems that support RL01 or RL02 disk subsystems. No operating system modifications are required.

Table 1-1
RL11/RL12/RL01/RL02 Disk Subsystem Characteristics

Characteristics	Specifications	
	RL01	RL02
Surfaces/Drive	2	2
MBytes/Logical Unit	10.24	20.48
Blocks/Drive	10,240	20,480
Tracks/Cylinder	2	2
Cylinders/Drive	256	512
Sectors/Track	40	40
Data Bytes/Sector	256	256
Sectors/Block	2	2
Drives/Controller, Max	4	4

Table 1-2. General Specification

Functional	
Emulation	DEC RL01 and RL02. RL02 only on VAX-11.
Media Format	3-to-1 or 2-to-1 sector interlace
Drive Interface	Storage Module Drive (SMD)
Number of Drives	2 maximum
Error Control	32-bit ECC for data and 32-bit CRC for headers. Correction of single data error burst of up to 11 bits.
Sector Size	256 words (512 bytes)
Sectors/Track	Selectable for each physical drive

continued on next page

Functional Compatibility

Table 1-2. General Specification (continued)

Functional	
Tracks/Cylinder	Selectable for each physical drive
Cylinders/Drive	Selectable for each physical drive
Drive Type Code	Selectable RL01 or RL02 for each physical drive
Computer Interface	Unibus
Vector Address	
Standard	160
Optional	214
Priority Level	Level 5
Data Bufferring	1 Sector (256 words)
Data Transfer	High speed DMA operation
Self-Test	Extensive internal self-test on powering up
Indicator	Fault/Activity LED
Unibus Addresses	Standard: 774400 Alternate: 777340
Design	High-speed bipolar microprocessor using 2901 bit-slice components
Physical	
Packaging	One quad-sized board
Mounting	Any SPC slot in CPU or expansion box
Connectors	One 60-pin A Cable flat connector and two 26-pin B Cable flat connectors.
Electrical	
Unibus Interface	DEC approved line drivers and receivers
Drive Interface	Differential line drivers and receivers. A cable accumulative length to 35 feet. B cable length to 25 feet.
Power	+5V \pm 5%, 5 Amps

BLANK

2.1 CONTROLLER ORGANIZATION

A block diagram showing the major functional elements of the SC12/LX controller is shown in Figure 2-1. The controller is organized around an eight-bit high-speed bipolar microprocessor. The arithmetic and logic unit (ALU) and register file portion of the microprocessor are implemented with two 2901 bit-slice components. The microinstruction is 48 bits in length and the control memory of 1K words is implemented with twelve 2K x 4 PROMs.

The controller incorporates a 1K x 8 high-speed RAM buffer which is used to store the controller's device registers and one sector (512 bytes) of data buffering.

The A Cable Register (ACR) provides the storage of all A cable signals going to the disk drives. The inputs from the selected drive are testable by the microprocessor.

Serial data from the drive is converted into eight-bit parallel data and transferred to the buffer via the microprocessor. Likewise, the data access from the buffer by the microprocessor is serialized and sent to the drive under the control of the servo clock received from the drive. A 32-bit ECC Shift Register is used to generate and check the ECC for the data field. The same register is also used in a 32-bit CRC mode for the headers. The actual ECC polynomial operation is done independently of the microprocessor, but the determination of the error position and error pattern is done under the control of the microprocessor.

The Unibus interface consists of 18 address lines and 16 bi-directional data lines. The Unibus also carries interrupt vector, address data, data control signals, and control signals for granting and receiving bus mastership. The Unibus interface is used for programmed input/output (I/O), CPU interrupts, and Data Transfers. The microprocessor responds to all programmed I/O and carries out the I/O functions required for the addressed controller register. The microprocessor also controls all direct memory access (DMA) operations and transfers data between the Unibus data lines and the buffer.

2.2 PHYSICAL DESCRIPTION

The SC12/LX controller consists of a single quad-size board which plugs directly into a Unibus backplane.

The controller board is shown in Figure 2-2.

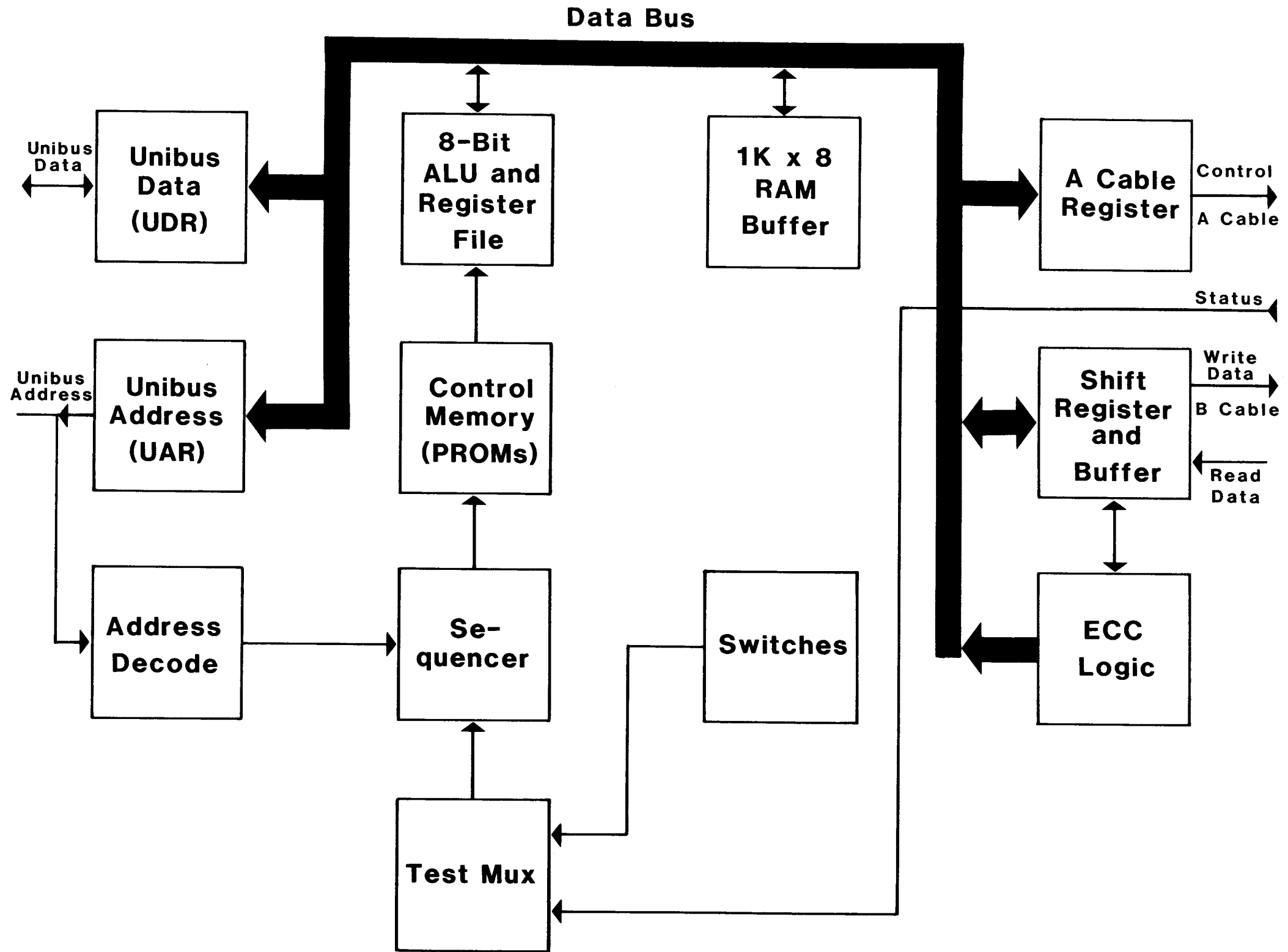

Figure 2-1. SC12 Block Diagram

SC1203-0031

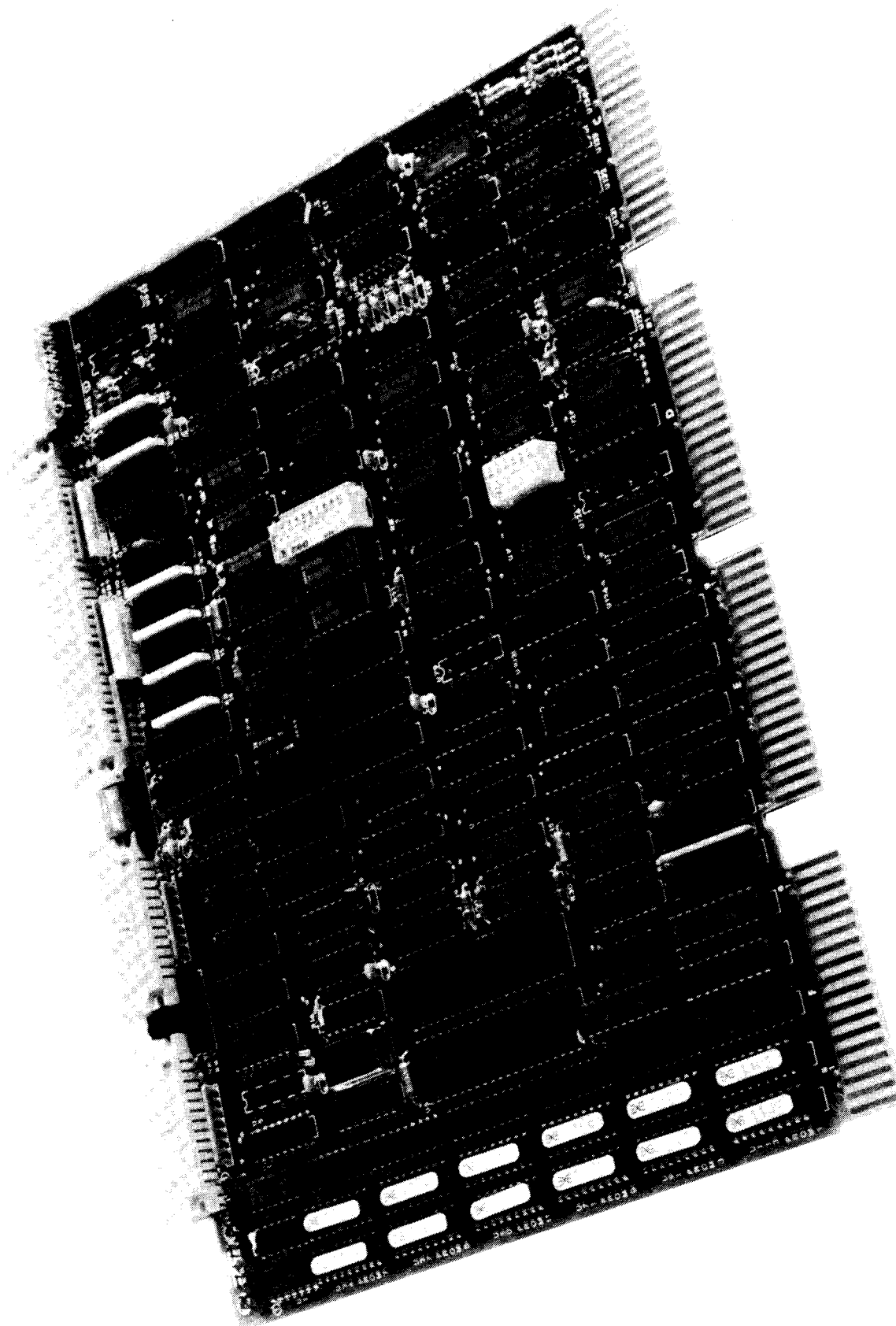

Figure 2-2. SC12 Controller Board

Physical Description

2.2.1 CONNECTORS

2.2.1.1 A Cable Connector

The 60-pin flat cable connector labeled J3 at the top edge of the board is for the A Cable which daisy-chains to all the drives for control and status. Pin 1 is located on the left side of the connector.

2.2.1.2 B Cable Connector

The two 26-pin flat cable connectors labeled J1 and J2 are for the radial B Cables to each of two physical drives which may be attached to the controller. Pin 1 is located on the left side of the connector. The two B Cable ports are both identical and any drive may be plugged into either connector.

2.2.1.3 Test Connectors

Connectors J4 and J5 are used with the Emulex test panel during manufacturing test and factory repair. They have no use in normal operation.

2.2.2 SWITCHES

There are three sets of switches on the controller board, labeled SW1-SW3. SW1 is a four pole DIP 'piano-type' switch accessible from the PC board edge. SW1 is located so that it is accessible to the operator while the controller is imbedded in the CPU chassis, making the selection of common options such as hardware format simpler to perform.

The other two sets of switches, SW2 and SW3, provide controller address decoding selection, option selection, and drive configuration selection. (See Appendix A for a complete description of the switch functions.)

2.2.3 LED INDICATOR

There is an LED indicator mounted between the connectors at the top of the board. The controller executes an extensive self-test when powering up and the LED is turned on as the controller starts its self-test. It is turned off only when the controller successfully completes the test. If a malfunction is detected by the built-in diagnostics, the LED remains on and the controller will not respond to program I/O. The LED blinks at approximately a one-second rate if the self-test is successful but no drive is seen on-line. The LED also functions as an activity indicator during read and write operations.

2.2.4 FIRMWARE PROMS

There are twelve PROM sockets, used for the control memory, located along the left edge of the board. The sockets are labeled PROM 0 through PROM 11 in a discontinuous physical order. The numbers on the top of the PROM ICs are Emulex part numbers, which identify the unique pattern of the PROM. When inserting PROMs in the board, the ID numbers are placed in the same sequence as the PROM numbers on the board beside each socket.

2.3 INTERFACES

2.3.1 DISK INTERFACE

The controller's disk interface conforms to the Flat Cable Interface Specification for the SMD, MMD, and CMD (CDC Document No. 64712400). The controller has been tested with most drives using the SMD interface and is compatible with these drives electrically and in timing.

2.3.1.1 A Cable

The 60-conductor A Cable is daisy-chained to both drives and terminated at the last drive. The signals in this cable, along with their function when the control tag (Tag 3) is asserted, are listed in Table 2-1. The A Cable should be 30 twisted pair flat cable with an impedance of 100 ohms and a cumulative length of no more than 35 feet.

A Spectra-Strip P/N 455-248-60 flat cable or its equivalent is recommended. A Cable assemblies may be ordered from Emulex in one of four lengths:

Emulex P/N	Length (ft.)
SU1111201	8.0
SU1111203	15.0
SU1111205	25.0
SU1111207	35.0

2.3.1.2 B Cable

The 26-conductor B Cable is radial to both drives and contains the data and clock signals. The signals and grounds in this cable are listed in Table 2-1. The B Cable should be 26 conductor flat cable with ground plane and drain wire. The impedance should be 130 ohms and the length must not exceed 25 feet.

Interfaces

Table 2-1. Disk Drive Connections

Pins Lo/Hi	Signal (Tag 3 Function)	From/To
A Cable		
22/52	Unit Select Tag	To
23/53	Unit Select bit 0	To
24/54	Unit Select bit 1	To
26/56	Unit Select bit 2	To
27/57	Unit Select bit 3	To
4/34	Bit 0 (Write Gate)	To
5/35	Bit 1 (Read Gate)	To
6/36	Bit 2 (Servo Offset Plus)	To
7/37	Bit 3 (Servo Offset Minus)	To
8/38	Bit 4 (Fault Clear)	To
9/39	Bit 5 (AM Enable)	To
10/40	Bit 6 (Return to Zero)	To
11/41	Bit 7 (Data Strobe Early)	To
12/42	Bit 8 (Data Strobe Late)	To
13/43	Bit 9 (Release)	To
30/60	Bit 10	To
14/44	Open Cable Detect	To
15/45	Fault	From
16/46	Seek Error	From
17/47	On Cylinder	From
18/48	Index	From
19/49	Unit Ready	From
20/50	Not Used	From
21/51	Busy (dual port only)	From
25/55	Sector	From
28/58	Write Protected	From
29	Power Sequence Hold	To
59	Power Sequence Pick	To
B Cable		
8/20	Write Data	To
6/19	Write Clock	To
2/14	Servo Clock	From
3/16	Read Data	From
5/17	Read Clock	From
10/23	Not Used	From
22/9	Unit Selected	From
12/24	Not Used	From
13/26	Not Used	From

A 3M P/N 3476/26 flat cable or its equivalent is recommended. B Cable assemblies may be ordered from Emulex in one of three lengths:

Emulex P/N	Length (ft.)
SU1111202	8.0
SU1111204	15.0
SU1111206	25.0

2.3.2 UNIBUS INTERFACE

The controller interfaces to the Unibus via a Small Peripheral Controller (SPC) connector. The Unibus consists of 18 address lines and 16 bi-directional data lines, plus control signals for data and interrupt vector address transfer and for becoming bus master. The signal connections of the controller to the Unibus are shown in Table 2-2.

2.3.2.1 BR (Interrupt) Priority Level

The controller is hardwired for BR5. The other three Bus Grant signals are jumpered through.

2.3.2.2 Register Address

The register address and the number of registers assigned to the controller are decoded by a PROM at U127. The selections available are determined by configuration switch SW3 as described in Appendix A.

2.3.2.3 DCLO and INIT Signals

The DCLO and INIT signals both perform a controller clear. The self-test is performed only if DCLO has been asserted.

2.4 LOGICAL DISK FORMAT

To the system software, the SC12/LX disk subsystem appears to be formatted exactly as would an RL01 or RL02. In actual fact, the controller firmware multiplies the logical address out to obtain a block address which is then divided by the physical drive configuration constants to provide an address for the physical drive. For this reason a 1:1 correspondence between logical and physical addresses will most likely not exist.

Logical Disk Format

Table 2-2. SPC Unibus Connections

Column	C		D		E		F		
	Pin	1	2	1	2	1	2	1	2
A	NPGIN	+5V		+5V		+5V		+5V	
B	NPGOUT					-15V		-15V	
C	PA	GND		GND	A12	GND		GND	
D		D15		BR7	A17	A15	BBSY		
E		D14		BR6	MSYN	A16			
F		D13		BR5	A02	C1			
H	D11	D12		BR4	A01	A00			
J		D10			SSYN	C0	NPR		
K		D09		BG7 IN	A14	A13			
L		D08	INIT	BG7 OUT	A11				
M		D07		BG6 IN			INTR		
N	DCLO	D04		BG6 OUT		A08			
P		D05		BG5 IN	A10	A07			
R		D01		BG5 OUT	A09				
S	PB	D00		BG4 IN					
T	GND	D03	GND	BG4 OUT	GND		GND	SACK	
U		D02			A06	A04			
V	ACLO	D06			A05	A03			

Depending upon the type and size of the disk drive, one to four logical units may be mapped on it. The controller can handle a maximum of four logical units distributed across a maximum of two physical disk drives.

2.4.1 SECTOR FORMAT

2.4.1.1 Header Field

The logical header can be read by software by issuing the read header command. The header data is not actually read from the disk, but is generated by the firmware in accordance with the logical position of the disk heads. The headers have the format illustrated in Figure 2-3.

2.5 PHYSICAL DISK FORMAT

2.5.1 DISK PACK ORGANIZATION

The formatting of a disk pack and the mapping of one or more logical drives onto a physical drive varies with the drive size. Some of this information is supplied by the configuration PROM. The rest is computed based upon configuration PROM information. In all cases, the headers actually written on the drives are not standard RL01/RL02 headers. In addition, a three-to-one or two-to-one sector interleave is generated by the hardware formatter. A two-to-one sector interleave is used when the physical disk drive has 23 sectors or less per track. Otherwise, a three-to-one interleave is used. Disk packs formatted with an SC12/LX controller are media compatible with disk packs formatted by Emulex SC02/L and SC04/L controllers but not with DEC RL01/RL02 packs.

2.5.2 MAPPING

Depending upon the type and size of the disk drive, one to four logical units may be mapped on it. The controller can handle a maximum of four logical units distributed across a maximum of two physical disk drives. A logical drive may not be mapped across a physical unit boundary.

2.5.3 SECTOR FORMAT

Each sector contains a detached two-word header and a 256 word data field. The header field is terminated with two vertical check characters and the data field is terminated with a 32-bit ECC. The controller attempts corrections only on the data field, never on the header. Each field is preceded by at least 11 bytes of zeroes and an eight-bit SYNC byte.

In detail, each sector is organized as illustrated in Figure 2-4.

Physical Disk Format

Header Word 1:

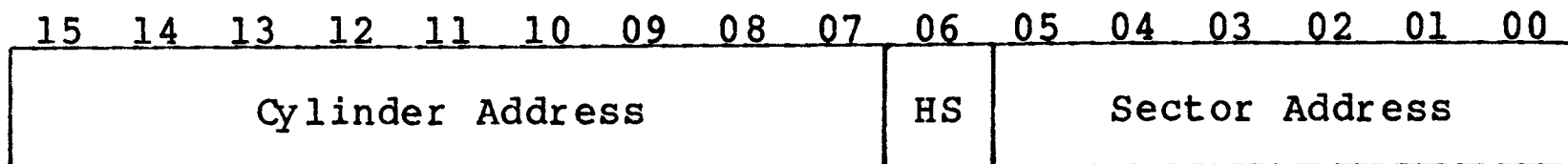

Header Word 2:

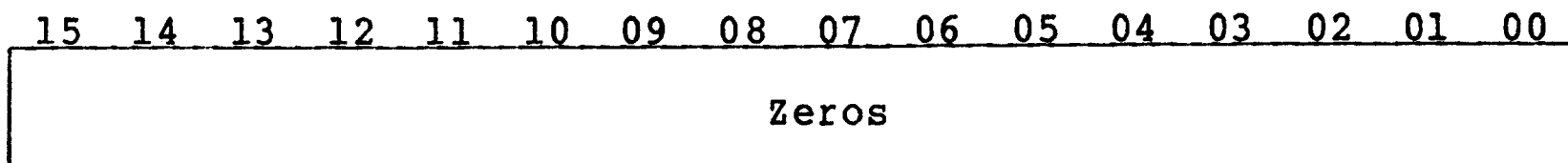

Header Word 3:

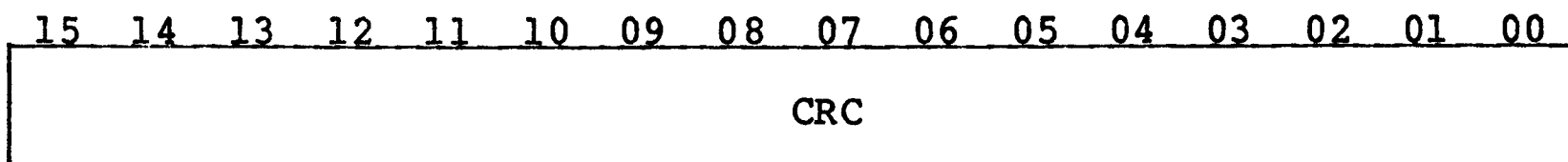
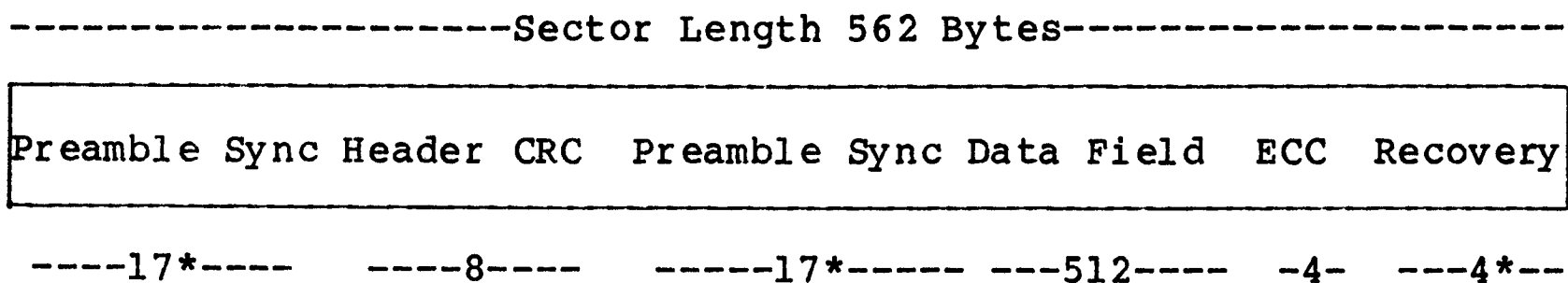

Figure 2-3. Logical Header Format



*Values shown are minimums which apply to most Winchester type units. However, these values may vary to accommodate different physical drive types and are determined by configuration PROM data.

Figure 2-4. Sector Format

2.5.3.1 Header Field

The header preamble is used to synchronize the Phase Locked Oscillator (PLO) in the drive to the data on the pack. The SYNC byte is used by the controller to synchronize to the data bytes and their boundaries, and by the drive to synchronize to the phase of the data stream. The two header data words are organized as illustrated in Figure 2-5.

Physical Disk Format

Header Word 1:

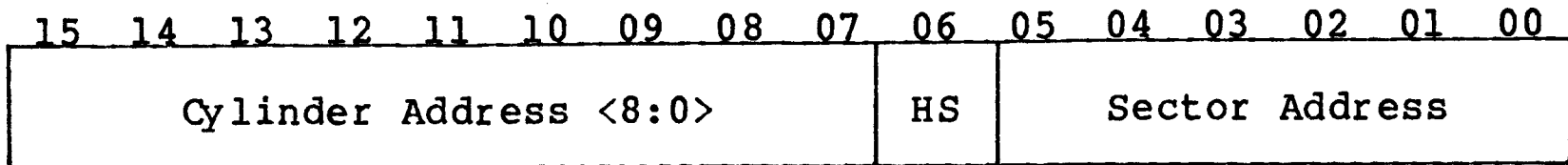

Header Word 2:

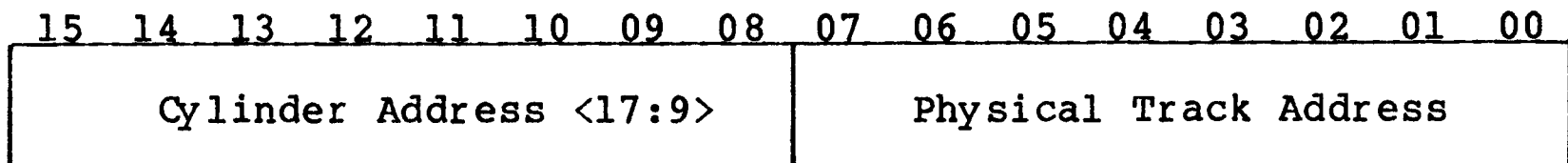

Header Word 3:

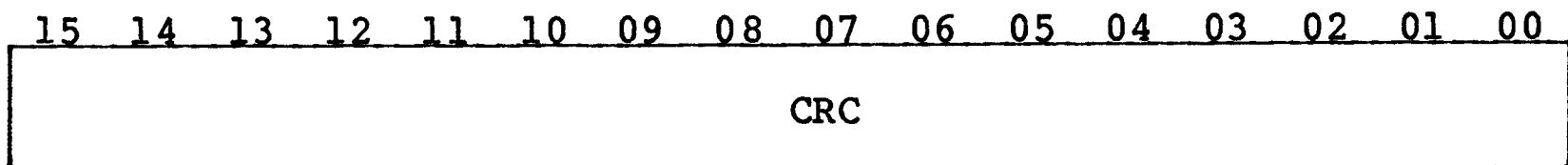

Header Word 4:

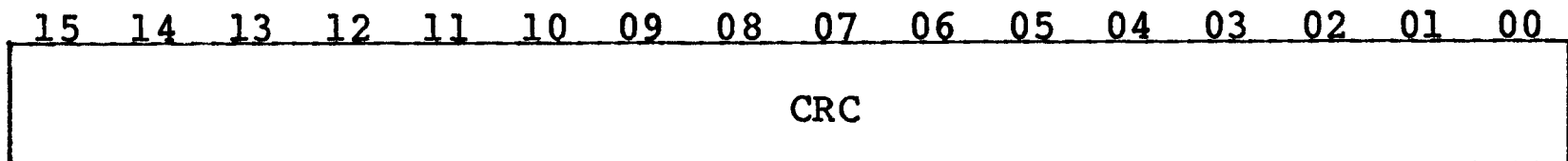

Figure 2-5. Physical Header Format

2.5.3.2 Data Field

The data field preamble and SYNC bytes have the same functions as the header preamble and SYNC bytes. The data field itself is always 256 words long. Any unused portion of the sector will be terminated with zero bytes during a write operation. The 32-bit ECC is generated during a write, and is used during a read to check the validity of the data. Any single error burst anywhere in the data field of 11 bits or less may be corrected.

2.5.3.3 Postambles

The postambles provide areas for turning off the write amplifiers, for turning on read amplifiers, and for switching from read-to-write. Write splices will exist within all of these areas. The sector pulse postamble will also include a head-scatter area on removable media drives.

Replaced Tracks

2.5.3.4 Recovery Area

The recovery area along with the preceding postamble is required for head-scatter tolerances on removable media drives.

2.6 REPLACED TRACKS

The four words of the Replaced Track Header are written consecutively over the entire corrupted track. The Replaced Track Header contains the address of the track that is being substituted for the corrupted track. The Replaced Track Header is illustrated in Figure 2-6.

The substitute track to which the Replaced Track Header points looks exactly as the corrupt track would if replacement had not been required. This duplication includes the cylinder and track addresses contained in the header for each sector.

When a sector (and thus a track) has been identified as corrupt, its physical address can only be obtained by examining the controller's internal registers. This is necessary because the read header command implemented by the SC12/LX gives only the logical track address and not the physical. The controller does not implement a physical read header command.

To obtain the physical address of a bad sector, the program should issue a read of the preceding logical sector. Next, the program should issue the multipurpose command (0). This will cause the all of the firmware registers to be loaded into the data silo. The software may then access the registers by repeatedly reading the Multipurpose Register (MPR). Words 118, 119 and 120 will contain the physical address (cylinder, track and sector, respectively) of the logical sector immediately following the one just read, which will be the address desired.

Because a logical track may be mapped over two physical tracks, it is necessary to read each sector before and after the corrupt sector and examine the physical address of each. By reading each logical sector below and above the corrupt sector and watching the physical track address obtained with the multipurpose command we can determine the physical track boundaries in relation to the logical sectors. When the physical track address changes we know that the lower or upper limits of the track. We can then correlate the logical sector addresses with physical track limits.

This information is required so that the headers and data on the track with the corrupted sector can be moved to the replacement track. The information is also necessary to allow the appropriate logical sectors to be written with the replaced track headers.

General Programming Information

Header Word 1:

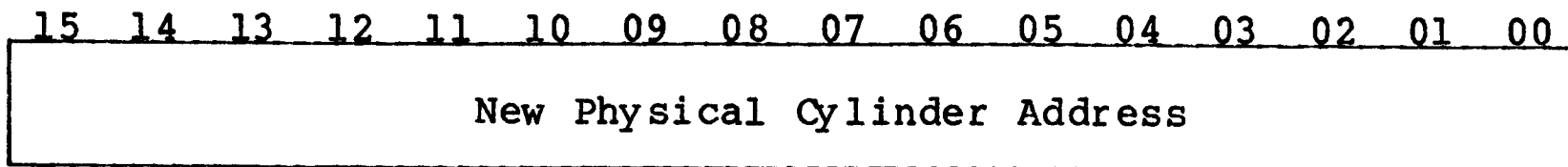

Header Word 2:

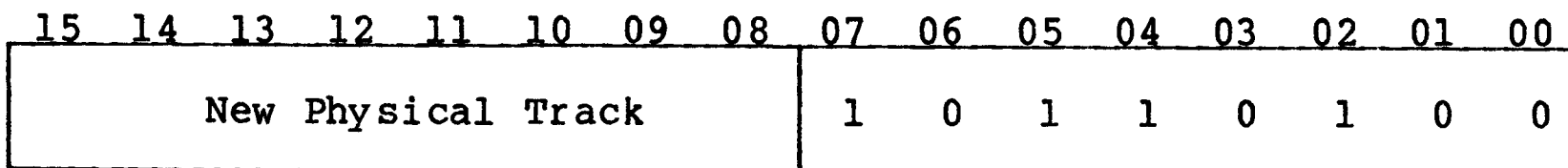

Header Word 3:

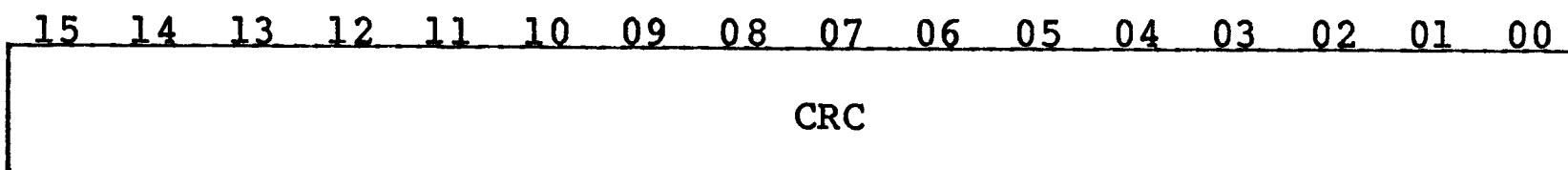

Header Word 4:

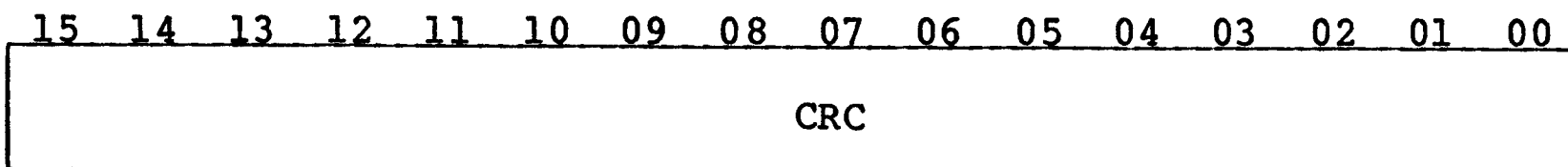

Figure 2-6. Replaced Track Header Format

2.7 GENERAL PROGRAMMING INFORMATION

2.7.1 INTERRUPTS

The controller will request an interrupt if the IE bit and the CRDY bit are both set in the CSR. The IE bit is set or reset by the software and reset with the initialize condition. The CRDY bit is set by the hardware upon completion of a function or upon the setting of an error flag. It is also set by the initialize condition. It is reset by the software to cause the controller to start a function (negative GO bit). The standard interrupt vector address is 160. The normal priority level for the RL11 is BUS REQUEST 5. The RL11 Controller uses the one priority level provided by the PDP-11 processor.

General Programming Information

2.7.2 SEEK OPERATIONS

The following sequence is an example of performing a seek function.

1. Issue read header function to drive and wait for interrupt or wait for CRDY.
2. Check error flag.
3. Read the header word from the MP register.
4. Calculate difference and direction for the seek.
5. Move difference word to the DA register.
6. Issue seek function to drive and wait for seek to be completed as indicated by drive ready bit.
7. Check error flag.

A software system that optimizes positional latency would keep current cylinder and head select information in core so that Steps 1, 2 and 3 would be unnecessary.

2.7.3 OVERLAPPED SEEKS

Since the controller comes ready and interrupts as soon as a seek is issued, it is possible to issue seeks to additional drives while the first is seeking. However, no interrupt occurs when the seeks are completed, so the transfer command should be issued to the drive requiring the shortest seek as soon as all seeks are issued. In this way, the drive completing its seek first will immediately perform its transfer and interrupt when done.

2.7.4 DATA TRANSFER

Data transfer is via DMA facility. The SC12 provides, as does the RL11, 256 words of FIFO (RAM) buffering which prevents data lates from occurring. Transfers to memory are initiated after the entire sector has been read. Transfers to the disk are initiated only after an entire sector of data has be loaded into the FIFO.

To do a data transfer, the software should perform the following steps:

1. Load BA register with address of first memory location to be transferred.
2. Load DA register with address of first disk location to be transferred.
3. Load WC register with two's complement of number of words to be transferred.
4. Issue read data or write data and wait for interrupt or test for ready.
5. Check error flag.

Other drives could do seeks or data transfers between the issuing of seek and the issuing of the data transfers.

2.7.5 RECOVERY OF DATA WITH BAD HEADERS

Function 7, read data without header check, is provided to allow the recovery of data should headers become unreadable. If constant HNF or HCRC errors are encountered on a particular sector so that the data is not recoverable by the standard read command, proceed as follows. Perform successive read header commands until the sector preceding the bad sector is found. Then, issue a read data without header check. The data portion of the next sector will be read without either header compare or header CRC check. Data CRC errors will be reported.

2.7.6 ERROR CORRECTION

The controller automatically corrects correctable errors in the data during read commands using the ECC characters appended to each data field. To allow the operating system to log errors, the correction operation will be only performed only on every other attempt to read a sector with an error. Correction is never attempted for bad disk data during write-check operations.

2.7.7 DELETED COMMANDS

The SC12/LX emulates the RL11/RL12 controller in its responses to all normal commands and register modifications.

2.7.8 EXTENDED COMMANDS

The SC12/LX incorporates extended commands not implemented by the RL11/RL12 controllers. These commands allow the media to be formatted, allow track replacement to be accomplished, allow write protection of logical disk drives and allow various diagnostic functions. For details, see subsection 5.2 of this manual.

BLANK

Section 3 INSTALLATION

This section describes the step-by-step procedure for installation of the SC12/LX Disk Controller in a PDP-11 or VAX-11 system. The following list is an outline of the procedure. Each step corresponds to a second level heading in this section (i.e., item one, Inspect the SC12/LX, is covered in subsection 3.1).

Emulex recommends that Section 3 be read in its entirety before installation is begun.

1. Inspect the SC12/LX.
2. Prepare the disk drives.
3. Prepare the CPU.
4. Route the drive I/O cables.
5. Configure the SC12/LX.
6. Install the SC12/LX.
7. Run the diagnostics.

3.1 INSPECTION

A visual inspection of the board is recommended after unpacking. Specific checks should be made for such items as bent or broken connector pins, damaged components or any other visual evidence of physical damage. The PROMs should be examined carefully to ensure that they are firmly and completely seated in the sockets.

3.2 DISK DRIVE PREPARATION

3.2.1 DRIVE PLACEMENT

Uncrate and install the disk drives according to the manufacturer's instructions. Position and level the disk drives in their final places before beginning the installation of the SC12/LX. This allows the I/O cable routing and length to be accurately judged. Place the drives side by side to make installation of the daisy-chained A Cable simpler.

3.2.2 LOCAL/REMOTE

The LOCAL/REMOTE switch controls whether the drive can be powered up from the drive (local) or the controller (remote). Place the switch

Controller Setup

in the REMOTE position. With the CPU powered down, press the START switch on the front panel of each of the drives (the START LED will light, but the drive will not spin up and become ready). When the CPU is powered up, the drives will spin up sequentially. This prevents the heavy current draw that would be caused if all of the drives were powered up at once. When in the remote mode the drives will power down when the CPU is powered down. While the CPU is powered on, the drives may be powered up and down individually (to change disk media, for example) using the drive START switch.

3.2.3 SECTORING

See Appendix A, Configuration Selection, for the correct sector count settings for the disk drives in use. Because the procedure for entering the sector numbers differs from drive to drive, consult the drive manufacturer's installation manual for instructions.

3.2.4 DRIVE NUMBERING

A drive number of zero or one is assigned according to the configuration selected for the subsystem. Appendix A, Table A-2 defines the physical drive to logical drive relationship. In any case, make sure that no two drives are assigned the same number.

Refer to the manual provided by the drive's manufacturer for instructions on selecting a number for your particular drive.

3.3 SYSTEM PREPARATION

3.3.1 POWERING DOWN THE SYSTEM

Power down the system and switch off the main AC breaker at the rear of the cabinet (the AC power light will remain lit). Slide the CPU rack out of the cabinet and remove the card rack cover. Open the rear door of the cabinet.

3.4 CONTROLLER SETUP

Several configuration setups must be made on the controller before inserting it into the chassis. These are made by SW1 and SW2.

Figure 3-1 shows an assembly diagram of the controller board.

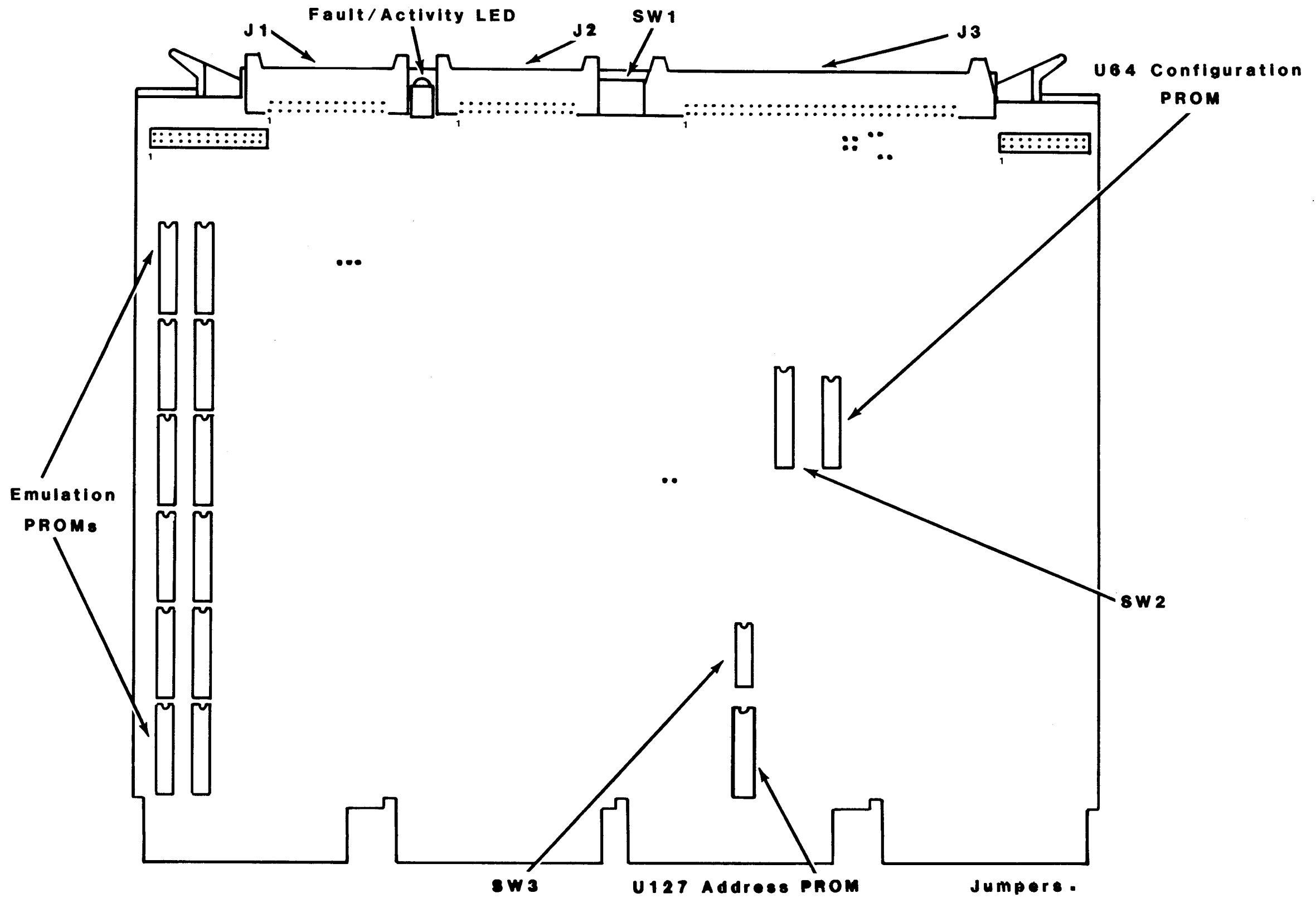

Figure 3-1. SC12 Controller Assembly

SC1203-0033

Controller Setup

3.4.1 CONTROLLER ADDRESS SELECTION

All Unibus controllers have a block of several command and status registers through which the system can command and monitor the controller. The registers are addressed sequentially from a starting address assigned to that device type, in this case a disk controller.

The starting address for the controller's Unibus registers is selected by DIP switch SW3.

Table 3-1. Unibus Starting Addresses

Address	SW3-2	SW3-3	Comment
774400	Open	Closed	Standard (factory setting)
777340	Closed	Open	Alternate

Open = OFF Closed = ON

3.4.2 INTERRUPT VECTOR ADDRESS

The interrupt vector address is programmed by means of switch SW3-1 located on the controller board. When SW3-1 is OFF (open), the standard interrupt vector of 160 is chosen. When SW3-1 is ON (closed), the alternate interrupt vector of 214 is chosen.

Switch	ON	OFF	Factory Setting
SW3-1	214	160	OFF

3.4.3 INDEX AND SECTOR PULSE SELECTION

The SC12/LX controller is designed to have the Index and Sector signals on the A Cable from each physical drive. The signals are necessary for proper operation of the sector counters associated with each drive.

3.4.4 DRIVE CONFIGURATION SELECTION

The phrase "drive configuration selection" describes the process that is used to configure the SC12/LX to use a particular type of physical disk drive to perform the RL01 or RL02 emulation. That is, you must tell the controller what kind of physical disk drive you are going to

use. On the SC12/LX, switches SW2-1 through SW2-6 and switches SW2-9 and SW2-10 on the controller board are used for that purpose.

For ease of manual maintenance, the configuration table for the SC12/LX is contained in Appendix A.

3.5 PHYSICAL INSTALLATION

3.5.1 SLOT SELECTION

The controller may be placed in any SPC slot along the Unibus without regard to NPR priority. The controller contains adequate buffering to prevent data lates and will automatically get off the bus if any other device is waiting for the Unibus. If the system contains a Unibus repeater, the controller will not give priority to devices which are on the CPU side of the repeater when the controller is on the far side of the repeater. This may require that the controller be placed on the CPU side of the repeater or that all DMA devices be on the far side of the repeater.

3.5.2 NPG SIGNAL JUMPER

The NPG signal jumper between pins CA1 and CB1 on the backplane must be removed so that the NPG signal passes through the controller. See Figure 3-2.

3.5.3 MOUNTING

The controller board should be plugged into the Unibus backplane with components oriented in the same direction as the CPU and other modules. Always insert and remove the boards with the computer power OFF to avoid possible damage to the circuitry. Be sure that the board is properly positioned in the throat of the connector before attempting to seat the board by means of the extractor handles.

3.6 CABLING

The subsystem cabling of the drives and controller is shown in Figure 3-3.

3.6.1 A CABLE

The 60-wire A Cable should be plugged into J3 of the controller and wired to the first drive. If more than one drive is used, it is then daisy-chained to the second drive.

The last drive on the A Cable must have a terminator installed. This part is available from the drive manufacturer. The terminator is

Cabling

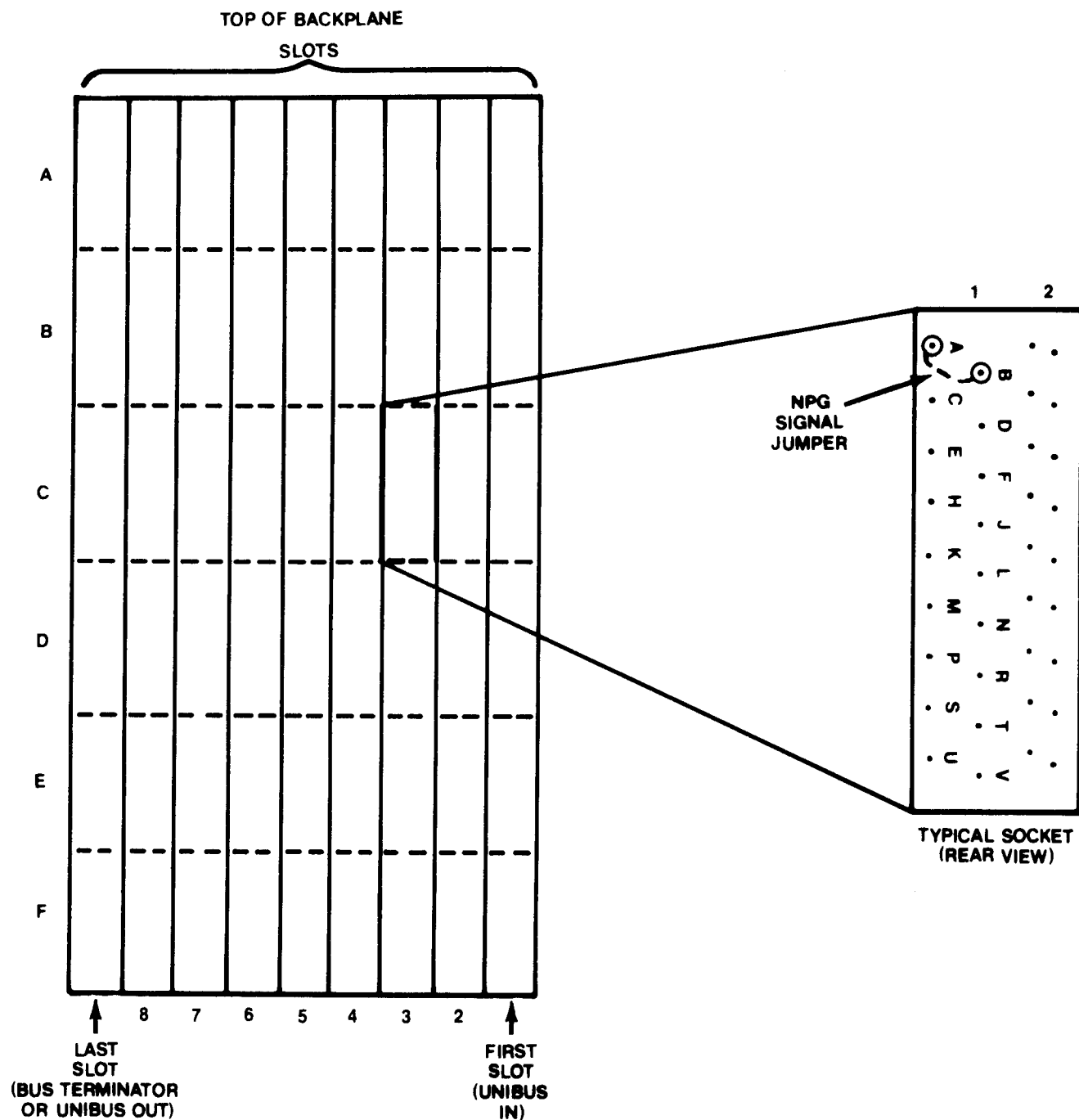

SC1203-0001

Figure 3-2 NPG Signal Jumper Removal

generally plugged into one of two A Cable connectors on the drive. In some cases, a ground wire emerging from the terminator assembly will have to be connected to the drive to provide a ground return for the resistors in the terminator. Pin 1 of the board connector is on the left. Pin 1 of the cable connector has a notch on the connector body to identify it. Twist and flat cables will have a brown-brown twist followed by a red-brown twist on the pin 1 edge of the cable. The cable will normally egress to the rear of the controller.

NOTE

The connector is not keyed and can be physically reversed in the header. No damage should result, but the system will not operate.

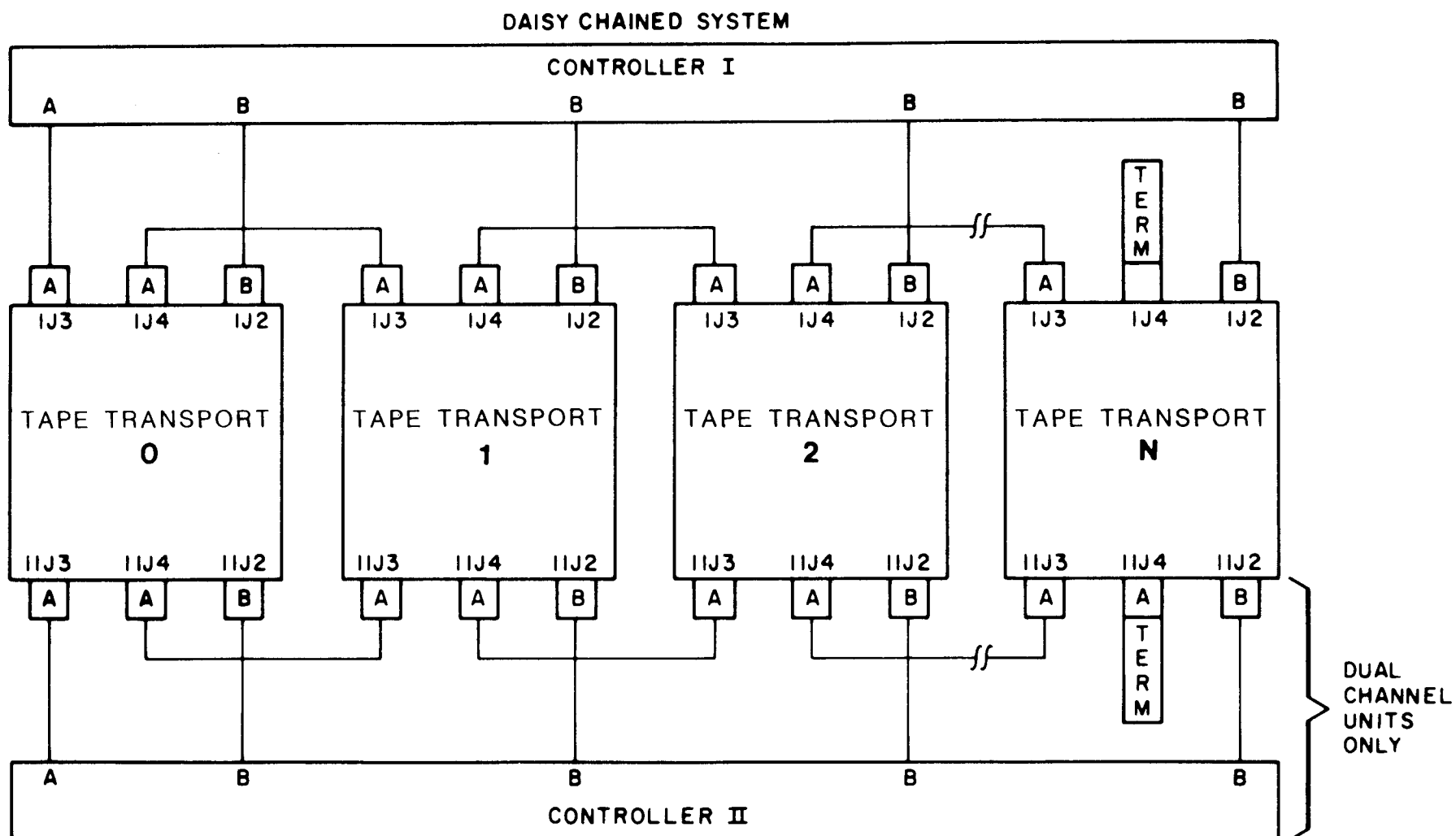

NOTES:

1. MAXIMUM INDIVIDUAL A CABLE LENGTHS = 100 FEET
2. MAXIMUM INDIVIDUAL B CABLE LENGTHS = 50 FEET

SC1203-0000

Figure 3-3. Cabling Diagram

3.6.2 B CABLE

Each drive must have a 26-wire B Cable wired from the drive to one of the B ports of the controller (J1 and J2). It makes no difference which B port connection is used by a drive. No external terminators are used with the B Cable. Pin 1 of the cable connector has a notch on the connector body to identify it. The pin 1 edge of the cable has a black stripe.

NOTE

Observe the same caution on connector reversal given in subsection 3.6.1.

Testing

3.6.3 GROUNDING

For proper operation of the disk subsystem, it is very important that the disk drives have a good ground connection to the logic ground of the computer. The ground connection should be a 1/4 inch braid (preferably insulated) or AWG No. 10 wire or larger. The grounding wire may daisy-chain between drives. If the drive has a switch or jumper which connects the logical signal ground to the cabinet ground (DC ground to AC ground), this connection should be removed once the drive is put on-line with the controller. It can be connected for performing local off-line maintenance on the drive.

NOTE

Failure to observe proper grounding methods will generally result in marginal operation with random error conditions.

3.7 TESTING

3.7.1 SELF-TEST

When power is applied to the CPU, the controller automatically executes a built-in self test. This self test is not executed with every bus INIT but only on power up. If the self test has been executed successfully, the LED on the top edge of the controller board will be OFF or flashing. The LED flashes when the controller cannot properly address at least one drive after successfully executing its self test. This will occur if the A and B cables are not properly plugged in, a drive is not powered up with a code plug, or two drives have an identical code plug. If the LED is ON steadily the controller did not pass its self test and the controller cannot be addressed from the CPU.

3.7.2 REGISTER EXAMINATION

After powering up the CPU and noting that the LED indicator is not ON steadily, a quick check should be made to ensure that the controller registers can be read from the computer console. The Control Status Register (CSR) 774400 will contain 000201 if the controller and drive 0 are ready.

3.7.3 HARDWARE FORMATTING THE DISK

The controller has the means to format the disk by writing headers and bad sector file data in all sectors of the disk. This command does not verify the data or headers.

If the drive is on line, the formatting is carried out as follows. Repeat the operation for each drive to be formatted.

1. Deposit 000013 into DAR (774404).
2. Select the drive to be formatted by depositing the drive number in bits 09 and 08 of CSR (774400). Bit 02 must also be set simultaneously.
3. Examine CSR (774400). Bit 15 (error) should be zero, and bit 01 should be 1 (drive ready).
4. Deposit a number to be used as a pack ID in MPR (774406).
5. Deposit 1000018 in BAR (774402) to enable the extended command set.
6. Deposit a hardware format command (34004 for drive 0, 34404 for drive 1, 35004 for drive 2 or 35404 for drive 3) for the appropriate drive in CSR (774400) to start formatting. The Activity LED will flash as long as the format operation is in progress. When it goes completely out, the operation is complete.

3.7.4 DIAGNOSTICS

The following DEC RL01/RL02 diagnostics should be run on the PDP-11:

- ZRLMB0 - Bad Sector File Tool
- ZRLKB1 - Performance Exerciser

The following DEC diagnostic should be run on the VAX-11:

- EVRFA

BLANK

Section 4
CONTROLLER REGISTERS

The standard RL12 has five registers that are used to control and monitor operations within the controller and disk drive units. In addition to the standard registers, the SCL2/LX incorporates three extra registers that are used to implement extended features such as the ability to format the disk media. All of the registers are described in detail in the subsections below.

4.1 CONTROL STATUS REGISTER (CSR)

4.1.1 CSR NORMAL FUNCTIONS

15	14	13	12	11	10	09	08	07	06	05	04	03	02	01	00
ERR	DE	NXM	E2	E1	E0	DS1	DS0	CRDY	IE	BA17	BA16	F2	F1	F0	DRDY

Composite Error (ERR) - Bit 15

When set, this bit indicates that one or more of the error bits (bits <14:10> is set. If the IE bit (bit 06 of CS) is set and an error occurs (which sets bit 07), and interrupt will be initiated.

Drive Error (DE) - Bit 14

This bit reports error status directly from the emulated drive. When set, it indicates that the selected drive has flagged an error. (The source of the error can be determined by executing a Get Status command.)

DE can be cleared by executing a Get Status command with bit 03 of the DA register set.

Non-Existent Memory (NXM) - Bit 13

This bit is set when the addressed memory does not respond within 10 to 20 microseconds of the beginning of a direct memory access (DMA) data transfer.

Data Late (DLT) or Header Not Found (HNF) - Bit 12

This bit is set during a write when the silo is empty but the word count has not yet reached zero (meaning that the bus request was ignored for too long). The OPI bit will not be set.

When this and OPI are both set, the controller could not find the correct sector to read or write (no header compare - HNF).

Control Status Register

ERROR SUMMARY

ERROR NAME	BITS		
	12	11	10
OPI	0	0	1
Read Data CRC	0	1	0
Write Check	0	1	0
Header CRC	0	1	1
Data Late	1	0	0
Header Not Found	1	0	1

Data CRC (DCRC) or Header CRC (HCRC) or Write Check (WCE) - Bit 11

If OPI (bit 10) is cleared and this bit is set, a CRC error has occurred when reading the data (DCRC).

If OPI (bit 10) is set and bit 11 is also set, the CRC error has occurred on the header (HCRC).

If OPI (bit 10) is cleared and bit 11 is set and the function command was a write check, a write check error (WCE) has occurred.

NOTE

Cyclic redundancy checking is performed on the first and second header words, even though the second header word always contains zeros.

Operation Incomplete (OPI) - Bit 10

When set, this bit indicates that the current command could not be completed.

Drive Select (DS0, DS1) - Bits <09:08>

These bits determine which drive will communicate with the controller via the drive bus.

Controller Ready (CRDY) - Bits 07

When cleared by software, this bit indicates that the command in bits <03:01> is to be executed. When set, this bit indicates the controller is ready to accept another command.

Interrupt Enable (IE) - Bits 06

When this bit is set by software, the controller is allowed to interrupt the processor at the normal command or error termination.

Control Status Register

Bus Address Extension Bits (BA16, BA17) - Bits <05:04>

The two most significant bus address bits. Read and written as data bits 05 and 04 of the CS register but considered as address bits 16 and 17 of the bus address register.

Function Code - Bits <03:01>

These bits are set by software to indicate the command to be executed.

Command execution requires that bit 07 (controller ready) be cleared by software. A zero bit being transferred into bit 07 of the CSR can be considered a GO bit.

F2	F1	F0	Command	Octal Code
0	0	0	Maintenance	0
0	0	1	Write Check	1
0	1	0	Get Status	2
0	1	1	Seek	3
1	0	0	Read Header	4
1	0	1	Write Data	5
1	1	0	Read Data	6
1	1	1	Read Data Without Header Check	7

Drive Ready (DRDY) - Bit 0

When set, this bit indicates that the selected drive is ready to receive a command. The bit is cleared when a seek operation is initiated and set when the seek operation is completed.

4.1.2 CSR EXTENDED FUNCTIONS

15	14	13	12	11	10	09	08	07	06	05	04	03	02	01	00
0	0	1	1	1	0	0	0	0	0	0	0	F3	F2	F1	F0

To enable the extended command set, BAR must be written with 1000018. The command is then immediately written into CSR with bits <13:11> set to one and with the extended command function code set into bits <03:00>.

Disk Address Register (DAR)

Function Code (<F3:F0>) - Bits <03:00>

The function code selects one of the extended commands as shown in the table below. All codes are even. Codes 2 and 6 through 16 are reserved.

Code No.	F3	F2	F1	F0	Command
0	0	0	0	0	Multipurpose Command
4	0	1	0	0	Firmware Format Command

4.2 BUS ADDRESS REGISTER (BAR)

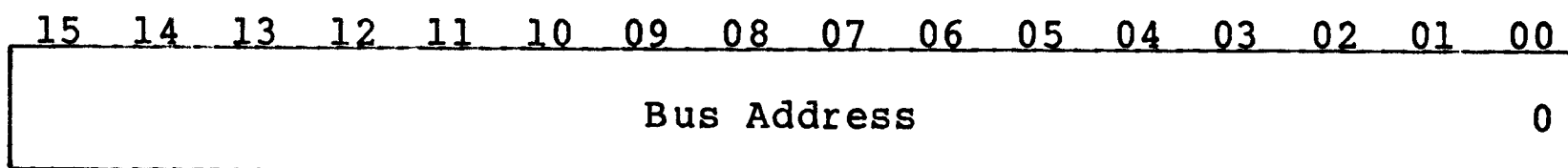

The Bus Address Register (BAR) is a 16-bit register with an address of 774402. Bits <15:01> can be read or written; bit 00 is always zero. Bus address bits 16 and 17 are contained in bits 05 and 04 of the CSR.

The BAR indicates the memory location involved in the data transfer during a normal read or write operation. The contents of the BAR are automatically incremented by two as each word is transferred between the bus and the I/O buffer. This register overflows into CSR bits 05 and 04.

The BAR is cleared by initializing the drive or by loading the register with zeros.

Bus Address - Bits <15:00>

These bits point to the UNIBUS address that data is to be transferred to/from (normally a memory address). Bit 00 is always zero. BA16 and BA17 are in CSR bits 05 and 04.

4.3 DISK ADDRESS REGISTER (DAR)

The Disk Address register (DAR) is a 16-bit register with an address of 774404. Its contents can have one of three meanings, depending on the function being performed. This register is cleared by initializing the device or loading the register with zeros. All 16 bits can be read or written by the processor.

Disk Address Register (DAR)

4.3.1 DAR DURING A SEEK COMMAND

15	14	13	12	11	10	09	08	07	06	05	04	03	02	01	00
DF8	DF7	DF6	DF5	DF4	DF3	DF2	DF1	DF0	0	0	HS	0	DIR	0	1

To perform a Seek function, it is necessary to provide cylinder address difference, head select, and head directional information to the selected drive as indicated.

Cylinder Address Difference (DF) 08:00 - Bits <15:07>

Indicates the number of cylinders the heads are to move on a seek.

Head Select (HS) - Bit 04

Indicates which head (disk surface) is selected. A one indicates the lower head; a zero, the upper head.

Direction (DIR) - Bit 02

This bit indicates the direction in which a seek is to take place. When the bit is set, the heads move toward the spindle (to a higher cylinder address). When the bit is cleared, the heads move away from the spindle (to a lower cylinder address). The actual distance moved depends on the cylinder address difference (bits <15:07>).

4.3.2 DAR DURING READ OR WRITE DATA COMMAND

15	14	13	12	11	10	09	08	07	06	05	04	03	02	01	00
CA8	CA7	CA6	CA5	CA4	CA3	CA2	CA1	CA0	HS	SA5	SA4	SA3	SA2	SA1	SA0

For a read or write operation, the DA register is loaded with the address of the first sector to be transferred. As each successive sector is transferred, the DA register is automatically incremented.

Cylinder Address (CA) 08:00 - Bits <15:07>

Address of the cylinders being accessed. (Range is 0 through 777, octal)

Head Select (HS) - Bits 06

Indicates which head (disk surface) is to be selected. A one indicates the lower head; a zero, the upper head.

Sector Address (SA) 05:00 - Bits <05:00>

Address of one of the 40 sectors on a track

Multipurpose Register

4.3.3 DAR DURING A GET STATUS COMMAND

15	14	13	12	11	10	09	08	07	06	05	04	03	02	01	00
X	X	X	X	X	X	X	X	0	0	0	0	RST	0	1	1

For a Get Status command, the DAR bits must be programmed as indicated in the figure above.

Reset (RST) - Bit 03

When this bit is set, the drive clears its error register before sending a status word to the controller.

Get Status (GS) - Bit 01

Must be a one, indicating to the drive that the status word is being requested. At the completion of the Get Status command, the drive status word can be read from the controller Multipurpose (MP) register (see paragraph 4.4). With this bit set, the drive ignores bits <15:08>.

4.4 MULTIPURPOSE REGISTER

The Multipurpose Register (MPR) is a 16-bit register with an address of 744406. This register has several different bit meanings, as explained below.

4.4.1 MPR AFTER A GET STATUS COMMAND

15	14	13	12	11	10	09	08	07	06	05	04	03	02	01	00
0	0	WL	SKTO	SPE	WGE	VC	DSE	DT	HS	C0	H0	BH	State		

When a Get Status command (subsection 4.3.3) is executed the status word is returned to the controller and transferred to the MPR. The contents of the MPR are defined as follows.

Write Lock (WL) - Bits 13

Set when the drive is logically or physically write protected.

Seek Time Out (SKTO) - Bit 12

Set when seek cannot be completed on a drive because of a drive fault or because it has gone off-line.

Write Gate Error (WGE) - Bit 10

Set if an attempt is made to write on a drive that is logically or physically write protected.

Volume Check (VC) - Bit 09

Set when physical drive becomes on-line and ready. Cleared by execution of a Get Status command with RST (bit 03) asserted.

Drive Type (DT) - Bit 07

A zero indicates an RL01; a one, an RL02.

Head Select (HS) - Bit 06

Indicates the currently selected head. A zero indicates the upper head; a one, the lower head.

Cover Open (CO) - Bit 05

Set when physical drive is not on-line and ready.

Heads Out (HO) - Bit 04

Set when physical drive is on-line and ready.

Brush Home (BH) - Bit 03

Set when physical drive is not on-line and ready.

State (State) - Bits <02:00>

These bits define the state of the drive:

02	01	00	
0	0	0	Load Cartridge - drive exists but not on line
1	0	0	Seek - Seek state
1	0	1	Lock On - normal ready state

4.4.2 MPR AFTER A READ HEADER COMMAND

When a Read Header command is executed, the next header will be read and its three words will be stored in the data buffer and transferred to the MP register. The first word will contain sector address, head select, and cylinder address information. The second word will

Multipurpose Register

contain all zeros. The third word will contain the header CRC information. All three words can be read sequentially by the program.

15	14	13	12	11	10	09	08	07	06	05	04	03	02	01	00
CA8	CA7	CA6	CA5	CA4	CA3	CA2	CA1	CA0	HS	SA5	SA4	SA3	SA2	SA1	SA0

15	14	13	12	11	10	09	08	07	06	05	04	03	02	01	00
ZEROES															

15	14	13	12	11	10	09	08	07	06	05	04	03	02	01	00
CRC															

Cylinder Address (CA) 08:00 - Bits <15:07>

Address of the cylinders being accessed. (Range is 0 through 777, octal)

Head Select (HS) - Bits 06

Indicates which head (disk surface) is to be selected. A one indicates the lower head; a zero, the upper head.

Sector Address (SA) 05:00 - Bits <05:00>

Address of one of the 40 sectors on a track

4.4.3 MPR DURING READ/WRITE DATA COMMANDS

15	14	13	12	11	10	09	08	07	06	05	04	03	02	01	00
1	1	1	Word Count												

Before the reading or writing data, the program should load the word count into the MP register in two's complement form. The counter is incremented as each word is transferred. Usually, the reading or writing operation is terminated when the word counter reaches zero (overflows). The word counter can keep track of any number of data words, from one to the full 40-sector count of 5120 data words (decimal). Bits <15:13> must be ones.

Word Count (WC) 12:00 - Bits <12:00>

Contains the two's complement of total number of words to be transferred. Bit 00 is the LS bit.

MPR PROGRAMMING NOTE - The RL01/RL02 Disk Drive will not do spiral read/writes. If data is to be transferred past the end of the last sector of a track, it is necessary to break up the operation into the following steps:

1. Program the data transfer to terminate at the end of the last sector of the track.
2. Program a seek to the next track. This can be either a head switch to the other surface but same cylinder or a head switch and move to the next cylinder.
3. Program the data transfer to continue at the start of the first sector at the next track.

4.4.4 MPR DURING MULTIPURPOSE COMMAND (EXTENDED)

15	14	13	12	11	10	09	08	07	06	05	04	03	02	01	00
0	0	0	HSL	0	0	0	0	0	0	0	0	WL3	WL2	WL1	WL0

The figure above defines the bits of the MPR during a Multipurpose Command. The bits should be set in this register prior to issuing the Multipurpose command.

Header Search Limit (HSL) - Bit 12

When set, this bit limits header search attempts to one revolution of the disk instead of three.

Write Locked (WL) <3:0> - Bits <03:00>

When set, bits <03:00> cause logical drives 3 through 0 to be write locked, respectively. Each bit may be set independently of the others.

BLANK

5.1 STANDARD FUNCTIONS

5.1.1 WRITE CHECK - FUNCTION CODE 1

The write check command is used to verify that data was written on the disk correctly. It is used after writing a block of data onto the disk and compares it with the contents of its source data buffer in main memory. Because this comparison is performed in the controller, this source data must be transferred out of memory and into the controller silo.

Prior to issuing this command, the BA register must be loaded with the address of the first location of the data block in main memory. The word counter register must be loaded with the data block length. The DAR is then loaded with the starting disk address location. At this point, the write check command can be loaded into the CSR.

Once a header match is found, and the header CRC validates the match, the 128 words of data are read from the disk. The data is then compared serially with the serial data coming out of the silo (SER DATA OUT). Either a compare error or a data CRC error will set bit 11 in the CSR.

5.1.2 GET STATUS - FUNCTION CODE 3

The Get Status command causes the status word from a drive to be transferred to the controller where the software can access it through the MPR. The software should first verify that the controller is ready to perform an operation (the drive does not have to be ready). Then, the software should load the DAR with ones in bits 01 and 00, a reset bit at 03 and zeros in the other locations. Next, the software should load the CSR with drive select bits, a negative GO bit, IE (if desired) and a code of 2 in the function bits. The controller will now command the selected drive to transfer its status word to the MPR in the controller. If the "reset" bit was set, the drive would reset its status register first.

5.1.3 SEEK - FUNCTION CODE 3

The seek operation causes the positioner to move (either forward or reverse) some number of cylinders. The software should first verify that the drive is ready to accept a command, then load the DAR with the difference word (difference between the present position and desired position). This word contains the number of cylinders to move (bits 15 through 07), the head select bit (04) and the direction bit (bit 02, 1=forward, 0=reverse). Bits 06, 05 and 01 must be reset

Standard Functions

and bit 00 must be set. After the DAR is loaded, the software should load the CSR with the command word. This word should contain the drive select bits, the negative GO bit, IE bit if desired and a code of 3 in the function bits. The controller sends the Seek command to the selected drive, causing the drive to start its Seek operation. At this time, the controller goes ready and interrupts if IE is set. The controller is now ready to accept another command to perform another operation on another drive while the Seek is occurring.

If the difference word is large enough that the heads attempt to move past the innermost or outermost limits, the head will stop at the guard band and retreat to the first even-numbered data track.

5.1.4 READ HEADER - FUNCTION CODE 4

When a Read Header function is decoded, the controller will read the first header encountered on the selected drive and place the three header words in the silo. They pass through the silo and stop with the first word in the MP register. The software can then access the first word to determine the current sector, head, and cylinder address. When the software extracts the first word from the MP register, the third word automatically moves in the MP. This is the CRC word. The software can now access it for checking purposes. (This command is simulated, no actual read of header takes place. Each time command is performed the next sequential header data will be used.)

5.1.5 WRITE DATA - FUNCTION CODE 5

When this function is decoded with CRDY cleared, the controller starts reading successive header words and comparing them to the DA register. When a match is found, the header CRC is checked and, if correct, that sector is written with the words from memory designated by the BA register. The BA and MP registers (word count in two's complement form) are incremented for each word transferred. For partial sector writes, the remaining sector area is filled with zeros. At the end of the sector, the sector portion of the DA register is incremented. The next sector is written if all the words have not been written. At the end of the transfer, CRDY is set and an interrupt made if IE is set.

5.1.6 READ DATA - FUNCTION CODE 6

When this function is decoded, the controller begins reading successive header words and comparing them to the contents of the DA register. When a match is found, the header CRC is checked and, if correct, that sector is read and the words are placed in the memory location designated by the BA register. Both the BA and MP registers (word count in two's complement form) are incremented for each word

transferred. This operation continues until the contents of the MP register is all zeros. Data CRC is checked and the DA register is incremented at the end of each sector. If the word count has not overflowed; the next sector is read. Otherwise, CRDY is set and an interrupt is made if IE is set.

5.1.7 READ DATA WITHOUT HEADER CHECK - FUNCTION CODE 7

When this function is decoded, the data portion of the sector following the next sector pulse is read and the words requested are placed in the memory locations designated by the BA register. The BA and MP registers (word count in two's complement form) are incremented for each word transferred. The header is neither compared nor checked for CRC errors. Data CRC is checked at the end of a sector. If the word count has not overflowed, the next sector is read. Otherwise, CRDY is set and an interrupt is made if IE is set.

5.2 EXTENDED COMMANDS

The SC12/LX will execute an extended set of commands not found on the RL11/RL12 controller. To execute any of the extended commands, an enable flag must be set prior to issuing the command. The enable flag is set by loading a 000001g into the Bus Address Register.

5.2.1 HARDWARE FORMAT - FUNCTION CODE 4

The hardware format command (code 4 in CSR) will cause the entire logical drive to be formatted. All headers are written and the data fields are written with zeros. The bad sector file will be created at the end of the cylinder address. The number entered into the Multipurpose Register will be used for the pack ID (121g is the default pack ID). The Disk Address Register is not used in this command. The controller will become ready and will interrupt the processor (if enabled) when finished.

5.2.2 MULTIPURPOSE COMMAND - FUNCTION CODE 0

This command has several functions, one of which is to write protect a logical drive. This command is executed by writing a "0" into the CSR after which bits <03:00> of the Multipurpose Register (MPR) will be copied and used as the write protect switches for drives <3:0>

Extended Commands

respectively. A set bit will cause a drive to be write protected; a reset bit will cause the drive to be not write protected only if the physical disk unit which the drive is mapped onto is also not write protected.

A second function of this command is to load a firmware Switch Register. When the command is executed, bits <15:04> of the MPR are copied to an internal firmware Switch Register. The Switch Register bits are cleared by writing into them with this command or whenever a power-up sequence occurs on the controller. Only one switch (bit 12) is used presently. When it is set, the number of disk revolutions before a header search may abort is limited to one revolution. Normally the search is continued for four revolutions except for write check commands, for which the search is limited to one revolution also.

A third function of this command is to fill the data silo with the first 255 words of the Firmware Register block which contains the Controller Registers and configuration constants. After the command has completed, successive reads of the MPR will enable software to read this information for diagnostic purposes. Words 118, 119 and 120 are of particular use for the track replacement function. Those words contain the physical cylinder, track and sector address, respectively, of the sector which follows the last sector to be read or written.

As with other commands, the controller will become ready and interrupt the processor (if enabled) when its function is completed.

APPENDIX A CONFIGURATION AND OPTION SELECTION

A.1 INTRODUCTION

To allow the user of the SCL2/LX the greatest amount of flexibility in selecting disk drives for his system, the SCL2/LX supports a wide variety of disk types and offers a number of other user selectable options. This appendix is designed as a quick reference to the various switches which make this flexibility possible.

A.2 CONTROLLER CONFIGURATION

The SCL2/LX unit is capable of controlling a variety of disk drives of various sizes and types. The drives that are supported are defined by the configuration PROM. Table A-1 is a list of the drive types and sizes that are supported. The user may choose between the available options by means of configuration switch SW2. The correct switch settings for each of the various configurations are given in Table A-2.

A.2.1 SINGLE DRIVE INSTALLATIONS

To find the configuration setting that is suitable for your single disk drive installation, use the following process. Note that all configurations require that the drive be hard sectored as noted in the Sec column of Table A-1. See the manufacture's drive installation manual for instructions.

1. Locate your drive type and size in Table A-1. Only standard RL01/RL02 configurations are useable (nonstandard sizes are marked with an asterisk). Note down the configuration number(s) assigned to your drive. Note also the cylinder (Cyl), track (Trk) and sector (Sec) figures for the drive.
2. Set the switches on the drive that determine the number of hard sectors per track according to the sector figure from Table A-1. Also set the drive number to 0 using switches or jumpers on the drive. See the installation manual provided by the drive manufacturer for instructions.
3. Find the configuration number for your drive in the CONF NO. column of Table A-2. If there is more than one number for an individual drive, start with the smallest. Note that for most configuration rows, specifications are given for two physical drives, Units 0 and 1.
4. When you find the proper row, compare the Physical Drive cylinder, track and sector figures for Unit 0 in Table A-2

Controller Configuration

with the numbers you noted down from Table A-1. The track and sector numbers must match; the cylinder number from Table A-2 must be smaller than the number from Table A-1. If those conditions are not met, go on to the next higher configuration number, etc, until you find a match.

5. When you find a match, set the Configuration Switches (SW2) as indicated in Table A-2. (Generally, there is more than one match. In such cases, look at the Logical Unit and Drive Type column for each configuration where a match was found. Choose the configuration you like best, and set the configurations switches accordingly.)

A.2.2 MULTIPLE DRIVE INSTALLATIONS (SAME TYPE DRIVE)

To find the configuration setting that is suitable for your multiple disk drive installation (drives same size and type), use the following process. Note that all configurations require that the drives both be hard sectored as noted in the Sec column of Table A-1. See the manufacture's drive installation manual for instructions. All multiple drive configurations that use only one type of drive have configuration numbers with a letter suffix. Configuration numbers without the suffix should be ignored.

1. Locate your drive type and size in Table A-1. Only standard RL01/RL02 configurations are useable (nonstandard sizes are marked with an asterisk). Note down the configuration number(s) assigned to your drives. Note also the cylinder (Cyl), track (Trk) and sector (Sec) figures for the drives.
2. Find the configuration number for your drives in the CONF NO. column of Table A-2. If more than one number was given for the drives, start with the smallest. Note that for each configuration row, specifications are given for two types of physical drives, Units 0 and 1.
3. When you find the proper row, compare the Physical Drive cylinder, track and sector figures for both Units 0 and 1 in Table A-2 with the numbers you noted down from Table A-1. The track and sector figures must match; the cylinder number from Table A-2 must be smaller than the cylinder number from Table A-1. If those conditions are not met, go on to the next higher configuration number, etc, until you find a match.
4. When you find a match, set the Configuration Switches (SW2) as indicated in Table A-2. (Generally, there is more than one match. In such cases, look at the Logical Unit and Drive Type column for each configuration where a match was found. Choose the configuration you like best, and set the configuration switches accordingly.)

Controller Configuration

5. Set the switches on the drive that determine the number of hard sectors per track according to the sector figure from Table A-1. Also assign each drive a unique drive number of 0 or 1 using an ID plug or switches on the drive. See the installation manual provided by the drive manufacturer for instructions.

A.2.3 MULTIPLE DRIVE INSTALLATIONS (DIFFERENT DRIVE TYPES)

To find the configuration settings that are suitable for your multiple disk drive installation (different drive size and type), use the following process. Note that all configurations require that the drives both be hard sectored as noted in the Sec column of Table A-1. See the manufacture's drive installation manual for instructions.

1. Locate your drive types and sizes in Table A-1. Only standard RL01/RL02 configurations are useable (nonstandard sizes are marked with an asterisk). Note down the configuration code(s) assigned to each drive. Note also the cylinder (Cyl), track (Trk) and sector (Sec) figures for each drive.
2. Once you have located and noted your drive configuration numbers, compare the numbers for each drive to one another. There must be at least one match if that drive combination is supported.
3. Consult Table A-2. Find the configuration number that both drive types have in common in the CONF NO. column. If there is more than one matched number for the drives, start with the smallest.
4. For each configuration row, specifications are given for two physical drives, Units 0 and 1. The two sets of cylinder, sector and track numbers will be different. Compare the physical cylinder, track and sector numbers for each unit with the corresponding numbers from Table A-1. The physical drive that matches the numbers for physical unit 0 becomes unit 0. The physical drive(s) whose numbers match physical drive number 1's becomes unit one. Not all of the physical cylinders need be used.
5. If there is more than one configuration supported, look at the Logical Unit and Drive Type column for each configuration where a match was found. Choose the configuration you like best, and set the configuration switches (SW2) accordingly.
6. Set the switches on the drives that determine the number of hard sectors per track according to the sector figures from Table A-1. Set the drive number as discussed in step 4, above. See the installation manual provided by the drive manufacturer for instructions.

Controller Configuration

Table A-1. Drives Supported

Mfg. - Model	Cyl	Trk	Sec	Configuration No.
Amcodyne 7110	644	4	32	13, 13
BASF 6172	614	3	23	4, 4A
BASF 6173	614	5	23	4, 4B, 11*, 11B*
CDC 9410	596	5	21	15, 15A, 15B
CDC 9455	206	4	32	6*, 6A, 6B*, 7*, 7A, 7B*
CDC 9448-32	823	2	35	5, 5A
CDC 9448-64	823	4	35	5, 5B
Century 2075	644	6	32	14A*, 14B*
FUJITSU 2311	589	4	35	11*, 11A
KENNEDY 7300	411	5	35	0, 0B
PRIAM 2050	525	3	23	3*, 3A, 3B*
PRIAM 3350	561	3	32	0, 0A
PRIAM 3350	561	3	35	1*, 1A, 1B*
PRIAM 3450	525	5	23	2*, 2A, 2B*
SLI 3100-2	656	3	20	12*, 12A, 12B*
SLI 3100-3	656	5	20	10, 10A
SLI 3100-4	656	7	20	10, 10B
TOSHIBA MK-80F-30	370	5	35	16, 16A

*These configurations are non standard drive sizes; i.e., an RL01 with more or less than the standard 256 cylinders or an RL02 with more or less than the standard 512 cylinders. They are not supported by the SC12/LX. Only RL02 emulations are supported on VAX-11 systems.

Table A-2. Drive Configurations
PROM #584

CONF NO.	SW2-								Physical				Logical		Rev
	10	9	6	5	4	3	2	1	Unit	Cyl	Trk	Sec	Unit(s)	= Dr Type	
0	0	0	0	0	0	0	0	0	0	534	3	32	0,1 = RL02	2 = RL01	A
									1	118	5	35			
0A	0	C	0	0	0	0	0	0	0	534	3	32	0,1 = RL02	2 = RL01	A
									1	214	3	32			
0B	C	C	0	0	0	0	0	0	0	411	5	35	0-2 = RL02	3 = RL01	A
1	0	0	0	0	0	0	0	C	0	489	3	35	0,1 = RL02	2 = RL01	A
									1	196	3	35			
1A	0	C	0	0	0	0	0	C	0	489	3	35	0,1 = RL02	2 = RL01	A
									1	196	3	35			
1B	C	C	0	0	0	0	0	C	0	561	3	35	0,1 = RL02	2 = RL01(448)	A
									1	196	3	35			
2	0	0	0	0	0	0	C	0	0	446	5	23	0,1 = RL02	2 = RL01	A
									1	179	5	23			

continued on next page

Controller Configuration

Table A-2. Drive Configurations (continued)

CONF NO.	SW2-								Physical				Logical		Rev
	10	9	6	5	4	3	2	1	Unit	Cyl	Trk	Sec	Unit(s) = Dr	Type	
2A	0	C	0	0	0	0	C	0	0	446	5	23	0,1 = RL02 2 = RL01 3 = RL02	A	
	1								1	446	2	23		A	
2B	C	C	0	0	0	0	C	0	0	524	5	23	0,1 = RL02 2 = RL01(480) 3 = RL02	A	
	1								1	179	5	23		A	
3	0	0	0	0	0	0	C	C	0	446	3	23	0 = RL02 1 = RL01 2 = RL02 3 = RL01(392)	A	
	1								1	525	3	23		A	
3A	0	C	0	0	0	0	C	C	0	446	3	23	0 = RL02 1 = RL01 2 = RL02 3 = RL01	A	
	1								1	446	3	23		A	
3B	C	C	0	0	0	0	C	C	0	525	3	23	0 = RL02 1 = RL01(392) 2 = RL02 3 = RL01(392)	A	
	1								1	525	3	23		A	
4	0	0	0	0	0	C	0	0	0	594	3	23	0,1 = RL02 2,3 = RL02	A	
	1								1	357	5	23		A	
4A	0	C	0	0	0	C	0	0	0	594	3	23	0,1 = RL02 2,3 = RL02	A	
	1								1	594	3	23		A	
4B	C	C	0	0	0	C	0	0	0	535	5	23	0-2 = RL02 3 = RL02	A	
	1								1	179	5	23		A	
5	0	0	0	0	0	C	0	C	0	586	2	35	0,1 = RL02 2,3 = RL02	A	
	1								1	586	2	35		A	
5A	0	C	0	0	0	C	0	C	0	586	2	35	0,1 = RL02 2,3 = RL02	A	
	1								1	586	2	35		A	
5B	C	C	0	0	0	C	0	C	0	586	4	35	0-3 = RL02	A	
	1								1	586	4	35		A	
6	0	0	0	0	0	C	C	0	0	160	4	32	0,1 = RL01 2,3 = RL01(328)	A	
	1								1	205	4	32		A	
6A	0	C	0	0	0	C	C	0	0	160	4	32	0,1 = RL01 2,3 = RL01	A	
	1								1	160	4	32		A	
6B	C	C	0	0	0	C	C	0	0	205	4	32	0,1 = RL01(328) 2,3 = RL01(328)	A	
	1								1	205	4	32		A	
7	0	0	0	0	0	C	C	C	0	160	4	32	1,0 = RL01 3,2 = RL01	A	
	1								1	205	4	32		A	
7A	0	C	0	0	0	C	C	C	0	160	4	32	1,0 = RL01 3,2 = RL01	A	
	1								1	160	4	32		A	
7B	C	C	0	0	0	C	C	C	0	205	4	32	1,0 = RL01(328) 3,2 = RL01(328)	A	
	1								1	205	4	32		A	
10	0	0	0	0	C	0	0	0	0	615	5	20	0-2 = RL02 3 = RL02	A	
	1								1	147	7	20		A	
10A	0	C	0	0	C	0	0	0	0	615	5	20	0-2 = RL02 3 = RL02	A	
	1								1	205	5	20		A	
10B	C	C	0	0	C	0	0	0	0	586	7	20	0-3 = RL02	A	
	1								1	586	7	20		A	
11	0	0	0	0	C	0	0	C	0	586	4	35	0-3 = RL02	A	
	1								1	586	4	35		A	
11A	0	C	0	0	C	0	0	C	0	586	4	35	0-3 = RL02	A	
	1								1	586	4	35		A	
11B	C	C	0	0	C	0	0	C	0	613	5	23	0,1 = RL02 2,3 = RL01(368)	A	
	1								1	613	5	23		A	

continued on next page

Controller Configuration

Table A-2. Drive Configurations (continued)

CONF NO.	SW2-								Physical				Logical		Rev
	10	9	6	5	4	3	2	1	Unit	Cyl	Trk	Sec	Unit(s) =	Dr Type	
12	0	0	0	0	C	0	C	0	0	512	3	20	0 = RL02	1 = RL01	A
									1	656	3	20	2 = RL02	3 = RL01(472)	A
12A	0	C	0	0	C	0	C	0	0	512	3	20	0 = RL02	1 = RL01	A
									1	512	3	20	2 = RL02	3 = RL01	A
12B	C	C	0	0	C	0	C	0	0	656	3	20	0 = RL02	1 = RL01(472)	A
									1	656	3	20	2 = RL02	3 = RL01(472)	A
13	0	0	0	0	C	0	C	C	0	644	4	32	0-3 = RL02		B
13A	0	C	0	0	C	0	C	C	0	644	4	32	0-3 = RL02		B
13B	C	C	0	0	C	0	C	C	(Do not select)					B	
14	0	0	0	0	C	C	0	0	(Do not select)						
14A	0	C	0	0	C	C	0	0	0	644	6	32	0-3 = RL02	(1024)	C
14B	C	C	0	0	C	C	0	0	(Do not select)						
15	0	0	0	0	C	C	0	C	0	596	5	21	0-2 = RL02		C
									1	187	5	21	3 = RL02		C
15A	0	C	0	0	C	C	0	C	0	596	5	21	0-2 = RL02		C
									1	187	5	21	3 = RL02		C
15B	C	C	0	0	C	C	0	C	0	596	5	21	0-2 = RL02		C
									1	187	5	21	3 = RL02		C
16	0	0	0	0	C	C	C	0	0	370	5	35	0,1 = RL02		E
									1	370	5	35	2,3 = RL02		E
16A	0	C	0	0	C	C	C	0	0	370	5	35	0,1 = RL02		E
									1	370	5	35	2,3 = RL02		E
16B	C	C	0	0	C	C	C	0	0	370	5	35	0,1 = RL02		E
									1	370	5	35	2,3 = RL02		E

A.3 USER SELECTABLE OPTIONS

Several other options including the register starting address for the SC12/L can be user selected. The functions of the switches that select those options are defined in Tables A-3, A-4 and A-5, below.

Controller Configuration

Table A-3. Option Switch Settings

Option Sw	Open	Closed	Function
SW1-1	Run	Halt-Reset	Controller Run/Halt-Reset
SW1-2			Not used ¹
SW1-3	Disable	Enable	Enhanced Features (impld seek, spiral read/write, etc.)
SW1-4	Disable	Enable	Drives to be write-locked on power-up

¹All unused switches MUST BE OPEN.

Table A-4. Configuration Switch Settings

Config Sw	Open	Closed	Function
SW2-1			Drive Configuration ¹
SW2-2			Drive Configuration ¹
SW2-3			Drive Configuration ¹
SW2-4			Drive Configuration ¹
SW2-5			Drive Configuration ¹
SW2-6			Drive Configuration ¹
SW2-7	Disable	Enable	VAX diagnostic compatibility
SW2-8	3:1	2:1	Sector Interleave
SW2-9			Drive Configuration ¹
SW2-10			Drive Configuration ¹

¹See Table A-2 for settings.

Table A-5. Address Switch Settings

Address Sw	Open	Closed	Function
SW3-1	160	214	Interrupt Vector
SW3-2		777340	Alternate Unibus Address ²
SW3-3		774400	Standard Unibus Address ²
SW3-4			Not used ¹
SW3-5			Not used ¹
SW3-6	2K	1K	Microcode Address Range (must be open for SC12/LX)

¹All unused switches MUST BE OPEN.

²Only one address may be selected. The other address switch must be open.

BLANK