

# GE-625/635 GECOS-III Flowcharts

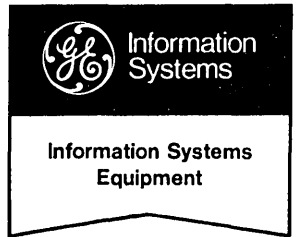

*Peter J. Colman*

SOFTWARE MAINTENANCE DOCUMENT

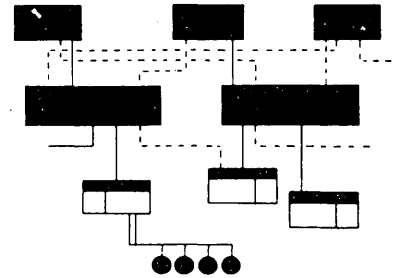

GENERAL  ELECTRIC

# GE-625/635 GECOS-III Flowcharts

SOFTWARE MAINTENANCE DOCUMENT

---

March 1968

INFORMATION SYSTEMS

GENERAL  ELECTRIC

## PREFACE

GE-625/635 GECOS-III FLOWCHARTS contains flowcharts for selected sections of the GECOS-III system. The flowcharts are arranged in CPB-1500 in the same sequential order as the corresponding text in the series of documents CPB-1488 to CPB-1499.

The initial page of each flowchart carries the full title of the corresponding program or routine. In addition, each flowchart page has a quick reference box at the top of the page to identify the flowchart on that page. The quick reference box contains the symbolic name of the program, the symbolic name of the higher level module, and when available, the entry point into the program.

Flowchart symbols follow the United States American Standard, USAS X3.5-1966.

Suggestions and criticisms relative to form, content, purpose, or use of this manual are invited. Comments may be sent on the Document Review Sheet in the back of this manual or may be addressed directly to Documentation Standards and Publications, B-90, Computer Equipment Department, General Electric Company, 13430 North Black Canyon Highway, Phoenix, Arizona 85029.

© 1968 by General Electric Company

(2M 3-68)

CPB-1500

# CONTENTS

	1. DISPATCHER AND PERIPHERAL ALLOCATION.....	1
	REDISPATCH AFTER INTERRUPT OR TIMER RUNOUT, DSP.....	3
	DSP (EP1) .MDISP.....	3
<i>GEROAD</i>	ROADBLOCK, GRD.....	17
	GRD (EP2) .MDISP.....	17
	FORCED RELINQUISH, FRLC.....	19
	FRLC (EP3) .MDISP.....	19
<i>GEELC</i>	RELINQUISH CONTROL, RLC.....	20
	RLC (EP4) .MDISP.....	20
<i>GEENDC</i>	END COURTESY CALL, ENCC.....	21
	ENCC (EP5) .MDISP.....	21
	ENABLE PROGRAM, ENB.....	22
	ENB (EP6) .MDISP.....	22
	PROGRAM NUMBER AT FRONT OF QUEUE, DSPQH.....	24
	DSPQH (EP7) .MDISP.....	24
	PROGRAM NUMBER AT END OF QUEUE, DSPQT.....	25
	DSPQT (EP8) .MDISP.....	25
	ACCUMULATE PROCESSOR TIME, DACNB.....	26
	DACNB (EP9) .MDISP.....	26
	RESTORE STATE AFTER SWAP, MOVE, GEPR, DRSTR.....	27
	DRSTR (EP10) .MDISP.....	27
	RELINQUISH CONTROL UNTIL PROGRAM ENABLED, DSCNT.....	28
	DSCNT (EP11) .MDISP.....	28
	DO DISC I/O USING SYSTEM I/O QUEUE, DMIOA.....	29
	DMIOA (EP12) .MDISP.....	29
	SET ALARM, SCK.....	32
	SCK (EP13) .MDISP.....	32
	PROGRAM NUMBER IN QUEUE FOLLOWING INTERRUPT, DSPQM.....	33
	DSPQM (EP14) .MDISP.....	33
	SAVE TRACE BUFFER AND WRITE OUT, TRACF.....	34
	TRACF (EP15) .MDISP.....	34
	INITIALIZATION, .IDISP.....	35
	.IDISP .MDISP.....	35
	.CALL MACRO, HCL.....	36
	HCL .MDISP.....	36
	.EXIT MACRO, HEX.....	38
	HEX .MDISP.....	38
	.GOTO MACRO, HGT.....	40
	HGT .MDISP.....	40
	SYSTEM TRACE, TRACE.....	49
	TRACE .MDISP.....	49
	OPEN SYSTEM GATES, OPGAT.....	51
	OPGAT .MDISP.....	51
	CLOSE SYSTEM GATES, SHUG.....	52
	SHUG .MDISP.....	52

2. FAULT PROCESSING AND SERVICE MME'S..... 53

	SECONDARY FAULT VECTOR, FPRC.....	55
	FPRC .MFALT.....	55
	RECOGNIZE FAULT TYPE AND PROCESS, FLT.....	56
	FLT .MFALT.....	56
	TAKE DUMP FOR SYSTEM ABORT, FSB.....	77
	FSB (EP1) .MFALT.....	77
<i>GETADR</i>	GET ADDRESS FOR FILE CODE, FGAD (.MFALT).....	78
	FGAD (EP2) .MFALT.....	78
<i>GETCON</i>	PUT INFORMATION IN FCB, FGCON.....	79
	FGCON (EP3) .MFALT.....	79
<i>GETFILS</i>	SWITCH PRIMARY AND SECONDARY LOGICAL UNITS, FGFIL.....	80
	FGFIL (EP4) .MFALT.....	80
<i>GETLAP</i>	PROVIDE PROCESSOR TIME PRIOR TO REQUEST, FGLAP.....	81
	FGLAP (EP5) .MFALT.....	81
<i>GETRET</i>	RESET PROGRAM SWITCH WORD BITS, FGRET.....	82
	FGRET (EP6) .MFALT.....	82
<i>GETSET</i>	SET PROGRAM SWITCH WORD BITS, FGSET.....	83
	FGSET (EP7) .MFALT.....	83
<i>GETTIM</i>	PROVIDE DATA AND TIME OF DAY, FGTIM.....	84
	FGTIM (EP8) .MFALT.....	84
<i>GETLOP</i>	DIVIDE EXECUTION TIME INTO SECONDS, FGLP (.MFALT).....	85
	FGLP (EP9) .MFALT.....	85
<i>GETM</i>	LET SLAVE PROGRAM ENTER MASTER MODE, FEMM.....	86
	FEMM (EP10) .MFALT.....	86
	FIND PAT FROM FILE CODE, FNDE.....	87
	FNDE (EP11) .MFALT.....	87
<i>GETMRL</i>	DEALLOCATE MEMORY, GMRL (.MFALT).....	88
	GMRL (EP12) .MFALT.....	88
	CALL .MDUMP AT EP2, BOOT.....	89
	BOOT (EP13) .MFALT.....	89
	FAULT PROCESSOR INITIALIZATION, .IFALT.....	91
	.IFALT .MFALT.....	91
	GET ADDRESS FOR FILE CODE, FGAD (.MFLT1).....	95
	FGAD (EP1) .MFLT1.....	95
	PUT INFORMATION IN FCB, FCON.....	96
	FCON (EP2) .MFLT1.....	96
	SWITCH PRIMARY AND SECONDARY LOGICAL UNITS, FLSW.....	100
	FLSW (EP3) .MFLT1.....	100
	DEALLOCATE MEMORY, GMRL (.MFLT1).....	101
	GMRL (EP4) .MFLT1.....	101
	DIVIDE EXECUTION TIME INTO SECONDS, FGLP (.MFLT1).....	105
	FGLP (EP5) .MFLT1.....	105
<i>GETPRIO</i>	GIVE I/O ACTION PRIORITY, FPRIO.....	106
	FPRIO (EP6) .MFLT1.....	106
<i>GETBAR</i>	RESET BAR TO SMALLER AREA, FLBAR.....	107
	FLBAR (EP7) .MFLT1.....	107
<i>GETWAKE</i>	ALLOW A PROGRAM TO DELAY, FWAKE.....	109
	FWAKE (EP8) .MFLT1.....	109
	MEMORY RELEASE ENTRY FOR TIME-SHARING, GMRLM.....	110
	GMRLM (EP9) .MFLT1.....	110

3. I/O SUPERVISION..... 111

	LINK I/O TO END OF QUEUE, LINK.....	113
	LINK (EP1) .MIOS.....	113
	LINK I/O TO FRONT OF QUEUE, LINKF.....	116
	LINKF (EP2) .MIOS.....	116
	LINK REISSUED I/O TO FRONT OF QUEUE, LINKR.....	117

	LINKR (EP3) .MIOS.....	117
	ASSIGN AN I/O ENTRY, QUEUE.....	118
GEINOS	QUEUE (EP4) .MIOS.....	118
	MME GEINOS PROCESSOR, INOS.....	120
	INOS (EP5) .MIOS.....	120
GESPEC	MME GESPEC PROCESSOR, SPEC.....	133
	SPEC (EP6) .MIOS.....	133
	MASTER MESSAGE PROCESSOR, ITYM.....	135
	ITYM (EP7) .MIOS.....	135
	POINTER VALIDATION, PTRVL.....	138
	PTRVL .MIOS.....	138
	DCW POINTER VALIDATION, DCWCK.....	139
	DCWCK .MIOS.....	139
	FIND FILE CODE, FNDFC.....	141
	FNDFC .MIOS.....	141
	FORMAT ERROR ACCOUNTING RECORD, FMTAR.....	142
	FMTAR .MIOS.....	142
	INTERRUPT HANDLER, IOTRM.....	144
	IOTRM .MIOS.....	144
	UNLINK I/O ENTRY, UNLNK.....	169
	UNLNK .MIOS.....	169
	CALCULATE LOGICAL PRIMARY CHANNEL INDEX, ILPCX.....	170
	ILPCX .MIOS.....	170
	STATUS RETURN, STRET.....	171
	STRET .MIOS.....	171
	START I/O, STIO.....	175
	STIO .MIOS.....	175
	CONNECT MULTIRECORD SIMULATION DCW, STIOM.....	187
	STIOM .MIOS.....	187
	CONNECT REISSUE OF SECOND TYPEWRITER COMMAND, TYPER... ..	188
	TYPER .MIOS.....	188
	CONNECT SELECTED GESPECED ENTRY, STGPC.....	189
	STGPC .MIOS.....	189
	RESUME I/O FOR PROGRAM, RSMIO.....	190
	RSMIO (EP8) .MIOS.....	190
	ABORT I/O FOR PROGRAM, ABTIO.....	192
	ABTIO (EP9) .MIOS.....	192
	FORMAT I/O STATUS WORDS AND RETURN STATUS, GSTRT.....	196
	GSTRT (EP10) .MIOS.....	196
	RESUME I/O ON CHANNEL, RSMCH.....	197
	RSMCH (EP12) .MIOS.....	197
	ACCOUNTING FILE REQUEST, ACTFL.....	198
	ACTFL (EP13) .MIOS.....	198
	MAIN IOS MODULE INITIALIZATION, .IIOS.....	201
	.IIOS .MIOS.....	201
	CARD PUNCH INTERRUPT HANDLER, CPIT.....	204
	CPIT (EP1) .MCPIO.....	204
	CARD PUNCH REQUEST, CPIO.....	207
	CPIO (EP2) .MCPIO.....	207
	CARD PUNCH INITIALIZATION, .ICPIO.....	208
	.ICPIO .MCPIO.....	208
	MDS200 INTERRUPT HANDLER, DRIT.....	209
	DRIT (EP1) .MDR20.....	209
	MDS200 REQUEST, DRIO.....	212
	DRIO (EP2) .MDR20.....	212
	MDS200 SELECT, DRSL.....	214
	DRSL (EP3) .MDR20.....	214
	MDS200 ERROR AND EOF RECOVERY, DRGP.....	217
	DRGP (EP4) .MDR20.....	217
	MDS200 NEGATIVE ENTRY POINTS, NEGATIVE EP.....	222

NEGATIVE EP .MDR20.....	222
MDS200 INITIALIZATION, .IDR20.....	230
.IDR20 .MDR20.....	230
DSU200 INTERRUPT HANDLER, DSIT.....	231
DSIT (EP1) .MDS20.....	231
DSU200 REQUEST, DSIO.....	233
DSIO (EP2) .MDS20.....	233
DSU200 SELECT, DSSL.....	234
DSSL (EP3) .MDS20.....	234
DSU200 ERROR AND EOF RECOVERY, DSGP.....	236
DSGP (EP4) .MDS20.....	236
DSU200 NEGATIVE ENTRY POINTS, NEGATIVE EP.....	247
NEGATIVE EP .MDS20.....	247
DSU200 INITIALIZATION, .IDS20.....	254
.IDS20 .MDS20.....	254
CARD READER INTERRUPT HANDLER, CRIT.....	255
CRIT (EP1) .MGPIO.....	255
CARD READER REQUEST, CRIO.....	257
CRIO (EP2) .MGPIO.....	257
CARD READER INITIALIZATION, .IGPIO.....	258
.IGPIO .MGPIO.....	258
MAGNETIC TAPE INTERRUPT HANDLER, MTIT.....	259
MTIT (EP1) .MMTAP.....	259
MAGNETIC TAPE REQUEST, MTIO.....	264
MTIO (EP2) .MMTAP.....	264
MAGNETIC TAPE INITIALIZATION, .IMTAP.....	265
.IMTAP .MMTAP.....	265
PRINTER INTERRUPT HANDLER, PRIT.....	266
PRIT (EP1) .MPRIO.....	266
PRINTER REQUEST, PRIO.....	269
PRIO (EP2) .MPRIO.....	269
PRINTER INITIALIZATION, .IPRIO.....	270
.IPRIO .MPRIO.....	270
PAPER TAPE INTERRUPT HANDLER, PTIT.....	271
PTIT (EP1) .MPTAP.....	271
PAPER TAPE REQUEST, PTIO.....	272
PTIO (EP2) .MPTAP.....	272
PAPER TAPE INITIALIZATION, .IPTAP.....	273
.IPTAP .MPTAP.....	273
TYPEWRITER INTERRUPT HANDLER, TYIT.....	274
TYIT (EP1) .MTYPE.....	274
TYPEWRITER REQUEST, TYIO.....	277
TYIO (EP2) .MTYPE.....	277
TYPEWRITER SELECT, TYSL.....	279
TYSL (EP3) .MTYPE.....	279
TYPEWRITER INITIALIZATION, .ITYPE.....	280
.ITYPE .MTYPE.....	280
NORMAL CLOSE OF ACCOUNTING FILE, ACTS1.....	281
ACTS1 (EP1) .MACTS.....	281
ERROR CLOSE OF ACCOUNTING FILE, ACTS2.....	282
ACTS2 (EP2) .MACTS.....	282
EXTERNAL REQUEST FOR ACCOUNTING FILE CLOSE, ACTS3.....	289
ACTS3 (EP3) .MACTS.....	289
4. TERMINATION AND SYSTEM OUTPUT.....	291
PROCESS MME GESYOT, MME.....	293
MME (EP1) .MSYOT.....	293

GESYOT

WRITE EXECUTION REPORT MESSAGE (RELATIVE), EXEC.....	310
EXEC (EP2) .MSYOT.....	310
PROCESS END OF ACTIVITY, EOA.....	311
EOA (EP3) .MSYOT.....	311
PROCESS END OF JOB, EOJ.....	313
EOJ (EP4) .MSYOT.....	313
WRITE EXECUTION REPORT MESSAGE (ABSOLUTE), EXCA.....	324
EXCA (EP5) .MSYOT.....	324
PROCESS CALL FROM GEIN, GEIN.....	325
GEIN (EP6) .MSYOT.....	325
DISPATCHER, DISP.....	326
DISP .MGEOT.....	326
START REPORT/ACTIVITY, STACT.....	336
STACT .MGEOT.....	336
READ INTO BUFFER, READ.....	338
READ .MGEOT.....	338
WRITE FROM BUFFER, WRITE.....	340
WRITE .MGEOT.....	340
COURTESY CALL FOR READ, CCCRD.....	351
CCCRD .MGEOT.....	351
COURTESY CALL FOR WRITE, CCCWR.....	354
CCCWR .MGEOT.....	354
COURTESY CALL FOR GESPEC, CCGSP.....	356
CCGSP .MGEOT.....	356
ASSIGN DEVICE AND JOB, ASIGN.....	366
ASIGN .MGEOT.....	366
START JOB, STRJB.....	368
STRJB .MGEOT.....	368
ANALYZE INPUT REQUEST, NEWJB.....	369
NEWJB .MGEOT.....	369
RELEASE BLINKS, FLUSH.....	373
FLUSH .MGEOT.....	373
CREATE FRONT BANNER, FOR.....	375
FOR (EP1) .MGOUL.....	375
CREATE TRAILER ENSIGN, AFT.....	377
AFT (EP2) .MGOUL.....	377
CREATE IDENT BANNER, IDENT.....	378
IDENT (EP3) .MGOUL.....	378
CREATE REPORT HEADER, START.....	379
START (EP1) .MGOU3.....	379
INDEX.....	381





1. DISPATCHER  
~~AND PERIPHERAL ALLOCATION~~

(Reference CPB-1491)



REDISPATCH AFTER INTERRUPT OR TIMER RUNOUT

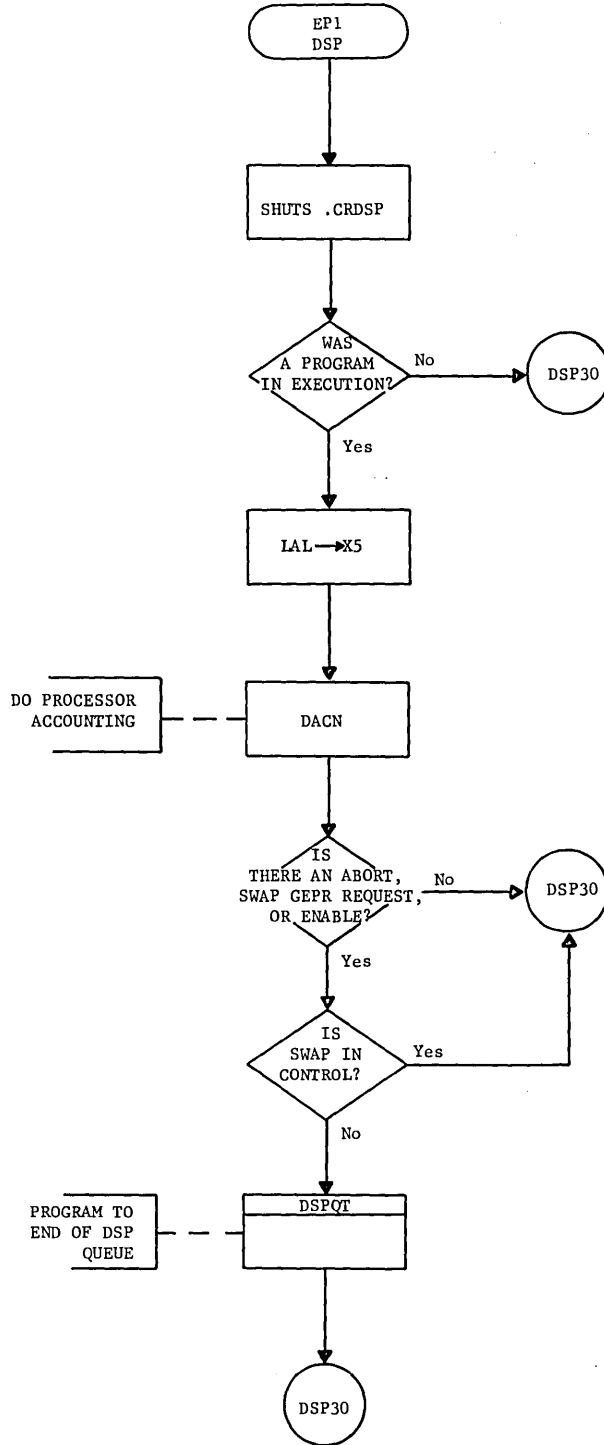

DSP (EP1)  
.MDISP

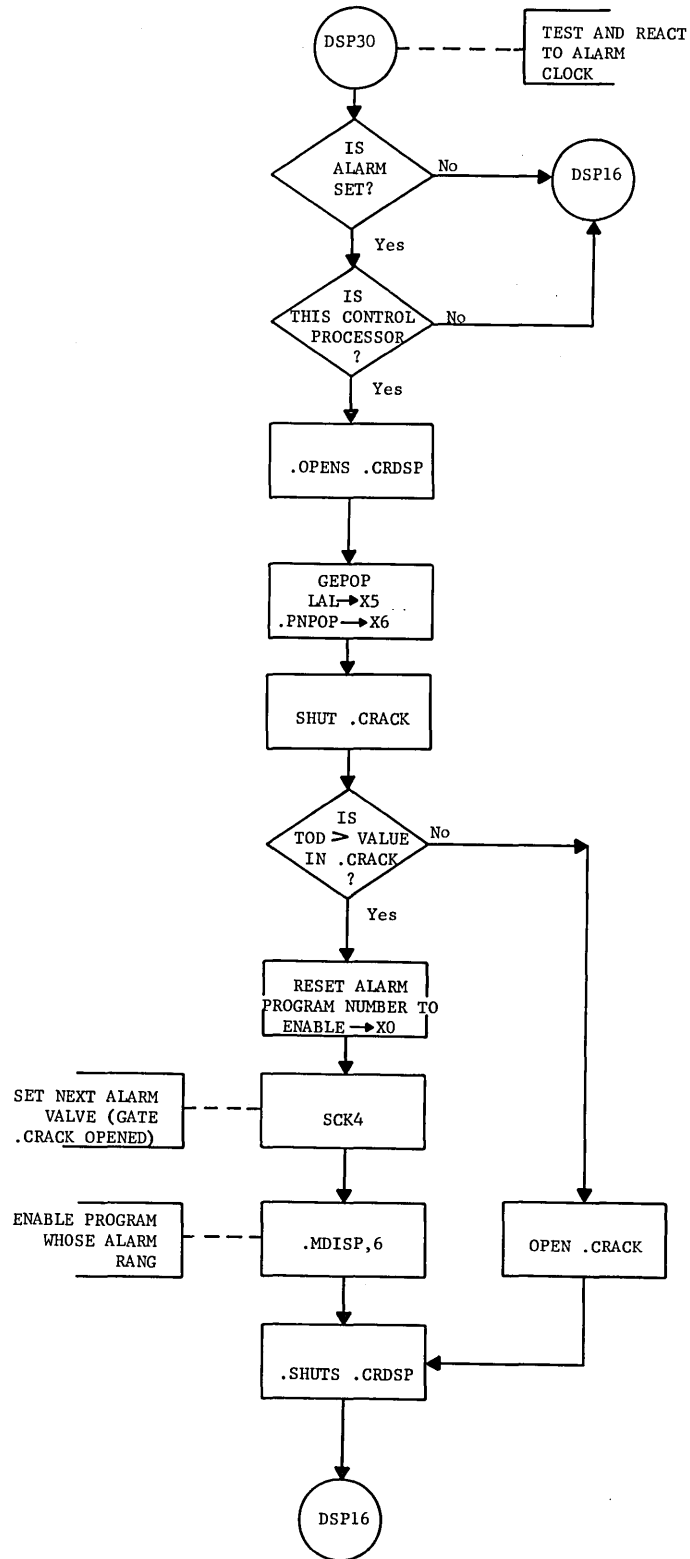

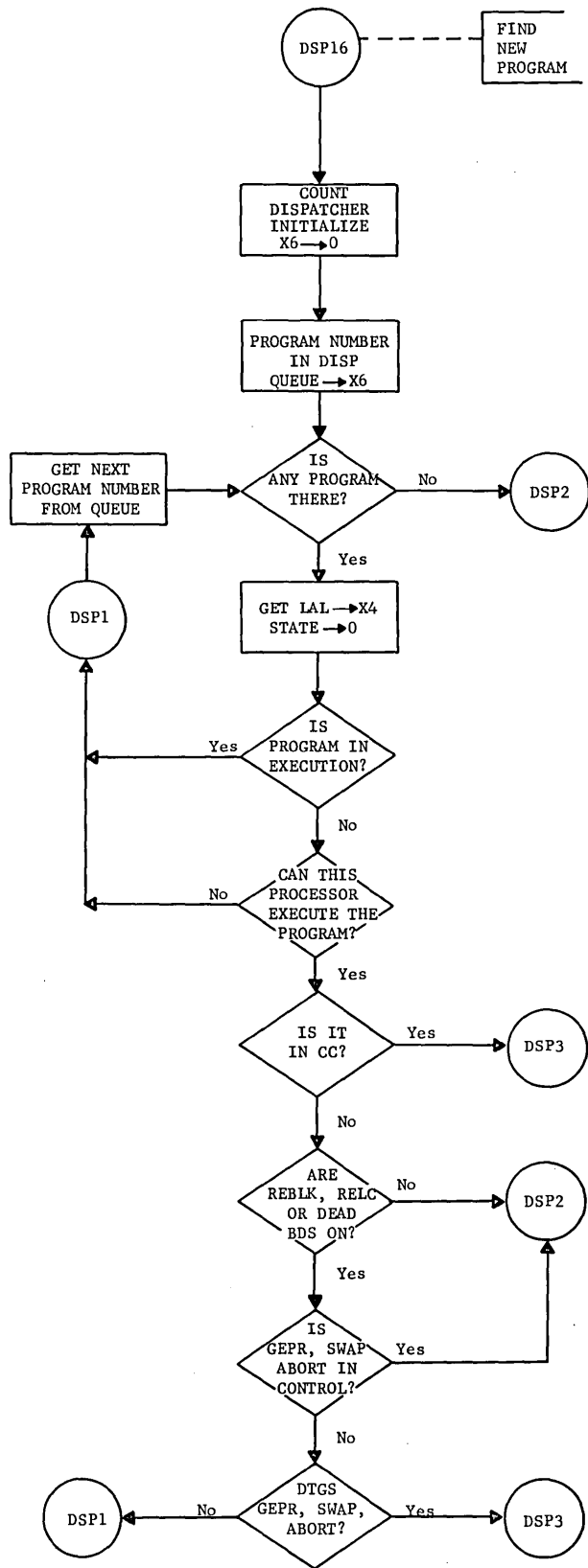

DSP (EP1)  
.MDISP

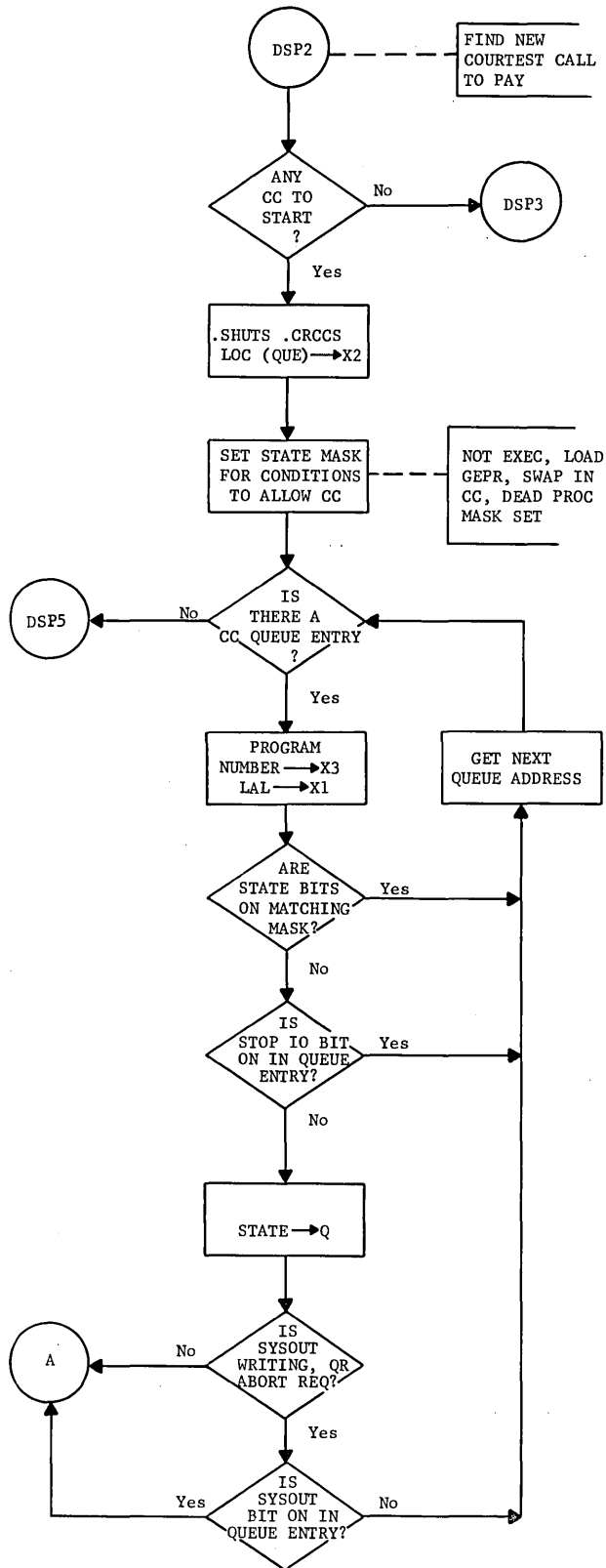

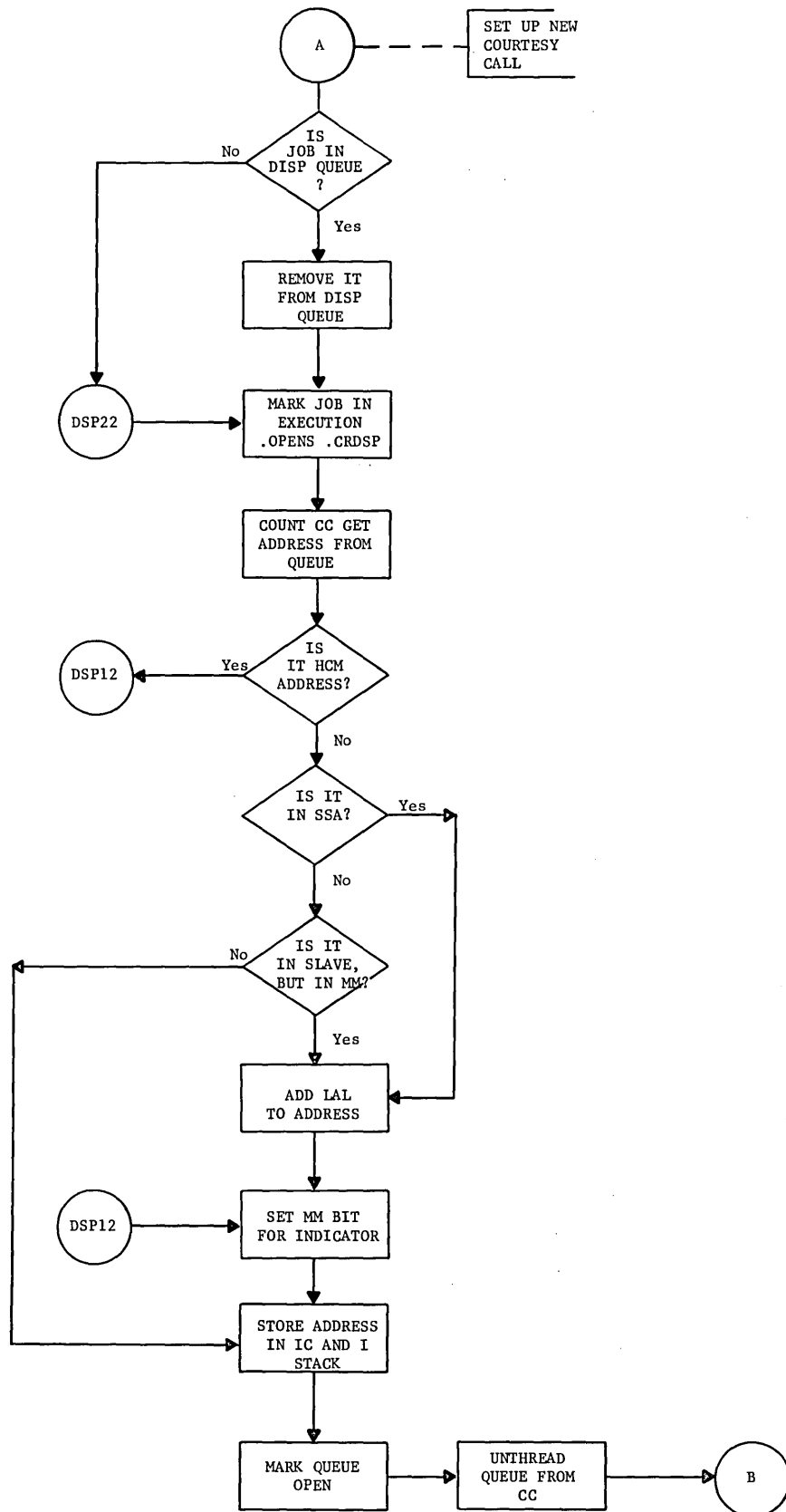



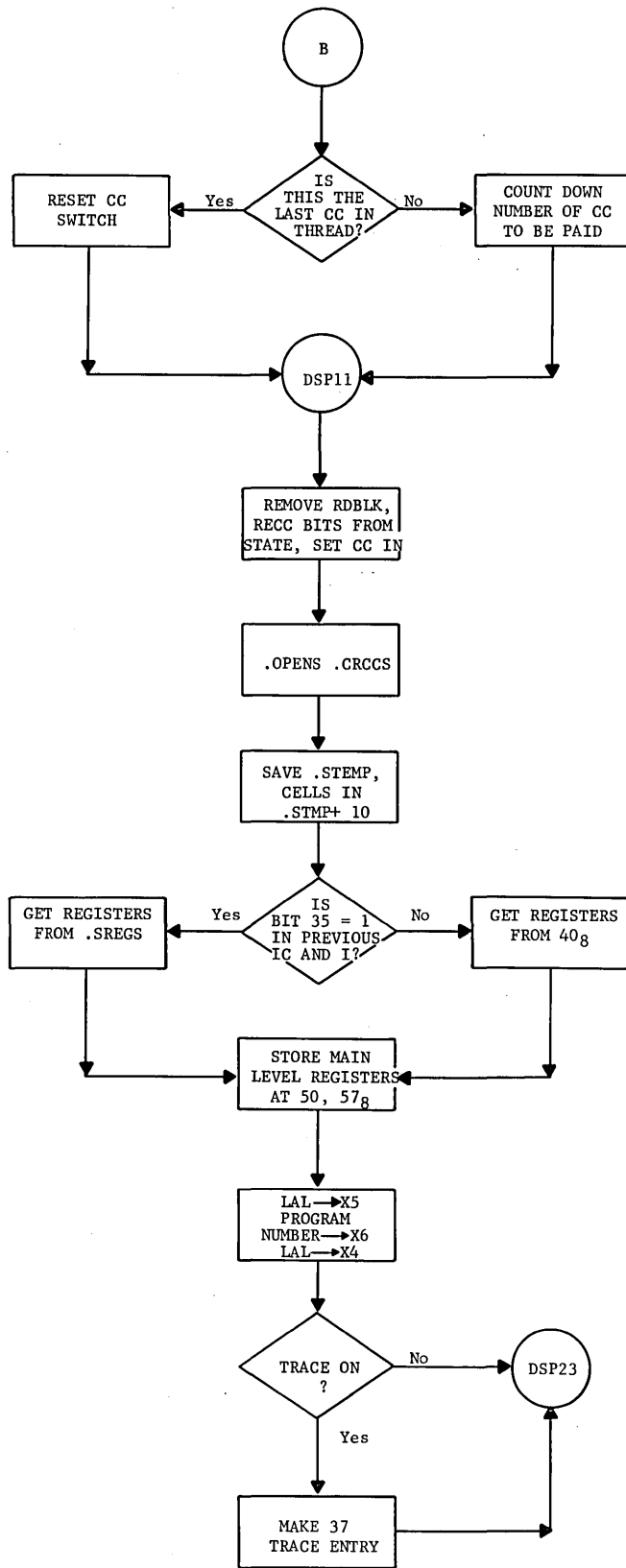

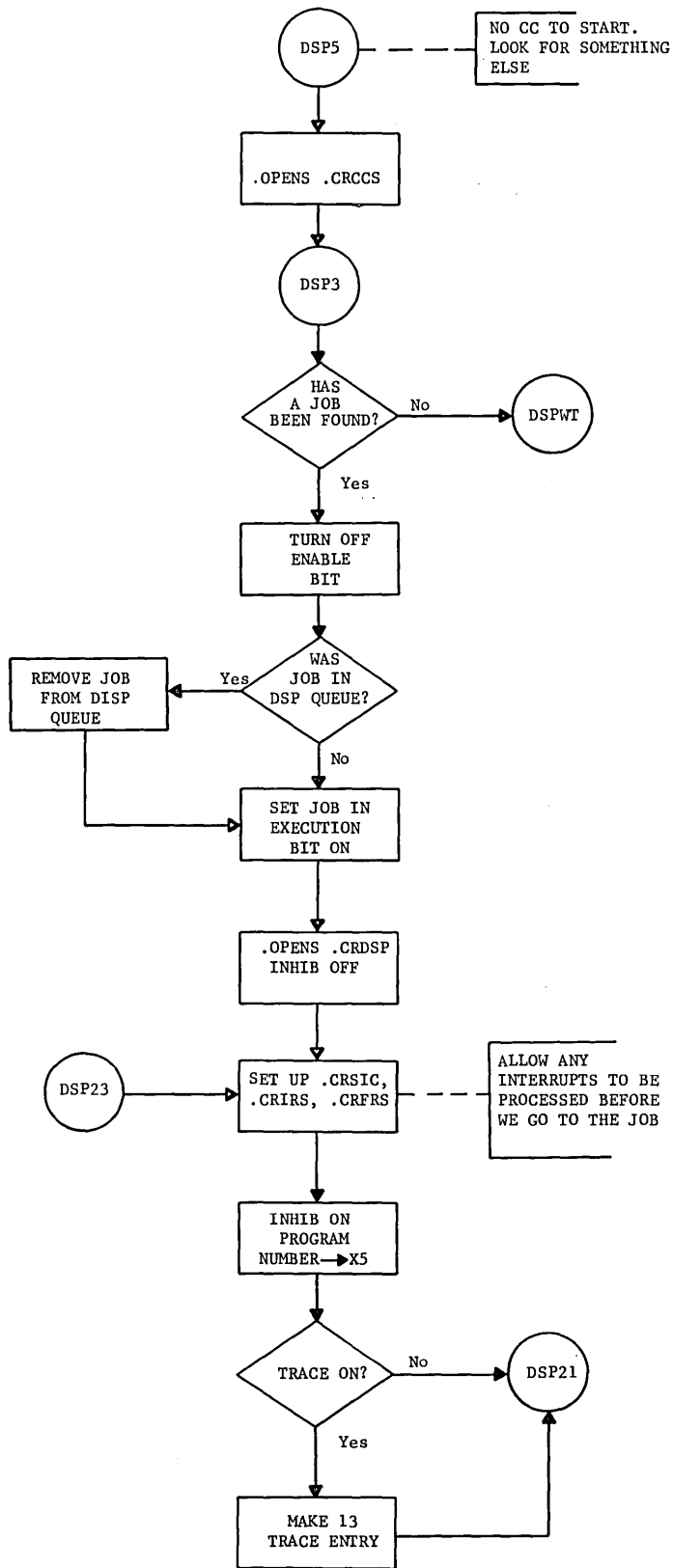

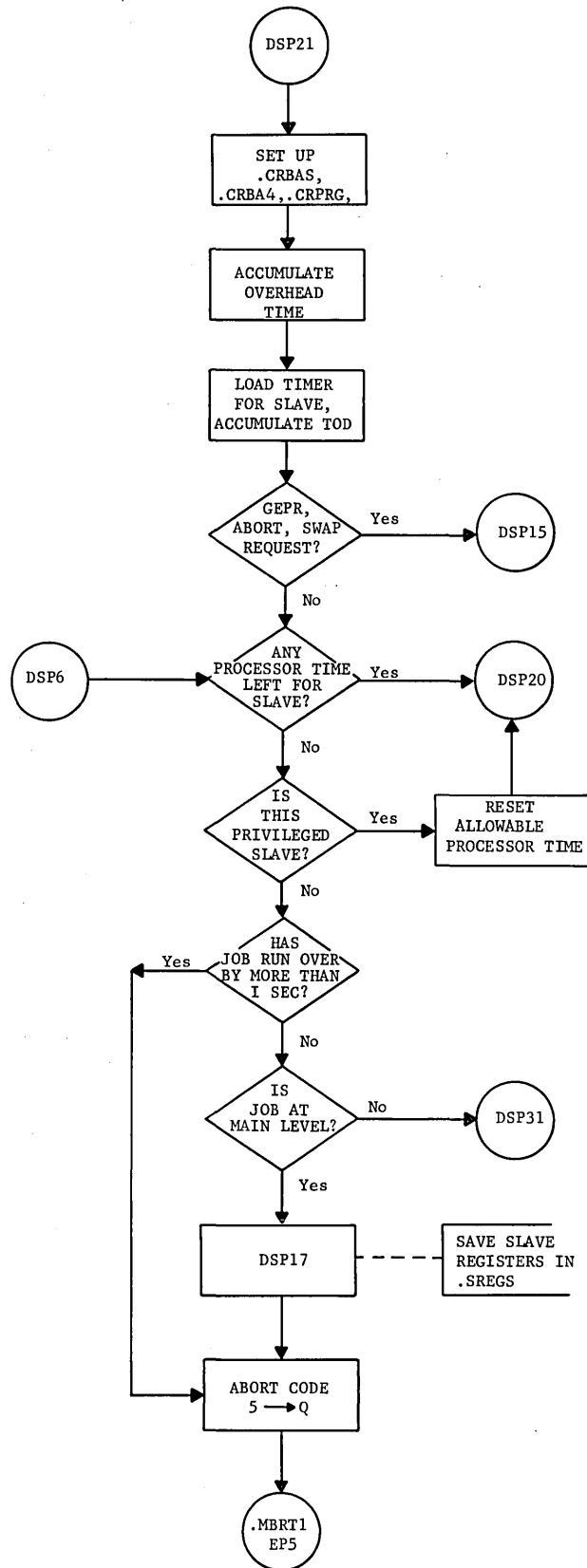

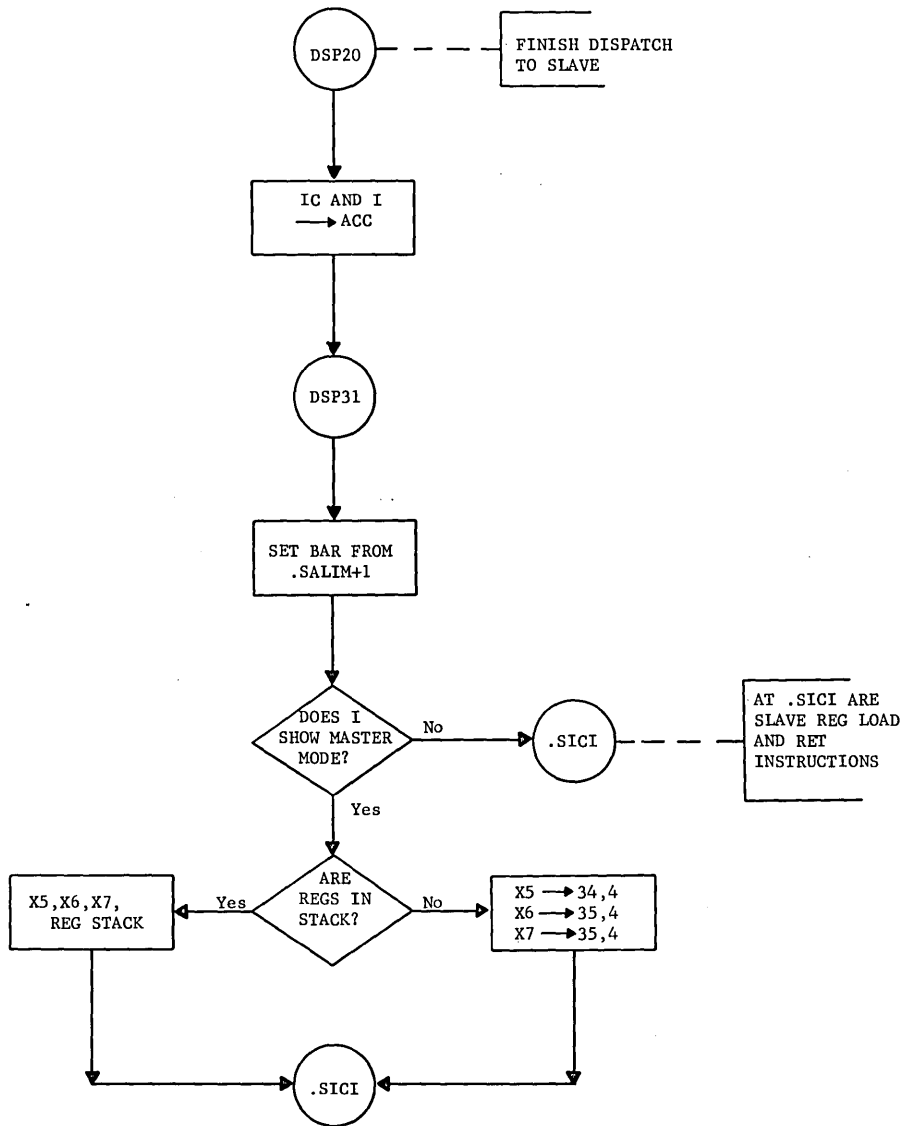

DSP (EP1)  
.MDISP

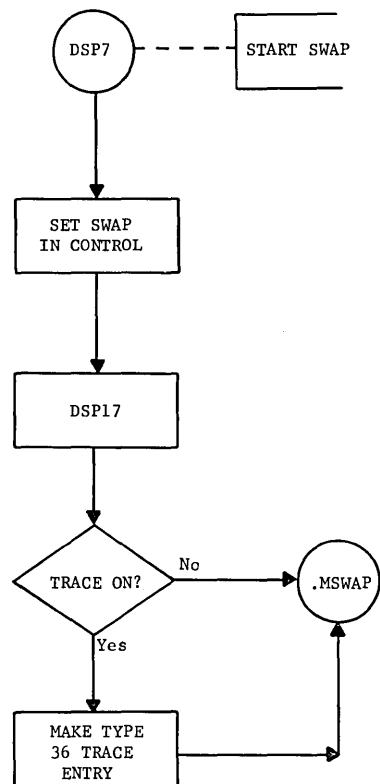
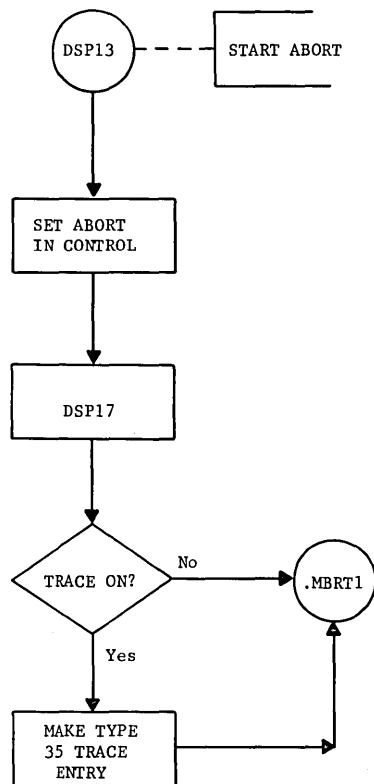
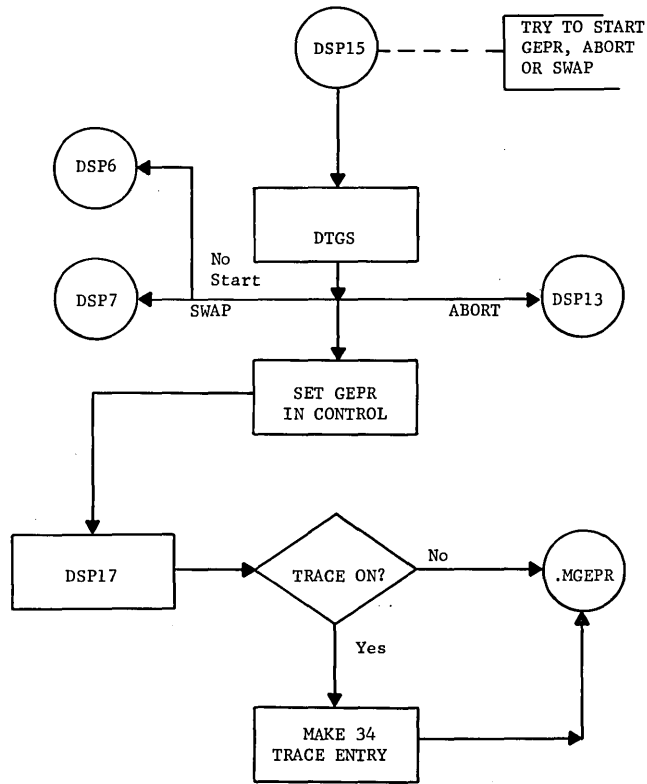

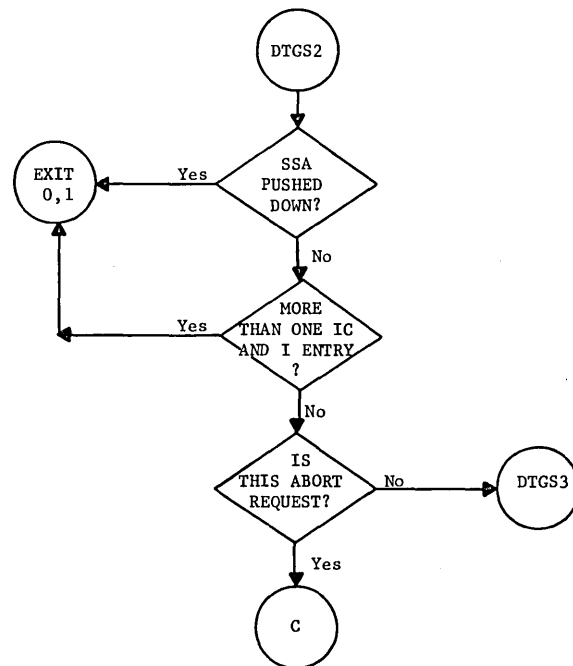
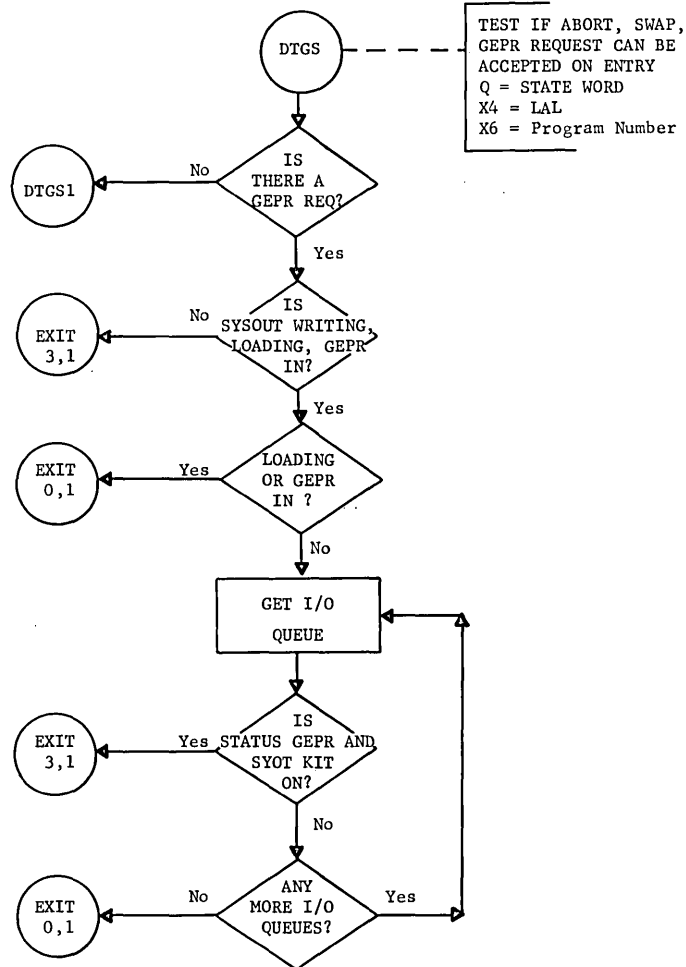

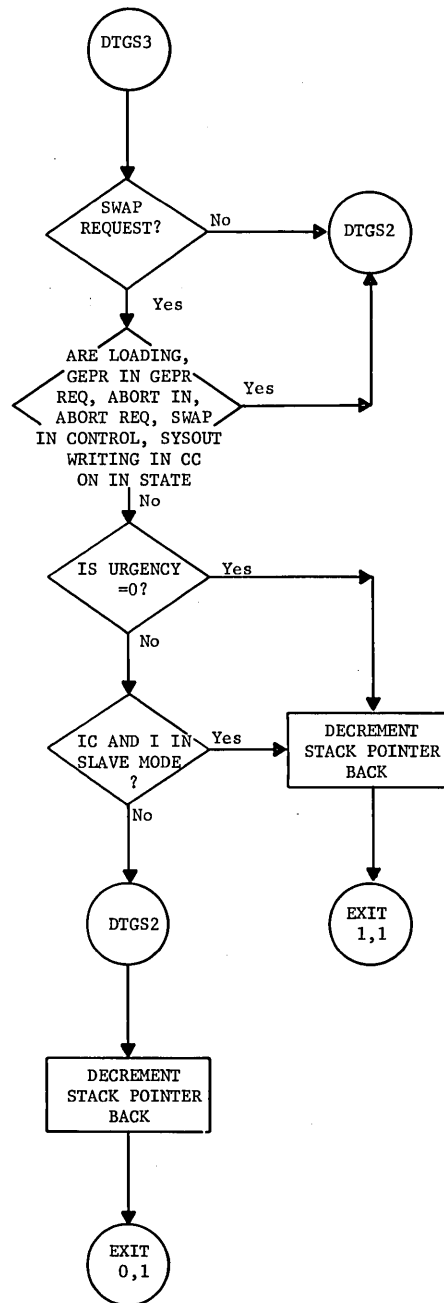
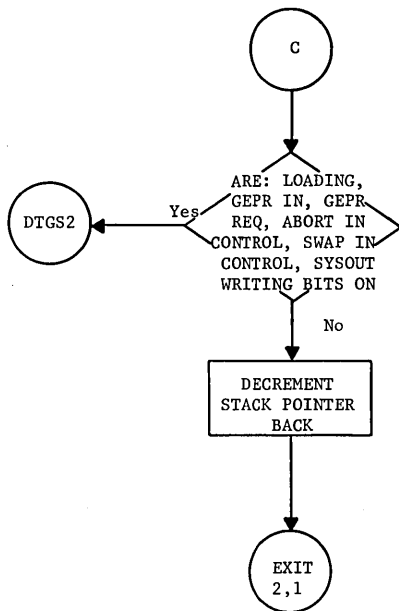

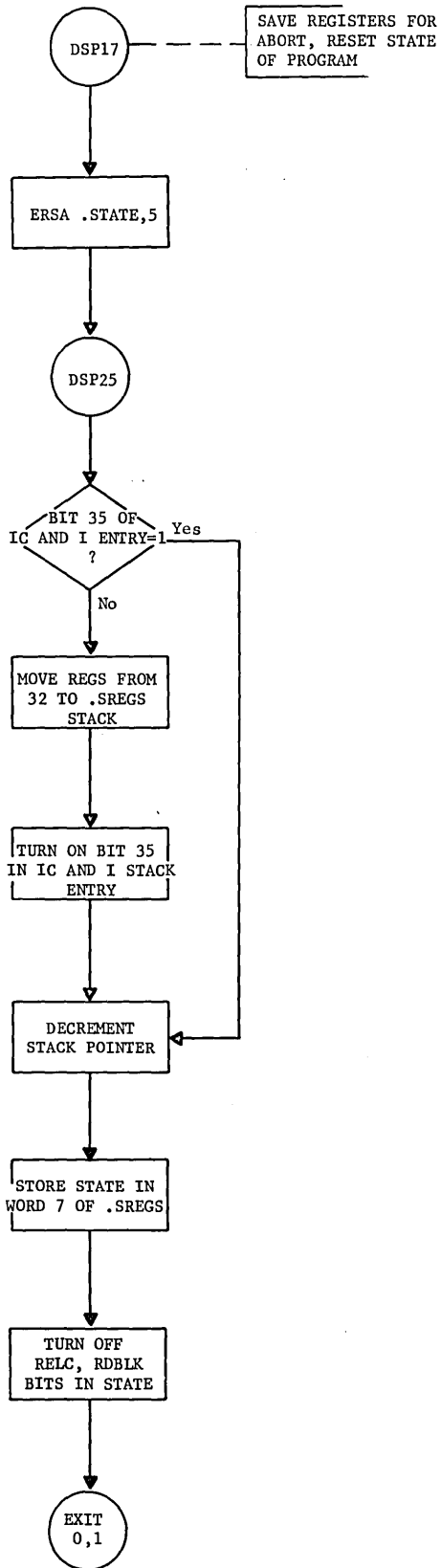



DSP (EP1)  
.MDISP

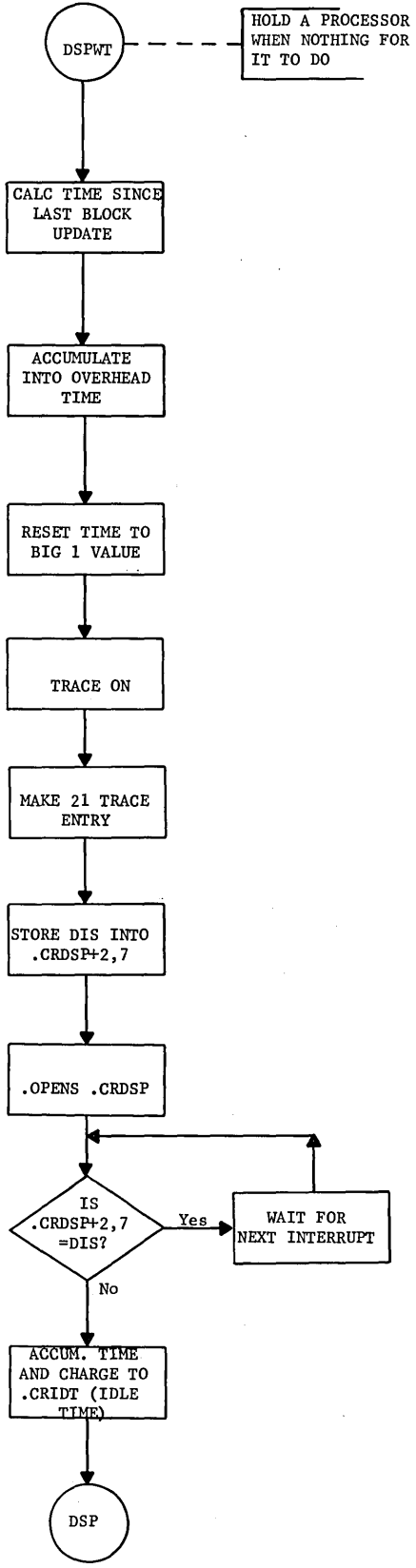

ROADBLOCK

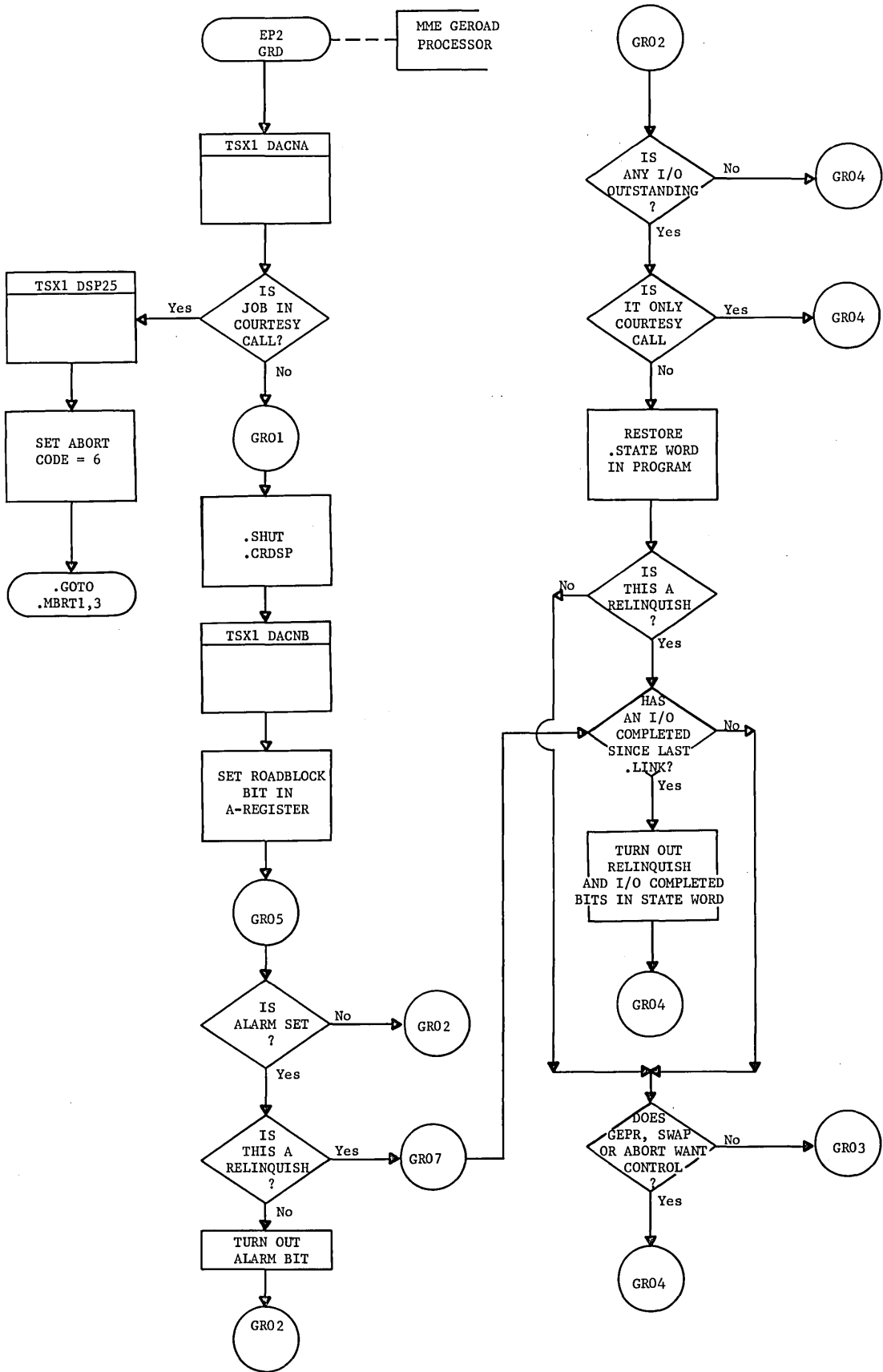

GRD (EP2)  
.MDISP

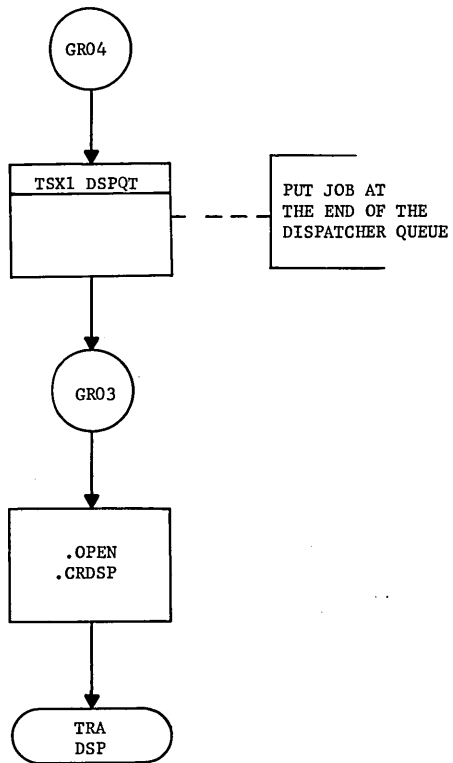

FORCED RELINQUISH

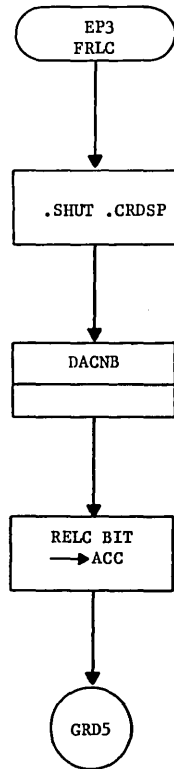

RLC (EP4)  
.MDISP

RELINQUISH CONTROL

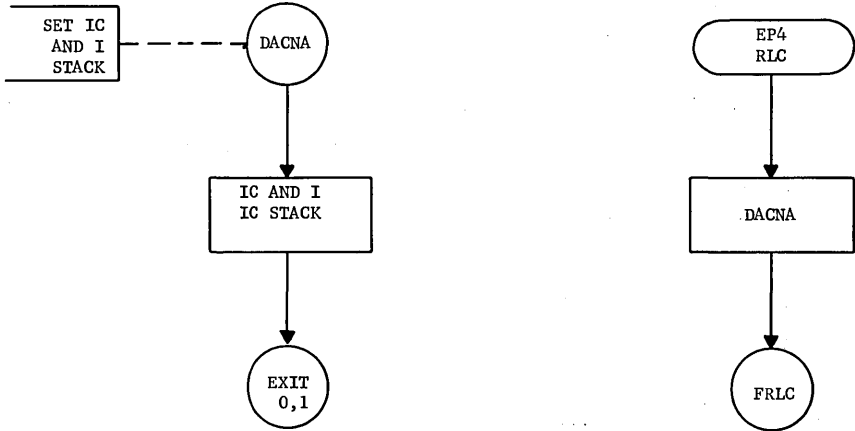

END COURTESY CALL

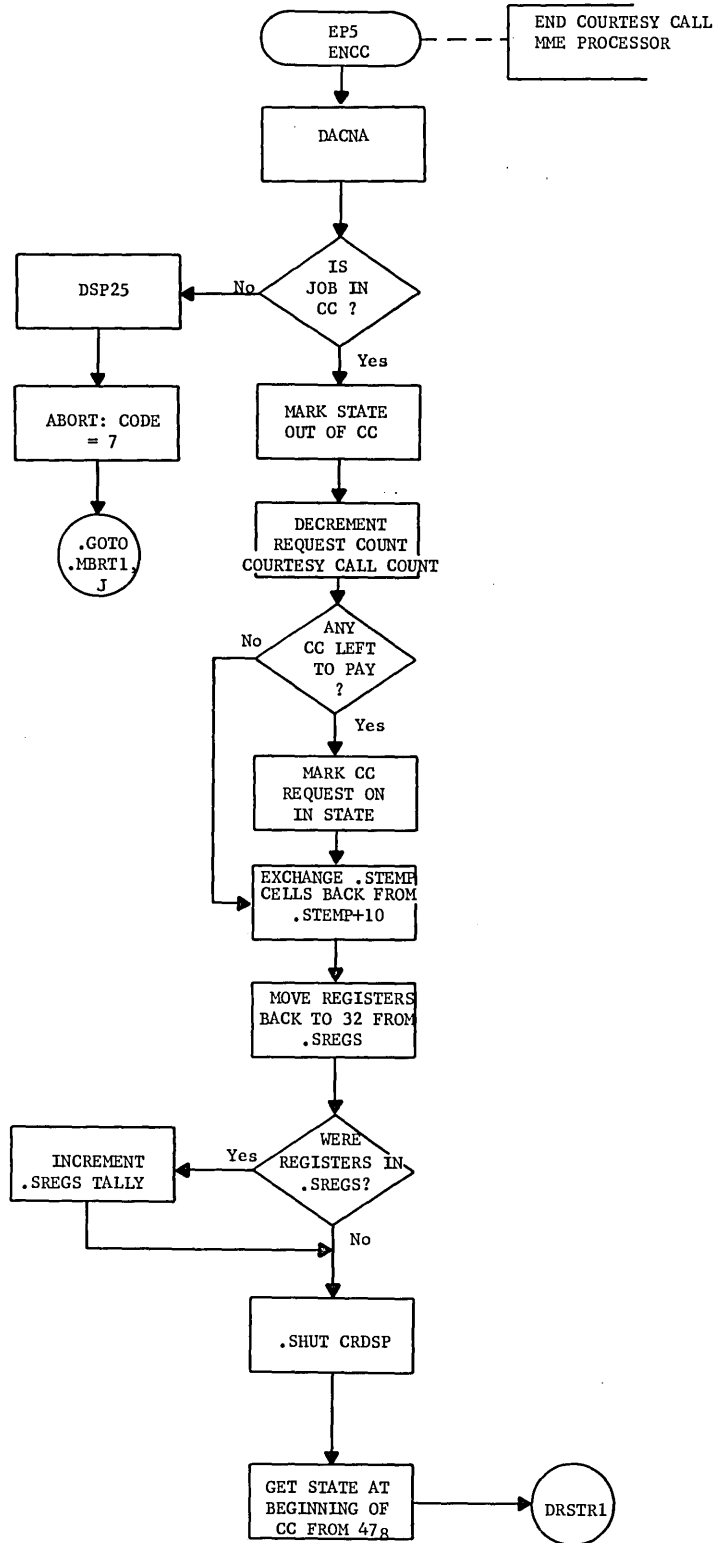

ENB (EP6)  
.MDISP

### ENABLE PROGRAM

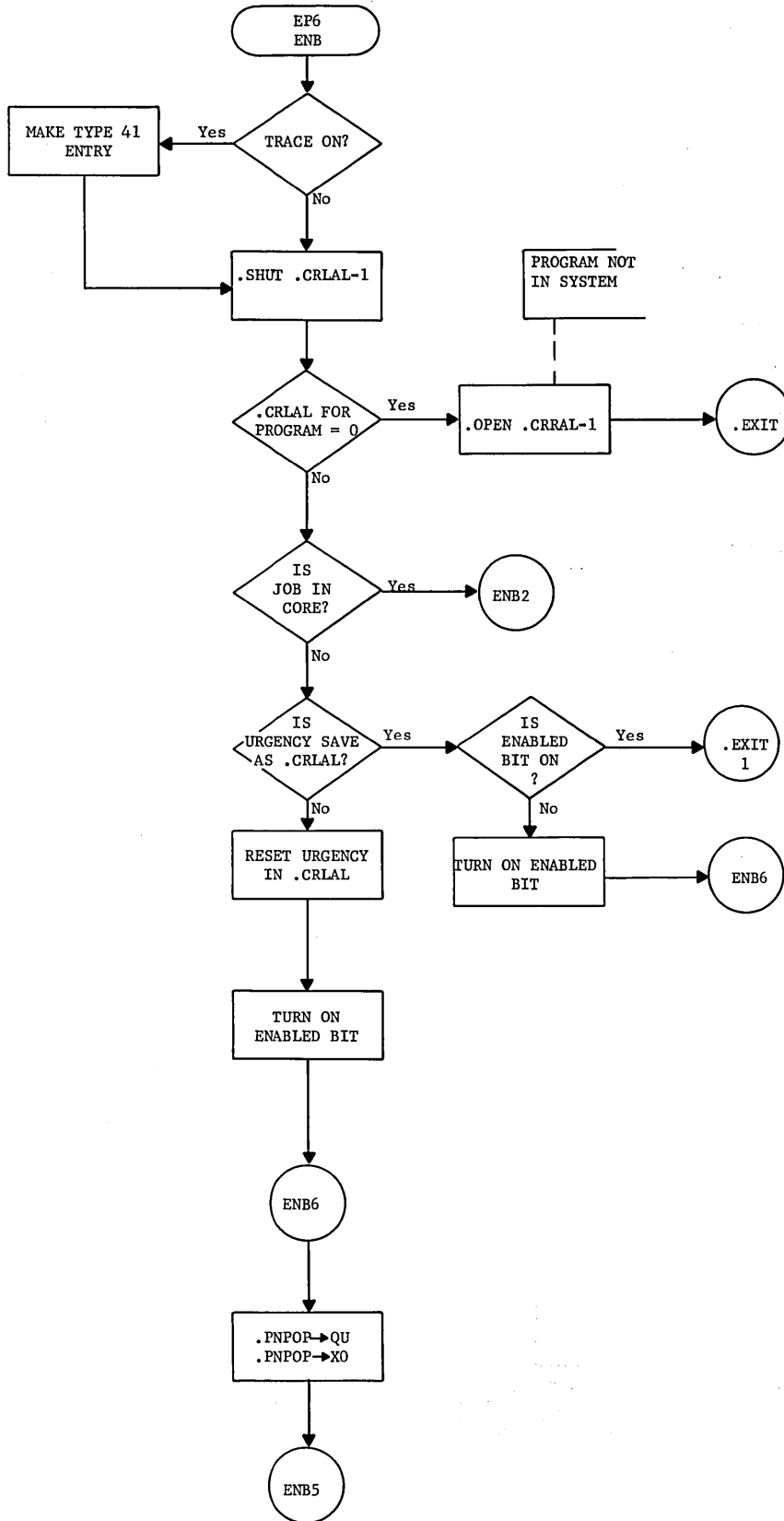

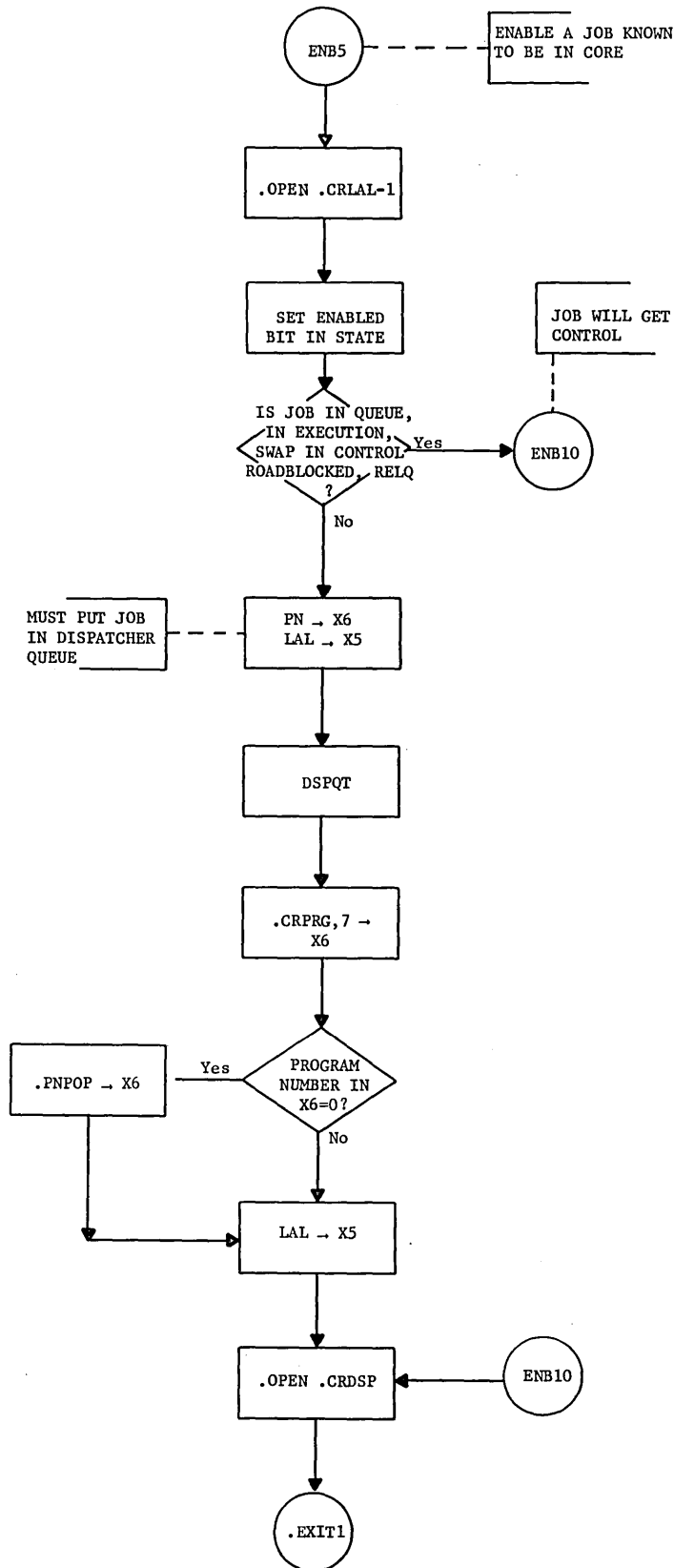



DSPQH (EP7)  
.MDISP

PROGRAM NUMBER AT FRONT OF QUEUE

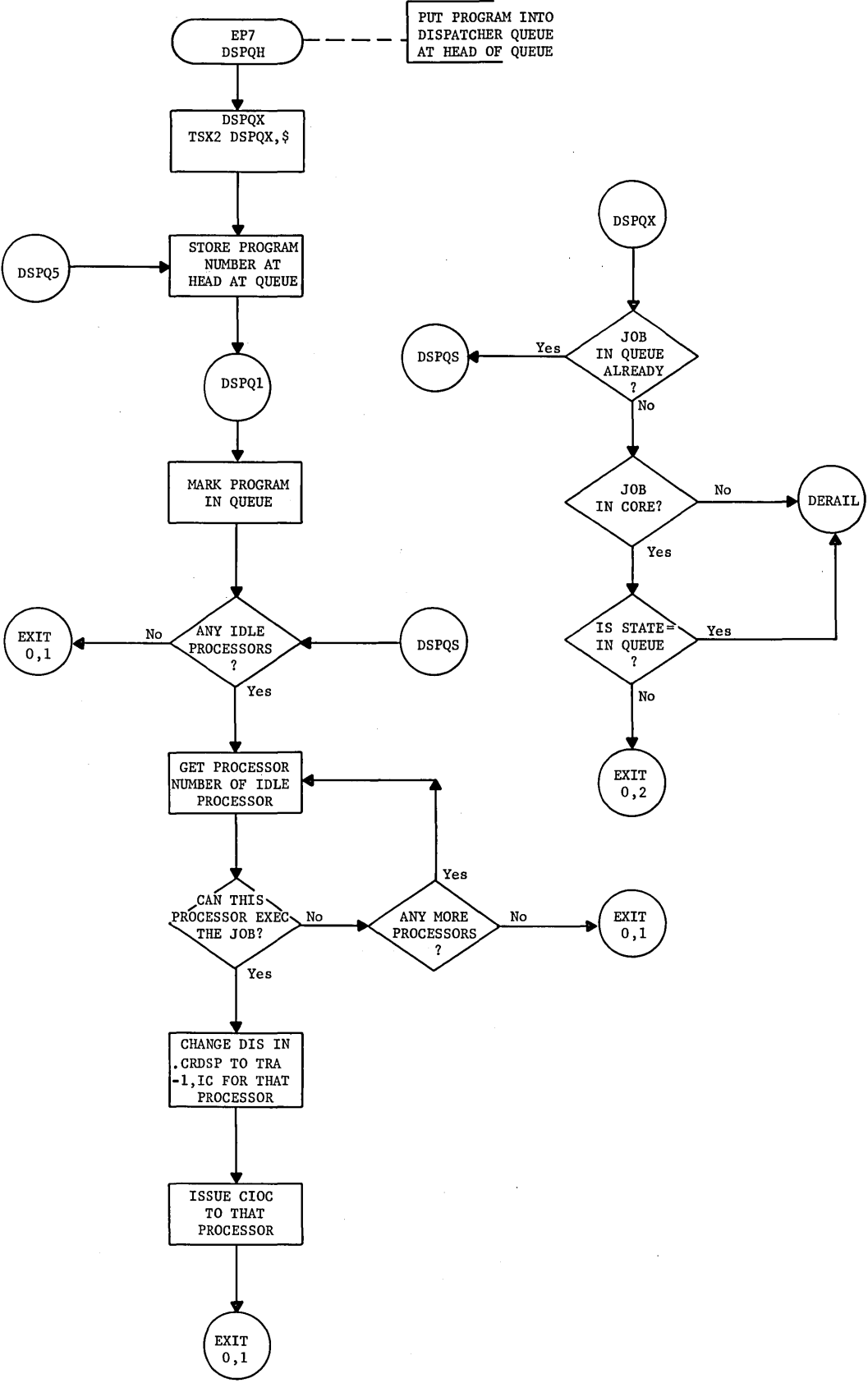

PROGRAM NUMBER AT END OF QUEUE

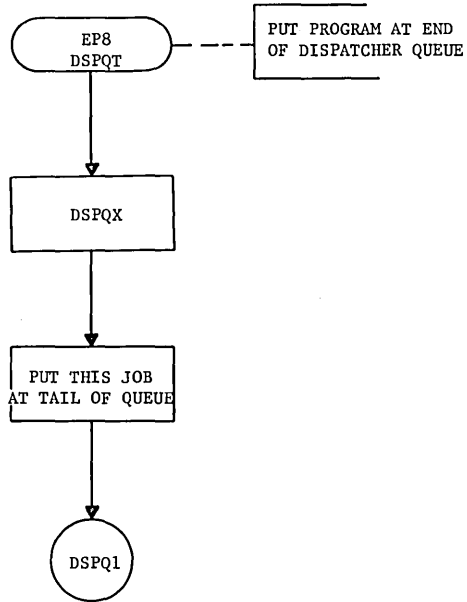

DACNB (EP9)  
.MDISP

### ACCUMULATE PROCESSOR TIME

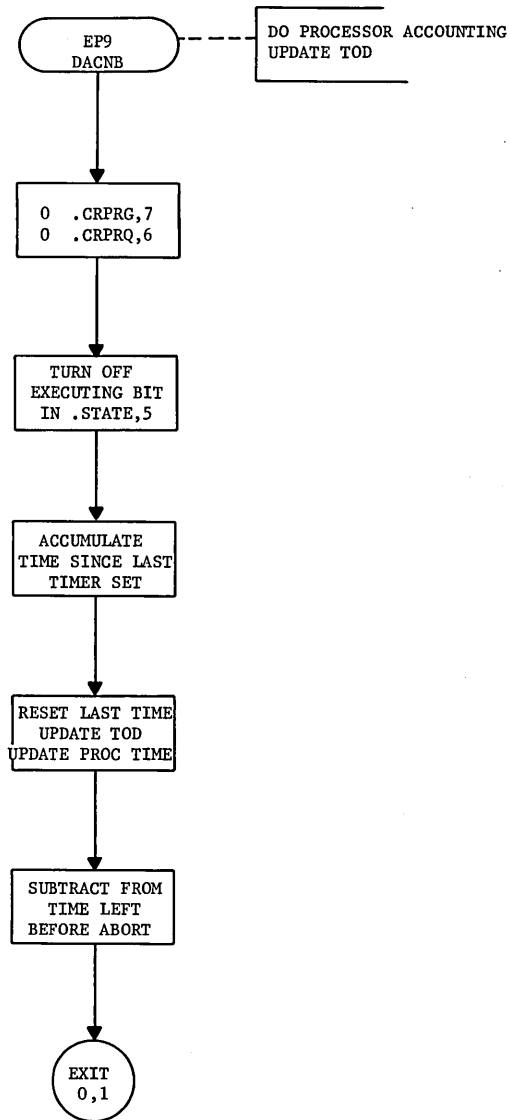

RESTORE STATE AFTER SWAP, MOVE, GEPR

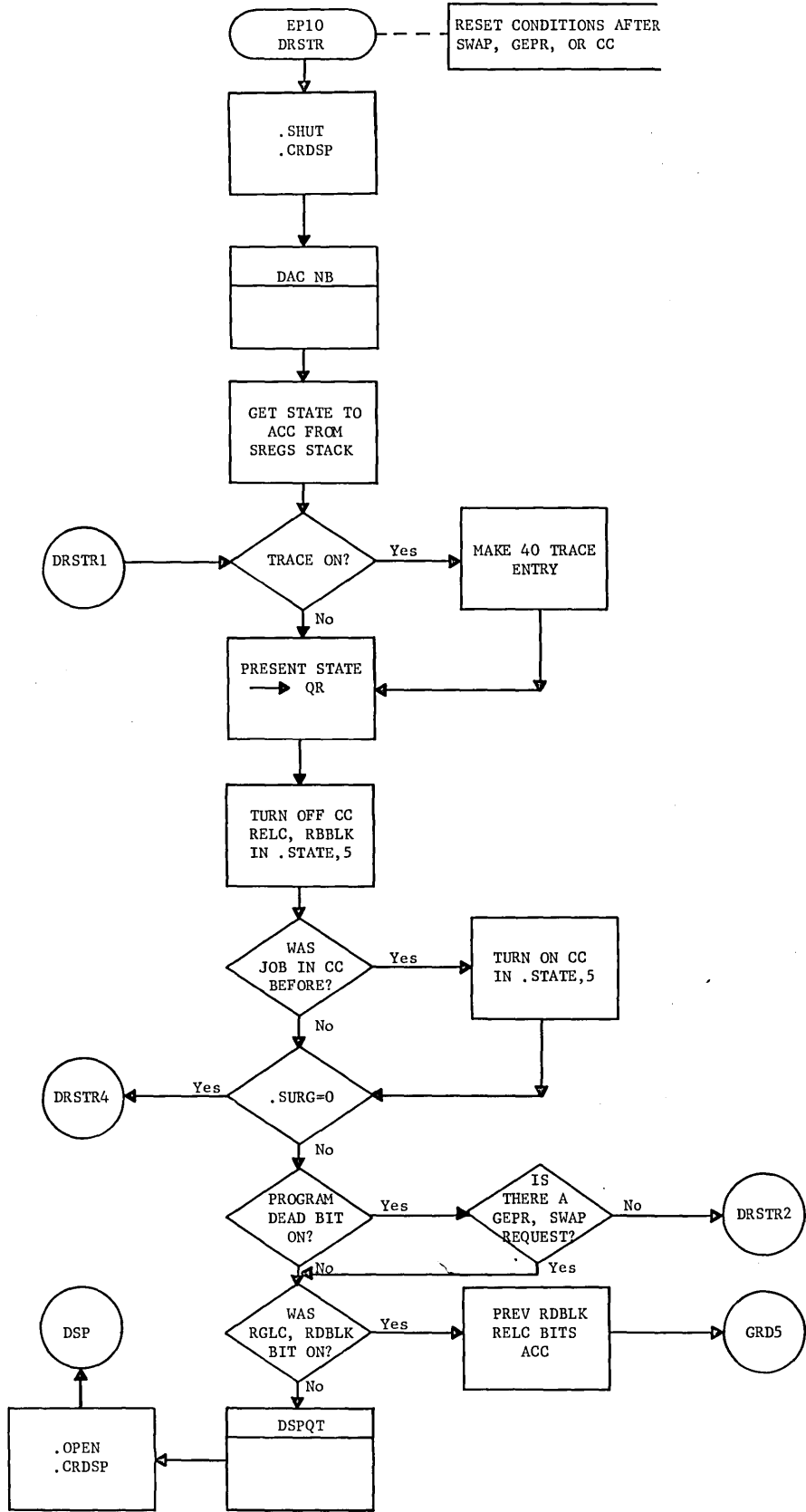

DSCNT (EP11)  
.MDISP

RELINQUISH CONTROL UNTIL PROGRAM ENABLED

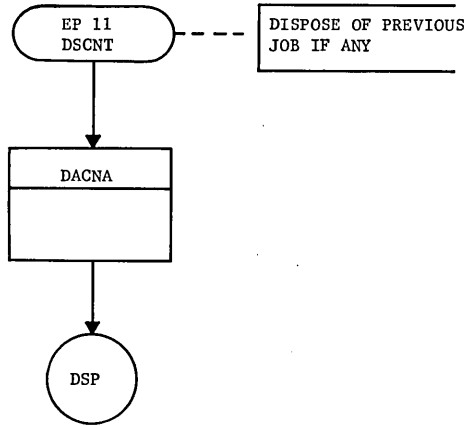

DO DISC I/O USING SYSTEM I/O QUEUE

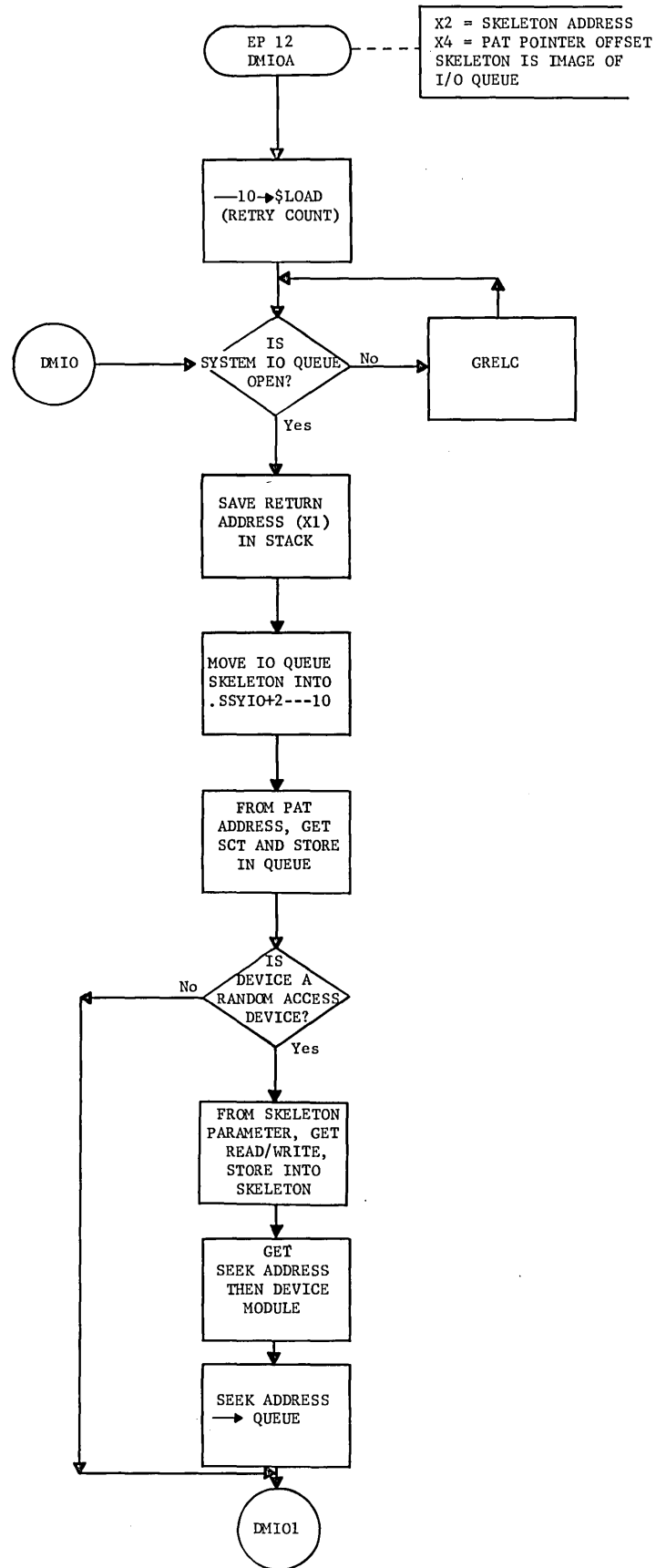

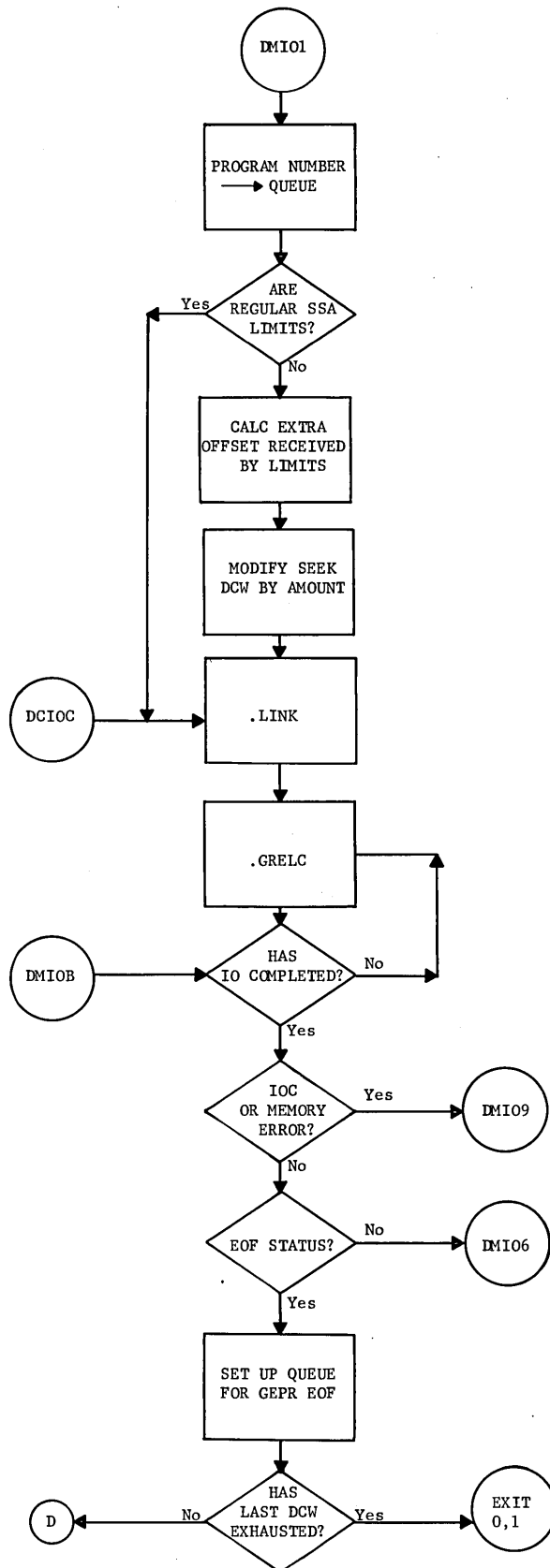

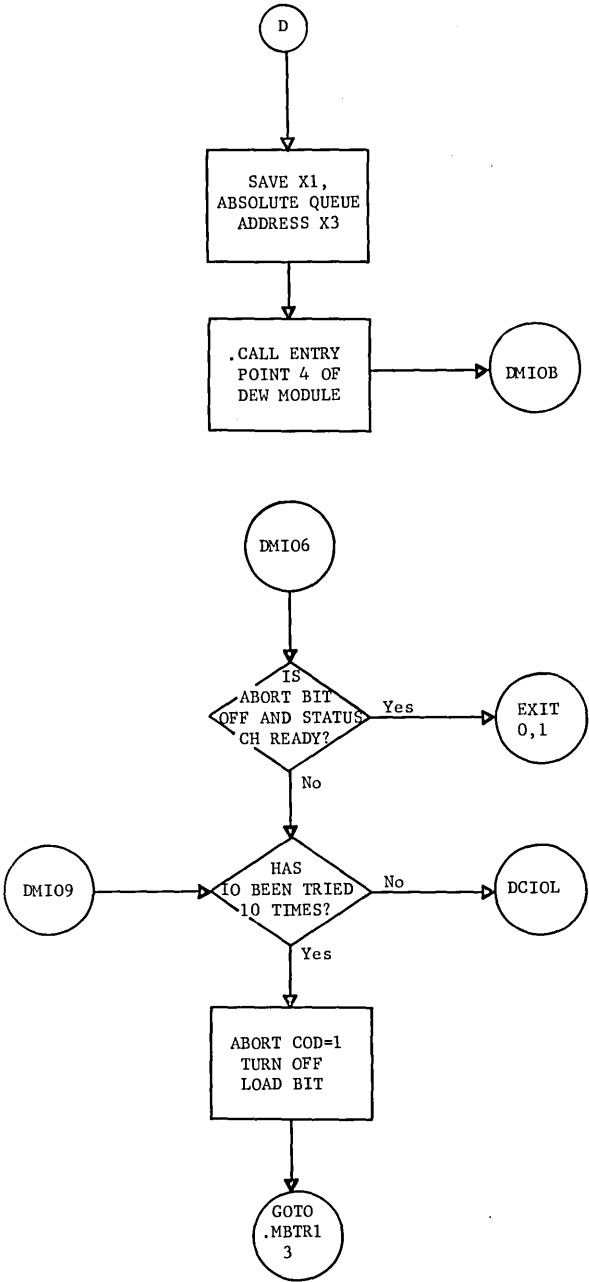



SET ALARM

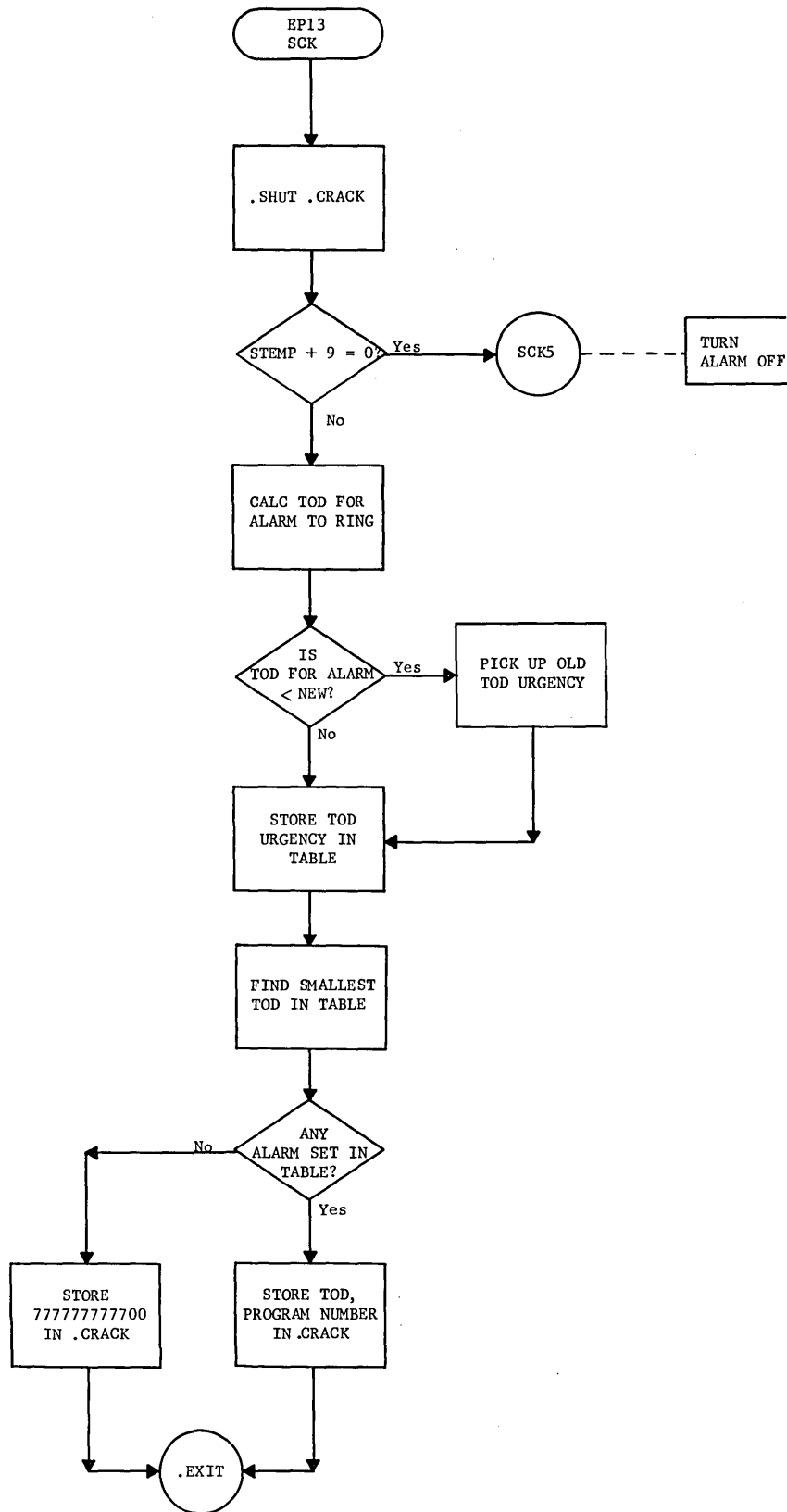

PROGRAM NUMBER IN QUEUE FOLLOWING INTERRUPT

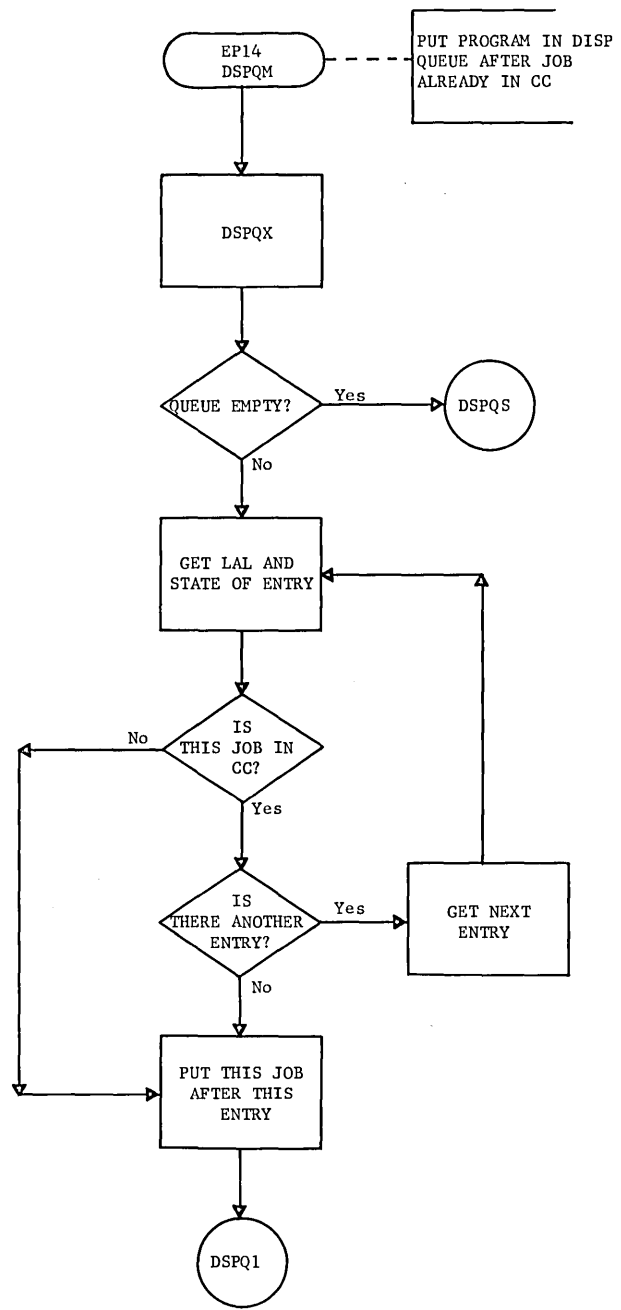

TRACF (EP15)  
.MDISP

### SAVE TRACE BUFFER AND WRITE OUT

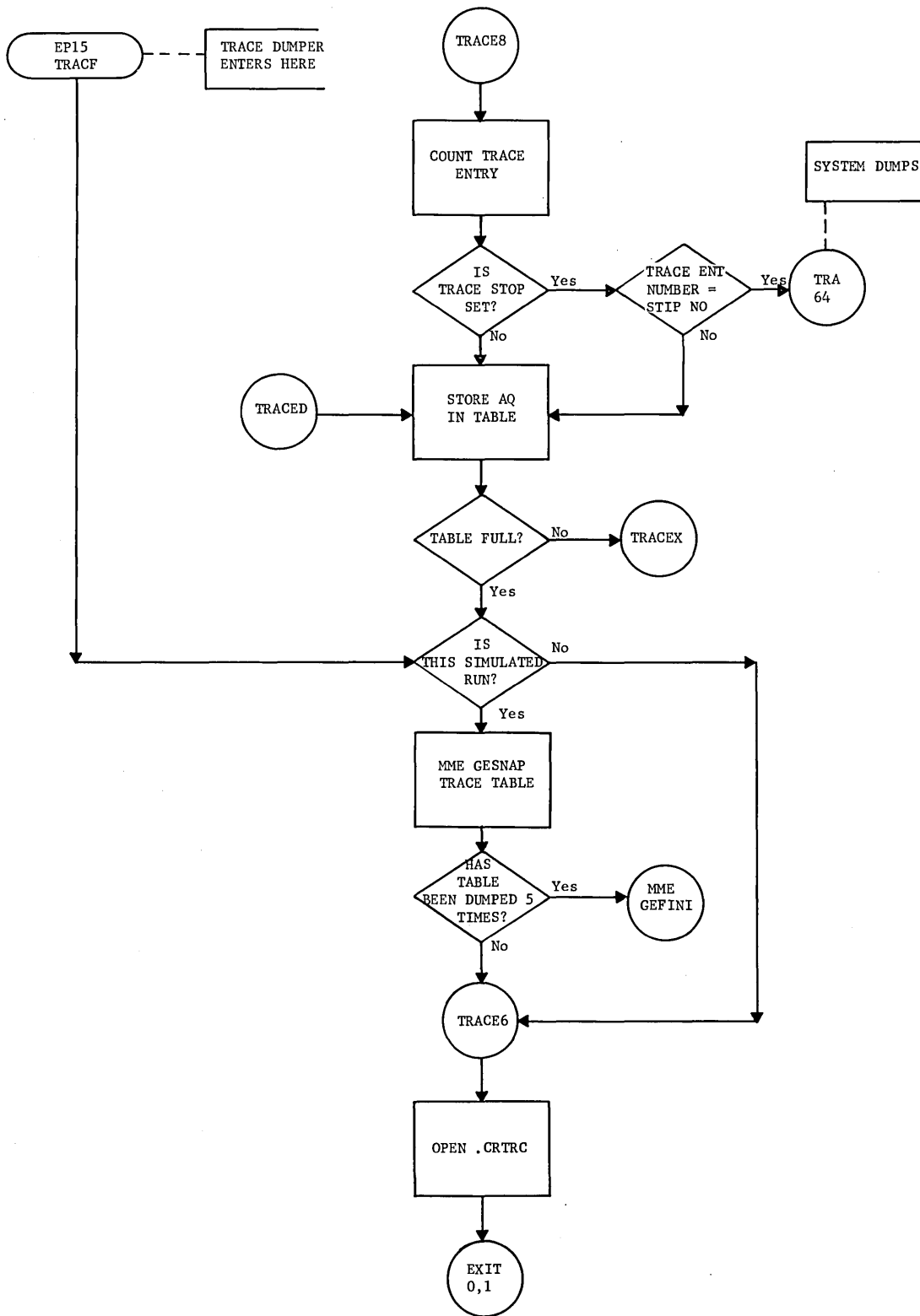

.IDISP  
.MDISP

INITIALIZATION

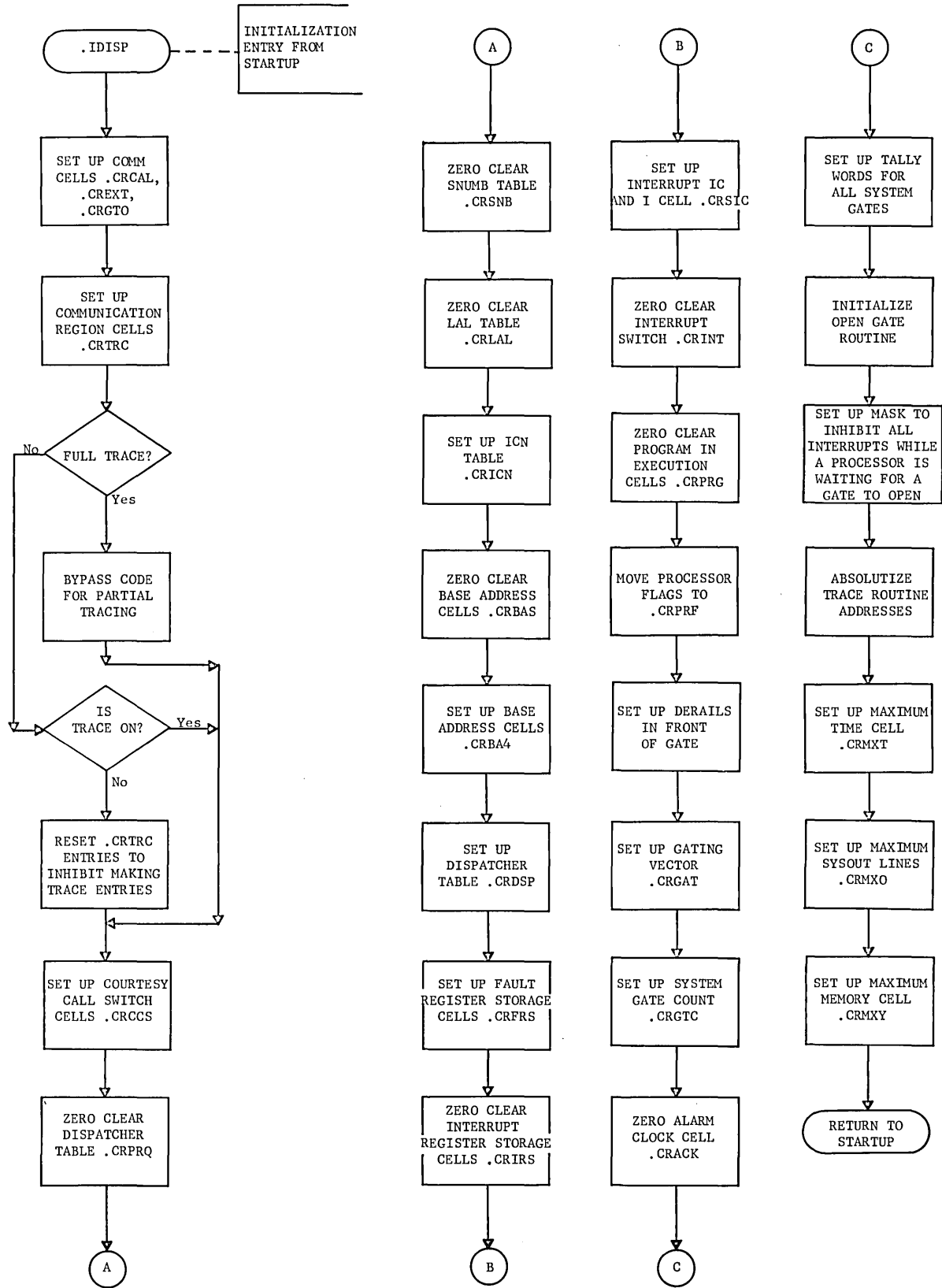

HCL  
.MDISP

.CALL MACRO

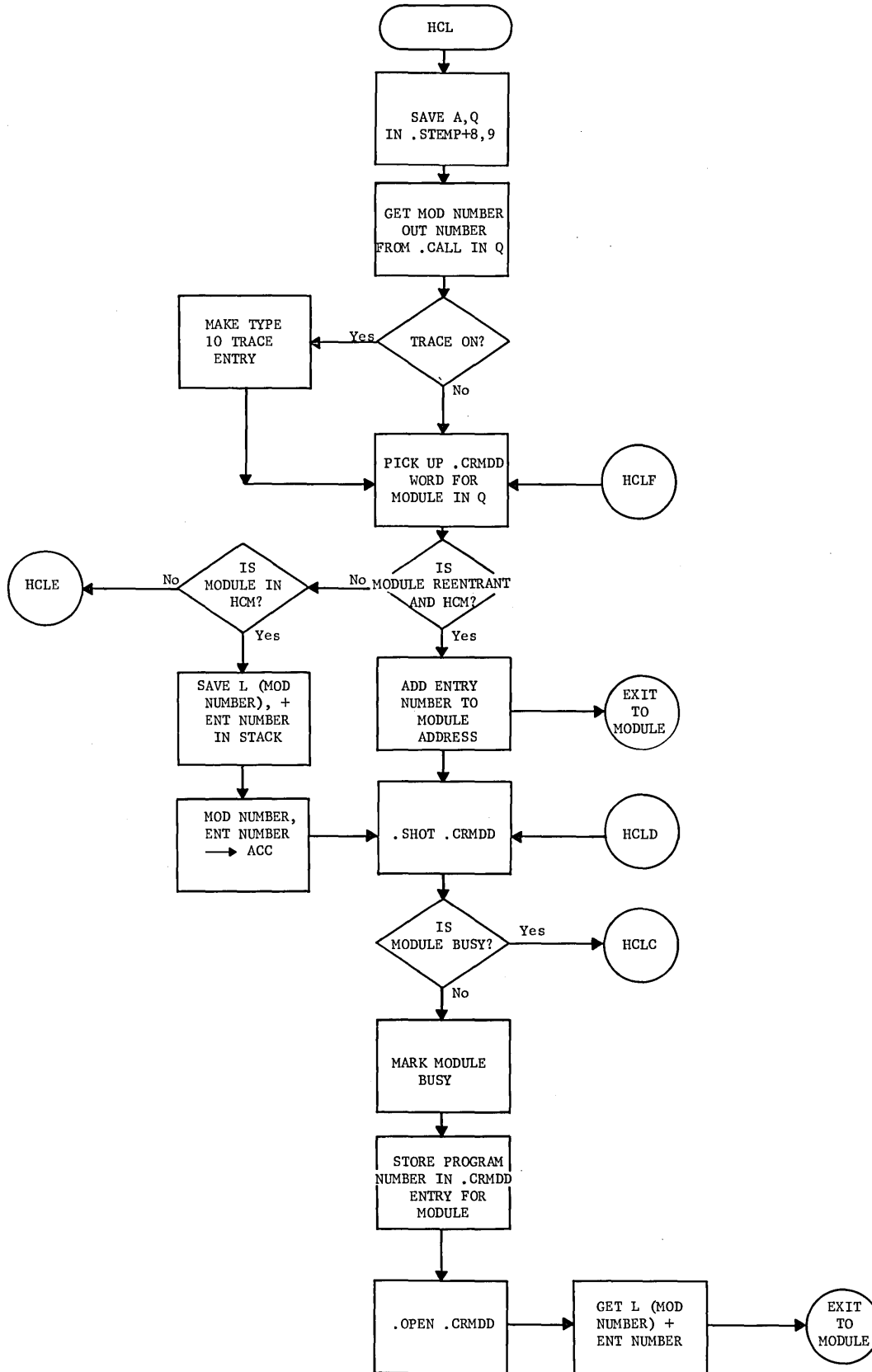

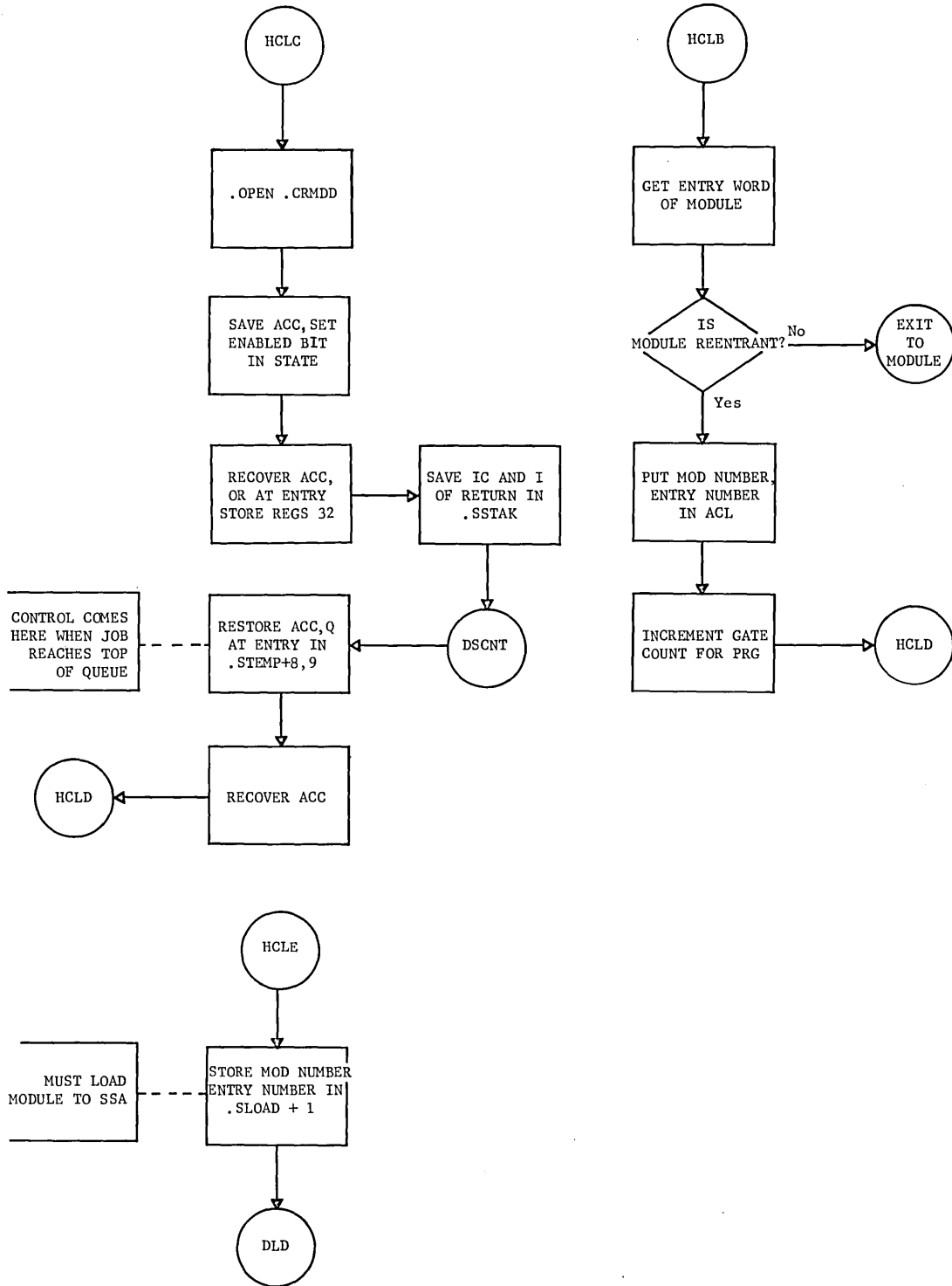

HEX  
.MDISP

.EXIT MACRO

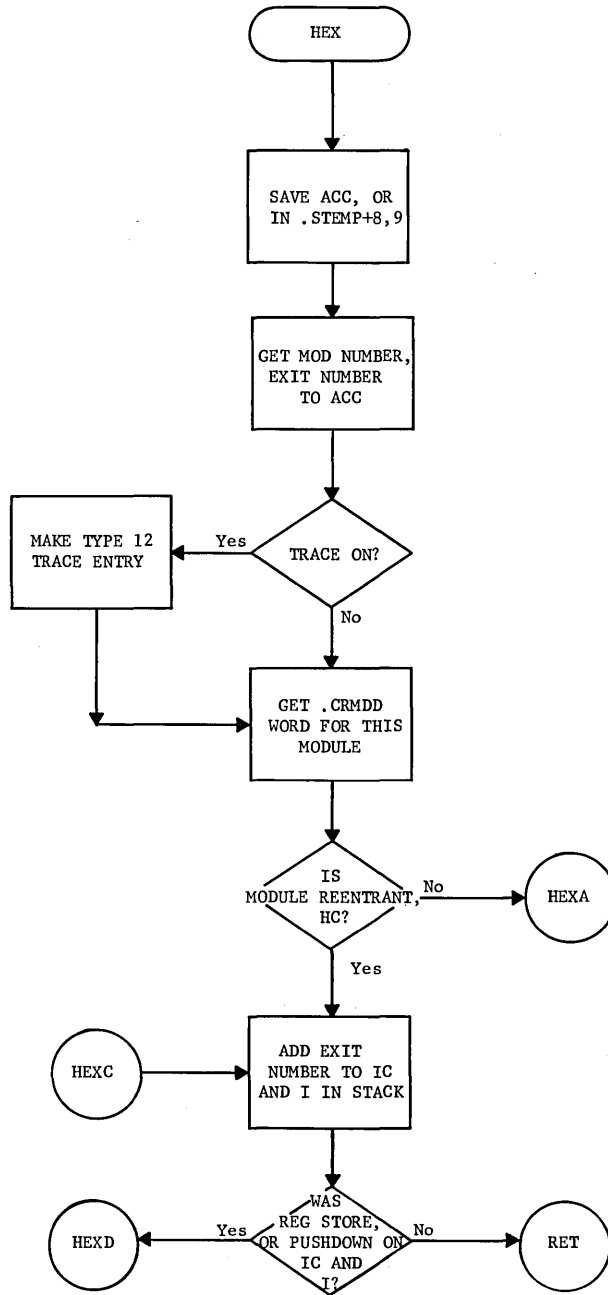

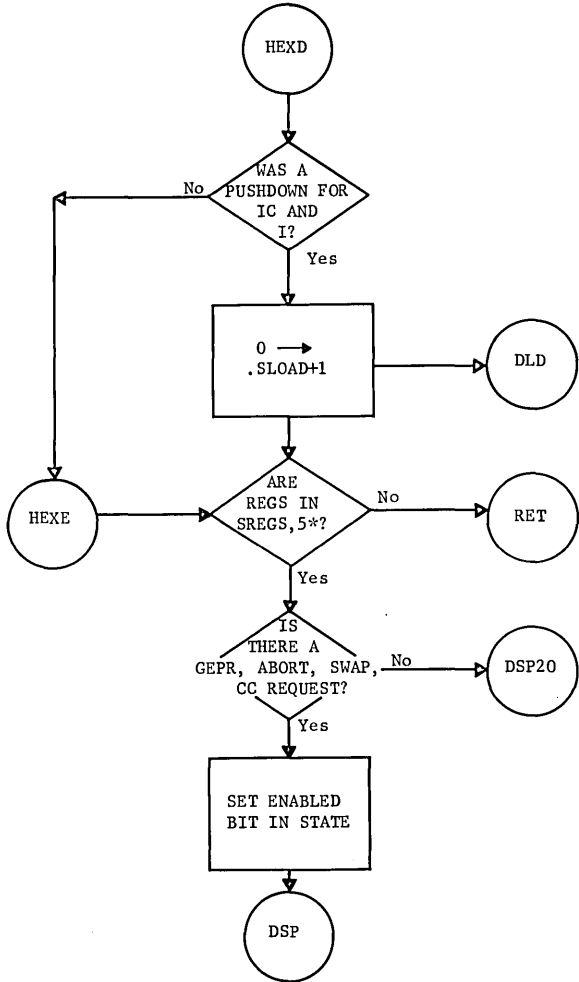
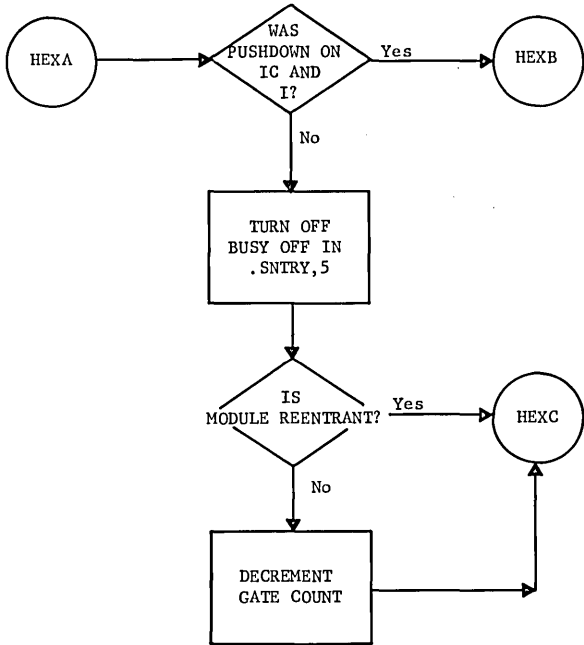



HGT  
.MDISP

.GOTO MACRO

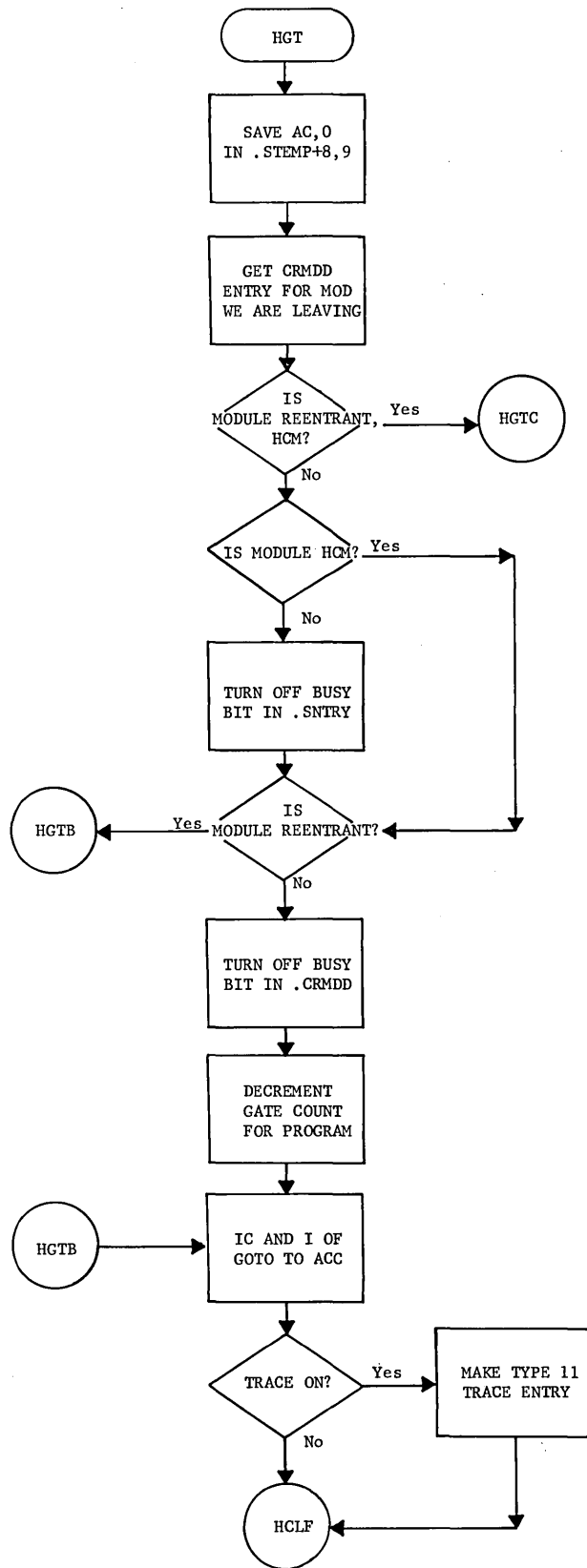

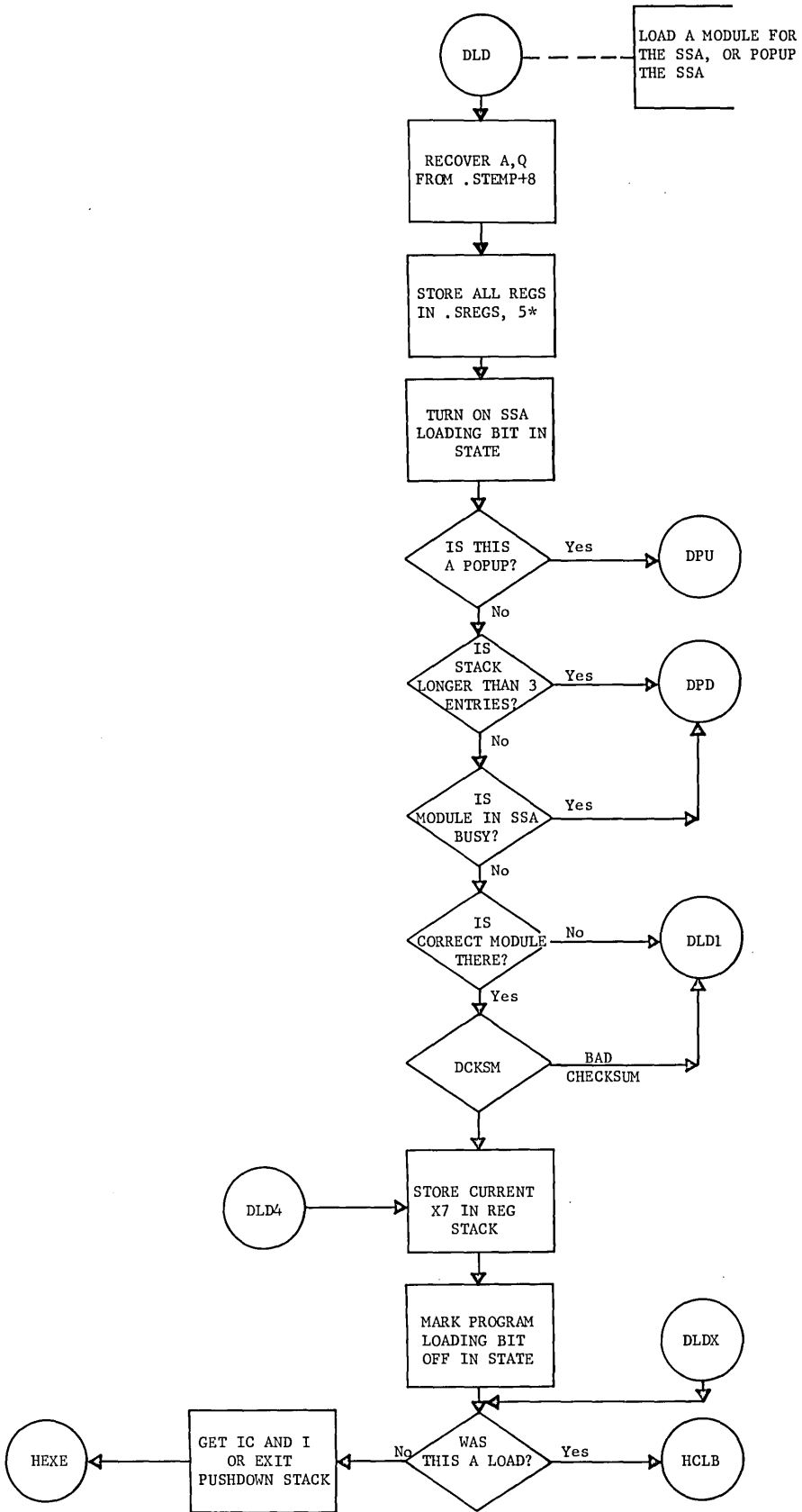

HGT  
.MDISP

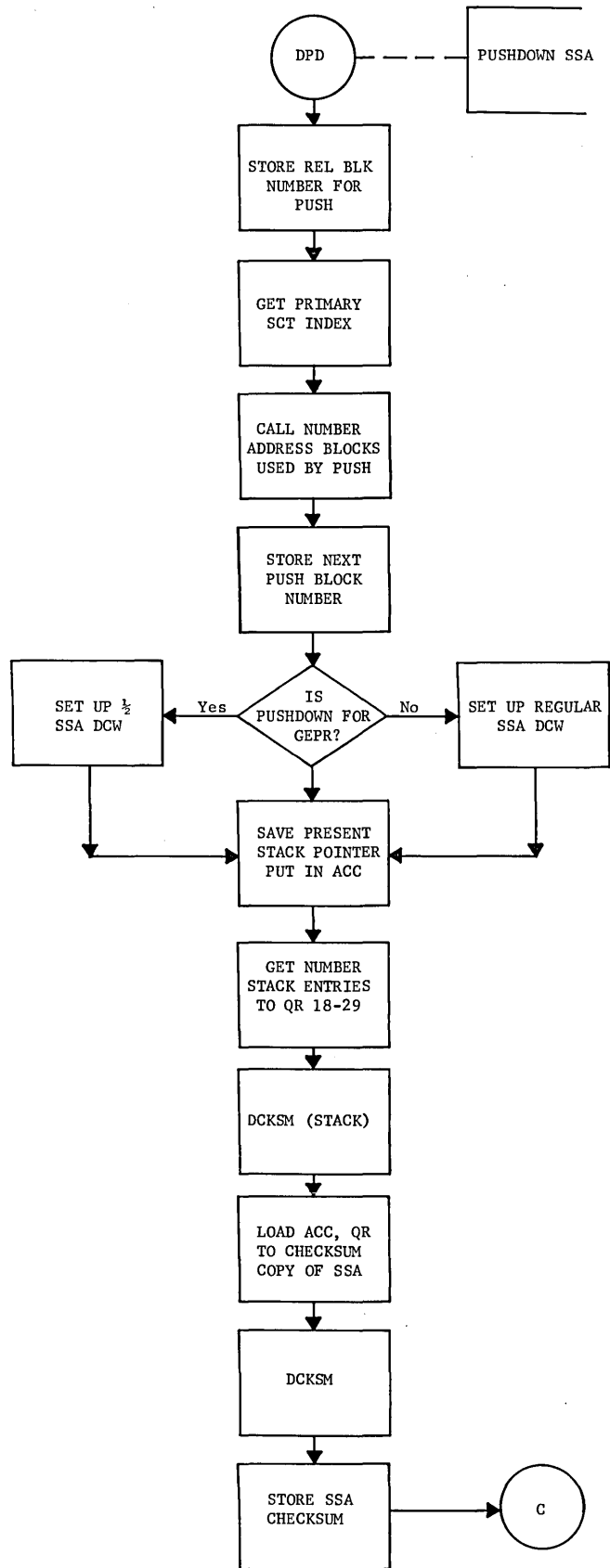

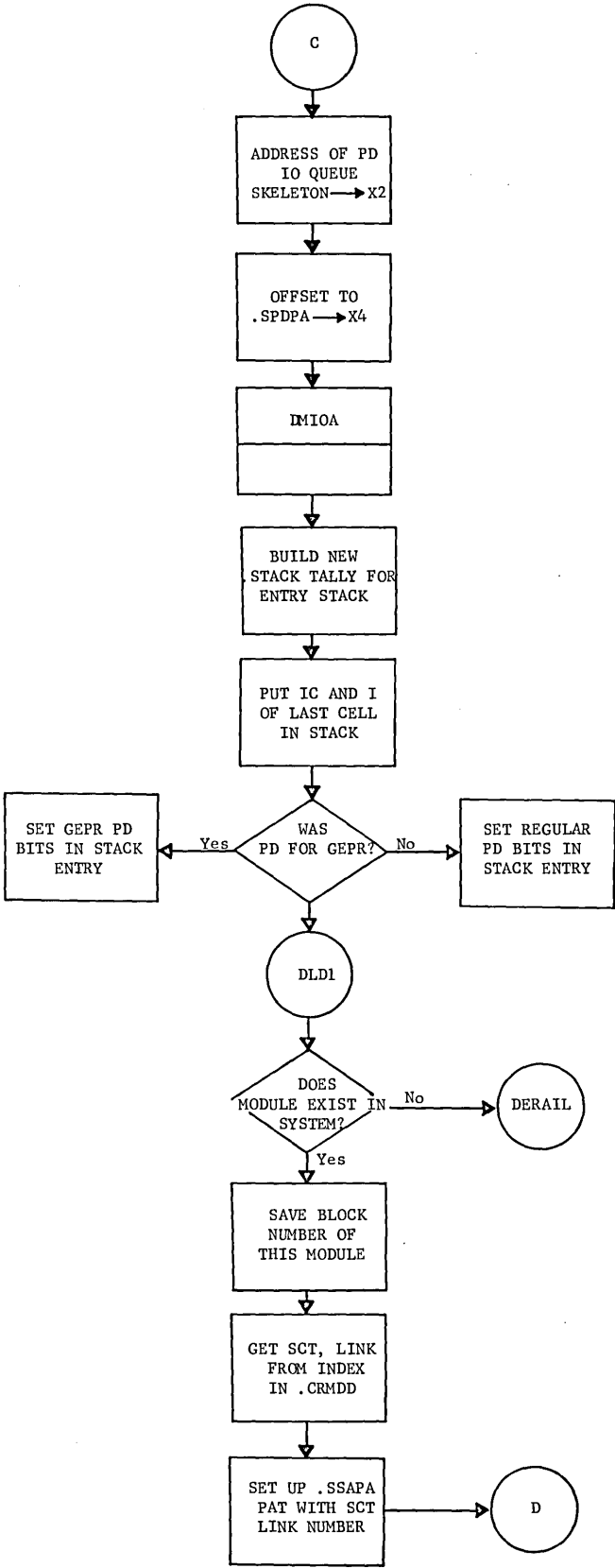

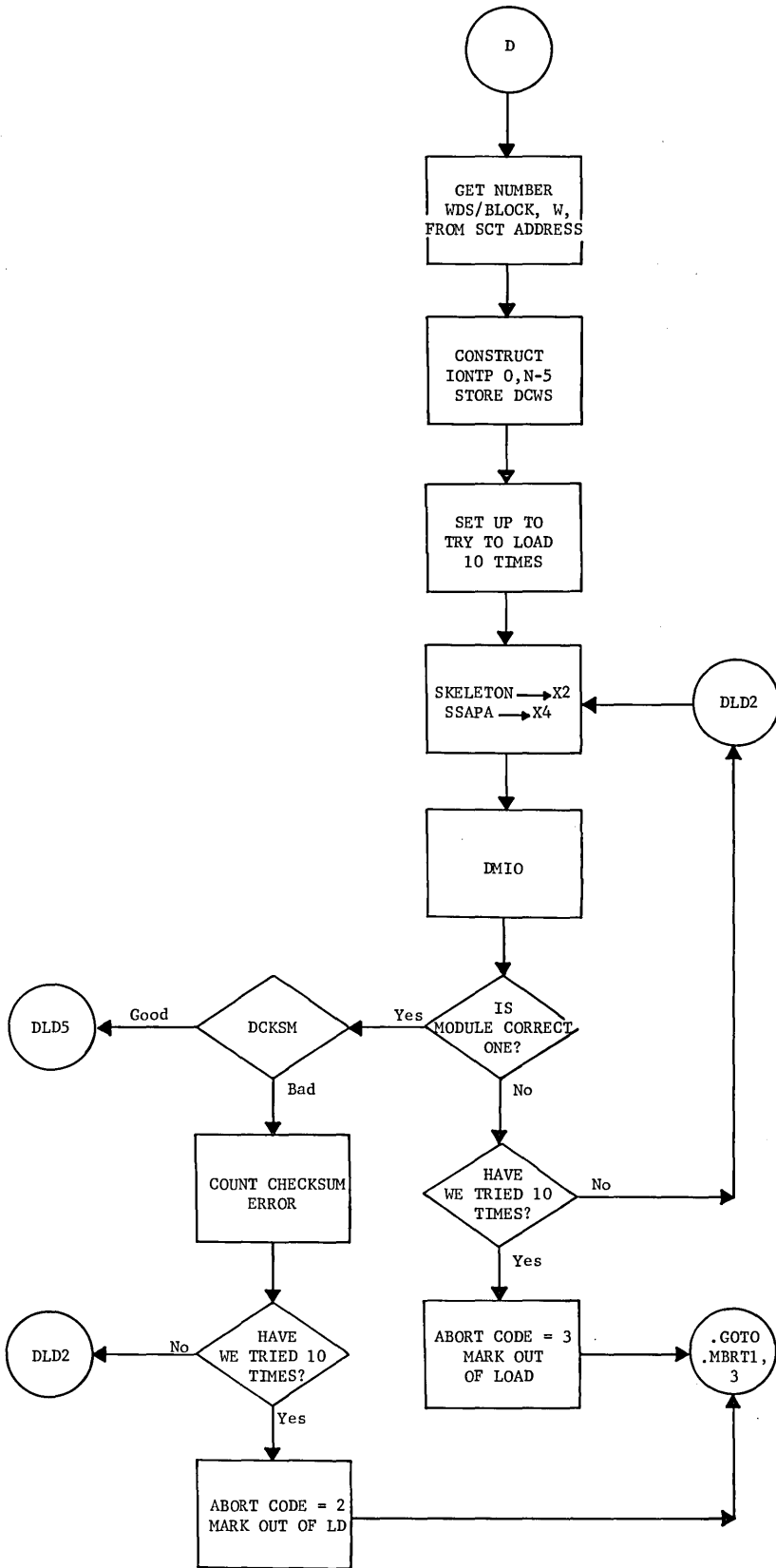

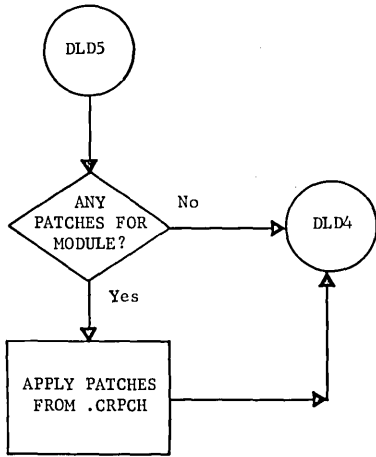

HGT  
.MDISP

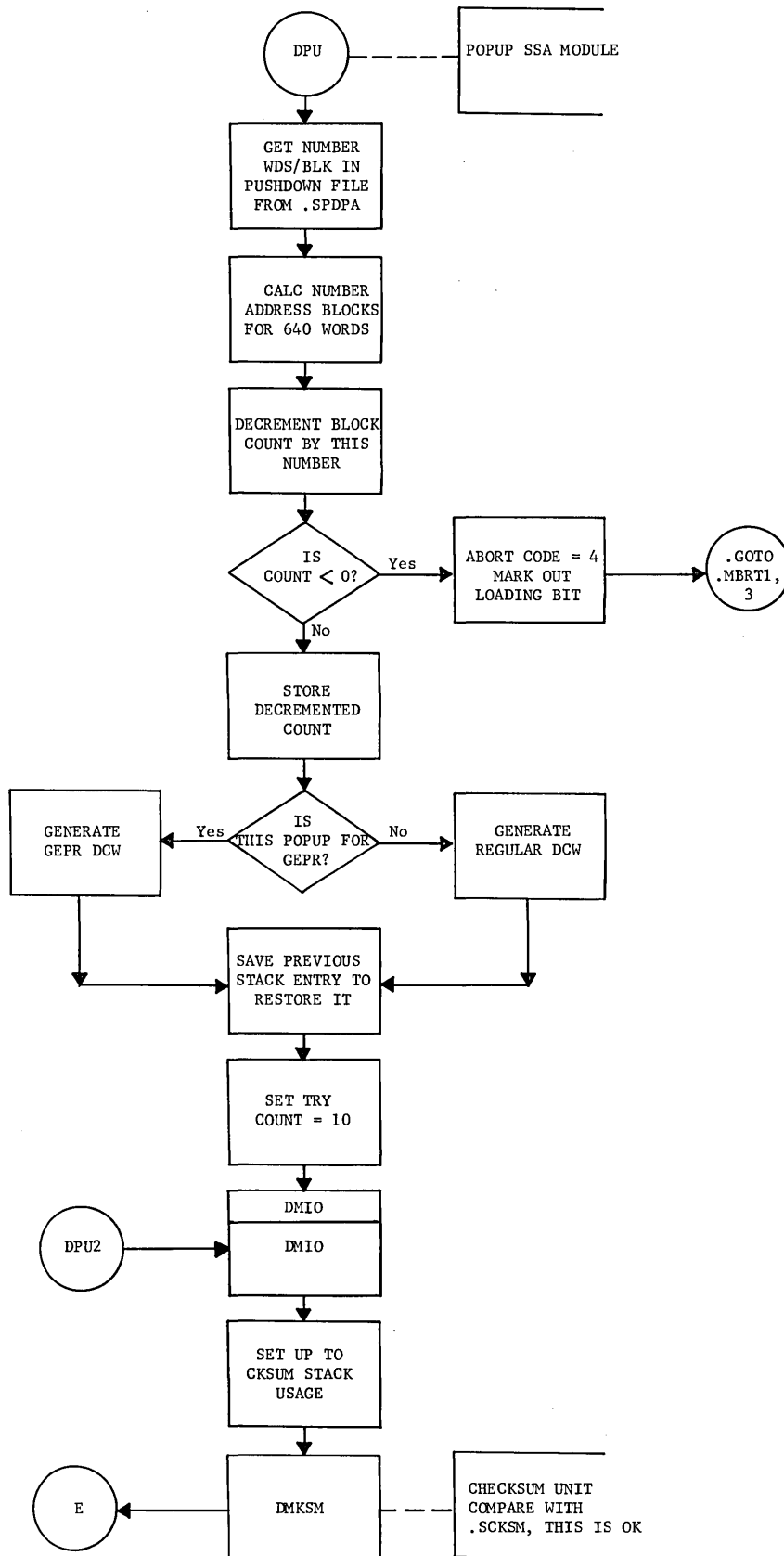

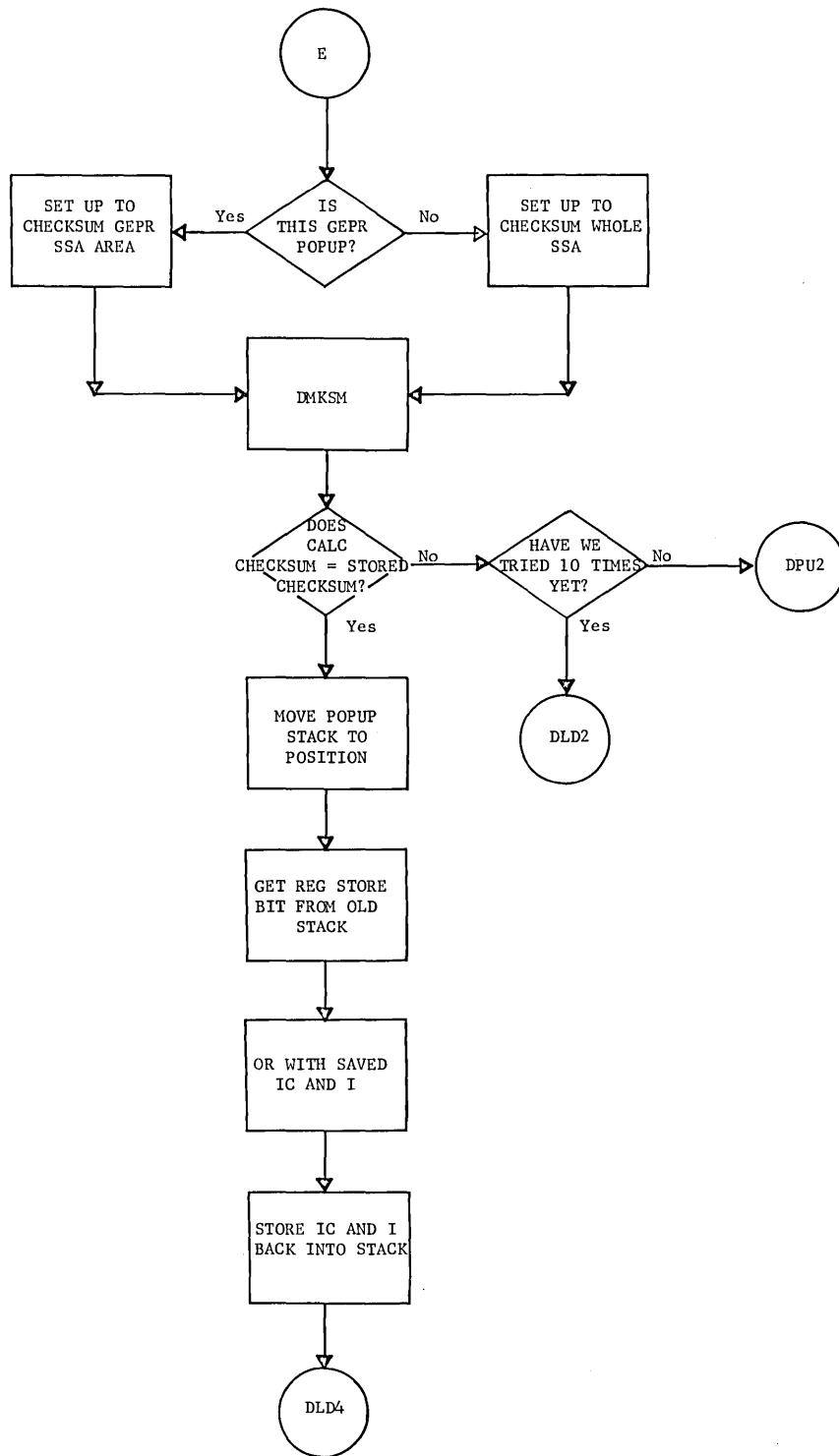



HGT  
.MDISP

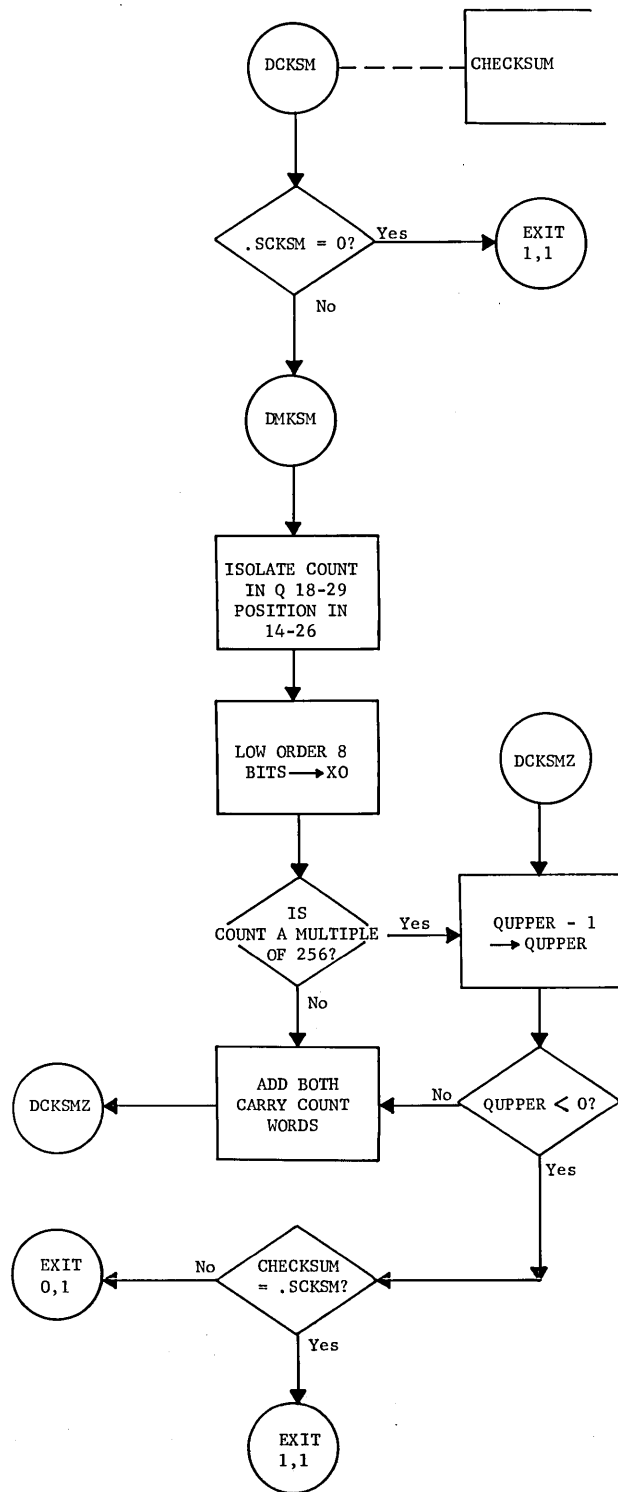



TRACE  
.MDISP

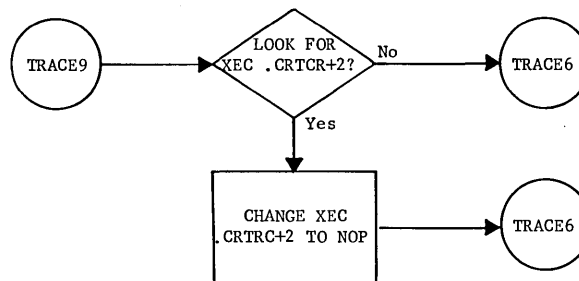
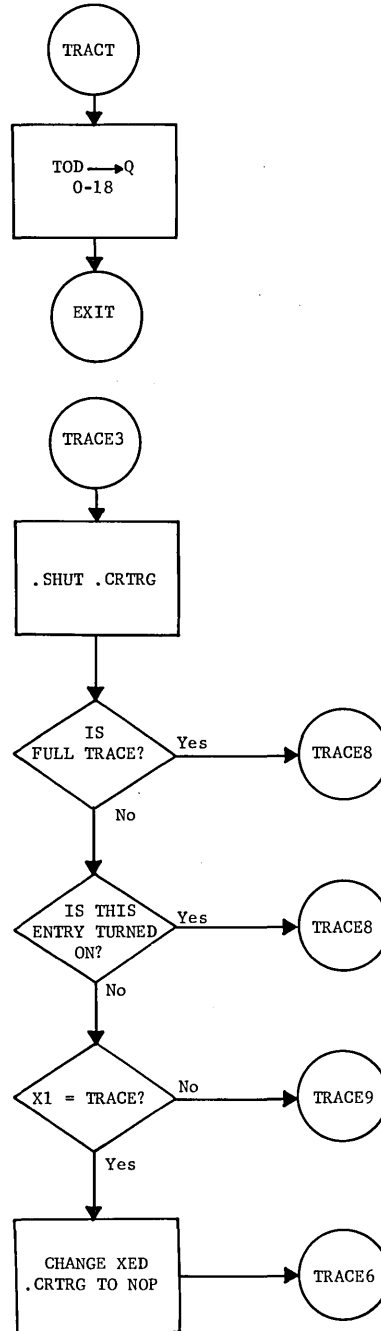
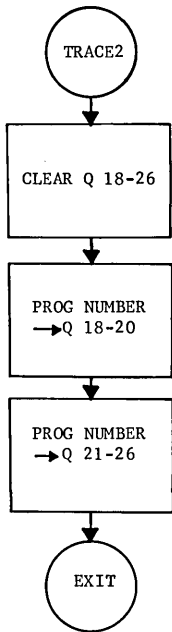

OPEN SYSTEM GATES

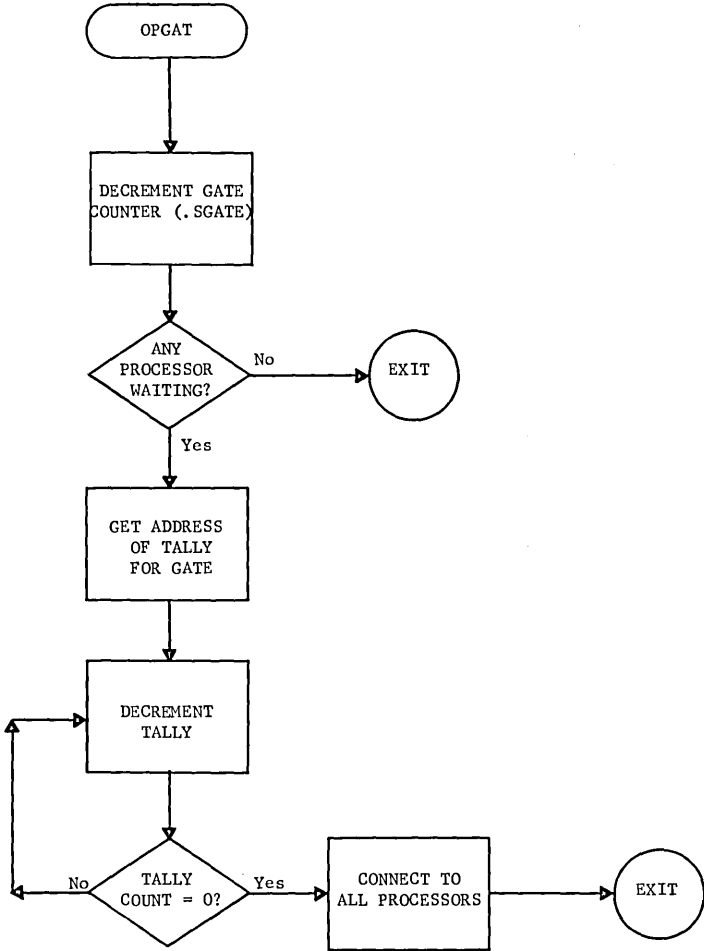

SHUG  
.MDISP

CLOSE SYSTEM GATES

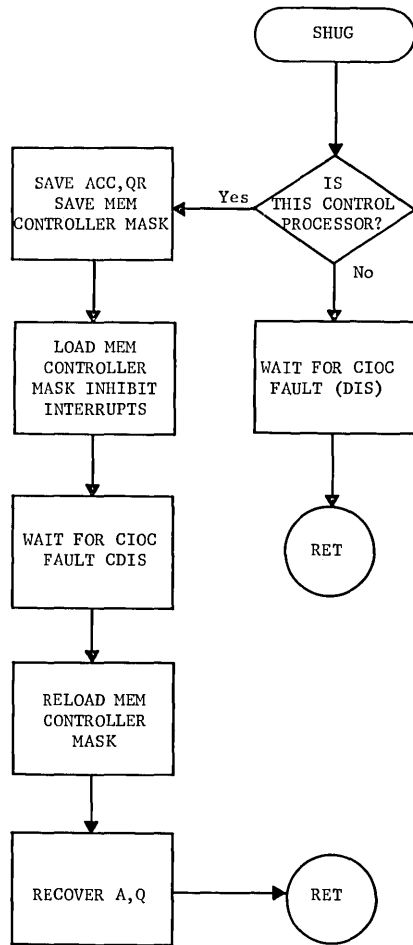

## 2. FAULT PROCESSING AND SERVICE MME'S

(Reference CPB-1493)



FPRC  
.MFALT

SECONDARY FAULT VECTOR

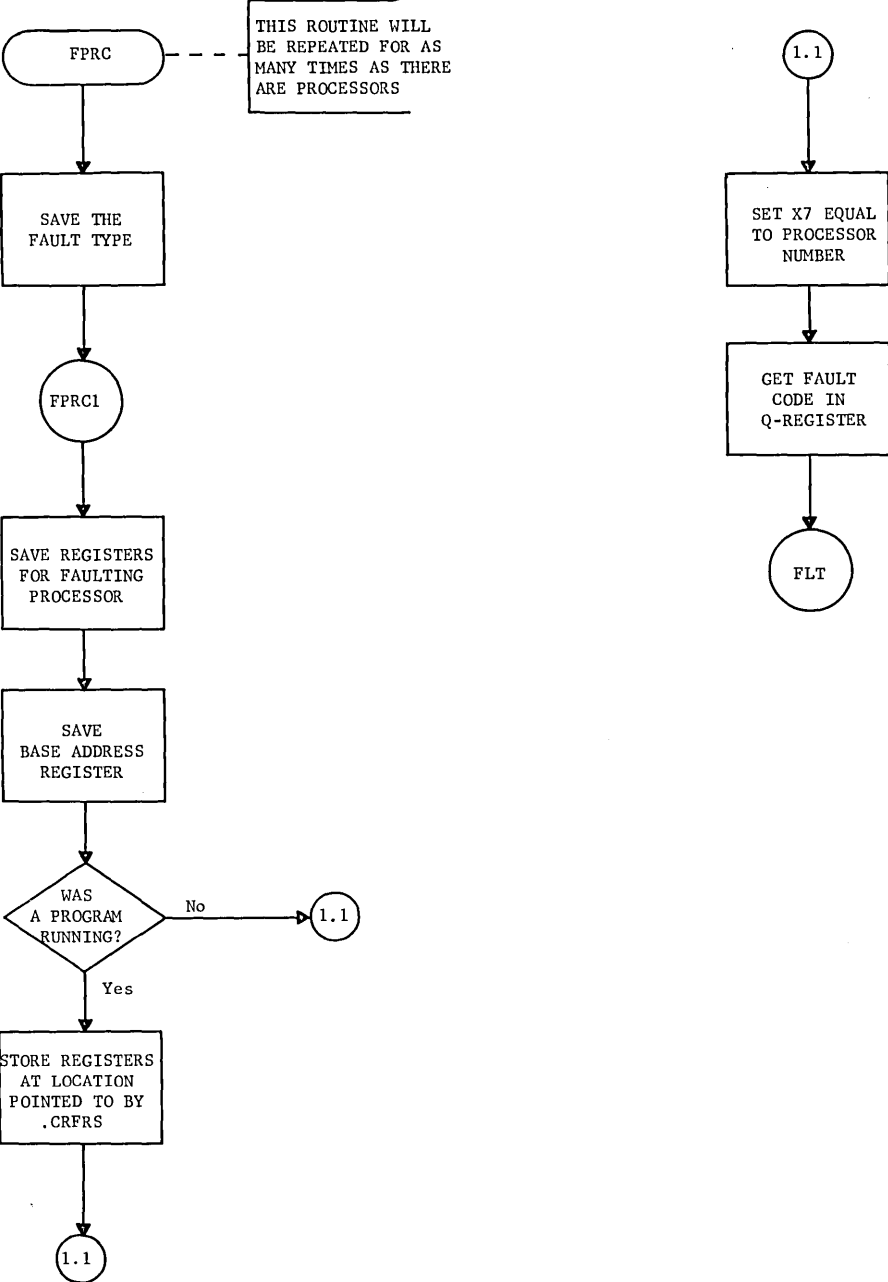



FLT  
.MFALT

### RECOGNIZE FAULT TYPE AND PROCESS FAULT

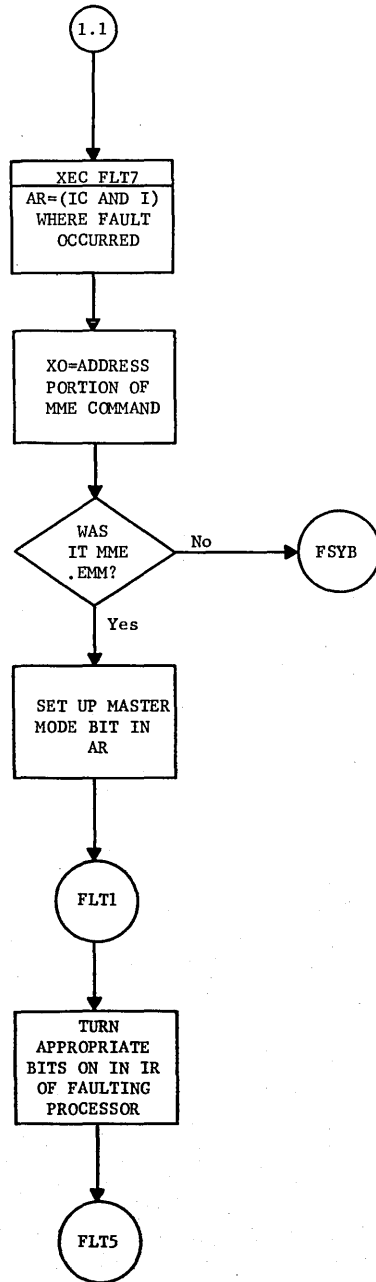
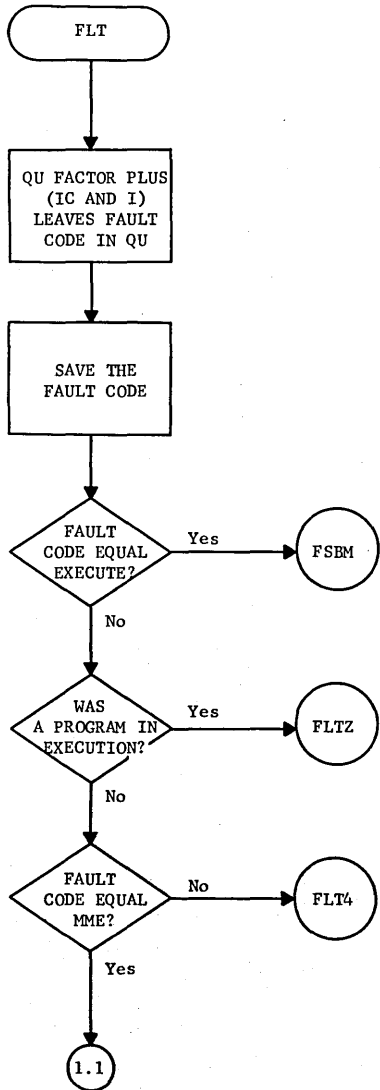

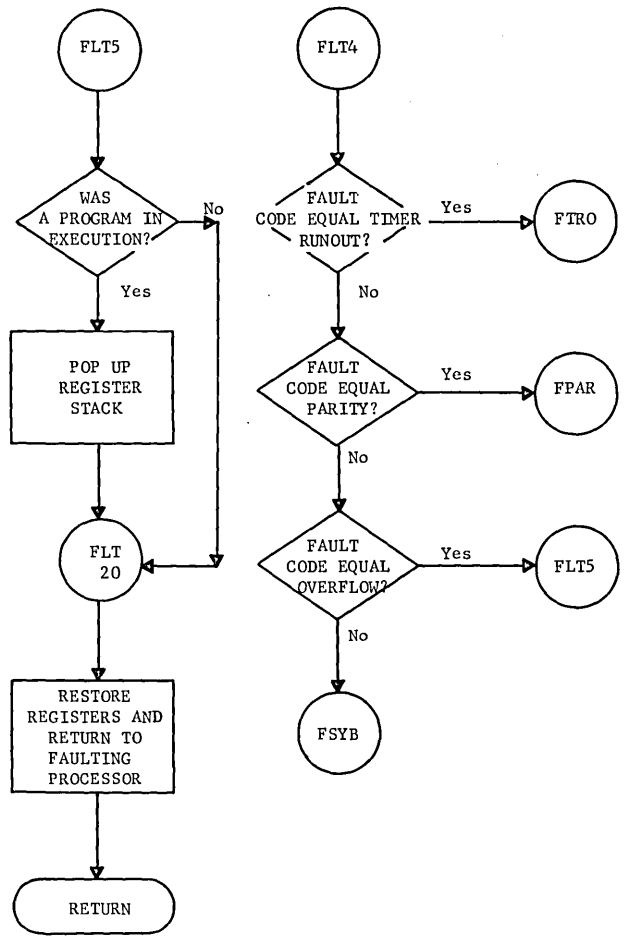

**FLT  
.MFALT**

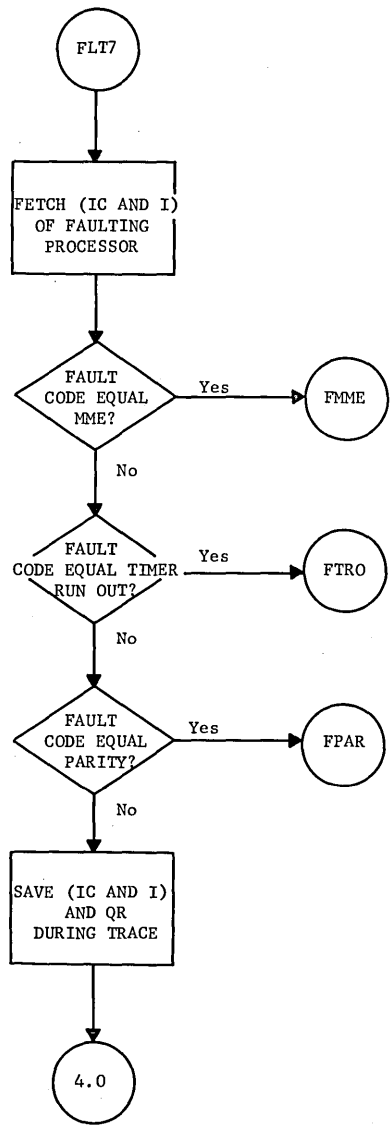
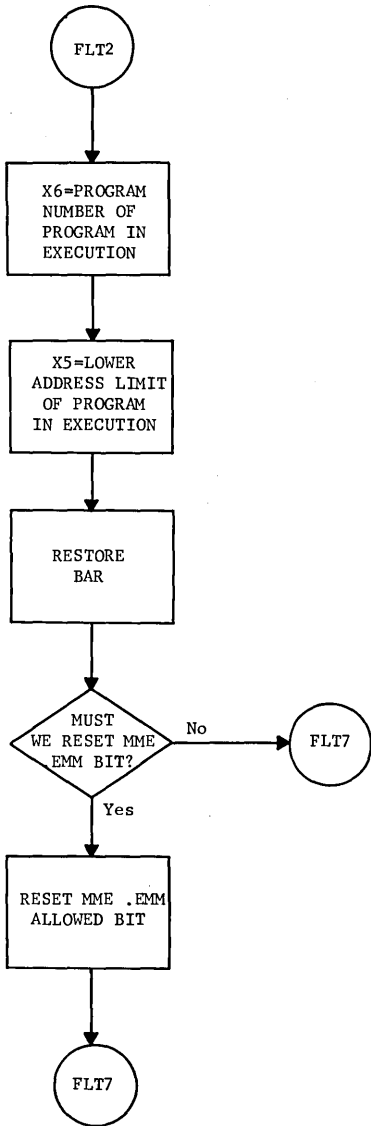

FLT  
.MFALT

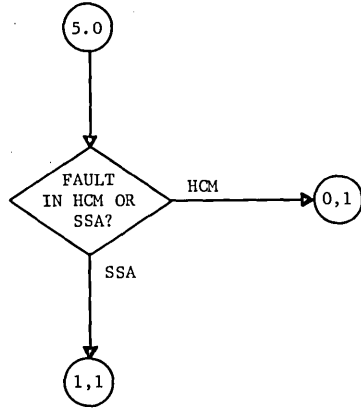
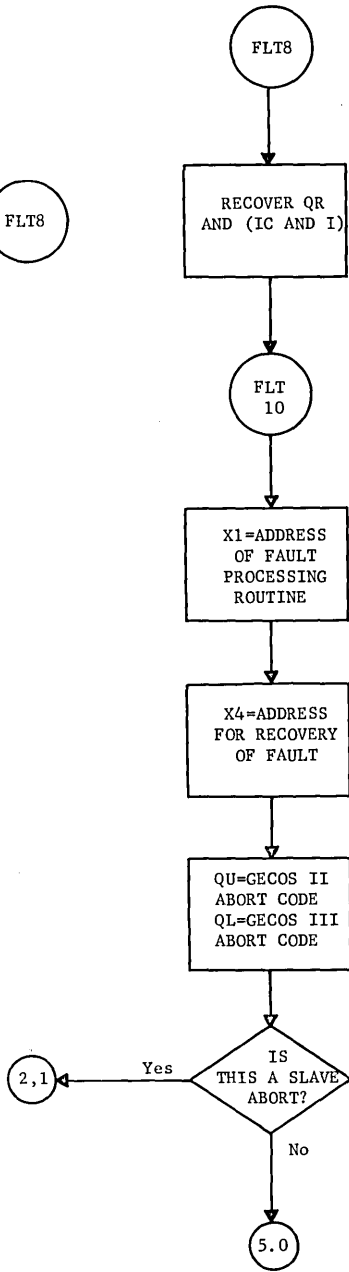
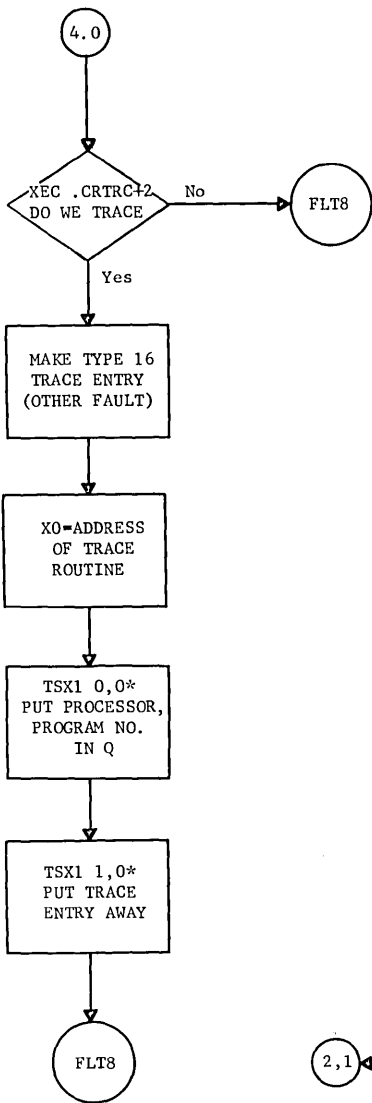

FLT  
.MFALT

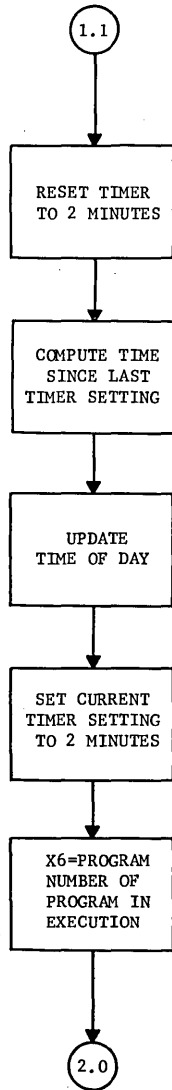
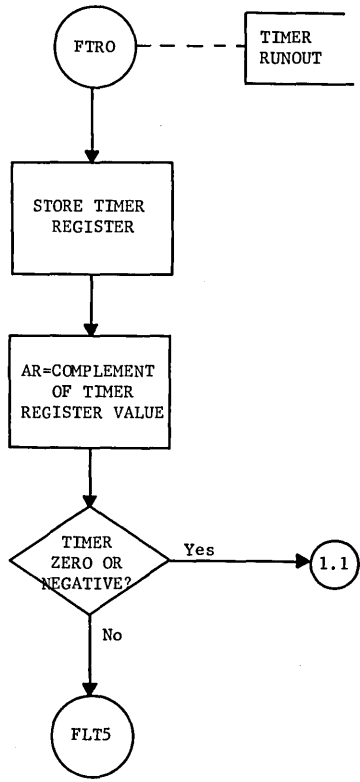

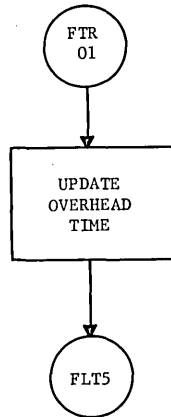
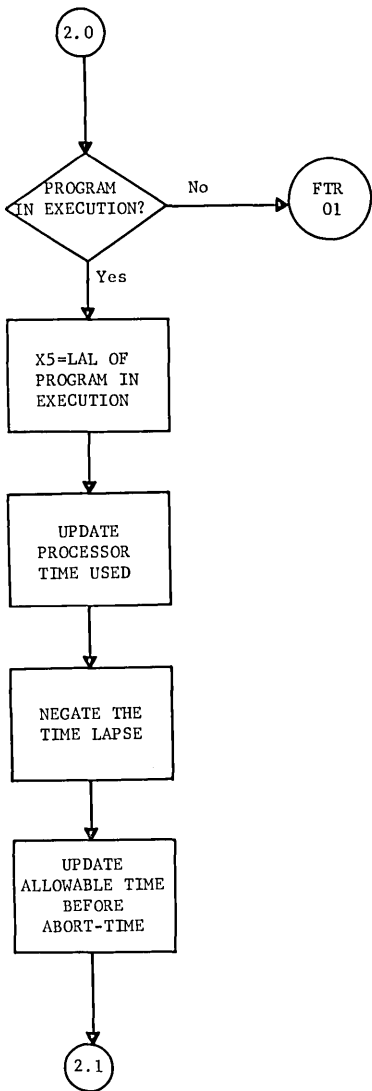

FLT  
.MFALT

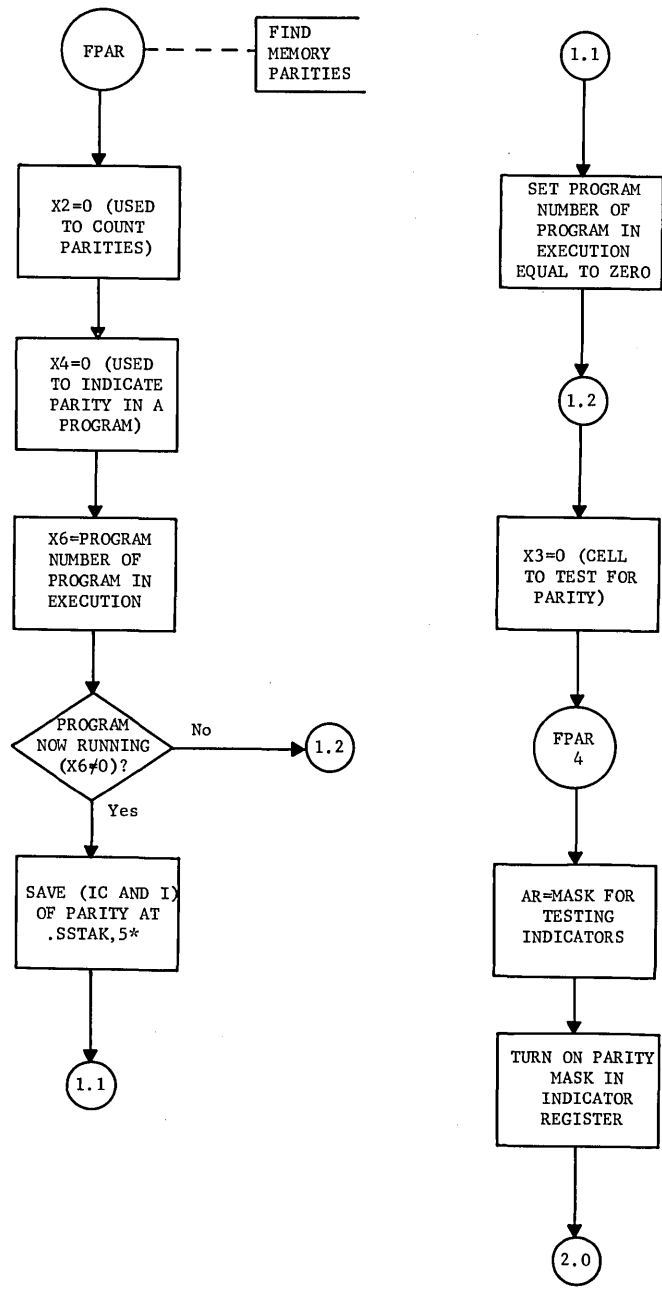

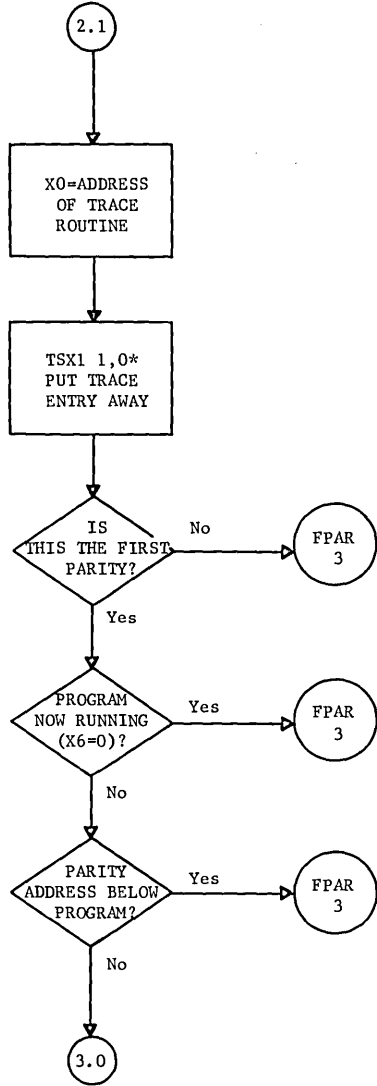
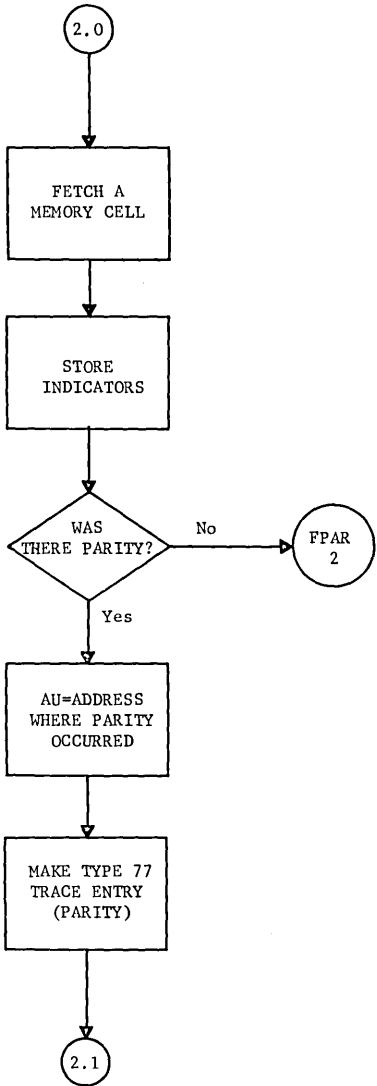



FLT  
.MFALT

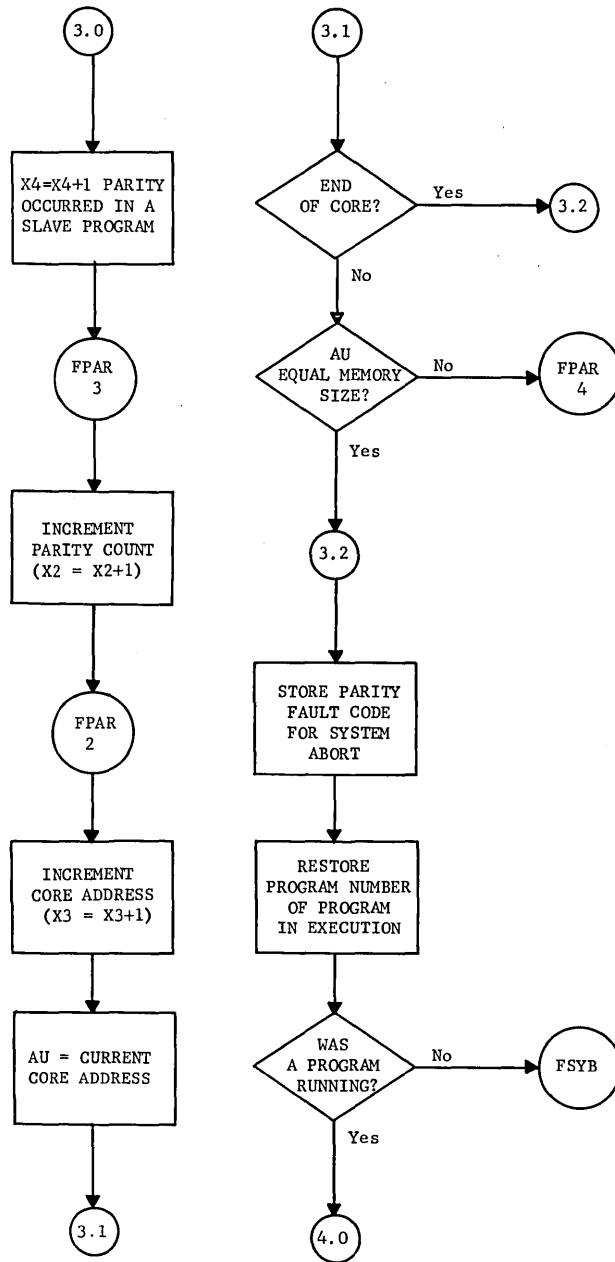

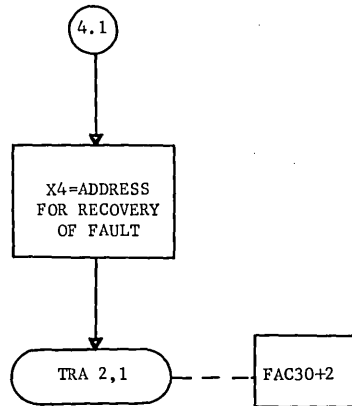
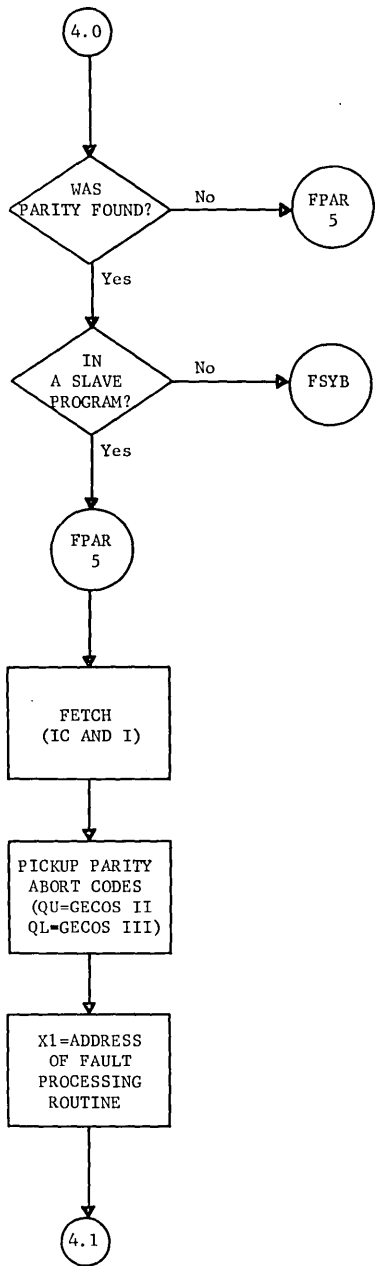

FLT  
.MFALT

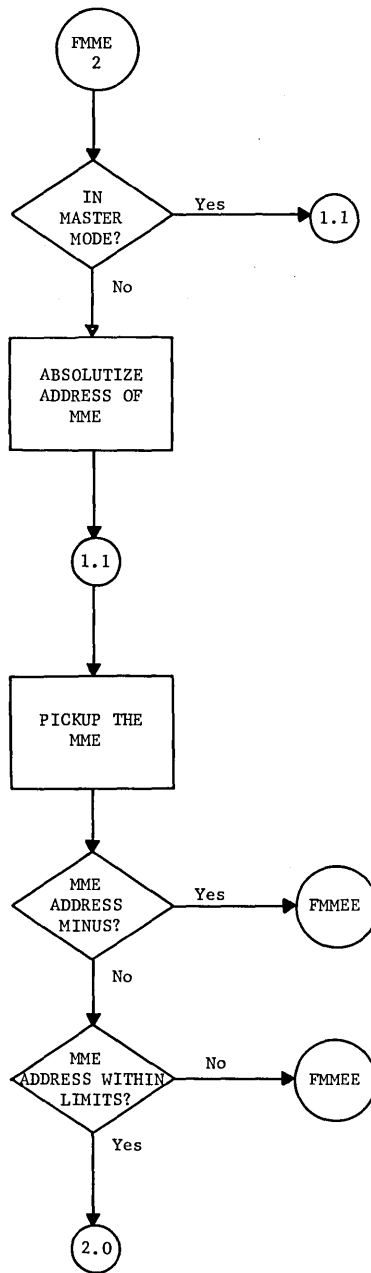
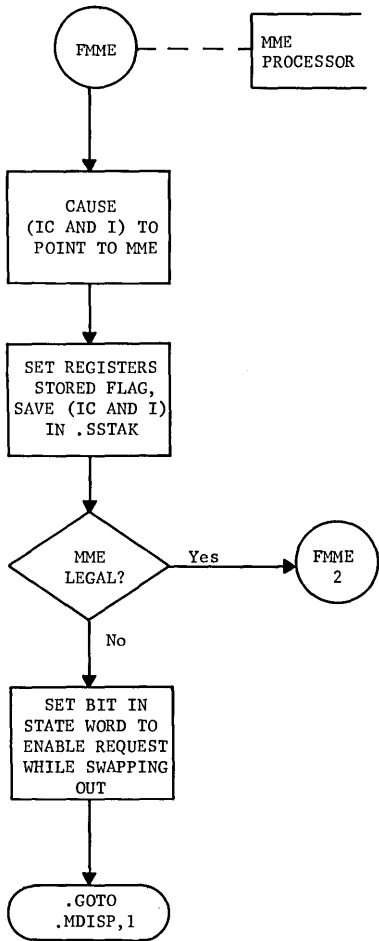

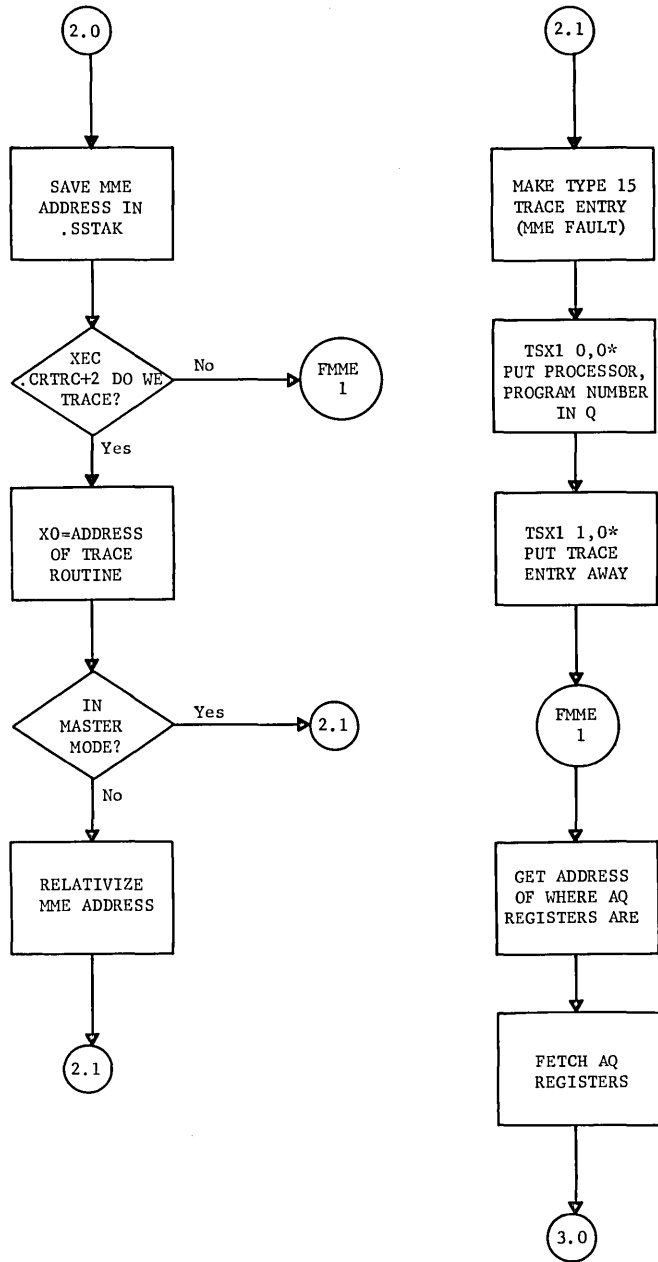

FLT  
.MFALT

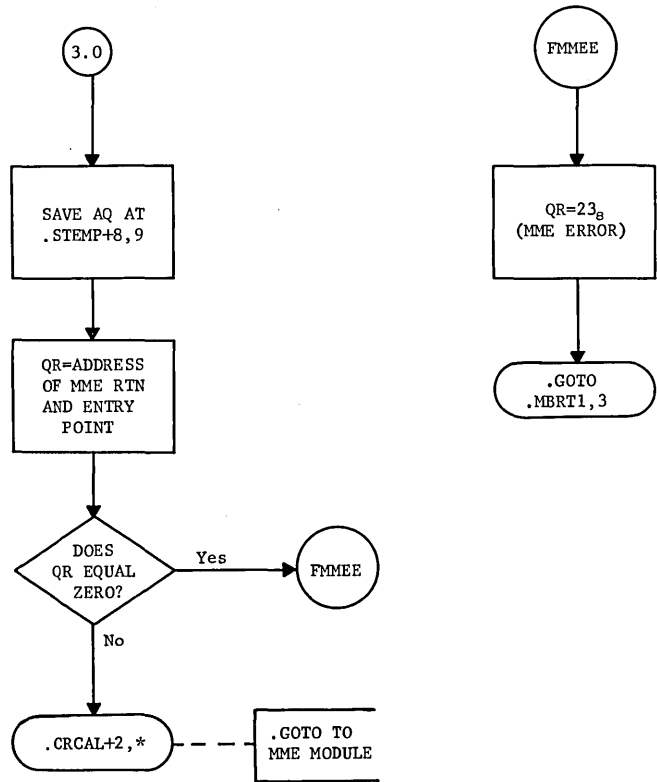

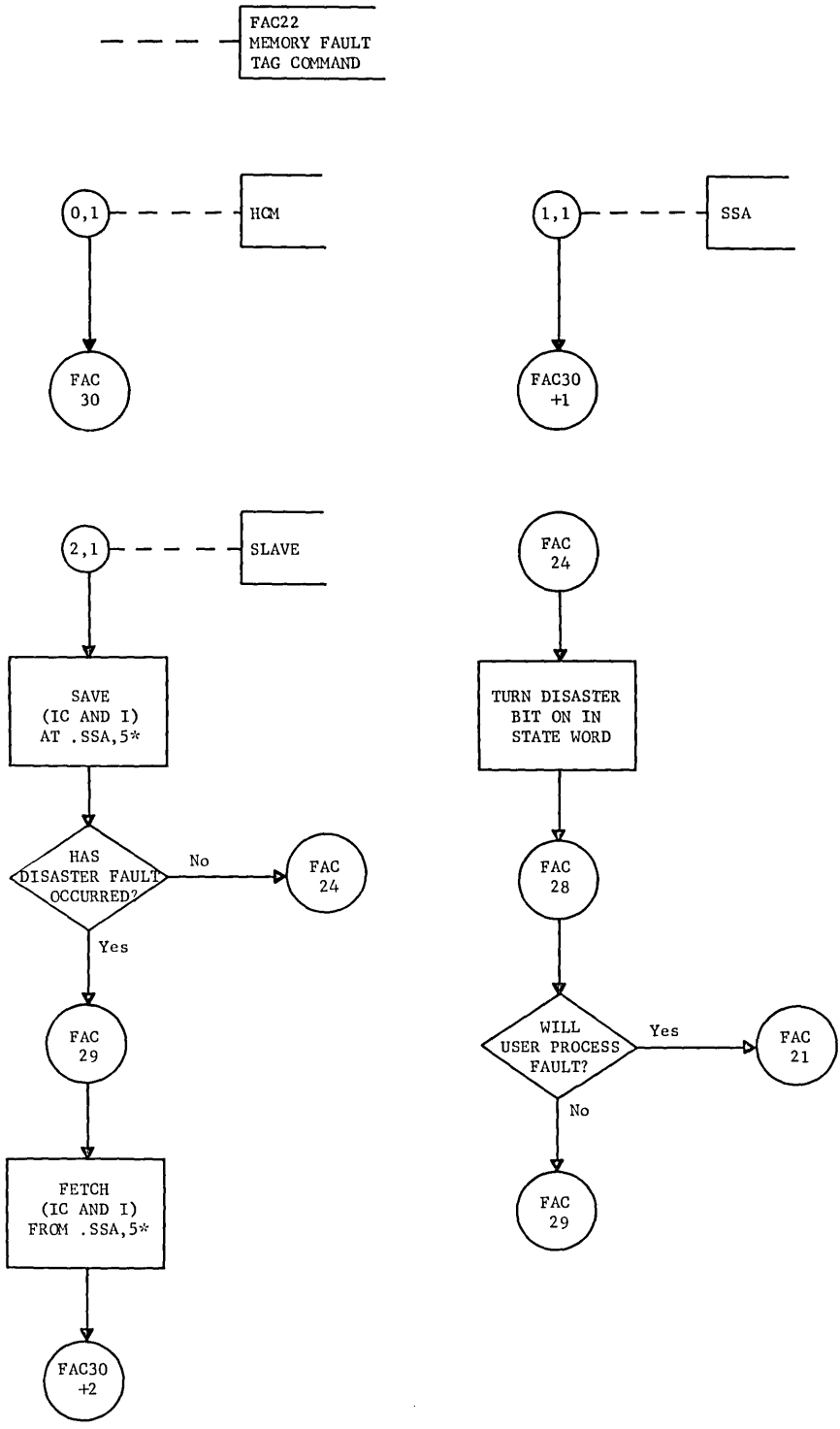

FLT  
.MFLAT

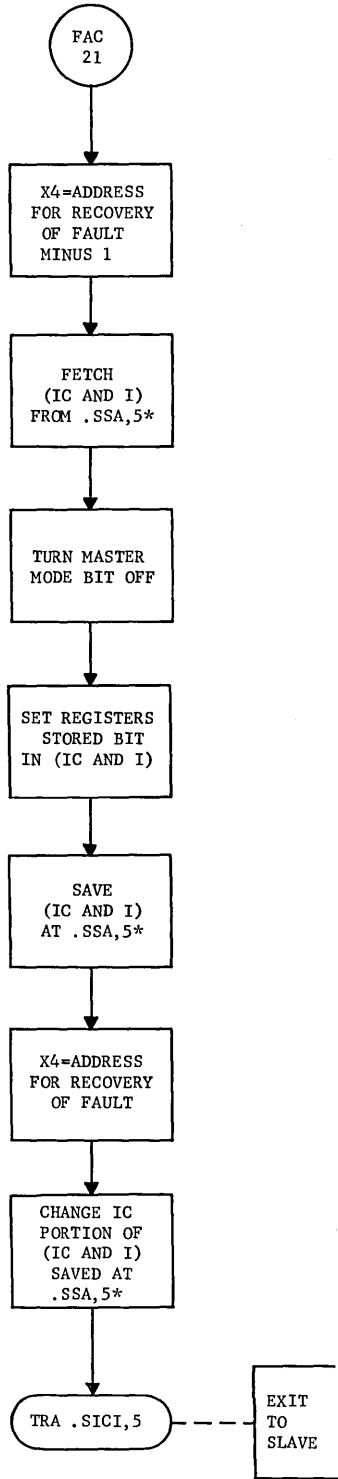

-----  
FAC23  
ZERO OP CODE

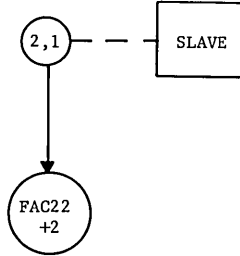
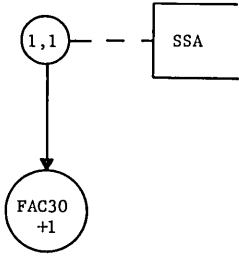
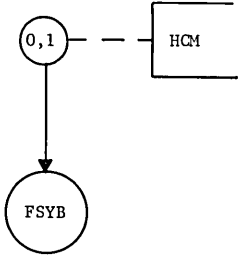



**FLT  
.MFALT**

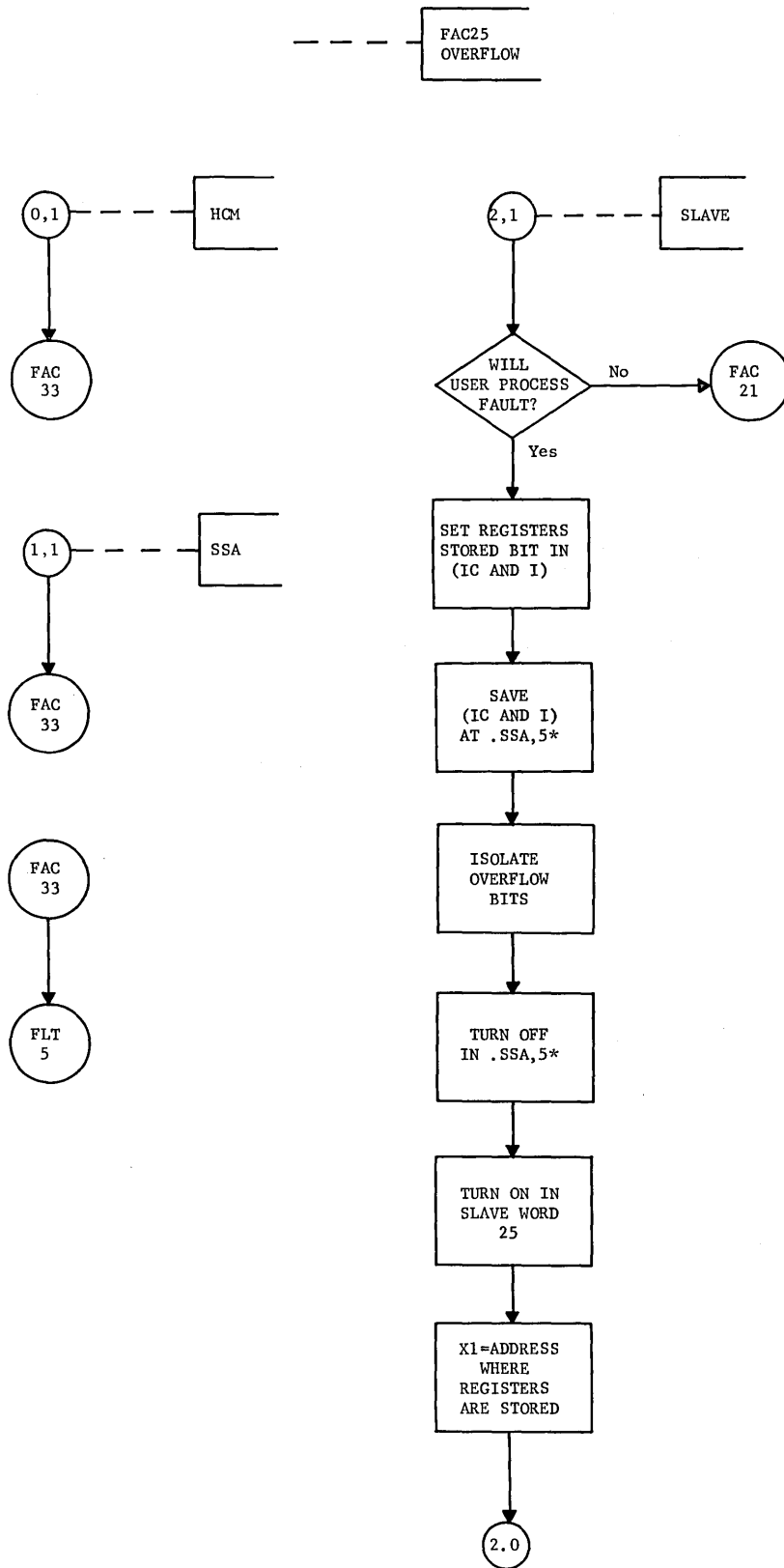

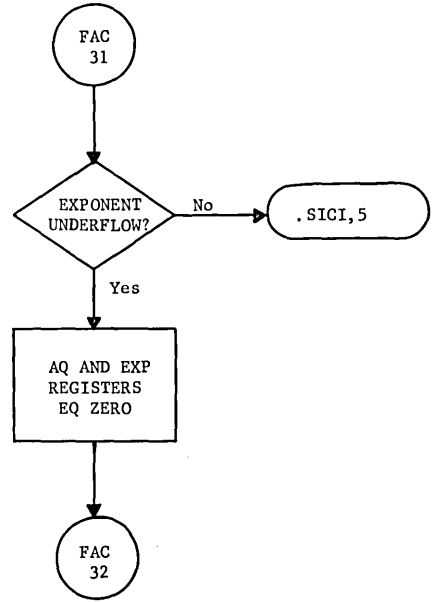
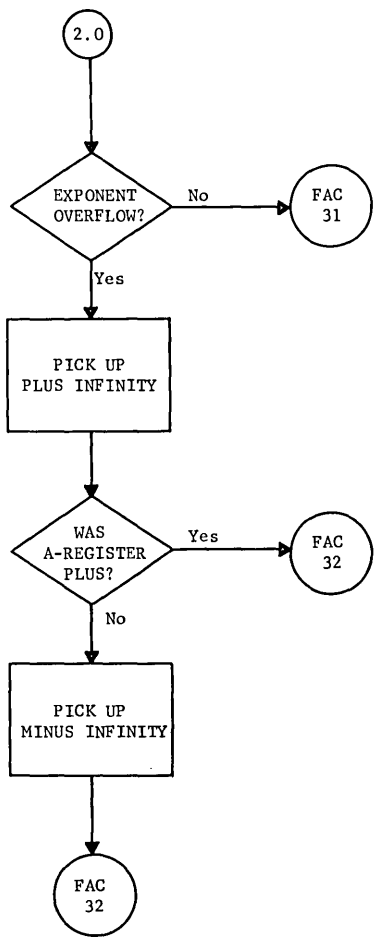

FLT  
.MFALT

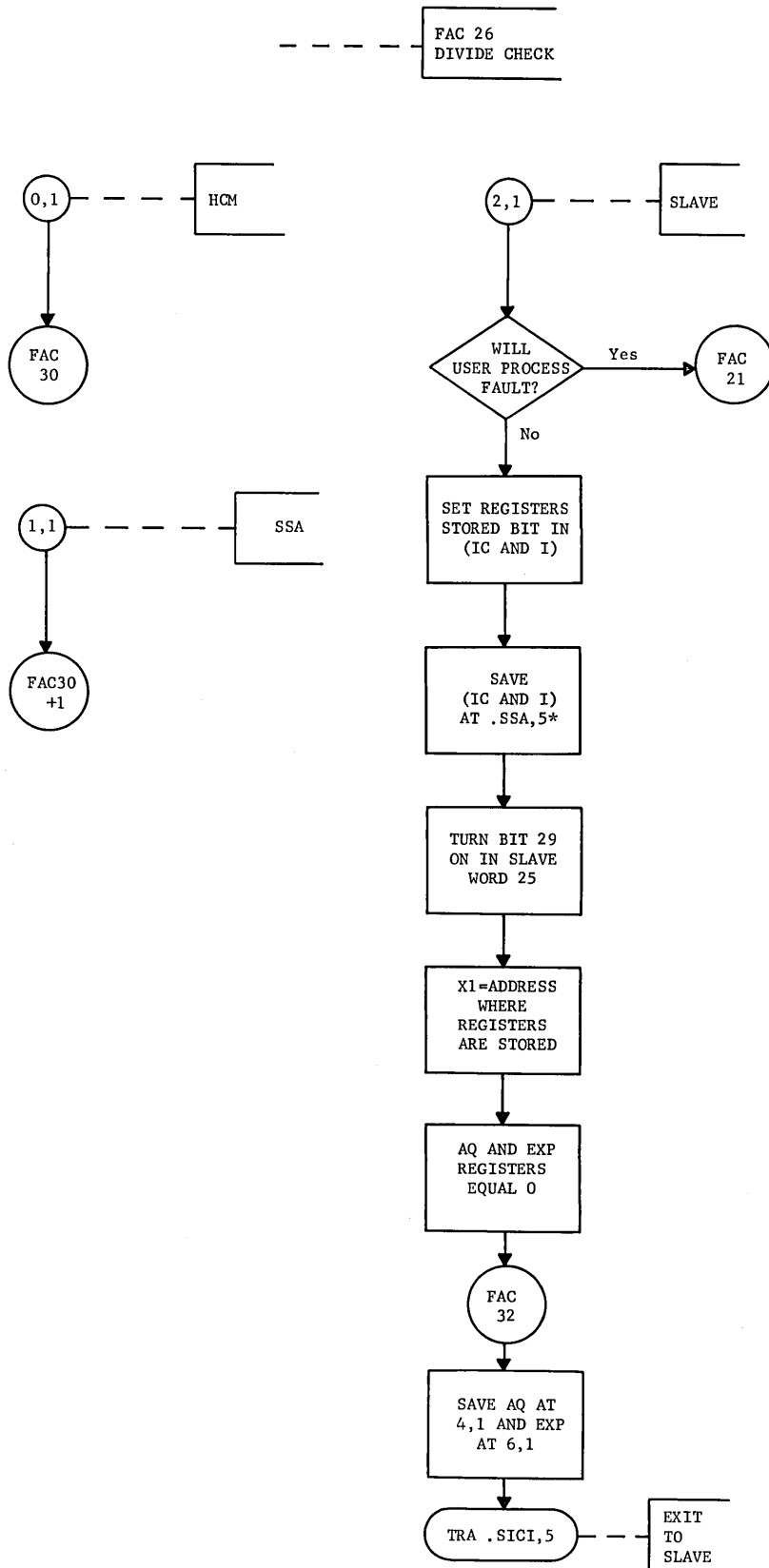

FLT  
.MFALT

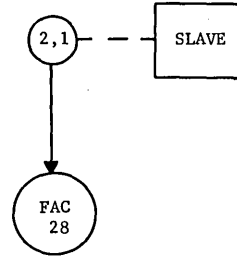
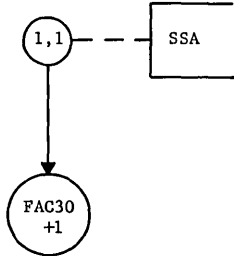
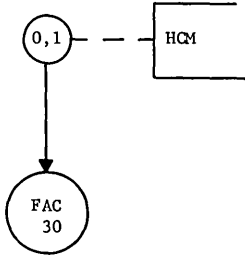
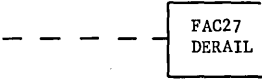

FLT  
.MFALT

FAC30  
PARITY OF  
NOT COMPLETE  
LOCKUP

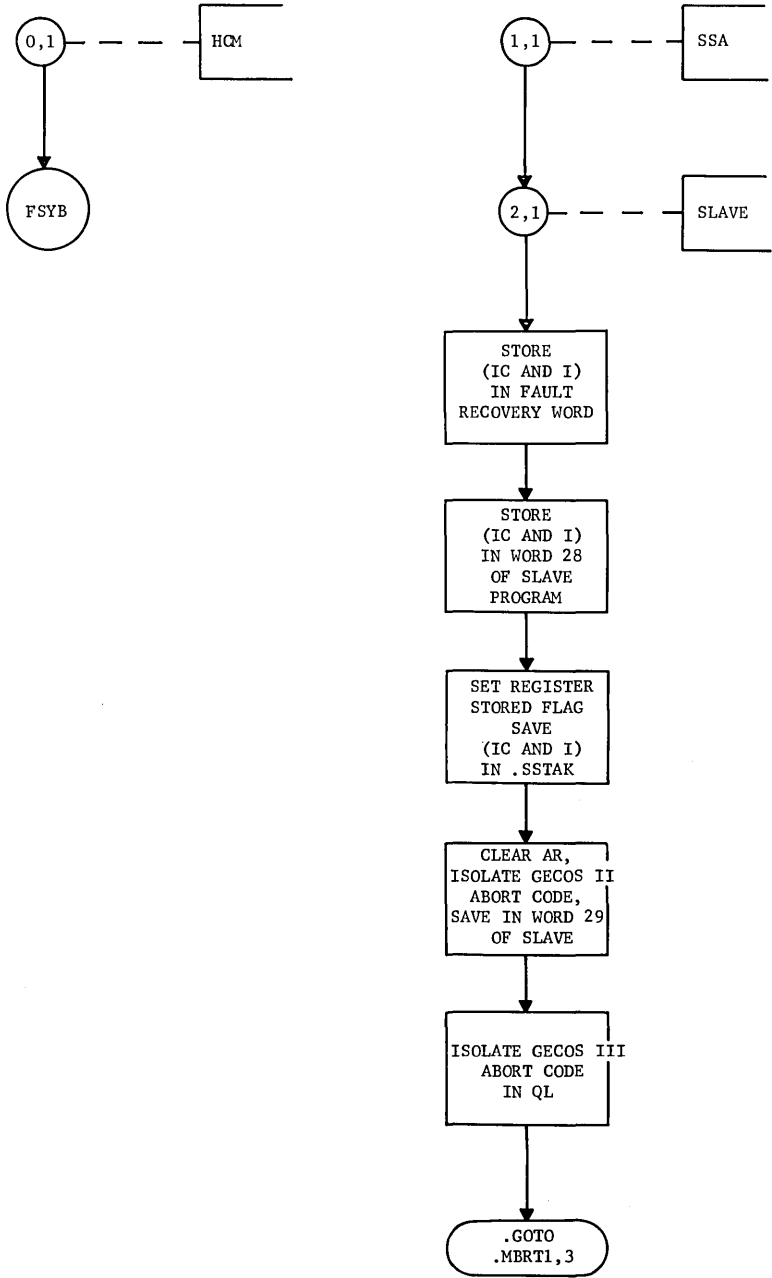

FSB (EP1)  
.MFALT

TAKE DUMP FOR SYSTEM ABORT

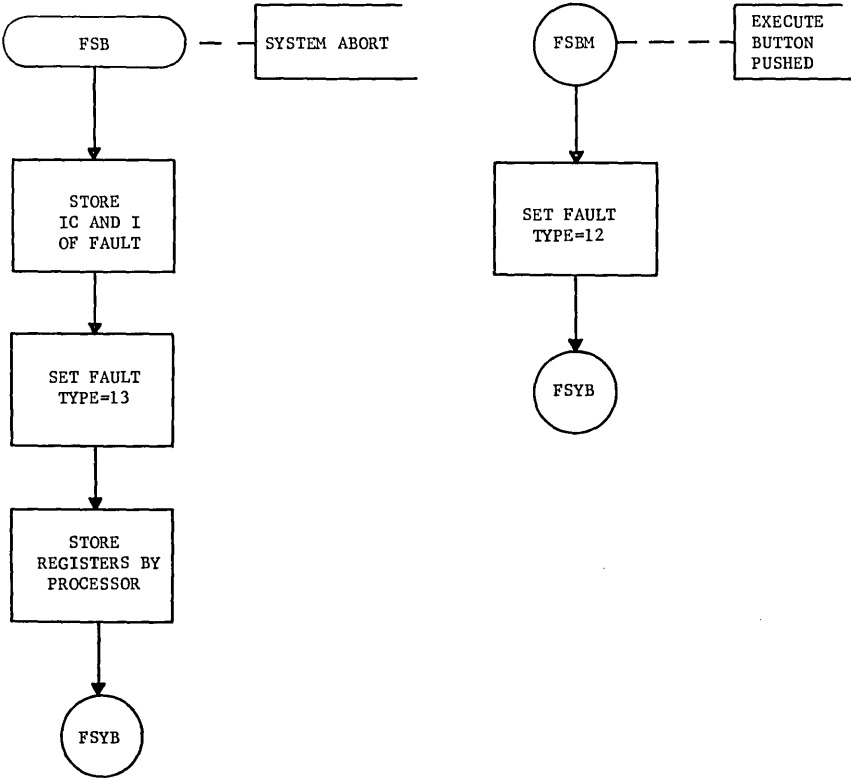

FGAD (EP2)  
.MFALT

GET ADDRESS FOR FILE CODE

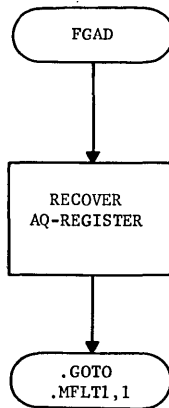

FGCON (EP3)  
.MFALT

PUT INFORMATION IN FCB

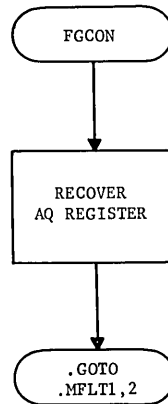



FGFIL (EP4)  
.MFALT

SWITCH PRIMARY AND SECONDARY LOGICAL UNITS

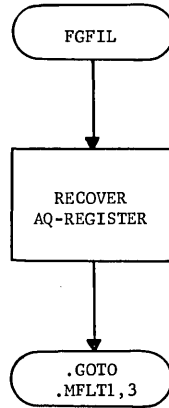



FGRET (EP6)  
.MFALT

RESET PROGRAM SWITCH WORD BITS

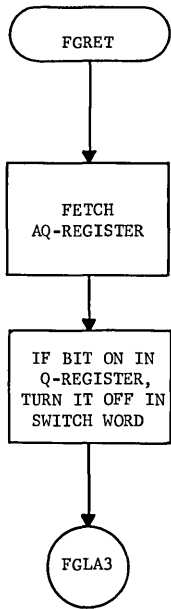

SET PROGRAM SWITCH WORD BITS

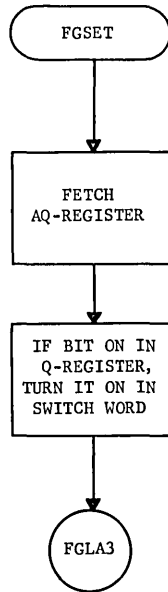

FGTIM (EP8)  
.MFALT

PROVIDE DATE AND TIME OF DAY

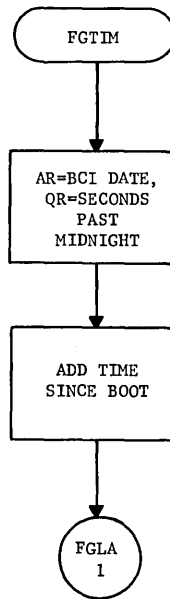

DIVIDE EXECUTION TIME INTO SECONDS

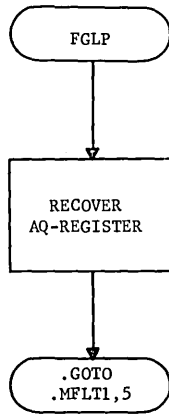

FEMM (EP10)  
.MFALT

LET SLAVE PROGRAM ENTER MASTER MODE

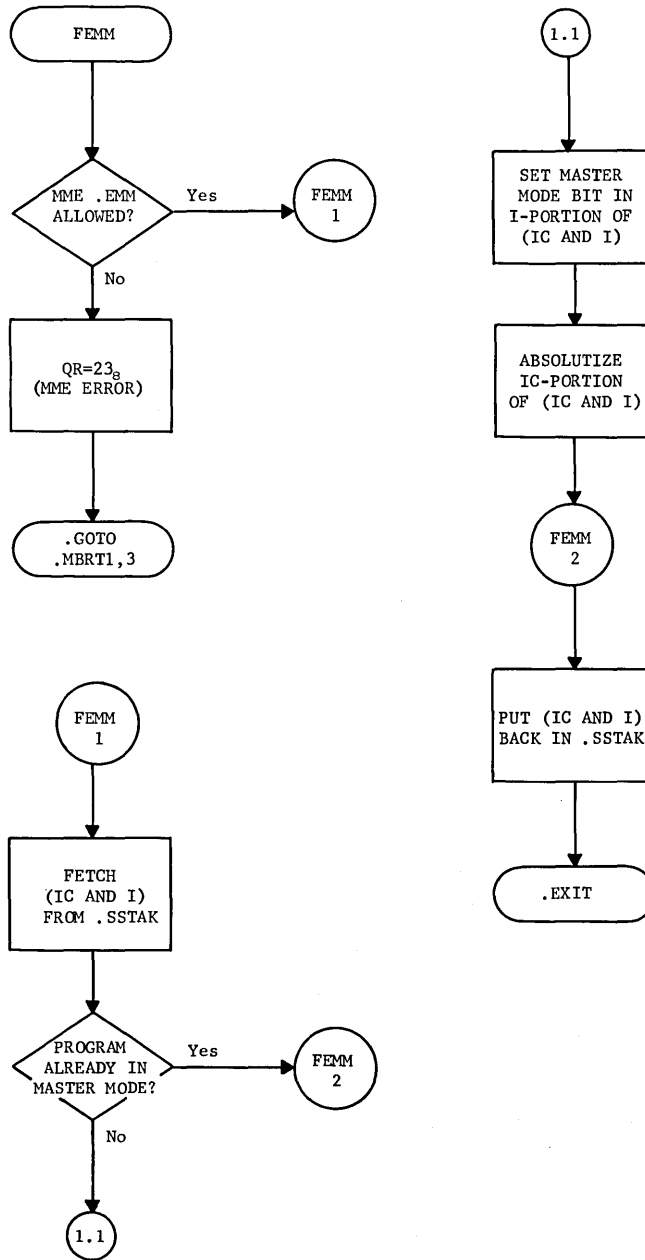

FIND PAT FROM FILE CODE

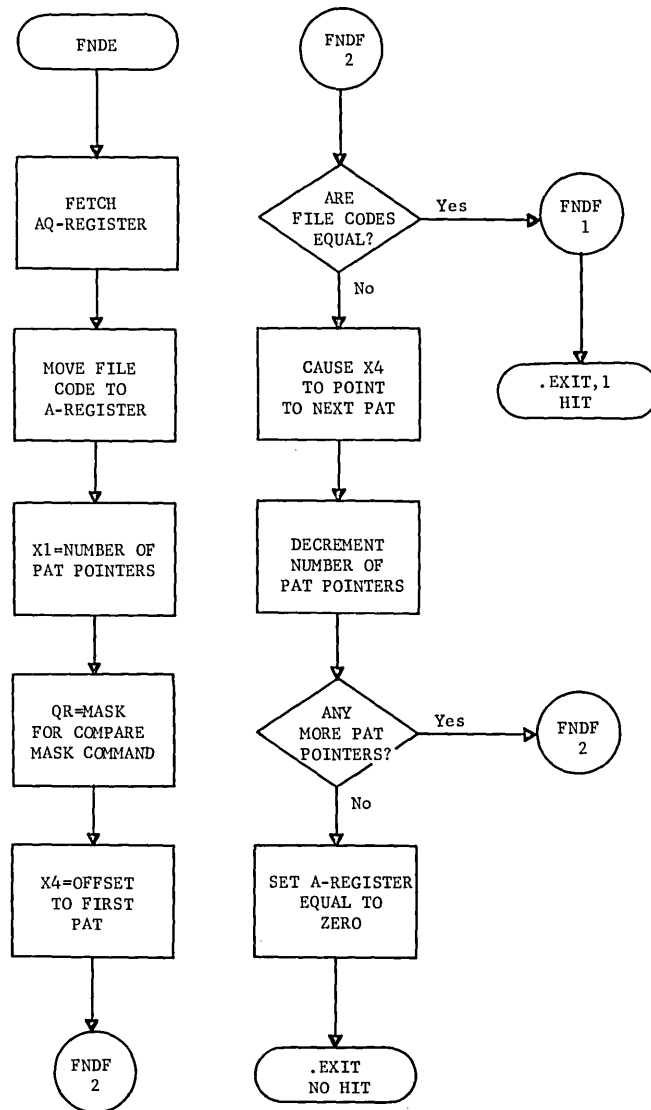



GMRL (EP12)  
.MFALT

### DEALLOCATE MEMORY

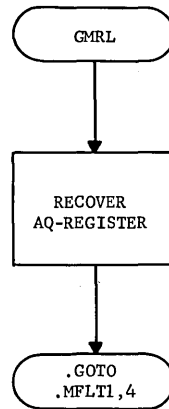

CALL .MDUMP AT EP2

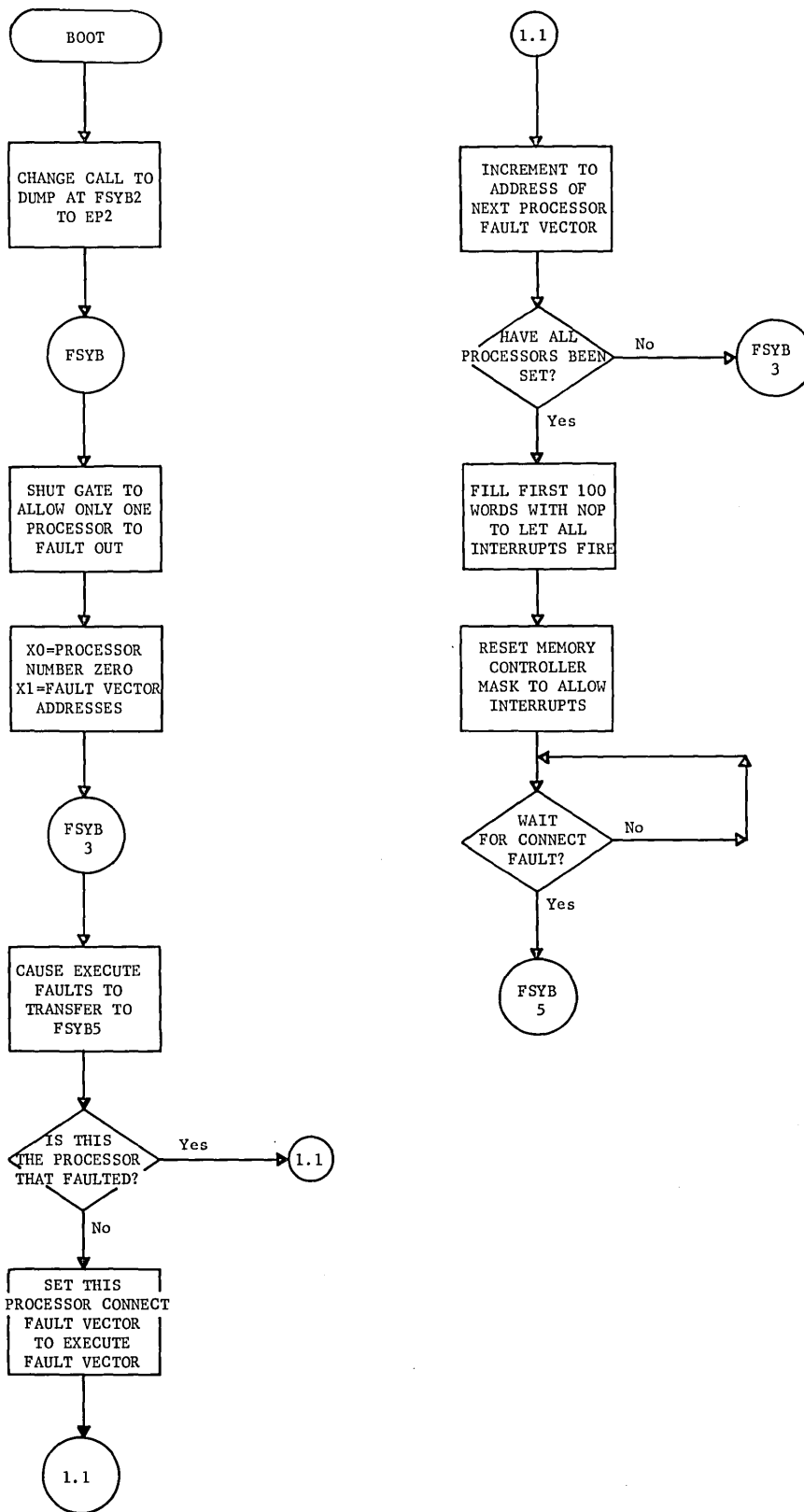

BOOT (EP13)  
.MFAULT

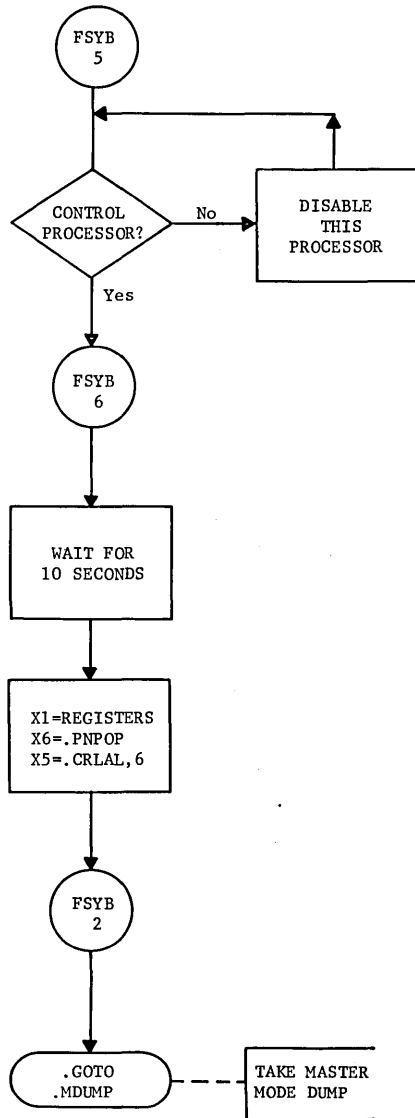

.IFALT  
.MFALT

FAULT PROCESSOR INITIALIZATION

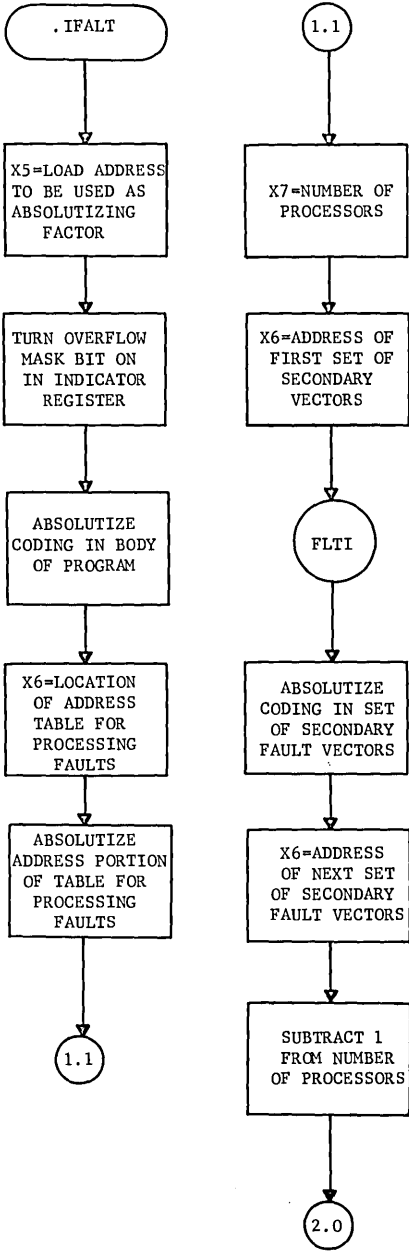

.IFALT  
.MFALT

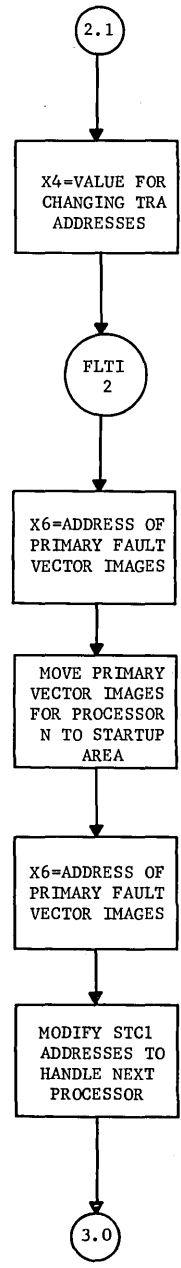
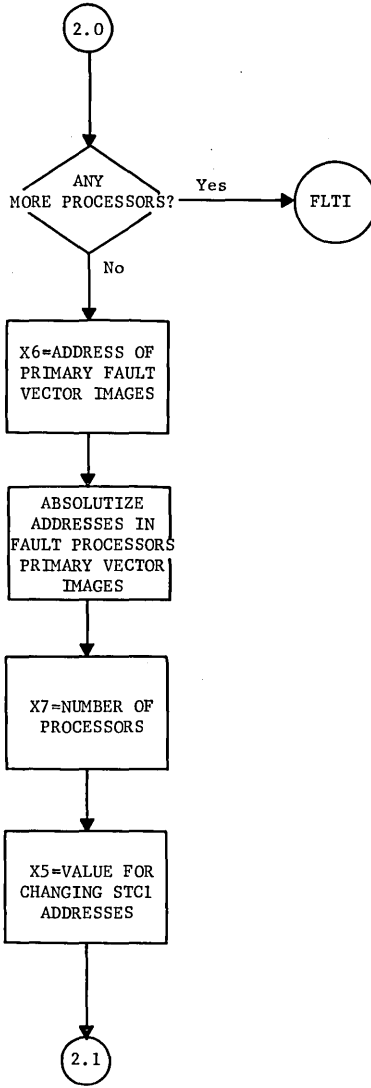

.IFALT  
.MFALT

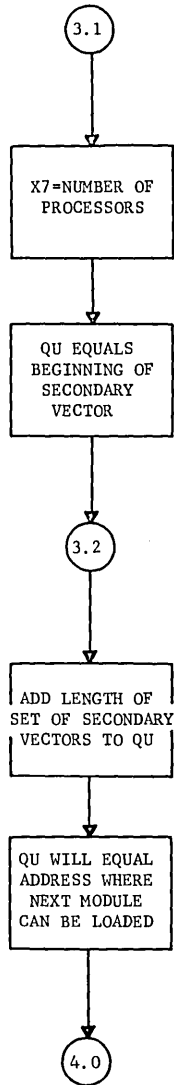
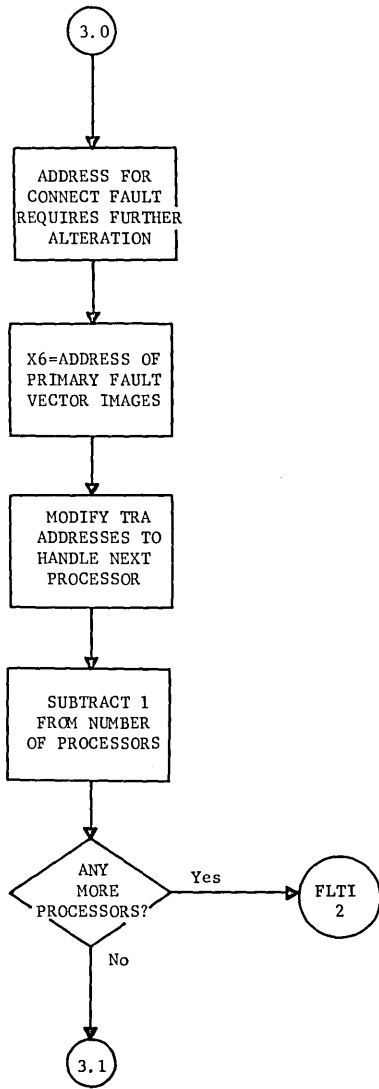

.IFALT  
.MFALT

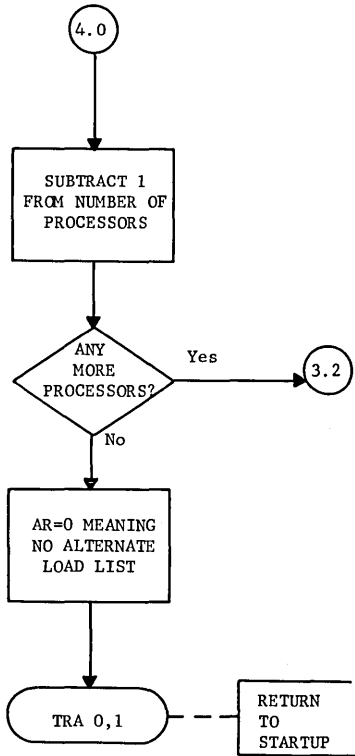

GET ADDRESS FOR FILE CODE

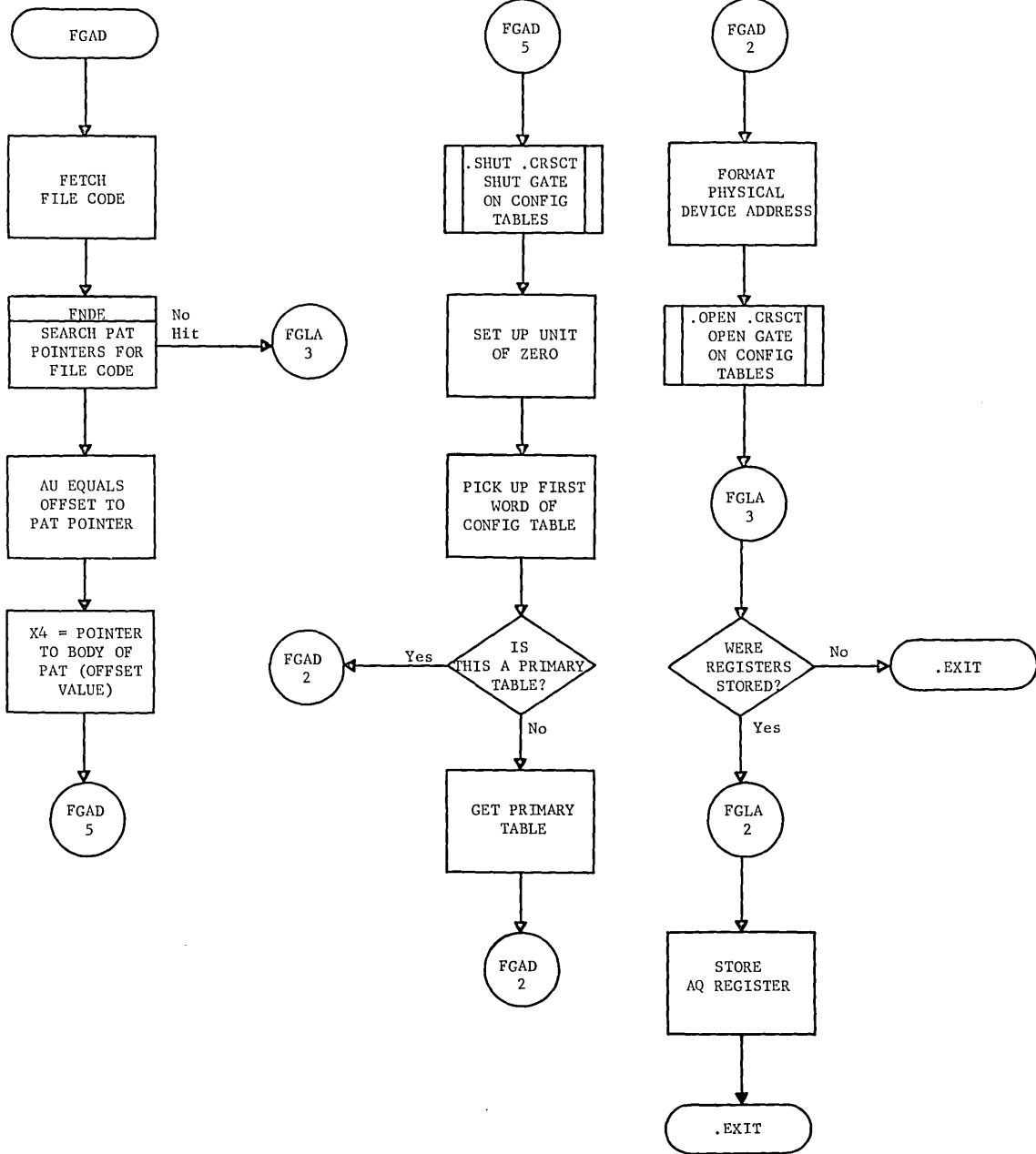



FCON (EP2)  
.MFLT1

### PUT INFORMATION IN FCB

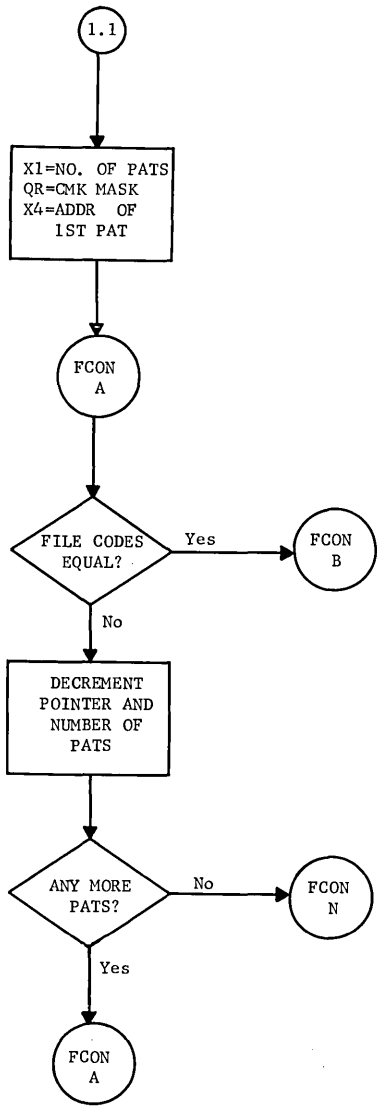
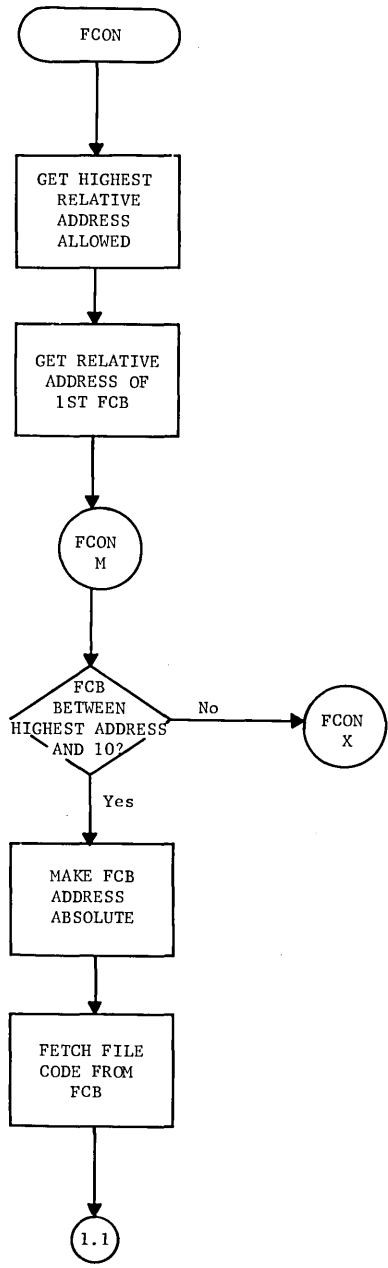

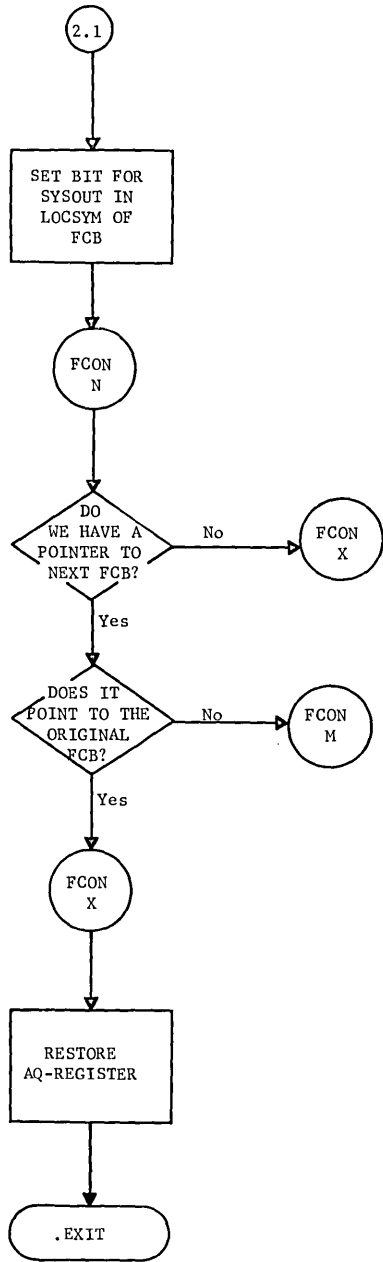
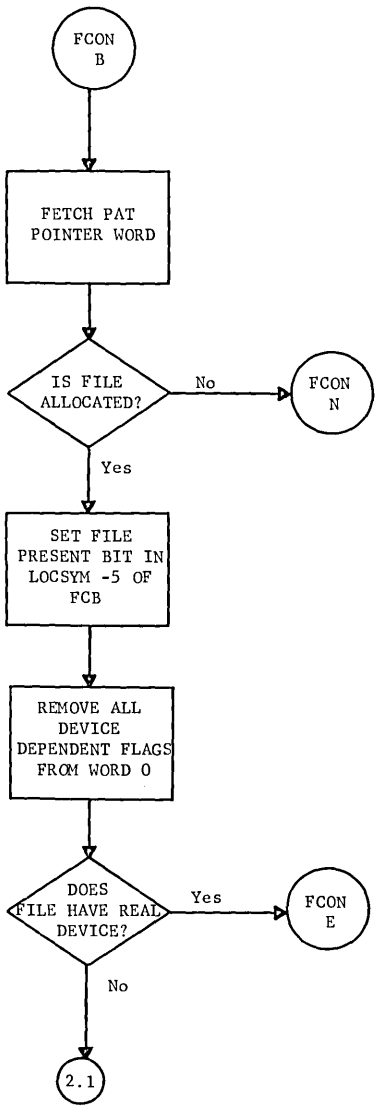

FCON (EP2)  
.MFLT1

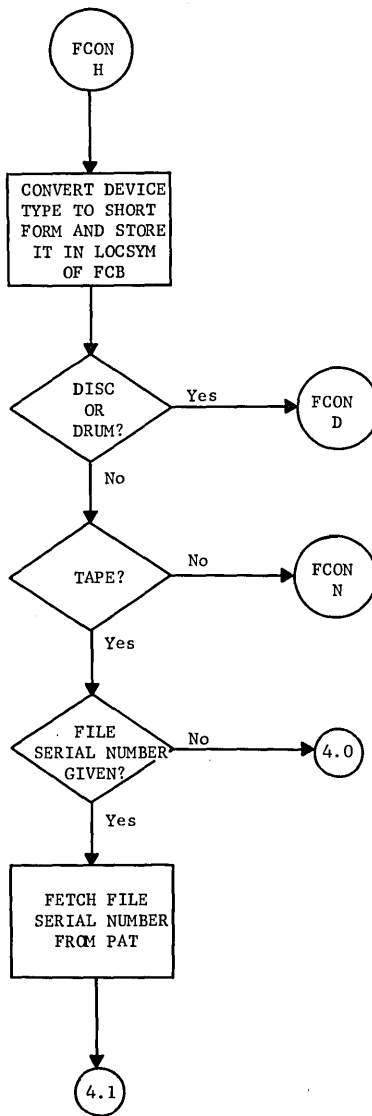
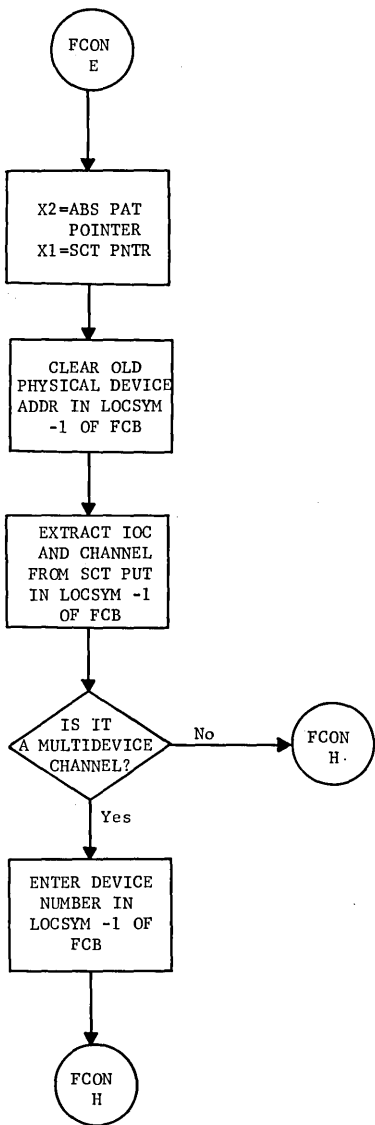

FCON (EP2)  
.MFLT1

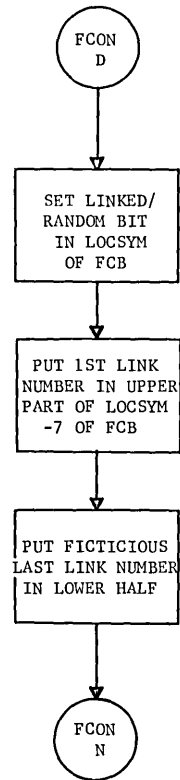
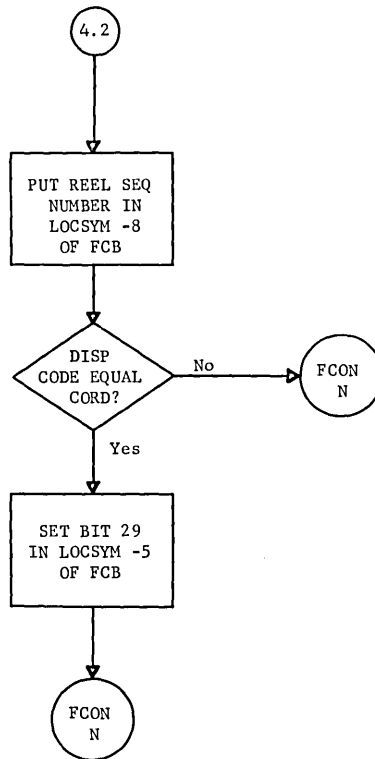
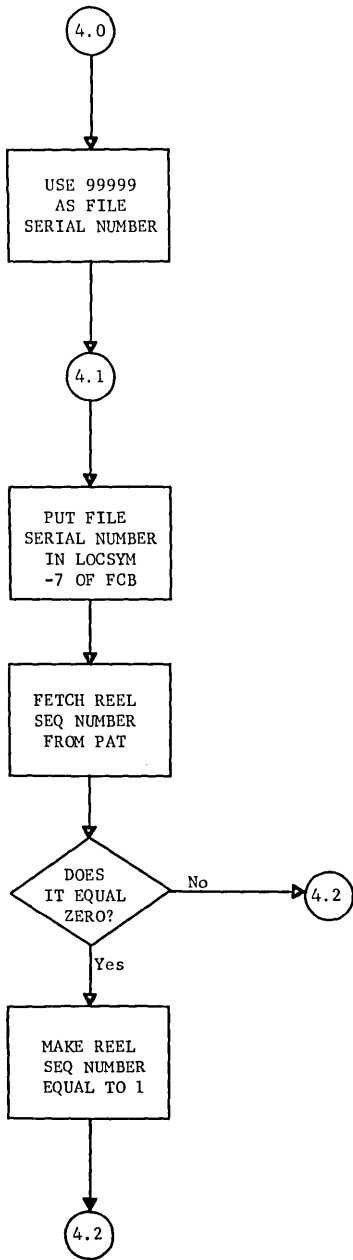

FLSW (EP3)  
.MFLT1

SWITCH PRIMARY AND SECONDARY LOGICAL UNITS

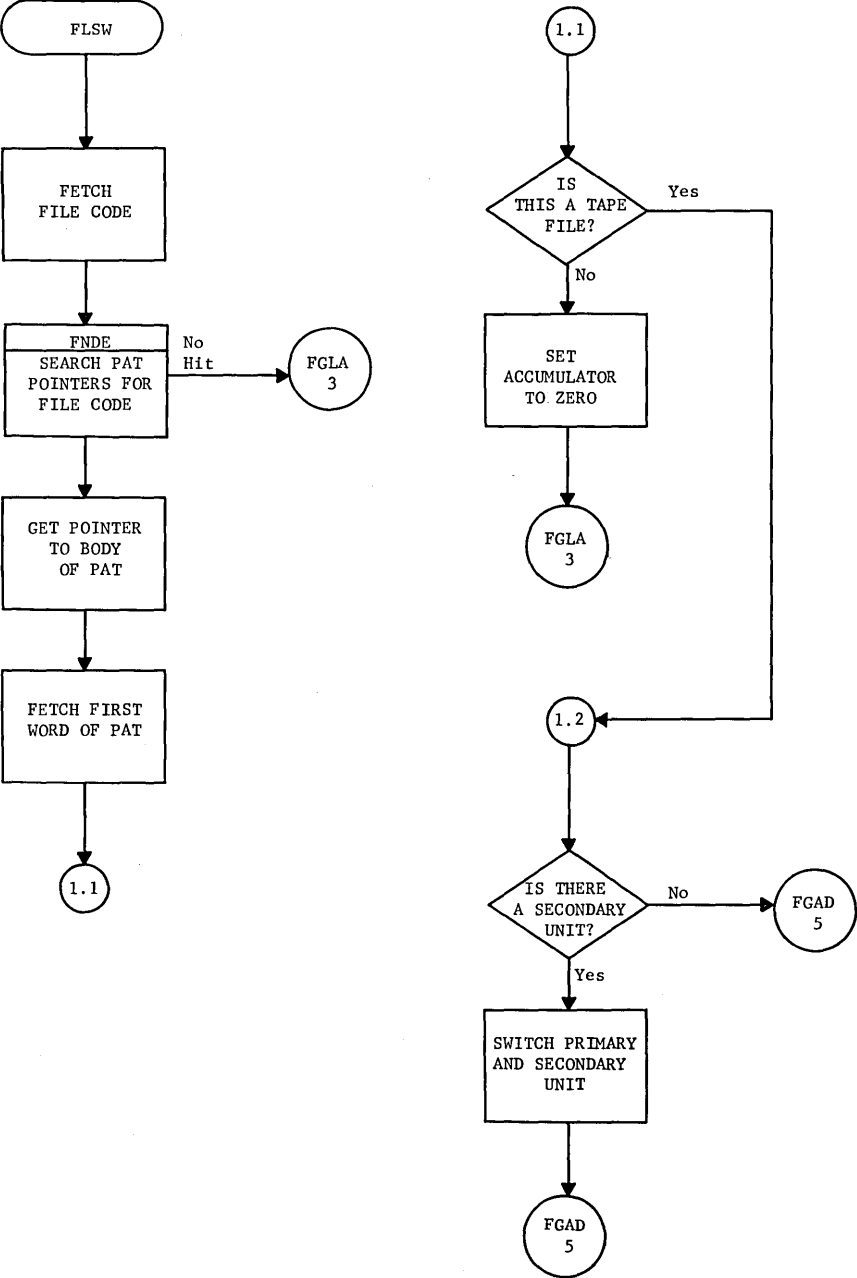

DEALLOCATE MEMORY

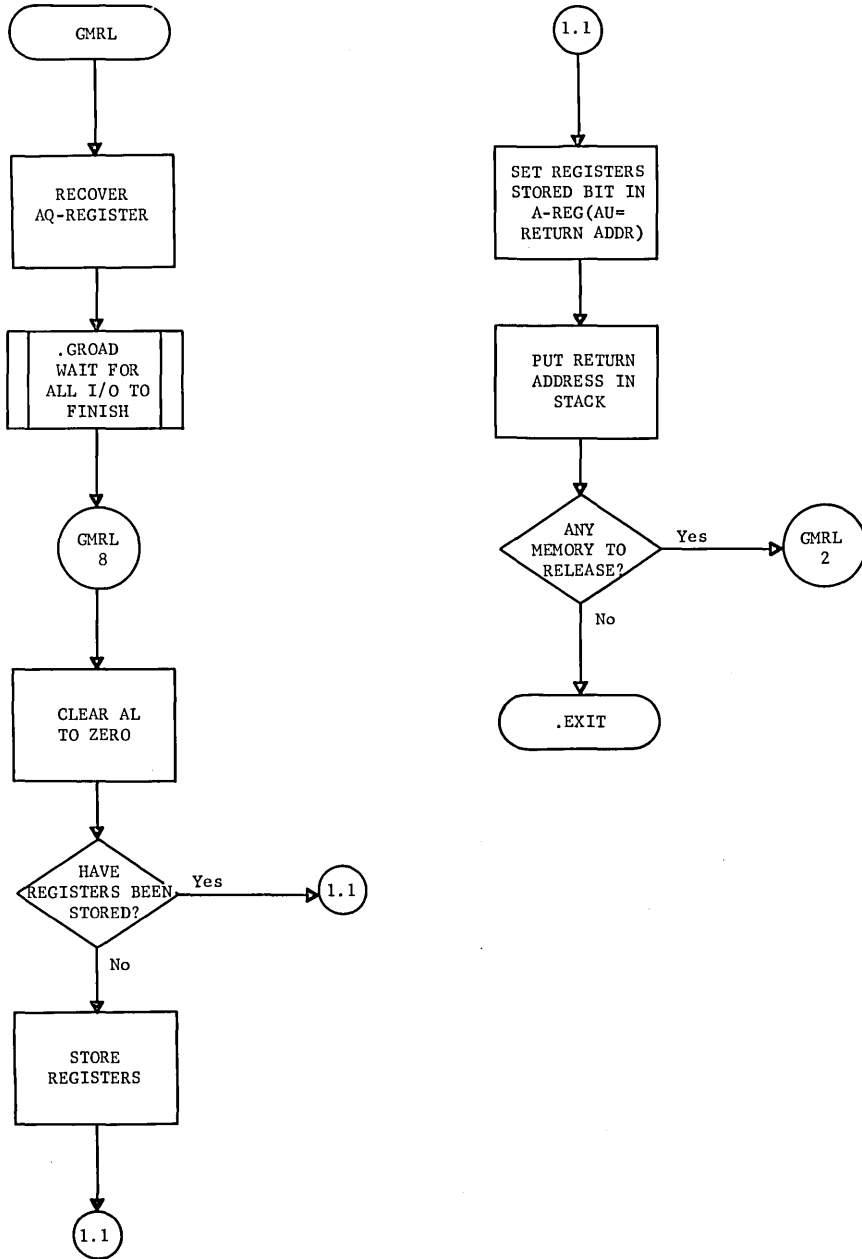

GMRL (EP4)  
.MFLT1

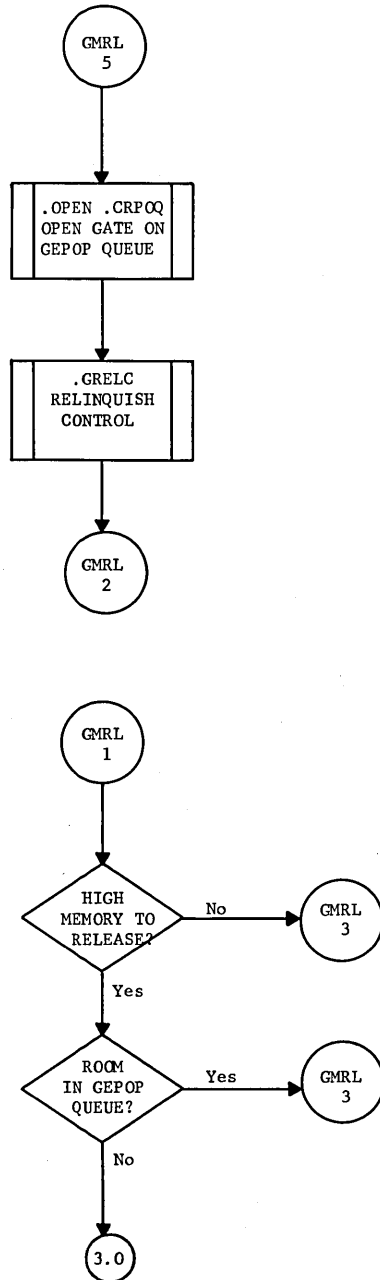
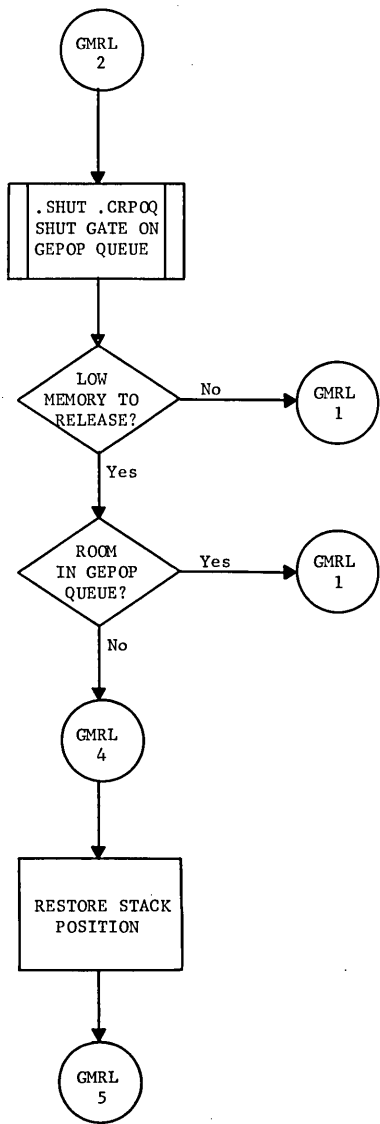

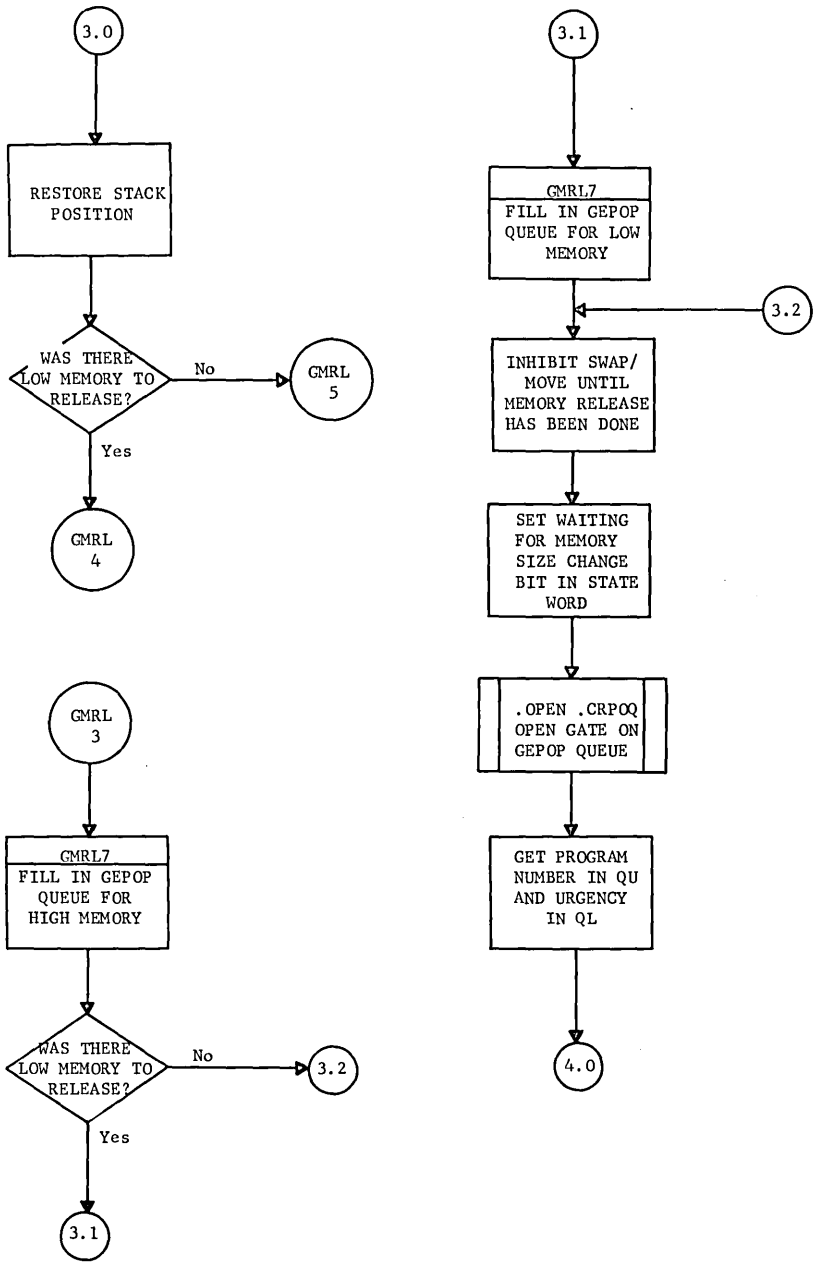



GMRL (EP4)  
.MFLT1

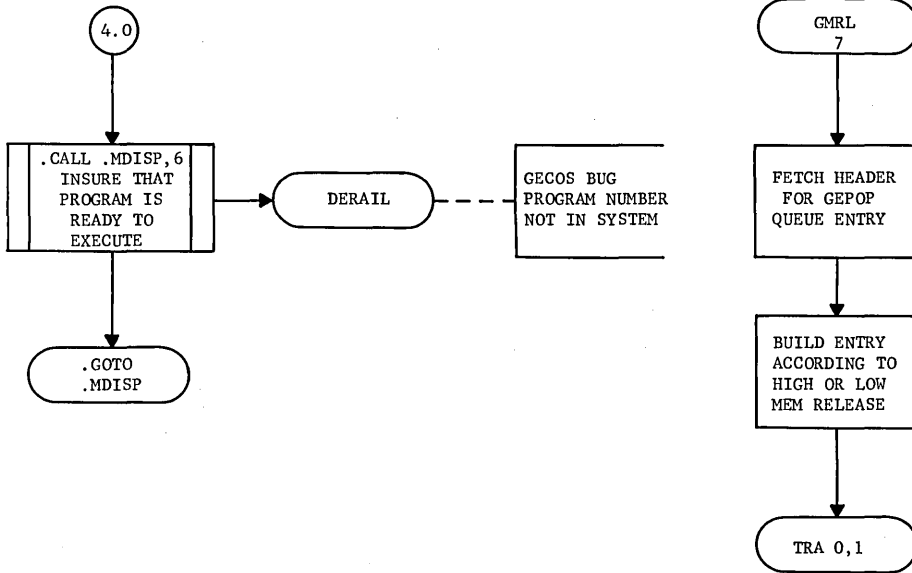

DIVIDE EXECUTION TIME INTO SECONDS

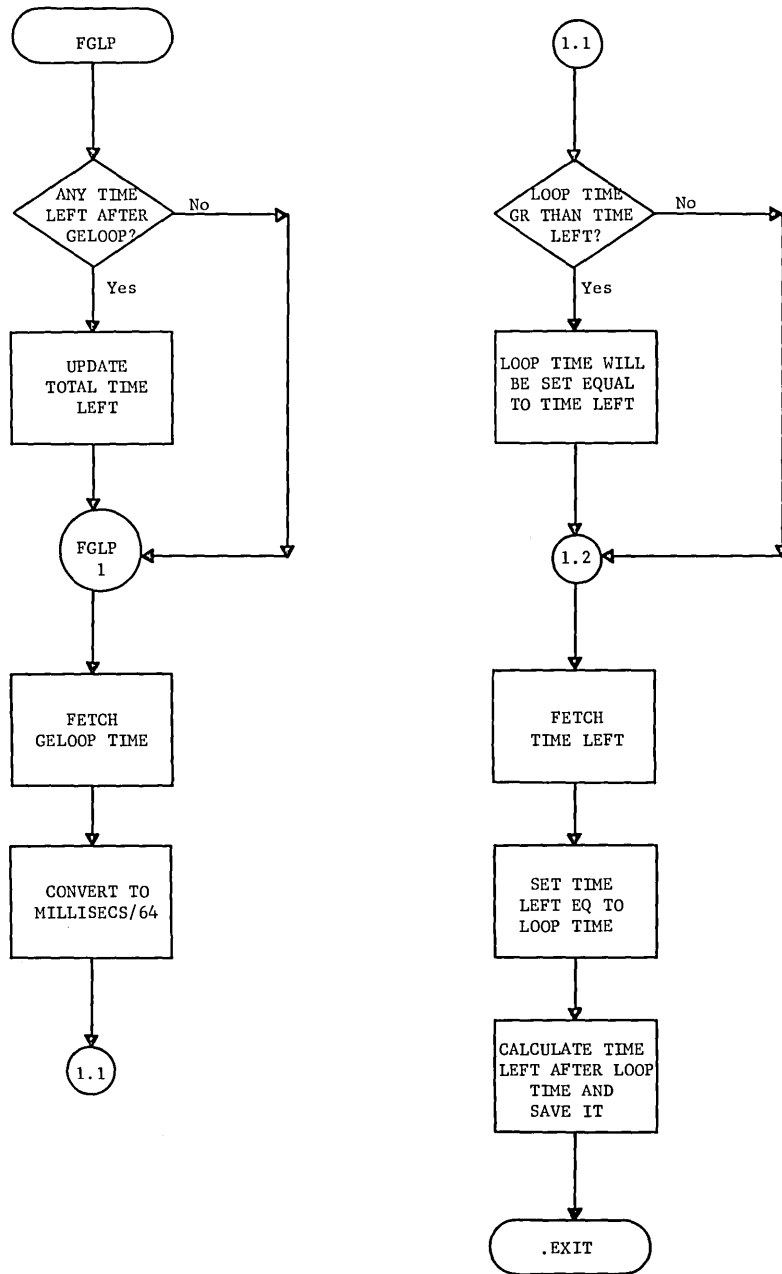

FPRIO (EP6)  
.MFLT1

### GIVE I/O ACTION PRIORITY

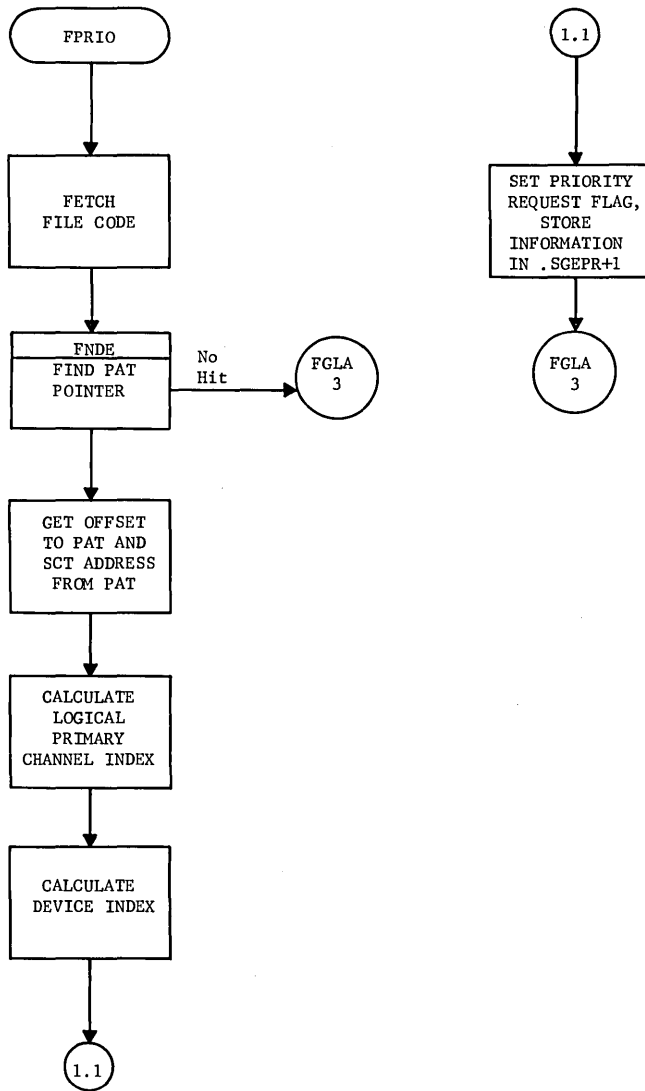

RESET BAR TO SMALLER AREA

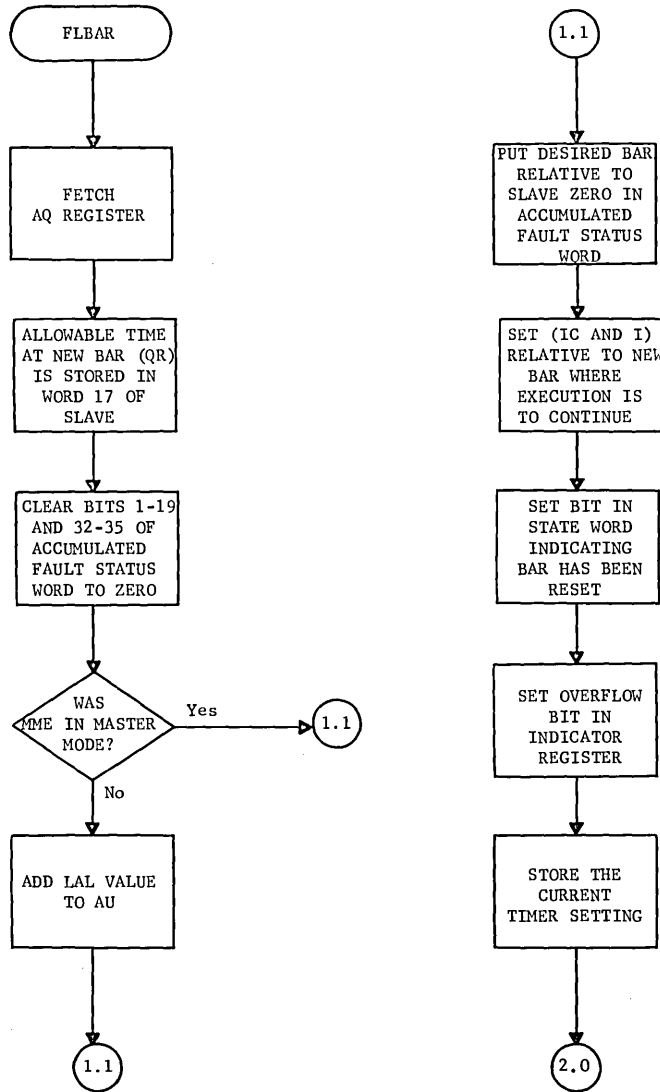

FLBAR (EP7)  
.MFLT1

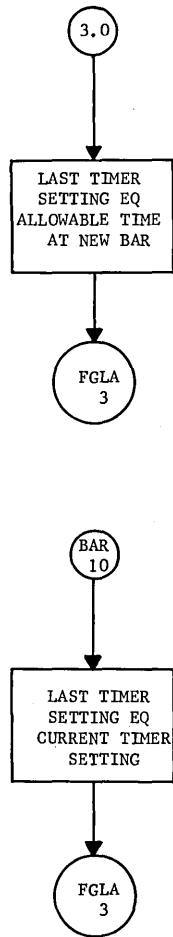
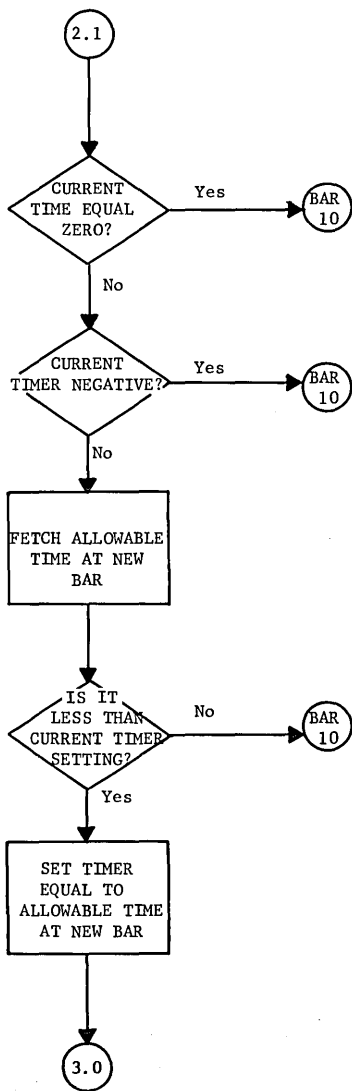
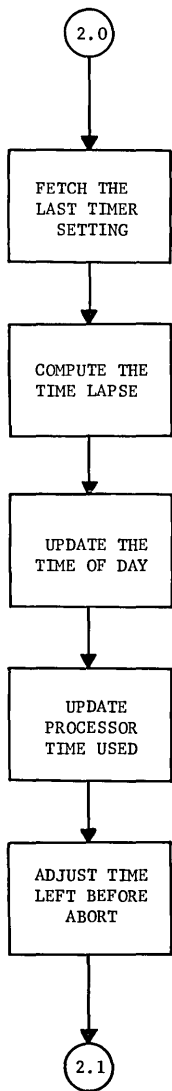

ALLOW A PROGRAM TO DELAY

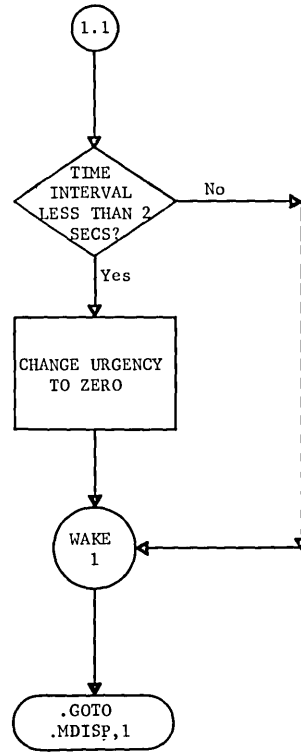
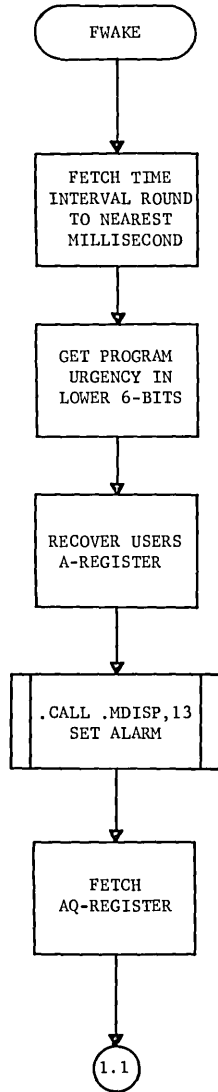

GMRLM (EP9)  
.MFLT1

MEMORY RELEASE ENTRY FOR TIME-SHARING

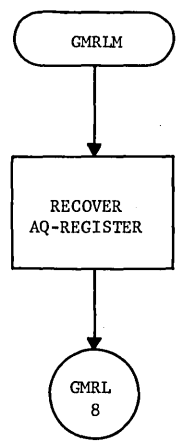

### 3. I/O SUPERVISION

(Reference CPB-1494)





LINK I/O TO END OF QUEUE

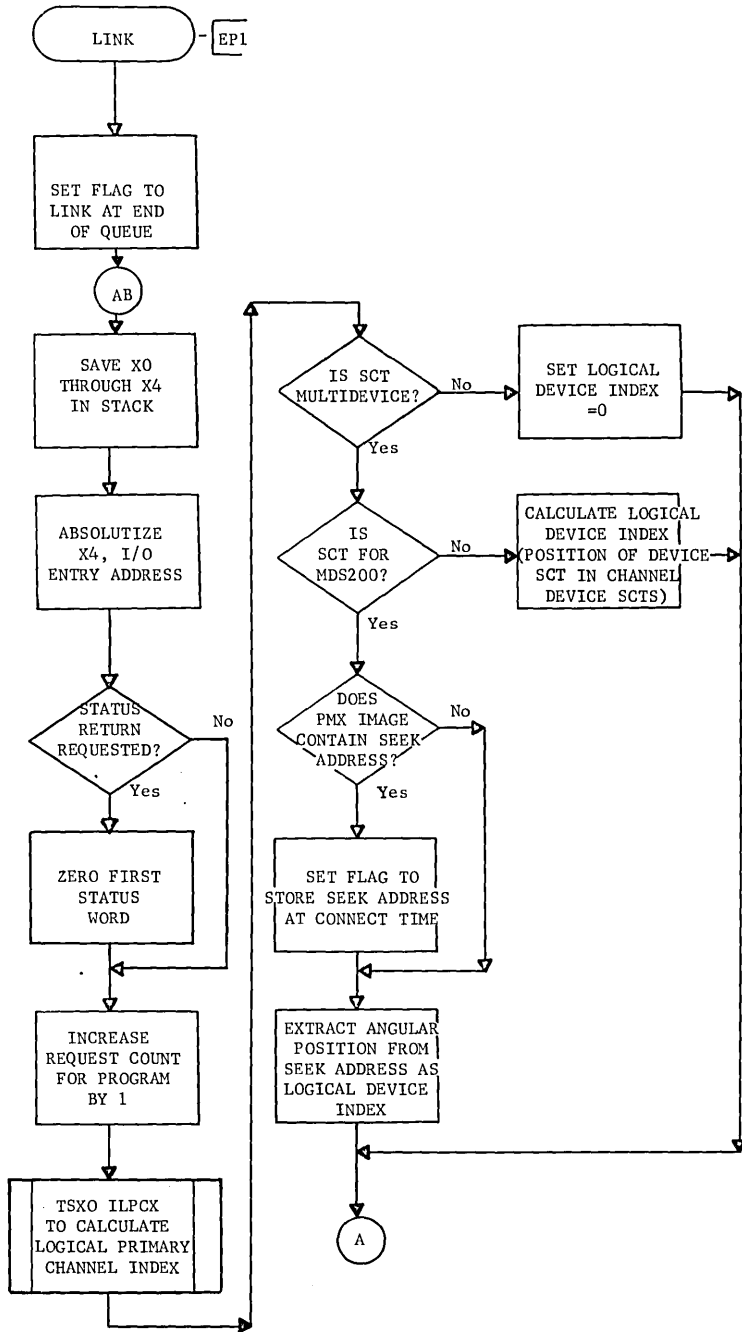

LINK (EP1)  
.MIOS

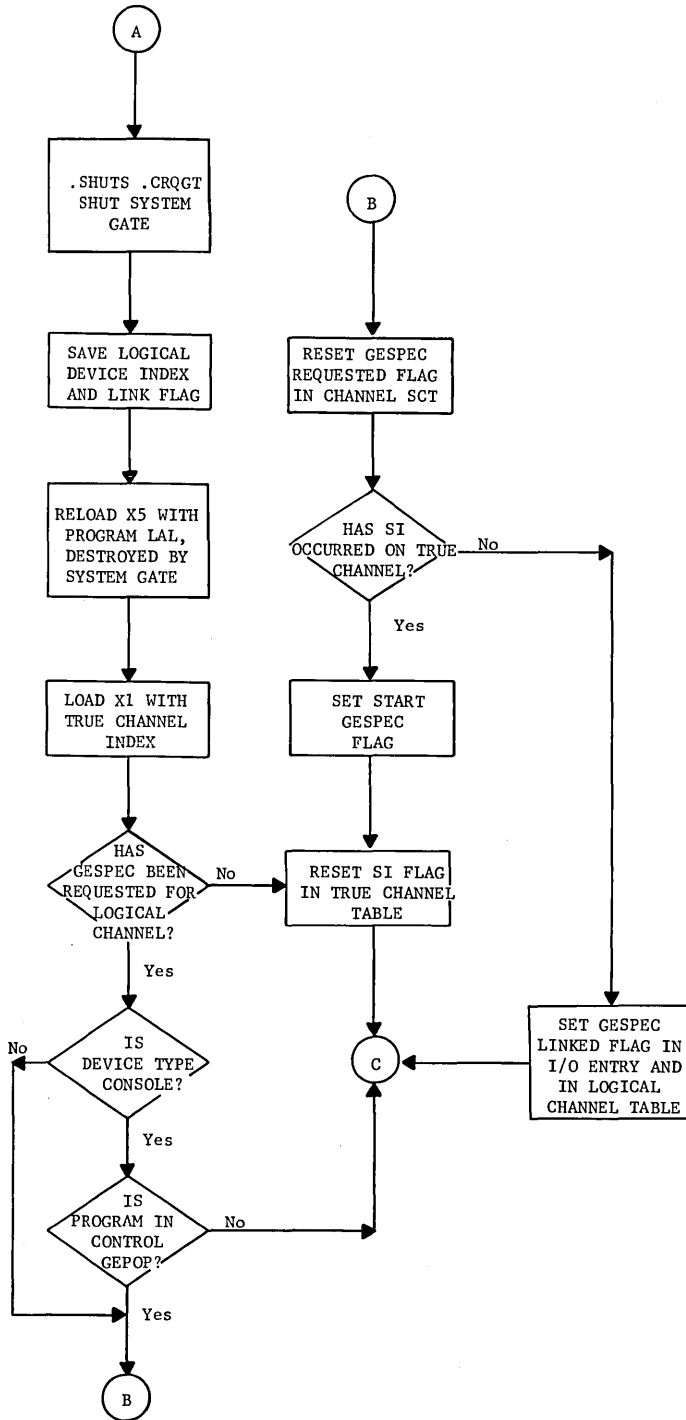

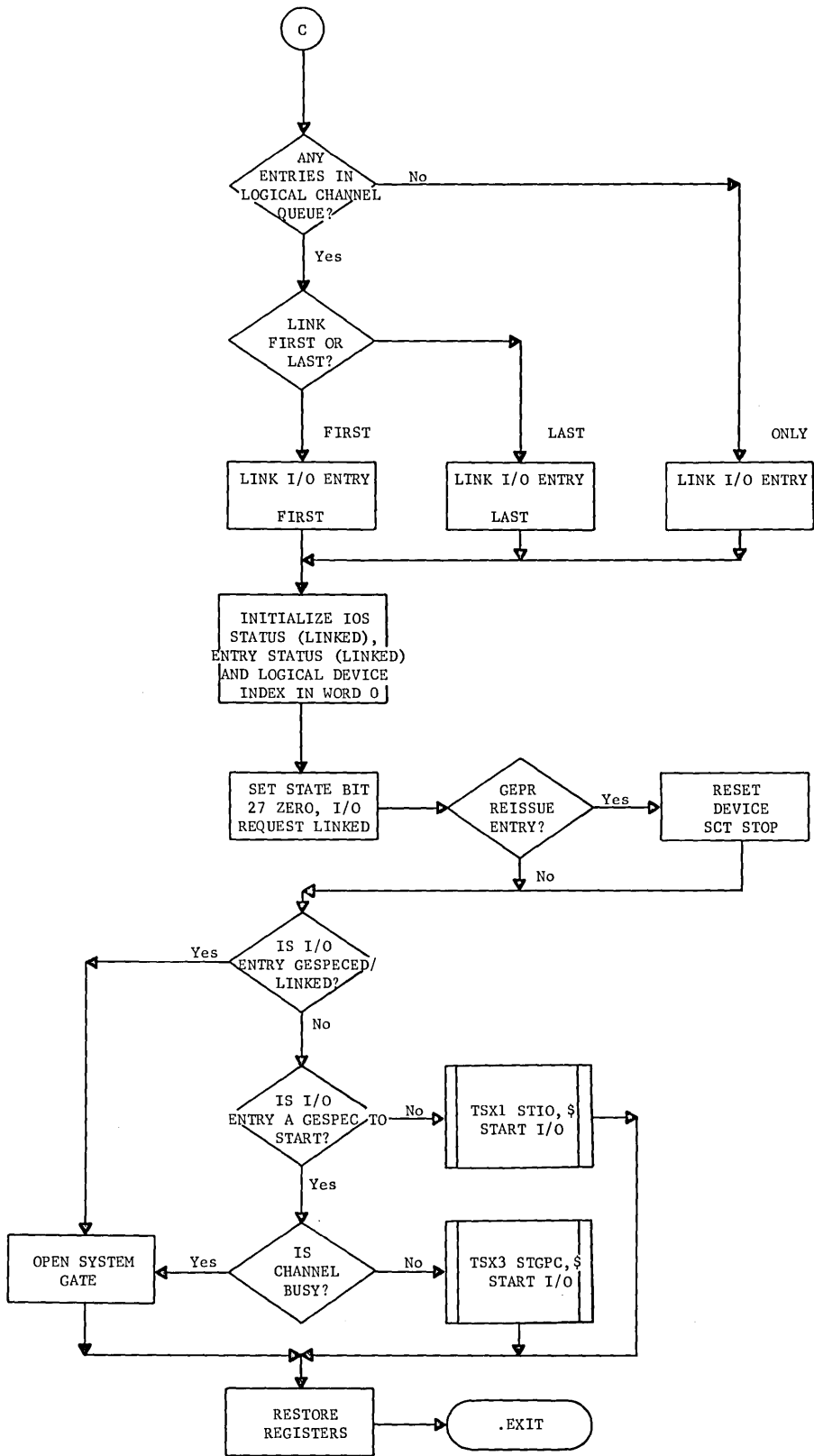

LINKF (EP2)  
.MIOS

LINK I/O TO FRONT OF QUEUE

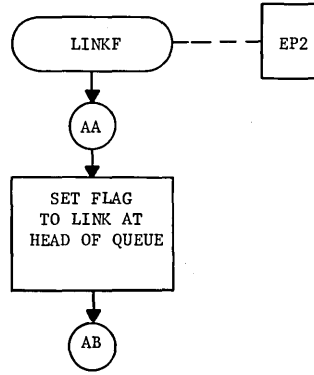

LINK REISSUED I/O TO FRONT OF QUEUE

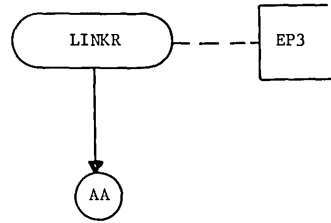

ASSIGN AN I/O ENTRY

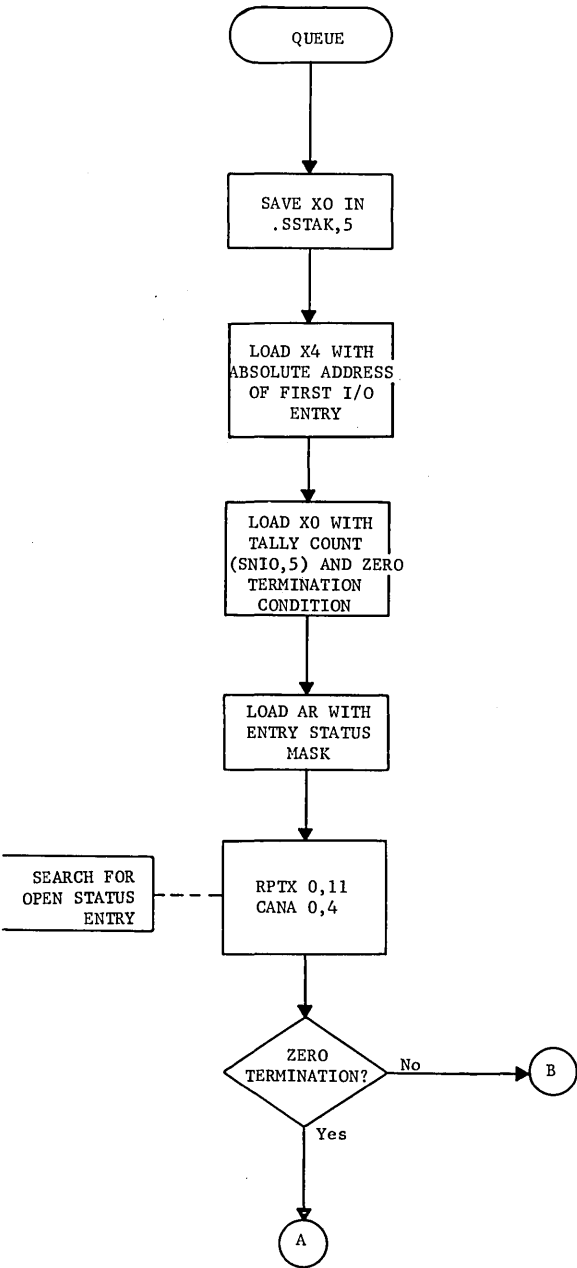

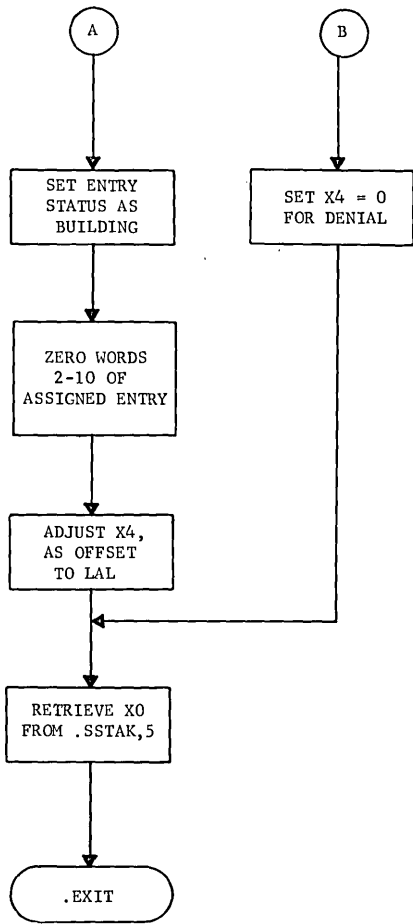



MME GEINOS PROCESSOR

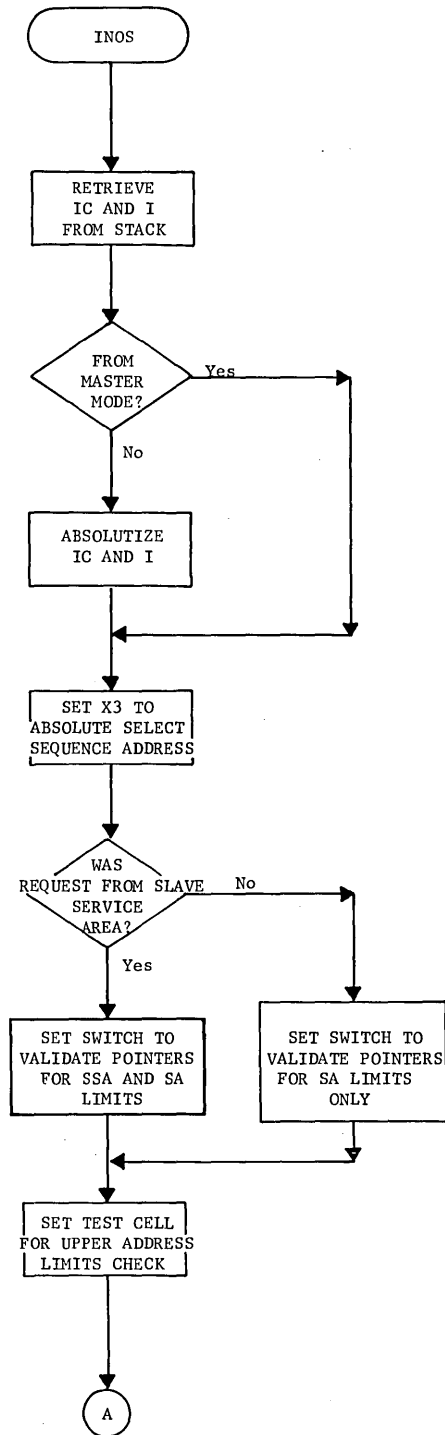

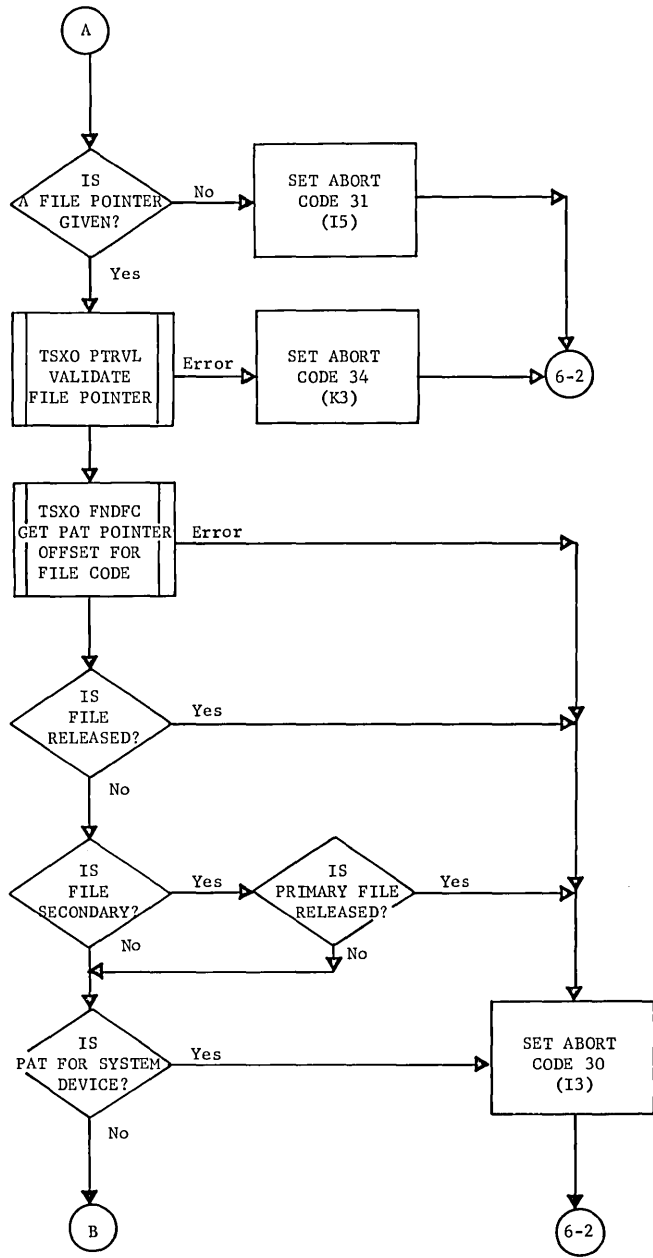

INOS (EP5)  
.MIOS

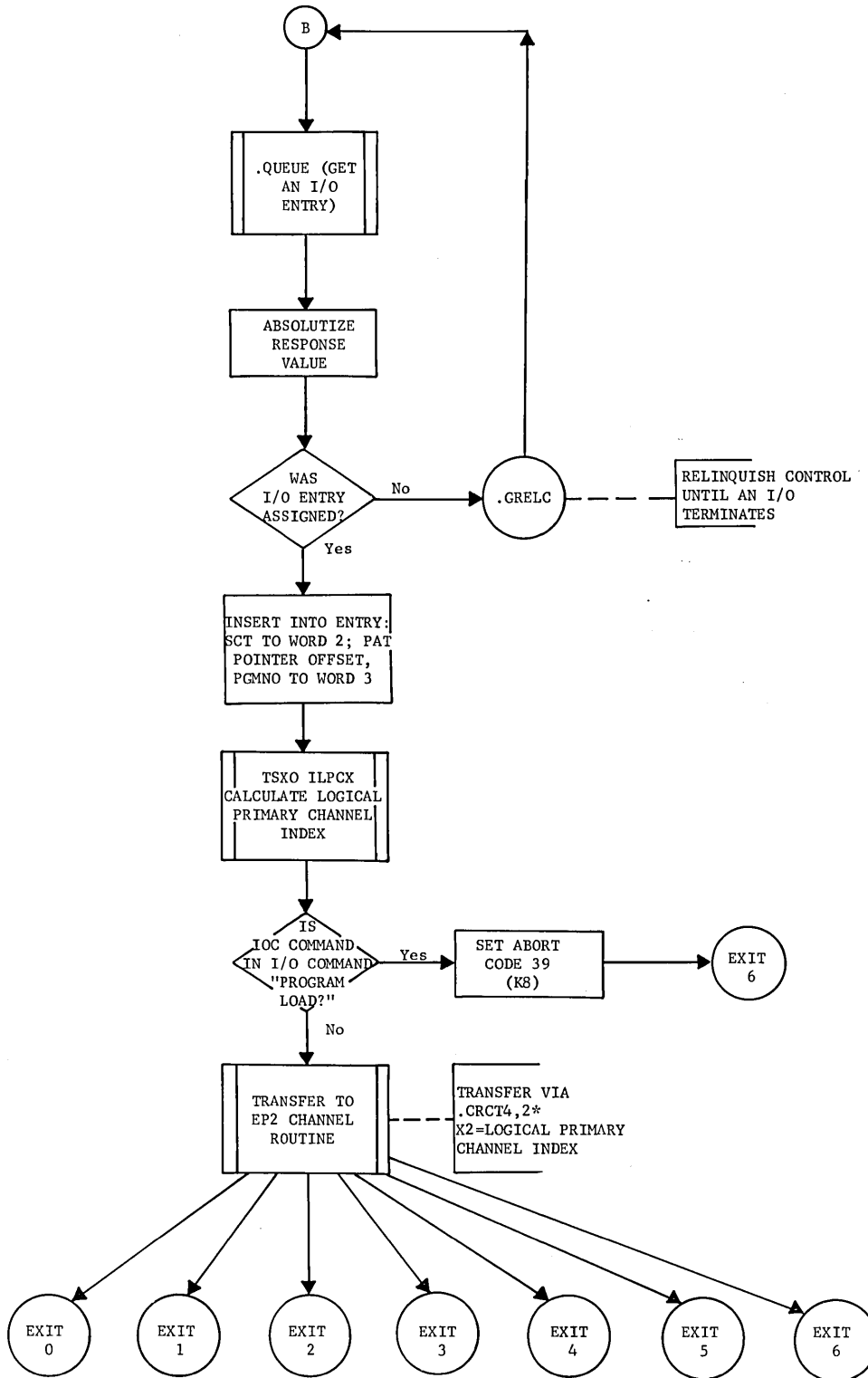

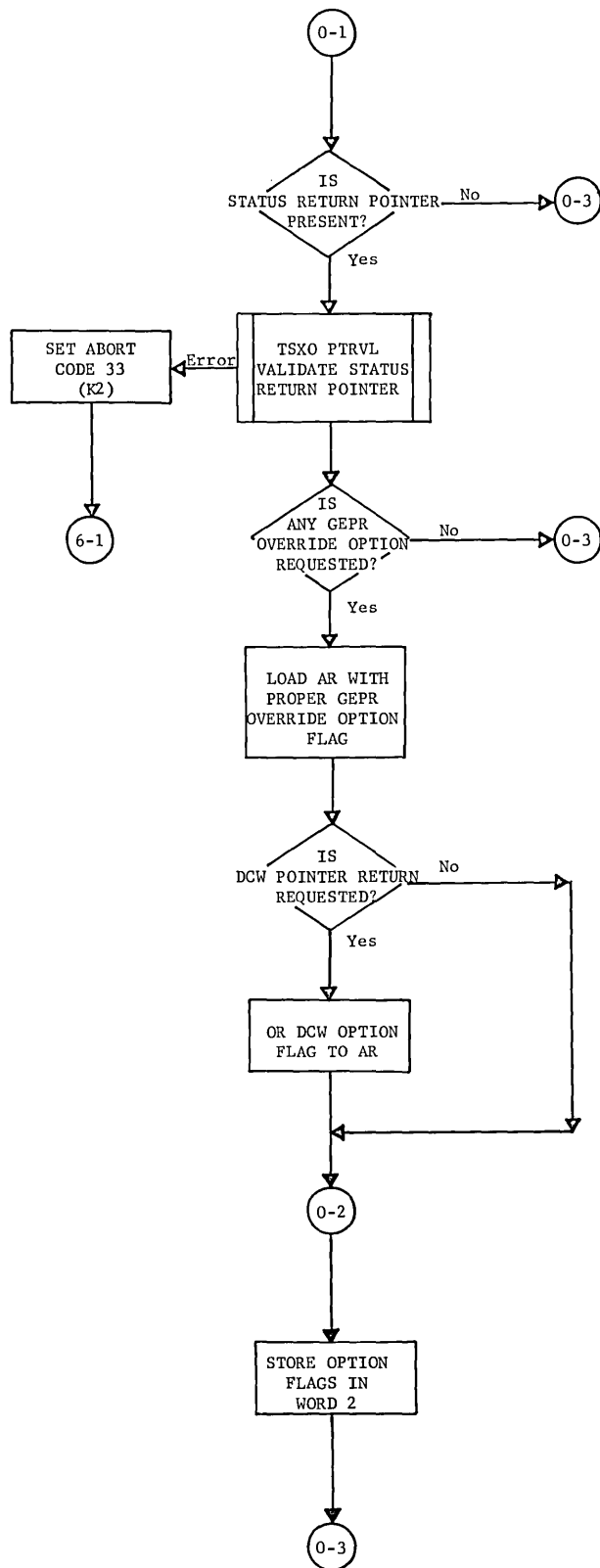
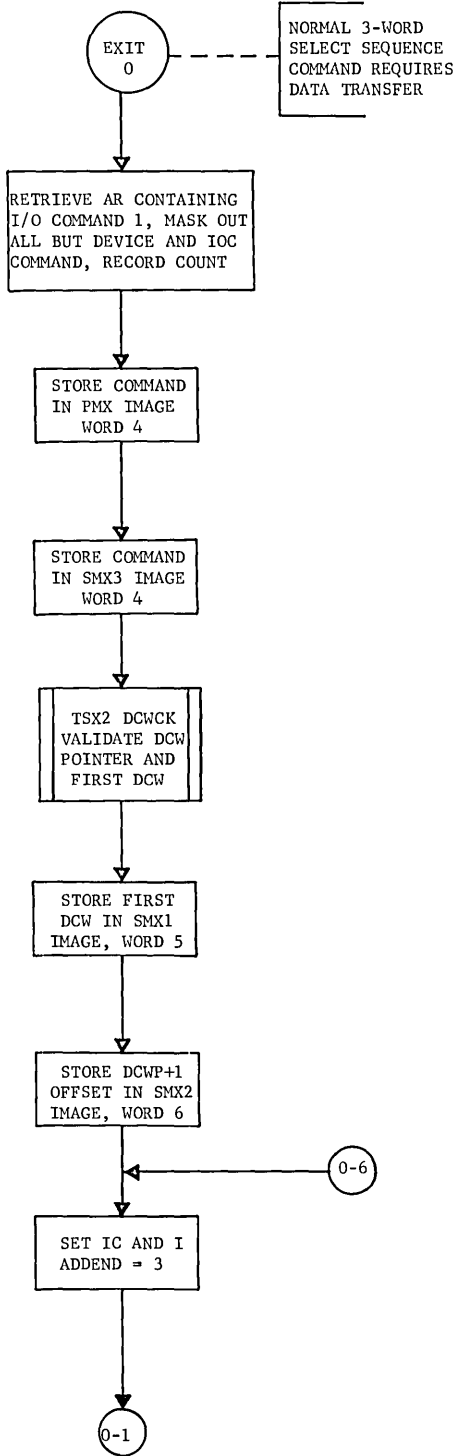

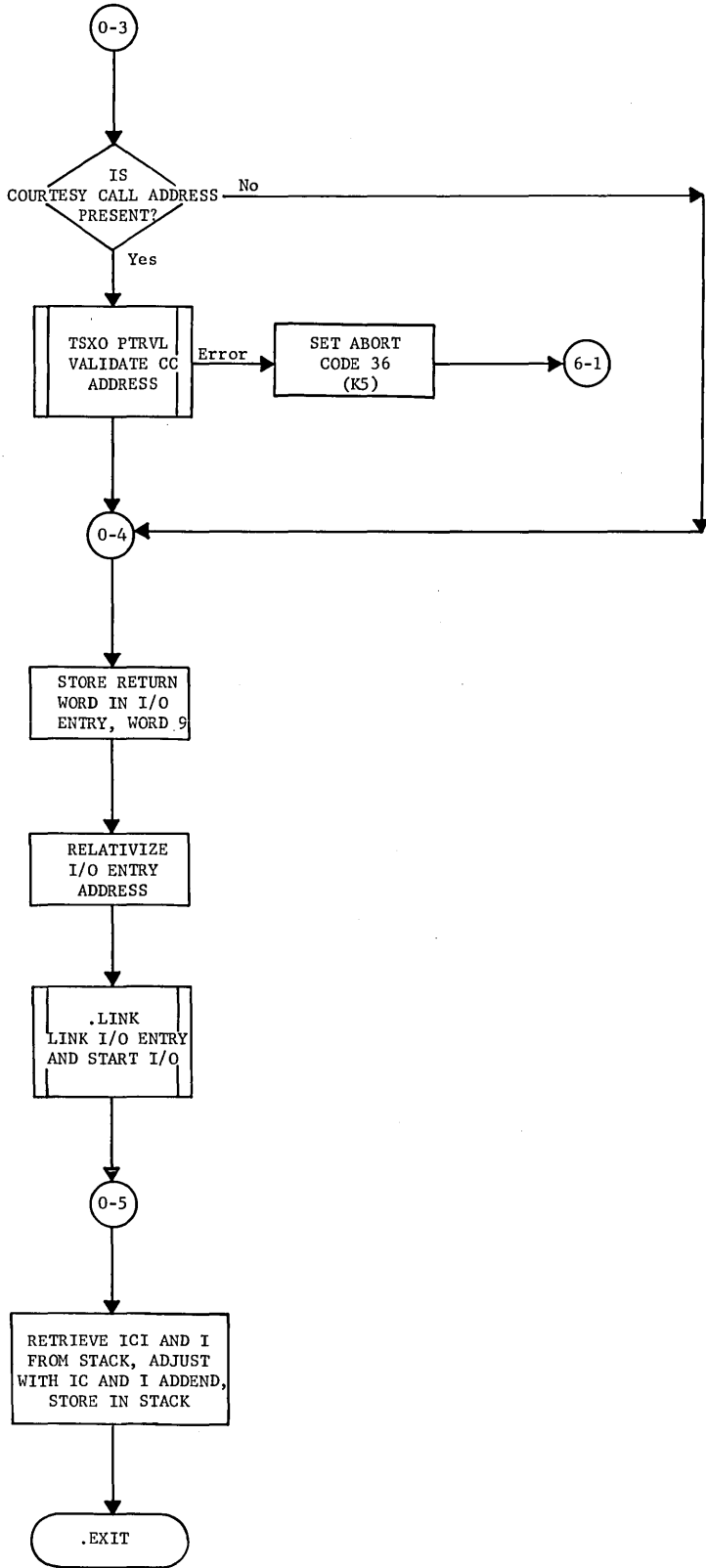

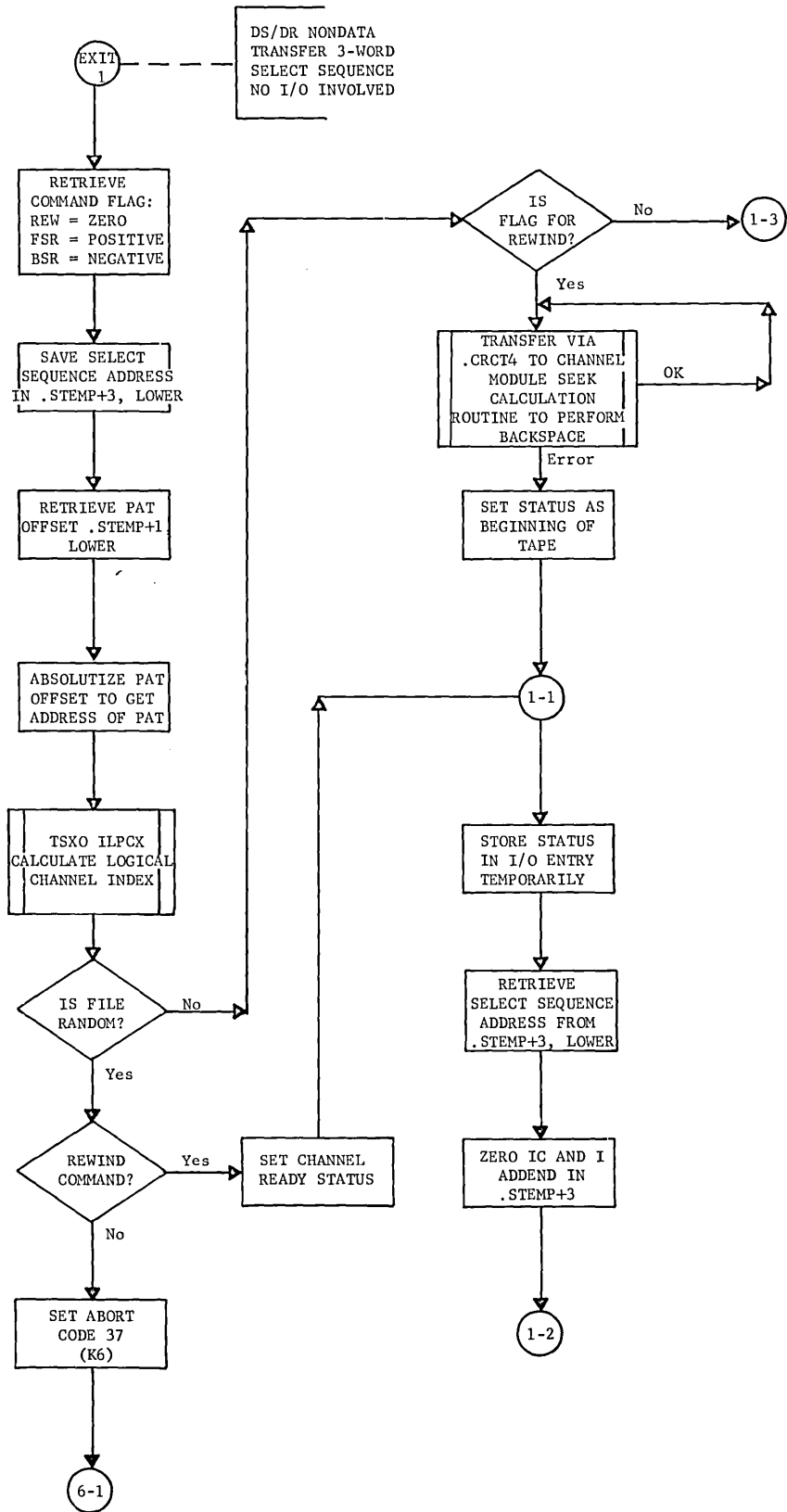

INOS (EP5)  
.MIOS

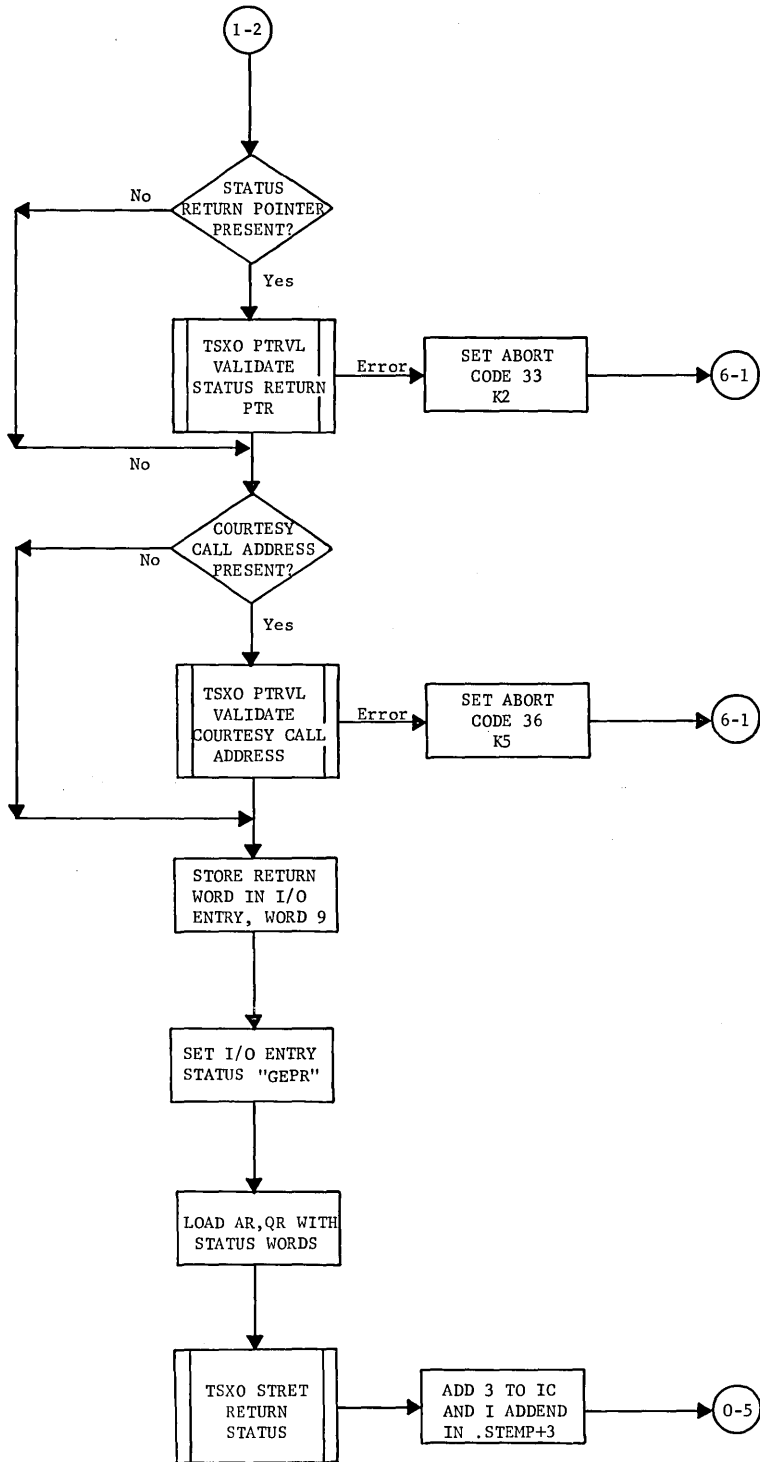

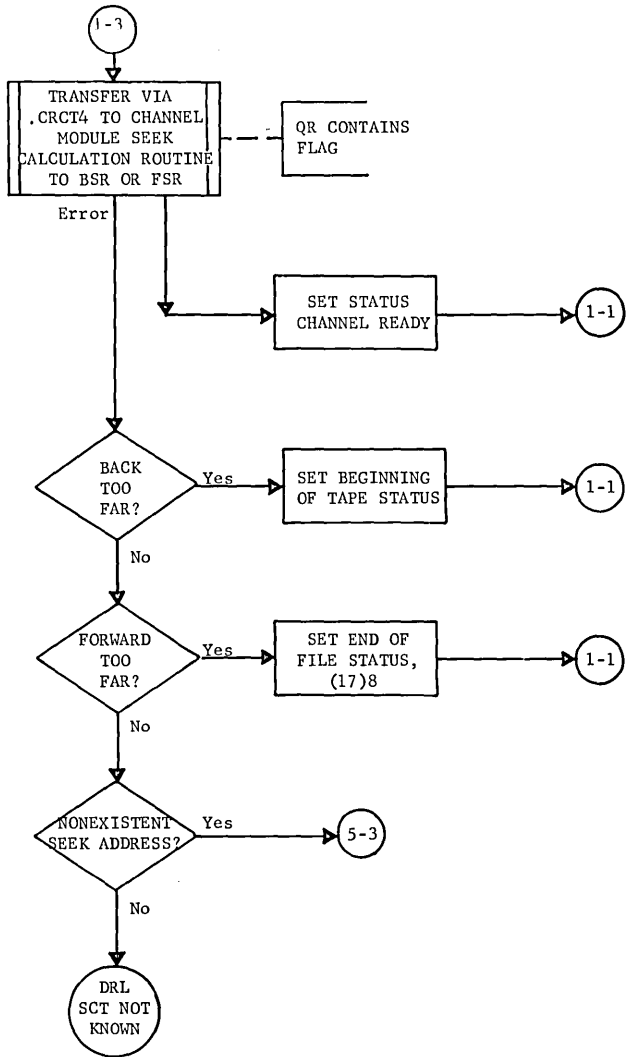



INOS (EP5)  
.MIOS

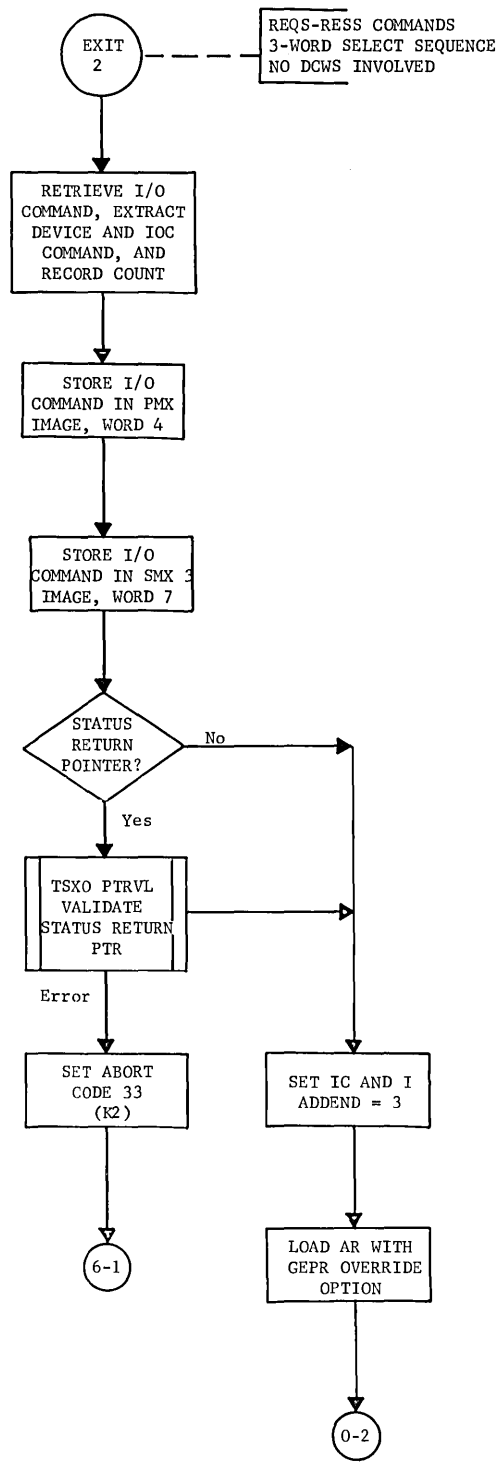

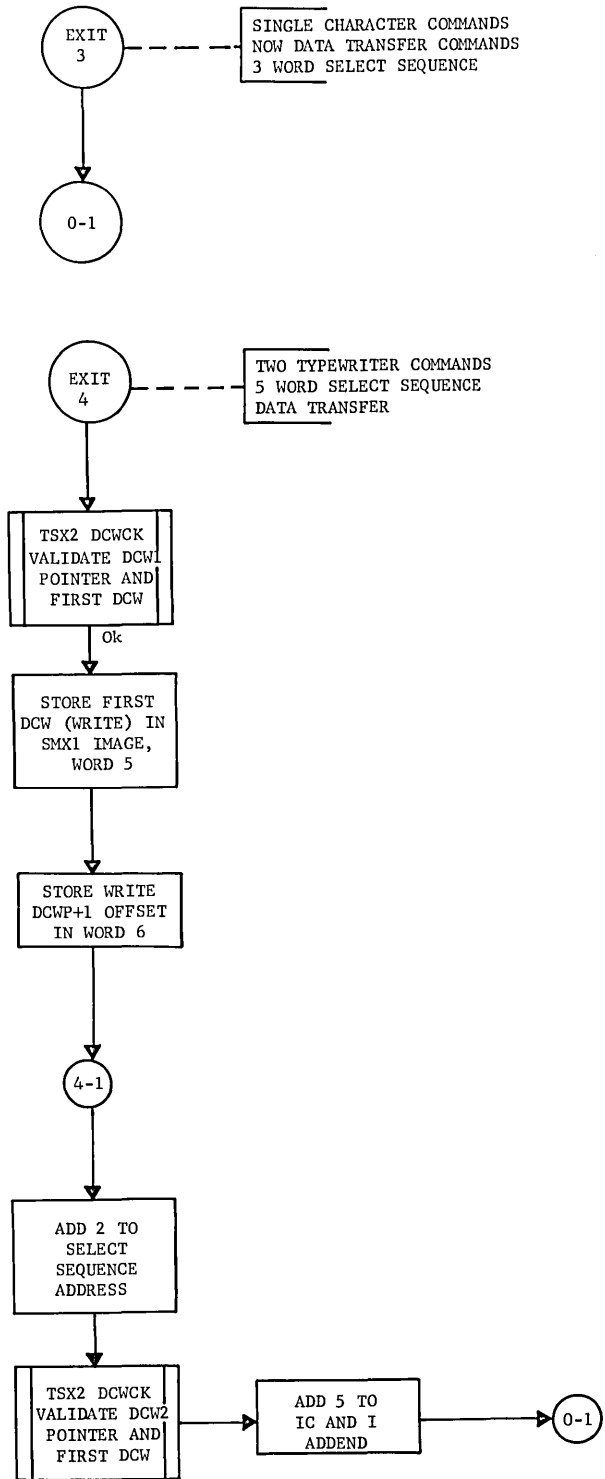

INOS (EP5)  
.MIOS

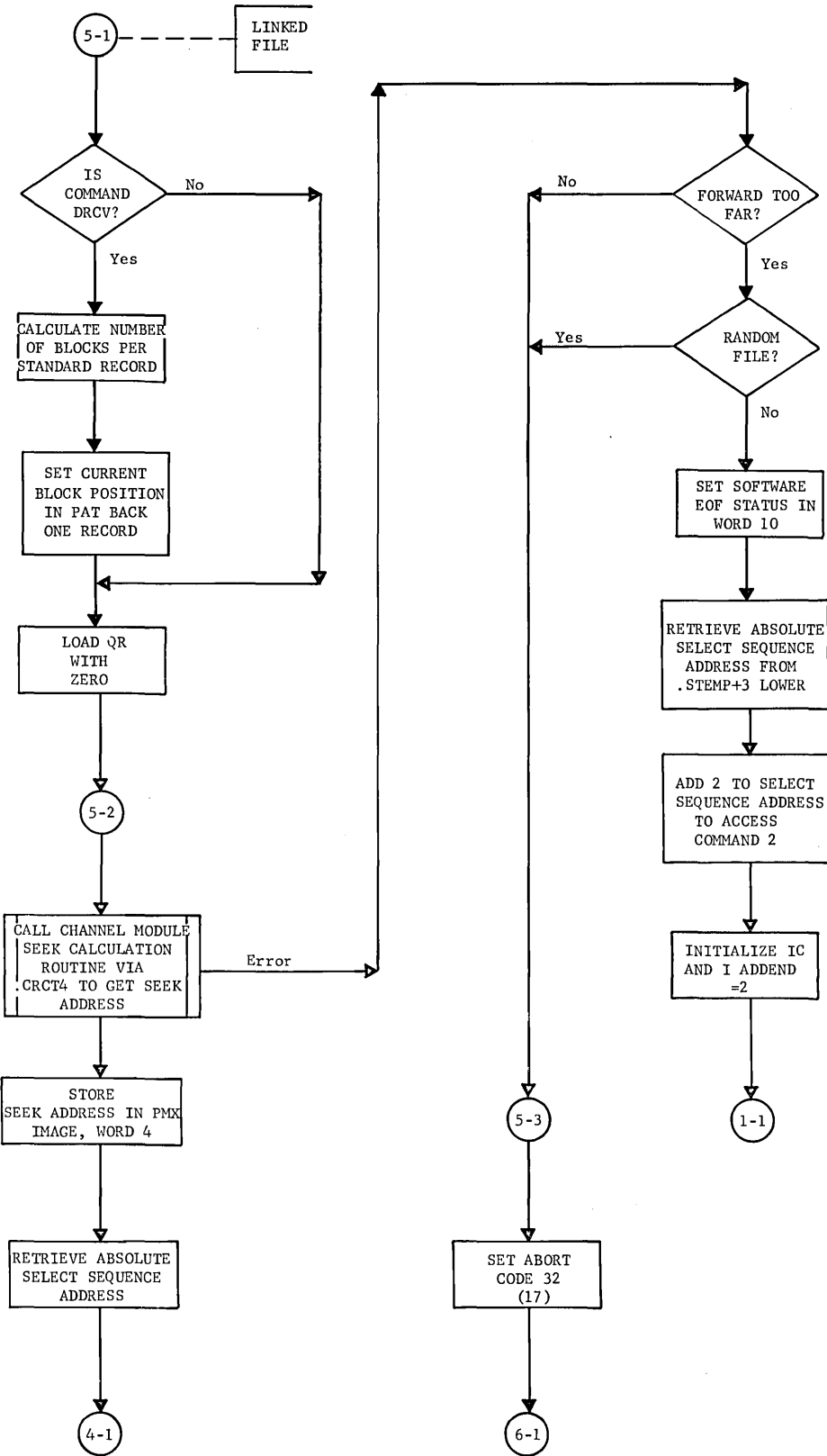

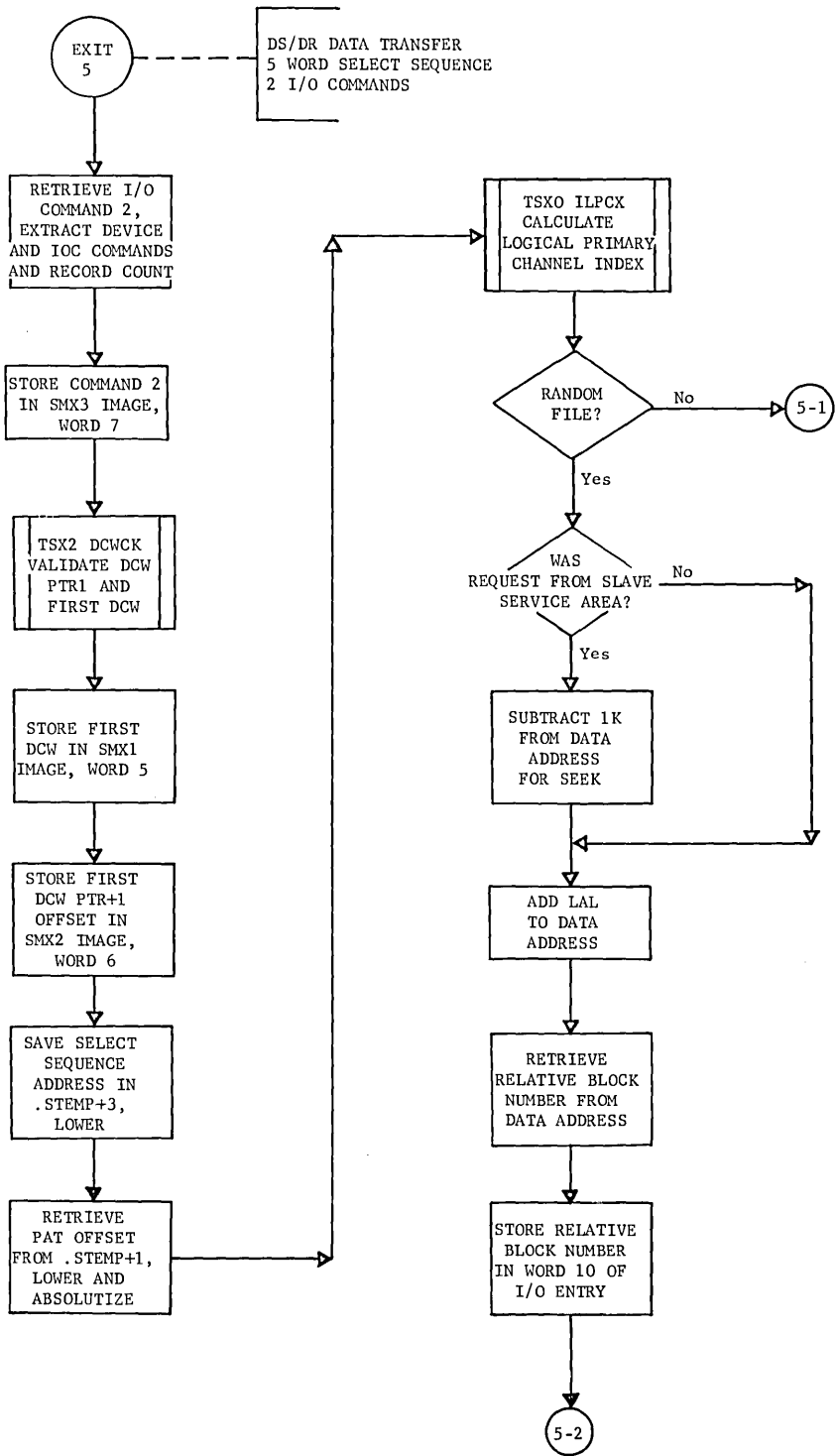

INOS (EP5)  
.MIOS

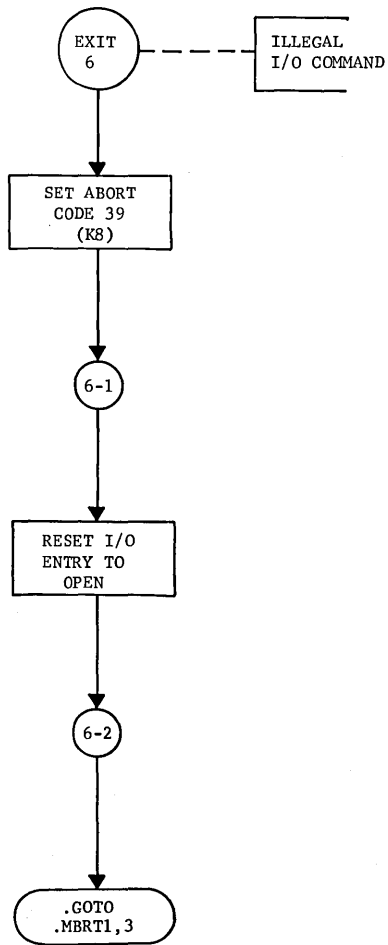

MME GESPEC PROCESSOR

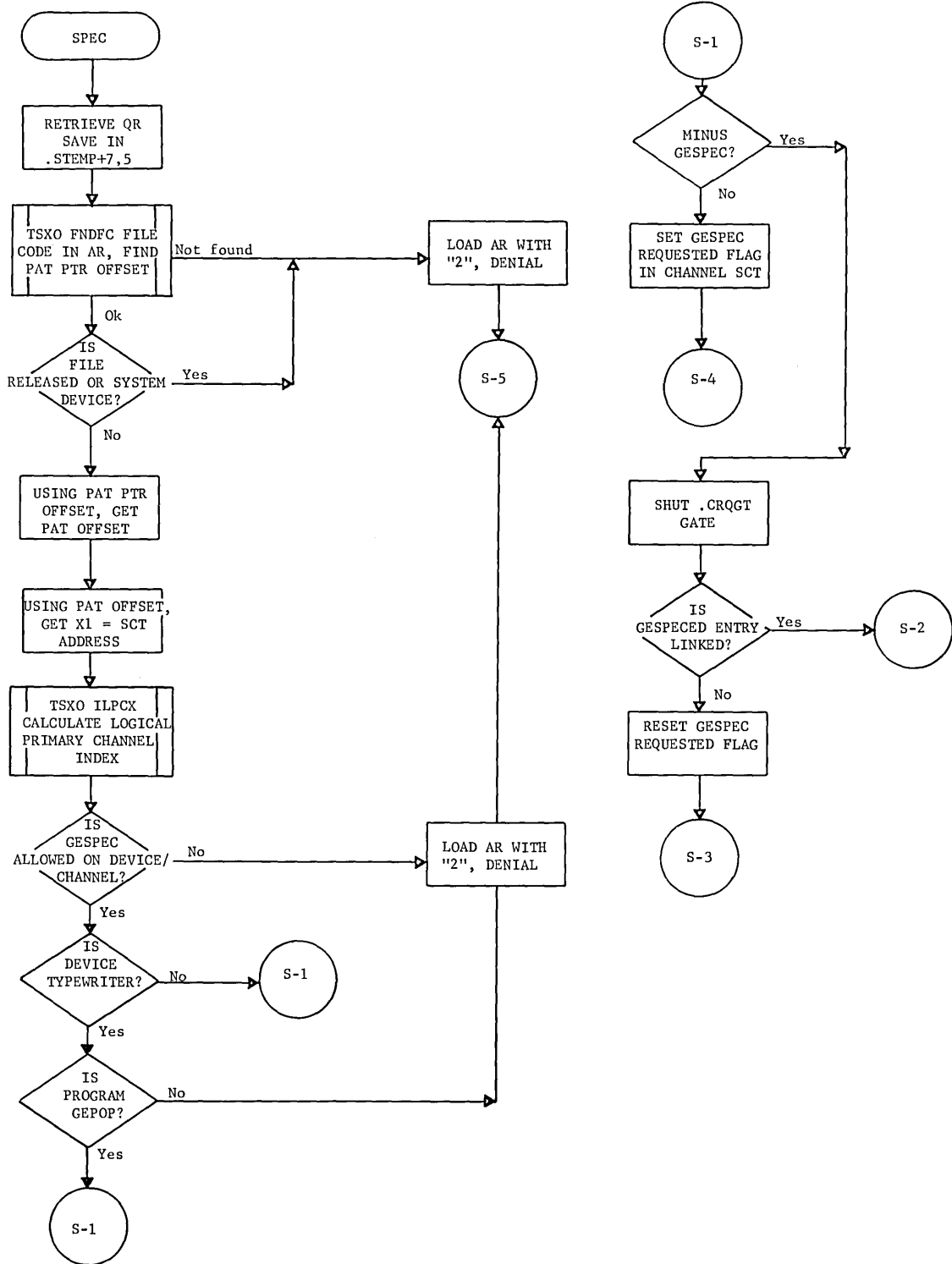

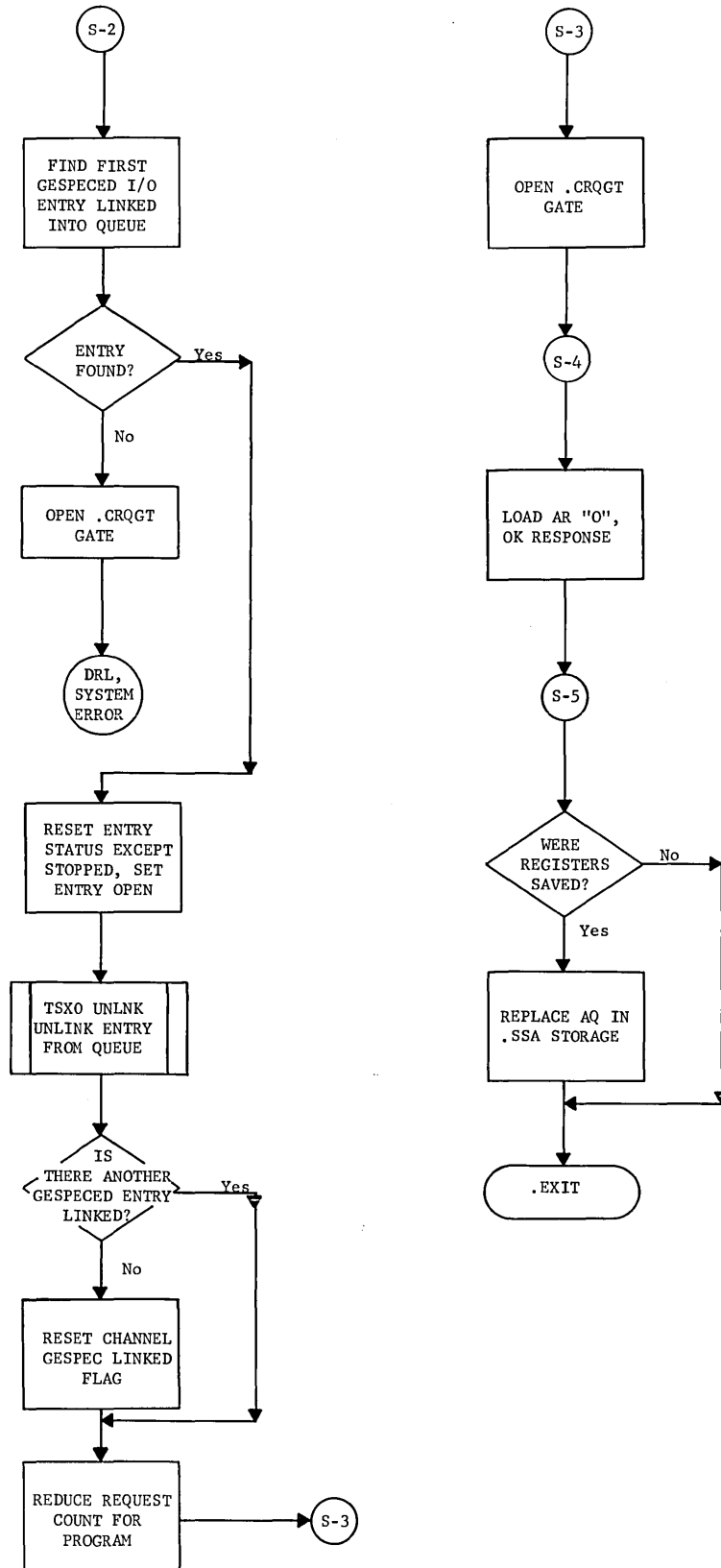

MASTER MESSAGE PROCESSOR

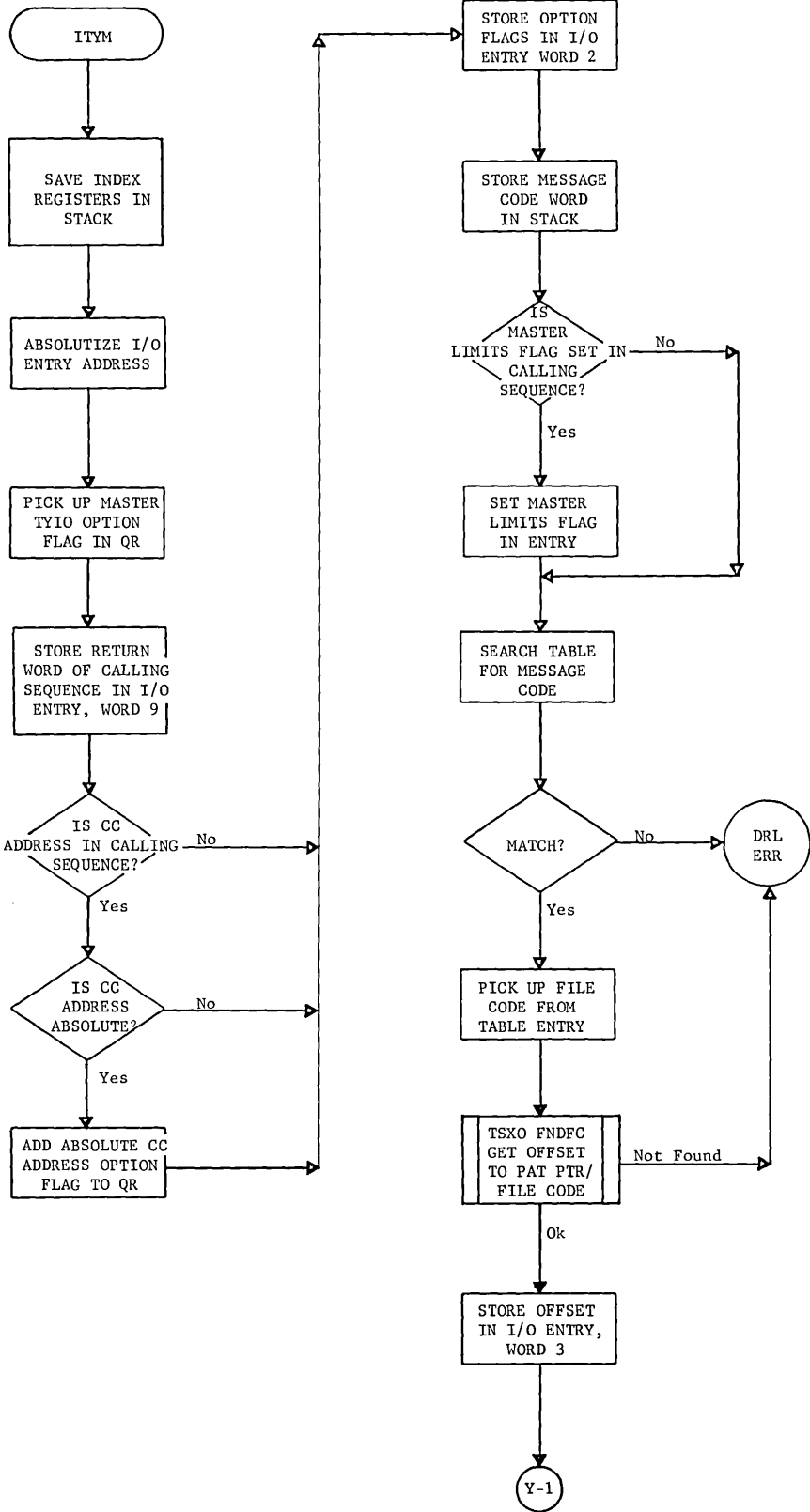



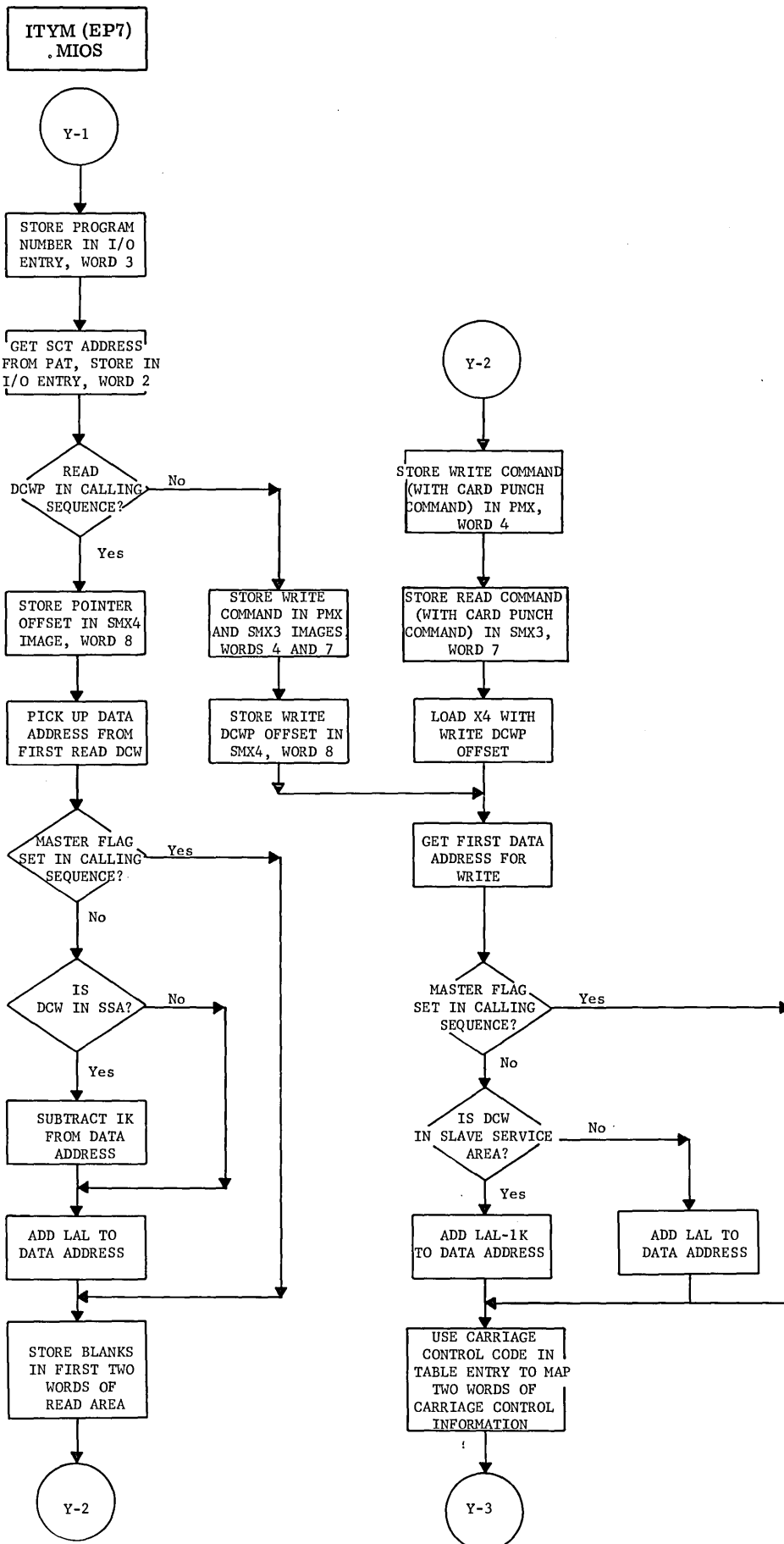

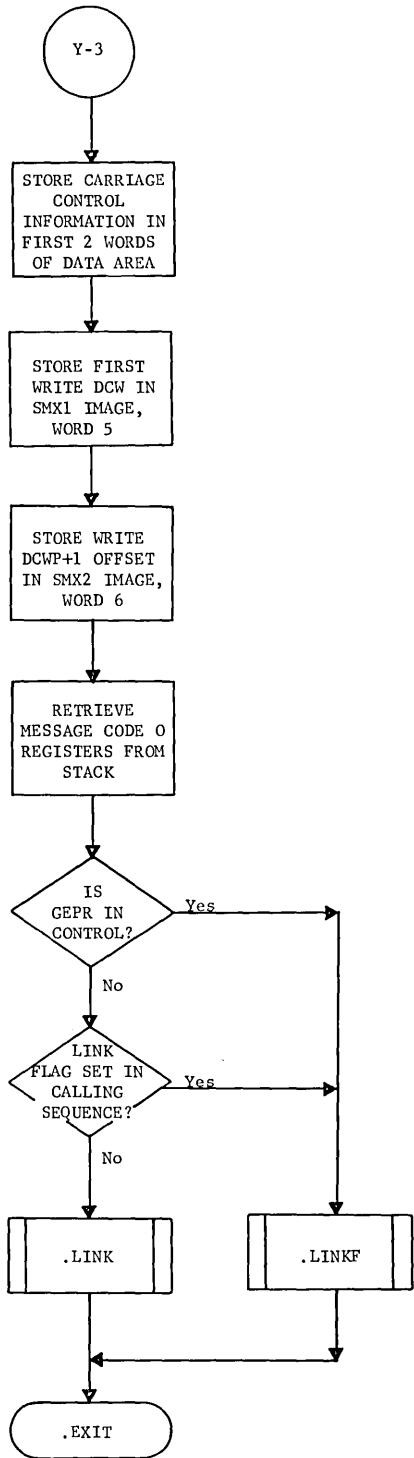

PTRVL  
.MIOS

### POINTER VALIDATION

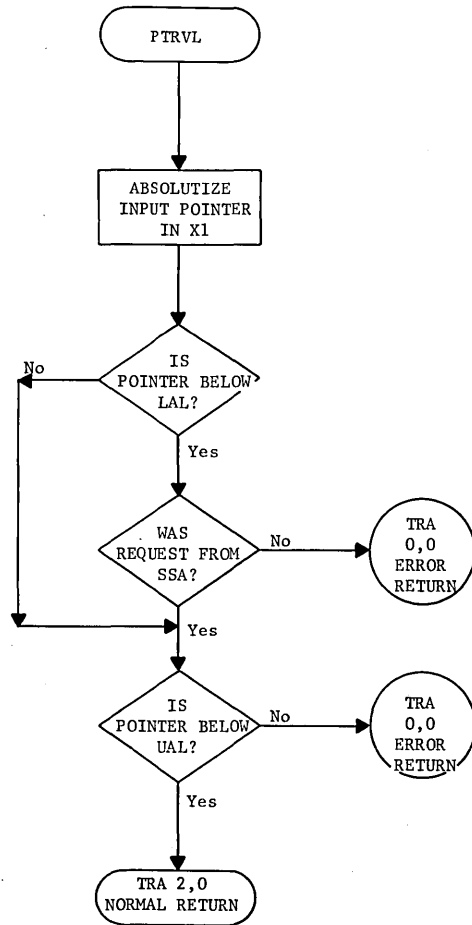

DCW POINTER VALIDATION

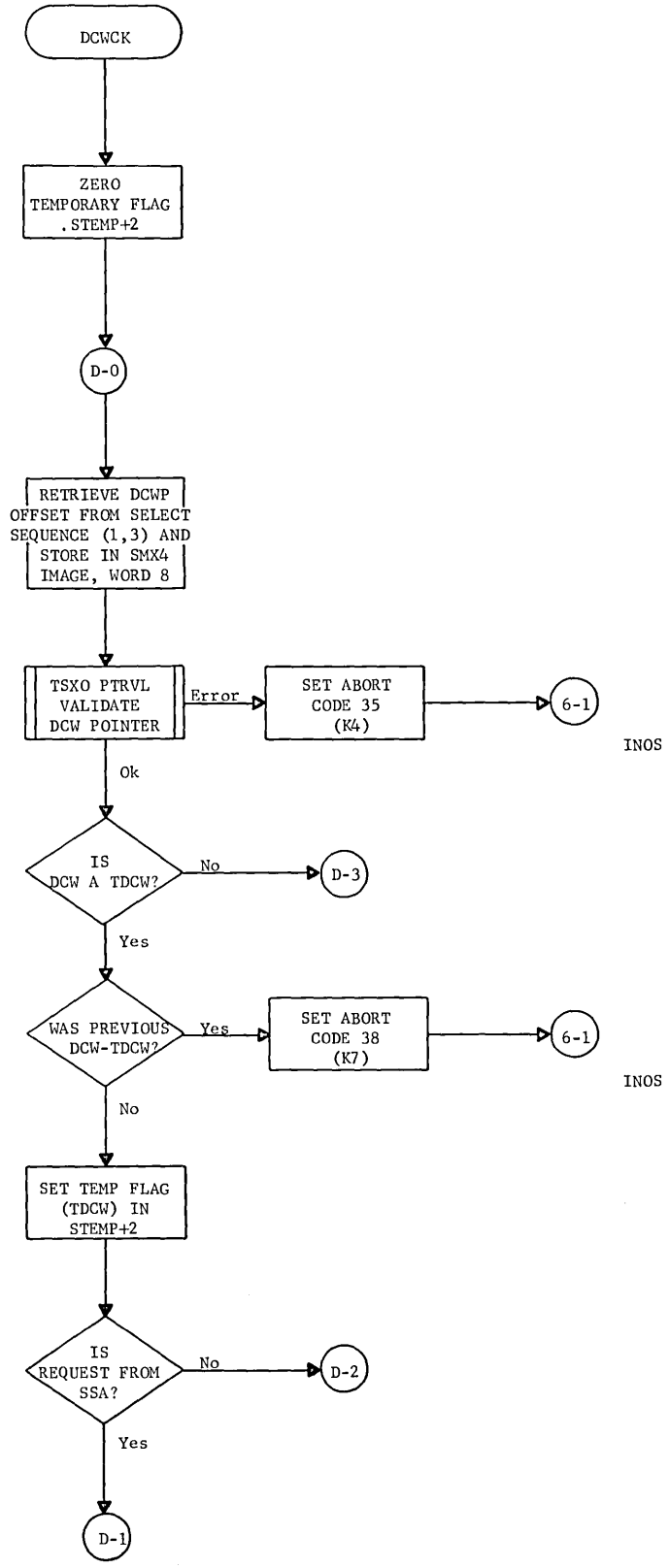

DCWCK  
.MIOS

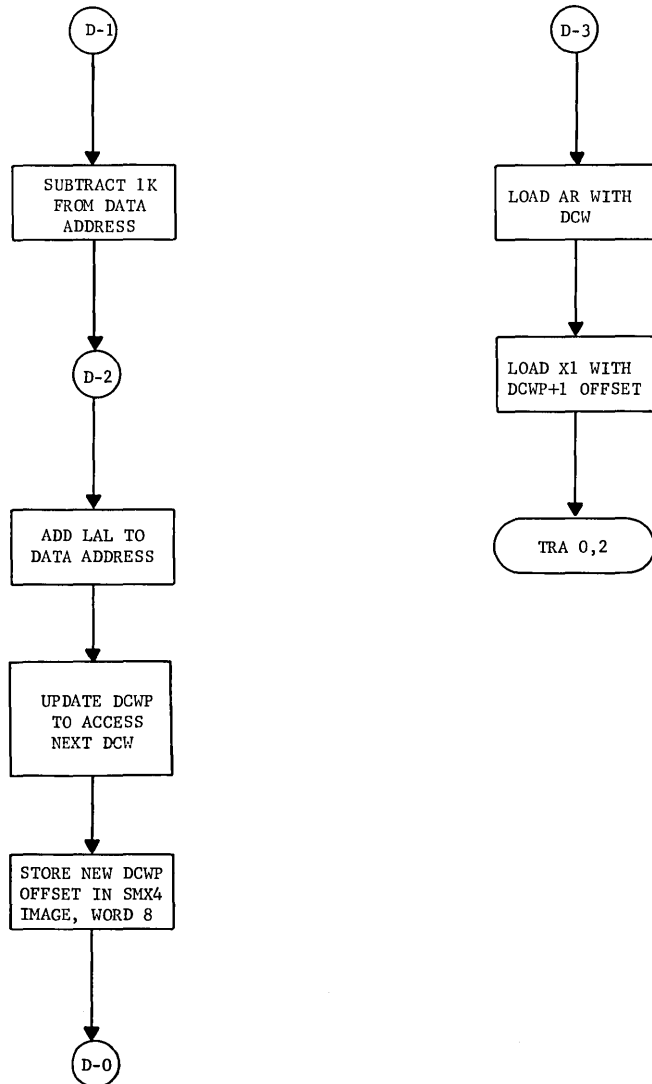

FIND FILE CODE

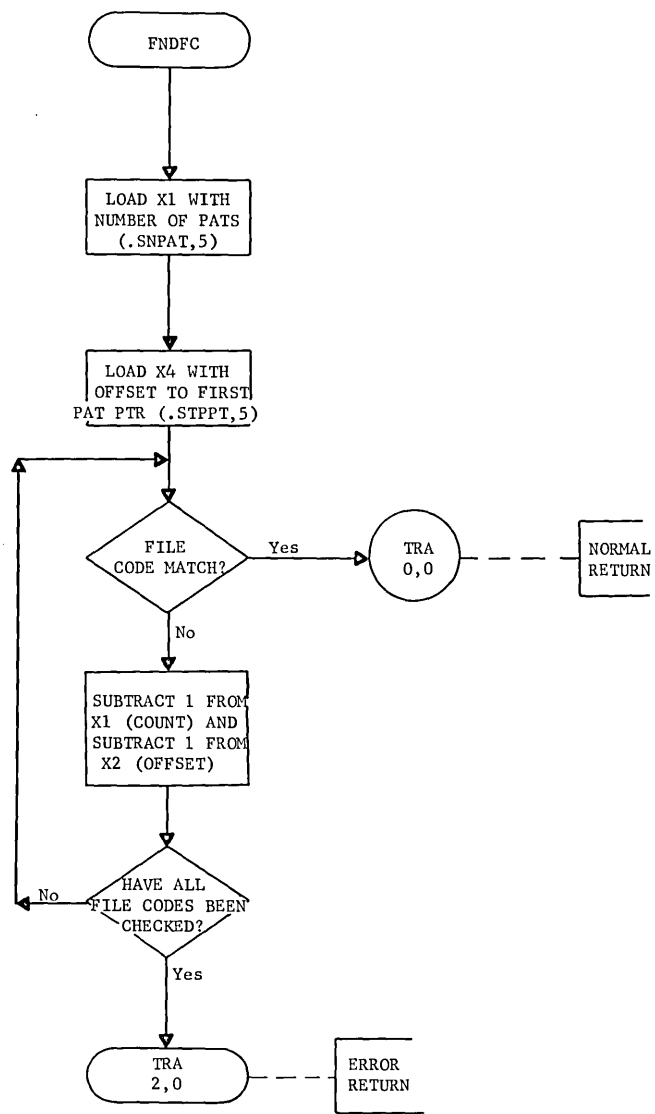

FMTAR  
.MIOS

### FORMAT ERROR ACCOUNTING RECORD

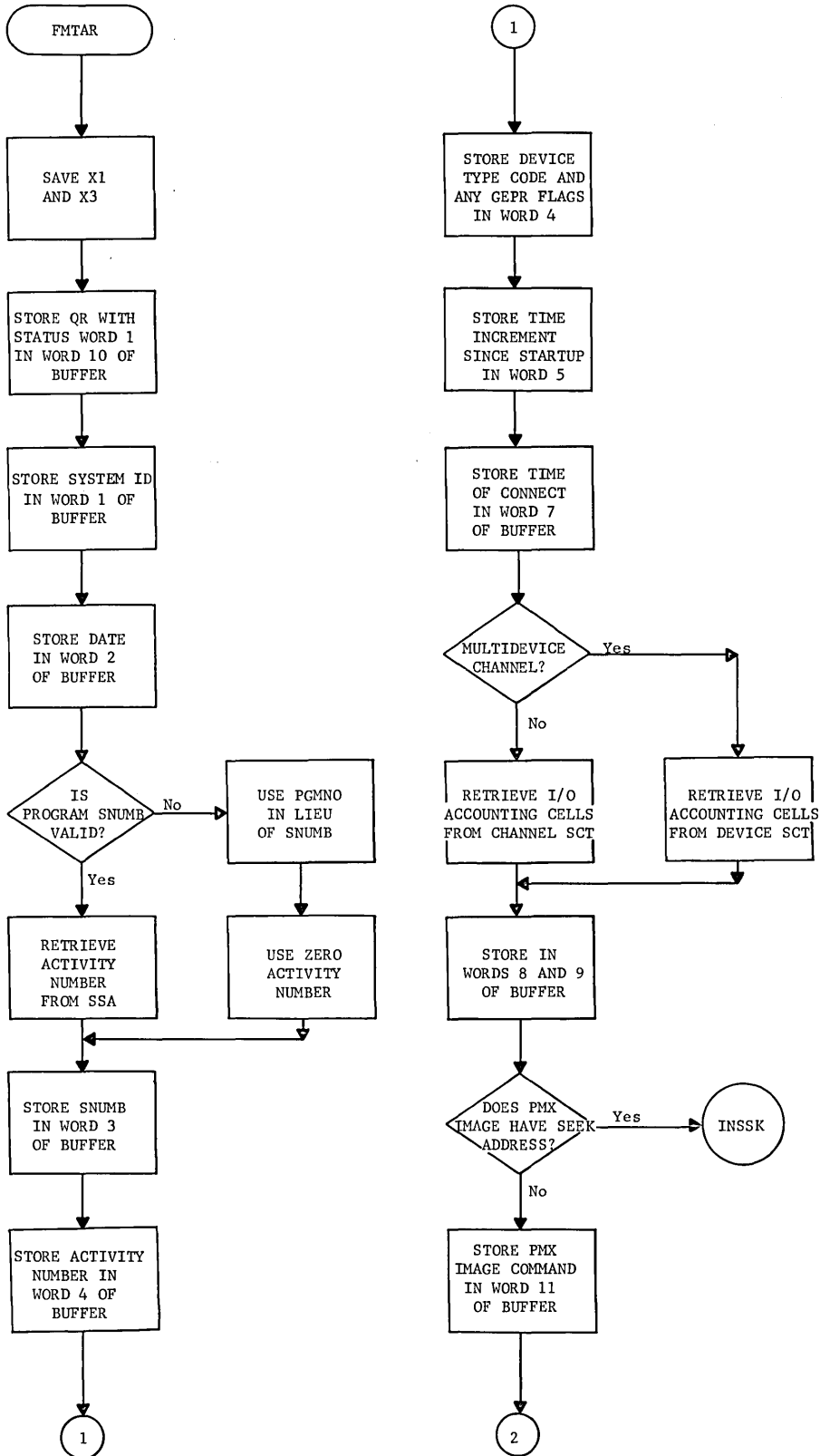

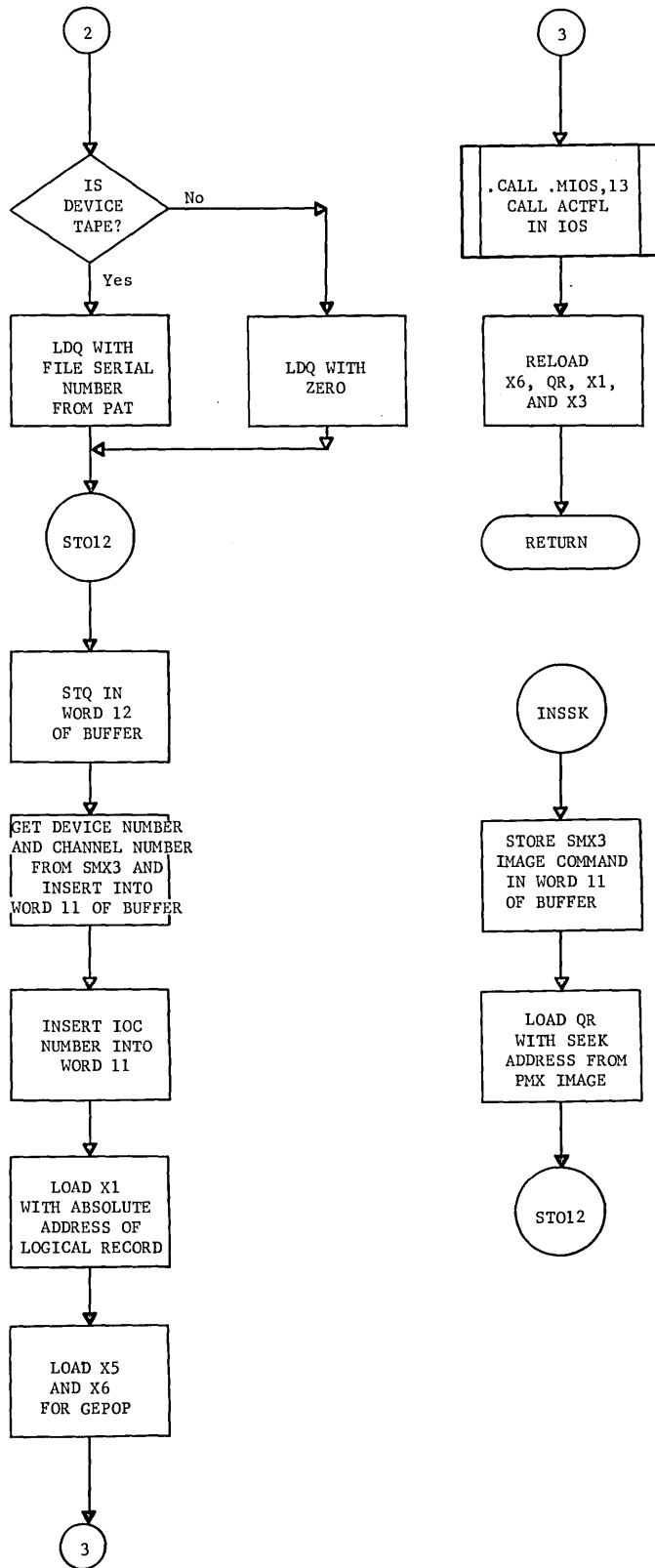



IOTRM  
.MIOS

### INTERRUPT HANDLER

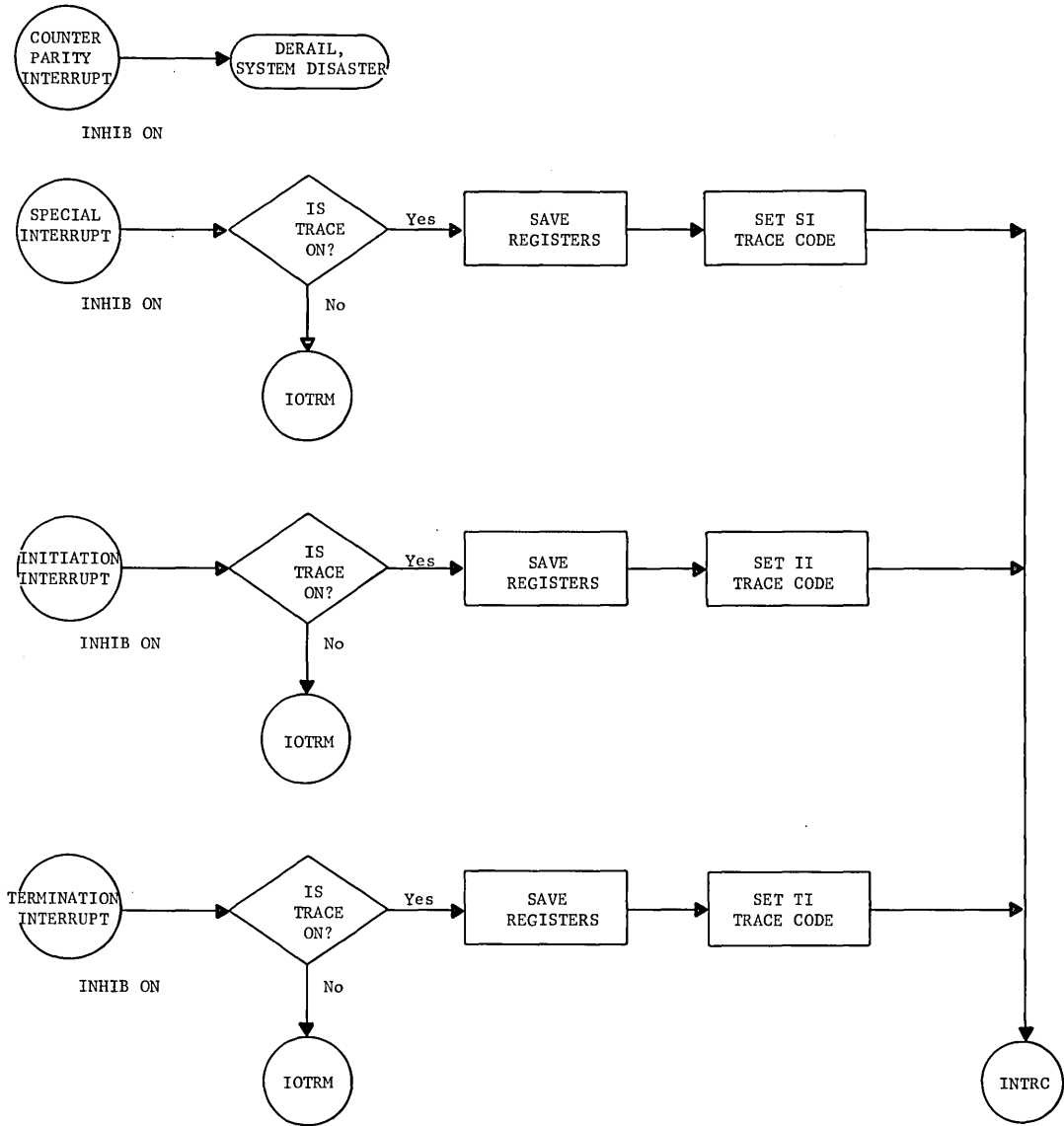

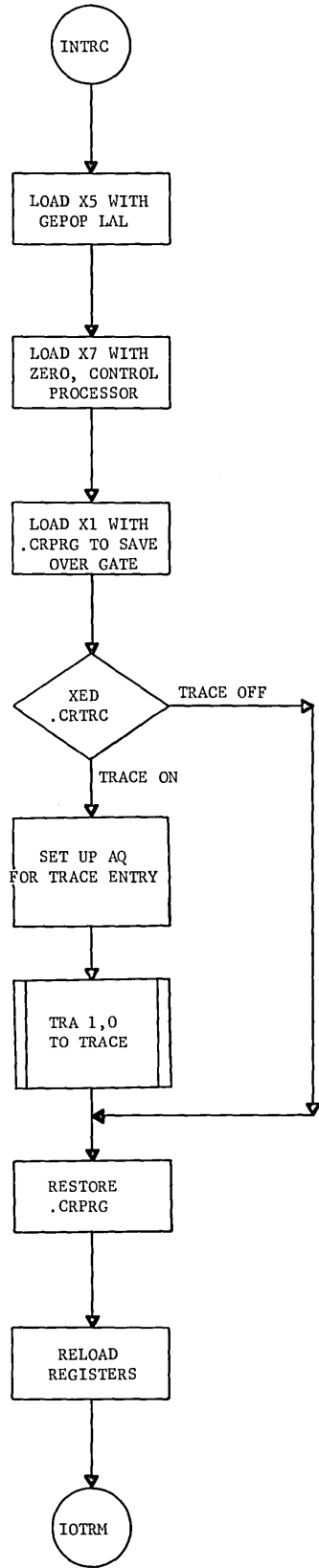

**IOTRM  
.MIOS**

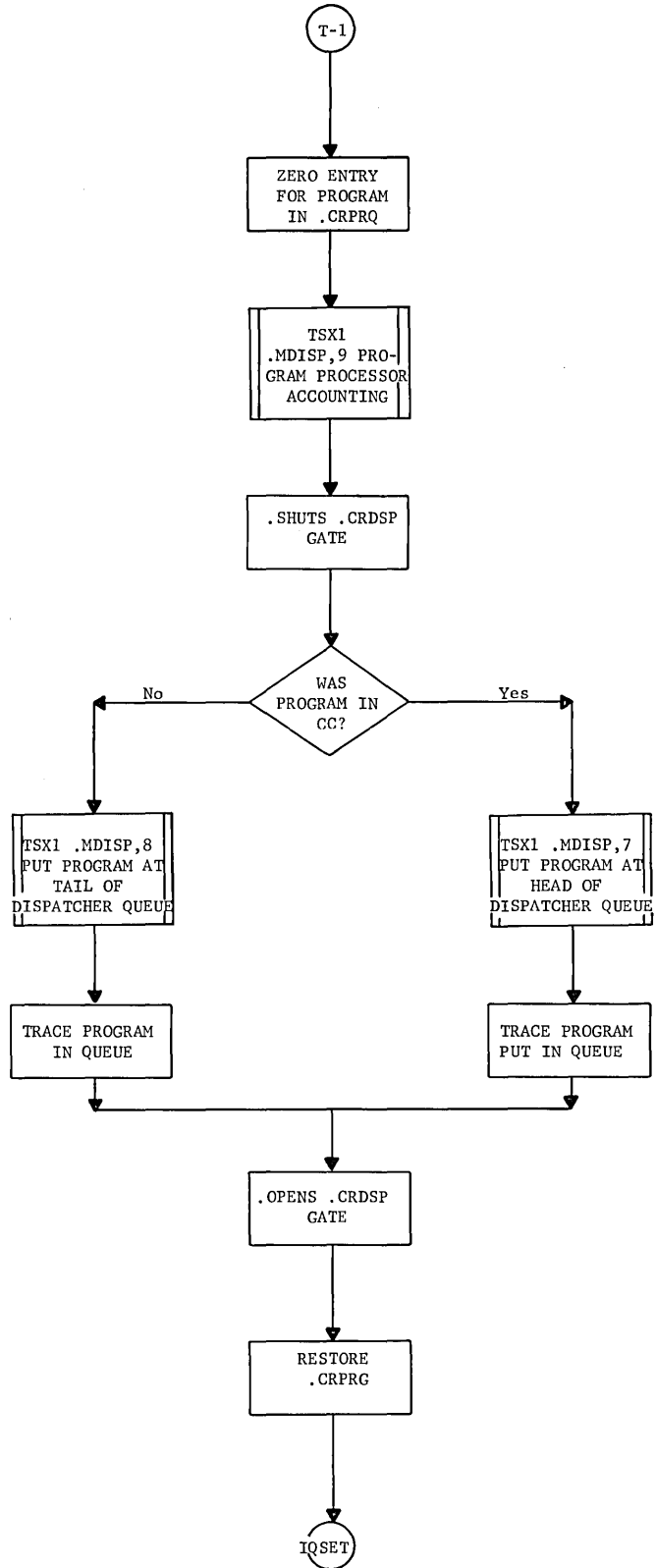
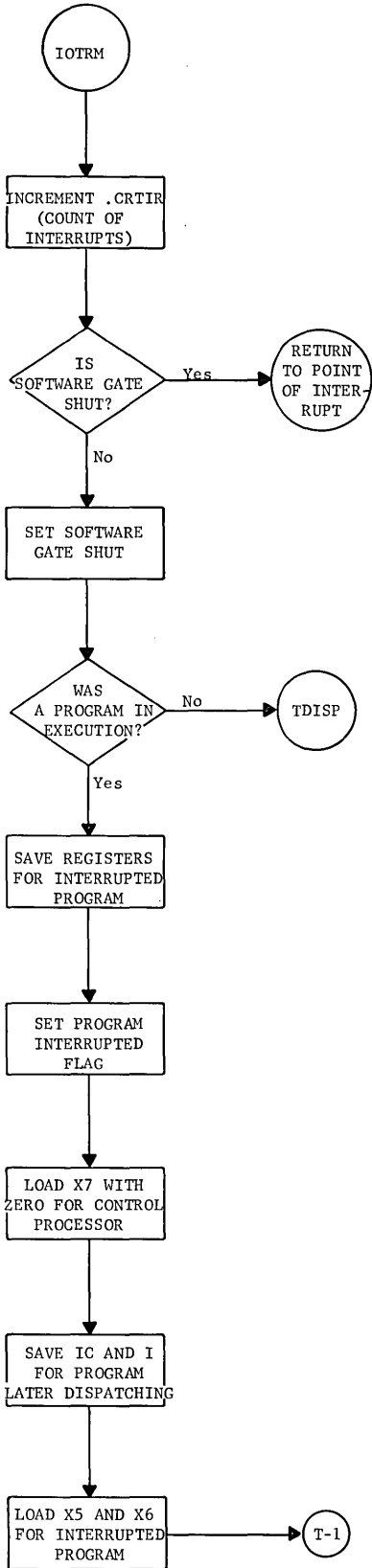

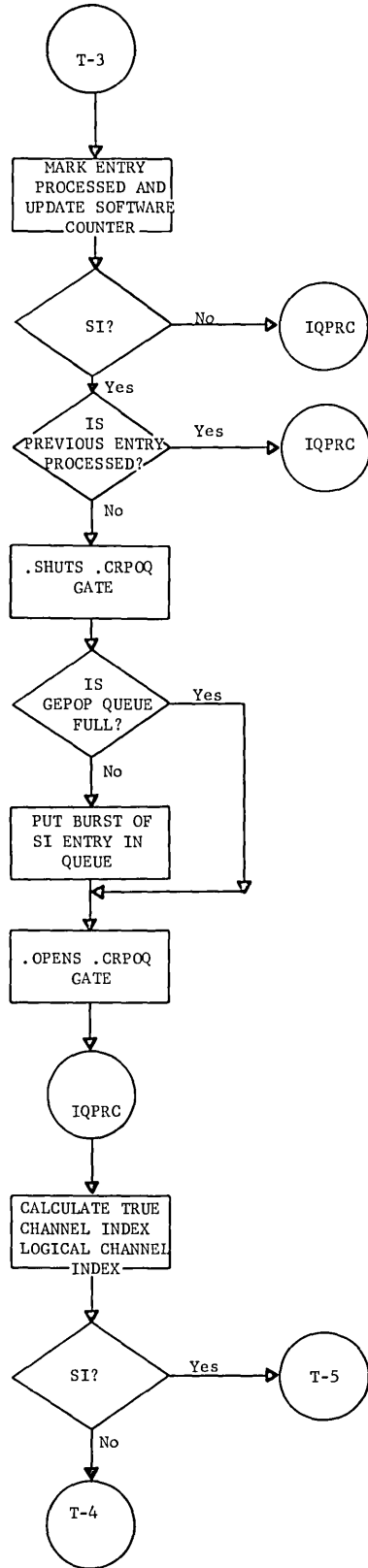
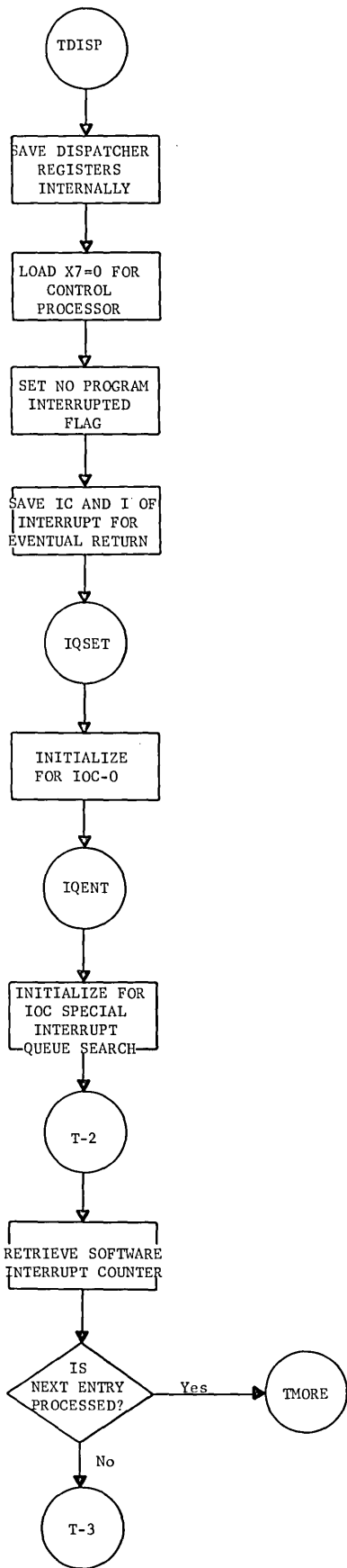

**IOTRM  
.MIOS**

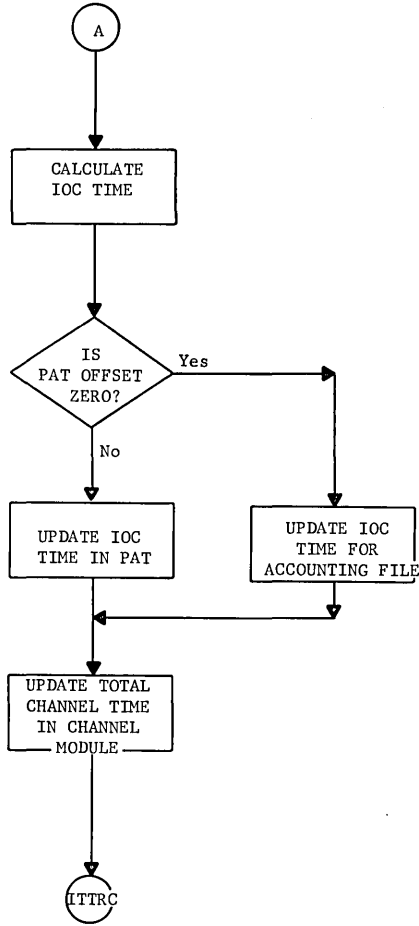
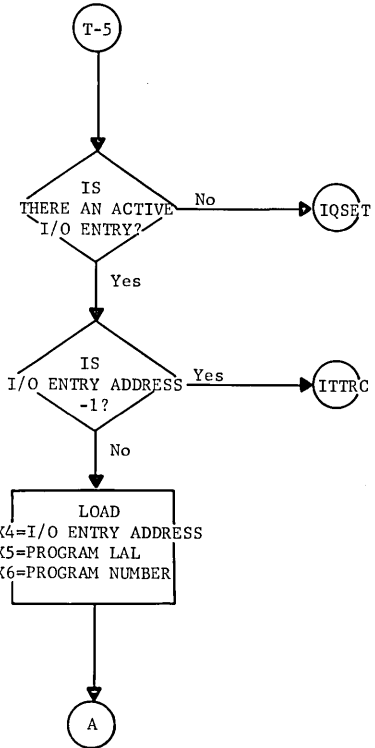
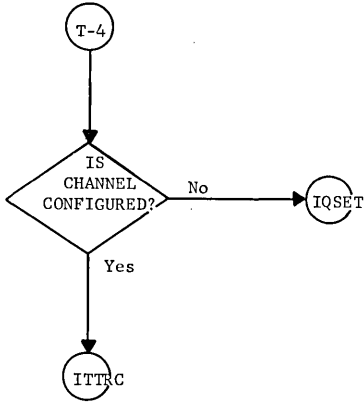

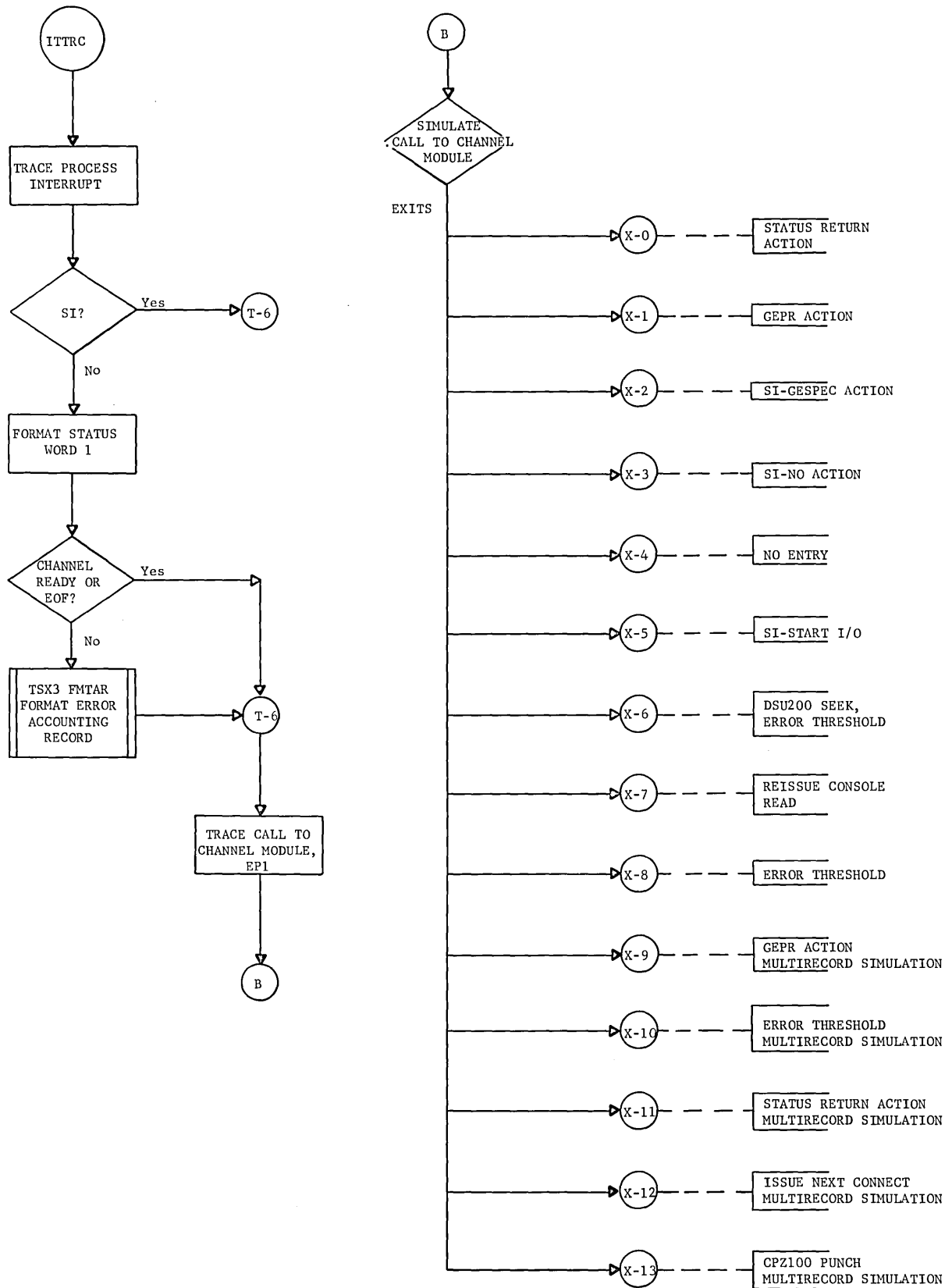

**IOTRM  
.MIOS**

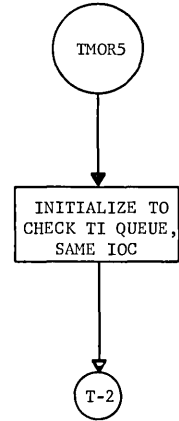
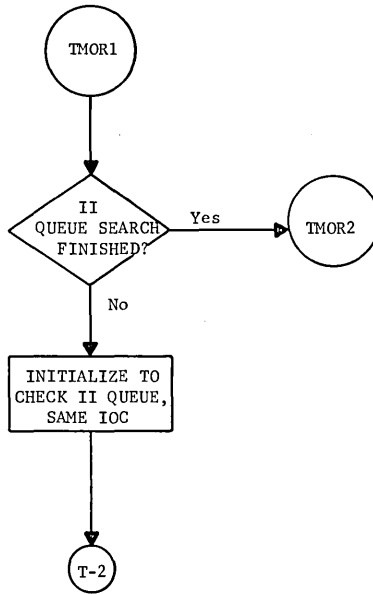
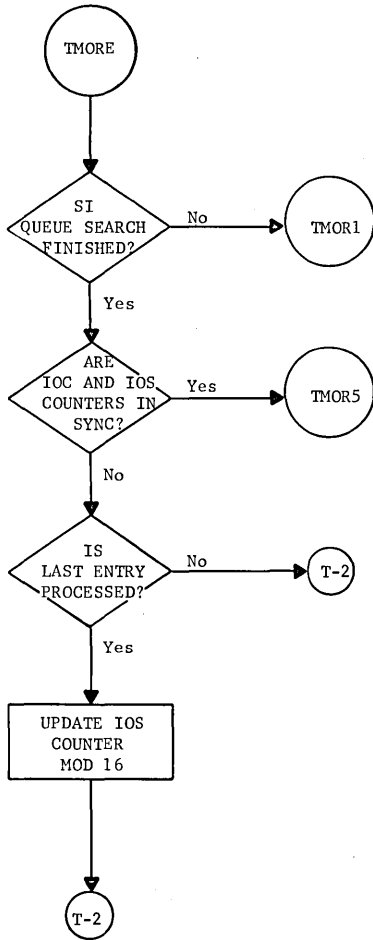

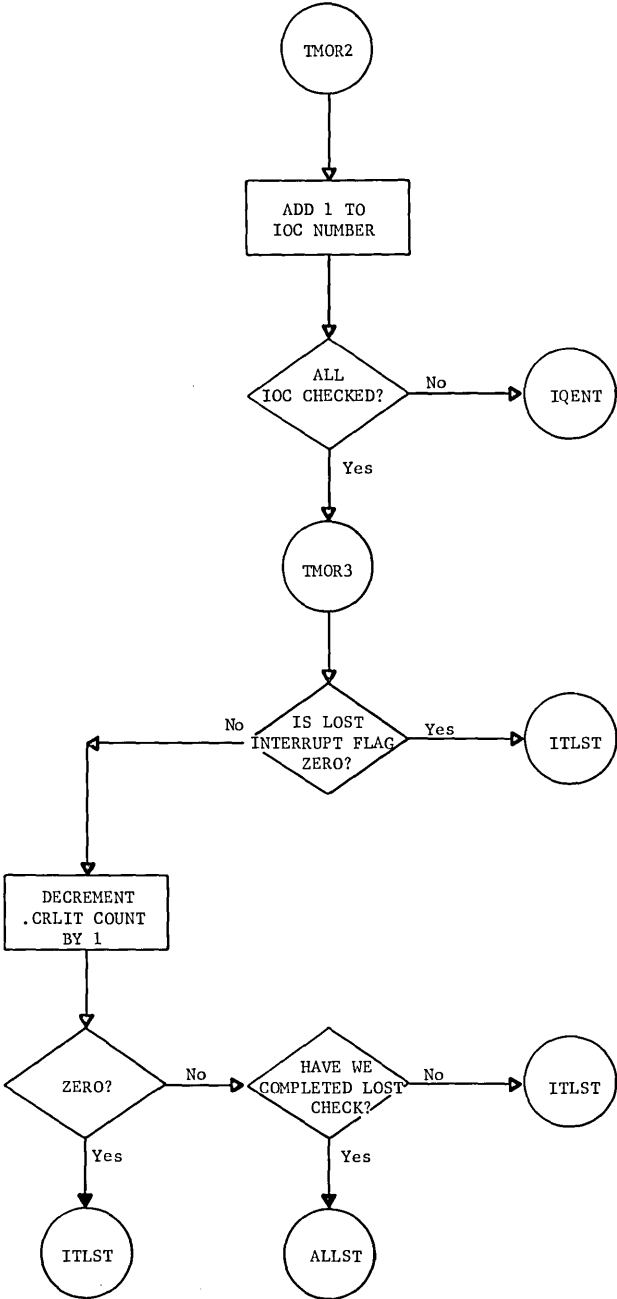



**IOTRM  
.MIOS**

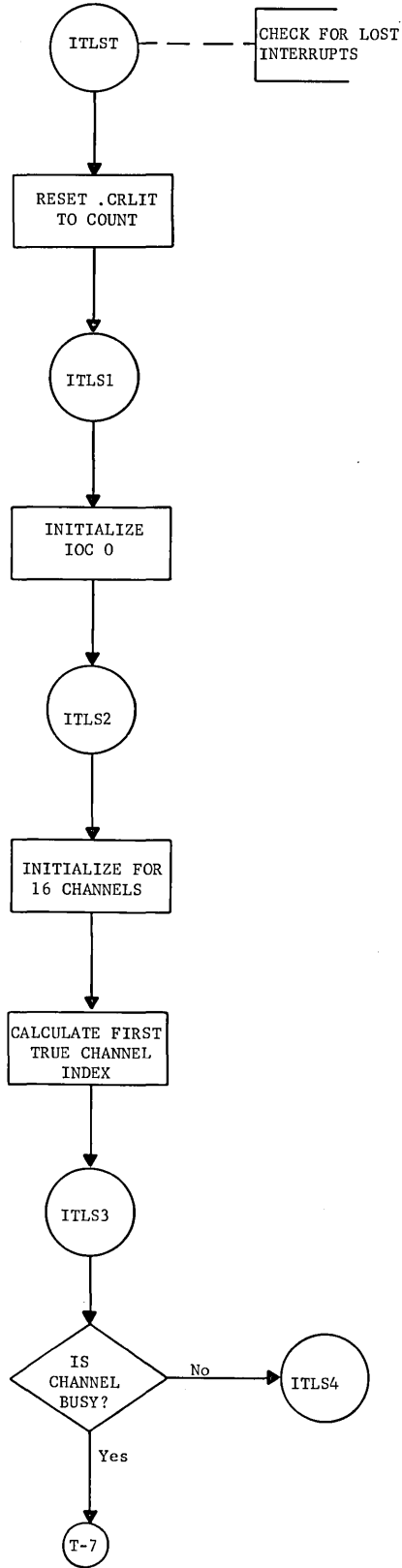
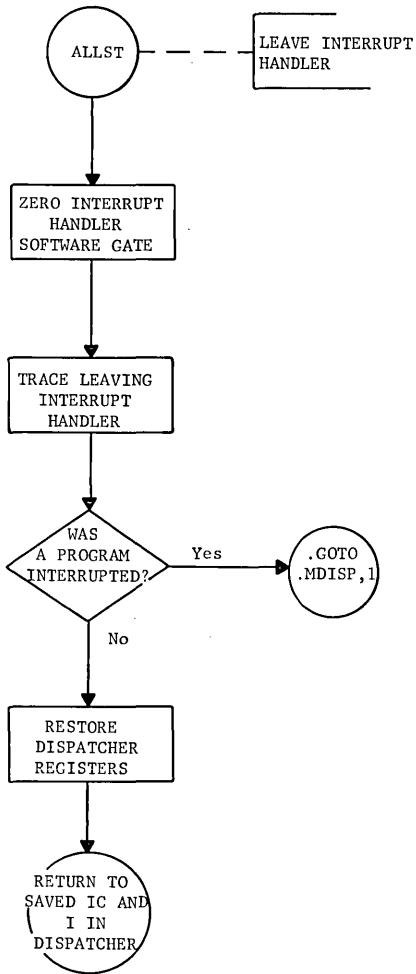

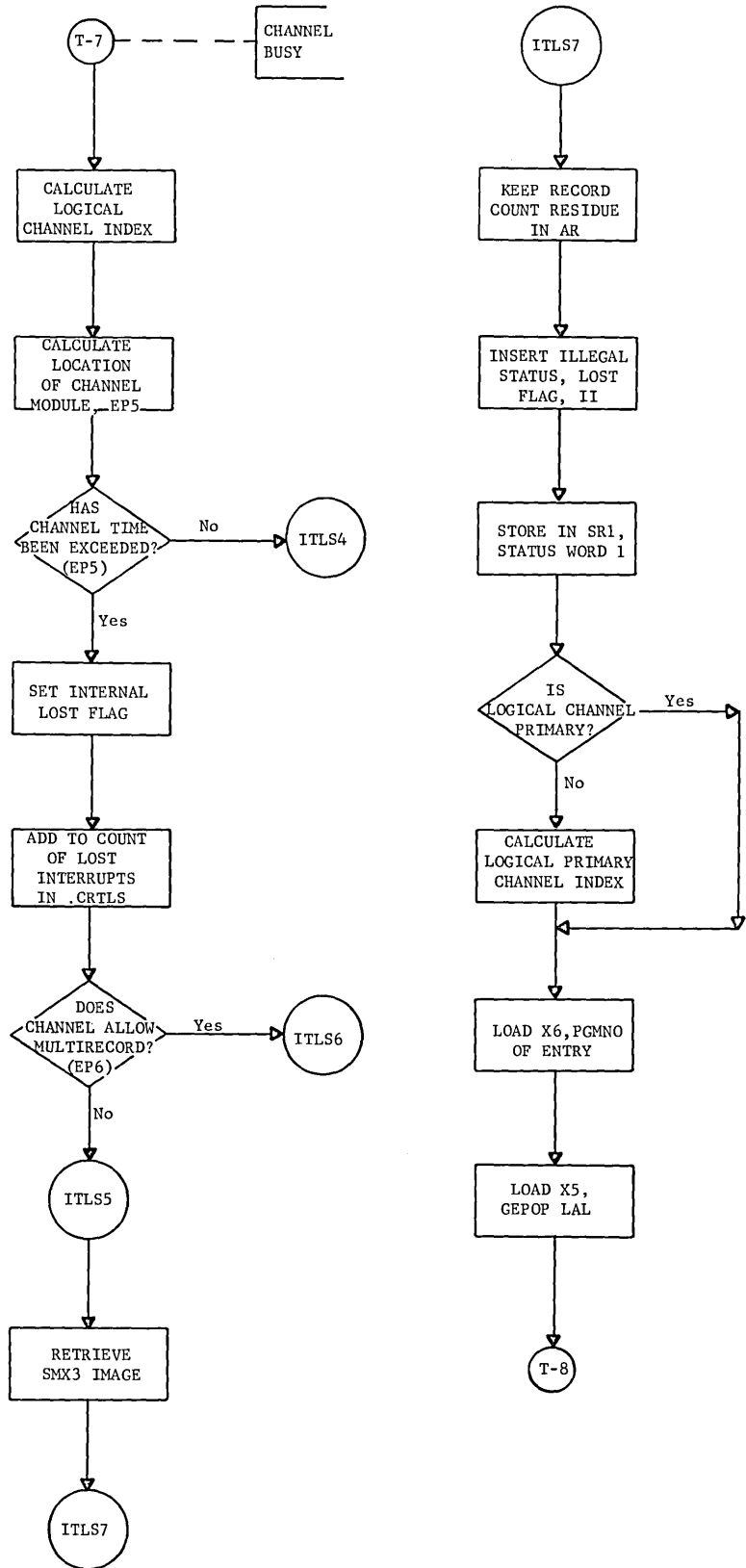

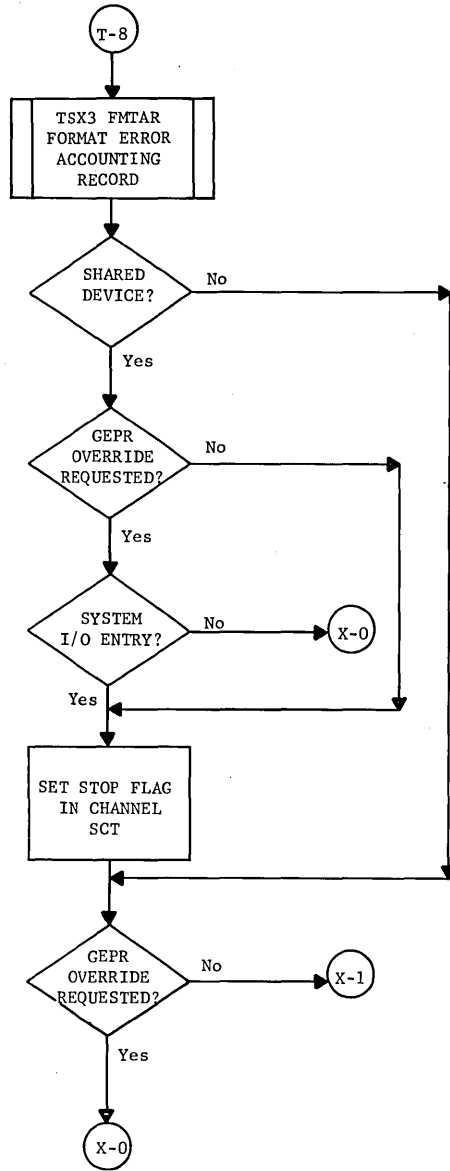

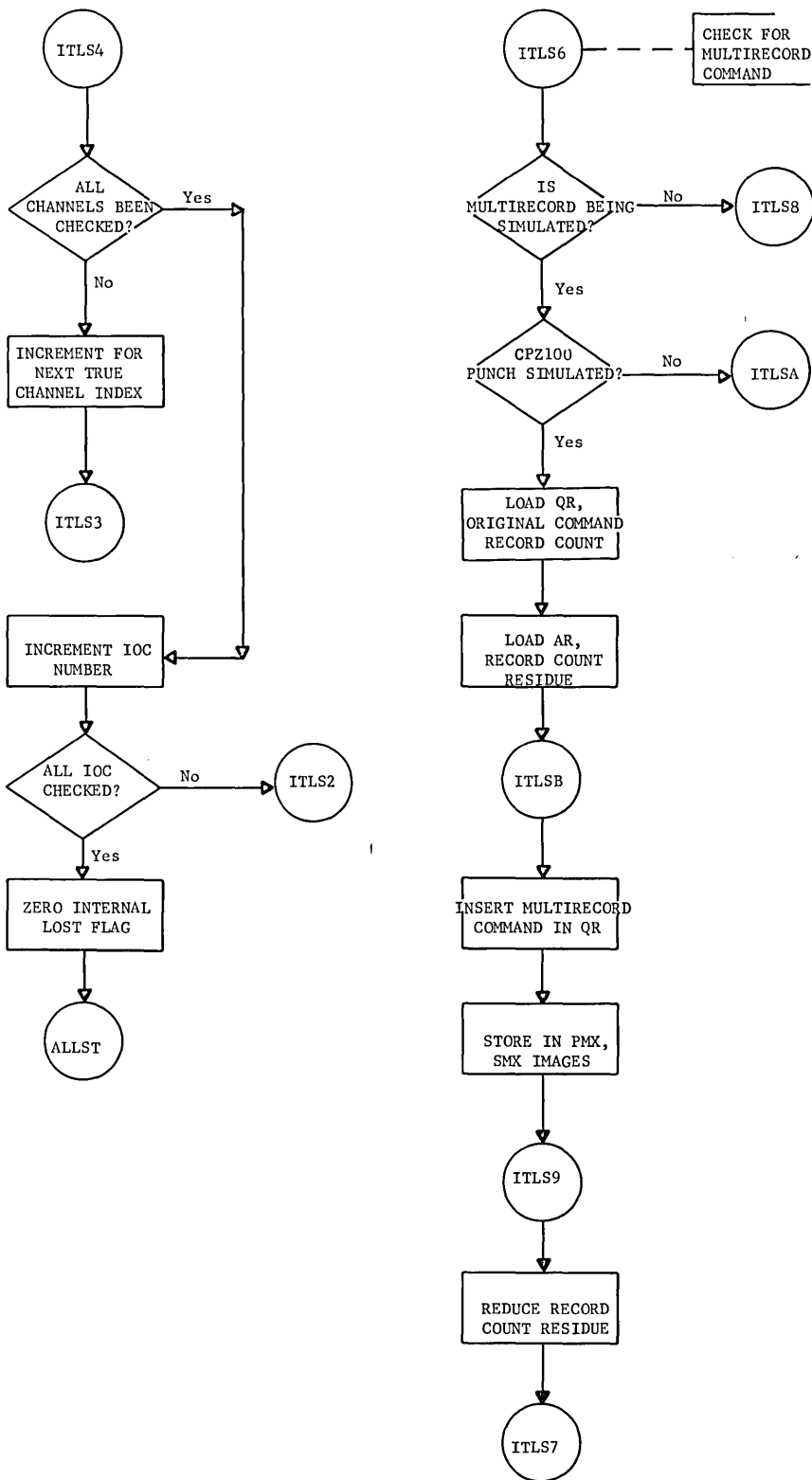

IOTRM  
.MIOS

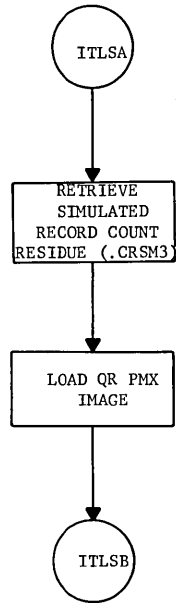
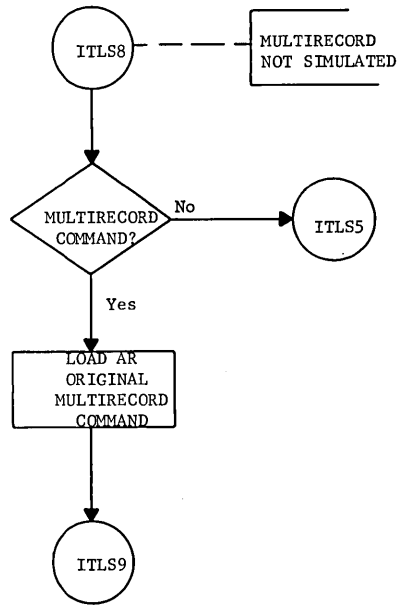

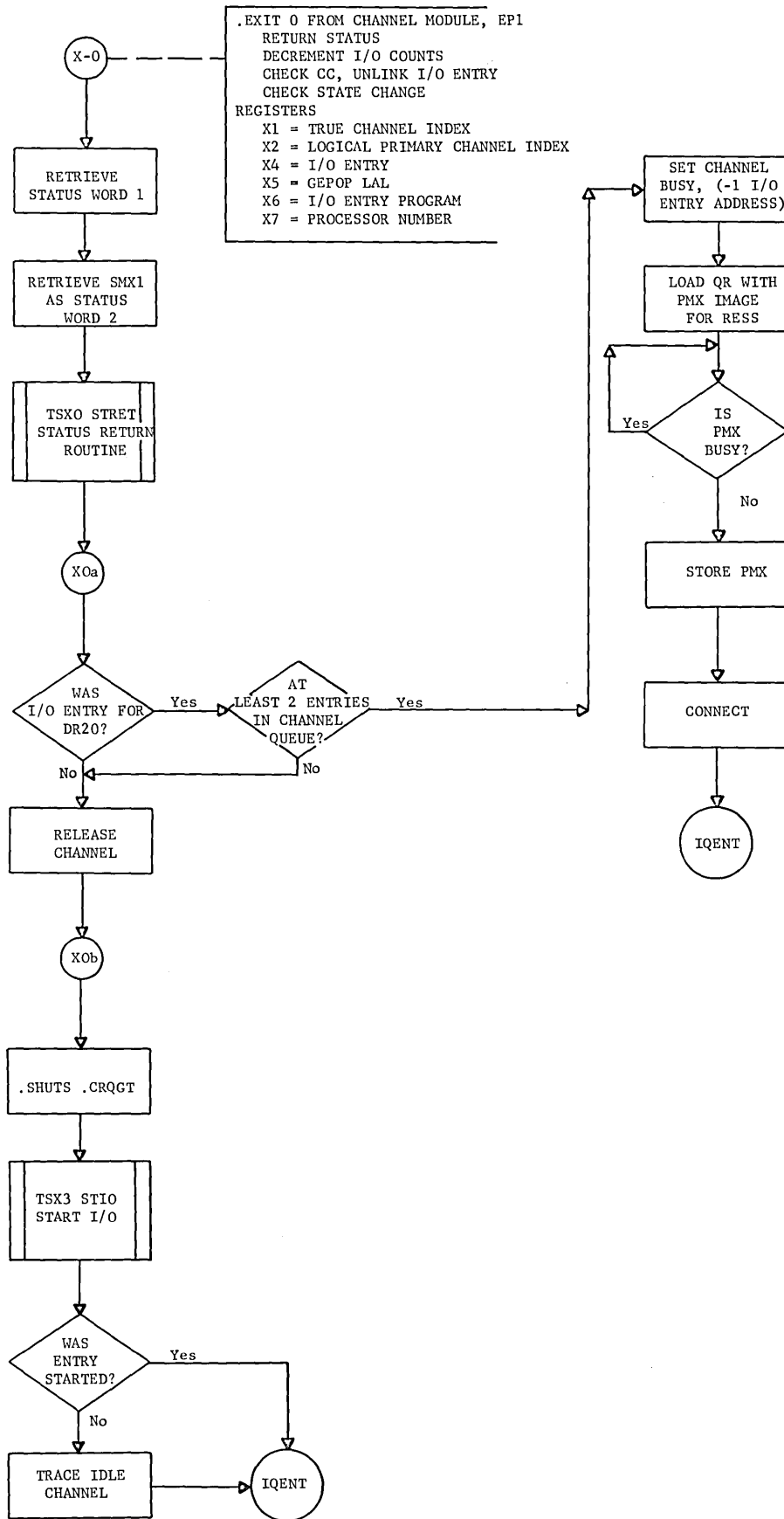

IOTRM  
.MIOS

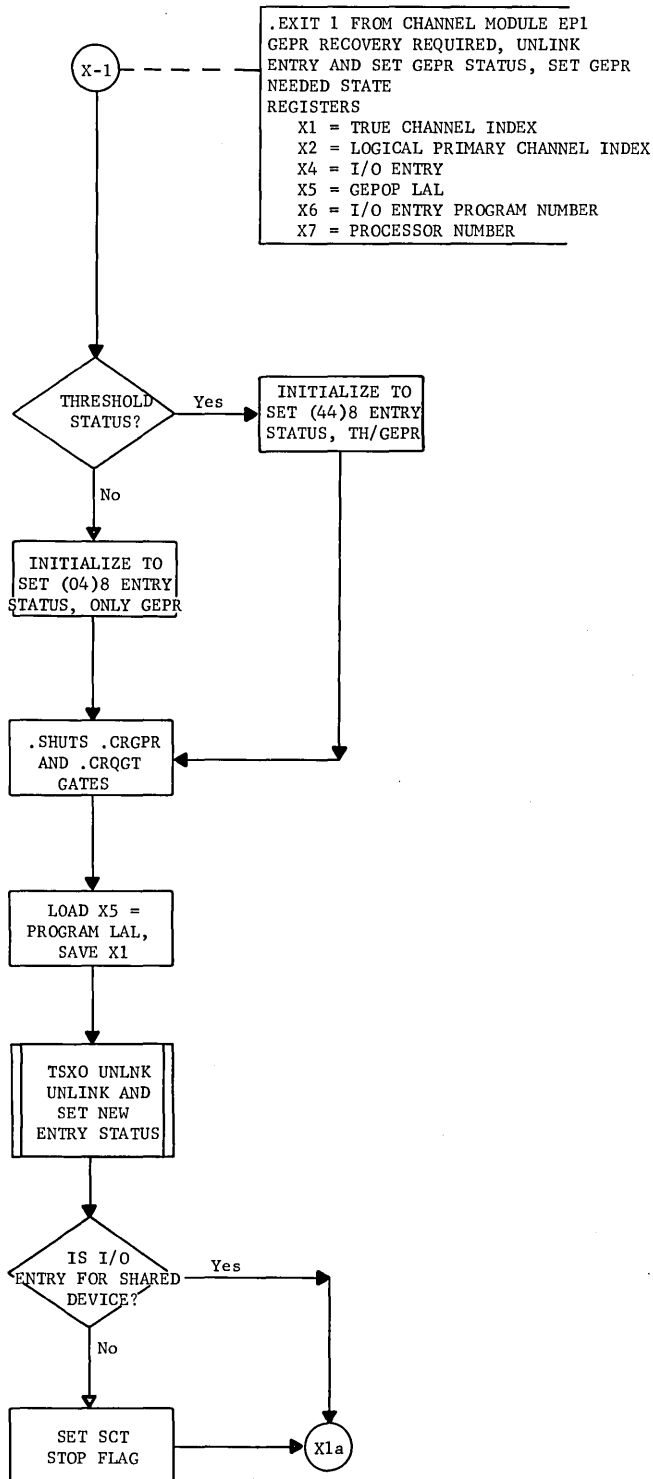

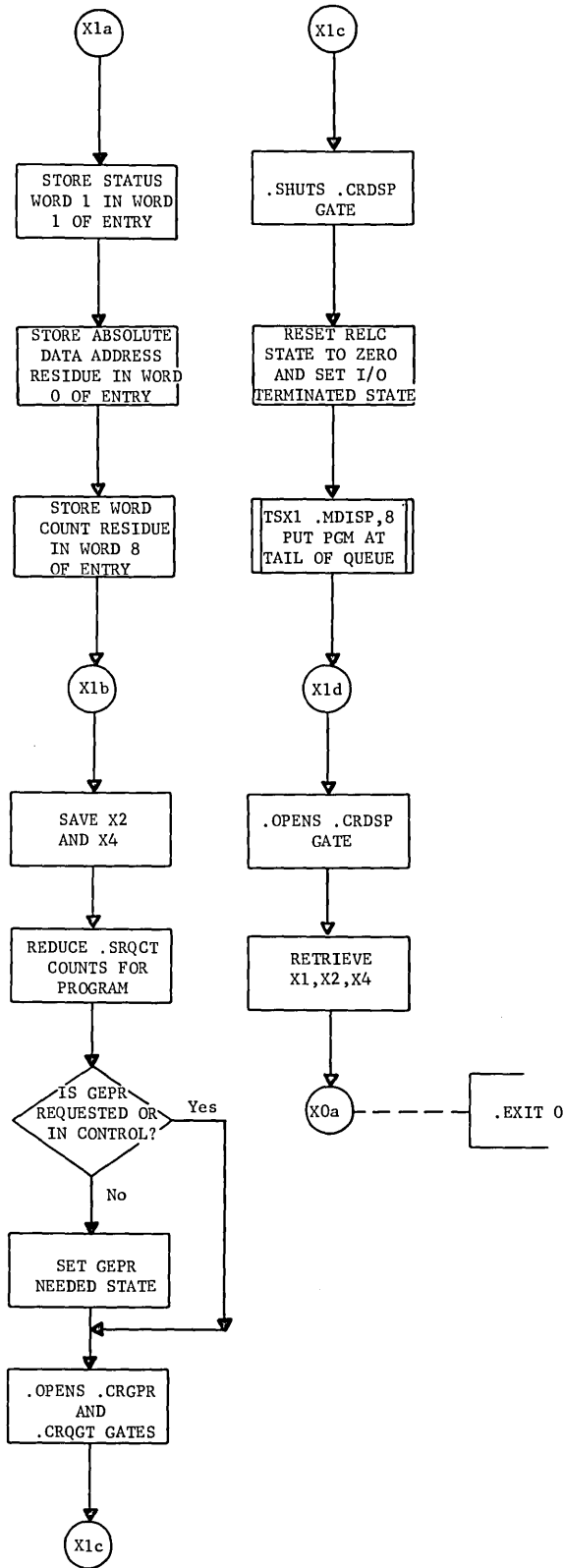



IO'TRM  
.MIOS

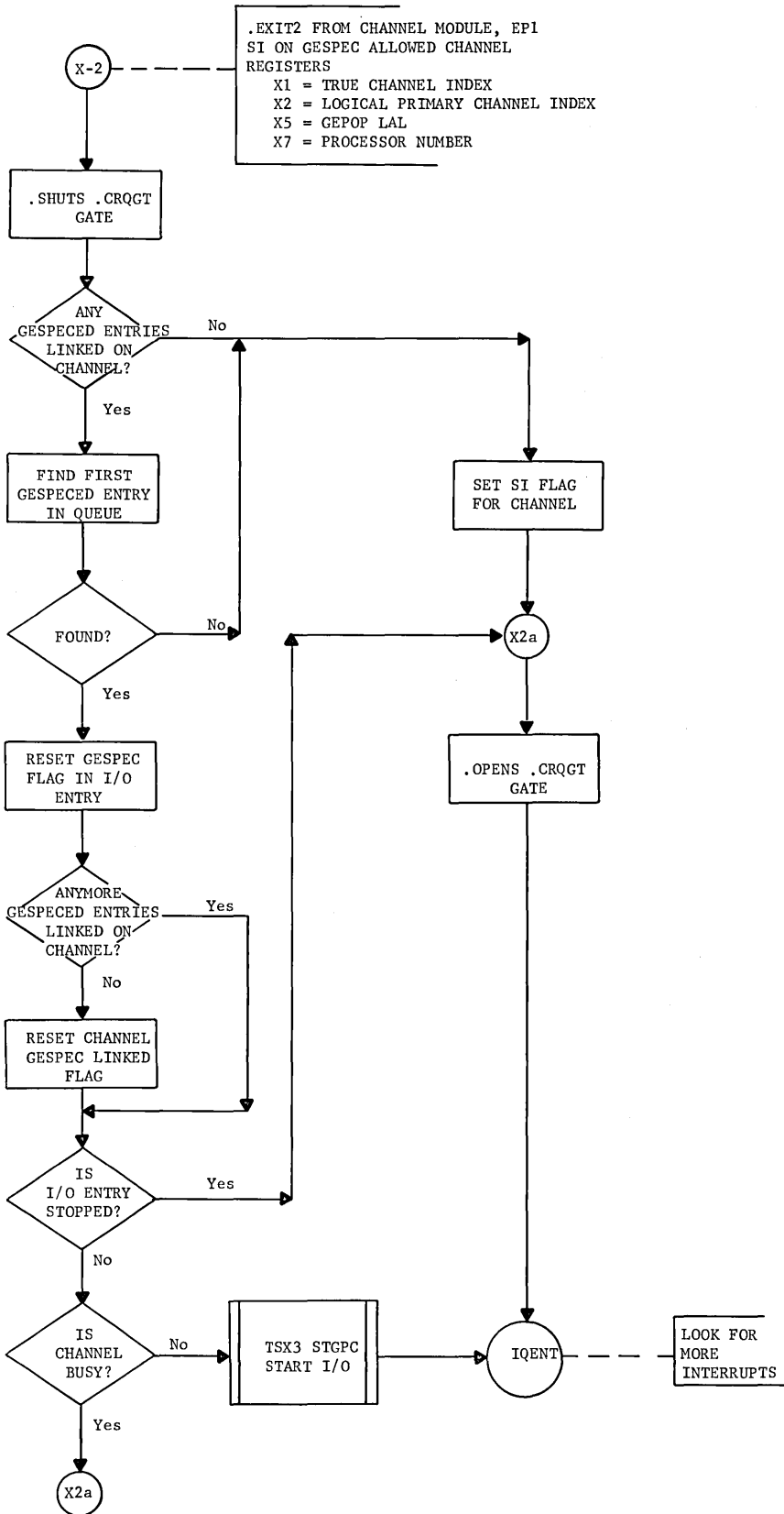

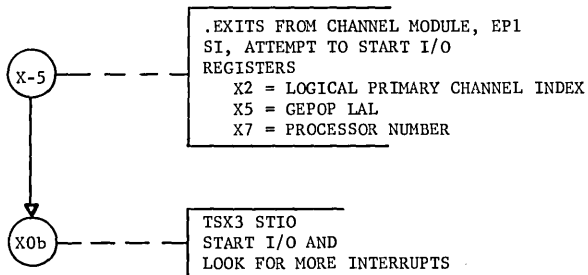
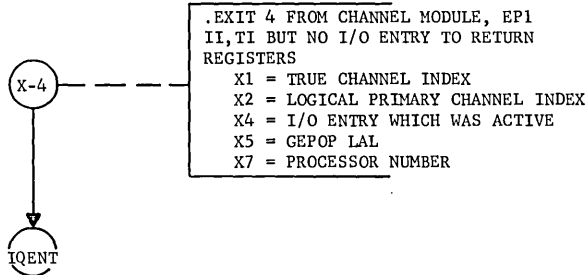
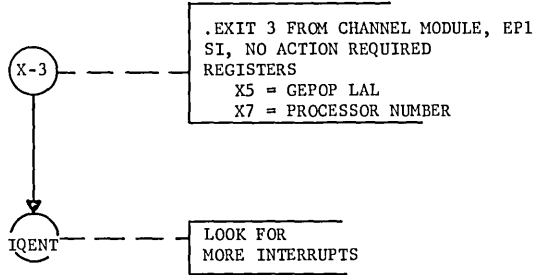

IOTRM  
.MIOS

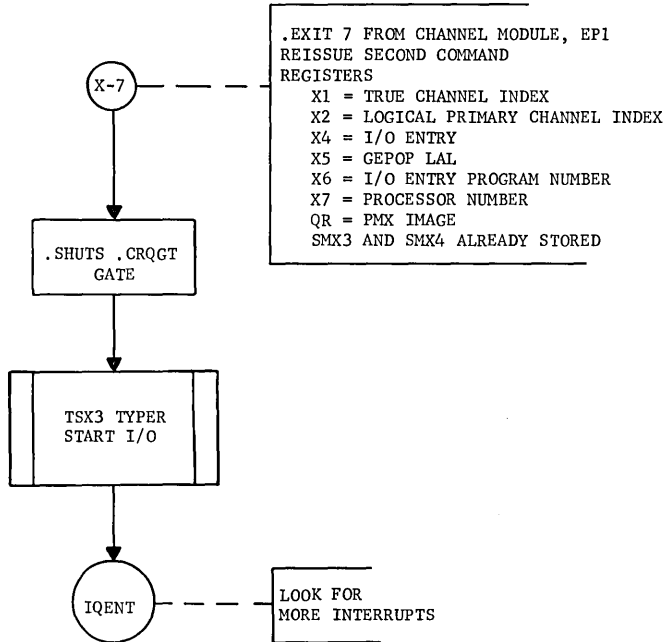
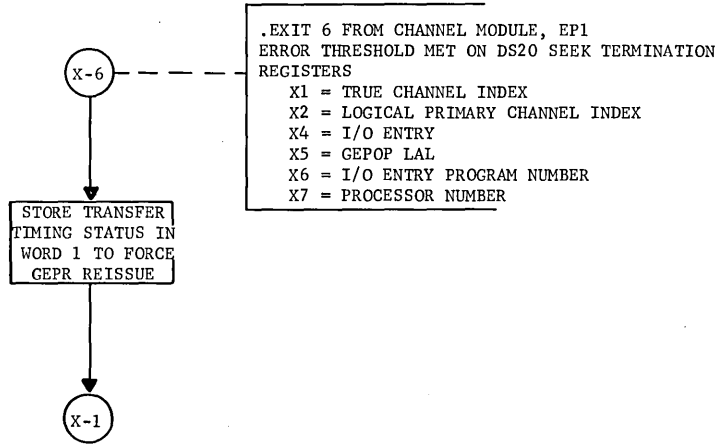

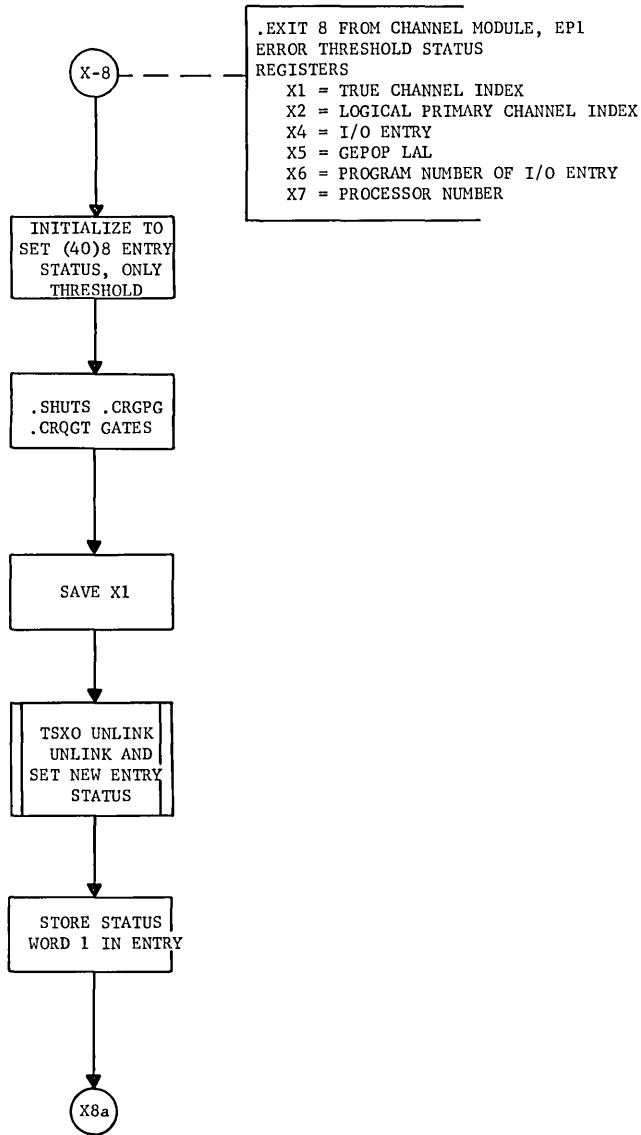

IOTRM  
.MIOS

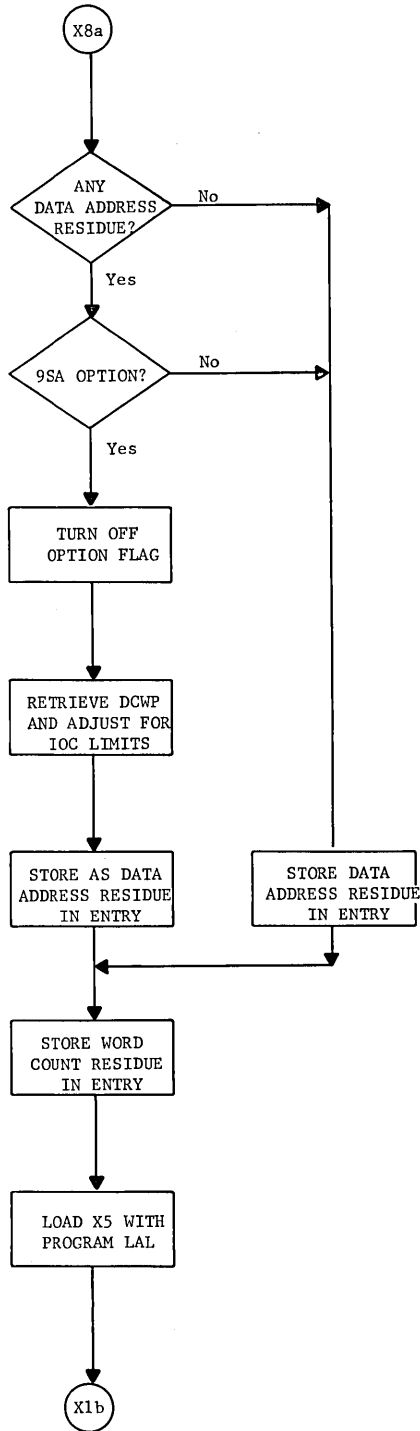

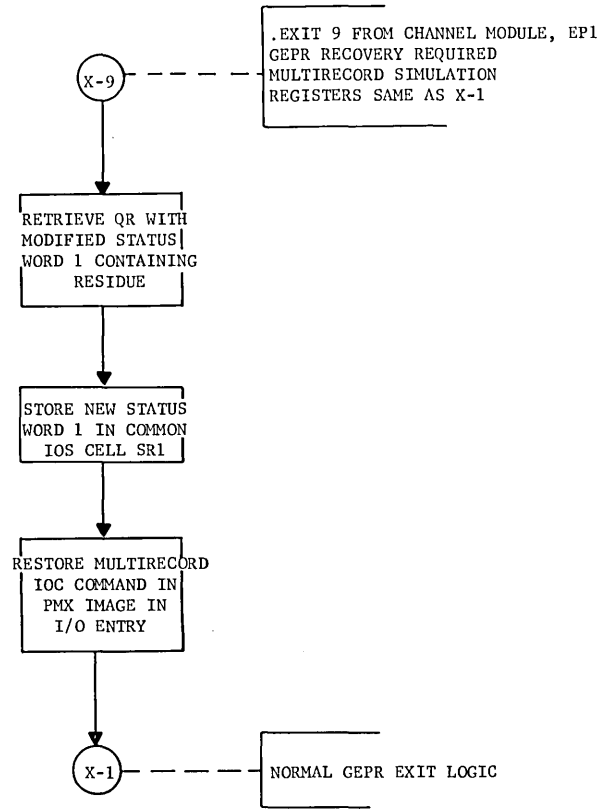

IOTRM  
.MIOS

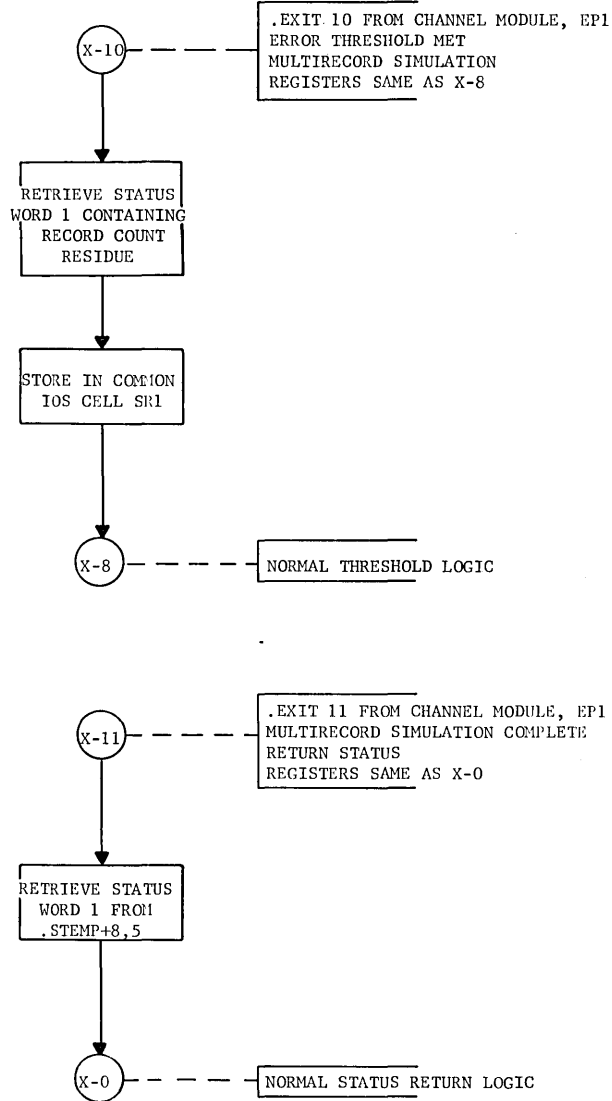

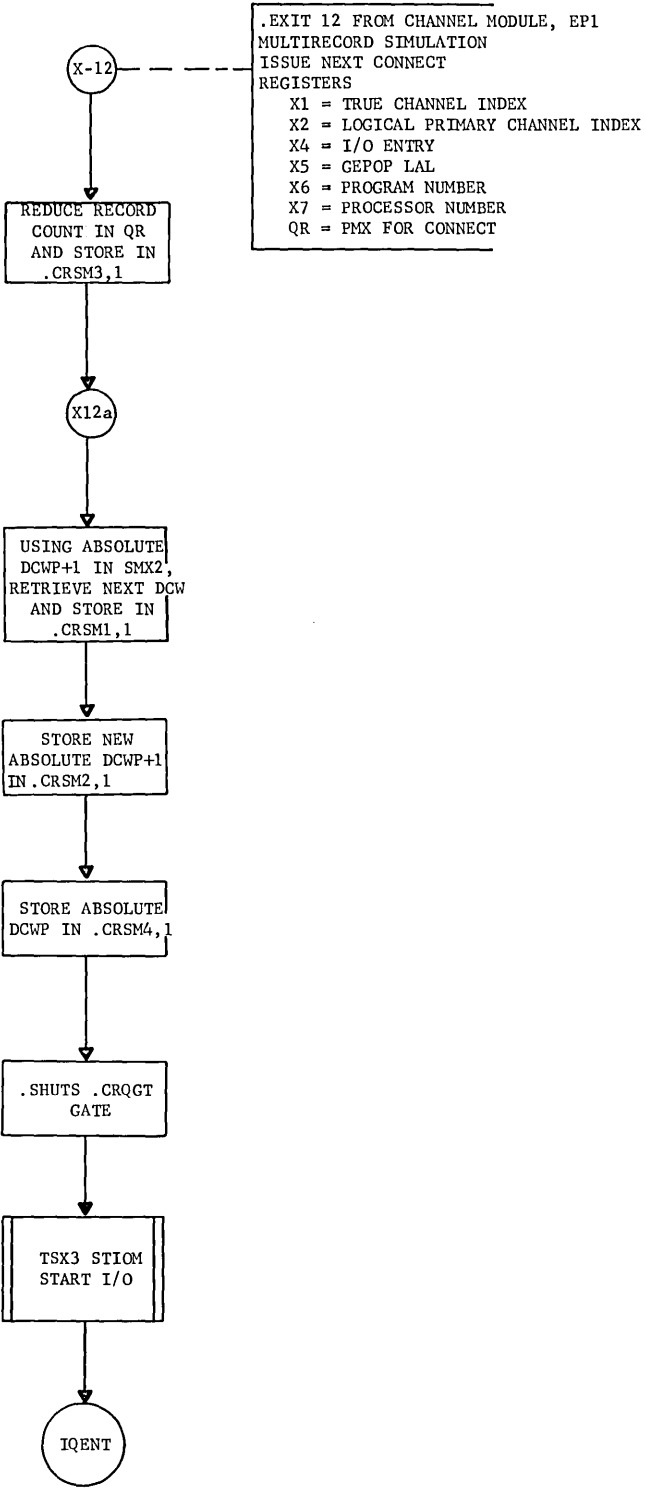



IOTRM  
.MIOS

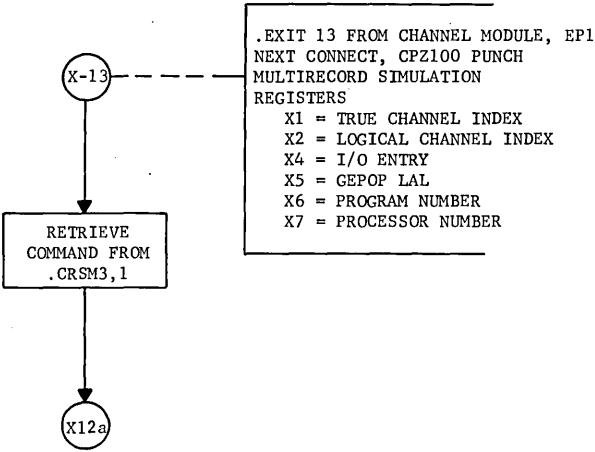

UNLINK I/O ENTRY

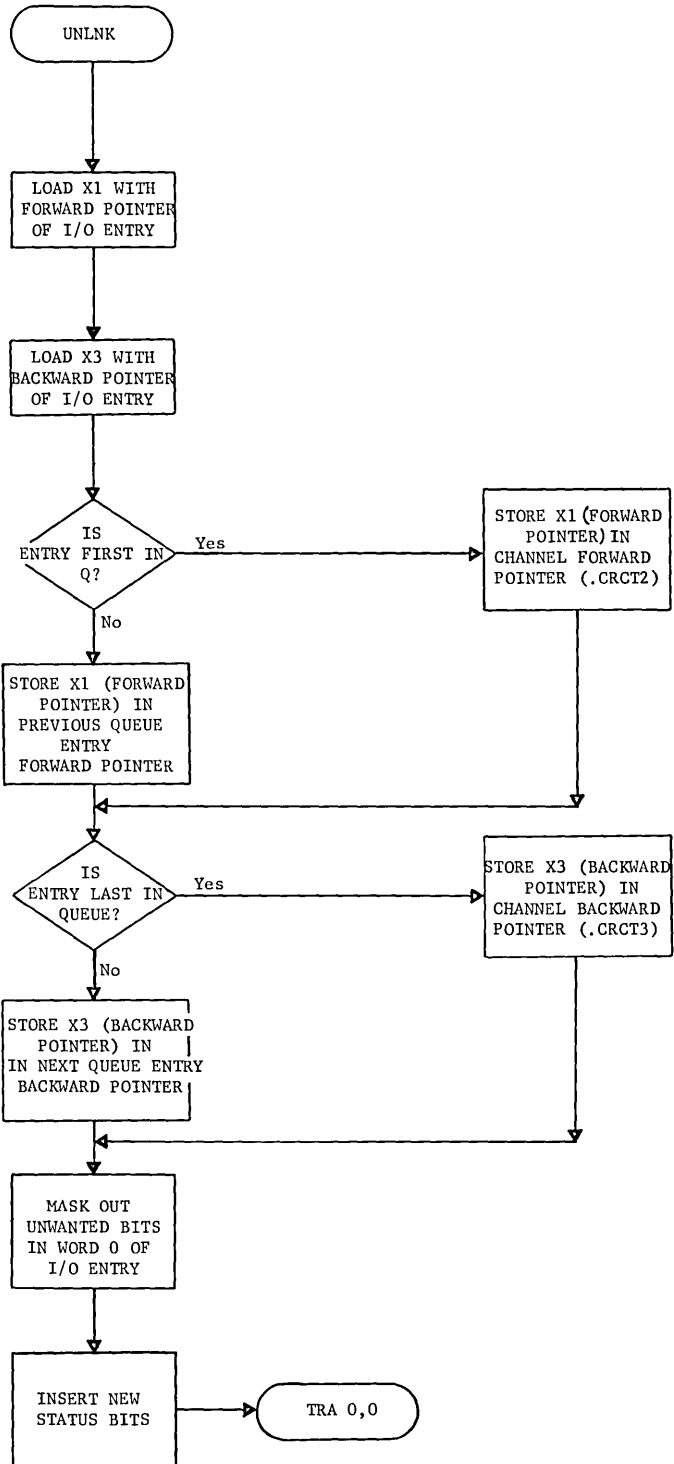

CALCULATE LOGICAL PRIMARY CHANNEL INDEX

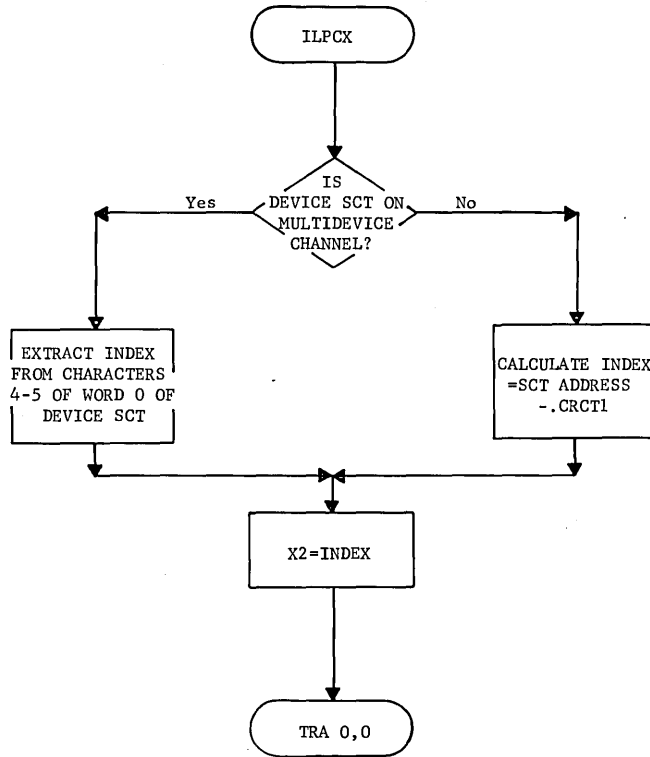

STATUS RETURN

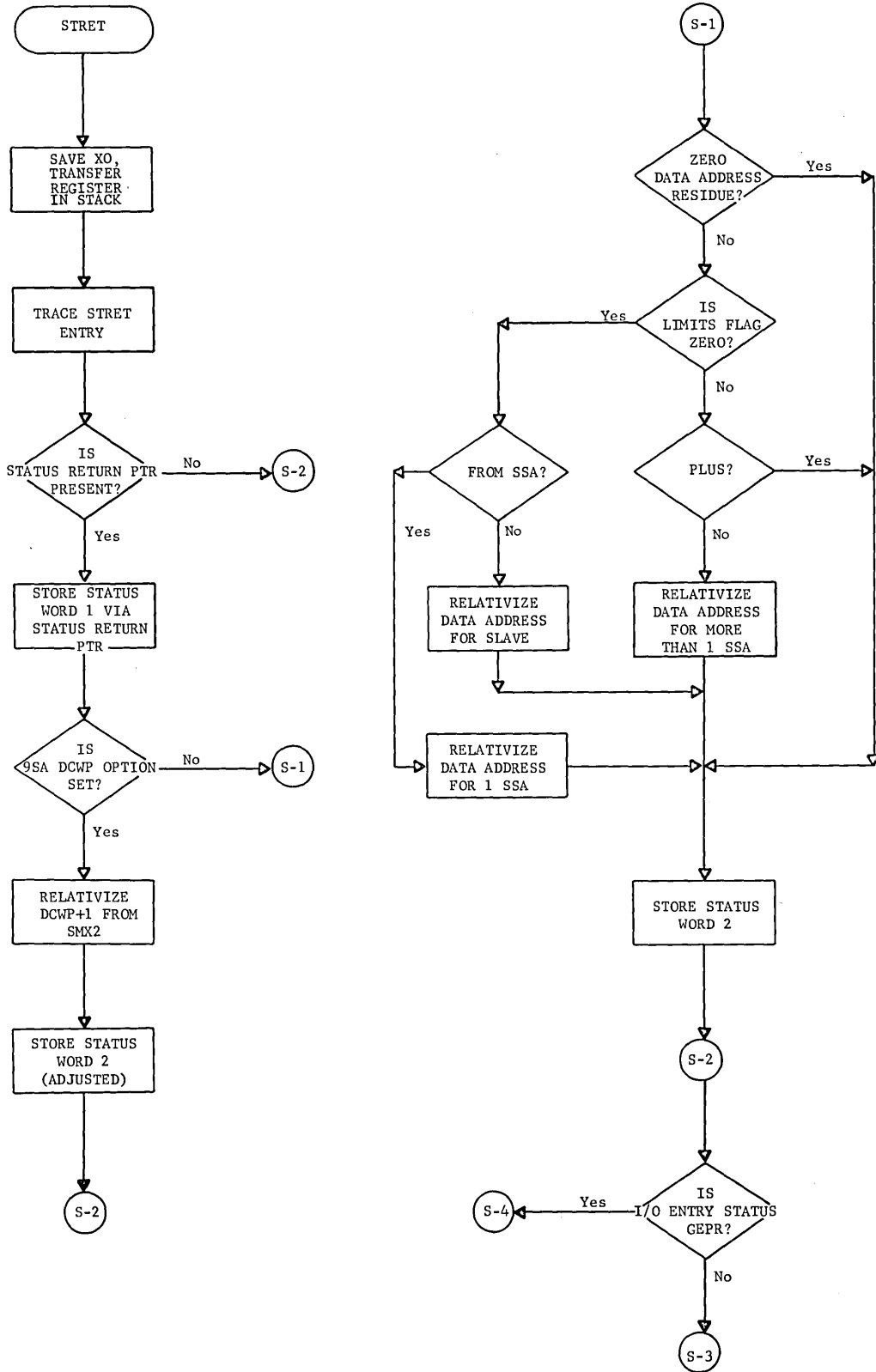

STRET  
.MIOS

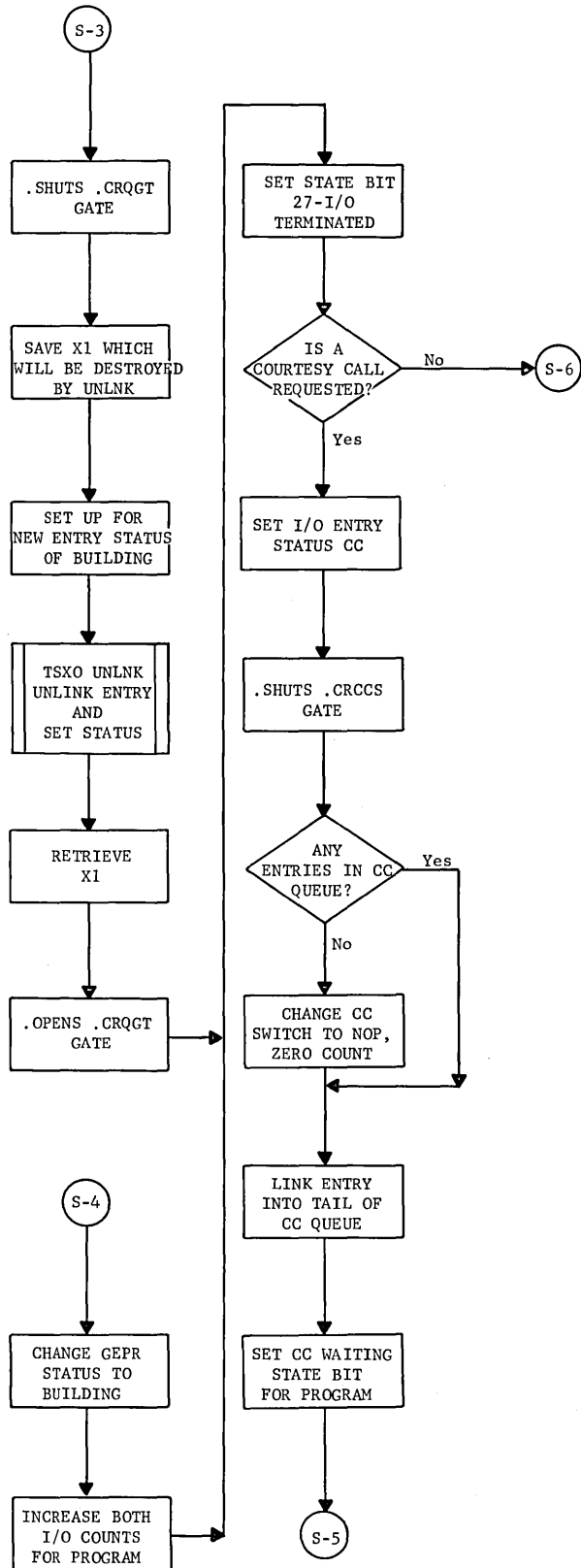

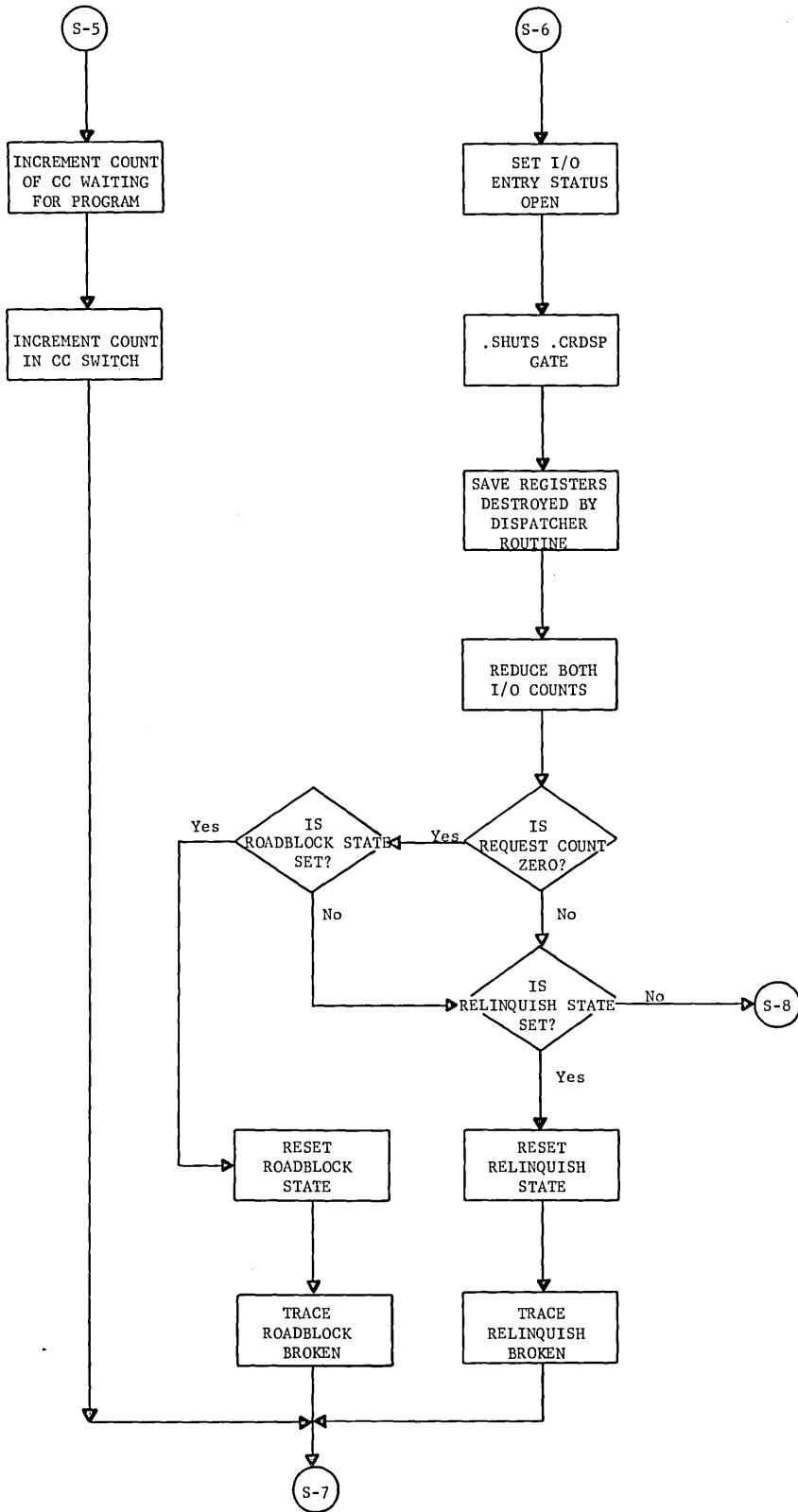

STRET  
.MIOS

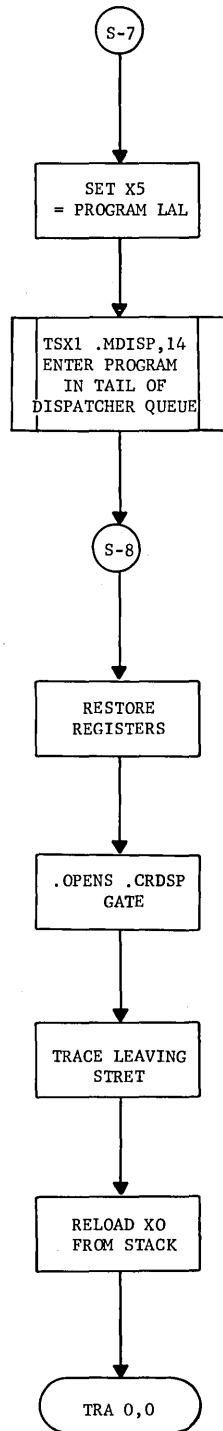

START I/O

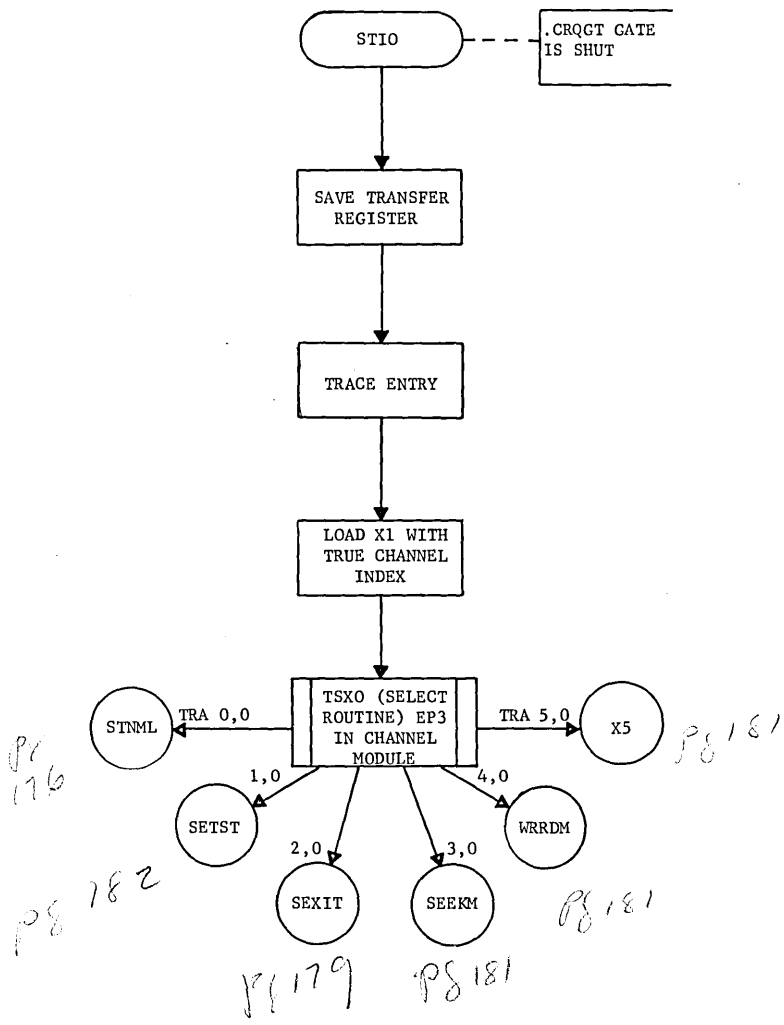



STIO  
.MIOS

*Start  
normal I/O*

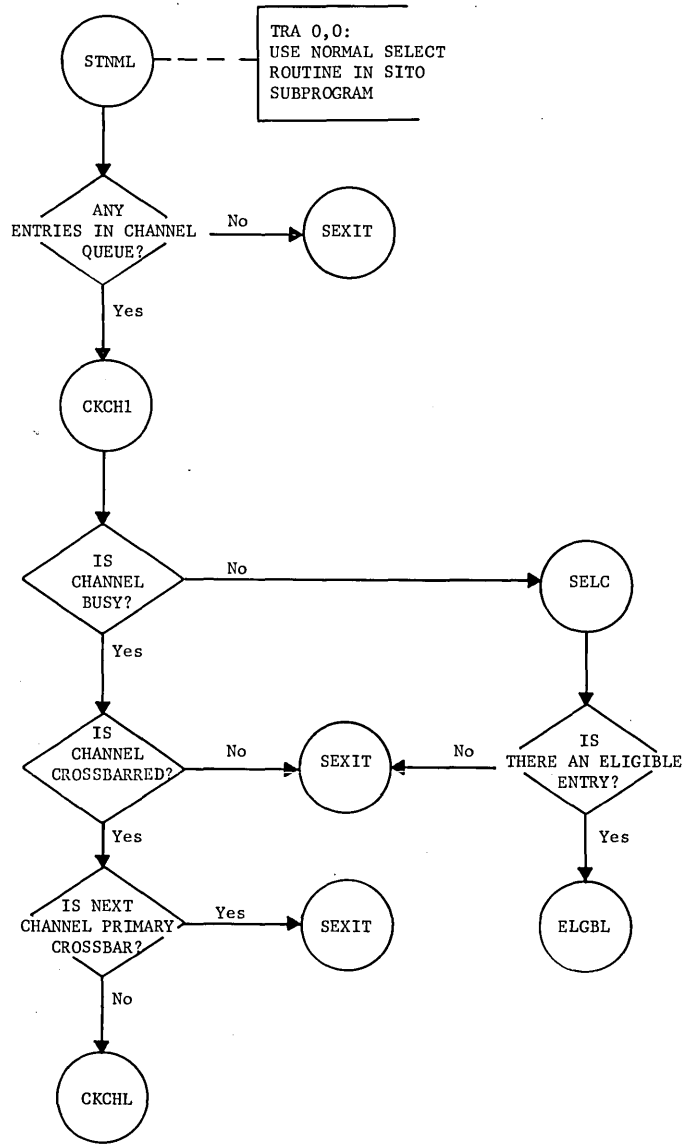

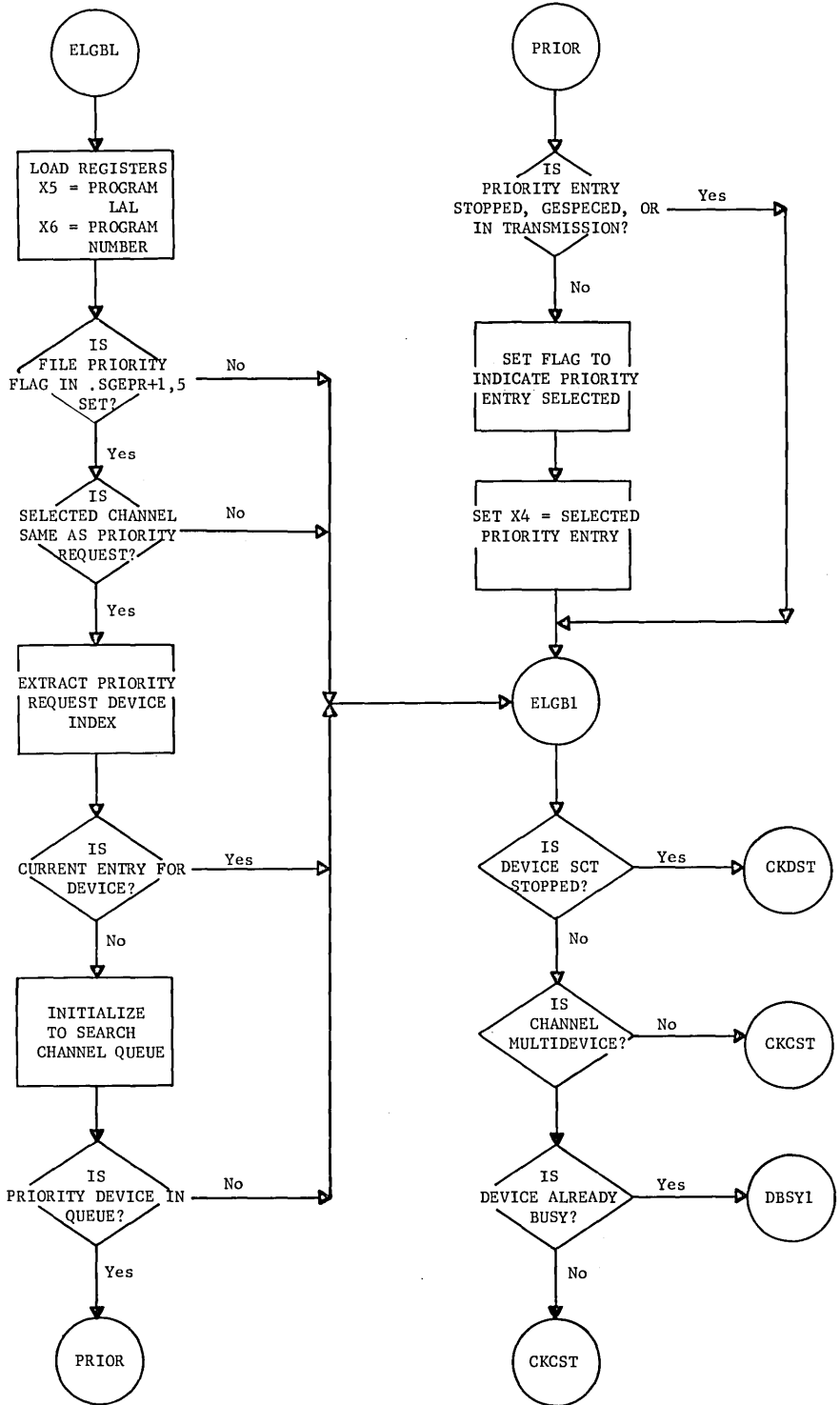

STIO  
.MIOS

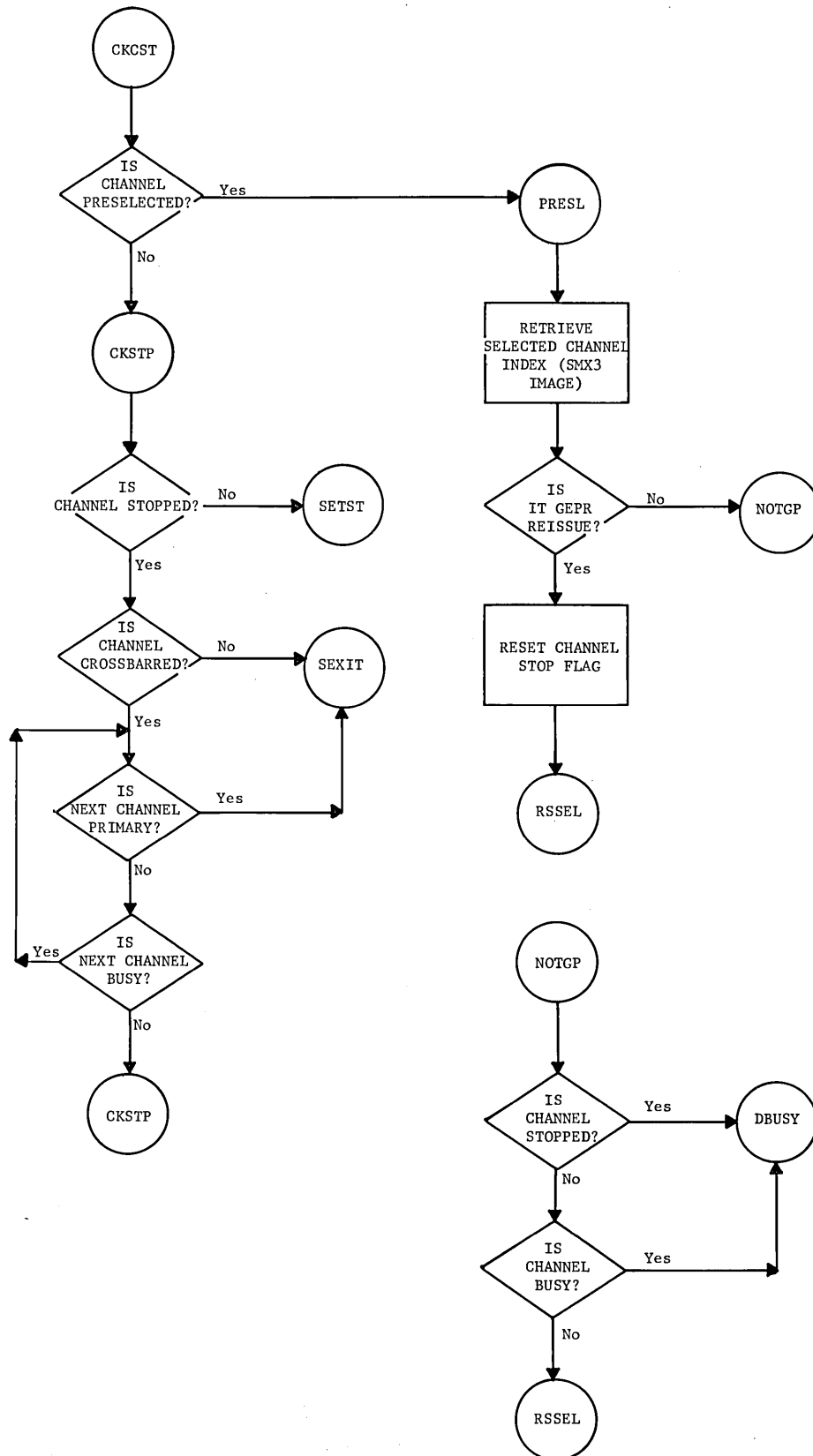

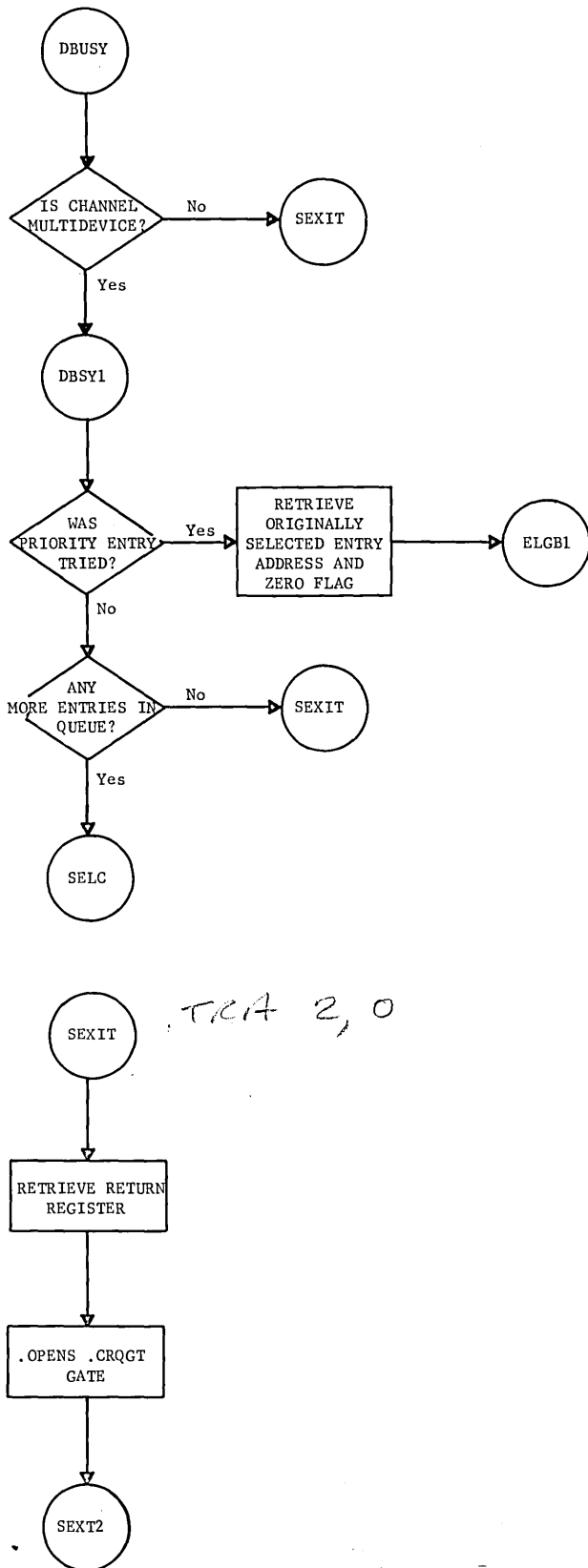
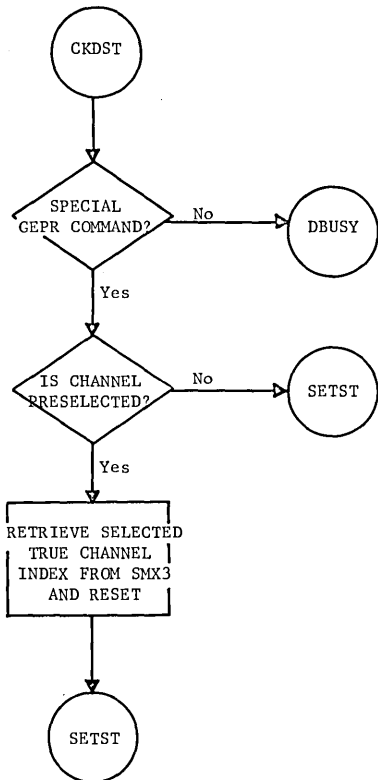
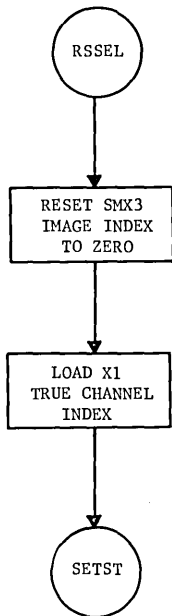

STIO  
.MIOS

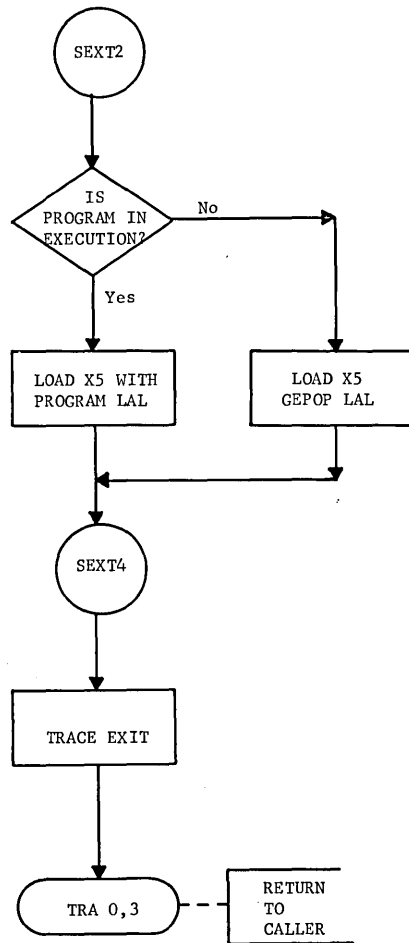

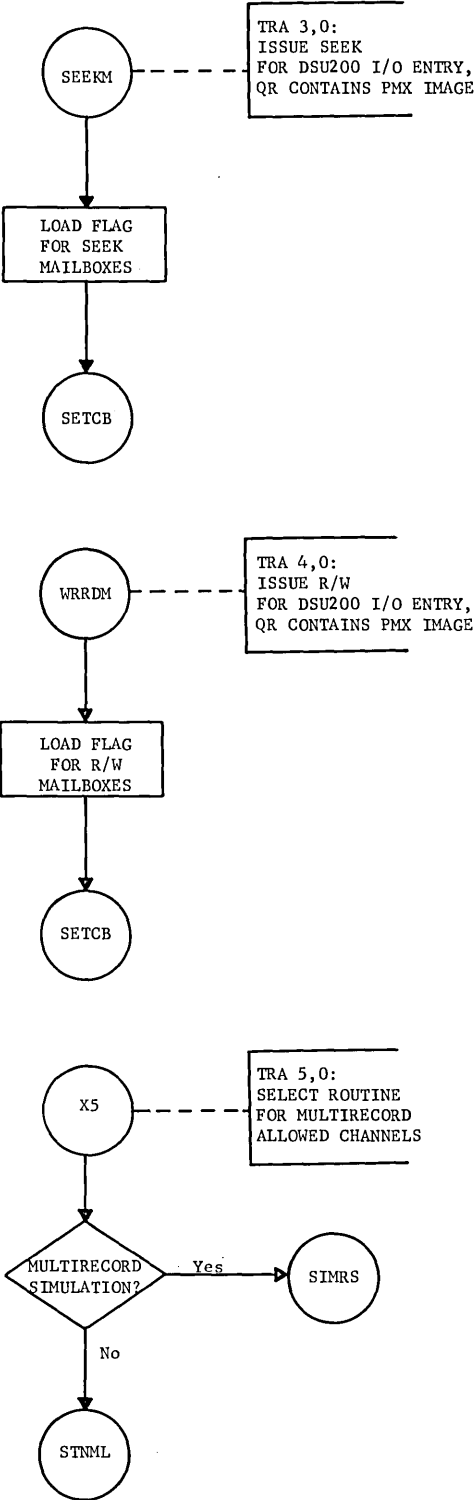

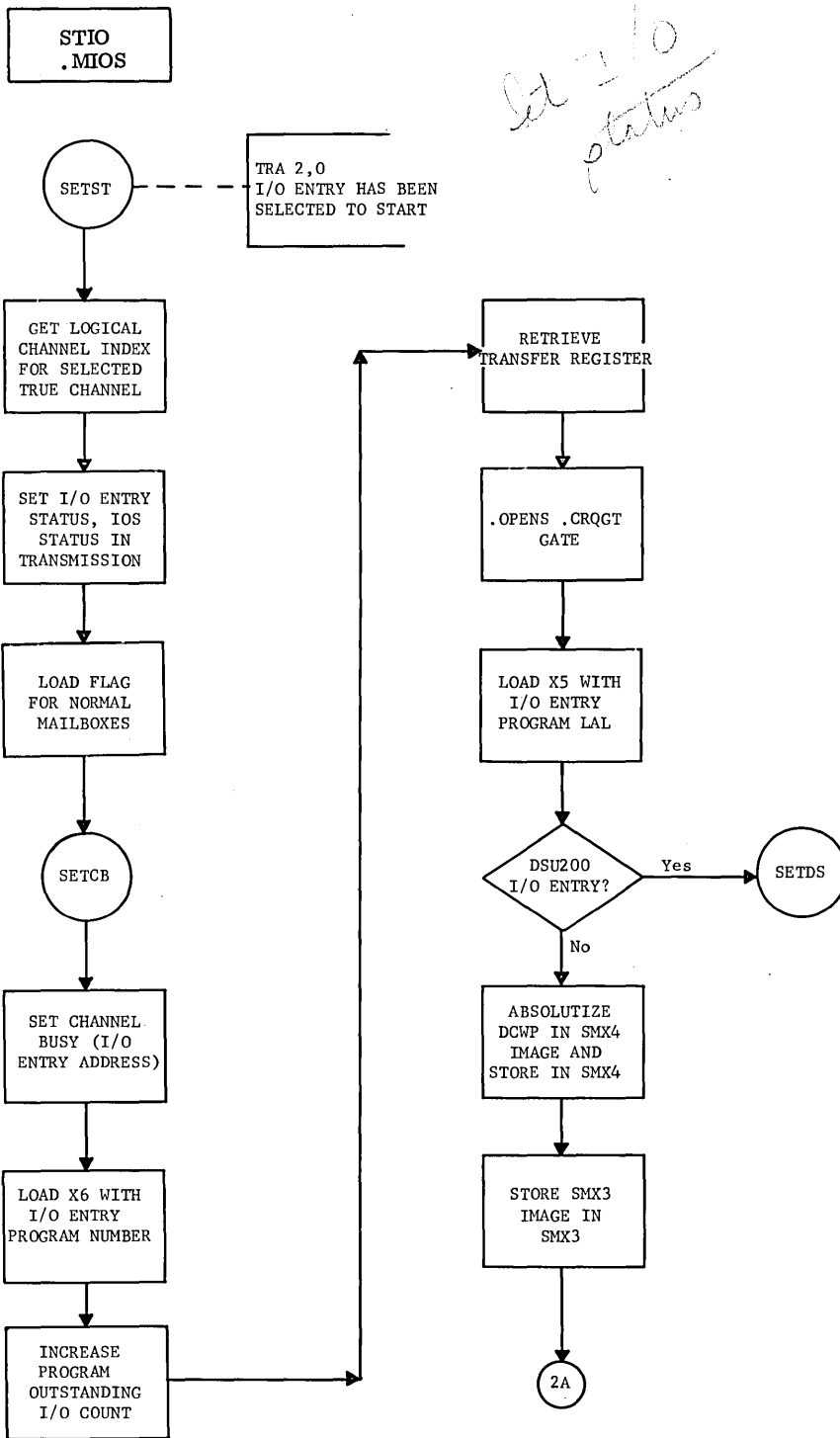

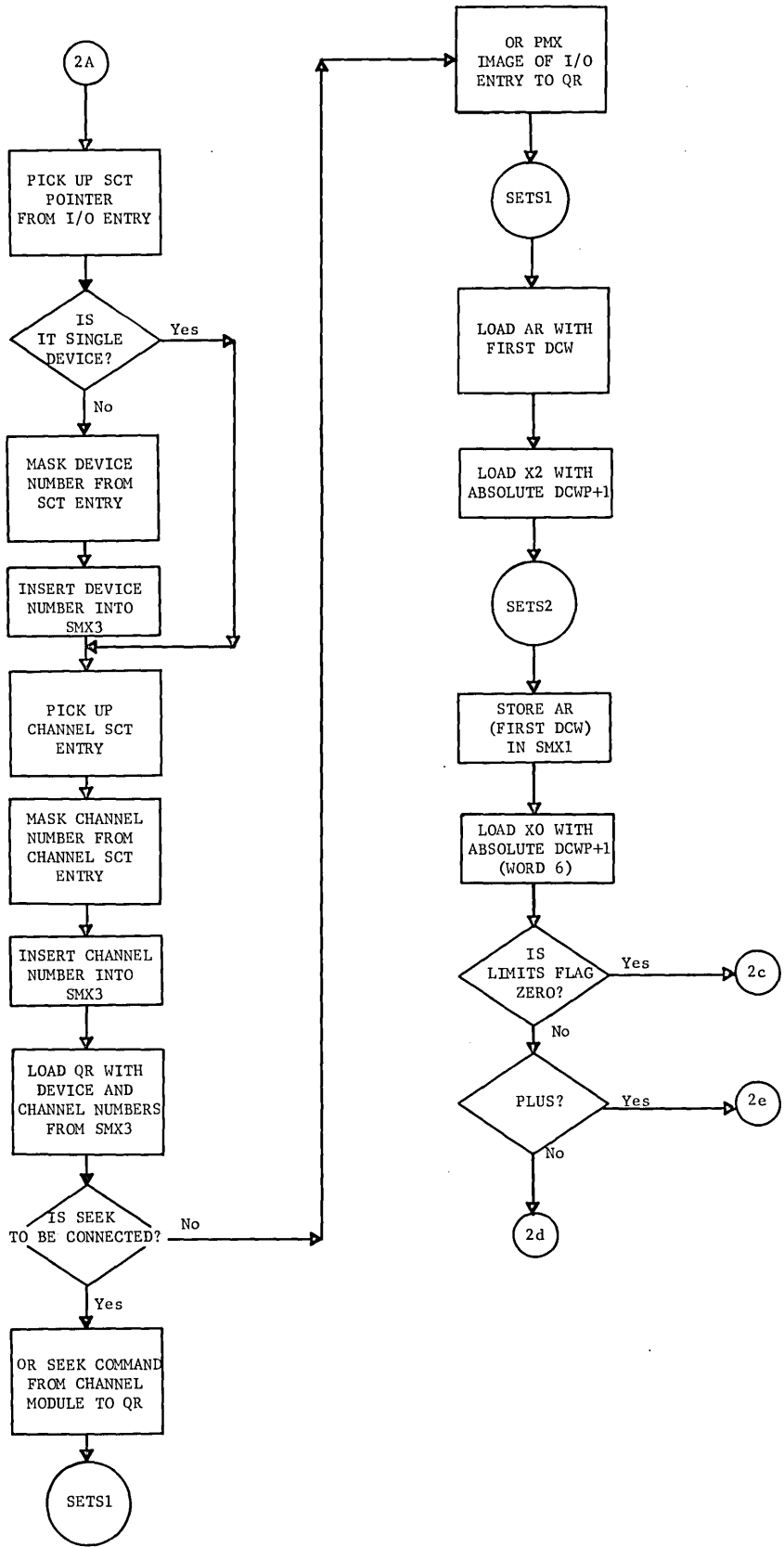



STIO  
.MIOS

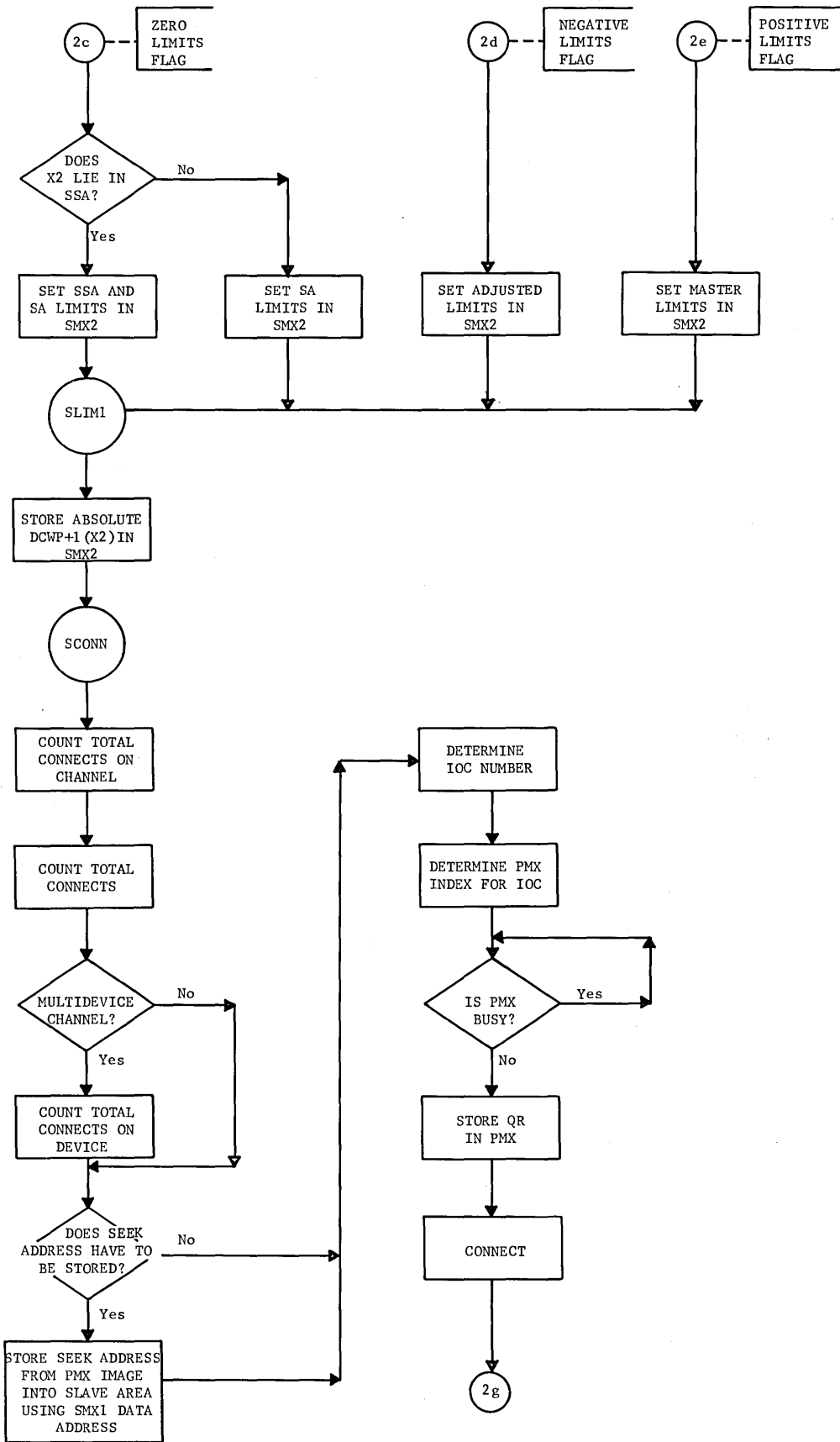

STIO  
.MIOS

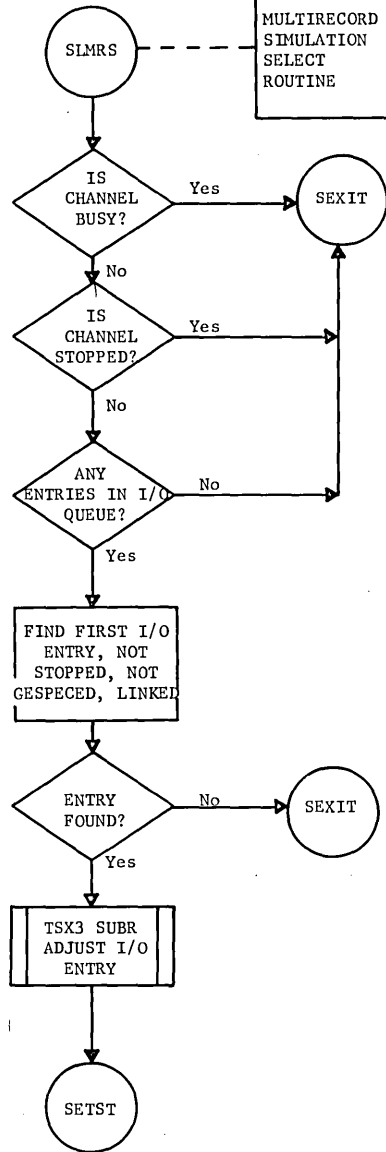
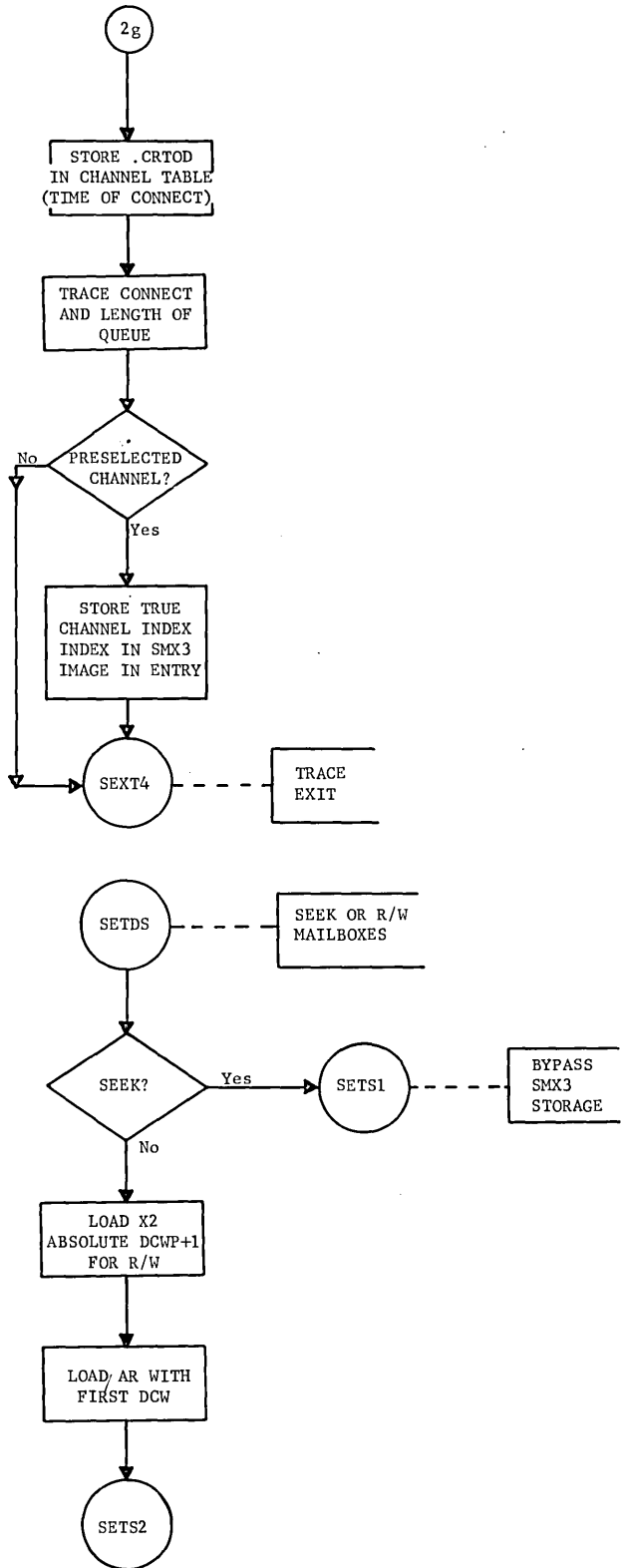

STIO  
.MIOS

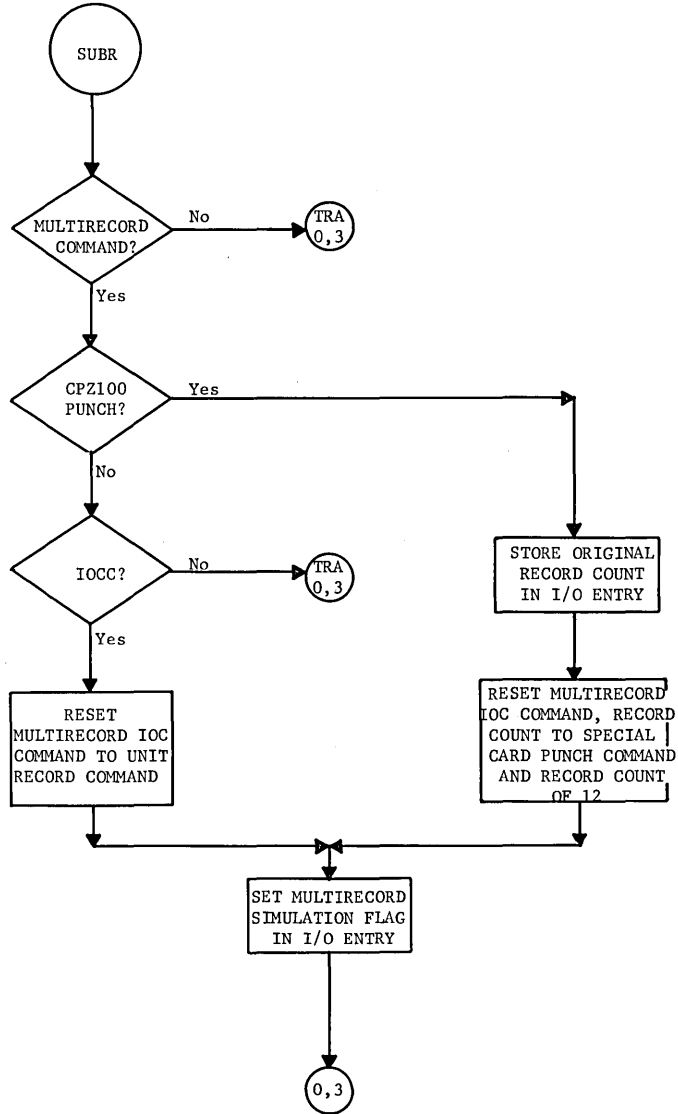

STIOM  
.MIOS

CONNECT MULTIRECORD SIMULATION DCW

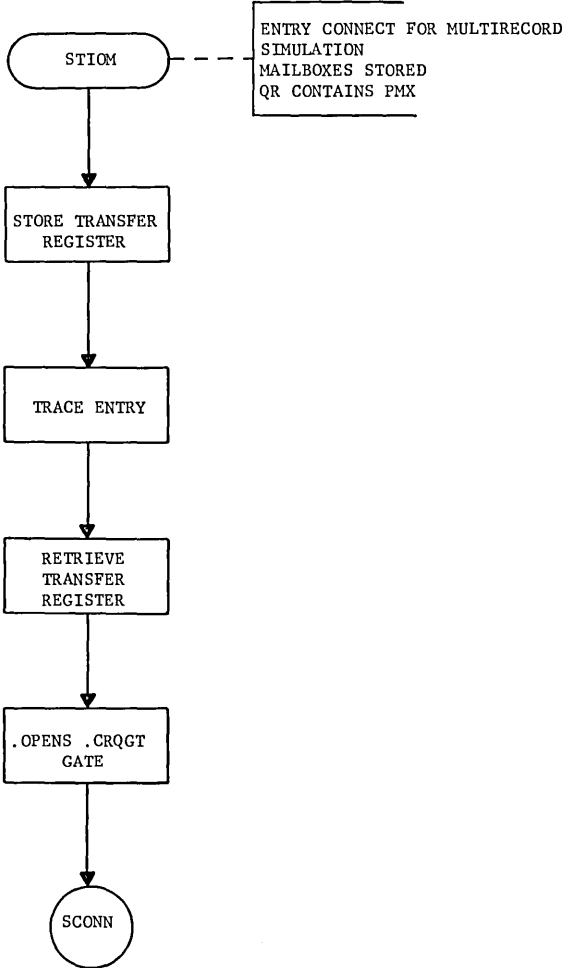

TYPER  
.MIOS

CONNECT REISSUE OF SECOND TYPEWRITER COMMAND

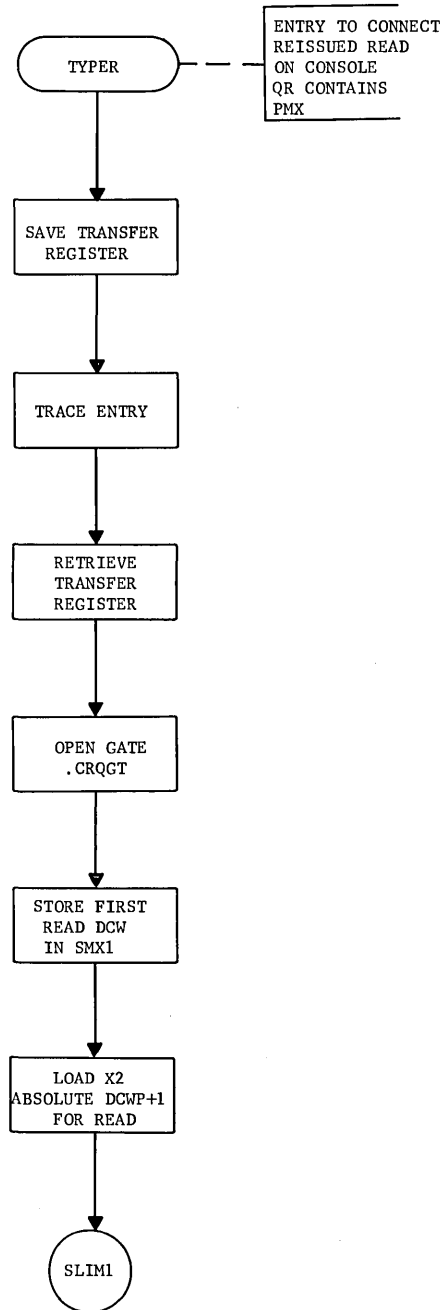

CONNECT SELECTED GESPECED ENTRY

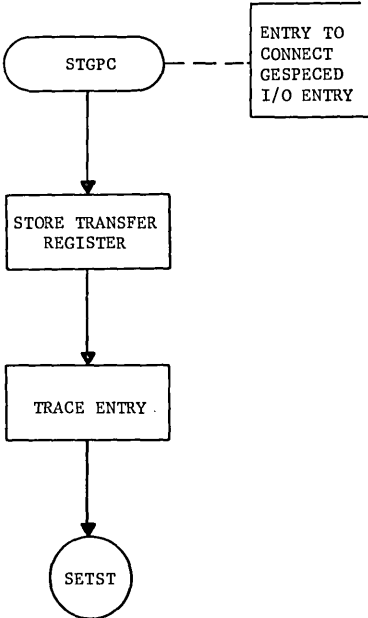

RESUME I/O FOR PROGRAM

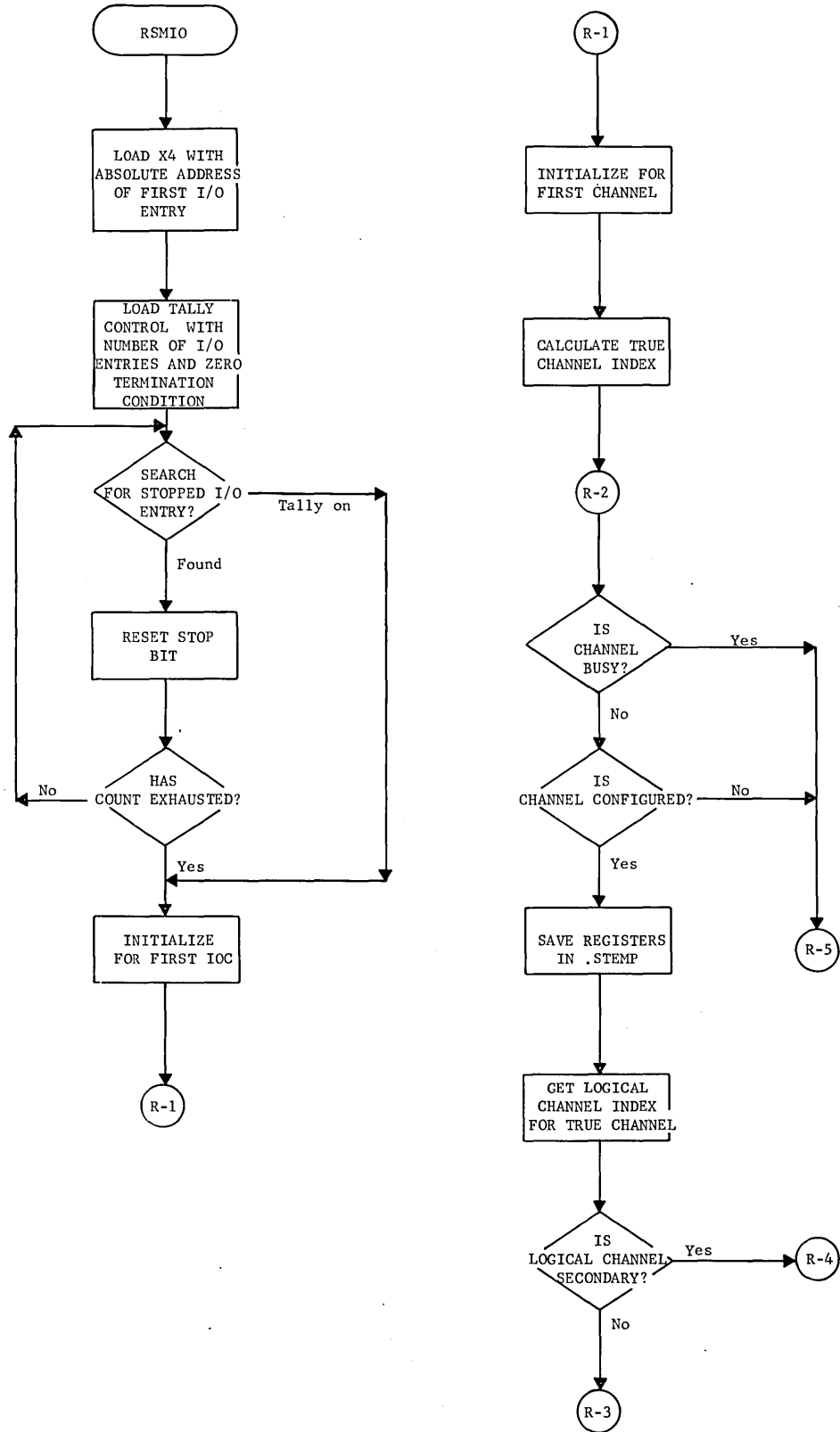

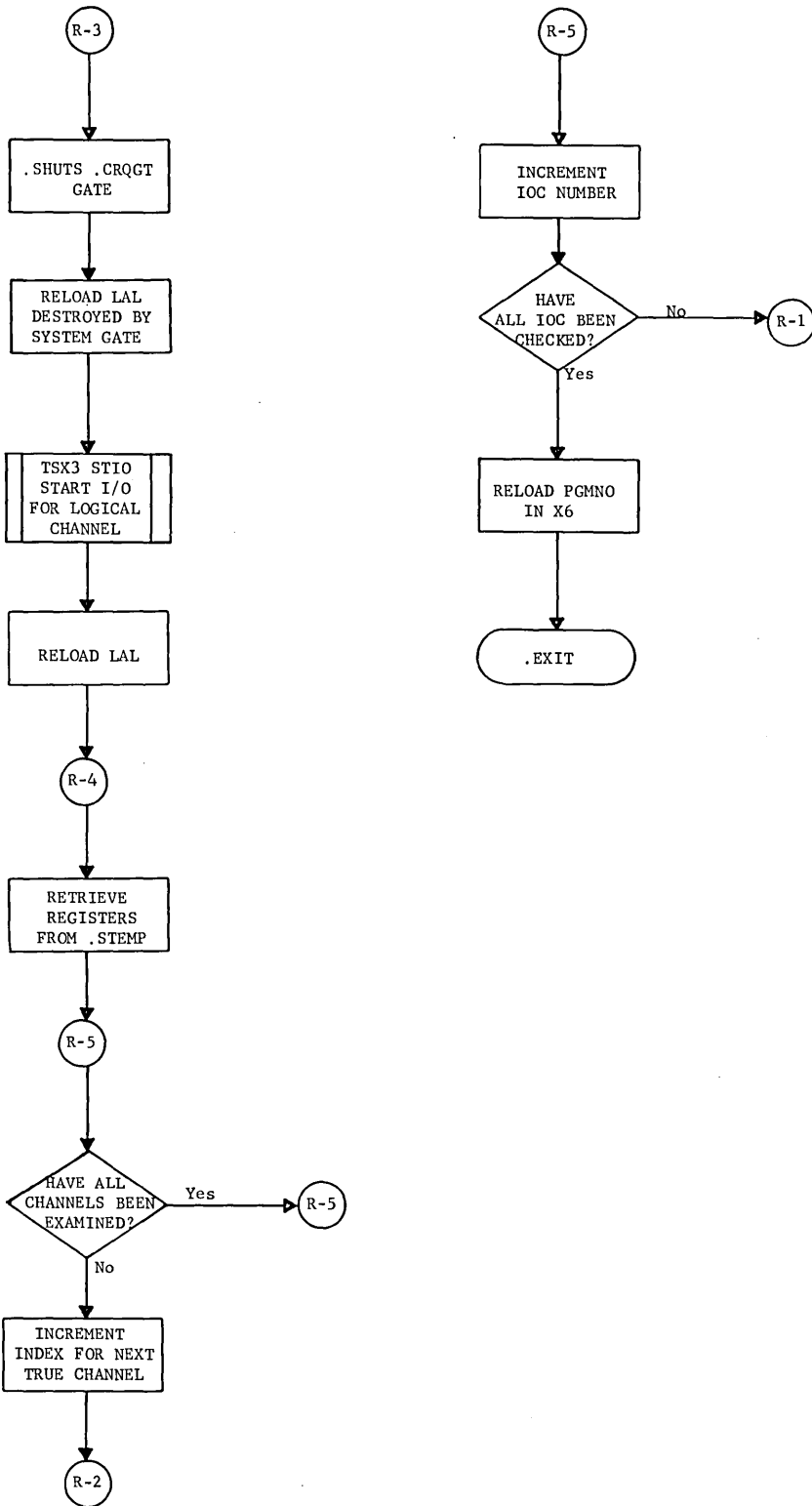



ABTIO (EP9)  
.MIOS

ABORT I/O FOR PROGRAM

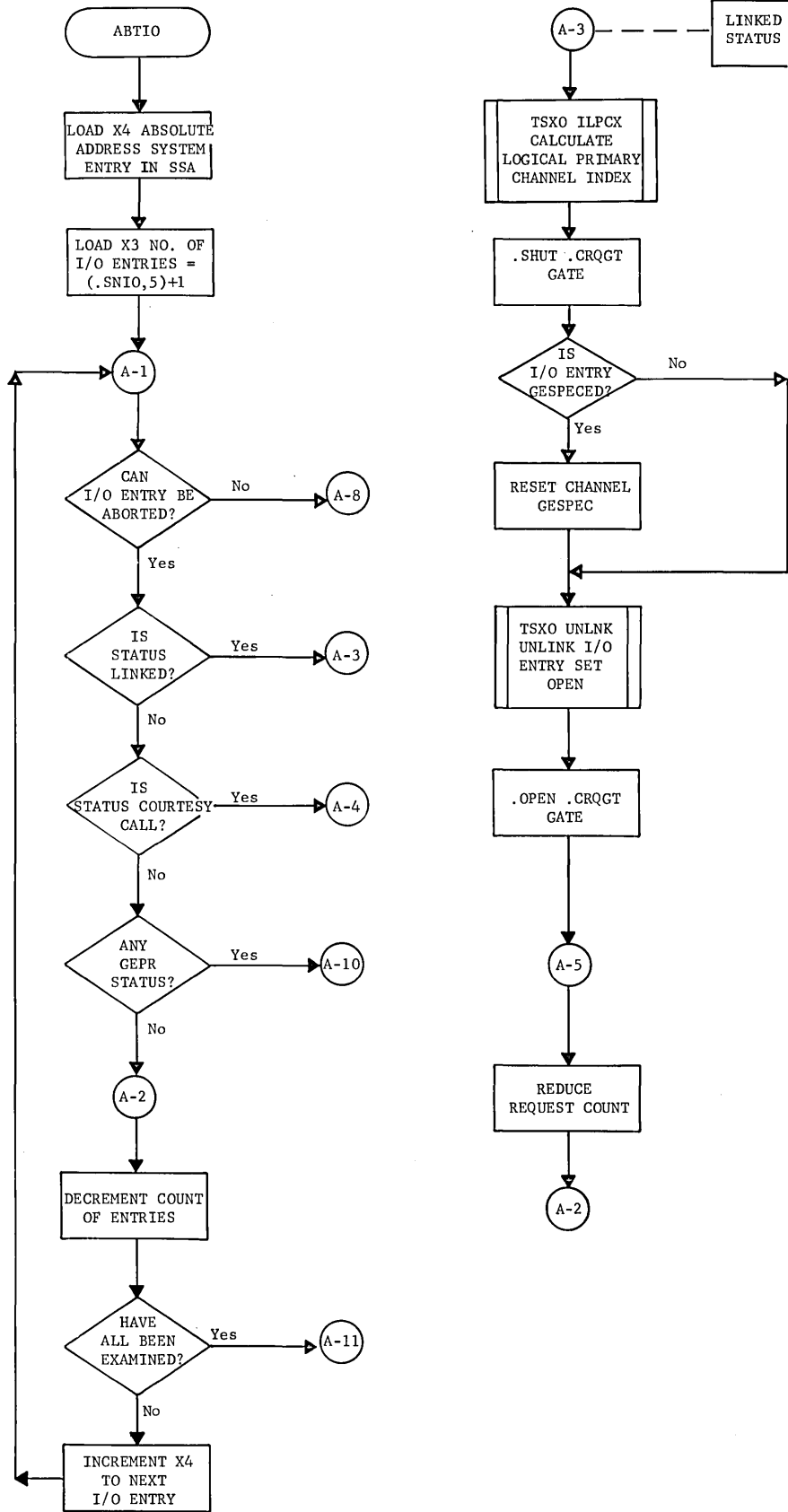

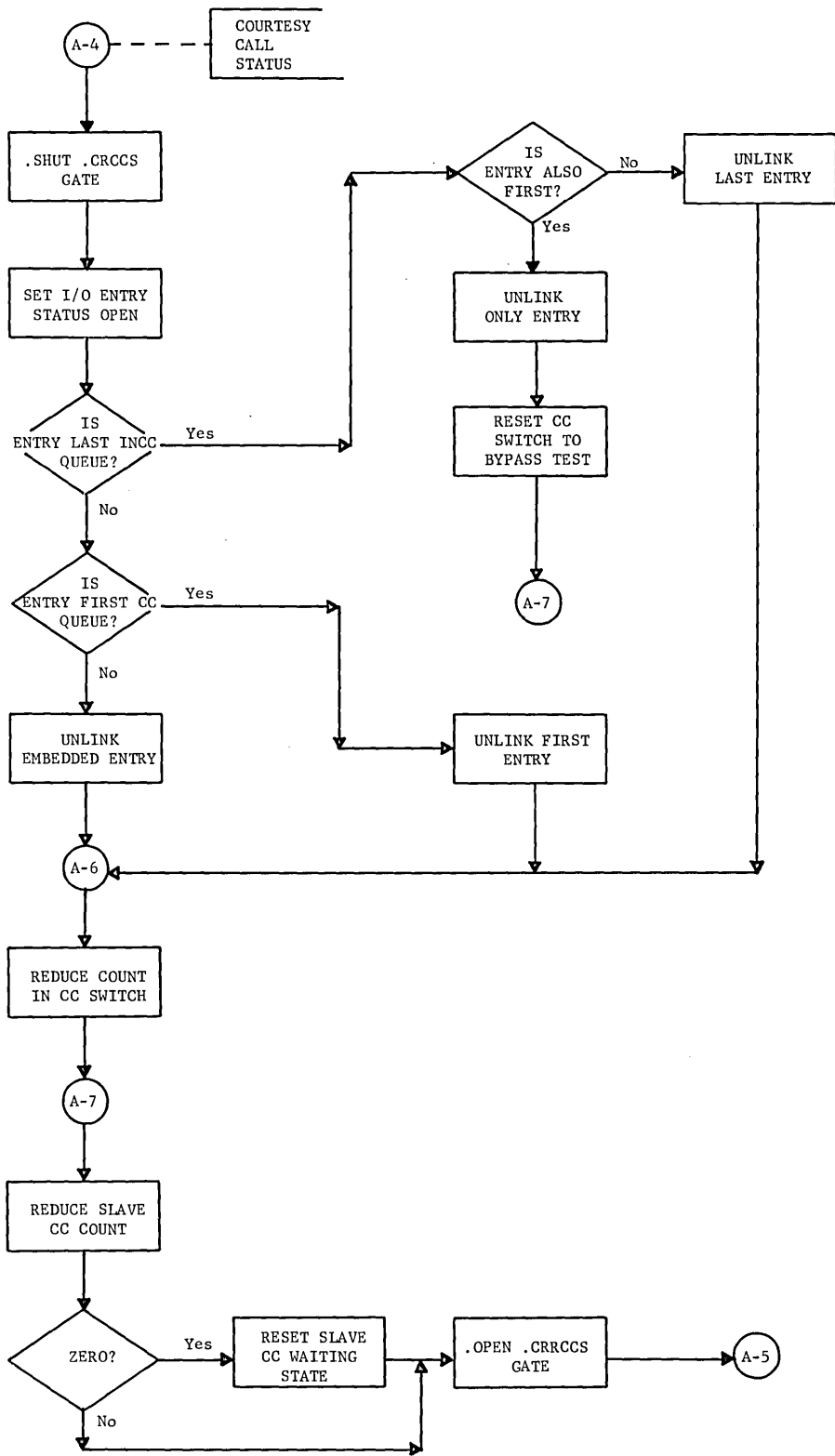

ABTIO (EP9)  
.MIOS

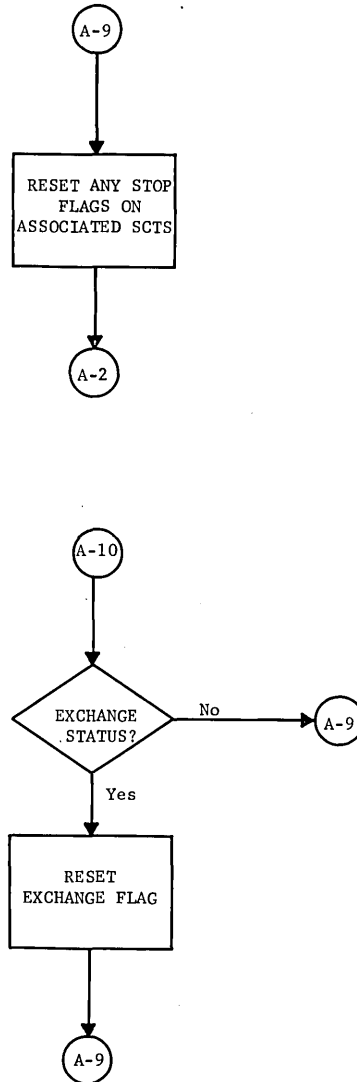
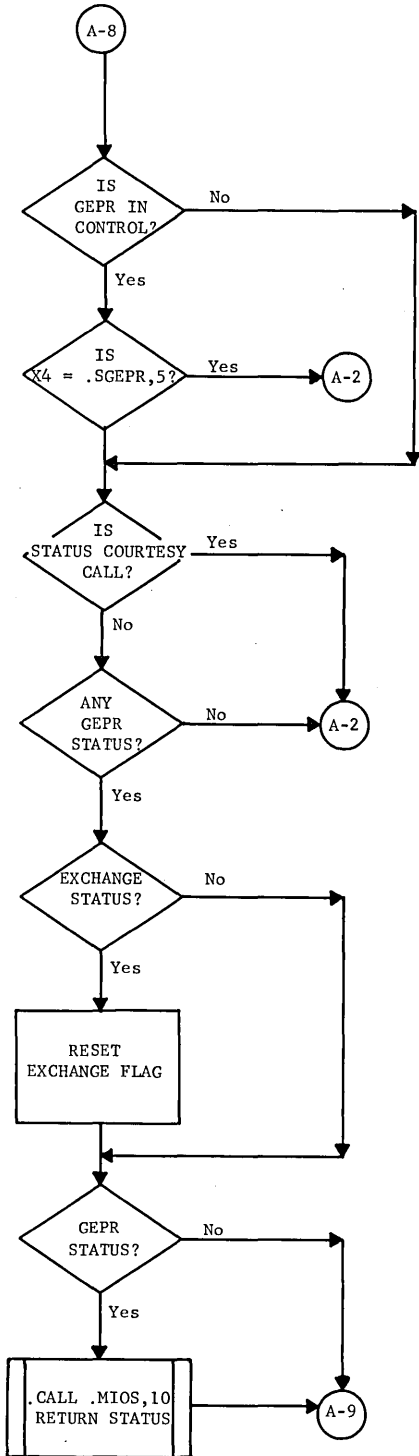

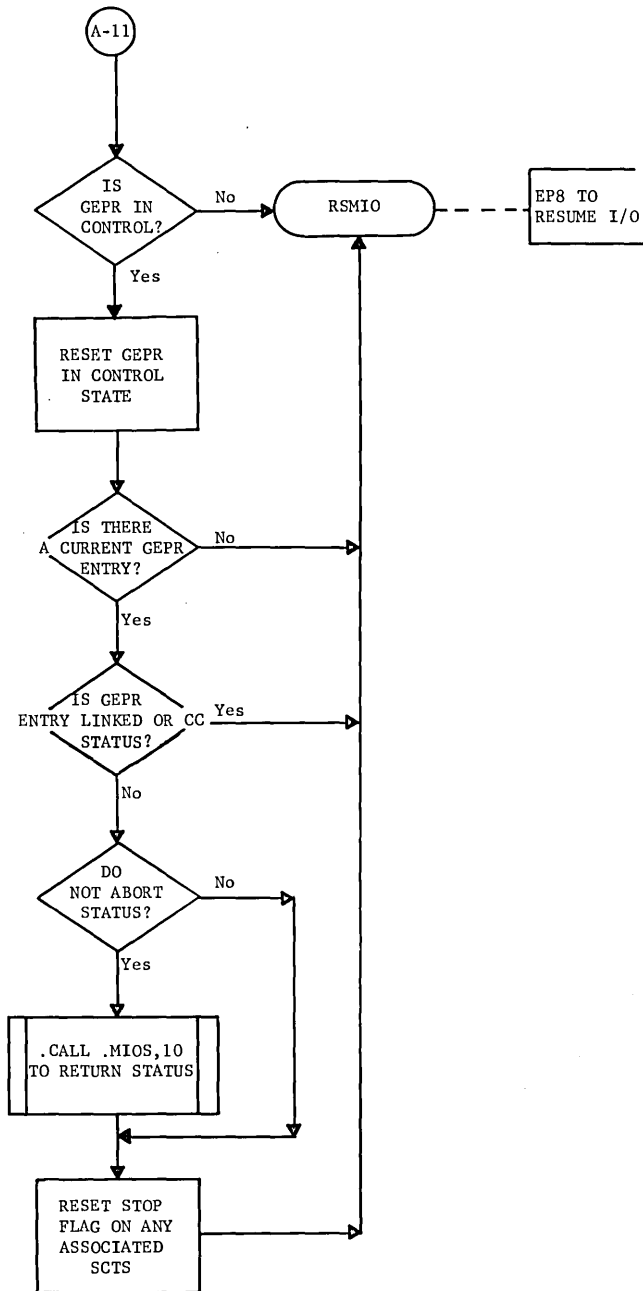

GSTRT (EP10)  
.MIOS

FORMAT I/O STATUS WORDS AND RETURN STATUS

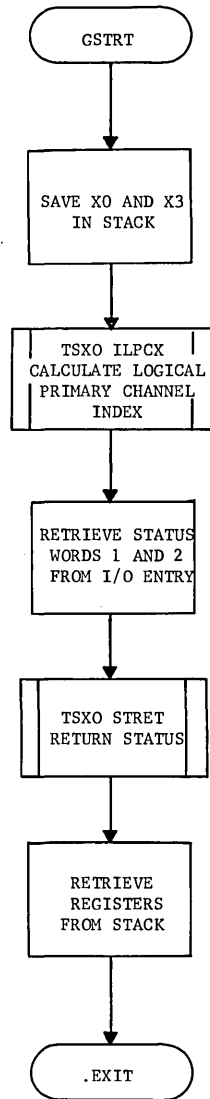

RESUME I/O ON CHANNEL

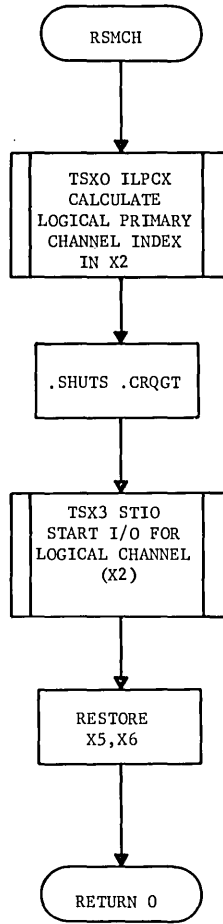

ACTFL (EP13)  
.MIOS

### ACCOUNTING FILE REQUEST

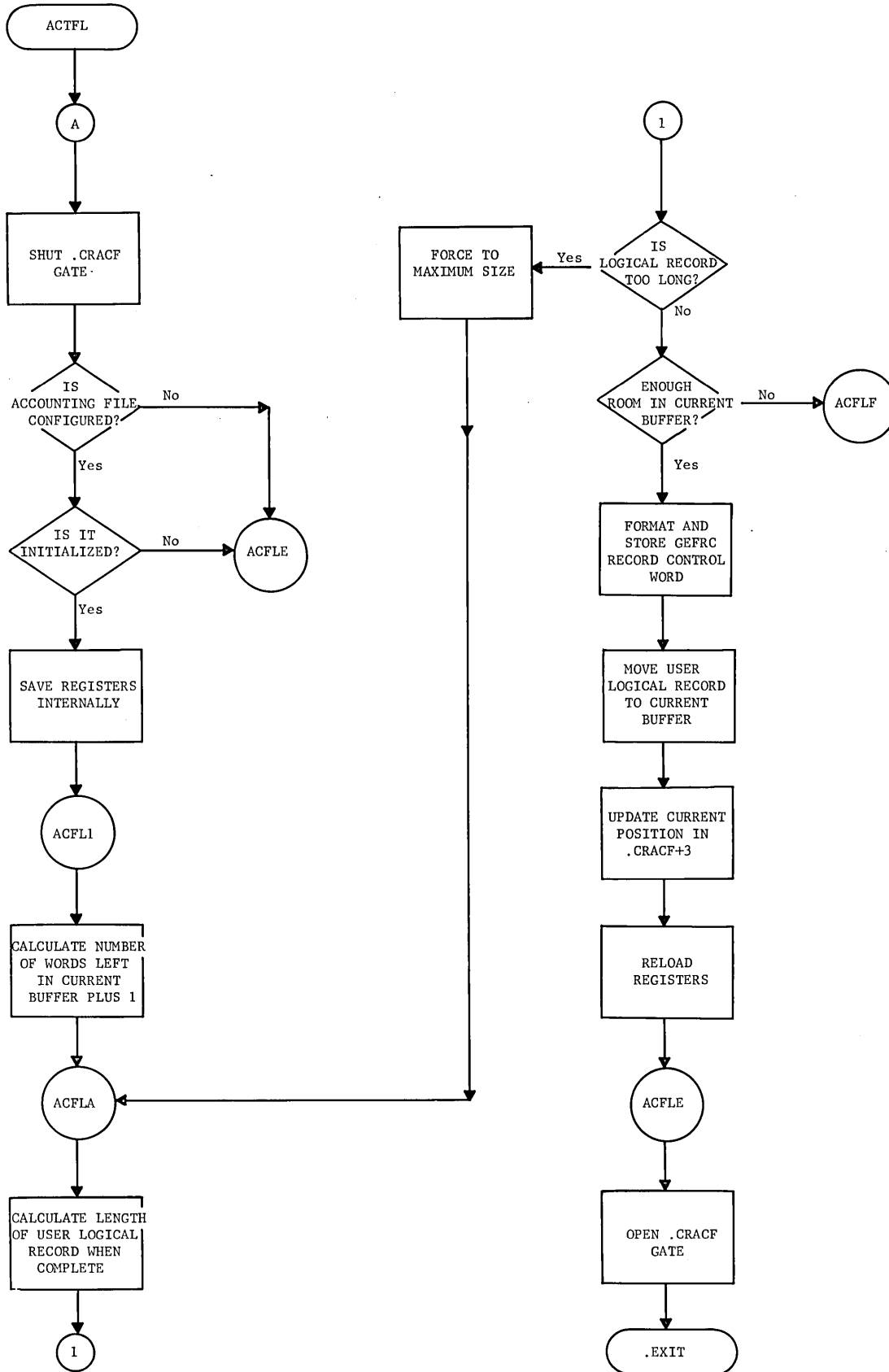

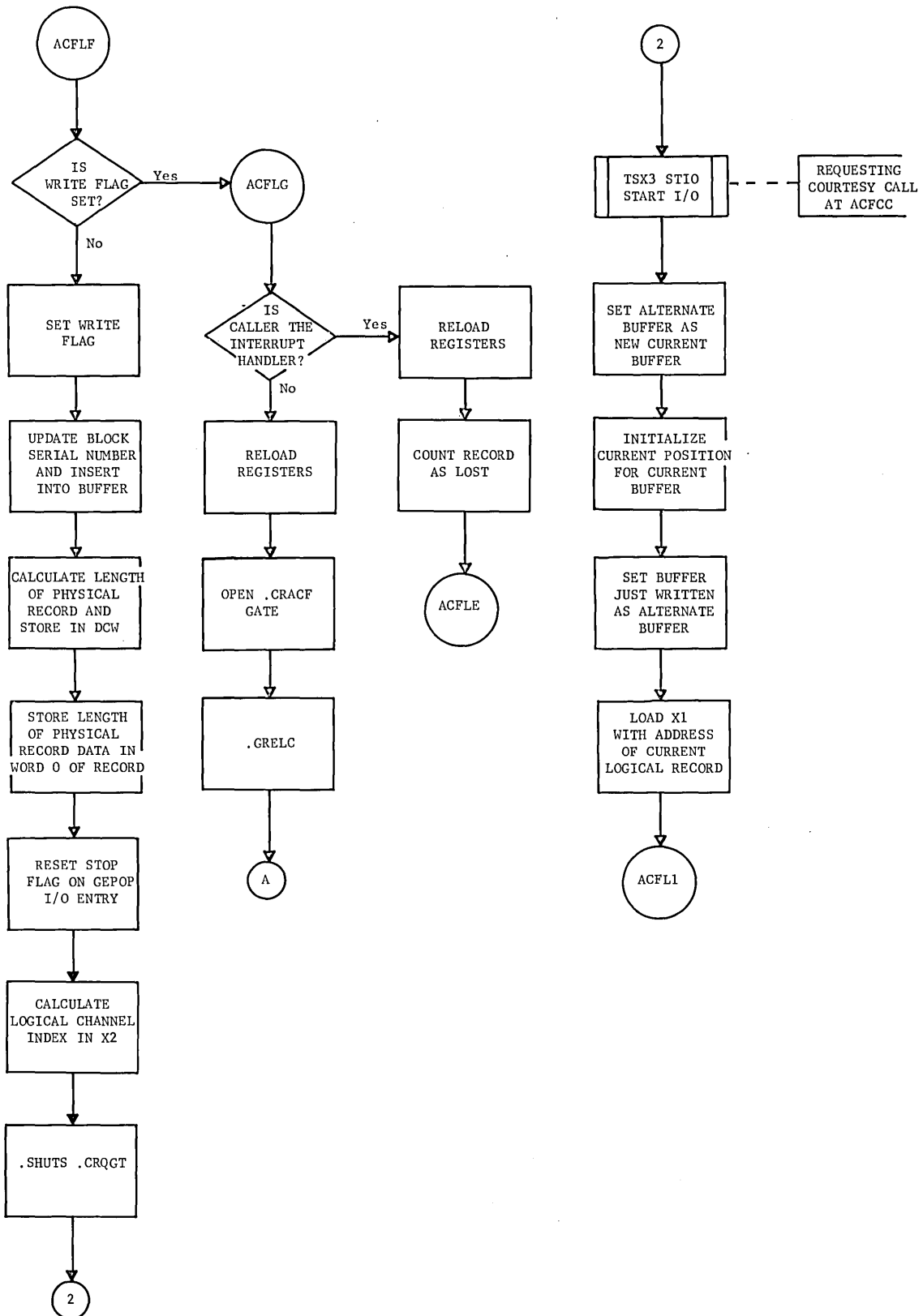



ACTFL (EP13)  
.MIOS

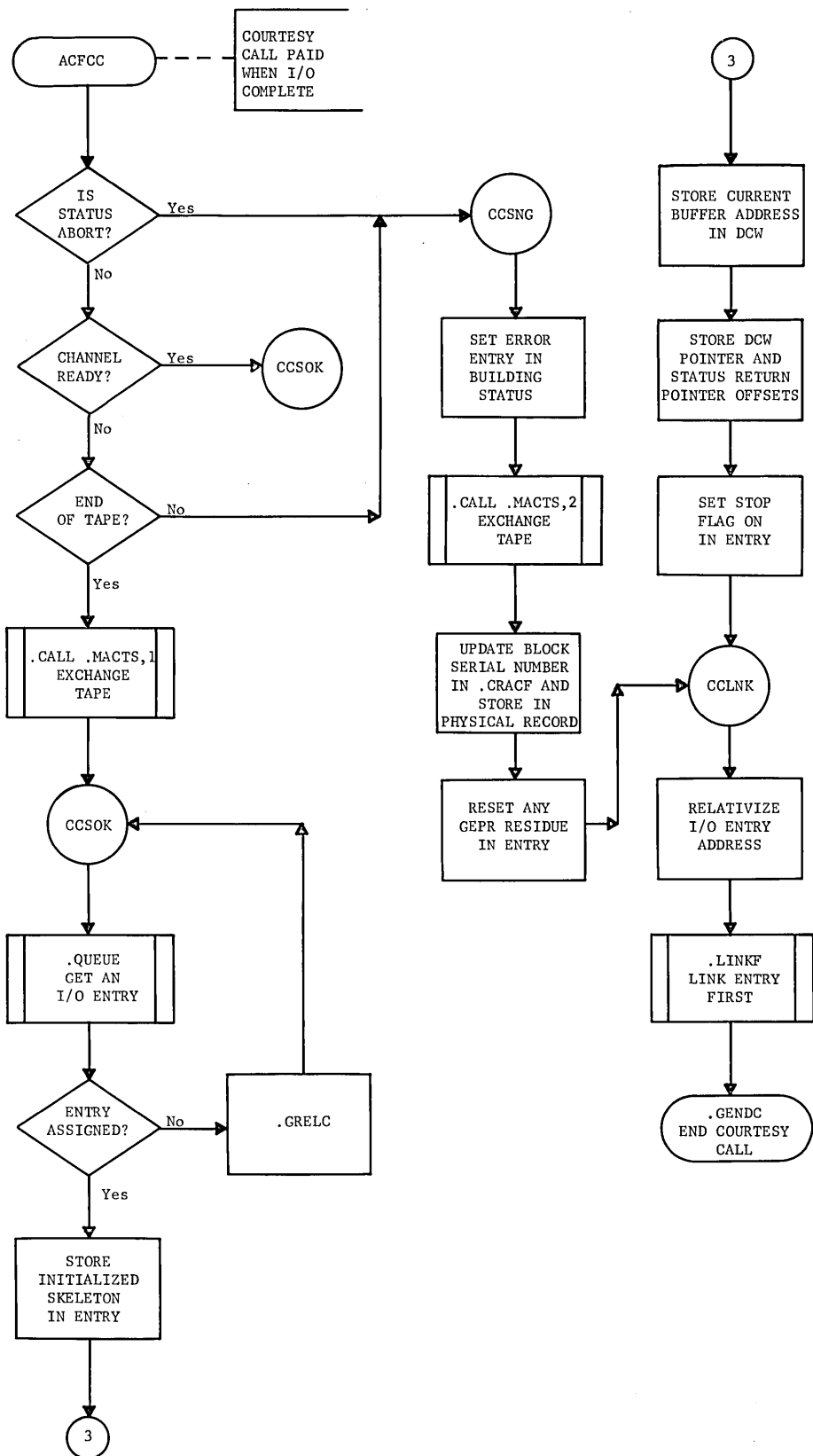

### MAIN IOS MODULE INITIALIZATION

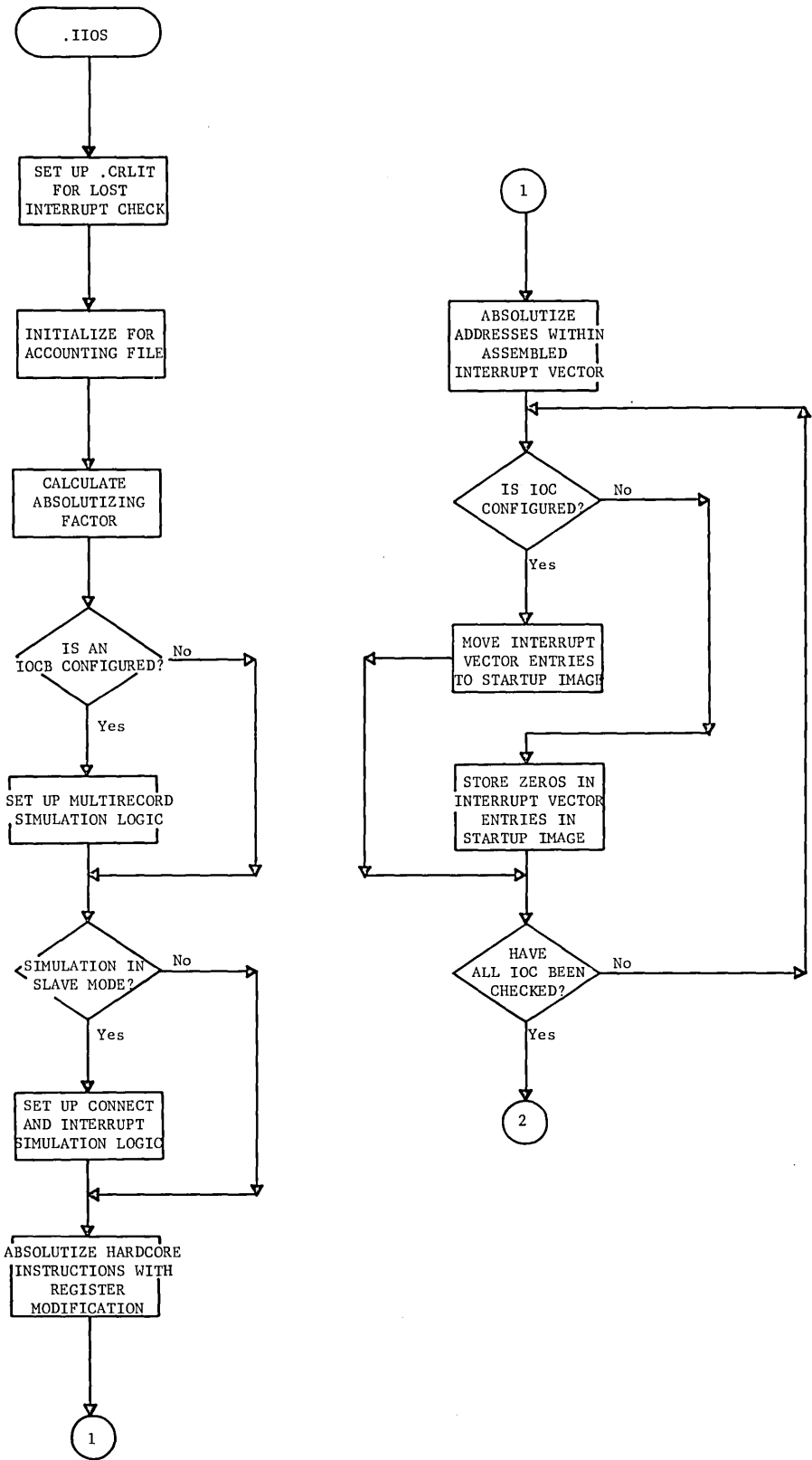

.IIOS  
.MIOS

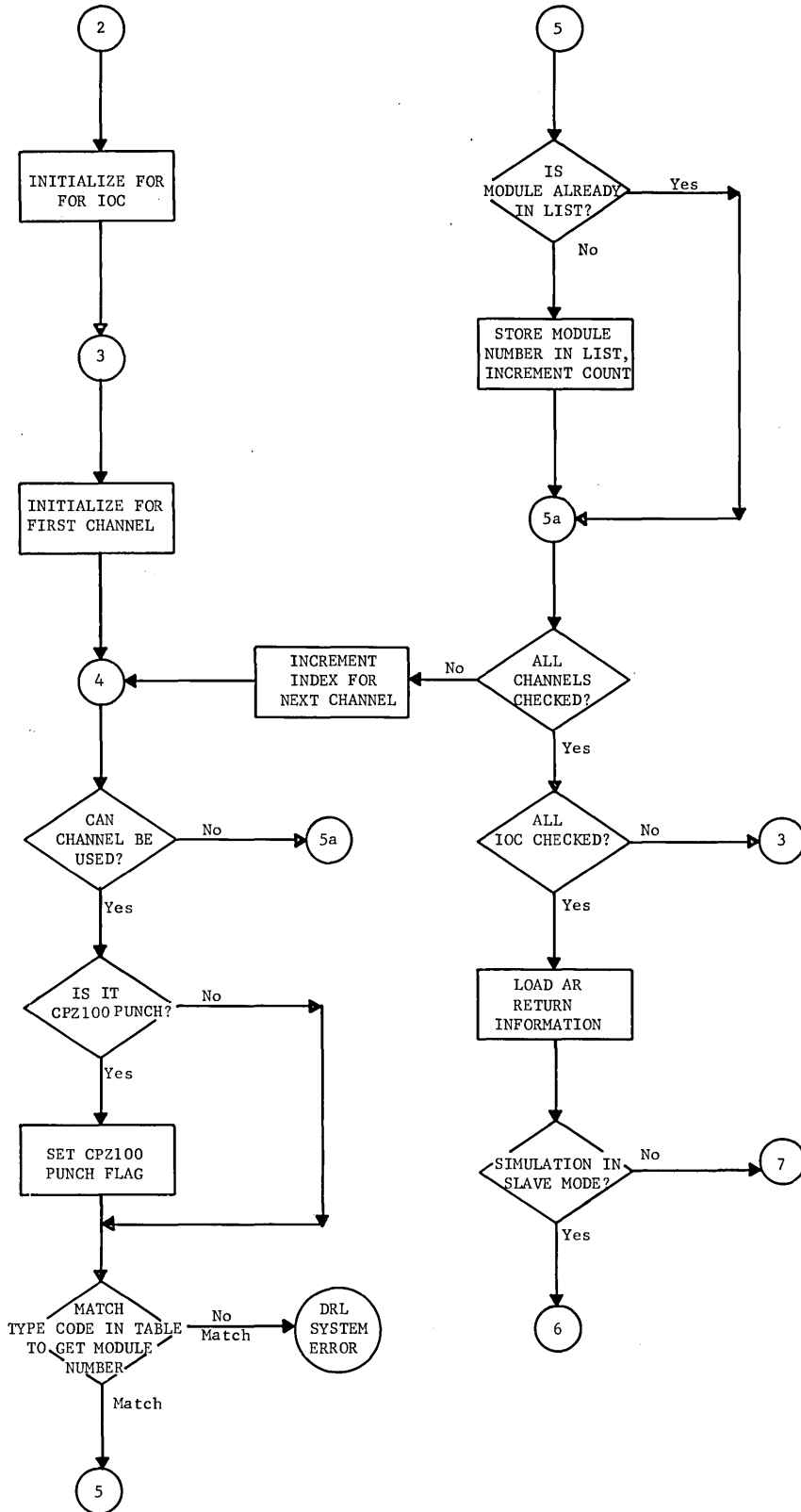

.IIOS  
.MIOS

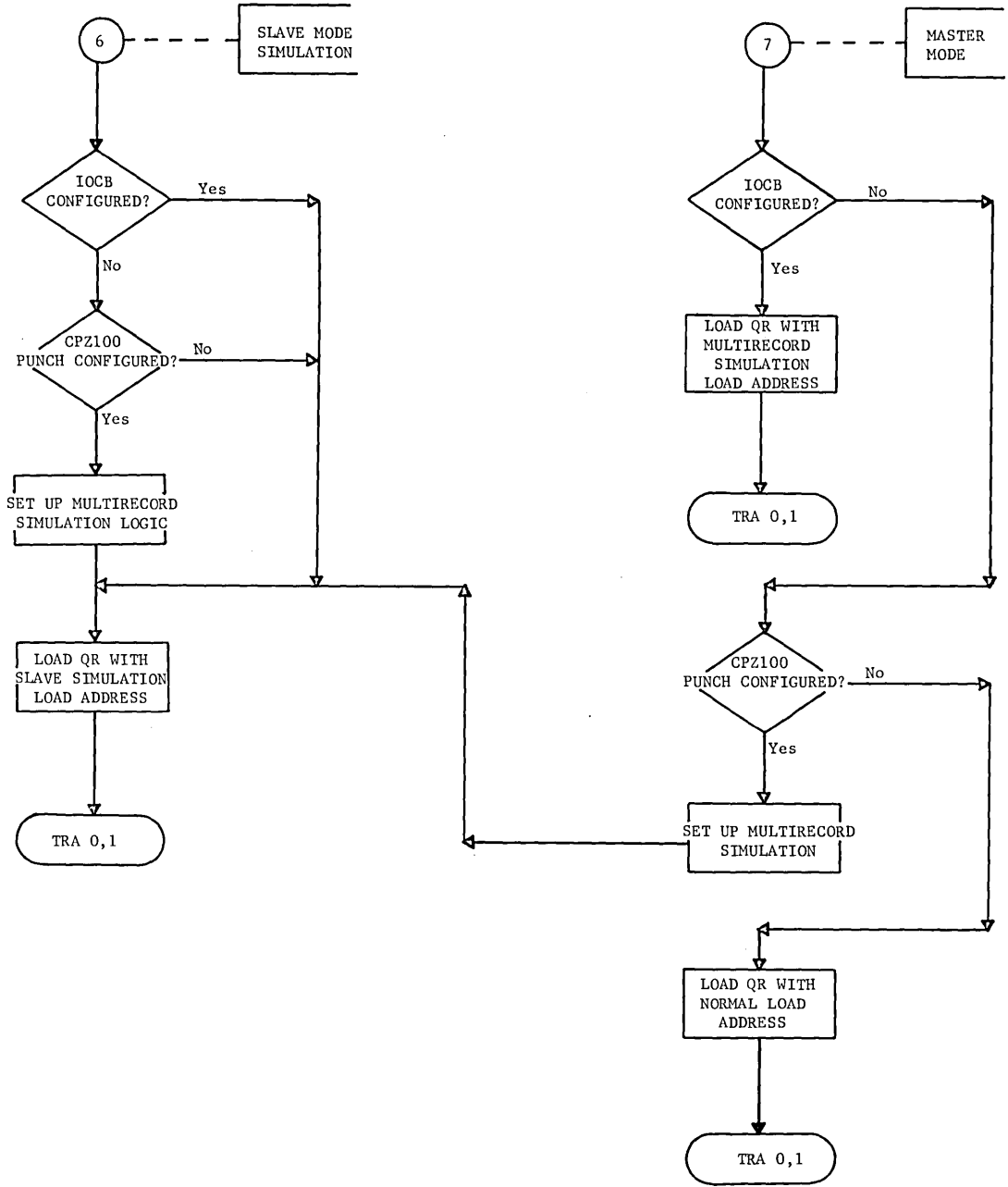

CPIT (EP1)  
.MCPIO

CARD PUNCH INTERRUPT HANDLER

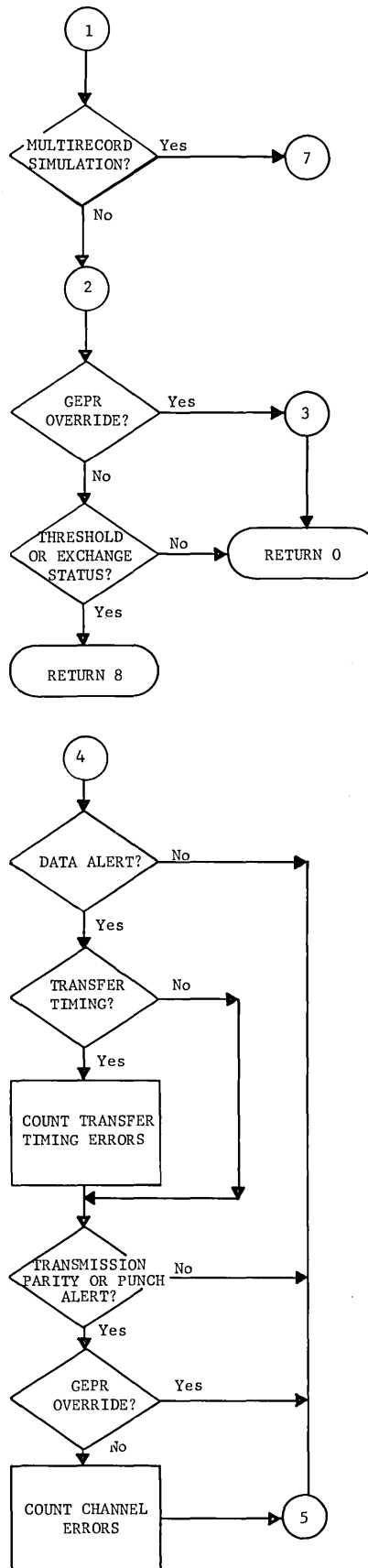
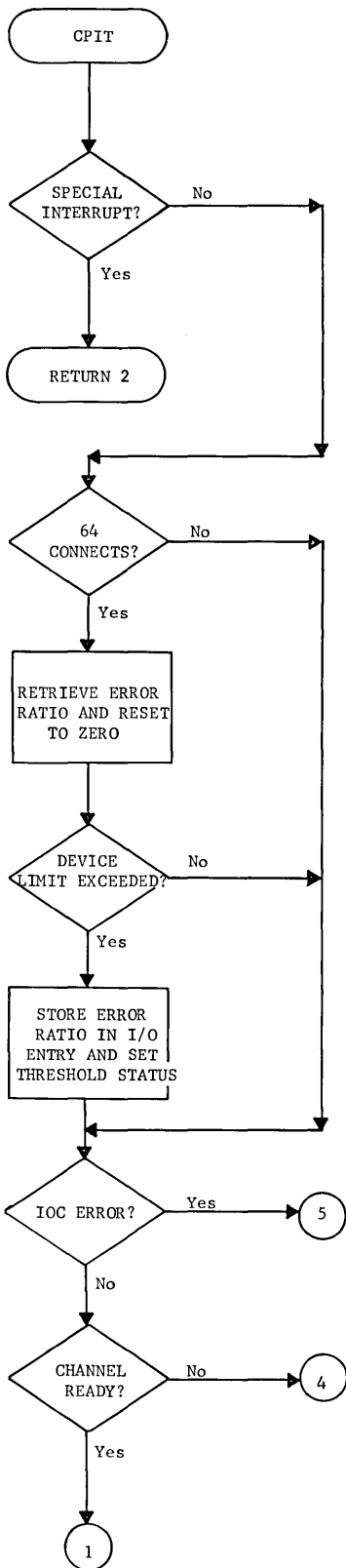

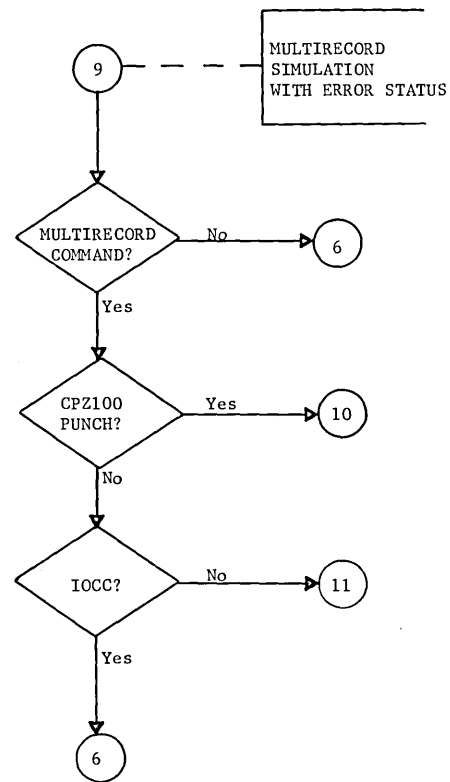
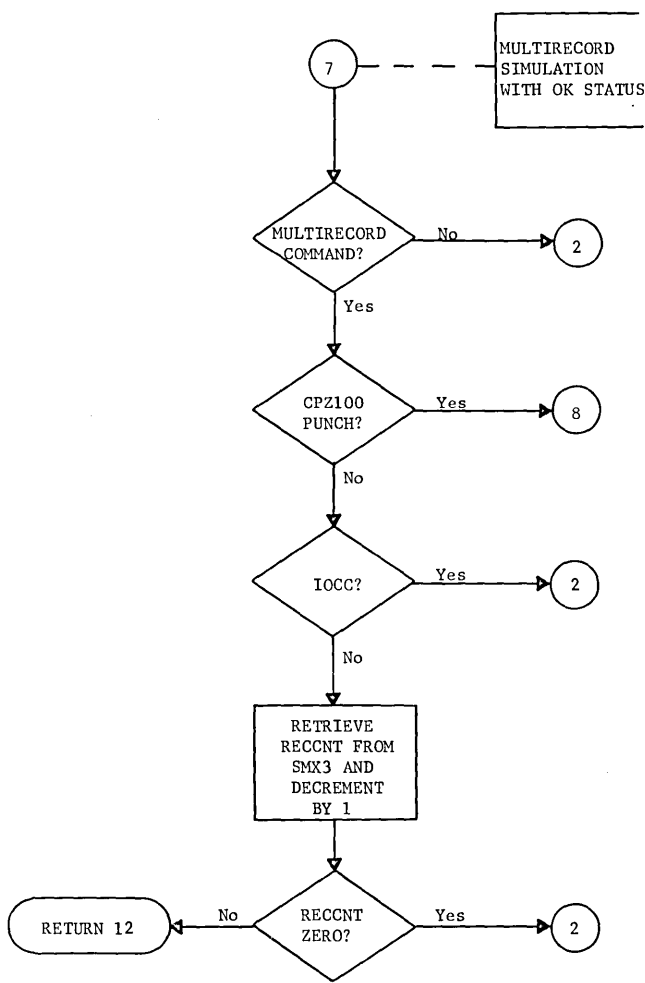
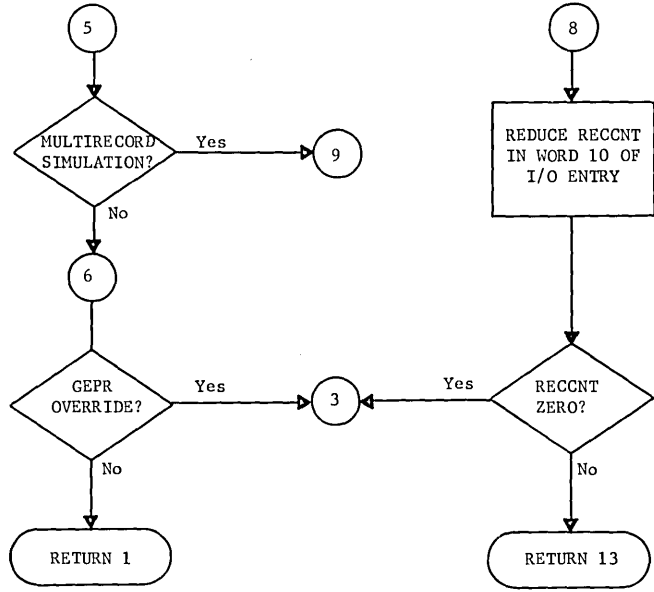

CPIT (EP1)  
.MCPIO

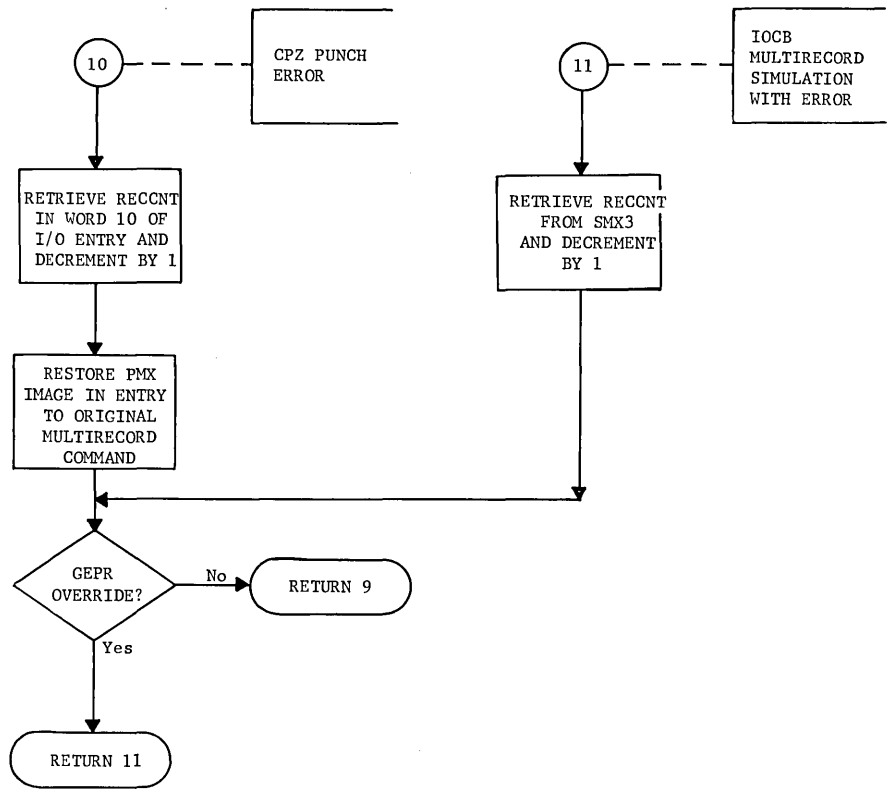

CPIO (EP2)  
.MCPIO

### CARD PUNCH REQUEST

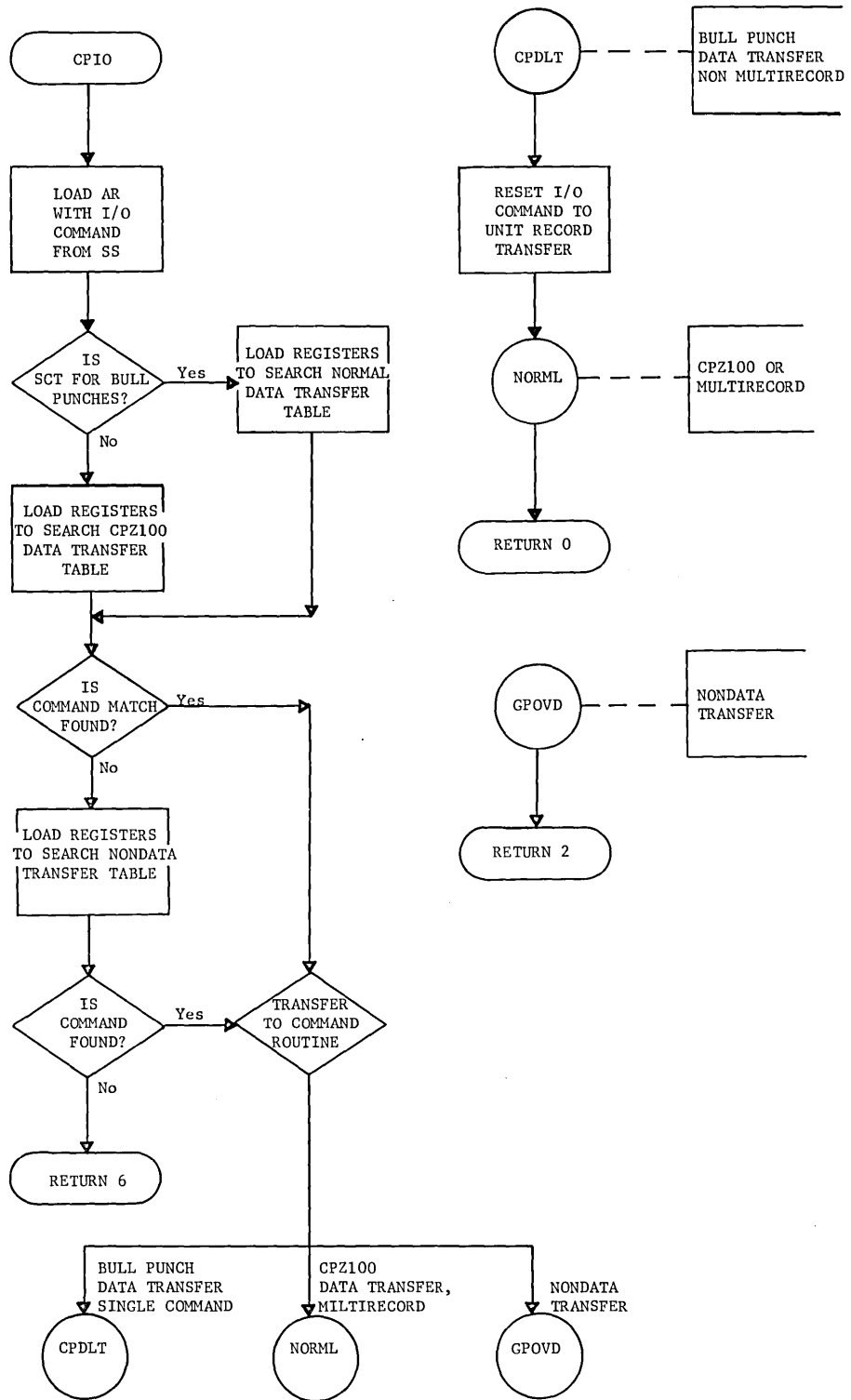



.ICPIO  
.MCPIO

### CARD PUNCH INITIALIZATION

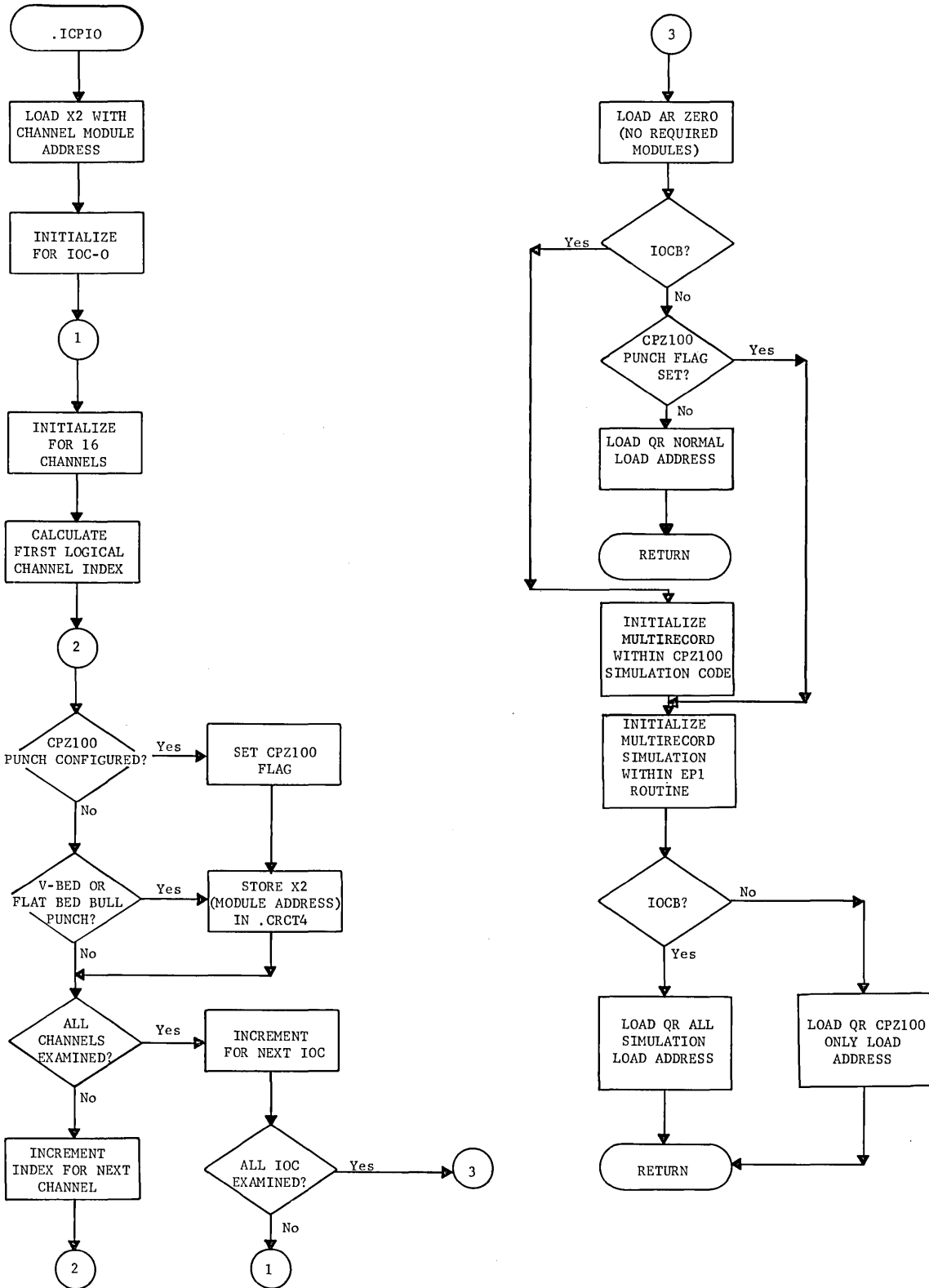

MDS200 INTERRUPT HANDLER

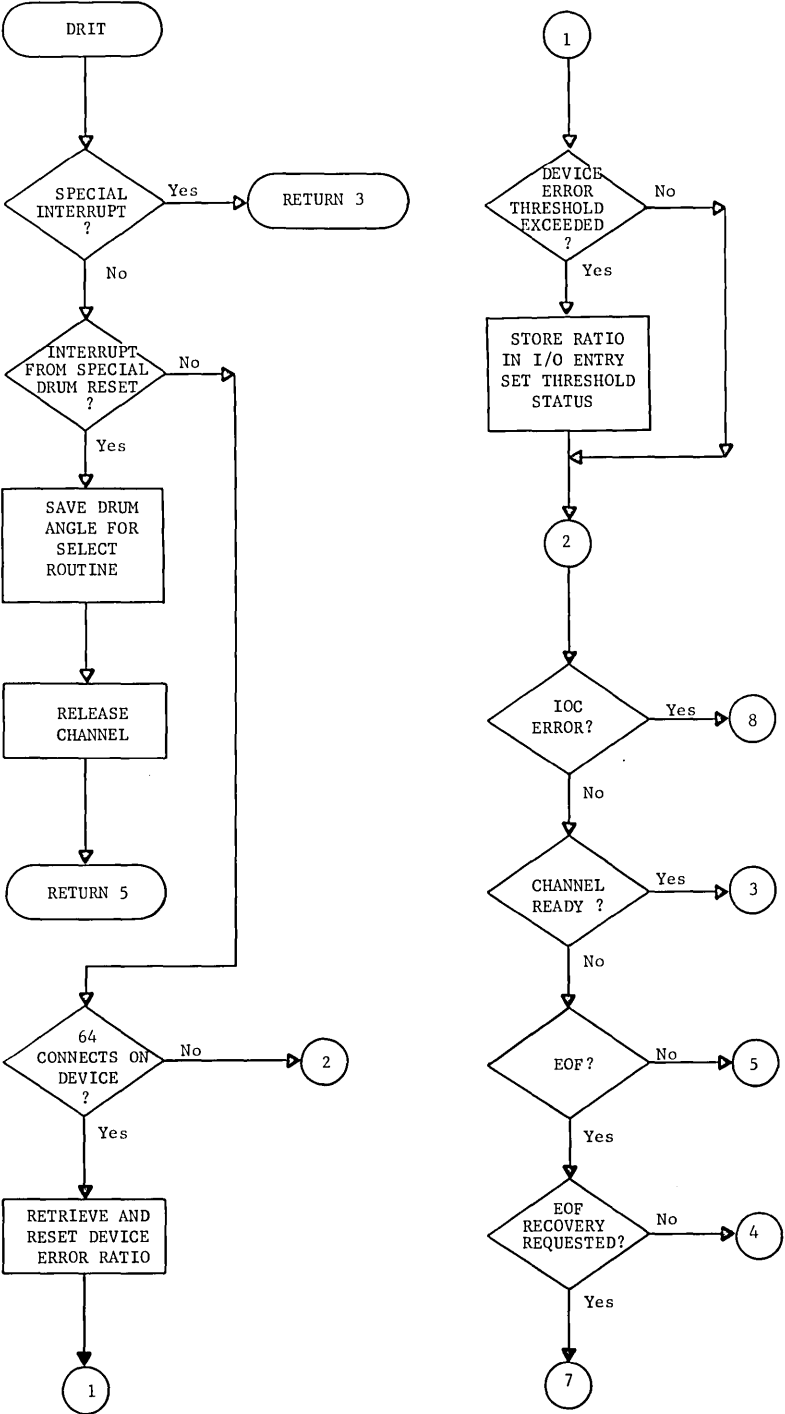

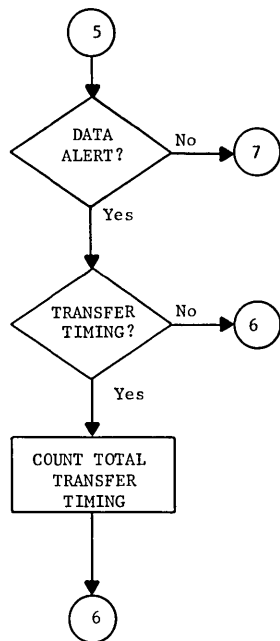
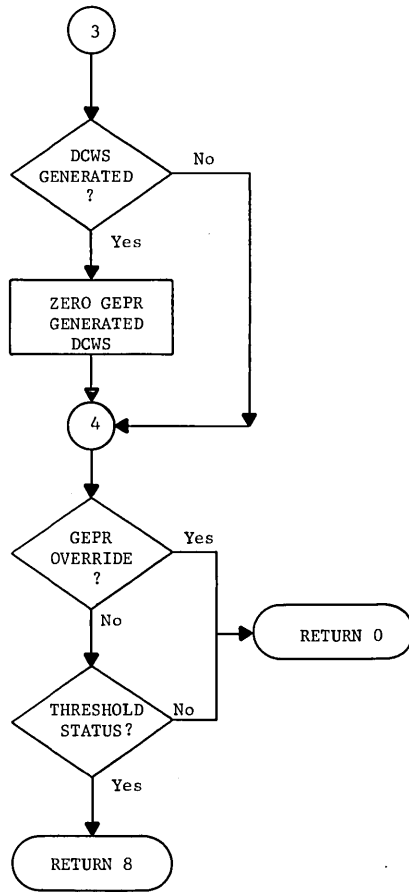

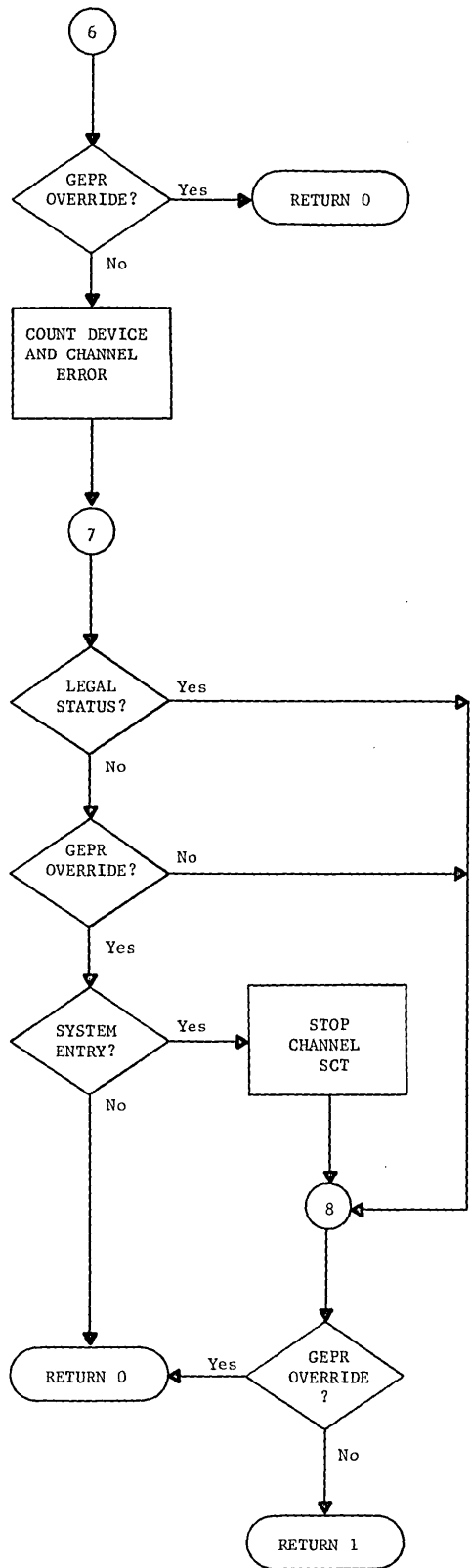

DRIO (EP2)  
.MDR20

MDS200 REQUEST

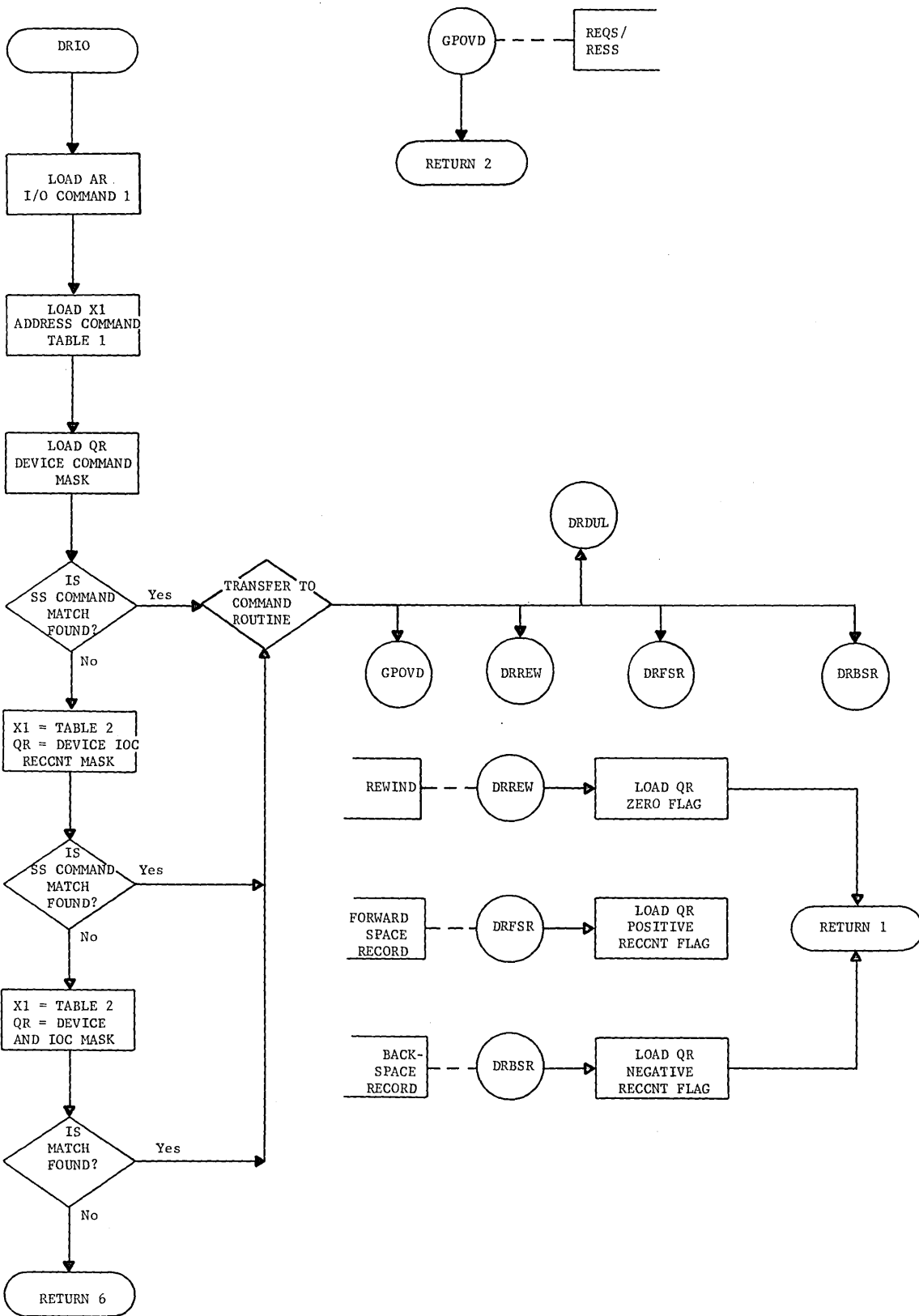

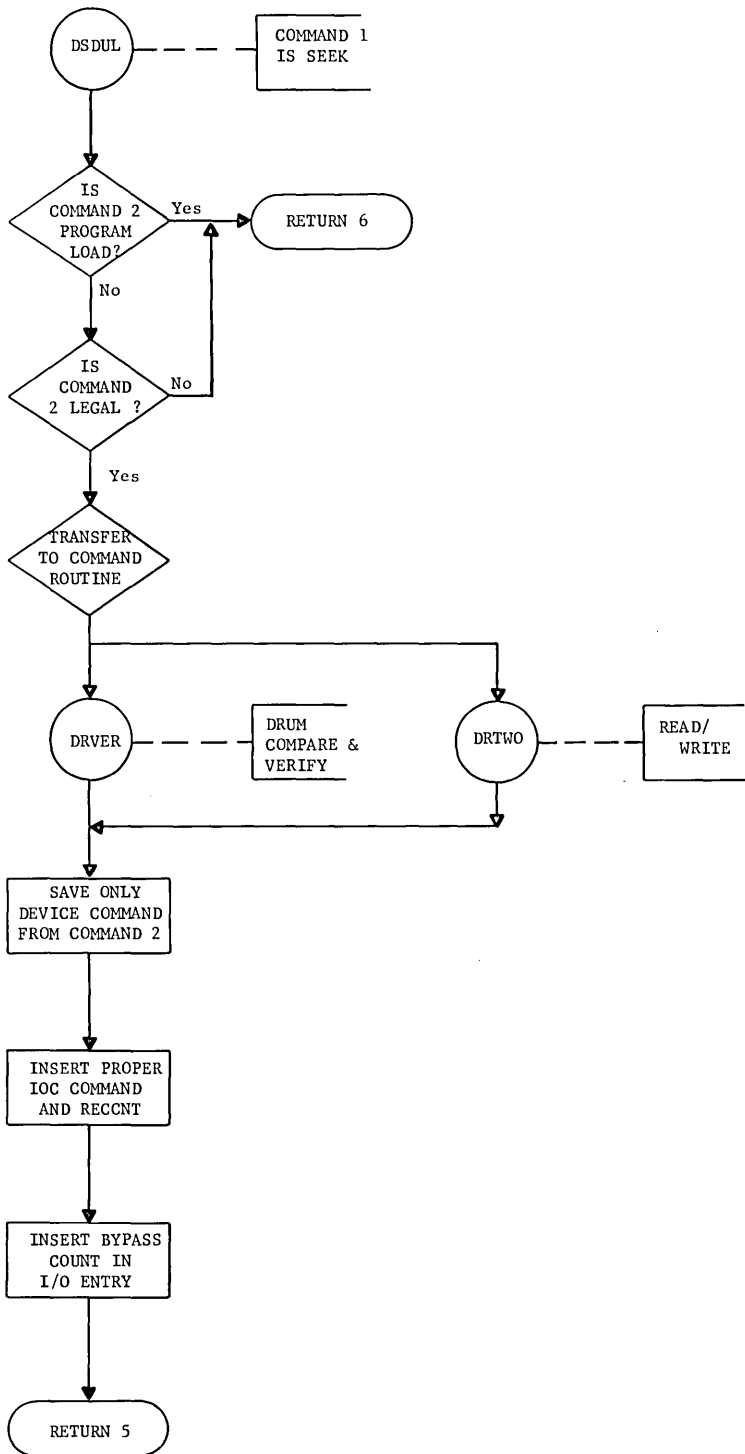

DRSL (EP3)  
.MDR20

### MDS200 SELECT

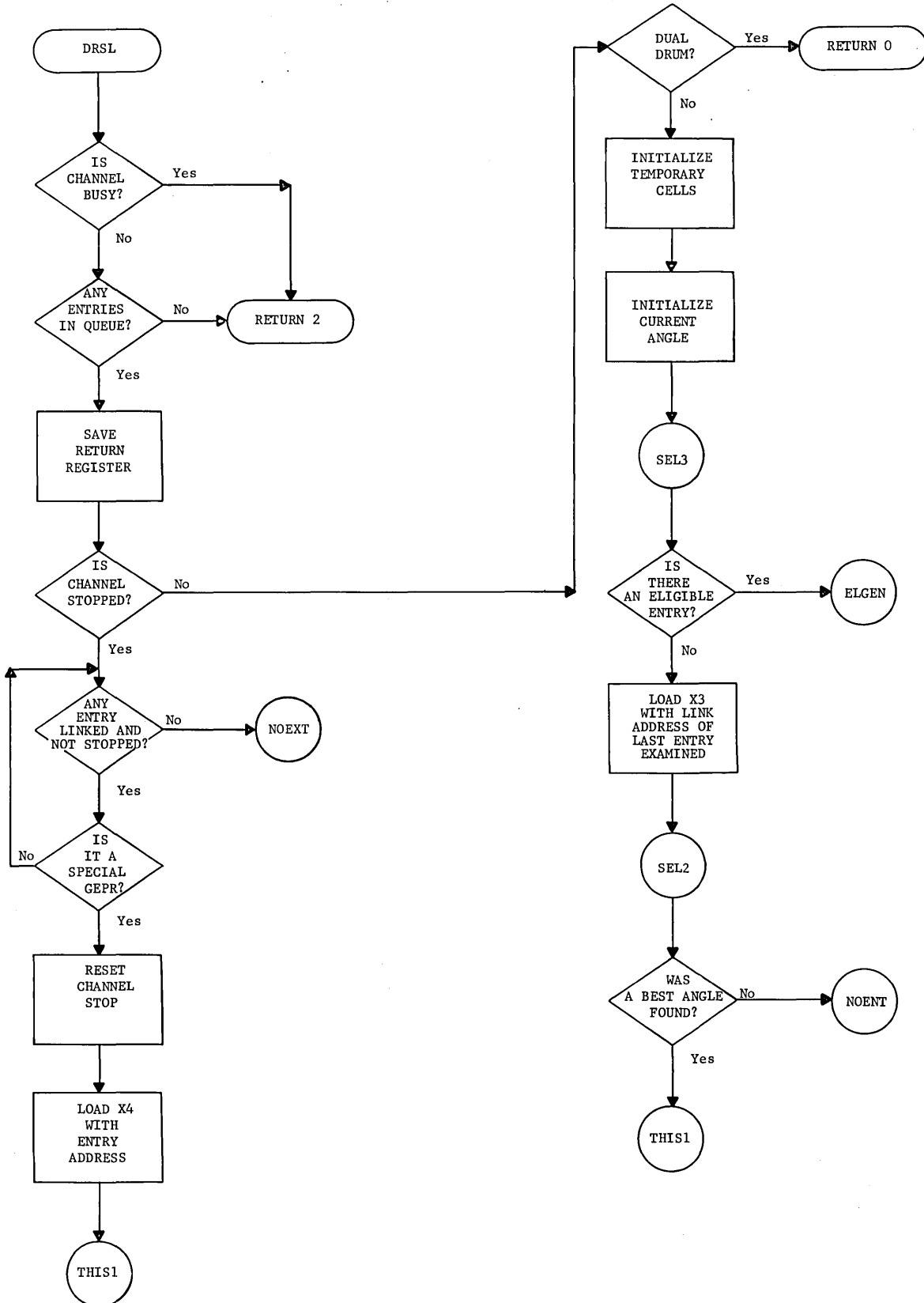

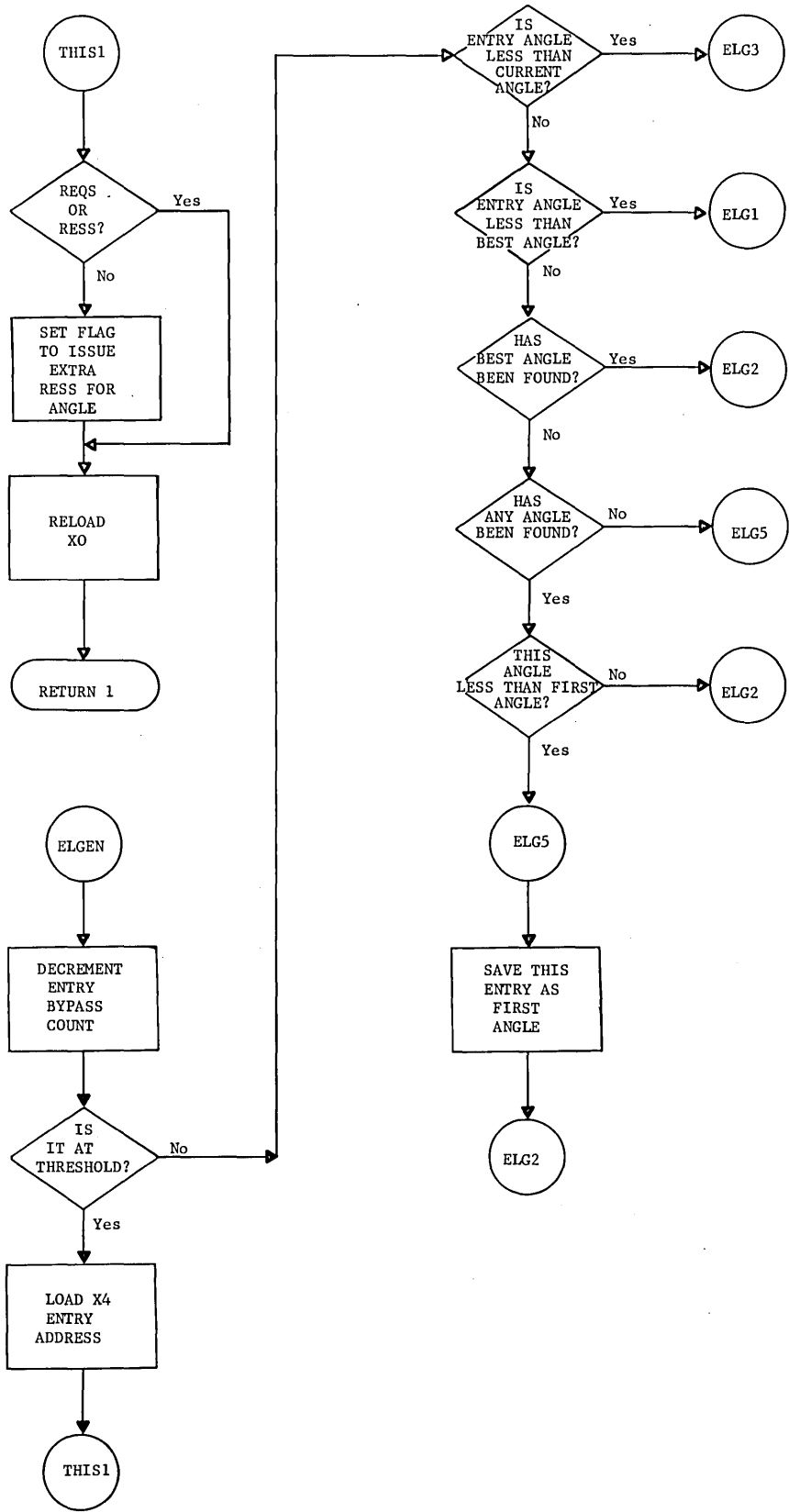



DRSL (EP3)  
.MDR20

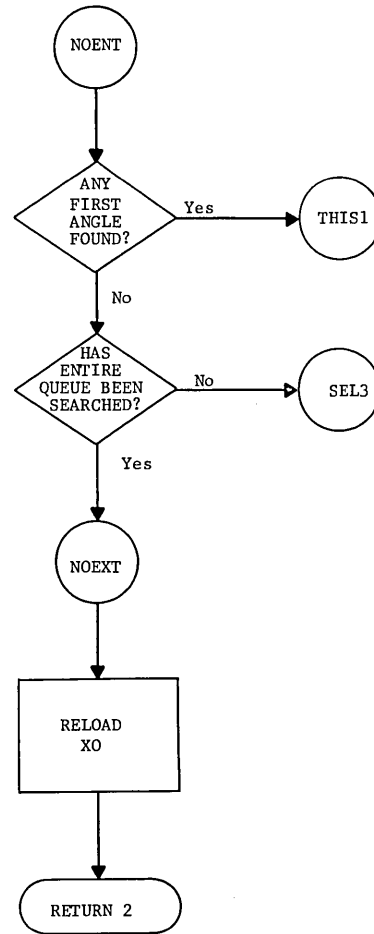
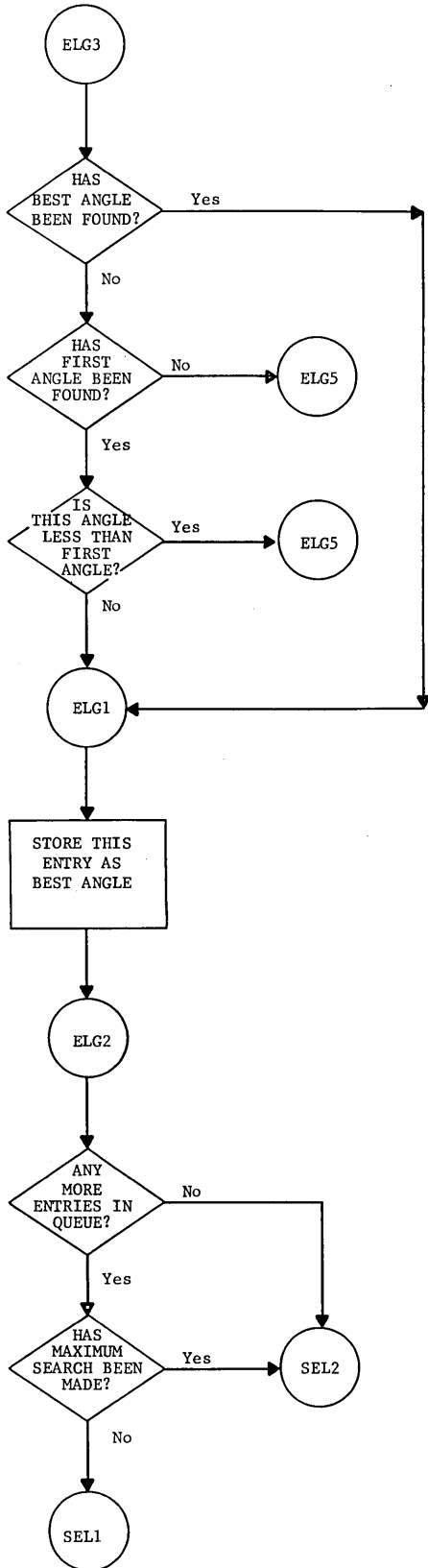

MDS200 ERROR AND EOF RECOVERY

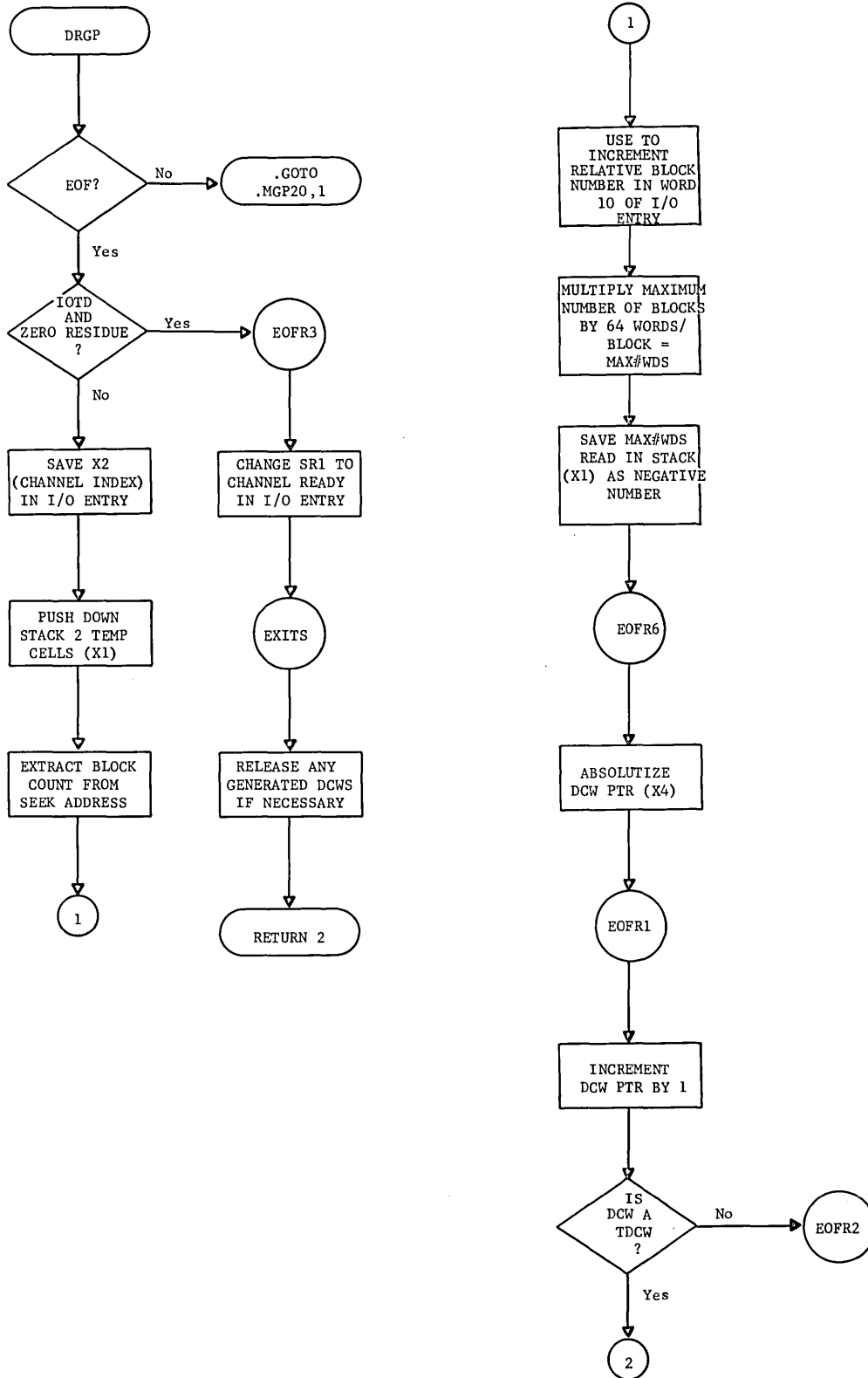

DRGP (EP4)  
.MDR20

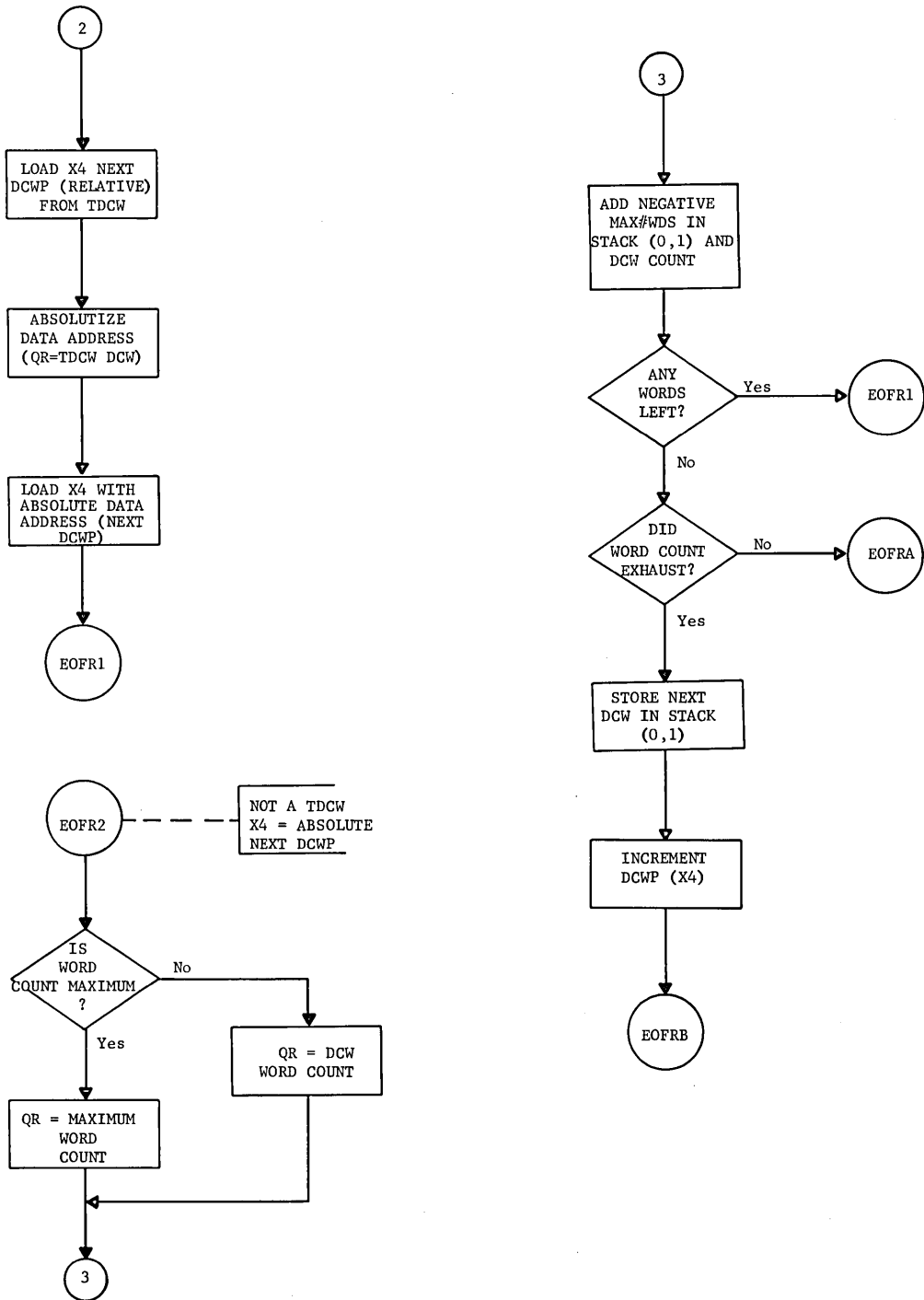

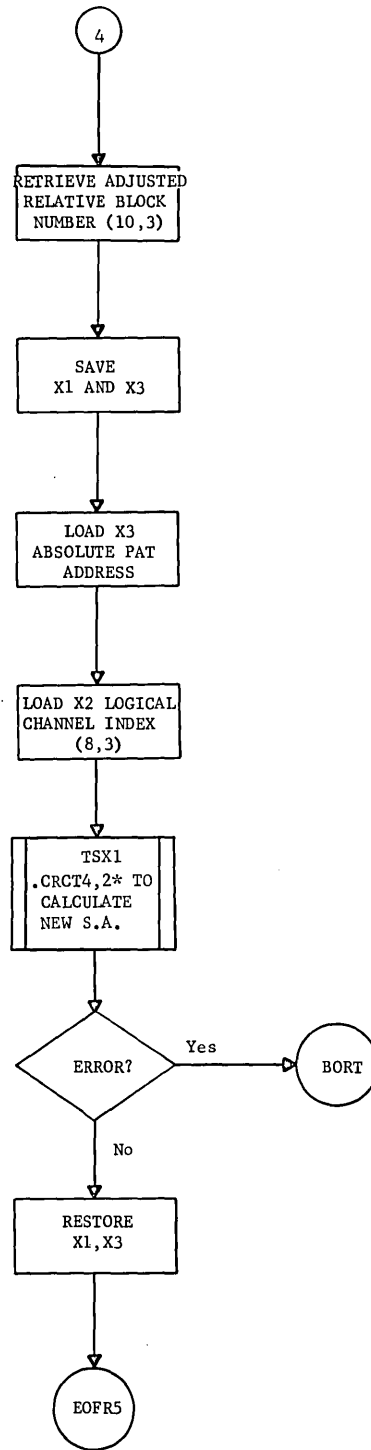
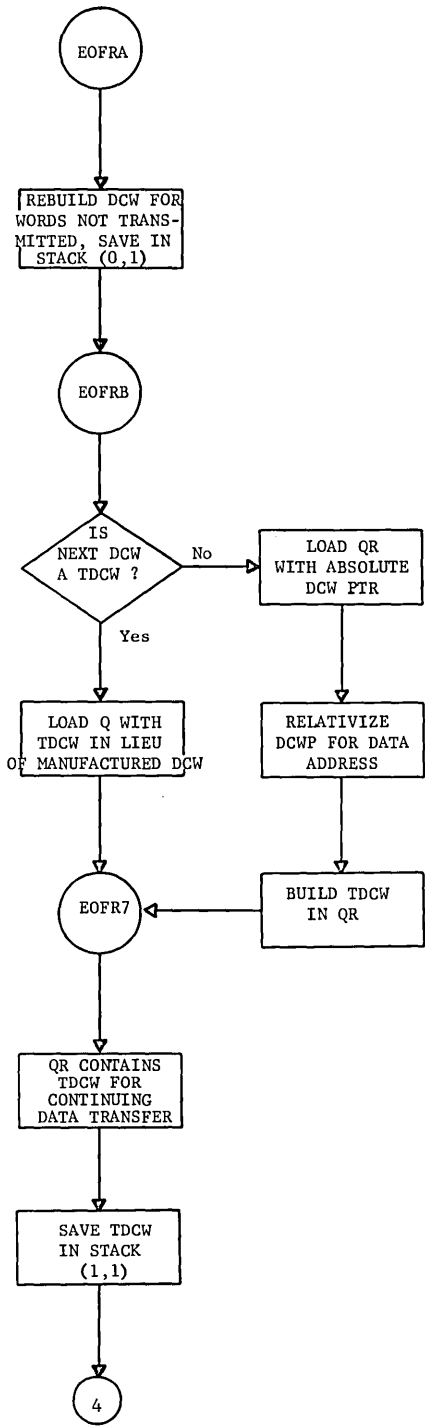

DRGP (EP4)  
.MDR20

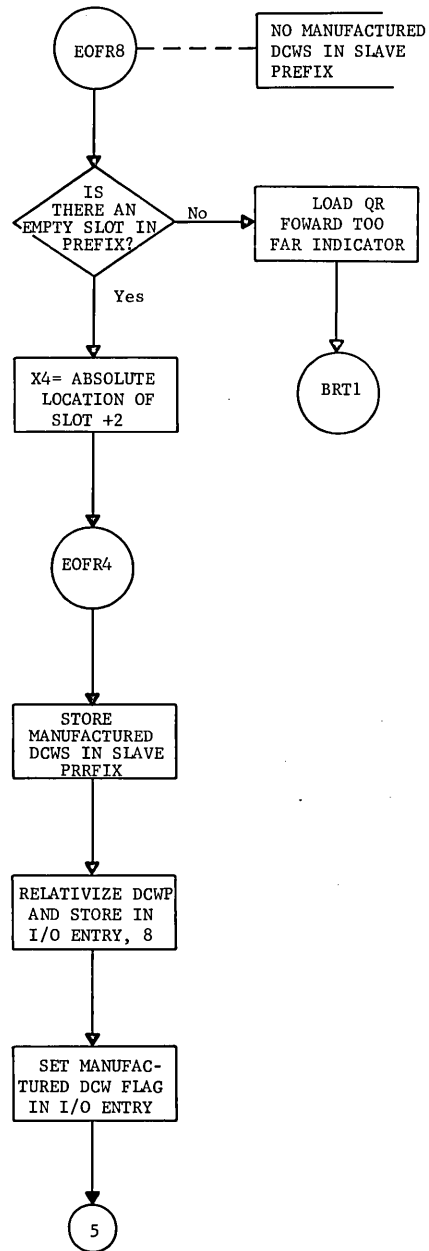
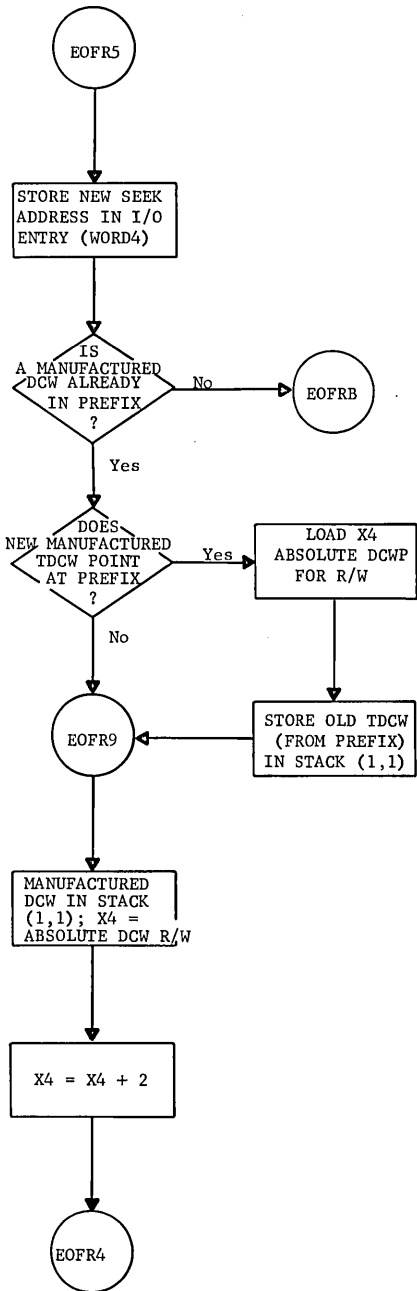

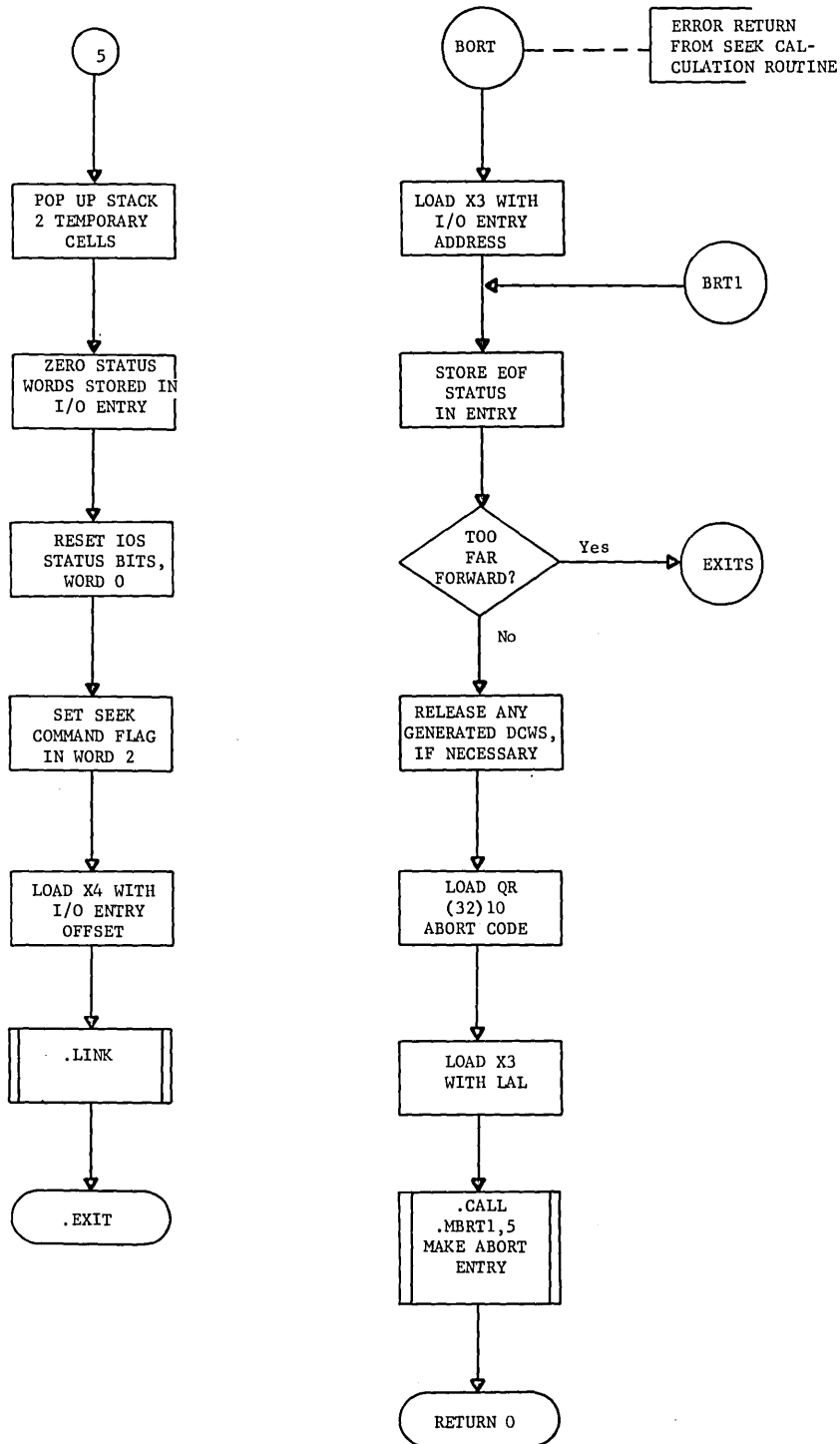

NEGATIVE EP  
.MDR20

MDS200 NEGATIVE ENTRY POINTS

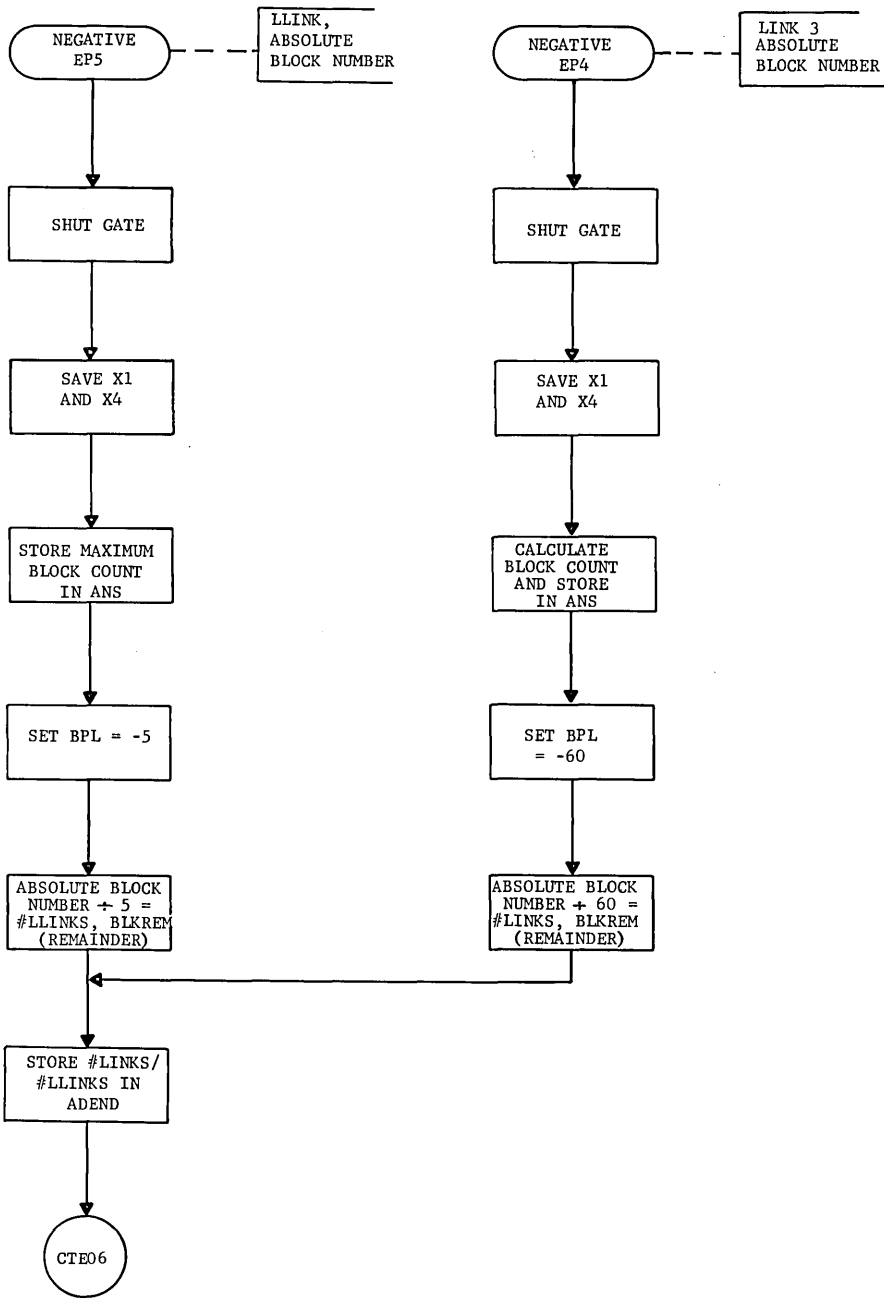

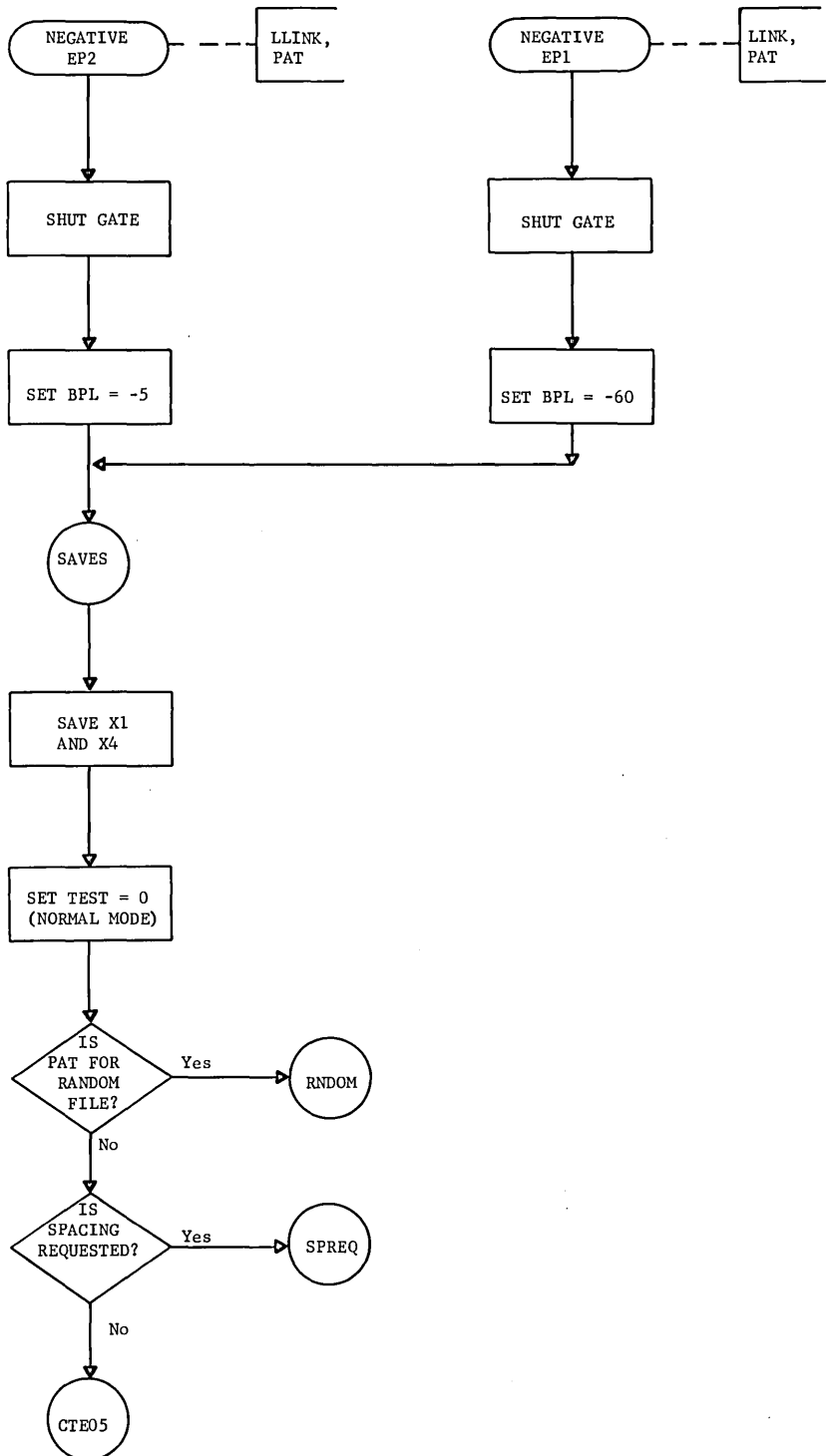



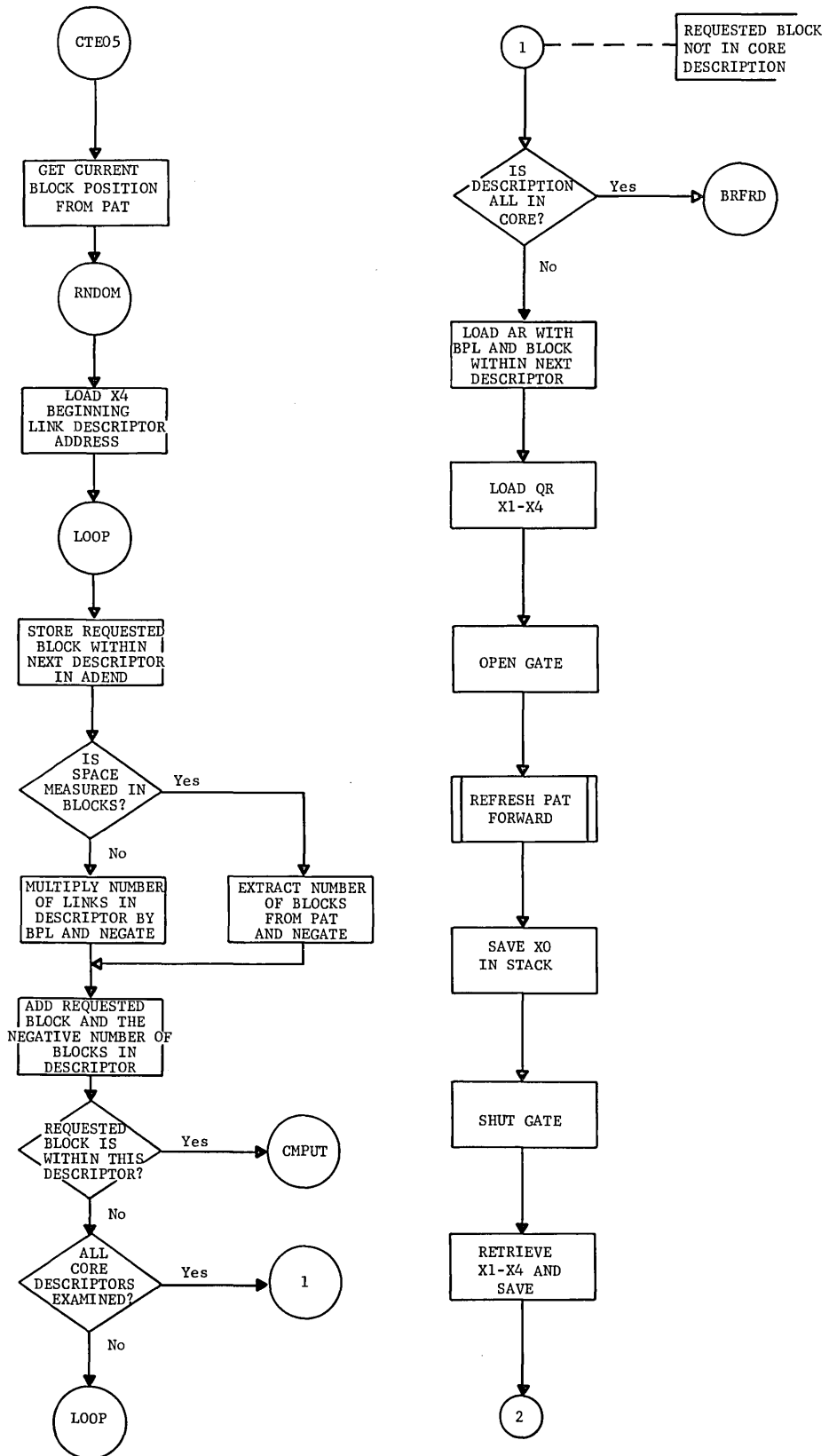

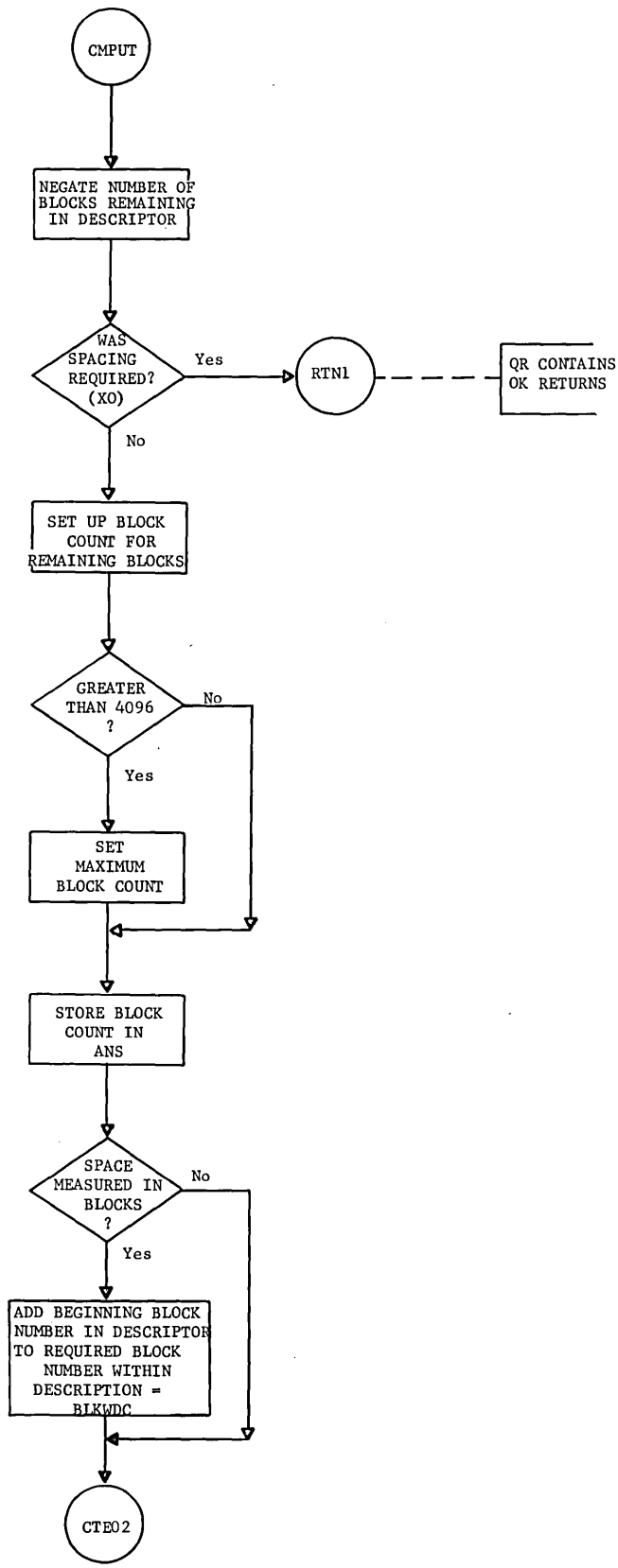
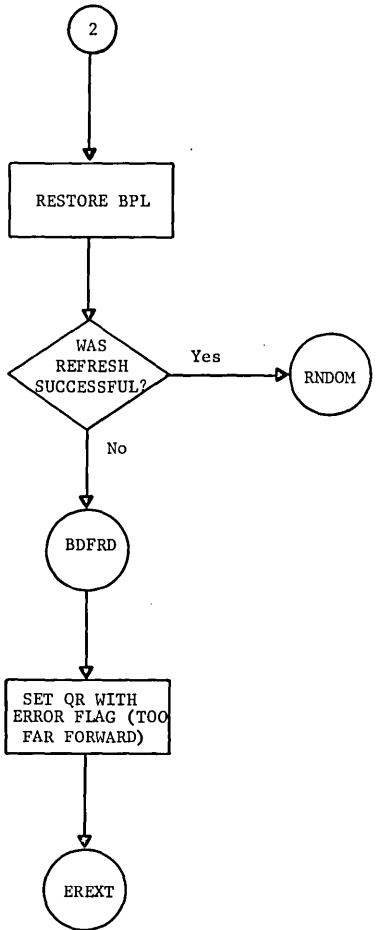

NEGATIVE EP  
.MDR20

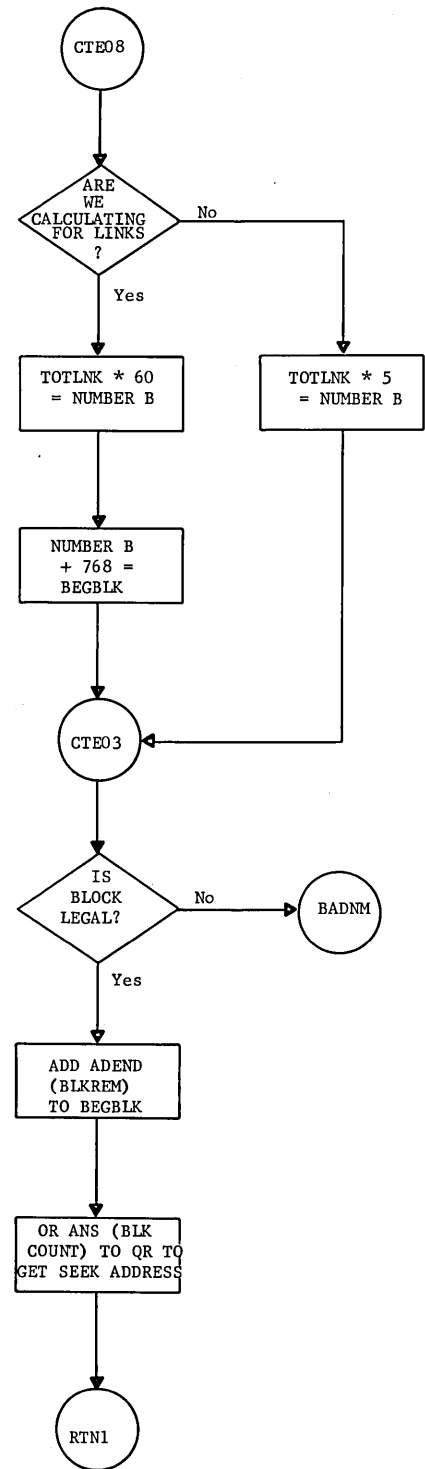
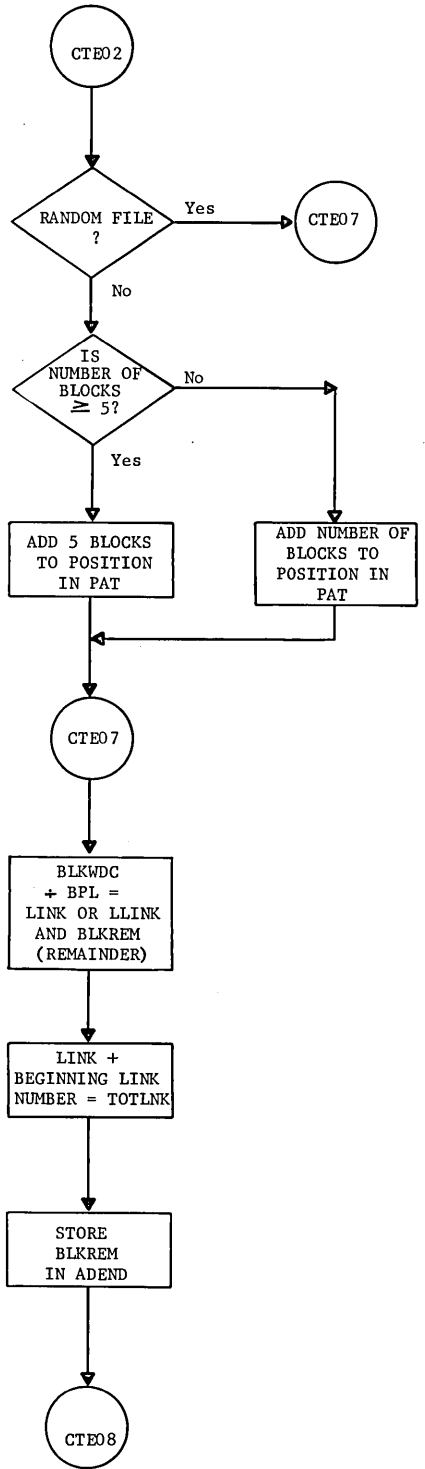

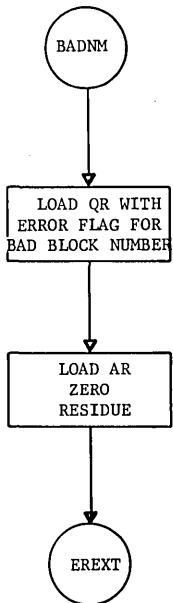
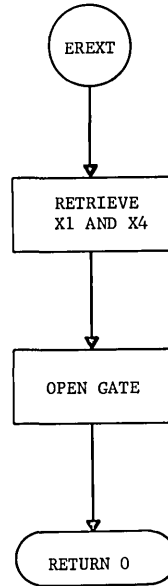
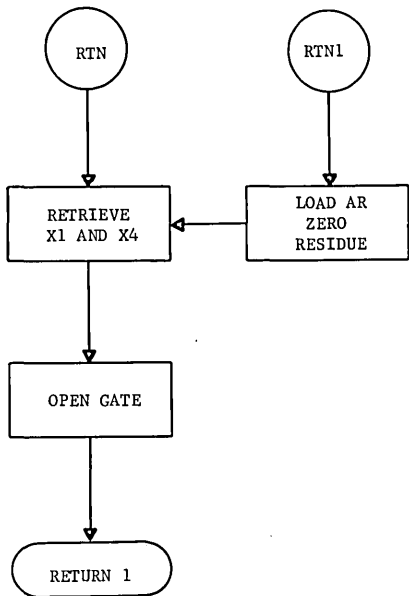

NEGATIVE EF  
.MDR20

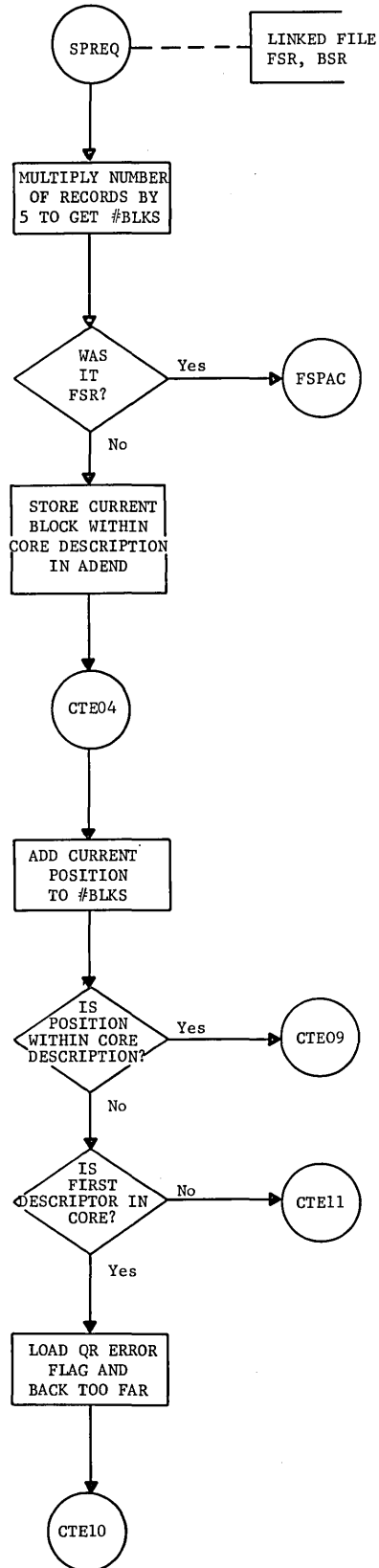

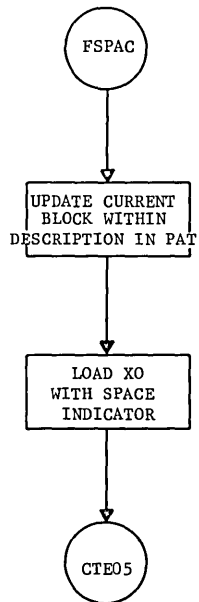
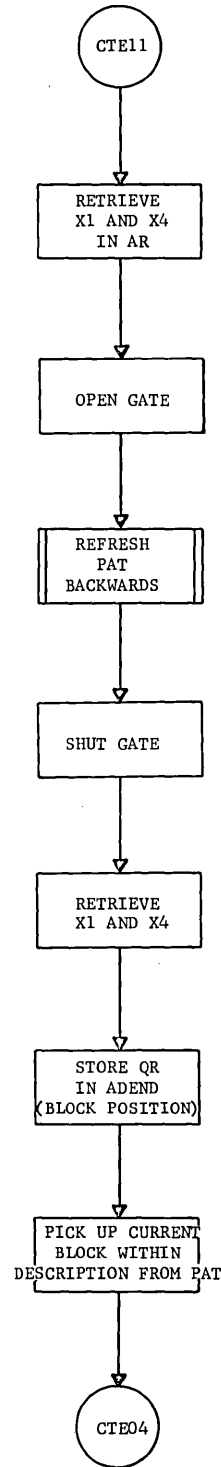
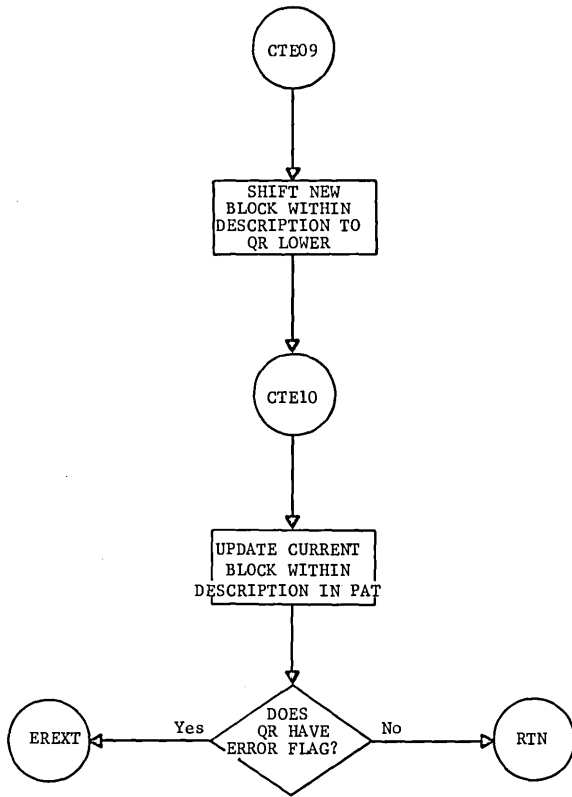

.IDR20  
.MDR20

### MDS200 INITIALIZATION

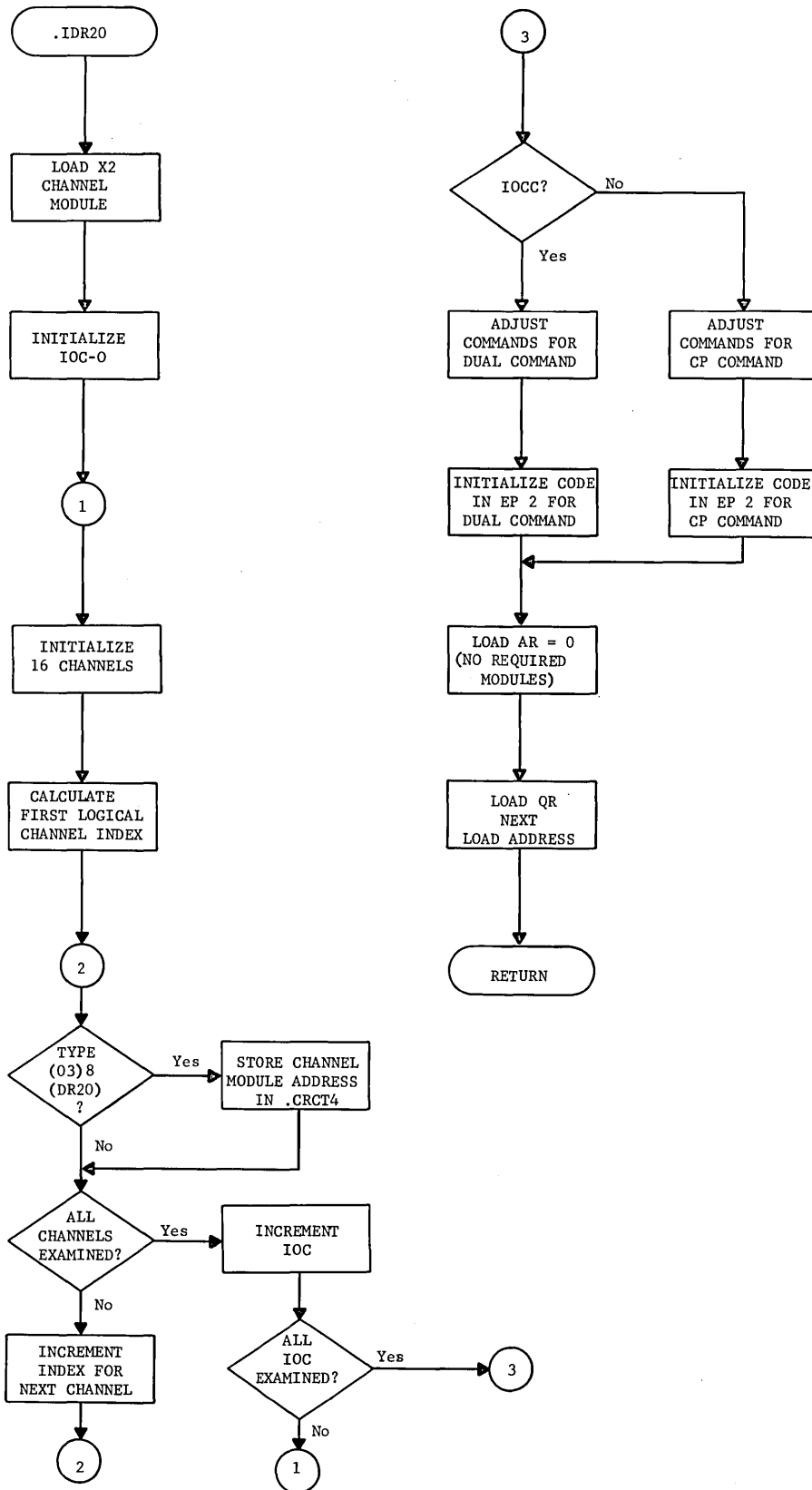

DSU200 INTERRUPT HANDLER

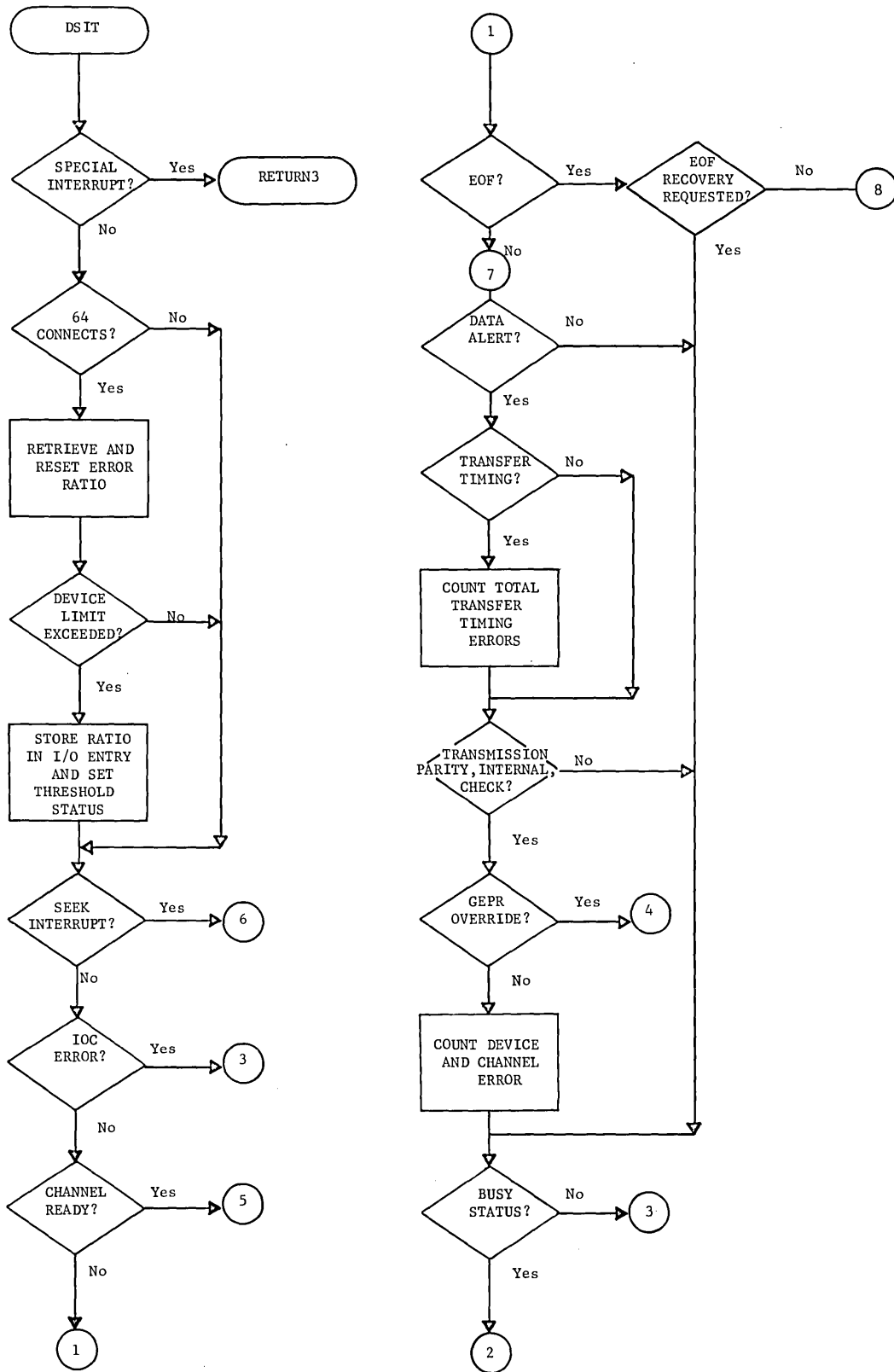



DSIT (EP1)  
.MDR20

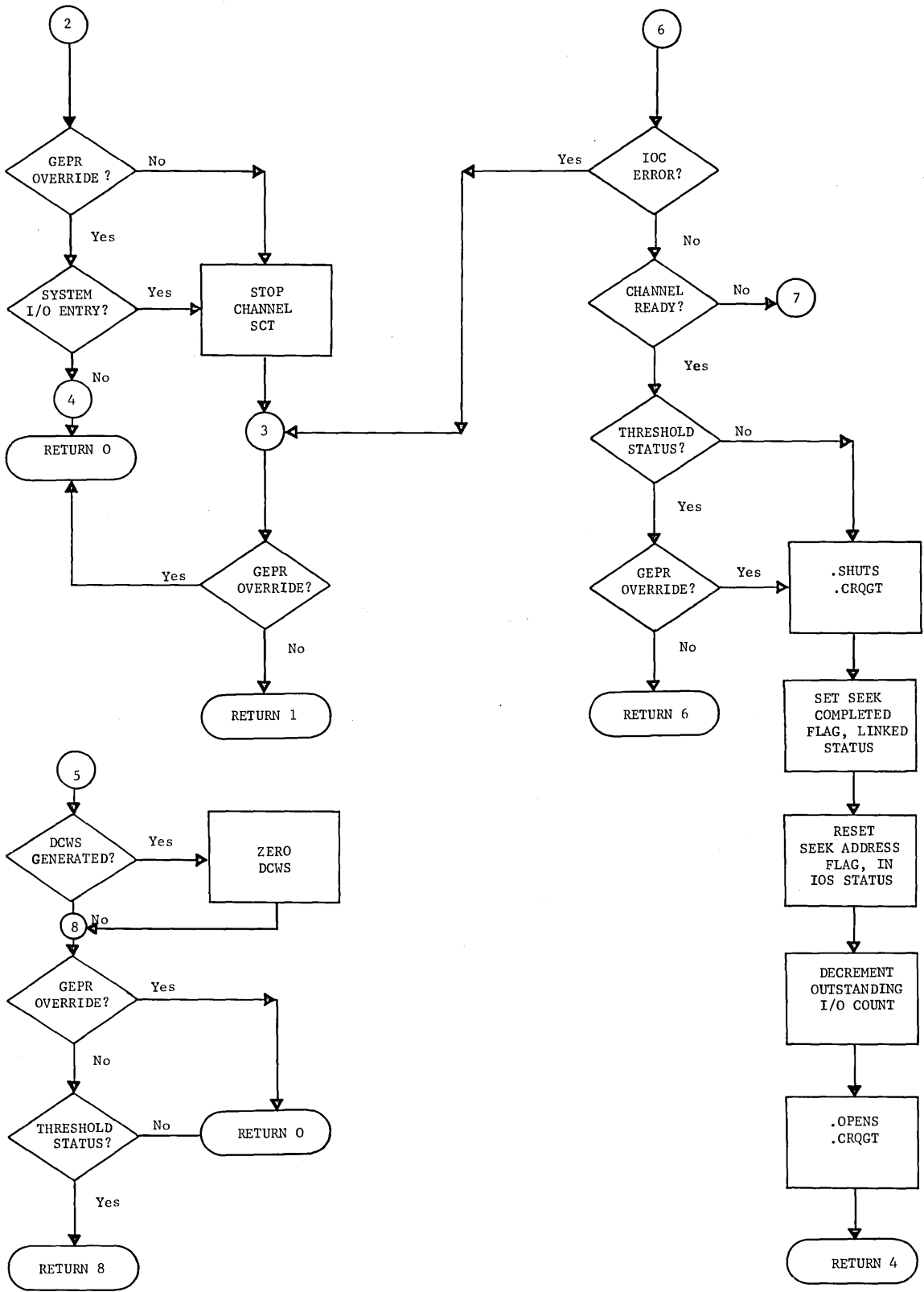

DSU200 REQUEST

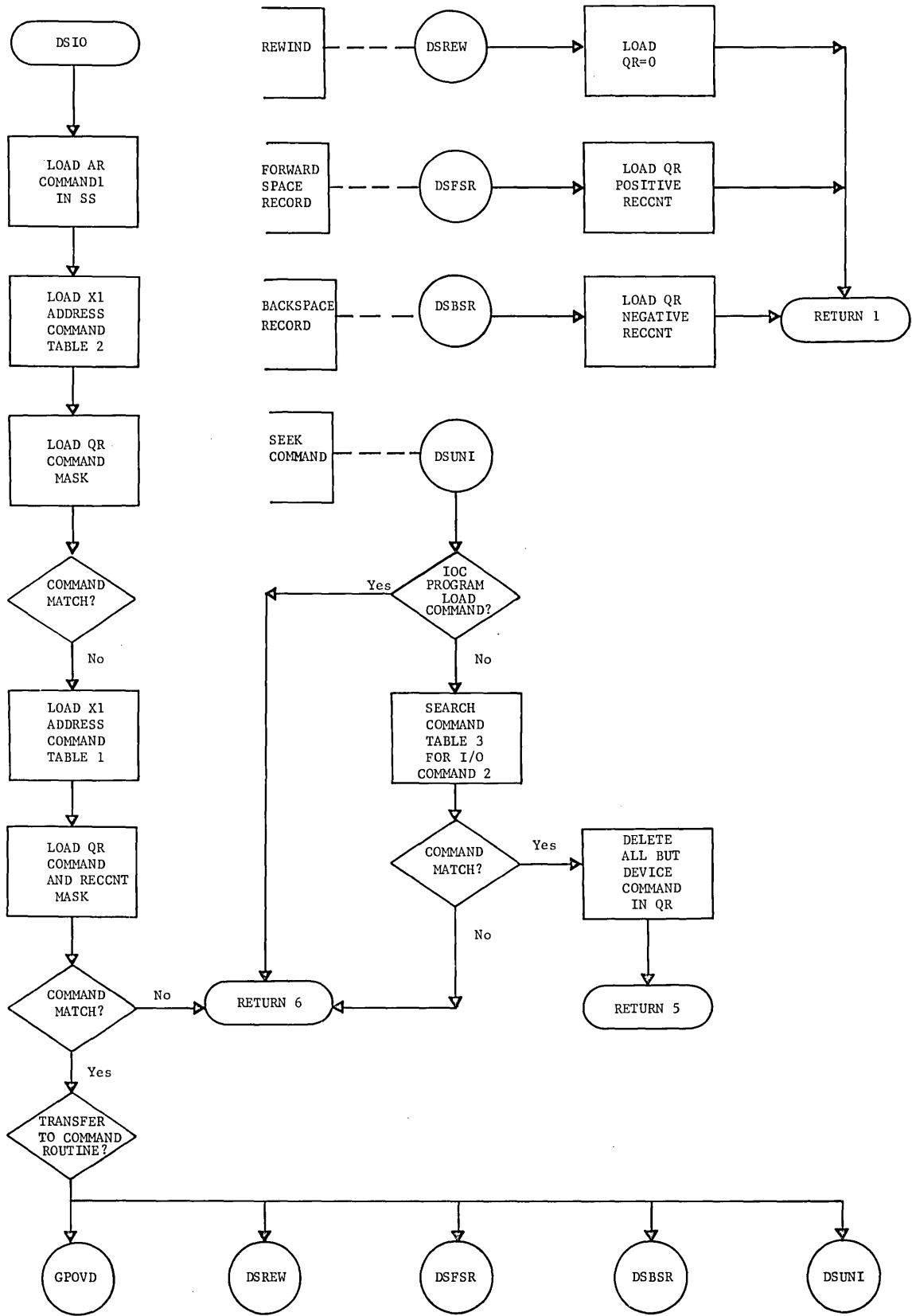

DSSL (EP3)  
.MDS20

DSU200 SELECT

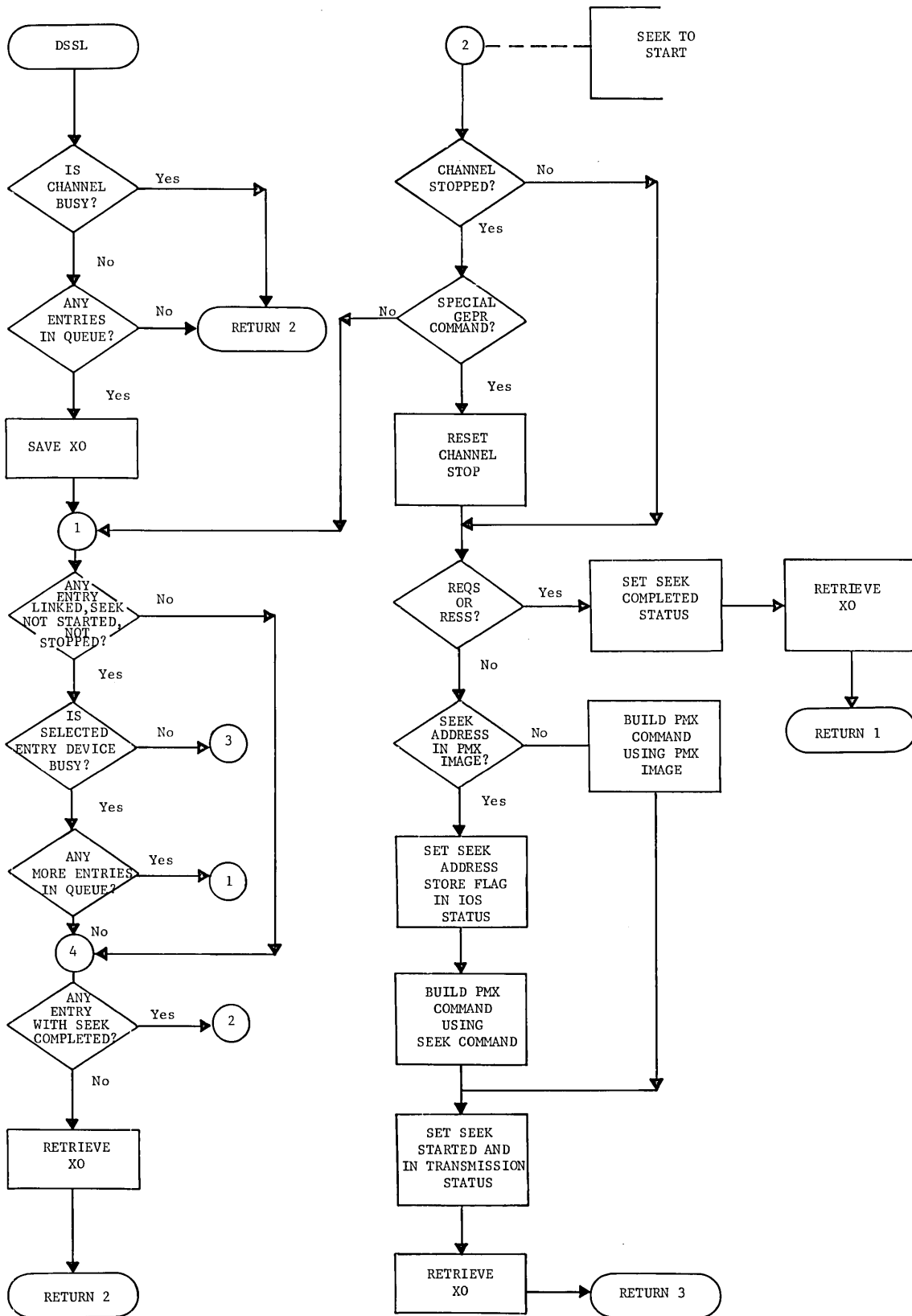

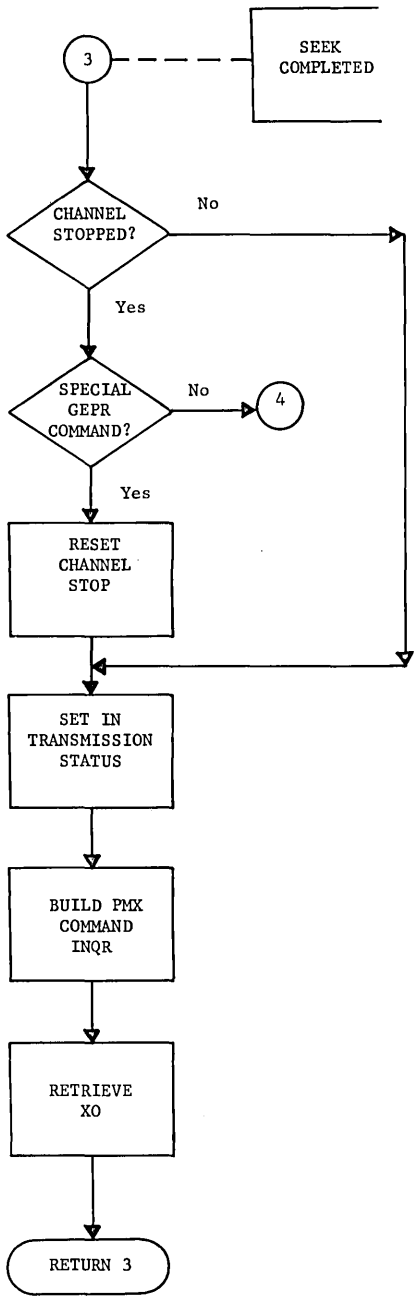

DSU200 ERROR AND EOF RECOVERY

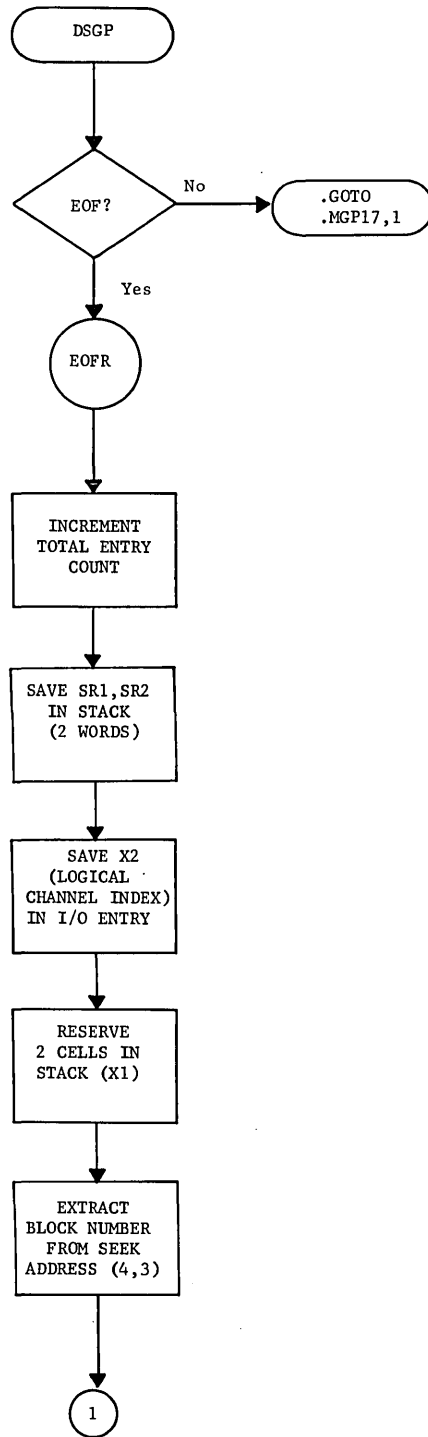

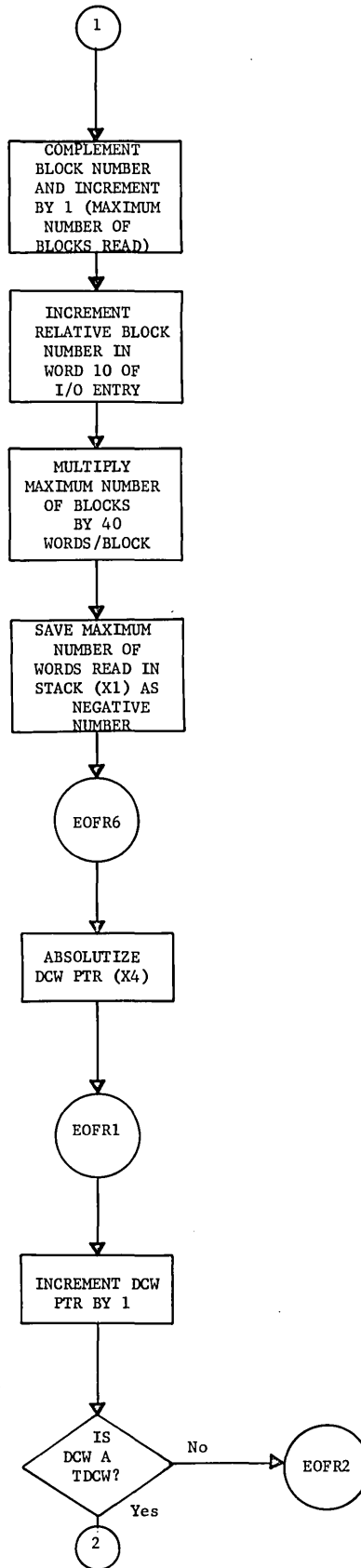

DSGP (EP4)  
.MDS20

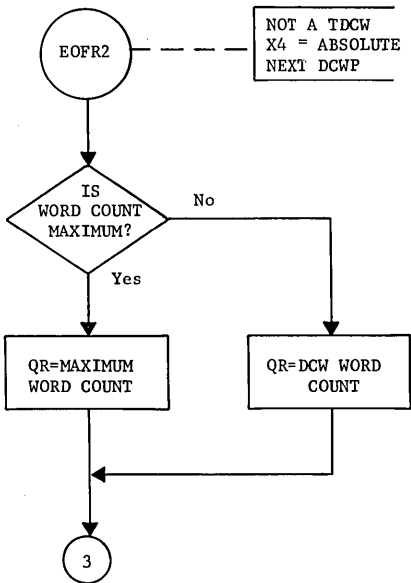
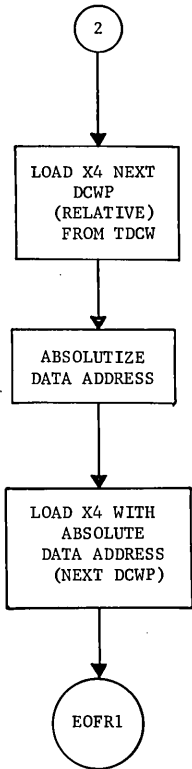

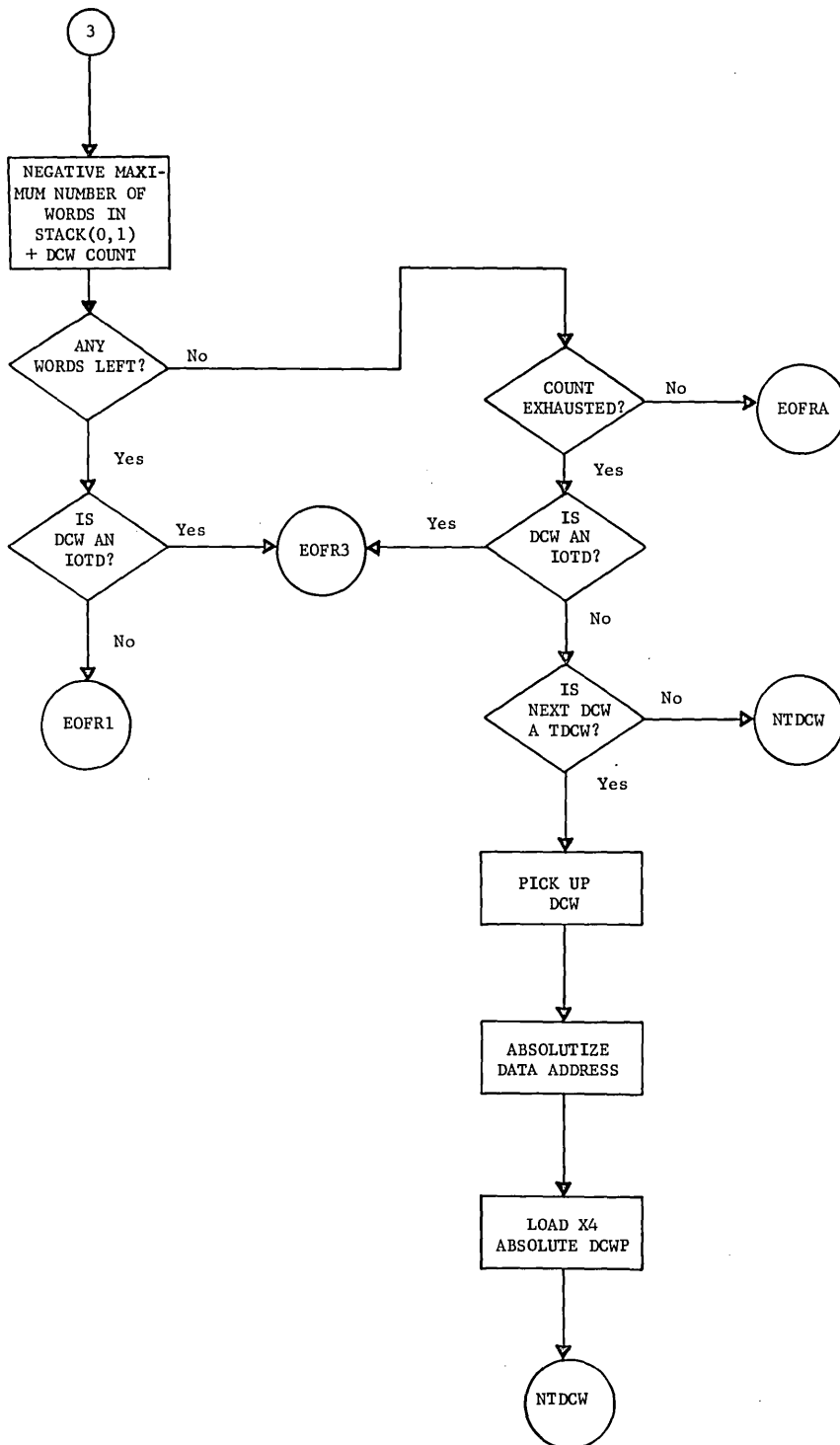



DSGP (EP4)  
.MDS20

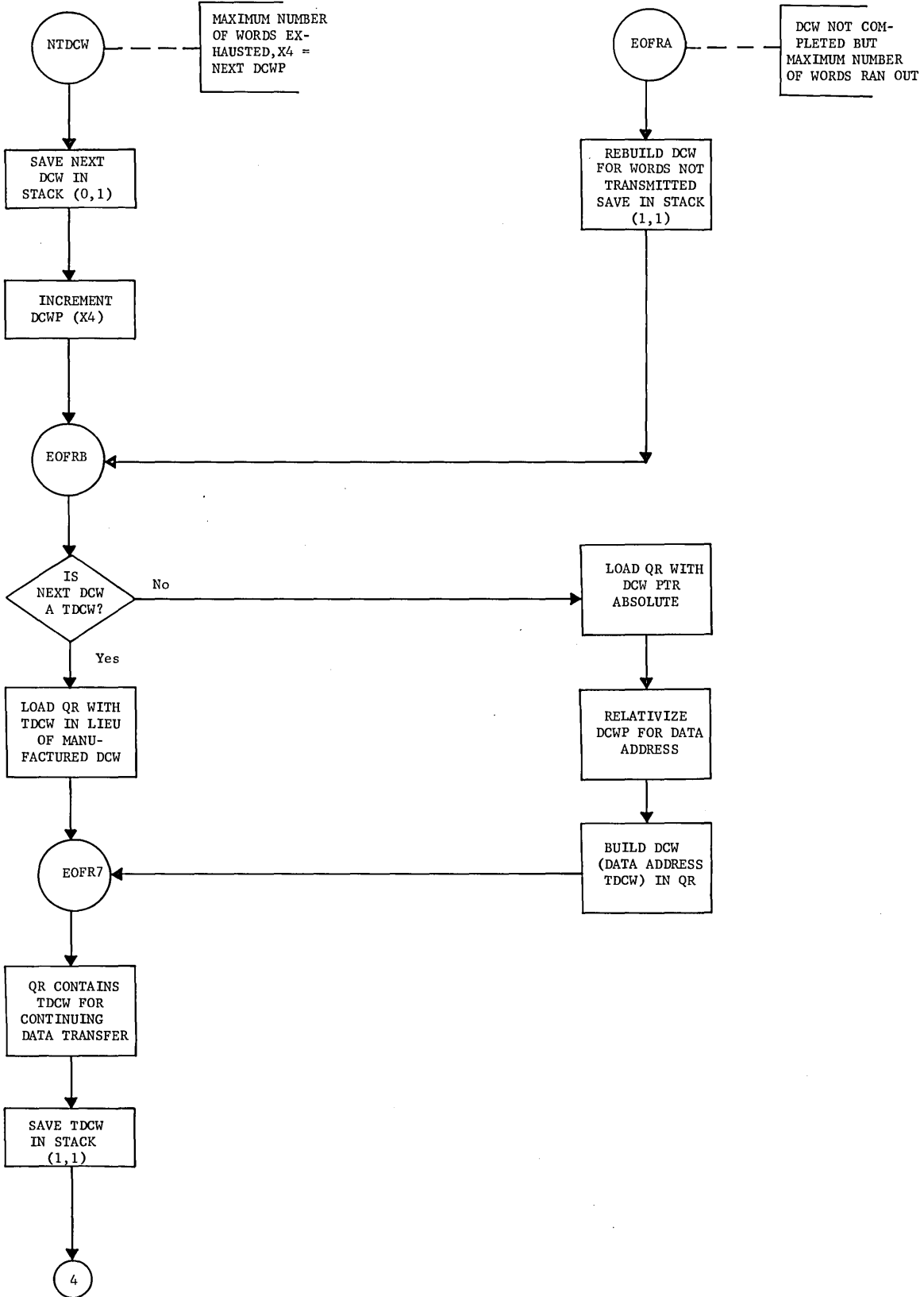

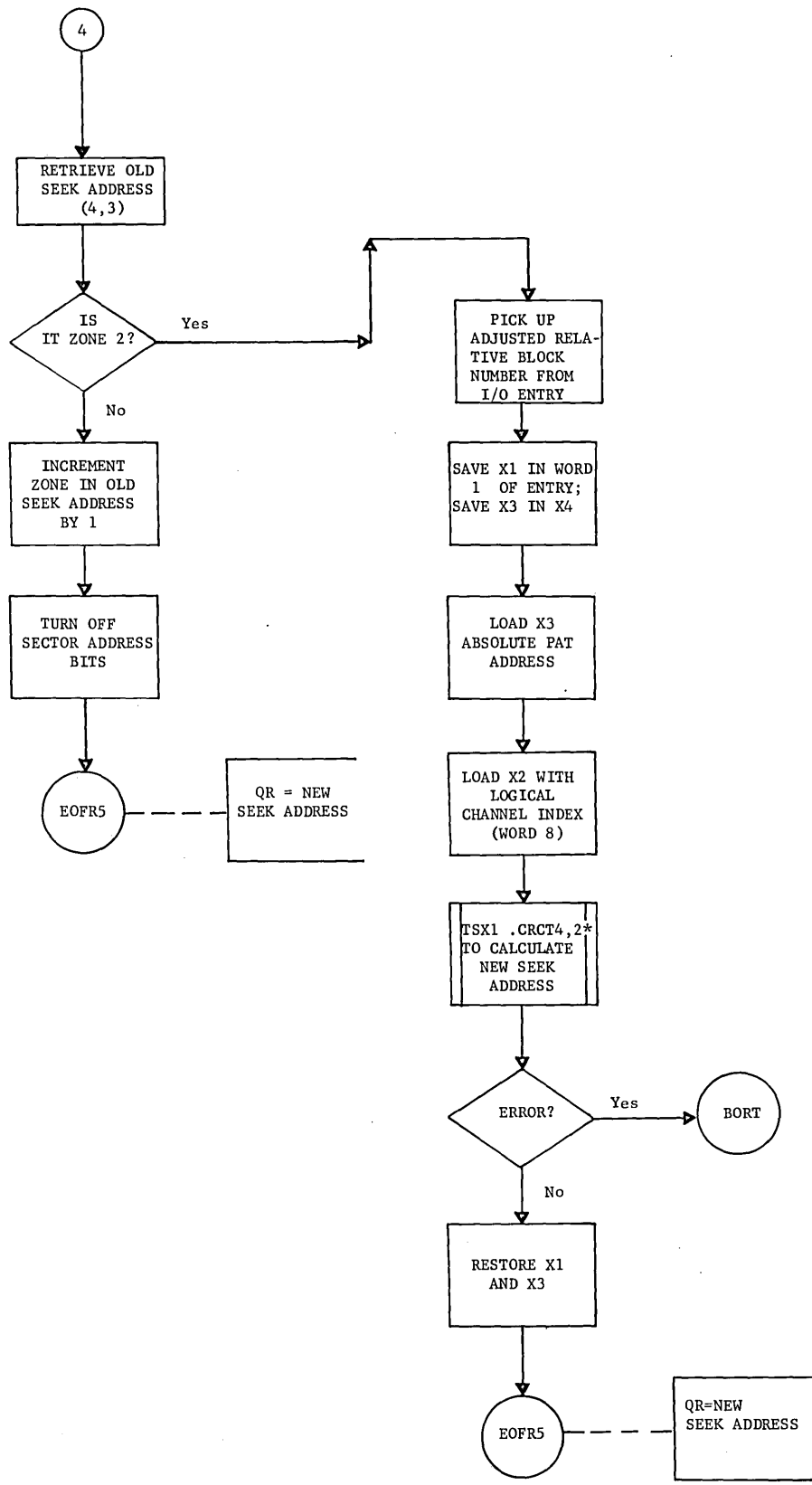

DSGP (EP4)  
.MDS20

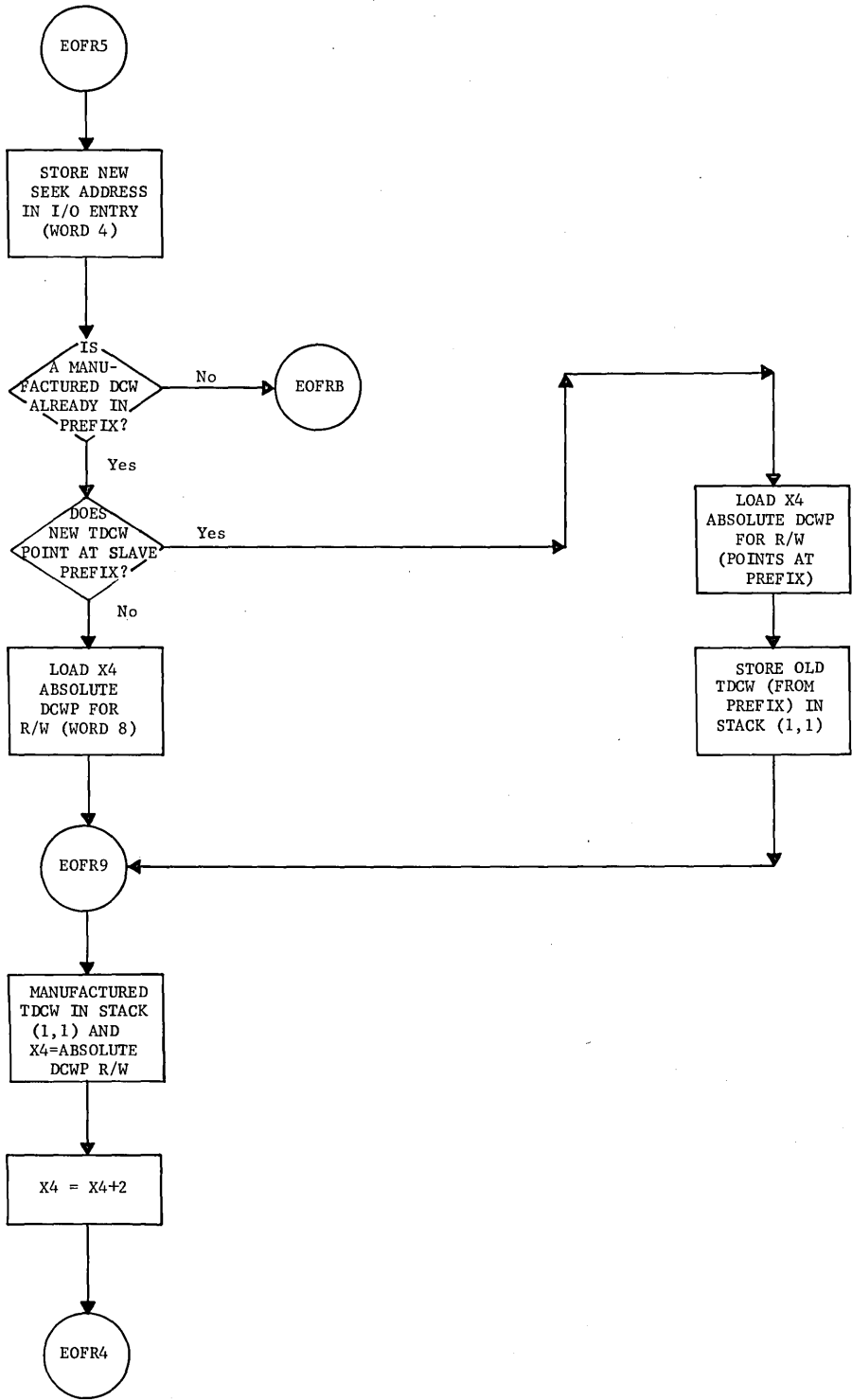

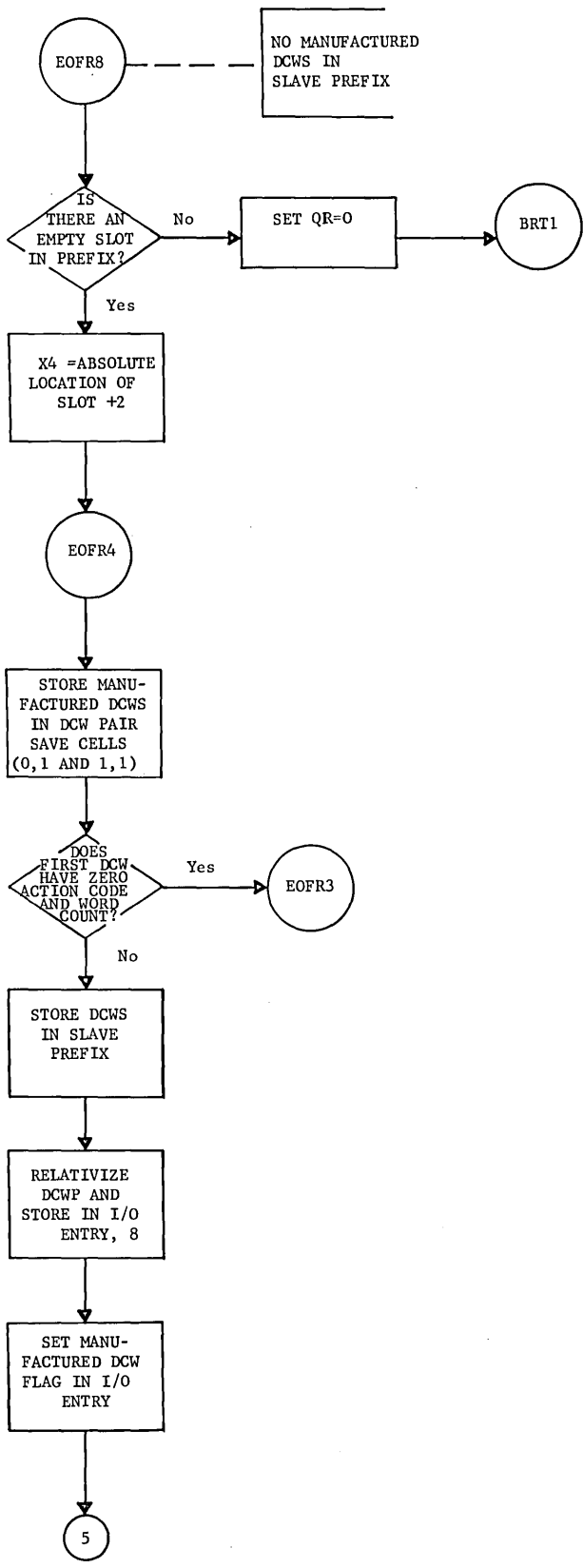

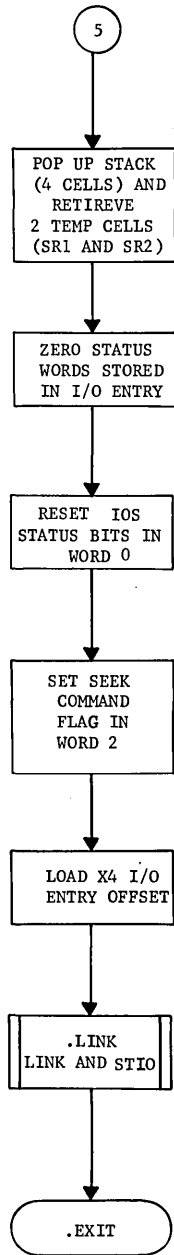

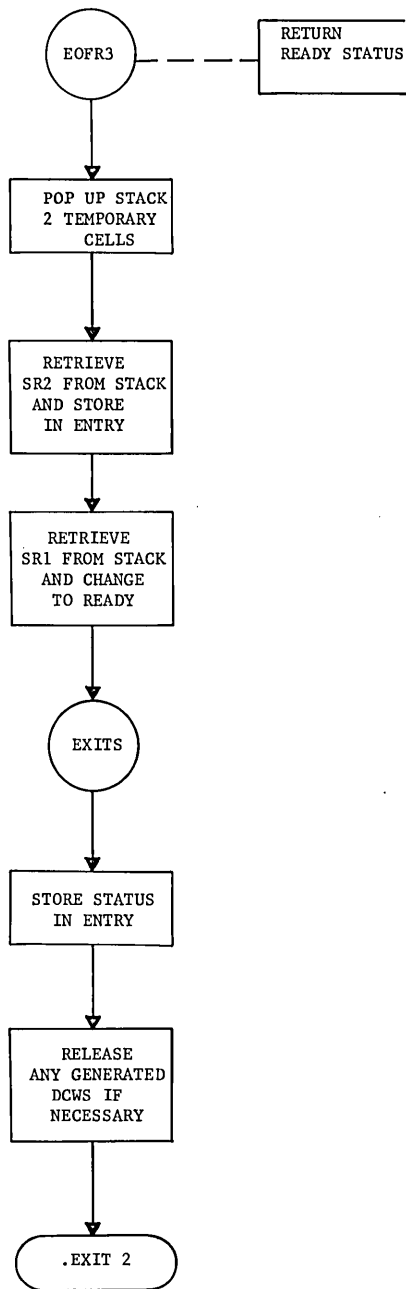

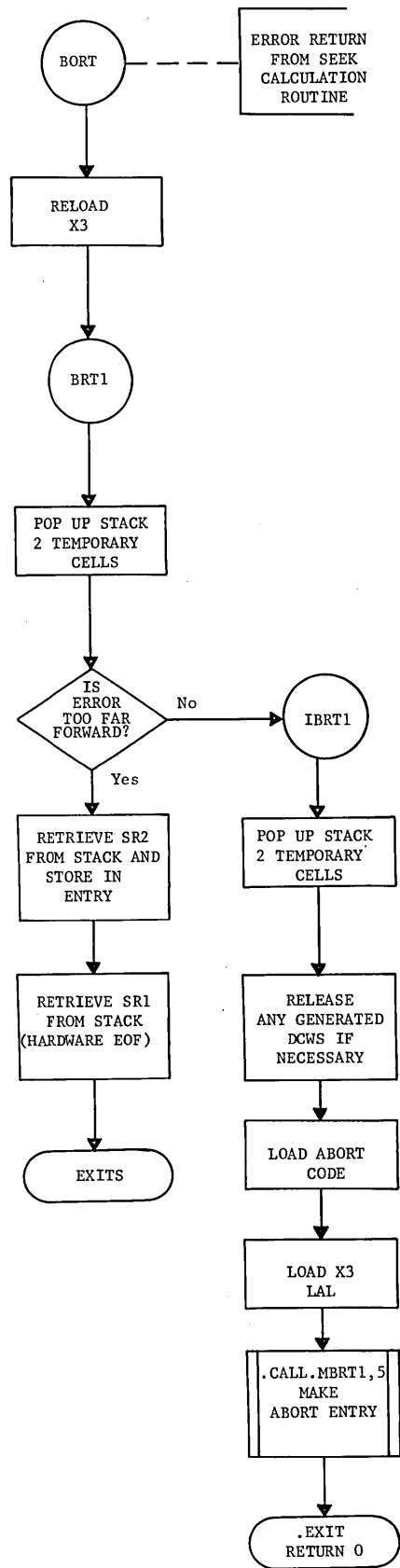

DSU200 NEGATIVE ENTRY POINTS

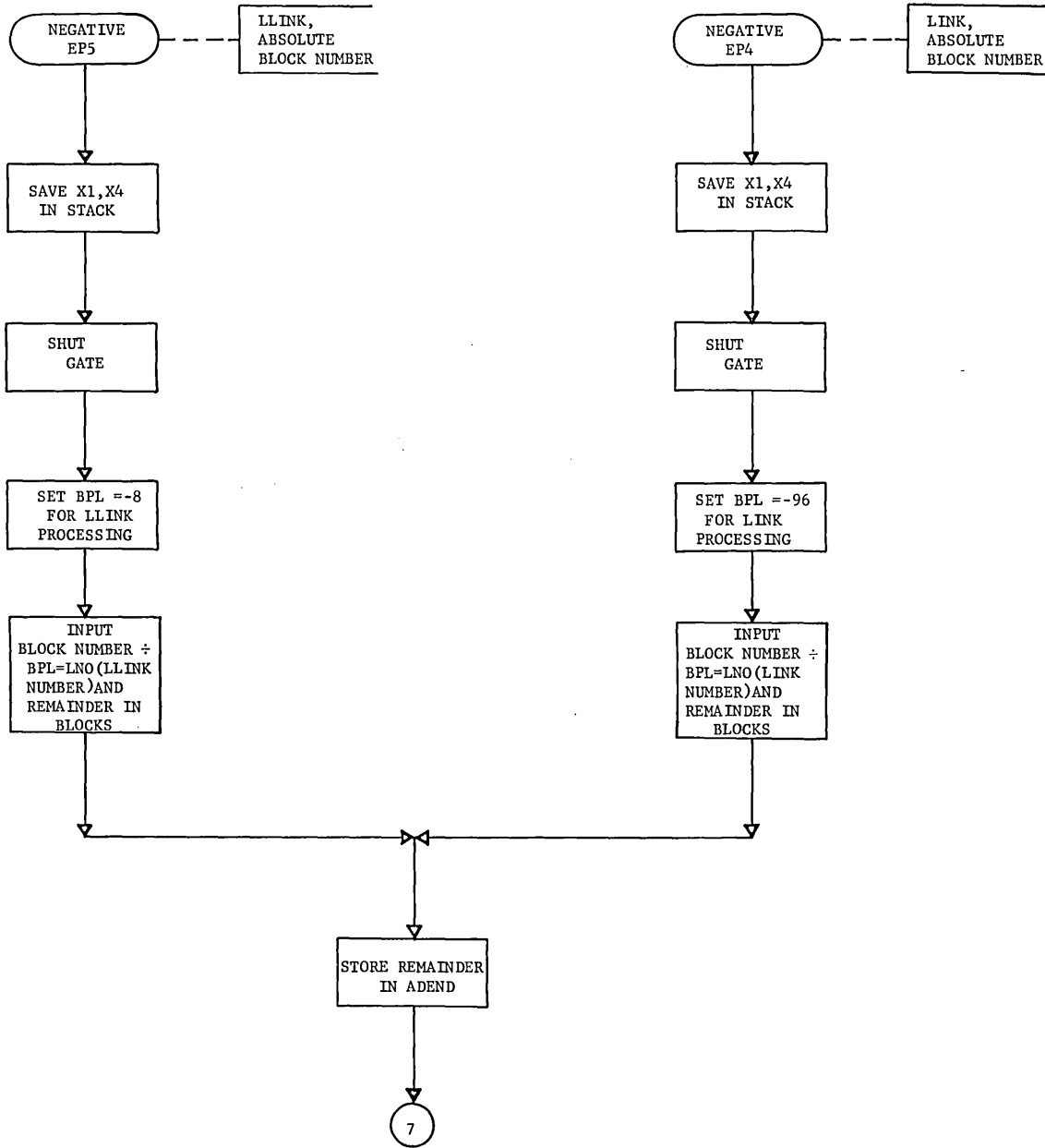



NEGATIVE EP  
.MDS20

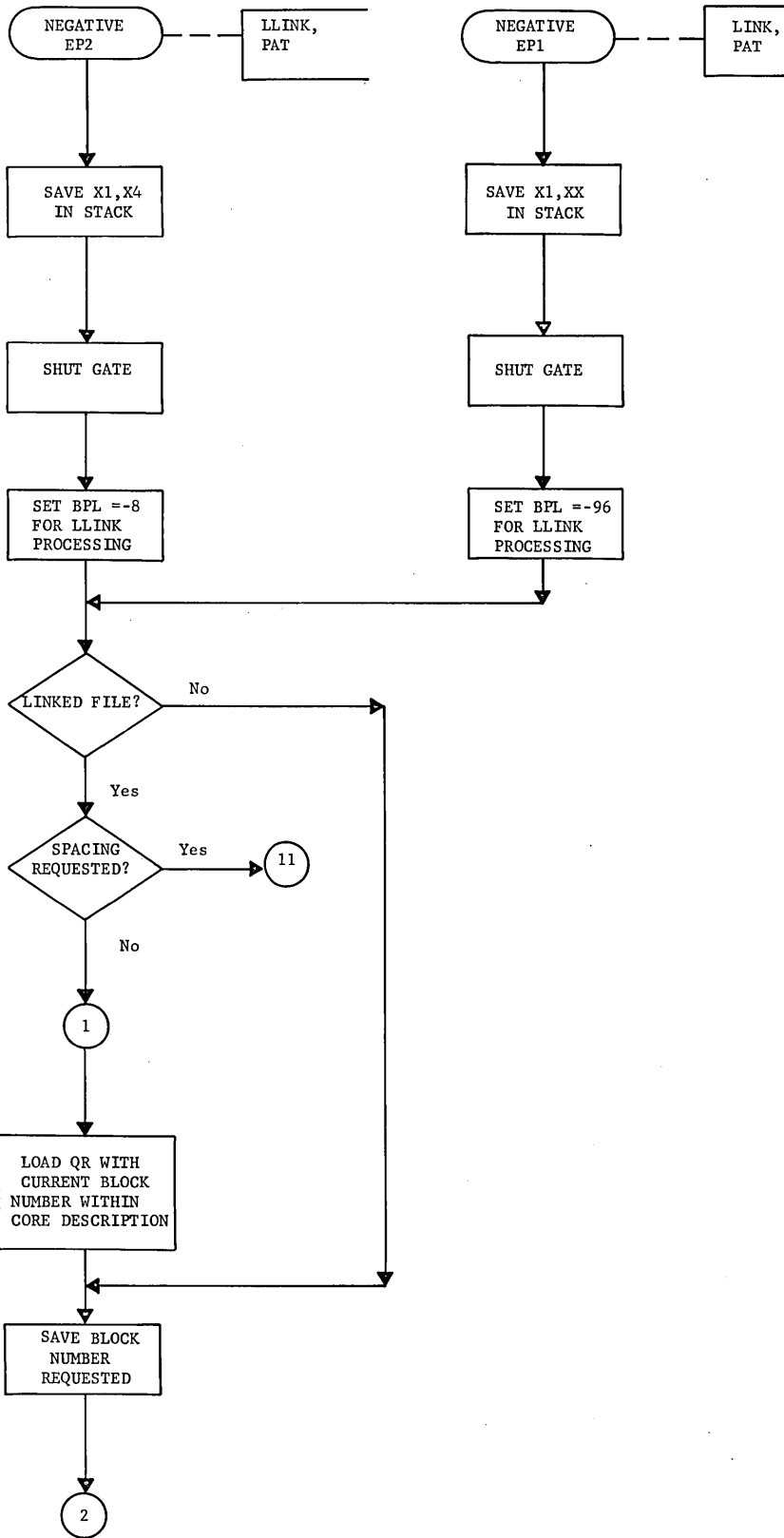

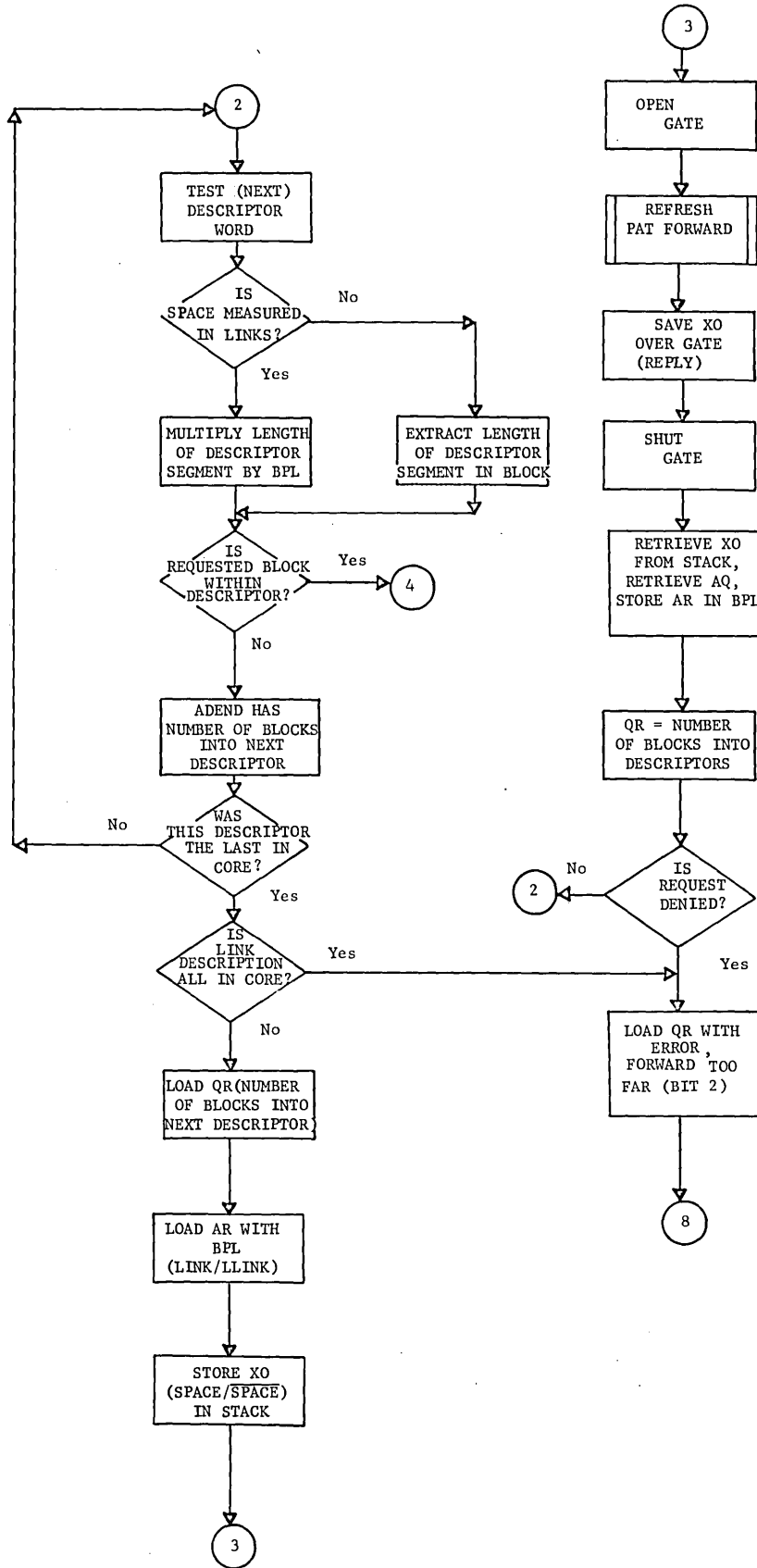

NEGATIVE EP  
.MDS20

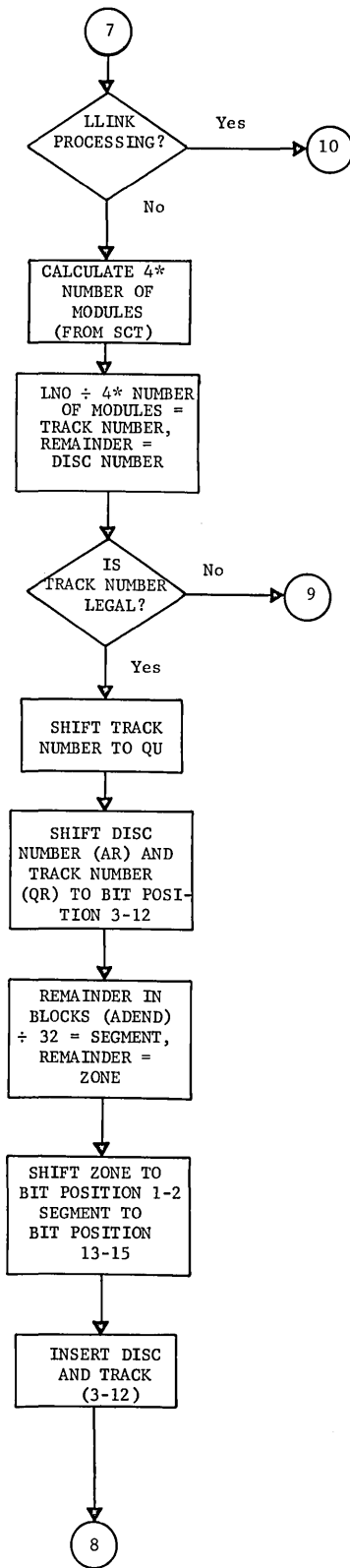
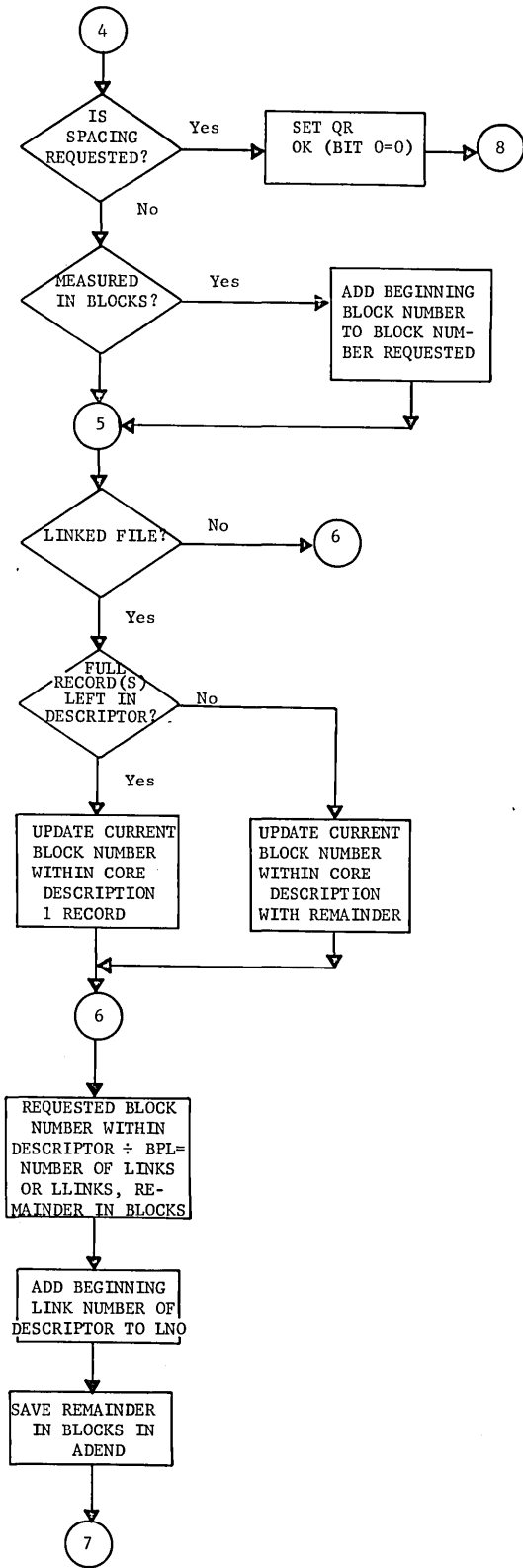

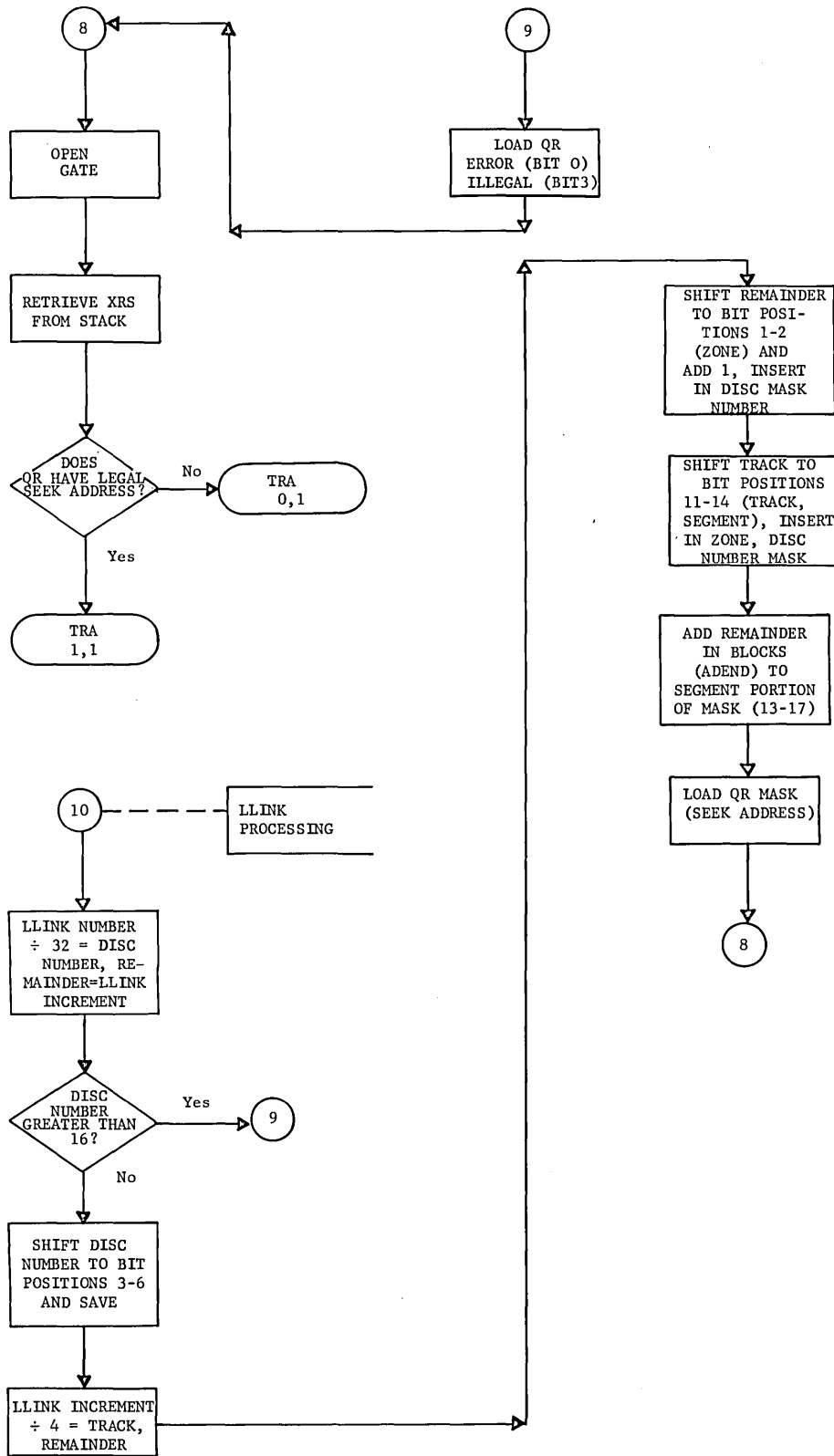

NEGATIVE EP  
.MDS20

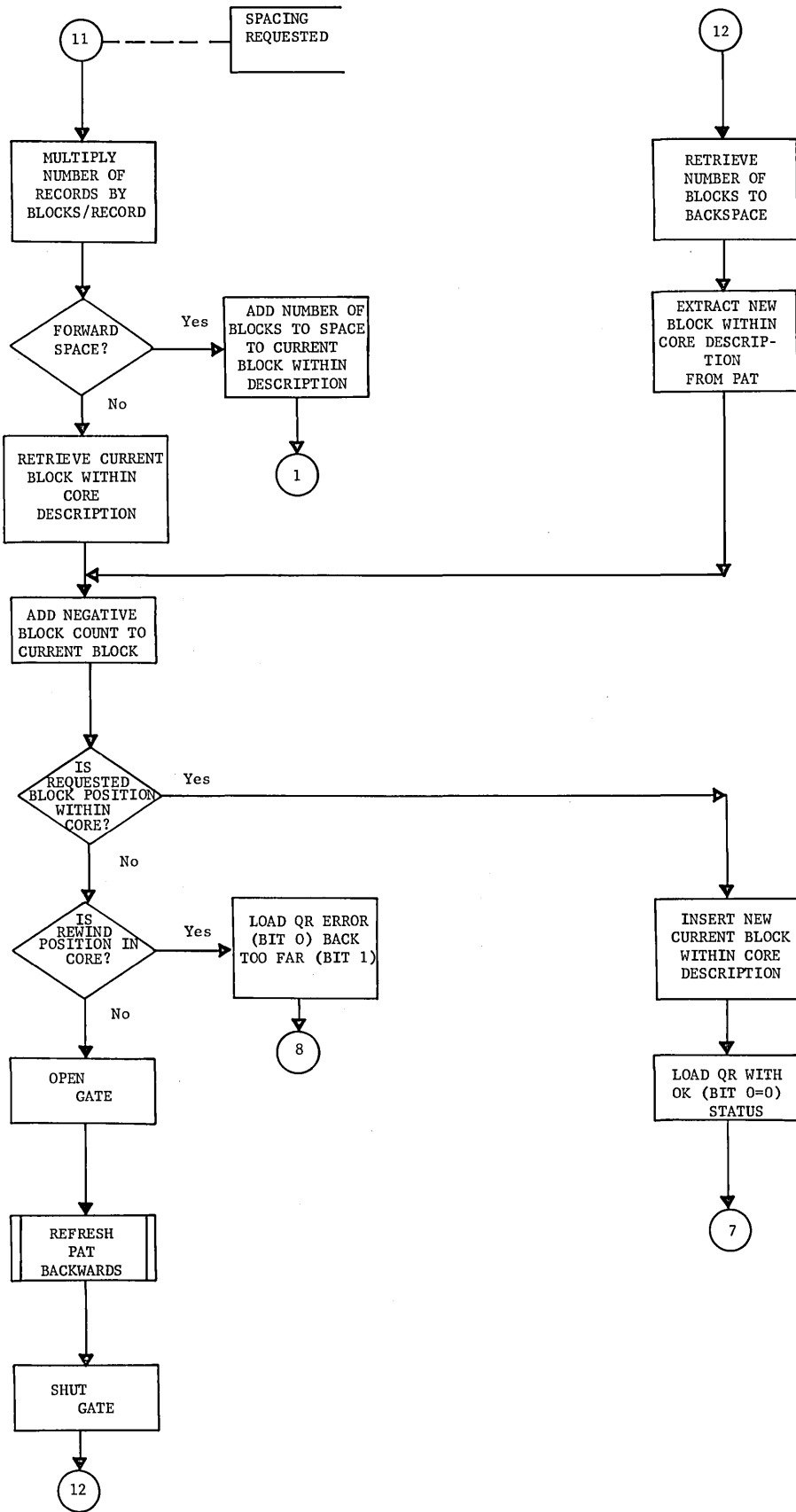

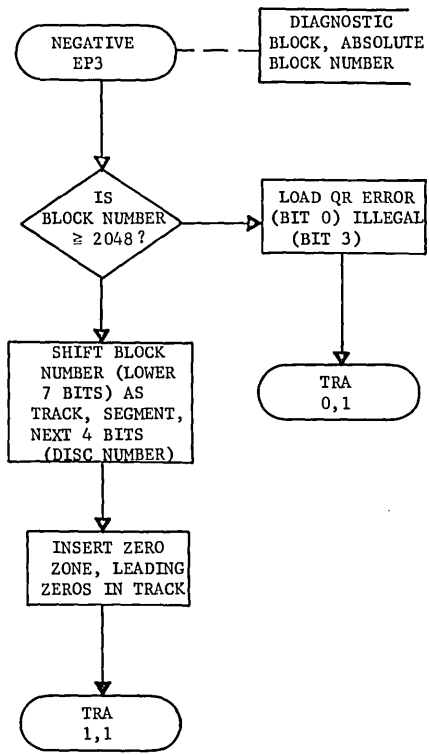

.IDS20  
.MDS20

### DSU200 INITIALIZATION

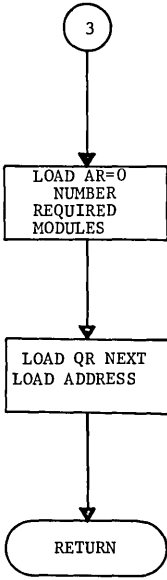
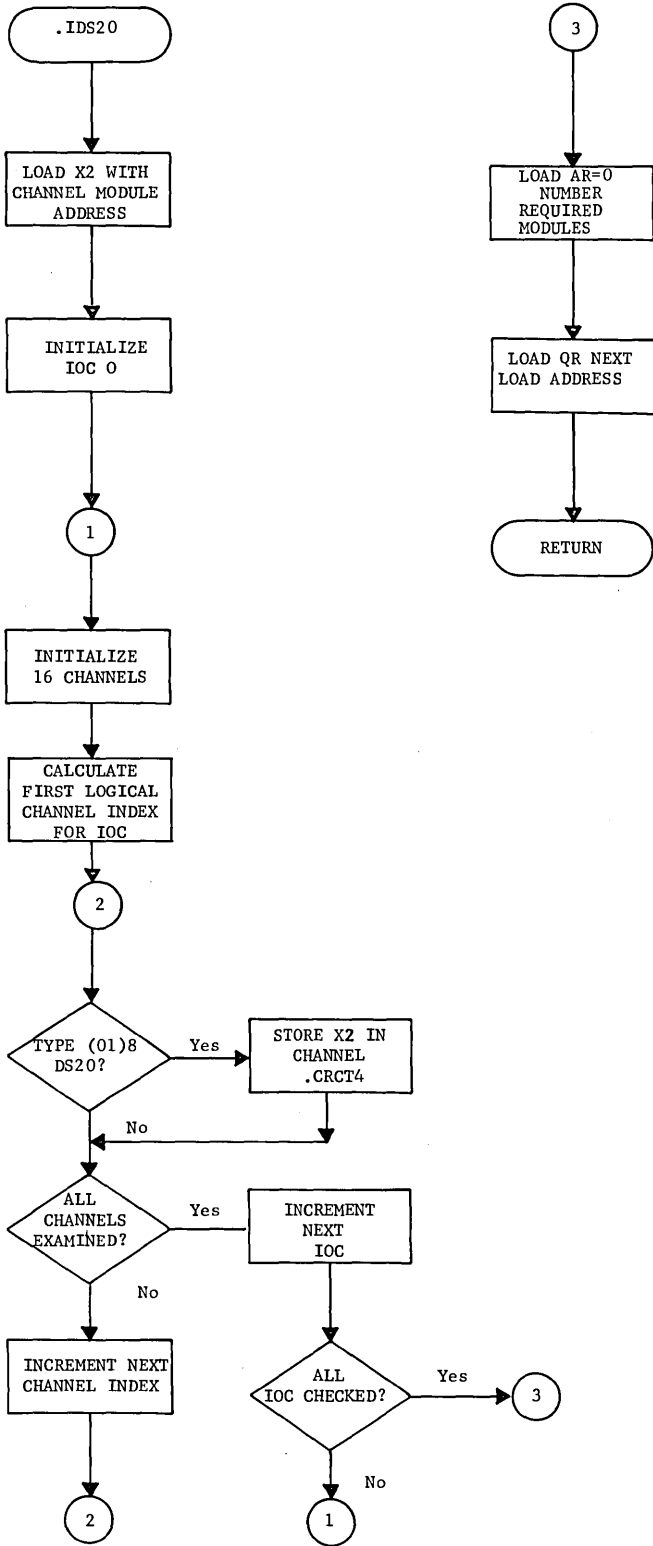

# CARD READER INTERRUPT HANDLER

CRIT (EP1)  
.MGPIO

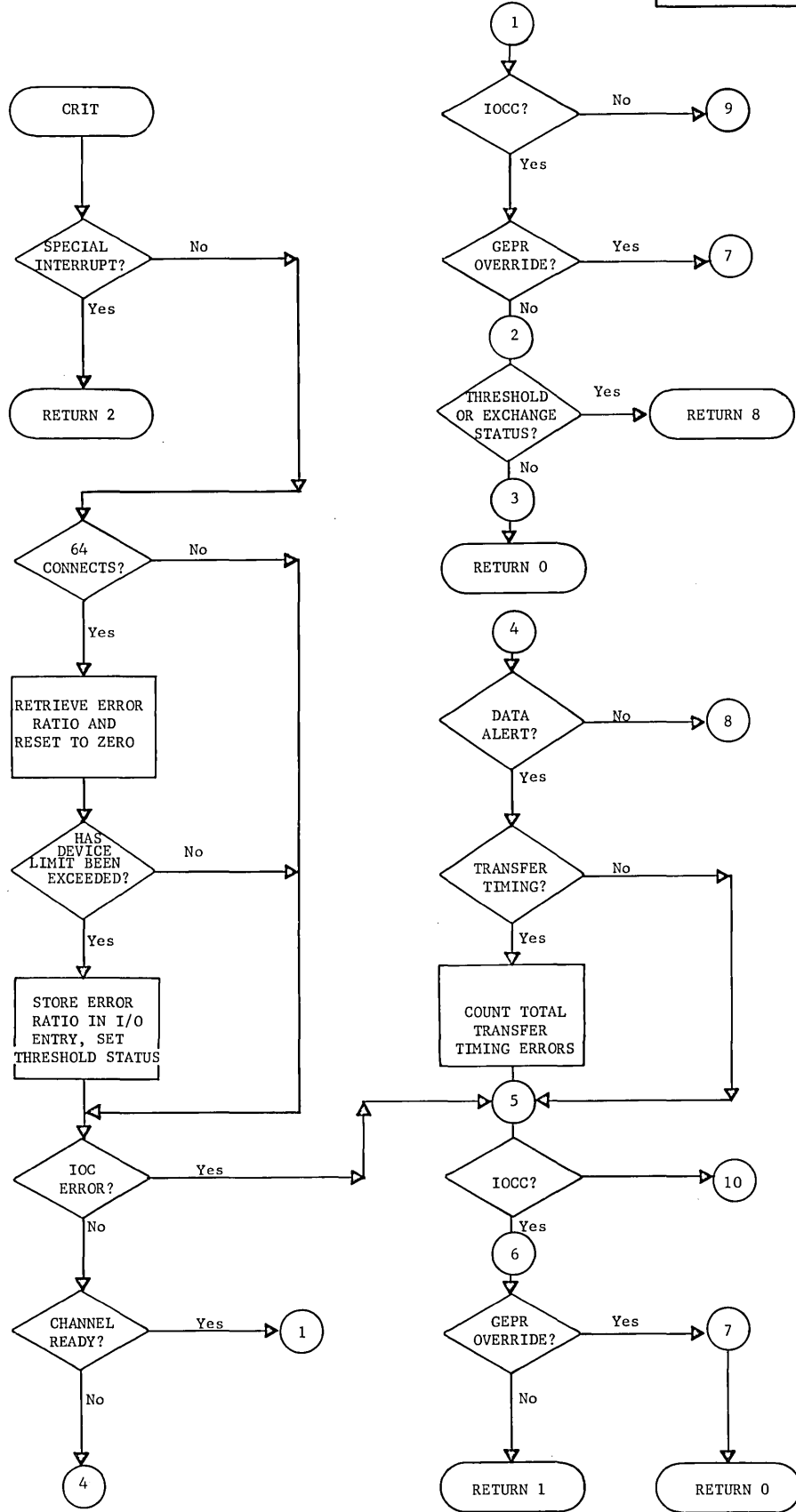



CRIT (EP1)  
.MGPIO

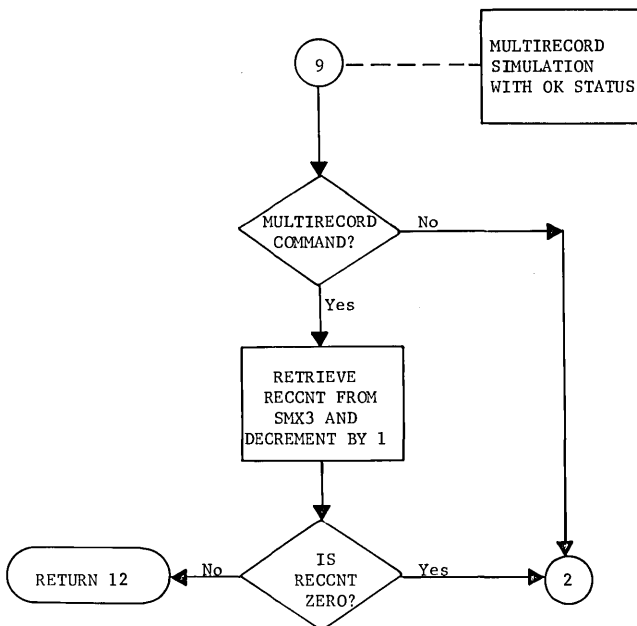
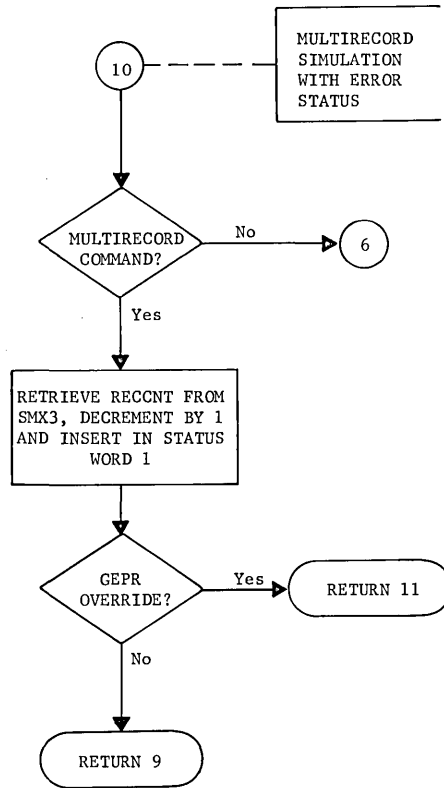
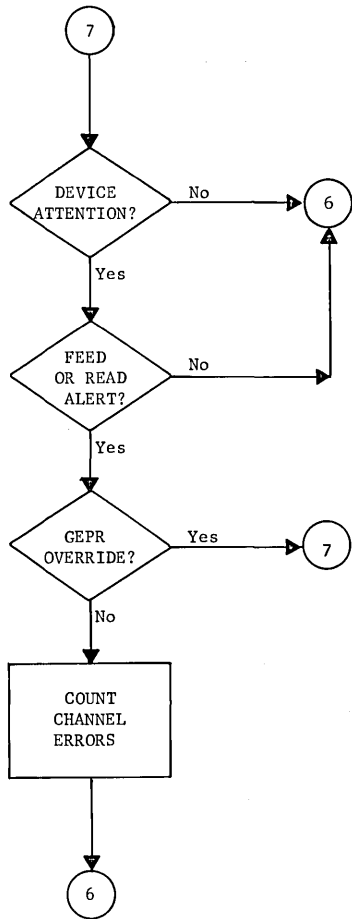

CRIO (EP2)  
.MGPIO

### CARD READER REQUEST

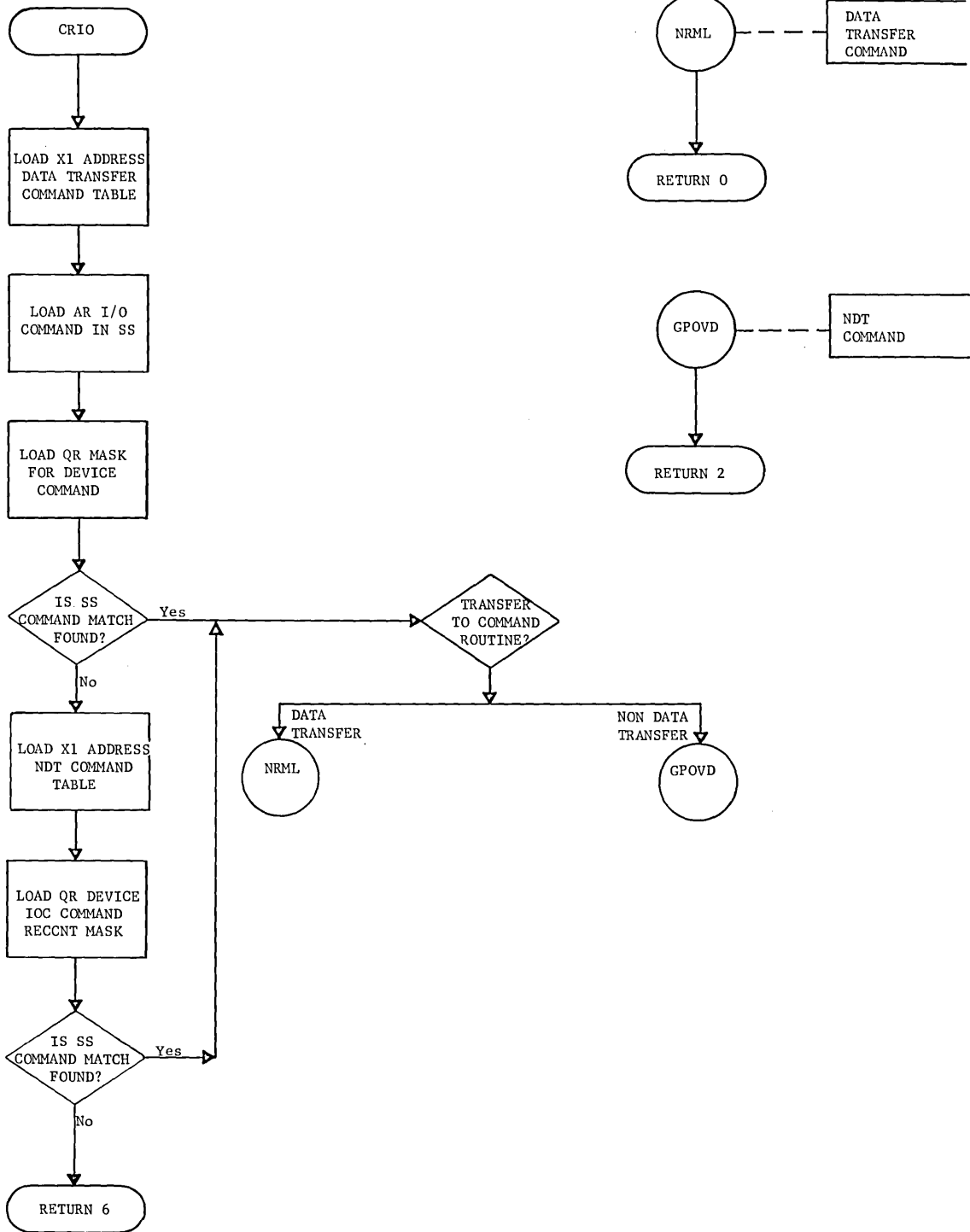

.IGPIO  
.MGPIO

CARD READER INITIALIZATION

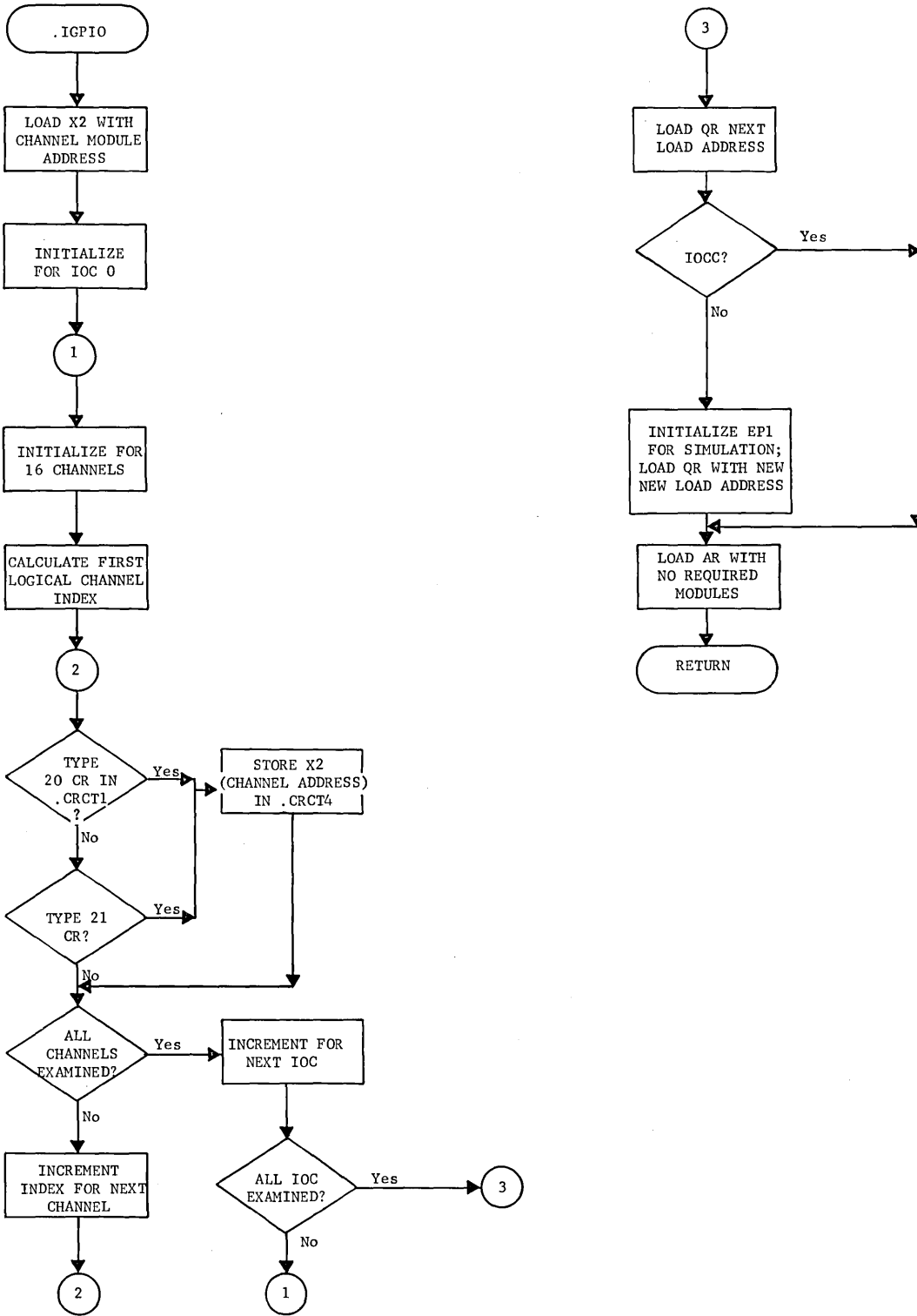

MAGNETIC TAPE INTERRUPT HANDLER

MTIT (EP1)  
.MMTAP

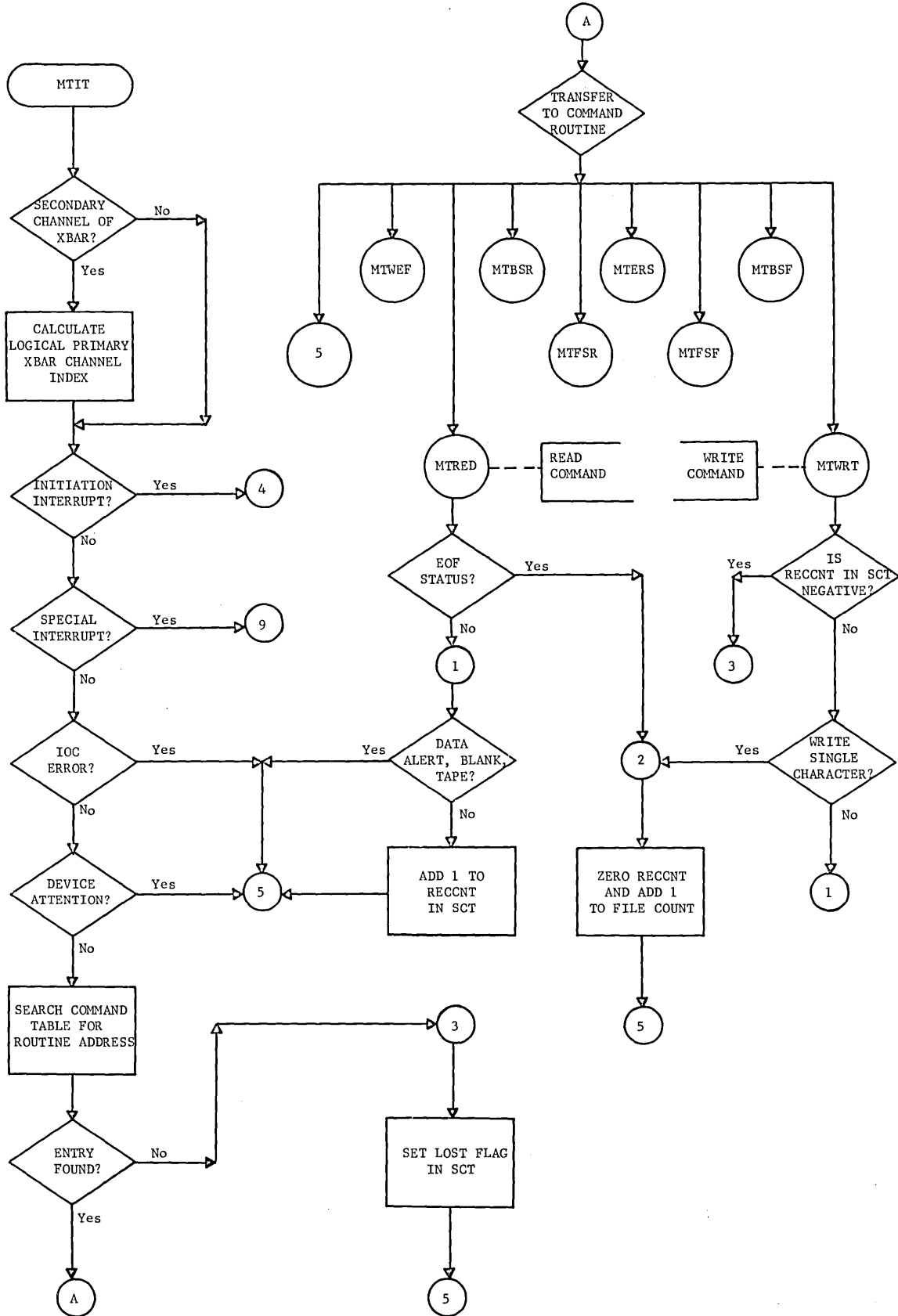

MTIT (EP1)  
.MMTAP

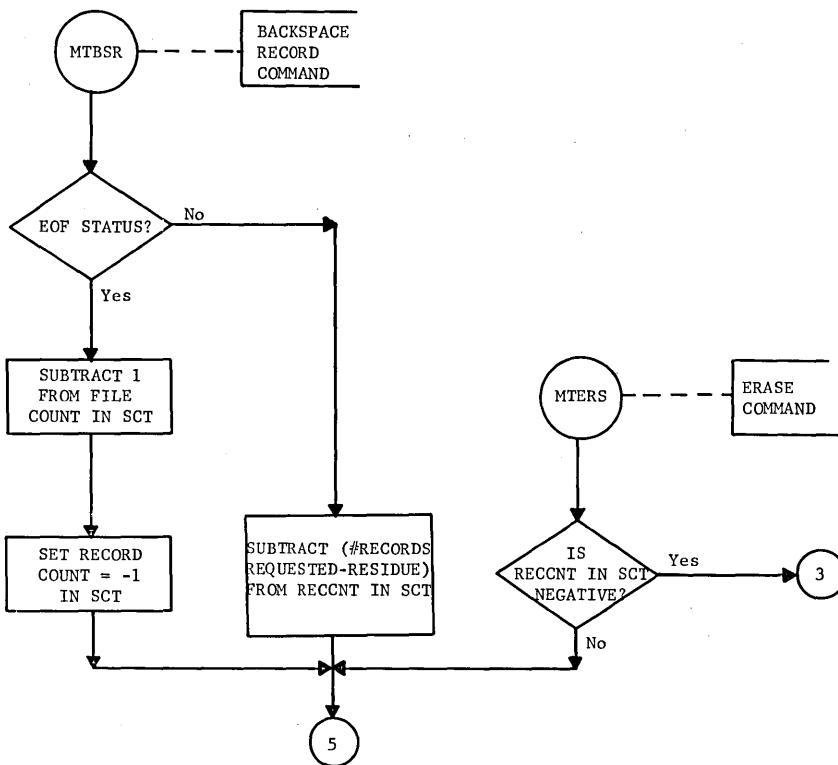
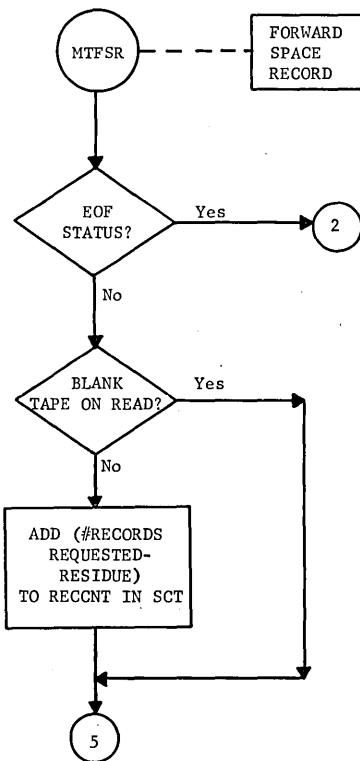
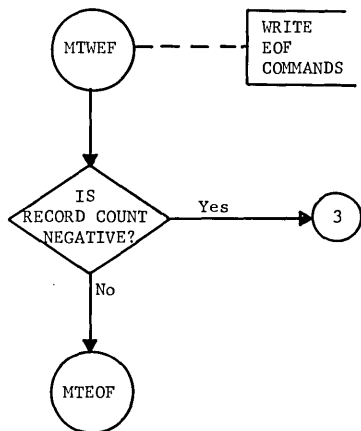

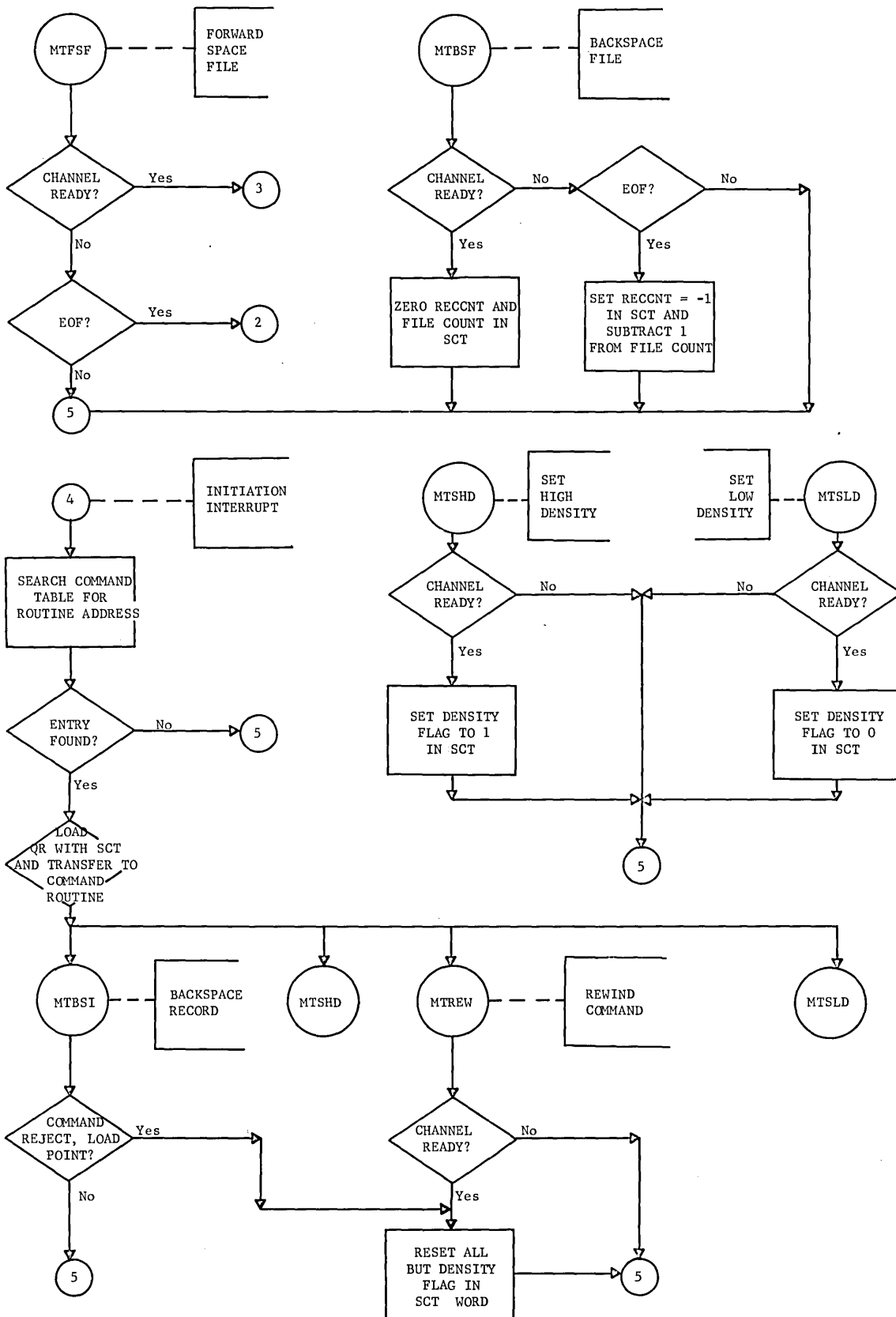

MTIT (EP1)  
.MMTAP

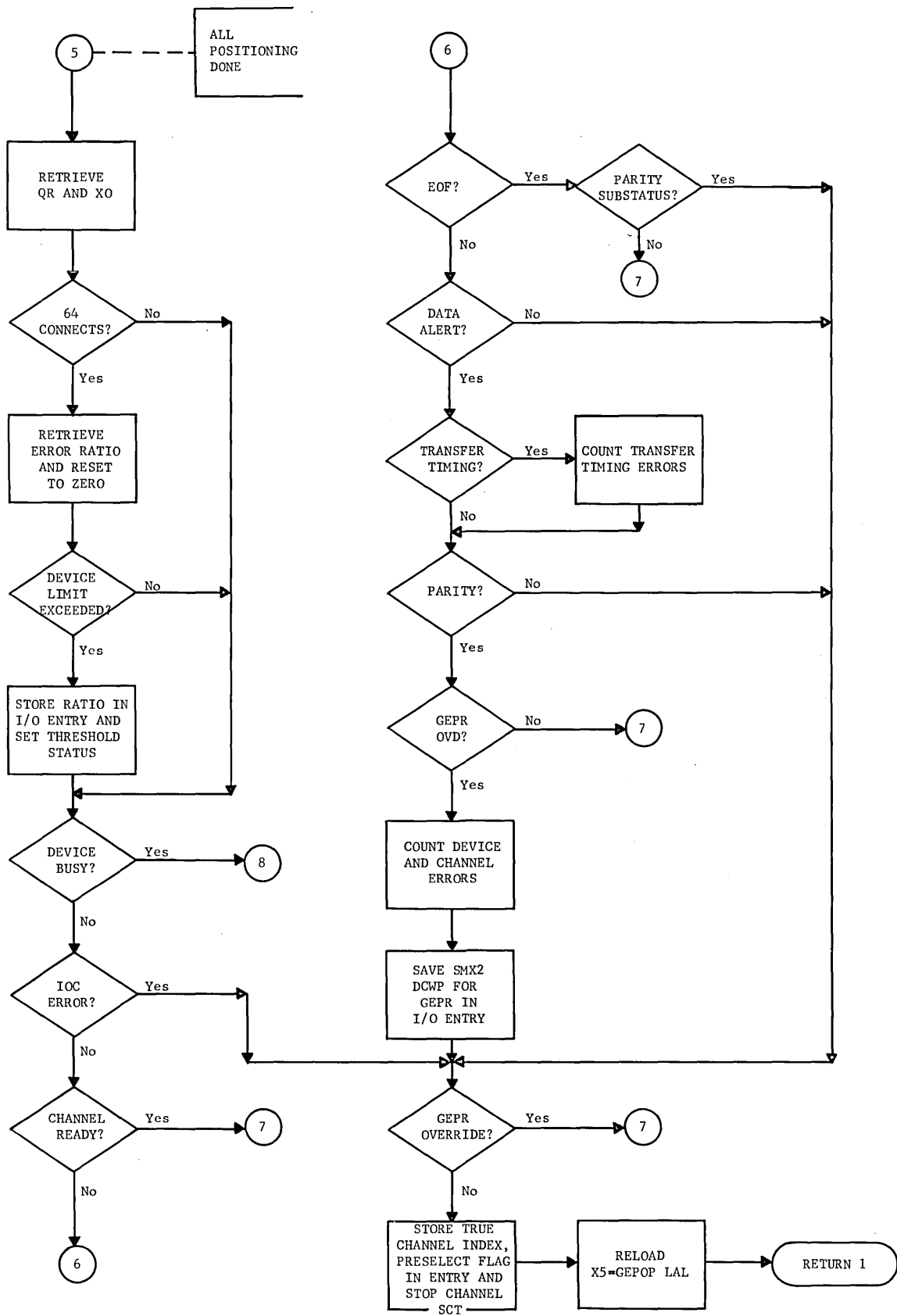

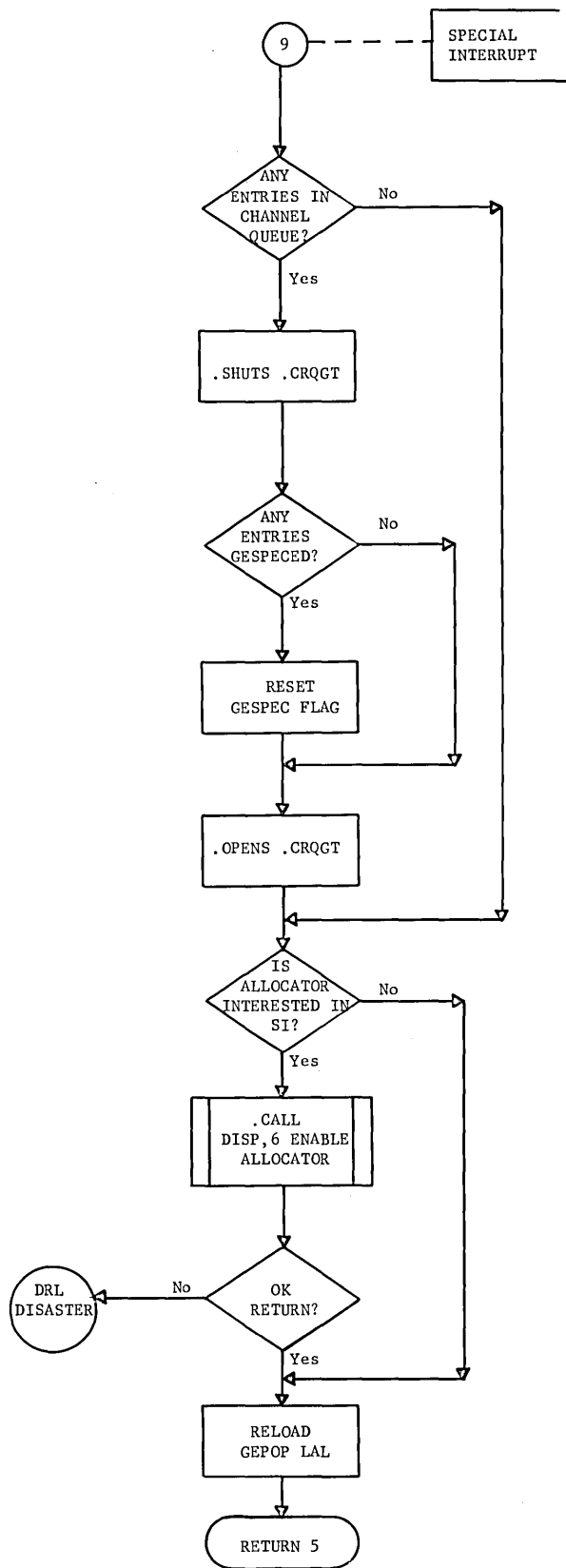
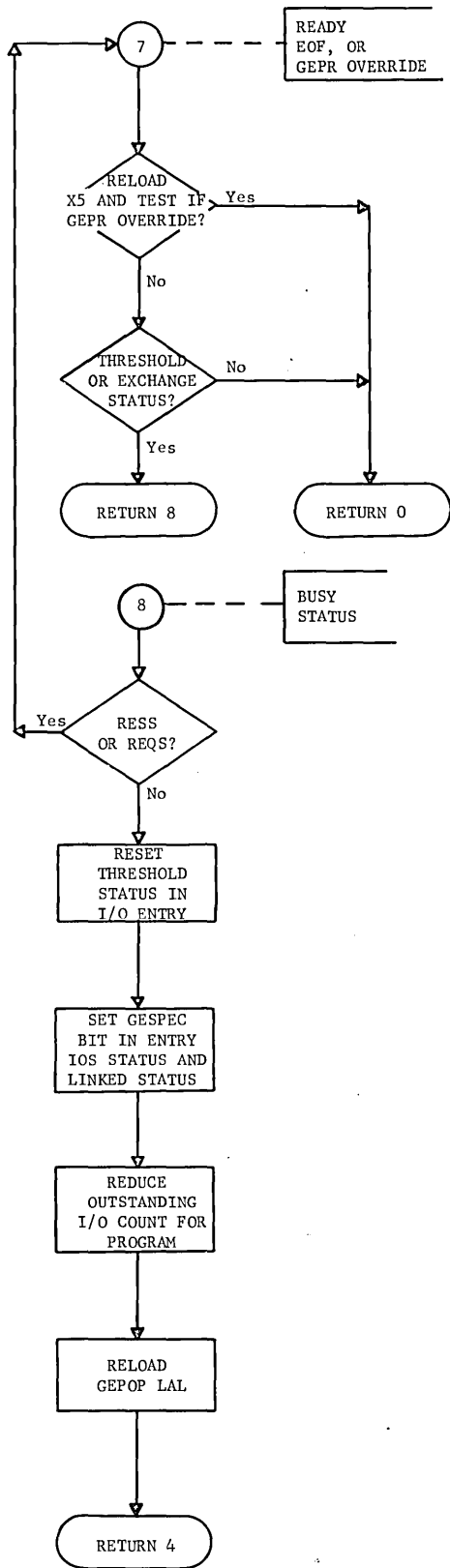



MAGNETIC TAPE REQUEST

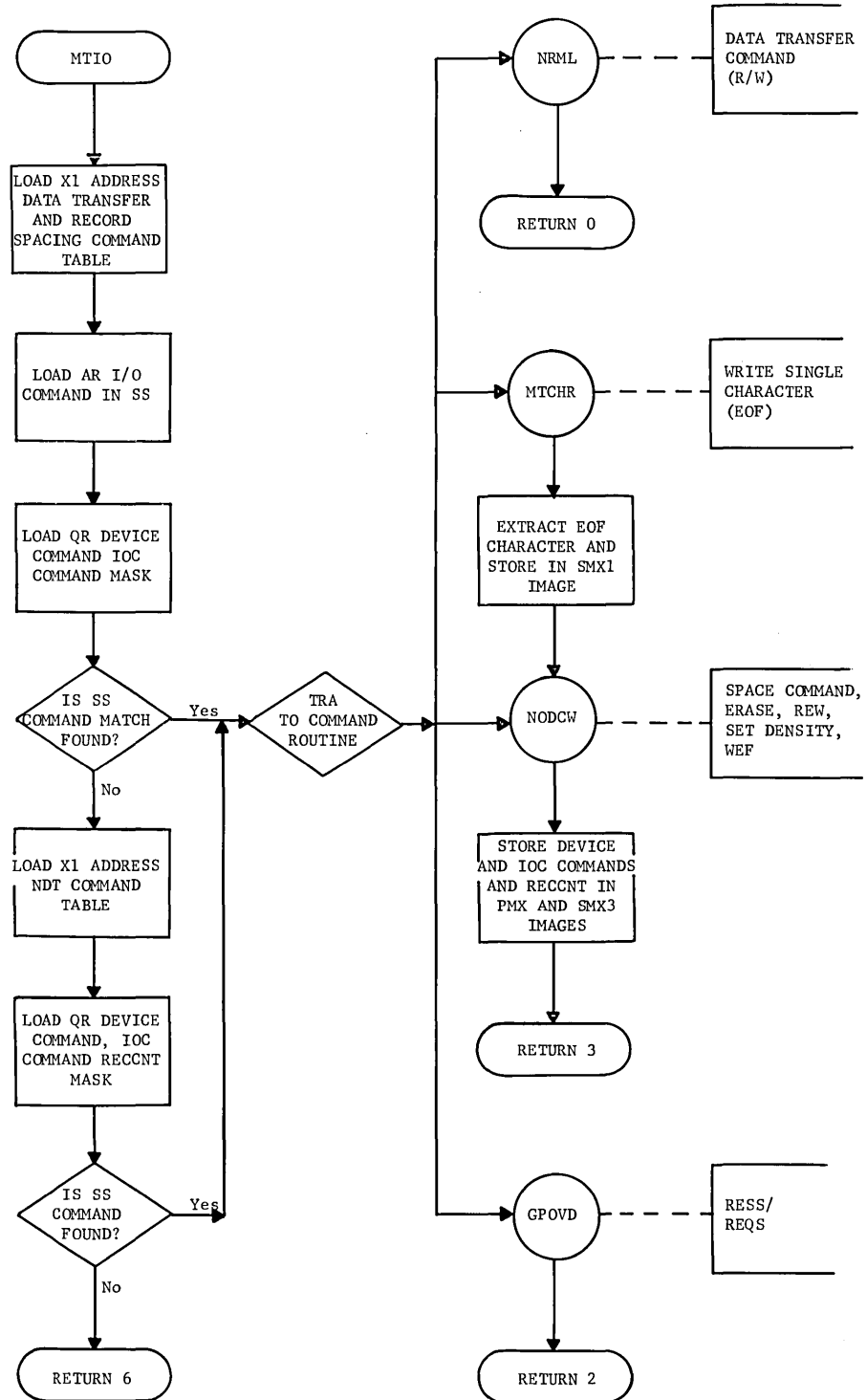

MAGNETIC TAPE INITIALIZATION

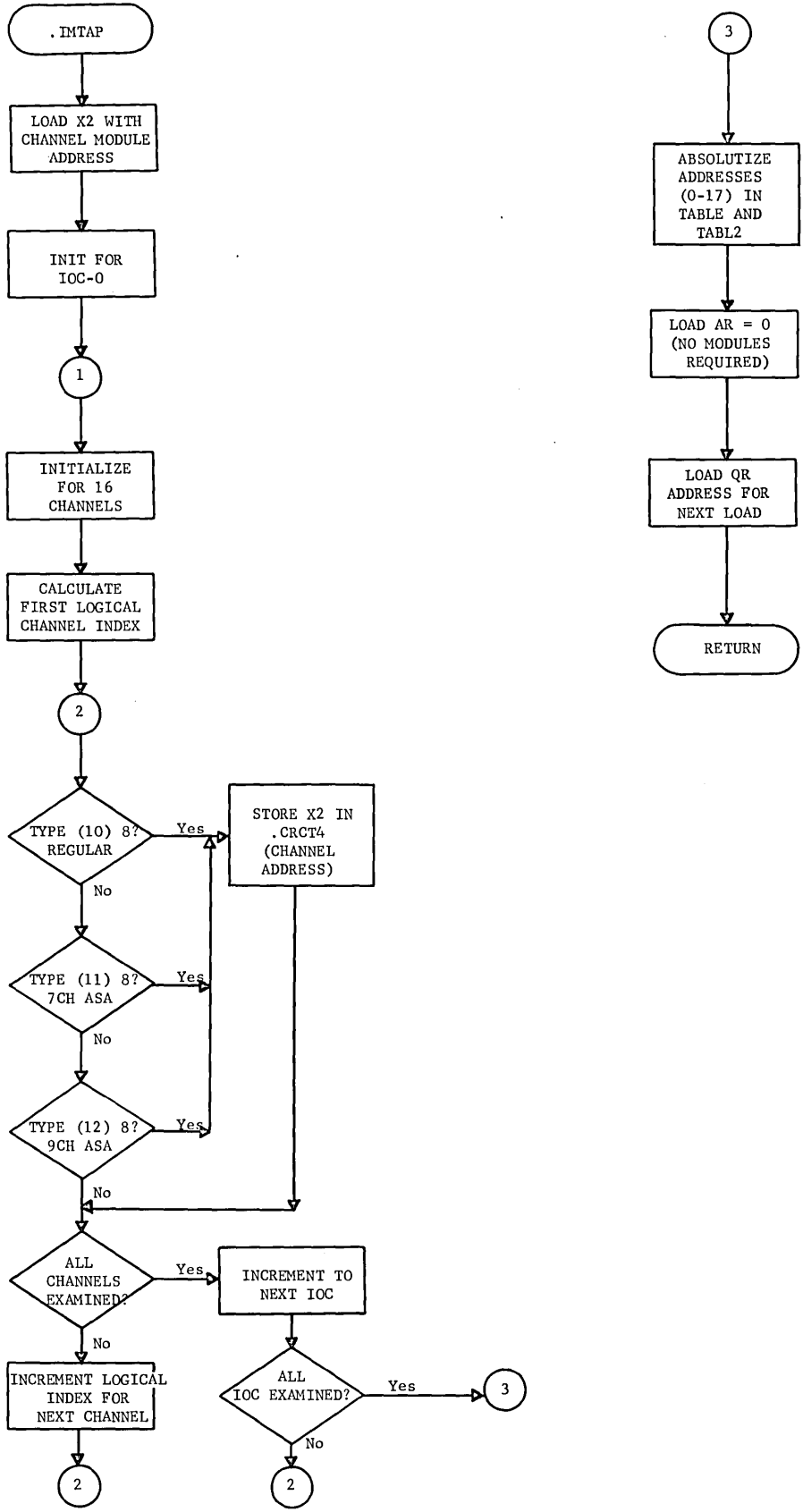

PRINTER INTERRUPT HANDLER

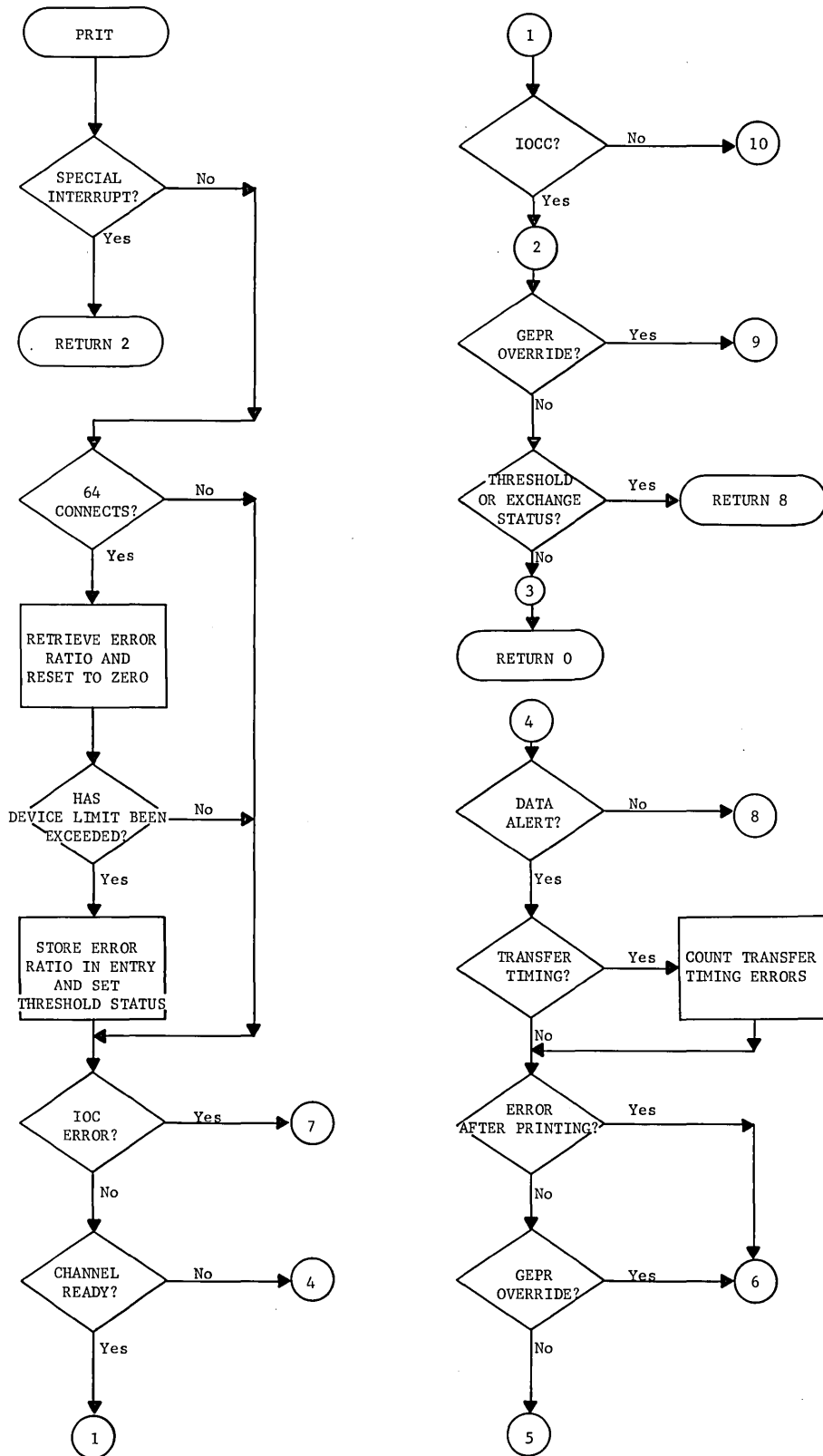

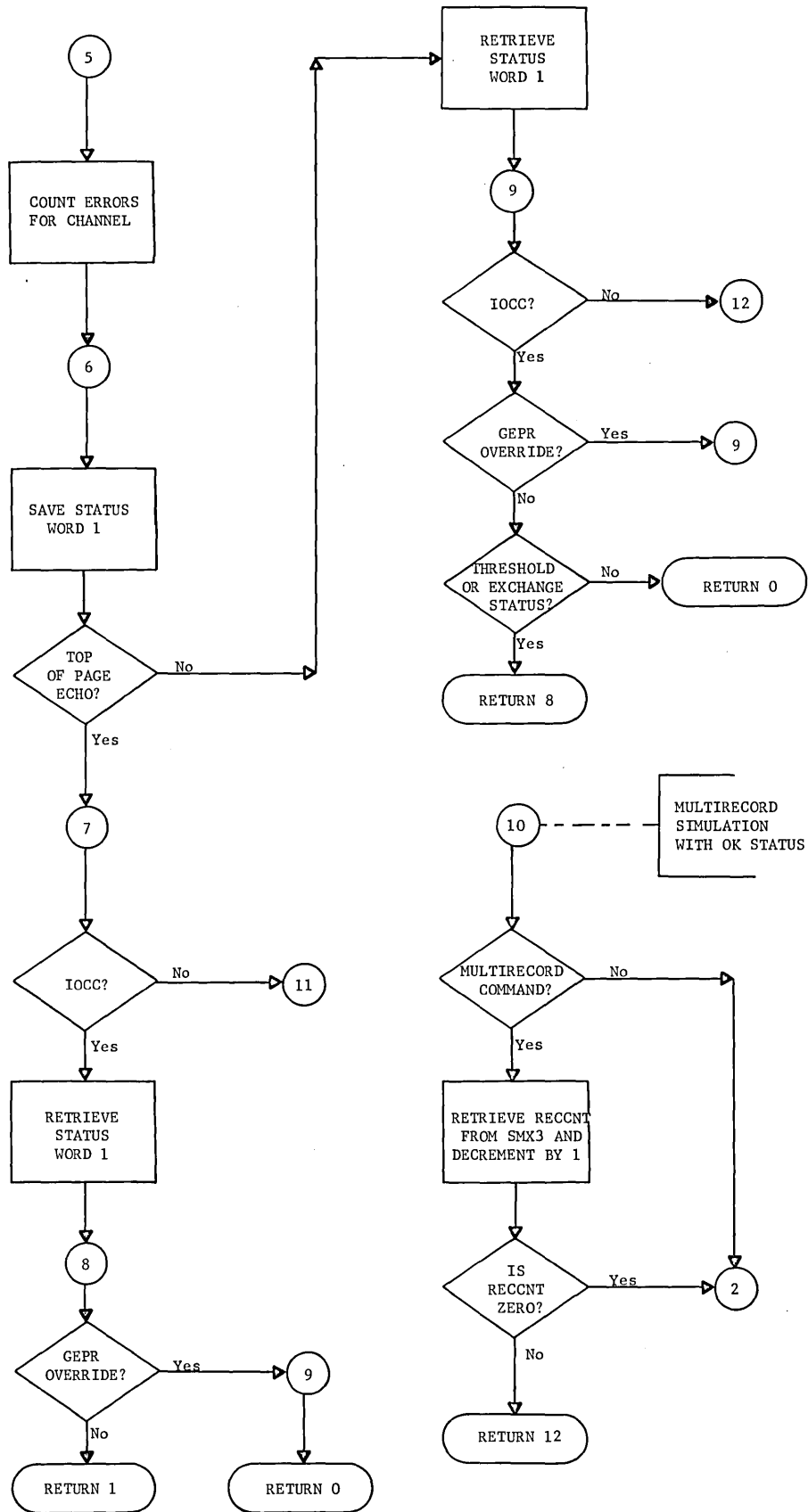

PRIT (EP1)  
. MPRIO

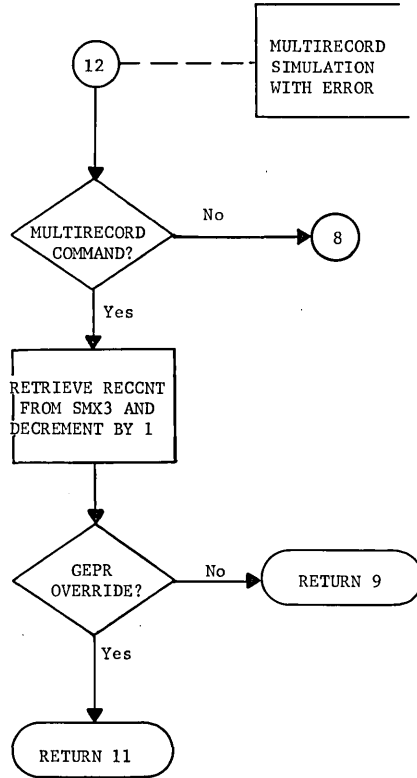
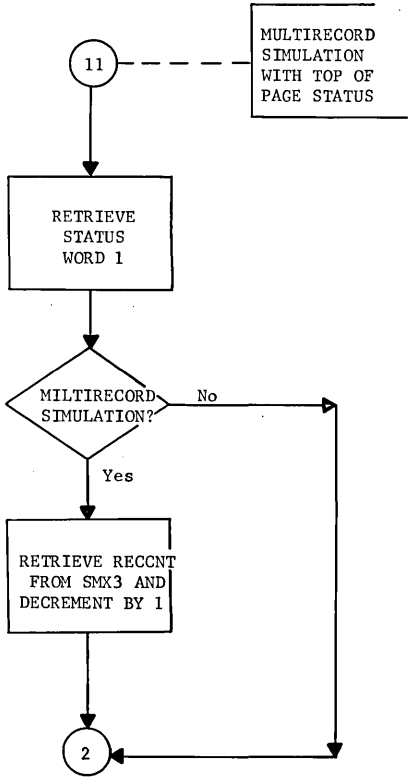

PRIO (EP2)  
.MPRIO

### PRINTER REQUEST

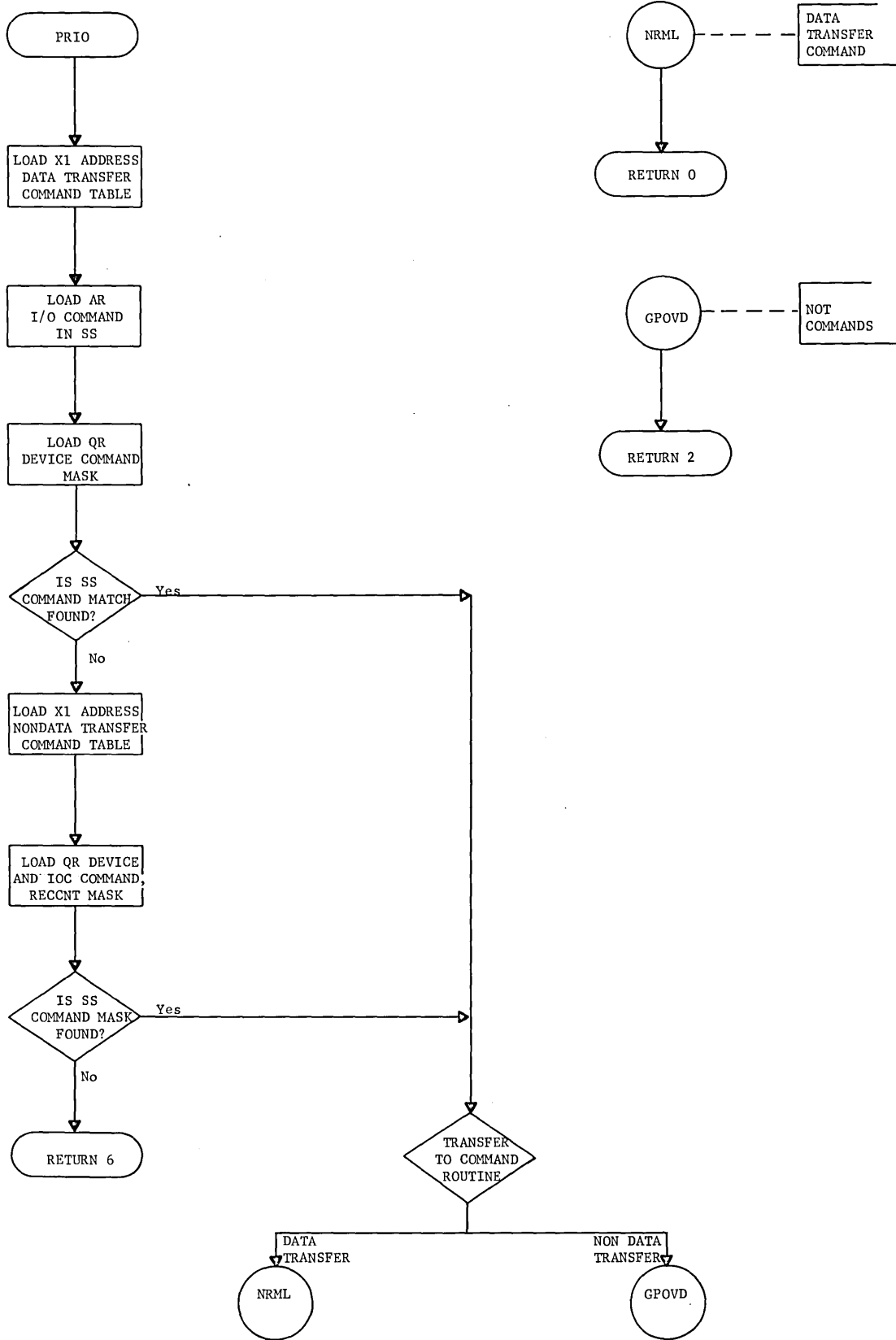

.IPRIO  
.MPRIO

### PRINTER INITIALIZATION

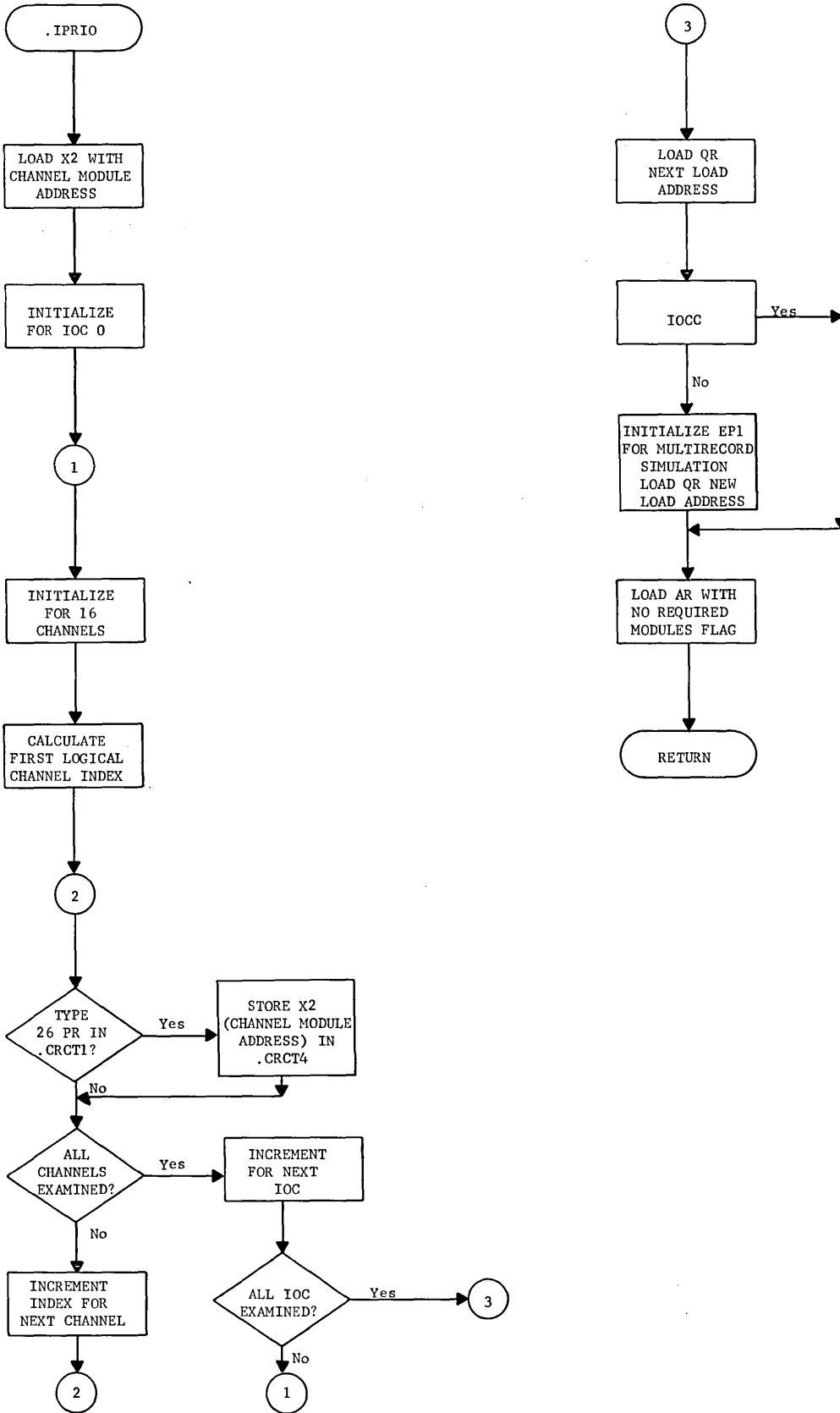

PAPER TAPE INTERRUPT HANDLER

PTIT (EP1)  
.MPTAP

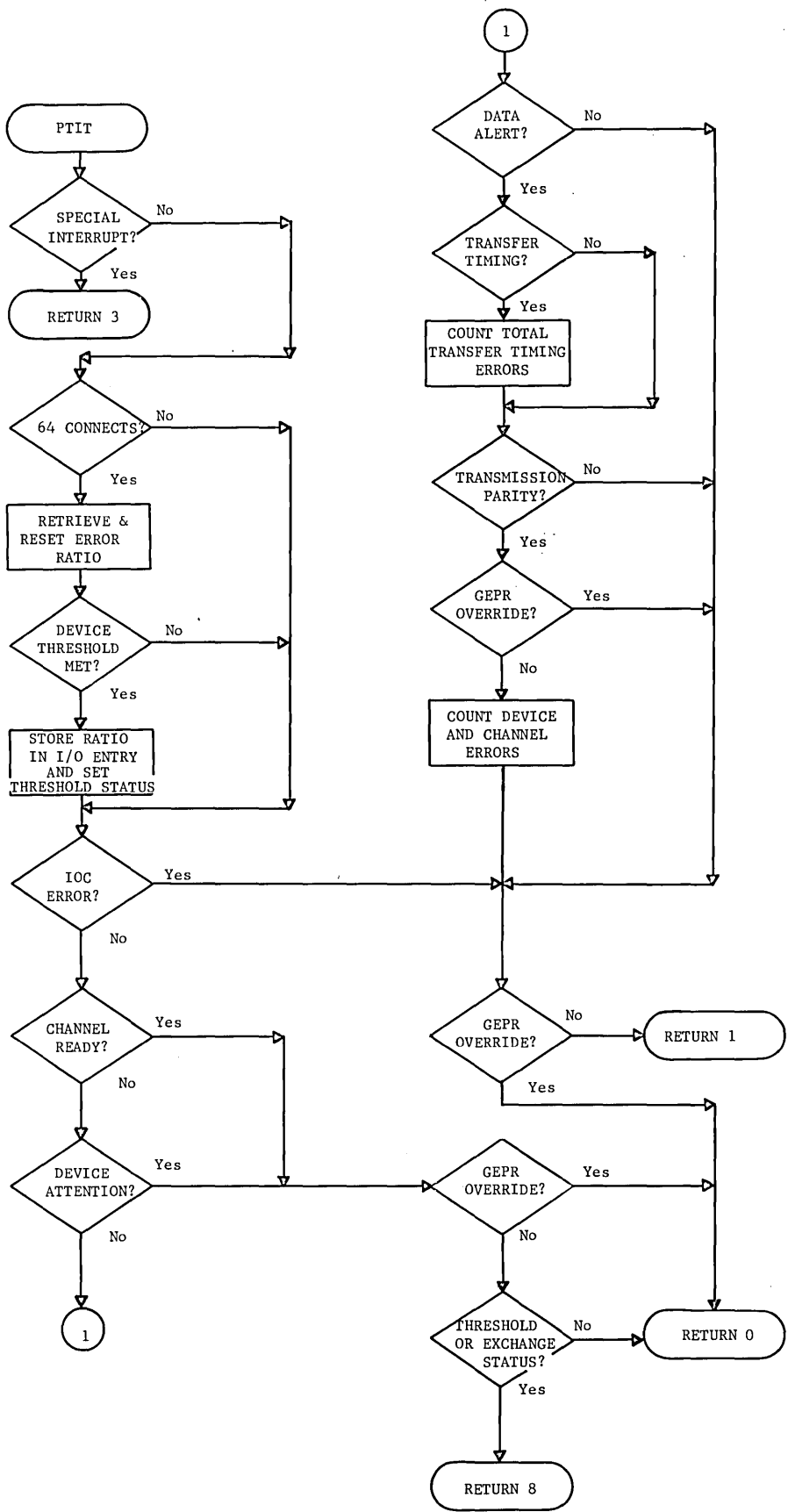



PTIO (EP2)  
.MPTAP

### PAPER TAPE REQUEST

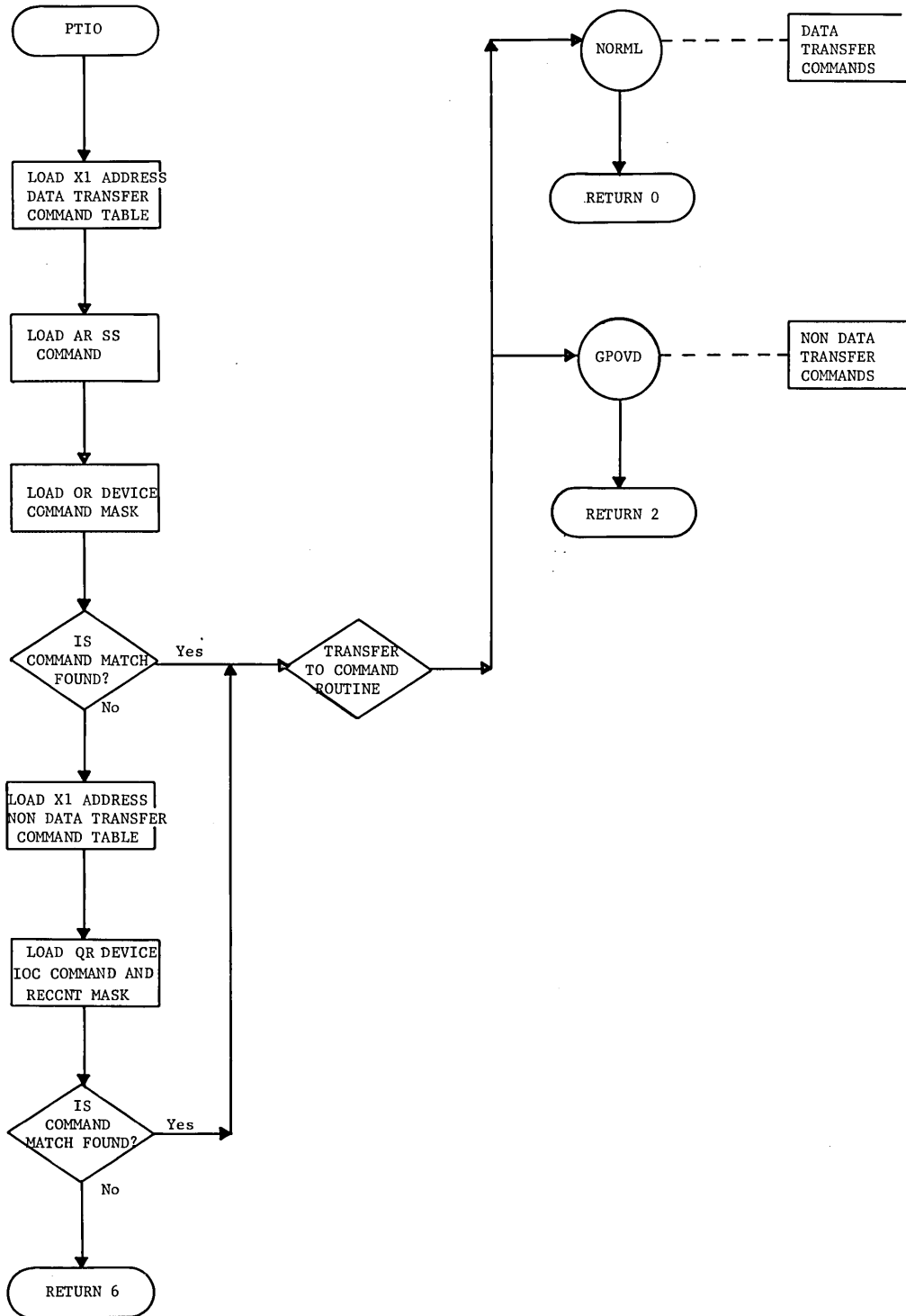

PAPER TAPE INITIALIZATION

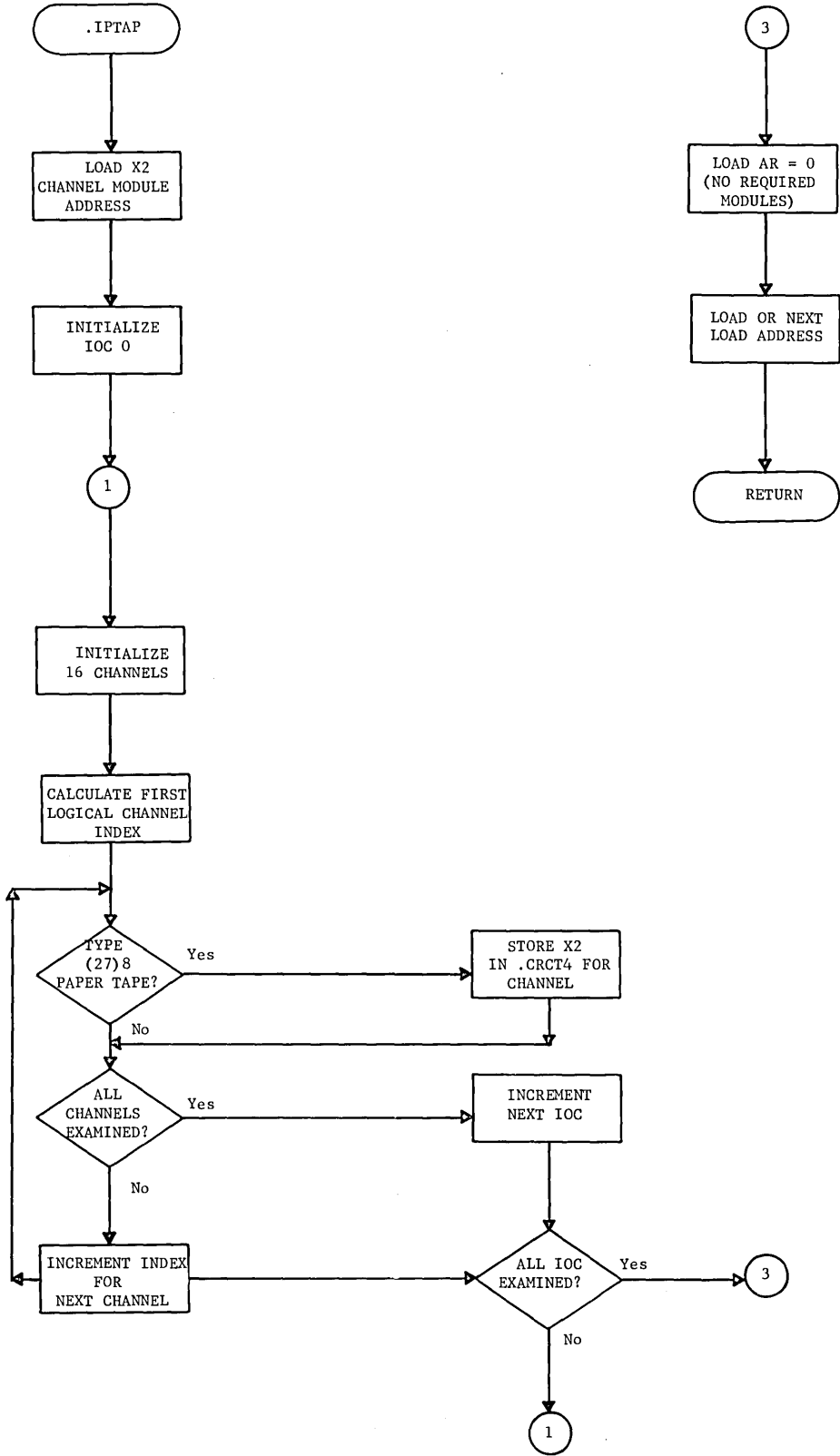

TYIT (EP1)  
.MTYPE

TYPEWRITER INTERRUPT HANDLER

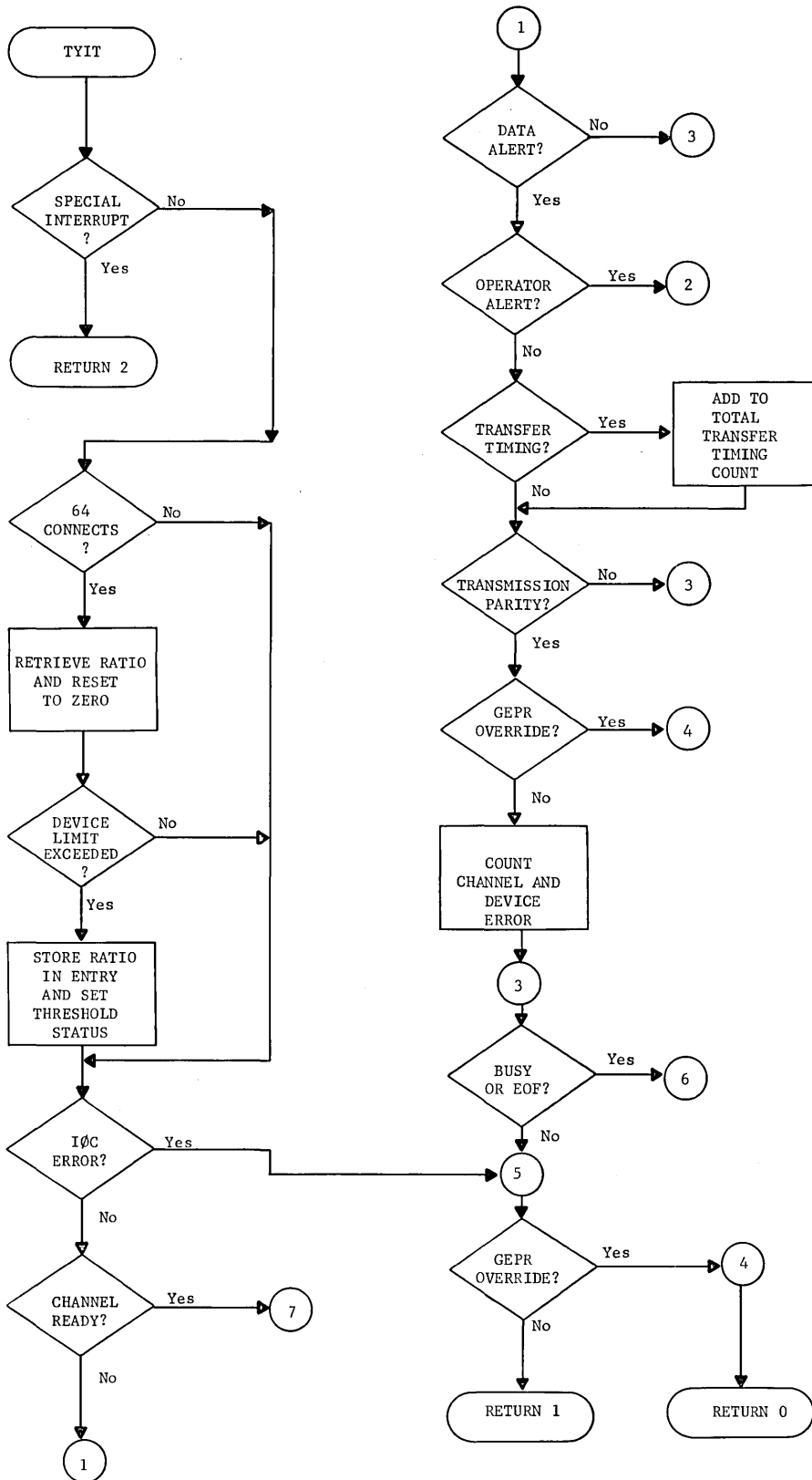

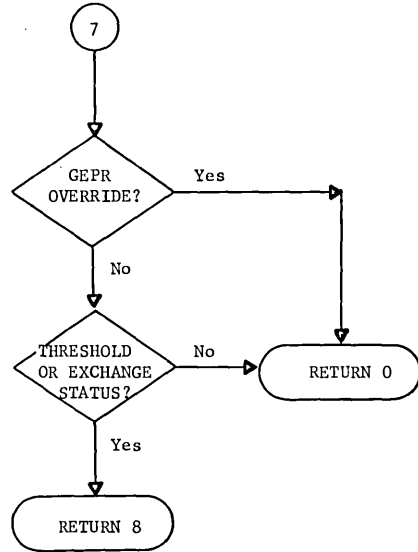
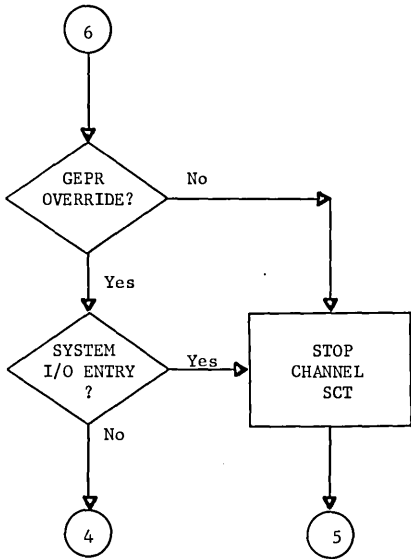

TYIT (EP1)  
.MTYPE

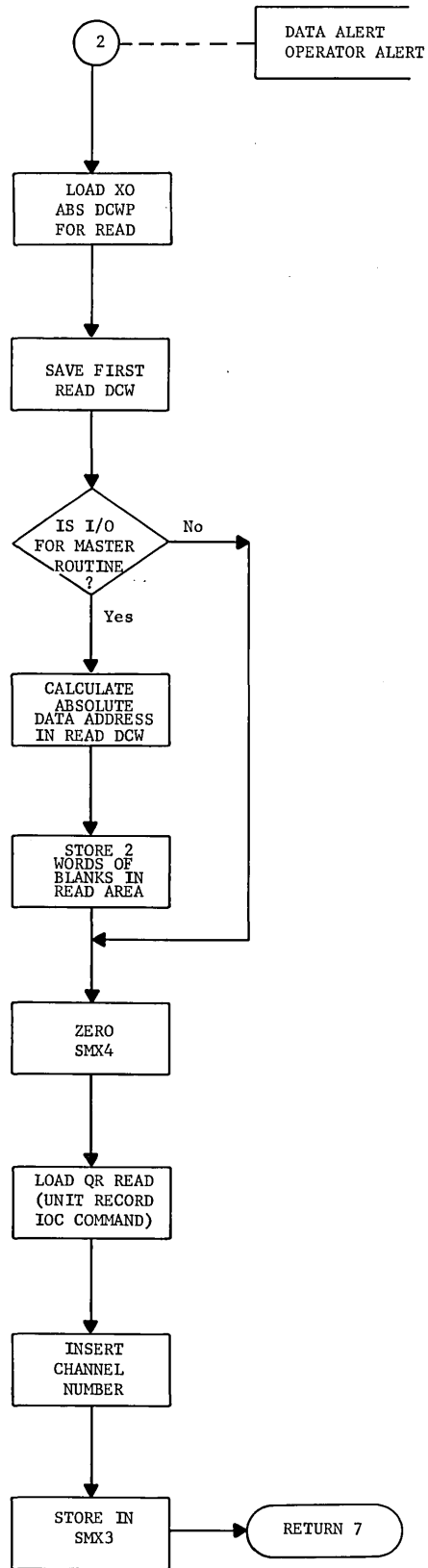

TYIO (EP2)  
.MTYPE

### TYPEWRITER REQUEST

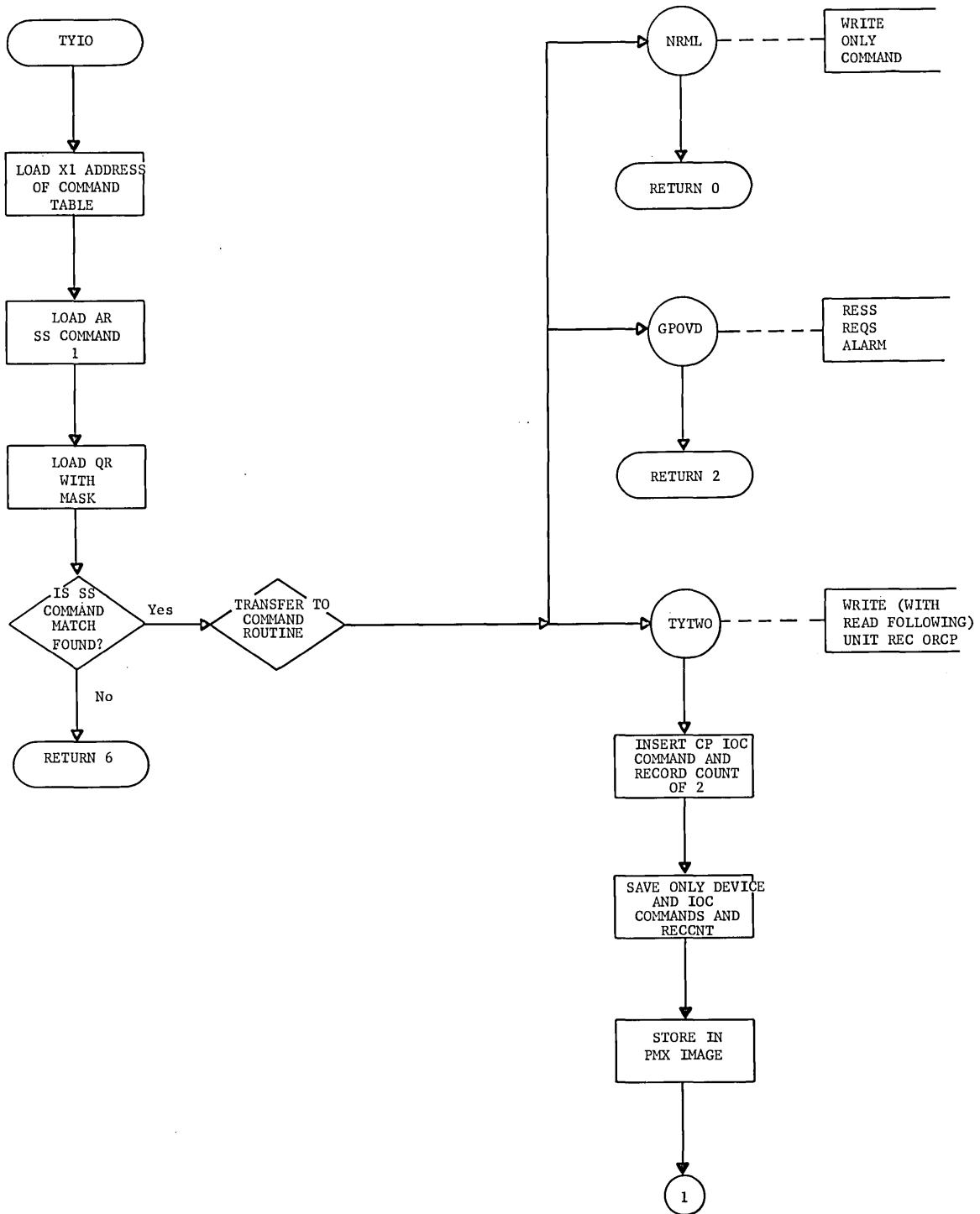

TYIO (EP2)  
.MTYPE

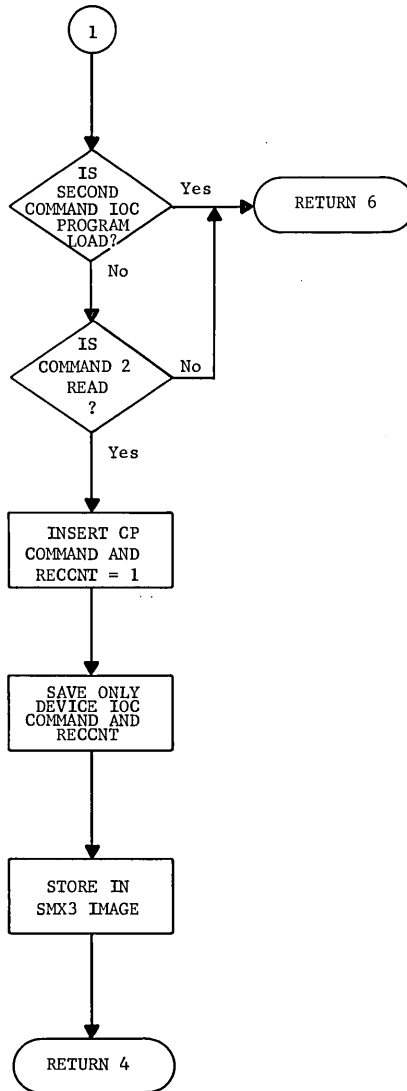

TYPEWRITER SELECT

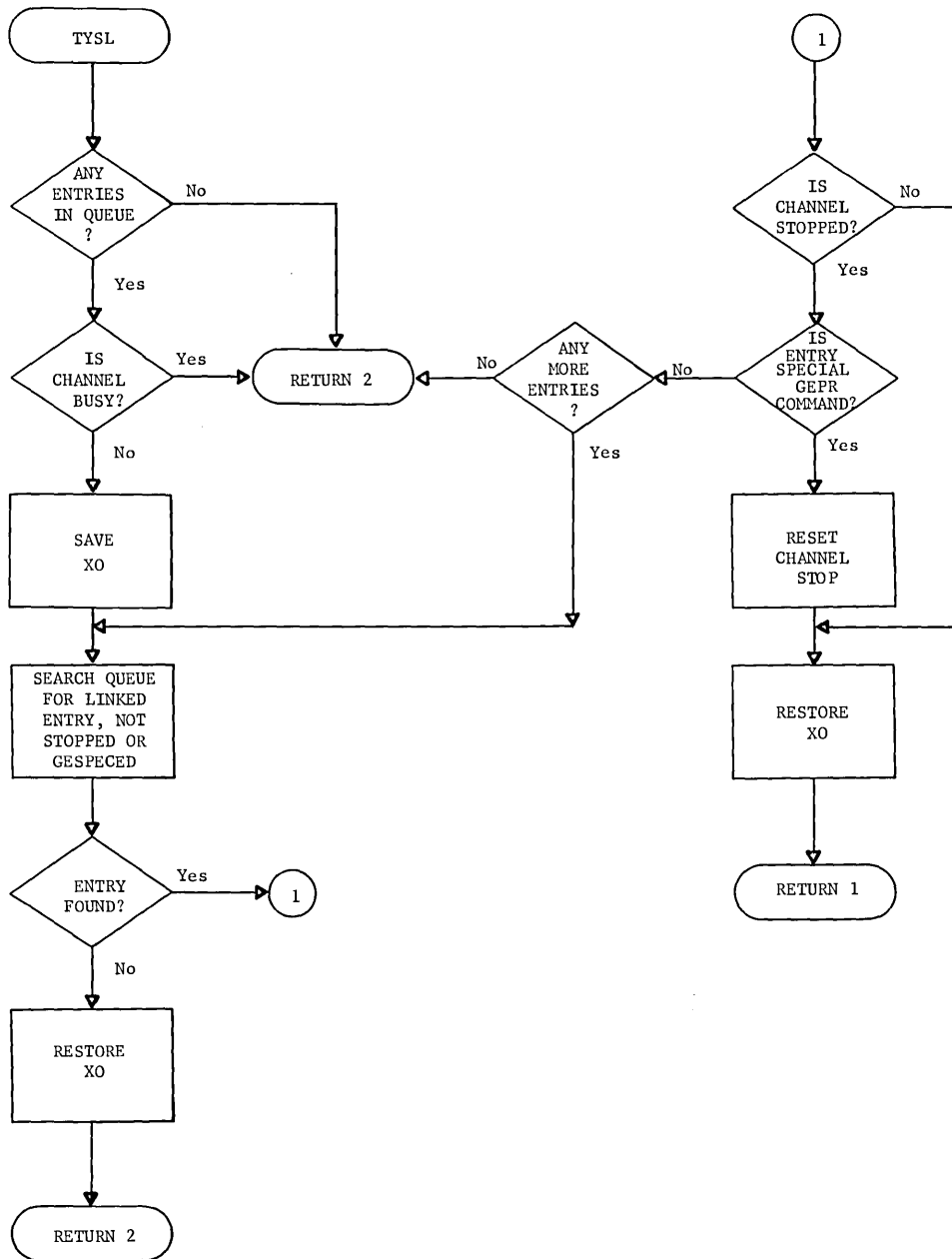



.ITYPE  
.MTYPE

### TYPEWRITER INITIALIZATION

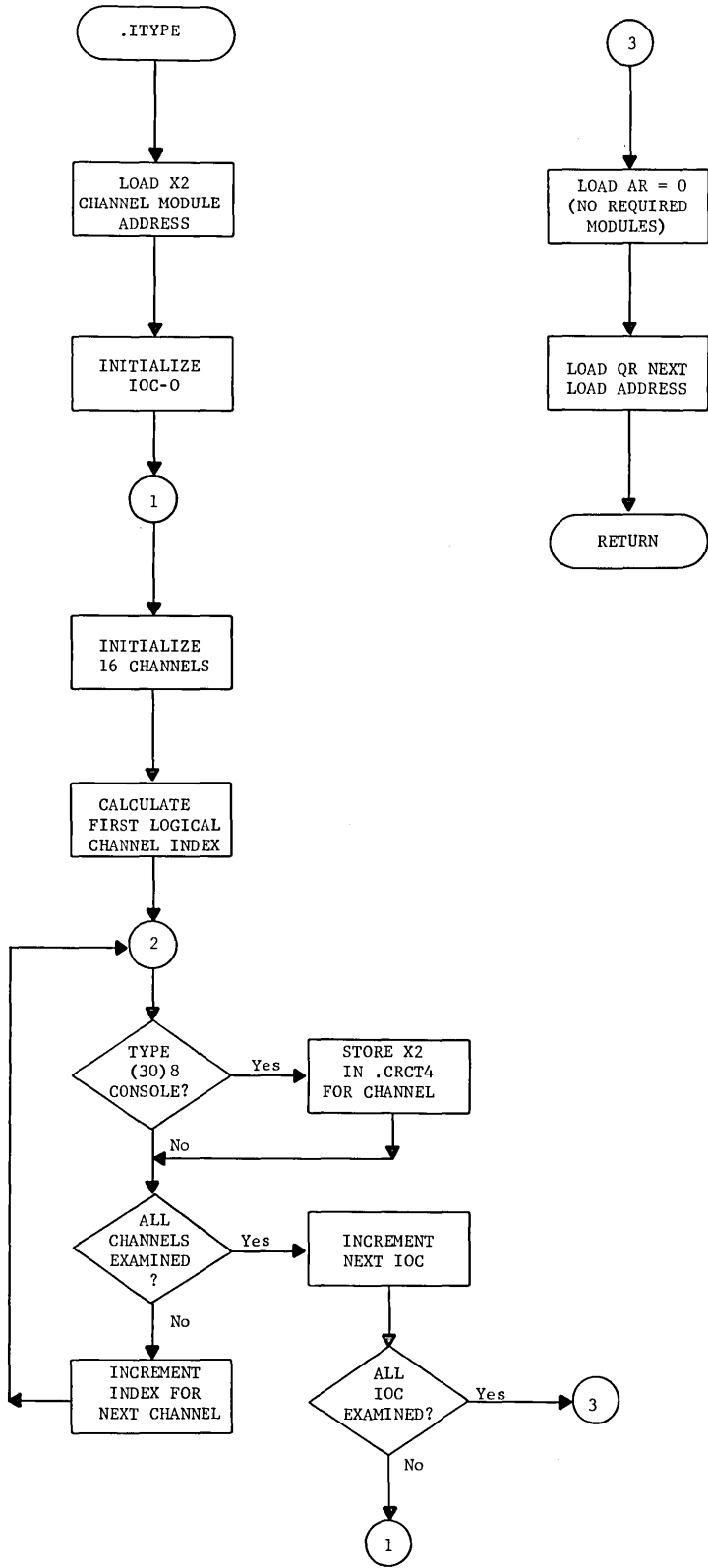

NORMAL CLOSE OF ACCOUNTING FILE

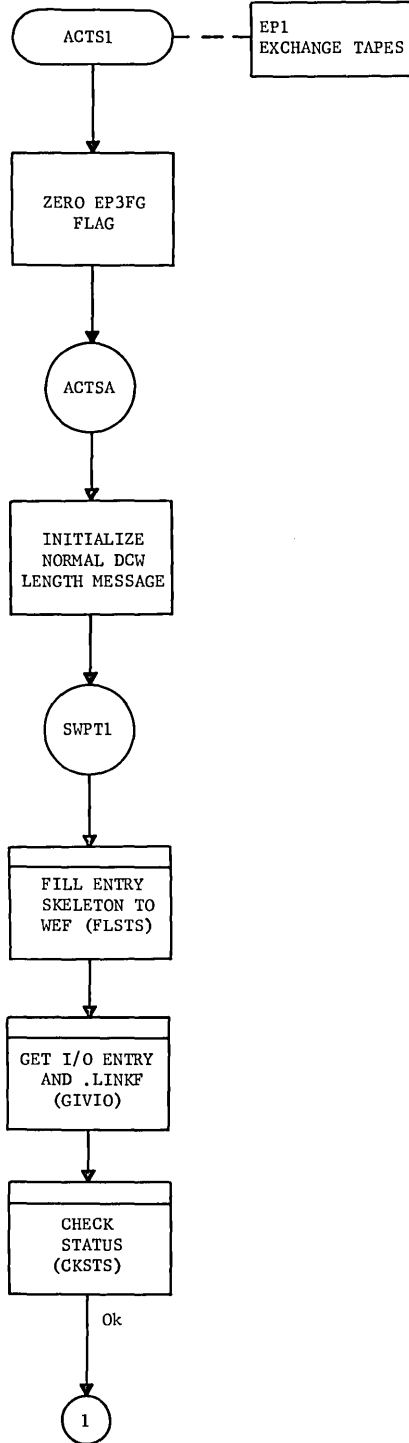

ACTS2 (EP2)  
.MACTS

### ERROR CLOSE OF ACCOUNTING FILE

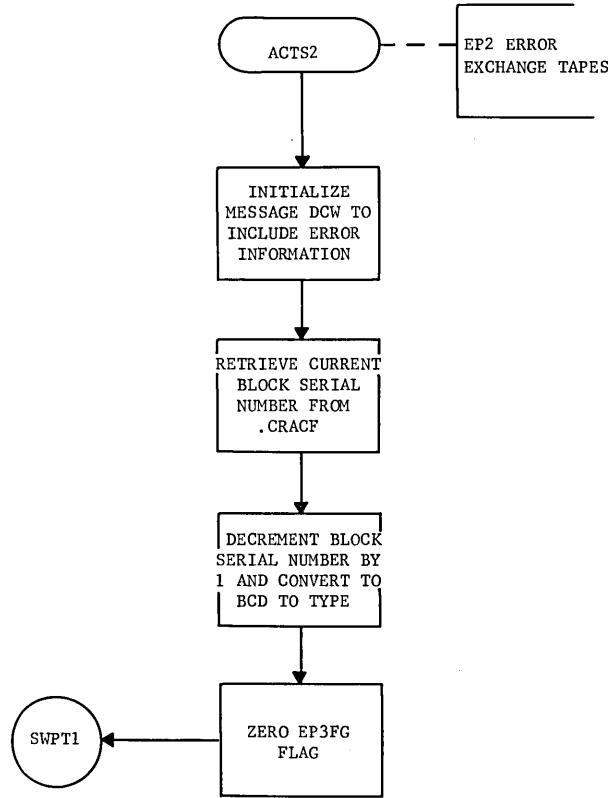

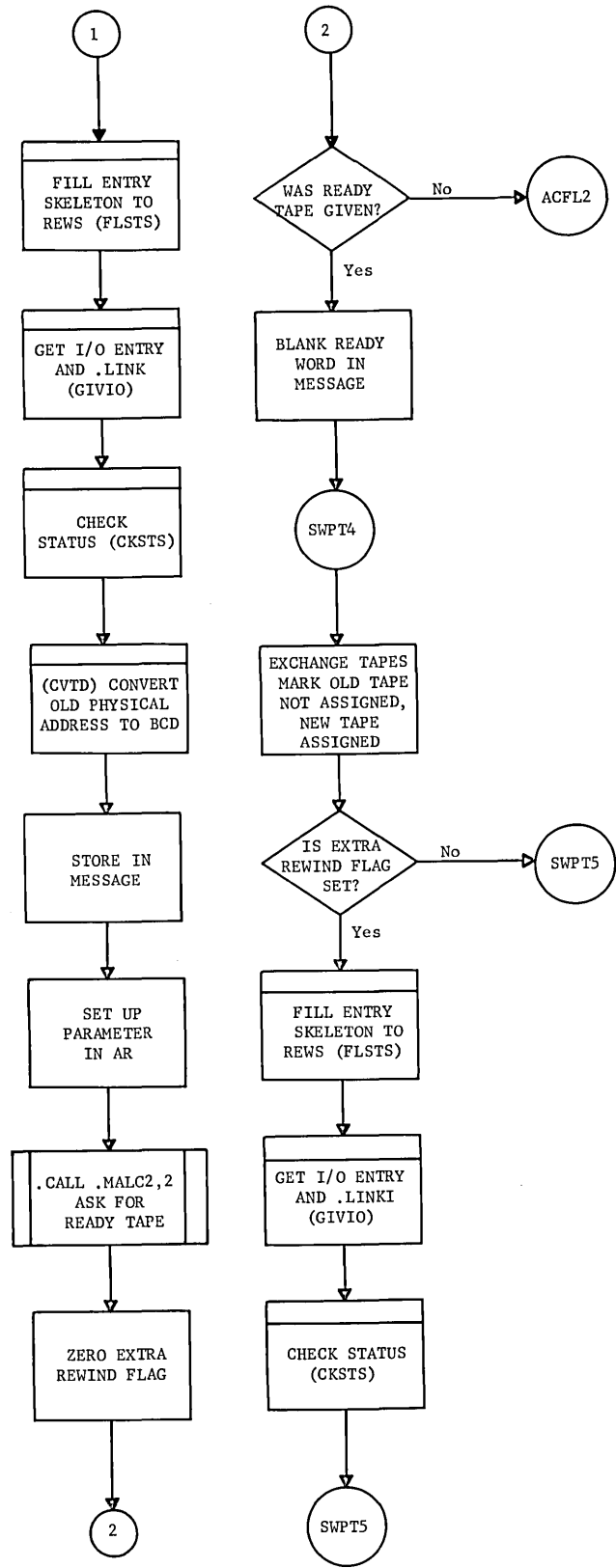

ACTS2 (EP2)  
.MACTS

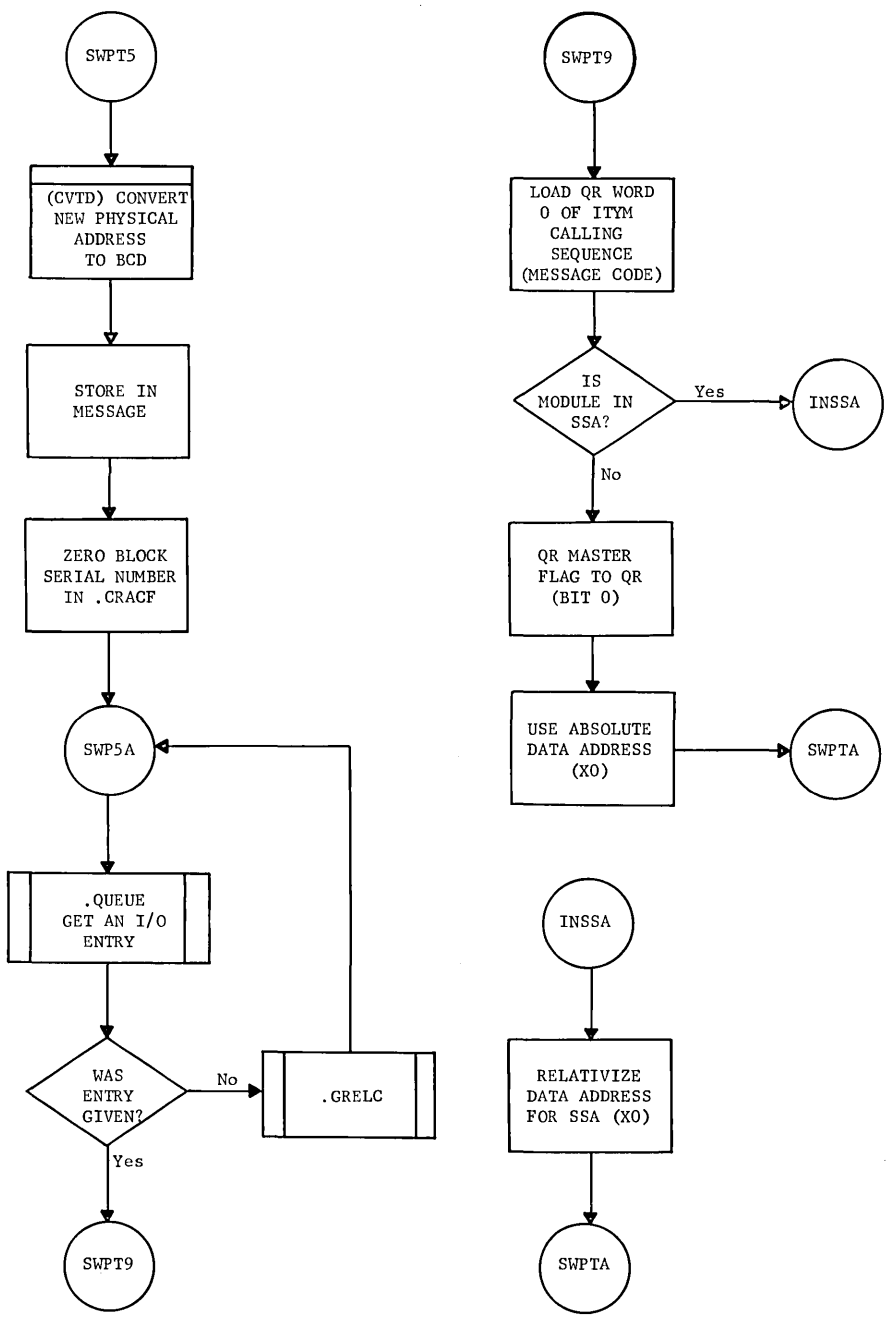

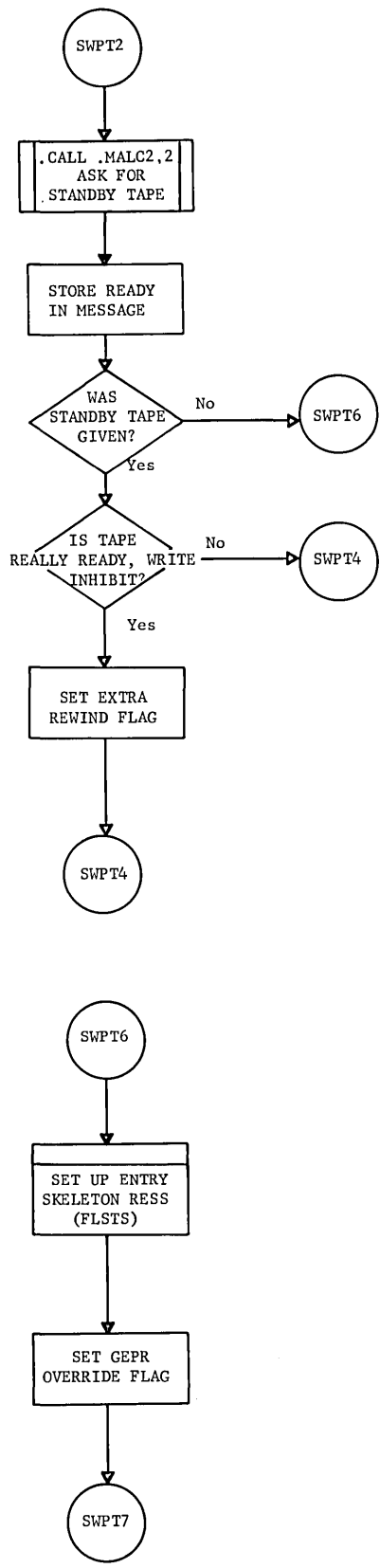
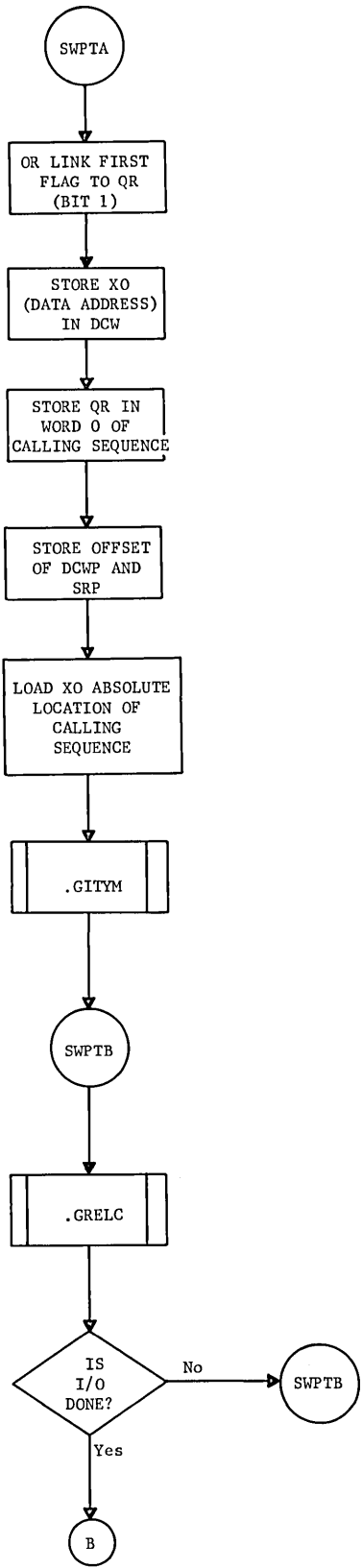

ACTS2 (EP2)  
.MACTS

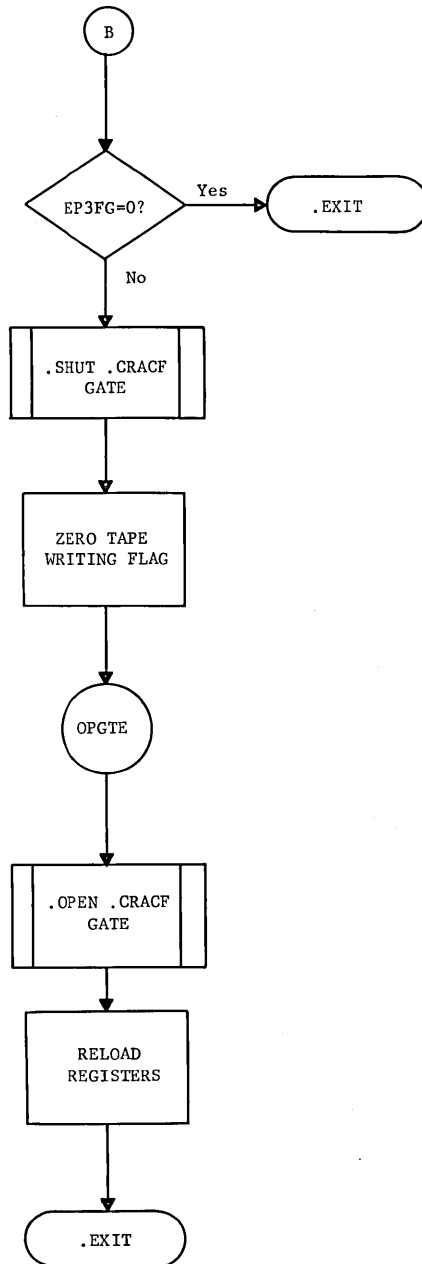

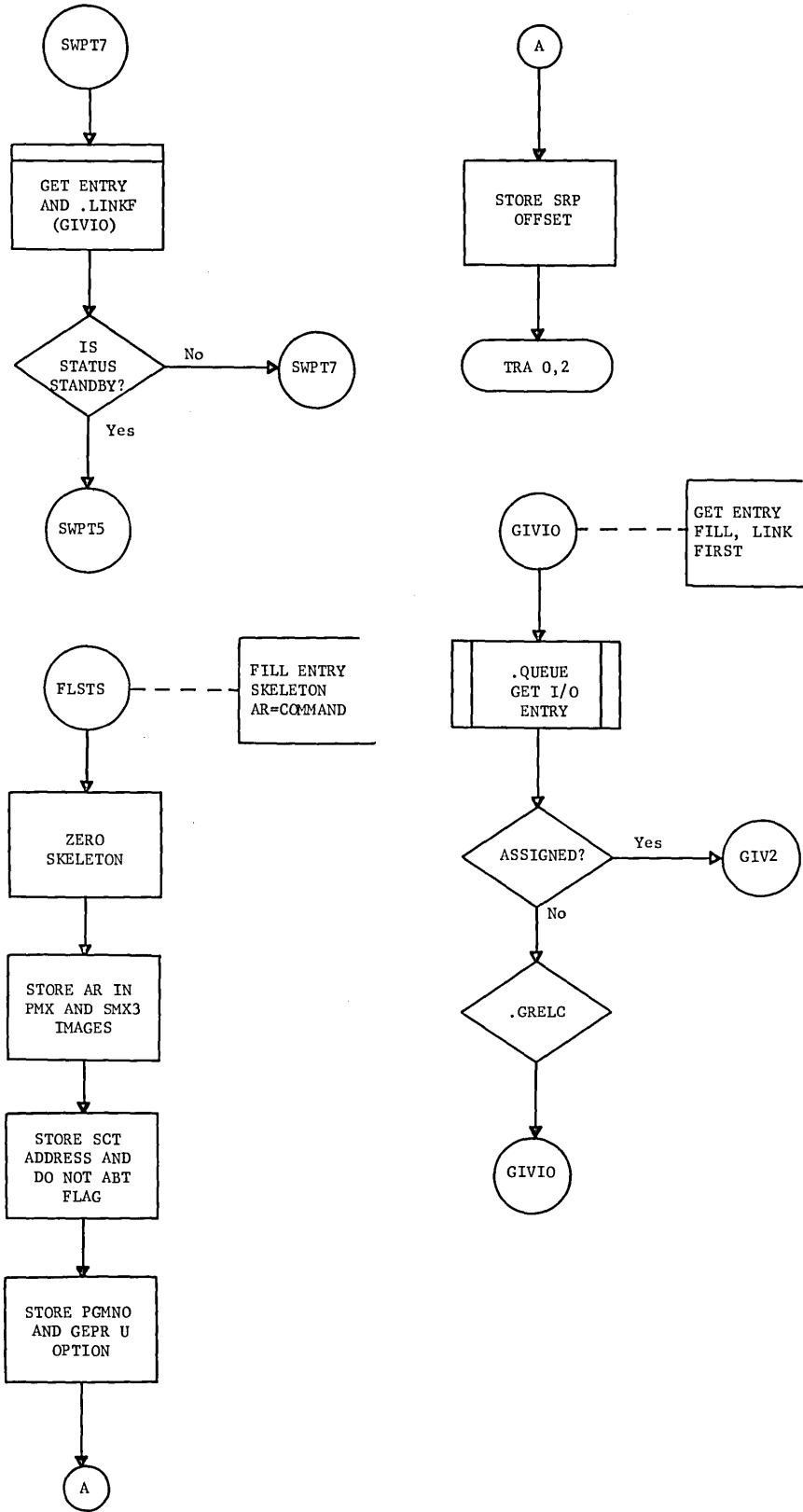



ACTS2 (EP2)  
.MACTS

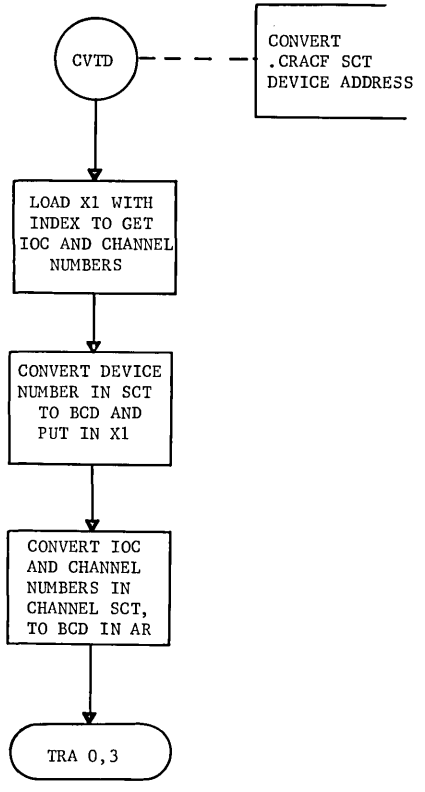
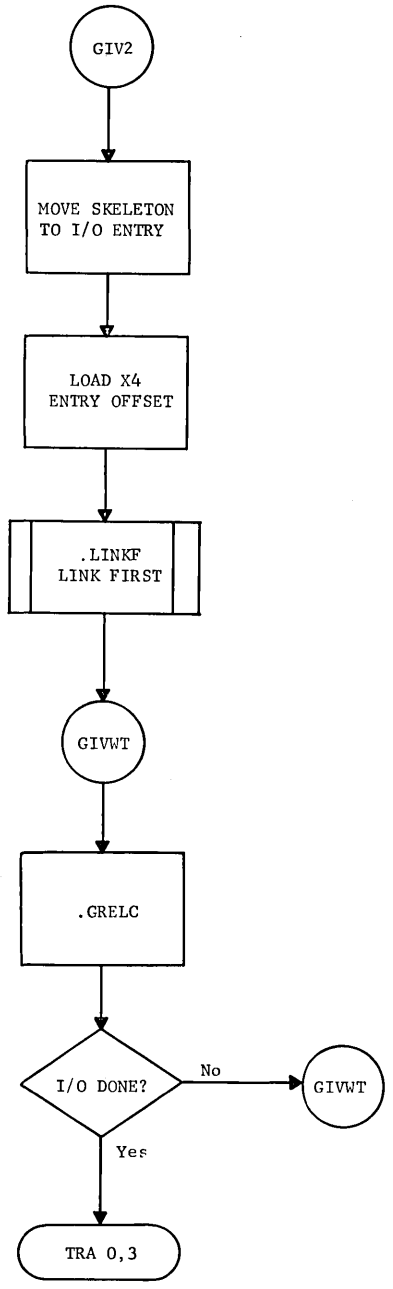

EXTERNAL REQUEST FOR ACCOUNTING FILE

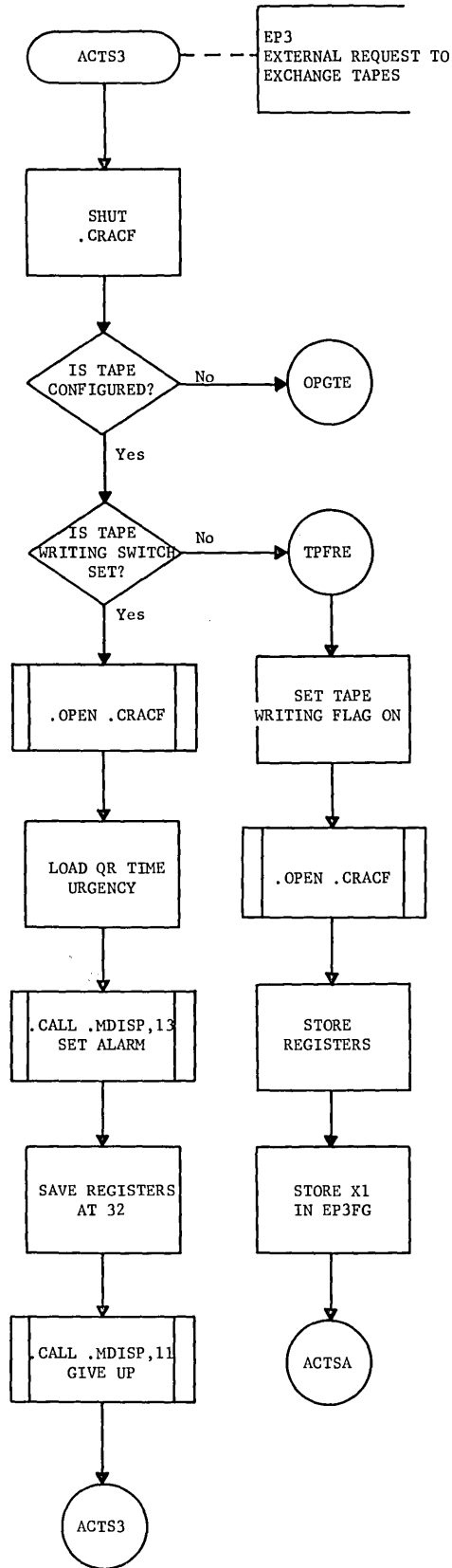



## 4. TERMINATION AND SYSTEM OUTPUT

(Reference CPB-1496)



PROCESS MME GESYOT

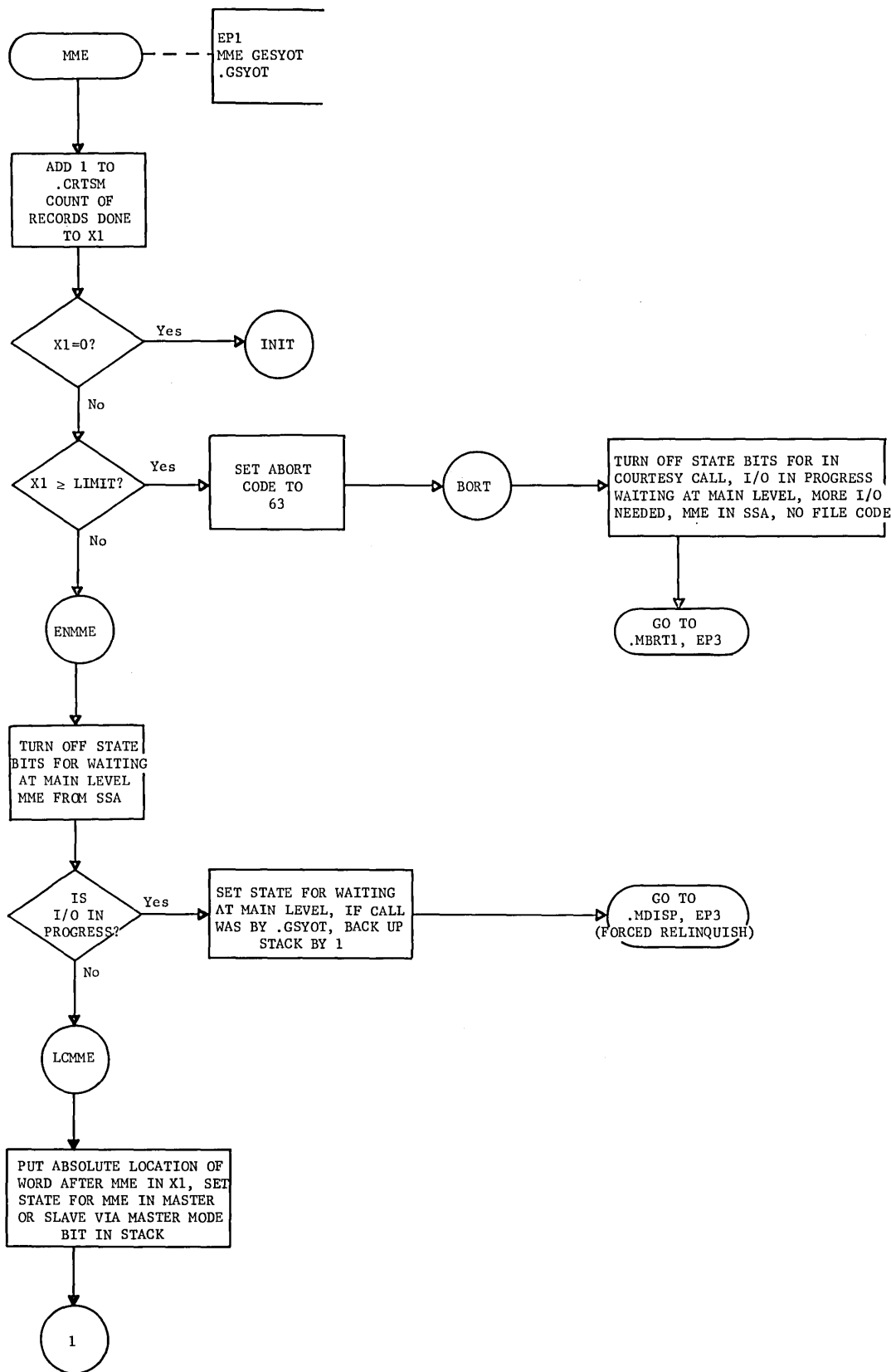

MME (EP1)  
.MSYOT

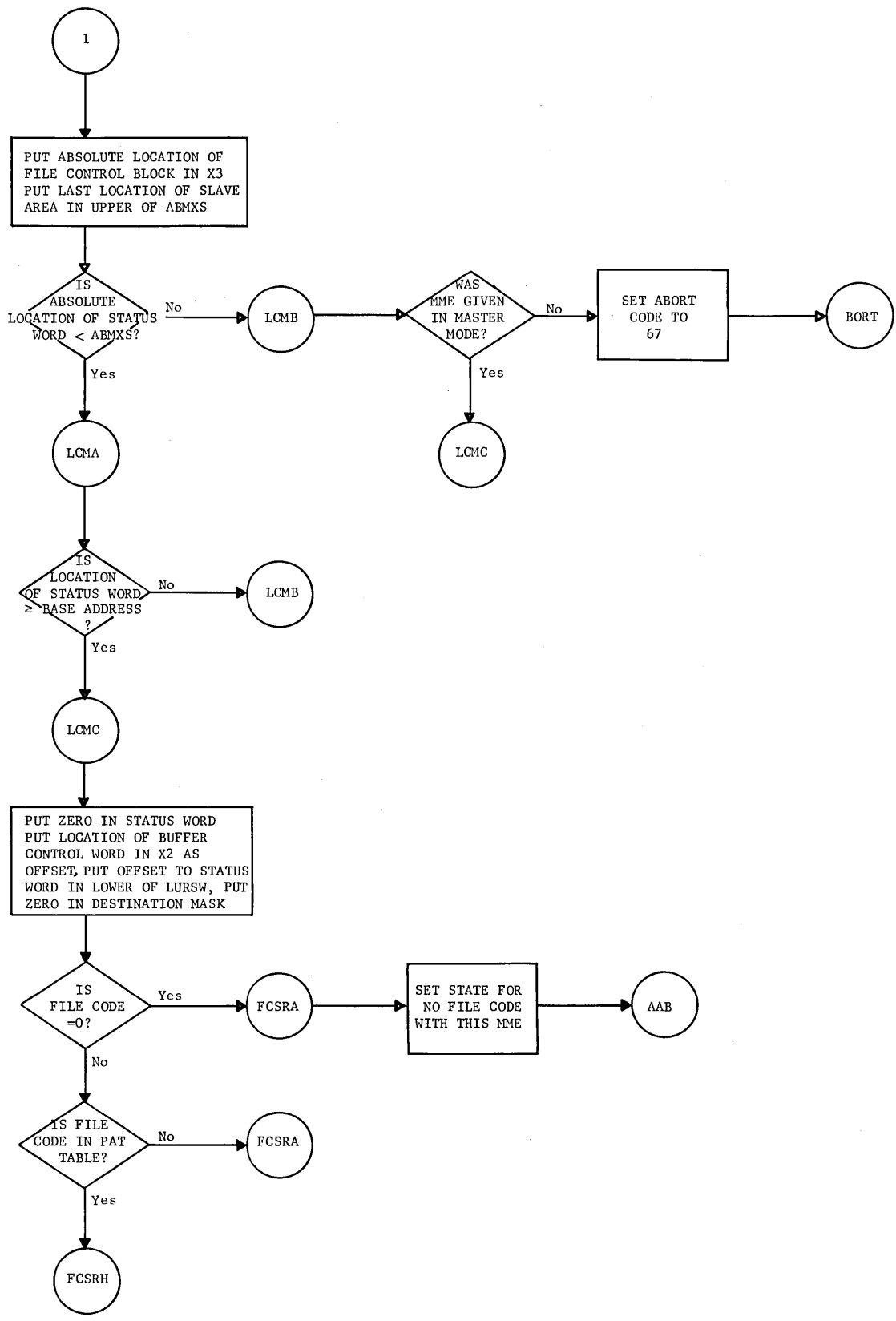

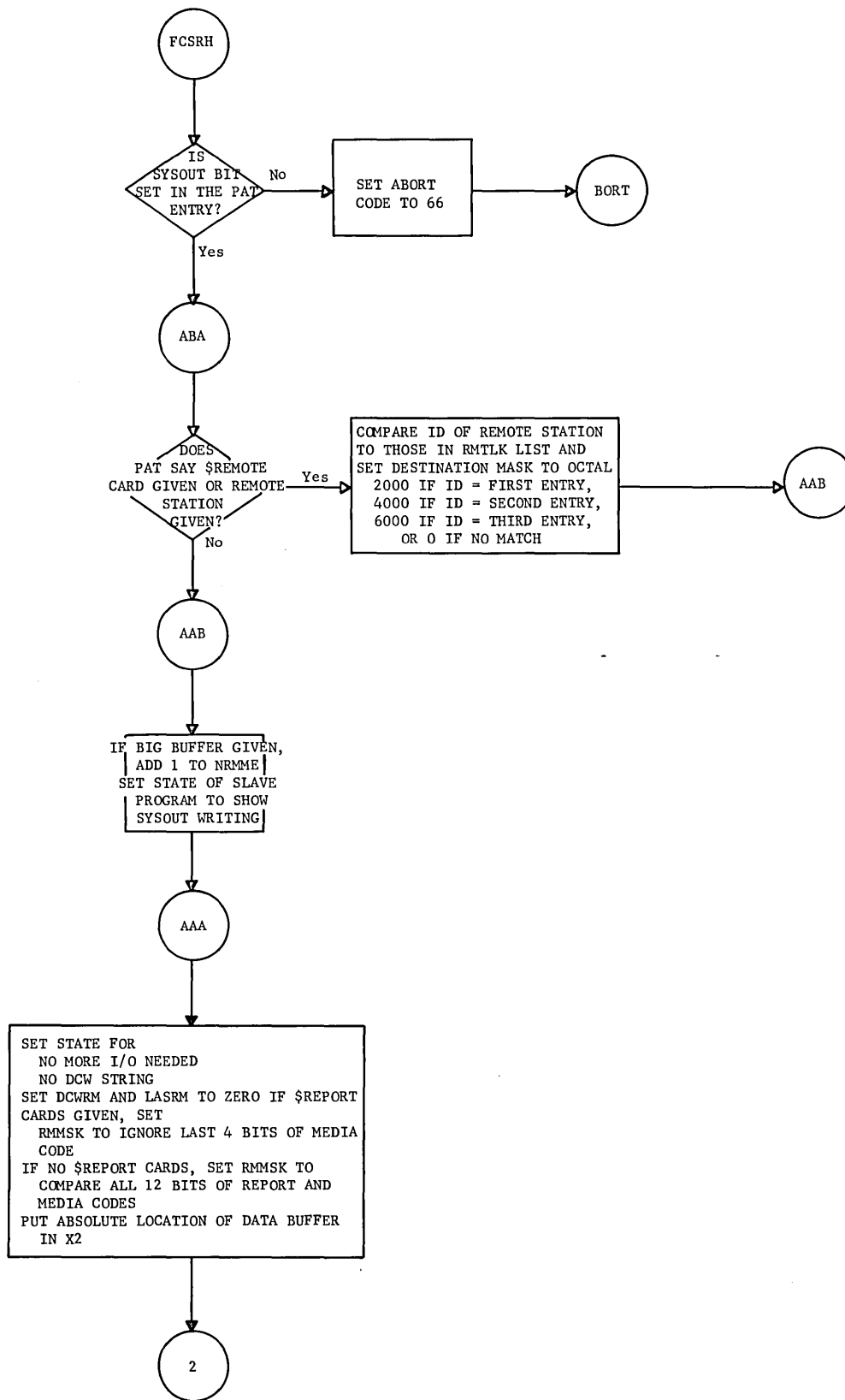



MME (EP1)  
.MSYOT

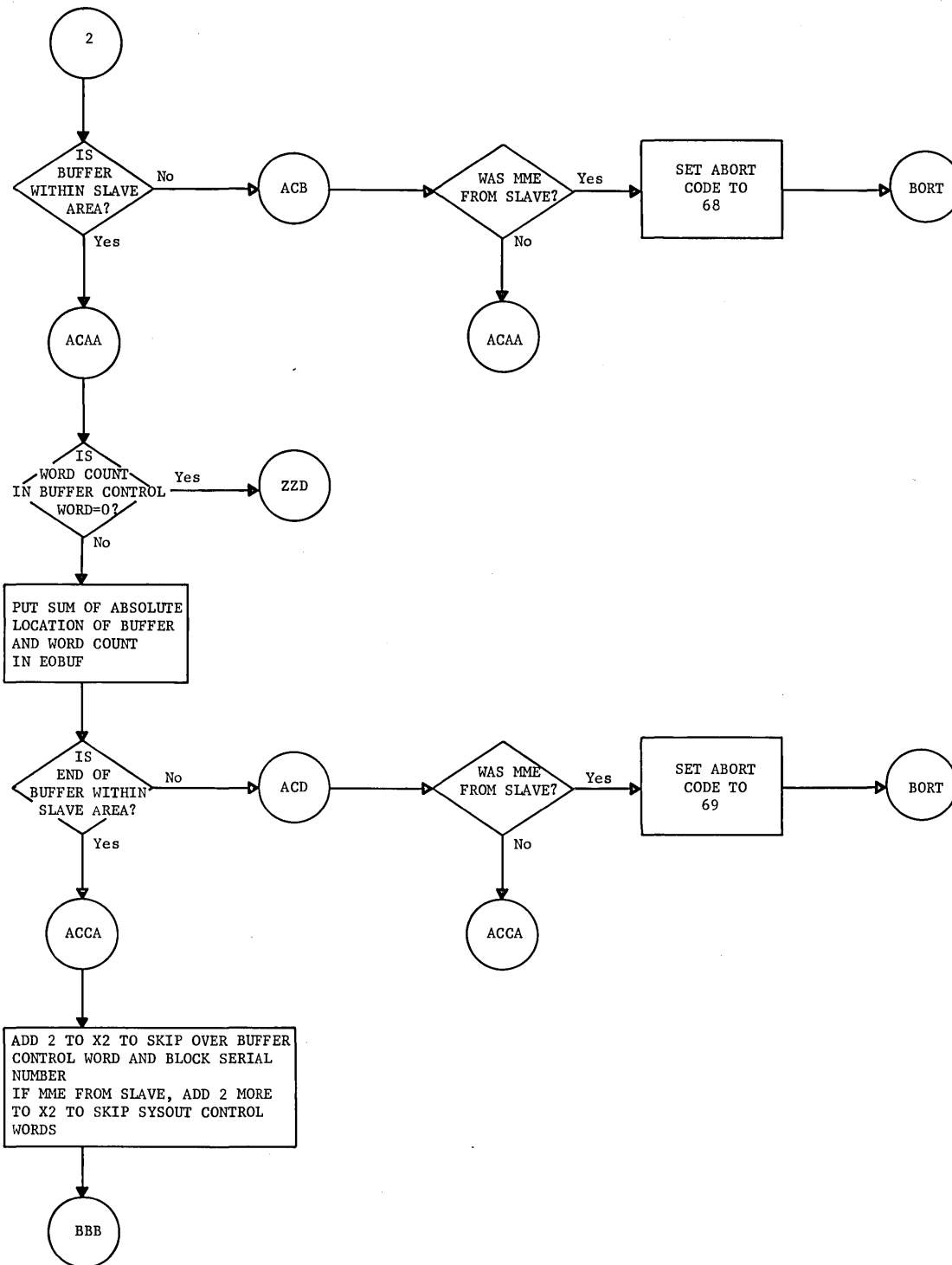

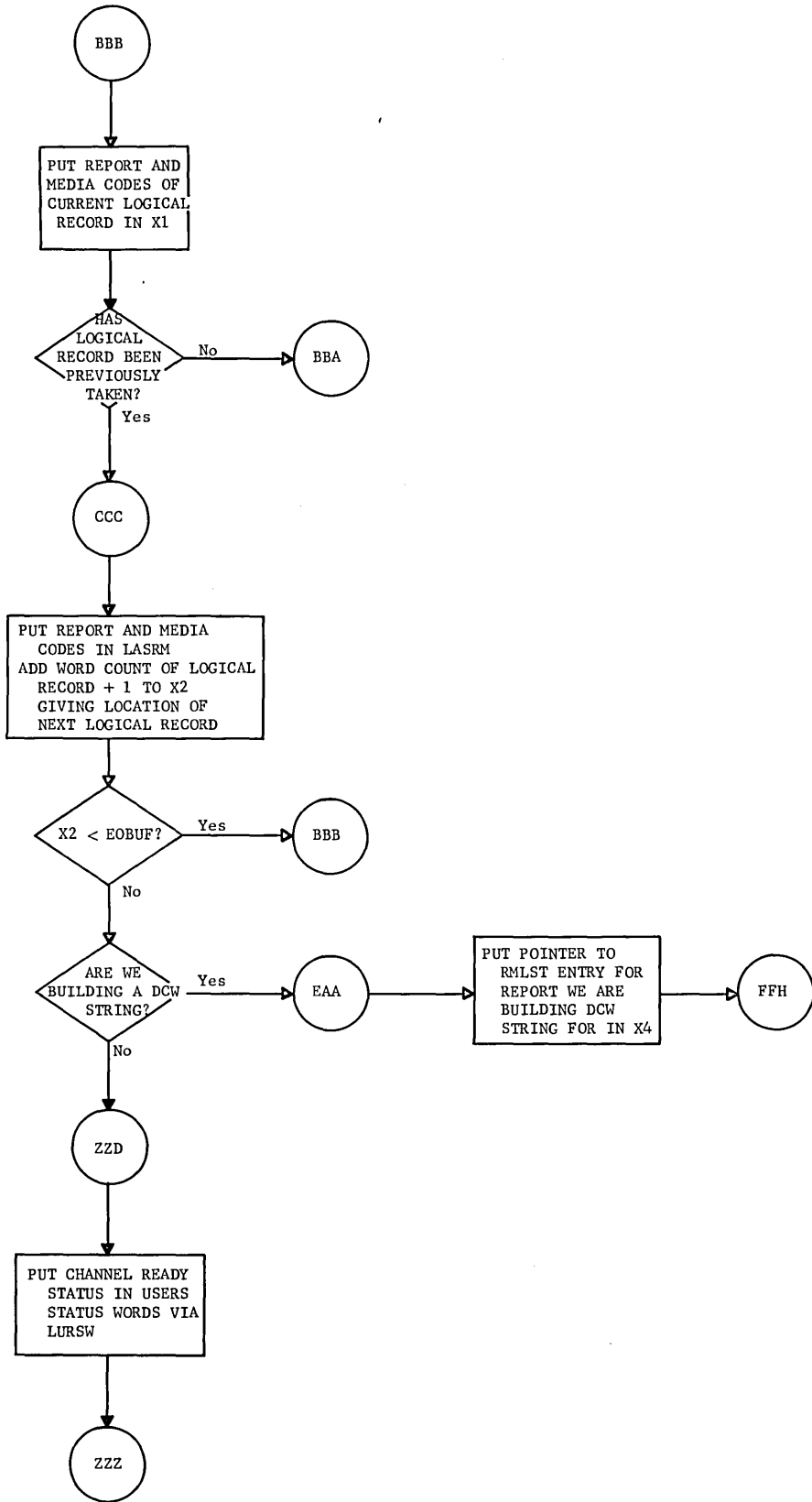

MME (EP1)  
.MSYOT

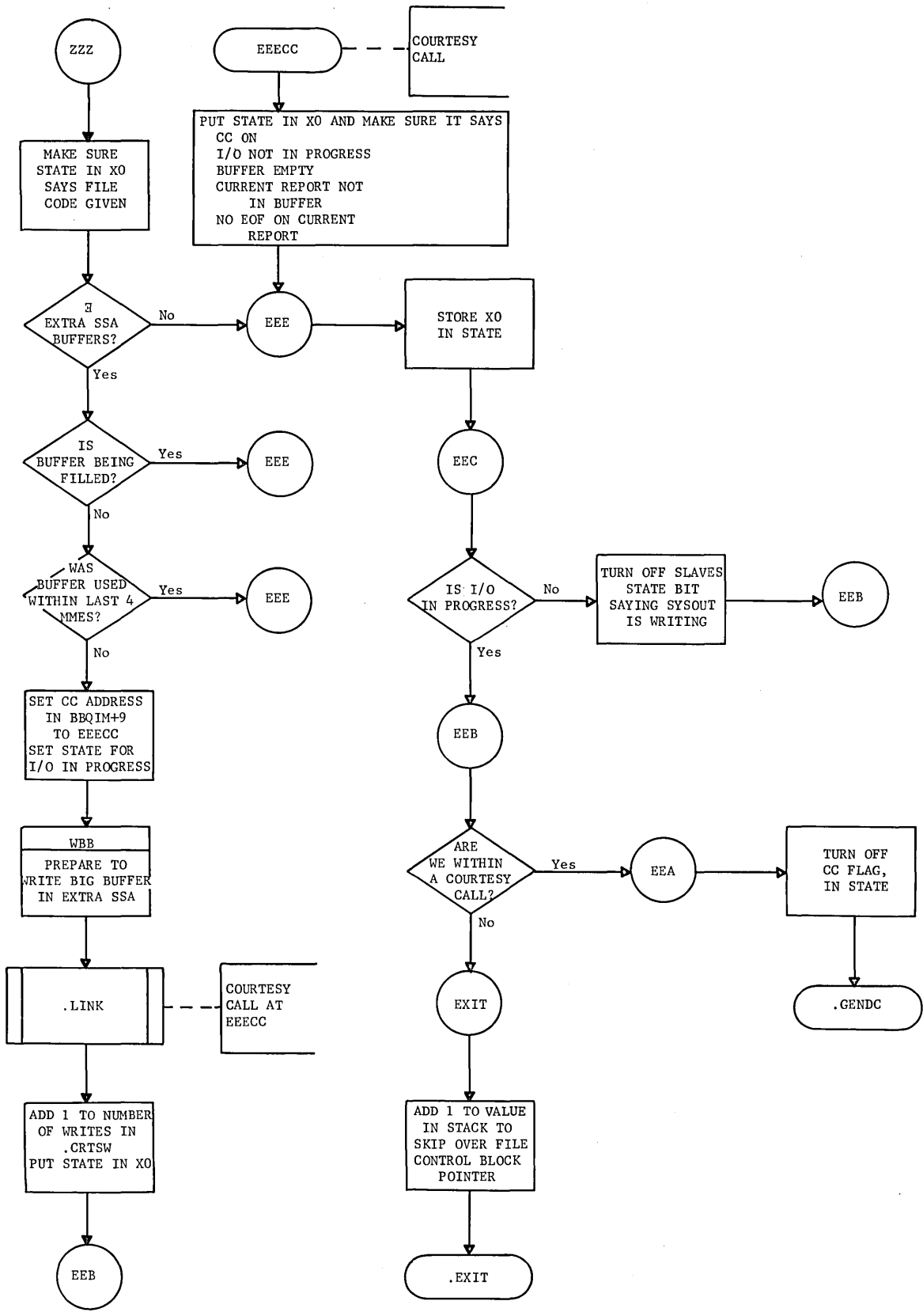

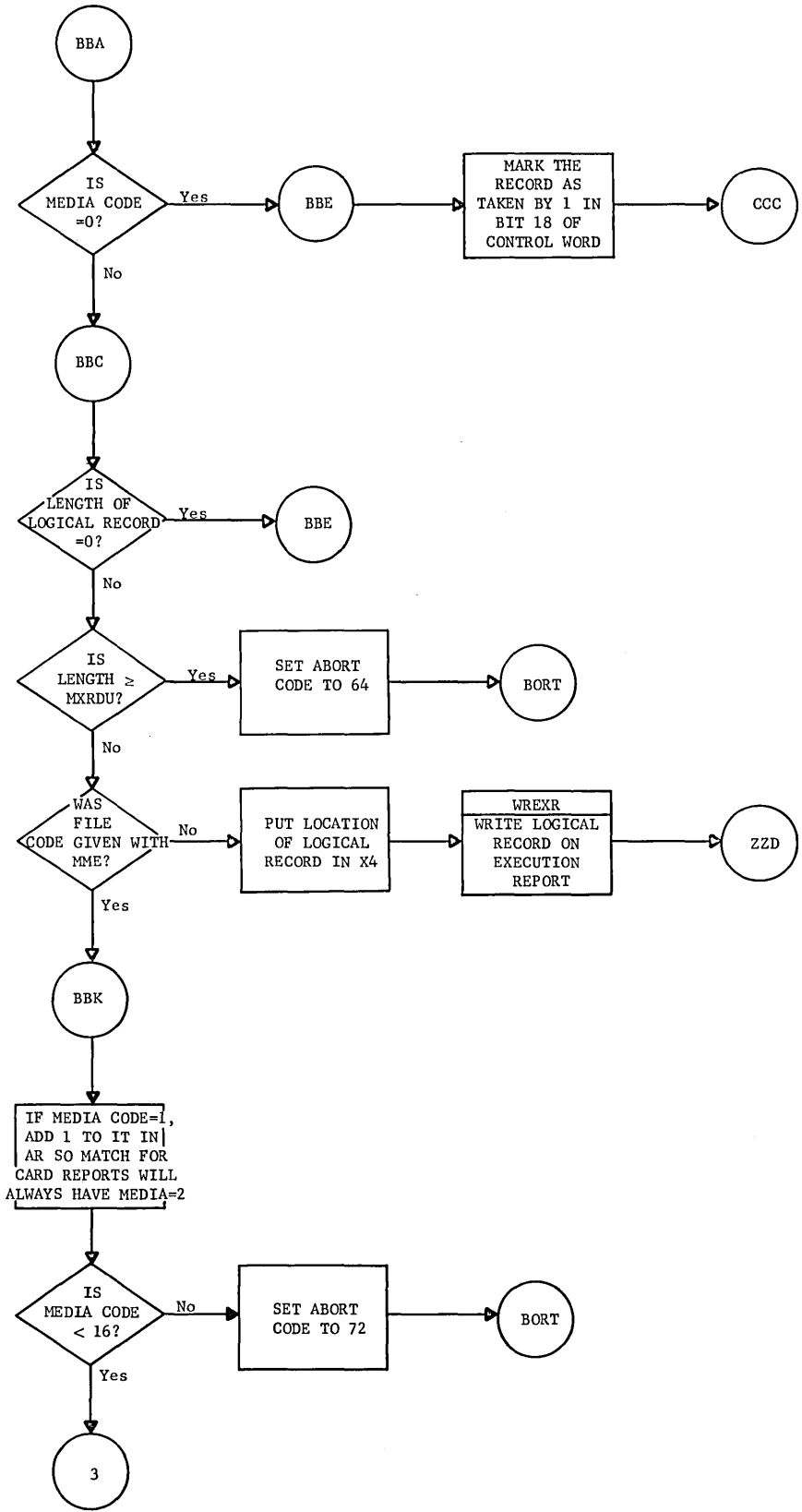

MME (EP1)  
.MSYOT

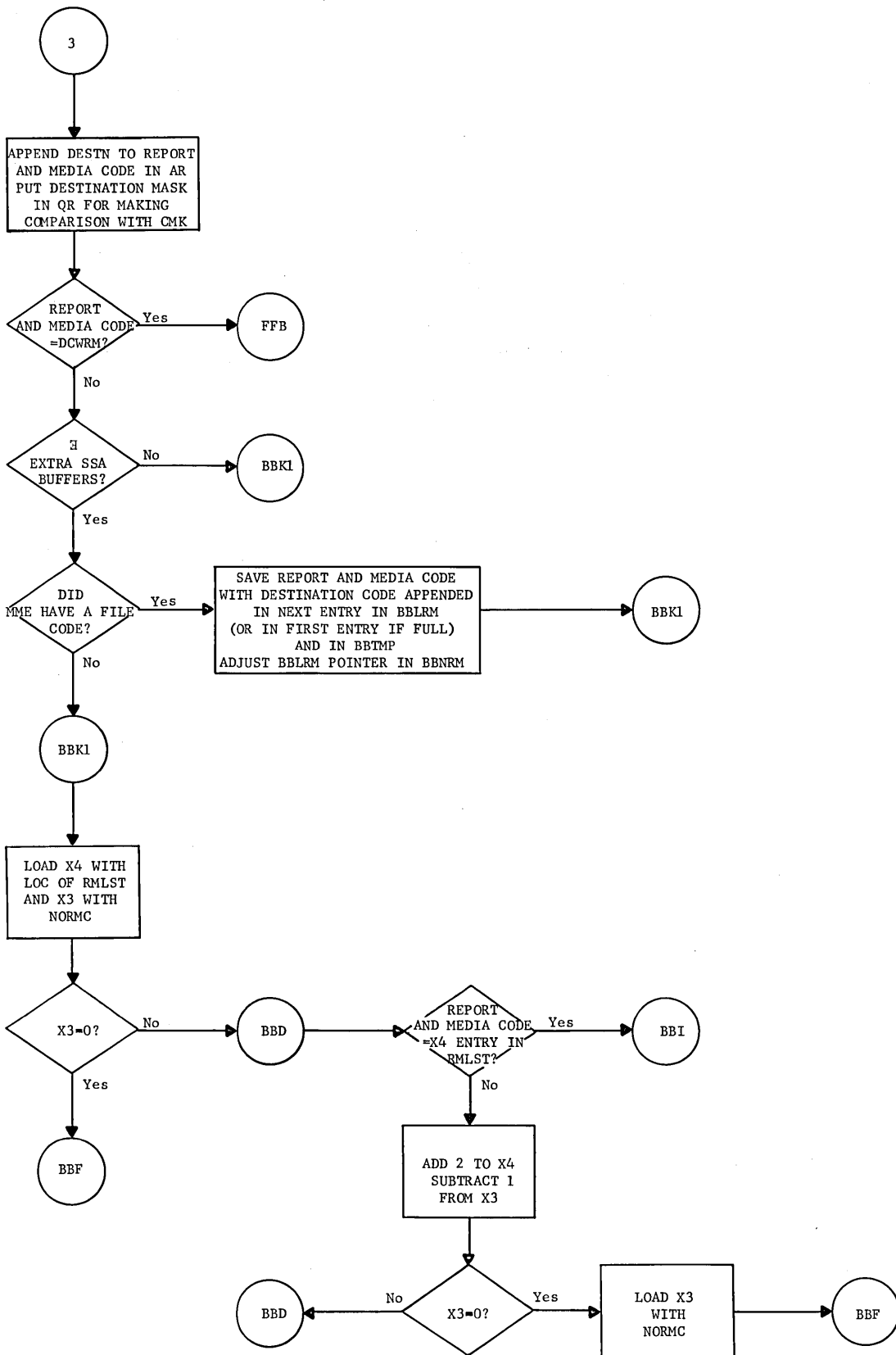

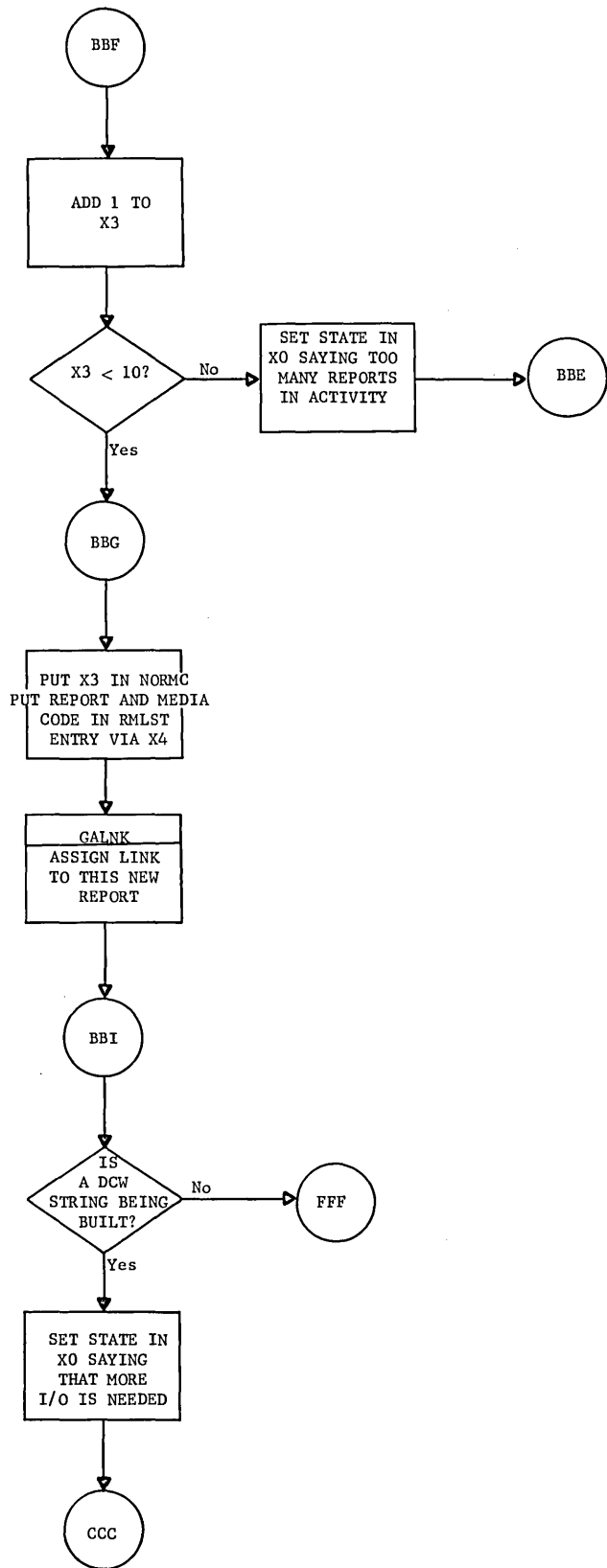

MME (EP1)  
.MSYOT

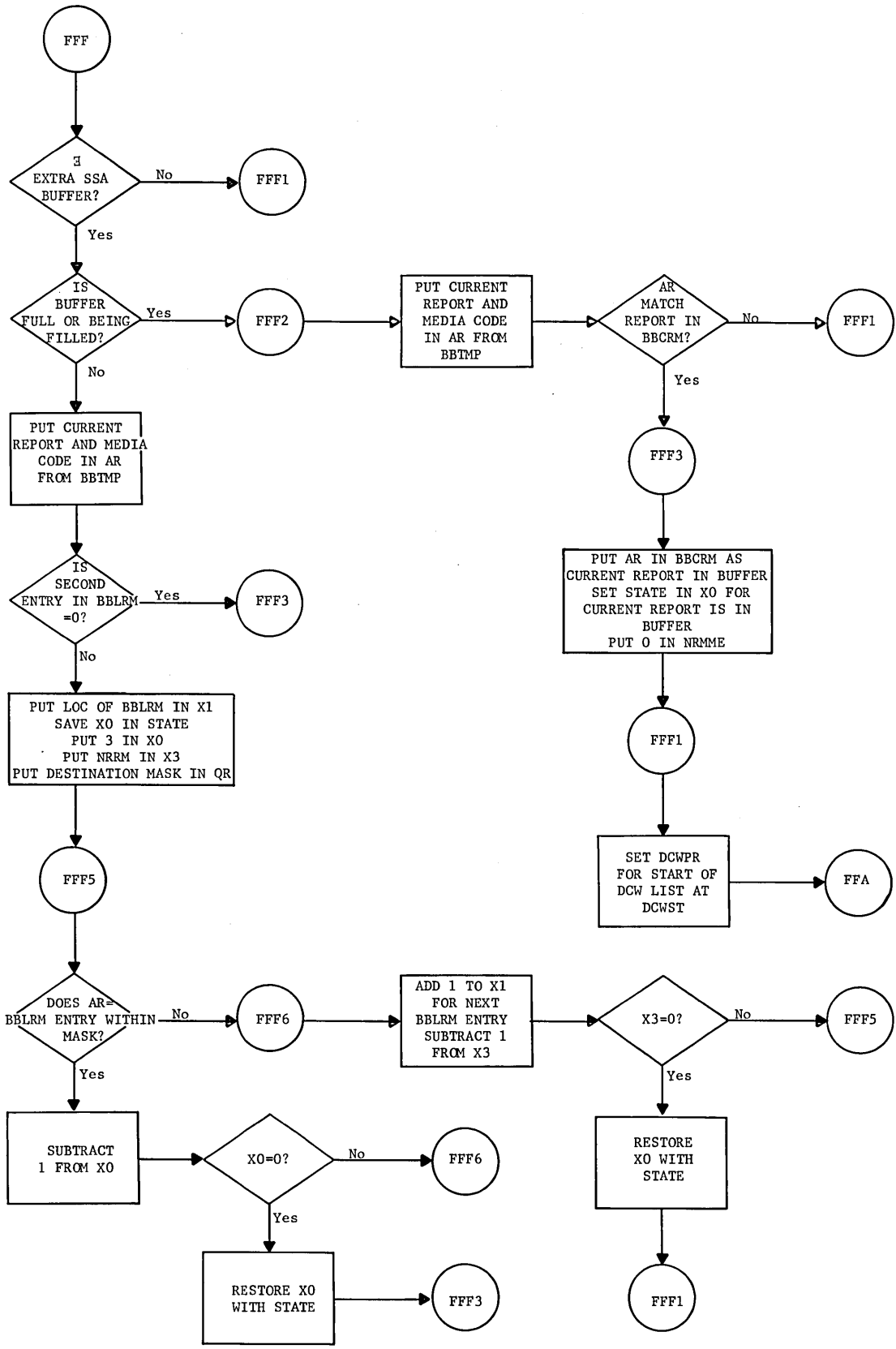

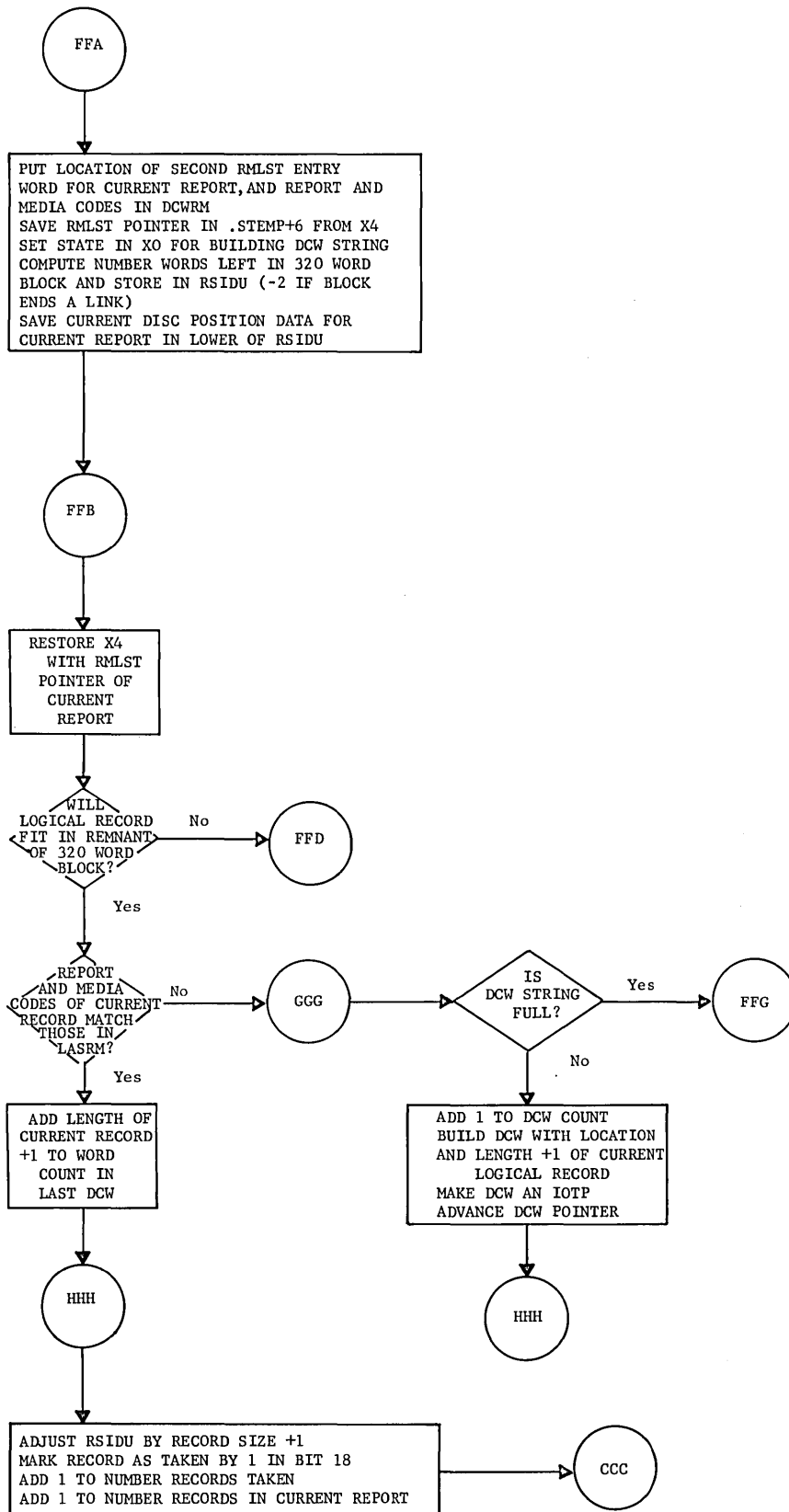



MME (EP1)  
.MSYOT

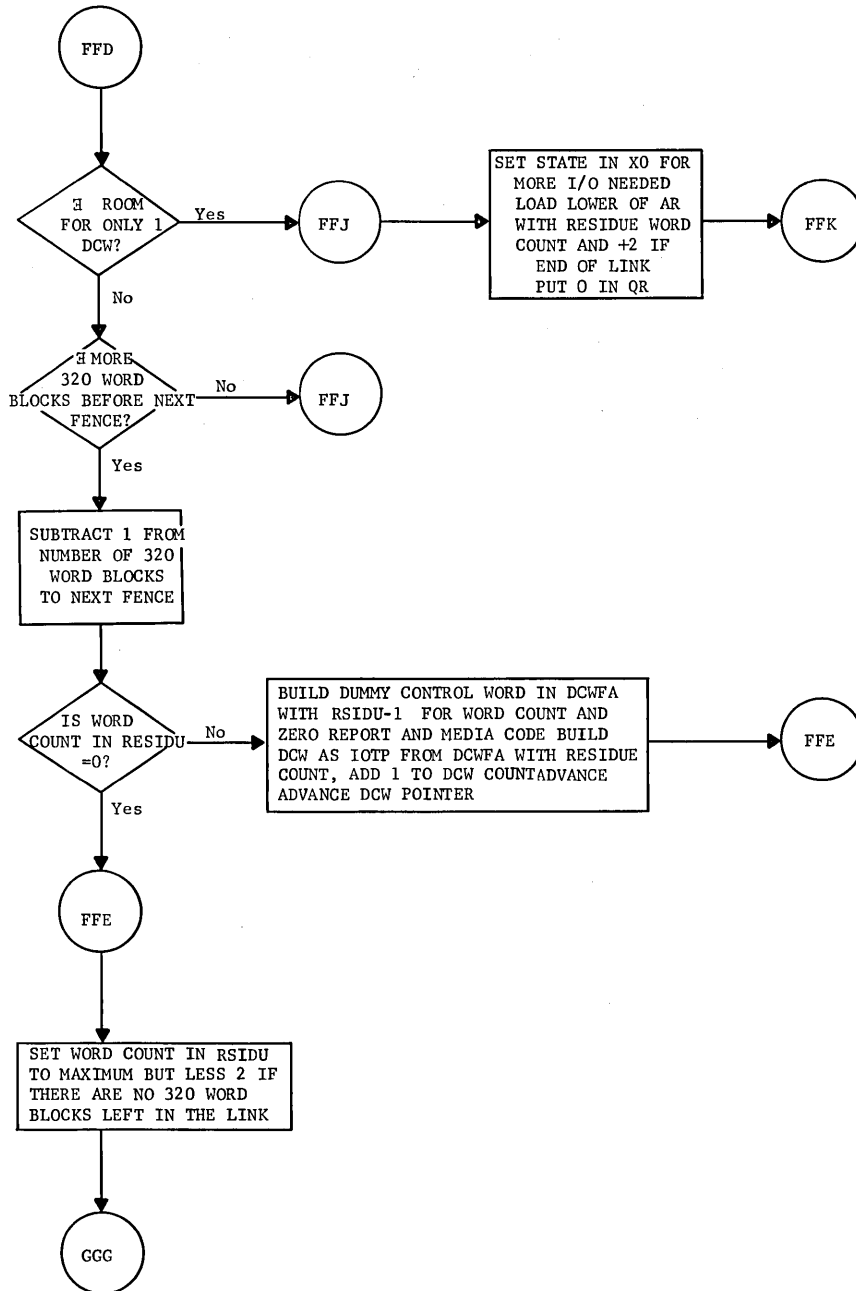

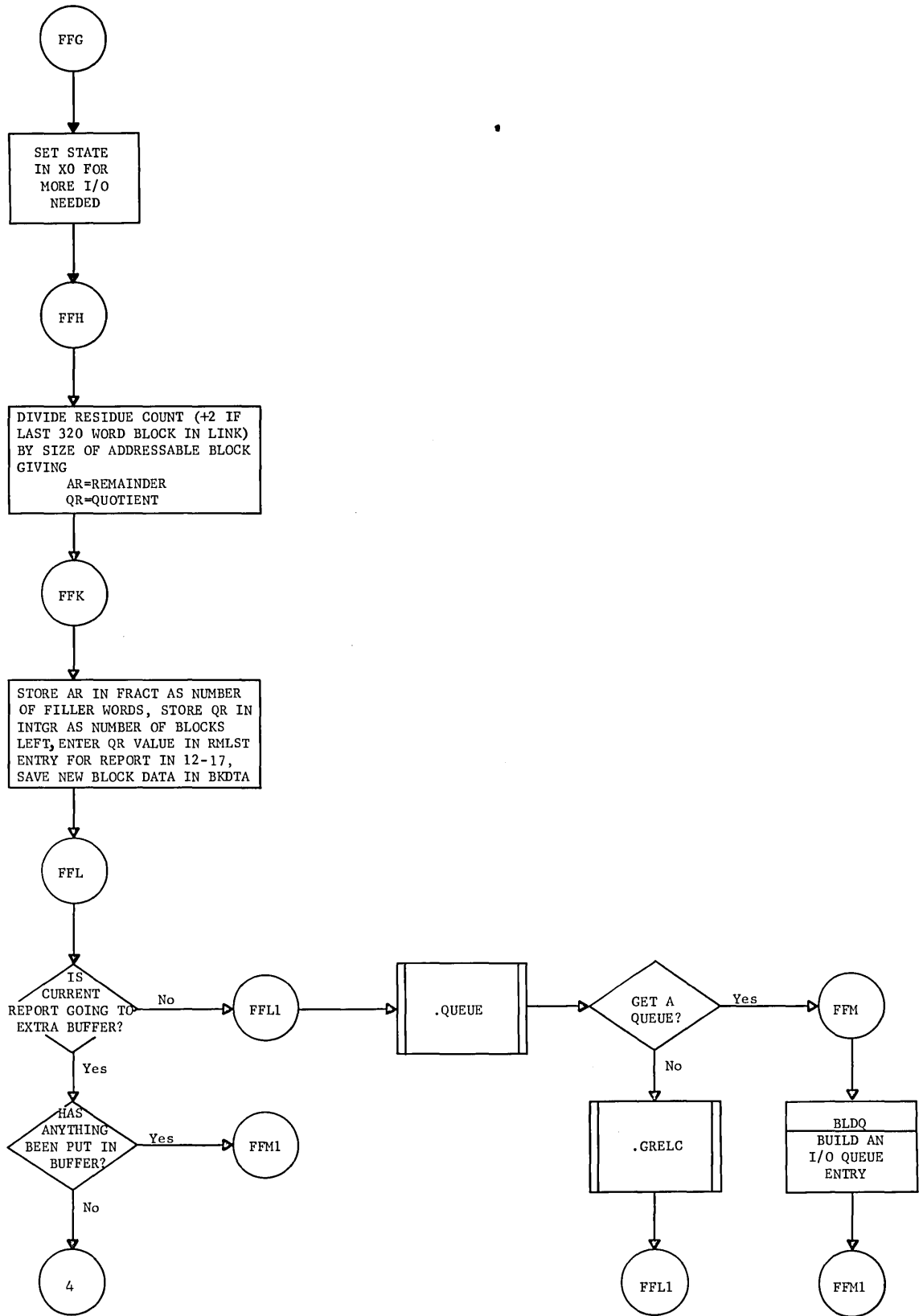

MME (EP1)  
.MSYOT

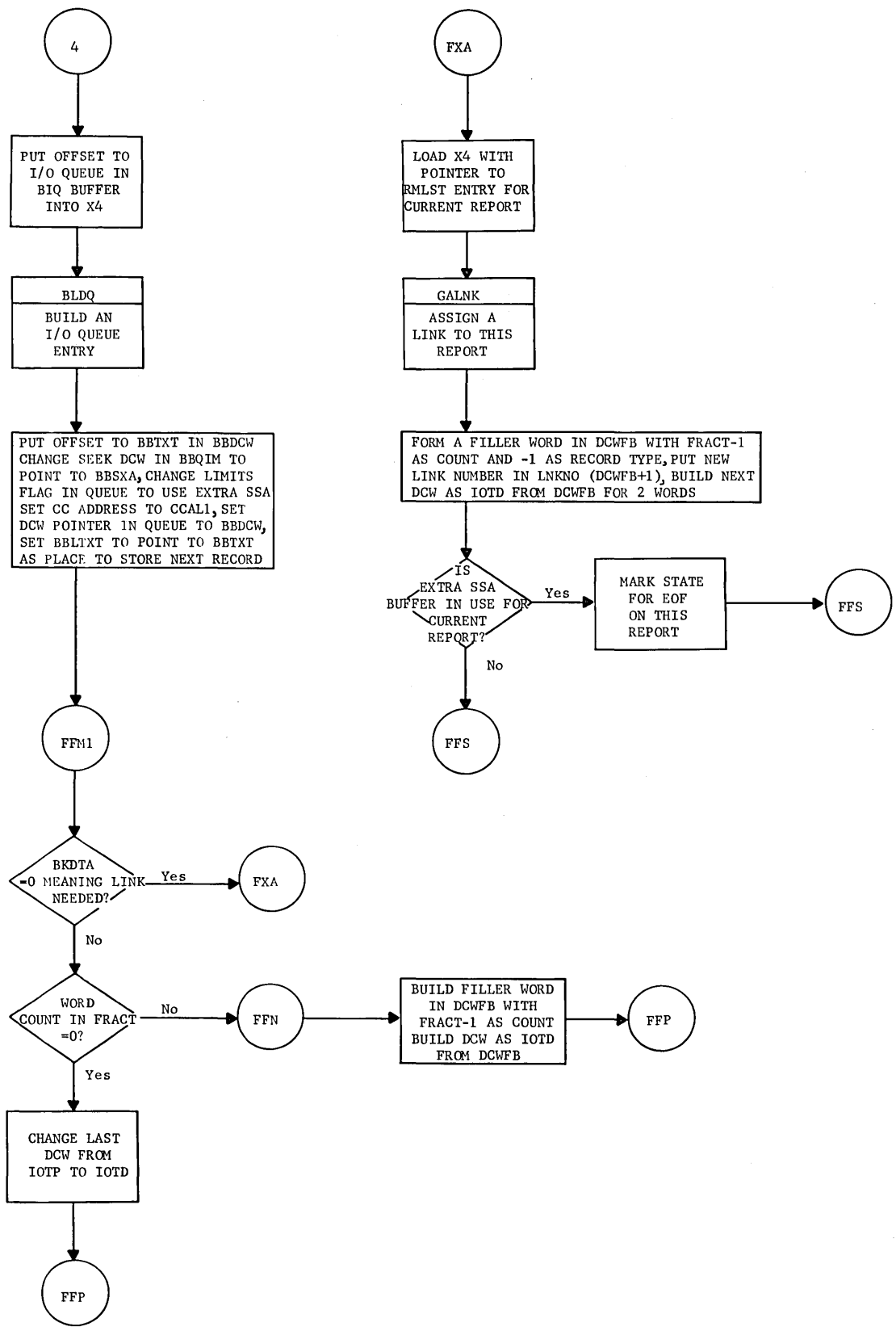

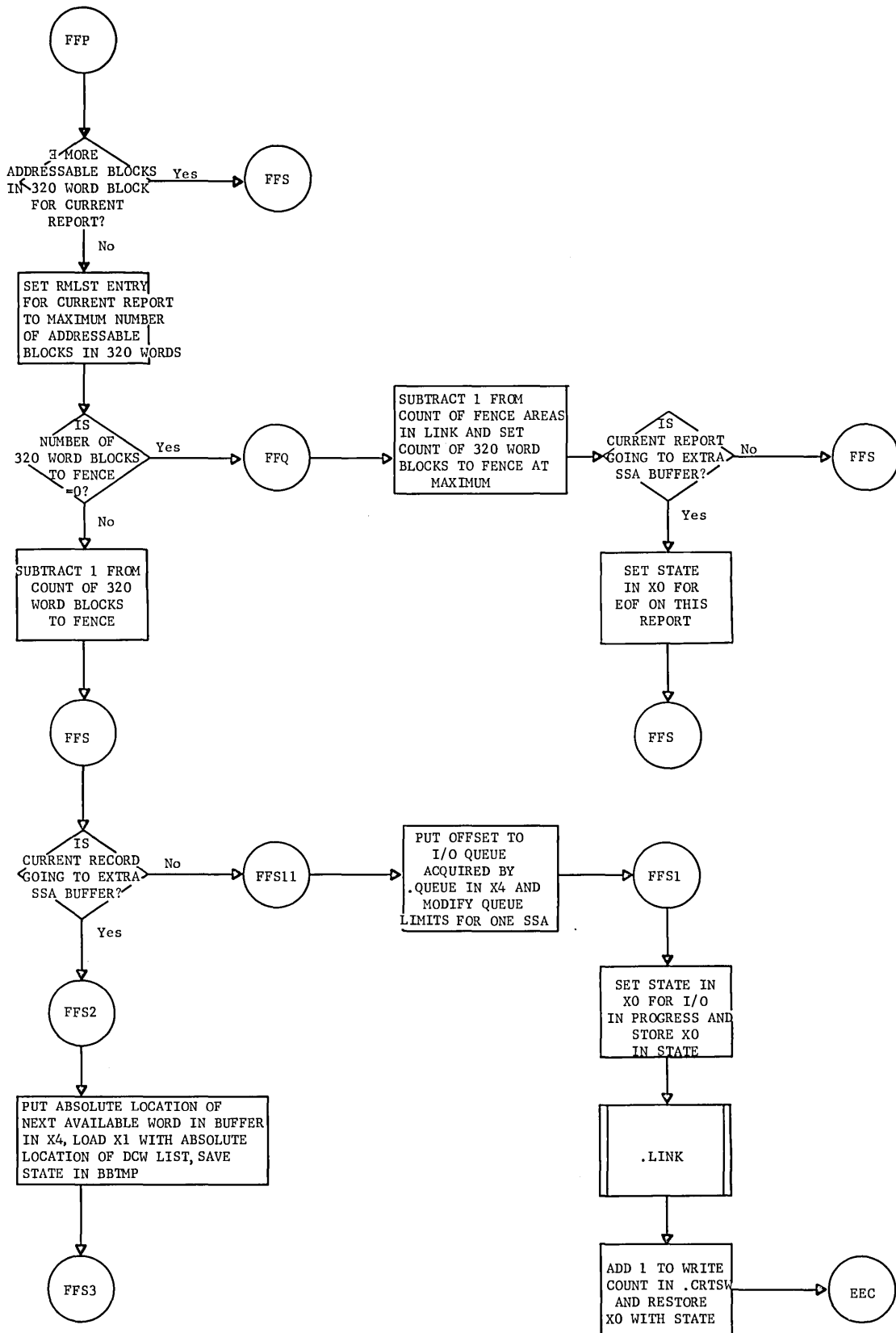

MME (EP1)  
.MSYOT

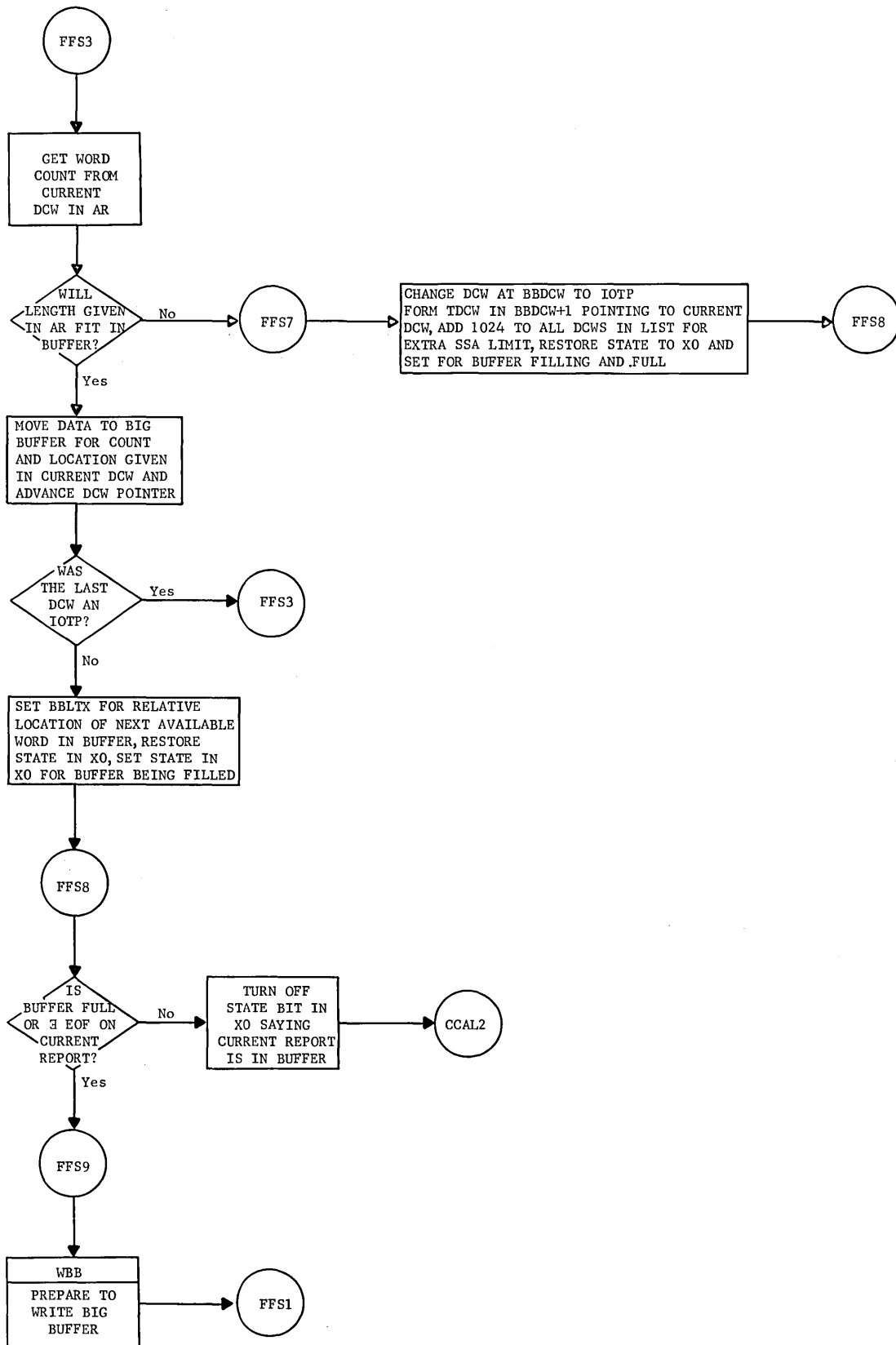

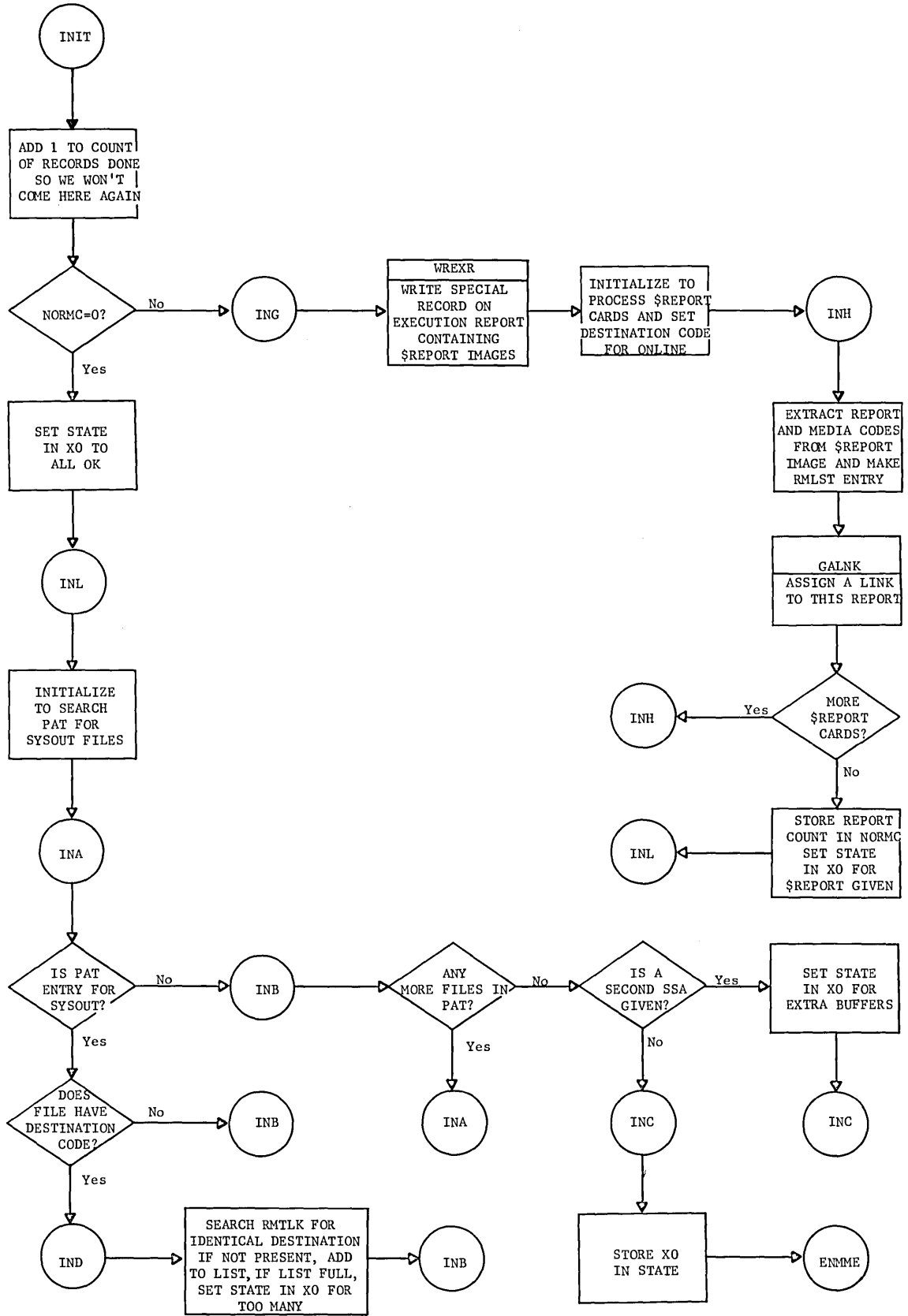

EXEC (EP2)  
.MSYOT

### WRITE EXECUTION REPORT MESSAGE (RELATIVE LOCATION)

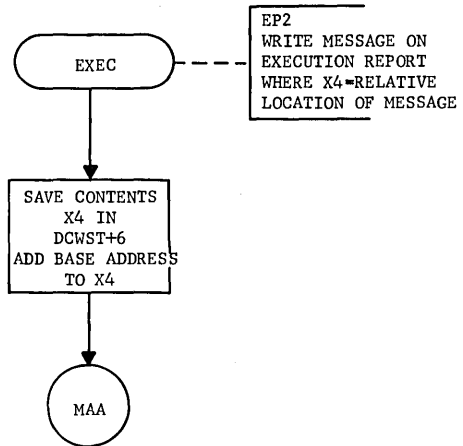

PROCESS END OF ACTIVITY

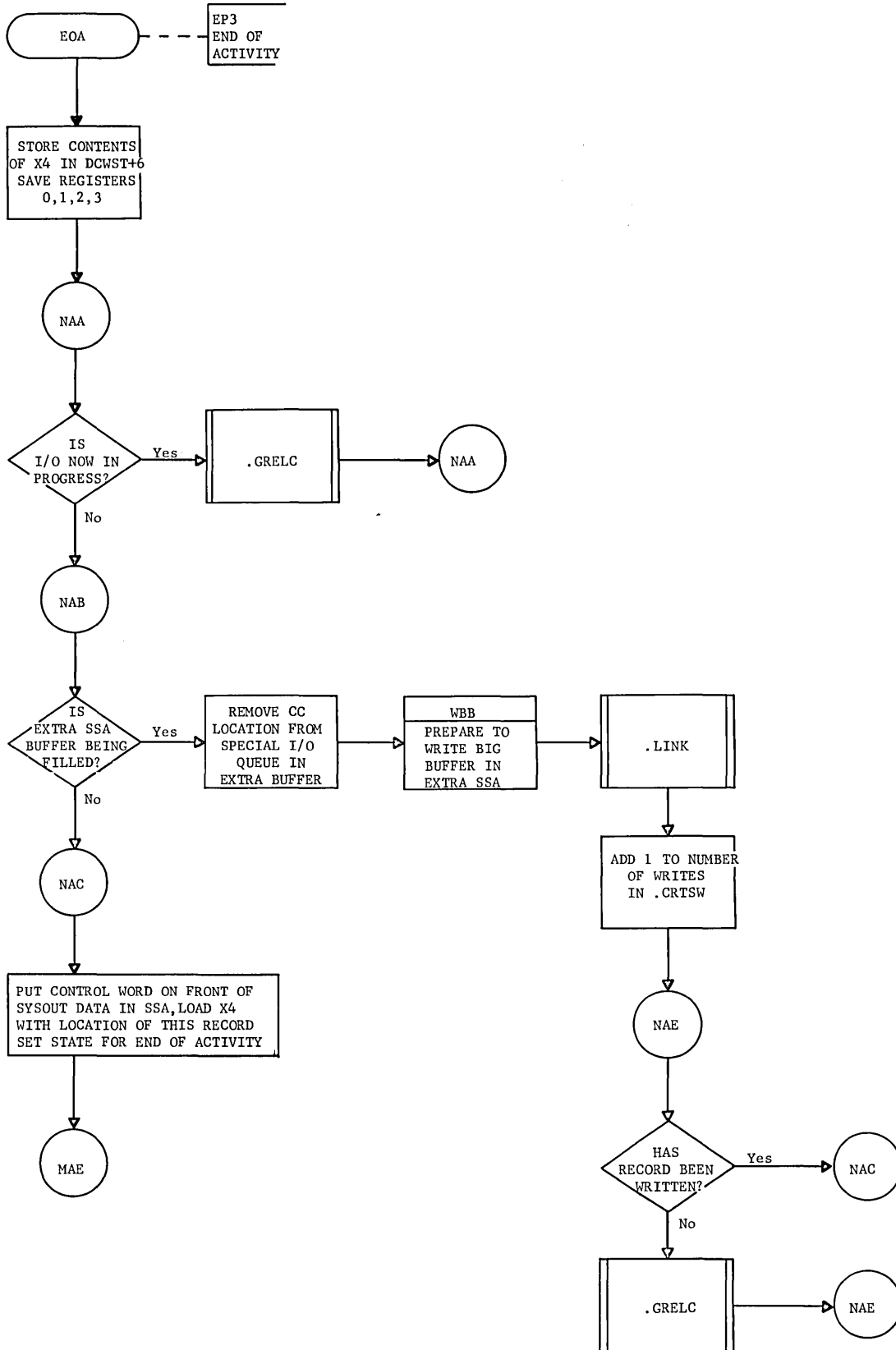



EOA (EP3)  
.MSYOT

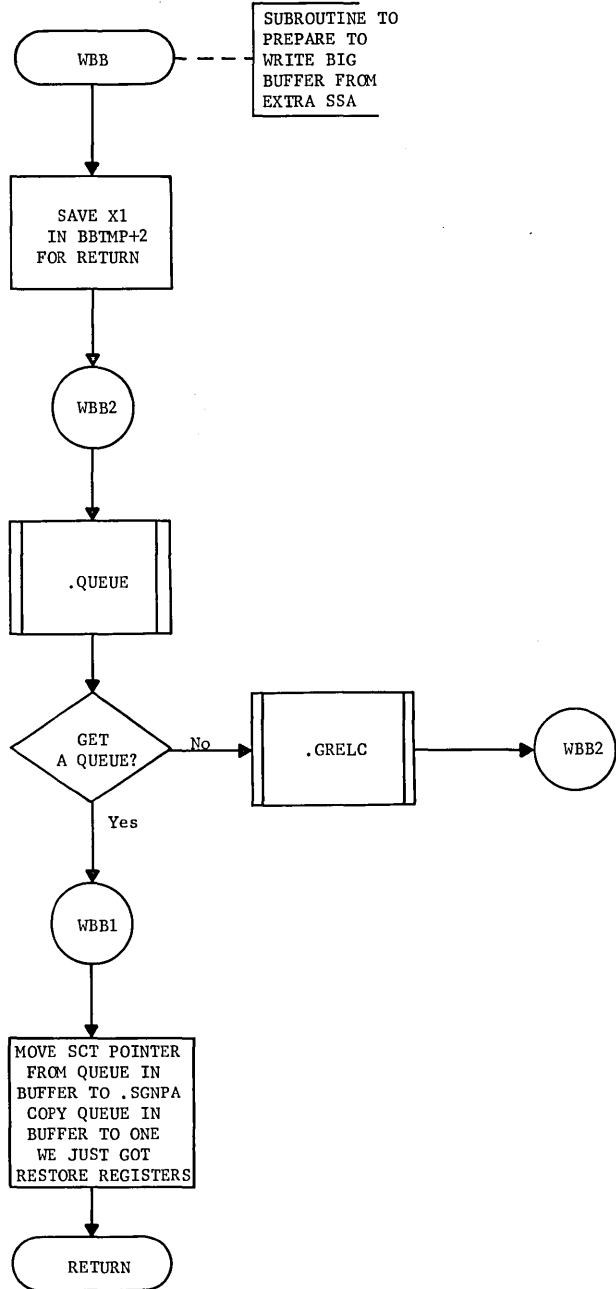

PROCESS END OF JOB

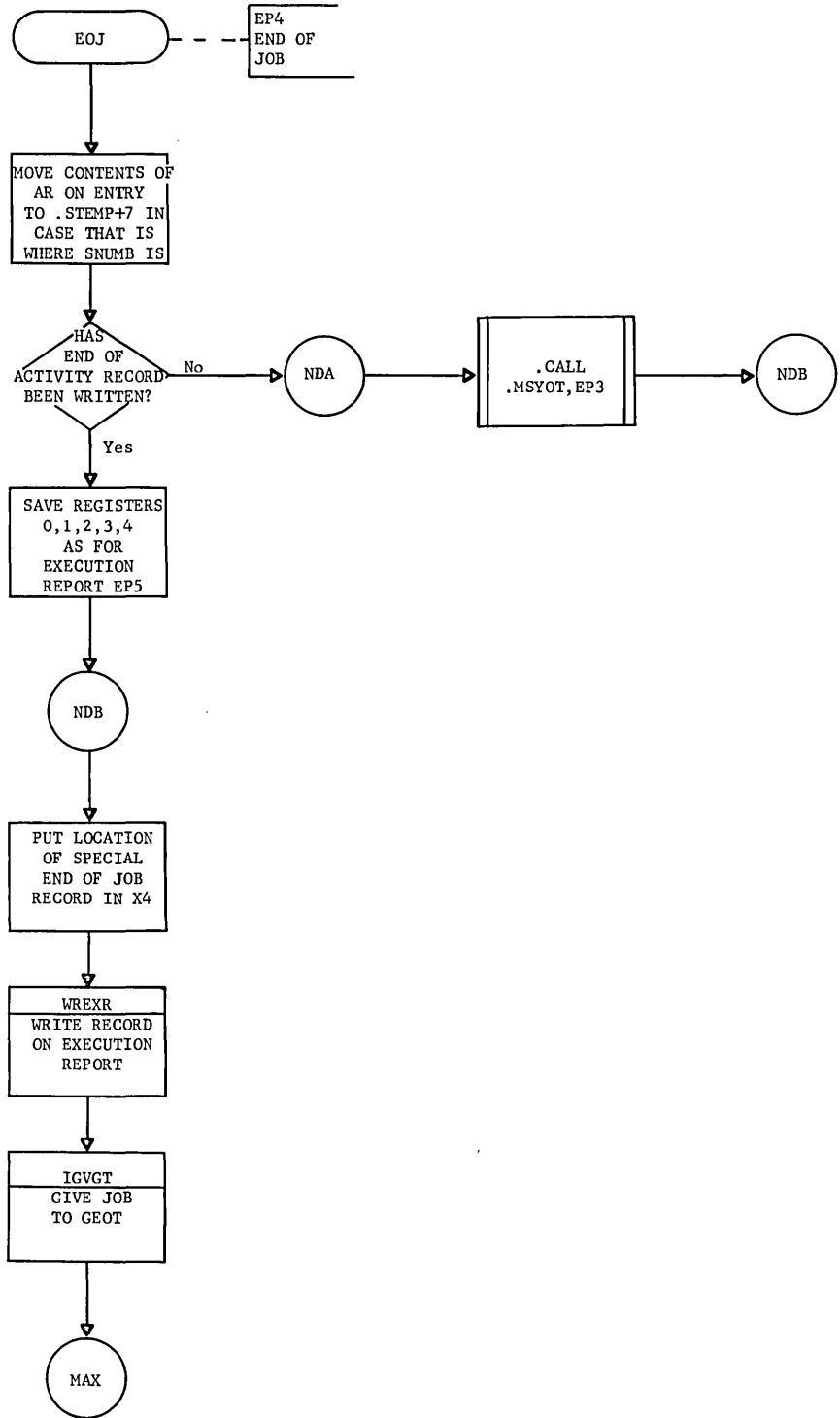

EOJ (EP4)  
.MSYOT

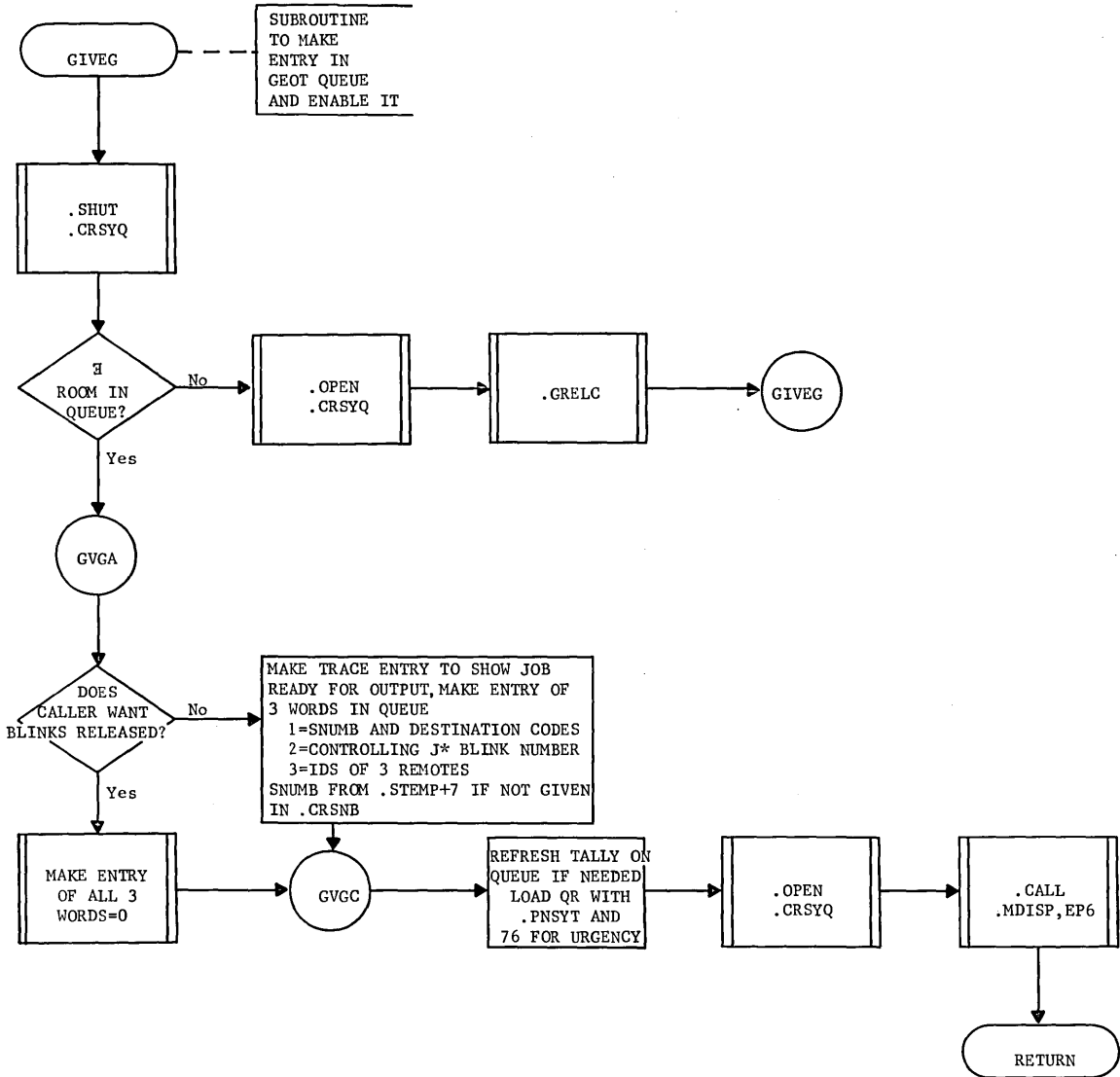
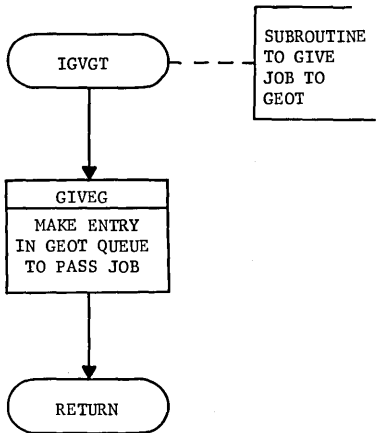

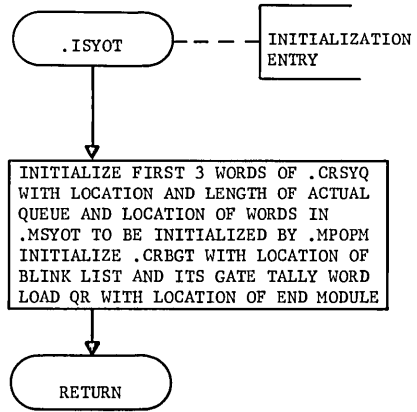
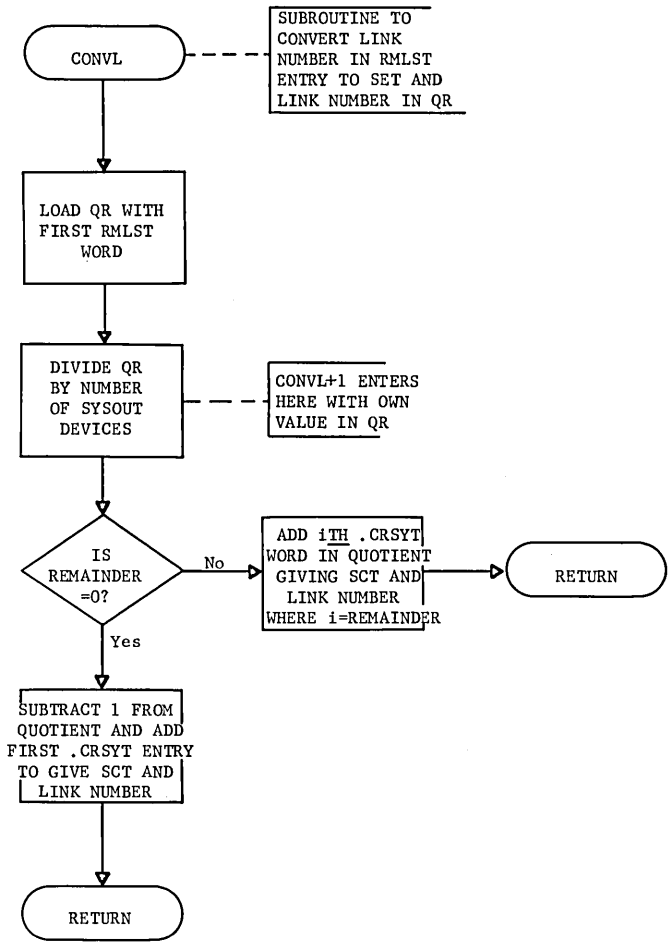

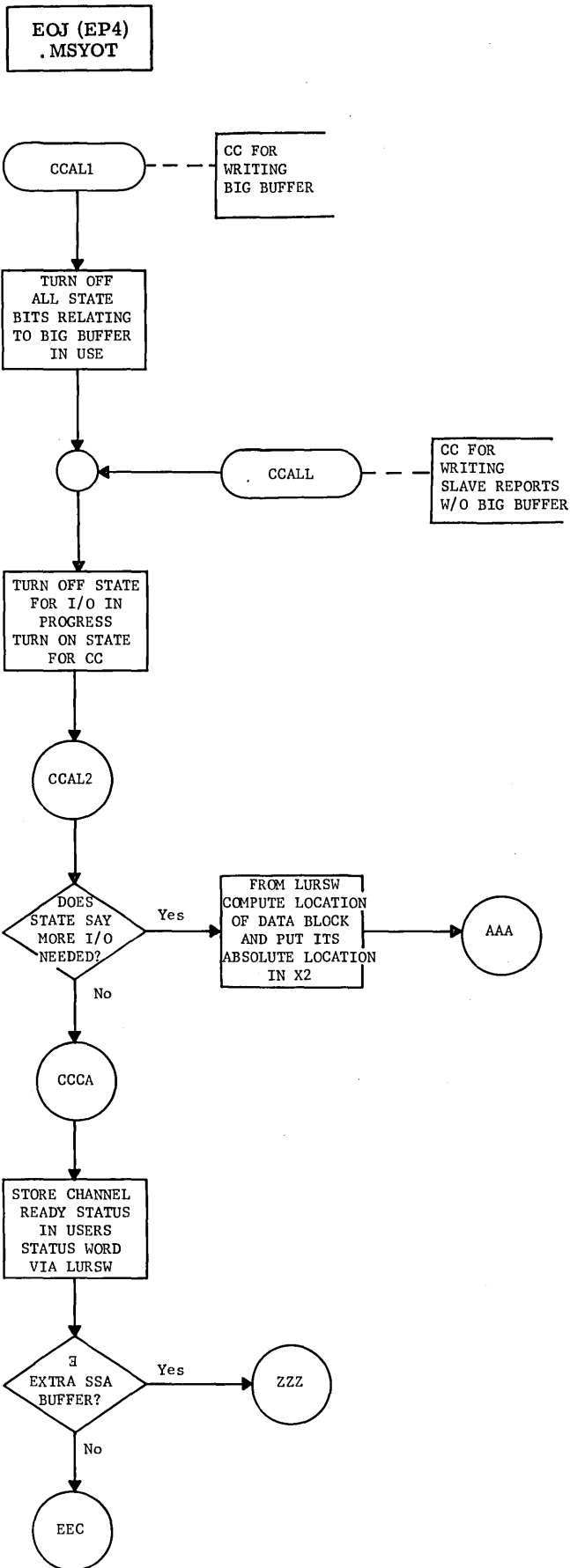

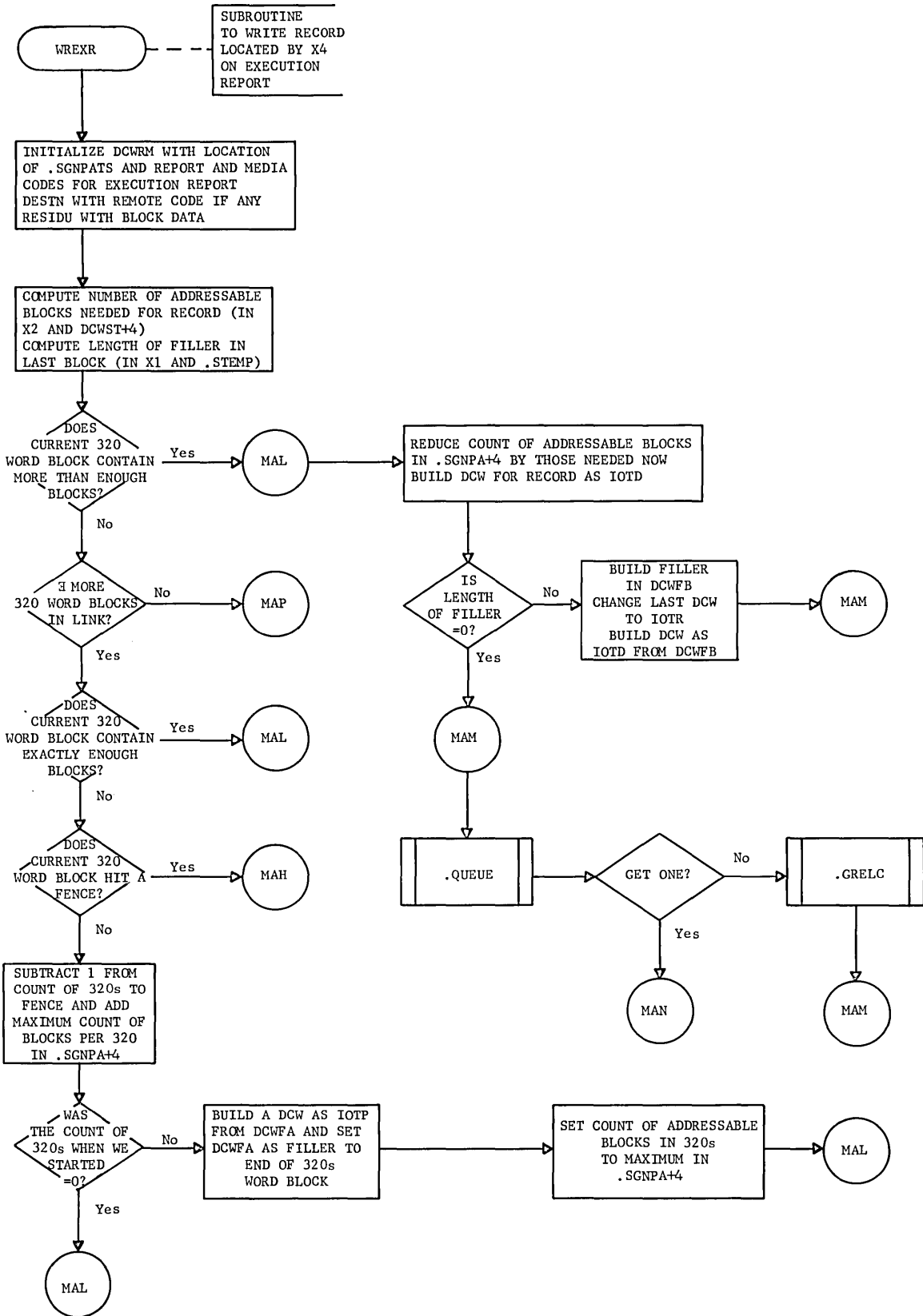

EOJ (EP4)  
.MSYOT

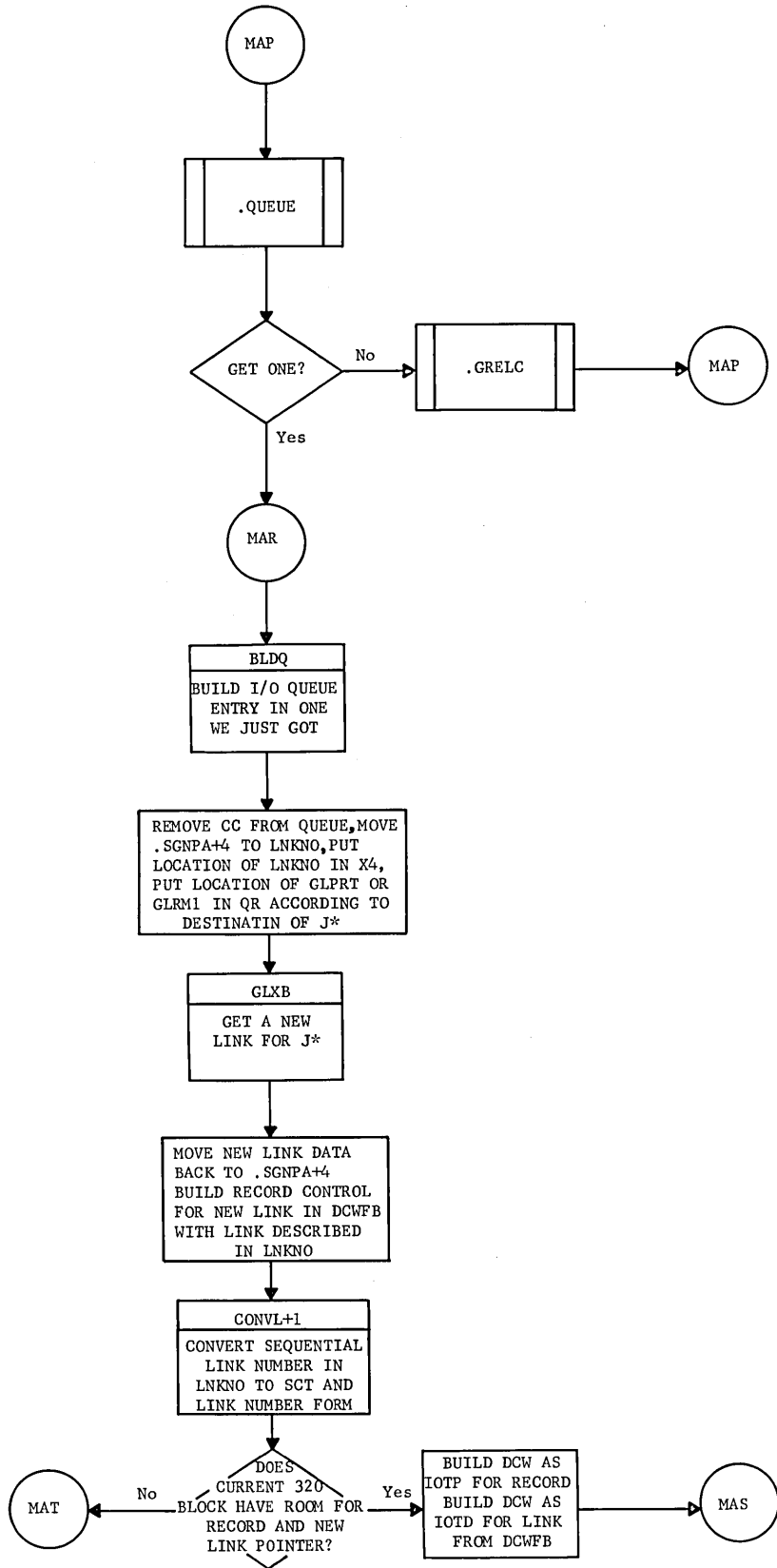
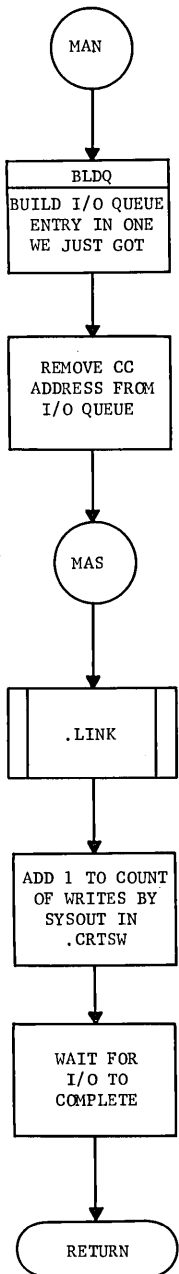

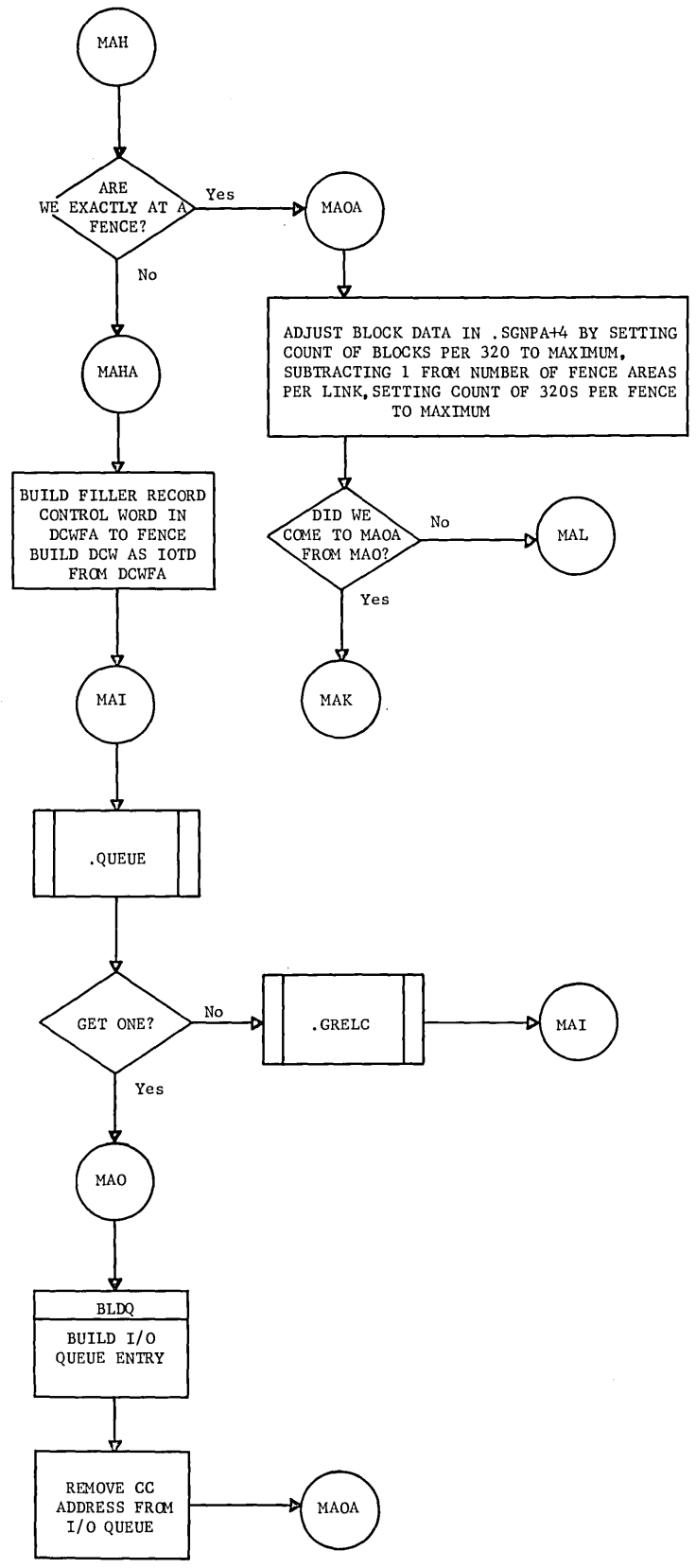
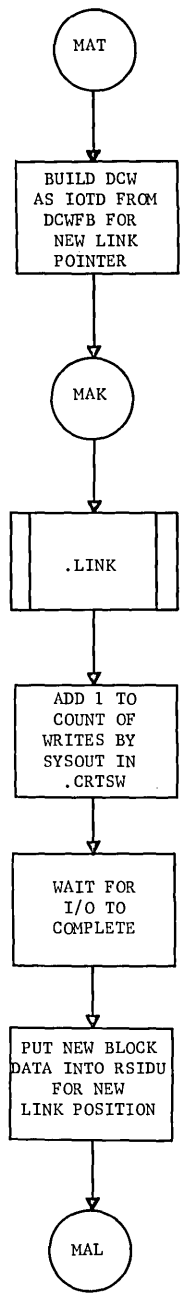



EOJ (EP4)  
.MSYOT

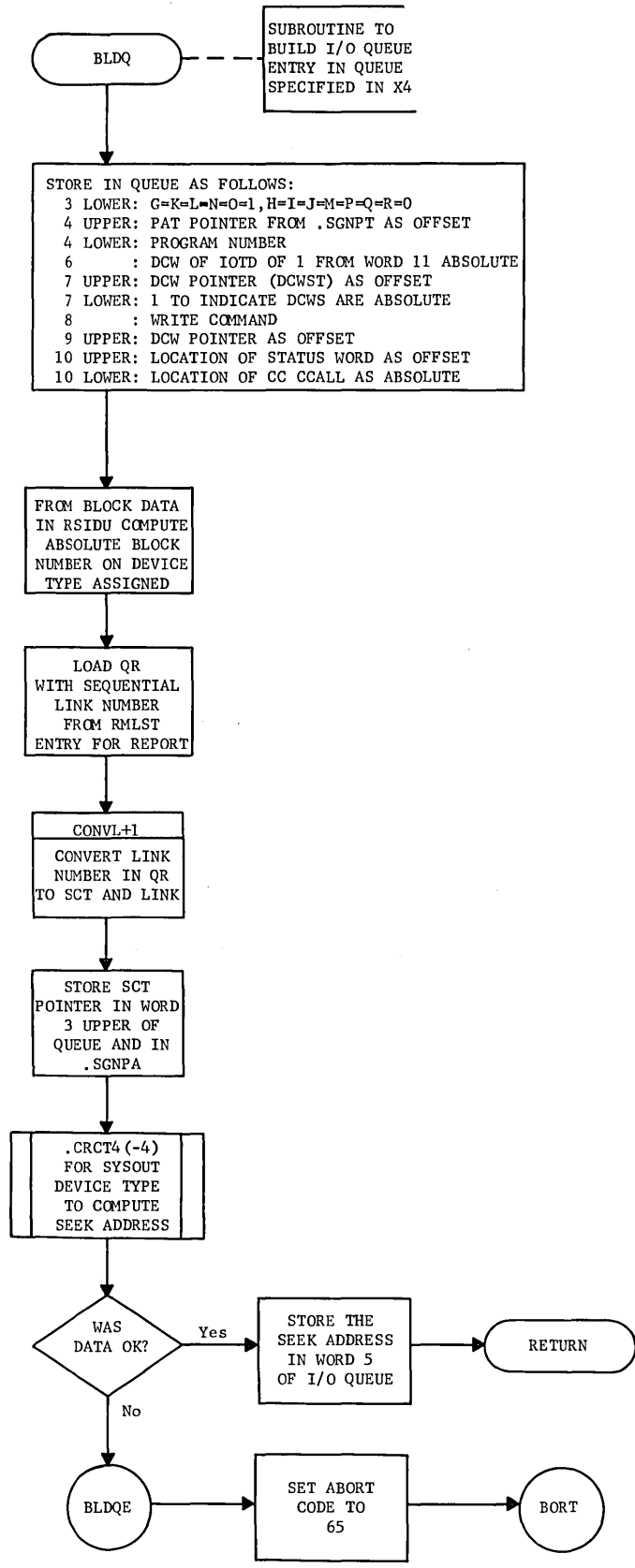

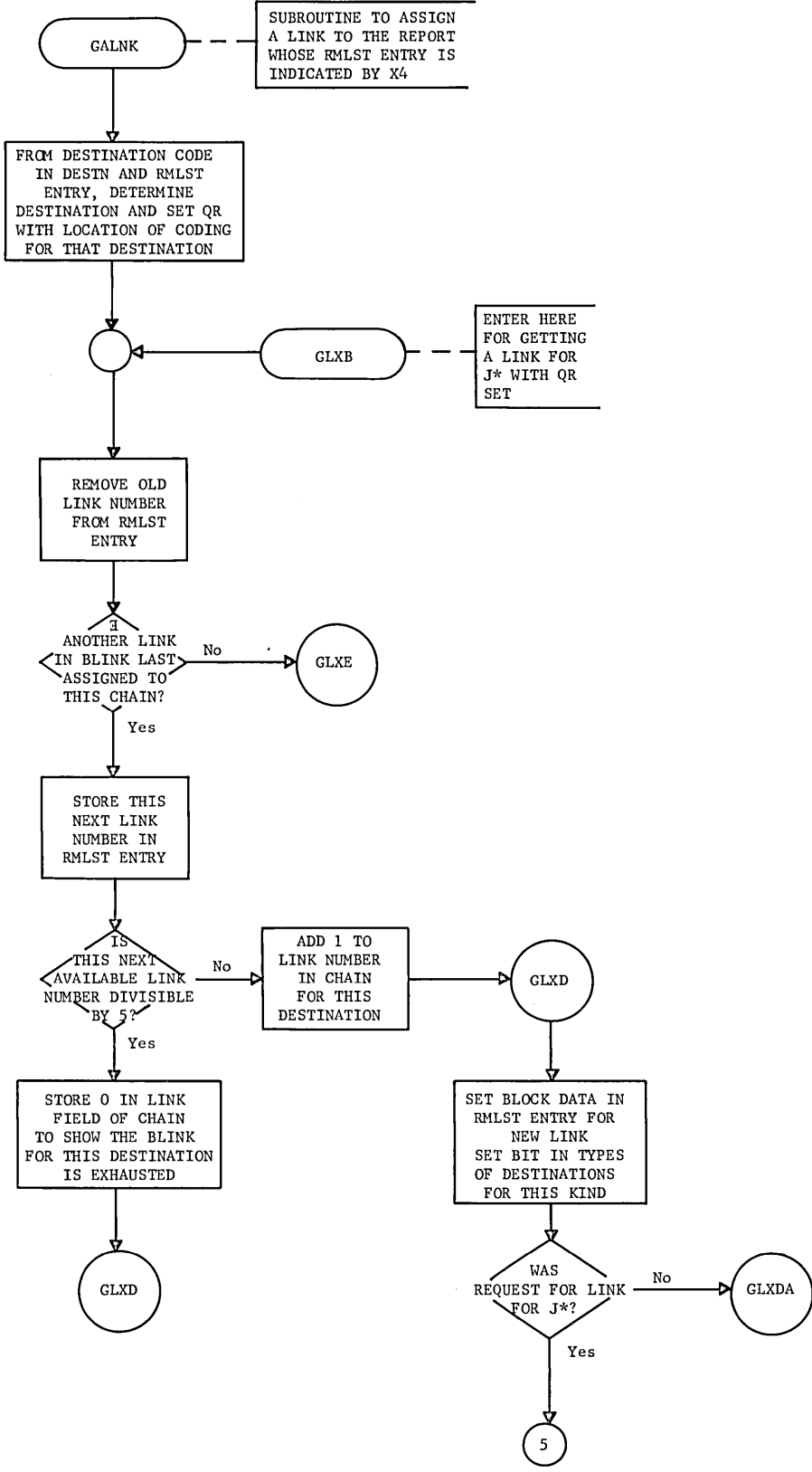

EOJ (EP4)  
.MSYOT

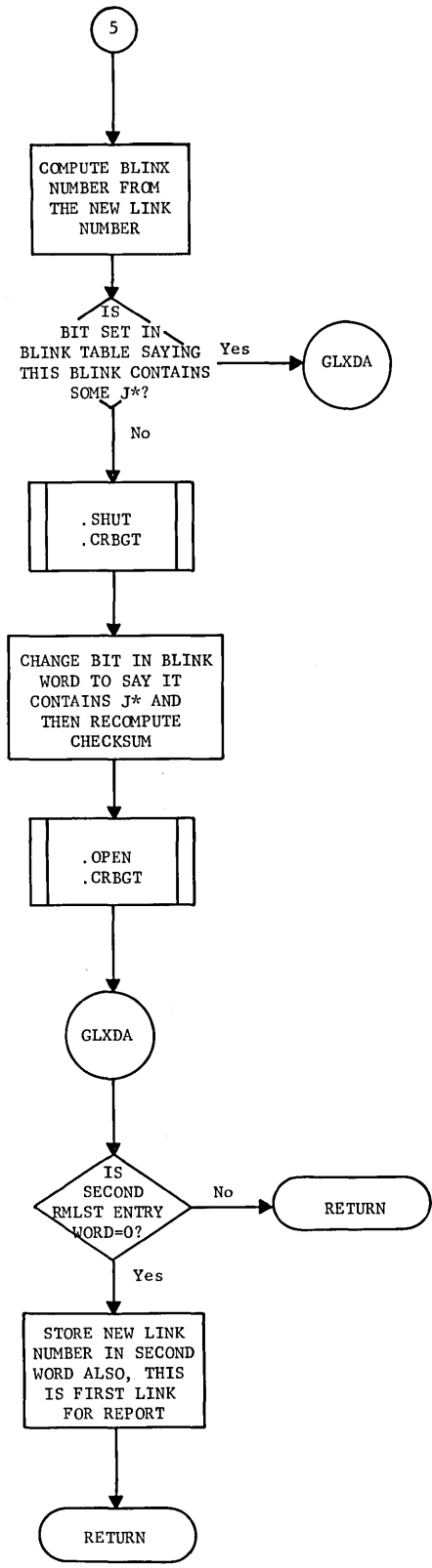

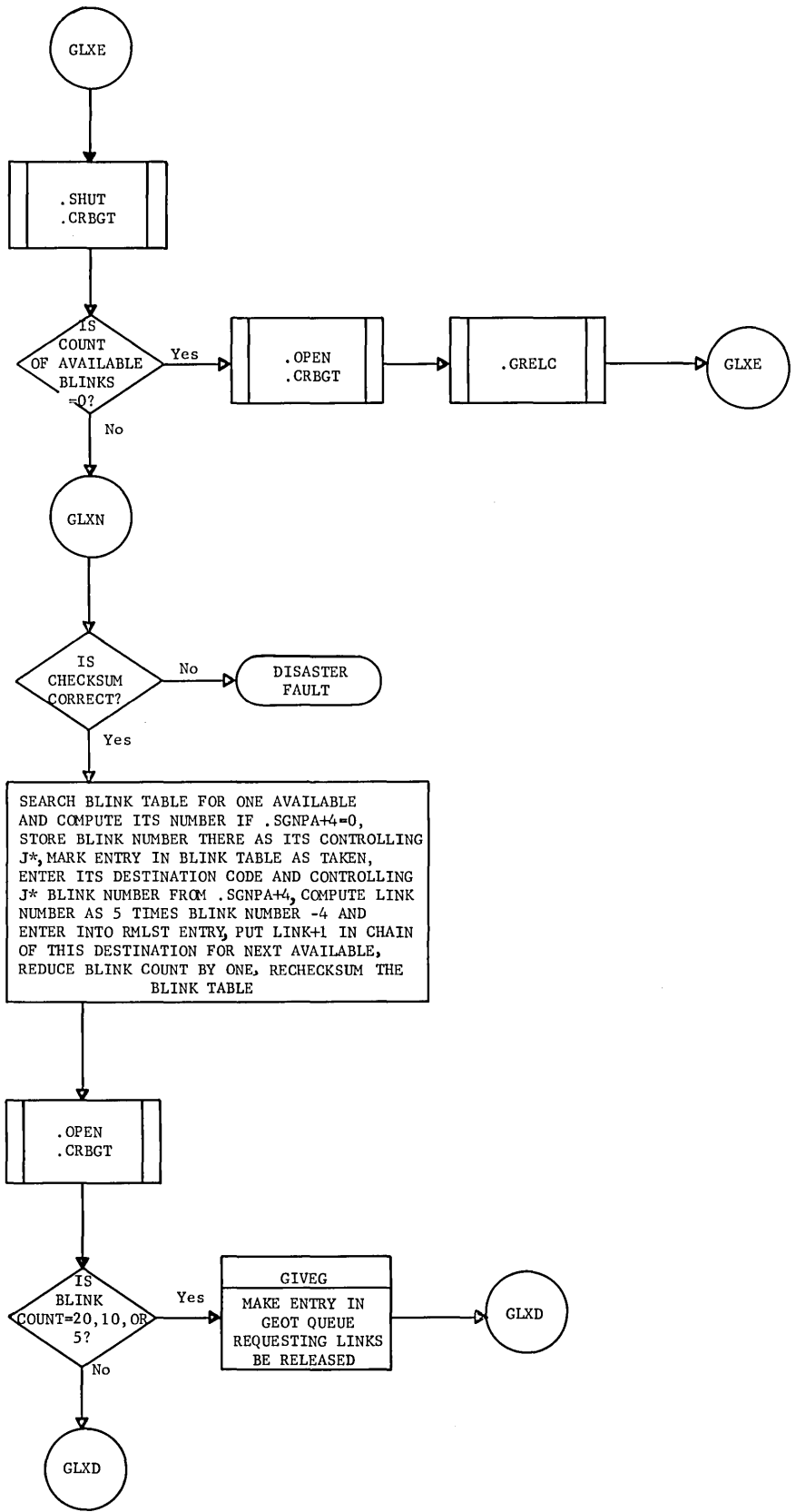

EXCA (EP5)  
.MSYOT

### WRITE EXECUTION REPORT MESSAGE (ABSOLUTE LOCATION)

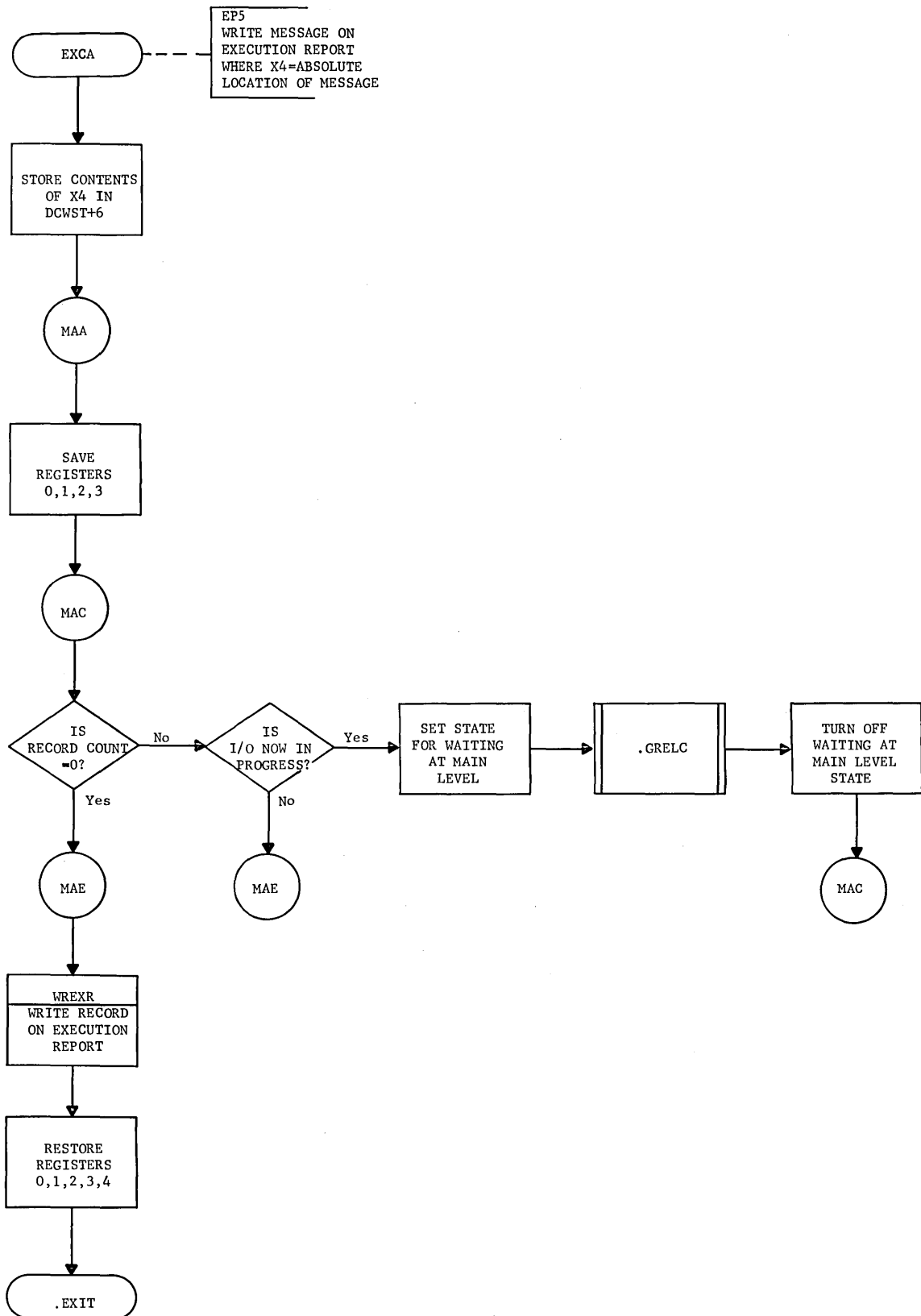

GEIN (EP6)  
.MSYOT

### PROCESS CALL FROM GEIN

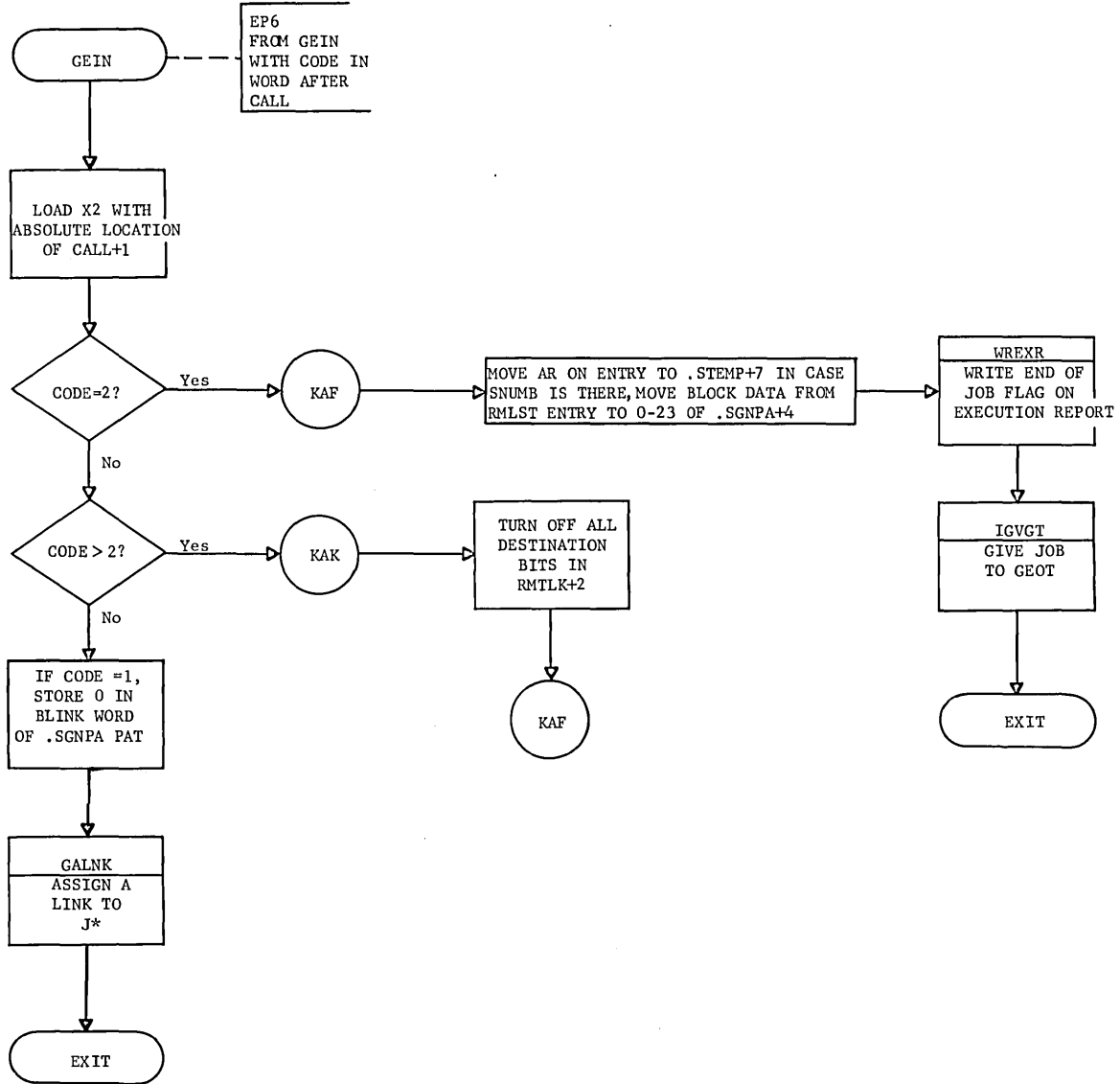

DISP  
.MGEOT

### DISPATCHER

DISP

ADD 1 TO  
MAINL TO  
SHOW WE ARE  
OPERATING AT  
MAIN LEVEL

LFTOF

LOAD X4 WITH  
SUBPROGRAM NUMBER  
WHERE WE LEFT OFF  
(ORIGINALLY=0),  
LOAD AR WITH  
THING COUNT

DISPC

STORE AR IN  
LTHING SO WE  
CAN TEST COUNT  
OF EVENTS  
SINCE NOW

DISPA

IS  
SUBPROGRAM  
IDENTIFIED BY X4  
IN EXECUTION?

DISPB

Yes  
FMWER+  
FMEOR+FMEOJ  
+FMTRA  
=0?

DISPB

No  
PUT ORIGIN  
OF SUBPROGRAM  
IN X3

FMTRA  
=0?

DISPK

SAVE X4 IN LFTOF,  
TURN OFF ALL  
STATE BITS  
EXCEPT DEVICE  
TYPE AND FMINK

LOCATION  
GIVEN IN  
LOWER STATE  
AT DISPA

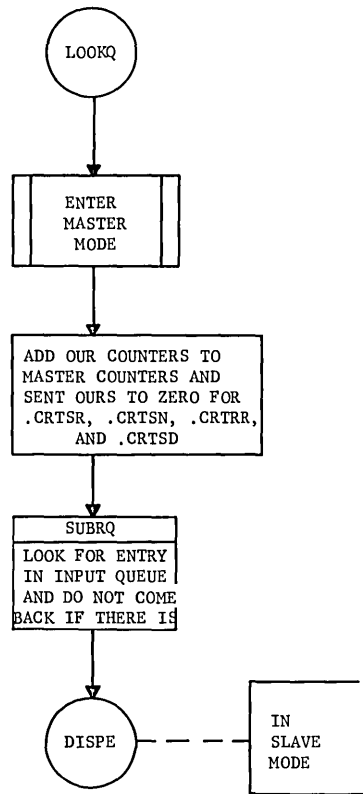
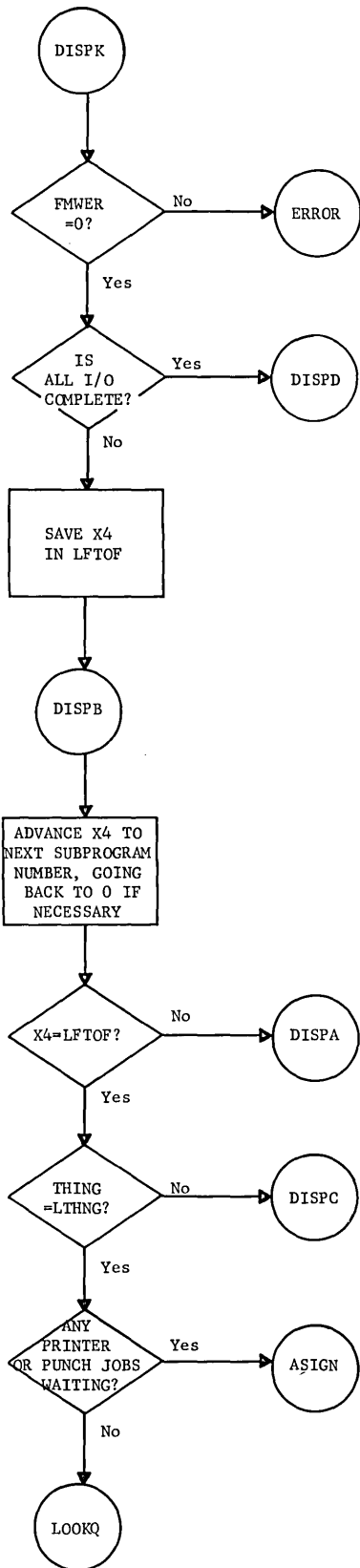



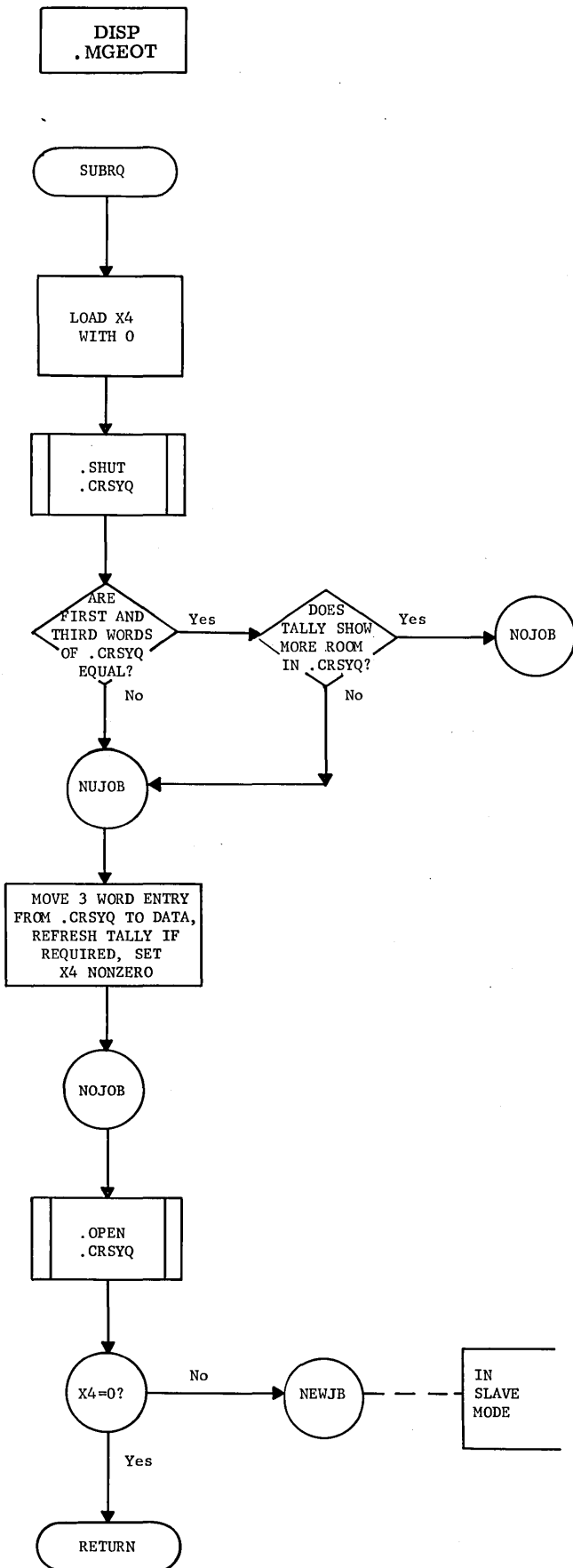

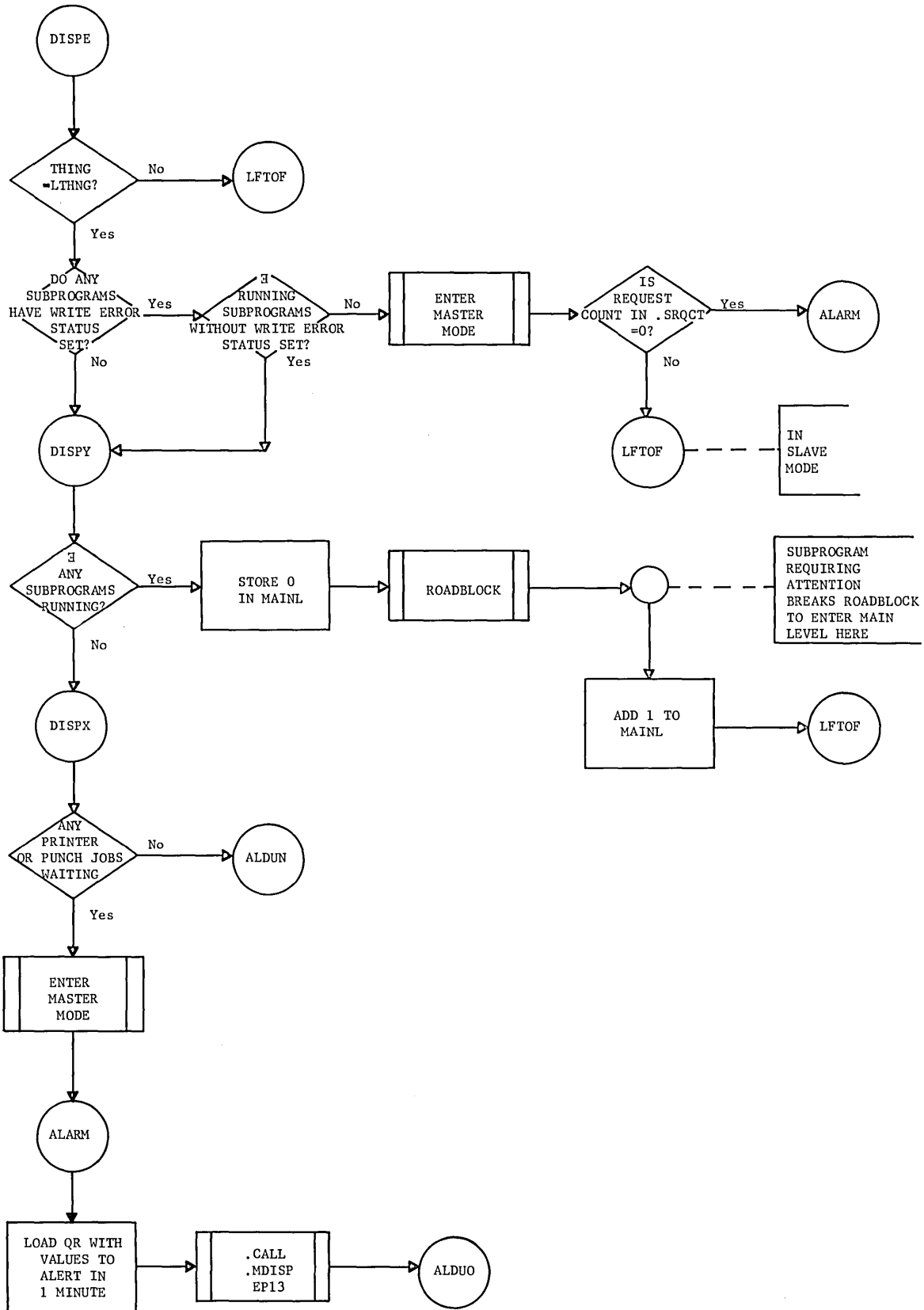

DISP  
.MGEOT

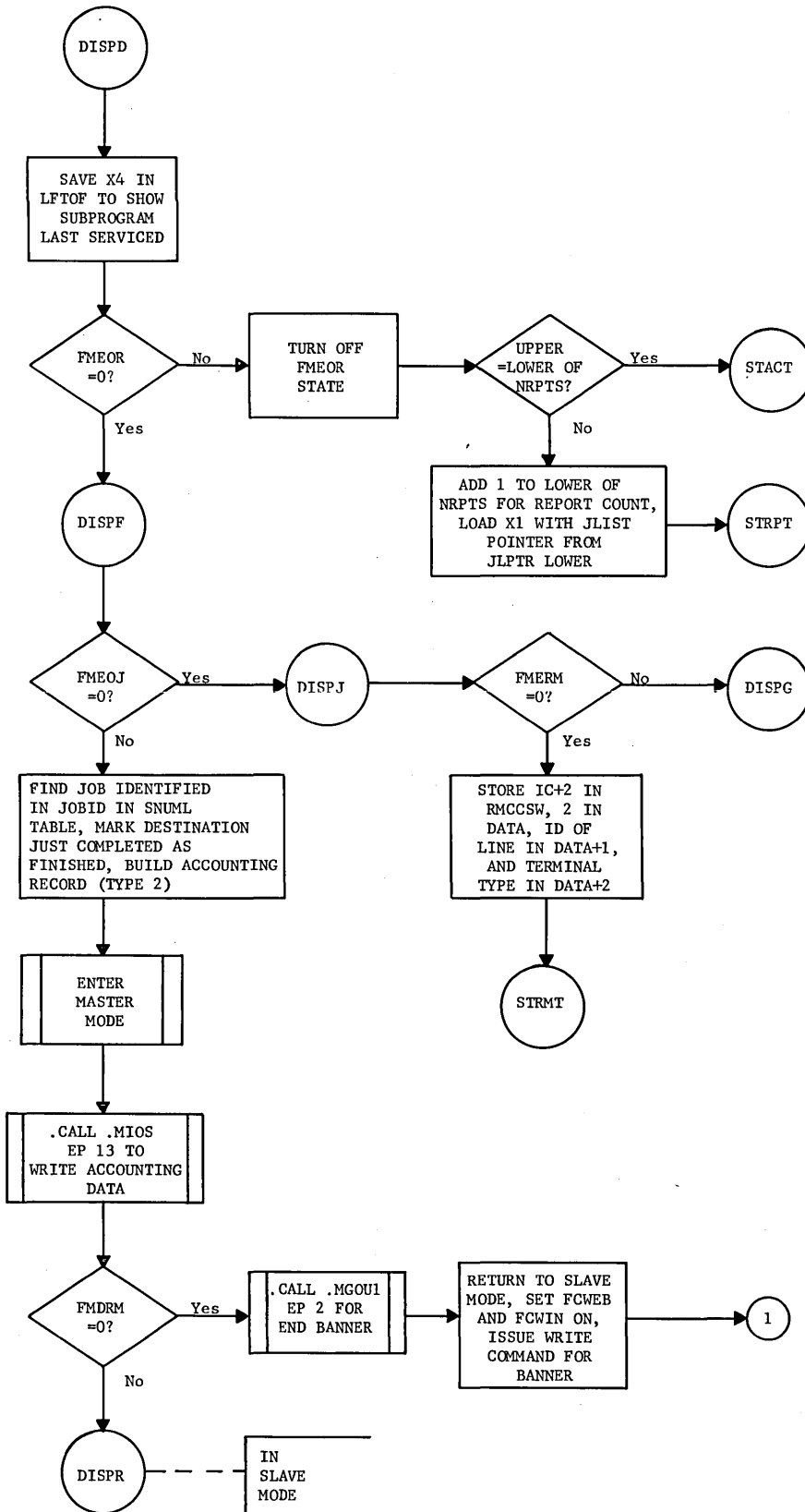

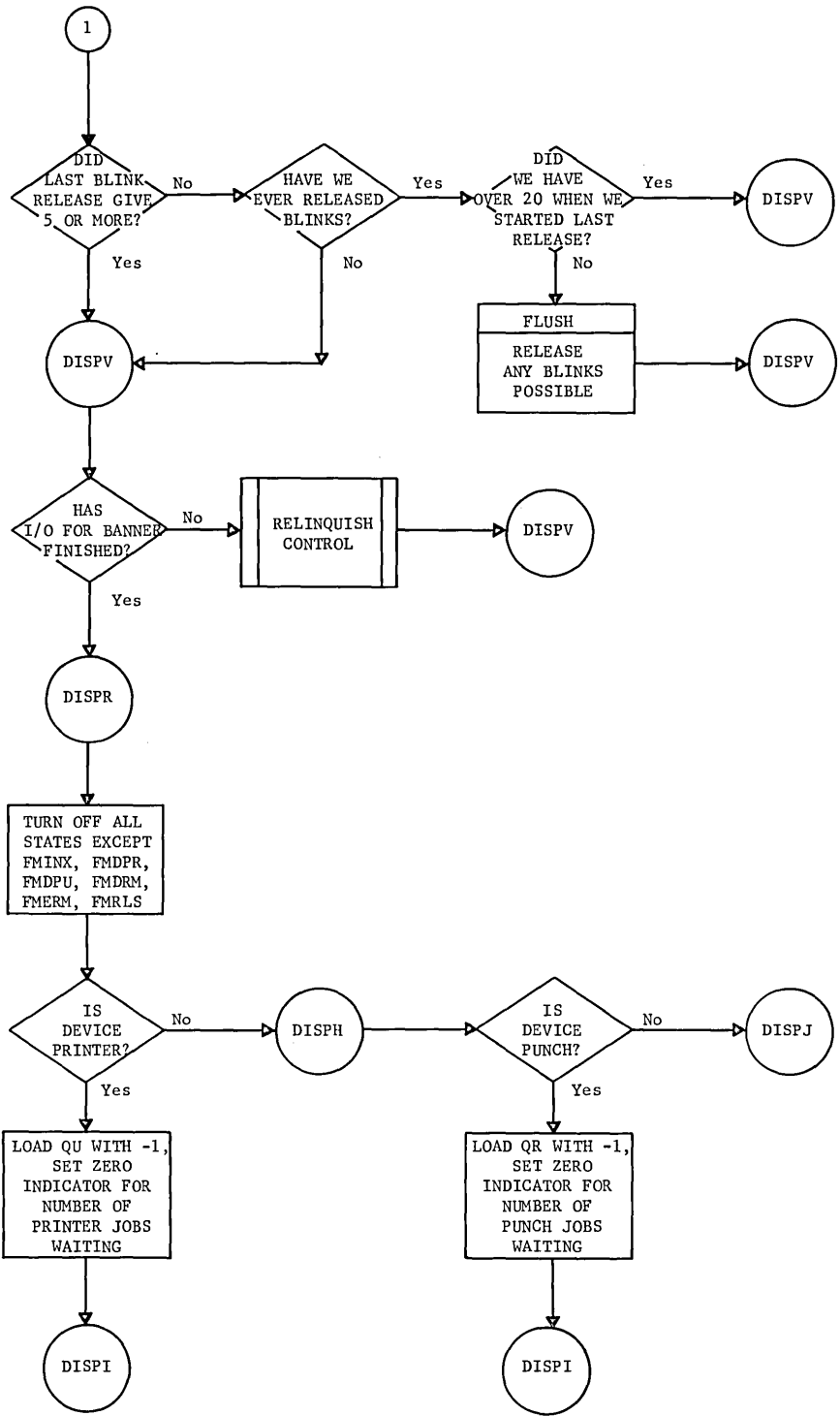

DISP  
.MGEOT

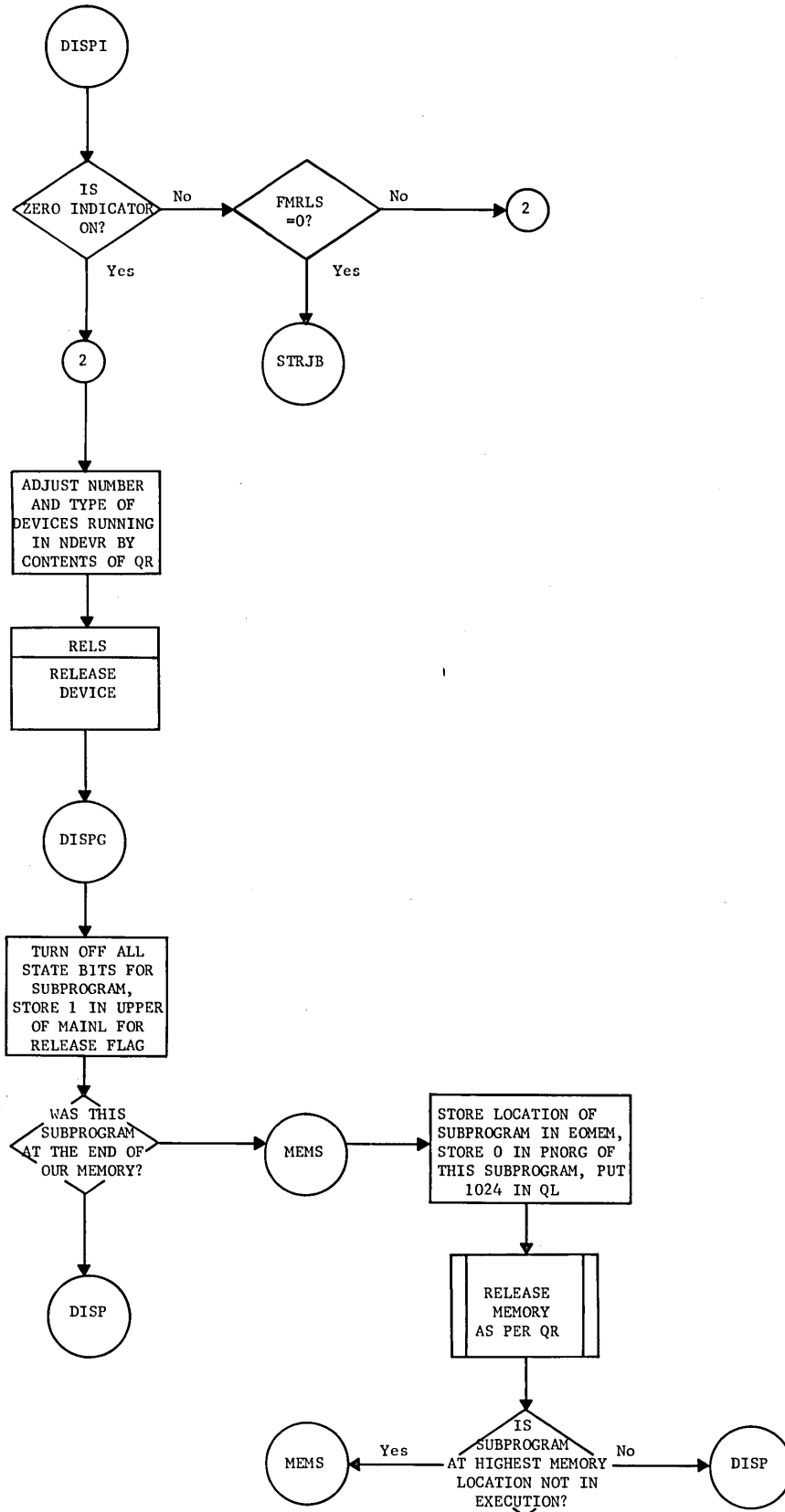

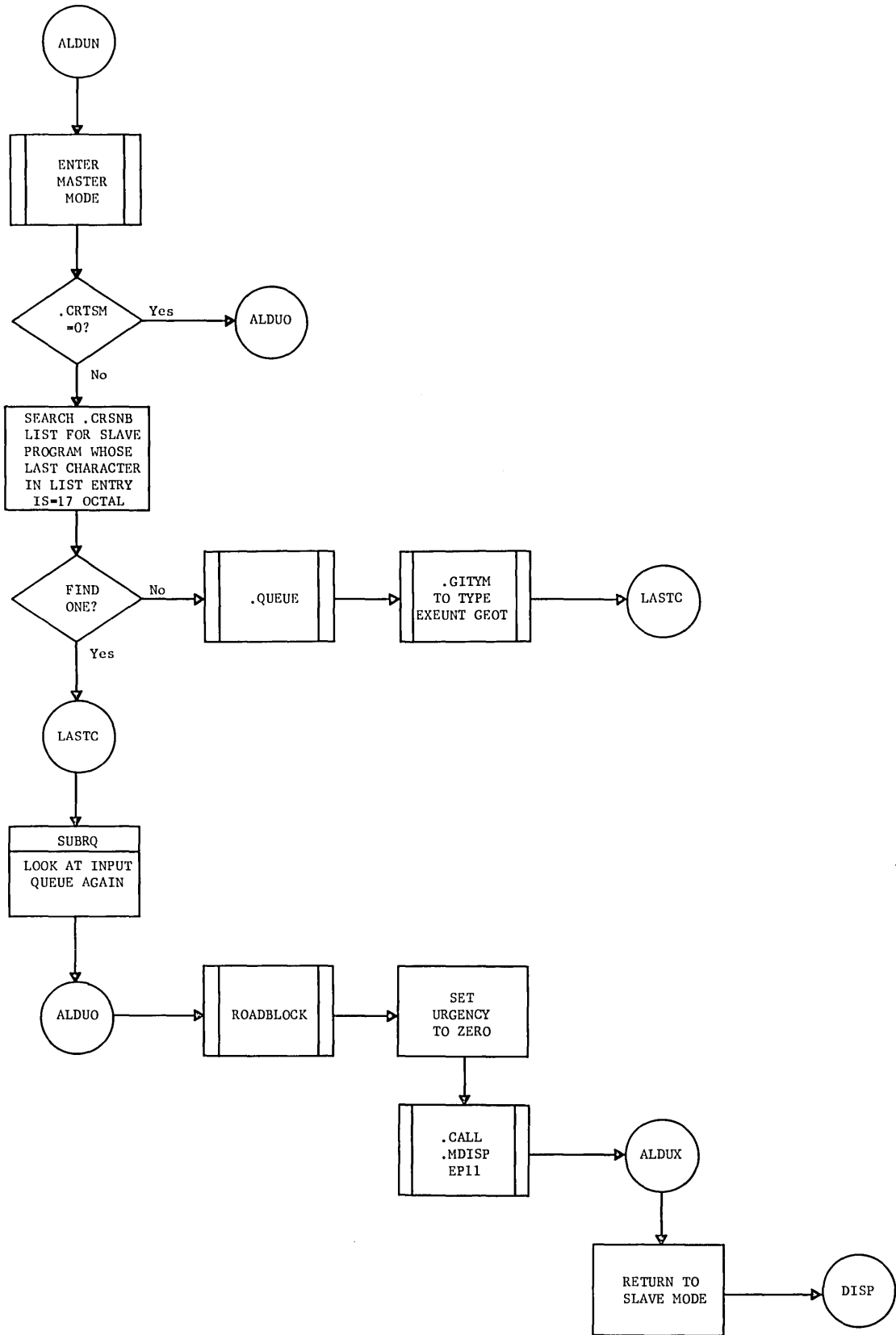

DISP  
.MGEOT

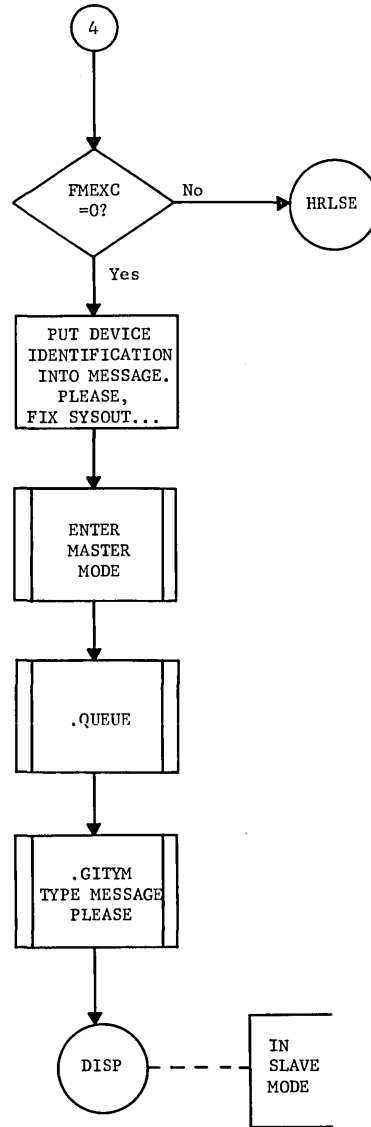
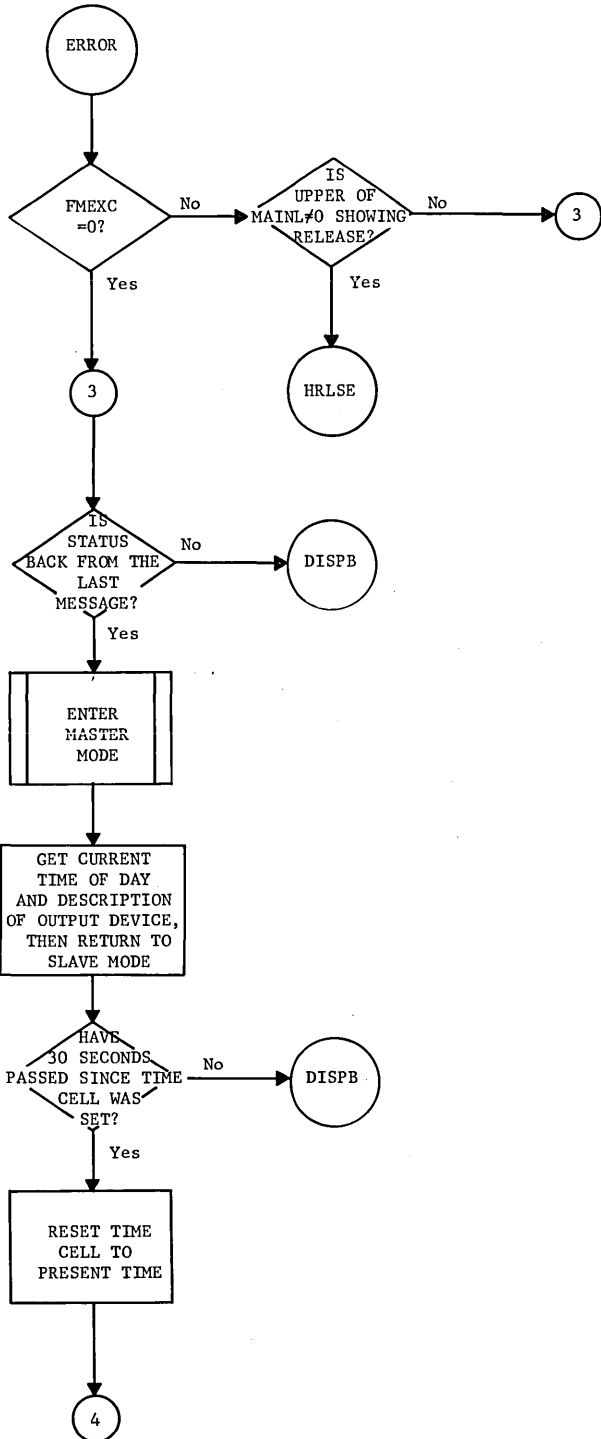

DISP  
.MGEOT

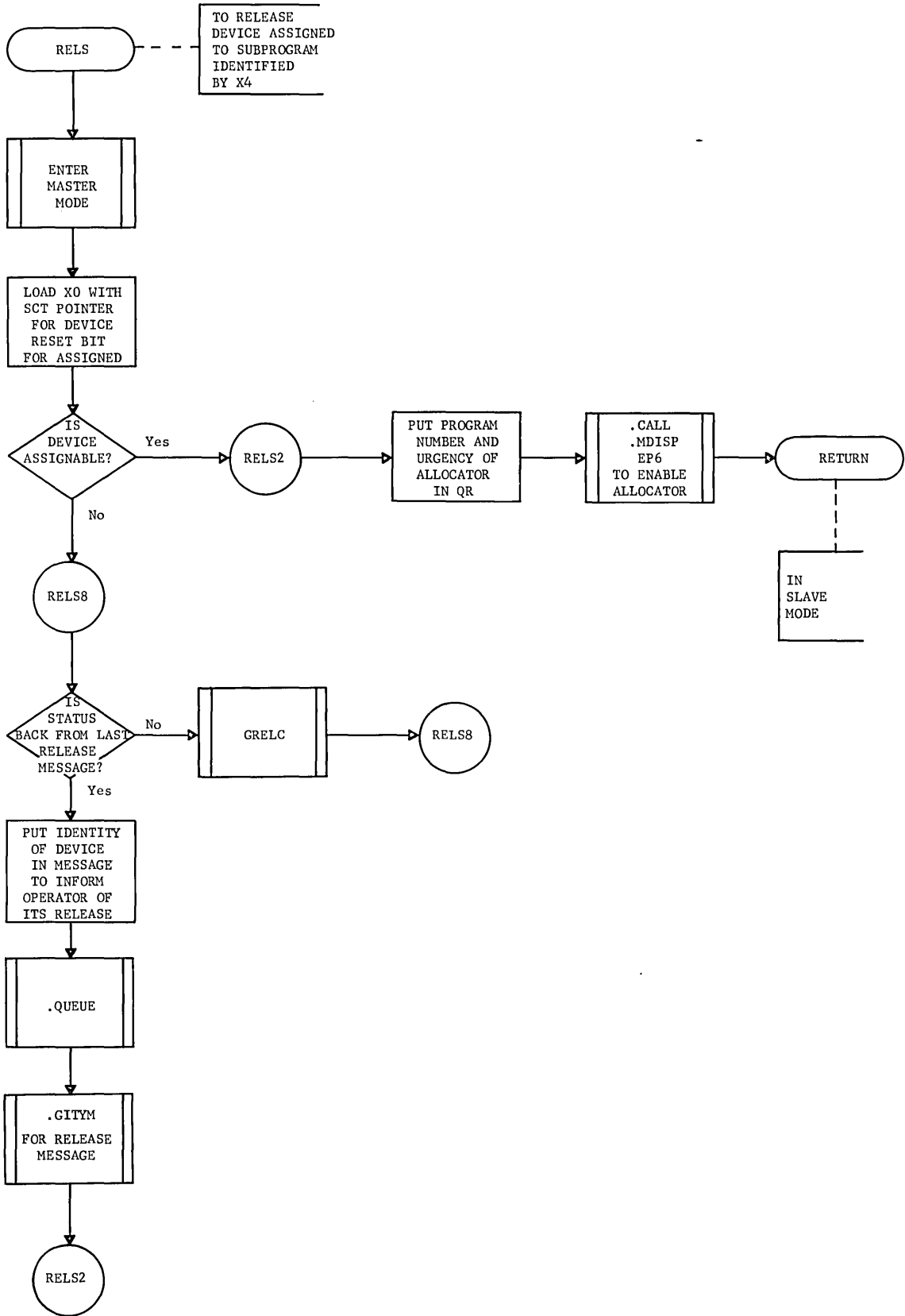



STACT  
.MGEOT

### START REPORT/ACTIVITY

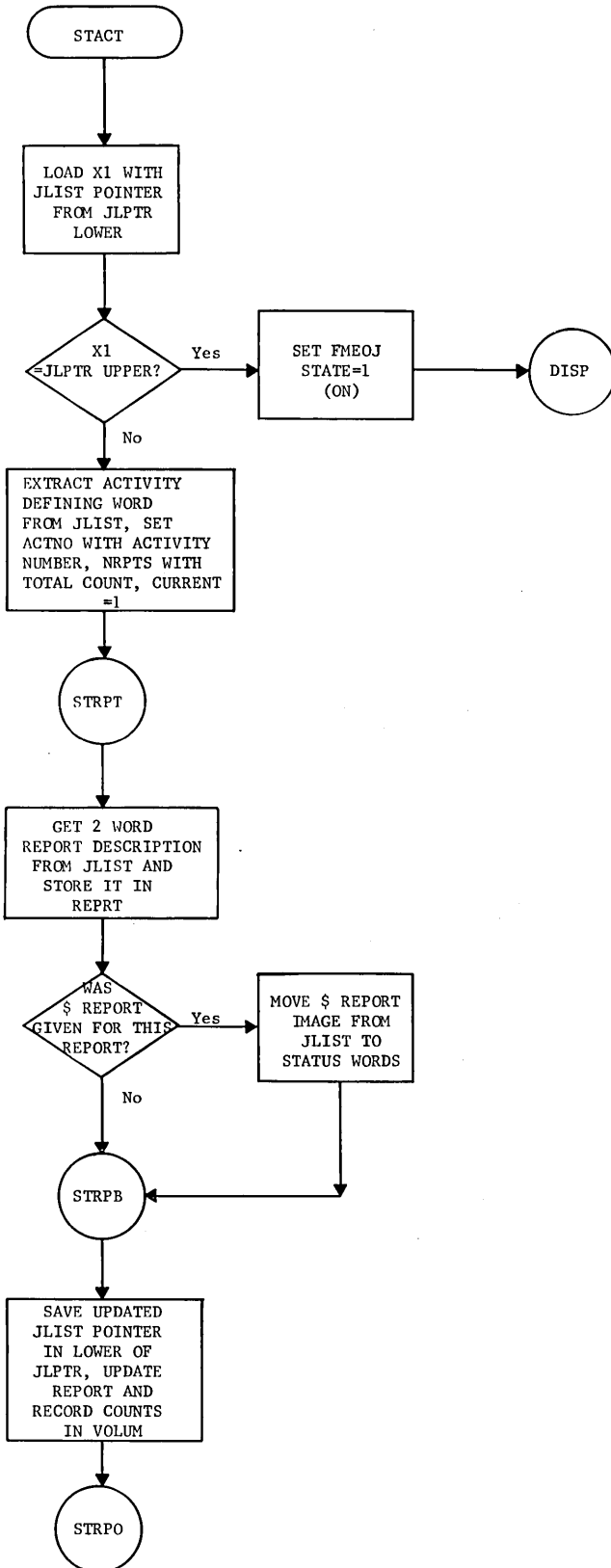

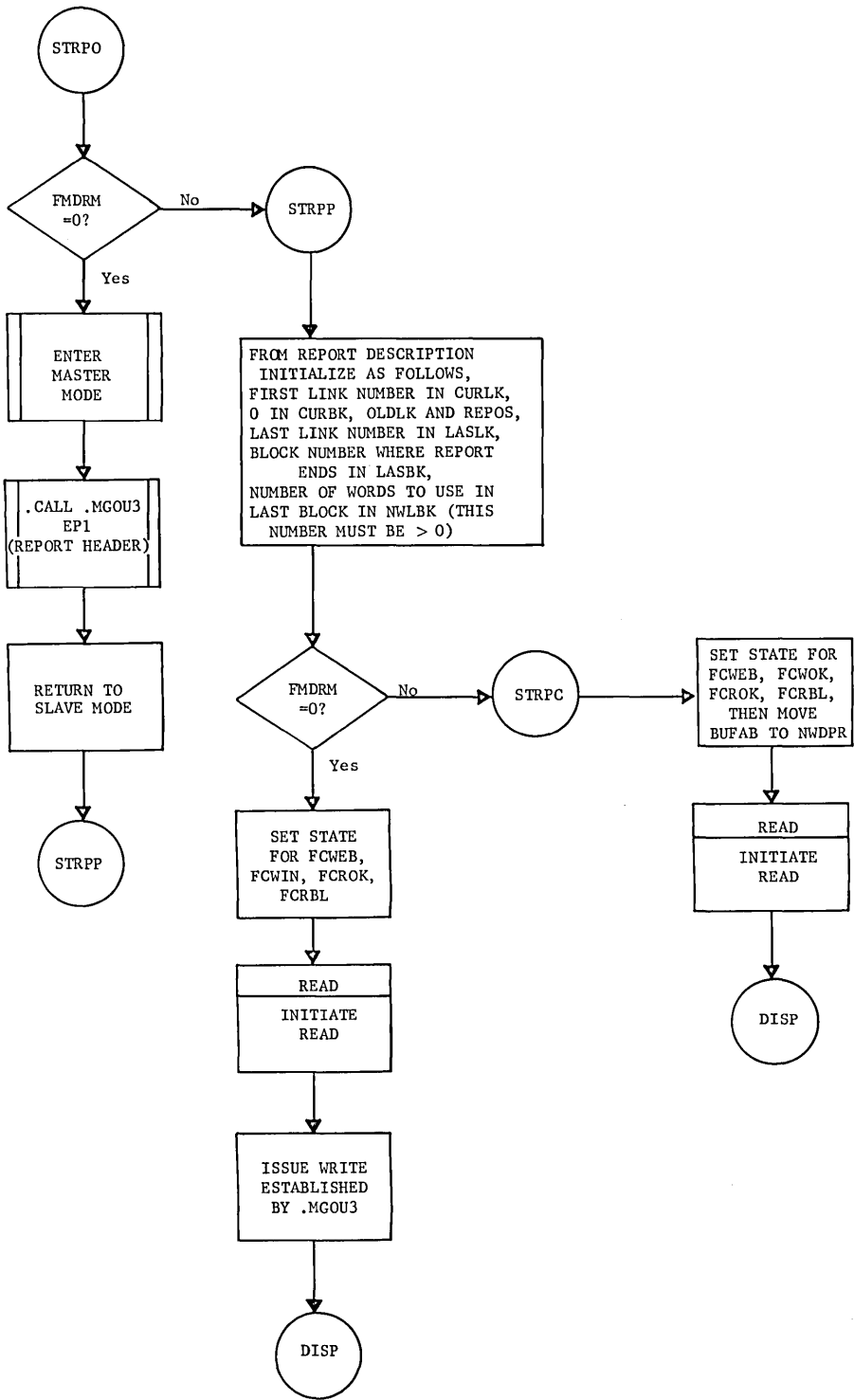

READ  
.MGEOT

### READ INTO BUFFER

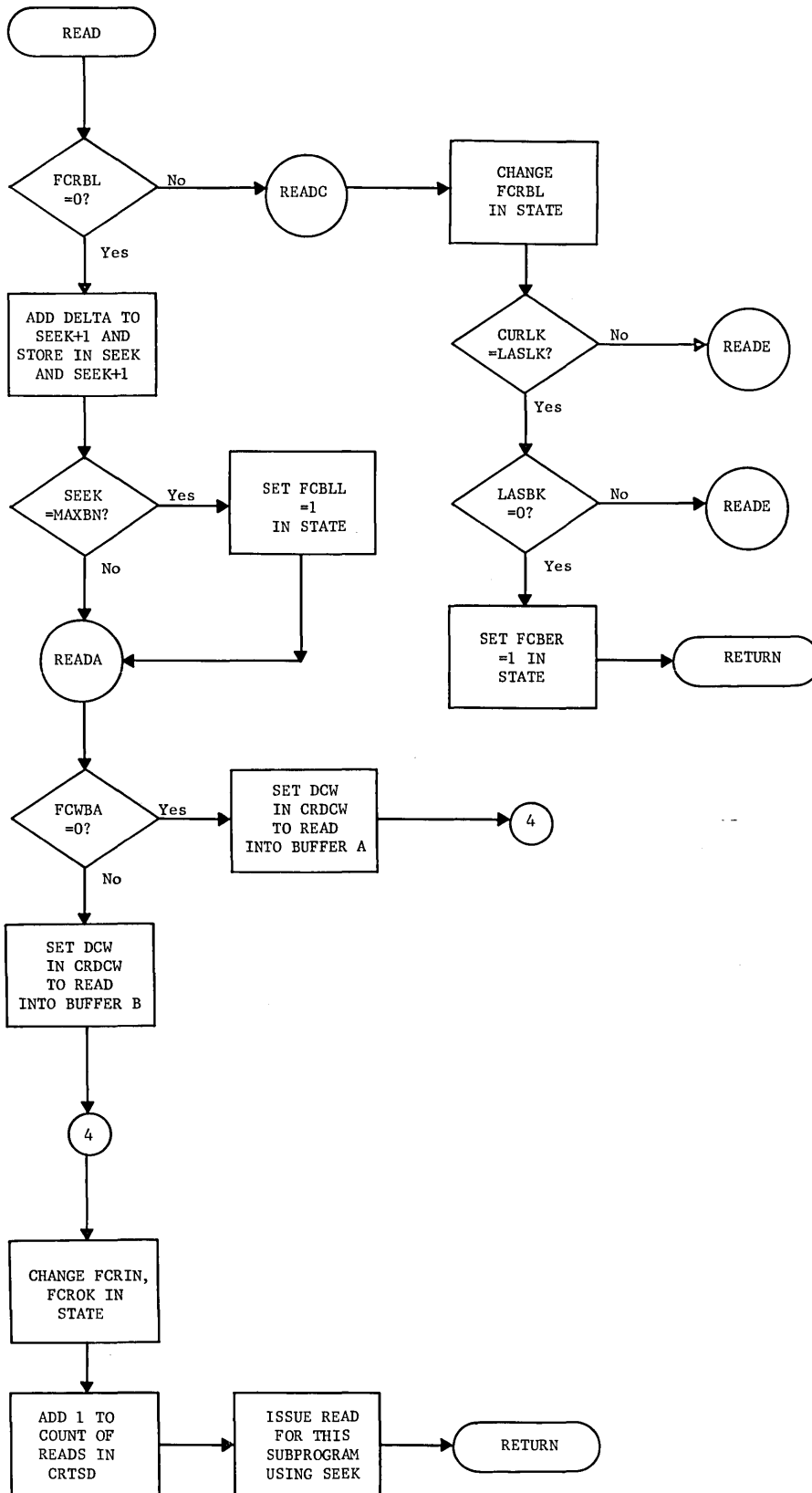

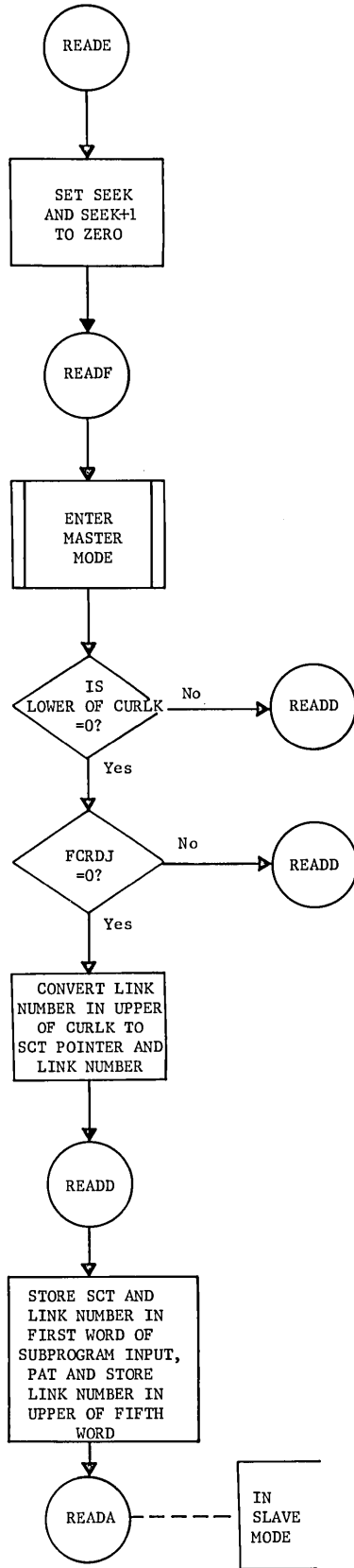

WRITE  
.MGEOT

### WRITE FROM BUFFER

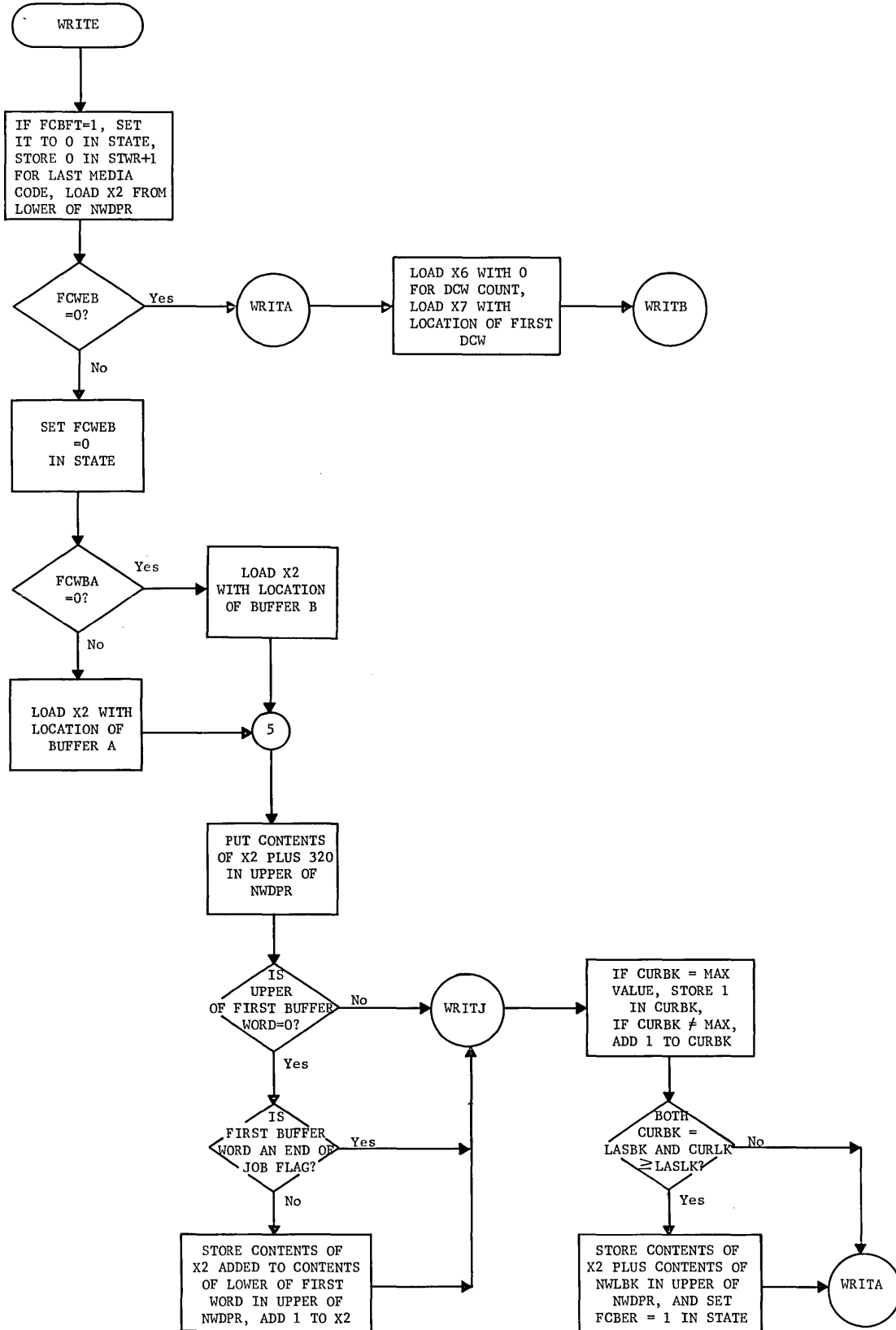

WRITE  
.MGEOT

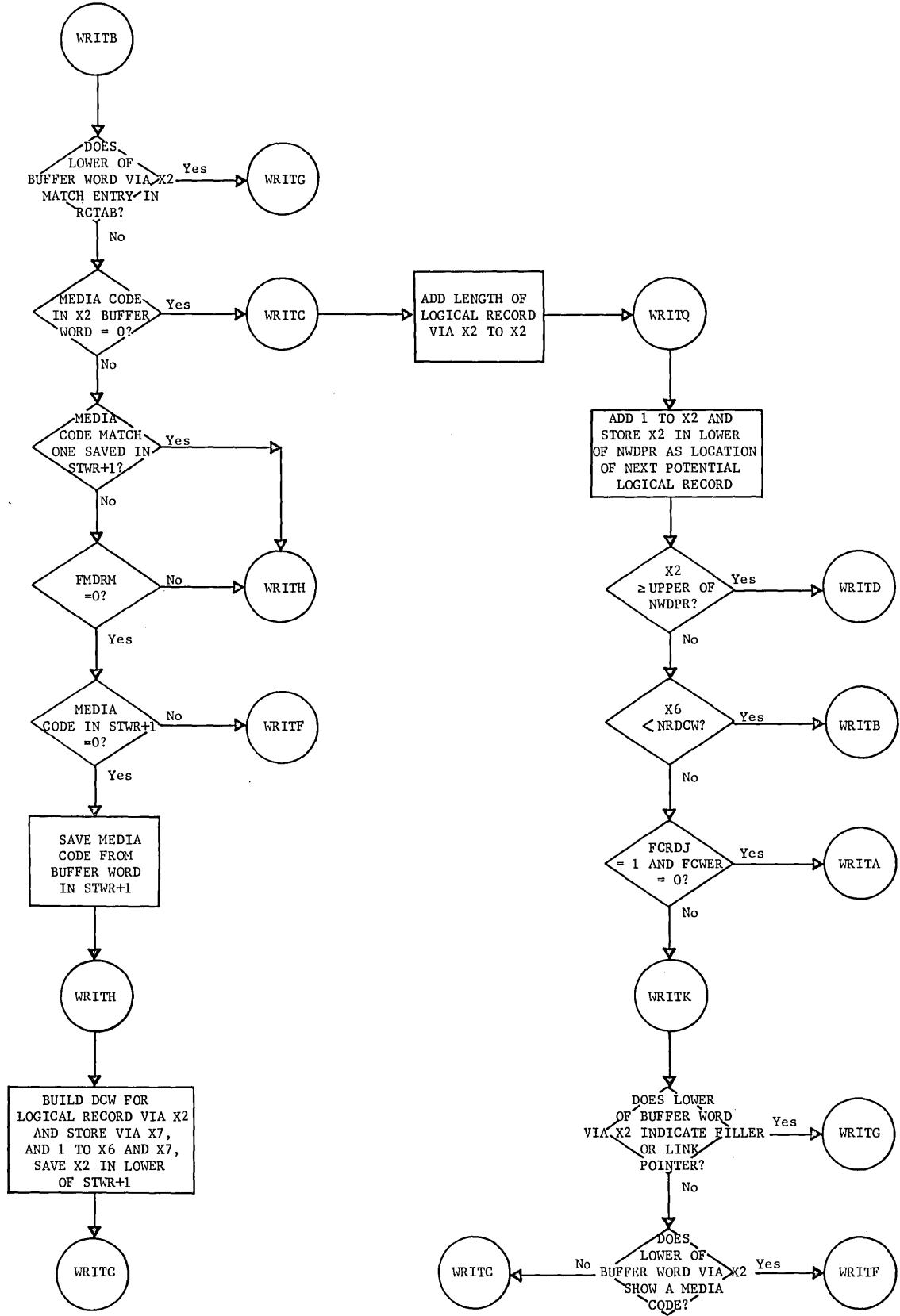

**WRITE  
.MGEOT**

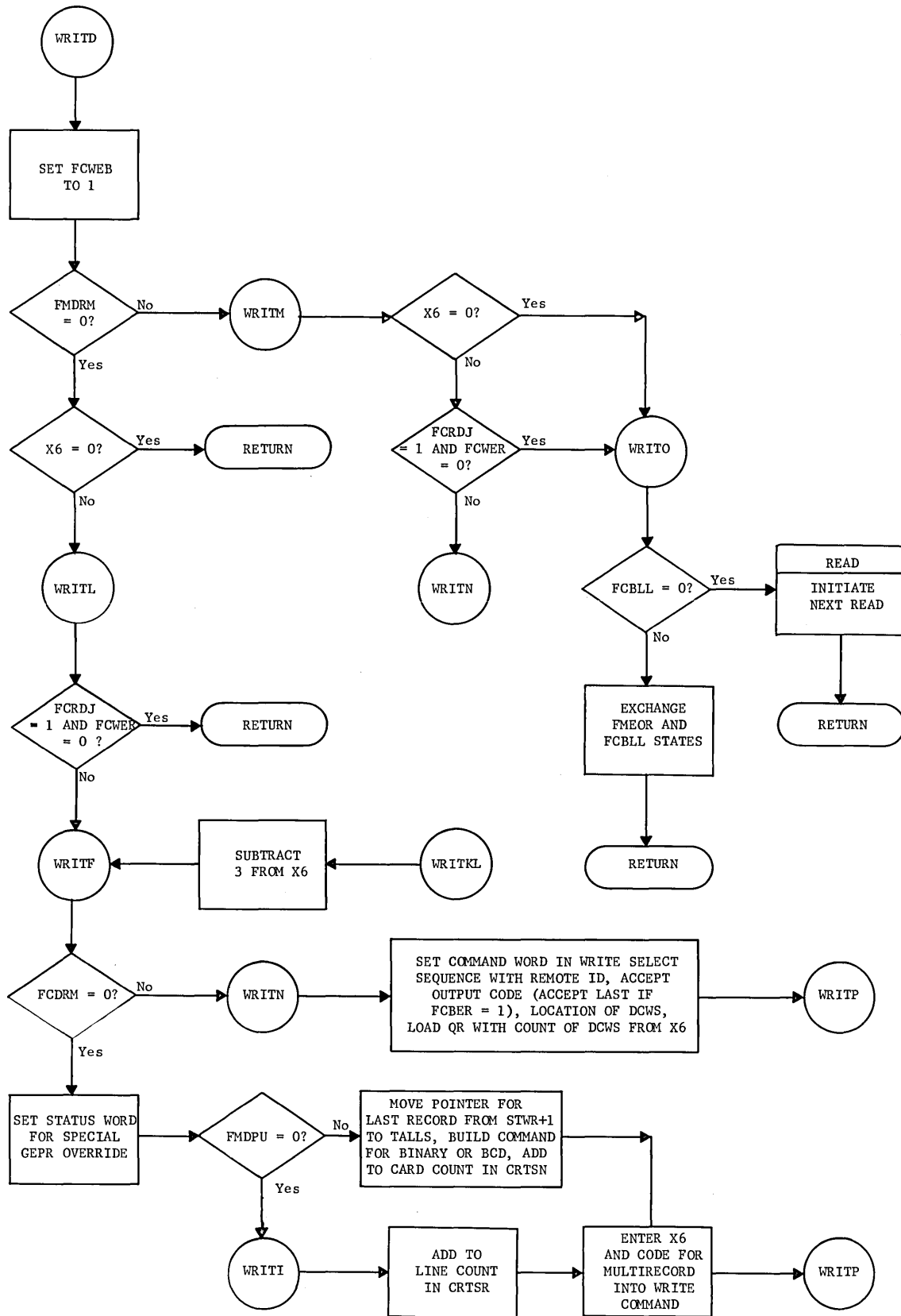

WRITE  
.MGEOT

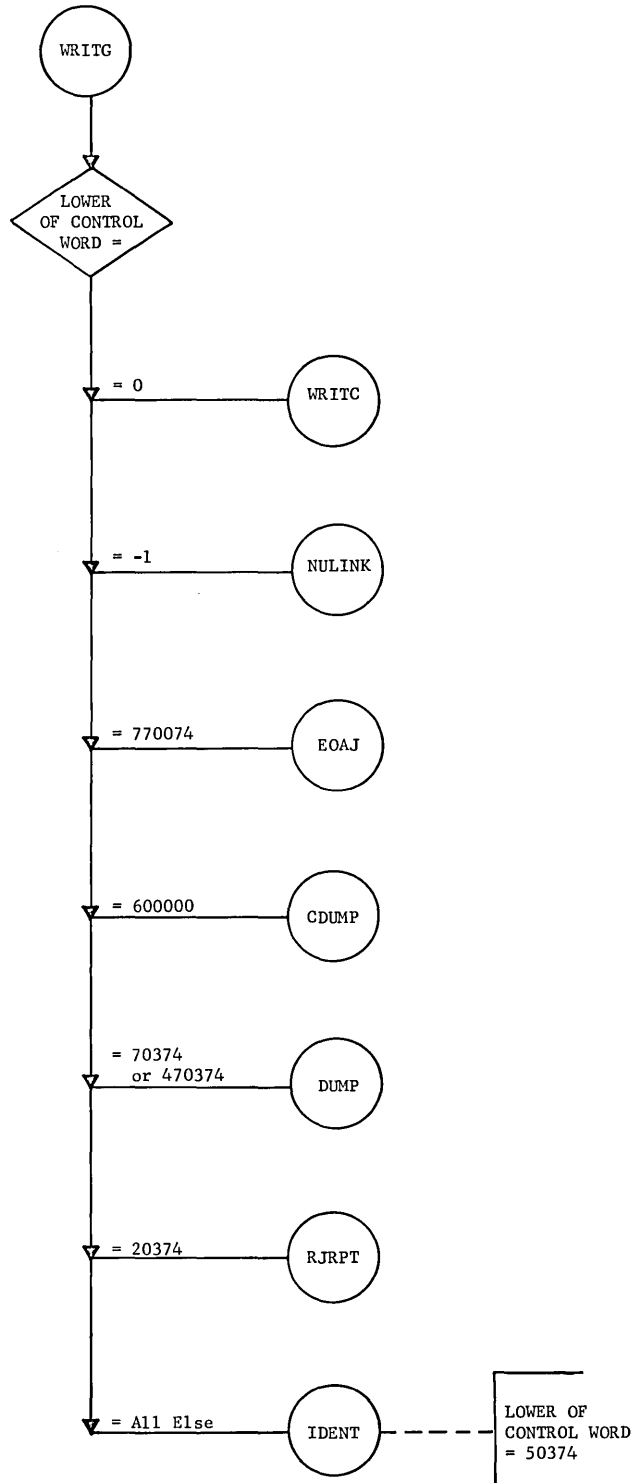
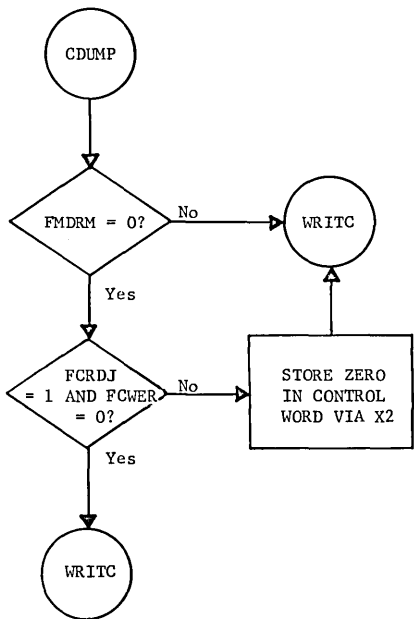
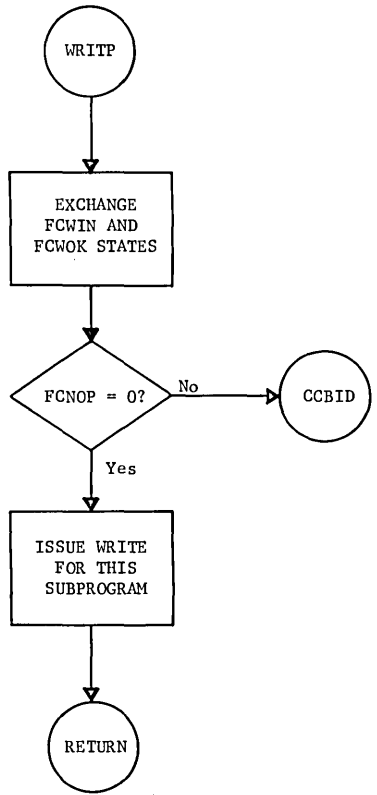



WRITE  
.MGEOT

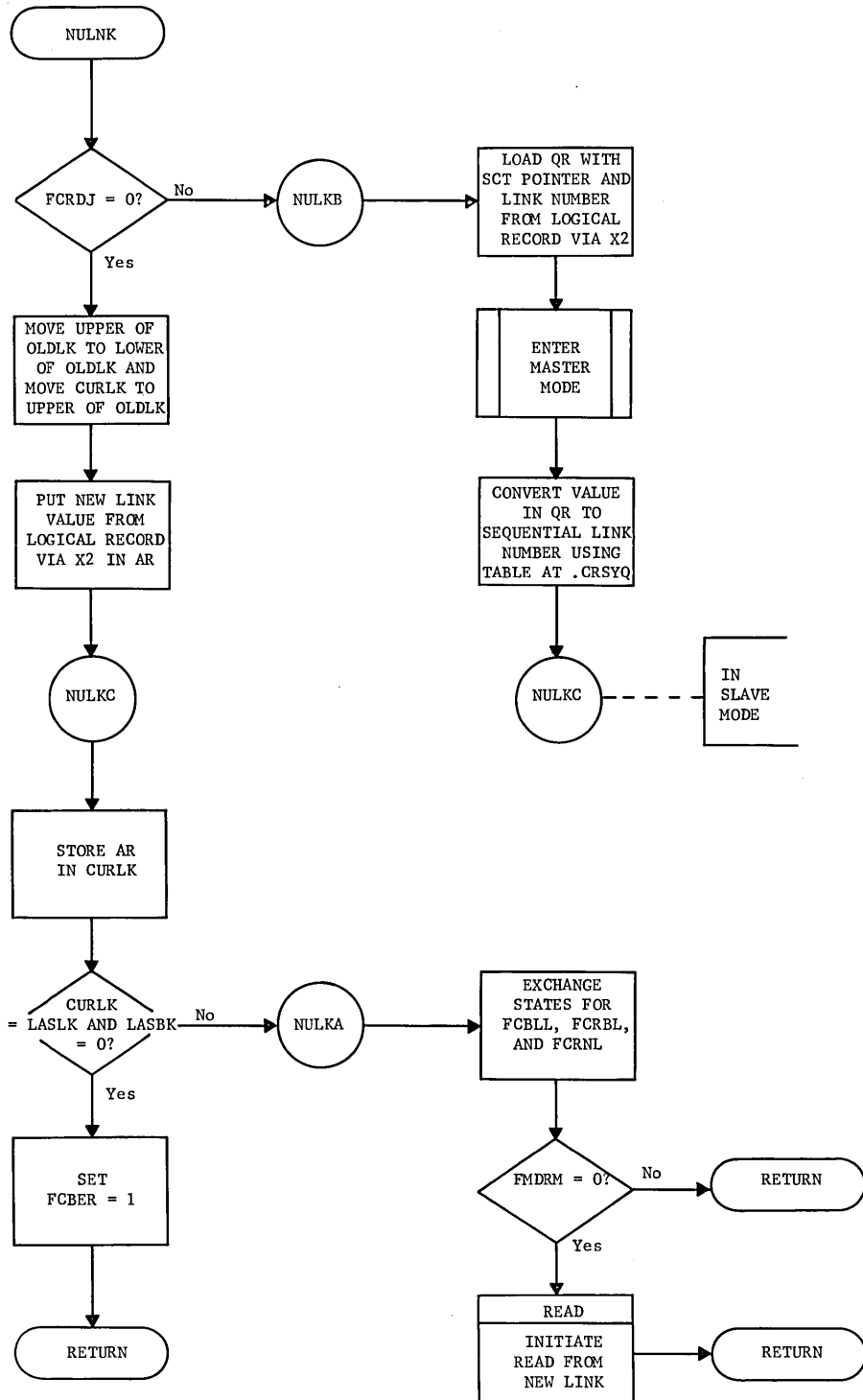
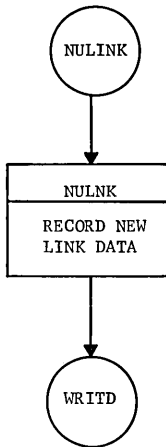

WRITE  
.MGEOT

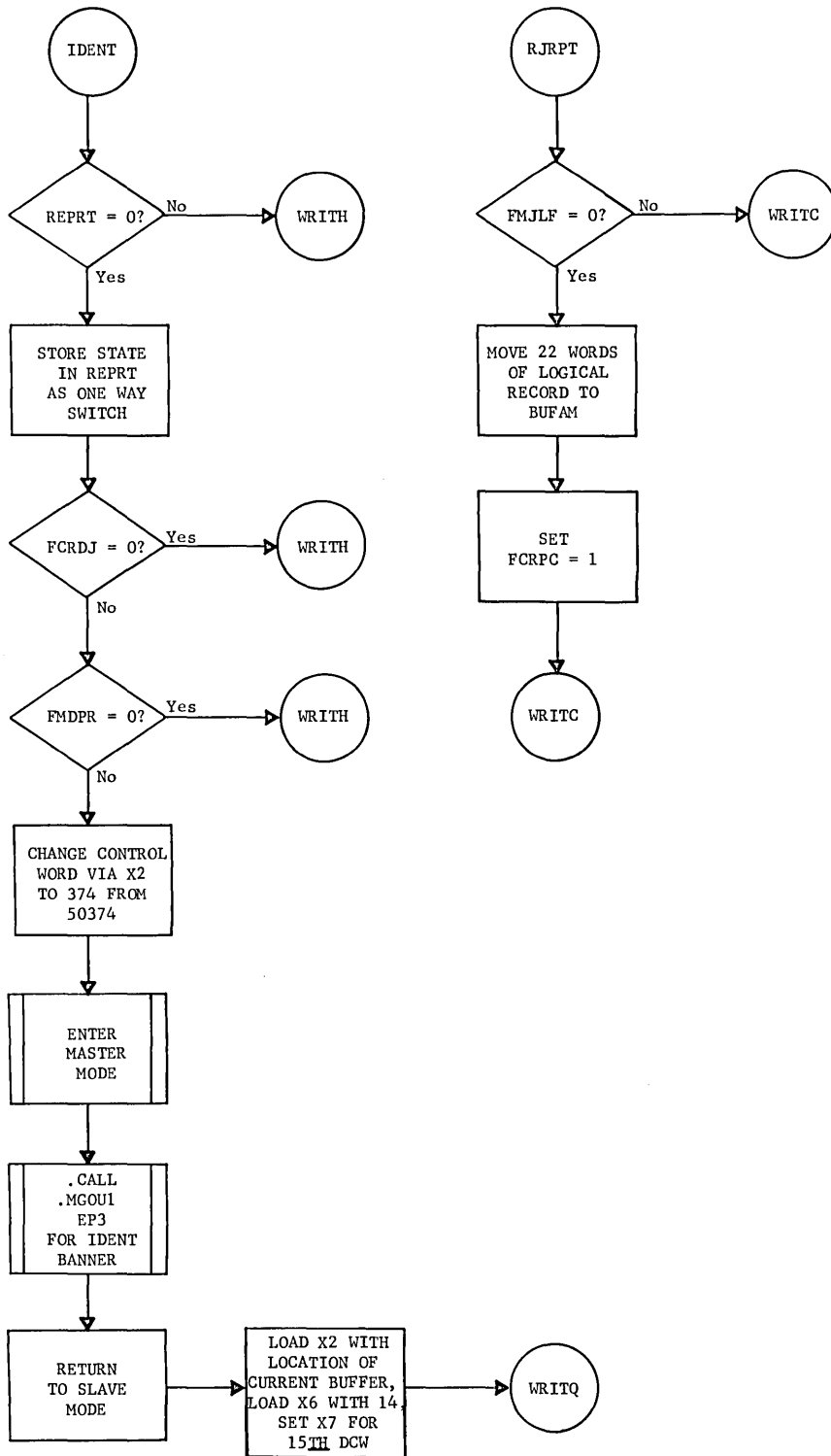

WRITE  
.MGEOT

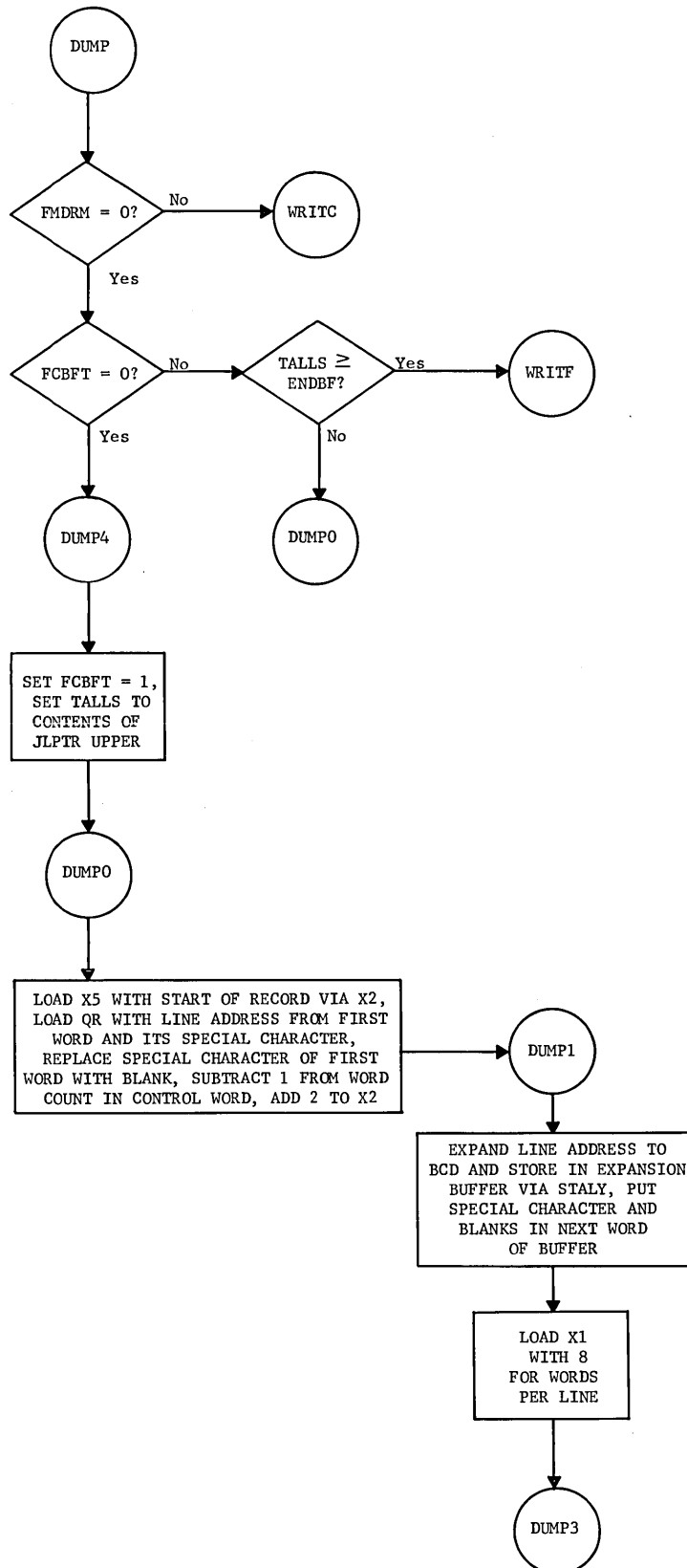

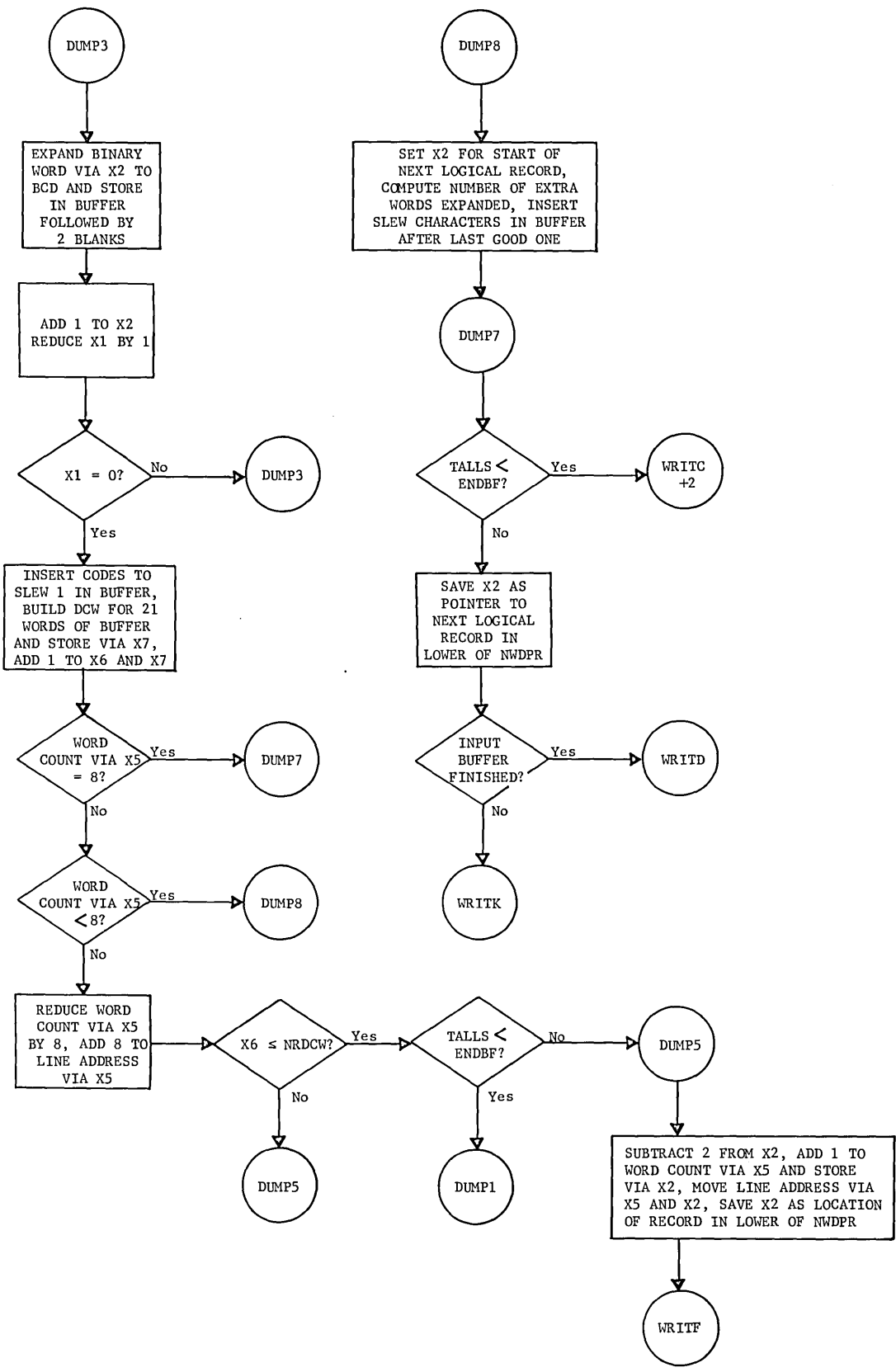

**WRITE  
.MGEOT**

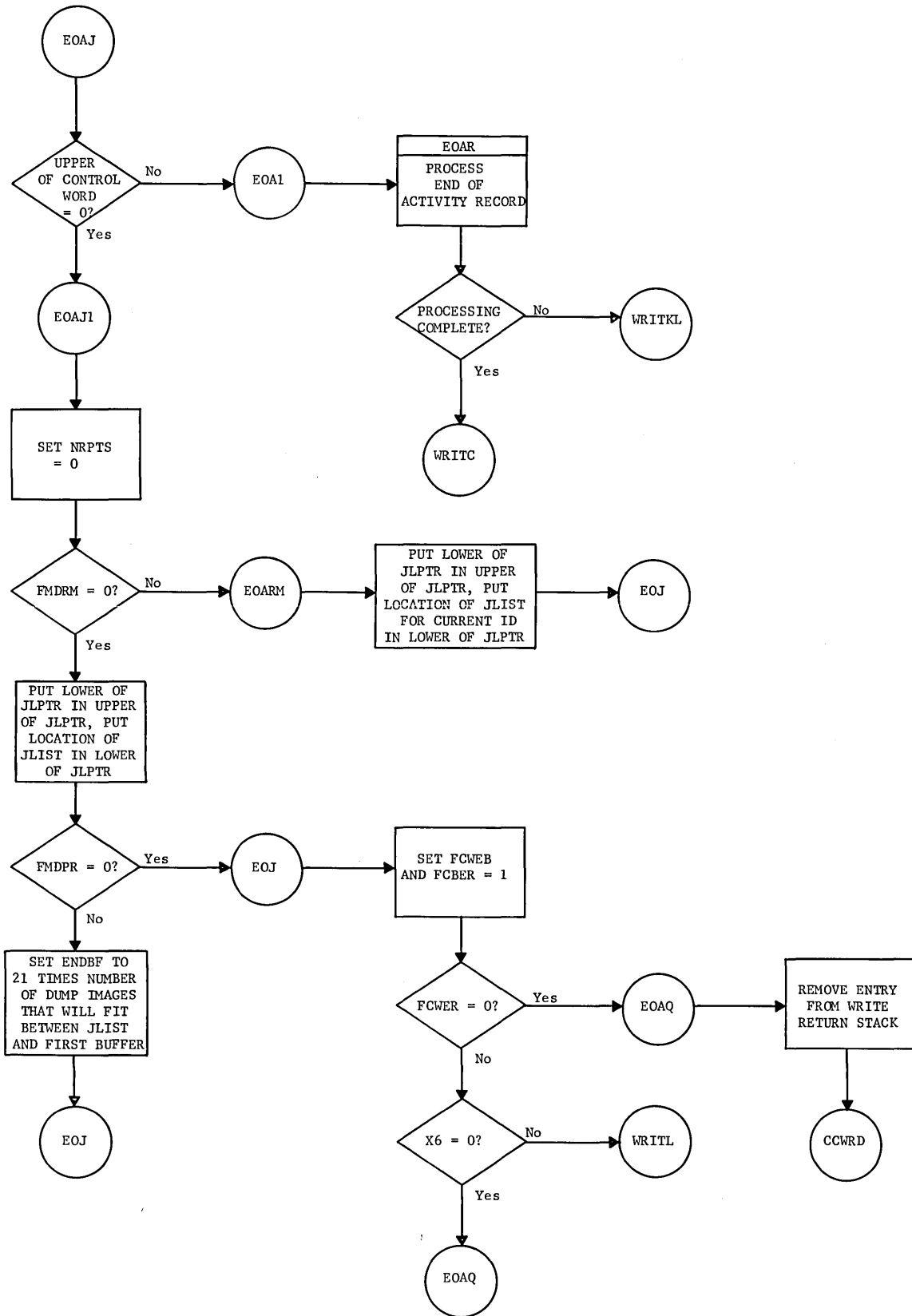

WRITE  
.MGEOT

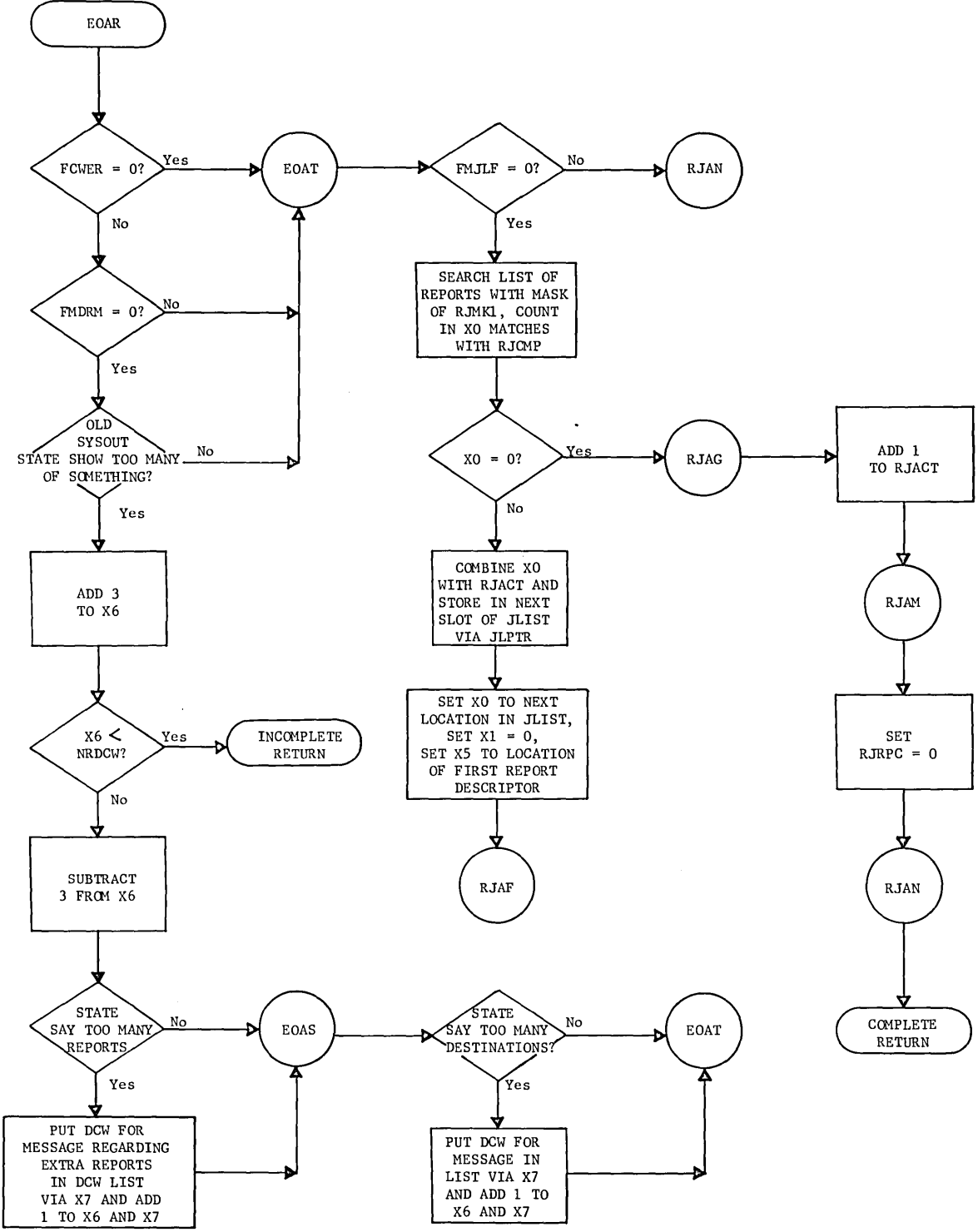

WRITE  
.MGEOT

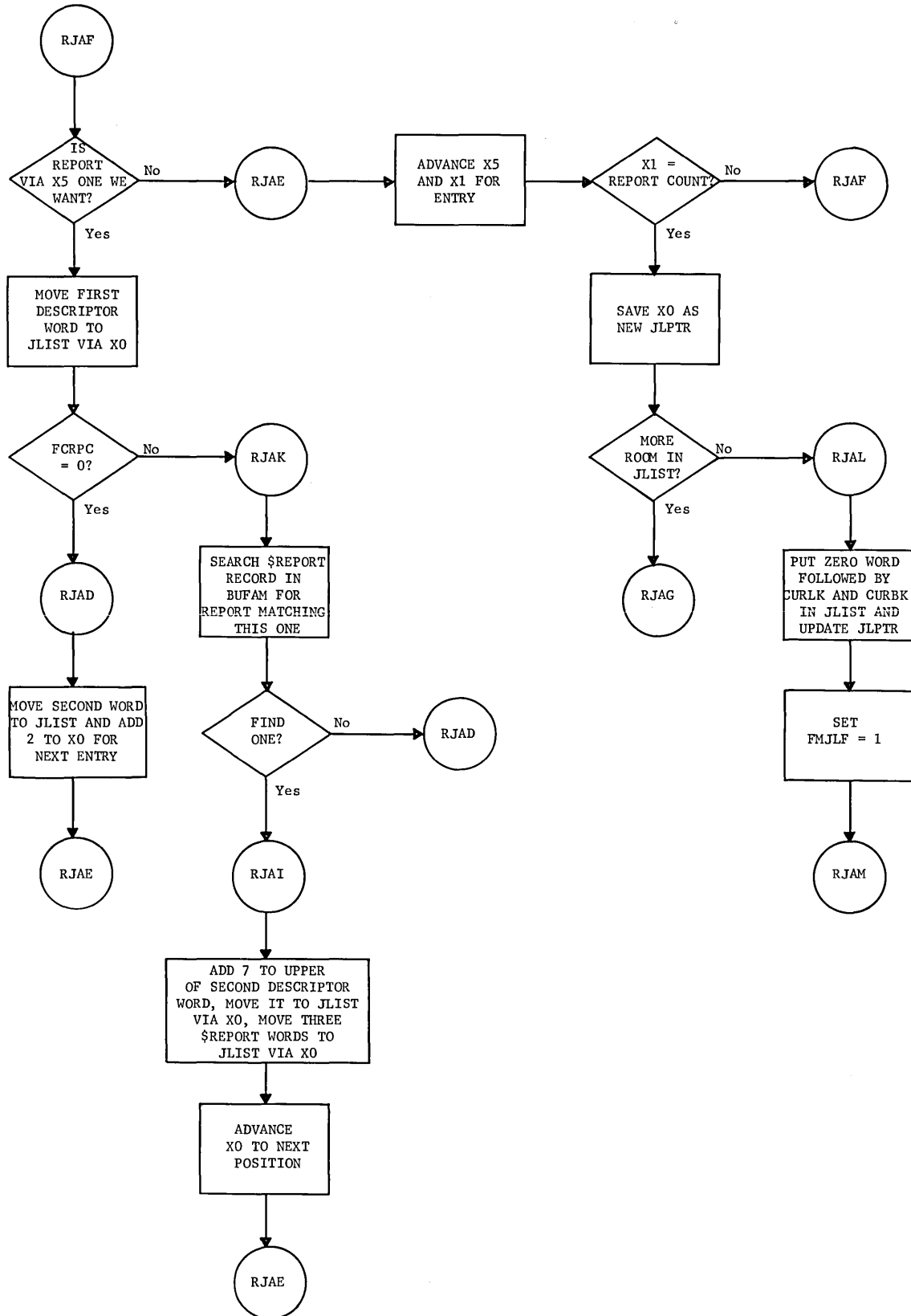

COURTESY CALL FOR READ

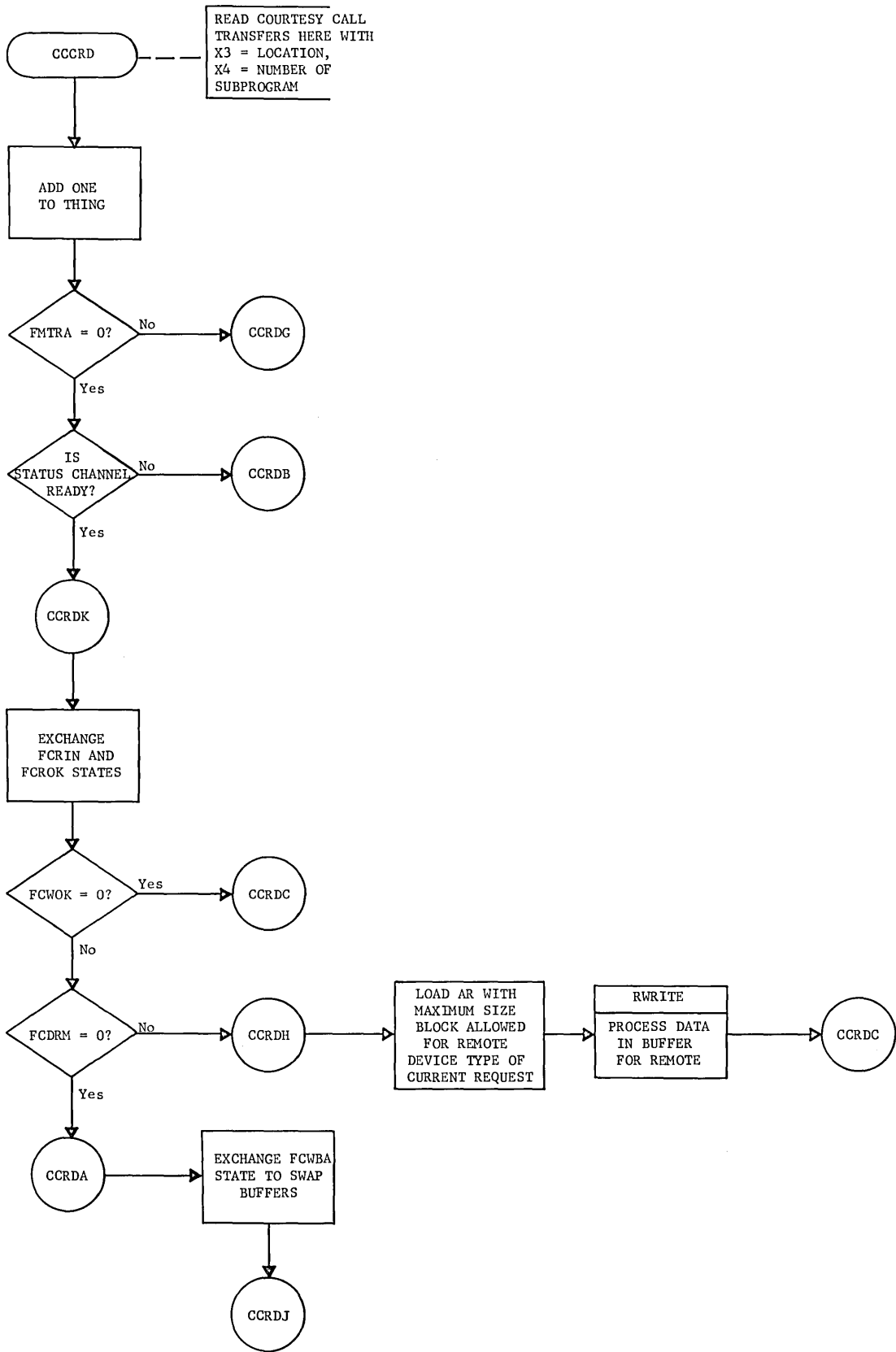



CCCRD  
.MGEOT

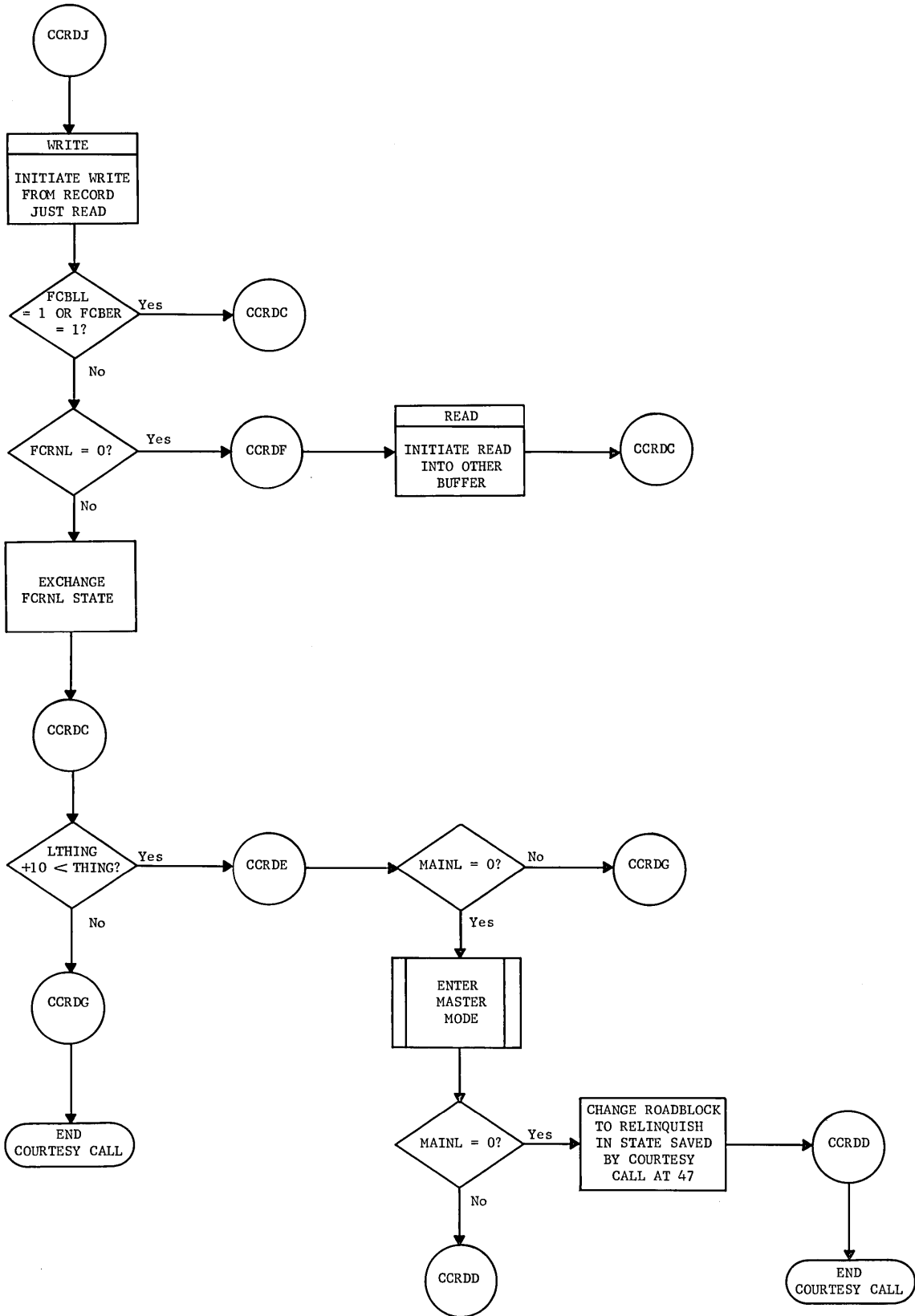

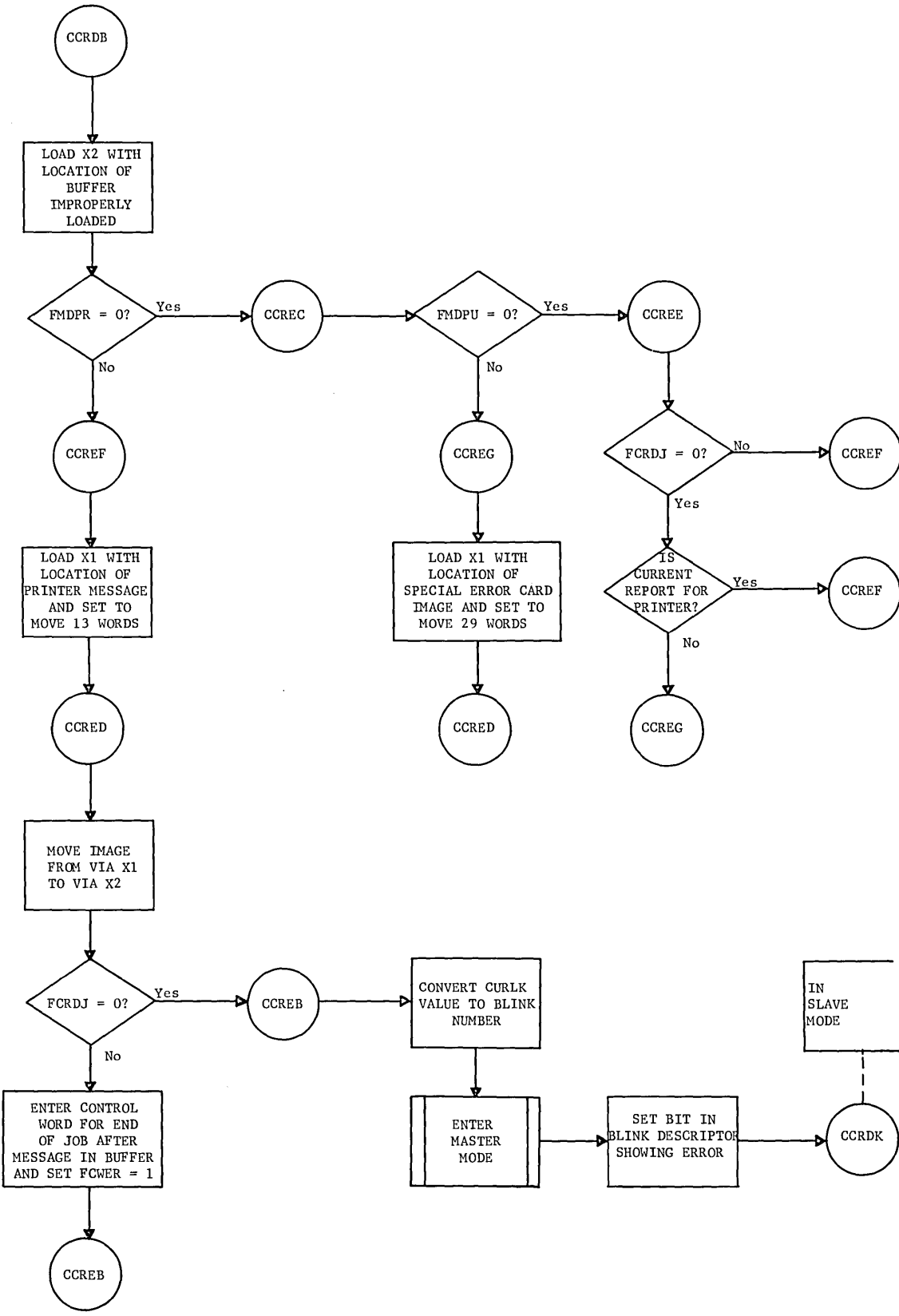

CCCWR  
.MGEOT

COURTESY CALL FOR WRITE

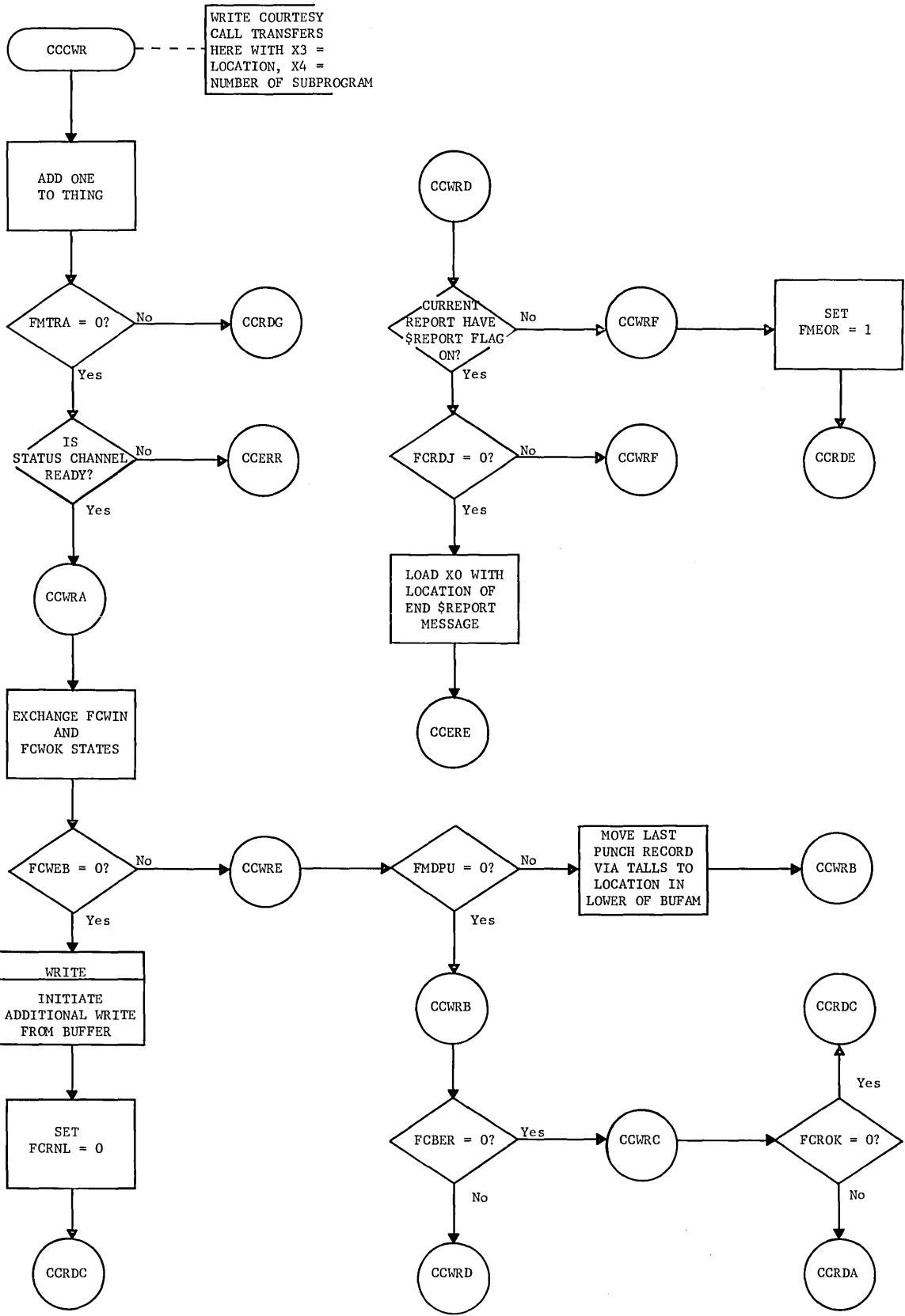

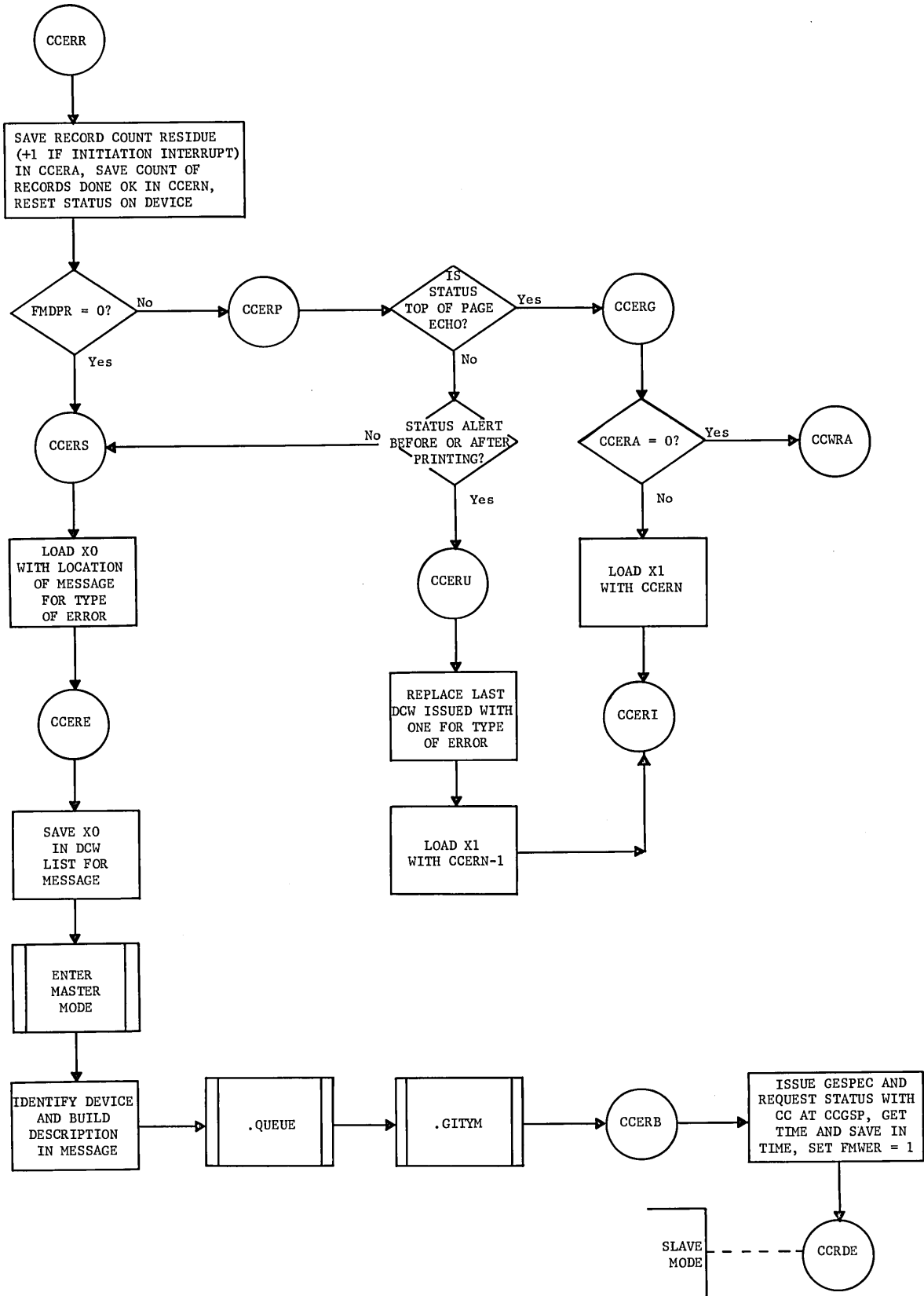

CCGSP  
.MGEOT

### COURTESY CALL FOR GESPEC

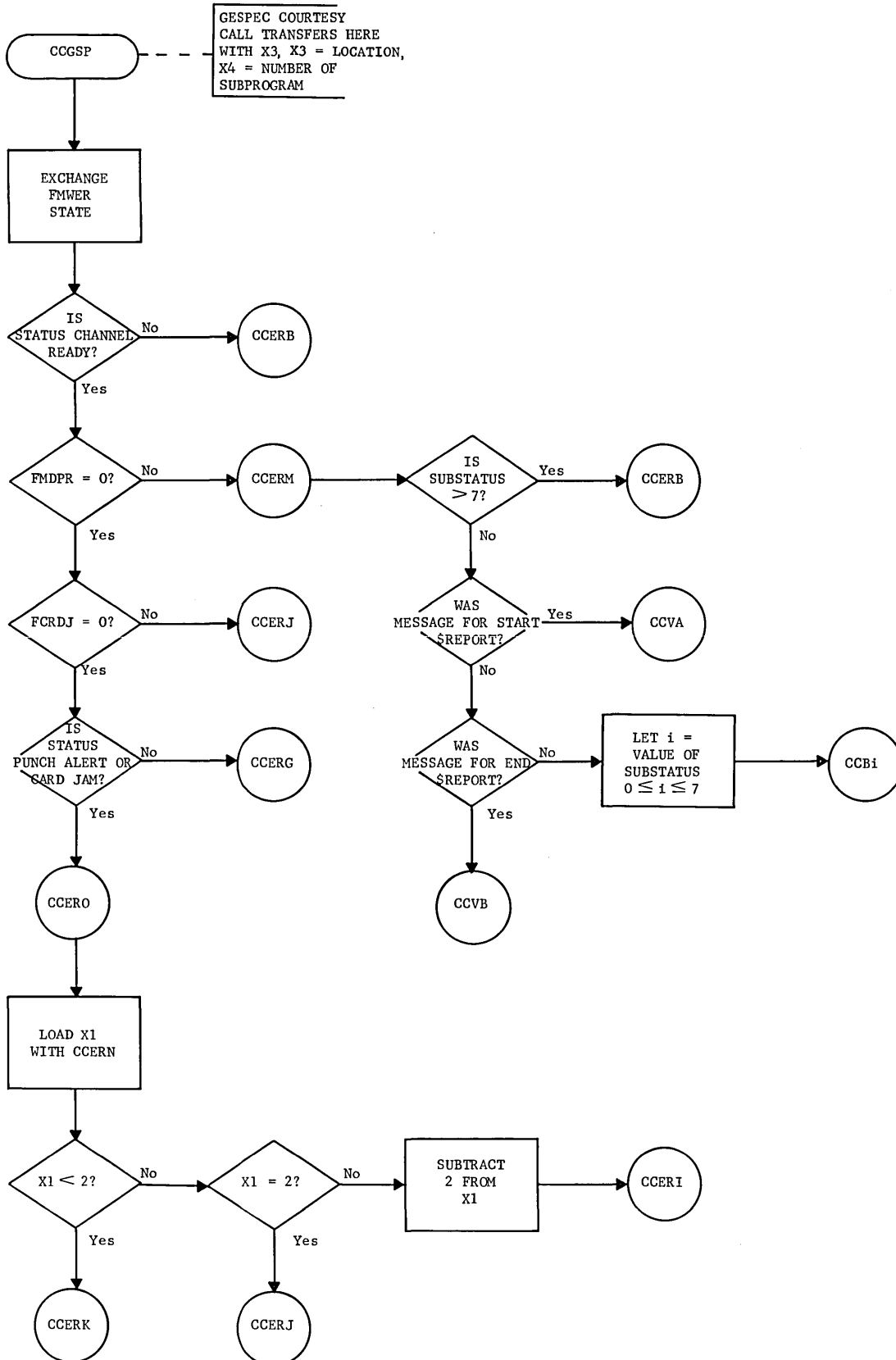

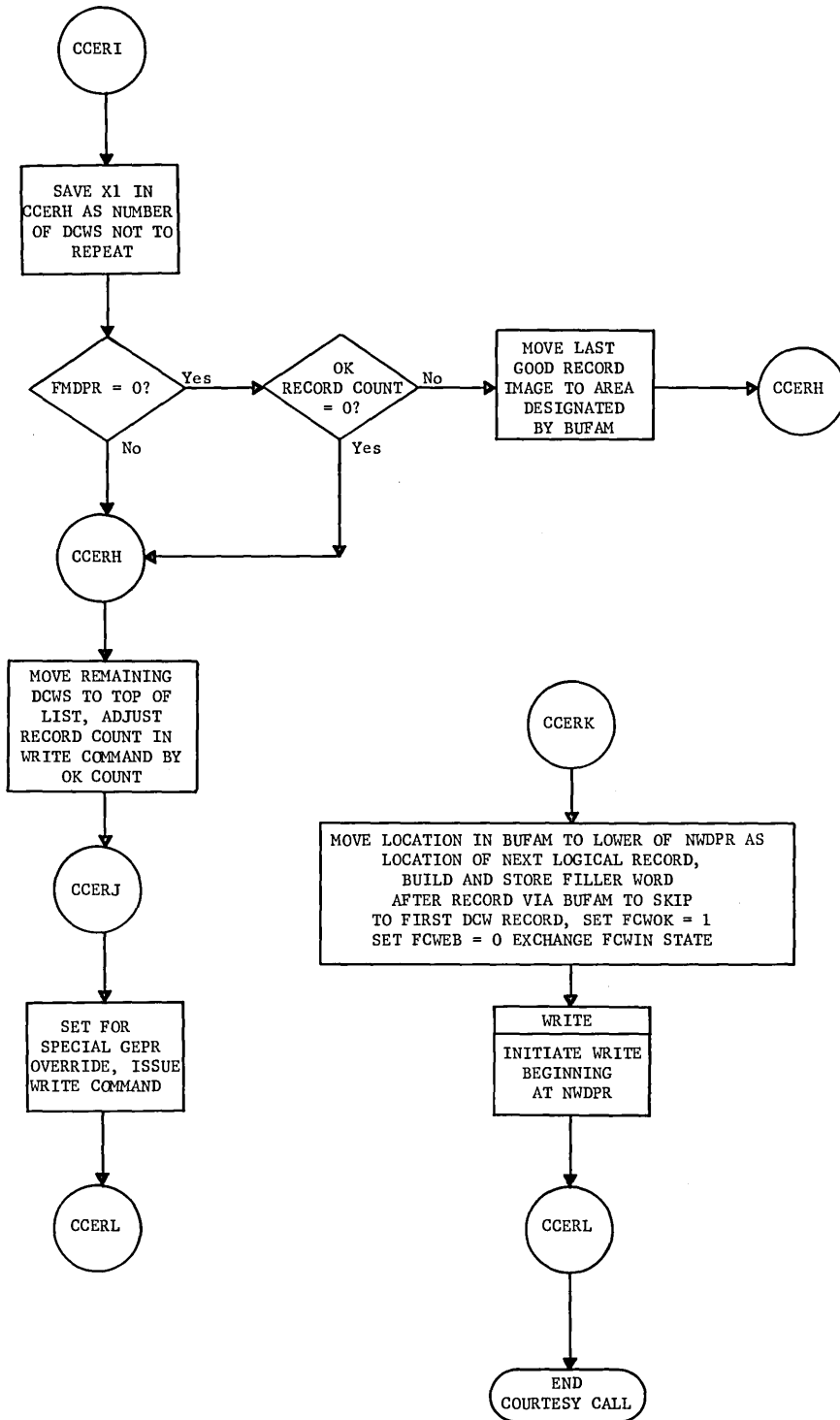

CCGSP  
.MGEOT

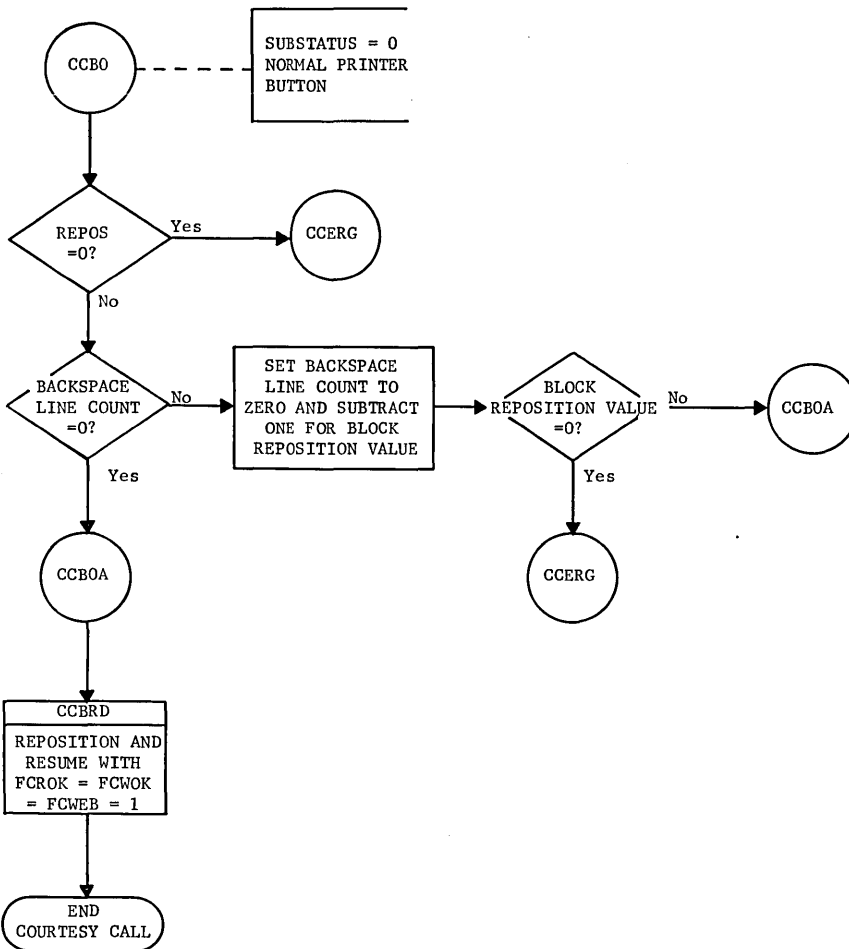
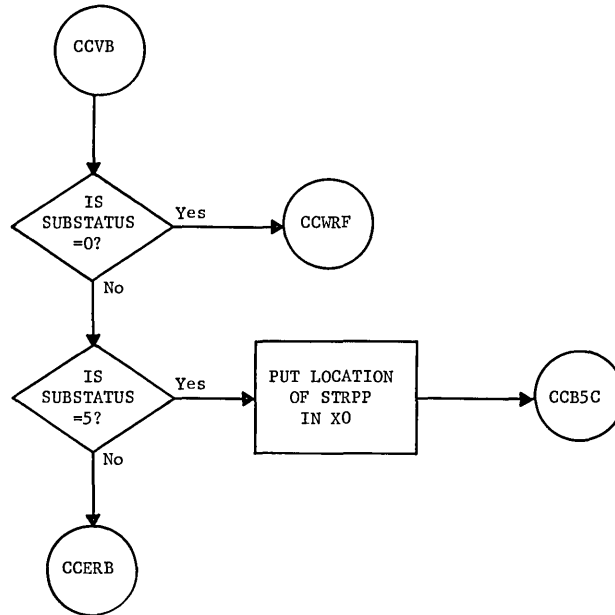
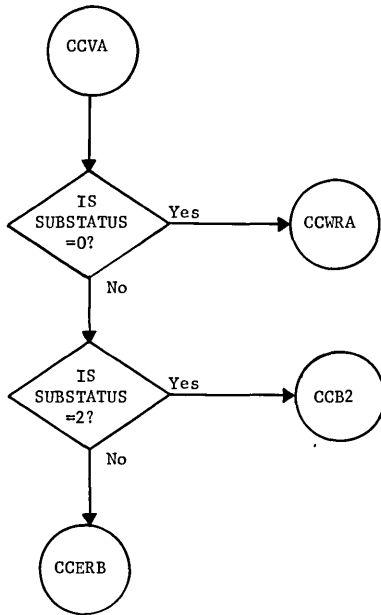

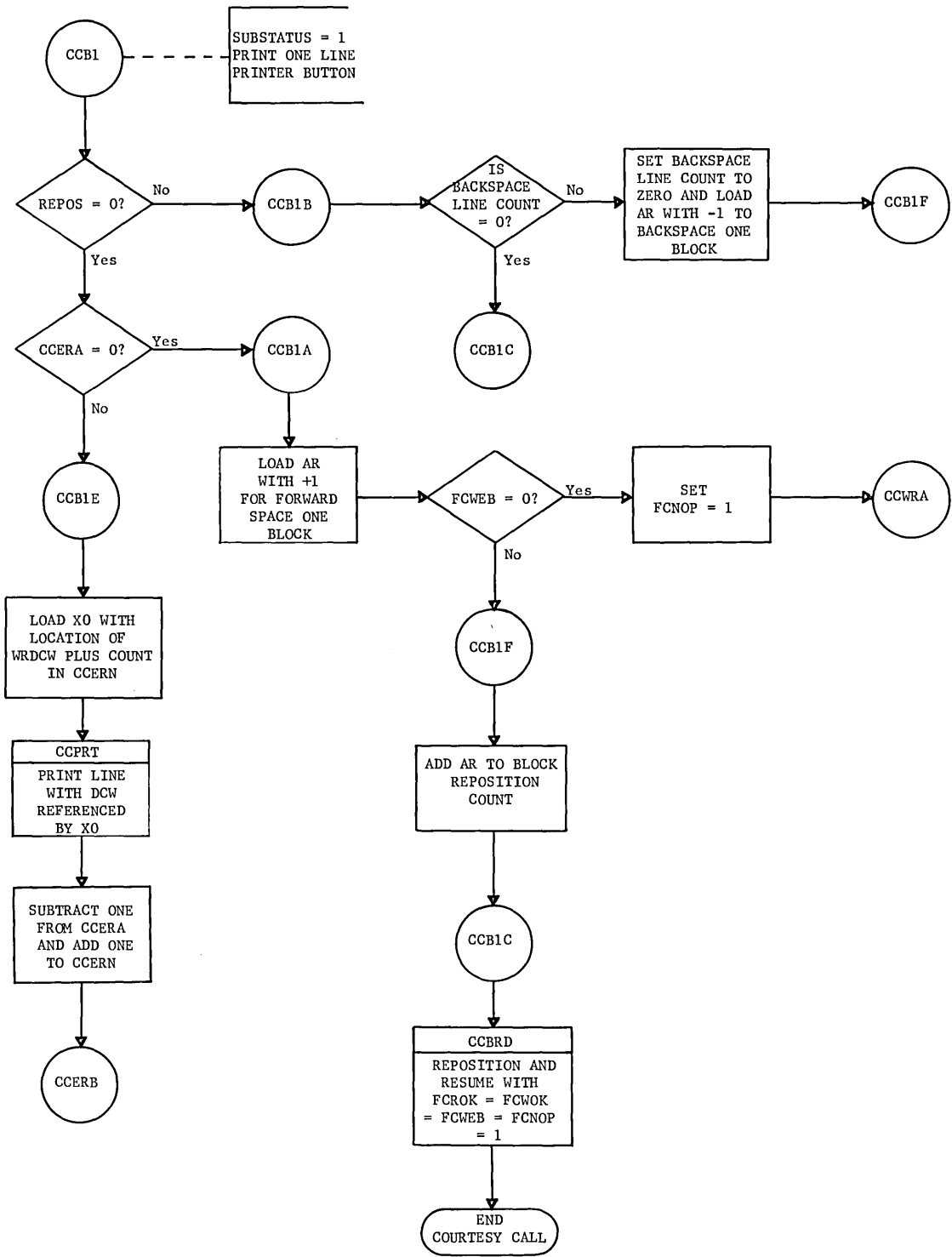



CCGSP  
.MGEOT

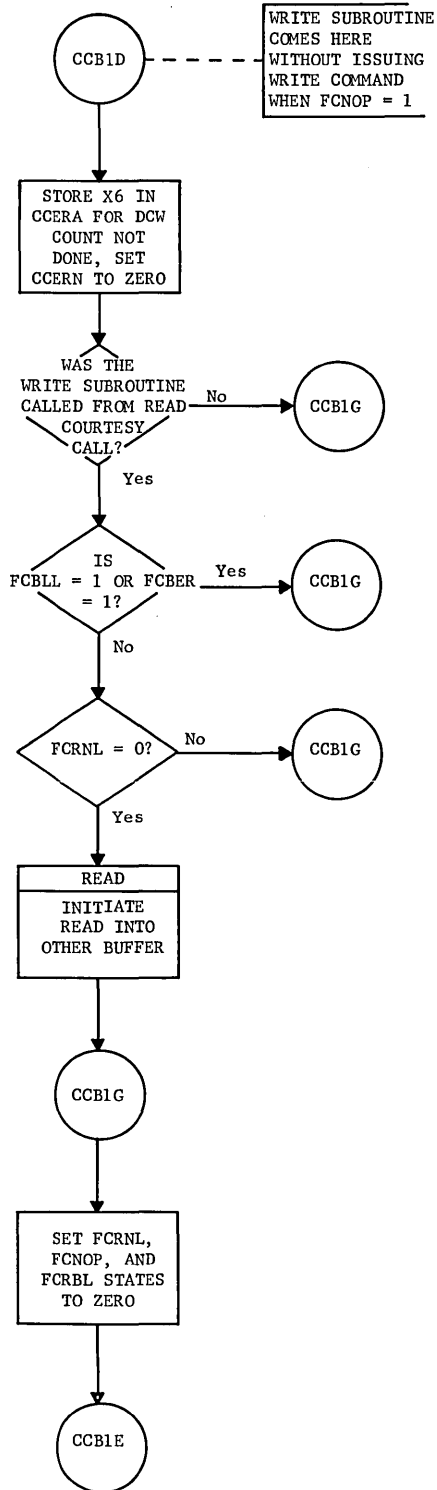

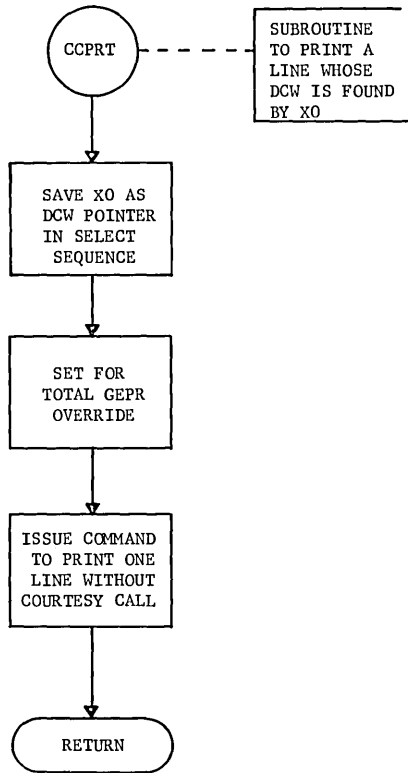

CCGSP  
.MGEOT

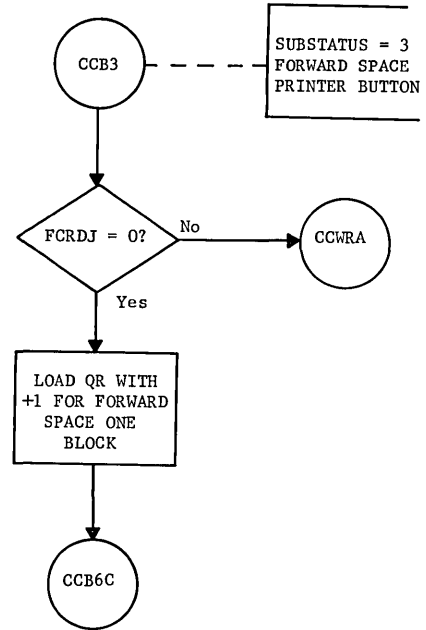
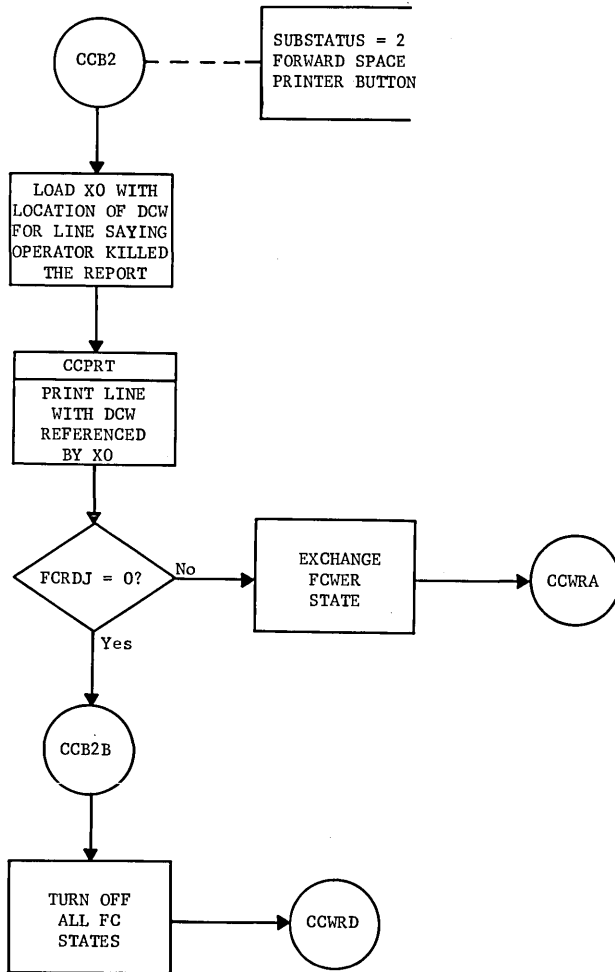

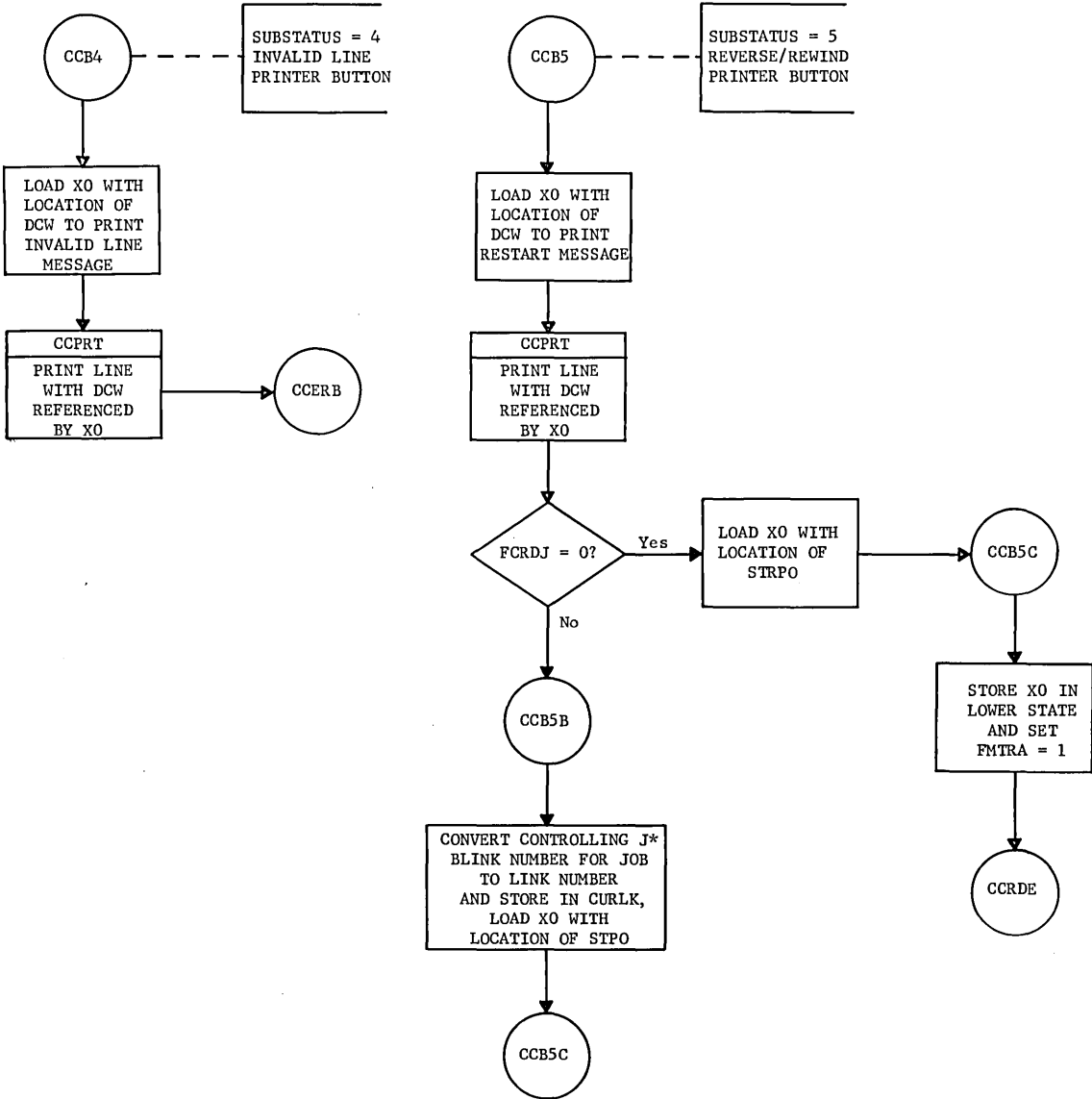

CCGSP  
.MGEOT

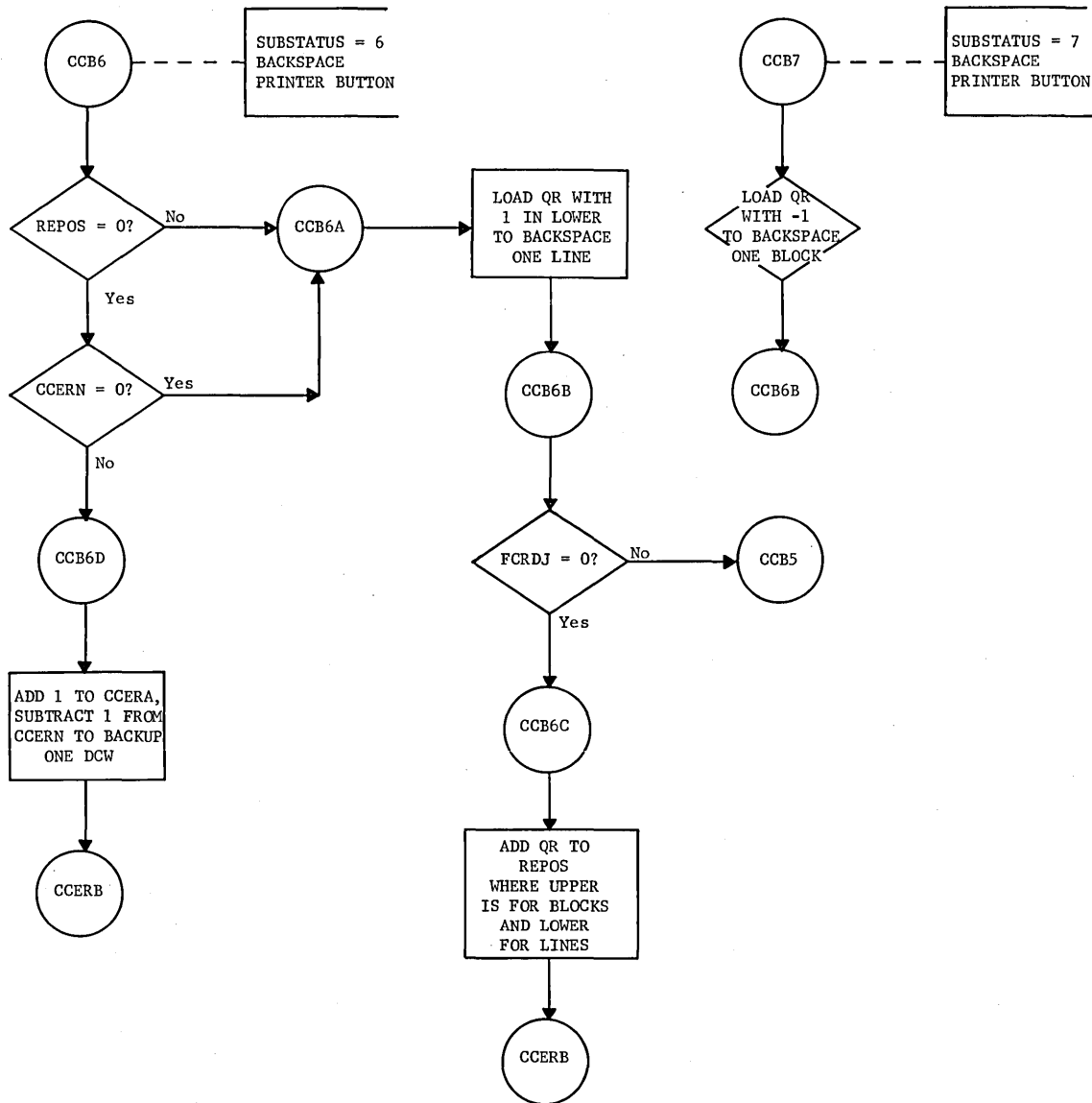

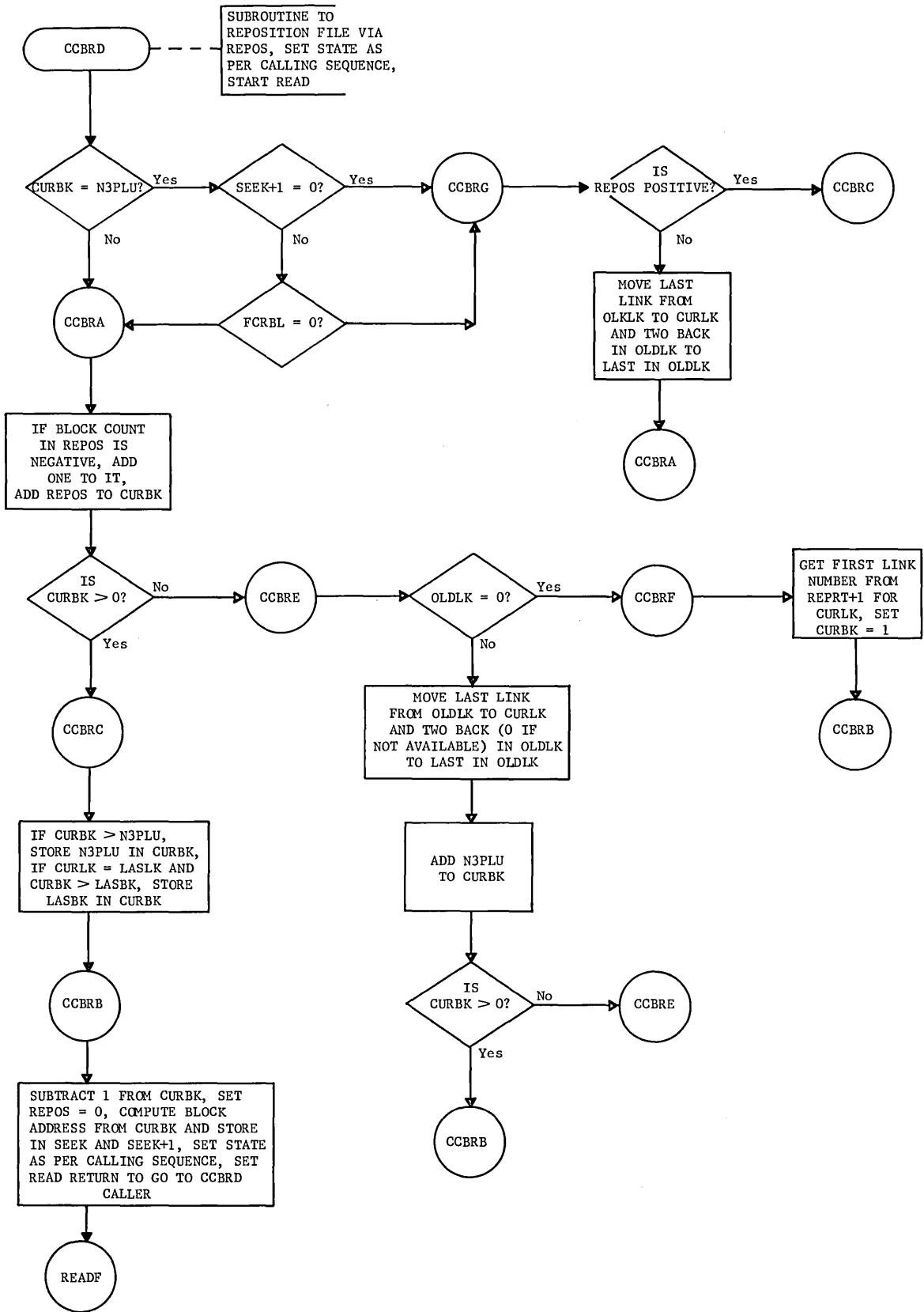

ASIGN  
.MGEOT

ASSIGN DEVICE AND JOB

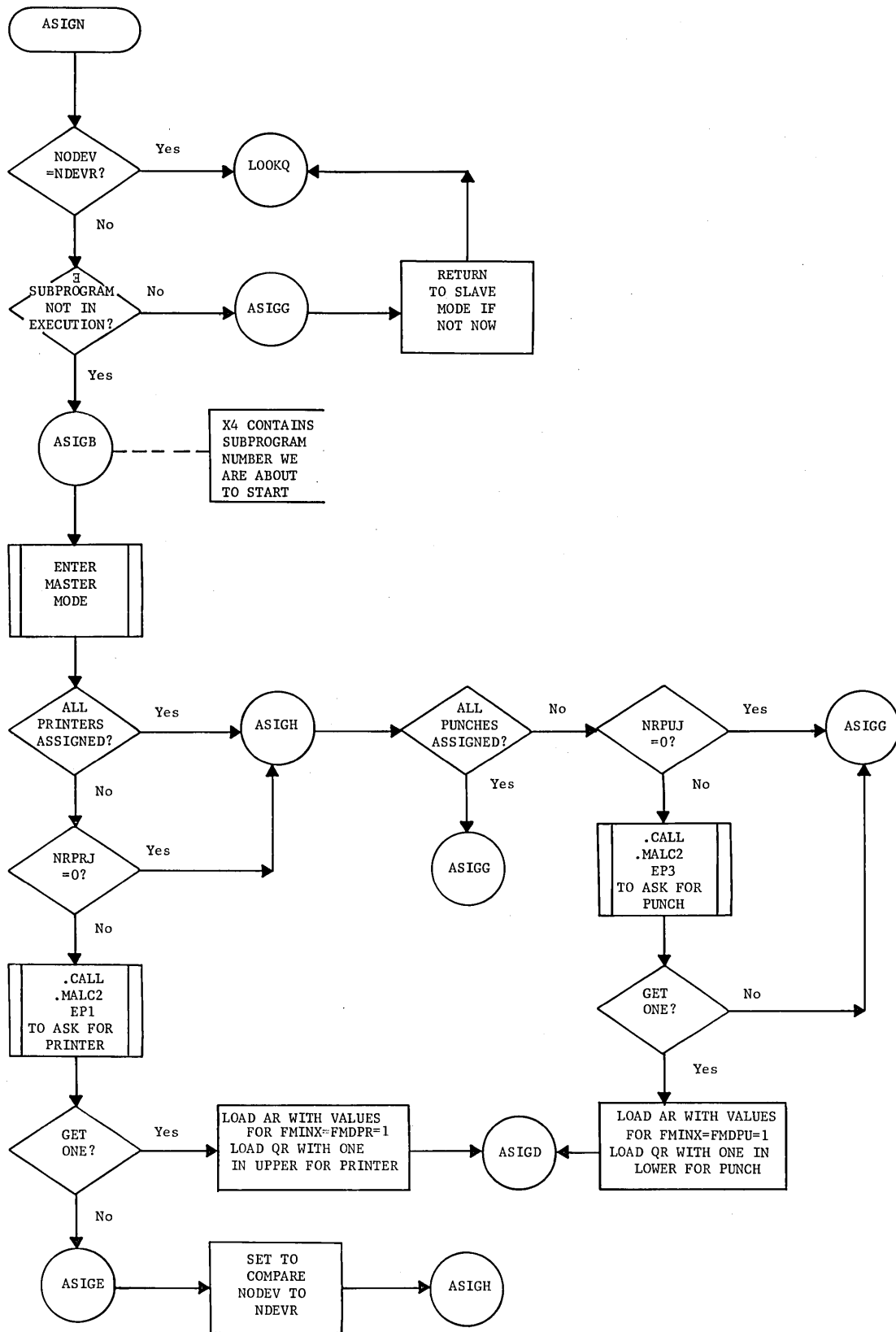

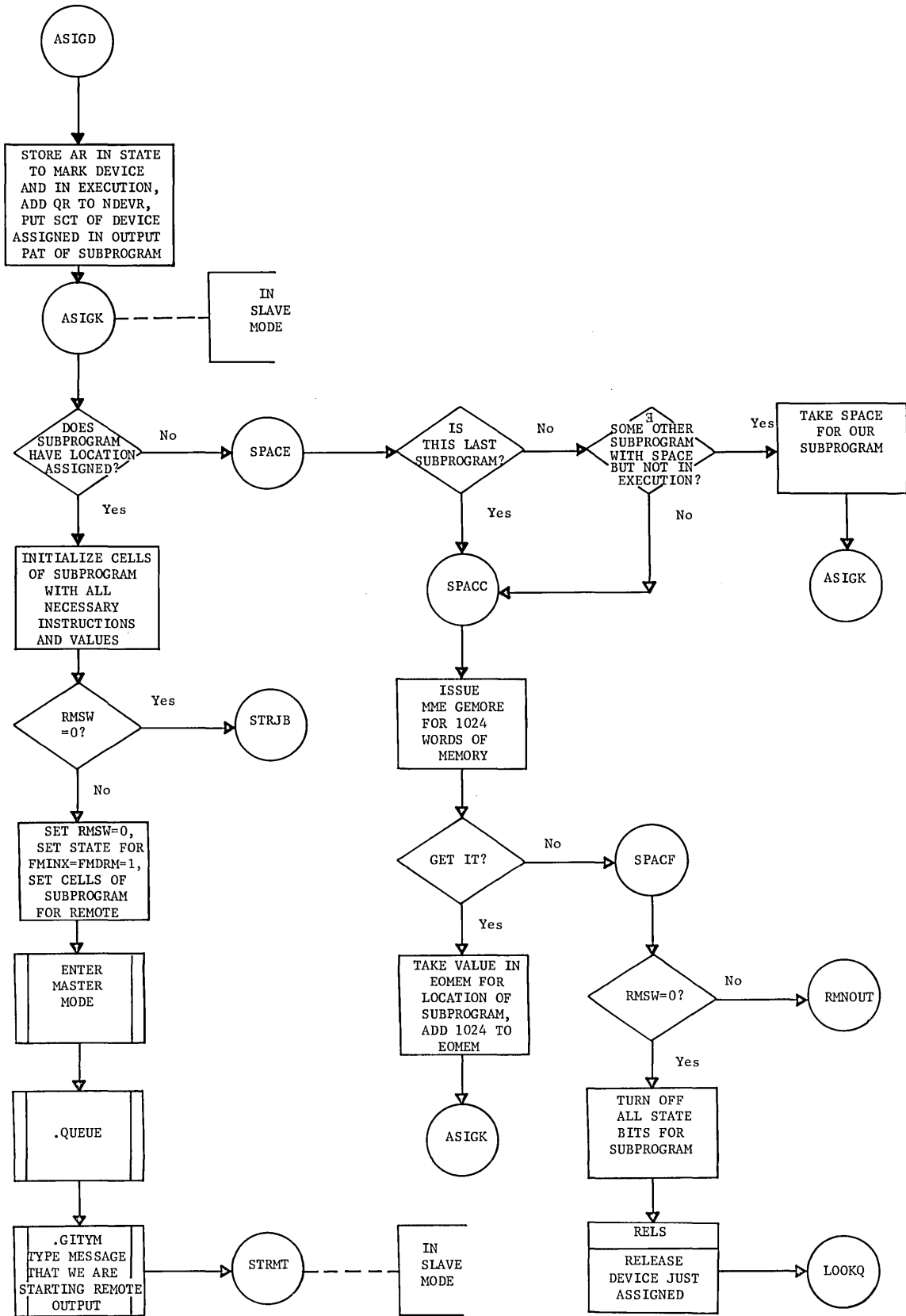





ANALYZE INPUT REQUEST

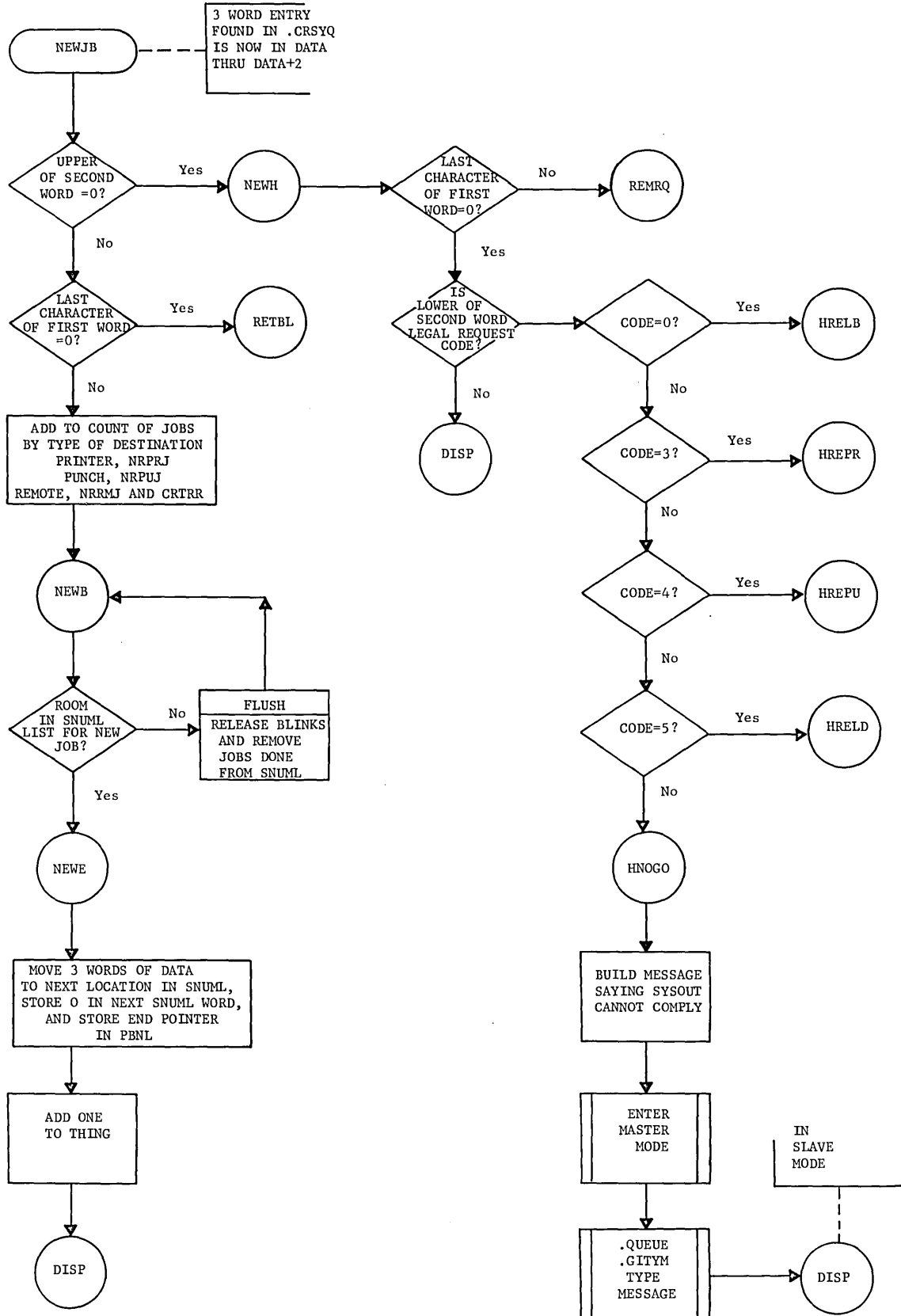

NEWJB  
.MGEOT

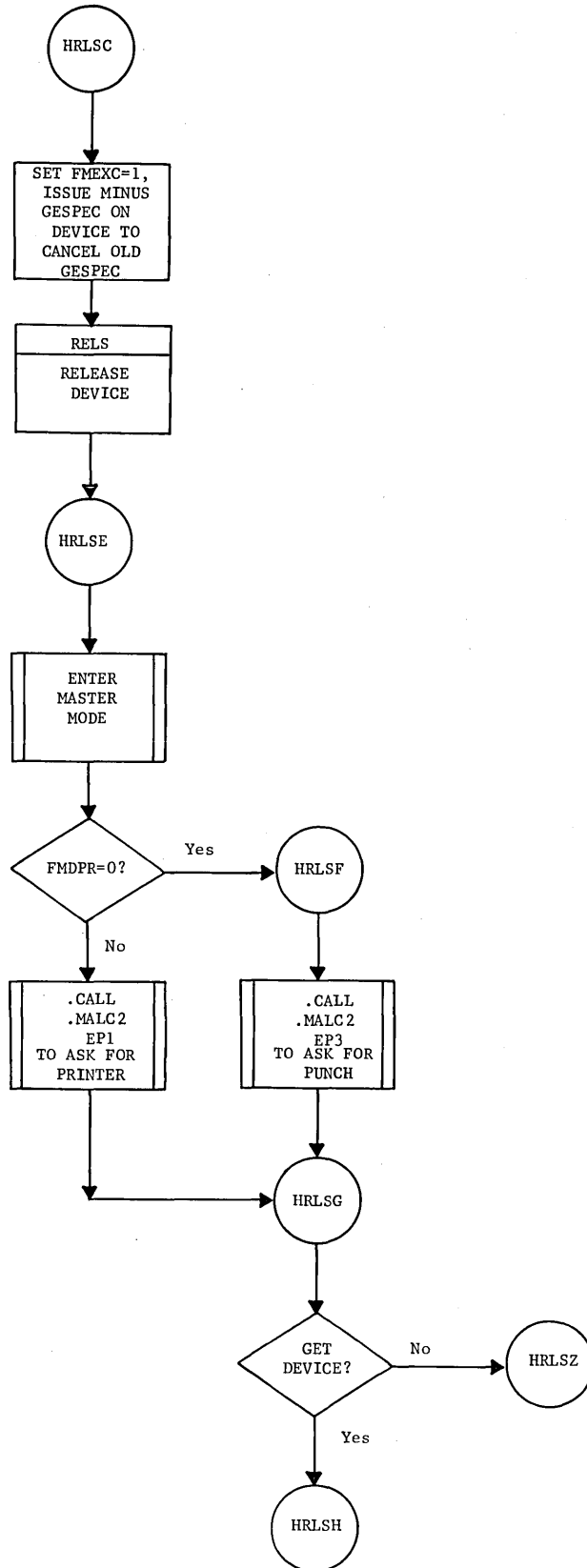
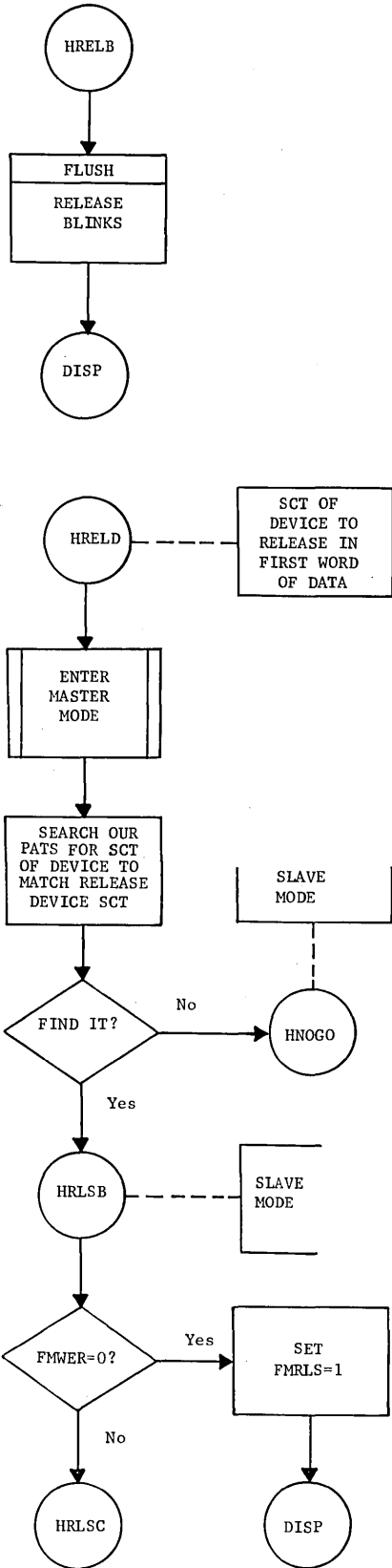

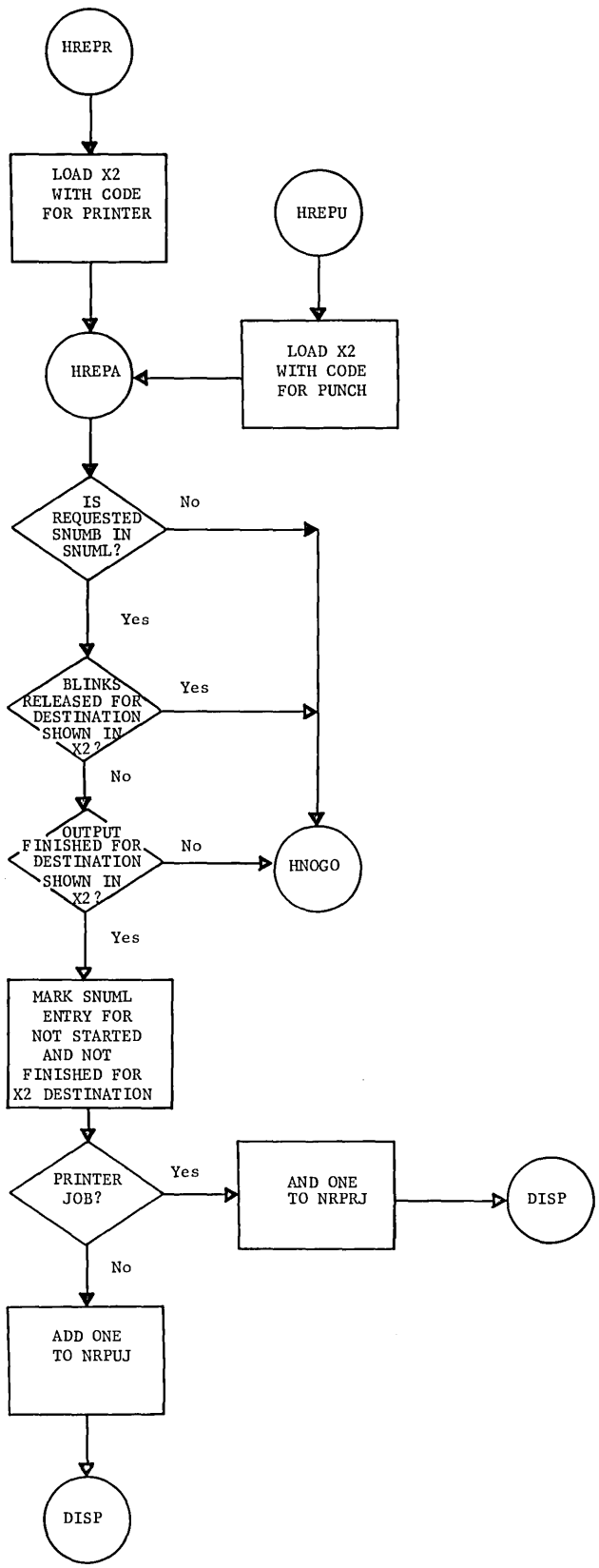
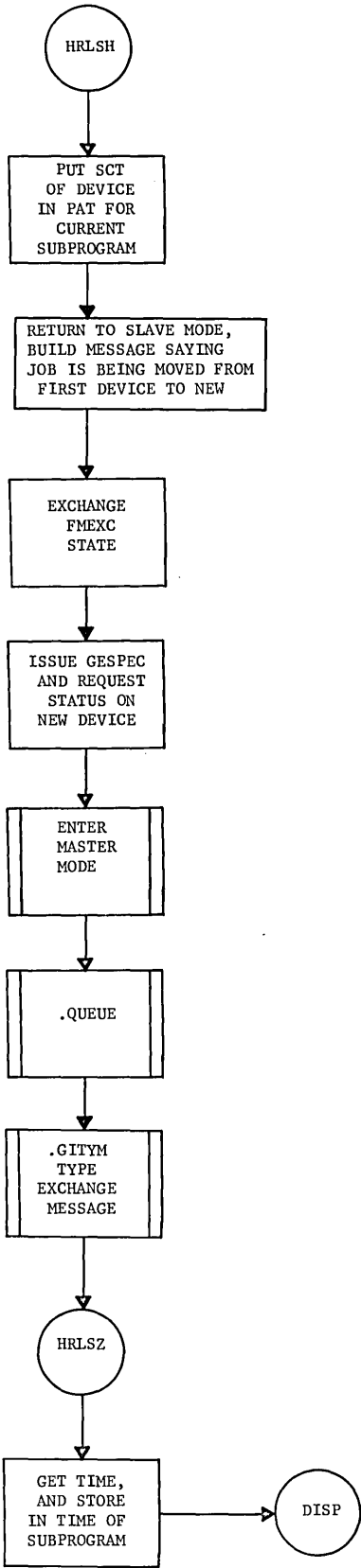

NEWJB  
.MGEOT

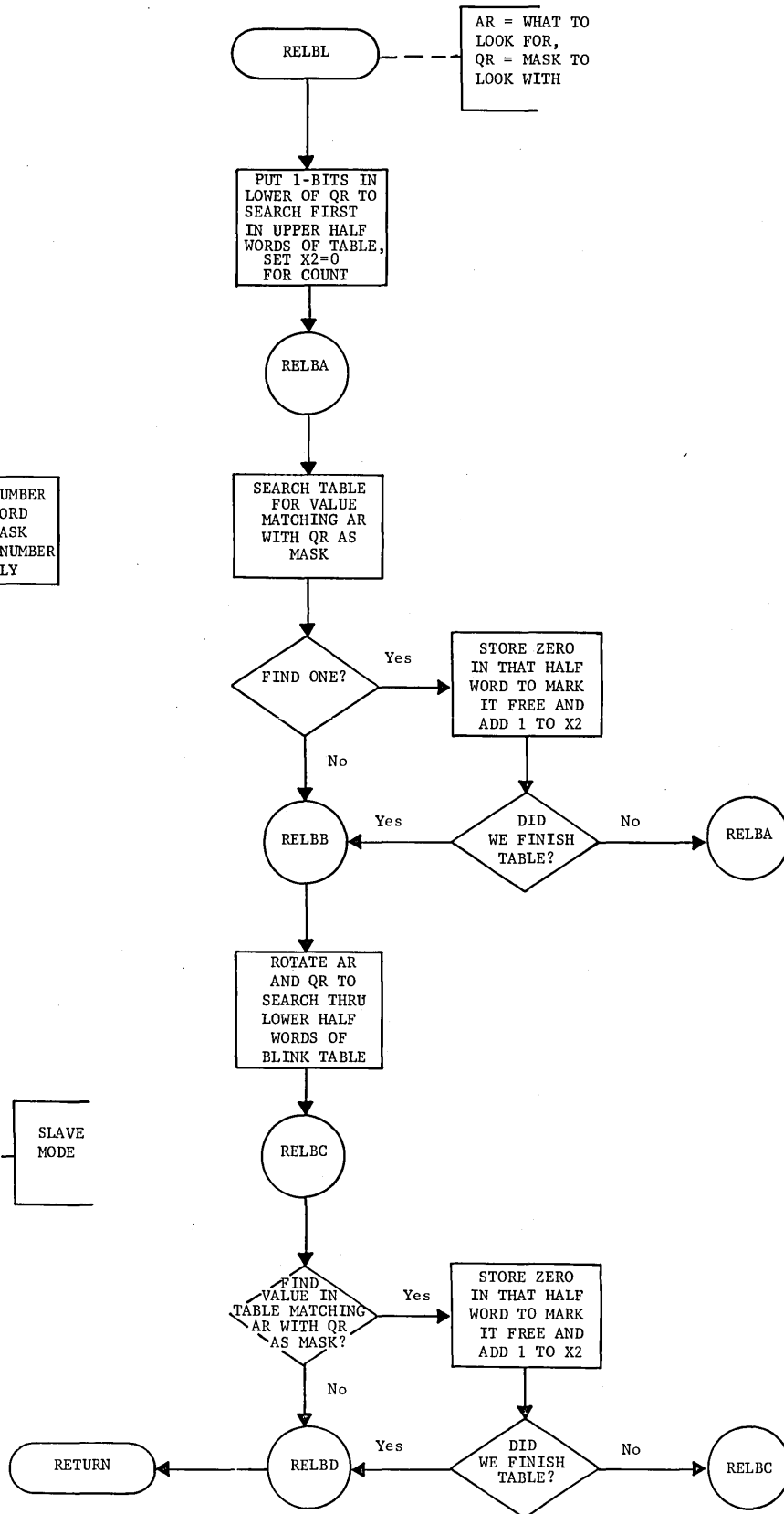
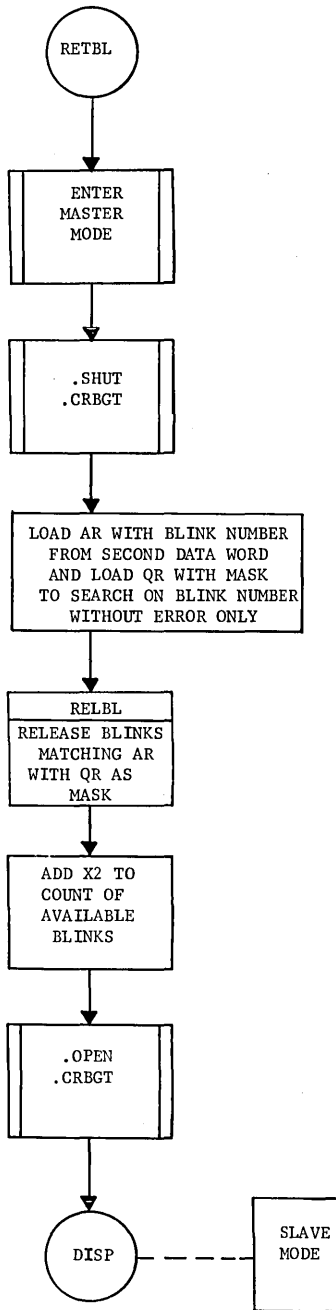

RELEASE BLINKS

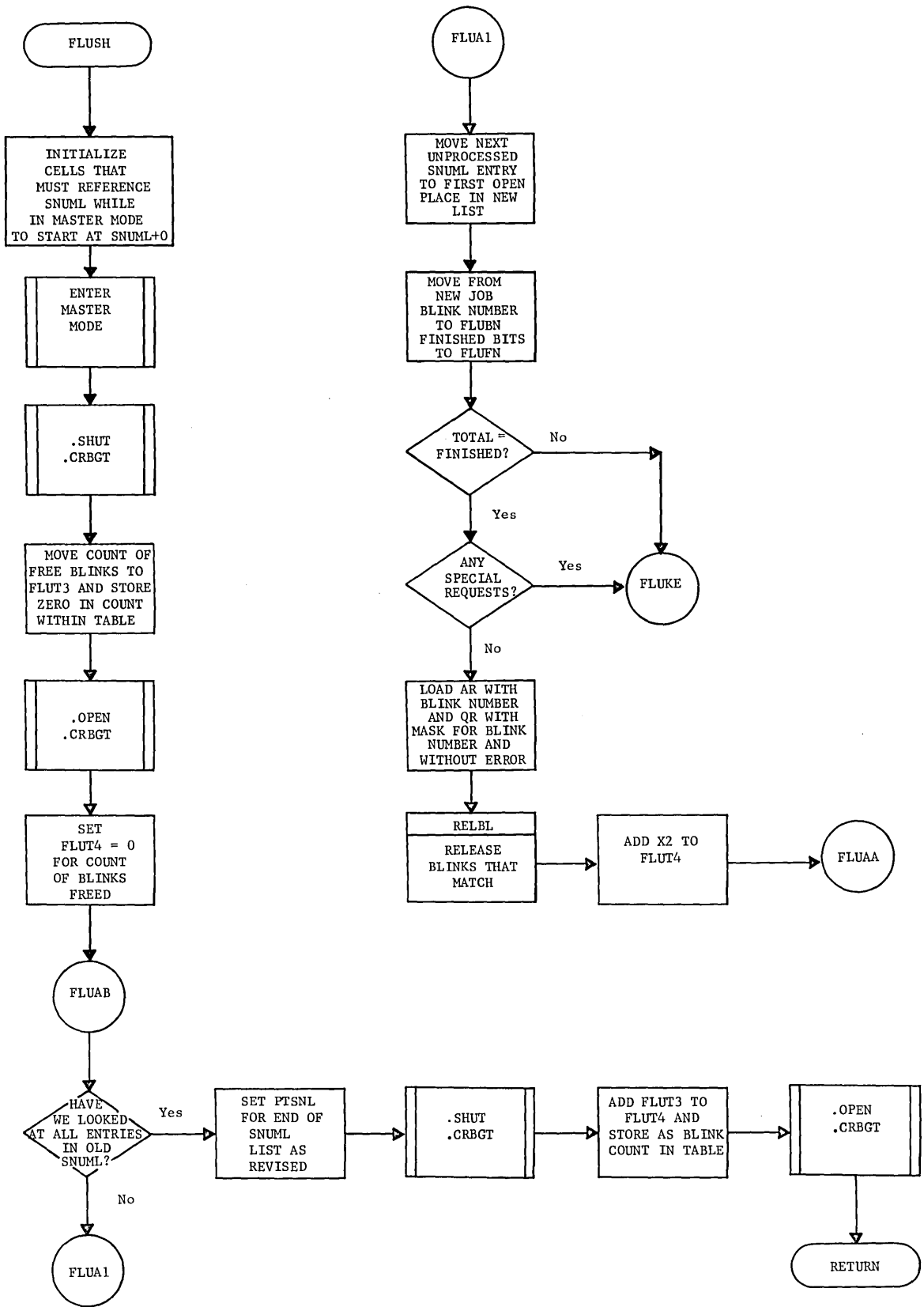

FLUSH  
.MGEOT

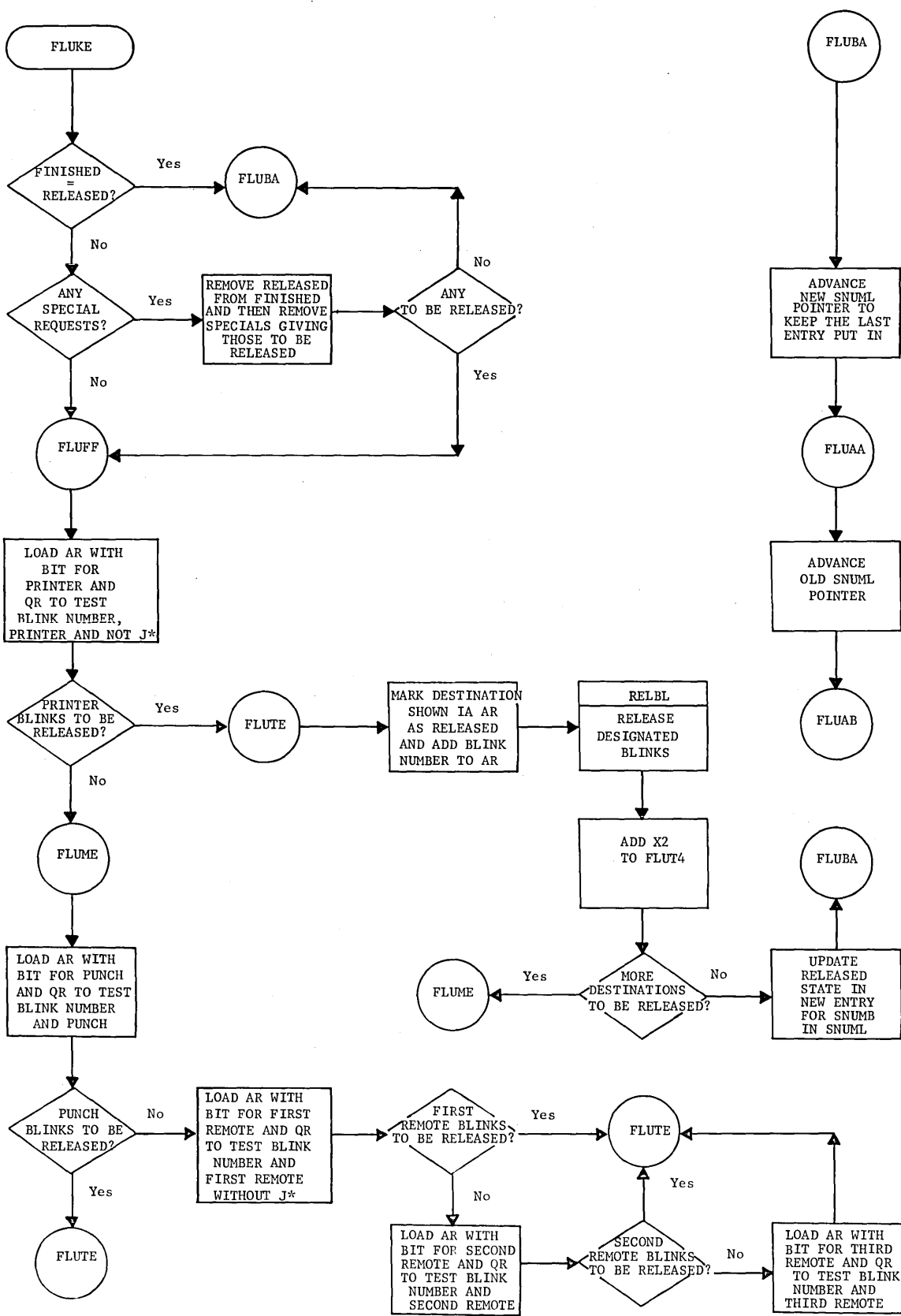

CREATE FRONT BANNER

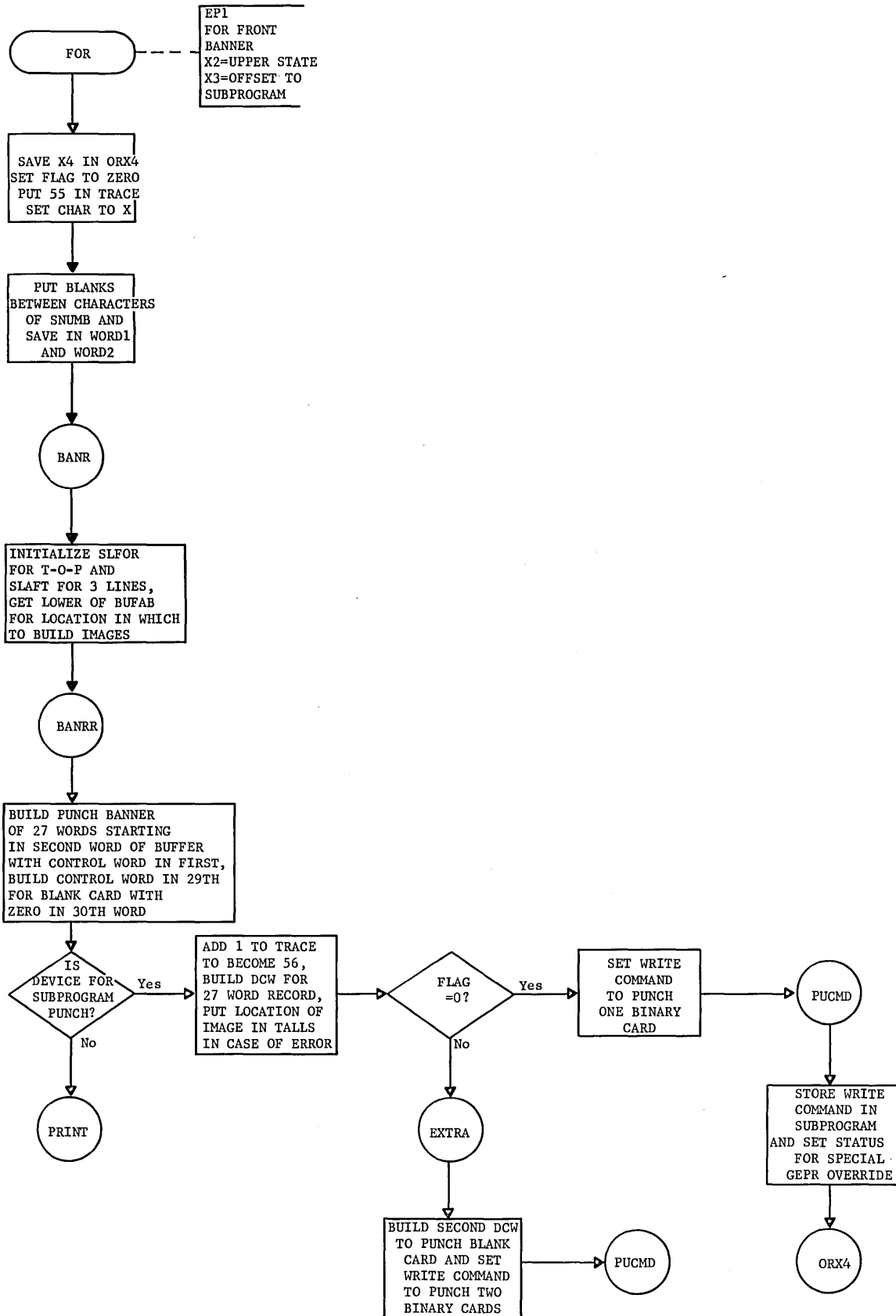



FOR (EP1)  
.MGOU1

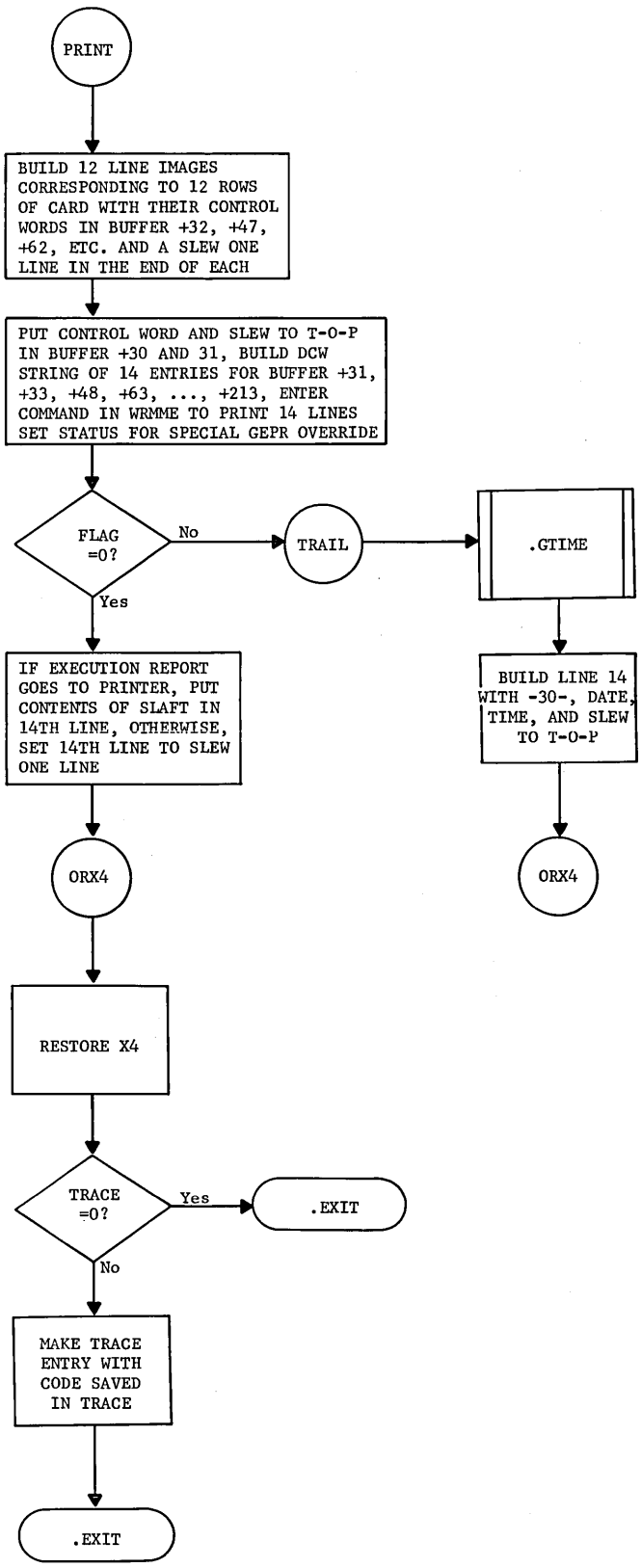

AFT (EP2)  
.MGOU1

CREATE TRAILER ENSIGN

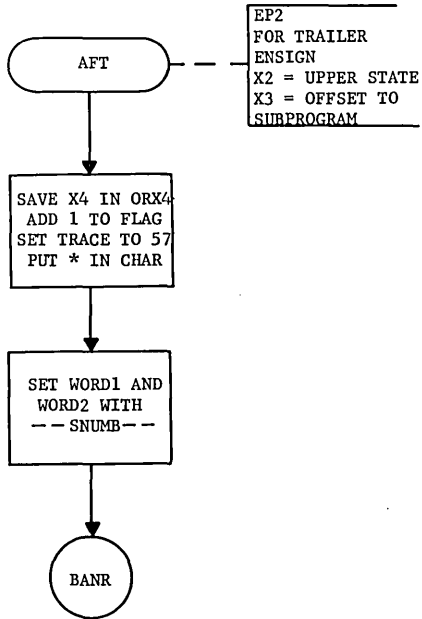

IDENT (EP3)  
.MGOU1

### CREATE IDENT BANNER

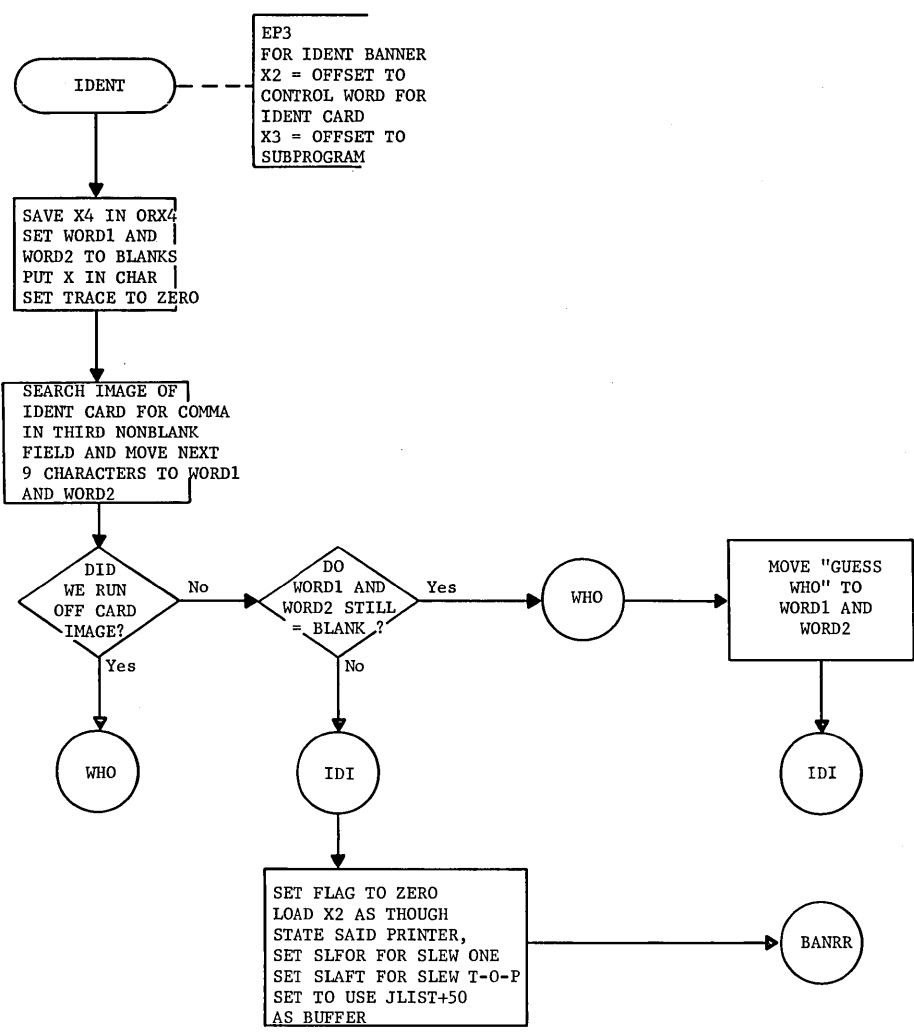

START (EP1)  
.MGOU3

### CREATE REPORT HEADER

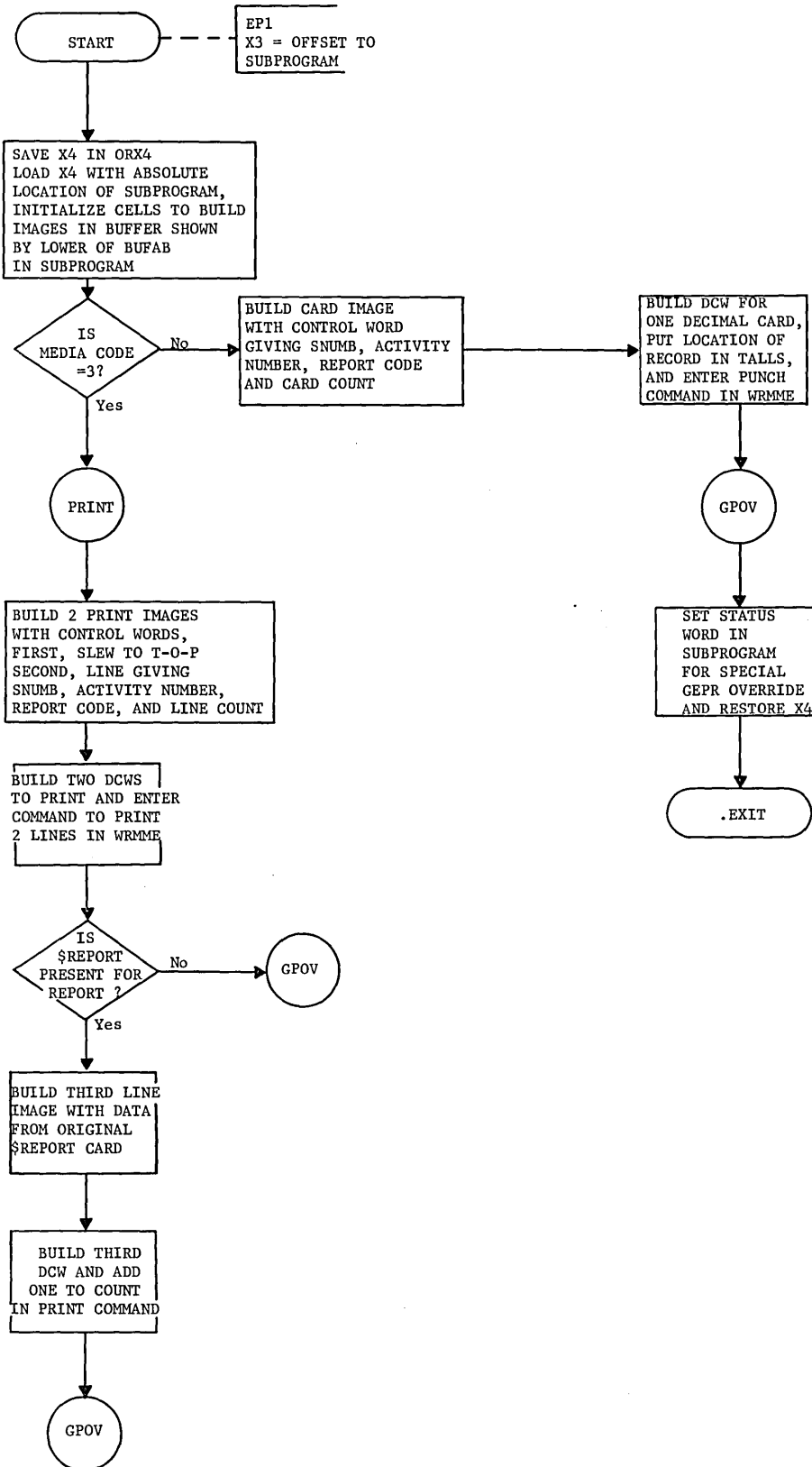



# INDEX

ABORT		
TAKE DUMP FOR SYSTEM ABORT, FSB		77
ABORT I/O FOR PROGRAM, ABTIO		192
ABSOLUTE		
WRITE EXECUTION REPORT MESSAGE (ABSOLUTE), EXCA		324
ABTIO		
ABORT I/O FOR PROGRAM, ABTIO		192
ABTIO (EP9) .MIOS		192
ACCOUNTING		
FORMAT ERROR ACCOUNTING RECORD, FMTAR		142
ACCOUNTING FILE REQUEST, ACTFL		198
NORMAL CLOSE OF ACCOUNTING FILE, ACTS1		281
ERROR CLOSE OF ACCOUNTING FILE, ACTS2		282
EXTERNAL REQUEST FOR ACCOUNTING FILE CLOSE, ACTS3		289
ACCUMULATE		
ACCUMULATE PROCESSOR TIME, DACNB		26
ACTFL		
ACCOUNTING FILE REQUEST, ACTFL		198
ACTFL (EP13) .MIOS		198
ACTION		
GIVE I/O ACTION PRIORITY, FPRIO		106
ACTIVITY		
PROCESS END OF ACTIVITY, EOA		311
ACTS1		
NORMAL CLOSE OF ACCOUNTING FILE, ACTS1		281
ACTS1 (EP1) .MACTS		281
ACTS2		
ERROR CLOSE OF ACCOUNTING FILE, ACTS2		282
ACTS2 (EP2) .MACTS		282
ACTS3		
EXTERNAL REQUEST FOR ACCOUNTING FILE CLOSE, ACTS3		289
ACTS3 (EP3) .MACTS		289
ADDRESS		
GET ADDRESS FOR FILE CODE, FGAD (.MFALT)		78
GET ADDRESS FOR FILE CODE, FGAD (.MFLT1)		95
AFT		
CREATE TRAILER ENSIGN, AFT		377
AFT (EP2) .MGOUL		377
ALARM		
SET ALARM, SCK		32

ALLOCATION		
1. DISPATCHER AND PERIPHERAL ALLOCATION		1
ALLOW		
ALLOW A PROGRAM TO DELAY, FWAKE		109
ANALYZE		
ANALYZE INPUT REQUEST, NEWJB		369
ASIGN		
ASSIGN DEVICE AND JOB, ASIGN		366
ASIGN .MGEOT		366
ASSIGN		
ASSIGN AN I/O ENTRY, QUEUE		118
ASSIGN DEVICE AND JOB, ASIGN		366
BANNER		
CREATE FRONT BANNER, FOR		375
CREATE IDENT BANNER, IDENT		378
BAR		
RESET BAR TO SMALLER AREA, FLBAR		107
BITS		
RESET PROGRAM SWITCH WORD BITS, FGRET		82
SET PROGRAM SWITCH WORD BITS, FGSET		83
BLINKS		
RELEASE BLINKS, FLUSH		373
BOOT		
CALL .MDUMP AT EP2, BOOT		89
BOOT (EP13) .MFALT		89
BUFFER		
SAVE TRACE BUFFER AND WRITE OUT, TRACF		34
READ INTO BUFFER, READ		338
WRITE FROM BUFFER, WRITE		340
CALCULATE		
CALCULATE LOGICAL PRIMARY CHANNEL INDEX, ILPCX		170
CALL		
CALL .MDUMP AT EP2, BOOT		89
PROCESS CALL FROM GEIN, GEIN		325
CARD PUNCH		
CARD PUNCH INTERRUPT HANDLER, CPIT		204
CARD PUNCH REQUEST, CPIO		207
CARD PUNCH INITIALIZATION, .ICPIO		208
CARD READER		
CARD READER INTERRUPT HANDLER, CRIT		255
CARD READER REQUEST, CRIO		257
CARD READER INITIALIZATION, .IGPIO		258

CCCRD		
	COURTESY CALL FOR READ, CCCRD	351
	CCCRD .MGEOT	351
CCCWR		
	COURTESY CALL FOR WRITE, CCCWR	354
	CCCWR .MGEOT	354
CCGSP		
	COURTESY CALL FOR GESPEC, CCGSP	356
	CCGSP .MGEOT	356
CHANNEL		
	CALCULATE LOGICAL PRIMARY CHANNEL INDEX, ILPCX	170
	RESUME I/O ON CHANNEL, RSMCH	197
CLOSE		
	CLOSE SYSTEM GATES, SHUG	52
	NORMAL CLOSE OF ACCOUNTING FILE, ACTS1	281
	ERROR CLOSE OF ACCOUNTING FILE, ACTS2	282
	EXTERNAL REQUEST FOR ACCOUNTING FILE CLOSE, ACTS3	289
COMMAND		
	CONNECT REISSUE OF SECOND TYPEWRITER COMMAND, TYPER	188
CONNECT		
	CONNECT MULTIRECORD SIMULATION DCW, STIOM	187
	CONNECT REISSUE OF SECOND TYPEWRITER COMMAND, TYPER	188
	CONNECT SELECTED GESPECED ENTRY, STGPC	189
CONTROL		
	RELINQUISH CONTROL, RLC	20
	RELINQUISH CONTROL UNTIL PROGRAM ENABLED, DSCNT	28
COURTESY CALL		
	END COURTESY CALL, ENCC	21
	COURTESY CALL FOR READ, CCCRD	351
	COURTESY CALL FOR WRITE, CCCWR	354
	COURTESY CALL FOR GESPEC, CCGSP	356
CPIO		
	CARD PUNCH REQUEST, CPIO	207
	CPIO (EP2) .MCPIO	207
CPIT		
	CARD PUNCH INTERRUPT HANDLER, CPIT	204
	CPIT (EP1) .MCPIO	204
CREATE		
	CREATE FRONT BANNER, FOR	375
	CREATE TRAILER ENSIGN, AFT	377
	CREATE IDENT BANNER, IDENT	378
	CREATE REPORT HEADER, START	379
CRIO		
	CARD READER REQUEST, CRIO	257
	CRIO (EP2) .MGPIO	257



CRIT		
	CARD READER INTERRUPT HANDLER, CRIT	255
	CRIT (EP1) .MGPIO	255
DACNB		
	ACCUMULATE PROCESSOR TIME, DACNB	26
	DACNB (EP9) .MDISP	26
DATA		
	PROVIDE DATA AND TIME OF DAY, FGTIM	84
DCW		
	DCW POINTER VALIDATION, DCWCK	139
	CONNECT MULTIRECORD SIMULATION DCW, STIOM	187
DCWCK		
	DCW POINTER VALIDATION, DCWCK	139
	DCWCK .MIOS	139
DEALLOCATE		
	DEALLOCATE MEMORY, GMRL (.MFALT)	88
	DEALLOCATE MEMORY, GMRL (.MFLT1)	101
DELAY		
	ALLOW A PROGRAM TO DELAY, FWAKE	109
DEVICE		
	ASSIGN DEVICE AND JOB, ASIGN	366
DISC		
	DO DISC I/O USING SYSTEM I/O QUEUE, DMIOA	29
DISP		
	DISPATCHER, DISP	326
	DISP .MGEOT	326
DISPATCHER		
	1. DISPATCHER AND PERIPHERAL ALLOCATION	1
	DISPATCHER, DISP	326
DIVIDE		
	DIVIDE EXECUTION TIME INTO SECONDS, FGLP (.MFALT)	85
	DIVIDE EXECUTION TIME INTO SECONDS, FGLP (.MFLT1)	105
DMIOA		
	DO DISC I/O USING SYSTEM I/O QUEUE, DMIOA	29
	DMIOA (EP12) .MDISP	29
DO		
	DO DISC I/O USING SYSTEM I/O QUEUE, DMIOA	29
DRGP		
	MDS200 ERROR AND EOF RECOVERY, DRGP	217
	DRGP (EP4) .MDR20	217
DRIO		
	MDS200 REQUEST, DRIO	212
	DRIO (EP2) .MDR20	212

DRIT		
	MDS200 INTERRUPT HANDLER, DRIT	209
	DRIT (EP1) .MDR20	209
DRSL		
	MDS200 SELECT, DRSL	214
	DRSL (EP3) .MDR20	214
DRSTR		
	RESTORE STATE AFTER SWAP, MOVE, GEPR, DRSTR	27
	DRSTR (EP10) .MDISP	27
DSCNT		
	RELINQUISH CONTROL UNTIL PROGRAM ENABLED, DSCNT	28
	DSCNT (EP11) .MDISP	28
DSGP		
	DSU200 ERROR AND EOF RECOVERY, DSGP	236
	DSGP (EP4) .MDS20	236
DSIO		
	DSU200 REQUEST, DSIO	233
	DSIO (EP2) .MDS20	233
DSIT		
	DSU200 INTERRUPT HANDLER, DSIT	231
	DSIT (EP1) .MDS20	231
DSP		
	REDISPATCH AFTER INTERRUPT OR TIMER RUNOUT, DSP	3
	DSP (EP1) .MDISP	3
DSPQH		
	PROGRAM NUMBER AT FRONT OF QUEUE, DSPQH	24
	DSPQH (EP7) .MDISP	24
DSPQM		
	PROGRAM NUMBER IN QUEUE FOLLOWING INTERRUPT, DSPQM	33
	DSPQM (EP14) .MDISP	33
DSPQT		
	PROGRAM NUMBER AT END OF QUEUE, DSPQT	25
	DSPQT (EP8) .MDISP	25
DSSL		
	DSU200 SELECT, DSSL	234
	DSSL (EP3) .MDS20	234
DSU200		
	DSU200 INTERRUPT HANDLER, DSIT	231
	DSU200 REQUEST, DSIO	233
	DSU200 SELECT, DSSL	234
	DSU200 ERROR AND EOF RECOVERY, DSGP	236
	DSU200 NEGATIVE ENTRY POINTS, NEGATIVE EP	247
	DSU200 INITIALIZATION, .IDS20	254
DUMP		
	TAKE DUMP FOR SYSTEM ABORT, FSB	77

ENABLE		
ENABLE PROGRAM, ENB		22
ENABLED		
RELINQUISH CONTROL UNTIL PROGRAM ENABLED, DSCNT		28
ENB		
ENABLE PROGRAM, ENB		22
ENB (EP6) .MDISP		22
ENCC		
END COURTESY CALL, ENCC		21
ENCC (EP5) .MDISP		21
END		
END COURTESY CALL, ENCC		21
PROGRAM NUMBER AT END OF QUEUE, DSPQT		25
LINK I/O TO END OF QUEUE, LINK		113
PROCESS END OF ACTIVITY, EOA		311
PROCESS END OF JOB, EOJ		313
ENSIGN		
CREATE TRAILER ENSIGN, AFT		377
ENTER		
LET SLAVE PROGRAM ENTER MASTER MODE, FEMM		86
ENTRY		
MEMORY RELEASE ENTRY FOR TIME-SHARING, GMRLM		110
ASSIGN AN I/O ENTRY, QUEUE		118
UNLINK I/O ENTRY, UNLNK		169
CONNECT SELECTED GESPECED ENTRY, STGPC		189
MDS200 NEGATIVE ENTRY POINTS, NEGATIVE EP		222
DSU200 NEGATIVE ENTRY POINTS, NEGATIVE EP		247
EOA		
PROCESS END OF ACTIVITY, EOA		311
EOA (EP3) .MSYOT		311
EOF		
MDS200 ERROR AND EOF RECOVERY, DRGP		217
DSU200 ERROR AND EOF RECOVERY, DSGP		236
EOJ		
PROCESS END OF JOB, EOJ		313
EOJ (EP4) .MSYOT		313
ERROR		
FORMAT ERROR ACCOUNTING RECORD, FMTAR		142
MDS200 ERROR AND EOF RECOVERY, DRGP		217
DSU200 ERROR AND EOF RECOVERY, DSGP		236
ERROR CLOSE OF ACCOUNTING FILE, ACTS2		282
EXCA		
WRITE EXECUTION REPORT MESSAGE (ABSOLUTE), EXCA		324
EXCA (EP5) .MSYOT		324

EXEC		
	WRITE EXECUTION REPORT MESSAGE (RELATIVE), EXEC	310
	EXEC (EP2) .MSYOT	310
EXECUTION		
	DIVIDE EXECUTION TIME INTO SECONDS, FGLP (.MFALT)	85
	DIVIDE EXECUTION TIME INTO SECONDS, FGLP (.MFLT1)	105
	WRITE EXECUTION REPORT MESSAGE (RELATIVE), EXEC	310
	WRITE EXECUTION REPORT MESSAGE (ABSOLUTE), EXCA	324
EXTERNAL		
	EXTERNAL REQUEST FOR ACCOUNTING FILE CLOSE, ACTS3	289
FAULT		
	2. FAULT PROCESSING AND SERVICE MME'S	53
	SECONDARY FAULT VECTOR, FPRC	55
	RECOGNIZE FAULT TYPE AND PROCESS, FLT	56
	FAULT PROCESSOR INITIALIZATION, .IFALT	91
FCB		
	PUT INFORMATION IN FCB, FGCON	79
	PUT INFORMATION IN FCB, FCON	96
FCON		
	PUT INFORMATION IN FCB, FCON	96
	FCON (EP2) .MFLT1	96
FEMM		
	LET SLAVE PROGRAM ENTER MASTER MODE, FEMM	86
	FEMM (EP10) .MFALT	86
FGAD		
	GET ADDRESS FOR FILE CODE, FGAD (.MFALT)	78
	FGAD (EP2) .MFALT	78
	GET ADDRESS FOR FILE CODE, FGAD (.MFLT1)	95
	FGAD (EP1) .MFLT1	95
FGCON		
	PUT INFORMATION IN FCB, FGCON	79
	FGCON (EP3) .MFALT	79
FGFIL		
	SWITCH PRIMARY AND SECONDARY LOGICAL UNITS, FGFIL	80
	FGFIL (EP4) .MFALT	80
FGLAP		
	PROVIDE PROCESSOR TIME PRIOR TO REQUEST, FGLAP	81
	FGLAP (EP5) .MFALT	81
FGLP		
	DIVIDE EXECUTION TIME INTO SECONDS, FGLP (.MFALT)	85
	FGLP (EP9) .MFALT	85
	DIVIDE EXECUTION TIME INTO SECONDS, FGLP (.MFLT1)	105
	FGLP (EP5) .MFLT1	105
FGRET		
	RESET PROGRAM SWITCH WORD BITS, FGRET	82
	FGRET (EP6) .MFALT	82

FGSET		
SET PROGRAM SWITCH WORD BITS, FGSET		83
FGSET (EP7) .MFALT		83
FGTIM		
PROVIDE DATA AND TIME OF DAY, FGTIM		84
FGTIM (EP8) .MFALT		84
FILE		
GET ADDRESS FOR FILE CODE, FGAD (.MFALT)		78
FIND PAT FROM FILE CODE, FNDE		87
GET ADDRESS FOR FILE CODE, FGAD (.MFLT1)		95
FIND FILE CODE, FNDFC		141
ACCOUNTING FILE REQUEST, ACTFL		198
NORMAL CLOSE OF ACCOUNTING FILE, ACTS1		281
ERROR CLOSE OF ACCOUNTING FILE, ACTS2		282
EXTERNAL REQUEST FOR ACCOUNTING FILE CLOSE, ACTS3		289
FIND		
FIND PAT FROM FILE CODE, FNDE		87
FIND FILE CODE, FNDFC		141
FLBAR		
RESET BAR TO SMALLER AREA, FLBAR		107
FLBAR (EP7) .MFLT1		107
FLSW		
SWITCH PRIMARY AND SECONDARY LOGICAL UNITS, FLSW		100
FLSW (EP3) .MFLT1		100
FLT		
RECOGNIZE FAULT TYPE AND PROCESS, FLT		56
FLT .MFALT		56
FLUSH		
RELEASE BLINKS, FLUSH		373
FLUSH .MGEOT		373
FMTAR		
FORMAT ERROR ACCOUNTING RECORD, FMTAR		142
FMTAR .MIOS		142
FNDE		
FIND PAT FROM FILE CODE, FNDE		87
FNDE (EP11) .MFALT		87
FNDFC		
FIND FILE CODE, FNDFC		141
FNDFC .MIOS		141
FORCED		
FORCED RELINQUISH, FRLC		19
FORMAT		
FORMAT ERROR ACCOUNTING RECORD, FMTAR		142
FORMAT I/O STATUS WORDS AND RETURN STATUS, GSTRT		196

FPRC		
	SECONDARY FAULT VECTOR, FPRC	55
	FPRC .MFALT	55
FPRIO		
	GIVE I/O ACTION PRIORITY, FPRIO	106
	FPRIO (EP6) .MFLT1	106
FRLC		
	FORCED RELINQUISH, FRLC	19
	FRLC (EP3) .MDISP	19
FRONT		
	PROGRAM NUMBER AT FRONT OF QUEUE, DSPQH	24
	LINK I/O TO FRONT OF QUEUE, LINKF	116
	LINK REISSUED I/O TO FRONT OF QUEUE, LINKR	117
	CREATE FRONT BANNER, FOR	375
FSB		
	TAKE DUMP FOR SYSTEM ABORT, FSB	77
	FSB (EP1) .MFALT	77
FWAKE		
	ALLOW A PROGRAM TO DELAY, FWAKE	109
	FWAKE (EP8) .MFLT1	109
GATES		
	OPEN SYSTEM GATES, OPGAT	51
	CLOSE SYSTEM GATES, SHUG	52
GEIN		
	PROCESS CALL FROM GEIN, GEIN	325
	PROCESS CALL FROM GEIN, GEIN	325
	GEIN (EP6) .MSYOT	325
GEINOS		
	MME GEINOS PROCESSOR, INOS	120
GEPR		
	RESTORE STATE AFTER SWAP, MOVE, GEPR, DRSTR	27
GESPEC		
	MME GESPEC PROCESSOR, SPEC	133
	COURTESY CALL FOR GESPEC, CCGSP	356
GESPECED		
	CONNECT SELECTED GESPECED ENTRY, STGPC	189
GESYOT		
	PROCESS MME GESYOT, MME	293
GET		
	GET ADDRESS FOR FILE CODE, FGAD (.MFALT)	78
	GET ADDRESS FOR FILE CODE, FGAD (.MFLT1)	95
GIVE		
	GIVE I/O ACTION PRIORITY, FPRIO	106

GMRL		
DEALLOCATE MEMORY, GMRL (.MFALT)		88
GMRL (EP12) .MFALT		88
DEALLOCATE MEMORY, GMRL (.MFLT1)		101
GMRL (EP4) .MFLT1		101
GMRLM		
MEMORY RELEASE ENTRY FOR TIME-SHARING, GMRLM		110
GMRLM (EP9) .MFLT1		110
GRD		
ROADBLOCK, GRD		17
GRD (EP2) .MDISP		17
GSTRT		
FORMAT I/O STATUS WORDS AND RETURN STATUS, GSTRT		196
GSTRT (EP10) .MIOS		196
HCL		
.CALL MACRO, HCL		36
HCL .MDISP		36
HEADER		
CREATE REPORT HEADER, START		379
HEX		
.EXIT MACRO, HEX		38
HEX .MDISP		38
HGT		
.GOTO MACRO, HGT		40
HGT .MDISP		40
IDENT		
CREATE IDENT BANNER, IDENT		378
CREATE IDENT BANNER, IDENT		378
IDENT (EP3) .MGOUL		378
ILPCX		
CALCULATE LOGICAL PRIMARY CHANNEL INDEX, ILPCX		170
ILPCX .MIOS		170
INDEX		
CALCULATE LOGICAL PRIMARY CHANNEL INDEX, ILPCX		170
INDEX		381
INFORMATION		
PUT INFORMATION IN FCB, FGCON		79
PUT INFORMATION IN FCB, FCON		96
INITIALIZATION		
INITIALIZATION, .IDISP		35
FAULT PROCESSOR INITIALIZATION, .IFALT		91
MAIN IOS MODULE INITIALIZATION, .IIOS		201
CARD PUNCH INITIALIZATION, .ICPIO		208
MDS200 INITIALIZATION, .IDR20		230
DSU200 INITIALIZATION, .IDS20		254
CARD READER INITIALIZATION, .IGPIO		258

INITIALIZATION (continued)	
MAGNETIC TAPE INITIALIZATION, .IMTAP	265
PRINTER INITIALIZATION, .IPRIO	270
PAPER TAPE INITIALIZATION, .IPTAP	273
TYPEWRITER INITIALIZATION, .ITYPE	280
INOS	
MME GEINOS PROCESSOR, INOS	120
INOS (EP5) .MIOS	120
INPUT	
ANALYZE INPUT REQUEST, NEWJB	369
INTERRUPT	
REDISPATCH AFTER INTERRUPT OR TIMER RUNOUT, DSP	3
PROGRAM NUMBER IN QUEUE FOLLOWING INTERRUPT, DSPQM	33
INTERRUPT HANDLER	
INTERRUPT HANDLER, IOTRM	144
CARD PUNCH INTERRUPT HANDLER, CPIT	204
MDS200 INTERRUPT HANDLER, DRIT	209
DSU200 INTERRUPT HANDLER, DSIT	231
CARD READER INTERRUPT HANDLER, CRIT	255
MAGNETIC TAPE INTERRUPT HANDLER, MTIT	259
PRINTER INTERRUPT HANDLER, PRIT	266
PAPER TAPE INTERRUPT HANDLER, PTIT	271
TYPEWRITER INTERRUPT HANDLER, TYIT	274
IOS	
MAIN IOS MODULE INITIALIZATION, .IIOS	201
IOTRM	
INTERRUPT HANDLER, IOTRM	144
IOTRM .MIOS	144
ITYM	
MASTER MESSAGE PROCESSOR, ITYM	135
ITYM (EP7) .MIOS	135
I/O	
DO DISC I/O USING SYSTEM I/O QUEUE, DMIOA	29
DO DISC I/O USING SYSTEM I/O QUEUE, DMIOA	29
GIVE I/O ACTION PRIORITY, FPRIO	106
3. I/O SUPERVISION	111
LINK I/O TO END OF QUEUE, LINK	113
LINK I/O TO FRONT OF QUEUE, LINKF	116
LINK REISSUED I/O TO FRONT OF QUEUE, LINKR	117
ASSIGN AN I/O ENTRY, QUEUE	118
UNLINK I/O ENTRY, UNLNK	169
START I/O, STIO	175
RESUME I/O FOR PROGRAM, RSMIO	190
ABORT I/O FOR PROGRAM, ABTIO	192
FORMAT I/O STATUS WORDS AND RETURN STATUS, GSTRT	196
RESUME I/O ON CHANNEL, RSMCH	197
JOB	
PROCESS END OF JOB, EOJ	313
ASSIGN DEVICE AND JOB, ASIGN	366
START JOB, STRJB	368



LET		
	LET SLAVE PROGRAM ENTER MASTER MODE, FEMM	86
LINK		
	LINK I/O TO END OF QUEUE, LINK	113
	LINK I/O TO END OF QUEUE, LINK	113
	LINK (EP1) .MIOS	113
	LINK I/O TO FRONT OF QUEUE, LINKF	116
	LINK REISSUED I/O TO FRONT OF QUEUE, LINKR	117
LINKF		
	LINK I/O TO FRONT OF QUEUE, LINKF	116
	LINKF (EP2) .MIOS	116
LINKR		
	LINK REISSUED I/O TO FRONT OF QUEUE, LINKR	117
	LINKR (EP3) .MIOS	117
LOGICAL		
	CALCULATE LOGICAL PRIMARY CHANNEL INDEX, ILPCX	170
LOGICAL UNITS		
	SWITCH PRIMARY AND SECONDARY LOGICAL UNITS, FGFIL	80
	SWITCH PRIMARY AND SECONDARY LOGICAL UNITS, FLSW	100
MACRO		
	.CALL MACRO, HCL	36
	.EXIT MACRO, HEX	38
	.GOTO MACRO, HGT	40
MAGNETIC TAPE		
	MAGNETIC TAPE INTERRUPT HANDLER, MTIT	259
	MAGNETIC TAPE REQUEST, MTIO	264
	MAGNETIC TAPE INITIALIZATION, .IMTAP	265
MAIN		
	MAIN IOS MODULE INITIALIZATION, .IIOS	201
MASTER		
	LET SLAVE PROGRAM ENTER MASTER MODE, FEMM	86
	MASTER MESSAGE PROCESSOR, ITYM	135
MDS200		
	MDS200 INTERRUPT HANDLER, DRIT	209
	MDS200 REQUEST, DRIO	12
	MDS200 SELECT, DRSL	214
	MDS200 ERROR AND EOF RECOVERY, DRGP	217
	MDS200 NEGATIVE ENTRY POINTS, NEGATIVE EP	222
	MDS200 INITIALIZATION, .IDR20	230
MEMORY		
	DEALLOCATE MEMORY, GMRL (.MFALT)	88
	DEALLOCATE MEMORY, GMRL (.MFLT1)	101
	MEMORY RELEASE ENTRY FOR TIME-SHARING, GMRLM	110

MESSAGE		
MASTER MESSAGE PROCESSOR, ITYM		135
WRITE EXECUTION REPORT MESSAGE (RELATIVE), EXEC		310
WRITE EXECUTION REPORT MESSAGE (ABSOLUTE), EXCA		324
MME		
MME GEINOS PROCESSOR, INOS		120
MME GESPEC PROCESSOR, SPEC		133
PROCESS MME GESYOT, MME		293
PROCESS MME GESYOT, MME		293
MME (EP1) .MSYOT		293
MODE		
LET SLAVE PROGRAM ENTER MASTER MODE, FEMM		86
MODULE		
MAIN IOS MODULE INITIALIZATION, .IIOS		201
MOVE		
RESTORE STATE AFTER SWAP, MOVE, GEPR, DRSTR		27
MTIO		
MAGNETIC TAPE REQUEST, MTIO		264
MTIO (EP2) .MMTAP		264
MTIT		
MAGNETIC TAPE INTERRUPT HANDLER, MTIT		259
MTIT (EP1) .MMTAP		259
MULTIRECORD		
CONNECT MULTIRECORD SIMULATION DCW, STIOM		187
NEGATIVE		
MDS200 NEGATIVE ENTRY POINTS, NEGATIVE EP		222
DSU200 NEGATIVE ENTRY POINTS, NEGATIVE EP		247
NEGATIVE EP		
MDS200 NEGATIVE ENTRY POINTS, NEGATIVE EP		222
NEGATIVE EP .MDR20		222
DSU200 NEGATIVE ENTRY POINTS, NEGATIVE EP		247
NEGATIVE EP .MDS20		247
NEWJB		
ANALYZE INPUT REQUEST, NEWJB		369
NEWJB .MGEOT		369
NORMAL		
NORMAL CLOSE OF ACCOUNTING FILE, ACTS1		281
OPEN		
OPEN SYSTEM GATES, OPGAT		51
OPGAT		
OPEN SYSTEM GATES, OPGAT		51
OPGAT .MDISP		51

OUTPUT		
4. TERMINATION AND SYSTEM OUTPUT		291
PAPER TAPE		
PAPER TAPE INTERRUPT HANDLER, PTIT		271
PAPER TAPE REQUEST, PTIO		272
PAPER TAPE INITIALIZATION, .IPTAP		273
PAT		
FIND PAT FROM FILE CODE, FNDE		87
PERIPHERAL		
1. DISPATCHER AND PERIPHERAL ALLOCATION		1
POINTER		
POINTER VALIDATION, PTRVL		138
DCW POINTER VALIDATION, DCWCK		139
POINTS		
MDS200 NEGATIVE ENTRY POINTS, NEGATIVE EP		222
DSU200 NEGATIVE ENTRY POINTS, NEGATIVE EP		247
PRIMARY		
SWITCH PRIMARY AND SECONDARY LOGICAL UNITS, FGFIL		80
SWITCH PRIMARY AND SECONDARY LOGICAL UNITS, FLSW		100
CALCULATE LOGICAL PRIMARY CHANNEL INDEX, ILPCX		170
PRINTER		
PRINTER INTERRUPT HANDLER, PRIT		266
PRINTER REQUEST, PRIO		269
PRINTER INITIALIZATION, .IPRIO		270
PRIO		
PRINTER REQUEST, PRIO		269
PRIO (EP2) .MPRIO		269
PRIOR		
PROVIDE PROCESSOR TIME PRIOR TO REQUEST, FGLAP		81
PRIORITY		
GIVE I/O ACTION PRIORITY, FPRIO		106
PRIT		
PRINTER INTERRUPT HANDLER, PRIT		266
PRIT (EP1) .MPRIO		266
PROCESS		
RECOGNIZE FAULT TYPE AND PROCESS, FLT		56
PROCESS MME GESYOT, MME		293
PROCESS END OF ACTIVITY, EOA		311
PROCESS END OF JOB, EOJ		313
PROCESS CALL FROM GEIN, GEIN		325
PROCESSING		
2. FAULT PROCESSING AND SERVICE MME'S		53

PROCESSOR		
ACCUMULATE PROCESSOR TIME, DACNB		26
PROVIDE PROCESSOR TIME PRIOR TO REQUEST, FGLAP		81
FAULT PROCESSOR INITIALIZATION, .IFALT		91
MME GEINOS PROCESSOR, INOS		120
MME GESPEC PROCESSOR, SPEC		133
MASTER MESSAGE PROCESSOR, ITYM		135
PROGRAM		
ENABLE PROGRAM, ENB		22
RELINQUISH CONTROL UNTIL PROGRAM ENABLED, DSCNT		28
RESET PROGRAM SWITCH WORD BITS, FGRET		82
SET PROGRAM SWITCH WORD BITS, FGSET		83
LET SLAVE PROGRAM ENTER MASTER MODE, FEMM		86
ALLOW A PROGRAM TO DELAY, FWAKE		109
RESUME I/O FOR PROGRAM, RSMIO		190
ABORT I/O FOR PROGRAM, ABTIO		192
PROGRAM NUMBER		
PROGRAM NUMBER AT FRONT OF QUEUE, DSPQH		24
PROGRAM NUMBER AT END OF QUEUE, DSPQT		25
PROGRAM NUMBER IN QUEUE FOLLOWING INTERRUPT, DSPQM		33
PROVIDE		
PROVIDE PROCESSOR TIME PRIOR TO REQUEST, FGLAP		81
PROVIDE DATA AND TIME OF DAY, FGTIM		84
PTIO		
PAPER TAPE REQUEST, PTIO		272
PTIO (EP2) .MPTAP		272
PTIT		
PAPER TAPE INTERRUPT HANDLER, PTIT		271
PTIT (EP1) .MPTAP		271
PTRVL		
POINTER VALIDATION, PTRVL		138
PTRVL .MIOS		138
PUT		
PUT INFORMATION IN FCB, FGCON		79
PUT INFORMATION IN FCB, FCON		96
QUEUE		
PROGRAM NUMBER AT FRONT OF QUEUE, DSPQH		24
PROGRAM NUMBER AT END OF QUEUE, DSPQT		25
DO DISC I/O USING SYSTEM I/O QUEUE, DMIOA		29
PROGRAM NUMBER IN QUEUE FOLLOWING INTERRUPT, DSPQM		33
LINK I/O TO END OF QUEUE, LINK		113
LINK I/O TO FRONT OF QUEUE, LINKF		116
LINK REISSUED I/O TO FRONT OF QUEUE, LINKR		117
ASSIGN AN I/O ENTRY, QUEUE		118
QUEUE (EP4) .MIOS		118
READ		
READ INTO BUFFER, READ		338
READ INTO BUFFER, READ		338
READ .MGEOT		338

READ (continued)		
COURTESY CALL FOR READ, CCCRD		351
RECOGNIZE		
RECOGNIZE FAULT TYPE AND PROCESS, FLT		56
RECORD		
FORMAT ERROR ACCOUNTING RECORD, FMTAR		142
RECOVERY		
MDS200 ERROR AND EOF RECOVERY, DRGP		217
DSU200 ERROR AND EOF RECOVERY, DSGP		236
REDISPATCH		
REDISPATCH AFTER INTERRUPT OR TIMER RUNOUT, DSP		3
REISSUE		
CONNECT REISSUE OF SECOND TYPEWRITER COMMAND, TYPER		188
REISSUED		
LINK REISSUED I/O TO FRONT OF QUEUE, LINKR		117
RELATIVE		
WRITE EXECUTION REPORT MESSAGE (RELATIVE), EXEC		310
RELEASE		
MEMORY RELEASE ENTRY FOR TIME-SHARING, GMRLM		110
RELEASE BLINKS, FLUSH		373
RELINQUISH		
FORCED RELINQUISH, FRLC		19
RELINQUISH CONTROL, RLC		20
RELINQUISH CONTROL UNTIL PROGRAM ENABLED, DSCNT		28
REPORT		
WRITE EXECUTION REPORT MESSAGE (RELATIVE), EXEC		310
WRITE EXECUTION REPORT MESSAGE (ABSOLUTE), EXCA		324
CREATE REPORT HEADER, START		379
REPORT/ACTIVITY		
START REPORT/ACTIVITY, STACT		336
REQUEST		
PROVIDE PROCESSOR TIME PRIOR TO REQUEST, FGLAP		81
ACCOUNTING FILE REQUEST, ACTFL		198
CARD PUNCH REQUEST, CPIO		207
MDS200 REQUEST, DRIO		212
DSU200 REQUEST, DSIO		233
CARD READER REQUEST, CRIO		257
MAGNETIC TAPE REQUEST, MTIO		264
PRINTER REQUEST, PRIO		269
PAPER TAPE REQUEST, PTIO		272
TYPEWRITER REQUEST, TYIO		277
EXTERNAL REQUEST FOR ACCOUNTING FILE CLOSE, ACTS3		289
ANALYZE INPUT REQUEST, NEWJB		369
RESET		
RESET PROGRAM SWITCH WORD BITS, FGRET		82
RESET BAR TO SMALLER AREA, FLBAR		107

RESTORE		
RESTORE STATE AFTER SWAP, MOVE, GEPR, DRSTR		27
RESUME		
RESUME I/O FOR PROGRAM, RSMIO		190
RESUME I/O ON CHANNEL, RSMCH		197
RETURN		
STATUS RETURN, STRET		171
FORMAT I/O STATUS WORDS AND RETURN STATUS, GSTRT		196
RLC		
RELINQUISH CONTROL, RLC		20
RLC (EP4) .MDISP		20
ROADBLOCK		
ROADBLOCK, GRD		17
RSMCH		
RESUME I/O ON CHANNEL, RSMCH		197
RSMCH (EP12) .MIOS		197
RSMIO		
RESUME I/O FOR PROGRAM, RSMIO		190
RSMIO (EP8) .MIOS		190
RUNOUT		
REDISPATCH AFTER INTERRUPT OR TIMER RUNOUT, DSP		3
SAVE		
SAVE TRACE BUFFER AND WRITE OUT, TRACF		34
SCK		
SET ALARM, SCK		32
SCK (EP13) .MDISP		32
SECONDARY		
SECONDARY FAULT VECTOR, FPRC		55
SWITCH PRIMARY AND SECONDARY LOGICAL UNITS, FGFIL		80
SWITCH PRIMARY AND SECONDARY LOGICAL UNITS, FLSW		100
SECONDS		
DIVIDE EXECUTION TIME INTO SECONDS, FGLP (.MFALT)		85
DIVIDE EXECUTION TIME INTO SECONDS, FGLP (.MFLT1)		105
SELECT		
MDS200 SELECT, DRSL		214
DSU200 SELECT, DSSL		234
TYPEWRITER SELECT, TYSL		279
SELECTED		
CONNECT SELECTED GESPECED ENTRY, STGPC		189
SERVICE		
2. FAULT PROCESSING AND SERVICE MME'S		53

SET		
SET ALARM, SCK		32
SET PROGRAM SWITCH WORD BITS, FGSET		83
SHUG		
CLOSE SYSTEM GATES, SHUG		52
SHUG .MDISP		52
SIMULATION		
CONNECT MULTIRECORD SIMULATION DCW, STIOM		187
SLAVE		
LET SLAVE PROGRAM ENTER MASTER MODE, FEMM		86
SPEC		
MME GESPEC PROCESSOR, SPEC		133
SPEC (EP6) .MIOS		133
STACT		
START REPORT/ACTIVITY, STACT		336
STACT .MGEOT		336
START		
START I/O, STIO		175
START REPORT/ACTIVITY, STACT		336
START JOB, STRJB		368
CREATE REPORT HEADER, START		379
START (EP1) .MGOU3		379
STATE		
RESTORE STATE AFTER SWAP, MOVE, GEPR, DRSTR		27
STATUS		
STATUS RETURN, STRET		171
FORMAT I/O STATUS WORDS AND RETURN STATUS, GSTRT		196
STATUS WORDS		
FORMAT I/O STATUS WORDS AND RETURN STATUS, GSTRT		196
STGPC		
CONNECT SELECTED GESPECED ENTRY, STGPC		189
STGPC .MIOS		189
STIO		
START I/O, STIO		175
STIO .MIOS		175
STIOM		
CONNECT MULTIRECORD SIMULATION DCW, STIOM		187
STIOM .MIOS		187
STRET		
STATUS RETURN, STRET		171
STRET .MIOS		171
STRJB		
START JOB, STRJB		368
STRJB .MGEOT		368

SUPERVISION		
3. I/O SUPERVISION		111
SWAP		
RESTORE STATE AFTER SWAP, MOVE, GEPR, DRSTR		27
SWITCH		
SWITCH PRIMARY AND SECONDARY LOGICAL UNITS, FGFIL		80
RESET PROGRAM SWITCH WORD BITS, FGRET		82
SET PROGRAM SWITCH WORD BITS, FGSET		83
SWITCH PRIMARY AND SECONDARY LOGICAL UNITS, FLSW		100
SYSTEM		
DO DISC I/O USING SYSTEM I/O QUEUE, DMIOA		29
SYSTEM TRACE, TRACE		49
OPEN SYSTEM GATES, OPGAT		51
CLOSE SYSTEM GATES, SHUG		52
TAKE DUMP FOR SYSTEM ABORT, FSB		77
4. TERMINATION AND SYSTEM OUTPUT		291
TAKE		
TAKE DUMP FOR SYSTEM ABORT, FSB		77
TERMINATION		
4. TERMINATION AND SYSTEM OUTPUT		291
TIME		
ACCUMULATE PROCESSOR TIME, DACNB		26
PROVIDE PROCESSOR TIME PRIOR TO REQUEST, FGLAP		31
PROVIDE DATA AND TIME OF DAY, FGTIM		84
DIVIDE EXECUTION TIME INTO SECONDS, FGLP (.MFALT)		85
DIVIDE EXECUTION TIME INTO SECONDS, FGLP (.MFLT1)		105
TIMER		
REDISPATCH AFTER INTERRUPT OR TIMER RUNOUT, DSP		3
TIME-SHARING		
MEMORY RELEASE ENTRY FOR TIME-SHARING, GMRLM		110
TRACE		
SAVE TRACE BUFFER AND WRITE OUT, TRACF		34
SYSTEM TRACE, TRACE		49
SYSTEM TRACE, TRACE		49
TRACE .MDISP		49
TRACF		
SAVE TRACE BUFFER AND WRITE OUT, TRACF		34
TRACF (EP15) .MDISP		34
TRAILER		
CREATE TRAILER ENSIGN, AFT		377
TYIO		
TYPEWRITER REQUEST, TYIO		277
TYIO (EP2) .MTYPE		277



TYIT		
	TYPEWRITER INTERRUPT HANDLER, TYIT	274
	TYIT (EP1) .MTYPE	274
TYPE		
	RECOGNIZE FAULT TYPE AND PROCESS, FLT	56
TYPER		
	CONNECT REISSUE OF SECOND TYPEWRITER COMMAND, TYPER	188
	TYPER .MIOS	188
TYPEWRITER		
	CONNECT REISSUE OF SECOND TYPEWRITER COMMAND, TYPER	188
	TYPEWRITER INTERRUPT HANDLER, TYIT	274
	TYPEWRITER REQUEST, TYIO	277
	TYPEWRITER SELECT, TYSL	279
	TYPEWRITER INITIALIZATION, .ITYPE	280
TYSL		
	TYPEWRITER SELECT, TYSL	279
	TYSL (EP3) .MTYPE	279
UNLINK		
	UNLINK I/O ENTRY, UNLNK	169
UNLNK		
	UNLINK I/O ENTRY, UNLNK	169
	UNLNK .MIOS	169
VALIDATION		
	POINTER VALIDATION, PTRVL	138
	DCW POINTER VALIDATION, DCWCK	139
VECTOR		
	SECONDARY FAULT VECTOR, FPRC	55
WORD		
	RESET PROGRAM SWITCH WORD BITS, FGRET	82
	SET PROGRAM SWITCH WORD BITS, FGSET	83
WRITE		
	SAVE TRACE BUFFER AND WRITE OUT, TRACF	34
	WRITE EXECUTION REPORT MESSAGE (RELATIVE), EXEC	310
	WRITE EXECUTION REPORT MESSAGE (ABSOLUTE), EXCA	324
	WRITE FROM BUFFER, WRITE	340
	WRITE FROM BUFFER, WRITE	340
	WRITE .MGEOT	340
	COURTESY CALL FOR WRITE, CCCWR	354
.CALL		
	.CALL MACRO, HCL	36
.EXIT		
	.EXIT MACRO, HEX	38

.GOTO		
.GOTO MACRO, HGT		40
.ICPIO		
CARD PUNCH INITIALIZATION, .ICPIO		208
.ICPIO .MCPIO		208
.IDISP		
INITIALIZATION, .IDISP		35
.IDISP .MDISP		35
.IDR20		
MDS200 INITIALIZATION, .IDR20		230
.IDR20 .MDR20		230
.IDS20		
DSU200 INITIALIZATION, .IDS20		254
.IDS20 .MDS20		254
.IFALT		
FAULT PROCESSOR INITIALIZATION, .IFALT		91
.IFALT .MFALT		91
.IGPIO		
CARD READER INITIALIZATION, .IGPIO		258
.IGPIO .MGPIO		258
.IIOS		
MAIN IOS MODULE INITIALIZATION, .IIOS		201
.IIOS .MIOS		201
.IMTAP		
MAGNETIC TAPE INITIALIZATION, .IMTAP		265
.IMTAP .MMTAP		265
.IPRIO		
PRINTER INITIALIZATION, .IPRIO		270
.IPRIOR .MPRIO		270
.IPTAP		
PAPER TAPE INITIALIZATION, .IPTAP		273
.IPTAP .MPTAP		273
.ITYPE		
TYPEWRITER INITIALIZATION, .ITYPE		280
.ITYPE .MTYPE		280
.MACTS		
ACTS1 (EP1) .MACTS		281
ACTS2 (EP2) .MACTS		282
ACTS3 (EP3) .MACTS		289
.MCPIO		
CPIT (EP1) .MCPIO		204
CPIO (EP2) .MCPIO		207
.ICPIO .MCPIO		208

<b>.MDISP</b>		
DSP (EP1) .MDISP		3
GRD (EP2) .MDISP		17
FRLC (EP3) .MDISP		19
RLC (EP4) .MDISP		20
ENCC (EP5) .MDISP		21
ENB (EP6) .MDISP		22
DSPQH (EP7) .MDISP		24
DSPQT (EP8) .MDISP		25
DACNB (EP9) .MDISP		26
DRSTR (EP10) .MDISP		27
DSCNT (EP11) .MDISP		28
DMIOA (EP12) .MDISP		29
SCK (EP13) .MDISP		32
DSPQM (EP14) .MDISP		33
TRACF (EP15) .MDISP		34
.IDISP .MDISP		35
HCL .MDISP		36
HEX .MDISP		38
HGT .MDISP		40
TRACE .MDISP		49
OPGAT .MDISP		51
SHUG .MDISP		52
<b>.MDR20</b>		
DRIT (EP1) .MDR20		209
DRIO (EP2) .MDR20		212
DRSL (EP3) .MDR20		214
DRGP (EP4) .MDR20		217
NEGATIVE EP .MDR20		222
.IDR20 .MDR20		230
<b>.MDS20</b>		
DSIT (EP1) .MDS20		231
DSIO (EP2) .MDS20		233
DSSL (EP3) .MDS20		234
DSGP (EP4) .MDS20		236
NEGATIVE EP .MDS20		247
.IDS20 .MDS20		254
<b>.MDUMP</b>		
CALL .MDUMP AT EP2, BOOT		89
<b>.MFALT</b>		
FPRC .MFALT		55
FLT .MFALT		56
FSB (EP1) .MFALT		77
GET ADDRESS FOR FILE CODE, FGAD (.MFALT)		78
FGAD (EP2) .MFALT		78
FGCON (EP3) .MFALT		79
FGFIL (EP4) .MFALT		80
FGLAP (EP5) .MFALT		81
FGRET (EP6) .MFALT		82
FGSET (EP7) .MFALT		83
FGTIM (EP8) .MFALT		84
DIVIDE EXECUTION TIME INTO SECONDS, FGLP (.MFALT)		85
FGLP (EP9) .MFALT		85
FEMM (EP10) .MFALT		86
FNDE (EP11) .MFALT		87
DEALLOCATE MEMORY, GMRL (.MFALT)		88

.MFALT (continued)	
GMRL (EP12) .MFALT	88
BOOT (EP13) .MFALT	89
.IFALT .MFALT	91
.MFLT1	
GET ADDRESS FOR FILE CODE, FGAD (.MFLT1)	95
FGAD (EP1) .MFLT1	95
FCON (EP2) .MFLT1	96
FLSW (EP3) .MFLT1	100
DEALLOCATE MEMORY, GMRL (.MFLT1)	101
GMRL (EP4) .MFLT1	101
DIVIDE EXECUTION TIME INTO SECONDS, FGLP (.MFLT1)	105
FGLP (EP5) .MFLT1	105
FPRIO (EP6) .MFLT1	106
FLBAR (EP7) .MFLT1	107
FWAKE (EP8) .MFLT1	109
GMRLM (EP9) .MFLT1	110
.MGEOT	
DISP .MGEOT	326
STACT .MGEOT	336
READ .MGEOT	338
WRITE .MGEOT	340
CCCRD .MGEOT	351
CCCWR .MGEOT	354
CCGSP .MGEOT	356
ASIGN .MGEOT	366
STRJB .MGEOT	368
NEWJB .MGEOT	369
FLUSH .MGEOT	373
.MGOUL	
FOR (EP1) .MGOUL	375
AFT (EP2) .MGOUL	377
IDENT (EP3) .MGOUL	378
.MGOU3	
START (EP1) .MGOU3	379
.MGPIO	
CRIT (EP1) .MGPIO	255
CRIO (EP2) .MGPIO	257
.IGPIO .MGPIO	258
.MIOS	
LINK (EP1) .MIOS	113
LINKF (EP2) .MIOS	116
LINKR (EP3) .MIOS	117
QUEUE (EP4) .MIOS	118
INOS (EP5) .MIOS	120
SPEC (EP6) .MIOS	133
ITYM (EP7) .MIOS	135
PTRVL .MIOS	138
DCWCK .MIOS	139
FNDFC .MIOS	141
FMTAR .MIOS	142
IOTRM .MIOS	144
UNLNK .MIOS	169
ILPCX .MIOS	170

.MIOS (continued)	
STRET .MIOS	171
STIO .MIOS	175
STIOM .MIOS	187
TYPER .MIOS	188
STGPC .MIOS	189
RSMIO (EP8) .MIOS	190
ABTIO (EP9) .MIOS	192
GSTRT (EP10) .MIOS	196
RSMCH (EP12) .MIOS	197
ACTFL (EP13) .MIOS	198
.IIOS .MIOS	201
.MMTAP	
MTIT (EP1) .MMTAP	259
MTIO (EP2) .MMTAP	264
.IMTAP .MMTAP	265
.MPRIO	
PRIT (EP1) .MPRIO	266
PRIO (EP2) .MPRIO	269
.IPRIO .MPRIO	270
.MPTAP	
PTIT (EP1) .MPTAP	271
PTIO (EP2) .MPTAP	272
.IPTAP .MPTAP	273
.MSYOT	
MME (EP1) .MSYOT	293
EXEC (EP2) .MSYOT	310
EOA (EP3) .MSYOT	311
EOJ (EP4) .MSYOT	313
EXCA (EP5) .MSYOT	324
GEIN (EP6) .MSYOT	325
.MTYPE	
TYIT (EP1) .MTYPE	274
TYIO (EP2) .MTYPE	277
TYSL (EP3) .MTYPE	279
.ITYPE .MTYPE	280

DOCUMENT REVIEW SHEET

TITLE: GE-625/635 GECOS-III Flowcharts

CPB #: 1500

FROM:

Name: \_\_\_\_\_

Position: \_\_\_\_\_

Address: \_\_\_\_\_

\_\_\_\_\_

Comments concerning this publication are solicited for use in improving future editions. Please provide any recommended additions, deletions, corrections, or other information you deem necessary for improving this manual. The following space is provided for your comments.

COMMENTS: \_\_\_\_\_

\_\_\_\_\_

\_\_\_\_\_

\_\_\_\_\_

\_\_\_\_\_

\_\_\_\_\_

\_\_\_\_\_

\_\_\_\_\_

\_\_\_\_\_

\_\_\_\_\_

\_\_\_\_\_

\_\_\_\_\_

\_\_\_\_\_

\_\_\_\_\_

\_\_\_\_\_

\_\_\_\_\_

\_\_\_\_\_

\_\_\_\_\_

\_\_\_\_\_

\_\_\_\_\_

\_\_\_\_\_

\_\_\_\_\_

Please cut along this line

NO POSTAGE NECESSARY IF MAILED IN U.S.A.  
Fold on two lines shown on reverse  
side, staple, and mail.

FOLD

FIRST CLASS  
PERMIT, No 4332  
PHOENIX, ARIZONA

**BUSINESS REPLY MAIL**  
NO POSTAGE STAMP NECESSARY IF MAILED IN THE UNITED STATES

POSTAGE WILL BE PAID BY

GENERAL ELECTRIC COMPANY  
COMPUTER EQUIPMENT DEPARTMENT  
13430 NORTH BLACK CANYON HIGHWAY  
PHOENIX, ARIZONA - 85029

ATTENTION: DOCUMENTATION STANDARDS AND PUBLICATIONS B-90

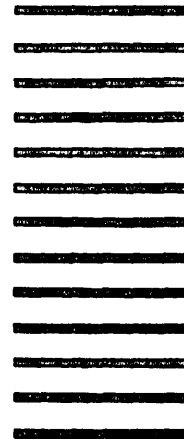

FOLD





INFORMATION SYSTEMS

**GENERAL**  **ELECTRIC**