

COMPUTER DEPARTMENT

DATA BOOK

GENERAL  ELECTRIC

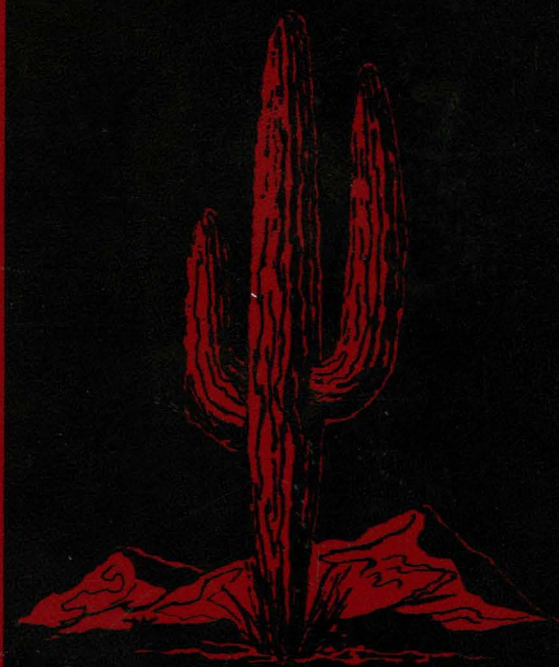

PHOENIX, ARIZONA

July 26, 1957

Here is your personal copy of the new COMPUTER DEPARTMENT DATA BOOK, which has been registered in your name as shown on the flyleaf.

Immediately following the flyleaf you will find a detailed explanation on HOW TO USE THE COMPUTER DEPARTMENT DATA BOOK. Supplementary information to fit into the various portions of this book will be mailed to you as frequently and often as available, and will be indexed in accordance with the instructions so that it should be no problem for you to either have your DATA BOOK kept up-to-date for you by your secretary or keep it up-to-date yourself.

One thing will be immediately obvious to you: the punching is such as to make it difficult to put sheets in the DATA BOOK unless they are especially punched in this exact manner. This was deliberate, because it is not intended that this book become a catch-all for correspondence, newspaper clippings, and what have you. Only those materials which are properly punched, titled, and indexed are to be placed in your DATA BOOK. However, should you run across data which you think should be put in all DATA BOOKS, please send it in. It can be reviewed by the interested people in Marketing, and possibly then issued to all books -- properly punched, titled, indexed, etc.

We confidently expect this book to grow. We do not regard it as the last word in formats -- in this area alone nothing will be so certain as change. But, we do offer it as a beginning in the vital interest of COMMUNICATION.

ROY JORDAN

IMPORTANT: Please note the "FOR THE USE OF GENERAL ELECTRIC EMPLOYEES ONLY" which appears on many of the pages of this DATA BOOK. Any and all materials so marked ARE NOT UNDER ANY CIRCUMSTANCES TO BE SHOWN OR GIVEN TO CUSTOMERS -- the material is for your use only.



**COMPUTER
DEPARTMENT**

DATA BOOK

This Data Book is the property of the General Electric Company, Computer Department, 1103 North Central Avenue, Phoenix, Arizona, and has been assigned to:

Date 7-29-57

No. 3



HOW TO USE THE COMPUTER DEPARTMENT DATA BOOK

The Data Book is designed to give you a comprehensive picture of our product line as well as general information concerning the Department.

ORGANIZATION

It is organized as follows, with appropriate tabs:

<u>Main Sections</u>	<u>Secondary Breakdown (Abbreviation)</u>	<u>Third Breakdown</u>
1. General	Facilities	FAC ---
	Organization	ORG ---
2. Sales Policies	---	---
3. Products	Digital Computers and Data Processing	DIG Systems Units Components Accessories Applications
	Analog Computers	ANA Systems Units Components Accessories Applications
4. Services	Advertising and Sales Promotion	ADV Publications numbering Mailing list index
	Computer Applications Laboratory	LAB ---
	Product Service	PS ---



DEFINITIONS OF PRODUCT BREAKDOWNS

A System is a combination of two or more units, requiring engineering integration, that will perform a specified function which cannot be performed by any of the constituents alone. It may be large or small, may consist of several packages suitably connected, or may be enclosed in one cabinet. An Electronic Data Processor such as the General Electric Model 2B-100 is a system.

A Unit (or equipment) is a combination of two or more components, appropriately connected and usually mechanically related as a single package that will perform a specified function which cannot be performed by any of the constituents alone. The G-E Magnetic Print Reader, for example, is a unit. It can be used in conjunction with other units to form a complete data processing system.

A Component is an assembly of parts and processed materials that depends on and must be connected to other constituents to perform its function. A transistor would be classified as a component.

Accessories are devices which are added to units or systems for special applications, testing, remote control, etc. They are not usually sold as integral parts of the unit or system.

Applications are descriptions of typical ways in which any of the above items can be or have been used.

HOW TO FILE NEW PAGES

An indexing system has been devised, based on the organization of the Data Book, to provide for simple, rapid filing. Each "page index" (the group of letters and numbers in the upper right corner of the page) is largely self-explanatory.

Here is a sample page index:

PRODUCTS-DIG-1.002-P2(of 5)

This item will be filed under **Products, Digital, Systems** (designated by the number 1 to the left of the decimal point), **Data Sheet number 2** in the systems section (designated by the number .002), and page 2 of five pages.



A further explanation of the decimal designation: the digit to the left of the point indicates, in the case of Products, the following categories:

- Systems - 1.
- Units - 2.
- Components - 3.
- Accessories - 4.
- Applications - 5.

The use of the number 0 to the left of the point merely indicates that no third breakdown has been made in that category. Where no breakdown exists at present but may be made in the future, a simple renumbering of indexes and distribution of appropriate tabs will provide a solution.

The three digits to the right of the point indicate the order in which Data Sheets were issued. For instance, 4.029 would be the 29th Accessory for which a Product Data Sheet was prepared.

Thus, in filing new pages it is merely necessary to file under the appropriate tabs and in numerical order, as indicated on the page index.

REVISIONS

A Revision of a whole page will be indexed the same as the original page, but with the addition of the revision date, as in this example:

PRODUCTS-DIG-1.002-P2(of 5)REV 5 MAR 58

Please destroy the original pages when they are replaced so that each Data Book will be up to date and in good order.

introduction to the department

The General Electric Computer Department is designing, manufacturing, and marketing data processing and computing systems. It is also providing service in the areas of analysis, study, programming, training, and computer time.

Home office of the department is in Phoenix, Arizona. Here, complete facilities exist for the engineering and manufacturing of all the department's products.

A large staff of engineers is engaged in computer research, design, and development. Their projects include business, military, and industrial systems utilizing both analog and digital techniques.

Marketing personnel are located on both coasts with headquarters in Phoenix.

a message from the general manager

Establishment of the Computer Department of General Electric represents the fruition of efforts which have been underway for more than a decade. Two laboratories of the Company -- The Knolls Research Laboratory and The Electronics Laboratory -- have long been engaged in programs to evolve solid state devices, magnetic techniques, high vacuum technology, and computer circuitry adapted for use with the most advanced computer concepts. In parallel, our Electronics Laboratory and General Engineering Laboratory have pioneered in computer system design and have created an impressive series of digital and analog devices. A partial list would include OARAC, SPA-13, GPA-37, Power Control Simulator, TPQ-5, Penalty Factor Computer, Matrix Rotator, and the well-known G-E Network Analyzer. These products have arisen out of specific customer needs, and are well known in the fields where they have application. The General Electric computer activity is perhaps less well known to business and industry in general because of this concentration on the more specialized and difficult problems, and on many projects still classified as secret by the armed forces.

The Computer Department was formed in 1956 to permit more effective application of these skills to the problems of industry, business, and the Government. Gathered together in Phoenix, Arizona, and Menlo Park, California are carefully selected individuals from the Company laboratories, supplemented by design engineers and experienced manufacturing personnel from the operating departments of General Electric. They have been joined by a sizable number of experienced computer engineers from outside the company to form an organization of unique skills and capabilities. The engineering staff now numbers over 200 people (as of May, 1957), and is being expanded steadily to meet the growing requirements of this exciting and fast moving business.

The Computer Department is dedicated to the creation of advanced products based upon careful and painstaking study of overall customer needs. Our basic aim is to build equipment which is custom-designed to the fulfillment of these needs, rather than forcing the customer to compromise his own operation and warp his procedures to meet the limitations of the data processing equipment he can purchase.

You will be interested in some of these new products, as described briefly on the following pages. We hope you will be stimulated to invite a departmental representative to analyze your own problems -- be they industrial, business, or military -- with the aim of applying these same skills to your data processing needs.



H. R. Oldfield, Jr.

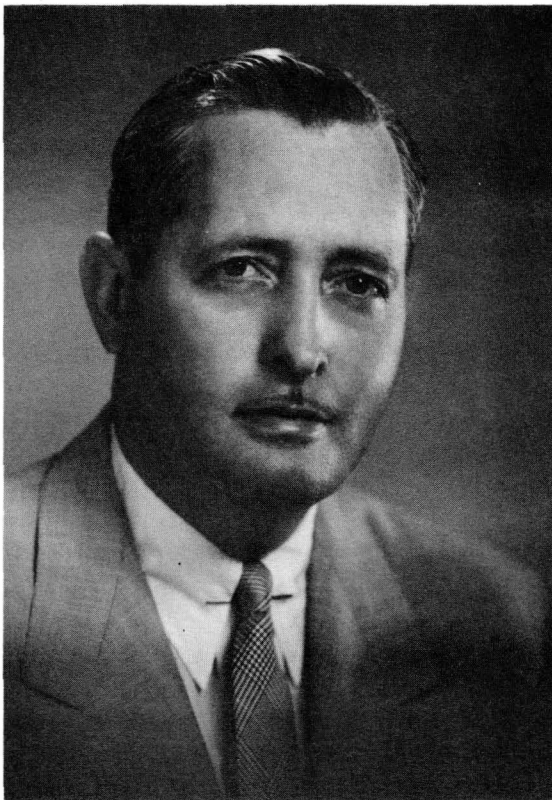

H. R. Oldfield, Jr.

Mr. Oldfield received BS and MS degrees from MIT, where he was a research assistant and instructor in the Instrumentation Laboratory. He was also concerned with the early development of a "rate-of-turn" meter which was the technical prototype of the famous series of computing gunsights developed at MIT during World War II.

During the war he was called to active duty, becoming head of the Electronics Section of the Anti-aircraft Artillery Board. There, he was prominent in the early testing and development of anti-aircraft microwave radar.

After his release in 1945 he joined the General Electric Company. Prior to his present appointment, he was Manager of the General Electric Microwave Laboratory at Palo Alto. Before that he managed the General Electric Advanced Electronics Center at Ithaca, N. Y. He also organized both laboratories.

He is a senior member of IRE and a member of the Institute of the Aeronautical Sciences. He received the Legion of Merit and the Army Commendation Ribbon for his achievements in the fields of ground and airborne radar fire control during World War II.

nearly fifty years of computer manufacturing

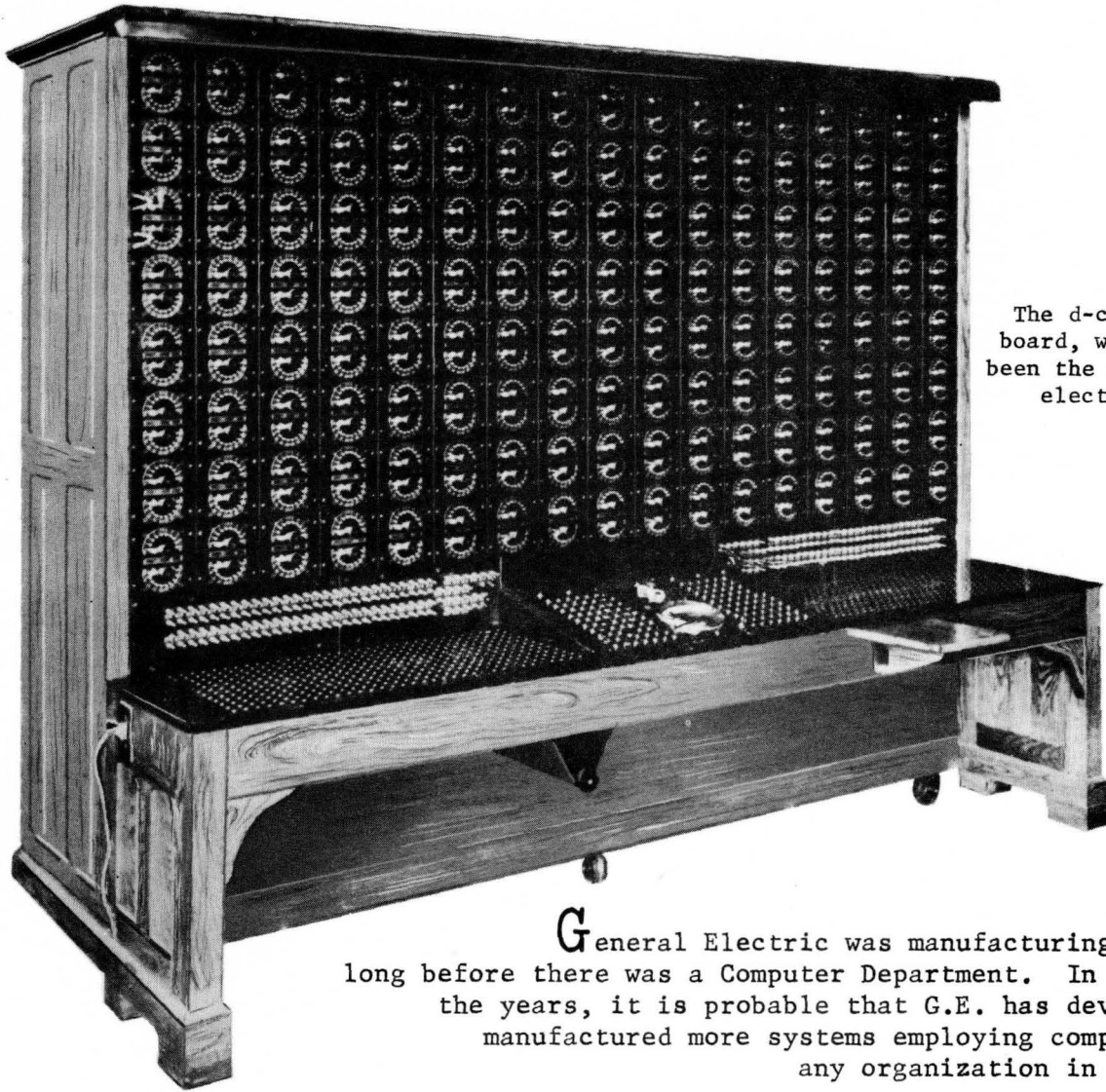

The d-c calculating board, which may have been the first practical electric computer.

General Electric was manufacturing computers long before there was a Computer Department. In fact, over the years, it is probable that G.E. has developed and manufactured more systems employing computers than any organization in the world.

Perhaps the first practical electric computer was the d-c calculating board developed by General Electric at the end of the first world war. This device, designed to simulate short-circuit conditions in network power systems, was superceded in 1923 by the 60 cycle a-c network analyzer developed in cooperation with the Massachusetts Institute of Technology.

Throughout the following years, computers have been developed, manufactured and used by General Electric to perform varied functions. These included systems for the automatic control of precision tools, for the remote guidance of jet interceptors, for large scale computation and analysis; more recently for the control of nuclear power plants where reliability must be absolute, and for a variety of purposes too numerous to classify.

General Electric has specialized at integrating computers into overall systems. During World War Two, the integrated defense system of the B-29 Superfortress -- the first of its kind -- was a major factor in the Pacific air war.

Today, more modern and complex versions of this system protect nearly every strategic bomber in the Air Force, while a modified version is used in jet interceptors. Because of the secrecy of these programs, General Electric's progress in the computer field is almost unknown to the general public.

These systems, along with other computer systems developed for use within the General Electric Company to solve engineering, production, and financial problems were found to be readily adaptable for use in other types of business or military applications. And, in the fields of basic materials research and development General Electric has pioneered in the development of those solid state and magnetic devices which are major computer components. Some of these are transistors, ferrites, ceramics, and magnetic cores and drums.

Thus, for some time General Electric has been well-equipped to design and construct computers. The establishment of the Industrial Computer Section under the Technical Products Department of the Electronics Division localized the computer function within the General Electric Company.

Now, as the Computer Department, computer responsibility is vested in a large and autonomous department of the Company. It is a young, expanding group -- one that is moving and growing just as fast as the exciting business in which it is involved.

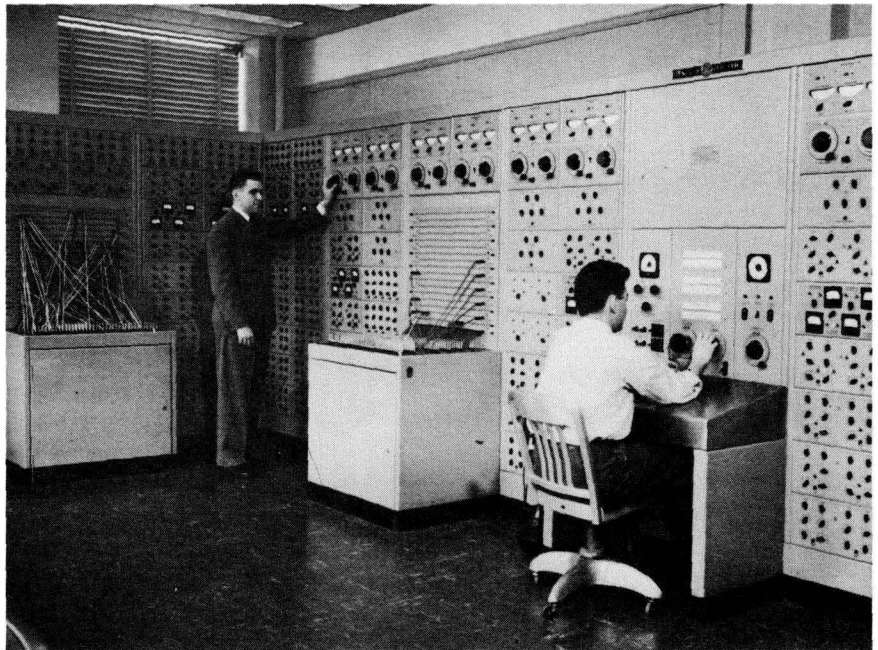

A 480 cycle a-c network analyzer built in 1947.

manufacturing

...the latest techniques, automation wherever possible



General Electric computer and computer component manufacturing techniques are automated to the fullest possible extent while maintaining the highest standards of reliability.

Most of the large computers are built from a number of modular units which lend themselves to modern mass production methods -- automatic assembly, printed wiring, and automatic testing.

A well-designed module is interchangeable with other units in a given computer and with similar units in other equipment.

This, of course, leads to economies in production costs. Also, General Electric has done more toward applying transistorized circuitry to computer design and manufacture than any other organization.

Some of the cost-cutting techniques used in producing computers and computer components are:

--printed wiring using printed circuits manufactured automatically by General Electric.

--pallet conveyors, moving units in continuous flow, reducing time in materials handling.

--automatic testing on both sub-assemblies and complete units.

--semi-automatic component placement.

--use of computers as manufacturing tools.

--automatic dip soldering.

--"ferris wheel" type storage for parts used in manual component placement. This enables the operator to have a wide variety of parts at his finger tips. Reloading can be done from the rear without slowing down the operator's efforts.

PREVIOUS EXPERIENCE IN INDUSTRIAL ON-LINE COMPUTER SYSTEM APPLICATIONS

GENERAL

The following are brief descriptions of the 20 process computing systems incorporating the GE 312 computer which are now on order and in various stages of engineering and production. These will serve to illustrate the already broad experience which the General Electric Company offers for applications involving the GE 312 digital control computer with its associated input and output equipment. A distinction is made between an on-line computer system for processing data, and one which includes feedback control signals to "close the loop." The former is designated a GE 312 process computer system, the latter a GE 312 process computer control system. These are on-line systems incorporating the GE 312 digital control computer with the scanning and analog-to-digital conversion equipment for sampling inputs from process instrumentation.

1. GE 312 Process Computer System for Sintering Plant (Shipped Nov. 1959)

This system samples inputs from instrumentation on a new sinter plant at a large midwestern steel mill. Raw data will be scaled, linearized, alarmed, and computed for logged output. This is the first stage in complete automation of this plant. It will be used in the analysis of the sinter process to derive process relationships which at present are relatively unknown.

System Inputs (75 Analog, 1 Digital)

Retransmitting slidewires	(0-1000 ohms)
X-ray emission gages	(0-10 volts)
Adjustable voltages	(0-250 volts DC)
Resistance type strain gages	(0-28 MV DC)
IC Thermocouples	(0-36 MV DC)
Radiation type pyrometer	(0.44-57.02 MV DC)
Potentiometer (manual adjust)	(0-150 ohms)
Thermal converter	(0-60 MV DC)
Push button stations	(0-10 volts)
Spares	

2. GE 312 Process Computer System for Steel Mill Fuel & Utilities Dispatching (Shipped June 1960)

This system will be installed in a large eastern steel mill to monitor purchased and home-generated electric power, steam coke oven gas and purchased gas flow. It will enable the fuel dispatcher to more accurately control use of fuel and utilities throughout the mill, for optimum allocation and minimum utility costs. All flows are integrated by the computer with hourly and 24-hour totals logged. The computer will also monitor use of purchased power, predicting peak demand during each demand period. All inputs are sampled and compared for high-low limit on a 15 second cycle. All readings are logged out hourly as well as on-demand.

System Inputs (82 analog 10-50 ma dc, 2 impulse)

Power Demand - impulse
Flow, orifice (0-4" up to 0-150" H₂O)
Flow, computer sums
Flow pressure and temperature corrected
Pressures, averaged 0-1000 psig
Position, gas holders
Temperatures 0-700°F

3. GE 312 Process Computer Control System for Continuous Annealing Line
(Shipped March 1960)

This is a complex system for control and data processing on a continuous strip steel annealing line in a large steel mill. The computer will regulate temperature in the heating, soak and cooling zones of the annealing furnace. It will accumulate and record operational and production data. The 312 system monitors the various analog inputs, and alarms for off-normal conditions. Coil production data, furnace and line operating data and a computed summary will be typed out at prescribed intervals. This data also is transmitted to a remote paper tape punch for later conversion to punched cards tying in with the accounting operation.

System Inputs (61 Analog, 55 Contact Devices)

Temperature 0-212° T.C.	
Temperatures 0-1800 T.C.	
Temperatures 0-1000 Rayotube	
Temperature Bristol Pyrometer	
Salt Concentration 0-400 oz/gal	
Cleaner Current	0-23,000 amps
PH	L & N
Strip Emissivity	X-ray
Tachometer	G.E. Co.
Hardness detector	
Pressures	Differential Transformers
Dew Point	Beckman
Flow, gas	Orifice
Gas composition	Bailey & MSA
Strip Tension	Tension meter
Electrical, amps	Shunt
Gage deviation	Daystrom X gage
Loop length	Potentiometer
Manual inputs data	
Manual inputs operation	
Contact closures	

System Outputs

Analog temperature and speed control.

4. GE 312 Process Computer Control System for Hot Strip Mill

This system will control strip speed and mill screwdown settings on a large 6-stand hot strip rolling mill. Data on each coil will also be logged as the coil leaves the rolling mill. Screwdown settings are calculated at the beginning of a pass, and the computer generates control signals to set mill rolls at the calculated settings. Computation of optimum screwdown positions will allow production of desired strip thickness with minimum number of passes through the mill.

System Inputs (42 Analog, 50 Contact Devices)

Thickness gage - potentiometer
Width gage - potentiometer
Temperature - rayotube
X-ray thickness gage
Electrical DC current transformer
Tachometer
Force - strain gage
Electrical - DC volts
Manual inputs
Pulse input
Contact closures

System Outputs

Binary coded decimal outputs (2 to 4 digits)
Contact closures

5. & 6. GE 312 Process Computer Control System for Boiler-Turbine Generator Control (Southern California Edison Co., Huntington Beach Steam Stations #3 & 4)

These two systems will be used for automatic starting and shutdown control of two large boiler-turbine-generator combinations in an electric utility steam station. Hot start, cold start, normal and emergency shutdown are all included in the computer program. During normal steam plant operation, the 312 system will scan and alarm inputs as well as compute performance data. Inputs are monitored for off-normal conditions. When an off-normal condition is detected, the abnormal condition is diagnosed and corrective control action (or shutdown) is taken by the computer system.

System Inputs (615 Analog, 285 Contact Devices)

Pressures	3-15 psi M-H transducers (4-20 made)
Electric	0-250 V DC
AC	0-240 V DC (thermal Converters) 0-50 MV
Temperatures	4 types Thermocouples
Temperatures	Resistance Temperature Detectors
Wattour Meters	Impulse
Contact Closures	(Limit switches, etc.)

System Outputs

Pneumatic analog
Electric - analog
Contact closures

7. GE 312 Process Computer System for Boiler-Turbine Generator
(Public Service Co. of Oklahoma)

This system will be used for on-line data processing on a large steam boiler-turbine-generator combination in an electric utility steam plant station. Inputs are monitored for off-normal, scaled, linearized, and stored for periodic logging. In addition performance data is periodically calculated.

There are over 500 analog and digital input signals to this system. These are very similar to 5 and 6 above.

8. GE 312 Process Computer System for Boiler Turbine Generator

This system will be used for on-line data processing on a large steam boiler turbine generator combination in an electric utilities steam plant station. Its functions will include those itemized for No. 7, and in addition will monitor the sequencing of start-up and shut-down of the units, and inform the station operator of the status of startup or shut-down operation. In this respect, although it will not provide automatic control outputs to the unit, it will check the operations as the operator performs them and alarm if an unallowable condition has occurred, and will inform the operator of the next step to be taken as the sequence progresses.

There are over 500 analog and digital input signals to this system, which are similar to those of No. 7.

9. GE 312 Computer for Economic Dispatching -

This computer will be used off-line by an electric utility for economic dispatching calculations, and load flow and short circuit studies.

10. GE 312 Process Computer System for Boiler Turbine Generator
(Puerto Rico Water Resources Authority)

This system will be used for on-line data processing at the Palo Seco Steam Plant of PRWRA on two new boiler turbine generator installations. It will perform functions similar to those of No. 7.

11. GE 312 Computer Control System for Quality Control
(General Electric Company, Missile and Space Vehicle Department)

This system will be used as an automatic test director and analyzer for the quality control inspection of classified electronic systems. It will control testing of the equipment and will perform computations analyzing the results of the tests. Included in the scope of the system are unit, sub-system, and complete systems testing.

This system will have over 800 inputs and 125 control outputs.

12. GE 312 Process Computer System for Atomic Material Plant

This system will be used for production accounting associated with the manufacture of atomic material. Included in its functions are the tracking of material through the various process operations, inventory and production accounting, and scheduling of the unit operations in the process. The system will schedule and allocate material to various operations in the entire manufacturing process as the material moves through the process.

13. & 14. GE 312 Computer Control System for Boiler-Turbine-Generator Control
(Southern California Edison Company, Alamitos Steam Station)

These two systems will be used for automatic start-up and shut-down control of two large boiler-turbine-generator combinations in an electric utility steam station. Hot start, cold start, normal and emergency shut-down are all included in the computer program. During normal steam plant operation, the 312 system will scan and alarm inputs as well as compute performance data. Inputs are monitored for off-normal conditions. When an off-normal condition is detected, the abnormal condition is diagnosed and corrective control action (or shut-down) is taken by the computer system.

Each system will have approximately 1,200 inputs and 500 control outputs.

15. GE 312 Computer Control System for Chemical Plant

This system will control a large chemical process. Details of the system are not available for release at this time, due to the proprietary nature of the application.

16. GE 312 Computer Control System for Chemical Plant

This system will be used to control a large chemical plant. Details of this application are not available for release at this time, due to the proprietary nature of the process.

17. GE 312 Process Computing System for Refrigerator Testing
(General Electric Company, Household Refrigerator Department)

This system will be used to automatically monitor and evaluate the results of quality control inspection on household refrigerators as they move from the production line.

18. GE 312 Computer Control System for Experimental Research
(General Electric Company, Apparatus Sales Division)

This system will be used for process control systems research and development of new computer control techniques. It will be used in conjunction with an analog computer facility to simulate actual processes, to develop computer control programs for specific applications.

19. & 20. In addition to the systems mentioned above, 2 GE 312 Computer Control Systems are currently in manufacture for use as demonstration systems. One of these will be permanently located at the Computer Department Manufacturing facility in Phoenix, Arizona, where it will be available for demonstration to customers and for extensive use in program debugging and check out for GE 312 system data processing and control programs being developed for customer applications.

Further Experience

The General Electric Company has gained further experience in the application of transistorized data systems to industrial processes through the design, development and installation of systems using other equipments in the industrial computer family. These include the GE 302 and 309, for data logging applications in the steel industry. A total of 6 of these systems are installed, and 8 more in production. A large high-speed multipoint data acquisition system for a jet engine test facility is in its final stages of test; and a heat rate computer has been installed at WADC and another is in production; a large analog computer designed and built by the Computer Department is now in use calculating optimum loading of system power generation for a large electric utility complex. While the foregoing do not comprise the entire industrial product line, they are of particular significance to most industrial customers. These systems have as primary data input, many diverse process instrumentation equipments.

In addition to the specific applications of the GE 312 computer cited before, the General Electric Company has made or is now engaged in numerous applications studies involving a GE 312 computer system. These include the cement making process, several chemical plants, petroleum refining, as well as oil and gas pipelines.

5 general electric laboratories support the computer department

The General Electric Computer Department is really many departments. While it is an autonomous segment of the General Electric Company, it can call on the many other departments and laboratories of the Company. There, the outstanding minds in their fields can apply their particular knowledge toward making General Electric computers the best available. Some of these General Electric facilities are described on these pages.



General Electric Microwave Laboratory

These laboratories are fully equipped and staffed to undertake any problems, from exploration of the basic physical sciences through the development of new components and circuitry techniques to actual production of operating equipment.

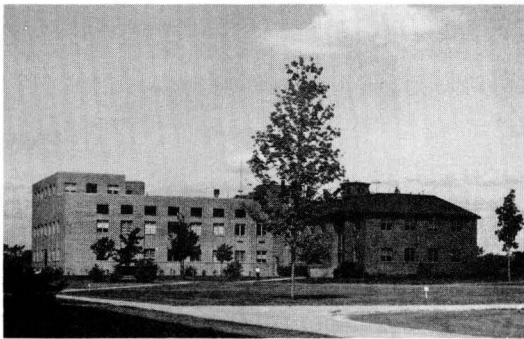

Electronics Park

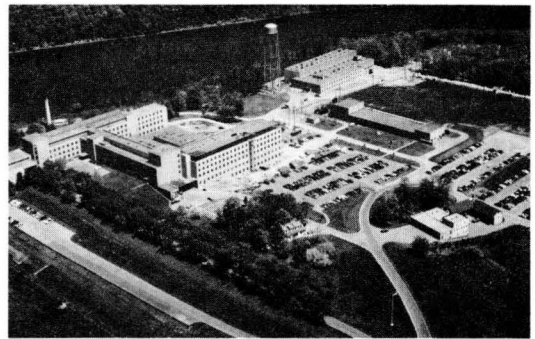

General Electric Research Laboratory



General Engineering Laboratory

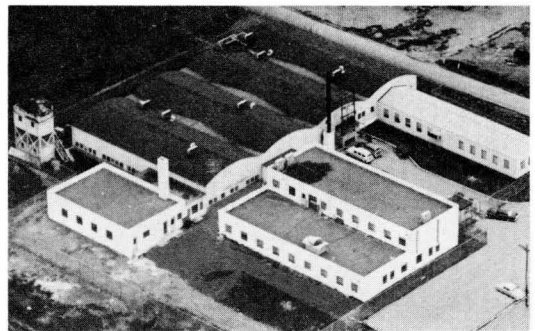

Advanced Electronics Center

engineering facilities

...modern equipment and quarters

Laboratories in the building are equipped with the most modern equipment available to help the engineers design both digital and analog computers and components.

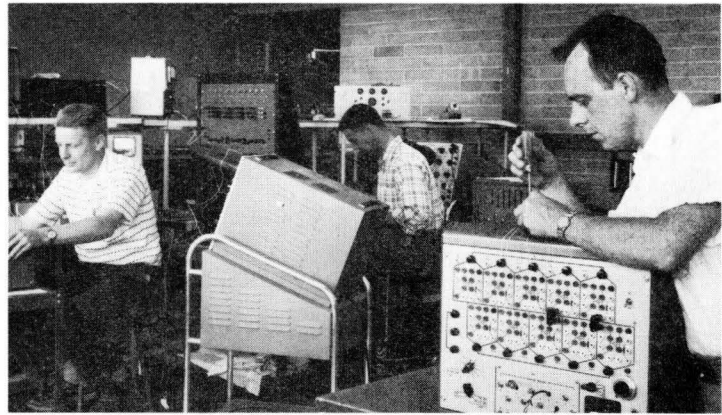

The Computer Department engineering building is spacious, modern, well-lighted, and air conditioned. Wall-size windows, aside from providing an excellent source of natural light, offer a beautiful view of the Arizona countryside.

Overlooking the campus of Arizona State College, the engineering offices operate in a relaxed, informal atmosphere conducive to easy interchange of ideas -- an excellent environment for creativity.

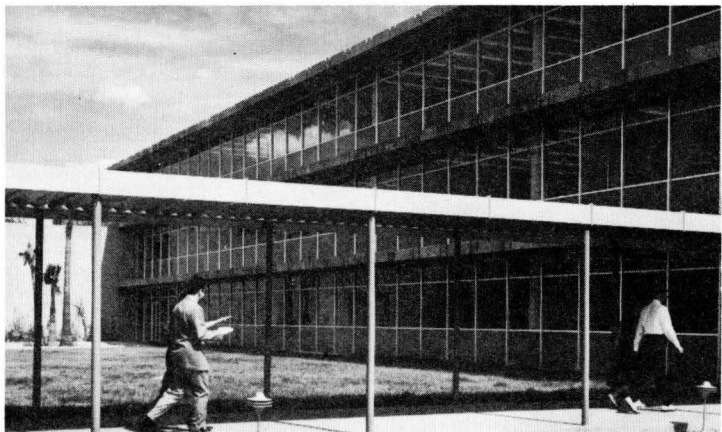

systems studies and systems engineering

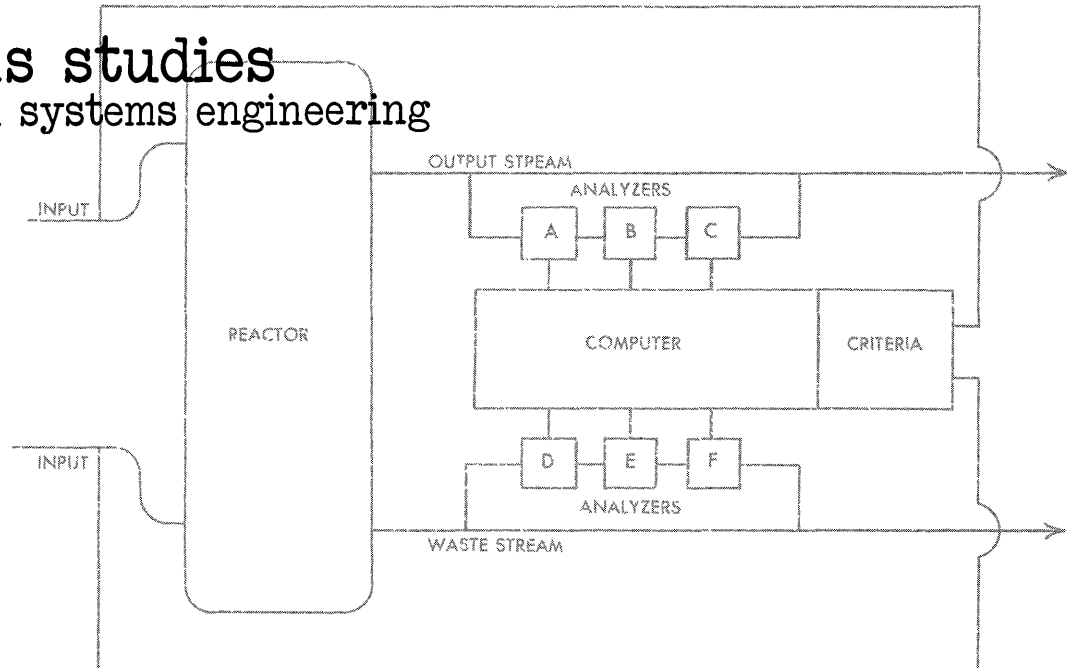

A system may be described as a dynamic relationship existing among various elements. Each element is capable of contributing to the overall performance or configuration of the group. For example, a jet engine is a system. So is the organization of a company or a truck dispatching procedure.

With the present advanced state of systems analysis and synthesis, it is almost mandatory that far-sighted management takes a look at the fundamental dynamics of its organization. Such study will invariably result in practices that will improve the structure of the system.

The Computer Department analysts will study the system to determine exactly what the system is trying to accomplish, what generalities can be made about the system, and what the relationships are among the elements of the system. Then, the system can be modeled on a computer, and the optimum system structure determined. This is possible in the case of proposed as well as existing systems.

In many cases the computer department analysts do not recommend a new system structure, but provide management with the most modern and effective means of determining optimum system structure. This may be in the form of a computer program or a computing system.

Systems Engineering consists of analysis of a system under design with the objective of improving the design so as to achieve either optimum performance for a given expenditure, or achieve minimum expenditure for a prescribed performance.

A system design is the product of team work by a group of specialists. They work closely to achieve a system design which will take advantage of the most recent scientific knowledge in every field of engineering and science.



Kenneth R. Geiser

Kenneth R. Geiser, Manager of Engineering, has been in the computer field for over 10 years. A 1937 Purdue graduate in electrical engineering, Mr. Geiser spent a good deal of his career with General Electric at the General Engineering Laboratory. In 1948 he was a section engineer in charge of analog computers; 1953 saw him as engineering unit supervisor of special digital and analog computers. In 1955 he was appointed engineering manager of the lab's computer engineering section. The following year he was named manager of engineering for the Industrial Computer Section in Syracuse. He retained that position when the Section became the Computer Department.



Lowell J. Hartley

Lowell J. Hartley brings many years of varied electronics experience to his position as Manager of Peripheral Equipment. Starting with General Electric in 1926 after receiving his degree from the University of Minnesota, Mr. Hartley was involved in the early development of television for General Electric. He also has been a senior section engineer on the development and production design of military electronics equipment. Later, he was Department Engineer for G.E.'s Government Radar Components Department. Before coming to the Computer Department he spent two years away from General Electric at the Fairchild Camera & Instrument Corp. where he was engineering manager of their Reconnaissance Systems Division. In 1935 he received General Electric's highest honor -- the Coffin Award -- for his work in setting up factory test equipment.



George Jacobi

George Jacobi, Manager of Analog Engineering & System Analysis has made many outstanding contributions to the computer art. With General Electric's General Engineering Laboratory he was project supervisor of a psychological rotation computer for the solution of conceptual problems in experimental psychology. He also was one of the creators of the Power Control Simulator. This is a huge analog computer with real time simulation equipment for the testing of actual jet engine controls on simulated aircraft gas turbine engines.

A native of Germany, he attended Ohio State University, graduating with a BEE and an MSC, after serving three years in the U. S. Army Signal Corps.



Dr. R. R. Johnson

Dr. R. R. Johnson is Manager of Systems Integration and Laboratory. Dr. Johnson is well known in the field of computer engineering. He has worked in the fields of research in the design of digital airborne computers, business data systems, and machine tool automation projects. He has several patents pending and has written chapters for two computer handbooks on the subjects of "special purpose digital computers", and "logical design." He received his BSEE from the University of Wisconsin, his master's from Yale, specializing in servo-mechanisms, and his Doctorate in electrical engineering from Cal. Tech.



Arnold Spielberg

Arnold Spielberg is Manager of Digital Military and Industrial Computers. During World War II he served as project engineer on the RAZON guidance receiver development program. He then became affiliated with RCA as an engineer working on the development of the Regulus and Shoran guidance systems. From there he became, successively, project leader of the BIZMAC System, Leader of BIZMAC Advanced Development and Manager of BIZMAC Advanced Product Development. Some of the projects he has worked on are: a sales recording system employing a special-purpose digital computer; a high speed electron-optical printer; and a long range circuits program for solid-state devices.

Mr. Spielberg joined the General Electric Company Computer Department at his present status in 1956. He received his degree from the University of Cincinnati.



Robert L. Wooley

Robert L. Wooley is Manager of Business and Scientific Applications, Digital Computers. A 1941 MIT graduate, he became project engineer for analog computers for the U.S. Air Force. He joined General Electric in 1948 and organized the transistor application unit for the Heavy Military Electronic Equipment Department and was supervisor of reliability techniques for the Advanced Electronics Center.

MARKETING SECTION
 COMPUTER DEPARTMENT
 PROPOSED ORGANIZATION
 DECEMBER 31, 1957

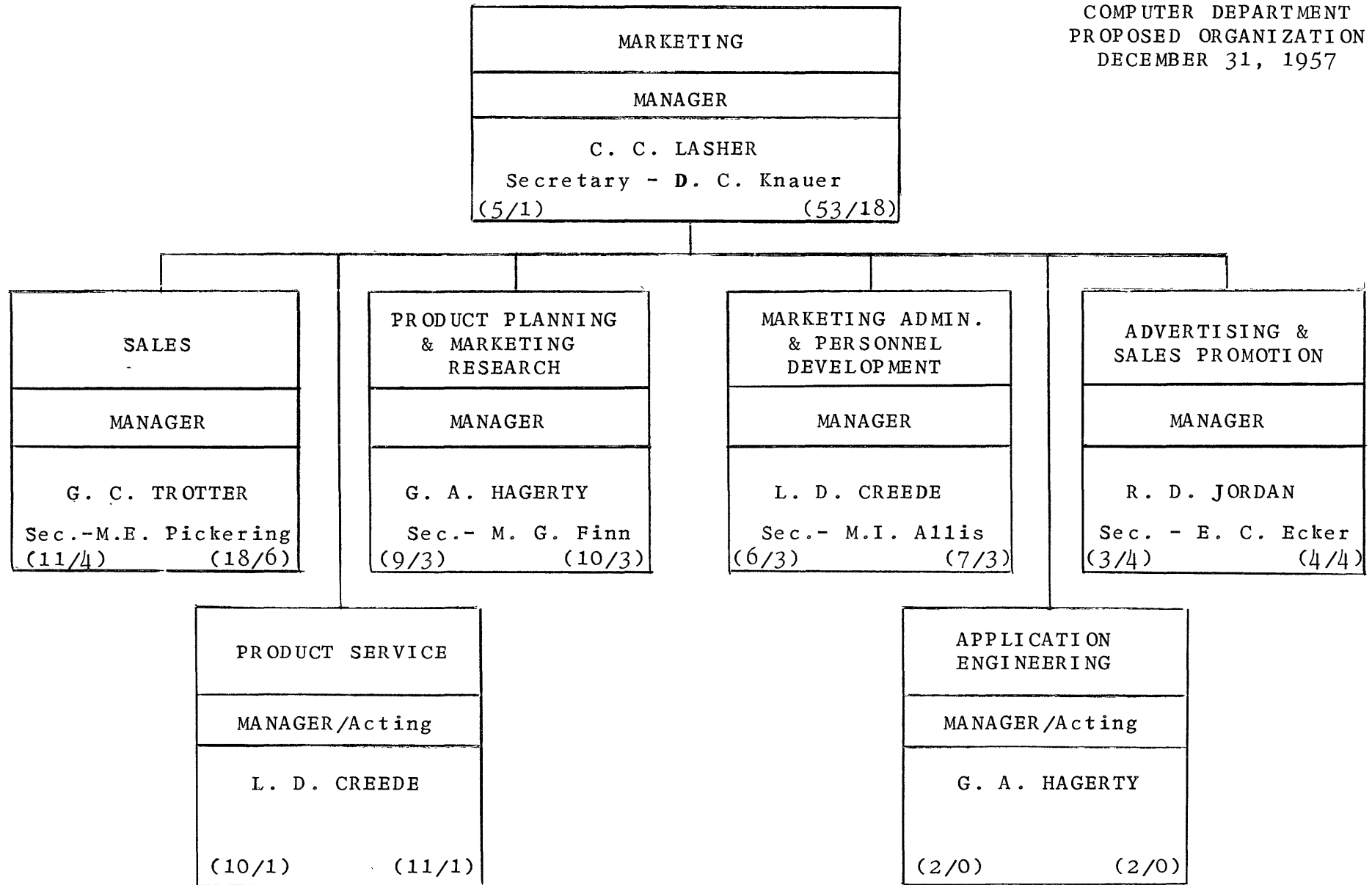

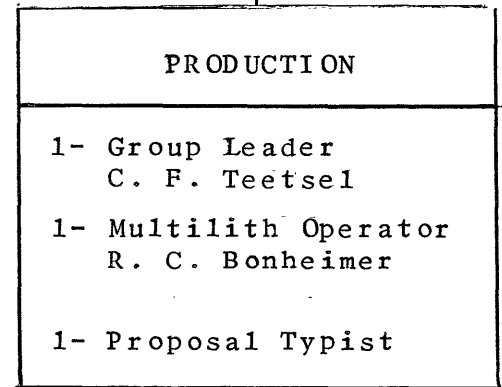
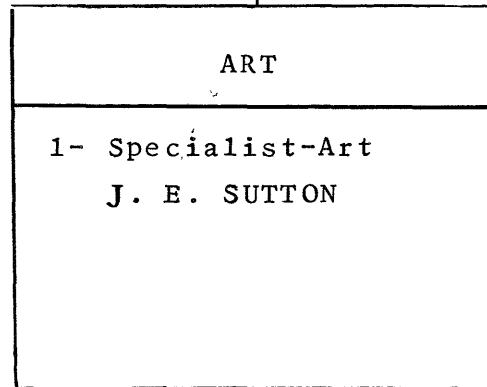
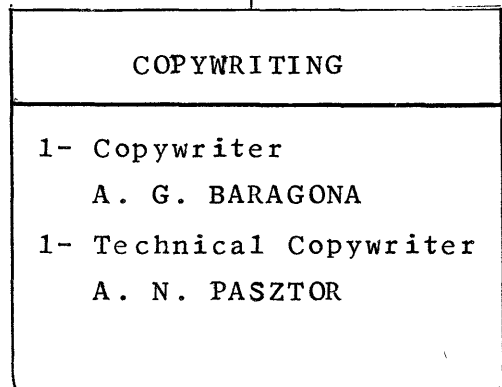
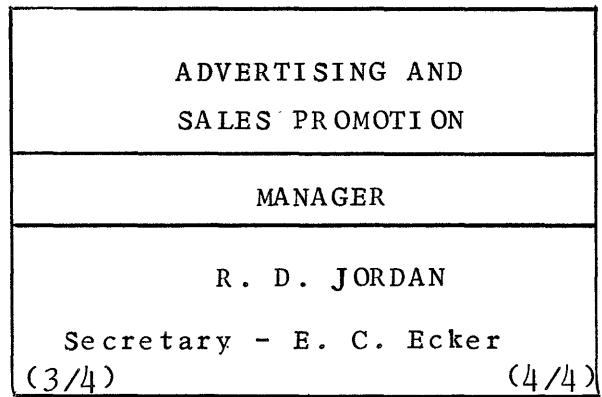

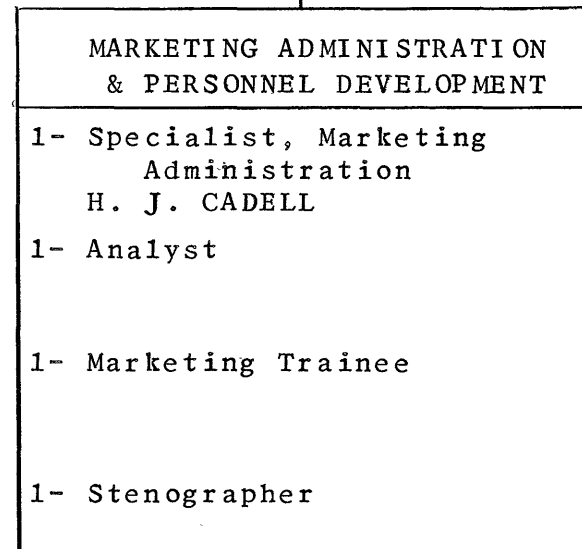
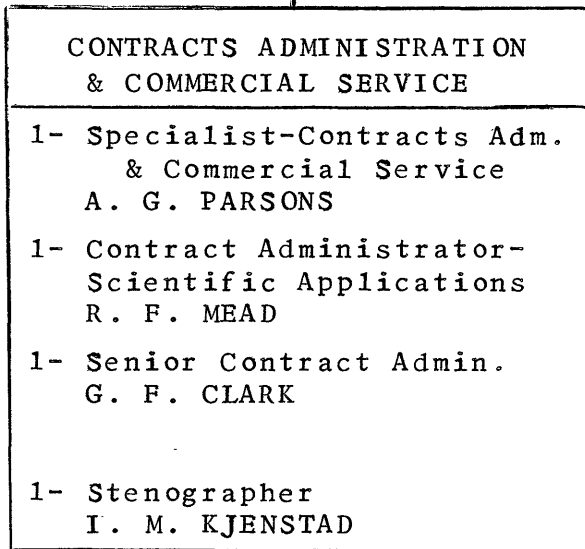
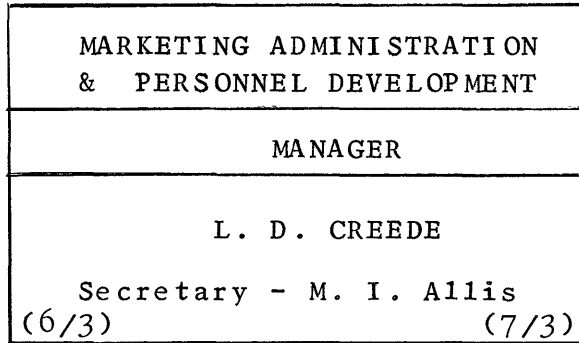

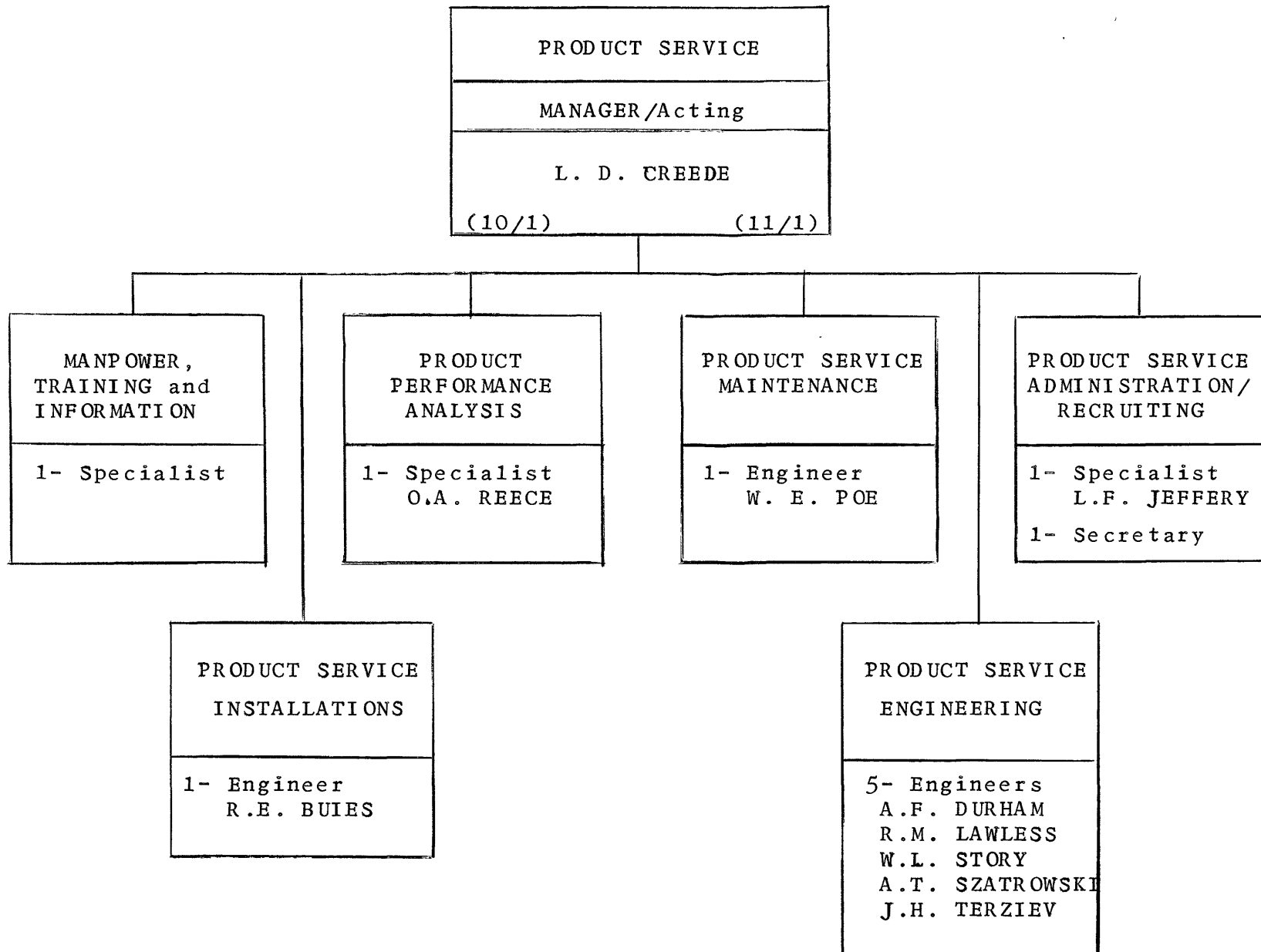

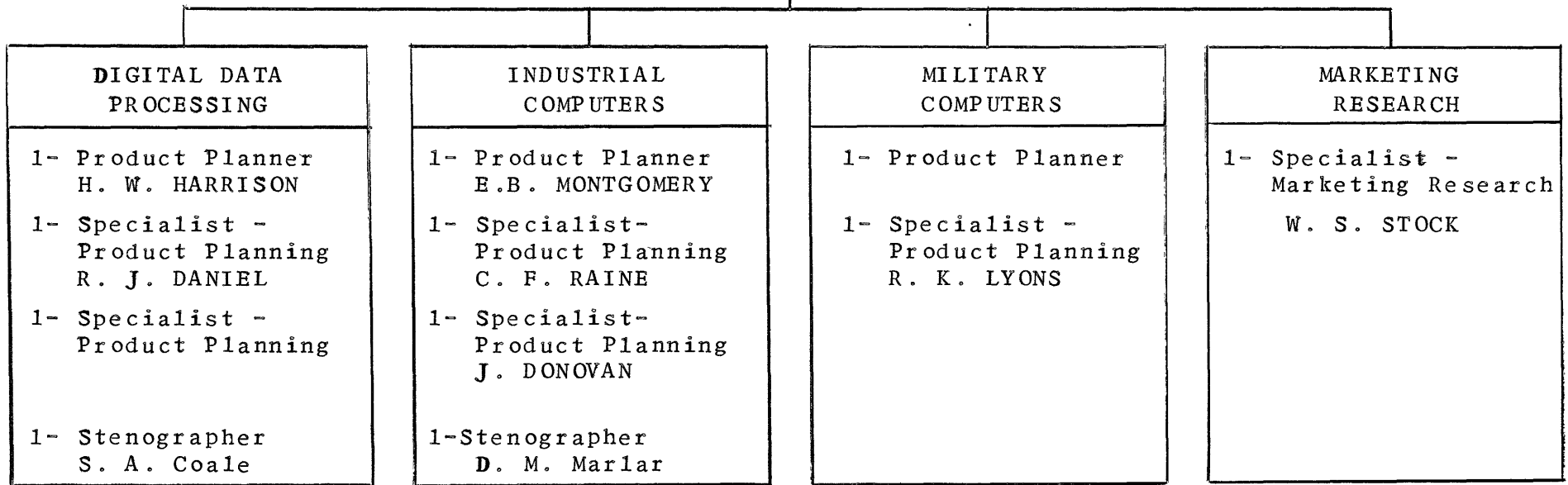
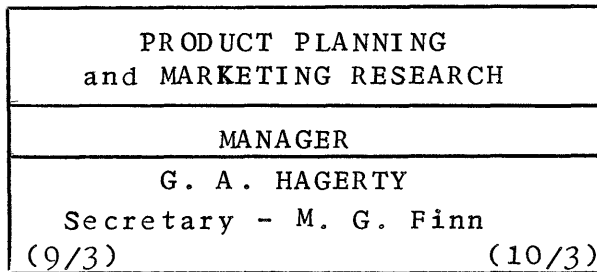

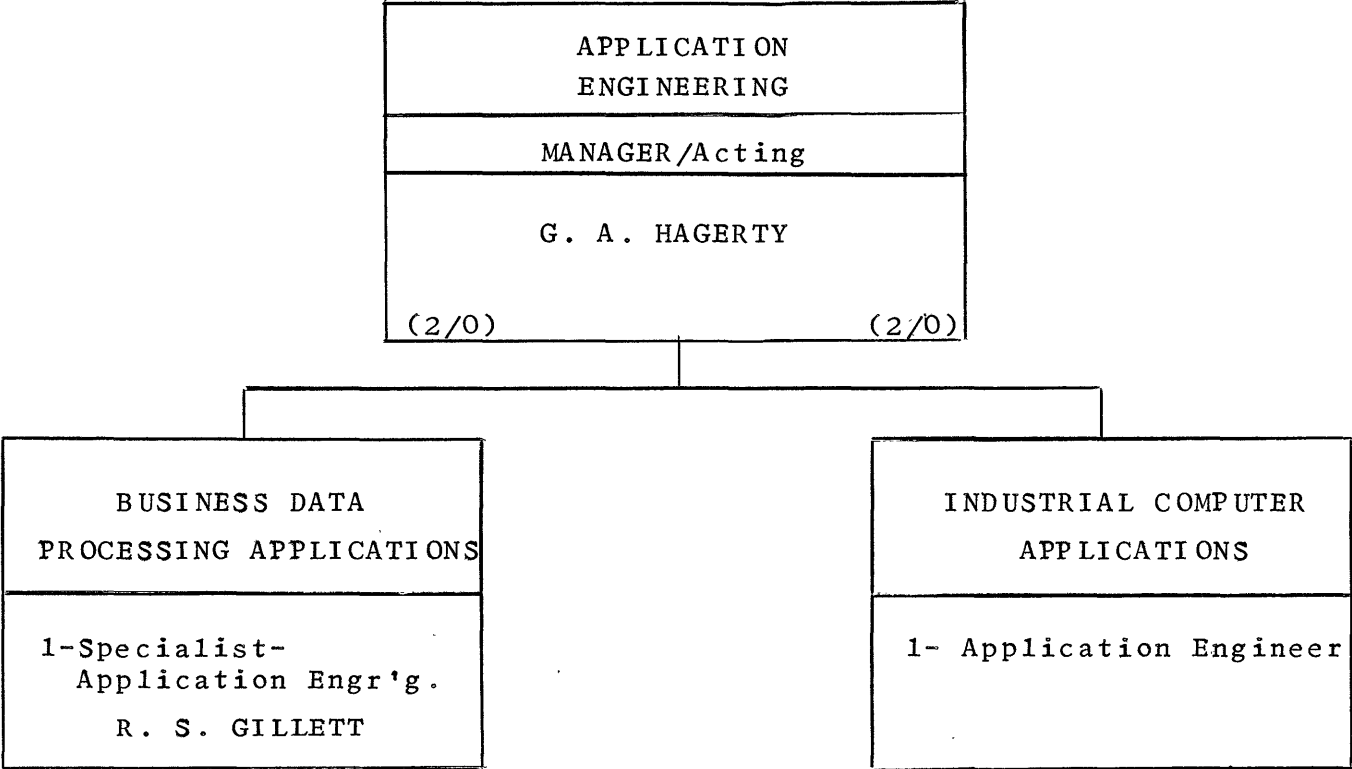

SALES
MANAGER
G. C. TROTTER Secretary-M.E. Pickering (11/4) (18/6)

BANKING & FINANCE APPLICATIONS
SALES MANAGER
A. M. SUTTON Sec.- 1-Senior Sales Engineer T. B. HORTON

MILITARY & SCIENTIFIC APPLICATIONS
SALES MANAGER
G. W. GAMBLE Sec.- A. L. Kuerth 1-Sales Engineer 1-Sr.Sales Engineer A. T. CLAWSON

INDUSTRIAL APPLICATIONS
SALES MANAGER
B. WARRINER Sec.- B. B. Bland 1-Sales Specialist R. R. DAVISSON 1-Sr.Sales Engineer G. E. WARNER

COMPUTER SERVICES
SALES MANAGER/Acting
G. W. GAMBLE

WESTERN REGION
MANAGER
J. E. HOGG Sec.- A.B. Ortega

EASTERN REGION
MANAGER
O. K. LINDLEY Sec.- M.C. Halpin.

LOS ANGELES DISTRICT
Senior Sales Engr. T. J. O'ROURKE

DAYTON DISTRICT Sr. Sales En

WASHINGTON DISTRICT MANAGER
W.E.WRIGHT

SENIOR SALES ENGINEER

SALES ENGINEER

DISTRICT REPRESENTATIVE
R.W.JOHNSON



THE GENERAL ENGINEERING LABORATORY

is General Electric's central engineering facility, concentrating on applied research and development. It also serves the Computer Department by conducting special engineering programs and providing consulting engineering in many specialized fields.

In recent years, the General Engineering Laboratory has done a great deal of computer research -- both analog and digital -- although much of the work is still classified. Products which have evolved from this effort are the AC and DC network analyzers, penalty factor computer, analog devices, and OMIBAC, a large scientific digital computer. In the analog field, the laboratory is presently working on analog to digital conversion equipment, analog simulation development, map readers and Bodemeters. Digital developments include thin film magnetic memory work, Cryotron applications, and numerical analysis for the solution of dynamic problems.

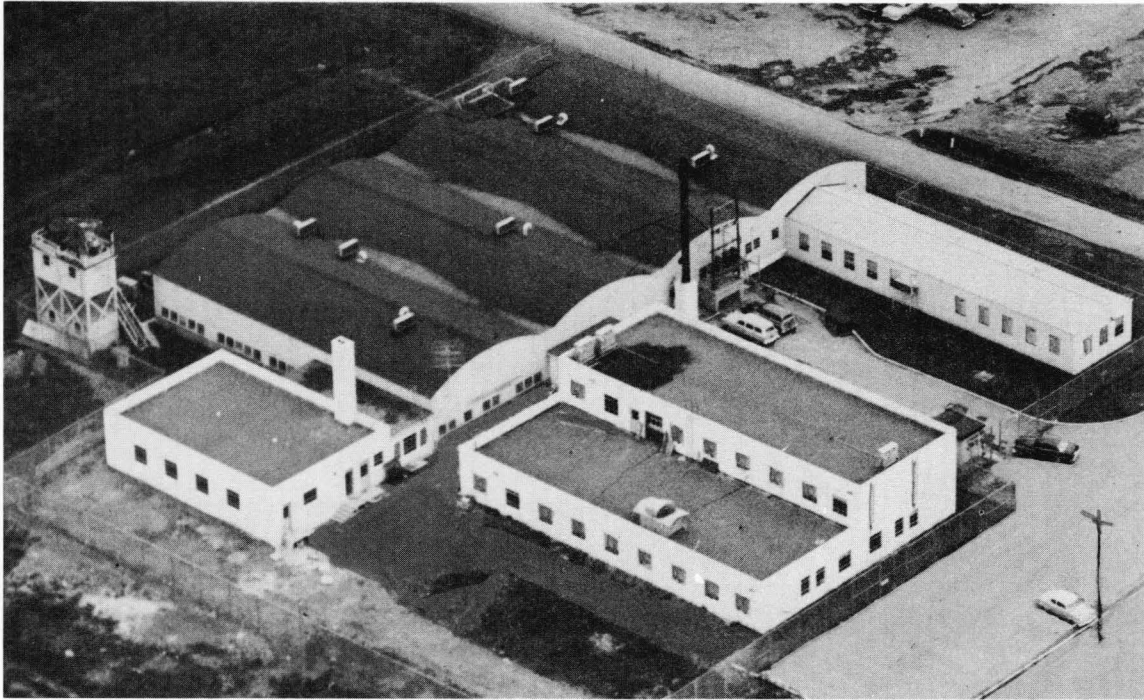

THE ADVANCED ELECTRONICS CENTER

in Ithaca, New York is a joint venture of General Electric and Cornell University. The center is an applied research and advance development laboratory specializing in electronic systems analysis and operations research. Many of the 134 scientists and engineers at the center have had broad computer experience, and have contributed inventions that have materially advanced the state of General Electric's computer art.

Outstanding systems projects have included the solution of linear programming problems by analog means and the extension of these techniques to non-linear equations, and the conception and development of radically new techniques in the automation of electronic assemblies using digital control. In the process of this work they have contributed significantly to the transistorization of analog and digital circuitry.

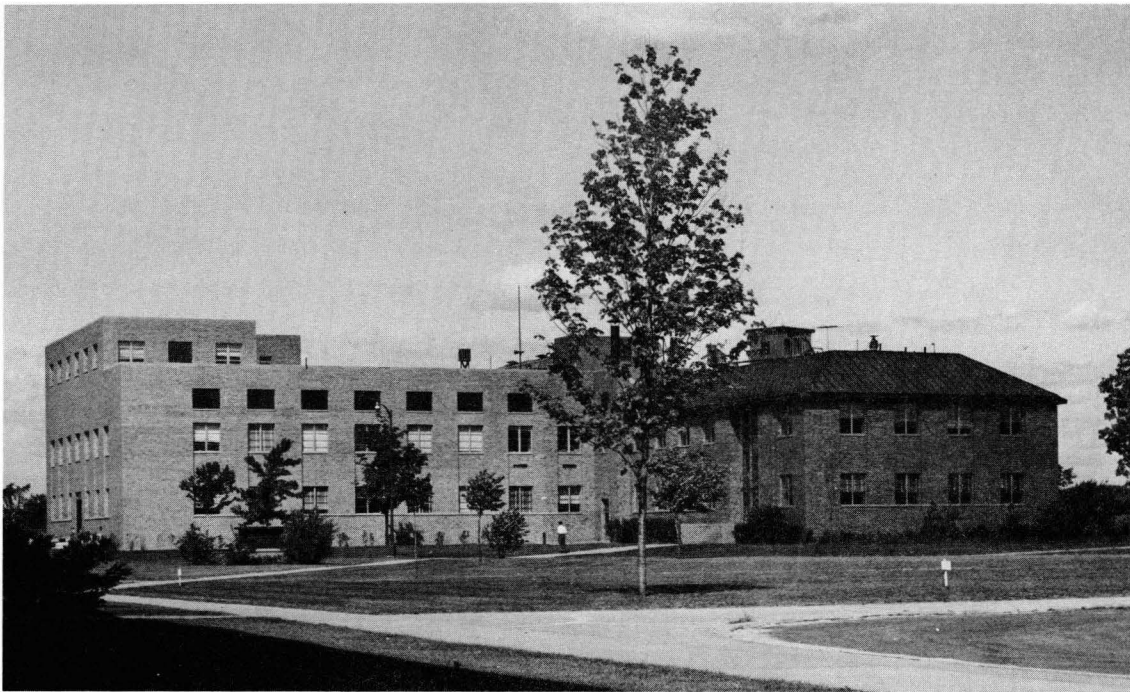

AT ELECTRONICS PARK,

Syracuse the Electronics Laboratory is devoted to the development and application of new and improved dielectric and magnetic materials, semiconductors and solid state devices and their applications to advanced electronics circuits and products. The laboratory is well known for its contributions in the fields of logical and circuitry design for digital computers.

Some of the projects under way at present are ferrite delay line, high frequency magnetic drum, and photo-luminescent storage device developments; exploration of new image recognition techniques; advanced transistorized digital circuitry development -- both static and dynamic; as well as equipment developments in the machine tool director and control field and air traffic landing systems field.

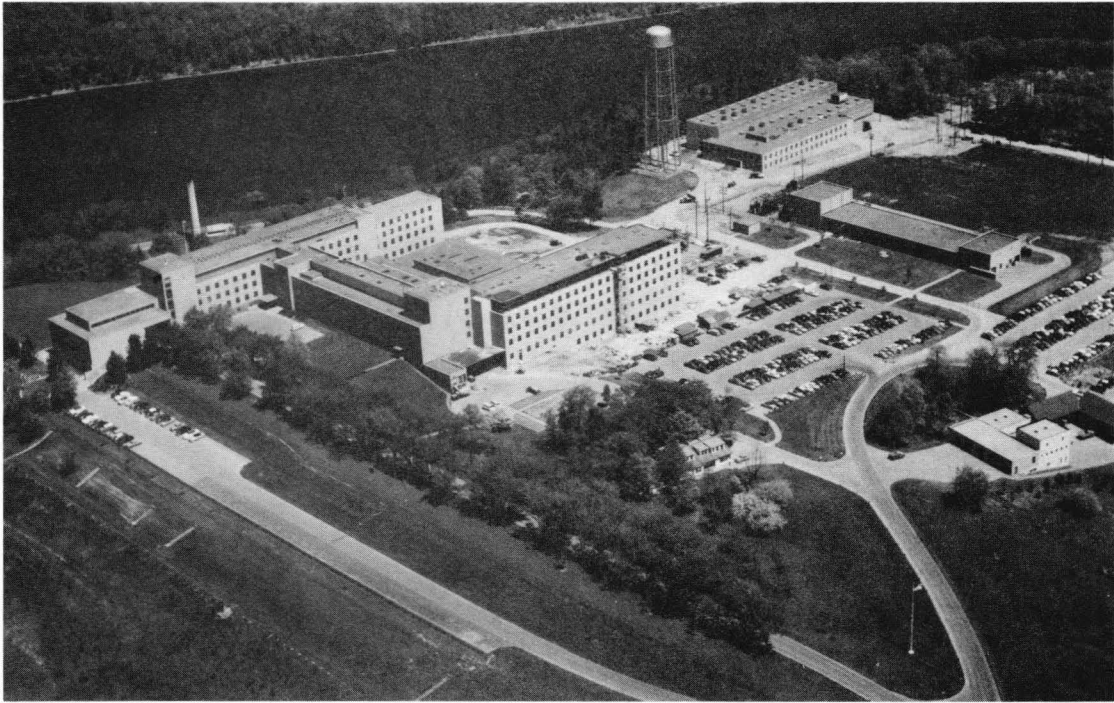

THE GENERAL ELECTRIC RESEARCH LABORATORY

in Schenectady, New York special-

izes in the exploration of the basic physical sciences, applying a great depth of scientific engineering talent to extend our frontiers of knowledge in fields relating to the electrical and electronic industry. Throughout the years the laboratory has pioneered in development in the fields of electronics, magnetics and metallurgy, which have made General Electric one of the world's outstanding producers of electronic equipment.

Presently this creative talent is assisting the Computer Department by doing research on electrostatic storage tubes working on the Day principle, exploring Cryotron techniques, developing basic new magnetic core materials, and studying the operational synthesis of computer systems.



SALES GUIDE - Proposition Procedure for Non-Standard Products:

- I. Purpose: This Guide has been designed to provide Sales Personnel with a detailed outline of their responsibilities throughout the non-standard product proposition routine.
- II. A. Proposition Routine: The Proposition Routine is broken into four functional steps, as follows:
 1. Proposition Opening Letter
 2. Request for Proposal Letter
 3. Quotation Letter
 4. Proposition Closing Letter

Detailed outlines of the information which must be provided by Sales, as well as action required by Sections and Subsections of the Department are attached as supplements to this Guide. In addition, a Proposition Checklist, Supplement C, is attached for reference use by Sales Engineers who are preparing Quotations.

B. General:

Proposition Numbering: Proposition numbers will be the principal medium of referencing, filing, and keeping track of the work being done and the workload ahead in pursuit of new orders. Proposition numbers are assigned by the cognizant Sales Unit with a Proposition Opening Letter. Each proposition number has four parts, as follows:

1. Prefix: The particular Sales Unit is identified by a three letter prefix:

CDI - Industrial
CDB - Business
CDL - Computer Applications Laboratory
CDG - Government

2. Product Line Code: The Product Line Code is composed of four digits. The first two digits indicate the product line, while the last two digits are assigned to specific products.

For the use of General Electric Employees only



3. Series: A single series of three numbers will be used to identify the chronological order of a proposition. The series will be renewed each year. This series will be assigned from a master series which will be controlled by the Sales Subsection.
4. Suffix: If and when a proposition outgrows the original conception and becomes two or more separate opportunities with the same customer, respective new facts of the proposition should be broken-out and each given its own designation by means of a suffix letter A, B, C, etc. added to the original number. Each expanded proposition containing a suffix should be treated as a new opportunity to do business with respect to proposition procedures.

To illustrate the use of the Proposition Number, the third proposition opened in a calendar year by the Sales Manager-Banking and Financial Applications for an ERMA system would be:

CDB-0101-003

For the use of General Electric Employees only



SALES POLICIES-1.001

SUPPLEMENT A - PROPOSITION OPENING LETTER

Originator: Cognizant Headquarters product line Sales Manager or his delegated representative.

Source of Approval: Unit Sales Manager

Addressee: Those to whom requests for action are made, i. e.

- Manager - Cost Accounting
- Manager - General Accounting
- Manager - Cognizant Engineering Sub-Section (where applicable)
- Manager - Manufacturing Engineering (where applicable)
- Manager - Product Service (where applicable)
- Manager - Applications Engineering (where applicable)
- Manager - Cognizant Scientific Applications Sub-Section (where applicable)
- Manager - Advertising & Sales Promotion (where applicable)

Copies (As applicable): General Manager

- Manager - Engineering/Manager - Engineering Administration (Non-Standard Products and Engineering Research and Development)
- Manager - Scientific Applications/Manager - Scientific Applications Administration (Computing Service)
- Manager - Marketing/Manager - Sales
- Manager - Marketing Administration

For the use of General Electric Employees only



SALES POLICIES-1.001

Manager - Product Planning

Cognizant Regional or District Sales Manager

Manager - Advertising & Sales Promotion, if
not addressed above

Manager - Applications Engineering (products--
if not addressed above)

Manager - Product Service (all products, -if not
addressed above.)

Legal Counsel

Patent Attorney

Manager - Finance

Manager - Manufacturing/Manager-Materials
(for products only)

Proposition File (Sales), Consolidated Propo-
sition Book (Sales)

- Paper: Green
- Timing: In most cases a proposition should be opened well in advance of a formal bid request.
- Reference: 1. The newly assigned proposition number.
2. Customer PR or Work Order Number (if available).
- Subject: Carefully chosen, short (usually not more than 10 words) and description, to be used as Job Title within the Department.

For the use of General Electric Employees only



SALES POLICIES-1.001

Purpose:

A Proposition Opening Letter is written to alert the Department to the existence of a "new opportunity to do business." It is a means of alerting Management that a decision may be required as to whether or not the Department should pursue the opportunity, "no bid", or conduct a study of the situation to obtain more information. It also establishes the new Proposition Number.

In addition, where applicable the Proposition Opening Letter should specifically:

1. Ask Product Planning for a Product Appraisal.
2. Alert Advertising and Sales Promotion of possible need for a brochure.
3. Alert Engineering of possible need for a technical proposal.
4. Alert Manufacturing of possible factory loading and possible need for delivery estimates.
5. Alert Cost Accounting of possible need for cost estimates.
6. Specifically requests from General Accounting a tax analysis and credit approval.
7. Alert Product Service of possible need for installation, maintenance, training, publication quotation and spare parts.
8. Obtain Management approval, at a level corresponding to the source of approval to quote (see Supplement F) to proceed with the proposition.

For the use of General Electric Employees only



SALES POLICIES-1.001

Body of Proposition
Opening Letter:

1. A definite statement that a new proposition is being opened.
2. It must define the nature (development, production, etc.) and scope of the proposition clearly while delineating the problem completely as possible.

The scope, as set forth in this letter, may be quite broad, and often has to be if the proposition is fairly long range or embryonic in nature.

3. This letter must contain sufficient facts to persuade other Marketing, Engineering, Manufacturing, Finance, and Management personnel that this opportunity to do business is worthy of aggressive action, and the expenditure of both time and money to prepare a proposal to the customer. Consequently, when prior information is insufficient, inapplicable, or obsolete, it must include:
 - a) One or more paragraphs which clearly but briefly describe the customer's requirements, including equipment or system description, specific requirements for installation or service, quantity applicable, intended application, delivery requirements, preliminary pricing information.
 - b) History and background of, as well as outlook for, equipment or system.
 - c) Competitive analysis - competitive equipment available, its speed, storage capacity, and other pertinent operating characteristics which are common knowledge.
 - d) Estimated dollar value of proposition.
 - e) Estimate of margins.

For the use of General Electric Employees only



SALES POLICIES-1.001

- f) Factory loading and dollar volume opportunities and ultimate production prospects of further systems.
 - g) Value of Engineering experience to be gained.
 - h) Prestige to be derived.
 - i) Concurrent effect on other Departments of the Company.
4. To substantiate and expand the data fulfilling paragraph 3 above, the Proposition Opening Letter will place a specific request on Product Planning for a Product Appraisal unless a previous appraisal applies to the Proposition.
 5. This letter shall explicitly request necessary action, when it is to be accomplished, where and by whom. If the letter is for information only, it should so state.
 6. Opportunities to do business which are of "no interest" to the Department may be - and should be - screened out by Sales. It is important, however, that Management and other interested individuals be advised of the existence of the opportunity and of Sales' "no bid" decision. This should be done by blind carbon copies of the "no bid" letter to the customer.

For the Use of General Electric Employees only



SALES POLICIES-1.001

SUPPLEMENT B - REQUEST FOR PROPOSAL LETTER

- Originator: Cognizant Headquarters product line Sales Manager or his delegated representative.
- Source of Approval: See Supplement F.
- Addressee: Those to whom requests for action are made, i. e.
- Manager - Cost Accounting
 - Manager - General Accounting
 - Manager - Cognizant Engineering Sub-Section (where applicable)
 - Manager - Manufacturing Engineering (where applicable)
 - Manager - Product Service (where applicable)
 - Manager - Applications Engineering (where applicable)
 - Manager - Cognizant Scientific Applications Sub-Section (where applicable)
 - Manager - Advertising & Sales Promotion (where applicable)
- Copies (As applicable): General Manager
- Manager - Engineering/Manager - Engineering Administration (Non-Standard Products and Engineering Research and Development)
 - Manager - Scientific Applications/Manager - Scientific Applications Administration (Computing Service)

For the use of General Electric Employees only



SALES POLICIES-1.001

Manager - Marketing/Manager - Sales

Manager - Marketing Administration

Manager - Product Planning

Cognizant Regional or District Sales

Manager - Advertising & Sales Promotion, if
not addressed above

Manager - Applications Engineering (products--
if not addressed above)

Manager - Product Service (all products, -if not
addressed above.)

Manager - Finance

Legal Counsel

Patent Attorney

Manager - Manufacturing/Manager Material
(Products) Proposition File (Sales),
Consolidated Quotation Book (Sales)

Paper: Yellow

Timing: The Request for Proposal Letter should be prepared as soon as it is known that the prospective customer will buy and that the Computer Department wishes to quote. The Proposition Opening Letter and the Request for Proposal Letter may be combined if a specific request from the customer is made at the time the proposition is opened. However, a good sales engineer recognizes the business opportunity well in advance of the date when a proposal request is issued.

Reference: 1. Proposition Number
2. Customer identification numbers

For the use of General Electric Employees only



SALES POLICIES-1.001

- Subject: Same as Proposition Opening Letter
- Purpose: The Request for Proposal Letter initiates action by appropriate Sections to obtain and prepare technical information, cost information, delivery estimates, and any other background that the Sales Engineer will require to make a complete quotation. So that each section can effectively perform its responsibility, each request for proposal must clearly indicate the amount of detail required for adequate preparation of the quotation.
- Body of Letter: The Request for Proposal Letter must request specifications from definite responsible persons in the Department. Some, if not all, of the following requests with the date on which such information is required should be included:
1. A specific request to Engineering for technical information or technical proposal.
 2. A specific request to Engineering for estimates of Engineering time necessary to complete design and release to Manufacturing.
 3. A specific request to Engineering Manufacturing and Finance for cost estimates.
 4. A specific request to Finance for a tax analysis (where applicable).
 5. A specific request to District or Field Personnel for customer liaison and immediate notification of changes in or new status, requirements, specifications, etc.
 6. A specific request to Advertising and Sales Promotion for a brochure.
 7. A specific request to Scientific Applications for information and estimates.

For the use of General Electric Employees only



SALES POLICIES-1.001

8. A specific request to Product Service for installation, maintenance, instruction books, and training quotations.
9. A specific request to the Legal group for Patent and Contract review, as soon as practicable.
10. A specific request on Applications Engineering for an Application review, study or approval.
11. Any other specific requests necessary to obtain any missing information or action to enable the Sales Engineer to prepare the quotation so as to completely fulfill the requirements of the Proposition Checklist (Supplement C).

In order to assure that all of the above requests are fulfilled and that the personnel responsible for fulfilling the request are all oriented to the requirements of the customer, the Request for Proposal Letter must very clearly and specifically state:

1. Exactly what type and quantity of equipment, system or services the customer wishes to buy, including all applicable specifications or codes to be met.
2. Customer requirements of delivery.
3. Customer requirements of contract terms. (Customer "boiler plate" should be attached for legal and patent review).
4. Customer requirements for product service.
5. Customer requirements for spare parts.

For the use of General Electric Employees only



SALES POLICIES-1.001

6. A clear statement of any proposed exceptions to the Computer Department's Standard Conditions of Sale.
7. Where possible, A "Target" price range should be indicated.
8. Any deviation from information which was incorporated in the proposition opening letter.

In expediting the preparation of the estimate, the cognizant product line Sales Manager or his delegated representative who requested the estimate, will contact the specified person in each function to follow the progress of the task. Where delays are encountered and expediting is necessary the cognizant product line Sales Manager or his delegated representative will expedite each function via their specified contact. The persons from each Section who are responsible for coordinating the activities of their Section, are:

1. Manager - Cost Accounting
2. Manager - Product Service
3. Product Sales Manager
4. Cognizant Engineering Sub-Section Manager
5. Cognizant Scientific Applications Sub-Section Manager
6. Manager - Manufacturing Engineering

Action Required on Request for Proposal Letter

When an approved Request for Proposal is issued, cognizant sections shall initiate and pursue a course of action which will enable Sales to obtain the information they must have to prepare and submit a timely quotation. The Action required to do this may consist of any or all of the following contributory requisites:

For the use of General Electric Employees only



SALES POLICIES-1.001

- 1) Engineering or Scientific Applications prepares a Technical Proposal with Advertising's assistance where applicable.
- 2) Engineering prepares suitable specifications and material lists for Manufacturing and Product Service.
- 3) Engineering forwards cost estimates to Cost Accounting.
- 4) Manufacturing forwards cost estimates to Cost Accounting.
- 5) Product Service forwards cost estimates to Cost Accounting.
- 6) Cost Accounting issues a Memorandum of Cost to Sales.
- 7) A tax analysis is prepared (if applicable).
- 8) Legal and Patent reviews are conducted.

For the use of General Electric Employees only



SALES POLICIES-1.001

SUPPLEMENT C - PROPOSITION CHECKLIST

The following checklist is supplied as a reference for Sales Engineers who are preparing a Quotation. This list should also be utilized in preparing Request for Proposal Letter to assure the availability of this information when the quote is prepared.

PRELIMINARY TO QUOTINGTHESE ARE REQUIRED

1. Written comment from Legal and Patent Counsel concerning the proposal.
2. A valid Cost Estimate, in writing, from the Financial Section.
3. Valid technical information from Engineering forwarded to Sales in writing (this information may, however, be in draft form from Engineering).
4. Valid delivery estimate from Marketing Administration.
5. Tax Analysis.
6. Credit analysis and approval.
7. Approvals to quote. (See Supplement F)

PREPARATION OF QUOTETHESE ARE REQUIRED*

(as applicable)

1. Customer's address, preferably to the attention of a specific person in the customer's organization.
2. Subject, as used in other proposition correspondence and including the G.E. Proposition Number and customer reference numbers.
3. The reason for the quotation (in answer to a specific request or unsolicited and the reasons therefore).
4. Exact description of all products and services including instruction books, installation drawings, installation service, spare parts, etc., stressing customer benefits and referencing the descriptive specification or proposal if one is attached.

For the use of General Electric Employees only



SALES POLICIES-1.001

5. Quantity and any other specific instructions regarding instruction books must be indicated in list of equipment to be supplied.
6. Delivery date specified from the date on which authority to proceed is formally given by the customer, or a calendar date contingent on receipt of authority to proceed at a definite time. All delivery dates will be quoted at _____ days or _____ months after receipt of order.
7. Delivery point f. o. b. Phoenix is standard Computer Department policy for all products requiring acceptance tests at the customer's plant.
8. All spare parts and replacement parts will be shipped f. o. b. , Phoenix, Arizona.
9. Price.
10. Pricing basis: CPFF, firm fixed price, progress payments, etc.
11. Price Adjustment
 - All quotations will include a price adjustment clause. Use CD Form #276 as an attachment.
 - Clause 2 will be used on all quotations where shipments are to be under two (2) years and less than \$1,000,000 in value.
 - Clause 1 or 3 will be selected at the discretion of the Manager - Marketing for all quotations where shipment is over two (2) years or over \$1,000,000 in value.
12. Requirements for installation drawings (Manufacturing drawings will not be furnished.)
13. All quotations will indicate an expiration date - normally 30 to 60 days from date of quotation letter.
14. Computer Department Standard Conditions of Sale (specific approval of the Manager of Marketing must be obtained to deviate from the Standard Conditions of Sale or Air Force Basic Agreement.)
15. Any special provisions which must be part of the particular quotation, such as patent agreements, product service, application engineering, installation information, spare parts, etc.

*Supporting document must be placed in Proposition File including all internal commitments.

For the use of General Electric Employees only.



SALES POLICIES-1.001

SUPPLEMENT D - QUOTATION LETTER

Originator: Cognizant Headquarters product line Sales Manager or his delegated representative.

Source of Approval: As per Supplement F

Addressee: Customer

Copies: General Manager

(Blind) Manager - Engineering/Manager - Cognizant Engineering Sub-Section.

Manager - Scientific Applications/Manager - Administration for Scientific Applications.

Manager - Marketing, Manager - Sales, Manager - Product Planning, Manager - Applications Engineering, Manager - Product Service, Cognizant Regional or District Sales Manager.

Manager - Marketing Administration

Manager - Finance/Manager - Cost Accounting

Legal Counsel

Patent Attorney

Proposition File (Sales), Consolidated Quotation Book (Sales)

Paper: Standard G. E. Blue for customer.

Pink for internal copies.

Reference: 1. Proposition Number

2. Customer identification numbers.

Subject: Same as Proposition Opening Letter.

For the use of General Electric Employees only



SALES POLICIES-1.001

Purpose:

Every quotation provides an estimate of cost, delivery, and description of product to be supplied to a customer, and should be written with the intent of selling the customer on the personnel, the know-how, the facilities and the products of the Computer Department to satisfy the needs he has. It is possible to compose a Quotation Letter which contains all of the basic elements listed above and is mechanically perfect but it will be a good quotation only if each of these elements is presented in a persuasive manner.

Body of Letter:

All of the necessary information, as listed in the Checklist (Supplement C) should be included in the Quotation Letter. Furthermore, in order to create the quality of selling, three specific considerations should be observed when writing a Quotation Letter.

1. It should be personal. Every quotation should be written with the specific person in mind who will receive it. A desire to buy is created in persons and every quotation should be written with this in mind.
2. The Quotation should be informative with the information given in the Quotation Letter and the accompanying technical proposal, if there is one. The customer, by referring to the complete Quotation, should be able to describe completely in contractual or specification language the article which is being offered for sale. The writer of the Quotation Letter should keep in mind at all times the thought that his quotation should include all the information necessary for the customer to completely write up the resulting contract. In the idealized case, the customer would only have to retype the material presented in the quotation and/or technical proposal to furnish the Computer Department with a contract for execution. Although this ideal is seldom attained, it is worthwhile goal to work toward in the preparation of our quotations.

For the use of General Electric Employees only



SALES POLICIES-1.001

3. All of the information presented in the quotation should be presented in a persuasive and convincing manner. This is the quality of selling which identifies a good quotation. In a description of the product or service offered, every feature should be brought out with specific reference to the benefit which will accrue to the customer, the customer's requirements, the customer's present equipment, and a knowledge of competing equipments. This is the unique challenge to the professional sales engineering in the quoting process.

For the use of General Electric Employees only



SALES POLICIES-1.001

Reference: 1. Proposition Number
2. Customer identification numbers

Subject: Same as Proposition Opening Letter

Purpose: A Proposition Closing Letter is written as soon as Sales learns that a proposition has resulted in an order received or an order lost (including "no bid") or when the proposition has become inactive through cancellation or long term postponement.

The Proposition Closing Letter forms the basis for a number of important reports which are utilized by Management. The importance of submitting a prompt, complete and accurate Proposition Closing analysis is almost as great as the quotation itself.

- A. The letter should begin with a definite statement to the effect that a proposition is being closed and the reason for its being closed.
1. If the order was received, the contract or order number and date, requisition number, customer, amount, type of program and any additional information should be given. In addition, the following information, where applicable, should be included:
 - a. Any changes in requirements, contractual details, selling price, delivery estimates, etc., from the quotation letter and recommendations concerning acceptance of changes.
 - b. Names of contacts in customer's organization and means of contact.

For the use of General Electric Employees only



SALES POLICIES-1.001

SUPPLEMENT E - PROPOSITION CLOSING LETTER

Originator: Cognizant Headquarters product line Sales Manager or his delegated representative.

Source of Approval: Unit Sales Manager

Addressee: A) Contract or Order Received - Contracts Administration.
B) Lost Business (Proposition inactivity, or Decision to no Bid) - Manager - Sales

Copies (As applicable): General Manager
(Distribution list of Quotation Letter)
Manager - Engineering/Manager - Engineering Administration (where applicable)
Manager - Scientific Applications/Manager - Administration for Scientific Applications (where applicable)
Manager - Marketing, Manager - Sales, Manager - Product Planning, Manager - Product Service (all product or service quotes), Manager, Applications Engineering, cognizant Regional or District Sales Manager.
Manager - Marketing Administration
Manager - Finance
Manager - Manufacturing
Proposition File (Sales), Consolidated Proposition Book (Sales)

Paper: Internal Buff

For the use of General Electric Employees only



SALES POLICIES-1.001

- c. A summary of any unique features of the contract or order, including technical information, pricing, overtime provisions, handling of proprietary information, etc.
2. If the business was lost; the successful competitor, date of award, the reasons for losing the business, and the date concerning competitive offerings should be given. Always give price details if known. This should be as complete a "self appraisal" as possible so that the Department may benefit by experience.
- B. Disposition of the Proposition File:
1. When contract or order is received, Sales will forward to Contracts Administration, along with a copy of the Proposition Closing Letter, the complete proposition file, and a copy of any letter to the customer acknowledging receipt of the order. (Acceptance of the customer's order or of any terms thereof, should not be Sales thanking customer for or acknowledging receipt of the order.)
 2. When Business Lost: The complete proposition file will be forwarded to Contracts Administration as soon as practicable after the Proposition Closing Letter has been written. Contracts Administration is responsible for maintaining files for propositions which have been closed. (All documents indicating the manner which the quoted price was derived will be maintained by Contracts Administration for an indefinite period.)

For the use of General Electric Employees only



SUPPLEMENT F

TABLE OF CONTENTS

APPROVAL TO INITIATE PROPOSAL

APPROVAL TO QUOTE

ACCEPT ORDERS & CONTRACTS

CONTRACT & ORDER REVIEW PROCEDURE

NOTE: The approval routines indicated in this Supplement were extracted from Computer Department Instruction 820.04, entitled "Approval Routines."



APPROVAL TO INITIATE PROPOSAL

LESS THAN GREATER THAN APPROVAL IN SEQUENCE

I.	A. Standard Products. No change from published prices, terms of sale and approved delivery.	\$1,000,000	\$1,000,000	Mgr-Sales Mgr-Sales, Mgr-Mktg., Dept. Gen. Mgr.
				(Approval of Product Planning & Engineering is implied by published data)
	B. Standard Product modified or Non-Standard Product included in scope of Orders Received Forecast.	\$ 100,000	\$ 100,000	Mgr-Sales Mgr-Mktg., Dept. Gen. Mgr.
				(Proposal can be requested if negative reaction is not received from Product Planning or Engineering upon receipt of Proposition Opening Letter.)
	Military CPFF (Primarily R&D) within established limits. By letter from Mgr-Mktg. and/or Orders Received Forecast.	\$1,000,000	\$1,000,000	Mgr-Sales Mgr-Sales, Mgr-Mktg., Dept. Gen. Mgr.
				(Proposal can be requested if negative reaction is not received from Product Planning or Engineering upon receipt of Proposition Opening Letter.)
	New Products.	\$ 100,000	\$ 100,000	Mgr-Sales Mgr-Sales, Mgr-Mktg., Dept. Gen. Mgr.
				(Product Planning and Engineering must approve prior to issuance of Request for Proposal Letter.)

APPROVAL TO QUOTELESS THANGREATER THANAPPROVAL IN SEQUENCE

I.	A.	Standard Products. No change from published prices, terms of sale and approved delivery.	\$1,000,000	\$1,000,000	Mgr-Sales Mgr-Sales, Mgr-Mktg., Dept. Gen. Mgr., Div. Gen. Mgr.
	B.	Non-Standard Products; Standard Products modified; or terms of sale changes from standard terms.	\$ 100,000	\$ 100,000 \$1,000,000	Mgr-Sales* Mgr-Sales, Mgr-Mktg., Dept. Gen. Mgr. Div. Gen. Mgr.
II.	A.	Military CPFF (Primarily R&D)	\$1,000,000	\$1,000,000	Mgr-Sales* Mgr-Sales, Mgr-Mktg., Dept. Gen. Mgr., Div. Gen. Mgr.
III.	A.	New Products.	\$ 100,000	\$ 100,000 \$1,000,000	Mgr-Sales Mgr-Sales, Mgr-Mktg., Dept. Gen. Mgr. Div. Gen Mgr.

* Within scope and in accordance with special requirements regarding margins, terms, etc. imposed by letter from Manager-Marketing.



ACCEPT ORDERS AND CONTRACTS

<u>LESS THAN</u>	<u>GREATER THAN</u>	<u>APPROVAL REQUIRED (IN SEQUENCE)</u>	<u>AUTHORIZED TO EXECUTE CONTRACTS</u>
------------------	---------------------	----------------------------------------	----------------------------------------

I.

<p>A. Standard Products, \$ 50,000 Standard Terms, \$1,000,000 no change from \$2,000,000 quotation prices, terms of Sale and approved delivery.</p>	<p>\$2,000,000</p>	<p>Mgr-Mktg. Admin. Mgr-Mktg. Admin, Mgr-Sales Mgr-Mktg. Admin, Mgr-Sales, Mgr-Mktg. Mgr-Mktg. Admin, Mgr-Sales, Mgr-Mktg. Dept. Gen. -Mgr.</p>	<p>Mgr-Mktg. Admin. Mgr-Sales Mgr-Marketing Dept. Gen. Mgr.</p>
<p>B. Non-Standard Products on \$ 100,000 standard terms \$2,000,000 or standard products with non-standard terms, or both, no change from Quotation.</p>	<p>\$2,000,000</p>	<p>Mgr-Mktg. Admin, Mgr-Sales Mgr-Mktg. Admin, Mgr-Sales, Mgr-Mktg. Mgr-Mktg. Admin, Mgr-Sales Mgr-Mktg., Dept. Gen. Mgr.</p>	<p>Mgr-Sales Mgr-Marketing Dept. Gen. Mgr.</p>
<p>Any deviation from quotation.</p>	<p>\$2,000,000</p>	<p>Mgr-Mktg. Admin, Mgr-Sales, Mgr-Mktg. Mgr-Mktg. Admin, Mgr-Sales, Mgr-Mktg. Gen. Mgr.</p>	<p>Mgr-Marketing Dept. Gen. Mgr.</p>
<p>Military CPFF 1. (Primarily R&D). No \$ 100,000 change from \$2,000,000 Quotation Prices, Terms of Sale and Ap- proved Deliver- ies.</p>	<p>\$2,000,000</p>	<p>Mgr-Mktg. Admin, Mgr-Sales Mgr-Mktg. Admin, Mgr-Sales, Mgr-Mktg. Mgr-Mktg. Admin, Mgr-Sales, Mgr-Mktg. Dept. Gen. Mgr.</p>	<p>Mgr-Sales Mgr-Marketing Dept. Gen. Mgr.</p>





ACCEPT ORDERS AND CONTRACTS (Cont'd)

	<u>LESS THAN</u>	<u>GREATER THAN</u>	<u>APPROVAL REQUIRED (IN SEQUENCE)</u>	<u>AUTHORIZED TO EXECUTE CONTRACTS</u>
II.				
A. Military CPFF (Cont'd)				
2. Any deviation from quotation.	\$2,000,000	\$2,000,000	Mgr-Mktg. Admin, Mgr-Sales, Mgr-Mktg. Dept. Gen. Mgr.	Mgr-Marketing Dept. Gen. Mgr.
III.				
A. New Products				
1. No change from Quotation.	\$ 100,000 \$2,000,000	\$2,000,000	Mgr-Mktg. Admin, Mgr-Sales Mgr-Mktg. Admin, Mgr-Sales, Mgr-Mktg. Gen. Mgr.	Mgr-Sales Mgr-Marketing Dept. Gen. Mgr.
2. Any deviation from Quotation.	\$2,000,000	\$2,000,000	Mgr-Mktg. Admin, Mgr-Sales, Mgr-Mktg. Gen. Mgr.	Mgr-Marketing Dept. Gen. Mgr.

ACCEPT AMENDMENTS

Amendments are individually considered on the same basis as Orders or Contracts for acceptance.



CONTRACT & ORDER REVIEW PROCEDURE

<u>ORDERS</u>	<u>SALES TRANSMITTAL</u>	<u>CONTRACTS ADMINISTRATION ANALYSIS</u>	<u>ORDER REVIEW</u>	<u>RESOLUTION OF DEVIATIONS</u>	<u>ACCEPTANCE</u>
I. A. Standard No deviation from Quote	Sales Manager approval and recommendations & transmittal of order & complete Prop. Folder to Contract Administration	Contracts Administration analyzes order in terms of Quotation & Sales recommendations and: 1. Where no discrepancy exists forwards order analysis to Mgr-Mktg. Admin. 2. Resolves any discrepancies and/or omissions.			Order acceptance per Instructions I. A. "Accept Orders & Contracts".
B. Non-Standard No deviation from Quote	Sales Manager approval and recommendations & transmittal of order & complete Prop. Folder to Contract Administration	Contracts Administration analyzes order in terms of Quotation & Sales recommendations and: 1. Where no discrepancy exists forwards order analysis to Mgr-Mktg. Admin. 2. Resolves any discrepancies and/or omissions.			Order acceptance per Instructions I. B. "Accept Orders & Contracts".



<u>ORDERS</u>	<u>SALES TRANSMITTAL</u>	<u>CONTRACTS ADMINISTRATION ANALYSIS</u>	<u>ORDER REVIEW</u>	<u>RESOLUTION OF DEVIATIONS</u>	<u>ACCEPTANCE</u>
I. C. Standard or Non-Standard Deviation from Quote	Sales Manager approval, explanation of deviations, recommendations and transmittal of order & complete Prop. Folder to Contracts Administration	Contracts Administration analyzes order in terms of Quotation & Sales recommendations and: 1. Resolves any discrepancies and/or omissions. 2. Contracts Administration sends Analysis to any Section Manager/ Sub-Section Manager who is affected by a deviation.	3. Affected Manager's review & recommend acceptance or rejection of the deviation-with comments. Gen. Mgr. must review all orders over \$500,000 with deviations.	5. If deviations are resolved with affected Mgrs., order is forwarded to Mgr-Marketing. 6. If deviation cannot be resolved by affected Managers or Sales by customer changing his requirements:	5a. Order acceptance per Instructions I. C. "Accept Orders & Contracts". 6a. Order is referred to Mgr.-Mktg. for resolution & acceptance in accordance with I. C. "Accept Orders & Contracts".



PRODUCT NUMBERING SYSTEM
(as of January 27, 1958)

A formal instruction on product nomenclature is being issued. The following model numbers, in accordance with that instruction, shall be used for Computer Department products that are now in existence or being actively planned.

MODEL NUMBERS - EXISTING PRODUCTS

a. Electronic Data Processing System GE-100 (ERMA)

<u>Description</u>	<u>Model Number</u>
Main Frame	4WC100A1
Console	4WK100A1
Lister	4WL100A1
Input, Output Control and Memory	4WM100A1
Computer Power Supply	4WN100A1
High Speed Printer	4WP100A1
Printer Controller	4WR100A1
Sorter	4WS100A1
Tape Unit and Control	4WT100A1
Character Reader	4WV100A1
Imprinter - Qualification	4WW100A1
Imprinter - Amount	4WW100B1

- Notes:
1. MG Set should be in model list with power supply.
 2. Thyatron should be in model list with printer controller.
 3. Up to 8 tape units with each controller.

For the use of General Electric employees only.



PRODUCTS - GENERAL INFORMATION--
1.001-P2(of 4)

b. Heat Rate Computer - GE 301

<u>Description</u>	<u>Model Number</u>
--------------------	---------------------

Not available at this issue.

c. Tinning Line Data Processing System - GE 302

<u>Description</u>	<u>Model Number</u>
--------------------	---------------------

Central Electronics Cabinet	4WC302A1
-----------------------------	----------

Control Console	4WK302A1
-----------------	----------

Output Console	4WK302B1
----------------	----------

d. Economic Dispatch Computer System - GE 303

<u>Description</u>	<u>Model Number</u>
--------------------	---------------------

Not available at this issue.

e. Electronic Data Processing System - GE 304 (NCR-304)

<u>Description</u>	<u>Model Number</u>
--------------------	---------------------

Main Frame	4WC304A1
------------	----------

Card Reader	4WD304A1
-------------	----------

Card Punch	4WE304A1
------------	----------

Converter Media	4WF304A1
-----------------	----------

Paper Tape Reader	4WG304A1
-------------------	----------

Paper Tape Punch	4WH304A1
------------------	----------

Console	4WK304A1
---------	----------

Memory	4WM304A1
--------	----------

Printer	4WP304A1
---------	----------

For the use of General Electric employees only.



PRODUCTS - GENERAL INFORMATION--
1.001-P3(of 4)

e. (continued)

<u>Description</u>	<u>Model Number</u>
Printer Controller	4WR304A1
Tape Unit	4WT304A1
Tape Controller	4WU304A1

f. Test Data Reduction System - GE 305

<u>Description</u>	<u>Model Number</u>
Input Electronic	4WC305A1
Analog Cabinet	4WC305B1
Transient Cabinet	4WC305C1
Computer	4WC305D1

g. Production Analog Computer - GE 306

Model Number 4WX306A1

h. Small AC Network Analyzer - GE 307

Model Number 4WX307A1

j. Economic Dispatch Computer - GE 308

Model Number 4WX308A1

k. Building Blocks

<u>Description</u>	<u>Model Number</u>
D.C. Operational Amplifier	4WJ5000A1
Stabilizing AC Amplifier	4WJ5001A1
Operational Amplifier Module	4WJ5002A1

For the use of General Electric employees only.



PRODUCTS - GENERAL INFORMATION--
1.001-P4(of 4)

k. (continued)

<u>Description</u>	<u>Model Number</u>
Electronic Multiplier Module	4WJ5003A1
Function Generator Module	4WJ5004A1
Basic Power Supply	4WJ5005A1
Reference Regulator	4WJ5006A1
Automatic Potentiometer Mechanism	4WJ5007A1
Thermocouple Linearizer	4WJ5008A1
Low Level Differential Amplifier	4WJ5009A1
Electronic Switch (or High Speed Commutator)	4WJ5010A1
Analog - Digital Converter Module	4WJ5011A1

For the use of General Electric employees only.



GE 210 System

THE GE 210 SYSTEM

INTRODUCTION

The GE 210 system is a fully integrated, general purpose digital computer system specifically developed for business data processing, and proved in high volume operation at customer sites. Combining the latest and most reliable design techniques and components, the system is fully transistorized, has printed circuit wiring throughout, and utilizes high-speed random-access core memory.

In addition to the usual system ability of handling alpha and numeric data with magnetic tape, 80-column punched cards, paper tape, and printers, the GE 210 system offers magnetic ink character recognition, processing, and printing. For the first time in the history of the computer art, a language common to both man and machine is being used effectively. With General Electric's introduction of both recognition and high speed printing of magnetic ink characters, the full cycle of automatic techniques in computing systems has been achieved.

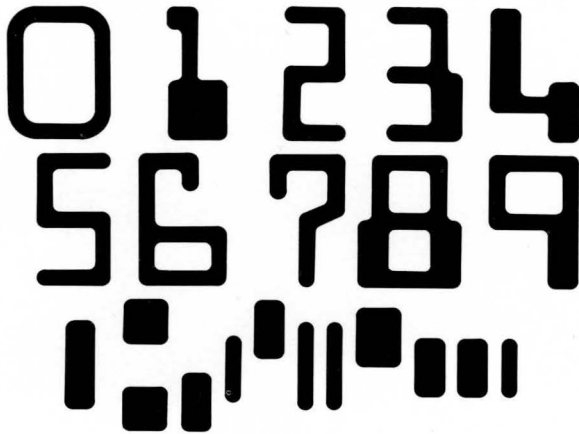

E13B Font

Magnetic ink characters can be printed on or read from original source documents.

Translation of data to a different form, acceptable to data processing equipment, is eliminated.

Error possibility, during translation, due to the human element is eliminated.

Verification, reconciliation and other accounting procedures are simplified since the original source information is the machine-processed document and is in human language rather than in the form of bars, punches, spots or the like.

Magnetic ink characters are not destroyed or obliterated, as far as acceptance by the GE 210 system is concerned, by overprinting, dirt or even by adhesive tape placed over them to repair a torn document.

Magnetic ink characters can be applied to and recognized from many existing documents having varying physical properties.

Documents with magnetic ink printing can be prepared by the GE 210 system as output and the same documents used later as input in further processing.

Accuracy in the 210 system is assured by built-in automatic Modulo 3 checking of data transfer to and from peripheral devices, data transfer within the computer, and arithmetic operations. Moreover, each of these automatic checking features, in the event of error detection, provides either an instantaneous external indication and/or an internal signal which allows program recoverability. A console key prevents undetected operator intervention during processing.

System efficiency is further increased by:

1. An instruction repertoire of broad scope.
2. Extremely fast operation execution times.
3. Simultaneous computation, reading and writing of magnetic tape, reading of cards, punching of paper tape, or printing.
4. A combination of fixed and variable data organization.
5. Many unique features aimed at reducing the complexity of the programming job.

GENERAL DESCRIPTION

The 210 computer is a general purpose, self-checking, highly efficient and compactly designed machine consisting of several integrated units and associated power supply.



Central Processor

The CORE MEMORY consists of 4000 or 8000 28-bit words which provide storage for instructions and data. Each word is individually addressable with random access. Any word can be addressed, transferred to the memory register, and regenerated in its original location in one 32 microsecond cycle. Transfers to and from core memory are in one-word parallel form. Each word is automatically checked for accuracy of its bit configuration as it leaves memory, enters the central processor, or is operated on in the arithmetic unit.

There are eight ARITHMETIC AND CONTROL REGISTERS of significance to programmers and operators. These are designated as the N, B, R, L, P, M, J and I registers and are discussed more fully in a later section.

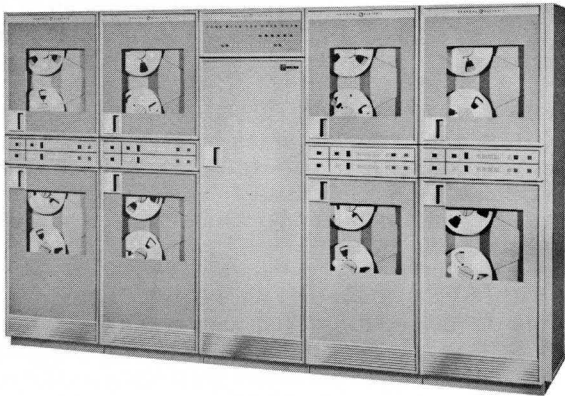

Magnetic Tape System

The TAPE CONTROLLER permits the use of as many as thirteen tape transports on-line with the computer, and controls the reading from and writing to these transports.

The TAPE TRANSPORTS provide for handling of magnetic tapes on-line under the control of the tape controller or off-line with the printers.

The CONSOLE provides for external communication with and control over the operation of the computer and related on-line equipment. The console includes:

1. Direct control via console switches and buttons.
2. Indirect control via the console typewriter, which provides a printed record of all control operations.
3. Indicator panel for contents display of pertinent registers.
4. Indicator lights showing status of various on-line peripheral devices.
5. Alert condition indicators.
6. Power controls.

The CONSOLE TYPEWRITER is an on-line input, output and control device. It is similar to an ordinary electric typewriter, but with additional functions included to allow direct control of the computer and produce an output of "hard copy". It operates under program control with both input and output buffered to allow simultaneous internal computation, read, and write magnetic tape.

The PAPER TAPE PHOTOREADER is an on-line input device available in two models. Each reads paper



Control Console

tape under program control. Rates are 200 or 500 characters per second. Input from the photoreader is buffered to allow simultaneous computation, read and write magnetic tape.

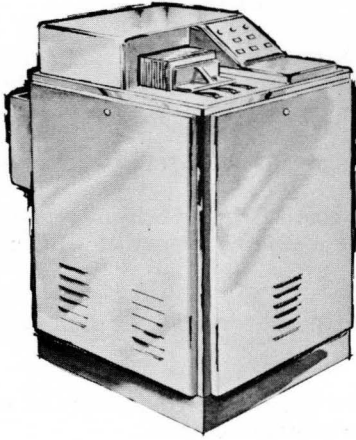

Card Reader

The CARD READER is an on-line input device which reads 80 column punched cards. It is available in two models: 400 cards per minute or 1500 cards per minute. Input is buffered to allow simultaneous computation, write magnetic tape, or print.

The DOCUMENT READER/HANDLER is an on-line input/output device which reads paper documents printed with E13B font and magnetic ink. It is avail-

able in two models: a 12-pocket DOCUMENT HANDLER with a speed of 750 documents per minute and a 2-pocket DOCUMENT READER with a speed of 1200 10-inch documents per minute. Both devices are buffered to allow simultaneous computation and magnetic tape write. Both devices are capable not only of sending data to the computer but also of receiving signals from the computer for allocating documents to specified pockets.

The 72-COLUMN PRINTER is an on-line output device which prints alpha or numeric data at rates of 600 (alpha) or 1200 (numeric) lines per minute under program control.

The PAPER TAPE PUNCH is an on-line output device which punches seven channel paper tape at the rate of 60 characters per second under program control.

The COMPUTER-EDITED HIGH SPEED PRINTER is an on or off-line output device which prints up to 120 positions per line. Printing rate is 1000 lines per minute, alpha or numeric.

The SELF-EDITING HIGH SPEED PRINTER is an on or off-line output device which prints up to 120 positions per line. Alpha rate is 600 lines per minute; numeric rate is 900. Control flexibility is increased by use of special printer command characters within the original information.

The HIGH SPEED RE-ENTRY PRINTER is an on or off-line output device which prints standard Gothic characters and, in addition, prints lines of E13B type font. Standard Gothic character printing is at the rate of 1000 lines per minute; E13B character printing is at the minimum rate of 300 lines per minute.

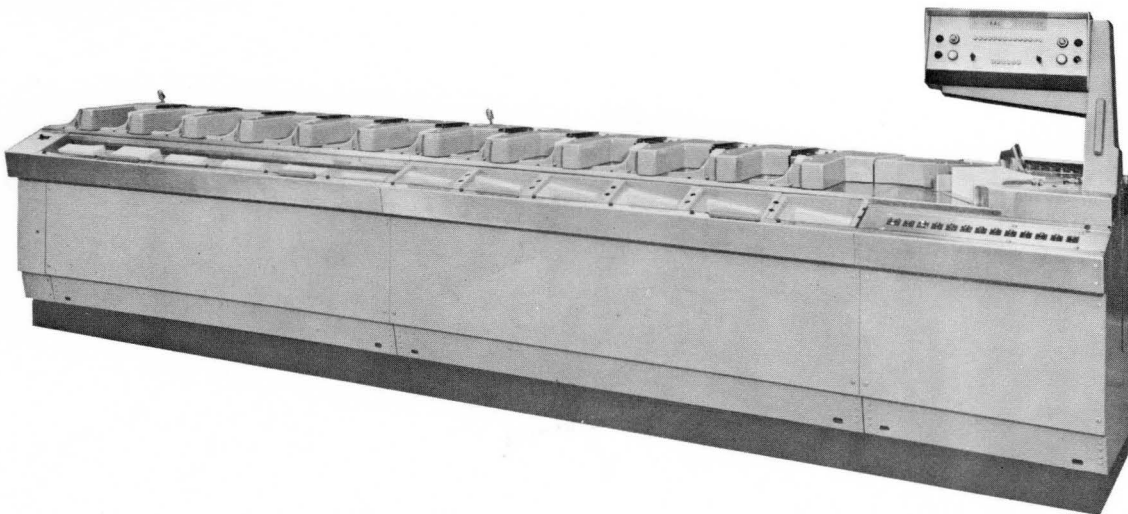

Twelve-pocket Document Handler

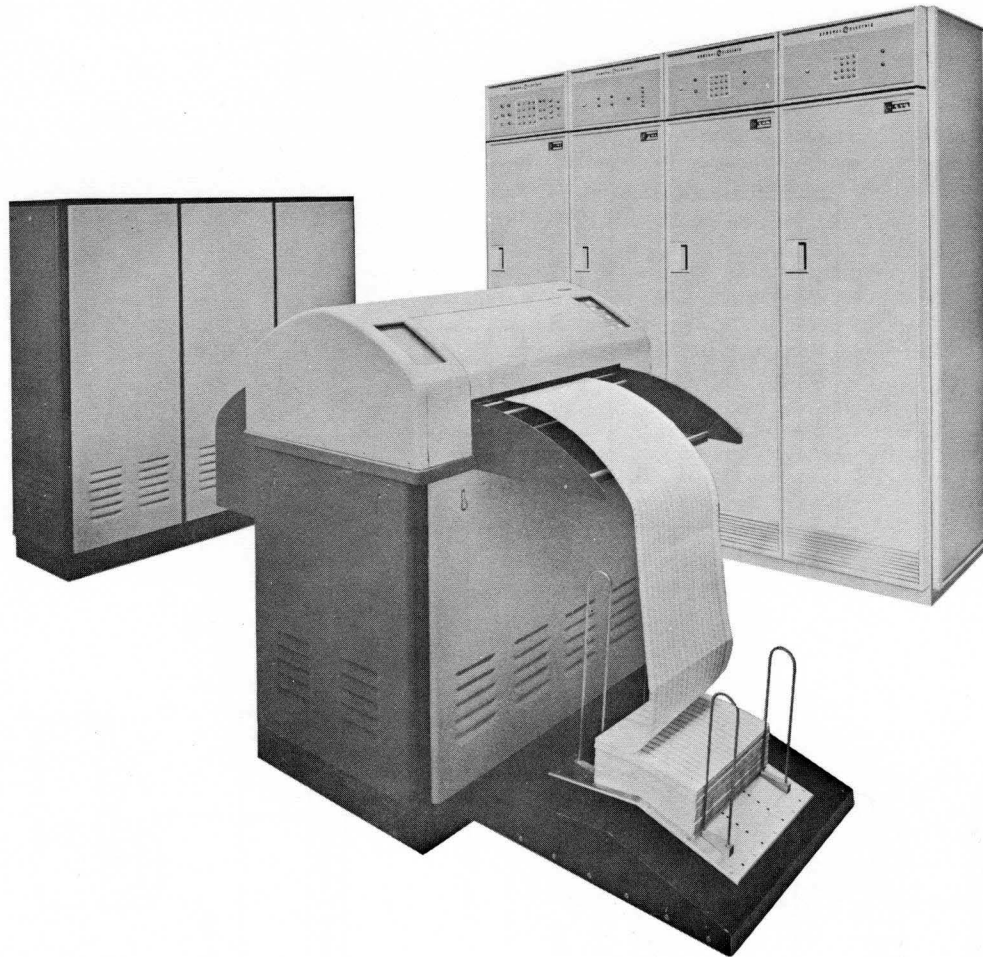

Self-editing Printer

GE-210 SYSTEM: SUMMARY OF PERIPHERAL EQUIPMENT SPEEDS

ON LINE:

INPUT:

MAGNETIC TAPE	30 or 50 KC
MAGNETIC DOCUMENTS	750 or 1200 documents per minute
PAPER TAPE	200 or 500 characters per second
CARDS	400 or 1500 cards per minute
CONSOLE TYPEWRITER	10 characters per second

OUTPUT:

MAGNETIC TAPE	30 or 50 KC
MAGNETIC DOCUMENTS (SEGREGATION)	750 or 1200 documents per minute
PAPER TAPE	60 characters per second
CONSOLE TYPEWRITER	10 characters per second

HIGH SPEED PRINTING:

72 column	600 (alpha), 1200 (numeric) lines per minute
120 column	600 to 1000 lines per minute

OFF LINE:

HIGH SPEED PRINTING (from MAGNETIC TAPE):

120 column	600 to 1000 lines per minute
E13B Magnetic font	300 lines per minute
MAGNETIC DOCUMENT SORTING	750 documents per minute

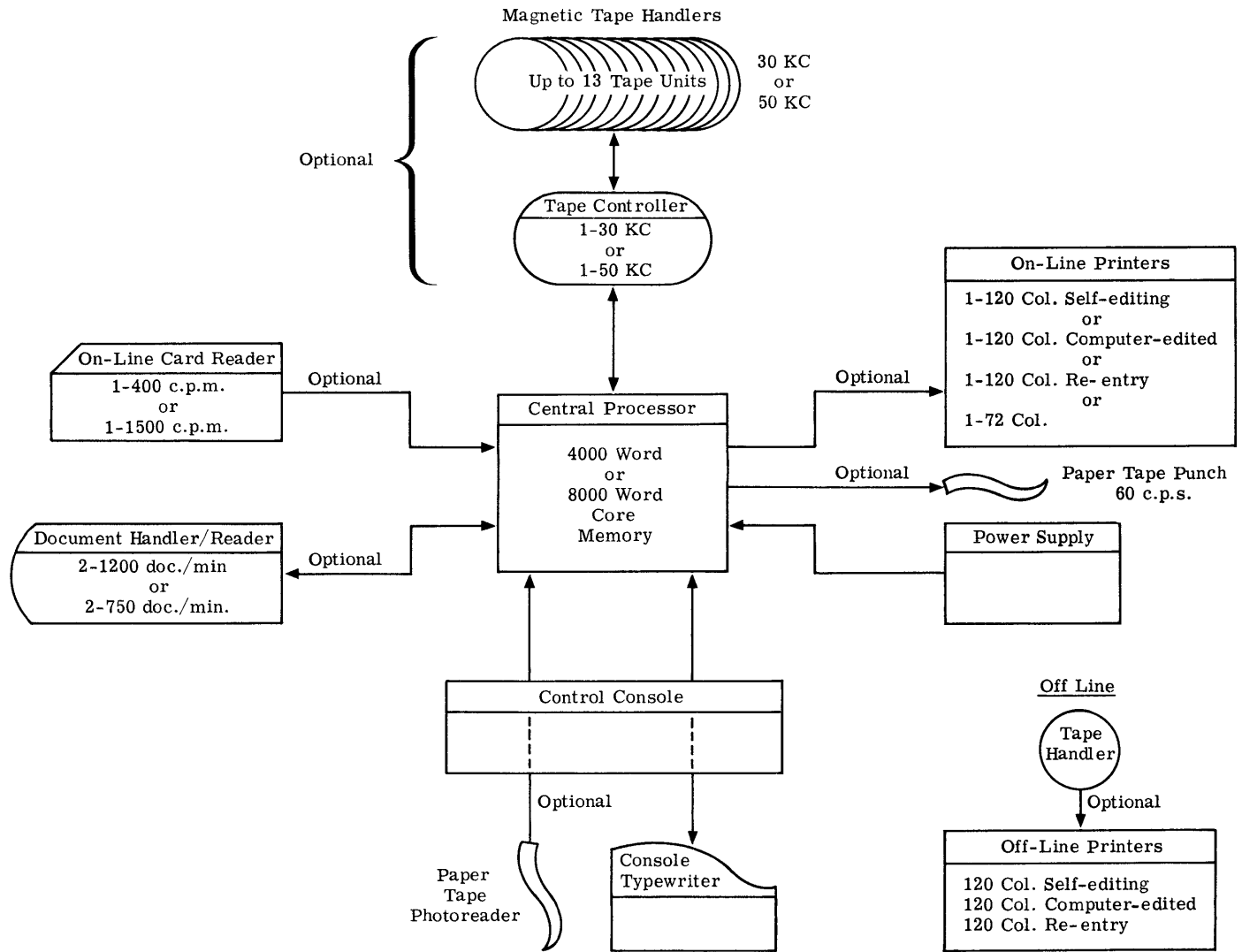

GE 210 System Components

REPRESENTATION OF INFORMATION

The GE 210 relies upon a binary coded decimal numbering system for representation of information. A four-bit code is used to represent each of the ten decimal digits plus five additional special characters. Two numeric characters are utilized to represent an alphabetic character.

Information is stored in the GE 210 memory in increments called WORDS. Each word consists of seven digit positions or 28 bits. Six of the digit positions represent data, while the seventh is reserved for indicators of special significance. A word, therefore, may consist of six numeric characters or three alphabetic characters. A word is identifiable as being numeric or alphabetic by the condition of two of the four bits in the seventh digit position.

A GE 210 word, in review, appears as follows:

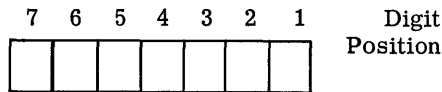

The bit configuration can be illustrated as follows:

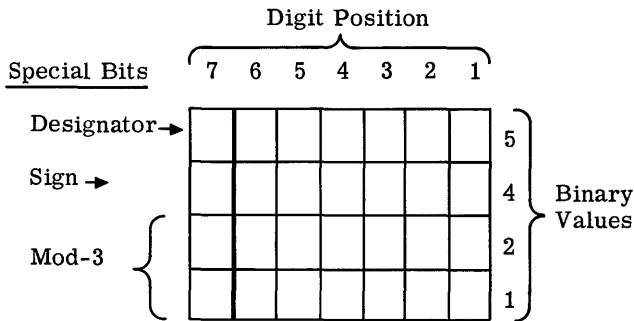

Externally, all data is prepared without regard to details of bit configuration. For example, the number 136742 is introduced into the computer and conversion of the number to its 5-4-2-1 binary value is accomplished automatically. To further understand the information representation, this is how the number 136742 would appear inside the computer.

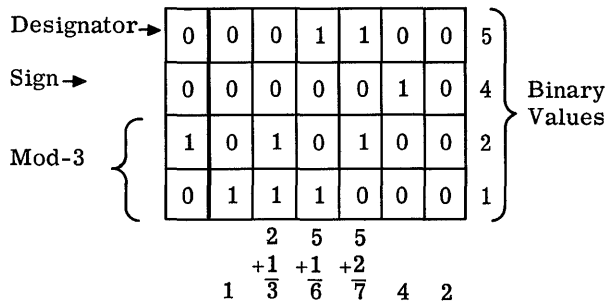

The seventh digit position of the 210 word contains four bits just as do the other six digit positions. In the seventh position, however, the bits have special significance:

The five-bit is known as the DESIGNATOR BIT. The condition of this bit has special meaning in instruction words as explained later; in data words it may be utilized as a "flag" or special indicator.

The four-bit is the SIGN BIT and is used to indicate the algebraic sign, plus (0) or minus (1), of numeric data words. In instruction words it has special significance when used with certain commands.

The two and one bits are known as the MOD-3-BITS. These serve three functions:

1. They are used as an automatic checking device to insure that all numeric words are read correctly and that no bits have been lost or added as data is moved around within the computer. The mod-3 bits are set automatically by the computer to show either 0(00), 1(01), or 2(10).
2. They are used to verify the accuracy of arithmetic and other internal operations.
3. They are used to indicate that a word of information is alphabetic, in which case both mod-3 bits are automatically set to 3(11) by the computer.

An INSTRUCTION WORD, in the 210, is always numeric. The operation code is located in digit positions 6 and 5; the operand address is located in digit positions four through one.

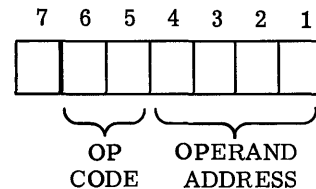

The GE 210 is a single address system. As such, each digit position of an instruction word is utilized fully in an extremely high percentage of commands.

A DATA WORD, in the 210, may be numeric or alphabetic. It is of the same word length as an instruction word: 28 bits. In business data processing, most fields of data to be processed can be represented in six digit positions (SINGLE PRECISION) or less; some fields, however, will exceed six digits. The GE 210 has the ability to represent AND OPERATE UPON a field of information of 12 digit positions or two data words at a time. This is known as a DOUBLE PRECISION representation and operation. Special operation codes are incorporated in the computer to achieve single or double precision modes of operation, at the option of the programmer.

DATA STORAGE

Data storage in the GE 210 system is based on fixed word and fixed block length. As mentioned previously, a word consists of seven digit positions, of which the seventh is reserved for special purposes. A block consists of one hundred words.

Within the fixed word and block length, variability of field can be achieved by packing of words and by use of one or two of the seventh digit position bits as flags. The "variable within fixed" concept of the 210 system combines the best features of a fixed length approach with the important advantages of a variable concept.

The fixed length method does not require use of extra characters as control symbols; it does not require the allocation of more memory as an input area than may

be needed. It does simplify design of files and actual programming, and it does provide simple program recoverability in the event of magnetic tape errors. Variability, within the fixed concept, is provided by inclusion of operation codes and special programming features in the 210 system which permit testing of fields within packed words without the necessity of unpacking, and which remove the usual "fixed" restrictions on spreading fields over multiple words or blocks.

The selection of the "variable within fixed" concept for the GE 210 system is thus based on achieving the most efficient method of data storage and processing, not only from the point of view of magnetic tape space saving but also in the balanced best interests of memory allocation, ease of application design, and programming simplification.

FUNCTIONAL DESCRIPTION - COMPUTER



Memory Unit

MAGNETIC CORE MEMORY

The MEMORY of the GE 210 system is made up of magnetic cores. One magnetic core is required to represent each bit. With a 4000 word memory there are 112,000 cores; with an 8000 word memory, 224,000 cores. Either memory size is available.

Access time, including restoration, is 32 microseconds per word. Single precision word transfers from or to memory require a total of 64 microseconds; double precision word transfers require a total of 96 microseconds. Transfers to and from memory are made in one-word parallel form. Addressability is by word.

Internal checking is by Modulo-3 on all words as they leave memory, enter the central processor, or are operated on in the arithmetic unit. The Modulo-3 method automatically sums the value of the bits (24) representing digit positions one through six, divides the sum by 3, and compares the remainder for equality with the value of the Mod-3 bits in the seventh digit position. In arithmetic operations, the Mod-3 bits of the components of the operation are automatically checked with the generated Mod-3 bits of the result of the operation. Any Mod-3 error causes an instantaneous halt in processing.

ARITHMETIC AND CONTROL REGISTERS

There are eight significant arithmetic and control registers in programming and operating the 210 system.

1. N Register

A four digit (16 bit) register which contains the location in memory of the instruction following the one currently being executed. Instructions are taken by the computer from sequential memory locations unless otherwise directed by the program. N can shift right or transfer information serially to the B register. N accepts information from or transmits information to the address portion of the I register in parallel.

2. M Register

A one word (28 bit) register which receives all data coming from or going to the memory. It is capable of transmitting its contents in parallel to the J register and to the tape write buffer, and of receiving data in parallel from the R register, the P register and the tape read buffer.

3. J Register

A one word (28 bit) register which receives all information coming from memory. It acts as a buffer and a distribution point from which information is directed to other registers and components of the central processor as indicated by the operation being executed. It holds the addend in addition, the subtrahend in subtraction, the divisor in division, and the multiplier in multiplication. It holds the memory operand during comparison instructions. The J register can shift right, transmit data in parallel to the I register, or transfer data serially to either the arithmetic unit or to the R, L and P registers.

4. I Register

A six digit register which contains the current instruction being executed. The left two digits (sometimes referred to as the C register) contain the operation code; the right four digits contain the operand address (and are sometimes referred to as the A register).

5. R Register

A one word (28 bit) register which serves as the accumulator for the central processor and fulfills the following requirements.

- a. Holds the augend during addition.
- b. Holds the minuend during subtraction.
- c. Holds the multiplier during multiplication.

- d. Holds the least significant half of the dividend during division.
- e. Holds the result after addition or subtraction.
- f. Holds the most significant half of the product after multiplication.
- g. Holds the remainder after division.
- h. Holds the least significant half of all double precision words.
- i. Holds one operand during certain instructions where this is required.

The R register can shift right, either open-end or ring fashion. It may transfer its contents serially or transmit its contents in parallel. Data is accepted by R in a serial mode.

6. L Register

A one word (28 bit) register which is used primarily in conjunction with the R register to form a twelve digit accumulator. During all double precision instructions, L contains the most significant half of one operand. It holds the least significant half of the product upon the completion of multiplication. L contains the most significant half of the dividend during division and the quotient with its sign upon completion of division. L may be shifted right open-ended

or ring in conjunction with R. L accepts and transmits data serially.

7. B Register

A four digit (16 bit) register whose digits correspond to the address portion of an instruction. If the sign bit of the instruction in the I register is on (negative), the contents of the B register are added absolutely to the address portion of the instruction in the I register before it is executed. Possible overflow into digit 5 of the instruction is ignored.

8. P Register

A six digit (24 bit) buffer register used for all word transfers between the central computer and the console typewriter, paper tape photoreader and the paper tape punch.

TIME SHARING

The GE 210 system is designed to time share many functions. Time sharing is, briefly, the logically designed ability of the system to do more than one thing at a given time. Time sharing is automatic and is achieved through an interruption technique and the use of buffering.

This feature of the 210 system permits the following time-shared (simultaneous) operations:

Time Shared Simultaneous Operations

	Read	Write	Other
Compute	Documents	Mag. tape	Read paper tape
Compute	Documents	Mag. tape	Type in
Compute	Documents	Mag. tape	Type out
Compute	Documents	Mag. tape	Punch paper tape
Compute	Documents	72 or 120 col. print	Read paper tape
Compute	Documents	72 or 120 col. print	Type in
Compute	Documents	72 or 120 col. print	Type out
Compute	Documents	72 or 120 col. print	Punch paper tape
Compute	Mag. tape	Mag. tape	Read paper tape
Compute	Mag. tape	Mag. tape	Type in
Compute	Mag. tape	Mag. tape	Type out
Compute	Mag. tape	Mag. tape	Punch paper tape
Compute	Mag. tape	120 col. print	Read paper tape
Compute	Mag. tape	120 col. print	Type in

Time Shared Simultaneous Operations (Continued)

	Read	Write	Other
Compute	Mag. tape	120 col. print	Type out
Compute	Mag. tape	120 col. print	Punch paper tape
Compute	Cards	Mag. tape	Read paper tape
Compute	Cards	Mag. tape	Type in
Compute	Cards	Mag. tape	Type out
Compute	Cards	Mag. tape	Punch paper tape
Compute	Cards	72 or 120 col. print	Read paper tape
Compute	Cards	72 or 120 col. print	Type in
Compute	Cards	72 or 120 col. print	Type out
Compute	Cards	72 or 120 col. print	Punch paper tape

During all time-shared combinations, any number of tape rewinds may also be executed.

It is important to note that achievement of any of the possible combinations of time-shared operations re-

quires no special operation codes or programming. Simultaneity is accomplished through hardware design and takes no additional time in the majority of instances. In general, time sharing of operations will not increase operating time by more than about 15%.

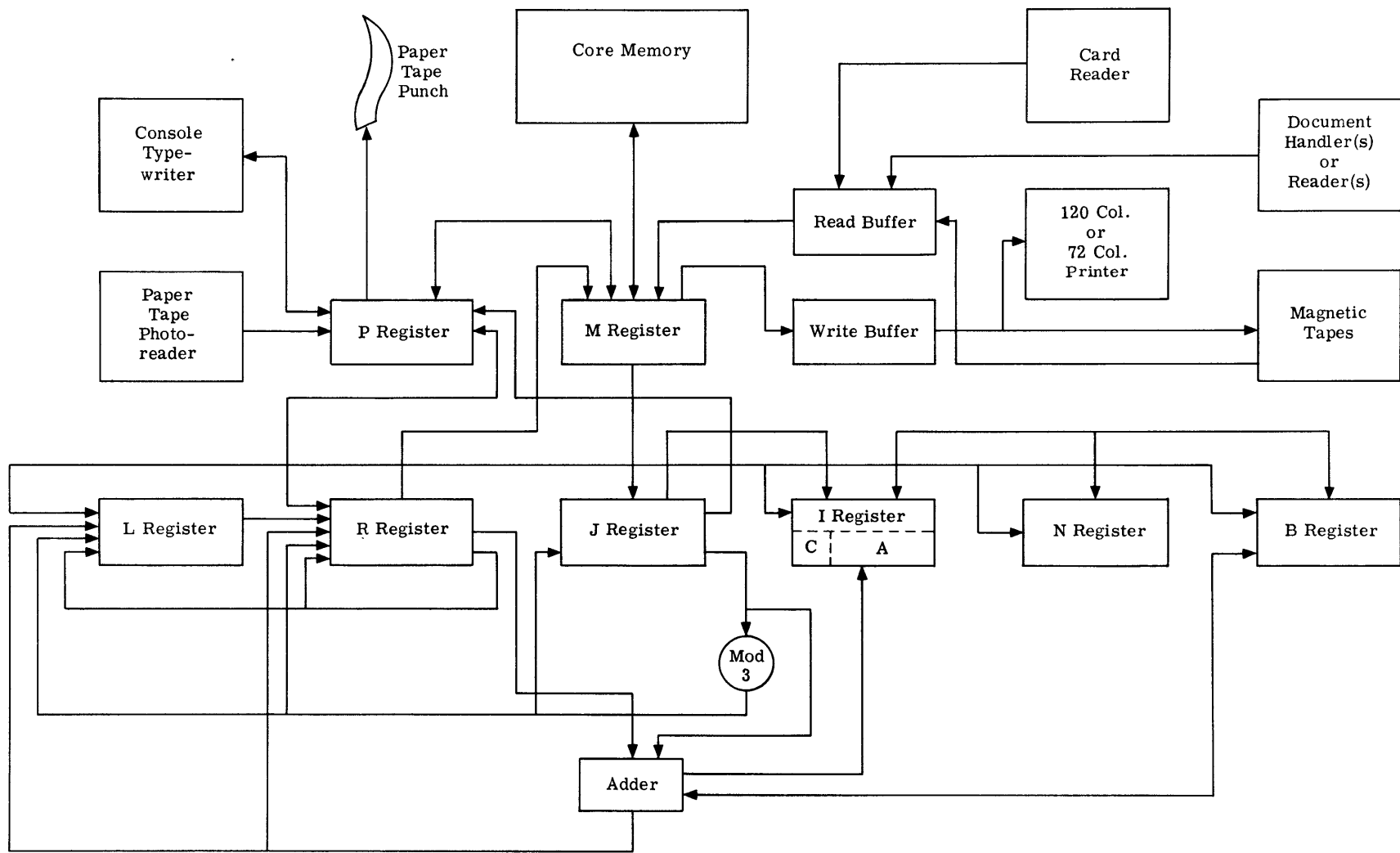

Schematic Diagram of Register Relationships

FUNCTIONAL DESCRIPTION - PERIPHERAL EQUIPMENT

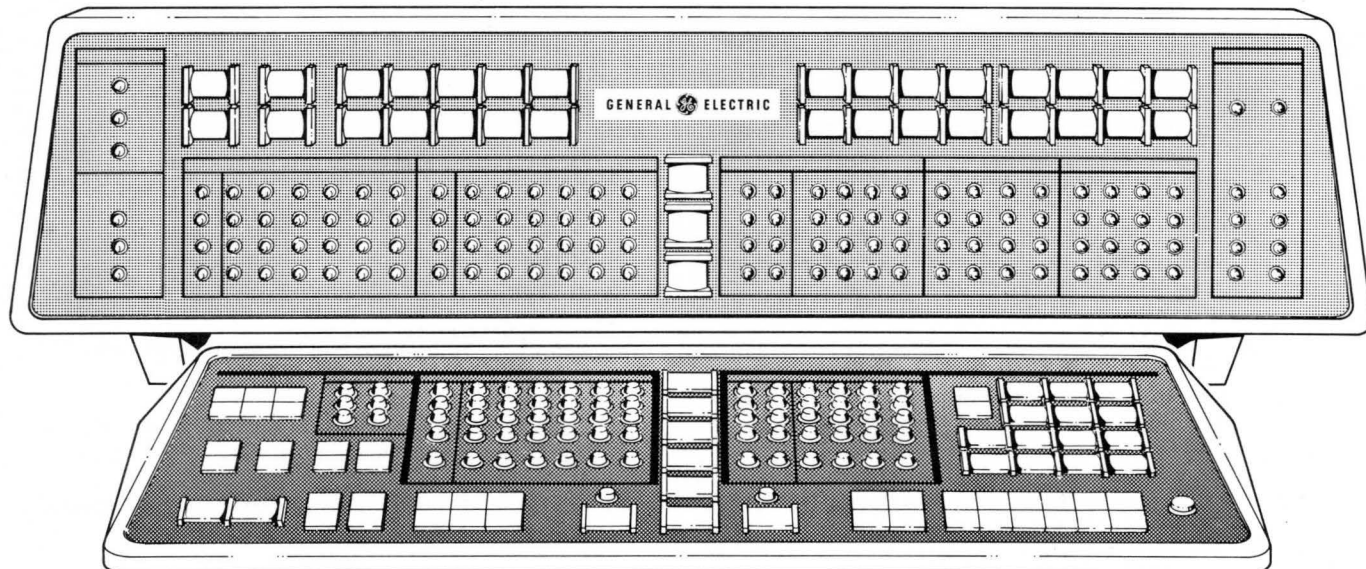

Console Panel

CONTROL CONSOLE

The primary function of the control console is to provide an indicating control center for the computer operator, from which he has visual representation and manual control of operation of the system.

The upper panel on the control console is the indicator panel; below this is the control panel. On the right extension of the desk is the console typewriter. The paper tape photoreader (optional) is housed in the lower left side of the desk.

A. Control Key Modes

1. Direct

Console switches directly control the operation of the computer.

2. Locked

The computer is controlled only through the console typewriter, which provides a printed record of all external control operations.

B. Indicator Panel

1. Neon indicators for contents display of the following registers:

a. L Register

b. R Register

c. I Register

d. N Register

e. B Register

2. Indicator lights for condition display of the console typewriter and its input-output buffer.

a. A light which indicates that information is being requested from the typewriter.

b. A light which indicates that the P register is full.

c. A light which signifies the type of information - alpha or numeric - being requested or transmitted.

d. A light which indicates that a single precision numeric word is being requested or sent out.

e. Lights which denote that either first or second half of a double precision word is being requested or sent out.

3. Not Ready Indicators

These lights indicate that one or more conditions exist in designated on-line devices making them unready for operation.

4. Normal - Idle - Alert Indicators

These lights show the status of the operation of the central processor.

5. Alert sub-indicators

- a. The ARITH (arithmetic) light, when on, indicates that a Mod-3 check on the adder output failed; or that a non-numeric character entered or left the arithmetic unit.
- b. The INST (instruction) light, when on, indicates that the I register does not contain a legitimate instruction.
- c. The MEMORY light, when on, indicates that the word just picked up from memory did not pass the Mod-3 check; or that the word contained an illegal character.
- d. The MEMORY TAPE light, when on with the memory light, indicates that the alerting (invalid) word was picked up from memory during a time shared output order.
- e. The CONSOLE PARITY light, when on, indicates that an input from the console typewriter or the paper tape photoreader failed the parity check.
- f. The READ TAPE and WRITE TAPE lights, when on, indicate a parity check failure during magnetic tape read or write operations.
- g. The DISABLED TAPE light, when on, indicates that the magnetic tape unit addressed is disabled due to no tape on transport, write attempt with write inhibit switch on, or mechanical problems with the transport.
- h. The BLOCK MARKER light, when on, indicates that block markers on magnetic tape are out of sequence.
- i. The POCKET DECISION light, when on, indicates that a document handler/reader pocket decision was made late, or was not made.

6. Multiplex Indicators

a. Sorter-Printer-Card Reader

The lights indicate when each of the specified devices is operating and on-line.

b. Read Busy - Write Busy

These lights indicate that a read or write instruction to magnetic tape is in progress.

c. Last Read - Last Write

These lights denote the tape unit or peripheral device from which information was last read or to which information was last written.

7. Decision and Flip-Flop Indicators

These lights show the current condition of six vital program controlled condition indicators, for example, the overflow flip-flop.

C. Control Panel

1. The SET and RESET buttons control the decision and overflow indicators.
2. The R REGISTER Control buttons allow manual insertion of information into R.
3. The I REGISTER Control buttons permit manual insertion of instructions into I.
4. The BRANCH HALT switch, when on, causes a halt after completion of each BD1 branch instruction.
5. The six manual PROGRAM DECISION switches can be interrogated for off-on condition by the program and depending upon the condition, appropriate programmed options may be taken.
6. The ADDRESS HALT buttons permit the setting up of any fixed memory address. When "ON" is depressed the computer halts on all references to the specified address and/or when that address is contained in the N register.

7. Card Reader Control

- a. A LOAD MEMORY switch provides sequential storing of successive words from the card reader input into core memory starting with the address specified in the I register.

8. Console Typewriter Controls

- a. A LOAD MEMORY switch provides sequential storing of successive words from the console typewriter input into core memory starting with the address specified in the I register. This Load Memory Switch is also used with the paper tape photoreader.

b. ALPH STORE switch

This switch determines the internal reaction of paper tape put-away characters.

c. INHIBIT TYPE switch

This switch determines whether programmed type-outs are made or ignored.

d. MEMORY DUMP switch

This switch, when on, causes consecutive words to be typed out of the core memory.

9. Power Controls

a. Power "on" light.

b. Emergency power "off" light.

c. Key lock "on" or "off"

If the key is on, the control panel becomes operative; if off, the majority of control panel functions are inoperable and control functions must be executed via the console typewriter.

10. Operation Controls

a. COMPUTE switch

This switch, when pushed, puts the computer into continuous operation state.

b. HALT switch

This switch, when pushed, causes the computer to cease operation and idle.

c. SINGLE CYCLE switch

This switch, when pushed, causes the computer to execute one instruction and return to idle state.

11. ALERT OVERRIDE switch

This switch, when depressed, causes the computer to ignore conditions which would normally cause an "alert".

12. RE-CYCLE MEMORY switch

This switch, when on, causes the computer to repeat the instruction in the I register.

13. CLEAR switch

a. EXT CLEAR (External)

This switch, when depressed, causes all on-line peripheral equipment to reset their input-output buffers to an initial state.

b. CONSOLE CLEAR

This switch, when depressed, causes the console typewriter to cease operating and resets its related buffer to an initial state.

c. COMPUTER CLEAR

This switch, when depressed, resets all registers to zero.

d. ALERT CLEAR

This switch, when depressed, resets all alert flip-flops.

e. TOTAL CLEAR

This switch, when depressed, causes a, b, c and d above simultaneously.

14. Paper tape PHOTOREADER switch turns the photoreader on or off. When on, the photoreader is ready to read paper tape on command from the computer program or in conjunction with console typewriter load memory switch.

D. Audio Signals

1. TWO BELLS

These signals are addressable by program; one rings and the other gongs.

2. RELEASE BELL

This switch, when depressed, turns off the above bells.

3. IDLE BUZZER

This buzzer is operative when the computer is in an idle state, unless turned off by the IDLE BUZZER "off" switch.

CONSOLE TYPEWRITER

The console typewriter is located on the right "arm" of the control console desk. It is used in much the same manner as a standard electric typewriter. The key board is similar, though not identical, to that of a standard typewriter. Type faces are equipped with both upper and lower case letters, although both are not normally used in operation of the device. The carriage moves from right to left and, at the full extent of its travel or at a preset point, automatically returns to start a new line.

Several of the keys have dual functions and are distinguished by the use of contrasting colors.

The console typewriter has two modes of operation which are governed by the use of a power switch located on the frame to the right of the key board. This switch has three positions: OFF, COMPUTER IN, COMPUTER OUT.

In the "OFF" position the console typewriter is totally inoperative.

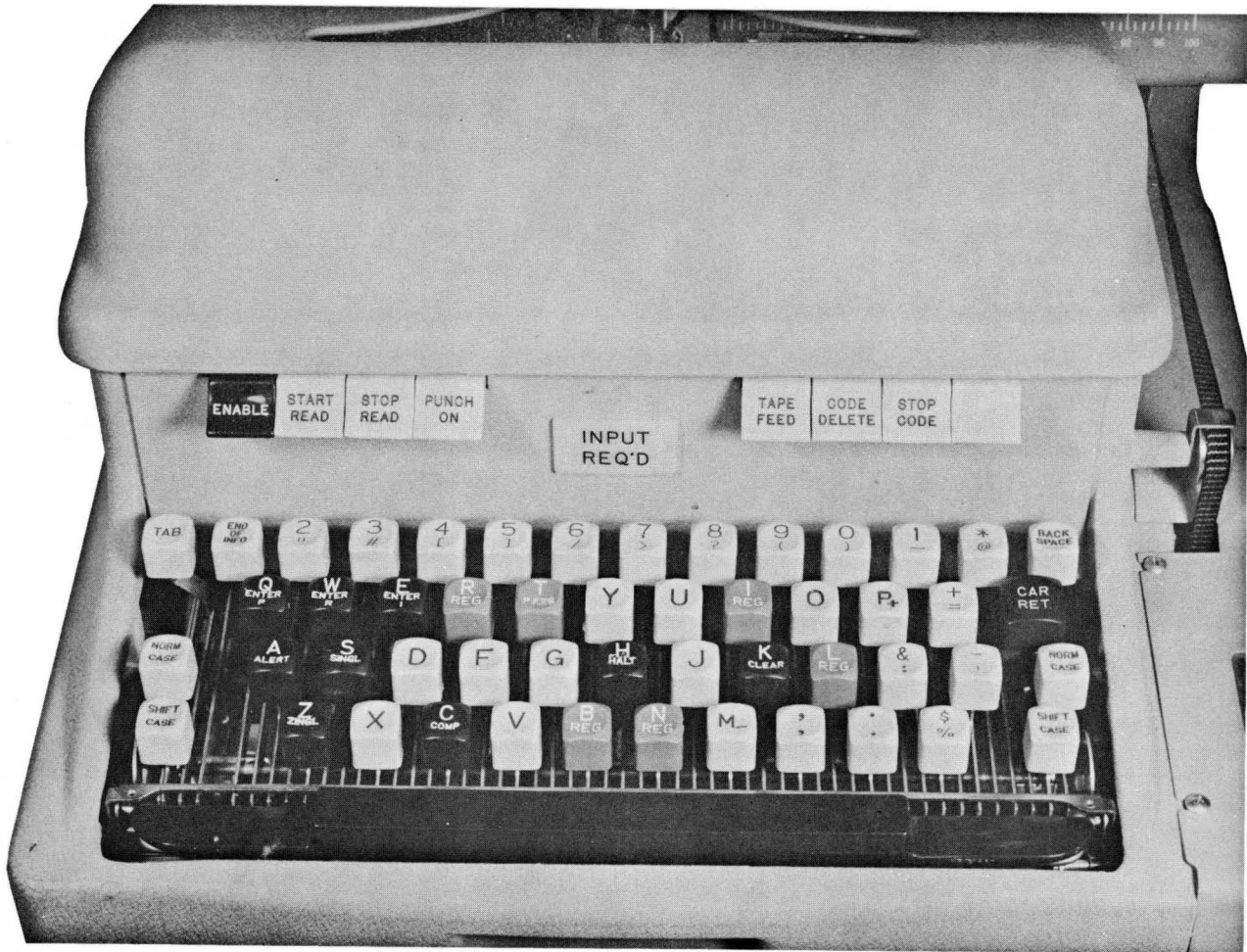

Typewriter Keyboard

In the "COMPUTER IN" mode, the console typewriter is connected to the computer and may:

1. Control operation of the computer.
2. Feed data into the computer, under program or manual control via manual type in.
3. Accept output from the computer as typed copy.

In the "COMPUTER IN" mode, the data going into memory from the console typewriter keyboard has the appropriate Mod-3 bits added automatically.

A one-word buffer, called the P buffer, is utilized for all console typewriter input and output. Speed of loading the P register is a function of typing speed. Sixty-four microseconds are required to transfer the buffer contents to memory.

In the "COMPUTER OUT" mode the console typewriter acts independently of the computer and does

not affect its operation. In this mode, notations may be typed on the hard copy.

The console typewriter types out at the rate of 10 characters per seconds.

PAPER TAPE PHOTOREADER

The paper tape photoreader provides a rapid means of entering punched paper tape into the computer memory. It is available, as optional equipment, for the 210 system. There are two models, with rated speeds of either 200 or 500 characters per second.

Seven-channel paper tape is used with the GE 210 code. 96,000 characters may be represented on one 800 foot roll of tape.

The photoreader consists of two spoolers and one high speed photoelectric character reader positioned centrally above the spoolers. Guide switches and take-up arms are provided for rapid rewind.

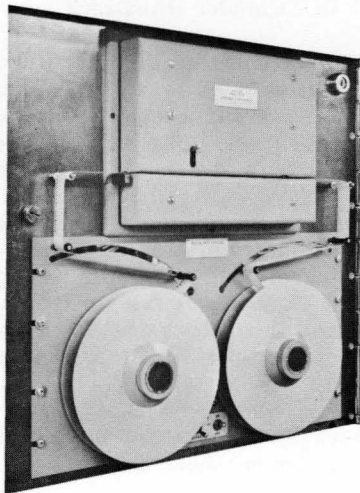

Paper Tape Photo Reader

Reading of punched paper tape through the photoreader is under program control or the Load Memory feature. The photoreader switch, located on the control console, must be "ON" for operation of the device.

Mod-3 bits are automatically added to words going from the photoreader to memory. Parity is then checked and any error causes paper tape feed to stop.

A one word buffer, called the P buffer, is utilized for transfer of data from the photoreader to the memory. At 200 characters per second, approximately thirty-two milliseconds are required to load the buffer from tape; 64 microseconds to transfer the buffer contents to memory; and approximately 30 milliseconds remain before the next word is available from tape. Computation may proceed while the buffer is loading.

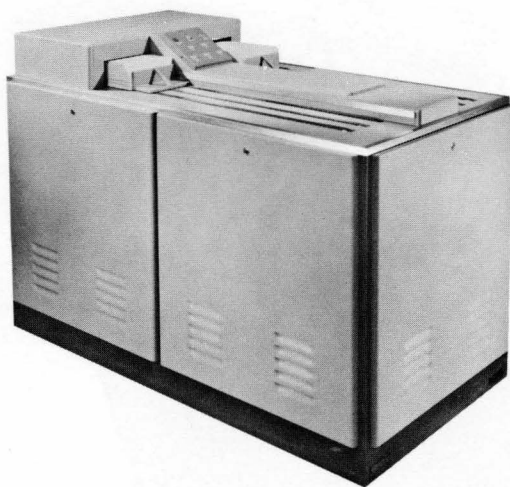

Card Reader

CARD READER

Either 400 or 1500 card-per-minute readers are available as optional on-line input equipment for the 210 system. Both devices are serially fed and read the cards column by column. Card feed is under program control and may be continuous or card-by-card.

Standard 7 3/8 " x 3 1/4 " , 80 column, 12 row cards are accepted as input. Checking features provided in the card reader electronics include code conversion, code parity, card column and row synchronization, and slipping error detection.

Data rearrangement is achieved through program and/or plugboard control. Plugboard control is simple and extremely flexible. Fields are assigned as numeric or alpha; each field becomes one word in memory, "padded" or filled automatically if the field is less than a word of characters. Illegal punches or characters are identified on conversion by an error indication in the resulting memory word.

Table of Equivalent Characters:
80-Column Card and GE 210

Card Character	Row Punches	GE 210 Character	Binary 5-4-2-1 Code	
0	0	0	0000	
1	1	1	0001	
2	2	2	0010	
3	3	3	0011	
4	4	4	0100	
5	5	5	1000	
6	6	6	1001	
7	7	7	1010	
8	8	8	1011	
9	9	9	1100	
A	12-1	A	0001	0001
B	12-2	B	0001	0010
C	12-3	C	0001	0011
D	12-4	D	0001	0100
E	12-5	E	0001	1000
F	12-6	F	0001	1001
G	12-7	G	0001	1010
H	12-8	H	0001	1011
I	12-9	I	0001	1100
J	11-1	J	0010	0001
K	11-2	K	0010	0010
L	11-3	L	0010	0011
M	11-4	M	0010	0100
N	11-5	N	0010	1000
O	11-6	O	0010	1001
P	11-7	P	0010	1010
Q	11-8	Q	0010	1011
R	11-9	R	0010	1100
S	0-2	S	0011	0010
T	0-3	T	0011	0011
U	0-4	U	0011	0100
V	0-5	V	0011	1000
W	0-6	W	0011	1001
X	0-7	X	0011	1010
Y	0-8	Y	0011	1011

Table of Equivalent Characters:
80-Column Card and GE 210

Card Character	Row Punches	GE 210 Character	Binary 5-4-2-1 Code	
Z	0-9	Z	0011	1100
&	12	&		0111
.	12-3-8	.		1101
□	12-4-8	ignore	0001	0111
-	11	-	0010	1110
\$	11-3-8	\$		0101
*	11-4-8	*		1110
/	0-1	/	0011	0001
,	0-3-8	,		0110
%	0-4-8	%	0001	0101
#	3-8	#	0001	0110
@	4-8	@	0011	1101
space	no punch	0 (numeric)		0000
		or		or
		space (alpha)	0001	0000

12-POCKET DOCUMENT HANDLER

The 12-pocket document handler is a key input device of the GE 210 system. It is capable of reading the 10 Arabic numerals and four special characters (referred to as "cue" characters) of the E13B type font which are printed on documents in magnetic ink.

The document handler operates at 750 documents per minute. Two handlers may be controlled by the computer (multiplexed) on-line simultaneously to achieve an input speed of 1500 documents per minute. Off-line, any number of handlers may be utilized with each handler under the control of its own manual control panel.

Stringent checking features are included in the document handler. Among these are:

1. Complete jam detection and prevention devices which automatically stop the feeding of docu-

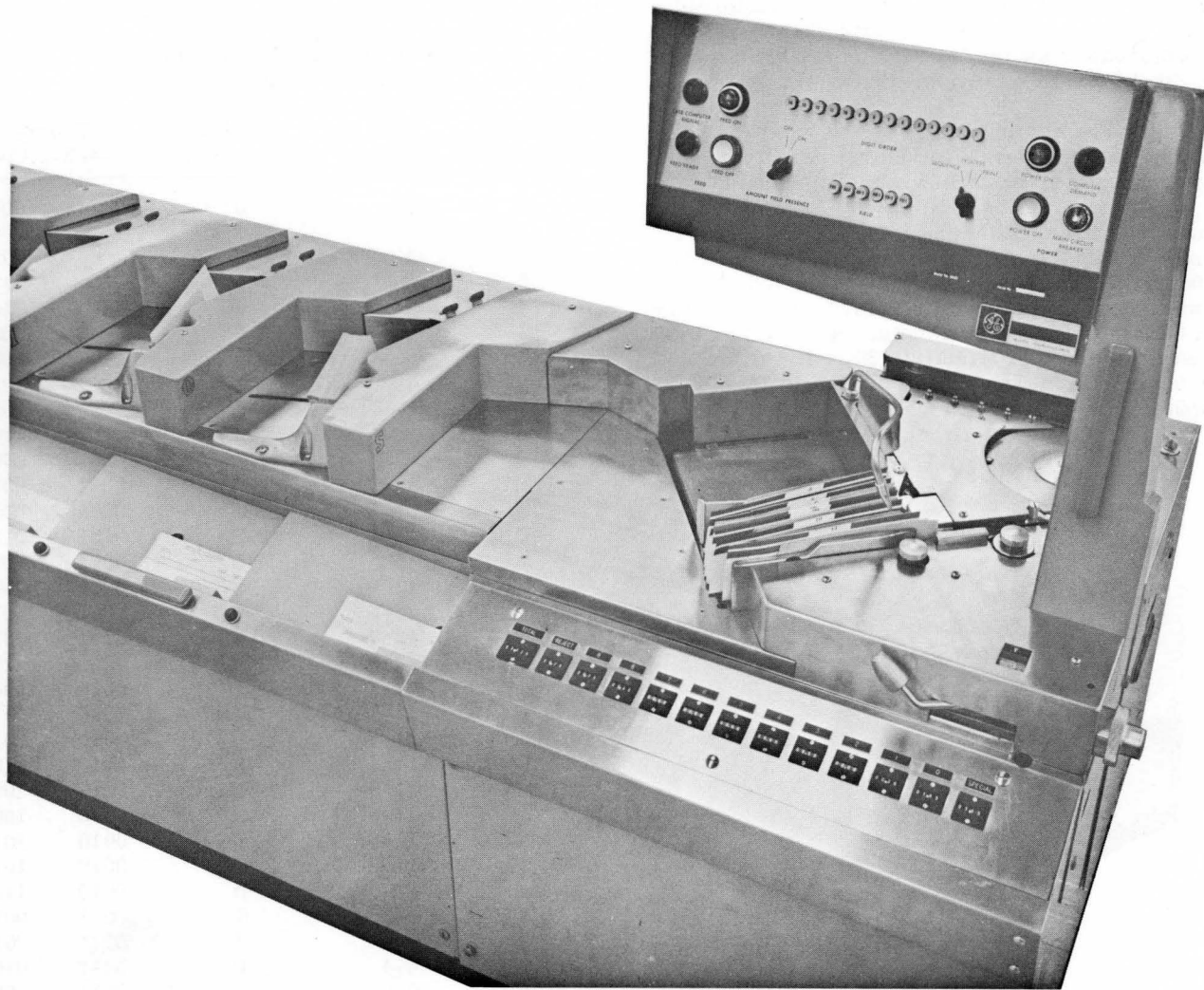

Close-up of Twelve-Pocket Document Handler

ments in the event of a jam condition WITHOUT document mutilation.

2. Optional rejection of items with missing cue characters.
3. Automatic generation and transmittal of an error signal to the central processor in the event of missing or erroneous ("multiple") reads.

The handler will feed, transport and stack magnetically encoded documents of intermixed sizes and thicknesses, including paper and punched cards, within the following limits.

Short dimension: Min. 2 1/2 " Max. 3 3/4 "
 Long dimension: Min. 5 1/4 " Max. 10 "
 Thickness: Min. .0027 " Max. .007 "

The 12-pocket handler consists of the handler itself, the character reader, and the control electronics.

The HANDLER contains the following components:

1. The Feeder and Transport Mechanism feeds and transports each document through the character reader and to the selected pocket stacking station. Items are fed from the loading hopper which has a capacity of document bundles up to 12 inches thick. Transported documents are held in place by pressure units ("bogies") which release the items when a jam is detected.
2. The Stackers are 12 sorting pockets, each of which will accommodate a six-inch stack of items. The pockets are identified as special, 0-9, and reject. Items can be unloaded from the pockets without stopping the feed.

3. The Filled Stacker Signals automatically halt the feeding of documents when any stacker has reached its capacity.
4. The Remote Stop Bars, when depressed, will halt power to all motors and turn off all indicator lights, except the main circuit breaker light.
5. The Item Counters display the number of items which have been allocated to each of the 12 pockets, plus a grand total.
6. The Operator's Control Panel contains the various operating buttons, selector switches, and indicator lights needed for off-line use of the handler.

The CHARACTER READER consists of the following components:

1. The Magnetizing Head magnetizes to saturation the magnetic ink characters on the documents prior to their reaching the magnetic read head.
2. The Magnetic Read Head picks up the pulses created by the various magnetically printed characters and sends them to the character recognition electronics.
3. The Character Recognition Electronics identifies the pulses and signals the sorter to open a specific pocket, or transmits the information to the central computer, depending upon whether the handler is operating off-line or on-line.

The CONTROL ELECTRONICS consists of the character reader electronics, the sequencer control, and

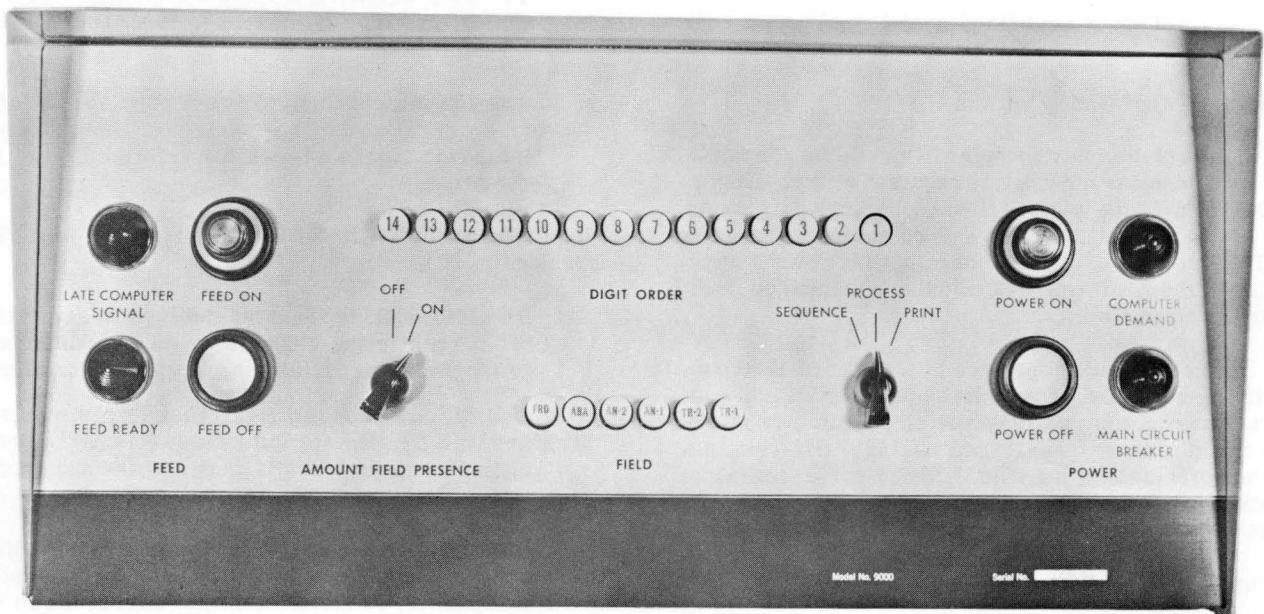

Twelve-pocket Document Handler Control Panel

the power supply. The sequencer control is the device which controls pocket gates during off-line use of the sorter.

The one-word input buffer ("read" buffer) is employed by the document handler for transmitting data to the core memory, permitting computation to proceed while documents are being read. Data rearrangement is accomplished by the computer program; no plugboard is associated with the document handler. There is a maximum of 80 milliseconds available (for programmed operations) between receipt of the information in the core memory and the latest time at which a pocket decision signal must be communicated to the document handler. This represents an average of about 1060 time-shared program steps which may be performed on each document's data prior to making a pocket decision for that document. If two handlers are used simultaneously on-line, approximately 530 operations may be performed upon the data received from each.

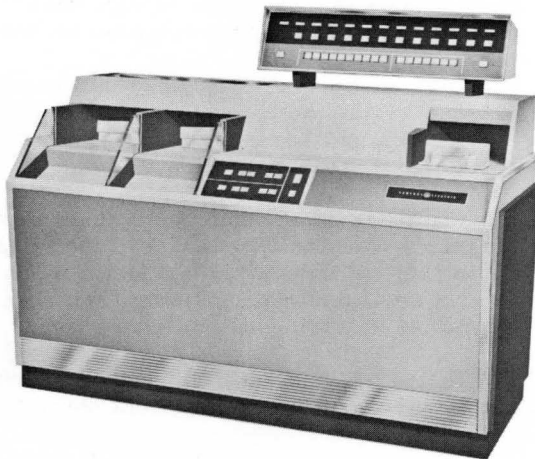

Two-pocket Document Reader

2-POCKET DOCUMENT READER

The 2-pocket document reader is available for applications where on-line entry is required without the necessity for off-line sorting of the physical documents. It is a "go, no go" device which is capable of reading the 10 Arabic numerals and four special ("cue") characters of the E13B type font which are printed on documents in magnetic ink.

The document reader operates at a speed of 1200 documents per minute. Dependent upon application considerations, it may or may not be possible to multiplex two document readers on-line. Off-line, any number of readers may be utilized for encoding or printing validation with each reader under the control of its own manual control panel.

Stringent checking features are included in the document reader. Among these are:

1. Complete jam detection and prevention devices

which automatically stop the feeding of documents in the event of a jam condition WITHOUT document mutilation.

2. Automatic generation and transmittal of an error signal to the central processor in the event of missing or erroneous ("multiple") reads.

The reader will feed, transport and stack magnetically encoded documents of intermixed sizes and thicknesses, including paper and punched cards, within the following limits;

Short dimension:	Min. 2 1/2 "	Max. 3 3/4 "
Long dimension:	Min. 5 1/4 "	Max. 10 "
Thickness:	Min. .0027 "	Max. .007 "

The 2-pocket document reader consists of the reader itself, the character reader, and the control electronics.

The READER contains the following components:

1. The Feeder and Transport Mechanism feeds and transports each document through the character reader and to the selected pocket. Items are fed from the loading hopper. Transported documents are held in place by pressure units ("bogies") which release the items when a jam is detected.
2. The Stackers are 2 sorting pockets identified as "good" and "reject". Items can be unloaded from the stackers without stopping the feed.
3. The Filled Stacker Signals automatically halt the feeding of documents when either stacker has reached its capacity.
4. The Item Counters display the number of items which have been allocated to each pocket, plus a grand total.
5. The Operator's Control Panel contains the various operating buttons, selector switches, and indicator lights needed for off-line use of the reader.

The CHARACTER READER consists of the following components:

1. The Magnetizing Head magnetizes to saturation the magnetic ink characters on the documents prior to their reaching the magnetic read head.
2. The Magnetic Read Head picks up the pulses created by the various magnetically printed characters and sends them to the character recognition electronics.
3. The Character Recognition Electronics identifies the pulses and signals the sorter to open a specific pocket, or transmits the information to the central computer, depending upon whether the document is off-line or on-line.

The CONTROL ELECTRONICS consist of the character reader electronics and is the decision making equipment for off-line use of the reader.

The one-word input buffer ("read" buffer) is employed by the document reader for transmitting data to the core memory. Data rearrangement is accomplished by the computer program; no plugboard is associated with the document reader. The time available (for programmed operations) between receipt of the information in the core memory and the latest time at which a pocket decision signal must be communicated to the document reader is a function of the number of inches of characters to be read from the documents. A four-inch span of characters to be read allows an average of about 660 time-shared program steps which may be performed on each document's data prior to making a pocket decision for that document. If two readers are used simultaneously on-line, approximately 330 operations may be performed upon the data received from each.

MAGNETIC TAPE SYSTEM

The magnetic tape input-output system consists of up to 13 tape transports and associated electronic equipment.

Tape Transports

Transports are available in either single or dual cabinet styles and at either 30 or 50 KC speed. Single cabinets hold one tape unit, either 30 or 50 KC; dual cabinets contain two tape units, either 30 or 50 KC. Actual cabinet size is identical for the two types.

Tapes

The magnetic tapes used with the GE 210 system are of 3/4 inch wide mylar material on 10-1/2 inch reels. The tape is available in 1200, 2400 or 3600 foot lengths. Information is recorded at a density of 250 bits per inch (2 digits recorded in parallel). All tape is pre-

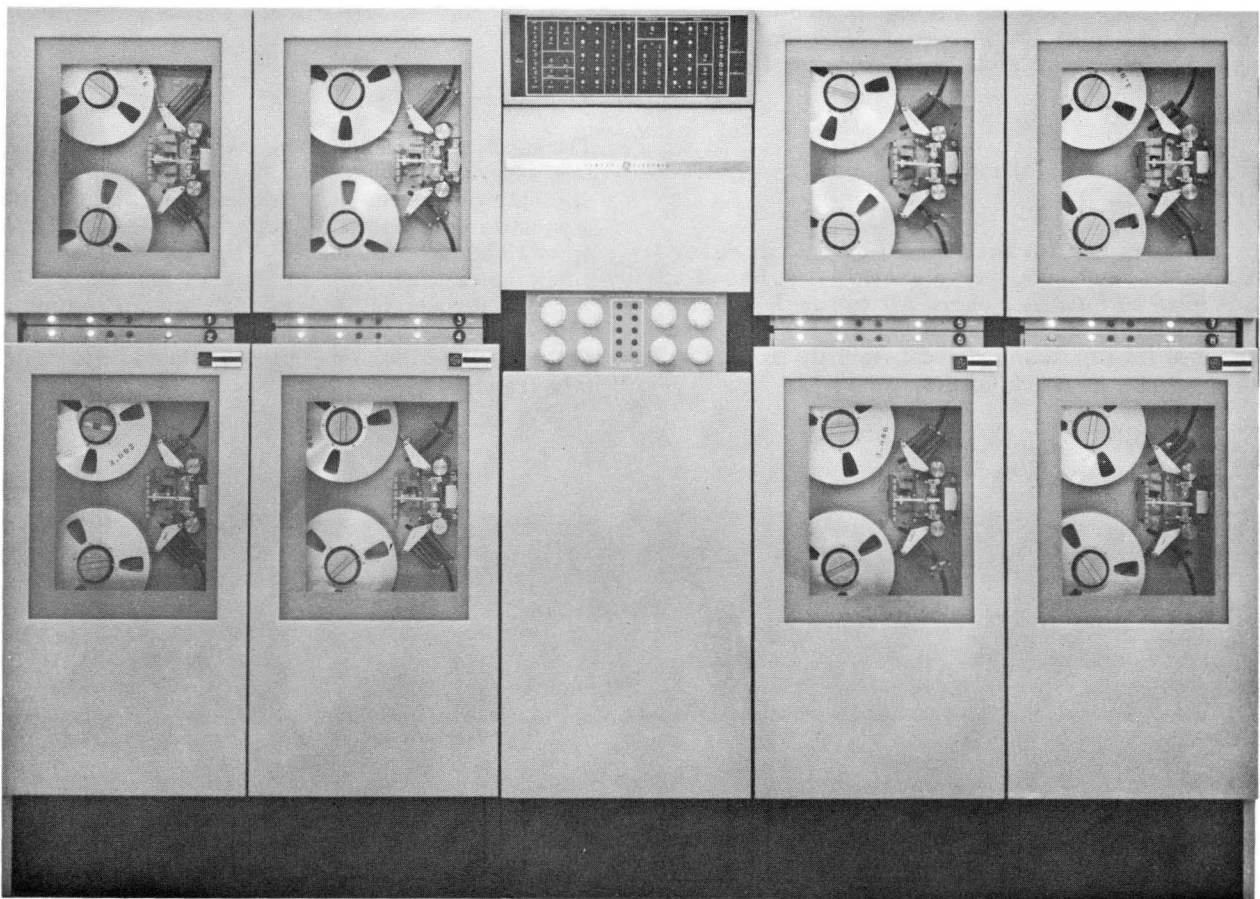

Magnetic Tape System

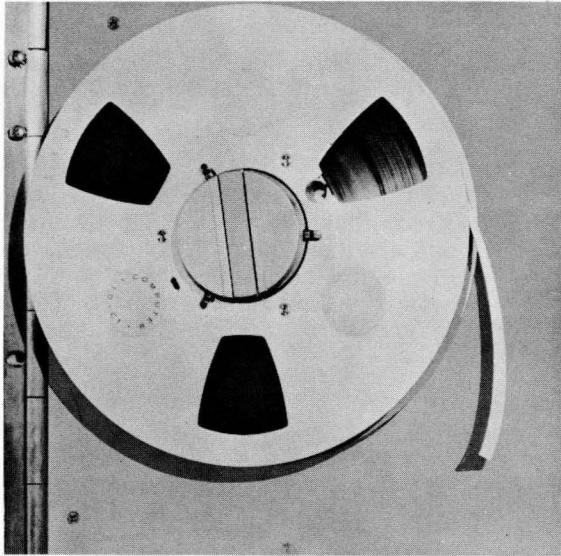

Reel of Magnetic Tape

edited for "block markers" in accordance with the fixed block length of 100 words. A 3600 foot reel of tape has a capacity at least 14,000 blocks of data.

Operation Modes

Any tape may be used for either input or output (reading or writing).

Writing is done in a forward direction only at either 30 or 50 KC speed. An "echo check" (i.e. use of a trailing head to read and check all writing) is automatically performed on each block written and provision made for programmed recoverability (re-write) in the event of echo check failure.

Reading is done in a forward direction only at either the 30 or 50 KC speed. Mis-reads are detected by parity checking and programmed recoverability is provided in case of error.

Rewinding may occur simultaneously on any number of tape units. A maximum of six minutes is required to rewind a 3600 foot reel of tape.

Control

On-line control of tape units is achieved by the computer program.

Commands include read, write, back-up, back-up and erase block markers.

Off-line control is available through the small operator panel associated with each tape unit and located on the transport. Manual controls include:

1. Local/remote switch
2. Forward button
3. Reverse button
4. Rewind button
5. Stop button
6. Write inhibit switch

Electronic Control Equipment

The electronic control equipment, or tape controller, is a separate cabinet. The 30 KC tape controller contains the control devices for handling up to 10 30 KC tape units and the 50 KC tape controller will handle up to 13 50 KC tape units. The tape controller provides the capability for simultaneous read, write and compute through buffering arrangements. Automatic stopping of tape in the event of tape breakage or power failure is provided by controls incorporated in each tape transport.

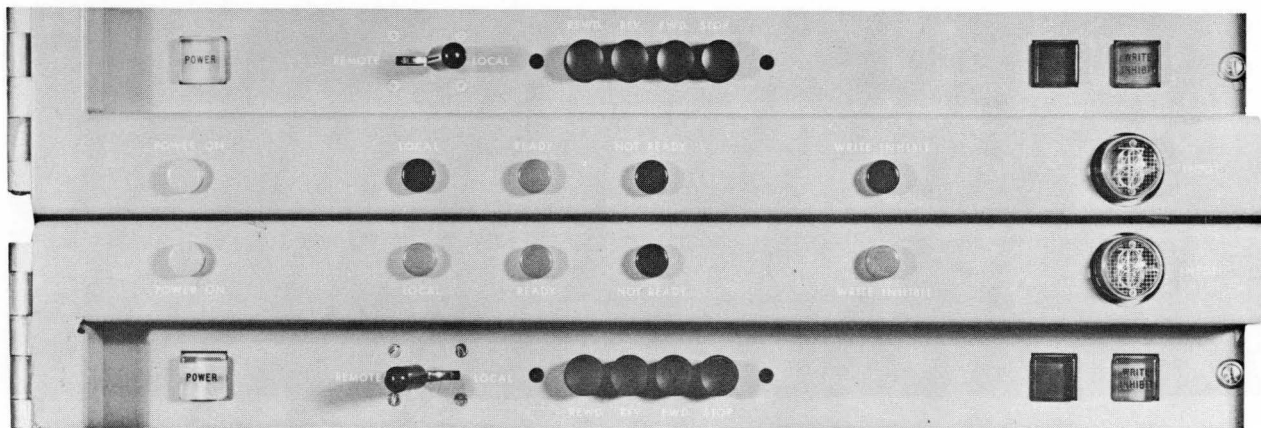

Magnetic Tape Transport Control

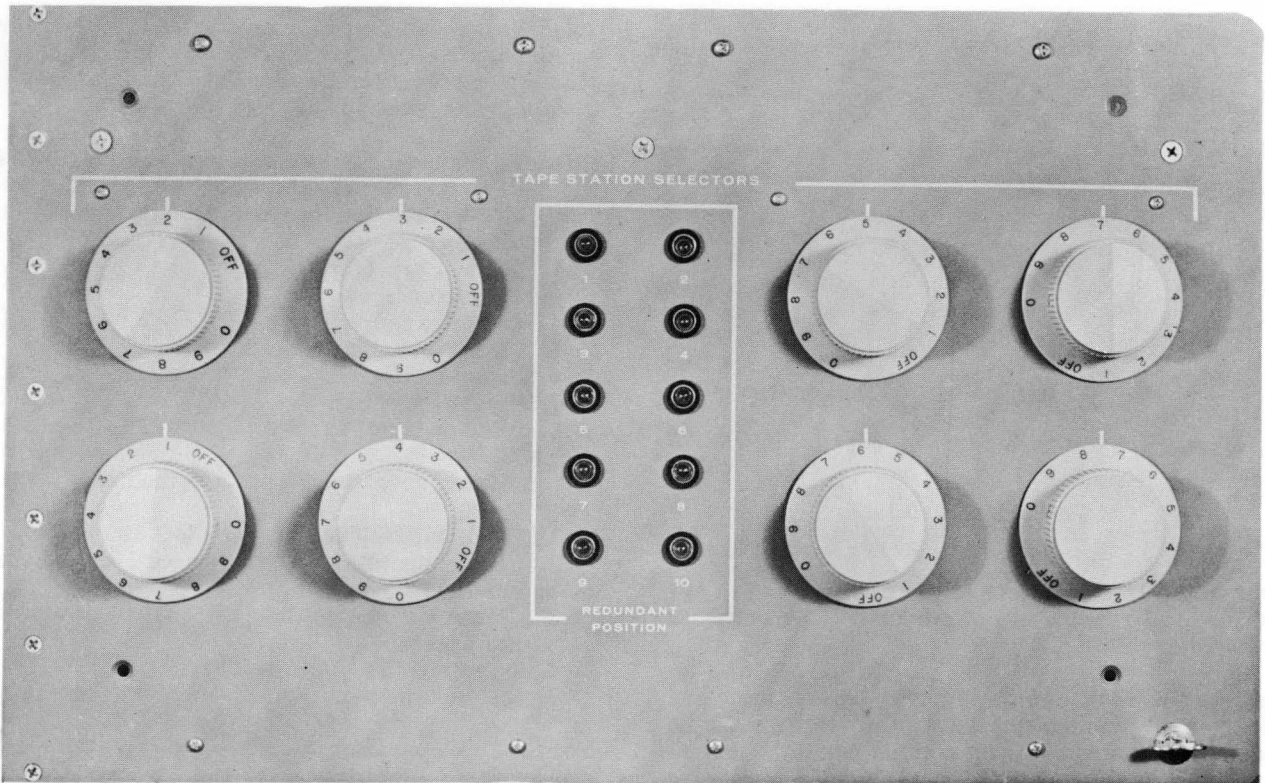

Magnetic Tape Station Selector Control

PAPER TAPE PUNCH

The paper tape punch is an optional on-line device which operates under computer control at a punching speed of 60 characters per second.

A one-word buffer is utilized between the core memory and the punch. Information is punched in GE 210 code in 7-channel tape. 96,000 characters may be represented on one 800 foot roll of tape.

Parity is generated on output and is punched into the parity channel of the paper tape.

72-COLUMN PRINTER

The 72-column printer is an on-line device which prints at the rate of 1200 numeric or 600 alphanumeric lines per minute. Skipping (or "slewing") speed is no less than 16 inches per seconds.

A total of 50 printable characters are capable of representation: 10 numerals, 26 alphabets, and 14 special. There are 72 print positions per line. Printing is open Gothic, spaced 10 characters per inch horizontally and 6 lines per inch vertically.

Built in checking features include end of paper signal and thyatron check.

Control of printing format is by plugboard, an endless paper tape belt, and computer program.

Data is transmitted from the core memory through the one-word write buffer into a 72-column printer buffer and thence to the printer. Computer commands are provided to achieve loading of the 72-column printer buffer (and subsequent printing of the contents thereof), to space (single, double or triple as indicated by plugboard wiring), to interrogate for

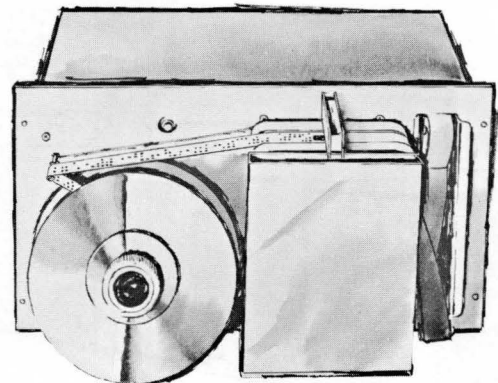

Paper Tape Punch

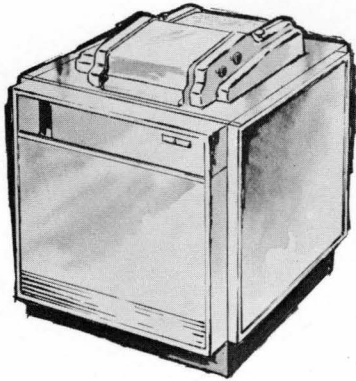

72-column Printer

error in the line just sent to the printer, and to determine the "readiness" of the 72-column buffer to receive more data.

Plugboard control is on a digit-for-digit basis. Any character position in the 72-column buffer may be transmitted to any one print column position. Printing or non-printing of the sign position is controlled by plugboard and program.

COMPUTER-EDITED PRINTER

The computer-edited printer may be utilized on-line or off-line. Printing speed is 1000 lines per minute alpha or numeric. Skipping (or slewing) speed is no less than 16 inches per second.

There are 47 printable characters: 10 numerals, 26 alphabets, and 11 special. Each line of printing may contain a maximum of 120 characters. Printing is open Gothic style, 10 characters to the inch horizontally and 6 lines to the inch vertically.

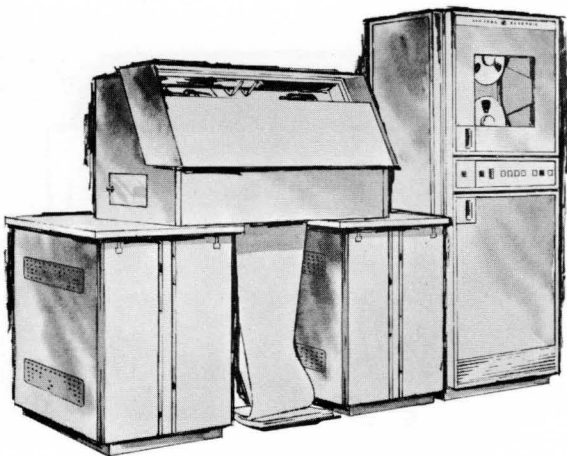

Computer-edited Printer

There is a one-block buffer associated with the printer which receives data from magnetic tape (off-line) or from the write buffer (on-line) and transmits the line of data to the typeline buffer of the printer.

Checking features incorporated in the printer include:

1. Row-column parity check from tape and to line buffer
2. Illegal character check
3. Thyatron check
4. End of paper
5. "Block overflow" check
6. Paper motion
7. "End of file" check
8. "End of tape" check

The following special features are included:

1. Block back-up and re-read (off-line)
2. Restart operation when a "check" error occurs (off-line)
3. Character recognition for control of carriage and printer
4. Selective file print capability
5. End of tape sensing (off-line)

For off-line operation, there is a complete tape unit sub-system incorporated in the printer system to handle magnetic tape input to the printer.

SELF-EDITING PRINTER

The self-editing printer may be utilized on-line or off-line. Printing speed is 900 lines per minute numeric and 600 lines per minute alphanumeric. Skipping or slewing speed is not less than 16 inches per second.

There are 56 printable characters: 10 numerals, 26 alphabets, and 20 special. Each line of printing may contain a maximum of 120 characters. Printing is open Gothic style, 10 characters to the inch horizontally and 6 lines to the inch vertically.

A feature of this printer is its automatic page heading device or "restore" capability which enables the computer to write header information out only once and reuse it repeatedly in the printer (e.g., a report heading which is identical for a series of pages).

Checking features incorporated in the printer include:

1. Row-column parity check
2. Printer control parity check
3. Thyatron check
4. Wrong block markers
5. Loss of power
6. Broken paper
7. No paper or no ribbon
8. Broken paper loop
9. Prolonged paper slew

Data rearrangement or format is controlled by plug-



Self-editing Printer

board and by the use of special printer command characters included within the data transmitted to the printer.

Automatic line counting and page numbering are available within the equipment by plugboard, paper loop, and special command characters.

Selective printing of information is possible. Up to five unique reports can be intermixed on one magnetic tape and each selected individually for printing by plugboard and paper loop control.

Selective positioning of data on any printed line can be achieved by plugboard wiring associated with type of information received. For example, numeric data may be printed only in certain columnar positions (or alpha, or negative numeric, or positive numeric as plugged or selected); if non-numeric data has been received, the printer will continue to skip across the line or into the next line until it finds a position in which it is "allowed" to print alphabetic information.

Comma and/or decimal point insertion is automatically available through plugboard wiring. Zero suppression may also be controlled by plugboard.

The self-editing printer paper feed device accepts the following size forms:

Minimum form length: 1";	width 3 1/2"
Maximum form length: 22";	width 22"

The printer system consists of the printing unit, the thyatron drive unit, the electronic control unit, and (off-line) the tape unit.

The PRINTING UNIT consists of:

1. Print wheel - a rotating drum which contains 120 individual print wheels.
2. Operator control panel - provides switches, buttons, and indicator lights for operator control and display.
3. Vertical format unit - controls the vertical spacing of the paper by means of codes punched in a paper loop.

The THYRATRON DRIVE UNIT houses the circuitry necessary to drive the 120 hammers associated with the 120 individual print wheels. The characters are printed on the paper, which lies between the hammers and print wheel, when the hammers are driven against the print wheel.

The ELECTRONIC CONTROL UNIT contains:

1. Plugboard - wired to govern format of data to be printed.
2. Block buffer - the 200 word area for read-in storage plus the 72 word area for heading storage.

3. Type line buffer - a 56 by 120 bank of core storage corresponding to the 120 individual print wheels and the 56 possible characters on each. Prior to being printed, each line of data is set up in this buffer.
4. Character register - used as a buffer between the block buffer and tape unit or computer, and also between the block buffer and the typeline buffer.

The TAPE UNIT is a sub-system complete with control logic and electronics which is incorporated in the printer system to handle magnetic tape input to the printer.

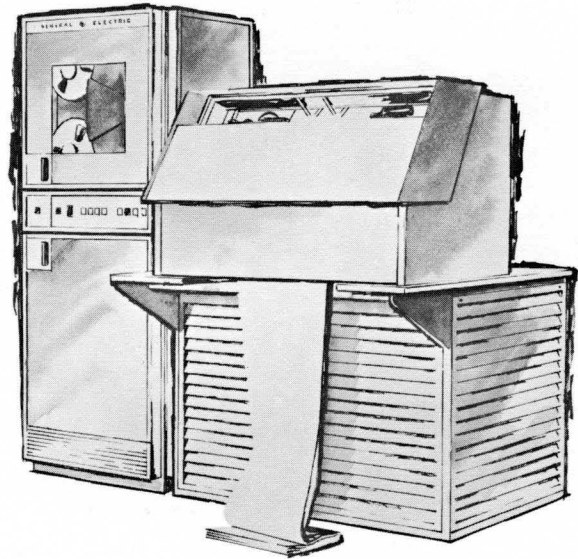

Re-entry Printer

RE-ENTRY PRINTER

The re-entry printer is an on or off-line printer which prints both Gothic and E13B font with a special magnetic ink ribbon. Thus, the printer may produce documents which, in turn, can be read directly back into the computer by the document handler or reader. These might be documents such as customer bills, accounts payable checks, payroll checks, or loan coupons.

The more usual types of reports and listings may also be printed using the Gothic type. Gothic and E13B printing may be intermixed on the same document in one pass of the paper through the printer.

The re-entry printer operates at a speed of 1000 lines per minute for Gothic font and at a minimum of 300 lines per minute for E13B font. Up to 120 columns may be printed on one line.

Skipping or slewing speed is no less than 16 inches per second.

There are 58 printable characters:

Gothic: 10 numerals
 26 alphabets
 8 special

E13B: 10 numerals
 4 cue characters

All printing is 8 characters to the inch horizontally and 6 lines to the inch vertically.

There is a one-block buffer associated with the printer which receives data from magnetic tape and transmits it to the typeline buffer of the printer.

Checking features incorporated in the printer include:

1. Row-column parity check from tape and to line buffer
2. Illegal character check
3. Thyatron check

4. End of paper
5. Block overflow check
6. Paper motion
7. "End of file" check
8. "End of tape" check

The following special features are included:

1. Block back-up and re-read (off-line)
2. Restart operation when a check error occurs (off-line)
3. Character recognition for control of carriage and printer
4. Selective file print capability
5. End of tape sensing (off-line)

Vertical format control may be single, double or triple space by plugboard or tape programmed line skipping. Horizontal format control is by plugboard and/or programmed editing of data at preparation.

PRICES⁽¹⁾ - GE 210 DATA PROCESSING SYSTEM

Model No.	Component	Sales Price ⁽²⁾ Incls. Install.	Lease ⁽³⁾ Price	Maint. on Sale Only
4WC210A1	Central Processor (4K Memory)	\$ 268,800	\$ 4,890	\$ 250
4WM210A1	Additional 4K Memory	72,100	1,540	101
4WN210A1	Power Supply	22,000	480	144
4WK210A1	Console, incl. Typewriter	23,000	520	230
4WK210A2	plus Photoreader	26,400	555	250
4WU210A1	Tape Controller, 30KC	65,500	1,200	71
	Magnetic Tape Handlers:			
4WT210A1	30KC Single	26,000	610	126
4WT210A2	30KC Dual	42,300	950	259
4WT210C1	Printer Reader	26,000	560	76
	Card Readers:			
4WD210A1	400 cpm	29,100	690	84
	High Speed Printers:			
4WL210A1	72 col. On-line	49,500	1,100	202
4WP210B1	120 col. Computer Edited	110,000	2,450	375
4WP210A1	120 col. Re-entry	126,000	2,800	385
4WP210D1	120 col. Self-editing	180,900	3,840	511
	Document Handlers:			
4WS100E1	12 Pocket	87,500	1,750	491
4WU12A1	12 Pocket	87,500	1,750	842
4WU2A1	2 Pocket	60,600	1,210	350
4WU210A1	High Speed Paper Tape Punch	13,500	280	104

(1) All applicable Federal, State and Local taxes are additional.

(2) F. O. B. Phoenix, Arizona

(3) Lease prices include equipment installation, maintenance and 176 hours of use per month. Overtime hours computed at 40% of basic shift (176) hourly rate per unit used.

Standard lease agreement of the Computer Department to be the determinant of the individual sale/lease agreements.

Availability: Subject to prior commitments. For estimated delivery, use current Product Availability Schedule issued monthly by Marketing Administration. Marketing Administration should be contacted before making firm commitment on delivery.

THE PRICES SHOWN ARE SUBJECT TO CHANGE WITHOUT PRIOR NOTIFICATION

For the use of General Electric employees only.

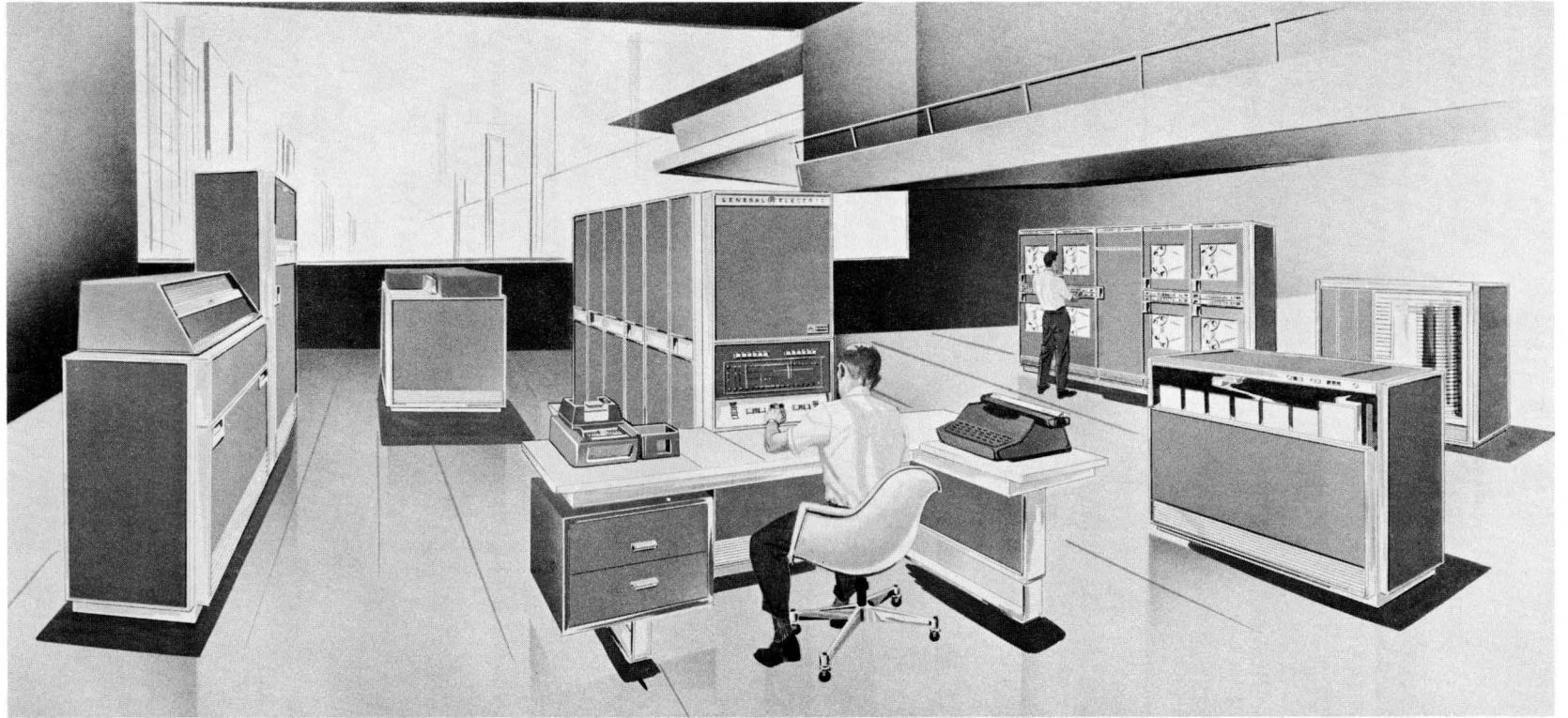

THE GE 225 SYSTEM

THE GE 225 SYSTEM

To serve the urgent needs for well-informed decision-making and the automatic preparation of data to guide and assure the continued progress and success of your organization, General Electric presents the **GE 225 INFORMATION PROCESSING SYSTEM** — a fully transistorized, general purpose computer which assures the most efficient use of the data processing dollar.

Employing the optimum combination of high speed, low cost and peak efficiency, the GE 225 is application-designed for a wide variety of data processing requirements. The speed, expansible magnetic core memory and wide range of input-output equipment, all under direct control of the computer, mark the GE 225 as one of the most flexible and completely integrated systems in its field.

KEY FEATURES

EQUIPMENT FLEXIBILITY

The equipment flexibility of the GE 225 offers a new degree of freedom in the planning of your system. In conjunction with the versatile central processor, the full complement of optional peripheral capabilities includes:

MAGNETIC TAPES for sequential storage of large files of information

PUNCHED CARDS for input-output of information

MASS RANDOM ACCESS MEMORY for storing files for random

HIGH SPEED PRINTER for printing reports

PUNCHED PAPER TAPE for input-output of information

TYPEWRITER for print-out of small amounts of data and program monitoring

MAGNETIC CHARACTER DOCUMENT SORTER for sorting documents and entering data

AUXILIARY DRUM MEMORIES for storing instructions and files

SIMULTANEOUS OPERATION OF EQUIPMENT The central processor of the GE 225, while computing, time-shares, on an automatic basis, every major associated peripheral device.

DATA MATING FUNCTION An outstanding feature of the GE 225 system is the data-buffering and priority-assigning component of the central processor. Through the use of convenient plug-in connectors on the back of this linking and matching device, the rapid additions and substitutions of peripheral equipments used in conjunction with the system is made possible. The many peripheral devices exchange information with the computer's magnetic core memory through this universal coupling unit, thus allowing the time-sharing of simultaneous operation of the equipments in the integrated system.

AUTOMATIC MODIFICATION OF INSTRUCTIONS The advantages of the GE 225's three standard-equipment registers for automatic address modification include reduced storage requirements for the program, reduced coding costs, and increased speed of your operating program.

BUILT-IN FLOATING POINT The GE 225's floating point circuitry simplifies coding by eliminating your need to keep track of number scaling during coding. This optional circuitry maintains decimal point location at all times, a feature essential for most engineering and statistical computations.

INSTRUCTION VERSATILITY The exceedingly versatile, standard instruction repertoire of the GE 225, containing over 50 operational codes exclusive of those used for input and output functions, offers you great flexibility in adapting the computer to your specific requirements. This versatility enables a program to be written with a minimum number of instructions, thus reducing running time.

SPECIAL PURPOSE ADAPTABILITY Unusual or special purpose requirements often demand special purpose computers designed to do a specific processing job. The standard peripheral equipment available with the GE 225 is designed to meet most requirements. A unique feature of this normally data-processing-oriented computer is its ability to communicate with many special purpose input-output devices.

REMOTE DATA ENTRY Remote data entry, via high speed transmission lines, allows direct, immediate access to your central GE 225 computer from widely separated geographical locations. With such optional facility, one GE 225 can process orders, inventory control, and even payroll, from information originating at many remote offices or warehouses. Results are relayed back to the point of origin, or another remote location, in a matter of seconds.

GENERAL ASSEMBLY PROGRAM The GE 225 General Assembly Program, which assumes all of the details of memory allocation, provides the programmer with an efficient and convenient method of writing his program in a completely symbolic language. All of the machine's operation codes are represented by mnemonic abbreviations, thus facilitating the programmer's learning and recollection of these codes. Thus, the programmer has the tremendous advantage of being able to write

in a number of independent, complete, logical pieces which the General Assembly Program will automatically combine in an efficient manner.

THE GENERAL COMPILER

The GE 225 General Compiler provides the programmer with a highly advanced and effective automatic coding technique. The system has a flexible source language that permits convenient description of a problem and the data it is to process. The compiler language was designed specifically to meet the needs of business data processing and scientific applications alike. It may be termed "common" in that it is the basis of present and future compilers for the General Electric line of computer systems.

The system is equipped to handle all types of library routines. Generators, as well as open and closed sub-routines, are provided as part of a basic library. These may be called upon by source statements, resembling English sentences, to produce an efficient object program of GE 225 computer instructions. The library is "open-ended" in that any routine written in the source language can be expanded easily and called upon in future problems.

The repertoire of statements includes the basic arithmetic operations ADD, SUBTRACT, MULTIPLY and DIVIDE. Also, provision is made for solving logical expressions, equations, data transfer, single- and multi-branching for program control, and input-output functions.

SPECIFICATIONS



CENTRAL PROCESSOR

(including Control Console, Console Typewriter and Card Reader)

CENTRAL PROCESSOR

- magnetic core memory
- 2048, 4096, 8192 or 16384 binary words
- double-precision word capability
- single- and double-precision arithmetic
- built-in floating point option
- simultaneous read-write-compute of all peripheral units
- parity check of information transfers
- 59 commands, not including input-output
- solid state throughout
- accommodates alphabetic or numeric binary or decimal information
- arithmetic and control registers
- 3 registers for automatic instruction modification (direct and indirect addressing)

EXECUTION TIMES (Fetch and Execute)

- Add — 40 microseconds
- Multiply — 250 microseconds (average)
- Divide — 500 microseconds
- Logic — 40 microseconds

CONTROL CONSOLE

- register display lights
- indicator lights
- power switches
- status lights
- 20 program control switches

CONSOLE TYPEWRITER

- types 10 characters per second maximum under control of Central Processor



DOCUMENT SORTER

DOCUMENT SORTERS (2- and 12-pocket)

- 1200 documents per minute
- sorting pockets under control of Central Processor
- recognizes 14 magnetic characters
- data entered into Central Processor

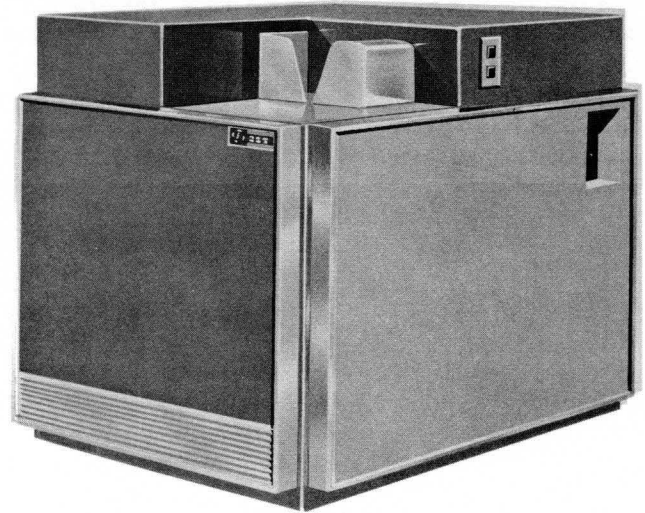

CARD PUNCH

CARD PUNCH

- 100 cards per minute
- punches binary or Hollerith cards
- double punch and blank column checking
- accepts numeric or alphabetic information

CARD READER

- 400 cards per minute
- reads binary or Hollerith cards
- photoelectric
- synchronization check
- accepts numeric or alphabetic information

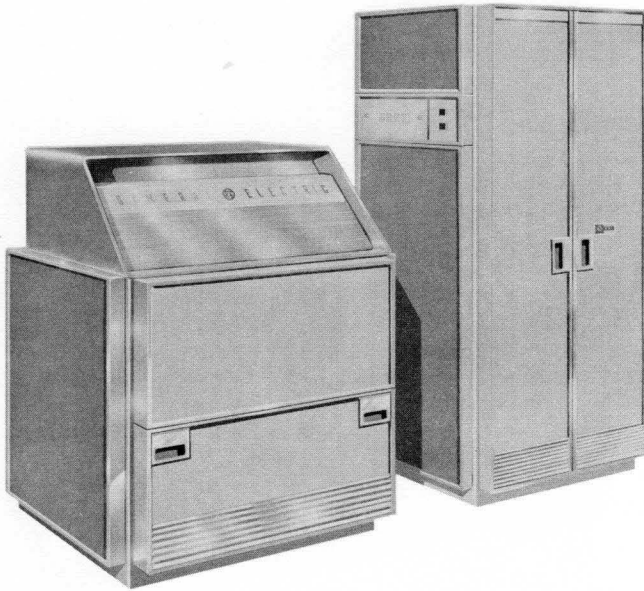

HIGH SPEED PRINTER

HIGH SPEED PRINTER

- 500 lines per minute
- 120 printing positions
- prints 10 numerics, 26 alphabetic and 11 special characters
- flexible print format
- parity check

PAPER TAPE READER

- 200 characters per second
- reads 5, 6, 7 or 8 channel tape
- parity check

PAPER TAPE PUNCH

- 60 characters per second
- punches 5, 6, 7 or 8 channel tape

AUXILIARY MAGNETIC DRUM STORAGE

- 8192 or 16384 20-bit binary words
- average access time: 8.3 milliseconds
- 3600 rpm
- word time: .128 milliseconds
- high speed block transfer codes
- "write control" switches for information protection

TRANSMISSION LINE SCANNER-CONTROLLER

- horizontal and vertical parity checking of messages at both sending and receiving ends
- translates data into machine-acceptable form

DATA TRANSMITTER-RECEIVER UNIT

- sends or receives data at speeds of up to 60 characters per second.

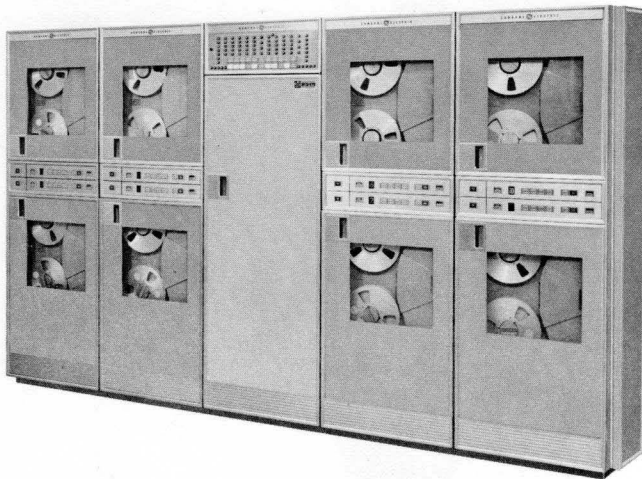

MAGNETIC TAPE SYSTEM

MAGNETIC TAPE SYSTEM

- 15,000 characters per second transfer rate
- up to 64 tape units
- horizontal and vertical parity checking
- 200 characters per inch at 75 inches per second
- tape language is compatible with most existing tape installations

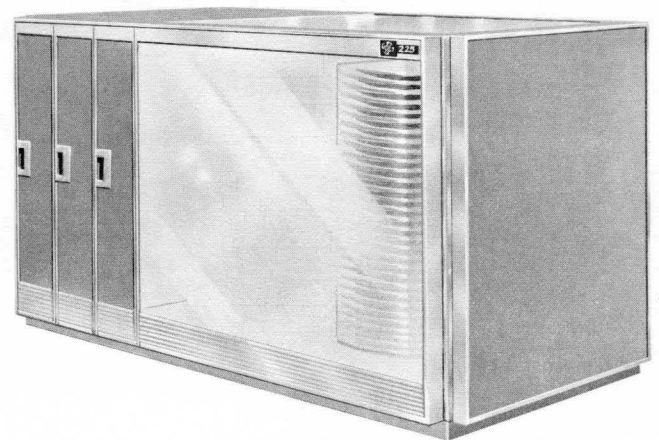

MASS RANDOM ACCESS FILE MEMORY

The GE 225 is also the nerve center of the General Electric System for the Computation of Automatically Transmitted Data. Planned for the future, this system provides for centralized processing of remote data.

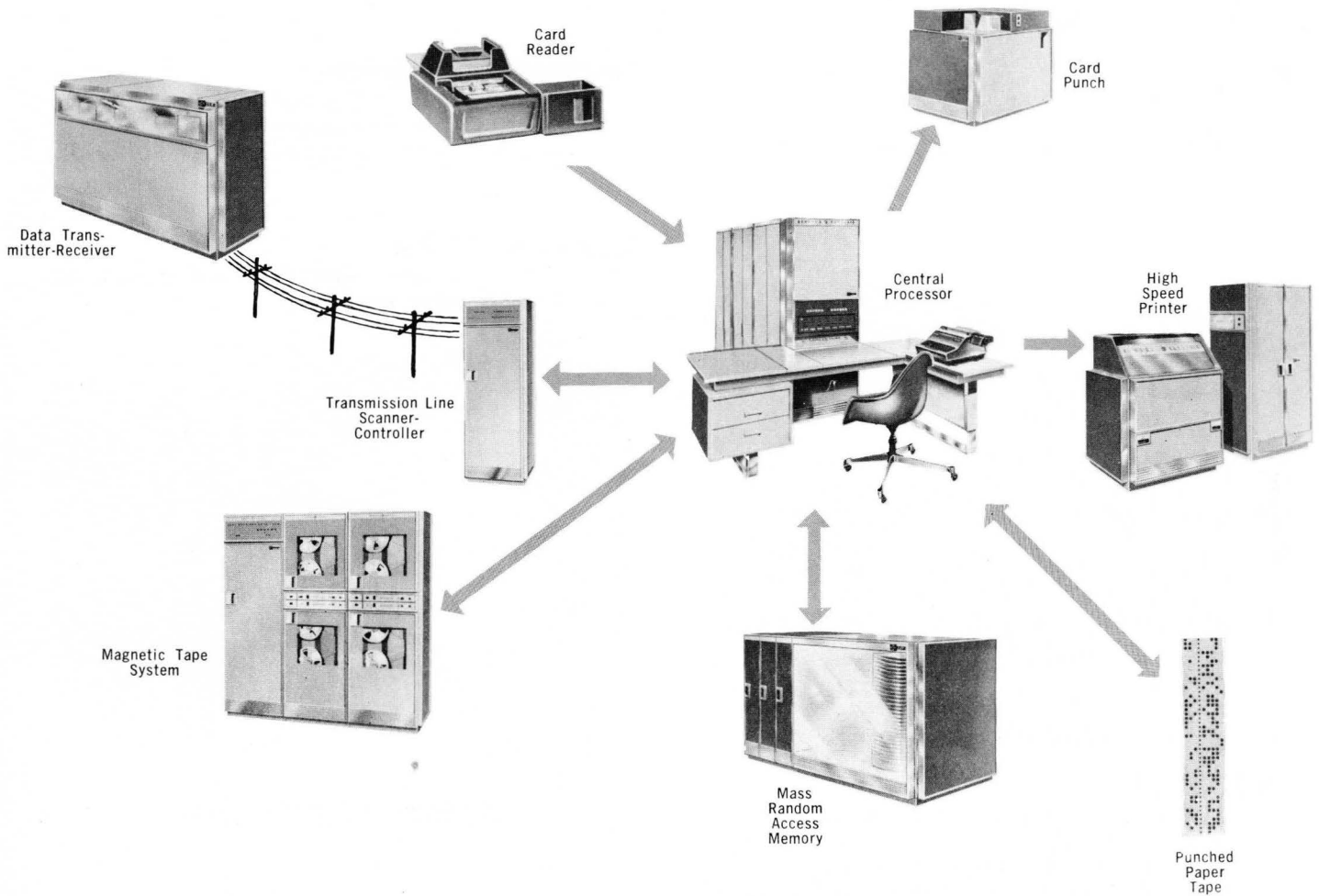

PRICES (1) - GE 225 INFORMATION PROCESSING SYSTEM

Model No.	Component	Sales Price (2) Incls. Install.	Lease (3) Price	Maint. on Sale Only
	Central Processor, including Console & Typewriter:			
4WC225A1	2,048 words	\$130,000	\$2,600	\$240
4WC225C1	4,096 words	145,000	2,900	250
4WC225B1	8,192 words	175,000	3,500	263
	Additional 8K Memory	56,000	1,400	113
4WD225A1	Card Reader & Control	29,100	605	105
IBM 523	Card Punch	4,560	94	30
4WE225A1	Card Punch Control	25,620	500	90
4WG225A1	Paper Tape Reader	12,000	270	40
4WH225A1	Paper Tape Punch	6,000	130	25
	Mass Memory:			
4WM225C1	Control Unit	60,000	1,250	420
IBM 355	Disk File (Lease and Drop Ship or Purchase)	74,800	1,650	*
	Magnetic Tape:			
4WT225A1	Single Handler	24,000	560	124
4WT225B1	Dual Handler	38,000	950	248
4WU225A1	Magnetic Tape Control	48,000	1,000	77
	Floating Point	30,000	600	*
4WP225A1	Printer (On-Line) 120 Column	75,000	1,500	275

*Final approval pending on sale and maintenance prices where not shown.

(1) All applicable Federal, State and Local taxes are additional.

(2) F.O.B. Phoenix, Arizona.

(3) Lease prices include equipment installation, maintenance and 176 hours of use per month. Overtime hours computed at 40% of basic shift (176) hourly rate per unit used.

Standard lease agreement of the Computer Department to be the determinant of the individual sale/lease agreements.

Availability: Subject to prior commitments. For estimated delivery, use current Produce Availability Schedule issued monthly by Marketing Administration. Marketing Administration should be contacted before making firm commitment on delivery.

THE PRICES SHOWN ARE SUBJECT TO CHANGE WITHOUT PRIOR NOTIFICATION.

For the use of General Electric employees only.



PRODUCTS-DIG-1.002-P1(of 5)

NCR #304FUNCTION:

A moderate size electronic data processor for general business use.

CHIEF MARKETS:

Merchandising (large retail stores), Inventory Control, Payroll and General Accounting, Banking, Insurance, Credit Accounting.

CUSTOMER BENEFITS:

Reduces data handling expenses. Speeds up processing cycle. Reduces human errors. Permits gathering of statistical data heretofore unavailable. Offers performance capabilities comparable to those of a large scale system at a price more nearly what they can afford.

COMPETITORS:

IBM-650, IBM-650 RAMAC, IBM-705
Sperry Rand - Univac I and II, File Computer
Burroughs - Datatron

COMPETITIVE ADVANTAGES:

1. Building block approach
 - (a) Memory can be expanded from 1,000 to 2,000 or 4,000 words.
 - (b) Peripheral equipment including up to 64 magnetic tape units may be added as required.
2. Power and flexibility of command structure
 - (a) Commands are of a business type..
 - (b) Subroutines having a high use expectancy are built into the commands.
 - (c) Great freedom of operation with partial words in non-regular fields.

For the use of General Electric employees only.



COMPETITIVE ADVANTAGES: (page 2)

3. Common language versatility
 - (a) Magnetic tape, paper tape, and punched card input and output available.
 - (b) Addition of new media capabilities only as required.
4. Speed of peripheral equipment
 - (a) Balanced to processor speed.
 - (b) Faster than most competitive equipment, for example, 1500 characters per second paper tape reader, 1000 card per minute reader.
5. Rapid sorting and magnetic tape handling
 - (a) Information transfer rate for magnetic tape will be between 15,000 and 30,000 characters per second.
 - (b) Ability to pack numerical data on magnetic tape at extra high density.
 - (c) A six-word "merge" command which can be used for sorting is estimated to be equivalent to 150-200 Univac 2 instructions or 70-75 instructions on the IBM 705.
 - (d) No between-record gaps.
6. Multiplexing and off-line operations
 - (a) General purpose off-line converter can go to or from magnetic tape with paper tape and punched cards. High-speed printer tied in.
 - (b) Separate off-line magnetic tape to high-speed printer operation.
 - (c) Processor can initiate off-line searching and copying operation of magnetic tape units.
 - (d) Two or more time-shared programs possible during file "updating" operations.

For the use of General Electric employees only.





PRODUCTS-DIG-1.002-P3(of 5)

COMPETITIVE ADVANTAGES: (page 3)

7. Use of transistor and magnetic core logical elements.
 - (a) Increased reliability.
 - (b) Low power requirements.
 - (c) Low heat generation, therefore reduced requirements for air conditioning.
 - (d) Compact size.
8. Index registers
 - (a) Ten words in memory used as index registers.
 - (b) Flexible system of using these registers.
9. Table lookup feature.
10. Easy handling of alphanumerical information.
11. Logical tests - elaborate and direct.
12. Variable or fixed length records.
13. Ease and speed of programming once machine is learned.
14. Elaborate parity checking.
15. Extensive automatic facilities for selectively monitoring execution of instructions as an aid in program-checking.
16. Simple console operation.
17. Ability to move multiple records.
18. Price.
19. Ability to sell within General Electric with price advantage over NCR.

COMPETITIVE DISADVANTAGES:

1. Lack of large volume, random access memory.

The major advantage of the random access machine is where there is a low ratio of active to file records. The 304 is at less of a disadvantage compared to other sequential type processors for certain ap-

For the use of General Electric employees only.



COMPETITIVE DISADVANTAGES; (page 4)

plications because of the off-line file updating feature.

2. Lack of read-write buffering.

This will reduce processing speed, which is part of the price paid for economy. Simultaneous reading and writing is not possible save for off-line operation, which can reduce this drawback. The high-speed printer, however, is buffered to allow on-line operation.

On high density applications both in the nature of the file and in the percent of activity, the 304 may not be competitive with the IBM 704 or Univac 2. Depending on where the information transfer rate will be finalized (15,000 to 30,000 characters per second) will determine how well the 304 can compete in this area.

3. It will be more difficult to learn to program this machine primarily because of the power and flexibility of its command structure. Once learned, however, the 304 will be relatively easy to program because of the built-in subroutines.
4. Program checks will be needed for determination of arithmetic accuracy for certain applications.
5. The use of only a single key check in the write-copy and write-copy-read operations reduces its usefulness in some applications where a split-key is needed.
6. A backward read feature could save processing time on certain applications.
7. There is an inability to enter certain output readily back into input. Thus in utility billing, it would be desirable to print cards and punch them simultaneously for later re-entry into the system. This problem, however, is common to other machines which require several steps in the chain of processing.
8. The ostensible limitation on minimum record size of 10 words can be circumvented. Proper record design and programming allows the use of smaller size records.

For the use of General Electric employees only.



COMPETITIVE DISADVANTAGES: (page 5)

9. The apparently slow processing speed is deceiving. While an "add" instruction may take 600 microseconds it consists of the entire operation, including unpacking and packing and storage. Some of the more powerful commands may replace hundreds of commands on other machines. The off-line magnetic tape operation and multiplexing may save considerable time in application. What is significant is not the basic clock speed or number of cycles required to perform an operation, but the elapsed time needed to perform a data processing job. Therefore, a thorough application study is required for realistic evaluation of the machine, with the system geared to the strong points of the 304. Competitive machines may require very different system approaches. Unfortunately, how well the machine stacks up depends very significantly on the skill, experience, and available time of the systems analyst.

GENERAL PRICE RANGE:

A representative system should sell in the neighborhood of \$800,000, when sold by NCR, slightly less when sold by Computer Department internally.

DELIVERY DATE:

None available before late 1959 or early 1960, except for strategic pilot sales which may be as early as mid 1959.

Note: The Computer Department plans to sell the NCR-304 with the General Electric Company. The items produced by the Computer Department are: 304 Computer, 320 Converter, 330 Controller, and electronics for 340 Printer.

For the use of General Electric employees only.





PRODUCTS-DIG-1.002-P5A

SALE AND RENTAL PRICES FOR GE-304 SYSTEM COMPONENTS

March 24, 1959

<u>GE Model No. (1)</u>	<u>Component Description</u>	<u>Sale Price(2)</u>	<u>Monthly Rental (3)</u>
4WC 304 A	304 Central Processor, 2000 word memory, console, Flexowriter and cabling	\$347,850	\$6,800
4WC 304 B	304 Central Processor, 4000 word memory, console, Flexowriter and cabling	366,400	7,760
4WF 304 A	320 Multi-Purpose Converter	121,400	2,300
4WU 304 A	330 Magnetic Tape Controller	104,450	2,050
4WR 304 A	322 Printer Converter	43,550	850
	340 High Speed Printer	125,500	2,425
	332 Magnetic Tape Handler	30,200	670
	360 Paper Tape Reader	39,350	850
	370 Paper Tape Punch	21,750	500
	380 Card Reader	35,700	795
	351 Off-line Flexowriter	5,300	120

(1) Model Numbers assigned only to Components manufactured by General Electric

(2) F. O. B. Phoenix, Arizona, all taxes additional.

(3) Rental includes installation, maintenance and 176 hours of use per month. Overtime charge on Rentals to be computed at 40% of the hourly rate for the basic shift.

Maintenance facilities (such as work space), light, heat, power including 400 cycle frequency converter and air conditioning will be furnished by the customer.

Site preparation is the responsibility of the customer.

Computer Department will pick up the required AC power at a point within the equipment room and connect to the computer. Normal between-unit cabling will be supplied by the Computer Department.

THE PRICES SHOWN ARE SUBJECT TO CHANGE WITHOUT PRIOR NOTIFICATION.



PRODUCTS-DIG-1. 002-P5B

INSTALLATION AND MAINTENANCE CHARGES
FOR GE-304 SYSTEM SALES

March 24, 1959

<u>Component Description</u>	<u>Installation Charge</u>	<u>Maintenance Charges per Month (1)</u>
304 Central Processor 2000 Word Memory	\$14,000	\$2,200
304 Central Processor 4000 Word Memory	14,000	2,250
320 Multi-Purpose Converter	1,500	800
330 Magnetic Tape Controller	1,500	600
322 Printer Converter	400	220
340 High Speed Printer	2,500	1,100
332 Magnetic Tape Handler	400	380
360 Paper Tape Reader	300	180
370 Paper Tape Punch	200	130
380 Card Reader	400	180
351 Off-Line Flexowriter	-	40

(1) Maintenance includes 176 hours of use per month. Overtime maintenance to be computed at 50% of the hourly rate for the basic shift.

Maintenance Contract is for a period of one year.

Maintenance and Installation Charges for individual units apply only as a part of a system installation.

THE PRICES SHOWN ARE SUBJECT TO CHANGE WITHOUT PRIOR NOTIFICATION.

September 12, 1960

(1)
PRICES - 304 DATA PROCESSING SYSTEM

Model No.	Component	Sales Price (Incl. Install)	Monthly Lease	Monthly Maint. on Sale Only
(2) C304D	304 B Central Processor* 4000 Word Memory	\$455,000	\$7,100	\$1,490
(3) F304A	320 Media Converter	121,400	1,900	460
U304A	330 Mag. Tape Controller	104,450	1,635	390
R304A	322 Printer Converter	43,550	680	166
P304B**	340 High Speed Printer	125,500	1,965	475
12A6406	332 Magnetic Tape Handler	30,200	475	110
12A6437	360 Paper Tape Reader	38,300	850	180
12A6446	370 Paper Tape Punch	21,200	500	130
12A6453	380 Card Reader	35,700	560	135
12A7786	351 Off-line Flexowriter	5,100	120	40
(4) E304A1	354 Card Punch Controller	55,500	925	180

* Including (1) Console 12A6405 and (1) Typewriter 12A7786.

** Includes Printer Buffer P304B1 and one (1) 12A6416 Printer Mechanism and Thyratron.

1. F. O. B. Shipping Point - all taxes additional. All Sales/Leases to be in accordance with Standard Terms and Conditions of Computer Department Sales/Lease Contracts and Agreements.
2. Cost of Motor Generator Set (Spec. #43A110312) is not included. Your customer can purchase this through the local ASD Office.
3. Customer to Lease/Buy from IBM model 523 Card Punch.
4. Customer to Lease/Buy from IBM model 7550 Card Punch.

For the use of General Electric employees only



PRODUCTS-DIG-1.003-P1(of 2)

TINPLATE INSPECTION DATA PROCESSORFUNCTION:

This equipment is the central unit of a system for automatic inspection of tinplate as it is processed on a continuous tinning mill line. The tin mill is equipped with inspection devices which detect any defects (pinholes, over and under gage, heavy and light coat, etc.) in the tinplate as it comes off the mill. This inspection information is the input to the data processor. There is also provision for manual input of certain accounting data (such as customer information), and input (some manual and some automatic) of certain operating data (coil number, operator number, time coil started, etc.). Manual input of visually detected defects is provided as well. The output records the total footage in the coil and the total footage of defects by type. In addition, the equipment performs logical operations which provide a record of the total footage of prime strip (directly salable), mender strip (salable with rework) and scrap. The output provides information for quality control, customer billing, and records of operating data. This automatic inspection system makes it possible to sell coiled tinplate directly to the customer without further inspection. This is essential to the industry, since the major consumers of tinplate are now requiring delivery in coiled form rather than in classified sheets (which heretofore were inspected as a process separate from the operation of the tinning line).

CHIEF MARKETS:

For the present, the 33 tinplate mills in the United States which have not automated their inspection process (these mills are part of the steel industry). There are also about 10 foreign mills who are potential customers. Ultimately, this type of equipment should be applicable to all continuous strip mill processes (steel, aluminum, copper, etc.) where an automatic process of continuous inspection is required, as well as the consumers (can manufacturers, for example).

FEATURES:

- * Total footage of each defect is automatically classified and recorded, as well as total feet of prime, mender, and scrap.
- * Output can be in various forms, as customer desires (automatic typewriter, punched tape, punched cards, magnetic tape).





PRODUCTS-DIG-1.003-P2(of 2)

- * Profile recording equipment available as added feature, to record location within the coil of prime strip and various defects.
- * Speed of computer will not require slow-down of mill operating speed.
- * Transistorized for ruggedness, reliability, and long life.
- * Designed for operation in steel mill environment.
- * Modular construction for ease of maintenance, lower costs.
- * Accurate to 1 part in 30,000 or better at a speed of 1500 feet per minute.
- * Highly trained operators are not required.

COMPETITORS:

Beckman - Two installed to date. Also Industrial Nucleonics, Austin and Westinghouse.

COMPETITIVE ADVANTAGES:

G. E. has good reputation with Steel Industry and, through A. S. D., a thorough understanding of problems of steel mill operation.

COMPETITIVE DISADVANTAGES:

Beckman already has two installed - field experience plus publicity advantage. Reportedly a very good system.

PRICE RANGE:

In the neighborhood of \$70,000 to \$100,000.

DELIVERY:

10-12 months from receipt of order.



PRODUCTS-DIG-1.003-P3

January 30, 1959

SUBJECT: PRICES-- GE 302 DATA ACCUMULATOR

Effective January 30, 1959, and until superceded, the prices in effect on the basic GE 302 DATA ACCUMULATOR, and optional features, are established as follows:

I. Basic System \$70,000.00

Includes dual channels, 500 feet of delay, 26 numerical digits of manual input, 15 output tallies, 6-item visual input panel, standard typewriter.

II. Optional Features

A. Additions to Basic System

- | | |
|------------------------------------------------------------------------------------------------------------------------|--------------|
| 1. Additional delays - per increment of 500 ft. | 1,100.00 ea. |
| 2. Additional tallies - per tally (total characters and spaces not to exceed 120) | 1,000.00 ea. |
| 3. Accumulative tallies - provision for two tallies to be accumulative | 1,000.00 ea. |
| 4. Flexowriter output - additional price for substituting flexowriter with punch tape for standard electric typewriter | 4,000.00 ea. |
| 5. Digital clock - added to manual input panel | 450.00 ea. |

B. Deletions from Basic System

To allow flexible pricing, the following features may be deleted from the basic system, with a reduction of the basic system price as indicated.

- | | |
|--------------------------------------|---------------|
| 1. Delete the 500 foot delay channel | Less 1,150.00 |
| 2. Delete the manual input panel | Less 5,000.00 |

FOR THE USE OF GENERAL ELECTRIC EMPLOYEES ONLY



PRODUCTS-DIG-1,003-P4

January 30, 1959

SUBJECT: PRICES-- GE 302 DATA ACCUMULATOR (continued)

3. Delete the dual channel feature (i. e. , one channel only)	Less	\$3,000.00
4. Delete the visual input panel	Less	320.00
III. Auxilliary Equipment		
A. Tachometer, Berkley type 467A, with power supply and filament transformer		320.00

NOTES:

1. Modifications to the basic system will be quoted on request to Computer Department, Phoenix, Arizona
2. Sale of the above equipment is subject to Computer Department Standard Conditions of Sale - Products
3. Prices are:
 - a. Subject to change without notice
 - b. F. O. B. point of shipment, with transportation not allowed.
 - c. Exclusive of installation and maintenance, although prices do include installation inspection supervision and instruction. Thereafter, initial customer service requirements will be initiated through the local I&SE office.
4. Sales Promotion Brochure: CPB-14B (GEA-6537A)
5. Terms: net 30 days
6. A. S. D. Price Clause 1 b applies
7. Applicable federal, state and local taxes not included in above prices.

FOR THE USE OF GENERAL ELECTRIC EMPLOYEES ONLY

October 12, 1960

GE 210 SYSTEM COMPONENTS SALE AND LEASE PRICES

Model No.	Component	Sales Price (Incl. Install.)	Lease Price	Monthly Maint. on Sale Only
4WC210A1	Central Processor (4K Memory)	\$268,800	\$4,890	\$250
4WM210A1	Additional 4K Memory	72,100	1,540	101
4WN210A1	Power Supply	22,000	480	144
4WK210A1	Console, incl. Typewriter	23,000	520	230
4WK210A2	plus Photoreader	26,400	555	250
4WU210A1	Tape Controller, 30KC	65,500	1,200	71
4WU210B1	Tape Controller, 50KC	80,700	1,490	78
	Magnetic Tape Handlers:			
4WT210B2	30KC Single	26,000	610	126
4WT210A2	30KC Dual	42,300	950	259
4WT210D1	50KC Single	34,800	870	164
4WT210E1	50KC Dual	55,500	1,275	328
4WT210C1	Printer Reader	26,000	560	76
	Card Readers:			
4WD210A1	400cpm	29,100	690	84
	High Speed Printers:			
4WL210A1	72 Col. On-line	49,500	1,100	202
4WP210B1	120 Col. Computer Edited	110,000	2,450	375
4WP210A1	120 Col. Re-entry	126,000	2,800	385
4WP210D1	120 Col. Self-editing	180,900	3,840	511
	Document Handlers:			
4WS100E1	12 Pocket	87,500	1,750	491
4WU12A1	12 Pocket	87,500	1,750	842
4WU2A1	2 Pocket	60,600	1,210	350
4WU210A1	High Speed Paper Tape Punch	13,500	280	104
	Full Field Proof Encoder:			
	one (1) Pocket	5,900	130	
	two (2) Pocket	6,950	150	
	three (3) Pocket	7,800	160	

F. O. B. Phoenix, Arizona - - All taxes additional.

Rental includes installation, maintenance, and 176 hours of use per month.

Overtime charge on rentals to be computed at 40 percent of the hourly rate per basic shift.

Standard lease agreement of the Computer Department to be the determinant of the individual sale/lease agreements.

Availability: Subject to prior commitments. For estimated delivery, use current Product Availability Schedule issued monthly by Marketing Administration. Marketing Administration should be contacted before making firm commitment on delivery.

For the use of General Electric Employees only



PRODUCTS-DIG-1.004-P1

January 30, 1959

SUBJECT: PRICES -- GE 309 GAGE LOGGING SYSTEM

Effective January 30, 1959, and until superceded, the prices in effect on the basic GE 309 GAGE LOGGING SYSTEM, and optional features, are established as follows:

- | | |
|--------------------------------------------------------------------------------------------------------------------------------------------------------------------------------|------------------|
| I. Basic System | \$23,000.00 |
| Includes four counters (four digits each), six digit product identification panel and remotely operated standard electric typewriter. | |
| II. Optional Features | |
| A. Dual counters - to make 6 or 8 counter system of 4 digits per counter | 2,500.00 ea. |
| B. Additional digits per dual counter - expandable to 5 or 6 digit. (The existing 4 counters in the basic system should also be included.) | 700.00 ea. |
| C. 26-digit manual input panel - for substitution in place of 6-digit manual input panel | 3,500.00 ea. |
| D. Digital clock (hours and minutes) - can be mounted only in the 26-digit manual input panel (feature C) | 450.00 ea. |
| E. Flexowriter output with paper tape punch - may be substituted in place of standard electric typewriter to provide a punched tape output as well as the typewriter log sheet | 4,000.00 ea. |
| F. Roll diameter compensator and Berkley type 467A Tachometer | 3,000.00 ea. set |

FOR THE USE OF GENERAL ELECTRIC EMPLOYEES ONLY



PRODUCTS-DIG-1.004-P2

January 30, 1959

SUBJECT: PRICES -- GE 309 GAGE LOGGING SYSTEM (continued)

NOTES:

1. Modifications to the basic system will be quoted on request to Computer Department, Phoenix, Arizona.
2. Sale of the above equipment is subject to Computer Department Standard Conditions of Sale - Products.
3. Prices are:
 - a. Subject to change without notice
 - b. F. O. B. point of shipment, with transportation not allowed.
 - c. Exclusive of installation and maintenance, although prices do include installation inspection supervision and instruction. Thereafter, initial customer service requirements will be initiated through the local I&SE office.
4. Sales Promotion Brochure: CPB-22 (GEA-6873)
5. Terms: net 30 days
6. A. S. D. Price Clause 1 b applies
7. Applicable federal, state and local taxes not included in above prices.

FOR THE USE OF GENERAL ELECTRIC EMPLOYEES ONLY

PRICES GE 210E "BANKPAC" SYSTEM

	<u>Model No.</u>	<u>Sales Price (Incls. Install.)</u>	<u>Lease Rates</u>	<u>Monthly Maint. on Sales only</u>
GE 210 Model "E" Banking System				
Consisting of:				
1 Central Processor (4K Memory)	C210	\$527,800	\$10,500	\$1,811
1 Power Supply	N210			
1 Console with Photo Reader	K210			
1 Tape Controller 30 KC	U210			
2 Dual Mag. Tape Handlers	T210			
1 Printer (on line) 72 col.	L210			
1 Document Handler, 12 pocket	U12A			

F.O.B. Phoenix Arizona. All taxes additional.

Rental includes installation, maintenance, and basic shift of 176 hours use per month.

Overtime charge on rental to be computed at 40 percent, of the hourly rate per basic shift.

Stand. terms and conditions of the Computer Department Sales/Lease Contract apply.

GE 210 LIST PRICES IN EFFECT WILL APPLY ON ALL
ITEMS NOT INCLUDED IN THIS PACKAGE OFFERING.

For the use of General Electric employees only



PRODUCTS-DIG-1.005-P1

December 12, 1958

SUBJECT: PRICES -- GE 311 DATA PROCESSING SYSTEM

Effective December 12, 1958, and until superceded, the price in effect on the basic GE 311 DATA PROCESSING SYSTEM is established as follows:

Unit Selling Price: \$100,000.00

The basic system includes:

100 point input

1 attenuator

1 amplifier (low level)

1 analog-to-digital converter

1 GE 312A Digital Control Computer

1 Flexowriter input-output (or equivalent)

- Notes:
1. Sale of the above equipment is subject to Computer Department Standard Conditions of Sale - Products.
 2. Prices are:
 - a. Subject to change without notice
 - b. Exclusive of installation and maintenance

FOR THE USE OF GENERAL ELECTRIC EMPLOYEES ONLY



PRODUCTS-DIG-1.006-P1

December 12, 1958

SUBJECT: PRICES -- GE 312A DIGITAL CONTROL COMPUTER

Effective December 12, 1958, and until superceded, the prices in effect on the GE 312A DIGITAL CONTROL COMPUTERS are established as follows:

1. 2048-word memory unit, no input or output equipment:

Unit Selling Price: \$ 75,000.00

2. 8192-word memory unit, no input or output equipment:

Unit Selling Price: \$ 85,000.00

- Notes:
1. Sale of the above equipment is subject to Computer Department Standard Conditions of Sale - Products.
 2. Prices are:
 - a. Subject to change without notice
 - b. Exclusive of installation and maintenance

FOR THE USE OF GENERAL ELECTRIC EMPLOYEES ONLY



PRODUCTS-DIG-1.007-P1

December 12, 1958

SUBJECT: PRICES -- GE 310 DATA ACQUISITION SYSTEM

Effective December 12, 1958, and until superceded, the price in effect on the basic GE 310 DATA ACQUISITION SYSTEM is established as follows:

Unit Selling Price: \$35,000.00

The basic system includes:

Input: 100 dc voltages (.01 to 100 volts full scale)

Scanning and printout at better than 1 point/second

All signals scaled, linearized, attenuated - selectable
by pin-board program

Output: Standard electric typewriter (3 digits/point)

- Notes:
1. Sale of the above equipment is subject to Computer Department Standard Conditions of Sale - Products
 2. Prices are:
 - a. Subject to change without notice
 - b. Exclusive of installation and maintenance

FOR THE USE OF GENERAL ELECTRIC EMPLOYEES ONLY



PRODUCTS-DIG-1. 008-P.1 (of 4)
July 29, 1959

G-E 150 DATA PROCESSING SYSTEM

Function: A medium to large scale electronic data processing system for general business use. In addition to cards, tapes and paper tape, there is a combination input device and sorter which reads documents printed in magnetic ink and a re-entry printer for printing magnetic ink fields on output documents.

Chief Markets: Utilities, banks, retail stores, insurance companies, integrated business data processing.

Customer Benefits: Greater speed in processing data, reduction of data preparation time and cost by use of original documents, greater accuracy, reduction in clerical costs, availability of current statistical and management data.

Competitors:

IBM:	7070	Datamatic:	800
NCR:	304	Philco:	Transac 2000
Sperry Rand:	Univac II		
RCA:	501		

Competitive Advantages:

1. Price
2. Input/output peripheral flexibility
 - a. Input methods
 - i. Paper documents with magnetic encoding
 - ii. Magnetic tapes
 - iii. Paper tape
 - iv. 80 column punched cards
 - v. Typewriter

For the use of General Electric employees only.



July 29, 1959

- b. Output methods
 - i. Magnetic tape
 - ii. High speed printer with optional magnetic ink printing
 - iii. Paper tape
 - iv. 80 column punched cards
 - v. Typewriter
 - vi. Segregated documents
- 3. Building block equipment flexibility
 - a. 4000 or 8000 word memory
 - b. 30 or 60 KC magnetic tape system
 - c. Up to 13 magnetic tape transports
- 4. Powerful and flexible command structure
 - a. Double or single precision operations
 - b. Business type instruction codes
 - c. Unique commands "Find Equal", "Find Greater", "Tumble", and "Blockette Write"
- 5. Unusual programming features
 - a. Designator bits provide automatic counters, flexibility in item design, and facilitate data transfer.
 - b. Index register or B-box
 - c. Asterisk digit compares equal to anything, reducing need for extraction and enabling "pacing" of files.
- 6. Use of transistor and magnetic core logical elements for increased reliability, low power requirements, low heat generation, and compact size.
- 7. Read-write buffering provides simultaneous reading, writing and computation.
- 8. Comparatively simple to program. An experienced programmer can learn the GE-150 in two weeks or less, without formal training.
- 9. Programming package of utility routines, general purpose routines, Assembler-Compiler immediately available.

For the use of General Electric employees only.



10. Highly qualified personnel with pioneer applications experience and know-how in areas of business data processing, and especially in the new area of paper document processing.
11. High speed of input devices makes on-line data entry feasible and practical.

Competitive Disadvantages:

No off-line tape or card processing capabilities.

General Price Range:

From \$16,000 to \$25,000 per month rental.

Delivery Date From Time of Order:

Eighteen months.



PRODUCTS-DIG-1. 008-P. 4 (of 4)
July 29, 1959

PRICES FOR GE-150 SYSTEM COMPONENTS

Model No.	Component	Lease ⁽¹⁾	Sale ⁽²⁾	Installation	Maintenance ⁽³⁾
	Central Processor:				
4 WC 150A	4000 word memory	6530	331600	15000	1400
4 WC 150B	8000 word memory	8100	404700	16000	1700
4 WK 150A	Control console, including typewriter & photoreader	620	30700	1000	125
4 WN 150A	Power Supply	780	39200	1600	160
4 WB 150A	Tape Controller	1490	75600	3000	325
	Magnetic Tape Handler:				
4 WT 150A	30 KC Single	560	22300	1200	160
4 WT 150B	30 KC Dual	950	38000	2000	320
4 WT 150C	55 KC Single	870	34800	1800	275
	Document Handler:				
4 WS 100A	12 Pocket	1750	87500	3400	500
4 WU 2A	2 Pocket	1210	60600	2200	350
	High Speed Printer:				
	computer edited	2450	110000	4000	650
	re-entry	3300	150000	6000	900
4 WP 150A	Self-editing	4280	204900	8000	1200

(1) Lease prices include installation, maintenance and 176 hours of use per month.

Overtime hours computed at 40% of basic shift hourly rate.

(2) F. O. B. Phoenix, Arizona, all taxes additional.

(3) Second shift maintenance charge is 60% of first shift.

Charges for individual units apply only as a part of a system installation.

Site preparation is the responsibility of the customer.

Air conditioning to be furnished by the customer.

Maintenance facilities, such as work space, light, heat, power, will be furnished by the customer.

Computer Department will pick up the required AC power at a point within the equipment room and connect to the computer. Normal between-unit cabling will be supplied by the Computer Department.

THE PRICES SHOWN ARE SUBJECT TO CHANGE WITHOUT PRIOR NOTIFICATION.

For the use of General Electric employees only.



PRODUCTS-DIG-2.001-P1(of 1)

MAGNETIC PRINT READERFUNCTION:

An electronic device for reading numbers and symbols which have been printed with magnetic ink. When used in conjunction with a paper transport device, it becomes a high speed input for a Data Processor, or with the proper control circuitry, a high speed paper sorter.

CHIEF MARKETS:

Banks, Public Utilities, Oil Companies, Department Stores, Insurance Companies, Airlines.

CUSTOMER BENEFITS:

Eliminates costly conversion of information to machine language by clerical help. Reduces number of errors.

COMPETITORS:

None. An optical reader has been built but has not proven satisfactory.

COMPETITIVE ADVANTAGES:

Only competitive idea is "bar code", which cannot be conveniently read by a human being.

COMPETITIVE DISADVANTAGES:

None.

GENERAL PRICE RANGE:

\$12,000 to \$14,000 sales price, in reasonable scale production.

DELIVERY DATE FROM TIME OF ORDER:

First available about end of 1958 or early 1959, except for special orders at higher prices.

For the use of General Electric employees only.





PRODUCTS-DIG-3.001-P2

YOU CAN NOW BUY LEAD TIME in both development and production while improving your industrial digital data-processing equipment design with General Electric's newest line of low-cost, all-transistorized DIGITAL COMPUTING PLUG-IN BOARDS.

SUBSTANTIAL IMPROVEMENTS over vacuum tube circuits which perform the same functions are designed into these miniaturized, etched-circuit packages. Because solid-state components exclusively are used, heat dissipation and power consumption of electronic circuitry are cut by 90%; size is reduced 50%. Cooling equipment cost is drastically reduced. Reliability is increased because there are no parts susceptible to wear, vibration, or shock failure.

YOU OBTAIN DESIGN FLEXIBILITY heretofore impractical because only two basic circuit elements are used to form most G-E DIGITAL PLUG-IN BOARDS. These two basic circuit elements, each mounted on a 1" by 2" etched-circuit board, are combined in quantity and mounted on larger boards to form digital building blocks such as these:

Counters

Shift Registers

Storage Registers

Flip-flops.



PRODUCTS-DIG-3.001-P3

Other possible applications of the basic boards are limited only by the designer's imagination. A single logic element can act as an "AND gate," "OR gate," "INHIBITOR," or "INVERTER." Each logic element provides its own amplification and reshaping. Additional power drivers, often necessary with diode logic, are eliminated.

DESIGN STANDARDS as listed here insure maximum reliability without excessive cost:

Resistors -- 5%, carbon composition, always used at less than 1/2 rated power.

Capacitors -- 10%, silver/mica.

Allowable D. C. voltage variation -- $\pm 5\%$.

- Transistors --
1. Used at less than 50% of maximum power derated to 50°C.
 2. Less than 80% of maximum rated inverse junction voltage.
 3. 80% of specified minimum Beta.
 4. Less than 80% of maximum emitter current.

SYSTEM PACKAGING is accomplished with General Electric's standard line of rugged, compact modular racks (shown on next page) mounted in heavy industrial-environment cabinets. Cabinets are constructed with 3/16" steel angle supports and sealed with oil-resistant synthetic gaskets where required.



PRODUCTS-DIG-3.001-P4



Formed steel modules are used to hold the PLUG-IN BOARDS. Gold-flashed, staked connectors on each board plug into connections on the module frame. Wire-wrapped interconnections are used to eliminate soldering. Each board has several easily accessible test points for in-operation circuit checks. A plastic channel carries inter-rack wiring along the sides of modules.



PRODUCTS-DIG-3.001-P5

INQUIRE TODAY

For more complete, detailed technical information, contact your nearest

Computer Department Sales Engineer:

W. E. Tice
1103 North Central Avenue
Phoenix, Arizona
ALpine 4-3171

B. E. Bowers
3001 James Street
Syracuse, New York
GRanite 6-4411, Ext. 5125

J. E. Hogg
951 Commercial Street
Palo Alto, California
YOrkshire 8-0061

W. E. Wright
7235 Wisconsin Avenue
Bethesda 14, Maryland

T. J. O'Rourke
3325 Wilshire Blvd.
Los Angeles, California
DUnkirk 1-3641

G. A. Doxey
General Electric Company
Computer Department Sales Office
Dayton, Ohio



PRODUCTS-DIG-3.001-P6

G-E's NEW LINE OF DIGITAL COMPUTING PLUG-INS FOR INDUSTRIAL USE

Model 5018A, Type LE-G1

LOGIC ELEMENT

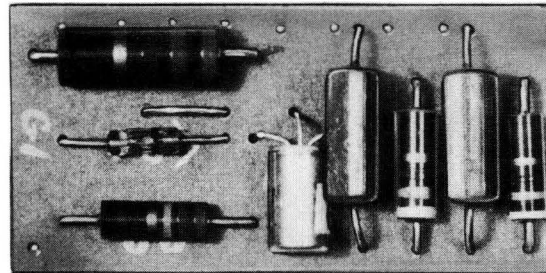

- USES:
1. AND gate
 2. OR gate
 3. INVERTER

Most other G-E Digital Computing Plug-ins are formed by combining this LOGIC ELEMENT and the Model 5017A(SC-G1) STEERING CIRCUIT in requisite quantities to form counters, flip-flops, etc.



PRODUCTS-DIG-3.001-P8

G-E's NEW LINE OF DIGITAL COMPUTING PLUG-INS FOR INDUSTRIAL USE

Model 5019A(SC-G1)

STEERING CIRCUIT

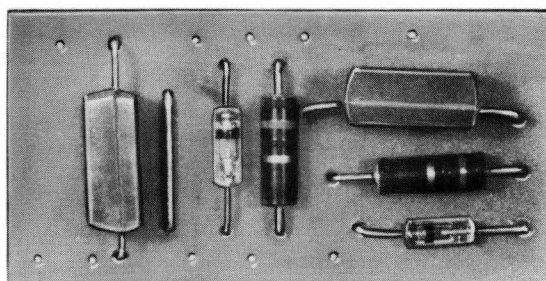

USES: Operates in conjunction with the Model 5018A(LE-G1) Logic Element to form flip-flops, counters, etc.

OUTPUT CAPABILITIES: Each Steering Circuit can drive two Logic Elements.

SPEED: The time constant is 2.4 microseconds.

CONSTRUCTION: Both the Steering Circuit and Logic Element are mounted on 1" by 2" etched wiring boards which are coated with a transparent protective compound after the components have been mounted and dip-soldered.



PRODUCTS-DIG-3.001-P9

G-E's NEW LINE OF DIGITAL COMPUTING PLUG-INS FOR INDUSTRIAL USE

Model 5016A(6G1)

GENERAL PURPOSE GATE CARD

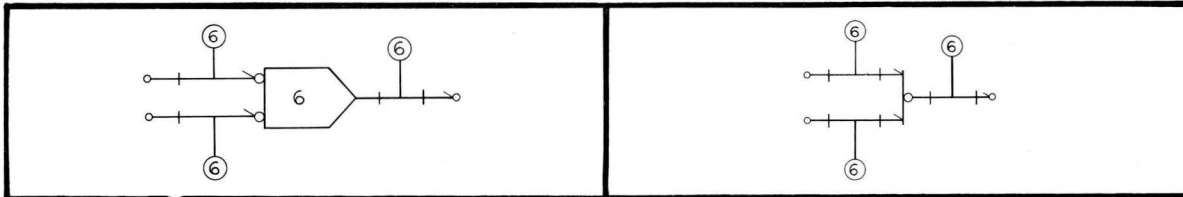

APPLICATION SHEET No. 1

Three different logic configurations are possible with the same card.

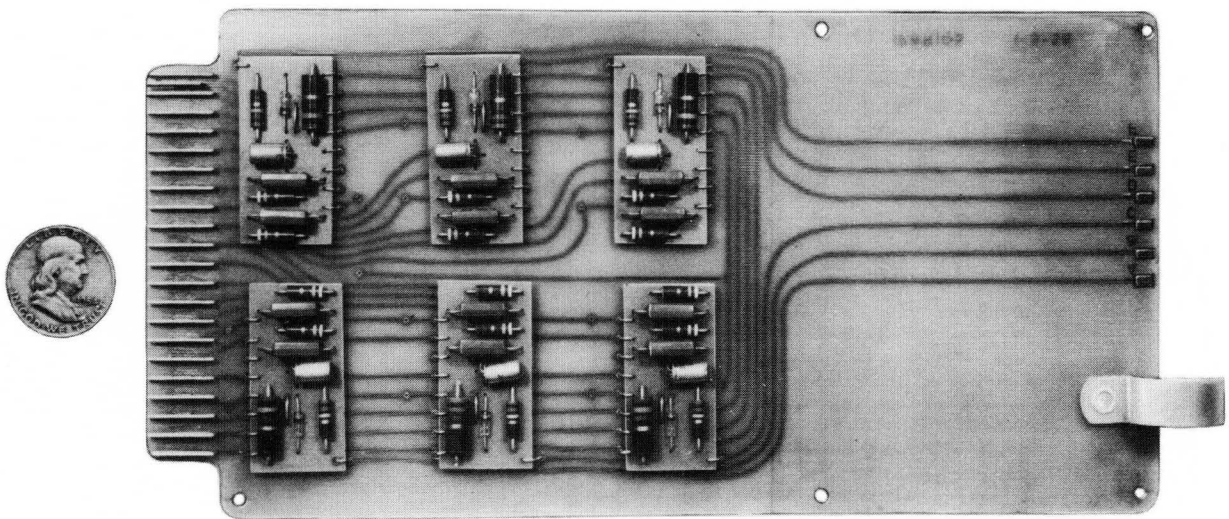

USES: This card carries six Logic Elements for use as general purpose two-input gates.

OUTPUT CAPABILITIES: Each gate can drive five Logic Element inputs (8 ma. total).



PRODUCTS-DIG-3.001-P10

TIME DELAY: The delay through each gate with one load attached is 0.3 microsecond. The delay increases by 0.1 microsecond for each additional load.

POWER REQUIREMENTS:

+12 volts	±5%	1.5 ma	max.
+6 volts	±5%	86.4 ma	max.
-18 volts	±5%	80.0 ma	max.
Ground		51.0 ma	max.

Total power: 2.0 watts.

*GE 210 ACCESSORY ITEM PRICES

<u>Recommended Start Up Quantities</u>				<u>Description</u>	<u>**Single Order Amt. Prices - - - -</u>			<u>Delivery</u>
D210A	P210A P210B	L210A	U12A S100E1		Less than \$100	Less than \$1,000	Greater than \$1,000	
				<u>Plugboards (24x34 holes, incl. Markings)</u>				
15				Card Reader, Dwg. No. 43C108189 -each	43.56	37.03	30.49	30 days
		15		Printer, 72 col., Dwg. No. 43C108190 -each	"	"	"	" "
	30			Printers, CE & RE, 120 col., Dwg. No. 43C108191 - each	"	"	"	" "
			1	G. P. Sorter Control Dwg. No. 43C108197 - each	"	"	"	" "
				<u>Patchcords (all boards - package of 25)</u>				
75	100	75		Shunt— Dwg. No. 43A110244-1 - Pkg.	11.88	10.58	9.50	30 days
25	25	25		5 in — Dwg. No. -3 - "	9.98	8.90	7.70	" "
25	25	25		7 in — " " -4 - "	10.13	9.03	7.83	" "
25	25	25		9 in — " " -5 - "	10.25	9.15	7.93	" "
25	25	25		11 in — " " -6 - "	10.43	9.28	8.05	" "

* One set of the above is shipped with each original peripheral. Additional requirements will vary depending on applications.

** Any combination of items apply to meet single order amount criteria for prices shown.

For the use of General Electric Employees only



PRODUCTS-ANA-1.002-P1(of 2)

HEAT RATE COMPUTERFUNCTION:

The Heat Rate Computer is designed to compute the heat flow which will result from aerodynamic conditions during flight. It forms the central unit of a system which will simulate the heating effects of the "thermal barrier" on an aircraft structure under dynamic flight conditions. From the input data, the heating effects of the simulated flight conditions are calculated. This calculated heat flow is compared with input from thermal sensors on the specimen under test, and the resulting output signal is used to control the heat source (infra-red heat lamps or rf induction heaters) to produce a thermal environment which is very nearly identical to that which the structure would experience in actual flight.

CHIEF MARKETS:

Large airframe manufacturers, and government agencies such as Wright Air Development Center. Activity is heavy now, will probably taper sharply within a few months. Probably maximum market for about 30 computers, some of which may be expanded at a later date.

FEATURES:

1. Response time of computed output fast enough for radiant or induction heating systems.
2. Digital storage of curves on magnetic drum for excellent definition and accuracy. (Stores 400 data points per curve).
3. Accuracy of output within 2% or better.
4. Multichannel operation with central computer plus multiplexing of inputs and outputs realizes the cost advantages of multiplexing as well as the uniform output of one central computer.
5. Constructed of transistorized plug-in units for reliability and low-cost operation.
6. Simple data entry--can be punched cards, magnetic tape, or manual keyboard, as customer desires.
7. Modular design permits flexibility in use, ease of maintenance, and lower cost.

For the use of General Electric employees only.





PRODUCTS-ANA-1.002-P2(of 2)

COMPETITORS: (page 2)

Research, Inc. (2 jobs to date)

Beckman Instruments (1 job to date)

Westinghouse

Alabama Engineering (bid on one job - Redstone Arsenal)

Spar Engineering (bid on job for Philadelphia Naval Yards)

COMPETITIVE ADVANTAGES:

Faster response time (suitable for rf induction heating) and good accuracy. We believe we are unique in our approach of storing curves on magnetic drum.

COMPETITIVE DISADVANTAGES:

Mainly higher price, plus the fact that competition has already secured jobs.

GENERAL PRICE RANGE:

\$200,000 to \$500,000, depending on the number of channels.

DELIVERY:

About 10 months to a year from date of order.

For the use of General Electric employees only.



GENERAL ELECTRIC'S *NEW...*

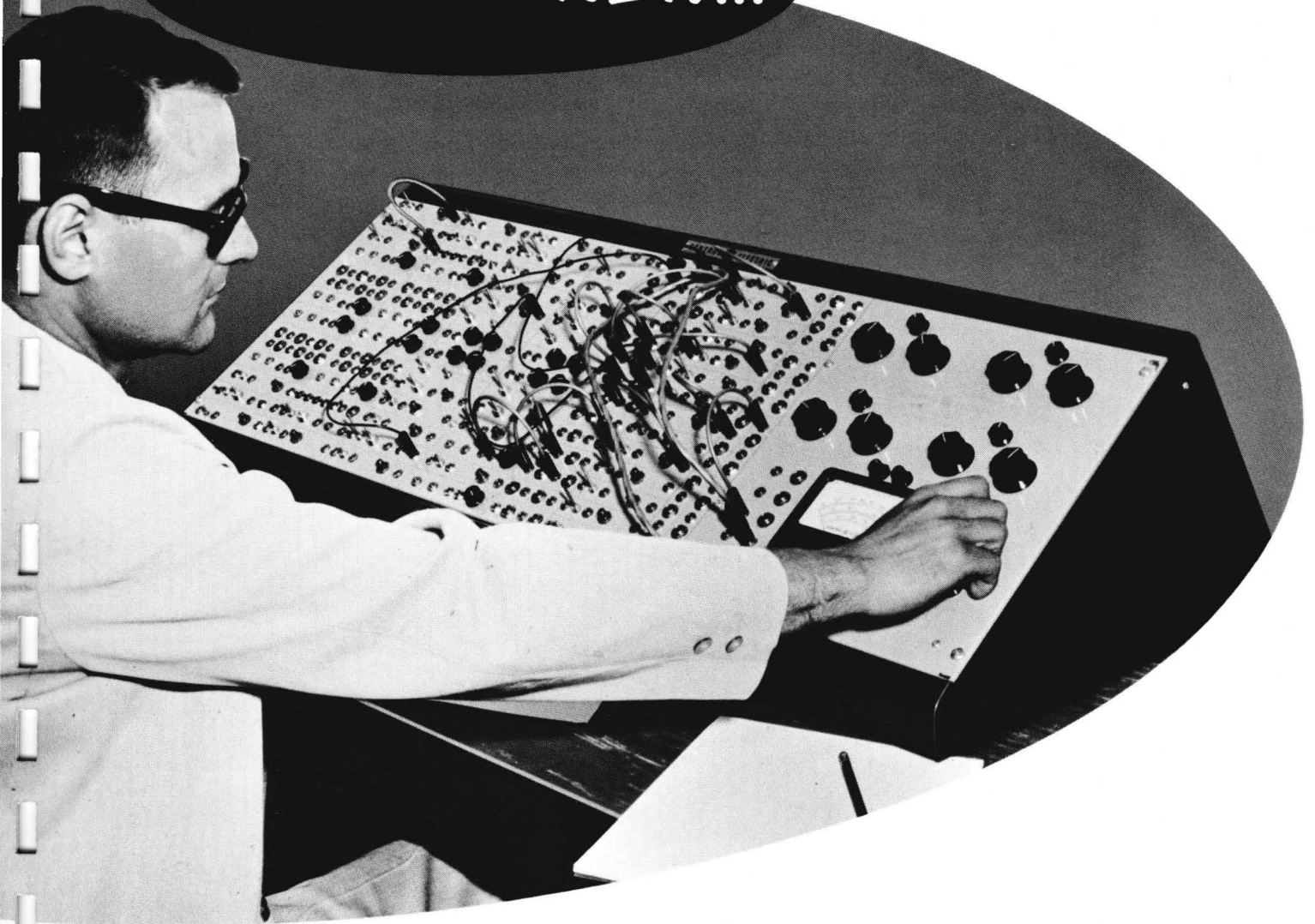

MODEL 307

MINIATURIZED

A-C NETWORK ANALYZER

GENERAL  ELECTRIC

- low cost
- small, compact
- easy to operate

computer department • phoenix, arizona

features

applications

savings

The Miniaturized AC Network Analyzer, Model 307, is the instrument that will aid your engineering staff by solving the day-to-day problems that are too large to do by hand calculation, but too small to justify the time and expense of taking to a large network analyzer installation.

It will eliminate the unnecessary expense often incurred because "safe" or half-guessed solutions must be accepted in lieu of an actual detailed solution of the problem.

The Miniaturized AC Network Analyzer is an engineering tool to simulate the actual power system network for analysis of power transmission problems and for calculations of system design.

it can make short work of:

- *Load flow studies (watt and var flow and voltage).*
- *Analysis of transmission requirements to supply new loads.*
- *Analysis of transmission capabilities of existing systems or proposed additions.*
- *Short circuit and relay studies.*
- *Calculation of specifications and optimum locations for additions to portions of existing networks.*
- *Incremental loss studies.*

The circuits are easily understood by anyone familiar with communications equipment such as carrier current or mobile radio. Utility communications maintenance personnel will find this equipment easy to service.

A seated operator can easily reach and see all parts of the analyzer. Any office will do for its location. No external cooling equipment is required. The analyzer operates through all normal ranges of temperature and humidity.

dual operation:

- *Two standard units may be readily coupled together to form an eight-generator board.*

specifications

The unit is comprised of a 10-KC stabilized oscillator driving four amplifiers which simulate the generating stations. Line, load, and shunt capacity units are connected by patch cords to represent the network configurations under study. A single panel type indicating instrument isolated by electronic amplifiers measures powers, voltages, currents and vars. Standards of resistance, capacity and inductance are provided for checking the network constants.

All adjustments and measurements are made from the front panel. Extensive study has been made of switching and patch cord layout to provide extreme flexibility.

components

Oscillator (Quantity — 1)

10-KC electronic high capacity tuned circuit oscillator, with separately regulated supply voltage. A pair of cathode followers provides low impedance outputs and isolates the oscillator from the generator phase shifters which feed the generator amplifiers.

Generator Units (Quantity — 4)

Each consists of an electronic amplifier driven by the phase shift network. The amplifiers have very low internal impedance giving a good voltage regulation characteristic. Phase angle is continuously adjustable from 0° to 90°. A four quadrant switch selects the quadrant in which phase angle is varied. Phase and amplitude are adjustable from front panel.

Metering (Quantity — 1)

Single 4½ inch panel instrument isolated by electronic amplifiers measures voltage, current, watts, and vars. Metering functions and ranges are selected by a front panel switch. The following ranges are provided:

Voltage: .1, .5, and 1 per unit volts
 Watts: .03 to 10 per unit watts
 Current: .3, 1, 3, and 10 per unit amps
 Vars: .03 to 10 per unit vars

Load Units (4 hi-lo, 6 medium)

Made up of a series combination of a variable resistor and a variable inductor. Two types of units are furnished: a hi-lo unit and a medium range unit. Range of either may be selected by a switch. The junction of the inductor and resistor is connected to a panel jack. Low end of the load unit is grounded. Per unit impedance range:

Hi-Lo Unit

Hi — 0.5 + j7.5 to 25 + j16
 Lo — 0.06 + j.13 to 1.0 + j1.1

Medium Unit

0.3 + j3.75 to 25 + j8.0
 0.1 + j.95 to 25 + j3.75

Auto Transformer (Quantity — 4)

Designed for low loss and low leakage reactance. The ratio can be adjusted by switches in 1% increments from 80% to 129%.

Line Impedance Units

(12 low, 8 medium, 10 high)

Made up of a series combination of a variable resistor and a variable inductance. Each end as well as the junction of resistor and inductor terminates in a panel jack. This arrangement permits the parallel or series connection of resistance and inductance. Per unit impedance ranges:

Low impedance unit — .005 + j.01 to .25 + j.06
 Medium impedance unit — .005 + j.03 to .25 + j.30
 High impedance unit — .003 + j.12 to .50 + j1.12

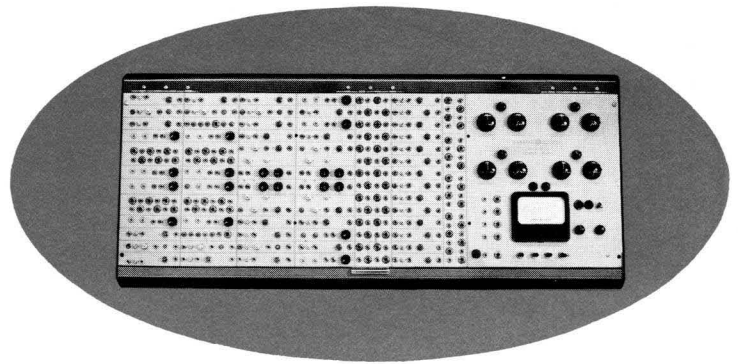

Front view of Miniaturized Network Analyzer. Note main controls grouped together at right, patchcord system on left.

Shunt Capacitor Units (Quantity — 12)

Consists of 8 combinations of fixed capacitors and variable capacitors selected by an eight-position switch. The variable capacitance provides small increments of adjustment on fixed positions. The low end of each unit is grounded. Capacitance ranges:

Switch pos.	Per unit Fixed cap.	Per unit Var. cap.	Switch pos.	Per unit Fixed cap.	Per unit Var. cap.
1	Open	Open	5	.2	.04 to .12
2	Open	.012 to .04	6	.3	.04 to .12
3	Open	.04 to .12	7	.4	.04 to .12
4	.1	.04 to .12	8	.5	.04 to .12

Reference Unit (Quantity — 1)

Provides three standards having per-unit impedance of 0.1, 1.0 and 10.0 for checking equipment accuracy. Panel-mounted switches enable metering of individual resistors, inductors, capacitors or combinations of them.

Busses (Quantity — 15)

10 four point and 5 six point busses with a metering jack for each circuit.

Cabinet

Sloping front desk-top type, 39" long, 22" deep, and 10" high. Net weight 115 lbs.

Power

115v, ± 10%, 300 watts.

Base Values

10v, 1000 ohms impedance, 10 milliamps current, are used in the equipment in order to standardize on one set of values. These are numerically converted to desired values by the user.

INQUIRE TODAY!

For more information or assistance in applying other Computer Department products and services to your process or operation, contact: 1) the nearest Regional Office listed below; 2) your nearest General Electric Apparatus Sales District Office; or 3) the General Electric Company, Computer Department, Deer Valley Park, Phoenix, Arizona.

REGIONAL OFFICES:

General Electric Company
Building 34, Room 2
Pittsfield, Massachusetts

3325 Wilshire Blvd.
Los Angeles 5, California

941 Charleston Rd.
Palo Alto, California

2600 Far Hills Ave.
Dayton, Ohio

7401 Wisconsin Avenue
Suite 514
Bethesda 14, Maryland

215 Euclid Avenue
Suite 1013
Cleveland, Ohio

General Electric Company
Building 2, Room 745
Schenectady, New York

3001 James Street
Syracuse, New York

840 S. Canal Street
Chicago 80, Illinois

1260 Boston Avenue
Bridgeport 9, Connecticut

Room 302-303
570 Lexington Avenue
New York 22, New York

Building 6, Room 239
Appliance Park
Louisville, Kentucky

FOR FIGURES IN A HURRY—FIGURE ON A G-E COMPUTER



In the construction of the equipment described, General Electric Company reserves the right to modify the design for reasons of improved performance and operational flexibility.

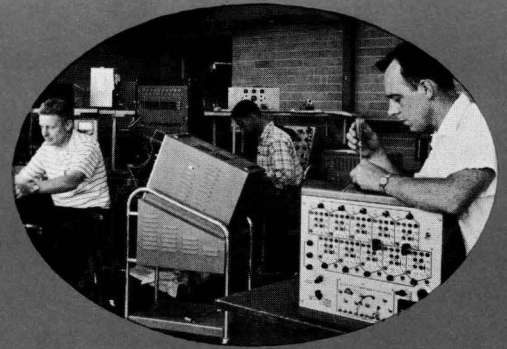

LABORATORY FACILITIES



MANUFACTURING



ENGINEERING



Progress Is Our Most Important Product

GENERAL  ELECTRIC

COMPUTER DEPARTMENT • PHOENIX, ARIZONA



PURCHASERS AND USERS OF THE GE-307 MINIATURIZED
A.C. NETWORK ANALYZER

Australian Electrical Industries
Black Hills Power & Light Co.
C. F. Braun & Co.
Central Louisiana Electric Co.
Cia Cubana de Electricidad
El Paso Electric Co.
S. A. Electra de Viesgo (Spain)
Idaho Power & Light Co.
Kansas Power & Light Co.
Knoxville Utilities Board
Minnesota Power & Light Co.
North Dakota Agricultural College
Orange & Rockland Utilities, Inc.
Plains Electric Generation & Transmission Cooperative, Inc.
Public Service Co. of New Mexico
University of Louisville
University of New Brunswick
U. S. Navy, Bu Ships
Utah Power & Light Co.
Virginia Polytechnic Institute



PRODUCTS-ANA-1.003-P1(of7) REV Aug 57
Supersedes previous data sheet

MINIATURIZED AC NETWORK ANALYZER

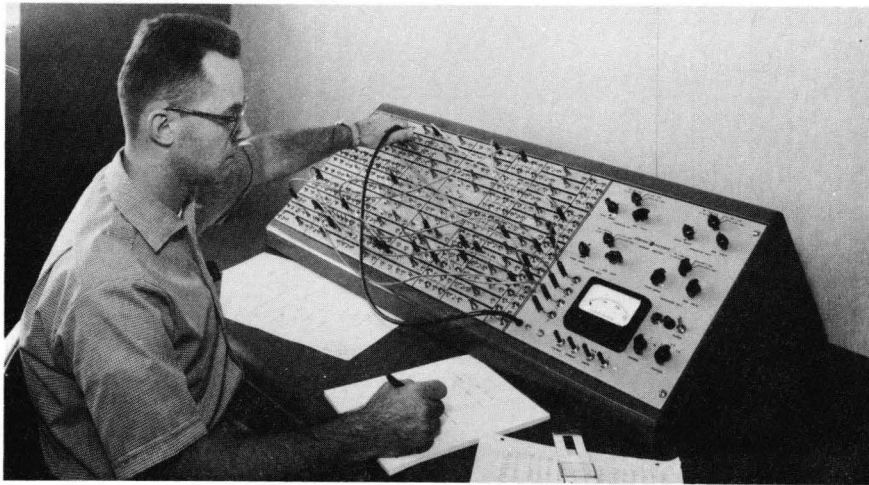

Analyzer in use, showing patchcords

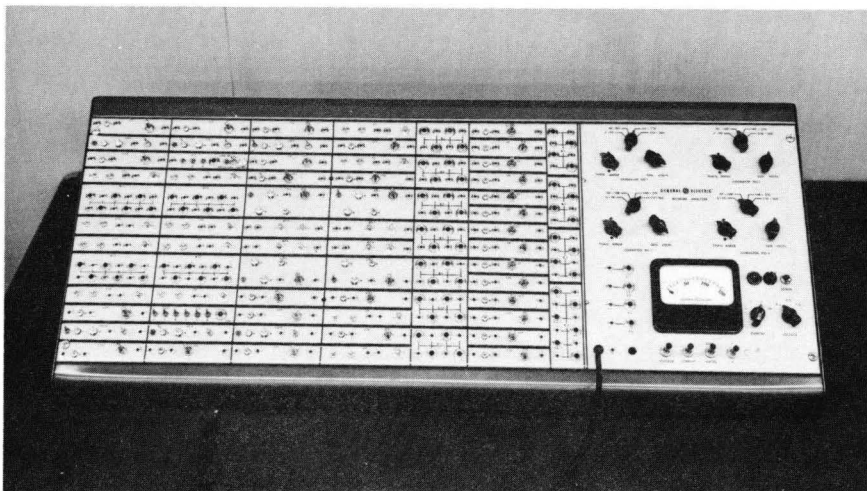

Detail of Analyzer panel

For the use of General Electric employees only.





PRODUCTS-ANA-1.003-P2(of 7) REV AUG 57

FEATURES -- APPLICATIONS -- SAVINGS

The Miniaturized AC Network Analyzer is the instrument that will aid your engineering staff by solving the day-to-day problems that are too large to do by hand calculation, but too small to justify the time and expense of taking to a large network analyzer installation.

It will eliminate the unnecessary expense often incurred because "safe" or half-guessed solutions must be accepted in lieu of an actual detailed solution of the problem.

The Miniaturized AC Network Analyzer is an engineering tool to simulate the actual power system network for analysis of power transmission problems and for calculations of system design.

It can make short work of:

- * Load flow studies (watt and var flow and voltage).
- * Analysis of transmission requirements to supply new loads.
- * Analysis of transmission capabilities of existing systems or proposed additions.
- * Short circuit and relay studies.
- * Calculation of specifications and optimum location for additions to portions of existing networks.
- * Incremental loss studies.

The simple and straightforward circuits are easily understood by anyone familiar with communications equipment such as carrier current

For the use of General Electric employees only.



PRODUCTS-ANA-1.003-P3(of 7) REV AUG 57

or mobile radio. Utility communications maintenance personnel will find this equipment easy to service.

A seated operator can easily reach and see all parts of the analyzer. Any office will do for its location. No external cooling equipment is required, because the analyzer operates through all normal ranges of temperature and humidity.

SPECIFICATIONS -- MINIATURIZED AC NETWORK ANALYZER

The unit is comprised of a 10-KC stabilized oscillator driving four amplifiers which simulate the generating stations. Line, load, and shunt capacity units are connected by patch cords to represent the network configurations under study. A single panel type indicating instrument isolated by electronic amplifiers measures powers, voltages, currents and vars. Standards of resistance, capacity and inductance are provided for calibrating the network constants.

All adjustments and measurements are made from the front panel. Extensive study has been made of switching and patch cord layout to provide extreme flexibility.

For the use of General Electric employees only.

COMPONENTSOscillator (Quantity - 1)

10-KC electronic phase shift oscillator, stabilized. A pair of cathode followers provides low impedance outputs and isolates the oscillator from the generator phase shifters which feed the generator amplifiers.

Generator Units (Quantity - 4)

Each consists of an electronic amplifier driven by the phase shift network. Its output is stabilized by an automatic gain control. Phase angle is continuously variable from 0° to 90° . A four quadrant switch selects the quadrant in which phase angle is varied. Phase and amplitude are adjustable from front panel.

Metering (Quantity - 1)

Single 4-1/2 inch panel instrument isolated by electronic amplifiers measures voltage, current, watts, and vars. Metering functions and ranges are selected by a front panel switch. The following ranges are provided:

Voltage: .1, .5, and 1 per unit volts	Current: .3, 1, 3, and 10 per unit amps
Watts: .03 to 10 per unit watts	Vars: .03 to 10 per unit vars

For the use of General Electric employees only.



Load Units (4 hi-lo, 6 medium)

Made up of a series combination of a variable resistor and a variable inductor. Two types of units are furnished: a hi-lo unit and a medium range unit. Range of either may be selected by a switch. The junction of the inductor and resistor is connected to a panel jack. Low end of the load unit is grounded. Per unit impedance range:

<u>Lo-Hi Unit</u>	<u>Medium Unit</u>
Hi -- $0.1 \angle j7.5$ to $25 \angle j14.4$	$0.1 \angle j3.75$ to $25 \angle j8.2$
Lo -- $0.1 \angle j.12$ to $1.0 \angle j1.13$	$0.1 \angle j.95$ to $25 \angle j3.57$

Auto Transformer (Quantity - 4)

Designed for low loss and low leakage reactance. The ratio can be adjusted by switches in 1% increments from 80% to 119%.

Line Impedance Units (12 low, 18 high)

Made up of a series combination of a variable resistor and a variable inductance. Each end as well as the junction of resistor and inductor terminates in a panel jack. This arrangement permits the parallel or series connection of resistance and inductance. Per unit impedance ranges:

Low impedance unit - $0.1 \angle j.011$ to $.25 \angle j.06$
 High impedance unit - $0.1 \angle j.03$ to $.50 \angle j1.03$

For the use of General Electric employees only.



Shunt Capacitor Units (Quantity - 12)

Consists of 8 combinations of fixed capacitors and variable capacitors selected by an eight-position switch. The variable capacitance provides small increments of adjustment on fixed positions. The low end of each unit is grounded. Capacitance ranges:

<u>Switch pos.</u>	<u>Per unit Fixed cap.</u>	<u>Per unit Var. cap.</u>	<u>Switch pos.</u>	<u>Per unit Fixed cap.</u>	<u>Per unit Var. cap.</u>
1	Open	Open	5	.2	.04 to .12
2	Open	.012 to .04	6	.3	.04 to .12
3	Open	.04 to .12	7	.4	.04 to .12
4	.1	.04 to .12	8	.5	.04 to .12

Calibration Circuits (Quantity - 1)

Three standards, having per unit impedances of 0.1, 1, and 10, are provided for checking accuracy of the equipment. Switches facilitate metering of individual resistors, inductors, or capacitors.

Busses (Quantity - 15)

10 four point and 5 six point busses with a metering jack for each circuit.

Cabinet

Sloping front desk-top type, 39" long, 22" deep, and 10" high

Power

115v, 300 w

For the use of General Electric employees only.



PRODUCTS-ANA-1.003-P7(of 7) REV JUNE 58

Base Values

10v, 1000 ohms impedance, 10 milliamps current, are used in the equipment in order to standardize on one set of values. These are numerically converted to desired values by the user.

(SCOPE OF SPECIFICATIONS)

(In the construction of the equipment described the full intent of the specifications will be met. The General Electric Company, however, reserves the right to make any departure from the specifications for reasons of improved design.)

CHIEF MARKETS:

Medium and large electric utilities throughout the United States and export, particularly where distant from a computer center. Some possibility of a secondary market in universities having large electrical departments. Consulting engineering firms.

COMPETITORS:

None to date. The Large AC Network Analyzers do not have economic application to the same class of problem. DC boards cannot perform same functions.

GENERAL PRICE RANGE:

\$7,950 f.o.b. Phoenix exclusive of Federal, State and Local taxes.

(Note: 15% discount available to Company-accredited educational institutions within the United States, if unit to be used only for instructional purposes.)

DELIVERY DATE:

First production unit available January, 1958.

For the use of General Electric employees only.



PRODUCTS-ANA-1.003-P8

December 12, 1958

SUBJECT: PRICES -- GE 307 MINIATURIZED A-C NETWORK ANALYZER

Effective January 5, 1959, and until superceded, the price in effect on the GE 307 MINIATURIZED A-C NETWORK ANALYZER will be established as follows:

Unit Selling Price: \$ 8,590.00

- Notes:
1. Sale of the above equipment is subject to Computer Department Standard Conditions of Sale - Products
 2. Prices are:
 - a. Subject to Change without notice
 - b. Exclusive of installation and maintenance
 3. A 15% discount is available to Company-accredited educational institutions within the United States, if the unit is to be used only for instructional purposes.

FOR THE USE OF GENERAL ELECTRIC EMPLOYEES ONLY



PRODUCTS-ANA-1.004-P1(of 2)

PRODUCTRONFUNCTION:

The productron is a multipurpose analog computer for solving many important office and factory business problems. It is ideally suited for solving such problems as:

Factory load-capacity analyses.

Optimizing machine utilization.

Evaluation of process changes as they affect production schedules.

Material explosions-computing material requirements for varying product quantities.

Budget syntheses and preparation of operating reports.

CHIEF MARKETS:

Primarily other General Electric Departments but many other plants could use the machine.

FEATURES AND CUSTOMER BENEFITS:

1. Will assist in determining work load for 50 production, 24 work stations.
2. Typical problems are solved in about two minutes by a trained operator after the unit has been calibrated.
3. Accurate within 3%.
4. Economical - low initial cost, low maintenance costs, no extras (such as air conditioning, dust proofing, etc.), long life, operates on standard 115V AC.
5. Easy to operate - set dials, push buttons, read answers. Operator can be trained in one day.
6. Desk-size, rugged construction, clean simple lines.

For the use of General Electric employees only.





PRODUCTS-ANA-1.004-P2(of 2)

FEATURES AND CUSTOMER BENEFITS: (page 2)

7. Number of products is expandable with additional memory panels.

COMPETITION:

No direct competitive products. Digital computers, 650, etc. can be used for same job but at considerable programming effort and cost.

PRICE RANGE:

\$12,000 f.o.b. Phoenix exclusive of federal, state and local taxes.

DELIVERY:

Immediate.

For the use of General Electric employees only.





PRODUCTS-ANA-3.001-P1
(CPB-13)

NEW GENERAL PURPOSE

G-E ANALOG COMPUTING MODULES

Will save you Time, Money, Manpower in Design and Production

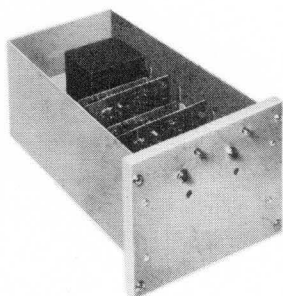

Model 5006A
Reference Regulator

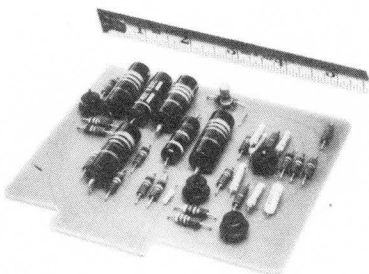

Model 5001A
Stabilizing Amplifier

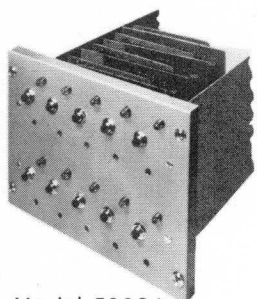

Model 5002A
Operational Amplifier Module

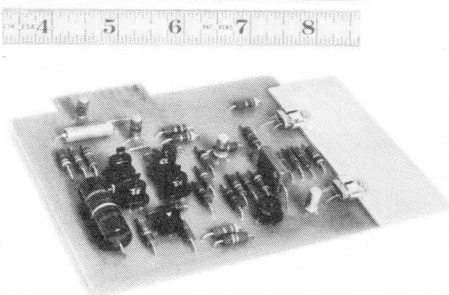

Model 5000A Transistorized
DC Operational Amplifier

ALL-TRANSISTORIZED DESIGN
MEANS MINIATURIZATION

GENERAL  ELECTRIC



GENERAL  ELECTRIC



PRODUCTS-ANA-3.001-P2

ANALOG COMPUTING MODULES

FUNCTION:

These Analog building blocks are designed for use in both general purpose and special purpose (i.e. Heat Rate Computer, Economic Dispatch Computer) analog machines. The line now includes these units:

1. Model 5000A1, DC Operational Amplifier Board, and Model 5001A1, Stabilizing AC Amplifier Board.
2. Model 5002A1 Operational Amplifier Module (with 20 Operational Amplifiers, non-stabilized), and Model 5002A2 Operational Amplifier Module (10 Operational Amplifiers, stabilized).
3. Model 5003A1 Electronic Multiplier Module.
4. Model 5004A1 Electronic Function Generator Module (unstabilized, one 20-segment fixed-function-card generator) and Model 5004A2 Electronic Function Generator Module (unstabilized, two 10-segment fixed-function-card generators).
5. Model 5005A1 Basic Power Supply.
6. Model 5006A1 Reference Regulator.

In addition, several analog instrumentation building blocks (for data acquisition) are listed as part of the analog line:

1. Model 5009A Differential Amplifier
2. Model 5008A Thermocouple Linearizer

CHIEF MARKETS:

The general market for our amplifier modules will be in our own department and other General Electric departments. This market has been considered in detail. There may be an external market in the special purpose applications area, particularly where the need for solid state circuitry is of primary concern. This latter market has not yet been evaluated because it involves special applications. Inquiries which may result from our advance product bulletins may give us some feel for this market.

For the use of General Electric employees only.



PRODUCTS-ANA-3.001-P3

FEATURES AND CUSTOMER BENEFITS:

The building block concept provides maximum flexibility in system design, economically. The customer can save development and manufacturing lead time. For internal G.E. sales, the G. E. Company can best apply its engineering manpower if other departments will make use of our existing products instead of designing their own.

Transistorization has these advantages over vacuum tube designs: higher reliability, lower heat dissipation, lower power consumption, smaller size, and greater ruggedness.

The modular mechanical design (with standard module size) provides for greater interchangeability of units as well as good accessibility for easier maintenance.

COMPETITORS:

Major competitors are the other analog computer manufacturers -- Electronics Associates (EIA), Goodyear (GEDA), Minneapolis-Honeywell, Berkeley, Reeves, Philbrick, Donner. Also, Kin-Tel, Ford Instrument, Hewlet-Packard, and many other smaller firms make either analog computing or instrumentation components.

COMPETITIVE DISADVANTAGES:

50 volt output and power supply requirements make these units incompatible with existing vacuum tube equipment (the usual output range is \pm 100 volts).

PRICE RANGE:

<u>PRODUCT</u>	<u>Model No.</u>	<u>Selling Price</u>	<u>Reference RPA No.</u>
AC Amplifier Board	5001A1	\$ 70.00	101
Amplifier Module - 10 amp., stab.	5002A2	3,210.00	102
Amplifier Module - 20 amp., unstab.	5002A1	3,210.00	103
Electronic Function Generator (one 20-segment generator)	5004A1	1,000.00	104
Electronic Function Generator (two 10-segment generators)	5004A2	2,000.00	105
DC Amplifier Board	5000A1	130.00	106
Electronic Multiplier Module	5003A1	2,700.00	107
Basic Power Supply	5005A1	1,200.00	108
Reference Regulator	5006A1	1,000.00	109

Availability: 3 to 4 months. Inquire of Contracts Administration for more exact data.

For the use of General Electric employees only.



AN INDUSTRY FIRST -- A Complete Line of All-Transistorized
General Purpose Analog Modules

Model 5000A

TRANSISTORIZED D. C. OPERATIONAL AMPLIFIER

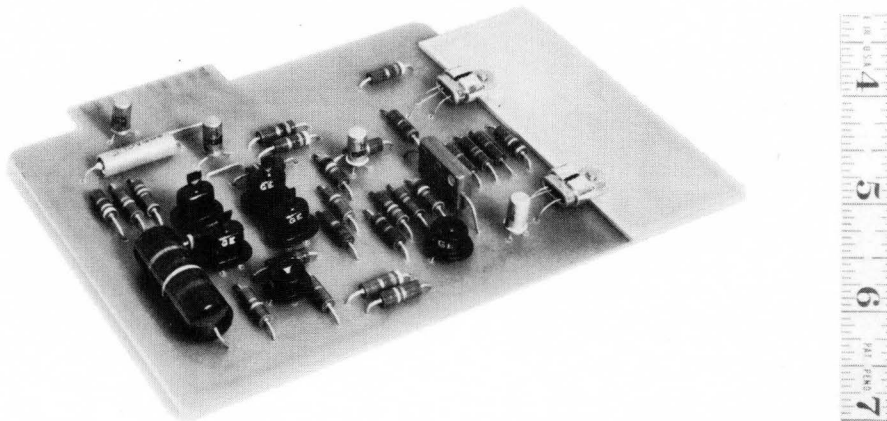

Fig. 1 - Entire D. C. Operational Amplifier
with 12 solid-state elements fits on
one small (4" x 6" x 1") board.

FUNCTION

A high-gain, extremely stable feedback amplifier for analog
computer application. Extensively used in G-E analog modules.

FEATURES

- * Solid State Circuitry - Etched Wiring
 - * Rugged
 - * Reliable
 - * Low Power Requirement
 - * Low Heat Dissipation
 - * Light (2-3/4 ounces)
 - * Compact (4"x6"x1")
 - * Easy to Maintain - Accessible





SPECIFICATIONS (without drift-stabilization)

1. Gain (Mu-beta minimum with 100k ohm external feedback resistor):
 10^4 or better
2. Output range (DC): ± 50 v -- 5ma
3. Recommended external impedance level: input -- 100k ohms
feedback -- 100k ohms
4. Response: 3 db down at 100 kc
5. Accuracy (linearity): better than 0.02%
6. Typical Drift at output: 1 mv per degree C
7. Wideband Noise (maximum): 2 mv RMS
8. Power requirements:
+80 volts, quiescent current 11 ma, variation under load ± 7 ma,
and
-80 volts, quiescent current 12 ma, variation under load ± 7 ma.
9. Dimensions: 4"H x 6"W x 1"D
10. Weight: 2-3/4 ounces



DRIFT-STABILIZATION

When even greater stability than that obtainable with the D. C. Operational Amplifier alone is required, a chopper and an AC stabilizing amplifier are added. This stabilizer increases low frequency and DC response, raising accuracy and virtually eliminating drift.

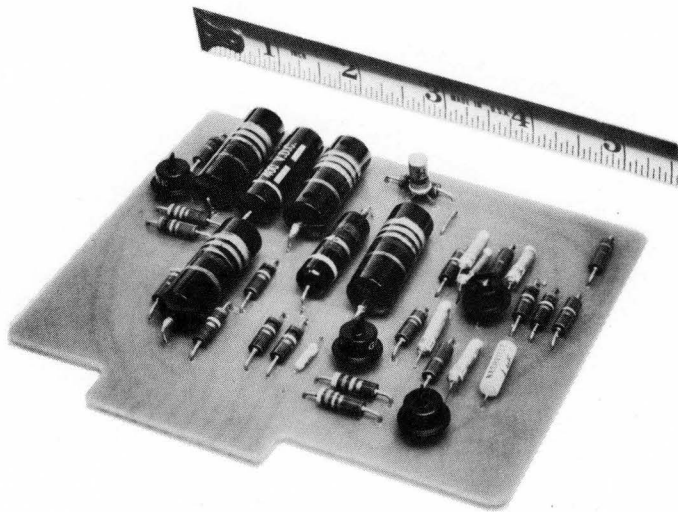

Fig. 2 - Entire Stabilizing Model 5001A AC Amplifier is one compact package.

Components:

1. Model 5001A AC amplifier (Fig. 2)
2. chopper with miniature socket
3. miniature transformer
4. neon lamp
5. zero-adjust potentiometer
6. pushbutton switch





SPECIFICATIONS (with drift-stabilization)

All specifications are identical to the non-stabilized version, with the following exceptions:

1. Gain (Mu-beta with 100k ohm external feedback resistor):
 10^7 or better.
2. Accuracy (linearity): better than 0.005%.
3. Typical Drift at output: 100 microvolts per week max.
4. Power requirements:
+80 volts, quiescent current 11 ma, variation under load \pm 7 ma,

and

-80 volts, quiescent current 18 ma, variation under load \pm 7 ma.
5. Dimensions: 4"H x 6"W x 2"D plus front panel space (1-1/2" x 3-1/2") for switch, lamp, and potentiometer.
6. Weight: 12 ounces





AN INDUSTRY FIRST -- A Complete Line of All-Transistorized
General Purpose Analog Modules

Model 5002A

OPERATIONAL AMPLIFIER MODULE

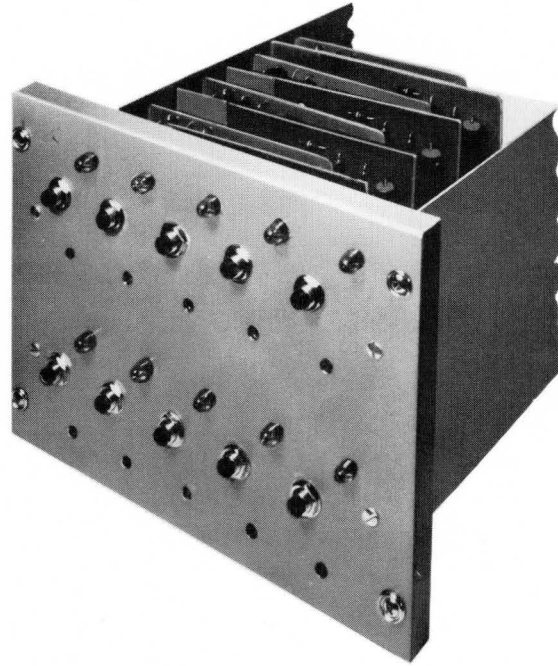

An assembly of Transistorized D. C. Operational Amplifiers in a compact (7" x 9-1/2" x 20") standard size cabinet.

FEATURES

- * Capacity: 10 drift-stabilized Operational Amplifiers or 20 Operational Amplifiers without drift-stabilization.
- * Unitized construction -- etched-circuit amplifier cards plug into chassis sockets.
- * Controls and indicator lights on front panel.
- * For D.C. Operational Amplifier specifications and power requirements, see pages 4, 5, 6, and 7 of this bulletin.





AN INDUSTRY FIRST -- A Complete Line of All-Transistorized
General Purpose Analog Modules

Model 5004A

FUNCTION GENERATOR MODULE

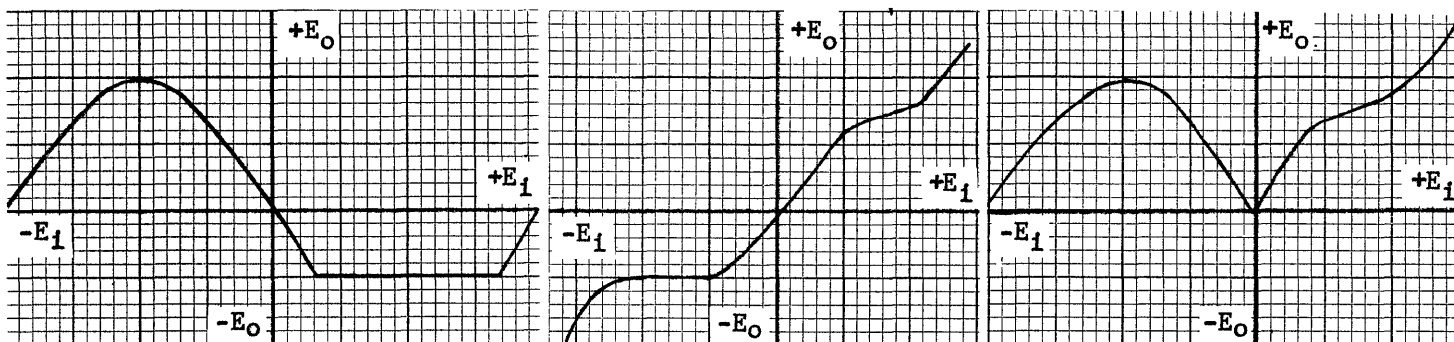

Typical curves possible with G-E Function Generator. Curves may lie in any quadrant and may have positive or negative slopes, inflection points, etc.

OPERATION

- * Generates arbitrary four-quadrant functions of one variable.
- * Curve is approximated by series of straight line segments.
- * Uses biased diodes and Transistorized D. C. Operational Amplifiers (described on pages 4, 5, 6, and 7 of this bulletin).
- * Slopes and breakpoints set by precision potentiometers.
- * Generates either one 20-segment function or two 10-segment functions.





FEATURES

- * Available either fully adjustable or with fixed function cards.
- * Resolution of slopes and breakpoints exceptionally high.
- * Low Drift
- * Solid-state components throughout
 - * Rugged
 - * Reliable
 - * Low power, heat
- * Compact, (7" x 9-1/2" x 20") standard size cabinet.
- * Unitized, etched-circuit, plug-in construction.

SPECIFICATIONS

1. Slope and breakpoint resolution: 0.03% or better.
2. Slope of any one segment: ± 1.5 volts/volt max.
3. Drift: Less than 20 mv per degree C
4. Output: ± 50 volts at 5 ma.
5. Frequency response: 3 db down at 100 kc.
6. Input impedance: Approximately 500k ohms per segment (25 k ohms for a 20-segment function).
7. a) Power requirements for one 20-segment function: ± 80 volts at 22 ma, ± 10 ma) for the and) operational -80 volts at 24 ma, ± 10 ma) amplifiers

b) Power requirements for two 10-segment functions: ± 80 volts at 44 ma, ± 20 ma) for the and) operational -80 volts at 48 ma, ± 20 ma) amplifiers

c) Additional power required for each segment (to obtain diode bias): either ± 50 volts at 5 ma or -50 volts at 5 ma





AN INDUSTRY FIRST -- A Complete Line of All Transistorized
General Purpose Analog Modules

Model 5003A

MULTIPLIER MODULE

(contains 2 independent electronic multipliers)

OPERATION

Each multiplier:

- * multiplies two independently varying voltages.
- * Either input may vary between ± 50 volts.
- * Output is continuous product: $Z = \frac{XY}{50}$.
- * Operating principle: area summation of triangles generated by precision triangular wave generator.

FEATURES

- * High Accuracy
- * Low Drift
- * Low Noise
- * All electronic, completely transistorized.
 - * Rugged
 - * Reliable
 - * Low power, heat
- * Compact -- (7" x 9-1/2" x 20") Standard size cabinet
- * Unitized -- plug-in etched circuits





SPECIFICATIONS (Each multiplier)

1. Output range: ± 50 volts at 5 ma
2. Accuracy: $\pm 0.25\%$
3. Drift: less than 15 mv per degree C
4. Wideband Noise (max): less than 45 mv RMS
5. Frequency response: 3 db down at 500 cps
6. Input impedance: 400 k ohms per input
7. Power requirements:
 - a) 4 Operational Amplifiers -- each amplifier needs:
 ± 80 volts at 11 ma quiescent current, variation under load
 ± 7 ma,
and
-80 volts at 12 ma quiescent current, variation under load
 ± 7 ma.
 - b) 1 carrier generator -- ± 80 volts at 40 ma
and
-80 volts at 40 ma.

COMPONENTS FOR ONE MODULE (2 multipliers)

- 4 Operational Amplifiers
- 4 Drift-stabilized Operational Amplifiers
- 1 Carrier-generator
- 30 resistors
- 4 diodes
- 2 capacitors
- 4 RF chokes





AN INDUSTRY FIRST -- A Complete Line of All-Transistorized

General Purpose Analog Modules

Model 5005A

BASIC POWER SUPPLY

FUNCTION

- * Supplies ± 80 volts and -80 volts to operate G-E Analog Modules or their equivalents.
- * Will easily handle 100 drift-stabilized G-E Operational Amplifiers (or 130 non-stabilized) or equivalent.

FEATURES

- * Solid-state components exclusively
 - much more power per cubic inch of space with less heat dissipation.
 - Over 300 watts continuous output, yet is only 10-1/2 inches high, 19 inches wide, 20 inches deep
 - Needs no external cooling equipment in most cases
- * 60% efficiency at full load
- * Built-in short-circuit protection -- inherently current-limiting circuits, with input circuit protection.
- * Suitable for square-wave pulsed loading
- * Low output impedance





SPECIFICATIONS

Output voltage:	± 80 volts and -80 volts
Output current:	2.5 amps. max.; 1.8 amps. nominal
Voltage variation:	1.25% max. variation with: $\pm 25\%$ load change or 105-125 volt line voltage range.
Ripple:	50 millivolts peak to peak, max.
Nominal Output Impedance:	2 ohms from DC to 100 kc

COMPONENTS

- 1 constant voltage transformer
- 4 power diodes
- 3 inductors
- 1 circuit protective device
- 10 4.2 millifarad capacitors





AN INDUSTRY FIRST -- A Complete Line of All-Transistorized
General Purpose Analog Modules

Model 5006A

REFERENCE REGULATOR

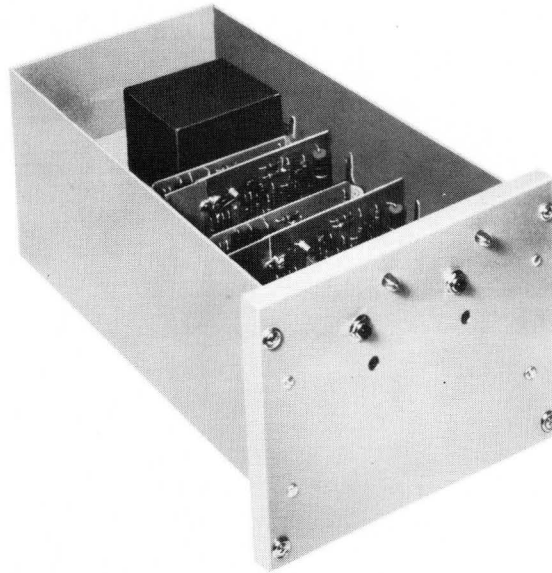

A fixed DC secondary standard especially designed to serve as a source of reference potential for transistorized analog computing components or similar applications.

FEATURES

- * Solid-state internal voltage-standard replaces standard cell.
 - * Much more rugged than supplies using standard cell
 - * Better than standard-cell accuracy
 - * Extreme stability
 - * Excellent dynamic characteristics



**Other Advantages**

- * Much lower power requirement than vacuum tube equipment
- * Less heat dissipation - in most cases eliminates need for cooling
- * Light weight - 12 pounds
- * Compact - (7" x 9-1/2" x 20"), Standard size cabinet
- * Lower maintenance cost

SPECIFICATIONS

Output voltage:	fixed, \pm 50 volts and -50 volts
Output current:	0 to 100 ma
Ripple:	less than 500 microvolts RMS
Accuracy:	\pm 0.005%
Frequency response:	3 db down at 10 kc
Response time:	0.2 millisecond
Power requirements:	240 ma at \pm 80 volts and -80 volts
Size:	7" high, 9-1/2" wide, 20" deep
Weight:	12 pounds

COMPONENTS

- 2 drift-stabilized operational amplifiers
- 1 voltage reference unit (temperature stabilized)
- 2 power transistors
- 8 resistors
- 4 capacitors
- 1 oven-on indicating jewel on front panel



G-E ALL-TRANSISTORIZED ANALOG MODULES

Tentative Specifications
for G-E's new Computer Instrumentation Components --

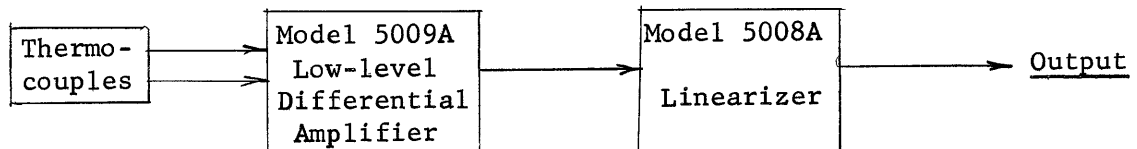

Model 5009A
DIFFERENTIAL AMPLIFIER

General Electric Computer Department now offers you a high quality, low-level differential amplifier with floating input and grounded single-ended output. Completely transistorized and built on a compact etched-circuit board mounted on a plug-in metal chassis, this amplifier features the same ruggedness, low heat dissipation and power consumption as the other units in G-E's Analog Computing Module line.

Here are the preliminary specifications:

1. Gain: maximum 1000; adjustable to 0.1 percent
Gain change: less than 0.1 percent per 1000 hours,
less than 0.1 percent from 50 to 100 degrees F
2. Response: 3db down at 60 cps
3. Noise: less than 2 microvolts referred to input
4. Drift: less than 2 microvolts from 50 to 100 degrees F
Offset: less than 5 microvolts referred to input
5. Linearity: better than 0.1 percent
6. Input: floating, impedance 100K ohms.
Common mode rejection: dc - 10^6
60 cps - 10^5
7. Output: grounded, impedance 300 ohms, level is ± 10 volts across 10K ohms.
8. External Power Supply Requirements:
-80 volts d-c 15 ma., ± 80 volts dc 1 ma.
6.3 volts, 400 cps, 70 ma (to operate modulators)
9. 2" x 7" x 17" approximately



G-E ALL-TRANSISTORIZED ANALOG MODULES

Tentative Specifications

for G-E's new Computer Instrumentation Components --

Model 5008A

THERMOCOUPLE LINEARIZER

Fixed non-linear diode networks are combined with a G-E Model 5001A D.C. Operational Amplifier to form this stable, accurate thermocouple linearizer. Completely transistorized, rugged, etched-circuit plug-in board construction is featured throughout.

The linearizer will correct the following thermocouple types over the indicated ranges (after indicated amplification):

		<u>Preamp gain</u>
Iron-Constantin	135-1660° R	150.0
Chromel-Alumel	460-2860° R	150.0
Chromel-Constantin	460-1960° R	150.0
Plat.- Plat. Rhodium	460-3460° R	500.0
Reference temperature:	610° Rankin	

The linearizer has a full scale output of -50 volts. Each thermocouple type has three full-scale ranges of 4000, 2000, and 1000 degrees R.

Thus the scale factors are:

80° R per volt for 4000° full scale
 40° R per volt for 2000° full scale
 20° R per volt for 1000° full scale

The correction curves are derived from the Instrument Society of America's output vs. temperature tables for the thermocouples listed. The correction curves are stored and the gain is set such that an over-all accuracy of 1/4% of full scale is obtained.

Power requirements: same as for Model 5001A D.C. Operational Amplifier.

INTERNAL INFORMATION

For the use of General Electric employees only.



PRODUCTS-ANA-3.001-P19

PRELIMINARY SPECIFICATIONS

NOW AVAILABLE FROM GENERAL ELECTRIC....

A NEW ANALOG TO DIGITAL CONVERTER

To fill the need for conversion of analog data to a digital form, G-E now brings you a low-input-level (250 mv as compared to the usual 10 volt to 100 volt requirement), self-balancing converter of the weighted-current feedback type.

This compact, lightweight unit uses etched circuit construction.

Combining high speed with accuracy, it can accept inputs from transducers or other analog sources and can convert them to any desired three-character, parallel output digital code. With appropriate commutating equipment it will sample in sequence data from any number of sources. The sampling rate of the standard model is 5000 samples per second from a single input.

Digital output may be printed, used as input to a computer, or stored by a programmed tape unit.

Resolution when operating with a single input channel is 250 microvolts for an output change of one unit. In addition, modifications can be made giving up to 1 part in 4000 resolution.

A unique zero-balance feature increases accuracy while at the same time eliminating the need for zero-adjustment at the input. The converter automatically reads amount of drift at predetermined intervals, then compensates in the output.

Accuracy is better than one digital count, or 250 microvolts, or $\pm 0.1\%$, whichever is greatest.

For the use of General Electric employees only.

Product Services Maintenance Prices -
All Products

<u>RATE</u>	<u>A</u>	<u>B</u>	<u>C</u>	
<u>Period</u>	<u>Straight Time</u>	<u>Weekday Overtime and Saturday</u>	<u>Sunday and Holiday</u>	<u>Monthly</u>
Hourly	\$12.00	\$15.00	\$18.00	
<u>Monthly</u>				
	1 to 6 months			\$2,600
	over 6 months			2,500

Note:

1. All prices for Domestic Service only, contact Product Services, C. Worlock, for cost estimates for quoting foreign services.
2. Services include: Installation and Maintenance Consultation
Equipment checkout
Emergency Service or Assistance
Installation and/or maintenance assistance.
- * 3. Class A Hourly Rates, Time and Expense:
 - A. Hourly rates for services (up to 30 days) will be in accordance with the following rates plus actual travel and living expenses.
 - B. All labor charges will be based on standard work week of five eight hour days, Monday through Friday.
 - C. The normal work day begins at the start of the recognized first shift in the morning and continues to the end of the third shift. This work day (24 hours) may be divided into three recognized shifts of eight each, with an allowance for lunch time.
 - D. When in an emergency a man works continuously over eight hours overtime rates - either Rate B or C as the case may be, will be billed for all time after the first eight hours even though the work may continue into the following day or days.
 - E. All time worked and/or traveled Monday through Friday will be billed at Rates A or B. (except when Monday through Friday is an observed holiday)
 - F. All time worked and/or traveled on Saturdays will be billed at Rate B. (except when Saturday is an observed holiday)

August 26, 1960

Product Services Maintenance Prices -
All Products

- G. All time worked and/or traveled on Sundays, holidays, and in excess of 12 hours per day Monday through Saturday will be billed at Rate C. (only those days will be considered holidays that are generally observed in the community where the work is being done)
 - H. Time and expense of men will be billed from the time they leave their headquarters until they return, except that no time will be charged for men traveling at night when sleeping accommodations are available. Holidays occurring within the work week, but not worked, will be not billed.
4. Class "B" Monthly Rates:
- A. One (1) to six (6) Months: In those cases where the customers require services from one to six months inclusive, the Product Service Representative will be available at the customer's plant for the normal work week. Also, when in an emergency he will be available for on-call services.
 - 1. This rate is for an eight hour work day, and includes living expense and required local travel expense.
 - 2. All overtime work will be billed in accordance with Class I, Rates B or C, as the case may be.
 - 3. Transportation and living expenses will be billed from the General Electric Headquarters to the work location and return. Also, we will bill where unusual job circumstances exist requiring more than normal local travel and living expenses.
 - B. Six (6) Months or longer: In those cases where the customers require services in excess of six months or more, the Product Service Representative will be available at the customer's plant for the normal work week. Also, when in an emergency he will be available for on-call services.
 - 1. This rate is for an eight hour work day, and includes all travel and living expenses.
 - 2. All overtime work will be billed in accordance with Class I, Rates B or C, as the case may be.
5. Billing for Material: Parts, supplies, transportation, etc. provided by General Electric Co. which is required to perform such services will be billed.

For the use of General Electric Employees only

Product Services Maintenance Prices -
All Products

6. Test equipment: Standard tools and test equipment will be provided by Product Services.

* "Headquarters" means the man's permanent home base such as Chicago, New York, etc. However, it could mean also Phoenix, depending on the nature of the service required or the lack of available people in the field.



SERVICES-ADV-1.001-P1(of 5)

ADVERTISING AND SALES PROMOTION PROJECT NUMBERING SYSTEM

Consistent with Company practice, a PROJECT NUMBERING SYSTEM has been devised and is in use covering publications, advertisements, mailing lists, etc., utilized under the supervision of the Advertising and Sales Promotion Sub-Section Marketing Section, Computer Department.

This system consists of three letters, the first two of which are always the same, and the third of which is descriptive of the item. For example:

ADVERTISEMENTS

C (for COMPUTER) P (for PHOENIX) A (for ADVERTISEMENT)

Continuing this same example: Advertisement No. 1 would be numbered CPA-1

There is a further need to identify each advertisement by the date (month only) of its first appearance. Thus, the complete number for the advertisement in this example becomes:

CPA - 1 (1-57)

indicating that it appeared first in January 1957. Subsequent numbers will run consecutively so that if there were 10 advertisements which first appeared in 1957, the first NEW advertisement appearing for the first time in January 1958 would bear the number:

CPA - 11 (1-58)

Repeats -- that is advertisements which are being used for the second or third or more times in the same media -- will not have their numbers changed, hence, CPA-1 (1-57) might conceivably be run any time in 1958, for example, as CPA-1 (1-57).

PUBLICATIONS (other than DATA BOOK)

Publications will be generally thought of as "BULLETINS" or "BROCHURES", with no distinction being made as to size, number of pages, etc.

For the use of General Electric employees only.



SERVICES-ADV-1.001-P2 (of 5)

Again: C (for COMPUTER) P (for PHOENIX) B (For BULLETIN)

Thus, bulletin No. 1 will be numbered CPB-1.

In addition to the bulletin number, there is a need to know when the bulletin was printed and how many copies were printed. Therefore, in addition to the bulletin number, information covering "when" and "how many" has been added as follows:

C (for COMPUTER) P (for PHOENIX) B (for BULLETIN) - 1 (4-57-5M) -- the last grouping to indicate that CPB-1 was first printed in April 1957 in the quantity of five thousand.

When necessary to revise an existing bulletin, revisions will simply be indicated by adding "A" for first revision, "B" for second revision, and so on, plus the date and quantity of the revision. For example:

CPB-1(4-57-5M) is revised on 4-58 and the quantity changed to 2,000. The number of the revised bulletin then becomes:

CPB-1A (4-58-2M)

Straight reprints without change of any publication will continue to bear the original publication number but will bear the date of re-printing plus the quantity reprinted. For example:

CPB-1 (4-57-5M) is reprinted exactly as is on 5-58 in the quantity of 2,000. Its number will be:

CPB-1 (5-58-2M)

Where the amount of revision is so great that it is more desirable to re-do the entire bulletin but at the same time maintain the same title as the original as well as the same subject, a new publication number will be assigned with the designation "SUPERSEDES . . .". For example:

A publication MAGNETIC CHARACTER READING, CPB-1 (4-57-10M)

For the use of General Electric employees only.



SERVICES-ADV-1.001-P3 (of 5)

exists. A great deal of new information gathered on the general subject of MAGNETIC CHARACTER READING indicates that a whole new publication should be done on the subject, including material in CPB-1, plus. The new publication will then become known as:

CPB-(Number) (Month-and-Year-Quantity)
Supersedes CPB-1 (4-57-10M)

Whenever another Department of the Company acts in a sales capacity for the Computer Department or is for any other reason interested in integrating Computer Department bulletins into its numbering and filing system, the Computer Department bulletin which is involved will bear both the CPB Number and the Bulletin Number, Docket File, Description, etc., of the other Department. For example:

Assuming that the Apparatus Sales Division should enter into sales agreement with Computer Department to sell the PORTABLE A-C NETWORK ANALYZER. Computer Department bulletin number CPB-4, together with date and quantity will be printed together with ASD's GEA Number and Docket File Number.

DATA BOOK

An indexing system has been devised, based on the organization of the Data Book, to provide for simple, rapid filing. Each "page index" (the group of letters and numbers in the upper right corner of the page) is largely self-explanatory.

Here is a sample page index:

PRODUCTS-DIG-1.002-P2 (of 5)

This item will be filed under Products, Digital, Systems (designated by the number 1 to the left of the decimal point), Data Sheet number 2 in the systems section (designated by the number .002), and page 2 of five pages.

A further explanation of the decimal designation: the digit to the left of

For the use of General Electric employees only.



SERVICES-ADV-1.001-P4(of 5)

the point indicates, in the case of Products, the following categories:

- Systems - 1.
- Units - 2.
- Components - 3.
- Accessories - 4.
- Applications - 5.

The use of the number 0 to the left of the point merely indicates that no third breakdown has been made in that category. Where no breakdown exists at present but may be made in the future, a simple renumbering of indexes and distribution of appropriate tabs will provide a solution.

The three digits to the right of the point indicate the order in which Data Sheets were issued. For instance, 4.029 would be the 29th Accessory for which a Product Data Sheet was prepared.

Thus, in filing new pages it is merely necessary to file under the appropriate tabs and in numerical order, as indicated on the page index.

A Revision of a whole page will be indexed the same as the original page, but with the addition of the revision date, as in this example:

PRODUCTS-DIG-1.002-P2(of 5)REV 5 MAR 58

Please destroy the original pages when they are replaced so that each Data Book will be up to date and in good order.

SALES PROMOTION LETTERS

Sales promotion letters prepared for distribution to CUSTOMER and PROSPECT MAILING LISTS maintained by Computer Department or by any other Department of the Company making its lists available to Computer Department will not bear number, quantity, date, etc., data on the letter-heads, but will be recorded separately in A&SP as:

CPSPL-Number (consecutively) No Quantity, No Date.

For the use of General Electric employees only.



SERVICES-ADV-1.001-P5 (of 5)

MARKETING MEMOS

MARKETING MEMOS will simply be numbered in sequence as CPMM - Number and Date. No Quantity will be indicated.

For the use of General Electric employees only.



SERVICES-ADV-2.001-P1 (of 1)

INDEX TO COMPUTER DEPARTMENT MAILING LISTS

<u>List No.</u>	<u>Title</u>	<u>Property of: *</u>
CPL-1 (Internal)	Payroll	Personnel Accounting (Van Wagenen)
CPL-2 (Internal)	CD NEWS	E&CR (Widmark)
CPL-3 (External)	Community Leaders	E&CR (Michael)
CPL-4 (Internal)	Management NEWS LETTER	E&CR (Newman)
CPL-5 (Internal)	CD DATA BOOK	A&SP (Jordan)
CPL-6 (External)	CD DATA BOOK	A&SP (Jordan)
CPL-7 (Internal)	ADMINISTRATIVE MANUAL	Procedures (Kilfoyle)
CPL-8 (External)	Executives Leading Banks	Sales (Sutton)

Note: All mailing lists indexed above and subsequent lists to be established are the "property" of the individual indicated above as having PRIMARY INTEREST AND RESPONSIBILITY. Except where blanket AUTHORITY-TO-RUN-AS-REQUIRED is given to the Manager - A&SP, Computer Department, no list will be run for any purpose except upon receipt by the Manager - A&SP, or whoever he may designate, of authorization to do so from the individuals designated above.

For example: A&SP desires to make a mailing of the DEPARTMENT BROCHURE CPB-1 to all Computer Department employees on CPL-1 Payroll. Unless blanket AUTHORITY-TO-RUN-AS-REQUIRED has been obtained by A&SP from Manager - Personnel Accounting, specific authorization must be obtained, in the interests of better control of list utilization.

For the use of General Electric employees only.



SERVICES-ADV-2.002-P1
Revised Febr. 1958

INITIAL INTERNAL DISTRIBUTION OF TECHNICAL BULLETINS, BROCHURES, ETC., PREPARED BY COMPUTER DEPARTMENT ADVERTISING AND SALES PROMOTION, PHOENIX.

Wherever practical, initial internal distribution of technical (equipment) bulletins and promotional brochures produced by Advertising and Sales Promotion, Computer Department, Phoenix will automatically be made direct from the vendor to A&SP mailing lists CPL-12 and CPL-13.

The balance of the run will be held in ADVERTISING AND SALES PROMOTION PUBLICATION STOCKS, KTAR Building, Phoenix (Mrs. Mary Odell, Extension 56, should be contacted for additional copies after initial distribution).

Normally, this initial internal distribution will be specified on the COMPUTER DEPARTMENT "Authorization for Advertising and Sales Promotion" (see attached sample) by the A&SP Account Representative handling the bulletin, brochure, etc., but it can be modified at his discretion when desirable.

It is the responsibility of the A&SP Account Representative to furnish initial internal distribution instructions to A&SP Production and Distribution which, in turn, will be responsible for placing initial internal distribution requirements on the vendor at the time of placing the order.

For the use of General Electric employees only.



SERVICES-ADV-2.003-P1

INDEX TO COMPUTER DEPARTMENT BULLETINS AND BROCHURES

Here is a list of all Computer Department Bulletins, Article Reprints, and Advance Bulletins published before February 10, 1958. Copies may be obtained from A&SP upon request.

<u>Publication No.</u>	<u>Subject</u>
CPB-1	Progress report on: Magnetic Ink Character Reading
CPB-2	Computer Applications Laboratory
CPB-3	Computer Department
CPB-4	Miniaturized AC Network Analyzer
CPB-5	Operations Analysis
CPB-6	"Computers in Business" (article reprint)
CPB-7	"Let's Really Put the Computer to work" (article reprint)
CPB-8	304 Bulletin*
CPB-9	(Project withdrawn -- number unassigned)
CPB-10	304 Product Report*
CPB-11	Economic Dispatch Computer
CPB-12	Traffic Study Data Processing
CPB-13	Analog Computing Modules
CPB-14	Automatic Tinplate Inspection Data Processor
CPB-15	(Project delayed -- number assigned for record purposes)
CPB-16	306 Analog Computer (formerly called PRODUCTRON)

*Distribution strictly within Company -- for GE employees only.

For the use of General Electric employees only.



SERVICES-ADV-3.001-P1 (of 1)

AUTHORIZED ADVERTISING AGENCY

The authorized Advertising Agency of the COMPUTER DEPARTMENT is THE McCARTY COMPANY with its headquarters office at 3576 Wilshire Boulevard, Los Angeles 5, California, and with Branch Offices located at:

116 New Montgomery Street
San Francisco 5, California

122 East Forty-Second Street
New York 17, New York

520 N. Michigan Avenue
Chicago 11, Illinois

1500 Jackson Street
Dallas 1, Texas

1117 Second Avenue
Seattle 1, Washington

In addition, THE McCARTY COMPANY -- now in its 38th year -- has an affiliation on a reciprocal basis with nine carefully selected European agencies, leaders in their respective areas and located in:

Copenhagen, Denmark
London, England
Paris, France
Milan, Italy

Oslo, Norway
Stockholm, Sweden
Zurich, Switzerland
Frankfurt, Germany

Account Executives concerned with the account of the Computer Department, Phoenix, and located in the Los Angeles Office of the agency are:

Hiram "Hi" E. Cassidy,
Executive Vice President

Clarence "Davey" G. Davenport,
Vice President

William "Bill" Atwell
Account Supervisor

Representatives of the Computer Department are cordially invited by the McCARTY COMPANY to drop in at any of its offices and become better acquainted.

For the use of General Electric Employees only



PRODUCT DATA SHEET

SERVICES-ADV-4.001-PI(of 4)

FUNCTIONAL ADVERTISING AND SALES PROMOTION EXPENSES

There is a need for a set of definitions of functional advertising and sales promotional expenses for use as a general frame of reference in the budgeting and allocation of advertising, sales promotion, and related expenses. The definitions herein listed are based on current practice in several advertising operations of the Company and are recommended as a guide to items to be included in advertising and sales promotion expense, or administered by advertising operations.

ADVERTISING

Note: Does not in any category include help wanted, community and employee relations, or other non-product advertising.

1. Space Advertising.

Cost of factory-paid product advertising in printed media, including general magazines, newspapers, trade papers, and display directory advertising. Includes space, art, photography, and production costs.

2. Radio and Television Advertising.

Cost of factory-paid radio and television programs sponsored for product-advertising purposes. Includes cost of station time, program production, program promotion, prizes, and all other direct costs.

3. Outdoor Advertising.

Cost of factory-paid product advertising in outdoor media including spectacular signs, billboards, posters, painted bulletins and signs, etc. Includes lease, art, and production costs.

Note: Does not include plant or other property identification signs.

4. Transportation Media.

Cost of factory-paid product advertising in transportation media, including urban and interurban transit, vehicular advertising, etc. Includes space, art, and production costs.

SALES PROMOTION

Note: Costs for each category include copy preparation, art, photography, and all other production costs; and warehousing, collating, packaging, and shipping charges applicable to the distribution of sales promotion material.

For the use of GE employees only.





SERVICES-ADV-4.001-P2(of 4)

Sales Promotion - continued

1. Literature.

Product promotional literature of all types -- specifications, broadsides, envelope stuffers, catalogs, descriptive booklets, etc. Does not include fact tags, warranties, use and care instructions, or other inserts packed with products and necessitated primarily by product requirements. Does not include salesmen's handbook binders*, technical data, product or repair parts price lists, or product service manuals or bulletins.

2. Special Campaigns.

Promotional material for special product sales campaigns and promotions including window streamers, announcement portfolios, brochures, customer-contest announcements, individual-customer campaigns, etc. Does not include: Cost of merchandising allowances granted in connection with special campaigns; cost of prize catalogs and incentive prizes to factory representatives and distributor or dealer salesmen; cost of prize awards or administration expense of customer contests; or cost of charts or other program or preparatory expense for sales meetings.

3. Displays.

Point-of-sale displays including window, floor, counter, and shelf set-ups, backgrounds, signs, and merchandisers, constructed of cardboard, wood, metal, plastic, or other materials. Includes also itinerant displays, and the cost of traveling and refurbishing such displays.

4. Motion Pictures.

Motion pictures, slides, and other projected programs directed to consumers or other user-customers. Does not include those used for sales training or those prepared in connection with cooperative advertising. Includes production and print costs.

5. Direct Mail.

Preparation, processing, and mailing of letters, post-cards, and other direct-mail communications, and of enclosure material when prepared solely for direct-mail use. Includes return postal expense.

6. Exhibits.**

Participation in industrial, trade, and professional expositions. Includes cost of space rental, exhibit preparation, installation, dismantling, shipping, field operation, and storage. Does not include time and expense of

*Carried under "INTERNAL PUBLICATIONS;" **Carried as "CONVENTIONS AND MEETINGS."

For



of GE employees only.

GENERAL  ELECTRIC



SERVICES-ADV-4.001-P3(of 4)

sales department personnel who staff exhibits.

7. Demonstration Kits.

Product demonstration kits for general promotional use, such as those used by retailers, but not including kits for use as salesmen's selling tools. Does not include cost of sales training materials, or of sample products, product components, or product materials normally supplied to salesmen as selling tools.

8. Giveaways.

Note pads, pencils, book matches, and other novelties. Does not include premiums given with products to product purchasers.

9. Advertising Reprints.

Reprints of space advertisements used in connection with specific product-promotional campaigns. Does not include cost of advertisement reprints used for routine distribution, which are an element of space-advertising production.

10. Reproduction Material.

Mat books, mats, and electros, when this type of material is not included in cooperative advertising plans.

11. Make-up Material.

Cost of copy preparation, art work, and engravings supplied to distributors or resale customers for catalogs of their preparation. Also includes engravings supplied to premium houses.

12. Announcement Material.

Bulletins, lists, or handbooks announcing and merchandising sales promotional materials.

13. Special Presentations.

Stage shows, program presentations, multi-unit exhibits, traveling live TV or radio shows, and other special activities of a theatrical nature directed to consumer or user-customer groups for purposes of sales promotion. Does not include sales meetings with distributor, dealer, or district sales personnel. Expense includes preparation and production costs, and direct costs of transportation and field operation. Does not

For the use of GE employees only.





PRODUCT DATA SHEET

SERVICES-ADV-4.001-P4 (of 4)

include time and expense of sales personnel, or supplemental banquet or entertainment expense.

PRODUCT PUBLICITY1. Product News.

Cost of preparing and releasing news related to specific products or product lines. Includes cost of news photography, press meetings, and of special events, giveaways, display and exhibit construction, and other activities especially undertaken in connection with product press announcements.

2. Sales Promotion Periodicals.

House organs, newspapers, and other sales promotion periodical publications directed to distributors and dealers, resale agents, builders, home economists, and other specialized groups. (Examples: NEWS GRAPHIC, SALES PROMOTER, TRAFFIC BUILDER, etc.) Includes cost of copy preparation, art, photography, and production costs, and distribution expense.

DISTRIBUTOR, DEALER, AND AGENT IDENTIFICATION

Standard and custom signs, decals, truck panels, store fronts, uniforms, and related materials used to identify distribution with the signature and monogram and other principal Company trade-marks.

COOPERATIVE ADVERTISING

Allowances granted to distributors, jobbers, and resale agents on their advertising and sales promotion in acceptable media as defined in current cooperative advertising plans and offers. Includes headquarters preparatory expense and cost of telephone directory trade-mark listings.

Authority: General Electric MARKETING ADVICES, TAB 14, DATED July 3, 1953--
not superseded by subsequent instructions.

For the use of GE employees only.





SERVICES-ADV-5.001-P1

April 3, 1959

SUBJECT: Individual Functional Assignments--
Personnel of Advertising and Sales Promotion

ROY JORDAN	--	Manager - Advertising and Sales Promotion Computer Department.
ESTHER ECKER	--	Secretary to the Manager.
COLEMAN J. ROSS	--	Promotional Specialist -- "Account Supervisor," Industrial Accounts.
A. G. BARAGONA	--	Copywriter -- Account Supervisor, Military, Computer Services, Data Processing (Internal) and Data Processing (External) Accounts.
P. H. KINSEY	--	Press Relations (<u>National</u>) -- All Accounts.
JAMES E. SUTTON	--	Specialist - Art - <u>All</u> Accounts.
ROBERT BONHEIMER	--	Production - Photography - Exhibits <u>All</u> Accounts.
JAMES DeWITT	--	Publication Stocks and Distribution - Mailing Lists - PO's and MR:s (for review and approval of Manager) -- Inquiries - Commitment Control and Records,