

HONEYWELL

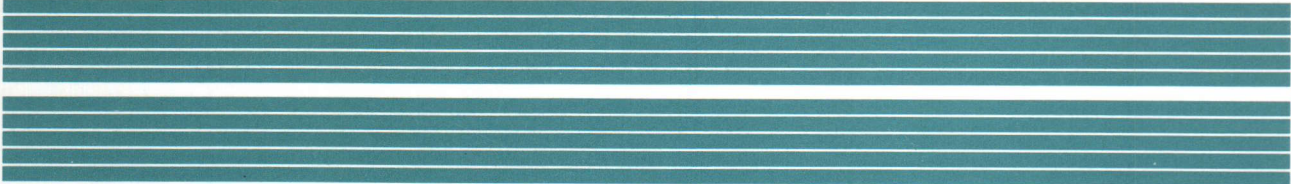

SERIES 60
PRU1200/1600
PRINTER OPERATION



HARDWARE

SERIES 60

PRU1200/1600 PRINTER OPERATION

SUBJECT

Description, Operation, and Maintenance for the PRU1200 and PRU1600 Printers, and the URP0600, URP0601, and URP0602 Unit Record Processors

SPECIAL INSTRUCTIONS

This manual supersedes the previous manual, Revision 1, dated March 1976. Change bars indicate technical changes.

The following notice is provided in accordance with the United States Federal Communications Commission's (FCC) regulations.

Warning: This equipment generates, uses, and can radiate radio frequency energy and if not installed and used in accordance with the instructions manual, may cause interference to radio communications. As temporarily permitted by regulation it has not been tested for compliance with limits for Class A computing devices pursuant to Subpart J of Part 15 of FCC Rules, which are designed to provide reasonable protection against such interference. Operation of this equipment in a residential area is likely to cause interference in which case the user at his own expense will be required to take whatever measures may be required to correct the interference.

ORDER NUMBER

AP88, Rev. 2

November 1978

Honeywell

Preface

This reference document provides hardware-oriented descriptive and instructive material for the user of the PRU1200 and PRU1600 Printers, and for others concerned with their technical aspects, applications, or use.

Divided into three sections and two appendixes, this manual contains a general description of the hardware, including performance specifications, features, and options (Section 1); a description of the operator-accessible control panel push buttons and indicators (Section 2); the operating and maintenance procedures necessary to enable personnel to properly and safely operate these printers (Section 3); paper and ribbon specifications (Appendix A); and Unit Record Processor information relevant to Level 66 and 68 system users (Appendix B).

Latest versions of PRU1200/1600 Printers (above serial number 2180) have slight design and engineering changes, incorporated for ease of manufacturing. Operation and maintenance procedures (Section 3) reflect these changes.

The information and specifications in this document are subject to change without notice. This document contains information about Honeywell products or services that may not be available outside the United States. Consult your Honeywell Marketing Representative.

520

SERIES 60
PRU1200/1600 PRINTER OPERATION
ADDENDUM A

SUBJECT

Addition of a Special Notice Required by the United States Federal Communications Commission

SPECIAL INSTRUCTIONS

This is the first addendum to AP88, Revision 2, dated November 1978.

Note:

Insert this cover after the manual cover to indicate the updating of the document with Addendum A.

ORDER NUMBER

AP88A, Rev. 2

December 1980

29897
7.5C1280
Printed in U.S.A.

Honeywell

COLLATING INSTRUCTIONS

To update this manual, remove old pages and insert new pages as follows:

Remove

Title Page, Preface

Insert

Title Page, Preface

SERIES 60
PRU1200/1600 PRINTER OPERATION
ADDENDUM B

SUBJECT

Additions and changes to the manual.

SPECIAL INSTRUCTIONS

This is the second addendum to AP88, Revision 2, dated November 1978. Change bars in the margins indicate new and changed information; asterisks denote deletions.

Note:

Insert this cover after the manual cover to indicate the updating of the document with Addendum B.

ORDER NUMBER

AP88B, Rev. 2

April 1981

COLLATING INSTRUCTIONS

To update this manual, remove old pages and insert new pages as follows:

Remove

iii, iv
2-1, 2-2
3-9 through 3-12

Insert

iii, iv
2-1, 2-2
3-9 through 3-12

CONTENTS

	<i>Page</i>
Section 1. Introduction	1-1
Features	1-1
Option	1-1
Required Option	1-1
Characteristics	1-2
Specifications	1-2
Section 2. Controls and Indicators	2-1
Main Control Panel	2-1
Auxiliary Control Panel	2-1
Maintenance Panel	2-1
Power	2-5
Section 3. Operation and Maintenance	3-1
Device States	3-1
Operating Procedures	3-1
Power-Up Sequence	3-1
Power-Down Sequence	3-3
Emergency Power-Down Sequence	3-3
Paper Loading	3-3
Print Test	3-5
Stacker Control	3-5
Changing Print Ribbon	3-6
Changing/Adjusting Print Belt Cartridge	
Serial Numbers 2179 and below	3-10
Serial Numbers 2180 and above	3-11
Restart Procedures	3-12
Maintenance Procedures	3-12
General Vacuum Cleaning	3-12
Ribbon Checking	3-13
Maintenance Supplies	3-13
Print Quality Checking	3-13
Control Panel Indicator Lamp	
Checking	3-13
Filter Cleaning	3-14
Character Belt Cleaning	3-14
Anvil Cleaning	3-14
Pulley Support Assembly Cleaning	3-14
Pulley Cleaning	3-14
Paper Pressure Plates Cleaning	3-15
Sensors Assembly Cleaning	3-15
Belt Deflector Replacement	3-15
Filter Replacement	3-15
Appendix A. Paper and Ribbon	
Specifications	A-1
Media Format	A-1
Ribbon	A-1
Appendix B. Unit Record Processors	B-1
Configurability	B-1

	<i>Page</i>
Options	B-1
Components	B-2
Controls and Indicators	B-2
Power	B-4

ILLUSTRATIONS

<i>Figure</i>		<i>Page</i>
1-1.	PRU1200/1600 Printer	1-1
2-1.	Main Control Panel	2-1
2-2.	Auxiliary Control Panel	2-3
2-3.	Maintenance Panel	2-4
2-4.	Circuit Breaker Panel	2-5
3-1.	Printer Assembly Front View (Pre-Serial Number 2180)	3-3
3-2.	Printer Assembly Front View (Post-Serial Number 2180)	3-3
3-3.	Paper Positioning Controls (Left-hand Side)	3-4
3-4.	Printer Paper Guides Positioning	3-4
3-5.	Paper Positioning in Tractors	3-4
3-6.	Paper Positioning Controls (Right-hand Side)	3-4
3-7.	Belt Gate (Pre-Serial Number 2180)	3-4
3-8.	Belt Gate (Post-Serial Number 2180)	3-5
3-9.	Paper Stacker (Pre-Serial Number 2180)	3-5
3-10.	Paper Stacker (Post-Serial Number 2180)	3-5
3-11.	Paper Feed Path on Stacker	3-6
3-12.	Stacker Controls	3-6
3-13.	Paper Height Adjustment Scale on Stacker	3-6
3-14.	Ribbon Loading Diagram (Pre- Serial Number 2180)	3-6
3-15.	Ribbon Loading Diagram (Post- Serial Number 2180)	3-7
3-16.	Changing Print Ribbon (1)	3-7
3-17.	Changing Print Ribbon (2)	3-7
3-18.	Changing Print Ribbon (3)	3-8
3-19.	Changing Print Ribbon (4)	3-8
3-20.	Changing Print Ribbon (5)	3-9
3-21.	Changing Print Ribbon (6)	3-9
3-22.	Changing Print Ribbon (7)	3-10
3-23.	Changing the Print Belt Cartridge (1)	3-10
3-24.	Changing the Print Belt Cartridge (2)	3-11
3-25.	Changing the Print Belt Cartridge (3)	3-11

3-26.	Belt Adjusting Key Inserted	3-11
3-27.	Cartridge Removal Key Inserted	3-12
3-28.	Belt Adjusting Key Inserted	3-12
3-29.	Print Hammers	3-13
3-30.	Lamp Replacement	3-13
3-31.	Filter Replacement	3-14
3-32.	Pulleys Support Assembly, Pulleys, and Anvil	3-14
3-33.	Dirty Finger and Belt Sensors	3-15
3-34.	Belt Deflector Replacement	3-15
A-1.	Maximum Form Width	A-1
A-2.	Minimum Form Width.	A-2
B-1.	URP Subsystem.	B-1
B-2.	Unit Record Processor Components	B-2
B-3.	URP0600 Control Panel	B-2
B-4.	URP0601/0602 Control Panel.	B-3
B-5.	URP0600/0601 Cabinet Circuit Breaker Location.	B-4

TABLES

Table

Page

1-1.	Print Belts	1-2
1-2.	Printer Characteristics	1-2
2-1.	Main Control Panel Controls and Indicators	2-1
2-2.	Auxiliary Control Panel Controls and Indicators	2-3
2-3.	Maintenance Panel Controls and Indicators	2-4
3-1.	Restart Procedures	3-1
3-2.	Maintenance Schedule.	3-12
A-1.	Paper Weights	A-2
B-1.	Unit Record Processor Options.	B-2
B-2.	URP Controls and Indicators.	B-3

SECTION 1

INTRODUCTION

The PRU1200 and PRU1600 high-speed belt printers produce clear printed copy at a speed of 1200 and 1600 lines per minute for continuous single-spaced line operation with a 48-character set. Line width is 136 print positions; however, an extended print option allows 160 print positions per line.

The print belt is packaged in a lightweight cartridge that enables easy removal, interchange, and storage. Each character on the print belt is mounted on a flexible "finger." During printing, the belt passes continuously at high speed in front of the print hammers. When a character is struck, the flexibility of the finger causes the character to be immobilized at the moment of impact. This eliminates drag and results in smearless, ghost-free, high-quality printed copy. The system is programmed to recognize the belt being used from the code on the cartridge.

The PRU1200/1600 printer units connect to Series 60 Level 62, 64, 66, and 68 systems. The printers connect to Model 62/60 systems via physically-integrated controls in the input/output control (IOC); to Level 64 systems through an integrated Unit Record Processor; to Level 66 systems through either a freestanding (URP0600) or integrated Unit Record Processor (URP0601/0602); and to Level 68 systems through a freestanding Unit Record Processor (URP0600). An addressing feature is required with each printer unit to enable connection to the control function. The URP0600/0601/0602 require operator interaction which is described in Appendix B.

FEATURES

The following features are standard on both printers.

- o *Exceptional print quality* – accomplished through the use of a new and unique print belt with 136 print positions standard (160 optional)
- o *Advanced acoustical design* – results in extremely quiet and efficient operation;

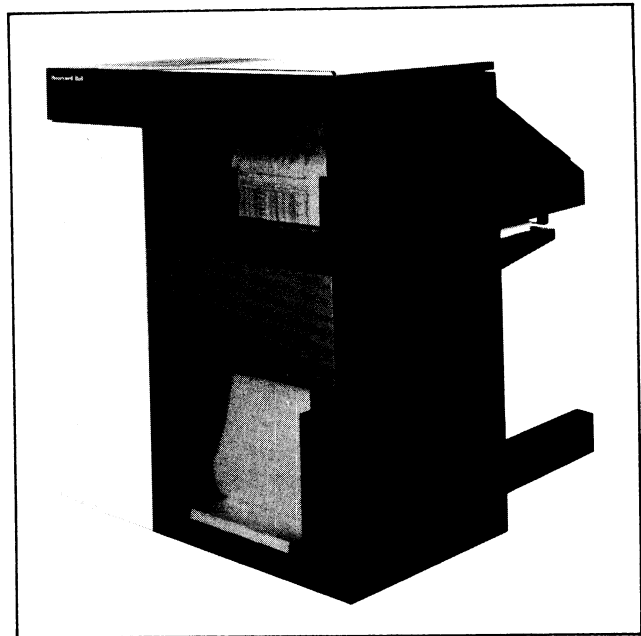

Figure 1-1. PRU1200/1600 Printer

conforms to the Occupational Safety and Health Act (OSHA) regulations

- o *Longer ribbon life* – achieved as a result of reduced ribbon drag during the printing process
- o *Extended printer life* – made possible by an automatic standby feature that deactivates the operating mechanism of the device when it is not being used
- o *Variety of character sets* – available in 48-character IBM "AN," 63-character Series 400/600/6000, 63-character ASCII, 64-character Series 200/2000, or 94-character ASCII (U/L case)
- o *Improved operator efficiency* – accomplished by an automatic paper stacker, simple paper loading and ribbon changing procedures, quick and easy exchange of lightweight belt cartridges, and clear, color-coded displays

OPTION

Extended Print Positions (PRF0022) increases the number of print positions per line from 136 to 160. (Not offered on Level 64.)

REQUIRED OPTION

Table 1-1 lists the various print belts available. One of these print belts must be specified when ordering.

TABLE 1-1. PRINT BELTS

Option Number	Characters	Character Set
PRB0402 ^a	48	IBM "AN"
PRB0500 ^b	63	Series 400/600/6000
PRB0501	63	IBM
PRB0513	63	ASCII
PRB0524 ^b	63	OCR-A Numeric
PRB0532	63	Puerto Rico
PRB0549	63	OCR-A Alphanumeric
PRB0703 ^a	64	Series 200/2000
PRB0600	94	ASCII (U/L Case)

^aNot standard on Level 66 and 68 systems.

^bNot standard on Model 62/60.

CHARACTERISTICS

Table 1-2 lists the characteristics of the printers.

SPECIFICATIONS

Physical

Printer

Height: 61 in. (155 cm)
 Width: 55 in. (140 cm)
 Depth: 30 in. (76 cm)
 Weight: 1500 lb (680 kg)

Stacker

Height: 57 in. (145 cm)
 Width: 27 in. (69 cm)
 Depth: 30 in. (76 cm)
 Weight: 280 lb (128 kg)

Electrical

The printer is available in the following versions:

50 Hz, 220V (3-phase, 4-wire)
 50 Hz, 380V (3-phase, 5-wire)
 50 Hz, 415V (3-phase, 5-wire)
 60 Hz, 208V (3-phase, 5-wire)

The power consumed is approximately 4.4 kw.

Environmental

Temperature

Minimum: 50°F (10°C)
 Maximum: 100°F (38°C)

Relative Humidity

Minimum: 10% (without condensation)
 Maximum: 80% (without condensation)

TABLE 1-2. PRINTER CHARACTERISTICS

Characteristics	PRU1200	PRU1600
Speed (lpm)		
48 character set	1200	1600
63 character set	975	1375
94 character set	700	900
Print positions		
Standard	136	136
Optional	160	160
Lines per inch ^a	6 or 8	6 or 8
Characters per inch	10	10
Forms control		
Vertical format control	No space; single space; double space; skip to top of page; skip to any of 15 coded positions	
Horizontal format control (selective space insertion)	8-120 spaces (in multiples of 8)	
Character set	48, 63, 64, or 94 (see Table 1-1)	
Reproduction system	Hammer stroke against flexible belt "finger"	
Programmed operations	Print and space; space only; skip; vertical line spacing	
Line skip speed (ips)		
1- to 3-space skips	27.5	
4- to 6-space skips	65.0	
7- (or more) space skips	90.0	

TABLE 1-2 (CONT). PRINTER CHARACTERISTICS

Characteristics	PRU1200	PRU1600
Paper stock ^b		
Width	4 in. (10.2 cm) to 22 in. (55.9 cm), pin-to-pin	
Weight	Single-part form: 16 lb (min) to 125 lb card stock Multipart form: one original and five carbon copies can be produced, with a maximum form thickness of 0.019 in. (0.5 cm).	
Ribbon ^b	Type M3571: 18.5 in. (46.9 cm) mandrel with a 17.640 ± 0.079 in. (44.805 ± 0.200 cm) wide fabric ribbon	
Field Upgradability	To a PRU1600	N/A

^aProgram selectable.

^bSee Appendix A.



SECTION 2

CONTROLS AND INDICATORS

There are two operator control panels on the PRU1200/1600 Printer units: a main control panel located on the front of the unit and an auxiliary control panel located on the rear of the unit along with the stacker controls (Figures 2-1 and 2-2). A description of the function of each indicator and control is listed in Tables 2-1 and 2-2. Indicators are visible only when illuminated. A maintenance panel, located behind the left front door, contains some controls applicable to the operator. These are shown in Figure 2-3 and described in Table 2-3.

The indicators are color-coded as follows:

- o Green – indicates normal operation
- o Yellow – indicates operator action required
- o Red – indicates major fault possibly requiring field engineering assistance

Restart procedures for the various error conditions are listed in Section 3, Table 3-1.

MAIN CONTROL PANEL

The main control panel contains six push buttons and sixteen indicators.

AUXILIARY CONTROL PANEL

The auxiliary control panel contains six push buttons and five indicators.

MAINTENANCE PANEL

The maintenance panel contains a variety of push buttons and indicators; however, only a few of these are for operator use.

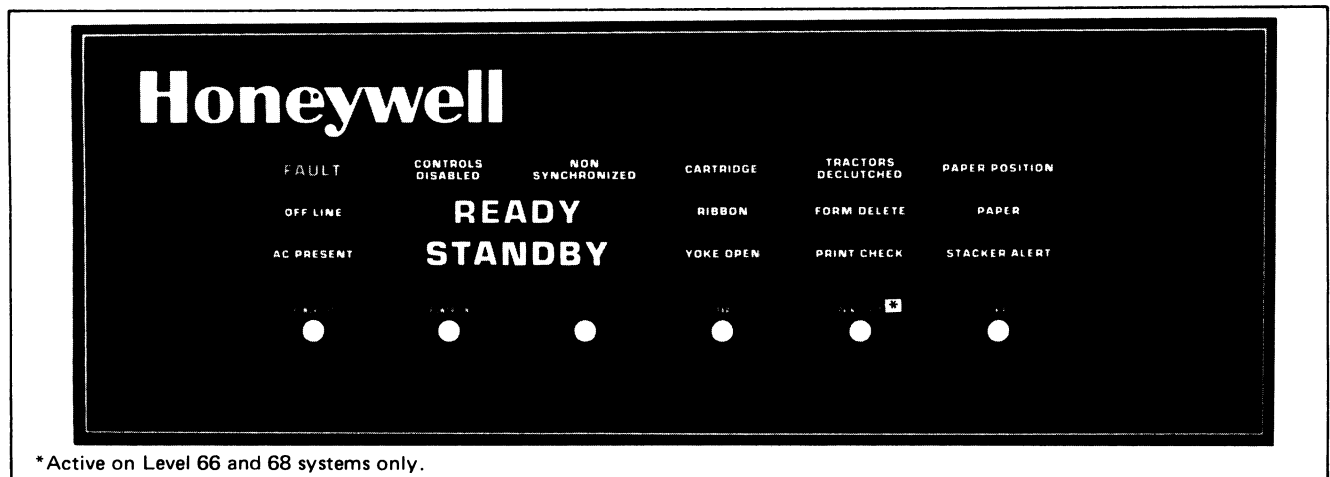

Figure 2-1. Main Control Panel

TABLE 2-1. MAIN CONTROL PANEL CONTROLS AND INDICATORS

Push Button/Indicator	Function
POWER OFF	This push button removes dc power from printer.
POWER ON	This push button applies dc power to printer. It also initiates lamp test illuminating all of the indicators.
STOP	This push button changes printer from ready state to standby state.
START	This push button changes printer from standby state to ready state and resets any alert indicators if fault was cleared.

TABLE 2-1 (CONT). MAIN CONTROL PANEL CONTROLS AND INDICATORS

Push Button/Indicator	Function
PRINT TEST	This push button is used in checking print quality or forms positioning, and is operable in only standby state. It causes a line of Es to be printed and a slew of one line to occur, thus enabling operator to verify that all hammers are operational. NOTE: This push button is active on Level 66 and 68 systems only.
SKIP	This push button advances paper and is usable in only standby state. If firmware is loaded and a Vertical Format Control (VFC) image is loaded, a slew to the top of page as specified by current VFC image will occur each time SKIP is pressed. If no firmware VFC image is loaded, no slew will occur.
AC PRESENT (green)	Indicates ac power is applied to printer.
OFF LINE (green)	Indicates printer is not logically connected to processor.
STANDBY (yellow)	Indicates printer is not available for operation.
READY (green)	Indicates printer is available for operation.
FAULT (red)	Indicates major fault possibly requiring field engineering attention.
CONTROLS DISABLED (yellow)	Indicates all push buttons except POWER OFF are disabled either because tests are being run or a fault has been detected by tests.
NON- SYNCHRONIZED (yellow)	Indicates printer is not initialized properly.
CARTRIDGE (yellow)	Indicates print belt is incorrectly positioned or damaged and is inoperable until fixed.
RIBBON (yellow)	Indicates ribbon is incorrectly positioned or badly worn.
YOKE OPEN (yellow)	Indicates belt gate or ribbon door is not fully closed.
TRACTORS DECLUTCHED (yellow)	Indicates tractors lever is disengaged.
FORM DELETE (yellow)	Indicates operator should look for a console message from system, giving information as to marking or destroying last page or pages printed. NOTE: This push button is not active on Level 66 and 68 systems.
PRINT CHECK (yellow)	Indicates PRINT TEST was pressed or it was illuminated in conjunction with a system-initiated printout.
* PAPER POSITION (yellow)	A flashing indicator signifies that the left-hand tractor is not in line with column 1 of reference mark.
PAPER (yellow)	Indicates paper torn, no paper, or end of paper.
STACKER ALERT (yellow)	Indicates stacker is full or a stacker jam.

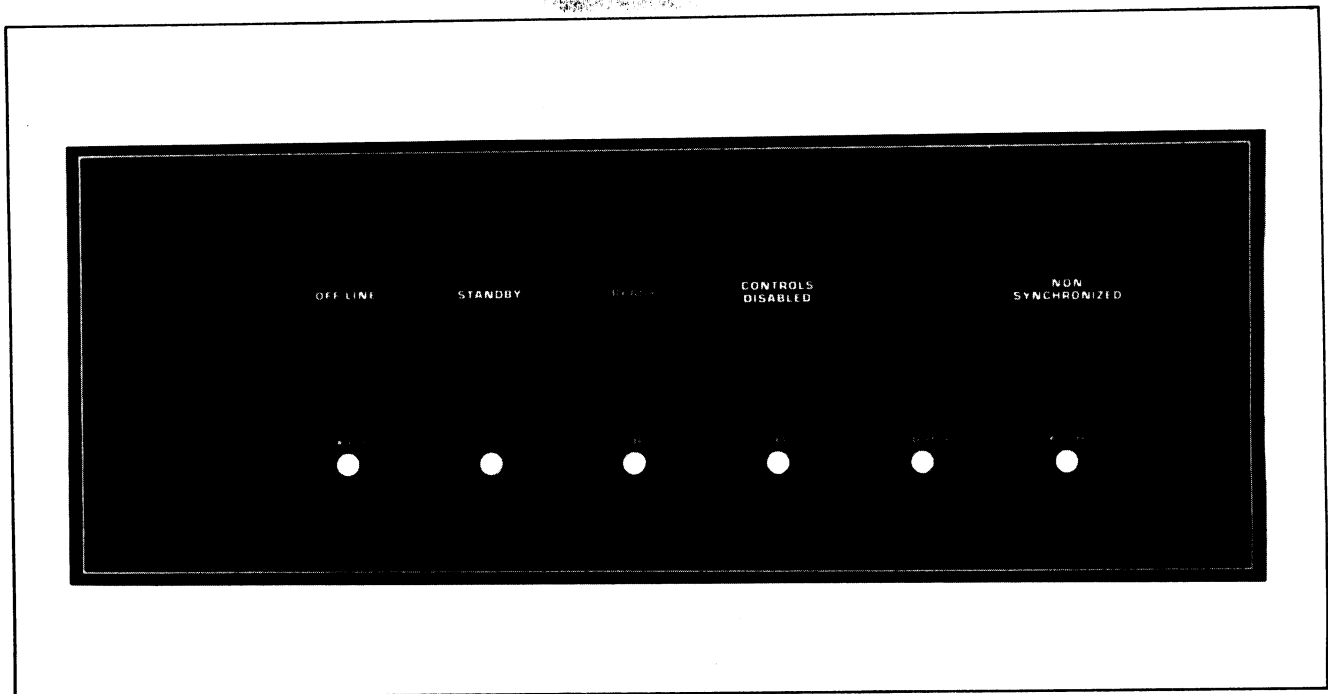
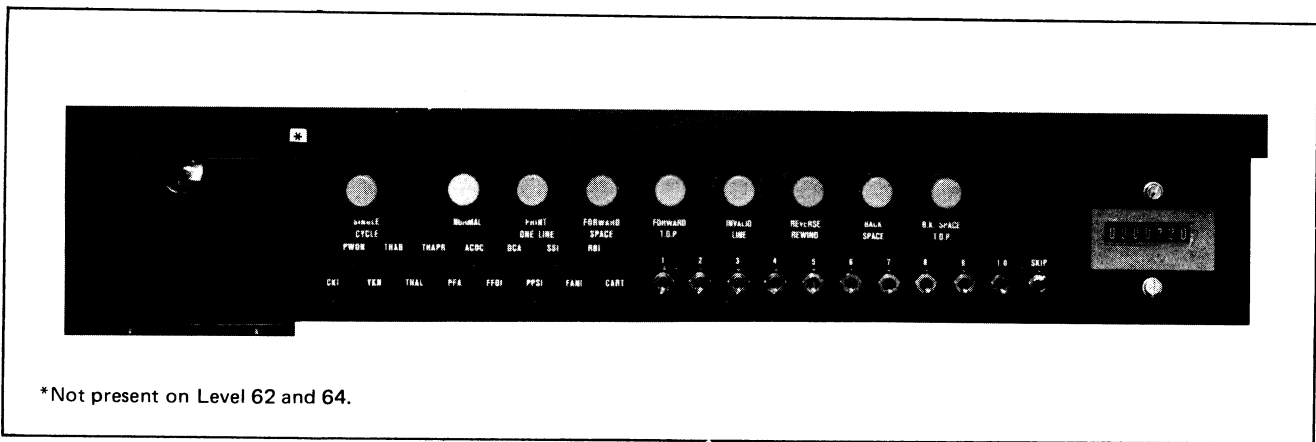

Figure 2-2. Auxiliary Control Panel

TABLE 2-2. AUXILIARY CONTROL PANEL CONTROLS AND INDICATORS

Push Button/Indicators	Function
POWER OFF	This push button removes dc power from printer.
STOP	This push button changes printer from ready state to standby state.
START	This push button changes printer from standby state to ready state and resets any alert indicators if fault was cleared.
SKIP	This push button advances paper and is usable in only standby state. If firmware is loaded and a Vertical Format Control (VFC) image is loaded, a slew to the top of page as specified by current VFC image will occur each time SKIP is pressed. If no firmware VFC image is loaded, no slew will occur.
CLEAR PAPER	This push button feeds last printed forms into stacker if they are ripped off above tractors.
LOWER TABLE	This push button causes stacker table to lower to facilitate removal of printed forms.
OFFLINE (green)	Indicates printer is not logically connected to processor.
STANDBY (yellow)	Indicates printer is not available for operation.
READY (green)	Indicates printer is available for operation.
NON- SYNCHRONIZED (yellow)	Indicates printer is not initialized properly.



*Not present on Level 62 and 64.

Figure 2-3. Maintenance Panel

TABLE 2-3. MAINTENANCE PANEL CONTROLS AND INDICATORS

Control/Indicator	Function
PWON	Indicates belt motor power is on.
THAB	Indicates thermal alert in belt motor.
THAPR	Indicates thermal alert in print power supply.
ACOC	Indicates ac overcurrent condition.
DCA	Indicates dc power supplies alert.
SSI	Indicates skip supply incident.
RBI	Indicates ribbon incident.
CKI	Indicates clock fault.
YKN	No power to belt motor.
YKN·PWON	Belt motor on but not up to speed.
THASL	Indicates thermal alert in skip motor.
PFA	Indicates phase failure alert.
FFOI	Indicates frame or filters open incident.
PPSI	Indicates print power supply incident.
FANI	Indicates fans incident.
CART	Indicates cartridge incident.
SKIP	Up for normal operation. Down for operation with flimsy paper (cancels medium and high skip speeds).

The following push button is applicable to Level 66 and 68 systems.

SINGLE CYCLE	If pressed with printer in ready state and printing, printing terminates and skip that normally follows printing is not executed; standby state is entered.
--------------	---

NOTE: The eight clustered printer-software interface push buttons, which are located on the maintenance panel, permit the operator to communicate with the control program to which the printer is allocated. The function and software (SYSOUT or BMC) response for each push button is described in Section 3 of the *Series 60 (Level 66/6000) GCOS System Operation Techniques* manual, Order Number DD50.

POWER

Primary power to the printer is controlled by a group of circuit breakers – Device Main and Secondary – located at the rear of the printer (Figure 2-4). When both groups of circuit breakers are set to ON, AC PRESENT is illuminated on the main control panel.

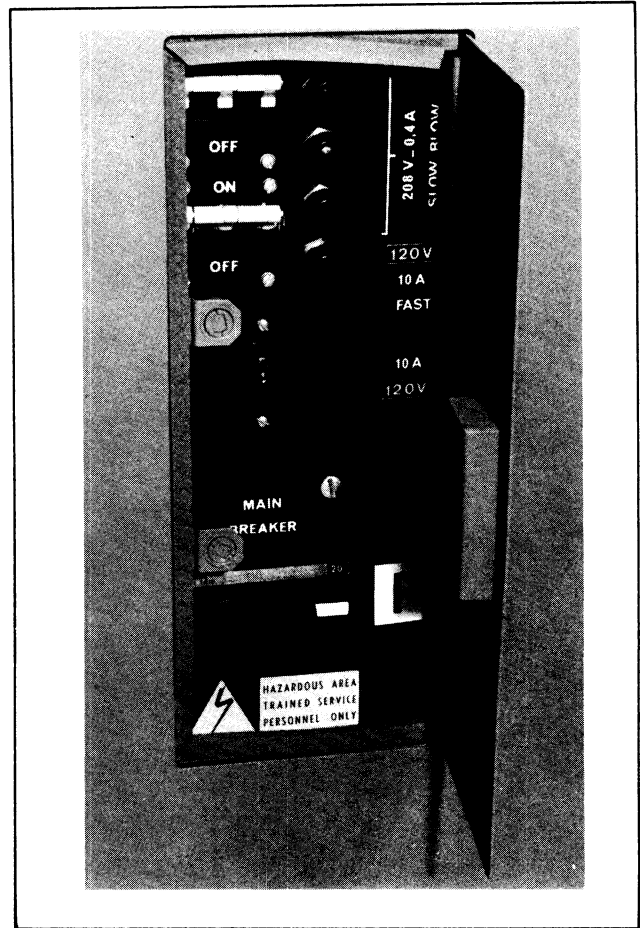

Figure 2-4. Rear Circuit Breaker Panel



SECTION 3

OPERATION AND MAINTENANCE

This section first details routine as well as exceptional operating procedures, and then explains the operator's tasks in preventive maintenance. To minimize the possibility of error or damage to the paper/printer, it is important that the operator understand the use and function of the various controls and indicators previously explained in Section 2.

DEVICE STATES

The three main device states for the printer unit are displayable on the main control panel:

- o *Offline* – not logically connected to the central processor
- o *Standby* – logically connected to the central processor but not operational (e.g., operator loading or removing paper)
- o *Ready* – fully operational and ready to receive and process commands from the processor

OPERATING PROCEDURES

Power-Up Sequence

In the following procedure, it is assumed that all cables have been properly connected and that power is applied to the unit.

1. Set device main and secondary circuit breakers located on rear circuit breaker panel to ON. AC PRESENT illuminates on main operator control panel.
2. Press POWER ON. The following events take place:
 - o While POWER ON is pressed, all display panel indicators illuminate. If any do not illuminate, lamps should be checked and replaced if necessary (refer to "Control Panel Indicator Lamp Checking.")
 - o When POWER ON is released, all indicators except OFF LINE and AC PRESENT turn off.
 - o If processor is initialized, OFF LINE turns off and STANDBY illuminates. This occurs about 4 seconds after pressing POWER ON push button. If processor is not initialized, OFF LINE remains illuminated until initialization has terminated on processor. STANDBY then illuminates and OFF LINE turns off.
3. When STANDBY indicator illuminates and paper is properly positioned, press START push button. If printer is ready, STANDBY indicator goes off, and READY illuminates. If READY does not illuminate, check alert indicators and take appropriate action, as described in Table 3-1.

TABLE 3-1. RESTART PROCEDURES

Indicator(s) Illuminated	Procedure
PRINT CHECK STANDBY	1. Check printout. 2. If satisfactory, press START; if not satisfactory, adjust forms, and press PRINT TEST. 3. Repeat steps 1 and 2 until satisfied.
CONTROLS DISABLED STANDBY or READY	No action required. Controls are disabled because tests are being run on device. As soon as tests are finished, printer returns to ready or standby state that existed before tests began.
CONTROLS DISABLED OFFLINE	Fault diagnosed by test routines, and printer is in offline state. There is either a fault in printer or processor, or printer firmware package is absent. Obey any console messages and if fault persists, notify Honeywell field engineer.
CARTRIDGE STANDBY	Check belt for incorrect positions on pulleys, or broken/twisted belt finger. Refer to "Changing/Adjusting Print Belt Cartridge" procedures.

TABLE 3-1 (CONT). RESTART PROCEDURES

Indicator(s) Illuminated	Procedure
NONSYNCHRONIZED STANDBY	<ol style="list-style-type: none"> 1. Declutch tractors. 2. Reposition paper for head-of-form. 3. Press SKIP. 4. Engage tractors. 5. Press START.
FAULT STANDBY	<ol style="list-style-type: none"> 1. Trip main circuit breaker. 2. Check all other breakers. 3. Reset circuit breakers if necessary. 4. Reset main circuit breaker. 5. Perform "Power-up Sequence." 6. If fault persists, set main circuit breaker to OFF and notify Honeywell field engineer.
FORM DELETE STANDBY	Refer to console for message providing instructions.
PAPER STANDBY	<p>Refer to appropriate procedures:</p> <p><i>Paper Torn</i> If only last page needs reprinting – reposition paper, press SKIP, and press START. If more than one page needs reprinting – press PRINT TEST, and indicate restart point from console.</p> <p><i>No Paper/End of Paper Sensed</i> Reload and press START.</p> <p>NOTE: The printer senses end of paper 12 in. (30.5 cm) before actual end, and continues printing to end of current form before giving paper alert.</p> <p><i>None of the above</i> Check sensors in tractors for blockage. Remove any paper fragments, press SKIP, and press START.</p>
RIBBON STANDBY	<ol style="list-style-type: none"> 1. Reposition and visually check ribbon. 2. Replace if necessary. 3. Check printout and decide how many pages need reprinting. If only last page to be reprinted – press START. If more than one page to be reprinted – press PRINT TEST, and indicate restart point from console.
STACKER ALERT STANDBY	<ol style="list-style-type: none"> 1. Unload stacker. 2. Reset stacker table. 3. Press START.
TRACTORS DECLUTCHED STANDBY	<ol style="list-style-type: none"> 1. Engage tractors lever. 2. Press START.
YOKE OPEN STANDBY	<ol style="list-style-type: none"> 1. Check to see if belt gate or ribbon door is not fully closed. 2. Press START.
PAPER POSITION	<ol style="list-style-type: none"> 1. Declutch tractors. 2. Align fold of form with scribe mark on tractors. 3. Press SKIP. 4. Reclutch tractors. 5. Press SKIP. (A slew to the top of the page as defined by the current VFC image will be executed if there is an image resident in the URP. If there is no image resident, the slew will be executed at the time the VFC image is loaded into the URP.)

Power-Down Sequence

1. Press STOP to put printer in standby state; otherwise data may be lost. STANDBY illuminates.
2. Press POWER OFF.
3. Set device main circuit breaker to OFF.

Emergency Power-Down Sequence

In an emergency, switch off device main circuit breakers on all peripherals and ac main circuit breaker to system.

Paper Loading

Position paper in response either to console message or to PAPER alert on operator control panel. To load paper:

1. If printer is in ready state, press STOP push button. Printer then goes into standby state.
2. Press SKIP.
3. To gain access to paper track, open both front doors and then open belt gate by pulling release lever on right-hand end of gate (Figure 3-1, 3-2).
4. Remove paper from box and then place paper on platform (Figure 3-1, 3-2).
5. Disengage tractors by pulling tractors lever, on left-hand side, down. (Figure 3-3).
6. Position left-hand tractor. Tractor must be position on reference mark and locked in position unless otherwise specified in operating instructions. Both left- and right-hand tractors can be moved independently by loosening their tractor locks (Figure 3-3).
7. Position right-hand tractor in approximately correct position for paper width, and position center guides evenly between tractors. For narrow paper it may be necessary to pull off one of these guides (Figure 3-4).
8. Open tractor guides by pulling tractor guides handle and position paper with its fold so that top of paper is in stacker (refer to "Stacker Control") and a fold is near head-of-form mark on the printer. Close tractor guides and check that paper is taut (Figure 3-5). If not taut, adjust right-hand tractor and then lock into position.

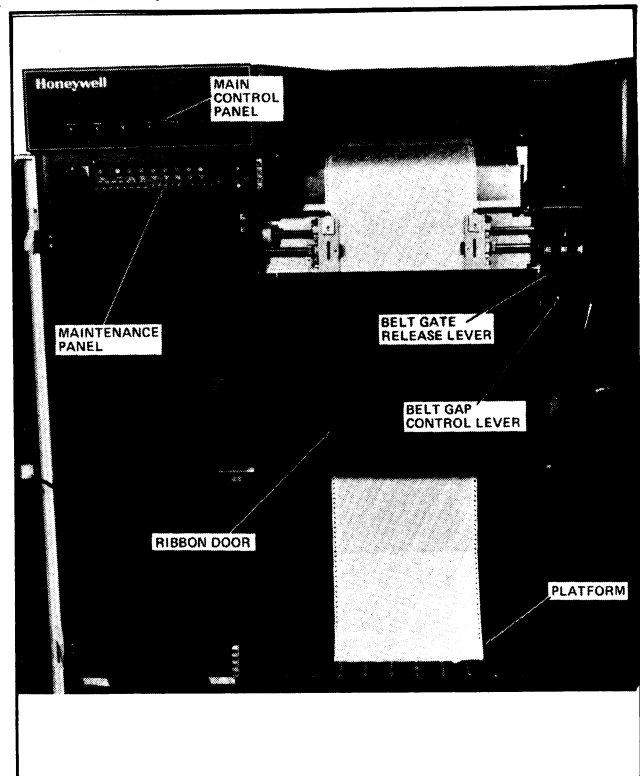

Figure 3-1. Printer Assembly Front View
(Pre-Serial Number 2180)

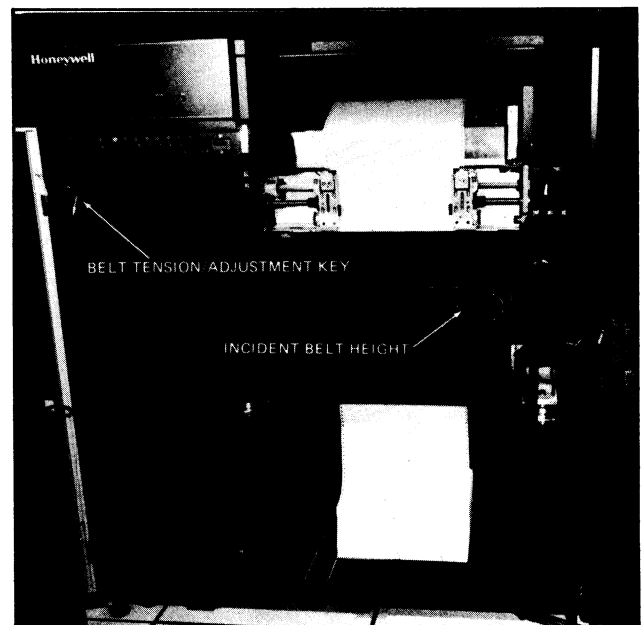

Figure 3-2. Printer Assembly Front View
(Post-Serial Number 2180)

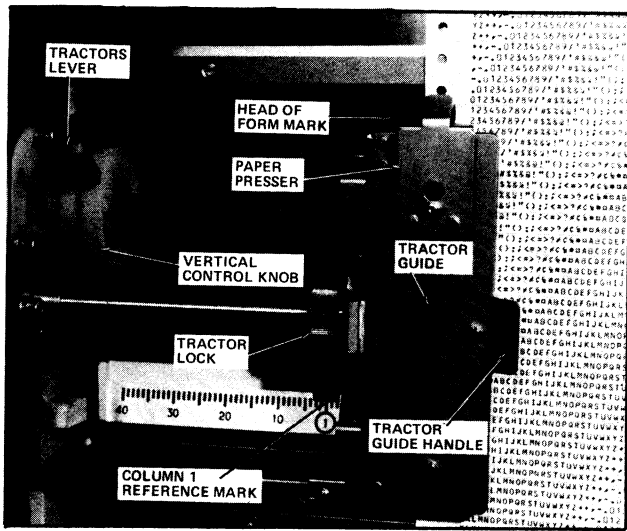

Figure 3-3. Paper Positioning Controls (Left-hand Side)



Figure 3-4. Printer Paper Guides Positioning

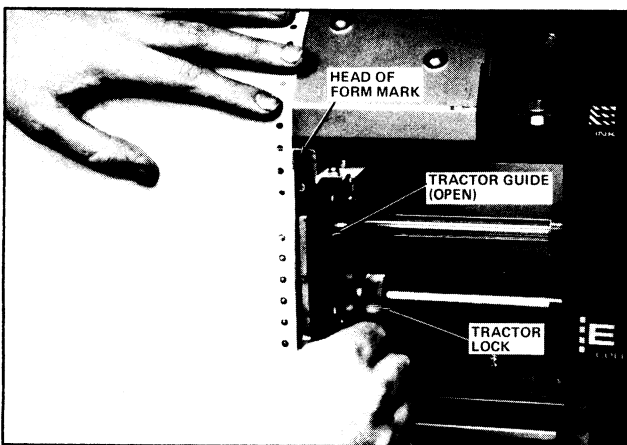

Figure 3-5. Paper Positioning in Tractors

9. By turning vertical control knob, adjust paper so that fold coincides with head-of-form mark (Figure 3-3).

10. If necessary, adjust horizontal positioning by turning horizontal control knob (Figure 3-6). PAPER POSITION indicator illuminates unless paper is correctly positioned.

11. Close belt gate.

12. Set paper thickness control according to paper thickness. When set correctly, both indicator lamps will be off (Figure 3-7, 3-8). If an indicator lamp is illuminated, move paper thickness control all the way to rear, and then slowly move it forward until indicator A is extinguished. If indicator B is illuminated, start step 12 over again.

13. Reengage tractors lever (Figure 3-3).

14. Close doors and press START.

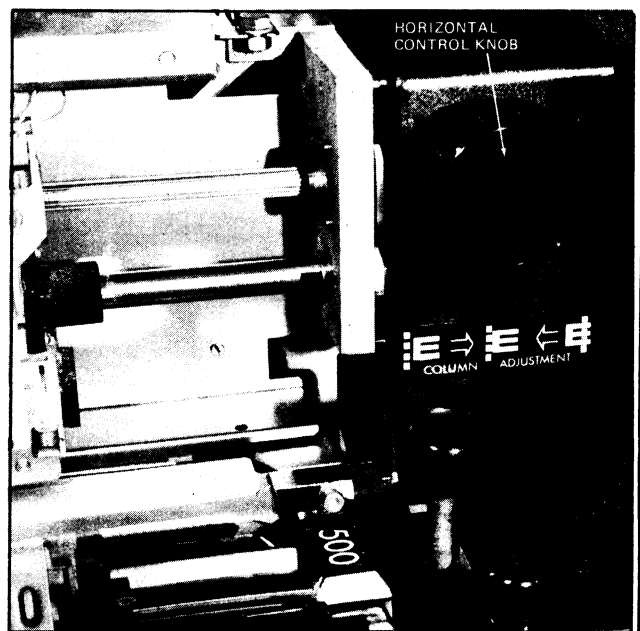

Figure 3-6. Paper Positioning Controls (Right-hand Side)

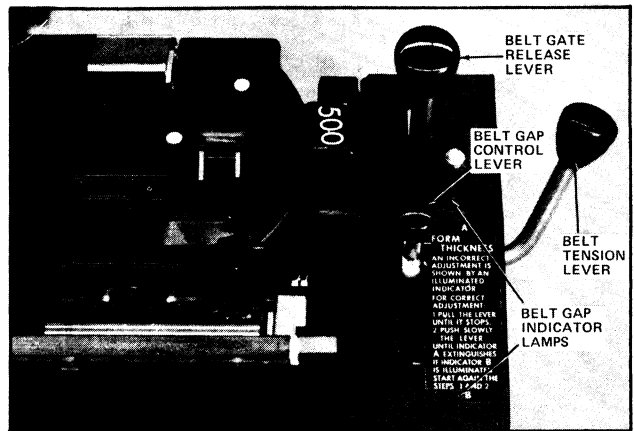

Figure 3-7. Belt Gate (Pre-Serial Number 2180)

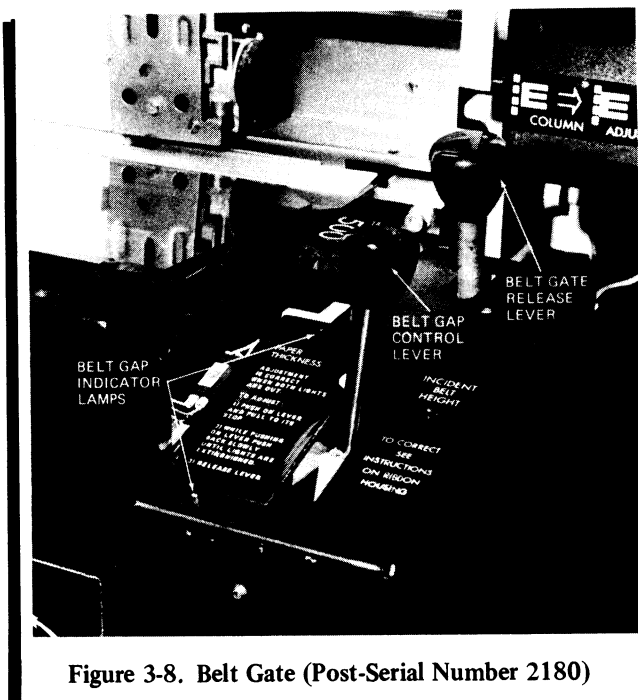

Figure 3-8. Belt Gate (Post-Serial Number 2180)

Print Test

After loading the paper, check the paper alignment by pressing the PRINT TEST push button. A line of Es is printed, after which the device goes into the standby state, and the PRINT CHECK indicator illuminates. Adjust the paper position and repeat the operation until satisfied with the alignment; then press START.

NOTE: The PRINT TEST push button is active on only Level 66 and 68 systems.

Stacker Control

The high speed of the printer necessitates the use of a dynamic stacking mechanism for the printer output. The PRU1200/1600 has a fully soundproofed, easily-movable stacker which is attached by magnets to the rear of the printer (Figure 3-9, 3-10). The paper comes out the rear of the printer between the tension rollers onto the stacker table. Rotating paddles ensure correct folding of the paper (Figure 3-11). The stacker is activated as soon as printing begins.

When loading paper onto the printer, pass the paper from the rear of the printer between the tension rollers (Figure 3-12). Adjust the paper height control (Figure 3-12) for the correct form height. The scale (Figure 3-13) indicates the paper height in inches and is located inside the front left-hand side of the stacker. Raise the stacker table by pulling it up. Set the NORMAL/SPECIAL switch to NORMAL for lightweight to medium-weight paper or to SPECIAL for mediumweight to heavyweight paper.

As paper is stacked, the stacker table automatically descends. When full, the STACKER ALERT indicator illuminates on both control panels, and the device goes into the standby state.

Before removing paper from the stacker table, put the device into the standby state, if it is not already in this state, by pressing STOP. To remove paper from the stacker table, press SKIP to eject the last printed sheet from the printer station, and then tear the paper along a fold and press the CLEAR PAPER push button on the auxiliary control panel. This causes the tension rollers to rotate and stack the last few forms. Press the LOWER TABLE push button on the rear control panel until it is possible to reach and remove the printed forms.

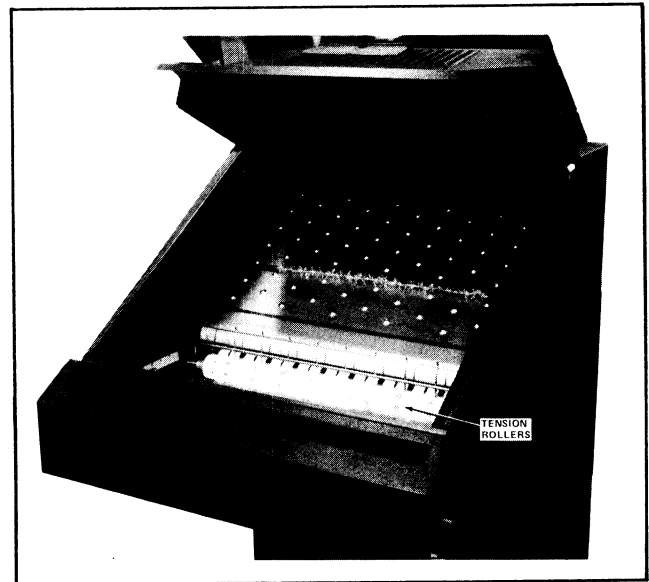

Figure 3-9. Paper Stacker (Pre-Serial Number 2180)

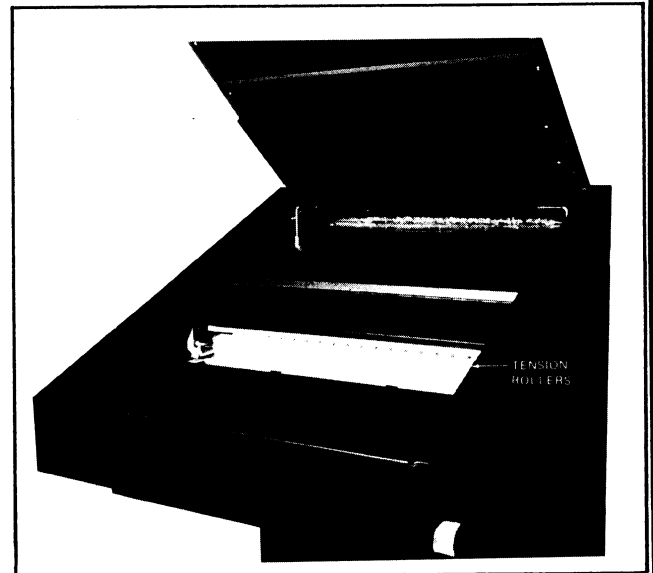

Figure 3-10. Paper Stacker (Post-Serial Number 2180)

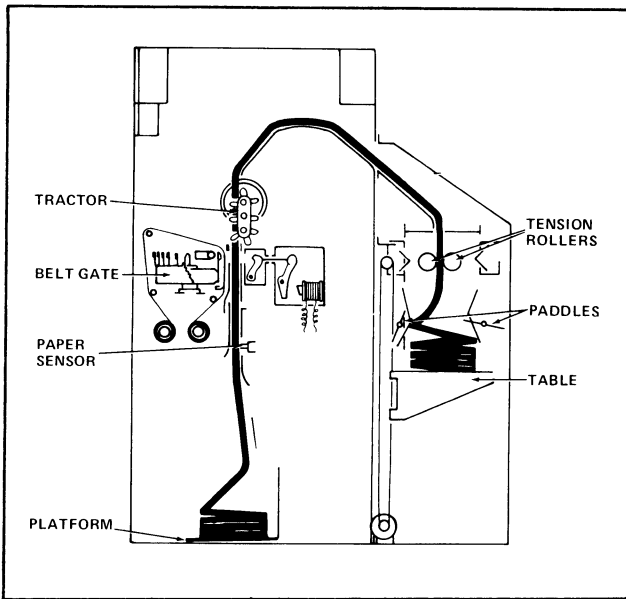

Figure 3-11. Paper Feed Path on Stacker

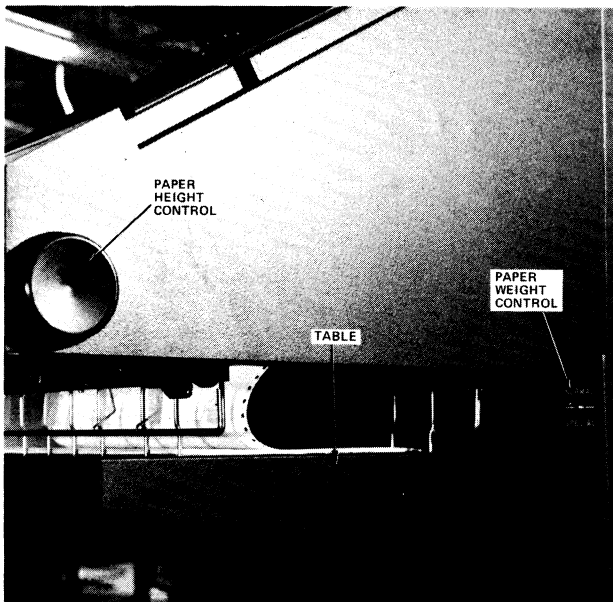

Figure 3-12. Stacker Controls

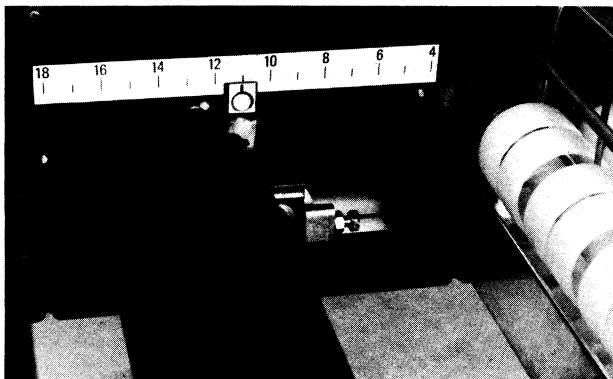

Figure 3-13. Paper Height Adjustment Scale on Stacker

Changing Print Ribbon

To change the ribbon:

1. Refer to ribbon-loading diagrams on the right-hand front door. (See Figure 3-14 and 3-15.)
2. Open front doors and then the ribbon door, which covers front of belt gate (Figure 3-1, 3-2) by pulling on right-hand side. (The ribbon door separated from the belt gate is shown in Figure 3-23.)
3. Remove old front ribbon spool (Figure 3-16) and place on cartridge (Figure 3-17).
4. Place one of the new ribbon spools on the front mandrel and the other new spool on cartridge (Figure 3-18).
5. Open belt gate by pulling the release lever (Figure 3-7, 3-8).
6. Separate paper track gate from belt gate (Figure 3-19).
7. Remove second old ribbon spool and place in empty carton (Figure 3-20).
8. Before installing new ribbon, wipe both sides of antismudge shield (Figure 3-21), belt deflector (Figure 3-20) and ribbon sensors (Figure 3-20) using a Honeywell-approved general cleaner.
9. Place second new ribbon spool on rear mandrel (Figure 3-22).
10. Wind up any loose ribbon.
11. Close paper gate, belt gate, ribbon door, and front doors.

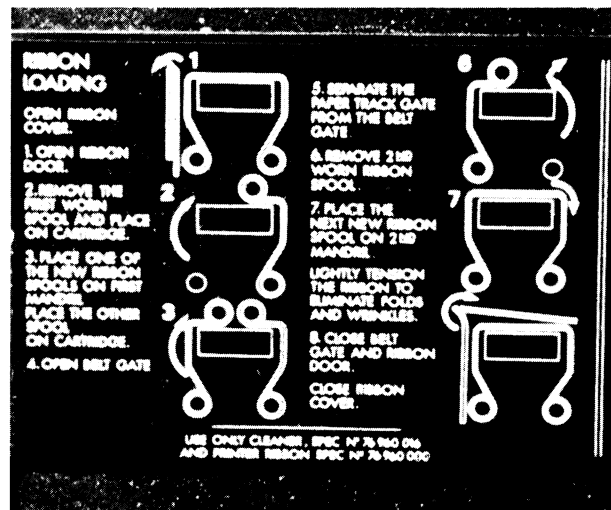

Figure 3-14. Ribbon Loading Diagram (Pre-Serial Number 2180)

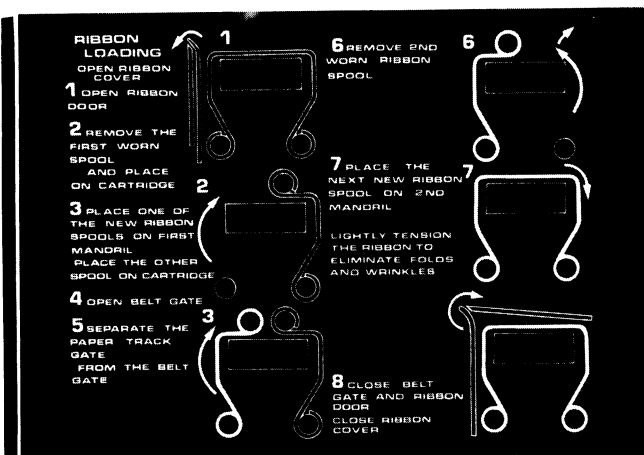

Figure 3-15. Ribbon Loading Diagram (Post-Serial Number 2180)

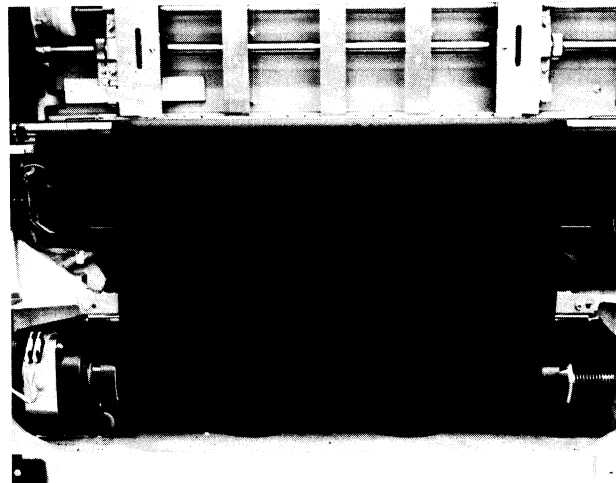

Figure 3-16. Changing Print Ribbon (1)

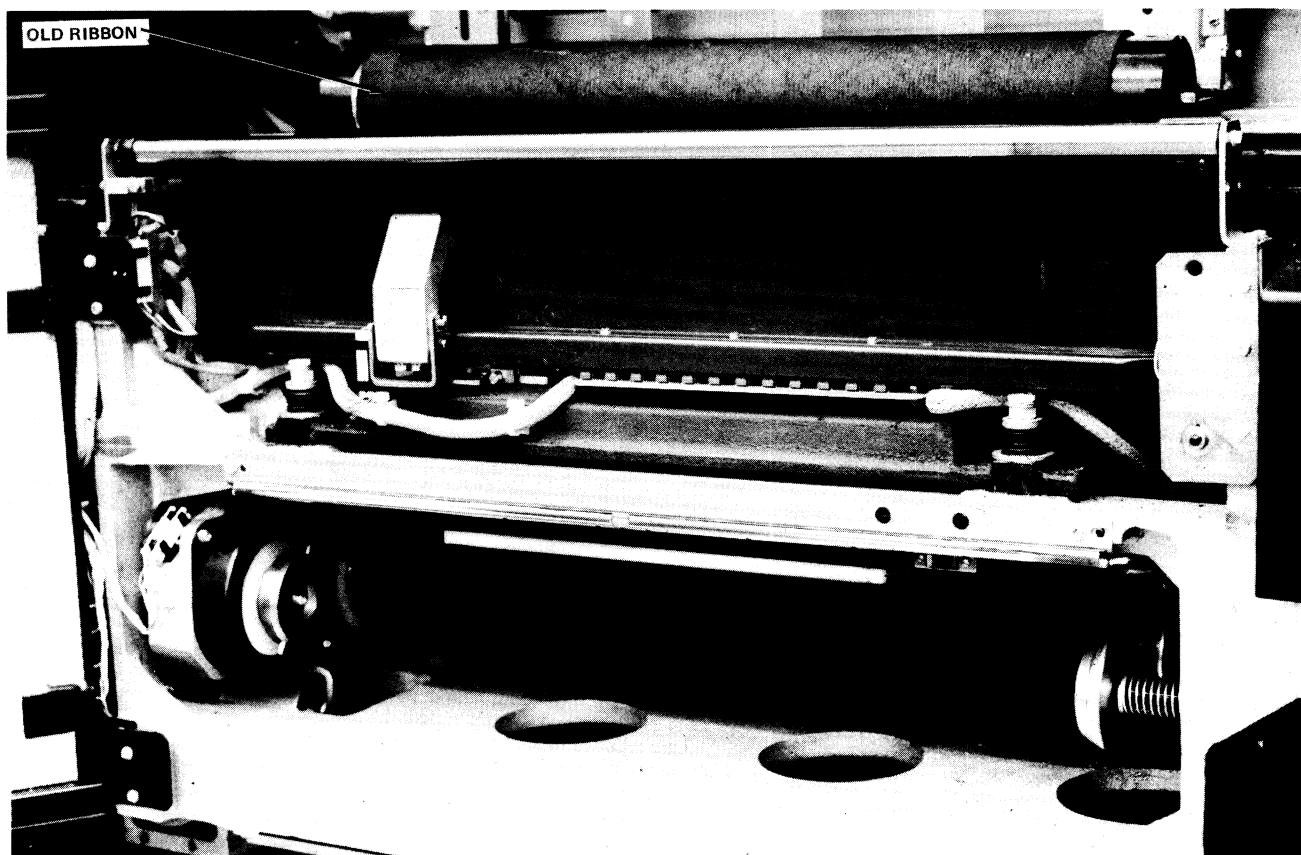

Figure 3-17. Changing Print Ribbon (2)



Figure 3-18. Changing Print Ribbon (3)

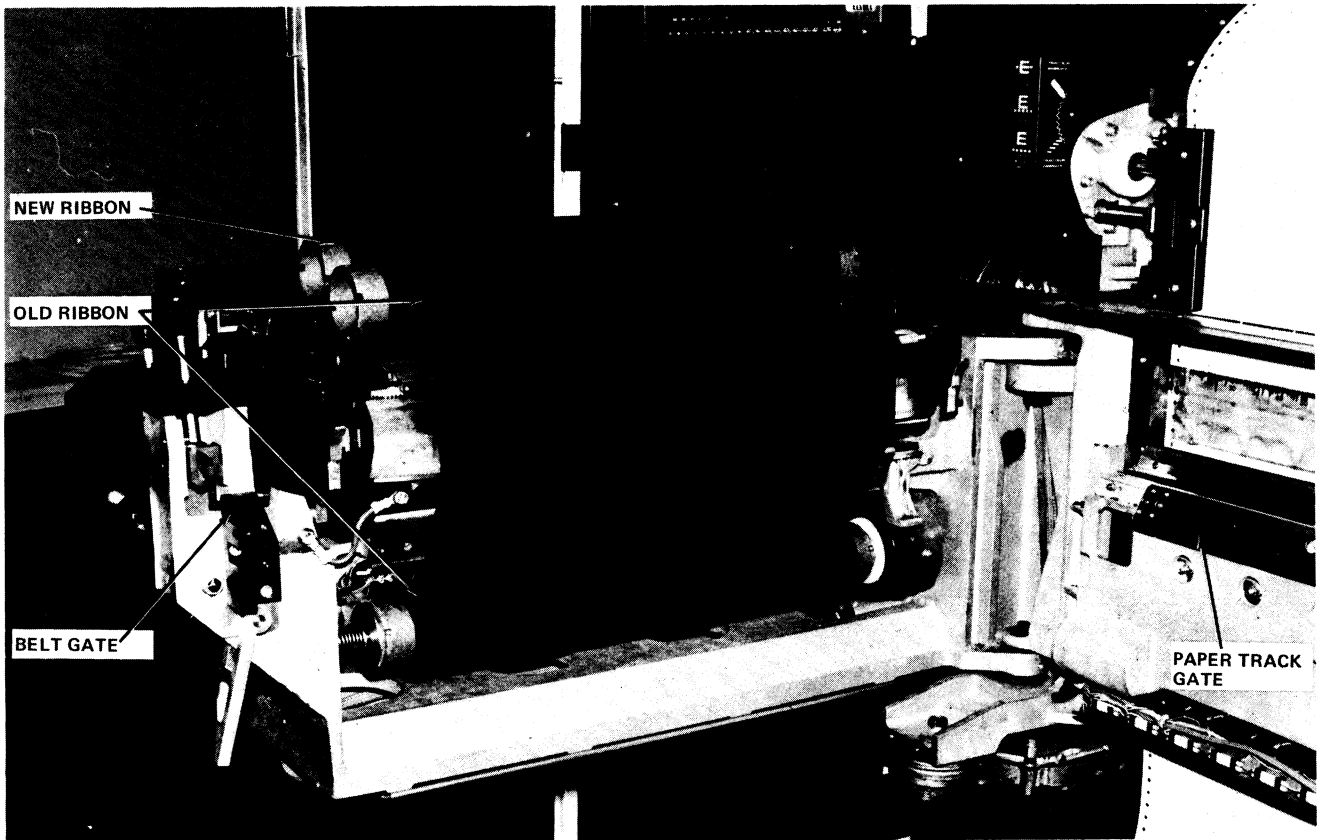

Figure 3-19. Changing Print Ribbon (4)

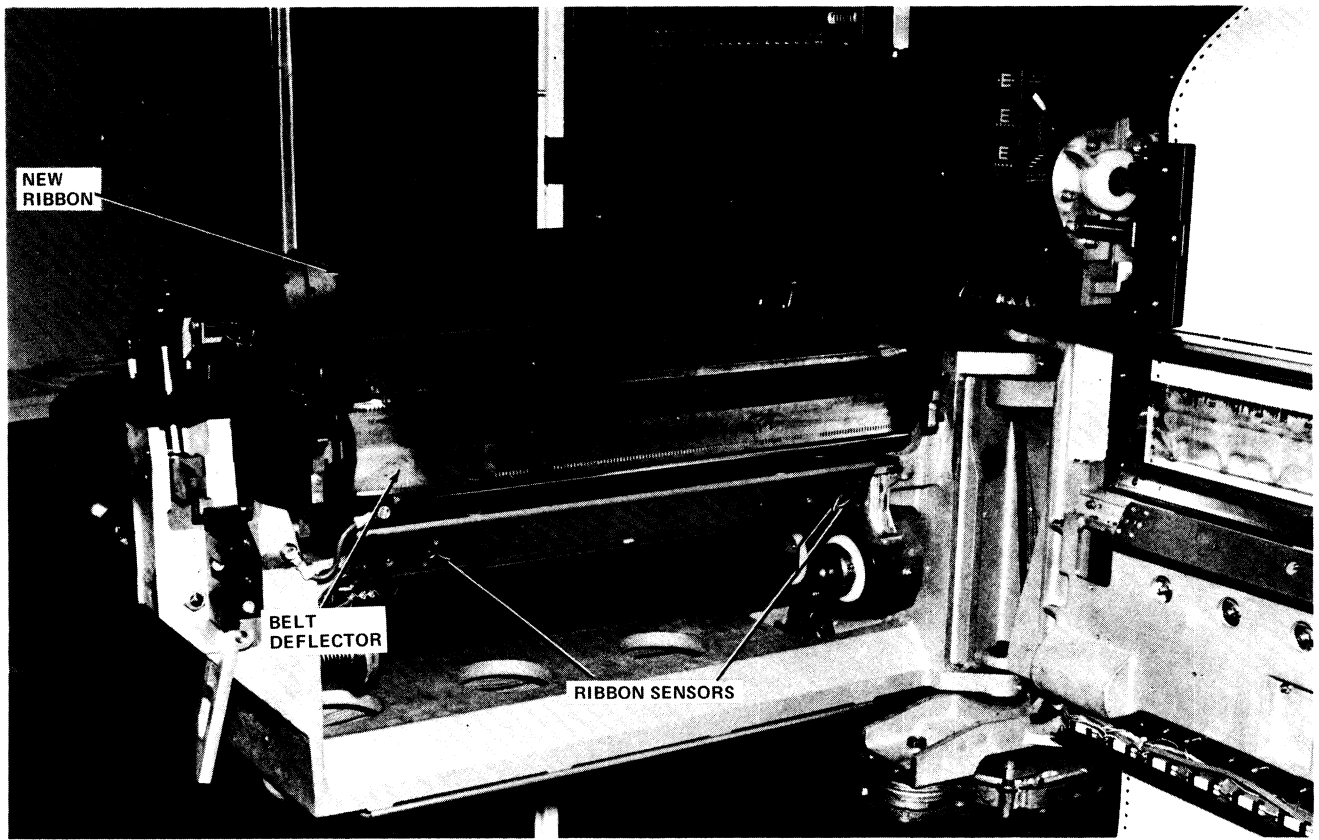

Figure 3-20. Changing Print Ribbon (5)

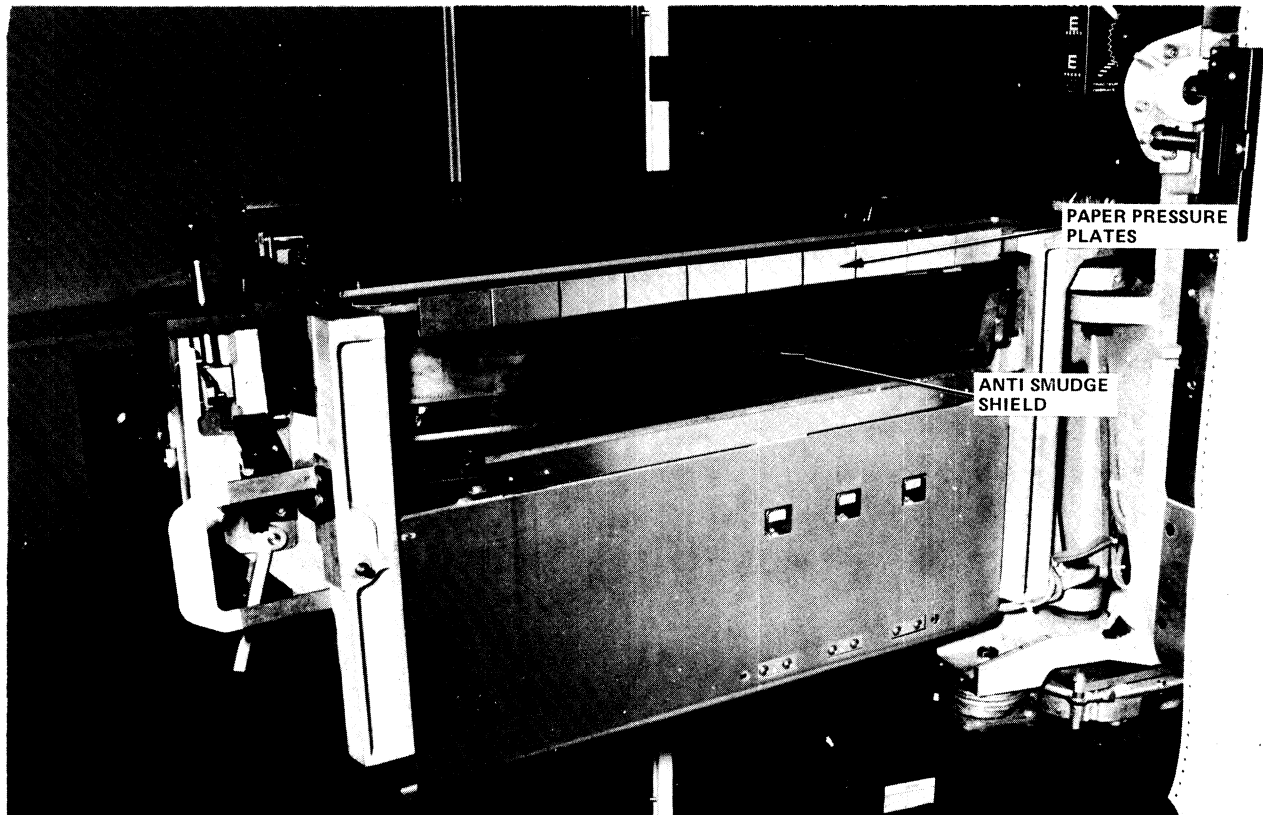

Figure 3-21. Changing Print Ribbon (6)

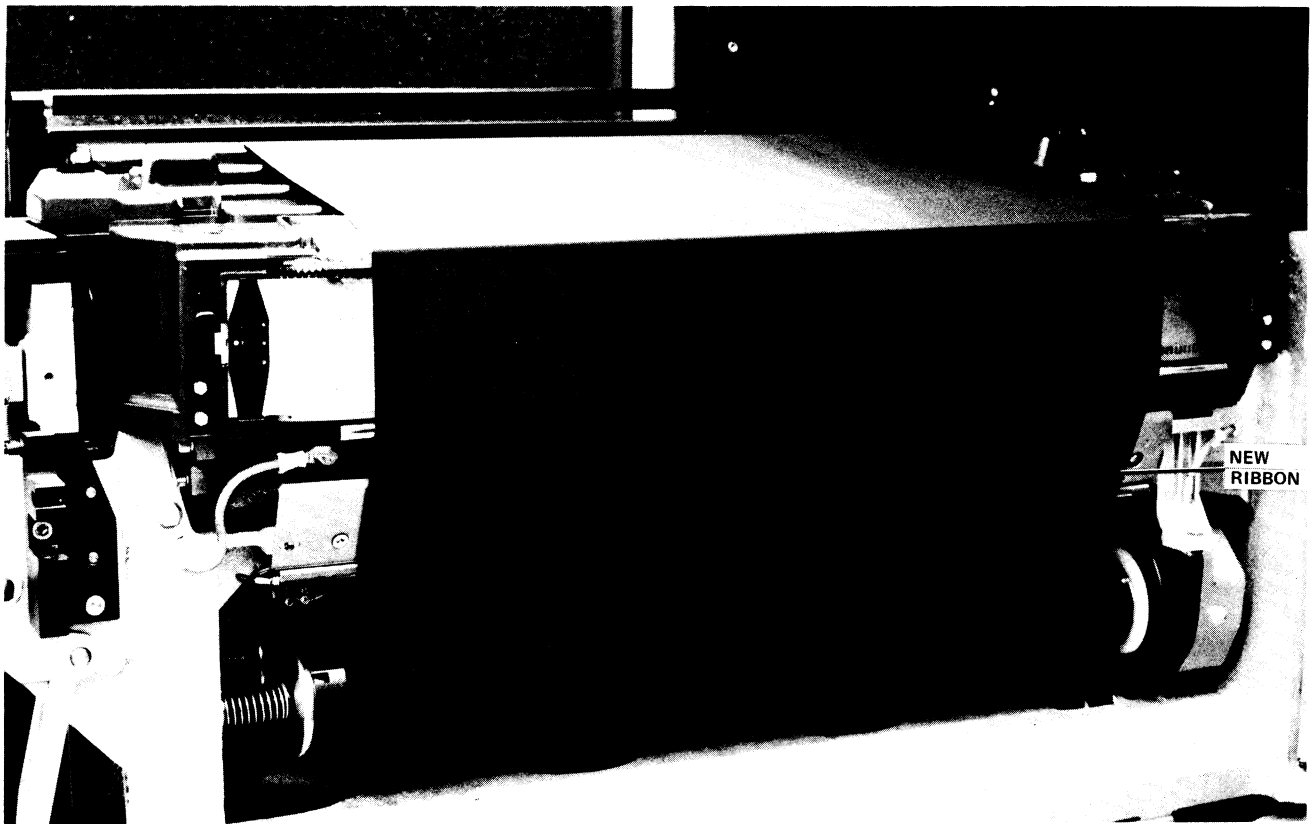

Figure 3-22. Changing Print Ribbon (7)

Changing/Adjusting Print Belt Cartridge

Serial Number 2179 and Below

Change/adjust the cartridge either after a console message or after the illumination of the CARTRIDGE indicator on the control panel. An interlock mechanism ensures that the steps in loading a cartridge are performed in the correct sequence.

NOTE: No force is required for any of the following steps. If any of the steps are difficult, check that the preceding step has been executed correctly.

To change the cartridge:

1. Remove print ribbon according to steps 1, 2, 4, 5, and 6 of "Changing Print Ribbon."
2. Insert belt adjusting key into slot (Figure 3-26).
3. Slowly turn key to center locking position.
4. Close cartridge cover to protect belt and also to gain access to cartridge handle (Figure 3-23).
5. Move tension lever counterclockwise to release belt (Figure 3-24).
6. Lift cartridge handle.

7. Pull cartridge out vertically by its handle (Figure 3-25).
8. Insert new cartridge.
9. Close cartridge handle.
10. Move tension lever downward in clockwise direction to lock cartridge in place.
11. Open cartridge cover. (Belt gate cannot be closed until cover has been opened.)
12. Rotate belt one turn with your fingers on rollers. (Belt moves left to right only.)
13. Replace print ribbon according to steps 3, 7, 8, and 9 of "Changing Print Ribbon."

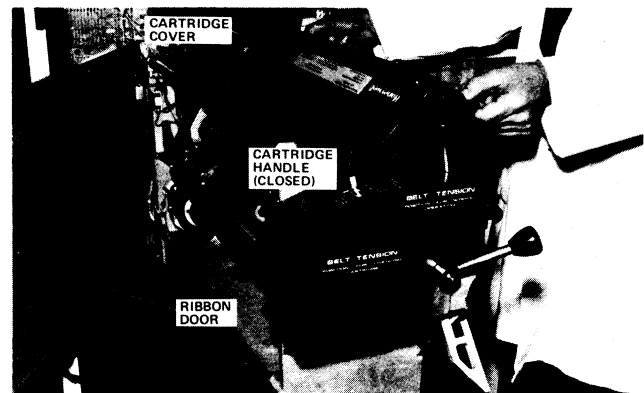

Figure 3-23. Changing the Print Belt Cartridge (1)



Figure 3-24. Changing the Print Belt Cartridge (2)

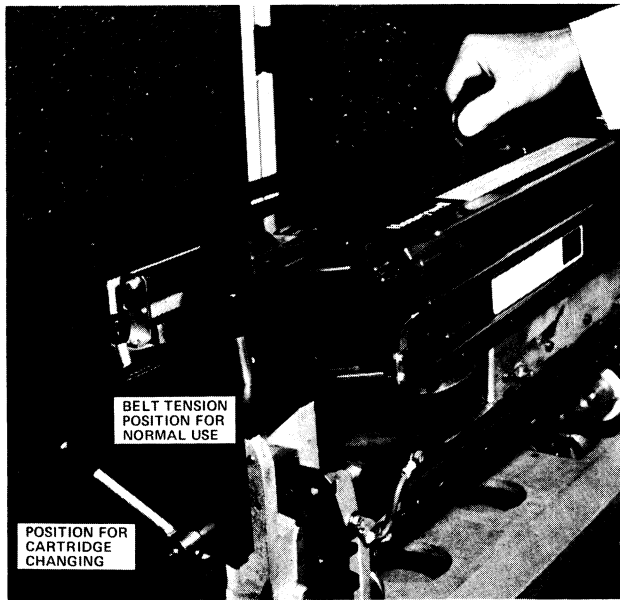

Figure 3-25. Changing the Print Belt Cartridge (3)

To adjust the cartridge:

1. Open front doors.
2. Open belt gate.
3. Insert belt adjusting key (Figure 3-26).
4. Slowly turn adjusting key until belt lever incident indicator extinguishes *and* key encounters locking position.
5. Remove adjusting key and place it in its holder.
6. Close belt gate.
7. Close front doors.

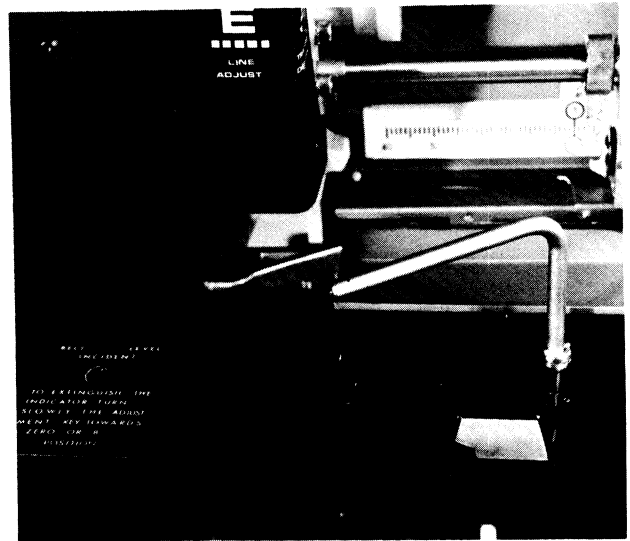

Figure 3-26. Belt Adjusting Key Inserted

Serial Number 2180 and Above

Change/adjust the cartridge either after a console message or after the illumination of the CARTRIDGE indicator on the control panel. An interlock mechanism is provided to ensure that the steps in loading a cartridge are performed in the correct sequence.

NOTE: No force is required for any of the following steps. If any of the steps are difficult, check that the preceding step has been executed correctly.

To change the cartridge:

1. Remove print ribbon according to steps 1, 2, 4, 5, and 6 of "Changing Print Ribbon."
2. Lower the cartridge cover (flap).
3. Insert the key provided in the hole located on top of the cartridge (Figure 3-27). Push and turn half a turn.
4. Remove the key.
5. Raise handle and remove cartridge.
6. Place new cartridge into position.
7. Push handle down as far as possible.
8. Repeat step 3.
9. Remove and replace key in its support.
10. Raise cartridge cover.

NOTE: Do not insert key without cartridge.



Figure 3-27. Cartridge Removal Key Inserted

To adjust the cartridge:

1. Open front doors.
2. Insert belt adjusting key (Figure 3-28).
3. Slowly turn adjusting key (Figure 3-28). incident indicator extinguishes and continue turning in same direction until key encounters locking position.
4. Remove adjusting key and place it in its holder.
5. Close front doors.

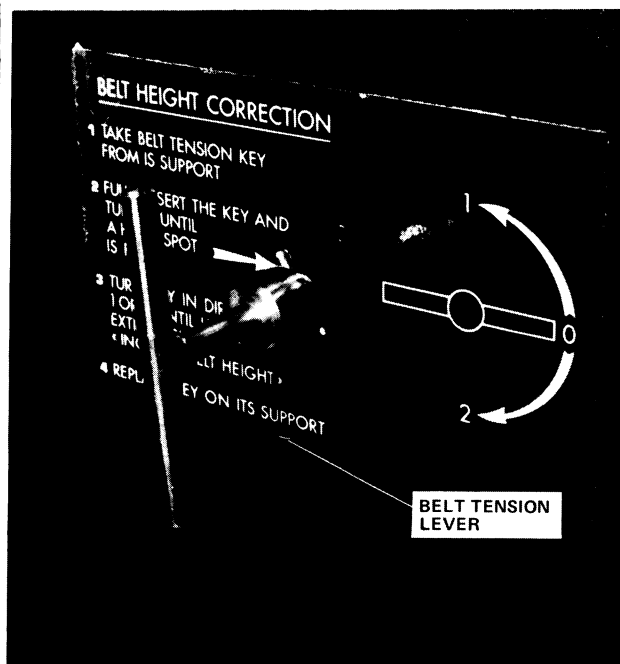

Figure 3-28. Belt Adjusting Key Inserted

Restart Procedures

The restart procedures are outlined in Table 3-1.

MAINTENANCE PROCEDURES

Operators must perform preventive maintenance to ensure efficient, trouble-free operation. Table 3-2 lists the various procedures and the frequency with which they should be performed.

TABLE 3-2. MAINTENANCE SCHEDULE

Procedure	Frequency
<ul style="list-style-type: none"> o General vacuum cleaning o Control panels indicator lamps checking o Printing quality checking o Ribbon checking 	Daily
<ul style="list-style-type: none"> o Filter cleaning 	Monthly
<ul style="list-style-type: none"> o Characters cleaning o Anvil assembly cleaning o Pulleys support assembly vacuum cleaning o Pulleys driving surfaces cleaning o Belt sensors assembly cleaning o Antismudge shield cleaning o Paper pressure plates cleaning o Belt deflector cleaning 	Every 10 million lines
<ul style="list-style-type: none"> o Belt protector replacement 	Every 40 million lines
<ul style="list-style-type: none"> o Filter replacement 	Yearly

General Vacuum Cleaning

To vacuum the printer:

1. Perform "Power-Down Sequence."
2. Open front doors, ribbon door, and belt gate.
3. Using vacuum cleaner, clean the following areas:
 - o Paper track
 - o Hammer line print block (Figure 3-29)
 - o Paper track gate
4. Close belt gate, ribbon door, and front doors.
5. Perform "Power-Up Sequence."

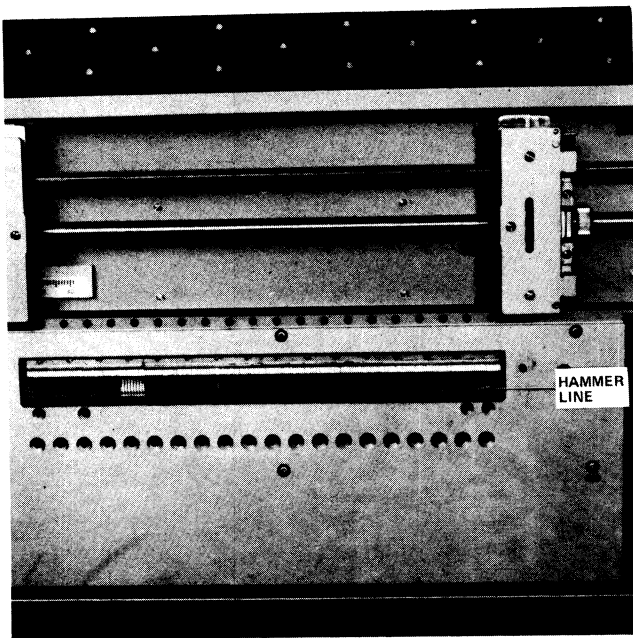

Figure 3-29. Print Hammers

Ribbon Checking

Check the ribbon visually for bad wear, folds, or holes. If necessary replace the ribbon by following the instructions under "Changing Print Ribbon" in this section.

Maintenance Supplies

Necessary maintenance supplies and their respective Honeywell part numbers are:

Part Number	Description
00373562	Honeywell General Cleaner
76960000-002	Ribbon Assembly
76960005-001	Cleaner Kit Cleaner kit comprises: Cleaner 76960005-002 and sprayer 76960005-003
00564971	Control panel lamps 28V
76951601-009	Air Intake Filter
76951601-011	Air Intake Filter

Print Quality Checking

Perform the following checks. Where changing/adjusting the ribbon and/or cleaning can correct the problem, do so; otherwise notify field engineer.

- o Check horizontal alignment:
 - Column pitch
 - Horizontal clipping
 - Misalignment in same column

- o Check vertical alignment:
 - Vertical clipping
 - Misalignment in same line
- o Character clearness (Character cleaning – needed or not):
 - Dirty characters
 - Worn characters
 - Print fading

Control Panel Indicator Lamp Checking

Check that all indicator lamps on the main control panel and auxiliary control panel illuminate when POWER ON is pressed. Replace any faulty lamps.

To replace lamps on the control panels:

1. Perform "Power Down Sequence."
2. To gain access to the lamps, open control panel by pulling top forward and down to a horizontal position.
3. Turn contact to free lamps (Figure 3-30).
4. Lift out lamps.
5. Place new lamps in place. (These are kept behind the front left-hand side door, under the maintenance panel).
6. Close contact.
7. Close control panel.
8. Perform "Power Up Sequence."

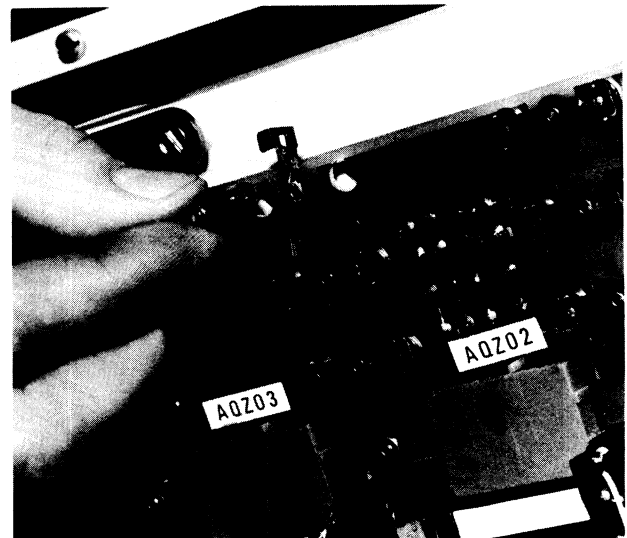

Figure 3-30. Lamp Replacement

Filter Cleaning

To clean filters:

1. Remove paper stacker. (It is attached by magnets.)
2. Open rear doors of printer.
3. Remove two filters which are located at bottom of cabinet (Figure 3-31).
4. Tap filters over a bin to remove any loose dirt.
5. Vacuum filters.
6. Replace filters, close rear doors, and reposition stacker.
7. Check that filters are correctly positioned by observing that alerts on main control panel and maintenance panel are not illuminated.

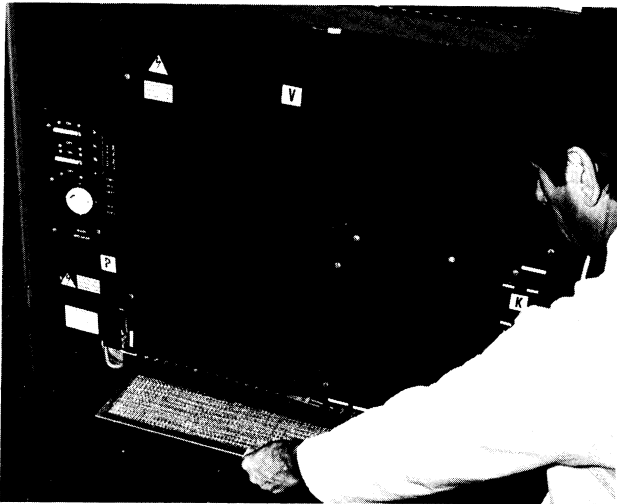

Figure 3-31. Filter Replacement

Character Belt Cleaning

The print belt characters should be cleaned every 10 million lines or when the belt is going to be stored for more than a week. To clean the characters:

1. Open front doors, ribbon door, and belt gate.
2. Separate belt gate from paper track gate.
3. Remove ribbon.
4. Position Honeywell special belt cleaner in tractors with velvet surface facing belt and top of cleaner in line with head-of-form reference marks.
5. Spray Honeywell special ink solvent evenly on cleaner, covering approximately two pages from print line.
6. Close belt gate and paper track gates.
7. Position paper thickness lever for maximum thickness (i.e., as far back as possible).

8. Load and run functional test for cleaning characters.
9. After cleaning, open belt gate and remove cleaner. Do not reuse cleaner.
10. Remove cartridge. (See "Changing Print Belt Cartridge" procedures.)
11. Wipe antismudge shield and belt protector clean using Honeywell general cleaner.
12. Perform the following five preventive maintenance tasks, viz., anvil, pulley support assembly, pulley, paper pressure plates, and sensors assembly cleaning procedures.

NOTE: If FAULT illuminates in conjunction with SSI on the maintenance panel during cleaning, remove the cartridge and clean the dirty finger sensor. Then replace the cartridge, and press START to continue cleaning.

Anvil Cleaning

1. Remove cartridge.
2. Clean ceramic track of anvil without removing finger protector (Figure 3-32) using Honeywell general cleaner.

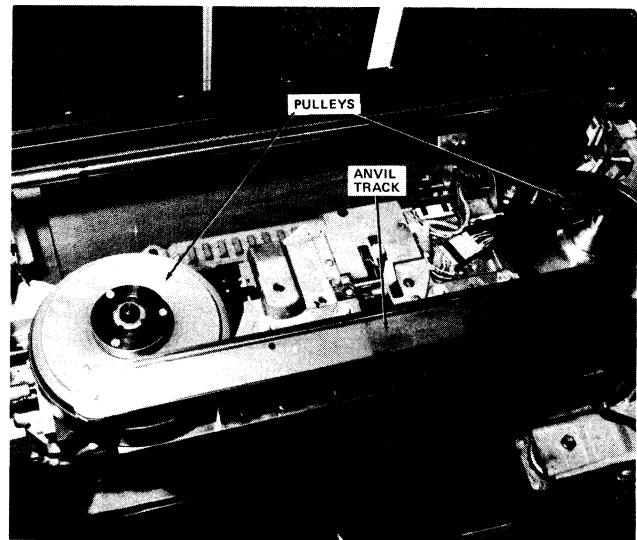

Figure 3-32. Pulleys Support Assembly, Pulleys, and Anvil

Pulley Support Assembly Cleaning

Vacuum cartridge mechanism, pulleys, and casting (Figure 3-32).

Pulley Cleaning

Clean driving surfaces of both pulleys (Figure 3-32) using Honeywell general cleaner.

Paper Pressure Plates Cleaning

Clean surfaces of paper pressure plates (Figure 3-21) using Honeywell general cleaner.

Sensors Assembly Cleaning

Clean surfaces of dirty finger and belt sensors (Figure 3-33) using Honeywell general cleaner.

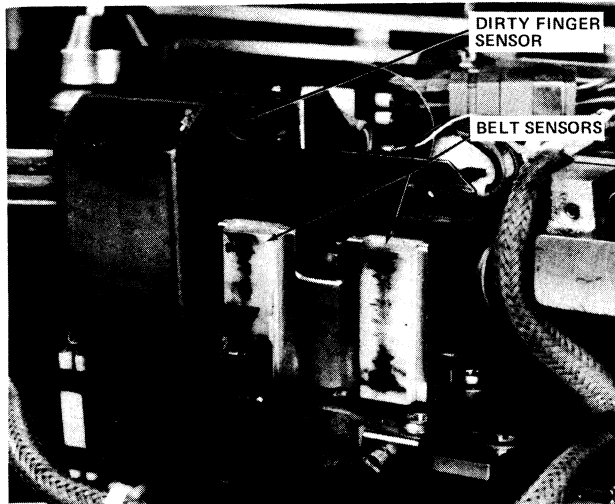

Figure 3-33. Dirty Finger and Belt Sensors

Belt Deflector Replacement

To replace the belt deflector:

1. Open front doors, ribbon door, and belt gate.
2. Separate belt gate from paper track gate.
3. Press on orange zone to remove worn deflector (Figure 3-34).

NOTE: Spares should be kept in the area behind main control panel.

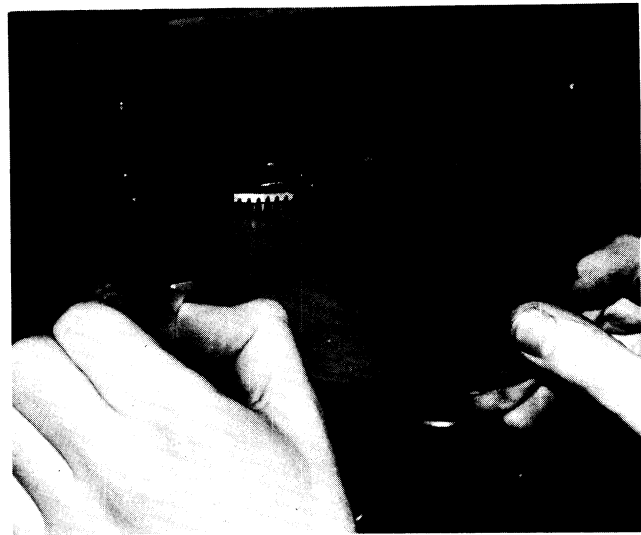

Figure 3-34. Belt Deflector Replacement

4. Slide new deflector into place (cut corner should be at top) between film presser and cartridge until it “clicks” home.
5. Pull gently on deflector to be sure that it is correctly positioned.
6. Close paper track gate, belt gate, ribbon doors, and front doors.

Filter Replacement

To replace the filters:

1. Remove paper stacker.
2. Open rear doors of printer.
3. Remove two filters (Figure 3-31).
4. Position two new filters.
5. Check that filters are correctly positioned by checking that the FF01 indicator on maintenance panel is not illuminated.

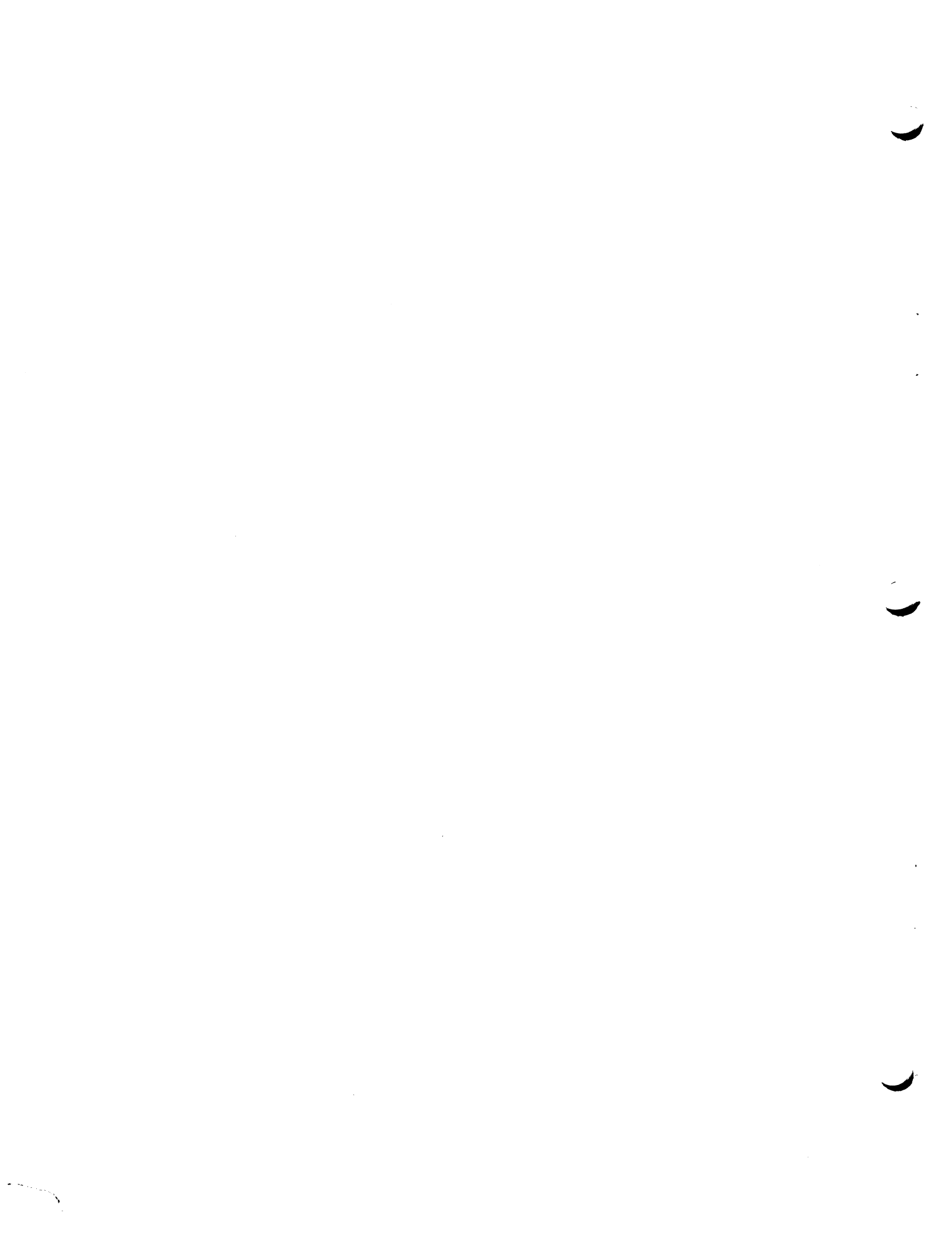

APPENDIX A

PAPER AND RIBBON SPECIFICATIONS

MEDIA FORMAT

Standard edge punched 1/2 in. (1.2 cm) hole centers continuous fanfold:

- Maximum width: 22 in. (55.9 cm); width over 18-1/4 in. (46.4 cm) should be checked to ensure desired print positions are within the lateral movement of the tractors. (See Figure A-1.)
- Maximum height: 24 in. (55.9 cm); heights greater than 18-1/4 in. (46.4 cm) require that

stacker be removed. Heights greater than 16 in. (40.6 cm) require that front door be left open.

- Minimum width: 4 in. (10.2 cm) (See Figure A-2.)
- Minimum height: 4 in. (10.2 cm)
- Maximum weight: Single sheet – 160g/m² (43 lb)
Multisheet – Up to 6-ply continuous forms may be printed with a maximum weight of 84.5 lb (320g/m²). See Table A-1.
- Minimum weight: 16 lb

RIBBON

Ribbon (M3571) is record black ink, heavy duty nylon; it is specified in the following sizes:

- Length: 21.87 yd (20 m)
- Width: 17.640 ± 0.079 in. (44.805 ± .200 cm)

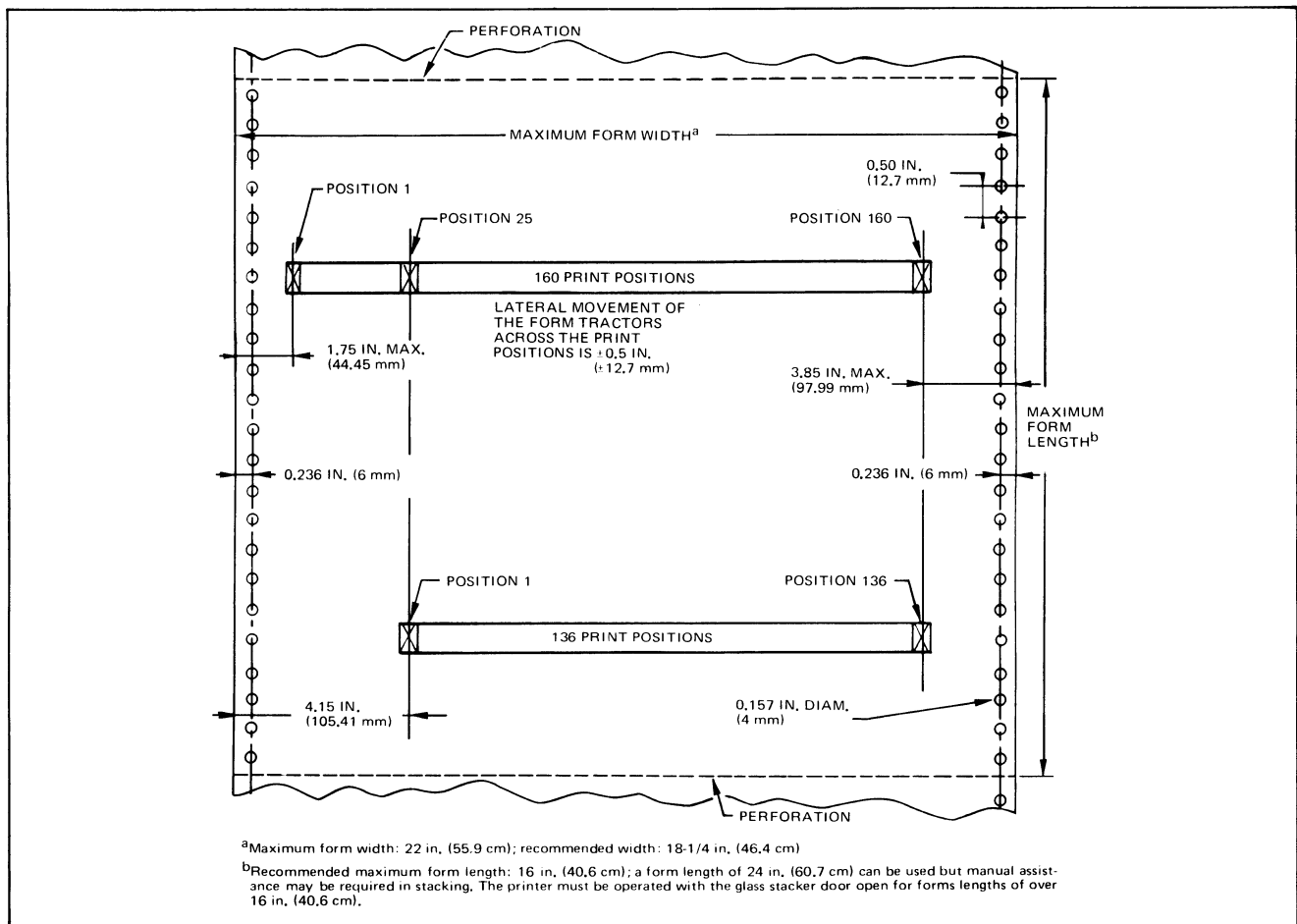

Figure A-1. Maximum Form Width

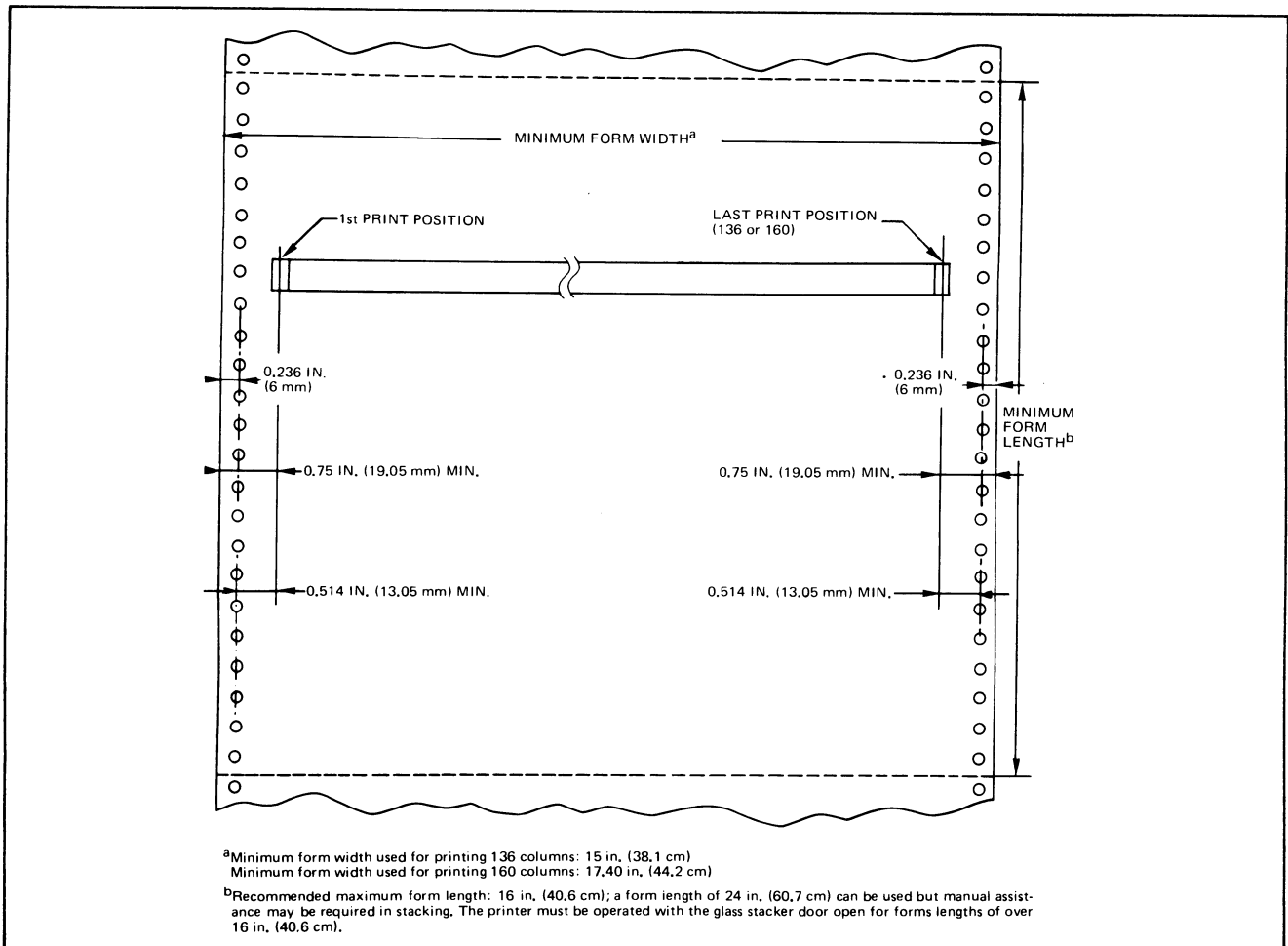

Figure A-2. Minimum Form Width

TABLE A-1. PAPER WEIGHTS

Paper	No. of Parts	Weight ^a (lb)	Weight ^a (g/m ²)	Remarks
Register bond	1	16	56	Min single sheet
Ledger stock	1	43	160	Max single sheet
Register bond	2	12 each	45 each	Min two-sheet; 49 lb (186g/m ²)
Carbon	1	9 max		
Register bond	5	First sheet: 12 Copies: 9	First sheet: 45 Copies: 34	Max 5-sheet; 70 lb (265g/m ²)
Carbon	4	5.5 max		
Register bond	6	First sheet: 12 Copies: 9	First sheet: 45 Copies: 34	Max 6-sheet; 84.5 lb (320g/m ²)
Carbon	5	5.5 max	21 max	
Punch card stock	1	99	160	Thickness: 0.007 ±0.0004 in. (0.18 ±0.01 mm)

^aThe weights specified are based on:

Paper: 500 sheets of 17 x 24 in. (43.2 x 61.0 cm)
 Punch card stock: 500 sheets of 24 x 36 in. (61 x 91.4 cm)

APPENDIX B

UNIT RECORD PROCESSORS

The URP0600, URP0601, and URP0602 Unit Record Processors are microprogrammed peripheral processors that connect to the central processor system via high-speed input/output channels and essentially relieve the central processor system of all device-oriented functions.

The Unit Record Processors connect printers, card readers, and punches to the Level 66 and 68 systems. To afford the user configuration flexibility and economy of choice, three versions are offered, all with the same capabilities:

- o URP0600 – freestanding control
- o URP0601 – integrated into the integrated control unit (ICU)
- o URP0602 – integrated into the input/output multiplexer (IOM)

CONFIGURABILITY

A maximum mixed configuration of seven units can be controlled by a Unit Record Proc-

essor. When both card equipment and printers are configured you can have up to:

- o 2 Card readers
- o 2 Card punches
- o 3 Printers

All seven will operate at their maximum rated speeds.

When only printers are configured, as many as eight printers can be connected. The maximum allowable for the different types of printers are:

- o 5 PRU1100 Drum Printers
- o 2 PRU1200 Belt Printers
- o 3 PRU1600 Belt Printers

A configuration of only printers may include no more than three belt printers. In any configuration no more than two PRU1200 printers can be connected to a Unit Record Processor. (See Figure B-1.)

A Unit Record Processor simultaneously controls up to eight units with only a single-channel interface to the central system. Even with the Unit Record Processor integrated into the input/output multiplexer (IOM), the maximum configurations can be multiplexed through a single channel to the IOM.

An additional IOM channel is available as an option with the Unit Record Processor.

OPTIONS

The options available for the Unit Record Processors are listed in Table B-1.

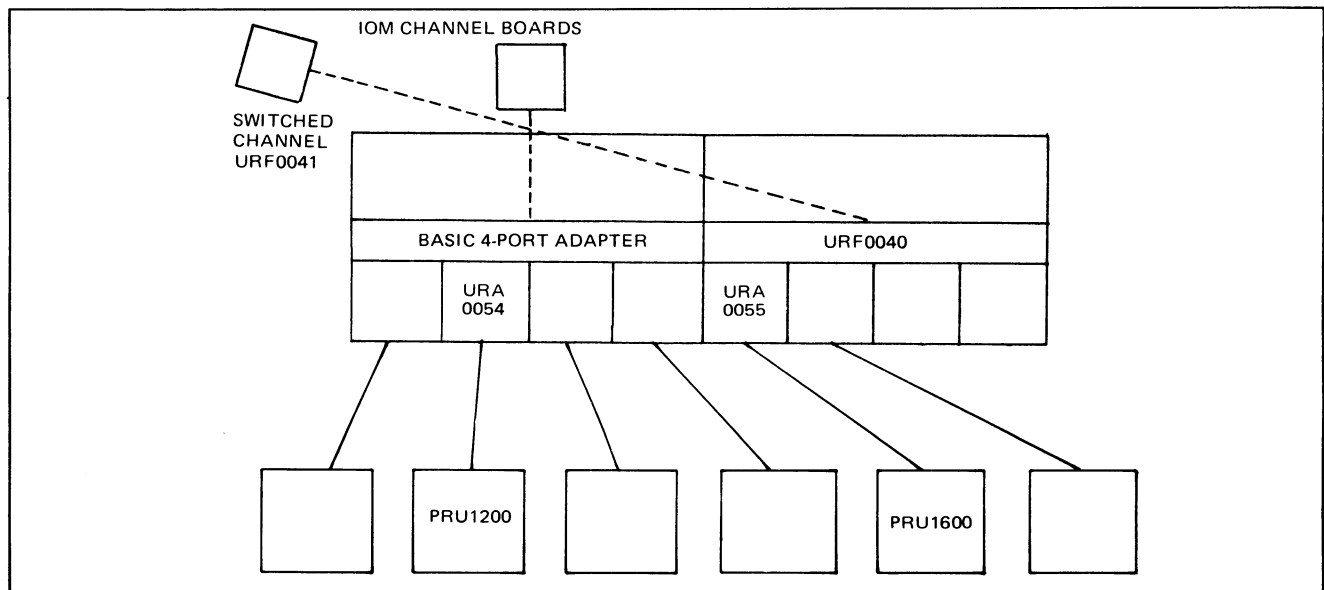

Figure B-1. URP Subsystem

COMPONENTS

A Unit Record Processor consists of the following components (also see Figure B-2):

- o *Read-Only Memory* – provides access and storage to resident control and diagnostic microprograms.
- o *Microprocessor* – interprets all the micro-instructions and performs their specified operations.
- o *Scratch-pad Memory* – provides temporary storage for data buffering parameters and command storage.
- o *Peripheral Subsystem Interface Control* – provides the logic and buffering necessary to interface with the one-byte-wide PSI to sustain data transfer and control dialogs.
- o *Device Adapter Interface Control* – provides the logic and buffering necessary to interface with DAIs to sustain data transfers and control dialogs in addition to verification information generation and checking.

required for normal operation of the URP (Figures B-3 and B-4). A description of each push button and indicator is given in Table B-2.

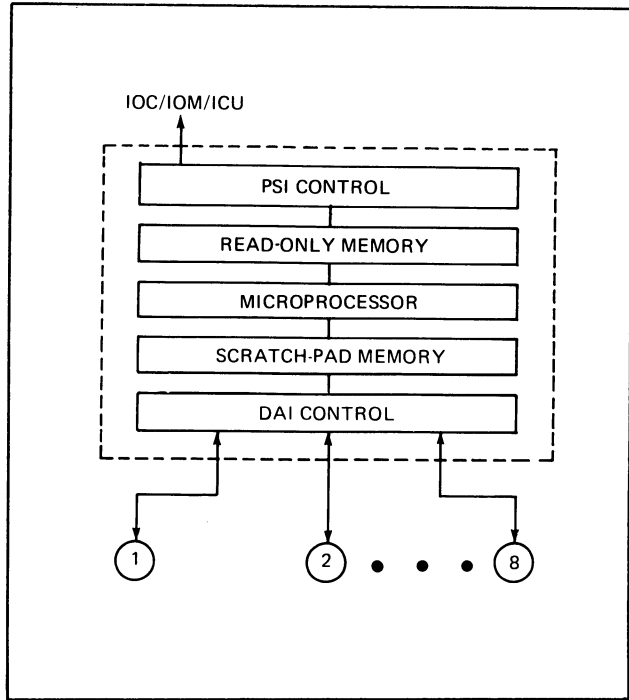

Figure B-2. Unit Record Processor Components

CONTROLS AND INDICATORS

The operator control panel located on top of the URP contains the controls and indicators

TABLE B-1. UNIT RECORD PROCESSOR OPTIONS

Unit Record Processor	Option Number	Description
URP0600/0601/0602	URF0040	Additional 4-port adapter. Required when more than four devices, or printer types are mixed.
	URF0041	Switched channel (includes IOM channel). Enables processor to be logically switched between I/O channels from central processor system.
	URA0054	Addressing capability for each PRU1200.
	URA0055	Addressing capability for each PRU1600.

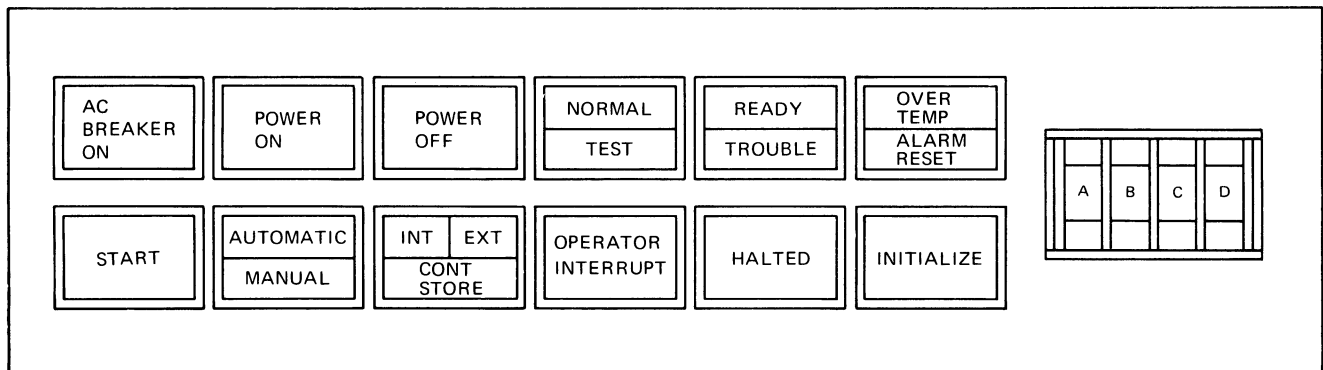

Figure B-3. URP0600 Control Panel

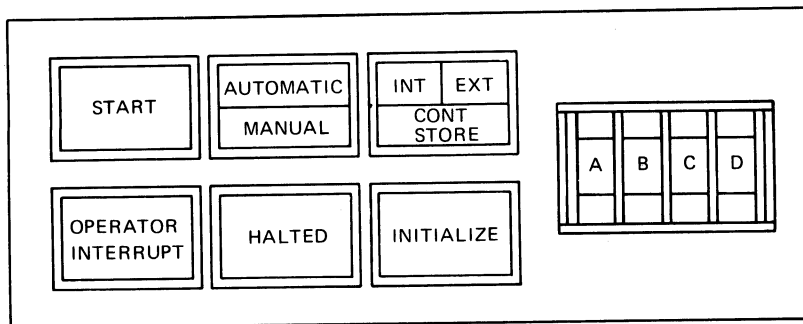

Figure B-4. URP0601/0602 Control Panel

TABLE B-2. URP CONTROLS AND INDICATORS

Push Button/Indicator	Function
URP0600/0601/0602	
START	Pressing this button when the control/processor is in the halted state changes it from the TROUBLE state to the ready state (see READY/TROUBLE indicator) and the indicator lights white.
AUTOMATIC/MANUAL	This split-field indicator identifies the operational mode (green = AUTOMATIC, blue = MANUAL) of the control/processor. The button allows the operator to control the execution of the initialize and halt options of the microprogram. These options are logically enabled in the MANUAL mode. Pressing this button changes the state of the switch.
INT/EXT/ CONT STORE	This three-way split-field indicator lights red in the individual field when an error is detected. Pressing this button or executing the microprogram's error option should reset the error and turn off the indicator light. If the error persists, notify the Honeywell field engineer.
OPERATOR INTERRUPT	Pressing this button lights the indicator white and causes the execution of a special interrupt that transfers the information stored in the ADDRESS/SIMULATE switches to the central system. The OPERATOR INTERRUPT state is reset by the microprogram and the indicator goes out.
HALTED	This indicator lights blue when the control/processor goes into the halted state.
INITIALIZE	Pressing this button lights the HALTED indicator and resets the control/processor to the initialized state. The indicator lights white.
ADDRESS/SIMULATE	These four thumbwheel switches, used in conjunction with the maintenance panel switches, permit the user to address various functions of the control/processor, depending upon the specific application required. These switches are used mainly by the field engineer in conjunction with the maintenance panel to diagnose the control/processor. Do not change the state of these switches when a program is running.
AC BREAKER ON	This indicator lights red when the cabinet primary branch service power circuit breaker is on and power is being applied to it from its power source panel.
NOTE: The cabinet circuit breaker is located behind the right front door at the bottom right side of the cabinet on the CKP panel. This circuit breaker applies primary service power to the cabinet and protects it from overloads.	
POWER ON	Pressing this button when ac power is on (AC BREAKER ON indicator lit) turns the cabinet dc power on. The POWER ON indicator lights yellow and the POWER OFF indicator goes out.
POWER OFF	Pressing this button when dc power is on turns the dc power off. The POWER OFF indicator lights green and the POWER ON indicator goes out.

TABLE B-2 (CONT). URP CONTROLS AND INDICATORS

Push Button/Indicator	Function
URP0600/0601/0602	
NORMAL/TEST	This split-field indicator identifies the state (green = NORMAL, yellow = TEST) of the MAINT PANEL MODE NORMAL/TEST switch located on the TEST area of the maintenance panel. The switch must be in the NORMAL state for online operation. NOTE: The maintenance panel is concealed behind the cover surrounding the operator panel. If the switch is in the TEST position, the operator may open the cover and reset the switch to NORMAL.
READY/TROUBLE	This split-field indicator identifies the operational state (green = READY, red = TROUBLE) of the control/processor. NOTE: The trouble state exists when the HALTED indicator is on or when the OPERATIONAL MODE OFFLINE/ONLINE switch located on the TEST area of the maintenance panel is set to OFFLINE. If the HALTED indicator is on, the operator may attempt to set the control/processor to the ready state by using the START switch. If it does not leave the halted state, open the maintenance panel cover and check and reset the OFFLINE/ONLINE switch to ONLINE if needed. If the trouble persists, notify the Honeywell field engineer.
OVER TEMP/ ALARM RESET	This split-field push button/indicator lights red in the OVER TEMP field and white in the ALARM RESET field. The cabinet audible alarm sounds if the cabinet gets too warm. Pressing the switch turns off both the audible alarm and the white ALARM RESET indicator. Press the POWER OFF switch and wait for the cabinet to cool before switching power back on. If the overtemperature condition continues, notify the Honeywell field engineer.

POWER

Power is controlled by a circuit breaker panel located behind the right front door at the bottom right of the cabinet marked "CKP" (Figure B-5).

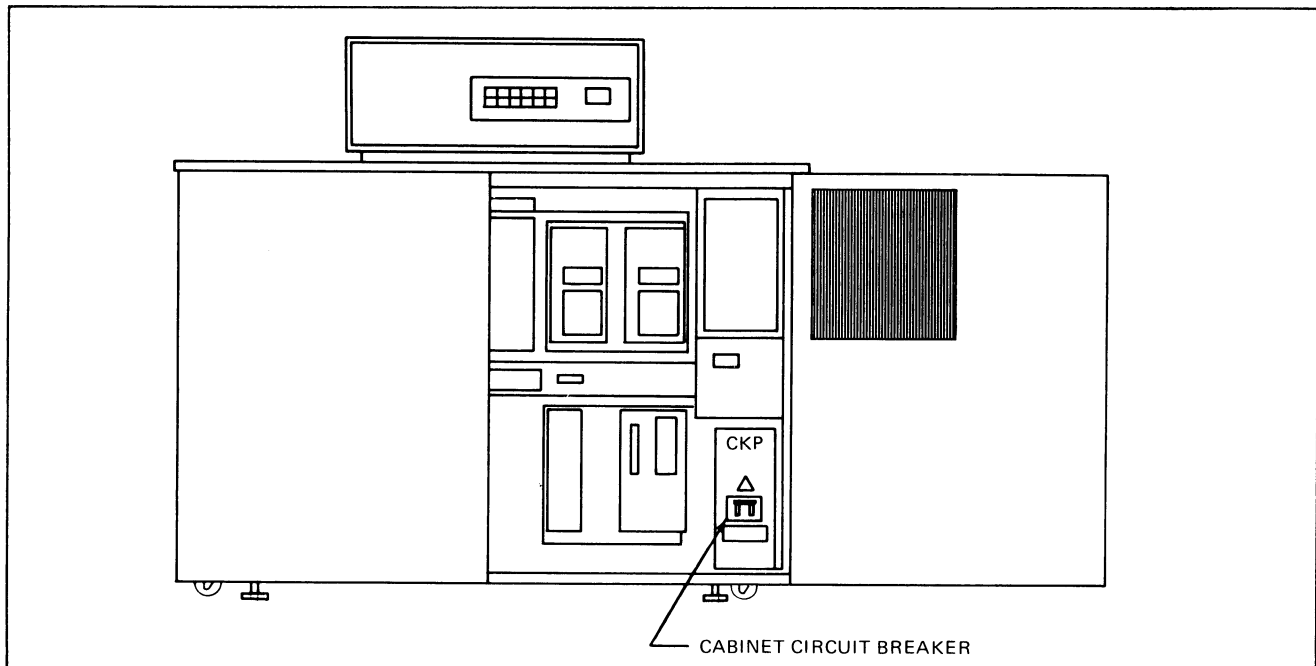

Figure B-5. URP0600/0601 Cabinet Circuit Breaker Location

1

2

3

4

5

6

7



HONEYWELL INFORMATION SYSTEMS
Technical Publications Remarks Form

CUT ALONG LINE

TITLE

SERIES 60
PRU1200/1600
PRINTER OPERATION

ORDER NO.

AP88-02

DATED

OCTOBER 1981

ERRORS IN PUBLICATION

[Empty box for reporting errors in publication]

SUGGESTIONS FOR IMPROVEMENT TO PUBLICATION

[Empty box for providing suggestions for improvement to publication]



Your comments will be investigated by appropriate technical personnel and action will be taken as required. Receipt of all forms will be acknowledged; however, if you require a detailed reply, check here.

FROM: NAME _____

DATE _____

TITLE _____

COMPANY _____

ADDRESS _____

PLEASE FOLD AND TAPE—
NOTE: U. S. Postal Service will not deliver stapled forms



NO POSTAGE
NECESSARY
IF MAILED
IN THE
UNITED STATES

BUSINESS REPLY MAIL
FIRST CLASS PERMIT NO. 39531 WALTHAM, MA 02154

POSTAGE WILL BE PAID BY ADDRESSEE

HONEYWELL INFORMATION SYSTEMS
200 SMITH STREET
WALTHAM, MA 02154

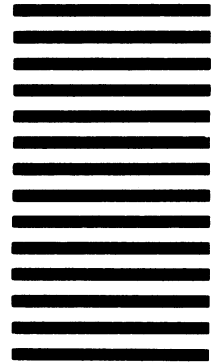

ATTN: PUBLICATIONS, MS486

Honeywell

FOLD ALONG LINE
FOLD ALONG LINE
FOLD ALONG LINE

HONEYWELL INFORMATION SYSTEMS
Technical Publications Remarks Form

TITLE

SERIES 60
PRU1200/1600 PRINTER OPERATION
ADDENDUM A

ORDER NO. AP88A, REV. 2

DATED DECEMBER 1980

ERRORS IN PUBLICATION

[Empty box for reporting errors in publication]

SUGGESTIONS FOR IMPROVEMENT TO PUBLICATION

[Empty box for providing suggestions for improvement to publication]



Your comments will be investigated by appropriate technical personnel and action will be taken as required. Receipt of all forms will be acknowledged; however, if you require a detailed reply, check here.

FROM: NAME _____

DATE _____

TITLE _____

COMPANY _____

ADDRESS _____

CUT ALONG LINE

PLEASE FOLD AND TAPE—
NOTE: U. S. Postal Service will not deliver stapled forms



NO POSTAGE
NECESSARY
IF MAILED
IN THE
UNITED STATES

BUSINESS REPLY MAIL
FIRST CLASS PERMIT NO. 39531 WALTHAM, MA02154

POSTAGE WILL BE PAID BY ADDRESSEE

HONEYWELL INFORMATION SYSTEMS
200 SMITH STREET
WALTHAM, MA 02154

ATTN: PUBLICATIONS, MS486



CUT ALONG LINE

FOLD ALONG LINE

FOLD ALONG LINE

Honeywell

HONEYWELL INFORMATION SYSTEMS
Technical Publications Remarks Form

TITLE

SERIES 60
PRU1200/1600 PRINTER OPERATION
ADDENDUM B

ORDER NO.

AP88B, REV. 2

DATED

APRIL 1981

ERRORS IN PUBLICATION

Large empty rectangular box for reporting errors in the publication.

SUGGESTIONS FOR IMPROVEMENT TO PUBLICATION

Large empty rectangular box for providing suggestions for improvement to the publication.



Your comments will be investigated by appropriate technical personnel and action will be taken as required. Receipt of all forms will be acknowledged; however, if you require a detailed reply, check here.

FROM: NAME _____

DATE _____

TITLE _____

COMPANY _____

ADDRESS _____

PLEASE FOLD AND TAPE—
NOTE: U. S. Postal Service will not deliver stapled forms



NO POSTAGE
NECESSARY
IF MAILED
IN THE
UNITED STATES

BUSINESS REPLY MAIL
FIRST CLASS PERMIT NO. 39531 WALTHAM, MA02154

POSTAGE WILL BE PAID BY ADDRESSEE

HONEYWELL INFORMATION SYSTEMS
200 SMITH STREET
WALTHAM, MA 02154

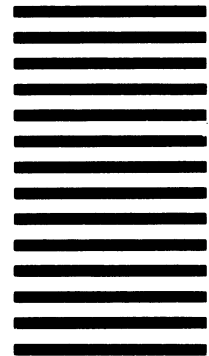

ATTN: PUBLICATIONS, MS486

Honeywell

FOLD ALONG LINE
FOLD ALONG LINE

Honeywell

Honeywell Information Systems

In the U.S.A.: 200 Smith Street, MS 486, Waltham, Massachusetts 02154
In Canada: 155 Gordon Baker Road, Willowdale, Ontario M2H 3N7
In the U.K.: Great West Road, Brentford, Middlesex TW8 9DH
In Australia: 124 Walker Street, North Sydney, N.S.W. 2060
In Mexico: Avenida Nuevo Leon 250, Mexico 11, D.F.

32994, 2C1081, Printed in U.S.A.

AP88-02