

# HP 92068A RTE-IVB System

Manager's Manual

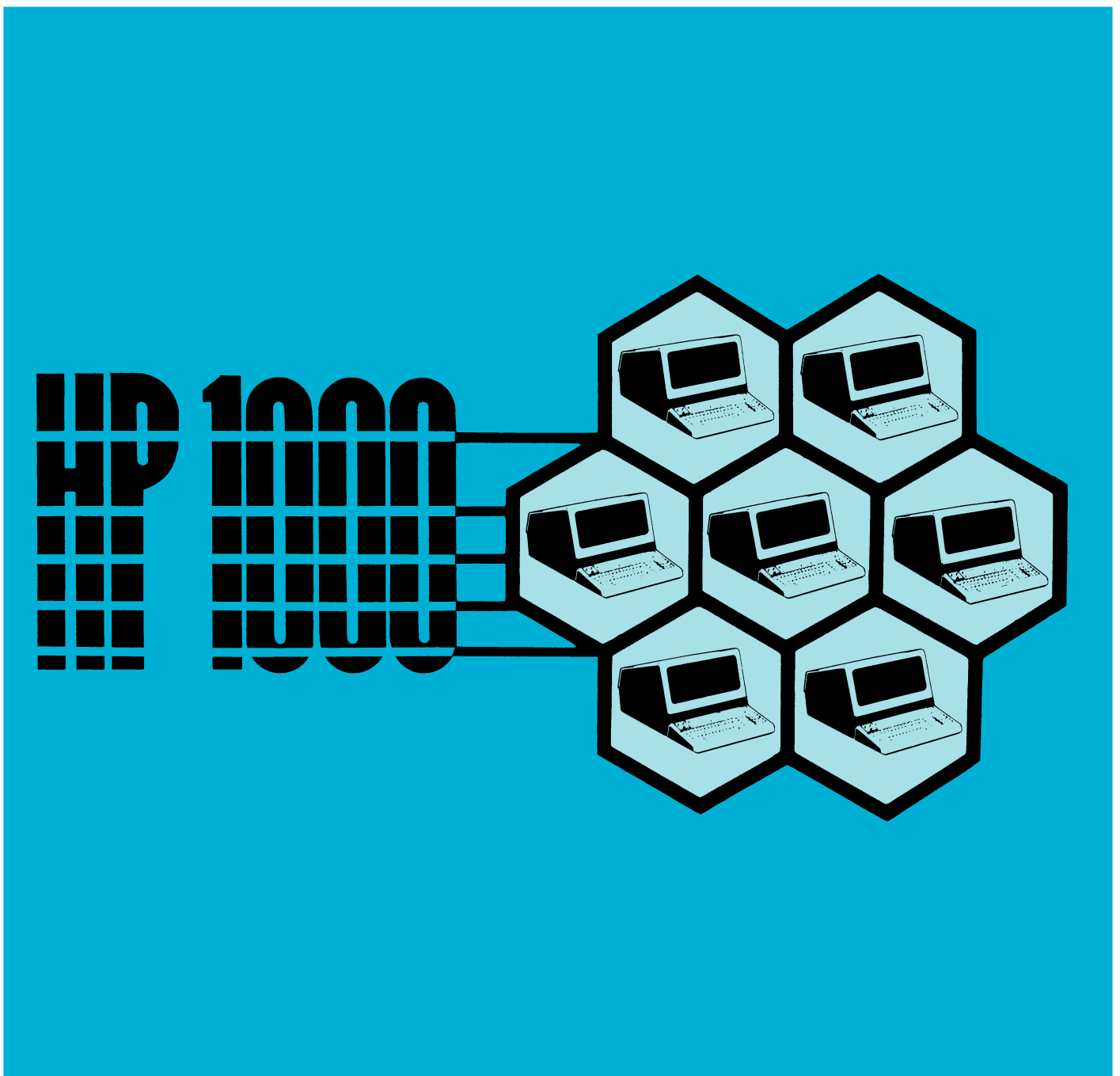



# **RTE-IVB System**

## **Manager's Manual**



# PRINTING HISTORY

The Printing History below identifies the Edition of this Manual and any Updates that are included. Periodically, Update packages are distributed which contain replacement pages to be merged into the manual, including an updated copy of this Printing History page. Also, the update may contain write-in instructions.

Each reprinting of this manual will incorporate all past Updates, however, no new information will be added. Thus, the reprinted copy will be identical in content to prior printings of the same edition with its user-inserted update information. New editions of this manual will contain new information, as well as all Updates.

To determine what manual edition and update is compatible with your current software revision code, refer to the appropriate Software Numbering Catalog, Software Product Catalog, or Diagnostic Configurator Manual.

|                      |          |  |
|----------------------|----------|--|
| Second Edition ..... | Jan 1980 |  |
| Update 1 .....       | Apr 1980 |  |
| Update 2 .....       | Jul 1980 |  |
| Update 3 .....       | Oct 1980 |  |
| Update 4 .....       | Jan 1981 |  |
| Reprint .....        | Jan 1981 | Includes Updates 1 through 4.<br>Manual Enhancement. |
| Update 5 .....       | Jul 1981 |  |
| Update 6 .....       | Oct 1981 |  |
| Reprint .....        | Oct 1981 | Incorporate Updates 5 and 6.                         |
| Update 7 .....       | Jul 1982 |  |
| Update 8 .....       | Jan 1983 | Introduction of Primary System disc.                 |

## NOTICE

The information contained in this document is subject to change without notice.

HEWLETT-PACKARD MAKES NO WARRANTY OF ANY KIND WITH REGARD TO THIS MATERIAL, INCLUDING, BUT NOT LIMITED TO, THE IMPLIED WARRANTIES OF MERCHANTABILITY AND FITNESS FOR A PARTICULAR PURPOSE. Hewlett-Packard shall not be liable for errors contained herein or for incidental or consequential damages in connection with the furnishing, performance or use of this material.

Hewlett-Packard assumes no responsibility for the use or reliability of its software on equipment that is not furnished by Hewlett-Packard.

This document contains proprietary information which is protected by copyright. All rights are reserved. No part of this document may be photocopied, reproduced or translated to another program language without the prior written consent of Hewlett-Packard Company.

# Preface

The System Manager's Manual provides the system manager with the information required to plan, generate, initialize, and maintain the 92068A RTE-IVB Software System. The system manager is assumed to have a working knowledge of RTE and should be familiar with the family of RTE-IVB manuals, see the documentation map shown on the following page.

Chapter 1 is a description of the system manager's responsibilities. A procedural summary is provided. Also included in the summary is the appropriate manuals required for certain system functions.

Chapter 2 shows how to plan the Session Account System. It talks about evaluating user base, setting up group/user account structure, and allocating disc resources.

Chapter 3 describes what you need for system generation and the purpose of the major steps to be followed as described in the RTE-IVB On-Line Generator Manual. This chapter lists the software components and system resources required for the operating system, the File Management System, Terminal Interface, Session Account System, and Batch and Spooling System.

Chapter 4 provides information for making your newly generated system the operating system.

Chapter 5 contains the procedures required after system generation to activate the RTE-IVB System. Included in this chapter are the boot-up, the appropriate file installation, system utilities loading, and file management and spooling system initialization procedures.

Chapter 6 provides detailed information on initializing your Session Account System.

Chapter 7 provides additional information to guide you on the operation and utilization of the Accounts Program. This chapter will help you to alter the account structure, back it up, and add more accounts into the system.

Chapter 8 gives you the detailed information for adjusting system parameters and tables once the system is operational.

Chapter 9 discusses the operation of the Reconfigurator Program used for I/O and memory reconfiguration.

Appendix A provides detailed information on the Grandfather Disc.

Appendix B discusses real-time disc usages.

Appendix C describes the system communication area and provides detailed information on RTE system tables.

Appendix D contains the RTE record formats.

Appendix E shows the differences among the various RTE systems.

Appendix F contains a table of RTE-IVB program types.

Appendix G lists and describes the RTE table area I and II entry points.

Appendix H is a listing of the HELP file.

Appendix I is a summary of system and subsystem entry points. A listing correlating entry points to relocatable modules is provided.

Appendix J is a description of the Session Monitor Table formats.

Appendix K describes the Data Control Block and Directory formats.

Appendix L contains the blank worksheets used through out this manual. These worksheets may be copied for use in your session and system planning.

A Glossary and an Index have also been provided for your convenience.

# RTE-IVB DOCUMENTATION MAP

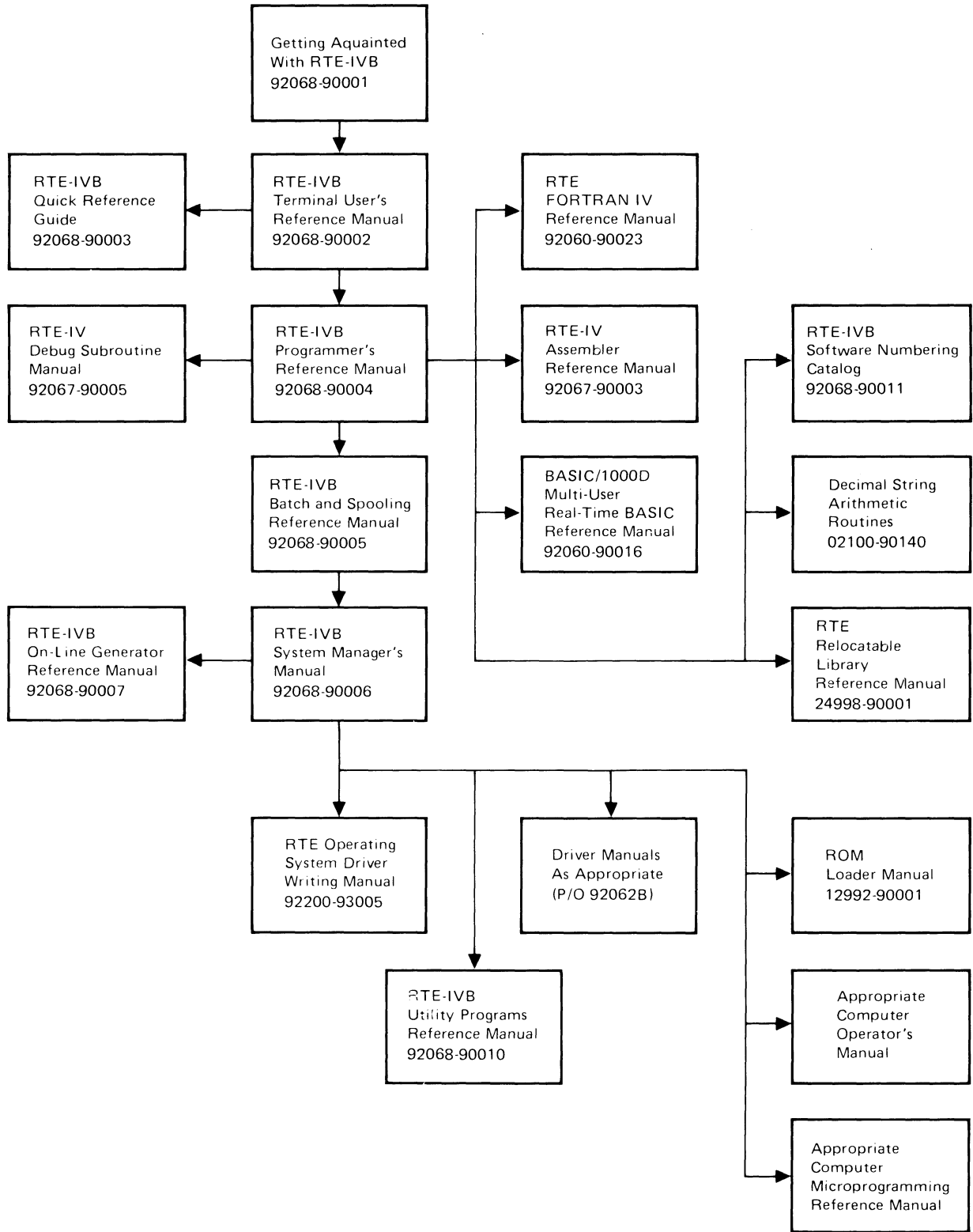





# Table of Contents

## Chapter 1 System Management Overview

|   |      |
|---|------|
| GENERAL.....                            | 1-1  |
| EVALUATE USER BASE.....                 | 1-1  |
| SELECTING THE MULTI-USER INTERFACE..... | 1-2  |
| Session Monitor.....                    | 1-5  |
| Multi-Terminal Monitor.....             | 1-6  |
| SYSTEM PLANNING.....                    | 1-6  |
| SYSTEM GENERATION.....                  | 1-7  |
| SYSTEM INSTALLATION.....                | 1-7  |
| SYSTEM INITIALIZATION.....              | 1-7  |
| MAINTAINING THE SYSTEM.....             | 1-8  |
| DETERMINING USER REQUIREMENTS.....      | 1-8  |
| User Category.....                      | 1-10 |
| System Applications.....                | 1-10 |
| Peripheral Resource Usage.....          | 1-11 |

## Chapter 2 Session Account Planning

|  |      |
|--|------|
| GENERAL INFORMATION.....                     | 2-1  |
| THE SESSION ENVIRONMENT.....                 | 2-1  |
| Session Concept.....                         | 2-1  |
| Session Control Blocks.....                  | 2-2  |
| Session Switch Table.....                    | 2-3  |
| Account Structure.....                       | 2-3  |
| SESSION MONITOR COMPONENTS.....              | 2-5  |
| Account System.....                          | 2-5  |
| Session Account File.....                    | 2-5  |
| Break Mode Processors.....                   | 2-6  |
| Session Log-on/Log-off Processors.....       | 2-6  |
| Operating System.....                        | 2-6  |
| File Management System.....                  | 2-6  |
| PLANNING YOUR ACCOUNT STRUCTURE.....         | 2-6  |
| User Accounts.....                           | 2-6  |
| Group Accounts.....                          | 2-7  |
| DISC CARTRIDGE MANAGEMENT.....               | 2-8  |
| Cartridge Types.....                         | 2-8  |
| Spare Cartridge Pool.....                    | 2-9  |
| Cartridge Mounting Considerations.....       | 2-9  |
| File Access Considerations.....              | 2-11 |
| Cartridge Dismounting Considerations.....    | 2-12 |
| DISC PLANNING.....                           | 2-12 |
| Cartridge Requirements worksheet.....        | 2-12 |
| Cartridge Size Requirements.....             | 2-14 |
| System Global Cartridge Requirements.....    | 2-16 |
| Non-Session Cartridge Requirements.....      | 2-17 |
| Group and User Cartridge Requirements.....   | 2-17 |
| Spare Cartridge Pool.....                    | 2-18 |
| Meeting Changing Cartridge Requirements..... | 2-19 |

# Table of Contents

## Chapter 3 System Generation Response Preparation

|  |       |
|--|-------|
| GENERAL.....                                       | 3-1   |
| NOTE TO THE USER.....                              | 3-1   |
| DISC PLANNING.....                                 | 3-3   |
| System/Auxiliary Subchannels.....                  | 3-3   |
| Peripheral Subchannels.....                        | 3-5   |
| Multiple Disc Controllers.....                     | 3-5   |
| Multiple CPU Disc Systems.....                     | 3-5   |
| DISC CONFIGURATION.....                            | 3-6   |
| HP 7900 Disc Configuration.....                    | 3-7   |
| HP 7905 Disc Configuration.....                    | 3-7   |
| HP 7906(H) Disc Configuration.....                 | 3-14  |
| HP 7920(H) Disc Configuration.....                 | 3-19  |
| HP 7925(H) Disc Configuration.....                 | 3-25  |
| HP 9895 Disc Configuration.....                    | 3-31  |
| I/O STRUCTURE PLANNING.....                        | 3-34  |
| Devices and Interface Cards.....                   | 3-34  |
| Select Code Assignments.....                       | 3-35  |
| Logical Unit Assignments.....                      | 3-37  |
| Equipment Table Entry Assignments.....             | 3-38  |
| SAMPLE WORKSHEET CONVENTIONS.....                  | 3-42  |
| DEVICE CONFIGURATION INPUTS.....                   | 3-43  |
| Automatic Output Buffering.....                    | 3-45  |
| Terminal Driver DVR00.....                         | 3-54  |
| Paper Tape Reader Driver DVR01.....                | 3-55  |
| Paper Tape Punch Driver DVR02.....                 | 3-56  |
| Terminal Driver DVR05/DVA05.....                   | 3-58  |
| Card Reader Driver DVR11.....                      | 3-60  |
| Line Printer Driver DVR12.....                     | 3-62  |
| Line Printer Driver DVA12.....                     | 3-63  |
| Line Printer Driver DVBl2.....                     | 3-64  |
| TV Interface Driver DVA13.....                     | 3-66  |
| Card Reader Driver DVR15.....                      | 3-68  |
| Magnetic Tape Driver DVR23.....                    | 3-69  |
| Disc Driver DVR31.....                             | 3-71  |
| Disc Driver DVR32.....                             | 3-73  |
| Disc Driver DVA32.....                             | 3-75  |
| Disc Driver DVR33.....                             | 3-76  |
| HB-IB Interface Driver DVR37.....                  | 3-78  |
| SOFTWARE COMPONENTS AND RESOURCE REQUIREMENTS..... | 3-81  |
| Operating System.....                              | 3-81  |
| Firmware Configuration.....                        | 3-82  |
| Power Fail/Auto Restart.....                       | 3-93  |
| File Management System.....                        | 3-94  |
| Spooling System.....                               | 3-97  |
| System Libraries.....                              | 3-103 |
| System Utilities.....                              | 3-105 |
| Generation VS. Online Loading.....                 | 3-112 |
| SESSION MONITOR.....                               | 3-114 |
| MULTI-TERMINAL MONITOR.....                        | 3-116 |
| NON-SESSION AND NON-MTM SYSTEMS.....               | 3-117 |

**Chapter 4 Transferring the New RTE-IVB Operating System**

|  |      |
|--|------|
| SWTCH PROGRAM.....                         | 4-1  |
| GLOSSARY.....                              | 4-1  |
| TYPES OF TRANSFERS.....                    | 4-2  |
| SWTCH OPTIONS.....                         | 4-4  |
| SWTCH LOADING INSTRUCTIONS.....            | 4-5  |
| SWTCH OPERATING INSTRUCTIONS.....          | 4-6  |
| FILENAME SPECIFICATION.....                | 4-9  |
| DESTINATION I/O CONFIGURATION.....         | 4-10 |
| SYSTEM SUBCHANNEL DEFINITION.....          | 4-10 |
| DISC LU/SELECT CODE SPECIFICATION.....     | 4-11 |
| ADDRESS/UNIT/PLATTER SPECIFICATION.....    | 4-12 |
| DISC CARTRIDGE EXCHANGE.....               | 4-12 |
| FILE SAVE SPECIFICATION.....               | 4-13 |
| OVERLAID FMP FILES.....                    | 4-14 |
| TYPE-6 SPECIFICATION.....                  | 4-14 |
| SUBCHANNEL INITIALIZATION.....             | 4-15 |
| 7900 Subchannel Initialization.....        | 4-15 |
| ICD and MAC Subchannel Initialization..... | 4-16 |
| AUTOBOOT SPECIFICATION.....                | 4-17 |
| NORMAL TERMINATION MESSAGES.....           | 4-19 |
| ABNORMAL TERMINATION MESSAGES.....         | 4-19 |
| BAD TRACK INFORMATION.....                 | 4-20 |
| SWTCH EXAMPLE.....                         | 4-21 |
| SWTCH ERROR CONDITIONS.....                | 4-24 |

**Chapter 5 System Initialization**

|  |      |
|--|------|
| GENERAL.....                                   | 5-1  |
| STANDARD BOOT-UP PROCEDURES.....               | 5-2  |
| BOOT LOADERS AND BOOT EXTENSION.....           | 5-2  |
| DISC LOADER ROM.....                           | 5-2  |
| BOOTSTRAP LOADER.....                          | 5-3  |
| BOOT EXTENSION EXECUTION.....                  | 5-4  |
| SYSTEM TRACK ALLOCATION.....                   | 5-4  |
| FMGR INITIALIZATION.....                       | 5-6  |
| SYSTEM TESTS.....                              | 5-8  |
| FILE SYSTEM CONVENTIONS.....                   | 5-9  |
| UTILITY INSTALLATION PROCEDURES.....           | 5-10 |
| WELCOM FILE.....                               | 5-18 |
| HI FILE (MTM ONLY).....                        | 5-23 |
| HELP UTILITY.....                              | 5-24 |
| STRUCTURE OF THE HELP FILE.....                | 5-24 |
| MAINTAINING YOUR HELP FILE.....                | 5-25 |
| HELP OPERATION IN THE SESSION ENVIRONMENT..... | 5-26 |
| SPOOL SYSTEM INITIALIZATION.....               | 5-27 |
| SYSTEM PROTECTION.....                         | 5-27 |
| CHANGING AUXILIARY CARTRIDGES.....             | 5-27 |
| SHORT ID HANDLER.....                          | 5-29 |

## Table of Contents

### Chapter 6 Session Monitor Initialization

|                                      |      |
|--------------------------------------|------|
| GENERAL.....                         | 6-1  |
| SESSION LU DEFINITION.....           | 6-1  |
| SESSION LU ALLOCATION WORKSHEET..... | 6-2  |
| RUNNING ACCTS.....                   | 6-5  |
| INITIALIZATION DIALOGUE.....         | 6-5  |
| GROUP ACCOUNT DEFINITIONS.....       | 6-13 |
| USER ACCOUNT DEFINITIONS.....        | 6-15 |

### Chapter 7 Maintaining the Account System

|                                     |      |
|-------------------------------------|------|
| GENERAL.....                        | 7-1  |
| SESSION MONITOR ACCOUNT FILE.....   | 7-1  |
| ACCOUNT FILE HEADER.....            | 7-1  |
| ACTIVE SESSION TABLE.....           | 7-2  |
| CONFIGURATION TABLE.....            | 7-2  |
| SPARE CARTRIDGE POOL.....           | 7-3  |
| USER/GROUP ID MAP.....              | 7-4  |
| ACCOUNT DIRECTORY.....              | 7-4  |
| GROUP AND USER ACCOUNT ENTRIES..... | 7-4  |
| ACCOUNTS PROGRAM OPERATION.....     | 7-6  |
| SYNTAX.....                         | 7-10 |
| GENERAL COMMANDS.....               | 7-10 |
| ADDING NEW ACCOUNTS.....            | 7-15 |
| MODIFYING OLD ACCOUNTS.....         | 7-19 |
| DISPLAYING ACCOUNT INFORMATION..... | 7-23 |
| PURGING ACCOUNTS.....               | 7-26 |
| SESSION MONITOR SYSTEM CONTROL..... | 7-26 |
| ACCOUNTS SYSTEM MAINTENANCE.....    | 7-30 |
| ACCOUNT COMMAND FILE FORMATS.....   | 7-35 |
| ERROR MESSAGES.....                 | 7-36 |

### Chapter 8 Adjusting System Parameters

|   |     |
|---|-----|
| INTRODUCTION.....                         | 8-1 |
| DEVICE CONTROL.....                       | 8-1 |
| TIME SLICING.....                         | 8-3 |
| SYSTEM CONSOLE AS A SESSION TERMINAL..... | 8-4 |
| PARTITION MANAGEMENT.....                 | 8-6 |
| CHANGING THE MASTER SECURITY CODE.....    | 8-6 |

**Chapter 9      Memory and I/O Reconfiguration**

|  |      |
|--|------|
| GENERAL.....   | 9-1  |
| SCHEDULING THE CONFIGURATOR FROM DISC LOADER ROM.....  | 9-1  |
| SCHEDULING THE CONFIGURATOR FROM BOOTSTRAP LOADER..... | 9-3  |
| CONFIGURATOR PROGRAM.....                              | 9-3  |
| CONFIGURATOR HALTS AND ERROR MESSAGES.....             | 9-4  |
| RECONFIGURATION PROCEDURES.....                        | 9-4  |
| I/O RECONFIGURATION STEPS.....                         | 9-5  |
| MEMORY RECONFIGURATION PROCEDURES.....                 | 9-8  |
| Excluding Bad Pages.....                               | 9-9  |
| SAM Extension Reconfiguration.....                     | 9-10 |
| Changing Partition Definitions.....                    | 9-10 |
| Changing Program Partition Assignments.....            | 9-14 |
| Program Partition Assignments.....                     | 9-15 |
| RECONFIGURATION EXAMPLE.....                           | 9-16 |
| BOOT-UP AND RECONFIGURATION HALTS.....                 | 9-19 |
| CONFIGURATOR ERROR MESSAGES.....                       | 9-21 |

## Table of Contents

|                     |  |                |
|---------------------|--|----------------|
| <b>Appendix A</b>   | <b>Grandfather Disc Cartridge .....</b>              | <b>A-1</b>     |
| <b>Appendix B</b>   | <b>Real-Time Disc Usage .....</b>                    | <b>B-1</b>     |
| <b>Appendix C</b>   | <b>RTE System Tables .....</b>                       | <b>C-1</b>     |
| <b>Appendix D</b>   | <b>Record Formats .....</b>                          | <b>D-1</b>     |
| <b>Appendix E</b>   | <b>Differences Among RTE Operating Systems .....</b> | <b>E-1</b>     |
| <b>Appendix F</b>   | <b>Program Types .....</b>                           | <b>F-1</b>     |
| <b>Appendix G</b>   | <b>Table Areas I and II Entry Points .....</b>       | <b>G-1</b>     |
| <b>Appendix H</b>   | <b>HELP File Listing .....</b>                       | <b>H-1</b>     |
| <b>I Appendix I</b> | <b>Summary of System Entry Points .....</b>          | <b>I-1</b>     |
| <b>Appendix J</b>   | <b>Session Monitor Tables .....</b>                  | <b>J-1</b>     |
| <b>Appendix K</b>   | <b>DCB and Directory Formats .....</b>               | <b>K-1</b>     |
| <b>Appendix L</b>   | <b>Blank Worksheets .....</b>                        | <b>L-1</b>     |
| <b>Glossary</b>     | <b>.....</b>   | <b>GL-1</b>    |
| <b>Index</b>        | <b>.....</b>   | <b>Index-1</b> |

## List of Illustrations

|              |   |      |
|--------------|---|------|
| Figure 1-1.  | System Management Procedural Overview.....        | 1-3  |
| Figure 1-2.  | Sample User Evaluation Sheet.....                 | 1-9  |
| Figure 2-1.  | Sample Account Structure.....                     | 2-4  |
| Figure 2-2.  | Sample Account Matrix.....                        | 2-7  |
| Figure 2-3.  | Sample Cartridge Requirement Worksheet.....       | 2-15 |
| Figure 3-1.  | HP 7900 Disc Worksheet Example.....               | 3-8  |
| Figure 3-2.  | HP 7905 Disc.....                                 | 3-9  |
| Figure 3-3.  | HP 7905 Disc Worksheet Example.....               | 3-12 |
| Figure 3-4.  | HP 7906 and 7920 Discs.....                       | 3-15 |
| Figure 3-5.  | HP 7906 Disc Worksheet Example.....               | 3-18 |
| Figure 3-6.  | HP 7920 Disc Worksheet Example.....               | 3-22 |
| Figure 3-7.  | HP 7925 Disc.....                                 | 3-26 |
| Figure 3-8.  | HP 7925 Disc Worksheet Example.....               | 3-28 |
| Figure 3-9.  | HP 9895 Disc.....                                 | 3-33 |
| Figure 3-10. | HP 9895 Disc Worksheet.....                       | 3-34 |
| Figure 3-11. | Sample I/O Configuration Worksheet.....           | 3-41 |
| Figure 3-12. | Sample Device Configuration.....                  | 3-47 |
| Figure 5-1.  | Sample System and Auxiliary Subchannels.....      | 5-6  |
| Figure 5-2.  | Sample Program Load.....                          | 5-15 |
| Figure 5-3.  | Sample WELCOM File.....                           | 5-19 |
| Figure 5-4.  | *STIME Listing.....                               | 5-21 |
| Figure 6-1.  | Session LU Allocation Worksheet.....              | 6-4  |
| Figure 6-2.  | Sample Message File.....                          | 6-8  |
| Figure 6-3.  | Sample Account System Initialization Dialogue.... | 6-12 |
| Figure 6-4.  | Sample NEW,GROUP Command Dialogue.....            | 6-14 |
| Figure 6-5.  | Sample NEW,USER Command Dialogue.....             | 6-23 |
| Figure 9-1.  | Reconfiguration Example.....                      | 9-16 |
| Figure A-1.  | 7905/7906(H)/7920(H) Grandfather Disc Layout....  | A-9  |
| Figure A-2.  | 7925(A) Grandfather Disc Layout.....              | A-9  |
| Figure C-1.  | ID Segment Format.....                            | C-5  |
| Figure C-2.  | ID Segment Extension.....                         | C-9  |
| Figure D-1.  | Source Record Formats.....                        | D-2  |
| Figure D-2.  | Record Formats.....                               | D-3  |

## List of Tables

|            |  |       |
|------------|--|-------|
| Table 3-1. | Compatible Disc Drive Characteristics.....                               | 3-6   |
| Table 3-2. | Peripheral Device Interface Cards and Drivers....                        | 3-45  |
| Table 3-3. | Spool Monitor Programs.....  | 3-98  |
| Table 3-4. | Utility Relocatable File Names.....                                      | 3-108 |
| Table 3-5. | Programs Requiring Buffer Space in Partitions....                        | 3-110 |
| Table 3-6. | Session Monitor Programs.....  | 3-115 |
| Table 5-1. | Utility and Subsystem Transfer File.....                                 | 5-12  |
| Table 6-1. | Command Capability Level Assignments.....                                | 6-22  |
| Table 7-1. | ACCTS Command Summary.....   | 7-9   |
| Table 7-2. | NEW,USER Command Defaults.....   | 7-18  |
| Table 7-3. | ACCTS Error Summary.....   | 7-36  |
| Table 9-1. | System Boot-up and Reconfigure Halts.....                                | 9-20  |
| Table 9-2. | I/O and Memory Reconfiguration Error Codes.....                          | 9-23  |
| Table A-1. | Standard System Assignment for 92068A Grandfather<br>Disc Cartridge..... | A-6   |
| Table A-2. | 7905/7906(H)/7920(H) Grandfather Disc<br>Configuration.....              | A-7   |
| Table A-3. | 7925(H) Grandfather Disc Configuration.....                              | A-8   |
| Table A-4. | Track Map Table \$TB32 for MAC Driver DVR32.....                         | A-10  |
| Table A-5. | Track Map Table \$TA32 for ICD Driver DVR32.....                         | A-11  |
| Table C-1. | System Communications Area Locations.....                                | C-2   |



# Chapter 1

## System Management Overview

### General

This chapter provides a procedural overview for planning, generating, and maintaining the HP 92068A RTE-IVB Software System. RTE-IVB is a powerful operating system that offers considerable flexibility in its operation and configuration. It supports program execution in background, time-shared, and batch environments. Multi-user interfaces are provided to manage concurrent user access to system resources. As the system manager, you are responsible for system planning, generation, installation, and initialization as well as maintenance of the system after it is operational. The following steps should be performed:

1. Evaluate the system user base.
2. Select appropriate user interface: single user, MTM, or Session Monitor.
3. Plan the system architecture.
4. Generate the system, using the RTE-IVB On-Line Generator.
5. Install and bootstrap the newly generated operating system.
6. Initialize the system and appropriate subsystems.
7. Maintain the system.

The whole process and the corresponding references for details are shown in Figure 1-1. The major steps are described in the following paragraphs.

### Evaluate User Base

The system manager should be cognizant of user requirements before generating the system. Typically, the following information is determined prior to system generation:

- \* Who will be using the system?
- \* What applications will be run in the system?
- \* What system resources and peripherals will be required?

Further discussion of user evaluation is given in the DETERMINING USER REQUIREMENTS section of this chapter.

## Selecting the Multi-User Interface

RTE-IVB provides two optional multi-user interface packages, Session Monitor (SM) and Multi-Terminal Monitor (MTM). SM or MTM (or neither) may be selected during system generation. The choice depends on user requirements and the capabilities offered by the appropriate package. Both packages allow multi-terminal access to the operating system.

Throughout this manual, references will be made to SM or MTM. Either one (but not both) may be generated into the system for a multi-terminal or multi-user environment. Portions of this manual apply to only one multi-user interface package and are so noted. Unless stated otherwise, this chapter applies to both interface packages.

# System Management Overview

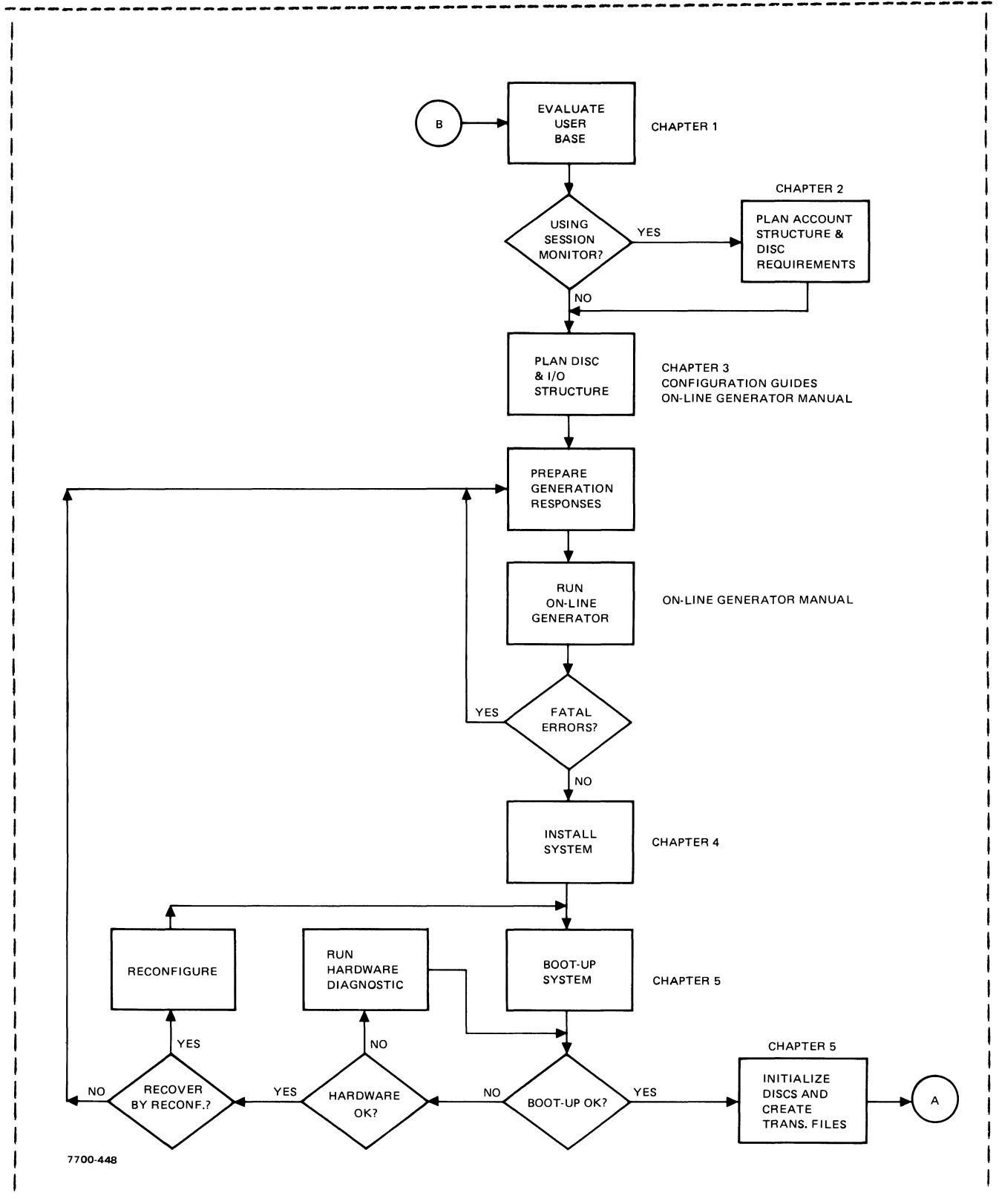

Figure 1-1. System Management Procedural Overview

# System Management Overview

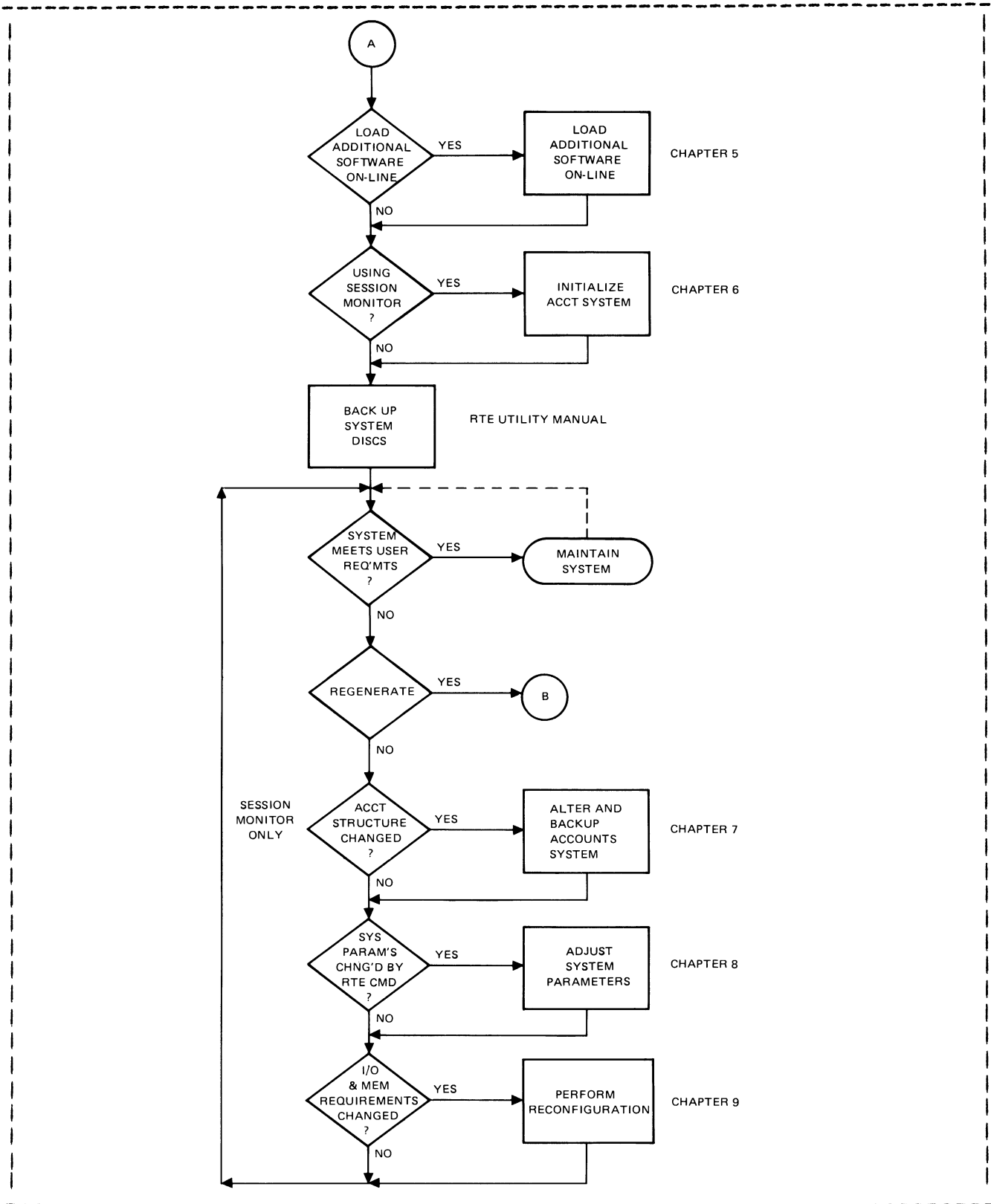

Figure 1-1. System Management Procedural Overview (Cont.)

## Session Monitor

The Session Monitor facilitates multiuser system operation by providing protected file domains and controlled access to system resources and functions. Features provided by the Session Monitor are:

- \* User activity on the system is defined in terms of "sessions": the user logs on, interacts with the system to perform a specific function, then logs off. A copy of the File Manager is available as soon as log-on is successful.
- \* The user base is broken into two levels: that of groups (sets of users who share common functions, applications, and/or resources) and that of the individual users.
- \* Each individual using the system must be assigned a group and user account name by the system manager. The user must provide this information in order to log-on to the system. The account will also determine what resources and file cartridges can be accessed.
- \* A capability level is associated with each user. Each File Manager and operating system command has an associated capability level. Users must have a capability level greater than or equal to the command capability level in order to execute the command.
- \* User names, capability levels, and resource access information are stored in a system account file. This file is created using the system accounts program. The system manager has control over the account structure and resource access.
- \* When the user logs on, the system builds a session control block for that user based on the account name and the terminal where the session is initiated. This session control block contains all the pertinent information about the user's session, including: cartridges that are mounted to that session, system resources (in terms of logical units) the user may access, the user capability level, and possibly other pertinent session related application information.
- \* While a user is in session, the system prevents adverse interaction between sessions. This is accomplished by various means. For example: cartridges are mounted to specific users (or groups); only those users (or group members) may access them.
- \* Break Mode. This mode is entered when the user causes an unsolicited interrupt by striking any key on the terminal. Session Monitor will then read a user command and process it, or if appropriate, send it to the operating system for processing. Only commands with capability levels less than or equal to the user's level will be accepted.

## System Management Overview

- \* Permanent programs scheduled from file manager are automatically copied for each user, permitting multiterminal use of utilities and application programs.
- \* After a user has completed his session, he must "log-off". The system will then update the account file with the user's CPU and total session connect time and release system resources (e.g., memory for session control block) allocated for the session.

## Multi-Terminal Monitor

The Multi-Terminal Monitor allows multi-terminal access to operating system and file manager functions. The major features are:

- \* Automatic scheduling of the File Manager. When the user's copy of the File Manager is dormant and he strikes any key on his terminal, MTM will schedule this copy to run from the user's terminal. This allows full access of the system.
- \* Break mode. This mode is entered when a user causes an unsolicited interrupt by striking any key on his terminal. MTM will then read a user command and, if appropriate, send it to the system for processing. The user may issue virtually any system command from his terminal.
- \* Every user in the system has complete access to all system resources. Each user may access all file cartridge directories in the system and there is no automatic means to separate one user's file activities from another. Furthermore, every user may enter all possible system commands and accordingly adjust system parameters. The implication of this feature is that users must agree among themselves to restrict their system activities to pre-defined domains.

## System Planning

Information obtained in the user base evaluation is used for system planning. Worksheets are filled in to prepare responses to the RTE-IVB On-Line Generator. Steps involved in system planning include:

- \* Plan the session account structure and disc cartridge requirements (Session Monitor only).
- \* Plan disc subchannel assignments.
- \* Plan the computer I/O structure including setting up system LU, EQT, and interrupt table assignments.
- \* Allocate optional system resources such as number of classes, resource numbers, size of common, etc.

- \* Plan the RTE-IVB I/O memory configuration including the size of partitions, the number of partitions, etc.

## System Generation

System generation is accomplished by running the RTE-IVB On-Line Generator. This requires the use of the information supplied in the generation chapter of this manual, the On-Line Generator Manual, and other appropriate documentation as required by your particular system.

## System Installation

After the RTE-IVB system has been generated, the RTE-IVB SWTCH program must be run to place the generated system on the disc in the correct format.

Refer to Chapter 4 of this manual for details. However, be sure to backup your disc so that you always have a working operating system in case of trouble (i.e., planning errors, etc.).

## System Initialization

Initialization of the system consists of the following steps:

- \* Initialize File Manager directories on system disc cartridges LU2 and LU3.
- \* Create the system WELCOM file.
- \* Bootstrap the new system. Run the reconfigurator to correct generation errors if necessary.
- \* Create the system message file.
- \* Create user welcome files (called HI and HELLO files).
- \* Load system and user utilities on-line if not generated into the system and make type 6 files for utility programs.
- \* Run a disc backup utility to save the copy of the system on tape (if magnetic tape unit is used).
- \* Start up appropriate subsystems, such as the spooling system.

For systems operating with the Session monitor, these additional steps should be performed:

## System Management Overview

- \* Set up the user account structure by running the accounts (ACCTS) program.
- \* Initialize the appropriate system disc cartridges.
- \* Enable the system console as a session terminal (if desired).

## Maintaining the System

After the system is operational, you may wish to alter various system definitions. For example:

- \* Alter and/or backup the Session Account System by running the accounts program.
- \* Save and restore disc cartridges and spare bad disc tracks using the disc backup utility programs.
- \* Alter system parameters such as the time-slice quantum, device timeouts, buffer limits, etc.
- \* Reconfigure the system to meet new user requirements or change generation parameters.

## Determining User Requirements

It is suggested that the potential system users be interviewed to find out what their needs are. A sample user questionnaire is shown in Figure 1-2. This questionnaire is provided as a guide. You should modify it to suit your specific needs. The primary function of the questionnaire is to determine user requirements. Most users will not think in terms of disc tracks, memory or disc resident programs, or priority levels when describing their needs. The questions should be such that the users can readily understand them and furnish the necessary information. You can then translate the information into data useful for system generation, initialization, and maintenance.



I. USER CATEGORY

- Technician/Data Entry Operator
- Secretary/Word Processing Operator
- General Programmer
- System Programmer/Support Personnel

II. APPLICATIONS

Subsystems

---



---



---



---

EMA Programs  Size: \_\_\_\_\_

Special Program Requirements: # of Classes \_\_\_\_\_

# SAM Required \_\_\_\_\_

# of Resource Numbers \_\_\_\_\_

# of Scratch Tracks \_\_\_\_\_

# Number of Programs Active at One Time \_\_\_\_\_

Program Partition Sizes \_\_\_\_\_

Real-Time Common Size \_\_\_\_\_

Background Common Size \_\_\_\_\_

III. PERIPHERAL RESOURCE USAGE

Using Files

|  | CRN | SIZE | FREQ OF ACCESS |
|--|-----|------|----------------|
|--|-----|------|----------------|

|  |  |  |  |
|--|--|--|--|
| <input type="checkbox"/> Private Cartridge Required: |  |  |  |
|  |  |  |  |
|  |  |  |  |

Common Data Base/File Access

Users \_\_\_\_\_

\_\_\_\_\_

Line Printer Access

Magnetic Tape Unit Access

Paper Tape Reader/Punch Access

Others: \_\_\_\_\_

Special Requirements: \_\_\_\_\_

\_\_\_\_\_

Figure 1-2. Sample User Evaluation Sheet

## User Category

The first questionnaire section deals with the level of user sophistication. This section, which is applicable primarily to users of the Session Monitor, defines four levels of sophistication. The first level is that of a technician or data entry operator. Users in this group interface to the system only to the extent of operating specific programs or procedure files. No programming knowledge is necessary and very little knowledge of the system is required. Users are expected to follow pre-defined procedures when dealing with the computer.

The next level of user sophistication is that of a secretary or word processing operator. Users at this level may require knowledge of the editor and cursory knowledge of the file system. Only limited access to system functions is needed.

The next level is for the general programmers. Most users of RTE will fall into this category. They have knowledge of operator commands, programming calls, etc. They are expected to take advantage of most system capabilities. This will include operation of compilers, managing data bases, manipulation of the file system, performing network operations, etc. However, they are not concerned with the activities of other users on the system. Furthermore, detailed system knowledge will not usually be required.

Users of the highest level of sophistication will include system programmers and support personnel. These users will have a good working knowledge of system operation. They are capable of changing overall system operating parameters.

## System Applications

The second section of the questionnaire deals with intended system applications. These applications will be the primary source used to decide how to allocate system resources and to set up system parameters. You should determine the following:

- \* Subsystems required-HP supplied subsystems, languages, utilities, and user application programs to be used on the system. In situations where this is difficult to ascertain, it is recommended that as many subsystem and/or utilities as possible be included in the system.
- \* Response time requirements. Users should be queried as to their terminal and real-time response requirements. Based on their inputs, modules may be given higher priority levels, generated into the system as memory resident, or assigned to partitions. For example, in a real-time environment, response considerations may dictate that certain programs be memory resident at all times. If this is the case, you must obtain these modules before generating the system.

- \* Memory requirements. If users will be running large application programs, partitions generated should be large enough to execute these programs. For some applications, HP supported subsystems will require larger partitions for their execution (i.e., compiling very large programs). Refer to chapters 4 and 5 for specific subsystem or utility memory requirements. Extended Memory Area (EMA) usage is another factor to be considered. User application programs making use of the EMA feature will require mother partitions of at least a certain size to be generated into the system. Therefore, user should be queried about the maximum EMA array sizes used in application programs.

## Peripheral Resource Usage

The third section of the questionnaire determines peripheral resources required. The following information needs to be asked of each user (or group of users):

- \* Will the user be storing files or creating data bases on the system? If so, how many and how big? Does the user require disc space on a permanent or temporary basis. This will give an indication of the amount of disc space (if any) to be allocated to the user and of the disc cartridge (subchannel) sizes required in the system.
- \* Will the user's files be accessed by other users in the system? Will this user access other user's files? Which users? Does this user have files that cannot be shared? These questions are important in systems using the Session Monitor because file cartridge access can be restricted to the individual users, members of a group, or made available to all system users.
- \* Will user application programs require system scratch tracks? System scratch tracks (which are managed directly by the operating system on LU2 and LU3) are used in many system functions. If this usage is heavy, then a greater proportion of the system disc space should be allocated for scratch tracks when the system is initialized.
- \* Does the user have special peripheral generation and access requirements? Certain peripherals (i.e., HP-IB) may have several devices attached to one controller. You should determine (if possible) the number of devices attached to the controller and how these devices will be addressed. This will facilitate setting up the logical unit and subchannel designations during system planning. In systems with the Session Monitor, peripheral device access can be restricted to specified users. Therefore, what devices each user, or group of users, will need to access must be determined.

## System Management Overview

- \* Will the user be accessing common system peripherals such as the line printer, magnetic tape unit, etc. This information is primarily useful in the Session Monitor. It will indicate which peripherals should be included in the user's account SST and whether certain procedures (e.g., spool setup) need to be placed in the user's HELLO file.

# Chapter 2

## Session Account Planning

### General Information

This section will help you plan your session account structure and disc cartridge requirements.

If the Session Monitor will be operational in your system, certain steps should be taken before preparing generator responses:

- \* Determine intended system applications and resource requirements. This may be accomplished by interviewing your users. Details are discussed in Chapter 1.
- \* Organize the user base into a hierarchy of groups and users. Groups will include sets of users with common characteristics or requirements. For example, groups might be composed of members of a project team or users performing similar functions. If desired, users can be members of more than one group. This organization will serve as the basis for the overall account structure. An account planning matrix worksheet is provided in this chapter to aid you in this process.
- \* Estimate the number and size of disc cartridges in the system. This will depend on your account structure, user application requirements, and the degree of file independence required by various users of the system. This chapter discusses the various ways disc cartridges can be mounted in the system and how they are accessed in both session and non-session environments. You should have a thorough understanding of this information before planning your cartridge configuration. A requirements worksheet is provided to aid you in cartridge configuration planning.

### The Session Environment

#### Session Concept

Before any user can gain access to the system, he must "log-on" by supplying the system with an account name. The system will then set up a specific operating environment for that user based on his account and the particular terminal at which the user logged on.

Once logged on, the system will permit only those user peripheral access requests and commands allowed within the operating environment. In addition user's can access many of their peripherals with default logical unit numbers. This eliminates the need to know system logical unit assignments. For example, each user's terminal is referred to as LU 1 rather than by the actual system logical unit number assigned to it.

## Session Account Planning

When finished interacting with the system, the session user will "log off". The system will update its record of the users cumulative CPU and connect times and clear its record of the user session from internal tables. The process of logging on, interacting with the system, and logging off is referred to as a "session". With careful planning by the System Manager, each session should provide a secure, "friendly", and productive problem solving environment.

The System Manager may define his account structure such that users have varying degrees of access to system functions, files, and peripheral resources. These Account definitions can be based on user applications, levels of sophistication, and other special requirements. The importance of good planning here cannot be over emphasized.

## Session Control Block

Every time a user logs on, the system allocates a session control block (SCB) for that user. Session control blocks will be created for all currently active sessions in the system. The SCB is the primary means used by the system to check user requests for validity and restrict access to system resources.

Among other things, each SCB contains the following information:

- \* user command capability level
- \* error information associated with the user's session
- \* a record of the session's CPU usage and connect times
- \* session user ID and group ID
- \* the maximum number of disc cartridges that may be mounted to the session at any one time
- \* a record of all cartridges currently mounted to the session
- \* Session Switch Table

The complete session control block format is shown in appendix J.

## Session Switch Table

The Session Switch Table (SST) allows session users to reference peripherals associated with their operating environment via default logical units or session LU's. When a peripheral is accessed, the supplied session LU is mapped into the SST to obtain the corresponding system LU. This allows the session user to access peripherals without requiring knowledge of system logical unit assignments and also system logical units greater than 63. Every peripheral that the session user may access must be defined in his SST. The feature can be used to restrict the users access to a predefined subset of system peripherals.

## Account Structure

The Session Monitor maintains two types of accounts: user accounts and group accounts. Group accounts are used to assign selected peripherals and disc cartridges to specific sets of users. User accounts provide the system with the information necessary to set up and maintain the operating environment for that user.

Every session user must be assigned at least one user account. The user account may specify which group account it is to be associated with. A user account can optionally include the resources assigned to its group account. If desired, you can assign an individual several user accounts belonging to different groups. These accounts can be structured such that the same set of private resources will be retained in the user's operating environment irrespective of the group he is currently logged on with. Accounts structured in this manner are said to be "linked".

The System Manager's account is treated specially by the system; it is given access to all system functions and resources.

All accounts are specified to the system in the form "<user>.<group>". where <user> and <group> are identifiers of one to ten characters in length. Within groups, the user identifier must be unique. An example account structure is shown in Figure 2-1. As can be seen from the example, the account structure is broken down into three levels: System Manager, Group, and User. Note that, in the diagram, Jones is a member of three groups and has three separate accounts. The System Manager has linked these accounts together so that Jones can access the same private files and/or peripherals from all three accounts. Note that linked accounts need not be share the same user names.

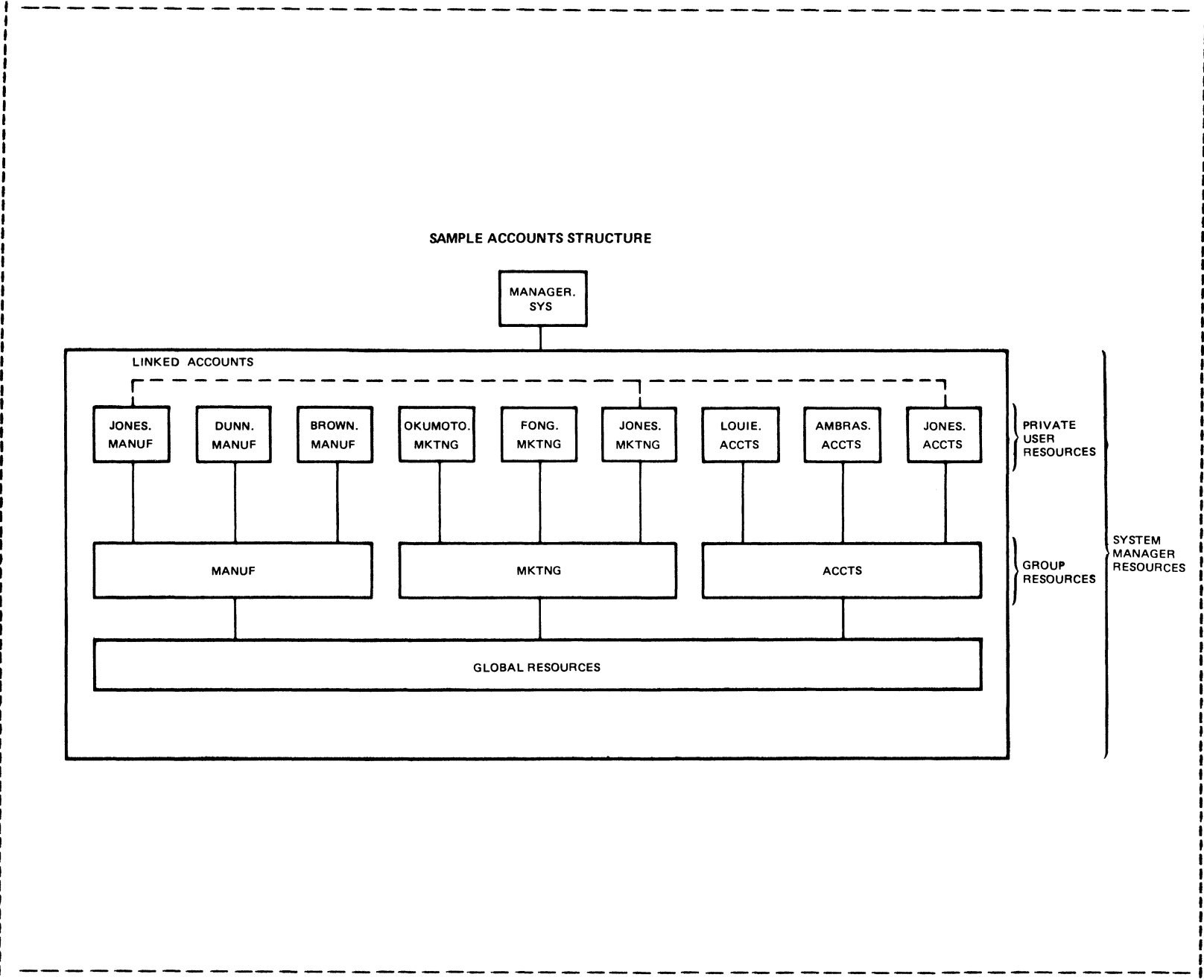

Figure 2-1. SAMPLE ACCOUNT STRUCTURE



## Session Monitor Components

The Session Monitor consists of modules and subsystems that in total create a tailored operating environment for each user. The following components comprise the Session Monitor:

### Account System

The account system is maintained by the accounts program (ACCTS). This program is run during system initialization by the System Manager and is also run automatically at boot-up to allocate system resources for the session monitor. It may be run at any time to maintain the account structure.

Using ACCTS, you can: define all groups (and their associated resources); all users (and their associated resources, capability levels, etc.); display the current status of the account system (including all users currently logged on); send messages to various users of the system; shut-down and restart the entire session system. You may also use ACCTS to save current account definitions off-line and restore them when desired. Chapters 6 and 7 describe the operation of the ACCTS program in detail.

### Session Accounts File

The accounts file is created by the ACCTS program during system initialization. It contains four major sections: user account definitions, group account definitions, the Configuration Table, and system global information.

Each user account definition contains the user's SST definitions, command capability level, log on command transfer file (HELLO file), mounted disc limit, user and group identifiers, and CPU and connect time.

The group account definitions contain additional SST definitions. These definitions are optionally placed in each group members user account definition.

In addition to user and group accounts, the account file contains global session monitor parameters and tables, including the Configuration Table.

The Configuration Table contains additional SST definitions for selected stations. (In this manual, the term station refers to the session terminal and its associated peripherals. It will be used interchangeably with terminal). When a user logs on, his SST will be a composite of his user account SST definitions and his stations Configuration Table SST definitions. For example, a terminal with cartridge tape units could have SST definitions equating default session LU's to their system LU assignments. Refer to Chapter 7 for details of the session account file.

## **Break Mode Processors**

The break mode processors consist of two programs: PRMPT and R\$PN\$. These programs process break mode commands. They provide a means of interrupting program execution, examining system status, etc., when a user's programs are running or his copy of the file manager is unavailable.

## **Session Log-On/Log-Off Processors**

These processors operate in conjunction with the accounts program and the break mode processors. The log-on processor, LOGON, is used to create active sessions in the system. It is invoked by PRMPT when no active session is operating from the terminal. LOGON prompts the user for an account name and password (if required). An attempt is made to match this name to an existing user account stored in the account file. If a match is found, a session control block is created for the session, and the user's session is initiated. When a user has completed his session and logs off, the LGOFF processor updates the session account file with the CPU usage and connect time and deallocates system resources for the session.

## **Operating System**

In the session environment, the operating system message processor MESSS will execute only those commands having equal or lower capability levels than the level specified in the user's SCB. User capability level assignments are made by the System Manager when the user account is defined.

## **File Management System**

All file manager commands have capability levels associated with them similar to operating system commands. Users may perform only those file management commands whose capability levels are equal to or less than the level assigned to the user. The file management system also restricts user access to disc cartridges. Users may access only the cartridges which are specifically mounted to their session. Checks are made to restrict the number and type of cartridges which may be mounted to the session.

# **Planning Your Account Structure**

## **User Accounts**

Use the account planning worksheet to list all the individual users of your system. For planning convenience, you should assign a unique identifier (up to 10 characters) to each user. A sample account matrix is shown in Figure 2-2.

| USERS   | GROUPS |       |       |  |
|---------|--------|-------|-------|--|
|         | MANUF  | MKTNG | ACCTS |  |
| JONES   | ✓      | ✓     | ✓     |  |
| DUNN    | ✓      |       |       |  |
| BROWN   | ✓      |       |       |  |
| OKUMOTO |        | ✓     |       |  |
| FONG    |        | ✓     |       |  |
| LOUIE   |        |       | ✓     |  |
| AMBRAS  |        |       | ✓     |  |

Figure 2-2. Sample Account Matrix

### Group Accounts

Once you have listed your system users you should divide them into various groups. Members of a group will usually share one or more common attributes. Some of the criteria that may apply here are explained below.

**EXISTING ORGANIZATION.** You may find it convenient to follow an existing organizational pattern. Your account structure could reflect the actual groups in your user community.

**COMMON FILES.** Users who must share files or data bases with each other can be included in the same group. Disc cartridges can be associated with a group such that they may be accessed solely by members of the group.

## Session Account Planning

**COMMON PERIPHERALS.** Groups can be formed around special peripheral access requirements. If desired, peripherals can be restricted to selected groups and/or users. These peripherals may be defined to the account system such that they will automatically be added to the list of peripherals individual group members may access.

**COMMON APPLICATIONS.** You can separate users into groups based on their applications and/or job functions. Users performing similar tasks could then share related files and peripherals.

As a starting point in dividing your user community into groups, you might pattern the account structure after a group structure already existing in your user community. You might also want to form groups based on common peripheral or data base access requirements. Make a list of all such resources and the users requiring access to them. You should only form new groups when the list of users sharing a common resource is composed of users from two or more existing groups. If not (i.e. the list of users are all members of one existing group), you can add the resource to that group's domain. The information gathered here will be used later on to initialize and maintain the account system.

Assign a name or an identifier, up to ten characters, to each group in your user community. This identifier must be unique. It will be used by members of that group to identify themselves to the system. List each group in the diagonal group column in the account planning matrix, see Figure 2-2.

Next, indicate the members of each group. In each group column, place a check (✓) in all rows corresponding to the members of that particular group. Note that there is no restriction on the number of groups that a user may belong to. This may be a requirement in situations where individuals need to access resources owned by several different groups.

## Disc Cartridge Management

The following sections will discuss how cartridges are allocated and accessed both in and out of the session environment. You should be familiar with this material before determining your disc requirements and cartridge configuration.

### Cartridge Types

Before users can access files, their associated cartridges must be mounted on the system. Cartridges may be mounted in one of four ways:

1. **CARTRIDGES MAY BE MOUNTED TO INDIVIDUAL GROUPS.** Cartridges mounted in this manner may be accessed by all members of the same group. Group cartridges allow members of the same group to share programs, data bases, information files, etc.

2. CARTRIDGES MAY BE MOUNTED TO PRIVATE USERS. When a cartridge is mounted to a private user, only that user (or other users linked to his account) may access that cartridge. Private cartridges permit file security and are designed to prevent users from inadvertently accessing each others files.
3. CARTRIDGES MAY BE MOUNTED TO THE SYSTEM. These cartridges, known as System Global cartridges, are accessible to all users of the system. The primary system cartridge (LU2) and the auxiliary cartridge (LU3) are always mounted to the system. You may mount additional cartridges to the system by mounting them as private cartridges to the MANAGER.SYS account. With the exception of LU2 and LU3, files residing on System Global cartridges may be both read from and written into by any user of the system. Files on LU's 2 and 3 are subject to special access restrictions (described later).
4. CARTRIDGES MAY BE MOUNTED OUT OF SESSION. These cartridges can be accessed by programs not under the control of the Session Monitor. Non-session cartridges are mounted from a FMGR operating in non-session mode (e.g. from the system console). Note that in most cases LU2 and 3 are system type cartridges. They may however, be made non-session cartridges (see DC command). In this case they may be neither read nor written on by session users.

It should be emphasized that all file manager cartridges have the same format. The method cartridges are mounted determines the access restrictions imposed on them. For example, one user may mount a cartridge to his group (e.g.,:MC,-25,G), use it, then dismount it (:DC,-25,RR). Another user may mount the same cartridge to his private account (:MC,-25,P). The cartridge and its contents might remain the same; only the list of users who could access it would change. If necessary, you may permanently dedicate certain cartridges to groups and users. This will depend on how your account system is set up.

### **Spare Cartridge Pool**

In many cases, private users and groups may not need to have cartridges permanently allocated to them. They may need use of the cartridge disc space for only relatively short periods of time. The Session Monitor recognizes this need by maintaining a spare cartridge pool. This pool consists of cartridges to be allocated when users request scratch private and group cartridges (i.e. :AC,crn). When dismounted from the system, the scratch cartridges are returned to the spare cartridge pool. The cartridge pool may be setup when the account system is initialized or altered.

### **Cartridge Mounting Considerations**

A cartridge is defined to be mounted to a session when it is defined in the system cartridge list as being mounted to that session's group or private account and the cartridge LU is defined in the session's SST and SCB cartridge list.

## Session Account Planning

At log-on, the following cartridges are automatically mounted to the users session:

- \* All cartridges in the system cartridge list which are mounted to his private account or to other private accounts linked to his account.
- \* All cartridges in the system cartridge list which are mounted to his group account.
- \* All cartridges in the system cartridge list currently mounted as System Global cartridges. This will include system cartridges LU2 and LU3 unless they have been changed to non-session cartridges.

The total number of private and group cartridges mounted to a users session at any one time is controlled by a parameter in each user's account definition. This parameter, called the disc limit, is included in the user's SCB when he logs-on. If the user attempts to mount more private and group cartridges to his session than is permitted by this limit, he will receive an error message. The system will also warn him of this condition at log-on if more cartridges can be automatically mounted to his session than is permitted. System Global cartridges are not included in the user's disc limit.

When a disc cartridge is mounted to a session with an MC command, the cartridge LU must be predefined in the user's SST. This insures that low capability users (i.e. those users not able to modify their SST with the SL command) will only be able to mount cartridges defined in their account. Once the cartridge is mounted, it will appear in the system cartridge list as belonging to the user's private or group account, depending on MC command parameters. Note that if a previously uninitialized cartridge is mounted in session, the MC command will initialize it. The system will not allow a user to mount a cartridge to his session if it is already mounted to some other group or private user account or as a non-session cartridge.

When scratch cartridges are requested with the AC command, the system first checks to see whether a cartridge with the requested CRN is already mounted to the user's group or private account or as a system global cartridge. If so, this cartridge is merely added to the users session. Otherwise, the spare cartridge pool is searched for an unmounted cartridge of (at least) the requested size. Cartridges are searched in the order defined when the accounts system is initialized (using ACCTS). The first cartridge that meets the size requirement will be allocated from the pool. (Note that this is not necessarily the best fit). If none can be found, an error is issued and no further action is taken. Otherwise, the cartridge is initialized according to the parameters in the AC command. All files previously stored on that cartridge are purged.

Note that cartridges mounted privately to the MANAGER.SYS account will appear in the system cartridge list as System Global (S) cartridges. Their CRNs must be unique to all the cartridges in the system cartridge list.

## File Access Considerations

Once a cartridge is mounted to a users session, files on that cartridge may be created, read from, modified, and purged. However, files on LU2 and LU3 are subject to the following access restrictions:

- \* All files on LU's 2 and 3 may be read by all system users.
- \* Users may create type 6 files on LU's 2 and 3 via file manager :SP commands. A type file 6 may be purged only by the specific user who created it.
- \* When operating from the MANAGER.SYS account, the System Manager is given complete access to all files on LU's 2 and 3. He may read, write, modify and purge all files, including type 6 files.
- \* When operating outside the session environment (i.e. from FMGR on the system console when not enabled as a session terminal) users are given complete access to all files on LU's 2 and 3.
- \* When users invoke transfer files residing on LU's 2 and 3, the commands within those transfer files are given complete access to all files on LU's 2 and 3.

Programs operating outside the session environment (i.e. without a SCB), may access System Global cartridges and those cartridges mounted outside the session environment (non-session cartridges). They are given complete access to files on these cartridges, including LU's 2 and 3. Non-session programs, however, cannot access mounted session Group or Private cartridges. Likewise, programs operating under session control cannot access non-session cartridges. Since System Global cartridges can be accessed in both non-session and session environments, they may be used for file sharing on a system wide basis. For example, programs operating in the non-session environment performing data communication or acquisition functions could update files on a System Global cartridge. Session users would then have full access to these files.

The System Manager, when operating in the MANAGER.SYS account, is given complete access to all cartridges mounted on the system. this includes complete access to files on LU's 2 and 3, non-session cartridges, and cartridges mounted to group and private accounts. To access these cartridges, place the cartridge LU(s) in your SST. References to that cartridge should be through LU rather than CRN (the CRN might not be unique to your session). For example, to get a directory list of a cartridge mounted to some other user (assuming you are in the MANAGER.SYS account), enter the following commands:

```
:SL,30,30
:DL,-30
```

Note LU30 is not, and cannot be, mounted to your session.

## Cartridge Dismounting Considerations

Cartridges in the spare cartridge pool are intended for short term use. At the end of their session, it is suggested that users back up these cartridges on magnetic tape (using WRITT) and dismount them from the system. This will return the disc space to the available disc pool. Once dismounted from the system, files on a pool cartridge may not be recoverable. The cartridge will be completely reinitialized (i.e. all files purged) when reallocated with an :AC command. you can recover files by mounting the cartridge by LU (i.e. :MC,lu) before it is reallocated.

Dedicated cartridges are allocated to users on a longer term basis. They are assigned to users and/or groups by including the cartridge LU in their respective account definitions. Dedicated cartridges should be dismounted from the system only when they need to be physically removed or transferred to different accounts. This will prevent unauthorized access and will cause the system to automatically mount these cartridges to the users session at log on.

## Disc Planning

The following sections will help you to estimate disc cartridge requirements and plan your cartridge configuration. To perform this planning function you should:

1. Estimate the size of your primary and auxiliary system disc subchannels (LU's 2 and 3). Determine the number and size of globally accessible cartridges in your system. Remember that LU2 and LU3 can not be greater than 256 tracks.
2. Determine the number and size of cartridges that will accessed outside the session environment.
3. Determine the number, size and allocation of cartridges that will be dedicated to users and groups operating in the session environment.
4. Determine the number and size of cartridges in the spare cartridge pool.

## Cartridge Requirements Worksheet

The cartridge requirements worksheet is provided to help you allocate your disc space and assign cartridges to various users. The information gathered here will be used in Chapter 3 when you determine your disc subchannel layout and in Chapter 6 when you initialize the session account system. An example worksheet is shown in Figure 2-3.



Before you start filling out this worksheet, find out the number of available tracks on your disc(s). This will depend on both the type and number of discs you have. Using this total track size as a base, start allocating cartridge space for your system global, non-session, dedicated group, dedicated private, and disc pool cartridges. Circle the intended use of the cartridge alongside the cartridge size allocation as shown in the example. As you fill out this worksheet, the right most column (tracks left) should reflect the number of unassigned tracks remaining on the disc at that point. When you finish filling out the worksheet this value should be zero.

As can be seen from the sample worksheet, the System Manager allocated his disc as follows:

- \* Three system cartridges are dedicated: for the system cartridge (LU2), an auxiliary system cartridge (LU3), and an additional system global cartridge.
- \* One non-session cartridge is dedicated that will be used for non-session programs.
- \* Three cartridges were dedicated to groups: one cartridge each is dedicated to the MKTNG, ACCTS and MANUF groups.
- \* Two cartridges dedicated to private users: JONES, and DUNN.
- \* The remaining eight cartridges comprise the spare cartridge pool. These will be mounted to groups or private users on an as-needed basis.

The following sections will discuss some of the requirements and special considerations to be taken into account when planning each of the various cartridge types. Use the information provided in these sections along with your account planning matrix, and your general knowledge of the user base, to fill out your cartridge requirements worksheet.

#### NOTE

Use the cartridge sizes specified in your cartridge requirements worksheet as a guideline for your disc subchannel layout (discussed in Chapter 3). The actual cartridge sizes will depend on additional considerations such as disc type, spare track allocations, and the physical layout of subchannels on your disc.

## **Cartridge Size Requirements**

There are many criteria for selecting the size of a cartridge. Among the factors you should take into consideration are:

- \* The amount of program development being done on the cartridge. Many users will require relatively little disc space (say less than 30 tracks) in order to hold source files, documentation, relocatables, etc. On the other hand, if the project is large, or many versions must be kept on disc at the same time, you will want to allocate more tracks to the cartridge.

AVAILABLE TRACK SPACE ON DISC CONTROLLER = 1644 TRACKS

| CARTRIDGE TYPE | USER                        | # TRACKS | TRACKS LEFT |
|----------------|-----------------------------|----------|-------------|
| (S)G P D N     | Primary System Subchannel   | 256      | 1388        |
| (S)G P D N     | Auxiliary System Subchannel | 100      | 1288        |
| (S)G P D N     | System-Wide File Sharing    | 200      | 1088        |
| S G P D (N)    | Non-Session Applications    | 75       | 1013        |
| S (G) P D N    | MKTNG GROUP                 | 100      | 913         |
| S (G) P D N    | ACCTS GROUP                 | 75       | 838         |
| S (G) P D N    | MANUF GROUP                 | 125      | 713         |
| S G (P) D N    | Private User JONES          | 50       | 663         |
| S G (P) D N    | Private User Dunn           | 30       | 633         |
| S G P (D) N    | Pool Cartridge # 1          | 203      | 430         |
| S G P (D) N    | " # 2                       | 150      | 280         |
| S G P (D) N    | " # 3                       | 75       | 205         |
| S G P (D) N    | " # 4                       | 50       | 155         |
| S G P (D) N    | " # 5                       | 50       | 105         |
| S G P (D) N    | " # 6                       | 35       | 70          |
| S G P (D) N    | " # 7                       | 35       | 35          |
| S G P (D) N    | " # 8                       | 35       | 0           |

S = SYSTEM CARTRIDGE  
 G = GROUP CARTRIDGE  
 P = PRIVATE CARTRIDGE  
 D = DISC POOL CARTRIDGE  
 N = NON - SESSION CARTRIDGE

Figure 2-3. Sample Cartridge Requirement Worksheet

## Session Account Planning

- \* The amount of word processing functions being done on the cartridge. If the user or group will be storing large text files on the cartridge, more tracks should be allocated.
- \* The number and size of IMAGE data bases/data sets on the cartridge if used. Refer to the IMAGE Reference Manual for the information needed to calculate data base sizes.
- \* The number and size of data files on the cartridge.
- \* The number of potential users of the cartridge. You might multiply the intended number of users of the cartridge by some track constant (say 20 tracks) to give a rough estimate of the cartridge size.
- \* Approximately 3% of each subchannel should be reserved for spare tracks.

## System Global Cartridge Requirements

System cartridges include the FMP cartridges on the primary and auxiliary system disc subchannels (LUs 2 and 3) all other cartridges mounted to the MANAGER.SYS account.

The primary system subchannel is limited to a maximum of 256 tracks. The first tracks of this subchannel will be used to contain the operating system, and its size will be determined by the number of modules included in the system at generation time. This figure is displayed by the On-Line Generator when it has completed the system generation process. The remainder of the subchannel must then be divided at system initialization into the system scratch track and FMP areas. It is recommended that the maximum size of 256 tracks be allocated for the primary subchannel in active systems or when many files will be stored on the LU2 FMP area. You may want to put LU2 and LU3 on fast discs for high speed scratch work and program swapping.

The auxiliary system subchannel (LU3) is used for additional FMP files and system scratch tracks. The auxiliary system cartridge is optional. Its use is recommended if your system will be heavily loaded (to provide additional swapping tracks) and/or you will require additional FMP area for type 6 files, etc. A maximum of 256 tracks may be allocated for the auxiliary system subchannel.

You may wish to dedicate space for additional global cartridges in your system. These cartridges can be used for file sharing on a system wide basis. In particular, global cartridges are very useful in cases where files must be shared by different groups or by both session and non-session programs. Global cartridges should also be used for message and spool files. Even if you can foresee no requirement for global cartridges at this time, it is recommended that you dedicate one disc cartridge for this purpose. This will give users in different groups a means to share files with one another when the need arises.

### **Non-Session Cartridge Requirements**

Certain applications require that programs be run outside of the session environment. Programs in the time list, or that operate continuously, should not be associated with a session since they will be terminated by the system whenever the session user logs off. Programs will operate in the non-session environment when they are dispatched from the system console in non-session mode or by detaching themselves from their session using library calls. These programs may then access system and non-session cartridges. You should determine the disc storage required by programs and subsystems operating in the non-session environment. If desired, this storage can be partitioned into more than one cartridge to isolate different non-session subsystem files from each other. If you decide not to allocate cartridges for this purpose, non-session programs will use the file space on LU's 2 and 3 and the other system global cartridges in your system.

### **Group and User Cartridge Requirements**

Depending on user requirements, you should dedicate cartridges to various groups and/or private users. Cartridges are allocated to users by defining the cartridge LU(s) in their group or user account SST definition. These dedicated cartridges should not be specified in any other account SST (unless the cartridges will be traded between different group and private accounts). Chapters 6 and 7 describe the account definition process in detail.

It may be advantageous to allocate at least one cartridge to each group. This will be used by group members to share files with each other and to save information on a permanent basis. When required, users can allocate additional disc space for themselves by requesting cartridges from the spare cartridge pool. This space should be used on a temporary basis and will be returned to the pool when dismounted from the system. If possible, users should save files accessed infrequently on magnetic using WRITT so that pool cartridges will be available for other uses.

## Session Account Planning

Since disc space in the spare cartridge pool can be allocated to users as their needs and requirements dictate, it is strongly recommended that disc cartridges should be allocated from the disc pool. Cartridges should be dedicated to users only in the following situations:

- \* **GROUP CARTRIDGES.** It is recommended that all group cartridges be dedicated rather than from the spare cartridge pool. When allocated from the pool, the group runs the risk of losing all files on that cartridge if it is inadvertently dismounted from the system by a group member.
- \* **CARTRIDGES ON USER REMOVEABLE DISC MEDIA.** If you have users who will be inserting and removing private disc packs from the system, the cartridges on those packs should be dedicated to those users. They must NOT be included in the spare cartridge pool.
- \* **USER "TRADED" CARTRIDGES.** Cartridges that may be mounted to different private users or groups at different times, where files on those cartridges need to be preserved, should be dedicated.
- \* **PRIVATE CARTRIDGES CONTAINING FREQUENTLY ACCESSED FILES.** It is recommended that a cartridge be dedicated to a user when he will be accessing the same files on a long term basis and does not wish to place these files on a group or global cartridge. This will free the user from the risk of losing his files if the cartridge is inadvertently dismounted and returned to the spare cartridge pool. Examples of applications which might fall in this category are long term data base access, large word processing functions (e.g. documentation development), long term program development projects, etc.
- \* **SPECIAL PURPOSE CARTRIDGES.** Users requiring specific cartridge sizes or storage on specific disc areas should have those respective cartridges dedicated to them. The disc pool should not be used here since the location of a cartridge can not be guaranteed and/or a cartridge of the required size may not be presently available.

## Spare Cartridge Pool

After you have allocated space for your system global cartridges, non-session cartridges, and your dedicated group and private cartridges, the remaining space on your disc should be divided into cartridges for your spare cartridge pool. These cartridges will be allocated to private users and groups on an "as-needed" basis. The number and size of the cartridges in your pool will depend on several factors, including:

- \* Disc storage requirements of users who will be accessing cartridges from the cartridge pool.

- \* The estimated number of disc pool cartridges that will need to be mounted to private users/groups concurrently.
- \* The size of the remaining disc area.

Since disc storage needs are sometimes difficult to anticipate, it is suggested that there be a broad spectrum of cartridge sizes in the pool. One way to plan the pool is to divide half your total remaining disc space into relatively small cartridges (say 20 to 50 tracks). These cartridges can be used by users to save a relatively small number of temporary files. Divide the other half of your disc pool area into successively larger cartridges. These cartridges can be used by individuals requiring relatively large amounts of disc storage. The allocation of cartridges from the spare pool will depend on the order of cartridge LU's in the pool (specified during accounts setup) and the parameters specified by the user in his allocate cartridge (:AC, CRN) command.

### **Meeting Changing Cartridge Requirements**

System disc storage utilization is a dynamic variable and will vary as user applications and levels of sophistication change. When a user or group of users runs out of cartridge space, you can accommodate their needs via several means listed in order of preference.

- \* Dedicate a cartridge out of the spare cartridges pool just for their use. This will mean altering the definition of the spare cartridge pool and their account SST with the system accounts program ACCTS.
- \* If possible, allocate additional cartridges to that user.
- \* Trade cartridges with another user/group to obtain a larger cartridge. This will require exchanging the files on those cartridges and modifying affected user accounts.
- \* Increase the size of their cartridge(s) by regenerating the system. Certain applications will require all files to be on the same cartridge. If the cartridge can no longer accommodate all these files, you may be forced to regenerate the system specifying a new disc subchannel mapping. This has the disadvantage, however, that files on LU3 and other cartridges affected by the subchannel redefinition will have to be saved before the new system is installed.
- \* Generate additional disc storage space (and corresponding disc subchannels) in to the system. Obviously, this will require adding more disc storage units to your system.





# Chapter 3

## System Generation Response Preparation

### General

This chapter will aid you in preparing specific responses to the On-Line Generator for the 92068A Operating System. It should be used in conjunction with the RTE-IVB On-Line Generator Reference Manual. The system generation process can be broken down into the following steps:

1. **DISC STRUCTURE PLANNING.** Determine your disc subchannel configuration. If you have Session Monitor in your system, use the disc requirement worksheet (filled out in Chapter 2 of this manual) as a basis for planning your disc.
2. **I/O CONFIGURATION PLANNING.** Determine the select code, LU, and EQT entry assignments for the devices in your system. Procedures are given in this chapter to aid you in planning your I/O configuration.
3. **PREPARE GENERATOR RESPONSES.** Prepare responses to the Online Generator by filling in associated worksheets. Generator responses are explained in this chapter in the context of these worksheets.
4. **GENERATING YOUR SYSTEM.** Running the On-Line Generator (RT4GN) to generate your system.
5. **SYSTEM BACKUP.** Backup your newly generated system, if possible.
6. **INSTALLATION.** After all these procedures have been followed and you are confident that your operating system has been properly generated, install the new system by following the procedures described in Chapter 4 of this manual.

### Note to the New User

Your first attempt at system generation should be as simple as possible. Generation information is contained in this manual, the On-Line Generator Manual, and other appropriate configuration documentation, such as the subsystem configuration manuals. Build an answer file by modifying the sample answer file on the Primary System disc to suit your application. Follow the recommended generation guidelines unless you have specific requirements which cannot be met. Since most subsystems require additional steps, it is suggested that you exclude all non-standard subsystems (any subsystems not included in the RTE-IVB product) from your first generation. An overview of the generation process is given below.

## System Generation Response Preparation

After you have prepared your worksheets, run the On-Line Generator following the procedures described in the On-Line Generator Manual. You may wish to compare the information on your I/O Configuration Worksheet with your actual generator inputs.

When you are satisfied that the generation is correct,

**BACK UP YOUR DISC!!**

before you go any further (if possible). This is an important part of generation. You must always be sure that you have a working system available. The Primary System disc shipped with your system contains an archival operating system that must not be altered; it is the working system on which you can always rely. As soon as you receive the Primary System disc, make a back-up as described in the RTE-IVB Utility Programs Reference Manual. The working system that you generate also be treated as archival software, and should always be backed up as described in the utility manual.

If you back up your disc by copying it to another disc, be sure that you do not overwrite any part of the factory-generated disc.

There is an alternative to disc backup, which is useful only if your disc drive has a fixed platter. Initialize the fixed platter using the FMGR and copy your newly-generated system file to that platter. Then, at the point in the switchover procedure where you are directed to place the proper disc cartridge in the disc drive, remove the factory-generated disc and place another one in the drive, making sure that the drive has come up to speed before continuing the switchover process. The SWTCH program will then copy to the new disc, without destroying data on the factory cartridge.

Another technique, which also requires a fixed disc surface, is to modify the generation answer file so that the system is generated to run on the fixed platter. Then SWTCH can be run to install the generated system to the fixed platter.

If the factory-generated disc is to remain in the disc drive, ensure that it is protected by means of the hardware protect switch. Then transfer the new system as described in Chapter 4 of this manual.

Set the factory-generated cartridge aside in a safe, clean place, to be used only when generating systems. Place another disc pack into the drive, which can be used for storing data.

When the system is booted up, test it according to the instructions in Chapter 5. If you notice anything peculiar, note the specific symptoms, and continue testing until you are satisfied that it has been well tested. If you noted any errors, consult the RTE-IVB On-Line Generator Reference Manual, making use of examples and the factory-generation listing. Pay particular attention to those questions you answered differently from those shown in the examples. When you've identified the problems, replace the factory-generated cartridge in the disc drive, boot up that system, purge all copies of the previous generation and list file, pack the disc, edit the answer file, and re-run the generator.

When you have successfully generated an RTE system, and are familiar with the use of the Generator and SWITCH, make a copy of your generation answer file (so you can use it again if necessary) and then modify the original to include the other HP subsystems you want. Consult the appropriate subsystem manuals and configuration guides for the generation requirements of each subsystem. Generate the new system using this answer file and the procedures outlined in the first part of this chapter. Your new system may overlay your first system, but **DO NOT ALLOW YOUR FACTORY-GENERATED DISC TO BE OVERLAID!** Boot the new system up, and test it, using the procedures described previously and the information provided in the system manuals. When satisfied that the subsystems work, make a copy of your generation answer file for subsequent backup if necessary.

### Disc Planning

RTE-IVB is a disc-based operating system in which the disc provides the primary storage area for the following items:

- \* Configured operating system
- \* Relocated memory resident library and programs
- \* Relocated disc resident programs
- \* Relocatable library modules
- \* Temporary storage for programs (source programs for editing, etc.)
- \* Temporary storage for swapped out programs
- \* User files.

Disc storage is managed in terms of groups of contiguous tracks called subchannels (after generation, subchannels are referenced through logical unit numbers that are assigned in the I/O planning section). The primary purpose of the disc planning section is to configure available disc tracks into one or more subchannels. The operating system further defines the subchannels as system, auxiliary, and peripheral subchannels. The generator allows you to define a group of subchannels on a single disc controller. Multiple controllers are discussed here under the heading "MULTIPLE DISC CONTROLLERS".

### System/Auxiliary Subchannels

The system and auxiliary subchannels contain tracks controlled by the system. A track usage table is maintained by the system for these subchannels. Programs may obtain and release tracks from these subchannels by using EXEC calls. These tracks are considered system tracks and may be obtained from the system subchannel (LU2) or the auxiliary subchannel (LU3). The system tracks are used for:

## System Generation Response Preparation

- \* Program swapping
- \* On-line loading of programs
- \* Scratch area (by the generator, editor, assembler, and compilers)
- \* Temporary storage (by user programs).

The difference between a system subchannel and an auxiliary subchannel is that the configured system (including the memory resident system, the generator relocated disc resident programs, and the relocatable library) is stored only on the system subchannel.

An auxiliary disc is not required, but is sometimes useful for:

- \* Large file edits
- \* More Type 6 (SAVE PROGRAM) files.
- \* More general file space
- \* Decreasing swapping time, since system swap tracks are allocated from the top of the available track list downward (i.e., from tracks on LU3 before LU2). This feature permits the auxiliary disc to be used as a "swapping disc". Because LU3 can be on another disc or another controller, head movement is reduced, thus optimizing a system for speed (refer to Appendix B).

The size of a system or auxiliary subchannel is limited to 256 tracks. This size may be reduced, depending on the type of disc used (for example, 203 tracks on a 7900 disc).

### NOTE

More than one system or type of system can be located on, and/or share a disc, and these systems may share tracks on one or more discs. In designating tracks, those that are shared should be included and declared during each system generation. The restriction is that any tracks of an RTE system that are assigned to Logical Unit 2 or 3 (the system or auxiliary subchannel) must be unique to that RTE system. Remaining tracks on other disc subchannels can be assigned to more than one system.

## Peripheral Subchannels

Disc subchannels other than system and auxiliary are classified as peripheral subchannels and must be assigned logical unit numbers greater than 6. Note that if no LU is assigned for a peripheral disc, that disc cannot be accessed. Tracks on the peripheral subchannels are not subject to the operating system assignment and release mechanism. Management of these areas can be accomplished directly by user supplied programs or by the File Management Package. Peripheral subchannels to be used by the File Manager can be defined with up to 32,767 tracks.

## Multiple Disc Controllers

The generator assumes a single 13037B/C Multiple Access Controller disc (MAC) or a 12821A Integrated Controller Disc (ICD) interface for purposes of interactive subchannel definition. Therefore, if a system has more than one controller or interface, a table must be constructed before beginning system generation. Refer to Appendix B for multiple disc controller information and assistance in constructing this table. You must include the appropriate disc driver and define an Equipment Table entry and the logical unit numbers for the subchannels defined (described in I/O STRUCTURE planning).

The optional auxiliary subchannel may be placed on a different controller than the system subchannel. The preceding discussion applies in this case with the added requirement that the user specify the number of tracks in the subchannel when the generator inquires about the auxiliary option (refer to Chapter 2 of the On-Line Generator Manual).

## Multiple CPU — 7905/7906/7920/7925 Systems

Multiple CPU operation (associated with only the 13037B/C disc controller) is supported by the SWTCH program, the bootstrap loader, and the DVR32 disc driver. More than one CPU can share one or more disc drives under the following conditions:

- \* System area (LU2 and LU3) for one CPU cannot occupy the same system disc tracks as that of another CPU.
- \* Systems may map tracks in the same peripheral disc area. However, they should share access to these areas only as described in Appendix B under "MULTIPLE CPU - MAC SYSTEM OPERATION".
- \* The File Management System does NOT support multiple CPU operation.

As an aid to using a multiple CPU system, it is recommended that the subchannel definitions be identical for each CPU. Logical unit numbers should not be assigned to subchannels already assigned to another CPU.

## Disc Configuration

Characteristics of the disc drives supported by RTE-IVB are given in Table 3-1. Discussion of each disc type is given in the following sections. Refer to the appropriate section for the disc drive used in your system.

Table 3-1. Compatible Disc Drive Characteristics

| MODEL  | RECORDING SURFACES | TRACKS/SURFACE | DRIVER | WORDS/TRACK |
|--|--------------------|----------------|--------|-------------|
| The following disc drive utilizes the 13210 interface occupying two I/O slots. A maximum of four drives may be connected through a single plug-in controller. Up to 8 subchannels may be defined for this controller.  |                    |                |        |             |
| 7900   | 2                  | 203            | DVR31  | 6144        |
| The following disc drives utilize the 13037B/C MAC controller. Any combination of eight of these drives may be connected to a single controller. The controller is interfaced to the computer through the 13175 interface card occupying one I/O slot. Up to 32 subchannels may be defined for this controller.  |                    |                |        |             |
| 7905   | 3                  | 411            | DVR32  | 6144        |
| 7906   | 4                  | 411            | DVR32  | 6144        |
| 7920   | 5                  | 823            | DVR32  | 6144        |
| 7925   | 9                  | 823            | DVR32  | 8192        |
| Each of the following disc drives contains its own (integrated) controller which is connected to the computer through the 12821A ICD interface card occupying one I/O slot. On a single 12821A interface card, any combination of four of these drives may be connected and up to 32 subchannels may be defined. |                    |                |        |             |
| 9895   | 2                  | 77             | DVA32  | 3840        |
| 7906H  | 4                  | 411            | DVA32  | 6144        |
| 7920H  | 5                  | 823            | DVA32  | 6144        |
| 7925H  | 9                  | 823            | DVA32  | 8192        |

## HP 7900 Disc Configuration

The HP 7900 Disc Drive is a single unit that contains two discs, one permanently mounted, designated as an even subchannel, and the other housed in a removable cartridge, designated as an odd subchannel. Each disc platter is a subchannel and is accessed through a logical unit number that is referenced to the Equipment Table (EQT) entry number of the controller. Therefore, one controller, containing eight subchannels linked to eight logical unit numbers, can control up to eight discs on four drives. See Figure 3-1 for an example of the 7900 Disc Worksheet and fill in the blanks on the worksheet according to the following instructions.

Determine the number of tracks available and the starting track number for each subchannel, and fill in the blanks on the worksheet. Note that the maximum number of tracks available per subchannel for the 7900 disc is 203. The disc ROM loader or the RPL feature using the ROM loader will bootup a system on a 7900 disc only if it starts at physical track 0 on subchannel 0 or 1. Locating the system tracks elsewhere will require that the bootstrap loader optionally produced during generation be used each time the system is booted up.

Determine which subchannel will be the system and which subchannel the auxiliary (if any). Fill in the appropriate blanks on the worksheet.

If the auxiliary subchannel is on a controller different from that for the system subchannel, refer to the MULTIPLE DISC CONTROLLER section previously given in this chapter.

## HP 7905 Disc Configuration

The HP 7905 Disc Drive is a single unit that contains two disc platters, one permanently mounted, and the other housed in a removable cartridge. Each disc platter has two surfaces; however, one surface of the 7905 fixed platter is used for timing purposes and is not available for data recording. Therefore, a single HP 7905 Disc Drive contains 3 surfaces (requiring three heads) and 1,233 tracks in 411 cylinders. Note that a cylinder consists of one track from each surface. For example, cylinder #3 is made up of the fourth track on surface 0, the fourth track on surface 1, and the fourth track on surface 2. See Figure 3-2 for a pictorial diagram of the 7905 disc platter organization.

# System Generation Response Preparation

SUBCHANNEL 1

REMOVABLE

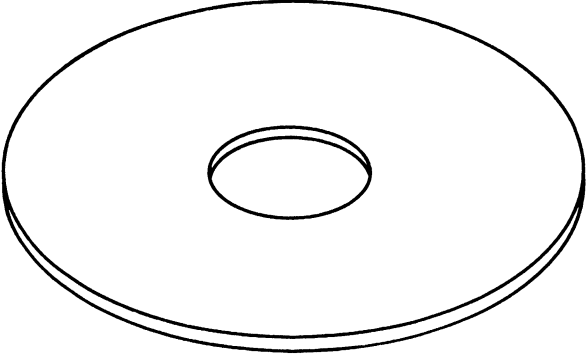

NO. OF TRACKS AVAILABLE 205

FIRST TRACK 0

SUBCHANNEL 0

FIXED

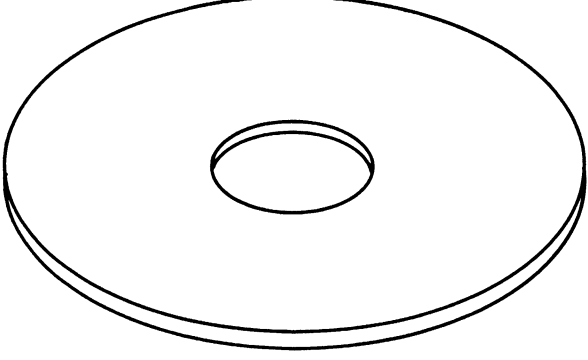

NO. OF TRACKS AVAILABLE 203

FIRST TRACK 0

SYSTEM SUBCHANNEL NUMBER 0 (LOGICAL UNIT 2)

AUXILIARY SUBCHANNEL NUMBER 1 (LOGICAL UNIT 3)

Figure 3-1. HP 7900 Disc Worksheet Example



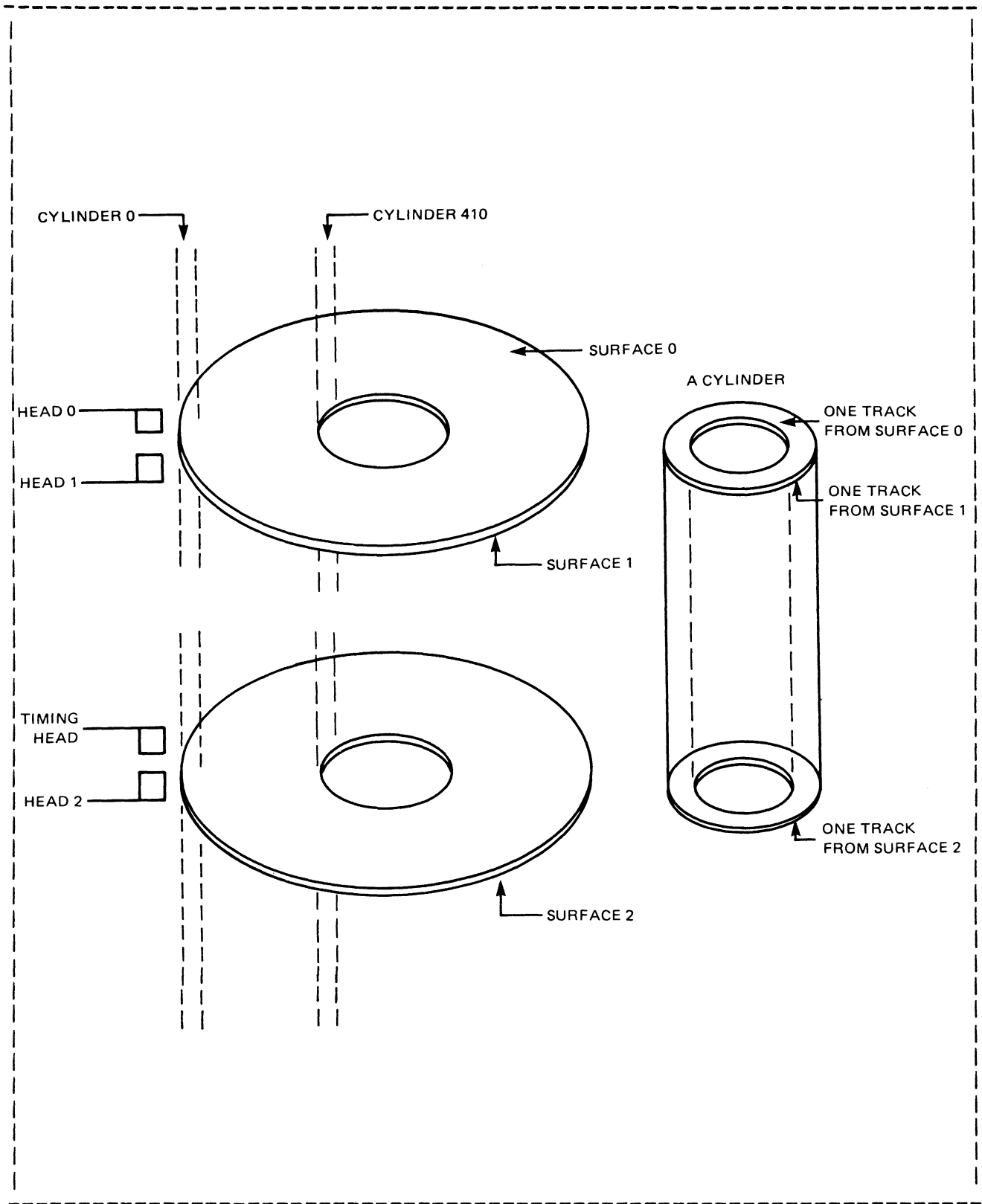

Figure 3-2. HP 7905 Disc

## System Generation Response Preparation

The following discussion provides the criteria for subchannel configuration. Each subchannel consists of a group of contiguous tracks on a single drive. One drive may contain several subchannels, and up to 32 subchannels may be defined for one controller. There is no fixed hardware relationship between a subchannel and a given disc area (as on 7900 discs); it is your responsibility to define these relationships.

The completed disc worksheet describes each subchannel on a drive in the following terms: unit number of the drive, size of the subchannel in number of tracks, starting head and the cylinder numbers, surface organization, number of tracks, and number of spare tracks. In dividing up the HP 7905 disc tracks, bear in mind that the goal is to assign a logical unit number referencing a group of disc tracks.

When filling in the worksheet illustrated in Figure 3-3, there are several important rules and guidelines to remember:

- \* Surface organization. Tracks on a subchannel must be contiguous. Head movement should be kept to a minimum for fastest response time to sequential tracks. This means that track assignment should alternate between surfaces. For example, if track 0 (of the first subchannel) is accessed by head 0 at cylinder 0, and track 1 is accessed by head 1 at cylinder 0, physical head movement (changing cylinders) is kept to a minimum.

If a subchannel includes both fixed and removable platters, flexibility is lost because the absence of either platter invalidates all data on the subchannel. Also, the rotational alignment between two platters depends on drive orientation when the cartridge is inserted. This makes track-to-track access time across platters unpredictable. In fact, it may be better or worse than on one platter, depending on alignment and the time required for software processing between tracks.

If more than one surface is to be used, tracks are cyclically allocated downward and back to the original surface when necessary. For example, a subchannel beginning with head 0 and using two surfaces will use head 0, head 1, and head 0 repeatedly, and in that order. Note that any 7905 subchannel using three surfaces must start on head 0.

## System Generation Response Preparation

- \* Spare tracks. Some tracks on a disc surface may be unusable. When such a track is encountered, another track may be assigned (provided spares are available) in its place by the system transfer program SWTCH or the disc initialization program FORMT. In this case the disc controller will automatically switch to that track on future references. During generation, spare tracks can be assigned to each subchannel for this purpose. When a bad track is encountered during the system transfer or FORMT process (see Chapter 5), a subchannel may draw from its spares. Note that spare tracks are allocated on a subchannel basis and belong only to that subchannel; i.e., one subchannel cannot use spare tracks from another subchannel.

You should plan on about 1,200 usable tracks per drive, dividing the remaining 33 tracks as spares among the subchannels in proportion to their size. Spares immediately follow the main tracks for the associated subchannel and use the same surface organization. Spares are recommended even though they may not be used on a given disc. A subchannel or complete disc might later be copied to another disc where bad tracks are encountered, and all data would not "fit" if the receiving disc did not have sufficient spares.

### NOTE

Spare track assignment occurs only in SWTCH or FORMT and does not occur in the on-line disc driver.

- \* Subchannel size. A subchannel to be used as the system or auxiliary subchannel (LU2 or LU3) must not exceed 256 tracks, excluding spares. A peripheral subchannel may be assigned to be used by the File Management Package may have up to 32,767 tracks.
- \* Subchannel numbering. Subchannels on a given disc controller are numbered sequentially from 0 to 31. Do not skip or duplicate any numbers.
- \* System subchannel. The disc ROM loader will boot a system on a 7905 disc only if it starts at cylinder 0, head 0, 1, or 2 on drive 0. The RPL feature using the disc ROM loader will boot a system only if it starts at cylinder 0, head 0 or 2. Locating the system subchannel elsewhere will require that the bootstrap loader optionally produced during generation be used each time the system is booted up.

Subchannels on the 7905 are defined in a manner directly translatable for input to the generator. Refer to Figure 3-3 and fill in the blanks on the worksheet form according to the following instructions.

HP 7905 DISC WORKSHEET

**STEP 1** FILL IN UNIT NUMBER: 0

**STEP 2** TRACKS ARE SHOWN END-TO-END ON THREE SURFACES. USE PENCIL TO CIRCLE YOUR SUBCHANNELS. WITHIN EACH CIRCLE WRITE THE FOLLOWING INFORMATION: THE SUBCHANNEL NUMBER; THE NUMBERS OF THE STARTING AND ENDING CYLINDERS; THE TOTAL NUMBER OF TRACKS, EXCLUDING SPARES; THE NUMBER OF SPARE TRACKS; AND THE LOGICAL UNIT NUMBER FOR EACH SUBCHANNEL.

| CYLINDER | 0  | 30 | 60 | 90 | 120   | 150 | 180 | 210 | 240   | 270 | 300 | 330 | 360   | 390 | 410 |
|----------|--|----|----|----|---|-----|-----|-----|---|-----|-----|-----|---|-----|-----|
| HEAD 0   | SUBCHANNEL 0<br>START CYL - 0<br>END CYL - 131<br>256 TRACKS<br>8 SPARES<br>LU 2 |    |    |    | SUBCHANNEL 1<br>START CYL - 132<br>END CYL - 235<br>203 TRACKS<br>5 SPARES<br>LU 19 |     |     |     | SUBCHANNEL 2<br>START CYL - 236<br>END CYL - 339<br>203 TRACKS<br>5 SPARES<br>LU 20 |     |     |     | SUBCHANNEL 3<br>START CYL - 340<br>END CYL - 410<br>138 TRACKS<br>4 SPARES<br>LU 21 |     |     |
| HEAD 1   |  |    |    |    |   |     |     |     |   |     |     |     |   |     |     |
| HEAD 2   | SUBCHANNEL 4<br>START CYL - 0<br>END CYL - 410<br>400 TRACKS                     |    |    |    | 11 SPARES<br>LU 22  |     |     |     |   |     |     |     |   |     |     |

**STEP 3** TRANSLATE **STEP 2** TO NUMBERS:

| SUBCHANNEL | # OF TRACKS, EXCLUDING SPARES | STARTING CYLINDER | STARTING HEAD | TOTAL # OF SURFACES INCLUDED IN SUBCHANNEL | NUMBER OF SPARES | SYSTEM? (✓) | AUXILIARY? (✓) |
|------------|-------------------------------|-------------------|---------------|--|------------------|-------------|----------------|
| 0          | 256                           | 0                 | 0             | 2  | 8                | ✓           |                |
| 1          | 203                           | 132               | 0             | 2  | 5                |             |                |
| 2          | 203                           | 236               | 0             | 2  | 5                |             |                |
| 3          | 138                           | 340               | 0             | 2  | 4                |             |                |
| 4          | 400                           | 0                 | 2             | 1  | 11               |             |                |

Figure 3-3. HP 7905 Disc Worksheet Example

## System Generation Response Preparation

### CAUTION

Care must be exercised when defining disc subchannels to avoid including tracks in more than one subchannel. The generator assumes the disc subchannel organization is valid and performs no checks on the definition. Remember that when a subchannel covers more than one surface, the starting head is incremented to determine the surfaces covered by that subchannel. In addition, remember that spares immediately follow each subchannel. To ensure correct subchannel definitions, the second part of the worksheet (see Figure 3-3) must be filled in correctly.

Follow the instructions below for each HP 7905 drive.

STEP 1. A hardware unit number is associated with each drive and is selected by a switch located behind the perforated front panel. Set the switch to the appropriate number and then write the number on the worksheet. No two disc drives should have the same number.

### NOTE

This hardware switch should not be re-positioned while the drive is loaded (i.e., active).

STEP 2. The second part of the worksheet represents the three surfaces of the disc drive and is provided as an aid in dividing the surfaces into subchannels. For example, for subchannel 0, you could allocate 256 tracks for data and 8 tracks for spares, encompassing two surfaces. This makes a total of 264 tracks, which is 132 cylinders. The first cylinder contains the first and second addressable tracks:

- first track = head #0, cylinder #0
- second track = head #1, cylinder #0.

Divide up the surfaces, grouping the tracks into subchannels. Allow approximately 6 spare tracks for each 200 data tracks allocated. The number for the first cylinder of succeeding subchannels is found by adding the number of cylinders used by preceding subchannels. (To count cylinders, add tracks and spares, then divide by the number of surfaces.) In the example above, 132 cylinders were assigned to subchannel 0 (256 tracks plus 8 spares). Therefore the starting cylinder for subchannel 1 could be cylinder 132, head 0 or 1, or cylinder 0, head 2 (for a one-surface subchannel only), depending on how you assign the tracks.

STEP 3. When the third part of the worksheet is filled out, it will provide the answers to all of the questions that the generator will ask about each subchannel. For the most part, the numbers are filled in from Step 2.

## System Generation Response Preparation

Fill in the blanks for all subchannels created in Step 2.

Determine which subchannel will be the system and which subchannel the auxiliary (if any) and check the appropriate boxes.

### HP 7906(H) Disc Configuration

Except where otherwise noted the following sections apply to both 7906 and 7906H.

The HP 7906 Disc Drive is a single unit that contains two disc platters, one permanently mounted, and the other housed in a removable cartridge. Each 7906 disc platter has two surfaces available for data recording. One surface of the fixed disc is also used for timing purposes, but it is still available for data recording. Utilization of that surface by the system disc controller is transparent to the user. Therefore, a single HP 7906 Disc Drive contains 4 surfaces (4 heads), and 411 cylinders, giving 1,644 tracks. Note that a cylinder consists of one track from each surface. For example, cylinder #5 is made up of the sixth track on surface 0, the sixth track on surface 1, the sixth track on surface 2, and the sixth track on surface 3. See Figure 3-4 for a pictorial diagram of the 7906 disc platter organization.

The following discussion provides the criteria for configuring each disc into subchannels. Each subchannel will consist of a group of contiguous tracks on a single drive, and one drive may contain several subchannels. Up to 32 subchannels may be defined for one controller/disc interface. There is no fixed hardware relationship between a subchannel and a given disc area (as on 7900 discs); it is your responsibility to define these relationships.

The completed disc worksheet describes each subchannel on a drive in the following terms: unit number/ICD address number of the drive, size of the subchannel in tracks, starting head and cylinder numbers, surface organization, number of tracks, and number of spare tracks. In dividing up the HP 7906 disc tracks, bear in mind that the goal is to define a logical unit number referencing a group of disc tracks.

When filling in the worksheet illustrated in Figure 3-5 there are several important rules and guidelines to remember:

- \* Surface organization. Tracks on a subchannel must be contiguous. Head movement should be kept to a minimum for fastest response time to sequential tracks. This means that track assignment should alternate between surfaces. For example, if track 0 (of the first subchannel) is accessed by head 0 at cylinder 0, and track 1 is accessed by head 1 at cylinder 0, physical head movement (changing cylinders) is kept to a minimum.

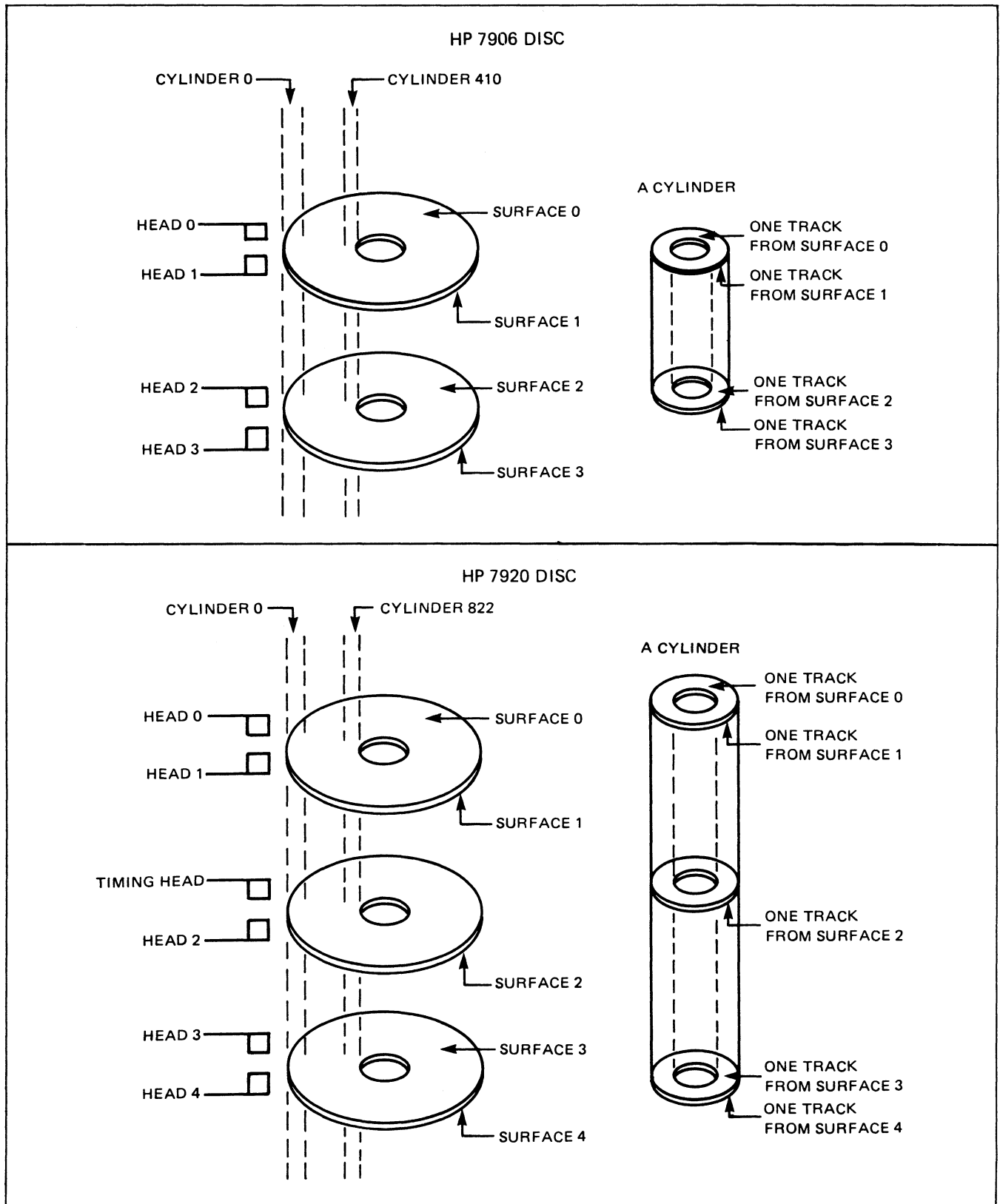

Figure 3-4. HP 7906 and 7920 Discs

## System Generation Response Preparation

If a subchannel includes both fixed and removable platters, flexibility is lost because the absence of either platter invalidates all data on the subchannel. Also, the rotational alignment between two platters depends on drive orientation when the cartridge is inserted. This makes track-to-track access time across platters unpredictable. In fact, it may be better or worse than on one platter, depending on alignment and the time required for software processing between tracks.

If more than one surface is to be used, tracks are cyclically allocated downward and back to the original surface when necessary. For example, a subchannel beginning with head 0 and using two surfaces will use head 0, head 1, and head 0 repeatedly, and in that order. Note that any subchannel using four surfaces must start on head 0; any subchannel using three surfaces must start on head 0 or 1, etc.

- \* Spare tracks. Some tracks on a disc surface may be unusable. When such a track is encountered, it may be replaced by another track (provided that spares are available) by the system transfer program SWTCH or the FORMT utility. In this case, the disc controller will automatically switch to that track on future references. During generation, spare tracks can be assigned to each subchannel for this purpose. When a bad track is encountered during the system transfer or FORMT process, a subchannel may draw from the spares for that subchannel. Note that spare tracks are allocated on a subchannel basis and belong only to that subchannel; i.e., one subchannel cannot use spare tracks from another subchannel.

You should plan on about 1600 usable tracks per drive, dividing the remaining 44 tracks as spares among the subchannels in proportion to their size. Spares immediately follow the main tracks for the associated subchannel and use the same surface organization. Spares are recommended even though they may not be used on a given disc. A subchannel or complete disc might later be copied to another disc where bad tracks are encountered, and all data would not "fit" if the receiving disc did not have sufficient spares.

- \* Subchannel size. A subchannel to be used as the system or auxiliary subchannel (LU2 or LU3) must not exceed 256 tracks, excluding spares.

Similarly, a peripheral subchannel to be used by the File Management Package must not exceed 32,767 tracks, excluding spares.

- \* Subchannel numbering. Subchannels on a given disc controller/interface are numbered sequentially from 0 to 31. Do not skip or duplicate numbers.



## System Generation Response Preparation

- \* System subchannel. The disc ROM loader will boot a system on a 7906 disc only if it starts at cylinder 0, head 0, 1, 2, or 3 on drive 0. The RPL feature using the disc ROM loader will boot a system on a 7906 disc only if it starts at cylinder 0, head 0 or 2. Locating the system subchannel elsewhere will require that the bootstrap loader optionally produced during generation be used each time the system is booted up.

Subchannels on the 7906 are defined in a manner directly translatable for input to the generator. Refer to Figure 3-5 and fill in the blanks on the worksheet forms according to the following instructions.

### CAUTION

Care must be exercised to avoid including tracks in more than one subchannel when defining 7906 subchannels. The generator assumes the disc subchannel organization is valid and performs no checks on the definition. Remember that when a subchannel covers more than one surface, the starting head is incremented to determine the surfaces covered by that subchannel. In addition, remember that spares immediately follow each subchannel. To obtain the correct subchannel definitions, the second part of the worksheet (see Figure 3-5) must be filled in correctly in step 2 below.

Follow the instructions below for each HP 7906 drive.

STEP 1. A hardware unit number is associated with each 7906 drive. An ICD address number is associated with each 7906H drive. Both numbers are selected by a switch located behind the perforated front panel. Set the switch to the appropriate number and then write the number on the worksheet. No two disc drives should have the same number.

### NOTE

This hardware switch should not be repositioned while the drive is loaded (i.e., active).

STEP 2. The second part of the worksheet represents the four surfaces of the disc drive and is provided as an aid in dividing the surfaces into subchannels. For example, for subchannel 0, you could allocate 256 tracks for data and 8 tracks for spares, encompassing two surfaces. This makes a total of 264 tracks, which is 132 cylinders. The first cylinder contains the first and second addressable tracks:

- first track = head #0, cylinder #0
- second track = head #1, cylinder #0.

HP 7906 DISC WORKSHEET

**STEP 1** FILL IN UNIT/ADDRESS NUMBER: 0

**STEP 2** TRACKS ARE SHOWN END-TO-END ON FOUR SURFACES. USE PENCIL TO CIRCLE YOUR SUBCHANNELS. WITHIN EACH CIRCLE WRITE THE FOLLOWING INFORMATION: THE SUBCHANNEL NUMBER; THE NUMBERS OF THE STARTING AND ENDING CYLINDERS; THE TOTAL NUMBER OF TRACKS, EXCLUDING SPARES; THE NUMBER OF SPARE TRACKS; AND THE LOGICAL UNIT NUMBER FOR EACH SUBCHANNEL.

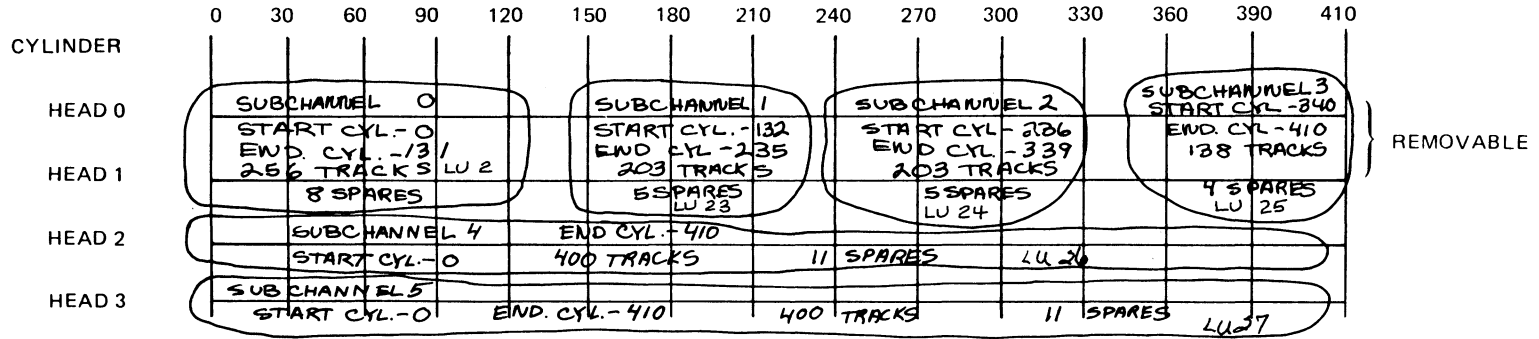

**STEP 3** TRANSLATE **STEP 2** TO NUMBERS:

| SUBCHANNEL | # OF TRACKS, EXCLUDING SPARES | STARTING CYLINDER | STARTING HEAD | TOTAL # OF SURFACES INCLUDED IN SUBCHANNEL | NUMBER OF SPARES | SYSTEM? (✓) | AUXILIARY? (✓) |
|------------|-------------------------------|-------------------|---------------|--|------------------|-------------|----------------|
| 0          | 256                           | 0                 | 0             | 2  | 8                | ✓           |                |
| 1          | 203                           | 132               | 0             | 2  | 5                |             |                |
| 2          | 203                           | 236               | 0             | 2  | 5                |             |                |
| 3          | 138                           | 340               | 0             | 2  | 4                |             |                |
| 4          | 400                           | 0                 | 2             | 1  | 11               |             |                |
| 5          | 400                           | 0                 | 3             | 1  | 11               |             |                |

Figure 3-5. HP 7906 Disc Worksheet Example

Divide up the surfaces, grouping the tracks into subchannels. Allow approximately 6 spare tracks for each 200 data tracks allocated. The number for the first cylinder of succeeding subchannels is found by adding the number of cylinders used by preceding subchannels. (To count cylinders, add tracks and spares, then divide by the number of surfaces.) In the example above, 132 cylinders were assigned to subchannel 0 (256 tracks plus 8 spares). Therefore the starting cylinder for subchannel 1 could be cylinder 132, head 0 or 1, or cylinder 0, head 2 or 3, depending on how you assign the tracks.

STEP 3. When the third part of the worksheet is filled out, it will provide the answers to all of the questions the generator will ask about each subchannel. For the most part, the numbers are filled in from Step 2.

Fill in the blanks for all subchannels created in Step 2.

Determine which subchannel will be the system and which subchannel the auxiliary (if any) and check the appropriate boxes.

## HP 7920(H) Disc Configuration

Except where otherwise noted the following sections apply to both the 7920 and 7920H.

The HP 7920 Disc Drive is a single unit that contains three disc data platters. Each data disc platter on the 7920 has two surfaces; however, one surface of the middle disc platter is used for timing purposes and is not available for data recording. Therefore, a single HP 7920 Disc Drive contains 5 surfaces (5 heads), and 823 cylinders, giving 4,115 tracks. Note that a cylinder consists of one track from each surface. For example, cylinder #7 is made up of the eighth track on surface 0, the eighth track on surface 1, the eighth track on surface 2, the eighth track on surface 3, and the eighth track on surface 4. See Figure 3-4 for a pictorial diagram of the 7920 platter organization.

The following discussion provides the criteria for configuring each disc into subchannels. Each subchannel consists of a group of contiguous tracks on a single drive, and one drive may contain several subchannels. Up to 32 subchannels may be defined on one controller/disc interface. There is no fixed hardware relationship between a subchannel and a given disc area (as on 7900 discs); it is your responsibility to define these relationships.

The completed disc worksheet describes each subchannel on a drive in the following terms: unit number/ICD address number of the drive, size of the subchannel in tracks, starting head and cylinder numbers, surface organization, number of tracks, and number of spare tracks. In dividing up the HP 7920 disc tracks, bear in mind that the goal is to define a logical unit number referencing a group of disc tracks.

## System Generation Response Preparation

When filling in the worksheet illustrated in Figure 3-6, there are several important rules and guidelines to remember:

- \* Surface organization. Tracks on a subchannel must be contiguous. Head movement should be kept to a minimum for fastest response time to sequential tracks. This means that track assignment should alternate between surfaces. For example, if track 0 (of the first subchannel) is accessed by head 0 at cylinder 0, and track 1 is accessed by head 1 at cylinder 0, physical head movement (changing cylinders) is kept to a minimum.

If more than one surface is to be used, tracks are cyclically allocated downward and back to the original surface when necessary. For example, a subchannel beginning with head 0 and using two surfaces will use head 0, head 1, and head 0 repeatedly, and in that order. Note that any subchannel using five surfaces must start on head 0; any subchannel using four surfaces must start on head 0 or 1, etc.

- \* Spare tracks. Some tracks on a disc surface may be unusable. When such a track is encountered, another track may be assigned (provided spares are available) in its place by the system transfer program SWTCH or the FORMT utility, and the disc controller will automatically switch to that track on future references. During generation, spare tracks can be assigned to each subchannel for this purpose. When a bad track is encountered during the system transfer or FORMT process, a subchannel may draw from its spares. Note that spare tracks are allocated on a subchannel basis and belong only to that subchannel; i.e., one subchannel cannot use spare tracks from another subchannel.

You should plan on at least 4,000 usable tracks per drive, dividing the remaining 115 tracks as spares among the subchannels in proportion to their size. Spares immediately follow the main tracks for the associated subchannel and use the same surface organization. Spares are recommended even though they may not be used on a given disc. A subchannel or complete disc might later be copied to another disc where bad tracks are encountered, and all data would not "fit" if the receiving disc did not have sufficient spares.

- \* Subchannel size. A subchannel to be used as the system or auxiliary subchannel (LU2 or LU3) must not exceed 256 tracks, excluding spares. Similarly, a peripheral subchannel to be used by the File Management Package must not exceed 32,767 tracks, excluding spares.
- \* Subchannel numbering. Subchannels on a given disc controller/interface are numbered sequentially from 0 to 31. Do not skip or duplicate any numbers.

## System Generation Response Preparation

- \* System subchannel. The disc ROM loader will boot a system on a 7920 disc only if it starts at cylinder 0, head 0, 1, 2, or 3 on drive 0. The RPL feature using the disc ROM loader will boot a system on a 7920 disc only if it starts at cylinder 0, head 0 or 2. Locating the system subchannel elsewhere will require that the bootstrap loader optionally produced during generation be used each time the system is booted up.

Subchannels on the 7920 are defined in a manner directly usable as input to the generator. Fill in the blanks on the worksheet according to the following instructions. See Figure 3-6 for an example of a 7920 worksheet.

### CAUTION

When defining 7920 subchannels, avoid including tracks in more than one subchannel. The generator assumes the disc subchannel organization is valid and performs no checks on the definition. Remember that when a subchannel covers more than one surface, the starting head is incremented to determine the surfaces covered by that subchannel. In addition, remember that spares immediately follow each subchannel. The second part of the worksheet is designed so that if correctly filled in during Step 2 (given below), the definitions will be correct.

HP 7920 DISC WORKSHEET

**STEP 1** FILL IN UNIT/ADDRESS NUMBER: 0

**STEP 2** TRACKS ARE SHOWN END-TO-END ON FIVE SURFACES. USE PENCIL TO CIRCLE YOUR SUBCHANNELS. WITHIN EACH CIRCLE WRITE THE FOLLOWING INFORMATION: THE SUBCHANNEL NUMBER; THE NUMBERS OF THE STARTING AND ENDING CYLINDERS; THE TOTAL NUMBER OF TRACKS, EXCLUDING SPARES; THE NUMBER OF SPARE TRACKS; THE LOGICAL UNIT NUMBER FOR EACH SUBCHANNEL.

| CYLINDER | 0  | 50 | 100 | 150 | 200  | 250 | 300 | 350 | 400   | 450 | 500 | 550 | 600  | 650 | 700 | 750 | 800 | 822 |
|----------|--|----|-----|-----|--|-----|-----|-----|---|-----|-----|-----|--|-----|-----|-----|-----|-----|
| HEAD 0   | LU 2<br>SUBCHANNEL 0<br>START CYL. - 0<br>END CYL. - 131<br>256 TRACKS<br>8 SPARES   |    |     |     | LU 16<br>SUBCHANNEL 2<br>START CYL. - 132<br>END CYL. - 410<br>542 TRACKS<br>16 SPARES |     |     |     | LU 19<br>SUBCHANNEL 5<br>START CYL. - 411<br>END CYL. - 621<br>1024 TRACKS<br>31 SPARES |     |     |     | LU 20<br>SUBCHANNEL 6<br>START CYL. - 622<br>END CYL. - 822<br>976 TRACKS<br>29 SPARES |     |     |     |     |     |
| HEAD 1   | LU 3<br>SUBCHANNEL 1<br>START CYL. - 0<br>END CYL. - 131<br>256 TRACKS<br>8 SPARES   |    |     |     | LU 17<br>SUBCHANNEL 3<br>START CYL. - 132<br>END CYL. - 410<br>542 TRACKS<br>16 SPARES |     |     |     | LU 19<br>SUBCHANNEL 5<br>START CYL. - 411<br>END CYL. - 621<br>1024 TRACKS<br>31 SPARES |     |     |     | LU 20<br>SUBCHANNEL 6<br>START CYL. - 622<br>END CYL. - 822<br>976 TRACKS<br>29 SPARES |     |     |     |     |     |
| HEAD 2   | LU 3<br>SUBCHANNEL 1<br>START CYL. - 0<br>END CYL. - 131<br>256 TRACKS<br>8 SPARES   |    |     |     | LU 17<br>SUBCHANNEL 3<br>START CYL. - 132<br>END CYL. - 410<br>542 TRACKS<br>16 SPARES |     |     |     | LU 19<br>SUBCHANNEL 5<br>START CYL. - 411<br>END CYL. - 621<br>1024 TRACKS<br>31 SPARES |     |     |     | LU 20<br>SUBCHANNEL 6<br>START CYL. - 622<br>END CYL. - 822<br>976 TRACKS<br>29 SPARES |     |     |     |     |     |
| HEAD 3   | LU 3<br>SUBCHANNEL 1<br>START CYL. - 0<br>END CYL. - 131<br>256 TRACKS<br>8 SPARES   |    |     |     | LU 17<br>SUBCHANNEL 3<br>START CYL. - 132<br>END CYL. - 410<br>542 TRACKS<br>16 SPARES |     |     |     | LU 19<br>SUBCHANNEL 5<br>START CYL. - 411<br>END CYL. - 621<br>1024 TRACKS<br>31 SPARES |     |     |     | LU 20<br>SUBCHANNEL 6<br>START CYL. - 622<br>END CYL. - 822<br>976 TRACKS<br>29 SPARES |     |     |     |     |     |
| HEAD 4   | LU 18<br>SUBCHANNEL 4<br>START CYL. - 0<br>END CYL. - 410<br>400 TRACKS<br>11 SPARES |    |     |     | LU 18<br>SUBCHANNEL 4<br>START CYL. - 0<br>END CYL. - 410<br>400 TRACKS<br>11 SPARES   |     |     |     | LU 19<br>SUBCHANNEL 5<br>START CYL. - 411<br>END CYL. - 621<br>1024 TRACKS<br>31 SPARES |     |     |     | LU 20<br>SUBCHANNEL 6<br>START CYL. - 622<br>END CYL. - 822<br>976 TRACKS<br>29 SPARES |     |     |     |     |     |

Figure 3-6. HP 7920 Disc Worksheet Example

HP 7920 DISC WORKSHEET (Cont.)

**STEP 3**

TRANSLATE **STEP 2** TO NUMBERS:

| SUBCHANNEL | # OF TRACKS, EXCLUDING SPARES | STARTING CYLINDER | STARTING HEAD | TOTAL # OF SURFACES INCLUDED IN SUBCHANNEL | NUMBER OF SPARES | SYSTEM? (✓) | AUXILIARY? (✓) |
|------------|-------------------------------|-------------------|---------------|--|------------------|-------------|----------------|
| 0          | 256                           | 0                 | 0             | 2  | 8                | ✓           |                |
| 1          | 256                           | 0                 | 2             | 2  | 8                |             | ✓              |
| 2          | 542                           | 132               | 0             | 2  | 16               |             |                |
| 3          | 542                           | 132               | 2             | 2  | 16               |             |                |
| 4          | 460                           | 0                 | 4             | 1  | 11               |             |                |
| 5          | 1024                          | 411               | 0             | 5  | 31               |             |                |
| 6          | 976                           | 622               | 0             | 5  | 29               |             |                |

Figure 3-6. HP 7920 Disc Worksheet Example (Cont.)

## System Generation Response Preparation

Follow the instructions given below for each HP 7920 drive.

STEP 1. A hardware unit number is associated with each 7920 drive. An ICD address number is associated with each 7920H drive. Both numbers are selected by a switch located behind the perforated front panel. Set the switch to the appropriate number and then write the number on the worksheet. No two disc drives should have the same number.

### NOTE

This hardware switch should not be repositioned while the drive is loaded (i.e., active).

STEP 2. The second part of the worksheet represents the five surfaces of the disc drive and is provided as an aid in dividing the surfaces into subchannels. For example, for subchannel 0, you could allocate 256 tracks for data and 8 tracks for spares, encompassing two surfaces. This makes a total of 264 tracks, which is 132 cylinders. The first cylinder contains the first and second addressable tracks:

- first track = head #0, cylinder #0
- second track = head #1, cylinder #0.

Divide up the surfaces, grouping the tracks into subchannels. Allow approximately 6 spare tracks for each 200 data tracks allocated. The number for the first cylinder of succeeding subchannels is found by adding the number of cylinders used by preceding subchannels. (To count cylinders, add tracks and spares, then divide by the number of surfaces.) In the example above, 132 cylinders were assigned to subchannel 0 (256 tracks plus 8 spares). Therefore the starting cylinder for subchannel 1 could be cylinder 132, head 0 or 1, or cylinder 0, head 2, 3, or 4, depending on how you assign the tracks.

STEP 3. When the third part of the worksheet is filled out, it will provide the answers to all of the questions the generator will ask about each subchannel. For the most part, the numbers are filled in from Step 2.

Fill in the blanks for all subchannels created in Step 2.

Determine which subchannel will be the system and which subchannel the auxiliary (if any) and check the appropriate boxes.



## HP 7925(H) Disc Configuration

Except where otherwise noted, the following sections apply to both the 7925 and 7925H.

The HP 7925 Disc Drive is a single unit that contains five disc data platters and two platters for media protection only. Each data disc platter on the 7925 has two surfaces; however, one surface is used for timing purposes and is not available for data recording. Therefore, a single HP 7925 Disc Drive contains 9 surfaces (9 heads), and 823 cylinders, giving 7,407 tracks. Note that a cylinder consists of one track from each surface. For example, cylinder #7 would be made up of the eighth track on surface 0, the eighth track on surface 1, the eighth track on surface 2, the eighth track on surface 3, and the eighth track on surfaces 4,5,6,7, and 8. Refer to Figure 3-7 for a pictorial diagram of the 7925 disc platter organization.

The following discussion provides the criteria for configuring each disc into subchannels. Each subchannel consists of a group of contiguous tracks on a single drive. Each drive may contain several subchannels. Up to 32 subchannels may be defined for one controller/disc interface. There is no fixed hardware relationship between a subchannel and a given disc area (as on 7900 discs); it is your responsibility to define these relationships.

The completed disc worksheet describes each subchannel on a drive in the following terms: unit number/ICD address number, size of the subchannel in tracks, starting head and cylinder numbers, surface organization, number of tracks, and number of spare tracks. In dividing up the HP 7925 disc tracks, bear in mind that the goal is to define a logical unit number referencing a group of disc tracks.

When filling in the worksheet illustrated in Figure 3-8, there are several important rules and guidelines to remember:

- \* Surface organization. Tracks on a subchannel must be contiguous. Head movement should be kept to a minimum for fastest response time to sequential tracks. This means that track assignment should alternate between surfaces. For example, if track 0 (of the first subchannel) is accessed by head 0 at cylinder 0, and track 1 is accessed by head 1 at cylinder 0, physical head movement (changing cylinders) is kept to a minimum.

If more than one surface is to be used, tracks are cyclically allocated downward and back to the original surface when necessary. For example, a subchannel beginning with head 0 and using two surfaces will use head 0, head 1, and head 0 repeatedly, and in that order. Note that any subchannel using nine surfaces must start on head 0; any subchannel using eight surfaces must start on head 0 or 1, etc.

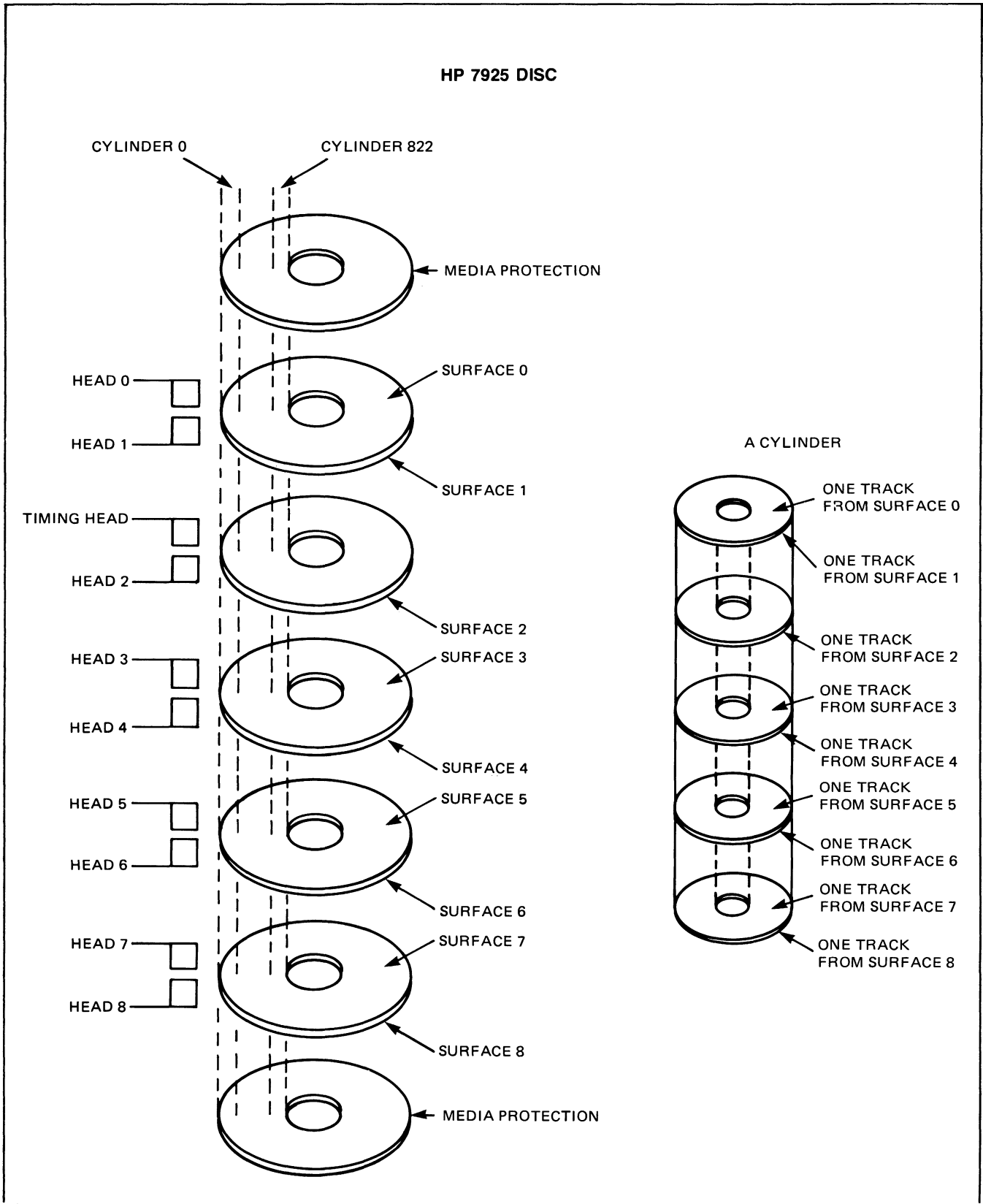

Figure 3-7. HP 7925 Disc

## System Generation Response Preparation

- \* Spare tracks. Some tracks on a disc surface may be unusable. When such a track is encountered, another track may be assigned (provided spares are available) in its place by the system transfer program SWTCH or the FORMT utility. The disc controller will automatically switch to that track on future references. During generation, spare tracks can be assigned to each subchannel for this purpose. When a bad track is encountered during the system transfer or FORMT process, a subchannel may draw from its spares. Note that spare tracks are allocated on a subchannel basis and belong only to that subchannel; i.e., one subchannel cannot use spare track from another subchannel.

You should plan on at least 7,200 usable tracks per drive, dividing the remaining 207 tracks as spares among the subchannels in proportion to their size. Spares immediately follow the main tracks for the associated subchannel and use the same surface organization. Spares are recommended even though they may not be used on a given disc. A subchannel or complete disc might later be copied to another disc where bad tracks are encountered, and all data would not "fit" if the receiving disc did not have sufficient spares.

- \* Subchannel size. A subchannel to be used as the system or auxiliary subchannel (LU2 or LU3) must not exceed 256 tracks, excluding spares. Similarly, a peripheral subchannel to be used by the File Management Package must not exceed 32,767 tracks, excluding spares.
- \* Subchannel numbering. Subchannels on a given disc controller/interface are numbered sequentially from 0 to 31. Do not skip or duplicate any numbers.
- \* System subchannel. The disc ROM loader will boot a system on a 7925 disc only if it starts at cylinder 0, head 0, 1, 2, or 3 on drive 0. The RPL feature using the disc ROM loader will boot a system on a 7925 disc only if it starts at cylinder 0, head 0 or 2. Locating the system subchannel elsewhere will require that the bootstrap loader optionally produced during generation be used each time the system is booted up.

Subchannels on the 7925 are defined in a manner directly translatable for input to the generator. Refer to Figure 3-8 and fill in the blanks on the worksheet form according to the following instructions.



System Generation Response Preparation

STEP 3 TRANSLATE STEP 2 TO NUMBERS:

| SUBCHANNEL | # OF TRACKS, EXCLUDING SPARES | STARTING CYLINDER | STARTING HEAD | TOTAL # OF SURFACES INCLUDED IN SUBCHANNEL | NUMBER OF SPARES | SYSTEM? ( ) | AUXILIARY? ( ) |
|------------|-------------------------------|-------------------|---------------|--|------------------|-------------|----------------|
| 0          | 256                           | 0                 | 0             | 9  | 5                | ✓           |                |
| 1          | 1500                          | 29                | 0             | 9  | 66               |             |                |
| 2          | 193                           | 203               | 0             | 9  | 5                |             |                |
| 3          | 193                           | 225               | 0             | 9  | 5                |             |                |
| 4          | 193                           | 247               | 0             | 9  | 5                |             |                |
| 5          | 193                           | 269               | 0             | 9  | 5                |             |                |
| 6          | 193                           | 291               | 0             | 9  | 5                |             |                |
| 7          | 193                           | 313               | 0             | 9  | 5                |             |                |
| 8          | 193                           | 335               | 0             | 9  | 5                |             |                |
| 9          | 193                           | 357               | 0             | 9  | 5                |             |                |
| 10         | 193                           | 379               | 0             | 9  | 5                |             |                |
| 11         | 193                           | 401               | 0             | 9  | 5                |             |                |
| 12         | 256                           | 423               | 0             | 9  | 5                |             | ✓              |
| 13         | 193                           | 452               | 0             | 9  | 5                |             |                |
| 14         | 193                           | 474               | 0             | 9  | 5                |             |                |
| 15         | 193                           | 496               | 0             | 9  | 5                |             |                |
| 16         | 193                           | 518               | 0             | 9  | 5                |             |                |
| 17         | 193                           | 540               | 0             | 9  | 5                |             |                |

Figure 3-8. HP 7925 Disc Worksheet Example (Cont.)

System Generation Response Preparation

STEP 3 TRANSLATE STEP 2 TO NUMBERS:

| SUBCHANNEL | # OF TRACKS, EXCLUDING SPARES | STARTING CYLINDER | STARTING HEAD | TOTAL # OF SURFACES INCLUDED IN SUBCHANNEL | NUMBER OF SPARES | SYSTEM? ( ) | AUXILIARY? ( ) |
|------------|-------------------------------|-------------------|---------------|--|------------------|-------------|----------------|
| 18         | 193                           | 562               | 0             | 9  | 5                |             |                |
| 19         | 193                           | 584               | 0             | 9  | 5                |             |                |
| 20         | 193                           | 606               | 0             | 9  | 5                |             |                |
| 21         | 193                           | 628               | 0             | 9  | 5                |             |                |
| 22         | 193                           | 650               | 0             | 9  | 5                |             |                |
| 23         | 193                           | 672               | 0             | 9  | 5                |             |                |
| 24         | 96                            | 694               | 0             | 9  | 3                |             |                |
| 25         | 150                           | 705               | 0             | 9  | 3                |             |                |
| 26         | 96                            | 722               | 0             | 9  | 3                |             |                |
| 27         | 96                            | 733               | 0             | 9  | 3                |             |                |
| 28         | 194                           | 744               | 0             | 9  | 4                |             |                |
| 29         | 194                           | 766               | 0             | 9  | 4                |             |                |
| 30         | 194                           | 788               | 0             | 9  | 4                |             |                |
| 31         | 114                           | 810               | 0             | 9  | 3                |             |                |
|            |                               |                   |               |  |                  |             |                |
|            |                               |                   |               |  |                  |             |                |
|            |                               |                   |               |  |                  |             |                |
|            |                               |                   |               |  |                  |             |                |

Figure 3-8. HP 7925 Disc Worksheet Example (Cont.)

## System Generation Response Preparation

### CAUTION

Care must be exercised when defining 7925 subchannels to avoid including tracks in more than one subchannel. The generator assumes the disc subchannel organization is valid and performs no checks on the definition. Remember that when a subchannel covers more than one surface, the starting head is incremented to determine the surfaces covered by that subchannel. In addition, remember that spares immediately follow each subchannel. If the second part of the worksheet (Figure 3-8) is correctly filled in during Step 2 (given below), the definitions will be correct.

Follow the instructions below for each HP 7925 drive.

STEP 1. A hardware unit number is associated with each 7925 drive. An ICD address number is associated with each 7925H drive. Both numbers are selected by a switch located behind the perforated front panel. Set the switch to the appropriate number and then write the number on the worksheet. No two disc drives should have the same number.

### NOTE

This hardware switch should not be repositioned while the drive is loaded (i.e., active).

STEP 2. The second part of the worksheet represents the nine surfaces of the disc drive and is provided as an aid in dividing the surfaces into subchannels. For example, for subchannel 0, you could allocate 244 tracks for data and 8 tracks for spares, encompassing nine surfaces. This makes a total of 252 tracks, which is 28 cylinders. The first cylinder contains the first and second addressable tracks:

```
-- first track      = head #0, cylinder #0
-- second track     = head #1, cylinder #0
-- third track      = head #2, cylinder #0
-- fourth track     = head #3, cylinder #0
      :
      :
      :
-- tenth track      = head #0, cylinder #1
-- eleventh track   = head #1, cylinder #1
      :
      :
      :
```

## System Generation Response Preparation

Divide up the surfaces, grouping the tracks into subchannels. Allow approximately 6 spare tracks for each 200 data tracks allocated. The number for the first cylinder of succeeding subchannels is found by adding the number of cylinders used by preceding subchannels. (To count cylinders, add tracks and spares, then divide by the number of surfaces.) In the example above, 28 cylinders were assigned to subchannel 0 (244 tracks plus 8 spares). Therefore the starting cylinder for subchannel 1 would be cylinder 28.

STEP 3. When the third part of the worksheet is filled out, it will provide the answers to all of the questions the generator will ask about each subchannel. For the most part, the numbers are filled in from Step 2.

Fill in the blanks for all subchannels created in Step 2.

Determine which subchannel will be the system and which subchannel the auxiliary (if any) and check the appropriate boxes.

### HP 9895 Disc Configuration

The HP 9895 Disc unit contains two disc drives. Either single-sided or double-sided flexible discs may be used in the 9895. The drive mechanism determines which type of media is currently loaded in the drive by checking the position of the index hole on the flexible media. Refer to Figure 3-9 for a pictorial diagram of the 9895 platter and unit organization.

Double-sided Operation. Each 9895 double-sided flexible disc has two surfaces available for data recording. Each drive contains 2 heads which may be positioned over 77 cylinders, giving a total of 154 tracks per drive. One subchannel per drive will be defined - with an allocation of 134 tracks per subchannel, leaving 20 extras. This definition is an HP standard and should be used if FMGR compatibility across RTE Systems is desired. The two drives are distinguished by their unit numbers, either 0 or 1, indicating the left or right drive respectively. Figure 3-10 gives the worksheet entries for 9895 discs.

Single-sided Operation. Each 9895 single-sided flexible disc has one surface available for data recording and thus only uses one of the two heads of the 9895 disc drive. The head may be positioned over 77 cylinders, giving 77 tracks per drive. One subchannel per drive will be defined with an allocation of 67 tracks per subchannel leaving 10 extra. This definition is an HP standard and should be used if FMGR compatibility across RTE Systems is desired. The two drives are distinguished by their unit numbers, either 0 or 1, indicating the left or right drive respectively. Figure 3-10 gives the worksheet entries for 9895 discs.



# System Generation Response Preparation

The 9895 discs do not have the sparing capability - instead defective tracks are marked invisible, and the tracks following the defective track are renumbered by the FORMT program.

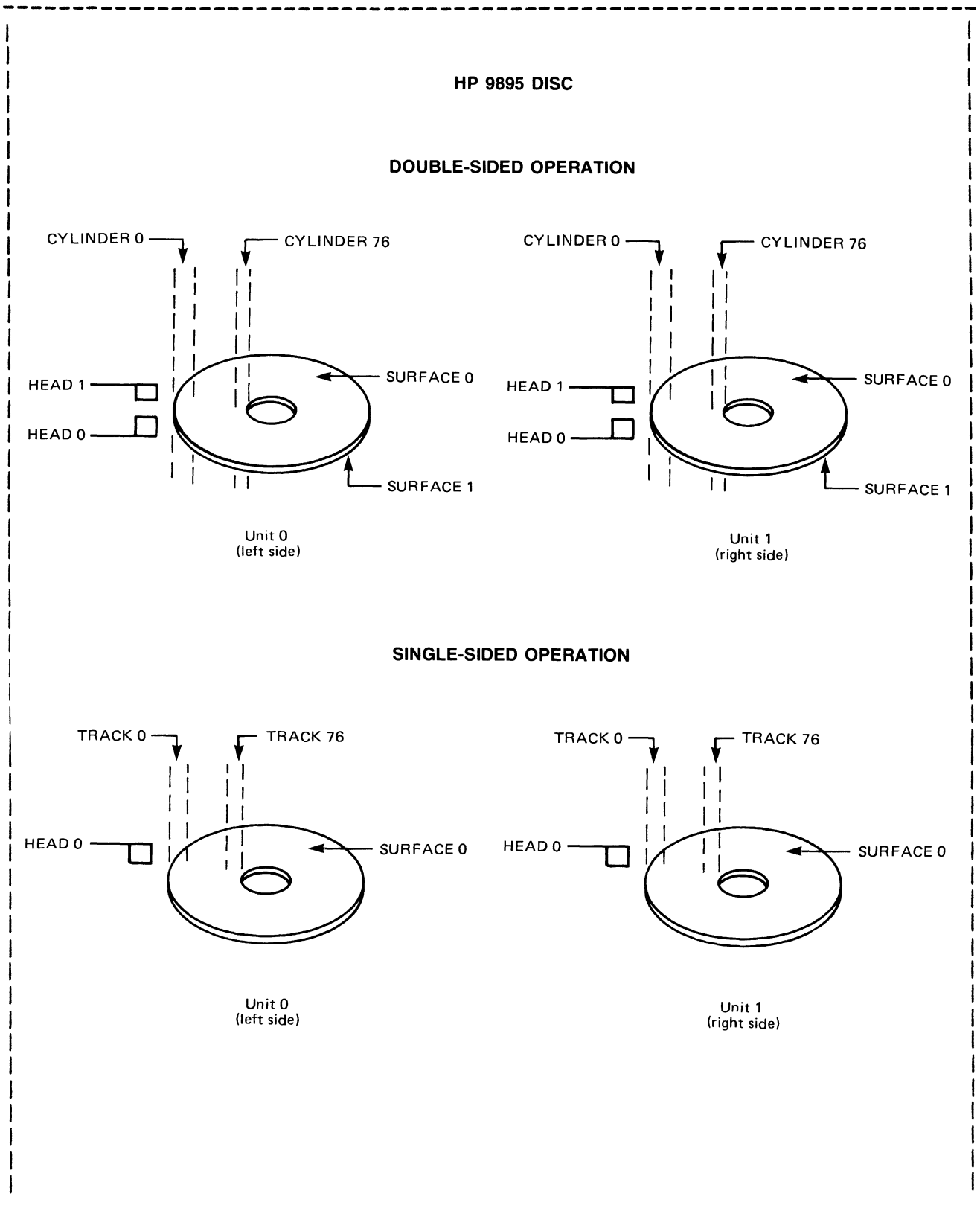

Figure 3-9. HP 9895 Disc.

System Generation Response Preparation

HP 9895 DISC WORKSHEET

STEP 1 FILL IN ICD ADDRESS NUMBER: 1

STEP 2 ONLY ONE SUBCHANNEL PER DRIVE WILL BE DEFINED. THE FOLLOWING DEFINITION IS HP STANDARD DEFINITION FOR 9895 FLEXIBLE DISC

| SUBCHANNEL             | # OF TRACKS, EXCLUDING SPARES | STARTING CYLINDER | STARTING HEAD | TOTAL # OF SURFACES INCLUDED IN SUBCHANNEL | NUMBER OF SPARES | UNIT # |
|------------------------|-------------------------------|-------------------|---------------|--|------------------|--------|
| DOUBLE-SIDED OPERATION |                               |                   |               |  |                  |        |
| 1                      | 134                           | 0                 | 0             | 2  | 20               | 0      |
| 2                      | 134                           | 0                 | 0             | 2  | 20               | 1      |
| SINGLE-SIDED OPERATION |                               |                   |               |  |                  |        |
| 1                      | 67                            | 0                 | 0             | 1  | 10               | 0      |
| 2                      | 67                            | 0                 | 0             | 1  | 10               | 1      |

Figure 3-10. HP 9895 Disc Worksheet.

## I/O Structure Planning

The following sections will aid you in assigning select codes, logical unit (LU) numbers, and equipment table (EQT) entry numbers, for the devices to be included in your system. The I/O configuration worksheet should be filled out during the I/O planning process. The sample worksheet shown in Figure 3-11 should be referred to during each planning phase.

### Device and Interface Cards

Use the INTERFACE and DEVICE NAME columns in the I/O configuration worksheet to list the interface cards and devices in your system. List only interface cards and/or devices to be uniquely referred to by logical unit (LU) numbers in your system. The planning process will be simplified if all devices attached to the same interface card are grouped together. List each interface card only once; leave the INTERFACE column blank for subsequent devices attached to the same card.

A sample list of devices normally assigned logical unit numbers is as follows:

- \* All terminals in the system, including terminals on multipoint or the multiplexer.
- \* All terminal cartridge tape units (CTU) and auxiliary printers connected to terminal drivers offering device support (e.g. DVR05, DVA05).
- \* Every disc subchannel to be accessed by the File Management System or user application programs. Usually all disc subchannels will be assigned logical unit numbers.
- \* All line printers, magnetic tape units, paper tape reader/punches, card readers, plotters, etc. Note that certain peripherals (card readers, 2608 printer) may require more than one LU to implement certain driver control and data conversion functions.
- \* Every communication line including DS/1000 links, DS/3000 link, RJE links and Multipoint control lines.
- \* Devices to be individually accessed by LU numbers or common interface buses (i.e. HP-IB, 2313, 6940, etc). You may also have to assign LU numbers to the interface buses themselves for control.
- \* Interface cards such as the WCS, TV interface.
- \* Custom user devices.

This list is by no means complete. You should refer to the appropriate subsystem manuals and configuration guides for more information.

If spooling is to be included in your system, a "pseudo-device" must exist for each concurrent spool operation. Each spool device should be listed in the worksheet since it will require LU, EQT entry, and Interrupt Table assignments. For an estimate of the number of spool devices to be configured into your system, refer to the section titled "Spooling System" later in this chapter.

If automatic restart after power fail is to be included in your system, the power fail logic is treated as a device. This device should be entered on your worksheet.

Certain interface cards, such as the Time Base Generator (TBG) and privileged fence card, do not require LU and EQT entries. These cards do have to be taken into account however, when planning your overall system select code assignments since each occupies an I/O slot (see below). If you make entries for these cards in your I/O configuration worksheet, it is recommended that a line be drawn through their "LU" and "EQT" columns.

## Select Code Assignments

Every device controller connected to the computer must be plugged in to an I/O slot in the CPU. The operating system accesses device controllers by the address of their I/O slot, or Select Code. Device interrupt service priority is determined by select codes. When two or more device controllers request interrupt servicing concurrently, the controller with the lowest select code will be serviced first. Device controller select codes must be in the range 10 through 77 (octal).

Interface cards should be assigned to select codes according to the speed of interrupt response required by the I/O device. Interface cards for high-speed devices should be assigned higher priority addresses (i.e. lower select codes) than low-speed devices. Devices requiring privileged interrupt are always assigned to the highest priority addresses (a privileged interrupt bypasses normal interrupt processing to achieve faster response for interrupts having the greatest urgency), while devices using DCPC transfers are assigned the lowest priority addresses. The one exception to this rule is in regard to the moving head system disc controller. For the fastest interrupt response, assign the moving head disc controller to the next available I/O slots after the Time Base Generator.

The following detailed steps show how to assign select codes to devices, starting at the highest priority address, octal select code 10. In addition to these steps, make certain that any peripheral devices or subsystems that use multiple I/O slots have their I/O cards together and in the relative order required by that device or subsystem.

- a. Assign all devices that require privileged interrupt in order of decreasing response time requirements (i.e., time from interrupt to service).

## System Generation Response Preparation

- b. After the privileged devices, assign the privileged interrupt I/O card (note that this card is not necessary if no privileged devices exist).
- c. Assign the Time Base Generator (TBG) I/O card.
- d. Assign the moving head disc controller I/O card(s).
- e. Assign all devices that do not use DCPC transfers in order of decreasing interrupt rate.

### NOTE

If a device uses DCPC for data transfers and still generates an interrupt for end-of-record (EOR) processing, the hardware priority of the device should be treated as a non-DCPC device, with the interrupt rate of the EOR condition determining its priority location. Some consideration should be given to the priority of a data transfer versus the priority of a record termination. Data transfers would normally be given priority over EOR interrupts of equivalent or even slightly slower interrupt rates.

- f. Assign all devices that do use DCPC transfers in order of decreasing interrupt rate.
- g. If an I/O extender is required and the extender does not have DCPC transfer capability, the order of steps "e" and "f" can be reversed so that all DCPC devices are in the computer mainframe. If this step is necessary, maintain the same relative order of interrupt rate assignment among the DCPC and non-DCPC devices.
- h. If automatic restart after power fail is to be included in your system, the power fail logic is treated as a device. Assign it select code 4.
- i. If spooling is to be included in your system, an unused select code must be assigned to each spool "pseudo-device". Usually the spool devices are assigned high numbered select codes. It is recommended that you start your select code assignments at 77 and work downwards. For a discussion of the number of spool devices to configure in your system, refer to the "Spooling System" section in this chapter.

Refer to the SELECT CODE column in Figure 3-11 for sample select code assignments.

## Logical Unit Assignments

### a. Standard LU Assignments:

In the LU number column, make standard logical unit assignments (1-6) for appropriate devices. Standard logical unit assignments are as follows:

LU1 System Console

LU2 Primary System Disc Subchannel

LU3 Auxiliary System Disc Subchannel (optional)

LU4 Standard Output Device

LU5 Standard Input Device

LU6 Standard List Device

The auxiliary system disc (LU3) may be generated into your system when additional system scratch tracks or system files are required. The standard output device may be a minicartridge or paper tape punch. The standard input device is usually a minicartridge or paper tape reader. If a magnetic tape unit is to be configured into the system, it is recommended that it be made logical unit 8.

### b. Disc Subchannel Assignments

Beginning with LU7, consecutively assign LU numbers to your peripheral disc subchannels (other than LU2 and LU3). Note: Disc subchannels must be assigned LU numbers less than 64.

### c. Non-Session Accessible Peripheral Assignments

Assign logical unit numbers for those peripherals that must be accessed outside of the session environment. (This will include all peripherals in systems running without the Session Monitor). The power fail device is also in this category. Peripherals to be accessed outside the session environment must be assigned LU numbers less than 64.

#### NOTE

If you are NOT using the Session Monitor, skip steps d and e.

### d. Session Terminal Assignments

Assign logical unit numbers to the keyboard/display subchannel of each session terminal (usually subchannel 0). Session terminal LU numbers must be less than 100.

## System Generation Response Preparation

### e. Session Accessible Peripheral Assignments.

Assign logical unit numbers to the remaining devices in your system. Peripheral devices having LU numbers greater than 63 will only be accessible from the session and batch environments. LU assignments for your spool devices should also be made at this point.

### f. Spare LU assignments.

You may wish to configure spare logical units into the system. Assign these units an EQT entry number of zero (the "bit bucket"). Spare logical unit numbers are used to point to devices not specified during generation (providing their EQT entries and drivers are configured). If the need arises and there are no spare logical unit numbers in the system, you will have to switch another device LU to the new device or regenerate your system with additional logical unit numbers.

It is recommended that you include at least several spare LU numbers in your system. Systems using the Session Monitor may use a total of 254 LU numbers; other systems are restricted to 63.

For sample LU assignments, refer to the LU column in Figure 3-11.

## Equipment Table Entry Assignments

There should be one Equipment Table (EQT) entry, for every device controller (interface card). In cases where multiple devices are attached to the same controller, the same EQT entry number should be assigned to each device.

- a. Assign your primary system disc subchannel (LU2) and all other disc subchannels on that controller to EQT entry #1. If you do not have an auxiliary disc subchannel in your system, it is recommended that you assign LU3 to EQT entry #0 (the bit bucket).
- b. Beginning with EQT entry #2, other DCPC devices should be consecutively assigned EQT numbers in order of their DCPC priority. Devices which rely heavily on the EQT timeout feature for processing (e.g. DS/1000 links and privileged devices) should also be assigned low EQT numbers in order of their processing priority.
- c. Consecutively assign EQT numbers to the remaining devices in your system. (Remember, multiple devices on the same controller will share the same EQT number). You may want to equate EQT numbers assigned with the (lowest) LU number assigned to the controller's device(s). These matching LU and EQT numbers will aid the user in operating the system after it is running (e.g. when "upping" downed devices).

## System Generation Response Preparation

### NOTE

Certain HP subsystems (e.g. Multipoint, Multiplexer, DATACAP/1000) require more than one EQT per controller. Consult the appropriate subsystem manuals and configuration guides for their EQT assignment procedures.

- d. Assign the last (highest numbered) EQT to the power fail device.

You now have enough information to form the basic structure of your system Device Reference Table, Equipment Table, and Interrupt Table. You should refer to the following sections of this manual and appropriate subsystem manuals and configuration guides for table parameter specifications.

Recall that generator inputs for the Device Reference Table (DRT) must be in order of increasing LU number. Inputs for the Equipment Table (EQT) must be in order of increasing EQT entry number. Inputs for the Interrupt Table must be in order of increasing select code. The generator worksheets for the DRT and EQT tables are numbered by LU and EQT entry numbers. The generator Interrupt Table worksheet is unnumbered (since select codes do not have to be contiguous). It is suggested that you fill in your Interrupt Table worksheet with the select codes to be configured into the system before filling out the rest of that worksheet.



System Generation Response Preparation

| INTERFACE | DEVICE                         | SELECT CODE | LU    | EQT |
|-----------|--------------------------------|-------------|-------|-----|
| 12539     | TBG                            | 11          | —     | —   |
| 13037     | 7925 Disc Subchannel 0         | 12          | 2     | 1   |
|           | 7925 Disc Subchannel 1         |             | 10    | 1   |
|           | 7925 Disc Subchannel 2         |             | 11    | 1   |
|           | 7925 Disc Subchannel 3         |             | 12    | 1   |
|           | 7925 Disc Subchannel 4         |             | 13    | 1   |
|           | 7925 Disc Subchannel 5         |             | 14    | 1   |
|           | 7925 Disc Subchannel 6         |             | 15    | 1   |
|           | 7925 Disc Subchannel 7         |             | 16    | 1   |
|           | 7925 Disc Subchannel 8         |             | 17    | 1   |
|           | 7925 Disc Subchannel 9         |             | 18    | 1   |
|           | 7925 Disc Subchannel 10        |             | 19    | 1   |
|           | 7925 Disc Subchannel 11        |             | 3     | 1   |
|           | 7925 Disc Subchannel 12        |             | 20    | 1   |
|           | 7925 Disc Subchannel 13        |             | 21    | 1   |
|           | 7925 Disc Subchannel 14        |             | 22    | 1   |
|           | 7925 Disc Subchannel 15        |             | 23    | 1   |
|           | 7925 Disc Subchannel 16        |             | 24    | 1   |
|           | 7925 Disc Subchannel 17        |             | 25    | 1   |
|           | 7925 Disc Subchannel 18        |             | 26    | 1   |
|           | 7925 Disc Subchannel 19        |             | 27    | 1   |
|           | 7925 Disc Subchannel 20        |             | 28    | 1   |
|           | 7925 Disc Subchannel 21        |             | 29    | 1   |
|           | 7925 Disc Subchannel 22        |             | 30    | 1   |
|           | 7925 Disc Subchannel 23        |             | 31    | 1   |
|           | 7925 Disc Subchannel 24        |             | 32    | 1   |
| 12966     | 2645 System Console            | 15          | 1     | 2   |
|           | 2645 System Left CTU           |             | 4     | 2   |
|           | 2645 System Right CTU          |             | 5     | 2   |
|           | 2631 Line Printer              | 25          | 61    | 18  |
|           | 7970 Magnetic Tape Unit        | 17, 20      | 8     | 8   |
| 12966     | 2645 Terminal #1               | 24          | 62    | 17  |
|           | 2645 Terminal Left CTU         |             | 63    | 17  |
|           | 2645 Terminal Right CTU        |             | 64    | 17  |
| 12966     | 2645 Terminal #2               | 60          | 50    | 19  |
|           | 2645 Terminal Left CTU         |             | 51    | 19  |
|           | 2645 Terminal Right CTU        |             | 52    | 19  |
| 12966     | 2645 Terminal #3               | 61          | 53    | 20  |
|           | 2645 Terminal Left CTU         |             | 54    | 20  |
|           | 2645 Terminal Right CTU        |             | 55    | 20  |
| 12966     | 2648 Terminal #4               | 62          | 56    | 21  |
|           | 2648 Terminal Left CTU         |             | 57    | 21  |
|           | 2648 Terminal Right CTU        |             | 58    | 21  |
| —         | Power Fail                     | 4           | 59    | 22  |
| 59310B    | HP-IB Line Control             | 21          | 41    | 7   |
|           | HP-IB Auto Address Device #1   |             | 42    | 7   |
|           | HP-IB Auto Address Device #2   |             | 43    | 7   |
|           | HP-IB Auto Address Device #3   |             | 44    | 7   |
|           | HP-IB Auto Address Device #4   |             | 45    | 7   |
|           | HP-IB Auto Address Device #5-8 |             | 46-49 | 7   |
|           | Spare LU                       | —           | 33-40 | —   |

Figure 3-11. Sample I/O Configuration Worksheet

This page intentionally left blank.

## Sample Worksheet Conventions

In this manual, the generator inputs are given in the context of the generator worksheets. It is recommended that these worksheets be filled in as you read this Chapter. Worksheet inputs are keyed to the step numbers given in the On-Line Generator Manual. The step numbers may be used to cross reference the generator manual and associated worksheets.

For example:

```
+-----+
| 16c
| *
| *   RTE OPERATING SYSTEM
| *
|   REL  %CR4S1           *OPERATING SYSTEM MODULES PART #1
|   -----,-----
|   --
|   REL  %CR4S2           *OPERATING SYSTEM MODULES PART #2
|   -----,-----
|   --
+-----+
```

The function and syntax of the above input are discussed in step 16c of the generator manual. These inputs would also be added to section 16c of the generator worksheets.

### NOTE

The file names (e.g. %CR4S1) discussed in this chapter refer to relocatable files supplied on the 92068A grandfather disc.

Generator inputs for certain system resources will be shown in the form "(+n)", where "n" is the number of resource units required in addition to those already allocated for other system components.

For example, a subsystem requiring three resource numbers, would be indicated as follows:

```
+-----+
| 27
|
|   # OF RESOURCE NUMBERS?
|   (+3)
|   -----
+-----+
```

You would therefore allocate an additional three resource numbers to the current total. Note that the resource limits indicated in this manual and other configuration documentation will, in general, be a minimum value. The actual numbers should also include resources used by user application programs.

Generation variables are shown in lower case. These must be substituted with the desired values when your worksheets are filled in. For example, if a 7920 disc controller is assigned to EQT entry 1 with a select code of 12, and the worksheet example is:

```
+-----+
| 21
|
|   INTERRUPT TABLE
|
|   sc, EQT, nn   *79XX Disc Controller
|   --  ---  --
+-----+
```

Where: "sc" is the select code of the disc

"nn" is the assigned disc controller  
EQT entry

Your worksheet should be filled as follows:

```
+-----+
| 21
|
|   INTERRUPT TABLE
|
|   12, EQT, 1   *7920 Disc Controller
|   --  ---  --
+-----+
```

## Device Configuration Inputs

The following sections describe the generation inputs required for many common peripherals. This information is organized by driver type. Most drivers supplied with the RTE-IVB 92068A grandfather disc are discussed. For other drivers, consult the appropriate driver manuals, subsystem manuals or configuration guides. A sample device configuration is shown in Figure 3-12.

Table 3-2 correlates peripherals and interface cards with their respective drivers. Note that certain devices may be supported by more than one driver and interface card. In this case, select the driver which supports the interface card in your configuration.

### NOTE

It is recommended that your I/O configuration worksheet be filled in before specific generator device configuration inputs are made. This worksheet will list the interface cards and LU accessible devices in your system, together with their select code, logical unit, and Equipment Table entry assignments.

System Generation Response Preparation

Table 3-2. Peripheral Device Interface Cards and Drivers

| DEVICE<br>-----          | I/F CARD<br>----- | DRIVER<br>----- | MANUAL PART NO.  <br>----- |
|--------------------------|-------------------|-----------------|----------------------------|
| 12556A UNIV. INTERFACE   | 12556A            | DVM72           | 09580-93027                |
| 12566B UNIV. INTERFACE   | 12566B            | DVM72           | 09580-93027                |
| 12566B 40 BIT REGISTER   | 12566B            | DVR54           | 25117-93001                |
| 12604A/B UNIV. INTERFACE | 12604A/B          | DVM72           | 09580-93027                |
| 12604B DATA SOURCE       | 12604B            | DVR40           | 29100-93001                |
| 12661A UNIV. INTERFACE   | 12661A            | DVM72           | 09580-93027                |
| 12665 DS/1000 HARD LINK  | 12665A            | DVA65           | 91740-90003                |
| 12770 COUPLER            | 12665A            | DVR66           | 29003-93003                |
| 12771 SERIAL LINK KIT    | 12665A            | DVR65           | 12665-93001                |
| 12773 DS/1000 MODEM LINK | 12773A            | DVA65           | 91740-90003                |
| 12773 MODEM LINK KIT     | 12773A            | DVR65           | 12773-90001                |
| 12889 DS/3000 LINK       | 12889A            | DVG67           | 91740-90003                |
| 12978/13197 WCS          | 12978A/13197A     | DVR36           | 13197-90001                |
| 2313B A/D CONVERTER      | 2313-60020        | DVR62           | 29009-93001                |
| 2320A DATA ACQUISITION   | 2320A             | DVR76           | 02320-93002                |
| 2321A DATA ACQUISITION   | 2321A             | DVR74           | 02321-93001                |
| 2323A DATA ACQUISITION   | 2323A             | DVR77           | 02323-93001                |
| 2570A/2575A COUPLER      | 12665A            | DVR66           | 29003-93003                |
| 2570A/2575A COUPLER      | 12773A            | DVR66           | 29003-93001                |
| 2600A TERMINAL           | 12531/12880A      | DVR00           | 29029-95001                |
| 2607A LINE PRINTER       | 12845A/12845B     | DVA12           | 92001-90010                |
| 2608A LINE PRINTER       | 26099A            | DVB12           | 92062-90004                |
| 2610A LINE PRINTER       | 12845A/12845B     | DVA12           | 92001-90010                |
| 2613A LINE PRINTER       | 12845B            | DVA12           | 92001-90010                |
| 2614A LINE PRINTER       | 12845A/12845B     | DVA12           | 92001-90010                |
| 2615A TERMINAL           | 12531/12880A      | DVR00           | 29029-95001                |
| 2617A LINE PRINTER       | 12845B            | DVA12           | 92001-90010                |
| 2618A LINE PRINTER       | 12845B            | DVA12           | 92001-90010                |
| 2619A LINE PRINTER       | 12845B            | DVA12           | 92001-90010                |
| 262XA/P TERMINAL         | 12531D/12880A     | DVR00           | 29029-95001                |
| 262XA/P TERMINAL         | 12966A            | DVR05           | 92001-90015                |
| 262XA/P TERMINAL (MODEM) | 12966A-002        | DVA05           | 92001-90015                |
| 2631A LINE PRINTER       | 12531D/12880A     | DVR00           | 29029-95001                |
| 2631A LINE PRINTER       | 12845B            | DVA12           | 92001-90010                |
| 2635A TERMINAL           | 12531D/12880A     | DVR00           | 29029-95001                |
| 2635A TERMINAL           | 12966A            | DVR05           | 92001-90015                |
| 2635A TERMINAL (MODEM)   | 12966A-002        | DVA05           | 92001-90015                |
| 264XA/B TERMINAL         | 12531D/12880A     | DVR00           | 29029-95001                |
| 264XB TERMINAL           | 12966A            | DVR05           | 92001-90015                |
| 264XB TERMINAL (MODEM)   | 12966A-002        | DVA05           | 92001-90015                |
| 2748B PAPER TAPE READER  | 12597             | DVR00           | 29029-95001                |
| 2752A TELEPRINTER        | 12531C            | DVR00           | 29029-95001                |
| 2754A TELEPRINTER        | 12531C            | DVR00           | 29029 95001                |
| 2761A CARD READER        | 12602B            | DVR15           | 12602-90023                |
| 2767A LINE PRINTER       | 12653             | DVR12           | 02767-90007                |
| 2892A CARD READER        | 12924A            | DVR11           | 09600-93010                |
| 2894A CARD READER/PUNCH  | 12930A-003        | DVA15           | 12989-90007                |

## System Generation Response Preparation

Table 3-2. Peripheral Device Interface Cards and Drivers (Cont.)

|                           |                 |       |             |
|---------------------------|-----------------|-------|-------------|
| 2895B PAPER TAPE PUNCH    | 12597           | DVR00 | 29029-95001 |
| 3840D/3845A DVM SCANNER   | 28037           | DVR45 | 91062-93003 |
| 565 CALCOMP PLOTTER       | 12560-6001      | DVR10 | 12560-90023 |
| 59310B HPIB INTERFACE     | 59310B          | DVR37 | 59310-90063 |
| 6129/30/31 VOLTAGE SOURCE | 12661A          | DVR70 | 25117-93005 |
| 6940B/6941B MULTIPROGR.   | 14550A/12665A   | DVA72 | 29100-93003 |
| 7210A PLOTTER             | 17210           | DVR10 | 17210-90004 |
| 7261A CARD READER         | 12986A          | DVR15 | 09601-93014 |
| 7310A THERMAL PRINTER     | 59310B          | DVR37 | 59310-90063 |
| 7900/7901 DISC            | 13210A          | DVR31 | 92067-16466 |
| 7905/06/20/25 MAC DISC    | 13175           | DVR32 | 92067-16330 |
| 7905/06/20/25 MAC DISC #2 | 13175           | DVP32 | 92067-16508 |
| 7906H/20H/25H/9895 DISC   | 12821           | DVA32 | 92063-16553 |
| 7906H/20H/25H/9895 DISC#2 | 12821           | DVC32 | 92067-16506 |
| 7970 9 TRACK MAG TAPE     | 13181A/13183A   | DVR23 | 92202-93001 |
| 91200B TV INTERFACE       | 91200B          | DVA13 | 91200-90005 |
| 91730A MULTIPOINT TERM.   | 12970A          | DVR07 | 91730-90002 |
| 91731A MULTIPLEXER        | 12920B          | DVS00 | 91731-90001 |
| 91780 RJE/1000            | 12618A          | DVR50 | 91780-90006 |
| 92900A SERIAL LINK        | 40280A          | DVA47 | 92900-90005 |
| 93012A METER/SCANNER      | 28037/2116-6123 | DVR47 | 93012-93001 |
| 93500A SCANNER            |                 | DVR66 | 93500-93003 |
| 9885A/M FLOPPY DISC       | 12732A/12733A   | DVR33 | 92067-16467 |
| 9866A THERMAL PRINTER     | 12566           | DVR00 | 29029-95001 |

Note: Not all of the drivers are supported on RTE-IVB. Refer to the Software Numbering Catalog to see if a driver is supported.

### AUTOMATIC OUTPUT BUFFERING

In the following sections, many of the EQT entry definitions will specify the "B" (output buffering) parameter for devices. This parameter is optional but recommended. It will cause the system to buffer output for the device into SAM. This will allow device output operations and program execution to proceed concurrently. It will also allow programs to be swapped out during output operations since buffers will not be in program partitions.

The buffering feature has no effect on input operations. Therefore, it makes no sense to specify it for input-only devices (e.g. card readers). This feature must NOT be enabled for disc devices.

The number and type of buffered devices in your system will affect the amount of SAM required in your system. Refer to the On-Line Generator Manual for SAM generation considerations.

The output buffering feature can be enabled/disabled on line via the system EQ command.

System Generation Response Preparation

TABLE AREA I << PAGE XXXXX >> :

(output by generator  
at start of Table  
Generation Phase)

EQUIPMENT TABLE ENTRY

EQT 01?

11 DVR32 D \_\_\_\_\_

(oct. select code,  
driver [,B] [,D]  
[,S] [,M] [,T = ttttt]  
[,X = xxx])

EQT 02?

12 DVA32 D T=100 \_\_\_\_\_

(do not specify SDA  
for system disc  
driver)

EQT 03?

13 DVA05 B X=13 T=12000 \_\_\_\_\_

(terminate your  
final entry with a /E)

EQT 04?

14 DVA12 B T=300 \_\_\_\_\_

EQT 05?

15 DVR37 B X=50 T=20000 \_\_\_\_\_

EQT 06?

16 DVR23 B D \_\_\_\_\_

EQT 07?

20 DVA05 B X=13 T=12000 \_\_\_\_\_

EQT 08?

21 DVA05 B X=13 T=12000 \_\_\_\_\_

EQT 09?

22 DVA05 B X=13 T=12000 \_\_\_\_\_

EQT 10?

23 DVA05 B X=13 T=12000 \_\_\_\_\_

EQT 11?

24 DVA05 B X=13 T=12000 \_\_\_\_\_

EQT 12?

25 DVA05 B X=13 T=12000 \_\_\_\_\_

EQT 13?

26 DVA05 B X=13 T=12000 \_\_\_\_\_

EQT 14?

70 DVS43 M X=18 \_\_\_\_\_

EQT 15?

71 DVS43 M X=18 \_\_\_\_\_

EQT 16?

72 DVS43 M X=18 \_\_\_\_\_

EQT 17?

73 DVS43 M X=18 \_\_\_\_\_

EQT 18?

74 DVS43 M X=18 \_\_\_\_\_

EQT 19?

75 DVS43 M X=18 \_\_\_\_\_

Figure 3-12. Sample Device Configuration

System Generation Response Preparation

Equipment Table Entry (Continued)

EQT 20?

76 DVS43 M X=18

EQT 21?

77 DVS43 M X=18

EQT 22?

4 DVP43 M

EQT 23?

/E

EQT 24?

EQT 25?

EQT 26?

EQT 27?

EQT 28?

EQT 29?

EQT 30?

EQT 31?

EQT 32?

EQT 33?

EQT 34?

EQT 35?

EQT 36?

EQT 37?

EQT 38?

EQT 39?

Figure 3-12. Sample Device Configuration, continued



# System Generation Response Preparation

| DEVICE REFERENCE TABLE |                                       |
|------------------------|---------------------------------------|
| (system console)       | 001 = EQT # ?<br><u>3</u>             |
|                        | (LU1 = EQT # ?)                       |
| (system disc)          | 002 = EQT # ?<br><u>1</u>             |
| (auxiliary disc)       | 003 = EQT # ?<br><u>1</u> , <u>14</u> |
| (standard output)      | 004 = EQT # ?<br><u>3</u> , <u>1</u>  |
| (standard input)       | 005 = EQT # ?<br><u>3</u> , <u>2</u>  |
| (standard list)        | 006 = EQT # ?<br><u>4</u>             |
|                        | 007 = EQT # ?<br><u>5</u>             |
| (mag. tape)            | 008 = EQT # ?<br><u>6</u>             |
|                        | 009 = EQT # ?<br><u>1</u> , <u>1</u>  |
|                        | 010 = EQT # ?<br><u>1</u> , <u>2</u>  |
|                        | 011 = EQT # ?<br><u>1</u> , <u>3</u>  |
|                        | 012 = EQT # ?<br><u>1</u> , <u>4</u>  |
|                        | 013 = EQT # ?<br><u>1</u> , <u>5</u>  |
|                        | 014 = EQT # ?<br><u>1</u> , <u>6</u>  |
|                        | 015 = EQT # ?<br><u>1</u> , <u>7</u>  |
|                        | 016 = EQT # ?<br><u>1</u> , <u>8</u>  |
|                        | 017 = EQT # ?<br><u>1</u> , <u>9</u>  |
|                        | 018 = EQT # ?<br><u>1</u> , <u>10</u> |
|                        | 019 = EQT # ?<br><u>1</u> , <u>11</u> |
|                        | 020 = EQT # ?<br><u>1</u> , <u>12</u> |

Figure 3-12. Sample Device Configuration, continued

Device Reference Table (Continued)

|                                      |                                      |   |
|--------------------------------------|--------------------------------------|---|
| 021 = EQT #?<br><u>1</u> , <u>13</u> | 041 = EQT #?<br><u>2</u> , <u>3</u>  | 061 = EQT #?<br><u>2</u> , <u>23</u>      |
| 022 = EQT #?<br><u>1</u> , <u>15</u> | 042 = EQT #?<br><u>2</u> , <u>4</u>  | 062 = EQT #?<br><u>2</u> , <u>24</u>      |
| 023 = EQT #?<br><u>1</u> , <u>16</u> | 043 = EQT #?<br><u>2</u> , <u>5</u>  | 063 = EQT #?<br><u>2</u> , <u>25</u>      |
| 024 = EQT #?<br><u>1</u> , <u>17</u> | 044 = EQT #?<br><u>2</u> , <u>6</u>  | 064 = EQT #?<br><u>2</u> , <u>26</u>      |
| 025 = EQT #?<br><u>1</u> , <u>18</u> | 045 = EQT #?<br><u>2</u> , <u>7</u>  | 065 = EQT #?<br><u>2</u> , <u>27</u>      |
| 026 = EQT #?<br><u>1</u> , <u>19</u> | 046 = EQT #?<br><u>2</u> , <u>8</u>  | 066 = EQT #?<br><u>2</u> , <u>28</u>      |
| 027 = EQT #?<br><u>1</u> , <u>20</u> | 047 = EQT #?<br><u>2</u> , <u>9</u>  | 067 = EQT #?<br><u>2</u> , <u>29</u>      |
| 028 = EQT #?<br><u>1</u> , <u>21</u> | 048 = EQT #?<br><u>2</u> , <u>10</u> | 068 = EQT #?<br><u>2</u> , <u>30</u>      |
| 029 = EQT #?<br><u>1</u> , <u>22</u> | 049 = EQT #?<br><u>2</u> , <u>11</u> | 069 = EQT #?<br><u>2</u> , <u>31</u>      |
| 030 = EQT #?<br><u>1</u> , <u>23</u> | 050 = EQT #?<br><u>2</u> , <u>12</u> | 070 = EQT #?<br><u>22</u> , <u>      </u> |
| 031 = EQT #?<br><u>1</u> , <u>24</u> | 051 = EQT #?<br><u>2</u> , <u>13</u> | 071 = EQT #?<br><u>7</u> , <u>      </u>  |
| 032 = EQT #?<br><u>1</u> , <u>25</u> | 052 = EQT #?<br><u>2</u> , <u>14</u> | 072 = EQT #?<br><u>8</u> , <u>      </u>  |
| 033 = EQT #?<br><u>1</u> , <u>26</u> | 053 = EQT #?<br><u>2</u> , <u>15</u> | 073 = EQT #?<br><u>9</u> , <u>      </u>  |
| 034 = EQT #?<br><u>1</u> , <u>27</u> | 054 = EQT #?<br><u>2</u> , <u>16</u> | 074 = EQT #?<br><u>10</u> , <u>      </u> |
| 035 = EQT #?<br><u>1</u> , <u>28</u> | 055 = EQT #?<br><u>2</u> , <u>17</u> | 075 = EQT #?<br><u>11</u> , <u>      </u> |
| 036 = EQT #?<br><u>1</u> , <u>29</u> | 056 = EQT #?<br><u>2</u> , <u>18</u> | 076 = EQT #?<br><u>12</u> , <u>      </u> |
| 037 = EQT #?<br><u>1</u> , <u>30</u> | 057 = EQT #?<br><u>2</u> , <u>19</u> | 077 = EQT #?<br><u>13</u> , <u>      </u> |
| 038 = EQT #?<br><u>1</u> , <u>31</u> | 058 = EQT #?<br><u>2</u> , <u>20</u> | 078 = EQT #?<br><u>7</u> , <u>1</u>       |
| 039 = EQT #?<br><u>2</u> , <u>1</u>  | 059 = EQT #?<br><u>2</u> , <u>21</u> | 079 = EQT #?<br><u>7</u> , <u>2</u>       |
| 040 = EQT #?<br><u>2</u> , <u>2</u>  | 060 = EQT #?<br><u>2</u> , <u>22</u> | 080 = EQT #?<br><u>7</u> , <u>4</u>       |

Figure 3-12. Sample Device Configuration, continued

# System Generation Response Preparation

Device Reference Table (Continued)

|                                       |                                       |                                |
|---------------------------------------|---------------------------------------|--------------------------------|
| 081 = EQT # ?<br><u>8</u> , <u>1</u>  | 101 = EQT # ?<br><u>13</u> , <u>4</u> | 121 = EQT # ?<br>_____ , _____ |
| 082 = EQT # ?<br><u>8</u> , <u>2</u>  | 102 = EQT # ?<br><u>14</u> , _____    | 122 = EQT # ?<br>_____ , _____ |
| 083 = EQT # ?<br><u>8</u> , <u>4</u>  | 103 = EQT # ?<br><u>15</u> , _____    | 123 = EQT # ?<br>_____ , _____ |
| 084 = EQT # ?<br><u>9</u> , <u>1</u>  | 104 = EQT # ?<br><u>16</u> , _____    | 124 = EQT # ?<br>_____ , _____ |
| 085 = EQT # ?<br><u>9</u> , <u>2</u>  | 105 = EQT # ?<br><u>17</u> , _____    | 125 = EQT # ?<br>_____ , _____ |
| 086 = EQT # ?<br><u>9</u> , <u>4</u>  | 106 = EQT # ?<br><u>18</u> , _____    | 126 = EQT # ?<br>_____ , _____ |
| 087 = EQT # ?<br><u>10</u> , <u>1</u> | 107 = EQT # ?<br><u>19</u> , _____    | 127 = EQT # ?<br>_____ , _____ |
| 088 = EQT # ?<br><u>10</u> , <u>2</u> | 108 = EQT # ?<br><u>20</u> , _____    | 128 = EQT # ?<br>_____ , _____ |
| 089 = EQT # ?<br><u>10</u> , <u>4</u> | 109 = EQT # ?<br><u>21</u> , _____    | 129 = EQT # ?<br>_____ , _____ |
| 090 = EQT # ?<br><u>11</u> , <u>1</u> | 110 = EQT # ?<br><u>1E</u> , _____    | 130 = EQT # ?<br>_____ , _____ |
| 091 = EQT # ?<br><u>11</u> , <u>2</u> | 111 = EQT # ?<br>_____ , _____        | 131 = EQT # ?<br>_____ , _____ |
| 092 = EQT # ?<br><u>11</u> , <u>3</u> | 112 = EQT # ?<br>_____ , _____        | 132 = EQT # ?<br>_____ , _____ |
| 093 = EQT # ?<br><u>11</u> , <u>4</u> | 113 = EQT # ?<br>_____ , _____        | 133 = EQT # ?<br>_____ , _____ |
| 094 = EQT # ?<br><u>12</u> , <u>1</u> | 114 = EQT # ?<br>_____ , _____        | 134 = EQT # ?<br>_____ , _____ |
| 095 = EQT # ?<br><u>12</u> , <u>2</u> | 115 = EQT # ?<br>_____ , _____        | 135 = EQT # ?<br>_____ , _____ |
| 096 = EQT # ?<br><u>12</u> , <u>3</u> | 116 = EQT # ?<br>_____ , _____        | 136 = EQT # ?<br>_____ , _____ |
| 097 = EQT # ?<br><u>12</u> , <u>4</u> | 117 = EQT # ?<br>_____ , _____        | 137 = EQT # ?<br>_____ , _____ |
| 098 = EQT # ?<br><u>13</u> , <u>1</u> | 118 = EQT # ?<br>_____ , _____        | 138 = EQT # ?<br>_____ , _____ |
| 099 = EQT # ?<br><u>13</u> , <u>2</u> | 119 = EQT # ?<br>_____ , _____        | 139 = EQT # ?<br>_____ , _____ |
| 100 = EQT # ?<br><u>13</u> , <u>3</u> | 120 = EQT # ?<br>_____ , _____        | 140 = EQT # ?<br>_____ , _____ |

Figure 3-12. Sample Device Configuration, continued

INTERRUPT TABLE

(enter octal select codes in ascending order)

(generator prompt)

(select code, option, destination)

(terminate your final entry with a /E)

|           |            |               |
|-----------|------------|---------------|
| <u>4</u>  | <u>ENT</u> | <u>\$POWR</u> |
| <u>11</u> | <u>EQT</u> | <u>1</u>      |
| <u>12</u> | <u>EQT</u> | <u>2</u>      |
| <u>13</u> | <u>EQT</u> | <u>3</u>      |
| <u>14</u> | <u>EQT</u> | <u>4</u>      |
| <u>15</u> | <u>EQT</u> | <u>5</u>      |
| <u>16</u> | <u>EQT</u> | <u>6</u>      |
| <u>17</u> | <u>EQT</u> | <u>6</u>      |
| <u>20</u> | <u>PRG</u> | <u>PRMPT</u>  |
| <u>21</u> | <u>PRG</u> | <u>PRMPT</u>  |
| <u>22</u> | <u>PRG</u> | <u>PRMPT</u>  |
| <u>23</u> | <u>PRG</u> | <u>PRMPT</u>  |
| <u>24</u> | <u>PRG</u> | <u>PRMPT</u>  |
| <u>25</u> | <u>PRG</u> | <u>PRMPT</u>  |
| <u>26</u> | <u>PRG</u> | <u>PRMPT</u>  |
| <u>70</u> | <u>EQT</u> | <u>13</u>     |
| <u>71</u> | <u>EQT</u> | <u>14</u>     |
| <u>72</u> | <u>EQT</u> | <u>15</u>     |
| <u>73</u> | <u>EQT</u> | <u>16</u>     |

Figure 3-12. Sample Device Configuration, continued

# System Generation Response Preparation

|    |                                    |   |
|----|------------------------------------|---|
| 21 | Interrupt Table (Continued)        | (enter octal select codes in ascending order) |
|    | <u>74</u> , <u>EQT</u> , <u>17</u> | (generator prompt)                            |
|    | <u>75</u> , <u>EQT</u> , <u>18</u> | (select code, option, destination)            |
|    | <u>76</u> , <u>EQT</u> , <u>19</u> |   |
|    | <u>77</u> , <u>EQT</u> , <u>20</u> | (terminate your final entry with a /E)        |
|    | <u>/E</u> , _____ , _____          |   |
|    | - , _____ , _____                  |   |
|    | - , _____ , _____                  |   |
|    | - , _____ , _____                  |   |
|    | - , _____ , _____                  |   |
|    | - , _____ , _____                  |   |
|    | - , _____ , _____                  |   |
|    | - , _____ , _____                  |   |
|    | - , _____ , _____                  |   |
|    | - , _____ , _____                  |   |
|    | - , _____ , _____                  |   |
|    | - , _____ , _____                  |   |
|    | - , _____ , _____                  |   |
|    | - , _____ , _____                  |   |
|    | - , _____ , _____                  |   |

Figure 3-12. Sample Device Configuration, continued

## Terminal Driver DVR00

This terminal driver is available in the following relocatable module:

```
+-----+
| 16c
|
| REL  %DVR00                *Terminal/Reader/Punch Driver
| -----
|  --
+-----+
```

The following information should be generated into the system for each terminal supported by driver DVR00:

```
+-----+
| 19
| EQUIPMENT TABLE ENTRY
|
| EQT nn?
|
| sc  DVR00  T=30000  B          *Terminal EQT
| -----
|
| 20
| DEVICE REFERENCE TABLE
|
| lu = EQT # ?
|
| nn  type                      *Terminal # LU
| -----
|
| 21
| INTERRUPT TABLE
|
|  --
|
| sc  PRG  PRMPT                *Terminal #
| -----
+-----+
```

Where: "nn" is the EQT number assigned to the terminal.

"lu" is the logical unit number assigned to the terminal.

"type" is the device type. For 2615, 262X, 263X, and 264X terminals, type = 1. Otherwise, type = 0.

"sc" is the select code of the terminal interface card.

## System Generation Response Preparation

For the system console (LU1), and all dedicated terminals not to be handled by Session Monitor or MTM, the Interrupt Table entry above should be changed to:

```
+-----+
| 21
|   INTERRUPT TABLE
|
|   sc    EQT    nn          *System Console (dedicated terminal)
|   ---,-----,-----,
+-----+
```

The EQT time-out (T) determines the length of time programs can wait for terminal inputs before the driver issues a zero-length record. If the time-out is set too small, the operator may not have enough time to enter the required response. Long EQT time-outs may unnecessarily tie-up system resources. In the Session Monitor, if no operator input is received during a period of five consecutive system time-outs, the system will automatically log the user off. The recommended T value of 30000 therefore, will allow 25 minutes before automatic log off. The time-out can be increased/decreased by adjusting the T parameter during generation or via the TO command. The value of T should not be less than 500. If the T parameter is omitted, time-outs will not occur on the terminal.

Refer to the DVR00 driver manual (part no. 29029-95001) for more detailed configuration information.

### Paper Tape Reader Driver DVR01

The paper tape photoreader driver is actually a part of driver DVR00. If relocatable %DVR00 is already specified in your worksheets, skip the following step.

```
+-----+
| 16c
|
|   REL    %DVR00 *DVR00/DVR01/DVR02 Driver
|   -----,-----
+-----+
```

## System Generation Response Preparation

The recommended EQT, DRT, and Interrupt Table entries for each photoreader in your system are as follows:

|    |   |
|----|---|
| 20 | EQUIPMENT TABLE ENTRY                                   |
|    | EQT nn?   |
|    | sc    DVR01    T=xxx                    *Photoreader LU |
|    | -----,-----,-----,-----,-----,-----,-----,-----         |
| 21 | DEVICE REFERENCE TABLE                                  |
|    | lu = EQT #?   |
|    | nn        6                            *Photoreader LU  |
|    | -----,-----   |
| 22 | INTERRUPT TABLE   |
|    | -   |
|    | sc    EQT        nn                    *Photoreader     |
|    | -----,-----,-----                                       |

Where: "sc" is the select code of the photoreader interface card.

"lu" is the assigned logical unit.

"nn" is the assigned EQT entry number.

"xxx" is the photoreader timeout value. A value of 300 to 500 (3-5 seconds) is recommended to allow reading of long leaders. You may wish to increase this value to allow the operator a few moments to realize there is no tape motion and ready the device before the timeout period expires (otherwise the system will set the device down).

For more information on photoreader configuration, refer to the Driver DVR00 manual (part 29029-95001).

### Paper Tape Punch Driver DVR02

The paper tape punch driver is actually a part of driver DVR00. If relocatable %DVR00 is already specified in your worksheets, skip the following step.



## System Generation Response Preparation

```
16c
REL    %DVR00    *DVR00/DVR01/DVR02 DRIVER
-----,
```

The recommended EQT, DRT, and Interrupt Table entries for each paper tape punch in your system are as follows:

```
19
EQUIPMENT TABLE ENTRY
EQT nn?
sc    DVR02    B    T=xxx
-----,
```

```
20
DEVICE REFERENCE TABLE
lu = EQT #?
nn    4
-----,
```

```
21
INTERRUPT TABLE
sc    EQT    nn
-----,
```

Where: "sc" is the select code of the punch interface card.

"lu" is the assigned logical unit.

"nn" is the assigned EQT entry number.

"xxx" is the punch time-out value. A minimum value of 500 (5 seconds) is suggested to allow the operator a few moments to ready the device before the time-out period expires (and the system sets the device down).

For more information on punch configuration, refer to the Driver DVR00 manual (part no. 29029-95001).

## System Generation Response Preparation

### Terminal Driver DVR05/DVA05

This driver is available in one of three relocatable modules. One (and ONLY ONE) of these modules should be generated into the system.

If any 26XX terminals will be connected by modem link:

```
+-----+
| 16c                                         |
|      REL      %DVA05                       |
|-----,----- ----- *DVA05 Modem Version |
+-----+
```

Otherwise, if any 26XX terminals have cartridge tape units, (CTUs), auxiliary printers, or graphics, relocate:

```
+-----+
| 17c                                         |
|      REL      %4DV05                       |
|-----,----- ----- *DVR05 Complete Version |
+-----+
```

If you have a 26xx without either of the above, relocate:

```
+-----+
| 16c                                         |
|      REL      %0DV05                       |
|-----,----- ----- *DVR05 Minimum Version |
+-----+
```

## System Generation Response Preparation

The recommended EQT, DRT, and Interrupt Table definitions for each DVR05/DVA05 terminal in your system are as follows:

```
+-----+
| 19    | EQUIPMENT TABLE ENTRY
|       |
| EQT nn?
|
| sc    DVR05    X=13    T=30000    B    *Terminal EQT
|-----|
| 20    | DEVICE REFERENCE TABLE
|       |
| lu = EQT # ?
|
| nn                                *Keyboard Display LU
|-----|
|
| lu = EQT # ?
|
| nn    1                                *Left CTU LU (optional)
|-----|
|
| lu = EQT # ?
|
| nn    2                                *Right CTU LU (optional)
|-----|
|
| lu = EQT # ?
|
| nn    3                                *Graphics LU (optional)
|-----|
|
| lu = EQT # ?
|
| nn    4                                *Auxiliary Printer LU (optional)
|-----|
| 21    | INTERRUPT TABLE
|       |
| sc    PRG    PRMPT
|-----|
|                               *Terminal
+-----+
```

## System Generation Response Preparation

Where: "nn" is the EQT number assigned to the terminal.

"lu" are the logical unit numbers assigned to the terminal and associated peripheral devices. The assignments need not be to contiguous LU's. For LU assignment restrictions, refer to the section titled "LOGICAL UNIT ASSIGNMENTS" earlier in this chapter.

"sc" is the select code assigned to terminal interface card.

For the system console (LU1), and all dedicated application terminals not being handled by Session Monitor or MTM, the Interrupt Table entry above should be changed to:

```
+-----+
| 21      |
|         |
|   INTERRUPT TABLE   |
|         |
|   sc    EQT    nn      *System Console (dedicated terminal) |
|   ---,---,---         |
+-----+
```

In the above inputs, "DVA05" should be substituted for "DVR05" in the EQT definition(s) if relocatable %DVA05 will be generated into the system.

The EQT time-out (T) determines the length of time programs can wait for terminal input before the driver issues a zero length record. If the time-out value is set too small, the operator may not have enough time to enter the required response. Long EQT time-outs may unnecessarily tie-up system resources. In the Session Monitor, if no operator input is received during a period of five consecutive system time-outs, the system will automatically log the user off. The recommended T value of 30000 therefore, will allow 25 minutes before automatic log off. The time-out can be increased/decreased by adjusting the T parameter during generation or via the TO command on line. The value of T should not be less than 500. If the T parameter is omitted, or is set to less than 2000, time-outs will not occur on the terminal.

Refer to the DVR05/DVA05 Driver Manual (part 92001-90015) for more detailed configuration information.

### Card Reader Driver DVR11

The driver for the 2892A card reader is found in the following relocatable module:

System Generation Response Preparation

```

+-----+
| 16c                                         |
|      REL      %DVR11      *2892A Card Reader Driver |
|-----,-----,-----,-----,-----|
+-----+

```

The recommended EQT, DRT, and Interrupt Table entries for each 2892A card reader in your system are as follows:

```

+-----+
| 19                                         |
| EQUIPMENT TABLE ENTRY                   |
|      EQT nn?                               |
|      sc      DVR11      D      T=10      *2892A Card Reader EQT |
|-----,-----,-----,-----,-----|
| 20                                         |
| DEVICE REFERENCE TABLE                 |
|      lu = EQT # ?                           |
|      nn      code                               |
|-----,-----                               |
|                                         *2892A Card Reader LU |
| 21                                         |
| INTERRUPT TABLE                         |
|      sc      EQT      nn                               |
|-----,-----,-----                               |
+-----+

```

Where: "sc" is the select code of the card reader interface card.

"lu" is the assigned logical unit.

"nn" is the assigned EQT entry number.

"code" indicates the code set punched on the cards to be read:

|   |             |  |
|---|-------------|--|
| 0 | EBCDIC      | Punch Set  |
| 1 | BCD         | Punch Set  |
| 2 | EDCDIC-RDTS | Punch Set (91780 remote data transmission system). |

If you will be reading in cards having more than one of these punch sets it is recommended that you configure a separate LU for each type of card to be read. For more information, refer to the DVR11 Driver Manual (Part No. 09600-93010).

## Line Printer Driver DVR12

The 2767A line printer driver is found in the following relocatable module:

```
+-----+
| 16c                                         *
|
|      REL      %DVR12          *2767 Line Printer Driver
|-----,-----
+-----+
```

The recommended EQT, DRT, and Interrupt Table entries for each 2767 line printer in your system are as follows:

```
+-----+
| 19
|  EQUIPMENT TABLE ENTRY
|
|  EQT nn?
|
|  sc    DVR12    B    T=200    *2767 Line Printer EQT
|-----,-----,-----,-----,-----,-----
|
| 20
|  DEVICE REFERENCE TABLE
|
|  lu = EQT # ?
|
|  nn
|-----,-----
|
|  *2767 Line Printer LU
|
| 21
|  INTERRUPT TABLE
|
|  sc    EQT    nn          *2767 Line Printer
|-----,-----,-----
+-----+
```

Where: "sc" is the select code of the line printer interface card.  
"lu" is the assigned logical unit.  
"nn" is the assigned EQT number.

A timeout value of two seconds (T=200) is recommended to accommodate printer top of form operations.

## Line Printer Driver DVA12

This line printer driver is found in the following relocatable module:

```

+-----+
| 16c
|
|      REL      %DVA12              *26XX Line Printer Driver
|-----,-----
+-----+
  
```

The recommended EQT, DRT, and Interrupt Table entries for each line printer in your system using driver DVA12 are as follows:

```

+-----+
| 19
|  EQUIPMENT TABLE ENTRY
|
|  EQT nn?
|
|  sc   DVA12   B   T=xxx           *26XX Line Printer EQT
|-----,-----,-----,-----,-----,-----,-----
|
| 20
|  DEVICE REFERENCE TABLE
|
|  lu = EQT # ?
|
|  nn                               *26XX Line Printer LU
|-----,-----
|
| 21
|  INTERRUPT TABLE
|
|  sc   EQT   nn                       *26XX Line Printer
|-----,-----,-----
+-----+
  
```

Where: "sc" is the select code of the line printer interface card.  
 "lu" is the assigned logical unit.  
 "nn" is the assigned EQT entry number.  
 "xxx" is the line printer time-out value. This should reflect the time it takes the printer to do a top of form operation. This value will depend on the type of line printer. Recommended time-out values are shown below.

## System Generation Response Preparation

|       |          |     |
|-------|----------|-----|
| 2607A | 200 lpm  | 600 |
| 2610A | 200 lpm  | 200 |
| 2613A | 300 lpm  | 120 |
| 2614A | 600 lpm  | 100 |
| 2617A | 600 lpm  | 100 |
| 2618A | 1250 lpm | 100 |
| 2619A | 1000 lpm | 500 |
| 2631A | 180 cps  | 300 |

For more information on DVA12 printer configuration, refer to the DVA12 driver manual (part no. 92001-90010).

### Line Printer Driver DVB12

The 2608A line printer driver is found in the following relocatable module:

```
+-----+
| 16c                                         |
|      REL      %DVB12                       *2608 LINE PRINTER DRIVER |
|-----,-----|
+-----+
```



## System Generation Response Preparation

The recommended EQT, DRT, and Interrupt Table entries for each 2608 line printer in your system are as follows:

|    |   |
|----|---|
| 19 | <p>EQUIPMENT TABLE ENTRY</p> <p>EQT nn?</p> <p>sc    DVB12    B    X=5    *2608 Line Printer EQT</p> <p>-----,-----,-----,-----,-----,-----,-----,</p>  |
| 20 | <p>DEVICE REFERENCE TABLE</p> <p>lu = EQT # ?</p> <p>nn        pwr                    *2608 Line Printer LU</p> <p>-----,-----</p> <p>lup= EQT #</p> <p>nn        3                    *Character Set Read Back LU</p> <p>-----,-----                    (optional)</p> |
| 21 | <p>INTERRUPT TABLE</p> <p>sc    EQT    nn                    *2608 Line Printer</p> <p>-----,-----,-----</p>  |

Where: "sc" is the select code of the line printer interface card.

"lu" is the assigned output logical unit.

"pwr" indicates how the driver is to process power failures. If pwr=0, the driver will, after a power failure, attempt to restore the printer to its previous state (as much as possible) and resume output operations. If pwr=1, the driver will set the printer OFF LINE after a power failure.

"nn" is the assigned EQT number.

"lup" is the assigned read back logical unit. This should be included if you will be using the 92840A graphics package or you will be spooling to the line printer.

Note that the driver automatically handles device timeout functions. Refer to the DVB12 driver manual (part no. 92062-90004) for more details on 2608 configuration.

## TV Interface Driver DVA13

The TV interface driver is found in the following relocatable module.

```
+-----+
| 16c                                         |
|      REL      %DVA13      *91200B TV Interface Driver      |
|-----,-----|
+-----+
```

If you will be using the TV interface library described in the 91200B programming and operating manual part no. 91200-90006, the following relocatable module should be generated into your system.

```
+-----+
| 16c                                         |
|      REL      %TVLIB      *TV Interface Library      |
|-----,-----|
+-----+
```

When your new system is operational, the TV interface may be tested with the TV verifier program (found in relocatable module %TVVER). It is recommended that this program be relocated on-line.

## System Generation Response Preparation

The recommended EQT, DRT, and Interrupt Table entries for each 91200B TV interface in your system are as follows:

|    |   |
|----|---|
| 19 | <p>EQUIPMENT TABLE ENTRY</p> <p>EQT nn?</p> <p>sc    DVA13    D    T=4            *91200B TV Interface EQT</p> <p>-----,-----,-----,-----,-----,-----,-----</p>   |
| 20 | <p>DEVICE REFERENCE TABLE</p> <p>lu = EQT # ?</p> <p>nn                            *91200B TV Interface LU</p> <p>-----,-----</p> <p>lub = EQT # ?</p> <p>nn    2                        *B/W Mode LU (optional)</p> <p>-----,-----</p> |
| 21 | <p>INTERRUPT TABLE</p> <p>sc    EQT    nn                    *91200B TV Interface</p> <p>-----,-----,-----</p>  |

Where: "sc" is the select code of the TV interface card. this will be the single card in a Black and White (B/W) system or the master card (card A, red) of a color system.

"lu" is the assigned logical unit.

"nn" is the assigned EQT entry number.

"lub" is the assigned B/W mode LU. It provides the user with a convenient means of checking the black and white appearance of a color program. This will only be useful in multiple card systems where users desire this capability.

European systems and certain output operations may require a timeout value larger than 40 milliseconds. For more information refer to the DVA13 Driver Manual (part no. 91200-90005).

System Generation Response Preparation

**7261A Card Reader Driver DVR15**

The 7261A card reader driver is contained in the following relocatable module:

```
+-----+
| 16c                                         |
|      REL      %DVR15                      *7261A Card Reader Driver |
|-----,-----|
+-----+
```

The recommended EQT, DRT, and Interrupt Table entries for each 7261A card reader in your system are as follows:

```
+-----+
| 19                                         |
|  EQUIPMENT TABLE ENTRY                  |
|  EQT nn?                                 |
|  sc   DVR15   D   T=10                   *7261A Card Reader EQT |
|-----,-----,-----,-----,-----|
| 20                                         |
|  DEVICE REFERENCE TABLE                |
|  lu = EQT # ?                           |
|  nn   code                                  *7261A Card Reader LU |
|-----,-----|
| 21                                         |
|  INTERRUPT TABLE                       |
|  sc   EQT   nn                            *7261A Card Reader |
|-----,-----,-----|
+-----+
```

- Where: "sc" is the select code of the card reader interface card.
- "lu" is the assigned logical unit.
- "nn" is the assigned EQT entry number.

## System Generation Response Preparation

"code" indicates the code set marked/punched on the cards to be read:

|   |             |  |
|---|-------------|--|
| 0 | EBCDIC      | code set   |
| 1 | BCD         | code set   |
| 2 | EBCDIC-RDTS | code set (91780 remote data transmission system) |

If you will be reading in cards having more than one of these punch sets, it is recommended that you configure a separate LU for each type of card to be read. For more information, refer to the DVR15 Driver Manual (part no. 07261-90010).

### Magnetic Tape Driver DVR23

The 7970, 9 track magnetic tape driver is contained in the following relocatable module:

```
+-----+
| 16c                                         |
|      REL      %DVR23                       *7970 Magnetic Tape Driver |
|-----,-----|
+-----+
```

## System Generation Response Preparation

The recommended EQT, DRT, and Interrupt Table entries for each magnetic tape controller in your system are as follows:

|    |                               |       |      |                                 |
|----|-------------------------------|-------|------|---------------------------------|
| 19 | EQUIPMENT TABLE ENTRY         |       |      |                                 |
|    | EQT nn?                       |       |      |                                 |
|    | sc                            | DVR23 | D B  | *Magnetic Tape Controller EQT   |
|    | -----,-----,-----,-----,----- |       |      |                                 |
| 20 | DEVICE REFERENCE TABLE        |       |      |                                 |
|    | lu = EQT # ?                  |       |      |                                 |
|    | nn                            | unit  |      | *Magnetic Tape Controller       |
|    | ---                           | ----  |      | Unit, LU                        |
|    | .                             |       |      |                                 |
|    | .                             |       |      |                                 |
|    | .                             |       |      |                                 |
| 21 | INTERRUPT TABLE               |       |      |                                 |
|    | sc                            | EQT   | nn   | *Magnetic Tape Controller       |
|    | ---                           | ----- | ---- | Lower s.c.                      |
|    | sc+1                          | EQT   | nn   | *Magnetic Tape Controller Upper |
|    | ---                           | ----- | ---- | s.c.                            |

Where: "sc" is the select code of the lower magnetic tape interface card. ("sc+1" is the select code of the upper card).

"lu" is the assigned logical unit. There should be a logical unit configured in your system for each magnetic tape unit.

"unit" is the magnetic tape unit number (ranging from 0 to 3).

"nn" is the assigned controller EQT entry number.

If a device timeout is specified for magnetic tape units you must allow sufficient time to handle the longest file/records in search operations (e.g. forward space files, records, backspace files, etc.). For this reason a timeout may not be desirable on magnetic tape. For more information on magnetic tape configuration, refer to the DVR23 Driver Manual (part no. 92202-93001).

### Disc Driver DVR31

The 7900/7901 disc driver is contained in the following relocatable module:

```

+-----+
| 16c                                         |
|                                           |
|      REL      %DVR31                      *7900 Disc Driver |
|-----,-----|
+-----+
  
```

The recommended EQT, DRT, and Interrupt Table entries for the disc controller are as follows:

```

+-----+
| 19                                         |
| EQUIPMENT TABLE ENTRY                   |
|                                           |
| EQT nn?                                  |
|                                           |
| sc   DVR31   D                           *7900 Disc EQT   |
|-----,-----,-----,-----,-----,-----|
|                                           |
| 20                                         |
| DEVICE REFERENCE TABLE                 |
|                                           |
| lu = EQT # ?                             |
|                                           |
| nn   sub                               *7900 Disc Subchannel |
|-----,-----|
|      :                                   :                   |
|      :                                   :                   |
|                                           |
| 21                                         |
| INTERRUPT TABLE ENTRY                   |
|                                           |
| sc   EQT   nn                             |
|-----,-----,-----|
|                                           |
| sc+1 EQT   nn                             *7900 Disc Controller |
|-----,-----,-----|
+-----+
  
```

Where: "sc" is the select code of the lower disc controller interface card. ("sc+1" is the select code of the upper card).

## System Generation Response Preparation

- "lu" is an assigned disc subchannel (platter) logical unit. A logical unit must be configured into your system for each subchannel, or the corresponding disc space will be inaccessible. The subchannel definitions should be determined from the 7900 disc worksheet filled out earlier in this chapter.
- "sub" is a disc subchannel number, in the range of 0 through 7.
- "nn" is the assigned disc controller EQT entry number. The system disc controller should be assigned EQT entry #1.

### NOTE

If the 7900 disc controller does not contain the system subchannel, the user is responsible for building the disc controllers track map table (\$TB31) and generating it into the system. Refer to Appendix B ("REAL TIME DISC USAGE").



### Disc Driver DVR32

The driver for the 13037B/C Multiple Access Controller (MAC) discs (7905/06/20/25) is contained in the following relocatable module:

```

+-----+
| 16c                                         |
|                                           |
|      REL      %DVR32                      *79XX Disc Driver |
|-----,-----|
+-----+
  
```

The recommended EQT, DRT, and Interrupt Table entries for the disc controller are:

```

+-----+
| 19                                         |
| EQUIPMENT TABLE ENTRY                   |
| EQT nn?                                  |
| sc   DVR32   D                           *13037B/C Disc Controller EQT. |
|-----,-----,-----,-----,-----,-----|
| 20                                         |
| DEVICE REFERENCE TABLE                 |
| lu = EQT # ?                             |
| nn   sub                                   *79XX Disc Subchannel |
|-----,-----|
|      .                                     . |
|      .                                     . |
|      .                                     . |
| 21                                         |
| INTERRUPT TABLE                       |
| sc   EQT   nn                           *13037B/C Disc Controller |
|-----,-----,-----|
+-----+
  
```

Where "sc" is the select code of the disc.

"lu" is an assigned disc subchannel logical unit. A logical unit must be configured into your system for each subchannel, or the corresponding disc space will be inaccessible. The subchannel definitions and number should be determined from the disc worksheets filled out earlier in this chapter.

## System Generation Response Preparation

"sub" is the disc subchannel number. It must be in the range 0 through 31.

"nn" is the assigned disc controller EQT entry number. The system disc controller should be assigned EQT entry #1.

### NOTE

RT4GN will always build one track map table for all discs on the same controller as the system subchannel. When the 13037B/C is being used with peripheral disc subchannels (non-system) it is the user's responsibility to build the appropriate track map table (\$TB32) and generate it into the system.

Likewise, if a multiple 13037B/C configuration is desired, the user must include in the generation a track map table and a renamed version of DVR32 for each disc controller that does not contain the system subchannel. HP supplies one renamed version of the driver (DVP32) which may be generated into the system along with the correct Track Map Table (\$TP32). Include entries in the Equipment Table, Device Reference Table, and Interrupt Table for the second controller. Refer to Appendix B ("REAL TIME DISC USAGE") for additional details.

Multiple Controller operation will allow an I/O operation to be active on each controller at the same time, thus providing greater throughput in systems that make intensive use of disc I/O.

For more information on DVR32 configuration, refer to the DVR32/DVA32 Driver Manual (part number 92068-90012).

## Disc Driver DVA32

The driver for the 12821A ICD discs (7906H, 7920H, 7925H, and 9395) is contained in the following relocatable module:

```

+-----+
| 16c                                         |
|                                             |
|      REL      %DVA32                      *79xxH Disc Driver |
|-----,-----|
+-----+
  
```

### NOTE

See the DVA32/DVR32 Driver Manual (part number 92068-90012) for additional information concerning the correct timeout value for your system. If a timeout is not specified, the default value of 2 seconds will be assumed by DVA32.

The recommended EQT, DRT, and Interrupt Table entries for the disc controller are:

```

+-----+
| 19                                         |
| EQUIPMENT TABLE ENTRY                   |
| EQT nn?                                   |
| sc   DVA32   D   T=100                   *12821A Disc Interface EQT. |
|-----,-----,-----,-----,-----,-----|
| 20                                         |
| DEVICE REFERENCE TABLE                  |
| lu = EQT # ?                             |
| nn   sub                                       *79xxH Disc Subchannel |
|-----,-----|
|      .                                       . |
|      .                                       . |
|      .                                       . |
| 21                                         |
| INTERRUPT TABLE                         |
| sc   EQT   nn                               *12821A Disc Interface |
|-----,-----,-----|
+-----+
  
```

## System Generation Response Preparation

Where: "sc" is the select code of the disc.

"lu" is an assigned disc subchannel logical unit. A logical unit must be configured into your system for each subchannel, or the corresponding disc space will be inaccessible. The subchannel definitions and number should be determined from the disc worksheets filled out earlier in this chapter.

"sub" is the disc subchannel number. It must be in the range 0 through 31.

"nn" is the assigned disc controller EQT entry number. The system disc controller should be assigned EQT entry #1.

### NOTE

RT4GN will always build one track map table for all discs on the same 12821A interface card as the system disc. When the 12821A is being used with peripheral (non-system) disc subchannels, it is the user's responsibility to build the appropriate track map table (\$TA32) and generate it into the system.

Likewise, if multiple 12821A cards are to be used, the user must supply a track map table and a renamed version of DVA32 for each additional card that does not contain the system subchannel. HP supplies one renamed version of the driver (DVC32) which may be generated into the system along with the correct Track Map Table (\$TC32). Include entries in the Equipment Table, Device Reference Table, and Interrupt Table for additional interface cards. Refer to Appendix B ("REALTIME DISC USAGE") for additional details.

Multiple ICD interface cards will allow an I/O operation to be active on each card at the same time, thus providing greater throughput in systems that make intensive use of disc I/O.

## Disc Driver DVR33

The 9885 M/S flexible disc driver is contained in the following relocatable module:

```
+-----+
| 16c                                         |
|      REL      %DVR33                       *9885 Flexible Disc Driver      |
|-----,-----,-----|
+-----+
```

## System Generation Response Preparation

The recommended EQT, DRT, and Interrupt Table entries for each flexible disc controller in your system are as follows:

|    |                        |       |       |                           |            |
|----|------------------------|-------|-------|---------------------------|------------|
| 19 | EQUIPMENT TABLE ENTRY  |       |       |                           |            |
|    | EQT nn?                |       |       |                           |            |
|    | sc                     | DVR33 | D     | *Flexible Disc Controller | EQT        |
|    | ----                   | ----- | ----- | -----                     | -----      |
| 20 | DEVICE REFERENCE TABLE |       |       |                           |            |
|    | lu = EQT # ?           |       |       |                           |            |
|    | nn                     | unit  |       | *Flexible Disc Unit       |            |
|    | ----                   | ----- |       |                           |            |
| 21 | INTERRUPT TABLE        |       |       |                           |            |
|    | sc                     | EQT   | nn    | *Flexible Disc Controller | Lower s.c. |
|    | ----                   | ----- | ----- |                           |            |
|    | sc+1                   | EQT   | nn    | *Flexible Disc Controller | Upper s.c. |
|    | ----                   | ----- | ----- |                           |            |

where: "sc" is the select code of the lower interface card. ("sc+1" is the select code of the upper card).

"lu" is the assigned logical unit. There should be a logical unit configured into your system for each disc unit.

"unit" is the disc unit number. This will be the unit number of the master/slave drive according to the drive number set on the rear of the device. Each drive is set to a different number from 0 to 3.

"nn" is the assigned controller EQT entry number.

The device timeout is automatically set by the driver. For more information, refer to the DVR33 driver manual (part no. 12732-90001).

## HP-IB Interface Driver DVR37

The HP-IB driver is supplied in two versions. The two drivers are identical except that one provides service request (SRQ) capability and the other does not. SRQ service is desirable if you will need to activate application programs or BASIC programs on HP-IB device interrupts. The HP-IB driver with SRQ capability is contained in the following relocatable module:

```
+-----+
| 16c
|
|      REL      %2DV37      *HPIB Driver With SRQ
|-----,-----
+-----+
```

Otherwise, if SRQ capability is not desired, relocate the following driver (under no circumstances do you relocate both):

```
+-----+
| 16c
|
|      REL      %1DV37      *HPIB Driver Without SRQ
|-----,-----
+-----+
```

The HP-IB utility subroutine and message library are found in the following relocatable module:

```
+-----+
| 16c
|
|      REL      %IB4A *HPIB Utility Routine and Message Library
|-----,-----
+-----+
```

System Generation Response Preparation

If you have BASIC in your system, and have included the HP-IB driver with SRQ capability, and wish to handle HP-IB interrupts in BASIC; then enter the following inputs:

```
+-----+
| 16c                                         |
|      REL      %SRQ.P      *SRQ/TRAP Program for BASIC |
|-----,-----|
|      REL      %BAMLB      *BASIC Memory Resident Library |
|-----,-----|
| 17                                         |
| PARAMETERS                               |
|      TTYEV     17      *Memory Resident W/SSGA |
|-----,-----|
|      TRAP     30      *Put in SSGA |
|-----,-----|
+-----+
```

## System Generation Response Preparation

The recommended EQT, DRT, and Interrupt Table entries for each HP-IB controller in your system are:

|    |                        |       |       |       |                       |
|----|------------------------|-------|-------|-------|-----------------------|
| 19 | EQUIPMENT TABLE ENTRY  |       |       |       |                       |
|    | EQT nn?                |       |       |       |                       |
|    | sc                     | DVR37 | T=xxx | X=yy  | *HPIB Controller EQT  |
|    | ----                   | ----- | ----- | ----- | -----                 |
| 20 | DEVICE REFERENCE TABLE |       |       |       |                       |
|    | lu = EQT # ?           |       |       |       |                       |
|    | nn                     | 0     |       |       | *HPIB Line Control LU |
|    | ----                   | ----- |       |       |                       |
|    | lud = EQT #            |       |       |       |                       |
|    | nn                     | unit  |       |       | *HPIB Device Unit     |
|    | ----                   | ----- |       |       |                       |
|    | .                      |       |       |       | .                     |
|    | :                      |       |       |       | :                     |
|    | .                      |       |       |       | .                     |
| 21 | INTERRUPT TABLE        |       |       |       |                       |
|    | sc                     | EQT   | nn    |       | *HPIB Controller      |
|    | ----                   | ----- | ----- |       |                       |

Where: "sc" is the select code of the HP-IB interface card

"lu" is the assigned line control logical unit.

"lud"s are the assigned auto addressing logical units for devices. Devices not assigned on auto addressing LU must be addressed through the line control LU. You should configure a logical unit in your system for each device to be auto-addressed. It is suggested that you configure spare lu's in your system to handle additional devices added at a later date.

"unit" is the hardware address of the device. It must be in the range 1 through 31.

"nn" is the assigned EQT entry number for the interface card.



"xxx" is the maximum device timeout for the slowest device on the bus.

"yy" is the size of the EQT extension. Calculate the number of extension words required as follows:

$$7 * (\# \text{ auto-addressable devices on bus}) + 18$$

Be sure to include enough extension words to allow for adding devices to the system at a later date. Since the maximum number of devices on a bus is 31, the largest EQT extension size is 255 words.

The recommendations above are "cookbook" in nature. Refer to the DVR37 driver manual (part no. 59310-90063) for a more detailed discussion of HP-IB configuration.

## Software Components and Resource Requirements

The following sections discuss the software modules, resources, and generation parameters required for the following components:

- \* RTE Operating System
- \* Firmware Configuration
- \* File Management System
- \* Spooling System
- \* Libraries
- \* Utilities
- \* Session Monitor
- \* Multi-Terminal Monitor

### Operating System

The RTE-IVB Operating System is contained in the following relocatable modules:

```

+-----+
| 16c   |
| *     |
| * RTE OPERATING SYSTEM |
| *     |
| REL   %CR4S1          *Operating System Modules Part #1 |
| -----,----- |
| --    |
| REL   %CR4S2          *Operating System Modules Part #2 |
| -----,----- |
| --    |
| REL   %$CNFX          *Configurator Extension |
| -----,----- |
| --    |
+-----+
    
```

## Firmware Configuration

In 21MX M,E, and F-series computers there are many subroutines implemented in firmware. The system must be told what subroutines are implemented in firmware and their instruction opcode equivalents. In all RTE-IVB systems the following subroutines are implemented in firmware:

|   |                                  |        |       |           |
|---|----------------------------------|--------|-------|-----------|
| 18  | CHANGE ENTS?                     |        |       |           |
| *   | EAU And HFP Firmware Equivalents |        |       |           |
| *   |                                  |        |       |           |
| *   |                                  |        |       |           |
| .MPY  | RP                               | 100200 | IFIX  | RP 105100 |
| ---   | ---                              | ---    | ---   | ---       |
| .DIV  | RP                               | 100400 | FLOAT | RP 105120 |
| ---   | ---                              | ---    | ---   | ---       |
| .DLD  | RP                               | 104200 | .MVW  | RP 105777 |
| ---   | ---                              | ---    | ---   | ---       |
| .DST  | RP                               | 104400 | .CMW  | RP 105776 |
| ---   | ---                              | ---    | ---   | ---       |
| .FAD  | RP                               | 105000 | .LBT  | RP 105763 |
| ---   | ---                              | ---    | ---   | ---       |
| .FSB  | RP                               | 105020 | .MBT  | RP 105765 |
| ---   | ---                              | ---    | ---   | ---       |
| .FMP  | RP                               | 105040 | .SBT  | RP 105764 |
| ---   | ---                              | ---    | ---   | ---       |
| .FDV  | RP                               | 105060 | CLRIO | RP 2001   |
| ---   | ---                              | ---    | ---   | ---       |
| Z\$DBL  | RP                               | 3      | .CBT  | RP 105766 |
| ---   | ---                              | ---    | ---   | ---       |
| *Z\$DBL used by FTN4 Compiler (1901 or later)   |                                  |        |       |           |
| If it contains 3, then double precision values will be 3 words. If it contains 4, then double precision values will be 4 words. |                                  |        |       |           |

## System Generation Response Preparation

In HP 1000 E and F Series Computers, the EMA Subroutines are implemented in firmware:

```
+-----+
| 18      CHANGE ENTS?
|
| *      EMA Firmware Equivalents
| *
| *
| .EMAP   RP   105257
|-----,-----,-----
| --
|
| .EMIO   RP   105240
|-----,-----,-----
| --
|
| MMAP    RP   105241
|-----,-----,-----
+-----+
```

System Generation Response Preparation

In HP 1000 M and E Series computers with the Fast Fortran Option (FFP) the following subroutines are implemented in firmware:

| 18 CHANGES ENTS?           |    |           |                       |
|----------------------------|----|-----------|-----------------------|
| * FFP Firmware Equivalents |    |           |                       |
| *                          |    |           |                       |
| DBLE                       | RP | 105201    | .FLUN RP 105226       |
| --                         |    |           | --                    |
| SNGL                       | RP | 105202    | \$.SETP RP 105227 *** |
| --                         |    |           | --                    |
| .XMPY                      | RP | 105203    | .PACK RP 105230       |
| --                         |    |           | --                    |
| .XDIV                      | RP | 105204    | .XFER RP 105220       |
| --                         |    |           | --                    |
| .DFER                      | RP | 105205    | .XPAK RP 105206       |
| --                         |    |           | --                    |
| .XADD                      | RP | 105213    | XADD RP 105207        |
| --                         |    |           | --                    |
| .XSUB                      | RP | 105214    | XSUB RP 105210        |
| --                         |    |           | --                    |
| .GOTO                      | RP | 105221    | XMPY RP 105211        |
| --                         |    |           | --                    |
| .MAP                       | RP | 105222    | XDIV RP 105212        |
| --                         |    |           | --                    |
| .ENTR                      | RP | 105223    | .XCOM RP 105215       |
| --                         |    |           | --                    |
| .ENTP                      | RP | 105224    | .DCM RP 105216        |
| --                         |    |           | --                    |
| .PWR2                      | RP | 105225    | DDINT RP 105217       |
| --                         |    |           | --                    |
| .CFER                      | RP | 105231 ** |                       |
| --                         |    |           |                       |

\*\* Not in M-Series and also E-Series manufactured before 1978.

\*\*\* Replaces .SETP.

System Generation Response Preparation

In HP 1000 F-Series Computers, the following subroutines are implemented in firmware.

```
18 CHANGE ENTS?  
* F-SERIES  
* SCIENTIFIC INSTRUCTION SET (SIS)  
*
```

```
TAN RP 105320  
-----
```

```
SQRT RP 105321  
-----
```

```
ALOG RP 105322  
-----
```

```
ATAN RP 105323  
-----
```

```
COS RP 105324  
-----
```

```
SIN RP 105325  
-----
```

```
EXP RP 105326  
-----
```

```
ALOGT RP 105327  
-----
```

```
TANH RP 105330  
-----
```

```
DPOLY RP 105331**  
-----
```

```
/CMRT RP 105332**  
-----
```

```
/ATLG RP 105333**  
-----
```

```
.FPWR RP 105334**  
-----
```

```
.TPWR RP 105335**  
-----
```

\*\* These instructions are included in SIS firmware part nos. 12823-80007 thru 12823-80012 or 12823-800xx where xx is greater than 12.

-----CONTINUED NEXT PAGE-----

System Generation Response Preparation

-----CONTINUED-----

\* F-SERIES  
\* FAST FORTRAN (FFP)  
\*

--  
DBLE RP 105201  
-----  
--  
SNGL RP 105202  
-----  
--  
.DFER RP 105205  
-----  
--  
.XPAK RP 105206  
-----  
--  
.BLE RP 105207\*\*  
-----  
--  
.NGL RP 105214\*\*  
-----  
--  
.XCOM RP 105215  
-----  
--  
..DCM RP 105216  
-----  
--  
DDINT RP 105217  
-----  
--  
.XFER RP 105220  
-----  
--  
.GOTO RP 105221  
-----  
--  
..MAP RP 105222  
-----  
--  
.ENTR RP 105223  
-----  
--  
.ENTP RP 105224  
-----  
--  
.PWR2 RP 105225  
-----  
--

\*\* These instructions  
are included in FFP  
firmware part nos.  
5090-1615 thru  
5090-1623 or  
5090-16xx where xx  
is greater than 23.

-----CONTINUED NEXT PAGE-----

System Generation Response Preparation

```
+-----CONTINUED-----+
|.FLUN RP      105226
|-----,-----,-----,-----
|--
|$.SETP RP     105227
|-----,-----,-----,-----
|--
|.PACK RP      105230
|-----,-----,-----,-----
|--
|.CFER RP      105231
|-----,-----,-----,-----
|--
|..FCM RP      105232**
|-----,-----,-----,-----
|--
|..TCM RP      105233**
|-----,-----,-----,-----
|--
|* F-SERIES
|* HFPP - Two Word
|*
|.FAD  RP      105000
|-----,-----,-----,-----
|--
|.FSB  RP      105020
|-----,-----,-----,-----
|--
|.FMP  RP      105040
|-----,-----,-----,-----
|--
|.FDV  RP      105060
|-----,-----,-----,-----
|--
|IFIX  RP      105100
|-----,-----,-----,-----
|--
|.FIXD RP      105104
|-----,-----,-----,-----
|--
|FLOAT RP      105120
|-----,-----,-----,-----
|--
|.FLTD RP      105124
|-----,-----,-----,-----
|--
+-----CONTINUED NEXT PAGE-----+
```

\*\* These instructions are included in FFP firmware part nos. 5090-1615 thru 5090-1623 or 5090-16xx where xx is greater than 23.

System Generation Response Preparation

```
+-----CONTINUED-----+
*
* HFPP-Three Word
*
.XADD  RP      105001
-----,-----,-----,-----
--
.XSUB  RP      105021
-----,-----,-----,-----
--
.XMPY  RP      105041
-----,-----,-----,-----
--
.XDIV  RP      105061
-----,-----,-----,-----
--
.XFXS  RP      105101
-----,-----,-----,-----
--
.DINT  RP      105101
-----,-----,-----,-----
--
.XFXD  RP      105105
-----,-----,-----,-----
--
.XFTS  RP      105121
-----,-----,-----,-----
--
.IDBL  RP      105121
-----,-----,-----,-----
--
.XFTD  RP      105125
-----,-----,-----,-----
--
+-----CONTINUED NEXT PAGE-----+
```



System Generation Response Preparation

```
+-----CONTINUED-----+
*
* HFPP Four Word
*
.TADD RP 105002
-----
.TSUB RP 105022
-----
.TMPY RP 105042
-----
.TDIV RP 105062
-----
.TFXS RP 105102
-----
.TINT RP 105102
-----
.TFXD RP 105106
-----
.TFTS RP 105122
-----
.ITBL RP 105122
-----
.TFTD RP 105126
-----
+-----+

```

## System Generation Response Preparation

For F-series computers with FFP firmware, part numbers 5090-1615 thru 5090-1623 or 5090-16xx (where xx is greater than 23), the following firmware equivalents should be generated in your system:

```
+-----+
| 18      CHANGE ENTS?
| *
| *      DOUBLE WORD INTEGER
| *
|
| .DAD   RP   105014
| -----,-----,-----,-----
| --
| .DSB   RP   105034
| -----,-----,-----,-----
| --
| .DMP   RP   105054
| -----,-----,-----,-----
| --
| .DDI   RP   105074
| -----,-----,-----,-----
| --
| .DSBR  RP   105114
| -----,-----,-----,-----
| --
| .DDIR  RP   105134
| -----,-----,-----,-----
| --
| .DNG   RP   105203
| -----,-----,-----,-----
| --
| .DIN   RP   105210
| -----,-----,-----,-----
| --
| .DDE   RP   105211
| -----,-----,-----,-----
| --
| .DIS   RP   105212
| -----,-----,-----,-----
| --
| .DDS   RP   105213
| -----,-----,-----,-----
| --
| .DCO   RP   105204
| -----,-----,-----,-----
| --
+-----+
```

System Generation Response Preparation

For F-series processors with the Vector Instruction Set (VIS) option, the following firmware equivalents should be generated into your system:

```
+-----+
| 18
|  CHANGE ENTS?
|  *
|  *
|  *
|  .VECT  RP  101460
|  -----,-----,-----,-----
|  --
|  VPIV   RP  101461
|  -----,-----,-----,-----
|  --
|  VABS   RP  101462
|  -----,-----,-----,-----
|  --
|  VSUM   RP  101463
|  -----,-----,-----,-----
|  --
|  VNRM   RP  101464
|  -----,-----,-----,-----
|  --
|  VDOT   RP  101465
|  -----,-----,-----,-----
|  --
|  VMAX   RP  101466
|  -----,-----,-----,-----
|  --
|  VMAB   RP  101467
|  -----,-----,-----,-----
|  --
|  VMIN   RP  101470
|  -----,-----,-----,-----
|  --
|  VMIB   RP  101471
|  -----,-----,-----,-----
|  --
|  VMOV   RP  101472
|  -----,-----,-----,-----
|  --
|  VSWP   RP  101473
|  -----,-----,-----,-----
|  --
|  .ERES  RP  101474
|  -----,-----,-----,-----
|  --
|  .ESEG  RP  101475
|  -----,-----,-----,-----
|  --
|-----CONTINUED NEXT PAGE-----
```



## System Generation Response Preparation

The firmware interface routines for the Vector Instruction Set (VIS) option are contained in the following relocatable file on minicartridge. Optionally, \$VLIB2 (Software equivalent) can be used if the VIS Firmware is not installed. Either \$VLIB1 or \$VLIB2 can be relocated but not both.

```
+-----+
| 16c
|   *
|   *  VIS
|   *
|   REL    $VLIB1          *Vector Instruction Set Firmware
|   -----,----- Interface Routines (#12824-12001)
| or
|   REL    $VLIB2          *Software Equivalents for VIS
|   -----,----- Firmware (12824-12002)
+-----+
```

### Power Fail/Auto Restart

If you desire power fail/auto restart capability for your system, enter the following inputs:

```
+-----+
| 16c
| REL    %4DP43          *Power Fail Driver
| -----,-----
|
| REL    %4AUTR          *Restart Utility
| -----,-----
|
| 19
| EQUIPMENT TABLE ENTRY
|
| EQT nn?
|
| 4     DVP43    M          *Power Fail EQT Entry
| -----,-----,-----,-----,-----,-----
|
| 20
| DEVICE REFERENCE TABLE
|
| lu = EQT # ?
|
| nn
| -----,-----          *Power Fail LU
|
| 21
| INTERRUPT TABLE
|
| 4     ENT    $POWR          *Power Fail
| -----,-----
+-----+
```

## System Generation Response Preparation

Where: "lu" is the assigned logical unit.

"nn" is the assigned EQT entry. The power fail EQT should be the last EQT entry assigned.

The power fail restart utility, AUTOR, is responsible for re-enabling terminals and outputting messages indicating the time of the failure. Additional user specified functions can be performed after restart by modifying the AUTOR source file: %4AUTR and reloading the utility.

## File Management System

The File Management system is contained in the following relocatable modules:

```
+-----+
| 16c
| *
| * FILE MANAGEMENT SYSTEM PROGRAMS
| *
| REL %BMPG1
| -----,-----
| --
| REL %BMPG2
| -----,-----
| --
| REL %BMPG3
| -----,-----
| --
| -----,-----
+-----+
```

The File Management system consists of the following components:

FMGR--FMGR provides the interactive interface between the user and the file system. In multi-terminal environments a copy of FMGR will normally be provided for each user. The System Manager should allocate two long blank ID segments for every terminal on the system. In addition a resource number should be allocated to FMGR and each copy to permit LU locks.

System Generation Response Preparation

```
+-----+
| 27      # OF RESOURCE NUMBERS?
|          (+nn+1)
|          -----
|
| 29      # OF BLANK ID SEGMENTS?          ("long" ID segments)
|          (+nn*2)
|          -----
+-----+
```

Where "nn" is the number of Session or MTM terminals configured into the system.

FMP LIBRARY -- The FMP library consists of a set of subroutines that are appended to user programs which access File Management system disc files. These subroutines are stored (in relocatable form) on disc in the system library area.

D.RTR -- D.RTR is the system file directory manager. D.RTR is called upon by all copies of File Manager and programs accessing the file system. It is responsible for mounting cartridges, manipulating file directories, and allocating additional file space when files overflow their extents. Since it is used by so many modules, D.RTR should be assigned a high priority relative to other programs in the system. D.RTR is defaulted as a real-time disc resident program with a priority of 1. In systems with a great deal of file activity, you may want to insure that D.RTR is always memory resident. This will eliminate any potential time required to swap D.RTR into main memory from disc. One of two methods may be used to insure that D.RTR is memory resident. First, D.RTR may be generated as a memory resident program:

```
+-----+
| 17      PARAMETERS
|
|      D.RTR 1          *D.RTR Memory Resident
|      -----,-----,-----,-----
+-----+
```

If there are many programs to be generated memory resident in your system, D.RTR (which requires 10 pages) may not fit in the memory resident program area. An alternative procedure is to assign it to a partition and reserve that partition for D.RTR's exclusive use:

# System Generation Response Preparation

```
+-----+
| 34      DEFINE PARTITIONS:
|
|      PART nn?
|
|      10      RT      R      *D.RTR's Partition
|      -----,-----,-----
|              :
| 36      ASSIGN PROGRAM PARTITIONS?
|      --
|      D.RTR  nn
|      -----,-----
+-----+
```

Where "nn" is the partition assigned to D.RTR.

The first of the above two methods is preferred as it is a more efficient use of memory (although it will permanently use 10 pages).

User Alterable D.RTR Directory Track Buffer--The buffer for directory reads is in the HP supplied source file &D.BUF. The initial size of the buffer is 6144 words (one full 7905/06/20 track). The lower buffer limit is 512 words. No more than one full disc track can be read at a time, but D.RTR does not do any upper limit checks. If the buffer supplied for D.RTR is less than 512 words, FMGR-105 error will be given each time D.RTR is scheduled.

In order to modify the buffer size, alter the value of the constant D.LEN within D.BUF. Re-assemble &D.BUF and then either merge %D.BUF and %BMPG2 with the MERGE utility before generating or generate %D.BUF separately.

The System Manager may, at his option, protect the peripheral disc subchannels from alteration by user EXEC calls. Use of this feature will force usage of the file management system when modifying peripheral discs. It will also prevent use of the on-line COPY and RSTOR utilities on peripheral cartridges. Due to this constraint, this feature is NOT recommended for most systems:

```
+-----+
| 18      CHANGE ENTS?
|
|      $PDSK    AB    1
|      -----,-----,-----      *Protect Peripheral Discs
+-----+
```



## Spooling System

The spooling system operates in conjunction with the File Management system to automatically provide spool capability within batch jobs or sessions. In addition, the spooling system allows programmatic control of spooling operations via SMP calls.

It is recommended that spooling be included in your system if:

1. Users will have access to common system peripherals (i.e., line printers). The spool system will synchronize access to selected peripherals when accessed from different sessions and batch jobs.
2. Peripheral device EXEC I/O calls (to selected LU's) must be diverted to/from disc. The spool system will divert output (input) operations destined for peripheral devices to FMP disc files.
3. Users will tie up peripherals for long periods of time, though with minimal use.
4. Allow tasks (i.e., compiling, listing, etc.) to complete rapidly and return to user rather than waiting for I/O completion.
5. Perform tasks first and then have output occur at low-activity period (lunch, evenings, etc.).
6. Allow batch jobs to be processed.
7. Restart and perhaps re-direct output of a task if output was lost or partly destroyed due to device failure without restarting the task.

If you decide to include spooling in your system, the following modules (in addition to the File Management System modules described in the previous section) must be included in your generation:

```

+-----+
| 16c    |
| *      |
| * Spooling System |
| *      |
| REL  %SPO1B      *Spooling Modules Part #1 |
| -----,----- |
| --      |
| REL  %SPO2B      *Spooling Modules Part #2 |
| -----,----- |
+-----+

```

A brief description of the major components in the spooling system is given below. For a detailed description of the operation of the spooling system and these modules refer to the RTE-IVB Batch and Spooling Reference Manual.

## System Generation Response Preparation

- JOB Spooling of Batch Jobs is initiated by running program JOB. This program controls the phase known as in spooling.
- SMP SMP monitors the spooling process including maintaining the spool directory, assigning outspool files, and monitoring the output spooling program, SPOUT.
- SPOUT SPOUT takes the output from the outspool files and directs the output to the actual devices.
- GASP GASP is an interactive utility which is used to initialize the spool system and control the inspool and outspool processes with operator commands.
- DVS43 DVS43 is a system driver which reroutes standard EXEC I/O calls into spool files.
- SP.CL SP.CL is a spool communication area which resides in Table Area II.

The spool monitor programs have the default priority and program types shown in Table 3-3.

Table 3-3. Spool Monitor Programs

| PROGRAM | PRIORITY | SIZE *<br>(Pages) | PROGRAM TYPE                  |
|---------|----------|-------------------|-------------------------------|
| JOB     | 30       | 6                 | 130 (REAL TIME DISC RESIDENT) |
| GASP    | 30       | 10                | 3 (BACKGROUND DISC RESIDENT)  |
| SMP     | 30       | 6                 | 130 (REAL TIME DISC RESIDENT) |
| EXTND   | 10       | 2                 | 129 (MEMORY RESIDENT)         |
| SPOUT   | 11       | 3                 | 1 (MEMORY RESIDENT)           |
| DVS43   | --       | --                | 0 (SYSTEM MODULE)             |
| SP.CL   | --       | --                | 13 (TABLE AREA II MODULE)     |

\* SIZE includes base page.

Generally, optimal performance is provided by using these default values. For some programs, the program type code may be changed during generation if the rules stated below are observed.

JOB may be any disc resident type as long as it does not compete for the same partition as FMGR. If both JOB and FMGR are disc resident there should be enough partitions to avoid competition.

For best performance, SMP should be left real time disc resident. SMP must not be made memory resident.

SPOUT is normally memory resident. If SPOUT cannot be memory resident (due to space limitations), you can insure that SPOUT will reside in memory at all times by assigning it to a partition and reserving that partition exclusively for SPOUT:

```

+-----+
| 34
|
|   DEFINE PARTITIONS:
|
|   PART nn?
|
|   3   BG   R   *Spout's Partition
|   ---,-----,-----
|
| 36
|
|   ASSIGN PROGRAM PARTITIONS?
|
|   SPOUT nn
|   -----,-----
+-----+

```

Where "nn" is the partition to be reserved.

CAUTION

If both SPOUT and D.RTR are real-time (or background) disc resident programs, you should have at least 2 real-time (or background) partitions defined. If both programs must contend for the same partition, a deadlock situation may occur when SPOUT needs to create an extent for a spool file.

I/O Configuration -- In RTE-IVB you must have a spool "pseudo-device" generated into your system for every concurrent spool operation. Each spool operation requires one LU and one EQT. The number of spool LU numbers and EQT entries generated in your system should depend on the amount of anticipated spool system usage.

Estimate the number of spool LU numbers and EQT entries needed for your system with the following in mind:

- \* In the session environment each user may set up several spools. Each SL spool command uses ONE spool LU. If the NOW attribute is specified, TWO spool LU numbers are used.
- \* A Batch job normally uses TWO spool LU numbers plus the number used for any SL commands. One spool LU is used for LU5 and one is used for LU6. If NO is specified as an option on the job statement, two spool LU's are used for LU6.

## System Generation Response Preparation

If your system does not have Session Monitor, the number of concurrent spool operations depends on the mix and type of batch jobs in the system and the programs using spooling through FMP calls. It is suggested that you configure the system to allow at least four concurrent spool operations.

If you are using the Session Monitor, spooling operations can be initiated from all sessions able to execute the spool SL command, batch jobs initiated from these sessions, and batch jobs initiated outside the session environment. If possible, allow for at least one concurrent spool operation per terminal and several for batch jobs.

Use the spooling portion of the I/O configuration worksheet to make your device LU and EQT entry assignments. The generator inputs described below give the spool DRT, EQT, and interrupt table specifications after the assignments have been made.

### NOTE

Each spool EQT will require an additional 33 words in System Table Area I. If you have many spool EQT entries in your system, Table Area I may overflow to an additional page, thereby reducing logical address space available for program use.

The following table definitions must be made for each spool device to be configured in the system:

|    |   |
|----|---|
| 19 | EQUIPMENT TABLE ENTRY                     |
|    | EQT nn?                                   |
|    | sc DVS43 M X=18 *Spool DEV EQT            |
|    | -----,-----,-----,-----,-----,-----,----- |
| 20 | DEVICE REFERENCE TABLE                    |
|    | lu = EQT # ? *Spool DEV # LU              |
|    | nn  |
|    | ----,-----                                |
| 21 | INTERRUPT TABLE                           |
|    | sc EQT nn *Spool DEV #                    |
|    | ----,-----,-----                          |

Where: "sc" is the select code of the spool device.

System Generation Response Preparation

"nn" is its assigned EQT entry

"lu" is its assigned logical unit.

RESOURCE REQUIREMENTS -- Two class numbers should be allocated for the spool monitor; one for outspooling and one for SMP:

```
+-----+
| 25     |
| # OF I/O CLASSES? |
|         |
|  (+2)   |
|  -----|
+-----+
```

The Batch LU switch table should be configured as follows:

```
+-----+
| 26     |
| # OF LU MAPPINGS |
|         |
|  nn+2   |
|  -----|
+-----+
```

where: "nn" is the maximum number of SL Commands expected batch jobs initiated outside the Session environment.

Four resource numbers should be allocated for the spooling system:

```
+-----+
| 27     |
| # OF RESOURCE NUMBERS? |
|         |
|  (+4)   |
|  -----|
+-----+
```

## System Generation Response Preparation

### NOTE

SAM REQUIREMENTS -- The SPOUT program attempts to keep four requests in System Available Memory (SAM) for each device to which it is outpooling. For optimum performance, spool system SAM requirements should be estimated as follows:

(# Outpool devices) X (Max record size) X (Queue depth)

Where:

# Outpool devices is the number of peripheral devices in the system to which spooled output will be sent to; max record size is the largest expected outpool record in SAM for each device, and queue depth is the number of requests SPOUT attempts to keep in SAM for each outpool LU (default is 4). Follow the guidelines in the RTE-IVB Batch and Spooling Reference Manual (92068-90005) for setting queue depth.

For the outpool record, you may assume a maximum record size of 68 words plus a 10 word SAM header. For example, in a system with spooling to two line printers and a paper tape punch, the optimum amount of additional SAM for SPOUT would be  $3 \times 78 \times 4 = 936$  words.

If you cannot generate this much additional SAM you may experience a degradation in system performance. As a bare minimum, generate enough SAM for one outpool device. Thus,  $78 \text{ words} \times 4 \text{ records} =$  the minimum SAM required by SPOUT.

## System Libraries

Required Libraries--The following libraries should be generated into every system:

```

+-----+
| 16c
|  *
|  *
|  *
|  REL  %CLIB          *Compiler Library
|  ----,-----,----,----,----
|  --
|
|  REL  $MLIB1        *Math/Formatter Library Part #1
|  ----,-----,----,----,----
|  --
|
|  REL  $MLIB2        *Math/Formatter Library Part #2
|  ----,-----,----,----,----
|  --
|
|  REL  $FNDLB        *For System with DS use $FDSL
|  ----,-----,----,----,----
|  --
|
|  REL  %4SYLB        *System Library
|  ----,-----,----,----,----
|  --
|
|  REL  $LDRLB        *Loader Library
|  ----,-----,----,----,----
|  --
|
|  REL
|  ----,-----,----,----,----
|  --
+-----+

```

These libraries, as with all other libraries generated into the system, will be stored in relocatable form in the system library area on disc. Program RT4GN and the on-line LOADR will automatically search these libraries to satisfy undefined externals. A brief description of these libraries are as follows:

%CLIB This is the compiler library. It contains common subroutines used by HP supported compilers, assemblers, and utilities.

## System Generation Response Preparation

\$MLIB1 These modules are part of the RTE Math/Formatter Library  
\$MLIB2 (MLIB). This library should be generated into your system if  
\$MLIB3 users will be running FORTRAN programs or calling the  
formatter from assembly language. For a description of the  
subroutines contained in this library, refer to the  
Relocatable Library Manual.

\$FDSL B These modules are also part of the RTE Math/Formatter Library  
\$FN DL B (MLIB). One but not both must generated into your system  
when using MLIB. If your system has DS use \$FDSL B, otherwise  
use \$FN DL B.

%4SYLB This relocatable module contains the system library  
subroutines. These subroutines provide an interface for  
selective operating system functions and provide a set of  
system table and data handling routines.

\$LDRL B This relocatable module contains library subroutines for the  
loader.

Optional Libraries--The following utility libraries may optionally be  
generated into the system:

```
+-----+
| 16c
| REL  $DKULB          *ICD/MAC Disc Backup Utility Library
| ---,-----,---,---,---
| ---
| REL  $DSCLB          *Disc Utility Library
| ---,-----,---,---,---
| ---
| REL  %DECAR          *Decimal String Arithmetic Library
| ---,-----,---,---,---
| ---
| REL  %DBUGR          *DBUGR Subroutine
| ---,-----,---,---,---
| ---
| REL  $VLIB1          *VIS Library (or $VLIB2 if VIS firmware
| ---,-----,---,---,---          is not installed)
| ---
| REL  %UTLIB          *UTILITY Library
| ---,-----,---,---,---
| ---
| REL  %DB KLB        *7900 Disc Backup Utility Library
| ---,-----,---,---,---
| ---
+-----+
```



## System Generation Response Preparation

- \$DKULB** This library is used by the ICD/MAC disc backup utilities (LSAVE, USAVE, LCOPY, RESTR). If you will be generating one or more of these utilities into the system, this library must be included.
- \$DSCLB** This is the disc utility library. It contains common subroutines for accessing ICD/MAC discs and is used only by the SWTCH, FORMT, LSAVE, USAVE, LCOPY, and RESTR utilities.
- %DECAR** This library consists of the decimal string arithmetic package. It should be generated into the system if used by HP supplied (i.e. IMAGE) or user programs.
- %DBUGR** This module contains the debug subroutine. It should be included in your generation if the debugger will be used for program development.
- \$VLIB1** This module contains the VIS (Vector Instruction Set) interface subroutines. It should be generated into your system if you have VIS Firmware. If you do not have VIS firmware, use \$VLIB2 which contains the software equivalents.
- %UTLIB** This library is used by the READT, WRITT, COMPL and CLOAD Utilities.
- %DBKLB** This library is used by the 7900 disc backup utilities (SAVE, RSTOR, COPY, VERIFY). If you will be generating one or more of these utilities into the system, this library must be included.

### System Utilities

Utility Loading Considerations--Utilities may be permanently included into the system using one of the following procedures:

1. Utilities may be generated into the system. When a program is generated into the system, the generator permanently allocates ID segments and disc storage for it. When the system is booted up, the utility will be automatically defined to the operating system. No blank temporary ID segments will be required to run the utility, except if a copy of the program is made.
2. Utilities may be added as Type 6 files. The utility disc image will be stored in a FMP file on LU2 or LU3. When the utility is run (or RP'ed), a blank ID segment will be allocated for it. Type 6 files are created by loading the utility via the on-line LOADR, saving the utility (and segments if applicable) via FMGR SP commands, and releasing the temporary ID segments of the utility and segments via the OF command. Type 6 files are system specific, that is, they are not generally transportable from one system to the next. Type 6 programs cannot be run from breakmode unless they have been previously RP'd.

## System Generation Response Preparation

3. Utilities may be loaded on line as permanent programs. When utilities are added to the system in this manner, the LOADR permanently allocates blank ID segments and disc tracks for them. The LOADR allocates disc space in track multiples for each program loaded on line. If less than a full track is required, the remaining space on the track is unavailable for other uses. Since this method of adding programs to the system uses disc space and ID segments least efficiently, the two methods mentioned above are preferable.

Multiterminal Use--When run in the Session or MTM environment, programs permanently added to the system (via one of the above methods) will be automatically copied for each user. This feature allows multiple copies of the utility to be active at one time. The first three characters of the program name will be concatenated with the terminal LU or session number.

For example, assume a user on terminal LU13 types:

```
:RU, LOADR
```

The system will create a copy of LOADR and actually run LOA13. This feature allows multiple copies of the utility to be active at one time.

Certain utilities, e.g., SWTCH, should not be automatically copied by the system. If they will be generated into the system, 128 should be added to their program type in the parameters phase of your generation. For example, to inhibit copying of SWTCH, (which is normally type 3) the program type should be set to  $128 + 3 = 131$ :

```
+-----+
| 17    |
|      |
|  PARAMETERS |
|      |
|  SWTCH,131  |
|  -----,-----,-----,----- |
|      |
+-----+
```

UTILITY Relocatables--Refer to Table 3-4 for the various utility relocatable file names for the utilities supplied in the standard 92068A Grandfather disc. It is recommended that at least the following subset of these utilities be generated into the system:

16c

```
*
* RTE UTILITIES
*

REL    %EDITR  *Interactive Editor
-----,-----
--

REL    %LGTAT  *Track Assign. Table Status
-----,-----
--

REL    %4LDR   *LOADR
-----,-----
--

REL    %WHZAT  *WHZAT Utility
-----,-----
--

REL    %USAVE  *Disc Unit Save Utility for ICD/MAC Discs
-----,-----
--

REL    %LSAVE  *Disc LU Save Utility for ICD/MAC Discs
-----,-----
--

REL    %HELP   *HELP Utility
-----,-----
--

REL    %READT  *Restore Files from MT
-----,-----
--

REL    %WRITT  *Save Files on MT
-----,-----
--

REL    %T5IDM  *Short ID Segment Manager
-----,-----
--
```

# System Generation Response Preparation

Table 3-4. Utility Relocatable File Names

| Program<br>----- | Segments<br>-----  | Relocatable<br>File<br>---- | Description<br>-----                            | Documentation<br>----- |
|------------------|--|-----------------------------|---|------------------------|
| EDITR            |  | %EDITR                      | Interactive Editor                              | A                      |
| LGTAT            |  | %LGTAT                      | Track Assignment<br>Table Status<br>Utility     | A                      |
| LOADR            |  | %4LDR                       | On-Line Loader                                  | A                      |
| WHZAT            |  | %WHZAT                      | Program/Partition<br>Status Utility             | A                      |
| SAVE             |  | %SAVE                       | 7900 Disc Save Utility                          | B                      |
| LSAVE            |  | %LSAVE                      | ICD/MAC LU Save Utility                         | B                      |
| USAVE            |  | %USAVE                      | ICD/MAC Unit Save Utility                       | B                      |
| RESTR            |  | %RESTR                      | ICD/MAC Disc Copy Utility                       | B                      |
| RSTOR            |  | %RSTOR                      | 7900 Disc Restore Utility                       | B                      |
| VERFY            |  | %VERFY                      | 7900 Disc Verify Utility                        | B                      |
| COPY             |  | %COPY                       | 7900 Disc Copy Utility                          | B                      |
| LCOPY            |  | %LCOPY                      | ICD/MAC Disc Restore<br>Utility                 | B                      |
| RT4GN            | RT4G1 RT4G5<br>RT4G2 RT4G6<br>RT4G3 RT4G7<br>RT4G4 RT4G8 | %RT4GN                      | On Line Generator                               | C                      |
| SWTCH            | SWSG1 SWSG2  | %SSTCH                      | System Installation<br>Utility                  | C                      |
| FORMT            |  | %FORMT                      | Disc Initialization/<br>On-line Sparing Utility | B                      |
| COMPL            |  | %COMPL                      | Program Compilation<br>Utility                  | A                      |
| CLOAD            |  | %CLOAD                      | Compile and Load<br>Utility                     | A                      |

Table 3-4. Utility Relocatable File Names (Cont.)

| Program<br>----- | Segments<br>----- | Relocatable<br>File<br>---- | Description<br>-----                 | Documentation<br>----- |
|------------------|-------------------|-----------------------------|--------------------------------------|------------------------|
| FTN4             |                   | %FTN4<br>%FFT4              | Fortran IV Main<br>Fortran IV        | D                      |
|                  | F4.0              | %0FTN4                      | Fortran IV Segment                   |                        |
|                  | F4.1              | %1FTN4                      | Fortran IV Segment                   |                        |
|                  | F4.2              | %2FTN4                      | Fortran IV Segment                   |                        |
|                  | F4.3              | %3FTN4                      | Fortran IV Segment                   |                        |
|                  | F4.4              | %4FTN4                      | Fortran IV Segment                   |                        |
|                  | F4.5              | %5FTN4                      | Fortran IV Segment                   |                        |
| XREF             |                   | %4XREF                      | Assembler Cross<br>Reference Utility | E                      |
| ASMB             |                   | %4ASMB                      | Assembler                            | E                      |
| ASMB0            |                   | %4ASB0                      | Assembler Segments                   |                        |
| ASMB1            |                   | %4ASB1                      | Assembler Segments                   |                        |
| ASMB2            |                   | %4ASB2                      | Assembler Segments                   |                        |
| ASMB3            |                   | %4ASB3                      | Assembler Segments                   |                        |
| ASMB4            |                   | %4ASB4                      | Assembler Segments                   |                        |
| HELP             |                   | %HELP                       | Help Utility                         | A                      |
| READT            |                   | %READT                      | File Restore<br>Utility              | A                      |
| WRITT            |                   | %WRITT                      | File Save Utility                    | A                      |
| MERGE            |                   | %MERGE                      | File Merge Utility                   | A                      |
| TVVER            |                   | %TVVER                      | 91200 TV Interface<br>Verifier       | F                      |
| KEYS             |                   | %KEYS                       | Soft Key Utility                     | A                      |
| KYDMP            |                   | %KYDMP                      | Soft Key Dump Utility                | A                      |
| SAFD             |                   | %MSAFD                      | Flexible Disc Backup<br>Utility      | B                      |
| #EMA             |                   | %#EMA                       | EMA Firmware Verifier                | G                      |
| T5IDM            |                   | %T5IDM                      | Short ID segment<br>handler          | H                      |

## Documentation Key

|   |             |  |
|---|-------------|--|
| A | 92068-90002 | RTE-IVB Terminal User's Reference Manual.                    |
| B | 92068-90010 | RTE-IVB Utility Programs Reference Manual.                   |
| C | 92068-90007 | RTE-IVB On-Line Generator Reference Manual.                  |
| D | 92060-90023 | RTE FORTRAN IV Reference Manual.                             |
| E | 92067-90003 | RTE-IV Assembler Reference Manual.                           |
| F | 91200-90006 | HP91200B TV Interface Kit, Programming and Operating Manual. |
| G | 92067-90007 | Extended Memory Area, On-Line Diagnostic Manual.             |
| H | 92068-90006 | RTE-IVB System Manager's Manual.                             |

System Generation Response Preparation

Table 3-5. PROGRAMS REQUIRING BUFFER SPACE IN PARTITIONS

| PROGRAM NAME | MINIMUM*<br>OVERRIDE | RECOMMENDED<br>(PAGES) | SUGGESTED OVERRIDE<br>(PAGES) |
|--------------|----------------------|------------------------|-------------------------------|
| EDITR        | 8                    |                        | 9 (NOTE 2)                    |
| ASMB         | 10                   | (NOTE 1)               | 13 (NOTE 3)                   |
| XREF         | 8                    | (NOTE 1)               | >=14 (NOTE 3)                 |
| LOADR        | 15                   | (NOTE 1)               | 18 (NOTE 3)                   |
| FTN4         | 12                   | (NOTE 1)               | 14 (NOTE 3)                   |
| RT4GN        | 14                   |                        | > 14 (NOTE 5)                 |
| VERFY        | 7                    | (NOTE 7)               | 20 (NOTE 2)                   |
| FMGR         | 10                   |                        | 11 (NOTE 4)                   |
| HELP         | 5                    |                        | (NOTE 3)                      |
| FORMT        | 15                   |                        | 18 (NOTE 6)                   |
| SAVE         | 8                    | (NOTE 7)               | 14 (NOTE 2)                   |
| RSTOR        | 8                    | (NOTE 7)               | 14 (NOTE 2)                   |
| COPY         | 7                    | (NOTE 7)               | 14 (NOTE 2)                   |

NOTE 1: Running this program with this size partition will limit the size of the programs it can process. In some cases, however, experience may show that even small partitions will suffice.

NOTE 2: Limited to "Maximum Program Size" printed during generation. Extra space increases size of disc buffers, thereby improving performance.

NOTE 3: Limited to "Maximum Program Size" printed during generation for large background programs. Extra space increases symbol table space, thereby allowing larger programs to be processed.

NOTE 4: Limited to "Maximum Program Size" printed during generation for programs with Table Area II access. Extra space is used during a disc packing operation only.

NOTE 5: Limited to the "Maximum Program Size" (printed at the beginning of the generator's partition definition phase) for large background programs. Extra space for the generator virtual symbol tables increases the generator's speed; i.e., each page you can allow above the minimum override will significantly increase the execution speed of the generator.

NOTE 6: The size override provides space for a track size buffer, and is dependent upon the disc type. See the RTE-IVB Utility Programs Reference Manual (part no. 92068-90010) for additional information.

NOTE 7: These Utilities are for 7900 discs.

\* In F series CPU with double integer firmware (Serial prefix 1920 or later), page requirement is reduced by 3k bytes.

## System Generation Response Preparation

Of all the utilities listed above, only LOADR must be included in your system at generation time.

The remaining utilities can be loaded on line after the system has been brought up.

**BUFFER SPACE CONSIDERATIONS**--Some utilities require additional space to dynamically construct buffer space areas or symbol tables. Standard RTE utilities needing additional space are shown with their size requirements in Table 3-5. If any of these utilities is to be generated into your system, it is recommended that the minimum partition size be overridden.

For example, assuming EDITR and LOADR are being generated into the system, the minimum page requirements might be overridden as follows:

```
+-----+
| 35
| *
| * MODIFY PROGRAM PAGE REQUIREMENTS?
| * INCREASE UTILITY BUFFER AREAS
| --
|
| EDITR  9
| -----,-----
|
| LOADR  15
| -----,-----
+-----+
```

The partition sizes given in Table 3-5 should be used as guidelines only. If you are developing very large programs, the partition sizes may need to be increased. The appropriate Generator input values should be sized to the largest partition generated into your system (excluding EMA partitions). If possible, optimum performance can be obtained by making the partition the same size as the maximum large background partition allowed in your system. This number is given by the generator before partition definitions are made (it is usually 27-29 pages).

**FLOATING POINT DEFAULT**- The FORTRAN-IV Compiler will default double precision variables and arrays to extended precision (48 bit) format unless overridden by a parameter in the control statement. You can change the default to full double precision (64 bit) format as follows:

```
+-----+
| 18
| CHANGE ENTS
|
| Z$DBL  A3  4          *Four Word DP default
| -----,-----,-----,-----
+-----+
```

## System Generation Response Preparation

Note that the above input does NOT require that the FORTRAN Compiler be generated into system.

### Generation vs. Online Loading

Generating fewer programs into your system will increase the speed of your generation and (possibly) make better use of system resources.

In general, the following guidelines can be observed when deciding whether to generate a program into the system:

- \* Programs scheduled at system startup. Programs scheduled by the operating system at system startup should be generated into the system since they must be permanently allocated an ID segment and system disc tracks. (It is also possible to permanently add them on-line with LOADR, but disc space may not be used as efficiently because the disc storage is allocated in # of tracks.) Generated program disc storage is allocated in # blocks (128 words per block). System programs in this category are FMGR and the session ACCTS program.

You can cause a user application program to be scheduled at system startup by adding 80 to its program type during the generator parameter definition phase (refer to the On-Line Generator Manual).

- \* Programs Scheduled from break mode. ID Segments of programs run in break mode must have been previously defined to the system. This can be accomplished either by: generating the program in the system; issuing an RP command from file manager (assuming a type 6 file exists for the program); permanently adding the program to the system with LOADR; temporarily loading the program with LOADR (usually done with programs under development). If a program is to be run from break mode frequently it is suggested that it be generated into the system or RP'ed into the system from the WELCOM File at system startup. Otherwise, users should define programs to the system only when actually needed. This should reduce unnecessary use of ID segments (a valuable system resource). Among the HP utilities that may be regularly scheduled from break mode are WHZAT, LGTAT, and HELP.
- \* Programs required during system installation. Certain utilities are used to facilitate installation. Obviously, the LOADR is required to add new programs to the system. The editor can be used to create and modify file manager command files, system message files, documentation files, and utility command files, File restore utilities may be used to retrieve HP and user relocatable binaries from tape. These programs can be then loaded on line and type 6 files created for them.



## System Generation Response Preparation

\* Memory resident requirements. If you want to eliminate disc swap time as a factor in program operation, you can follow one of three procedures (listed in the order of most efficient memory utilization):

1. Generate the program into the system as a memory resident program (type 1 module).
2. Generate the program into the system as disc resident, but assign it to a partition and reserve that partition.
3. After generation, load the program on line via LOADR and assign it a partition; reserve that partition by reconfiguring memory.

If you decide to load certain programs on-line rather than during generation, their relocatable files will obviously have to be accessed after the new system has been brought up. Users may also require that their files be accessible on the new system. One way of making files immediately accessible to the new system is to have a common disc subchannel definition between the new and old systems. Files to be used on the new system can be stored on a cartridge identified by a common subchannel before system switchover. This cartridge can then be mounted on the new system.

Magnetic tape is another convenient medium for file transportation, if both new and old systems support have compatible magnetic tape units. Files can be grouped individually with file manager commands or entire cartridges can be copied via the READT/WRITT utilities.

When neither of the above methods can be employed, you will have to use some other compatible media (e.g. cartridge tape units, paper tape, DS links, etc.).

## Session Monitor

Skip this section if you are not using the session monitor. If you are using the session monitor, include the %SMON and %SMON2 during generation. The accounts program (%ACCTS) can be included in the generation or loaded on-line, as described below.

```
+-----+
| 16c
| * Session Monitor
|
| REL %SMON1          *Session Monitor modules #1
| -----
| --
| REL %SMON2          *Session Monitor Modules #2
| -----
| --
| REL %ACCTS          *ACCTS Program
| -----
| --
+-----+
```

The Software Components contained in these relocatable modules are briefly described below.

- PRMPT Session Break Mode Interrupt Processor. This program is responsible for issuing the break mode prompt and queuing command inputs to the command processor.
- R\$PN\$ Session Monitor Break Mode Command Processor. Handles all break mode commands queued onto it by PRMPT. R\$PN\$ will either route commands to the operating system or process them itself (depending on the command).
- LOGON Session Monitor Log On Processor. This processor is scheduled by PRMPT when there is no active session on the terminal. It accepts the user log-on ID, checks the ID against the account file, and sets up the session.
- LGOFF Session Monitor Log Off Processor. This processor is scheduled by the session copy of FMGR at log off. LGOFF is responsible for updating the accounts file and releasing system resources allocated to the session.
- ACCTS Session Accounts Management Program, requires library \$ACCLB. ACCTS is used by the system manager to initialize, maintain, and back up the account system. Normally, it is run only by the system manager. Although it is not necessary to generate ACCTS into the system, it is recommended, because ACCTS is scheduled during system startup. If ACCTS is loaded on-line, use the OP,SS loader command to gain access to SSGA. If ACCTS is not generated into the system or loaded permanently, it should be RP'ed and scheduled in the WELCOM file. (Refer to "WELCOM File," in Chapter 5.)

## System Generation Response Preparation

**!BITM** A table used by session modules to indicate whether terminals are enabled for break mode interrupts.

**\$YCOM** Used by the system to activate LOGON and R\$PN\$ to process break mode interrupts from the system console when enabled as a session terminal.

The default module respective priority levels, sizes, and program types is shown below.

Table 3-6. Session Monitor Programs

| Program | Size (K)  | Priority | Program Type                                      |
|---------|-----------|----------|---|
| PRMPT   | .3        | 5        | 1 (MEMORY RESIDENT)                               |
| R\$PN\$ | 4         | 5        | 3 (BG DISC RESIDENT)                              |
| LOGON   | 11        | 50       | 3 (BG DISC RESIDENT)                              |
| LGOFF   | 9         | 90       | 3 (BG DISC RESIDENT)                              |
| ACCTS   | 17        | 90       | 20 (large BG DISC RESIDENT<br>and access to SSGA) |
| !BITM   | (7 words) | --       | 13 (TABLE AREA II)                                |
| \$YCOM  | .2        | 10       | 1 (MEMORY RESIDENT)                               |

The Session Monitor software requires four class numbers:

|    |                   |
|----|-------------------|
| 25 | # OF I/O CLASSES? |
|    | (+4)              |
|    | -----             |

Session Monitor requires SAM for storage of session control blocks and the spare cartridge pool. If the Session memory allocation algorithm is used during account system initialization (described in Chapter 6), SAM requirements will depend on the Session Limit:

Session Limit < 20: (70-Session Limit) \* Session Limit

Session Limit > 20: Session Limit \* 50

## System Generation Response Preparation

At the very minimum, you should allocate an additional 50 words of SAM per session terminal. This should be increased if the terminals have automatic output buffering enabled. Refer to the On-Line Generator Manual for a more detailed discussion of SAM requirements and usage.

Every Session terminal requires entries in the Device Reference Table, Equipment Table, and Interrupt Table. Refer to your I/O configuration worksheet for the LU, EQT and select code assignments. Table definitions for session terminals will depend on the type of terminal and interface. For recommended generator inputs, refer to the section titled "DEVICE CONFIGURATION" in this Chapter.

### Multi-Terminal Monitor

NOTE: If you will not be using the Multi-Terminal Monitor in your system, skip this section.

The Multi-Terminal Monitor is contained in the following relocatable modules:

```
+-----+
| 16c
| * Multi-Terminal Monitor
|
| REL %4MTM          *Multi-terminal Monitor
| ----,----- ----
| --
|
| REL %NSES          *Dummy Non-Session Module
| ----,----- ----
| --
+-----+
```

These modules contains the following programs:

PRMPT MTM break mode interrupt processor. This program is responsible for issuing the break mode prompt and queuing inputs to the command processor.

R\$PN\$ MTM break mode command processor. Handles all break mode commands queued onto it by PRMPT. R\$PN\$ will either route commands to the operating system or process them itself (depending on the command).

## System Generation Response Preparation

The size, priority and program types for these programs is shown below:

| Program | Size (K) | Priority | Program Type         |
|---------|----------|----------|----------------------|
| PRMPT   | .3       | 10       | 1 (MEMORY RESIDENT)  |
| R\$PN\$ | 3        | 10       | 3 (BG DISC RESIDENT) |

MTM requires one class number for communication between PRMPT and R\$PN\$.

|                  |
|------------------|
| 25               |
| # of I/O CLASSES |
| (+1)             |
| ----             |

At the very minimum you should allocate an additional 50 words of SAM per MTM terminal. This should be increased if the terminals have automatic output buffering enabled. Refer to the On-Line Generator Manual for a more detailed discussion of SAM requirements and usage.

Every MTM terminal requires entries in the Device Reference Table, Equipment Table, and Interrupt Table. Refer to your I/O configuration worksheet for the LU, EQT, and select code assignments. Table definitions for MTM terminals depend on the type of terminal and interface. For recommended generator inputs, refer to the section titled "DEVICE CONFIGURATION" in this chapter.

### Non-Session and Non-MTM Systems

If you will not be generating either Session Monitor or MTM in your system, relocate the following module:

|                                       |
|---------------------------------------|
| 16c                                   |
| REL %NSESN * Dummy Non-Session Module |
| -----                                 |



# Chapter 4

## Transferring the New RTE-IVB Operating System

### SWTCH Program

After you have completed the on-line generation of your RTE-IVB operating system, the new system will reside on the disc in a Type 1 FMP file. Use the SWTCH program to transfer your new system to the system disc of the new configuration.

When you are finished with the generation, you should always back up your disc. It is important that you can always get back to a working operating system in case a planning mistake was made during generation. The disc shipped with your system contains the software you will need to generate all systems in the future and must not be overwritten by any RTE generation, even one that is error free. Hewlett-Packard provides utility routines for disc backup, verification, and restoration. Consult the RTE-IVB Utility Programs Reference Manual (part no. 92068-90010) for disc backup instructions.

After assuring that your factory-generated disc has been suitably protected and cannot be destroyed by the switch, follow the procedures that are given in this section for executing the SWTCH program.

### Glossary

The following terms will be used in the description of SWTCH:

|                    |   |
|--------------------|---|
| MAC discs          | Multiple Access Controller disc drives use the 13037 disc controller and the on-line disc driver, DVR32. The 7905, 7906, 7920 and 7925 models are MAC discs.                                  |
| ICD discs          | Integrated Controller Discs have their own controller in each disc drive. They use the 12821 interface card and the DVA32 disc driver. The 7906H, 7920H, 7925H and 9895 models are ICD discs. |
| host system        | the current RTE operation system under which SWTCH is executing.  |
| host configuration | the hardware system on which the host system is executing.  |
| destination system | the RTE operating system that was defined during system generation.   |

## Transferring the New RTE-IVB Operating System

|                           |  |
|---------------------------|--|
| destination configuration | the hardware system where the destination system will execute.   |
| target disc               | the portion of a disc in the host configuration where SWTCH will store the destination system. "Target disc" does not refer to a complete platter, but to the specified subchannel only.   |
| target select code        | the select code of the I/O slot where the target disc is plugged in. Applies to 7900 switches only.  |
| target disc LU            | a logical unit number in the host system which references any disc subchannel on the target disc. This LU is not affected by SWTCH. It is a point of reference for SWTCH to find the select code of the target disc driver. Applies to MAC and ICD switches. |
| batch mode                | SWTCH executes without user intervention. Batch mode is disallowed when a YES response is given for the subchannel initialization option parameter.  |

## Types of Transfers

The SWTCH program offers flexibility in transferring your new operating system. For example, you may transfer your new RTE system to an I/O configuration that differs from the current I/O configuration. In this case, the destination can still be booted up using the RTE-IVB I/O reconfiguration procedure (see the RTE-IVB Programmer's Reference Manual for more information).

Below is a summary of the basic types of transfers offered by SWTCH.

1. SWTCH can transfer the new system to the current host system thereby replacing the host system while saving its file structure. Be sure to back up your host system.
2. SWTCH can transfer the new system to the target disc in the host configuration. You have the option of preserving the file structure contained on any previous system disc subchannel that exists on the target. The destination system can then be booted up with a different I/O configuration than the host.



## Transferring the New RTE-IVB Operating System

For example, the select code of the 7900 system disc controller may be number 12 in the host system. A 7900 system that has been generated may have the system disc controller in select code 13. Using a target select code of 12, SWTCH will allow you to store the destination system on the target disc. When SWTCH completes the transfer, you may physically change the I/O cards of the host configuration to the proper slots for the destination configuration. After the necessary cards are moved you can boot up the destination system.

3. SWTCH can transfer the new system to the host disc drive, where the system cartridge has been replaced by a temporary target cartridge for the duration of the SWTCH process. This temporary target can be transported to a system having the destination configuration and that system booted up. The original system cartridge can be placed back in the host and all activity there is resumed where it was suspended by SWTCH.

SWTCH provides maximum protection for MAC and ICD switches by suspending all I/O to the target disc while SWTCH is executing. For 7900 switches, the system must be quiescent to keep from corrupting the target disc.

4. SWTCH can transfer a newly generated ICD based system to a MAC target disc drive containing a temporary target cartridge. This target disc is later transported to an ICD destination configuration where it can then be booted up. Only the MAC driver, DVR32 needs to have been generated into the host. The opposite case of transferring a new MAC based system to an ICD target disc drive for later installation in a MAC destination system is also possible.

For example, suppose that the host system is configured with a 7906 MAC disc. DVR32 (Rev. 2001 or later) is the only driver generated into this system. RT4GN is run on the host system to create an FMP type 1 file containing an ICD based system. SWTCH is run on the host system. At the proper time, the host's system cartridge is removed, and is replaced with the target cartridge. The destination system is installed on the cartridge by SWTCH, using the online DVR32 MAC disc driver. SWTCH tells the operator to remove the target cartridge and replace the host system's LU2 cartridge. Control is passed back to the host when SWTCH terminates. All disc I/O resumes where it was suspended by SWTCH. The target cartridge can then be transported to an ICD configuration and booted up.

In order to understand the flexibility available with SWTCH, it is helpful to understand how SWTCH communicates with the disc drivers.

For 7900 discs, SWTCH has its own internal driver. SWTCH asks for the select code of the target 7900 drive and then the platter where the new system will be stored. The host may be a 7900 based system or it may be MAC or ICD based without the 7900 disc driver configured into the system.

## Transferring the New RTE-IVB Operating System

For MAC and ICD discs, the appropriate driver DVR32 or DVA32 (Rev. 2001 or later) must have been generated into the host system. SWTCH asks for the target disc LU (see the glossary at the front of the chapter for the definition of target disc LU). It then asks for the MAC hardware unit number or the ICD address number where the new system will be stored.

If you are transferring a newly generated ICD based system to a MAC target disc drive, or vice versa (see the above paragraphs about SWTCH transfer types), only the appropriate driver for the host disc drive needs to be present in the host system.

## SWTCH Options

In addition to the various types of transfers possible with SWTCH, the following options are available.

**Autoboot:** The autoboot option can be specified so SWTCH will automatically boot up the new system on the completion of transfer. The destination configuration must be the same as the host configuration.

Note that if the bootstrap loader was sent to a file during the generation process, the file should be punched or written out before SWTCH is executed.

**Filesave:** The filesave option gives you the opportunity to save the files on the system subchannel of the target disc. The target system subchannel definition must be the same as the destination system subchannel. If this match does not occur, SWTCH will warn you that information on the target disc will be destroyed and give you the option of proceeding.

**Purge Type 6 Files:** SWTCH provides the option of saving or purging the Type 6 files (memory image program files) existing in the file structure of the target disc.

**Subchannel Initialization:** The destination disc system subchannel is initialized automatically. SWTCH gives you the option of initializing all of the destination disc subchannels, none of them, or interactively allows you to specify which subchannels are to be initialized. Do not confuse disc subchannel initialization with FMGR disc cartridge initialization.

## Transferring the New RTE-IVB Operating System

\*\*\*\*\* CAUTION \*\*\*\*\*

ALL ACTIVITY MUST BE TERMINATED BEFORE SYSTEM TRANSFER PROCESS.

**7900 Switches:** For switching 7900 based systems, remember that SWITCH has its own internal driver. Therefore, the interrupt system is turned OFF during the transfer process, and you must be careful to terminate ALL system activity before initiating this process.

If this precaution is not observed strictly, the new system may be corrupted as it is written on the target disc. The host system may also be damaged, because output normally going to the host LU2 will be on the target disc.

**MAC and ICD Switches:** For switching MAC and ICD systems, SWITCH uses the on-line drivers and locks all discs on the same EQT of the target disc for the duration of the switch. All loads, swaps, and all other I/O to these discs will be held off by SWITCH to protect both the target cartridge and the integrity of the host system.

Although it is not strictly necessary to have a quiescent system during ICD/MAC switches, the performance will be severely degraded for the entire duration of SWITCH. For example, if PRMPT and R\$PN\$ are disc resident, all session terminals will appear to be dead until SWITCH terminates and unlocks the discs.

### SWTCH Loading Instructions

SWTCH may be loaded as a large background (type 4) program, and requires 18 pages. SWITCH references the disc utilities library \$DSCLB, and makes use of special tables in the system. Therefore, it is necessary to have Rev. 2001 or later software (including DVR32 and DVA32) in the host system. If the disc utilities library is not generated into the host system, this library may be searched when loading on-line as follows:

```
/LOADR:OP, LB  
/LOADR:RE, %SWTCH  
/LOADR:SE, $DSCLB  
/LOADR:EN
```

## Transferring the New RTE-IVB Operating System

Backward Compatibility. It is strongly recommended that you install a factory generated, Rev. 2001 (or later) system to facilitate running SWTCH. If a Rev. 2001 host system is not available, the Rev. 1903 SWTCH may be loaded and used to transfer 7900 and MAC based systems only. (Remember to "OF" all other programs, so that the Rev. 1903 SWTCH runs in a totally quiescent system.) Backward compatibility is possible because the format of the Type 1 file produced by RT4GN has not been changed for 7900 and MAC systems.

If you want to transfer an ICD system file, you must use the Rev. 2001 SWTCH, and have a Rev. 2001 host with current system software.

### SWTCH Operating Instructions

The RU command is used to schedule SWTCH for execution. You may specify any or all of the seven parameters with the run command or enter them interactively as responses to SWTCH prompts.

The command is issued in the following form:

```
:RU,SWTCH,namr,scB/disc LU,addr/unit/pltr,autoboot,filesave,type-6,init
```

where:

namr is the name of the FMP file that contains your generated system. This may be specified in the following form:

```
filename[:security code[:cartridge label]]
```

This file must exist on a standard host system subchannel. If a target cartridge is to be inserted for the SWTCH process, the file must not exist on the cartridge that is to be swapped out for the target.

scB/disc LU sc: for the 7900 disc, sc is the select code of the target disc controller (octal value with a B as the terminating character). This target select code does not need to be configured into either the host or the destination RTE system. It is used as a means of specifying the correct controller I/O card for the transfer. SWTCH configures its own driver to this select code.

disc LU: for switching MAC or ICD based systems the target disc LU is the logical unit number of any disc subchannel on the target disc. The LU is not affected by SWTCH. It is a reference for SWTCH to find the select code of the target disc driver. The target disc driver, DVR32 for MAC discs, or DVA32 for ICD discs must be present in the host system.

## Transferring the New RTE-IVB Operating System

If the target disc being initialized contains more sectors per track than the host systems LU2 or LU3, SWTCH will be aborted with an IO07 error.

**addr/unit/platter**      address: for ICD discs, enter the target ICD address number (0-7) where the new system will be stored.

unit: for MAC discs, enter the hardware unit number (0-7) where the new system will be stored.

platter: for 7900 discs, enter the logical surface number where the new system will be stored (0, 2, 4, or 6 for the fixed platter; 1, 3, 5, or 7 for the removable platter).

The disc system will be transferred to the subchannel that was defined as LU2 during system generation.

**autoboot**                      is the automatic boot-up option.

Specify Y (yes) to attempt an automatic boot-up following the transfer of the new system. The host configuration must match the destination configuration. See the paragraph titled AUTOBOOT SPECIFICATION for more detail on this match.

Specify N (no) to deny automatic boot-up.

**filesave**                      is the filesave option.

Specify Y (yes) to attempt saving the target disc's current file structure during the transfer.

Specify N (no) to deny saving the target disc's current file structure.

**type-6**                          is the option to purge Type 6 files.

Specify Y (yes) to purge the target disc's Type 6 files during the transfer.

Specify N (no) to deny purging the target disc's Type 6 files.

## Transferring the New RTE-IVB Operating System

### NOTE

Remember that a Type 6 file can be executed ONLY by the operating system within which it was created.

`init` is the subchannel initialization option.

Specify Y (yes) to request initialization of destination disc subchannels other than the system subchannel. `SWTCH` will prompt you for each subchannel that was defined to be on the same disc controller (MAC discs) or interface card (ICD discs) as the system subchannel.

Note that `SWTCH` will not initialize subchannels defined on the 9895 floppy disc. This must be done with the `FORMAT` utility.

Specify N (no) to deny additional subchannel initializations. Batch mode is implied.

You can omit any of the above parameters from the command entry string. If any parameters were omitted, a comma must be specified as a place holder for each of the omitted leading parameters. Omitted trailing parameters do not require a place holder. During execution, `SWTCH` displays a prompt message for any omitted or illegally specified parameters. If the response entered interactively is invalid, `SWTCH` will reissue the prompt.

### Examples:

`:RU,SWTCH,NEWGEN::17` Only the file name (with a cartridge label) is specified. `SWTCH` will request the other six parameters.

`:RU,SWTCH` No parameters are specified. `SWTCH` will request all of the parameter information.

`:RU,SWTCH,,,,Y` Only the autoboot option is specified. `SWTCH` will request the omitted information.

If you specify all of the parameters and a NO response was entered for the subchannel initialization option, batch mode is implied and `SWTCH` will execute without your intervention. However, if FMP files within the new system will be destroyed at the target subchannel, you will be warned and asked for permission to continue.

`SWTCH` displays the following message at the beginning of its execution:

\*\*\*\*\* WARNING \*\*\*\*\*

ALL ACTIVITY MUST BE TERMINATED BEFORE SYSTEM TRANSFER PROCESS.

Remember that the transferred system may be corrupted if other processes continue while SWTCH is executing.

## FILENAME SPECIFICATION

SWTCH performs a validity check on the FMP file name specified by the filename parameter. The file named must exist as an FMP file in the host system and must be an RTE-IVB system generated by RT4GN. This file must also be a Type 1 file beginning with the track 0, sector 0 boot extension. If this validity check fails, SWTCH displays the short version of the message below. If an error occurs during the FMP OPEN call, SWTCH displays the entire message indicating which FMP error occurred.

```
ILLEGAL FILENAME [ -FMP ERR XXXX]
FILE NAME OF NEW RTE SYSTEM?
```

At this point a valid file name of an RTE-IVB system must be entered.

If the filename parameter was omitted from the RU command entry string, SWTCH requests:

```
FILE NAME OF NEW RTE SYSTEM?
```

You enter the name of the file that contains your new system in the form:

```
filename[:security code[:cartridge label]]
```

### NOTE

Only at this point (when SWTCH is asking for a new file name) can SWTCH be aborted with the !! command. If a file name begins with the exclamation characters (!!), precede the file name with a blank character.

At this point, SWTCH checks to see if the system software is up to date. SWTCH uses the on-line disc driver (either DVR32 or DVA32), and special routines in the operating system itself, so REV-2001 (or later) software is required. If the host system does not have the required software, SWTCH displays:

```
OUTDATED SYSTEM SOFTWARE
```

and terminates without switching the system.

## Destination I/O Configuration

Then SWTCH displays the I/O configuration of the new system:

```
NEW SYSTEM I/O CONFIGURATION:
SELECT CODE cc PRIVILEGED INTERRUPT (if present)
SELECT CODE cc TBG
SELECT CODE cc TYPE= ee
.      .
.      .      (in order of select code number)
.      .
SELECT CODE cc TYPE= ee
```

Where "cc" is the I/O select code and "ee" is the equipment type code (the last two digits of the driver name; e.g., 05 for DVR05).

## System Subchannel Definition

SWTCH derives the destination system's select code and subchannel from the file and displays the following message:

```
NEW SYSTEM (LU2) SELECT CODE = cc SUBCHANNEL = ss
```

Where "cc" and "ss" are the actual select code and subchannel numbers.

Depending on the disc model of the new system, SWTCH reports the system subchannel definition:

For a 7900 disc:

```
PLATTER p    FIRST TRACK ttt    #TRACKS nnn
```

For ICD and MAC discs:

```
#TRACKS      nnnn    FIRST CYL      cccc
HEAD #       hhhh    #SURFACES     ssss
ADDR/UNIT    uuuu    #SPARES       pppp
#SECTORS/TRACK kkkk
```

where:

p is the platter number  
t t t is the first track number  
n n n is the number of tracks  
n n n n is the number of tracks  
c c c c is the first cylinder number  
h h h h is the starting head number  
s s s s is the number of surfaces  
u u u u is the MAC hardware unit number or ICD address number  
p p p p is the number of spares  
k k k k is the number of (64 word) sectors/track.



## Transferring the New RTE-IVB Operating System

### DISC LU/SELECT CODE SPECIFICATION

If the select code or target disc LU parameter is omitted from the RU command entry string, SWTCH prompts:

For 7900 discs: TARGET SELECT CODE FOR NEW SYSTEM (XX OR " " CR)

For a 7900 disc, you respond with the octal select code (XX) of the correct controller I/O card, or a space followed by a carriage return. The select code number specified may refer to a select code in the host system, the destination system, or it may be a select code that is not configured into either system (SWTCH will configure its own driver to the select code specified). Entry of " "CR results in a default to the destination select code defined during the generation of the new system. If the select code is invalid SWTCH will issue the warning:

ILLEGAL TARGET

For ICD and MAC discs: TARGET DISC LU FOR NEW SYSTEM?(XX)

For ICD and MAC discs, you respond with a decimal disc LU number that refers to DVA32 or DVR32 in the host system as it is presently configured. This LU is not affected by SWTCH, it is used as a reference for SWTCH to find the select code of the target disc drive. If LU2 or LU3 was specified and if the target disc being initialized contains more sectors per track than the host systems LU2 or LU3, SWTCH will be aborted with an IO08 error. If the target disc LU does not point to a disc subchannel on the target disc, SWTCH will issue the warning:

ILLEGAL TARGET

There is no default allowed for ICD and MAC target discs, i.e., you must enter a decimal disc LU rather than " "CR. This prevents the user from accidentally overlaying their system disc.

## Address/Unit/Platter Specification

If the address/unit/platter is omitted from the RU command entry string, SWTCH asks:

TARGET ADDRESS/UNIT/PLATTER FOR NEW SYSTEM? (X OR " "CR)

You respond with one of the following:

For 7900 discs, enter the logical surface number 0, 2, 4, or 6 for the fixed disc; 1, 3, 5, or 7 for the removable platter where the new system will be stored.

For MAC discs, enter the hardware unit number (0-7) where the new system will be stored.

For ICD discs, enter the ICD address number (0-7) where the new system will be stored.

Entry of " "CR results in a default to the destination value defined during generation.

Note that this hardware unit number or address number does not have to exist in the host system. This allows the user to plug a temporary target disc drive into the 13037 controller or ICD bus for the duration of SWTCH without regenerating to include the drive in the host system. The only requirement is that the temporary target disc drive must be connected to the same controller or bus as the target disc LU specified above.

The flexibility provided by the select code and address/unit/platter specifications permits temporary storage of your destination system, on a target disc cartridge. Notice that you can boot up your destination system only on the destination select code and address/unit/platter that was specified during the generation process (unless the disc select code is changed during I/O reconfiguration).

## Disc Cartridge Exchange

Except when batch mode is implied, SWTCH reminds you that the correct disc cartridge must be in place at the target address/unit/platter number. The following message is displayed:

NOW IS THE TIME TO INSERT CARTRIDGE  
IN TARGET ADDRESS/UNIT/PLATTER. (" "CR TO CONTINUE)

At this point even the operating system platter (LU2) may be removed and another cartridge inserted. The absolute output file, however, must not reside on the removed cartridge, nor should it lie in the area of the target subchannel.

Perform the appropriate action and signal SWTCH to continue by entering " "CR.

## Filesave Specification

If the filesave parameter is omitted from the RU command entry string, SWTCH requests:

SAVE FILES AT TARGET? (Y OR N)

You respond with a Y (yes) to save files on the system subchannel (subject to the match conditions described in the following paragraphs), or with an N (no) to indicate that no files are to be saved.

A "match" must exist between the subchannel definition already on the target disc and the destination system subchannel definition. In other words, the first track, the number of tracks, the number of surfaces, and the starting head of both subchannel definitions must be the same. SWTCH reads from the target disc area in order to determine a match. An FMP file directory must exist on the last track of the target disc subchannel in order to save the existing file structure.'

If the match conditions fail, a warning is displayed, followed by a request for your permission to continue:

INFORMATION STORED ON ADDRESS/UNIT/PLATTER x OF TARGET SELECT  
CODE yy WILL BE DESTROYED.

OK TO PROCEED? (Y OR N)

You respond with a Y (yes) if the information on address/unit/platter "x" of target select code "yy" may be destroyed, or with an N (no) to prevent the destruction of this information.

### CAUTION

Since RT4GN places a new cartridge directory with a null master security code at the end of the new RTE-IVB system generated, no cartridges will be mounted after the system transfer. SWTCH makes no attempt to preserve any files on the auxiliary subchannel (LU3) or any other peripheral disc subchannel. Unless you request additional subchannel initializations, only the area occupied by the system subchannel on the disc is accessed by SWTCH. Therefore, it is your responsibility to save any of these files before the transfer.

## Overlaid FMP Files

If the new system will overlay any of the existing FMP files on the system subchannel of the target disc, a warning message is displayed, followed by a request for your permission to continue:

NEW SYSTEM WILL DESTROY SOME FMP FILES.

OK TO PROCEED? (Y OR N)

## Type-6 File Specification

SWTCH provides the option of saving or purging (for the destination system) the target disc's Type 6 files during the transfer. The match conditions described under the heading "FILESAVE SPECIFICATIONS" must be met in order to save Type 6 files on the system subchannel.

If the target file structure is to be saved and the type-6 parameter is omitted from the RU command entry string, SWTCH displays:

PURGE TYPE 6 FILES? (Y OR N)

You respond with a Y (yes) to purge the Type 6 files, or with an N (no) to save them.

Type 6 files contain a program in memory-image format (created during the execution of the on-line LOADR or RT4GN) that the system assumes is ready to execute. Type 6 files are created by the FMGR Save Program (SP) command. The first two sectors of the file contain ID segment information.

When a Type 6 file is restored with the Restore Program (RP) command, an ID segment is set up for that program in memory. Note that such a program can execute only in the system within which it was created. The base page linkages and the setup word will be specific to the system in which the program was created, so a program could not execute in two different systems.

You may want to save Type 6 files in those situations where you switch back and forth (using the SWTCH program) between RTE systems and do not wish to reload your programs after each change. Care must still be exercised however, to RP only the Type 6 files that were created in the particular system that is currently executing.

## Subchannel Initialization

SWTCH reformats the disc track areas defined for RTE subchannels by writing their physical track and sector addresses in the preamble of each sector. For the system code area, the preambles are set to indicate write-protected tracks. When a defective track is encountered during the initialization of an ICD or MAC disc subchannel, a spare track is assigned to it. The preamble of the defective track indicates that it is defective and gives the address of the spare track that is replacing it so the disc controller will automatically switch to that track in future references. The preamble of the spare track indicates that it is acting as a spare, and gives the address of the defective track it is replacing.

A ICD or MAC disc must be formatted (see the Glossary at the end of this manual for a definition of disc formatting) before SWTCH initialization because SWTCH must check and acknowledge a previously detected defective track. For 7900 disc subchannels, any bad tracks encountered outside the system area are flagged defective; bad tracks within the absolute code of the system are not allowed.

If the "init" parameter is omitted from the RU command entry string, SWTCH requests:

INITIALIZE SUBCHANNELS? (Y OR N)

You respond with a Y (yes) to continue with the initialization requests for the disc subchannels, excluding the system subchannel. An N (no) response terminates SWTCH after only the system subchannel has been transferred and initialized.

SWTCH will prompt you (interactively) for each additional subchannel defined for the system disc controller or ICD interface during generation. The actual subchannel initializations will follow the system transfer process. If the disc is new, if it has any write protect flags written on it, or if you are changing the subchannel definition for this pack, the disc must be initialized with the SWTCH or FORMT program. If you do not wish to disturb the information that is contained on the disc in the subchannel's designated area, you should respond with an N (no) to the initialization request. Depending on the disc model of the new system, one of the following procedures takes place.

### 7900 Subchannel Initialization

For each 7900-based disc subchannel defined during the generation, SWTCH prompts:

INITIALIZE SUBCHANNEL s? (Y OR N)

You respond with a Y (yes) to initialize subchannel "s," and N (no) to indicate that the subchannel is not to be initialized, or a /E to terminate the initialization prompting.

## Transferring the New RTE-IVB Operating System

If the subchannel is to be initialized, SWTCH asks:

TARGET PLATTER? (X OR " "CR)

You respond with the logical surface number (0, 2, 4, or 6 for the fixed platter; 1, 3, 5, or 7 for the removable platter) where subchannel s is to be initialized. Entry of " "CR results in a default to the destination platter that was defined for subchannel s during generation. Specifying a target platter that is identical to the target platter for the system subchannel is not allowed. If you specify matching target platters, SWTCH will reissue the prompt.

### ICD And MAC Subchannel Initialization

For ICD and MAC disc subchannels, the subchannels are grouped according to their generation-defined MAC hardware unit number or ICD address select number. For those subchannels having their destination address/unit the same as the system subchannel's address/unit, the target unit will automatically be that target unit specified for the system subchannel. SWTCH displays:

TARGET ADDRESS/UNIT u FOR SUBCHANNELS XX,YY,...,ZZ

and then asks:

INITIALIZE SUBCHANNEL XX? (Y or N)

.

.

.

INITIALIZE SUBCHANNEL ZZ? (Y or N)

After each prompt, you respond with a Y (yes) to initialize subchannel "nn", an N (no) to indicate that the subchannel is not to be initialized, or a /E to terminate the initialization prompting.

For each group of subchannels defined on other destination ICD addresses/MAC units, you may specify a target address/unit, and the following prompts occur:

DESTN. ADDRESS/UNIT u FOR SUBCHANNELS XX,YY,...,ZZ

TARGET ADDRESS/UNIT? (X OR " "CR)

You respond with a MAC unit number or ICD address number (0-7) for this group of subchannels or with a /E to decline initialization for the group. Entry of " "CR results in a default to the destination address/unit LU. Specifying a target address/unit that is identical to the target address/unit for the system subchannel is not allowed. If you specify matching target address/units, SWTCH will reissue the prompts.

NOTE: SWTCH reports the DESTINATION ADDRESS for 9895 discs, but does not prompt for TARGET ADDRESS/UNIT, since the FORMT utility must be used for floppy disc initialization.

If you did not respond with a /E to the TARGET ADDRESS/UNIT question, SWTCH prompts:

```
INITIALIZE SUBCHANNEL XX? (Y or N)
.
.
INITIALIZE SUBCHANNEL ZZ? (Y or N)
```

After each prompt, you respond with a Y (yes) to initialize subchannel "nn", an N (no) to indicate that the subchannel is not to be initialized, or a /E to terminate initialization prompting for this group of subchannels.

SWTCH stops prompting when all generation-defined subchannels have been prompted for initialization, or when a /E has been entered. Actual initialization will be done (by SWTCH) following the system transfer.

### Autoboot Specification

Automatic boot-up of the new system may occur following the transfer and initialization operations if the first five of the following six conditions are true. The sixth condition must also be true if both systems have a privileged interrupt card.

1. Target disc select code = Destination disc select code
2. Target disc address/unit/platter = Destination disc address/unit/platter
3. Host TBG select code = Destination TBG select code
4. Host system console select code = Destination system console select code
5. Target disc type (ICD vs. MAC) = Destination system disc type (ICD vs. MAC)
6. Host privileged interrupt select code = Destination privileged interrupt select code

If the automatic boot-up conditions are true and the autoboot parameter is not specified in the RU command entry string, SWTCH prompts:

```
AUTO BOOTUP? (Y OR N)
```

If any of the automatic boot-up conditions are false, SWTCH displays the following message:

```
PRESENT CONFIGURATION DOESN'T PERMIT AUTO BOOT-UP.
```

If it is not possible to return to the host system following the transfer operation, or if a transfer or initialization was done to the same address/unit/platter as the host (LU2) and automatic boot-up is not to be done, SWTCH displays this message:

```
DISC IN HOST SYSTEM DISC DRIVE WILL BE OVERLAID.
```

## Transferring the New RTE-IVB Operating System

When batch mode is not implied, SWITCH requests final permission to proceed with the system transfer. The following message is displayed:

```
READY TO TRANSFER. OK TO PROCEED?
```

Respond with a Y (yes) to proceed with the system transfer, or with an N (no) to deny the transfer.

At this point the host system is shut down and the transfer begins. Track sparing is done for the ICD or MAC subchannels. If appropriate, SWITCH reports, under the following headings, the names of any files that are overlaid or purged during the system transfer:

```
OVERLAID FMP FILES:  
file list
```

or

```
TYPE 6 FILES PURGED:  
file list
```

Next, the new system subchannel is installed on the target disc (doing sparing as needed). The message,

```
INSTALLING SYSTEM SUBCHANNEL XX
```

is displayed as the transfer begins. At this point, SWITCH does another validity check on the system file to make sure the operator has not accidentally removed the cartridge containing the new system. (This may have happened when the operator was given a chance to remove the host and insert a target disc cartridge.) If the FMP file containing the new system has been removed, SWITCH displays the message,

```
DISC CARTRIDGE CONTAINING NEW SYSTEM FILE  
XXXXXX HAS BEEN REMOVED FROM DISC DRIVE
```

(where XXXXXX is the filename), and aborts.

After successfully installing the system subchannel, SWITCH initializes any other subchannels requested by the operator, and prints the message:

```
INITIALIZING SUBCHANNEL XX
```

for each subchannel specified.



## Normal Termination Messages

After system installation and subchannel initialization are complete, SWTCH checks again to see if the host system may have been overlaid. (It checks for a match between the target address/unit/platter and the host address/unit/platter number.) If there is a possibility that the host system was overlaid, and the automatic boot-up is not to be done, SWTCH displays the warning:

```
IF TRANSFERRING CONTROL TO NEW SYSTEM,  
IT MUST BE BOOTED AFTER SWTCH TERMINATES.
```

Next, before I/O to the target disc is allowed to resume, SWTCH gives the user an opportunity to remove a temporary target cartridge, by displaying the message:

```
IF RETURNING TO HOST SYSTEM, TARGET CARTRIDGE MUST NOW BE  
REPLACED BY HOST CARTRIDGE (" "CR TO CONTINUE)
```

If in batch mode, or auto-boot mode, the above message is skipped, since it requires an interactive " "CR response from the user. Finally SWTCH prints the normal termination message:

```
SWTCH FINISHED
```

If the host system's LU2 has been overlaid with the new system, be sure to halt the CPU at this point and boot the new system. Attempting to run the old system (which is still in memory) will cause memory violations because the new system on disc does not match the old one in memory.

## Abnormal Termination Messages

If an error condition makes it necessary to terminate SWTCH, the user is given a chance to reinstall the host system disc cartridge before SWTCH unlocks the disc controller interface card of the target disc drive. This feature is useful when the operator wants to return to the host system, and resume all I/O that was held off by the disc lock.

SWTCH does not do the disc lock for 7900 target discs, so the operator must be certain there is no I/O being done while SWTCH is executing.

The abort sequence is:

```
TRANSFER CANCELLED.
```

```
IF RETURNING TO HOST SYSTEM, TARGET CARTRIDGE MUST NOW BE  
REPLACED BY HOST CARTRIDGE (" "CR TO CONTINUE)
```

```
SWTCH TERMINATED.
```

## Transferring the New RTE-IVB Operating System

If the error condition which caused the abort occurred before the user was given an opportunity to insert a temporary disc cartridge, the abort sequence is simply:

```
TRANSFER CANCELLED.  
SWTCH TERMINATED.
```

### Bad Track Information

A maximum of ten bad tracks are allowed on a 7900 disc before SWTCH will abort the transfer. Bad tracks in the area where the absolute system and relocatable library are stored will prevent operation of the system and are not allowed.

Defective tracks are reported as follows:

```
BAD TRACK PLATTER x  
000yyy
```

where "x" is the platter number and "000yyy" is the logical track number needed when initializing the File Manager on the subchannel.

Bad tracks on the ICD and MAC discs are automatically spared to tracks set aside for that purpose. Bad tracks reported and spared will not prevent operation of the system and should not be specified during File Manager initialization on the subchannel.

Defective tracks are reported as follows:

```
BAD TRACKS SUBCHANNEL xx  
  
          LOGICAL  CYL  HEAD  ADDR/UNIT  
BAD TRACK  tttt   cccc  h     u  
SPARED TO  tttt   cccc  h     u
```

where:

```
tttt  is the logical track number (relative to the  
       beginning of the subchannel).  
cccc  is the physical cylinder number on the disc pack.  
h     is the physical head number on the disc pack.  
u     is the ICD address or MAC hardware unit number of  
       the target disc drive.
```

## Transferring the New RTE-IVB Operating System

### SWTCH EXAMPLE

For this example, the user is in this situation:

- He has a cartridge where he wants to put his newly generated system.
- He wants to save the cartridge's file structure. Remember that Type 6 files can only execute on the system on which they were created.
- The new system (destination) will use an I/O configuration that is different from the host's and therefore will not be eligible for the autoboot option (specifically, the select codes for the devices will be changed).
- The target cartridge with the new system installed on it may be the current host system. The host system disc will be overlaid.
- Or, it may be a temporary target replacing the host only for the duration of SWTCH.
- Comments within the body of the example are in lower case letters.

:RU,SWTCH

- \* No parameters are specified so
- \* SWTCH is not in batch mode. SWTCH
- \* will prompt for all parameters.

\*\*\*\*\* W A R N I N G \*\*\*\*\*

ALL ACTIVITY MUST BE TERMINATED BEFORE SYSTEM TRANSFER PROCESS.

FILE NAME OF NEW RTE SYSTEM?

RTE06H::SS

NEW SYSTEM I/O CONFIGURATION:

```
SELECT CODE 14 TBG
SELECT CODE 04 TYPE=43
SELECT CODE 10 TYPE=12
SELECT CODE 11 TYPE=32
SELECT CODE 12 TYPE=01
SELECT CODE 13 TYPE=32
SELECT CODE 15 TYPE=00
SELECT CODE 16 TYPE=00
SELECT CODE 17 TYPE=02
SELECT CODE 20 TYPE=12
SELECT CODE 21 TYPE=31
SELECT CODE 23 TYPE=23
SELECT CODE 25 TYPE=05
```

(continued on following page)

Transferring the New RTE-IVB Operating System

NEW SYSTEM (LU2) SELECT CODE= 13 SUBCHANNEL= 00

#TRACKS 0256 FIRST CYL 0000  
HEAD # 0000 #SURFACES 0002 \* destination system subchannel  
ADDR/UNIT 0000 #SPARES 0006 \* definition.  
#SECTORS/TRACK 0096

TARGET DISC LU FOR NEW SYSTEM? (XX)

2

\* defining the target disc driver

TARGET ADDRESS/UNIT/PLATTER FOR NEW SYSTEM? (X OR " "CR)

0

\* defining the specific target disc

NOW IS THE TIME TO INSERT CORRECT CARTRIDGE IN  
TARGET ADDRESS/UNIT/PLATTER. (" "CR TO CONTINUE)

\* host system's lu 2 may be  
\* replaced by a temporary  
\* target cartridge now.

SAVE FILES AT TARGET? (Y OR N)

Y

PURGE TYPE 6 FILES? (Y OR N)

N

INITIALIZE SUBCHANNELS ? (Y OR N)

Y

\* prompting for subchannel  
\* initialization begins here

TARGET ADDRESS/UNIT 0 FOR SUBCHANNELS 01, 02, 03, 04, 05, 06, 07,

\* these subchannels were  
\* configured to address/unit 0

INITIALIZE SUBCHANNEL 01? (Y OR N)

/E

\* terminates subchannel prompts  
\* for this address/unit

DESTN. ADDRESS/UNIT 1 FOR SUBCHANNELS 08, 09, 10,

\* unit 1 is a 9895 floppy disc

DESTN. ADDRESS/UNIT 2 FOR SUBCHANNELS 11, 12, 13, 14, 15, 16,  
TARGET ADDRESS/UNIT? (XX OR " "CR)

\* default is the destination  
\* address/unit specified during  
\* generation

(continued on following page)

Transferring the New RTE-IVB Operating System

INITIALIZE SUBCHANNEL 11? (Y OR N)

N

INITIALIZE SUBCHANNEL 12? (Y OR N)

Y

INITIALIZE SUBCHANNEL 13? (Y OR N)

/E

\* terminates subchannel initialization  
\* prompts for this unit

DESTN. ADDRESS/UNIT 3 FOR SUBCHANNELS 17, 18, 19, 20, 21, 22, 23,  
24, 25, 26, 27, 28, 29, 30, 31,

TARGET ADDRESS/UNIT? (XX OR " "CR)

/E

\* terminates destination  
\* address/unit prompts

PRESENT CONFIGURATION DOESN'T PERMIT AUTO BOOT-UP.

DISC IN HOST SYSTEM WILL BE OVERLAID.

READY TO TRANSFER. OK TO PROCEED?

YES

INSTALLING SYSTEM SUBCHANNEL 00

BAD TRACKS SUBCHANNEL 00

LOGICAL CYL HEAD ADDR/UNIT

BAD TRACK 0004 0002 00 00

SPARED TO 0256 0128 00 00

BAD TRACK 0015 0007 01 00

SPARED TO 0257 0128 01 00

INITIALIZING SUBCHANNEL 12

IF TRANSFERRING CONTROL TO NEW SYSTEM, IT  
MUST BE BOOTED AFTER SWTCH TERMINATES.

IF RETURNING TO HOST SYSTEM, TARGET CARTRIDGE MUST NOW  
BE REPLACED BY HOST CARTRIDGE (" "CR TO CONTINUE)

\* if LU2 of host system was  
\* removed, it may be reinstalled  
\* now.

SWTCH FINISHED

## SWTCH Error Conditions

An appropriate message will be displayed for any errors encountered during the execution of SWTCH. If SWTCH is aborted because of a disc error on the system subchannel, the system on the disc may not be a workable system.

Error conditions that result in an error message may be encountered at the following points in the execution of SWTCH:

1. While SWTCH is testing for the file structure on the target disc; i.e., it is reading from the target disc in a non-initialization mode.
2. While SWTCH is transferring the destination system to the target disc.
3. While SWTCH is initializing the remainder of the destination system subchannel.
4. While SWTCH is initializing one of the remaining disc subchannels.

Below are listed the SWTCH error messages, their meanings, and the suggested actions to be taken if any of the errors occur:

```
+-----+
| INVALID DISC SPECIFICATIONS ss |
+-----+
```

**Meaning:** Disc specifications do not conform to system disc type, or track areas are too large. This could occur in two places. The first is attempting to read the disc after the save file option was specified. The second is attempting to initiate a write to the target disc. SWTCH is aborted (ss is the destination subchannel causing the error) if this error occurs on the system subchannel. 7900 switches terminate immediately. If initializing a non-system subchannel, SWTCH aborts this subchannel initialization and proceeds to the next.

**Action:** Redefine track areas of generated destination system and regenerate.

Transferring the New RTE-IVB Operating System

```
+-----+
| PARITY OR DATA ERROR TRACK yyy ss |
+-----+
```

Meaning: Read parity/decode error. Ten attempts have been made to read or write to disc track "yyy". SWITCH is aborted (ss is the destination subchannel causing the error) if the error occurs on the system subchannel.

Action: For a 7900, disc recovery is not possible. ICD or MAC discs will proceed to the next subchannel rather than aborting SWITCH.

```
+-----+
| TURN OFF DISC PROTECT--PRESS RUN ss          7900 Disc |
|                --ENTER " "CR ss          ICD/MAC Discs |
+-----+
```

Meaning: The disc protect switch is in the PROTECT position. For 7900 discs, the system executes a HALT 32B (ss is the destination subchannel causing the error).

Action: Turn off the switch and press RUN on the CPU control panel, or enter " "CR. (This switch is called the READ-ONLY switch for the 7920 model disc.)

```
+-----+
| TURN ON FORMAT SWITCH--PRESS RUN ss          7900 Disc |
|                --ENTER " "CR ss          ICD/MAC Discs |
+-----+
```

Meaning: The Format switch is not in the ON position. For 7900 discs the system executes a HALT 32B (ss is the destination subchannel causing the error).

Action: Set the Format switch to ON and press RUN on the CPU control panel or enter " "CR.

Transferring the New RTE-IVB Operating System

```
+-----+
| READY DISC AND PRESS RUN ss           7900 Disc |
|           --ENTER " "CR ss           ICD/MAC Discs |
+-----+
```

Meaning: The disc device is not ready. For 7900 discs the system executes a HALT 33B (ss is the destination subchannel causing the error).

Action: Ensure that the disc drive is ready and press RUN on the CPU control panel, or enter " "CR.

```
+-----+
| DEFECTIVE CYLINDER - TRACK XXXX SS |
+-----+
```

Meaning: Disc error. SWTCH is aborted (ss is the destination subchannel causing the error).

Action: Recovery is not possible.

```
+-----+
| LIMIT OF 10 BAD TRACKS EXCEEDED ss |
| (7900 Disc only)                   |
+-----+
```

Meaning: More than ten bad tracks exist on a subchannel. SWTCH is aborted (ss is the destination subchannel causing the error).

Action: Redefine the track area and regenerate, or get a new disc.

```
+-----+
| OUT OF SPARES XX                    |
| (ICD and MAC DISCS only)           |
+-----+
```

Meaning: All available spare tracks have been used up. If this error occurs while installing the system subchannel, SWTCH will abort. When initializing a peripheral subchannel, SWTCH will abort this subchannel, and proceed to the next.

Action: Define more spare tracks for the problem subchannels, and regenerate.



## Transferring the New RTE-IVB Operating System

```
+-----+  
| UNABLE TO INITIALIZE SUBCHANNEL XX |  
| (ICD/MAC DISCS only)              |  
+-----+
```

Meaning: Because of one of the previous error conditions, SWITCH  
"soft aborted" subchannel xx and will proceed to the next.

Action: None.



# Chapter 5

## System Initialization

### General

After you've generated and installed your new system, perform the following steps to make your system operational:

1. Boot up your new system.
2. Initialize your primary and auxiliary system cartridges (LU2 and LU3).
3. Check your system. Perform simple checks that will check the operation of commands and devices for proper functioning. Check for generation errors. If appropriate, run the RTE reconfigurator to correct these errors.
4. Install utilities. Utilities not generated into the system should be configured into the system with the on-line LOADR. Type 6 files should be created for them and transfer files made to set up/clean up utility short ID segments. This chapter will give the on-line installation procedures for utilities included on the 92068A grandfather disc.
5. Create the system WELCOM file. The WELCOM file is a FMGR command file that is automatically transferred at system startup. It can be used to enable terminals, initialize subsystems, set up ID segments, correct generation errors, and pack cartridges.
6. Install various user transfer files, documentation files, and support files. If desired, the HELP utility message file "HELP" can be installed on the system and modified to suit the needs of your particular installation. On MTM systems, you may install a transfer file called the HI file to be executed when users invoke their copy of FMGR. For session systems, the System Manager may install specific transfer files to give low capability users access to special high capability level commands or to perform various privileged system functions.
7. Initialize the spooling system. If spooling has been configured into the system, you must initialize the spooling system by running GASP. This process is described in the RTE-IVB Batch and Spooling Reference Manual.
8. Create a backup copy of your system on magnetic tape or disc. The procedures required to save/restore your system on disc or magnetic tape are given in the utilities reference manual.

This chapter discusses these steps in greater detail. For your convenience, it is recommended that they be followed in the order presented.

## Standard Bootup Procedures

System boot-up is the process of loading the operating system software into memory so that it is ready for execution. Boot-up begins by using either the Disc Loader ROM or Bootstrap Loader to load the Boot Extension into memory from track 0, sector 0 of the system disc subchannel. The Boot Extension, in turn, loads the operating system into memory.

At this point, the user has the option of either completing a "standard" system boot-up procedure as described in this section, or reconfiguring the current I/O and memory assignments as described in chapter 9, "Memory and I/O Reconfiguration." In a standard boot-up, the operating system immediately completes the rest of the initialization process as follows:

1. Displays a SET TIME message.
2. Executes a startup program (optional).
3. Passes control to the File Manager (FMGR), which tries to execute a procedure file named WELCOM. If the WELCOM file does not exist on the system, the FMGR displays a FMGR -006 error message.

If memory and/or I/O reconfiguration are to be performed during system boot-up, completion is delayed and an interactive Configurator program is scheduled via S-register settings to make the new memory and I/O assignments. At the end of the reconfiguration process, control is returned to the system to complete the boot-up procedure as described above.

Use the procedures described below to perform a standard system boot-up. Use the procedures described in Chapter 9 to perform a boot-up with I/O and memory reconfiguration.

## BOOT LOADERS AND BOOT EXTENSION

The Disc Boot Extension can be loaded into memory from the disc using either the Disc Loader ROM or Bootstrap Loader.

### Disc Loader ROM

The Disc Loader ROM can be used to load the Boot Extension if the Boot Extension resides on physical track 0, sector 0 of the system disc. Refer to the HP 12992 Loader ROM's Installation Manual (12992-90001) for a description of the S-register setting to load the Boot Extension into memory. An example of a standard system boot-up using the 12992B RPL-compatible 7905/7906/7920 Disc Loader ROM is as follows:

1. Select the S-register for display on the computer front panel.
2. Press CLEAR DISPLAY.
3. Set the S-register bits as follows:

| Bits: | Enter:  |
|-------|---|
| ----  | -----   |
| 0-2   | Surface number of the disc where the RTE-IVB system subchannel starts (surface numbers start at 0). |
| 3-4   | 0 (reserved)  |
| 5     | 0 for standard boot-up  |
| 6-11  | Octal select code of the disc.  |
| 12    | 1 to indicate a manual boot from the S-register.  |
| 13    | 0 (reserved)  |
| 14-15 | Loader ROM selection (number of the ROM cell containing the Disc Boot Loader).                      |

4. Press STORE.
5. Press PRESET, IBL and PRESET (again) to load contents of Disc Loader ROM. A successful load is indicated if the OVERFLOW indicator does not light up.
6. Press RUN.

**EXAMPLE:**

1. Assume a standard boot-up from ROM #2, with a 7906 in select code 21 and surface 0.
2. Set the S-register = 112100. Press STORE.
3. Press PRESET, IBL, PRESET (again) and RUN.

### **Bootstrap Loader**

The Bootstrap Loader is used to load the Boot Extension into memory if the Boot Extension does not reside on physical track 0, sector 0 of the system disc, or if the Disc Loader ROM is not available. The procedure is as follows:

## System Initialization

1. Select the S-register for display on the computer front panel.
2. Press CLEAR DISPLAY.
3. Set the S-register bits as follows:

| Bits: | Enter:  |
|-------|---|
| ----- | -----   |
| 0-5   | 0   |
| 6-11  | Octal select code of input device (e.g., photoreader) |
| 12-15 | 0   |

4. Press STORE.
5. Press PRESET, IBL and PRESET (again) to load the bootstrap Loader. A successful load is indicated if the OVERFLOW indicator does not light up.
6. Press RUN.

When the HLT 77B occurs, clear the S-register, set the P-register to octal 100 and press RUN to continue.

## Boot Extension Execution

The disc Boot Extension uses the S-register to communicate with the configurator program (see Chapter 9). Do NOT change the S-register contents until the system boot-up procedure is completed and the SET TIME message is displayed.

## System Track Allocation

The system maintains complete control over the allocation and ownership of disc tracks on the system (LU2) and auxiliary system (LU3) subchannels. Track control is maintained via the Track Assignment Table (TAT). Peripheral discs (NOT LU2 or LU3) are not managed through the TAT.

Figure 5-1a shows the structure of the system disc subchannel (LU2). This subchannel has three distinct areas. The first area, starting at track 0, is the system area. A memory image of the operating system, drivers, and all programs loaded at generation time are stored here. In addition, this location contains the system library relocatable modules and an entry point directory.

The second area forms the System Scratch track pool. System Scratch tracks are used in a variety of ways:

- o Scratch tracks can be allocated to programs requesting scratch disc space with EXEC calls. If you need to run application

programs in the system making extensive use of system scratch tracks, their requirements should be considered when estimating the number of scratch tracks to be configured in your system.

- o Scratch tracks can be allocated for swap space. A contiguous block of available scratch tracks must exist for each program swapped out from memory on to disc. Generally, the amount of scratch tracks used for swapping will be determined by the number of active programs contending for the same memory partitions.
- o Scratch tracks are allocated to contain programs added to the system with the on-line Loader. At least one track will be allocated for each program added to the system in this manner.
- o Scratch tracks are used for the logical source (LS) and load and go (LG) areas. These areas were used by pre-RTE-IVB Compilers, Assemblers, and Loaders when accessing source programs (LS) or relocatable binaries (LG) on disc. In the session environment, these areas are not generally accessible.

There must be a minimum of 8 tracks in the scratch track pool on LU2, however, a minimum of 50 is recommended. If the EMA feature of RTE-IVB is being used, a larger system scratch track area may be necessary to allow swapping of large arrays. The additional space needed can be determined by dividing the EMA program size by the number of words per track (i.e., 6144 words for 7900/05/06(H)/20(H) type discs, 8192 words for 7925(H) type discs, 3840 words for 9895 type discs).

The scratch track pool begins at the next available track following the system area. The upper boundary of this area is determined the first time a generated system is booted up. This boundary is set up with the FMGR LU2 cartridge initialize command (refer to FMGR INITIALIZATION section of this chapter).

The LU2 FMP cartridge comprises the third area on the system subchannel. This area is used for type 6 files, transfer files, and other files to be made accessible to all system users.

An auxiliary system subchannel (LU3) can be used to extend your system file space (e.g., for additional type 6 files) and/or provide additional scratch tracks for swapping, etc. A sample LU3 configuration is shown in Figure 5-1b. The boundary between the scratch track area and FMP area on LU3 is determined by the FMGR LU3 cartridge initialize command.

When initializing LU2 and LU3 at system startup, you will have to make a trade-off between the number of tracks allocated for the scratch track pool and the number allocated for the FMP cartridges on these areas.

## System Initialization

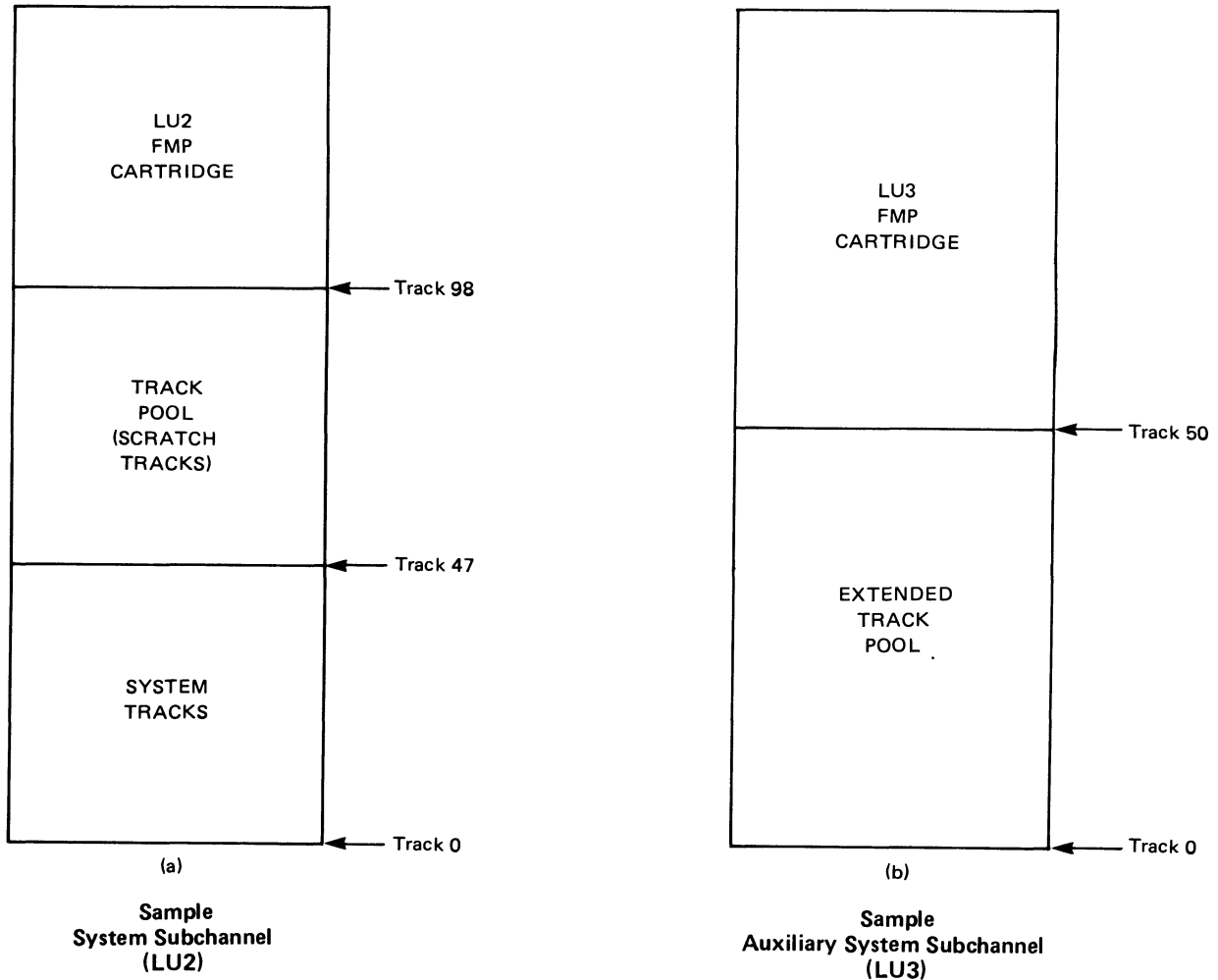

Figure 5-1. Sample System and Auxiliary Subchannels

## FMGR Initialization

In order to use FMGR, an FMP cartridge must be initialized on LU2. The first time the system is started up after generation, an FMP cartridge on LU2 will exist only if a request to save files was made during system switchover (refer to Chapter 4). Even when the FMP cartridge exists on LU2 the Master Security Code is set to the null characters (control@control@) by SWITCH. If not, FMGR will ask you to initialize the FMP area on LU2. It will display the message FMGR 002 and then issue the standard prompt:

```
SET TIME
```

```
FMGR 002
```

```
:
```



You should enter an IN command to initialize the FMP area on LU2. This command will specify the number of directory tracks on the cartridge, the FMGR master security code, an ASCII identifier for the FMP cartridge, and any bad tracks on that cartridge. Refer to the Terminal User's Reference Manual for IN command syntax.

## CAUTION

If you assign a master security code here, remember it because it cannot be recovered. The master security code is always reset to the null character (control@control) during SWTCH.

The FMP starting track must be at least 8 tracks greater than the last track used by the system. The system size in tracks is reported in the generation dialog. The system scratch track area will begin on the next track. It will extend up to the first track specified in your IN command. For example, if you have the following: LU2 has 256 tracks, you wish to allocate 50 scratch tracks, and your system needs 47 tracks; then the first track of your LU2 FMP cartridge will be the 98th track (47+1+50).

If an auxiliary system disc subchannel (LU3) has also been configured into your system, a portion (or all) of the tracks on this subchannel may be used for system scratch tracks. The remainder will be used for the LU3 FMP cartridge area. The number of tracks used for the FMP cartridge is determined by the way LU3 is initialized. The first time the system is booted up after generation, FMGR will prompt:

```
FMGR 003
:
```

You should now enter an IN command to initialize this cartridge. The system scratch track area will precede the FMP area on this LU. Therefore, the number of scratch tracks allocated on LU3 will be determined by the start of the FMP cartridge specified in the IN command. If a FMP cartridge is not needed on LU3, the IN command should still be specified in response to FMGR 003, but the cartridge reference number should be specified as 0.

Before FMGR is initialized at system start up, it obtains all available tracks on the system and auxiliary system disc. After successful initialization with the IN commands, or upon subsequent system restarts, only those tracks residing in the FMP cartridges on these LUs will be assigned to the file management system. The cartridge directory tracks on LU2 (and LU3 if a cartridge exists on it) will be assigned to the file directory manager, D.RTR. After the FMP tracks have been reserved, FMGR transfers control to the WELCOM file. If the LU2 FMP area has just been initialized, this will not exist; so error FMGR -006 is generated and control is passed to the system console.

## System Initialization

Example: To initialize the system subchannel with a FMP cartridge starting at track 100 and the auxiliary system subchannel with no tracks assigned to a FMP cartridge:

SET TIME

FMGR 002 (Request system subchannel initialization.)

:IN,XX,-2,2,SYSTEM,100 (Start at track 100. Set master security code to XX.)

FMGR 003 (Request auxiliary system subchannel initialization.)

:IN,XX,-3,0 (Do not assign auxiliary disc tracks to an FMP cartridge, CRN 0).

FMGR-006 (FMGR fails to find WELCOM and transfers to the system console)  
:

If there is no auxiliary system subchannel configured into your system, FMGR will not request LU3 initialization.

If you respond with command other than IN to the prompts FMGR 002 or FMGR 003, the error message FMGR 004 is issued. If you correctly enter IN but request a starting track that is not available, FMGR 005 is issued. The first available track and sector can be obtained at this point by entering "??".

## System Tests

Simple and easy to use test procedures are provided below. They cannot test for all possible generation errors, but they do exercise the software and equipment sufficiently well to test for major hardware failures or generation errors. You may wish to supplement them with tests of your own.

Test your system using operator commands. For example, enter TI several times; if the time-of-day message that is printed does not change, the Time Base Generator is installed in the wrong slot, or is not working. Run the File Manager, list the directory and list some of the source files. Create some simple source files using EDITR, preferably a simple FORTRAN program, which you should compile, load and run. Dump source files to any output device, and re-submit the output tape, listing it. It should be identical to the disc file. If you notice anything peculiar, note the specific symptoms, and continue testing until you are satisfied that it has been well tested. If you noted any errors, consult the RTE generation manual examples, your own and the factory-generation listing. Pay particular attention to those questions you answered differently from those shown in the factory examples. When you've identified the problems, restore your previous system, boot-up that system, purge all copies of the previous generation boot, output, and list files, pack the disc, edit the answer file, and re-run the RTE generator.

Note that certain errors pertaining to I/O table definitions and memory partition definitions can be corrected by running the RTE-IVB Reconfigurator (described in Chapter 9).

If generation errors can be corrected with operator commands (e.g., LU reassignments with system LU commands), these commands may be inserted in the WELCOM file for execution at system startup.

## File System Conventions

There should be a standard system of file conventions in order to simplify the installation and maintenance of your file system. You may follow the Hewlett-Packard conventions given below or you may design your own.

- o The primary and auxiliary system FMP cartridges (LUs 2 and 3) are initialized with cartridge reference numbers (CRNs) of 2 and 3 respectively.
- o Files for general user access (such as utility type 6 files, standard transfer files, system documentation files, etc.) are protected from inadvertant destruction by a "general security code" such as RT.
- o If users agree to use a convention for naming files, it is much easier to examine (and remember) the contents of a disc. A convention in wide use, and supported by RTE-IVB compilers and assemblers, is to attach significance to the first character of a file name as follows:

```

& Program source code file
% Binary relocatable code file
! Binary absolute object code file
/ Program setup procedure file
\ Program cleanup procedure file
# Alternate relocatable code file
" Documentation, information, or list file
* General purpose file manager command transfer file
$ Alternate source code file for a program (e.g. in
developmental or test stage)

```

Type 6 files and system transfer files (like WELCOM) begin with letters.

- o In systems generated without the Session Monitor, dummy "fill" files can be used to control the space on LU's 2 and 3. This space should be reserved for type 6 files and documentation and transfer files to be made available to all users. A fill file can be created on LU's 2 and 3 to take up unused space remaining at the end of the FMP cartridge. This will prevent user files from being stored here since file space will be unavailable. When files are to be added to FMP LU's 2 or 3, the fill files can be temporarily purged and then recreated once the files have been

## System Initialization

added. Fill files can be created on these cartridges with the commands:

```
:CR,FILL02:RT:2:3:-1 (create fill file on LU2)
```

```
:CR,FILL03:RT:3:3:-1 (create fill file on LU3)
```

Note that, if the Session Monitor is used on your system, fill files should not be created since user access to LU's 2 and 3 is automatically restricted.

- o The system generation listing is stored in file "SYSTEM on a globally accessible cartridge. Generation parameters can then be easily accessed by users, such as systems programmers, when troubleshooting or modifying the system. For example, to copy the generation map from LU5 onto LU2, specify:

```
:ST,5,"SYSTEM:RT:2:.-1
```

Normally the list file is rather large, so it may be desirable to put it on a cartridge other than LU2 or LU3.

- o If the Multi-Terminal Monitor (MTM) is used in your system, and you have enough disc space, it is a good idea to "logically" associate each terminal with a specific disc LU. You can put an identifying tag on each terminal to tell the terminal user which disc LU he should use. There is actually nothing to prevent users from using LU's not assigned to them in this fashion. However, if they agree to the rules, interference among users can be minimized.

## Utility Installation Procedures

This section gives the procedures required for on-line installation of utilities and programs supplied on the 92068A Grandfather disc. The generation procedures for a subset of these programs are given in Chapter 3. Use the procedures given in this section for utilities not generated into the system.

After the system is operational, programs can be permanently added in one of two ways: They may be permanently added with the on-line LOADR (i.e. OP,PE loader directive), or type 6 files can be created for them. The latter method is preferable because better use is made of available disc space and ID segments are not permanently allocated to the utilities (refer to the "SYSTEM UTILITIES AND LIBRARIES" section in Chapter 3).

It is recommended the steps below be followed for each utility that you want to permanently add to the system after generation:

1. Load the utility temporarily using the on-line LOADR. LOADR can be run to take its inputs either from the terminal or from a command file. Refer to the Terminal User's Reference Manual for a description of LOADR operating parameters. Table 5-1 gives minimum and recommended utility partition sizes for those utilities requiring additional buffer space.
2. Type 6 files should be created for each utility and its segments. The utility (main and segments) should then be aborted (i.e. :OF,name) to deallocate the ID segments occupied by the temporary load. To assist you in this process, you can create a general purpose transfer file (usually called \*SP) to make a type 6 file of a program and then remove the program from the system:

```

(MTM*SP)                                (Session *SP)
:PU,FILL02:RT:2                          :SP,lg:RT
:SP,lg:RT:2                              :OF,lg
:OF,lg                                    ::
:CR,FILL02:RT:2:3:-1
::

```

3. If the utility has segments, create file manager command transfer files to allocate and deallocate short ID segments for the utility segments. Usually, transfer files used to set up short ID segments for utility are named "/prog" where "prog" is the utilities name. Similarly, transfer files which perform clean up functions (i.e. release ID segments) are called "\prog". Utility T5IDM may be used for this purpose. T5IDM is described at the end of this section.

Table 5-1 shows the LOADR command procedures, type 6 file creation commands, and the set-up and clean-up transfer files for all the utilities and subsystems supplied on the standard 92068A Primary System Disc.

It is recommended that all type 6 files and associated transfer files be given security codes. Normally there is no need to set up ID segments for utility main type 6 files since this is automatically done when the utility is run with the file manager :RU command. Normally, this command will create a copy of the utility for that user. This allows several users to operate the utility at the same time. Note that the same set of utility segments (identified in the system with short ID segments) can be shared by different copies of the utility main. They should not be copied.

An example installation dialog for the FTN4 compiler is listed in Figure 5-2. Note that operator inputs are underlined.

System Initialization

Table 5-1. Utility and Subsystem Transfer Files

| Program<br>Description        | LOADR*<br>Commands  | Type 6 File<br>Creation  | Setup<br>Transfer File   | Clean-up<br>Transfer File  |
|-------------------------------|---|--|--|--|
| RTE Editor                    | SZ,9(8)<br>REL,%EDITR<br>END  | ::*SP,EDITR  | Not<br>Required  | Not<br>Required  |
| FORTRAN IV<br>Compiler<br>*** | SZ,12(12)<br>REL,%FTN4<br>REL,%FFTN4<br>REL,%0FTN4<br>REL,%1FTN4<br>REL,%2FTN4<br>REL,%3FTN4<br>REL,%4FTN4<br>REL,%5FTN4<br>END | ::*SP,FTN4<br>:*SP,F4.0<br>:*SP,F4.1<br>:*SP,F4.2<br>:*SP,F4.3<br>:*SP,F4.4<br>:*SP,F4.5 | (File /FTN4)<br>:RP,F4.0<br>:RP,F4.1<br>:RP,F4.2<br>:RP,F4.3<br>:RP,F4.4<br>:RP,F4.5<br>:<br>: | (File \FTN4)<br>:RP,,F4.0<br>:RP,,F4.1<br>:RP,,F4.2<br>:RP,,F4.3<br>:RP,,F4.4<br>:RP,,F4.5<br>:<br>: |
| RTE<br>Assembler<br>***       | SZ,12(10)<br>REL,%4ASMB<br>REL,%4ASB0<br>REL,%4ASB1<br>REL,%4ASB2<br>REL,%4ASB3<br>REL,%4ASB4<br>END                            | ::*SP,ASMB<br>:*SP,ASMB0<br>:*SP,ASMB1<br>:*SP,ASMB2<br>:*SP,ASMB3<br>:*SP,ASMB4         | (File /ASMB)<br>:RP,ASMB0<br>:RP,ASMB1<br>:RP,ASMB2<br>:RP,ASMB3<br>:RP,ASMB4<br>:<br>:        | (File \ASMB)<br>:RP,,ASMB0<br>:RP,,ASMB1<br>:RP,,ASMB2<br>:RP,,ASMB3<br>:RP,,ASMB4<br>:<br>:         |
| RTE SWTCH<br>Utility**        | REL,%SSTCH<br>END   | ::*SP,SWTCH<br>:*SP,SWSG1<br>:*SP,SWSG2  | (File /SWTCH)<br>:RP,SWSG1<br>:RP,SWSG2<br>:<br>:  | (File \SWTCH)<br>:RP,,SWSG1<br>:RP,,SWSG2<br>:<br>:  |
| WHZAT<br>Utility              | OP,PE<br>REL,%WHZAT<br>END  | Not<br>Required  | Not<br>Required  | Not<br>Required  |
| Cross<br>Reference<br>Utility | SZ,12(8)<br>REL,%4XREF<br>END   | ::*SP,XREF   | Not<br>Required  | Not<br>Required  |
| Track<br>Status<br>Utility    | OP,PE<br>REL,%LGTAT<br>END  | Not<br>Required  | Not<br>Required  | Not<br>Required  |

\* LOADR SZ commands are shown with recommended sizes. Minimum sizes are shown in parentheses.

\*\* Generally, SWTCH needs to be loaded only before its use.

\*\*\* Set up and clean up transfer files not required if T5IDM is loaded in the system.

Table 5-1. Utility and Subsystem Transfer Files (Cont.)

| Program Description          | LOADR* Commands                                       | Type 6 file Creation  | Setup Transfer File   | Clean-up Transfer File  |
|------------------------------|---|---|---|---|
| Disc Copy Utility            | REL,%LCOPY<br>END                                     | ::*SP,LCOPY   | Not Required  | Not Required  |
| Terminal Softkey Utility     | REL,%KEYS<br>END                                      | ::*SP,KEYS  | Not Required  | Not Required  |
| Softkey Dump Utility         | REL,%KYDMP<br>END                                     | ::*SP,KYDMP   | Not Required  | Not Required  |
| Flexible Disc Backup Utility | REL,%MSAFD<br>END                                     | ::*SP,SAFD  | Not Required  | Not Required  |
| MT to Disc Restore Utility   | REL,%RESTR<br>END                                     | ::*SP,RESTR   | Not Required  | Not Required  |
| RTE-IVB On-Line Generator    | OP,LB<br>SZ,28(14)<br>REL,%RT4G1<br>REL,%RT4G2<br>END | ::*SP,RT4GN<br>::*SP,RT4G1<br>::*SP,RT4G2<br>::*SP,RT4G3<br>::*SP,RT4G4<br>::*SP,RT4G5<br>::*SP,RT4G6<br>::*SP,RT4G7<br>::*SP,RT4G8 | (File /RT4GN)<br>:RP,RT4G1<br>:RP,RT4G2<br>:RP,RT4G3<br>:RP,RT4G4<br>:RP,RT4G5<br>:RP,RT4G6<br>:RP,RT4G7<br>:RP,RT4G8<br>:: | (File \RT4GN)<br>:RP,,RT4G1<br>:RP,,RT4G2<br>:RP,,RT4G3<br>:RP,,RT4G4<br>:RP,,RT4G5<br>:RP,,RT4G6<br>:RP,,RT4G7<br>:RP,,RT4G8<br>:: |
| Disc to MT Save Utility      |   |   |   |   |
| Unit Save                    | REL,%USAVE<br>END                                     | ::*SP,USAVE   | Not Required  | Not Required  |
| Specified Disc LU's          | REL,%LSAVE<br>END                                     | ::*SP,LSAVE   | Not Required  | Not Required  |
| Compile Utility              | REL,%COMPL<br>END                                     | ::*SP,COMPL   | Not Required  | Not Required  |
| Merge Utility                | REL,%MERGE<br>END                                     | ::*SP,MERGE   | Not Required  | Not Required  |

CONTINUED NEXT PAGE

System Initialization

Table 5-1. Utility and Subsystem Transfer Files (Cont.)

| +-----CONTINUED FROM PREVIOUS PAGE-----+ |                               |                      |                     |                        |      |
|--|-------------------------------|----------------------|---------------------|------------------------|------|
| Program Description                      | LOADR* Commands               | Type 6 file Creation | Setup Transfer File | Clean-up Transfer File |      |
| Compile and Load Utility                 | REL,%CLOAD<br>END             | ::*SP,CLOAD          | Not Required        | Not Required           |      |
| File Cart. Save Utility                  | REL,%WRITT<br>END             | ::*SP,WRITT          | Not Required        | Not Required           |      |
| File Cart. Restore Utility               | REL,%READT<br>END             | ::*SP,READT          | Not Required        | Not Required           |      |
| EMA Firmware Verify Utility              | REL,%#EMA<br>END              | ::*SP,#EMA           | Not Required        | Not Required           |      |
| HELP Utility                             | OP,PE<br>REL,%HELP<br>END     | Not Required         | Not Required        | Not Required           |      |
| Short ID Handler T5IDM                   | OP,PE<br>REL,%T5IDM<br>END    | Not Required         | Not Required        | Not Required           |      |
| Disc Format Utility                      | SZ,17<br>REL,%FORMT<br>END    | ::*SP,FORMT          | Not Required        | Not Required           |      |
| Disc Copy Utility                        | SZ,12(7)<br>REL,%COPY<br>END  | ::*SP,COPY           | Not Required        | Not Required           | **** |
| MT to Disc Restore Utility               | SZ,12(8)<br>REL,%RSTOR<br>END | ::*SP,RSTOR          | Not Required        | Not Required           | **** |
| Disc to MT Save Utility                  | REL,%SAVE<br>END              | ::*SP,SAVE           | Not Required        | Not Required           | **** |
| Disc Verify Utility                      | SZ,12(7)<br>REL,%VERFY<br>END | ::*SP,VERFY          | Not Required        | Not Required           | **** |

\*\*\*\* These Utilities are for 7900 discs.



```

:RU,EDITR
-----
SOURCE FILE?
/0
-
EOF
/ SZ,15
-----
/ REL,%FTN4
-----
/ REL,%FFT4
-----
/ REL,%0FTN4
-----
/ REL,%1FTN4
-----
/ REL,%2FTN4
-----
/ REL,%3FTN4
-----
/ REL,%4FTN4
-----
/ REL,%5FTN4
-----
/ END
-----
/EC*FTN4:RT:2
-----
END OF EDIT
:RU,LOADR,*FTN4
-----
.
.
.
(FTN4 load listing appears here)
.
.
.
11 PAGES RELOCATED 15 PAGES REQ'D NO PAGES EMA NO PAGES MSEG
/LOADR:FTN4 READY AT 6:03 PM TUE., 27 FEB., 1979

/LOADR:$END
:RU,EDITR
-----
SOURCE FILE?
/0
-
EOF

```

Figure 5-2. Sample Program Load



System Initialization

```
:RP,F4.0
:RP,F4.1
:RP,F4.2
                                (Create transfer file FTN4 to setup
                                short ID segments)

:RP,F4.3
:RP,F4.4
:RP,F4.5
::
EOF
/EC/FTN4:RT:2
-----
END OF EDIT
:RU,EDITR
-----
SOURCE FILE?
//FTN4
-----
:RP,F4.0
/X,/,,
-----
/L20
-----
:RP,,F4.0
:RP,,F4.1
:RP,,F4.2
:RP,,F4.3
:RP,,F4.4
:RP,,F4.5
::
EOF
/EC\FTN4:RT:2
-----
END OF EDIT
:
```

Figure 5-2. Sample Program Load (Continued)

## WELCOM File

At system start up, the system schedules FMGR to execute commands from the file WELCOM. This file should contain the file manager and operating system commands necessary to initialize your system. A sample WELCOM file listing is shown in Figure 5-3. This WELCOM file performs the following functions which should be included, if applicable, in your WELCOM file:

- o COMMAND ECHO (line 1). A severity level of one can be specified to inhibit the echoing of WELCOM file commands to the system console. The "IH" parameter in this case will inhibit echoing of the SV command itself.
- o OPERATOR MESSAGE (lines 2-7). It is suggested that you print a start up message on the system console indicating that the initialization process has begun. The file manager :TE command provides a convenient way of doing this on a line by line basis.
- o ALTER SYSTEM PARAMETERS (lines 8-11). The WELCOM file can alter system parameters in order to correct generation errors and/or change system default values. The commands will be of the form:

:SY<operating system command>.

Types of commands you may wish to place here are:

1. Commands which alter I/O table definitions. The LU command can be used to redefine logical unit/equipment table (EQT)/subchannel assignments. The EQ command can be used to enable/disable automatic output buffering on selected devices. The BL command can alter the automatic buffering limits. The TO command can be used to change device time-out values.
2. Commands which control program execution. The PR command can change program priority levels. The IT command will place programs on the time list and/or change execution intervals. The ON and RU commands will schedule programs for execution. The QU command will alter the system time slicing parameters.
3. Commands which alter partition definitions. The AS command will assign programs to execute in specific partitions. The UR command will release a previously reserved partition.

The Terminal User's Reference Manual describes the operating system commands in detail.

- o PACK SYSTEM CARTRIDGES (line 12). Reference is made to a user created transfer file called \*PACK. Sample listings of \*PACK for both session and non-session users are shown below:

System Initialization

|                           |                   |
|---------------------------|-------------------|
| (MTM/non-session version) | (Session version) |
| :PU,FILL02:R7:-2          | :PK,-2            |
| :PK,-2                    | :PK,-3            |
| :CR,FILL02:RT:-2:3:-1     | ::                |
| :PU,FILL03:RT:-3          |                   |
| :PK,-3                    |                   |
| :CR,FILL03:RT:-3:3:-1     |                   |
| ::                        |                   |

```

0001 :SV,1,,IH
0002 :TE,*****
0003 :TE,*
0004 :TE,* RPE-IVB 92068A SYSTEM REV 2001 *
0005 :TE,* GENERATED 3/1/80 *
0006 :TE,*
0007 :TE,*****
0008 :SYEQ,1,UN
0009 :SYLU,50,15,1
0010 :SYBL,100,400
0011 :SYQU,90,2000
0012 ::*PACK
0013 ::*STIME
0014 ::/FTN4
0015 ::/ASMB
0016 ::/QUERY
0017 ::*COPY,FMGR,FMG07
0018 ::*COPY,FMGR,FMG09
0019 ::*COPY,FMGR,FMG15
0020 ::*COPY,FMGR,FMG22
0021 ::*COPY,FMGR,FMG23
0022 ::*COPY,FMGR,FMG24
0023 ::*COPY,FMGR,FMG25
0024 :RU,LSTEN,*LSTEN
0025 :CT,7,20B,,RTE IS UP....TERMINAL #7....STRIKE ANY KEY
0026 :CT,9,20B,,RTE IS UP....TERMINAL #9....STRIKE ANY KEY
0027 :CT,15,20B,,RTE IS UP....TERMINAL #15....STRIKE ANY KEY
0028 :CT,21,20B,100001B
0029 :CT,22,20B,10101B,RTE IS UP....TERMINAL #22....HIT ENTER KEY
0030 :CT,23,20B,10102B,RTE IS UP....TERMINAL #23....HIT ENTER KEY
0031 :CT,24,20B,10103B,RTE IS UP....TERMINAL #24....HIT ENTER KEY
0032 :CT,25,20B,10104B,RTE IS UP....TERMINAL #25....HIT ENTER KEY
0033 :TE,
0034 :TE, <<<< INITIALIZATION COMPLETE >>>>
0035 :TE,
0036 :EX

```

Figure 5-3. Sample WELCOM File

## System Initialization

In the above listings, references to LU3 should be omitted if an auxiliary system cartridge is not configured into your system.

Once ID segments are allocated to programs on any disc cartridge identified as type 6 files (via file manager :RP or :RU commands), these cartridges cannot be packed. Packing will recover disc space returned to the system when files on these cartridges are purged. It is strongly suggested that these cartridges be packed using the WELCOM file at system start up. It may not be possible to do so (and reclaim unused disc space) at a later time.

The PACK commands are put in the separate \*PACK file instead of directly in the WELCOM file because the WELCOM file itself may be moved during the packing process.

- o SET SYSTEM TIME (line 13). It is recommended that the system time be set correctly during initialization. Certain HP subsystems will (and user application programs may) make use of the system time for scheduling and accounting purposes. Therefore, the time should be set correctly before these subsystems are initialized. In the sample WELCOM file, reference is made to a transfer file \*STIME which queries the operator for the time. A listing for this file is shown in Figure 5-4. When run, \*STIME queries the operator with:

ENTER DATE/TIME AS FOLLOWS::,MONTH,DAY,HOUR,MIN,SEC[,PM]

:PA,,WHERE PM IS ENTERED AFTER NOON.

- o SETUP SHORT ID SEGMENTS (lines 14-16). At system start up, short ID segments should be set up for utilities and subsystems to be run frequently or by more than one user at a time. Programs in this category might be compilers, assemblers, utilities, etc. Multiple copies of the program can share the same short ID segments. When the main program is run (e.g. FTN4), file manager will make a copy of it for that particular user (e.g. FTN07, FTN09, etc.). By setting up short ID segments in the WELCOM file for a program, users of that program are freed from this function later on. Short ID segments need not be set up in the WELCOM file for the following: utilities generated into the system (their short ID segments are already defined in the system), compilers and assemblers if T5IDM is loaded in the system, utilities without segments (no short ID segments are required), and utilities run infrequently or by only one user at a time. The "/prog" and "\prog" transfer files can be used to set up and remove short ID segments when required.

```

0001 :SV,1,8,IH
0002 :DP,ENTER DATE/TIME AS FOLLOWS: : ,MONTH,DAY,HOUR,MIN,SEC [,PM]
0003 :PA,,WHERE 'PM' IS ENTERED IF AFTER NOON.
0004 :** CLEAR MONTH TO A.3 CHAR. ABBREV.
0005 :CA,-33:P,20040B
0006 :CA,-34:P,-34P,AND,177400B,+ ,40B
0007 :** ACCUMULATE DAYS IN 1P
0008 :CA,1:P,2G
0009 :IF,1G,EQ,JAN,25
0010 :CA,1:P,31,+ ,1P
0011 :IF,1G,EQ,FEB,23
0012 :** ASSUME FOR STANDARD YEAR
0013 :CA,1:P,28,+ ,1P
0014 :IF,1G,EQ,MAR,20
0015 :CA,1:P,31,+ ,1P
0016 :IF,1G,EQ,APR,18
0017 :CA,1:P,30,+ ,1P
0018 :IF,1G,EQ,MAY,16
0019 :CA,1:P,31,+ ,1P
0020 :IF,1G,EQ,JUN,14
0021 :CA,1:P,30,+ ,1P
0022 :IF,1G,EQ,JUL,12
0023 :CA,1:P,31,+ ,1P
0024 :IF,1G,EQ,AUG,10
0025 :CA,1:P,31,+ ,1P
0026 :IF,1G,EQ,SEP,8
0027 :CA,1:P,30,+ ,1P
0028 :IF,1G,EQ,OCT,6
0029 :CA,1:P,31,+ ,1P
0030 :IF,1G,EQ,NOV,4
0031 :CA,1:P,30,+ ,1P
0032 :IF,1G,EQ,DEC,2
0033 :DP,MONTH MISPELLED. TRY AGAIN
0034 :IF,,EQ,,-33
0035 :IF,3G,NE,12,1
0036 :CA,3,0
0037 :** NOW HAVE DAY CHECK FOR PM
0038 :IF,6G,NE,PM,1
0039 :CA,3,3G,+ ,12
0040 :** OK SET THE TIME
0041 :SYTM,1979,1P,3G,4G,5G
0042 :SV,8G,,IH

```

Figure 5-4. \*STIME Listing

- o FILE MANAGER COPIES (lines 17-23). Copies of the File Manager need only be made for systems operating with the Multi-Terminal Monitor (MTM). If you will not be using this system, SKIP this step.

To make copies of the File Manager (FMGR), you will first need to make a type 6 file of FMGR:

```
:SP,FMGR:RT:2
```

## System Initialization

This must be done before the WELCOM file is executed. The transfer file \*COPY referenced in the sample WELCOM file can be used to make copies of FMGR for each terminal:

```
:RN,1G:RT,2G
:RP,2G
:RN,2G:RT,1G
::
```

For example, executing `::*COPY,FMGR,FMG07` would cause the following commands to be executed.

```
:RN,FMGR:RT,FMG07 (re-name FMGR)
:RP,FMG07 (RP in copy)
:RN,FMG07:RT,FMGR (re-name it back)
```

When an MTM terminal key is struck in break mode and the terminal's copy of FMGR is dormant, that copy of FMGR will be scheduled by MTM (i.e. PRMPT). If a copy has not been created for the terminal, or if it is not dormant, the terminal user will get the standard MTM break mode prompt: "lu>".

- o SUBSYSTEM INITIALIZATION (line 24). The WELCOM file can be used to initialize subsystems you will want to initialize during system start up. In this example, DS/1000 is initialized from an answer file. Note that certain subsystems, such as DS/1000, should be initialized at start up for optimum system performance and resource utilization.

To execute ACCTS and initialize Session automatically at bootup, you must generate ACCTS into the System or load it permanently (via LOADR PE or RP commands). If ACCTS is not permanent, it will not execute and a "SESSION NOT INITIALIZED" error message is displayed when you try to enable a terminal for Session. If you on-line load (but not permanently) and save ACCTS as a type 6 file, you should schedule it in the WELCOM file by Rping it and its segments and `:RU,ACCTS,-1` or `:RU,ACCTS,namr`. This is recommended before enabling terminals and early in the WELCOM file to ensure that ACCTS is allocated enough SAM.

- o ENABLE TERMINALS (lines 25-32). Terminals must be enabled before they will respond to break mode interrupts (and log-on interrupts for Session Monitor). The file manager `:CT` command provides a convenient means of enabling terminals and sending out terminal initialization messages. In the sample WELCOM file, three point-to-point terminals (e.g. 2645's using 12966 I/F cards) are enabled (lines 20-22). A multipoint line LU and four multipoint terminals are also enabled (lines 23-27).

Terminal Initialization commands are generally of the following form:

```
:CT,lu,20B ,sub,string
```



where: lu is the terminals keyboard/display logical unit. In session systems, lu must be in the range 7-99. In MTM systems, lu must be in the range 7-63.

sub is the initialization subfunction code. It may be omitted for all terminals operating with DVR00 or DVR05. For other terminals (e.g. multipoint, multiplexer, DVA05 modem links, etc.) consult the appropriate driver manuals, subsystem manuals, and configuration guides.

string is an ASCII message to be sent to the terminal upon initialization. This message might indicate the terminal's LU and/or give instructions.

- o INITIALIZATION COMPLETED MESSAGE (lines 33-35). It is suggested that the operator be informed when a successful initialization has been completed.
- o WELCOM FILE TERMINATION (line 36). The WELCOM file should be terminated with an EX command (which terminates FMGR) instead of a TR (or ::) which merely transfers back to the system console.

NOTE

Whenever FMGR encounters an error when processing WELCOM file commands, transfer will be made to the system console. Additional commands may then be entered at this time. Transfer can be made back to the WELCOM file by entering TR.

## HI File (MTM Only)

If the Multi-Terminal Monitor (MTM) is included in your system, you can optionally specify a set of commands to be executed whenever a terminal's copy of File Manager is started up by MTM. The commands must reside on transfer file HI.

Typically, HI file commands will dump out softkey definitions to terminals (these can be created by the KEYS utilities), display system welcome messages, and send system status messages to the terminal. You may also wish to use them to set up File Manager global parameters and the File Manager severity level. Note that the HI file should be general purpose in nature as it will be executed by all MTM File Manager users.

## System Initialization

Example:

```
:SV,1,,IH          (do not echo commands)
:DU,"SOFTK,0G      (dump soft key files to terminal)
:DP,***
:DP,***           (WELCOME TO RTE-IVB)
:DP,***           REV 2001 2/11/80
:DP,***
:DU,"SYSMS,0G      (dump system message file to terminal)
:SV,0             (set severity level)
::               (transfer to terminal)
```

If a HI file cannot be found, File Manager will take its initial input from the terminal.

## HELP Utility

The HELP utility can provide assistance to system users in a variety of ways. It can provide detailed explanations of errors, provide information on system or subsystem related features, and serve as an index to documentation.

All HELP messages are obtained from the file "HELP. In this file, each message has a keyword associated with it. Keywords can be up to eight characters in length and relate to the HELP message in some way. For example, the keyword FMGR-006 identifies the HELP file message describing the file manager error FILE NOT FOUND.

The HELP utility always searches "HELP from the beginning of the file. If there are two or more messages with identical keywords, the first message found with that keyword will be displayed. Note that if a keyword supplied to HELP is less than eight characters, the corresponding keyword in the "HELP file must be the same length for a match to occur.

## Structure of the HELP File

All keywords and their corresponding explanations are contained in a single file, "HELP. This file should reside on a system (global) disc so that it may be accessed by any session or non-session user.

### 1. Header record

The first record of the Help File is:

```
HELP FILE FOR PROGRAM 92067-18121
```

The header must be the first record in the Help File. It is used only to make sure the file opened by HELP is truly the Help File and not some user file that has the same name.

## 2. File format

```

""          (delimiter)
KEYWORD
help information related to the keyword -----
-----
----- . . .
""
KEYWORD
-----
----- . . .

```

Example: A section of the HELP file might look like this.

```

HELP FILE FOR PROGRAM 92067-18121
""
FMGR-001
    DISC ERROR      The disc accessed is down. Try
                    again and then report it to the system manager.
""
FMGR-002
    DUPLICATE FILE NAME      A file with the specified
                    file name already exists in caller's disc space.
                    Try using a different name or purge or rename the
                    existing file.
""
etc.

```

### Maintaining Your HELP File

The standard version of the "HELP file is supplied on the 92068A grandfather disc. This standard file contains error explanations and documentation for the operating system, file management system, and other HP supported subsystems and utilities. If so desired, the system manager can add new entries and modify existing entries in this file. This will allow the Help file to be "tailored" to the specific needs of your system. In order to insure the file's integrity, modifications to the Help file should be performed only by the system manager.

In systems operating with the session monitor, the "HELP file should reside on a global system disc (e.g. LU's 2 or 3) so that it may be accessed by any session or non-session user.

Additional keywords and their explanations should be kept in a file of your own to be merged onto the HP supplied Help File. Each time a new and improved Help File is released and distributed to users, the file containing additional keywords may be easily merged onto the HP Help File.

## System Initialization

If you choose to modify existing keywords, the keyword and its modified explanation should also be kept in a separate file. Each time a new Help File is received, the file of modified entries can be merged onto the beginning of the HP supplied Help file. Since there is a top-down search, the Help program will always find the modified explanation first.

Example:

```
:RU,EDITR
-----
SOURCE FILE?
/"HELP::32767                (Get standard "HELP file)
-----
HELP INFO FILE FOR PROGRAM 92068-18121
/M"APPl::1000                (Merge in application file)
-----
" "
/^
-

/M"HELPl::1000              (Merge in alternate Help file)
-----
" "
/EC"HELP:RT:2                (Put "HELP file on global disc)
-----
END OF EDIT
:
```

## HELP Operation in the Session Environment

The Session Monitor provides special error handling for users under session control. The SCB associated with each session contains space for an 8-character error code. Whenever a subsystem detects an error, it calls library subroutine PTERR to put the error in the user's SCB. As a result, the SCB contains the error code for the most recent error that occurred in a session.

Example:

|       |       |       |
|-------|-------|-------|
| SCB   | ----- | ----- |
|       | F     | M     |
|       | ----- | ----- |
|       | G     | R     |
|       | ----- | ----- |
| -     | 0     |       |
| ----- | ----- |       |
| 0     | 6     |       |
| ----- | ----- |       |

When HELP is invoked by a session user and a particular keyword is not specified, HELP uses the 8-character error code in the SCB as the keyword. Help will not clear the error code in the SCB. If desired, you may replace the HP supplied HELP Utility Program with your own.

The same scheme may be used by the system manager if he chooses to have the SCB updated with errors occurring in his system's application software.

## Spool System Initialization

The spooling system is initialized by running GASP. Refer to the Batch and Spooling Reference Manual (92068-90005) for a complete description of the spooling system and initialization procedures.

## System Protection

It is strongly recommended that once your new system has been installed and initialized, it should be backed up onto magnetic tape or another disc. This will allow you to recover your system in the event of a disc hardware failure or a system crash.

When your system is installed with the SWTCH utility, the disc track preambles for the system area on LU2 are set to indicate protected tracks. The system area can be protected from being written over by switching your format switch to "OFF" mode (7905/06/20/25) or your override switch to protect mode (7900). Note that the system scratch track and FMP areas on LU2 are not affected by these switches (i.e. they are on unprotected tracks). If your system tracks are protected, the Loader can not perform permanent load, replace or purge operations. Also, you will not be able to permanently change I/O or memory definitions with the Reconfigurator.

Knowledge of the master security code will give users complete access to all File Manager files. It is strongly suggested that you do not publicize it.

## Changing Auxiliary Cartridges

If your auxiliary cartridge (LU3) is on a removable disc subchannel, physically separated from the primary system subchannel (LU2), certain procedures will have to be followed when changing auxiliary cartridges.

Where possible, auxiliary cartridges should be changed when the system is down (i.e. Halted). When the system is restarted (bootstrapped), the system checks to see if an FMP area has already been initialized on LU3. The FMP file area tracks are assigned to the FMP and the directory tracks are assigned to D.RTR. If the cartridge has not been initialized, a FMGR 003 will be issued and the user must initialize the cartridge with an IN command (see "FMGR INITIALIZATION" section in this chapter).

## System Initialization

If your auxiliary cartridge must be changed when the system is active, the following steps should be performed:

1. Run the LGTAT utility to determine if there are tracks on LU3 used by programs other than the file management package (i.e. LU3 tracks should either be unassigned, assigned to FMP, or assigned to D.RTR). Program swap tracks and tracks assigned to programs for temporary storage can be unassigned by entering :OF,prog. LU3 tracks containing programs permanently added to the system, can be unassigned by purging them with LOADR. If any LU3 tracks are still assigned to programs when the auxiliary cartridge is changed, unpredictable (potentially disastrous) results will occur.
2. The FMP area on the new auxiliary cartridge must be initialized to the same first track as the old cartridge (preferably track 0 since this prevents the loader or system from placing a program in this area.)

To change auxiliary cartridges, use the DC command as follows:

```
:DC,-3 <----- this insures that all files are closed
```

Remove the cartridge from the drive and insert the replacement.

```
:DC,-3 <----- places new cartridge in disc directory
```

Note that MC is not used to mount the cartridge. This is because DC remounts the cartridge as part of its procedure when the logical unit is 2 or 3.

3. If the new auxiliary cartridge has not been initialized, FMGR will lock it and a subsequent attempt to initialize the cartridge results in FMGR 059 error message. The error is caused because the directory tracks are already assigned to D.RTR. You must, therefore, release the D.RTR tracks and then re-assign them by scheduling FMGR. After assigning the D.RTR tracks, FMGR terminates and you must schedule it again in order to enter FMGR commands. This special case, where FMGR terminates immediately, occurs only when the D.RTR tracks are unassigned.

### Example

```
:EX
```

```
$END FMGR
```

```
*RT,D.RTR <----- release the D.RTR tracks
```

```
*RU,FMGR <----- scheduling FMGR assigns D.RTR tracks on LU2;  
FMGR terminates
```

```
*RU,FMGR <----- re-schedule FMGR
```

```
:IN,SC,-3,AUX <-- initialize new auxiliary disc on LU3
```

Be sure that the new auxiliary FMP area cartridge has been initialized to the same starting track as the previous one.

## Short ID Handler

The short ID handler T5IDM and its interface routine SEGLD can be used to dynamically install and release short ID segments for segmented programs (overlays). The advantage of SEGLD is that many segments can be called with only one free short ID segment in the system.

CALLING SEQUENCE: CALL SEGLD (INAM, IERR [,IP1 through IP5])

where: INAM is the segment name, IERR is the error return, and IP1 through IP5 are optional parameters passed to the segment in INAM. Refer to the RTE-IVB Programmer's Reference Manual for details.

Error return: If SEGLD returns, there was an error. Either the name passed in INAM was not a program segment, or it was not found.

To be accessed by T5IDM, a main program and all of its segments must be saved (SP'd) as Type 6 files on LU 2 or LU 3. The main and all of its segments must be on the same LU.

The names of SP'd program segments must not be changed (by RN, for example), because the relationship between the main program and its segments will be lost.

ID segments produced by T5IDM may be released at any time. This is not a problem, however, as long as SEGLD is always used to call program segments.

Short ID segments are built by LOADR when the program is loaded and are copied into Type 6 files when the segments are SP'd on the disc. When a program segment is OF'd, its ID segment is released and reused by the operating system. If that program segment is rescheduled, the ID segment must be rebuilt. If the program uses SEGLD to load the program segments, SEGLD schedules T5IDM to build it. Only SEGLD should schedule T5IDM to build ID segments.

T5IDM produces only short ID segments. If a short ID segment is not available, T5IDM will not use a long one.

When T5IDM builds a short ID segment, it copies the necessary information from the Type 6 file into internal tables and then into the short ID segment. When the program segment completes execution, the short ID segment is released so that the system can reuse it. If the program segment is rescheduled, and T5IDM still has the program segment information in its internal tables, it builds the short ID segment without referring to the Type 6 file.

## System Initialization

Included in T5IDM's internal tables are the starting locations of the program segments' Type 6 files. If these addresses are incorrect, the program may abort with a DM or MP error.

How could the address be incorrect? This example illustrates one possibility. Suppose that a segmented program is loaded, SP'd, OF'd, and then run. SEGLD schedules T5IDM to build short ID segments. T5IDM has no information on the program segments, so it refers to the Type 6 files. Now suppose that the program is OF'd and the Type 6 files are purged. The program is reloaded, SP'd, OF'd and run again. It is possible that T5IDM's internal tables contain program segment information from the program's previous run. If so, T5IDM uses it, ignoring the Type 6 files. Since the Type 6 files were purged and resaved, they may not be in the same locations. If not, the program segment starting locations in T5IDM's tables are wrong, and the program may abort with a DM or MP error.

If this happens, purge the Type 6 files and run T5IDM with a parameter of -1 (RU,T5IDM,-1). This flushes the tables and forces T5IDM to get program segment information from the Type 6 files. Currently executing segmented programs are not affected.



# Chapter 6

## Session Monitor Initialization

### General

This chapter describes three aspects of accounts system operation: system initialization, setting up new group accounts, and setting up new user accounts. For other aspects of account system operation, such as altering accounts or backing up the accounts system, refer to Chapter 7.

It is suggested that you complete the accounts planning matrix and cartridge requirements worksheets (refer to Chapter 2) before following the procedures outlined in this chapter. You should also have your generation listing and user application notes (e.g. questionnaires) handy as they will also prove useful during this process.

### Session LU Definition

Session LU assignments may be predefined by the System Manager in one of two ways:

- \* **Account SST Definition.** When group and user accounts are defined, Session LU to System LU mappings may be included in the definitions. When the user logs on to the system, those mappings will be included in the session switch table (SST) of his session control block (SCB). In this chapter, the term Account SST refers to the Session LU to System LU mapping contained in the individual group and user account file definitions.
- \* **Configuration Table Definition.** The Configuration Table allows you to define Session LU to System LU mappings for various terminals in the system. When a user logs on to a terminal with entries in the Configuration Table, those LU mappings associated with his terminal will automatically be included in his SST. Typically, entries in the Configuration Table are made for auxiliary printers, cartridge tape units (CTU's) and other devices (e.g. instrumentation) associated with terminals. The Configuration Table is contained in the account file.

Note that a session user can only access devices defined in his SST. When defining user accounts and the Configuration Table, you should insure that each user will have access to the resources required by his application.

## Session Monitor Initialization

An overall scheme for assigning session LU numbers in your system should be developed before defining group accounts, user Account, and Configuration Table SST entries. This will prevent conflicting definitions where the same session LU is mapped to different system LU's. The following paragraphs will discuss where Account SST entries are defined and considerations to be taken when planning the session LU assignment scheme for your system.

### Session LU Allocation Worksheet

This worksheet will provide a framework for the allocation of session LU numbers in the system. It should be referred to when setting up your Account SST and Configuration Table definitions. To adequately fill out this worksheet, you should rely upon the following items: the account planning matrix and cartridge requirements worksheet (filled out in Chapter 2), the system generation listing, and your general knowledge of the user community (e.g. user questionnaires, applications knowledge, etc.).

A sample Session LU Allocation Worksheet is shown in Figure 6-1. Use this example in conjunction with the instructions given below to fill out your own worksheet.

1. Standard LU Allocations. In the session environment LU1 is always the keyboard display LU. LU2 and LU3 are the primary and auxiliary system cartridges. LU's 4 and 5 are the users standard input and output devices. Typically, they are assigned to terminal CTU's or paper tape reader/punches. LU6 should be reserved for the standard list device. It is suggested that auxiliary list devices (e.g., terminal auxiliary printers) be assigned to some other LU (LU7 in the example). This will prevent conflicts when users require access to both printers. LU8 should be reserved for the system magnetic tape unit.
2. Disc Cartridge LU Allocations. In the session environment all disc cartridge session LU numbers must be identical to the cartridge system LU numbers. Use the worksheet to indicate what session LU numbers are to be used for disc pool cartridges and dedicated private, group, and system global cartridges. Disc Cartridge LU's dedicated for non-session use should not be included here. For your convenience later on, it is suggested that you indicate who owns which cartridges and, in the case of disc pool cartridges, cartridge sizes. Refer to the disc requirements worksheet and your system generation listing for this information.

## Session Monitor Initialization

3. Subsystems LU Allocation. Certain subsystems may require access to peripherals by their system LU numbers. For example, if DS/1000 is configured into your system, session communication LU numbers should be the same as the system communication LU numbers. It is therefore suggested that these session LU numbers be reserved for this purpose in the worksheet. This will insure that when you are adding DS capability to an Account SST, it will not conflict with previous Account SST or Configuration Table definitions.
4. Station LU Allocations. A set of session LU numbers should be reserved for devices specifically associated with stations. This will assure that user account and Configuration Table SST definitions will not conflict with each other regardless of the station a user logs on at. You might wish to reserve session LU's 4, 5, and 7 for station left CTU's, right CTU's, and auxiliary printers, respectively. These default LU's can be used to access similar types of devices from any system station. You need only reserve as many session LU numbers as is required to accommodate your largest station (i.e. with the greatest number of associated peripheral devices).
5. Group and User Peripheral LU Allocation. A set of session LU numbers should be reserved for devices specifically associated with group and/or user accounts. It is suggested that one set of LU's be reserved for groups and one set for users. Note that although many groups (users) will share the same session LU numbers in their account SST, they will not necessarily be mapped to the same system LUs.

The session LU allocation worksheet should be used as a guideline only. In some cases you may find a need for more session LU's of a certain type than what you have provided for in your worksheet. When such conditions arise you will have to use session LU numbers allocated for other things (e.g., cartridges that the user is unlikely to access).

# Session Monitor Initialization

| LU# | PURPOSE                          | LU# | PURPOSE                          |
|-----|----------------------------------|-----|----------------------------------|
| 1   | Terminal Keyboard/Display        | 34  | Disc Cartridge, Pool, 101 tracks |
| 2   | Primary System Cartridge         | 35  | Disc Cartridge, Pool, 102 tracks |
| 3   | Auxiliary System Cartridge       | 36  | Disc Cartridge, Pool, 102 tracks |
| 4   | Standard Input                   | 37  | Disc Cartridge, User Dunn        |
| 5   | Standard Output                  | 38  | Disc Cartridge, Pool, 102 tracks |
| 6   | Standard List                    | 39  | Disc Cartridge, User Dickey      |
| 7   | Auxiliary List                   | 40  | Disc Cartridge, group, LC        |
| 8   | System Mag Tape Unit             | 41  | Disc Cartridge, Pool, 75 tracks  |
| 9   | <available>                      | 42  | <available>                      |
| 10  | ↑                                | 43  | <available>                      |
| 11  |                                  | 44  | ↑                                |
| 12  |                                  | 45  |                                  |
| 13  | Station                          | 46  | Private                          |
| 14  | Peripherals                      | 47  | User                             |
| 15  |                                  | 48  | Peripherals                      |
| 16  |                                  | 49  | ↓                                |
| 17  |                                  | 50  | ↑                                |
| 18  |                                  | 51  |                                  |
| 19  | ↓                                | 52  |                                  |
| 20  | Disc Cartridge, group, HP        | 53  | Group                            |
| 21  | Disc Cartridge, group, FP        | 54  | Peripherals                      |
| 22  | Disc Cartridge, Pool, 203 tracks | 55  |                                  |
| 23  | Disc Cartridge, group, HP        | 56  | ↓                                |
| 24  | Disc Cartridge, Pool, 203 tracks | 57  | Disc Cartridge, Pool, 75 tracks  |
| 25  | ↑                                | 58  | Disc Cartridge, Pool, 203 tracks |
| 26  | DS Links                         | 59  | Disc Cartridge, Pool, 203 tracks |
| 27  | ↓                                | 60  | Disc Cartridge, Pool, 75 tracks  |
| 28  | Disc Cartridge, group, General   | 61  | Disc Cartridge, Pool, 50 tracks  |
| 29  | Disc Cartridge, Pool, 203 tracks | 62  | <available>                      |
| 30  | Disc Cartridge, Pool, 800 tracks | 63  | <available>                      |
| 31  | Disc Cartridge, Pool, 600 tracks |     |                                  |
| 32  | Disc Cartridge, Pool, 102 tracks |     |                                  |
| 33  | Disc Cartridge, Pool, 102 tracks |     |                                  |

Figure 6-1. Session LU Allocation Worksheet

## Running ACCTS

Program ACCTS is responsible for the initialization, maintenance and overall control of your session monitor system. Inputs to ACCTS are made either interactively from a terminal or directly from an answer file. Unless, you are familiar with ACCTS operation, it is suggested that ACCTS be run interactively:

```
:RU,ACCTS,,namr
-----
```

All ACCTS messages and operator inputs will be recorded on the list file namr. For example:

```
:RU,ACCTS,,"LIST
-----
```

will direct all ACCTS messages and inputs to file "LIST. This file should be saved as it may prove useful when diagnosing initialization errors or when creating an answer file.

### CAUTION

If a list file is specified with previous list output in it, this previous information will be lost.

## Initialization Dialogue

When program ACCTS is run after the operating system is installed and initialized, it will begin with the following message and prompt:

```
SESSION NOT INITIALIZED
ENTER IN,LO,/TR OR /HE
```

The /HE command can be entered at any time to get a list of valid commands or (if entered immediately after an error) to schedule HELP for a detailed error explanation. The /TR command can be used at any time to transfer to an answer file. The LO command can be used to rebuild the accounts system from a previously backed up account system file. (Refer to Chapter 7 for detailed descriptions of the LO,/TR, and /HE commands.)

Enter IN to start the initialization sequence.

ACCTS will first request the DISC LU on which the accounts file is to be located.

```
ENTER DISC LU FOR ACCTS FILE:
```

**CAUTION:** For all session subroutines to operate properly, the subsystem DISC cartridge must be mounted as a system disc.

## Session Monitor Initialization

Program ACCTS will then prompt with:

SESSION LIMIT?

Enter the maximum number of active sessions to be allowed in your system at any one time. This should be the number of session terminals in your system (including the system console if it may be operating in session mode). If batch jobs will be submitted from sessions in your system, you should add one to this number. For example, for a system with five session terminals, a system console to be operated in session mode and batch jobs to be submitted from sessions, a session limit of 7 would be entered.

SESSION MEMORY ALLOCATION? (Y OR N)

The Session Monitor requires a block of system memory to contain the active Session Control Blocks (SCBs) and the list of LUs in the spare cartridge pool. Enter N if you want ACCTS to use the session memory allocation algorithm to calculate the amount of system memory for the SCBs. The algorithm is as follows:

$$\begin{aligned} \text{Session Limit} < 20: & (70 - (\text{Session Limit})) * (\text{Session Limit}) \\ \text{Session Limit} > 20: & 50 * (\text{Session Limit}) \end{aligned}$$

It is recommended that the session memory allocation algorithm be used unless you have: very large user account or Configuration Table SST definitions or limited system memory space.

Enter Y to override this algorithm and manually set the memory allocation size. In this case, ACCTS will ask:

NO. WORDS TO ALLOCATE?

Enter the decimal number of words to be allocated from system memory for session use. Refer to Appendix J for a description of internal SCB formats. Remember to check if you will have enough SAM to contain active SCBs. If not, either allocate more SAM or reduce the SCBs in number or in size.

NUMBER OF USER ACCOUNTS?

Enter the maximum number of user accounts to be defined in your system. This quantity can be derived from the total number of check marks made in your account planning matrix plus an additional amount (e.g. 5-10) for future users.

NUMBER OF GROUP ACCOUNTS?

Enter the maximum number of group accounts to be defined in your system. This quantity can be derived from the number of groups listed in your account planning matrix plus an additional amount (e.g. 3) for future groups.

## Session Monitor Initialization

The number of accounts specified in the above two questions are used by ACCTS to determine the size of the account file. The account is organized into records of 64 words. Each user and group account definition requires at least one record. This will accommodate approximately 30 user Account SST entries (mappings) and 55 group Account SST entries. If one record is not large enough to accommodate an account entry, ACCTS will allocate an additional record for that definition. When creating the accounts file during initialization, ACCTS allocates slightly more records than would be necessary to contain all the accounts at one record per account. (The algorithm used here is:  $(\#users + \#users/5 + \#groups) / 8 * 8 + 7$ . If more than 10% of your user and/or group account definitions are large (i.e. require more than one record), you should increase the number of accounts specified.

### SYSTEM MESSAGE FILE?

Enter a file name (filename:sc:crn) of the file to be output to each users session terminal at log on. Enter " " (blank) for no file. The system message file provides a convenient means for you to share informational messages on a system wide basis. Some of the items you might want to place in the system message file are:

- o Scheduled preventive maintenance down time
- o New software or hardware additions to the system
- o Procedures to follow when using the system
- o Greetings

Note that the message file does not have to exist when specified at this time.

The system message should be short and to the point. Otherwise, parts of it are apt to get overlooked by users at log on. A sample message file is shown in Figure 6-2.

### PROMPT STRING?

Enter " " if you want users to be prompted with the default "PLEASE LOG ON:" when attempting to log on to the system. Otherwise, enter a string of up to 20 characters for the log on prompt. ACCTS will always append a backarrow (underscore) to the prompt to suppress a carriage return/line feed at the end of the prompt.

### LOCATION OF MESSAGE FILES?

Enter the CRN (+ number) or -LU of the cartridge to which user message files (accessed with file manager SM or ME commands) will be directed. This cartridge must be mounted as a global system disc in order for the message file mechanism to work properly for all users. If " " (space) is entered, message files will be directed to LU's 2 and 3.

## Session Monitor Initialization

```

+-----+
|                                     |
|          **** WELCOME ****         |
|          RTE-IVB REV                |
|                                     |
| 1) The system will be down for PM  | Saturday from 0800 to 1000 |
| 2) We have installed an additional | lineprinter.                |
|     For most users it is LU7       |
| 3) Any problems contact Dave x2629 |
|                                     |
+-----+

```

Figure 6-2. Sample Message File

### STATION CONFIGURATION (Y OR N)?

Enter Y if you wish to define a Configuration Table for your system. The Configuration Table allows you to associate default session logical unit/system logical unit mappings for various stations in your system. When a user logs on from a station with entries in the Configuration Table, those mappings will automatically be included in his SST. For example, say a terminal has an auxiliary printer assigned to system LU90. You can make this printer the standard output device (LU6) for every user logging on from that station by specifying a Configuration Table entry mapping session LU6 to system LU90.

The keyboard/display session LU is always LU1 and therefore does not require a Configuration Table entry.

If N is entered in response to the station configuration question, no Configuration Table will be defined at this time. In this case, the next question will ask for a disc pool LU, see below.

If Y is entered, the next prompt will be:

### STATION LU?

Enter the first (next) station terminal keyboard/display LU to have entries in the Configuration Table. Enter /E if no additional stations are to be included in the Configuration Table. Note that station LU numbers may not exceed 99. To redefine your entire station Configuration Table, enter /A.

### SESSION LU, SYSTEM LU?

Enter the session LU/system LU mapping for this station. ACCTS will continue to prompt for station LU mappings until a /E is entered. At that time, it will ask for the next station ("STATION LU?", see above). To redefine all Configuration Table entries for this station, enter /A.



## Session Monitor Initialization

Note that session LU numbers must be in the range of 4 to 63. System LU numbers must be in the range of 0 to 254.

If a session LU has been defined for a station more than once, ACCTS will respond with:

```
DUPLICATE SESSION LU XXX
  OVERRIDE PRIOR DEFINITION (Y OR N)?
```

Enter Y if you want the last definition mode to be included in the Configuration Table, thus removing the prior definition. Enter N if the last definition is to be ignored.

At log on, if a users account definition and the station's Configuration Table entries contain conflicting mappings for the same session LU, the user will be informed with a LGON 06 error. You can prevent this from happening by reserving a set of session LU numbers exclusively for the Configuration Table (refer to your Session LU Allocation Worksheet).

```
DISC POOL LU?
```

Enter the first (next) disc logical unit to be included in the spare cartridge pool. ACCTS will continue to prompt with this question until you terminate the spare cartridge pool definition by entering /E.

ACCTS will not verify that the LU number entered is a disc LU. If a non-disc LU is entered, ACCTS includes it in the disc pool, but a message is displayed in the pool listing. If, for example, a graphics terminal LU number is entered as a disc pool entry, the driver name is displayed under the size column in the disc pool listing. A non-disc LU can be removed from the disc pool by using the ALTER,ACCT command described in chapter 7.

The order that you input disc pool LU's will determine the order of the spare cartridge list. This gives you a degree of control over their allocation. Whenever a cartridge is allocated from the spare cartridge pool with an AC command, the system allocates the first unused cartridge in the list greater than or equal to the size specified in the command. If no cartridge size is specified, the first unused cartridge in the list will be allocated.

It is suggested that two criteria be used when determining the order of LU's in the spare cartridge pool. If you want to order your cartridges so that users will get the smallest possible cartridge that will meet their needs, enter disc pool LU's in order of increasing subchannel size. If you want the system to give allocation priority to one disc unit over another (e.g. cartridges on fixed disc platters before cartridges on removable platters), enter the disc pool LU's for the primary device first. In practice, you should use a combination of the above criteria to determine the order of disc cartridge pool LU's for your system.

To re-input the order of your spare cartridge LU's during this phase, enter /A. ACCTS will respond with:

```
REDEFINE DISC POOL (Y OR N)?
```

## Session Monitor Initialization

Enter Y to start over. Any other input will abort the accounts initialization process and terminate ACCTS.

PASSWORD FOR MANAGER.SYS?

Enter a character string for the MANAGER.SYS account password. REMEMBER THIS PASSWORD. Without it, you will not be able to run ACCTS. The password can consist of up to ten of the following characters: A through Z, 0 through 9, !, ", #, \$, %, &, ', (, ), ;, <, =, >, ?, \, ], ^, -. The characters ",", "." (period), and "/" (slash) are not allowed.

### CAUTION

It is important that this password be kept secret from most system users as it will allow users access to the entire account structure and all files.

At this point ACCTS completes the Session Monitor initialization process. It performs the following functions:

- a. Creates and initializes the session account file
- b. Creates the following accounts:
  - (1) Group SYS
  - (2) Group SUPPORT
  - (3) Group GENERAL
  - (4) User MANAGER.SYS
  - (5) User ENGINEER.SUPPORT
- c. Allocates and initializes system memory for SCB's and the spare cartridge pool.

Refer to Figure 6-3 for a sample initialization dialogue up to this point.

If the amount of system available memory required for initialization is unavailable, ACCTS responds with:

```
XXXX WORDS REQUESTED
XXXX WORDS AVAILABLE
ENTER NO. OF WORDS OR /E
```

It is suggested that you enter /E and reboot. This message may be caused if a large enough contiguous block of System Available Memory (SAM) is unavailable due to fragmentation. After you reboot, rerun ACCTS. If this message is not repeated, the problem has been solved.

If the above message persists after rebooting the system, there is not enough System Available Memory (SAM) generated in your system. You have several options:

## Session Monitor Initialization

a) Reconfigure your system to add more System Available Memory. It is recommended that you have at LEAST 2K more SAM than is required by ACCTS.

b) Reduce your session limit. As a rule of thumb, reduce your session limit by:

$$((\text{Amount Requested}) - (\text{Amount Available}) + 2000) / 50$$

Enter a number smaller than that indicated by the "XXXX WORDS AVAILABLE" message. Reduce your session limit using the ALTER,ACCTS command (see Chapter 7), and reboot.

c) Regenerate your system with more System Available Memory. If you cannot add more System Available Memory by reconfiguration, you will have to regenerate your system. (You will have to reduce system table areas, or system common to achieve this increase).

d) Enter an amount at least 2000 less than that indicated by the "XXXX WORDS AVAILABLE" message. This is likely to degrade both session monitor and overall system performance (depending on your systems particular SAM requirements).

# Session Monitor Initialization

```

(User inputs are underlined)

:RU,ACCTS,, "ACCTI           Run ACCTS, list to file "ACCTI
SESSION NOT INITIALIZED
ENTER IN,LO,/TR OR /HE   IN   Start initialization dialogue
SESSION LIMIT? 10
SESSION MEMORY ALLOCATION? (Y OR N) Y   Let ACCTS determine size
NUMBER OF USER ACCOUNTS? 40
NUMBER OF GROUP ACCOUNTS? 8
SYSTEM MESSAGE FILE? "SYSTEMS:RT:2     Message file on LU 2
PROMPT STRING?
---
LOCATION OF MESSAGE FILES?--           Default to PLEASE LOG ON:
STATION CONFIGURATION (Y OR N)?       Default to LU 2 and LU 3
Y
STATION LU? 15
SESSION LU, SYSTEM LU?
4,98                                   Left CTU
SESSION LU, SYSTEM LU?
5,99                                   Right CTU
SESSION LU, SYSTEM LU?
7,100                                  Auxiliary Printer
SESSION LU, SYSTEM LU?
/E
STATION LU? 16
SESSION LU, SYSTEM LU?
.
.
.
SESSION LU, SYSTEM LU?
/E
STATION LU? 21
SESSION LU, SYSTEM LU?
13,142                                 Instrumentation
SESSION LU, SYSTEM LU?
/E
STATION LU? /E                         Terminate Configuration Table
DISC POOL LU? 30                       Define Spare Cartridge Pool LUs
DISC POOL LU? 32
DISC POOL LU? 33
.
.
.
DISC POOL LU? 60
DISC POOL LU? /E                       Terminate Disc Pool definition
PASSWORD FOR MANAGER. SYS?   RDS>WED   Input ACCTS password
NEXT?

```

Figure 6-3. Sample Account System Initialization Dialogue

## Group Account Definitions

After the account system has been initialized and ACCTS has verified the password, it will prompt for the next command with:

NEXT?

To start your group definitions, enter:

NEW,GROUP  
-----

ACCTS will respond with:

GROUP NAME?

Enter the name of the group for which an account is to be created. The name must consist of one to ten of the following characters: A through Z, 0 through 9, !, ", #, \$, %, &, ', (, ), ;, <, =, >, ?, [, \, ], ^, \_ . The characters ",", "." (comma), "/" (period), "/" (slash), and " " are invalid. If you enter /A, the NEW,GROUP command will be aborted.

Note that all group names must be unique. Enter the first (next) group name listed in your Account Planning Matrix worksheet.

After the group name is entered, ACCTS will ask:

SST DEFINITION? (ENTER SESSION LU, SYSTEM LU OR ENTER /E)

Enter a session LU/system LU mapping to be associated with this group. ACCTS will continue prompting for entries until a /E is entered. Session LU numbers must be in the range 4 to 63. System LU numbers must be in the range 0 to 254. For each disc cartridge to be dedicated to this group, enter:

cartridge lu,cartridge lu  
-----

Session LU's assigned to disc cartridges must be identical to their respective system LU's.

You should also enter definitions here for those devices that are to be associated with this group. These devices will optionally be accessible to members of the group, depending on how each group member's user account is defined.

It is suggested that session LU numbers assigned to group devices be in the range indicated by your session LU allocation worksheet (if possible). This will prevent conflicts with user account SST and Configuration Table definitions.

After the current group account SST definitions are terminated with /E, ACCTS will respond with:

## Session Monitor Initialization

NEXT?

If you have more groups to define, enter additional NEW,GROUP commands. Otherwise, you are ready to define your user accounts. Note that group accounts must be defined prior to their member's user accounts.

Refer to figure 6-4 for a sample group account definition.

```
(User inputs are underlined)
NEXT?
NEW,GROUP
-----
GROUP NAME?
INVEN                               Assign group name INVEN
-----
SST DEFINITION? (ENTER SESSION LU, SYSTEM LU, OR ENTER /E)
40,40                               Dedicated group cartridge
-----
SST DEFINITION?
41,101                              Device to be associated with group
-----
SST DEFINITION?
6,6                                  Allow group access to line printer
---
SST DEFINITION?
/E                                   Terminate Account SST definition
--
NEXT?
```

Figure 6-4. Sample NEW,GROUP Command Dialogue

## User Account Definitions

New user accounts can be added with the command:

```
NEW,USER
-----
```

ACCTS will then ask:

USER NAME?

Enter the name of the user for which an account is to be created. The name must consist of one to ten of the following characters A through Z, 0 through 9, !, ", #, \$, %, &, ', (, ), ;, <, =, >, ?, [, \, ], ^, \_ . The characters ",", " ." (comma), "." (period), "/" and " " are invalid. If you enter /A the NEW,USER command will be aborted.

The Account Planning Matrix Worksheet should be referred to for user names. Note that user names must be unique within groups. To simplify accounts system maintenance, it is suggested that each system user be assigned a unique user name.

After the user name is input, ACCTS will ask:

GROUP NAME?

Enter the name (in the format described above) of an existing group account to which this user belongs. Enter " " (blank) to use the default group GENERAL.

USE GROUP SST (Y OR N)?

Enter Y if group devices (defined in the group Account SST) are to be accessible in the users session. This will cause all devices in the group Account SST to be automatically included in the user Account SST. (This applies to devices currently defined in the group Account SST as well as those devices added later on with the ALTER,GROUP command.) Enter N if group Account SST entries are not to be included in the user Account SST.

USER PASSWORD?

Enter the user account password. The password may consist of up to ten of the following characters: A through Z, 0 through 9, !, ", #, \$, %, &, ', (, ), ;, <, =, >, ?, [, \, ], ^, \_ . The characters ",", " ." (comma), "." (period), and "/" are invalid. Enter a " " (space) if no password will be required for this account.

It is suggested that the user account password be obtained from the user himself. This will make it easier to remember and reduce the likelihood of other users breaking accounts security.

USER HELLO FILE?

## Session Monitor Initialization

Enter the file name (filename:sc:crn) of the command file to be transferred to by the user's copy of FMGR when the user logs on. Enter " " (space) if no such file is to be transferred to a log on.

User HELLO files must reside on cartridges accessible from the users session. You may wish to place user HELLO files on cartridge LU2 or LU3 to prevent users from modifying these files. Recall also that command transfer files on these cartridge LUs are granted special capabilities by the system. Commands in these transfer files may modify files on LUs 2 and 3 and may execute any file manager or break mode command.

In many applications it may be advantageous to give a user complete control over his HELLO file. In this case, the HELLO file should reside on a cartridge completely accessible to the user (e.g. private or group cartridge). You may wish to create system transfer files on LU's 2 and 3 to perform various functions associated with session initialization. User HELLO files can then invoke these transfer files when appropriate.

Example (HELLO file line numbers are for reference purposes only):

```
00001 :SV,4,,IH
00002 :RU,BASIC
00003 :EX,SP
```

This example illustrates how the HELLO file can be used to create a particular application environment. Setting the file manager severity level to 4 (in line 00001) will inhibit file manager from echoing HELLO file commands on the terminal. More importantly, if an error occurs, file manager will not transfer control to the user's terminal.

When a user logs on with this HELLO file, he will be brought immediately into BASIC. After exiting BASIC, he will be automatically logged off the system (in line 00003). If the user is given a low enough capability level (see below) he will be unable to interfere with this process. Note that instead of running BASIC, the HELLO file can run any set of programs (e.g., automatic test programs for instrumentation, data base access programs/utilities, text editors etc.). Basically, HELLO files used in this manner will allow you to present a "customized" system to the user. If desired, user accounts can be structured to keep interaction with the operating and file management systems to a minimum after logging on.



## Session Monitor Initialization

### EXAMPLE:

```
00001 :SV,2,,IH
00002 :RU,KYDMP,0G,DEVKYS
00003 :SL,6,,,6
00004 :CA,9,"BANNR
00005 :DU,9G,6
00006 :DP, YOUR GROUP CARTRIDGE LU IS 35
00007 :DP, YOUR PRIVATE CARTRIDGE LU IS 43.
00008 :DP, OUTPUT TO LU 6 WILL AUTOMATICALLY BE SENT TO
00009 :DP, THE PRINTER WHEN YOU LOG OFF.
00010 :DP, TO PRINT THIS OUTPUT SOONER, TYPE TR, DISPOSE
00011 :SV,0,,IH
00012 ::
```

This HELLO file might be used for individuals doing program development. The severity code (line 00001) is set to inhibit command echoing but allow transfers to the terminal in case of errors. In line 00002, the KYDMP utility is run to dump a set of softkey definitions to the terminal. You might set up softkeys to run utilities (e.g., EDITR,COMPL,LOADR), list files, log off, etc. Softkey definitions are easily set up with the KEYS utility. Refer to the Terminal User's Reference Manual for a description of KYDMP and KEYS.

The SL command in line 00003 will cause the system to setup a spool file for LU 6. Output to this LU will then be diverted to this spool file. The spool file is automatically placed in the queue for output to the printer when (either) the user logs off, a :CS,6 is executed, or another :SL,6,... command is executed. The spool system will automatically control access to the printer so output from different users will not be interspersed.

The HELLO file then proceeds to send a banner to the spool file to identify the users output (lines 00004 and 00005). This will be useful in environments where many individuals will be making use of the printer at one time. Note that a file manager global parameter is setup to indicate the particular banner file to be associated with the user. Globals provide a convenient method for system transfer files to communicate with each other. In this example, global 9 may be used by other system transfer files requiring a user banner file. A transfer file referred to as DISPOSE in the example, can be created to release spool files for output and to create a new spool file and banner on LU6:

```
:SL,6,,,6
:DU,9G,6
::
```

At the end of the sample HELLO file, the severity level is set to 0 (line 00011) and a transfer is made to the users terminal (line 00012).

## Session Monitor Initialization

### CAUTION

Spool files are a potentially scarce system resource - use them wisely. It is suggested that you examine user requirements carefully before automatically setting up spool files in HELLO files. You should not be automatically creating spool files for users with little likelihood of using them. The number of spool files that can be active at any one time will be determined by the number of spool EQTs generated into your system. Note that the COMPL and CLOAD utilities create spool files for list output, eliminating the need for HELLO file spool creation in many cases.

### USER CAPABILITY?

Enter the user capability level. The capability level must be an integer in the range 1 to 63. Enter " " (space) for the default capability level of 30.

The user capability level will determine the subset of file manager and break mode commands the user will be allowed to execute. A user with capability level 20, for example, will be allowed to execute those commands assigned capability levels of twenty or less. The file manager and break mode command tables are used to associate capability levels with commands. If desired, these tables can be substituted with your own tables during generation to alter capability level assignments. Refer to Appendix J for command table formats.

Table 6-1 lists the file manager and break mode capability assignments defined in the command tables as supplied by HP. The various capability levels are summarized as follows:

- 1      User's may only transfer to command files or log off. Transfers will only be meaningful if command files reside in LU2 or LU3 since higher capability commands may be invoked from these files. No break mode commands are acted upon at this capability level. (User's will, however, still receive the break mode prompt).
  
- 10     Users can list files, obtain system status, obtain system table definitions, send and receive messages, mount and dismount cartridges, and up/down devices.
  
- 20     Users may create and manipulate files and pack cartridges.

## Session Monitor Initialization

- 30 This level is intended for the general application programmer. Users may run programs, abort programs, and create type 6 files.
- 40 This level allows for manipulation of file manager globals.
- 50 This level enables users to add entries to their SST (potentially giving them access to any system device). Users can place programs in the time list, schedule programs, assign programs to partitions, and adjust priority levels. At this level, programs do NOT have to be necessarily associated with the users session. Level 50 should be reserved for users who are very knowledgeable about the system (e.g., systems programmers, support personnel, etc.,).
- 60 This level should be reserved exclusively for support personnel. Access to all system commands is permitted.
- 63 This level is reserved for the system manager and/or group manager. In addition to all the capabilities of level 60, accounts of this level will be able to create, purge, and alter users within his group and alter the group wide parameters.

After the user capability level is entered, ACCTS asks:

### MAXIMUM DISC CARTRIDGES?

Enter the maximum number of group and/or private cartridges that the user can have mounted to his session at any one time. You should enter an integer from 0 to 60. Enter " " (blank) to use the default limit of 2.

The disc cartridge limit should reflect the number of dedicated private and group cartridges to be accessible to the user plus an additional amount (usually one) for scratch cartridges to be mounted from the spare cartridge pool. For example, say the user's group has two dedicated group cartridges, and the user himself has one dedicated private cartridge. Allowing for one additional scratch cartridge, you would enter 4 in response to this question.

Note that system global cartridges automatically mounted to the user's session at log on are NOT included in the cartridge limit.

### SST DEFINITION? (ENTER SESSION LU, SYSTEM LU OR ENTER /E)

Enter the first (next) session LU/system LU mapping to be associated with this user account. ACCTS will continue prompting for entries until a /E is entered. Session LUs must be in the range 4 to 63. System LU numbers must be in the range 0 to 254.

## Session Monitor Initialization

For each disc cartridge to be dedicated as a private cartridge for this user, enter:

```
cartridge lu,cartridge lu
-----
```

Session LUs assigned to disc cartridges must be identical to their respective system LUs.

You should also enter definitions here for those devices that are to be associated with this user account. It is suggested that session LU numbers assigned to these devices be in the range indicated by your session LU allocation worksheet for dedicated user peripherals (if possible). This will prevent conflicts with group Account SST and Configuration Table definitions.

After the user's Account SST definitions are terminated with /E, ACCTS will respond with:

NUMBER OF SST SPARES?

Enter the number of spare SST entries to be included in the user's SCB at log on. This must be in the range 0 to 60. Enter " " (space) for the default value of 0. Spare SST entries are used when users mount cartridges to their session with the AC command, and create new session LU definitions with the SL command. Certain utilities (e.g. COMPL, CLOAD) also use spare SST entries for spooled list output.

### NOTE

The total number of spare SST entries configured into the SCB at log on will be the sum of the NUMBER OF SST SPARES plus the MAXIMUM DISC CARTRIDGES as defined in the users account.

The SST has a limit of 70 entries. The number of SST spares + the drive limit + LU1 + LU2 (+ LU3 if you have it on your system) cannot be greater than 70.

If the user will be initiating spooling operations with the SL command or utilities, you should allocate one SST spare for each concurrent operation. For many applications, one will be sufficient.

ACCTS will now ask:

LINK TO AN EXISTING ACCOUNT? (ENTER " " OR USER.GROUP/PASSWORD)

If this account is to be linked to an existing user account, enter the account name in USER.GROUP format (or USER.GROUP/PASSWORD if a password exists for the account). Otherwise, enter " "(space). This feature allows several users to share the same set of private disc cartridges.

## Session Monitor Initialization

At this point ACCTS will create the user account in the account file. If it finds conflicting User and Group account SST definitions, ACCTS will report:

```
CONFLICTING SST DEFINITION - ASSUMING USER DEFINITION
USER: SES LU XX, SYS LU XX   GROUP: SES LU XX, SYS LU YY
```

When Group and User account SST definitions specify different system LU mappings for the same session LU, the group definition is ignored.

Now ACCTS asks if this user is to have a user account defined in another group:

```
NEXT GROUP OR /E?
```

Enter the group indicated by the next column checked ( ) for that user in the account planning matrix worksheet. This group must have been defined prior to this point with the NEW, GROUP command. If the user does not belong to any more groups enter /E. A " " (space) entered here will default the group name to GENERAL. Note that the new account will be linked to the previously defined user account and will share the same account definition except for group Account SST entries.

If the name of an existing group is entered, ACCTS will ask whether to include the group's Account SST in the user Account SST:

```
USE GROUP SST (Y OR N)?
```

ACCTS will proceed to define an account for the user in that group. It will re-prompt for additional groups with "NEXT GROUP OR /E?" until /E is entered.

Refer to Figure 6-5 for a sample NEW, USER command dialogue.

After the NEW, USER command has completed, ACCTS will prompt for the next command with:

```
NEXT?
```

At this time, you may define additional group and user accounts. Refer to Chapter 7 for the procedures required to alter and back up accounts.

# Session Monitor Initialization

Table 6-1. Command Capability Level Assignments

| File Manager |     |    | Break Mode |     |      | Capability Level |  |  |
|--------------|-----|----|------------|-----|------|------------------|--|--|
| EX           | HE  | SY | HE         | OP  |      |                  |  |  |
| TR           |     |    |            |     |      |                  |  |  |
| AC           | LI  | TE | \$BL       | *SL | UP   |                  |  |  |
| CL           | MC  | WH | +BR        | ST  | RS   |                  |  |  |
| DC           | ME  | ?? | *EQ        | TE  | \$QU |                  |  |  |
| DL           | *SL | ** | FL         | TI  | WH   |                  |  |  |
|              | SM  |    |            | *TO |      |                  |  |  |
| AN           | DP  | RN |            |     |      |                  |  |  |
| CN           | DU  | ST |            |     |      |                  |  |  |
| CO           | LL  | SV |            |     |      |                  |  |  |
| CR           | PK  |    |            |     |      |                  |  |  |
| CT           | PU  |    |            |     |      |                  |  |  |
| +DF          | JO  |    | *GO        | RU  |      |                  |  |  |
| RP           | EO  |    | +OF        | SZ  |      |                  |  |  |
| RT           | CS  |    |            | +SS |      |                  |  |  |
| RU           | AB  |    | RT         |     |      |                  |  |  |
| SP           | TL  |    |            |     |      |                  |  |  |
| CA           |     |    |            |     |      |                  |  |  |
| IF           |     |    |            |     |      |                  |  |  |
| PA           |     |    |            |     |      |                  |  |  |
| SE           |     |    |            |     |      |                  |  |  |
| LD           |     |    | UR         |     |      |                  |  |  |
| SL           |     |    | IT         |     |      |                  |  |  |
|              |     |    | AS         |     |      |                  |  |  |
|              |     |    | ON         |     |      |                  |  |  |
|              |     |    | PR         |     |      |                  |  |  |
| IN           |     |    | BR         | LU  | TO   |                  |  |  |
| OF           |     |    | BL         | OF  |      |                  |  |  |
|              |     |    | DN         | QU  |      |                  |  |  |
|              |     |    | EQ         | SS  |      |                  |  |  |
|              |     |    | GO         | TM  |      |                  |  |  |

The diagram shows vertical arrows on the right side of the table, labeled 'Capability Level'. The arrows indicate the following levels for various commands:

- Level 1: EX, TR
- Level 10: AC, CL, DC, DL, AN, CN, CO, CR, CT
- Level 20: \$BL, +BR, \*EQ, FL, \*GO, +OF, RT
- Level 30: \*SL, ST, TE, TI, RU, SZ, +SS
- Level 40: UP, RS, \$QU, WH, \*TO
- Level 50: JO, EO, CS, AB, TL
- Level 60: UR, IT, AS, ON, PR

- \* Single Parameter Only
- + Program must be under session's control
- \$ No Parameters permitted

```

(User inputs are underlined)

NEXT?
NEW,USER
-----
USER NAME
JOHNSON
-----
Definition for user JOHNSON

GROUP NAME?
INVEN
-----
Create account JOHNSON.INVEN

USE GROUP SST (Y OR N)?
Y
-----
Include group Account SST definitions

USER PASSWORD?
CLARK
-----

USER HELLO FILE?
*CJHEL:RT:2
-----
User Account HELLO file on LU 2

USER CAPABILITY?
30
-----
Use standard capability level

MAXIMUM DISC CARTRIDGES?
3
-----

SST DEFINITION? (ENTER SESSION LU, SYSTEM LU, OR ENTER /E)
8,8
-----
Allow user access to mag tape

SST DEFINITION?
50,50
-----
Dedicated private cartridge

SST DEFINITION?
51,200
-----
Device to be associated with account

SST DEFINITION?
/E
-----
Terminate user Account SST definitions

NUMBER OF SST SPARES?
1
-----
One SST spare (for spool operations)

LINK TO AN EXISTING ACCOUNT? (ENTER " " OR USER.GROUP/PASSWORD)
-
-----
Do not link to existing account

NEXT GROUP OR /E?
HP
-----
Create account JOHNSON.HP

```

Figure 6-5. Sample NEW, USER Command Dialogue

## Session Monitor Initialization

```
USE GROUP SST (Y OR N)?
Y
-
NEXT GROUP OR /E?
FP                               Create account JOHNSON.FP
--
USE GROUP SST (Y OR N)?
Y
-
NEXT GROUP OR /E?

-                               Create account JOHNSON.GENERAL
USE GROUP SST (Y OR N)?
Y
-
NEXT GROUP OR /E?
LC                               Create account JOHNSON.LC
--
USE GROUP SST (Y OR N)?
Y
-
NEXT GROUP OR /E?
/E                               Terminate user account definitions
--
NEXT?
```

Figure 6-5. Sample NEW,USER Command Dialogue (Continued)



# Chapter 7

## Maintaining The Account System

### General

The Session Monitor Accounts System is maintained by means of the Accounts Setup program ACCTS. This program is run by the System Manager to build, maintain, and backup the system account file. It is also used to startup and shutdown the Session Monitor and to perform other account maintenance functions.

### Session Monitor Account File

The account file must be set up before any user can log on to the system. The Account Setup Program (ACCTS) provides the System Manager the capabilities to build and maintain the account file. ACCTS allows new accounts to be added to the account file, existing account definitions to be modified, selected accounts to be deleted from the account file, and account parameters to be changed. The account file may be saved in a disc file or a backup medium (i.e., magnetic tape). If necessary, it may be restored from the backup file (or medium).

The Account File is comprised of the following components:

- o Account File Header
- o Active Session Table
- o Configuration Table
- o Spare Cartridge Pool
- o User-Group ID Map
- o Account Directory
- o User and Group Account Entries

The overall account structure is shown in Figure 7-1. The following sections describe the various Account File components in detail. (Refer to Appendix J for internal table formats).

### Account File Header

The account file header contains the following information.

- o File record pointers of various account tables and directories.
- o Resource parameters used during Session Monitor initialization and to control access to the system.

## Maintaining the Accounts System

- o Session operating parameters such as the System message file NAMR, log on prompt string, etc.

### Active Session Table

The active session table contains a list of all users currently logged on, their station, and the time of log on.

### Configuration Table

The Configuration Table contains default logical unit definitions for specific stations (terminals) in the system. Each station defined in the Configuration Table has a set of default logical units which included in the user's Session Switch Table (SST), when logging on from that station. The default logical unit associated with the station itself is always logical unit 1 (LU1).

The following example illustrates the use of the Configuration Table:

|       |        |                                 |
|-------|--------|---------------------------------|
| ----- | 3      | length of entry                 |
| ----- | 30   1 | station (terminal) LU           |
| ----- | 34   4 | default left CTU (LU34) to LU4  |
| ----- | 35   5 | default right CTU (LU35) to LU5 |
| ----- | 4      | length of next entry            |
| ----- | 40   1 | station (terminal) LU           |
| ----- | 44   4 | default left CTU (LU44) to LU4  |
| ----- | 45   5 | default right CTU (LU45) to LU5 |
| ----- | 57   6 | default printer (LU57) to LU6   |
| ----- | 0      | end of Configuration Table      |
| ----- |        |                                 |

The left and right cartridge tape units (CTU's) at station LU30 can be accessed by a session user at this station as LU4 and LU5, respectively. Similarly station LU40 has left and right CTU's which are to be accessed by session users at this station as LU4 and LU5. Also associated with station LU40 is a dedicated line printer (actually LU57), to be accessed by session users at this station as LU6.

Only those stations with default LU's in addition to the station LU (Session LU1) will require entries in the Configuration Table.

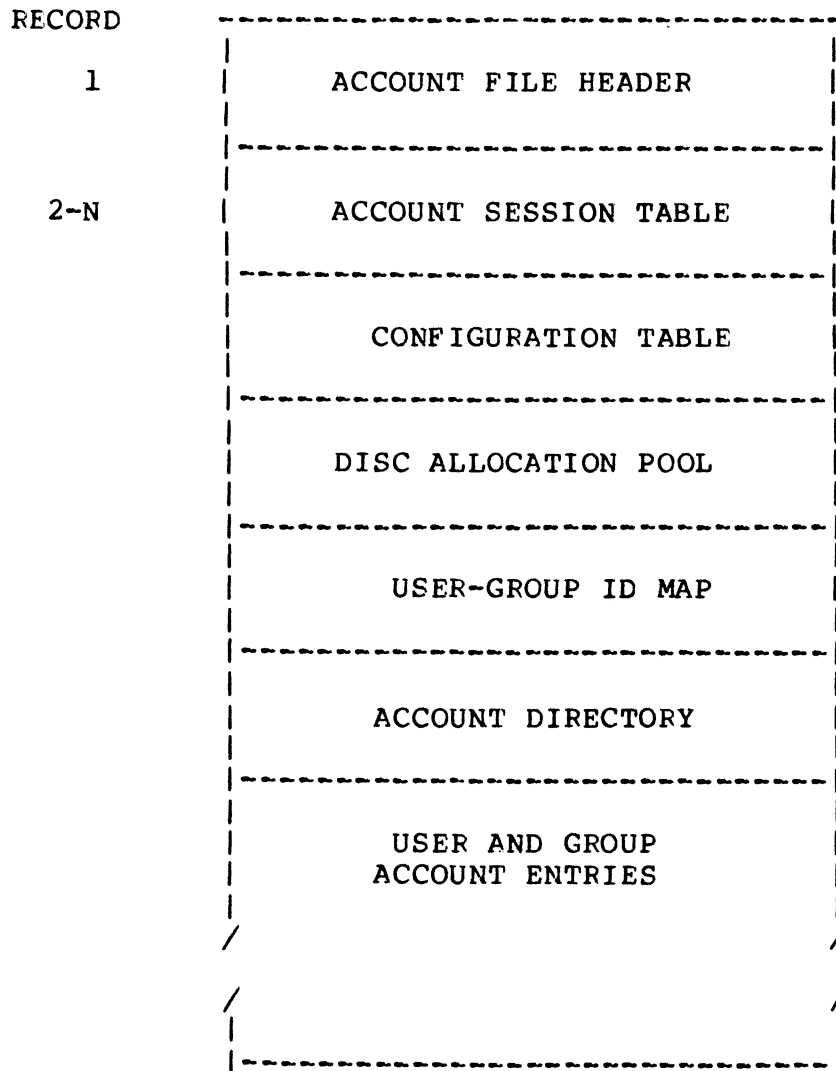

Figure 7-1. Account File Structure

### Spare Cartridge Pool

The Spare Cartridge Pool is a table of disc logical units assigned to individual users or groups when they require scratch disc space. When a session user requests a disc cartridge via the Allocate Cartridge (AC) command, a spare (unused) cartridge is allocated from this pool. The cartridge is then marked as taken and identified with the user who allocates the cartridge. The cartridge is not returned to the pool until it is dismounted from the system cartridge list.

## User/Group ID Map

Every group account and private user accounts are identified in the system internally by a 12-bit account ID number. When a user logs on, both the 12-bit group ID and 12-bit private ID will be placed in the user's SCB. Private user accounts linked to each other are given the same private 12-bit ID.

The account ID number is used by the system to control access to cartridges. When a user mounts a cartridge on the system, his group or private ID is placed in the system cartridge list along with the cartridge's LU. Users sharing the same group or private account ID are then permitted to mount the cartridge to their session. Since linked accounts share the same private ID, the same set of private cartridges can be shared by these accounts.

The system uses a 4096 bit map to keep track of allocated account numbers. When an account is defined, and a new account ID must be assigned to it, the system will allocate an unused number (indicated in the map with a 0 bit) and mark it as assigned (i.e. 1-bit). Group accounts are allocated lower numbered account ID's and private accounts are allocated higher numbered ID's.

## Account Directory

The account directory contains a list of all the user and group accounts defined in the system. The "User.Group" character string identifier is saved here together with the corresponding account ID numbers and pointers to the actual account definitions.

## Group and User Account Entries

These entries define the various operating parameters for all the accounts defined in the system. User account file entries contain the following primary components:

- o Account Password. A password may optionally specified with each account. It may be up to ten characters in length.
- o User Hello File NAMR.

Each user account file entry may be used to define the name of a Hello file. The Hello file is a file manager procedure file which is transferred to when a user logs on to the system. For this reason, it must reside on a disc which is already mounted to the user's session when he logs on. Refer to Chapter 6 for a more detailed discussion of Hello files and examples.

## Maintaining the Accounts System

- o Command Capability Level. The command capability level (integer in the range 1 to 63) defines the subset of file manager and break mode commands that the user may execute. A user assigned capability level 20, for example, will be allowed to execute only those commands which have been defined as requiring capability level 20 or less.
- o Account SST Entries. Each account can have SST entries defined specifically for it. This may be done to include dedicated disc cartridges and/or peripherals in the user operating environment. In addition to predefined SST entries, each account can be allocated a specified number of spare SST entries to be used during the session as needed (e.g. for disc pool cartridges or to reference additional peripherals).
- o User Message file NAMR. The message file will contain messages sent to the user by other users of the system. Message files are manipulated by file manager :ME and :SM commands.
- o Connect Time and CPU Usage. The connect time indicates the total time (in minutes) that the user has been logged on since his account was initialized or last reset by the system manager (via the ACCTS RESET command). The CPU usage is similar except that it indicates actual CPU time and it is stored in seconds. The last time the user logged off with this account is also recorded.
- o Disc Limit. The disc limit specifies the maximum number of group and private cartridges the user can have mounted at any one time.
- o Private and Group account ID numbers.

Each group account file definition contains the following information:

- o Group account ID number.
- o Cumulative connect and CPU usage time. These times are similar to these described above. They are the sum of all group member connect and CPU usage times.
- o Group SST entries. These entries are optionally included in each group members SCB at log-on. They may define peripheral or dedicated cartridges belonging to the group.

## Maintaining the Accounts System

Two special accounts are predefined in the Session Monitor. The `MANAGER.SYS` account (user=`MANAGER`, group=`SYS`) is intended for the system Manager. The System Manager has the most extensive capabilities of any user on the system. Among these capabilities are privileged access to all disc cartridges on the system and access to the Account Setup Program. Initially a password is specified for the `MANAGER.SYS` account during account system initialization. The System Manager can modify this password afterwards with the `ALTER, USER` command.

### WARNING

It is important that the `MANAGER.SYS` account be protected with an unpublicized password since any user able to successfully log on as the System Manager will have access to protected file domains and will possess the ability to modify any account.

The `ENGINEER.SUPPORT` account, like the `MANAGER.SYS` account, is predefined and should not be purged. This support account is for the use of Hewlett Packard support engineers. Its account capabilities do not include access to all file domains, but will allow the support engineer to execute all system commands.

In addition to the `SYS` and `SUPPORT` group accounts, a `GENERAL` group account is also predefined. When a new user is added to the account system but no group is specified for this user (i.e., the default is used), the user is made a member of the `GENERAL` group. Note that the general group account initially has no group SST entries defined, but SST entries can be added with the `ALTER, GROUP` command.

## Account Program Operation

Responses to the `ACCTS` program are provided using two modes of operation, interactive or direct. In the interactive mode, commands are input from the terminal keyboard. `ACCTS` prompts the user for each input.

In the direct mode, commands are supplied to the `ACCTS` program from a disc file or a logical input unit (that is, from a command file).

The System Manager can alternate between these two modes at any point at which the `ACCTS` program is waiting for input by using the `.TRANSFER` command.

To run the account setup program, enter:

```
:RU,ACCTS[,control[,list[,echo]]]
```

where:

**control** If specified, control is the name of a file or logical unit number of a device from which a command file will be retrieved.

If control is omitted, or is a logical unit of an interactive device (terminal), ACCTS will operate in interactive mode. It will take its inputs from, and output prompt messages to, the user's terminal (if operating on session) or the system console (if operating non-session). For batch jobs commands will be taken from LU 5.

If control is -1, ACCTS is scheduled to initialize Session. This can be done in the WELCOM file if ACCTS is not a permanent program but was loaded on-line, has an account file, and was RPed. Refer also to "WELCOM FILE" in Chapter 5, System Initialization.

**list** If specified, list is the name of a file or logical unit number of a device on which all prompts and responses will be recorded.

If the list parameter is omitted, ACCTS prompts and responses will not be sent to a list file/device (this can be altered later with the TRANSFER command).

**ECHO** If specified, ACCTS prompts and responses will be sent to the user's log device. The log device is the users terminal (if operating in session) or the system console (if operating in non-session mode or within a batch job). If the control parameter is omitted, the ECHO parameter should also be omitted since prompts will automatically be sent to the terminal.

Note that when ACCTS is echoing prompts and responses to a list file/device all prompts will be preceded by an asterisk-blank ("\* ").

EXAMPLE:

```
:RU,ACCTS,5,LSTFIL:YL,ECHO
```

This command will schedule ACCTS to take its input from logical unit 5, record prompts and responses on list file LSTFIL (with file security code YL), and echo the prompts and responses to the user's terminal for monitoring purpose.

## Maintaining the Account System

### EXAMPLE:

```
:RU,ACCTS,ANSFIL:-1:1000,,ECHO
```

This command will schedule ACCTS to take its inputs from answer file ANSFIL (with file security code -1 on cartridge 1000), generate no list file, and echo prompts and responses to the user's terminal.

### EXAMPLE:

```
:RU,ACCTS
```

This command will schedule accounts to take its inputs in interactive mode from the user's terminal and generate no list file.

### EXAMPLE:

```
:RU,ACCTS,,LSTFIL
```

This command will schedule accounts to take its inputs in interactive mode from the user's terminal and echo prompts and responses to file LSTFIL.

The procedures to follow when initializing the account system are described in Chapter 6. They are summarized in this chapter under "ACCOUNT SYSTEM INITIALIZATION".

After the account system has been initialized and ACCTS was scheduled from the system console, ACCTS will request a password before it will accept any commands:

```
PASSWORD?
```

The user must supply the password defined for the MANAGER.SYS account. Upon verification of the password, ACCTS will prompt:

```
NEXT?
```

Any legal account system command (except IN) can be entered here. A summary of legal accounts commands is shown in Table 7-1.



Table 7-1. ACCTS Command Summary

| COMMAND     | DESCRIPTION  |
|-------------|--|
| ALTER,ACCTS | Alters global Session Monitor parameters   |
| ALTER,GROUP | Alters attribute(s) defined for groups   |
| ALTER, USER | Alters attribute(s) defined for users  |
| EXIT        | Terminates the account setup program   |
| HELP        | lists valid commands and schedule HELP utility   |
| IN          | Initializes the account file; can be entered only when no account file exists          |
| LIST,ACCTS  | Lists session-wide information   |
| LIST,GROUP  | Lists one or more group account entries  |
| LIST,USER   | Lists one or more user account entries   |
| LOAD        | Rebuilds the account system from an UNLOADED account file and expands the account file |
| NEW,GROUP   | Creates an account file entry for a new group  |
| NEW,USER    | Creates an account file entry for a new user   |
| PASSWORD    | Alters the password in the account of the session in which ACCTS is running.           |
| PURGE,ACCTS | Purges the entire account structure  |
| PURGE,GROUP | Removes a group from the account file  |
| PURGE,USER  | Removes a user from the account file   |
| RESET,GROUP | Clears group time clocks   |
| RESET,USER  | Clears user time clocks  |
| SD,LU       | Shuts down specified session   |
| SD,0        | Disable system console as a session terminal   |
| SD          | Shutdown entire session Monitor System   |
| SU          | Restarts the session system after a shut down  |
| TELL        | Sends a message to a single active user or group or to all active sessions             |
| TRANSFER    | Transfers control from one LU or file to another                                       |
| UNLOAD      | Creates a backup copy of the account file  |
| /ABORT      | Aborts current command   |
| /HELP       | Schedules HELP from within a command   |
| /TRANSFER   | Invokes TRANSFER from within a command   |

## Command Syntax

Each ACCTS command consists of one of the commands shown in Table 7-2 followed by, in many cases, a parameter list. The parameter list contains one or more parameters that specify operands for the command. The parameter list is required in some commands, but is optional or prohibited in others. Optional parameters are shown enclosed in brackets in the command formats. Within the list, any delimiter can be surrounded by any number of blanks.

Whenever ACCTS is run after it has been initialized, it prompts immediately for a command with NEXT?, if not run interactively, to process commands from the control namr.

## General Commands

There are a number of general commands for use by the System Manager when running ACCTS. These are: HELP, TELL, TRANSFER, EXIT, and /ABORT.

```
+-----+  
|   HELP   |  
+-----+
```

The HELP command lists the various ACCTS command and schedules the HELP utility. Use one of the following formats:

```
HE[LP] [,keyword][,list]  
HE[LP],error number [,list]  
/HE[LP],error number [,list]
```

**keyword** is the name of the command about which further explanation is desired. The default is a list of all commands with brief descriptions. If keyword is numeric, the HELP utility is scheduled to expand the error.

**list** is the list device to which the explanation will be written. The default is LUL.

**error number** is the number of the error which is to expand. If omitted, the most recent error posted to SCB will be expanded.

The HELP and /HELP commands are interchangeable with the exception that /HELP may be entered from within general commands, (e.g. NEW,USER) and HELP may not.

If HELP is entered immediately after an "ACCT nnn" error, the HELP utility will be scheduled to supply information on the particular error. Otherwise, HELP will supply a list of all commands (keyword omitted) or a brief description of a specific command (keyword supplied).

EXAMPLE:

```

NEXT?
NE,USER?
-----
ACCT-nnn
HELP                (schedule HELP immediately after error
                    message)

```

```

EXAMPLE: NEXT?
HELP                (list all commands)
-----

```

```

EXAMPLE: NEXT?
HELP,NEW           (list NEW command description)

```

```

EXAMPLE: NEW,GROUP
GROUP NAME? LC
SESSION LU,SYSTEM LU? 1,10
ACCT-XXX
SESSION LU,SYSTEM LU? /HE (schedule HELP from within
                          command)
      .
      .
SESSION LU,SYSTEM LU? 9,10

```

```

+-----+
|  TELL  |
+-----+

```

The TELL command allows any user to send a message to a specific user or group of users who are logged on.

```
TE[LL],user.group,[namr[,message]]
```

**user.group** is the currently logged-on user to whom the message is to be sent. "@.@" may be specified to indicate that all users currently logged-on are to receive the message at their terminals. "@.group" may be used to send a message to all currently logged-on members of the same group.

**namr** is a file name or device logical unit number containing the message to be sent to the user(s). If both **namr** and **message** parameters are specified, the message contained in the **namr** will be transmitted first.

**message** is an ASCII string to be sent to the user(s). The entire TELL command line, including this message string, is limited to a maximum of 80 characters.

## Maintaining the Accounts System

### EXAMPLE:

```
TELL,@.@,SHUTD
```

The SYSTEM will be shut down for PM in 5 minutes.  
Please Log off by then.

### EXAMPLE:

```
TELL, JIM.HP,,Please release your spool files
```

```
+-----+  
|  TRANSFER  |  
+-----+
```

The TRANSFER command allows the system manager to alternate between interactive and direct command input modes. Command format is:

```
TR[ANSFER] [,control[,list<  
                                     [,NO[ECHO]]]]  
                                     [,EC[HO]]]]  
or  
/TR[ANSFER] [,control[,list<  
                                     [,NO[ECHO]]]]  
                                     [,EC[HO]]]]
```

### Where:

- control** is the logical unit or filename (name:sc:crn) from which all further commands are read. If this parameter specifies an interactive device, prompt messages will be displayed on this device for each command. TRANSFER commands can be nested to a depth of ten levels (see below). If control is omitted, ACCTS will accept command input from the previous control file or LU. A negative integer -N specified for this parameter will cause the control input to go back N files or the LU specified N levels previously.
- list** is the logical unit or filename (name:sc:crn) where all prompts and responses are listed. A "0" specified for this parameter will stop listing to the current list file or LU. If list is omitted, the current list file remains unchanged. Note that all ACCTS prompts will be preceded by a "\*" in the list file.
- ECHO** enables echoing of all prompts and responses to the log device. When ACCTS is in interactive mode (i.e. log device same as control device), prompts and responses are not echoed to this device. The ECHO mode remains in effect until changed with the NOECHO parameter in another TRANSFER command.

NOECHO disables echoing of all prompts and responses to the log device. The NOECHO mode remains in effect until changed with an ECHO parameter in another TRANSFER command. If both ECHO and NOECHO are omitted, the current echo mode will remain in effect.

The TRANSFER and /TRANSFER commands are interchangeable except that /TRANSFER may be entered from within general commands (e.g. NEW,USER) and TRANSFER may not.

You may enter the TRANSFER command from the terminal to transfer control to an answer file (or input device). The answer file may contain a TRANSFER command to transfer control to yet another answer file or device. At this point, transfers are said to be nested two deep. This nesting process can continue to a depth of ten levels. To transfer control back to the control file (or device) in effect at the previous level, a TRANSFER command with a null control parameter should be specified (e.g. TR). To transfer control back to the control file/device in effect N levels from the current level, a "TR,-N" should be entered.

Note that an end-of-file condition (or control D input from the terminal) is interpreted as a /TR command and will therefore transfer control back to the previous level.

When an error occurs, ACCTS will automatically transfer to the terminal (if it is not already the control device). The operator is then re-prompted for a response. A subsequent /TR or TR entered from the terminal will transfer back to the control file/device in effect when the error occurred.

The operator can force a transfer to the terminal at any time by breaking the ACCTS program (i.e. BR breakmode command). ACCTS will print ACCT 000 and then prompt for the next command. A transfer can be made back to the control file or device in effect at the time of the break by entering a TR or /TR.

#### CAUTION

List output always starts at the beginning of the list file. If the list file specified in the TRANSFER command has already been specified in another TRANSFER command or the ACCTS run string, the original list data will be lost.

EXAMPLE: Assume file LUFILF contains the following entries:

## Maintaining the Accounts System

7,10  
9,53  
10,105  
/E  
TR

NEXT?  
NEW,GROUP (Operator inputs are underlined)  
-----  
GROUP NAME?WED  
----  
SESSION LU,SYSTEM LU? /TR,LUFILE,,ECHO  
-----  
\*SESSION LU,SYSTEM LU?  
7,10  
\*SESSION LU,SYSTEM LU?  
9,53  
\*SESSION LU,SYSTEM LU?  
10,105  
\*SESSION LU,SYSTEM LU?  
/E  
\*NEXT?  
TR  
NEXT?

```
+-----+  
|   EXIT   |  
+-----+
```

The EXIT command enables the System Manager to terminate the ACCTS program. The command format is:

EX[IT]

```
+-----+  
|  ABORT  |  
+-----+
```

The /ABORT command allows the System Manager to abort the current command or subfunction within a command. The command format is:

/A[BORT]

If /ABORT is entered within a command, the command will not be acted upon and therefore, will have no effect on system operation. If /ABORT is entered as a general command (i.e. in response to NEXT?) it will terminate the ACCTS program.

EXAMPLE:

```

NEXT?
NEW,GROUP
-----
GROUP NAME? FP
      --
SESSION LU, SYSTEM LU? 8,9
      ---
SESSION LU, SYSTEM LU? /A
NEXT?      --
    
```

Group FP will not be defined because the command was aborted with /A.

### Adding New Accounts

New accounts can be added to the account file by using the NEW,USER and NEW,GROUP commands. New accounts can be added during and after system initialization and the accounts may be used as soon as they are defined.

```

+-----+
| NEW,GROUP |
+-----+
    
```

The NEW,GROUP command is used to enter a new group into the Account File. The command format is:

```
NE[W],G[ROUP]
```

ACCTS prompts for the group name with:

```
GROUP NAME? <group name>
```

The group name must consist of 1 to 10 of the following ASCII characters: A through Z, 0 through 9, !, ", #, \$, %, &, ', (, ), ;, <, =, >, ?, [, \, ], ^.

ACCTS then prompts for group account SST definition:

```
SST DEFINITION? <session LU, sys LU> or </E>
```

Enter session LU and system LU separated by a comma. ACCTS will prompt for additional SST entries until /E is entered.

EXAMPLE:

```

NEXT?
NEW,GROUP
GROUP NAME? FP
      --
    
```

## Maintaining the Accounts System

```
SST DEFINITION? 8,8
SST DEFINITION? 6,10
SST DEFINITION? 6,12
SST DEFINITION? /E
NEXT?
```

Refer to GROUP ACCOUNT DEFINITIONS in Chapter 6 for a more detailed discussion of the NEW,GROUP command and associated considerations.

```
+-----+
| NEW,USER |
+-----+
```

The NEW,USER command is used to enter a new user account definition into the Account File. The command format is:

```
NE[W] [,U[SER]]
```

To define an account for a user, the following information is required:

- \* User name
- \* Group name(s)
- \* Password
- \* User hello file
- \* Capability
- \* Disc limit
- \* SST entries
- \* SST spares

When the NEW,USER command is entered interactively, ACCTS will prompt with:

```
USER NAME? <user name> or </E>
```

Enter the name of the user for whom an account is to be created. The name must consist of 1 to 10 of the following ASCII characters: A through Z, 0 through 9, !, ", #, \$, %, &, ', (, ), \*, +, <, =, >, ?, [, \, ], ^, and \_ . Note that within groups, the user name must be unique.

```
GROUP NAME? <group name>
```

Enter the name of an existing group to which this user is to be included. (The NEW,GROUP command is used to create and define new group accounts.)

ACCTS will then ask whether the group SST (if one exists) is to be used with:

```
USE GROUP SST (Y OR N)? <Y> or <N>
```



If the group account does not currently have a group SST defined, a Y response may still be entered. If Y is entered, then when a group SST is defined for this group, it will be mapped into this user's addressing space.

The next prompt from ACCTS is:

USER PASSWORD? <password>

The password may consist of up to 10 of the following ASCII characters: A through Z, 0 through 9, , " , # , \$ , % , & , ' , ( , ) , ; , < , = , > , [ , \ , ] , and <- , ^ . An ASCII space entered for the password signifies no password required. Following the password, ACCTS prompts for the user's HELLO file with:

USER HELLO FILE? <name>

The name of the the user Hello file is entered. The Hello file should reside on a disc which is already mounted when a user logs on.

An ASCII space entered for the user Hello file indicates no Hello File. ACCTS next prompts for the user's capability:

USER CAPABILITY? <capability level>

Enter the user capability level, an integer from 1 to 63. The first user defined in the account file is the System Manager, who must have the highest capability defined. Following the capability, ACCTS prompts for the maximum number of disc cartridges which the user is allowed to have mounted at any given time.

MAXIMUM DISC CARTRIDGES? <total number of disc cartridges>

Enter the maximum number of private and/or group cartridges which the user can have mounted to a session at any given time. ACCTS next prompts (and continues to prompt) for the SST entries:

SST DEFINITION? <session LU,system LU> or </E>

Enter system LU, session LU or enter /E to terminate the list. ACCTS next prompts for the number of spare SST entries:

SST SPARES? <number of SST spares>

Enter the number of SST spares, an integer. Finally, ACCTS will ask whether the user is to be linked to an existing account. This allows the user access to files that the user may own as a member of a different account.

LINK TO AN EXISTING ACCOUNT? <blank> or <user.group/password>

## Maintaining the Account System

Enter a blank or user.group,password. The user.group name specified must be the name of one of the user's existing accounts. Note that if this existing account is protected with a password, the password must be specified.

At this point, the user's account is set up. If currently being run in the MANAGER.SYS session, ACCTS asks for the next group that this user is to be included in:

```
NEXT GROUP OR /E? <group name> or </E>
USE GROUP SST (Y OR N)? <Y> or <N>
```

The new account will be linked to the previously defined user account and will share the same account definition except for group account SST entries. The group account must have been previously defined with the NEW,GROUP command. ACCTS will prompt for additional groups until \E is entered.

Default values may be used for defining many of the user attributes. Table 7-2 describes these default values. The default value is used if " " (ASCII space) is entered when ACCTS prompts for a user attribute (such as capability or password).

Table 7-2. NEW,USER Command Defaults

| ATTRIBUTE                   | DEFAULT VALUE |
|-----------------------------|---------------|
| GROUP NAME                  | GENERAL       |
| USE GROUP SST               | yes           |
| USER PASSWORD               | no password   |
| USER HELLO FILE             | no hello file |
| USER CAPABILITY             | 30            |
| MAXIMUM DISC CARTRIDGES     | 2             |
| SST SPARES                  | 5             |
| LINK TO AN EXISTING ACCOUNT | no (blank)    |

Refer to the USER ACCOUNT DEFINITIONS section in Chapter 6 for a more detailed discussion of the NEW,USER command and associated considerations.

## Modifying Old Accounts

The ALTER and RESET commands allow modification of specific user or group account attributes in the account file. For example, a user may wish to change the log-on password or a group leader may request that the capability levels defined for the members of the group be raised.

```
+-----+
| ALTER,GROUP |
+-----+
```

The ALTER,GROUP command allows the modification of attributes defined in group accounts. When an attribute is modified, the change is made to the account file, but it does not apply to users currently logged on; it will take effect for the next log-on by users belonging to this group. The command format is:

```
AL[TER],G[ROUP],group
```

Where:

group is the name of the group account to be modified. Specify GENERAL to modify the general group account.

ACCTS will prompt with:

```
NEW GROUP NAME or /? <groupname> or </>
```

If the group name is to be changed, enter the new group name. This will change the name of the group in the group account definition and all user accounts in this group. This prompt will not be given if the GENERAL group was specified in the ALTER,GROUP command because the group name GENERAL cannot be changed. If the group name does not need to be changed, enter a "/".

ACCTS will then prompt for group SST modifications:

```
SST DEFINITION? (Enter Session LU, System LU, or enter /E)
SESSION LU,SYSTEM LU? <session LU,system LU> or </E>
```

Enter a new or modified group SST entry (session LU, system LU). ACCTS will continue to prompt for SST entries until /E is entered. Note that if the same session LU is specified more than once, the last one entered will be the value in effect after modification. Specifying "-" for the system LU deletes the entry for the specified session LU from the group Session Switch Table.

EXAMPLES:

1. To add or modify a SST entry for system LU 12, session LU 11.

```
ALTER,GROUP,<groupname>
NEW GROUP NAME or /? /
```

## Maintaining the Account System

```
          -  
SST? 11,12  
-----  
SST? /E  
---
```

If an entry already exists for session LU 11, the associated system LU in the entry is changed to 12. If no entry exists for session LU 11, a new entry is added with session LU 11 associated with system LU 12.

2. To delete an existing SST entry for session LU 11.

```
AL,G,<groupname>  
GROUPNAME? NEWNAME  
-----  
SST? 11,-  
-----  
SST? /E  
---
```

3. To change the name of an existing group and all user accounts of the group.

```
AL,G,<groupname>  
GROUPNAME? NEWNAME  
-----  
SST? /E  
---
```

```
+-----+  
| ALTER,USER |  
+-----+
```

The ALTER,USER command allows the modification of any of the following attributes defined for a user: password, hello file, capability level, disc cartridge limit, SST entries, number of SST spares, and whether or not to use the group SST. When an attribute is modified, the change is made to the account file, but it does not apply to users currently logged on; it will take effect for users who subsequently log-on to a session. The command format is:

```
AL[TER],[U[SER]], user.group
```

where:

user.group is the user and group name assigned to the user in the NEW,USER command. "user.@", "@.group" and "@.@" are also valid, where @ means all.

ACCTS will prompt for the attributes as shown below. If no change to the value of the attribute is desired, enter "/". (slash).

If the user specified is one unique account (i.e. a "@" was not specified) the user name can be changed and the account can be assigned to a different group. The account may be linked to another account. For single account alters ACCTS will issue the next prompt.

NEW USER NAME?

If the user NAME is to be changed enter new user name. This will change the name of the user. If the user name does not need to be changed enter a "/".

Then ACCTS will prompt with:

NEW GROUP?

If the account is to be assigned to a different group, enter the new groupname. This will assign the user to this group. If the account is to remain unchanged, enter "/".

GROUP SST (Y OF N)?

Enter either "Y" or "N". This attribute indicates whether the group SST for this user is to be mapped into the user account SST.

ACCTS prompts:

PASSWORD?

Enter the new account password to be assigned to the user. To delete the password assigned to the account, enter " " (blank).

HELLO FILE?

Enter the namr of the new file to which control is transferred when the user logs on.

CAPABILITY?

Enter the new capability level, an integer from 1 to 63, to be assigned to the user.

MAXIMUM DISC?

Enter the new maximum number of private and/or group cartridges which the user may have mounted to his session at any given time.

SESSION LU,SYSTEM LU?

Enter the new or modified SST entry. ACCTS repeats this prompt until "/"E" is entered. If the same session LU is specified more than once, the last value specified is used. Specifying "-" for the system LU deletes the entry for the specified session LU.

SST SPARES?

## Maintaining the Account System

Enter the number of spare entries in the SST to be allowed.

### LINK TO AN EXISTING ACCOUNT?

Enter a blank or "/" to effect no change in the accounts association.  
Enter a User.Group/password if you want the account linked to a different user.

```
+-----+
| RESET,GROUP |
+-----+
```

The RESET,GROUP command clears the CPU and/or connect-time clocks for a specific group or all groups. The command format is:

```
RE[SET],G[ROUP],group <
                        [,CP[U]]
                        [,CO[NNECT]]
```

Where:

group is the name of the group whose time clocks are to be reset. @ may be specified to indicate that all group time clocks be reset.

CPU is a specification that only the actual processor usage counter is to be reset (optional parameter).

Connect is a specification that only the connect-time usage counter is to be reset (optional parameter).

Note that resetting the group clocks does not effect the individual user clocks for members of that group. User clocks can be reset with the "RESET,USER,@.@" command.

### EXAMPLE:

To reset the group connect-time and CPU usage clocks for group HP:

```
RESET,GROUP,HP
```

```
+-----+
| RESET,USER |
+-----+
```

The RESET,USER command will clear the CPU and/or connect-time clocks for a specific user, a group of users, or all users and groups.

```
RE[SET],U[SER],user.group <
                        [,CP[U]]
                        [,CO[NNECT]]
```

Where:

user.group is the name of the user whose time clocks are to be reset. "@.group" may be specified to indicate all users in the group. Also, "@.@" may be specified to indicate that all user and group time clocks be reset. Note that user.@ is invalid.

CPU is an optional parameter that resets the actual processor usage counter.

CONNECT is an optional parameter that resets only the connect-time usage counter.

EXAMPLE:

To reset the CPU counter for all users belonging to group LAP.

```
RESET,USER,@.LAP,CPU
```

```
+-----+  
| PASSWORD |  
+-----+
```

The PASSWORD command allows any user to change his own password. ACCTS asks for his current password first.

```
ENTER CURRENT PASSWORD
```

As the password is input, it is not echoed. When this is verified with the password in the account, ACCTS asks for the new password.

```
ENTER NEW PASSWORD
```

Again, the input is not echoed. ACCTS will then display the new password just entered and ask the user to verify its correctness. Once the password is verified, ACCTS will change the password in the Accounts File. All future references to the account will require the new password. ACCTS will then over-print the password several times to obscure it.

## Displaying Account Information

The LIST,USER and LIST,GROUP commands will list user or group account file entries. Unless specified, user passwords and account ID numbers will not be listed. One of the attributes to be listed, which might be of some accounting use, is the total user or group connect-time. The LIST,ACCT command will list system information, including the users currently logged on, the status of the spare cartridge pool, etc.

## Maintaining the Accounts System

### +-----+ | LIST,GROUP | +-----+

The LIST,GROUP command will list the specified group account entries.

```
LI[ST],G[ROUP],group[,list[,ID]]
```

Where:

group is the name of the group whose account file entry is to be listed. "@" may be specified to indicate all group accounts (default).

list is the list device (logical unit or file name) to which the listing is to be directed. The default value is the list file device or the log device terminal if no list device is specified.

ID is an optional parameter that includes the group account ID number in the listing.

EXAMPLE:

To list the group account for the group HP.

```
LI,G,HP,,ID
```

### +-----+ | LIST,USER | +-----+

This command is used to list user account definitions. The command format is:

```
LI[ST],[U[SER]],user.group[,list[,PA[SS][,ID]]]
```

Where:

user.group is the name of the user whose account file entry is to be listed. "@.group" may be specified to list all users in a group. "user.@" may be specified to list account definitions for a user belonging to several groups. "@" may be specified to list account file entries for all users (default). "@.@" may be specified to list all users and all group accounts.

list is the list device (logical unit or name) to which the listing is to be directed. The default is the current list file/device or the log device (terminal) if no list device has been specified.

PASS is an optional parameter that includes the user password in the account listing.



**list** is the list device (logical unit or namr) to which the listing is to be directed. The default is the current list file/device or the log device (terminal) if no list device has been specified.

**PASS** is an optional parameter that includes the user password in the account listing.

**ID** is an optional parameter that includes the user account ID number in the account listing.

```
+-----+
| LIST,ACCT |
+-----+
```

The LIST,ACCT command is used to list session information. This command will list:

1. The name of the system message file, the cartridge CRN or LU where user message files are stored and the session limit.
2. The currently active sessions.
3. The current status of cartridges in the spare cartridge pool.
4. The Configuration Table.

```
LI[ST],A[CCT][,list<
                    [,AC[TIVE SESSIONS]]]
                    [,PO[OL]]]
                    [,CO[NFIGURATION TABLE]]]

Ll,ACCTS,,ALL
```

## Maintaining the Account System

### PURGING ACCOUNTS

The PURGE,USER and PURGE,GROUP commands delete accounts (user or group) from the account file.

```
+-----+
| PURGE,GROUP |
+-----+
```

The PURGE,GROUP command removes a group from the account file. All users belonging to the group are also removed from the account file.

```
PU[RGE],G[ROUP],group
```

Where:

group is the name of the group whose account entry is to be purged. "@" can be specified to purge all user and group accounts with the exception of the MANAGER.SYS, ENGINEER.SUPPORT and GENERAL accounts.

The program will prompt for verification :

```
GROUP group TO BE PURGED (Y OR N)?
```

Note that this command does not affect users currently logged on under this group account.

```
+-----+
| PURGE,USER |
+-----+
```

The PURGE,USER command deletes a user from the account file. The user will not be able to log-on again until a new account file entry for this user is created with the NEW,USER command. All disc cartridges for the user account to be purged will be reassigned to the SYS group account.

```
PU[RGE],[U]SER],user.group
```

Where:

user.group is the name of the user whose account is to be purged. "@.group" may be specified to purge all users in a group, but leave the group account intact. The MANAGER.SYS account cannot be purged. "PU,U,@" will purge all users in the GENERAL group.

The program prompts for verification:

```
USER user.group TO BE PURGED (Y OR N)?
```

Note that this command does not affect users currently logged on to this account.

## Session Monitor System Control

The system control commands are used to perform the following: terminate individual sessions, terminate all sessions and shut the session monitor system down, disable the system console as a session terminal, and restart the session monitor after it has been shutdown. These commands are described in the following paragraphs.

```
+-----+
| SD,SESSION |
+-----+
```

The SD command is used to terminate a session. This command performs the following: logs the specified session off the system, terminates associated processes, and releases session related resources. The command format is:

```
SD,session <
           [,SP or SG]
           [,RP or RG]
```

Where:

Session is the session identifier of the user to be logged off. Normally this will be the station LU.

SP or RP is an optional parameter entered to save (SP) or to remove (RP) the session private cartridges. The default is SP.

SG or RG is an optional parameter entered to save (SG) or to remove (RG) the group cartridges. The default is SG.

The "SD,session" command is entered to log a particular user off, remove all programs associated with that user's session, close and release the associated spool files, and release the session control block (and extensions). After this command is entered, the following message is displayed on the specified station terminal:

```
SESSION ABORTED BY SYSTEM MANAGER
```

```
+-----+
| SD,0   |
+-----+
```

The "SD,0" command is used to disable the system console as a session terminal. This command is used only after the EN command has been entered at the system console to enable it as a session terminal. The disable system console command format is:

```
SD,0
```

## Maintaining the Account System

If there is an active session at the system console, the system console will revert to its standard operation when the session user logs off.

### EXAMPLE:

Assuming the System Manager is on the system console, and it is not enabled as a session terminal:

```
:RU,ACCTS
-----
PASSWORD? -----
NEXT?
SD,0
----
NEXT?
EXIT
----
ENDACCTS
:EX,SP

(Log off Msg)

*ST
```

```
+-----+
|      SD      |
+-----+
```

The SD command is used to shut down the Session Monitor. The following functions are performed when this command is entered:

1. Prohibit future users from logging on, leaving current sessions unaffected.
2. Terminate all current sessions and session related batch, jobs and spools.
3. Completely deallocate session monitor system resources.

The command format is:

```
SD [,RE[LEASE MEMORY]]
```

Where:

RELEASE MEMORY is a specification to release all system memory resources allocated to Session Monitor.

When this command is entered, ACCTS responds with:

DO YOU REALLY WANT TO SHUT DOWN THE SESSION SYSTEM (YES OR NO)?

Enter YES to shut down the Session Monitor. Enter NO to terminate this command. System operation will not be affected.

If YES is entered, ACCTS asks for a shut down message:

SHUT DOWN MESSAGE (20 CHARS)

This message will be displayed whenever users try to log on the system. Enter " " (blank) for the default message: SESSION SHUT DOWN.

At this point, new users will be unable to log on, but currently active sessions will remain unaffected. If there are active sessions, ACCTS prints the active sessions, jobs and spools. ACCTS then asks if these sessions are to be shut down now:

TO SHUT DOWN "NOW" WE MUST ABORT THE ABOVE PROCESSES  
ABORT THE ABOVE PROCESSES (YES OR NO)?

Enter NO if these sessions, jobs, and spools are to remain active until their normal completion. Enter YES if all session related activity is to be terminated in the system immediately.

If YES is entered, ACCTS will proceed to log all users off, terminate any session related batch jobs in progress (or waiting to be run), and close and release all open session related spool files. If the RELEASE MEMORY parameter was specified in the SD command, the memory allocated at bootup (or at least startup) will be deallocated and returned to the system.

#### CAUTION

It is strongly recommended that the RELEASE MEMORY parameter NOT be specified in the SD command if session monitor is to be restarted at a later time before rebooting the system. If restarted under these circumstances, the session memory area may permanently fragment System Available Memory, possibly severely degrading system performance.

After the session monitor has been shut down, ACCTS will display the following messages when prompting for each new command:

SHUT DOWN  
NEXT?

## Maintaining the Account System

```
+-----+  
|   SU   |  
+-----+
```

The SU (StartUp) command restarts the session monitor after a shut down. The command format is:

SU

After the SU command is entered, users will again be able to log on the system. If the system was shut down with an SD,RE command, session monitor will re-allocate memory for itself at this time. The prompt password is only requested when running accounts outside of session control.

EXAMPLE:

```
;RU,ACCTS  
-----  
PASSWORD?<password> (Not echoed)  
-----  
SHUT DOWN  
NEXT?  
SU  
--  
NEXT?
```

## Account System Maintenance

The ALTER,ACCT and PURGE,ACCT commands allow either altering or purging of the entire account structure. The UNLOAD and LOAD commands are provided for maintenance of the account file. The UNLOAD command is used to transfer the contents of the account file to a logical unit or another file. This provides a backup of the account file. The LOAD command is used to rebuild the account file, if necessary.

```
+-----+  
| ALTER,ACCT |  
+-----+
```

The ALTER,ACCT command is used to change the following:

1. the maximum number of active sessions allowed by the Session Monitor.
2. the system message file.
3. the disc allocated to the Session Monitor disc pool.

4. the Configuration Table.

The command format is:

AL[TER],A[CCT]

ACCTS will prompt for the attributes shown below. If no change to the value of the attribute is desired, enter "/" (slash). To change a value to the default or delete it enter " " (space).

SESSION LIMIT?

Enter a nonnegative integer signifying the maximum number of active sessions. If set to zero, all users will be turned away with a SESSION LIMIT EXCEEDED message. This does not affect users who are currently logged on.

CHANGE MEMORY ALLOCATION (Y OR N)?

Enter Y to change the amount of memory allocated for session control blocks. The memory is allocated at system start-up, using the memory allocation algorithm. ACCTS will display the MESSAGE FILE? prompt if N was entered. If Y was entered, the following prompt is displayed:

NO. of WORDS?

This question will be asked only if the memory allocation algorithm is not to be used (Y entered above). Enter the decimal number of words to be allocated for the Session Monitor at start-up.

MESSAGE FILE?

Enter the namr (file name:sc;crn) of the system message file. The default is no message file.

PROMPT STRING?

Enter the log-on prompt string of up to 20 characters. The default is "PLEASE LOG ON:".

LOCATION OF MESSAGE FILES?

Enter the cartridge reference number (CRN) or negative disc LU of the cartridge where message files are located. Default is LU2 and LU3. At this time the above changes are posted to the Account File.

ADD DISC POOL LU (Y OR N)?

If "Y" is entered, ACCTS will prompt with DISC LU?

Enter the logical unit of the disc to be added to the spare cartridge pool. ACCTS will repeat this prompt until "/E" is entered.

PURGE DISC POOL LU?

## Maintaining the Account System

If "Y" is entered, ACCTS will prompt with DISC LU?

Enter the logical unit of the disc to be purged from the disc pool. ACCTS will repeat this prompt until "/E" is entered. When this phase is complete, ACCTS posts the new disc pool to memory and the Account File.

STATION CONFIGURATION (A(DD), D(ELETE), M(ODIFY) OR " " (NO CHANGE))?

If A is entered, ACCTS prompts for a station LU and associated device and default logical unit pairs.

If D is entered, ACCTS prompts for the station LU number to be deleted from the Configuration Table.

If M is entered, ACCTS prompts for the station LU number to be modified in the Configuration Table. ACCTS then prompts for the SST definitions to be associated with this station LU.

### EXAMPLE:

Suppose the Configuration Table contains an entry for station LU30 as shown below:

```
+-----+-----+
| 30 | 1 | Station (terminal) LU
+-----+-----+
| 34 | 4 | Default LU34 to 4
+-----+-----+
| 35 | 5 | Default LU35 to 5
+-----+-----+
```

To modify the entry so that default LU5 is directed to LU39 instead of LU35 and to include a new entry association LU38 with default LU6, enter the following commands:

```
ALTER,A
SESSION LIMIT?
.
.
.
```

ACCTS will prompt with:

CONFIGURATION TABLE (A(DD), D(ELETE), M(ODIFY) OR " " (NO CHANGE))?

Enter "M". ACCTS will then prompt for the station LU whose entries are to be modified:

STATION LU?



Enter "30", the station logical unit. ACCTS will then prompt (and continue prompting until "/E" is entered) for each pair of device/default logical units to be associated with station LU30:

```
SESSION LU, SYSTEM LU? Enter "4,34".
SESSION LU, SYSTEM LU? Enter "5,39".
SESSION LU, SYSTEM LU? Enter "6,38".
SESSION LU, SYSTEM LU? Enter "/E".
```

ACCTS makes the modifications and returns with the "NEXT?" prompt.

The modified Configuration Table entry for Station LU30 now looks like:

```
+-----+-----+
| 30 | 1 | Station (terminal) LU
+-----+-----+
| 34 | 4 | Default LU34 to LU4
+-----+-----+
| 39 | 5 | Default LU39 to LU5
+-----+-----+
| 38 | 6 | Default LU38 to LU6
+-----+-----+
```

```
+-----+
| PURGE,ACCT |
+-----+
```

The PURGE,ACCT command is used to purge the entire Session Monitor account structure including all user and group accounts, the Configuration Table and the spare disc pool. ACCTS will accept this command only if there are no active sessions. The command format is:

PU[RGE],A[CCT]

The following prompt is always issued to verify the purge request:

DO YOU REALLY WANT TO PURGE THE ACCOUNT STRUCTURE (YES OR NO)?

A YES response will purge the account structure. ACCTS must be run to create another account file. To reconstruct the account file from a backup file created by the UNLOAD command, use the LOAD command.

```
+-----+
| UNLOAD |
+-----+
```

The UNLOAD command is used to write the contents of the account file to a logical unit or another file. This provides a backup copy of the account system for use with the LOAD command in the event that the account file is destroyed. The command format is:

UN[LOAD],namr

## Maintaining the Account System

where:

namr is the logical unit or new file name to which the account file is to be dumped. The default is LU8.

Note: UNLOAD compresses empty spaces out of Account File. Also, prior to unloading the Account File, it is recommended that all disc cartridges be dismounted. This eliminates the chance of errors in the user cartridge list if user accounts are purged and added between UNLOAD and LOAD operations.

```
+-----+
|   LOAD   |
+-----+
```

The LOAD command is used to restore the account system using the backup file produced by the UNLOAD command. The command can be used to restore user and group accounts or the entire account file including the header information, the Configuration Table, the spare disc pool, the directory and all accounts. The command format is:

```
LO[AD] ,namr <
                [,ACCTS]
                [,ALL]
```

where:

namr is the logical unit or name of the account backup file. A "0" parameter entered specifies that a new account file is to be constructed from the current file to expand the Account File.

ACCTS indicates that the accounts in the account file will be purged and those on the backup file will be loaded into the existing account file. This is the default parameter.

ALL is similar to ACCTS. This parameter also rebuilds the header information, the Configuration Table, and the spare cartridge from the backup file.

The accounts system must be shut down before loading a new accounts file except when loading from the current file (i.e. LOAD, 0 command). If there are active sessions when any other LOAD command is entered, ACCTS prints the number of the sessions, jobs, and spools and asks if these processes can be aborted:

```
TO SHUT DOWN "NOW" WE MUST ABORT
THE ABOVE PROCESSES
ABORT THE ABOVE PROCESSES (YES OR NO)?
```

Enter NO to allow a "soft" shut down to occur. The sessions, jobs and spools currently active will be allowed to proceed until their normal termination; however, new users attempting to log on will see this message at their terminals:

SESSION SHUT DOWN

ACCTS then responds with a NEXT? prompt. Once the current session activity has completed, you can enter a new LOAD command to restore your account system.

Enter YES to allow ACCTS to log all active users off and terminate and clean-up any session related batch jobs and spools. ACCTS will display a shut down message and then proceed with the LOAD operation.

ACCTS will first request the DISC LU on which the accounts file is to be located.

ENTER DISC LU FOR ACCTS FILE:

CAUTION: For all session subsystems to operate properly the DISC cartridge must be mounted as a system disc.

ACCTS reports the size of the current Configuration Table and the total number of accounts:

STATION TABLE XXXXX WORDS  
XXXX ACCOUNTS REQUIRED

ACCTS then allows changing of the account file contents by prompting with:

NUMBER OF USER ACCOUNTS? <number> or <space>  
NUMBER OF GROUP ACCOUNTS? <number> or <space>

If no changes are required, enter " " (space) to both questions. Otherwise, enter the new maximum number of user and group accounts. ACCTS will use the following algorithm for calculating account directory size and the number of records allocated in the account file for account definitions.

$(\# \text{ USER} + \# \text{ USERS}/5 + \# \text{ GROUPS}) * 8 / 8 + 7$

Note: UNLOAD compresses the Account File to an absolute minimum. Therefore, the default would not allow the addition of any new accounts.

ACCTS next prompts for an estimate of the new Configuration Table size:

ENTER <number of stations>,<average size>

## Maintaining the Account System

Enter the number of stations in your system and the estimated average number of Configuration Table SST definitions for each station (plus two for the entry length word and station LU word). If you wish to use the minimum length necessary to accommodate the Configuration Table defined in the backup file, enter " " (space).

### Account Command File Formats

The account command file format is shown below:

For new user accounts:

| CONTENTS              | COMMENTS                     |
|-----------------------|------------------------------|
| NE,U                  |                              |
| user name             | (1-10 ASCII characters)      |
| group name            | (1-10 ASCII characters)      |
| Y or N                | (group SST definition)       |
| password or " "       | (1-10 ASCII characters)      |
| hello file            | (filename:sc:crn)            |
| capability            | (integer, 1-63)              |
| disc limit            | (integer)                    |
| session LU, system LU | (user SST definition)        |
| /E                    | (terminate SST definition)   |
| SST spares            |                              |
| link                  | (user,group/password of " ") |
| group name            | (1-10 ASCII characters)      |
| Y or N                | (group SST definition)       |
| :                     |                              |
| :                     |                              |
| /E                    |                              |

For new group accounts:

| CONTENTS              | COMMENTS                   |
|-----------------------|----------------------------|
| NE,G                  |                            |
| group name            | (1-10 ASCII characters)    |
| session LU, system LU | (group SST definition.)    |
| /E                    | (terminate SST definition) |

## Error Messages

Error conditions encountered during the execution of the ACCTS program result in the display of numbered error codes in the format:

ACCT nnn

where: nnnn is the error number

A list of the common error messages is provided in Table 7-3. When an error is detected, a transfer to the operator console occurs, allowing the operator to enter the correct response in order to continue ACCTS execution. Refer to Appendix H for a complete list of the ACCTS program errors.

Table 7-3. ACCTS Error Summary

| ERROR CODE | MEANING  |
|------------|--|
| ACCT-000   | ACCOUNT BREAK  |
| ACCT-001   | DISC DOWN  |
| ACCT-012   | LU NOT IN SESSION SWITCH TABLE                       |
| ACCT-013   | TRANSFER STACK OVERFLOW                              |
| ACCT-019   | ILLEGAL ACCESS ON A SYSTEM DISC                      |
| ACCT-046   | CAPABILITY ERROR                                     |
| ACCT-200   | ACCOUNT NOT FOUND                                    |
| ACCT-201   | NO FREE ACCOUNTS                                     |
| ACCT-202   | ACCOUNT WITH THIS NAME ALREADY EXISTS                |
| ACCT-203   | INVALID ACCOUNT NAME                                 |
| ACCT-204   | INVALID PASSWORD                                     |
| ACCT-205   | INVALID COMMAND                                      |
| ACCT-206   | INVALID FILE NAME                                    |
| ACCT-207   | INVALID CAPABILITY                                   |
| ACCT-208   | INVALID DISC LIMIT                                   |
| ACCT-209   | INVALID SST ENTRY                                    |
| ACCT-210   | CONFLICT IN SST DEFINITION                           |
| ACCT-211   | USER OR GROUP ID NOT AVAILABLE                       |
| ACCT-212   | INVALID NUMBER OF SST SPARES                         |
| ACCT-220   | CORRUPT STATION TABLE SPARES                         |
| ACCT-221   | NOT AN ACTIVE SESSION                                |
| ACCT-222   | ILLEGAL SYSTEM LU                                    |
| ACCT-223   | ILLEGAL SHUT DOWN PARAMETER                          |
| ACCT-225   | SESSION MEMORY CANNOT BE RETURNED TO SYSTEM (REBOOT) |



# Chapter 8

## Adjusting System Parameters

### Introduction

Certain system and FMGR commands can be used to enable your system to meet specific requirements of your installation. The overall effects of these commands are described below. For a discussion of command syntax and operation, refer to the RTE-IVB Terminal User's Reference Manual.

### Device Control

The TO command can be used to set EQT timeout values for device controllers. EQT timeout values are initially set during system generation. The TO command can be used to correct generation values and adjust timeouts after operating experience is gained with your system. EQT timeouts are used to place a time limit on an I/O request once it is sent to a device driver. When the time limit expires, the system will either set the device down or inform the driver of the timeout.

For example, timeouts are frequently associated with terminals in order to limit the amount of time programs may wait for commands or data from the keyboard. The Session Monitor will automatically log a user off his terminal after five consecutive timeouts.

EQT timeout settings depend on both the device and the associated driver. Unless you have a good reason to do otherwise, it is recommended that EQT timeout be set according to the values given in this manual (refer to the DEVICE CONFIGURATION section in Chapter 3) and other subsystem manuals and configuration guides.

The LU command can be used to alter system Logical Unit/EQT Subchannel relationships. LU commands are frequently used to:

- \* Correct generation errors. If device LU assignments were incorrectly specified during generation, you can fix these definitions at system startup by putting the appropriate LU commands in the WELCOM file.
- \* Configure new devices into the system. The LU command can assign unused LU numbers to new devices attached to an existing controller. It is recommended that you generate spare LU numbers in your system just for this purpose (refer to the I/O PLANNING section in Chapter 3).
- \* Change device control parameters. Certain drivers (e.g., DVR00) obtain device control information from the LU subchannel definition. The LU command can redefine the subchannel to accommodate changing application requirements.

## Adjusting System Parameters

The EQ command can be used to enable/disable automatic output buffering to selected devices. When this feature is enabled for a device, output data will be buffered in SAM before it is sent to the device. When a program does standard output to a device without output buffering, the program must wait for the output request to complete before resuming execution. In addition, if the program is partition resident, it is locked into that partition for the duration of the output request, i.e., the partition will be unavailable for other higher priority tasks. On the other hand, if automatic output buffering is enabled, these restrictions are lifted. Therefore programs may perform output operations without waiting for device completion and they may be swapped at any time.

It is advantageous to enable output buffering on devices with very slow output rates relative to the rate of output requests. Typical peripherals in this category are line printers, terminals, paper tape punches, etc. Magnetic tape peripherals would also fall into this category for control operations such as rewind and file skip. By buffering these devices, you may significantly improve system throughput and resource utilization. Certain devices, such as discs, must NOT be buffered.

The decision whether to enable buffering on a device must be balanced with considerations of your system SAM requirements. Buffering output requests through SAM will reduce the amount available for other operations (e.g., class I/O, reentrant processing, scheduling strings, etc.). To keep a program from monopolizing SAM with buffered output requests, the system enforces upper and lower limits on the amount of memory queued on any I/O device. When a program makes an I/O request, the system sums up all output requests already on the device I/O request queue. If this sum exceeds the high buffer limit, the program is suspended. Suspended programs are not rescheduled until the queued memory drops below the lower limit.

The upper and lower buffer limits are initially set during system generation, but can be modified on-line with the BL command. For optimum operation, the differential between the high and low buffer limits should be set such that once a program is suspended on buffer limits, there will be enough time for lower priority programs to do useful work before the low limit is reached. The low limit should be set high enough so that there is sufficient data to keep the device busy until the rescheduled program can issue a new I/O request (e.g., it might have to be swapped in from disc). Remember, these considerations must be tempered with the availability of SAM in your system.

It is recommended that your system high and low buffer limits be set initially to 400 and 100, respectively. After your system is operational with the intended mix of applications, run performance tests with different limits to find the optimum settings.



## Time Slicing

The system manager can control time slicing in the following ways:

- \* Modify the system time slice Quantum Multiplier (QU command).
- \* Modify the system time slice Priority Fence (QU command).
- \* Modify a specific program time slice level (PR command).

All programs competing for the central processor (CPU) access it according to their order in the scheduled list. Programs are placed in the scheduled list in order of their priority. Within priorities, scheduling can be performed in a linear or circular fashion. (Refer to the RTE-IVB Programmer's Reference Manual for a detailed description of linear and circular scheduling.) The scheduled list is divided into two partitions. Those programs with priority numbers less than the priority fence will be scheduled in linear fashion. Programs with priority numbers greater than or equal to the fence will be scheduled in circular fashion.

Program priority levels should be set such that real time, response time critical tasks have priority numbers below the Priority Fence (i.e., they will be linear scheduled). Background tasks should have priority numbers above the fence. To make most effective use of time slicing, programs performing similar types of functions should have identical priority numbers. This will allow them to compete more evenly for CPU time. You might want to establish several standard priority levels for different types of functions. For example, highly interactive programs such as editors and data entry processors might be assigned priority level 50, and less interactive programs, such as FMGR and BASIC, level 90; and highly compute bound tasks might be assigned level 300.

RTE-IVB operating system gives time sliced programs a full execution slice (quantum) when: they are initially scheduled; they are rescheduled after leaving the scheduled list (due to I/O suspend, buffer limit suspend, etc.); or they have exhausted their current quantum. In all three cases, the program is placed in the scheduled list after all programs of the same priority, thereby allowing programs to execute on a round-robin basis. The maximum quantum given to a program is calculated as follows:

$$\text{Maximum Quantum} = \text{Quantum Multiplier} * (\text{program priority}/256 + 1)$$

For programs with a priority level of between 0 and 255, the maximum quantum is equal to the quantum multiplier. For programs with a priority level of 256 to 511, the maximum quantum is 2 \* the quantum multiplier and so on. This algorithm gives lower priority (higher priority numbered) programs a longer execution slice as they are assumed to execute less frequently.

## Adjusting System Parameters

The primary advantage of time slicing programs is to prevent programs from monopolizing available CPU time. If the Quantum Multiplier is set low enough (e.g. less than .25 seconds), it can give users the illusion of a dedicated processor. However, keep in mind that as the quantum multiplier is decreased, the system may dispatch programs for execution more often. If enough memory partitions exist to hold all active time sliced programs, this extra system overhead is minimal (it basically involves a switch in user maps). However, if there are more time sliced programs than available partitions, the system overhead involved to switch between scheduled programs can increase substantially due to disc swapping. In this case, the Quantum Multiplier should be relatively large (e.g. greater than 1 sec) or time slicing can be turned off altogether (i.e. QU,0,32767). It is recommended that, after the system is operational, you run performance tests to find a quantum multiplier acceptable to system users. This value can be adjusted as your memory configuration changes.

### NOTE

The system makes no attempt to adjust the partition list so that swapping is evenly distributed over a set of programs competing for the same partitions. Therefore it is possible for time sliced programs to receive unequal shares of CPU time even though they have identical priority levels.

## System Console as a Session Terminal

In many installations it may not be desirable to operate the system console as a session terminal since users on LUL will see system messages unrelated to their session. However, if you need session operation from LUL, the system console can be enabled with the EN command. (It is recommended that the security code option be specified here, i.e. EN,sc,1).

After the system console is enabled as a session terminal, commands can be routed directly to the operating system (instead of the Session Monitor break mode processors) with OP commands. In addition, OP will suppress command checking on the supplied command. For example, to abort the current batch job, from the system console when enabled as a session terminal, enter:

```
S=01 COMMAND? OP,sc,AB,1
-----
```

Where "sc" is the master security code (required if EN,sc,1 was specified.) This command will have the same effect as:

```
*AB,1
-----
```

when entered in non-session mode. Note that OP commands can be entered from any capability level session. System security is maintained through specification of the master security code.

To convert the system console back to non-session operation run the ACCPS program and enter the SD,0 command (Chapter 7). Note that this command will not shut down any session that is currently active on LUL. It merely converts break mode to non-session operation. Use SD,1 to shut down the session on LUL.

Under certain circumstances, the user may receive the following break mode prompt on the system console when operating in session mode:

S=?? COMMAND? OP,

This prompt is issued when LOGON or R\$PN\$ are already processing a break mode request from LUL and an additional break mode interrupt is made. This can occur if:

1. LOGON and/or R\$PN\$ are busy processing other requests.
2. LOGON and/or R\$PN\$ have been temporarily shut down by the ACCTS program (e.g. during a LOAD,0).
3. LOGON and/or R\$PN\$ can not process inputs due to unavailable system resources (e.g. SAM, swap tracks, partitions, etc.)
4. LOGON and/or R\$PN\$ have been aborted and permanently purged from the system.

For the first two cases, it is suggested that you wait a short period and try again. If you still receive the special prompt, there are probably more serious system problems. At this point it is suggested that the system console be changed back to non-session mode.

EXAMPLE:

|                              |   |
|------------------------------|---|
| S=01 COMMAND? WH             | (User issues WH command)  |
|                              | (No response)   |
| S=?? COMMAND? OP, <cr>       | (He tries again - gets special prompt and types RETURN)         |
| S=?? COMMAND? OP,sc,RU,ACCTS | (The system manager runs ACCTS)                                 |
| PASSWORD?                    | (enters password)   |
| NEXT?                        |   |
| SD,0                         | (disable session break mode. Session 1 is still active however) |
| NEXT?                        |   |
| EXIT                         | (terminates ACCTS)  |
| END ACCTS                    |   |
| *RU,WHZAT,1                  | (WHZAT run in non-session mode)                                 |
| .                            |   |
| .                            | (Corrects problem)  |
| .                            |   |
| *EN,sc,1                     | (reenables system console for session)                          |

## Partition Management

The AS command will assign programs to specific partitions. This may be done for a variety of reasons:

- \* To keep programs from contending for the same partitions, you can assign each to a different partition.
- \* For response time critical tasks, programs can be assigned to previously reserved partitions. If there is only one program assigned to a partition, the program will effectively be made memory resident.
- \* Non EMA programs must be assigned to mother partitions in order to run in them (these programs would do their own mapping).

The UR command can be used to release a previously reserved partition. This will allow programs not specifically assigned to this partition to run in it. Partitions cannot be reserved on line. They may be reserved only during system generation or reconfiguration.

The SZ command can be used to change the minimum partition size a program can run in. Certain HP supported programs use the space between the end of the program and the partition for buffer areas (refer to the UTILITY LOADING CONSIDERATIONS section in Chapter 3).

## Changing the Master Security Code

The system master security code can be changed with the following file manager command:

```
:IN,ol--nw
```

Where "ol" is the old master security code and "nw" is the new code. In the session environment, this command requires a command capability level of 60. It is STRONGLY advised that the system master security code not be publicized, as it will give users access to all file security codes (which will in turn give access to all system files).

**CAUTION:** If the character "Control E" is used in the Master Security Code, the MSC cannot be changed until a "SWITCH" to a new system is accomplished.

# Chapter 9

## Memory and I/O Reconfiguration

### General

The ability to reconfigure the I/O and memory assignments during system boot-up without going through a complete, new system generation is a feature of the RTE-IV operating system. The reconfiguration option is exercised during RTE system boot-up through S-register settings (described below) in order to postpone completion of the boot-up process and schedule an interactive Configurator program that performs the desired I/O and/or memory reconfiguration.

I/O reconfiguration is performed by user reassignment of I/O devices to octal select codes other than those assigned at system generation time.

Memory reconfiguration includes changing the size of the System Available Memory (SAM) extension, redefining user partitions, modifying program page requirements and assigning programs to partitions. Defective pages in memory (pages with parity errors) can be avoided by using the Configurator to redefine the SAM extension and user partitions around the defective pages.

I/O and memory reconfigurations (either or both) can be made permanent by changing the system on the disc.

### Scheduling the Configuration from Disc Loader ROM

If a disc loader ROM is used to load the boot-extension into memory during system boot-up, the Configurator can be scheduled by setting bit 5 of the S-register, in addition to the S-register settings for the disc loader ROM. The example given below assumes the system boot-up will be performed using the 12992B RPL-compatible 7905/7906/7920/7925 Disc Loader ROM, and that the Boot Extension resides on physical track 0, "sector 0 of the system disc". Standard boot-up procedures can be found in the HP 12992 Loader ROM Installation Manual (part number 12992-90001).

## Memory And I/O Reconfiguration

Begin the boot-up by performing the following steps:

1. Select the S-register for display on the computer front panel.
2. Press CLEAR DISPLAY
3. Set the S-register bits for the disc loader ROM. In addition, set bit 5 of the S-register for I/O or memory reconfiguration:

| Bits<br>---- | Enter<br>-----   |
|--------------|--|
| 0-2          | Surface number of the disc where the RPE-IV system subchannel starts (surface numbers start at 0). |
| 3-4          | 0 (reserved).  |
| 5            | 1 to specify reconfiguration is to be performed. A HLT 77B will be issued at the end of the load.  |
| 6-11         | Octal select code of the disc.   |
| 12           | 1 to indicate a non-RPL boot from the S-register.  |
| 13           | 0 (reserved).  |
| 14-15        | Loader ROM selection (number of the ROM cell containing the Disc Boot Loader).                     |

Press STORE

4. Press PRESET, IBL, PRESET (again, this resets parity error logic if set by IBL) and RUN to load the contents of the Disc Loader ROM. A successful load will be indicated when the HLT 77B occurs.

5. Following the HLT 77B, set the S-register as follows:

| Bits<br>---- | Enter<br>-----  |
|--------------|---|
| 0-5          | System console octal select code if either the select code or device type is different from generation specification; otherwise, 0. |
| 6-11         | System disc octal select code if different from generation specification; otherwise, 0.   |
| 12-14        | 0 (reserved)  |
| 15           | 1 to specify reconfiguration of I/O (including disc and console, above) and/or memory assignments.                                  |

6. Press RUN to perform reconfiguration processes.

### Scheduling the Configuration from Bootstrap Loader

If the Bootstrap Loader is used to load the Boot Extension into memory, set the S-register as described above in Step 5 when the HLT 77B occurs.

Set the P-register to 100 octal and press RUN to perform reconfiguration.

### Configuration Program

The Configurator works interactively with the user to make specified changes to the current I/O and memory configurations. Reconfiguration is performed in accordance with user responses to a series of Configurator prompts and queries output on the system console. When reconfiguration is completed, the Configurator queries whether it is to be made permanent. Boot-up of the RTE-IVB system is then completed in accordance with the user's reply.

The Configurator is divided into two programs: \$CNFG and \$CNFX. \$CNFG is a module located at the end of the system modules. After configuration has completed, the memory area occupied by \$CNFG is allocated to SAM. \$CNFX is used to reconfigure memory and is a Type 3 disc resident program, brought into the user partition area from disc by the \$CNFG program. \$CNFG changes \$CNFX's program name to ".,.,.,." and therefore \$CNFX cannot be executed on-line.

## Memory And I/O Reconfiguration

The Configurator program first checks the contents of the S-register. If bit 15 is set, I/O and memory reconfiguration are performed. The system is reconfigured in accordance with any specified new disc and console select codes. Entering invalid disc and console select codes in the S-register will cause the system not to function properly. The Configurator then loads the driver partitions, memory resident library and memory resident programs (if they are defined for the system) into memory.

If bit 15 is not set in the S-register, control is given to the operating system.

Reconfiguration is performed interactively by using the system console and list device. Note that the standard method of getting system attention by pressing any key on the system console will not work during reconfiguration, since the system is not yet completely initialized. The bootup procedure must therefore be restarted if any equipment I/O errors occur (e.g., a device not ready or a parity error).

### **Configuration Halts and Error Messages**

Various halts and Configurator error messages may occur during system boot-up or reconfiguration that require corrective action by the operator. Halts are displayed on the computer front panel. System boot-up and configuration HLTs, their meaning and required operator action are itemized in Table 10-1 at the end of this section.

Whenever the user enters an invalid response to a Configurator prompt or query, the Configurator will issue an error message in the form

```
CONFIG ERR xx
```

where xx is a Configurator error code as defined in Table 12-2 at the end of this section. Following the error message, the Configurator will usually repeat the prompt or query and the user need only enter the correct response. In the reconfiguration procedures given below, only error recovery procedures requiring further action will be described in text.

### **Reconfiguration Procedures**

The Configurator begins the reconfiguration process by first displaying the message

```
START RECONFIGURATION
```

on the system console, and followed by a set of queries to which the user enters responses on the console keyboard. The Configurator will redisplay a query if the user response is not what was expected.



The Configurator next displays the query

LIST DEVICE LU#?

Enter a Logical Unit number to which the Configurator can direct listings or press the space bar and RETURN key on the console keyboard for the default case, which is the system console. Entering a list device other than the system console causes the Configurator to display the following message:

LIST DEVICE SELECT CODE#?

Enter a list device select code or press the space bar and RETURN key for the default case, where the default is the list device select code configured into the system.

If the entered list device was not the system console, the Configurator displays the query

ECHO? (YES/NO)

Enter YES to have all output to the list device echoed on the system console.

## I/O Reconfiguration Steps

I/O reconfiguration is performed by assigning the Interrupt Table and trap cell values for the current select code to the corresponding entries for the new select code.

The Configurator first prompts for I/O reconfiguration by displaying a list of the current I/O configuration, beginning with octal select code 10 for the operating system, in the format:

CURRENT I/O CONFIGURATION:

|                  |          |        |     |        |     |
|------------------|----------|--------|-----|--------|-----|
|                  |          |        | +-- |        | --+ |
|                  |          | EQTyy  |     | PNAME  |     |
| SELECT CODE xx = | TBG      | [,TYPE | nn  |        |     |
|                  | PRIV I/O |        |     | nnnnnn |     |
|                  |          |        | +-- |        | --+ |

## Memory And I/O Reconfiguration

where:

xx = octal select code number ranging from 10 to 77.  
EQTy = EQT entry number  
TBG = Time Base Generator  
PRIV I/O = privileged I/O card  
TYPE nn = equipment type code  
PNAME = name of program to be automatically scheduled  
nnnnnn = absolute instruction to be executed upon interrupt; for example, a JSB LINK,I where LINK contains the entry point address.

The CURRENT I/O CONFIGURATION data is automatically displayed to provide a basis on which to make decisions regarding reconfiguration. If the system disc, system console or the list device were assigned to a new select code, they have already been configured in memory and must NOT be reconfigured during I/O reconfiguration.

The list does not include the select codes previously configured to the system disc, system console, or list device that have been reconfigured via the SWITCH register at bootup. However, these previously-occupied select codes are still available for reassignment. Also, those devices formerly occupying the select codes now reconfigured to the system disc, console, or list device may be reassigned if referenced by their old select code.

Following display of the current configuration, the Configurator then displays the query

I/O RECONFIGURATION? (YES/NO)

Enter NO to bypass I/O reconfiguration. The Configurator will skip all further I/O reconfiguration prompts and begin prompting for memory configuration entries (see below).



## Memory And I/O Reconfiguration

Following entry of a /E to terminate select code changes, the Configurator prints a list of the NEW I/O CONFIGURATION. The next query displayed is:

NEW I/O CONFIGURATION PERMANENT? (YES/NO)

Enter YES to modify the system on the disc to the new I/O configuration. Enter NO otherwise. The format switch on the system disc drive (7905/06/20/25) must be in the ON position or the override switch (7900) must be in the override position if the new I/O configuration has to be made permanent. If it is desirable to restart I/O reconfiguration for any reason, enter the request

/R

and I/O reconfiguration will restart by another display of the list

CURRENT I/O RECONFIGURATION:

The list will contain what the I/O configuration was changed to during the reconfiguration just completed.

### CAUTIONS:

1. It is strongly recommended that the system subchannel of the disc be backed up before making I/O reconfiguration permanent.
2. If a select code has been given a new assignment and its current I/O device has not been reassigned, the I/O device cannot be added to the system at a later date if the new I/O configuration is made permanent.
3. If a device has multiple select codes, make sure that all select codes are moved and kept in the same relative order.
4. Reassigning some devices to empty I/O slots may cause unexpected results.

## Memory Reconfiguration Procedures

After the I/O reconfiguration phase is either bypassed or terminated, the Configurator will display the following statement and query:

CURRENT PHYSICAL MEM SIZE: xxxx PAGES  
MEM RECONFIGURATION? (YES/NO)

Enter NO if memory reconfiguration is not desired. The Configurator will then transfer control to the operating system after displaying the message

RECONFIGURATION COMPLETED

Enter YES if memory is to be reconfigured. The Configurator will then display the query

PHYSICAL MEM SIZE? (#PAGES)

Enter the desired total number of memory pages, between 48 and 1024 (decimal).

## EXCLUDING BAD PAGES

The Configurator program can be used to redefine the SAM extension and user partitions to exclude any bad pages (pages containing parity errors) within these areas. Each user partition must be a contiguous block of memory; therefore, user partitions must be defined on blocks of memory between the bad pages. Bad pages in the system area, driver partitions and the memory resident area cannot be avoided.

The Configurator displays the query

DEFINE BAD PAGES BEGINNING AT PAGE xxxx (/E TO END)

-

where the hyphen (-) prompts for the decimal number of a bad memory page. The hyphen is repeated after acceptance of each entry until a /E or 100 bad page numbers are entered, terminating the list. (The Configurator will accept up to 100 bad memory page entries.) The bad page specifications entered can range from xxxx to the maximum page number in physical memory and must be entered in an increasing order.

If /R is entered in response to the hyphen prompt, the Configurator will redisplay the query

DEFINE BAD PAGES BEGINNING AT PAGE xxxx (/E TO END)

-

and the entire list of bad pages must be re-entered.

When a /E is entered either to terminate bad page entries or bypass the entire phase, the Configurator displays the following information:

CURRENT SIZE OF SAM DEFAULT: xxxxx WORDS EXTENSION: yy PAGES  
SAM EXTENSION STARTS AT PHYSICAL PAGE xx MAX PAGES AVAIL FOR  
SAM EXTENSION: xx

The number of words displayed for default SAM are the decimal number of words assigned to the first block of SAM.

### SAM Extension Reconfiguration

The Configurator next prompts for any desired change in the size of SAM extension by displaying the query:

```
CHANGE SAM EXTENSION?(# PAGES/" " CR)
```

Press the space bar and RETURN key (the default case) if no change is desired.

Enter the decimal number of pages desired if the SAM extension is to be changed. The number of pages can vary from 0 (which removes SAM extension) to the maximum pages available for the SAM extension. Note that this count must not include any bad pages that fall within the SAM extension (see above).

The Configurator sets up the System Map to avoid bad pages in the SAM extension regardless of whether or not a change was requested.

If the specified SAM extension extends beyond the size of physical memory because of bad pages within this area, the Configurator displays the message

```
CONFIG ERR 12
CHANGE SAM EXTENSION?(# PAGES/" " CR)
```

Enter a smaller number of pages for SAM extension size. The Configurator allows SAM extension to be divided up into a maximum of five blocks of memory between bad pages. If the number of pages in SAM extension requires division into more than five blocks, the Configurator displays the message

```
CONFIG ERR 22
```

and the query is redisplayed. Enter a smaller size of SAM extension.

### CHANGING PARTITION DEFINITIONS

The Configurator next displays a list of current partition definitions in the format:

CURRENT PART'N DEFINITIONS:

|                      |      |     |     |     |
|----------------------|------|-----|-----|-----|
|                      | +--  | --+ | +-- | --+ |
| PART'N nn = pp PAGES |      |     |     |     |
|                      | ,RT  |     | ,R  |     |
|                      | ,BG  |     |     |     |
|                      | ,RTM |     |     |     |
|                      | ,BGM |     |     |     |
|                      | ,S   |     |     |     |
|                      | +--  | --+ | +-- | --+ |

where

nn = the partition number

pp = is the number of pages in partition nn

RP = a real-time partition

BG = a background partition

RPM = a real-time mother partition

BGM = a real-time mother partition

S = a subpartition

R = a reserved partition

Following the definition list, the Configurator next displays a list of current partition requirements in the form:

```

CURRENT PART'N REQMS:
REALTIME
PNAME  XX PAGES [E][PART'N=nn]
  .
  .
  .
BACKGROUND
PNAME  XX PAGES [*][E][PART'N=nn]
  .
  .
  .
    
```

where

PNAME = the real-time or background program name

E = indicates an EMA (Extended Memory Area) program

\* = indicates the background program does not include Table Area II (i.e., a Type 4 program)

nn = is the number of the partition into which program PNAME is assigned.

## Memory And I/O Reconfiguration

The Configurator then displays the following information:

```
MAX PROGRAM SIZE:
W/OUT COMMON:   xx PAGES
W/COMMON:       xx PAGES
W/TABLE II:     xx PAGES
MAX # OF PART'NS:  xx
PAGES REMAINING:  xx
DEFINE PART'NS FOR xxxx PAGES
#PAGES,RT(M)/BG(M)/S(,R)
PART'N x,pppp(,mmmm) PAGES?
```

where

MAX PROGRAM SIZE = maximum logical space a program may occupy. However, the partition size may be larger than the stated maximum if the partition will be used for EMA program execution.

MAX # OF PART'NS = decimal number of partitions that can be defined in memory.

PAGES REMAINING = decimal number of pages available for defining user partitions (including bad pages that may have been listed earlier).

#PAGES,RT(M)/BG(M)/S(,R) = indicates the required format for user entries in response to the partition definition prompt described below.

PART'N x,pppp(,mmmm) PAGES? = Configurator program prompt asking the user for the size (in pages) and format for the next partition to be defined. x is the partition number. pppp is the number of contiguous pages to be defined before the next page. mmmm is the number of pages remaining to be defined in the mother partition.

If the maximum number of partitions was defined as 0 during generation time, the Configurator skips the rest of memory reconfiguration and displays the query

```
NEW MEMORY CONFIGURATION PERMANENT?
```

Since partitions must be defined contiguously, they must be within the section of memory between the bad pages. If a section of memory between bad pages has a size of one page, it is skipped by the Configurator. The Configurator will prompt for a partition definition after each accepted entry until partitions have been defined for all xxxx pages in this section of memory.



As each entry is accepted, the Configurator will reissue the prompt with a consecutively increasing partition number for the next partition. If the number of pages entered for a partition is greater than the maximum logical address space, and RT or BG was specified, the Configurator displays the message

SUBPARTITIONS? (YES/NO)

Enter a NO if the configurator is to ignore subpartition considerations and proceed with the normal partition definitions.

Enter a YES if subpartitions are to be defined. Subpartition definitions are specified by using the following format in response to the prompt:

#PAGES,S(,R)

where S specifies a subpartition and the optional R specifies the subpartition is to be reserved.

If RTM or BGM is specified, subpartition definition phase is automatically entered. If no subpartitions are to be defined, enter a /E or define the next partition of RT, BG, RTM, or BGM type.

The memory space allocated for subpartitions is the same area occupied by the "mother" partition. Subpartition definition will end as soon as an RT(M) or BG(M) partition is defined, or can be terminated by entering a /E.

When an attempt is made to end the subpartition definition phase by defining an RT or BG partition and there are no more pages left in this section of memory, an ERR 13 will be displayed. In this case, either enter a /E to terminate subpartition definitions and continue partition definitions for the next block of memory, or enter /R to restart the partition definition phase.

The total number of pages defined for subpartitions must not exceed the size of the mother partition or an error code will be issued and the last subpartition must be redefined.

The Configurator analyzes each partition definition for possible errors as soon as it is entered. Any error code issued will be followed by a prompt to redefine the last partition displayed. If /R is entered instead of a partition description, the partition definition phase is restarted from the first partition definition.

## Memory And I/O Reconfiguration

Partitions defined for each section of memory between bad pages must be defined for all pages available within the section. A running total is maintained of the number of pages currently defined within a section of good memory. The Configurator will then take one of five possible courses of action, depending upon the prevailing memory structure and size:

1. If the remaining total equals the number of pages available, the Configurator automatically requests partition definitions for the next section of good memory.
2. If the number of pages remaining to be defined is one, the Configurator increments the last defined partition by one page and then requests partition definitions for the next block of good memory.
3. If the running total exceeds the number of available pages defined within the memory block, the Configurator displays an error message and prompts for the last partition to be redefined.
4. If the number of partitions already defined is equal to the maximum number of partitions allowed and more undefined good pages remain, the Configurator displays an error message and all user partitions must be redefined. The Configurator will then prompt for new partition definitions and repeat the prompt after each accepted entry.
5. If the running total is less than the number of pages in the block of memory, definition for next partition is requested.

A list of NEW PART'N DEFINITIONS will be issued to the list device when all partitions have been defined.

### Changing Program Partition Assignments

The Configurator performs a check to ensure that every program assigned to a partition fits its partition size. A program will be unassigned if the program size is larger than the partition size or if the partition number does not exist. Following the check, the Configurator will issue a list under the heading:

UNASSIGNED PROGS

.  
.  
.

followed by the query

MODIFY PROG PAGE REQMTS? (/E TO END)  
PNAME,#PAGES

-

Enter the specifications for any disc resident programs whose page requirements must be changed, using the format

program name,xx

where the number of pages entered for each program must include the base page. The number of pages must be greater than or equal to the program relocation size, and less than or equal to the maximum address space for the program. The program may only be Type 2, 3 or 4.

The hyphen prompt will be repeated after acceptance of each entry until a /E is entered to terminate the list.

Note that the page requirements for an EMA program cannot be modified.

### Program Partition Assignments

The Configurator now asks if any programs need to be assigned to partitions by displaying the query and prompt

```
ASSIGN PROG PART'NS? (/E TO END)
PNAME, PART'N#
-
```

where the hyphen prompt will be repeated after each accepted entry until a /E is entered to terminate the list.

Enter each desired program partition assignment in the form

program name,xx

where xx is the partition number to which the program is to be assigned. If xx is 0, the program is unassigned and can be dispatched to any partition of the proper type large enough to run the program. The program must be a Type 2, 3 or 4. When a /E is entered to terminate the list, the Configurator issues the query

```
NEW MEMORY CONFIGURATION PERMANENT? (YES/NO)
```

Enter a YES to a change the appropriate tables and locations on the disc resident system. The format switch on the system disc drive must be in the "on" position (7905/06/20/25) or the override switch (7900) must be in the override position, if the new memory configuration has to be made permanent. The Configurator then issues the message

```
RECONFIGURATION COMPLETED
```

and turns control over to the operating system.

If a /R is entered in response to the prompt instead of YES, memory reconfiguration is restarted from the query

```
PHYSICAL MEM SIZE? (#PAGES)
```

and the system is in the state it was changed to during the earlier reconfiguration.

### Reconfiguration Example

The sample reconfiguration illustrated in Figure 9-1 assumes that reconfiguration was requested by setting the switch register as described at the beginning of this chapter.

```
START RECONFIGURATION
LIST DEVICE LU#?
20
LIST DEVICE SELECT CODE#?
20
ECHO?(YES/NO)
YES
CURRENT I/O CONFIGURATION:
SELECT CODE 10= TBG
SELECT CODE 13= EQT 1,TYPE 32
SELECT CODE 14= EQT 6,TYPE 0
SELECT CODE 15= EQT 7,TYPE 1
SELECT CODE 16= EQT 3,TYPE 23
SELECT CODE 17= EQT 3,TYPE 23
SELECT CODE 20= EQT 5,TYPE 12
SELECT CODE 22= EQT 4,TYPE 2
SELECT CODE 25= EQT 2,TYPE 5
I/O RECONFIGURATION?(YES/NO)
YES
CURRENT SELECT CODE#,NEW SELECT CODE#?(/E TO END)
-
10,14
-
14,15
-
15,16
-
16,23
-
17,24
-
22,17
-
/E
*SPECIFY A LIST DEVICE.
*SPECIFY LIST DEVICE'S SELECT CODE.
*ECHO OUTPUT ON LIST DEVICE.
*CURRENT I/O CONFIGURATION
* IS DISPLAYED.
*SPECIFY I/O RECONFIGURATION.
*RECONFIGURE SELECT CODES.
```

Figure 9-1. Reconfiguration Example

```

NEW I/O CONFIGURATION:                *NEW I/O CONFIGURATION
SELECT CODE 13= EQT  1,TYPE 32      * IS DISPLAYED.
SELECT CODE 14= TBG
SELECT CODE 15= EQT  6,TYPE  0
SELECT CODE 16= EQT  7,TYPE  1
SELECT CODE 17= EQT  4,TYPE  2
SELECT CODE 20= EQT  5,TYPE 12
SELECT CODE 23= EQT  3,TYPE 23
SELECT CODE 24= EQT  3,TYPE 23
SELECT CODE 25= EQT  2,TYPE  5
NEW I/O CONFIGURATION PERMANENT? (YES/NO)
NO                                    *SPECIFY NONPERMANENT.
CURRENT PHYSICAL MEM SIZE:          48 PAGES
MEM RECONFIGURATION? (YES/NO)
YES                                   *SPECIFY MEMORY RECONFIGURATION.
PHYSICAL MEM SIZE? (#PAGES)
256                                  *SPECIFY AN INCREASE IN MEMORY SIZE.
DEFINE BAD PAGES BEGINNING AT PAGE 28 (/E TO END)
-
44                                   *SPECIFY TWO BAD PAGES.
-
124
-
/E
CURRENT SIZE OF SAM:
DEFAULT: 3802 WORDS
EXTENSION: 0 PAGES
SAM EXTENSION STARTS AT PHYSICAL PAGE 28
MAX PAGES AVAIL FOR SAM EXTENSION: 12
CHANGE SAM EXTENSION? (#PAGES/" "CR)
6                                    *INCREASE SIZE OF SAM.
CURRENT PART'N DEFINITIONS:         *CURRENT PARTITION DEFINITIONS
PART'N 1 = 20 PAGES,BG              * ARE DISPLAYED.
CURRENT PART'N REQMTS:              *CURRENT PARTITION REQUIREMENTS
REALTIME                             * FOR VARIOUS PROGRAMS ARE
BACKGROUND                             *   DISPLAYED.
$CNFX  3 PAGES
EDITR  16 PAGES
ASMB   16 PAGES
XREF   16 PAGES
LOADR  16 PAGES
WHZAT  3 PAGES
FMGR   7 PAGES
RT4GN  20 PAGES
SWTCH  11 PAGES

```

Figure 9-1. Reconfiguration Example (continued)

# Memory And I/O Reconfiguration

MAX PROGRAM SIZE:  
W/OUT COMMON: 29 PAGES  
W/ COMMON: 29 PAGES  
W/ TABLE II: 27 PAGES  
MAX # OF PART'NS: 15  
PAGES REMAINING: 222  
DEFINE PART'NS FOR 10 PAGES:  
#PAGES,RT(M)/BG(M)/S(,R)  
PART'N 1, 10 PAGES?  
10,RT  
DEFINE PART'NS FOR 79 PAGES:  
#PAGES,RT(M)/BG(M)/S(,R)  
PART'N 2, 79 PAGES?  
49,RT  
SUBPARTITIONS? (YES/NO)  
NO  
PART'N 3, 30 PAGES?  
27,RT,R  
PART'N 4, 3 PAGES?  
3,RT,R  
DEFINE PART'NS FOR 131 PAGES:  
#PAGES,RT(M)/BG(M)/S(,R)  
PART'N 5, 131 PAGES?  
115,BGM  
PART'N 6, 16,(115) PAGES?  
48,S  
PART'N 7, 16,(67) PAGES?  
29,S  
PART'N 8, 16,(38) PAGES?  
29,S  
PART'N 9, 16,(9) PAGES?  
9,S  
PART'N 10, 16 PAGES?  
16,BG  
NEW PART'N DEFINITIONS:  
PART'N 1 = 10 PAGES,RT  
PART'N 2 = 49 PAGES,RT  
PART'N 3 = 27 PAGES,RT,R  
PART'N 4 = 3 PAGES,RT,R  
PART'N 5 = 115 PAGES,BG  
PART'N 6 = 48 PAGES,S  
PART'N 7 = 29 PAGES,S  
PART'N 8 = 29 PAGES,S  
PART'N 9 = 9 PAGES,S  
PART'N 10 = 16 PAGES,BG

\*MAXIMUM PARTITION SIZES FOR  
\* VARIOUS PROGRAM TYPES ARE  
\* DISPLAYED.

\*RT PARTITION TO THE FIRST BAD PAGE.

\*RT PARTITION WITH NO SUBPARTITIONS.

\*RT PARTITION WHICH IS RESERVED.

\*RT PARTITION WHICH IS RESERVED.

\*BG MOTHER PARTITION BEGINS

\* AFTER SECOND BAD PAGE.

\*SUBPARTITION LARGER THAN 32K WORDS.

\*SECOND SUBPARTITION.

\*THIRD SUBPARTITION.

\*FOURTH SUBPARTITION.

\*BG PARTITION.

\*NEW PARTITION DEFINITIONS

\* ARE DISPLAYED.

Figure 9-1. Reconfiguration Example (continued)

## Memory And I/O Reconfiguration

```
UNASSIGNED PROGRAMS:
MODIFY PROG PAGE REQMTS? (/E TO END)
PNAME,#PAGES *SPECIFY NEW PROGRAM PAGE REQUIREMENTS.
-
RT4GN,27
-
ASMB,27
-
/E
ASSIGN PROG PART'NS? (/E TO END)
PNAME,PART'N# *ASSIGN PROGRAMS TO PARTITIONS.
-
RT4GN,3
-
WHZAT,4
-
/E
NEW MEM CONFIGURATION PERMANENT? (YES/NO)
NO *DO NOT MAKE MEMORY CHANGES PERMANENT.

*END OF I/O AND MEMORY RECONFIGURATION.
*SYSTEM WILL NOW ATTEMPT TO BOOTUP.

SET TIME
:SV,4
TE,*****
TE,***** 92068A RTE-IV 7905 7906 7920 7925 DISC CARTRIDGE
TE,***** HP 92068-13101 (7905/7906)
TE,***** HP 92068-13201 (7920)
TE,***** HP 92068-13202 (7925)
TE,*****
:
```

Figure 9-1. Reconfiguration Example (continued)

### Boot-Up and Reconfiguration Halts

During either system boot-up or reconfiguration, various HLTS (of the form l020xx) may be issued on the computer front panel. The meaning of these halts and any required operator action are given in Table 9-1.

Table 9-1. System Boot-up and Reconfiguration Halts

| HLT | Meaning  | User Action   |
|-----|--|---|
| 4   | Powerfail occurred and powerfail automatic restart is enabled.   | Restart system boot-up procedure.   |
| 5   | Memory protect switch was set and memory parity error occurred.  | Restart system boot-up procedure.   |
| 10B | FMGR or D.RTR cannot be scheduled at startup because there is not a large enough partition (issued by the system).   | Restart system boot-up and redefine memory to include a partition large enough for FMGR and D.RTR.  |
| 11B | Attempt was made to re-execute a non-RPL compatible ROM Loader Part #12992A, or Bootstrap Loader.  | Reload the ROM Loader or Bootstrap Loader before re-executing.  |
| 22B | One of the following conditions was encountered:<br>1. \$CNFG cannot find an ID segment for Configurator extension \$CNFX.<br>2. \$CNFX is not a Type 3 program.<br>3. A contiguous memory block of three good pages cannot be found in the user partition area.   | Restart system boot-up procedure. If memory reconfiguration is desired \$CNFX must be permanently loaded as a Type 3 program and there must be at least 3 good pages of contiguous memory in the user partition area. |
| 30B | Error was encountered in the disc I/O process by one of the RPL-compatible ROM Loaders Part #12992B & 12992F. If the disc is a 7900 the disc status is displayed in the A-register. If the disc is a 7905/20 the disc status word 1 is displayed in the B-register and disc status word 2 in the A-register. | Retry the system boot-up procedure.   |
| 31B | Error encountered in the disc I/O process by the Boot Extension. If the disc is a 7900, the disc status is displayed in the A-register. If the disc is 7905 or 7920, the disc status word 1 is displayed in the B-register and disc status word 2 is displayed in the A-register.                            | Retry the system boot-up procedure.   |
| 55B | An EQT with the equipment type code of console cannot be found.  | Restart boot-up procedure with a console for which an EQT is generated in the system.   |



## Configuration Error Messages

Whenever a user response to a Configurator prompt is illegal or inappropriate, the Configurator issues a CONFIG ERR message and prompts for a correct entry. All possible Configurator error codes are listed sequentially in Table 9-2. Locate the appropriate code and take the described action.

Memory And I/O Reconfiguration

Table 9-2. I/O and Memory Reconfiguration Error Codes

| CONFIG ERR | Meaning  | User Action  |
|------------|--|--|
| 1          | Invalid LU number or a bit bucket LU.  | Enter valid logical unit number.   |
| 2          | Illegal select code number.  | Enter valid number that must be between 10 and 77 octal.   |
| 3          | New select code entered is identical to new select code assigned to disc, system console or list device, or else the current select code entered is identical to the old select code for disc, system console or list device (i.e., do not reconfigure that which was already done via the SWITCH register). | Enter different select code.   |
| 10         | Specified total number of pages outside the range.   | Enter valid number in the range 48-1024 for physical memory size and between 0 and maximum pages available for SAM extension.                                      |
| 11         | Invalid bad page number.   | Enter valid number greater than the previous entry and less than the physical memory size, or enter /E to terminate the list.                                      |
| 12         | Specified SAM extension entry beyond physical memory size due to bad pages.  | Enter smaller number of pages for SAM extension.   |
| 13         | Current running total exceeds available pages in block of good memory or exceeds size of mother partition.   | Redefine last partition or subpartition size. If there are no more pages available in the block of memory to be defined, /E or /R are the only responses accepted. |

Table 9-2. I/O and Memory Reconfiguration Error Codes (cont'd)

| CONFIG ERR | Meaning   | User Action  |
|------------|---|--|
| 14         | Second parameter of partition definition entry other than RT, BG or S, or else S was entered when a subpartition definition was not expected. | Reenter definition with correct parameter.   |
| 15         | Third parameter of partition definition entry other than R.   | Reenter definition with R as third parameter if partition is to be reserved.   |
| 16         | No such program, or the name of a segment was entered or invalid type was entered for partition assignment.                                   | Reenter assignment with correct program name or type or /E to end this sequence.   |
| 17         | Invalid partition number.   | Enter valid number or /E to end this sequence.   |
| 18         | Program does not fit in the assigned partition.   | Assign program to larger partition if available, or continue without assigning the program.  |
| 19         | Invalid number of pages was entered for program size.   | Enter valid number of pages for program, between the size of the program at load time and the maximum logical address space for the program. |
| 20         | Number of defined partitions already equal to allowed maximum number and more undefined pages remain.   | Redefine all partitions  |
| 21         | Page requirements of an EMA program cannot be modified.   | Entry is skipped.  |
| 22         | Number of pages in SAM extension requires division into more than five blocks.  | Enter a smaller size of SAM extension  |



# Appendix A

## Primary System Disc Cartridge

### INTRODUCTION

This appendix describes the structure, contents, and initial use of your 92068A Primary System disc cartridge. The Primary System disc cartridge contains a standard RTE-IVB operating system, and is available on any of the following disc cartridges:

| Disc Cartridge | HP Part Number |
|----------------|----------------|
| 7905           | 92068-13002    |
| 7906           | 92068-13002    |
| 7925           | 92068-13003    |
| 7906H          | 92068-13004    |
| 7925H          | 92068-13005    |
| 7920           | 92068-13006    |
| 7920H          | 92068-13007    |

Notice the label on the upper surface of your Primary System disc cartridge:

PRIMARY SYSTEM 40X RTE-IVB DISC CARTRIDGE.  
MASTER FILES. DO NOT ERASE.

Where X corresponds to the last digit of your primary system.

Use your Primary System disc cartridge carefully; it contains all the master files for your operating system on LU 10.

### DISC CARTRIDGE CONTENTS AND STRUCTURE

The system disc contains the current 92068A product, organized as a standard operating system, with subsystems (DS, BASIC, and so on), and a file manager cartridge. The file manager cartridge has been assigned a file manager cartridge reference number of 32767, has a NULL security code, and begins at track 120 of the 7905/7906(H)/7920(H)/7925(H) system disc cartridge. Each file in CR 32767 has a security code of RT.

## Appendix A

The following files were used to generate your primary system:

```
#AN400 7905, 7906, 7920 Primary System
#AN401 7925 Primary System
#AN402 7905H, 7906H, 7920H Primary System
#AN403 7925H Primary System
```

In addition to the files listed in this manual, CR 2 contains two files created during the manufacturing process of the Primary System disc cartridge. These files are:

A WELCOM file, which displays a welcome message each time the system is booted up from disc.

A list file, which is a generation map of the system created when the master disc was generated.

| Primary System<br>Disc | Welcome File | List File |
|------------------------|--------------|-----------|
| -----                  | -----        | -----     |
| 7905/06/20             | WELCOM       | 'LF400    |
| 7925                   | WELCOM       | 'LF401    |
| 7905H/06H/20H          | WELCOM       | 'LF402    |
| 7925H                  | WELCOM       | 'LF403    |

The above files are created by the software manufacturing process. They do not have HP part numbers, so they cannot be ordered. They do not appear in the lists of part numbers for 92068A.

### DISC CARTRIDGE BACKUP AND UPDATING

We strongly urge you to back up the disc cartridge as soon as is practical after you receive it. You can back it up onto magnetic tape or onto another disc cartridge by following the instructions in the RTE-IVB Utility Programs Reference Manual (92068-90010).

You should use LU 10 of the disc cartridge as a storage place for the current version of 92068A. As changes to the software modules in the product occur, you should update the disc cartridge to make sure that you always have the current version of every 92068A module. The updating procedures are also described in the utilities manual, in the "Disc Update Program" section.

The reason that the Primary System cartridge is distributed with a file manager cartridge reference number of 32767, and the reason that all files in CR 32767 have a security code of RT is that the Disc Update Program requires those values, as described in the utilities manual.

#### SYSTEM DISC I/O STRUCTURE

Your Primary System disc cartridge has been copied and verified from a master software cartridge which was generated at the factory to a standard I/O configuration. The configuration is shown in Table A-1.

For MAC disc (7905/06/20/25) Primary Systems, DVR32 is the system disc driver, and the corresponding track map table \$TB32 is built by RT4GN. For ICD disc (7906H/20H/25H) Primary Systems, DVA32 is the system disc driver, and the corresponding track map table \$TA32 is built by RT4GN.

The structure of the 7905/06(H)/20(H) Primary System disc is listed in Table A-2, and illustrated in Figure A-1. The structure of the Primary System disc is listed in Table A-3 and illustrated in Figure A-2.

Track map tables describe subchannel definitions for a single disc controller or interface card. The track map tables built by RT4GN are called the system track map tables. They can be modified by editing the appropriate section of the answer file before regeneration. When disc subsystems are added to the system disc in your generation, the appropriate track map table must be included via a relocatable module of the correct name and module type. The files %\$TB32 and %\$TA32 (the source files for \$TB32 and \$TA32) are the relocatable files that correspond to DVR32 and DVA32, when neither of those drivers is the system disc driver. Tables A-4 and A-5 describe disc subchannels defined in those two tables. It is worth noting that these track map tables define the 7905/06/20/25 subchannels in the same manner as to the appropriate Primary System disc answer files. You may use these tables as they exist for your own generation of a system containing more than one disc subsystem, or you may edit them to create new relocatable modules. For more information on multiple disc subsystems, such as interfaces or controllers, and track map table formats, refer to Appendix B of this manual.

## Appendix A

The track map table \$TB32 (MAC driver) contains the disc configuration for a 7905/06/20 disc drive and the configuration for a 7925 disc drive. If you are using a 7905/06/20 disc drive, set the hardware unit number on the drive (a switch located behind the slotted front panel) to 0. DVR32 will access the configuration for a 7905/06/20 drive.

The same is true for the ICD track map table, \$TA32. Set the hardware unit number to 0 to select the 7906H/20H configuration.

### BOOT-UP OF DISC CARTRIDGE

The disc cartridge can be booted up using the standard I/O and memory configurations, or it can be booted up with the I/O, the memory, or both reconfigured. A brief description of boot-up with and without reconfiguration follows.

1. The standard boot-up procedure is described in the 12992 Loader ROM Installation Manual (part no. 12992-90001, print date Jan, 1980 or later). If there is to be no reconfiguration, bit 5 of the switch register should be set to 0.

Below is an example of the switch register settings if the 12992B RPL-compatible 7905/06/20/25 ROM loader is used:

- Bits 0-2 = surface number of the disc where the RTE-IVB system starts (surfaces are numbered from 0).
- 3-4 = reserved
- 5 = 1, if I/O, memory, or both are to be reconfigured; 0, if no reconfiguration.
- 6-11 = select code of the disc.
- 12 = 1 to indicate a manual boot from the switch register.
- 14-15 = loader ROM selection; the number of the ROM cell that contains the disc boot loader.



2. If the I/O, memory, or both are to be reconfigured, set bit 5 of the switch register to 1 to follow the specific procedures given in the memory and I/O reconfiguration section of this manual.

Reconfiguration of the I/O, memory, or both can be made permanent, but be sure that the Primary System disc has been backed up before beginning this procedure.

Refer to Chapter 9 of this manual for an explanation of any error messages that occur during boot-up.

Appendix A

Table A-1. Standard System Assignments for 92068A  
Primary System Disc Cartridge

| Device or Accessory        | Driver Is | Uses DMA ? | Buffered Output ? | Timeout Value = | EQT Extension | I/O Slot | LU #   | EQT #  | Subchannel  |
|----------------------------|-----------|------------|-------------------|-----------------|---------------|----------|--|--|---|
| Time-base Generator 12539C |           |            |                   |                 |               | 11       |  |  |   |
| 7905, 7906 or 7920 Disc    | DVR32     | Yes        |                   |                 |               | 12       | 2 14<br>10 15<br>11 16<br>12 17<br>13 18                         | 1 1<br>1 1<br>1 1<br>1 1<br>1 1                    | 0 5<br>1 6<br>2 7<br>3 8<br>4 9                         |
| 7925 Disc                  | DVR32     | Yes        |                   |                 |               | 12       | 2 17<br>10 18<br>11 19<br>12 20<br>13 21<br>14 22<br>15 23<br>16 | 1 1<br>1 1<br>1 1<br>1 1<br>1 1<br>1 1<br>1 1<br>1 | 0—14  |
| 7906H or 7920H Disc        | DVA32     | Yes        |                   | T=200           |               | 12       | 2 14<br>10 15<br>11 16<br>12 17<br>13 18                         | 1 1<br>1 1<br>1 1<br>1 1<br>1 1                    | 0 5<br>1 6<br>2 7<br>3 8<br>4 9                         |
| 7925H Disc                 | DVA32     | Yes        |                   | T=200           |               | 12       | 2 17<br>10 18<br>11 19<br>12 20<br>13 21<br>14 22<br>15 23<br>16 | 1 1<br>1 1<br>1 1<br>1 1<br>1 1<br>1 1<br>1 1<br>1 | 0 8<br>1 9<br>2 10<br>3 11<br>4 12<br>5 13<br>6 14<br>7 |
| System Console 2645        | DVR05     | No         | Yes               | T=12000         | X=13          | 13       | 1<br>4<br>5  | 2<br>2<br>2  | 0 (console)<br>1 (left CTU)<br>2 (right CTU)            |
| Terminal 2600              | DVR00     | No         | Yes               |                 |               | 14       | 7  | 6  | 0   |
| Photoreader 2748B          | DVR01     | No         |                   | T=50            |               | 15       | 9  | 7  | 0   |
| Magnetic Tape 7970B        | DVR23     | Yes        | Yes               | T=9999          |               | 16<br>17 | 8  | 3  | 0   |
| Line Printer 2607/13/17/18 | DVA12     | No         | Yes               | T=100           |               | 20       | 6  | 8  | 0   |
| Line Printer 2767A         | DVR12     | No         | Yes               | T=100           |               | 21       | 20/25**  | 5  | 0   |
| Line Printer 2608          | DVB12     | No         | Yes               |                 | X=5           | 25       | 21/26**  | 9  | 0   |
| Tape Punch 2895B           | DVR02     | No         | Yes               | T=50            |               | 22       | 19/24**  | 4  | 4   |
| Unassigned                 |           |            |                   |                 |               |          | 3  |  |   |

Note: This information is compiled from the &LISTF file; you may wish to get a copy of &LISTF to ensure that this information is current.

\*If your primary disc is a 7905, do not attempt to execute a "MOUNT CARTRIDGE" command for the LU#'s 15, 16, 17, or 18. If your primary disc is a 7906(H), do not attempt to execute a "MOUNT CARTRIDGE" command for the LU#'s 16, 17, or 18.

\*\*For a 7925(H) Primary

Table A-2. 7905/7906(H)/7920(H) Primary System Disc Configuration

| The 7905/7906(H)/7920(H) primary disc contains ten subchannels. The disc configuration is as follows: |            |                |                  |               |                 |                      |                        |
|---|------------|----------------|------------------|---------------|-----------------|----------------------|------------------------|
| LU NUMBER   | SUBCHANNEL | STARTING TRACK | NUMBER OF TRACKS | STARTING HEAD | NUMBER OF HEADS | ADDRESS/ UNIT NUMBER | NUMBER OF SPARE TRACKS |
| 2   | 0          | 0              | 256              | 0             | 2               | 0                    | 8                      |
| 10  | 1          | 132            | 203              | 0             | 2               | 0                    | 5                      |
| 11  | 2          | 236            | 203              | 0             | 2               | 0                    | 5                      |
| 12  | 3          | 340            | 138              | 0             | 2               | 0                    | 4                      |
| 13  | 4          | 0              | 203              | 2             | 1               | 0                    | 5                      |
| 14  | 5          | 208            | 198              | 2             | 1               | 0                    | 5                      |
| 15  | 6          | 0              | 400              | 3             | 1               | 0                    | 11                     |
| 16  | 7          | 0              | 400              | 4             | 1               | 0                    | 11                     |
| 17  | 8          | 411            | 1024             | 0             | 5               | 0                    | 26                     |
| 18  | 9          | 621            | 985              | 0             | 5               | 0                    | 25                     |

Appendix A

Table A-3. 7925(H) Primary System Disc Configuration

| LU NUMBER | SUBCHANNEL | STARTING TRACK | NUMBER OF TRACKS | STARTING HEAD | NUMBER OF HEADS | ADDRESS/ UNIT NUMBER | NUMBER OF SPARE TRACKS |
|-----------|------------|----------------|------------------|---------------|-----------------|----------------------|------------------------|
| 2         | 0          | 0              | 256              | 0             | 2               | 0                    | 8                      |
| 10        | 1          | 0              | 256              | 2             | 2               | 0                    | 8                      |
| 11        | 2          | 0              | 256              | 4             | 4               | 0                    | 8                      |
| 12        | 3          | 66             | 256              | 4             | 4               | 0                    | 8                      |
| 13        | 4          | 132            | 203              | 0             | 4               | 0                    | 5                      |
| 14        | 5          | 132            | 203              | 4             | 4               | 0                    | 5                      |
| 15        | 6          | 184            | 203              | 0             | 4               | 0                    | 5                      |
| 16        | 7          | 184            | 203              | 4             | 4               | 0                    | 5                      |
| 17        | 8          | 0              | 228              | 8             | 1               | 0                    | 8                      |
| 18        | 9          | 236            | 400              | 0             | 9               | 0                    | 14                     |
| 19        | 10         | 282            | 400              | 0             | 9               | 0                    | 14                     |
| 20        | 11         | 328            | 228              | 0             | 9               | 0                    | 6                      |
| 21        | 12         | 354            | 1024             | 0             | 9               | 0                    | 29                     |
| 22        | 13         | 471            | 1024             | 0             | 9               | 0                    | 29                     |
| 23        | 14         | 588            | 2048             | 0             | 9               | 0                    | 67                     |

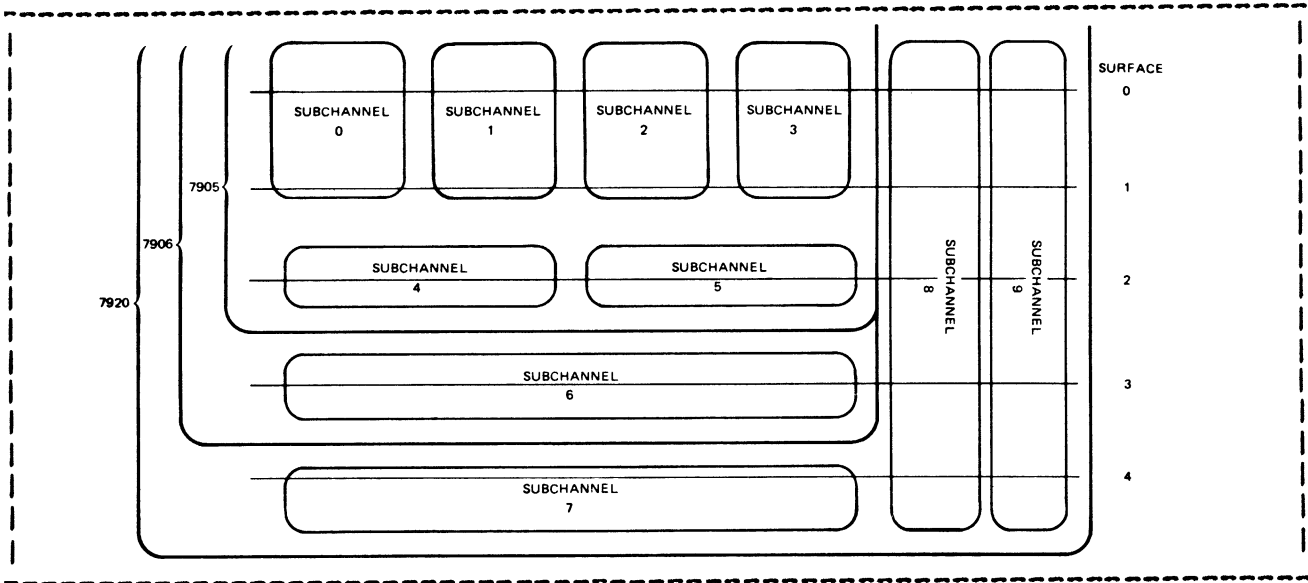

Figure A-1. 7905/7906/7920 Primary System Disc Layout

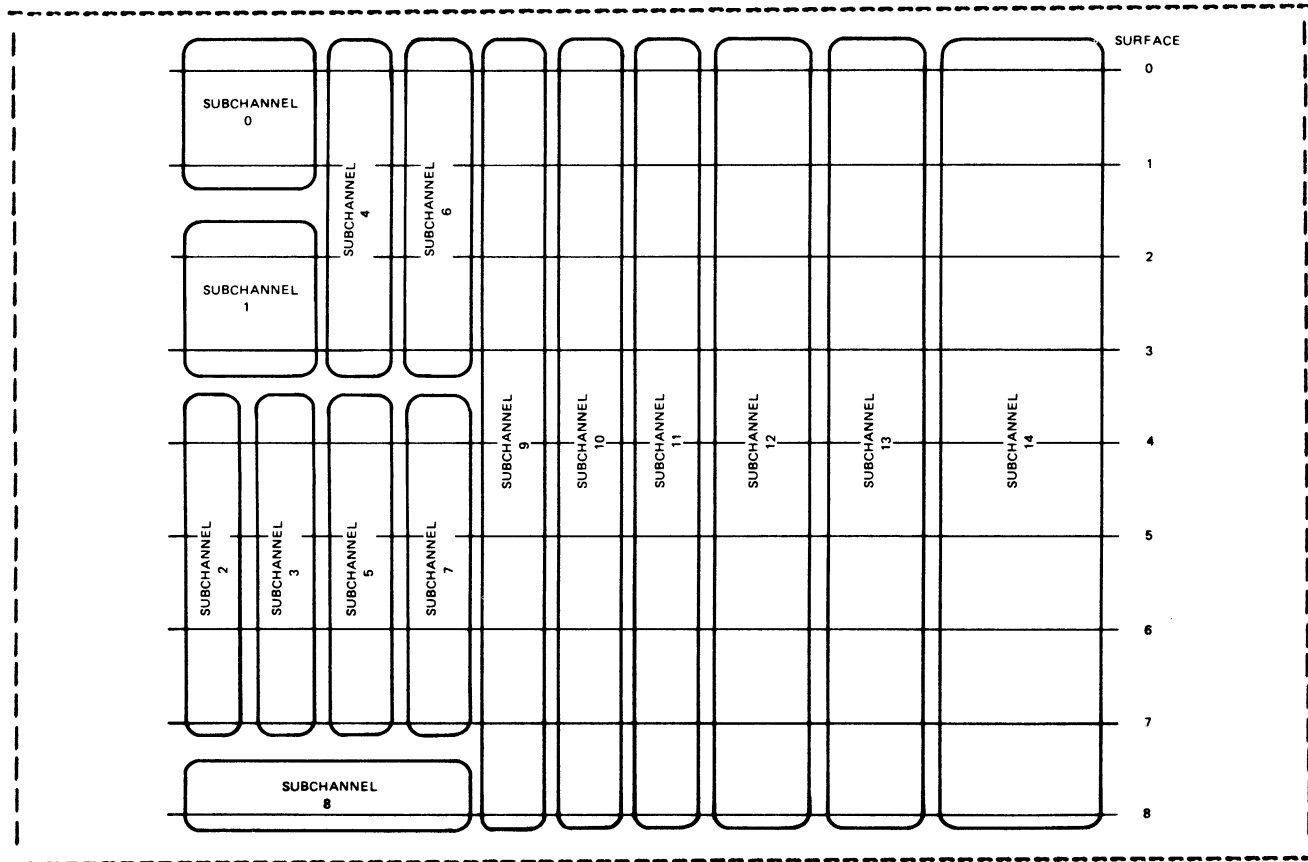

Figure A-2. 7925 Primary System Disc Layout

Appendix A

Table A-4. Track Map Table \$TB32 for MAC Driver DVR32

| SUBCHANNEL   | NUMBER OF TRACKS | STARTING CYLINDER | STARTING HEAD | NUMBER OF SURFACES | NUMBER OF SPARE TRACKS | UNIT NUMBER |
|--|------------------|-------------------|---------------|--------------------|------------------------|-------------|
| <b>7905/06/20:</b>   |                  |                   |               |                    |                        |             |
| 0  | 256              | 0                 | 0             | 2                  | 8                      | 0           |
| 1  | 203              | 132               | 0             | 2                  | 5                      | 0           |
| 2  | 203              | 236               | 0             | 2                  | 5                      | 0           |
| 3  | 138              | 340               | 0             | 2                  | 4                      | 0           |
| 4  | 203              | 0                 | 2             | 1                  | 5                      | 0           |
| 5  | 198              | 208               | 2             | 1                  | 5                      | 0           |
| 6  | 400              | 0                 | 3             | 1                  | 11                     | 0           |
| 7  | 400              | 0                 | 4             | 1                  | 11                     | 0           |
| 8  | 1024             | 411               | 0             | 5                  | 26                     | 0           |
| 9  | 985              | 621               | 0             | 5                  | 25                     | 0           |
| <b>7925:</b>   |                  |                   |               |                    |                        |             |
| 10   | 256              | 0                 | 0             | 2                  | 8                      | 1           |
| 11   | 256              | 0                 | 2             | 2                  | 8                      | 1           |
| 12   | 256              | 0                 | 4             | 4                  | 8                      | 1           |
| 13   | 256              | 66                | 4             | 4                  | 8                      | 1           |
| 14   | 203              | 132               | 0             | 4                  | 5                      | 1           |
| 15   | 203              | 132               | 4             | 4                  | 5                      | 1           |
| 16   | 203              | 184               | 0             | 4                  | 5                      | 1           |
| 17   | 203              | 184               | 4             | 4                  | 5                      | 1           |
| 18   | 228              | 0                 | 8             | 1                  | 8                      | 1           |
| 19   | 400              | 236               | 0             | 9                  | 14                     | 1           |
| 20   | 400              | 282               | 0             | 9                  | 14                     | 1           |
| 21   | 228              | 328               | 0             | 9                  | 6                      | 1           |
| 22   | 1024             | 354               | 0             | 9                  | 29                     | 1           |
| 23   | 1024             | 471               | 0             | 9                  | 26                     | 1           |
| 24   | 2048             | 588               | 0             | 9                  | 67                     | 1           |
| <p>Note: Subchannels 0-9 are illustrated in Figure A-1, and subchannels 10-24 are illustrated in Figure A-2, with subchannels 10-24 shown as 0-14.</p> |                  |                   |               |                    |                        |             |

Table A-5. Track Map Table \$TA32 for ICD Driver DVA32

| SUBCHANNEL   | NUMBER OF TRACKS | STARTING CYLINDER | STARTING HEAD | NUMBER OF SURFACES | NUMBER OF SPARE TRACKS | UNIT/ADDR NUMBER |
|--|------------------|-------------------|---------------|--------------------|------------------------|------------------|
| <b>7906H/20H:</b>  |                  |                   |               |                    |                        |                  |
| 0  | 256              | 0                 | 0             | 2                  | 8                      | 0                |
| 1  | 203              | 132               | 0             | 2                  | 5                      | 0                |
| 2  | 203              | 236               | 0             | 2                  | 5                      | 0                |
| 3  | 138              | 340               | 0             | 2                  | 4                      | 0                |
| 4  | 203              | 0                 | 2             | 1                  | 5                      | 0                |
| 5  | 198              | 208               | 2             | 1                  | 5                      | 0                |
| 6  | 400              | 0                 | 3             | 1                  | 11                     | 0                |
| 7  | 400              | 0                 | 4             | 1                  | 11                     | 0                |
| 8  | 1024             | 411               | 0             | 5                  | 26                     | 0                |
| 9  | 985              | 621               | 0             | 5                  | 25                     | 0                |
| <b>7925H:</b>  |                  |                   |               |                    |                        |                  |
| 10   | 256              | 0                 | 0             | 2                  | 8                      | 1                |
| 11   | 256              | 0                 | 2             | 2                  | 8                      | 1                |
| 12   | 256              | 0                 | 4             | 4                  | 8                      | 1                |
| 13   | 256              | 66                | 4             | 4                  | 8                      | 1                |
| 14   | 203              | 132               | 0             | 4                  | 5                      | 1                |
| 15   | 203              | 132               | 4             | 4                  | 5                      | 1                |
| 16   | 203              | 184               | 0             | 4                  | 5                      | 1                |
| 17   | 203              | 184               | 4             | 4                  | 5                      | 1                |
| 18   | 228              | 0                 | 8             | 1                  | 8                      | 1                |
| 19   | 400              | 236               | 0             | 9                  | 14                     | 1                |
| 20   | 400              | 282               | 0             | 9                  | 14                     | 1                |
| 21   | 228              | 328               | 0             | 9                  | 6                      | 1                |
| 22   | 1024             | 354               | 0             | 9                  | 29                     | 1                |
| 23   | 1024             | 471               | 0             | 9                  | 26                     | 1                |
| 24   | 2048             | 588               | 0             | 9                  | 67                     | 1                |
| <p>*Unit 0 = left drive<br/> **Unit 1 = right drive</p> <p>Note: Subchannels 0-9 are illustrated in Figure A-1, and subchannels 10-24 are illustrated in Figure A-2, with subchannels 10-24 shown as 0-14.</p> |                  |                   |               |                    |                        |                  |

## LOADING FROM MAGNETIC TAPE

This section describes the structure, contents, and initial use of your 92068A Primary System disc cartridge image on magnetic tape. The tape is a track-by-track image of a Primary System disc which contains a standard RTE-IVB operating system. The tape is available in any of the following forms:

| Primary System<br>Disc | Magnetic Tape<br>Format | HP Part Number |
|------------------------|-------------------------|----------------|
| -----                  | -----                   | -----          |
| 7905/06/20             | 800 BPI/9-track         | 92068-13717    |
| 7905/06/20             | 1600 BPI/9-track        | 92068-13718    |
| 7925                   | 800 BPI/9-track         | 92068-13719    |
| 7925                   | 1600 BPI/9-track        | 92068-13720    |
| 7906H/20H              | 800 BPI/9-track         | 92068-13721    |
| 7906H/20H              | 1600 BPI/9-track        | 92068-13722    |
| 7925                   | 800 BPI/9-track         | 92068-13723    |
| 7925                   | 1600 BPI/9-track        | 92068-13724    |

With the 92068A product on magnetic tape, you also receive the off-line disc backup utility program !DISK on a mini-cartridge tape (HP part no. 92068-133030).

Follow the procedures in this section to load !DISK (for MAC/ICD discs) from mini cartridge. Refer to the HP 12992 Loader ROM Installation Manual for further instructions regarding the mini-cartridge ROM loader. Then execute the off-line disc backup program to copy your magnetic tape onto disc.



## CAUTION

If you are replacing a previous version of the Primary System disc, you should back up the previous version on magnetic tape before overwriting it with the new system. See the RTE-IVB Utility Programs Reference Manual for disc backup instructions.

## LOADING !DISK FROM MINI-CARTRIDGE

The following procedure for loading the !DISK disc backup utility assume that you have a 2644/45/48 Display Station terminal.

1. Press the RESET key twice to clear the terminal memory.
2. Insert the mini-cartridge into the left cartridge tape unit (CTU).
3. Make sure the REMOTE key is down, so the terminal and computer can communicate.
4. At the computer control panel, display the S-register by pressing the Register Select switch until the LED over the S-register is on.
5. Press the CLEAR DISPLAY switch.
6. Enter the address of the mini-cartridge ROM loader in bits 14 and 15. Enter the select code of the system console in bits 6-11.
7. Press the STORE switch, then the IBL switch.
8. Press the PRESET switch, then the RUN switch.

The disc backup utility program will now be loaded from the CTU into main memory. The green indicator light on the CTU will flash while the tape is being read.

When the loading is complete, a halt of 102077 will be displayed in the T-register. The CTU indicator light will turn on and stay on. The mini-cartridge can be rewound and removed.

Go to the next section of this appendix for further instructions.



5. Display the P-register by pressing the Register Select switch until the indicator light is over the P-register label.
6. Press the CLEAR DISPLAY switch, then set address 2 (octal) in the Display register.
7. Press the STORE switch, then the PRESET switch, and then press the RUN switch to begin execution.

!DISK will display the following on the system console:

```
DISK BACKUP UTILITY
```

!DISK also displays the current I/O configuration and its revision code.

The following section describes your dialogue with !DISK when you restore a magnetic tape master to a 7905/06(H)/20(H)/25(H) disc. You may type a double question mark (??) in response to any prompt from !DISK to get a description of the expected responses. You may restart !DISK by typing /E, EX, or EN in response to a !DISK prompt.

#### STORING FROM A MAGNETIC TAPE TO A 7905/06(H)/20(H)/25(H) DISC

The disc drivers are configured into the !DISK utility program as follows:

| LU | Driver | Octal Select Code                 |
|----|--------|-----------------------------------|
| 5  | DVR32  | 11 (13037B/C MAC Disc Controller) |
| 4  | DVA32  | 13 (12821A ICD Interface Card)    |

!DISK asks you to enter new select codes for DVR32 and DVA32:

ENTER SELECT CODE FOR DVR32, DVA32:

You can respond with one of the following:

- a. ?? for more information about the requested codes.
- b. /E, EX, or EN and carriage return to restart !DISK.
- c. Select codes for DVR32 and DVA32, separated by commas. Enter zero to leave either code unchanged.

## Appendix A

The following dialogue occurs when restoring a unit-save (online USAVE utility) on magnetic tape to a 7905, 7906(H), 7920(H), 7925(H) disc:

TASK?

RE (restore)

The program will read the header record from magnetic tape and display it on the console.

8:30 AM OCT. 22, 1979 USAVE,,2,,VE, REV. 2001 UNIT SAVE OF 79xx(H) DISC  
TAPE # 1  
OK?

Enter one of the following answers:

- a. If the tape header is correct, type YES to perform the restore.
- b. Otherwise, type NO and the header from the next file will be read and displayed.
- c. Type /E, EX, or EN and carriage return to exit from REstore and return to TASK? mode.

After a YES response, the program prints the following message and will proceed to store from the master magnetic tape to the disc.

RESTORE TO 13037 DISC UNIT 0  
OR  
RESTORE TO 12821 DISC ADDR 0

When the restoration is complete, the mag tape will not be rewound, and the following message will be displayed:

TASK?

The mag tape can now be rewound and removed from the mag tape drive, and the disc can be booted up by following the procedures described earlier in this section.

# Appendix B

## Real-Time Disc Usage

This Appendix covers the following subjects:

- Disc Parity Errors
- Track Configuration
- Multiple Disc Controller Operation
- Multiple Interface Card Operation
- Multiple CPU - MAC System Operation

### DISC PARITY ERRORS

When a program tries to write to a track with either a track number greater than the number of tracks assigned to a given subchannel, or with a track number equal to -1, the driver for the disc sets bit 5 in the status word (end-of-disc) and exits with the transmission log (B-Reg) set to the number of tracks assigned to the subchannel. If the request is a read, the driver will also return the number of 64-word sectors per track for the subchannel in the first word of the buffer. To obtain this information, a program can request an impossible track number once and thereafter stay within the bounds on the subchannel.

Further information on disc I/O requests and error returns can be obtained from the RTE-IVB DVA32/DVR32 Driver Manual (92068-90012).

If a parity error occurs during disc transfer, a special error message is printed:

```
TR nnn EQT eqt, U pp S (or U)
```

where:

nnn is the logical track number within the subchannel pp

eqt is the EQT entry number

pp is the subchannel or unit number.

This is an irrecoverable disc transfer parity error. If the transfer is to a system or auxiliary disc, the following results apply:

- a. If user request (U), then the program is abnormally terminated and the track is made unavailable for further operations. If the user request was an on-line modification with the RTE loader, the parity error could be the result of failing to turn off the hardware disc protect switch. The loader should be executed again with the protect switch off, and the format switch in the "on" position.
- b. If system request (S), the program transfer terminates.

For peripheral disc transfers, a parity error causes the transmission log to be returned to the calling program as a -1.

#### TRACK CONFIGURATION

The configuration of disc tracks is normally done through the interactive generation process described in Chapter 2 of the RTE-IVB On-Line Generator Manual. However, when more than one type of disc controller/interface is needed, the generator dialogue cannot be used and a track map table for the additional controller/interface must be defined in a user module. Because the track map tables for 7900 discs, MAC discs and ICD discs are different, these processes are described separately.

#### 7900 EXTRA CONTROLLER TRACK CONFIGURATION

The track map table used for a 7900 disc system must contain the following information:

- \* Number of sectors per logical track
- \* First track number on subchannels 0 through 7
- \* Number of tracks on subchannels 0 through 7.

The information needed to properly configure a disc is fully described in Chapter 2. The most necessary information is recapitulated here.

The 7900 Disc Drive has a maximum of 203 tracks per platter. The two platters on each drive are divided as follows:

- 128 words per sector
- 48 sectors per track
- 203 tracks per platter.

The RTE 7900 Disc Driver DVR31 treats a logical track as:

64 words per sector  
96 sectors per track.

#### SUBCHANNELS

The moving head driver for an HP 7900 disc system can have four drives connected to a single controller. There may be two platters per drive, and each disc platter is a subchannel accessed through a logical unit number that is referenced back to the Equipment Table (EQT) entry number of the controller. Thus, the disc system can control a maximum of eight subchannels, numbered 0 through 7.

Subchannels are numbered so that even numbered subchannels are fixed platters, and odd numbered subchannels are removable platters.

#### SECTORS

The following paragraphs describe how to optimally read from or write to a 7900 disc (using sector organization):

READ DATA---The drivers divide each track into 64-word sectors. Whenever more than 64 words are transmitted, the READ request is fastest when begun on an even sector.

WRITE DATA---WRITE requests starting on an odd sector or ending in an even sector require more time; thus, the fastest transfers are WRITE requests that start on an even sector and end in an odd sector. The system always organizes programs and swaps them out in such a way that transfers start on an even sector and end on an odd sector, thereby minimizing program load and swap times. The WRITE request data can be checked for recoverability by setting bit 10 in the control word (ICNWD). This check on all data written slows the WRITE process.

#### TRACKS

Each subchannel may contain from 0 to 203 tracks. The 7900 physical disc has a maximum of 203 tracks available. The first track may be any track on the platter. Tracks available to the driver are numbered relative to the first track assigned to the system on each subchannel; thus, if the first available physical track on a subchannel is 10, access by the user to this track must specify logical track number 0.

#### DEFINING 7900 TRACK MAP TABLE.

When the 7900 controller is not the system disc controller, tracks can only be mapped by defining a table in a user module as follows:

```

ASMB,R,B,L
    NAM $TB31,15          ($TB31 must be Type 15)
    ENT $TB31
$TB31 DEC -n
    DEC ft0,ft1,ft2,ft3,ft4,ft5,ft6,ft7
    DEC no0,no1,no2,no3,no4,no5,no6,no7
    END

```

where:

n is the number of 64-word sectors per track.

ft0 - ft7 are the first track numbers for each subchannel 0 through 7.

no0 - no7 are the number of tracks on subchannels 0 through 7.

Note that none of the above numbers (ft0-ft7 and no0-no7) may be omitted. If any of the subchannels do not exist, a zero must be entered as a placeholder (see the example below).

Example:

Assume a 7900 disc with two subchannels, 0 and 1. Place tracks 0 through 100 on subchannel 0 and tracks 20 through 80 on subchannel 1.

```

ASMB,R,B,L
    NAM $TB31,15          ($TB31 must be Type 15)
    ENT $TB31
$TB31 DEC -96            (96 sectors per track)
    DEC 0,20,0,0,0,0,0,0
    DEC 101,61,0,0,0,0,0,0
    END

```

#### TRACK CONFIGURATION FOR 13037B/C MULTIPLE ACCESS CONTROLLER DISC

The table used to map the 7905, 7906, 7920, and/or 7925 discs contains the following information:

\* Total number of subchannels on controller.

And the following information for each subchannel:

\* Number of 64-word sectors per track

\* Cylinder number of track 0

\* Number of surfaces included in subchannel

\* Head number of track 0

\* Unit number of disc drive

\* Number of tracks on subchannel.



\* Number of spares allocated to each subchannel

Information that is required to properly configure a track on a 7905, 7906, 7920, or 7925 disc is given below (a full description of track configuration can be found in Chapter 3).

The drive specifications are:

|                        |                        |
|------------------------|------------------------|
| 7905                   | 7906                   |
| 64 words per sector    | 64 words per sector    |
| 96 sectors per track   | 96 sectors per track   |
| 411 tracks per surface | 411 tracks per surface |
| 3 surfaces per drive   | 4 surfaces per drive   |
| 7920                   | 7925                   |
| 64 words per sector    | 64 words per sector    |
| 96 sectors per track   | 128 sectors per track  |
| 823 tracks per surface | 823 tracks per surface |
| 5 surfaces per drive   | 9 surfaces per drive   |

#### NOTE

The RTE MAC Disc Driver DVR32 treats a logical track as 64 words per sector, with the number of sectors per track dependent upon the subchannel definition. Therefore, 7905/7906/7920 discs would have 96 logical sectors per track, and a 7925 disc would have 128 logical sectors per track.

#### SUBCHANNELS

The HP MAC disc system can control up to eight disc drives connected to one 13037B/C controller. Any combination of 7905, 7906, 7920, and 7925 disc drives can be used. Unlike the 7900, the MAC subchannels are not directly related (one per platter) to the disc drive, and they are not restricted to eight subchannels.

Each subchannel is a contiguous group of tracks on a single drive. There may be more than one subchannel per drive, but subchannels cannot cross drive boundaries. The exact number of subchannels is specified by the user. There may be as many as 32 subchannels per controller. Subchannels are numbered sequentially from zero; no numbers may be skipped.

#### SECTORS

The discussion of sectors for the 7900 disc is also true for MAC Discs.

## TRACKS

The number of tracks on a disc drive is determined by multiplying the cylinders (or head positions) by the number of surfaces on the drive.

| DISC DRIVE | CYLINDERS OR HEAD POSITIONS | # SURFACES | MAXIMUM # OF TRACKS |
|------------|-----------------------------|------------|---------------------|
| 7905       | 411                         | 3          | 1233                |
| 7906       | 411                         | 4          | 1644                |
| 7920       | 823                         | 5          | 4115                |
| 7925       | 823                         | 9          | 7407                |

Theoretically, the number of tracks could all be assigned to one subchannel; however, there are limitations. Peripheral disc subchannels must not have more than 32,767 tracks (excluding spares) per subchannel. Each subchannel on the system or auxiliary disc (Logical Units 2 or 3) is limited to 256 tracks (excluding spares).

Head positions or cylinders are numbered sequentially starting from 0. Heads are numbered sequentially starting from 0, one for each surface.

## SURFACE ORGANIZATION

Subchannels on a 7905 may be on one, two, or three surfaces. Subchannels on a 7906 may be on from one to four surfaces. Subchannels on a 7920 may be on from one to five surfaces. Subchannels on a 7925 may be on from one to nine surfaces.

It is best to alternate surfaces (to minimize head movement) when more than one surface is used. For example, if track 0 is at cylinder 10 on head 0, then track 1 should be at cylinder 10 on head 1 and track 2 at cylinder 11 on head 0. The implications of splitting a subchannel between 7905/7906 fixed and removable platters are discussed in Chapter 3 of this manual under "DISC PLANNING."

## UNIT NUMBER

The unit number is a number associated with each 7905, 7906, 7920, or 7925 disc drive. The unit number is set (by the user) behind the front panel of the drive, and is always displayed on the front panel. There may be eight units, numbered 0 through 7. Do not change the unit specification while the drive is being accessed.

## DEFINING THE MAC TRACK MAP TABLE

When the 13037B/C controller is not the system disc controller, tracks are mapped in a table defined as follows:

```

ASMB,R,B,L
  NAM  $TB32,15*
  ENT  $TB32
$TB32  DEC  -n          n is the total number of subchannels
SC0    DEC  word 0     See entry format below
      DEC  word 1
      OCT  word 2
      DEC  word 3
      DEC  word 4
SC1    DEC  word 0     Repeat for next subchannel
      DEC  word 1
      OCT  word 2
      DEC  word 3
      DEC  word 4
SCn-1  DEC  word 0     Until all subchannels are defined
      .
      .
      .
      END

```

\*\$TB32 must be type 15 if it is to be accessed by the disc backup utilities SAVE, RSTOR, COPY, or VERIFY. This forces \$TB32 into Table Area I. \$TB32 can be changed to a type 8 if it is to be referenced only by the ICD/MAC disc backup utilities LSAVE, USAVE, LCOPY or RESTR. This appends \$TB32 to its driver DVR32 in a driver partition, thus saving Table Area I space.

#### \$TB32 ENTRY FORMAT

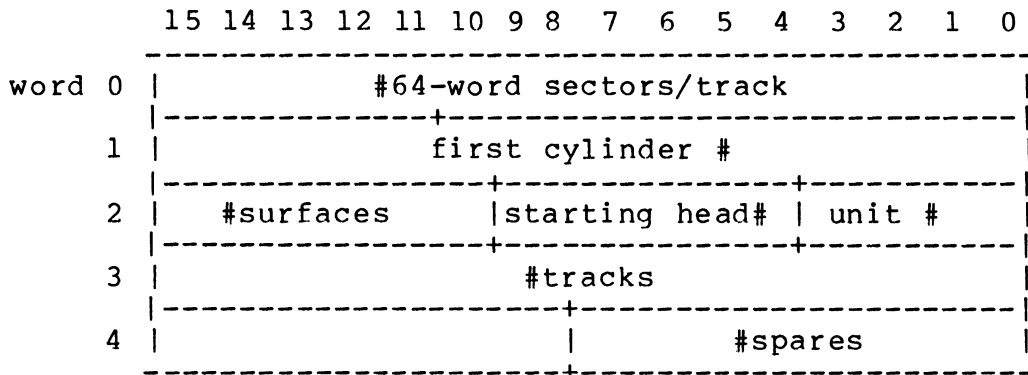

Where the # of sectors per track is based on 64-word sectors. The following apply:

|                |                   |
|----------------|-------------------|
| 7905/7906/7920 | 96 sectors/track  |
| 7925           | 128 sectors/track |

All unused fields should be set to zero.

Example:

Define five HP 7905 subchannels using two surfaces of the removable disc cartridge. Each subchannel starts at head 0.

```
ASMB,R,B,L
  NAM $TB32,15
  ENT $TB32
| $TB32 DEC -05      Total of five subchannels
| SC00  DEC 96      # 64 word sectors/track
        DEC 0       Subchannel 0 starts at cylinder 0
        OCT 04005   Two surfaces, head 0, unit 5
        DEC 150     150 tracks for subchannel 0
        DEC 4       4 spare tracks
| SC01  DEC 96
        DEC 77     Subchannel 1 starts at cylinder 77
        OCT 04005
        DEC 200    200 tracks for subchannel 1
        DEC 6      6 Spare tracks
| SC02  DEC 96
        DEC 180   Subchannel 2 starts at cylinder 180
        OCT 04005
        DEC 200    200 tracks for subchannel 2
        DEC 6      6 spare tracks
| SC03  DEC 96
        DEC 283   Subchannel 3 starts at cylinder 283
        OCT 04005
        DEC 150    150 tracks for subchannel 3
        DEC 4      4 spare tracks
| SC04  DEC 96
        DEC 360   Subchannel 4 starts at cylinder 360
        OCT 04005
        DEC 99     99 tracks for subchannel 4
        DEC 3      3 spare tracks
END
```

NOTE: Use approximately 6 spare tracks per 200 data tracks.

## MULTIPLE 13037B/C CONTROLLER OPERATION

In order to increase disc throughput, the user may wish to include more than one 13037B/C controller in the system generation. This involves relocating a second copy of DVR32 (named %DVP32) during the generation, and including entries in the equipment table, the device reference table, and the interrupt table for the discs on the second 13037B/C controller. In addition to this, the user must supply the track map table (\$TP32) to describe the subchannel configuration. The format of this table is identical with \$TB32, but the name must be changed to satisfy the driver, DVP32. The user may wish to take the HP supplied source for \$TB32 (filename &\$TB32), and modify it to meet his particular requirements. See the DVR32/DVA32 Driver Manual (part no. 92068-90012) for additional information. The track map table for DVP32 should appear as follows:

```
ASMB,R,B,L
      NAM $TP32,15
      ENT $TP32
$TP32 DEC -n (n is the total number of subchannels)
      DEC word 0
      DEC word 1
      .
      .
      .
      END
```

## TRACK CONFIGURATION FOR 12821A INTEGRATED CONTROLLER DISC INTERFACE

The table used to map the 9895, 7906H, 7920H, and/or 7925H contains the following information:

\* Total number of subchannels defined.

The following information must also be specified for each subchannel:

\* Number of sectors per track

\* Cylinder number of track 0

\* Number of surfaces included in subchannel

\* Head number of track 0

\* Address select number of disc drive

\* Number of tracks on subchannel

\* Number of spares allocated to subchannel

\* Unit number for 9895 drives only.

Information that is required to properly configure a track on these disc models is given below (a full description of track configuration can be found in Chapter 3).

|                        |                        |
|------------------------|------------------------|
| 9895                   | 7906H                  |
| 64 words per sector    | 64 words per sector    |
| 60 sectors per track   | 96 sectors per track   |
| 67 tracks per surface  | 411 tracks per surface |
| 2 surfaces per drive   | 4 surfaces per drive   |
| 7920H                  | 7925H                  |
| 64 words per sector    | 64 words per sector    |
| 96 sectors per track   | 128 sectors per track  |
| 823 tracks per surface | 823 tracks per surface |
| 5 surfaces per drive   | 9 surfaces per drive   |

#### NOTE

The RTE ICD Disc Driver DVA32 treats a logical track as 64 words per sector, with the number of sectors per track dependent upon the subchannel definition.

#### SUBCHANNELS

The 12821A ICD Disc Interface can address up to two disc controllers. Any combination of 9895, 7906H, 7920H and 7925H disc drives can be used. Unlike the 7900, these subchannels are not directly related (one per platter) to the disc drive, and they are not restricted to eight subchannels.

Each subchannel is a contiguous group of tracks on a single drive. There may be more than one subchannel per drive, but subchannels cannot cross drive boundaries. The exact number of subchannels is specified by the user. There may be as many as 32 subchannels per interface card. Subchannels are numbered sequentially from zero; no numbers may be skipped.

#### SECTORS

The discussion of sectors for the 7900 disc and MAC Discs is also true for the 9895, 7906H, 7920H, and 7925H.

#### TRACKS

The number of tracks on a disc drive is determined by multiplying the cylinders (or head positions) by the number of surfaces on the drive.

| DISC DRIVE | CYLINDERS OR HEAD POSITIONS | # SURFACES | MAXIMUM # OF TRACKS |
|------------|-----------------------------|------------|---------------------|
| 9895       | 77                          | 2          | 154                 |
| 7906H      | 411                         | 4          | 1644                |
| 7920H      | 823                         | 5          | 4115                |
| 7925H      | 823                         | 9          | 7407                |

Theoretically, the number of tracks could all be assigned to one subchannel; however, there are limitations. Peripheral disc subchannels must not have more than 32767 tracks (excluding spares) per subchannel. Each subchannel on the system or auxiliary disc (LU2 or LU3) is limited to 256 tracks (excluding spares).

Head positions (or cylinders) are numbered sequentially starting from 0. There is one head for each surface numbered sequentially from 0.

#### SURFACE ORGANIZATION

Subchannels on a 9895 should match the anticipated floppy media in use, single or double sided (or both). Subchannels on a 7906H may be on from one to four surfaces. Subchannels on a 7920H may be on from one to five surfaces. Those on a 7925H may be from one to nine surfaces.

It is best to alternate surfaces (to minimize head movement) when more than one surface is used. For example, if track 0 is at cylinder (head position) 10 on head 0, then track 1 should be at cylinder 10 on head 1 and track 2 at cylinder 11 on head 0.

#### ICD ADDRESS AND UNIT NUMBERS

The ICD Address is a number associated with each 9895, 7906H, 7920H and 7925H disc drive. The ICD Address number is set (by the user) behind the front panel of the drive, and is always displayed on the front panel. They may be numbered 0 through 7. Do not change the ICD address specifications while the heads are loaded.

In addition the two drives on a 9895 controller are addressed by their respective unit numbers (0 or 1) which refers to the left and right drives respectively.

DEFINING THE ICD TRACK MAP TABLE

When an extra disc interface is needed, tracks are mapped in a table defined as follows:

```

ASMB,R,B,L
    NAM $TA32, 8    ($TA32 must be Type 8)
    ENT $TA32
$TA32 DEC -n      n is the total number of subchannels
SC0   word 0      See entry format below
      word 1
      word 2
      word 3
      word 4
SC1   word 0      Repeat for next subchannel
      .
      .
      .
SCn-1 word 0      Until all subchannels are defined
      .
      .
      .
      END
    
```

\$TA32 ENTRY FORMAT

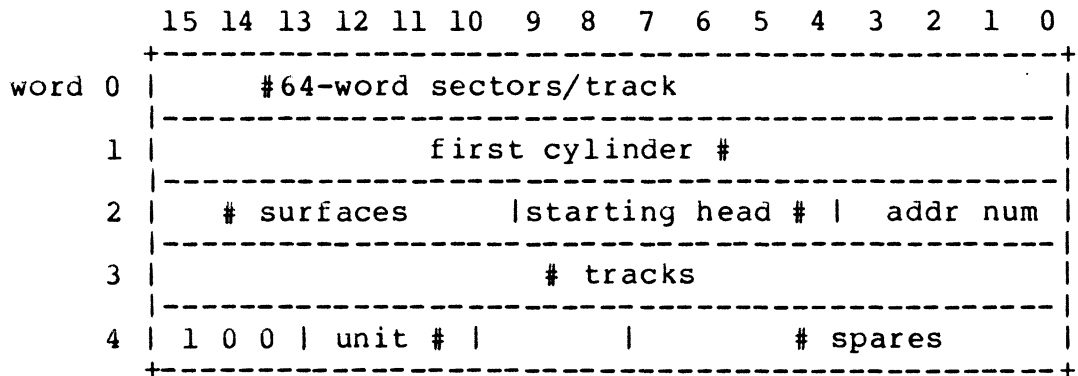

Where the # of sectors per track is based on 64-word sectors. The following apply:

|             |                   |
|-------------|-------------------|
| 7906H/7920H | 96 sectors/track  |
| 7925H       | 128 sectors/track |
| 9895        | 60 sectors/track  |

Unit # is used for the 9895 (0 for the left drive, 1 for the right drive).

All unused fields should be set to zero.



Example:

Define three HP 7906H subchannels using two surfaces of the removable disc cartridge, and two subchannels for a 9895 using double-sided flexible media. The number of tracks on each 7906H subchannel is 76 plus 4 spare tracks per subchannel. Each subchannel starts at head 0.

```
ASMB,R,B,L
  NAM $TA32,8      ($TA32 must be Type 8)
  ENT $TA32
$TA32 DEC -10      Total of ten subchannels
SC0   DEC 96       # 64 word sectors/track
      DEC 0        Subchannel 0 starts at cylinder 0
      OCT 04005    Two surfaces, head 0, select address 5
      DEC 76       76 tracks for subchannel 0
      OCT 100004   # spares=4, ICD controller indicator
SC1   DEC 96
      DEC 40       Second subchannel starts at cylinder 40
                        (4 spare tracks)
      OCT 04005
      DEC 76
      OCT 100004
SC2   DEC 96
      DEC 80       Third subchannel starts at cylinder 80
                        (4 spare tracks)
      OCT 04005
      DEC 76
      OCT 100004
      :           :
      :           :
SC3   DEC 60       #64-word sectors/track
      DEC 0        Subchannel 3 starts of cylinder 0 on
                        the 9895.
      OCT 04006    Two surfaces, head 0, select address 6.
      DEC 134      134 tracks (RTE standard for double-
                        sided media)
      OCT 100024   #spares = 20 controller indicator, unit
                        0 (left side)
SC4   DEC 60
      DEC 0
      OCT 04006    134 tracks (RTE standard)
      DEC 134      # spares = 20 ICD Controller indicator,
                        Unit 1 (right side)
      OCT 102024
      END
```

## MULTIPLE 12821A INTERFACE CARD OPERATION

In order to increase disc throughput, the user may wish to include more than one 12821A interface card in the system generation. This involves relocating a second copy of the DVA32 driver (named %DVC32) during the generation, and including entries in the equipment table, the device reference table, and the interrupt table for all discs on the second 12821A interface card. In addition to this, the user must supply a track map table (\$TC32) to describe the subchannel configuration. The format of this table is identical with \$TA32, but the name must be changed to satisfy the driver, DVC32. The user may wish to take the source (&\$TA32) of the HP supplied ICD track map table and modify it to meet his particular requirements. See the DVR32/DVA32 Driver Manual (part no. 92068-90012) for additional information.

The track map table for DVC32 should appear as follows:

```
ASMB,R,B,L
      NAM $TC32,8 ($TC32 must be Type 8)
      ENT $TC32
$TC32 DEC -n      (n is the total number of subchannels)
      DEC word 0
      DEC word 1
      .
      .
      END
```

## MULTIPLE CPU - MAC OPERATION WITH 13037 CONTROLLER

In a multiple CPU system environment, the MAC disc driver, DVR32, and the 13037B/C controller prevent destructive interference during transfers of data to and from the disc. The drivers and controller provide adequate protection if a CPU is not to share access to the same physical disc addresses with any other CPU.

If a file or set of files is to be shared by more than one CPU, a procedure is needed to prevent the following possible events:

- a. CPU A reads a sector to update it.
- b. CPU B reads the same sector to update it.
- c. CPU A writes its updated sector back to the disc.
- d. CPU B writes its updated sector back to the disc, destroying the effect of CPU A access.

To allow software to be written to effect multiple CPU - MAC system operation without destructive interference, the 13037B/C disc controller driver (DVR32) services a lock/unlock function call. This call can be issued from one CPU to lock the disc during an I/O operation or set of I/O operations. No other CPU can access the locked disc until an unlock function call is issued by the original CPU.

#### DVR32 LOCK/UNLOCK FUNCTION CALL

The I/O Control request is used to hold a Resource Number (RN) and, subsequently, to release the RN. The RN must be allocated and set as a global RN prior to issuing the I/O Control request. For a description of the I/O Control request and Resource Numbering, see the appropriate RTE Software System Programming and Operating Manual.

The RTE FORTRAN IV calling sequence for an I/O Control request containing a lock/unlock function call is:

```

ICOD=3
ICNWD=control word
IRNUM=resource number
CALL EXEC (ICODE,ICNWD,IRNUM)

```

ICNWD defines a one-word octal value containing control information. For DVR32, control word bits 12-6 contain a function code for the following control states:

| Function Code<br>(bits 12-6) | Meaning |
|------------------------------|---------|
| 15                           | Lock    |
| 00                           | Unlock  |

IRNUM is specified only for function code 15. IRNUM contains the RN to be cleared when the lock function call is executed. If a lock is currently in effect from another CPU, the calling program is suspended until the disc is available. If the lock is obtained immediately, the I/O Control request completes immediately. If a lock is already in force by this disc controller, the request completes with the RN cleared.

The lock/unlock function codes are provided to alleviate any CPU contention problem. If a CPU wishes to modify the same disc area as another CPU, the following code sequence could be executed from both units to prevent their interfering with each other:

```

ICOD=12B                               Allocate and set global RN
CALL RNRQ(ICOD,IRNUM,ISTAT)

CALL EXEC(3,IDLU+1500B,IRNUM) Issue lock call, function code=15

```

|                          |   |
|--------------------------|---|
| CALL RNRQ(5,IRNUM,ISTAT) | Set/clear the RN                        |
| .                        | Lock is granted by this point           |
| .                        |   |
| .                        |   |
| CALL EXEC(1,IDLU,....)   | Next, read the disc and modify data     |
| .                        |   |
| .                        |   |
| .                        |   |
| CALL EXEC(2,IDLU,....)   | Then, write it back                     |
| CALL EXEC(3,IDLU)        | Now, issue unlock call, function code=0 |
| .                        |   |
| .                        |   |
| .                        |   |

To use the lock/unlock function, each CPU operating system must support this function.

The sequence described previously for CPU A and CPU B using the lock/unlock function would now be:

- Step 1 : CPU A requests a lock from the driver and it is granted (no other CPU has a lock in force).
- Step 2 : CPU A reads a sector to update it.
- Step 3 : CPU B requests a lock from its driver. Because CPU A has a lock, CPU B must wait.
- Step 4 : CPU A writes its updated sector back to the disc.
- Step 5 : CPU A releases its lock.
- Step 6 : CPU B disc driver gets an interrupt from the disc controller informing it that the lock is now available and completes the lock requested by b at Step 3.
- Step 7 : CPU B reads the same sector to update it.
- Step 8 : CPU B writes its updated sector back to the disc. The sector now has both updates.
- Step 9 : CPU B releases its lock.

# Appendix C

## RTE System Tables

This Appendix contains information about the following topics:

- \* SYSTEM COMMUNICATIONS AREA - Base page locations of area used for system communications.
- \* PROGRAM ID SEGMENT MAP - Format of ID segments kept in system area for user programs, ID segment extension, and short ID segments.
- \* DISC LAYOUT - Allocation of disc space for an RTE-IVB system.

Other system tables relating to I/O considerations, such as the Equipment Table, Device Reference Table and Driver Mapping Table are described in Appendix C of the RTE-IVB Programmers Reference Manual.

### SYSTEM COMMUNICATION AREA

This area is a block of storage in the system base page, starting at location 1645, that is used by RTE-IVB to define request parameters, I/O tables, scheduling lists, operating parameters, memory bounds, etc. The RTE-IVB Assembler allows relocatable programs to reference this area by absolute addresses 1645 through 1777 octal. User programs can read information from this area but cannot alter it because of the memory protect feature.

The contents and description of each location in this area are listed in Table C-1.

System Communication Area and System Tables

Table C-1. System Communications Area Locations

| Octal Location                              | Contents | Description  |
|---|----------|--|
| SYSTEM TABLE DEFINITION                     |          |  |
| 01645                                       | XIDEX    | Address of current program's ID extension  |
| 01646                                       | XMATA    | Address of current program's MAT entry   |
| 01647                                       | XI       | Address of index register save area  |
| 01650                                       | EQTA     | FWA of Equipment Table   |
| 01651                                       | EQT#     | Number of EQT entries  |
| 01652                                       | DRT      | FWA of Device Reference Table, word 1  |
| 01653                                       | LUMAX    | Number of logical units in DRT   |
| 01654                                       | INTBA    | FWA of Interrupt Table   |
| 01655                                       | INTLG    | Number of Interrupt Table Entries  |
| 01656                                       | TAT      | FWA of Track Assignment Table  |
| 01657                                       | KEYWD    | FWA of keyword block   |
| I/O MODULE/DRIVER COMMUNICATION             |          |  |
| 01660                                       | EQT1 \   | Addresses of first 11 words of current EQT entry (see 01771 for last four words) |
| 01661                                       | EQT2     |  |
| 01662                                       | EQT3     |  |
| 01663                                       | EQT4     |  |
| 01664                                       | EQT5 \   |  |
| 01665                                       | EQT6 /   |  |
| 01666                                       | EQT7     |  |
| 01667                                       | EQT8     |  |
| 01670                                       | EQT9     |  |
| 01671                                       | EQT10    |  |
| 01672                                       | EQT11 /  |  |
| 01673                                       | CHAN     | Current DCPC channel number  |
| 01674                                       | TBG      | I/O address of time-base card  |
| 01675                                       | SYSTY    | EQT entry address of system TTY  |
| SYSTEM REQUEST PROCESSOR/EXEC COMMUNICATION |          |  |
| 01676                                       | RQCNT    | Number of request parameters -1  |
| 01677                                       | RQRTN    | Return point address   |
| 01700                                       | RQP1 \   | Addresses of request parameters (set for a maximum of nine parameters)           |
| 01701                                       | RQP2     |  |
| 01702                                       | RQP3     |  |
| 01703                                       | RQP4 \   |  |
| 01704                                       | RQP5 /   |  |
| 01705                                       | RQP6     |  |
| 01706                                       | RQP7     |  |
| 01707                                       | RQP8     |  |
| 01710                                       | RQP9 /   |  |

System Communication Area and System Tables

Table C-1. System Communications Area Locations (continued)

| Octal Location                     | Contents | Description                           |
|------------------------------------|----------|---------------------------------------|
| SYSTEM LISTS ADDRESSES             |          |                                       |
| 01711                              | SKEDD    | Schedule list                         |
| 01713                              | SUSP2    | Wait Suspend list                     |
| 01714                              | SUSP3    | Available Memory list                 |
| 01715                              | SUSP4    | Disc Allocation list                  |
| 01716                              | SUSP5    | Operator Suspend list                 |
| PROGRAM ID SEGMENT DEFINITION      |          |                                       |
| 01717                              | XEQT     | ID segment address of current program |
| 01720                              | XLINK    | Linkage                               |
| 01721                              | XTEMP    | Temporary (five words)                |
| 01726                              | XPRIO    | Priority word                         |
| 01727                              | XPENT    | Primary entry point                   |
| 01730                              | XSUSP    | Point of suspension                   |
| 01731                              | XA       | A-register at suspension              |
| 01732                              | XB       | B-register at suspension              |
| 01733                              | XEO      | E and overflow register suspension    |
| SYSTEM MODULE COMMUNICATION FLAGS  |          |                                       |
| 01734                              | OPATN    | Operator/keyboard attention flag      |
| 01735                              | OPFLG    | Operator communication flag           |
| 01736                              | SWAP     | RT disc resident swapping flag        |
| 01737                              | DUMMY    | I/O address of dummy interface flag   |
| 01740                              | IDSDA    | Disc address of first ID segment      |
| 01741                              | IDSDP    | Position within disc sector           |
| MEMORY ALLOCATION BASES DEFINITION |          |                                       |
| 01742                              | BPA1     | FWA user base page link area          |
| 01743                              | BPA2     | LWA user base page link area          |
| 01744                              | BPA3     | FWA user base page link               |
| 01745                              | LBORG    | FWA of resident library area          |
| 01746                              | RTORG    | FWA of real-time COMMON               |
| 01747                              | RTCOM    | Length of real-time COMMON            |
| 01750 D                            | RTDRA    | FWA of real-time partition            |
| 01751 D                            | AVMEM    | LWA+1 of real-time partition          |
| 01752                              | BGORG    | FWA of background COMMON              |
| 01753                              | BGCOM    | Length of background COMMON           |
| 01754 D                            | BGDRA    | FWA of background partition           |

System Communication Area and System Tables

Table C-1. System Communication Area Locations (continued)

| Octal Location   | Contents | Description  |
|--|----------|--|
| UTILITY PARAMETERS   |          |  |
| 01755  | TATLG    | Negative length of track assignment table                                      |
| 01756  | TATSD    | Number of tracks on system disc  |
| 01757  | SECT2    | Number of sectors/track on LU2 (system)  |
| 01760  | SECT3    | Number of sectors/track on LU3 (aux.)  |
| 01761  | DSCLB    | Disc address of library entry points   |
| 01762  | DSCLN    | Number of user available library entry points.                                 |
| 01763  | DSCUT    | Disc address of relocatable disc resident library.                             |
| 01764  | SYSLN    | Number of system library entry points  |
| 01765  | LGOTK    | LGO: LU#, starting track, number of tracks (same format as ID segment word 28) |
| 01766  | LGOC     | Current LGO track/sector address (same format as ID segment word 26)           |
| 01767  | SFCUN    | LS: LU# and disc address (same format as ID segment word 26)                   |
| 01770  | MPTFL    | Memory protect ON/OFF flag (0/1)   |
| 01771  | EQT12 \  | Address of last four words of current EQT                                      |
| 01772  | EQT13 \  |  |
| 01773  | EQT14 /  |  |
| 01774  | EQT15 /  |  |
| 01775 D  | FENCE    | Memory protect fence address   |
| 01777  | BGLWA    | LWA memory background partition  |
| D letter indicates the contents of the location are set dynamically by the dispatcher. |          |  |

PROGRAM ID SEGMENT

Each user program has a 33-word ID segment located in Table Area II that contains static and dynamic information defining the properties of the program. The static information is set during generation time or when the program is loaded on-line. The dynamic information is maintained by the operating system Executive.



## System Communication Area and System Tables

The number of ID segments contained in a system is established during system generation, and is directly related to the number of programs that can be in main memory at any given time. If all the ID segments are in use, no more programs can be added on-line unless some other existing program is first "offed" (removed from the system) to recover an ID segment.

The format of the ID segment is illustrated in Figure C-1. Each ID segment's address is located in the Keyword Table (see location 01657).

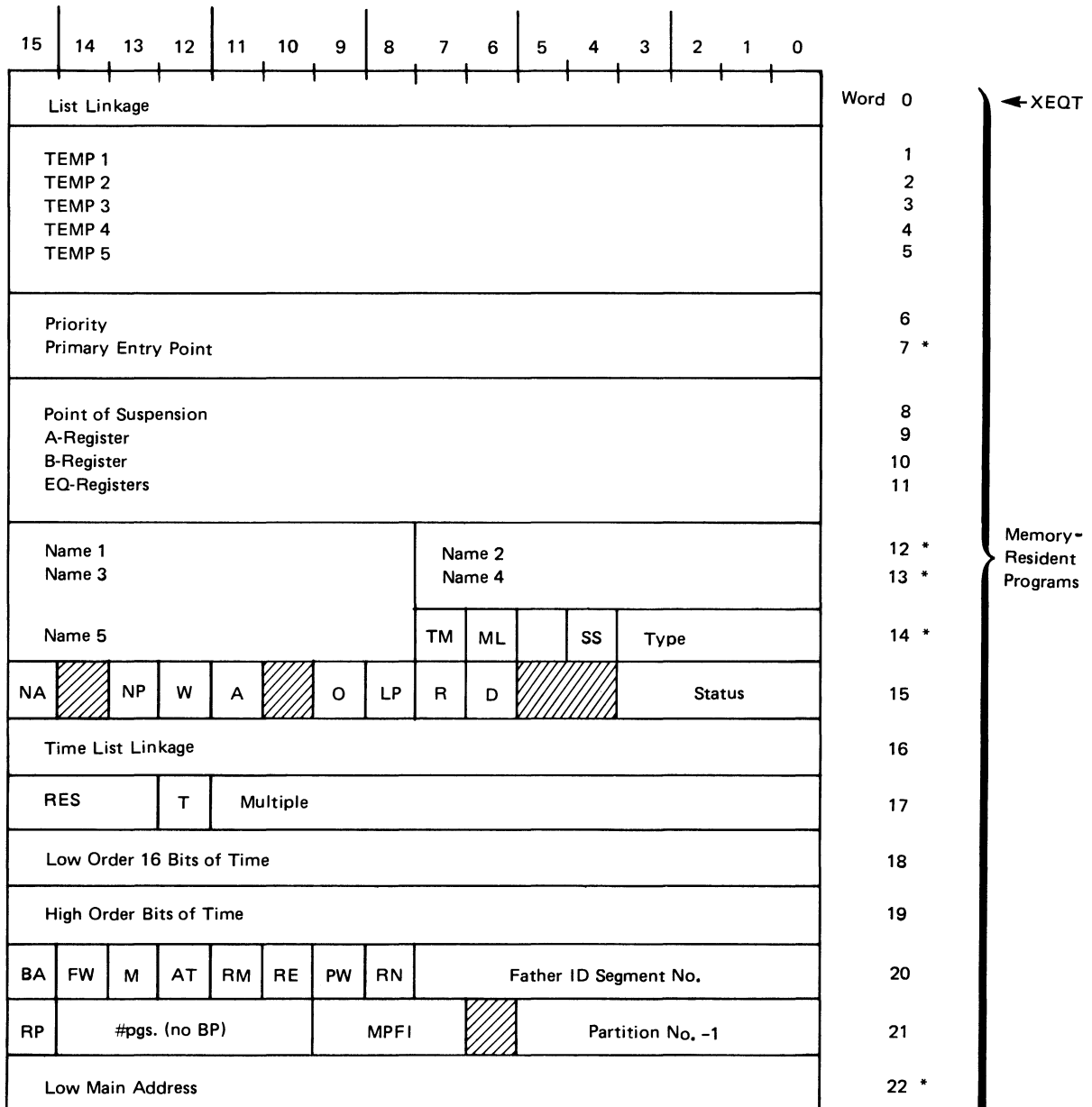
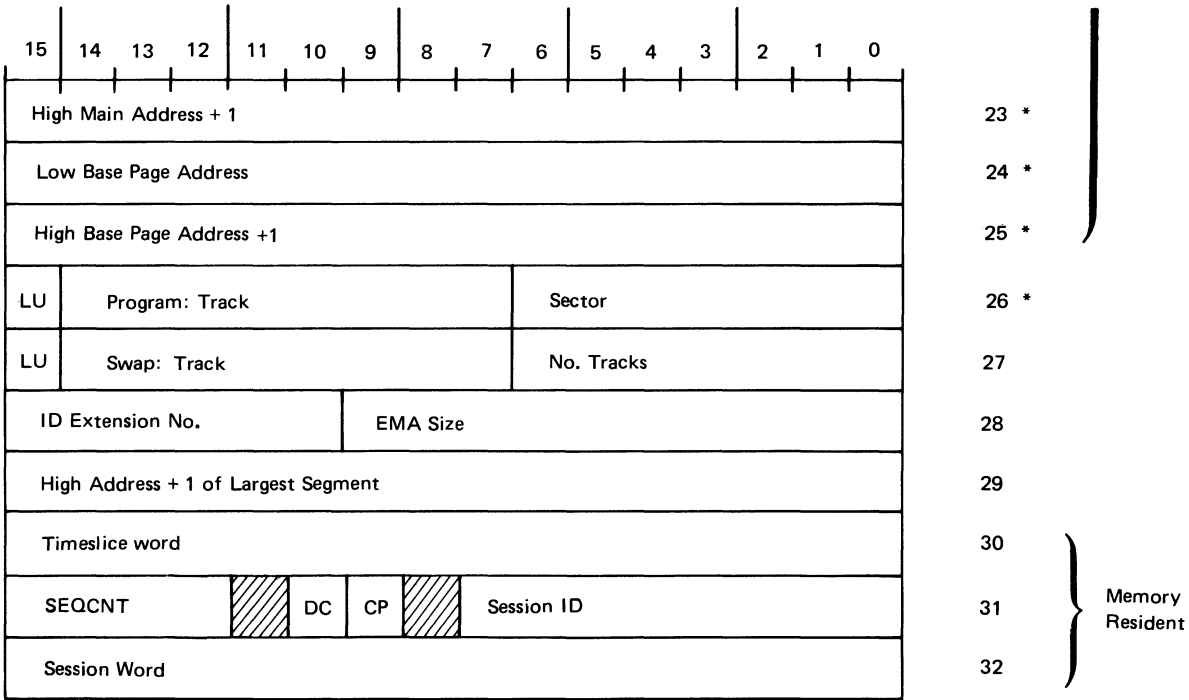

Figure C-1. ID Segment Format

# System Communication Area and System Tables

Figure C-1. ID Segment Format (Continued)



where:

- \* = words used in short ID segments for program segments
- TM = temporary load (copy of ID segment is not on the disc)
- ML = memory lock (program may not be swapped)
- SS = short segment (indicates a nine-word segment)
- Type = specified program type (1-5)
- NA = no abort (instead, pass abort errors to program)
- NP = no parameters allowed on reschedule
- W = wait bit (waiting for program whose ID segment address is in word 2)
- A = abort on next list entry for this program
- O = operator suspend on next schedule attempt
- LP = load in progress; program is being dispatched from disc.

## System Communication Area and System Tables

R = resource save (save resources when setting dormant)

D = dormant bit (set dormant on next schedule attempt)

Status = current program status

T = time list entry bit (program is in the time list)

BA = batch (program is running under batch)

FW = father is waiting (father scheduled with wait)

M = Multi-Terminal Monitor bit

AT = attention bit (operator has requested attention)

RM = reentrant memory must be moved before dispatching program

RE = reentrant routine now has control

PW = program wait (some other program wants to schedule this one)

RN = Resource Number either owned or locked by this program

RP = reserved partition (only for programs that request it)

MPFI = memory protect fence index

### TIMESLICE WORD (30):

The timeslice word defines the timeslicing status of a program. This word is defined as follows:

1 = This program has just been rescheduled or is not timesliced.

0 = This program has used a full timeslice or program is not scheduled.

<0 = This program was running (under timeslice control) and was "bumped" from execution by a higher priority program. This word represents the remaining timeslice for this program.

## System Communication Area and System Tables

### OPEN FLAG WORD(31):

SEQCNT = sequence counter. Each time a program is aborted or terminates (unless saving resources) the counter is incremented. The counter value is used to build FMP open Flags.

DC = don't copy flag. Set by the generator (if 128 is added to program type) or the loader (using Don't Copy op-code).

CP = copy flag. Indicates that the program is a copy.

Session ID = System LU of terminal that program was loaded from. For programs permanently loaded or temporarily loaded by the system manager, a zero is shown here.

### SESSION WORD(32):

The session word identifies the user of a program.

A negative value represents the logical unit number of the terminal from which the program was invoked (not under session).

A positive value represents the address of the SST length word of the session control block for the session currently using this program (under session).

Programs scheduled by interrupt will have a zero in this word.

## System Communication Area and System Tables

### ID SEGMENT EXTENSIONS

Each EMA program requires a 3-word ID segment extension in addition to its 33-word ID segment. The number of ID extensions contained in the system is also set at generation time, and if all are in use, no more EMA programs can be added on-line. The format of the ID segment is illustrated in Figure C-2.

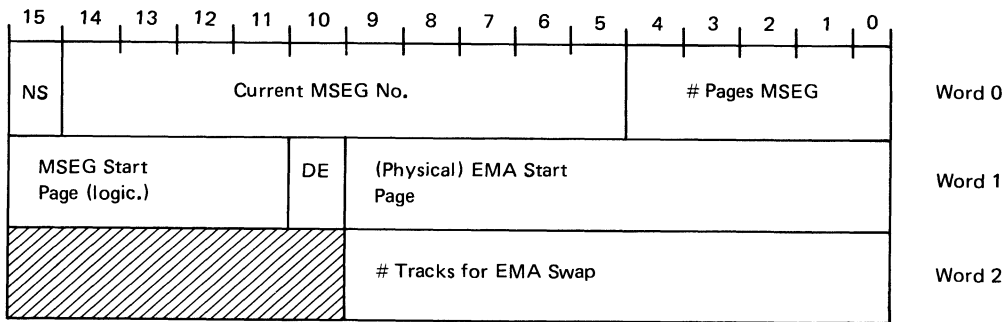

where:

- NS = 0 if the MSEG is pointing to a standard segment of the EMA (set up by .EMAP)
- = 1 if the MSEG is pointing to a non-standard segment (set up by .EMIO)
- DE = 0 if the EMA size was specified by the user
- = 1 if the EMA size is allowed to default to the maximum size available to the system.

Figure C-2. ID Segment Extension

### SHORT ID SEGMENTS

Short ID segments requiring nine words are used only for program segments. A short ID segment is required for each segment of a segmented program. If no empty short ID segments are available during an on-line load, a standard 33-word ID segment will be used. The information contained in a short ID segment is illustrated in Figure C-1.

### RTE-IVB SYSTEM DISC LAYOUT

Figure C-3 illustrates how disc space is allocated when a RTE-IVB system is generated.

# System Communication Area and System Tables

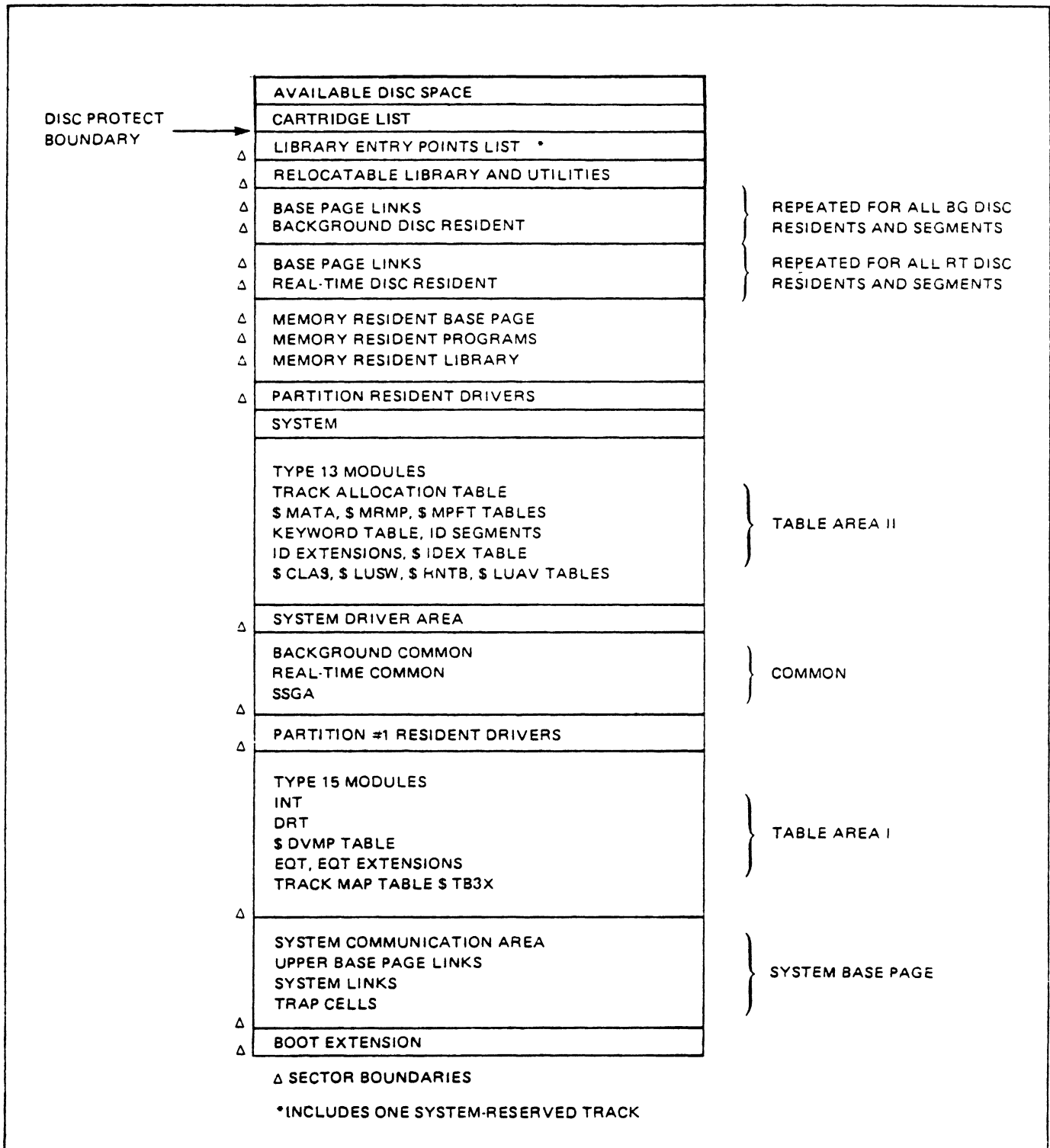

Figure C-3. RTE-IVB System Disc Layout

# Appendix D

## Record Formats

This Appendix contains information on the following:

- \* SOURCE RECORD FORMAT
- \* RELOCATABLE AND ABSOLUTE RECORD FORMATS
- \* ABSOLUTE TAPE FORMAT
- \* DISC FILE RECORD FORMATS
- \* SIO TAPE RECORD FORMATS
- \* MEMORY-IMAGE PROGRAM FILE FORMAT (TYPE 6)

### SOURCE RECORD FORMATS

The source format used for the disc records by the system program EDITR and FMGR is given in Figure D-1. All records are packed ignoring sector boundaries. Binary records are packed directly onto the disc. After an END record, a zero word is written and the rest of the sector is skipped. If this zero word is the first word of the sector, it is not written. Binary files are always contiguous so a code word is not required.

## Record Formats

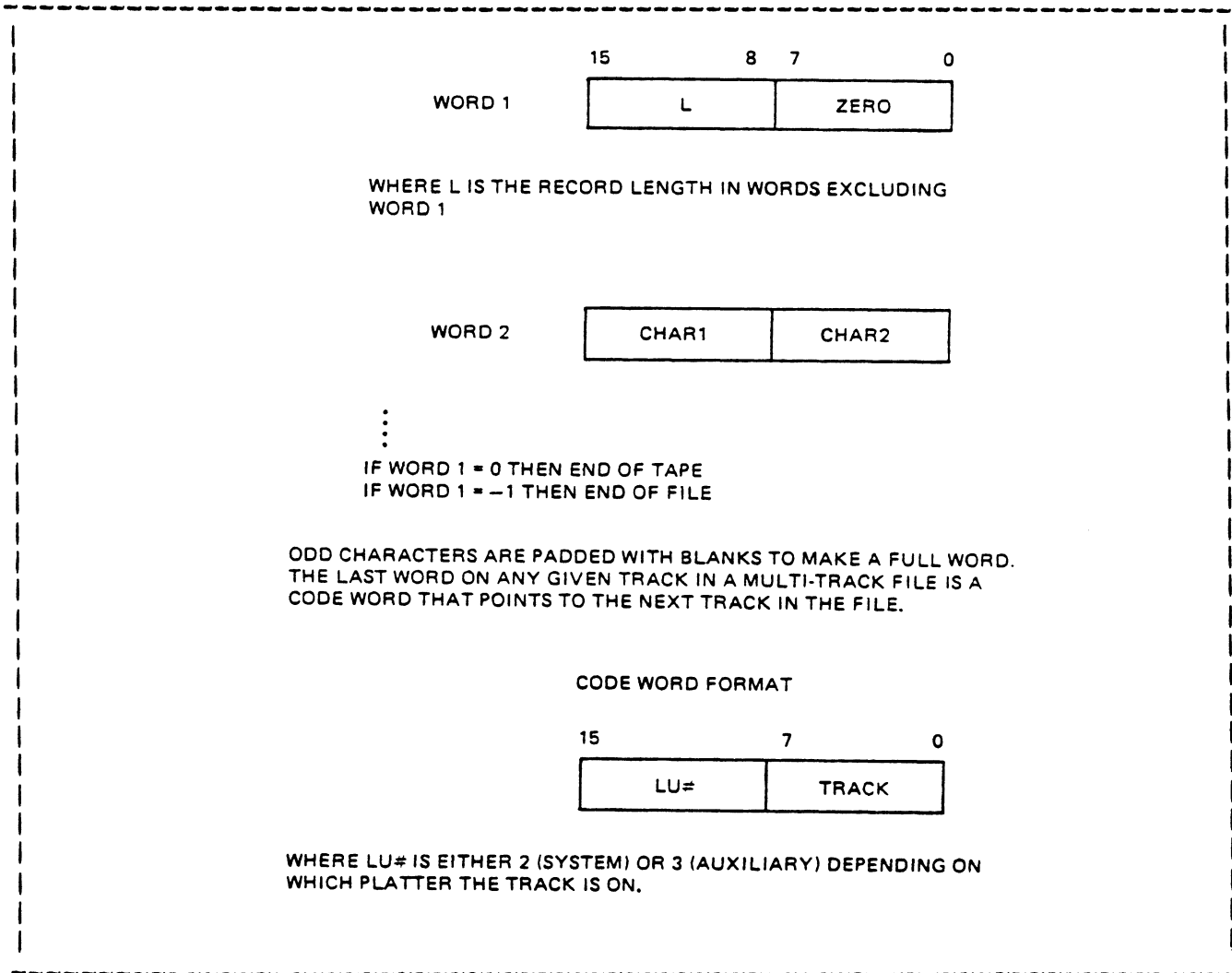

Figure D-1. Source Record Formats

### RELOCATABLE AND ABSOLUTE RECORD FORMATS

The following describes the formats of relocatable and absolute records produced as object code for a given source program. The relocatable records are generated by compilers or by the assembler for a relocatable assembly. These records are stored in a relocatable file. The generator or the loader processes these relocatable records to produce an absolute module which has all program links resolved and the program is relocated and ready to run.

The absolute records are produced by the assembler for an absolute assembly. The module of records thus produced requires no processing by the generator or loader. Absolute programs must be loaded into memory and run off-line.



NAM RECORD

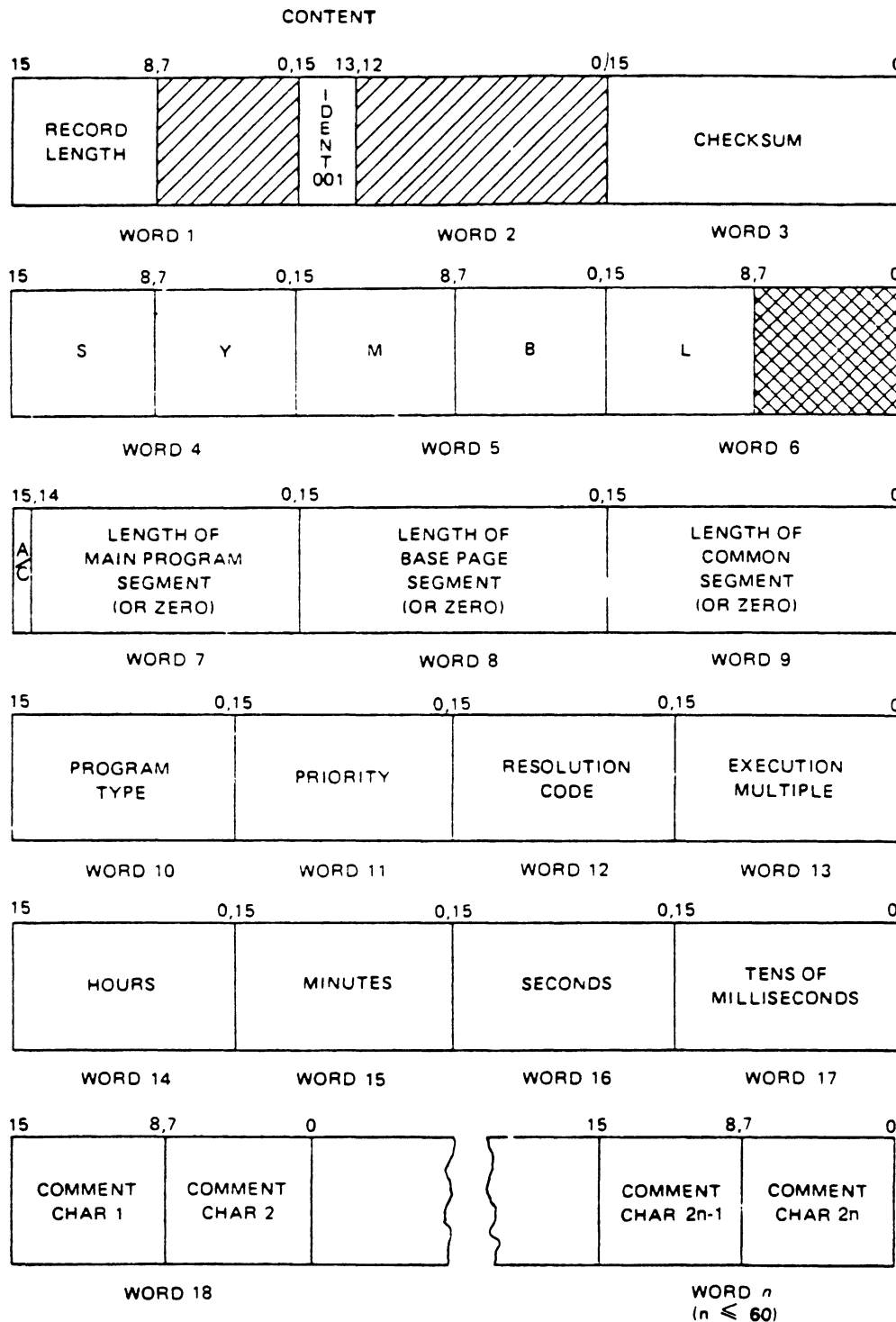

EXPLANATION

RECORD LENGTH = 9-60 WORDS

IDENT = 001

CHECKSUM ARITHMETIC TOTAL OF ALL WORDS IN RECORD EXCLUDING WORDS 1 AND 3.

SYMBL. FIVE CHARACTER NAME OF PROGRAM

A/C: BINARY TAPE PRECESSION  
 = 0 IF ASSEMBLER PRODUCED OR LENGTH IS EXACT  
 = 1 IF COMPILER PRODUCED, AND LENGTH IS UNKNOWN

 HATCH-MARKED AREAS SHOULD BE ZERO-FILLED WHEN THE RECORDS ARE GENERATED

 CROSS-HATCH-MARKED AREAS SHOULD BE SPACE-FILLED WHEN THE RECORDS ARE GENERATED

Figure D-2. Record Formats

# Record Formats

## ENT RECORD

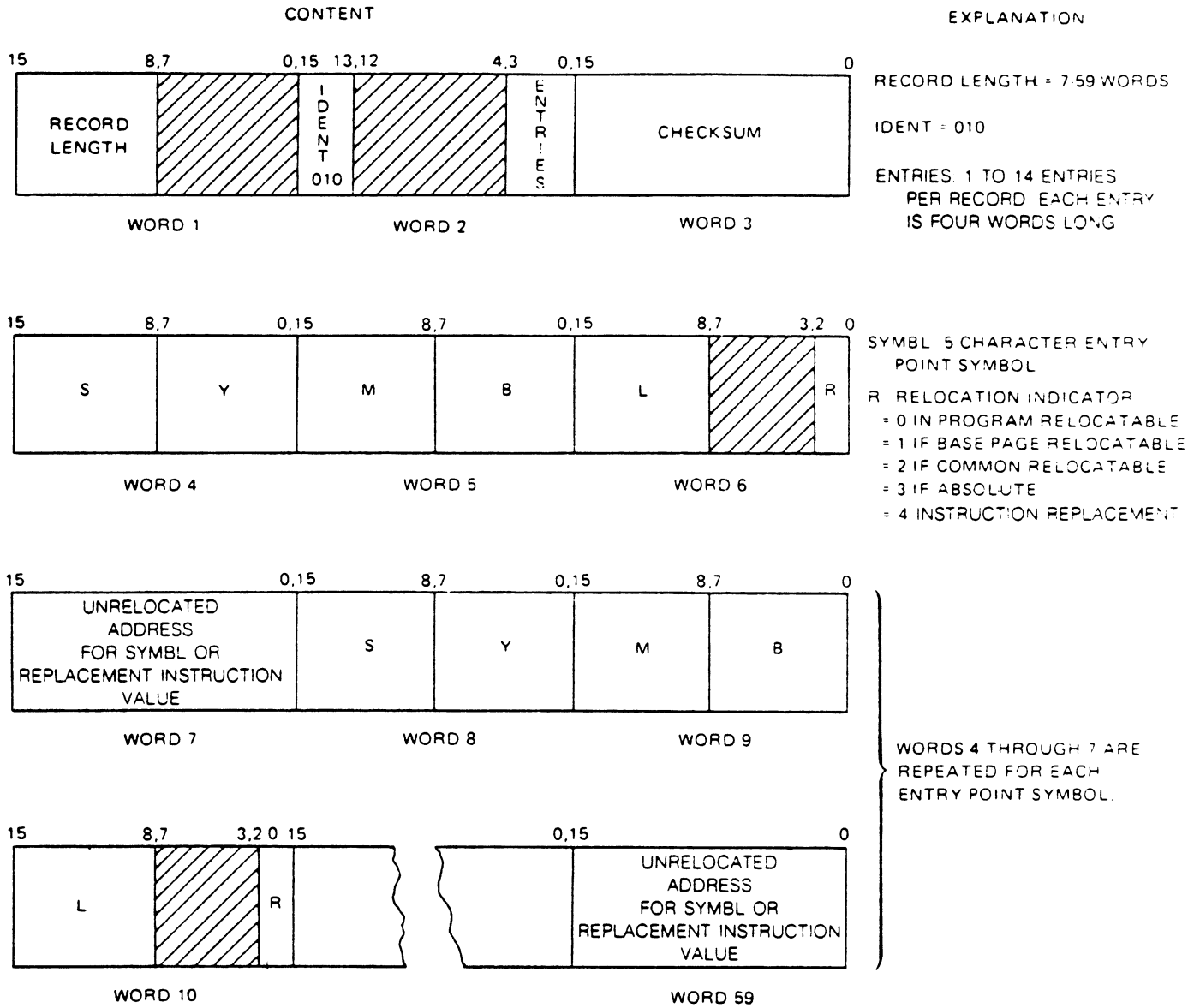
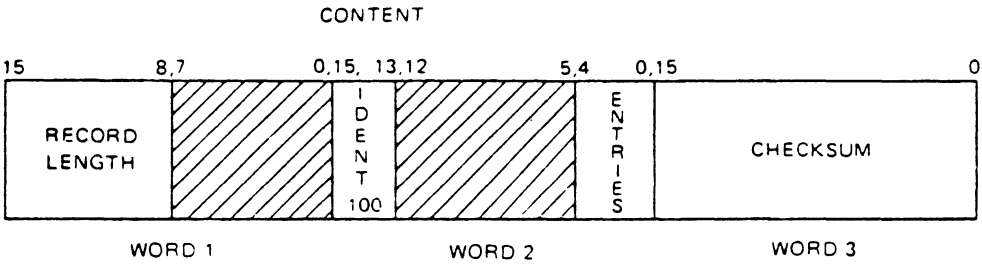

Figure D-2. Record Formats (continued)

EXT RECORD



EXPLANATION

RECORD LENGTH = 6-60 WORDS

IDENT = 100

ENTRIES. 1 TO 19 PER RECORD. EACH ENTRY IS THREE WORDS LONG

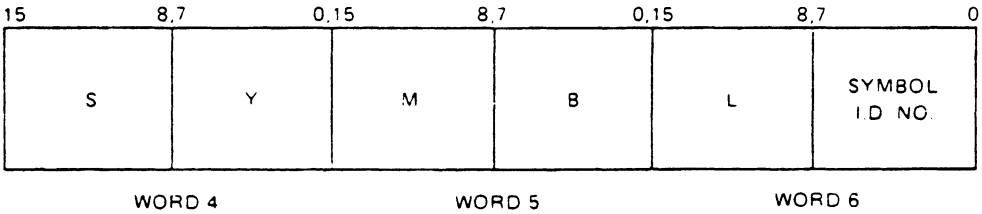

SYMBL 5 CHARACTER EXTERNAL SYMBOL

SYMBOL ID. NO. NUMBER ASSIGNED TO SYMBL FOR USE IN LOCATING REFERENCE IN BODY OF PROGRAM.

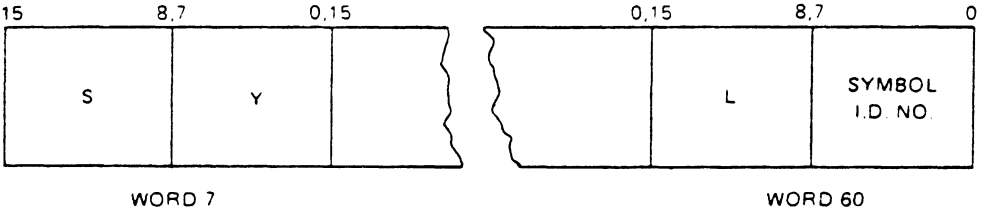

WORDS 4 THROUGH 6 REPEATED FOR EACH EXTERNAL SYMBOL (MAXIMUM OF 19 PER RECORD)

Figure D-2. Record Formats (continued)

**DBL RECORD**

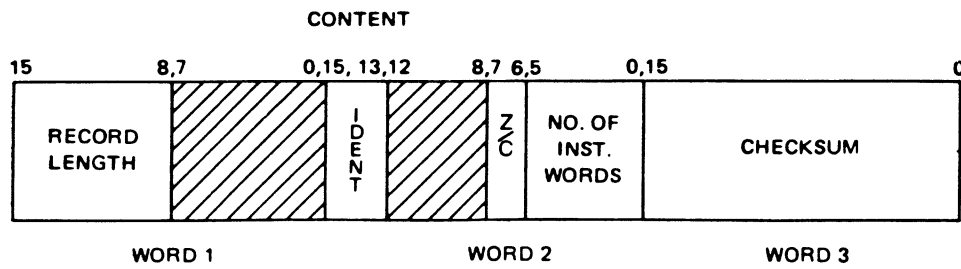

**EXPLANATION**

RECORD LENGTH = 6-60 WORDS  
 IDENT = 011  
 Z/C: RELOCATION OF LOAD ADDRESS  
 = 0 FOR BASE PAGE  
 = 1 FOR PROGRAM  
 = 2 FOR ABSOLUTE  
 = 3 FOR COMMON  
 NO. OF INST. WORDS: 1 TO 45  
 LOADABLE INSTRUCTION WORDS PER RECORD

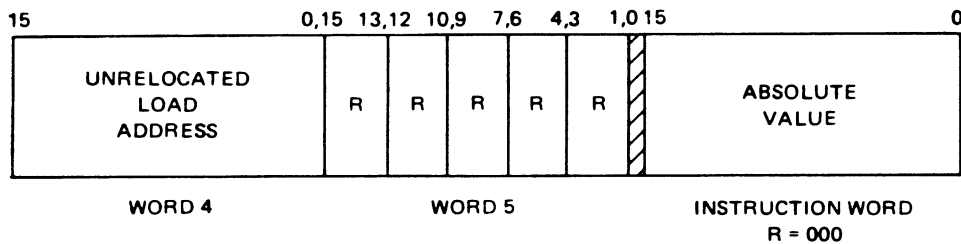

RELOCATABLE LOAD ADDRESS: STARTING ADDRESS FOR LOADING THE INSTRUCTIONS WHICH FOLLOW;

R's: RELOCATION INDICATORS:  
 000 = ABSOLUTE  
 001 = 15-BIT PROGRAM RELOCATABLE  
 010 = 15-BIT BASE PAGE RELOCATABLE  
 011 = 15-BIT COMMON RELOCATABLE  
 100 = EXTERNAL REFERENCE  
 101 = MEMORY REFERENCE  
 110 = BYTE REFERENCE

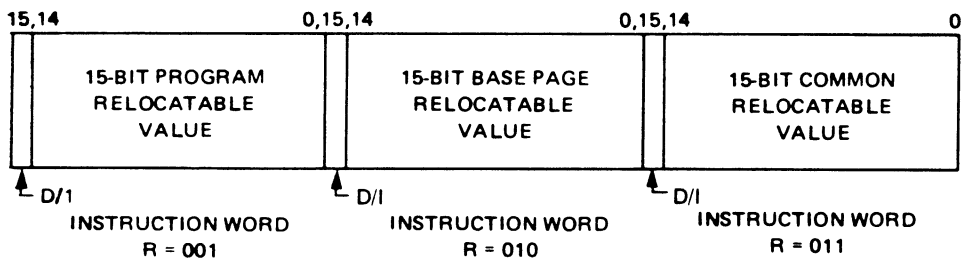

R<sub>1</sub> IS RELOCATION INDICATOR FOR INSTRUCTION WORD<sub>1</sub>; R<sub>2</sub>, FOR INSTRUCTION WORD<sub>2</sub>; ETC.

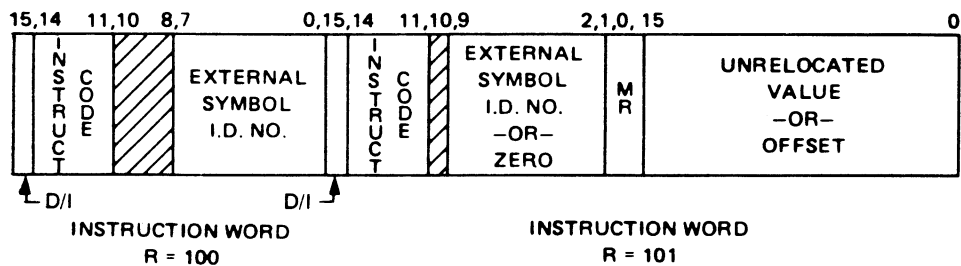

D/I: INDIRECT ADDRESSING

0 = DIRECT  
 1 = INDIRECT

MEMORY REFERENCE INSTRUCTIONS USE TWO WORDS, WITHIN THE TWO-WORD GROUP, "MR" INDICATES RELOCATABILITY OF OPERAND SPECIFIED IN SECOND WORDS:

00 = PROGRAM RELOCATABLE  
 01 = BASE PAGE RELOCATABLE  
 10 = COMMON RELOCATABLE  
 11 = ABSOLUTE

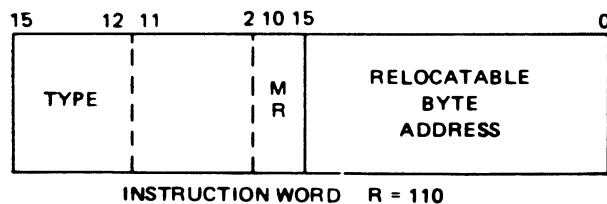
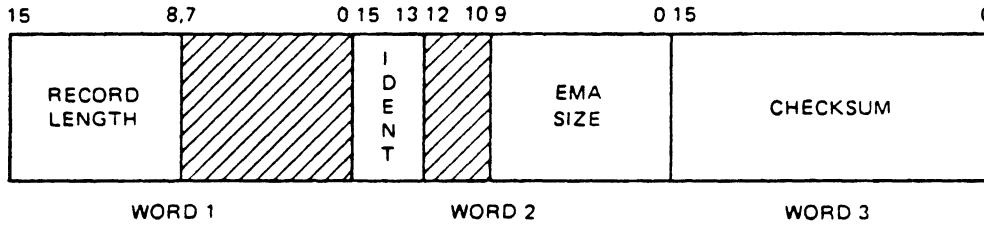

Figure D-2. Record Formats (continued)

**EMA RECORD**

**Record Formats**



**EXPLANATION**

RECORD LENGTH = 7 WORDS  
IDENT = 110

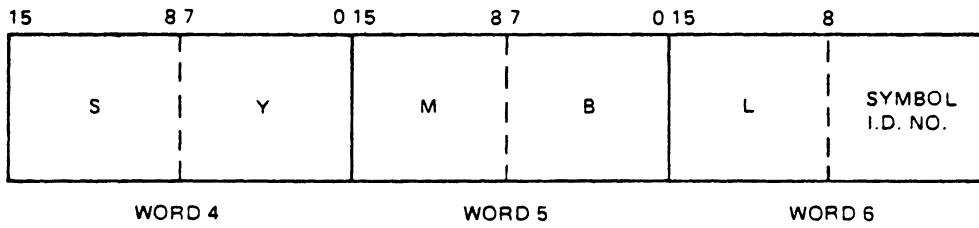

SYMBOL I.D. NO.: NUMBER ASSIGNED TO SYMBOL FOR USE IN LOCATING REFERENCE IN COPY OF PROGRAM.

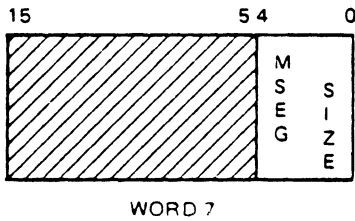

**END RECORD**

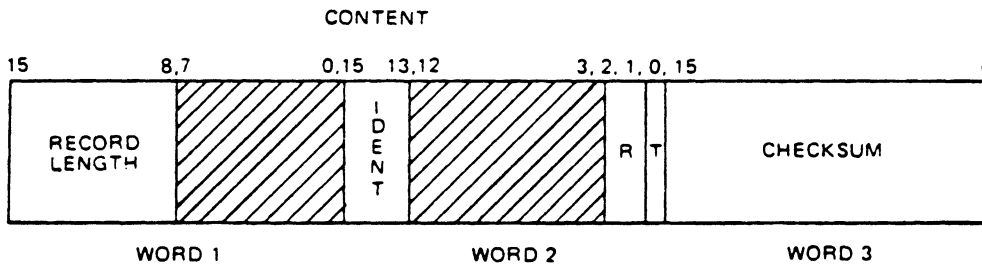

**EXPLANATION**

RECORD LENGTH = 4 WORDS  
IDENT = 101

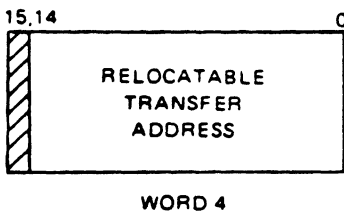

- R: RELOCATION INDICATOR FOR TRANSFER ADDRESS
  - = 0 IF PROGRAM RELOCATABLE
  - = 1 IF BASE PAGE RELOCATABLE
  - = 2 IF COMMON RELOCATABLE
  - = 3 IF ABSOLUTE
- T TRANSFER ADDRESS INDICATOR
  - = 0 IF NO TRANSFER ADDRESS IN RECORD
  - = 1 IF TRANSFER ADDRESS PRESENT

Figure D-2. Record Formats (continued)

Record Formats

ABSOLUTE TAPE FORMAT

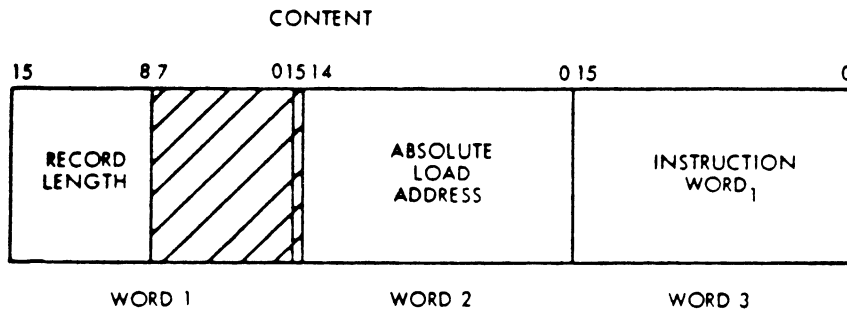

EXPLANATION

RECORD LENGTH = NUMBER OF WORDS IN RECORD EXCLUDING WORDS 1 AND 2 AND THE LAST WORD.

ABSOLUTE LOAD ADDRESS: STARTING ADDRESS FOR LOADING THE INSTRUCTIONS WHICH FOLLOW

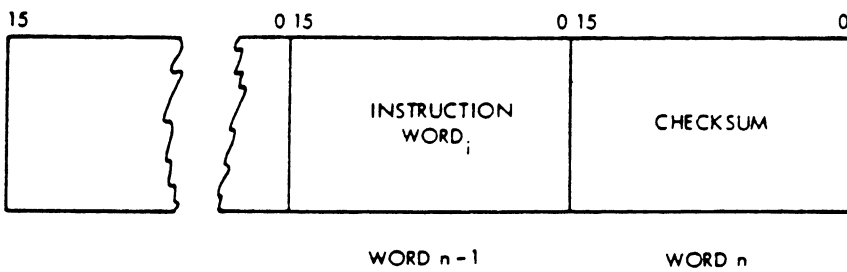

INSTRUCTION WORDS: ABSOLUTE INSTRUCTIONS OR DATA

CHECKSUM: ARITHMETIC TOTAL OF ALL WORDS EXCEPT FIRST AND LAST

† On paper tape, each word represents two frames arranged as follows:

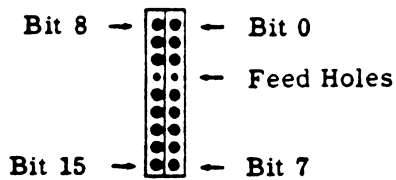

DISC FILE RECORD FORMATS

Fixed Length Formats (Types 1 and 2)

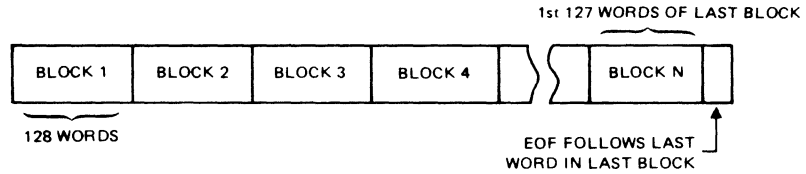

Type 1 Record length = Block length = 128 words

Type 2 Record length is user defined; may cross block boundaries but not past EOF

Variable Length Formats (Types 3 and Above)

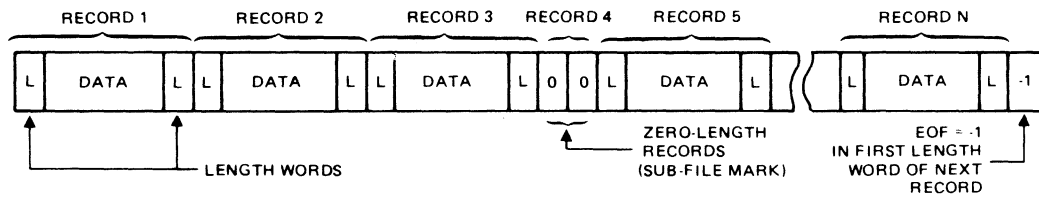

# Record Formats

## SIO RECORD FORMAT

Magnetic tape SIO binary records have the following format:

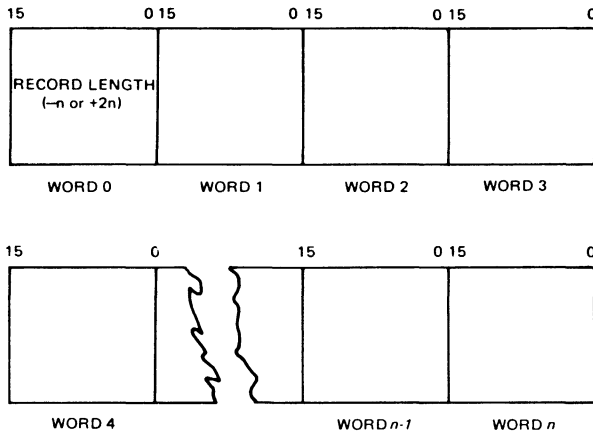

*Record length = number of words or characters in record, excluding word 0; negative value denotes words, positive value denotes characters.*

### NOTE

The length (word 0) is not considered part of the data record. When written with the MS option of the DU command, the length is supplied by FMGR. When read with the MS option of the ST command, the length is removed (in this case, the length word is used instead of the length supplied by the driver).



## Memory-Image Program File Format (Type 6)

Files created by the SP command as memory-image program files are always accessed as type 1 files (fixed length, 128-words per record).

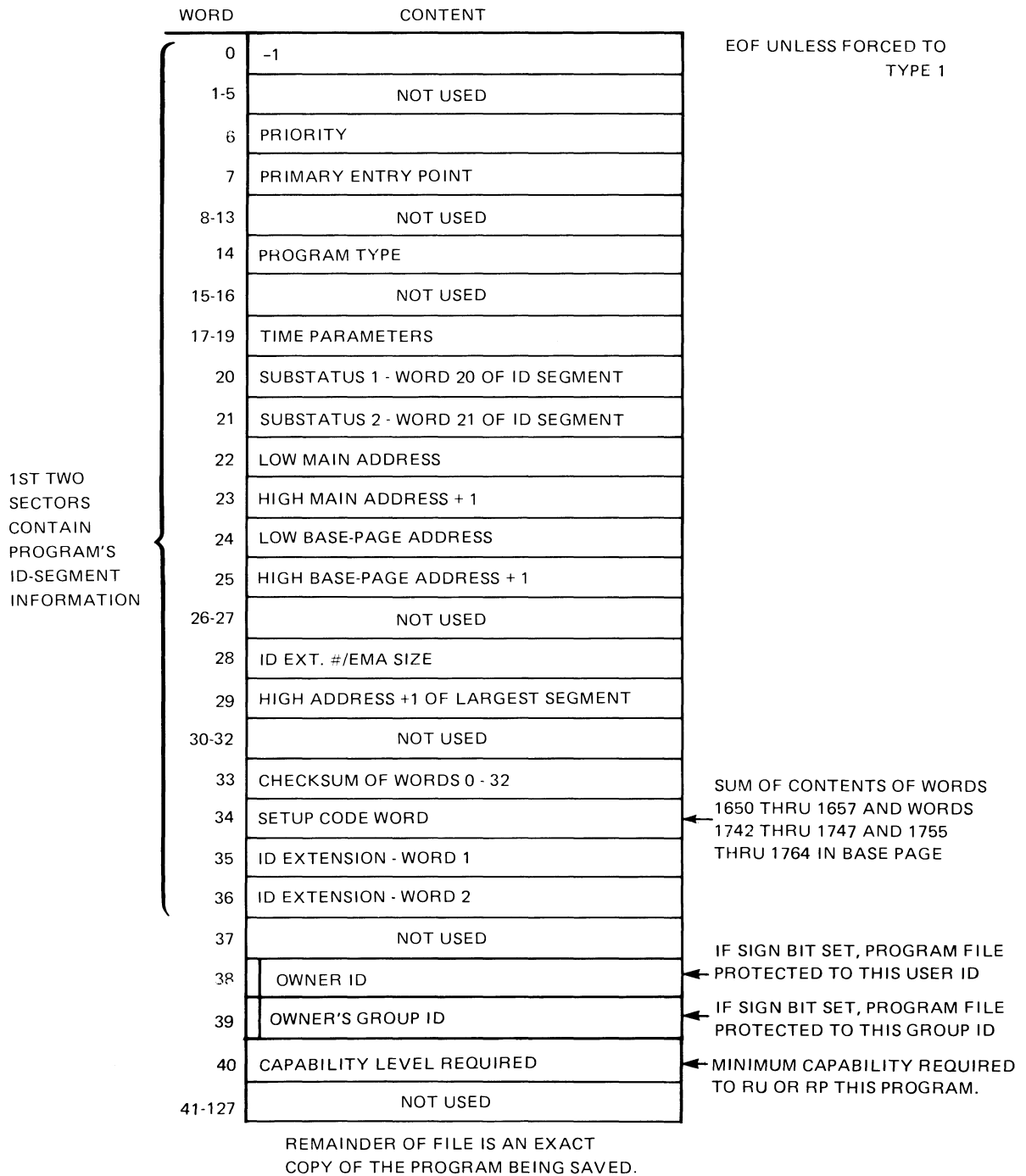



# Appendix E

## Differences Among RTE Operating System

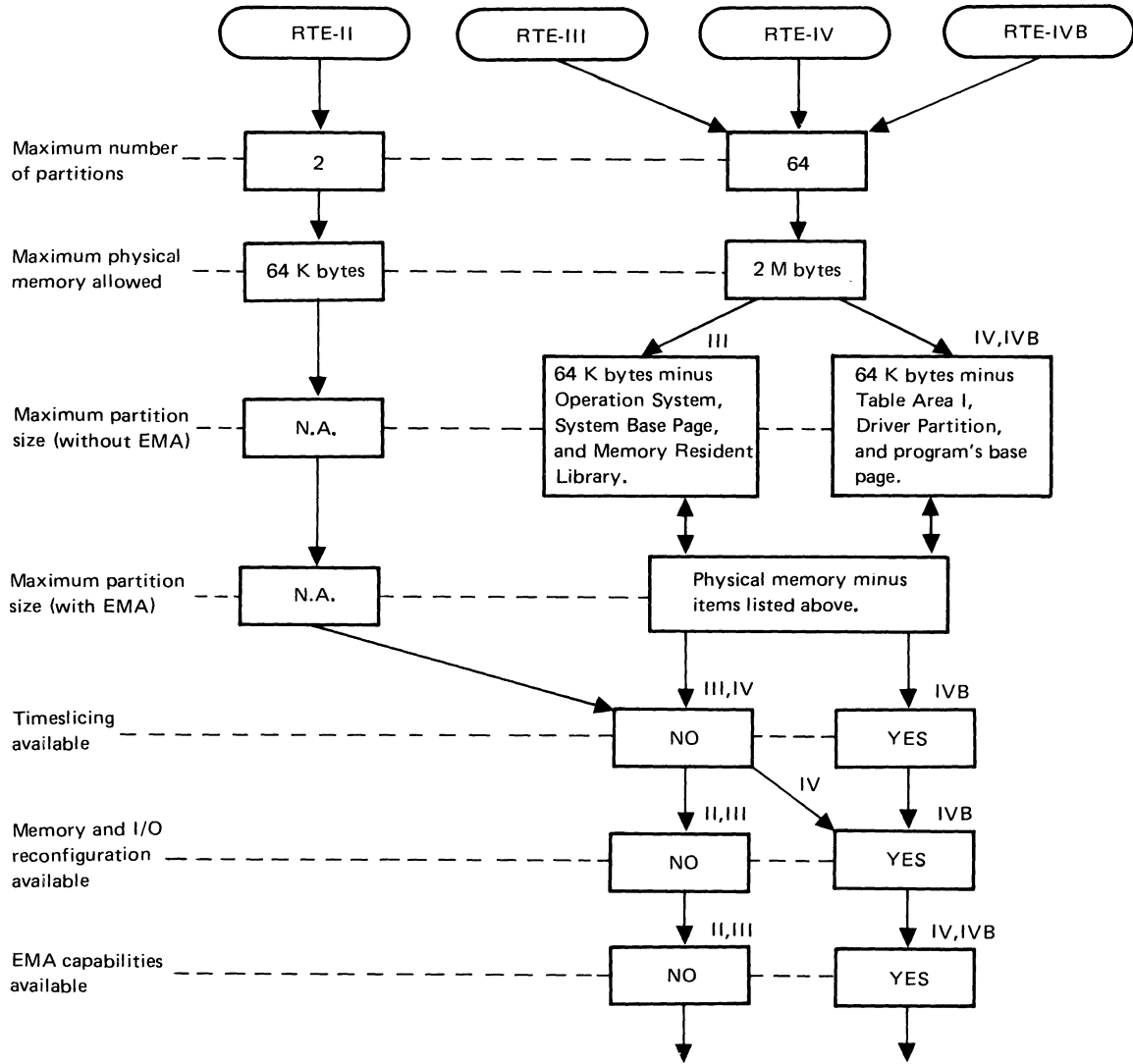

# Differences Among RTE Operating Systems

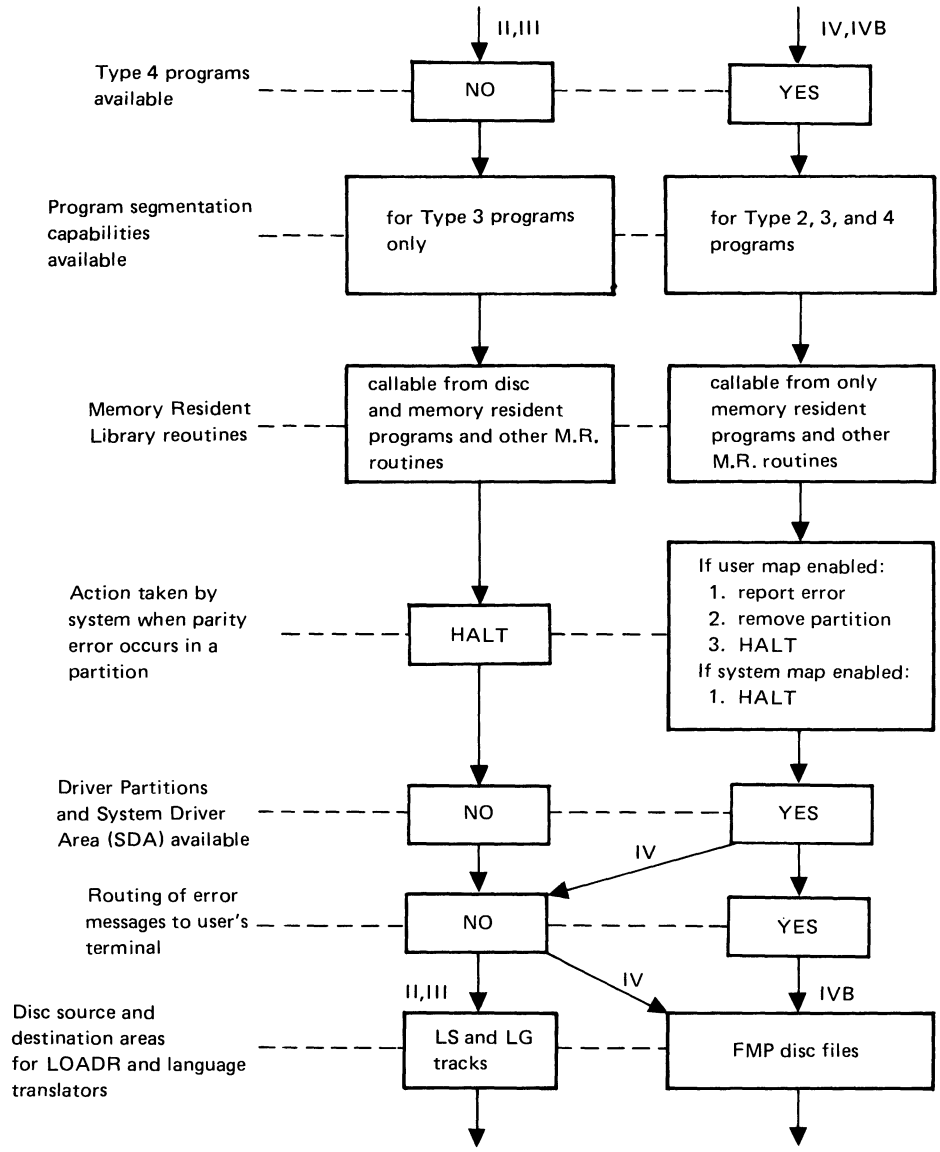

# Differences Among RTE Operating Systems

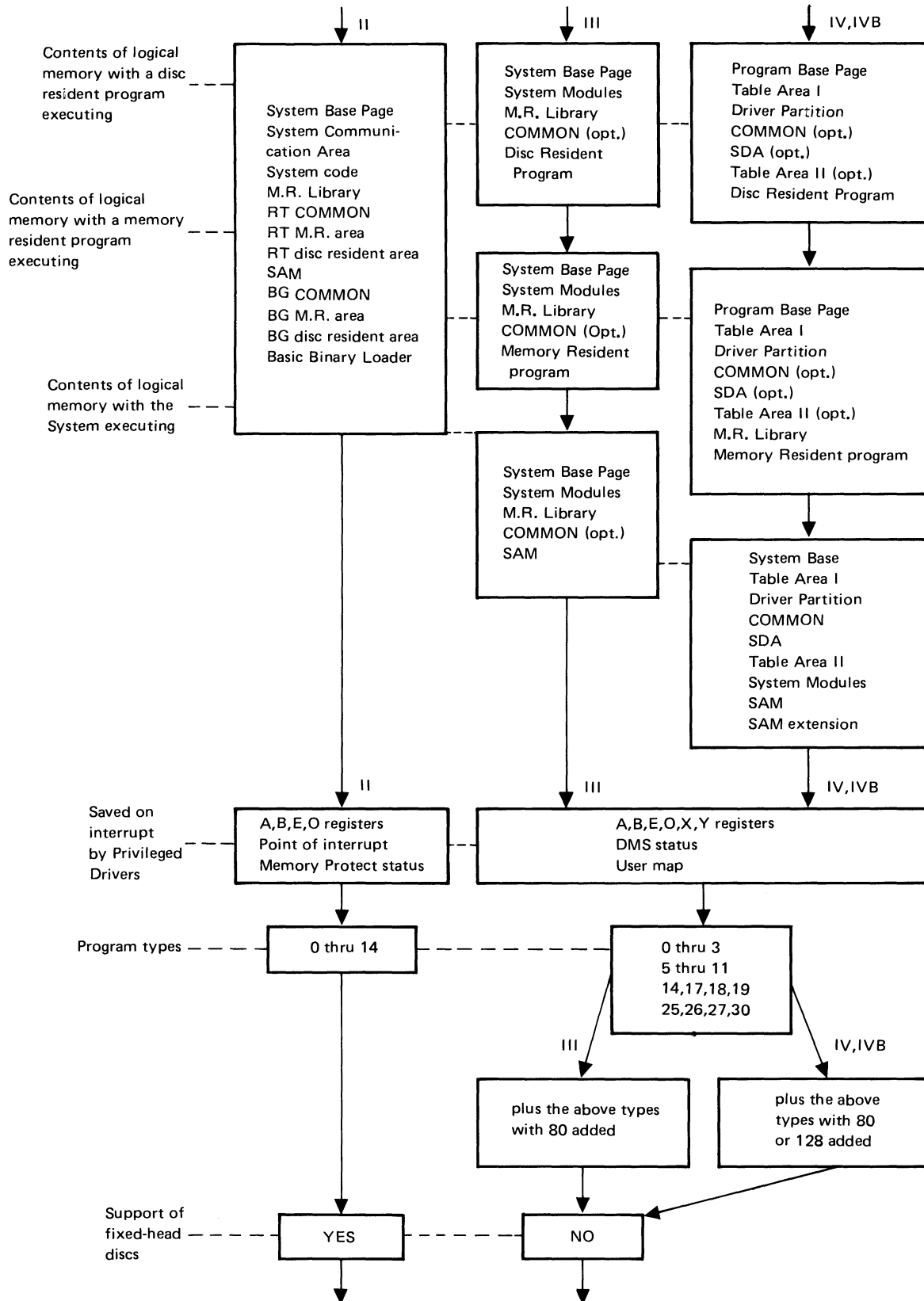

# Differences Among RTE Operating Systems

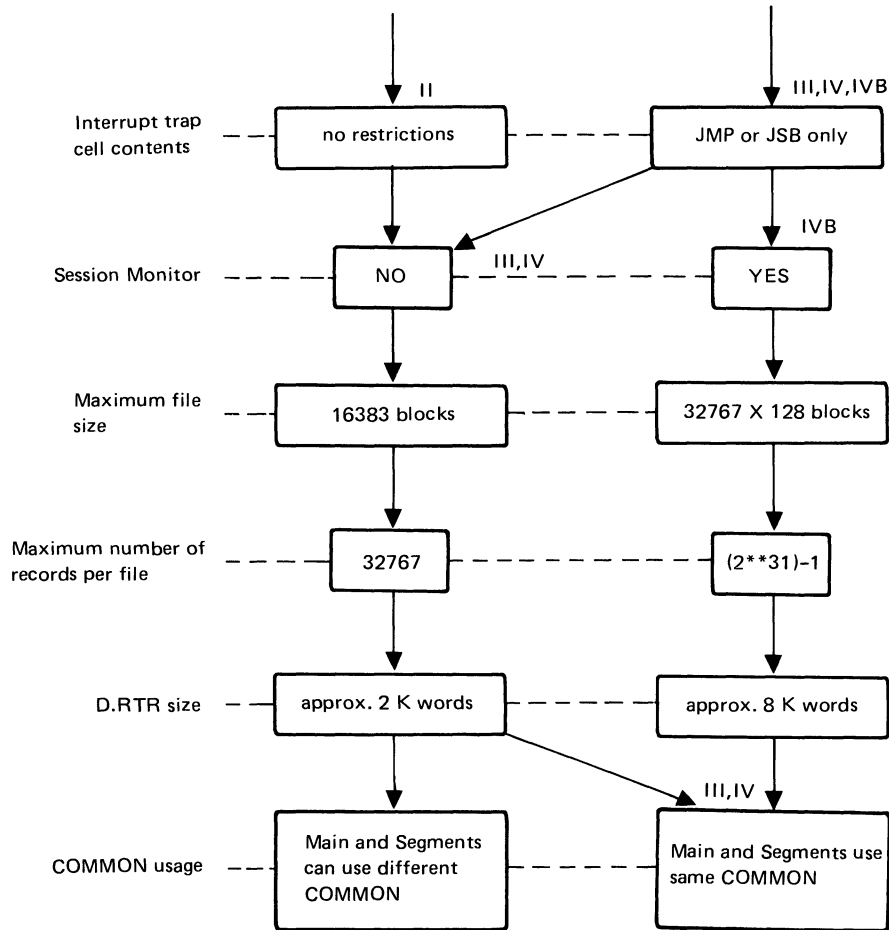

# Appendix F Program Types

Table F-1. Summary of RTE-IVB Program Types

| PROGRAM CATEGORY             | PROGRAM TYPE | COMMON ACCESS    |                   |      |                  |                  |             | LOAD POINT         |                      | MEMORY PROTECT FENCE |                      |
|------------------------------|--------------|------------------|-------------------|------|------------------|------------------|-------------|--------------------|----------------------|----------------------|----------------------|
|                              |              | REAL-TIME COMMON | BACKGROUND COMMON | SSGA | RT COMMON & SSGA | BG COMMON & SSGA | EMA ALLOWED | NO COMMON DECLARED | SOME COMMON DECLARED | NO COMMON DECLARED   | SOME COMMON DECLARED |
| EXECUTABLE PROGRAMS          | 1            | ✓                |                   |      |                  |                  |             | L <sub>1</sub>     | L <sub>1</sub>       | F <sub>5</sub>       | F <sub>3</sub>       |
|                              | 9            |                  | ✓                 |      |                  |                  |             | L <sub>1</sub>     | L <sub>1</sub>       | F <sub>5</sub>       | F <sub>4</sub>       |
|                              | 17           |                  |                   | ✓    |                  |                  |             | L <sub>1</sub>     | L <sub>1</sub>       | F <sub>1</sub>       | F <sub>1</sub>       |
|                              | 17           |                  |                   |      | ✓                |                  |             | L <sub>1</sub>     | L <sub>1</sub>       | F <sub>1</sub>       | F <sub>1</sub>       |
|                              | 25           |                  |                   |      |                  | ✓                |             | L <sub>1</sub>     | L <sub>1</sub>       | F <sub>1</sub>       | F <sub>1</sub>       |
| MEMORY RESIDENT*             | 2            | ✓                |                   |      |                  |                  | ✓           | L <sub>4</sub>     | L <sub>4</sub>       | F <sub>6</sub>       | F <sub>3</sub>       |
|                              | 10           |                  | ✓                 |      |                  |                  | ✓           | L <sub>4</sub>     | L <sub>4</sub>       | F <sub>6</sub>       | F <sub>4</sub>       |
|                              | 18           |                  |                   | ✓    |                  |                  | ✓           | L <sub>4</sub>     | L <sub>4</sub>       | F <sub>1</sub>       | F <sub>1</sub>       |
|                              | 18           |                  |                   |      | ✓                |                  | ✓           | L <sub>4</sub>     | L <sub>4</sub>       | F <sub>1</sub>       | F <sub>1</sub>       |
|                              | 26           |                  |                   |      |                  | ✓                | ✓           | L <sub>4</sub>     | L <sub>4</sub>       | F <sub>1</sub>       | F <sub>1</sub>       |
| REAL TIME DISC RESIDENT*     | 3            |                  | ✓                 |      |                  |                  | ✓           | L <sub>4</sub>     | L <sub>4</sub>       | F <sub>6</sub>       | F <sub>4</sub>       |
|                              | 11           | ✓                |                   |      |                  |                  | ✓           | L <sub>4</sub>     | L <sub>4</sub>       | F <sub>6</sub>       | F <sub>3</sub>       |
|                              | 19           |                  |                   | ✓    |                  |                  | ✓           | L <sub>4</sub>     | L <sub>4</sub>       | F <sub>1</sub>       | F <sub>1</sub>       |
|                              | 19           |                  |                   |      |                  | ✓                | ✓           | L <sub>4</sub>     | L <sub>4</sub>       | F <sub>1</sub>       | F <sub>1</sub>       |
|                              | 27           |                  |                   |      | ✓                |                  | ✓           | L <sub>4</sub>     | L <sub>4</sub>       | F <sub>1</sub>       | F <sub>1</sub>       |
| BACKGROUND DISC RESIDENT**†† | 4            |                  | ✓                 |      |                  |                  | ✓           | L <sub>3</sub>     | L <sub>2</sub>       | F <sub>2</sub>       | F <sub>4</sub>       |
|                              | 12           | ✓                |                   |      |                  |                  | ✓           | L <sub>3</sub>     | L <sub>2</sub>       | F <sub>2</sub>       | F <sub>3</sub>       |
|                              | 20           |                  |                   | ✓    |                  |                  | ✓           | L <sub>2</sub>     | L <sub>2</sub>       | F <sub>1</sub>       | F <sub>1</sub>       |
|                              | 20           |                  |                   |      |                  | ✓                | ✓           | L <sub>2</sub>     | L <sub>2</sub>       | F <sub>1</sub>       | F <sub>1</sub>       |
|                              | 28           |                  |                   |      | ✓                |                  | ✓           | L <sub>2</sub>     | L <sub>2</sub>       | F <sub>1</sub>       | F <sub>1</sub>       |

\*ADD 80 TO ANY OF THESE TYPES TO SPECIFY AUTOMATIC SCHEDULING AT SYSTEM STARTUP.

††ADD 128 TO ANY OF THESE TYPES TO SPECIFY THAT THE PROGRAM CANNOT BE DUPLICATED.

Table F-1. Summary of RTE-IVB Program Types (continued)

| SPECIAL PROGRAMS | TYPE | DESCRIPTION   |
|------------------|------|---|
| SYSTEM MODULE    | 0    | MODULE TO BE LOADED WITH RESIDENT SYSTEM. PART OF HP-SUPPLIED SYSTEM, USER-WRITTEN DRIVER, ETC.                           |
| PROGRAM SEGMENT  | 5    | OVERLAYABLE MODULE USED WITH DISC RESIDENT MAIN. COMMON TYPE, MEMORY-PROTECT FENCE ADDR. AND LOAD PT. DETERMINED BY MAIN. |
| SUBROUTINE       | 6    | RELOCATED INTO RESIDENT LIBRARY IF CALLED BY ANY MEMORY RESIDENT PROGRAM (ALWAYS BECOME 7'S).                             |
| SUBROUTINE       | 7    | STORED ON DISC IN RELOCATABLE FORM. ANY PROGRAM CALLING A TYPE 7 HAS A COPY APPENDED TO IT.                               |
| SUBROUTINE       | 8    | APPENDED TO CALLING PROGRAM. ALL TYPE 8 RELOCATABLES ARE DISCARDED AFTER GENERATION.                                      |
| TABLE AREA II    | 13   | MODULE TO BE LOADED WITH RESIDENT SYSTEM IN TABLE AREA II. PART OF HP-SUPPLIED SYSTEM, USER-WRITTEN TABLES, ETC.          |
| SUBROUTINE       | 14   | RELOCATED INTO RESIDENT LIBRARY, WHETHER CALLED OR NOT (ALWAYS BECOME TYPE 7).  |
| TABLE AREA I     | 15   | MODULE TO BE LOADED WITH RESIDENT SYSTEM IN TABLE AREA I. PART OF HP-SUPPLIED SYSTEM, USER-WRITTEN TABLES, ETC.           |
| SSGA MODULE      | 30   | RELOCATED INTO SUBSYSTEM GLOBAL AREA OF SYSTEM. ACCESSIBLE ONLY TO PROGRAMS OF PROPER TYPE (ABOVE).                       |

**LOAD POINT & FENCE DEFINITIONS**

- |  |  |
|--|--|
| L <sub>1</sub> - NEXT AVAILABLE LOCATION DURING LOAD OF RESIDENTS PLUS 2 | F <sub>1</sub> - FIRST WORD OF SSGA                            |
| L <sub>2</sub> - 35TH WORD OF NEXT PAGE AFTER COMMON AREAS               | F <sub>2</sub> - FIRST WORD OF PAGE FOLLOWING DRIVER PARTITION |
| L <sub>3</sub> - 35TH WORD OF NEXT PAGE AFTER DRIVER PARTITION           | F <sub>3</sub> - FIRST WORD OF RT COMMON                       |
| L <sub>4</sub> - 35TH WORD OF NEXT PAGE AFTER TABLE AREA II              | F <sub>4</sub> - FIRST WORD OF BG COMMON                       |
|  | F <sub>5</sub> - FIRST WORD OF RESIDENT PROGRAM AREA           |
|  | F <sub>6</sub> - FIRST WORD OF PAGE FOLLOWING TABLE AREA II    |



# Appendix G

## Table Areas I and II Entry Points

TABLE AREA I entry points are as follows:

|        |        |        |        |
|--------|--------|--------|--------|
| \$ERAB | \$PVCN | EXEC   | \$LIBR |
| \$LIBX | \$PVST | \$UPIO | \$CIC  |
| \$XCIC | \$YCIC | \$UIN  | \$UCON |
| \$XEQ  | \$XDMP | \$IDLE | \$SCD3 |
| \$IDNO | \$MEU  | \$LIST | \$MESS |
| \$WORK | \$SOP  | \$ULLU | \$CGRN |
| \$MTM  | \$OPSY |        |        |
| \$ERRA | \$LBR  | \$LBX  | \$XEX  |
| \$UP   | \$CICO | \$CXC  | \$CYC  |
| \$CON1 | \$CON2 | \$CON3 | \$XCQ  |
| \$XDM  | \$SCD  | SID#   | \$LST  |
| \$MSG  | \$IDSM | \$OP   | \$ULU  |
| \$CRN# |        |        |        |

TABLE AREA II entry points are as follows:

|        |        |        |        |
|--------|--------|--------|--------|
| \$MATA | \$MCHN | \$MBGP | \$MRTP |
| \$DLTH | \$DVPT | \$TIME | \$BATM |
| \$DLP  | \$PLP  | \$ENDS | \$MPFT |
| \$BGFR | \$RIFR | \$IDEX | \$MRMP |
| \$MPS2 | \$EMRP | \$MPSA | \$SDA  |
| \$SDT2 | \$CMST | \$COML | \$CFR  |
| \$MNP  | \$DVMP | \$RLB  | \$RLN  |
| \$SBTB |        |        |        |



# Appendix H

## HELP File Listing

HELP INFO FILE FOR PROGRAM 92067-18121

""

REV

"HELP 92067-18122 REV.2026 800430 RTE-IVB HELP FILE

""

FMGR-102

ILLEGAL D.RTR CALL SEQUENCE

A LOCK WAS NOT REQUESTED FIRST OR THE FILE WAS NOT OPENED EXCLUSIVELY. POSSIBLY AN OPERATOR ERROR, SUCH AS REMOVING A CARTRIDGE WITHOUT DISMOUNTING IT FIRST.

""

FMGR-101

ILLEGAL PARAMETER IN D.RTR CALL

POSSIBLY AN OPERATOR ERROR. RECHECK THE PREVIOUS ENTRIES FOR ILLEGAL OR MISPLACED PARAMETERS.

THIS ERROR CAN ALSO HAPPEN WHEN A REQUEST IS MADE TO CREATE A SCRATCH FILE AND THAT SCRATCH FILE ALREADY EXISTS. IF D.RTR IS UNABLE TO PURGE THE EXISTING SCRATCH FILE, THIS ERROR IS RETURNED. THIS CAN ONLY HAPPEN IF SOME OTHER PROGRAM HAS THE SCRATCH FILE OPEN. SEE THE SYSTEM MANAGER.

""

FMGR-099

DIRECTORY MANAGER EXEC REQUEST WAS ABORTED

AN EXEC REQUEST MADE BY D.RTR WAS ABORTED. MAKE SURE THAT ALL DISCS BEING ACCESSED ARE UP. NOTIFY SYSTEM MANAGER.

""

FMGR-048

SPOOL NOT INITIALIZED OR SMP CANNOT BE SCHEDULED

IF SPOOLING NOT INITIALIZED RUN GASP TO DO SO. OTHERWISE, SMP PROGRAM IS NOT FOUND OR THERE IS NOT A BIG ENOUGH PARTITION TO RUN SMP. THE DEFAULT FOR SMP IS TYPE 2 (REALTIME) AND 6 PAGES IN SIZE.

""

FMGR-047

NO SESSION LU AVAILABLE FOR SPOOL FILE

IF THE SESSION LU TO BE USED FOR THE SPOOL FILE IS NOT SPECIFIED DURING SET UP, SMP ALLOCATES A SESSION LU LESS THAN 64 THAT IS NOT ALREADY USED IN THE SESSION SWITCH TABLE. USE :SL,LU,- COMMAND TO RELEASE A SESSION LU IN THE SPARE PART OF THE SESSION SWITCH TABLE.

## HELP File Listing

""

### FMGR-046

GREATER THAN 255 EXTENTS  
ATTEMPT TO CREATE EXTENT 256. MAKE FILE SIZE OF MAIN LARGER.  
IF GENERATED DURING A SM COMMAND, THE MESSAGE IS NOT PUT IN THE  
MESSAGE FILE. IT IS TRUNCATED AT THE LAST VALID MESSAGE.

""

### FMGR-041

NO ROOM IN SST  
THERE ARE NO SPARE ENTRIES LEFT IN THE SESSION SWITCH TABLE. SPARE  
ENTRIES CAN BE RECOVERED BY USING THE :SL,LU,- COMMAND, WHERE LU IS  
A SESSION LOGICAL UNIT NUMBER THAT IS NOT NEEDED.

""

### FMGR-040

LU NOT FOUND IN SST  
TRYING TO ACCESS AN LU THAT IS NOT IN YOUR SESSION SWITCH TABLE.  
USE THE SL COMMAND TO ADD THE LU TO THE SST.

""

### FMGR-039

SPOOL LU NOT MAPPED TO THE SPOOL DRIVER  
SPOOL LU MUST POINT TO A SPOOL EQT. SWITCH ALL SPOOL LU'S TO POINT TO  
SPOOL EQT'S AND TRY THE SPOOL FILE SET UP AGAIN.

""

### FMGR-038

ILLEGAL SCRATCH FILE NUMBER  
ATTEMPT TO CREATE A SCRATCH FILE WILL AN ILLEGAL SCRATCH FILE NUMBER.  
THE RANGE FOR SCRATCH FILE NUMBERS IS 0 THROUGH 99. ISSUE CREATE AGAIN  
WITH A NUMBER IN THE CORRECT RANGE.

""

### FMGR-036

LOCK ERROR ON DEVICE  
A CALL TO OPENF CAUSED AN ATTEMPTED LOCK ON A DEVICE AND THAT LOCK  
WAS UNSUCCESSFUL. THIS COULD HAPPEN IF THE DEVICE IS ALREADY LOCKED  
OR IF THERE ARE NO RESOURCE NUMBERS AVAILABLE.

""

### FMGR-035

ALREADY 63 DISCS MOUNTED TO SYSTEM  
AN ATTEMPT WAS MADE TO MOUNT A DISC WHEN THERE ARE ALREADY 63 DISCS  
MOUNTED. A DISC WILL HAVE TO BE DISMOUNTED BEFORE A NEW ONE MAY BE  
MOUNTED.

""

### FMGR-034

DISC ALREADY MOUNTED.  
AN ATTEMPT WAS MADE TO MOUNT A DISC THAT IS ALREADY MOUNTED IN THE  
CARTRIDGE DIRECTORY. EITHER DISMOUNT THE DUPLICATE DISC OR MOUNT A  
DIFFERENT ONE.

""

FMGR-033

NOT ENOUGH ROOM ON CARTRIDGE

AN ATTEMPT WAS MADE TO ACCESS A CARTRIDGE WHICH DOES NOT HAVE ENOUGH ROOM. TRY USING ANOTHER CARTRIDGE OR DECREASE THE FILE SIZE.

""

FMGR-032

CARTRIDGE NOT FOUND

AN ATTEMPT WAS MADE TO ACCESS A CARTRIDGE THAT CANNOT BE FOUND IN THE CARTRIDGE LIST. CHECK THE CARTRIDGE NUMBER FOR CORRECTNESS.

""

FMGR-030

VALUE TOO LARGE FOR PARAMETER

1. THE VALUE SUPPLIED IN THE PARAMETER IS BEYOND THE DEFINED RANGE.
2. THIS ERROR CAN BE GENERATED WHEN A PARAMETER IS SUPPLIED FOR THE PURPOSE OF GETTING RETURN INFORMATION FROM A ROUTINE. IF THE PARAMETER SUPPLIED IS A SINGLE WORD BUT THE VALUE OF THE INFORMATION TO BE RETURNED IS A DOUBLE WORD, THE ERROR WILL BE GENERATED.

""

FMGR-026

QUEUE FULL OR MAX PENDING SPOOLS EXCEEDED

THE SPOOL QUEUE IS FULL OR THE MAXIMUM NUMBER OF SPOOLS PENDING HAS BEEN EXCEEDED. THE JOB MUST BE RE-RUN WHEN THE SPACE BECOMES AVAILABLE.

""

FMGR-025

NO SPLCON ROOM

THE SPLCON IS FULL. THIS ERROR MAY OCCUR WHEN THE SPOOL SYSTEM IS COMPETING WITH PROGRAMS USING THEIR OWN SPOOLING FILE AND RUNNING OUTSIDE OF BATCH.

""

FMGR-024

NO MORE BATCH SWITCHES

THE LU SWITCH TABLE IS FULL. THE SIZE OF THE SWITCH TABLE SPECIFIED AT SYSTEM GENERATION IS INADEQUATE. NOTIFY THE SYSTEM MANAGER OF THIS CONDITION.

""

FMGR-023

NO AVAILABLE SPOOL FILES

ALL SPOOL FILES ARE CURRENTLY BEING USED. RE-RUN THE JOB AFTER A SPOOL FILE BECOMES AVAILABLE.

""

FMGR-022

NO AVAILABLE SPOOL LU'S

ALL SPOOL LOGICAL UNITS ARE CURRENTLY UNAVAILABLE. RE-RUN THE JOB AFTER A SPOOL LU BECOMES AVAILABLE.

HELP File Listing

""

FMGR-021

ILLEGAL DESTINATION LU

THE LU SPECIFIED WAS NOT ALLOCATED BY GASP. TRY AGAIN USING A LU ALLOCATED BY GASP.

""

FMGR-020

ILLEGAL ACCESS LU

1. THE LOGICAL UNIT NUMBER SPECIFIED IN THE LU OR CS COMMAND WAS NOT A POSITIVE LOGICAL UNIT NUMBER. RE-ENTER THE CORRECTED COMMAND. OR
2. THERE IS AN LU ENTRY IN THE CARTRIDGE LIST THAT DOES NOT POINT TO A DISC DEVICE. THIS HAPPENED BECAUSE AFTER THE DISC WAS MOUNTED THE LU COMMAND WAS USED TO DO A LOGICAL UNIT SWITCH ON THE DEVICE. SWITCH THE LU BACK TO ITS DISC DEFINITION. IF DESIRED, DISMOUNT THE DISC. THE LU CAN THEN BE SWITCHED TO A NON-DISC DEVICE.

""

FMGR-019

ILLEGAL ACCESS ON A SYSTEM DISC

AN ATTEMPT WAS MADE TO WRITE ON A SYSTEM DISC. THE SYSTEM MANAGER IS THE ONLY USER THAT HAS THIS CAPABILITY.

""

FMGR-018

ILLEGAL LU

ATTEMPT TO ACCESS AN LU THAT IS (1) NOT ASSIGNED TO THE SYSTEM, OR (2) IS NOT DEFINED IN THE USER'S SESSION SWITCH TABLE (SST).

""

FMGR-017

ILLEGAL READ/WRITE ON TYPE 0 FILE

1. AN ATTEMPT WAS MADE TO READ, WRITE, OR POSITION A TYPE 0 FILE THAT DOES NOT SUPPORT THE OPERATION. THIS ERROR MAY ALSO OCCUR ON AN ATTEMPT TO PERFORM SUCH AN OPERATION ON A SPOOL FILE WHICH DOES NOT SUPPORT THE OPERATION (E.G., AN ATTEMPTED WRITE ON A READ-ONLY SPOOL FILE). CHECK THE FILE PARAMETERS OR THE NAMR.
2. WRITING TO A SPOOL FILE AND THERE IS NO MORE ROOM ON CARTRIDGE.

""

FMGR-016

ILLEGAL TYPE 0 OR SIZE=0

ONE OF THE FOLLOWING OCCURRED:

- 1) THE WRONG FILE TYPE WAS SPECIFIED,
  - 2) AN ATTEMPT WAS MADE TO CREATE OR PURGE A TYPE 0 FILE, OR
  - 3) THE SIZE SPECIFIED WAS ZERO.
- CHECK THE SIZE AND TYPE PARAMETERS.

""

FMGR-015

ILLEGAL NAME

THE FILE NAME DOES NOT CONFORM TO THE SYNTAX RULES. CORRECT THE NAME AND RE-ENTER THE COMMAND.

""

FMGR-014

DIRECTORY FULL

THERE IS NO MORE ROOM IN THE FILE DIRECTORY. PURGE ANY UNUSED FILES AND PACK THE DISC IF POSSIBLE. OTHERWISE, TRY ANOTHER CARTRIDGE.

""

FMGR-013

DISC LOCKED

THE CARTRIDGE SPECIFIED IS LOCKED. INITIALIZE THE CARTRIDGE IF IT WAS NOT INITIALIZED, OTHERWISE KEEP TRYING.

""

FMGR-012

EOF OR SOF ERROR

AN ATTEMPT WAS MADE TO READ, WRITE, OR POSITION A FILE BEYOND THE FILE BOUNDARIES. CHECK THE RECORD POSITION PARAMETERS. THE RESULTS DEPEND ON THE FILE TYPE AND THE CALL.

""

FMGR-011

DCB NOT OPEN

AN ATTEMPT WAS MADE TO ACCESS AN UNOPENED DCB. USE THE CREATE OR OPEN CALL TO OPEN THE DCB AND CHECK FOR ERRORS.

""

FMGR-010

NOT ENOUGH PARAMETERS

ONE OR MORE OF THE REQUIRED PARAMETERS WERE OMITTED FROM THE CALL. ENTER THE REQUIRED PARAMETERS.

""

FMGR-009

ATTEMPT TO USE A POSN OR FORCE TO 1 A TYPE 0 FILE

A TYPE 0 FILE CANNOT BE POSITIONED WITH A POSN OR BE FORCED TO A TYPE 1 FILE. CHECK THE FILE TYPE.

""

FMGR-008

FILE OPEN OR LOCK REJECTED

AN ATTEMPT WAS MADE TO OPEN A FILE THAT WAS ALREADY OPENED EXCLUSIVELY OR WAS ALREADY OPENED TO SEVEN PROGRAMS, OR THE CARTRIDGE CONTAINING THE FILE IS LOCKED. USE THE CL OR DL COMMAND TO LOCATE THE LOCK. IF THE CARTRIDGE IS BEING PACKED, CHECK TO SEE IF SPOOLING IS SHUT DOWN.

""

FMGR-007

ILLEGAL SECURITY CODE OR ILLEGAL WRITE ON LU2 OR 3

1. AN ATTEMPT WAS MADE TO ACCESS A FILE WITHOUT SPECIFYING THE SECURITY CODE OR WITH THE WRONG SECURITY CODE. FIND OUT THE CORRECT CODE AND USE IT OR DO NOT ACCESS THE FILE. OR
2. AN ATTEMPT WAS MADE BY A SESSION USER (NOT THE SYSTEM MANAGER) TO WRITE ON LU 2 OR 3. SESSION USERS DO NOT HAVE WRITE ACCESS TO LU 2 OR 3.

## HELP File Listing

""

FMGR-006

FILE NOT FOUND

AN ATTEMPT WAS MADE TO ACCESS A FILE THAT CANNOT BE FOUND. CHECK THE FILE NAME OR THE CARTRIDGE REFERENCE.

""

FMGR-005

RECORD LENGTH ILLEGAL

AN ATTEMPT WAS MADE TO READ OR POSITION A FILE TO A RECORD THAT HAS NOT BEEN WRITTEN, OR TO WRITE AN ILLEGAL RECORD LENGTH ON AN UPDATE. CHECK THE FILE POSITION OR SIZE PARAMETER.

""

FMGR-004

RECORD SIZE OF TYPE 2 FILE IS 0 OR UNDEFINED

AN ATTEMPT WAS MADE TO CREATE A TYPE 2 FILE WITHOUT SPECIFYING THE RECORD SIZE OR SPECIFYING IT TO BE 0. CHECK THE SIZE PARAMETER.

""

FMGR-003

BACKSPACE ILLEGAL

AN ATTEMPT WAS MADE TO BACKSPACE A DEVICE (OR TYPE 0 FILE) THAT CANNOT BE BACKSPACED. CHECK THE DEVICE TYPE.

""

FMGR-002

DUPLICATE FILE NAME

A FILE ALREADY EXISTS WITH THE NAME SPECIFIED. REPEAT THE COMMAND WITH A NEW NAME OR PURGE THE EXISTING FILE.

""

FMGR-001

DISC ERROR

THE DISC IS DOWN. TRY AGAIN AND THEN REPORT THE PROBLEM TO THE SYSTEM MANAGER.

""

FMGR 000

BREAK

THIS IS AN INFORMATIVE MESSAGE ONLY. NO ERROR HAS OCCURRED.

""

FMGR 001

DISC ERROR - LU REPORTED

THE DISC ASSOCIATED WITH THE LU REPORTED IS DOWN. REPORT THE PROBLEM TO THE SYSTEM MANAGER.

EXAMPLE: FMGR 001 THIS 2-LINE MESSAGE INDICATES A DISC ERROR  
FMGR 034 HAS BEEN DETECTED ON DISC LU 34.



""

## FMGR 002

INITIALIZE LU 2!

THIS ERROR INDICATES A REQUEST FOR THE USER TO INITIALIZE THE SYSTEM DISC (LU 2) BY ASSIGNING SPECIFIC SYSTEM TRACKS TO FMGR. BEFORE IT IS INITIALIZED, FMGR OBTAINS ALL THE AVAILABLE TRACKS ON THE SYSTEM AND AUXILIARY DISCS AND ASSIGNS THEM TO ITSELF. AFTER IT IS INITIALIZED, FMGR OWNS ONLY THOSE TRACKS SPECIFICALLY ASSIGNED TO IT. THEREAFTER, EACH TIME THE SYSTEM IS LOADED FROM DISC (BOOTED UP), IT RECOVERS THESE TRACKS AUTOMATICALLY AND NO FURTHER INITIALIZATION IS REQUIRED. TO INITIALIZE THE SYSTEM DISC, USE THE FMGR INITIALIZE (IN) COMMAND.

EXAMPLE: IN,SC,-2,2,SYS,100

THIS COMMAND WOULD INITIALIZE LU 2, SETTING THE MASTER SECURITY CODE TO "SC", THE CRN TO 2, THE ASCII LABEL TO "SYS" AND THE STARTING FMP DISC TRACK TO 100.

THE STARTING FMP TRACK MUST BE AT LEAST 8 TRACKS GREATER THAN THE LAST TRACK USED BY THE SYSTEM. (SYSTEM SIZE IS REPORTED AT THE END OF SYSTEM GENERATION.)

""

## FMGR 003

INITIALIZE LU 3!

THIS ERROR INDICATES A REQUEST FOR THE USER TO INITIALIZE THE AUXILIARY DISC (LU 3) BY ASSIGNING SPECIFIC SYSTEM TRACKS TO FMGR. BEFORE IT IS INITIALIZED, FMGR OBTAINS ALL THE AVAILABLE TRACKS ON THE SYSTEM AND AUXILIARY DISCS AND ASSIGNS THEM TO ITSELF. AFTER IT IS INITIALIZED, FMGR OWNS ONLY THOSE TRACKS SPECIFICALLY ASSIGNED TO IT. THEREAFTER, EACH TIME THE SYSTEM IS LOADED FROM DISC (BOOTED UP), FMGR RECOVERS THESE TRACKS AUTOMATICALLY AND NO FURTHER INITIALIZATION IS REQUIRED. TO INITIALIZE THE AUXILIARY DISC, USE THE FMGR INITIALIZE (IN) COMMAND.

EXAMPLE: IN,SC,-3,3,AUX,70

THIS COMMAND WOULD INITIALIZE LU 3, SETTING THE CRN TO 3, THE ASCII LABEL TO "AUX" AND THE STARTING FMP DISC TRACK TO 70.

IF AUXILIARY DISC TRACKS ARE NOT TO BE ASSIGNED TO FMGR, THE INITIALIZE COMMAND SHOULD STILL BE SPECIFIED IN RESPONSE TO FMGR 003, BUT THE CARTRIDGE REFERENCE NUMBER SHOULD BE SPECIFIED AS 0.

""

## FMGR 004

ILLEGAL RESPONSE TO FMGR 002 OR FMGR 003

A COMMAND OTHER THAN AN INITIALIZE COMMAND WAS ENTERED IN RESPONSE TO EITHER A FMGR 002 OR FMGR 003 ERROR. ENTER THE APPROPRIATE INITIALIZE COMMAND.

## HELP File Listing

""

FMGR 005  
REQUIRED TRACK NOT AVAILABLE - RELATIVE TAT POSITION REPORTED  
THE FIRST TRACK SPECIFIED IN THE INITIALIZE COMMAND IS NOT AVAILABLE.  
NOTE THAT THE STARTING TRACK MUST BE AT LEAST 8 TRACKS GREATER THAN  
THE LAST TRACK USED BY THE SYSTEM. RE-ENTER THE INITIALIZE COMMAND  
WITH THE FIRST AVAILABLE TRACK REPORTED IN THIS MESSAGE.

""

FMGR 006  
FMGR SUSPENDED  
THE FILE MANAGER SUSPENDED ITSELF. RE-ENTER THE DOWN DEVICE AND ENTER  
'GO,FMGR'.

""

FMGR 007  
CHECKSUM ERROR  
A CHECKSUM ERROR OCCURRED WHEN READING A PAPER TAPE OR THE FILE BEING  
READ IS NOT BINARY (TYPE 5 OR 7). CHECK THE FILE TYPE.

""

FMGR 008  
D.RTR NOT LOADED  
THE PROGRAM D.RTR WAS NOT FOUND IN THE SYSTEM. LOAD D.RTR AS A  
PERMANENT PROGRAM.

""

FMGR 009  
ID SEGMENT NOT FOUND  
AN RP COMMAND WAS USED TO DEALLOCATE OR REASSIGN THE ID SEGMENT TO  
THE PROGRAM BEING RESTORED. THE SYSTEM LOOKS FOR A BLANK ID SEGMENT.

""

FMGR 010  
INPUT ERROR  
A SYNTAX ERROR IN THE STATEMENT OCCURRED. LOOK FOR A MISSING COLON  
(BATCH INPUT) OR EXTRA COLON (INTERACTIVE INPUT), AN UNDEFINED COMMAND,  
AN ERROR IN THE NAMR SUBPARAMETERS, A COMMAND THAT IS TOO LONG, ETC.  
RE-ENTER THE COMMAND. IF RECEIVED AFTER ENTERING AN ABORT COMMAND,  
THERE WERE NO ACTIVE JOBS.

""

FMGR 011  
DO 'OF,XXXXX,8' ON NAMED PROGRAMS  
AN ATTEMPT WAS MADE TO PACK A DISC TO WHICH THE NAMED PROGRAMS ARE STILL  
ALLOCATED. ENTER EITHER 'RP,NAMR,PROGRAM' OR 'OF,PROGRAM,8' TO REMOVE  
THE NAMED PROGRAMS.

""

FMGR 012

DUPLICATE DISC LABEL OR LU

AN ATTEMPT WAS MADE TO MOUNT A CARTRIDGE THE SAME LABEL OR LOGICAL UNIT NUMBER OF A CARTRIDGE THAT IS ALREADY MOUNTED. RE-ENTER THE THE COMMAND WITH ANOTHER LABEL OR LU, OR DISMOUNT THE DUPLICATE CARTRIDGE. THE ERROR MAY ALSO OCCUR IF THE USER DISMOUNTS A PRIVATE CARTRIDGE FROM HIS SESSION AND ATTEMPTS TO RE-MOUNT IT AS A GROUP CARTRIDGE, OR CONVERSELY, IF HE DISMOUNTS A GROUP CARTRIDGE FROM HIS SESSION AND ATTEMPTS TO RE-MOUNT IT AS A PRIVATE CARTRIDGE (DEFAULT).

""

FMGR 013

TR STACK OVERFLOW

MORE THAN 10 NESTED TR COMMANDS HAVE BEEN USED.

""

FMGR 014

REQUIRED ID SEGMENT NOT FOUND

AN ID SEGMENT CANNOT BE FOUND FOR THE SPECIFIED PROGRAM. CHECK THE PROGRAM NAME OR LOAD THE PROGRAM. A BLANK ID SEGMENT CANNOT BE FOUND FOR A PROGRAM BEING RESTORED. ENTER AN 'OF' COMMAND TO RELEASE AN ID SEGMENT.

""

FMGR 015

LS TRACK REPORT

THIS IS AN INFORMATIVE MESSAGE TO REPORT THE LOGICAL UNIT NUMBER AND TRACK OF THE CURRENT LS AREA.

""

FMGR 016

INSUFFICIENT SYSTEM TRACKS FOR RP

AN ATTEMPT WAS MADE TO RESTORE A PROGRAM FILE THAT IS NOT ON THE SYSTEM OR AUXILIARY DISC AND THERE IS INSUFFICIENT SPACE IN THE SYSTEM TRACK POOL TO COPY THE PROGRAM. EITHER WAIT UNTIL MORE TRACK POOL SPACE BECOMES AVAILABLE, OR MOVE THE FILE TO LU 2 OR LU 3, AND THEN RE-ENTER THE COMMAND.

""

FMGR 017

ID SEGMENT NOT SET UP BY RP

IN ORDER FOR AN ID SEGMENT TO BE RELEASED BY A 'RP' COMMAND, IT MUST HAVE BEEN SET UP BY A 'RP' COMMAND. TRY USING 'OF,PROGRAM' TO RELEASE THE SPECIFIED PROGRAM.

""

FMGR 018

PROGRAM NOT DORMANT

AN 'RP,NAMR,PROGRAM' COMMAND WAS ATTEMPTED WHEN THE PROGRAM IS ACTIVE. ENTER 'OF,PROGRAM' AND THEN REPEAT THE 'RP' COMMAND.

## HELP File Listing

""

FMGR 019

FILE NOT SET UP BY SP ON CURRENT SYSTEM  
THE PROGRAM FILE BEING RESTORED HAD A PARITY ERROR, WAS NOT SET UP  
CORRECTLY, OR WAS NOT SET UP BY A 'SP' COMMAND IN THE CURRENT SYSTEM.  
RELOAD THE PROGRAM AND TRY AGAIN.

""

FMGR 020

ILLEGAL TYPE 0 FILE  
AN ATTEMPT WAS MADE TO CREATE A TYPE 0 FILE ON A LOGICAL UNIT THAT IS  
NOT ASSIGNED IN THE SYSTEM. RE-ENTER THE COMMAND USING ANOTHER LOGICAL  
UNIT.

""

FMGR 021

ILLEGAL DISC SPECIFIED  
AN ATTEMPT WAS MADE TO COPY FILES TO OR FROM THE SAME DISC OR A DISC  
THAT IS NOT MOUNTED. MOUNT ANOTHER DISC OR USE ANOTHER ALREADY MOUNTED.

""

FMGR 022

COPY TERMINATED  
COPY HAS BEEN TERMINATED AS A RESULT OF COPY ERROR. CHECK THE  
PARAMETERS AND THE SPECIFIED DISCS.

""

FMGR 023

DUPLICATE PROGRAM NAME  
THE PROGRAM BEING RESTORED IS ALREADY DEFINED IN THE SYSTEM. CHANGE THE  
NAME OF THE PROGRAM, ENTER 'OF,PROGRAM', OR RELEASE THE ID SEGMENT.

""

FMGR 041

PROGRAM CANNOT BE A SEGMENT  
THE PROGRAM SPECIFIED IS A PROGRAM SEGMENT (TYPE 5). LS TRACKS  
CANNOT BE ASSIGNED TO A PROGRAM SEGMENT. ORDINARILY, THE LS TRACKS  
ARE ASSIGNED TO THE PROGRAM EDITR WHEN MS IS EXECUTED. IF THE LS  
TRACKS ARE TO BE ASSIGNED TO A DIFFERENT PROGRAM, SPECIFY THIS  
PROGRAM'S NAME.

""

FMGR 042

LU CANNOT BE SWITCHED  
AN ATTEMPT WAS MADE TO SWITCH A LOGICAL UNIT WHICH CANNOT BE SWITCHED.  
IF A DISC LU, THE SESSION LU MUST BE THE SAME AS THE SYSTEM LU.  
SESSION LU 1 CANNOT BE SWITCHED.

""

FMGR 043

LU NOT FOUND IN SST  
AN ATTEMPT WAS MADE TO ACCESS A LOGICAL UNIT THAT IS NOT DEFINED IN  
THE USER'S SESSION SWITCH TABLE. USE THE SL COMMAND TO ADD THE LU  
TO THE SST.

""

FMGR 044  
NO MESSAGES WAITING  
CALLER ISSUED A ME COMMAND BUT THERE WERE NO MESSAGES WAITING TO  
BE READ.

""

FMGR 045  
SESSION COMMAND ONLY  
THE SPECIFIED COMMAND OPERATES ONLY IN THE SESSION ENVIRONMENT.

""

FMGR 046  
INSUFFICIENT CAPABILITY  
AN ATTEMPT WAS MADE TO EXECUTE A COMMAND THAT REQUIRES A HIGHER CAPABILITY  
LEVEL THAN THE CAPABILITY LEVEL DEFINED FOR THIS SESSION USER. THE  
USER'S CAPABILITY LEVEL CAN BE DISPLAYED USING THE FMGR COMMAND :DP,9P.  
TO INCREASE YOUR COMMAND CAPABILITY LEVEL, SEE THE SYSTEM MANAGER.

""

FMGR 047  
SPOOL SET UP FAILED  
THERE ARE NO AVAILABLE SPOOL FILES OR LOGICAL UNITS, OR THE LOGICAL UNIT  
TABLE IS FULL. YOU CAN TRY RUNNING THE JOB AGAIN, BUT IF THE ERROR IS  
FROM A LACK OF SPOOL LOGICAL UNITS OR THE LOGICAL UNIT TABLE BEING FULL  
YOU MUST RECONFIGURE.

""

FMGR 048  
GLOBAL SET OUT OF RANGE  
A GLOBAL WAS SPECIFIED OUT OF THE RANGE OF THE GLOBALS. CHECK THE  
PARAMETERS AND RE-ENTER THE COMMAND CORRECTLY.

""

FMGR 049  
CAN'T RUN RP'ED PROGRAM  
THE PROGRAM RESTORED FROM THE FILE DOES NOT EXECUTE. USUALLY THIS IS  
CAUSE BY ATTEMPTING TO RUN A SEGMENT OF THE SPECIFIED PROGRAM. CHECK  
THE PROGRAM.

""

FMGR 050  
NOT ENOUGH PARAMETERS  
LESS THAN THE REQUIRED NUMBER OF PARAMETERS WERE SPECIFIED. RE-ENTER  
COMMAND CORRECTLY.

""

FMGR 051  
ILLEGAL MASTER SECURITY CODE  
AN ATTEMPT WAS MADE TO RE-INITIALIZE A CARTRIDGE OR LIST FILES WITH AN  
INCORRECT MASTER SECURITY CODE. RE-ENTER THE COMMAND WITH THE CORRECT  
CODE.

## HELP File Listing

""

### FMGR 052

#### ILLEGAL LU

1. AN ATTEMPT WAS MADE TO SWITCH A SESSION LU TO A SYSTEM LU WHICH IS A DISC, BUT THE SESSION LU NUMBER DOES NOT EQUAL THE SYSTEM LU NUMBER. (FOR DISCS, THE MAPPING FROM SESSION LU TO SYSTEM LU MUST BE DIRECT.) OR
2. ILLEGAL LU(S) SPECIFIED IN THE SL COMMAND. CHECK THAT THE LU IS POSITIVE AND LESS THAN THE LARGEST LU DEFINED IN THE SYSTEM, AND THAT THE SESSION LU IS LESS THAN 64. OR
3. AN ATTEMPT WAS MADE TO INITIALIZE THE FILE MANAGER USING A LOGICAL UNIT OTHER THAN LU 2 OR 3. THE RESPONSE TO THE FMGR 002 MESSAGE MUST BE A COMMAND TO INITIALIZE LU 2. THE RESPONSE TO THE FMGR 003 MESSAGE MUST BE A COMMAND TO INITIALIZE LU 3.

""

### FMGR 053

#### ILLEGAL LABEL OR ILABEL

THE SPECIFIED CARTRIDGE REFERENCE NUMBER OR CARTRIDGE ID IS ILLEGAL. THE CARTRIDGE REFERENCE NUMBER MUST BE A POSITIVE NON-ZERO INTEGER AND THE CARTRIDGE ID MUST BE A LEGAL FILE NAME.

""

### FMGR 054

#### DISC NOT MOUNTED

AN ATTEMPT WAS MADE TO DISMOUNT OR REFERENCE A DISC CARTRIDGE NOT MOUNTED TO THE CALLER. TO REFERENCE IT, MOUNT THE DISC CARTRIDGE USING THE "MC" COMMAND. IF UNDER SESSION CONTROL, THE "AC" COMMAND COULD BE USED INSTEAD TO ALLOCATE DISC SPACE WITH THE SPECIFIED CRN. THIS ERROR ALSO OCCURS IF AN ATTEMPT IS MADE BY A SESSION USER (NOT THE SYSTEM MANAGER) TO DISMOUNT A SYSTEM DISC. A SESSION USER IS ALLOWED ACCESS TO A SYSTEM DISC EVEN THOUGH IT DOES NOT REALLY BELONG TO HIM, I.E. HE HAS NO CONTROL OVER THE MOUNTING OR THE DISMOUNTING OF IT.

""

### FMGR 055

#### MISSING PARAMETER

A REQUIRED PARAMETER HAS BEEN OMITTED. CHECK THE COMMAND AND RE-ENTER IT WITH THE MISSING PARAMETER.

""

### FMGR 056

#### BAD PARAMETER

A PARAMETER WAS SPECIFIED INCORRECTLY OR A TRACK PARAMETER SPECIFIES A TRACK THAT IS OUTSIDE THE RANGE OF THE FMGR TRACKS. CHECK THE COMMAND AND RE-ENTER IT CORRECTLY.

""

### FMGR 057

#### BAD TRACK NOT IN FILE AREA

THE SPECIFIED TRACK IS IN THE SYSTEM AREA OR IS A DIRECTORY TRACK. CORRECT THE COMMAND AND RE-ENTER IT.

""

FMGR 058

LG AREA EMPTY

AN ATTEMPT WAS MADE TO SAVE THE CONTENTS OF THE LG AREA WHICH IS EMPTY.  
USE THE MR COMMAND TO MOVE A FILE TO THE LG AREA.

""

FMGR 059

REPORTED TRACK UNAVAILABLE

A RE-INITIALIZATION ATTEMPT WILL LOWER THE FIRST TRACK INTO THE SYSTEM  
AREA. THE LAST TRACK IS REPORTED. RE-ENTER THE COMMAND WITH THE  
FIRST TRACK SPECIFIED AS THE LAST TRACK + 8 (THE MINIMUM).

""

FMGR 060

DO YOU REALLY WANT TO PURGE THIS DISC?

A RE-INITIALIZATION ATTEMPT WILL RAISE THE FIRST TRACK OR LOWER  
THE DIRECTORY TRACKS INTO THE FILE AREA AND DESTROY A FILE. ENTER  
'??' OR 'NO' TO STOP THE REINITIALIZATION. ENTER 'YES' TO CONTINUE.

""

FMGR 061

DO A "DC" AND A "MC" ON THIS CR

AN ATTEMPT WAS MADE TO REPLACE A MOUNTED CARTRIDGE WITH AN CARTRIDGE  
THAT HAS NOT BEEN PREVIOUSLY INITIALIZED WITHOUT ENTERING A 'DC' AND A  
'MC' COMMAND. ENTER A 'DC' AND 'MC' COMMAND FOR THIS CARTRIDGE.  
NOTE: BE SURE TO DO A DC SPECIFYING THE RELEASE RESOURCES "RR" OPTION.

""

FMGR 062

MORE THAN 63 DISCS

AN ATTEMPT WAS MADE TO MOUNT THE 64TH CARTRIDGE (THE LIMIT IS 63  
CARTRIDGES). DISMOUNT A CARTRIDGE TO MAKE ROOM, IF POSSIBLE.

""

FMGR 063

EXCEEDING SESSION DISC LIMIT

AN ATTEMPT IS BEING MADE TO MOUNT MORE DISCS TO A SESSION THAN IS  
ALLOWED IN THE USER'S ACCOUNT. DISMOUNT AN UNUSED DISC AND RE-ENTER  
THE COMMAND. TO INCREASE YOUR ACCOUNT'S DISC LIMIT, CONSULT THE  
SYSTEM MANAGER.

## HELP File Listing

""  
FMGR 064  
NO DISC AVAILABLE FROM DISC POOL  
ALL DISCS IN DISC POOL ARE ALLOCATED OR THERE ARE NO DISCS AVAILABLE  
THAT ARE BIG ENOUGH.  
THIS ERROR CAN ALSO OCCUR IF # DIRECTORY TRACKS SPECIFIED IS TOO LARGE.  
#DIRECTORY TRACKS SPECIFIED MUST BE A REASONABLE NUMBER IN RELATIONSHIP TO  
THE TOTAL NUMBER OF TRACKS ON THE DISC. IF DISC SPACE IS BEING ALLOCATED  
FROM THE DISC POOL AND SIZE WAS NOT SPECIFIED (I.E. FIRST FREE DISC IS  
ALLOCATED), THE MOUNT ROUTINE WILL CONTINUE TO SEARCH THE DISC POOL UNTIL  
A DISC IS FOUND THAT WIL PASS THE "REASONABLE" TEST. IN THIS CASE, IT IS  
POSSIBLE THAT EVEN THOUGH THERE ARE FREE DISCS IN THE POOL, NONE WILL BE  
ALLOCATED BECAUSE # DIRECTORY TRACKS WAS SO LARGE.

""  
FMGR 065  
CONFLICT IN SST DEFINITION  
THE SPECIFIED LU NUMBER IS ALREADY DEFINED AS A SESSION LU IN THE  
USER'S SESSION SWITCH TABLE (SST). THIS WILL OCCUR IF THE USER HAS  
SPECIFIED A DISC LU NUMBER IN THE MOUNT COMMAND, BUT THIS NUMBER IS  
ALREADY DEFINED IN THE SST. IF IT IS NECESSARY TO MOUNT THIS DISC  
LU, CHANGE THE CONFLICTING ENTRY IN THE SST. THIS CAN BE DONE BY  
USING THE SL COMMAND TO REMOVE THE SST ENTRY WITH THE CONFLICTING  
SESSION LU AND, IF DESIRED, RE-ENTERING IT IN THE SWITCH TABLE WITH  
A DIFFERENT SESSION LU NUMBER.

""  
FMGR 066  
NO ROOM IN SST  
THERE ARE NO SPARE ENTRIES LEFT IN THE SESSION SWITCH TABLE. SPARE  
ENTRIES CAN BE RECOVERED BY USING THE :SL,LU,- COMMAND, WHERE LU IS  
A SESSION LOGICAL UNIT NUMBER THAT IS NOT NEEDED.

""  
FMGR 067  
PROGRAM NOT FOUND  
THE PROGRAM TO BE EXECUTED WAS NOT FOUND AMONG THE SYSTEM ID SEGMENTS,  
NOR WAS IT FOUND AS A TYPE 6 FILE ON A SYSTEM DISC. CHECK THE PROGRAM  
NAME SPECIFIED FOR CORRECTNESS OR RELOAD THE PROGRAM. ON A HE (HELP)  
COMMAND, THE FMGR 067 ERROR INDICATES THE PROGRAM HELP COULD NOT BE  
FOUND. ON A WH (WHZAT) COMMAND, THE ERROR INDICATES THE PROGRAM WHZAT  
COULD NOT BE FOUND.

""  
FMGR 068  
LU NOT IN VARIABLE PART OF SST  
ONLY LU'S IN THE VARIABLE PART OF THE SESSION SWITCH TABLE (SST)  
MAY BE DELETED.

""  
FMGR 069  
JOB LOGON FAILED  
THE JOB ACCOUNT COULD NOT BE LOGGED ON. THE REASON FOR THE FAILURE  
IS PRINTED ON THE SYSTEM CONSOLE.



""

FMGR 070

SECTORS/TRACK VALUE TOO LARGE

THE SECTORS PER TRACK VALUE SPECIFIED IN THE INITIALIZE COMMAND IS LARGER THAN THE ACTUAL SECTORS PER TRACK VALUE FOR THE DISC. LET THE SECTORS PER TRACK PARAMETER DEFAULT TO THE ACTUAL SECTORS PER TRACK VALUE FOR THE DISC, OR SPECIFY A SMALLER VALUE.

""

FMGR 071

DO "EX,SP" TO SAVE OR "EX,RP" TO RELEASE PRIVATE CARTRIDGES AN ATTEMPT WAS MADE TO LOG-OFF WITH A PRIVATE DISC(S) STILL MOUNTED TO THE USER'S SESSION. SPECIFYING "EX,RP" WILL RELEASE THE USER'S PRIVATE DISC(S); IF THE DISC WAS ALLOCATED FROM THE DISC POOL, IT IS RETURNED TO THE POOL FOR POSSIBLE RE-ALLOCATION TO ANOTHER USER. IF "EX,SP" IS SPECIFIED, THE USER'S PRIVATE DISC(S) WILL REMAIN MOUNTED TO THIS USER; ON THE NEXT LOG-ON BY THIS USER, THE DISC(S) WILL BE MOUNTED TO THE NEW SESSION. NOTE THAT GROUP DISCS ARE, BY DEFAULT, LEFT MOUNTED AT LOG-OFF. TO RELEASE GROUP DISCS AT LOG-OFF, SPECIFY "EX,,RG".

""

FMGR 072

LU NOT INTERACTIVE

THE LOGICAL UNIT SPECIFIED IN A CT COMMAND MUST REFER TO AN INTERACTIVE DEVICE.

""

FMGR 073

ACCOUNT NOT FOUND

AN ATTEMPT WAS MADE TO SEND A MESSAGE TO A USER FOR WHOM AN ACCOUNT DOES NOT EXIST. CHECK THE USER.GROUP NAME OR THE ORDER OF THE PARAMETERS IN THE SM COMMAND FOR CORRECTNESS.

""

FMGR 074

JO COMMAND EXPECTED

THE FIRST COMMAND IN A JOB MUST BE, AND WAS NOT, A JO COMMAND.

""

FMGR 075

CAN'T RESTORE TYPE 6 PGM (USER PROTECTED)

THE SPECIFIED PROGRAM IS SAVED AS A TYPE 6 FILE WITH USER PROTECTION ("SP,PROG,PR"). IT CAN ONLY BE RUN OR RP'ED FROM THE TYPE 6 FILE BY THE USER WHO ISSUED THE SP COMMAND, OR BY USERS WHO ARE LINKED TO THE ACCOUNT OF THE USER WHO ISSUED THE SP COMMAND.

""

FMGR 076

CAN'T RESTORE TYPE 6 PGM (GROUP PROTECTED)

THE SPECIFIED PROGRAM IS SAVED AS A TYPE 6 FILE WITH GROUP PROTECTION ("SP,PROG,GR"). IT CAN ONLY BE RUN OR RP'ED FROM THE TYPE 6 FILE BY USERS BELONGING TO THE SAME GROUP AS THE USER WHO ISSUED THE SP COMMAND.

## HELP File Listing

""

FMGR 077

CAN'T RESTORE TYPE 6 PGM (INSUFFICIENT CAPABILITY)  
THE SPECIFIED PROGRAM IS SAVED AS A TYPE 6 FILE WITH CAPABILITY LEVEL  
PROTECTION ("SP,PROG,,CAP", WHERE CAP IS THE MINIMUM CAPABILITY  
LEVEL REQUIRED TO RUN OR RP THE PROGRAM). THE PROGRAM CAN ONLY  
BE RUN OR RP'ED FROM THE TYPE 6 FILE BY USERS POSSESSING A  
CAPABILITY LEVEL GREATER THAN OR EQUAL TO THE LEVEL SPECIFIED WHEN  
THE PROGRAM WAS SP'ED. FOR EXAMPLE, THE COMMAND "SP,PROG,,50" WILL  
SAVE PROGRAM "PROG" AND ONLY USERS WITH A CAPABILITY LEVEL OF 50 OR  
GREATER WILL BE ALLOWED TO RUN OR RP THE PROGRAM FROM THE TYPE 6  
FILE. NOTE THAT COMMAND CAPABILITY CHECKING IS STILL IN EFFECT.  
(THE USER STILL MUST HAVE SUFFICIENT CAPABILITY TO INVOKE THE RU OR  
RP COMMAND, REGARDLESS OF THE CAPABILITY LEVEL SPECIFIED IN THE SP  
COMMAND.)

""

FMGR 078

CAN'T RESTORE TYPE 6 PGM (INTERNAL ERROR)  
INTERNAL CONSISTENCY CHECKS HAVE FAILED WHILE ATTEMPTING TO  
RESTORE A PROGRAM FILE.

""

FMGR 079

WARNING - RECORDS TRUNCATED TO 128 WORDS  
IN A TYPE 2 FILE, RECORDS WHICH ARE LONGER THAN 128 WORDS HAVE  
BEEN TRUNCATED TO 128 WORDS.

""

READ 001

THE REQUESTED MAG TAPE UNIT IS DOWN. USE THE "UP" COMMAND (SPECIFYING THE APPROPRIATE EQT) TO ENABLE THE DEVICE.

""

READ 002

THE MAG TAPE READT IS TRYING TO RESTORE CONTAINS INFORMATION IN A FORMAT NOT RESTORABLE BY READT. THE TAPE MAY HAVE BEEN SAVED WITH ANOTHER UTILITY, OR IT MAY HAVE BEEN CONSTRUCTED THROUGH THE FMGR'S "DU" OR "ST" COMMANDS. IN ANY CASE READT CANNOT RESTORE THE DATA. THIS ERROR WILL ALSO RESULT WHEN THE NEXT TAPE OF A TWO OR MORE TAPE CARTRIDGE IS NOT THE CORRECT ONE. MOUNT THE CORRECT TAPE AND DO AS THE UTILITY SUGGESTS.

""

READ 003

THE MAG TAPE UNIT YOU WISH TO USE IS LOCKED TO SOME PROCESS. FIND OUT WHO CURRENTLY HAS THE MAG TAPE LOCKED (.E.G. RU,WHZAT) AND WAIT UNTIL IT'S RELEASED OR HAVE THE USER RELEASE IT FOR YOU.

""

READ 004

THE PARAMETER DESCRIBING THE DESIRED MAG TAPE UNIT DOES NOT SATISFY READT'S REQUIREMENTS FOR A LEGAL MAG TAPE LU. THE POSSIBLE CAUSES FOR THIS ERROR INCLUDE:

1. THE SPECIFIED MAG TAPE LU IS NOT BETWEEN -63 AND +63.
2. THE DRIVER OF THE SPECIFIED LU IS NOT A MAG TAPE DRIVER.

""

READ 005

THE DESIRED MAG TAPE UNIT IS OFF-LINE. THE ON-LINE BUTTON MUST BE DEPRESSED TO ENABLE THE ON-LINE SWITCH.

""

READ 006

READT REJECTED THE USE OF THE SPECIFIED DISC LU. THERE ARE A VARIETY OF REASONS FOR THIS, THEY INCLUDED:

1. THE DISC LU NUMBER MUST BE A NEGATIVE NUMBER BUT NO SMALLER THAN -63.
2. THE DESIRED DISC LU IS NOT IN YOUR SST.
3. THE DRIVER TYPE OF THE REQUESTED DISC LU IS NOT A DISC DRIVER.

""

READ 007

THE DRIVER DETECTED A PARITY ERROR WHEN READING FROM THE MAG TAPE. IF THIS HAPPENS AGAIN THE TAPE MAY BE IRRECOVERABLE. CALL THE SYSTEM MANAGER AGAIN, IF IT OCCURS THEN THE TAPE MAY BE IRRECOVERABLE. CALL SYSTEM MANAGER.

HELP File Listing

""  
READ 008  
THE END OF TAPE WAS REACHED. MOUNT THE FOLLOWING TAPE TO READ  
THE REMAINING PORTIONS OF THE CARTRIDGE. TO CONTINUE THE PROGRAM  
ENTER "GO". TO HALT THE PROCESS ENTER "AB". NOTE HOWEVER THAT A REPLY  
OF AN "AB" WHEN RUNNING READT WILL CAUSE AN INCOMPLETE CARTRIDGE TO BE  
PRESENT ON THE SYSTEM.

""  
READ 009  
THE DESIRED CARTRIDGE HAS A FILE OPEN OR THE CARTRIDGE IS LOCKED TO  
ANOTHER PROGRAM. TRY DOING A DL ON THAT CARTRIDGE AND FIND OUT WHAT'S  
LOCKING THE PROGRAM OR WHAT FILE IS OPEN.

""  
READ 010  
YOU ARE OPERATING IN A NONSESSION ENVIRONMENT. AN LU MUST BE SPECIFEID  
(NEGATIVE LU) SINCE THERE ISN'T A FREE DISC POOL.  
""

READ 011

READT REJECTED THE SIZE (NUMBER OF TRACKS) YOU SPECIFIED BECAUSE IT'S OF A BAD FORMAT (E.G. NEGATIVE VALUE) OR THE SIZE REQUESTED IS NOT LARGE ENOUGH TO RESTORE THE CARTRIDGE ON MAG TAPE.

""

READ 012

THE ROUTINE READT USES TO MOUNT A CARTRIDGE DETECTED AN ERROR. THIS ERROR IS RETURNED IN THE FMGR FORMAT. THE FOLLOWING ARE POSSIBLE ERROR CONDITIONS. FIND THE ONE THAT APPLYS TO YOU AND DO AS SUGGESTED.

FMGR 012 DUPLICATE LABEL OR CRN ALREADY MOUNTED.

HAVE THAT DISC OR CRN REMOVED THEN RUN READT AGAIN.

FMGR 056 THE SIZE REQUESTED IS TOO LARGE FOR THE DISC LU SPECIFIED. RUN READT AGAIN WITH A SMALLER SIZE PARAMETER.

FMGR 063 YOU CURRENTLY HAVE MOUNTED THE MAXIMUM NUMBER OF DISC CARTRIDGES IN YOUR SESSION. REMOVE ONE AND RUN READT AGAIN.

FMGR 064 THERE ARE PRESENTLY NO MORE FREE DISC LUS IN THE DISC POOL. HAVE SOMEONE RELEASE A CARTRIDGE THAT THEY ARE NOT CURRENTLY USING.

FMGR 065 THERE IS A CONFLICT IN SST DEFINITION. YOU ARE TRYING TO MOUNT A DISC LU THAT HAS A SESSION LU NUMBER ASSIGNED TO TO SOME OTHER DEVICE. CHECK YOUR SST AND FIND OUT TO WHAT LU THAT NUMBER IS ASSIGNED, THEN CHANGE IT OR CHOOSE ANOTHER DISC LU.

FMGR 066 THERE IS NO MORE ROOM IN YOUR SST TO PLACE AN ENTRY. REMOVE AN ENTRY FROM YOUR SST IF POSSIBLE. IF THAT'S NOT DESIRABLE THEN CALL SYSTEM MANAGER.

""

READ 013

THE DESIRED DISC LU OR THE AVAILABLE FREE LUS IN THE DISC POOL ARE NOT LARGE ENOUGH TO RESTORE THE CARTRIDGE THAT'S ON MAG TAPE.

""

READ 014

THE FMP TRACKS ON LU 2 OR LU 3 (IF 3 EXISTS) ARE NOT RESTORABLE WITH READT.

""

READ 015

BAD TRANSMISSION -- MEMORY TO DISC TRK XXX SEC YYY

READT TRIED TO TRANSFER DATA FROM MEMORY TO A DISC LU. DURING THIS PROCESS A CHECK OF THE TRANSMISSION LOG SHOWED AN UNEXPECTED VALUE. RUN READT AGAIN, IF IT HAPPENS ONCE MORE CALL YOUR SYSTEM MANAGER.

""

READ 016

BAD TRANSMISSION -- MAG TAPE TO MEMORY REC XXX

READT DETECTED AN ERROR IN TRANSMISSION OF DATA FROM THE MAG TAPE UNIT INTO MEMORY. TRY READING THE TAPE AGAIN. IF IT HAPPENS ONCE MORE CALL YOUR SYSTEM MANAGER.

HELP File Listing

""

WRIT 001

THE REQUESTED MAG TAPE UNIT IS DOWN. BY UPPING THE APPROPRIATE EQT THE DEVICE CAN BE ENABLED.

""

WRIT 002

ONLY THE SYSTEM MANAGER CAN SAVE SYSTEM DISCS.

""

WRIT 003

THE MAG TAPE YOU WISH TO USE IS LOCKED TO SOME PROCESS. FIND OUT WHO CURRENTLY HAS THE MAG TAPE LOCKED (E.G. RU,WHZAT) AND WAIT UNTIL IT'S RELEASED OR HAVE THE USER RELEASE IT FOR YOU.

""

WRIT 004

THE PARAMETER DESCRIBING THE DESIRED MAG TAPE UNIT DOES NOT SATISFY READT'S REQUIREMENTS FOR A LEGAL MAG TAPE UNIT. THE POSSIBLE CAUSES FOR THIS ERROR INCLUDE:

1. THE SPECIFIED MAG TAPE LU IS NOT BETWEEN -63 AND +63.
2. THE DRIVER OF THE SPECIFIED LU IS NOT A MAG TAPE DRIVER.

""

WRIT 005

THE DESIRED MAG TAPE UNIT IS OFF-LINE. THE ON-LINE BUTTON MUST BE DEPRESSED TO ENABLE THE ON-LINE SWITCH.

""

WRIT 006

A WRITE RING IS REQUIRED TO WRITE INFORMATION ON A MAG TAPE. PLACE A WRITE RING ON THE TAPE SPOOL AND RUN WRITT AGAIN.

""

WRIT 007

THE DRIVER DETECTED A PARITY ERROR WHEN READING FROM THE MAG TAPE. TRY AGAIN, IF IT OCCURS AGAIN THEN THE TAPE MAY BE IRRECOVERABLE. CALL SYSTEM MANAGER.

""

WRIT 008

THE END OF TAPE WAS REACHED. MOUNT THE FOLLOWING TAPE TO WRITE THE REMAINING PORTIONS OF THE CARTRIDGE. TO CONTINUE THE PROGRAM ENTER "GO". TO HALT THE PROCESS ENTER "AB". NOTE HOWEVER THAT A RESPONSE OF AN "AB" WILL PLACE A PARTIALLY COMPLETED CARTRIDGE ON YOUR TAPE.

""

WRIT 009

THE DESIRED CARTRIDGE HAS A FILE OPEN OR THE CARTRIDGE IS LOCKED TO ANOTHER PROGRAM. TRY DOING A DL ON THAT CARTRIDGE AND FIND OUT WHAT'S LOCKING THE PROGRAM OR WHAT FILE IS OPEN.

""

WRIT 010

THE DESIRED CARTRIDGE OR DISC LU COULD NOT BE FOUND. DO A CL (CARTRIDGE LIST) TO MAKE SURE THAT WHAT YOU'RE SEEKING IS REALLY THERE.

""

WRIT 011

WRITT REJECTED THE USE OF THE SPECIFIED DISC LU. THERE ARE A VARIETY OF REASONS FOR THIS, THEY INCLUDE:

1. THE DISC LU NUMBER MUST BE A NEGATIVE NUMBER BUT NO SMALLER THAN -63.
2. THE DESIRED DISC LU IS NOT IN YOUR SST.
3. THE DRIVER TYPE OF THE REQUESTED DISC LU IS NOT A DISC DRIVER.

""

WRIT 012

YOU CANNOT SAVE FMP TRACKS OFF LU 2 OR LU 3 (IF 3 EXISTS) WITH WRITT.

""

WRIT 013

WRITT TRIED TO READ DATA FROM A DISC LU INTO MEMORY AND FOUND THE TRANSMISSION IRREGULAR. RUN WRITT AGAIN, IF THE SITUATION OCCURS ONCE MORE THERE MAY BE A BAD TRACK ON THAT DISC LU. SAVE AS MUCH DATA AS YOU CAN AND NOTIFY YOUR SYSTEM MANAGER.

""

WRIT 014

THE TRANSMISSION OF DATA FROM MEMORY TO MAG TAPE MAY BE FAULTY. RUN WRITT AGAIN, IF IT HAPPENS ONCE MORE CALL YOUR SYSTEM MANAGER.

""

DM

MAPPING ERROR. AN ATTEMPT WAS MADE TO READ/WRITE OUTSIDE OF THE MAPPED ADDRESS SPACE.

""

MP

MEMORY PROTECT ERROR. THE CALL WAS NOT AN EXEC, \$L1BR, OR \$L1BX CALL.

""

RE

A RE-ENTRANT SUBROUTINE ATTEMPTED TO CALL ITSELF.

""

RQ

AN ILLEGAL REQUEST CODE IS SPECIFIED IN AN EXEC CALL.

""

TI

A BATCH PROGRAM EXCEEDS THE ALLOWED TIME.

""

SC00

A BATCH PROGRAM ATTEMPTED TO SUSPEND (EXEC(7)).

HELP File Listing

""

SC01  
MISSING PARAMETER.

""

SC02  
ILLEGAL PARAMETER

""

SC03  
THE SPECIFIED PROGRAM CANNOT BE SCHEDULED.

""

SC04  
THE SPECIFIED PROGRAM IS NOT A SUBORDINATE (OR "SON") TO THE PROGRAM  
ISSUING THE COMPLETION CALL.

""

SC05  
THE PROGRAM GIVEN IS NOT DEFINED.

""

SC06  
NO RESOLUTION CODE IS SPECIFIED IN THE EXECUTION TIME EXEC CALL.

""

SC07  
A PROHIBITED CORE LOCK WAS ATTEMPTED.

""

SC08  
THE PROGRAM JUST SCHEDULED IS ASSIGNED TO A PARTITION SMALLER THAN  
THE PROGRAM ITSELF OR TO AN UNDEFINED PARTITION. UNASSIGN THE PROGRAM  
OR REASSIGN THE PROGRAM TO A PARTITION THAT IS AS LARGE OR LARGER  
THAN THE PROGRAM.

""

SC09  
THE PROGRAM JUST SCHEDULED IS TOO LARGE FOR ANY PARTITION OF THE  
SAME TYPE. FOR EXAMPLE, TRYING TO SCHEDULE A 23K BACKGROUND PROGRAM  
WHEN THE LARGEST BACKGROUND PARTITION IS ONLY 21K.

""

SC10  
THERE IS NOT ENOUGH SYSTEM AVAILABLE MEMORY FOR THE STRING PASSAGE.

""

SC11  
EXEC SCHEDULE OR TIMED EXECUTION REQUEST WAS ISSUED AND PROGRAM  
SPECIFIED IS ALREADY IN THE TIME LIST FOR ANOTHER SESSION.

""

RN00  
THERE ARE NO OPTION BITS SET IN THE CALL.



""

RN01  
NOT USED

""

RN02  
THE SPECIFIED RESOURCE NUMBER IS NOT DEFINED.

""

RN03  
AN UNAUTHORIZED ATTEMPT WAS MADE TO CLEAR A LOCAL RESOURCE NUMBER.

""

LU01  
A PROGRAM HAS ONE OR MORE LOGICAL UNITS LOCKED AND IS TRYING TO LOCK ANOTHER WITH WAIT.

""

LU02  
ILLEGAL LOGICAL UNIT REFERENCE. THE LU SPECIFIED IS EITHER 1) ILLEGAL OR NON-EXISTENT FOR THE CURRENT SESSION/SYSTEM CONFIGURATION, OR 2) A DISK LU, BUT THE "DISK ALSO" BIT WAS NOT SET IN THE LU LOCK REQUEST.

""

LU03  
NOT ENOUGH PARAMETERS ARE FURNISHED IN THE CALL. LOGICAL UNIT REFERENCE LESS THAN ONE. LOGICAL UNIT NOT LOCKED TO CALLER.

""

LU04  
TRYING TO LOCK A LOGICAL UNIT NOT DEFINED IN CALLER'S SST.

""

DR01  
NOT ENOUGH PARAMETERS WERE SPECIFIED.

""

DR02  
THE NUMBER OF TRACKS IS <= ZERO OR AN ILLEGAL LOGICAL UNIT WAS SPECIFIED.

""

DR03  
AN ATTEMPT TO RELEASE A TRACK ASSIGNED TO ANOTHER PROGRAM WAS MADE.

""

IO00  
AN ILLEGAL CLASS NUMBER WAS SPECIFIED. OUTSIDE TABLE, NOT ALLOCATED, OR BAD SECURITY CODE.

""

IO01  
NOT ENOUGH PARAMETERS WERE SPECIFIED.

## HELP File Listing

""  
IO02  
AN ILLEGAL LOGICAL UNIT NUMBER WAS SPECIFIED.

""  
IO03  
ILLEGAL EQT REFERENCED BY LU IN I/O CALL (SELECT CODE=0).

""  
IO04  
AN ILLEGAL USER BUFFER WAS SPECIFIED. EXTENDS BEYOND RT\BG AREA  
OR NOT ENOUGH SYSTEM AVAILABLE MEMORY TO BUFFER THE REQUEST.

""  
IO05  
AN ILLEGAL DISC TRACK OR SECTOR WAS SPECIFIED.

""  
IO06  
A REFERENCE WAS MADE TO A PROTECTED TRACK OR TO UNASSIGNED LG TRACKS.

""  
IO07  
THE DRIVER HAS REJECTED THE CALL.

""  
IO08  
THE SPECIFIED DISC TRANSFER IS LONGER THAN ONE TRACK.

""  
IO09  
THE LG TRACKS OVERFLOWED.

""  
IO10  
CLASS GET CALL ISSUED WHILE ONE CALL ALREADY OUTSTANDING.

""  
IO11  
A TYPE 4 PROGRAM MADE AN UNBUFFERED I/O REQUEST TO A DRIVER THAT DID  
NOT DO ITS OWN MAPPING.

""  
IO12  
AN I\O REQUEST SPECIFIED A LOGICAL UNIT NOT DEFINED FOR USE BY  
THIS SESSION. THE "SL" COMMAND WILL REPORT ALL LOGICAL UNITS  
AVAILABLE TO YOUR SESSION.

""  
IO13  
AN I/O REQUEST SPECIFIED AN LU WHICH WAS EITHER LOCKED TO ANOTHER  
PROGRAM, OR POINTED TO AN EQT WHICH WAS LOCKED TO ANOTHER PROGRAM.

""

IO20

READ ATTEMPTED ON WRITE ONLY SPOOL FILE.  
REVISE PROGRAM CALL TO SPOPN OR CHECK "SL" COMMAND PARAMETERS.

""

IO21

READ ATTEMPTED PAST END-OF-FILE.  
REVISE PROGRAM AND RE-RUN.

""

IO22

SECOND ATTEMPT TO READ JCL CARD FROM BATCH INPUT FILE BY OTHER  
THAN FMGR. REVISE PROGRAM AND RE-RUN.

""

IO23

WRITE ATTEMPTED ON READ ONLY SPOOL FILE.  
REVISE PROGRAM CALL TO SPOPN OR CHECK "SL" COMMAND PARAMETERS.

""

IO24

WRITE ATTEMPTED BEYOND END-OF-FILE; USUALLY, SPOOL FILE OVERFLOW.  
OBTAIN MORE SPOOL ROOM ON DISC (SEE PK COMMAND IN BATCH SPOOL MANUAL)  
OR DO NOT USE SPOOLING AT THIS TIME.

""

IO25

ATTEMPT TO ACCESS SPOOL LU THAT IS NOT CURRENTLY SET UP.  
MAY BE CAUSED BY GASP KS COMMAND - IF OTHER REASON CORRECT OFFENDING  
PROGRAMS.

""

IO26

I/O REQUEST MADE TO A SPOOL THAT HAS BEEN TERMINATED BY THE GASP  
KS COMMAND. RESET THE SESSION LOGICAL UNIT WITH THE "CS" OR "SL"  
COMMAND.

""

IOET

AN END-OF-TAPE CONDITION OCCURRED ON THE SPECIFIED LU. CORRECT THE  
CONDITION AND SET THE EQT UP.

""

IONR

THE SPECIFIED LU IS NOT READY. MAKE THE DEVICE READY AND SET THE EQT UP.

""

IOTO

THE SPECIFIED LU HAS TIMED OUT. EXAMINE THE DEVICE, CORRECT THE PROBLEM,  
AND SET THE EQT UP.

""

IOPE

HELP File Listing

A PARITY ERROR OCCURRED IN THE DATA TRANSMISSION FROM THE SPECIFIED LU.  
EXAMINE THE DEVICE, CORRECT THE PROBLEM, AND SET THE EQT UP.

""

ILL INT

AN ILLEGAL INTERRUPT OCCURRED ON THE SPECIFIED CHANNEL.

""

L 01

THIS IS A CHECKSUM ERROR. MOST LIKELY YOU SPECIFIED A FILE TO THE LOADR THAT DID NOT CONTAIN RELOCATABLE FORMAT CODE. A TYPICAL MISTAKE IS SPECIFYING THE SOURCE FILE NAME INSTEAD OF THE BINARY FILE NAME. IF THE FILE YOU SPECIFIED WAS THE CORRECT ONE THEN THAT FILE HAS BEEN OVERLAYED OR CORRUPTED. PURGE THAT FILE AND RECOMPILE THE ORIGINAL SOURCE AND TRY AGAIN.

""

L 02

THE LOADR FOUND A RECORD THAT WAS NOT A NAM, ENT, EXT, DBL, EMA, OR END RECORD. THE CHECKSUM WAS OK BUT THE RECORD WAS UNIDENTIFIED. WAS THE FILE SPECIFIED A RELOCATABLE FILE ? TRY RECOMPILING AND LOADING.

""

L 03

THE SIZE OF THE CODE LOADED SO FAR EXCEEDS THE MAX SIZE THAT YOU SPECIFIED OR EXCEEDS THE LARGEST POSSIBLE SIZE FOR A PROGRAM. MAX SIZE FOR LARGE BACKGROUND (LB) NON EMA PROGRAMS IS 28K WORDS (INCLUDING BASE PAGE) AND 26K FOR LB EMA PROGRAMS. CONSULT THE GENERATION MAP FOR THE MAX SIZE OF REAL TIME AND BACKGROUND PROGRAMS. IF YOUR PROGRAM IS JUST TOO LARGE THE FOLLOWING SOLUTIONS MIGHT BE TRIED:

1. IF THE PROGRAM IS NOT TYPE 4 (LARGE BACKGROUND [LB]) MAKE IT A TYPE 4 BY SPECIFYING THE 'OP,LB' COMMAND TO THE LOADR.
2. IF YOU SPECIFIED A SIZE, THEN DON'T SPECIFY A SIZE THE LOADR WILL DO ALL IT CAN TO MAKE YOUR PROGRAM FIT.
3. SEGMENT THE PROGRAM
4. TRY WRITING SOME OF THE PROGRAM IN ASSEMBLY
5. SEE IF THERE ARE ANY DATA DECLARATIONS THAT CAN BE REMOVED OR ANY DATA DECLARATIONS THAT CAN BE MOVED TO EMA.

""

L 04

BASE PAGE OVERFLOW. THIS PROGRAM HAS USED TOO MANY BASE PAGE LINKS. RELOAD THE PROGRAM BUT THIS TIME SPECIFY THE 'OP,LE' OPTION. THIS WILL LIST ALL ENTRY POINTS AND THE BASE PAGE LINKAGES. THIS LOAD WILL ALSO FAIL, HOWEVER, NOW YOU KNOW WHICH MODULES ARE USING UP ALL THE LINKS. BY USING THE LO,XXXXX COMMAND AND ALIGNING THOSE MODULES TO PAGE BOUNDARIES THE LINKAGE NEEDS CAN BE REDUCED. ALTERNATELY YOU MAY WISH TO REARRANGE THE LOADING ORDER OF YOUR SUBROUTINES. THIS MAY IMPROVE (OR MAKE WORSE) THE LINKAGE NEEDS OF YOUR PROGRAM.

## HELP File Listing

""

L 05

THIS IS A SYMBOL TABLE OVERFLOW. THE LOADR NEEDS MORE ROOM FOR ITS INTERNAL SYMBOL TABLE AND FIX UP TABLE. SINCE THE LOADR IS A TYPE 4 PROGRAM IT CAN BE MADE AS LARGE AS THE LARGEST NORMAL BACKGROUND PARTITION. TO GIVE THE LOADR MORE ROOM USE THE 'SZ' OPERATOR COMMAND. THAT IS,

\*SZ,LOADR,XX      XX = # OF PAGES

OR FROM FMGR,

:SYSZ,LOADR,XX

BY INCREASING THE SPACE FOR THE LOADR THE L 05 PROBLEM SHOULD BE SOLVED. CONSULT THE RTE IV PROGRAMMERS REFERENCE MANUAL FOR MORE INFORMATION ON THE 'SZ' COMMAND.

IF THE SZ COMMAND DOES NOT SOLVE THE PROBLEM, THEN TRY USING THE LOADR 'SE' COMMAND AFTER EVERY LOADR 'RE' COMMAND. THIS WILL REDUCE SPACE NEEDED FOR FIXUPS. IN ADDITION TO USING THE 'SE' COMMAND AFTER EVERY 'RE' COMMAND, TRY LOADING A NUMBER OF YOUR SUBROUTINES (STILL DOING 'SE') BEFORE THE MAIN OF THE PROGRAM.

""

L 06

THIS IS A COMMON BLOCK ERROR. THIS ERROR ONLY OCCURS IF THE LARGEST COMMON DECLARATION OF A PROGRAM DOES NOT APPEAR IN THE FIRST MODULE OF THE PROGRAM LOADED. PROGRAMS THAT USE COMMON MUST DECLARE THAT COMMON IN THE FIRST ROUTINE LOADED AND THAT COMMON DECLARATION MUST BE THE LARGEST ENCOUNTERED IN THE LOAD.

""

L 07

DUPLICATE ENTRY POINT. GENERALLY THIS OCCURS WHEN THE SAME SUBROUTINE WAS LOADED TWICE. ALTERNATELY YOU NAMED A SUBROUTINE WITH THE SAME NAME (ENT IN ASMB) THAT WAS ALREADY BEING USED SOMEWHERE ELSE WITHIN THE PROGRAM THAT YOU WERE TRYING TO LOAD. CONFUSION SOMETIMES OCCURS WITH SEGMENTED PROGRAMS. A SUBROUTINE LOADED WITH THE MAIN MUST NOT BE AGAIN LOADED WITH A SEGMENT. LOOK AT THE LOAD MAP FOR THE LOAD. DID YOU TRY TO LOAD THE SUBROUTINE WITH A SEGMENT WHERE THAT SUBROUTINE WAS ALREADY LOADED WITH THE MAIN? THE LOAD MAP WILL LIST ALL SUBROUTINES LOADED WITH THE MAIN.

""

L 08

NO TRANSFER ADDRESS. ONLY SUBROUTINES WERE LOADED. THE LOADR COULD NOT TELL WHICH MODULE OF THE PROGRAM WAS THE MAIN AND WHICH ONES WERE SUBROUTINES. IF THE PROGRAM WAS WRITTEN IN FORTRAN NO MODULES WERE FOUND THAT CONTAINED THE 'PROGRAM XXXXX' STATEMENT. IF THE PROGRAM WAS WRITTEN IN ASMB YOU PROBABLY FORGOT TO PUT A LABEL ON THE END STATEMENT. IN ASMB THE MAIN OF A SEGMENT OR OF A PROGRAM IS DIFFERENTIATED FROM SUBROUTINES BY PLACING THE LABEL OF WHERE THE PROGRAM OR SEGMENT IS TO START EXECUTION AS THE OPERAND OF THE END STATEMENT. IF MULTIPLE ROUTINES HAVE LABELS ON THE END STATEMENT THE FIRST ONE ENCOUNTERED IS USED AS THE MAIN OF THE PROGRAM.

""

L 09

RECORD OUT OF SEQUENCE. THE LOADR WAS RELOCATING AND ENCOUNTERED RECORDS IN THE WRONG ORDER. RELOCATIBLE RECORDS ARE IN THE ORDER OF NAM, ENT, EXT, DBL, AND END. GENERALLY THIS ERROR OCCURS WHEN RELOCATING FROM AN LU, SAY A MAG TAPE, AND THE TAPE IS INCORRECTLY POSITIONED. IF THE RELOCATION WAS FROM A FILE, RECOMPILE THE SOURCE AND TRY AGAIN, AS THE FILE IS CORRUPT.

""

L 10

THE RUN STRING SUBMITTED TO THE LOADER WAS IN ERROR. TRY AGAIN.

""

L 11

ATTEMPT TO REPLACE A MEMORY RESIDENT PROGRAM. YOU TRIED TO REPLACE A MEMORY RESIDENT PROGRAM. THIS IS ILLEGAL.

""

L 14

THE COMPILER PRODUCED AN ILLEGAL RECORD. A DBL RECORD WAS PRODUCED THAT REFERENCED AN EXTERNAL BUT THAT EXTERNAL WAS NOT IN ANY OF THE EXT RECORDS. THIS IS AN IMPOSSIBLE CONDITION. RECOMPILE AND TRY AGAIN. THIS COULD ALSO BE A COMPILER BUG.

""

L 16

YOU SPECIFIED A PARTITION IN THE LOAD OF THE PROGRAM, HOWEVER, THAT PARTITION DOES NOT EXIST OR HAS BEEN DOWNED DUE TO A PARITY ERROR. TRY AGAIN, THIS TIME SPECIFY A PARTITION THAT EXISTS OR DON'T SPECIFY ANY PARTITION AT ALL.

""

L 17

THE NUMBER OF PAGES THAT YOU SPECIFIED IN THE LOAD OF THE PROGRAM EXCEEDS THAT NUMBER OF PAGES IN THE PARTITION YOU SPECIFIED. EITHER SPECIFY A DIFFERENT PARTITION OR NO PARTITION AT ALL.

""

L 18

THE SPECIFIED PROGRAM SIZE IS TOO LARGE FOR THE PARTITION. EITHER SPECIFY A SMALLER SIZE OR NO SIZE AT ALL. SEE ALSO L 03 ERROR FOR OTHER ALTERNATIVES.

""

L 19

ILLEGAL EMA DECLARATION. TWO DIFFERENT EMA LABELS WERE USED, OR THE EMA DECLARATION WAS NOT MADE IN THE MAIN OF A PROGRAM AND THAT MAIN LOADED FIRST, OR AN EMA LABEL WAS ALSO DECLARED AS AN ENTRY POINT IN ANOTHER MODULE. THE EMA DECLARATION MUST BE IN THE MAIN OF THE PROGRAM AND THAT MAIN MUST BE THE FIRST MODULE LOADED. THE EMA STATEMENT MUST BE IN ANY SEGMENT OR SUBROUTINE REFERENCING ANY ELEMENT IN EMA.

## HELP File Listing

""

L 20

NO ID EXTENSIONS AVAILABLE FOR THE EMA PROGRAM. YOU MUST FREE UP SOME ID EXTENSIONS BEFORE THE EMA PROGRAM CAN BE SUCCESSFULLY LOADED.

""

L 21

THE PROGRAMS DECLARED EMA SIZE IS TOO LARGE FOR THIS SYSTEMS PARTITIONS DEFINITION, IE THERE IS NO EXISTING PARTITION LARGE ENOUGH TO RUN THIS PROGRAM. EITHER REBOOT AND RECONFIGURE SYSTEM TO ALLOW MORE EMA SPACE OR DECLARE LESS EMA SPACE IN THE PROGRAM.

""

L 24

YOU ATTEMPTED TO ACCESS AN SSGA ENTRY POINT BUT YOU DID NOT ASK FOR SSGA AT THE BEGINNING OF THE LOAD. RELOAD THE PROGRAM BUT THIS TIME DO A 'OP,SS' AT THE BEGINNING OF THE LOAD.

""

L 25

ATTEMPT TO PURGE A PROGRAM UNDER BATCH OR ATTEMPT TO USE THE 'LI' OR 'PU' COMMANDS WITHIN A LOADR COMMAND FILE. LI AND PU COMMANDS ARE NOT ALLOWED WITHIN A LOADR COMMAND FILE UNLESS THAT COMMAND FILE IS AN INTERACTIVE DEVICE (IE A TTY OR CRT).

""

L 26

NOT ENOUGH LONG AND SHORT ID SEGMENTS TO FINISH THE LOAD. THIS IS AN EXTREMELY RARE ERROR. THE LOADR WAS CREATING ID SEGMENTS AND THERE WERE ENOUGH ID SEGMENTS AT THE BEGINING TO FINISH THE LOAD, HOWEVER, BETWEEN CREATING ONE ID SEGMENT AND CREATING THE NEXT ALL OTHER ID SEGMENTS WERE USED UP (MAYBE ANOTHER LOADR OR FILE MANAGER GOT THEM) AT ANY RATE THERE AREN'T ENOUGH TO FINISH THE LOAD. THE PROPER RESPONSE TO THIS ERROR IS TO 'OF' OR PURGE ALL SEGMENTS AND THE MAIN OF THE LOAD THAT WAS JUST UNSUCCESSFUL FREE UP SOME ADDITIONAL ID SEGMENTS AND TRY THE LOAD AGAIN. IF ENOUGH ID SEGMENTS ARE FREED UP THE LOAD WILL SUCCEED. THIS ERROR COULD ONLY OCCUR IN SEGMENTED LOADS.

""

L 27

ATTEMPT TO ACCESS AN EMA EXTERNAL WITH OFFSET OR INDIRECT. IF THIS IS A FORTRAN PROGRAM YOU MORE THAN LIKELY FORGOT TO PUT THE \$EMA STATEMENT IN A SUBROUTINE THAT ACCESSED AN EMA ELEMENT. IF THE PROGRAM WAS WRITTEN IN ASMB USE THE H-P SUPPLIED ROUTINES .EMAP AND .EMIO TO MAP IN THE ARRAYS AND THEN INDEX INTO THE ARRAY VIA THE ADDRESS RETURNED, NOT VIA A REFERENCE TO THE EMA LABEL.



""

L 28

UNDEFINED EXTERNALS EXIST WHICH PROHIBITS THE LOAD FROM COMPLETING. AN UNDEFINED EXTERNAL IS A REFERENCE MADE BY THE ROUTINE YOU ARE LOADING TO ANOTHER ROUTINE. FOR EXAMPLE IF YOUR FORTRAN PROGRAM HAD THE FOLLOWING CODE :

```
CALL XYZ (I,J,K)
```

THEN THE SUBROUTINE XYZ WOULD BE AN EXTERNAL. THE PROBLEM YOU HAVE IS THAT YOU LOADED THE ROUTINE THAT CONTAINED THE CALL TO XYZ BUT YOU DIDN'T LOAD THE XYZ SUBROUTINE ITSELF. XYZ IS THE UNDEFINED EXTERNAL. THE PROPER COURSE HERE IS TO RELOAD YOUR PROGRAM BUT THIS TIME DON'T FORGET TO LOAD THE ROUTINES LISTED WHEN THE LOADR ABORTED THE LAST TIME YOU TRIED TO LOAD THE PROGRAM. ONE LAST POINT. IT IS POSSIBLE TO FORCE LOAD A PROGRAM OR SEGMENTS THAT HAVE UNDEFINED EXTERNALS. THIS IS DONE WITH THE LOADR 'FORCE' COMMAND. HOWEVER, IF YOU FORCE LOAD THE PROGRAM IT IS YOUR RESPONSIBILITY TO MAKE SURE THAT THE LINE OF CODE THAT REFERENCES THE EXTERNAL IS NEVER EXECUTED. THAT IS, MAKE SURE THAT THE CALL TO XYZ IS NOT EXECUTED OR YOUR PROGRAM WILL PROBABLY BE ABORTED WITH A DM OR MP ERROR.

""

L 29

ATTEMPT TO REPLACE OR PURGE A PROGRAM WHERE COPIES OF THAT PROGRAM EXIST. IT IS NOT POSSIBLE TO REPLACE OR PURGE A PROGRAM FROM THE SYSTEM IF COPIES OF THAT PROGRAM EXIST. THE PROBLEM HERE IS THAT OTHER COPIES OF THE SAME PROGRAM EXIST AND MAY BE IN USE. THE PROPER COURSE HERE IS TO DO AN 'OF,PROG,8' ON ALL THE PROGRAMS LISTED AS COPIES. THIS WILL GET RID OF THOSE PROGRAMS SO THAT YOU CAN PERFORM THE PROGRAM PURGE OR REPLACE. NOTE THAT THIS PROCESS SHOULD ONLY BE DONE BY THE SYSTEM MANAGER.

""

L 30

ATTEMPT TO REPLACE A COPIED PROGRAM. YOU TRIED TO DO A PROGRAM REPLACE ON A PROGRAM THAT WAS A COPY OF ANOTHER PROGRAM. REPLACEMENT OPERATIONS MAY ONLY BE DONE ON THE ORIGINAL PROGRAM NOT THE COPIED PROGRAM. THE PROPER THING TO DO NOW IS EDIT THE SOURCE OF YOUR PROGRAM AND MAKE SURE THE NAME IS THE ORIGINAL PROGRAM NAME.

""

L 31

TRYING TO DO A PURGE OR PERMANENT LOAD WITH A COPY OF THE LOADR. RE-RUN THE LOADR USING THE REAL PROGRAM: RU,LOADR:IH .

## HELP File Listing

""

L 32

THIS PROBLEM RESULTS WHEN YOU TRY TO LOAD THE SAME PROGRAM SEVERAL TIMES BUT DO NOT GET RID OF THE EARLIER LOADS. FOR EXAMPLE, YOU LOADED A PROGRAM CALLED XXXXX AND FOR SOME REASON LOADED THE SAME PROGRAM AGAIN. IN THIS CASE THE LOADR WARNED YOU WITH A W 32 WARNING MESSAGE AND THEN RENAMED YOUR PROGRAM TO ..XXX . THAT IS THE LOADR FORGIVES YOU THE FIRST TIME. HOWEVER, YOU HAVE NOW LOADED A PROGRAM WITH THE SAME NAME A THIRD TIME. THE LOADR WILL NOT FORGIVE THIS AGAIN. THE SOLUTION IS TO DO A

:OF,XXXXX,8

:OF,..XXX,8

AND NOW START THE LOAD OVER AGAIN.

""

L 33

NOT ENOUGH ID SEGMENTS TO FINISH THE LOAD. YOUR SYSTEM HAS RUN OUT OF ID SEGMENTS. CALL THE SYSTEM MANAGER TO FREE UP SOME ID SEGMENTS. HE WILL PROBABLY USE THE OFF COMMAND TO PURGE SOME PROGRAMS FROM THE SYSTEM.

""

L 34

YOU TRIED TO REPLACE A PERMANENT PROGRAM. HOWEVER, THAT PROGRAM TERMINATED SERIALY REUSABLE, SAVING RESOURCES, OR WAS OPERATOR SUSPENDED. THAT IS, THE PROGRAM STILL OWNED A SYSTEM PARTITION. OFF THE PROGRAM AND REPEAT THE LOAD.

""

CL- 01  
THE INPUT TO THE COMPL & CLOAD PROGRAMS MUST BE A SOURCE FILE.  
THESE PROGRAMS DO NOT ACCEPT INPUT FROM AN LU. THUS THE ANSWER  
TO THE PROMPT

NAMR(S),NAMR(L),NAMR(R),<C.S.>  
MUST NOT CONTAIN AN LU FOR THE 1ST PARAMETER IE THE SOURCE NAMR.

""

CL- 02  
NO CONTROL STATEMENT WAS SPECIFIED SO COMPL OR CLOAD OPENED THE  
SOURCE FILE TO FIND OUT WHICH LANGUAGE TO INVOKE (IE FTN4, ASMB).  
AN FMP ERROR WAS DETECTED ON THE OPEN REQUEST. THIS FMP ERROR  
WAS LISTED ALONG WITH THE CL- 02 ERROR MESSAGE.

""

CL- 03  
NO CONTROL STATEMENT WAS SPECIFIED SO COMPL OR CLOAD OPENED THE  
SOURCE FILE TO FIND OUT WHICH LANGUAGE TO INVOKE (IE FTN4,ASMB).  
WHILE SCANNING THE FILE FOR THE CONTROL STATEMENT AN FMP READ  
ERROR OCCURRED. THIS ERROR WAS LISTED ALONG WITH THE CL- 03  
ERROR MESSAGE.

""

CL- 04  
NO CONTROL STATEMENT WAS SPECIFIED SO COMPL OR CLOAD OPENED THE  
SOURCE FILE TO FIND OUT WHICH LANGUAGE TO INVOKE (IE FTN4,ASMB).  
THAT CONTROL STATEMENT MAY OR MAY NOT HAVE BEEN FOUND. HOWEVER,  
AN FMP ERROR WAS DETECTED DURING THE CLOSE OF THE FILE. THAT  
ERROR WAS LISTED ALONG WITH THE CL- 04 MESSAGE.

""

CL- 05  
COMPL & CLOAD RECOGNIZE THE EXISTENCE OF ALL H-P SUPPLIED LANGUAGES  
AND SOME NOT SUPPLIED BY H-P. THE LANGUAGES IT RECOGNIZES ARE  
FTN4, PASCL, ASMB, COBOL, RPG, MICRO, SPL, ALGOL, HPAL, AND SNOBL.  
THE CONTROL STATEMENT MUST BE SPELLED EXACTLY AS SHOWN.  
IF NO CONTROL STATEMENT WAS SPECIFIED AND THE CONTROL STATEMENT  
OF THE PROGRAM WAS NOT IN THE FIRST 10 LINES OF THE PROGRAM, THEN  
A CL- 05 ERROR WILL RESULT.

""

CL- 06  
THE LANGUAGE REQUESTED WAS FOUND AND INVOKED BY COMPL OR CLOAD,  
HOWEVER, THE EXEC 23 REQUEST MADE BY CLOAD OR COMPL WAS REJECTED  
BY THE OPERATING SYSTEM. THIS ERROR COULD ONLY HAPPEN IF THE  
LANGUAGE WAS PURGED FROM THE SYSTEM BETWEEN THE 'RP' AND THE  
EXEC REQUEST. IF YOU GET THIS ERROR, TRY AGAIN. IF IT HAPPENS  
AGAIN REPORT IT TO THE SYSTEM MANAGER.

## HELP File Listing

""

### CL- 07

THIS ERROR MAY OCCUR WHEN THE LANGUAGE REQUESTED IN THE OPTIONAL CONTROL STATEMENT OR THE SOURCE FILE CONTROL STATEMENT WAS RECOGNIZED BUT THE LANGUAGE WAS NOT FOUND. COMPL & CLOAD BOTH TRY TO SCHEDULE THE REQUESTED LANGUAGE, FAILING THAT, THEY BOTH TRY TO 'RP' THE LANGUAGE. IF THAT FAILS THEN THE LANGUAGE DOES NOT EXIST ON THE SYSTEM. IF THIS ERROR OCCURS FOR A LANGUAGE THAT WAS PREVIOUSLY ON THE SYSTEM, CONTACT THE SYSTEM MANAGER AS THE LANGUAGE HAS BEEN REMOVED FROM THE SYSTEM.

""

### CL- 08

THE LANGUAGE REQUESTED EXISTS ON THE SYSTEM AND COMPL OR CLOAD WAS IN THE PROCESS OF 'RP'ING IT. WHEN THE FILE WAS CLOSED AN FMP ERROR OCCURRED. THAT ERROR WAS LISTED WITH THE CL- 08 ERROR MESSAGE.

""

### CL- 09

THE LANGUAGE REQUESTED EXISTS ON THE SYSTEM AND COMPL OR CLOAD WAS IN THE PROCESS OF 'RP'ING IT. HOWEVER, THAT 'RP' FAILED BECAUSE THE CHECKSUM CALCULATED WHEN THE LANGUAGE WAS 'SP'ED DID NOT MATCH THE SYSTEM CHECKSUM. GENERALLY THIS ERROR MEANS THAT THE PROGRAM WAS NOT LOADED ON THIS SYSTEM BUT THAT THE ABSOLUTE MEMORY IMAGE OF THE PROGRAM (TYPE 6 FILE) WAS BROUGHT OVER TO THIS SYSTEM VIA A FMGR 'ST' OR 'DU' COMMAND. PROGRAMS TO BE RUN ON THIS SYSTEM MUST BE LOADED ON THIS SYSTEM WITH THE LOADR PROGRAM OR THE GENERATOR. NO OTHER METHOD OF CREATING ABSOLUTE PROGRAMS IS ALLOWED. THE FILE CONTAINING THE LANGUAGE AND ALL ITS SEGMENT FILES SHOULD BE PURGED AND THE PROGRAM LOADED WITH THE LOADR.

""

### CL- 10

THE LANGUAGE REQUESTED EXISTS ON THE SYSTEM AND COMPL OR CLOAD WAS IN THE PROCESS OF 'RP'ING THE LANGUAGE. HOWEVER, DURING THE OPEN REQUEST AN FMP ERROR OCCURRED. THIS ERROR WAS REPORTED WITH THE CL- 10 ERROR MESSAGE.

""

CL- 11

.THIS SESSION HAS MORE THAN 80 SPOOL FILES CURRENTLY RESIDING ON THE SPOOL DISC. CLOAD AND COMPL USE FILE NAMES CONSTRUCTED AS FOLLOWS:

CHAR 1 & 1 = CO  
 CHAR 3 & 4 = SESSION # (01 - 99)  
                   THIS IS THE NUMBER LISTED IN THE  
                   BREAK POINT MODE S = XX COMMAND ?  
                   THE XX IS THE USERS SESSION #  
 CHAR 5 & 6 (01 - 80) THIS IS JUST A COUNTER  
                   THE FILES WOULD BE CREATED AS  
                   COXX01 THEN COXX02 AND SO ON.

THESE FILES CONTAIN THE OUT SPOOLED LISTING. THE CL- 11 ERROR MEANS THAT 80 OF THESE FILES ALREADY EXIST AND NO MORE WILL BE CREATED FOR THIS SESSION.

NOTE THAT RU ,COMPL ,SOURCE ,6:NS WILL INHIBIT SPOOLING TO LU 6. THAT IS, A ' 6:NS ' IN THE LIST NAMR POSITION WILL INHIBIT SPOOLING AND BYPASS THIS ERROR CONDITION.

""

CL- 12

THE COMPILER WAS ABORTED AND THUS THE COMPLILATION WAS NOT SUCCESSFULLY COMPLETED. THE ABNORMAL END WAS PROBABLY DUE TO AN ' OF ' COMMAND. IF THE ABNORMAL END WAS DUE TO OTHER TYPE COMPILER ERRORS THE ERROR WILL BE ON THE LISTING OR REPORTED TO YOUR TERMINAL. TRY THE COMPILATION AGAIN. IF IT FAILS AGAIN CONSULT YOUR SYSTEM MANAGER.

""

CL- 13

THE COMPILATION WAS NOT SUCCESSFUL. ERRORS OR WARNINGS WERE FOUND. YOUR BEST BET IS TO GO GET THE LISTING, CORRECT THE ERROR, AND TRY AGAIN. GOOD LUCK !

""

CL- 14

THIS ERROR RESULTS WHEN THE SYSTEM IS OUT OF ID SEGMENTS AND IT IS IMPOSSIBLE TO ' RP ' THE COMPILER OR LOADR. GO GET THE SYSTEM MANAGER AS HE IS THE ONLY ONE WHO WILL KNOW WHICH ID SEGMENTS CAN BE DONE AWAY WITH. AFTER SOME ID SEGMENTS ARE FREE TRY AGAIN AND THE COMPILATION SHOULD WORK.

""

CL- 15

THIS ERROR MEANS THAT ONE OF THE INPUT PARAMETERS WAS IN ERROR. MOST OFTEN IT MEANS THAT THE LIST LU THAT YOU SPECIFIED IS ILLEGAL OR NOT DEFINED FOR YOUR SESSION.

""

CL- 30

CLOAD WAS TRYING TO ' RP ' THE LOADR BUT ENCOUNTERED AN FMP ERROR ON THE CLOSE OF THE FILE THAT CONTAINED THE LOADR. THE FMP ERROR WAS LISTED WITH THE CL- 30 ERROR. YOU SHOULD REPORT THIS TO THE SYSTEM MANAGER.

## HELP File Listing

""

CL- 31

CLOAD WAS TRYING TO ' RP ' THE LOADR AND A CHECKSUM ERROR RESULTED. THIS COULD ONLY OCCUR IF THE LOADR WAS NOT LOADED ON THIS SYSTEM BUT WAS BROUGHT OVER TO THIS SYSTEM VIA A FMGR 'ST' OR 'DU' COMMAND. THIS ERROR IS A SERIOUS ONE AND THE SYSTEM MANAGER SHOULD BE CONSULTED.

""

CL- 32

CLOAD WAS TRYING TO ' RP ' THE LOADR BUT ENCOUNTERED AN FMP ERROR ON THE FMP OPEN REQUEST. YOU SHOULD REPORT THIS TO THE SYSTEM MANAGER.

""

CL- 33

THIS SHOULD BE AN IMPOSSIBLE ERROR ! THE ONLY WAY THIS COULD HAPPEN IS IF THE LOADR WAS NOT LOADED AT GENERATION TIME OR IF AN ILLEGAL NON SUPPORTED MEMORY OR DISC MODIFICATION HAS BEEN MADE. REPORT THIS TO THE SYSTEM MANAGER IMMEDIATELY !

""

CL- 34

THE LOADR WAS LOADING YOUR PROGRAM BUT WAS ABORTED ABNORMALLY. THIS WAS PROBABLY THE RESULT OF AN ' OF ' COMMAND. ANY OTHER ABNORMAL ENDING ERROR WILL BE REPORTED TO YOUR CONSOLE. TRY THE LOAD AGAIN. IF THE ERROR OCCURS AGAIN REPORT IT TO THE SYSTEM MANAGER.

""

CL- 35

THE LOAD WAS NOT SUCCESSFUL. MORE OFTEN THAN NOT LOAD ERRORS ARE A RESULT OF UNDEFINED EXTERNALS. CHECK THE LOADR LISTING FOR THE TYPE OF ERROR. IF IT IS AN UNDEFINED EXTERNAL, THEN YOU ARE PROBABLY MISSING A SUBROUTINE SOMEWHERE. IF THIS IS THE CASE CLOAD IS NOT THE PROGRAM YOU SHOULD BE USING. RATHER, YOU SHOULD BE USING THE PROGRAMS COMPL TO COMPILE YOUR CODE AND THE LOADR TO LOAD THE SEPARATE MODULES THAT THE PROGRAM REQUIRES.

""

CL- 36

THIS IS A LOADR SCHEDULING ERROR. FOR SOME REASON THE CLOAD PROGRAM WAS UNABLE TO CREATE A COPY OF THE LOADR FOR YOU AND EVEN THE ORIGINAL LOADR WAS NOT AVAILABLE. CALL THE SYSTEM MANAGER FOR ASSISTANCE.

""

CL- 37

THE LIST DEVICE FOR CLOAD MUST BE AN LU BECAUSE BOTH THE COMPILER AND THE LOADR MUST TALK TO THE DEVICE. IF THE LOADR WERE TO LIST TO THE SAME FILE THAT THE COMPILER DID THE COMPILER LISTING WOULD BE OVERLAYED. YOU CAN GET THE LISTING TO GO TO A FILE, HOWEVER, IF YOU USE THE SPOOL SYSTEM. (IE THE :SL,LU#,NAMR COMMAND.)

GASP -48

SMP CANNOT BE SCHEDULED

SMP PROGRAM IS NOT FOUND OR THERE IS NOT A BIG ENOUGH PARTITION TO RUN SMP. THE DEFAULT FOR SMP IS TYPE 2 (REALTIME) AND 6 PAGES IN SIZE.

""

GASP -33

NOT ENOUGH ROOM ON CARTRIDGE

AN ATTEMPT WAS MADE TO ACCESS A CARTRIDGE WHICH HAS NO MORE ROOM. TRY USING ANOTHER CARTRIDGE OR DECREASE THE FILE SIZE.

""

GASP -32

CARTRIDGE NOT FOUND

AN ATTEMPT WAS MADE TO ACCESS A CARTRIDGE THAT CANNOT BE FOUND IN THE CARTRIDGE LIST. CHECK THE CARTRIDGE NUMBER FOR CORRECTNESS.

""

GASP -14

DIRECTORY FULL

THERE IS NO MORE ROOM IN THE FILE DIRECTORY. PURGE ANY UNUSED FILES AND PACK THE DISC IF POSSIBLE. OTHERWISE, TRY ANOTHER CARTRIDGE.

""

GASP -13

DISC LOCKED

THE CARTRIDGE SPECIFIED IS LOCKED. INITIALIZE THE CARTRIDGE IF IT WAS NOT INITIALIZED, OTHERWISE KEEP TRYING.

""

GASP -12

EOF OR SOF ERROR

AN ATTEMPT WAS MADE TO READ, WRITE, OR POSITION A FILE BEYOND THE FILE BOUNDARIES. CHECK THE RECORD POSITION PARAMETERS. THE RESULTS DEPEND ON THE FILE TYPE AND THE CALL.

""

GASP -8

FILE OPEN OR LOCK REJECTED

AN ATTEMPT WAS MADE TO OPEN A FILE THAT WAS ALREADY OPENED EXCLUSIVELY OR WAS ALREADY OPENED TO EIGHT PROGRAMS, OR THE CARTRIDGE CONTAINING THE FILE IS LOCKED. USE THE CL OR DL COMMAND TO LOCATE THE LOCK. IF THE FILE IS BEING PACKED, CHECK TO SEE IF SPOOLING IS SHUT DOWN.

""

GASP -7

ILLEGAL SECURITY CODE OR ILLEGAL WRITE ON LU2 OR 3

1. AN ATTEMPT WAS MADE TO ACCESS A FILE WITHOUT SPECIFYING THE SECURITY CODE OR WITH THE WRONG SECURITY CODE. FIND OUT THE CORRECT CODE AND USE IT OR DO NOT ACCESS THE FILE. OR
2. AN ATTEMPT WAS MADE BY A SESSION USER (NOT THE SYSTEM MANAGER) TO WRITE ON LU 2 OR 3. SESSION USERS DO NOT HAVE WRITE ACCESS TO LU 2 OR 3.

HELP File Listing

""

GASP -6  
FILE NOT FOUND  
AN ATTEMPT WAS MADE TO ACCESS A FILE THAT CANNOT BE FOUND. CHECK THE  
FILE NAME.

""

GASP -4  
MORE THAN 32767 RECORDS IN A TYPE 2 FILE  
AN ATTEMPT WAS MADE TO CREATE A TYPE 2 FILE WITH TOO MANY RECORDS OR  
WITH A RECORD SIZE THAT IS TOO LARGE. CHECK THE SIZE PARAMETER.

""

GASP -2  
DUPLICATE FILE NAME  
A FILE ALREADY EXISTS WITH THE NAME SPECIFIED. REPEAT THE COMMAND WITH  
A NEW NAME OR PURGE THE EXISTING FILE.

""

GASP -1  
DISC ERROR  
THE DISC IS DOWN. TRY AGAIN AND THEN REPORT THE PROBLEM TO THE SYSTEM  
MANAGER.

""

GASP 1  
DISC ERROR NN  
DISC ASSOCIATED WITH LU NN IS DOWN; REPORT PROBLEM TO THE SYSTEM MANAGER.

""

GASP 2  
NUMBER OUT OF RANGE  
NUMBER ENTERED IN GASP INITIALIZATION IS INCONSISTENT WITH PREVIOUS  
ENTRIES OR EXCEEDS MAXIMUM SPECIFIED AT GENERATION; CHECK LAST ENTRY  
AND CHANGE.

""

GASP 3  
BAD JOB NUMBER!  
SPECIFIED JOB NUMBER NOT CURRENTLY ASSIGNED; CHECK ASSIGNED JOB NUMBERS  
WITH DJ COMMAND; RE-ENTER COMMAND WITH VALID JOB NUMBER.

""

GASP 4  
ILLEGAL STATUS  
COMMAND IS NOT VALID FOR CURRENT STATE OF JOB OR SPOOL FILE; CHECK STATUS  
WITH DJ OR DS.

""

GASP 5  
ILLEGAL COMMAND  
COMMAND NOT RECOGNIZED BY GASP; CHECK AND RE-ENTER COMMAND CORRECTLY.



""

GASP 6  
NOT FOUND  
SPECIFIED JOB OR SPOOL NOT CURRENTLY ASSIGNED; CHECK WITH DJ OR DS.

""

GASP 43  
LU NOT FOUND IN SST  
THE OUTSPOOL LU SPECIFIED IN COMMAND IS NOT DEFINED IN THE SESSION SWITCH  
TABLE FOR THIS SESSION USER. USE FMGR SL COMMAND TO ADD THE LU TO THE  
SST OR USE ANOTHER OUTSPOOL LU.

""

GASP 46  
INSUFFICIENT CAPABILITY  
AN ATTEMPT WAS MADE TO EXECUTE A COMMAND THAT REQUIRES A HIGHER CAPABILITY  
LEVEL THAN THE CAPABILITY LEVEL DEFINED FOR THIS SESSION USER.

""

GASP 55  
MISSING PARAMETER  
A REQUIRED PARAMETER HAS BEEN OMITTED. CHECK THE COMMAND AND RE-ENTER  
IT WITH THE MISSING PARAMETER.

""

GASP 56  
BAD PARAMETER  
A PARAMETER WAS SPECIFIED INCORRECTLY; CHECK THE COMMAND AND RE-ENTER  
IT CORRECTLY.

HELP File Listing

""

LGON 06

THIS IS AN INFORMATIONAL DIAGNOSTIC. THE STATION (TERMINAL) BEING LOGGED ONTO HAS A CONFIGURATION TABLE ENTRY WHICH IS A DUPLICATE OF AN ENTRY IN THE USERS ACCOUNT FILE ENTRY. IF THE USER HAS THE CAPABILITY TO MAKE CHANGES IN THE SESSION SWITCH TABLE (SL,X,Y), BOTH THE CONFIGURATION TABLE AND THE USERS ACCOUNT FILE DEFINITION (OF THE SESSION LU) ARE REPORTED. IN EITHER CASE, THE USER'S ACCOUNT FILE DEFINITION IS USED. CONTACT YOUR SYSTEM MANAGER TO HAVE THE CONFLICT REMOVED.

""

LGON 07

NO ROOM FOR SESSION CONTROL BLOCK. UNABLE TO COMPLETE LOGON. ALLOCATE MORE SAM OR REDUCE THE SCB'S EITHER IN NUMBER OR IN SIZE. CONTACT YOUR SYSTEM MANAGER TO CORRECT THIS SITUATION.

""

LGON 09

YOUR SESSION HAS EXCEEDED THE MAXIMUM SESSION SWITCH TABLE SIZE. THE OVERFLOW WAS DETECTED IN ONE OF THE FOLLOWING AREAS: BUILDING THE SST ENTRIES DEFINED BY THE USER'S ACCOUNT ENTRY, BUILDING SST ENTRIES DEFINED BY THE STATION CONFIGURATION TABLE OR MOUNTING SYSTEM GLOBAL DISCS. CONTACT YOUR SYSTEM MANAGER AS YOU MAY BE MISSING SOME DEVICE DEFINITIONS.

""

LGON 11

THE LOGON PROGRAM RECEIVED THE SPECIFIED ERROR WHEN ATTEMPTING TO MOUNT A PRIVATE OR GROUP DISC TO THIS SESSION. CHECK THE TERMINAL USERS MANUAL (ERROR SUMMARY) FOR MORE INFORMATION.

""

LGON 13

THIS IS AN INFORMATIONAL DIAGNOSTIC. LOGON DETECTED A USER SST WHICH ATTEMPTED TO REDEFINE A SYSTEM DISC'S LOGICAL UNIT NUMBER. DISC LU'S MUST BE DIRECT MAPS (SESSION LU=SYSTEM LU). CONTACT YOUR SYSTEM MANAGER TO CORRECT YOUR ACCOUNT.

""

ACCT 012  
LU NOT IN SESSION SWITCH TABLE  
ENTER THE CORRECT LU OR EXIT ACCTS  
AND PUT LU IN SST WITH SL COMMAND

""

ACCT 004  
ILLEGAL LU  
A LU WAS SPECIFIED WHICH:  
1) CAN NOT HANDLE BINARY DATA  
2) IS NOT AN INPUT DEVICE  
3) IS NOT AN OUTPUT DEVICE  
4) THE DEVICE IS WRITE PROTECTED

""

ACCT 013  
TRANSFER STACK OVERFLOW  
THE TRANSFER STACK IS ONLY 10 DEEP  
TR,-11 CLEARS THE TRANSFER STACK

""

ACCT 046  
INSUFFICIENT CAPABILITY  
AN ATTEMPT WAS MADE TO EXECUTE A COMMAND WHICH IS RESERVED FOR  
GROUP MANAGERS OR THE SYSTEM MANAGER.

""

ACCT-200  
ACCOUNT NOT FOUND  
GROUP ACCOUNT MUST BE DEFINED BEFORE  
A USER CAN BE ASSIGNED TO IT

""

ACCT-201  
NO FREE ACCOUNTS  
THE "LO,0" COMMAND CAN BE USED TO EXPAND THE ACCOUNTS FILE

""

ACCT-202  
ACCOUNT WITH THIS NAME ALREADY EXISTS

""

ACCT-203  
INVALID ACCOUNT NAME  
1) ONLY 10 ALPHANUMERIC CHARACTERS  
ARE ALLOWED FOR A NAME.  
2) WHEN LINKING TO AN ACCOUNT WHICH BELONGS  
TO GROUP GENERAL ".GENERAL" MUST BE  
SPECIFIED.

HELP File Listing

""

ACCT-204

INVALID PASSWORD

- 1) THE PASSWORD OF THE SYSTEM  
MANAGER IS REQUIRED TO RUN  
ACCTS FROM A NON SESSION  
CONSOLE.
- 2) THE PASSWORD OF THE ACCOUNT  
TO WHICH THIS IS BEING LINKED  
IS REQUIRED.
- 3) THE PASSWORD FOR CURRENT ACCOUNT  
IS INCORRECT.
- 4) THE NEW PASSWORD CONTAINS AN ILLEGAL  
CHARACTER. THE CHARACTER MUST BE  
PRINTABLE AND NOT A DELIMITER ( . , \* / ).

""

ACCT-205

INVALID COMMAND

ENTER "HE" TO GET THE COMMANDS

""

ACCT-206

INVALID FILE NAME

""

ACCT-207

INVALID CAPABILITY

CAPABILITY MUST BE BETWEEN 1 AND 63

""

ACCT-208

INVALID DISC LIMIT

ONLY 60 DISCS ARE ALLOWED

""

ACCT-209

INVALID SST ENTRY

SESSION LU MUST BE GREATER THAN 3 AND LESS THAN 64  
SYSTEM LU MUST BE GREATER THAN 0 AND LESS THAN 255  
SESSION LU IS ALREADY DEFINED.

""

ACCT-210

CONFLICT IN SST DEFINITION

USER AND GROUP SST'S DISAGREE

""

ACCT-211

USER OR GROUP ID NOT AVAILABLE

ENTER "LIST,USER,@.@,6,ID" TO FIND  
LARGEST GROUP ID AND SMALLEST USER ID  
PURGE AND REBUILD THE CONFLICTING ACCOUNT(S)

""

ACCT-212  
INVALID NUMBER OF SST SPARES  
MUST BE BETWEEN 0 AND 60  
SPARES PLUS DISC LIMIT MUST BE LESS THAN 68

""

ACCT-213  
INVALID MEMORY REQUEST  
MEMORY REQUEST MUST BE BETWEEN 70 AND 7000 WORDS

""

ACCT-215  
LIST NAMR IN TRANSFER STACK  
REISSUE TR COMMAND

""

ACCT-218  
SESSION NOT SHUT DOWN  
SESSION MUST SHUT DOWN FOR LOAD, <NAMR>

""

ACCT-219  
NOT ENOUGH ROOM IN FILE FOR NEW TABLE  
ENTER "LO,0" TO EXPAND FILE

""

ACCT-220  
CORRUPT STATION TABLE SPARES  
SORRY MUST BUILD ACCOUNTS FILE FROM SCRATCH

""

ACCT-221  
NOT AN ACTIVE SESSION  
THE SESSION ADDRESSED IS NOT ACTIVE

""

ACCT-222  
ILLEGAL SYSTEM LU  
SYSTEM LU MUST BE BETWEEN 1 AND 255

""

ACCT-223  
ILLEGAL SHUT DOWN PARAMETER  
SHUT DOWN OPTIONS ARE:  
1) "SD" SHUT DOWN THE SESSION SYSTEM  
2) "SD,RE" SHUT DOWN THE SESSION SYSTEM AND RELEASE SESSION MEMORY  
3) "SD,<LU>,RP" SHUT DOWN SESSION <LU> AND RELEASE PRIVATE DISCS  
4) "SD,<LU>,RG" SHUT DOWN SESSION <LU> AND RELEASE GROUP DISCS  
<LU> CANNOT BE TERMINAL LU FROM WHICH ACCTS IS  
RUNNING. YOU CANNOT SHUT DOWN YOUR OWN  
SESSION.

## HELP File Listing

""  
ACCT-225  
SESSION MEMORY CAN NOT BE RETURNED TO SYSTEM (REBOOT)

""  
ACCT-046  
GREATER THAN 255 EXTENTS  
ATTEMPT TO CREATE EXTENT 256. MAKE FILE SIZE OF MAIN LARGER.

""  
ACCT-099  
DIRECTORY MANAGER EXEC REQUEST WAS ABORTED  
AN EXEC REQUEST MADE BY D.RTR WAS ABORTED. MAKE SURE THAT ALL DISCS  
BEING ACCESSED ARE UP. NOTIFY SYSTEM MANAGER.

""  
ACCT-041  
NO ROOM IN SST

""  
ACCT-040  
LU NOT FOUND IN SST  
TRYING TO ACCESS AN LU THAT IS NOT IN YOUR SST. USE THE SL COMMAND  
TO ADD THE LU TO THE SST.

""  
ACCT-039  
CONFLICT IN SST DEFINITION

""  
ACCT-035  
ALREADY 63 DISCS MOUNTED TO SYSTEM  
AN ATTEMPT WAS MADE TO MOUNT A DISC WHEN THERE ARE ALREADY 63 DISCS  
MOUNTED. A DISC WILL HAVE TO BE DISMOUNTED BEFORE A NEW ONE MAY BE  
MOUNTED.

""  
ACCT-034  
DISC ALREADY MOUNTED.  
AN ATTEMPT WAS MADE TO MOUNT A DISC THAT IS ALREADY MOUNTED ON THE  
CARTRIDGE LIST. EITHER DISMOUNT THE DUPLICATE DISC OR MOUNT A  
DIFFERENT ONE.

""  
ACCT-033  
NOT ENOUGH ROOM ON CARTRIDGE  
AN ATTEMPT WAS MADE TO ACCESS A CARTRIDGE WHICH HAS NO MORE ROOM.  
TRY USING ANOTHER CARTRIDGE OR DECREASE THE FILE SIZE.

""  
ACCT-032  
CARTRIDGE NOT FOUND  
AN ATTEMPT WAS MADE TO ACCESS A CARTRIDGE THAT CANNOT BE FOUND IN THE  
CARTRIDGE LIST. CHECK THE CARTRIDGE NUMBER FOR CORRECTNESS.

""

ACCT-030  
VALUE TOO LARGE FOR PARAMETER

""

ACCT-026  
QUEUE FULL OR MAX PENDING SPOOLS EXCEEDED  
THE SPOOL QUEUE IS FULL OR THE MAXIMUM NUMBER OF PENDING SPOOLS HAS  
BEEN EXCEEDED. THE JOB MUST BE RE-RUN WHEN THE SPACE BECOMES AVAILABLE.

""

ACCT-025  
NO SPLCON ROOM  
THE SPLCON IS FULL. THIS ERROR MAY OCCUR WHEN THE SPOOL SYSTEM IS  
COMPETING WITH PROGRAMS USING THEIR OWN SPOOLING FILE AND RUNNING  
OUTSIDE OF BATCH.

""

ACCT-024  
NO MORE BATCH SWITCHES  
THE LU SWITCH TABLE IS FULL. THE SIZE OF THE SWITCH TABLE SPECIFIED  
AT SYSTEM GENERATION IS INADEQUATE. NOTIFY THE SYSTEM MANAGER OF THIS  
CONDITION.

""

ACCT-023  
NO AVAILABLE SPOOL FILES  
ALL SPOOL FILES ARE CURRENTLY BEING USED. RE-RUN THE JOB AFTER A  
SPOOL FILE BECOMES AVAILABLE.

""

ACCT-022  
NO AVAILABLE SPOOL LU'S  
ALL SPOOL LOGICAL UNITS ARE CURRENTLY UNAVAILABLE. RE-RUN THE JOB  
AFTER A SPOOL LU BECOMES AVAILABLE.

""

ACCT-021  
ILLEGAL DESTINATION LU  
THE LU SPECIFIED WAS NOT ALLOCATED BY GASP. TRY AGAIN USING A LU  
ALLOCATED BY GASP.

""

ACCT-020  
ILLEGAL ACCESS LU

1. THE LOGICAL UNIT NUMBER SPECIFIED IN THE LU OR CS COMMAND WAS NOT A  
POSITIVE LOGICAL UNIT NUMBER. RE-ENTER THE CORRECTED COMMAND. OR
2. THERE IS AN LU ENTRY IN THE CARTRIDGE LIST THAT DOES NOT POINT  
TO A DISC DEVICE. THIS HAPPENED BECAUSE AFTER THE DISC WAS MOUNTED  
THE LU COMMAND WAS USED TO DO A LOGICAL UNIT SWITCH ON THE DEVICE.  
SWITCH THE LU BACK TO ITS DISC DEFINITION. IF DESIRED, DISMOUNT THE  
DISC. THE LU CAN THEN BE SWITCHED TO A NON-DISC DEVICE.

## HELP File Listing

""

ACCT-019  
ILLEGAL ACCESS ON A SYSTEM DISC  
AN ATTEMPT WAS MADE TO WRITE ON A SYSTEM DISC. THE SYSTEM MANAGER IS  
THE ONLY USER THAT HAS THIS CAPABILITY.

""

ACCT-018  
ILLEGAL LU; LU NOT ASSIGNED TO SYSTEM  
ATTEMPT TO ACCESS AN LU THAT IS NOT ASSIGNED TO THE SYSTEM.

""

ACCT-017  
ILLEGAL READ/WRITE ON TYPE 0 FILE  
AN ATTEMPT WAS MADE TO READ, WRITE, OR POSITION A TYPE 0 FILE THAT  
DOES NOT SUPPORT THE OPERATION. CHECK THE FILE PARAMETERS OR THE  
NAMR.

""

ACCT-016  
ILLEGAL TYPE 0 OR FILE BLOCKSIZE=0  
ONE OF THE FOLLOWING OCCURRED:  
1) THE WRONG FILE TYPE WAS SPECIFIED,  
2) AN ATTEMPT WAS MADE TO CREATE OR PURGE A TYPE 0 FILE, OR  
3) THE SIZE SPECIFIED WAS ZERO BLOCKS.  
CHECK THE SIZE AND TYPE PARAMETERS.

""

ACCT-015  
ILLEGAL NAME  
THE FILE NAME DOES NOT CONFORM TO THE SYNTAX RULES. CORRECT THE NAME  
AND RE-ENTER THE COMMAND.

""

ACCT-014  
DIRECTORY FULL  
THERE IS NO MORE ROOM IN THE FILE DIRECTORY. PURGE ANY UNUSED FILES  
AND PACK THE DISC IF POSSIBLE. OTHERWISE, TRY ANOTHER CARTRIDGE.

""

ACCT-013  
DISC LOCKED  
THE CARTRIDGE SPECIFIED IS LOCKED. INITIALIZE THE CARTRIDGE IF IT WAS  
NOT INITIALIZED, OTHERWISE KEEP TRYING.

""

ACCT-012  
EOF OR SOF ERROR  
AN ATTEMPT WAS MADE TO READ, WRITE, OR POSITION A FILE BEYOND THE FILE  
BOUNDARIES. CHECK THE RECORD POSITION PARAMETERS. THE RESULTS DEPENDS  
ON THE FILE TYPE AND THE CALL.



""

ACCT-011

DCB NOT OPEN

AN ATTEMPT WAS MADE TO ACCESS AN UNOPENED DCB. USE THE CREATE OR OPEN CALL TO OPEN THE DCB AND CHECK FOR ERRORS.

""

ACCT-010

NOT ENOUGH PARAMETERS

ONE OR MORE OF THE REQUIRED PARAMETERS WERE OMITTED FROM THE CALL. ENTER THE REQUIRED PARAMETERS.

""

ACCT-009

ATTEMPT TO USE APOSN OR FORCE A TYPE 0 FILE TO TYPE 1

A TYPE 0 FILE CANNOT BE POSITIONED WITH APOSN OR BE FORCED TO A TYPE 1 FILE. CHECK THE FILE TYPE.

""

ACCT-008

FILE OPEN OR LOCK REJECTED

AN ATTEMPT WAS MADE TO OPEN A FILE THAT WAS ALREADY OPENED EXCLUSIVELY OR WAS ALREADY OPENED TO EIGHT PROGRAMS, OR THE CARTRIDGE CONTAINING THE FILE IS LOCKED. USE THE CL OR DL COMMAND TO LOCATE THE LOCK. IF THE FILE IS BEING PACKED, CHECK TO SEE IF SPOOLING IS SHUT DOWN.

""

ACCT-007

ILLEGAL SECURITY CODE OR ILLEGAL WRITE ON LU2 OR 3

1. AN ATTEMPT WAS MADE TO ACCESS A FILE WITHOUT SPECIFYING THE SECURITY CODE OR WITH THE WRONG SECURITY CODE. FIND OUT THE CORRECT CODE AND USE IT OR DO NOT ACCESS THE FILE. OR
2. AN ATTEMPT WAS MADE BY A SESSION USER (NOT THE SYSTEM MANAGER) TO WRITE ON LU 2 OR 3. SESSION USERS DO NOT HAVE WRITE ACCESS TO LU 2 OR 3.

""

ACCT-006

FILE NOT FOUND

AN ATTEMPT WAS MADE TO ACCESS A FILE THAT CANNOT BE FOUND. CHECK THE FILE NAME.

""

ACCT-005

RECORD LENGTH ILLEGAL

AN ATTEMPT WAS MADE TO READ OR POSITION A FILE TO A RECORD THAT HAS NOT BEEN WRITTEN, OR TO WRITE AN ILLEGAL RECORD LENGTH ON AN UPDATE. CHECK THE FILE POSITION OR SIZE PARAMETER.

HELP File Listing

""

ACCT-004

MORE THAN 32767 RECORDS IN A TYPE 2 FILE  
AN ATTEMPT WAS MADE TO CREATE A TYPE 2 FILE WITH TOO MANY RECORDS OR  
WITH A RECORD SIZE THAT IS TOO LARGE. CHECK THE SIZE PARAMETER.

""

ACCT-003

BACKSPACE ILLEGAL  
AN ATTEMPT WAS MADE TO BACKSPACE A DEVICE (OR TYPE 0 FILE) THAT CANNOT  
BE BACKSPACED. CHECK THE DEVICE TYPE.

""

ACCT-002

DUPLICATE FILE NAME  
A FILE ALREADY EXISTS WITH THE NAME SPECIFIED. REPEAT THE COMMAND WITH  
A NEW NAME OR PURGE THE EXISTING FILE.

""

ACCT-001

DISC ERROR  
THE DISC IS DOWN. TRY AGAIN AND THEN REPORT THE PROBLEM TO THE SYSTEM  
MANAGER.

""

## L-CK SUM

THIS IS A CHECKSUM ERROR. MOST LIKELY YOU SPECIFIED A FILE TO THE LOADR THAT DID NOT CONTAIN RELOCATABLE FORMAT CODE. A TYPICAL MISTAKE IS SPECIFYING THE SOURCE FILE NAME INSTEAD OF THE BINARY FILE NAME. IF THE FILE YOU SPECIFIED WAS THE CORRECT ONE THEN THAT FILE HAS BEEN OVERLAYED OR CORRUPTED. PURGE THAT FILE AND RECOMPILE THE ORIGINAL SOURCE AND TRY AGAIN.

""

## L-IL REC

THE LOADR FOUND A RECORD THAT WAS NOT A NAM, ENT, EXT, DBL, EMA, GEN, LOD, OR END RECORD. THE CHECKSUM WAS OK BUT THE RECORD WAS UNIDENTIFIED. WAS THE FILE SPECIFIED A RELOCATABLE FILE? TRY RECOMPILING AND LOADING.

""

## L-OV MEM

THE SIZE OF THE CODE LOADED SO FAR EXCEEDS THE MAX SIZE THAT YOU SPECIFIED OR EXCEEDS THE LARGEST POSSIBLE SIZE FOR A PROGRAM. MAX SIZE FOR LARGE BACKGROUND (LB) NON EMA PROGRAMS IS 28K WORDS (INCLUDING BASE PAGE) AND 26K FOR LB EMA PROGRAMS. CONSULT THE GENERATION MAP FOR THE MAX SIZE OF REAL TIME AND BACKGROUND PROGRAMS. IF YOUR PROGRAM IS JUST TOO LARGE THE FOLLOWING SOLUTIONS MIGHT BE TRIED:

1. IF THE PROGRAM IS NOT TYPE 4 (LARGE BACKGROUND [LB]) MAKE IT A TYPE 4 BY SPECIFYING THE 'OP,LE' COMMAND TO THE LOADR.
2. IF YOU SPECIFIED A SIZE, THEN DON'T SPECIFY A SIZE THE LOADR WILL DO ALL IT CAN TO MAKE YOUR PROGRAM FIT.
3. SEGMENT THE PROGRAM
4. TRY WRITING SOME OF THE PROGRAM IN ASSEMBLY
5. SEE IF THERE ARE ANY DATA DECLARATIONS THAT CAN BE REMOVED OR ANY DATA DECLARATIONS THAT CAN BE MOVED TO EMA.

""

## L-OV BSE

BASE PAGE OVERFLOW. THIS PROGRAM HAS USED TOO MANY BASE PAGE LINKS. IF THE CP OPTION WAS NOT USED, TRY USING IT TO PUT LINKS ON THE CURRENT PAGE INSTEAD OF ALL ON THE BASE PAGE. IF THE CP OPTION WAS USED, RELOAD THE PROGRAM BUT THIS TIME SPECIFY THE 'OP,LE' OPTION. THIS WILL LIST ALL ENTRY POINTS AND THE BASE PAGE LINKAGES. THIS LOAD WILL ALSO FAIL, HOWEVER, NOW YOU KNOW WHICH MODULES ARE USING UP ALL THE LINKS. BY USING THE LO,XXXXX COMMAND AND ALIGNING THOSE MODULES TO PAGE BOUNDARIES THE LINKAGE NEEDS CAN BE REDUCED. ALTERNATELY YOU MAY WISH TO REARRANGE THE LOADING ORDER OF YOUR SUBROUTINES. THIS MAY IMPROVE (OR MAKE WORSE.) THE LINKAGE NEEDS OF YOUR PROGRAM.

## HELP File Listing

""

### L-OV SYM

THIS IS A SYMBOL TABLE OVERFLOW. THE LOADR NEEDS MORE ROOM FOR ITS INTERNAL SYMBOL TABLE AND FIX UP TABLE. SINCE THE LOADR IS A TYPE 4 PROGRAM IT CAN BE MADE AS LARGE AS THE LARGEST NORMAL BACKGROUND PARTITION. TO GIVE THE LOADR MORE ROOM USE THE 'SZ' OPERATOR COMMAND. THAT IS,

\*SZ,LOADR,XX      XX = # OF PAGES

OR FROM FMGR,

:SYSZ,LOADR,XX

BY INCREASING THE SPACE FOR THE LOADR THE L-OV SYM PROBLEM SHOULD BE SOLVED. CONSULT THE RTE-IVB TERMINAL USER'S REFERENCE MANUAL FOR MORE INFORMATION ON THE 'SZ' COMMAND.

IF THE SZ COMMAND DOES NOT SOLVE THE PROBLEM, THEN TRY USING THE LOADR 'SE' COMMAND AFTER EVERY LOADR 'RE' COMMAND. THIS WILL REDUCE SPACE NEEDED FOR FIXUPS. IN ADDITION TO USING THE 'SE' COMMAND AFTER EVERY 'RE' COMMAND, TRY LOADING A NUMBER OF YOUR SUBROUTINES (STILL DOING 'SE') BEFORE THE MAIN OF THE PROGRAM.

""

### L-CM BLK

THIS IS A COMMON BLOCK ERROR. THIS ERROR OCCURS IF THE LARGEST COMMON DECLARATION OF A PROGRAM DOES NOT APPEAR IN THE FIRST MODULE OF THE PROGRAM LOADED. PROGRAMS THAT USE COMMON MUST DECLARE THAT COMMON IN THE FIRST ROUTINE LOADED AND THAT COMMON DECLARATION MUST BE THE LARGEST ENCOUNTERED IN THE LOAD. THIS ERROR IS ALSO GENERATED IF THE AMOUNT OF COMMON REQUESTED EXCEEDS THAT WHICH IS AVAILABLE.

""

### L-DU ENT

DUPLICATE ENTRY POINT. GENERALLY THIS OCCURS WHEN THE SAME SUBROUTINE WAS LOADED TWICE. ALTERNATELY YOU NAMED A SUBROUTINE WITH THE SAME NAME (ENT IN ASMB) THAT WAS ALREADY BEING USED SOMEWHERE ELSE WITHIN THE PROGRAM THAT YOU WERE TRYING TO LOAD. CONFUSION SOMETIMES OCCURS WITH SEGMENTED PROGRAMS. A SUBROUTINE LOADED WITH THE MAIN MUST NOT BE AGAIN LOADED WITH A SEGMENT. LOOK AT THE LOAD MAP FOR THE LOAD. DID YOU TRY TO LOAD THE SUBROUTINE WITH A SEGMENT WHERE THAT SUBROUTINE WAS ALREADY LOADED WITH THE MAIN? THE LOAD MAP WILL LIST ALL SUBROUTINES LOADED WITH THE MAIN.

""

## L-TR ADD

NO TRANSFER ADDRESS. ONLY SUBROUTINES WERE LOADED. THE LOADR COULD NOT TELL WHICH MODULE OF THE PROGRAM WAS THE MAIN AND WHICH ONES WERE SUBROUTINES. IF THE PROGRAM WAS WRITTEN IN FORTRAN NO MODULES WERE FOUND THAT CONTAINED THE 'PROGRAM XXXXX' STATEMENT. IF THE PROGRAM WAS WRITTEN IN ASMB YOU PROBABLY FORGOT TO PUT A LABEL ON THE END STATEMENT. IN ASMB THE MAIN OF A SEGMENT OR OF A PROGRAM IS DIFFERENTIATED FROM SUBROUTINES BY PLACING THE LABEL OF WHERE THE PROGRAM OR SEGMENT IS TO START EXECUTION AS THE OPERAND OF THE END STATEMENT. IF MULTIPLE ROUTINES HAVE LABELS ON THE END STATEMENT THE FIRST ONE ENCOUNTERED IS USED AS THE MAIN OF THE PROGRAM.

""

## L-RE SEQ

RECORD OUT OF SEQUENCE. THE LOADR WAS RELOCATING AND ENCOUNTERED RECORDS IN THE WRONG ORDER. RELOCATABLE RECORDS ARE IN THE ORDER OF GEN/LOD, NAM, ENT, EXT, DBL, AND END. GENERALLY THIS ERROR OCCURS WHEN RELOCATING FROM AN LU, SAY A MAG TAPE, AND THE TAPE IS INCORRECTLY POSITIONED. IF THE RELOCATION WAS FROM A FILE, RECOMPILE THE SOURCE AND TRY AGAIN, AS THE FILE IS CORRUPT.

""

## L-IL PRM

THE RUN STRING SUBMITTED TO THE LOADER WAS IN ERROR. TRY AGAIN.

""

## L-CO RES

ATTEMPT TO REPLACE A MEMORY RESIDENT PROGRAM. YOU TRIED TO REPLACE A MEMORY RESIDENT PROGRAM. THIS IS ILLEGAL.

""

## L-OV FIX

THIS IS A FIXUP TABLE OVERFLOW. THE LOADR NEEDS MORE ROOM FOR ITS INTERNAL SYMBOL TABLE AND FIX UP TABLE. SINCE THE LOADR IS A TYPE 4 PROGRAM IT CAN BE MADE AS LARGE AS THE LARGEST NORMAL BACKGROUND PARTITION. TO GIVE THE LOADR MORE ROOM USE THE 'SZ' OPERATOR COMMAND. THAT IS,

\*SZ,LOADR,XX      XX = # OF PAGES

OR FROM FMGR,

:SYSZ,LOADR,XX

BY INCREASING THE SPACE FOR THE LOADR THE L-OV SYM PROBLEM SHOULD BE SOLVED. CONSULT THE RTE-IVB TERMINAL USER'S REFERENCE MANUAL FOR MORE INFORMATION ON THE 'SZ' COMMAND. IF THE SZ COMMAND DOES NOT SOLVE THE PROBLEM, THEN TRY USING THE LOADR 'SE' COMMAND AFTER EVERY LOADR 'RE' COMMAND. THIS WILL REDUCE SPACE NEEDED FOR FIXUPS. IN ADDITION TO USING THE 'SE' COMMAND AFTER EVERY 'RE' COMMAND, TRY LOADING A NUMBER OF YOUR SUBROUTINES (STILL DOING 'SE') BEFORE THE MAIN OF THE PROGRAM.

## HELP File Listing

""

### L-LM LIB

THE LIMIT ON THE NUMBER OF LIBRARIES SPECIFIED BY THE 'LI' COMMAND HAS BEEN EXCEEDED. YOU MAY SPECIFY 10 LIBRARIES. INSTEAD OF SPECIFYING ANOTHER LIBRARY YOU CAN SPECIFICALLY DO A 'SE' OF THE FILE.

""

### L-IL REL

THE COMPILER PRODUCED AN ILLEGAL RECORD. ONE OF THE FOLLOWING OCCURRED: THE NUMBERS OF ENTRIES SPECIFIED IN AN ENT OR EXT RECORD WAS ZERO. THE NUMBER OF INSTRUCTION WORDS SPECIFIED IN A DBL RECORD WAS ZERO. A RELOCATABLE INDICATOR IN A DBL RECORD WAS SEVEN. A DBL RECORD WAS PRODUCED THAT REFERENCED AN EXTERNAL BUT THAT EXTERNAL WAS NOT IN ANY OF THE EXT RECORDS. ALL OF THE ABOVE ARE IMPOSSIBLE CONDITIONS. RECOMPILE AND TRY AGAIN. THIS COULD ALSO BE A COMPILER BUG.

""

### L-IL PTN

YOU SPECIFIED A PARTITION IN THE LOAD OF THE PROGRAM, HOWEVER, THAT PARTITION DOES NOT EXIST OR HAS BEEN DOWNED DUE TO A PARITY ERROR. TRY AGAIN, THIS TIME SPECIFY A PARTITION THAT EXISTS OR DON'T SPECIFY ANY PARTITION AT ALL.

""

### L-RQ PGS

THE NUMBER OF PAGES THAT YOU SPECIFIED IN THE LOAD OF THE PROGRAM EXCEEDS THAT NUMBER OF PAGES IN THE PARTITION YOU SPECIFIED. EITHER SPECIFY A DIFFERENT PARTITION OR NO PARTITION AT ALL.

""

### L-OV PTN

THE SPECIFIED PROGRAM SIZE IS TOO LARGE FOR THE PARTITION. EITHER SPECIFY A SMALLER SIZE OR NO SIZE AT ALL. SEE ALSO L-OV MEM ERROR FOR OTHER ALTERNATIVES.

""

### L-ML EMA

ILLEGAL EMA DECLARATION. TWO DIFFERENT EMA LABELS WERE USED, OR THE EMA DECLARATION WAS NOT MADE IN THE MAIN OF A PROGRAM AND THAT MAIN LOADED FIRST, OR AN EMA LABEL WAS ALSO DECLARED AS AN ENTRY POINT IN ANOTHER MODULE. THE EMA DECLARATION MUST BE IN THE MAIN OF THE PROGRAM AND THAT MAIN MUST BE THE FIRST MODULE LOADED. THE EMA STATEMENT MUST BE IN ANY SEGMENT OR SUBROUTINE REFERENCING ANY ELEMENT IN EMA.

""

### L-ID EXT

NO ID EXTENSIONS AVAILABLE FOR THE EMA PROGRAM. YOU MUST FREE UP SOME ID EXTENSIONS BEFORE THE EMA PROGRAM CAN BE SUCCESSFULLY LOADED.

""

## L-SZ EMA

THE PROGRAMS DECLARED EMA SIZE IS TOO LARGE FOR THIS SYSTEMS PARTITIONS DEFINITION, IE THERE IS NO EXISTING PARTITION LARGE ENOUGH TO RUN THIS PROGRAM. EITHER REBOOT AND RECONFIGURE SYSTEM TO ALLOW MORE EMA SPACE OR DECLARE LESS EMA SPACE IN THE PROGRAM.

""

## L-SS ENT

YOU ATTEMPTED TO ACCESS AN SSGA ENTRY POINT BUT YOU DID NOT ASK FOR SSGA AT THE BEGINNING OF THE LOAD. RELOAD THE PROGRAM BUT THIS TIME DO A 'OP,SS' AT THE BEGINNING OF THE LOAD.

""

## L-IL CMD

ATTEMPT TO PURGE A PROGRAM UNDER BATCH OR ATTEMPT TO USE THE 'LI' OR 'PU' COMMANDS WITHIN A LOADR COMMAND FILE. LI AND PU COMMANDS ARE NOT ALLOWED WITHIN A LOADR COMMAND FILE UNLESS THAT COMMAND FILE IS AN INTERACTIVE DEVICE (IE A TTY OR CRT).

""

## L-ID SEG

NOT ENOUGH LONG AND SHORT ID SEGMENTS TO FINISH THE LOAD. THIS IS AN EXTREMELY RARE ERROR. THE LOADR WAS CREATING ID SEGMENTS AND THERE WERE ENOUGH ID SEGMENTS AT THE BEGINNING TO FINISH THE LOAD, HOWEVER, BETWEEN CREATING ONE ID SEGMENT AND CREATING THE NEXT ALL OTHER ID SEGMENTS WERE USED UP (MAYBE ANOTHER LOADR OR FILE MANAGER GOT THEM) AT ANY RATE THERE AREN'T ENOUGH TO FINISH THE LOAD. THE PROPER RESPONSE TO THIS ERROR IS TO 'OF' OR PURGE ALL SEGMENTS AND THE MAIN OF THE LOAD THAT WAS JUST UNSUCCESSFUL, FREE UP SOME ADDITIONAL ID SEGMENTS AND TRY THE LOAD AGAIN. IF ENOUGH ID SEGMENTS ARE FREED UP THE LOAD WILL SUCCEED. THIS ERROR COULD ONLY OCCUR IN SEGMENTED LOADS.

""

## L-RF EMA

ATTEMPT TO ACCESS AN EMA EXTERNAL WITH OFFSET OR INDIRECT. IF THIS IS A FORTRAN PROGRAM YOU MORE THAN LIKELY FORGOT TO PUT THE \$EMA STATEMENT IN A SUBROUTINE THAT ACCESSED AN EMA ELEMENT. IF THE PROGRAM WAS WRITTEN IN ASMB USE THE H-P SUPPLIED ROUTINES .EMAP AND .EMIO TO MAP IN THE ARRAYS AND THEN INDEX INTO THE ARRAY VIA THE ADDRESS RETURNED, NOT VIA A REFERENCE TO THE EMA LABEL.

## HELP File Listing

""

### L-UN EXT

UNDEFINED EXTERNALS EXIST WHICH PROHIBITS THE LOAD FROM COMPLETING. AN UNDEFINED EXTERNAL IS A REFERENCE MADE BY THE ROUTINE YOU ARE LOADING TO ANOTHER ROUTINE. FOR EXAMPLE IF YOUR FORTRAN PROGRAM HAD THE FOLLOWING CODE :

```
CALL XYZ(I,J,K)
```

THEN THE SUBROUTINE XYZ WOULD BE AN EXTERNAL. THE PROBLEM YOU HAVE IS THAT YOU LOADED THE ROUTINE THAT CONTAINED THE CALL TO XYZ BUT YOU DIDN'T LOAD THE XYZ SUBROUTINE ITSELF. XYZ IS THE UNDEFINED EXTERNAL. THE PROPER COURSE HERE IS TO RELOAD YOUR PROGRAM BUT THIS TIME DON'T FORGET TO LOAD THE ROUTINES LISTED WHEN THE LOADR ABORTED THE LAST TIME YOU TRIED TO LOAD THE PROGRAM.

ONE LAST POINT. IT IS POSSIBLE TO FORCE LOAD A PROGRAM OR SEGMENTS THAT HAVE UNDEFINED EXTERNALS. THIS IS DONE WITH THE LOADR 'FORCE' COMMAND. HOWEVER, IF YOU FORCE LOAD THE PROGRAM IT IS YOUR RESPONSIBILITY TO MAKE SURE THAT THE LINE OF CODE THAT REFERENCES THE EXTERNAL IS NEVER EXECUTED. THAT IS, MAKE SURE THAT THE CALL TO XYZ IS NOT EXECUTED OR YOUR PROGRAM WILL PROBABLY BE ABORTED WITH A DM OR MP ERROR.

""

### L-EX CPY

ATTEMPT TO REPLACE OR PURGE A PROGRAM WHERE COPIES OF THAT PROGRAM EXIST. IT IS NOT POSSIBLE TO REPLACE OR PURGE A PROGRAM FROM THE SYSTEM IF COPIES OF THAT PROGRAM EXIST. THE PROBLEM HERE IS THAT OTHER COPIES OF THE SAME PROGRAM EXIST AND MAY BE IN USE. THE PROPER COURSE HERE IS TO DO AN 'OF,PROG,8' ON ALL THE PROGRAMS LISTED AS COPIES. THIS WILL GET RID OF THOSE PROGRAMS SO THAT YOU CAN PERFORM THE PROGRAM PURGE OR REPLACE. NOTE THAT THIS PROCESS SHOULD ONLY BE DONE BY THE SYSTEM MANAGER.

""

### L-RP CPY

ATTEMPT TO REPLACE A COPIED PROGRAM. YOU TRIED TO DO A PROGRAM REPLACE ON A PROGRAM THAT WAS A COPY OF ANOTHER PROGRAM. REPLACEMENT OPERATIONS MAY ONLY BE DONE ON THE ORIGINAL PROGRAM NOT THE COPIED PROGRAM. THE PROPER THING TO DO NOW IS EDIT THE SOURCE OF YOUR PROGRAM AND MAKE SURE THE NAME IS THE ORIGINAL PROGRAM NAME.

""

### L-PE LDR

TRYING TO DO A PURGE OR PERMANENT LOAD WITH A COPY OF THE LOADR. RE-RUN THE LOADR USING THE REAL PROGRAM: RU,LOADR:IH.



""

## L-DU PGM

THIS PROBLEM RESULTS WHEN YOU TRY TO LOAD THE SAME PROGRAM SEVERAL TIMES BUT DO NOT GET RID OF THE EARLIER LOADS. FOR EXAMPLE, YOU LOADED A PROGRAM CALLED XXXXX AND FOR SOME REASON LOADED THE SAME PROGRAM AGAIN. IN THIS CASE THE LOADR WARNED YOU WITH A W-DU PGM WARNING MESSAGE AND THEN RENAMED YOUR PROGRAM TO ..XXX. THAT IS THE LOADR FORGIVES YOU THE FIRST TIME. HOWEVER, YOU HAVE NOW LOADED A PROGRAM WITH THE SAME NAME A THIRD TIME. THE LOADR WILL NOT FORGIVE THIS AGAIN. THE SOLUTION IS TO DO A

:OF,XXXXX,8

:OF,..XXX,8

AND NOW START THE LOAD OVER AGAIN.

""

## L-NO IDS

NOT ENOUGH ID SEGMENTS TO FINISH THE LOAD. YOUR SYSTEM HAS RUN OUT OF ID SEGMENTS. CALL THE SYSTEM MANAGER TO FREE UP SOME ID SEGMENTS. HE WILL PROBABLY USE THE OFF COMMAND TO PURGE SOME PROGRAMS FROM THE SYSTEM.

""

## L-RP PGM

YOU TRIED TO REPLACE A PERMANENT PROGRAM. HOWEVER, THAT PROGRAM TERMINATED SERIALY REUSABLE, SAVING RESOURCES, OR WAS OPERATOR SUSPENDED. THAT IS, THE PROGRAM STILL OWNED A SYSTEM PARTITION. OFF THE PROGRAM AND REPEAT THE LOAD.

""



# Appendix I

## Summary of System Entry Points

| ENTRY   | FILE    | ENTRY  | FILE    | ENTRY  | FILE    | ENTRY   | FILE    |
|---------|---------|--------|---------|--------|---------|---------|---------|
| !BITM   | %CR4S2  | \$CALL | %CR4S1  | \$DMAL | %CR4S1  | \$IOUP  | %CR4S1  |
| #COS    | \$MLIB1 | \$CES  | %CR4S2  | \$DMEQ | %CR4S1  | \$IRT   | %CR4S1  |
| #EMA    | %#EMA   | \$CFR  | %CR4S2  | \$DMS  | %CR4S1  | \$IS43  | %SPO2B  |
| #EXP    | \$MLIB1 | \$CGRN | %CR4S2  | \$DRAD | %4SYLB  | \$SKIP  | %BMPG3  |
| #LOG    | \$MLIB1 | \$CHTO | %CR4S2  | \$DREL | %CR4S1  | \$LBR   | %CR4S1  |
| #RSFG   | %4SYLB  | \$CIC  | %CR4S2  | \$DREQ | %CR4S1  | \$LBX   | %CR4S1  |
| #SIN    | \$MLIB1 | \$CICO | %CR4S1  | \$DRVN | %CR4S1  | \$LEND  | %CR4S1  |
| \$SBG1  | \$LIB4E | \$CJMP | %CR4S1  | \$DS1K | %CR4S1  | \$LGBS  | %CR4S1  |
| \$SBG2  | \$LIB4E | \$CKLO | %CR4S1  | \$DSCS | %CR4S2  | \$LGOF  | %CR4S2  |
| \$SBG3  | \$LIB4E | \$CL1  | %CR4S2  | \$DVC  | %CR4S1  | \$LGON  | %CR4S2  |
| \$SCPU  | %CR4S2  | \$CL2  | %CR4S2  | \$DVMP | %CR4S2  | \$LIA4  | %CR4S1  |
| \$SDLS  | %4SYLB  | \$CL3  | \$LIB4E | \$DVPT | %CR4S2  | \$LIBR  | %CR4S2  |
| \$SMM1  | \$LIB4E | \$CLCK | %CR4S1  | \$DVTB | %\$DVTB | \$LIBX  | %CR4S2  |
| \$SMM2  | \$LIB4E | \$CMAD | %CR4S2  | \$ELTB | %CR4S2  | \$LICE  | %CR4S1  |
| \$SMM3  | \$LIB4E | \$CMND | %NSESN  | \$EMRP | %CR4S2  | \$LIST  | %CR4S2  |
| \$SOP   | %CR4S2  | \$CMND | %SMON2  | \$ENDS | %CR4S2  | \$LME\$ | %CR4S2  |
| \$SRT1  | \$LIB4E | \$CMST | %CR4S2  | \$EQCL | %CR4S1  | \$LMES  | %CR4S2  |
| \$SRT2  | \$LIB4E | \$CNFG | %\$CNFX | \$EQST | %CR4S2  | \$LOG   | \$MLIB1 |
| \$SRT3  | \$LIB4E | \$CNFG | %CNF4E  | \$ERAB | %CR4S2  | \$LOGO  | \$MLIB1 |
| \$ABDP  | %\$CNFX | \$CNV1 | %CR4S2  | \$ERIN | %CR4S1  | \$LOGT  | \$MLIB1 |
| \$ABDP  | %CNF4E  | \$CNV3 | %CR4S2  | \$ERMG | %CR4S1  | \$LST   | %CR4S2  |
| \$ABRE  | %CR4S1  | \$COML | %CR4S2  | \$ERRA | %CR4S1  | \$LSTM  | %CR4S2  |
| \$ABRT  | %CR4S2  | \$CON1 | %CR4S1  | \$ESTB | %4SYLB  | \$LU??  | %CR4S1  |
| \$ABXY  | %CR4S1  | \$CON2 | %CR4S1  | \$ETEQ | %CR4S1  | \$LUEX  | %4SYLB  |
| \$ACFL  | %CR4S2  | \$CON3 | %CR4S1  | \$ETTM | %CR4S1  | \$LUPR  | %CR4S2  |
| \$ALC   | %CR4S2  | \$CREL | %CR4S1  | \$EX15 | %CR4S1  | \$LUSU  | %4SYLB  |
| \$ALDM  | %CR4S1  | \$CRN# | %CR4S2  | \$EX16 | %CR4S1  | \$MATA  | %CR4S2  |
| \$ALRN  | %4SYLB  | \$CVEQ | %CR4S1  | \$EX4  | %CR4S1  | \$MAXE  | %CR4S2  |
| \$ASTM  | %CR4S2  | \$CVT1 | %4SYLB  | \$EX5  | %CR4S1  | \$MAXI  | %CR4S2  |
| \$B\$RB | %4SYLB  | \$CVT3 | %4SYLB  | \$EX8  | %CR4S1  | \$MAXP  | %CR4S1  |
| \$BALC  | %4SYLB  | \$CVWD | %CR4S2  | \$EXIT | %\$CNFX | \$MBGP  | %CR4S2  |
| \$BATM  | %CR4S2  | \$CXC  | %CR4S1  | \$EXIT | %CNF4E  | \$MCHN  | %CR4S2  |
| \$BFOT  | %CR4S1  | \$CYC  | %CR4S1  | \$EXP  | \$MLIB1 | \$MEMR  | %4SYLB  |
| \$BG1   | %CR4S1  | \$D.AB | %D.BUF  | \$FREV | %BMPG3  | \$MESS  | %CR4S2  |
| \$BG2   | %CR4S1  | \$D.BF | %D.BUF  | \$GDPG | %\$CNFX | \$MEU   | %CR4S2  |
| \$BG3   | %CR4S1  | \$D.BL | %D.BUF  | \$GDPG | %CNF4E  | \$MM1   | %CR4S1  |
| \$BG4   | %CR4S1  | \$DATC | %CR4S2  | \$GTIO | %CR4S1  | \$MM2   | %CR4S1  |
| \$BG5   | %CR4S1  | \$DBP1 | %4SYLB  | \$ID#  | %CR4S2  | \$MM3   | %CR4S1  |
| \$BGFR  | %CR4S2  | \$DBP2 | %4SYLB  | \$IDEX | %CR4S2  | \$MM4   | %CR4S1  |
| \$BITB  | %CR4S1  | \$DBP3 | %4SYLB  | \$IDLE | %CR4S2  | \$MM5   | %CR4S1  |
| \$BLLO  | %CR4S1  | \$DCPU | %CR4S1  | \$IDNO | %CR4S2  | \$MNP   | %CR4S2  |
| \$BLUP  | %CR4S1  | \$DEVT | %CR4S1  | \$IDSM | %CR4S2  | \$MPFT  | %CR4S2  |
| \$BMON  | %BMPG1  | \$DHED | %CR4S1  | \$ILST | %CR4S1  | \$MPS2  | %CR4S2  |
| \$BRED  | %CR4S1  | \$DIGL | %4SYLB  | \$INER | %CR4S2  | \$MPSA  | %CR4S2  |
| \$BRKP  | %CR4S2  | \$DLAY | %CR4S1  | \$IOCL | %CR4S1  | \$MPT1  | %CR4S2  |
| \$BRTN  | %4SYLB  | \$DLP  | %CR4S2  | \$IODN | %CR4S1  | \$MPT2  | %CR4S2  |
| \$BRTX  | %CR4S2  | \$DLTH | %CR4S2  | \$IORQ | %CR4S1  | \$MPT3  | %CR4S2  |

Appendix I

| ENTRY  | FILE   | ENTRY  | FILE   | ENTRY  | FILE    | ENTRY  | FILE   |
|--------|--------|--------|--------|--------|---------|--------|--------|
| \$MPT4 | %CR4S2 | \$RLB  | %CR4S2 | \$SMEX | %CR4S2  | \$UPIO | %CR4S2 |
| \$MPT5 | %CR4S2 | \$RLN  | %CR4S2 | \$SMGP | %CR4S2  | \$USER | %CR4S1 |
| \$MPT6 | %CR4S2 | \$RLNK | %CR4S2 | \$SMID | %CR4S2  | \$USRS | %%CNFX |
| \$MPT7 | %CR4S2 | \$RNEX | %4SYLB | \$SMII | %CR4S2  | \$USRS | %CNF4E |
| \$MPT8 | %CR4S2 | \$RNSU | %4SYLB | \$SMLK | %CR4S2  | \$WATR | %CR4S2 |
| \$MPT9 | %CR4S2 | \$RQST | %CR4S1 | \$SMLN | %CR4S2  | \$WORK | %CR4S2 |
| \$MRMP | %CR4S2 | \$RSM  | %CR4S1 | \$SMST | %CR4S2  | \$WRRD | %%CNFX |
| \$MRTP | %CR4S2 | \$RSRE | %CR4S1 | \$SMTB | %%CNFX  | \$WRRD | %CNF4E |
| \$MSEX | %CR4S2 | \$RT1  | %CR4S1 | \$SMTB | %CNF4E  | \$XCIC | %CR4S2 |
| \$MSG  | %CR4S2 | \$RT2  | %CR4S1 | \$SMVE | %4SYLB  | \$XCQ  | %CR4S1 |
| \$MTM  | %CR4S2 | \$RT3  | %CR4S1 | \$SPCL | %SPO2B  | \$XDM  | %CR4S1 |
| \$MVBF | %CR4S1 | \$RT4  | %CR4S1 | \$SPCR | %CR4S2  | \$XDMP | %CR4S2 |
| \$NMEM | %CR4S1 | \$RT5  | %CR4S1 | \$SPOK | %SPO2B  | \$XEQ  | %CR4S2 |
| \$NOLG | %CR4S1 | \$RTFR | %CR4S2 | \$SPRI | %CR4S2  | \$XEX  | %CR4S1 |
| \$NOPG | %CR4S1 | \$RTN  | %CR4S2 | \$SQRT | %MLIB1  | \$XSIO | %CR4S1 |
| \$NPGQ | %%CNFX | \$RTST | %CR4S2 | \$SRTI | %CR4S2  | \$XXUP | %CR4S1 |
| \$NPGQ | %CNF4E | \$RVAL | %CR4S1 | \$SRTN | %NSES   | \$YCIC | %CR4S2 |
| \$ONTM | %CR4S1 | \$SALC | %NSES  | \$SRTN | %SMON2  | \$YCOM | %SMON1 |
| \$OP   | %CR4S2 | \$SALC | %SMON2 | \$SSCT | %CR4S2  | \$YMG  | %CR4S1 |
| \$OPEN | %BMPG3 | \$SALI | %CR4S2 | \$STH  | %CR4S2  | \$ZZZZ | %CR4S1 |
| \$OPER | %CR4S1 | \$SAVE | %%CNFX | \$STRG | %CR4S2  | %ABS   | %MLIB1 |
| \$OPRI | %CR4S2 | \$SAVE | %CNF4E | \$STRK | %CR4S2  | %ACOS  | %MLIB1 |
| \$OPSY | %CR4S2 | \$SBTB | %CR4S2 | \$STRT | %CR4S2  | %ACSH  | %MLIB1 |
| \$OSAM | %CR4S2 | \$SC1  | %CR4S2 | \$SVAL | %CR4S2  | %AN    | %MLIB1 |
| \$OTAT | %CR4S2 | \$SC2  | %CR4S2 | \$SYMG | %CR4S1  | %AND   | %MLIB1 |
| \$OTRL | %CR4S1 | \$SC3  | %CR4S2 | \$SZIT | %CR4S2  | %ANH   | %MLIB1 |
| \$PARS | %4SYLB | \$SC4  | %CR4S2 | \$TA32 | %\$TA32 | %ANNT  | %MLIB1 |
| \$PBUF | %CR4S2 | \$SCD  | %CR4S2 | \$TADD | %CR4S1  | %ASIN  | %MLIB1 |
| \$PCHN | %%CNFX | \$SCD3 | %CR4S2 | \$TAN  | %MLIB1  | %ASNH  | %MLIB1 |
| \$PCHN | %CNF4E | \$SCLK | %CR4S1 | \$TB32 | %\$TB32 | %ATNH  | %MLIB1 |
| \$PDSK | %CR4S1 | \$SCRN | %ED1K4 | \$TIME | %CR4S2  | %BS    | %MLIB1 |
| \$PERR | %CR4S2 | \$SCXX | %CR4S2 | \$TIMR | %CR4S1  | %COSH  | %MLIB1 |
| \$PETB | %CR4S2 | \$SDA  | %CR4S2 | \$TIMV | %CR4S1  | %CTAN  | %MLIB1 |
| \$PGID | %CR4S1 | \$SDRL | %CR4S1 | \$TMRQ | %CR4S1  | %DACH  | %MLIB1 |
| \$PLP  | %CR4S2 | \$SDSK | %CR4S1 | \$TREM | %CR4S1  | %DACS  | %MLIB1 |
| \$PNTI | %CR4S2 | \$SDT2 | %CR4S2 | \$TREN | %%CNFX  | %DAND  | %MLIB1 |
| \$PNTR | %CR4S2 | \$SETP | %MLIB2 | \$TRRN | %CR4S2  | %DASH  | %MLIB1 |
| \$PQWR | %4DP43 | \$SGAF | %CR4S1 | \$TRTB | %%CNFX  | %DASN  | %MLIB1 |
| \$PRCN | %CR4S1 | \$SGID | %CR4S1 | \$TRTB | %CNF4E  | %DATH  | %MLIB1 |
| \$PRSE | %CR4S2 | \$SHED | %CR4S2 | \$TYPE | %CR4S2  | %DCSH  | %MLIB1 |
| \$PSTE | %CR4S1 | \$SMAP | %CR4S1 | \$UCON | %CR4S2  | %DNOT  | %MLIB1 |
| \$PVCN | %CR4S2 | \$SMCA | %CR4S2 | \$UIN  | %CR4S2  | %DOR   | %MLIB1 |
| \$PVMP | %4PVMP | \$SMCP | %CR4S2 | \$ULLU | %CR4S2  | %DSNH  | %MLIB1 |
| \$PVST | %CR4S2 | \$SMD# | %CR4S2 | \$ULU  | %CR4S2  | %DXOR  | %MLIB1 |
| \$PWR5 | %CR4S1 | \$SMDL | %CR4S2 | \$UNLK | %CR4S1  | %FIX   | %MLIB1 |
| \$REIO | %CR4S1 | \$SMEM | %CR4S2 | \$UNPE | %CR4S1  | %FIXD  | %MLIB1 |
| \$RENT | %CR4S1 | \$SMER | %CR4S2 | \$UP   | %CR4S1  | %FLTD  | %MLIB1 |

| ENTRY | FILE    | ENTRY | FILE    | ENTRY | FILE    | ENTRY  | FILE    |
|-------|---------|-------|---------|-------|---------|--------|---------|
| %IBCL | \$MLIB1 | %WBUF | %4SYLB  | .CADD | \$MLIB2 | .CYB   | %4SYLB  |
| %IBST | \$MLIB1 | %WEOF | %4SYLB  | .CAX  | \$RSLIB | .CZPX  | \$MLIB1 |
| %IBTE | \$MLIB1 | %WRIF | %4SYLB  | .CAX  | %4SYLB  | .DACH  | \$MLIB1 |
| %IBTS | \$MLIB1 | %WRIN | %4SYLB  | .CAY  | \$RSLIB | .DACS  | \$MLIB1 |
| %IDNT | \$MLIB1 | %WRIS | %4SYLB  | .CAY  | %4SYLB  | .DAD   | \$MLIB2 |
| %IGN  | \$MLIB1 | %WRIT | %4SYLB  | .CAY. | \$MLIB1 | .DAND  | \$MLIB1 |
| %ILEN | \$MLIB2 | %XFXD | \$MLIB1 | .CBS  | \$RSLIB | .DASH  | \$MLIB1 |
| %IMBS | \$MLIB1 | %XP   | \$MLIB1 | .CBS  | %4SYLB  | .DASN  | \$MLIB1 |
| %IN   | \$MLIB1 | %ZCOS | \$MLIB1 | .CBT  | \$ED1K4 | .DATH  | \$MLIB1 |
| %INDX | \$MLIB2 | %ZEXP | \$MLIB1 | .CBT  | \$RSLIB | .DBSG  | %4SYLB  |
| %INT  | \$MLIB1 | %ZLOG | \$MLIB1 | .CBT  | %4SYLB  | .DEBUG | %DBUGR  |
| %ISH  | \$MLIB1 | %ZSIN | \$MLIB1 | .CBX  | \$RSLIB | .DCO   | \$MLIB2 |
| %ISHC | \$MLIB1 | %ZTAN | \$MLIB1 | .CBX  | %4SYLB  | .DCPX  | \$MLIB1 |
| %JABS | \$MLIB1 | ..BF. | %BMPG1  | .CBY  | \$RSLIB | .DCSH  | \$MLIB1 |
| %JBCL | \$MLIB1 | ..BL. | %BMPG1  | .CBY  | %4SYLB  | .DDE   | \$MLIB2 |
| %JBST | \$MLIB1 | ..CCM | \$MLIB2 | .CDBL | \$MLIB1 | .DDI   | \$MLIB2 |
| %JBTE | \$MLIB1 | ..DCM | \$MLIB2 | .CDIV | \$MLIB2 | .DDIM  | \$MLIB1 |
| %JBTS | \$MLIB1 | ..DLC | \$MLIB2 | .CFER | \$MLIB2 | .DDIR  | \$MLIB2 |
| %JDNT | \$MLIB1 | ..FCM | \$MLIB2 | .CFTD | \$MLIB1 | .DDS   | \$MLIB2 |
| %JFIL | %4SYLB  | ..MAP | \$MLIB2 | .CFXD | \$MLIB1 | .DEQV  | \$MLIB1 |
| %JLEN | \$MLIB2 | ..MP  | %4SYLB  | .CHEB | \$MLIB2 | .DFER  | \$MLIB2 |
| %JMBS | \$MLIB1 | ..TCM | \$MLIB2 | .CINT | \$MLIB1 | .DIN   | \$MLIB2 |
| %JMOD | \$MLIB1 | ..ZCM | \$MLIB2 | .CIO. | \$MLIB1 | .DINT  | \$MLIB1 |
| %JNDX | \$MLIB2 | .ZTOI | \$MLIB2 | .CLGN | %BMPG3  | .DIO.  | \$MLIB1 |
| %JSGN | \$MLIB1 | .4ZRO | \$MLIB2 | .CLRB | %4SYLB  | .DIS   | \$MLIB2 |
| %JSH  | \$MLIB1 | .ABS  | \$MLIB1 | .CMPY | \$MLIB2 | .DIV   | %4SYLB  |
| %JSHC | \$MLIB1 | .ACOS | \$MLIB1 | .CMRS | \$MLIB1 | .DLD   | %4SYLB  |
| %LOAT | \$MLIB1 | .ACSH | \$MLIB1 | .CMW  | \$ED1K4 | .DLDE  | \$MLIB2 |
| %LOG  | \$MLIB1 | .ADX  | \$RSLIB | .CMW  | \$RSLIB | .DMAP  | %4SYLB  |
| %LOGO | \$MLIB1 | .ADX  | %4SYLB  | .CMW  | %4SYLB  | .DMOD  | \$MLIB1 |
| %LOGT | \$MLIB1 | .ADY  | \$RSLIB | .COS  | \$MLIB1 | .DMOD  | \$PLIB  |
| %NINT | \$MLIB1 | .ADY  | %4SYLB  | .COSH | \$MLIB1 | .DMP   | \$MLIB2 |
| %NJNT | \$MLIB1 | .AMNJ | \$MLIB1 | .CPM  | \$MLIB2 | .DNCL  | \$FDSL  |
| %NT   | \$MLIB1 | .AMXJ | \$MLIB1 | .CSTR | \$MLIB1 | .DNCL  | \$FNDL  |
| %OR   | \$MLIB1 | .ANNT | \$MLIB1 | .CSUB | \$MLIB2 | .DNCN  | \$FDSL  |
| %OS   | \$MLIB1 | .ARRY | %4SYLB  | .CTAN | \$MLIB1 | .DNCN  | \$FNDL  |
| %OT   | \$MLIB1 | .ARTN | \$MLIB2 | .CTBL | \$MLIB1 | .DNG   | \$MLIB2 |
| %QRT  | \$MLIB1 | .ASIN | \$MLIB1 | .CTOC | \$MLIB1 | .DNIN  | \$FDSL  |
| %RDSC | %4SYLB  | .ASNH | \$MLIB1 | .CTOI | \$MLIB1 | .DNIN  | \$FNDL  |
| %READ | %4SYLB  | .ATA2 | \$MLIB1 | .CTOJ | \$MLIB1 | .DNOP  | \$FDSL  |
| %SIGN | \$MLIB1 | .ATAN | \$MLIB1 | .CXA  | \$RSLIB | .DNOP  | \$FNDL  |
| %SINH | \$MLIB1 | .ATN2 | \$MLIB1 | .CXA  | %4SYLB  | .DNRW  | \$FDSL  |
| %SSW  | %4SYLB  | .ATNH | \$MLIB1 | .CXB  | \$RSLIB | .DNRW  | \$FNDL  |
| %TAN  | \$MLIB1 | .BIO. | \$MLIB1 | .CXB  | %4SYLB  | .DOR   | \$MLIB1 |
| %TFXD | \$MLIB1 | .BLAB | %DVB12  | .CYA  | \$RSLIB | .DPRD  | \$MLIB1 |
| %TFXS | \$MLIB1 | .BLE  | \$MLIB1 | .CYA  | %4SYLB  | .DRCT  | \$MLIB2 |
| %TNNT | \$MLIB1 | .CACT | %BMPG3  | .CYB  | \$RSLIB | .DRES  | %4SYLB  |

Appendix I

| ENTRY | FILE    | ENTRY | FILE    | ENTRY | FILE    | ENTRY | FILE    |
|-------|---------|-------|---------|-------|---------|-------|---------|
| .DSB  | \$MLIB2 | .FAD  | %4SYLB  | .IAY. | \$MLIB1 | .JIO. | \$MLIB1 |
| .DSBR | \$MLIB2 | .FDV  | %4SYLB  | .IBCL | \$MLIB1 | .JLY  | \$RSLIB |
| .DSCL | \$FDSL  | .FFCL | \$MLIB1 | .IBST | \$MLIB1 | .JLY  | %4SYLB  |
| .DSCL | \$FNDLB | .FFCN | \$MLIB1 | .IBTE | \$MLIB1 | .JMBS | \$MLIB1 |
| .DSCN | \$FDSL  | .FFIN | \$MLIB1 | .IBTS | \$MLIB1 | .JMN0 | \$MLIB1 |
| .DSCN | \$FNDLB | .FFOP | \$MLIB1 | .ICPX | \$MLIB1 | .JMN1 | \$MLIB1 |
| .DSIN | \$FDSL  | .FFRW | \$MLIB1 | .IDAD | %BMPG1  | .JMX0 | \$MLIB1 |
| .DSIN | \$FNDLB | .FIO. | \$MLIB1 | .IDBL | \$MLIB1 | .JMX1 | \$MLIB1 |
| .DSNH | \$MLIB1 | .FIOI | \$MLIB1 | .IDL  | \$MLIB2 | .JNDX | \$MLIB2 |
| .DSOP | \$FDSL  | .FION | \$MLIB1 | .IDLP | \$MLIB2 | .JPY  | \$RSLIB |
| .DSOP | \$FNDLB | .FIX  | %4SYLB  | .IDNT | \$MLIB1 | .JPY  | %4SYLB  |
| .DSRW | \$FDSL  | .FIXD | \$MLIB1 | .IENT | \$MLIB2 | .JSGN | \$MLIB1 |
| .DSRW | \$FNDLB | .FLT  | %4SYLB  | .IIO. | \$MLIB1 | .JSH  | \$MLIB1 |
| .DST  | %4SYLB  | .FLTD | \$MLIB1 | .IMBS | \$MLIB1 | .JSHC | \$MLIB1 |
| .DSX  | \$RSLIB | .FLUN | \$MLIB2 | .INDA | \$MLIB2 | .JTOI | \$MLIB1 |
| .DSX  | %4SYLB  | .FMB? | \$MLIB1 | .INDR | \$MLIB2 | .JTOJ | \$MLIB1 |
| .DSY  | \$RSLIB | .FMCN | \$MLIB1 | .INDX | \$MLIB2 | .JZPX | \$MLIB1 |
| .DSY  | %4SYLB  | .FMCV | \$MLIB1 | .IOCL | \$MLIB1 | .LAE. | %4SYLB  |
| .DTA. | \$MLIB1 | .FMDG | \$MLIB1 | .IOCM | \$MLIB1 | .LAR. | \$MLIB1 |
| .DTBL | \$MLIB1 | .FMER | \$MLIB1 | .IOCN | \$MLIB1 | .LAX  | \$RSLIB |
| .DTOD | \$MLIB1 | .FMFP | \$MLIB1 | .IOER | \$MLIB2 | .LAX  | %4SYLB  |
| .DTOI | \$MLIB1 | .FMGB | \$MLIB1 | .IOI. | \$MLIB1 | .LAY  | \$RSLIB |
| .DTOJ | \$MLIB1 | .FMIC | \$MLIB1 | .IOIN | \$MLIB1 | .LAY  | %4SYLB  |
| .DTOR | \$MLIB1 | .FMIN | \$MLIB1 | .IOJ. | \$MLIB1 | .LAY. | \$MLIB1 |
| .DTOT | \$MLIB1 | .FMIO | \$MLIB1 | .IOL. | \$MLIB1 | .LBP  | \$PLIB  |
| .DUF  | \$MLIB1 | .FMLD | \$MLIB1 | .IOM. | \$MLIB1 | .LBPR | \$PLIB  |
| .DXOR | \$MLIB1 | .FMO? | \$MLIB1 | .IOOP | \$MLIB1 | .LBT  | \$ED1K4 |
| .DZPX | \$MLIB1 | .FMOC | \$MLIB1 | .IOR. | \$MLIB1 | .LBT  | \$RSLIB |
| .E.R. | %BMPG1  | .FMP  | %4SYLB  | .IPGS | %4SYLB  | .LBT  | %4SYLB  |
| .EIO. | \$MLIB1 | .FMSU | \$MLIB1 | .ISH  | \$MLIB1 | .LBT  | %4SYLB  |
| .EMAP | %4SYLB  | .FMUI | \$MLIB1 | .ISHC | \$MLIB1 | .LBX  | \$RSLIB |
| .EMAS | %4SYLB  | .FMUO | \$MLIB1 | .ISX  | \$RSLIB | .LBX  | %4SYLB  |
| .EMAT | %4SYLB  | .FMUP | \$MLIB1 | .ISX  | %4SYLB  | .LBY  | \$RSLIB |
| .EMIO | %4SYLB  | .FMUR | \$MLIB1 | .ISY  | \$RSLIB | .LBY  | %4SYLB  |
| .EMSZ | %4SYLB  | .FMWD | \$MLIB1 | .ISY  | %4SYLB  | .LDX  | \$RSLIB |
| .ENTC | \$MLIB2 | .FOP? | \$MLIB1 | .ITBL | \$MLIB1 | .LDX  | %4SYLB  |
| .ENTM | \$MLIB2 | .FPAU | \$MLIB1 | .ITOI | \$MLIB1 | .LDY  | \$RSLIB |
| .ENTN | \$MLIB2 | .FPWR | \$MLIB1 | .ITOI | \$MLIB1 | .LDY  | %4SYLB  |
| .ENTP | \$MLIB2 | .FSB  | %4SYLB  | .IZPX | \$MLIB1 | .LGON | %BMPG3  |
| .ENTR | \$MLIB2 | .FSIU | \$MLIB1 | .JAE. | %4SYLB  | .LIO. | \$MLIB1 |
| .EOF1 | %EDITA  | .FSOU | \$MLIB1 | .JAR. | \$MLIB1 | .LOG  | \$MLIB1 |
| .ERES | %4SYLB  | .FSTP | \$MLIB1 | .JAY. | \$MLIB1 | .LOG0 | \$MLIB1 |
| .ERR0 | \$MLIB2 | .FXDE | \$MLIB1 | .JBCL | \$MLIB1 | .LOGT | \$MLIB1 |
| .EXIT | \$MLIB1 | .FZPX | \$MLIB1 | .JBST | \$MLIB1 | .LPX  | \$PLIB  |
| .EXP  | \$MLIB1 | .GOTO | \$MLIB2 | .JBTE | \$MLIB1 | .LPXR | \$PLIB  |
| .F6PA | \$MLIB1 | .IAE. | %4SYLB  | .JBTS | \$MLIB1 | .LUAV | %BMPG3  |
| .F6ST | \$MLIB1 | .IAR. | \$MLIB1 | .JDIM | \$MLIB1 | .MAC. | %4SYLB  |
|       |         |       |         | .JDNT | \$MLIB1 | .MAE. | %4SYLB  |

| ENTRY  | FILE    | ENTRY | FILE    | ENTRY | FILE    | ENTRY | FILE    |
|--------|---------|-------|---------|-------|---------|-------|---------|
| .MANT  | \$MLIB2 | .R5   | %CLIB   | .STDB | %4SYLB  | .XAY  | %4SYLB  |
| .MAP.  | \$MLIB2 | .R6   | %CLIB   | .STOP | \$MLIB1 | .XAY. | \$MLIB1 |
| .MAR.  | \$MLIB1 | .R7   | %CLIB   | .STX  | \$RSLIB | .XBX  | \$RSLIB |
| .MAX1  | \$MLIB1 | .RAE. | %4SYLB  | .STX  | %4SYLB  | .XBX  | %4SYLB  |
| .MAY.  | \$MLIB1 | .RAR. | \$MLIB1 | .STY  | \$RSLIB | .XBY  | \$RSLIB |
| .MBF   | %4SYLB  | .RAY. | \$MLIB1 | .STY  | %4SYLB  | .XBY  | %4SYLB  |
| .MBI   | %4SYLB  | .RCNG | \$MLIB2 | .SUM2 | %4SYLB  | .XCA  | %4SYLB  |
| .MBT   | \$ED1K4 | .RENM | %BMPG1  | .SWCH | \$MLIB2 | .XCB  | %4SYLB  |
| .MBT   | \$RSLIB | .RIO. | \$MLIB1 | .TADD | \$MLIB2 | .XCOM | \$MLIB2 |
| .MBT   | %4SYLB  | .RND  | \$MLIB2 | .TAE. | %4SYLB  | .XDIM | \$MLIB1 |
| .MBW   | %4SYLB  | .RTOD | \$MLIB1 | .TAN  | \$MLIB1 | .XDIV | \$MLIB2 |
| .MIN1  | \$MLIB1 | .RTOI | \$MLIB1 | .TANH | \$MLIB1 | .XENT | \$MLIB2 |
| .MIO.  | \$MLIB1 | .RTOJ | \$MLIB1 | .TAPE | %4SYLB  | .XFER | \$MLIB2 |
| .MMAP  | %4SYLB  | .RTOR | \$MLIB1 | .TAR. | \$MLIB1 | .XFTD | \$MLIB1 |
| .MOD   | \$MLIB1 | .RTOT | \$MLIB1 | .TAY. | \$MLIB1 | .XFTS | \$MLIB1 |
| .MPY   | %4SYLB  | .SAX  | \$RSLIB | .TBS  | \$RSLIB | .XFXD | \$MLIB1 |
| .MSG#  | %4SYLB  | .SAX  | %4SYLB  | .TBS  | %4SYLB  | .XFXS | \$MLIB1 |
| .MSGS  | %4SYLB  | .SAY  | \$RSLIB | .TCPX | \$MLIB1 | .XIO. | \$MLIB1 |
| .MW    | \$RSLIB | .SAY  | %4SYLB  | .TDBL | \$MLIB1 | .XLA  | \$RSLIB |
| .MW    | %4SYLB  | .SAY. | \$MLIB1 | .TDIV | \$MLIB2 | .XLA  | %4SYLB  |
| .MWF   | \$RSLIB | .SBS  | \$RSLIB | .TENT | \$MLIB1 | .XLB  | \$RSLIB |
| .MWF   | %4SYLB  | .SBS  | %4SYLB  | .TFTD | \$MLIB1 | .XLB  | %4SYLB  |
| .MWI   | %4SYLB  | .SBST | \$MLIB2 | .TFTS | \$MLIB1 | .XLD  | %4SYLB  |
| .MWW   | %4SYLB  | .SBT  | \$ED1K4 | .TFXD | \$MLIB1 | .XMPY | \$MLIB2 |
| .NFCL  | \$MLIB1 | .SBT  | \$RSLIB | .TFXS | \$MLIB1 | .XPAK | \$MLIB2 |
| .NFCN  | \$MLIB1 | .SBT  | %4SYLB  | .TINT | \$MLIB1 | .XPLY | \$MLIB1 |
| .NFEX  | \$MLIB2 | .SBX  | \$RSLIB | .TIO. | \$MLIB1 | .XSA  | \$RSLIB |
| .NFIN  | \$MLIB1 | .SBX  | %4SYLB  | .TMPY | \$MLIB2 | .XSA  | %4SYLB  |
| .NFOP  | \$MLIB1 | .SBY  | \$RSLIB | .TNNT | \$MLIB1 | .XSB  | \$RSLIB |
| .NGL   | \$MLIB1 | .SBY  | %4SYLB  | .TPWR | \$MLIB1 | .XSB  | %4SYLB  |
| .NINT  | \$MLIB1 | .SC   | \$MLIB2 | .TSUB | \$MLIB2 | .XST  | %4SYLB  |
| .NJNT  | \$MLIB1 | .SCO  | \$MLIB2 | .TTOD | \$MLIB1 | .XSUB | \$MLIB2 |
| .NPGS  | %4SYLB  | .SCOC | \$MLIB2 | .TTOI | \$MLIB1 | .YINT | \$MLIB1 |
| .OPN?  | \$MLIB1 | .SDBG | %DBUGR  | .TTOJ | \$MLIB1 | .ZABS | \$MLIB1 |
| .OPSY  | %4SYLB  | .SETB | %4SYLB  | .TTOR | \$MLIB1 | .ZADD | \$MLIB2 |
| .OWNER | %4SYLB  | .SFB  | \$ED1K4 | .TTOT | \$MLIB1 | .ZAE. | %4SYLB  |
| .PACK  | %4SYLB  | .SFB  | \$RSLIB | .TTY  | %4SYLB  | .ZAIM | \$MLIB1 |
| .PARS  | %BMPG1  | .SFB  | %4SYLB  | .TZPX | \$MLIB1 | .ZAY. | \$MLIB1 |
| .PAUS  | \$MLIB1 | .SIGN | \$MLIB1 | .UACT | %BMPG3  | .ZCNG | \$MLIB1 |
| .PCAD  | \$MLIB2 | .SIN  | \$MLIB1 | .UFMP | \$MLIB1 | .ZCOS | \$MLIB1 |
| .PRAM  | \$MLIB2 | .SINH | \$MLIB1 | .UNAM | %BMPG3  | .ZCPX | \$MLIB1 |
| .PWR2  | \$MLIB2 | .SIO. | \$MLIB1 | .XADD | \$MLIB2 | .ZDIV | \$MLIB2 |
| .R.E.  | %BMPG1  | .SMAP | %4SYLB  | .XAE. | %4SYLB  | .ZEXP | \$MLIB1 |
| .R1    | %CLIB   | .SORT | \$MLIB1 | .XAR. | \$MLIB1 | .ZFER | \$MLIB2 |
| .R2    | %CLIB   | .SRES | %4SYLB  | .XAX  | \$RSLIB | .ZFXD | \$MLIB1 |
| .R3    | %CLIB   | .SST  | \$MLIB2 | .XAX  | %4SYLB  | .ZINT | \$MLIB1 |
| .R4    | %CLIB   | .SSTC | \$MLIB2 | .XAY  | \$RSLIB | .ZIO. | \$MLIB1 |

Appendix I

| ENTRY | FILE    | ENTRY | FILE   | ENTRY | FILE   | ENTRY | FILE      |
|-------|---------|-------|--------|-------|--------|-------|-----------|
| .ZLOG | \$MLIB1 | ?CNTR | %4ASMB | ?MOVE | %4ASMB | ?V    | %4ASMB    |
| .ZMPX | \$MLIB1 | ?CODE | %4ASMB | ?MSYM | %4ASMB | ?X    | %4ASMB    |
| .ZMPY | \$MLIB2 | ?DCOD | %4ASMB | ?MSYS | %4ASMB | @1    | %FMG4E    |
| .ZSIN | \$MLIB1 | ?DSIG | %4ASMB | ?NAME | %4ASMB | @2    | %FMG4E    |
| .ZSQR | \$MLIB1 | ?EMP  | %4ASB1 | ?NAMI | %4ASMB | @@RUN | \$PLIB    |
| .ZSUB | \$MLIB2 | ?ENDS | %4ASMB | ?NDOP | %4ASMB | @APND | \$PLIB    |
| .ZTAN | \$MLIB1 | ?ENER | %4ASMB | ?NDSY | %4ASMB | @BNX1 | \$PLIB    |
| .ZTOI | \$MLIB1 | ?ENFL | %4ASMB | ?NEAU | %4ASMB | @BNX2 | \$PLIB    |
| .ZTOJ | \$MLIB1 | ?ENP  | %4ASB1 | ?OPER | %4ASMB | @CKB  | \$PLIB    |
| .ZTOZ | \$MLIB1 | ?ENT. | %4ASMB | ?OPLK | %4ASMB | @CKBD | \$PLIB    |
| /ATA2 | \$MLIB1 | ?ENTC | %4ASMB | ?ORGS | %4ASMB | @CKI  | \$PLIB    |
| /ATLG | \$MLIB1 | ?ENTV | %4ASMB | ?ORRP | %4ASMB | @CKID | \$PLIB    |
| /ATN2 | \$MLIB1 | ?ERPR | %4ASMB | ?PASS | %4ASMB | @CKP1 | \$PLIB    |
| /CMRT | \$MLIB1 | ?EXP  | %4ASB1 | ?PBUF | %4ASMB | @CKP2 | \$PLIB    |
| /COS  | \$MLIB1 | ?FLAG | %4ASMB | ?PEEK | %4ASMB | @CKS1 | \$PLIB    |
| /EXP  | \$MLIB1 | ?FLAQ | %4ASMB | ?PERL | %4ASMB | @CKS2 | \$PLIB    |
| /EXTH | \$MLIB1 | ?FLEX | %4ASMB | ?PKUP | %4ASMB | @CKST | \$PLIB    |
| /LOG  | \$MLIB1 | ?FLGS | %4ASMB | ?PLCN | %4ASMB | @CLOS | \$PLIB    |
| /LOG0 | \$MLIB1 | ?FMPE | %4ASMB | ?PLEN | %4ASMB | @DCB1 | \$PLIB    |
| /LOGT | \$MLIB1 | ?FP   | %4ASMB | ?PLIN | %4ASMB | @DCB2 | \$PLIB    |
| /SIN  | \$MLIB1 | ?FPT  | %4ASMB | ?PLIT | %4ASMB | @DEP1 | \$PLIB    |
| /SQRT | \$MLIB1 | ?GETA | %4ASMB | ?PNCH | %4ASMB | @DEP2 | \$PLIB    |
| /TAN  | \$MLIB1 | ?GETC | %4ASMB | ?PNTR | %4ASMB | @DSP1 | \$PLIB    |
| /TINT | \$MLIB1 | ?HA38 | %4ASMB | ?PRNT | %4ASMB | @DSP1 | \$\$SHSLB |
| ??..  | %BMPG1  | ?HA3Z | %4ASB1 | ?PRPG | %4ASMB | @DSP2 | \$PLIB    |
| ?AFLG | %4ASMB  | ?ICSA | %4ASMB | ?RCNT | %4ASMB | @DSP2 | \$\$SHSLB |
| ?AREC | %4ASB4  | ?INS? | %4ASB3 | ?RELC | %4ASMB | @ELN  | \$PLIB    |
| ?ART  | %4ASB2  | ?INSR | %4ASB1 | ?RFLG | %4ASMB | @ENT1 | \$PLIB    |
| ?ARTL | %4ASMB  | ?INST | %4ASMB | ?RSTA | %4ASMB | @ENT2 | \$PLIB    |
| ?ASCI | %4ASMB  | ?IOBF | %4ASMB | ?SAVB | %4ASMB | @EOF  | \$PLIB    |
| ?ASCN | %4ASMB  | ?LABE | %4ASMB | ?SCN1 | %4ASMB | @ERR  | \$PLIB    |
| ?ASII | %4ASMB  | ?LAST | %4ASMB | ?SEGM | %4ASMB | @ERX  | \$PLIB    |
| ?ASM1 | %4ASMB  | ?LFLG | %4ASMB | ?SETM | %4ASMB | @EXT1 | \$PLIB    |
| ?ASMB | %4ASMB  | ?LINC | %4ASMB | ?SIGN | %4ASMB | @EXT2 | \$PLIB    |
| ?ASME | %4ASMB  | ?LINS | %4ASMB | ?SUMP | %4ASMB | @FERR | \$PLIB    |
| ?BASF | %4ASMB  | ?LIST | %4ASMB | ?SUP  | %4ASMB | @FILL | \$PLIB    |
| ?BINF | %4ASMB  | ?LITI | %4ASB1 | ?SVST | %4ASMB | @FINT | \$PLIB    |
| ?BNCN | %4ASMB  | ?LKLI | %4ASB2 | ?SYMI | %4ASMB | @GET  | \$PLIB    |
| ?BPKU | %4ASMB  | ?LOUT | %4ASMB | ?SYMK | %4ASMB | @GHS1 | \$PLIB    |
| ?BPSV | %4ASMB  | ?LPER | %4ASMB | ?SYML | %4ASMB | @GHS2 | \$PLIB    |
| ?BREC | %4ASB2  | ?LST  | %4ASMB | ?SYMP | %4ASMB | @GRNL | \$PLIB    |
| ?BUFF | %4ASMB  | ?LSTL | %4ASMB | ?SYMT | %4ASMB | @GRNS | \$PLIB    |
| ?BYFL | %4ASMB  | ?LTFL | %4ASMB | ?T    | %4ASMB | @HALT | \$PLIB    |
| ?CHOP | %4ASMB  | ?LTSA | %4ASMB | ?TEMP | %4ASMB | @HTS1 | \$PLIB    |
| ?CHPI | %4ASMB  | ?LTSB | %4ASMB | ?TERM | %4ASMB | @HTS2 | \$PLIB    |
| ?CMQ  | %4ASB1  | ?LWA  | %4ASMB | ?TEST | %4ASMB | @IERR | \$PLIB    |
| ?CNTB | %4ASMB  | ?MESX | %4ASMB | ?TFLG | %4ASMB | @IMMO | \$PLIB    |



| ENTRY | FILE    | ENTRY | FILE   | ENTRY | FILE    | ENTRY | FILE    |
|-------|---------|-------|--------|-------|---------|-------|---------|
| @IMM1 | \$PLIB  | @RLN  | \$PLIB | @WRS  | \$PLIB  | ACINM | %ACCTS  |
| @IMM2 | \$PLIB  | @RNAM | \$PLIB | @WRRT | \$PLIB  | ACINT | %ACCTS  |
| @INH1 | \$PLIB  | @RND  | \$PLIB | @XTR1 | \$PLIB  | ACITA | %ACCTS  |
| @INH2 | \$PLIB  | @RUNL | \$PLIB | @XTR2 | \$PLIB  | ACLCK | %ACCTS  |
| @LERR | \$PLIB  | @RUNS | \$PLIB | @ZTF  | \$PLIB  | ACLIA | %ACCTS  |
| @LPOS | \$PLIB  | @S2P  | \$PLIB | A.B   | \$MLIB2 | ACLIU | %ACCTS  |
| @LRND | \$PLIB  | @SDF  | \$PLIB | AA.F  | %FTN4   | ACLNK | %ACCTS  |
| @LSIZ | \$PLIB  | @SEEK | \$PLIB | AB..  | %BMPG1  | ACLOA | %ACCTS  |
| @MAX  | \$PLIB  | @SETF | \$PLIB | ABORT | %EDITA  | ACLTM | %ACCTS  |
| @MRK1 | \$PLIB  | @SGLD | \$PLIB | ABPRG | %EDITA  | ACMND | %ACCTS  |
| @MRK1 | \$SHSLB | @SGRT | \$PLIB | ABRCV | %EDITB  | ACMSN | %ACCTS  |
| @MRK2 | \$PLIB  | @SHN1 | \$PLIB | ABREG | %4SYLB  | ACNAM | %BMPG3  |
| @MRK2 | \$SHSLB | @SHN2 | \$PLIB | ABRT  | %IB4A   | ACNFG | %ACCTS  |
| @NEW1 | \$PLIB  | @SHS1 | \$PLIB | ABS   | \$MLIB1 | ACNVS | %ACCTS  |
| @NEW1 | \$SHSLB | @SHS2 | \$PLIB | ABT.. | %BMPG1  | ACNWG | %ACCTS  |
| @NEW2 | \$PLIB  | @SIN  | \$PLIB | ABX.. | %BMPG1  | ACNWU | %ACCTS  |
| @NEW2 | \$SHSLB | @SINV | \$PLIB | AC..  | %BMPG1  | ACNXA | %ACCTS  |
| @NSET | \$PLIB  | @STMP | \$PLIB | ACACP | %ACCTS  | ACODE | \$MLIB1 |
| @NSIN | \$PLIB  | @STP  | \$PLIB | ACALT | %ACCTS  | ACOM1 | %ACCTS  |
| @OP5  | \$PLIB  | @STP  | %FMG4E | ACALU | %ACCTS  | ACOM2 | %ACCTS  |
| @OPEN | \$PLIB  | @SUB  | \$PLIB | ACAPA | %ACCTS  | ACOM3 | %ACCTS  |
| @OPRT | \$PLIB  | @SUN  | \$PLIB | ACASB | %ACCTS  | ACOM4 | %ACCTS  |
| @PAG  | \$PLIB  | @SXN  | \$PLIB | ACAST | %ACCTS  | ACOM5 | %ACCTS  |
| @PAK  | \$PLIB  | @TCM  | \$PLIB | ACOGT | %ACCTS  | ACOM6 | %ACCTS  |
| @PAK5 | \$PLIB  | @TIME | \$PLIB | ACCLL | %ACCTS  | ACOM7 | %ACCTS  |
| @PERR | \$PLIB  | @TOH1 | \$PLIB | ACCLS | %ACCTS  | ACOM8 | %ACCTS  |
| @POS  | \$PLIB  | @TOH2 | \$PLIB | ACCRE | %ACCTS  | ACOM9 | %ACCTS  |
| @PREP | \$PLIB  | @TOS1 | \$PLIB | ACCT1 | %ACCTS  | ACOMA | %ACCTS  |
| @PRER | \$PLIB  | @TOS2 | \$PLIB | ACCT2 | %ACCTS  | ACOMB | %ACCTS  |
| @PRMT | \$PLIB  | @TRC5 | \$PLIB | ACCT3 | %ACCTS  | ACOMC | %ACCTS  |
| @PUT  | \$PLIB  | @UPK  | \$PLIB | ACCT4 | %ACCTS  | ACOMD | %ACCTS  |
| @RDC  | \$PLIB  | @UPK5 | \$PLIB | ACCT5 | %ACCTS  | ACOPL | %ACCTS  |
| @RDCB | \$PLIB  | @VAL  | \$PLIB | ACCTS | %ACCTS  | ACOPN | %ACCTS  |
| @RDD  | \$PLIB  | @VAR  | \$PLIB | ACDDV | %ACCTS  | ACPAS | %ACCTS  |
| @RDI  | \$PLIB  | @VARM | \$PLIB | ACDIR | %ACCTS  | ACPGA | %ACCTS  |
| @RDL  | \$PLIB  | @VARN | \$PLIB | ACERR | %ACCTS  | ACPRM | %ACCTS  |
| @RDR  | \$PLIB  | @WARN | \$PLIB | ACFDA | %ACCTS  | ACPSN | %ACCTS  |
| @RDS  | \$PLIB  | @WB1  | \$PLIB | ACFDF | %ACCTS  | ACPUA | %ACCTS  |
| @READ | \$PLIB  | @WB2  | \$PLIB | ACFID | %ACCTS  | ACPUU | %ACCTS  |
| @RED  | \$PLIB  | @WLN  | \$PLIB | ACFMT | %ACCTS  | ACREI | %ACCTS  |
| @REF  | \$PLIB  | @WRB  | \$PLIB | ACFST | %ACCTS  | ACREL | %ACCTS  |
| @REL1 | \$PLIB  | @WRC  | \$PLIB | ACGBT | %ACCTS  | ACRMC | %ACCTS  |
| @REL1 | \$SHSLB | @WRD  | \$PLIB | ACGID | %ACCTS  | ACROP | %ACCTS  |
| @REL2 | \$PLIB  | @WRI  | \$PLIB | ACGSP | %ACCTS  | ACSBT | %ACCTS  |
| @REL2 | \$SHSLB | @WRIT | \$PLIB | ACGTG | %ACCTS  | ACSDN | %ACCTS  |
| @RES  | \$PLIB  | @WRL  | \$PLIB | ACGTU | %ACCTS  | ACSES | %ACCTS  |
| @REW  | \$PLIB  | @WRR  | \$PLIB | ACHLP | %ACCTS  | ACSID | %ACCTS  |

Appendix I

| ENTRY  | FILE   | ENTRY  | FILE   | ENTRY | FILE   | ENTRY  | FILE   |
|--------|--------|--------|--------|-------|--------|--------|--------|
| ACSTR  | %ACCTS | ASMB   | %4ASMB | C.BIC | %CLIB  | C.RC#  | %CLIB  |
| ACTEL  | %ACCTS | ASMB0  | %4ASB0 | C.BIN | %CLIB  | C.RP   | %CLIB  |
| ACTIM  | %ACCTS | ASMB1  | %4ASB1 | C.BLI | %CLIB  | C.RSC  | %CLIB  |
| ACTIN  | %ACCTS | ASMB2  | %4ASB2 | C.BNS | %CLIB  | C.S/T  | %CLIB  |
| ACTRM  | %ACCTS | ASMB3  | %4ASB3 | C.BS0 | %CLIB  | C.SAU  | %CLIB  |
| ACTV.  | %BMPG1 | ASMB4  | %4ASB4 | C.BS1 | %CLIB  | C.SC   | %CLIB  |
| ACUNL  | %ACCTS | ATACH  | %4SYLB | C.BS2 | %CLIB  | C.SC0  | %CLIB  |
| ACUSH  | %ACCTS | ATAN   | %MLIB1 | C.BSA | %CLIB  | C.SC1  | %CLIB  |
| ACWRH  | %ACCTS | ATAN2  | %MLIB1 | C.BSO | %CLIB  | C.SC2  | %CLIB  |
| ACWRI  | %ACCTS | ATLOG  | %EDITA | C.BUF | %BMPG1 | C.SLU  | %CLIB  |
| ACWRL  | %ACCTS | AUTOR  | %4AUTR | C.CNT | %CLIB  | C.SON  | %CLIB  |
| ACXFR  | %ACCTS | AVAIL  | %BMPG3 | C.CR  | %CLIB  | C.SOR  | %CLIB  |
| ADDMK  | %EDITB | AVLM   | %MLIB2 | C.CRD | %CLIB  | C.SSC  | %CLIB  |
| ADDSK  | %EDITA | B.FLG  | %BMPG3 | C.DLM | %BMPG1 | C.S^TR | %CLIB  |
| ADDS^T | %EDITA | BCOPY  | %EDITA | C.DUM | %CLIB  | C.TAB  | %BMPG1 |
| ADRES  | %MLIB2 | BINAB  | %CNV4E | C.EXT | %CLIB  | C.TIM  | %CLIB  |
| ADS.C  | %CLIB  | BLT    | %EDITA | C.FAD | %CLIB  | C.TRN  | %CLIB  |
| AI.F   | %FTN4  | BNI.F  | %FTN4  | C.FCB | %CLIB  | C.TTY  | %CLIB  |
| AIMAG  | %MLIB1 | BQM.F  | %FTN4  | C.FID | %CLIB  | C.TYP  | %CLIB  |
| AINT   | %MLIB1 | BPR.L  | %LDRLB | C.FLG | %CLIB  | C.WRD  | %CLIB  |
| ALLFG  | %EDITA | BREAD  | %4SYLB | C.FLU | %CLIB  | CA..   | %BMPG1 |
| ALOG   | %MLIB1 | BRKF.  | %BMPG1 | C.FSZ | %CLIB  | CA05   | %DVA05 |
| ALOG0  | %MLIB1 | BUF.   | %BMPG1 | C.FTY | %CLIB  | CA12   | %DVA12 |
| ALOGT  | %MLIB1 | BUFFER | %DBKLB | C.GRW | %CLIB  | CA13   | %DVA13 |
| ALPNU  | %EDITA | BUFF3  | %EDITB | C.HLK | %CLIB  | CA32   | %DVA32 |
| AMATH  | %EDITA | BUMP.  | %BMPG3 | C.HLU | %CLIB  | CA47   | %2DV47 |
| AMAX0  | %MLIB1 | BWRIT  | %4SYLB | C.HTR | %CLIB  | CA47   | %3DV47 |
| AMAX1  | %MLIB1 | B^FNM  | %EDITA | C.INC | %CLIB  | CABS   | %MLIB1 |
| AMDEL  | %EDITA | C.#SC  | %CLIB  | C.INP | %CLIB  | CAD.   | %BMPG1 |
| AMINO  | %MLIB1 | C.00   | %DVR00 | C.INS | %CLIB  | CAD.L  | %LDRLB |
| AMIN1  | %MLIB1 | C.01   | %DVR00 | C.LEN | %CLIB  | CADD   | %MLIB2 |
| AMINS  | %EDITA | C.02   | %DVR00 | C.LNK | %CLIB  | CAM.I  | %BMPG1 |
| AMMOV  | %EDITB | C.05   | %0DV05 | C.LST | %CLIB  | CAM.O  | %BMPG1 |
| AMOD   | %MLIB1 | C.05   | %4DV05 | C.NA0 | %CLIB  | CAMS.  | %BMPG1 |
| AN..   | %BMPG1 | C.11   | %DVR11 | C.NA2 | %CLIB  | CAPCK  | %4SYLB |
| ANCCH  | %EDITA | C.12   | %DVR12 | C.NA3 | %CLIB  | CATSB  | %EDITA |
| APOSN  | %BMPG3 | C.15   | %DVR15 | C.NA9 | %CLIB  | CB12   | %DVB12 |
| APPND  | %MERGE | C.23   | %DVR23 | C.NAM | %CLIB  | CBP.L  | %LDRLB |
| ARCTA  | %MLIB1 | C.31   | %DVR31 | C.OLY | %CLIB  | CBYTE  | %EDITA |
| ASC.F  | %FTN4  | C.32   | %DVR32 | C.PAS | %CLIB  | CC32   | %DVC32 |
| ASDC   | %DBKLB | C.33   | %DVR33 | C.PR1 | %CLIB  | CCLAS  | %SMON1 |
| ASCFM  | %SAVER | C.37   | %1DV37 | C.PR2 | %CLIB  | CCOS   | %MLIB1 |
| ASCFR  | %READR | C.37   | %2DV37 | C.PR3 | %CLIB  | CCPLK  | %LDRLB |
| ASCHK  | %RSLIB | C.??   | %CLIB  | C.PR4 | %CLIB  | CD1ST  | %EDITA |
| ASCI1  | %EDITA | C.BBI  | %CLIB  | C.PR5 | %CLIB  | CDI.F  | %FTN4  |
| ASCOC  | %DBKLB | C.BFF  | %CLIB  | C.PR6 | %CLIB  | CDIV   | %MLIB2 |
| ASK    | %EDITA | C.BIA  | %CLIB  | C.PR7 | %CLIB  | CDVR5  | %EDITA |

| ENTRY  | FILE   | ENTRY  | FILE   | ENTRY  | FILE   | ENTRY | FILE   |
|--------|--------|--------|--------|--------|--------|-------|--------|
| CEXP   | %MLIB1 | COMD2  | %EDITA | CTFLG  | %EDITA | DL..  | %BMPG1 |
| CH#R   | %TVLIB | COMIN  | %LDRLB | CTOI   | %EDITA | DL.F  | %FTN4  |
| CHANG  | %EDITA | COMM1  | %READR | CUSE.  | %BMPG1 | DLOG  | %MLIB1 |
| CHAR   | %TVLIB | COMM1  | %SAVER | CVX    | %EDITA | DLOGO | %MLIB1 |
| CHARS  | %TVLIB | COMM2  | %READR | D\$XFR | %BMPG3 | DLOGT | %MLIB1 |
| CHDLU  | %DBKLB | COMM2  | %SAVER | D.     | %BMPG1 | DMAX1 | %MLIB1 |
| CHEL   | %4SYLB | COMM3  | %READR | D.LB   | %BMPG3 | DMIN1 | %MLIB1 |
| CHMSK  | %RSLIB | COMND  | %EDITA | D.LT   | %BMPG3 | DMOD  | %MLIB1 |
| CHUTP  | %DBKLB | COMPL  | %COMPL | D.R    | %BMPG3 | DMP   | %RSLIB |
| CID.F  | %FTN4  | COMPR  | %DKULB | D.RIO  | %BMPG3 | DMT   | %SAVE  |
| CK.ID  | %BMPG3 | COMRD  | %UTLIB | D.SDR  | %BMPG3 | DNODE | %FDSL  |
| CK.SM  | %BMPG3 | CONCA  | %FMG4E | DABS   | %MLIB1 | DODAH | %EDITA |
| CKSUM  | %CNV4E | CONJG  | %MLIB1 | DADD   | %SMON1 | DP..  | %BMPG1 |
| CL..   | %BMPG1 | CONV   | %SMON1 | DAF.F  | %FTN4  | DPOLY | %MLIB1 |
| CL.BF  | %BMPG3 | CONV.  | %BMPG1 | DAT.F  | %FTN4  | DR.RD | %BMPG3 |
| CLEAC  | %SMON1 | CONVM  | %CNV4E | DATA2  | %MLIB1 | DRT   | %DBKLB |
| CLEAR  | %IB4A  | COPY   | %EDITA | DATAN  | %MLIB1 | DS.DF | %BMPG3 |
| CLERR  | %UTLIB | COR.A  | %4SYLB | DATCO  | %DKULB | DS.F1 | %BMPG3 |
| CLO.C  | %CLIB  | COR.B  | %4SYLB | DATN2  | %MLIB1 | DS.LU | %BMPG3 |
| CLOAD  | %CLOAD | COS    | %MLIB1 | DBGLU  | %4SYLB | DSB   | %RSLIB |
| CLOG   | %MLIB1 | CP32   | %DVP32 | DBLE   | %MLIB1 | DSCAD | %DBKLB |
| CLONE  | %ED1K4 | CP43   | %4DP43 | DBLEI  | %RSLIB | DSCHD | %DSCHD |
| CLONE  | %BMPG3 | CPL.L  | %LDRLB | DBLVL  | %EDITA | DSIGN | %MLIB1 |
| CLOPN  | %BMPG1 | CPL1   | %LDRLB | DBUGR  | %DBUGR | DSIN  | %MLIB1 |
| CLOS.  | %BMPG1 | CPL1H  | %LDRLB | DCASC  | %DBKLB | DSQRT | %MLIB1 |
| CLOSE  | %BMPG3 | CPL2   | %LDRLB | DCMC   | %BMPG3 | DTACH | %4SYLB |
| CIRIO  | %MLIB1 | CPL2H  | %LDRLB | DCNCT  | %SMON1 | DTAN  | %MLIB1 |
| CLRSP  | %DKULB | CPLS   | %LDRLB | DCO    | %RSLIB | DTANH | %MLIB1 |
| CLUCR  | %EDITA | CPUT   | %4SYLB | DCOS   | %MLIB1 | DU..  | %BMPG1 |
| CM00   | %DVM00 | CR..   | %BMPG1 | DCPA   | %LDRLB | DVR05 | %EDITA |
| CM72   | %DVM72 | CRE.C  | %CLIB  | DCPEN  | %LDRLB | DVR07 | %EDITA |
| CMDR   | %IB4A  | CREA.  | %BMPG3 | DD     | %COPY  | DXPSQ | %MLIB1 |
| CMDSK  | %EDITA | CREAT  | %BMPG3 | DDI    | %RSLIB | DXSB2 | %MLIB1 |
| CMDW   | %IB4A  | CRETS  | %BMPG3 | DDINT  | %MLIB1 | E.P.  | %MLIB2 |
| CMPK   | %MLIB2 | CRLF   | %EDITB | DDV05  | %DDV05 | EA?.F | %1FTN4 |
| CMPLEX | %MLIB1 | CRLF.P | %EDITB | DDV12  | %DDV12 | EAPOS | %BMPG3 |
| CMPY   | %MLIB2 | CRP.F  | %FTN4  | DEBUG  | %4SYLB | EBP.L | %LDRLB |
| CN..   | %BMPG1 | CRSK.  | %BMPG1 | DEC    | %EDITA | EC.HO | %BMPG1 |
| CNFG   | %IB4A  | CRT.F  | %FTN4  | DELMK  | %EDITA | ECCNT | %EDITA |
| CNT.   | %BMPG3 | CS..   | %BMPG1 | DEXP   | %MLIB1 | ECH   | %EDITA |
| CNTC.  | %CLIB  | CS43   | %SPO2B | DIFLG  | %EDITA | ECH.  | %BMPG1 |
| CNUMD  | %4SYLB | CSIN   | %MLIB1 | DIM    | %MLIB1 | ECHF. | %BMPG1 |
| CNUMO  | %4SYLB | CSN.F  | %FTN4  | DIM.F  | %FTN4  | ECHL  | %EDITA |
| CNV2   | %SMON1 | CSQRT  | %MLIB1 | DIN    | %RSLIB | ECLOS | %BMPG3 |
| CO..   | %BMPG1 | CSTRP  | %EDITA | DISPL  | %EDITA | ECREA | %BMPG3 |
| CODE   | %MLIB1 | CSUB   | %MLIB2 | DIU.F  | %FTN4  | ED%#. | %EDITB |
| COM.L  | %LDRLB | CT..   | %BMPG1 | DI [T  | %TVLIB | ED%.. | %EDITB |

Appendix I

| ENTRY | FILE   | ENTRY | FILE    | ENTRY | FILE    | ENTRY | FILE   |
|-------|--------|-------|---------|-------|---------|-------|--------|
| ED%?. | %EDITA | ED%SL | %EDITB  | EQTRQ | %4SYLB  | F.CC  | %FTN4  |
| ED%?? | %EDITB | ED%SR | %EDITB  | ER.F  | %FTN4   | F.CCW | %FTN4  |
| ED%A. | %EDITA | ED%SZ | %EDITA  | ER0.E | \$MLIB2 | F.CIN | %FTN4  |
| ED%AK | %EDITA | ED%T. | %EDITB  | ERASE | %TVLIB  | F.CLN | %FTN4  |
| ED%AP | %EDITA | ED%TC | %EDITA  | ERCLN | %EDITA  | F.COM | %OFTN4 |
| ED%AS | %EDITA | ED%TI | %EDITB  | ERead | %BMPG3  | F.CON | %FTN4  |
| ED%B. | %EDITA | ED%TR | %EDITA  | ERFLG | %EDITA  | F.CPX | %OFTN4 |
| ED%BS | %EDITA | ED%U. | %EDITA  | ERFMP | %READR  | F.CSZ | %FTN4  |
| ED%C. | %EDITB | ED%UN | %EDITB  | ERPRN | %EDITA  | F.D   | %FTN4  |
| ED%CL | %EDITA | ED%UY | %EDITB  | ERR   | %EDITA  | F.D.T | %FTN4  |
| ED%CO | %EDITB | ED%WC | %EDITA  | ERR0  | \$MLIB2 | F.D0  | %FTN4  |
| ED%D. | %EDITA | ED%WR | %EDITA  | ERRCN | %4ASMB  | F.D1  | %FTN4  |
| ED%EC | %EDITA | ED%X. | %EDITA  | ERRLU | \$MLIB1 | F.D2  | %FTN4  |
| ED%ER | %EDITA | ED%Y. | %EDITA  | ERROR | %EDITA  | F.D3  | %FTN4  |
| ED%EX | %EDITA | ED% . | %EDITB  | ERTN  | %EDITA  | F.DAT | %OFTN4 |
| ED%F. | %EDITA | EDFLT | %EDITA  | ESC   | %EDITA  | F.DBL | %OFTN4 |
| ED%FC | %EDITA | EDIT  | %EDITA  | ESC.F | %FTN4   | F.DCF | %FTN4  |
| ED%FE | %EDITA | EDIT1 | %EDITA  | ESCCH | %EDITA  | F.DEF | %FTN4  |
| ED%FI | %EDITA | EDIT2 | %EDITA  | ESD.F | %FTN4   | F.DID | %FTN4  |
| ED%FS | %EDITA | EDIT3 | %EDITB  | ESHOW | %EDITB  | F.DIM | %OFTN4 |
| ED%G. | %EDITA | EDSK. | %BMPG1  | EWRT  | %BMPG3  | F.DLF | %FTN4  |
| ED%HL | %EDITB | EDTLO | %EDITA  | EX.TM | %BMPG3  | F.DNB | %FTN4  |
| ED%I. | %EDITB | EDTL4 | %EDITB  | EXCER | %EDITA  | F.DNI | %FTN4  |
| ED%IN | %EDITA | EE..  | %BMPG1  | EXEC  | %CR4S2  | F.DO  | %FTN4  |
| ED%J. | %EDITB | EE.F  | %1FTN4  | EXFLG | %EDITA  | F.DOP | %FTN4  |
| ED%KB | %EDITB | EFLG. | %BMPG3  | EXIT  | \$MLIB1 | F.DP  | %FTN4  |
| ED%KM | %EDITB | EHELP | %EDITA  | EXN.F | %FTN4   | F.DTY | %FTN4  |
| ED%LE | %EDITB | EJP.F | %FTN4   | EXP   | \$MLIB1 | F.E   | %FTN4  |
| ED%LI | %EDITB | ELCOM | %EDITA  | EXPSQ | \$MLIB1 | F.EFG | %FTN4  |
| ED%LK | %EDITA | ELOC  | %BMPG3  | EXSB2 | \$MLIB1 | F.EFP | %FTN4  |
| ED%LP | %EDITA | EMA.L | \$LDRLB | F..DP | %FTN4   | F.EMA | %FTN4  |
| ED%M. | %EDITA | EMAST | %4SYLB  | F..E  | %FTN4   | F.EMP | %OFTN4 |
| ED%MO | %EDITB | EMS.L | \$LDRLB | F.A   | %FTN4   | F.EMS | %FTN4  |
| ED%NL | %EDITA | ENAMR | %EDITA  | F.ABT | %FTN4   | F.END | %FTN4  |
| ED%O. | %EDITB | END.C | %CLIB   | F.ACC | %FTN4   | F.EQE | %FTN4  |
| ED%P. | %EDITB | ENDCK | %EDITA  | F.AF  | %FTN4   | F.EQF | %FTN4  |
| ED%Q. | %EDITB | ENDM  | \$MLIB2 | F.ARF | %FTN4   | F.EQU | %OFTN4 |
| ED%R. | %EDITB | ENTIE | \$MLIB2 | F.ASP | %FTN4   | F.ERO | %FTN4  |
| ED%RC | %EDITB | ENTIX | \$MLIB2 | F.ASS | %FTN4   | F.ERF | %FTN4  |
| ED%RU | %EDITA | EO..  | %BMPG1  | F.AT  | %FTN4   | F.ERN | %FTN4  |
| ED%RW | %EDITA | EOF   | \$MLIB1 | F.AT. | %FTN4   | F.EXF | %FTN4  |
| ED%S. | %EDITB | EOF.C | %CLIB   | F.BGN | %FTN4   | F.EXT | %OFTN4 |
| ED%S1 | %EDITA | EOFLN | %EDITA  | F.BLK | %OFTN4  | F.FMT | %FTN4  |
| ED%S2 | %EDITA | EOFPR | %EDITA  | F.BSP | %FTN4   | F.FUN | %OFTN4 |
| ED%SC | %EDITB | EOTAP | \$DKULB | F.BUF | %FTN4   | F.GOP | %FTN4  |
| ED%SE | %EDITB | EPOSN | %BMPG3  | F.C   | %FTN4   | F.HDL | %FTN4  |
| ED%SH | %EDITB | EQLU  | %4SYLB  | F.CAL | %FTN4   | F.IDI | %FTN4  |

| ENTRY | FILE   | ENTRY | FILE   | ENTRY | FILE   | ENTRY | FILE   |
|-------|--------|-------|--------|-------|--------|-------|--------|
| F.IFF | %FTN4  | F.S2T | %FTN4  | FID.  | %BMPG3 | GOEND | %SP01B |
| F.IFP | %FTN4  | F.SBF | %FTN4  | FID.F | %FTN4  | GOERH | %SP01B |
| F.IM  | %FTN4  | F.SCC | %FTN4  | FILLC | %EDITA | GOEXN | %SP01B |
| F.IMP | %OFTN4 | F.SEE | %FTN4  | FILST | %EDITA | GOINT | %SP01B |
| F.INP | %OFTN4 | F.SEG | %FTN4  | FINDE | %CNV4E | GOJBF | %SP01B |
| F.INT | %FTN4  | F.SET | %BMPG1 | FINIT | %EDITA | GOJDC | %SP01B |
| F.IOF | %FTN4  | F.SFF | %FTN4  | FIT.  | %BMPG3 | GOJDN | %SP01B |
| F.IU  | %FTN4  | F.SFP | %FTN4  | FIXAL | %LDRLB | GOJRN | %SP01B |
| F.L   | %FTN4  | F.SID | %FTN4  | FIXDR | %MLIB1 | GOKIL | %SP01B |
| F.LFF | %FTN4  | F.SLF | %FTN4  | FLLER | %EDITA | GOMXP | %SP01B |
| F.LLO | %FTN4  | F.SPF | %FTN4  | FLOAT | %4SYLB | GONJB | %SP01B |
| F.LLT | %FTN4  | F.SPS | %FTN4  | FLST  | %EDITA | GONLO | %SP01B |
| F.LO  | %FTN4  | F.SRL | %FTN4  | FLTDR | %MLIB1 | GONOP | %SP01B |
| F.LOG | %OFTN4 | F.STA | %FTN4  | FM.AB | %BMPG1 | GONPF | %SP01B |
| F.LOP | %FTN4  | F.STB | %FTN4  | FM.ER | %BMPG1 | GONPR | %SP01B |
| F.LPR | %FTN4  | F.STP | %FTN4  | FMGR  | %FMG4E | GONRD | %SP01B |
| F.LSF | %FTN4  | F.STS | %FTN4  | FMPE  | %EDITA | GONSP | %SP01B |
| F.LSN | %FTN4  | F.SUB | %OFTN4 | FMT.E | %MLIB2 | GOP1V | %SP01B |
| F.LSP | %FTN4  | F.SVL | %FTN4  | FNAME | %EDITA | GOP2V | %SP01B |
| F.MFL | %FTN4  | F.SXF | %FTN4  | FNDLU | %4SYLB | GOPBF | %SP01B |
| F.NC  | %FTN4  | F.T   | %FTN4  | FNDMK | %EDITA | GOPCA | %SP01B |
| F.NCR | %FTN4  | F.TAC | %FTN4  | FNEXT | %EDITA | GORDS | %SP01B |
| F.ND  | %FTN4  | F.TC  | %FTN4  | FNS.F | %FTN4  | GORTN | %SP01B |
| F.NEQ | %FTN4  | F.TIM | %FTN4  | FNSIZ | %EDITA | GOSDC | %SP01B |
| F.NT  | %FTN4  | F.TRM | %FTN4  | FOLD  | %EDITA | GOSDN | %SP01B |
| F.NTF | %FTN4  | F.TST | %BMPG1 | FOLDW | %EDITA | GOSLU | %SP01B |
| F.NW  | %FTN4  | F.TYP | %FTN4  | FPARM | %MLIB1 | GOSPF | %SP01B |
| F.NXN | %FTN4  | F.WRP | %FTN4  | FPOST | %MLIB1 | GOSWD | %SP01B |
| F.OFE | %FTN4  | F.X1  | %FTN4  | FREAD | %EDITA | GOSZF | %SP01B |
| F.OPF | %FTN4  | F.X2  | %FTN4  | FREE. | %BMPG3 | GOTTY | %SP01B |
| F.PAK | %FTN4  | F.X3  | %FTN4  | FSTAA | %SMON1 | GOU.G | %SP01B |
| F.PAP | %FTN4  | FA.F  | %FTN4  | FSTAT | %LIB4E | GOUG1 | %SP01B |
| F.PRO | %OFTN4 | FCB1. | %CLIB  | FSTAT | %BMPG3 | GOW10 | %SP01B |
| F.R   | %FTN4  | FCB2. | %CLIB  | FSYSU | %MLIB1 | GOW11 | %SP01B |
| F.RCO | %OFTN4 | FNCT  | %SMON1 | FTIME | %4SYLB | GOW14 | %SP01B |
| F.RDP | %FTN4  | FCONT | %BMPG3 | FUBP  | %4ASMB | GOW15 | %SP01B |
| F.REA | %OFTN4 | FCPU  | %SMON1 | FUBP2 | %4ASMB | GOWD1 | %SP01B |
| F.REL | %FTN4  | FD.CK | %BMPG3 | FWRIT | %EDITA | GOWD2 | %SP01B |
| F.RPL | %FTN4  | FDCB  | %ED1K4 | FXC.F | %FTN4  | GOWD3 | %SP01B |
| F.RPR | %FTN4  | FDCNT | %EDITA | FXN.L | %LDRLB | GOWD4 | %SP01B |
| F.RTN | %FTN4  | FDKCM | %EDITA | FXS.L | %LDRLB | GOWD6 | %SP01B |
| F.RWP | %FTN4  | FDKLM | %EDITA | GO..  | %BMPG1 | GOWD7 | %SP01B |
| F.S02 | %FTN4  | FDKWR | %EDITA | G0ACT | %SP01B | GOWD8 | %SP01B |
| F.S03 | %FTN4  | FEMSG | %EDITA | GOBUF | %SP01B | GOWD9 | %SP01B |
| F.S1B | %FTN4  | FER.F | %1FTN4 | GOCAP | %SP01B | G1CAB | %SP01B |
| F.S1T | %FTN4  | FESSN | %UTLIB | GOCHR | %SP01B | G1CAP | %SP01B |
| F.S2B | %FTN4  | FG.LU | %BMPG3 | GODCB | %SP01B | G1CCJ | %SP01B |

Appendix I

| ENTRY | FILE   | ENTRY | FILE   | ENTRY | FILE   | ENTRY | FILE   |
|-------|--------|-------|--------|-------|--------|-------|--------|
| G1CCS | %SP01B | GETST | %4SYLB | IC.F  | %FTN4  | IN6.F | %FTN4  |
| G1CDA | %SP01B | GEX.C | %CLIB  | IC32  | %DVC32 | IN7.F | %FTN4  |
| G1CDJ | %SP01B | GIM.F | %1FTN4 | ICAPS | %BMPG3 | INAM3 | %EDITB |
| G1CDS | %SP01B | GLOBS | %BMPG1 | ICH.F | %FTN4  | INAMR | %4SYLB |
| G1CEX | %SP01B | GMM.C | %CLIB  | ICONV | %4AUTR | IND.E | %MLIB2 |
| G1CHK | %SP01B | GMS.C | %CLIB  | ID.A  | %4SYLB | INDC. | %CLIB  |
| G1CIN | %SP01B | GNA.F | %FTN4  | ID.AD | %CLIB  | INDCK | %PLIB  |
| G1CKS | %SP01B | GPE.F | %FTN4  | IDCBS | %BMPG3 | INDEF | %EDITA |
| G1CQQ | %SP01B | GRAN  | %MLIB1 | IDDUP | %BMPG1 | INDX  | %EDITA |
| G1CRS | %SP01B | GSCRN | %ED1K4 | IDGET | %4SYLB | INI1. | %BMPG1 |
| G1CSD | %SP01B | GST.F | %1FTN4 | IDIM  | %MLIB1 | INI2. | %BMPG1 |
| G1CSU | %SP01B | GT.JB | %BMPG1 | IDINT | %MLIB1 | INIT  | %SMON1 |
| G1CUG | %SP01B | GTCID | %RSLIB | IDN.F | %FTN4  | INIT2 | %SMON1 |
| G1CUP | %SP01B | GTERR | %4SYLB | IDRP  | %BMPG1 | INITF | %EDITA |
| G1ERP | %SP01B | GTID  | %RSLIB | IDRPD | %BMPG1 | INITS | %EDITA |
| G1FLU | %SP01B | GTL   | %IB4A  | IDRPL | %BMPG1 | INL.L | %LDRLB |
| G1IMS | %SP01B | GTSCB | %BMPG3 | IDS.F | %FTN4  | INLST | %LDRLB |
| G1KLG | %SP01B | HE..  | %BMPG1 | IDSCH | %SMON1 | INM.F | %FTN4  |
| G1OLK | %SP01B | HELP  | %HELP  | IDSEG | %CNV4E | INPRS | %4SYLB |
| G1OMS | %SP01B | HPIB  | %IB4A  | IDSGA | %4SYLB | INSC. | %CLIB  |
| G1OPN | %SP01B | I.00  | %DVR00 | IDSGM | %UTLIB | INT   | %MLIB1 |
| G1PCR | %SP01B | I.01  | %DVR00 | IEOF  | %4SYLB | INTER | %SMON1 |
| G1RD  | %SP01B | I.02  | %DVR00 | IEOT  | %4SYLB | IOCNT | %IB4A  |
| G1RDF | %SP01B | I.05  | %0DV05 | IER.  | %BMPG1 | IOP.F | %FTN4  |
| G1ROT | %SP01B | I.05  | %4DV05 | IERR  | %4SYLB | IOR   | %MLIB1 |
| G1SEG | %SP01B | I.11  | %DVR11 | IF..  | %BMPG1 | IP32  | %DVP32 |
| G1SLU | %SP01B | I.12  | %DVR12 | IFBNR | %ACCTS | IP43  | %4DP43 |
| G1STM | %SP01B | I.15  | %DVR15 | IFBRK | %4SYLB | IPRSN | %BMPG3 |
| G1SUB | %SP01B | I.23  | %DVR23 | IFDVR | %DSCLB | IPUT  | %BMPG3 |
| G1U.G | %SP01B | I.31  | %DVR31 | IFIX  | %4SYLB | IRANP | %MLIB1 |
| G1WFI | %SP01B | I.32  | %DVR32 | IFLG. | %BMPG1 | IROFF | %CNV4E |
| G1ZAP | %SP01B | I.33  | %DVR33 | IFMTM | %BMPG3 | IS43  | %SPO2B |
| GE#SC | %CLIB  | I.37  | %1DV37 | IFT.F | %FTN4  | ISHFT | %EDITA |
| GENHP | %EDITA | I.37  | %2DV37 | IFTTY | %4SYLB | ISHL  | %DSCLB |
| GES.C | %CLIB  | I.BUF | %BMPG1 | IGET  | %4SYLB | ISIGN | %MLIB1 |
| GETAD | %MLIB2 | IA.F  | %FTN4  | IGN.L | %LDRLB | ISMVE | %4SYLB |
| GETBF | %MLIB2 | IA05  | %DVA05 | II.F  | %FTN4  | ISN.F | %FTN4  |
| GETCL | %EDITA | IA12  | %DVA12 | IIV.F | %FTN4  | ISNGL | %RSLIB |
| GETDK | %EDITA | IA13  | %DVA13 | IINAM | %ED1K4 | ISOT  | %4SYLB |
| GETEQ | %RSLIB | IA32  | %DVA32 | IM00  | %DVM00 | ISSR  | %4SYLB |
| GETEX | %EDITA | IA47  | %2DV47 | IM72  | %DVM72 | ISSW  | %4SYLB |
| GETFM | %EDITA | IA47  | %3DV47 | IN..  | %BMPG1 | ISTAT | %MLIB1 |
| GETL2 | %EDITA | IABS  | %MLIB1 | IN.IT | %BMPG1 | ISY.F | %FTN4  |
| GETND | %EDITA | IAND  | %MLIB1 | IN2.F | %FTN4  | ITASK | %DBKLB |
| GETPT | %EDITA | IB12  | %DVB12 | IN3.F | %FTN4  | ITLOG | %MLIB1 |
| GETSB | %EDITA | IBERR | %IB4A  | IN4.F | %FTN4  | ITRAL | %SAVER |
| GETSP | %UTLIB | IBSTS | %IB4A  | IN5.F | %FTN4  | ITS.F | %FTN4  |

| ENTRY | FILE   | ENTRY | FILE   | ENTRY | FILE   | ENTRY | FILE   |
|-------|--------|-------|--------|-------|--------|-------|--------|
| ITYPE | %MLIB1 | LIPAT | %EDITA | LS2.L | %LDRLB | MESSS | %SMON2 |
| IVBUF | %ACCTS | LISAV | %EDITA | LS3.L | %LDRLB | MFMPE | %EDITA |
| IWRDS | %4SYLB | L2ERR | %EDITA | LS4.L | %LDRLB | MIN0  | %MLIB1 |
| IWRIS | %BMPG3 | L2FLG | %EDITA | LS5.L | %LDRLB | MIN1  | %MLIB1 |
| IXGET | %4SYLB | L2LIN | %EDITA | LSAVE | %LSAVE | MKNOD | %EDITA |
| IXOR  | %MLIB1 | L2OFF | %EDITA | LSPAN | %EDITA | MKSCB | %SMON2 |
| IXPUT | %4SYLB | L2PAT | %EDITA | LST   | %EDITA | MKSST | %SMON1 |
| J.NAM | %BMPG1 | L2STR | %EDITA | LSTA  | %EDITA | MLFLG | %EDITA |
| J.PUT | %BMPG3 | LBS.L | %LDRLB | LSTF  | %EDITA | MLOAD | %MLD4E |
| J.REC | %BMPG1 | LBYTE | %ACCTS | LSTMK | %EDITB | MMAF  | %4SYLB |
| JCMW  | %RSLIB | LBYTE | %EDITA | LSTSB | %EDITA | MOD   | %MLIB1 |
| JER.  | %BMPG1 | LCASE | %EDITA | LSTSZ | %EDITA | MODBL | %READR |
| JO..  | %BMPG1 | LCLAS | %SMON1 | LSY.L | %LDRLB | MODFY | %CNV4E |
| JOBFL | %BMPG1 | LCLOF | %EDITA | LTABS | %EDITA | MOVLP | %EDITA |
| JREAD | %READR | LCOPY | %LCOPY | LU..  | %BMPG1 | MPFND | %DBKLB |
| JRN.  | %BMPG1 | LENGH | %EDITA | LU.CL | %BMPG3 | MPN.F | %FTN4  |
| JSCOM | %DECAR | LETTR | %EDITA | LU3.C | %CLIB  | MR..  | %BMPG1 |
| JTRAL | %READR | LG..  | %BMPG1 | LUCMD | %EDITA | MS..  | %BMPG1 |
| JULIA | %RSLIB | LGBUF | %MLIB1 | LULU. | %BMPG3 | MSC.  | %BMPG3 |
| KCVT  | %4SYLB | LGOFF | %SMON1 | LURQ  | %4SYLB | MSG   | %EDITA |
| KEY   | %EDITA | LGTAT | %LGTAT | LUSES | %4SYLB | MSG.L | %LDRLB |
| KEYS  | %KEYS  | LI..  | %BMPG1 | LUTRK | %DBKLB | MSS.  | %BMPG1 |
| KEYT3 | %EDITB | LIMEM | %4SYLB | LUTRU | %4SYLB | MTLOK | %UTLIB |
| KHAR  | %4SYLB | LINC. | %CLIB  | LWA   | %LDRLB | MTD   | %RSTOR |
| KILL  | %EDITA | LL..  | %BMPG1 | M3FLG | %BMPG1 | MTOK  | %DKULB |
| KSPCR | %ACCTS | LLO   | %IB4A  | MAKPT | %EDITA | MXCOM | %LDRLB |
| KYDMP | %KYDMP | LMES  | %ACCTS | MAKSB | %EDITA | MXGTA | %DKULB |
| L.ADD | %LDRLB | LN    | %MLIB1 | MAKST | %EDITA | N.OPL | %BMPG1 |
| L.BUF | %LDRLB | LN    | %EDITA | MAP.F | %1FTN4 | N.SEQ | %SPO2B |
| L.CLS | %LDRLB | LNK1  | %LDRLB | MATCH | %DBKLB | NAM.. | %BMPG3 |
| L.IFX | %LDRLB | LNK2  | %LDRLB | MATCH | %EDITA | NAME  | %EDITA |
| L.INT | %LDRLB | LNK3  | %LDRLB | MAX0  | %MLIB1 | NAMF  | %BMPG3 |
| L.LDF | %LDRLB | LNK4  | %LDRLB | MAX1  | %MLIB1 | NAMGP | %RSLIB |
| L.LUN | %LDRLB | LNKS  | %LDRLB | MBT   | %SMON1 | NAMR  | %4SYLB |
| L.MAT | %LDRLB | LO..  | %BMPG1 | MBYTE | %ACCTS | NAMRT | %EDITA |
| L.REL | %LDRLB | LOADR | %4LDR  | MC..  | %BMPG1 | NAMT  | %SMON1 |
| L.SCN | %LDRLB | LOCAE | %EDITA | MCC.F | %FTN4  | NCHEK | %RSLIB |
| L.SEG | %BMPG1 | LOCAL | %4SYLB | ME..  | %BMPG1 | NCOMP | %RSLIB |
| L.SFT | %LDRLB | LOCF  | %BMPG3 | ME.SB | %BMPG3 | NCT.F | %FTN4  |
| L.SG0 | %LDRLB | LOCK. | %BMPG3 | MEM   | %EDITA | NEQUN | %RSLIB |
| L.SGN | %LDRLB | LOCL  | %IB4A  | MEMGT | %DBKLB | NEW.F | %FTN4  |
| L.SYE | %LDRLB | LOGLU | %4SYLB | MERG1 | %MERGE | NEWIO | %MLIB1 |
| L1ERR | %EDITA | LOGON | %SMON1 | MERG2 | %MERGE | NEWND | %EDITA |
| L1FLG | %EDITA | LOPNF | %EDITA | MERGE | %MERGE | NEXTL | %EDITB |
| L1GIV | %EDITA | LPARS | %SMON1 | MESG  | %DBKLB | NEXTL | %EDITB |
| L1LIN | %EDITA | LPCON | %LP31  | MESSP | %SMON1 | NEXTN | %RSLIB |
| L1OFF | %EDITA | LS1.L | %LDRLB | MESSS | %NSESN | NFEET | %SAVER |

Appendix I

| ENTRY  | FILE    | ENTRY | FILE    | ENTRY | FILE    | ENTRY  | FILE    |
|--------|---------|-------|---------|-------|---------|--------|---------|
| NFI0B  | \$MLIB1 | OLDIO | \$MLIB1 | PLOAD | %CNV4E  | RDREC  | %EDITA  |
| NFNAM  | \$RSLIB | OLR.F | %FTN4   | PM00  | %PVM00  | REA.C  | %BMPG1  |
| NFNDF  | %EDITA  | OLY.C | %CLIB   | PNAME | %4SYLB  | READ.  | %BMPG3  |
| NFPUT  | \$RSLIB | OMATH | %EDITA  | PNTS  | %TVLIB  | READF  | %BMPG3  |
| NGEND  | \$LDRLB | OMR.F | %FTN4   | PNUM  | %EDITB  | READR  | %READR  |
| NID2T  | \$RSLIB | ONOFF | %BMPG3  | POINT | %TVLIB  | READS  | %EDITA  |
| NINIT  | \$RSLIB | OPEN  | %BMPG3  | POSNT | %BMPG3  | READT  | %READT  |
| NLFLG  | %EDITA  | OPEN. | %BMPG1  | POST  | %BMPG3  | READU  | %DBKLB  |
| NLSFG  | %EDITA  | OPENF | %BMPG3  | PPOLL | %IB4A   | REAL   | \$MLIB1 |
| NM1.L  | \$LDRLB | OPI.C | %CLIB   | PFST  | \$LDRLB | RECOV  | %EDITB  |
| NM2.L  | \$LDRLB | OPIN  | %MERGE  | PRESN | %EDITA  | REC.C  | %CLIB   |
| NM3.L  | \$LDRLB | OPIN1 | %MERGE  | PRI.L | \$LDRLB | REDC.  | %CLIB   |
| NM4.L  | \$LDRLB | OPN.C | %CLIB   | PRINT | %EDITA  | REDIR  | %UTLIB  |
| NMBT   | \$RSLIB | OS.F  | %FTN4   | PRM.C | %CLIB   | REFMT  | %UTLIB  |
| NMCHK  | %UTLIB  | OUTBK | %EDITA  | PRMTB | %EDITA  | REIO   | \$LIB4E |
| NMWV   | \$RSLIB | OUTCR | %EDITA  | PRNTH | %DBKLB  | REIO   | %4SYLB  |
| NO.RD  | %BMPG1  | OUTDB | %EDITA  | PROBT | %CLIB   | REPQF  | %EDITA  |
| NOCM.  | %BMPG1  | OUTUB | %EDITA  | PRTER | %EDITA  | RESTR  | %RESTR  |
| NODCK  | %EDITB  | OVF   | %4SYLB  | PRTM  | %4SYLB  | RETFB  | \$MLIB2 |
| NODE0  | %EDITA  | OVRD. | %BMPG3  | PRTN  | %4SYLB  | REVFG  | %EDITA  |
| NODE1  | %EDITA  | OW.F  | %FTN4   | PSL.F | %FTN4   | REWWT  | %READR  |
| NODE3  | %EDITA  | OZ.F  | %FTN4   | PSL1  | %EDITA  | REWWT  | %SAVER  |
| NOPRN  | %EDITA  | P..CK | %BMPG3  | PSTAT | %IB4A   | RFLG\$ | %BMPG3  |
| NOR.L  | \$LDRLB | P.PAS | %BMPG3  | PTAPE | %4SYLB  | RHPAR  | \$MLIB1 |
| NPRES  | %EDITA  | P.RAM | %BMPG1  | PTERR | %4SYLB  | RIC.L  | \$LDRLB |
| NSRCH  | \$RSLIB | P.SEG | %BMPG1  | PTFME | %EDITA  | RLMEM  | %ACCTS  |
| NST.F  | %FTN4   | P.TR  | %BMPG1  | PTFME | %EDITA  | RLSCB  | %SMON2  |
| NT2ID  | \$RSLIB | PA..  | %BMPG1  | PTM.F | %FTN4   | RMOTE  | %IB4A   |
| NTAPE  | %READR  | PACK  | %EDITA  | PU..  | %BMPG1  | RMOVI  | %DBKLB  |
| NTAPE  | %SAVER  | PAK.F | %FTN4   | PU2.F | %1FTN4  | RMPAR  | %4SYLB  |
| NTI.F  | %FTN4   | PARS. | %BMPG1  | PUNCT | %EDITA  | RNRQ   | %4SYLB  |
| NUMIN  | %EDITA  | PARSE | %4SYLB  | PUOFF | %EDITB  | ROFLG  | %EDITA  |
| NWAIT  | \$RSLIB | PARSN | %BMPG3  | PURGE | %BMPG3  | ROLL1  | %EDITA  |
| NWFLG  | %EDITA  | PASS1 | %EDITA  | QSFLG | %EDITA  | ROLLN  | %EDITA  |
| NWHAT  | \$RSLIB | PATCH | %EDITA  | QUFLG | %EDITA  | ROLLR  | %EDITA  |
| NWI.F  | %FTN4   | PATSZ | %EDITA  | R/W\$ | %BMPG3  | RP..   | %BMPG1  |
| NX\$EC | %BMPG3  | PAU.E | \$MLIB2 | R1FLG | %EDITA  | RP.F   | %FTN4   |
| NX.JB  | %BMPG1  | PBKE  | %EDITA  | RANGE | %BMPG3  | RPLSB  | %EDITA  |
| NXTK.  | %BMPG1  | PCIBF | %BMPG1  | RBT.L | \$LDRLB | RPOST  | %EDITA  |
| O.BUF  | %BMPG1  | PDF.F | %FTN4   | RC..  | %BMPG1  | RSBUF  | %EDITA  |
| OA.F   | %FTN4   | PERR  | %SMON1  | RCCNT | %EDITA  | RSFLG  | %4SYLB  |
| OAI.F  | %FTN4   | PGL.L | \$LDRLB | RCH   | %EDITA  | RSPAR  | \$PLIB  |
| OC.F   | %FTN4   | PGRUN | %EDITA  | RCHAR | %EDITA  | RTN.F  | %FTN4   |
| ODF.F  | %FTN4   | PGS.  | %BMPG3  | RCOVM | %EDITA  | RTNFG  | %EDITA  |
| OF..   | %BMPG1  | PGT.L | \$LDRLB | RCPAR | \$MLIB1 | RTNOD  | %EDITA  |
| OFFSP  | %EDITA  | PK..  | %BMPG1  | RDATK | \$DKULB | RTYPE  | %EDITA  |
| OKFLG  | %EDITA  | PK.DR | %BMPG3  | RDCBF | %EDITA  | RU..   | %BMPG1  |



| ENTRY  | FILE    | ENTRY | FILE    | ENTRY | FILE    | ENTRY | FILE    |
|--------|---------|-------|---------|-------|---------|-------|---------|
| RUN.C  | %CLIB   | SEGLD | \$LIB4E | SPOLY | \$MLIB1 | TL.P  | %BMPG1  |
| RW#EC  | %CLIB   | SEGLD | %4SYLB  | SPOP  | %BMPG3  | TM.VL | %BMPG1  |
| RW\$UB | %BMPG3  | SELST | \$LDRLB | SPUT  | \$RSLIB | TMP.  | %BMPG1  |
| RWBLK  | %EDITA  | SELUR | %BMPG3  | SPUT  | %DECAR  | TMP1  | \$LDRLB |
| RWDSK  | %EDITA  | SESID | %SMON1  | SQRT  | \$MLIB1 | TMP2  | \$LDRLB |
| RWN.C  | %CLIB   | SESSN | %BMPG3  | SQUZ  | %SMON1  | TMVAL | %4SYLB  |
| RWND\$ | %BMPG3  | SET.T | %BMPG3  | SRQ   | %IB4A   | TNAMR | %EDITA  |
| RWNDF  | %BMPG3  | SETAA | %SMON1  | SRQSN | %IB4A   | TPPOS | %DBKLB  |
| RWNOD  | %EDITA  | SETDB | %4SYLB  | SRTN  | %EDITA  | TPSK. | %BMPG1  |
| RWSTB  | %4SYLB  | SETFM | %EDITA  | SSEED | \$MLIB1 | TR    | %EDITA  |
| S.CAP  | %BMPG1  | SETMS | %EDITA  | SSG.L | \$LDRLB | TR..  | %BMPG1  |
| S.GET  | %DECAR  | SETOK | %EDITA  | SSIGN | %DECAR  | TRIGR | %IB4A   |
| S.TTY  | %BMPG1  | SETSB | %4SYLB  | SSUB  | %DECAR  | TRIM  | \$MLIB2 |
| SA..   | %BMPG1  | SETTY | %EDITA  | ST..  | %BMPG1  | TRL2  | %EDITA  |
| SA2DE  | %DECAR  | SFILL | \$RSLIB | ST.LU | %SPO1B  | TRMLU | %4SYLB  |
| SADD   | %DECAR  | SFILL | %DECAR  | ST.TM | %BMPG3  | TRN   | %EDITA  |
| SAFD   | %MSAFD  | SCB.L | \$LDRLB | STATS | %IB4A   | TRNCT | %EDITA  |
| SAVER  | %SAVER  | SCBPE | %DBUGR  | STCLS | %EDITA  | TRNL  | \$MLIB1 |
| SAVST  | %4SYLB  | SCBPT | %DBUGR  | STRPB | %EDITA  | TS.F  | %FTN4   |
| SBFIN  | %EDITA  | SGET  | \$RSLIB | SUB   | %DBKLB  | TSHIF | %SMON1  |
| SBYTE  | %EDITA  | SGET  | %DECAR  | SUFIX | %EDITA  | TSY.L | \$LDRLB |
| SCARY  | %DECAR  | SGM.L | \$LDRLB | SUP.C | %CLIB   | TTY.  | %BMPG1  |
| SCBAD  | %SMON1  | SHOW  | %READR  | SV..  | %BMPG1  | TTYIP | %EDITA  |
| SCC.F  | %FTN4   | SHOW  | %SAVER  | SWAPI | %EDITA  | TTYNO | %EDITA  |
| SCCNT  | %EDITA  | SHWUN | %EDITB  | SWPET | %EDITA  | TV.F  | %FTN4   |
| SCFLG  | %EDITA  | SIGN  | \$MLIB1 | SWTCH | %SSTCH  | TVERF | %TVER   |
| SCH    | %EDITA  | SILST | \$LDRLB | SXFLG | %EDITA  | TYOPN | %EDITA  |
| SCLST  | \$LDRLB | SIN   | \$MLIB1 | SY..  | %BMPG1  | TYPE  | %EDITA  |
| SCP.F  | %FTN4   | SKL.F | %FTN4   | SYCON | %4SYLB  | TYPEQ | \$ED1K4 |
| SCR.   | %BMPG1  | SLASH | %EDITA  | SYM.L | \$LDRLB | UC.F  | %FTN4   |
| SCSIZ  | \$ED1K4 | SM..  | %BMPG1  | SZONE | %DECAR  | UN    | %EDITB  |
| SD1D2  | %DECAR  | SM.BF | %BMPG3  | T5IDM | %T5IDM  | UNBGN | %EDITA  |
| SD2D1  | %DECAR  | SM.SB | %BMPG3  | TAG   | %EDITA  | UNCON | %EDITA  |
| SDCAR  | %DECAR  | SMCNT | %EDITA  | TAN   | \$MLIB1 | UNEND | %EDITA  |
| SDEA2  | %DECAR  | SMOFF | %EDITA  | TANH  | \$MLIB1 | UNKIL | %EDITA  |
| SDF1   | %EDITA  | SMOVE | \$RSLIB | TAPSZ | %SAVER  | UNM2  | \$MLIB2 |
| SDF2   | %EDITA  | SMOVE | %DECAR  | TBFIL | %EDITA  | UNMEM | \$MLIB2 |
| SDIV   | %DECAR  | SMPY  | %DECAR  | TBLE  | \$LDRLB | UNYNK | %EDITB  |
| SE..   | %BMPG1  | SNC.F | %FTN4   | TBUF  | \$LDRLB | UPSHF | %READR  |
| SECR   | %IB4A   | SNGL  | \$MLIB1 | TCT.F | %FTN4   | UPSHF | %SAVER  |
| SECRR  | %IB4A   | SNQM  | \$MLIB2 | TDO.F | %FTN4   | URAN  | \$MLIB1 |
| SECW   | %IB4A   | SOA.F | %FTN4   | TE..  | %BMPG1  | URFLG | %EDITA  |
| SECWR  | %IB4A   | SORTR | %SAVER  | TH1.L | \$LDRLB | URFWA | \$LDRLB |
| SEDIT  | %DECAR  | SP..  | %BMPG1  | TH2.L | \$LDRLB | USAVE | %USAVE  |
| SEG.F  | %FTN4   | SPC.C | %CLIB   | THISL | %EDITA  | UT.BF | %BMPG3  |
| SEG.L  | \$LDRLB | SPFLG | %EDITA  | TL.   | %BMPG3  | VALID | %SMON1  |
| SEG.R  | %BMPG1  | SPLIT | %EDITA  | TL..  | %BMPG1  | VALUE | %CNV4E  |

Appendix I

| ENTRY | FILE    | ENTRY  | FILE    | ENTRY | FILE   | ENTRY | FILE   |
|-------|---------|--------|---------|-------|--------|-------|--------|
| VAREA | %TVLIB  | XLGAD  | \$DSCLB | \BDCB | %RT4GN | \EXIT | %RT4GN |
| VECTR | %TVLIB  | XLUEX  | %CR4S2  | \BLIN | %SSTCH | \FFMP | %SSTCH |
| VEND  | %TVLIB  | XMPY   | %MLIB2  | \BOOT | %SSTCH | \FIX  | %RT4GN |
| VERSN | %SMON1  | XMTBU  | \$DKULB | \BOT0 | %RT4GN | \FIX1 | %RT4GN |
| VIDLU | %TVLIB  | XPHAD  | \$DSCLB | \BOT5 | %RT4GN | \FIX2 | %RT4GN |
| VRFBS | %VERFY  | XPOLY  | %MLIB1  | \BPAR | %RT4GN | \FIX3 | %RT4GN |
| VSCBA | %SMON2  | XPRTY  | \$DSCLB | \BUFA | %SSTCH | \FIX4 | %RT4GN |
| VVALD | %UTLIB  | XQPRG  | %BMPG3  | \BUFI | %SSTCH | \FLGT | %SSTCH |
| WAR.F | %FTN4   | XQPRG  | %EDITA  | \BUFL | %RT4GN | \FMRR | %RT4GN |
| WARC. | %CLIB   | XRCAL  | \$DSCLB | \CBPA | %RT4GN | \FSC0 | %RT4GN |
| WDCNT | %EDITA  | XRDFS  | \$DSCLB | \CFIL | %RT4GN | \FSC5 | %RT4GN |
| WDF1  | %EDITA  | XRDNV  | \$DSCLB | \CLDP | %RT4GN | \FSEC | %RT4GN |
| WDF2  | %EDITA  | XRDOF  | \$DSCLB | \CLEN | %SSTCH | \GDMA | %SSTCH |
| WEOF5 | %BMPG3  | XSECA  | \$DSCLB | \CLOS | %RT4GN | \GENS | %RT4GN |
| WH..  | %BMPG1  | XSEEK  | \$DSCLB | \CMFL | %RT4GN | \GET# | %RT4GN |
| WDF1  | %EDITA  | XSPAR  | \$DSCLB | \CONV | %RT4GN | \GETC | %RT4GN |
| WDF2  | %EDITA  | XSTAT  | \$DSCLB | \CPL2 | %RT4GN | \GETN | %RT4GN |
| WRCLR | \$ED1K4 | XSUB   | %MLIB2  | \CPLB | %RT4GN | \GINT | %RT4GN |
| WREOT | \$DKULB | XTIME  | \$ED1K4 | \CPLM | %RT4GN | \GNER | %RT4GN |
| WRIS  | %BMPG3  | XTTBL  | \$DSCLB | \CRET | %RT4GN | \GNIO | %RT4GN |
| WRITF | %BMPG3  | XVRFY  | \$DSCLB | \CUBP | %RT4GN | \IACM | %RT4GN |
| WRITS | %EDITA  | XWRFS  | \$DSCLB | \CURL | %RT4GN | \IBI  | %RT4GN |
| WRITT | %WRITT  | YESNO  | %READR  | \CVAS | %SSTCH | \ICBP | %RT4GN |
| WRLG. | %BMPG3  | YESNO  | %SAVER  | \D#ST | %SSTCH | \ID1  | %RT4GN |
| WRT.C | %CLIB   | Z\$DBL | %MLIB2  | \D#WT | %SSTCH | \ID10 | %RT4GN |
| WRTC. | %CLIB   | Z\$F67 | %MLIB2  | \DCON | %RT4GN | \ID11 | %RT4GN |
| WRTLN | %EDITA  | Z\$INT | %MLIB2  | \DDON | %RT4GN | \ID12 | %RT4GN |
| WRTRK | \$DKULB | Z\$LPP | %MLIB2  | \DFLT | %SSTCH | \ID13 | %RT4GN |
| WUDF1 | %EDITA  | ZCTRL  | \$DSCLB | \DFTR | %SSTCH | \ID14 | %RT4GN |
| WUDF2 | %EDITA  | ZDSJ   | \$DSCLB | \DNSP | %SSTCH | \ID15 | %RT4GN |
| XADD  | %MLIB2  | ZLENG  | %CNV4E  | \DNSU | %SSTCH | \ID16 | %RT4GN |
| XADRC | \$DSCLB | ZPPOL  | \$DSCLB | \DNTR | %SSTCH | \ID2  | %RT4GN |
| XCNTL | %XCNTL  | ZPUT   | %4SYLB  | \DPLD | %RT4GN | \ID3  | %RT4GN |
| XDCAS | \$DKULB | ZREAD  | \$DSCLB | \DER2 | %RT4GN | \ID4  | %RT4GN |
| XDIV  | %MLIB2  | ZRMVF  | %EDITA  | \DSHD | %SSTCH | \ID5  | %RT4GN |
| XDRED | \$DSCLB | ZSENS  | \$DSCLB | \DSK0 | %SSTCH | \ID6  | %RT4GN |
| XDSJ  | \$DSCLB | ZTMAP  | \$DSCLB | \DSK5 | %SSTCH | \ID7  | %RT4GN |
| XDWRT | \$DSCLB | ZWRIT  | \$DSCLB | \DSKA | %RT4GN | \ID8  | %RT4GN |
| XEND  | \$DSCLB | [TAB   | %TVLIB  | \DSKD | %RT4GN | \ID9  | %RT4GN |
| XFMSK | \$DSCLB | \ABCO  | %RT4GN  | \DSKI | %RT4GN | \IDX  | %RT4GN |
| XFRMT | \$DSCLB | \ABDO  | %RT4GN  | \DSKO | %RT4GN | \IDXS | %RT4GN |
| XFTTY | %4SYLB  | \ABOR  | %RT4GN  | \DSPL | %SSTCH | \IFIX | %RT4GN |
| XGTAD | \$DSCLB | \ADBF  | %RT4GN  | \DST0 | %RT4GN | \ILST | %RT4GN |
| XGTPM | \$DKULB | \ADBP  | %RT4GN  | \DST5 | %RT4GN | \INER | %RT4GN |
| XIDEN | \$DSCLB | \ADSK  | %RT4GN  | \DSUB | %SSTCH | \INID | %RT4GN |
| XINDX | %EDITA  | \ASKY  | %RT4GN  | \DSYS | %RT4GN | \INIT | %SSTCH |
| XINIT | \$DSCLB | \BADH  | %SSTCH  | \DUNT | %SSTCH | \INPO | %SSTCH |

| ENTRY  | FILE   | ENTRY | FILE   | ENTRY | FILE    | ENTRY | FILE |
|--------|--------|-------|--------|-------|---------|-------|------|
| \INT0  | %SSTCH | \PREL | %RT4GN | \TRUN | %RT4GN  |       |      |
| \IOTB  | %RT4GN | \PRMT | %RT4GN | \TSUB | %SSTCH  |       |      |
| \IRBP  | %RT4GN | \PRV  | %RT4GN | \TUNT | %SSTCH  |       |      |
| \IRER  | %RT4GN | \PTYP | %RT4GN | \UCBP | %RT4GN  |       |      |
| \LBUF  | %RT4GN | \RBIN | %RT4GN | \URBP | %RT4GN  |       |      |
| \LNK   | %RT4GN | \RDCB | %RT4GN | \USER | %RT4GN  |       |      |
| \LNK1  | %RT4GN | \RDIN | %SSTCH | \USRS | %RT4GN  |       |      |
| \LNK2  | %RT4GN | \RDMA | %SSTCH | \XOUT | %SSTCH  |       |      |
| \LNK3  | %RT4GN | \READ | %RT4GN | \YENO | %RT4GN  |       |      |
| \LNKS  | %RT4GN | \RET  | %SSTCH | \LDP  | %RT4GN  |       |      |
| \LNKX  | %RT4GN | \RNAM | %RT4GN | ^FMSA | \$MLIB1 |       |      |
| \LNTH  | %SSTCH | \RNME | %RT4GN | ^TBG  | \$PLIB  |       |      |
| \LODN  | %RT4GN | \RNT  | %RT4GN | ^TCL  | \$PLIB  |       |      |
| \LRBP  | %RT4GN | \SAVE | %SSTCH | ^TIN  | \$PLIB  |       |      |
| \LST1  | %RT4GN | \SCTK | %RT4GN | ^TND  | \$PLIB  |       |      |
| \LST2  | %RT4GN | \SECT | %SSTCH |       |         |       |      |
| \LST3  | %RT4GN | \SEGS | %RT4GN |       |         |       |      |
| \LST4  | %RT4GN | \SETD | %SSTCH |       |         |       |      |
| \LST5  | %RT4GN | \SKYA | %RT4GN |       |         |       |      |
| \LSTE  | %RT4GN | \SPAC | %RT4GN |       |         |       |      |
| \LSTS  | %RT4GN | \SRET | %RT4GN |       |         |       |      |
| \LSTX  | %RT4GN | \SSID | %RT4GN |       |         |       |      |
| \LU2   | %SSTCH | \STD0 | %SSTCH |       |         |       |      |
| \MDTB  | %RT4GN | \STRK | %SSTCH |       |         |       |      |
| \MESS  | %RT4GN | \SWPF | %RT4GN |       |         |       |      |
| \MODE  | %SSTCH | \SWTM | %SSTCH |       |         |       |      |
| \MRT2  | %RT4GN | \SYS  | %RT4GN |       |         |       |      |
| \MTCH  | %RT4GN | \SYTB | %RT4GN |       |         |       |      |
| \MULR  | %RT4GN | \TB31 | %RT4GN |       |         |       |      |
| \MXAB  | %RT4GN | \TB32 | %RT4GN |       |         |       |      |
| \NABP  | %RT4GN | \TBCH | %RT4GN |       |         |       |      |
| \NAMB  | %RT4GN | \TBLK | %RT4GN |       |         |       |      |
| \NAMN  | %RT4GN | \TBLS | %RT4GN |       |         |       |      |
| \NAMO  | %RT4GN | \TBUF | %RT4GN |       |         |       |      |
| \NDCB  | %RT4GN | \TCHR | %RT4GN |       |         |       |      |
| \NLOD  | %RT4GN | \TDLU | %SSTCH |       |         |       |      |
| \NUMP  | %RT4GN | \TERM | %RT4GN |       |         |       |      |
| \OBUF  | %RT4GN | \TFIX | %RT4GN |       |         |       |      |
| \OCTN  | %RT4GN | \TIDN | %RT4GN |       |         |       |      |
| \OLDA  | %RT4GN | \TIM1 | %RT4GN |       |         |       |      |
| \PART  | %RT4GN | \TIME | %RT4GN |       |         |       |      |
| \PDEF  | %RT4GN | \TLST | %RT4GN |       |         |       |      |
| \PFI X | %RT4GN | \TMSK | %RT4GN |       |         |       |      |
| \PIDN  | %RT4GN | \TMT  | %SSTCH |       |         |       |      |
| \PIOC  | %RT4GN | \TRAK | %SSTCH |       |         |       |      |
| \PIP   | %RT4GN | \TRCH | %RT4GN |       |         |       |      |
| \PLST  | %RT4GN | \TRCM | %RT4GN |       |         |       |      |



# Appendix J

## Session Monitor Tables

This appendix contains information on the following:

- \* SESSION CONTROL BLOCK (SCB)
- \* SESSION SWITCH TABLE (SST) AND CONFIGURATION TABLE
- \* SESSION TABLE RELATIONSHIP

### SESSION CONTROL BLOCK (SCB)

A Session Control Block (SCB) is established for each user who has successfully "logged-on" to the system. The SCB contains the information necessary to identify the user to the system and describe his capabilities in terms of command processing and I/O addressing space.

The format of the SCB is shown in Figure J-1.

# Session Monitor Tables

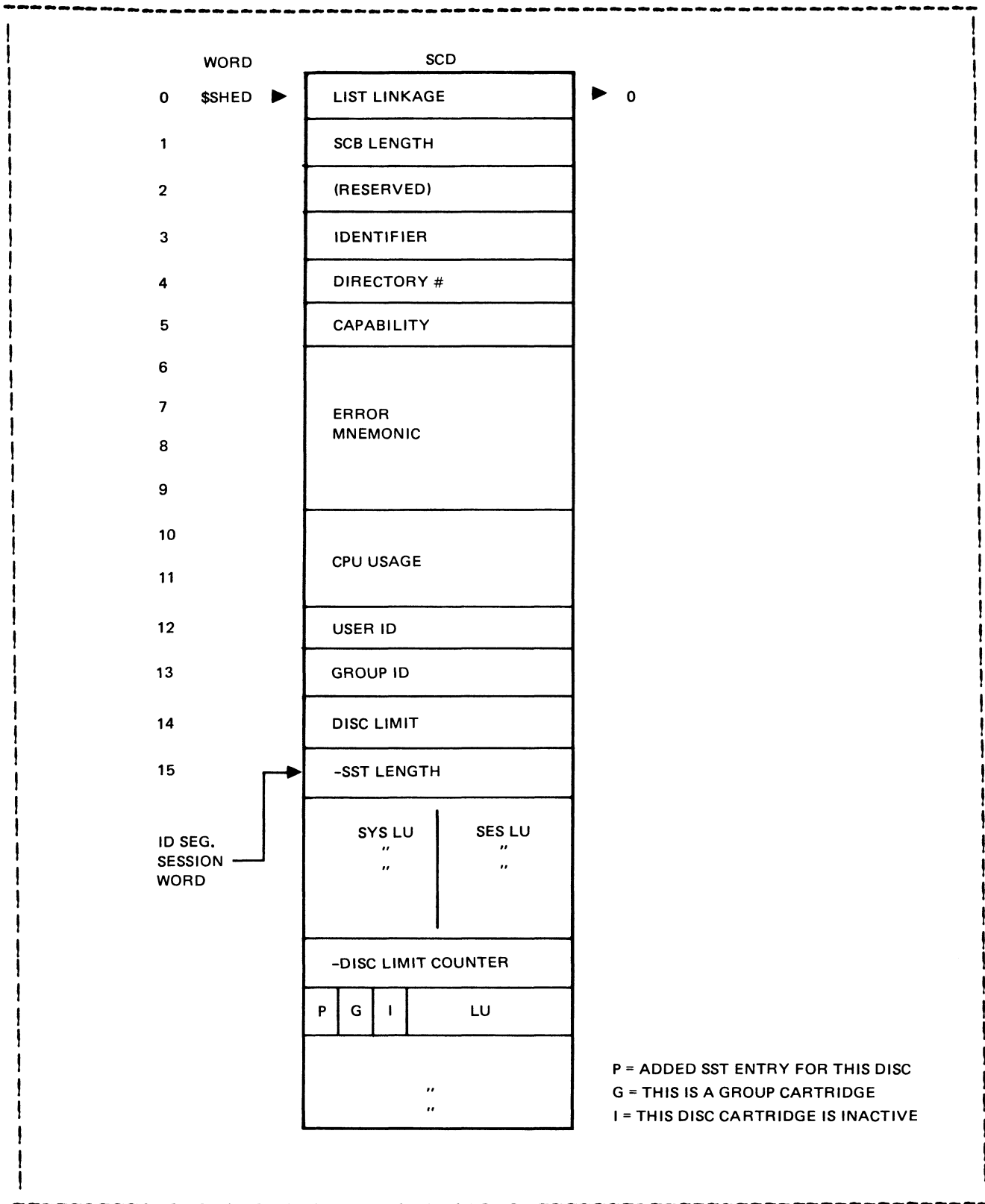

Figure J-1. SCB

## SESSION SWITCH TABLE (SST) AND CONFIGURATION TABLE

When operating in the session environment every I/O request is routed to the appropriate I/O device via the Session Switch Table (SST). Each SST entry describes a session LU, which the user addresses, and associated system LU where the I/O request will actually be directed. The SST describes the session user's I/O addressing capabilities by defining the system LUs the user has access to and the associated session LUs by which the user accesses them.

When the user makes an I/O request the SST is searched for the specified session LU. If the requested LU is found, it is switched to the associated system LU as specified in the SST entry and the I/O request is processed. If the requested LU is not found, an error is returned (IO12-LU not defined for this session).

The Session Switch Table is maintained in memory as part of the Session Control Block (SCB). The format of the SST is shown in Figure J-2.

System LUs can be integer numbers between 1 and 255. Session LUs can be integer numbers between 1 and 63. Session LUs are assigned:

- \* at log-on, via user and group account file entries, or
- \* on-line using SL command (refer to RTE-IVB Terminal User's Reference Manual), or
- \* at log-on, via Configuration Table entries.

The Configuration Table describes the default logical units to be used for specific device logical units. Each station (terminal) logical unit defined in the Configuration Table has associated with it a set of device logical units which are assigned default logical units to be used when a user logs on at this station (terminal). The default logical unit associated with the station itself is always 1.

At log-on, these default values are written from the Configuration Table in the account file into the user's Session Control Block (SCB), unless overridden by entries in this particular user's SST. The format of the Configuration Table is shown in Figure J-3, below.

# Session Monitor Tables

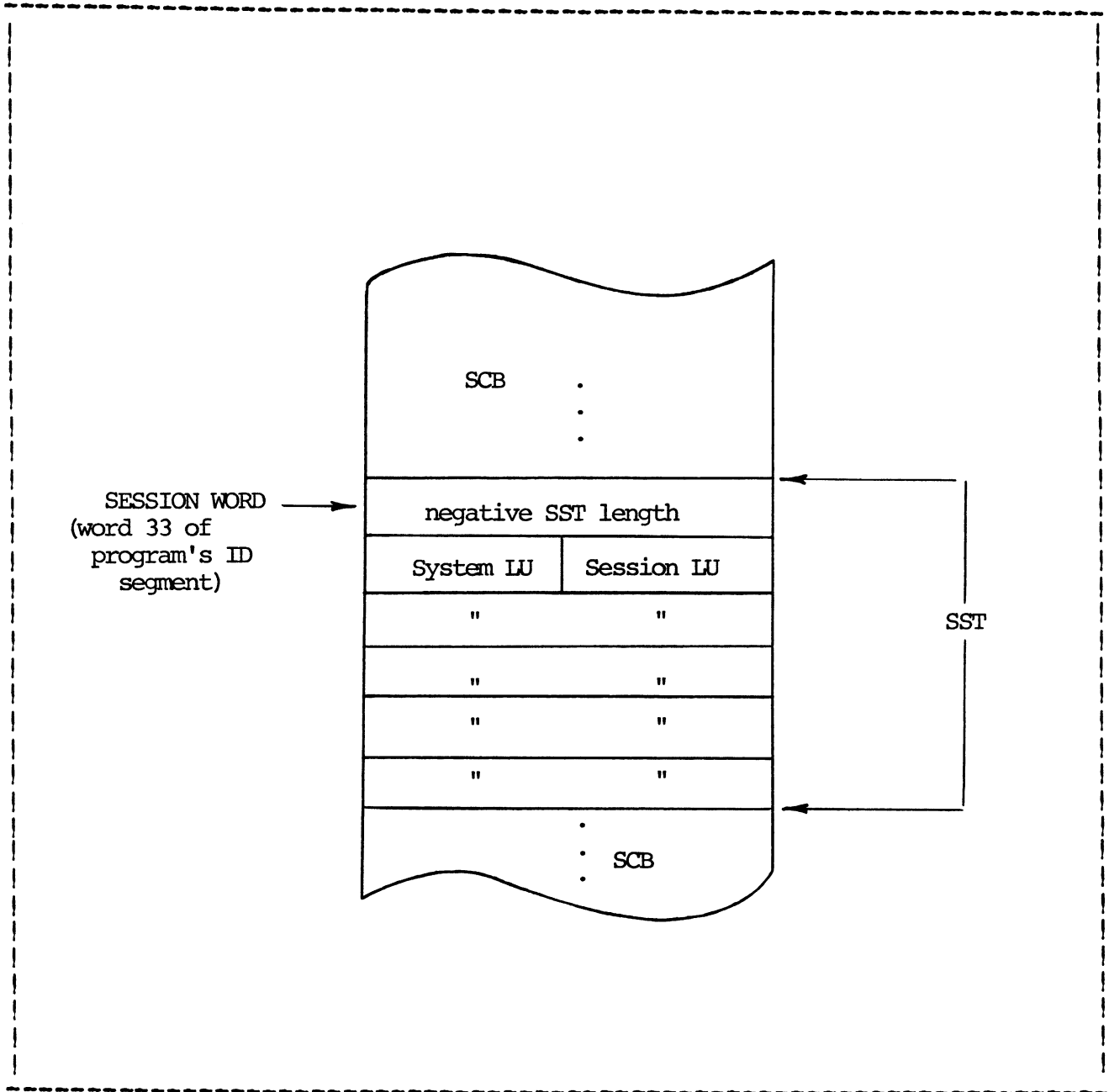

Figure J-2. Session Switch Table (SST) Format



|            |            |
|------------|------------|
| LENGTH     |            |
| STATION LU | 1          |
| SYSTEM LU  | DEFAULT LU |
| SYSTEM LU  | DEFAULT LU |
| LENGTH     |            |
| STATION LU | 1          |
| SYSTEM LU  | DEFAULT LU |
| SYSTEM LU  | DEFAULT LU |
| SYSTEM LU  | DEFAULT LU |
| 0          |            |

Figure J-3. Configuration Table



ACCOUNT FILE HEADER

|        |                                |  |
|--------|--------------------------------|--|
| WORD   |                                |  |
| 1      | LOCATION OF ACTIVE SESSN TABLE |  |
| 2      | LOCATION OF CONFIGURATION TBL  |  |
| 3      | LOCATION OF DISC POOL          |  |
| 4      | LOCATION OF USER/GROUP ID MAP  |  |
| 5      | LOCATION OF DIRECTORY          |  |
| 6      | LOCATION OF 1ST ACCOUNT ENTRY  |  |
| 7-9    | SYSTEM MESSAGE FILE            |  |
| 10     | SECURITY CODE                  |  |
| 11     | CARTRIDGE                      |  |
| 12     | # OF CHARS IN PROMPT STRING    | ← 0 if using default prompt                        |
| 13-22  | PROMPT STRING                  |  |
| 23     | LOWEST PRIVATE ID USED         |  |
| 24     | HIGHEST GROUP ID USED          |  |
| 25     | RESOURCE NO.                   |  |
| 26     | LU # OF MSG. FILES             |  |
| 27     | I MEMORY ALLOCATION SIZE (WDS) | If bit 15=1, use session monitor memory allocation |
| 28     | - SESSION LIMIT                |  |
| 29     | NUMBER OF ACTIVE SESSIONS      |  |
| 30     | SHUT DOWN FLAG                 |  |
| 31     | COPY OF SESSION LIMIT          |  |
| 32     | CLASS NUMBER                   |  |
| 33     | LENGTH OF CONFIG TABLE         |  |
| 34     | IRN2                           |  |
| 35     | DISC POOL LENGTH               |  |
| 36-128 |                                |  |

# Session Monitor Tables

ACTIVE SESSION TABLE

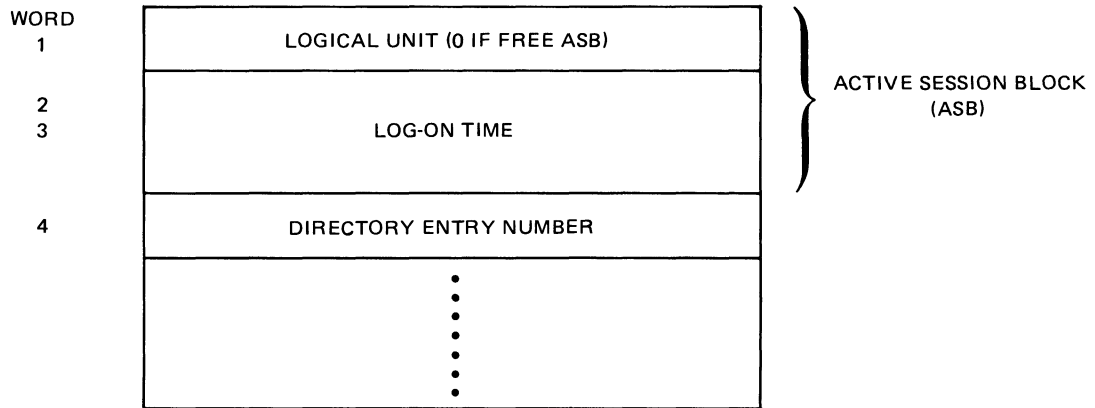

DISC ALLOCATION POOL

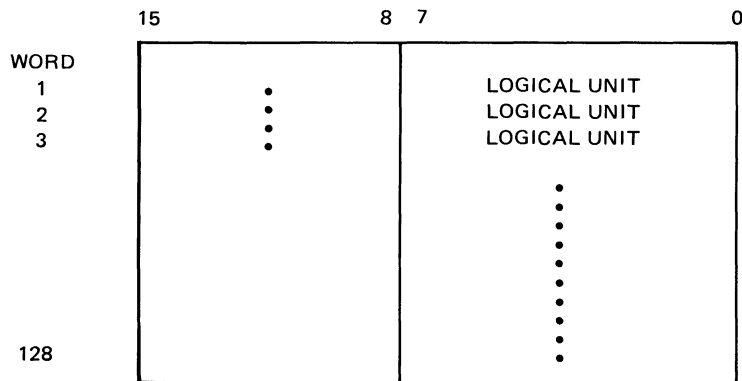

\*RESERVED FOR FUTURE USE

# Session Monitor Tables

## GROUP ACCOUNT ENTRY

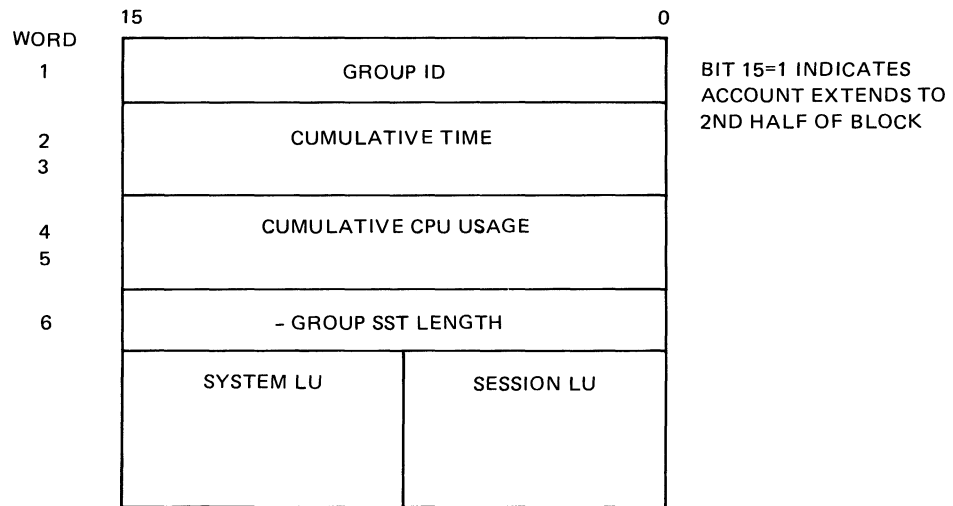

# Session Monitor Tables

## USER ACCOUNT ENTRY

| WORD  | 15                            | 6 | 7           | 0               |   |
|-------|-------------------------------|---|-------------|-----------------|---|
| 1     | I                             | * |             | CHARS IN PASSWD | BIT 15=1 INDICATES<br>ACCOUNT EXTENDS TO<br>2ND BLOCK   |
| 2-6   | PASSWORD                      |   |             |                 |   |
| 7-9   | USER HELLO FILE               |   |             |                 |   |
| 10    | SECURITY FILE                 |   |             |                 |   |
| 11    | CARTRIDGE                     |   |             |                 |   |
| 12-16 | *                             |   |             |                 |   |
| 17-19 | USER MESSAGE FILE             |   |             |                 |   |
| 20-21 |                               |   |             |                 |   |
| 22    | CAPABILITY                    |   |             |                 |   |
| 23-24 | LAST LOG-OFF TIME             |   |             |                 |   |
| 25-26 | CUMULATIVE TIME (MINUTES)     |   |             |                 | 2 WORDS   |
| 27-28 | CPU USAGE (SECONDS)           |   |             |                 | 2 WORDS   |
| 29    | USER ID                       |   |             |                 |   |
| 30    | GROUP ID                      |   |             |                 |   |
| 31    | DISC LIMIT                    |   |             |                 |   |
| 32    | GRP. SST LENGTH               |   | #SST SPARES |                 |   |
| 33    | USER/GROUP SST LENGTH (TOTAL) |   |             |                 |   |
| .     | SYSTEM LU                     |   | SESSION LU  |                 | USER SST  |
| .     | "                             |   | "           |                 |   |
| .     | "                             |   | "           |                 |   |
|       | SYSTEM LU                     |   | SESSION LU  |                 | GROUP SST   |
|       | "                             |   | "           |                 |   |
|       | "                             |   | "           |                 |   |
| 64    |                               |   |             |                 | IF BIT 15 OF WORD 1 IS<br>A 1 THEN THIS WORD IS<br>THE RECORD NUMBER OF 2ND<br>BLOCK OF ACCOUNT |

# Session Monitor Tables

## USER/GROUP ID MAP

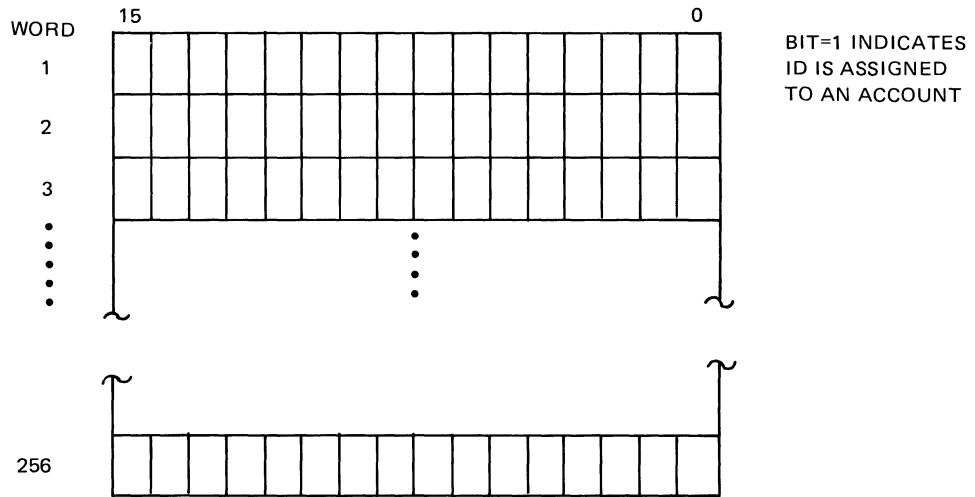

## ACCOUNT FILE DIRECTORY

| WORD | # CHARS             | # CHARS GROUP |
|------|---------------------|---------------|
| 1    |                     |               |
| 2    | USER NAME           |               |
| 3    |                     |               |
| 4    |                     |               |
| 5    |                     |               |
| 6    |                     |               |
| 7    | GROUP NAME          |               |
| 8    |                     |               |
| 9    |                     |               |
| 10   |                     |               |
| 11   | USER ID             |               |
| 12   |                     |               |
| 13   | GROUP ID            |               |
| 14   |                     |               |
| 15   | GROUP ACCT RECORD # |               |
| 16   | USER ACCT RECORD #  |               |
| 17   | *                   |               |

0=END OF DIRECTORY  
-1=FREE ENTRY  
-2=EXTENSION

IF BIT 15=1, ACCOUNT IS IN 2ND 64 WORDS

\* RESERVED FOR FUTURE USE

## Session Monitor Tables

A listing of the operating system command capability table, \$CMND appears on the following pages. Each command is defined by a two-word entry of the form:

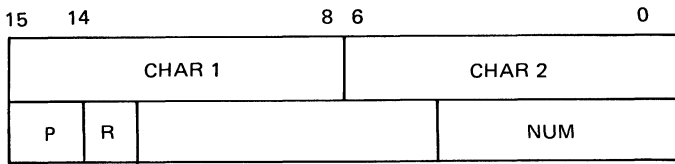

Where: CHAR1 and CHAR2 = the two character ASCII command

P = 0 If any number of parameters allowed.  
= 1 If a limitation is placed on the number of parameters allowed.

NUM = The maximum number of parameters allowed with this command (specified when P=1).

R = 0 No reference check required.  
= 1 Program specified for first parameter of command must be attached to this session (ID segment word 33 of program must equal word 33 of caller) or program must be non-session (word 33 equals zero).

The command capability level associated with a command will be determined by the position of the command entry relative to level pointers located at the head of the table. Refer to the listing for details.

If you wish to substitute your own command table for the HP supplied table, it must be specified AFTER the operating system relocatables during generation.



# Session Monitor Tables

\$CMND T=00003 IS ON CR00052 USING 00012 BLKS R=0000

```

0001 ASMB,R,L,C,Q
0002 * NAME: $CMND
0003 * SOURCE: 92067-18457
0004 * RELOC: 92067-16261
0005 * PGMR: G.L.M
0006 *
0007 * *****
0008 * * (C) COPYRIGHT HEWLETT-PACKARD COMPANY 1978. ALL RIGHTS *
0009 * * RESERVED. NO PART OF THIS PROGRAM MAY BE PHOTOCOPIED. *
0010 * * REPRODUCED OR TRANSLATED TO ANOTHER PROGRAM LANGUAGE WITHOUT *
0011 * * THE PRIOR WRITTEN CONSENT OF HEWLETT-PACKARD COMPANY. *
0012 * *****
0013 *
0014 NAM $CMND,0 92067-16261 REV.1903 790506
0015 ENT $CMND
0016 *
0017 *
0018 $CMND DEF EINDX DEFINE THE ADDRESS OF HIGHEST CAPABILITY
0019 DEF BEGIN DEFINE BEGINNING OF TABLE
0020 DEF END DEFINE END OF TABLE
0021 *
0022 L60 DEC -60 LEVEL 60
0023 L60A DEF BEGIN DEFINE START OF THIS CAPABILITY
0024 *
0025 L50 DEC -50
0026 L50A DEF L,50
0027 *
0028 L30 DEC -30
0029 L30A DEF L,30
0030 *
0031 L10 DEC -10
0032 L10A DEF L,10
0033 *
0034 L00 NOP
0035 L00A DEF L,00
0036 *
0037 EINDX EQU *-2
0038 *
0039 *
0040 *
0041 DRG $CMND
0042 BSS L10A-L30A
0043 BSS L30A-L50A
0044 BSS L50A-L60A
0045 DRR
0046 *
0047 SKP
0048 L,60 EQU *
0049 BEGIN ASC 1,00

```

Session Monitor Tables

```

0050      OCT 0
0051      ASC 1, DN
0052      OCT 0
0053      ASC 1, LU
0054      OCT 0
0055      ASC 1, EG
0056      OCT 0
0057      ASC 1, TO
0058      OCT 0
0059      ASC 1, SL
0060      OCT 0
0061      ASC 1, TK
0062      OCT 0
0063      ASC 1, OF
0064      OCT 0
0065      ASC 1, BR
0066      OCT 0
0067      ASC 1, GO
0068      OCT 0
0069      ASC 1, SS
0070      OCT 0
0071      ASC 1, RT
0072      OCT 0
0073      *
0074      L.50 ASC 1, LT
0075      OCT 0
0076      ASC 1, L3
0077      OCT 0
0078      ASC 1, AS
0079      OCT 0
0080      ASC 1, UR
0081      OCT 0
0082      ASC 1, ON
0083      OCT 0
0084      ASC 1, PR
0085      OCT 0
0086      *
0087      L.30 ASC 1, RU
0088      OCT 0
0089      ASC 1, OF
0090      OCT 40000
0091      ASC 1, SS
0092      OCT 40000
0093      ASC 1, GO
0094      OCT 40000
0095      ASC 1, RT
0096      OCT 0
0097      ASC 1, SZ
0098      OCT 0
0099      ASC 1, L2
0100      OCT 0
0101      *
0102      L.10 ASC 1, FL
0103      OCT 0
0104      ASC 1, RS
0105      OCT 0
0106      ASC 1, BU
0107      OCT 100000
0108      ASC 1, BL
0109      OCT 100000
0110      ASC 1, ST
0111      OCT 0
0112      ASC 1, BR
0113      OCT 40000
0114      ASC 1, EQ
0115      OCT 100001
0116      ASC 1, SL
0117      OCT 0

```

ABILITY TO ADD AN ENTRY IN SBT --- SL CMND

LEVEL 2 SL CMND -- SPOOL AN LU

```

0118      ASC 1, TC
0119      OCT 100001
0120      ASC 1, TE
0121      OCT 0
0122      ASC 1, WH
0123      OCT 0
0124      ASC 1, TC
0125      OCT 0
0126      ASC 1, UF
0127      OCT 0
0128      ASC 1, EN
0129      OCT 0
0130      *
0131      L.00 ASC 1, OP
0132      OCT 0
0133      ASC 1, HF
0134      OCT 0
0135      *
0136      END EQU *-2
0137      END $CMND

```

The file manager command table follows on subsequent pages. The capability levels assigned to various commands depends on their position within the table relative to table pointers located at the front of the command table. Each command is defined by a two-word entry. To change the capability level of a command, relocate the two-word entry to the appropriate table section for the desired capability level. Do not modify the two-word entry.

Then reassemble the modified capability table and relocate it after the file manager modules (i.e. %BMPG1,...) during generation. (You can ignore GEN05 and GEN08 errors here).

NOTE

Hewlett Packard does not support modified command capability tables.

# Session Monitor Tables

C.TAB T=00003 IS ON CR00052 USING 00022 BLKS R=0000

```

0001 ASMB,R,L,C
0002 * NAME: C.TAB
0003 * SOURCE: 92067-18201
0004 * RELOC: 92067-16185
0005 * PGMR: G.A.A., R.L.
0006 *
0007 * *****
0008 * * (C) COPYRIGHT HEWLETT-PACKARD COMPANY 1979. ALL RIGHTS
0009 * * RESERVED. NO PART OF THIS PROGRAM MAY BE PHOTOCOPIED, *
0010 * * REPRODUCED OR TRANSLATED TO ANOTHER PROGRAM LANGUAGE WITHOUT*
0011 * * THE PRIOR WRITTEN CONSENT OF HEWLETT-PACKARD COMPANY. *
0012 * *****
0013 *
0014 NAM C.TAB,B 92067-16185 REV.1903 790207
0015 ENT C.TAB
0016 *
0017 * SET UP SEGMENT AND ROUTINE NUMBERS.
0018 *
0019 R0 EQU 0
0020 R1 EQU 400B
0021 R2 EQU R1+R1
0022 R3 EQU R2+R1
0023 R4 EQU R3+R1
0024 R5 EQU R4+R1
0025 R6 EQU R5+R1
0026 R7 EQU R6+R1
0027 R8 EQU R7+R1
0028 R9 EQU R8+R1
0029 R10 EQU R9+R1
0030 SPC 1
0031 S0 EQU 60B
0032 S1 EQU S0+1
0033 S2 EQU S0+2
0034 S3 EQU S0+3
0035 S4 EQU S0+4
0036 S5 EQU S0+5
0037 S6 EQU S0+6
0038 S7 EQU S0+7
0039 S8 EQU S0+8
0040 S9 EQU S0+9
0041 SA EQU 101B
0042 *
0043 * THIS IS THE COMMAND DISPATCH TABLE FOR THE FMGR PROGRAM.
0044 * EACH COMMAND ID IS FOLLOWED BY ITS ADDRESS.
0045 * FOR ROUTINES IN THE HOME SEGMENT THIS IS AN ADDRESS (DEF XX).
0046 * FOR ROUTINES IN OTHER SEGMENTS IT IS THE ASCII SEGMENT
0047 * SUFFIX IN THE LOW HALF OF THE WORD AND THE ROUTINE
0048 * NUMBER IN THAT SEGMENT IN THE HIGH HALF OF THE WORD.
0049 * .PARS BREAKS THESE APART BY THE ADDRESS BEING 0( ADD < 10000B

```

## Session Monitor Tables

```

0050 *   FOR SEGMENT ADDRESS.
0051 *
0052 *   COMMANDS WITH THE SIGN BIT SET INDICATE THAT THE COMMAND
0053 *   NEED NOT SATISFY ALL THE SYNTAX RESTRICTIONS IMPOSED ON
0054 *   OTHER COMMANDS.
0055 *
0056 *   SPC 1
0057 *
0058 *   SESSION MONITOR COMMAND CAPABILITY LEVELS
0059 *
0060 C.TAB DEF BEGIN
0061      DEF ENDS
0062      DEF SCMD
0063 L1    DEC 1
0064 L1A  DEF LV10
0065 L10  DEC 10
0066 L10A DEF LV20
0067 L20  DEC 20
0068 L20A DEF LV30
0069 L30  DEC 30
0070 L30A DEF LV40
0071 L40  DEC 40
0072 L40A DEF LV50
0073 L50  DEC 50
0074 L50A DEF LV60
0075 L60  DEC 60
0076 L60A DEF SCMD
0077 ENDS DEF NONSN
0078 ENDT DEF END
0079      SPC 1
0080 *
0081 *   STRUCTURE CHECKS
0082 *
0083      ORG C.TAB
0084      BSS ENDT-ENDS
0085      BSS ENDS-L60A
0086      BSS L60A-L50A
0087      BSS L50A-L40A
0088      BSS L40A-L30A
0089      BSS L30A-L20A
0090      BSS L20A-L10A
0091      BSS L10A-L1A
0092      ORR
0093      SPC 1
0094 BEGIN EQU *
0095      NOP          NULL COMMAND (TR)
0096      DEF TR..
0097      ASC 1,TR
0098      EXT TR..
0099      DEF TR..
0100      ASC 1,EX
0101      EXT EE..
0102      DEF EE..
0103      OCT 151531   "SY" WITH SIGN BIT SET
0104      ABS S7+R2
0105 LV10 ASC 1,??   <<CAPABILITY LEVEL 10 COMMANDS>>
0106      ABS S7+R1
0107      OCT 125052   "***" WITH SIGN BIT SET
0108      DEF COMM
0109      OCT 125000   "**(NULL)" WITH SIGN BIT SET
0110      DEF COMM
0111      OCT 125040   "**(BLANK)" WITH SIGN BIT SET
0112      DEF COMM
0113      ASC 1,LI
0114      ABS S9+R1
0115      ASC 1,CL
0116      ABS S9+R0
0117      ASC 1,DL

```

## Session Monitor Tables

|      |      |            |                                  |
|------|------|------------|----------------------------------|
| 0118 |      | ABS S3+R1  |                                  |
| 0119 |      | ASC 1,MC   |                                  |
| 0120 |      | ABS S4+R3  |                                  |
| 0121 |      | ASC 1,DC   |                                  |
| 0122 |      | ABS S4+R4  |                                  |
| 0123 |      | ASC 1,WH   |                                  |
| 0124 |      | ABS S5+R6  |                                  |
| 0125 |      | OCT 151515 | "SM" WITH SIGN BIT SET           |
| 0126 |      | ABS S4+R0  |                                  |
| 0127 |      | ASC 1,ME   |                                  |
| 0128 |      | ABS S4+R1  |                                  |
| 0129 |      | ASC 1,AC   |                                  |
| 0130 |      | ABS S4+R5  |                                  |
| 0131 | LV20 | ASC 1,CR   | <<CAPABILITY LEVEL 20 COMMANDS>> |
| 0132 |      | ABS S8+R1  |                                  |
| 0133 |      | ASC 1,ST   |                                  |
| 0134 |      | ABS S0+R2  |                                  |
| 0135 |      | ASC 1,DU   |                                  |
| 0136 |      | ABS S0+R3  |                                  |
| 0137 |      | ASC 1,PU   |                                  |
| 0138 |      | ABS S2+R2  |                                  |
| 0139 |      | ASC 1,RN   |                                  |
| 0140 |      | ABS S6+R4  |                                  |
| 0141 |      | ASC 1,CO   |                                  |
| 0142 |      | ABS S0+R1  |                                  |
| 0143 |      | ASC 1,PK   |                                  |
| 0144 |      | ABS S0+R0  |                                  |
| 0145 |      | ASC 1,CN   |                                  |
| 0146 |      | ABS S5+R6  |                                  |
| 0147 |      | ASC 1,LL   |                                  |
| 0148 |      | ABS S4+R0  |                                  |
| 0149 |      | ASC 1,SV   |                                  |
| 0150 |      | ABS S4+R2  |                                  |
| 0151 |      | OCT 142120 | "DP" WITH SIGN BIT SET           |
| 0152 |      | EXT DP..   |                                  |
| 0153 |      | DEF DP..   |                                  |
| 0154 |      | OCT 140516 | "AN" WITH SIGN BIT SET           |
| 0155 |      | ABS S5+R5  |                                  |
| 0156 |      | OCT 141524 | "CT" WITH SIGN BIT SET           |
| 0157 |      | ABS S5+R7  |                                  |
| 0158 | LV30 | ASC 1,SP   | <<CAPABILITY LEVEL 30 COMMANDS>> |
| 0159 |      | ABS S8+R0  |                                  |
| 0160 |      | OCT 151125 | "RU" WITH SIGN BIT SET           |
| 0161 |      | ABS S5+R1  |                                  |
| 0162 |      | ASC 1,RP   |                                  |
| 0163 |      | ABS S5+R0  |                                  |
| 0164 |      | ASC 1,OF   |                                  |
| 0165 |      | ABS S6+R3  |                                  |
| 0166 |      | ASC 1,KT   |                                  |
| 0167 |      | ABS S6+R0  |                                  |
| 0168 |      | ASC 1,TD   |                                  |
| 0169 |      | ABS S6+R0  |                                  |
| 0170 |      | ASC 1,EO   |                                  |
| 0171 |      | ABS S6+R1  |                                  |
| 0172 |      | ASC 1,CS   |                                  |
| 0173 |      | ABS S3+R0  |                                  |
| 0174 |      | ASC 1,AB   |                                  |
| 0175 |      | EXT AB..   |                                  |
| 0176 |      | DEF AB..   |                                  |
| 0177 |      | ASC 1,TL   |                                  |
| 0178 |      | ABS S5+R2  |                                  |
| 0179 | LV40 | ASC 1,SE   | <<CAPABILITY LEVEL 40 COMMANDS>> |
| 0180 |      | EXT SE..   |                                  |
| 0181 |      | DEF SE..   |                                  |
| 0182 |      | ASC 1,IF   |                                  |
| 0183 |      | EXT IF..   |                                  |
| 0184 |      | DEF IF..   |                                  |
| 0185 |      | ASC 1,CA   |                                  |

## Session Monitor Tables

```

186     EXT CA..
187     DEF CA..
188     OCT 150101    "PA" WITH SIGN BIT SET
189     ABS S5+R3
190 LV50  ASC 1,LC    <<CAPABILITY LEVEL 50 COMMANDS>>
191     ABS S4+R1
192 LV60  ASC 1,IN    <<CAPABILITY LEVEL 60 COMMANDS>>
193     ABS S2+R1
194 SCMD  ASC 1,CL    <<SPECIAL SESSION COMMANDS>>
195     ABS S3+R5
196     OCT 144165    "HE" WITH SIGN BIT SET
197     ABS S5+R7
198     OCT 152105    "TE" WITH SIGN BIT SET
199     ABS S5+R4
200 NONSM ASC 1,LU    <<NON-SESSION COMMANDS>>
201     ABS S6+R5
202     ASC 1,LS
203     ABS S6+R2
204     ASC 1,LC
205     ABS S6+R2
206     ASC 1,MS
207     ABS S4+R6
208     ASC 1,MR
209     EXT MR..
210     DEF MR..
211     ASC 1,SA
212     ABS S8+R2
213 END   NOP        <<END OF COMMAND TABLE>>
214 *
215 *
216 COMM  NOP
217     LDA COMM,I
218     JMP 0,1
219     END

```





# Appendix K

## DCB and Directory Formats

This Appendix contains information on the following:

- \* DATA CONTROL BLOCK (DCB) FORMAT
- \* CARTRIDGE DIRECTORY FORMAT
- \* FILE DIRECTORY FORMAT

DCB and Directory Formats

DATA CONTROL BLOCK FORMAT

| bit                        | 15  | 14 | 13 | 12 | 11                         | 10 | 9 | 8 | 7   | 6 | 5 | 4 | 3                      | 2 | 1 | 0 |
|----------------------------|---|----|----|----|----------------------------|----|---|---|---|---|---|---|------------------------|---|---|---|
| word                       | -----   |    |    |    |                            |    |   |   |   |   |   |   |                        |   |   |   |
| / 0                        | Sector Offset   |    |    |    | Sector # of file directory |    |   |   | LU# of File Directory or of file if on disc |   |   |   | File Directory Address |   |   |   |
| 1                          | Track # of file directory   |    |    |    |                            |    |   |   |   |   |   |   |                        |   |   |   |
| 2                          | File Type (may be overridden at open, unless type 0)                    |    |    |    |                            |    |   |   |   |   |   |   |                        |   |   |   |
| 3                          | Track address of file (type >= 1)                                       |    |    |    |                            |    |   |   | LU# of file (type = 0)                      |   |   |   |                        |   |   |   |
| 4                          | Sector address of file (type >= 1)                                      |    |    |    |                            |    |   |   | End-of-file code (type = 0)                 |   |   |   |                        |   |   |   |
| 5                          | File size in -chunks / Spacing Code (type = 0)<br>+sectors (type >= 1)/ |    |    |    |                            |    |   |   |   |   |   |   |                        |   |   |   |
| 6                          | Record Length (type = 2)  |    |    |    |                            |    |   |   | Read/write Code (type = 0)                  |   |   |   |                        |   |   |   |
| 7                          | SC number of Blocks in DCB  buffer                                      |    |    |    |                            |    |   |   | S  O  I  E  W                               |   |   |   | Y  M  B  F  R          |   |   |   |
| 16-word cart-ridge entry 8 | Number of sectors per track (type >= 1)                                 |    |    |    |                            |    |   |   |   |   |   |   |                        |   |   |   |
| 9                          | Open/Close Indicator  |    |    |    |                            |    |   |   |   |   |   |   |                        |   |   |   |
| 10                         | Track # of current file position (type >= 1)                            |    |    |    |                            |    |   |   |   |   |   |   |                        |   |   |   |
| 11                         | Sector # of current file position (type >= 1)                           |    |    |    |                            |    |   |   |   |   |   |   |                        |   |   |   |
| 12                         | Location of next word in file (type >=1)                                |    |    |    |                            |    |   |   |   |   |   |   |                        |   |   |   |
| 13                         | Record # of current file  |    |    |    |                            |    |   |   |   |   |   |   |                        |   |   |   |
| 14                         | Position (Double word integer.)   |    |    |    |                            |    |   |   |   |   |   |   |                        |   |   |   |
| 15                         | Extent Number (type >= 3)   |    |    |    |                            |    |   |   |   |   |   |   |                        |   |   |   |
| 16                         | -----   |    |    |    |                            |    |   |   |   |   |   |   |                        |   |   |   |
| Buffer 128+n               | DCB Buffer Area   |    |    |    |                            |    |   |   |   |   |   |   |                        |   |   |   |

Legend for Data Control Block

| word  | Content  |
|---|--|
| 4 End-of-File Code, type 0 file:  | 01 lu = EOF on Magnetic Tape<br>10 lu = EOF on Paper Taype<br>11 lu = EOF on Line Printer  |
| 5 Spacing Code, type 0 file:  | bit 15 = 1.- backspace legal<br>bit 0 = 1.- forward space legal                            |
| 6 Read/Write Code, type 0 file:   | bit 15 = 1.- input legal<br>bit 0 = 1 - output legal                                       |
| 7 Security Code Check/Open Mode/Buffer Size/In Buffer/To Be Written/<br>EOF Read Flag, all file types |  |
| (SC) Security Code Check  | bit 15 = 1.- security codes agree<br>= 0.- security codes do not agree                     |
| DCB Buffer:   | bits 14-7 = Number of blocks in DCB buffer   |
| (SY) System Disc:   | bit 4 = 1 file is on a system disc<br>= 0 not on a system disc                             |
| (OM) Open Mode:   | bit 3 = 1.- update open<br>0.- standard open   |
| (IB) In Buffer Flag:  | bit 2 = 1.- data in DCB buffer<br>= 0.- data not in DCB buffer                             |
| (EF) EOF Read Flag:   | bit 0 = 1.- EOF has been read<br>= 0 - EOF has not been read                               |
| (WR) To Be Written:   | bit 0 = 1.- data in DCB buffer to be written<br>= 0.- data in DCB buffer not to be written |
| 9 Open/Close Indicator:   | if open, contains ID segment location of program performing open. If closed, set to zero.  |

# DCB and Directory Formats

## CARTRIDGE DIRECTORY FORMAT

The cartridge directory is located in the system area on LU2. Its length is two blocks.

|     | 5   | 4 | 3 | 2 | 1 | 0 | 9 | 8  | 7 | 6 | 5 | 4 | 3 | 2 | 1 | 0 |
|-----|---|---|---|---|---|---|---|----|---|---|---|---|---|---|---|---|
| 0   | lock  |   |   |   |   |   |   | LU |   |   |   |   |   |   |   |   |
| 1   | last track  |   |   |   |   |   |   |    |   |   |   |   |   |   |   |   |
| 2   | Cartridge Reference Label   |   |   |   |   |   |   |    |   |   |   |   |   |   |   |   |
| 3   |   |   |   |   |   |   |   | ID |   |   |   |   |   |   |   |   |
|     | Up to 32 4-word entries in the first block of the CL.<br>Up to 31 4-word entries in the second block. |   |   |   |   |   |   |    |   |   |   |   |   |   |   |   |
| 124 | 0   |   |   |   |   |   |   |    |   |   |   |   |   |   |   |   |
| 125 | Initialization code word  |   |   |   |   |   |   |    |   |   |   |   |   |   |   |   |
| 126 | master security code  |   |   |   |   |   |   |    |   |   |   |   |   |   |   |   |
| 127 | reserved for future use   |   |   |   |   |   |   |    |   |   |   |   |   |   |   |   |

lock = 0 if not locked; else in keyword table offset of ID segment address of locking program

Locked discs are available only to the locker.

ID identifies to whom the cartridge is mounted.

ID = 0000 --> non-session  
 ID = 7777B--> system cartridge  
 0<ID<7777B--> session monitor group or private cartridge

NOTE: Words 124, 125, 126, and 127 are unique only in the second block of the CL. The first block will hold 32 entries in words 0 through 127.

Sum of contents of base page words <---1650 thru 1657 and 1742 thru 1747 and 1755 thru 1764.

<--Set when system cartridge is initialized.

FILE DIRECTORY

The first entry in each File Directory is the specification entry for the cartridge itself. The directory starts on the last FMP track of each cartridge in sector zero on all discs. The directory blocks are written using sector skipping. The directory sector address can be obtained from the block address by the following formula:

$$\text{sector address} = (\text{block} * 7) \text{ modulo } S/T$$

where S/T is the number of sectors per track. Directory blocks are 128 words long. Each Directory entry is 16 words long.

| Word | Content   | IN Parameters  |
|------|---|--|
| 0    | 15<br>-----<br>  1  <br>-----                             | 0 bit 15 set to distinguish cartridge entry<br>←---from file entry |
| 1    | <br>-----   | 6 character cartridge label.                                       |
| 2    | <br>-----   |  |
| 3    | cartridge reference number  <br>-----                     |  |
| 4    | first available track for FMP  <br>-----                  | ←-----label  |
| 5    | next available sector  <br>-----                          |  |
| 6    | number of sectors per track  <br>-----                    |  |
| 7    | lowest directory track (last file track + 1)  <br>-----   |  |
| 8    | number of tracks in directory (negative value)  <br>----- |  |
| 9    | next available FMP track  <br>-----                       |  |
| 10   | first bad track  <br>-----                                |  |
|      | .  <br>  .  <br>  .  <br>  .  <br>-----                   |  |
| 15   | sixth bad track  <br>-----                                |  |

# DCB and Directory Formats

## Disc File Directory

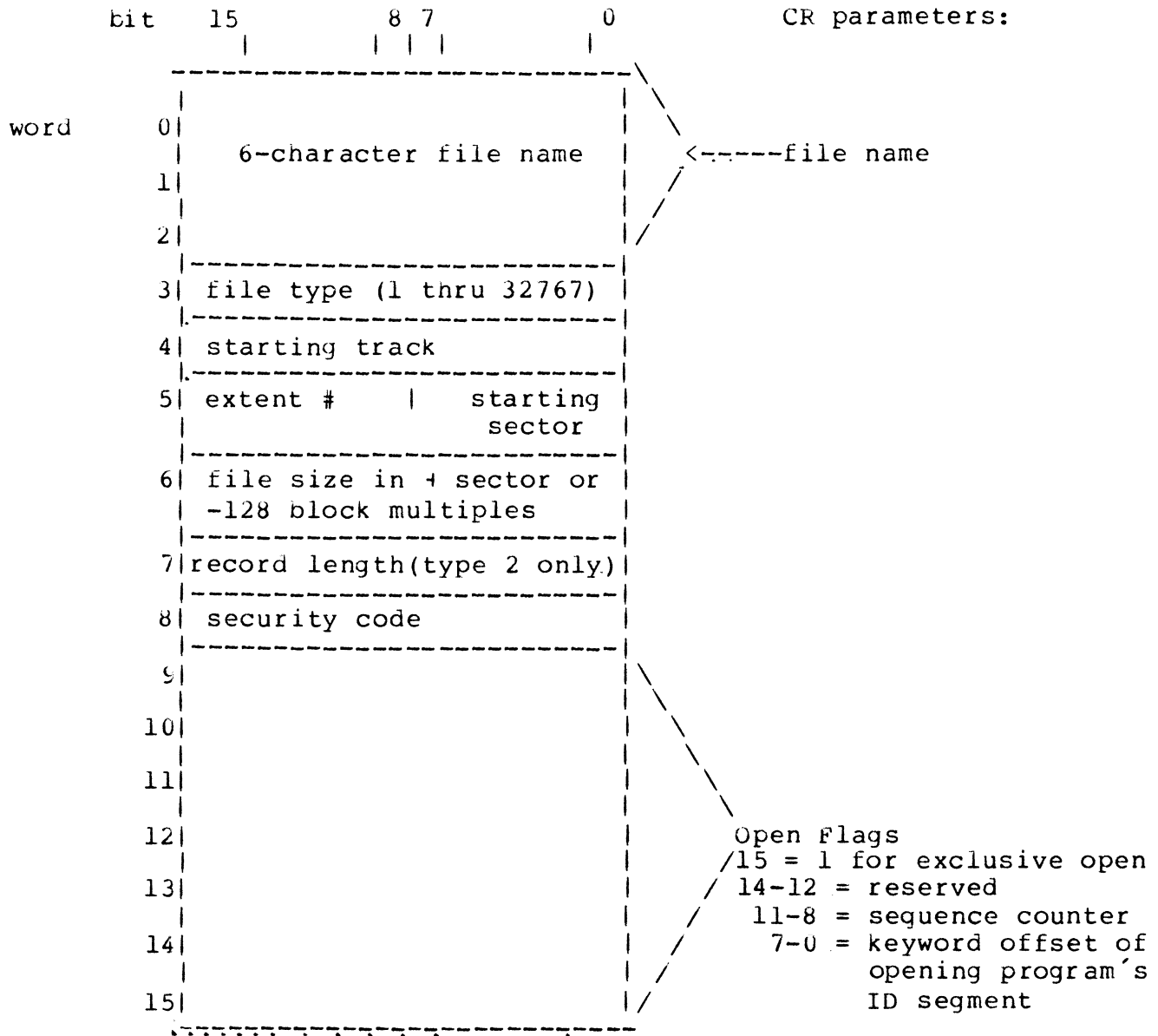

word 0 = 0 if the last entry in directory; = -1 if file is purged

## Type 0 File Directory Entry

The entries for non-disc (type 0) files differ from those for disc files in words 3 through 7:

|      | bit | 15                      |  | 0 | CR parameters:          |
|------|-----|-------------------------|--|---|-------------------------|
| word | 3   | 0 (file type default)   |  |   |                         |
|      | 4   | logical unit number     |  |   |                         |
|      | 5   | end of file subfunction |  |   | <---EO,LE,PA or control |
|      | 6   | spacing code            |  |   | <-----BS,FS, or BO      |
|      | 7   | input-output code       |  |   | <-----RE,WR, or BO      |

Words 5-7 are octal codes:

end-of-file subfunction = 01LU for MT(EO)  
 10LU for paper tape (LE)  
 11LU for line printer (PA)  
 or subfunction code

spacing code = bit 15 = 1 backspace legal (BS)  
 bit 0 = 1 forward space legal (FS)

input/output code = bit 15 = 1 input legal (RE)  
 bit 0 = 1 output legal (WR)





# **Appendix L**

## **Blank Worksheets**



HP 7900 DISC WORKSHEET

SUBCHANNEL 1

REMOVABLE

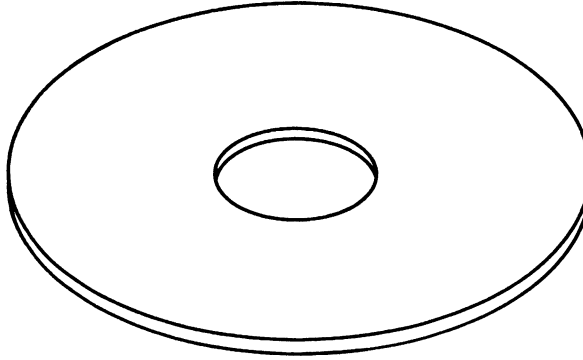

NO. OF TRACKS AVAILABLE \_\_\_\_\_

FIRST TRACK \_\_\_\_\_

SUBCHANNEL 0

FIXED

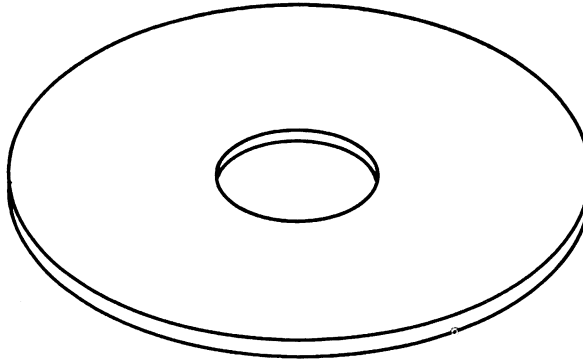

NO. OF TRACKS AVAILABLE \_\_\_\_\_

FIRST TRACK \_\_\_\_\_

SYSTEM SUBCHANNEL NUMBER \_\_\_\_\_ (LOGICAL UNIT 2)

AUXILIARY SUBCHANNEL NUMBER \_\_\_\_\_ (LOGICAL UNIT 3)



HP 7906(H) DISC WORKSHEET

**STEP 1**

FILL IN UNIT/ADDRESS NUMBER: \_\_\_\_\_

**STEP 2**

TRACKS ARE SHOWN END-TO-END ON FOUR SURFACES. USE PENCIL TO CIRCLE YOUR SUBCHANNELS. WITHIN EACH CIRCLE WRITE THE FOLLOWING INFORMATION: THE SUBCHANNEL NUMBER; THE NUMBERS OF THE STARTING AND ENDING CYLINDERS; THE TOTAL NUMBER OF TRACKS, EXCLUDING SPARES; THE NUMBER OF SPARE TRACKS; AND THE LOGICAL UNIT NUMBER FOR EACH SUBCHANNEL.

|          | 0 | 30 | 60 | 90 | 120 | 150 | 180 | 210 | 240 | 270 | 300 | 330 | 360 | 390 | 410 |
|----------|---|----|----|----|-----|-----|-----|-----|-----|-----|-----|-----|-----|-----|-----|
| CYLINDER |   |    |    |    |     |     |     |     |     |     |     |     |     |     |     |
| HEAD 0   |   |    |    |    |     |     |     |     |     |     |     |     |     |     |     |
| HEAD 1   |   |    |    |    |     |     |     |     |     |     |     |     |     |     |     |
| HEAD 2   |   |    |    |    |     |     |     |     |     |     |     |     |     |     |     |
| HEAD 3   |   |    |    |    |     |     |     |     |     |     |     |     |     |     |     |

} REMOVABLE

**STEP 3**

TRANSLATE **STEP 2** TO NUMBERS:

| SUBCHANNEL | # OF TRACKS, EXCLUDING SPARES | STARTING CYLINDER | STARTING HEAD | TOTAL # OF SURFACES INCLUDED IN SUBCHANNEL | NUMBER OF SPARES | SYSTEM? (✓) | AUXILIARY? (✓) |
|------------|-------------------------------|-------------------|---------------|--|------------------|-------------|----------------|
|            |                               |                   |               |  |                  |             |                |
|            |                               |                   |               |  |                  |             |                |
|            |                               |                   |               |  |                  |             |                |
|            |                               |                   |               |  |                  |             |                |
|            |                               |                   |               |  |                  |             |                |
|            |                               |                   |               |  |                  |             |                |
|            |                               |                   |               |  |                  |             |                |
|            |                               |                   |               |  |                  |             |                |
|            |                               |                   |               |  |                  |             |                |

### HP 7920(H) DISC WORKSHEET

**STEP 1**

FILL IN UNIT/ADDRESS NUMBER: \_\_\_\_\_

**STEP 2**

TRACKS ARE SHOWN END-TO-END ON FIVE SURFACES. USE PENCIL TO CIRCLE YOUR SUBCHANNELS. WITHIN EACH CIRCLE WRITE THE FOLLOWING INFORMATION: THE SUBCHANNEL NUMBER; THE NUMBERS OF THE STARTING AND ENDING CYLINDERS; THE TOTAL NUMBER OF TRACKS, EXCLUDING SPARES; THE NUMBER OF SPARE TRACKS; THE LOGICAL UNIT NUMBER FOR EACH SUBCHANNEL.

| CYLINDER | 0 | 50 | 100 | 150 | 200 | 250 | 300 | 350 | 400 | 450 | 500 | 550 | 600 | 650 | 700 | 750 | 800 | 822 |  |
|----------|---|----|-----|-----|-----|-----|-----|-----|-----|-----|-----|-----|-----|-----|-----|-----|-----|-----|--|
| HEAD 0   |   |    |     |     |     |     |     |     |     |     |     |     |     |     |     |     |     |     |  |
| HEAD 1   |   |    |     |     |     |     |     |     |     |     |     |     |     |     |     |     |     |     |  |
| HEAD 2   |   |    |     |     |     |     |     |     |     |     |     |     |     |     |     |     |     |     |  |
| HEAD 3   |   |    |     |     |     |     |     |     |     |     |     |     |     |     |     |     |     |     |  |
| HEAD 4   |   |    |     |     |     |     |     |     |     |     |     |     |     |     |     |     |     |     |  |

ALL ARE REMOVABLE



### HP 7925(H) DISC WORKSHEET

**STEP 1**

FILL IN UNIT/ADDRESS NUMBER: \_\_\_\_\_

**STEP 2**

TRACKS ARE SHOWN END-TO-END ON NINE SURFACES. USE PENCIL TO CIRCLE YOUR SUBCHANNELS. WITHIN EACH CIRCLE WRITE THE FOLLOWING INFORMATION: THE SUBCHANNEL NUMBER; THE NUMBERS OF THE STARTING AND ENDING CYLINDERS; THE TOTAL NUMBER OF TRACKS, EXCLUDING SPARES; THE NUMBER OF SPARE TRACKS; THE LOGICAL UNIT NUMBER FOR EACH SUBCHANNEL.

CYLINDER      0    50   100   150   200   250   300   350   400   450   500   550   600   650   700   750   800   822

|        | 0 | 50 | 100 | 150 | 200 | 250 | 300 | 350 | 400 | 450 | 500 | 550 | 600 | 650 | 700 | 750 | 800 | 822 |
|--------|---|----|-----|-----|-----|-----|-----|-----|-----|-----|-----|-----|-----|-----|-----|-----|-----|-----|
| HEAD 0 |   |    |     |     |     |     |     |     |     |     |     |     |     |     |     |     |     |     |
| HEAD 1 |   |    |     |     |     |     |     |     |     |     |     |     |     |     |     |     |     |     |
| HEAD 2 |   |    |     |     |     |     |     |     |     |     |     |     |     |     |     |     |     |     |
| HEAD 3 |   |    |     |     |     |     |     |     |     |     |     |     |     |     |     |     |     |     |
| HEAD 4 |   |    |     |     |     |     |     |     |     |     |     |     |     |     |     |     |     |     |
| HEAD 5 |   |    |     |     |     |     |     |     |     |     |     |     |     |     |     |     |     |     |
| HEAD 6 |   |    |     |     |     |     |     |     |     |     |     |     |     |     |     |     |     |     |
| HEAD 7 |   |    |     |     |     |     |     |     |     |     |     |     |     |     |     |     |     |     |
| HEAD 8 |   |    |     |     |     |     |     |     |     |     |     |     |     |     |     |     |     |     |



HP 7925 DISC WORKSHEET (Cont.)

**STEP 3** TRANSLATE **STEP 2** TO NUMBERS:

| SUBCHANNEL | # OF TRACKS,<br>EXCLUDING<br>SPARES | STARTING<br>CYLINDER | STARTING<br>HEAD | TOTAL # OF<br>SURFACES<br>INCLUDED IN<br>SUBCHANNEL | NUMBER<br>OF<br>SPARES | SYSTEM?<br>( ) | AUXILIARY?<br>( ) |
|------------|-------------------------------------|----------------------|------------------|---|------------------------|----------------|-------------------|
| 0          |                                     |                      |                  |   |                        |                |                   |
| 1          |                                     |                      |                  |   |                        |                |                   |
| 2          |                                     |                      |                  |   |                        |                |                   |
| 3          |                                     |                      |                  |   |                        |                |                   |
| 4          |                                     |                      |                  |   |                        |                |                   |
| 5          |                                     |                      |                  |   |                        |                |                   |
| 6          |                                     |                      |                  |   |                        |                |                   |
| 7          |                                     |                      |                  |   |                        |                |                   |
| 8          |                                     |                      |                  |   |                        |                |                   |
| 9          |                                     |                      |                  |   |                        |                |                   |
| 10         |                                     |                      |                  |   |                        |                |                   |
| 11         |                                     |                      |                  |   |                        |                |                   |
| 12         |                                     |                      |                  |   |                        |                |                   |
| 13         |                                     |                      |                  |   |                        |                |                   |
| 14         |                                     |                      |                  |   |                        |                |                   |
| 15         |                                     |                      |                  |   |                        |                |                   |
| 16         |                                     |                      |                  |   |                        |                |                   |
| 17         |                                     |                      |                  |   |                        |                |                   |

HP 7925 DISC WORKSHEET (Cont.)

STEP 3 TRANSLATE STEP 2 TO NUMBERS:

| SUBCHANNEL | # OF TRACKS,<br>EXCLUDING<br>SPARES | STARTING<br>CYLINDER | STARTING<br>HEAD | TOTAL # OF<br>SURFACES<br>INCLUDED IN<br>SUBCHANNEL | NUMBER<br>OF<br>SPARES | SYSTEM?<br>( ) | AUXILIARY?<br>( ) |
|------------|-------------------------------------|----------------------|------------------|---|------------------------|----------------|-------------------|
| 18         |                                     |                      |                  |   |                        |                |                   |
| 19         |                                     |                      |                  |   |                        |                |                   |
| 20         |                                     |                      |                  |   |                        |                |                   |
| 21         |                                     |                      |                  |   |                        |                |                   |
| 22         |                                     |                      |                  |   |                        |                |                   |
| 23         |                                     |                      |                  |   |                        |                |                   |
| 24         |                                     |                      |                  |   |                        |                |                   |
| 25         |                                     |                      |                  |   |                        |                |                   |
| 26         |                                     |                      |                  |   |                        |                |                   |
| 27         |                                     |                      |                  |   |                        |                |                   |
| 28         |                                     |                      |                  |   |                        |                |                   |
| 29         |                                     |                      |                  |   |                        |                |                   |
| 30         |                                     |                      |                  |   |                        |                |                   |
| 31         |                                     |                      |                  |   |                        |                |                   |
|            |                                     |                      |                  |   |                        |                |                   |
|            |                                     |                      |                  |   |                        |                |                   |
|            |                                     |                      |                  |   |                        |                |                   |
|            |                                     |                      |                  |   |                        |                |                   |

HP 9895 DISC WORKSHEET

**STEP 1** FILL IN ICD ADDRESS NUMBER: \_\_\_\_\_

**STEP 2** ONLY ONE SUBCHANNEL PER DRIVE WILL BE DEFINED. THE FOLLOWING DEFINITION IS THE HP STANDARD DEFINITION FOR 9895 FLEXIBLE DISC

| SUBCHANNEL             | # OF TRACKS,<br>EXCLUDING<br>SPARES | STARTING<br>CYLINDER | STARTING<br>HEAD | TOTAL # OF<br>SURFACES<br>INCLUDED IN<br>SUBCHANNEL | NUMBER<br>OF<br>SPARES | UNIT<br># |
|------------------------|-------------------------------------|----------------------|------------------|---|------------------------|-----------|
| DOUBLE-SIDED OPERATION |                                     |                      |                  |   |                        |           |
| 1                      | 134                                 | 0                    | 0                | 2   | 20                     | 0         |
| 2                      | 134                                 | 0                    | 0                | 2   | 20                     | 1         |
| SINGLE-SIDED OPERATION |                                     |                      |                  |   |                        |           |
| 1                      | 67                                  | 0                    | 0                | 1   | 10                     | 0         |
| 2                      | 67                                  | 0                    | 0                | 1   | 10                     | 1         |



# Glossary

**ABSOLUTE PROGRAM** - A program that has been relocated and is capable of being loaded into main memory for subsequent execution. An "absolute program" is synonymous with "relocated program."

**ABSOLUTE SYSTEM** - The binary memory image of an RTE system (stored on Logical Unit 2).

**ACCOUNT FILE** - A disc resident file created and maintained by the System Manager. It contains information on all authorized session users and other session related information.

**ADDRESS SPACE** - See LOGICAL MEMORY or PHYSICAL MEMORY.

**ASYNCHRONOUS DEVICE** - A device that can perform I/O operations that are independent of time considerations but operates simultaneously with program execution. Interaction with the computer is through request/response circuitry.

**AUXILIARY DISC SUBCHANNEL** - An optional subchannel that is treated as a logical extension of the system disc subchannel, Logical Unit 2. If used, it is assigned to Logical Unit 3. The binary memory image of RTE-IVB may not reside on the auxiliary subchannel.

**BACKGROUND (BG)** - An arbitrary name for one of two types of partitions in RTE; generally used for lower priority programs whose responses to interrupts are not time-critical.

**BASE PAGE** - A 1024-word area of memory corresponding to logical page 0. It contains the system's communication area, driver links, trap cells for interrupt processing, and system and/or user program links.

**BASE PAGE FENCE** - A hardware register that divides a logical base page into a portion containing the user's base page and a portion of the system's base page.

**BG** - See BACKGROUND.

**BIT BUCKET** - Logical unit number pointing to Equipment Table entry number zero, which in turn, does not point to any existing device. I/O directed to the bit bucket is lost.

**BLOCK** - Two logical disc sectors of 128 bytes each, totaling a 256 bytes.

**BOOT EXTENSION** - An absolute program that resides on the first two sectors of logical track 0 of the system subchannel. The Boot Extension itself is first loaded into memory by the Bootstrap Loader or ROM Loader.

## Glossary

**BOOT FILE** - An optional file to which the Bootstrap Loader produced by the On-Line Generator is stored. This may be a disc file or a logical unit (e.g., a mini-cartridge).

**BOOTSTRAP LOADER** - A loader produced by the Generator and stored in the boot file. The Bootstrap Loader loads the Boot Extension into memory and then transfers control to the Boot Extension.

**BOOT-UP** - The process of bringing the Bootstrap Loader or ROM Loader contents into memory. Control is then transferred to the Boot Extension to begin the initialization process.

**BUFFER** - An area of memory (main-memory, mass memory or local peripheral memory) used to temporarily store data.

**CAPABILITY LEVEL** - An integer from 1 to 63 which defines the FMGR, System, and Break-Mode commands which a session user may execute.

**CARTRIDGE** - A set of contiguous cylinders on a disc unit. Cartridges contain disc files with a directory of the files stored on each cartridge. All files on the same FMP cartridge must have unique names. The system disc on logical unit 2 contains the RTE operating system, and may contain FMP files.

**CHAINING** - A technique for coordinating sequential execution of independent programs in the same portion of main memory.

**CLASS I/O** - A means of buffering data between devices and user programs, and between programs themselves, that permits a user program to continue execution concurrently with its own I/O. The term "I/O without program wait" is a more commonly used term.

**CLOSE FILE** - A method of terminating a program's access to a file so that no further read/write operations may be performed on the file.

**COMMON** - An area of memory that can be accessed by a program and its subprograms. Usually used to pass data from a program to a subprogram. In RTE, system COMMON may be used to pass data from one program to another.

**CONFIGURATION TABLE** - A set of default logical units associated with the station that a session user logs on at.

**CONFIGURATOR** - A two-part program that allows reconfiguration of an RTE system's I/O and physical memory structures without going through a new system generation. The configurator is initiated as an option during the startup process.

**CURRENT PAGE** - The memory page in which the executing instruction is located. Some 2IMX memory reference instructions can only directly reference locations in two pages: current page and base page.

**CYLINDER** - The area that passes under all heads during one revolution of the disc surfaces.

DATA CONTROL BLOCK (DCB) - A table within an executable program that contains information used by the File Management Package (FMP) in performing disc accesses. (See the RTE Batch Spool Monitor Reference Manual.)

DCPC - See DUAL CHANNEL PORT CONTROLLER.

DEVICE DOWN - Relates to the state of a peripheral device or I/O controller. When the device is down, it is no longer available for use by the system. The term also refers to the DN operator command.

DEVICE INDEPENDENCE - Refers to the ability of a program to perform I/O without knowing which physical device is being accessed (see also Logical Unit Number).

DEVICE REFERENCE TABLE (DRT) - A table created during system generation corresponding to Logical Units 1 through 63. The contents of the Device Reference Table include a pointer to the associated EQT entry, subchannel number of the device, and information as to whether or not the device is locked. The table may be modified by the user through an LU command.

DEVICE TIMEOUT - A time interval associated with a specific I/O device. If the system expects a response from such a device and this response does not occur within the timeout period, the device is assumed to be inoperative by the system. This feature is necessary to prevent a program from getting "hung up" because it is waiting for a response from a non-functioning peripheral device.

DIRECT MEMORY ACCESS - See DUAL CHANNEL PORT CONTROLLER.

DIRECTORY - A list of programs and files currently stored on a disc subchannel that can be displayed by the user.

DISC - Strictly speaking, the term means the platter(s) with the storage medium only; however the term is also loosely used to mean the entire peripheral including the drive.

DISC-BASED - Refers to an operating system using a disc storage device as an integral part of the operating system.

DISC FORMATTING - The process by which physical track and sector addresses are written in the preamble of each disc track sector. Disc formatting may be performed by the appropriate disc diagnostic. After formatting is completed, the SWTCH program and Disc Backup utility may perform subchannel initialization.

DISC-RESIDENT - A term applied to programs in executable form (absolute) that are stored on disc and brought into main memory for execution by the system in response to a program or operator request, time-of-day schedule or an I/O interrupt.

## Glossary

DISC ROM BOOT - A loader residing in Read-Only Memory that loads (off-line) the Boot Extension from disc storage and transfers control to the Boot Extension. (See also BOOT EXTENSION and STARTUP.)

DISPATCHER - An RTE system module that selects, from the scheduled list, the highest priority program to be executed next. The dispatcher module loads the program into memory from disc (if the program is not already in memory) and transfers control to the program.

DMA - See DUAL CHANNEL PORT CONTROLLER.

DMS - See DYNAMIC MAPPING SYSTEM.

DORMANT PROGRAM - A dormant program is one that is "sleeping" or inactive. More specifically, in RTE it is a program that is neither executing, suspended nor scheduled.

DOWN - Status of a device controller EQT that is not available for use.

DRIVER - A software module that interfaces a device and its controller to an operating system. Drivers specified by EQT definitions will go into either a driver partition or into the System Driver area of memory.

DRIVER PARTITION - A block of memory that contains one or more drivers. In RTE-IV, all drivers are in physical memory; however, only the driver partition containing the driver currently being used is included (mapped) in the logical address space.

DRT - See DEVICE REFERENCE TABLE.

DUAL CHANNEL PORT CONTROLLER (DCPC) - A hardware accessory that permits an I/O process to transfer data to or from memory directly, or access memory, thus providing a much faster transfer of data. The operating system controls access to the DCPC channels.

DYNAMIC BUFFER SPACE - Additional buffer space allocated to a program after the program code itself. The additional size is determined by the user. Typically used only by assembly language program.

DYNAMIC MAPPING SYSTEM - A hardware accessory allowing partitioned memory systems to address memory configurations larger than 32K words of physical memory.

EMA - See EXTENDED MEMORY AREA.

EQT - See EQUIPMENT TABLE.

EQT EXTENSION - A method for increasing the size of an Equipment Table entry's buffer space, during system generation, that gives the specified I/O driver more words of storage space than are available in the EQT temporary storage area.



EQUIPMENT TABLE (EQT) - A table in memory associating each physical I/O device controller with a particular software processing routine (driver). For a given device, the EQT provides status information, temporary storage and parameter passing services (see also Device Reference Table and Interrupt Table).

EXEC - One of the RTE system modules that interfaces user programs to the operating system.

EXTENDABLE FILE - An FMP file that is automatically extended in response to a write request to points beyond the range of the currently defined file. An extent is created with the same name and size as the main, and the access is continued.

EXTENDED MEMORY AREA (EMA) - An area of physical memory that may extend beyond the user's logical address space and is used for large data arrays. Its size is limited only by the amount of physical memory available. An entire array is resident in physical memory although the entire array is not currently in the logical address space.

EXTERNAL REFERENCE - A reference to a declared symbolic name not defined in the software module in which the reference occurs. An external reference is satisfied by another module that defines the reference name by an entry point definition.

FILE - A defined section of memory on a storage device used to store data or programs.

FILE EXTENTS - See EXTENDABLE FILE.

FILE MANAGEMENT - The operating system functions associated with maintaining disc files (translating file names to physical disc memory areas; maintaining a directory; checking for security codes; etc.).

FILE MANAGEMENT PACKAGE (FMP) - A collection of subprograms used to access, control and maintain files.

FILE MANAGER (FMGR) - A program that provides FMP file creation, access and manipulation services through FMGR commands entered by the user.

FMGR - See FILE MANAGER.

FMP - See FILE MANAGEMENT PACKAGE.

BACKGROUND - A purely arbitrary name for one of the two types of partitions in RTE; generally used for higher-priority programs. The "background" area is synonymous with the real-time area.

GLOBAL TRACKS - Global tracks are a subset of system tracks and are accounted for in the track assignment table. Any program can read/write or release a global track (i.e., programs can share global tracks).

## Glossary

HP-IB - The Hewlett-Packard version of the IEEE standard 488-1975 Digital Interface for Programmable Instrumentation. The HP-IB provides two-way communication between instruments and/or between computers, instruments, or peripherals.

ID SEGMENT - A block of words, associated with each resident program, that is used by the system to keep track of the program's name, software priority field, current scheduling status and other characteristics. Every program must have its own ID segment.

ID SEGMENT EXTENSION - A method for increasing the size of an ID segment to save additional information about its associated program. The extensions are used only for EMA programs (see EMA). ID segment extensions are automatically allocated by the generator or loader, but only if sufficient ID segment extensions were specified during system generation.

INTEGRATED CONTROLLER DISCS - Discs that have their own controller in each disc drive are ICD Discs. They use the 12821A interface card and the DVA32 disc drive. The 7906H, 7920H, 7925H and 9895 disc models are ICD Discs.

INTERRUPT - The process (usually initiated by an I/O device controller) that causes the computer to signal an executing program, in an orderly fashion, for the purpose of transferring information between a device and the computer.

INTERRUPT LOCATION - A single memory location whose contents (always an instruction) are executed upon interrupt by an I/O device controller (same as trap cell).

INTERRUPT TABLE (INT) - A table that associates interrupt links with the octal select codes of peripheral devices to specific EQT entries or programs.

I/O - A general term referring to any activity between a computer and its peripheral devices.

I/O CONTROLLER - A combination of interface card(s), cable, and (for some devices) controller box used to control one or more I/O devices.

I/O DEVICE - A physical unit defined by an EQT entry (I/O controller) and subchannel.

I/O WITHOUT WAIT - See CLASS I/O.

KEYWORD TABLE - A table of ID segment addresses.

LG AREA - A group of tracks used to temporarily store relocatable code that can be accessed by the File Manager.

**LIBRARY** - A collection of relocatable subroutines that perform commonly-used (e.g., mathematical) functions. Subroutines are appended to referencing programs or are placed in the memory resident library for access by memory resident programs.

**LOADER** - A program that converts the relative addresses of relocatable programs to absolute addresses compatible with the memory layout of a particular system.

**LOCAL COMMON** - An area of COMMON appended to the beginning of a program and accessible only by that program, its subroutines or segments. This type of COMMON can be specified only during on-line relocation by the loader (LOADR).

**LOCKED DEVICE** - See LOGICAL UNIT LOCK.

**LOCKED FILE** - A file opened exclusively to one program and therefore not currently accessible to any other program.

**LOGICAL MEMORY** - Logical memory is the 32K-word (maximum) address space described by the currently enabled memory map. If the System Map is enabled, it describes those areas of physical memory necessary for the operation of RTE-IV. When the User Map is enabled, it describes those areas needed by the currently executing program. DCPC maps describe the address space to/from which the transfer is taking place.

**LOGICAL UNIT LOCK** - A mechanism for temporarily acquiring exclusive use of an I/O device or devices by a program, to ensure its I/O completion before being preempted by a another program.

**LOGICAL UNIT NUMBER (LU)** - A number used by a program to refer to an I/O device. Programs do not refer directly to the physical I/O device select code number, but rather through the LU number that has a cross-reference to the device.

**LOG-OFF** - The process by which a session is terminated.

**LOG-ON** - The process by which a session is initiated. The Log-On process involves checking the session user's identification to allow access to the system, and the creation of the user's operating environment through the User HELLO File and Session Control Block.

**LU** - See LOGICAL UNIT NUMBER.

**MAILBOX I/O** - A Class I/O term applied to a protected buffer that keeps track of the "sender" and "receiver" program for each block of data in the buffer used in program-to program communication.

**MAIN PROGRAM** - The main body of a user program (as opposed to the whole program, which may include subroutines or segments).

**MAP** - Applied to 21MX or XE machines, the term applies to a set of 32 registers that point to 32 pages of physical memory defining a 32K-word logical address space.

## Glossary

**MAPPING SEGMENT (MSEG)** - The area of an EMA that is currently accessible within the user program's logical address space.

**MEMORY PROTECT** - A hardware accessory that allows an address (memory protection fence) to be set so that when in protected mode, the locations below that address cannot be accessed by writes or JSB/JMP instructions.

**MEMORY-RESIDENT LIBRARY** - A collection of reentrant or privileged library routines available only to memory resident programs (in RTE-IV). These routines are included in the disc-resident relocatable library for appending to disc-resident programs.

**MEMORY-RESIDENT PROGRAM** - A program that executes from a designated area in physical memory and remains in memory, as opposed to a disc-resident program that may be swapped out to the disc or loaded from the disc to another area in memory. Memory resident programs are loaded during system generation (only), and usually are high priority programs with short execution times.

**MOTHER PARTITION** - A partition that may be larger than the maximum logical address space and which may consist of a group of subpartitions. The subpartitions allow many smaller programs to use the memory when the mother partition is not active.

**MSEG** - See **MAPPING SEGMENT**.

**MULTIPLE ACCESS CONTROLLER DISCS** - Disc Drives that use the 13037B/C disc controller are MAC disc drives. They use the on-line DVR32 disc driver. The 7905, 7906, 7920, and 7925 disc models are MAC discs.

**MULTIPROGRAMMING** - A technique whereby two or more routines or programs may be executed concurrently by an interleaving process, using the same computer. Multiprogramming is an attempt to improve equipment efficiency by building a queue of demands for resources, achieved by having available in main memory more than one task waiting for resource usage. The concurrent tasks are then multiplexed among each other's wait time intervals.

**MULTI-TERMINAL MONITOR** - A system software module that provides for interactive program development and editing in a multi-terminal environment controlled by a single computer.

**OFF-LINE** - Refers to use of the computer and/or I/O devices by resources other than the RTE operating system or subsystems.

**ON-LINE** - Refers to software or I/O devices recognized and controlled by the main operating system at the time they are being used.

**ON-LINE GENERATOR** - A program that permits use of an existing RTE operating system's services to generate a new system from relocatable software modules found in the File Manager Area. System control can then be transferred to the new operating system through use of a program called SWTCH. (See RTE-IVB On-Line Generator Reference

Manual.)

ON-LINE LOADING - The relocation of programs through use of the Relocating Loader (see RELOCATION).

OPEN FILE - A method of gaining access to a specific file to perform a read/write instruction.

OPERATOR'S CONSOLE - See SYSTEM CONSOLE.

OPERATING SYSTEM - An organized collection of programs designed to optimize the usage of a computer system. It provides the means by which user programs interact with hardware and other software. (See also REAL-TIME EXECUTIVE.)

OVERLAYS - Also called segments, these are routines that share the same portion of main memory and are called into memory by the program itself (see SEGMENTED PROGRAMS).

PAGE - The largest block of memory (1024 words) that can be directly addressed by the address field of a one-word memory reference instruction.

PARTITION - A predefined block of memory with a fixed number of pages (redefinable at system boot-up) located in the disc resident program area of memory. The user may divide the disc resident program area into as many as 64 partitions that can be classified as a mixture of real-time and background, all real-time, or all background. Disc-resident programs run in partitions and at least one partition of sufficient size must be defined during system generation to run disc resident programs.

PERIPHERAL DISC SUBCHANNEL - A disc subchannel available to the user for read/write operations but for which RTE-IVB does not manage nor maintain a track assignment table. It is the user's responsibility to manage these tracks; however, the File Manager may be used to manage peripheral subchannel tracks. A peripheral subchannel must have a logical unit number assignment greater than 6.

PHYSICAL MEMORY - Physical memory is the total amount of memory defined at generation or reconfiguration time. It refers to the actual memory in the computer; e.g., page 67 of physical memory is associated with a certain block of actual hardware, whereas the same page might be referred to as "page 5" in a particular block of logical memory.

POWER FAIL/AUTO-RESTART - The ability for a computer to save the current state of the system in permanent memory when power is lost, and to restore the system to defined conditions when power returns.

PRIORITY - A regulation of events allowing certain actions to take precedence over others in case of timing conflicts.

## Glossary

**PRIVILEGED DRIVERS** - I/O drivers whose interrupts are not processed by the RTE operating system. Such drivers offer improved response time but must perform their own internal housekeeping; i.e., saving status upon interrupt.

**PRIVILEGED INTERRUPTS** - Interrupts that by-pass normal interrupt processing to achieve optimum response time for interrupts having the greatest urgency. Privileged interrupts are handled by privileged I/O drivers.

**PRIVILEGED SUBROUTINE** - A privileged subroutine executes with the interrupt system off (and therefore by-passes the operating system). It allows high-speed processing at the cost of losing use of operating system housekeeping services and real-time response.

**PROGRAM STATE** - Refers to the status of an executable program at any given time. A user program is always in one of four possible states: executing, scheduled, suspended or dormant.

**PROGRAM SWAPPING** - See Swapping.

**PURGE** - Refers to the act of instructing an operating system to delete a file or program from its directory. Usually used with reference to disc files.

**REAL-TIME (RT)** - An arbitrary name for one of the two types of partitions in RTE; generally used for higher-priority programs. The real-time area is synonymous with the "foreground" area.

**REAL-TIME EXECUTIVE** - A collection of software modules comprising the total operating system; e.g., EXEC, SCHED, RTIOC, I/O drivers and various tables. For all practical purposes, Real-Time Executive, operating system and RTE are synonymous terms.

**RECORD** - A logical subdivision of a file that contains zero or more words, and is terminated by an end-of-record mark.

**REENTRANT** - Refers to a routine that can be shared by a number of programs simultaneously; i.e., one program can be interrupted in its usage of the routine to permit a higher-priority program to utilize the routine. The first program can then reenter the routine at the point where it was interrupted.

**RELOCATABLE LIBRARIES** - A collection of commonly-used subroutines in relocatable format. For example:

System Library - subroutines that are appended to each user program and that are unique to the operating system. This allows a user to write programs using operating system routines but which are independent of the operating system for subroutine execution.

DOS/RTE Relocatable Library - a collection of utility subroutines that are primarily accessed by FORTRAN and Assembly Language programs.

**FORTRAN Formatters** - format subroutines for FORTRAN I/O operations and other programming languages.

**RELOCATING LOADER (LOADR)** - A HP-supplied program that sets up communications links and forms an absolute load module from a relocatable program. LOADR creates the relocated program in conformance with current system constraints and loader commands entered by the user.

**RESOURCE MANAGEMENT** - A feature that allows the user to manage a specific resource shared by a particular set of cooperating programs.

**RESPONSE TIME** - The total amount of time required to bring a real-time program or routine into execution in response to an interrupt, interval timer, call from another program or operator call. Response time is usually measured in microseconds to milliseconds.

**ROM BOOT** - A loader residing in Read-Only Memory that on-line loads the boot Extension from disc storage and transfers control to the Boot Extension. The Boot Extension must reside on the disc physical unit 0, track 0, sector 0. (See also Boot Extension and Startup definitions.)

**RTE** - See REAL-TIME EXECUTIVE.

**SAM** - See SYSTEM AVAILABLE MEMORY.

**SCB** - See SESSION CONTROL BLOCK.

**SCHEDULING** - Entering a program in the schedule list for execution, either at the next entry into the dispatcher, or at the appropriate time when the program's priority is high enough.

**SEGMENTED PROGRAM** - A technique for accommodating programs larger than the available logical memory. "Segment" refers to those slices of the program that are brought into main memory as required, and overlay the previous segment.

**SELECT CODE** - An octal number (10 through 77) that specifies the address of an I/O device interface card.

**SESSION CONTROL BLOCK (SCB)** - A variable-length table built in physical memory by the log-on processor for each session.

**SESSION IDENTIFIER** - A number by which the system identifies each session. Typically it is the system logical unit number of the terminal on which the session user has logged on.

**SESSION SWITCH TABLE (SST)** - A table which defines a session's total I/O addressing range. It provides a mapping between Session Logical unit numbers which the user addresses and System Logical Unit numbers which is where the system processes the call.

## Glossary

**SIMULTANEOUS PERIPHERAL OPERATIONS ON-LINE (SPOOL)** - An RTE feature generally associated with batch operations. There is both in-spooling and out-spooling. In-spooling consists of a program and data being first read in from some peripheral device and placed on the disc. Program reads are translated to disc reads instead of reads from the peripheral device. Program writes are also translated to disc writes instead of peripheral device writes, so that program output is on disc. Out-spooling is the process of taking the program's output from disc to the appropriate peripheral device.

**SPARE CARTRIDGE POOL** - A set of cartridges defined by the System Manager as being available to session users for temporary disc space.

**SST** - See SESSION SWITCH TABLE.

**STARTUP** - The startup process is initiated by the Boot Extension. During the startup process, the tables, registers and pointers required by the system are established. Control is then transferred to the Configurator.

**STATION** - A terminal and its associated peripheral devices.

**SUBCHANNEL** - One of a group of I/O devices connected to a single I/O controller. For example, RTE driver DVR23 can operate more than one magnetic tape drive through subchannel assignments. In the case of moving head discs, contiguous groups of tracks are treated as separate subchannels. For example, a 7905 disc platter may be divided into four subchannels. Each subchannel is referenced by an LU number.

**SUBCHANNEL INITIALIZATION** - The process of preparing a disc subchannel for use by the RTE operating system.

**SUBCHANNEL NUMBERS** - Decimal numbers (0-31) associated with the LU numbers of devices with multiple functions on the same device. Each subchannel number is associated with a specific subchannel; e.g., a 2645A terminal could have four subchannels: one for the keyboard, one each for the right and left tape channels, and one for an optional line printer.

**SUBPARTITIONS** - Partitions that are optional subdivisions of a mother partition. Subpartitions have the same type (RT or BG) as the mother partition. Subpartitions are treated like other partitions except that they cannot be used while the mother partition contains an executing program.

**SUBSYSTEM GLOBAL AREA (SSGA)** - An area of memory that consists of all Type 30 modules loaded at generation time. The area is included in the system address space and in the address spaces of programs that access it (Types 17-20, and Types 25-28). The area may be used for data (i.e., COMMON).



**SWAPPING** - A technique whereby an executing program is suspended and transferred to mass storage (because another program needing the same portion of memory has been scheduled). When the interrupting program has terminated, becomes suspended, or becomes eligible to be swapped out, the previously swapped program may be reloaded into memory and resumes execution at the point where it was suspended.

**SWTCH PROGRAM** - A system utility program that transfers an RTE-IV operating system to a specific disc area from which it can be booted up.

**SYNCHRONOUS DEVICE** - Devices that perform I/O operations in a fixed timing sequence, regardless of the readiness of the computer.

**SYSTEM AVAILABLE MEMORY (SAM)** - A temporary storage area used by the system for class I/O, reentrant I/O, automatic buffering and parameter string passing.

**SYSTEM COMMON** - An area of memory that is sharable by programs.

**SYSTEM CONSOLE** - The interactive console or terminal (LU1) that controls system operation and from which all system and utility error messages are issued. In a multi-terminal environment, a system console is distinguished from "user consoles" from which users develop programs.

**SYSTEM DISC SUBCHANNEL** - The disc subchannel assigned to Logical Unit 2 that contains the memory image of the RTE-IVB system.

**SYSTEM DRIVER AREA** - An area for privileged drivers, very large drivers, drivers that do their own mapping or drivers not included in driver partitions. It is included in the system's address space, in the address space of RT and Type 3 BG programs, and optionally in the address space of memory resident programs.

**SYSTEM MAP** - The 32K-word address space used by the operating system during its own execution.

**SYSTEM TRACKS** - All subchannel tracks assigned to RTE-IVB for which a contiguous track assignment table is maintained. These tracks are located on Logical unit 2 (system), and 3 (auxiliary).

**TABLE AREA I** - An area of memory that is included in all address spaces and which includes the EQTs, Device Reference Table, Interrupt Table, Track Map Table, all Type 15 modules, and some system entry points.

**TABLE AREA II** - An area of memory that contains the system tables, ID segments, all Type 13 modules, and some system table and entry points. Table Area II is included in the address space of the system, real-time programs, Type 3 background programs, and (optionally) memory resident programs.

## Glossary

TIME BASE GENERATOR (TBG) - A hardware module (real-time clock) that generates an interrupt in 10 millisecond intervals. It is used to trigger execution of time-scheduled user programs at pre-determined intervals and for device time-outs.

TIME-OUT - Relating to the state of a peripheral device. When the device has timed-out, it is no longer available for system use (down). Also (noun) the parameter itself; the amount of time RTE will wait for the device to respond to an I/O transfer command before making the device unavailable.

TIME SCHEDULING - The process of automatically scheduling a program for execution at pre-determined time intervals. Program scheduling is established through use of the IT command, and requires that the Time Base Generator be installed in the CPU.

TIMESLICING - A means by which compute bound programs can be prevented from monopolizing CPU time. A timesliced program is placed in a round-robin queue with other programs of the same priority. Each program in the queue gets a quantum of CPU time to execute before another program gets its turn. Higher priority programs can interrupt any timesliced program at any time.

UP - See DEVICE UP.

USER HELLO FILE - A procedure file that control is automatically transferred to when the session user first logs on to the system.

USER MAP - The 32K-word address space used by a user program during its execution.

# Index

|                               | PAGE   |
|-------------------------------|--|
| Account Command File Formats  | 7-36   |
| Account Directory             | 7-4  |
| Account File                  | 2-5, 7-1                                     |
| Account File Components       | 7-1  |
| Account File Header           | 7-1  |
| Account Linking               | 2-3  |
| Account Planning Criteria     | 2-6, 2-7                                     |
| Account Planning Matrix       | 2-1, 2-8, 6-2                                |
| Account SST                   | 6-1, 6-13, 6-19, 7-5, 7-16, 7-18, 7-20, 7-21 |
| Account Structure             | 2-3  |
| Account Structure Planning    | 2-6  |
| Account System                | 2-5  |
| Account System Initialization | 6-5  |
| Accounts Program Operation    | 7-6  |
| ACCTS                         | 2-5  |
| ACCTS Command Summary         | 7-9  |
| ACCTS Command System          | 7-10   |
| ACCTS Commands:               |  |
| ABORT                         | 7-14   |
| ALTER,ACCT                    | 7-30   |
| ALTER,GROUP                   | 7-19   |
| ALTER,USER                    | 7-20   |
| EXIT                          | 7-14   |
| HELP                          | 7-10   |
| LIST,ACCT                     | 7-24   |
| LIST,GROUP                    | 7-24   |
| LIST,USER                     | 7-24   |
| LOAD                          | 7-34   |
| NEW,GROUP                     | 7-15   |
| NEW,USER                      | 7-16   |
| PURGE,ACCT                    | 7-31   |
| PURGE,GROUP                   | 7-26   |
| PURGE,USER                    | 7-26   |
| RESET,GROUP                   | 7-22   |
| RESET,USER                    | 7-22   |
| SD                            | 7-28   |
| SD,0                          | 7-27   |
| SD,SESSION                    | 7-27   |
| SU                            | 7-30   |
| TELL                          | 7-11   |
| TRANSFER                      | 7-12   |
| UNLOAD                        | 7-33   |
| ACCTS Error Summary           | 7-37   |
| ACCTS Operations              | 6-5  |
| ACCTS Program                 | 2-5, 3-114, 6-5, 7-6, 7-7, 7-8               |
| Active Session Table          | 7-2  |
| Autoboot Specification        | 4-17   |
| Automatic Output Buffering    | 3-45   |

## Index

|                           |           |
|---------------------------|-----------|
| Auxiliary Disc Usage      | 3-4       |
| Auxiliary Subchannel Size | 2-17, 3-4 |
| Auxiliary Subchannels     | 3-3       |

### B

|                           |       |
|---------------------------|-------|
| Bad Track Information     | 4-20  |
| BASIC Interrupts in HP-IB | 3-78  |
| Batch LU Switch Table     | 3-101 |
| Boot Extension            | 5-4   |
| Boot-up Procedure         | 5-2   |
| Bootstrap Loader          | 5-3   |
| Bootup Halts              | 9-20  |
| Break mode                | 1-5   |
| Break Mode Processor      | 2-5   |
| Buffer Limits             | 8-2   |

### C

|  |  |
|--|--|
| Capability Level                       | 1-5, 6-18, 6-19, 7-18                  |
| Card Reader Configuration              | 3-60, 3-68                             |
| Card Reader Driver DVR11               | 3-60                                   |
| Card Reader Driver DVR15               | 3-68                                   |
| Cartridge Dismounting Considerations   | 2-12                                   |
| Cartridge LU's 2 and 3                 | 2-11, 2-16, 5-5, 5-9, 5-18, 5-27, 5-28 |
| Cartridge Mounting Considerations      | 2-9                                    |
| Cartridge Requirements Worksheet       | 2-1, 2-12, 2-13, 6-2                   |
| Cartridge Size requirements            | 2-13, 2-14                             |
| Cartridge Types                        | 2-8                                    |
| Changing Auxiliary Cartridges          | 5-27                                   |
| Changing Master Security Code          | 8-6                                    |
| Changing Program Partition Assignments | 9-14                                   |
| Command Capability Level Assignments   | 6-22                                   |
| Configuration Error Messages           | 9-21                                   |
| Configuration Program                  | 9-3                                    |
| Configuration Table                    | 2-5, 6-1, 6-8, 7-2, 7-32               |
| Configurator Halts and Error Messages  | 9-4                                    |

## D

|                                    |                         |
|------------------------------------|-------------------------|
| D.RTR                              | 3-95,3-96               |
| Dedicated Cartridges               | 2-12,2-18               |
| Destination I/O Configuration      | 4-10                    |
| Device and Interface Cards         | 3-34                    |
| Device Configuration Inputs        | 3-43                    |
| Device Control                     | 8-1                     |
| Device Controllers                 | 3-34,3-35               |
| Device Interface Cards and Drivers | 3-44                    |
| Disc Backup                        | 3-2,3-3                 |
| Disc Cartridge Management          | 2-8                     |
| Disc Configuration                 | 3-6,3-71,3-73,3-75,3-76 |
| Disc Configuration:                |                         |
| HP 7900                            | 3-7                     |
| HP 7905                            | 3-7                     |
| HP 7906 (H)                        | 3-14                    |
| HP 7920 (H)                        | 3-19                    |
| HP 7925 (H)                        | 3-25                    |
| HP 9895                            | 3-31                    |
| Disc Drive Characteristics         | 3-6                     |
| Disc Level                         | 6-19                    |
| Disc Limit                         | 2-10,7-17               |
| Disc Loader ROM                    | 5-2                     |
| Disc Planning                      | 2-13,3-3                |
| Disc Protection                    | 3-96                    |
| Drivers                            | 3-43                    |
| DVA05                              | 3-58                    |
| DVA12                              | 3-63                    |
| DVA13                              | 3-66                    |
| DVA32                              | 3-75                    |
| DVB12                              | 3-64                    |
| DVR00                              | 3-54                    |
| DVR01                              | 3-55                    |
| DVR02                              | 3-56                    |
| DVR05                              | 3-58                    |
| DVR11                              | 3-60                    |
| DVR12                              | 3-62                    |
| DVR15                              | 3-68                    |
| DVR23                              | 3-70                    |
| DVR31                              | 3-71                    |
| DVR32                              | 3-73                    |
| DVR33                              | 3-76                    |
| DVR37                              | 3-78                    |

## E

|                                  |                |
|----------------------------------|----------------|
| EMA Firmware Configuration       | 3-83           |
| EQT Configuration                | 8-1            |
| Equipment Table Assignments      | 3-38,3-45,3-55 |
| Equipment Table Entry Assignment | 3-38           |
| Equipment Time-out               | 3-60           |

## Index

### F

|                                      |   |
|--------------------------------------|---|
| FFP Firmware Configuration           | 3-82,3-83,3-84,3-85,3-86,3-87,3-88,<br>3-89 |
| File Access Considerations           | 2-11  |
| File Management System Components    | 3-93  |
| File Management System Configuration | 3-94,3-95                                   |
| File Management System Programs      | 3-92  |
| File Name Specifications             | 4-9   |
| File System Conventions              | 5-9   |
| Fill Files                           | 5-9,5-19                                    |
| Firmware Configuration               | 3-79,3-82                                   |
| Firmware Subroutines:                |   |
| EMA                                  | 3-83  |
| F-Series Computers                   | 3-85  |
| Fast FORTRAN                         | 3-84  |
| General                              | 3-82  |
| VIS                                  | 3-93  |
| Floating Point Default               | 3-111                                       |
| FMGR Initializaion                   | 5-6,5-7,5-8                                 |

### G

|                               |   |
|-------------------------------|---|
| Global Cartridge Requirements | 2-17  |
| Grandfather Disc              | 3-2,3-42,3-43,5-11,A-1                                |
| Group Account Definition      | 6-13  |
| Group Account Entries         | 7-4   |
| Group Accounts                | 2-3,2-6,6-6,6-13,6-14,6-21,7-4,7-5,7-16,7-19,<br>7-20 |
| Group Cartridge Requirements  | 2-17  |
| Group Cartridges              | 2-8,2-17  |
| Group ID Map                  | 7-4   |

### H

|                           |                          |
|---------------------------|--------------------------|
| HELLO File                | 6-15,6-16,6-17,7-17,7-18 |
| HELP File Maintenance     | 5-25                     |
| HELP File Structure       | 5-24                     |
| HELP Operation in Session | 5-26                     |
| HELP Utility              | 5-24,5-25,5-26           |
| HI File                   | 5-23                     |
| HP-IB BASIC Interrupts    | 3-79                     |
| HP-IB Configuration       | 3-78                     |
| HP-IB SRQ Capability      | 3-79                     |

## I

|                                   |                  |
|-----------------------------------|------------------|
| I/O Configuration Worksheet       | 3-34             |
| I/O Reconfiguration               | 9-1, 9-5         |
| I/O Slot                          | 3-35             |
| I/O Structure Planning            | 3-34             |
| Integrated Controller Discs (ICD) | 3-5, 3-6, 3-75   |
| Interface Cards                   | 3-34, 3-36, 3-43 |
| Interrupt Service Priority        | 3-36, 3-37       |

## J-K-L

|                            |                             |
|----------------------------|-----------------------------|
| JOB                        | 3-97                        |
| Libraries                  | 3-103, 3-104                |
| Line Printer Configuration | 3-62, 3-63, 3-64            |
| Linked Accounts            | 2-3, 6-20, 7-17, 7-18, 7-19 |
| Logical Unit Assignments   | 3-34, 3-37, 3-38, 6-2, 6-3  |
| Logical Unit Configuration | 8-1                         |
| LU Switching               | 2-3                         |

## M

|   |                |
|---|----------------|
| Magnetic Tape Configuration             | 3-69           |
| Master Security Code                    | 5-7, 6-10, 8-6 |
| Meeting Changing Cartridge Requirements | 2-19           |
| Memory Reconfiguration                  | 9-1, 9-8       |
| Message Files                           | 6-7, 7-31      |
| MTM Configuration                       | 3-116          |
| Multi-Terminal Monitor Features         | 1-5            |
| Multi-Terminal Monitor Modules          | 3-111          |
| Multiple Access Controller (MAC) Discs  | 3-5, 3-6, 3-73 |
| Multiple CPU Disc Systems               | 3-5            |
| Multiple Disc Controllers               | 3-5            |
| Multiple Disc CPU Systems               | 3-5            |
| Multiterminal Monitor Features          | 1-6            |

## N-O

|  |              |
|--|--------------|
| Non-session Cartridge                    | 2-9          |
| Non-Session Cartridge Requirements       | 2-17         |
| On line Generator                        | 1-6, 3-1     |
| Operation System Generation Requirements | 3-78         |
| Optional Libraries                       | 3-104, 3-105 |
| \$DKULB                                  |              |
| \$DSCLB                                  |              |
| \$VLIB1                                  |              |
| %DBKLB                                   |              |
| %DBUGR                                   |              |
| %DECAR                                   |              |
| %UTLIB                                   |              |
| Output Buffering                         | 3-45, 8-2    |

## Index

### P

|                                  |                        |
|----------------------------------|------------------------|
| Partition Management             | 8-6                    |
| Peripheral Resource Usage        | 1-10,1-11              |
| Peripheral Subchannels           | 3-5,3-37               |
| Permanent Programs               | 3-115,3-116            |
| Permanent System Utilities       | 3-116                  |
| Photoreader Configuration        | 3-56                   |
| Power Fail/Restart Configuration | 3-93                   |
| Private Cartridge                | 2-9                    |
| Program Copies                   | 3-106,5-22             |
| Program Loading Considerations   | 3-105,3-112,3-113,5-10 |
| Prompt String                    | 6-7,7-31               |
| Punch Configuration              | 3-56                   |

### Q-R

|                                    |       |
|------------------------------------|-------|
| Quantum Multiplier                 | 8-3   |
| Reconfiguration Procedure          | 9-4   |
| Response Loading Considerations    | 3-113 |
| Response Time Considerations       | 1-9   |
| RTE Operating System Configuration | 3-81  |

### S

|   |                                      |
|---|--------------------------------------|
| SAM Extension Reconfiguration                   | 9-10                                 |
| Sample Worksheet Conventions                    | 3-42                                 |
| Select Code and Disc Platter/unit Specification | 4-9                                  |
| Select Code Assignments                         | 3-35,3-36,3-37                       |
| Session Account File                            | 2-5                                  |
| Session Account Planning Overview               | 2-1                                  |
| Session Account Structure                       | 2-2                                  |
| Session Account Structure Planning              | 2-6                                  |
| Session Break mode Processors                   | 2-6,3-114                            |
| Session Concept                                 | 2-1                                  |
| Session Control Block                           | 1-5,2-2,5-26                         |
| Session log on/log off Processors               | 2-6,3-114                            |
| Session LU Allocation Worksheet                 | 6-2                                  |
| Session LU Definition                           | 6-1                                  |
| Session Memory Allocation                       | 6-6,6-10,6-11,7-31                   |
| Session Monitor Components                      | 2-5                                  |
| Session Monitor Configuration                   | 3-113,3-114                          |
| Session Monitor Features                        | 1-4,1-5                              |
| Session Monitor Initialization                  | 6-1                                  |
| Session Monitor Loading Modules                 | 3-115                                |
| Session Switch Table                            | 2-2,2-3                              |
| Session Terminal Assignment                     | 3-37                                 |
| Shutdown  | 7-27,7-29,7-30                       |
| Single User Configuration                       | 3-117                                |
| Spare Cartridge Pool                            | 2-9,2-10,2-12,2-18,2-19,6-9,7-3,7-31 |
| Spare Logical Units                             | 3-37                                 |
| Spare LU Assignment                             | 3-37                                 |



|   |  |
|---|--|
| Special Considerations for Dedicated Discs          | 2-18   |
| Special Utility Loading Considerations              | 3-114  |
| Spool Devices                                       | 3-35,3-99  |
| Spool I/O Configuration                             | 3-98   |
| Spool Monitor Programs                              | 3-97   |
| Spool System Initialization                         | 5-26,5-27,6-17   |
| Spooling System                                     | 3-95   |
| Spooling System Components                          | 3-96   |
| Spooling System Configuration                       | 3-96,3-97,2-99,3-100   |
| SPOUT   | 3-96,3-97,3-98   |
| SST Spares  | 6-20,7-18  |
| Subchannel Initialization                           | 4-15   |
| Subroutines on Firmware                             | 3-79   |
| Support Engineer Account                            | 7-6  |
| SWTCH Error Conditions                              | 4-24   |
| SWTCH Loading Instructions                          | 4-5  |
| SWTCH Operating Instructions                        | 4-6  |
| SWTCH Options                                       | 4-4  |
| SWTCH Program                                       | 4-1  |
| System Backup                                       | 7-34   |
| System Bootup Halt                                  | 9-20   |
| System Buffer                                       | 5-1  |
| System Cartridges                                   | 2-9,2-11,2-16,2-17   |
| System Console                                      | 7-28,8-4,8-5   |
| System Console as Session Terminal                  | 8-4  |
| System Generation Overview                          | 3-1  |
| System Initialization                               | 5-1  |
| System Initialization Overview                      | 1-7  |
| System Installation Overview                        | 1-6  |
| System Management Overview                          | 1-2,1-3  |
| System Manager Account                              | 2-3,2-10,2-11,6-10,7-6   |
| System Message Files                                | 6-7,7-31   |
| System Parameters Adjustment                        | 8-1  |
| System Planning Overview                            | 1-5  |
| System Scratch Tracks                               | 1-11,5-4   |
| System Subchannel Size                              | 3-4  |
| System Subchannels                                  | 2-16,3-3,3-4,3-11,3-16,3-20,3-27,3-37,3-38,<br>5-4,5-5,5-6,5-7 |
| System Subchannels Definition                       | 4-10   |
| System Tests  | 5-8  |
| System Track Usage                                  | 3-3  |
| System Trade Allocation                             | 5-4  |
| System Utilities and Libraries                      | 3-103,3-104  |
| %BMLIB/%CLIB/\$MLIB1/\$MLIB2/\$MLIB3/\$FNDLB/%4SYLB |  |

## Index

### T

|                                     |                                |
|-------------------------------------|--------------------------------|
| T5IDM                               | 3-107,5-11,5-12,5-14,5-20,5-29 |
| Terminal Configuration              | 3-57                           |
| Terminal Driver DVR05/DVA05 Modules | 3-57                           |
| Terminal Initialization             | 5-22                           |
| Time Slicing                        | 8-3                            |
| Timeouts                            | 3-55,3-60                      |
| Track Map Table                     | 3-74,3-76                      |
| Track Sparing                       | 3-11,3-16,3-20,3-27            |
| TV Interface                        | 3-60                           |
| Type 6 Files                        | 3-105,3-112,5-11,5-20,5-29     |

### U-V-W

|                                      |  |
|--------------------------------------|--|
| User Account Definition              | 6-15   |
| User Account Entries                 | 7-4  |
| User Accounts                        | 2-3,2-6,6-6,6-15,7-4,7-5,7-17,7-18,7-19,7-21 |
| User Cartridge Requirements          | 2-17   |
| User Cartridges                      | 2-17   |
| User ID Map                          | 7-4  |
| User Questionnaire                   | 1-8,6-2                                      |
| Utility and Subsystem Transfer Files | 5-12   |
| Utility Buffer Space                 | 3-110  |
| Utility File Names                   | 3-107,3-108,3-109                            |
| Utility Installation Procedure       | 5-10   |
| Utility Relocatable File Names       | 3-109  |
| VIS Configuration                    | 3-91,3-92                                    |
| VIS Interface Module                 | 3-91   |
| WELCOM File                          | 5-7,5-18,5-20,5-22                           |
| Worksheet Conventions                | 3-42   |

### X-Y-Z

**READER COMMENT SHEET**  
**RTE-IVB SYSTEM**  
**Manager's Manual**

**92068-90006**

**October 1981**

**Update No. \_\_\_\_\_**  
**(If Applicable)**

We welcome your evaluation of this manual. Your comments and suggestions help us improve our publications. Please use additional pages if necessary.

---

**FROM:**

**Name** \_\_\_\_\_

**Company** \_\_\_\_\_

**Address** \_\_\_\_\_

\_\_\_\_\_

\_\_\_\_\_

FOLD

FOLD



NO POSTAGE  
NECESSARY  
IF MAILED  
IN THE  
UNITED STATES

**BUSINESS REPLY MAIL**

FIRST CLASS PERMIT NO. 141 CUPERTINO, CA.

— POSTAGE WILL BE PAID BY —

**Hewlett-Packard Company**  
Data Systems Division  
11000 Wolfe Road  
Cupertino, California 95014  
**ATTN: Technical Marketing Dept.**

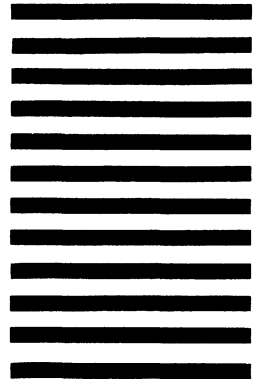

FOLD

FOLD

# SALES & SUPPORT OFFICES

Arranged alphabetically by country



## Product Line Sales/Support Key

- Key Product Line**  
**A** Analytical  
**CM** Components  
**C** Computer Systems  
**CP** Computer Systems Primary Service Responsible Office (SRO)  
**CS** Computer Systems Secondary SRO  
**E** Electronic Instruments & Measurement Systems  
**M** Medical Products  
**MP** Medical Products Primary SRO  
**MS** Medical Products Secondary SRO  
**P** Personal Computing Products  
 \* Sales only for specific product line  
 \*\* Support only for specific product line

**IMPORTANT:** These symbols designate general product line capability. They do not insure sales or support availability for all products within a line, at all locations. Contact your local sales office for information regarding locations where HP support is available for specific products.

*HP distributors are printed in italics.*

### ANGOLA

*Telectra*  
*Empresa Técnica de Equipamentos*  
*Eléctricos, S.A.R.L.*  
*R. Barbosa Rodrigues, 41-1 DT.*  
*Caixa Postal 6487*  
**LJUANDA**  
*Tel: 355 15 355 16*  
*A\*,E,M,P*

### ARGENTINA

Hewlett-Packard Argentina S.A.  
 Avenida Santa Fe 2035  
 Martínez 1640 BUENOS AIRES  
 Tel: 798-5735, 792-1293  
 Telex: 122443 AR CIGY  
 Cable: HEWPACKARG  
 A,E,CP,P

*Biotron S.A.C.I.y.M*  
*Avenida Paseo Colon 221*  
*9 Piso*  
*1399 BUENOS AIRES*  
*Tel: 30-4846, 30-1851, 30-8384*  
*Telex: (33)17595 BIONAR*  
 Cable: BIOTRON Argentina  
 M

*Fate S.A. Electronica*  
*Bartolomeu Mitre 833*  
*1036 BUENOS AIRES*  
*Tel: 74-41011, 74-49277,*  
*74-43459*  
*Telex: 18137, 22754*  
 P

### AUSTRALIA

**Adelaide, South Australia Pty. Ltd.**  
 Hewlett-Packard Australia Pty.Ltd.  
 153 Greenhill Road  
 PARKSIDE, S.A. 5063  
 Tel: 272-5911  
 Telex: 82536  
 Cable: HEWPARD Adelaide  
 A\*,CM,CS,E,MS,P

**Brisbane, Queensland Office**  
 Hewlett-Packard Australia Pty.Ltd.  
 5th Floor  
 Teachers Union Building  
 495-499 Boundary Street  
 SPRING HILL, Queensland 4000  
 Tel: 229-1544  
 Telex: 42133  
 Cable: HEWPARD Brisbane  
 A,CM,CS,E,MS,P

### Canberra, Australia Capital Office

Hewlett-Packard Australia Pty.Ltd.  
 121 Wollongong Street  
 Fyshwick, A.C.T. 2069  
 Tel: 804244  
 Telex: 62650  
 Cable: HEWPARD Canberra  
 A\*,CM,CS,E,MS,P

### Melbourne, Victoria Office

Hewlett-Packard Australia Pty.Ltd.  
 31-41 Joseph Street  
 BLACKBURN, Victoria 3130  
 Tel: 89-6351  
 Telex: 31-024  
 Cable: HEWPARD Melbourne  
 A,CM,CP,E,MS,P

### Perth, Western Australia Office

Hewlett-Packard Australia Pty.Ltd.  
 141 Stirling Highway  
 NEDLANDS, W.A. 6009  
 Tel: 386-5455  
 Telex: 93859  
 Cable: HEWPARD Perth  
 A,CM,CS,E,MS,P

### Sydney, New South Wales Office

Hewlett-Packard Australia Pty.Ltd.  
 17-23 Talavera Road  
 NORTH RYDE, N.S.W. 2113  
 P.O. Box 308  
 Tel: 887-1611  
 Telex: 21561  
 Cable: HEWPARD Sydney  
 A,CM,CP,E,MS,P

### AUSTRIA

Hewlett-Packard Ges.m.b.h.  
 Grottenhofstrasse 94  
 Verkaufsburo Graz  
 8052 GRAZ  
 Tel: 21-5-66  
 Telex: 32375  
 CM,C\*,E\*

Hewlett-Packard Ges.m.b.h.  
 Wehlstrasse 29  
 P.O. Box 7  
 A-1205 VIENNA  
 Tel: (222) 35-16-210  
 Telex: 135823/135066  
 A,CM,CP,E,MS,P

### BAHRAIN

*Green Salon*  
*P.O. Box 557*  
**BAHRAIN**  
*Tel: 5503*  
*Telex: 88419*  
 P

*Wael Pharmacy*  
*P.O. Box 648*  
**BAHRAIN**  
*Tel: 54886, 56123*  
*Telex: 8550 WAEL GJ*  
 M

### BELGIUM

Hewlett-Packard Belgium S.A./N.V.  
 Blvd de la Woluwe, 100  
 Woluwedal  
 B-1200 BRUSSELS  
 Tel: (02) 762-32-00  
 Telex: 23-494 paloben bru  
 A,CM,CP,E,MP,P

### BRAZIL

Hewlett-Packard do Brasil i.e.C. Ltda.  
 Alameda Rio Negro, 750  
 ALPHAVILLE 06400 Barueri SP  
 Tel: 421-1311  
 Telex: 011 23602 HPBR-BR  
 Cable: HEWPACK Sao Paulo  
 A,CM,CP,E,MS  
 Hewlett-Packard do Brasil i.e.C. Ltda.  
 Avenida Epitacio Pessoa, 4664  
 22471 RIO DE JANEIRO-RJ  
 Tel: 286-0237  
 Telex: 021-21905 HPBR-BR  
 Cable: HEWPACK Rio de Janeiro  
 A,CM,E,MS,P\*

### BURUNDI

*Typomeca S.P.R.L.*  
*B.P. 553*  
**BUJUMBURA**  
*Tel: 2659*  
 P

### CANADA

**Alberta**  
 Hewlett-Packard (Canada) Ltd.  
 210, 7220 Fisher Street S.E.  
 CALGARY, Alberta T2H 2H8  
 Tel: (403) 253-2713  
 Telex: 610-821-6141  
 A,CM,CP,E\*,MS,P\*

Hewlett-Packard (Canada) Ltd.  
 11620A-168th Street  
 EDMONTON, Alberta T5M 3T9  
 Tel: (403) 452-3670  
 Telex: 610-831-2431  
 A,CM,CP,E,MS,P\*

**British Columbia**  
 Hewlett-Packard (Canada) Ltd.  
 10691 Shellbridge Way  
 RICHMOND, British Columbia  
 V6X 2W7  
 Tel: (604) 270-2277  
 Telex: 610-922-5059  
 A,CM,CP,E\*,MS,P\*

### Manitoba

Hewlett-Packard (Canada) Ltd.  
 380-550 Century Street  
 WINNIPEG, Manitoba R3H 0Y1  
 Tel: (204) 786-6701  
 A,CM,CS,E,MS,P\*

### Nova Scotia

Hewlett-Packard (Canada) Ltd.  
 P.O. Box 931  
 900 Windmill Road  
 DARTMOUTH, Nova Scotia B2Y 3Z6  
 Tel: (902) 469-7820  
 Telex: 610-271-4482  
 CM,CP,E\*,MS,P\*

### Ontario

Hewlett-Packard (Canada) Ltd.  
 552 Newbold Street  
 LONDON, Ontario N6E 2S5  
 Tel: (519) 686-9181  
 Telex: 610-352-1201  
 A,CM,CS,E\*,MS,P\*

Hewlett-Packard (Canada) Ltd.  
 6877 Goreway Drive  
 MISSISSAUGA, Ontario L4V 1M8  
 Tel: (416) 678-9430  
 Telex: 610-492-4246  
 A,CM,CP,E,MP,P

Hewlett-Packard (Canada) Ltd.  
 1020 Morrison Drive  
 OTTAWA, Ontario K2H 8K7  
 Tel: (613) 820-6483  
 Telex: 610-563-1636  
 A,CM,CP,E\*,MS,P\*

### Quebec

Hewlett-Packard (Canada) Ltd.  
 17500 South Service Road  
 Trans-Canada Highway  
 KIRKLAND, Quebec H9J 2M5  
 Tel: (514) 697-4232  
 Telex: 610-422-3022  
 A,CM,CP,E,MP,P\*

### CHILE

*Jorge Calcagni y Cia. Ltda.*  
*Arturo Burile 065*  
*Casilla 16475*  
**SANTIAGO 9**  
*Tel: 220222*  
 Telex: JCALCAGNI  
 A,CM,E,M  
*Olympia (Chile) Ltd.*  
*Rodrigo de Araya 1045*  
*Casilla 256-V*  
**SANTIAGO 21**  
*Tel: 25-50-44*  
 Telex: 40-565  
 C,P

### COLOMBIA

*Instrumentación*  
*H. A. Langebaek & Kier S.A.*  
*Apartado Aéreo 6287*  
**BOGOTA 1, D.E.**  
*Carrera 7 No. 48-75*  
**BOGOTA, 2 D.E.**  
*Tel: 287-8877*  
 Telex: 44400  
 Cable: AARIS Bogota  
 A,CM,E,M,P

### COSTA RICA

*Cientifica Costarricense S.A.*  
*Avenida 2, Calle 5*  
*San Pedro de Montes de Oca*  
*Apartado 10159*  
**SAN JOSÉ**  
*Tel: 24-38-20, 24-08-19*  
 Telex: 2367 GALGUR  
 Cable: GALGUR  
 CM,E,M

### CYPRUS

*Telexra Ltd.*  
*P.O. Box 4809*  
*14C Stassinou Avenue*  
**NCOSIA**  
*Tel: 45628*  
 Telex: 2894  
 E,M,P

### CZECHOSLOVAKIA

*Hewlett-Packard*  
*Obchodni Zastupitelstvi v CSSR*  
*Post. schranka 27*  
**CS-118 01 PRAHA 011**  
*Tel: 66-296*  
 Telex: 121353 IHC

### DENMARK

Hewlett-Packard A/S  
 Datavej 52  
 DK-3460 BIRKEROD  
 Tel: (02) 81-66-40  
 Telex: 37409 hpas dk  
 A,CM,CP,E,MS,P

Hewlett-Packard A/S  
 Navervej 1  
 DK-8600 SILKEBORG  
 Tel: (06) 82-71-66  
 Telex: 37409 hpas dk  
 CM,CS,E

### ECUADOR

*CYEDE Cia. Ltda.*  
*P.O. Box 6423 CCI*  
*Avenida Eloy Alfaro 1749*  
**QUITO**  
*Tel: 450-975, 243-052*  
 Telex: 2548 CYEDE ED  
 Cable: CYEDE-Quito  
 A,CM,E,P  
*Hospitalar S.A.*  
*Casilla 3590*  
*Robles 625*  
**QUITO**  
*Tel: 545-250, 545-122*  
 Cable: HOSPITALAR-Quito  
 M

### EGYPT

*Sarniro*  
*Sami Amin Trading Office*  
*18 Abdel Aziz Gawish*  
**ABDINE-CAIRO**  
*Tel: 24-932*  
 P  
*International Engineering Associates*  
*24 Hussein Hegazi Street*  
**KASR-el-Aini**  
**CAIRO**  
*Tel: 23-829*  
 Telex: 93830  
 E,M  
*Informatic For Computer Systems*  
*22 Talaat Harb Street*  
**CAIRO**  
*Tel: 759006*  
 Telex: 93938 FRANK UN  
 C

### EL SALVADOR

*IPESA*  
*Boulevard de los Heroes*  
*Edificio Sarah 1148*  
**SAN SALVADOR**  
*Tel: 252787*  
 A,C,CM,E,P

### FINLAND

Hewlett-Packard Oy  
 Revontulentie 7  
 SF-02100 ESPOO 10  
 Tel: (90) 455-0211  
 Telex: 121563 hewpa sf  
 A,CM,CP,E,MS,P

### FRANCE

Hewlett-Packard France  
 Le Ligoures  
 Bureau de Vente de  
 Aix-en-Provence  
 Place Romée de Villeneuve  
 F-13090 AIX-EN-PROVENCE  
 Tel: (42) 59-41-02  
 Telex: 410770F  
 A,CM,CS,E,MS,P\*



# SALES & SUPPORT OFFICES

Arranged alphabetically by country

## FRANCE (Cont.)

Hewlett-Packard France  
Boite Postale No. 503  
F-25026 **BESANCON**  
28 Rue de la Republique  
F-25000 **BESANCON**  
Tel: (81) 83-16-22  
C,M

Hewlett-Packard France  
Bureau de Vente de Lyon  
Chemin des Mouilles  
Boite Postale No. 162  
F-69130 **ECULLY Cédex**  
Tel: (78) 33-81-25  
Telex: 310617F  
A,CM,CP,E,MP

Hewlett-Packard France  
Immeuble France Evry  
Tour Lorraine  
Boulevard de France  
F-91035 **EVRY Cédex**  
Tel: (60) 77-96-60  
Telex: 692315F  
CM,E

Hewlett-Packard France  
5th Avenue Raymond Chanas  
F-38320 **EYBENS**  
Tel: (76) 25-81-41  
Telex: 980124 HP GRENOB EYBE  
CM,CS

Hewlett-Packard France  
Bâtiment Ampère  
Rue de la Commune de Paris  
Boite Postale 300  
F-93153 **LE BLANC MESNIL**  
Tel: (01) 865-44-52  
Telex: 211032F  
CM,CP,E,MS

Hewlett-Packard France  
Le Montesquieu  
Avenue du President JF Kennedy  
F-33700 **MERIGNAC**  
Tel: (56) 34-00-84  
Telex: 550105F  
CM,CP,E,MS

Hewlett-Packard France  
32 Rue Lothaire  
F-57000 **METZ**  
Tel: (87) 65-53-50  
CM,CS

Hewlett-Packard France  
F-91947 Les Ulis Cédex **ORSAY**  
Tel: (1) 907-78-25  
Telex: 600048F  
A,CM,CP,E,MP,P

Hewlett-Packard France  
Paris Porte-Maillot 13, 15 25  
Boulevard De L'Amiral Bruix  
F-75782 **PARIS Cédex 16**  
Tel: (01) 502-12-20  
Telex: 613663F  
CM,CP,MS,P

Hewlett-Packard France  
2 Allée de la Bourgonette  
F-35100 **RENNES**  
Tel: (99) 51-42-44  
Telex: 740912F  
CM,CS,E,MS,P\*

Hewlett-Packard France  
4 Rue Thomas Mann  
Boite Postale 56  
F-67200 **STRASBOURG**  
Tel: (88) 28-56-46  
Telex: 890141F  
CM,CS,E,MS,P\*

Hewlett-Packard France  
20 Chemin de la Cèpière  
F-31081 **TOULOUSE Cédex**  
Tel: (61) 40-11-12  
Telex: 531639F  
A,CM,CS,E,P\*

Hewlett-Packard France  
Bureau de Vente de Lille  
Immeuble Péricentre  
Rue Van Gogh  
F-59650 **VILLENEUVE D'ASQ**  
Tel: (20) 91-41-25  
Telex: 160124F  
CM,CS,E,MS,P\*

## GERMAN FEDERAL REPUBLIC

Hewlett-Packard GmbH  
Technisches Büro Berlin  
Keithstrasse 2-4  
D-1000 **BERLIN 30**  
Tel: (030) 24-90-86  
Telex: 018 3405 hpbln d  
A,CM,CS,E,X,M,P

Hewlett-Packard GmbH  
Technisches Büro Böblingen  
Herrenberger Strasse 110  
D-7030 **BÖBLINGEN**  
Tel: (07031) 667-1  
Telex: 07265739 bbn or 07265743  
A,CM,CP,E,MP,P

Hewlett-Packard GmbH  
Technisches Büro Düsseldorf  
Emanuel-Leutze-Strasse 1  
D-4000 **DUSSELDORF**  
Tel: (0211) 5971-1  
Telex: 085/86 533 hpd d  
A,CM,CP,E,MS,P

Hewlett-Packard GmbH  
Vertriebszentrale Frankfurt  
Berner Strasse 117  
Postfach 560 140  
D-6000 **FRANKFURT 56**  
Tel: (0611) 50-04-1  
Telex: 04 13249 hpffm d  
A,CM,CP,E,MP,P

Hewlett-Packard GmbH  
Technisches Büro Hamburg  
Kapstadtring 5  
D-2000 **HAMBURG 60**  
Tel: (040) 63804-1  
Telex: 21 63 032 hphh d  
A,CM,CP,E,MS,P

Hewlett-Packard GmbH  
Technisches Büro Hannover  
Am Grossmarkt 6  
D-3000 **HANNOVER 91**  
Tel: (0511) 46-60-01  
Telex: 092 3259  
A,CM,CS,E,MS,P

Hewlett-Packard GmbH  
Technisches Büro Mannheim  
Rosslauer Weg 2-4  
D-6800 **MANNHEIM**  
Tel: (621) 70050  
Telex: 0462105  
A,C,E

Hewlett-Packard GmbH  
Technisches Büro Neu Ulm  
Messerschmittstrasse 7  
D-7910 **NEU ULM**  
Tel:  
Telex:  
C,E

Hewlett-Packard GmbH  
Technisches Büro Nürnberg  
Neumeyerstrasse 90  
D-8500 **NÜRNBERG**  
Tel: (0911) 56-30-83  
Telex: 0623 860  
CM,CS,E,MS,P

Hewlett-Packard GmbH  
Technisches Büro München  
Eschenstrasse 5  
D-8021 **TAUFKIRCHEN**  
Tel: (089) 6117-1  
Telex: 0524985  
A,CM,CP,E,MS,P

## GREAT BRITAIN

Hewlett-Packard Ltd.  
Trafalgar House  
Navigation Road  
**ALTRINCHAM**  
Cheshire WA14 1NU  
Tel: (061) 928-6422  
Telex: 668068  
A,C,E,M

Hewlett-Packard Ltd.  
Oakfield House, Oakfield Grove  
Clifton  
**BRISTOL BS8 2BN**  
Tel: 36806  
Telex: 444302  
P

Hewlett-Packard Ltd.  
14 Wesley Street  
**CASTLEFORD**  
Yorkshire WF10 1AE  
Tel: (0977) 550016  
Telex: 5557355  
C

Hewlett-Packard Ltd.  
Fourier House  
257-263 High Street  
**LONDON COLNEY**  
Herts., AL2 1HA  
Tel: (0727) 24400  
Telex: 1-8952716  
C,E

Hewlett-Packard Ltd  
Tradax House, St. Mary's Walk  
**MAIDENHEAD**  
Berkshire, SL6 1ST  
Tel: (0628) 39151  
E,P

Hewlett-Packard Ltd.  
308/314 Kings Road  
**READING, Berkshire**  
Tel: 61022  
Telex: 84-80-68  
CM,P

Hewlett-Packard Ltd.  
Quadrangle  
106-118 Station Road  
**REDHILL, Surrey**  
Tel: (0737) 68655  
Telex: 947234 C,E

Hewlett-Packard Ltd.  
Westminster House  
190 Stratford Road  
**SHIRLEY, Solihull**  
West Midlands B90 3BJ  
Tel: (021) 7458800  
Telex: 339105  
C

Hewlett-Packard Ltd.  
King Street Lane  
**WIMBORNE, Wokingham**  
Berkshire RG11 5AR  
Tel: (0734) 784774  
Telex: 847178  
A,C,E,M

## GREECE

Kostas Karayannis  
8 Omirou Street  
**ATHENS 133**  
Tel: 32-30-303, 32-37-371  
Telex: 21 59 62 RKAR GR  
E,M,P

"Plaiso"  
G. Gerados  
21 Stournara Street  
**ATHENS**  
Tel: 36-11-160  
Telex: 21 9492  
P

## GUATEMALA

IPESA  
Avenida Reforma 3-48  
Zona 9  
**GUATEMALA CITY**  
Tel: 316627, 314786, 664715  
Telex: 4192 Teletro Gu  
A,C,CM,E,M,P

## HONG KONG

Hewlett-Packard Hong Kong, Ltd.  
G.P.O. Box 795  
5th Floor, Sun Hung Kai Centre  
30 Harbour Road  
**HONG KONG**  
Tel: 5-8323211  
Telex: 66678 HEWPA HX  
Cable: HP ASIA LTD Hong Kong  
E,CP,P

Schmidt & Co. (Hong Kong) Ltd.  
Wing On Centre, 28th Floor  
Connaught Road, C.

## HONG KONG

IS-REYKJAVIK  
Tel: 5-455644  
Telex: 74766 SCHMX HX  
A,M

## ICELAND

Elding Trading Company Inc.  
Hafnarvöll: Tryggvagötu  
P.O. Box 895  
**IS-REYKJAVIK**  
Tel: 1-58-20, 1-63-03  
M

## INDIA

Blue Star Ltd.  
Bhavdeep  
Stadium Road  
**AMMEDABAD 380 014**  
Tel: 42932  
Telex: 012-234  
Cable: BLUEFROST  
E

Blue Star Ltd.  
11 Magarath Road  
**BANGALORE 560 025**  
Tel: 55668  
Telex: 0845-430  
Cable: BLUESTAR  
A,CM,C,E

Blue Star Ltd.  
Band Box House  
Prabhadevi  
**BOMBAY 400 025**  
Tel: 422-3101  
Telex: 011-3751  
Cable: BLUESTAR  
A,M

Blue Star Ltd.  
Sahas  
414/2 Vir Savarkar Marg  
Prabhadevi  
**BOMBAY 400 025**  
Tel: 422-6155  
Telex: 011-4093  
Cable: FROSTBLUE  
A,CM,C,E,M

Blue Star Ltd.  
7 Hare Street  
**CALCUTTA 700 001**  
Tel: 12-01-31  
Telex: 021-7655  
Cable: BLUESTAR  
A,M

Blue Star Ltd.  
Meenakshi Mandiram  
XXXXV/1379-2 M. G. Road  
**COCHIN 682-016**  
Tel: 32069  
Telex: 085-514  
Cable: BLUESTAR  
A\*

Blue Star Ltd.  
133 Kodambakkam High Road  
**MADRAS 600 034**  
Tel: 82057  
Telex: 041-379  
Cable: BLUESTAR  
A,M

Blue Star Ltd.  
Bhandari House, 7th/8th Floors  
91 Nehru Place  
**NEW DELHI 110 024**  
Tel: 682547  
Telex: 031-2463  
Cable: BLUESTAR  
A,CM,C,E,M

Blue Star Ltd.  
1-1-117/1 Sarojini Devi Road  
**SECUNDERABAD 500 033**  
Tel: 70126  
Telex: 0155-459  
Cable: BLUEFROST  
A,E

Blue Star Ltd.  
T.C. 7/603 Poornima  
Maruthankuzhi  
**TRIVANDRUM 695 013**  
Tel: 65799  
Telex: 0884-259  
Cable: BLUESTAR  
E

## INDONESIA

BERCA Indonesia P.T.  
P.O.Box 496/Jk1.  
Jin. Abdul Muis 62  
**JAKARTA**  
Tel: 373009  
Telex: 31146 BERSAL IA  
Cable: BERSAL JAKARTA  
A,C,E,M,P

BERCA Indonesia P.T.  
P.O. Box 174/Sby.  
J.L. Kutei No. 11  
**SUBAEE-SURABAYA**  
Tel: 68172  
Telex: 31146 BERSAL SD  
Cable: BERSAL-SURABAYA  
A\*,E,M,P

## IRAQ

Hewlett-Packard Trading S.A.  
Mansoor City 9B/3/7  
**BAGHDAD**  
Tel: 551-49-73  
Telex: 2455 HEPAIRAQ IK  
CP

## IRELAND

Hewlett-Packard Ireland Ltd.  
Kestrel House  
Clanwilliam Court  
Lower Mount Street  
**DUBLIN 2, Eire**  
Tel: 680424, 680426  
Telex: 30439  
A,C,CM,E,M,P

Cardiac Services Ltd.  
Kilmore Road  
Artane  
**DUBLIN 5, Eire**  
Tel: (01) 351820  
Telex: 30439  
M

**ISRAEL**

Electronics Engineering Division  
Motorola Israel Ltd.  
16 Kremenetski Street  
P.O. Box 25016  
TEL-AVIV 67899  
Tel: 338973  
Telex: 33569 Motil IL  
Cable: BASTEL Tel-Aviv  
A,CM,C,E,M,P

**ITALY**

Hewlett-Packard Italiana S.p.A.  
Traversa 99C  
Giulio Petrone, 19  
I-70124 BARI  
Tel: (080) 41-07-44  
M

Hewlett-Packard Italiana S.p.A.  
Via Martin Luther King, 38/111  
I-40132 BOLOGNA  
Tel: (051) 402394  
Telex: 511630  
CM,CS,E,MS

Hewlett-Packard Italiana S.p.A.  
Via Principe Nicola 43G/C  
I-95126 CATANIA  
Tel: (095) 37-10-87  
Telex: 970291  
C,P

Hewlett-Packard Italiana S.p.A.  
Via G. Di Vittorio 9  
I-20063 CERNUSCO SUL NAVIGLIO  
Tel: (2) 903691  
Telex: 334632  
A,CM,CP,E,MP,P

Hewlett-Packard Italiana S.p.A.  
Via Nuova san Rocco A  
Capodimonte, 62/A  
I-80131 NAPOLI  
Tel: (081) 7413544  
A,CM,CS,E

Hewlett-Packard Italiana S.p.A.  
Viale G. Modugno 33  
I-16156 GENOVA PEGLI  
Tel: (010) 68-37-07 E,C

Hewlett-Packard Italiana S.p.A.  
Via Turazza 14  
I-35100 PADOVA  
Tel: (49) 664888  
Telex: 430315  
A,CM,CS,E,MS

Hewlett-Packard Italiana S.p.A.  
Viale C. Pavese 340  
I-00144 ROMA  
Tel: (06) 54831  
Telex: 610514  
A,CM,CS,E,MS,P\*

Hewlett-Packard Italiana S.p.A.  
Corso Giovanni Lanza 94  
I-10133 TORINO  
Tel: (011) 682245, 659308  
Telex: 221079  
CM,CS,E

**JAPAN**

Yokogawa-Hewlett-Packard Ltd.  
Inoue Building  
1348-3, Asahi-cho  
ATSUGI, Kanagawa 243  
Tel: (0462) 24-0451  
CM,C\*,E

Yokogawa-Hewlett-Packard Ltd.  
3-30-18 Tsuruya-cho  
Kanagawa-ku, Yokohama-Shi  
KANAGAWA, 221  
Tel: (045) 312-1252  
Telex: 382-3204 YHP YOK  
CM,CS,E

Yokogawa-Hewlett-Packard Ltd.  
Sannomiya-Daiichi Seimei-Bldg. 5F  
69 Kyo-Machi Ikuta-Ku  
KOBE CITY 650 Japan  
Tel: (078) 392-4791  
C,E

Yokogawa-Hewlett-Packard Ltd.  
Kumagaya Asahi Yasoji Bldg 4F  
4-3 Chome Tsukuba  
KUMAGAYA, Saitama 360  
Tel: (0485) 24-6563  
CM,CS,E

Yokogawa-Hewlett-Packard Ltd.  
Mito Mitsui Building  
4-73, San-no-maru, 1-chome  
MITO, Ibaragi 310  
Tel: (0292) 25-7470  
CM,CS,E

Yokogawa-Hewlett-Packard Ltd.  
Sumitomo Seimei Bldg.  
11-2 Shimo-sasajima-cho  
Nakamura-ku  
NAGOYA, Aichi 450  
Tel: (052) 581-1850  
CM,CS,E,MS

Yokogawa-Hewlett-Packard Ltd.  
Chuo Bldg., 4th Floor  
5-4-20 Nishinakajima, 5-chome  
Yodogawa-ku, Osaka-shi  
OSAKA, 532  
Tel: (06) 304-6021  
Telex: YHPOSA 523-3624  
A,CM,CP,E,MP,P\*

Yokogawa-Hewlett-Packard Ltd.  
29-21 Takaido-Higashi 3-chome  
Suginami-ku TOKYO 168  
Tel: (03) 331-6111  
Telex: 232-2024 YHPTOK  
A,CM,CP,E,MP,P\*

**JORDAN**

Mouasher Cousins Company  
P.O. Box 1387  
AMMAN  
Tel: 24907, 39907  
Telex: 21456 SABCO JO  
E,M,P

**KOREA**

Samsung Electronics  
4759 Shinkil, 6 Dong  
Youngdeungpo-Ku,  
SEOUL  
Tel: 8334311, 8334312  
Telex: SAMSAN 27364  
A,C,E,M,P

**KUWAIT**

Al-Khalidya Trading & Contracting  
P.O. Box 830 Safat  
KUWAIT  
Tel: 42-4910, 41-1726  
Telex: 2481 Areeg kt  
A,E,M  
Photo & Cine Equipment  
P.O. Box 270 Safat  
KUWAIT  
Tel: 42-2846, 42-3801  
Telex: 2247 Matin  
P

**LUXEMBOURG**

Hewlett-Packard Belgium S.A./N.V.  
Blvd de la Woluwe, 100  
Woluwedal  
B-1200 BRUSSELS  
Tel: (02) 762-32-00  
Telex: 23-494 paloben bru  
A,CM,CP,E,MP,P

**MALAYSIA**

Hewlett-Packard Sales (Malaysia)  
Sdn. Bhd.  
Suite 2.21/2.22  
Bangunan Angkasa Raya  
Jalan Ampang  
KUALA LUMPUR  
Tel: 483544  
Telex: MA31011  
A,CP,E,M,P\*  
Protel Engineering  
Lot 319, Satok Rd.  
P.O. Box 1917  
KUCHING, SARAWAK  
Tel: 535-44  
Telex: MA 70904 Promal  
Cable: Proteleng  
A,E,M

**MEXICO**

Hewlett-Packard Mexicana, S.A. de  
C.V.  
Avenida Periferico Sur No. 6501  
Tepepan, Xochimilco  
MEXICO CITY 23, D.F.  
Tel: (905) 676-4600  
Telex: 017-74-507  
A,CP,E,MS,P  
Hewlett-Packard Mexicana, S.A. de  
C.V.  
Rio Volga 600  
Colonia del Valle  
MONTERREY, N.L.  
Tel: 78-42-93, 78-42-40, 78-42-41  
Telex: 038-410  
CS

**MOROCCO**

Dolbeau  
81 rue Karachi  
CASABLANCA  
Tel: 3041-82, 3068-38  
Telex: 23051, 22822  
E  
Gerep  
2 rue d'Agadir  
Boite Postale 156  
CASABLANCA  
Tel: 272093, 272095  
Telex: 23 739  
P

**NETHERLANDS**

Hewlett-Packard Nederland B.V.  
Van Heuven Goedhartlaan 121  
NL 1181KK AMSTELVEEN  
P.O. Box 667  
NL 1080 AR AMSTELVEEN  
Tel: (20) 47-20-21  
Telex: 13 216  
A,CM,CP,E,MP,P  
Hewlett-Packard Nederland B.V.  
Bongerd 2  
NL 2906VK CAPPELLE, A/D IJssel  
P.O. Box 41  
NL 2900 AA CAPELLE, IJssel  
Tel: (10) 51-64-44  
Telex: 21261 HEPAC NL  
A,CM,CP

**NEW ZEALAND**

Hewlett-Packard (N.Z.) Ltd.  
169 Manukau Road  
P.O. Box 26-189  
Epsom, AUCKLAND  
Tel: 68-7159  
Cable: HEWPACK Auckland  
CM,CS,E,P\*

Hewlett-Packard (N.Z.) Ltd.  
4-12 Cruickshank Street  
P.O. Box 9443  
Kilbirnie, WELLINGTON 3  
Tel: 877-199  
Cable: HEWPACK Wellington  
CM,CP,E,P  
Northrop Instruments & Systems  
Ltd.  
Eden House, 44 Khyber Pass Road  
P.O. Box 9682  
Newmarket, AUCKLAND  
Tel: 794-091  
A,M  
Northrop Instruments & Systems  
Ltd.  
Terrace House, 4 Oxford Terrace  
P.O. Box 8388  
CHRISTCHURCH  
Tel: 64-165  
A,M  
Northrop Instruments & Systems  
Ltd.  
Sturdee House  
85-87 Ghuznee Street  
P.O. Box 2406  
WELLINGTON  
Tel: 850-091  
Telex: NZ 3380  
A,M

**NIGERIA**

The Electronics Instrumentations  
Ltd.  
N6B/S70 Oyo Road  
Ouseun House  
P.M.B. 5402  
IBADAN  
Tel: 461577  
Telex: 31231 TEIL NG  
A,E,M,P  
The Electronics Instrumentations  
Ltd.  
144 Agege Motor Road, Mushin  
P.O. Box 6645  
Mushin, LAGOS  
A,E,M,P

**NORTHERN IRELAND**

Cardiac Services Company  
95A Finaghy Road South  
BELFAST BT 10 0BY  
Tel: (0232) 625-566  
Telex: 747626  
M

**NORWAY**

Hewlett-Packard Norge A/S  
Folke Bernadottesvei 50  
P.O. Box 3558  
N-5033 FYLLINGSDALEN (BERGEN)  
Tel: (05) 16-55-40  
Telex: 16621 hpnas n  
CM,CS,E  
Hewlett-Packard Norge A/S  
Oesterdalen 18  
P.O. Box 34  
N-1345 OESTERAAAS  
Tel: (02) 17-11-80  
Telex: 16621 hpnas n  
A\*,CM,CP,E,MS,P

**OMAN**

Khirmil Ramdas  
P.O. Box 19  
MUSCAT  
Tel: 72-22-17, 72-22-25  
Telex: 3289 BROKER MB MUSCAT  
P

**PAKISTAN**

Mushko & Company Ltd.  
10, Bazar Road  
Sector G-6/4  
ISLAMABAD  
Tel: 28624  
Cable: FEMUS Rawalpindi  
A,E,M  
Mushko & Company Ltd.  
Oosman Chambers  
Abdullah Haroon Road  
KARACHI 0302  
Tel: 511027, 512927  
Telex: 2894 MUSHKO PW  
Cable: COOPERATOR Karachi  
A,E,M,P\*

**PANAMA**

Electrónico Balboa, S.A.  
Apartado 4929  
Panama 5  
Calle Samuel Lewis  
Edificio "Alfa" No. 2  
CIUDAD DE PANAMA  
Tel: 64-2700  
Telex: 3480380  
Cable: ELECTRON Panama  
A,CM,E,M,P  
Foto Internacional, S.A.  
P.O. Box 2068  
Free Zone of Colon  
COLON 3  
Tel: 45-2333  
Telex: 3485126  
Cable: IMPORT COLON/Panama  
P

**PERU**

Cómpania Electro Médica S.A.  
Los Flamencos 145, San Isidro  
Casilla 1030  
LIMA 1  
Tel: 41-4325  
Telex: Pub. Booth 25424 SISIDRO  
Cable: ELMED Lima  
A,CM,E,M,P

**PHILIPPINES**

The Online Advanced Systems  
Corporation  
Rico House, Amorsolo Cor. Herrera  
Street  
Legaspi Village, Makati  
P.O. Box 1510  
Metro MANILA  
Tel: 85-35-81, 85-34-91, 85-32-21  
Telex: 3274 ONLINE  
A,C,E,M  
Electronic Specialists and  
Proponents Inc.  
690-B Epifanio de los Santos  
Avenue  
Cubao, QUEZON CITY  
P.O. Box 2649 Manila  
Tel: 98-96-81, 98-96-82, 98-96-83  
Telex: 742-40287  
P

**POLAND**

Buro Informasji Technicznej  
Hewlett-Packard  
Ul Stawki 2, 6P  
PL00-950 WARSZAWA  
Tel: 39-59-62, 39-67-43  
Telex: 812453 hepa pl



# SALES & SUPPORT OFFICES

Arranged alphabetically by country

## PORTUGAL

Telectra-Empresa Técnica de Equipamentos Eléctricos S.a.r.l.  
Rua Rodrigo da Fonseca 103  
P.O. Box 2531  
P-LISBON 1

Tel: (19) 68-60-72  
Telex: 12598

A,C,E,P

Mundinter

Intercambio Mundial de Comércio S.a.r.l.

P.O. Box 2761  
Avenida Antonio Augusto de Aguiar 138

P-LISBON

Tel: (19) 53-21-31, 53-21-37  
Telex: 16691 munter p

M

## PUERTO RICO

Hewlett-Packard Puerto Rico  
P.O. Box 4407

CAROLINA, Puerto Rico 00630  
Calle 272 Edificio 203

Urb. Country Club  
RIO PIEDRAS, Puerto Rico 00924  
Tel: (809) 762-7255

Telex: 345 0514  
A,CP

## QATAR

Nasser Trading & Contracting  
P.O. Box 1563

DOHA

Tel: 22170  
Telex: 4439 NASSER

M

Scitecharabia

P.O. Box 2750

!DOHA

Tel: 329515  
Telex: 4806 CMPARB

P

## ROMANIA

Hewlett-Packard Reprezentanta  
Boulevard Nicolae Balcescu 16

BUCURESTI

Tel: 130725  
Telex: 10440

## SAUDI ARABIA

Modern Electronic Establishment  
P.O. Box 193

AL-KHOBAR

Tel: 44-678, 44-813  
Telex: 670136

Cable: ELECTA AL-KHOBAR  
C,E,M,P

Modern Electronic Establishment  
P.O. Box 1228, Baghdadiyah Street

JEDDAH

Tel: 27-798  
Telex: 401035

Cable: ELECTA JEDDAH  
C,E,M,P

Modern Electronic Establishment  
P.O. Box 2728

RIYADH

Tel: 62-596, 66-232  
Telex: 202049

C,E,M,P

## SCOTLAND

Hewlett-Packard Ltd.  
Royal Bank Buildings

Swan Street  
BRECHIN, Angus, Scotland

Tel: 3101, 3102  
CM,CS

Hewlett-Packard Ltd.

## SOUTH QUEENSFERRY

West Lothian, EH30 9TG  
GB-Scotland

Tel: (031) 3311000  
Telex: 72682

A,CM,E,M

## SINGAPORE

Hewlett-Packard Singapore (Pty.) Ltd.

P.O. Box 58 Alexandra Post Office  
SINGAPORE, 9115

6th Floor, Inchcape House  
450-452 Alexandra Road

SINGAPORE 0511

Tel: 631788  
Telex: HPSGSO RS 34209

Cable: HEWPACK, Singapore  
A,CP,E,MS,P

## SOUTH AFRICA

Hewlett-Packard South Africa (Pty.) Ltd.

P.O. Box 120

Howard Place

Pine Park Center, Forest Drive,  
Pinelands

CAPE PROVINCE 7450

Tel: 53-7955, 53-7956, 53-7957  
Telex: 57-0006

A,CM,CS,E,MS,P

Hewlett-Packard South Africa (Pty.) Ltd.

P.O. Box 37066

Overport

DURBAN 4067

Tel: 28-4178, 28-4179, 28-4110  
CM,CS

Hewlett-Packard South Africa (Pty.) Ltd.

P.O. Box 33345

Glenstantia 0010 TRANSVAAL  
1st Floor East

Constantia Park Ridge Shopping  
Centre

Constantia Park

PRETORIA Tel: 98-1126 or 98-1220  
Telex: 32163

C,E

Hewlett-Packard South Africa (Pty.) Ltd.

Daphny Street

Private Bag Wendywood  
SANDTON 2144

Tel: 802-5111, 802-5125  
Telex: 89-84782

Cable: HEWPACK Johannesburg  
A,CM,CP,E,MS,P

## SPAIN

Hewlett-Packard Española S.A.  
c/Entenza, 321

E-BARCELONA 29

Tel: (3) 322-24-51, 321-73-54  
Telex: 52603 hpbee

A,CM,CP,E,MS,P

Hewlett-Packard Española S.A.  
c/San Vicente S/N

Edificio Albia II, 7 B  
E-BILBAO 1

Tel: (944) 423-8306, 423-8206  
A,CM,E,MS

Hewlett-Packard Española S.A.  
Calle Jerez 3

E-MADRID 16

Tel: 458-2600  
Telex: 23515 hpe

A,CM,E,MP,P

Hewlett-Packard Española S.A.

Colonia Mirasierra  
Edificio Juban

c/o Costa Brava 13, 2.  
E-MADRID 34

Tel: 734-8061, 734-1162  
CM,CP

Hewlett-Packard Española S.A.  
Av Ramón y Cajal 1-9

Edificio Sevilla 1,  
E-SEVILLA 5

Tel: 64-44-54, 64-44-58  
Telex: 72933

A,CM,CS,MS,P

Hewlett-Packard Española S.A.  
C/Ramon Gorrillo, 1 (Entlo.3)

E-VALENCIA 10

Tel: 361-1354, 361-1358  
CM,CS,P

## SWEDEN

Hewlett-Packard Sverige AB  
Enighetsvägen 3, Fack

P.O. Box 20502

S-16120 BROMMA

Tel: (08) 730-0550

Telex: (854) 10721 MESSAGES  
Cable: MEASUREMENTS

STOCKHOLM

A,CM,CP,E,MS,P

Hewlett-Packard Sverige AB  
Sunnanvagen 14K

S-22226 LUND

Tel: (46) 13-69-79

Telex: (854) 10721 (via BROMMA  
office)

CM,CS

Hewlett-Packard Sverige AB  
Vasira Vintergatan 9

S-70344 OREBRO

Tel: (19) 10-48-80

Telex: (854) 10721 (via BROMMA  
office)

CM,CS

Hewlett-Packard Sverige AB  
Fröbällisgatan 30

S-42132 VÄSTRA-FRÖLUNDA

Tel: (031) 49-09-50

Telex: (854) 10721 (via BROMMA  
office)

CM,CS,E,P

## SWITZERLAND

Hewlett-Packard (Schweiz) AG  
Clarastrasse 12

CH-4058 BASLE

Tel: (61) 33-59-20

A,CM

Hewlett-Packard (Schweiz) AG  
47 Avenue Blanc

CH-1202 GENEVA

Tel: (022) 32-30-05, 32-48-00  
CM,CP

Hewlett-Packard (Schweiz) AG  
29 Chemin Château Bloc

CH-1219 LE LIGNON-Geneva

Tel: (022) 96-03-22

Telex: 27333 hpag ch

Cable: HEWPACKAG Geneva  
A,CM,E,MS,P

Hewlett-Packard (Schweiz) AG  
Zürcherstrasse 20

Allmend 2

CH-8967 WIDEN

Tel: (57) 50-111

Telex: 59933 hpag ch

Cable: HPAG CH

A,CM,CP,E,MS,P

## SYRIA

General Electronic Inc.

Nuri Basha-Ahmat Ebn Kays Street  
P.O. Box 5781

DAMASCUS

Tel: 33-24-87

Telex: 11215 ITIKAL

Cable: ELECTROBOR DAMASCUS  
E

Sawah & Co.

Place Azmé

Boite Postale 2308

DAMASCUS

Tel: 16-367, 19-697, 14-268

Telex: 11304 SATACO SY

Cable: SAWAH, DAMASCUS  
M

## TAIWAN

Hewlett-Packard Far East Ltd.  
Kaohsiung Branch

68-2, Chung Cheng 3rd Road  
Shin Shin, Chu

KAOSHIUNG

Tel: 24-2318, 26-3253

CS,E,MS,P

Hewlett-Packard Far East Ltd.  
Taiwan Branch

5th Floor

205 Tun Hwa North Road

TAIPEI

Tel: (02) 751-0404

Cable: HEWPACK Taipei

A,CP,E,MS,P

Hewlett-Packard Far East Ltd.  
Taichung Branch

#33, Cheng Yih Street

10th Floor, Room 5

TAICHUNG

Tel: 289274

Ing Lih Trading Co.

3rd Floor 18, Po-la Road

TAIPEI

Tel:

Telex:

Cable: INGLIH TAIPEI

A

## THAILAND

UNIMESA Co. Ltd.

Elcom Research Building

2538 Sukhumvit Ave.

Bangchak, BANGKOK

Tel: 393-2387, 393-0338

Telex: TH81160, 82938, 81038

Cable: UNIMESA Bangkok

A,C,E,M

Bangkok Business Equipment Ltd.

5/5-6 Dejo Road

BANGKOK

Tel: 234-8670, 234-8671,

234-8672

Cable: BUSIQUIPT Bangkok

P

## TRINIDAD & TOBAGO

Caribbean Telecoms Ltd.

P.O. Box 732

50/A Jerningham Avenue

PORT-OF-SPAIN

Tel: 624-4213, 624-4214

A,CM,E,M,P

## TUNISIA

Tunisie Electronique

31 Avenue de la Liberté

TUNIS

Tel: 280-144

E,P

Corema

1 ter. Av. de Carthage

TUNIS

Tel: 253-821

Telex: 12319 CABAM TN  
M

## TURKEY

Teknim Company Ltd.

Riza Sah Pehievi

Caddesi No. 7

Kavaklidere, ANKARA

Tel: 275800

Telex: 42155

E

EMA, Muhendislik Kolektif Sirketi

Mediha Eldem

Sokak 41/6

Yüksek Caddesi, ANKARA

Tel: 17-56-22

Cable: Emaltrade

M

## UNITED ARAB EMIRATES

Emilat Ltd.

P.O. Box 1641

SHARJAH

Tel: 354121, 354123

Telex: 68136

E,M,P,C

## UNITED KINGDOM

see: GREAT BRITAIN

NORTHERN IRELAND

SCOTLAND

## UNITED STATES

### Alabama

Hewlett-Packard Co.  
700 Century Park South

Suite 128

BIRMINGHAM, AL 35226

Tel: (205) 822-6802

CM,CS,MP

Hewlett-Packard Co.

P.O. Box 4207

8290 Whitesburg Drive, S.E.

HUNTSVILLE, AL 35802

Tel: (205) 881-4591

CM,CP,E,M\*

### Alaska

Hewlett-Packard Co.

1577 "C" Street, Suite 252

ANCHORAGE, AK 99510

Tel: (206) 454-3971

CM,CS\*\*

### Arizona

Hewlett-Packard Co.

2336 East Magnolia Street

PHOENIX, AZ 85034

Tel: (602) 273-8000

A,CM,CP,E,MS

Hewlett-Packard Co.

2424 East Aragon Road

TUCSON, AZ 85702

Tel: (602) 889-4631

CM,CS,E,MS\*\*





## UNITED STATES (Cont.)

**California**

Hewlett-Packard Co.  
7621 Canoga Avenue  
CANOGA PARK, CA 91304  
Tel: (213) 702-8300  
A,CM,CP,E,P

Hewlett-Packard Co.  
1579 W. Shaw Avenue  
FRESNO, CA 93771  
Tel: (209) 224-0582  
CM,MS

Hewlett-Packard Co.  
1430 East Orangethorpe  
FULLERTON, CA 92631  
Tel: (714) 870-1000  
CM,CP,E,MP

Hewlett-Packard Co.  
5400 W. Rosecrans Boulevard  
LAWNDALE, CA 90260  
P.O. Box 92105  
LOS ANGELES, CA 90009  
Tel: (213) 970-7500  
CM,CP,MP

Hewlett-Packard Co.  
3939 Lankershim Blvd.  
NORTH HOLLYWOOD, CA 91604  
Tel: (213) 877-1282  
Regional Headquarters

Hewlett-Packard Co.  
3200 Hillview Avenue  
PALO ALTO, CA 94304  
Tel: (415) 857-8000  
CM,CP,E

Hewlett-Packard Co.  
646 W. North Market Boulevard  
SACRAMENTO, CA 95834  
Tel: (916) 929-7222  
A\*,CM,CP,E,MS

Hewlett-Packard Co.  
9606 Aero Drive  
P.O. Box 23333  
SAN DIEGO, CA 92123  
Tel: (714) 279-3200  
CM,CP,E,MP

Hewlett-Packard Co.  
3003 Scott Boulevard  
SANTA CLARA, CA 95050  
Tel: (408) 988-7000  
A,CM,CP,E,MP

Hewlett-Packard Co.  
454 Carlton Court  
SO. SAN FRANCISCO, CA 94080  
Tel: (415) 877-0772  
CM,CP

**Colorado**  
Hewlett-Packard Co.  
24 Inverness Place, East  
ENGLEWOOD, CO 80112  
Tel: (303) 771-3455  
A,CM,CP,E,MS

**Connecticut**  
Hewlett-Packard Co.  
47 Barnes Industrial Road South  
P.O. Box 5007  
WALLINGFORD, CT 06492  
Tel: (203) 265-7801  
A,CM,CP,E,MS

**Florida**  
Hewlett-Packard Co.  
P.O. Box 24210  
2727 N.W. 62nd Street  
FORT LAUDERDALE, FL 33309  
Tel: (305) 973-2600  
CM,CP,E,MP

Hewlett-Packard Co.  
4080 Woodcock Drive, #132  
Brownett Building  
JACKSONVILLE, FL 32207  
Tel: (904) 398-0663  
CM,C\*,E\*,MS\*\*

Hewlett-Packard Co.  
P.O. Box 13910  
6177 Lake Ellenor Drive  
ORLANDO, FL 32809  
Tel: (305) 859-2900  
A,CM,CP,E,MS

Hewlett-Packard Co.  
6425 N. Pensacola Blvd.  
Suite 4, Building 1  
PENSACOLA, FL 32575  
Tel: (904) 476-8422  
A,CM,MS

Hewlett-Packard Co.  
110 South Hoover, Suite 120  
Vanguard Bldg.  
TAMPA, FL 33609  
Tel: (813) 872-0900  
A\*,CM,CS,E\*,M\*

**Georgia**  
Hewlett-Packard Co.  
P.O. Box 105005  
2000 South Park Place  
ATLANTA, GA 30339  
Tel: (404) 955-1500  
Telex: 810-766-4890  
A,CM,CP,E,MP

Hewlett-Packard Co.  
Executive Park Suite 306  
P.O. Box 816  
AUGUSTA, GA 30907  
Tel: (404) 736-0592  
CM,MS

Hewlett-Packard Co.  
P.O. Box 2103  
1172 N. Davis Drive  
WARNER ROBINS, GA 31098  
Tel: (912) 922-0449  
CM,E

**Hawaii**  
Hewlett-Packard Co.  
Kawaiahao Plaza, Suite 190  
567 South King Street  
HONOLULU, HI 96813  
Tel: (808) 526-1555  
A,CM,CS,E,MS

**Idaho**  
Hewlett-Packard Co.  
11311 Chinden Boulevard  
BOISE, ID 83707  
Tel: (208) 376-6000  
CM,CS,M\*

**Illinois**  
Hewlett-Packard Co.  
211 Prospect Road  
BLOOMINGTON, IL 61701  
Tel: (309) 663-0383  
CM,CS,MS\*\*

Hewlett-Packard Co.  
1100 31st Street  
DOWNERS GROVE, IL 60515  
Tel: (312) 960-5760  
CM,CP

Hewlett-Packard Co.  
5201 Tollview Drive  
ROLLING MEADOWS, IL 60008  
Tel: (312) 255-9800  
A,CM,CP,E,MP

**Indiana**  
Hewlett-Packard Co.  
P.O. Box 50807  
7301 No. Shadeland Avenue  
INDIANAPOLIS, IN 46250  
Tel: (317) 842-1000  
A,CM,CS,E,MS

**Iowa**  
Hewlett-Packard Co.  
2415 Heinz Road  
IOWA CITY, IA 52240  
Tel: (319) 351-1020  
CM,CS,E\*,MS

**Kansas**

Hewlett-Packard Co.  
1644 S. Rock  
WICHITA, KA 67207  
Tel: (316) 265-5200  
CM,CS

**Kentucky**

Hewlett-Packard Co.  
10170 Linn Station Road  
Suite 525  
LOUISVILLE, KY 40223  
Tel: (502) 426-0100  
A,CM,CS,MS

**Louisiana**

Hewlett-Packard Co.  
P.O. Box 1449  
3229 Williams Boulevard  
KENNER, LA 70062  
Tel: (504) 443-6201  
A,CM,CS,E,MS

**Maryland**

Hewlett-Packard Co.  
7121 Standard Drive  
HANOVER, MD 21076  
Tel: (301) 796-7700  
A,CM,CP,E,MS

Hewlett-Packard Co.  
2 Choke Cherry Road  
ROCKVILLE, MD 20850  
Tel: (301) 948-6370  
Telex: 710-828-9685  
A,CM,CP,E,MP

**Massachusetts**

Hewlett-Packard Co.  
32 Hartwell Avenue  
LEXINGTON, MA 02173  
Tel: (617) 861-8960  
A,CM,CP,E,MP

**Michigan**

Hewlett-Packard Co.  
23855 Research Drive  
FARMINGTON HILLS, MI 48024  
Tel: (313) 476-6400  
A,CM,CP,E,MP

Hewlett-Packard Co.  
4326 Cascade Road S.E.  
GRAND RAPIDS, MI 49506  
Tel: (616) 957-1970  
CM,CS,MS

**Minnesota**

Hewlett-Packard Co.  
2025 W. Larpenteur Ave.  
ST. PAUL, MN 55113  
Tel: (612) 644-1100  
A,CM,CP,E,MP

**Mississippi**

Hewlett-Packard Co.  
P.O. Box 5028  
322 N. Mart Plaza  
JACKSON, MS 39216  
Tel: (601) 982-9363  
CM,MS

**Missouri**

Hewlett-Packard Co.  
11131 Colorado Avenue  
KANSAS CITY, MO 64137  
Tel: (816) 763-8000  
Telex: 910-771-2087  
A,CM,CS,E,MS

Hewlett-Packard Co.  
1024 Executive Parkway  
ST. LOUIS, MO 63141  
Tel: (314) 878-0200  
A,CM,CP,E,MP

**Nebraska**

Hewlett-Packard  
7101 Mercy Road  
Suite 101, IBX Building  
OMAHA, NE 68106  
Tel: (402) 392-0948  
CM,MS

**Nevada**

Hewlett-Packard Co.  
Suite D-130  
5030 Paradise Blvd.  
LAS VEGAS, NV 89119  
Tel: (702) 736-6610  
CM,MS\*\*

**New Jersey**

Hewlett-Packard Co.  
Crystal Brook Professional Building  
Route 35  
EATONTOWN, NJ 07724  
Tel: (201) 542-1384  
A\*,CM,C\*,E\*,P\*

Hewlett-Packard Co.  
W120 Century Road  
PARAMUS, NJ 07652  
Tel: (201) 265-5000  
A,CM,CP,E,MP

Hewlett-Packard Co.  
60 New England Avenue West  
PISCATAWAY, NJ 08854  
Tel: (201) 981-1199  
A,CM,CP,E

**New Mexico**

Hewlett-Packard Co.  
P.O. Box 11634  
11300 Lomas Blvd., N.E.  
ALBUQUERQUE, NM 87123  
Tel: (505) 292-1330  
Telex: 910-989-1185  
CM,CP,E,MS

**New York**

Hewlett-Packard Co.  
23855 Research Drive  
5 Computer Drive South  
ALBANY, NY 12205  
Tel: (518) 458-1550  
Telex: 710-444-4691  
A,CM,CS,E,MS

Hewlett-Packard Co.  
9600 Main Street  
CLARENCE, NY 14031  
Tel: (716) 759-8621  
Telex: 710-523-1893

Hewlett-Packard Co.  
200 Cross Keys Office  
FAIRPORT, NY 14450  
Tel: (716) 223-9950  
Telex: 510-253-0092  
CM,CP,E,MS

Hewlett-Packard Co.  
No. 1 Pennsylvania Plaza  
55th Floor  
34th Street & 8th Avenue  
NEW YORK, NY 10119  
Tel: (212) 971-0800  
CM,CP,E\*,M\*

Hewlett-Packard Co.  
5858 East Molloy Road  
SYRACUSE NY 13211  
Tel: (315) 455-2486  
A,CM,CS,E,MS

Hewlett-Packard Co.  
3 Crossways Park West  
WOODBURY, NY 11797  
Tel: (516) 921-0300  
Telex: 510-221-2183  
A,CM,CP,E,MS

**North Carolina**

Hewlett-Packard Co.  
P.O. Box 15579  
21905 Guess Road (27705)  
DURHAM, NC 27704  
Tel: (919) 471-8466  
C,M

Hewlett-Packard Co.  
5605 Roanne Way  
GREENSBORO, NC 27409  
Tel: (919) 852-1800  
A,CM,CP,E,MS

**Ohio**

Hewlett-Packard Co.  
9920 Carver Road  
CINCINNATI, OH 45242  
Tel: (513) 891-9870  
CM,CP,MS

Hewlett-Packard Co.  
16500 Sprague Road  
CLEVELAND, OH 44130  
Tel: (216) 243-7300  
Telex: 810-423-9430  
A,CM,CP,E,MS

Hewlett-Packard Co.  
962 Crupper Ave.  
COLUMBUS, OH 43229  
Tel: (614) 436-1041  
CM,CP,E\*

Hewlett-Packard Co.  
330 Progress Rd.  
DAYTON, OH 45449  
Tel: (513) 859-8202  
A,CM,CP,E\*,MS

**Oklahoma**

Hewlett-Packard Co.  
P.O. Box 366  
1503 W. Gore Blvd., Suite #2  
LAWTON, OK 73502  
Tel: (405) 248-4248  
C

Hewlett-Packard Co.  
P.O. Box 32008  
304 N. Meridian Avenue, Suite A  
OKLAHOMA CITY, OK 73107  
Tel: (405) 946-9499  
A\*,CM,CP,E\*,MS

Hewlett-Packard Co.  
Suite 121  
9920 E. 42nd Street  
TULSA, OK 74145  
Tel: (918) 665-3300  
A\*\*,CM,CS,M\*

**Oregon**

Hewlett-Packard Co.  
1500 Valley River Drive, Suite 330  
EUGENE, OR 97401  
Tel: (503) 683-8075  
C

Hewlett-Packard Co.  
9255 S. W. Pioneer Court  
WILSONVILLE, OR 97070  
Tel: (503) 682-8000  
A,CM,CP,E\*,MS

**Pennsylvania**

Hewlett-Packard Co.  
1021 8th Avenue  
King of Prussia Industrial Park  
KING OF PRUSSIA, PA 19406  
Tel: (215) 265-7000  
Telex: 510-660-2670  
A,CM,CP,E,MP

Hewlett-Packard Co.  
111 Zeta Drive  
PITTSBURGH, PA 15238  
Tel: (412) 782-0400  
A,CM,CP,E,MP

**South Carolina**

Hewlett-Packard Co.  
P.O. Box 6442  
6941-0 N. Trenholm Road  
COLUMBIA, SC 29260  
Tel: (803) 782-6493  
CM,CS,E,MS



# SALES & SUPPORT OFFICES

Arranged alphabetically by country

## UNITED STATES (Cont.)

### South Carolina (Cont.)

Hewlett-Packard Co.  
814 Wade Hampton Blvd.  
Suite 10  
GREENVILLE, SC 29609  
Tel: (803) 232-0917  
C

### Tennessee

Hewlett-Packard Co.  
P.O. Box 22490  
224 Peters Road  
Suite 102  
KNOXVILLE, TN 37922  
Tel: (615) 691-2371  
A\*,CM,MS

Hewlett-Packard Co.  
3070 Directors Row  
MEMPHIS, TN 38131  
Tel: (901) 346-8370  
A,CM,CS,MS

Hewlett-Packard Co.  
Suite 103  
478 Craighead Street  
NASHVILLE, TN 37204  
Tel: (615) 383-9136  
CM,MS\*\*

### Texas

Hewlett-Packard Co.  
Suite 310W  
7800 Shoal creek Blvd.  
AUSTIN, TX 78757  
Tel: (512) 459-3143  
CM,E

Hewlett-Packard Co.  
Suite C-110  
4171 North Mesa  
EL PASO, TX 79902  
Tel: (915) 533-3555  
CM,CS,E\*,MS\*\*

Hewlett-Packard Co.  
5020 Mark IV Parkway  
FORT WORTH, TX 76106  
Tel: (817) 625-6361  
CM,C\*

Hewlett-Packard Co.  
P.O. Box 42816  
10535 Harwin Street  
HOUSTON, TX 77036  
Tel: (713) 776-6400  
A,CM,CP,E,MP

Hewlett-Packard Co.  
3309 67th Street  
Suite 24  
LUBBOCK, TX 79413  
Tel: (806) 799-4472  
M

Hewlett-Packard Co.  
P.O. Box 1270  
930 E. Campbell Rd.  
RICHARDSON, TX 75081  
Tel: (214) 231-6101  
A,CM,CP,E,MP

Hewlett-Packard Co.  
205 Billy Mitchell Road  
SAN ANTONIO, TX 78226  
Tel: (512) 434-8241  
CM,CS,E,MS

### Utah

Hewlett-Packard Co.  
3530 W. 2100 South Street  
SALT LAKE CITY, UT 84119  
Tel: (801) 974-1700  
A,CM,CP,E,MS

### Virginia

Hewlett-Packard Co.  
P.O. Box 9669  
2914 Hungary Spring Road  
RICHMOND, VA 23228  
Tel: (804) 285-3431  
A,CM,CP,E,MS

Hewlett-Packard Co.  
P.O. Box 4786  
3110 Peters Creek Road, N.W.  
ROANOKE, VA 24015  
Tel: (703) 563-2205  
CM,CS,E\*\*

Hewlett-Packard Co.  
P.O. Box 12778  
5700 Thurston Avenue  
Suite 111  
VIRGINIA BEACH, VA 23455  
Tel: (804) 460-2471  
CM,CS,MS

### Washington

Hewlett-Packard Co.  
15815 S.E. 37th Street  
BELLEVUE, WA 98006  
Tel: (206) 643-4000  
A,CM,CP,E,MP

Hewlett-Packard Co.  
Suite A  
708 North Argonne Road  
SPOKANE, WA 99206  
Tel: (509) 922-7000  
CM,CS

### West Virginia

Hewlett-Packard Co.  
4604 MacCorkle Ave., S.E.  
CHARLESTON, WV 25304  
Tel: (304) 925-0492  
A,CM,MS

### Wisconsin

Hewlett-Packard Co.  
150 S. Sunny Slope Road  
BROOKFIELD, WI 53005  
Tel: (414) 784-8800  
A,CM,CS,E\*,MP

### URUGUAY

Pablo Ferrando S.A.C. e.i.  
Avenida Italia 2877  
Casilla de Correo 370  
MONTEVIDEO  
Tel: 403102  
Telex: 901 Public Booth Para Pablo  
Ferrando 919520  
Cable: RADIUM Montevideo  
A,CM,E,M

Guillermo Kraft del Uruguay S.A.  
Avda. Libertador Brig. Gral.  
Lavalaja 2083  
MONTEVIDEO  
Tel: 234588, 234808, 208830  
Telex: 6245 ACTOUR UY  
P

### U.S.S.R.

Hewlett-Packard Co.  
Representative Office  
Pokrovsky Blvd. 4/17 KV12  
MOSCOW 101000 Tel: 294-2024  
Telex: 7825 HEWPACK SU

### VENEZUELA

Hewlett-Packard de Venezuela C.A.  
Apartado 50933  
3A Transversal Los Ruices Norte  
Edificio Segre 2Y3  
CARACAS 1071  
Tel: 239-4133, 239-4777,  
239-4244  
Telex: 25146 HEWPACK  
Cable: HEWPACK Caracas  
A,CP,E,MS,P

### YUGOSLAVIA

Iskra-Commerce-Representation of  
Hewlett-Packard  
Sava Centar Delegacija 30  
Mientija Popovica 9  
11170 BEOGRAD  
Tel: 638-762  
Telex: 12042, 12322 YU SAV CEN

Iskra-Commerce-Representation of  
Hewlett-Packard  
Kopraska 46  
61000 LJUBLJANA  
Tel: 321674, 315879  
Telex:

### ZAMBIA

R. J. Tilbury (Zambia) Ltd.  
P.O. Box 2792  
LUSAKA  
Tel: 81243  
A,E,M,P

### ZIMBABWE

Field Technical Sales  
45 Kelvin Road, North  
P.B. 3458  
SALISBURY  
Tel:  
C,E,M,P

## FOR COUNTRIES AND AREAS NOT LISTED:

### CANADA

Ontario  
Hewlett-Packard (Canada) Ltd.  
6877 Goreway Drive  
MISSISSAUGA, Ontario L4V 1M8  
Tel: (416) 678-9430  
Telex: 610-492-4246

### EASTERN USA

Maryland  
Hewlett-Packard Co.  
4 Choke Cherry Road  
Rockville, MD 20850  
Tel: (301) 258-2000

### MIDWESTERN USA

Illinois  
Hewlett-Packard Co.  
5201 Tollview Drive  
ROLLING MEADOWS, IL 60008  
Tel: (312) 255-9800

### SOUTHERN USA

Georgia  
Hewlett-Packard Co.  
P.O. Box 105005  
450 Interstate N. Parkway  
ATLANTA, GA 30339  
Tel: (404) 955-1500

### WESTERN USA

California  
Hewlett-Packard Co.  
3939 Lankersim Blvd.  
LOS ANGELES, CA 91604  
Tel: (213) 877-1282

## EUROPEAN AREAS NOT LISTED, CONTACT

### SWITZERLAND

Hewlett-Packard S.A.  
7 Rue du Bois-du-Lan  
CH-1217 MEYRIN 2, Switzerland  
Tel: (022) 83-81-11  
Telex: 27835 hpse  
Cable: HEWPACKSA Geneve

## EAST EUROPEAN AREAS NOT LISTED, CONTACT

### AUSTRIA

Hewlett-Packard Ges.m.b.h.  
Wehlistrasse 29  
P.O. Box 7  
A-1205 VIENNA  
Tel: (222) 35-16-210  
Telex: 135823/135066

## MEDITERRANEAN AND MIDDLE EAST AREAS NOT LISTED, CONTACT

### GREECE

Hewlett-Packard S.A.  
Mediterranean & Middle East  
Operations  
35, Kolokotroni Street  
Platia Kefallariou  
GR-Kifissia, ATHENS, Greece  
Tel: 808-0359, 808-0429  
Telex: 21-6588  
Cable: HEWPACKSA Athens

## INTERNATIONAL AREAS NOT LISTED, CONTACT

### OTHER AREAS

Hewlett-Packard Co.  
Intercontinental Headquarters  
3495 Deer Creek Road  
PALO ALTO, CA 94304  
Tel: (415) 857-1501  
Telex: 034-8300  
Cable: HEWPACK



