

**000046**

**HP64000  
Logic Development  
System**

**Model 64191A  
6805 Emulator  
Controller**

---

 **HEWLETT  
PACKARD**

## **CERTIFICATION**

*Hewlett-Packard Company certifies that this product met its published specifications at the time of shipment from the factory. Hewlett-Packard further certifies that its calibration measurements are traceable to the United States National Bureau of Standards, to the extent allowed by the Bureau's calibration facility, and to the calibration facilities of other International Standards Organization members.*

## **WARRANTY**

This Hewlett-Packard system product is warranted against defects in materials and workmanship for a period of 90 days from date of installation. During the warranty period, HP will, at its options, either repair or replace products which prove to be defective.

Warranty service of this product will be performed at Buyer's facility at no charge within HP service travel areas. Outside HP service travel areas, warranty service will be performed at Buyer's facility only upon HP's prior agreement and Buyer shall pay HP's round trip travel expenses. In all other cases, products must be returned to a service facility designated by HP.

For products returned to HP for warranty service. Buyer shall prepay shipping charges to HP and HP shall pay shipping charges to return the product to Buyer. However, Buyer shall pay all shipping charges, duties, and taxes for products returned to HP from another country.

HP warrants that its software and firmware designated by HP for use with an instrument will execute its programming instructions when properly installed on that instrument. HP does not warrant that the operation of the instrument, or software, or firmware will be uninterrupted or error free.

## **LIMITATION OF WARRANTY**

The foregoing warranty shall not apply to defects resulting from improper or inadequate maintenance by Buyer, Buyer-supplied software or interfacing, unauthorized modification or misuse, operation outside of the environmental specifications for the product, or improper site preparation or maintenance.

NO OTHER WARRANTY IS EXPRESSED OR IMPLIED. HP SPECIFICALLY DISCLAIMS THE IMPLIED WARRANTIES OF MERCHANTABILITY AND FITNESS FOR A PARTICULAR PURPOSE.

## **EXCLUSIVE REMEDIES**

THE REMEDIES PROVIDED HEREIN ARE BUYER'S SOLE AND EXCLUSIVE REMEDIES. HP SHALL NOT BE LIABLE FOR ANY DIRECT, INDIRECT, SPECIAL, INCIDENTAL, OR CONSEQUENTIAL DAMAGES, WHETHER BASED ON CONTRACT, TORT, OR ANY OTHER LEGAL THEORY.

## **ASSISTANCE**

*Product maintenance agreements and other customer assistance agreements are available for Hewlett-Packard products.*

*For any assistance, contact your nearest Hewlett-Packard Sales and Service Office. Addresses are provided at the back of this manual.*

HEWLETT-PACKARD  
SERVICE MANUAL  
MODEL 64191A  
6805 EMULATOR CONTROLLER

REPAIR NUMBERS

This manual applies directly to models  
with repair numbers prefixed 2301A.

© COPYRIGHT HEWLETT-PACKARD COMPANY/LOGIC SYSTEMS DIVISION 1983  
1900 GARDEN OF THE GODS ROAD, COLORADO SPRINGS, COLORADO, U.S.A.

ALL RIGHTS RESERVED

Manual Part Number: 64191-90901  
Microfiche Part Number: 64191-90801

PRINTED: JANUARY 1983

## **SAFETY SUMMARY**

***The following general safety precautions must be observed during all phases of operation, service, and repair of this instrument. Failure to comply with these precautions or with specific warnings elsewhere in this manual violates safety standards of design, manufacture, and intended use of the instrument. Hewlett-Packard Company assumes no liability for the customer's failure to comply with these requirements.***

### **GROUND THE INSTRUMENT.**

To minimize shock hazard, the instrument chassis and cabinet must be connected to an electrical ground. The instrument is equipped with a three-conductor ac power cable. The power cable must either be plugged into an approved three-contact electrical outlet or used with a three-contact to two-contact adapter with the grounding wire (green) firmly connected to an electrical ground (safety ground) at the power outlet. The power jack and mating plug of the power cable meet International Electrotechnical Commission (IEC) safety standards.

### **DO NOT OPERATE IN AN EXPLOSIVE ATMOSPHERE.**

Do not operate the instrument in the presence of flammable gases or fumes. Operation of any electrical instrument in such an environment constitutes a definite safety hazard.

### **KEEP AWAY FROM LIVE CIRCUITS.**

Operating personnel must not remove instrument covers. Component replacement and internal adjustments must be made by qualified maintenance personnel. Do not replace components with power cable connected. Under certain conditions, dangerous voltages may exist even with the power cable removed. To avoid injuries, always disconnect power and discharge circuits before touching them.

### **DO NOT SERVICE OR ADJUST ALONE.**

Do not attempt internal service or adjustment unless another person, capable of rendering first aid and resuscitation, is present.

### **DO NOT SUBSTITUTE PARTS OR MODIFY INSTRUMENT.**

Because of the danger of introducing additional hazards, do not install substitute parts or perform any unauthorized modification of the instrument. Return the instrument to a Hewlett-Packard Sales and Service Office for service and repair to ensure that safety features are maintained.

### **DANGEROUS PROCEDURE WARNINGS.**

Warnings, such as the example below, precede potentially dangerous procedures throughout this manual. Instructions contained in the warnings must be followed.

**WARNING**

**Dangerous voltages, capable of causing death, are present in this instrument.  
Use extreme caution when handling, testing, and adjusting.**

## Table of Contents

Section	Page
I	GENERAL INFORMATION.....1-1
	1-1. Introduction.....1-1
	1-5. Related Service Manuals.....1-2
	1-7. Instruments Covered By This Manual.....1-2
	1-11. Description.....1-3
	1-19. Accessories Supplied.....1-4
	1-21. Additional Equipment Required.....1-4
	1-23. Power Requirements.....1-4
	1-25. Conventions.....1-4
II	INSTALLATION.....2-1
	2-1. Introduction.....2-1
	2-3. Initial Inspection.....2-1
	2-5. Development Station Configuration.....2-1
	2-7. Installation.....2-3
	2-9. Removal.....2-4
	2-11. RFI Ground Bracket Installation.....2-5
	2-15. Operating Environment.....2-5
	2-17. Storage and Shipping Environment.....2-6
	2-19. Original Packaging.....2-6
	2-21. Other Packaging.....2-6
III	OPERATION.....3-1
IV	PERFORMANCE TESTS.....4-1
V	ADJUSTMENTS.....5-1
VI	REPLACEABLE PARTS.....6-1
	6-1. Introduction.....6-1
	6-3. Abbreviations.....6-1
	6-5. Replaceable Parts.....6-1
	6-8. Ordering Information.....6-2
	6-11. Direct Mail Order System.....6-2
VII	MANUAL CHANGES.....7-1

Table of Contents (Cont'd)

Section	Page
VIII SERVICE.....	8-1
8-1. Introduction.....	8-1
8-4. General Theory.....	8-1
8-12. Development Station Interface.....	8-2
8-23. Control Logic.....	8-3
8-35. Foreground/Background Memory.....	8-5
8-38. Pod Interface and Memory Monitor.....	8-5
8-51. Last Address and Break Logic.....	8-7
8-58. Foreground/Background Logic.....	8-7
8-62. Pod Interface and Opcode Monitor.....	8-8

List of Illustrations

Figure	Title	Page
1-1.	Emulator Controller.....	1-1
2-1.	Development Station Card Cage.....	2-1
2-2.	Typical 6805 Emulator Subsystem.....	2-3
2-3.	RFI Ground Bracket/Clamp Bar.....	2-4
6-1.	Component Locator.....	6-4
8-1.	Emulator Subsystem Memory Map.....	8-5
8-2.	Emulator Controller Block Diagram.....	8-9
8-3.	Connector Diagram.....	8-11
8-4.	Schematic 1, Development Station Interface.....	8-29
8-5.	Schematic 2, Control.....	8-31
8-6.	Schematic 3, Foreground/Background Memory.....	8-33
8-7.	Schematic 4, Pod Interface and Memory Monitor.....	8-35
8-8.	Schematic 5, Last Address and Break Logic.....	8-37
8-9.	Schematic 6, Foreground/Background Logic.....	8-39
8-10.	Schematic 7, Pod Interface and Opcode Monitor.....	8-41

List of Tables

Table	Title	Page
1-1.	Emulator System Service Manuals.....	1-2
1-2.	Power Supply Loads.....	1-4
6-1.	Reference Designators and Abbreviations.....	6-3
6-2.	Replaceable Parts List.....	6-5
6-3.	List Of Manufacturers' Codes.....	6-8
8-1.	Connector Signals.....	8-10
8-2.	Mnemonics.....	8-12
8-3.	Logic Symbols.....	8-23
8-4.	Schematic Diagram Notes.....	8-26
8-5.	IC To Schematic Cross-Reference.....	8-28





SECTION I

GENERAL INFORMATION

1-1. INTRODUCTION.

1-2. This manual supports board-level servicing of the Model 64191A 6805 Emulator Controller. It contains installation, parts list, component locator, and schematics for the model 64191A. Operating instructions are provided in a separate operating manual supplied with the instrument. Because the controller only runs with an emulator pod attached, performance test information is included in the service manual for the emulator pod.

1-3. Described in this section are instruments covered, the general features of the emulator controller, power supply loads, and its use with the Hewlett-Packard emulator pods. Also included are conventions used in the manual.

1-4. Shown on the title page is a microfiche part number. This number can be used to order 4 x 6 inch microfilm transparencies of the manual. Each microfiche contains up to 96 photoduplicates of the manual pages.



Figure 1-1. 6805 Emulator Controller

General Information - Model 64191A

1-5. RELATED SERVICE MANUALS.

1-6. Table 1-1 shows the topics covered in the emulator controller and emulator pod service manuals. Service manuals for the models listed below provide additional information.

- a. Development station models 64100A and 64110A.
- b. Internal analyzer models 64300A and 64302A.

Table 1-1. Emulator Subsystem Service Manuals

Subject	Model 64191A Emulator Controller Service Manual	Emulator Pod Service Manual
General information	yes	yes
Installation	yes	yes
Operation	no, see op manual	no, see op manual
Testing	no, see pod	yes, control & pod
Adjustments	no, none required	no, none required
Parts list	yes, control only	yes, pod only
Service schematics and theory	yes, control only	yes, pod only

1-7. INSTRUMENTS COVERED BY THIS MANUAL.

1-8. Attached to the Model 64191A 6805 Emulator Controller is a repair number tag. The repair number is in the form 0000A00000. It is in two parts; the first four digits and the letter are the prefix and the last five are the suffix. The prefix is the same for each identical model 64191A; it only changes when a change is made to the instrument. The suffix is assigned sequentially and is different for each model 64191A manufactured. This manual applies to each model 64191A with a repair prefix listed on the title page.

1-9. A model 64191A manufactured after the printing of this manual may have a repair number not listed on the title page. The manual for the newer boards is accompanied by a yellow manual change supplement. The supplement explains how to adapt the manual to the newer emulator controller.

1-10. In addition to change information, the supplement may contain information for correcting errors in the manual. To keep this manual as current and accurate as possible, Hewlett-Packard recommends that you periodically request the latest manual changes supplement. The supplement is identified by the manual print and part number, both of which appear on the manual title page. Copies are available at the Hewlett-Packard sales/service offices listed in the back of this manual.

1-11. DESCRIPTION.

1-12. Emulation of MC6805 microcomputers is provided by an emulation subsystem consisting of a Model 64191A 6805 Emulator Controller (figure 1-1), an emulator pod, and emulator software. The Model 64191A 6805 Emulator Controller plugs into Hewlett-Packard 64000 system development stations and provides the interface functions between the station, emulator pod, and software analysis options.

1-13. The products in the MC6805 family are single-chip microcomputers with their architecture optimized for controller applications. They have a microprocessor similar to the 6800, a clock oscillator, timer, ROM, RAM, or EPROM, and I/O control, all located on the integrated circuit package. The microcomputers communicate with the outside world through eight bit ports and have various user-specified options that can be hardware masked during manufacture.

1-14. The Model 64191A 6805 Emulator Controller has several important features. The controller contains memory that duplicates the on-chip memory of the 6805 microcomputer being emulated; no additional memory options are needed. This is called foreground memory and is available to the user to load programs and store data. Also located on the controller is background memory, which contains routines that force the emulator processor to perform utility functions.

1-15. The controller hardware passes the identification code of the attached emulator pod to the development station so that the appropriate emulator software is used for the menu-driven user interface. This function is particularly important because of the wide variety of options available on the 6805 microcomputer family. When the user enters the desired microcomputer configuration, the controller latches the pod option bits and passes them to the attached emulator pod.

1-16. Based upon the 6805 microcomputer version chosen for emulation, the controller maps foreground memory as ROM and RAM and monitors each access by the emulator processor to see if it is legal. The controller also contains all the control circuitry required to coordinate memory accesses between the development station and the emulator pod.

General Information - Model 64191A

1-17. Another feature located on the controller is the opcode monitor. This circuitry checks each emulator opcode. When an invalid opcode is found, a break bit can be set.

1-18. All emulator address, data, and status information is tapped on the controller and routed to the emulation bus edge connectors. This bus can be connected to an internal analyzer option card.

1-19. ACCESSORIES SUPPLIED.

1-20. No accessories are supplied with the Model 64191A 6805 Emulator Controller.

1-21. ADDITIONAL EQUIPMENT REQUIRED.

1-22. To operate, the Model 64191A 6805 Emulator Controller must be plugged into a Hewlett-Packard 64000 series development station and connected to an emulator pod for MC6805 series microcomputers.

1-23. POWER REQUIREMENTS.

1-24. Power requirements of the 6805 emulator controller are shown in the table below. Typical power useage is 6 watts.

Table 1-2. Power Supply Loads

Supply	+5 V
Controller current	1.2 A

1-25. CONVENTIONS.

1-26. The following conventions are used in the text and schematics.

- a. Abbreviations, see table 6-1.
- b. Mnemonics (signal names), see table 8-2.
- c. Logic symbols, see table 8-3.

d. Component designators are assigned according to the numbered-row, lettered-column method for integrated circuit packages. Discrete components are assigned reference designators using the upper left to lower right method.

e. TTL logic levels (in volts):

Input high threshold	Input low threshold	Output high threshold	Output low threshold
+2.0	+0.8	+2.4	+0.2



SECTION II  
INSTALLATION

2-1. INTRODUCTION.

2-2. This section contains information necessary to install the Model 64191A 6805 Emulator Controller in the 64000 system. Also included is information concerning initial inspection, damage claims, environmental considerations, storage and shipment.

2-3. INITIAL INSPECTION.

2-4. Inspect the shipping container for damage. If the shipping container or cushioning material is damaged, it should be kept until contents have been checked for completeness and the model 64191A has been checked mechanically and electrically. If the contents are incomplete, if there is mechanical damage or defect, or if the 64191A does not pass performance verification, notify the nearest Hewlett-Packard office. If the shipping container or cushioning material is damaged, notify the carrier as well as the Hewlett-Packard office. Keep the shipping materials for carrier's inspection. The Hewlett-Packard office will arrange for repair or replacement at HP option without waiting for claim settlement.

2-5. DEVELOPMENT STATION CONFIGURATION.

2-6. The controller should be installed in the highest numbered slot of the development station. When a logic analyzer option card is used with the emulator, the analyzer should be installed in the next lower numbered slot adjacent to the emulator control board. See figure 2-1.

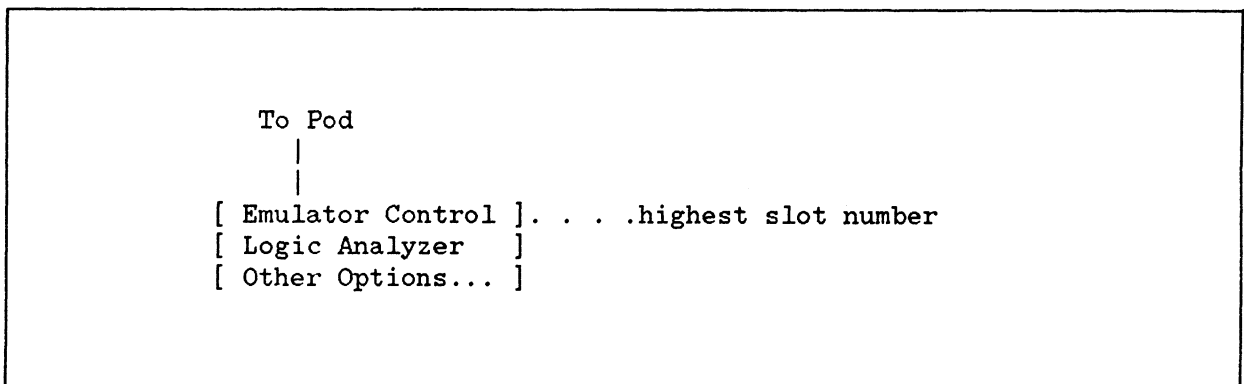



Figure 2-1. Development Station Card Cage

**WARNING**

Before installing the emulator subsystem, read the safety summary at the front of the manual.

**CAUTION**

The following precautions should be taken while using Hewlett-Packard emulator pods. Damage to the emulator circuitry may result if these precautions are not observed.

 **TURN OFF THE POWER.** Turn off power to the user target system and the emulation development station, before inserting the user plug, to avoid circuit damage resulting from voltage transients or mis-insertion of the user plug.

 **VERIFY USER PLUG ORIENTATION.** Make certain that pin 1 of the target system microprocessor socket, and pin 1 of the user plug, are properly aligned before inserting the user plug into the socket. Failure to do so may result in damage to the emulator circuitry.

 **PROTECT AGAINST STATIC DISCHARGE.** The emulator pod contains devices which are susceptible to damage by static discharge. Therefore, operators should take precautionary measures before handling the user plug to avoid emulator damage.

 **CONNECT THE RFI GROUND BRACKET.** The emulator controller and pod can be damaged by static discharge when the emulator pod cable is not firmly clamped in place.



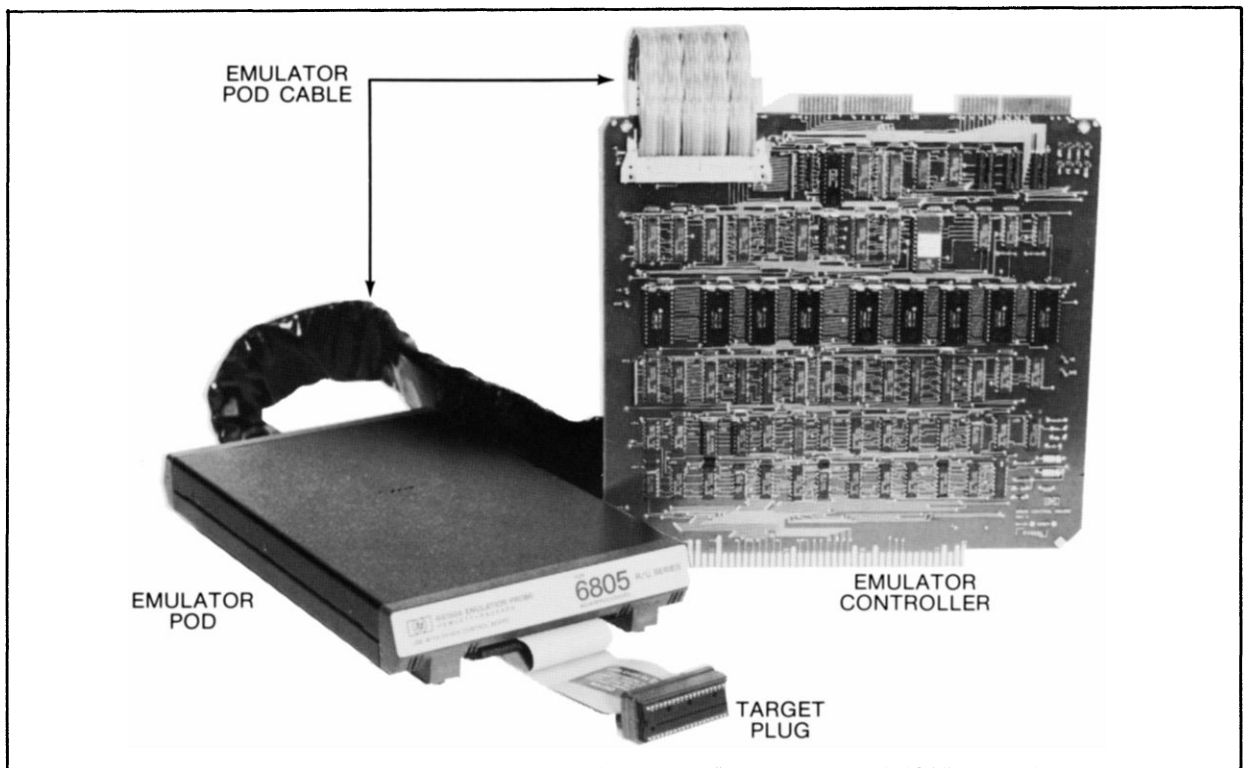

Figure 2-2. Typical 6805 Emulator Subsystem

2-7. INSTALLATION.

2-8. To install the emulator controller and pod proceed as follows:

- a. Remove the card cage cover. Position the development station so there is clear access to the card cage.
- b. Before placing the controller into the card cage, connect the emulator pod to it as directed in steps c and d.
- c. Locate the two multi-colored ribbon cables within the emulator pod cable. One cable is terminated in a female card-edge connector; the other is terminated in a female socket type connector. Locate pin 1, it is indicated by a triangle molded into the connector.
- d. Locate the mating male connectors on the controller. They are at the top left of the board, as you face the component side, and have color dots that match dots on the cables. Pin 1 of the male connectors is etched on the board. Align the connectors and attach the cables to the controller.
- e. Next, insert the controller into the highest numbered slot. Insure that it is completely seated in the motherboard.

## Installation - Model 64191A

- f. Refer to figure 2-3. If the development station has an RFI ground bracket/clamp bar as shown in the figure, perform the next step. If it does not have an RFI ground bracket/clamp bar, attach the bracket/bar as directed on the following page before going to step 'g'.
- g. Loosen the clamp bar and slip the emulator pod cable beneath it, placing the wire mesh is directly beneath the bar. Tighten the clamp bar to hold the cable firmly in place.
- h. If a logic analyzer option card is to be connected, refer to the appropriate manual and connect it to the control board now.
- i. Carefully fold all cables over the boards so as not to damage them. Replace the card cage cover.

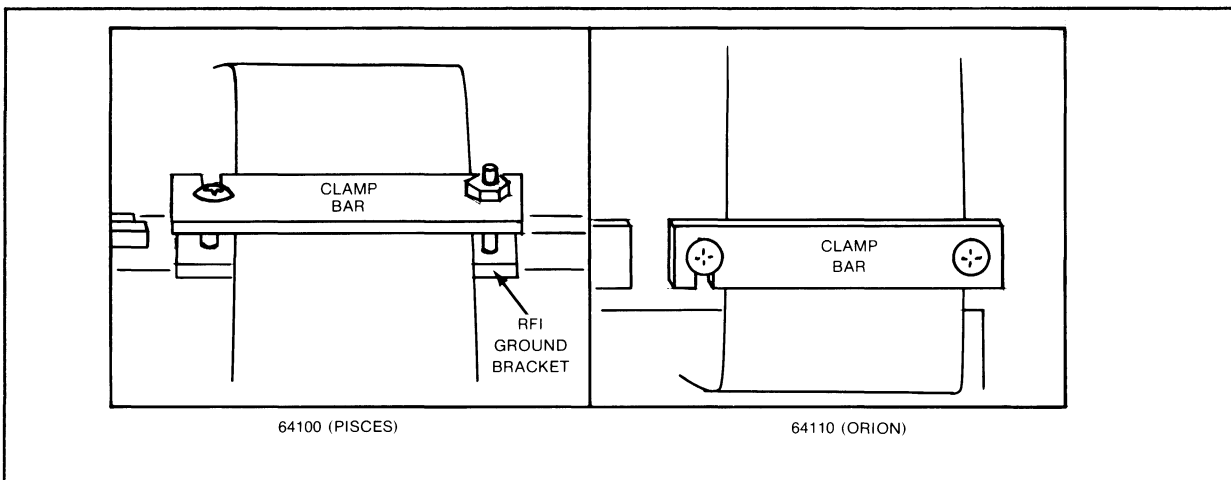

Figure 2-3. RFI Ground Bracket/Clamp Bar

### 2-9. REMOVAL.

2-10. To remove the controller and pod proceed as follows:

- a. Remove the card cage cover. Position the development station so there is clear access to the card cage.
- b. If a logic analyzer option card is connected to the controller, disconnect it.
- c. Loosen the RFI ground bracket clamp bar and slip the emulator pod cable from beneath it.
- d. Next, Remove the controller from the card cage slot.
- e. Replace the card cage cover.

2-11. RFI GROUND BRACKET INSTALLATION.

2-12. The emulator pod is shipped with a plastic bag that contains an RFI ground bracket assembly. The assembly includes an RFI ground bracket, clamp bar and miscellaneous hardware. These parts are used in the steps shown below.

2-13. MODEL 64100A DEVELOPMENT STATION.

- a. Position the development station so there is clear access to the back.
- b. Facing the back, remove the right cable clamp; it is secured by two #6-32 screws along the top edge. Discard these screws.
- c. Replace the old cable clamp with the RFI ground bracket, and attach with two new #6-32 x .375 long pan head screws, through the back of the card cage.
- d. Locate the clamp bar and position it with the oblong hole over the threaded stud.
- e. Install the #6-32 hex nut on the threaded stud, and install the #6-32 x 1.000 long pan head screw in the threaded hole along the top edge of the card cage.

2-14. MODEL 64110A DEVELOPMENT STATION.

- a. Position the development station so there is clear access to the back.
- b. Facing the back, remove the right cable clamp bracket; it is secured by two #4-40 screws. Discard these screws.
- c. Place a number 4 washer on each #4-40 x .750 pan head screw and insert one screw with washer through the oblong hole in the clamp bar. Then mount the clamp bar with the two #4-40 x .750 long pan head screws where the old cable clamp bracket had been.

2-15. OPERATING ENVIRONMENT.

2-16. The Model 64191A 6805 Emulator Controller can be operated in environments within the limits shown below. It should be protected from temperature extremes which cause condensation within the instrument.

Temperature.....0°to +40°degrees Celsius.  
Humidity.....5 to 80 % relative humidity.  
Altitude.....4 600 m (15 000 ft).

Installation - Model 64191A

2-17. STORAGE AND SHIPPING ENVIRONMENT.

2-18. The Model 64191A 6805 Emulator Controller can be stored and shipped in environments within the limits given below.

Temperature.....-40° to +40° degrees Celsius.  
Humidity.....5 to 80 % relative humidity.  
Altitude.....15 240 m (50 000 ft).

2-19. ORIGINAL PACKAGING.

2-20. Containers and packing materials identical to those used in factory packaging are available through Hewlett-Packard sales and service offices.

2-21. OTHER PACKAGING.

2-22. The following general instructions should be used for repackaging with commercially available materials.

- a. Wrap the Model 64191A 6805 Emulator Controller in heavy paper or plastic. Use a strong shipping container. A double wall carton made of 350 pound test material is adequate.
- b. Use a layer of shock absorbing material 70 to 100 mm (3 to 4 inch) thick around all sides of the model 64191A to provide firm cushioning and prevent movement inside the container
- c. Seal shipping container securely.
- d. Mark shipping container FRAGILE to request careful handling.
- e. In any correspondence, refer to instrument by model number and full repair number.

SECTION III

OPERATION

The operation of the Model 64191A 6805 Emulator Controller is a function of the HP 64000 system software. Complete operation from the development station keyboard is beyond the scope of this service manual. Please refer to the operator's manuals for the procedures.



SECTION IV

PERFORMANCE TESTS

This service manual does not contain performance test information. To test the Model 64191A 6805 Emulator Controller, it must be connected to a Hewlett-Packard 6805 series emulator pod. Refer to the service manual for the emulator pod being used.





SECTION V  
ADJUSTMENTS

There are no adjustments on the Model 64191A 6805 Emulator Controller.



SECTION VI

REPLACEABLE PARTS

6-1. INTRODUCTION.

6-2. This section contains information for ordering parts for the Model 64191A 6805 Emulator Controller. Table 6-1 lists abbreviations used in the parts list and throughout the manual. Table 6-2 lists all replaceable parts in reference designator order. Table 6-3 contains the names and addresses that correspond to the manufacturers' five digit code numbers.

6-3. ABBREVIATIONS.

6-4. Table 6-1 lists abbreviations used in the parts list, the schematics and throughout the manual. In some cases, two forms of the abbreviation are used: one, all in capital letters, and one partial or no capitals. This occurs because the abbreviations in the parts list are always capitals. However, in the schematics and other parts of the manual, other abbreviation forms are used with both lowercase and uppercase letters.

6-5. REPLACEABLE PARTS.

6-6. Table 6-2, the replaceable parts list, is organized as follows:

- a. Chassis mounted parts in alphanumerical order by reference designator.
- b. Electrical assemblies and their components in alphanumerical order by reference designator.
- c. Miscellaneous parts.

6-7. The total quantity for each part is given only once, at the first appearance of the part number in the list. The information given for each part consists of the following.

- a. The Hewlett-Packard part number and the check digit.
- b. The total quantity (Qty) in the instrument.
- c. The description of the part.
- d. A five digit code that indicates the manufacturer.
- e. The manufacturer's part number.

## Replaceable Parts - Model 64191A

### 6-8. ORDERING INFORMATION.

6-9. to order a part listed in the replaceable parts table, quote the Hewlett-Packard part number and check digit, indicate the quantity required, and address the order to the nearest Hewlett-Packard office.

6-10. to order a part that is not listed in the replaceable parts table, include the instrument model number, instrument repair number, the description and function of the part, and the number of parts required. Address the order to the nearest Hewlett-Packard office.

### 6-11. DIRECT MAIL ORDER SYSTEM.

6-12. Within the USA, Hewlett-Packard can supply parts through a direct mail order system. Advantages of using the system are as follows:

- a. Direct ordering and shipment from the HP parts center in Mountain View, California.
- b. No maximum or minimum on any mail order (there is a minimum order amount, for parts ordered through a local HP office when the orders require billing and invoicing).
- c. Prepaid transportation (there is a small handling charge for each order).
- d. No invoices - to provide these advantages, a check or money order must accompany each order.

6-13. Mail order forms and specific ordering information are available through your local HP office. Addresses and phone numbers are located at the back of this manual.

Table 6-1. Reference Designators and Abbreviations

REFERENCE DESIGNATORS			
<b>A</b>	= assembly	<b>F</b>	= fuse
<b>B</b>	= motor	<b>FL</b>	= filter
<b>BT</b>	= battery	<b>IC</b>	= integrated circuit
<b>C</b>	= capacitor	<b>J</b>	= jack
<b>CP</b>	= coupler	<b>K</b>	= relay
<b>CR</b>	= diode	<b>L</b>	= inductor
<b>DL</b>	= delay line	<b>LS</b>	= loud speaker
<b>DS</b>	= device signaling (lamp)	<b>M</b>	= meter
<b>E</b>	= misc electronic part	<b>MK</b>	= microphone
		<b>MP</b>	= mechanical part
		<b>P</b>	= plug
		<b>Q</b>	= transistor
		<b>R</b>	= resistor
		<b>RT</b>	= thermistor
		<b>S</b>	= switch
		<b>T</b>	= transformer
		<b>TB</b>	= terminal board
		<b>TP</b>	= test point
		<b>U</b>	= integrated circuit
		<b>V</b>	= vacuum, tube, neon bulb, photocell, etc
		<b>VR</b>	= voltage regulator
		<b>W</b>	= cable
		<b>X</b>	= socket
		<b>Y</b>	= crystal
		<b>Z</b>	= tuned cavity network
ABBREVIATIONS			
<b>A</b>	= amperes	<b>H</b>	= henries
<b>AFC</b>	= automatic frequency control	<b>HDW</b>	= hardware
<b>AMPL</b>	= amplifier	<b>HEX</b>	= hexagonal
<b>BFO</b>	= beat frequency oscillator	<b>HG</b>	= mercury
<b>BE CU</b>	= beryllium copper	<b>HR</b>	= hour(s)
<b>BH</b>	= binder head	<b>HZ</b>	= hertz
<b>BP</b>	= bandpass		
<b>BRS</b>	= brass	<b>IF</b>	= intermediate freq
<b>BWO</b>	= backward wave oscillator	<b>IMPG</b>	= impregnated
		<b>INCD</b>	= incandescent
<b>CCW</b>	= counter-clockwise	<b>INCL</b>	= include(s)
<b>CER</b>	= ceramic	<b>INS</b>	= insulation(ed)
<b>CMO</b>	= cabinet mount only	<b>INT</b>	= internal
<b>COEF</b>	= coefficient		
<b>COM</b>	= common	<b>K</b>	= kilo=1000
<b>COMP</b>	= composition		
<b>COMPL</b>	= complete	<b>LH</b>	= left hand
<b>CONN</b>	= connector	<b>LIN</b>	= linear taper
<b>CP</b>	= cadmium plate	<b>LK WASH</b>	= lock washer
<b>CRT</b>	= cathode-ray tube	<b>LOG</b>	= logarithmic taper
<b>CW</b>	= clockwise	<b>LPF</b>	= low pass filter
<b>DEPC</b>	= deposited carbon	<b>M</b>	= milli=10 <sup>-3</sup>
<b>DR</b>	= drive	<b>MEG</b>	= meg=10 <sup>6</sup>
		<b>MET FLM</b>	= metal film
<b>ELECT</b>	= electrolytic	<b>MET OX</b>	= metallic oxide
<b>ENCAP</b>	= encapsulated	<b>MFR</b>	= manufacturer
<b>EXT</b>	= external	<b>MHZ</b>	= mega hertz
		<b>MINAT</b>	= miniature
<b>F</b>	= farads	<b>MOM</b>	= momentary
<b>FH</b>	= flat head	<b>MOS</b>	= metal oxide substrate
<b>FIL H</b>	= fillister head	<b>MTG</b>	= mounting
<b>FXD</b>	= fixed	<b>MY</b>	= "mylar"
<b>G</b>	= giga (10 <sup>9</sup> )	<b>N</b>	= nano (10 <sup>-9</sup> )
<b>GE</b>	= germanium	<b>N/C</b>	= normally closed
<b>GL</b>	= glass	<b>NE</b>	= neon
<b>GRD</b>	= ground(ed)	<b>NI PL</b>	= nickel plate
		<b>N/O</b>	= normally open
		<b>NOM</b>	= nominal
		<b>NPO</b>	= negative positive zero (zero temperature coefficient)
		<b>NPN</b>	= negative-positive-negative
		<b>NRFR</b>	= not recommended for field replacement
		<b>NSR</b>	= not separately replaceable
		<b>OBD</b>	= order by description
		<b>OH</b>	= oval head
		<b>OX</b>	= oxide
		<b>P</b>	= peak
		<b>PC</b>	= printed circuit
		<b>PF</b>	= picofarads= 10 <sup>-12</sup> farads
		<b>PH BRZ</b>	= phosphor bronze
		<b>PHL</b>	= phillips
		<b>PIV</b>	= peak inverse voltage
		<b>PNP</b>	= positive-negative-positive
		<b>P/O</b>	= part of
		<b>POLY</b>	= polystyrene
		<b>PORC</b>	= porcelain
		<b>POS</b>	= position(s)
		<b>POT</b>	= potentiometer
		<b>PP</b>	= peak-to-peak
		<b>PT</b>	= point
		<b>PWV</b>	= peak working voltage
		<b>RECT</b>	= rectifier
		<b>RF</b>	= radio frequency
		<b>RH</b>	= round head or right hand
		<b>RMO</b>	= rack mount only
		<b>RMS</b>	= root-mean square
		<b>RWV</b>	= reverse working voltage
		<b>S-B</b>	= slow-blow
		<b>SCR</b>	= screw
		<b>SE</b>	= selenium
		<b>SECT</b>	= section(s)
		<b>SEMICON</b>	= semiconductor
		<b>SI</b>	= silicon
		<b>SIL</b>	= silver
		<b>SL</b>	= slide
		<b>SPG</b>	= spring
		<b>SPL</b>	= special
		<b>SST</b>	= stainless steel
		<b>SR</b>	= split ring
		<b>STL</b>	= steel
		<b>TA</b>	= tantalum
		<b>TD</b>	= time delay
		<b>TGL</b>	= toggle
		<b>THD</b>	= thread
		<b>TI</b>	= titanium
		<b>TOL</b>	= tolerance
		<b>TRIM</b>	= trimmer
		<b>TWT</b>	= traveling wave tube
		<b>U</b>	= micro=10 <sup>-6</sup>
		<b>VAR</b>	= variable
		<b>VDCW</b>	= dc working volts
		<b>W/</b>	= with
		<b>W</b>	= watts
		<b>WIV</b>	= working inverse voltage
		<b>WW</b>	= wirewound
		<b>W/O</b>	= without

# Replaceable Parts - Model 64191A

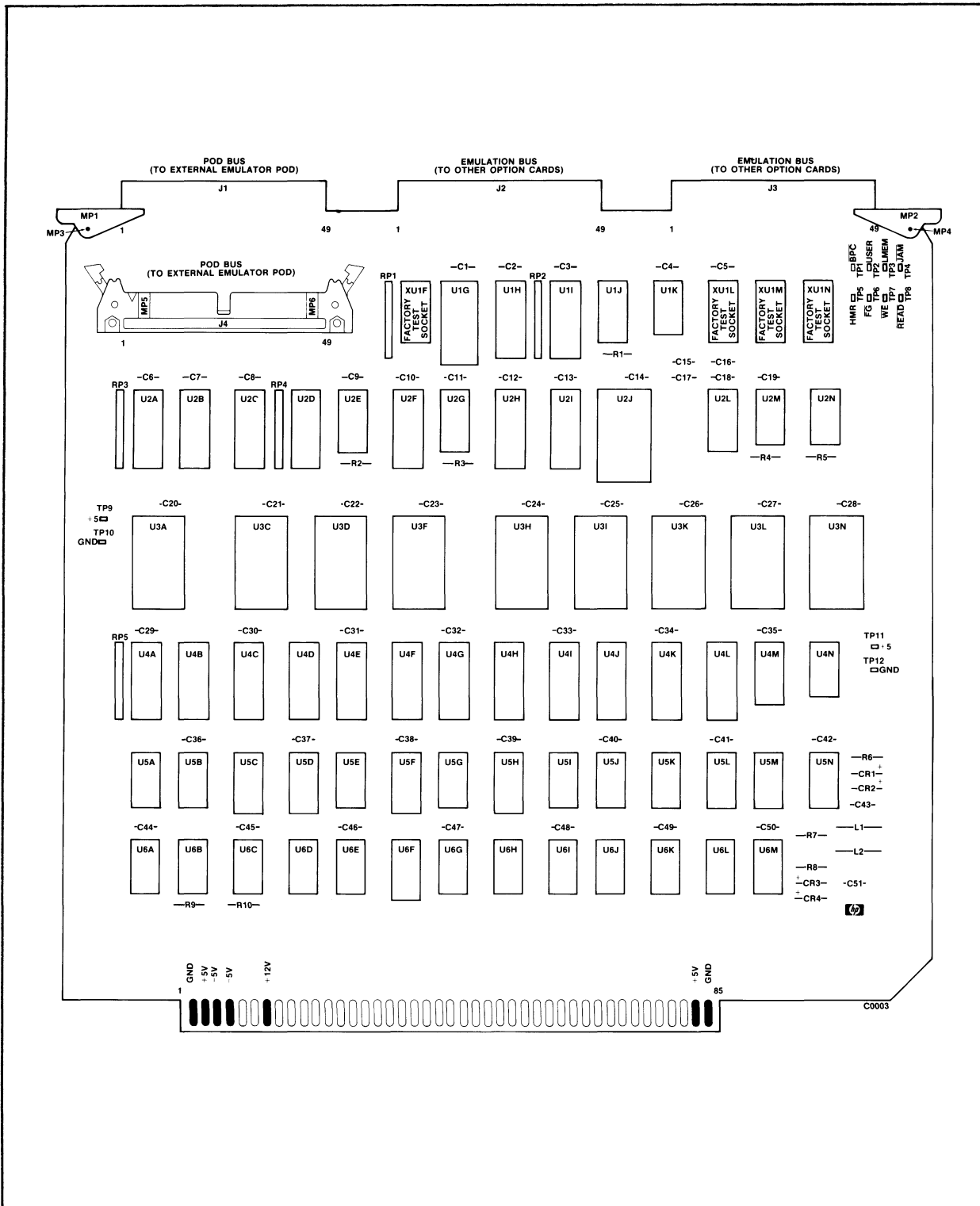

Figure 6-1. Component Locator

Table 6-2. Replaceable Parts List

Reference Designation	HP Part Number	C D	Qty	Description	Mfr Code	Mfr Part Number
A1	64191A 64191-66501	2 4	1 1	6805 EMULATOR CONTROLLER PC BOARD ASSEMBLY-CONTROL	28480 28480	64191A 64191-66501
C1	0160-5321	8	48	CAPACITOR-FXD CER 0.01UF 100VDC	28480	0160-5321
C2	0160-5321	8		CAPACITOR-FXD CER 0.01UF 100VDC	28480	0160-5321
C3	0160-5321	8		CAPACITOR-FXD CER 0.01UF 100VDC	28480	0160-5321
C4	0160-5321	8		CAPACITOR-FXD CER 0.01UF 100VDC	28480	0160-5321
C5	0160-5321	8		CAPACITOR-FXD CER 0.01UF 100VDC	28480	0160-5321
C6	0160-5321	8		CAPACITOR-FXD CER 0.01UF 100VDC	28480	0160-5321
C7	0160-5321	8		CAPACITOR-FXD CER 0.01UF 100VDC	28480	0160-5321
C8	0160-5321	8		CAPACITOR-FXD CER 0.01UF 100VDC	28480	0160-5321
C9	0160-5321	8		CAPACITOR-FXD CER 0.01UF 100VDC	28480	0160-5321
C10	0160-5321	8		CAPACITOR-FXD CER 0.01UF 100VDC	28480	0160-5321
C11	0160-5371	8	1	CAPACITOR-FXD CER 1000PF +/-20	28480	0160-5371
C12	0160-5321	8		CAPACITOR-FXD CER 0.01UF 100VDC	28480	0160-5321
C13	0160-5321	8		CAPACITOR-FXD CER 0.01UF 100VDC	28480	0160-5321
C14	0160-5321	8		CAPACITOR-FXD CER 0.01UF 100VDC	28480	0160-5321
C15	0160-5321	8		CAPACITOR-FXD CER 0.01UF 100VDC	28480	0160-5321
C16	0160-5321	8		CAPACITOR-FXD CER 0.01UF 100VDC	28480	0160-5321
C17	0160-5321	8		CAPACITOR-FXD CER 0.01UF 100VDC	28480	0160-5321
C18	0160-5321	8		CAPACITOR-FXD CER 0.01UF 100VDC	28480	0160-5321
C19	0160-5321	8		CAPACITOR-FXD CER 0.01UF 100VDC	28480	0160-5321
C20	0160-5321	8		CAPACITOR-FXD CER 0.01UF 100VDC	28480	0160-5321
C21	0160-5321	8		CAPACITOR-FXD CER 0.01UF 100VDC	28480	0160-5321
C22	0160-5321	8		CAPACITOR-FXD CER 0.01UF 100VDC	28480	0160-5321
C23	0160-5321	8		CAPACITOR-FXD CER 0.01UF 100VDC	28480	0160-5321
C24	0160-5321	8		CAPACITOR-FXD CER 0.01UF 100VDC	28480	0160-5321
C25	0160-5321	8		CAPACITOR-FXD CER 0.01UF 100VDC	28480	0160-5321
C26	0160-5321	8		CAPACITOR-FXD CER 0.01UF 100VDC	28480	0160-5321
C27	0160-5321	8		CAPACITOR-FXD CER 0.01UF 100VDC	28480	0160-5321
C28	0160-5321	8		CAPACITOR-FXD CER 0.01UF 100VDC	28480	0160-5321
C29	0160-5321	8		CAPACITOR-FXD CER 0.01UF 100VDC	28480	0160-5321
C30	0160-5321	8		CAPACITOR-FXD CER 0.01UF 100VDC	28480	0160-5321
C31	0160-5321	8		CAPACITOR-FXD CER 0.01UF 100VDC	28480	0160-5321
C32	0160-5321	8		CAPACITOR-FXD CER 0.01UF 100VDC	28480	0160-5321
C33	0160-5321	8		CAPACITOR-FXD CER 0.01UF 100VDC	28480	0160-5321
C34	0160-5321	8		CAPACITOR-FXD CER 0.01UF 100VDC	28480	0160-5321
C35	0160-5321	8		CAPACITOR-FXD CER 0.01UF 100VDC	28480	0160-5321
C36	0160-5321	8		CAPACITOR-FXD CER 0.01UF 100VDC	28480	0160-5321
C37	0160-5321	8		CAPACITOR-FXD CER 0.01UF 100VDC	28480	0160-5321
C38	0160-5321	8		CAPACITOR-FXD CER 0.01UF 100VDC	28480	0160-5321
C39	0160-5321	8		CAPACITOR-FXD CER 0.01UF 100VDC	28480	0160-5321
C40	0160-5321	8		CAPACITOR-FXD CER 0.01UF 100VDC	28480	0160-5321
C41	0160-5321	8		CAPACITOR-FXD CER 0.01UF 100VDC	28480	0160-5321
C42	0160-5321	8		CAPACITOR-FXD CER 0.01UF 100VDC	28480	0160-5321
C43	0160-5507	2	1	CAPACITOR-FXD 390PF	28480	0160-5507
C44	0160-5321	8		CAPACITOR-FXD CER 0.01UF 100VDC	28480	0160-5321
C45	0160-5321	8		CAPACITOR-FXD CER 0.01UF 100VDC	28480	0160-5321
C46	0160-5321	8		CAPACITOR-FXD CER 0.01UF 100VDC	28480	0160-5321
C47	0160-5321	8		CAPACITOR-FXD CER 0.01UF 100VDC	28480	0160-5321
C48	0160-5321	8		CAPACITOR-FXD CER 0.01UF 100VDC	28480	0160-5321
C49	0160-5321	8		CAPACITOR-FXD CER 0.01UF 100VDC	28480	0160-5321
C50	0160-5321	8		CAPACITOR-FXD CER 0.01UF 100VDC	28480	0160-5321
C51	0160-5573	2	1	CAPACITOR-FXD 560PF	28480	0160-5573
CR1	1901-0040	1	4	DIODE-SWITCHING 30V 50MA 2NS DO-35	28480	1901-0040
CR2	1901-0040	1		DIODE-SWITCHING 30V 50MA 2NS DO-35	28480	1901-0040
CR3	1901-0040	1		DIODE-SWITCHING 30V 50MA 2NS DO-35	28480	1901-0040
CR4	1901-0040	1		DIODE-SWITCHING 30V 50MA 2NS DO-35	28480	1901-0040
J4	1251-5653	3	1	CONNECTOR- 50 POSITION MREJT	28480	1251-5653
L1	9140-0179	1	2	INDUCTOR RF-CH-MLD 22UH 10% .166DX.385LG	28480	9140-0179
L2	9140-0179	1		INDUCTOR RF-CH-MLD 22UH 10% .166DX.385LG	28480	9140-0179
MP1	64191-85001	9	1	BOARD EXTRACTOR -- 64191A	28480	64191-85001
MP2	64191-85002	0	1	BOARD EXTRACTOR-- EM 6805	28480	64191-85002
MP3	1480-0116	8	2	PIN-GRV .062-IN-DIA .25-IN-LG STL	28480	1480-0116
MP4	1480-0116	8		PIN-GRV .062-IN-DIA .25-IN-LG STL	28480	1480-0116
MP5	1251-5595	2	2	POLARIZING KEY	28480	1251-5595
MP6	1251-5595	2		POLARIZING KEY	28480	1251-5595
R1	0757-0280	3	7	RESISTOR 1K 1% .125W F TC=0+-100	24546	C4-1/8-T0-1001-F
R2	0757-0280	3		RESISTOR 1K 1% .125W F TC=0+-100	24546	C4-1/8-T0-1001-F
R3	0757-0470	3	1	RESISTOR 162K 1% .125W F TC=0+-100	24546	C4-1/8-T0-1623-F
R4	0757-0280	3		RESISTOR 1K 1% .125W F TC=0+-100	24546	C4-1/8-T0-1001-F
R5	0757-0280	3		RESISTOR 1K 1% .125W F TC=0+-100	24546	C4-1/8-T0-1001-F

See introduction to this section for ordering information

Replaceable Parts - Model 64191A

Table 6-2. Replaceable Parts List (Cont'd)

Reference Designation	HP Part Number	C D	Qty	Description	Mfr Code	Mfr Part Number
R6	0757-0280	3		RESISTOR 1K 1% .125W F TC=0+-100	24546	C4-1/8-T0-1001-F
R7	0757-0280	3		RESISTOR 1K 1% .125W F TC=0+-100	24546	C4-1/8-T0-1001-F
R8	0757-0280	3		RESISTOR 1K 1% .125W F TC=0+-100	24546	C4-1/8-T0-1001-F
R9	0757-0407	6	2	RESISTOR 200 1% .125W F TC=0+-100	24546	C4-1/8-T0-201-F
R10	0757-0407	6		RESISTOR 200 1% .125W F TC=0+-100	24546	C4-1/8-T0-201-F
RP1	1810-0430	0	5	NETWORK-RES 10-SIP MULTI-VALUE	28480	1810-0430
RP2	1810-0430	0		NETWORK-RES 10-SIP MULTI-VALUE	28480	1810-0430
RP3	1810-0430	0		NETWORK-RES 10-SIP MULTI-VALUE	28480	1810-0430
RP4	1810-0430	0		NETWORK-RES 10-SIP MULTI-VALUE	28480	1810-0430
RP5	1810-0430	0		NETWORK-RES 10-SIP MULTI-VALUE	28480	1810-0430
TP12	0360-0535	0	12	TERMINAL TEST POINT PCB	00000	ORDER BY DESCRIPTION
U1G	1816-1308	5	1	IC-93L422 PC	07263	93L422PC
U1H	1820-1633	8	3	IC BFR TTL S INV OCTL 1-INP	01295	SN74S240N
U1I	1820-1633	8		IC BFR TTL S INV OCTL 1-INP	01295	SN74S240N
U1J	1820-1217	4	1	IC MUXR/DATA-SEL TTL LS 8-TO-1-LINE	01295	SN74LS151N
U1K	1820-1202	7	3	IC GATE TTL LS NAND TPL 3-INP	01295	SN74LS10N
U2A	1820-1624	7	1	IC BFR TTL S OCTL 1-INP	01295	SN74S241N
U2B	1820-1633	8		IC BFR TTL S INV OCTL 1-INP	01295	SN74S240N
U2C	1820-1997	7	7	IC FF TTL LS D-TYPE POS-EDGE-TRIG PRL-IN	01295	SN74LS374N
U2D	1820-1917	1	4	IC BFR TTL LS LINE DRVR OCTL	01295	SN74LS240N
U2E	1820-1130	0	1	IC GATE TTL S NAND 13-INP	01295	SN74S133N
U2F	1820-1917	1		IC BFR TTL LS LINE DRVR OCTL	01295	SN74LS240N
U2G	1820-1423	4	1	IC MV TTL LS MONOSTBL RETRIG DUAL	01295	SN74LS123N
U2H	1820-1917	1		IC BFR TTL LS LINE DRVR OCTL	01295	SN74LS240N
U2I	1820-2102	8	2	IC LCH TTL LS D-TYPE OCTL	01295	SN74LS373N
U2J	64191-80000	8	1	OPCODE MONITOR ROM	28480	64191-80000
U2L	1820-1430	3	2	IC CNTR TTL LS BIN SYNCHRO POS-EDGE-TRIG	01295	SN74LS161AN
U2M	1820-0686	9	1	IC GATE TTL S AND TPL 3-INP	01295	SN74S11N
U2N	1820-1205	0	1	IC GATE TTL LS AND DUAL 4-INP	01295	SN74LS21N
U3A	1818-1611	7	9	IC-HM6116P-3	54013	HM6116P-3
U3C	1818-1611	7		IC-HM6116P-3	54013	HM6116P-3
U3D	1818-1611	7		IC-HM6116P-3	54013	HM6116P-3
U3F	1818-1611	7		IC-HM6116P-3	54013	HM6116P-3
U3H	1818-1611	7		IC-HM6116P-3	54013	HM6116P-3
U3I	1818-1611	7		IC-HM6116P-3	54013	HM6116P-3
U3K	1818-1611	7		IC-HM6116P-3	54013	HM6116P-3
U3L	1818-1611	7		IC-HM6116P-3	54013	HM6116P-3
U3N	1818-1611	7		IC-HM6116P-3	54013	HM6116P-3
U4A	1820-1997	7		IC FF TTL LS D-TYPE POS-EDGE-TRIG PRL-IN	01295	SN74LS374N
U4B	1820-1997	7		IC FF TTL LS D-TYPE POS-EDGE-TRIG PRL-IN	01295	SN74LS374N
U4C	1820-1997	7		IC FF TTL LS D-TYPE POS-EDGE-TRIG PRL-IN	01295	SN74LS374N
U4D	1820-2024	3	4	IC DRVR TTL LS LINE DRVR OCTL	01295	SN74LS244N
U4E	1820-2024	3		IC DRVR TTL LS LINE DRVR OCTL	01295	SN74LS244N
U4F	1820-1997	7		IC FF TTL LS D-TYPE POS-EDGE-TRIG PRL-IN	01295	SN74LS374N
U4G	1820-1997	7		IC FF TTL LS D-TYPE POS-EDGE-TRIG PRL-IN	01295	SN74LS374N
U4H	1820-2102	8		IC LCH TTL LS D-TYPE OCTL	01295	SN74LS373N
U4I	1820-1917	1		IC BFR TTL LS LINE DRVR OCTL	01295	SN74LS240N
U4J	1820-2024	3		IC DRVR TTL LS LINE DRVR OCTL	01295	SN74LS244N
U4K	1820-2024	3		IC DRVR TTL LS LINE DRVR OCTL	01295	SN74LS244N
U4L	1820-1997	7		IC FF TTL LS D-TYPE POS-EDGE-TRIG PRL-IN	01295	SN74LS374N
U4M	1820-1430	3		IC CNTR TTL LS BIN SYNCHRO POS-EDGE-TRIG	01295	SN74LS161AN
U4N	1820-1144	6	5	IC GATE TTL LS NOR QUAD 2-INP	01295	SN74LS02N
U5A	1820-1144	6		IC GATE TTL LS NOR QUAD 2-INP	01295	SN74LS02N
U5B	1820-1206	1	1	IC GATE TTL LS NOR TPL 3-INP	01295	SN74LS27N
U5C	1820-1216	3	2	IC DCDR TTL LS 3-TO-8-LINE 3-INP	01295	SN74LS138N
U5D	1820-1282	3	3	IC FF TTL LS J-K BAR POS-EDGE-TRIG	01295	SN74LS109AN
U5E	1820-1112	8	5	IC FF TTL LS D-TYPE POS-EDGE-TRIG	01295	SN74LS74AN
U5F	1820-1216	3		IC DCDR TTL LS 3-TO-8-LINE 3-INP	01295	SN74LS138N
U5G	1820-1144	6		IC GATE TTL LS NOR QUAD 2-INP	01295	SN74LS02N
U5H	1820-1282	3		IC FF TTL LS J-K BAR POS-EDGE-TRIG	01295	SN74LS109AN
U5I	1820-1210	7	1	IC GATE TTL LS AND-OR-INV DUAL 2-INP	01295	SN74LS51N
U5J	1820-1202	7		IC GATE TTL LS NAND TPL 3-INP	01295	SN74LS10N
U5K	1820-1112	8		IC FF TTL LS D-TYPE POS-EDGE-TRIG	01295	SN74LS74AN
U5L	1820-1197	9	4	IC GATE TTL LS NAND QUAD 2-INP	01295	SN74LS00N
U5M	1820-1199	1	2	IC INV TTL LS HEX 1-INP	01295	SN74LS04N
U5N	1820-1307	3	1	IC SCHMITT-TRIG TTL S NAND QUAD 2-INP	01295	SN74S132N
U6A	1820-1197	9		IC GATE TTL LS NAND QUAD 2-INP	01295	SN74LS00N
U6B	1820-1112	8		IC FF TTL LS D-TYPE POS-EDGE-TRIG	01295	SN74LS74AN
U6C	1820-1112	8		IC FF TTL LS D-TYPE POS-EDGE-TRIG	01295	SN74LS74AN
U6D	1820-1197	9		IC GATE TTL LS NAND QUAD 2-INP	01295	SN74LS00N
U6E	1820-1112	8		IC FF TTL LS D-TYPE POS-EDGE-TRIG	01295	SN74LS74AN
U6F	1820-1282	3		IC FF TTL LS J-K BAR POS-EDGE-TRIG	01295	SN74LS109AN
U6G	1820-1197	9		IC GATE TTL LS NAND QUAD 2-INP	01295	SN74LS00N
U6H	1820-1144	6		IC GATE TTL LS NOR QUAD 2-INP	01295	SN74LS02N
U6I	1820-1202	7		IC GATE TTL LS NAND TPL 3-INP	01295	SN74LS10N
U6J	1820-1199	1		IC INV TTL LS HEX 1-INP	01295	SN74LS04N
U6K	1820-1274	3	1	IC GATE TTL LS NAND DUAL 4-INP	01295	SN74LS27N
U6L	1820-1144	6		IC GATE TTL LS NOR QUAD 2-INP	01295	SN74LS02N
U6M	1820-1285	6	1	IC GATE TTL LS AND-OR-INV 4-INP	01295	SN74LS54N
XU1F	1200-0607	0	6	SOCKET-IC 16-CONT DIP DIP-SLDR	28480	1200-0607
XU1G	1200-0612	7	1	SOCKET-IC 22-CONT DIP DIP-SLDR	28480	1200-0612
XU1L	1200-0607	0		SOCKET-IC 16-CONT DIP DIP-SLDR	28480	1200-0607
XU1M	1200-0607	0		SOCKET-IC 16-CONT DIP DIP-SLDR	28480	1200-0607
XU1N	1200-0607	0		SOCKET-IC 16-CONT DIP DIP-SLDR	28480	1200-0607

See introduction to this section for ordering information



Table 6-2. Replaceable Parts List (Cont'd)

Reference Designation	HP Part Number	C D	Qty	Description	Mfr Code	Mfr Part Number
XU2G	1200-0607	0		SOCKET-IC 16-CONT DIP DIP-SLDR	28480	1200-0607
XU2J	1200-0541	1	10	SOCKET-IC 24-CONT DIP DIP-SLDR	28480	1200-0541
XU3A	1200-0541	1		SOCKET-IC 24-CONT DIP DIP-SLDR	28480	1200-0541
XU3C	1200-0541	1		SOCKET-IC 24-CONT DIP DIP-SLDR	28480	1200-0541
XU3D	1200-0541	1		SOCKET-IC 24-CONT DIP DIP-SLDR	28480	1200-0541
XU3F	1200-0541	1		SOCKET-IC 24-CONT DIP DIP-SLDR	28480	1200-0541
XU3H	1200-0541	1		SOCKET-IC 24-CONT DIP DIP-SLDR	28480	1200-0541
XU3I	1200-0541	1		SOCKET-IC 24-CONT DIP DIP-SLDR	28480	1200-0541
XU3K	1200-0541	1		SOCKET-IC 24-CONT DIP DIP-SLDR	28480	1200-0541
XU3L	1200-0541	1		SOCKET-IC 24-CONT DIP DIP-SLDR	28480	1200-0541
XU3N	1200-0541	1		SOCKET-IC 24-CONT DIP DIP-SLDR	28480	1200-0541
XU5C	1200-0607	0		SOCKET-IC 16-CONT DIP DIP-SLDR	28480	1200-0607

See introduction to this section for ordering information

Replaceable Parts - Model 64191A

Table 6-3. List of Manufacturers' Codes

Mfr. No.	Manufacturer Name	Address	Zip Code
S4013 00000 01295 07263 24546 28480	HITACHI ANY SATISFACTORY SUPPLIER TEXAS INSTR INC SEMICOND CMPNT DIV FAIRCHILD SEMICONDUCTOR DIV CORNING GLASS WORKS (BRADFORD) HEWLETT-PACKARD CO CORPORATE HQ	TOKYO JP DALLAS TX MOUNTAIN VIEW CA BRADFORD PA PALO ALTO CA	75222 94042 16701 94304

SECTION VII

MANUAL CHANGES

This section normally contains backdating information for models with repair numbers prior to the one shown on the title page. Because this edition includes only the first repair number, there is no backdating material.



## SECTION VIII

## SERVICE

## 8-1. INTRODUCTION.

8-2. This section contains reference information for servicing the Model 64191A 6805 Emulator Controller. For convenience, the schematics, component locator, and other service information are provided on foldout sheets.

8-3. The purpose of the emulator controller is to act as an interface between the development station, emulator pod, and other option cards. To do this, the controller coordinates status and control bits, manages emulation memory, monitors emulator opcodes, and places emulator address, data, and status on the emulation bus within the development station. The following functional blocks implement these operations.

	Schematic
Development Station Interface.....	1
Control.....	2
Foreground/Background Memory.....	3
Pod Interface and Memory Monitor.....	4
Last Address and Break Logic.....	5
Foreground/Background Logic.....	6
Pod Interface and Opcode Monitor.....	7

## 8-4. GENERAL THEORY.

8-5. Perhaps the most important task of the controller hardware is to manage memory. Therefore, a good way to understand the emulator controller is to examine the functions of foreground and background memory.

8-6. Foreground memory is provided on the controller as a substitute for the on-chip memory of the 6805 microcomputer. When the user selects a version of the 6805 to emulate, software automatically maps foreground memory into 64 byte blocks that correspond to the on-chip memory of the 6805. That is, it is mapped as RAM or ROM. This memory space is available to the user to load programs or store data.

8-7. Each 6805 also has internal registers in the address space between 0 and 15. These addresses cannot be mapped in the foreground memory, but must remain as on-chip addresses. These 16 addresses are called user memory and typically are used for port data and direction control, and on-chip timer functions.

8-8. Background memory is not available to the user. It is loaded with utility routines by the emulator software. Typically, the routines instruct the emulator processor to read its own internal registers and store the information in background so the development station can read it. The emulator processor is forced to run these routines when the opcode for a software interrupt (SWI) is jammed onto its data bus.

8-9. Thus, the emulator processor is either running user programs in foreground memory, or it is running service routines in background memory.

8-10. When the user performs such tasks as loading programs into memory, or modifying a memory location, the development station issues a break to the emulator processor and forces it into background memory. In background, the emulator processor performs a wait loop while the development station processor accesses foreground memory. In this manner, the development station processor has complete access to the memory being used by the emulator.

8-11. It is the function of the emulator hardware to coordinate all the memory related operations described above. In addition, the controller hardware monitors all opcodes used by the emulator processor to see if they are valid. The controller also places all emulator processor address, data, and status information on the emulation bus inside the development station. This bus can be monitored by an attached internal logic analyzer option card. The following paragraphs describe in detail the functional blocks and operation of the controller.

8-12. DEVELOPMENT STATION INTERFACE, SCHEMATIC 1.

8-13. This circuitry includes break, pod option, and pod status registers, plus data and address bus buffering. The circuitry allows the development station to communicate with the controller.

8-14. BREAK, OPTION & STATUS REGISTERS, SCHEMATIC 1.

8-15. Break register U4L latches six bits that control the emulator operation. These bits are written to the controller by the development station. Five of the bits control breaks in operation and one, LEXT, selects a signal source. The bits are,

- LDEFIB...initialize operation, set to known state.
- LBPCBRK...stop operation at development station request.
- LOPCBRK...stop when an illegal opcode is detected.
- LMEMBRK...stop when an illegal address is detected.
- LROMBRK...stop when an a write to 'ROM' is attempted.
- LEXT.....select external crystal clock source

8-16. Option register U2C is a latch/driver that receives data from the development station via the LD0-7 data bus. These bits are used to drive the pod option bus LPOPT0-7. The attached emulator pod reads these bits and uses the information to configure pod operation. These bits implement the choices of emulator configuration selected by the user; for example, type of 6805 being emulated, clock source, timer clock source, and timer prescaler value.

8-17. The emulator status register consists of U4K, a buffer/driver, and U4A, a latch/driver. The status bits are,

LNCLK.....slow, or no processor clock.  
 HFG.....emulator is executing in foreground memory.  
 LILLOPC....illegal opcode detected.  
 LILLMEM....illegal memory operation detected.  
 LRESET.....target system has requested processor reset.  
 LIRQ.....target system has requested processor interrupt.  
 HTIMER.....target system has enabled processor timer to count.  
 LICE.....emulator plug is in target system, and receiving +5v.

8-18. DEVELOPMENT STATION DATA BUS BUFFER, SCHEMATIC 1.

8-19. Data transfer from the controller to the development station is controlled by chips U4H and U4I. The data-out latch U4H drives the LD0-7 data bus when the development station reads emulation memory. The emulator board identification is placed on the LD0-7 bus by U4I when the development station requests the board ID. Four bits of ID come from the controller and four come from the attached emulator pod.

8-20. Data transfer to the controller from the development station is controlled by chip U4J. Data is received from the development station via the LD0-7 data bus and is buffered onto the LED0-7 data bus.

8-21. DEVELOPMENT STATION ADDRESS BUS BUFFER, SCHEMATIC 1.

8-22. The development station address bus LA0-15 is received by the controller at buffer/drivers U4D and U4E. These chips then drive the controller LEA0-15 address bus.

8-23. CONTROL LOGIC, SCHEMATIC 2.

8-24. The main elements of the control circuitry are the board select, memory access control, register address decoder, and write enable logic. These circuits control access to foreground memory, background memory, and various registers located on the controller. Three main tasks performed by the circuitry are as follows.

8-25. One, the logic arbitrates requests between the attached pod, and the development station. Second, the logic decides if the access is to foreground memory, background memory, or to various registers. Third, the controller implements the read, or write, as requested. The majority of this circuitry is shown on schematic 2. Foreground/background memory circuitry is shown on schematic 3.

8-26. BOARD SELECT LOGIC, SCHEMATIC 2.

8-27. The board select logic determines when the development station wants to access memory. This is done by decoding the LSTM, LSEL, LID, LA12 and LA13 to produce HMR (high memory request). The logic looks at BLMEM (buffered low memory) to determine when the pod is requesting a memory access.

8-28. MEMORY ACCESS CONTROL LOGIC, SCHEMATIC 2.

8-29. The memory access control logic arbitrates between development station and pod access. Queuing flip-flop U5K places competing requests into a queue, so only one request is serviced at a time. When the development station requests a memory access, the read/write logic decodes LA12 and LA13 at NOR gate U6L. When both lines are high, the access is to the various registers, and the register address decoder U5F is enabled. When LA12 is low, the access is to foreground or background memory (see schematic 3). In this case, signal LA13 is decoded by foreground memory gate U5I and background memory gate U4N.

8-30. When the attached emulator pod requests a memory access, the monostable multivibrator U2G generates LMSYN (low memory synch). This signal to the development station causes the station processor to hold off its memory operation until the line goes high, indicating the pod access is complete.

8-31. REGISTER ADDRESS DECODER, SCHEMATIC 2.

8-32. Decoder U5F controls development station access to the registers shown below.

- Pod Option Register
- Status Register
- Break Register
- Last Address Register
- Last Opcode (address) Register

8-33. WRITE ENABLE LOGIC, SCHEMATIC 2.

8-34. The write enable logic consists of AND-OR gate U6M and discrete linear components in an LRC network. The read enable logic is shown on schematic 3, and consists of AND-OR gate U5I for foreground memory and OR gate U4N for the background memory. The foreground memory RAM chips are selected by decoder U5C which decodes address lines LEA10-13.



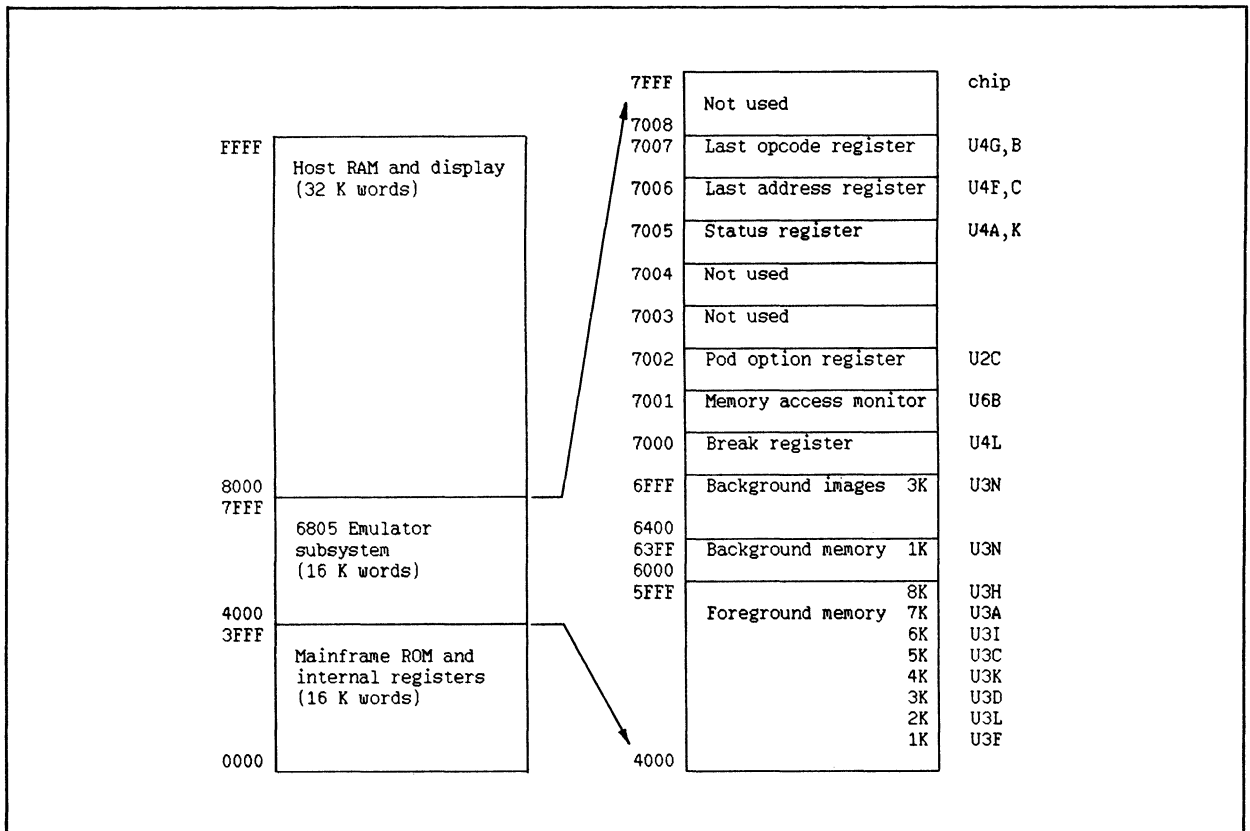

Figure 8-1. Emulator Memory Map

8-35. FOREGROUND/BACKGROUND MEMORY, SCHEMATIC 3.

8-36. The foreground memory consists of eight RAM chips. Each chip is a 2K x 8 bit RAM; however, pin 19 is grounded causing only the lower 1K of memory to be directly accessible. The background memory consists of a single RAM chip configured the same way as foreground memory.

8-37. Gates U5I and U4C decode foreground/background choices. Signal LA13 is decoded by foreground memory gate U5I and background memory gate U4N. Lines LEA10-12 are decoded by U5C to select the appropriate foreground RAM chip.

8-38. POD INTERFACE AND MEMORY MONITOR, SCHEMATIC 4.

8-39. This circuitry includes the pod data bus buffer, data bus jam buffer, pod address bus buffer, memory access monitor RAM, and port address detector. The circuitry allows the controller to transfer data to the attached pod and to monitor the addresses accessed by the pod.

8-40. POD DATA BUS BUFFER, SCHEMATIC 4.

8-41. Data transfers between the controller and attached emulator pod occur over the HD0-7 data bus. The data-in buffer/driver U2H receives the data from the pod and then drives it onto the LED0-7 data bus. Data is output from the controller to the attached pod by buffer/driver U1I.

8-42. DATA BUS JAM BUFFER, SCHEMATIC 4.

8-43. To force the emulator into background memory, buffer/driver U1H 'jams' the SWI opcode (software interrupt) onto the HD0-7 data bus.

8-44. POD ADDRESS BUS BUFFER, SCHEMATIC 4.

8-45. The controller receives addresses from the attached emulator pod. These addresses appear on the HEA0-15 address bus and are received by buffer/drivers U2D and U2E. These chips then drive the LEA0-15 address bus.

8-46. MEMORY ACCESS MONITOR RAM, SCHEMATIC 4.

8-47. RAM U1G monitors the foreground memory addresses accessed by the pod. Its data output lines indicate the type of memory being accessed; see below.

HGUARD.....when high, memory is outside range of 6805 being emulated.

HINT.....when high, memory is above address 63, ie. internal to the controller. When low, address is on-chip, ie. user memory.

HRAM.....when high, memory is mapped as RAM; when low, memory is mapped as ROM.

8-48. The memory access monitor is loaded by a development station write to address 7001H, which clears flip-flop U6B and allows the emulator pod write signal HPODWRT to be gated through U6A to the RAM. The final write to an address less than 0010H sets U6B and disables emulator processor writes to the memory access monitor.

8-49. PORT ADDRESS DETECTOR, SCHEMATIC 4.

8-50. Chip U2E is a NAND gate that monitors the address bus. Whenever an address in the range 0-15 is detected, its output LPORTS goes low. The addresses 0 - 15 are generally port or timer addresses, and are not mapped on the controller foreground memory.

8-51. LAST ADDRESS AND BREAK LOGIC, SCHEMATIC 5.

8-52. This circuitry consists of the last address registers and the break logic. It allows the controller to force breaks in emulator operation and record the last memory address accessed.

8-53. LAST ADDRESS REGISTERS, SCHEMATIC 5.

8-54. There are two registers on the controller that latch the address of a memory access. The last opcode register latches the memory address every time the pod processor reads in an opcode. This is accomplished by using the LOPCREG signal to clock the latches.

8-55. The last address register is clocked every time there is a foreground memory access. Whenever a break occurs, the break logic generates LBREAK which disables the clock inputs to the latches so that the registers cannot be written over. Later, the development station can read these registers to see what the last opcode address and the absolute last address were when the break occurred.

8-56. BREAK LOGIC, SCHEMATIC 5.

8-57. The break logic responds to breaks from the development station, from an attached internal analysis card on the emulation bus, and to breaks caused by illegal operations. The illegal opcode flip-flop U6C sets LBREAK whenever the user has chosen to break when an invalid opcode is detected. The illegal memory flip-flop U6B sets LBREAK when an illegal memory operation is detected. This occurs whenever an access is made to guarded memory. The user cannot override this action. When the user chooses to break on a write to memory mapped as ROM there is a break.

8-58. FOREGROUND/BACKGROUND LOGIC, SCHEMATIC 6.

8-59. Flip-flop U5H is the foreground/background controller, and when set, forces the emulator to execute in background memory. It is set by either the LDEFIB signal or the presence of a break. This causes jam flip-flop U6E and gate U6D to produce LJAM, which forces the emulation processor into a software interrupt (SWI opcode). The processor status is pushed onto its stack as the processor enters the background state.

8-60. The emulator is released from the background state by flip-flop U6F when the last cycle of the opcode occurs and LEA10 goes low, indicating execution of an opcode at an address greater than 0400H. Background memory above 0400H is loaded with the RTI opcode (return to interrupt) and causes the processor to continue operation from the SWI point.

8-61. There are times when the emulator is executing in background that a memory access must be made to the user memory; such as when memory display is requested by the user. To do this, the background routine issues a write to a background address greater than 0400H. Gate U5G detects this by looking at the HREAD (pod), and LEA10 lines. When detected, user memory operation flip-flop U6F is set and the lower four data bits of the write are loaded into user memory operation counter U4M. When the counter reaches terminal count, the HFGMEM signal is enabled for one cycle, allowing the access to user memory. The emulator immediately returns to background after the operation.

8-62. POD INTERFACE AND OPCODE MONITOR, SCHEMATIC 7.

8-63. This circuitry includes control bit buffer/drivers, pod option bus, status bus, pod identification bus, and the opcode monitor logic. It allows operating information to be passed between the pod and controller, for the controller to monitor the opcodes being executed by the emulator processor.

8-64. CONTROL BIT BUFFER/DRIVERS, SCHEMATIC 7.

8-65. Chips U2A and U2B drive and receive several control bits that are transferred between the controller and the attached pod. Each of the signals is explained in the table of mnemonics, table 8-2.

8-66. OPCODE MONITOR LOGIC, SCHEMATIC 7.

8-67. Latch U2I latches each opcode read by the emulator pod. The outputs of the latch directly drive the address lines the 2K x 8 bit opcode monitor ROM U2J. The ROM data lines are always enabled and feed the opcode cycle counter U2L and the opcode status bit selector U1J.

8-68. The ROM data bits indicate if the opcode is a valid or not. This includes checking whether the opcode is valid for the 6805 microcomputer being emulated. Not all opcodes are valid for all versions of the 6805. When the opcode is valid, the ROM data bits also load the cycle counter with the number of machine cycles in the opcode. The counter then counts to terminal count which is the HLASTCYCLE line, which tells the controller the opcode is about to be finished.

8-69. The opcode status bit selector gates the opcode status bit from the opcode ROM through to the emulation bus, where it can be read by an attached software analyzer. The bit, LES2, indicates whether the opcode is a read or write, etc.

8-70. Flip-flop U5E detects when the emulator is in foreground memory and drives an input to AND gate U2M. The gate then generates the LANAL signal when the pod is accessing memory. Signal LANAL tells an attached analyzer that the emulation bus has valid information on it.

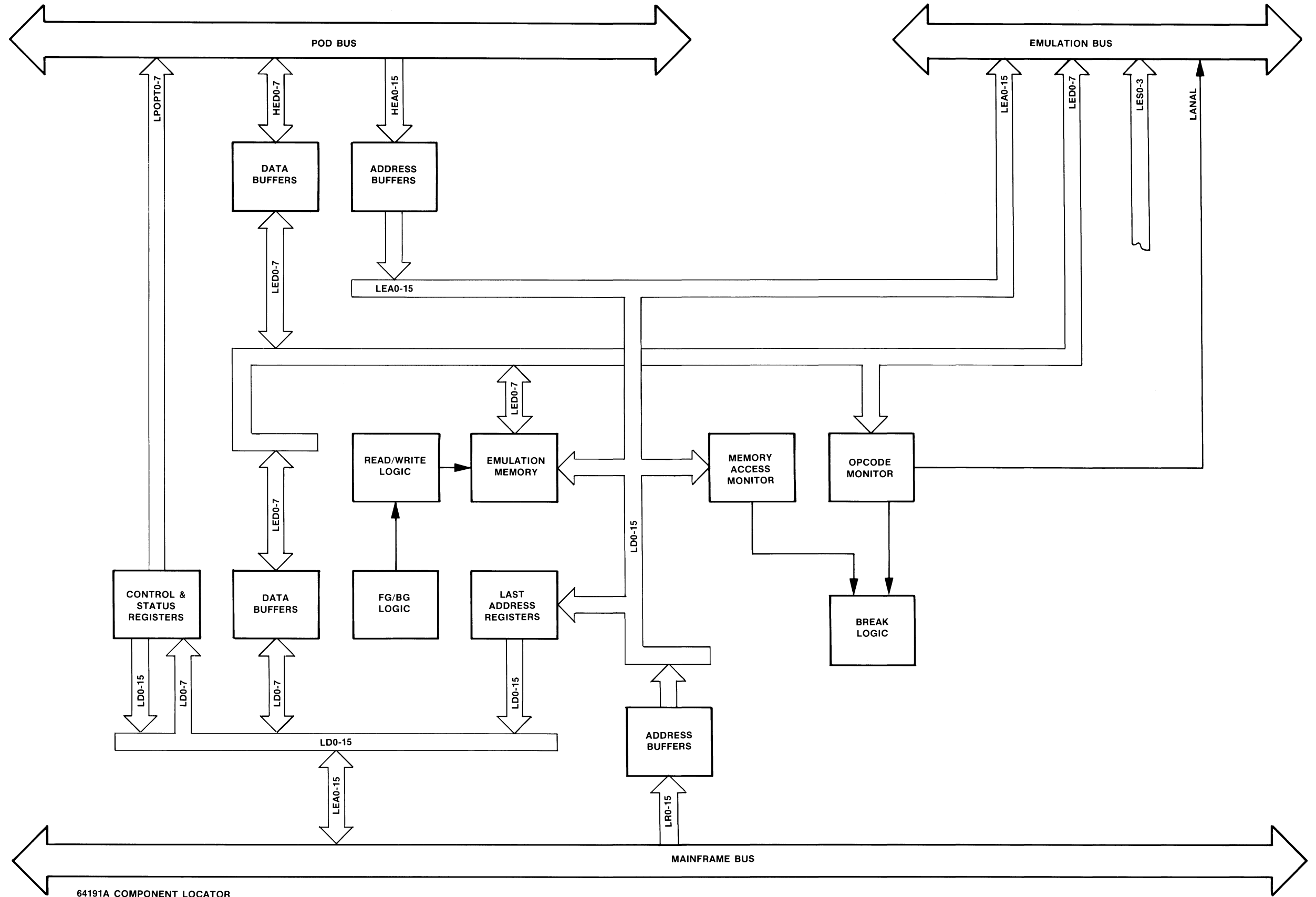

64191A COMPONENT LOCATOR

Figure 8-2. Emulator Controller Block Diagram

Table 8-1. Connector Signals

Connector P1		Connector J1	Connector J2	Connector J3	Connector J4
Schematic 1		Schematic 4	Schematic 7	Schematic 4	Schematic 7
Pin		Pin	Pin	Pin	Pin
1	gnd	1	LBRK	1	LEA0
2	gnd	2	not used	2	gnd
3	+5 v	3	HEA14	3	LEA1
4	+5 v	4	gnd	4	gnd
5	-5.2 v	5	HEA13	5	LEA2
6	-5.2 v	6	gnd	6	gnd
7	-5.2 v	7	HEA12	7	LEA3
8	-5.2 v	8	gnd	8	gnd
9	-3.2 v	9	HEA11	9	LEA4
10	-3.2 v	10	gnd	10	gnd
11	-12 v	11	HEA10	11	LEA5
12	-12 v	12	gnd	12	gnd
13	+12 v	13	HEA9	13	LEA6
14	+12 v	14	gnd	14	gnd
15	+17 v-ret	15	HEA8	15	LEA7
16	+17 v	16	gnd	16	gnd
17	+40 v	17	HEA7	17	LEA8
18	not used	18	gnd	18	gnd
19	LA0	19	HEA6	19	LEA9
20	LA1	20	gnd	20	gnd
21	LA2	21	HEA5	21	LEA10
22	LA3	22	gnd	22	gnd
23	LA4	23	HEA4	23	LEA11
24	LA5	24	gnd	24	gnd
25	LA6	25	HEA3	25	LEA12
26	LA7	26	gnd	26	gnd
27	LA8	27	HEA2	27	LEA13
28	LA9	28	gnd	28	gnd
29	LA10	29	HEA1	29	LEA14
30	LA11	30	gnd	30	gnd
31	LA12	31	HEA0	31	LEA15
32	LA13	32	gnd	32	gnd
33	LA14	33	HED7	33	LEA16
34	LA15	34	gnd	34	LEA20
35	SGND	35	HED6	35	LEA17
36	SGND	36	gnd	36	LEA21
37	LD0	37	HED5	37	LEA18
38	LD1	38	gnd	38	LEA22
39	LD2	39	HED4	39	LEA19
40	LD3	40	gnd	40	LEA23
41	LD4	41	HED3	41	HMAV
42	LD5	42	gnd	42	gnd
43	LD6	43	HED2	43	HREADY
44	LD7	44	gnd	44	gnd
45	LD8	45	HED1	45	LEWRT
46	LD9	46	gnd	46	gnd
47	LD10	47	HED0	47	LWDV
48	LD11	48	gnd	48	gnd
49	LD12	49	not used	49	HUSER
50	LD13	50	-5.2 v	50	gnd
51	LD14				
52	LD15				
	To Development Station	To Emulator Pod	To Internal Analyzer	To Emulator Pod	To Internal Analyzer

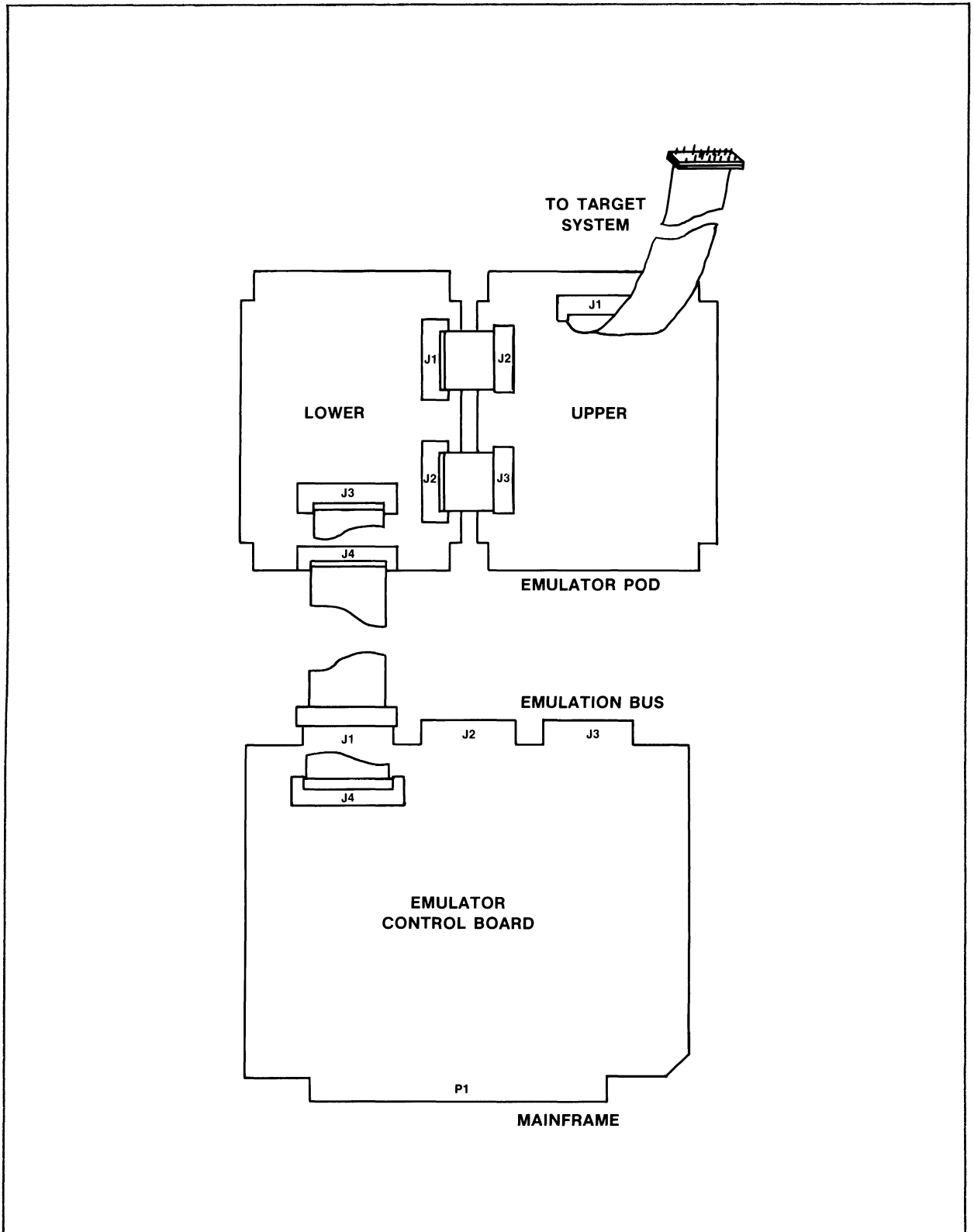

Figure 8-3. Connector Diagram

Table 8-2. Mnemonics

Mnemonic	Description
BLMEM	<p>Buffered Low Memory (pod).                      Clock from pod processor. When low, address lines contain valid address. When high, data lines contain valid data. See also LMEM and HMEM.                      Schematics 2, 5, 6, 7*.</p>
HBG	<p>High Background.                      Indicates the emulator is executing in background memory. It is the complementary signal of HFG.                      Schematics 5, 6*.</p>
HBGMEM	<p>High Background Memory.                      Indicates the memory access is to background memory. It is inverted LBGMEM.                      Schematics 2, 6*.</p>
HBPC	<p>High BPC.                      Indicates the development station is accessing controller memory. It is inverted LBPC.                      Schematics 1, 2*, 3, 4.</p>
HBRKREG	<p>High Break Register.                      On rising edge, clocks the break register; latches break option bits sent by the development station.                      Schematics 1, 2*.</p>
HDEFIB	<p>High Defibrillate.                      Inverted LDEFIB; passed to attached pod to initialize it to a known state.                      Schematic 7.</p>
HFG	<p>High Foreground.                      Indicates the emulator is executing in foreground memory. It is inverted LFG.                      Schematics 1, 6*, 7.</p>
HFGMEM	<p>High Foreground Memory.                      Indicates the memory access is to foreground memory.                      Schematics 3, 5, 6*, 7.</p>
<p>* indicates signal source.</p>	



Table 8-2. Mnemonics (Cont'd)

Mnemonic	Description
HGUARD	High Guarded Memory. Indicates an attempt by the emulator processor to access memory beyond limits of the microcomputer being emulated. When low, the access is within valid memory range. Schematics 4*, 5.
HINT	High Internal Memory. Indicates the emulator processor is accessing the foreground memory above address 63, ie., memory internal to the controller. When low, indicates an access to foreground memory below 64, ie, on-chip user memory. Schematics 3, 4*, 5.
HLASTCYCLE	High Last Cycle. Indicates the emulator processor is executing the last machine cycle of an opcode. Complementary signal to LLASTCYCLE. Schematics 2, 6, 7*.
HMEM	High Memory (pod). Clock from pod processor. When high, address lines contain valid address. When high, data lines contain valid data. it is inverted LMEM. See also BLMEM. Schematics 5, 6, 7*.
HMEMBRK	High Memory Break. Control bit from development station; initializes break logic to stop the emulator when an illegal memory operation occurs. Schematics 1*, 5.
HMR	High Memory Request. Indicates the development station wants to access controller memory. It can be tested on TP 5, HMR. Schematic 2.
HOPFETCH	High Opcode Fetch. Indicates the emulator processor is fetching an opcode from memory. Schematics 5, 6, 7*.
HOPTREG	High Pod Option Register. On rising edge, clocks the pod option register; latches pod option bits sent by the development station. Schematics 1, 2*.
* indicates signal source.	

Table 8-2. Mnemonics (Cont'd)

Mnemonic	Description
HPORTWRT	<p>High Port Write.                      Indicates the emulator processor is writing to an address less than 16, ie., port/timer on-chip addresses.                      Schematics 2*, 6.</p>
HPWRT	<p>High Pod Write.                      Indicates the emulator processor is writing to memory.                      Schematic 2.</p>
HRAM	<p>High RAM.                      Indicates the emulator processor is accessing memory that is mapped as RAM. When low, indicates the access is that is mapped as ROM.                      Schematics 2, 4*, 5.</p>
HREAD	<p>High Read (pod).                      Indicates the emulator processor is reading data. It is derived from the LREAD line.                      Schematics 2, 3, 5, 6, 7*.</p>
HSTATCLK	<p>High Status Register Clock.                      On rising edge, clocks the emulator status register; latches status bits to be read by the development station.                      Schematics 1, 6*.</p>
HTIMER	<p>High Timer.                      Signal directly from user target system plug. Enables timer circuitry on the pod to count. It is used on the controller as a bit to indicate timer status.                      Schematics 1, 7*.</p>
HUSER	<p>High User.                      Indicates an emulator processor access to memory below 16. It is inverted LUSER. Can be tested on TP2, USER.                      Schematic 7.</p>
LA0-15	<p>Low Address Bus 0-15.                      Address bus from the development station processor.                      Uses negative logic; high = 0, low = 1.                      Schematic 1.</p>
<p>* indicates signal source.</p>	

Table 8-2. Mnemonics (Cont'd)

Mnemonics	Description
LA0	<p>Low Address Line 0.            Address line from development station. It is decoded to determine the controller memory register being accessed. Uses negative logic; high = 0, low = 1.            Schematics 1*, 2.</p>
LA1	<p>Low Address Line 1.            Address line from development station. It is decoded to determine the controller register being accessed. Uses negative logic; high = 0, low = 1.            Schematics 1*, 2.</p>
LA12	<p>Low Address Line 12.            Address line from development station. It is decoded to determine if foreground or background memory is being accessed. Uses negative logic; high = 0, low = 1.            Schematics 1*, 2.</p>
LA13	<p>Low Address Line 13.            Address line from development station. It is decoded to determine if the controller registers are being accessed.            Schematics 1*, 2, 3.</p>
LADDREG	<p>Low Address Register.            Enables last-address register to drive LD0-15 data bus.            Schematics 2*, 5.</p>
LANAL	<p>Low Analysis.            Indicates to an attached internal analyzer option card that the emulation bus contains valid emulation information.            Schematic 7.</p>
LBADOPC	<p>Low Bad Opcode.            Indicates an invalid opcode has been detected.            Schematics 5, 7*.</p>
LBGMEM	<p>Low Background Memory.            Indicates the memory access is to background memory. See also HBGMEM.            Schematics 3, 6*.</p>
<p>* indicates signal source.</p>	

Table 8-2. Mnemonics (Cont'd)

Mnemonics	Description
LBPC	<p>Low BPC.                      Indicates the development station is accessing controller memory.                      When inverted, produces HBPC. It can be tested on TP1, BPC.                      Schematics 1, 2*, 3, 5.</p>
LBPCBRK	<p>Low BPC break.                      Signal from development station that forces the emulator                      processor into background memory.                      Schematics 1*, 5.</p>
LBREAK	<p>Low Break.                      Indicates an emulation break has occurred.                      Schematics 5*, 6.</p>
LD0-15	<p>Low Data Bus 0-15.                      Bidirectional data bus between the controller and the development                      station.                      Uses negative logic; high = 0, low = 1.                      Schematics 1*, 5*.</p>
LDATEIN	<p>Low Data In.                      Enables the development station to drive the LED0-7 data bus,                      ie., data comes into the controller.                      Schematics 1, 2*.</p>
LDATEOUT	<p>Low Data Out.                      Enables the emulator controller to drive the LED0-7 data bus,                      ie., data goes out of the controller.                      Schematics 1, 2*.</p>
LDEFIB	<p>Low Defibrillate.                      Signal from the development station that initializes the                      controller to a known state. When inverted, becomes HDEFIB.                      Schematics 1*, 2, 6, 7.</p>
LEA0-12	<p>Low Emulator Address Bus 0-12.                      Thirteen low order bits of LEA0-15. Determines address within 1K                      blocks of foreground and background memory.                      Uses negative logic; high = 0, low = 1.                      Schematics 3, 4*, 6.</p>
<p>* indicates signal source.</p>	

Table 8-2. Mnemonics (Cont'd)

Mnemonics	Descriptions
LEA0-15	<p>Low Emulator Address Bus 0-15.            Address lines used by the emulator processor. Can be monitored by attached internal analyzer option card. These lines can also be driven by the development station to access controller memory. Uses negative logic; high = 0, low = 1.            Schematics 1*, 4*, 5.</p>
LEBRK	<p>Low Emulator Break.            Indicates an internal analysis option card is requesting the emulator to stop running in foreground memory.            Schematics 5, 7*.</p>
LED0-3	<p>Low Emulator Data Bus 0-3.            Four low order bits of LED0-7. Used to load the user memory operation counter.            Schematics 1*, 3, 4, 6, 7.</p>
LED0-7	<p>Low Emulator Data Bus 0-7.            Data bus used by the emulator processor. Can be monitored by attached internal analyzer option card. These lines can also be driven by the development station.            Uses negative logic; high = 0, low = 1.            Schematics 1*, 3, 4*, 7.</p>
LEMID	<p>Low Emulator Identification.            Enables controller to drive the LD0-7 data bus with the controller and attached pod identification codes.            Schematics 1, 2*.</p>
LES0-3	<p>Low Emulator Status Bus 0-3.            Status bits made available to an attached internal analyzer option card; bit 0 = OPFETCH, 1 = LREAD, 2 = opcode status, 3 = opcode status.            Schematic 7.</p>
LES2	<p>Low Emulator Status Line 2.            Indicates opcode status.            Schematics 5, 7*.</p>
<p>* indicates signal source.</p>	

Table 8-2. Mnemonics (Cont'd)

Mnemonic	Description
LEXT	<p>Low External. Signal from development station; when low, selects external clock source on the users target system. When high, selects 4 MHz crystal located on the pod. Schematics 1*, 7.</p>
LFG	<p>Low Foreground. Indicates the emulator is executing in foreground memory. When inverted produces HFG. It is available on TP6, FG. Schematic 7.</p>
LICE	<p>Low In-circuit Emulation. Status bit from attached pod. Indicates target system plug is receiving +5v from user hardware. Schematics 1, 7*.</p>
LID	<p>Low Identification Request. Signal from development station; requests emulator identification be placed on the LDO-7 data bus. Also, see LEMID. Schematics 1*, 2.</p>
LILLMEM	<p>Low Illegal Memory. Indicates an error in addressing controller memory, such as a write to ROM-mapped memory or address out of range. Schematics 1, 5*.</p>
LILLOPC	<p>Low Illegal Opcode. Indicates the emulator processor has attempted to execute an illegal opcode. Schematics 1, 5*, 6.</p>
LIRQ	<p>Low Interrupt Request. Signal directly from target system plug; indicates the user hardware has issued an interrupt request. It is used by the controller as a bit to show processor status. Schematics 1, 7*</p>
LJAM	<p>Low Jam. Enables the controller to jam the software interrupt opcode SWI onto the data bus to the attached pod. It can be tested on TP4, JAM. Schematics 4, 5, 6*.</p>
	<p>* indicates signal source.</p>

Table 8-2. Mnemonics (Cont'd)

Mnemonics	Description
LLASTCYCLE	<p data-bbox="451 436 1492 558">Low Last Cycle. Indicates the emulator processor is executing the last machine cycle of an opcode. Complementary signal to HLASTCYCLE. Schematics 6, 7*.</p>
LMEM	<p data-bbox="451 657 1492 751">Low Memory (pod). Clock from pod processor. When low, address lines contain valid address. When high, data lines contain valid data. See also BLMEM and HMEM. It can be tested on TP3, LMEM. Schematics 5, 7*.</p>
LMEMMON	<p data-bbox="451 850 1492 924">Low Memory Monitor. Enables memory access monitor RAM to be loaded with data. Schematics 2*, 4.</p>
LMSYN	<p data-bbox="451 976 1492 1050">Low Memory Synchronization. Signal to development station; forces station to delay access to controller memory, until emulator processor has completed its memory access. Schematics 1, 2*.</p>
LNCLK	<p data-bbox="451 1165 1492 1239">Low No-clock. Indicates slow, or no clock, in the emulator pod. Schematics 1, 2*.</p>
LOPCBRK	<p data-bbox="451 1291 1492 1365">Low Opcode Break. Signal from development station that initializes controller break logic. Causes emulation break whenever an illegal opcode is found. Schematics 1*, 5.</p>
LOPCREG	<p data-bbox="451 1480 1492 1554">Low Opcode Register. Enables last-opcode register to drive the LD0-15 data bus; places the address of the last executed opcode on the bus. Schematics 2*, 5.</p>
LPODIN	<p data-bbox="451 1627 1492 1701">Low Pod Data In. Gates data from the attached pod onto the controller LED0-7 data bus. Schematics 4, 5*.</p>
<p data-bbox="451 1801 1492 1883">* indicates signal source.</p>	

Table 8-2. Mnemonics (Cont'd)

Mnemonics	Description
LPODOUT	<p>Low Pod Data Out. Gates data from the controller out to the attached pod. Schematics 4, 5*.</p>
LPOPT0-7	<p>Low Pod Option Bus 0-7. Option control bits from the development station. The controller passes the bits to the attached pod. Schematics 1*, 7.</p>
LPORTS	<p>Low Ports. Indicates the emulator processor is accessing memory in the range 0-15. These addresses are primarily for ports/timer. Schematics 2, 4*, 7.</p>
LPSTAT0-7	<p>Low Pod Status Bus 0-7. Indicate status of attached pod. The following bits have specific assigned names: 0 = LRESET, 1 = LIRQ, 2 = HTIMER, 7 = LICE. Some bits function depend upon the attached emulator. Uses negative logic; high = 0, low = 1. Schematics 1, 7*.</p>
LPSTAT3-6	<p>Low Pod Status Bus 3-6. Variable function bits showing pod status. See LPSTAT0-7. Uses negative logic; high = 0, low = 1. Schematics 1, 7*.</p>
LREAD	<p>Low Read. Indicates the emulator processor is reading data. When inverted, becomes HREAD. Schematic 7.</p>
LRESET	<p>Low Reset. Status bit from attached pod; indicates the emulator processor is reset. Schematics 1, 7*.</p>
LRESET1	<p>Low Reset 1. Derived from LRESET; resets user memory operation cycle counter, and illegal memory flip-flop. Schematics 5, 7*.</p>
<p>* indicates signal source.</p>	



Table 8-2. Mnemonics (Cont'd)

Mnemonics	Description
LROMBRK	<p>Low ROM Break. Signal from development station that initializes break logic. Whenever the emulator processor attempts to write to memory mapped as ROM, the emulator stops. Schematics 1*, 5.</p>
LSEL	<p>Low Select. Signal from development station; indicates the controller is selected. Schematics 1*, 2.</p>
LSTATREG	<p>Low Status Register. Enables emulator status buffer to drive the LD0-7 data bus, ie., the controller writes the status to the development station. Schematics 1, 2*, 6.</p>
LSTB	<p>Low Strobe. Signal from development station; when low and in the write mode, indicates station is driving LD0-15 data bus. When low and in the read mode, it indicates that the controller can drive the data bus. Schematics 1*, 2.</p>
LSTM	<p>Low Start Memory. Signal from the development station; indicates the station is driving the LD0-15 data bus. Schematics 1*, 2.</p>
LUSER	<p>Low User. Indicates an emulator processor access to memory below 63. When inverted it produces HUSER. Schematics 5*, 7.</p>
LWE	<p>Low Write Enable. Enables foreground and background memory to be written to. Can be tested on TP 7, WE. Schematics 2*, 3.</p>
LWRT	<p>Low Write. Signal from development station; indicates the station is attempting to write to controller memory.</p>
<p>* indicates signal source.</p>	

Table 8-2. Mnemonics (Cont'd)

Mnemonics	Description
PID0-3	Pod Identification Bus 0-3. Four bits that uniquely identify the attached emulator pod. Originates on the pod and is passed by the controller to the development station on the LD0-15 data bus. Schematics 1, 7*.

\* indicates signal source.

Table 8-3. Logic Symbols

**GENERAL**

All signals flow from left to right, relative to the symbol's orientation with inputs on the left side of the symbol, and outputs on the right side of the symbol (the symbol may be reversed if the dependency notation is a single term.)

All dependency notation is read from left to right (relative to the symbol's orientation).

An external state is the state of an input or output outside the logic symbol.

An internal state is the state of an input or output inside the logic symbol. All internal states are True = High.

**SYMBOL CONSTRUCTION**

Some symbols consist of an outline or combination of outlines together with one or more qualifying symbols, and the representation of input and output lines.

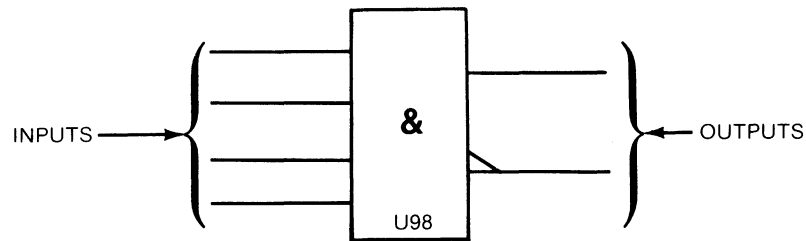

Some have a common Control Block with an array of elements:

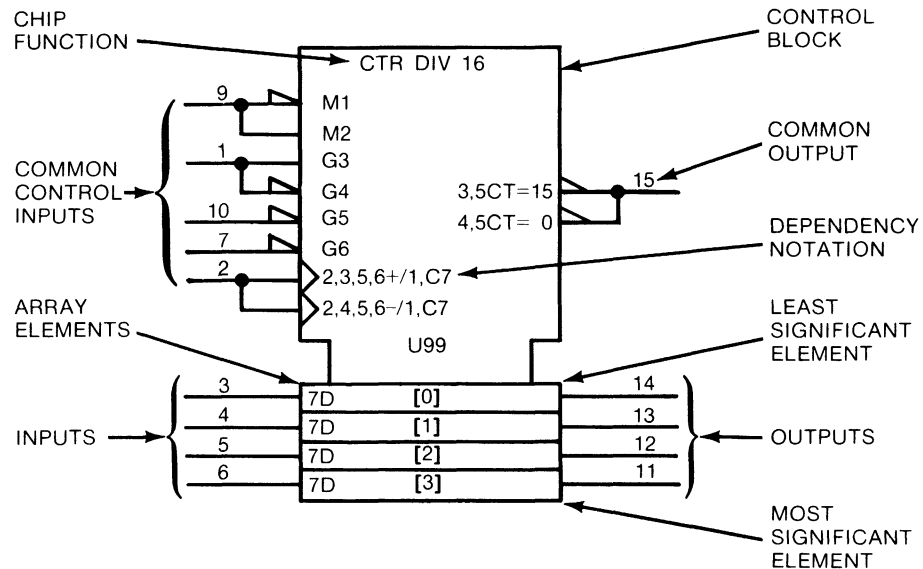

**CONTROL BLOCK** - All inputs and dependency notation affect the array elements directly. Common outputs are located in the control block. (Control blocks may be above or below the array elements.)

**ARRAY ELEMENTS** -All array elements are controlled by the control block as a function of the dependency notation. Any array element is independent of all other array elements. Unless indicated, the least significant element is always closest to the control block. The array elements are arranged by binary weight. The weights are indicated by powers of 2 (shown in [ ]).

Table 8-3. Logic Symbols (Cont'd)

**INPUTS** - Inputs are located on the left side of the symbol and are affected by their dependency notation.

Common control inputs are located in the control block and control the inputs/outputs to the array elements according to the dependency notation.

Inputs to the array elements are located with the corresponding array element with the least significant element closest to the control block.

**OUTPUTS** - Outputs are located on the right side of the symbol and are effected by their dependency notation.

Common control outputs are located in the control block.

Outputs of array elements are located in the corresponding array element with the least significant bit closest to the control block.

**CHIP FUNCTION** - The labels for chip functions are defined, i.e., CTR - counter, MUX - multiplexer.

**DEPENDENCY NOTATION**

Dependency notation is always read from left to right relative to the symbol's orientation.

Dependency notation indicates the relationship between inputs, outputs, or inputs and outputs. Signals having a common relationship will have a common number, i.e., C7 and 7D...C7 controls D. Dependency notation 2,3,5,6+/1,C7 is read as when 2 and 3 and 5 and 6 are true, the input will cause the counter to increment by one count....or (/) the input (C7) will control the loading of the input value (7D) into the D flip-flops.

The following types of dependencies are defined:

- a. AND (G), OR (V), and Negate (N) denote Boolean relationship between inputs and outputs in any combination.
- b. Interconnection (Z) indicates connections inside the symbol.
- c. Control (C) identifies a timing input or a clock input of a sequential element and indicates which inputs are controlled by it.
- d. Set (S) and Reset (R) specify the internal logic states (outputs) of an RS bistable element when the R or S input stands at its internal 1 state.
- e. Enable (EN) identifies an enable input and indicates which inputs and outputs are controlled by it (which outputs can be in their high impedance state).
- f. Mode (M) identifies an input that selects the mode of operation of an element and indicates the inputs and outputs depending on that mode.
- g. Address (A) identifies the address inputs.
- h. Transmission (X) identifies bi-directional inputs and outputs that are connected together when the transmission input is true.

**DEPENDENCY NOTATION SYMBOLS**

A	Address (selects inputs/outputs) (indicates binary range)	N	Negate (complements state)
C	Control (permits action)	R	Reset Input
EN	Enable (permits action)	S	Set Input
G	AND (permits action)	V	OR (permits action)
M	Mode (selects action)	Z	Interconnection
		X	Transmission

Table 8-3. Logic Symbols (Cont'd)

OTHER SYMBOLS		
	Analog Signal	
	AND	
	Bit Grouping	
	Buffer	
	Compare	
	Dynamic	$\geq 1$ OR
$\neq 1$	Exclusive OR	
	Hysteresis	
	Interrogation	
	Internal Connection	$\leftarrow$ Shift Left (or up)
		$\rightarrow$ Shift Right (or down)
		/ Solidus (allows an input or output to have more than one function)
		$\nabla$ Tri-State
		, Causes notation and symbols to effect inputs/outputs in an AND relationship, and to occur in the order read from left to right.
		( ) Used for factoring terms using algebraic techniques.
		[ ] Information not defined.
		$\Phi$ Logic symbol not defined due to complexity.
LABELS		
BG	Borrow Generate	CO
BI	Borrow Input	CP
BO	Borrow Output	CT
BP	Borrow Propagate	D
CG	Carry Generate	E
CI	Carry Input	F
		J
		K
		P
		T
		+
		-
		J
		K
		P
		T
		+
		-
		J
		K
		P
		T
		+
		-
		J
		K
		P
		T
		+
		-
MATH FUNCTIONS		
$\Sigma$	Adder	>
ALU	Arithmetic Logic Unit	<
COMP	Comparator	CPG
DIV	Divide By	$\pi$
=	Equal To	P-Q
		>
		<
		CPG
		$\pi$
		P-Q
		>
		<
		CPG
		$\pi$
		P-Q
CHIP FUNCTIONS		
BCD	Binary Coded Decimal	DIR
BIN	Binary	DMUX
BUF	Buffer	FF
CTR	Counter	MUX
DEC	Decimal	OCT
		RAM
		RCVR
		ROM
		SEG
		SRG
		DIR
		DMUX
		FF
		MUX
		OCT
		RAM
		RCVR
		ROM
		SEG
		SRG
DELAY and MULTIVIBRATORS		
	Astable	
	Delay	
	Nonretriggerable Monostable	
	Nonvolatile	
	Retriggerable Monostable	

Table 8-4. Schematic Diagram Notes









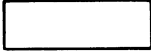
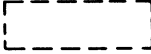

	ETCHED CIRCUIT BOARD	(925)	WIRE COLORS ARE GIVEN BY NUMBERS IN PARENTHESES USING THE RESISTOR COLOR CODE
	FRONT PANEL MARKING		[ (925) IS WHT-RED-GRN ]
	REAR-PANEL MARKING		0 - BLACK    5 - GREEN 1 - BROWN    6 - BLUE 2 - RED       7 - VIOLET 3 - ORANGE   8 - GRAY 4 - YELLOW   9 - WHITE
	MANUAL CONTROL		* OPTIMUM VALUE SELECTED AT FACTORY, TYPICAL VALUE SHOWN; PART MAY HAVE BEEN OMITTED.
	SCREWDRIVER ADJUSTMENT		
	ELECTRICAL TEST POINT TP (WITH NUMBER)		UNLESS OTHERWISE INDICATED: RESISTANCE IN OHMS CAPACITANCE IN PICO FARADS INDUCTANCE IN MICROHENRIES
	NUMBERED WAVEFORM NUMBER CORRESPONDS TO ELECTRICAL TEST POINT NO.	$\mu P$ = MICROPROCESSOR	
	LETTERED TEST POINT NO MEASUREMENT AID PROVIDED	P/O = PART OF	
	COMMON CONNECTIONS. ALL LIKE-DESIGNATED POINTS ARE CONNECTED.	NC = NO CONNECTION	
	NUMBER ON WHITE BACKGROUND = OFF-PAGE CONNECTION. LARGE NUMBER ADJACENT = SERVICE SHEET NUMBER FOR OFF-PAGE CONNECTION.	CW = CLOCKWISE END OF VARIABLE RESISTOR	
	CIRCLED LETTER = OFF-PAGE CONNECTION BETWEEN PAGES OF SAME SERVICE SHEET.		
	INDICATES SINGLE SIGNAL LINE		
	NUMBER OF LINES ON A BUS		
			

Table 8-5. IC To Schematic Cross-Reference

IC	Schematic	IC	Schematic
U1G	4	U5A	7
U1H	4	U5B	5
U1I	4	U5C	3
U1J	7	U5D	7
U1K	5	U5E	7
		U5F	2
U2A	7	U5G	6
U2B	4, 7	U5H	6
U2C	1	U5I	3
U2D	4	U5J	2
U2E	4	U5K	2
U2F	4	U5L	2
U2G	2	U5M	2, 5, 6
U2H	4	U5N	2
U2I	7		
U2J	7	U6A	2, 5
U2L	7	U6B	2, 5
U2M	5, 7	U6C	5
U2N	5	U6D	6, 7
		U6E	6, 7
U3A	3	U6F	6
U3C	3	U6G	6
U3D	3	U6H	2, 6
U3F	3	U6I	2, 6
U3H	3	U6J	2, 7
U3I	3	U6K	2
U3K	3	U6L	2
U3L	3	U6M	2
U3N	3		
U4A	1		
U4B	5		
U4C	5		
U4D	1		
U4E	1		
U4F	5		
U4G	5		
U4H	1		
U4I	1		
U4J	1		
U4K	1		
U4L	1		
U4M	6		
U4N	2, 3		

Service - Model 64191A



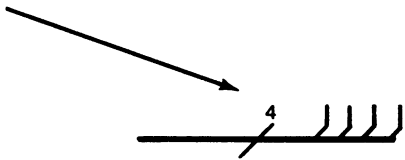
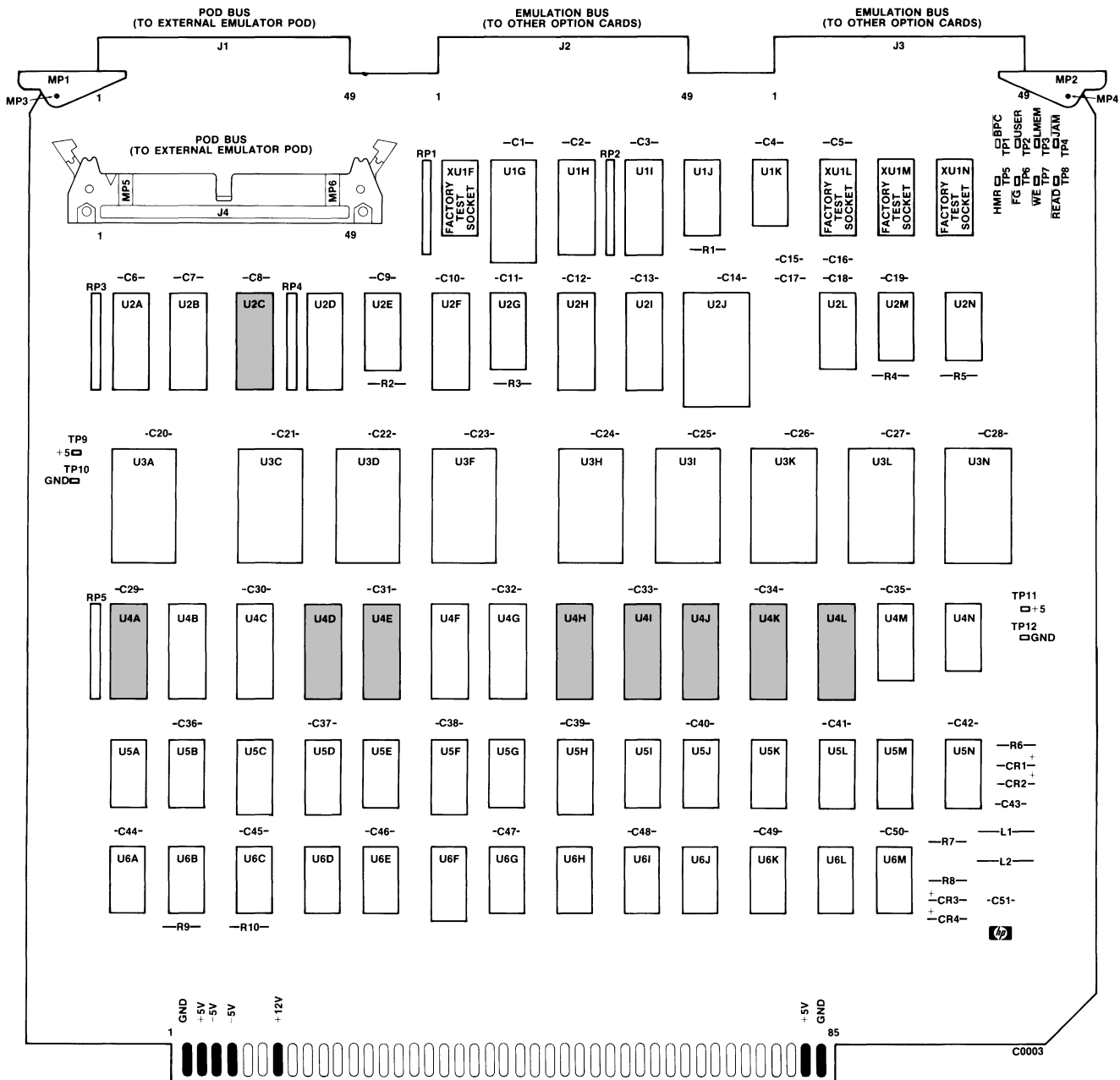

P/O 6805 EMULATOR CONTROLLER (64191-66501)  
DEVELOPMENT STATION INTERFACE

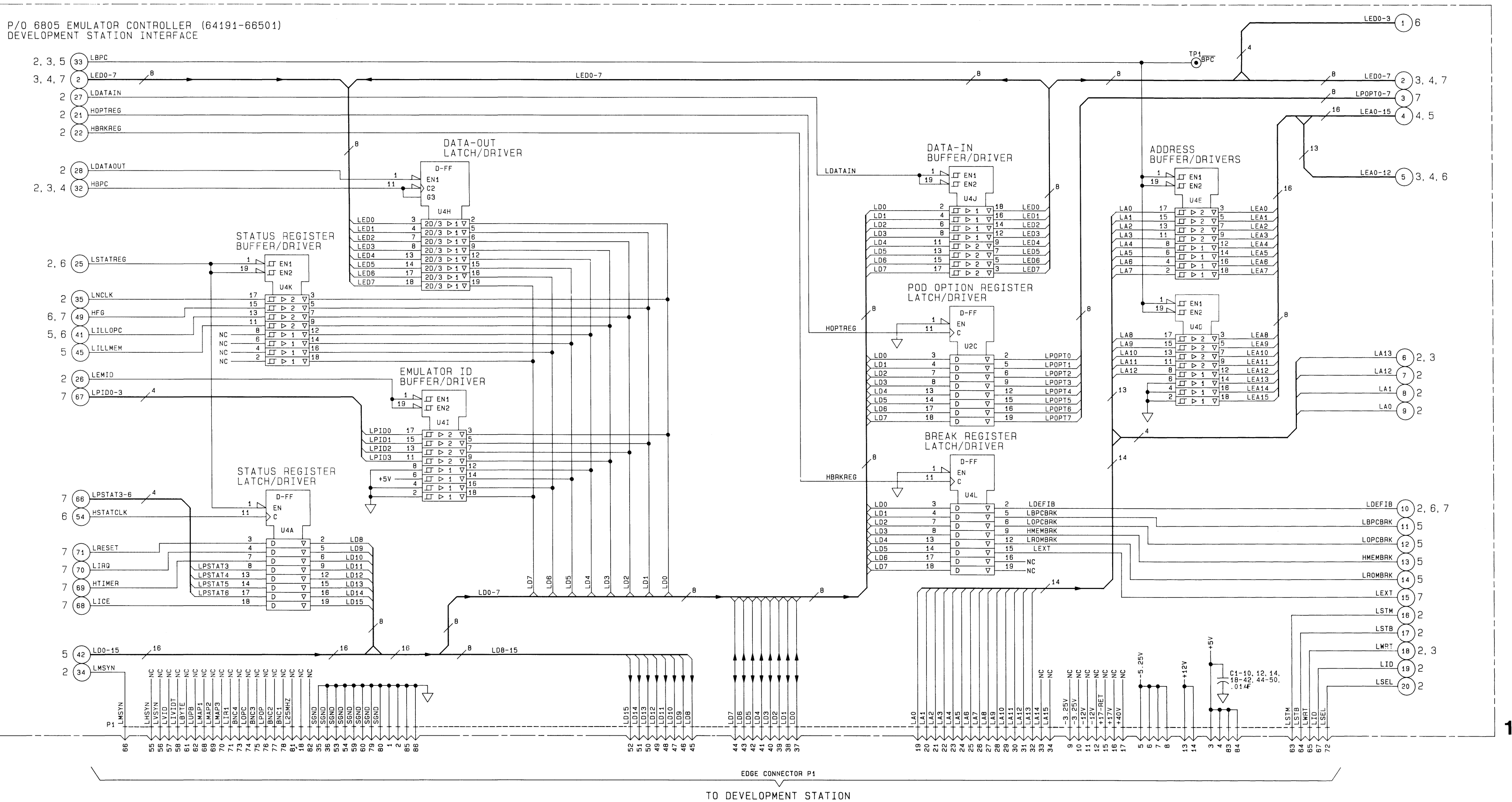

ICs On This Schematic

REF DES	HP PART NUMBER	MFG. PART NUMBER	+5V PIN	GND PIN
U2C	1820-1997	SN74LS374N	20	10
U4A	1820-1997	SN74LS374N	20	10
U4D	1820-2024	SN74LS244N	20	10
U4E	1820-2024	SN74LS244N	20	10
U4H	1820-2102	SN74LS373N	20	10
U4I	1820-1917	SN74LS240N	20	10
U4J	1820-2024	SN74LS244N	20	10
U4K	1820-2024	SN74LS244N	20	10
U4L	1820-1997	SN74LS374N	20	10

Parts On This Schematic

C1-10,12,14,15,18-42,44-50.

Figure 8-4. Schematic 1  
Development Station Interface  
8-29

Service - Model 64191A

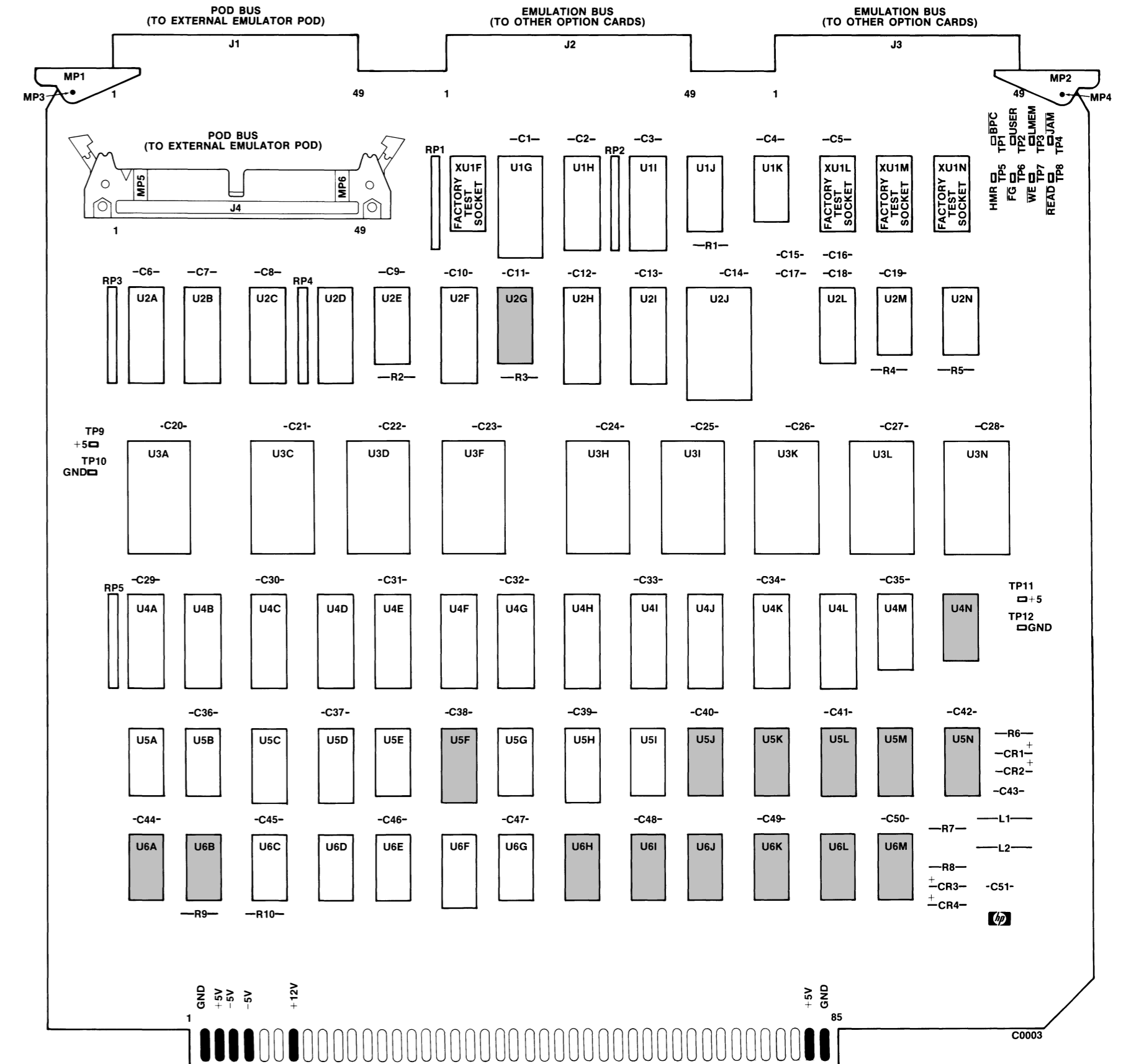

Component Locator

ICs On This Schematic

REF. DES	HP PART NUMBER	MFG. PART NUMBER	+5V PIN	GND PIN
U2G	1820-1423	SN74LS123N	16	8
U4N	1820-1144	SN74LS02N	14	7
U5F	1820-1216	SN74LS138N	16	8
U5J	1820-1202	SN74LS10N	14	7
U5K	1820-1112	SN74LS74AN	14	7
U5L	1820-1197	SN74LS00N	14	7
U5M	1820-1199	SN74LS04N	14	7
U5N	1820-1307	SN74S132N	14	7
U6A	1820-1197	SN74LS00N	14	7
U6B	1820-1112	SN74LS74AN	14	7
U6H	1820-1144	SN74LS02N	14	7
U6I	1820-1202	SN74LS10N	14	7
U6J	1820-1199	SN74LS04N	14	7
U6K	1820-1274	SN74LS22N	14	7
U6L	1820-1144	SN74LS02N	14	7
U6M	1820-1285	SN74LS54N	14	7

Parts On This Schematic

C1,51,43.	L1,2.
CR1,2,3,4.	R3,6,7,8.

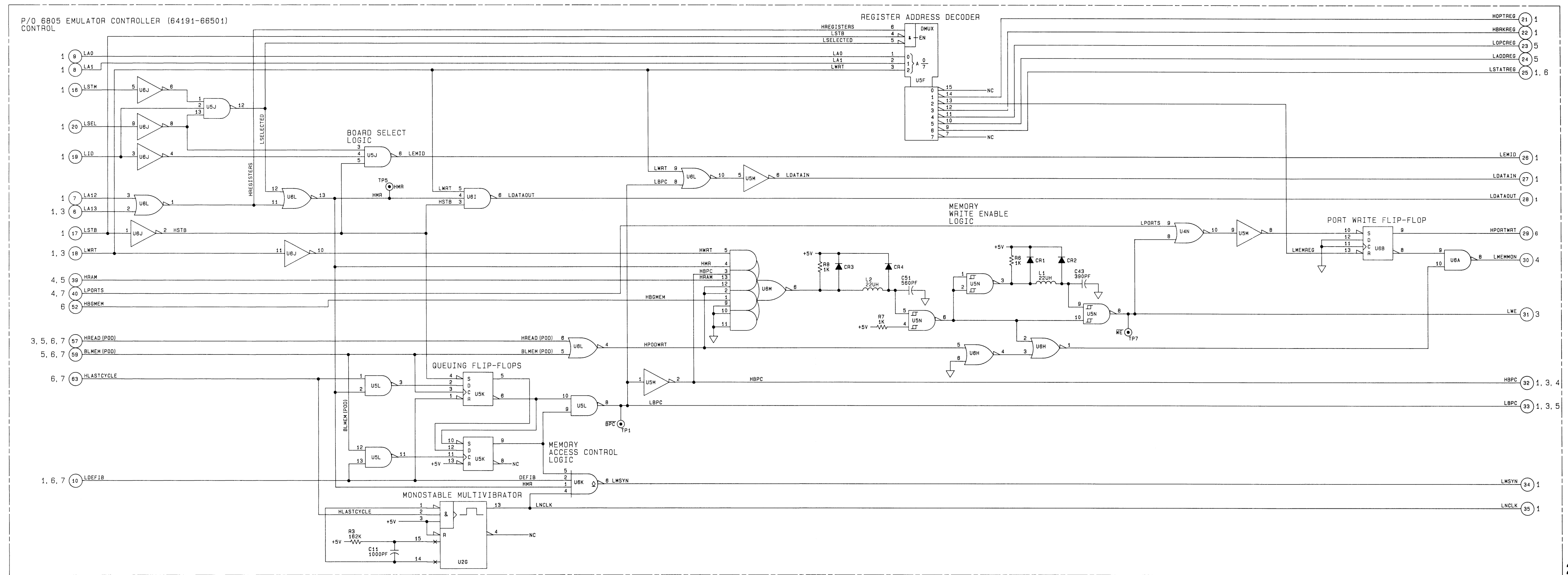
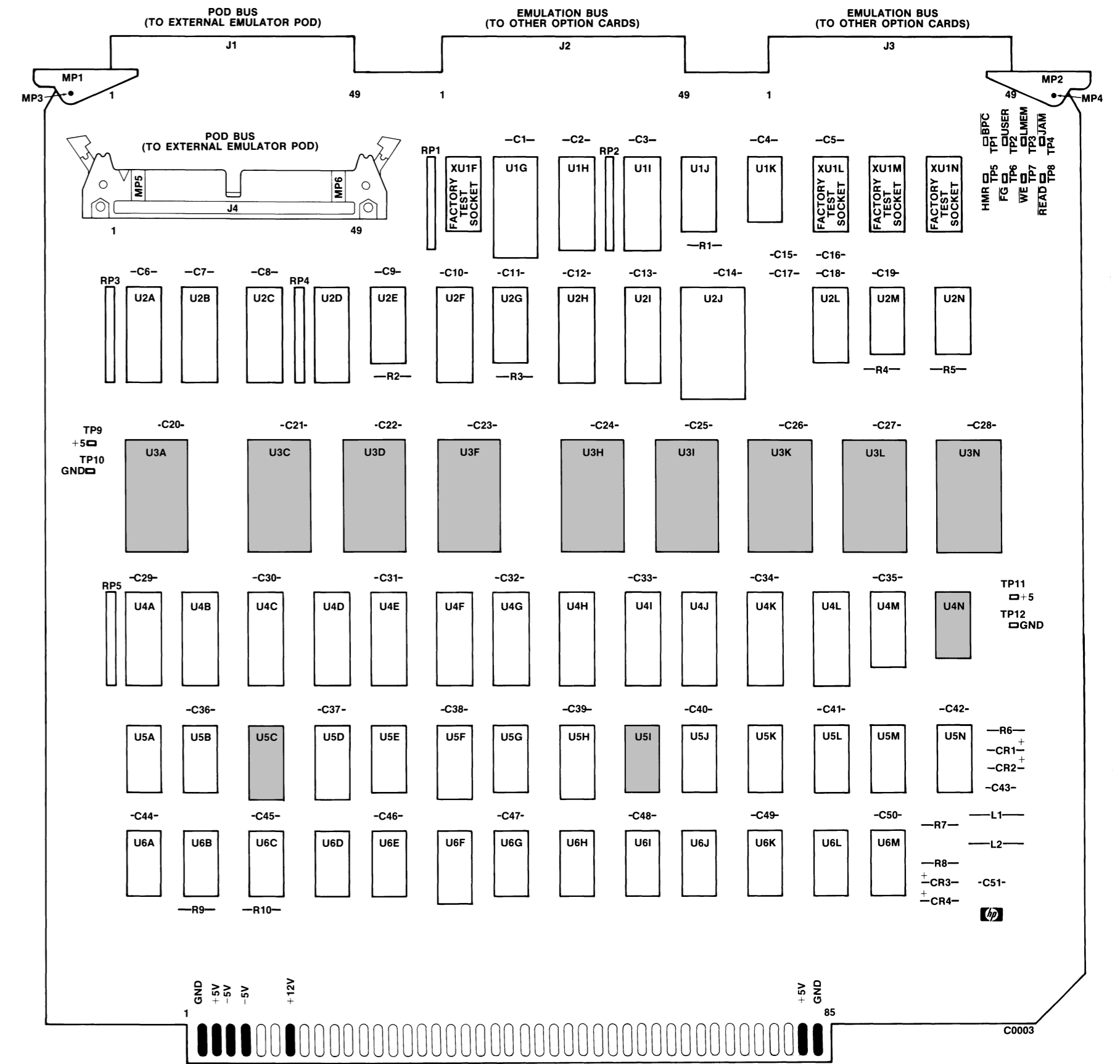
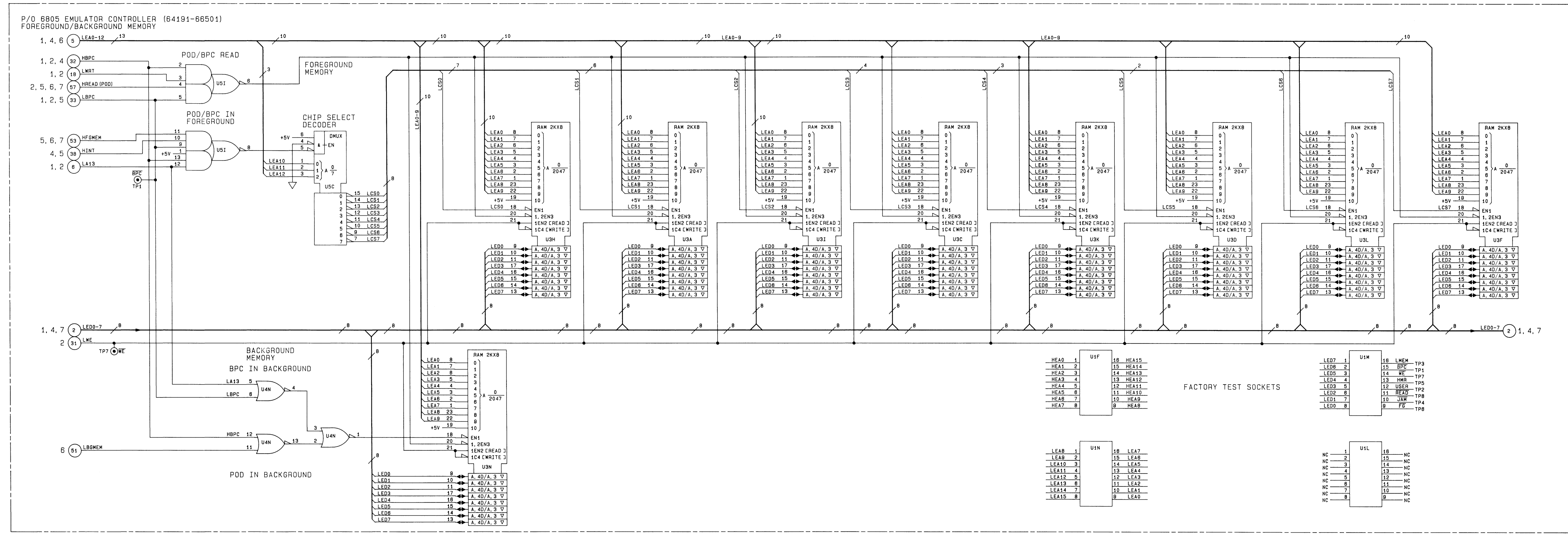

Figure 8-5. Schematic 2 Control 8-31



ICs On This Schematic

REF. DES	HP PART NUMBER	MFG. PART NUMBER	+5V PIN	GND PIN
U3A	1818-1611	HM6116P-3	24	12
U3C	1818-1611	HM6116P-3	24	12
U3D	1818-1611	HM6116P-3	24	12
U3F	1818-1611	HM6116P-3	24	12
U3H	1818-1611	HM6116P-3	24	12
U3I	1818-1611	HM6116P-3	24	12
U3K	1818-1611	HM6116P-3	24	12
U3L	1818-1611	HM6116P-3	24	12
U3N	1818-1611	HM6116P-3	24	12
U4N	1820-1144	SN74LS02N	14	7
U5C	1820-1216	SN74LS138N	16	8
U5I	1820-1210	SN74LS51N	14	7



3

Figure 8-6. Schematic 3  
Foreground/Background Memory  
8-33

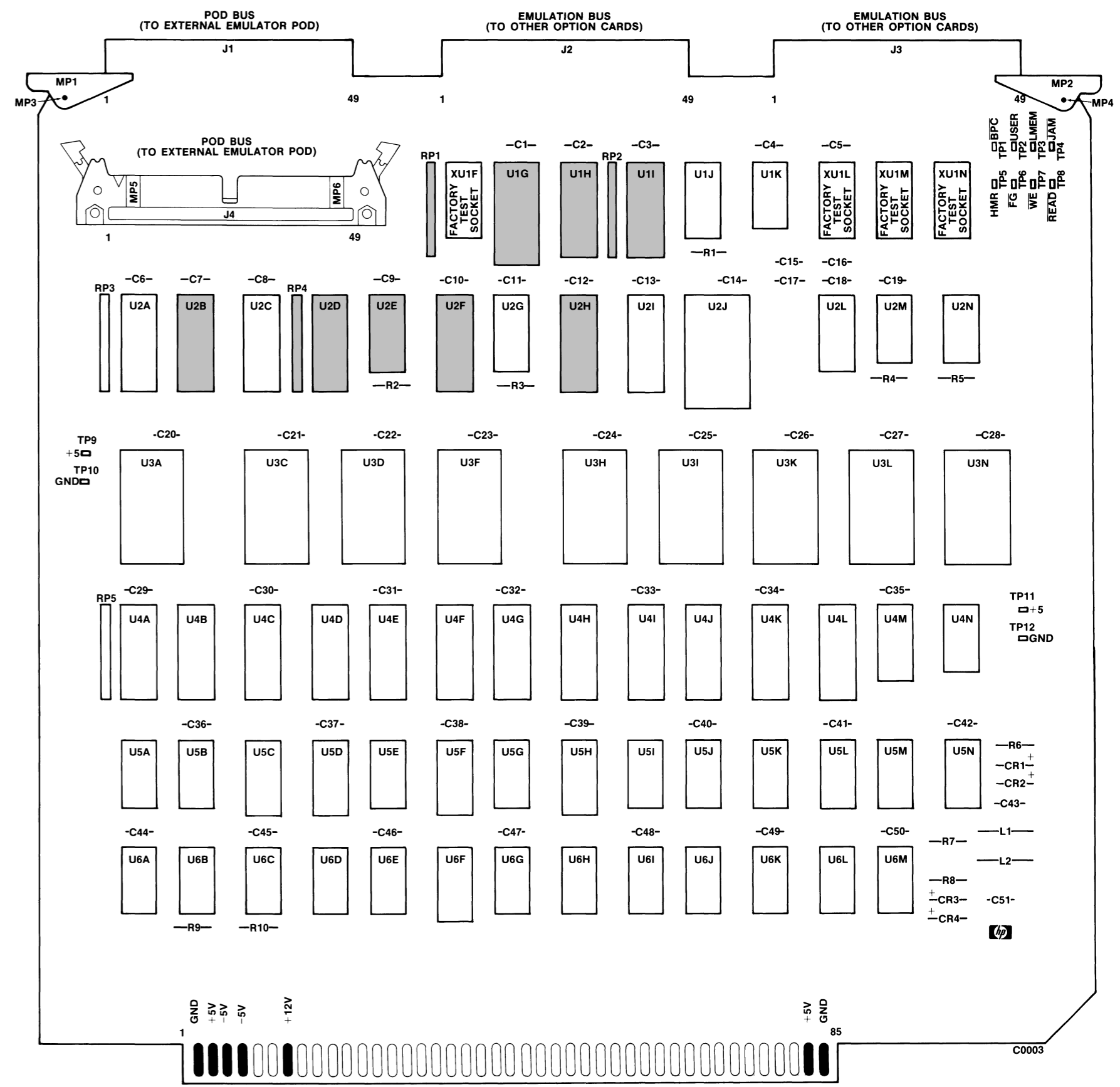

Component Locator

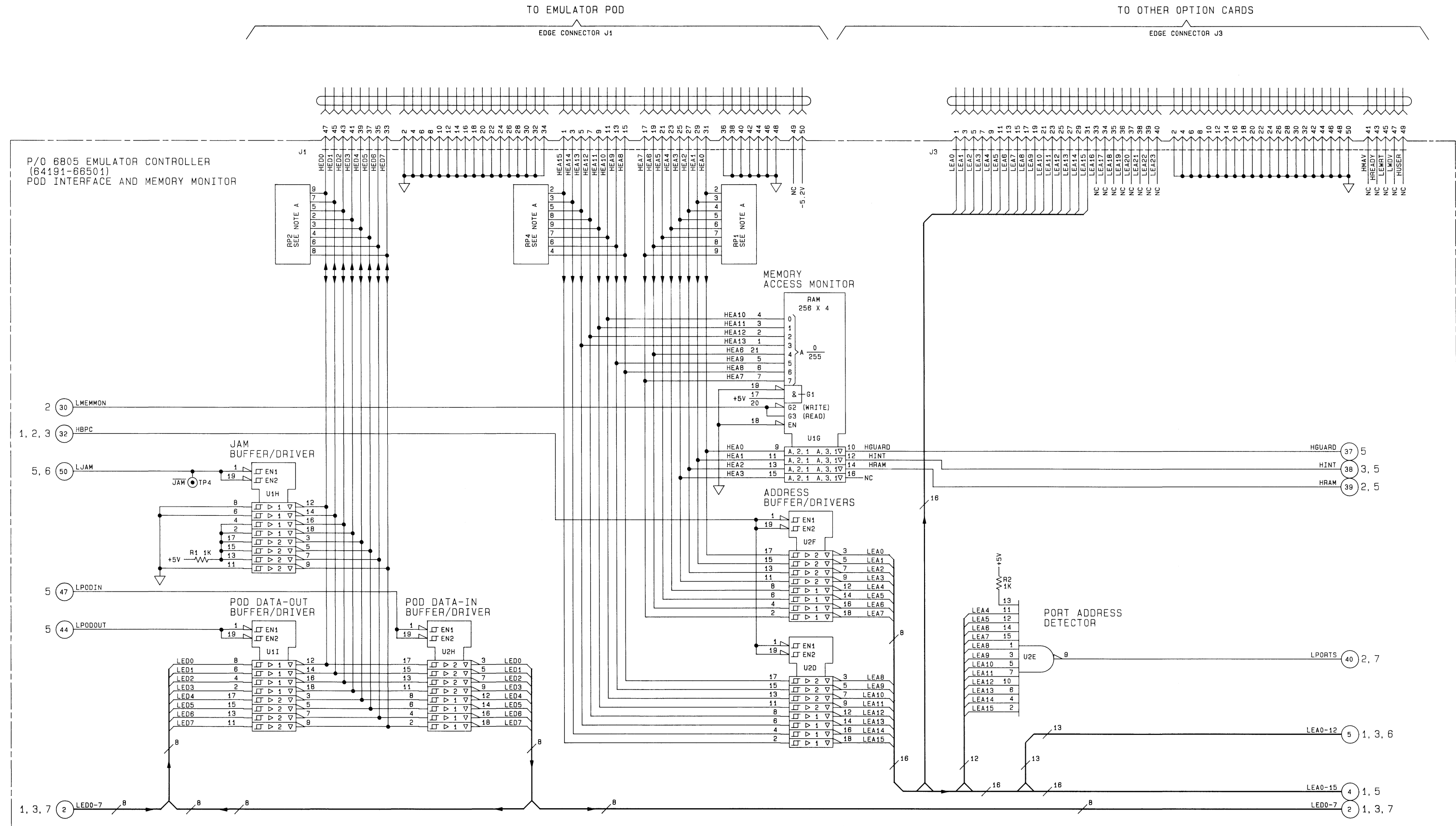

ICs On This Schematic

REF. DES	HP PART NUMBER	MFG. PART NUMBER	+5V PIN	GND PIN
U1G	1816-1308	93L422PC	22	8
U1H	1820-1633	SN74S240N	20	10
U1I	1820-1633	SN74S240N	20	10
U2B	1820-1633	SN74S240N	20	10
U2D	1820-1917	SN74LS240N	20	10
U2E	1820-1130	SN74S133N	16	8
U2F	1820-1917	SN74LS240N	20	10
U2H	1820-1917	SN74LS240N	20	10

Parts On This Schematic

R1,2.	RP1,2,4.
-------	----------

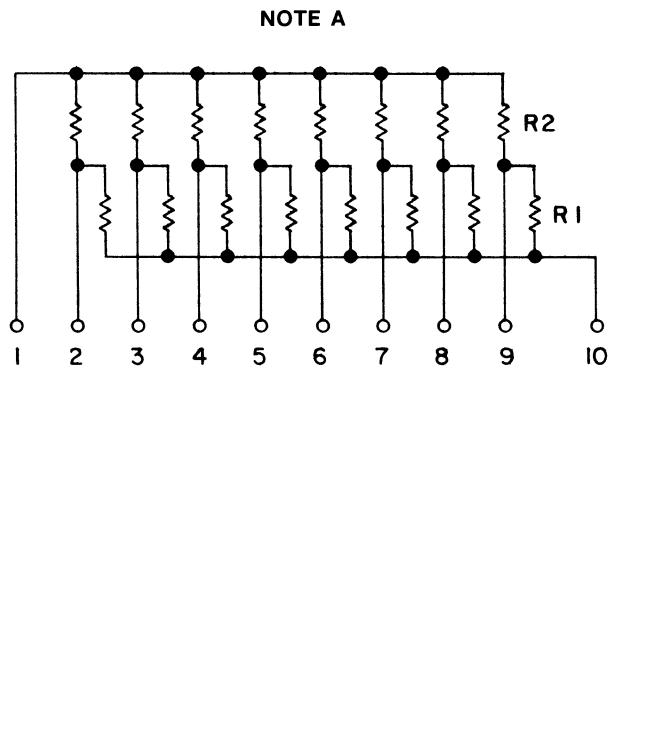

4

Figure 8-7. Service Sheet 4  
Pod Interface and Memory Monitor  
8-35

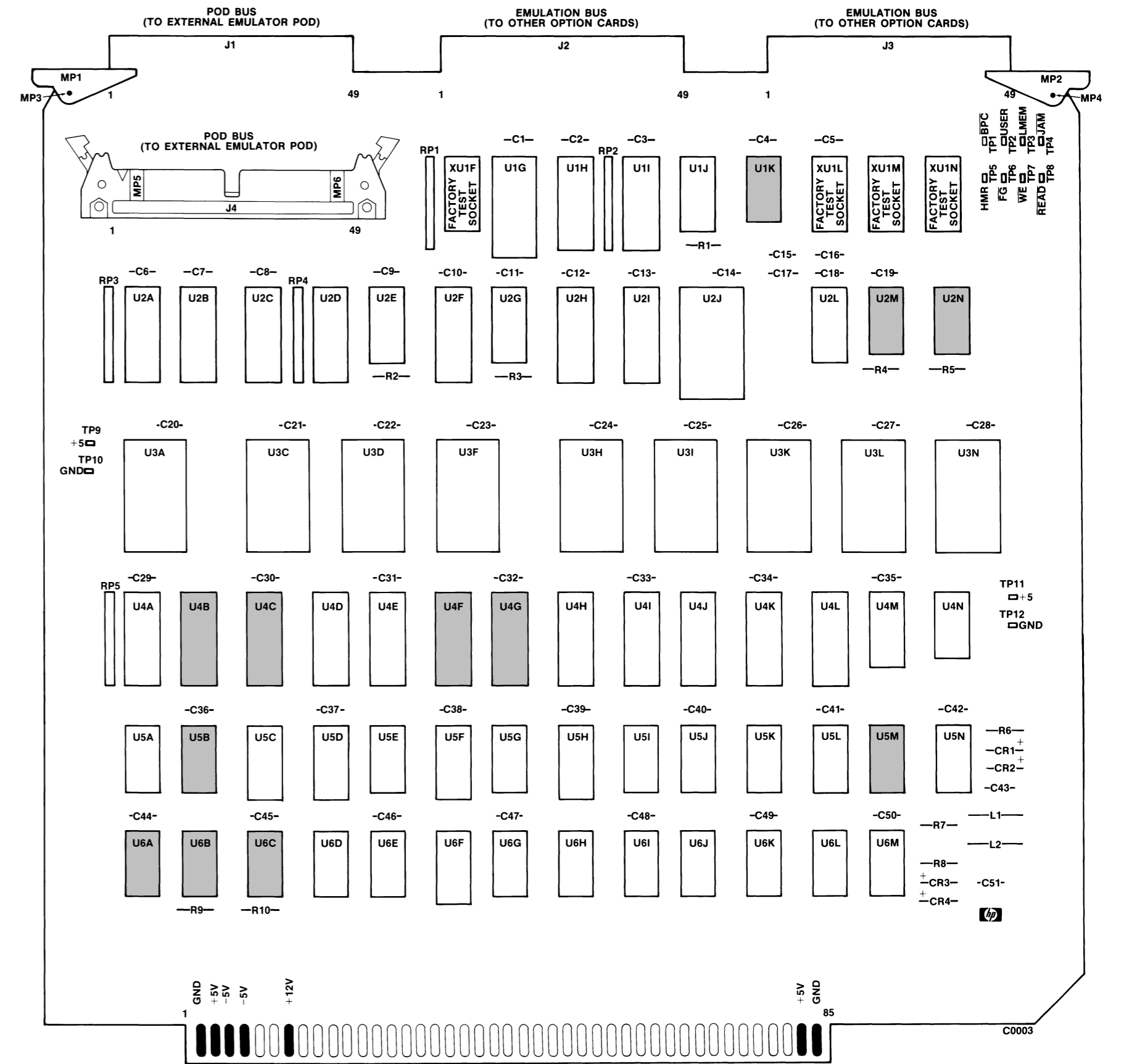

Component Locator



ICs On This Schematic

REF. DES	HP PART NUMBER	MFG. PART NUMBER	+5V PIN	GND PIN
U1K	1820-1202	SN74LS10N	14	7
U2M	1820-0686	SN74S11N	14	7
U2N	1820-1205	SN74LS21N	14	7
U4B	1820-1997	SN74LS374N	20	10
U4C	1820-1997	SN74LS374N	20	10
U4F	1820-1997	SN74LS374N	20	10
U4G	1820-1997	SN74LS374N	20	10
U5B	1820-1206	SN74LS27N	14	7
U5M	1820-1199	SN74LS04N	14	7
U6A	1820-1197	SN74LS00N	14	7
U6B	1820-1112	SN74LS74AN	14	7
U6C	1820-1112	SN74LS74AN	14	7

Parts On This Schematic

R4,9,10.

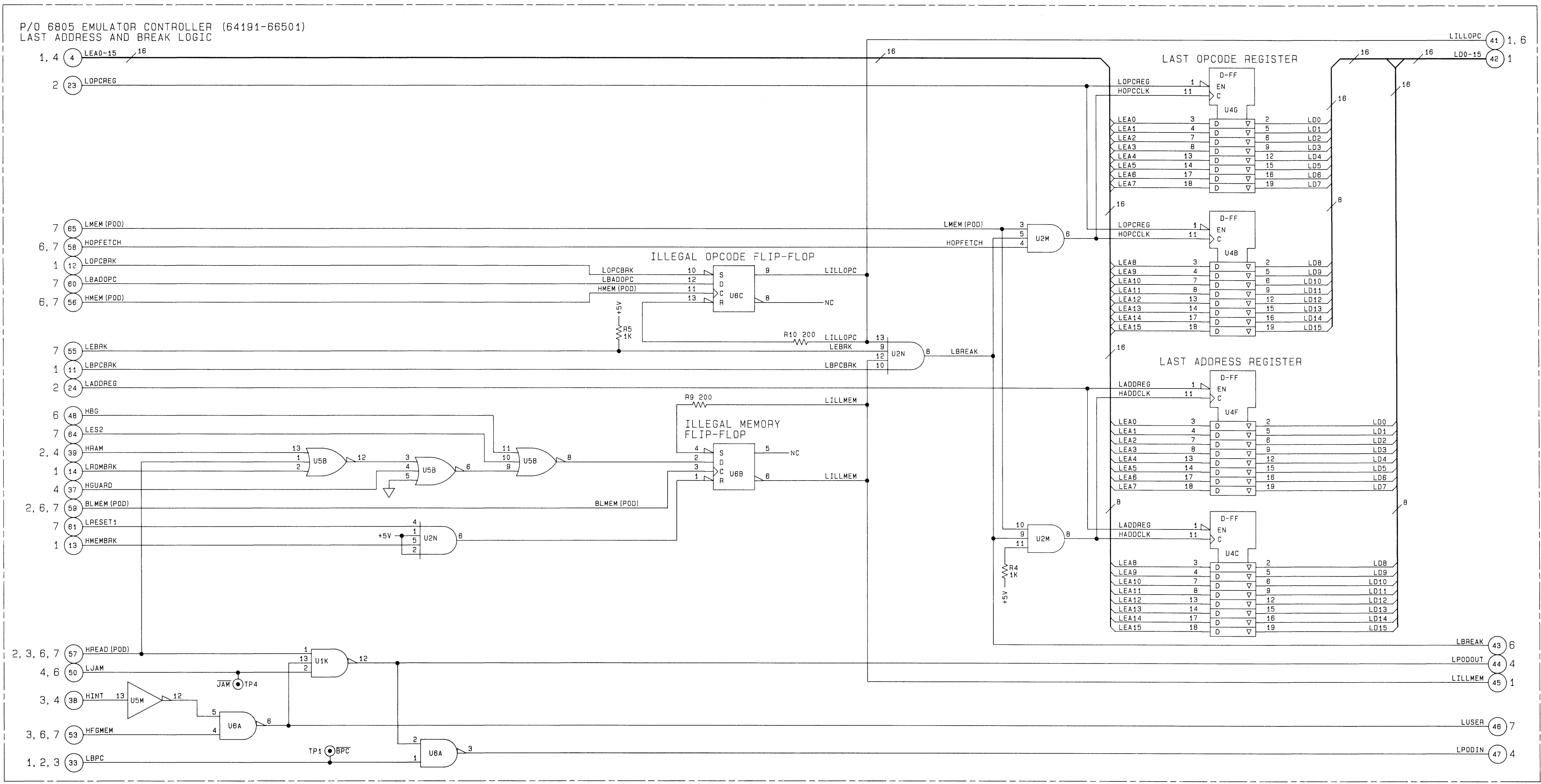

5

Figure 8-8. Schematic 5  
Last Address and Break Logic  
8-37

Service - Model 64191A

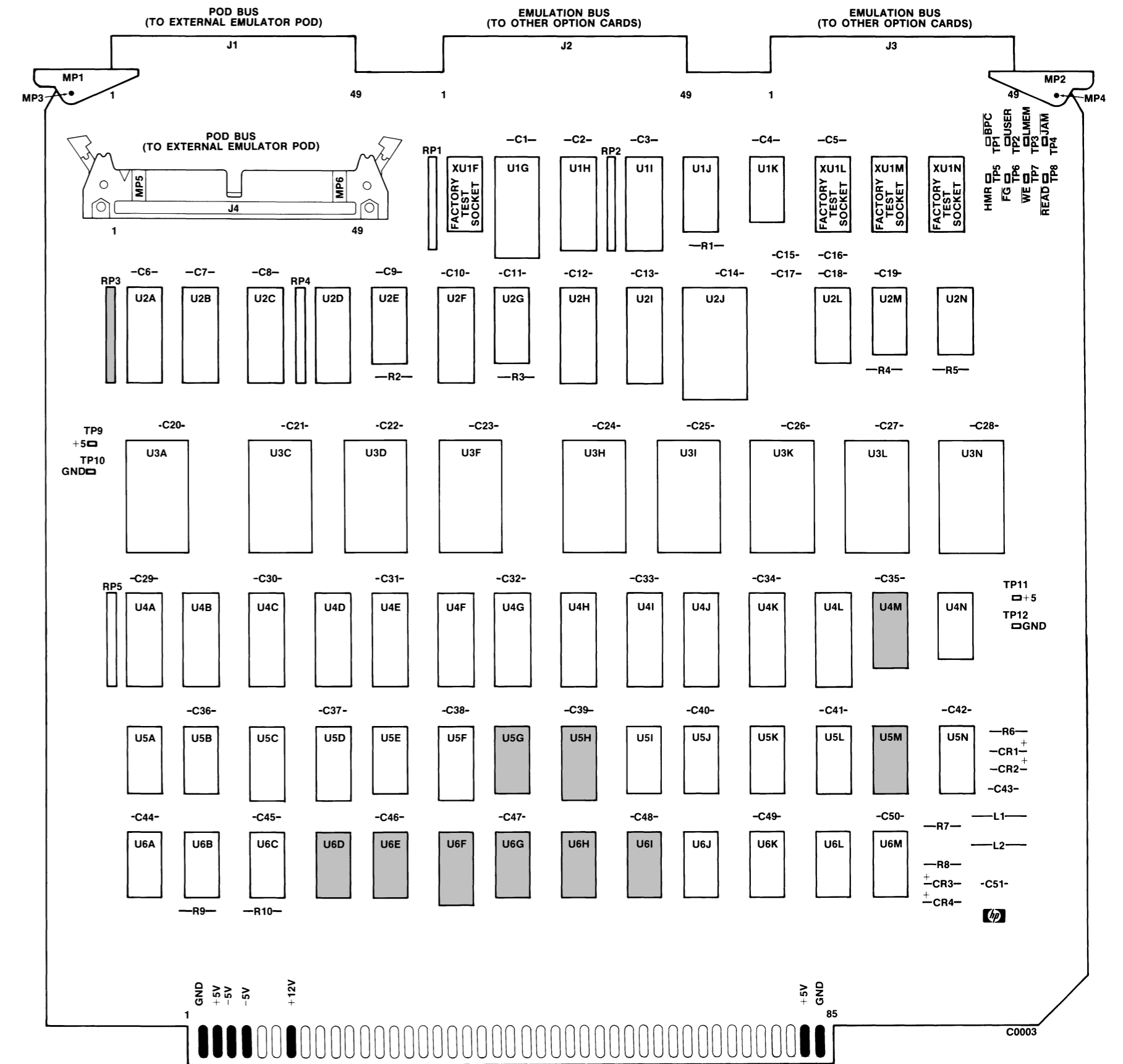

Component Locator

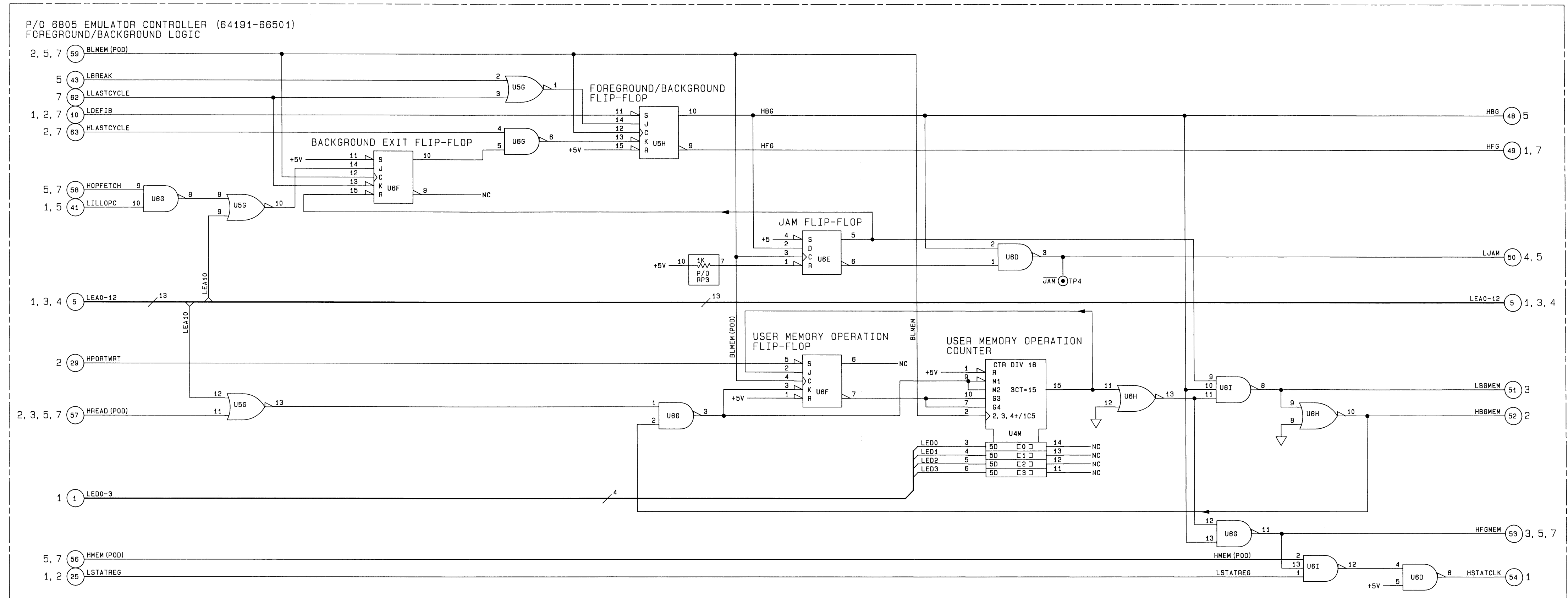

ICs On This Schematic

REF. DES	HP PART NUMBER	MFG. PART NUMBER	+5V PIN	GND PIN
U4M	1820-1430	SN74LS161AN	16	8
U5G	1820-1144	SN74LS02N	14	7
U5H	1820-1282	SN74LS109AN	16	8
U5M	1820-1199	SN74LS04N	14	7
U6D	1820-1197	SN74LS00N	14	7
U6E	1820-1112	SN74LS74AN	14	7
U6F	1820-1282	SN74LS109AN	16	8
U6G	1820-1197	SN74LS00N	14	7
U6H	1820-1144	SN74LS02N	14	7
U6I	1820-1202	SN74LS10N	14	7

Parts On This Schematic

RP3.
------

Figure 8-9. Schematic 6  
 Foreground/Background Logic  
 8-39

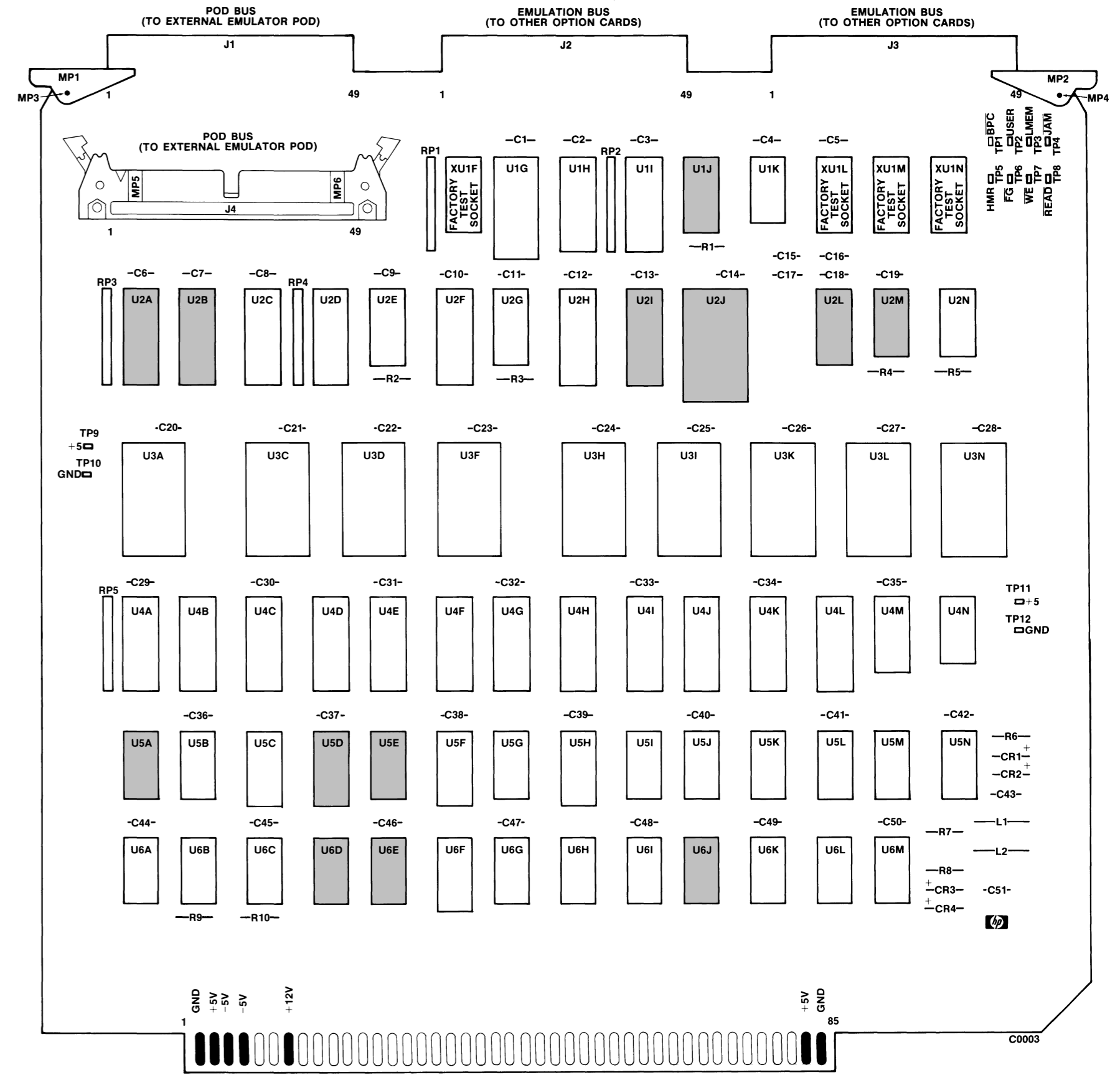

Component Locator

ICs On This Schematic

REF. DES	HP PART NUMBER	MFG. PART NUMBER	+5V PIN	GND PIN
U1J	1820-1217	SN74LS151N	16	8
U2A	1820-1624	SN74S241N	20	10
U2B	1820-1633	SN74S240N	20	10
U2I	1820-2102	SN74LS373N	20	10
U2J	64191-80000	64191-80000	24	12
U2L	1820-1430	SN74LS161AN	16	8
U2M	1820-0686	SN74S11N	14	7
U5A	1820-1144	SN74LS02N	14	7
U5D	1820-1282	SN74LS109AN	16	8
U5E	1820-1112	SN74LS74AN	14	7
U6D	1820-1197	SN74LS00N	14	7
U6E	1820-1112	SN74LS74AN	14	7
U6J	1820-1199	SN74LS04N	14	7

Parts On This Schematic

C13,15,16,17.	R4.	RP3,4,5.
---------------	-----	----------

NOTE A

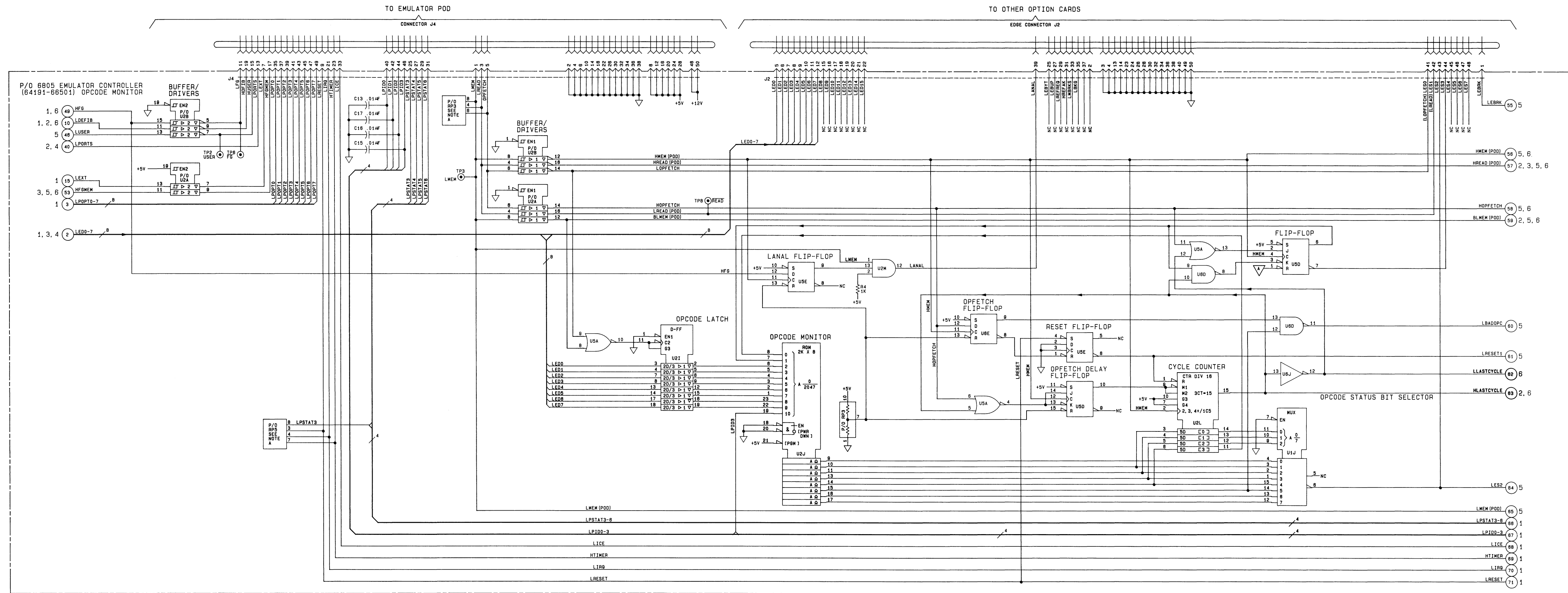
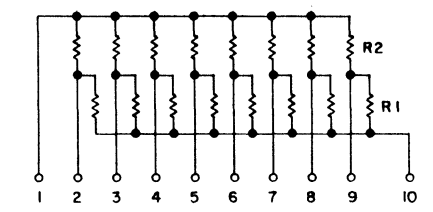

Figure 8-10. Schematic 7  
Pod Interface and Opcode Monitor  
8-41



# SALES & SUPPORT OFFICES

Arranged alphabetically by country



## Product Line Sales/Support Key

### Key Product Line

- A Analytical
- CM Components
- C Computer Systems Sales only
- CH Computer Systems Hardware Sales and Services
- CS Computer Systems Software Sales and Services
- E Electronic Instruments & Measurement Systems
- M Medical Products
- MP Medical Products Primary SRO
- MS Medical Products Secondary SRO
- P Personal Computation Products
- \* Sales only for specific product line
- \*\* Support only for specific product line

**IMPORTANT:** These symbols designate general product line capability. They do not insure sales or support availability for all products within a line, at all locations. Contact your local sales office for information regarding locations where HP support is available for specific products.

*HP distributors are printed in italics.*

## ANGOLA

*Telecta*  
*Empresa Técnica de Equipamentos*  
*R. Barbosa Rodrigues, 41-1 DT.*  
*Caixa Postal 6487*  
**LUANDA**  
*Tel: 35515,35516*  
*E,M,P*

## ARGENTINA

Hewlett-Packard Argentina S.A.  
Avenida Santa Fe 2035  
Martinez 1640 BUENOS AIRES  
Tel: 798-5735, 792-1293  
Telex: 17595 BIONAR  
Cable: HEWPACKARG  
A,E,CH,CS,P  
*Biotron S.A.C.I.M. e.l.*  
*Av Paseo Colon 221, Piso 9*  
**1399 BUENOS AIRES**  
*Tel: 30-4846, 30-1851*  
*Telex: 17595 BIONAR*  
**M**

## AUSTRALIA

### Adelaide, South Australia Office

Hewlett-Packard Australia Ltd.  
153 Greenhill Road  
PARKSIDE, S.A. 5063  
Tel: 272-5911  
Telex: 82536  
Cable: HEWPARD Adelaide  
A\*,CH,CM,\*,E,MS,P

### Brisbane, Queensland Office

Hewlett-Packard Australia Ltd.  
10 Payne Road  
THE GAP, Queensland 4061  
Tel: 30-4133  
Telex: 42133  
Cable: HEWPARD Brisbane  
A,CH,CM,\*,E,M,P

### Canberra, Australia Capital Territory Office

Hewlett-Packard Australia Ltd.  
121 Wollongong Street  
Fyshwick, A.C.T. 2609  
Tel: 80 4244  
Telex: 62650  
Cable: HEWPARD Canberra  
CH,CM,E,P

## Melbourne, Victoria Office

Hewlett-Packard Australia Ltd.  
31-41 Joseph Street  
BLACKBURN, Victoria 3130  
Tel: 890 6351  
Telex: 31-024  
Cable: HEWPARD Melbourne  
A,CH,CM,CS,E,MS,P

## Perth, Western Australia Office

Hewlett-Packard Australia Ltd.  
261 Stirling Highway  
CLAREMONT, W.A. 6010  
Tel: 383-2188  
Telex: 93859  
Cable: HEWPARD Perth  
A,CH,CM,\*,E,MS,P

## Sydney, New South Wales Office

Hewlett-Packard Australia Ltd.  
17-23 Talavera Road  
P.O. Box 308  
NORTH RYDE, N.S.W. 2113  
Tel: 887-1611  
Telex: 21561  
Cable: HEWPARD Sydney  
A,CH,CM,CS,E,MS,P

## AUSTRIA

Hewlett-Packard Ges.m.b.h.  
Grottenhofstrasse 94  
Verkaufsburo Graz  
A-8052 GRAZ  
Tel: 291-5-66  
Telex: 32375  
CH,E\*

Hewlett-Packard Ges.m.b.h.  
Liebigasse 1  
P.O. Box 72  
A-1222 VIENNA  
Tel: (0222) 23-65-11-0  
Telex: 134425 HEPA A  
A,CH,CM,CS,E,MS,P

## BAHRAIN

*Green Salon*  
*P.O. Box 557*  
**BAHRAIN**  
*Tel: 255503-255950*  
*Telex: 84419*  
**P**

*Wael Pharmacy*  
*P.O. Box 648*

**BAHRAIN**  
*Tel: 256123*  
*Telex: 8550 WAEI BN*  
**E,M**

## BELGIUM

Hewlett-Packard Belgium S.A./N.V.  
Blvd de la Woluwe, 100  
Woluwedal  
B-1200 BRUSSELS  
Tel: (02) 762-32-00  
Telex: 23-494 paloben bru  
A,CH,CM,CS,E,MP,P

## BRAZIL

Hewlett-Packard do Brasil I.e.C. Ltda.  
Alameda Rio Negro, 750  
Alphaville  
06400 BARUERI SP  
Tel: (011) 421.1311  
Telex: (011) 33872 HPBR-BR  
Cable: HEWPACK Sao Paulo  
A,CH,CM,CS,E,M,P  
Hewlett-Packard do Brasil I.e.C. Ltda.  
Avenida Epitacio Pessoa, 4664  
22471 RIO DE JANEIRO-RJ  
Tel: (021) 286.0237  
Telex: 021-21905 HPBR-BR  
Cable: HEWPACK Rio de Janeiro  
A,CH,CM,E,MS,P\*

## CANADA

**Alberta**  
Hewlett-Packard (Canada) Ltd.  
210, 7220 Fisher Street S.E.  
CALGARY, Alberta T2H 2H8  
Tel: (403) 253-2713  
A,CH,CM,\*,E,MS,P\*  
Hewlett-Packard (Canada) Ltd.  
11620A-168th Street  
EDMONTON, Alberta T5M 3T9  
Tel: (403) 452-3670  
A,CH,CM,CS,E,MS,P\*

## British Columbia

Hewlett-Packard (Canada) Ltd.  
10691 Shellbridge Way  
RICHMOND,  
British Columbia V6X 2W7  
Tel: (604) 270-2277  
Telex: 610-922-5059  
A,CH,CM,CS,E\*,MS,P\*

## Manitoba

Hewlett-Packard (Canada) Ltd.  
380-550 Century Street  
WINNIPEG, Manitoba R3H 0Y1  
Tel: (204) 786-6701  
A,CH,CM,E,MS,P\*

## New Brunswick

Hewlett-Packard (Canada) Ltd.  
37 Sheadiac Road  
MONCTON, New Brunswick E2B 2V0  
Tel: (506) 855-2841  
CH\*\*

## Nova Scotia

Hewlett-Packard (Canada) Ltd.  
P.O. Box 931  
900 Windmill Road  
DARTMOUTH, Nova Scotia B2Y 3Z6  
Tel: (902) 469-7820  
CH,CM,CS,E\*,MS,P\*

## Ontario

Hewlett-Packard (Canada) Ltd.  
552 Newbold Street  
LONDON, Ontario N6E 2S5  
Tel: (519) 686-9181  
A,CH,CM,\*,E,MS,P\*  
Hewlett-Packard (Canada) Ltd.  
6877 Goreway Drive  
MISSISSAUGA, Ontario L4V 1M8  
Tel: (416) 678-9430  
A,CH,CM,CS,E,MP,P

Hewlett-Packard (Canada) Ltd.  
2670 Queensview Dr.  
OTTAWA, Ontario K2B 8K1  
Tel: (613) 820-6483  
A,CH,CM,CS,E\*,MS,P\*  
Hewlett-Packard (Canada) Ltd.  
220 Yorkland Blvd., Unit #11  
WILLOWDALE, Ontario M2J 1R5  
Tel: (416) 499-9333  
CH

## Quebec

Hewlett-Packard (Canada) Ltd.  
17500 South Service Road  
Trans-Canada Highway  
KIRKLAND, Quebec H9J 2M5  
Tel: (514) 697-4232  
A,CH,CM,CS,E,MP,P\*  
Hewlett-Packard (Canada) Ltd.  
Les Galeries du Vallon  
2323 Du Versant Nord  
STE. FOY, Quebec G1N 4C2  
Tel: (418) 687-4570  
CH

## CHILE

*Jorge Calcagni y Cia. Ltda.*  
*Arturo Buhrie 065*  
*Casilla 16475*  
**SANTIAGO 9**  
*Tel: 222-0222*  
*Telex: Public Booth 440001*  
**A,CM,E,M**  
*Olympia (Chile) Ltda.*  
*Av. Rodrigo de Araya 1045*  
*Casilla 256-V*  
**SANTIAGO 21**  
*Tel: (02) 22 55 044*  
*Telex: 240-565 OLYMP CL*  
*Cable: Olympiachile Santiagochile*  
**CH,CS,P**

## CHINA, People's Republic of

*China Hewlett-Packard Rep. Office*  
*P.O. Box 418*  
*1A Lane 2, Luchang St.*  
*Beiwei Rd., Xuanwu District*  
**BEIJING**  
*Tel: 33-1947, 33-7426*  
*Telex: 22601 CTSHP CN*  
*Cable: 1920*  
**A,CH,CM,CS,E,P**

## COLOMBIA

*Instrumentación*  
*H. A. Langebaek & Kier S.A.*  
*Carrera 4A No. 52A-26*  
*Apartado Aereo 6287*  
**BOGOTA 1, D.E.**  
*Tel: 212-1466*  
*Telex: 44400 INST CO*  
*Cable: AARIS Bogota*  
**CM,E,M**

## COSTA RICA

*Cientifica Costarricense S.A.*  
*Avenida 2, Calle 5*  
*San Pedro de Montes de Oca*  
*Apartado 10159*  
**SAN JOSÉ**  
*Tel: 24-38-20, 24-08-19*  
*Telex: 2367 GALGUR CR*  
**CM,E,M**

## CYPRUS

*Telerexa Ltd.*  
*P.O. Box 4809*  
*14C Stassinou Avenue*  
**NICOSIA**  
*Tel: 62698*  
*Telex: 2894 LEVIDO CY*  
**E,M,P**

## DENMARK

Hewlett-Packard A/S  
Datavej 52  
DK-3460 BIRKEROD  
Tel: (02) 81-66-40  
Telex: 37409 hpas dk  
A,CH,CM,CS,E,MS,P  
Hewlett-Packard A/S  
Roihnedsvvej 32  
DK-8240 RISSKOV  
Tel: (06) 17-60-00  
Telex: 37409 hpas dk  
CH,E

## DOMINICAN REPUBLIC

*Microprog S.A.*  
*Juan Tomás Mejía y Cotes No. 60*  
*Arroyo Hondo*  
**SANTO DOMINGO**  
*Tel: 565-6268*  
*Telex: 4510 ARENTA DR (RCA)*  
**P**

## ECUADOR

*CYEDE Cia. Ltda.*  
*Avenida Eloy Alfaro 1749*  
*Casilla 6423 CCI*  
**QUITO**  
*Tel: 450-975, 243-052*  
*Telex: 2548 CYEDE ED*  
**CM,E,P**  
*Hospitalar S.A.*  
*Robles 625*  
*Casilla 3590*  
**QUITO**  
*Tel: 545-250, 545-122*  
*Telex: 2485 HOSPTEL ED*  
*Cable: HOSPITALAR-Quito*  
**M**

## EGYPT

*International Engineering Associates*  
*24 Hussein Hegazi Street*  
*Kasr-el-Aini*  
**CAIRO**  
*Tel: 23829, 21641*  
*Telex: IEA UN 93830*  
**CH,CS,E,M**  
*Informatic For Systems*  
*22 Talaat Harb Street*  
**CAIRO**  
*Tel: 759006*  
*Telex: 93938 FRANK UN*  
**CH,CS,P**  
*Egyptian International Office*  
*for Foreign Trade*  
*P.O.Box 2558*  
**CAIRO**  
*Tel: 650021*  
*Telex: 93337 EGPOR*  
**P**

## EL SALVADOR

*IPESA de El Salvador S.A.*  
*29 Avenida Norte 1216*  
**SAN SALVADOR**  
*Tel: 26-6858, 26-6868*  
*Telex: 20539 EPISA*  
**A,CH,CM,CS,E,P**



# SALES & SUPPORT OFFICES

## Arranged alphabetically by country

### FINLAND

Hewlett-Packard Oy  
Revontulentie 7  
SF-02100 **ESPOO** 10  
Tel: 00358-0-4550211  
Telex: 9100  
A,CH,CM,CS,E,MS,P  
Hewlett-Packard Oy  
Aatoksenkatu 10-C  
SF-40720-72 **JYVASKYLA**  
Tel: (941) 216318  
CH  
Hewlett-Packard Oy  
Kainuntie 1-C  
SF-90140-14 **OULU**  
Tel: (981) 338785  
CH

### FRANCE

Hewlett-Packard France  
Z.I. Mercure B  
Rue Berthelot  
F-13763 Les Milles Cedex  
**AIX-EN-PROVENCE**  
Tel: 16 (42) 59-41-02  
Telex: 410770F  
A,CH,E,MS,P\*  
Hewlett-Packard France  
64, rue Marchand Saillant  
F-61000**ALENCON**  
Tel: 16 (33) 29 04 42  
Hewlett-Packard France  
Boite Postale 503  
F-25026 **BESANCON**  
28 rue de la Republique  
F-25000 **BESANCON**  
Tel: 16 (81) 83-16-22  
CH,M  
Hewlett-Packard France  
13, Place Napoleon III  
F-29000 **BREST**  
Tel: 16 (98) 03-38-35  
Hewlett-Packard France  
Chemin des Mouilles  
Boite Postale 162  
F-69130 **ECULLY** Cedex  
Tel: 16 (78) 833-81-25  
Telex: 310617F  
A,CH,CS,E,MP  
Hewlett-Packard France  
Tour Lorraine  
Boulevard de France  
F-91035 **EVRY** Cedex  
Tel: 16 6 077-96-60  
Telex: 692315F  
E  
Hewlett-Packard France  
5, avenue Raymond Chanas  
F-38320 **EYBENS**  
Tel: 16 (76) 25-81-41  
Telex: 980124 HP GRENOB EYBE  
CH  
Hewlett-Packard France  
Centre d'Affaire Paris-Nord  
Bâtiment Ampère 5 étage  
Rue de la Commune de Paris  
Boite Postale 300  
F-93153 **LE BLANC MESNIL**  
Tel: 16 (1) 865-44-52  
Telex: 211032F  
CH,CS,E,MS  
Hewlett-Packard France  
Parc d'Activités Cadere  
Quartier Jean Mermoz  
Avenue du Président JF Kennedy  
F-33700 **MERIGNAC**  
Tel: 16 (56) 34-00-84  
Telex: 550105F  
CH,E,MS

Hewlett-Packard France  
Immeuble "Les 3 B"  
Nouveau Chemin de la Garde  
ZAC de Bois Briand  
F-44085 **NANTES** Cedex  
Tel: 16 (40) 50-32-22  
CH\*\*  
Hewlett-Packard France  
125, rue du Faubourg Bannier  
F-45000 **ORLEANS**  
Tel: 16 (38) 68 01 63  
Hewlett-Packard France  
Zone Industrielle de Courtaouef  
Avenue des Tropiques  
F-91947 Les Ulis Cedex **ORSAY**  
Tel: (6) 907-78-25  
Telex: 600048F  
A,CH,CM,CS,E,MP,P  
Hewlett-Packard France  
Paris Porte-Maillet  
15, Avenue de L'Amiral Bruix  
F-75782 **PARIS CEDEX** 16  
Tel: 16 (1) 502-12-20  
Telex: 613663F  
CH,MS,P  
Hewlett-Packard France  
124, Boulevard Tourasse  
F-64000 **PAU**  
Tel: 16 (59) 80 38 02  
Hewlett-Packard France  
2 Allée de la Bourgonnette  
F-35100 **RENNES**  
Tel: 16 (99) 51-42-44  
Telex: 740912F  
CH,CM,E,MS,P\*  
Hewlett-Packard France  
98 Avenue de Bretagne  
F-76100 **ROUEN**  
Tel: 16 (35) 63-57-66  
CH\*,CS  
Hewlett-Packard France  
Boite Postale 56  
F-67033 **STRASBOURG** Cedex  
4 Rue Thomas Mann  
F-67200 **STRASBOURG**Cedex  
Tel: 16 (88) 28-56-46  
Telex: 890141F  
CH,E,MS,P\*  
Hewlett-Packard France  
Le Péripole  
3, Chemin du Pigeonnier de la  
Cépière  
F-31083 **TOULOUSE** Cedex  
Tel: 16 (61) 40-11-12  
Telex: 531639F  
A,CH,CS,E,P\*  
Hewlett-Packard France  
9, rue Baudin  
F-26000 **VALENCE**  
Tel: 16 (75) 42 76 16  
Hewlett-Packard France  
Garolor  
ZAC de Bois Briand  
F-57640 **VIGY**  
Tel: 16 (8) 771 20 22  
CH  
Hewlett-Packard France  
Immeuble Péricentre  
F-59658 **VILLENEUVE D'ASCQ** Cedex  
Tel: 16 (20) 91-41-25  
Telex: 160124F  
CH,E,MS,P\*

### GERMAN FEDERAL REPUBLIC

Hewlett-Packard GmbH  
Geschäftsstelle  
Keithstrasse 2-4  
D-1000 **BERLIN** 30  
Tel: (030) 24-90-86  
Telex: 018 3405 hpbln d  
A,CH,E,M,P

Hewlett-Packard GmbH  
Geschäftsstelle  
Herrenberger Strasse 110  
D-7030 **BOBLINGEN**  
Tel: (7031) 667-750  
Telex: bbn or  
A,CH,CM,CS,E,MP,P  
Hewlett-Packard GmbH  
Geschäftsstelle  
Emanuel-Leutze-Strasse 1  
D-4000 **DUSSELDORF**  
Tel: (0211) 5971-1  
Telex: 085/86 533 hpdd d  
A,CH,CS,E,MS,P  
Hewlett-Packard GmbH  
Vertriebszentrale Frankfurt  
Bernier Strasse 117  
Postfach 560 140  
D-6000 **FRANKFURT** 56  
Tel: (0611) 50-04-1  
Telex: 04 13249 hpffm d  
A,CH,CM,CS,E,MP,P  
Hewlett-Packard GmbH  
Geschäftsstelle  
Kapstadter Strasse 5  
D-2000 **HAMBURG** 60  
Tel: (040) 63804-1  
Telex: 021 63 032 hphh d  
A,CH,CS,E,MS,P  
Hewlett-Packard GmbH  
Geschäftsstelle  
Heidering 37-39  
D-3000 **HANNOVER** 91  
Tel: (0511) 5706-0  
Telex: 092 3259  
A,CH,CM,E,MS,P  
Hewlett-Packard GmbH  
Geschäftsstelle  
Rosslauer Weg 2-4  
D-6800 **MANNHEIM**  
Tel: (0621) 70050  
Telex: 0462105  
A,C,E  
Hewlett-Packard GmbH  
Geschäftsstelle  
Messerschmittstrasse 7  
D-7910 **NEU ULM**  
Tel: 0731-70241  
Telex: 0712816 HP ULM-D  
A,C,E\*  
Hewlett-Packard GmbH  
Geschäftsstelle  
Neumeyerstrasse 90  
D-8500 **NÜRNBERG**  
Tel: (0911) 52 20 83-87  
Telex: 0623 860  
CH,CM,E,MS,P  
Hewlett-Packard GmbH  
Geschäftsstelle  
Eschenstrasse 5  
D-8028 **TAUFKIRCHEN**  
Tel: (089) 6117-1  
Telex: 0524985  
A,CH,CM,E,MS,P

### GREAT BRITAIN

See United Kingdom

### GREECE

Kostas Karayannis S.A.  
8 Omirou Street  
**ATHENS** 133  
Tel: 32 30 303, 32 37 371  
Telex: 215962 RKAR GR  
A,CH,CM,CS,E,M,P  
PLAISIO S.A.  
G. Gerardos  
24 Stourara Street  
**ATHENS**  
Tel: 36-11-160  
Telex: 221871  
P

### GUATEMALA

IPESA  
Avenida Reforma 3-48, Zona 9  
**GUATEMALA CITY**  
Tel: 316627, 314786  
Telex: 4192 TELTRO GU  
A,CH,CM,CS,E,M,P

### HONG KONG

Hewlett-Packard Hong Kong, Ltd.  
G.P.O. Box 795  
5th Floor, Sun Hung Kai Centre  
30 Harbour Road  
**HONG KONG**  
Tel: 5-8323211  
Telex: 66678 HEWPA HX  
Cable: HEWPACK HONG KONG  
E,CH,CS,P  
CET Ltd.  
1402 Tung Way Mansion  
199-203 Hennessy Rd.  
Wanchia, **HONG KONG**  
Tel: 5-729376  
Telex: 85148 CET HX  
CM  
Schmidt & Co. (Hong Kong) Ltd.  
Wing On Centre, 28th Floor  
Connaught Road, C.  
**HONG KONG**  
Tel: 5-455644  
Telex: 74766 SCHMX HX  
A,M

### ICELAND

Eliding Trading Company Inc.  
Hafnarvölví-Tryggvagotu  
P.O. Box 895  
**IS-REYKJAVIK**  
Tel: 1-58-20, 1-63-03  
M

### INDIA

Computer products are sold through  
Blue Star Ltd. All computer repairs  
and maintenance service is done  
through Computer Maintenance  
Corp.  
Blue Star Ltd.  
Sabri Complex II Floor  
24 Residency Rd.  
**BANGALORE** 560 025  
Tel: 55660  
Telex: 0845-430  
Cable: BLUESTAR  
A,CH\*,CM,CS\*,E  
Blue Star Ltd.  
Band Box House  
Prabhadevi  
**BOMBAY** 400 025  
Tel: 422-3101  
Telex: 011-3751  
Cable: BLUESTAR  
A,M  
Blue Star Ltd.  
Sahas  
41/2 Vir Savarkar Marg  
Prabhadevi  
**BOMBAY** 400 025  
Tel: 422-6155  
Telex: 011-4093  
Cable: FROSTBLUE  
A,CH\*,CM,CS\*,E,M  
Blue Star Ltd.  
Kalyan, 19 Vishwas Colony  
Alkapuri, **BORODA**, 390 005  
Tel: 65235  
Cable: BLUE STAR  
A  
Blue Star Ltd.  
7 Hare Street  
**CALCUTTA** 700 001  
Tel: 12-01-31  
Telex: 021-7655  
Cable: BLUESTAR  
A,M

Blue Star Ltd.  
133 Kodambakkam High Road  
**MADRAS** 600 034  
Tel: 82057  
Telex: 041-379  
Cable: BLUESTAR  
A,M  
Blue Star Ltd.  
Bhandari House, 7th/8th Floors  
91 Nehru Place  
**NEW DELHI** 110 024  
Tel: 682547  
Telex: 031-2463  
Cable: BLUESTAR  
A,CH\*,CM,CS\*,E,M  
Blue Star Ltd.  
15/16:C Wellesley Rd.  
**PUNE** 411 011  
Tel: 22775  
Cable: BLUE STAR  
A  
Blue Star Ltd.  
2-2-47/1108 Bolarum Rd.  
**SECUNDERABAD** 500 003  
Tel: 72057  
Telex: 0155-459  
Cable: BLUEFROST  
A,E  
Blue Star Ltd.  
T.C. 7/603 Poornima  
Maruthankuzhi  
**TRIVANDRUM** 695 013  
Tel: 65799  
Telex: 0884-259  
Cable: BLUESTAR  
E  
Computer Maintenance Corporation  
Ltd.  
115, Sarojini Devi Road  
**SECUNDERABAD** 500 003  
Tel: 310-184, 345-774  
Telex: 031-2960  
CH\*\*  
**INDONESIA**  
BERCA Indonesia P.T.  
P.O.Box 496/JKT.  
Jl. Abdul Muis 62  
**JAKARTA**  
Tel: 373009  
Telex: 46748 BERSAL IA  
Cable: BERSAL JAKARTA  
P  
BERCA Indonesia P.T.  
P.O.Box 2497/Jk1 Antara Bldg.,  
17th Floor  
Jl. Medan Merdeka Selatan 17  
**JAKARTA-PUSAT**  
Tel: 21-344-181  
Telex: BERSAL IA  
A,CS,E,M  
BERCA Indonesia P.T.  
P.O. Box 174/SBY.  
Jl. Kutei No. 11  
**SURABAYA**  
Tel: 68172  
Telex: 31146 BERSAL SB  
Cable: BERSAL-SURABAYA  
A\*,E,M,P  
**IRAQ**  
Hewlett-Packard Trading S.A.  
Service Operation  
Al Mansoor City 9B/3/7  
**BAGHDAD**  
Tel: 551-49-73  
Telex: 212-455 HEPAIRAQ IK  
CH,CS



# SALES & SUPPORT OFFICES

Arranged alphabetically by country

3



## IRELAND

Hewlett-Packard Ireland Ltd.  
82/83 Lower Leeson Street  
**DUBLIN 2**  
Tel: (1) 60 88 00  
Telex: 30439  
A,CH,CM,CS,E,M,P

Cardiac Services Ltd.  
Kilmore Road  
Artane  
**DUBLIN 5**  
Tel: (01) 351820  
Telex: 30439  
M

## ISRAEL

Eidan Electronic Instrument Ltd.  
P.O.Box 1270  
**JERUSALEM 91000**  
16, Ohaliv St.  
**JERUSALEM 94467**  
Tel: 533 221, 553 242  
Telex: 25231 AB/PAKRD IL  
A

Electronics Engineering Division  
Motorola Israel Ltd.  
16 Kremenski Street  
P.O. Box 25016  
**TEL-AVIV 67899**  
Tel: 3-338973  
Telex: 33569 Motil IL  
Cable: BASTEL Tel-Aviv  
CH,CM,CS,E,M,P

## ITALY

Hewlett-Packard Italiana S.p.A.  
Traversa 99C  
Via Giulio Petroni, 19  
I-70124 **BARI**  
Tel: (080) 41-07-44  
M

Hewlett-Packard Italiana S.p.A.  
Via Martin Luther King, 38/111  
I-40132 **Bologna**  
Tel: (051) 402394  
Telex: 511630  
CH,E,MS

Hewlett-Packard Italiana S.p.A.  
Via Principe Nicola 43G/C  
I-95126 **CATANIA**  
Tel: (095) 37-10-87  
Telex: 970291  
C,P

Hewlett-Packard Italiana S.p.A.  
Via G. Di Vittorio 9  
I-20063 **CERNUSCO SUL NAVIGLIO**  
Tel: (2) 903691  
Telex: 334632  
A,CH,CM,CS,E,MP,P

Hewlett-Packard Italiana S.p.A.  
Via Nuova San Rocco a  
Capodimonte, 62/A  
I-80131 **NAPLES**  
Tel: (081) 7413544  
Telex: 710698  
A,CH,E

Hewlett-Packard Italiana S.p.A.  
Viale G. Modugno 33  
I-16156 **GENOVA PEGLI**  
Tel: (010) 68-37-07  
Telex: 215238  
E,C

Hewlett-Packard Italiana S.p.A.  
Via Turazza 14  
I-35100 **PADOVA**  
Tel: (049) 664888  
Telex: 430315  
A,CH,E,MS

Hewlett-Packard Italiana S.p.A.  
Viale C. Pavese 340  
I-00144 **ROMA**  
Tel: (06) 54831  
Telex: 610514  
A,CH,CM,CS,E,MS,P\*

Hewlett-Packard Italiana S.p.A.  
Corso Svizzera, 184  
I-10149 **TORINO**  
Tel: (011) 74 4044  
Telex: 221079  
CH,E

## JAPAN

Yokogawa-Hewlett-Packard Ltd.  
152-1, Onna  
000 **ATSUGI**, Kanagawa, 243  
Tel: (0462) 28-0451  
CM,C\*,E

Yokogawa-Hewlett-Packard Ltd.  
Towa Building  
2-3, Kaigan-dori, 2 Chome Chuo-ku  
**KOBE**, 650  
Tel: (078) 392-4791  
C,E

Yokogawa-Hewlett-Packard Ltd.  
Kumagaya Asahi 82 Bldg  
3-4 Tsukuba  
**KUMAGAYA**, Saitama 360  
Tel: (0485) 24-6563  
CH,CM,E

Yokogawa-Hewlett-Packard Ltd.  
Asahi Shinbun Daiichi Seimei Bldg.  
4-7, Hanabata-cho  
**KUMAMOTO**, 860  
Tel: (0963) 54-7311  
CH,E

Yokogawa-Hewlett-Packard Ltd.  
Shin-Kyoto Center Bldg.

614, Higashi-Shiokoji-cho  
Karasuma-Nishiru  
Shiokoji-dori, Shimogyo-ku  
**KYOTO**, 600  
Tel: 075-343-0921  
CH,E

Yokogawa-Hewlett-Packard Ltd.  
Mito Mitsui Bldg  
4-73, Sannomaru, 1 Chome  
**MITO**, Ibaragi 310  
Tel: (0292) 25-7470  
CH,CM,E

Yokogawa-Hewlett-Packard Ltd.  
Sumitomo Seimei 14-9 Bldg.  
Meieki-Minami, 2 Chome  
Nakamura-ku  
**NAGOYA**, 450  
Tel: (052) 571-5171  
CH,CM,CS,E,MS

Yokogawa-Hewlett-Packard Ltd.  
Chuo Bldg.,  
4-20 Nishinakajima, 5 Chome  
Yodogawa-ku  
**OSAKA**, 532  
Tel: (06) 304-6021  
Telex: YHPOSA 523-3624  
A,CH,CM,CS,E,MP,P\*

Yokogawa-Hewlett-Packard Ltd.  
27-15, Yabe, 1 Chome  
**SAGAMIHARA** Kanagawa, 229  
Tel: 0427 59-1311

Yokogawa-Hewlett-Packard Ltd.  
Daiichi Seimei Bldg.  
7-1, Nishi Shinjuku, 2 Chome  
Shinjuku-ku, **TOKYO** 160  
Tel: 03-348-4611-5  
CH,E

Yokogawa-Hewlett-Packard Ltd.  
29-21 Takaido-Higashi, 3 Chome  
Suginami-ku **TOKYO** 168  
Tel: (03) 331-6111  
Telex: 232-2024 YHPTOK  
A,CH,CM,CS,E,MP,P\*

Yokogawa-Hewlett-Packard Ltd.  
Daiichi Asano Building  
2-8, Odori, 5 Chome  
**UTSUNOMIYA**, Tochigi 320  
Tel: (0286) 25-7155  
CH,CS,E

Yokogawa-Hewlett-Packard Ltd.  
Yasuda Seimei Nishiguchi Bldg.  
30-4 Tsuruya-cho, 3 Chome  
**YOKOHAMA** 221  
Tel: (045) 312-1252  
CH,CM,E

## JORDAN

Mouasher Cousins Company  
P.O. Box 1387  
**AMMAN**  
Tel: 24907, 39907  
Telex: 21456 SABCO JO  
CH,E,M,P

## KENYA

ADCOM Ltd., Inc., Kenya  
P.O.Box 30070  
**NAIROBI**  
Tel: 331955  
Telex: 22639  
E,M

## KOREA

Samsung Electronics Computer  
Division  
76-561 Yeoksam-Dong  
Kwangnam-Ku  
C.P.O. Box 2775  
**SEOUL**  
Tel: 555-7555, 555-5447  
Telex: K27364 SAMSAN  
A,CH,CM,CS,E,M,P

## KUWAIT

Al-Khaldiya Trading & Contracting  
P.O. Box 830 Safat  
**KUWAIT**  
Tel: 42-4910, 41-1276  
Telex: 22481 Areeg kt  
CH,E,M  
Photo & Cine Equipment  
P.O. Box 270 Safat  
**KUWAIT**  
Tel: 42-2846, 42-3801  
Telex: 22247 Matin kt  
P

## LEBANON

G.M. Dolmadjian  
Achratieh  
**NAGOYA**, 450  
Tel: (052) 571-5171  
CH,CM,CS,E,MS  
Tel: 290293  
MP\*\*

## LUXEMBOURG

Hewlett-Packard Belgium S.A./N.V.  
Blvd de la Woluwe, 100  
Woluwedal  
B-1200 **BRUSSELS**  
Tel: (02) 762-32-00  
Telex: 23-494 paloben br  
A,CH,CM,CS,E,MP,P

## MALAYSIA

Hewlett-Packard Sales (Malaysia)  
Sdn. Bhd.  
1st Floor, Bangunan British  
American  
Jalan Semantan, Damansara Heights  
**KUALA LUMPUR** 23-03  
Tel: 943022  
Telex: MA31011  
A,CH,E,M,P\*  
Protel Engineering  
P.O.Box 1917  
Lot 6624, Section 64  
23/4 Pending Road  
Kuching, **SARAWAK**  
Tel: 36299  
Telex: MA 70904 PROTEL  
Cable: PROTELENG  
A,E,M

## MALTA

Philip Toledo Ltd.  
Notabile Rd.  
**MRIHEL**  
Tel: 447 47, 455 66  
Telex: Media MW 649  
P

## MEXICO

Hewlett-Packard Mexicana, S.A.  
de C.V.  
Av. Periferico Sur No. 6501  
Tepepan, Xochimilco  
**MEXICO D.F.** 16020  
Tel: 676-4600  
Telex: 17-74-507 HEWPACK MEX  
A,CH,CS,E,MS,P  
Hewlett-Packard Mexicana, S.A.  
de C.V.  
Ave. Colonia del Valle #409  
Col. del Valle  
Municipio de Garza Garcia  
**MONTERREY**, N.L.  
Tel: 78 42 41  
Telex: 038 410  
CH  
ECISA  
José Vasconcelos No. 218  
Col. Condesa Deleg. Cuauhtémoc  
**MEXICO D.F.** 06140  
Tel: 553-1206  
Telex: 17-72755 ECE ME  
M

## MOROCCO

Dolbeau  
81 rue Karatchi  
**CASABLANCA**  
Tel: 3041-82, 3068-38  
Telex: 23051, 22822  
E  
Gerep  
2 rue d'Agadir  
Boite Postale 156  
**CASABLANCA**  
Tel: 272093, 272095  
Telex: 23 739  
P

## NETHERLANDS

Hewlett-Packard Nederland B.V.  
Van Heuven Goedhartlaan 121  
NL 1181KK **AMSTELVEEN**  
P.O. Box 667  
NL 1180 AR **AMSTELVEEN**  
Tel: (020) 47-20-21  
Telex: 13 216 HEPAC NL  
A,CH,CM,CS,E,MP,P

Hewlett-Packard Nederland B.V.  
Bonger 2  
NL 2906VK **CAPELLE, A/D IJSSEL**  
P.O. Box 41  
NL 2900AA **CAPELLE, A/D IJSSEL**  
Tel: (10) 51-64-44  
Telex: 21261 HEPAC NL  
A,CH,CS,E

## NEW ZEALAND

Hewlett-Packard (N.Z.) Ltd.  
169 Manukau Road  
P.O. Box 26-189  
Epsom, **AUCKLAND**  
Tel: 687-159  
Cable: HEWPACK Auckland  
CH,CM,E,P\*  
Hewlett-Packard (N.Z.) Ltd.  
4-12 Cruickshank Street  
Kilbirnie, **WELLINGTON 3**  
P.O. Box 9443  
Courtenay Place, **WELLINGTON 3**  
Tel: 877-199  
Cable: HEWPACK Wellington  
CH,CM,E,P

Northrop Instruments & Systems  
Ltd.  
369 Khyber Pass Road  
P.O. Box 8602  
**AUCKLAND**  
Tel: 794-091  
Telex: 60605  
A,M

Northrop Instruments & Systems  
Ltd.  
110 Mandeville St.  
P.O. Box 8388  
**CHRISTCHURCH**  
Tel: 486-928  
Telex: 4203  
A,M

Northrop Instruments & Systems  
Ltd.  
Sturdee House  
85-87 Ghuznee Street  
P.O. Box 2406  
**WELLINGTON**  
Tel: 850-091  
Telex: NZ 3380  
A,M

## NORTHERN IRELAND

See United Kingdom

## NORWAY

Hewlett-Packard Norge A/S  
Folke Bernadottes vei 50  
P.O. Box 3558  
N-5033 **FYLLINGSDALEN** (Bergen)  
Tel: (05) 16-55-40  
Telex: 16621 hpnas n  
CH,CS,E,MS  
Hewlett-Packard Norge A/S  
Østerdalen 18  
P.O. Box 34  
N-1345 **ØSTERÅS**  
Tel: (02) 17-11-80  
Telex: 16621 hpnas n  
A,CH,CM,CS,E,M,P

## OMAN

Khimil Ramdas  
P.O. Box 19  
**MUSCAT**  
Tel: 722225, 745601  
Telex: 3289 BROKER MB MUSCAT  
P  
Suhail & Saud Bahwan  
P.O.Box 169  
**MUSCAT**  
Tel: 734 201-3  
Telex: 3274 BAHWAN MB

## PAKISTAN

Mushko & Company Ltd.  
1-B, Street 43  
Sector F-8/1  
**ISLAMABAD**  
Tel: 26875  
Cable: FEMUS Rawalpindi  
A,E,M

Mushko & Company Ltd.  
Oosman Chambers  
Abdullah Haroon Road  
**KARACHI 0302**  
Tel: 524 131, 524 132  
Telex: 2894 MUSKO PK  
Cable: COOPERATOR Karachi  
A,E,M,P\*

## PANAMA

Electrónico Balboa, S.A.  
Calle Samuel Lewis, Ed. Alfa  
Apartado 4929  
**PANAMA 5**  
Tel: 64-2700  
Telex: 3483 ELECTRON PG  
A,CM,E,MP



# SALES & SUPPORT OFFICES

Arranged alphabetically by country

## PERU

Cía Electro Médica S.A.  
Los Flamencos 145, San Isidro  
Casilla 1030  
LIMA 1  
Tel: 41-4325, 41-3703  
Telex: Pub. Booth 25306  
CM,E,M,P

## PHILIPPINES

The Online Advanced Systems  
Corporation  
Rico House, Amorsolo Cor. Herrera  
Street  
Legaspi Village, Makati  
P.O. Box 1510  
Metro MANILA  
Tel: 85-35-81, 85-34-91, 85-32-21  
Telex: 3274 ONLINE  
A,CH,CS,E,M  
Electronic Specialists and  
Proponents Inc.  
690-B Epifanio de los Santos  
Avenue  
Cubao, QUEZON CITY  
P.O. Box 2649 Manila  
Tel: 98-96-81, 98-96-82, 98-96-83  
Telex: 40018, 42000 ITT GLOBE  
MACKAY BOOTH  
P

## PORTUGAL

Mundinter  
Intercambio Mundial de Comércio  
S.A.R.L.  
P.O. Box 2761  
Avenida Antonio Augusto de Aguiar  
138  
P-LISBON  
Tel: (19) 53-21-31, 53-21-37  
Telex: 16691 munter p  
M  
Soquímica  
Av. da Liberdade, 220-2  
1298 LISBOA Codex  
Tel: 56 21 81/2/3  
Telex: 13316 SABASA  
P  
Telectra-Empresa Técnica de  
Equipamentos Eléctricos S.A.R.L.  
Rua Rodrigo da Fonseca 103  
P.O. Box 2531  
P-LISBON 1  
Tel: (19) 68-60-72  
Telex: 12598  
CH,CS,E,P

## PUERTO RICO

Hewlett-Packard Puerto Rico  
P.O. Box 4407  
CAROLINA, Puerto Rico 00628  
Calle 272 Edificio 203  
Urb. Country Club  
RIO PIEDRAS, Puerto Rico  
Tel: (809) 762-7255  
A,CH,CS

## QATAR

Computerbia  
P.O. Box 2750  
DOHA  
Tel: 883555  
Telex: 4806 CHPARB  
P  
Eastern Technical Services  
P.O. Box 4747  
DOHA  
Tel: 329 993  
Telex: 4156 EASTEC DH

Nasser Trading & Contracting  
P.O. Box 1563  
DOHA  
Tel: 22170, 23539  
Telex: 4439 NASSER DH  
M

## SAUDI ARABIA

Modern Electronic Establishment  
Hewlett-Packard Division  
P.O. Box 281  
Thuobah  
AL-KHOBAR  
Tel: 864-46 78  
Telex: 671 106 HPMEEK SJ  
Cable: ELECTA AL-KHOBAR  
CH,CS,E,M,P  
Modern Electronic Establishment  
Hewlett-Packard Division  
P.O. Box 1228  
Redec Plaza, 6th Floor  
JEDDAH  
Tel: 644 38 48  
Telex: 4027 12 FARNAS SJ  
Cable: ELECTA JEDDAH  
CH,CS,E,M,P  
Modern Electronic Establishment  
Hewlett-Packard Division  
P.O. Box 2728  
RIYADH  
Tel: 491-97 15, 491-63 87  
Telex: 202049 MEERYD SJ  
CH,CS,E,M,P

## SCOTLAND

See United Kingdom

## SINGAPORE

Hewlett-Packard Singapore (Sales)  
Pte. Ltd.  
P.O. Box 58 Alexandra Post Office  
SINGAPORE, 9115  
6th Floor, Inchcape House  
450-452 Alexandra Road  
SINGAPORE 0511  
Tel: 631788  
Telex: HPSGSO RS 34209  
Cable: HEWPACK, Singapore  
A,CH,CS,E,MS,P  
Dynamar International Ltd.  
Unit 05-11 Block 6  
Kolam Ayer Industrial Estate  
SINGAPORE 1334  
Tel: 747-6188  
Telex: RS 26283  
CM

## SOUTH AFRICA

Hewlett-Packard So Africa (Pty.)  
Ltd.  
P.O. Box 120  
Howard Place CAPE PROVINCE 7450  
Pine Park Center, Forest Drive,  
Pinelands  
CAPE PROVINCE 7405  
Tel: 53-7954  
Telex: 57-20006  
A,CH,CM,E,MS,P  
Hewlett-Packard So Africa (Pty.)  
Ltd.  
P.O. Box 37099  
92 Overport Drive  
DURBAN 4067  
Tel: 28-4178, 28-4179, 28-4110  
Telex: 6-22954  
CH,CM

Hewlett-Packard So Africa (Pty.)  
Ltd.  
6 Linton Arcade  
511 Cape Road  
Linton Grange  
PORT ELIZABETH 6001  
Tel: 041-302148  
CH

Hewlett-Packard So Africa (Pty.)  
Ltd. P.O. Box 33345  
Glenstantia 0010 TRANSVAAL  
1st Floor East  
Constantia Park Ridge Shopping  
Centre  
Constantia Park  
PRETORIA  
Tel: 982043  
Telex: 32163  
CH,E

Hewlett-Packard So Africa (Pty.)  
Ltd.  
Private Bag Wendywood  
SANDTON 2144  
Tel: 802-5111, 802-5125  
Telex: 4-20877  
Cable: HEWPACK Johannesburg  
A,CH,CM,CS,E,MS,P

## SPAIN

Hewlett-Packard Española S.A.  
Calle Entenza, 321  
E-BARCELONA 29  
Tel: 322.24.51, 321.73.54  
Telex: 52603 hpbee  
A,CH,CS,E,MS,P

Hewlett-Packard Española S.A.  
Calle San Vicente S/No  
Edificio Albia II  
E-BILBAO 1  
Tel: 423.83.06  
A,CH,E,MS  
Hewlett-Packard Española S.A.  
Crta. de la Coruña, Km. 16, 400  
Las Rozas  
E-MADRID  
Tel: (1) 637.00.11  
CH,CS,M

Hewlett-Packard Española S.A.  
Avda. S. Francisco Javier, S/no  
Planta 10. Edificio Sevilla 2,  
E-SEVILLA 5  
Tel: 64.44.54  
Telex: 72933  
A,CS,MS,P

Hewlett-Packard Española S.A.  
Calle Ramon Gordillo, 1 (Entlo.3)  
E-VALENCIA 10  
Tel: 361-1354  
CH,P

## SWEDEN

Hewlett-Packard Sverige AB  
Sunnanvagen 14K  
S-22226 LUND  
Tel: (046) 13-69-79  
Telex: (854) 17886 (via Spånga  
office)  
CH  
Hewlett-Packard Sverige AB  
Vastra Vintergatan 9  
S-70344 OREBRO  
Tel: (19) 10-48-80  
Telex: (854) 17886 (via Spånga  
office)  
CH

Hewlett-Packard Sverige AB  
Skalhollsgatan 9, Kista  
Box 19  
S-16393 SPÅNGA  
Tel: (08) 750-2000  
Telex: (854) 17886  
A,CH,CM,CS,E,MS,P  
Hewlett-Packard Sverige AB  
Frötallsgatan 30  
S-42132 VÄSTRA-FRÖLUNDA  
Tel: (031) 49-09-50  
Telex: (854) 17886 (via Spånga  
office)  
CH,E,P

## SWITZERLAND

Hewlett-Packard (Schweiz) AG  
Clarastrasse 12  
CH-4058 BASLE  
Tel: (61) 33-59-20  
A  
Hewlett-Packard (Schweiz) AG  
7, rue du Bois-du-Lan  
Case Postale 365  
CH-1217 MEYRIN 1  
Tel: (0041) 22-83-11-11  
Telex: 27333 HPAG CH  
CH,CM,CS  
Hewlett-Packard (Schweiz) AG  
Allmend 2  
CH-8967 WIDEN  
Tel: (0041) 57 31 21 11  
Telex: 53933 hpag ch  
Cable: HPAG CH  
A,CH,CM,CS,E,MS,P

## SYRIA

General Electronic Inc.  
Nuri Basha P.O. Box 5781  
DAMASCUS  
Tel: 33-24-87  
Telex: 11216 ITKAL SY  
Cable: ELECTROBOR DAMASCUS  
E  
Middle East Electronics  
Place Azmé  
P.O. Box 2308  
DAMASCUS  
Tel: 334592  
Telex: 11304 SATACO SY  
M,P

## TAIWAN

Hewlett-Packard Far East Ltd.  
Kaohsiung Office  
2/F 68-2, Chung Cheng 3rd Road  
KAOHSIUNG  
Tel: 241-2318, 261-3253  
CH,CS,E  
Hewlett-Packard Far East Ltd.  
Taiwan Branch  
5th Floor  
205 Tun Hwa North Road  
TAIPEI  
Tel: (02) 712-0404  
Cable: HEWPACK Taipei  
A,CH,CM,CS,E,M,P  
Ing Lih Trading Co.  
3rd Floor, 7 Jen-Ai Road, Sec. 2  
TAIPEI 100  
Tel: (02) 3948191  
Cable: INGLIH TAIPEI  
A

## THAILAND

Unimesa  
30 Patpong Ave., Suriwong  
BANGKOK 5  
Tel: 235-5727  
Telex: 84439 Simonco TH  
Cable: UNIMESA Bangkok  
A,CH,CS,E,M  
Bangkok Business Equipment Ltd.  
5/5-6 Dejo Road  
BANGKOK  
Tel: 234-8670, 234-8671  
Telex: 87669-BEQUIPT TH  
Cable: BUSIQUIPT Bangkok  
P

## TRINIDAD & TOBAGO

Caribbean Telecoms Ltd.  
50/A Jerningham Avenue  
P.O. Box 732  
PORT-OF-SPAIN  
Tel: 62-44213, 62-44214  
Telex: 235,272 HUGCO WG  
CM,E,M,P

## TUNISIA

Tunisie Electronique  
31 Avenue de la Liberté  
TUNIS  
Tel: 280-144  
E,P  
Corema  
1 ter. Av. de Carthage  
TUNIS  
Tel: 253-821  
Telex: 12319 CABAM TN  
M

## TURKEY

Teknim Company Ltd.  
Iran Caddesi No. 7  
Kavaklıdere, ANKARA  
Tel: 275800  
Telex: 42155 TKNM TR  
E  
E.M.A.  
Medina Eldem Sokak No.41/6  
Yüksel Caddesi  
ANKARA  
Tel: 175 622  
M

## UNITED ARAB EMIRATES

Emitac Ltd.  
P.O. Box 1641  
SHARJAH  
Tel: 354121, 354123  
Telex: 68136 Emitac Sh  
CH,CS,E,M,P

## UNITED KINGDOM

GREAT BRITAIN  
Hewlett-Packard Ltd.  
Trafalgar House  
Navigation Road  
ALTRINCHAM  
Cheshire WA14 1NU  
Tel: (061) 928-6422  
Telex: 668068  
A,CH,CS,E,M  
Hewlett-Packard Ltd.  
Oakfield House, Oakfield Grove  
Clifton  
BRISTOL BS8 2BN, Avon  
Tel: (027) 38606  
Telex: 444302  
CH,M,P

**GREAT BRITAIN (Cont'd)**

Hewlett-Packard Ltd.  
Fourier House  
257-263 High Street  
**LONDON COLNEY**  
Herts., AL2 1HA, St. Albans  
Tel: (0727) 24400  
Telex: 1-8952716  
CH,CS,E

Hewlett-Packard Ltd.  
Quadrangle  
106-118 Station Road  
**REDHILL, Surrey**  
Tel: (0737) 68655  
Telex: 947234  
CH,CS,E

Hewlett-Packard Ltd.  
Avon House  
435 Stratford Road  
**SHIRLEY, Solihull**  
West Midlands B90 4BL  
Tel: (021) 745 8800  
Telex: 339105  
CH

Hewlett-Packard Ltd.  
West End House 41  
High Street, West End  
**SOUTHAMPTON**  
Hampshire SO3 3DQ  
Tel: (703) 886767  
Telex: 477138  
CH

Hewlett-Packard Ltd.  
King Street Lane  
**WINNERSH, Wokingham**  
Berkshire RG11 5AR  
Tel: (0734) 784774  
Telex: 847178  
A,CH,E,M

Hewlett-Packard Ltd.  
Nine Mile Ride  
**WOKINGHAM**  
Berkshire, RG11 3LL  
Tel: 3446 3100  
Telex: 84-88-05  
CH,CS,E

**NORTHERN IRELAND**

*Cardiac Services Company*  
95A Finaghy Road South  
**BELFAST BT 10 0BY**  
Tel: (0232) 625-566  
Telex: 747626  
M

**SCOTLAND**

Hewlett-Packard Ltd.  
**SOUTH QUEENSFERRY**  
West Lothian, EH30 9GT  
Tel: (031) 3311188  
Telex: 72682  
A,CH,CM,CS,E,M

**UNITED STATES****Alabama**

Hewlett-Packard Co.  
P.O. Box 7000  
8290 Whitesburg Drive, S.E.  
**HUNTSVILLE, AL 35802**  
Tel: (205) 830-2000  
CH,CM,CS,E,M\*

**Arizona**

Hewlett-Packard Co.  
8080 Point Parkway West  
**PHOENIX, AZ 85044**  
Tel: (602) 273-8000  
A,CH,CM,CS,E,MS  
Hewlett-Packard Co.  
2424 East Aragon Road  
**TUCSON, AZ 85706**  
Tel: (602) 889-4631  
CH,E,MS\*\*

**California**

Hewlett-Packard Co.  
99 South Hill Dr.  
**4BRISBANE, CA 94005**  
Tel: (415) 330-2500  
CH,CS  
Hewlett-Packard Co.  
7621 Canoga Avenue  
**CANOGA PARK, CA 91304**  
Tel: (213) 702-8363  
A,CH,CS,E,P

Hewlett-Packard Co.  
P.O. Box 7830 (93747)  
5060 E. Clinton Avenue, Suite 102  
**FRESNO, CA 93727**  
Tel: (209) 252-9652  
CH,CS,MS

Hewlett-Packard Co.  
P.O. Box 4230  
1430 East Orangethorpe  
**FULLERTON, CA 92631**  
Tel: (714) 870-1000  
CH,CM,CS,E,MP

Hewlett-Packard Co.  
320 S. Kellogg, Suite B  
**GOLETA, CA 93117**  
Tel: (805) 967-3405  
CH

Hewlett-Packard Co.  
5400 W. Rosecrans Boulevard  
**LAWDALE, CA 90260**  
P.O. Box 92105  
**LOS ANGELES, CA 90009**  
Tel: (213) 970-7500  
Telex: 910-325-6608  
CH,CM,CS,MP

Hewlett-Packard Co.  
3200 Hillview Avenue  
**PALO ALTO, CA 94304**  
Tel: (415) 857-8000  
CH,CS,E

Hewlett-Packard Co.  
P.O. Box 15976 (95813)  
4244 So. Market Court, Suite A  
**SACRAMENTO, CA 95834**  
Tel: (916) 929-7222  
A\*,CH,CS,E,MS

Hewlett-Packard Co.  
9606 Aero Drive  
P.O. Box 23333 **SAN DIEGO, CA**  
92123  
Tel: (619) 279-3200  
CH,CM,CS,E,MP

Hewlett-Packard Co.  
2305 Camino Ramon "C"  
**SAN RAMON, CA 94583**  
Tel: (415) 838-5900  
CH,CS

Hewlett-Packard Co.  
P.O. Box 4230  
Fullerton, CA 92631  
363 Brookhollow Drive  
**SANTA ANA, CA 92705**  
Tel: (714) 641-0977  
A,CH,CM,CS,MP  
Hewlett-Packard Co.  
3003 Scott Boulevard  
**SANTA CLARA, CA 95050**  
Tel: (408) 988-7000  
Telex: 910-338-0586  
A,CH,CM,CS,E,MP

Hewlett-Packard Co.  
5703 Corsa Avenue  
**WESTLAKE VILLAGE, CA 91362**  
Tel: (213) 706-6800  
E\*,CH\*,CS\*

**Colorado**

Hewlett-Packard Co.  
24 Inverness Place, East  
**ENGLEWOOD, CO 80112**  
Tel: (303) 771-3455  
Telex: 910-935-0785  
A,CH,CM,CS,E,MS

**Connecticut**

Hewlett-Packard Co.  
47 Barnes Industrial Road South  
P.O. Box 5007  
**WALLINGFORD, CT 06492**  
Tel: (203) 265-7801  
A,CH,CM,CS,E,MS

**Florida**

Hewlett-Packard Co.  
P.O. Box 24210 (33307)  
2901 N.W. 62nd Street  
**FORT LAUDERDALE, FL 33309**  
Tel: (305) 973-2600  
CH,CS,E,MP

Hewlett-Packard Co.  
P.O. Box 13910  
6177 Lake Ellenor Drive  
**ORLANDO, FL 32809**  
Tel: (305) 859-2900  
A,CH,CM,CS,E,MS

Hewlett-Packard Co.  
5750B N. Hoover Blvd., Suite 123  
**TAMPA, FL 33614**  
Tel: (813) 884-3282  
A\*,CH,CM,CS,E\*,M\*

**Georgia**

Hewlett-Packard Co.  
P.O. Box 105005  
30348 ATLANTA,GA  
2000 South Park Place  
**ATLANTA, GA 30339**  
Tel: (404) 955-1500  
Telex: 810-766-4890  
A,CH,CM,CS,E,MP

**Hawaii**

Hewlett-Packard Co.  
Kawaiahao Plaza, Suite 190  
567 South King Street  
**HONOLULU, HI 96813**  
Tel: (808) 526-1555  
A,CH,E,MS

**Illinois**

Hewlett-Packard Co.  
P.O. Box 1607  
304 Eldorado Road  
**BLOOMINGTON, IL 61701**  
Tel: (309) 662-9411  
CH,MS\*\*

Hewlett-Packard Co.  
1100 31st Street, Suite 100  
**DOWNERS GROVE, IL 60515**  
Tel: (312) 960-5760  
CH,CS

Hewlett-Packard Co.  
5201 Tollview Drive  
**ROLLING MEADOWS, IL 60008**  
Tel: (312) 255-9800  
Telex: 910-687-1066  
A,CH,CM,CS,E,MP

**Indiana**

Hewlett-Packard Co.  
P.O. Box 50807  
7301 No. Shadeland Avenue  
**INDIANAPOLIS, IN 46250**  
Tel: (317) 842-1000  
A,CH,CM,CS,E,MS

**Iowa**

Hewlett-Packard Co.  
1776 22nd Street, Suite 1  
**WEST DES MOINES, IA 50262**  
Tel: (515) 224-1435  
CH,MS\*\*  
Hewlett-Packard Co.  
2415 Heinz Road  
**IOWA CITY, IA 52240**  
Tel: (319) 351-1020  
CH,E\*,MS

**Kansas**

Hewlett-Packard Co.  
7804 East Funston Road  
Suite 203  
**WICHITA, KA 67207**  
Tel: (316) 684-8491  
CH

**Kentucky**

Hewlett-Packard Co.  
10300 Linn Station Road  
Suite 100  
**LOUISVILLE, KY 40223**  
Tel: (502) 426-0100  
A,CH,CS,MS

**Louisiana**

Hewlett-Packard Co.  
P.O. Box 1449  
**KENNER, LA 70063**  
160 James Drive East  
**ST. ROSE, LA 70087**  
Tel: (504) 467-4100  
A,CH,CS,E,MS

**Maryland**

Hewlett-Packard Co.  
3701 Koppers Street  
**BALTIMORE, Md. 21227**  
Tel: (301) 644-5800  
Telex: 710-862-1943  
A,CH,CM,CS,E,MS  
Hewlett-Packard Co.  
2 Choke Cherry Road  
**ROCKVILLE, MD 20850**  
Tel: (301) 948-6370  
A,CH,CM,CS,E,MP

**Massachusetts**

Hewlett-Packard Co.  
32 Hartwell Avenue  
**LEXINGTON, MA 02173**  
Tel: (617) 861-8960  
A,CH,CM,CS,E,MP

**Michigan**

Hewlett-Packard Co.  
23855 Research Drive  
**FARMINGTON HILLS, MI 48024**  
Tel: (313) 476-6400  
A,CH,CM,CS,E,MP  
Hewlett-Packard Co.  
4326 Cascade Road S.E.  
**GRAND RAPIDS, MI 49506**  
Tel: (616) 957-1970  
CH,CS,MS

Hewlett-Packard Co.  
1771 W. Big Beaver Road  
**TROY, MI 48084**  
Tel: (313) 643-6474  
CH,CS

**Minnesota**

Hewlett-Packard Co.  
2025 W. Larpenteur Ave.  
**ST. PAUL, MN 55113**  
Tel: (612) 644-1100  
A,CH,CM,CS,E,MP

**Missouri**

Hewlett-Packard Co.  
11131 Colorado Avenue  
**KANSAS CITY, MO 64137**  
Tel: (816) 763-8000  
A,CH,CM,CS,E,MS  
Hewlett-Packard Co.  
13001 Hollenberg Drive  
**BRIDGETON, MO 63044**  
Tel: (314) 344-5100  
A,CH,CS,E,MP

**Nebraska**

Hewlett-Packard  
10824 Old Mill Rd., Suite 3  
**OMAHA, NE 68154**  
Tel: (402) 334-1813  
CM,MS

**New Jersey**

Hewlett-Packard Co.  
170 Century Road  
**PARAMUS, NJ 07652**  
Tel: (201) 265-5000  
A,CH,CM,CS,E,MP  
Hewlett-Packard Co.  
60 New England Av. West  
**PISCATAWAY, NJ 08854**  
Tel: (201) 981-1199  
A,CH,CM,CS,E

**New Mexico**

Hewlett-Packard Co.  
P.O. Box 11634 (87192)  
11300 Lomas Blvd.,N.E.  
**ALBUQUERQUE, NM 87112**  
Tel: (505) 292-1330  
CH,CS,E,MS

**New York**

Hewlett-Packard Co.  
Computer Drive South  
**ALBANY, NY 12205**  
Tel: (518) 458-1550  
Telex: 710-444-4691  
A,CH,E,MS

Hewlett-Packard Co.  
P.O. Box AC  
9600 Main Street  
**CLARENCE, NY 14031**  
Tel: (716) 759-8621  
CH

Hewlett-Packard Co.  
200 Cross Keys Office Park  
**FAIRPORT, NY 14450**  
Tel: (716) 223-9950  
CH,CM,CS,E,MS

Hewlett-Packard Co.  
7641 Henry Clay Blvd.  
**LIVERPOOL, NY 13088**  
Tel: (315) 451-1820  
A,CH,CM,E,MS

Hewlett-Packard Co.  
No. 1 Pennsylvania Plaza  
55th Floor  
34th Street & 8th Avenue  
**MANHATTAN NY 10001**  
Tel: (212) 971-0800  
CH,CS,E\*,M\*

Hewlett-Packard Co.  
250 Westchester Avenue  
**WHITE PLAINS, NY 10604**  
Tel: (914) 328-0884  
CM,CH,CS,E

Hewlett-Packard Co.  
3 Crossways Park West  
**WOODBURY, NY 11797**  
Tel: (516) 921-0300  
Telex: 510-221-2183  
A,CH,CM,CS,E,MS



# SALES & SUPPORT OFFICES

Arranged alphabetically by country

## UNITED STATES (Cont'd)

### North Carolina

Hewlett-Packard Co.  
P.O. Box 26500 (27420)  
5605 Roanne Way  
GREENSBORO, NC 27409  
Tel: (919) 852-1800  
A,CH,CM,CS,E,MS

### Ohio

Hewlett-Packard Co.  
9920 Carver Road  
CINCINNATI, OH 45242  
Tel: (513) 891-9870  
CH,CS,MS

Hewlett-Packard Co.  
16500 Sprague Road  
CLEVELAND, OH 44130  
Tel: (216) 243-7300  
A,CH,CM,CS,E,MS

Hewlett-Packard Co.  
962 Crupper Ave.  
COLUMBUS, OH 43229  
Tel: (614) 436-1041  
CH,CM,CS,E\*

Hewlett-Packard Co.  
P.O. Box 280  
330 Progress Rd.  
DAYTON, OH 45449  
Tel: (513) 859-8202  
A,CH,CM,E\*,MS

### Oklahoma

Hewlett-Packard Co.  
P.O. Box 75609 (73147)  
304 N. Meridian, Suite A  
3  
OKLAHOMA CITY, OK 73107  
Tel: (405) 946-9499  
A\*,CH,E\*,MS

Hewlett-Packard Co.  
3840 S. 103rd E. Avenue  
Logan Building, Suite 100  
TULSA, OK 74145  
Tel: (918) 665-3300  
A\*\*,CH,CS,M\*

### Oregon

Hewlett-Packard Co.  
9255 S. W. Pioneer Court  
WILSONVILLE, OR 97070  
Tel: (503) 682-8000  
A,CH,CS,E\*,MS

### Pennsylvania

Hewlett-Packard Co.  
1021 8th Avenue  
KING OF PRUSSIA, PA 19046  
Tel: (215) 265-7000  
A,CH,CM,CS,E,MP

Hewlett-Packard Co.  
111 Zeta Drive  
PITTSBURGH, PA 15238  
Tel: (412) 782-0400  
A,CH,CS,E,MP

### South Carolina

Hewlett-Packard Co.  
P.O. Box 21708 (29221)  
Brookside Park, Suite 122  
1 Harbison Way  
COLUMBIA, SC 29210  
Tel: (803) 732-0400  
CH,E,MS

### Tennessee

Hewlett-Packard Co.  
3070 Directors Row  
MEMPHIS, TN 38131  
Tel: (901) 346-8370  
A,CH,MS

## Texas

Hewlett-Packard Co.  
Suite C-110  
4171 North Mesa  
EL PASO, TX 79902  
Tel: (915) 533-3555  
CH,E\*,MS\*\*

Hewlett-Packard Co.  
P.O. Box 42816 (77042)  
10535 Harwin Street  
HOUSTON, TX 77036  
Tel: (713) 776-6400  
A,CH,CM,CS,E,MP

Hewlett-Packard Co.  
P.O. Box 1270  
930 E. Campbell Rd.  
RICHARDSON, TX 75080  
Tel: (214) 231-6101  
A,CH,CM,CS,E,MP

Hewlett-Packard Co.  
P.O. Box 32993 (78216)  
1020 Central Parkway South  
SAN ANTONIO, TX 78232  
Tel: (512) 494-9336  
CH,CS,E,MS

## Utah

Hewlett-Packard Co.  
P.O. Box 26626 (84126)  
3530 W. 2100 South  
SALT LAKE CITY, UT 84119  
Tel: (801) 974-1700  
A,CH,CS,E,MS

## Virginia

Hewlett-Packard Co.  
P.O. Box 9669 (23228)  
RICHMOND, Va. 23228  
4305 Cox Road  
GLEN ALLEN, Va. 23060  
Tel: (804) 747-7750  
A,CH,CS,E,MS

## Washington

Hewlett-Packard Co.  
15815 S.E. 37th Street  
BELLEVUE, WA 98006  
Tel: (206) 643-4000  
A,CH,CM,CS,E,MP

Hewlett-Packard Co.  
Suite A  
708 North Argonne Road  
SPOKANE, WA 99206  
Tel: (509) 922-7000  
CH,CS

## West Virginia

Hewlett-Packard Co.  
P.O. Box 4297  
4604 MacCorkle Ave., S.E.  
CHARLESTON, WV 25304  
Tel: (304) 925-0492  
A,MS

## Wisconsin

Hewlett-Packard Co.  
150 S. Sunny Slope Road  
BROOKFIELD, WI 53005  
Tel: (414) 784-8800  
A,CH,CS,E\*,MP

## URUGUAY

Pablo Ferrando S.A.C. e l.  
Avenida Italia 2877  
Casilla de Correo 370  
MONTEVIDEO  
Tel: 80-2586  
Telex: Public Booth 901  
A,CM,E,M

## VENEZUELA

Hewlett-Packard de Venezuela C.A.  
3A Transversal Los Ruices Norte

Edificio Segre  
Apartado 50933  
CARACAS 1071  
Tel: 239-4133  
Telex: 25146 HEWPACK  
A,CH,CS,E,MS,P

Hewlett-Packard de Venezuela C.A.  
Calle-72-Entre 3H Y 3Y, No.3H-40  
Edificio Ada-Evelyn, Local B  
Apartado 2646  
MARACAIBO, Estado Zulia  
Tel: (061) 80.304  
C,E\*

Hewlett-Packard de Venezuela C.A.  
Calle Vargas Rondon  
Edificio Seguros Carabobo, Piso 10  
VALENCIA  
Tel: (041) 51 385  
CH,CS,P

Colimodio S.A.  
Este 2 - Sur 21 No. 148  
Apartado 1053  
CARACAS 1010  
Tel: 571-3511  
Telex: 21529 COLMODIO  
M

## ZIMBABWE

Field Technical Sales  
45 Kelvin Road, North  
P.B. 3458  
SALISBURY  
Tel: 705 231  
Telex: 4-122 RH  
C,E,M,P

## HEADQUARTERS OFFICES

If there is no sales office listed for your area, contact one of these headquarters offices.

## NORTH/CENTRAL AFRICA

Hewlett-Packard S.A.  
7 Rue du Bois-du-Lan  
CH-1217 MEYRIN 1, Switzerland  
Tel: (022) 83 12 12  
Telex: 27835 hpse  
Cable: HEWPACKSA Geneve

## ASIA

Hewlett-Packard Asia Ltd.  
6th Floor, Sun Hung Kai Centre  
30 Harbour Rd.  
G.P.O. Box 795

HONG KONG  
Tel: 5-832 3211  
Telex: 66678 HEWPA HX  
Cable: HEWPACK HONG KONG

## CANADA

Hewlett-Packard (Canada) Ltd.  
6877 Goreway Drive  
MISSISSAUGA, Ontario L4V 1M8  
Tel: (416) 678-9430  
Telex: 610-492-4246

## EASTERN EUROPE

Hewlett-Packard Ges.m.b.h.  
Liebigasse 1  
P.O.Box 72  
A-1222 VIENNA, Austria  
Tel: (222) 2365110  
Telex: 1 3 4425 HEPA A

## NORTHERN EUROPE

Hewlett-Packard S.A.  
Uilenstede 475  
NL-1183 AG AMSTELVEEN  
The Netherlands  
P.O.Box 999  
NL-1180 AZ AMSTELVEEN  
The Netherlands  
Tel: 20 437771

## OTHER EUROPE

Hewlett-Packard S.A.  
7 rue du Bois-du-Lan  
CH-1217 MEYRIN 1, Switzerland  
Tel: (022) 83 1212  
Telex: 27835 hpse  
Cable: HEWPACKSA Geneve

## MEDITERRANEAN AND MIDDLE EAST

Hewlett-Packard S.A.  
Mediterranean and Middle East  
Operations  
Atrina Centre  
32 Kifissias Ave.  
Maroussi, ATHENS, Greece  
Tel: 682 88 11  
Telex: 21-6588 HPAT GR  
Cable: HEWPACKSA Athens

## EASTERN USA

Hewlett-Packard Co.  
4 Choke Cherry Road  
Rockville, MD 20850  
Tel: (301) 258-2000

## MIDWESTERN USA

Hewlett-Packard Co.  
5201 Tollview Drive  
ROLLING MEADOWS, IL 60008  
Tel: (312) 255-9800

## SOUTHERN USA

Hewlett-Packard Co.  
P.O. Box 105005  
450 Interstate N. Parkway  
ATLANTA, GA 30339  
Tel: (404) 955-1500

## WESTERN USA

Hewlett-Packard Co.  
3939 Lankershim Blvd.  
LOS ANGELES, CA 91604  
Tel: (213) 877-1282

## OTHER INTERNATIONAL AREAS

Hewlett-Packard Co.  
Intercontinental Headquarters  
3495 Deer Creek Road  
PALO ALTO, CA 94304  
Tel: (415) 857-1501  
Cable: HEWPACK

March 1983 5952-6900

*HP distributors are printed in italics.*



