

---

**User's Guide for the Graphical User Interface**

---

**HP 64760/HP 64761  
80960  
Emulation/Analysis**

---

## Notice

**Hewlett-Packard makes no warranty of any kind with regard to this material, including, but not limited to, the implied warranties of merchantability and fitness for a particular purpose.** Hewlett-Packard shall not be liable for errors contained herein or for incidental or consequential damages in connection with the furnishing, performance, or use of this material.

Hewlett-Packard assumes no responsibility for the use or reliability of its software on equipment that is not furnished by Hewlett-Packard.

© Copyright 1987, 1991, 1992, 1993, Hewlett-Packard Company.

This document contains proprietary information, which is protected by copyright. All rights are reserved. No part of this document may be photocopied, reproduced or translated to another language without the prior written consent of Hewlett-Packard Company. The information contained in this document is subject to change without notice.

HP is a trademark of Hewlett-Packard Company.

Microtec is a registered trademark of Microtec Research Inc.

OSF/Motif and Motif are trademarks of the Open Software Foundation in the U.S. and other countries.

SunOS, SPARCsystem, OpenWindows, and SunView are trademarks of Sun Microsystems, Inc.

UNIX is a registered trademark of UNIX System Laboratories Inc. in the U.S.A. and other countries.

**Hewlett-Packard  
P.O. Box 2197  
1900 Garden of the Gods Road  
Colorado Springs, CO 80901-2197, U.S.A.**

**RESTRICTED RIGHTS LEGEND** Use, duplication, or disclosure by the U.S. Government is subject to restrictions as set forth in subparagraph (c) (1)(ii) of the Rights in Technical Data and Computer Software Clause at DFARS 252.227-7013. Hewlett-Packard Company, 3000 Hanover Street, Palo Alto, CA 94304 U.S.A. Rights for non-DOD U.S. Government Departments and Agencies are as set forth in FAR 52.227-19(c)(1,2).

---

## Printing History

New editions are complete revisions of the manual. The date on the title page changes only when a new edition is published.

A software code may be printed before the date; this indicates the version level of the software product at the time the manual was issued. Many product updates and fixes do not require manual changes, and manual corrections may be done without accompanying product changes. Therefore, do not expect a one-to-one correspondence between product updates and manual revisions.

Edition 1	64760-97001, June 1991
Edition 2	64760-97004, July 1991
Edition 3	B1488-97000, August 1992
<b>Edition 4</b>	<b>B1488-97001, December 1993</b>

---

## Safety, and Certification and Warranty

Safety and certification and warranty information can be found at the end of this manual on the pages before the back cover.

---

## 80960 Emulation and Analysis

The HP 64760 80960KA/KB/MC emulator or the HP 64761 80960SA/SB emulator replace the microprocessor in your embedded microprocessor system, also called the *target system*, so that you can control execution and view or modify processor and target system resources.

The emulator is used with an *emulation analyzer* that captures emulation processor bus cycle information synchronously with the processor's clock signal.

The HP 64760 emulator is used with the HP 64705A 35 MHz Analyzer which captures 108 channels of bus cycle information and optionally provides an *external analyzer* that captures up to 16 channels of data external to the emulator.

The HP 64761 emulator is used with the HP 64704A 80-Channel Emulation Bus Analyzer or the HP 64794 Deep Memory Emulation Bus Analyzer. No external analysis is available with the HP 64704A.

### With the Emulator, You Can ...

- Plug into 80960 target systems.
- Download programs into emulation memory or target system RAM.
- Display or modify the contents of processor registers and memory.
- Run programs, set up software breakpoints, step through programs, and reset the emulation processor.

### **With the Analyzer, You Can ...**

- Trigger the analyzer when a particular bus cycle state is captured. States are stored relative to the trigger state.
- Qualify which states get stored in the trace.
- Prestore certain states that occur before each normal store state.
- Trigger the analyzer after a sequence of up to 8 events have occurred.
- Capture data on other target system signals with the external analyzer.
- Cause emulator execution to break when the analyzer finds its trigger condition.
- With the HP 64705A analyzer (which is used with the HP 64760 80960KA/KB/MC emulator), you can use the 16-channels of external analysis as an independent 100 MHz timing analyzer with the Timing Analyzer Interface.

### **With the HP 64700 Card Cage, You Can ...**

- Use the RS-422 capability of the serial port and an RS-422 interface card on the host computer (HP 98659 for the HP 9000 Series 300) to provide upload/download rates of up to 230.4K baud.
- Easily upgrade HP 64700 firmware by downloading to flash memory.

### **With Multiple HP 64700s, You Can ...**

- Start and stop up to 16 emulators at the same time.
- Use the analyzer in one HP 64700 to arm (that is, activate) the analyzers in other HP 64700 card cages or to cause emulator execution in other HP 64700 card cages to break.
- Use the HP 64700's BNC connector to trigger an external instrument (for example, a logic analyzer or oscilloscope) when the analyzer finds its trigger condition, or you can allow an external instrument to arm the analyzer or break emulator execution.

### **With the Graphical User Interface, You Can ...**

- Use the emulator and analyzer under an X Window System that supports OSF/Motif interfaces.
- Enter commands using pull-down or pop-up menus.
- Enter, recall, and edit commands using the command line pushbuttons.
- Enter file names, recalled commands, recalled values, etc., using dialog boxes.
- Set breakpoints by pointing the mouse cursor on a line in the mnemonic memory display and clicking.
- Create action keys for commonly used commands or command files.

### **With the Softkey Interface, You Can ...**

- Use the emulator and analyzer with a terminal or terminal emulator.
- Quickly enter commands using softkeys, command recall, and command editing.

---

## 80960 Emulator Differences

<b>Differences Between the 80960 Emulators</b>		
<b>Category</b>	<b>HP 64760</b>	<b>HP 64761</b>
Processors	80960KA, 80960KB, and 80960MC (if the chip's Memory Management Unit is not used)	80960SA, 80960SB
Chip packages	132-pin PGA	84-lead PLCC, 80-lead QFP
Max chip clock Max bus rate	50 MHz 25 MHz	32 MHz 16 MHz
Emulation bus analyzer	HP 64705A 35 MHz Analyzer which: - optionally provides 16-channels of external analysis	HP 64704/794 80-Channel Emulation Bus Analyzer which: - does not provide external analysis
Emulator control card	part of HP 64760	uses HP 64748C
Max emulation memory	4 Mbytes	2 Mbytes
Mapper	16 terms with attributes for synchronizing emulation memory to the target system	8 terms, no attributes (emulation memory synchronized with configuration question)
Coverage memory	8 term/1 Mbytes	none
Emulation monitor program	Background	Background/Foreground

---

# In This Book

This book documents the Graphical User Interface and the Softkey Interface when used with the HP 64760 80960KA/KB/MC emulator and HP 64705 analyzer or the HP 64761 80960SA/SB emulator and HP 64704 analyzer. It is organized into five parts whose chapters are described below.

## Part 1. Quick Start Guide

Chapter 1 presents an overview of emulation and analysis and quickly shows you how to use the emulator and analyzer.

## Part 2. User's Guide

Chapter 2 shows you how to start and exit the HP 64700 interfaces.

Chapter 3 shows you how to enter commands.

Chapter 4 shows how to configure the emulator.

Chapter 5 shows how to use the emulator.

Chapter 6 shows how to use the analyzer.

Chapter 7 shows how to use the Software Performance Measurement Tool (SPMT) with the analyzer.

Chapter 8 shows how to use the external state analyzer.

Chapter 9 shows how to make coordinated measurements.

Chapter 10 shows how to change X resource settings for the Graphical User Interface.

## Part 3. Reference

Chapter 11 describes emulator/analyzer interface commands.

Chapter 12 lists the status and error messages that can occur while using the emulator/analyzer interface.

## Part 4. Concept Guide

Chapter 13 contains conceptual information on various topics.

## Part 5. Installation Guide

Chapter 14 outlines the installation of the Graphical User Interface.

Chapter 15 shows you how to install or update emulator firmware.



---

# Contents

---

## Part 1 Quick Start Guide

### 1 Getting Started

The Emulator/Analyzer Interface — At a Glance 26

The Softkey Interface 26

Softkey Interface Conventions 27

The Graphical User Interface 28

Graphical User Interface Conventions 30

The Getting Started Tutorial 33

Step 1: Start the demo 34

Step 2: Display the program in memory 35

Step 3: Run from processor reset 36

Step 4: Step high-level source lines 38

Step 5: Display the previous mnemonic display 39

Step 6: Run until an address 40

Step 7: Display data values 41

Step 8: Display registers 42

Step 9: Step assembly-level instructions 43

Step 10: Trace the program 44

Step 11: Display memory at an address in a register 46

Step 12: Patch assembly language code 47

Step 13: Exit the emulator/analyzer interface 50

## **Part 2 User's Guide**

### **2 Starting and Exiting HP 64700 Interfaces**

#### Starting the Emulator/Analyzer Interface 55

- To start the emulator/analyzer interface 55
- To start the interface using the default configuration 56
- To run a command file on interface startup 57
- To display the status of emulators 57
- To unlock an interface that was left locked by another user 58

#### Opening Other HP 64700 Interface Windows 59

- To open additional emulator/analyzer windows 59
- To open the high-level debugger interface window 60
- To open the software performance analyzer (SPA) interface window 60

#### Exiting HP 64700 Interfaces 61

- To close an interface window 61
- To exit a debug/emulation session 62

### **3 Entering Commands**

#### Using Menus, the Entry Buffer, and Action Keys 65

- To choose a pulldown menu item using the mouse (method 1) 66
- To choose a pulldown menu item using the mouse (method 2) 67
- To choose a pulldown menu item using the keyboard 67
- To choose popup menu items 69
- To place values into the entry buffer using the keyboard 70
- To copy-and-paste to the entry buffer 70
- To recall entry buffer values 73
- To use the entry buffer 73
- To copy-and-paste from the entry buffer to the command line entry area 74
- To use the action keys 75
- To use dialog boxes 75
- To access help information 79

<b>Using the Command Line with the Mouse</b>	<b>80</b>
To turn the command line on or off	80
To enter a command	81
To edit the command line using the command line pushbuttons	82
To edit the command line using the command line popup menu	83
To recall commands	84
To get help about the command line	84
<b>Using the Command Line with the Keyboard</b>	<b>85</b>
To enter multiple commands on one command line	85
To recall commands	86
To edit commands	86
To access on-line help information	87
<b>Using Command Files</b>	<b>88</b>
To start logging commands to a command file	91
To stop logging commands to a command file	91
To playback (execute) a command file	92
<b>Using Pod Commands</b>	<b>93</b>
To display the pod commands screen	94
To use pod commands	94
<b>Forwarding Commands to Other HP 64700 Interfaces</b>	<b>95</b>
To forward commands to the high-level debugger	95
To forward commands to the software performance analyzer	96

## **4 Configuring the Emulator**

<b>Using the Configuration Interface</b>	<b>101</b>
To start the configuration interface	102
To modify a configuration section	104
To store a configuration	106
To change the configuration directory context	107
To display the configuration context	108
To access help information	108
To exit the configuration interface	109
To load a configuration	109

## Contents

Modifying the General Configuration Items	110
To restrict the emulator to real-time runs	110
To turn OFF the restriction to real-time runs	111
Selecting the Emulation Monitor Program (HP 64761 Only)	112
To use the background monitor program	114
To use the foreground monitor program	115
To customize the foreground monitor program	116
Mapping Memory	117
To map memory ranges	119
To characterize unmapped ranges	121
To delete memory map ranges	122
Configuring the Emulator Pod	123
To synchronize to target system reset	123
To turn OFF synchronization to target system reset	126
To specify the target memory access size	126
To specify target system bus rate	127
To synchronize emulation memory accesses to target READY (HP 64761 Only)	127
Setting the Debug/Trace Options	128
To disable breaks on writes to ROM	128
To enable breaks on writes to ROM	129
To restrict breaks into monitor when released from reset	129
To allow breaks into monitor when released from reset	130
<b>5 Using the Emulator</b>	
Loading and Storing Absolute Files	133
To load absolute files	133
To load absolute files without symbols	134
To store memory contents into absolute files	134

Using Symbols	135
To load symbols	135
To display global symbols	136
To display local symbols	137
To display a symbol's parent symbol	141
To copy-and-paste a full symbol name to the entry buffer	142
Using Context Commands	143
To display the current directory and symbol context	144
To change the directory context	144
To change the current working symbol context	145
Executing User Programs	146
To initialize your programming environment	146
To run programs from the current PC	148
To run programs from an address	148
To run programs from the transfer address	148
To run programs from reset	149
To run programs until an address	150
To stop (break from) user program execution	151
To step high-level source lines	151
To step assembly-level instructions	152
To reset the emulation processor	153
Using Software Breakpoints	154
To display the breakpoints list	155
To enable/disable breakpoints	156
To set a permanent breakpoint	158
To set a temporary breakpoint	159
To set all breakpoints	160
To deactivate a breakpoint	160
To re-activate a breakpoint	161
To clear a breakpoint	163
To clear all breakpoints	165
Displaying and Modifying Registers	166
To display register contents	168
To modify register contents	171

## Contents

<b>Displaying and Modifying Memory</b>	<b>172</b>
To display memory	172
To display memory in mnemonic format	173
To return to the previous mnemonic display	173
To display memory in hexadecimal format	174
To display memory in real number format	175
To display memory at an address	176
To display memory repetitively	177
To modify memory	177
<b>Displaying Data Values</b>	<b>178</b>
To display data values	178
To clear the data values display and add a new item	179
To add items to the data values display	179
<b>Displaying 80960 System Tables</b>	<b>180</b>
To display the 80960 system tables	180
<b>Changing the Interface Settings</b>	<b>182</b>
To set the source/symbol modes	182
To set the display modes	183
<b>Using System Commands</b>	<b>185</b>
To set UNIX environment variables	185
To display the name of the emulation module	186
To display the event log	186
To display the error log	187
To edit files	188
To copy information to a file or printer	191
To open a terminal emulation window	192
<b>Using Simulated I/O</b>	<b>193</b>
To display the simulated I/O screen	193
To use simulated I/O keyboard input	194
<b>Using Basis Branch Analysis</b>	<b>195</b>
To store BBA data to a file	195

## 6 Using the Emulation Analyzer

### The Basics of Starting, Stopping, and Displaying Traces 199

- To start a trace measurement 200
- To display the trace status 200
- To stop a trace measurement 203
- To display the trace 204
- To position the trace display on screen 206
- To change the trace depth 207
- To modify the last  
**trace** command entered 207

### Using Execution Messages for Program Measurements 208

- To set execution trace messages 209
- To display execution trace messages 210
- To clear execution trace messages 211
- To disable the execution trace message feature 212
- To enable the execution trace message feature 212
- To capture execution messages with the analyzer 212

### Qualifying Trigger and Store Conditions 214

- To qualify the trigger state and position 233
- To trigger on a number of occurrences of some state 235
- To qualify states stored in the trace 236
- To prestore states before qualified store states 237
- To change the count qualifier (HP 64704 Only) 238
- To trace until the analyzer is halted 240
- To break emulator execution on the analyzer trigger 241

### Using the Sequencer 242

- To trigger after a sequence of states 242
- To specify a global restart state 244
- To trace "windows" of program execution 245

## Contents

Modifying the Trace Display	247
To display the trace about a line number	248
To display the trace in absolute format	249
To display the trace in mnemonic format	250
To display the trace with high-level source lines	253
To display the trace with symbol information	255
To change column widths in the trace display	256
To display time counts in absolute or relative format	257
To display the trace with addresses offset	258
To return to the default trace display	259
To display external analyzer information (HP 64705 Only)	260
Saving and Restoring Traces	261
To save trace commands	261
To restore trace commands	262
To save traces	263
To restore traces	264
<b>7 Making Software Performance Measurements</b>	
Activity Performance Measurements	267
To set up the trace command for activity measurements	269
To initialize activity performance measurements	270
To interpret activity measurement reports	274
Duration Performance Measurements	282
To set up the trace command for duration measurements	283
To initialize duration performance measurements	285
To interpret duration measurement reports	287
Running Measurements and Creating Reports	291
To run performance measurements	291
To end performance measurements	292
To create a performance measurement report	293



## 8 Using the External State Analyzer

### Setting Up the External Analyzer 297

To connect the external analyzer probe to the target system 298

### Configuring the External Analyzer 301

To control the external analyzer with the emulator/analyzer interface 302

To specify the threshold voltage 303

To specify the external analyzer mode 304

To specify the slave clock mode 305

To define labels for the external analyzer signals 308

## 9 Making Coordinated Measurements

### Setting Up for Coordinated Measurements 315

To connect the Coordinated Measurement Bus (CMB) 315

To connect to the rear panel BNC 317

### Starting/Stopping Multiple Emulators 319

To enable synchronous measurements 319

To start synchronous measurements 320

To disable synchronous measurements 320

### Using Trigger Signals 321

To drive the emulation analyzer trigger signal to the CMB 323

To drive the emulation analyzer trigger signal to the BNC connector 324

To drive the external analyzer trigger signal to the CMB 324

To drive the external analyzer trigger signal to the BNC connector 325

To break emulator execution on signal from CMB 325

To break emulator execution on signal from BNC 326

To break emulator execution on external analyzer trigger 326

To arm the emulation analyzer on signal from CMB 327

To arm the emulation analyzer on signal from BNC 327

To arm the emulation analyzer on external analyzer trigger 328

To arm the external analyzer on signal from CMB 328

To arm the external analyzer on signal from BNC 329

To arm the external analyzer on emulation analyzer trigger 329

## 10 Setting X Resources

- To modify the Graphical User Interface resources 334
- To use customized scheme files 338
- To set up custom action keys 340
- To set initial recall buffer values 341
- To set up demos or tutorials 343

---

## Part 3 Reference

### 11 Emulator/Analyzer Interface Commands

- How Pulldown Menus Map to the Command Line 350
- How Popup Menus Map to the Command Line 355
- Syntax Conventions 357

- Commands 358
  - break 359
  - bbaunld 360
  - cmb\_execute 361
  - copy 362
  - copy local\_symbols\_in 366
  - copy memory 367
  - copy registers 369
  - copy trace 370
  - display 371
  - display data 374
  - display global\_symbols 377
  - display local\_symbols\_in 378
  - display memory 379
  - display registers 383
  - display simulated\_io 385
  - display software\_breakpoints 386
  - display table 387
  - display trace 388
  - end 392
  - EXPR-- 394
  - forward 397

help	398
init_processor	400
load	402
log_commands	404
modify	405
modify configuration	406
modify execution_messages	407
modify keyboard_to_simio	410
modify memory	411
modify register	414
modify software_breakpoints	416
performance_measurement_end	419
performance_measurement_initialize	420
performance_measurement_run	422
pod_command	424
QUALIFIER	426
RANGE	428
reset	430
run	431
SEQUENCING	434
set	436
specify	441
STATE	443
step	446
stop_trace	448
store	449
--SYMB--	451
trace	458
TRIGGER	461
wait	463
WINDOW	465

## **12 Status and Error Messages**

80960 Emulation Status Messages	469
Graphical/Softkey Interface Messages - Unnumbered	471
Graphical/Softkey Interface Messages - Numbered	488
Terminal Interface Messages	491
Emulator Messages	491
General Emulator and System Messages	498
Analyzer Messages	512

---

## **Part 4 Concept Guide**

### **13 Concepts**

Target System Design Considerations	519
Resetting the Target System	519
Access for Emulator Probe	519
Probe Power Requirements and Processor Signal Considerations	519
The Effects of the Emulation Processor on Target Execution	520
Execution Messages	520
Trace Controls	521
Initial Memory Image	521
Background Monitor Execution	521
X Resources and the Graphical User Interface	523
X Resource Specifications	523
How X Resource Specifications are Loaded	525
Scheme Files	527

---

## Part 5 Installation Guide

### 14 Installation

Installation at a Glance 534

Installation Overview for HP 9000 Hosted Systems 534

Installation Overview for Sun SPARCsystems 536

Installation for HP 9000 Hosted Systems 537

Step 1. Install the hardware in the HP 64700 Series Cardcage 537

Step 2. Configure the emulator for the communication channel 537

Step 3. Connect the emulator to your system 538

Step 4. Install the software 538

Step 5. Verify the software installation 540

Step 6a. Start the X server and the Motif Window Manager (mwm) 541

Step 6b. Start HP VUE 541

Step 7. Set the necessary environment variables 542

Step 8. Determine the logical name of your emulator 544

Step 9. Start the interface with the

**emul700** command 545

Step 10. Exit the Graphical User Interface 547

Installation for Sun SPARCsystems 548

Step 1. Install the hardware in the HP 64700 Series Cardcage 548

Step 2. Configure the emulator for the communication channel 548

Step 3. Connect the emulator to your system 549

Step 4. Install the software 549

Step 5. Start the X server and OpenWindows 550

Step 6. Set the necessary environment variables 550

Step 7. Verify the software installation 552

Step 8. Map your function keys 553

Step 9. Determine the logical name of your emulator 554

Step 10. Start the interface with the

**emul700** command 555

Step 11. Exit the Graphical User Interface 557

## Contents

### **15 Installing/Updating Emulator Firmware**

- To update emulator firmware with "progflash" 561
- To display current firmware version information 564
- If there is a power failure during a firmware update 565

### **Glossary**

### **Index**

---

# Part 1

---

## Quick Start Guide

A one-glance overview of the product and a few task instructions to help you get comfortable.

Part 1





---

**1**



---

## **Getting Started**

## The Emulator/Analyzer Interface — At a Glance

When an X Window System that supports OSF/Motif interfaces is running on the host computer, the emulator/analyzer interface is the Graphical User Interface which provides pull-down and pop-up menus, point and click setting of breakpoints, cut and paste, on-line help, customizable action keys and pop-up recall buffers, etc.

The emulator/analyzer interface can also be the Softkey Interface which is provided for several types of terminals, terminal emulators, and bitmapped displays. When using the Softkey Interface, commands are entered from the keyboard.

### The Softkey Interface

The screenshot shows a window titled "Softkey Interface" with the following content:

```

Memory :mnemonic :file = ../usr/hp64000/demo/debug_env/hp64760/main.c":
address  data
00100000 8AB8300000 stos    g7, 00108C00
00100008 09000C58   call   00100C60
0010000C 0B001E1C   bal    00101E28
00100010 09000D70   call   00100D80
00100014 9080300000 ld      00107660, g0
00100018 59840801   addo   01, g0, g0
00100020 9280300000 st      g0, 00107660
00100028 8C80300000 lda     00107660, g0
00100030 09000030   call   00100060
00100034 9088300000 ld      00107658, g1
0010003C 32046008   cmpobe 00, g1, 00100044
00100040 09001CD0   call   00101D10
00100044 0B002024   bal    00102068
00100048 08FFFC8    b      00100010
0010004C 8AB8300000 stos    g7, 00108C02
00100054 0A000000   ret

STATUS:  cws: main."/usr/hp64000/demo/debug_env/hp64760/main.c": _____R...
display memory main mnemonic

run  trace  step  display  modify  break  end  ---ETC--
    
```

Labels on the left side of the image point to specific parts of the window:

- Display area.** Points to the main table of memory addresses and mnemonics.
- Status line.** Points to the line starting with "STATUS:".
- Command line.** Points to the line starting with "display memory main mnemonic".

**Display area.** Can show memory, data values, analyzer traces, registers, breakpoints, status, simulated I/O, global symbols, local symbols, pod commands (the emulator's underlying Terminal Interface), error log, or display log. You can use the UP ARROW, DOWN ARROW, PAGE UP, and PAGE DOWN cursor keys to scroll or page up or down the information in the active window.

**Status line.** Displays the emulator and analyzer status. Also, when error and status messages occur, they are displayed on the status line in addition to being saved in the error log.

**Command line.** Commands are entered on the command line by pressing softkeys (or by typing them in) and executed by pressing the Return key. The Tab and Shift-Tab keys allow you to move the cursor on the command line forward or backward. The Clear line key (or CTRL-e) clears from the cursor position to the end of the line. The CTRL-u key clears the whole command line.

### Softkey Interface Conventions

Example Softkey Interface commands throughout the manual use the following conventions:

<b>bold</b>	Commands, options, and parts of command syntax.
<b><i>bold italic</i></b>	Commands, options, and parts of command syntax which may be entered by pressing softkeys.
normal	User specified parts of a command.
\$	Represents the UNIX prompt. Commands which follow the "\$" are entered at the UNIX prompt.
<RETURN>	The carriage return key.

## The Graphical User Interface

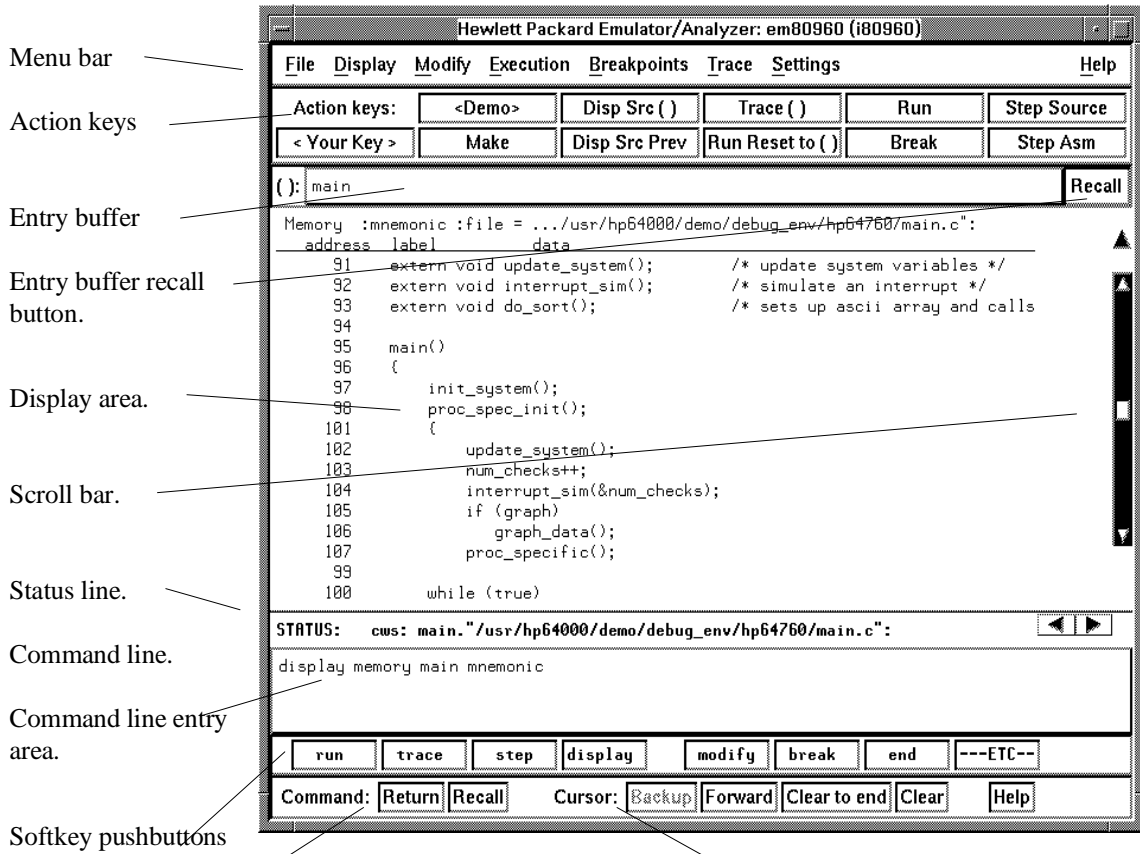

Command buttons. Includes command recall button.      Cursor buttons for command line area control.

**Menu Bar.** Provides pulldown menus from which you select commands. When menu items are not applicable, they appear half-bright and do not respond to mouse clicks.

**Action Keys.** User-defined pushbuttons. You can label these pushbuttons and define the action to be performed.

**Entry Buffer.** Wherever you see "(" in a pulldown menu, the contents of the entry buffer are used in that command. You can type values into the entry buffer, or you can cut and paste values into the entry buffer from the display area or from the command line entry area. You can also set up action keys to use the contents of the entry buffer.

**Entry Buffer Recall Button.** Allows you to recall entry buffer values that have been predefined or used in previous commands. When you click on the entry buffer **Recall** button, a dialog box appears that allows you to select values.

**Display Area.** Can show memory, data values, analyzer traces, registers, breakpoints, status, simulated I/O, global symbols, local symbols, pod commands (the emulator's underlying Terminal Interface), error log, or display log.

Whenever the mouse pointer changes from an arrow to a hand, you can press and hold the *select* mouse button to access popup menus.

**Scroll Bar.** A "sticky slider" that allows navigation in the display area. Click on the upper and lower arrows to scroll to the top (home) and bottom (end) of the window. Click on the inner arrows to scroll one line. Drag the slider handle up or down to cause continuous scrolling. Click between the inner arrows and the slider handle to page up or page down.

**Status Line.** Displays the emulator and analyzer status. Also, when error and status messages occur, they are displayed on the status line in addition to being saved in the error log. You can press and hold the *select* mouse button to access the Status Line popup menu.

**Command Line.** The command line area is similar to the command line in the Softkey Interface; however, the graphical interface lets you use the mouse to enter and edit commands.

- **Command line entry area.** Allows you to enter commands from the command line.
- **Softkey pushbuttons.** Clicking on these pushbuttons, or pressing softkeys, places the command in the command line entry area. You can press and hold the *select* mouse button to access the Command Line popup menu.
- **Command buttons** (includes command recall button). The command **Return** button is the same as pressing the carriage return key — it sends the command in the command line entry area to the emulator/analyzer.





The command **Recall** button allows you to recall previous or predefined commands. When you click on the command **Recall** button, a dialog box appears that allows you to select a command.

- **Cursor buttons for command line area control.** Allow you to move the cursor in the command line entry area forward or backward, clear to the end of the command line, or clear the whole command line entry area.

You can choose not to display the command line area by turning it off. For the most common emulator/analyzer operations, the pulldown menus, popup menus, and action keys provide all the control you need. Choosing menu items that require use of the command line will automatically turn the command line back on.

## Graphical User Interface Conventions

### Choosing Menu Commands

This chapter uses a shorthand notation for indicating that you should choose a particular menu item. For example, the following instruction

Choose **File**→**Load**→**Configuration**

means to first display the **File** pulldown menu, then display the **Load** cascade menu, then select the **Configuration** item from the Load cascade menu.

Based on this explanation, the general rule for interpreting this notation can be stated as follows:

- The leftmost item in bold is the pulldown menu label.
- If there are more than two items, then cascade menus are involved and all items between the first and last item have cascade menus attached.
- The last item on the right is the actual menu choice to be made.

## Mouse Button and Keyboard Bindings

Because the Graphical User Interface runs on different kinds of computers, which may have different conventions for mouse buttons and key names, the Graphical User Interface supports different bindings and the customization of bindings.

This manual refers to the mouse buttons using general (or "generic") terms. The following table describes the generic mouse button names and shows the default mouse button bindings.

---

### Mouse Button Bindings and Description

---

Generic Button Name	Bindings:		Description
	HP 9000	Sun SPARCsystem	
<i>paste</i>	left	left	Paste from the display area to the entry buffer.
<i>command paste</i>	middle <sup>1</sup>	middle <sup>1</sup>	Paste from the entry buffer to the command line text entry area.
<i>select</i>	right	right	Click selects first item in popup menus. Press and hold displays menus.
<i>command select</i>	left	right	Displays pulldown menus.
<i>pushbutton select</i>	left	left	Actuates pushbuttons outside of the display area.

---

<sup>1</sup> Middle button on three-button mouse. Both buttons on two-button mouse.

The following tables show the default keyboard bindings.

---

**Keyboard Key Bindings**

---

<b>Generic Key Name</b>	<b>HP 9000</b>	<b>Sun SPARCsystem</b>
menu select	extend char	extend char
insert	insert char	insert char
delete	delete char	delete char
left-arrow	left arrow	left arrow
right-arrow	right arrow	right arrow
up-arrow	up arrow	up arrow
down-arrow	down arrow	down arrow
escape	escape	escape
TAB	TAB	TAB

---



---

## The Getting Started Tutorial

This tutorial gives you step-by-step instructions on how to perform a few basic tasks using the emulator/analyzer interface. The tutorial examples presented in this chapter make the following assumptions:

- The emulator and analyzer are installed into the HP 64700 Card Cage, the HP 64700 is connected to the host computer, and the Softkey Interface software has been installed as outlined in the "Installation" chapter.
- The emulator is plugged into the demo board and contains at least 256 Kbytes of emulation memory.

### The Demonstration Program

The demonstration program used in this chapter is a simple environmental control system. The program controls the temperature and humidity of a room requiring accurate environmental control.

## Step 1. Start the demo

A demo program and its associated files are provided with the Graphical User Interface.

- 1 Change to the demo directory.

```
$ cd /usr/hp64000/demo/debug_env/hp64760 <RETURN>
```

Refer to the README file for more information on the demo program.

- 2 Check that "/usr/hp64000/bin" and "." are in your PATH environment variable. To see the value of PATH:

```
$ echo $PATH <RETURN>
```

- 3 If the Graphical User Interface software is installed on a different type of computer than the computer you are using, edit the "platformScheme" resource setting in the "Xdefaults.emul" file.

For example, if the Graphical User Interface will be run on a HP 9000 computer and displayed on a Sun SPARCsystem computer, change the platform scheme to "SunOS".

- 4 Start the emulator/analyzer demo.

```
$ startemul <logical_emul_name> <RETURN>
```

This script starts the emulator/analyzer interface (with a customized set of action keys), loads a configuration file for the demo program, and then loads the demo program.

The <logical\_emul\_name> in the command above is the logical emulator name given in the HP 64700 emulator device table file (/usr/hp64000/etc/64700tab.net).

## Step 2: Display the program in memory

- 1 If the symbol "main" is not already in the entry buffer, move the mouse pointer to the entry buffer (notice the flashing I-beam cursor) and type in "main".
- 2 Choose **Display**→**Memory**→**Mnemonic ()**.

Or, using the command line, enter:

```
display memory main mnemonic <RETURN>
```

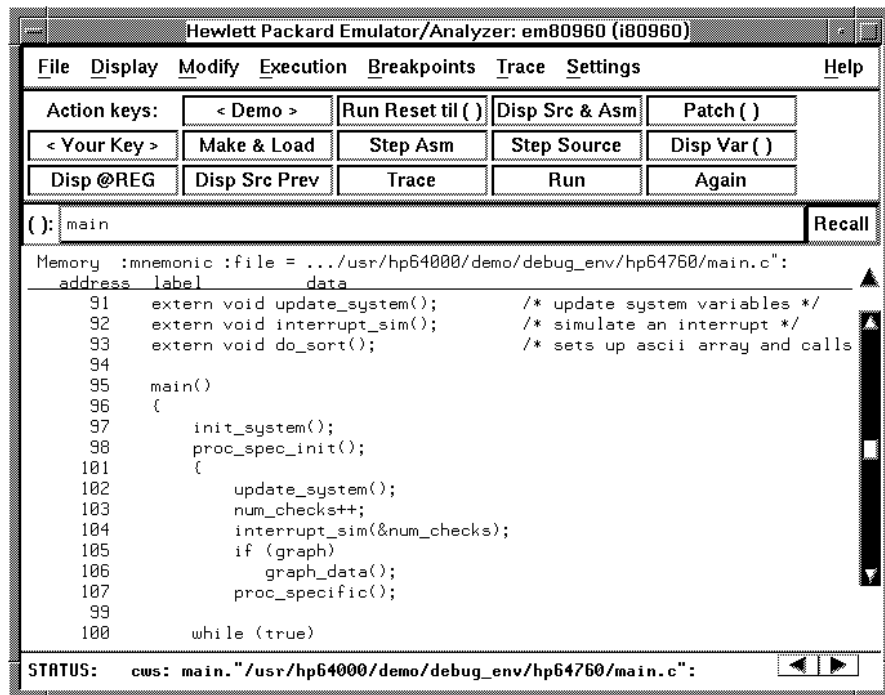

The screenshot shows the Hewlett Packard Emulator/Analyzer window for the em80960 processor. The menu bar includes File, Display, Modify, Execution, Breakpoints, Trace, Settings, and Help. Below the menu bar is a grid of action keys: < Demo >, Run Reset til ( ), Disp Src & Asm, Patch ( ), < Your Key >, Make & Load, Step Asm, Step Source, Disp Var ( ), Disp @REG, Disp Src Prev, Trace, Run, and Again. The entry buffer shows the symbol 'main' with a Recall button to its right. The main display area shows the memory contents for the 'main' symbol, with columns for address, label, and data. The code is as follows:

```
Memory :mnemonic :file = ../usr/hp64000/demo/debug_env/hp64760/main.c":
address label      data
  91  extern void update_system(); /* update system variables */
  92  extern void interrupt_sim(); /* simulate an interrupt */
  93  extern void do_sort(); /* sets up ascii array and calls
  94
  95  main()
  96  {
  97      init_system();
  98      proc_spec_init();
 101  {
 102      update_system();
 103      num_checks++;
 104      interrupt_sim(&num_checks);
 105      if (graph)
 106          graph_data();
 107      proc_specific();
  99
 100      while (true)
```

The STATUS bar at the bottom indicates the current command: `cws: main. "/usr/hp64000/demo/debug_env/hp64760/main.c":`

The default display mode settings cause source lines and symbols to appear in displays where appropriate. Notice you can use symbols when specifying expressions. The global symbol "main" is used in the command above to specify the starting address of the memory to be displayed.

## Step 3: Run from processor reset

The transfer address is the entry address defined by the software development tools and included with the program's symbol information.

- 1 Click on the **Run Reset til ()** action key.

Or, using the command line, enter:

```
run from reset until main <RETURN>
```

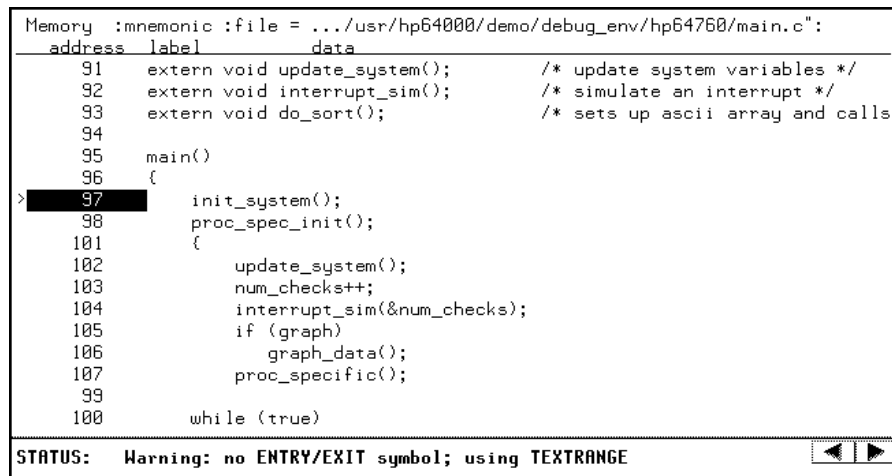

```
Memory :mnemonic :file = .../usr/hp64000/demo/debug_env/hp64760/main.c":
address label data
  91 extern void update_system(); /* update system variables */
  92 extern void interrupt_sim(); /* simulate an interrupt */
  93 extern void do_sort(); /* sets up ascii array and calls
  94
  95 main()
  96 {
> 97     init_system();
  98     proc_spec_init();
 101     {
 102         update_system();
 103         num_checks++;
 104         interrupt_sim(&num_checks);
 105         if (graph)
 106             graph_data();
 107         proc_specific();
  99
 100     while (true)
```

STATUS: Warning: no ENTRY/EXIT symbol; using TEXTRANGE

Notice the highlighted bar on the screen; it shows the current program counter.

Notice the message "Warning: no ENTRY/EXIT symbol; using TEXTRANGE" appears briefly on the status line. This message is from the Symbolic Retrieval Utilities (SRU). When displaying procedure symbols, SRU is called to determine the address range of the procedure.

This warning appears because the software development tools do not provide procedure entry and exit symbols; therefore, the closest approximation we can make is to use TEXTRANGE.

For more information on SRU, refer to the *Symbolic Retrieval Utilities User's Guide*.

Chapter 1: Getting Started  
**Step 3: Run from processor reset**

- 2 Move the mouse pointer to the status line, and click the *select* mouse button to remove the temporary message on the status line.

Notice the message "Breakpoint register: <address>" is displayed on the status line and that the emulator is "Running in monitor". When you run until an address, a breakpoint is set at the address before the program is run.

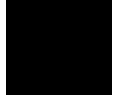

## Step 4: Step high-level source lines

You can step through the program by high-level source lines. The emulator executes as many instructions as are associated with the high-level program source lines.

- To step a source line from the current program counter, click on the **Step Source** action key.

Or, using the command line, enter:

***step source*** <RETURN>

```
Memory :mnemonic :file = ../hp64000/demo/debug_env/hp64760/init_system.c":
address label      data
-----
26
27 void init_val_arr();
28
29 void
30 init_system()
> 31 { /* FUNCTION init_system() */
32     /* Initialize the target values for temperature and humidity */
33     target_temp = 73;
34     target_humid = 45;
35
36     /* Intialize the variables indicating the current environment */
37     /* conditions */
38     current_temp = 68;
39     current_humid = 41;
40
41     /* Set starting directions for temp and humid */
42     temp_dir = up;
```

Notice that the highlighted bar (the current program counter) moves to the next high-level source line.

## Step 5: Display the previous mnemonic display

- Click on the **Disp Src Prev** action key.

Or, using the command line, enter:

```
display memory mnemonic previous_display <RETURN>
```

This command is useful, for example, when you have stepped into a function that you do not wish to look at—you can display the previous mnemonic display and run until the source line that follows the function call.

## Step 6: Run until an address

When displaying memory in mnemonic format, a selection in the popup menu lets you run from the current program counter address until a specific source line.

- Position the mouse pointer over the line "proc\_spec\_init();", press and hold the *select* mouse button, and choose **Run Until** from the popup menu.

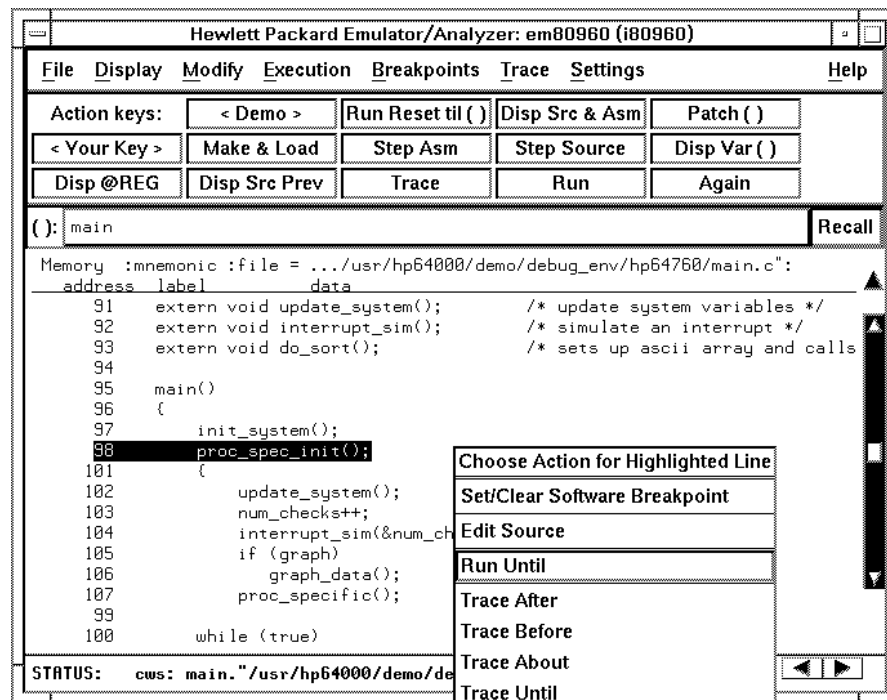

Or, using the command line, enter:

```
run until main."main.c": line 98 <RETURN>
```

After the command has executed, notice the highlighted bar indicates the program counter has moved to the specified source line.



---

## Step 7: Display data values

- 1 Click on the **Disp Src Prev** action key.

Or, using the command line, enter:

```
display memory mnemonic previous_display <RETURN>
```

- 2 Position the mouse pointer over "num\_checks" in the source line that reads "num\_checks++;" and click the *paste* mouse button (notice "num\_checks" is cut and pasted into the entry buffer).

- 3 Click on the **Disp Var ()** action key.

Or, using the command line, enter:

```
display data , num_checks int32 <RETURN>
```

Data :update			
address	label	type	data
00107660	_num_checks	int32	0

The "num\_checks" variable is added to the data values display and its value is displayed as a 32-bit integer.

## Step 8: Display registers

You can display the contents of the processor registers.

- Choose **Display**→**Registers**→**basic**.

Or, using the command line, enter:

***display registers*** <RETURN>

```
Registers
-----
LOCAL REGISTERS
pfp = 00118cc0  sp = 00118d40  rip = 00101e28  r3 = 00000002
r4 = 00106621  r5 = 00000002  r6 = 00107770  r7 = 00106610
r8 = 00000000  r9 = 00000000  r10 = 00000000 r11 = 00000000
r12 = 00000000 r13 = 00000000 r14 = 00000000 r15 = 00000000
GLOBAL REGISTERS
g0 = 00000020  g1 = 00000174  g2 = 00000041  g3 = 00000174
g4 = 00000029  g5 = 00000174  g6 = 00000000  g7 = 00000174
g8 = 00000000  g9 = 00000000  g10 = 00000000 g11 = 12004a26
g12 = 00000000 g13 = 00102a54  g14 = 00100010  fp = 00118d00
```

## Step 9: Step assembly-level instructions

You can step through the program one instruction at a time.

- To step one instruction from the current program counter, click on the **Step Asm** action key.

Or, using the command line, enter:

**step** <RETURN>

```
Registers
-----
g0 = 00000020  g1 = 00000174  g2 = 00000041  g3 = 00000174
g4 = 00000029  g5 = 00000174  g6 = 00000000  g7 = 00000174
g8 = 00000000  g9 = 00000000  g10 = 00000000  g11 = 12004a26
g12 = 00000000  g13 = 00102a54  g14 = 00100010  fp = 00118d00

Step_PC 00101E28  mov     g14,g13
Next_PC 00101e2c

LOCAL REGISTERS
pfp = 00118cc0  sp = 00118d40  rip = 00101e2c  r3 = 00000002
r4 = 00106521  r5 = 00000002  r6 = 00107770  r7 = 00106510
r8 = 00000000  r9 = 00000000  r10 = 00000000  r11 = 00000000
r12 = 00000000  r13 = 00000000  r14 = 00000000  r15 = 00000000

GLOBAL REGISTERS
g0 = 00000020  g1 = 00000174  g2 = 00000041  g3 = 00000174
g4 = 00000029  g5 = 00000174  g6 = 00000000  g7 = 00000174
g8 = 00000000  g9 = 00000000  g10 = 00000000  g11 = 12004a26
g12 = 00000000  g13 = 00100010  g14 = 00100010  fp = 00118d00
```

Notice, when registers are displayed, stepping causes the assembly language instruction just executed to be displayed.

## Step 10: Trace the program

When the analyzer traces program execution, it looks at the data on the emulation processor's bus and control signals at each clock cycle. The information seen at a particular clock cycle is called a state.

When one of these states matches the "trigger state" you specify, the analyzer stores states in trace memory. When trace memory is filled, the trace is said to be "complete."

- 1 Click on the **Recall** button to the right of the entry buffer.

A selection dialog box appears. You can select from entry buffer values that have been entered previously or that have been predefined.

- 2 Click on "main" in the selection dialog box, and click the "OK" pushbutton.

Notice that the value "main" has been returned to the entry buffer.

- 3 To trigger on the address "main" and store states that occur after the trigger, choose **Trace→After ()**.

Or, using the command line, enter:

```
trace after main <RETURN>
```

Move the mouse pointer to the status line, and click the *select* mouse button to remove the temporary message on the status line. Notice the message "Emulation trace started" appears on the status line. This shows that the analyzer has begun to look for the trigger state which is the address "main" on the processor's address bus.

- 4 Run the emulator demo program from its transfer address by choosing **Execution→Run→from Reset**.

Or, using the command line, enter:

```
run from reset <RETURN>
```

Notice that now the message on the status line is "Emulation trace complete". This shows the trigger state has been found and the analyzer trace memory has been filled.

5 To view the captured states, choose **Display→Trace**.

Or, using the command line, enter:

**display trace** <RETURN>

```

Trace List                               Offset=0                               More data off screen
Label:      Address      Opcode or Status w/ Source Lines      time count
Base:      symbols      mnemonic w/symbols      relative
#####/usr/hp64000/demo/debug_env/hp64760/main.c - line 1 thru
extern void interrupt_sim();           /* simulate an interrupt */
extern void do_sort();                 /* sets up ascii array and calls combs
main()
{
after  code|main.main  P: stos    g7, tags|mai.main.c: 11.i.e 240  nS
#####/usr/hp64000/demo/debug_env/hp64760/main.c - line 97 #####
      init_system();
+004  co|main+00000000 P: call    init.init_system 15.i.e 520  nS
#####/usr/hp64000/demo/debug_env/hp64760/main.c - line 98 #####
      proc_spec_init();
+006  co|main+00000000 P: bal     .proc_spec_init+000000 17.i.e 240  nS
+008  tags|mai.main.c: write short 4403 11.i.e 400  nS
#####/usr/hp64000/demo/debug_env/hp64760/init_system.c - line 1 t
      void init_val_arr();

```

The default display mode settings cause source lines and symbols to appear in the trace list.

Captured states are numbered in the left-hand column of the trace list. Line 0 always contains the state that caused the analyzer to trigger.

Other columns contain address information, data values, opcode or status information, and time count information.

## Step 11: Display memory at an address in a register

- 1 Click on the **Disp @REG** action key.

Or, using the command line, enter the name of the command file:

```
mematreg <RETURN>
```

A command file dialog box appears (or a prompt appears in the command line).

- 2 Move the mouse pointer to the dialog box text entry area, type "fp", and click on the "OK" button.

Or, if the prompt is in the command line:

```
fp <RETURN>
```

Memory	:bytes	:blocked	:update											
address	data			:hex				:ascii						
00118080-87	40	8D	11	00	00	8D	11	00	@	.	.	.	.	.
00118088-8F	20	0C	10	00	AC	0D	00	00	.	.	.	.	.	.
00118090-97	80	00	00	00	30	71	10	00	.	.	.	0	q	.
00118098-9F	AC	0D	00	00	00	AD	11	00	.	.	.	.	.	.
001180A0-A7	01	00	00	00	4B	00	00	00	.	.	.	K	.	.
001180A8-AF	20	00	00	00	C0	00	00	00	.	.	.	.	.	.
001180B0-B7	02	00	00	00	2B	09	00	00	.	.	.	+	.	.
001180B8-BF	20	00	00	00	36	00	00	00	.	.	.	6	.	.
001180C0-C7	08	00	00	00	30	2E	30	30	.	.	.	0	.	0
001180C8-CF	00	00	00	00	00	00	00	00	.	.	.	.	.	.
001180D0-D7	00	00	00	00	00	00	00	00	.	.	.	.	.	.
001180D8-DF	00	00	00	00	00	00	00	00	.	.	.	.	.	.
001180E0-E7	00	00	00	00	00	00	00	00	.	.	.	.	.	.
001180E8-EF	00	00	00	00	00	00	00	00	.	.	.	.	.	.
001180F0-F7	00	00	00	00	00	00	00	00	.	.	.	.	.	.
001180F8-FF	00	00	00	00	00	00	00	00	.	.	.	.	.	.
00118E00-07	80	8D	11	00	50	8E	11	00	.	.	.	P	.	.

## Step 12: Patch assembly language code

The **Patch ()** action key lets you patch code in your program.

- 1 Choose **Execution**→**Break** to break emulator execution into the monitor.
- 2 With "main" still in the entry buffer, choose **Display**→**Memory**→**Mnemonic ()**.
- 3 To display memory with assembly-level instructions intermixed with the high-level source lines, click on the **Disp Src & Asm** action key.

```
Memory :mnemonic :file = ../usr/hp64000/demo/debug_env/hp64760/main.c":
address  label      data
  91      extern void update_system();          /* update system variables */
  92      extern void interrupt_sim();          /* simulate an interrupt */
  93      extern void do_sort();                /* sets up ascii array and calls
  94
  95      main()
  96      {
00100000  co|main.main  8AB8300000  stos    g7, tags|mai.main.c:
  97          init_system();
00100008          09000C58  call    init.init_system
  98          proc_spec_init();
0010000C          0B001E1C  bal    .proc_spec_init+00000008
 101      {
 102          update_system();
00100010          09000D70  call    up.update_system
 103          num_checks++;
00100014          9080300000  ld     zero|_num_checks, g0
0010001C          59840801  addo   01, g0, g0
```

- 4 Click on the **Patch ()** action key.

A window appears and the **vi** editor is started. Add the line:

```
callx update_system
```

Exit out of the editor, saving your changes.

The file you just edited is assembled, and the patch main menu appears. Type "a" and press <RETURN> to apply the patch.

Chapter 1: Getting Started  
Step 12: Patch assembly language code

```
Memory :mnemonic :file = .../usr/hp64000/demo/debug_env/hp64760/main.c":
address  label      data
  91     extern void update_system();      /* update system variables */
  92     extern void interrupt_sim();      /* simulate an interrupt */
  93     extern void do_sort();            /* sets up ascii array and calls
  94
  95     main()
  96     {
00100000  call main.main 0600300000 callx  up.update_system
  97         init_system();
00100008  call          09000C58 call  init.init_system
  98         proc_spec_init();
0010000C  bal          0B001E1C bal   .proc_spec_init+00000008
 101     {
 102         update_system();
00100010  call          09000070 call  up.update_system
 103         num_checks++;
00100014  ld           9000300000 ld   zero|_num_checks,g0
0010001C  addo        59040001 addo  01,g0,g0
```

Notice in the emulator/analyzer interface that the instruction at address "main" has changed.

When patching a single address, make sure the new instruction takes up the same number of bytes as the old instruction; otherwise, you may inadvertently modify code that follows.

- 5 Type "main+8 thru main+15" in the entry buffer.

By entering an address range in the entry buffer (that is, <address> thru <address>) before clicking on the **Patch** ( ) action key, you can modify a patch template file which allows you to insert as much or as little code as you wish.



6 Click on the **Patch ()** action key again.

A window running the **vi** editor again appears. Suppose you want to patch the demo program so that the `proc_spec_init()` function is called before the `init_system()` function. Suppose also that there is memory available at address `11F000H`. Edit the patch template file as shown below.

```
# PCHS700 Assembly Patch File: PCHmain+8.s
#
# Date : Wed Aug 26 17:00:20 MDT 1992
# Dir  : /users/guest/demo/debug_env/hp64760
# Owner: guest
#
# Warning: do not use CTRL-format opcodes; they will not
# have the appropriate address when patched back
# into your code. For example, use 'bx' instead of 'b',
# and 'callx' instead of 'call'

        .include "PCHSINC.s"
        .sect patch,text,absolute main+8      # you may need to change this!
        bx xyzyyq      # You may want to change this name!
        .sect patch2,text,absolute 0x11f000   # You MUST set this address!
xyzyyq:
# !!!!!!!!!!! You may need to modify labels and operands of the      !!!!!!!!!!!
# !!!!!!!!!!! following code to match your assembler syntax          !!!!!!!!!!!
# !!!!!!!!!!! Patching Range: main+8 thru main+15
        callx   proc_spec_init
        callx   init_system
# !!!!!!!!!!! Insert new code here !!!!!!!!!!!
        bx main+8+8      # You MUST set this address also!
                        # (guessed as location+8)
```

Notice that symbols can be used in the patch file. Exit out of the editor, saving your changes.

The file you just edited is assembled, and the patch main menu appears. Type "`a`" `<RETURN>`" to apply the patch.

You can step through the program to view execution of the patch.





## **Step 13: Exit the emulator/analyzer interface**

- To exit the emulator/analyzer interface and release the emulator, choose **File→Exit→Released**.

Or, using the command line, enter:

*end release\_system* <RETURN>

---

## Part 2

---

### User's Guide

A complete set of task instructions and problem-solving guidelines, with a few basic concepts.

**Part 2**

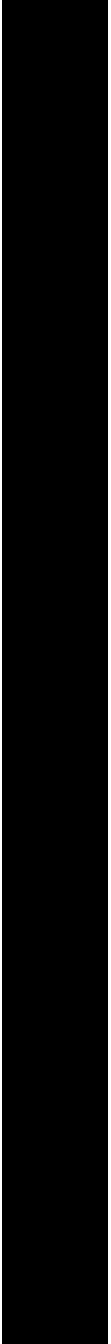



---

**Starting and Exiting HP 64700  
Interfaces**

---

## Starting and Exiting HP 64700 Interfaces

You can use several types of interfaces to the same emulator at the same time to give yourself different views into the target system.

The strength of the emulator/analyzer interface is that it lets you perform the real-time analysis measurements that are helpful when integrating hardware and software.

The C debugger interface (which is a separate product) lets you view the stack backtrace and high-level data structures, and it lets you use C language expressions and macros. These features are most useful when debugging software.

The Software Performance Analyzer interface (which is also a separate product) lets you make measurements that can help you improve the performance of your software.

These interfaces can operate at the same time with the same emulator. When you perform an action in one of the interfaces, it is reflected in the other interfaces.

Up to 10 interface windows may be started for the same emulator. Only one C debugger interface window and one SPA window are allowed, but you can start multiple emulator/analyzer interface windows.

The tasks associated with starting and exiting HP 64700 interfaces are grouped into the following sections:

- Starting the emulator/analyzer interface.
- Opening other HP 64700 interface windows.
- Exiting HP 64700 interfaces.

## Starting the Emulator/Analyzer Interface

Before starting the emulator/analyzer interface, the emulator and interface software must have already been installed as described in the "Installation" chapter.

This section describes how to:

- Start the interface.
- Start the interface using the default configuration.
- Run a command file on interface startup.
- Display the status of emulators defined in the 64700tab.net file.
- Unlock an interface that was left locked by another user.

---

## To start the emulator/analyzer interface

- Use the **emul700** <emul\_name> command.

If **/usr/hp64000/bin** is specified in your PATH environment variable (as shown in the "Installation" chapter), you can start the interface with the **emul700** <emul\_name> command. The "emul\_name" is the logical emulator name given in the HP 64700 emulator device table (/usr/hp64000/etc/64700tab.net).

If you are running a window system on your host computer (for example, the X Window System), you can run the interface in up to 10 windows. This capability provides you with several views into the emulation system. For example, you can display memory in one window, registers in another, an analyzer trace in a third, and data in the fourth.

## Chapter 2: Starting and Exiting HP 64700 Interfaces

### Starting the Emulator/Analyzer Interface

#### Examples

To start the emulator/analyzer interface for the 80960 emulator:

```
$ emul700 em80960 <RETURN>
```

The "em80960" in the command above is the logical emulator name given in the HP 64700 emulator device table file (/usr/hp64000/etc/64700tab.net).

```
# Blank lines and the rest of each line after a '#' character are ignored.
# The information in each line must be in the specified order, with one line
# for each HP series 64700 emulator. Use blanks or tabs to separate fields.
#
#-----+-----+-----+-----+
# Channel | Logical | Processor | Remainder of Information for the Channel
# Type   | Name   | Type     | (IP address for LAN connections)
#-----+-----+-----+-----+
# lan:   | em80960 | i80960   | 21.17.9.143
serial: | em80960 | i80960   | myhost /dev/emcom23 OFF 9600 NONE XON 2 8
```

If you're currently running the X Window System, the Graphical User Interface starts; otherwise, the Softkey Interface starts.

The status message shows that the default configuration file has been loaded. If the command is not successful, you will be given an error message and returned to the UNIX prompt. Error messages are described in the "Error Messages" chapter.

---

## To start the interface using the default configuration

- Use the **emul700 -d <emul\_name>** command.

In the **emul700 -d <emul\_name>** command, the **-d** option says to use the default configuration. The **-d** option is ignored if the interface is already running in another window or on another terminal.



## To run a command file on interface startup

- Use the **emul700 -c <cmd\_file> <emul\_name>** command.

You can cause command files to be run upon starting the interface by using the **-c <cmd\_file>** option to the **emul700** command.

Refer to the "Using Command Files" section in the "Entering Commands" chapter for information on creating command files.

---

### Examples

To start the emulator/analyzer interface and run the "startup" command file:

```
$ emul700 -c startup em80960 <RETURN>
```

---

## To display the status of emulators

- Use the **emul700 -l** or **emul700 -lv** command.

The **-l** option of the **emul700** command lists the status of all emulators defined in the 64700tab and 64700tab.net files. If a logical emulator name is included in the command, just the status of that emulator is listed.

You can also use the **-v** option with the **-l** option for a verbose listing of the status information.

---

### Examples

To list, verbosely, the status of the emulator whose logical name is "em80960":

```
$ emul700 -lv em80960 <RETURN>
```

The information may be similar to:

```
em80960 - i80960 running; user = guest
description:      80960SA/SB emulation w/internal analysis, 1024Kb emul mem
user interfaces:  xdebug, xemul, xperf, skemul, sktiming
device channel:  /dev/emcom23
```

## Chapter 2: Starting and Exiting HP 64700 Interfaces

### Starting the Emulator/Analyzer Interface

Or, the information may be similar to:

```
em80960 - i80960 running; user = guest@myhost
description:      80960SA/SB emulation w/internal analysis, 1024Kb emul mem
user interfaces:  xdebug, xemul, xperf, skemul, sktiming
internet address: 21.17.9.143
```

---

### To unlock an interface that was left locked by another user

- Use the **emul700 -U <emul\_name>** command.

The **-U** option to the **emul700** command may be used to unlock the emulators whose logical names are specified. This command will fail if there currently is a session in progress.

---

#### Examples

To unlock the emulator whose logical name is "em80960":

```
$ emul700 -U em80960 <RETURN>
```

## Opening Other HP 64700 Interface Windows

The **File→Emul700** menu lets you open additional emulator/analyzer interface windows or other HP 64700 interface windows if those products have been installed (for example, the software performance analyzer (SPA) interface and the high-level debugger interface).

This section shows you how to:

- Open additional emulator/analyzer interface windows.
- Open the high-level debugger interface window.
- Open the software performance analyzer (SPA) interface window.

---

### To open additional emulator/analyzer windows

- To open additional Graphical User Interface windows, choose **File→Emul700→Emulator/Analyzer** under *Graphic Windows*, or enter the **emul700 <emul\_name>** command in another terminal emulation window.
- To open additional conventional Softkey Interface windows, choose **File→Emul700→Emulator/Analyzer** under *Terminal Windows*, or enter the **emul700 -u skemul <emul\_name>** command in another terminal emulation window.

You can open additional Graphical User Interface windows, or terminal emulation windows containing the Softkey Interface.

When you open an additional window, the status line will show that this session is joining a session already in progress, and the event log is displayed.

You can enter commands in any window in which the interface is running. When you enter commands in different windows, the command entered in the first window must complete before the command entered in the second window can start. The status lines and the event log displays are updated in all windows.

### To open the high-level debugger interface window

- Choose **File**→**Emul700**→**High-Level Debugger ...** under "Graphic Windows", or enter the **emul700 -u xdebug <emul\_name>** command in another terminal emulation window.

For information on how to use the high-level debugger interface, refer to the debugger/emulator *User's Guide*.

---

### To open the software performance analyzer (SPA) interface window

- Choose **File**→**Emul700**→**Performance Analyzer ...** under "Graphic Windows", or enter the **emul700 -u xperf <emul\_name>** command in another terminal emulation window.

For information on how to use the software performance analyzer, refer to the *Software Performance Analyzer User's Guide*.

## Exiting HP 64700 Interfaces

There are several options available when exiting the HP 764700 interfaces. You can simply close one of the open interface windows, or you can exit the debug session by closing all the open windows. When exiting the debug session, you can lock the emulator so that you can continue later, or you can release the emulation system so that others may use it. This section describes how to:

- Close an interface window.
- Exit a debug/emulation session.

---

### To close an interface window

- In the interface window you wish to close, choose **File**→**Exit**→**Window**. In the emulator/analyzer interface command line, enter the **end** command with no options.

All other interface windows remain open, and the emulation session continues, unless the window closed is the only one open for the emulation session. In that case, closing the window ends the emulation session, but locks the emulator so that other users cannot access it.

## To exit a debug/emulation session

- To exit the interface, save your configuration to a temporary file, and lock the emulator so that it cannot be accessed by other users, choose **File→Exit→Locked**. In the emulator/analyzer interface command line, enter the **end locked** command.
- To exit the interface and release the emulator for access by other users, choose **File→Exit→Released**. In the emulator/analyzer interface command line, enter the **end release\_system** command.

If you exit the interface locked, the interface saves the current configuration to a temporary file and locks the emulator to prevent other users from accessing it. When you again start the interface with the **emul700** command, the temporary file is reloaded, and therefore, you return to the configuration you were using when you quit the interface locked.

Also saved when you exit the interface locked are the contents of the entry buffer and command recall buffer. These recall buffer values will be present when you restart the interface.

In contrast, if you end released, you must have saved the current configuration to a configuration file (if the configuration has changed), or the changes will be lost.

---

**3**



---

**Entering Commands**

---

## Entering Commands



When an X Window System that supports OSF/Motif interfaces is running on the host computer, the emulator/analyzer interface is the Graphical User Interface which provides pull-down and pop-up menus, point and click setting of breakpoints, cut and paste, on-line help, customizable action keys and pop-up recall buffers, etc.

The emulator/analyzer interface also provides the Softkey Interface for several types of terminals, terminal emulators, and bitmapped displays. When using the Softkey Interface, commands are entered from the keyboard.

When using the Graphical User Interface, the *command line* portion of the interface gives you the option of entering commands in the same manner as they are entered in the Softkey Interface. If you are using the Softkey Interface, you can only enter commands from the keyboard using the command line.

The menu commands in the Graphical User Interface are a subset of the commands available when using the command line. While you have a great deal of capability in the menu commands, you have even more in the command line.

This chapter shows you how to enter commands in each type of emulator/analyzer interface. The tasks associated with entering commands are grouped into the following sections:

- Using menus, the entry buffer, and action keys.
- Using the command line with the mouse.
- Using the command line with the keyboard.
- Using command files.
- Using pod commands.
- Forwarding commands to other HP 64700 interfaces.



## Using Menus, the Entry Buffer, and Action Keys

This section describes the tasks you perform when using the Graphical User Interface to enter commands. This section describes how to:

- Choose a pulldown menu item using the mouse.
- Choose a pulldown menu item using the keyboard.
- Use the popup menus.
- Use the entry buffer.
- Copy and paste to the entry buffer.
- Use action keys.
- Use dialog boxes.
- Access help information.



## To choose a pulldown menu item using the mouse (method 1)

- 1 Position the mouse pointer over the name of the menu on the menu bar.
- 2 Press and hold the *command select* mouse button to display the menu.
- 3 While continuing to hold down the mouse button, move the mouse pointer to the desired menu item. If the menu item has a cascade menu (identified by an arrow on the right edge of the menu button), then continue to hold the mouse button down and move the mouse pointer toward the arrow on the right edge of the menu. The cascade menu will display. Repeat this step for the cascade menu until you find the desired menu item.
- 4 Release the mouse button to select the menu choice.

If you decide not to select a menu item, simply continue to hold the mouse button down, move the mouse pointer off of the menu, and release the mouse button.

Some menu items have an ellipsis ("...") as part of the menu label. An ellipsis indicates that the menu item will display a dialog or message box when the menu item is chosen.

## To choose a pulldown menu item using the mouse (method 2)

- 1 Position the mouse pointer over the menu name on the menu bar.
- 2 Click the *command select* mouse button to display the menu.
- 3 Move the mouse pointer to the desired menu item. If the menu item has a cascade menu (identified by an arrow on the right edge of the menu button), then repeat the previous step and then this step until you find the desired item.
- 4 Click the mouse button to select the item.

If you decide not to select a menu item, simply move the mouse pointer off of the menu and click the mouse button.

Some menu items have an ellipsis ("...") as part of the menu label. An ellipsis indicates that the menu item will display a dialog or other box when the menu item is chosen.

---

## To choose a pulldown menu item using the keyboard

- To initially display a pulldown menu, press and hold the **menu select** key (for example, the "Extend char" key on a HP 9000 keyboard) and then type the underlined character in the menu label on the menu bar. (For example, "f" for "File". Type the character in lower case only.)
- To move right to another pulldown menu after having initially displayed a menu, press the **right-arrow** key.

## Chapter 3: Entering Commands

### Using Menus, the Entry Buffer, and Action Keys

- To move left to another pulldown menu after having initially displayed a menu, press the **left-arrow** key.
- To move down one menu item within a menu, press the **down-arrow** key.
- To move up one menu item within a menu, press the **up-arrow** key.
- To choose a menu item, type the character in the menu item label that is underlined. Or, move to the menu item using the arrow keys and then press the **<RETURN>** key on the keyboard.
- To cancel a displayed menu, press the **Escape** key.

The interface supports keyboard mnemonics and the use of the arrow keys to move within or between menus. For each menu or menu item, the underlined character in the menu or menu item label is the keyboard mnemonic character. Notice the keyboard mnemonic is not always the first character of the label. If a menu item has a cascade menu attached to it, then typing the keyboard mnemonic displays the cascade menu.

Some menu items have an ellipsis ("...") as part of the menu label. An ellipsis indicates that the menu item will display a dialog or other box when the menu item is chosen.

Dialog boxes support the use of the keyboard as well. To direct keyboard input to a dialog box, you must position the mouse pointer somewhere inside the boundaries of the dialog box. That is because the interface *keyboard focus policy* is set to *pointer*. That just means that the window containing the mouse pointer receives the keyboard input.

In addition to keyboard mnemonics, you can also specify keyboard accelerators which are keyboard shortcuts for selected menu items. Refer to the "Setting X Resources" chapter and the "Softkey.Input" scheme file for more information about setting the X resources that control defining keyboard accelerators.

## To choose popup menu items

- 1 Move the mouse pointer to the area whose popup menu you wish to access. (If a popup menu is available, the mouse pointer changes from an arrow to a hand.)
- 2 Press and hold the *select* mouse button.
- 3 After the popup menu appears (while continuing to hold down the mouse button), move the mouse pointer to the desired menu item.
- 4 Release the mouse button to select the menu choice.

If you decide not to select a menu item, simply continue to hold the mouse button down, move the mouse pointer off of the menu, and release the mouse button.

The following popup menus are available in the Graphical User Interface:

- Mnemonic Memory Display.
- Breakpoints Display.
- Global Symbols Display.
- Local Symbols Display.
- Status Line.
- Command Line.



## To place values into the entry buffer using the keyboard

- 1 Position the mouse pointer within the text entry area. (An "I-beam" cursor will appear.)
- 2 Enter the text using the keyboard.

To clear the entry buffer text area from beginning until end, press the <Ctrl>u key combination.

---

## To copy-and-paste to the entry buffer

- To copy and paste a discrete text string as determined by the interface, position the mouse pointer over the text to copy and click the *paste* mouse button.
- To specify the exact text to copy to the entry buffer: press and hold the *paste* mouse button; drag the mouse pointer to highlight the text to copy-and-paste; release the *paste* mouse button.

You can copy-and-paste from the display area, the status line, and from the command line entry area.

When you position the pointer and click the mouse button, the interface expands the highlight to include the most complete text string it considers to be discrete. Discrete here means that the interface will stop expanding the highlight in a given direction when it discovers a delimiting character not determined to be part of the string. A common delimiter would, of course, be a space.

When you press and hold the mouse button and drag the pointer to highlight text, the interface copies all highlighted text to the entry buffer when you release the mouse button.

Because the interface displays absolute addresses as hex values, any copied and pasted string that can be interpreted as a hexadecimal value (that is, the string

## Chapter 3: Entering Commands Using Menus, the Entry Buffer, and Action Keys

contains only numbers 0 through 9 and characters "a" through "f") automatically has an "h" appended.

---

**Note**

If you have multiple Graphical User Interface windows open, a copy-and-paste action in any window causes the text to appear in all entry buffers in all windows. That is because although there are a number of entry buffers being displayed, there is actually only one entry buffer and it is common to all windows. That means you can copy a symbol or an address from one window and then use it in another window.

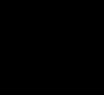

On a memory display or trace display, a symbol may not be completely displayed because there are too many characters to fit into the width limit for a particular column of the display. To make a symbol usable for copy-and-paste, you can scroll the screen left or right to display all, or at least more, of the characters from the symbol. The interface displays absolute addresses as hex values.

Text pasted into the entry buffer replaces that which is currently there. You cannot use paste to append text to existing text already in the entry buffer.

See "To copy-and-paste from the entry buffer to the command line entry area" for information about pasting the contents of the entry buffer into the command line entry area.

### Chapter 3: Entering Commands Using Menus, the Entry Buffer, and Action Keys

#### Example

To paste the symbol "num\_checks" into the entry buffer from the interface display area, position the mouse pointer over the symbol and then click the paste mouse button.

A mouse click causes the interface to expand the highlight to include the symbol "num\_checks" and paste the symbol into the entry buffer.

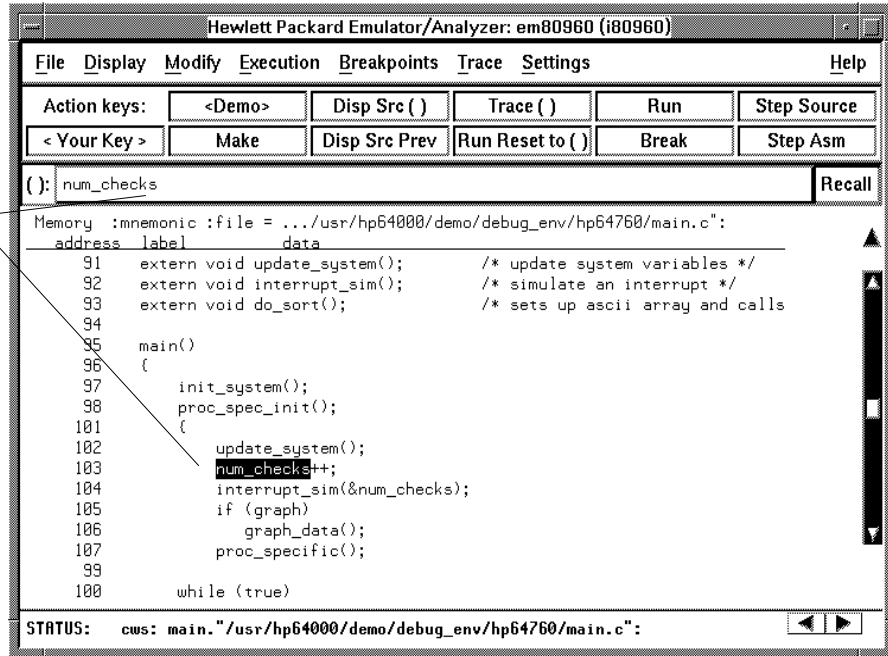



## To recall entry buffer values

- Position the mouse pointer over the **Recall** button just to the right of the entry buffer text area, click the mouse button to bring up the Entry Buffer Recall dialog box, and then choose a string from that dialog box.

The Entry Buffer Recall dialog box contains a list of entries gained during the emulation session as well as any predefined entries present at interface startup.

If you exit the emulation/analysis session with the interface "locked", recall buffer values are saved and will be present when you restart the interface.

You can predefine entries for the Entry Buffer Recall dialog box and define the maximum number of entries by setting X resources (refer to the "Setting X Resources" chapter).

See the following "To use dialog boxes" section for information about using dialog boxes.

---

## To use the entry buffer

- 1 Place information into the entry buffer (see the previous "To place values into the entry buffer using the keyboard", "To copy-and-paste to the entry buffer", or "To recall entry buffer values" task descriptions).
- 2 Choose the menu item, or click the action key, that uses the contents of the entry buffer (that is, the menu item or action key that contains "()").

## To copy-and-paste from the entry buffer to the command line entry area

- 1 Place text to be pasted into the command line in the entry buffer text area.

You may do that by:

- Copying the text from the display area using the copy-and-paste feature.
  - Enter the text directly by typing it into the entry buffer text area.
  - Choose the text from the entry buffer recall dialog box.
- 2 Position the mouse pointer within the command line text entry area.
  - 3 If necessary, reposition the cursor to the location where you want to paste the text.
  - 4 If necessary, choose the insert or replace mode for the command entry area.
  - 5 Click the *command paste* mouse button to paste the text in the command line entry area at the current cursor position.

The entire contents of the entry buffer are pasted into the command line at the current cursor position.

Although a paste from the display area to the entry buffer affects all displayed entry buffers in all open windows, a paste from the entry buffer to the command line only affects the command line of the window in which you are currently working.

See "To copy-and-paste to the entry buffer" for information about pasting information from the display into the entry buffer.

## To use the action keys

- 1 If the action key uses the contents of the entry buffer, place the desired information in the entry buffer.
- 2 Position the mouse pointer over the action key and click the action key.

Action keys are user-definable pushbuttons that perform interface or system functions. Action keys can use information from the entry buffer — this makes it possible to create action keys that are more general and flexible.

Several action keys are predefined when you first start the Graphical User Interface. You can use the predefined action keys, but you'll really appreciate them when you define and use your own.

Action keys are defined by setting an X resource. Refer to the chapter "Setting X Resources" for more information about creating action keys.

---

## To use dialog boxes

- 1 Click on an item in the dialog box list to copy the item to the text entry area.
- 2 Edit the item in the text entry area (if desired).
- 3 Click on the "OK" pushbutton to make the selection and close the dialog box, click on the "Apply" pushbutton to make the selection and leave the dialog box open, or click on the "Cancel" pushbutton to cancel the selection and close the dialog box.

The graphical interface uses a number of dialog boxes for selection and recall:

Directory Selection	Selects the working directory. You can change to a previously accessed directory, a predefined directory, or specify a new directory.
---------------------	---

## Chapter 3: Entering Commands

### Using Menus, the Entry Buffer, and Action Keys

File Selection	From the working directory, you can select an existing file name or specify a new file name.
Entry Buffer Recall	You can recall a previously used entry buffer text string, a predefined entry buffer text string, or a newly entered entry buffer string, to the entry buffer text area.
Command Recall	You can recall a previously executed command, a predefined command, or a newly entered command, to the command line.

The dialog boxes share some common properties:

- Most dialog boxes can be left on the screen between uses.
- Dialog boxes can be moved around the screen and do not have to be positioned over the graphical interface window.
- If you iconify the interface window, all dialog boxes are iconified along with the main window.

Except for the File Selection dialog box, predefined entries for each dialog box (and the maximum number of entries) are set via X resources (refer to the "Setting X Resources" chapter).

**Examples**

To use the File Selection dialog box:

The file filter selects specific files.

A list of filter-matching files from the current directory.

A list of files previously accessed during the emulation session.

A single click on a file name from either list highlights the file name and copies it to the text area. A double click chooses the file and closes the dialog box.

Label informs you what kind of file selection you are performing.

Text entry area. Text is either copied here from the recall list, or entered directly.

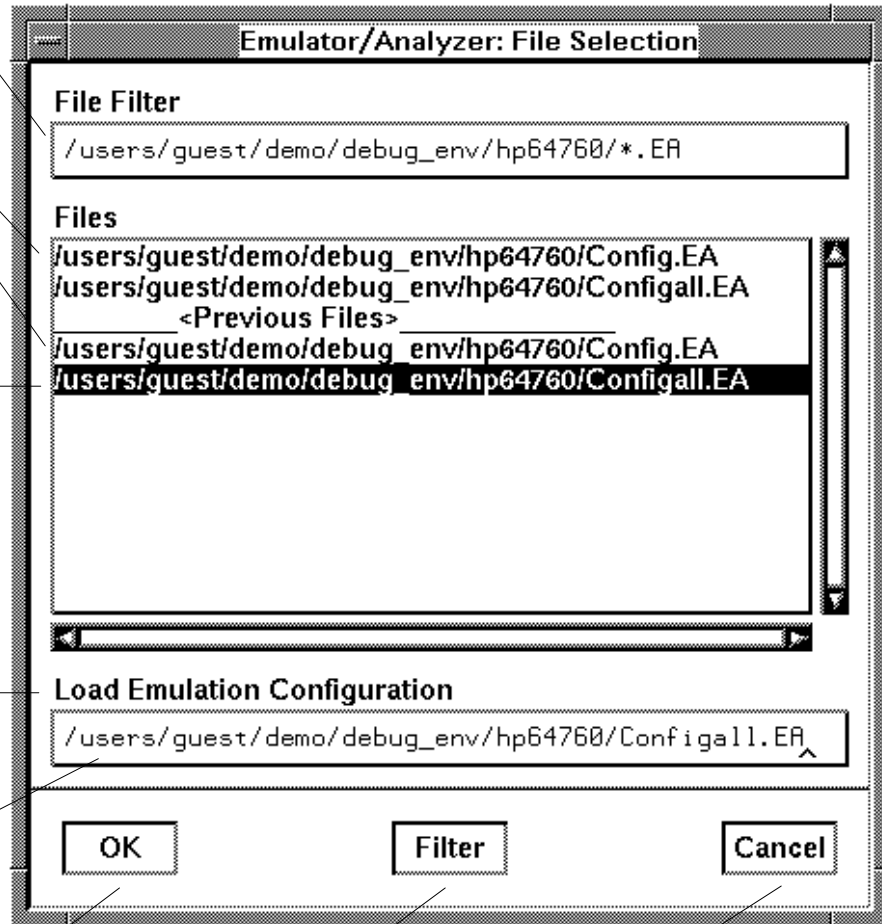

Clicking this button chooses the file name displayed in the text entry area and closes the dialog box.

Entering a new file filter and clicking this button causes a list of files matching the new filter to be read from the directory.

Clicking this button cancels the file selection operation and closes the dialog box.

Chapter 3: Entering Commands  
**Using Menus, the Entry Buffer, and Action Keys**

To use the Directory Selection dialog box:

Label informs you of the type of list displayed.

A list of predefined or previously accessed directories.

A single click on a directory name from the list highlights the name and copies it to the text area. A double click chooses the directory and closes the dialog box.

Text entry area. Directory name is either copied here from the recall list, or entered directly.

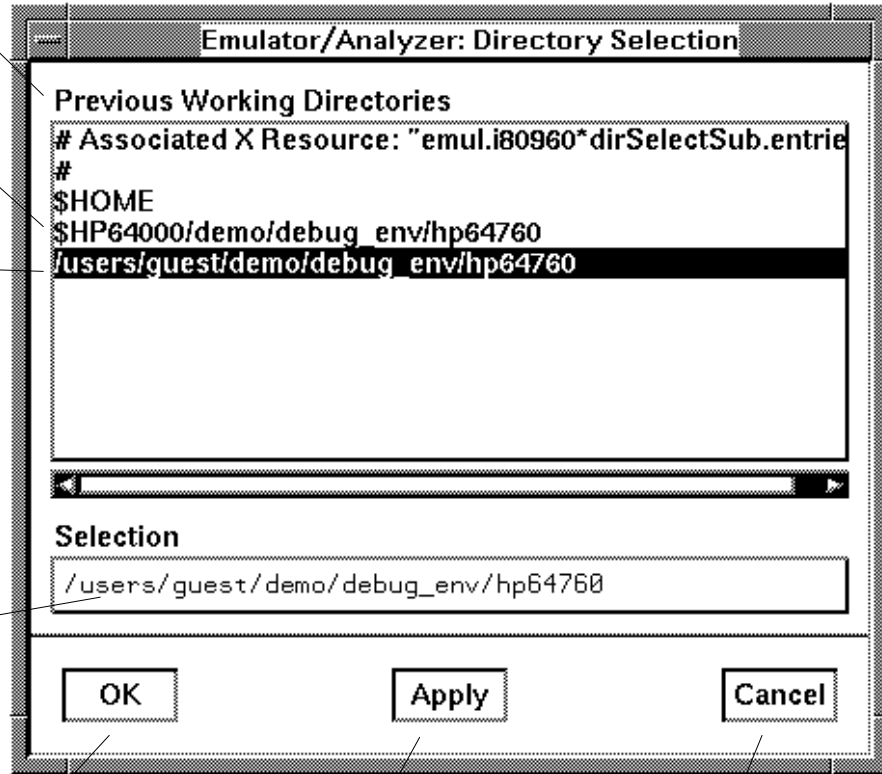

Clicking this button chooses the directory displayed in the text entry area and closes the dialog box.

Clicking this button chooses the directory displayed in the text entry area, but keeps the dialog box on the screen instead of closing it.

Clicking this button cancels the directory selection operation and closes the dialog box.

## To access help information

- 1 Display the Help Index by choosing **Help**→**General Topic...** or **Help**→**Command Line...**
- 2 Choose a topic of interest from the Help Index.

The Help Index lists topics covering operation of the interface as well other information about the interface. When you choose a topic from the Help Index, the interface displays a window containing the help information. You may leave the window on the screen while you continue using the interface.



## Using the Command Line with the Mouse

When using the Graphical User Interface, the *command line* portion of the interface gives you the option of entering commands in the same manner as they are entered in the Softkey Interface. Additionally, the graphical interface makes the softkey labels pushbuttons so commands may be entered using the mouse.

If you are using the Softkey Interface, using the command line with the keyboard is the only way to enter commands.

This section describes how to:

- Turn the command line off/on.
- Enter commands.
- Edit commands.
- Recall commands.
- Display the help window.

---

### To turn the command line on or off

- To turn the command line on or off using the pulldown menu, choose **Settings**→**Command Line**.
- To turn the command line on or off using the status line popup menu: position the mouse pointer within the status line area, press and hold the *select* mouse button, and choose **Command Line Off** from the menu.
- To turn the command line off using the command line entry area popup menu: position the mouse pointer within the entry area, press and hold the *select* mouse button, and choose **Command Line Off** from the menu.

Turns display of the command line area "on" or "off." On means that the command line is displayed and you can use the softkey label pushbuttons, the command return and recall pushbuttons, and the cursor pushbuttons for command line editing.



Off means the command line is not displayed and you use only the pulldown menus and the action keys to control the interface.

The command line area begins just below the status line and continues to the bottom of the emulator/analyzer window. The status line is not part of the command line and continues to be displayed whether the command line is on or off.

Choosing certain pulldown menu items while the command line is off causes the command line to be turned on. That is because the menu item chosen requires some input at the command line that cannot be supplied another way.



---

## To enter a command

- 1 Build a command using the softkey label pushbuttons by successively positioning the mouse pointer on a pushbutton and clicking the *pushbutton select* mouse button until a complete command is formed.
- 2 Execute the completed command by clicking the **Return** pushbutton (found near the bottom of the command line in the "Command" group).

Or:

Execute the completed command using the Command Line entry area popup menu: Position the mouse pointer in the command line entry area; press and hold the *select* mouse button until the Command Line popup menu appears; then, choose the **Execute Command** menu item.

You may need to combine pushbutton and keyboard entry to form a complete command.

A complete command is a string of softkey labels and text entered with the keyboard. You know a command is complete when **Return** pushbutton is not halfbright. The interface does not check or act on a command, however, until the command is executed. (In contrast, commands resulting from pulldown menu choices and action keys are supplied with the needed carriage return as part of the command.)

## To edit the command line using the command line pushbuttons

- To clear the command line, click the **Clear** pushbutton.
- To clear the command line from the cursor position to the end of the line, click the **Clear to end** pushbutton.
- To move to the right one command word or token, click the **Forward** pushbutton.
- To move to the left one command word or token, click the **Backup** pushbutton.
- To insert characters at the cursor position, press the **insert key** to change to insertion mode, and then type the characters to be inserted.
- To delete characters to the left of the cursor position, press the **<BACKSPACE>** key.

When the cursor arrives at the beginning of a command word or token, the softkey labels change to display the possible choices at that level of the command.

When moving by words left or right, the **Forward** pushbutton becomes halfbright and unresponsive when the cursor reaches the end of the command string. Similarly, the **Backup** pushbutton becomes halfbright and unresponsive when the cursor reaches the beginning of the command.

See "To edit the command line using the mouse and the command line popup menu" and "To edit the command line using the keyboard" for information about additional editing operations you can perform.

## To edit the command line using the command line popup menu

- To clear the command line: position the mouse pointer within the Command Line entry area; press and hold the *select* mouse button until the Command Line popup menu appears; choose **Clear Entire Line** from the menu.
- To clear the command line from the cursor position to the end of the line: position the mouse pointer at the place where you want the clear-to-end to start; press and hold the *select* mouse button until the Command Line popup menu appears; choose **Clear to End of Line** from the menu.
- To position the cursor and insert characters at the cursor location: position the mouse pointer in a non-text area of the command line entry area; press and hold the *select* mouse button to display the Command Line popup menu; choose **Position Cursor, Insert Mode** from the menu; type the characters to be inserted.
- To replace characters at the current cursor location: position the mouse pointer in a non-text area of the command line entry area; press and hold the *select* mouse button to display the Command Line popup menu; choose **Position Cursor, Replace Mode** from the menu; type the characters to be inserted.
- To position the cursor and replace characters at the cursor location: position the mouse pointer in a non-text area of the command line entry area; press and hold the *select* mouse button to display the Command Line popup menu; choose **Position Cursor, Replace Mode** from the menu; type the characters to be inserted.

When the cursor arrives at the beginning of a command word or token, the softkey labels change to display the possible choices at that level of the command.

See "To edit the command line using the mouse and the command line pushbuttons" and "To edit the command line using the keyboard" for information about additional editing operations you can perform.

## To recall commands

- 1 Click the pushbutton labeled **Recall** in the Command Line to display the dialog box.
- 2 Choose a command from the buffer list. (You can also enter a command directly into the text entry area of the dialog box.)

Because all command entry methods in the interface — pulldown menus, action keys, and command line entries — are echoed to the command line entry area, the contents of the Command Recall dialog box is not restricted to just commands entered directly into the command line entry area.

The Command Recall dialog box contains a list of interface commands executed during the session as well as any predefined commands present at interface startup.

If you exit the emulation/analysis session with the interface "locked", commands in the recall buffer are saved and will be present when you restart the interface.

You can predefine entries for the Command Recall dialog box and define the maximum number of entries by setting X resources (refer to the "Setting X Resources" chapter).

See "To use dialog boxes" for information about using dialog boxes.

---

## To get help about the command line

- To display the help topic explaining the operation of the command line, press the **Help** pushbutton located near the bottom-right corner of the Command Line area.

## Using the Command Line with the Keyboard

When using the command line with the keyboard, you enter commands by pressing softkeys whose labels appear at the bottom of the screen. Softkeys provide for quick command entry, and minimize the possibility of errors.

The command line also provides command completion. You can type the first few characters of a command (enough to uniquely identify the command) and then press <Tab>. The interface completes the command word for you.

Entering commands with the keyboard is easy. However, the interface provides other features that make entering commands even easier. For example, you can:

- Enter multiple commands on one line.
- Recall commands.
- Edit commands.
- Access on-line help information.

---

### To enter multiple commands on one command line

- Separate the commands with semicolons (;).

More than one command may be entered in a single command line if the commands are separated by semicolons (;).

---

#### Examples

To reset the emulator and break into the monitor:

```
reset ; break <RETURN>
```

## To recall commands

- Press <CTRL>r or <CTRL>b.

The most recent 20 commands you enter are stored in a buffer and may be recalled by pressing <CTRL>r. Pressing <CTRL>b cycles forward through the recall buffer.

---

### Examples

For example, to recall and execute the command prior to the last command:

```
<CTRL>r <CTRL>r <RETURN>
```

---

## To edit commands

- Use the <Left arrow>, <Right arrow>, <Tab>, <Shift><Tab>, <Insert char>, <Back space>, <Delete char>, <Clear line>, and <CTRL>u keys.

The <Left arrow> and <Right arrow> keys move the cursor single spaces to the left or right.

The <Tab> and <Shift><Tab> keys move the cursor to the next or previous word on the command line.

The <Insert char> key enters the insert editing mode and allows characters or command options to be inserted at the cursor location.

The <Back space> key deletes the character to the left of the cursor.

The <Delete char> key deletes the character to the right of the cursor.

The <Clear line> key deletes the characters from the cursor to the end of the line.

The <CTRL>u key erases the command line.

## To access on-line help information

- Use the **help** or **?** commands.

To access the command line's on-line help information, type either **help** or **?** on the command line. You will notice a new set of softkeys. By pressing one of these softkeys and <RETURN>, you can display information on that topic.

---

### Examples

To display information on the system commands:

```
help system_commands <RETURN>
```

Or:

```
? system_commands <RETURN>
```

The help information is scrolled on to the screen. If there is more than a screen full of information, you will have to press the space bar to see the next screen full, or the <RETURN> key to see the next line, just as you do with the UNIX **more** command. After all the information on the particular topic has been displayed (or after you press "q" to quit scrolling through information), you are prompted to press <RETURN> to return to the command line.

## Using Command Files

You can execute a series of commands that have been stored in a command file. You can create command files by logging commands while using the interface or by using an editor on your host computer.

Once you create a command file, you can execute the file in the emulation environment by typing the name of the file on the command line and pressing <RETURN>.

Command files execute until an end-of-file is found or until a syntax error occurs. You can stop a command file by pressing <CTRL>c or the <Break> key.

This section shows you how to:

- Start logging commands to a command file.
- Stop logging commands to a command file.
- Playback (execute) a command file.

### Nesting Command Files

You can nest a maximum of eight levels of command files. Nesting command files means one command file calls another.

### Comments in Command Files

Text that follows a pound sign (#), up to the end of the line, is interpreted as a comment.

### Using the wait Command

When editing command files, you can insert **wait** commands to pause execution of the command file at certain points.

If you press <CTRL>c to stop execution of a command file while the "wait" command is being executed from the command file, the <CTRL>c will terminate the "wait" command, but will not terminate command file execution. To do this, press <CTRL>c again.



Use the **wait measurement\_complete** command after changing the trace depth. By doing this, when you copy or display the trace after changing the trace depth, the new trace states will be available. Otherwise the new states won't be available.

### Passing Parameters

Command files provide a convenient method for passing parameters by using a parameter declaration line preceding the commands in the command file. When the command file is called, the system will prompt you for current values of the formal parameters listed.

Parameters are defined as:

**Passed Parameters** - These are ASCII strings passed to a command file. Any continuous set of ASCII characters can be passed. Spaces separate the parameters.

**Formal Parameters** - These are symbols preceded by an ampersand (&), which are the variables of the command file.

The ASCII string passed (passed parameter) will be substituted for the formal parameter when the command file is executed.

The only way to pass a parameter containing a space is to enclose the parameter in double quotes (") or single quotes ('). Thus, to pass the parameter HP 9000 to a command file, you can use either "HP 9000" or 'HP 9000'.

The special parameter **&ArG\_lEft** gets set to all the remaining parameters specified when the command file was invoked. This lets you use variable size parameter lists. If no parameters are left, **&ArG\_lEft** gets set to NULL.

Consider the command file example (named CMDFILE) shown below:

```
PARMS &ADDR &VALUE1
#
# modify a location or list of locations in memory
# and display the result
#
modify memory &ADDR words to &VALUE1 &ArG_lEft
display memory &ADDR blocked words
```

## Chapter 3: Entering Commands Using Command Files

When you execute CMDFILE, you will be prompted with:

```
Define command file parameter [&ADDR]
```

To pass the parameter, enter the address of the first memory location to be modified. You will then be prompted for **&VALUE1**. If you enter, for example, "0,-1,20, 0ffffh, 4+5\*4", the first parameter "0,-1,20," is passed to **&VALUE1** and the remaining parameters "0ffffh," and "4+5\*4" are passed to **&ArG\_IEFT**.

You can also pass the parameters when you invoke the command file (for example, CMDFILE 1000h 0,-1,20, 0ffffh, 4+5\*4).

### Other Things to Know About Command Files

You should know the following about using command files:

- 1 Command files may contain shell variables. Only those shell variables beginning with "\$" followed by an identifier will be supported. An identifier is a sequence of letters, digits or underscores beginning with a letter or underscore. The identifier may be enclosed by braces "{ }" or entered directly following the "\$" symbol. Braces are required when the identifier is followed by a letter, a digit or an underscore that is not interpreted as part of its name.

For example, assume a directory named /users/softkeys and the shell variable "S". The value of "S" is "soft". By specifying the directory as /users/\${S}keys the correct result is obtained. However, if you attempt to specify the directory as /users/\$Skeys, the Softkey Interface looks for the value of the variable "Skeys". This is not the operators intended result. You may not get the intended result unless Skeys is already defined to be "softkeys".

You can examine the current values of all shell variables defined in your environment with the command "env".

- 2 Positional shell variables, such as \$1, \$2, and so on, are not supported. Neither are special shell variables, such as \$@, \$\*, and so on, supported.
- 3 You can continue command file lines. This is done by avoiding the line feed with a backslash (\). A line terminated by "\" is concatenated with any following lines until a line that does not contain a backslash is found. A line constructed in this manner is recognized and executed as one single command line. If the last line in a command file is terminated by "\", it appears on the command line but is not executed. Normally, the line feed is recognized as the command terminator. The UNIX environment recognizes three quoting

characters for shell commands which are double quotes ("), single quotes ('), and the backslash symbol (\).

For example, the following three lines are treated as a single shell command. The two hidden line feeds are ignored because they are inside the two single quotes ('):

```
!awk '/$/ { blanks++ }  
END { print blanks }  
' an_unix_file
```



---

## To start logging commands to a command file

- Choose **File**→**Log**→**Record** and use the dialog box to select a command file name.
- Using the command line, enter the **log\_commands to <file>** command.

---

## To stop logging commands to a command file

- Choose **File**→**Log**→**Stop**.
- Using the command line, enter the **log\_commands off** command.

## To playback (execute) a command file

- Choose **File**→**Log**→**Playback** and use the dialog box to select the name of the command file you wish to execute.
- Using the command line, enter the name of the command file and press <RETURN>.

If you enter the name of the command file in the command line and the interface cannot find the command file in the current directory, it searches the directories specified in the HP64KPATH environment variable.

To interrupt playback of a command file, press the <CTRL>c key combination. (The mouse pointer must be within the interface window.)

If you press <CTRL>c to stop execution of a command file while the "wait" command is being executed from the command file, the <CTRL>c will terminate the "wait" command, but will not terminate command file execution. To do this, press <CTRL>c again.

## Using Pod Commands

Pod commands are Terminal Interface commands. The Terminal Interface is the low-level interface that resides in the firmware of the emulator.

A pod command used in the Graphical User Interface bypasses the interface and goes directly to the emulator. Because some pod commands can cause the interface to become out-of-sync with the emulator, or even cause the interface to terminate abnormally, they must be used with care.

For example, if you change configuration items, the actual state of the emulator will no longer match the internal record the interface keeps about the state of the emulator.

Issuing certain communications-related commands can prevent the interface from communicating with the emulator and cause abnormal termination of the interface.

However, it is sometimes necessary to use pod commands. For example, you must use a pod command to execute the emulator's *performance verification (pv)* routine. Performance verification is an internal self-test procedure for the emulator.

Remember that pod commands can cause trouble for the high-level interface if they are used indiscriminately.

This section shows you how to:

- Display the pod commands screen.
- Use pod commands.



## To display the pod commands screen

- Choose **Display**→**Pod Commands**.

The pod commands screen displays the results of pod (Terminal Interface) commands. To set the interface to use pod commands, choose **Settings**→**Pod Command Keyboard**.

---

## To use pod commands

- To begin using pod commands, choose **Settings**→**Pod Command Keyboard**.
- To end using pod commands, click the **suspend** pushbutton softkey.

The **Settings**→**Pod Command Keyboard** command displays the pod commands screen and activates the keyboard for entering pod command on the command line.

## Forwarding Commands to Other HP 64700 Interfaces

To allow the emulator/analyzer interface to run concurrently with other HP 64700 interfaces like the high-level debugger and software performance analyzer, a background "daemon" process is necessary to coordinate actions in the interfaces.

This background process also allows commands to be forwarded from one interface to another. Commands are forwarded using the **forward** command available in the command line. The general syntax is:

```
forward <interface_name> "<command_string>" <RETURN>
```

This section shows you how to:

- Forward commands to the high-level debugger.
- Forward commands to the software performance analyzer.

---

### To forward commands to the high-level debugger

- Enter the **forward debug "<command string>"** command using the command line.

---

#### Examples

To send the "Program Run" command to the debugger:

```
forward debug "Program Run" <RETURN>
```

Or, since only the capitalized key is required:

```
forward debug "P R" <RETURN>
```

## To forward commands to the software performance analyzer

- Enter the **forward perf "<command string>"** command using the command line.

---

### Examples

To send the "profile" command to the software performance analyzer:

```
forward perf "profile" <RETURN>
```



---

# 4

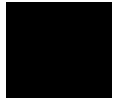

---

## Configuring the Emulator

---

## Configuring the Emulator

This chapter describes how to configure the emulator. You must map memory whenever you use the emulator. When you plug the emulator into a target system, you must configure the emulator so that it operates correctly in the target system. The configuration tasks are grouped into the following sections:

- Using the configuration interface.
- Modifying the general configuration items.
- Selecting the emulation monitor program.
- Mapping memory.
- Configuring the emulator pod.
- Setting the debug/trace options.

The simulated I/O feature and configuration questions are described in the *Simulated I/O User's Guide*.

The external analyzer configuration questions are described in the "Using the External State Analyzer" chapter.

The interactive measurement configuration questions are described in the "Making Coordinated Measurements" chapter.

### Configuring for Operation in the Target System

Refer to the *80960 Emulator User's Guide for the Terminal Interface* for information on plugging the emulator into a target system. This manual also lists the electrical and mechanical specifications of the emulator.

After you plug the emulator into a target system and turn on power to the HP 64700, you need to configure the emulator so that it operates properly with your target system.

The configuration tells the emulator how it should behave on reset, how emulation memory should behave, and whether user programs should be executed in real-time.

Before the emulator can operate in your target system, it needs to know the following things:

**Is there circuitry in the target system that requires programs to run in real-time?** Some emulator commands cause temporary breaks to the monitor program, typically to access microprocessor register values or target system memory. If the target system requires that programs run in real-time, you must restrict the emulator to real-time runs.

**Is there circuitry in the target system that constantly monitors bus cycle execution (for example, memory refresh circuitry or a watchdog timer)?** If so, you should use the BGND output signal to tell the target system when the emulator is executing in background.

**Where is memory located?** Because the emulator can use target system memory or emulation memory (or both), it is necessary to map ranges of memory so that the emulator knows where to direct its accesses.

You can synchronize emulation memory accesses to the target system in order to more closely imitate target system memory. For example, if emulation memory replaces slower target system memory that requires wait states, synchronizing emulation memory to the target system causes wait states to be inserted on emulation memory accesses as they would be on target system memory accesses.

You specify the synchronization of emulation memory differently depending on which emulator you're using: If you're using the HP 64760 emulator, you use the **sync** attribute when mapping emulation memory ranges. If you're using the HP 64761 emulator, you answer a configuration question to make the specification for all emulation memory accesses.

**Should the emulator reset be synchronized to the target system reset?** This is necessary in most target systems so that the emulator can be synchronized to the same clock edge as the processor.

**Should the emulator be allowed to temporarily break into the monitor program when it comes out of reset?**

**Should temporary breaks be allowed while the emulator is executing the user program or should user program execution occur in real-time?**

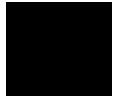

## Chapter 4: Configuring the Emulator

**What is the target system clock speed?** This is so the emulator knows how many wait states to insert on emulation memory accesses.

**Should emulation memory accesses be synchronized to target memory accesses?**

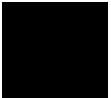

## Using the Configuration Interface

This section shows you how to modify, store, and load configurations using the emulator configuration interface.

This section shows you how to:

- Start the configuration interface.
- Modify a configuration section.
- Store a configuration.
- Change the configuration directory context.
- Display the configuration context.
- Access help information.
- Exit the configuration interface.
- Load a configuration.

This section describes emulator configuration in general terms. Refer to the remaining sections in this chapter for specific information about the emulator configuration questions.

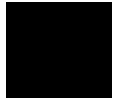

## To start the configuration interface

- Choose **Modify**→**Emulator Config...** from the emulator/analyzer interface pulldown menu.
- Using the command line, enter the **modify configuration** command.

The configuration interface main menu (see example below) is displayed.

The configuration sections that are presented depend on the hardware and features of your particular emulator.

The configuration interface may be left running while you are using the emulator/analyzer interface.

If you're using the Softkey Interface, you don't get a main menu from which to choose configuration sections; however, the same display area and command line are used to answer the configuration questions.

**Examples**

The 80960 emulator configuration interface main menu is shown below.

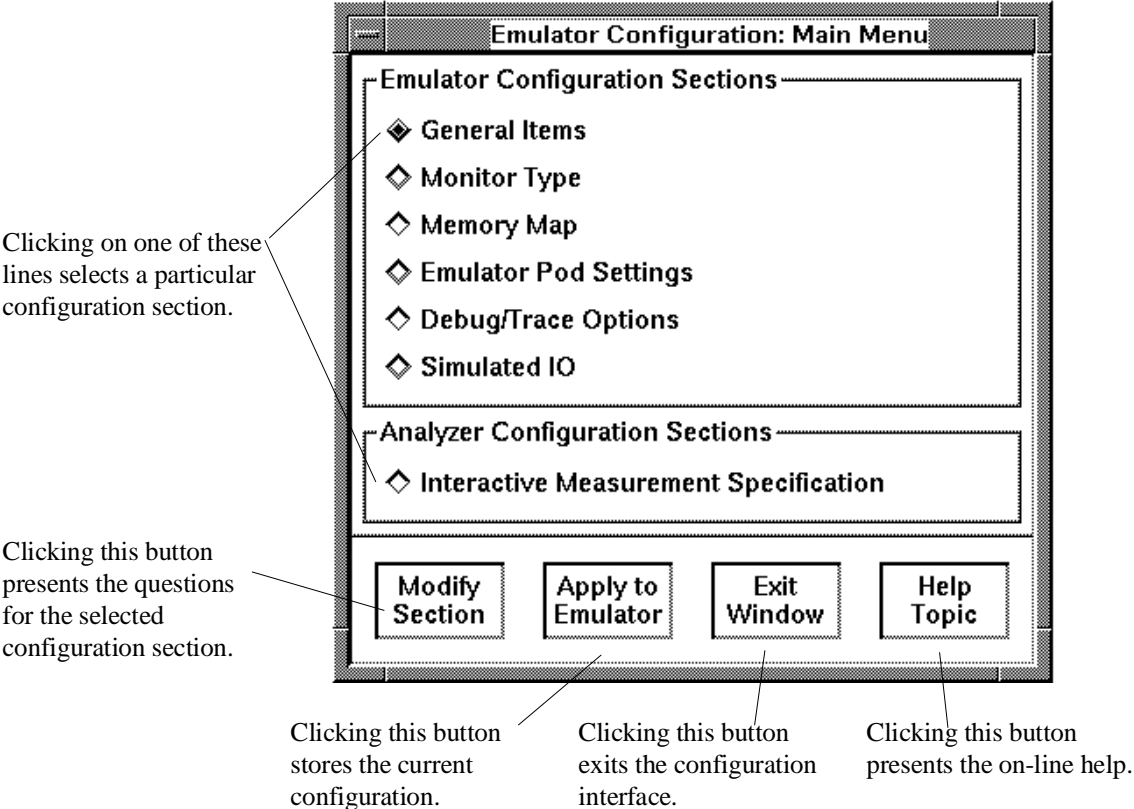

## To modify a configuration section

- 1 Start the emulator configuration interface.
- 2 Click on a section name in the configuration interface main menu, and click the "Modify Section" pushbutton.
- 3 Use the command line to answer the configuration questions.

If you're using the Softkey Interface:

The configuration questions in the "General Items" section are the first to be asked.

To access the questions in the "Monitor Type" section, answer "yes" to the "Modify memory configuration?" question.

To access the questions in the "Memory Map" section, answer "yes" to the "Modify memory configuration?" question.

To access the questions in the "Emulator Pod Settings" section, answer "yes" to the "Modify emulator pod configuration?" question.

To access the questions in the "Debug/Trace Options" section, answer "yes" to the "Modify debug/trace options?" question.



Chapter 4: Configuring the Emulator  
Using the Configuration Interface

Each configuration section presents a window similar to the following.

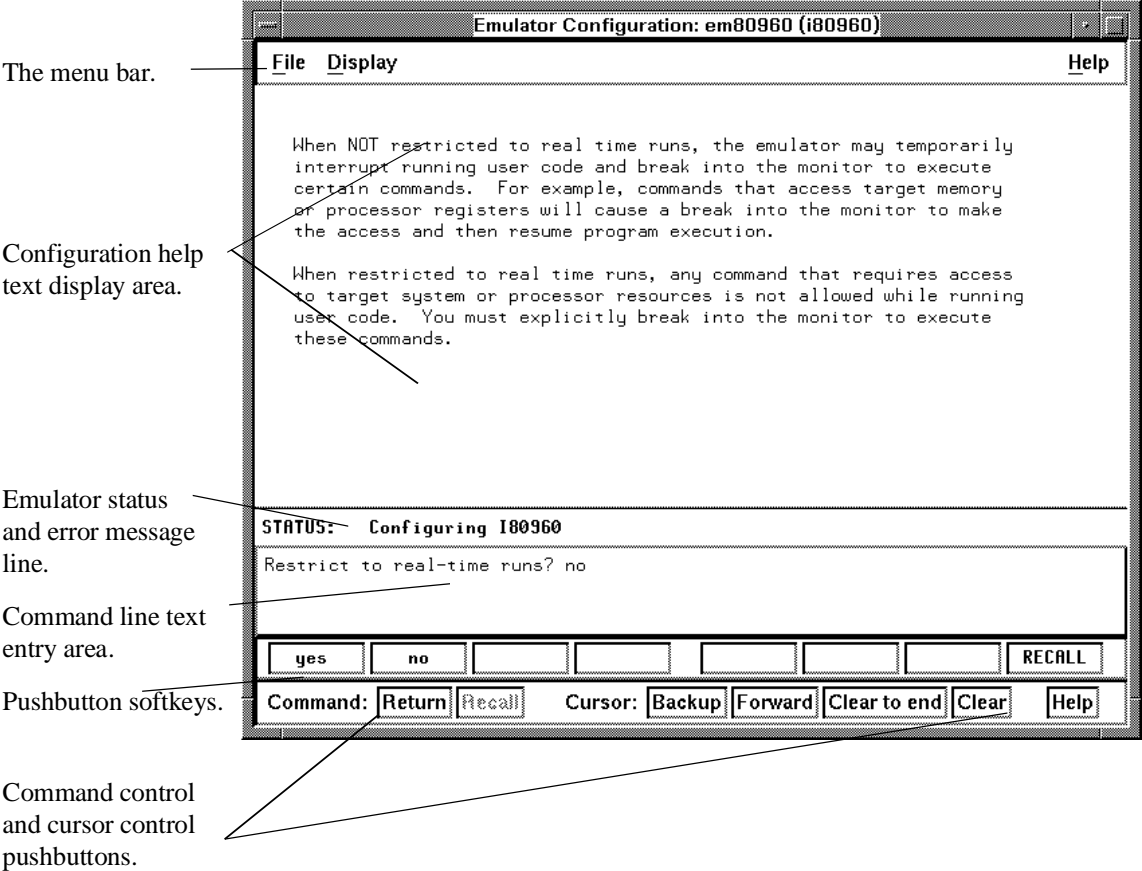

To answer a configuration question, click the softkey pushbutton that has your answer. Or, click on the "Return" command pushbutton to accept the answer that is shown.

When you answer a configuration question, you are normally presented with the next question in the section; however, there are some cases when a carriage return is required, and you can supply it by clicking the "Return" command pushbutton or by pressing the <RETURN> key.

## Chapter 4: Configuring the Emulator

### Using the Configuration Interface

At the last question of a configuration section, you are asked if you wish to return to the main menu. You can click the "next\_sec" softkey pushbutton to access the questions in the next configuration section.

To recall a configuration question, click the "RECALL" softkey pushbutton. If you do this at the starting question of a configuration section, you are asked if you want to return to the main menu.

In order for the emulator to recognize any configuration changes, the configuration must be applied to the emulator.

---

### To store a configuration

- When answering the configuration questions, choose **File**→**Store...** from the pulldown menu, and use the File Selection dialog box to name the configuration file.
- From the configuration interface main menu, click on the "Apply to Emulator" button, and use the File Selection dialog box to name the configuration file.
- If you're using the Softkey Interface, the last configuration question, "Configuration file name?", lets you name the file to which configuration information is stored. If you don't enter a name, configuration information is saved to a temporary file (which is deleted when you exit the interface and release the emulation system).

The file to which the configuration is stored becomes the current configuration file. The emulator only recognizes configuration changes when they are stored or loaded.

When modifying a configuration using the graphical interface, you can store your answers at any time. This is useful for quickly verifying the effect a configuration change has on the emulator.

Configuration information is saved in two files with extensions of ".EA" and ".EB". The file with the ".EA" extension is the "source" copy of the file, and the file with the ".EB" extension is the "binary" or loadable copy of the file.

For more information on how to use dialog boxes, refer to the "To use dialog boxes" description in the "Using Menus, the Entry Buffer, and Action Keys" section of the "Entering Commands" chapter.

---

## To change the configuration directory context

- When answering the configuration questions, choose **File→Directory...** from the pulldown menu, and use the Directory Selection dialog box to specify the new directory.

The directory context specifies the directory to which configuration files are stored and from which they are loaded.

For more information on how to use dialog boxes, refer to the "To use dialog boxes" description in the "Using Menus, the Entry Buffer, and Action Keys" section of the "Entering Commands" chapter.

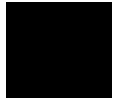

## To display the configuration context

- When answering the configuration questions, choose **Display**→**Context...** from the pulldown menu.

The current directory context and the current configuration files are displayed in a window. Click the "Done" pushbutton when you wish to close the window.

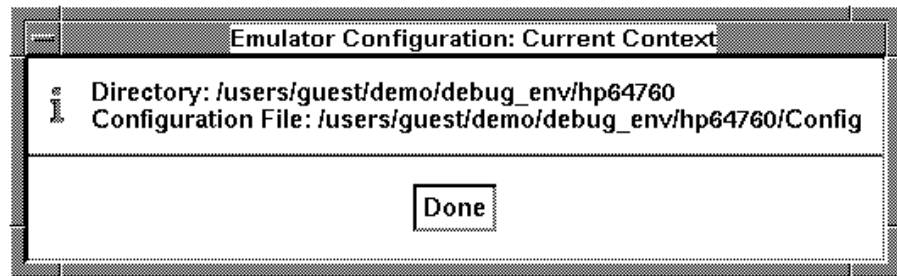

---

## To access help information

- When answering the configuration questions, choose **Help**→**General Topic...** from the pulldown menu.
- From the configuration interface main menu, click on the "Help Topic" button.

## To exit the configuration interface

- When answering the configuration questions, choose **File**→**Exit...** from the pulldown menu (or type <CTRL>x), and click "Yes" in the confirmation dialog box.
- From the configuration interface main menu, click the "Exit Window" button, and click "Yes" in the confirmation dialog box.

The confirmation dialog box only appears if changes have been made to the current configuration.

When you choose "Yes" from the confirmation dialog box, any modifications made to the configuration which haven't been stored are lost. Choosing "No" from the confirmation dialog box cancels the exit and keeps the emulator configuration interface running.

---

## To load a configuration

- In the emulator/analyzer interface, choose **File**→**Load**→**Emulator Config...** from the pulldown menu, and use the File Selection dialog box to specify the configuration file to be loaded.
- Using the command line, enter the **load configuration <FILE>** command.

This command loads previously created and stored configuration files.

## Modifying the General Configuration Items

In order to modify the general configuration items, you must first start the configuration interface and access the "General Items" configuration section (refer to the previous "Using the Configuration Interface" section).

This section shows you how to:

- Restrict to real-time runs.
- Turn OFF the restriction to real-time runs.

---

### To restrict the emulator to real-time runs

- Answer "yes" to the "Restrict to real-time runs?" question.

---

#### CAUTION

If your target system circuitry is dependent on constant execution of program code, you should restrict the emulator to real-time runs. This will help insure that target system damage does not occur. However, remember you can still execute the **reset**, **break**, and **step** commands; you should use caution in executing these commands.

The default configuration does not restrict the emulator to real-time runs. Therefore, the emulator might make temporary breaks into the monitor to complete certain commands. However, you may wish to restrict runs to real-time to prevent temporary breaks that might cause target system problems.

When runs are restricted to real-time and the emulator is running the user program, all commands that cause a break (except **reset**, **break**, **run**, **step**, and **init\_processor** are refused.

The following commands are not allowed when runs are restricted to real-time and the emulator is running the user program:

- Display/modify registers.
- Display/modify target system memory.
- Load/store target system memory.

- Display/modify execution messages.
- Run until.
- Display tables.

If you want to enter one of these commands, you must first make an explicit break into the monitor using the **break** command.

Because the emulator contains dual-port emulation memory, commands that access emulation memory are allowed while runs are restricted to real-time.

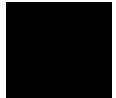

---

## **To turn OFF the restriction to real-time runs**

- Answer "no" to the "Restrict to real-time runs?" question.

All commands, regardless of whether or not they require a break to the emulation monitor, are accepted by the emulator.

## Selecting the Emulation Monitor Program (HP 64761 Only)

This section shows you how to:

- Use the background monitor program.
- Use the foreground monitor program.
- Customize the foreground monitor program.

When you power up the emulator, or when you initialize it, the background monitor is used by default. You can also configure the emulator to use a foreground monitor.

Regardless of which monitor you choose, a break command issued while the processor is reset will cause entry into the background monitor. The foreground monitor cannot run until your user programming environment is initialized either by running your program, or by explicitly entering a **init\_processor** command.

Before the background and foreground monitors are described, you should understand the foreground and background emulator modes as well as the function of the emulation monitor program.

### The Background Emulator Mode

Background is the mode in which emulation processor execution does not appear normally on the emulator probe. When in background, the emulator appears to the target system to be in a suspended state. (Though background monitor activity appears on the address and data lines, there are no ADS strobes.) In background mode, the emulation microprocessor executes out of background memory.

### The Foreground Emulator Mode

Foreground is the mode in which all emulation processor cycles appear on the emulation probe, and the emulator executes as if it were a real microprocessor. The emulator is in foreground when it executes user programs. In foreground mode, the emulation microprocessor typically executes out of target system or emulation memory.



### **The Function of the Monitor Program**

The monitor program is the interface between the emulation system controller and the target system. The emulation system controller uses its own microprocessor to accept and execute emulation, system, and analysis commands. The monitor program is executed by the emulation microprocessor.

The monitor program makes possible emulation commands which access target system resources. For example, when you enter a command to modify target system memory, it is the execution of monitor program instructions that cause the new values to be written to target system memory.

When the emulation system controller recognizes that an emulation command needs to access target system resources, it writes a command code to a communications area and breaks the emulation processor execution into the monitor program. The monitor program reads this command (and any associated parameters) from the communications area and executes the appropriate instructions to access these target system resources.

### **The Background Monitor**

On emulator power-up, or after initialization, the emulator uses the background monitor program. The background monitor program executes entirely in the *background* emulator mode. The background monitor does not occupy processor address space.

### **The Foreground Monitor**

You can configure the emulator to use the foreground monitor program. When the foreground monitor is selected, it executes in the *foreground* emulator mode. The foreground monitor occupies processor memory space and executes as if it were part of the user program.

When you use the foreground monitor, breaks into the monitor still cause the emulator to execute a number of cycles in background. The difference between the foreground monitor and the background monitor is that when the background monitor is used, all monitor functions are executed in background; when the foreground monitor is used, the monitor functions are executed in foreground.

You may customize the foreground monitor, by defining routines that are executed each time the monitor is entered, each time the monitor loops while waiting for command codes, or each time the monitor is exited.

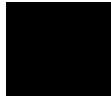

Chapter 4: Configuring the Emulator  
**Selecting the Emulation Monitor Program (HP 64761 Only)**

<b>Comparison of Background and Foreground Monitor Programs</b>		
<b>Monitor Program Characteristic</b>	<b>Background</b>	<b>Foreground</b>
Takes up processor memory space	No	Yes
Allows the emulator to respond to target system interrupts during monitor execution	No	Yes
Can be customized	No	Yes
Can be used when performing coordinated measurements with other emulators	Yes	No

---

## **To use the background monitor program**

- Answer "background" to the "Monitor type?" question.

When you select the background monitor program, a memory overlay is created and the background monitor is loaded into that area.

If your target system checks for processor execution (for example, it has a watchdog timer) you can use the BGND auxiliary output to signal the target system when the emulator is executing in the background monitor. The BGND signal is an active high signal.

## To use the foreground monitor program

- 1 Answer "foreground" to the "Monitor type?" question.
- 2 Answer the "Fixed or variable foreground monitor priority?" question.
- 3 If you answered "fixed" to the previous question, enter the fixed foreground monitor priority.

If you select the foreground monitor, it will be loaded for you in a portion of the reserved upper 16 MBytes of memory. The emulator provides this memory for the monitor independent of emulation memory or target system memory.

If you choose a variable foreground monitor priority, the foreground monitor will assume the priority of whatever process is interrupted when the break occurred.

If you choose a fixed foreground monitor priority, you must enter a decimal value between 0 and 31.

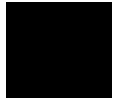

## To customize the foreground monitor program

- 1 Create the routines to be executed at monitor entry, exit, or at each loop of the monitor program.
- 2 Load the routines into memory.
- 3 Modify the appropriate memory locations to contain pointers to the routines.

The operation of the foreground monitor can be customized by initializing three function pointers to call routines which you have defined. You can invoke your own function on monitor entry, during the monitor command loop, or on monitor exit, by putting pointers to your functions in the following locations:

```
monitor entry:    0xffffc8ff0
monitor loop:     0xffffc8ff4
monitor exit:     0xffffc8ff8
```

## Mapping Memory

Because the emulator can use target system memory or emulation memory (or both), it is necessary to map ranges of memory so that the emulator knows where to direct its accesses.

In the HP 64760 80960KA/KB/MC emulator, up to 16 ranges of memory can be mapped. In the HP 64761 80960SA/SB emulator, up to 8 ranges of memory can be mapped. The resolution of mapped ranges is 256 bytes (that is, the memory ranges must begin on 256 byte boundaries and must be at least 256 bytes in length).

The amount of emulation memory that can be mapped depends on the number, and size, of memory modules installed on the emulator board. The HP 64760 80960KA/KB/MC emulator provides four slots for emulation memory modules. The HP 64761 80960SA/SB emulator provides two slots for emulation memory modules.

<b>Amount of Emulation Memory, HP 64760 80960KA/KB/MC Emulator</b>						
		<b>Number of 256 Kbyte memory modules</b>				
		<b>0</b>	<b>1</b>	<b>2</b>	<b>3</b>	<b>4</b>
<b>Number of 1 Mbyte memory modules</b>	<b>0</b>	0M	0.25M	0.5M	0.75M	1M
	<b>1</b>	1M	1.25M	1.5M	1.75M	
	<b>2</b>	2M	2.25M	2.5M		
	<b>3</b>	3M	3.25M			
	<b>4</b>	4M				

Chapter 4: Configuring the Emulator  
**Mapping Memory**

<b>Amount of Emulation Memory and Blocks Available to the Mapper, HP 64761 80960SA/SB Emulator</b>				
		<b>Number of 256 Kbyte memory modules</b>		
		<b>0</b>	<b>1</b>	<b>2</b>
<b>Number of 1 Mbyte memory modules</b>	<b>0</b>	0 Kbytes	256 Kbytes 8 blocks 32 Kbytes each	512 Kbytes 8 blocks 64 Kbytes each
	<b>1</b>	1024 Kbytes 8 blocks 128 Kbytes each	1280 Kbytes 5 blocks 256 Kbytes each	
	<b>2</b>	2048 Kbytes 8 blocks 256 Kbytes each		

Emulation memory is made available to the mapper in blocks. In the HP 64760 80960KA/KB/MC emulator, the block size is 16 Kbytes. In the HP 64761 80960SA/SB emulator, the total amount of emulation memory is divided into 8 equal blocks unless 256 Kbyte and 1 Mbyte memory modules are mixed, in which case there are 5 blocks, 256 Kbytes apiece.

When you map an address range to emulation memory, at least one block is assigned to the range. When a block of emulation memory is assigned to a range, it is no longer available, even though part of the block may be unused.

You should map all memory ranges used by your programs before loading programs into memory.

## To map memory ranges

- Enter the address range, memory type, and if you're using the HP 64760 80960KA/KB/MC emulator, you can also enter the **sync** attribute for emulation memory ranges.

You can characterize memory ranges as emulation RAM, emulation ROM, target system RAM, target system ROM, or as guarded memory.

Guarded memory accesses will cause emulator execution to break into the monitor program.

Writes to locations characterized as ROM will cause emulator execution to break into the monitor program if the "Break processor on write to ROM?" trace/debug configuration option is enabled.

Writes to emulation ROM will be inhibited. Writes by user code to target system memory locations mapped as ROM or guarded memory will result in a break to the monitor but are not inhibited (that is, the write still occurs).

If you're using the HP 64760 80960KA/KB/MC emulator, emulation memory ranges contain an attribute that specifies whether accesses in that range of emulation memory should be synchronized with the target system ADS signal (sync) or not (nosync).

If no attribute is specified when mapping emulation memory ranges, the sync attribute is chosen by default.

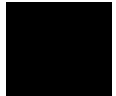

## Chapter 4: Configuring the Emulator

### Mapping Memory

#### Examples

For example, consider the following section summary from the linker load map output listing.

#### SECTION SUMMARY

SECTION	ATTRIBUTE	START	END	LENGTH	ALIGN
checksumtable	ABSOLUTE CODE	00000000	0000001F	00000020	0 (BYTE)
WARNING: (317) Section Assigned address below BASE					
code	NORMAL CODE	00100000	0010650F	00006510	256
literals		00106510	00106510	00000000	0 (BYTE)
strings	NORMAL CODE	00106510	00106636	00000127	16
const	NORMAL CODE	00106640	001066EB	000000AC	16
__INITDATA		001066EC	001066EC	00000000	0 (BYTE)
zerovars	NORMAL DATA	001066F0	00107243	00000B54	16
vars	NORMAL DATA	00107280	0010857F	00001300	64
tags	NORMAL DATA	00108580	001085D7	00000058	16
ioports		001085D8	001085D8	00000000	0 (BYTE)
heap	NORMAL DATA	001085E0	001185DF	00010000	16
stack	NORMAL CODE	001185E0	001185E0	00000000	4 (WORD)
	ABSOLUTE	FF000000	FFFFFFFF	01000000	0 (BYTE)

From the load map listing above, you can see the emulator demo program occupies locations in two address ranges:

The check-sum words of the Initial Memory Image occupy locations 0 through 1FH. Because the contents of these segments will eventually reside in target system ROM, this area should be characterized as ROM when mapped. This will prevent these locations from being written over accidentally. If you answer "yes" to the "Break processor on write to ROM?" debug/trace configuration question, instructions that attempt to write to these locations will cause emulator execution to break into the monitor.

The remaining code and data sections occupy locations 100000H through 1185E0H. Since the data sections are written to, this area should be characterized as RAM when mapped.

Enter the following commands to map memory for the emulator demo program.

```
delete all <RETURN>  
0 thru 0ffh emulation rom <RETURN>  
100000h thru 11ffffh emulation ram <RETURN>
```



The resulting memory mapper screen is shown below.

```
Emulation memory blocks: available = 6 mapped = 2 size = 128k bytes
entry  range      type
1      0H-        FFH EMUL/ROM
2      100000H-  11FFFFH EMUL/RAM
```

To exit out of the memory mapper, enter:

**end** <RETURN>



---

## To characterize unmapped ranges

- Use the **default** softkey to characterize unmapped ranges.

The **default** softkey in the memory mapper allows you to characterize unmapped memory ranges. Unmapped memory ranges are treated as target system RAM by default. Unmapped memory ranges cannot be characterized as emulation memory.

---

### Examples

To characterize unmapped ranges as target RAM:

**default target ram** <RETURN>

To characterize unmapped ranges as guarded memory:

**default guarded** <RETURN>

To exit out of the memory mapper, enter:

**end** <RETURN>

## To delete memory map ranges

- Use the **delete** softkey to characterize unmapped ranges.

Note that programs should be reloaded after deleting mapper terms. The memory mapper may re-assign blocks of emulation memory after the insertion or deletion of mapper terms.

---

### Examples

To delete term 1 in the memory map:

```
delete 1 <RETURN>
```

To delete all map terms:

```
delete all <RETURN>
```

To exit out of the memory mapper, enter:

```
end <RETURN>
```

## Configuring the Emulator Pod

In order to configure the emulator pod, you must first start the configuration interface and access the "Emulator Pod Settings" configuration section (refer to the previous "Using the Configuration Interface" section).

This section shows you how to:

- Synchronize to target system reset.
- Turn OFF synchronization to target system reset.
- Specify the target memory access size.
- Specify the target system bus rate.
- Synchronize emulation memory accesses to target READY (HP 64761 Only).

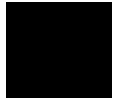

---

### To synchronize to target system reset

- 1 Answer "yes" to the "Wait for target '80960 RESET'?" question.
- 2 Set the target system reset polarity by answering the "Target 'system reset' polarity?" question.
- 3 Connect the emulator probe's SYS\_RESET line to the target system.

With most target systems, in order to synchronize the emulator with the same clock edge as the processor, it is necessary for the emulator to wait until a target 80960 RESET pulse occurs before releasing the processor from the reset state.

The answer to the "Wait for target '80960 RESET'?" question controls how the 80960 processor in the emulator leaves the reset state.

If the "Wait for target '80960 RESET'?" question is answered "yes", the 80960 processor in the emulator must detect a high level at the target system 80960 socket before the emulator hardware will allow the processor out of the reset state. If the emulator does not detect a high level at the target system 80960 socket reset pin,

## Chapter 4: Configuring the Emulator

### Configuring the Emulator Pod

the emulator status will be "Awaiting target reset". Once this high level is detected, the emulator will enter the "Awaiting target run" state and wait for a low level to be detected. As soon as a low level is detected the processor will start to run.

If the "Wait for target '80960 RESET'?" question is answered "no", the emulator only needs to detect a low level at the target system 80960 socket before the processor in the emulator will be allowed to run. If the emulator does not detect a low level, the processor will not be allowed to run, and the status will be "Awaiting target run". Regardless of the configuration, any time that the level at the target system 80960 socket is high, the processor in the emulator will remain in the reset condition, and the status will be "Awaiting target run".

Basically, "Waiting for target '80960 RESET'?" requires the target system to transition the RESET line at the 80960 socket from a high level to a low level before the emulator will allow the processor to run. Otherwise, only a low level is required.

Normally, the emulator should be configured to wait for target 80960 RESET. Probably one of two conditions exist in the target system that will require this configuration:

- First, the 80960 processor maintains an internal clock reference that is one-half the frequency of the CLK2 input. The internal clock is synchronized to the CLK2 input on the falling edge of the reset signal. Normally, the target system has hardware, other than the 80960, that is sensitive to the synchronization between the CLK2 input and reset.
- The second condition that may exist in the target system is that the hardware operation is different at the time the processor comes out of reset than it is after some initialization code is executed. When the 80960 processor is plugged in the target system this is not a problem. However, when an emulator is plugged into the target system, the processor in the emulator can be reset from the target system OR the emulator hardware. When the processor in the emulator is reset by the emulation hardware the target system does not know that the processor is reset therefore startup problems can occur.

Configuring the emulator to wait for target 80960 RESET can create a problem if the target system is not in the same location as the user. This configuration requires a reset pulse from the target system whenever the user tries to break or run after issuing the reset command. This is where the SYS\_RESET lead can be useful. When this lead is connected to the master or system reset of the target system, and is configured for the proper polarity (LOW or HIGH) the target system will know when the emulator reset command has been issued. Now, when a reset command is executed the SYS\_RESET will be asserted and the high reset level at the 80960

## Chapter 4: Configuring the Emulator Configuring the Emulator Pod

target socket will be generated. When the break or run command is issued, SYS\_RESET will be released, a low level at the target 80960 socket will be detected and the emulator and target system will maintain the correct synchronization.

If neither of the mentioned hardware conditions exist, then the emulator can be configured to NOT wait for the target 80960 RESET. In this case the SYS\_RESET lead is normally not needed.

The "Target 'system reset' polarity" controls the polarity of the SYS\_RESET lead that comes from the two pin connector J2, on the emulator probe board. This lead can be connected to the target system so that the target system knows when the emulator **reset** command has been executed. When the **reset** command is executed, SYS\_RESET is asserted. When the **break**, **run**, or **init\_processor** command is executed, the SYS\_RESET line is released.

This lead is provided so that the emulator can be used to reset all of the hardware in a target system. This may be necessary for some target systems whenever the 80960 processor is reset. The reset signal on the 80960 probe cannot be used to perform this function because it is not bi-directional and is only received by the emulator.

The SYS\_RESET lead uses an open collector driver and will require a pull-up in the target system. The probe does not provide a pull-up resistor because the SYS\_RESET lead is often connected to an RC network in the target system. The output driver device is a 74F38.

If the target system's reset line is an active high, answer "high" to the "Target 'system reset' polarity?" question. The pulse output on the SYS\_RESET line will be an active high.

If the target system's reset line is an active low, answer "low" to the "Target 'system reset' polarity?" question. The pulse output on the SYS\_RESET line will be an active low.

Target system power should be OFF when connecting the SYS\_RESET line to the target system reset.

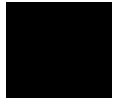

## To turn OFF synchronization to target system reset

- Answer "no" to the "Wait for target '80960 RESET'?" question.

---

## To specify the target memory access size

- Answer the "Target memory access size?" question.

When accessing target system memory locations, the access mode specifies the type of microprocessor cycles that are used to read or write the value(s). For example, when the access mode is byte and a target system location is modified to contain the value 12345678H, "stob" instructions are used to write the byte values 12H, 34H, 56H, and 78H to target system memory.

Answer "bytes" if the emulator should make 8-bit accesses to target system memory.

Answer "shorts" if the emulator should make 16-bit accesses to target system memory.

Answer "words" if the emulator should make 32-bit accesses to target system memory.

The 80960SA/SB processor has a 16-bit data bus. Thus, "word" accesses are generated as a burst of two successive 16-bit transfers.

If a command that requires an access of target memory cannot be satisfied with the specified access size, the access will be made with whatever size is required to complete the command. For example, an unaligned word access will be broken up into two accesses of smaller sizes. Similarly, a request to modify a single byte will use an access size of "bytes".

## **To specify target system bus rate**

- Answer the "Target system bus rate?" question.

The target system clock speed determines the number of wait states for accesses to emulation memory by the processor.

Answer "fast" if the target system clock is faster than 20 MHz. The wait states for emulation memory accesses will be 2,1,1,1 when using the HP 64760 80960KA/KB/MC emulator or 1,0,0,0,0,0,0 when using the HP 64761 80960SA/SB emulator.

Answer "slow" if the target system clock is 20 MHz or slower. The wait states for emulation memory accesses will be 1,1,1,1 when using the HP 64760 80960KA/KB/MC emulator or 0,0,0,0,0,0,0 when using the HP 64761 80960SA/SB emulator.

---

## **To synchronize emulation memory accesses to target READY (HP 64761 Only)**

- Answer the "Synchronize emulation memory accesses to target READY?" question.

When you answer "yes", accesses to emulation memory will wait for the target system ADS. This synchronizes emulation memory accesses with the target system READY signal.

When you answer "no", accesses to emulation memory will NOT wait for the target system ADS.

The HP 64760 emulator also lets you synchronize emulation memory accesses to the target READY signal by allowing attributes to be specified when mapping emulation memory ranges.

## **Setting the Debug/Trace Options**

In order to set the debug/trace options, you must first start the configuration interface and access the "Debug/Trace Options" configuration section (refer to the previous "Using the Configuration Interface" section).

This section shows you how to:

- Enable breaks on writes to ROM.
- Disable breaks on writes to ROM.
- Restrict breaks into monitor when released from reset.
- Allow breaks into monitor when released from reset.

---

### **To disable breaks on writes to ROM**

- Answer "no" to the "Break processor on write to ROM?" question.

The emulator will not break to the monitor upon a write to ROM.

The emulator will not modify the memory location if it is in emulation ROM.



## To enable breaks on writes to ROM

- Answer "yes" to the "Break processor on write to ROM?" question.

The emulator will break into the emulation monitor whenever the user program attempts to write to a memory region mapped as ROM.

The emulator will prevent the processor from actually writing to memory mapped as emulation ROM; however, it cannot prevent writes to target system RAM locations which are mapped as ROM, even though the write to ROM break is enabled.

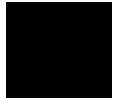

---

## To restrict breaks into monitor when released from reset

- Answer "no" to the "Enter monitor from reset?" question.

Two emulator features, execution breakpoints and execution messages, require initialization by the emulator after each reset. The emulator must execute in the monitor program for a short period of time to initialize these features.

The default configuration allows the emulator to temporarily break into the monitor when released from reset. However, if your target system requires that the processor run directly into user code after reset, you must turn off breaks when the emulator is reset.

When you run from reset while breaks into the monitor from reset are restricted, status messages inform you that execution messages and breakpoints are temporarily disabled. Execution messages and breakpoints will be re-enabled when emulator execution breaks into the monitor.

If breakpoints were enabled and software breakpoints were set in the program before the reset, then there are "fmark" instructions still in the program. If an "fmark" instruction is executed, it may cause the program to run incorrectly.

## To allow breaks into monitor when released from reset

- Answer "yes" to the "Enter monitor from reset?" question.

The emulator will enter the monitor when it comes out of reset. This means that a target system reset pulse will cause a break to the monitor. It also means that a **run** command from the reset state will cause entry into the monitor long enough to re-enable breakpoints and execution trace messages before running user code.

---

**5**



---

**Using the Emulator**

---

## Using the Emulator

This chapter describes general tasks you may wish to perform while using the emulator. These tasks are grouped into the following sections:

- Loading absolute files.
- Using symbols.
- Executing user programs (starting, stopping, stepping, and resetting the emulator).
- Using software breakpoints.
- Displaying and modifying registers.
- Displaying and modifying memory.
- Changing the interface settings.
- Using system commands.

## Loading and Storing Absolute Files

This section describes the tasks related to loading absolute files into the emulator and storing memory contents into absolute files. This section shows you how to:

- Load absolute files into memory.
- Load absolute files without symbols.
- Store memory contents into absolute files.

---

### To load absolute files

- Choose **File**→**Load**→**Executable** and use the dialog box to select the absolute file.
- Using the command line, enter the **load <absolute\_file>** command.

You can load absolute files into emulation or target system memory. You can load IEEE-695 format absolute files. You can also load HP format absolute files. The **store memory** command creates HP format absolute files.

If you wish to load only that portion of the absolute file that resides in memory mapped as emulation RAM or ROM, use the command line's **load emul\_mem** syntax.

If you wish to load only the portion of the absolute file that resides in memory mapped as target RAM, use the command line's **load user\_mem** syntax.

If you want both emulation and target memory to be loaded, do not specify **emul\_mem** or **user\_mem**.

---

### Examples

To load the demo program absolute file, enter the following command:

```
load ecs.x <RETURN>
```

To load only portions of the absolute file that reside in target system RAM:

## Chapter 5: Using the Emulator

### Loading and Storing Absolute Files

```
load user_mem absfile <RETURN>
```

To load only portions of the absolute file that reside in emulation memory:

```
load emul_mem absfile <RETURN>
```

---

### To load absolute files without symbols

- Choose **File**→**Load**→**Program Only** and use the dialog box to select the absolute file.
- Using the command line, enter the **load <absolute\_file> nosymbols** command.

---

### To store memory contents into absolute files

- Using the command line, enter the **store memory** command.

You can store emulation or target system memory contents into HP format absolute files on the host computer. Absolute files are stored in the current directory. If no extension is given for the absolute file name, it is given a ".X" extension.

---

#### Examples

To store the contents of memory locations 900H through 9FFH to an absolute file on the host computer named "absfile":

```
store memory 900h thru 9ffh to absfile <RETURN>
```

After the command above, a file named "absfile.X" exists in the current directory on the host computer.

## Using Symbols

If symbol information is present in the absolute file, it is loaded along with the absolute file (unless you use the **nosymbols** option). Both global symbols and symbols that are local to a program module can be displayed.

Long symbol names can be truncated in the symbols display; however, you can increase the width of the symbols display by starting the interface with more columns (refer to the "Setting X Resources" chapter).

This section describes how to:

- Load symbols.
- Display global symbols.
- Display local symbols.
- Display a symbol's parent symbol.
- Copy-and-paste a full symbol name to the entry buffer.

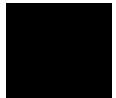

---

## To load symbols

- Choose **File**→**Load**→**Symbols Only** and use the dialog box to select the absolute file.
- Using the command line, enter the **load symbols <absolute\_file>** command.

Unless you use the **nosymbols** option when loading absolute files, symbols are loaded automatically. However, if you did use the **nosymbols** option when loading the absolute file, you can load the symbols without loading the absolute file again.

This option is particularly useful for loading symbols for files located in target ROM so that you can use symbols with that code.

**Examples**

To load symbols from the demo program:

```
load symbols ecs.x <RETURN>
```

---

## To display global symbols

- Choose **Display**→**Global Symbols**.
- Using the command line, enter the **display global\_symbols** command.

Listed are: address ranges associated with a symbol, the segment the symbol is associated with, and the offset of that symbol within the segment.

If there is more than a screen full of information, you can use the up arrow, down arrow, <NEXT>, or <PREV> keys to scroll the information up or down on the display.

---

**Examples**

To display global symbols in the demo program:

```
display global_symbols <RETURN>
```

Procedure name	Address range	Segment	Offset
Procedure symbols			
_START	00103030 - 00103007	code	0000
_flsbuf	00103010 - 0010302B	code	0100
clear_screen	00102BC0 - 00102B0B	code	0250
close	00102A80 - 00102A9B	code	0110
combsort	00100600 - 001009AB	code	0600
do_sort	00100980 - 00100C57	code	0980
exec_cmd	00102C20 - 00102CD7	code	0280
fflush	00102E00 - 00102F2B	code	0090
fileno	00102E40 - 00102E5F	code	0000
fputc	00102F30 - 00102F83	code	00F0
fputs	00102F90 - 00102FCB	code	0150
gen_ascii_data	00100380 - 001006C3	code	0380
get_targets	00100E40 - 0010111F	code	00C0
graph_data	00101010 - 00101E1F	code	0F90
initSimioForC	001029C0 - 00102A03	code	0050
init_system	00100C60 - 00100D07	code	0000



## To display local symbols

- When displaying symbols, position the mouse pointer over a symbol on the symbol display screen and click the *select* mouse button.
- When displaying symbols, position the mouse pointer over the symbol, press and hold the *select* mouse button, and choose **Display Local Symbols** from the popup menu.
- Position the mouse cursor in the entry buffer and enter the module whose local symbols are to be displayed; then, choose **Display→Local Symbols ()**.
- Using the command line, enter the **display local\_symbols\_in <module>** command.

To display the address ranges associated with the high-level program's source file line numbers, you must display the local symbols in the file.



## Chapter 5: Using the Emulator Using Symbols

### Examples

To use the Symbols Display popup menu:

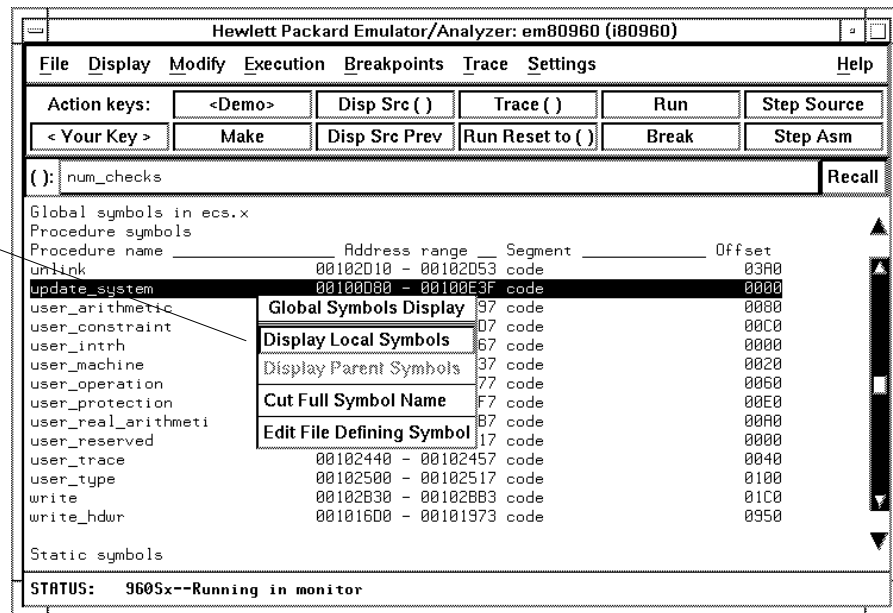

The screenshot shows the Hewlett Packard Emulator/Analyzer interface. The title bar reads "Hewlett Packard Emulator/Analyzer: em80960 (i80960)". The menu bar includes "File", "Display", "Modify", "Execution", "Breakpoints", "Trace", "Settings", and "Help". Below the menu bar is a row of action keys: "<Demo>", "Disp Src ( )", "Trace ( )", "Run", and "Step Source". A second row of keys includes "< Your Key >", "Make", "Disp Src Prev", "Run Reset to ( )", "Break", and "Step Asm". The main window displays a list of symbols for the file "num\_checks". The symbols are categorized into "Global symbols in ecs.x" and "Procedure symbols". The "Procedure symbols" section is highlighted, and a popup menu is open over it. The popup menu contains the following items: "Global Symbols Display", "Display Local Symbols", "Display Parent Symbols", "Cut Full Symbol Name", and "Edit File Defining Symbol". The "Display Local Symbols" item is selected. The status bar at the bottom reads "STATUS: 9605x--Running in monitor".

Procedure name	Address range	Segment	Offset
unlink	00102010 - 00102053	code	03A0
update_system	00100000 - 00100E3F	code	0000
user_arithmetic		37 code	0080
user_constraint		07 code	00C0
user_intrh		67 code	0000
user_machine		37 code	0020
user_operation		77 code	0060
user_protection		F7 code	00E0
user_real_arithmeti		87 code	00A0
user_reserved		17 code	0000
user_trace	00102440 - 00102457	code	0040
user_type	00102500 - 00102517	code	0100
write	00102B30 - 00102BB3	code	01C0
write_hdr	00101600 - 00101973	code	0950

View the local symbols associated with the highlighted symbol by choosing this menu item.

**Using the command line:**

To display local symbols in a module:

```
display local_symbols_in update_sys <RETURN>
```

```
Symbols in update_sys(module)
Procedure symbols
Procedure name _____ Address range __ Segment _____ Offset
get_targets                00100E40 - 0010111F code          00C0
graph_data                 00101D10 - 00101E1F code          0F90
read_conditions            00101120 - 001013B7 code          03A0
save_points                00101980 - 00101D03 code          0C00
set_outputs                001013C0 - 001016CF code          0640
update_system              00100D80 - 00100E3F code          0000
write_hdr                  00101600 - 00101973 code          0950

Filename symbols
Filename _____
/usr/hp64000/demo/debug_env/hp64760/update_sys.c
```

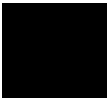

To display local symbols in a procedure:

```
display local_symbols_in update_sys.save_points <RETURN>
```

```
Symbols in update_sys(module).save_points(procedure)
Procedure special symbols
Procedure special name _____ Address range __ Segment _____ Offset
ENTRY                     00101980                code          0C00
TEXTRANGE                  00101980 - 00101D03 code          0C00
```

## Chapter 5: Using the Emulator Using Symbols

To display address ranges associated with the high-level source line numbers:

```
display local_symbols_in update_sys."update_sys.c":  
<RETURN>
```

```
Symbols in ../usr/hp64000/demo/debug_env/hp64760/update_sys.c":  
Source reference symbols  
Line range _____ Address range __ Segment _____ Offset  
#1-#47                00100080 - 00100087 code          0000  
#48-#48                00100088 - 0010008F code          0008  
#49-#49                00100090 - 00100093 code          0010  
#50-#53                00100094 - 001000A7 code          0014  
#54-#56                001000A8 - 001000B8 code          0028  
#57-#59                001000BC - 001000D8 code          003C  
#60-#60                001000DC - 001000E3 code          005C  
#60-#60                001000E8 - 001000EF code          0068  
#61-#61                001000E4 - 001000E7 code          0064  
#62-#63                001000F0 - 001000F7 code          0070  
#63-#63                001000FC - 001000FF code          007C  
#64-#64                001000F8 - 001000FB code          0078  
#65-#68                00100E00 - 00100E18 code          0080  
#69-#72                00100E1C - 00100E2F code          009C  
#73-#75                00100E30 - 00100E33 code          00B0  
#76-#77                00100E34 - 00100E3F code          00B4
```

### To display a symbol's parent symbol

- When displaying symbols, position the mouse pointer over the symbol, press and hold the *select* mouse button, and choose **Display Parent Symbols** from the popup menu.

#### Examples

View the parent symbol associated with the highlighted symbol by choosing this menu item.

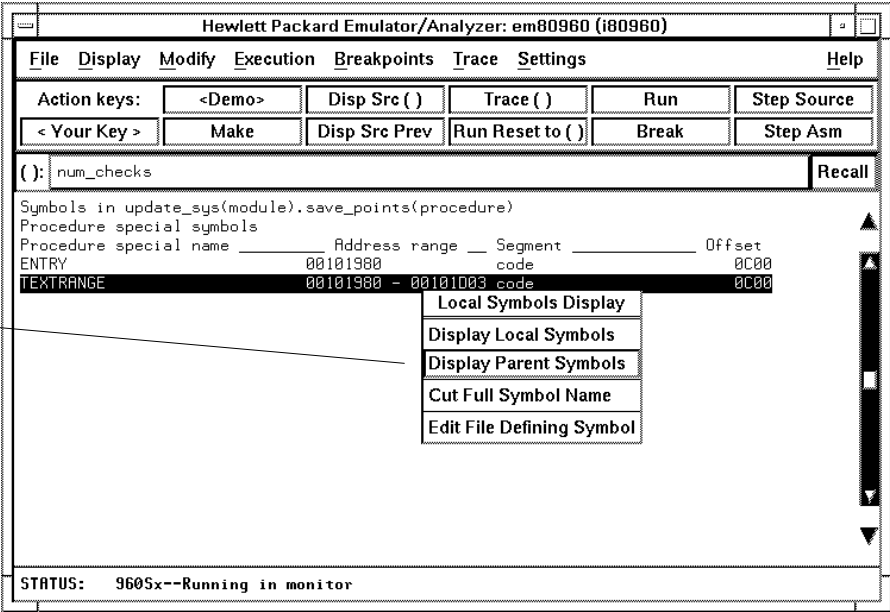

## To copy-and-paste a full symbol name to the entry buffer

- When displaying symbols, position the mouse pointer over the symbol, press and hold the *select* mouse button, and choose **Cut Full Symbol Name** from the popup menu.

Once the full symbol name is in the entry buffer, you can use it with pulldown menu items or paste it to the command line area.

By cutting the full symbol name, you get the complete names of symbols that have been truncated. Also, you are guaranteed of specifying the proper scope of the symbol.

### Examples

Copy the full name of the highlighted symbol to the entry buffer by choosing this menu item.

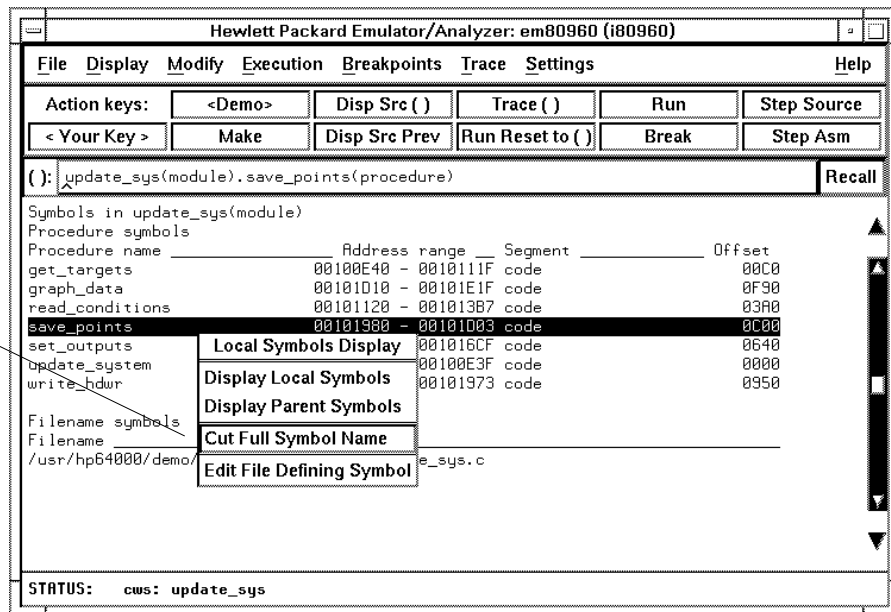

## Using Context Commands

The commands in this section display and control the directory and symbol contexts for the interface.

**Directory context.** The current directory context is the directory accessed by all system references for files—primarily load, store, and copy commands—if no explicit directory is mentioned. Unless you have changed directories since beginning the emulation session, the current directory context is that of the directory from which you started the interface.

**Symbol context.** The emulator/analyzer interface and the Symbol Retrieval Utilities (SRU) together support a current working symbol context. The current working symbol represents an enclosing scope for local symbols. If symbols have not been loaded into the interface, you cannot display or change the symbol context.



This section shows you how to:

- Display the current directory and symbol context.
- Change the directory context.
- Change the symbol context.

## To display the current directory and symbol context

- Choose **Display**→**Context**.
- Using the command line, enter the **pwd** and **pws** commands.

The current directory and working symbol contexts are displayed, and also the name of the last executable file from which symbols were loaded.

---

### Example

Directory context.

Executable from which symbols were last loaded.

Symbol context.

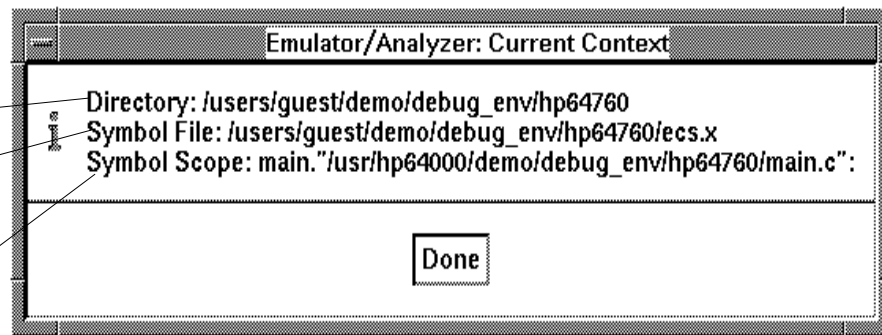

---

## To change the directory context

- Choose **File**→**Context**→**Directory** and use the dialog box to select a new directory.
- Using the command line, enter the **cd <directory>** command.

The Directory Selection dialog box contains a list of directories accessed during the emulation session as well as any predefined directories present at interface startup.



You can predefine directories and set the maximum number of entries for the Directory Selection dialog box by setting X resources (see the "Setting X Resources" chapter).

---

## To change the current working symbol context

- Choose **File**→**Context**→**Symbols** and use the dialog box to select the new working symbol context.
- Using the command line, enter the **cws <symbol\_context>** command. (Because **cws** is a hidden command and doesn't appear on a softkey label, you have to type it in.)

You can predefine symbol contexts and set the maximum number of entries for the Symbol Scope Selection dialog box by setting X resources (see the "Setting X Resources" chapter).

Displaying local symbols or displaying memory in mnemonic format causes the working symbol context to change as well. The new context will be that of the local symbols or memory locations displayed.



## Executing User Programs

You can use the emulator to run programs, break program execution into the monitor, step through the program by high-level source lines or by assembly language instructions, and reset the emulation processor.

When displaying memory in mnemonic format, a highlighted bar shows the current program counter address. When you step, the mnemonic memory display is updated to highlight the new program counter address.

When displaying registers, the register display is updated to show you the contents of the registers after each step.

You can open multiple interface windows to display memory in mnemonic format and registers at the same time. Both windows are updated after stepping.

This section describes how to:

- Initialize your programming environment.
- Start the emulator running the user program.
- Stop (break from) user program execution.
- Step through user programs.
- Reset the emulation processor.

---

## To initialize your programming environment

- Choose **Execution**→**Init Processor**.
- Using the command line, enter the **init\_processor** command.

The **init\_processor** command causes the processor to execute a continue initialization IAC message.

If the processor enters the monitor directly out of reset, your program's environment is not yet initialized. Therefore, commands that depend on that

environment, such as displaying the processor's registers, are not meaningful. If you enter such a command, the emulator will issue the following error message:

```
ERROR 184: You must do a processor initialization first
```

The **init\_processor** command allows you to initialize your programming environment and re-enter the monitor. First, the eight check-sum words in the program's initial memory image (IMI) are read to verify that they will compute to a valid checksum. Then the PRCB in the IMI is read to determine if it is valid. If the IMI verification passes, the monitor issues a continue initialization IAC message. This causes the processor to carry out the initialization procedure that follows the processor self test, ending just before the first user instruction is executed. The monitor is then re-entered in an initialized state.

If a **run** command is entered before the processor is initialized, the emulator will do the initialization, re-enter the monitor, and then run. If the check-sum words in the IMI are not valid, the processor FAILURE pin will be asserted and the processor will enter the stopped state.

The continue initialization IAC message clears the trace controls register which the emulator uses to establish execution messages and breakpoints. Therefore, the **init\_processor** command forces the monitor to be re-entered in order to restore the previous setting of the trace controls register.

However, a continue initialization IAC message issued by YOUR program does not cause the monitor to be entered. If your program executes a continue initialization IAC message, portions of your debug environment will be disabled until a subsequent break occurs.

This is similar to the situation that can occur if you run out of reset directly into your program without first entering the monitor. For more information, see the "Enter monitor from reset?" question in the configuration menu.

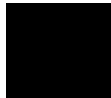

## To run programs from the current PC

- Choose **Execution**→**Run**→**from PC**.
- Using the command line, enter the **run** command.

When the emulator is executing the user program, the message "Running user program" is displayed on the status line.

---

## To run programs from an address

- Position the mouse pointer in the entry buffer and enter the address you want to run from; then, choose **Execution**→**Run**→**from ()**.
- Using the command line, enter the **run from <address>** command.

---

### Examples

To run from address 920H:

```
run from 920h <RETURN>
```

---

## To run programs from the transfer address

- Choose **Execution**→**Run**→**from Transfer Address**.
- Using the command line, enter the **run from transfer\_address** command.

Most software development tools allow you to specify a starting or entry address for program execution. That address is included with the absolute file's symbolic information and is known by the interface as the *transfer address*.

## To run programs from reset

- Choose **Execution**→**Run**→**from Reset**.
- Using the command line, enter the **run from reset** command.

The **run from reset** command specifies a run from the reset state. It is equivalent to entering a **reset** command followed by a **run** command. The processor will be reset and then allowed to run.

If the emulator is configured to synchronize to the target system reset (by answering "yes" to the "Wait for target reset?" configuration question), the processor will not begin running until the target 80960 RESET line becomes active and then inactive.

The SYS\_RESET output line on the emulator probe can be connected to your target system reset circuit to force a reset pulse whenever the emulator comes out of the reset state. If the SYS\_RESET output is not connected, the status line will show that the emulator is "Waiting for target reset".

If the emulator is not synchronized to the target system reset (by answering "no" to the "Wait for target reset?" configuration question), the processor will run without waiting for a pulse to occur on the target 80960 RESET line.

When the processor starts running, it may first enter the monitor before running user code. This behavior depends on the answer to the "Enter monitor from reset?" configuration question. If the emulator is configured to enter the monitor from reset, the monitor will be entered long enough to restore the setting of execution messages and breakpoints before running your program.

If the emulator is configured to run directly into user code out of reset (by answering "no" to the "Enter monitor from reset?" configuration question), the monitor will not be entered, and part of your debug environment may be temporarily disabled. A subsequent break into the monitor will restore the setting of execution messages and breakpoints.

A **run from reset** command may also be entered with the target powered down. The emulator will respond with the "No target system power" prompt, indicating no target system power. When the target is powered up and asserts and negates RESET, the emulator will run from processor initialization.

## To run programs until an address

- When displaying memory in mnemonic format, position the mouse pointer over the line that you want to run until; then press and hold the *select* mouse button and choose **Run Until** from the popup menu.
- Position the mouse pointer in the entry buffer and enter the address you want to run from; then, choose **Execution**→**Run**→**until** ().
- Using the command line, enter the **run until <address>** command.

The **run until** command allows you to break into the monitor immediately AFTER a particular execution event.

These break conditions are implemented by setting bits in the processor's trace control register and by setting the processor's on-chip breakpoint registers.

Unlike setting a software breakpoint, memory does not have to be modified to set a breakpoint register. This allows you to set a breakpoint in target ROM.

Please note that a software breakpoint occurs immediately before executing the instruction at the specified address, whereas a **run until** break condition occurs after the instruction has executed.

The **run until** command will not cause a break when the address contains certain instructions. For example, if you set a breakpoint register on an IAC instruction or a return from interrupt, the break will not occur.

If you run until an instruction that explicitly modifies the fp register (for example, `lda 2600,fp`), the break will occur; however, all local registers except the rip will be lost.

Refer to the **run** command description in the "Emulator/Analyzer Interface Commands" chapter for a complete description of the **run until** command.

---

### Examples

To run from the transfer address until the address of the global symbol main:

```
run from transfer_address until address main <RETURN>
```

## To stop (break from) user program execution

- Choose **Execution**→**Break**.
- Using the command line, enter the **break** command.

This command generates a break to the background monitor.

While the break will occur as soon as possible, the actual stopping point may be many cycles after the break request (dependent on the type of instruction being executed and whether the processor is in a hold state).

If the emulator is unable to break when execution messages are set, clear the execution messages and look at the "trace-enable" flag in the Process Controls Register. This flag is cleared (disabled) as a part of the processor's initialization procedure, and it should be left this way to avoid taking trace faults in your program. If you find the "trace-enable" flag is set, edit your program and make sure there are no "modpc" instructions that set this flag.

Software breakpoints and the **run until** command allow you to stop execution at particular points in the user program.

---

### Examples

To break emulator execution from the user program to the monitor:

```
break <RETURN>
```

---

## To step high-level source lines

- Choose **Execution**→**Step Source** and select one of the items from the cascade menu.
- Using the command line, enter the **step source** command.

When stepping through instructions associated with source lines, execution can remain in a loop and the message "Stepping source line 1; Next PC: <address>" is

## Chapter 5: Using the Emulator

### Executing User Programs

displayed on the status line. In this situation you can abort the step command by pressing <CTRL>c.

If you step on an instruction that explicitly modifies the fp register (for example, `lda 2600,fp`), all local registers except the rip will be lost.

---

#### Examples

To step through instructions associated with the high-level source lines at the current program counter:

```
step source <RETURN>
```

To step through instructions associated with high-level source lines at address "main":

```
step source from main <RETURN>
```

---

### To step assembly-level instructions

- Choose **Execution**→**Step Instruction** and select one of the items from the cascade menu.
- Using the command line, enter the **step** command.

The step command allows you to step through program execution an instruction or a number of instructions at a time. Also, you can step from the current program counter or from a specific address.

If you step on an instruction that explicitly modifies the fp register (for example, `lda 2600,fp`), all local registers except the rip will be lost.

---

#### Examples

To step one instruction from the current program counter:

```
step <RETURN>
```

To step a number of instructions from the current program counter:

```
step 8 <RETURN>
```



To step a number of instructions from a specified address:

```
step 16 from 920h <RETURN>
```

---

## To reset the emulation processor

- Choose **Execution**→**Reset**.
- Using the command line, enter the **reset** command.

The **reset** command causes the processor to be held in a reset state until a **break**, **run**, **step**, or **init\_processor** command is entered. A CMB execute signal will also cause the emulator to run if reset. Also, a request to access target memory while reset will cause a break into the monitor.

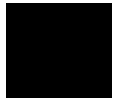

## Using Software Breakpoints

Software breakpoints provide a way to accurately stop the execution of your program at selected locations.

---

### Note

---

Version A.04.00 or greater of the HP 64700 system firmware provides support for permanent as well as temporary breakpoints. If your version of HP 64700 system firmware is less than A.04.00, only temporary breakpoints are supported.

When you set a software breakpoint at an address, the instruction at that address is replaced with an "fmark" instruction. When the "fmark" instruction is executed, control is passed to the emulator's monitor program, and the original instruction is restored in the user program. Thus, execution is interrupted before the instruction at the specified address is executed.

In order to successfully set a software breakpoint, the emulator must be able to write to the memory location specified. Therefore, software breakpoints cannot be set in target memory while the emulator is reset, and they can never be set in target ROM. (The **run until address** command allows you to break at locations in target ROM.)

Another way to break user program execution at a certain point is to break on the analyzer trigger. Please note, however, that the analyzer breakpoints are not precise. There is some delay between the time the trigger event occurs and the time the break occurs.

This section shows you how to:

- Display the breakpoints list.
- Enable/disable breakpoints.
- Set a permanent breakpoint.
- Set a temporary breakpoint.
- Set all breakpoints.
- Deactivate a breakpoint.
- Re-activate a breakpoint.

- Clear a breakpoint.
- Clear all breakpoints.

---

## To display the breakpoints list

- Choose **Display**→**Breakpoints** or **Breakpoints**→**Display**.
- Using the command line, enter the **display software\_breakpoints** command.

The breakpoints display shows the address and status of each breakpoint currently defined. If symbolic addresses are turned on (when setting the display modes), the symbolic label associated with a breakpoint is also displayed. Also, the breakpoints display shows whether the breakpoint feature is enabled or disabled.

Software breakpoints :enabled			
address	label		status
00100000	.../demo/debug_env/hp64760/main.c": line 96		pending
0010000C	.../demo/debug_env/hp64760/main.c": line 98		inactivated
00100010	.../demo/debug_env/hp64760/main.c": line 102		pending

The status of a breakpoint can be:

- |             |   |
|-------------|---|
| temporary   | Which means the temporary breakpoint has been set but not encountered during program execution. These breakpoints are removed when the breakpoint is encountered.     |
| pending     | Which means the temporary breakpoint has been set but not encountered during program execution. These breakpoints are inactivated when the breakpoint is encountered. |
| permanent   | Which means the permanent breakpoint is active.   |
| inactivated | Which means the breakpoint has been inactivated somehow. Temporary breakpoints are inactivated when they are encountered during program execution. Both temporary and |

permanent breakpoints may be inactivated using the breakpoints display popup menu.

In the breakpoints display, a popup menu is available. You can set, inactivate, or clear breakpoints as well as enable or disable the breakpoints feature from the popup menu.

---

## To enable/disable breakpoints

- Choose the **Breakpoints**→**Enable** toggle.
- When displaying the breakpoint list, press and hold the *select* mouse button and then choose **Enable/Disable Software Breakpoints** from the popup menu.
- Using the command line, enter the **modify software\_breakpoints enable** or **modify software\_breakpoints disable** command.

The breakpoints feature must be enabled before you can set, inactivate, or clear breakpoints.

If breakpoints were set when the feature was disabled, they are "inactivated" when the feature is re-enabled, and you must set them again.

**Examples**

To enable software breakpoints using the breakpoints display popup menu:

Bring up menu and choose this item to change states.

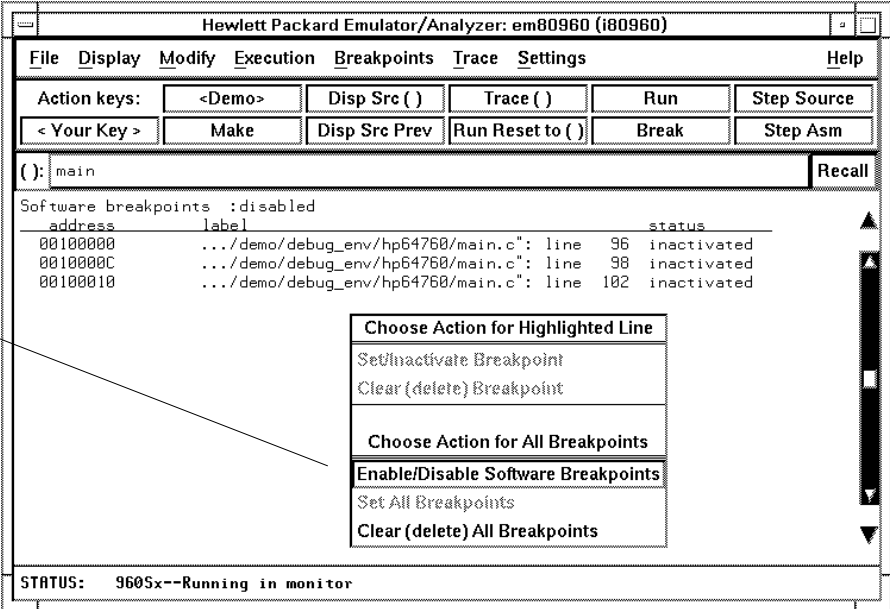

## To set a permanent breakpoint

- When displaying memory in mnemonic format, position the mouse pointer over the program line at which you wish to set the breakpoint and click the *select* mouse button. Or, press and hold the *select* mouse button and choose **Set/Clear Software Breakpoint** from the popup menu.
- Place an absolute or symbolic address in the entry buffer; then, choose **Breakpoints→Permanent ()**
- Using the command line, enter the **modify software\_breakpoints set <address> permanent** command.

Permanent breakpoints are available if your version of HP 64700 system firmware is A.04.00 or greater.

The breakpoints feature must be enabled before individual breakpoints can be set.

Note that you must only set software breakpoints at memory locations which contain instruction opcodes (not operands or data).

When displaying memory in mnemonic format, asterisks (\*) appear next to breakpoint addresses. An asterisk shows the breakpoint is active. Also, if assembly level code is being displayed, the disassembled instruction mnemonic at the breakpoint address will show the breakpoint instruction.

**Examples**

To set permanent breakpoints using the mnemonic memory display popup menu:

Click this line to set a breakpoint.

Click this line to clear a breakpoint. (Asterisks mark set breakpoints.)

Bring up menu and choose this item to set (or clear) a breakpoint on the highlighted line.

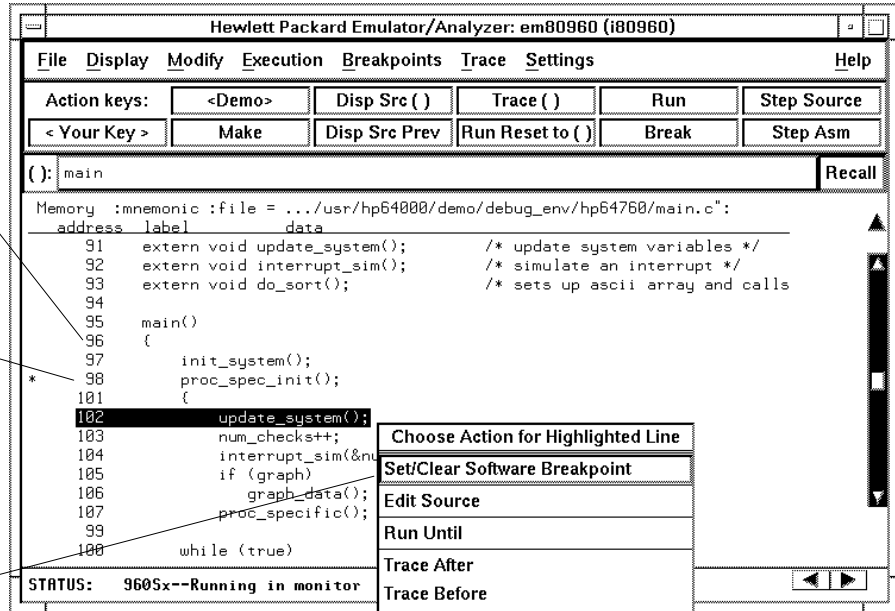

**To set a temporary breakpoint**

- Place an absolute or symbolic address in the entry buffer; then, choose **Breakpoints**→**Temporary ( )** (or **Breakpoints**→**Set ( )** if your version of HP 64700 system firmware is less than A.04.00).
- Using the command line, enter the **modify software\_breakpoints set <address> temporary** or **modify software\_breakpoints set <address>** command.

The breakpoints feature must be enabled before individual breakpoints can be set.

Note that you must only set software breakpoints at memory locations which contain instruction opcodes (not operands or data).

When displaying memory in mnemonic format, asterisks (\*) appear next to breakpoint addresses. An asterisk shows the breakpoint is active. Also, if assembly level code is being displayed, the disassembled instruction mnemonic at the breakpoint address will show the breakpoint instruction.

---

### To set all breakpoints

- When displaying the breakpoint list, position the mouse pointer within the breakpoints display screen, press and hold the *select* mouse button, and choose **Set All Breakpoints** from the popup menu.
- Choose **Breakpoints**→**Set All**.
- Using the command line, enter the **modify software\_breakpoints set** command.

Breakpoints must be enabled before being set.

---

### To deactivate a breakpoint

- When displaying breakpoints, position the mouse pointer over the line displaying the active breakpoint and click the *select* mouse button. Or, press and hold the *select* mouse button and choose **Set/Inactivate Breakpoint** from the popup menu.

A deactivated breakpoint remains in the breakpoint list and can be re-activated later. Deactivating a breakpoint is different than clearing a breakpoint because a cleared breakpoint is removed from the breakpoints list.



## To re-activate a breakpoint

- When displaying breakpoints, position the mouse pointer over the line displaying the inactivated breakpoint and click the *select* mouse button. Or, press and hold the *select* mouse button and choose **Set/Inactivate Breakpoint** from the popup menu.

The "inactivated" breakpoint either becomes "temporary" (or "pending") if it was set as a temporary breakpoint or "permanent" if it was set as a permanent breakpoint.



## Chapter 5: Using the Emulator Using Software Breakpoints

### Examples

To re-activate breakpoints using the breakpoints display popup menu:

Change status with a mouse click on this line (menu and highlight do not appear).

Choose this menu item to change the state of the highlighted breakpoint.

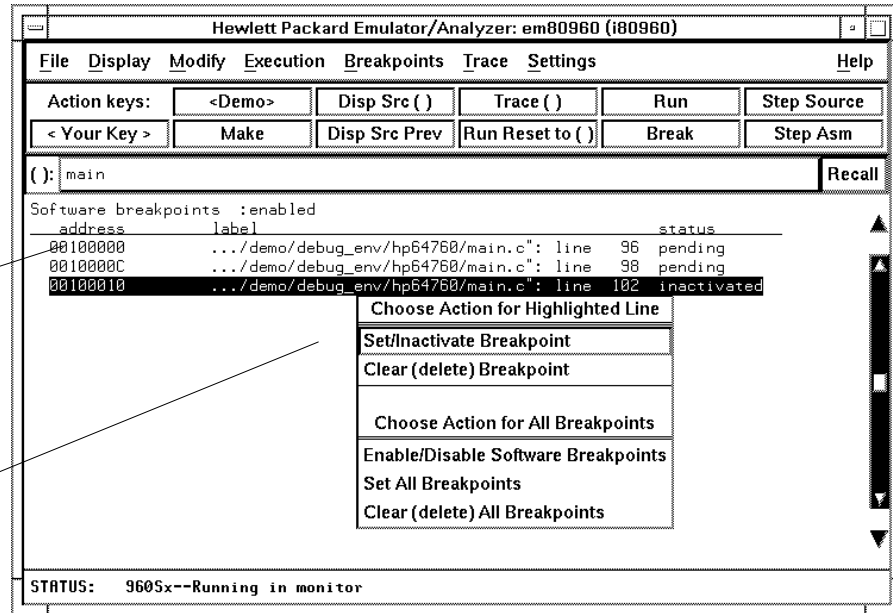

The screenshot shows the 'Hewlett Packard Emulator/Analyzer: em80960 (i80960)' window. The menu bar includes File, Display, Modify, Execution, Breakpoints, Trace, Settings, and Help. Below the menu bar are several buttons for actions like '<Demo>', 'Disp Src ( )', 'Trace ( )', 'Run', 'Step Source', '< Your Key >', 'Make', 'Disp Src Prev', 'Run Reset to ( )', 'Break', and 'Step Asm'. The main window displays a table of software breakpoints with columns for address, label, and status. The table is as follows:

address	label	status
00100000	.../demo/debug_env/hp64760/main.c": line 96	pending
0010000C	.../demo/debug_env/hp64760/main.c": line 98	pending
00100010	.../demo/debug_env/hp64760/main.c": line 102	inactivated

A context menu is open over the highlighted row (address 00100010). The menu items are:

- Choose Action for Highlighted Line
  - Set/Inactivate Breakpoint
  - Clear (delete) Breakpoint
- Choose Action for All Breakpoints
  - Enable/Disable Software Breakpoints
  - Set All Breakpoints
  - Clear (delete) All Breakpoints

The status bar at the bottom indicates 'STATUS: 9605x--Running in monitor'.

## To clear a breakpoint

- When displaying memory in mnemonic format, position the mouse pointer over the program line at which you wish to clear a currently set breakpoint (notice the asterisk at the left of the line) and click the *select* mouse button. Or, press and hold the *select* mouse button and choose **Set/Clear Software Breakpoint** from the popup menu.
- When displaying breakpoints, position the mouse pointer over the line displaying the breakpoint you wish to clear, press and hold the *select* mouse button, and choose **Clear (delete) Breakpoint** from the popup menu.
- Place an absolute or symbolic address in the entry buffer; then choose **Breakpoints→Clear ()**.
- Using the command line, enter the **modify software\_breakpoints clear <address>** command.

When you clear a breakpoint, it is removed from the breakpoints list.



Chapter 5: Using the Emulator  
Using Software Breakpoints

**Examples** To clear a software breakpoint using the breakpoints display popup menu:

Bring up the menu  
and choose this item  
to clear the  
highlighted  
breakpoint.

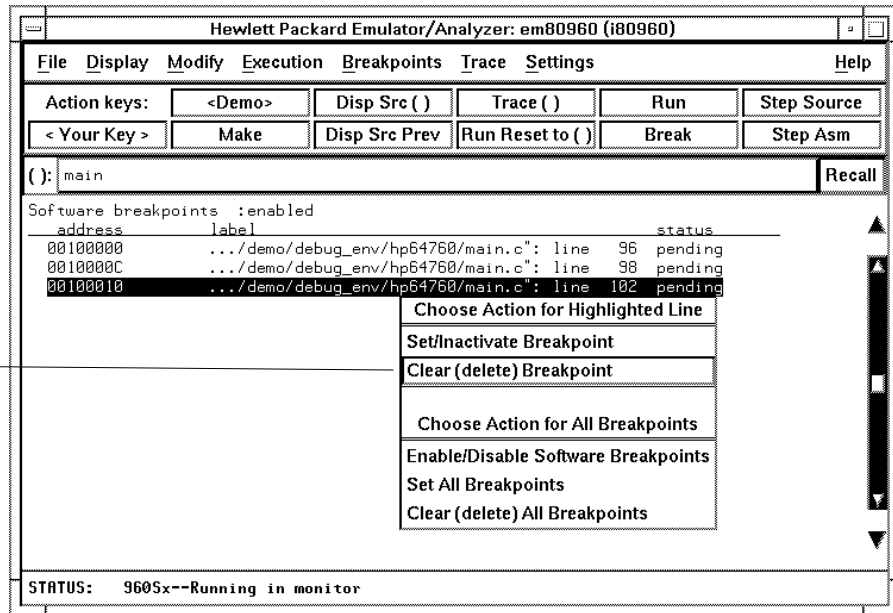

## To clear all breakpoints

- When displaying breakpoints, position the mouse pointer within the Breakpoints Display screen, press and hold the *select* mouse button, and choose **Clear (delete) All Breakpoints** from the popup menu.
- Choose **Breakpoints**→**Clear All**.
- Using the command line, enter the **modify software\_breakpoints clear** command.



## Displaying and Modifying Registers

This section describes tasks related to displaying and modifying emulation processor registers. Registers are grouped into the following classes: local, global, floating-point, and control.

You can display the contents of an individual register or of all the registers in a class. You can display or modify individual fields of the control registers.

This section shows you how to:

- Display register contents.
- Modify register contents.

The register classes, names, and control register fields are listed in the following table.

Register Class	Register	Field	Description
local	r3 through r15 pfp (or r0) sp (or r1) rip (or r2)		Local Registers for General Use Previous Frame Pointer Stack Pointer Return Instruction Pointer
global	g0 through g14 fp (or g15)		Global Registers Frame Pointer
float	fp0 through fp3		Floating-Point Registers
control	pctl (or pc)	istate pri state pend resume exec enable	Process Controls Internal State (31..21) Priority (20..16) State (13) Trace-Fault Pending (10) Resume (9) Execution Mode (1) Trace Enable (0)

Chapter 5: Using the Emulator  
**Displaying and Modifying Registers**

Register Class	Register	Field	Description
control (cont'd)	actl (or ac)	round norm fpm inm dzm iom unm ovm fpf inf dzf iof unf ovf nif iovm iovf stat cc	Arithmetic Controls Floating-Point Rounding Control (31..30) Floating-Point Normalizing Mode (29) Floating-Point Masks (28..24) Floating Inexact Mask (28) Floating Zero-Divide Mask (27) Floating Invalid-Op Mask (26) Floating Underflow Mask (25) Floating Overflow Mask (24) Floating-Point Flags (20..15): Floating Inexact Flag (20) Floating Zero-Divide Flag (19) Floating Invalid-Op Flag (18) Floating Underflow Flag (17) Floating Overflow Flag (16) No Imprecise Faults (15) Integer Overflow Mask (12) Integer Overflow Flag (8) Arithmetic Status (6..3) Condition Code (2..0)
control (cont'd)	tctl (or tc)	events brkpt_e super_e preret_e return_e call_e branch_e instr_e trace brkpt_t super_t preret_t return_t call_t branch_t instr_t	Trace Controls Trace Events (23..17): Breakpoint Trace Event (23) Supervisor Trace Event (22) Prereturn Trace Event (21) Return Trace Event (20) Call Trace Event (19) Branch Trace Event (18) Instruction Trace Event (17) Trace Modes (7..1): Breakpoint Trace Mode (7) Supervisor Trace Mode (6) Prereturn Trace Mode (5) Return Trace Mode (4) Call Trace Mode (3) Branch Trace Mode (2) Instruction Trace Mode (1)

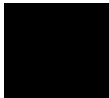

Chapter 5: Using the Emulator  
**Displaying and Modifying Registers**

Register Class	Register	Field	Description
control (cont'd)	ictl (or ic)	int0 int1 int2 int3	Interrupt Control Register INT0 Vector (7..0) INT1 Vector (15..8) INT2 Vector (23..16) INT3 Vector (31..24)

## To display register contents

- Choose **Display**→**Registers**.
- Using the command line, enter the **display registers** command.

When displaying registers, you can display classes of registers and individual registers. You can display individual fields of the control registers.

### Examples

To display the basic register contents:

**display registers** <RETURN>

```

                                LOCAL REGISTERS
    pfp = 000404c0    sp = 00040550    rip = 00000944    r3 = 00000000
    r4 = 00000000    r5 = 00000000    r6 = 00000000    r7 = 00000000
    r8 = 00000000    r9 = 00000000    r10 = 00000000   r11 = 00000000
    r12 = 00000000   r13 = 00000000    r14 = 00000000   r15 = 00000000
                                GLOBAL REGISTERS
    g0 = 3f001002    g1 = 00000020    g2 = 00040400    g3 = 00000000
    g4 = 000000b0    g5 = ff000010    g6 = 00000280    g7 = ffffffff
    g8 = 00000000    g9 = 00000000    g10 = 00000000   g11 = 00000000
    g12 = 00040000   g13 = 00000029    g14 = 00000000   fp = 00040500

```



## Chapter 5: Using the Emulator Displaying and Modifying Registers

To display the contents of an individual register:

```
display registers rip <RETURN>
```

```
rip = 0000094c
```

To display registers in the "global" class:

```
display registers global <RETURN>
```

```
GLOBAL REGISTERS
g0 = 3f001002  g1 = 00000020  g2 = 00040400  g3 = 00000000
g4 = 000000b0  g5 = ff000010  g6 = 00000280  g7 = ffffffff
g8 = 00000000  g9 = 00000000  g10 = 00000000  g11 = 00000000
g12 = 00040000  g13 = 00000029  g14 = 00000000  fp = 00040500
```

To display registers in the "local" class:

```
display registers local <RETURN>
```

```
LOCAL REGISTERS
pfp = 000404c0  sp = 00040550  rip = 00000948  r3 = 00000000
r4 = 00000000  r5 = 00000000  r6 = 00000000  r7 = 00000000
r8 = 00000000  r9 = 00000000  r10 = 00000000  r11 = 00000000
r12 = 00000000  r13 = 00000000  r14 = 00000000  r15 = 00000000
```

To display registers in the "float" class:

```
display registers float <RETURN>
```

```
FLOATING POINT REGISTERS
fp0 = +9.1584803445224064760e-2320  2202 00000013ffffffff
fp1 = +9.1584803445224064760e-2320  2202 00000013ffffffff
fp2 = +9.1584803445224064760e-2320  2202 00000013ffffffff
fp3 = +9.1584803445224064760e-2320  2202 00000013ffffffff
```

To display registers in the "control" class:

```
display registers control <RETURN>
```

```
CONTROL REGISTERS
pc = 001f2002  ac = 3f001002  tc = a0008082  ic = ff000000
```

## Chapter 5: Using the Emulator

### Displaying and Modifying Registers

To display the Process-Controls Word:

***display registers*** pctl <RETURN>

```
PROCESS CONTROLS (pctl = 001f2002)
istate: Internal State      = 0
pri: Priority                = 1f
state: State                 = 1 (interrupted)
pend: Trace Fault Pending   = 0 (none pending)
resume: Resume               = 0 (instruction not suspended)
exec: Execution Mode         = 1 (supervisor)
enable: Trace Enable         = 0 (disabled)
```

To display the Priority field of the Process-Controls Word:

***display registers*** pctl.pri <RETURN>

pctl.pri: Priority = 1f

## To modify register contents

- Choose **Modify**→**Registers...** and use the dialog box to name the register and specify its value.

Clicking the "Recall" pushbutton lets you select register names and values from predefined or previously specified entries.

Placing the mouse pointer in the text entry area lets you type in the register name and value.

To define the type of value, press and hold the *command select* mouse button and drag the mouse to select the value type.

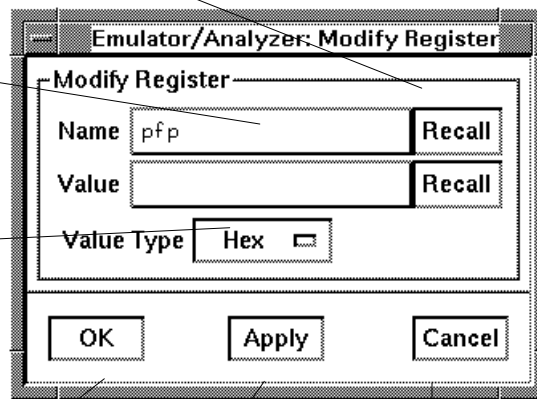

Clicking this button modifies the register to the value specified and closes the dialog box.

Clicking this button modifies the register to the value specified and leaves the dialog box open.

Clicking this button cancels modification and closes the dialog box.

- Using the command line, enter the **modify register <register> to <value>** command.

You can modify all registers except the trace control register; the emulation processor trace events are used by the emulator to implement the **run until** feature.

## Displaying and Modifying Memory

You can display and modify the contents of memory in hexadecimal formats and in real number formats. You can also display the contents of memory in assembly language mnemonic format.

This section shows you how to:

- Display memory.
- Display memory in mnemonic format.
- Display memory in mnemonic format at the current PC.
- Return to the previous mnemonic display.
- Display memory in hexadecimal format.
- Display memory in real number format.
- Display memory at an address.
- Display memory repetitively.
- Modify memory.
- Modify memory at an address.

---

### To display memory

- Choose **Display**→**Memory**.

This command either re-displays memory in the format specified by the last memory display command, or, if no previous command has been executed, displays memory as hexadecimal bytes beginning at address zero.

## To display memory in mnemonic format

- To display memory at a particular address, place an absolute or symbolic address in the entry buffer; then, choose **Display→Memory→Mnemonic ()**, or, using the command line, enter the **display memory <address> mnemonic** command.
- To display memory at the current program counter address, choose **Display→Memory→Mnemonic at PC**, or, using the command line, enter the **display memory mnemonic at\_pc** command.

A highlighted bar shows the location of the current program counter address. This allows you to view the program counter while stepping through user program execution.

Whether source lines, assembly language instructions, or symbols are included in the display depends on the modes you choose with the **Settings→Source/Symbols Modes** or **Settings→Display Modes** pulldown menu items. See the "Changing the Interface Settings" section.

If symbols are loaded into the interface, the default is to display source only.

---

## To return to the previous mnemonic display

- Choose **Display→Memory→Mnemonic Previous**.
- Using the command line, enter the **display memory mnemonic previous\_display** command.

This command is useful for quickly returning to the previous mnemonic memory display.

For example, suppose you are stepping source lines and you step into a function that you would like to step over. You can return to the previous mnemonic memory display, set a breakpoint at the line following the function call, and run the program from the current program counter.

## To display memory in hexadecimal format

- Place an absolute or symbolic address in the entry buffer; then, choose **Display→Memory→Hex ()** and select the size from the cascade menu.
- Using the command line, enter the **display memory <address> blocked <size>** command.

This command displays memory as hexadecimal values beginning at the address in the entry buffer.

---

### Examples

To display memory in absolute word format:

*display memory* *ascii\_old\_data* *absolute words* <RETURN>

Memory	:long	words	:absolute	:update	
address	label		data	:hex	:ascii
00107130	_ascii_old_d		20202020		
00107134			00333420		.34
00107138			73615023		saP#
0010713C			00342020		.4
00107140			30202020		0
00107144			0030302E		.00.
00107148			69775323		iwS#
0010714C			00312020		.1
00107150			41454C00		AEL.
00107154			00444552		.DER
00107158			206E654C		neL
0010715C			00312020		.1
00107160			41454C43		AELC
00107164			00444552		.DER
00107168			20657641		evA
0010716C			00302E30		.0.0
00107170			41454C43		AELC

To display memory in blocked byte format:

**display memory** *ascii\_old\_data* **blocked bytes** <RETURN>

Memory	:bytes	:blocked	:update						
address	data	:hex						:ascii	
00107130-37	20 20 20 20 20 34 33 00							4 3 .	
00107138-3F	23 50 61 73 20 20 34 00							# P a s 4 .	
00107140-47	20 20 20 30 2E 30 30 00							0 . 0 0 .	
00107148-4F	23 53 77 69 20 20 31 00							# S w i 1 .	
00107150-57	00 4C 45 41 52 45 44 00							. L E A R E D .	
00107158-5F	4C 65 6E 20 20 20 31 00							L e n 1 .	
00107160-67	43 4C 45 41 52 45 44 00							C L E A R E D .	
00107168-6F	41 76 65 20 30 2E 30 00							A v e 0 . 0 .	
00107170-77	43 4C 45 41 52 45 44 00							C L E A R E D .	
00107178-7F	43 4C 45 41 52 45 44 00							C L E A R E D .	
00107180-87	43 4C 45 41 52 45 44 00							C L E A R E D .	
00107188-8F	43 4C 45 41 52 45 44 00							C L E A R E D .	
00107190-97	43 4C 45 41 52 45 44 00							C L E A R E D .	
00107198-9F	43 4C 45 41 52 45 44 00							C L E A R E D .	
001071A0-A7	43 4C 45 41 52 45 44 00							C L E A R E D .	
001071A8-AF	43 4C 45 41 52 45 44 00							C L E A R E D .	
001071B0-B7	43 4C 45 41 52 45 44 00							C L E A R E D .	

---

## To display memory in real number format

- Place an absolute or symbolic address in the entry buffer; then, choose **Display→Memory→Real ()** and select the size from the cascade menu.
- Using the command line, enter the **display memory <address> real <size>** command.

Displays memory as a list of real number values beginning at the address in the entry buffer. Short means four byte real numbers and long means eight byte real numbers.

## Chapter 5: Using the Emulator

### Displaying and Modifying Memory

#### Examples

To display memory in 64-bit real number format:

*display memory real long* <RETURN>

Memory : long real :update			
address	label	data	:real
00107130	_ascii_old_d	1.06823655404120E-307	
00107138		1.11951782916463E-307	
00107140		9.00498781403420E-308	
00107148		9.52637256905403E-308	
00107150		2.25519984117886E-307	
00107158		9.52637014749612E-308	
00107160		2.25519984117888E-307	
00107168		9.00065842110188E-308	
00107170		2.25519984117888E-307	
00107178		2.25519984117888E-307	
00107180		2.25519984117888E-307	
00107188		2.25519984117888E-307	
00107190		2.25519984117888E-307	
00107198		2.25519984117888E-307	
001071A0		2.25519984117888E-307	
001071A8		2.25519984117888E-307	
001071B0		2.25519984117888E-307	

---

### To display memory at an address

- Place an absolute or symbolic address in the entry buffer; then, choose **Display→Memory→At ()**.

This command displays memory in the same format as that of the last memory display command. If no previous command has been issued, memory is displayed as hexadecimal bytes.



## To display memory repetitively

- Choose **Display**→**Memory**→**Repetitively**.
- Using the command line, enter the **display memory repetitively** command.

The memory display is constantly updated. The format is specified by the last memory display command.

This command is ignored if the last memory display command was a mnemonic display.

---

## To modify memory

- Choose **Modify**→**Memory** and complete the command using the command line.
- To modify memory at a particular address, place an absolute or symbolic address in the entry buffer; then, choose **Modify**→**Memory at ()** and complete the command using the command line.
- Using the command line, enter the **modify memory** command.

You can modify the contents of one memory location or a range of memory locations. Options allow you to modify memory in byte, short, word, and real number formats.

## Displaying Data Values

The data values display lets you view the contents of memory as data types. You can display data values in the following formats:

bytes  
8-bit integers  
unsigned 8-bit integers  
chars  
words  
16-bit integers  
unsigned 16-bit integers  
long words  
32-bit integers  
unsigned 32-bit integers

This section shows you how to:

- Display data values.
- Clear the data values display and add a new item.
- Add item to the data values display.

---

### To display data values

- Choose **Display→Data Values**.
- Using the command line, enter the **display data** command.

Items must be added to the data values display before you can use this command.

The data display shows the values of simple data types in the user program. When the display mode setting turns ON symbols, a label column that shows symbol values is added to the data display.

Step commands and commands that cause the emulator to enter the monitor (for example, encountering a breakpoint) cause the data values screen to be updated.

### To clear the data values display and add a new item

- Place an absolute or symbolic address in the entry buffer; then, choose **Display**→**Data Values**→**New ()** and select the data type from the cascade menu.
- Using the command line, enter the **display data <address>** command.

---

### To add items to the data values display

- Place an absolute or symbolic address in the entry buffer; then, choose **Display**→**Data Values**→**Add ()** and select the data type from the cascade menu.
- Using the command line, enter the **display data , <address>** command.

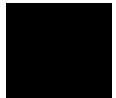

## Displaying 80960 System Tables

You can display the processor control block and the system interrupt tables.

This section shows you how to:

- Display the 80960 system tables.

---

### To display the 80960 system tables

- Choose **Display**→**System Table** and select the particular table from the cascade menu.
- Using the command line, enter the **display table** command.

The **display table** command gives you a formatted display of the 80960 processor control block, the system tables, and the interrupt and fault tables.

The system procedure, trace procedure, and interrupt tables contain more information than can be displayed on a 24-line screen or window. You can use the up arrow, down arrow, <NEXT>, or <PREV> keys to scroll the information up or down on the display.

---

#### Examples

To display the processor control block:

```
display table <RETURN>
```

Or:

```
display table processor_control_block <RETURN>
```

Table	
000107d40:	Processor Control Block (PRCB)
000107d44:	Processor Controls = 0000000c
000107d54:	Interrupt Table Pointer = 00107940
000107d58:	Interrupt Stack Pointer = 00100600
000107d60:	Offset 32 = 0000027f
000107d64:	Offset 36 (spt index) = 0000027f
000107d68:	Fault Table Pointer = 00102300
000107d6c:	Offset 44 = 00000000
000107d90:	Processor Scratch Space = 00000000 00000000 00000000 00000000
000107da0:	00000000 00000000 00000000 00000000
000107db0:	00000000 00000000 00000000 00000000
000107dc0:	00000000 00000000 00000000 00000000
000107dd0:	00000000 00000000 00000000 00000000
000107de0:	00000000 00000000 00000000 12804a26

To display the system address table:

***display table system\_address*** <RETURN>

To display the system procedure table:

***display table system\_procedure*** <RETURN>

To display the trace procedure table:

***display table trace\_procedure*** <RETURN>

To display the fault table:

***display table fault*** <RETURN>

To display the interrupt table:

***display table interrupt*** <RETURN>

## Changing the Interface Settings

This section shows you how to:

- Set the source/symbol modes.
- Set the display modes.

---

### To set the source/symbol modes

- To display assembly language mnemonics with absolute addresses, choose **Settings**→**Source/Symbol Modes**→**Absolute**, or, using the command line, enter the **set source off symbols off** command.
- To display assembly language mnemonics with absolute addresses replaced by global and local symbols where possible, choose **Settings**→**Source/Symbol Modes**→**Symbols**, or, using the command line, enter the **set source off symbols on** command.
- To display assembly language mnemonics intermixed with high-level source lines, choose **Settings**→**Source/Symbol Modes**→**Source Mixed**, or, using the command line, enter the **set source on symbols on** command.
- To display only high-level source lines, choose **Settings**→**Source/Symbol Modes**→**Source Only**, or, using the command line, enter the **set source only symbols on** command.

The source/symbol modes affect mnemonic memory displays and trace displays.

Each display mode cascade menu choice is a toggle. Choosing one of these items causes it to be the only one active and toggles all others off. Provided that symbols were loaded, the interface defaults to:

- Source only for mnemonic memory displays.
- Source mixed for trace listing displays.

## To set the display modes

- Choose **Settings**→**Display Modes...** to open the display modes dialog box.

Press and hold the *select* mouse button and drag the mouse to select "Source Only", "Source Mixed", or "Off".

Clicking toggles whether symbolic information is displayed.

Move the mouse pointer to the text entry area and type in the value. Descriptions of the modes follow.

Clicking toggles auto update settings.

Clicking this checkbox changes all display mode settings to their defaults.

Clicking this button saves your changes and closes the dialog box.

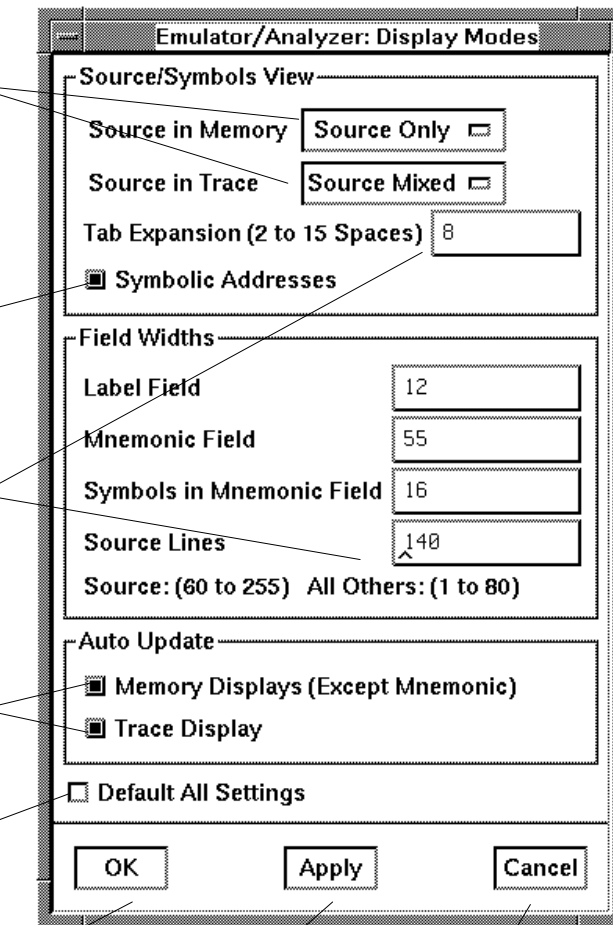

Clicking this button saves your changes and leaves the dialog box open.

Clicking this button cancels your changes and closes the dialog box.

### Source/Symbols View

**Source in Memory** specifies whether source lines are included, mixed with assembly code, or excluded from mnemonic memory displays.

**Source in Trace** specifies whether source lines are included, mixed with stored states, or excluded from trace displays.

**Symbolic Addresses** specifies whether symbols are included in displays.

**Tab Expansion** sets the number of spaces displayed for tabs in source lines.

### Source/Symbols View

**Label Field** sets the width (in characters) of the address field in the trace list or label (symbols) field in any of the other displays.

**Mnemonic Field** sets the width (in characters) of the mnemonic field in memory mnemonic, trace list, and register step mnemonic displays. It also changes the width of the status field in the trace list.

**Symbols in Mnemonic Field** sets the maximum width of symbols in the mnemonic field of the trace list, memory mnemonic, and register step mnemonic displays.

**Source Lines** sets the width (in characters) of the source lines in the memory mnemonic display.

### Auto Update

**Memory Displays** toggles whether memory displays are automatically updated after commands that change memory contents or whether you must enter memory display commands to update the display. You may wish to turn off memory display updates, for example, when displaying memory mapped I/O.

**Trace Displays** toggles whether trace displays are automatically updated when trace measurements complete or whether you must enter trace display commands to update the display. You may wish to turn off trace display updates in one emulator/analyzer window in order to compare the display with a new trace display in another emulator/analyzer window.



## Using System Commands

With the Softkey Interface system commands, you can:

- Set UNIX environment variables while in the Softkey Interface.
- Display the name of the emulation module.
- Display the event log.
- Display the error log.

---

### To set UNIX environment variables

- Using the command line, enter the **set <VAR>** command.

You can set UNIX shell environment variables from within the Softkey Interface with the **set <environment\_variable> = <value>** command.

---

#### Examples

To set the PRINTER environment variable to "lp -s":

```
set PRINTER = "lp -s" <RETURN>
```

After you set an environment variable from within the Softkey Interface, you can verify the value of it by entering **!set <RETURN>**.

## To display the name of the emulation module

- Using the command line, enter the **name\_of\_module** command.

While operating your emulator, you can verify the name of the emulation module. This is also the logical name of the emulator in the emulator device file.

---

### Examples

To display the name of your emulation module:

```
name_of_module <RETURN>
```

The name of the emulation module is displayed on the status line.

---

## To display the event log

- Choose **Display**→**Event Log**.
- Position the mouse pointer on the status line, press and hold the *select* mouse button, and then choose **Display Event Log** from the popup menu.
- Using the command line, enter the **display event\_log** command.

The last 100 events that have occurred during the emulation session are displayed.

The status of the emulator and analyzer are recorded in the event log, as well as the conditions that cause the status to change (for example, software breakpoints and trace commands).

## To display the error log

- Choose **Display**→**Error Log**.
- Position the mouse pointer on the status line, press and hold the *select* mouse button, and then choose **Display Error Log** from the popup menu.
- Using the command line, enter the **display error\_log** command.

The last 100 error messages that have occurred during the emulation session are displayed.



## To edit files

- Choose **File**→**Edit**→**File** and use the dialog box to specify the file name.
- To edit a file based on an address in the entry buffer, place an address reference (either absolute or symbolic) in the entry buffer; then, choose **File**→**Edit**→**At () Location**.
- To edit a file based on the current program counter, choose **File**→**Edit**→**At PC Location**.
- To edit a file associated with a symbol when you are displaying symbols, position the mouse pointer over the symbol, press and hold the *select* mouse button, and choose **Edit File At Symbol** from the popup menu.
- To edit a file when displaying memory in mnemonic format, position the mouse pointer over the line of source where you want to begin the edit, press and hold the *select* mouse button, and choose **Edit Source** from the popup menu.

When editing files at addresses, the interface determines which source file contains the code generated for the address and opens an edit session on the file. The interface will issue an error if it cannot find a source file for the address.

The interface will choose the "vi" editor as its default editor, unless you specify another editor by setting an X resource. Refer to the "Setting X Resources" chapter for more information about setting this resource.

You must load symbols before most commands will work because symbol information is needed to be able to locate the files.

**Examples**

To edit a file that defines a symbol:

Choosing this menu item brings up a terminal window with an edit session open on the file where the highlighted symbol is defined.

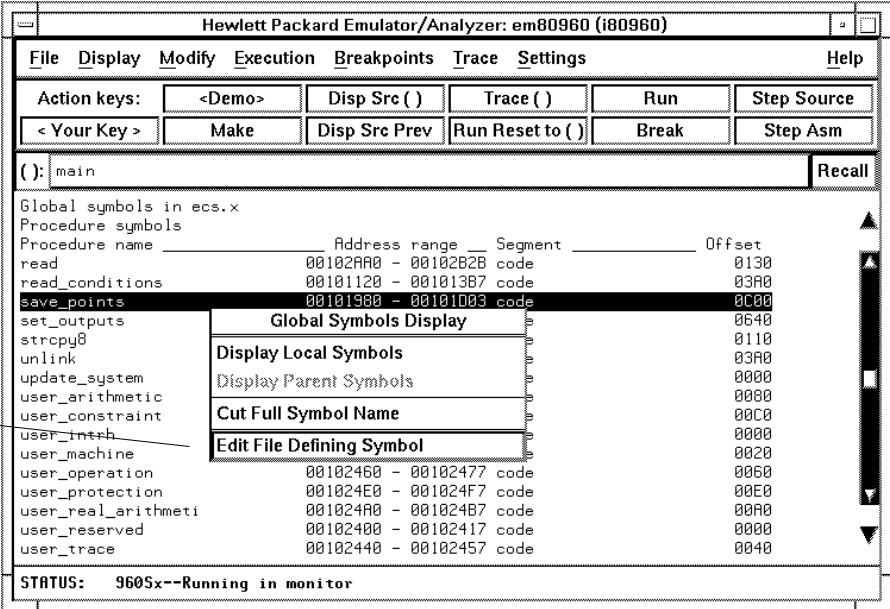

## Chapter 5: Using the Emulator Using System Commands

To edit a file at a source line:

Choosing this menu item brings up a terminal window with an edit session open on the file where the highlighted source line exists.

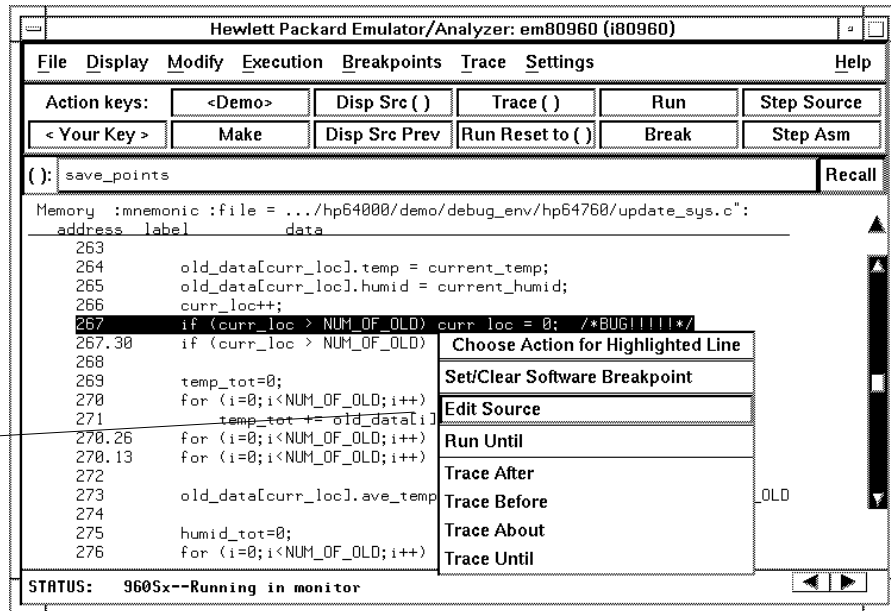

## To copy information to a file or printer

- Choose **File**→**Copy**, select the type of information from the cascade menu, and use the dialog box to select the file or printer.
- Using the command line, enter the **copy** command.

ASCII characters are copied to the file or printer.

If you copy information to an existing file, it will be appended to the file.

Refer to the following paragraphs for details about the different copy options.

**Display ...** Copies information currently in the display area. This option is useful for restricting the number of lines that are copied. Also, this option is useful for copying the contents of register classes other than BASIC.

**Memory ...** Copies the contents of a range of memory. The format is the same as specified in the last display memory command. For example, if you copy memory after displaying a range of memory in mnemonic format, the file would contain the mnemonic memory information. If there is no previous display memory command, the format used is a blocked hex byte format beginning at address zero.

**Data Values ...** Copies the contents of the defined data values last displayed. An error occurs if you try to copy data values to a file if you have not yet displayed data values.

**System Table ...** Copies the contents of the system table last displayed. An error occurs if you try to copy system table information to a file if you have not yet displayed one of the tables.

**Trace ...** The most recently captured trace is copied to the file. The copied trace listing is formatted according to the current display mode.

You can set the display mode with the **Settings**→**Source/Symbols Modes** or **Settings**→**Display Modes** pulldown menu items. See the "Changing the Interface Settings" section.

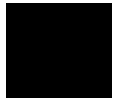

## Chapter 5: Using the Emulator

### Using System Commands

**Registers ...** Copies the current values of the BASIC register class to a file. To copy the contents of the other register classes, first display the registers in that class, and then use the **File→Copy→Display ...** command.

**Breakpoints ...** Copies the breakpoints list. If no breakpoints are present in the list, only the enable/disable status is copied.

**Status ...** Copies the emulator/analyzer status display.

**Global Symbols ...** Copies the global symbols. If symbols have not been loaded, this menu item is grayed-out and unresponsive.

**Local Symbols () ...** Copies the local symbols from the symbol scope named (by an enclosing symbol) in the entry buffer. If symbols have not been loaded, this menu item is grayed-out and unresponsive.

**Pod Commands ...** Copies the last 100 lines from the pod commands display.

**Error Log ...** Copies the last 100 lines from the error log display.

**Event Log ...** Copies the last 100 lines from event log display.

---

## To open a terminal emulation window

- Choose **File→Term...**

This command opens a terminal window into the current working directory context.



## Using Simulated I/O

Simulated I/O is a feature of the emulator/analyzer interface that lets you use the same keyboard and display that you use with the interface to provide input to programs and display program output.

To use simulated I/O, your programs must communicate with the simulated I/O control address and the buffer locations that follow it.

Also, before simulated I/O can work, the emulator must be configured to enable polling of the simulated I/O control address and to define the control address location.

This section shows you how to:

- Display the simulated I/O screen.
- Use simulated I/O keyboard input.

Refer to the *Simulated I/O User's Guide* for complete details on how simulated I/O works.

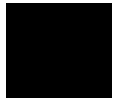

---

### To display the simulated I/O screen

- Choose **Display**→**Simulated IO**.

Before you can display simulated I/O, polling for simulated I/O must be enabled in the emulator configuration.

**Examples**

```
Simulated I/O display                               Status messages disabled
display is open
48 52 80 90      h  H                               t      T
49 53 80 89      h  H                               t      T
49 54 79 88      h  H                               t      T
50 55 79 87      h  H                               t      T
50 56 78 86      h  H                               t      T
51 57 78 85      h  H                               t      T
51 58 77 84      h  H                               t      T
52 59 77 83      h  H                               t      T
52 60 76 82      h  H                               t      T
53 53 76 76      h  H                               t      T
49 54 73 75      h  H                               t      T
50 55 72 74      h  H                               t      T
50 56 72 73      h  H                               t      T
51 57 71 72      h  H                               t      T
52 58 71 71      h  H                               t      T
52 59 70 70      h  H                               t      T
```

A message tells you whether the display is open or closed. You can modify the configuration to enable status messages.

---

## To use simulated I/O keyboard input

- To begin using simulated I/O input, choose **Settings**→**Simulated IO Keyboard**.
- To end simulated I/O and return to using the interface, use the **suspend** softkey.

The command line entry area is used for simulated input with the keyboard. Therefore, if the command line is turned off, choosing this menu item with turn command line display back on.

If you are planning to use even a modest amount of simulated I/O input during an emulation session, it might be a good idea to open another Emulator/Analyzer window to be used exclusively for simulated I/O input and output.

## Using Basis Branch Analysis

Basis branch analysis (BBA) is provided by the HP Branch Validator product. This product is used to analyze the testing of your programs, create more complete test suites, and quantify your level of testing.

The HP Branch Validator records branches executed in a program and generates reports that provide information about program execution during testing. It uses a special C preprocessor to add statements that write to a data array when program branches are taken. After running the program in the emulator (using test input), you can store the BBA information to a file. Then, you can generate reports based on the stored information.

This section shows you how to:

- Store BBA data to a file.

Refer to the *HP Branch Validator (BBA) User's Guide* for complete details on the BBA product and how it works.

---

### To store BBA data to a file

- Choose **File**→**Store**→**BBA Data** and use the selection dialog box to specify the file name.

The default file name "bbadump.data" can be selected from the dialog box.



---

**6**

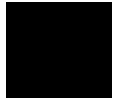

---

**Using the Emulation Analyzer**

---

## Using the Emulation Analyzer

This chapter describes tasks you may wish to perform while using the emulation analyzer. These tasks are grouped into the following sections:

- The basics of starting, stopping, and displaying traces.
- Using execution trace messages.
- Qualifying trigger and store conditions.
- Using the sequencer.
- Modifying trace displays.
- Saving and restoring traces.

## **The Basics of Starting, Stopping, and Displaying Traces**

This section describes the basic tasks that relate to starting and stopping trace measurements.

When you start a trace measurement, the analyzer begins looking at the data on the emulation processor's bus and control signals on each analyzer clock signal. The information seen on a particular clock is called a state.

When one of these states matches the "trigger state" you specify, the analyzer stores states in trace memory. When trace memory is filled, the trace is said to be "complete." The default trigger state specification is "any state," so when you start a trace measurement after initializing the analyzer, the analyzer will "trigger" on the first state it sees and store the following states in trace memory.

Once you start a trace measurement, you can view the progress of the measurement by displaying the trace status.

In some situations, for example, when the trigger state is never found or when the analyzer hasn't filled trace memory, the trace measurement does not complete. In these situations, you can halt the trace measurement.

Once a trace is displayed, you can use the cursor keys and other keys to position the trace list on the display. To speed up the display of traces, you can reduce the depth of the trace list. Also, when entering trace commands, there is a special command that allows you to recall and modify the last trace command entered.

This section describes how to:

- Start trace measurements.
- Display the trace status.
- Stop trace measurements.
- Display the trace.
- Position the trace display on the screen.
- Change the trace depth.
- Modify the last trace command entered.

## To start a trace measurement

- Choose **Trace**→**Everything**.
- Using the command line, enter the **trace** command.

The **trace** command tells the analyzer to begin monitoring the states which appear on the trace signals. You will see a message that confirms that a trace is started.

The default trace command (simply **trace** with no options) will trigger on any state, store all captured states.

---

### Examples

While the emulator is running the user program, you can start the default trace measurement with the command:

```
trace <RETURN>
```

A message is displayed on the status line to show you that the "Emulation trace [has] started", and another message will show you when the "Emulation trace [is] complete".

---

## To display the trace status

- Choose **Display**→**Status**.
- Using the command line, enter the **display status** command.

In addition to the analyzer information shown on the status line (Emulation trace started, Emulation trace complete, etc.), you can display complete analyzer status with the command below.



---

**Examples**

To display the trace status:

*display status* <RETURN>

```
Status
-----
Emulator Status
  9605x--Running user program

Trace Status
  Emulation trace complete
  Arm ignored
  Trigger in memory
  Arm to trigger ?
  States 512 (512) 0..511
  Sequence term 2
  Occurrence left 1
```

The first line of the emulation trace status display shows the user trace has been "completed"; other possibilities are that the trace is still "running" or that the trace has been "halted".

The "Arm ignored" line shows that the arm condition, which can be used to qualify trace measurements, is ignored. Consequently, the "Arm to trigger" time is not meaningful and a question mark is displayed. (The "Making Coordinated Measurements" chapter explains arm conditions.)

The second line of the trace status display contains information on the arm condition. If the analyzer is always armed, the message "Arm ignored" is displayed. If the analyzer is to be armed by one of the internal signals, either the message "Arm not received" or "Arm received" is displayed. The display indicates if the arm condition happened any time since the most recent trace started, even if it happened after the trace was halted or became complete.

The "Arm to trigger" line displays the amount of time between the arm condition and the trigger. When using the HP 64761 80960SA/SB emulator and HP 64704 analyzer, the time displayed will be from -0.04 microseconds to 41.943 milliseconds, less than -0.04 microseconds, or greater than 41.943 milliseconds. When using the HP 64760 80960KA/KB/MC emulator and HP 64705 analyzer, the time displayed is -22.9 minutes to +22.9 minutes. If the arm signal is ignored or the trigger is not in memory, a question mark (?) is displayed.

**The Basics of Starting, Stopping, and Displaying Traces**

The "States" line shows the number of states that have been stored (out of the number that is possible to store) and the line numbers that the stored states occupy. (The trigger state is always stored on line 0.)

The "Sequence term" line of the trace status display shows the number of the term the sequencer was in when the trace completed. Because a branch **out of the last sequence term** constitutes the trigger, the number displayed is what would be the next term (2 in the preceding example) even though that term is not defined. If the trace is halted, the sequence term number just before the halt is displayed; otherwise, the current sequence term number is displayed. If the current sequence term is changing too quickly to be read, a question mark (?) is displayed.

The "Occurrence left" line of the trace status display shows the number of occurrences remaining before the primary branch can be taken out of the current sequence term. If the occurrence left is changing too quickly to be read, a question mark (?) is displayed.

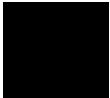

## To stop a trace measurement

- Choose **Trace**→**Stop**.
- Using the command line, enter the **stop\_trace** command.

You can, and most likely will, specify traces whose trigger or storage states are never found. When this happens, the "Emulation trace complete" message is never shown, and the trace continues to run ("Emulation trace running"). When these situations occur, you can halt the trace measurement with the **stop\_trace** command.

The **stop\_trace** command is also useful to deactivate signals which are driven when the trigger is found (refer to the "Making Coordinated Measurements" chapter).

---

### Examples

To halt a trace measurement:

```
stop_trace <RETURN>
```

When the **stop\_trace** command is entered, the message "Emulation trace halted" is displayed.

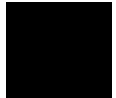

## To display the trace

- Choose **Trace**→**Display** or **Display**→**Trace**.
- Using the command line, enter the **display trace** command.

You can display captured trace data with the **display trace** command. The available options to the **display trace** command are described in the "Modifying the Trace Display" section later in this chapter.

### Examples

To display the trace:

```
display trace <RETURN>
```

Trace List	Offset=0	More data off screen	
Label:	Address	Opcode or Status w/ Source Lines	time count
Base:	symbols	mnemonic w/symbols	relative
	#####/usr/hp64000/demo/debug_env/hp64760/main.c - line	1 thru	
	extern void interrupt_sim();	/* simulate an interrupt */	
	extern void do_sort();	/* sets up ascii array and calls combs	
	main()		
	{		
after	code main.main P: stos g7, tags mai.main.c: 11.i.e	240	n5
	#####/usr/hp64000/demo/debug_env/hp64760/main.c - line	97	#####
	init_system();		
+004	co main+00000008 P: call init.init_system	15.i.e	520 n5
	#####/usr/hp64000/demo/debug_env/hp64760/main.c - line	98	#####
	proc_spec_init();		
+006	co main+0000000C P: bal .proc_spec_init+000000	17.i.e	240 n5
+008	tags mai.main.c: write short 4403	11.i.e	360 n5
	#####/usr/hp64000/demo/debug_env/hp64760/init_system.c - line	1	t
	void init_val_arr();		

The first column on the trace list contains the line number. The trigger is always on line 0 (labeled "after" above).

The second column contains the address information associated with the trace states. Addresses in this column may be locations of instruction opcodes on fetch cycles, or they may be sources or destinations of operand cycles.

The third column contains the data information associated with the trace states.

Chapter 6: Using the Emulation Analyzer  
**The Basics of Starting, Stopping, and Displaying Traces**

The fourth column shows mnemonic information about the emulation bus cycle. The disassembled instruction mnemonics are prefixed with a "P:" to show that these are prefetches. When execution messages are set, the disassembled instruction mnemonics associated with the execution message state are prefixed with "E:". An execution message that corresponds to a breakpoint event is prefixed with "E:\*".

The additional information at the right edge of the mnemonic field is defined as follows.

<b>Characters (from left to right)</b>	<b>Description</b>
0 through e *	Number of wait states. Greater than or equal to 15 wait states.
1 through 4	Size of the burst <sup>1</sup> .
1 through 4/8	Number of the transfer within the burst 80960Kx/80960Sx.
b or .	BADAC asserted or not <sup>1</sup> .
c or .	CACHE asserted or not <sup>1</sup> .
l or .	LOCK asserted or not.
i or .	One or more interrupt pins asserted or not.
h or .	HOLD asserted or not.
E or e T or t G b X	Emulation ROM or RAM. Target ROM or RAM. Guarded memory. Background memory. Execution message.
<sup>1</sup> This information is not present when using the HP 64761 80960SA/SB emulator and the HP 64704 analyzer.	

For execution messages, only the last three columns are shown. The other columns are irrelevant for execution message states.

## The Basics of Starting, Stopping, and Displaying Traces

The fifth column shows the time count information. The trace list header indicates each count is "relative" to the previous state.

You can use the <NEXT> and <PREV> keys to scroll through the trace list a page at a time. The <Up arrow> and <Down arrow> keys will scroll through the trace list a line at a time. You can also display the trace list centered around a specific line number (for example, **display trace 100 <RETURN>**). Refer to the "Modifying the Trace Display" section for more information on the trace list display.

Note that when a trigger condition is found but not enough states are captured to fill trace memory, the status line will show the trace is still running. You can display all but the last captured state in this situation; you must halt the trace to display the last captured state.

---

### To position the trace display on screen

- Use the scroll bar or the <Up arrow>, <Down arrow>, <PREV>, <NEXT>, <CTRL>f, and <CTRL>g keys.

The trace display command can display up to 1024 states, not all of which can appear on the screen at the same time. However, you can reposition the display on the screen with the keys described below.

The <Up arrow> and <Down arrow> (or roll up and roll down) keys move the display up or down on the screen one line at a time.

The <PREV> and <NEXT> (or page up and page down) keys allow you to move the display up or down a page at a time.

The <CTRL>f and <CTRL>g keys allow you to move the display left or right, respectively. These keys are used when the width of the address or mnemonic/absolute columns is increased so that not all the trace display data can be displayed across the screen.

## To change the trace depth

- Using the command line, enter the **display trace depth** command.

The **display trace depth** command allows you to specify the number of states that are displayed. By reducing the trace depth, you can shorten the time it takes for the Softkey Interface to upload the trace information. You can increase the trace depth to view more states of the current trace.

The maximum number of trace states is 1024. When using the HP 64704 analyzer and counting is turned on, the maximum number of trace states is 512. The minimum trace depth is 9.

If you wish to reduce the number of states that are displayed, the **display trace depth** command must be entered before the **trace** command. You cannot use this command to reduce the number of states displayed in the current trace.

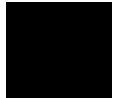

---

## To modify the last trace command entered

- Choose **Trace**→**Trace Spec** and use the dialog box to select and edit a trace command.
- Using the command line, enter the **trace modify\_command** command.

The Trace Specification Selection dialog box contains a list of trace specifications executed during the emulation session as well as any predefined trace specifications present at interface startup.

You can predefine trace specifications and set the maximum number of entries for the dialog box by setting X resources (see the "Setting X Resources" chapter).

The **trace modify\_command** command recalls the last trace command. The advantage of this command over command recall is that you do not have to move forward and backward over other commands to find the last trace command; also, the last trace command is always available, no matter how many commands have since been entered.

## Using Execution Messages for Program Measurements

The execution message feature of the 80960 emulator provides a powerful tool for measuring program activity. The 80960 processor has an internal instruction cache that is filled in 16-byte cache line prefetches. The analyzer can only measure bus activity external to the processor. By observing prefetch activity, it is possible to infer where the processor is executing code, but once instructions have been placed in the cache, no further external bus cycles are generated. With data items stored in the large register set of the processor, it is likely that the few external data cycles may not provide enough information to infer what the execution path is.

The execution message feature causes the 80960 bondout emulation processor to generate additional bus cycles that contain information about instruction execution. This information can be selectively emitted for various classes of instructions. The instruction classes correspond directly to the "Trace Modes" of the 80960 processor. Enabling execution messages results in execution performance degradation for the 80960 due to the additional bus cycles generated, as well as the internal bondout execution time caused by the message. Time critical systems may not be able to handle the execution speed penalty.

The execution messages appear on the L-bus using an 80960 bondout strobe signal. To the target system, these cycles appear as Idle (Ti) cycles. Each message is composed of two parts: the address of the executed instruction (AT) along with status describing the type of instruction, and the address of the next instruction to be executed (TO).

The trace status messages are presented to the analyzer as two separate events with a status bit indicating an AT or TO message.

Note that execution messages cannot be enabled, disabled, or displayed if the emulator is restricted to real-time runs and is executing the user program.

This section describes how to:

- Set (turn ON) execution messages.
- Display execution message settings.
- Clear (turn OFF) execution messages.
- Disable the execution trace message feature.



- Enable the execution trace message feature.
- Capture execution messages with the analyzer.

---

## To set execution trace messages

- Choose **Modify**→**Execution Messages**→**Set All**.
- Using the command line, enter the **modify execution\_messages set** command.

This command turns ON execution messages for all instructions.

You can use the command line to turn ON execution messages for specific execution events.

---

### Examples

To turn ON the default execution messages:

```
modify execution_messages set <RETURN>
```

To turn ON execution messages for call and return events:

```
modify execution_messages set call return <RETURN>
```

## To display execution trace messages

- Choose **Display**→**Execution Messages**.
- Using the command line, enter the **display execution\_messages** command.

The information displayed with the **display execution\_messages** command shows the execution message settings and whether execution messages are enabled or disabled.

---

### Examples

To display execution message settings:

*display execution\_messages* <RETURN>

```
Execution messages
-----
execution trace messages enabled:
instr      set
branch     set
call       set
return     set
preret     clear
super      set
brkpt      clear
```

## To clear execution trace messages

- Choose **Modify**→**Execution Messages**→**Clear All**.
- Using the command line, enter the **modify execution\_messages clear** command.

This command turns OFF all execution messages.

You can use the command line to turn OFF execution messages for specific events.

---

### Examples

To turn OFF all execution messages:

```
modify execution_messages clear <RETURN>
```

To turn OFF execution messages for branch events:

```
modify execution_messages clear branch <RETURN>
```

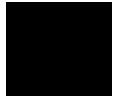

### To disable the execution trace message feature

- Using the command line, enter the **modify execution\_messages disable** command.

---

### To enable the execution trace message feature

- Using the command line, enter the **modify execution\_messages enable** command.

---

### To capture execution messages with the analyzer

- 1 Set execution messages.
- 2 Trace program execution, storing execution messages.
- 3 Display the trace.

When execution messages are enabled, they are included in the trace list. Execution messages in the trace list can be disassembled to indicate the opcode of the instruction executed. To accomplish this, the disassembler may need to access memory to get the instruction's opcode information. Consequently, there may be additional processor cycles due to the execution message display.

Chapter 6: Using the Emulation Analyzer  
Using Execution Messages for Program Measurements

**Examples**

To capture the analyzer demo program's function calling sequence:

```
break <RETURN>
modify execution_messages clear <RETURN>
modify execution_messages set call <RETURN>
trace only status call <RETURN>
run from reset <RETURN>
display trace <RETURN>
```

Trace List		Offset=0		More data off screen		
Label:	Address	Opcode or Status w/ Source Lines		time	count	
Base:	symbols	mnemonic w/symbols		relative		
after	checksum startup	read	short 3200	11.i.E	-----	
+001	startup+000001C0	call	to code startup+00000200	i.X	759.	uS
+003	startup+000001DC	call	to code startup+00000200	i.X	152.	uS
+005	c entry+0000001C	call	to code entry+00000024	i.X	55.04	uS
+007	c entry+00000054	call	to code _memset	i.X	9.88	uS
+009	c entry+0000006C	call	to code csys._START	i.X	459.	uS
+011	_START+00000024	call	to si.initSimioForC	i.X	9.56	uS
+013	si.initSimioForC	call	to  simio.initsimio	i.X	10.1	uS
+015	initSim+00000014	call	to code _fopen	i.X	414.	mS
+017	xfopen+00000010	call	to code strlen.lf	i.X	13.9	uS
+019	xfopen+000000194	call	to code simio.open	i.X	35.3	uS
+021	co open+00000018	call	to code strlen.lf	i.X	8.08	uS
+023	co open+00000040	call	to code memmove.lf	i.X	19.9	uS
+025	co open+00000048	call	to request_io_and_w	i.X	34.2	uS
+027	initSim+00000028	call	to code _fopen	i.X	300.	mS
+029	xfopen+00000010	call	to code strlen.lf	i.X	14.2	uS

## Qualifying Trigger and Store Conditions

This section describes tasks relating to the qualification of trigger and storage states.

You can trigger on, or store, specific states or specific values on a set of trace signals (which are identified by trace labels).

Also, you can *prestore* states. The prestore qualifier is a second storage qualifier used for storing states that occur before the normally stored states. Prestore is useful for capturing entry points to procedures or for identifying where global variables are accessed from.

This section describes how to:

- Qualify the trigger state and the trigger position in the trace.
- Trigger on a number of occurrences of some state.
- Qualify states stored in the trace.
- Prestore states before qualified store states.
- Change the count qualifier.
- Trace until the analyzer is halted.
- Cause the emulator to break into the monitor when the analyzer triggers.

### Expressions in Trace Commands

When modifying the analysis specification, you can enter expressions which consist of values, symbols, and operators.

**Values** Values are numbers in hexadecimal, decimal, octal, or binary. These number bases are specified by the following characters:

<b>B b</b>	Binary (example: 10010110b).
<b>Q q O o</b>	Octal (example: 377o or 377q).
<b>D d</b> (default)	Decimal (example: 2048d or 2048).

**H h** Hexadecimal (example: 0a7fh).  
You must precede any hexadecimal number that begins with an A, B, C, D, E, or F with a zero.

Don't care digits may be included in binary, octal, or hexadecimal numbers and they are represented by the letters **X** or **x**. A zero must precede any numerical value that begins with an "X".

**Symbols** A symbol database is built when the absolute file is loaded into the emulator. Both global and local symbols can be used when entering expressions. Global symbols are entered as they appear in the global symbols display. When specifying a local symbol, you must include the name of the module ("main.c") as shown below.

```
main.c:combsort
```

**Operators** Analysis specification expressions may contain operators. All operations are carried out on 32-bit, two's complement integers. (Values which are not 32 bits will be sign extended when expression evaluation occurs.)

The available operators are listed below in the order of evaluation precedence. Parentheses are also allowed in expressions to change the order of evaluation.

-, ~	Unary two's complement, unary one's complement. The unary two's complement operator is not allowed on constants containing don't care bits.
*, /, %	Integer multiply, divide, and modulo. These operators are not allowed on constants containing don't care bits.
+, -	Addition, subtraction. These operators are not allowed on constants containing don't care bits.
&	Bitwise AND.
	Bitwise inclusive OR.

Values, symbols, and operators may be used together in analysis specification expressions. For example, if the local symbol exists, the following is a valid expression:

```
module.c:symb+0b67dh&0fff00h
```

Chapter 6: Using the Emulation Analyzer  
**Qualifying Trigger and Store Conditions**

However, you cannot add two symbols unless one of them is an EQU type symbol.

**HP 64760 Emulation Analyzer Trace Signals**

When you qualify states, you specify values that should be found on the analyzer trace signals. The emulation analyzer trace signals are described in the table that follows.

<b>HP 64760 Emulation Analyzer Trace Signals</b>		
<b>Trace Signals</b>	<b>Signal Name</b>	<b>Signal Description</b>
31:0	Data[31:0]	For normal bus activity, these signals contain the data from the word wide data transfer on the data bus.  For execution trace messages, these signals are meaningless. The bytes in the data field are qualified by the byte enable status bits.
63:32	Addr[31:0]	For normal bus activity, this address corresponds to the lowest addressed byte for the current data item being accessed.  For execution trace messages, this address corresponds to the word address of either the from address or the to address. The status field contains from/to flag.
68 69 70 71	ByteEnable[0] ByteEnable[1] ByteEnable[2] ByteEnable[3]	Each word that is accessed is accompanied by a set of byte enables that control what bytes in the word are accessed. The processor requires that only adjacent byte enables be asserted so patterns such as 1001 are illegal whereas patterns such as 0110 are valid. These enables are active low. For example:  0000 - entire word 0111 - single byte 0011 - half word



<b>HP 64760 Emulation Analyzer Trace Signals</b>		
<b>Trace Signals</b>	<b>Signal Name</b>	<b>Signal Description</b>
72 73	Bstsize[0] Bstsize[1]	<p>The indicated size of the current burst transfer. Each memory transaction on the 80960 bus starts with a burst count. This count indicates the number of words that are contained in the current burst transaction. The actual data size in each word of the burst is indicated by AccessSize[1:0] trace signals (81:80).</p> <p style="margin-left: 40px;">00 - Single word            01 - dual word            10 - triple word            11 - quad word/cache line</p>
74 75	Bstcount[0] Bstcount[1]	<p>Shows which data transfer of a burst is associated with the current bus cycle. It progresses from 0 to 3. Non-burst cycles will always show 0.</p> <p>A burst consists of an address cycle followed by a number of data cycles. Each data cycle is stored in the analyzer as it occurs along with the properly determined address and burst count. This count field indicates the position of this analysis cycle in a burst transaction.</p> <p style="margin-left: 40px;">00 - Data was 1st data cycle            01 - Data was 2nd data cycle            10 - Data was 3rd data cycle            11 - Data was 4th data cycle</p>
76 77 78 79	Waitcnt[0] Waitcnt[1] Waitcnt[2] Waitcnt[3]	<p>A count of how many wait states proceeded the completion of this bus cycle. Each data cycle may be delayed by some number of wait states before the data is read/written. This counter runs from 0 to 15.</p>



Chapter 6: Using the Emulation Analyzer  
**Qualifying Trigger and Store Conditions**

<b>HP 64760 Emulation Analyzer Trace Signals</b>		
<b>Trace Signals</b>	<b>Signal Name</b>	<b>Signal Description</b>
80 81	AccessSize[0] AccessSize[1]	<p>Indicates the size of the current access. Each data cycle has a data size based on the byte enables. Since various patterns of enables represent the same data size, this field gives a single pattern to determine data size.</p> <p style="margin-left: 40px;">00 = Byte            01 = HalfWord            10 = triplebyte            11 = Word</p>
83	Cache	<p>The processor CACHE signal, which is active high, for the current bus transfer.</p> <p style="margin-left: 40px;">0 = current burst is not cacheable            1 = current burst is cacheable</p>
84	BusLock	<p>The processor LOCK signal, which is active low, for the current bus transfer.</p> <p style="margin-left: 40px;">0 = current cycle locked            1 = current cycle unlocked</p>
85	Write/Read	<p>The processor W/R signal for the current bus transfer.</p> <p style="margin-left: 40px;">0 = Read            1 = Write</p>

<b>HP 64760 Emulation Analyzer Trace Signals</b>		
<b>Trace Signals</b>	<b>Signal Name</b>	<b>Signal Description</b>
86 87 88 89	Int0Flg Int1Flg Int2Flg Int3Flg	<p>These flags indicate that the interrupt pins on the 80960 have been active since the last analysis state. The processor requires that the interrupt inputs be active for only one bus cycle, so these flags save the activity until an analysis state is generated. The pins can be programmed for different configurations which may change the users view of the pins, but these flags only indicate that the pin has been active, not that an interrupt has been requested/detected.</p> <p>All flags active high.            Int0Flg - 1 = Detected active low at the processor            Int1Flg - 1 = Detected active high at the processor            Int2Flg - 1 = Detected active high at the processor            Int3Flg - 1 = Detected active low at the processor</p>
91	ForeGround	<p>Indicates that the processor is running in foreground or that the bus cycle is an execution trace message. When using the raw analysis clock, this signal is meaningless (refer to the AnalValid trace signal (95)).</p> <p>1 = Foreground memory cycle or execution trace message cycle</p>
92	HoldAck	<p>Indicates that processor has entered a bus hold since the last analysis state. It is possible that no analysis states were generated or stored during the hold, so this bit indicates that the hold has occurred.</p> <p>0 = no hold occurred            1 = a hold has occurred</p>
93	Failure	<p>The processor Failure signal. This processor signal is active low. It indicates that the processor has failed initialization. The bit is deasserted after RESET, but then asserted during selftest, then deasserted, and only then reasserted if the IMI checksum fails.</p> <p>0 = processor failure is asserted            1 = processor failure is not asserted</p>

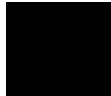

Chapter 6: Using the Emulation Analyzer  
**Qualifying Trigger and Store Conditions**

<b>HP 64760 Emulation Analyzer Trace Signals</b>		
<b>Trace Signals</b>	<b>Signal Name</b>	<b>Signal Description</b>
94	Reset1st	<p>This signal will remain low until the first foreground user cycle occurs after reset. It will then remain asserted.</p> <p>0 = No user foreground cycles seen since reset            1 = First user foreground cycle and all subsequent cycles</p>
95	AnalValid	<p>This status bit indicates that data stored by the analyzer is a valid 80960 processor information cycle. Information cycles are generated for normal Td cycles of the processor as well as for execution trace message Td cycles. Refer to the bus state diagram for the processor to understand the bus states. When clocking the analyzer with the raw processor clock (<b>cf aclk=all</b>), many analysis states will result from Ti, Tr, Tw, Th bus cycles, and these states contain no valid bus information.</p> <p>Valid states are marked by this bit being a 1</p>
96	BadAccess	<p>The processor BADAC signal is sampled after the last data cycle of a burst. This signal will be asserted on the last data transfer of bad burst. This bit is active low like the processor input BADAC.</p> <p>The analyzer holds this bit inactive during data cycles that are not the last of the burst (BstSize != BstCount).</p> <p>0 = bus transaction had unrecoverable error            1 = no error occurred</p>

<b>HP 64760 Emulation Analyzer Trace Signals</b>		
<b>Trace Signals</b>	<b>Signal Name</b>	<b>Signal Description</b>
97 98 99 100 101 102 103 104	InstructionTrace BranchTrace CallTrace ReturnTrace PrereturnTrace SupervisorTrace BreakpointTrace EmsgAt/To	<p>These bits are the processor event flags generated during an execution trace message.</p> <p>Bit 7 is the AT/TO flag generated by the analyzer during execution trace messages. The execution address will be marked AT=1 and the next address will be marked TO=0.</p> <p>7 - AT/TO            1=AT            0=TO            6 - Breakpoint            5 - Supervisor            4 - Prereturn            3 - Return            2 - Call            1 - Branch            0 - Instruction</p>



Chapter 6: Using the Emulation Analyzer  
**Qualifying Trigger and Store Conditions**

<b>HP 64760 Emulation Analyzer Trace Signals</b>		
<b>Trace Signals</b>	<b>Signal Name</b>	<b>Signal Description</b>
105 106 107	NormalBusFlg MonitorFlg ExecutionFlg	<p>These flags are mutually exclusive and indicate the cause of the current bus cycle. Only one flag will be active (1) at a time.</p> <p>The NormalBusFlg indicates a foreground bus cycle. This bus cycle may be caused by either the user program, or by the monitor performing a foreground access. To determine the cause of a NormalBusFlg marked cycle the ImodeFlg must be examined.</p> <p style="padding-left: 40px;">NormalBusFlg = 1 &amp; ImodeFlg=1 User cycle            NormalBusFlg = 1 &amp; ImodeFlg=0 Monitor Foreground cycle</p> <p>The ExecutionFlg indicates that the current cycle is an execution trace message cycle. When this flag is set the EventFlgs[7:0] are valid. The from/to flag will indicate which address of the message this is. The event flags are available in the status field.</p> <p>The MonitorFlg indicates that the current cycle is a background cycle. Execution trace messages are written to background memory, but will use the ExecutionFlag, therefore the MonitorFlag will be valid for monitor code/data.</p>
108	ImodeFlg	<p>Indicates that the processor is in background mode.</p> <p style="padding-left: 40px;">1 = inactive            0 = active</p>
109 110 111	Memstat[0] Memstat[1] Memstat[2]	<p>These bits represent the attribute of the memory cycle generated.</p> <p style="padding-left: 40px;">Memstat[0] = guarded access            Memstat[1] = rom access            Memstat[2] = low target memory access</p>

### **HP 64760 State Qualifiers**

Whenever a state can be specified in the trace command (trigger state, storage state, prestore state, etc.), you will see the following softkeys that allow you to qualify the state:

accsize	The value following this softkey is searched for on the lines over which the size of the current access is passed to the analyzer.
address	The value following this softkey is searched for on the lines that monitor the emulation processor's address bus.
bstsize	The value following this softkey is searched for on the lines over which bus burst size information is passed to the analyzer.
data	The value following this softkey is searched for on the lines that monitor the emulation processor's data bus.
memmap	The value following this softkey is searched for on the lines which monitor the memory map status.
status	The value following this softkey is searched for on the lines that monitor other emulation processor signals.
waitcnt	The value following this softkey is searched for on the lines over which the number of wait states that preceded the completion of the bus cycle is passed to the analyzer.

When a value is specified without one of these softkeys it is assumed to be an address value.

**Predefined Values for HP 64760 State Qualifiers** When you specify access size, burst size, memory mapper, or status qualifiers for analyzer states (by pressing the **accsize**, **bstsize**, **memmap**, or **status** softkeys), you will be given the following softkeys which are predefined values for the qualifiers.

Chapter 6: Using the Emulation Analyzer  
**Qualifying Trigger and Store Conditions**

<b>Predefined Values for State Qualifiers - HP 64760</b>			
<b>Trace Label</b>	<b>Equate</b>	<b>Value</b>	<b>Description</b>
accsize	byte	0h	8-Bit byte.
	short	1h	Two bytes.
	three	2h	Three bytes.
	word	3h	Four bytes.
bstsize	single	0h	One word.
	double	1h	Two words.
	triple	2h	Three words.
	quad	3h	Four words.
memmap	target	00xx x001b	Target memory access.
	emul	01xx x001b	Emulation memory access.
	rom	0x1x x001b	ROM access.
	ram	0x0x x001b	RAM access.
	guarded	0001 x001b	Guarded memory access.



Predefined Values for State Qualifiers - HP 64760			
Trace Label	Equate	Value	Description
status	read	0xx xx0x xxxx xxxx xx1x xxxx xxxx 0xxx	Data read.
	write	0xx xx0x xxxx xxxx xx1x xxxx xxxx 1xxx	Data write.
	cycle	0xx xx00 1xxx xxxx xx1x xx1x xxxx xxxx	Bus cycle.
	exec	0xx xx10 0xxx xxxx xx1x xx1x xxxx xxxx	Execution message.
	valid	0xx xxxx xxxx xxxx xx1x xxxx xxxx xxxx	Address/data valid.
	lock	0xx xx00 1xxx xxxx xx1x xx1x xxxx x0xx	Bus lock.
	cache	0xx xx00 1xxx xxxx xx1x xx1x xxxx xx1x	Cacheable.
	badac	0xx xx00 1xxx xxxx x01x xx1x xxxx xxxx	Bad access.
	bgnd	0xx xx01 0xxx xxxx xx1x xx0x xxxx xxxx	Background cycle.
	exec_at	0xx xx10 01xx xxxx xx1x xx1x xxxx xxxx	Execution at message.
	exec_to	0xx xx10 00xx xxxx xx1x xx1x xxxx xxxx	Execution to message.
	instr	0xx xx10 0xxx xxxx 1x1x xx1x xxxx xxxx	Instruction message.
	branch	0xx xx10 0xxx xxx1 xx1x xx1x xxxx xxxx	Branch message.
	call	0xx xx10 0xxx xx1x xx1x xx1x xxxx xxxx	Call message.
	return	0xx xx10 0xxx x1xx xx1x xx1x xxxx xxxx	Return message.
	preret	0xx xx10 0xxx 1xxx xx1x xx1x xxxx xxxx	Prereturn message.
	super	0xx xx10 0xx1 xxxx xx1x xx1x xxxx xxxx	Supervisor message.
brkpt	0xx xx10 0x1x xxxx xx1x xx1x xxxx xxxx	Breakpoint message.	
int0	0xx xxxx xxxx xxxx xxxx xxx1 xxx	Interrupt pin 0.	
int1	0xx xxxx xxxx xxxx xxxx xx1x xxx	Interrupt pin 1.	
int2	0xx xxxx xxxx xxxx xxxx x1xx xxx	Interrupt pin 2.	
int3	0xx xxxx xxxx xxxx xxxx 1xxx xxx	Interrupt pin 3.	
hold	0xx xxxx xxxx xxxx xxxx x1xx xxxx xxx	Bus hold.	

These predefined values may be used as other values would be used. For example:

*trace after status write*

is the same as:

*trace after status* 0xxxxx0xxxxxxxxxxxxx1xxxxxxxxxx1xxx

Chapter 6: Using the Emulation Analyzer  
**Qualifying Trigger and Store Conditions**

**HP 64761 Emulation Analyzer Trace Signals**

When you qualify states, you specify values that should be found on the analyzer trace signals. The emulation analyzer trace signals are described in the table that follows.

<b>HP 64761 Emulation Analyzer Trace Signals</b>		
<b>Trace Signals</b>	<b>Signal Name</b>	<b>Signal Description</b>
31:0	Addr[31:0]	For normal bus activity, this address corresponds to the lowest addressed byte for the current data item being accessed.  For execution trace messages, this address corresponds to the word address of either the from address or the to address. The status field contains from/to flag.
47:32	Data[15:0]	For normal bus activity, these signals contain the data from the short wide data transfer on the data bus.  For execution trace messages, these signals are meaningless. The bytes in the data field are qualified by the byte enable status bits.
48 49 50 51	Waitcnt[0] Waitcnt[1] Waitcnt[2] Waitcnt[3]	A count of how many wait states preceded the completion of this bus cycle. Each data cycle may be delayed by some number of wait states before the data is read/written. This counter runs from 0 to 15.

<b>HP 64761 Emulation Analyzer Trace Signals</b>		
<b>Trace Signals</b>	<b>Signal Name</b>	<b>Signal Description</b>
52 53 54	Bstcount[0] Bstcount[1] Bstcount[2]	<p>Shows which data transfer of a burst is associated with the current bus cycle. It progresses from 0 to 7. Non-burst cycles will always show 0.</p> <p>A burst consists of an address cycle followed by a number of data cycles. Each data cycle is stored in the analyzer as it occurs along with the properly determined address and burst count. This count field indicates the position of this analysis cycle in a burst transaction.</p> <p>000 - Data was 1st data cycle            001 - Data was 2nd data cycle            010 - Data was 3rd data cycle            011 - Data was 4th data cycle            100 - Data was 5th data cycle            101 - Data was 6th data cycle            110 - Data was 7th data cycle            111 - Data was 8th data cycle</p>
55	Blast	<p>The processor BLAST signal. This processor signal is active low. It indicates the last data cycle of a burst access.</p>
56	AccessSize	<p>Indicates the size of the current access. Each data cycle has a data size based on the byte enables. Since various patterns of enables represent the same data size, this field gives a single pattern to determine data size.</p> <p>0 = Byte            1 = HalfWord</p>
57	BusLock	<p>The processor LOCK signal, which is active low, for the current bus transfer.</p> <p>0 = current cycle locked            1 = current cycle unlocked</p>



Chapter 6: Using the Emulation Analyzer  
**Qualifying Trigger and Store Conditions**

<b>HP 64761 Emulation Analyzer Trace Signals</b>		
<b>Trace Signals</b>	<b>Signal Name</b>	<b>Signal Description</b>
58	HoldAck	<p>Indicates that processor has entered a bus hold since the last analysis state. It is possible that no analysis states were generated or stored during the hold, so this bit indicates that the hold has occurred.</p> <p style="margin-left: 40px;">0 = no hold occurred            1 = a hold has occurred</p>
59 60 61 62	Int0Flg Int1Flg Int2Flg Int3Flg	<p>These flags indicate that the interrupt pins on the 80960 have been active since the last analysis state. The processor requires that the interrupt inputs be active for only one bus cycle, so these flags save the activity until an analysis state is generated. The pins can be programmed for different configurations which may change the users view of the pins, but these flags only indicate that the pin has been active, not that an interrupt has been requested/detected.</p> <p>All flags active high.</p> <p style="margin-left: 40px;">Int0Flg - 1 = Detected active low at the processor            Int1Flg - 1 = Detected active high at the processor            Int2Flg - 1 = Detected active high at the processor            Int3Flg - 1 = Detected active low at the processor</p>
66	ImodeFlg	<p>Indicates that the processor is in background mode.</p> <p style="margin-left: 40px;">1 = inactive            0 = active</p>
64	FG_H	High marks foreground cycles.

<b>HP 64761 Emulation Analyzer Trace Signals</b>		
<b>Trace Signals</b>	<b>Signal Name</b>	<b>Signal Description</b>
65 66 67	NormalBusFlg MonitorFlg ExecutionFlg	<p>These flags indicate the cause of the current bus cycle.</p> <p>The NormalBusFlg indicates a foreground bus cycle. This bus cycle may be caused by the user program, the foreground monitor program, or by the background monitor performing a foreground access. To determine the cause of a NormalBusFlg marked cycle the ImodeFlg must be examined.</p> <p style="padding-left: 40px;">NormalBusFlg = 1 &amp; ImodeFlg=1 User cycle            NormalBusFlg = 1 &amp; ImodeFlg=0 Monitor Foreground cycle</p> <p>The MonitorFlg indicates that the current cycle is a monitor cycle. Execution trace messages are written to background memory, but will use the ExecutionFlag, therefore the MonitorFlag will be valid for monitor code/data.</p> <p>The ExecutionFlg is an active low flag that indicates that the current cycle is an execution trace message cycle. When this flag is set the EventFlgs[7:0] are valid. The from/to flag will indicate which address of the message this is. The event flags are available in the status field.</p>
68	Write/Read	<p>The processor W/R signal for the current bus transfer.</p> <p style="padding-left: 40px;">0 = Read            1 = Write</p>
69 70 71	Memstat[0] Memstat[1] Memstat[2]	<p>These bits represent the attribute of the memory cycle generated.</p> <p style="padding-left: 40px;">Memstat[0] = High indicates guarded or ROM cycle            Memstat[1] = Low=target memory cycle, High=emulation memory cycle            Memstat[2] = High=cycle came from default map term</p>



Chapter 6: Using the Emulation Analyzer  
**Qualifying Trigger and Store Conditions**

<b>HP 64761 Emulation Analyzer Trace Signals</b>		
<b>Trace Signals</b>	<b>Signal Name</b>	<b>Signal Description</b>
72 73 74 75 76 77 78 79	EmsgAt/To InstructionTrace BranchTrace CallTrace ReturnTrace PrereturnTrace SupervisorTrace BreakpointTrace	<p>These bits are the processor event flags generated during an execution trace message.</p> <p>Bit 0 is the AT/TO flag generated by the analyzer during execution trace messages. The execution address will be marked AT=1 and the next address will be marked TO=0.</p> <p>7 - Breakpoint            6 - Supervisor            5 - Prereturn            4 - Return            3 - Call            2 - Branch            1 - Instruction            0 - AT/TO                1=AT                0=TO</p>

**HP 64761 State Qualifiers**

Whenever a state can be specified in the trace command (trigger state, storage state, prestore state, etc.), you will see the following softkeys that allow you to qualify the state:

- accsize**            The value following this softkey is searched for on the lines over which the size of the current access is passed to the analyzer.
- address**            The value following this softkey is searched for on the lines that monitor the emulation processor's address bus.
- data**                The value following this softkey is searched for on the lines that monitor the emulation processor's data bus.
- memmap**            The value following this softkey is searched for on the lines which monitor the memory map status.
- status**             The value following this softkey is searched for on the lines that monitor other emulation processor signals.
- waitcnt**            The value following this softkey is searched for on the lines over which the number of wait states that preceded the completion of the bus cycle is passed to the analyzer.

When a value is specified without one of these softkeys it is assumed to be an address value.

**Predefined Values for HP 64761 State Qualifiers** When you specify access size, burst size, memory mapper, or status qualifiers for analyzer states (by pressing the **accsize**, **memmap**, or **status** softkeys), you will be given the following softkeys which are predefined values for the qualifiers.

Predefined Values for State Qualifiers - HP 64761			
Trace Label	Equate	Value	Description
accsize	byte	0h	8-Bit byte.
	short	1h	Two bytes.

Chapter 6: Using the Emulation Analyzer  
**Qualifying Trigger and Store Conditions**

Predefined Values for State Qualifiers - HP 64761			
Trace Label	Equate	Value	Description
memmap	emul	01x x101b	Emulation memory access.
	eram	010 x101b	Emulation RAM access.
	erom	011 x101b	Emulation ROM access.
	targ	10x x101b	Target memory access.
status	at	0xxxx xxx1 xxxx 0001 xxxx xxxx xxxx xxxxb	Execution at message.
	bgmon	0xxxx xxxx xxxx 1100 xxxx xxxx xxxx xxxxb	Background monitor cycle.
	branch	0xxxx x1xx xxxx 0001 xxxx xxxx xxxx xxxxb	Branch execution message.
	brkpt	01xxx xxxx xxxx 0001 xxxx xxxx xxxx xxxxb	Breakpoint exec. message.
	call	0xxxx 1xxx xxxx 0001 xxxx xxxx xxxx xxxxb	Call execution message.
	cycle	0xxxx xxxx xxxx 1011 xxxx xxxx xxxx xxxxb	Bus cycle.
	exec	0xxxx xxxx xxxx 0001 xxxx xxxx xxxx xxxxb	Execution message.
	fgmon	0xxxx xxxx xxxx 1111 xxxx xxxx xxxx xxxxb	Foreground monitor cycle.
	hold	0xxxx xxxx xxxx xxxx xxxx x1xx xxxx xxxxb	Bus hold.
	instr	0xxxx xx1x xxxx 0001 xxxx xxxx xxxx xxxxb	Instruction execution message.
	int0	0xxxx xxxx xxxx xxxx xxxx 1xxx xxxx xxxxb	Interrupt pin 0.
	int1	0xxxx xxxx xxxx xxxx xxx1 xxxx xxxx xxxxb	Interrupt pin 1.
	int2	0xxxx xxxx xxxx xxxx xx1x xxxx xxxx xxxxb	Interrupt pin 2.
	int3	0xxxx xxxx xxxx xxxx x1xx xxxx xxxx xxxxb	Interrupt pin 3.
	lock	0xxxx xxxx xxxx 1011 xxxx xx0x xxxx xxxxb	Bus lock.
	preret	0xx1x xxxx xxxx 0001 xxxx xxxx xxxx xxxxb	Prereturn execution message.
	read	0xxxx xxxx xxx0 1xxx xxxx xxxx xxxxb	Data read.
return	0xxx1 xxxx xxxx 0001 xxxx xxxx xxxx xxxxb	Return execution message.	
super	0x1xx xxxx xxxx 0001 xxxx xxxx xxxx xxxxb	Supervisor execution message.	
to	0xxxx xxx0 xxxx 0001 xxxx xxxx xxxx xxxxb	Execution to message.	
write	0xxxx xxxx xxx1 1xxx xxxx xxxx xxxxb	Data write.	

These predefined values may be used as other values would be used. For example:

*trace after memmap target*

is the same as:

*trace after memmap 10xxx101b*



## To qualify the trigger state and position

- Enter a trigger state specification in the entry buffer; then, choose **Trace→After ()**, **Trace→About ()**, or **Trace→Before ()**.
- When displaying memory in mnemonic format, position the mouse pointer over the source line where you want to set the trace trigger, press and hold the *select* mouse button and choose **Trace After**, **Trace Before**, or **Trace About** from the popup menu.
- Using the command line, enter the **trace after**, **trace about**, or **trace before** commands.

Tracing after the trigger state says states that occur after the trigger state should be saved; in other words, the trigger is positioned at the top of the trace.

Tracing before the trigger state says states that occur before the trigger state should be saved; in other words, the trigger is positioned at the bottom of the trace.

Tracing about the trigger state says states that occur before and after the trigger state should be saved; in other words, the trigger is positioned at the center of the trace.

The actual trigger position is within +/- 3 states of the number specified. When using the HP 64704 analyzer and counting is turned on, the actual trigger position is within +/- 1 state of the number specified.

Usually, when you enter a **trace about** command, the trigger state (line 0) is labeled "about". However, if there are three or fewer states before the trigger, the trigger state is labeled "after". Likewise, if there are 3 or fewer states after the trigger, the trigger state is labeled "before".

The state you define after **trace after**, **trace about**, or **trace before** is the state that will trigger the analyzer and cause states to be stored.

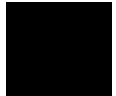

## Chapter 6: Using the Emulation Analyzer Qualifying Trigger and Store Conditions

### Examples

Suppose you want to look at the execution of the demo program after the call of the "update\_system()" function (main.c: line 102) occurs.

To turn ON the call execution message, enter the following command.

```
modify execution_messages clear <RETURN>  
modify execution_messages set call <RETURN>
```

To trigger on the call of the "update\_system()" function, enter:

```
trace after address main."main.c": line 102 status call  
<RETURN>
```

```
set source on inverse_video on symbols on <RETURN>
```

```
display trace <RETURN>
```

Trace List	Offset=0	More data off screen
Label:	Address	Opcode or Status w/ Source Lines
Base:	symbols	mnemonic w/symbols
after	co/main+00000010	call to up.update_system i.X 1.9 uS
#####/usr/hp64000/demo/debug_env/hp64760/update_sys.c - line 49 ##		
int limit_short = ARG5;		
+002	update_+00000010	P: lda 000003E8,r5 11.i.e 2.2 uS
#####/usr/hp64000/demo/debug_env/hp64760/update_sys.c - line 50 th		
int counter;		
/* get new targets */		
get_targets(&target_temp, &target_humid);		
+004	update_+00000014	P: lda ecs _target_temp,g0 13.i.e 280 nS
+008	update_+0000001C	P: lda ec _target_humid,g1 17.i.e 480 nS
+010	update_sy.updat:	write short 2400 11.i.e 400 nS
+013	update_+00000024	P: call upda.get_targets 13.i.e 480 nS
#####/usr/hp64000/demo/debug_env/hp64760/update_sys.c - line 54 th		
/* Read the environment conditions. */		

In the preceding trace list, line 0 (labeled "after") shows the beginning of the program loop.

## To trigger on a number of occurrences of some state

- Use the **occurs** <#TIMES> after specifying the trigger state.

When specifying a trigger state, you can include an occurrence count. The occurrence count specifies that the analyzer trigger on the Nth occurrence of some state.

The default base for an occurrence count is decimal. You may specify occurrence counts from 1 to 65535.

---

### Examples

To trigger on the 20th occurrence of the call of the "update\_system()" function (main.c: line 102):

```
modify execution_messages clear <RETURN>  
modify execution_messages set call <RETURN>
```

```
trace after address main."main.c": line 102 status call  
occurs 20 <RETURN>
```

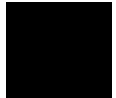

## To qualify states stored in the trace

- Enter a storage state specification in the entry buffer; then, choose **Trace→Only ()**.
- Using the command line, use the **only** option in the **trace** command.

By default, all captured states are stored; however, you can qualify which states get stored with the **trace** command's **only** option.

### Examples

When the emulator is running the demo program, to store *only* accesses of the "target\_temp" variable:

```
trace only target_temp <RETURN>
```

Trace List	Address	Offset=0	Opcode or Status w/ Source Lines	More data off screen
Label:	Address		mnemonic w/symbols	time count
Base:	symbols			relative
after	read_co+00000214		read short C802	13.i.e -----
+001	ecs_target_temp		read short 004B	11.i.e 12.2 mS
+002	ecs_target_temp		read short 004B	11.i.e 80.2 mS
+003	ecs_target_temp		read short 004B	11.i.e 3.0 uS
+004	ecs_target_temp		read short 004B	11.i.e 1.8 uS
+005	ecs_target_temp		read short 004B	11.i.e 2.5 uS
+006	ecs_target_temp		read short 004B	11.i.e 285. mS
+007	ecs_target_temp		write short 004D	11.i.e 440 nS
+008	ecs_target_temp		read short 004D	11.i.e 240 nS
+009	ecs_target_temp		read short 004D	11.i.e 16.0 mS
+010	ecs_target_temp		read short 004D	11.i.e 81.9 mS
+011	ecs_target_temp		read short 004D	11.i.e 3.0 uS
+012	ecs_target_temp		read short 004D	11.i.e 1.8 uS
+013	ecs_target_temp		read short 004D	11.i.e 2.5 uS
+014	ecs_target_temp		read short 004D	11.i.e 97.0 mS
+015	ecs_target_temp		write short 004F	11.i.e 440 nS

Notice the trigger state (line 0, labeled "after") is included in the trace list; trigger states are always stored.

## To prestore states before qualified store states

- Enter a storage state specification in the entry buffer; then, choose **Trace→Only () Prestore**.
- Use the **prestore** option in the **trace** command.

Prestore allows you to save up to two states which precede a normal store state. Prestore is turned off by default. However, you can use the **trace** command's **prestore** option to specify a prestore qualifier.

Prestore is useful when you want to find the cause of a particular state. For example, if a variable is accessed from many different places in the program, you can qualify the trace so that only accesses of that variable are stored. Then, you can turn on prestore to find out where accesses of that variable originate from.

States which satisfy the prestore qualifier and the storage qualifier at the same time are stored as normal states.

---

### Examples

To storing only write accesses to the variable "target\_temp" and prestore the two previous states:

```
trace only target_temp status write  
prestore anything <RETURN>
```

Chapter 6: Using the Emulation Analyzer  
**Qualifying Trigger and Store Conditions**

Trace List		Offset=0		More data off screen		
Label:	Address	Opcode or	Status w/	Source Lines	time count	
Base:	symbols	mnemonic w/	symbols	relative		
after	proc_sp+00000224	read	short	4001	13.i.e	-----
pstore	get_tar+0000024E	read	short	92A0	18.i.e	
pstore	ecs_target_temp	read	short	0041	11.i.e	
+003	ecs_target_temp	write	short	0043	11.i.e	18.0 mS
pstore	get_tar+0000024E	read	short	92A0	18.i.e	
pstore	ecs_target_temp	read	short	0043	11.i.e	
+006	ecs_target_temp	write	short	0045	11.i.e	190. mS
pstore	get_tar+0000024E	read	short	92A0	18.i.e	
pstore	ecs_target_temp	read	short	0045	11.i.e	
+009	ecs_target_temp	write	short	0047	11.i.e	190. mS
pstore	get_tar+0000024E	read	short	92A0	18.i.e	
pstore	ecs_target_temp	read	short	0047	11.i.e	
+012	ecs_target_temp	write	short	0049	11.i.e	191. mS
pstore	get_tar+0000024E	read	short	92A0	18.i.e	
pstore	ecs_target_temp	read	short	0049	11.i.e	
+015	ecs_target_temp	write	short	004B	11.i.e	288. mS

---

## To change the count qualifier (HP 64704 Only)

- Use the **counting** option in the **trace** command.

After initializing the analyzer, the default count qualifier is "time", which means that the time between states is saved. When time is counted, up to 512 states can be stored in the trace.

When you count states, the counter is incremented each time the state is captured (not necessarily stored) by the analyzer. When a state is counted, up to 512 states can be stored in the trace.

When you turn OFF counting, up to 1024 states can be stored in the trace.

**Examples**

Suppose you want to know how many loops of the program occur between calls of the "do\_sort" function. To change the count qualifier to count a state that occurs once for each loop of the program, enter:

```
modify execution_messages clear <RETURN>
modify execution_messages set call <RETURN>
```

```
trace only do_sort status call
counting state main."main.c": line 102 status call
<RETURN>
```

Trace List	Address	Opcode or Mnemonic	Status w/ Source Lines	Source Lines	state	count
Label:	Address	Opcode or Mnemonic	Status w/ Source Lines	Source Lines	state	count
Base:	symbols	mnemonic w/symbols	relative			
after	proc_sp+00000224	read short	4801	13.i.e		
+001	cod main.do_sort	call	to cod main.do_sort	i.X		1
+002	cod main.do_sort	call	to cod main.do_sort	i.X		4
+003	cod main.do_sort	call	to cod main.do_sort	i.X		4
+004	cod main.do_sort	call	to cod main.do_sort	i.X		4
+005	cod main.do_sort	call	to cod main.do_sort	i.X		4
+006	cod main.do_sort	call	to cod main.do_sort	i.X		4
+007	cod main.do_sort	call	to cod main.do_sort	i.X		4
+008	cod main.do_sort	call	to cod main.do_sort	i.X		4
+009	cod main.do_sort	call	to cod main.do_sort	i.X		4
+010	cod main.do_sort	call	to cod main.do_sort	i.X		4
+011	cod main.do_sort	call	to cod main.do_sort	i.X		4
+012	cod main.do_sort	call	to cod main.do_sort	i.X		4
+013	cod main.do_sort	call	to cod main.do_sort	i.X		4
+014	cod main.do_sort	call	to cod main.do_sort	i.X		4
+015	cod main.do_sort	call	to cod main.do_sort	i.X		4

The trace listing above shows that the program loops 4 times for each call of the "do\_sort" function.

## To trace until the analyzer is halted

- Choose **Trace→Until Stop**.
- Using the command line, enter the **trace on\_halt** command.

The **trace on\_halt** command allows you to prevent triggering. In other words, the trace runs until you enter the **stop\_trace** command. The **trace on\_halt** command is the same as tracing **before** a state that never occurs.

The **trace on\_halt** command is useful, for example, when you wish to trace the states leading up to a break into the monitor. Suppose your program breaks on an access to guarded memory. To trace the states that lead up to the break, enter the **trace on\_halt** command, and run the program. When the break occurs, the emulator is running in the background monitor, and the analyzer is no longer capturing states. To display the states leading up to the break, enter the **stop\_trace** command (and the **display trace** command if traces are not currently being displayed).

When the **on\_halt** option is used in a trace command, the trigger condition (and position) options, as well as the **repetitively** and **break\_on\_trigger** options, cannot be included in the command.

Also, note that this does not work the same when using a foreground monitor because the analyzer continues to capture states when the break to monitor occurs (unless the code that causes the break also causes processor to halt). In this case, you can use the command line to enter a trace command that stores only states outside the range of the foreground monitor program (for example, **trace only not range <mon\_start\_addr> thru <mon\_end\_addr> on\_halt**).



## To break emulator execution on the analyzer trigger

- Enter a trigger state specification in the entry buffer; then, choose **Trace→Until ()**.
- When displaying memory in mnemonic format, position the mouse pointer over the program line which you wish to trace before, press and hold the *select* mouse button and choose **Trace Until** from the popup menu.
- Using the command line, use the **break\_on\_trigger** option to the **trace** command.

The **break\_on\_trigger** option to the **trace** command allows you to cause the emulator to break when the analyzer finds the trigger state.

Note that the actual break may be several cycles after the analyzer trigger.

---

### Examples

To trace before source line 102 and cause the emulator to break into the monitor when the analyzer triggers:

```
modify execution_messages clear <RETURN>  
modify execution_messages set call <RETURN>
```

```
trace before address main."main.c": line 102 status  
call break_on_trigger <RETURN>
```

## Using the Sequencer

When you use the analyzer's sequencer, you can specify traces that trigger on a series, or sequence, of states. You can specify a state which, when found, causes the analyzer to restart the search for the sequence of states. Also, the analyzer's sequencer allows you to trace "windows" of code execution.

This section describes how to:

- Trigger on a sequence of states.
- Specify a global restart state.
- Trace "windows" of program execution.

The sequencing and windowing capabilities from within the Softkey Interface are not as powerful or flexible as they are from within the Terminal Interface. For example, in the Terminal Interface, you can specify different restart states for each sequence term and you can set up a windowing trace specification where the trigger does not have to be in the window. If you do not find the sequencing flexibility you need from within Softkey Interface, refer to the *80960 Emulator User's Guide for the Terminal Interface*.

---

### To trigger after a sequence of states

- Use the **trace find\_sequence** command.

The analyzer's sequencer has several levels (also called *sequence terms*). Each state in the series of states to be found before triggering, as well as the trigger state, is associated with a sequence term.

The sequencer works like this: The analyzer searches for the state associated with the first sequence term. When that state is captured, the analyzer starts searching for the state associated with the second term, and so on. The last sequence term used is associated with the trigger state. When the trigger state is captured the analyzer is triggered. Up to seven sequence terms and an optional occurrence count for each term are available.

**Examples**

In the demo program, suppose you wish to trigger on the following sequence of events: the "save\_points" function, the "interrupt\_sim" function, and finally the "do\_sort" function. Also, suppose you wish to store only call execution messages to show function entry addresses.

To set up the sequencing trace specification, enter the following trace command.

```

modify execution_messages clear <RETURN>
modify execution_messages set call <RETURN>

trace find_sequence save_points status call and exec_to
then interrupt_sim status call and exec_to
trigger about do_sort status call and exec_to
only status call and exec_to <RETURN>
  
```

Trace List		Offset=0		More data off screen	
Label:	Address	Opcode or Status w/	Source Lines		time count
Base:	symbols	mnemonic w/symbols			relative
-055	up.update_system	call	to up.update_system	i.X	18.2 mS
-054	upda.get_targets	call	to upda.get_targets	i.X	8.72 uS
-053	.read_conditions	call	to .read_conditions	i.X	12.8 mS
-052	upda.set_outputs	call	to upda.set_outputs	i.X	18.2 mS
-051	updat.write_hdr	call	to updat.write_hdr	i.X	79.7 mS
sq adv	upda.save_points	call	to upda.save_points	i.X	42.0 mS
-049	__floatsidf.lf	call	to __floatsidf.lf	i.X	20.8 mS
-048	co__rounddfs2	call	to co__rounddfs2	i.X	14.8 uS
-047	code__divsf3	call	to code__divsf3	i.X	18.6 uS
-046	__floatsidf.lf	call	to __floatsidf.lf	i.X	91.6 uS
-045	co__rounddfs2	call	to co__rounddfs2	i.X	8.04 uS
-044	code__divsf3	call	to code__divsf3	i.X	18.4 uS
sq adv	ma.interrupt_sim	call	to ma.interrupt_sim	i.X	30.6 uS
-042	proc_sp+00000008	call	to p.proc_specific+00000008	i.X	1.79 mS
-041	up.update_system	call	to up.update_system	i.X	18.2 mS
-040	upda.get_targets	call	to upda.get_targets	i.X	8.68 uS

Notice the states that contain "sq adv" in the first column (you may have to press <PREV> in order to see the states captured prior to the trigger). These are the states associated with (or captured for) each sequence term. Just as the trigger state is always stored in trace memory, the states captured in the sequence are always stored if the trace buffer is deep enough.

## To specify a global restart state

- Use the **restart** option to the **trace** command.

When using the analyzer's sequencer, an additional sequence restart term is also allowed. This restart is a "global restart"; that is, it applies to all the sequence terms.

The restart term is a state which, when captured before the analyzer has found the trigger state, causes the search for the sequence of states to start over. You can use the restart term to make certain some state does not occur in the sequence that triggers the analyzer.

---

### Examples

In the demo program, suppose you wish to trigger on the following sequence of events: the "save\_points" function, the "interrupt\_sim" function, and the "do\_sort" function. However, you only want to trigger when the "interrupt\_sim" calls the "do\_sort" function. In other words, if the "proc\_specific" function is entered before the "do\_sort" function is entered, you know "interrupt\_sim" did not call "do\_sort" this time, and the analyzer should start searching again from the beginning.

Again, suppose you wish to store only call execution messages.

To set up this sequencing trace specification, enter the following trace command.

```
modify execution_messages clear <RETURN>  
modify execution_messages set call <RETURN>  
  
trace find_sequence save_points status call and exec_to  
then interrupt_sim status call and exec_to  
restart proc_specific+8 status call and exec_to  
trigger about do_sort status call and exec_to  
only status call and exec_to <RETURN>
```

Trace List		Offset=0		More data off screen		
Label:	Address	Opcode or Status w/	Source Lines	time count		
Base:	symbols	mnemonic w/symbols		relative		
sq adv	ma.interrupt_sim	call	to ma.interrupt_sim	i.X	30.6	uS
sq adv	proc_sp+00000008	call	to p.proc_specific+00000008	i.X	359.	uS
-013	up.update_system	call	to up.update_system	i.X	18.2	mS
-012	upda.get_targets	call	to upda.get_targets	i.X	8.68	uS
-011	.read_conditions	call	to .read_conditions	i.X	12.8	mS
-010	upda.set_outputs	call	to upda.set_outputs	i.X	18.2	mS
-009	updat.write_hwdr	call	to updat.write_hwdr	i.X	79.7	mS
sq adv	upda.save_points	call	to upda.save_points	i.X	42.0	mS
-007	__floatsidf.1f	call	to  __floatsidf.1f	i.X	20.8	mS
-006	co __rounddfs2	call	to co __rounddfs2	i.X	14.8	uS
-005	code __divsf3	call	to code __divsf3	i.X	18.6	uS
-004	__floatsidf.1f	call	to  __floatsidf.1f	i.X	91.6	uS
-003	co __rounddfs2	call	to co __rounddfs2	i.X	8.08	uS
-002	code __divsf3	call	to code __divsf3	i.X	18.4	uS
sq adv	ma.interrupt_sim	call	to ma.interrupt_sim	i.X	30.6	uS
about	cod main.do_sort	call	to cod main.do_sort	i.X	579.	uS

Notice in the preceding trace (you may have to press <PREV> in order to see the states captured prior to the trigger) that, in addition to states captured in the sequence, "sq adv" is also shown next to states which cause a sequencer restart.

## To trace "windows" of program execution

- Use the **enable** and **disable** options to the **trace** command.

Windowing refers to the analyzer feature that allows you to turn on, or enable, the capturing of states after some state occurs then to turn off, or disable, the capturing of states when another state occurs. In effect, windowing allows you capture "windows" of code execution.

Windowing is different than storing states in a range (the **only range** option in the trace command syntax) because it allows you to capture execution of all states in a window of code whereas storing states in a range won't capture the execution of subroutines that are called in that range or reads and writes to locations outside that range.

When you use the windowing feature of the analyzer, the trigger state must be in the window or else the trigger will never be found.

## Chapter 6: Using the Emulation Analyzer Using the Sequencer

If you wish to combine the windowing and sequencing functions of the analyzer, there are some restrictions:

- Up to four sequence terms are available when windowing is in effect.
- Global restart is not available when windowing is in effect.
- Occurrence counts are not available.

### Examples

To trace only the demo program execution from the call of the "update\_system" function to the call of the "get\_targets" function, you would set up the sequencer specification so that the call to the "update\_system" function is the window enable term and the return at the call to the "get\_targets" function is the window disable term.

```
modify execution_messages clear <RETURN>
modify execution_messages set call <RETURN>
```

```
trace enable update_system status call and exec_to
disable get_targets status call and exec_to <RETURN>
```

Trace List	Offset=0	More data off screen	
Label:	Address	Opcode or Status w/ Source Lines	time count
Base:	symbols	mnemonic w/symbols	relative
+031	get_tar+0000000C	P: mov g1,r5	17.i.e 240 nS
+033	update_+00000024	call to upda.get_targets	i.X 2.0 uS
sq adv	up.update_system	call to up.update_system	i.X 190. mS
#####/usr/hp64000/demo/debug_env/hp64760/update_sys.c - line 49 ##			
int limit_short = ARG5;			
+036	update_+00000010	P: lda 000003E8,r5	11.i.e 2.0 uS
#####/usr/hp64000/demo/debug_env/hp64760/update_sys.c - line 50 th			
int counter;			
/* get new targets */			
get_targets(&target_temp, &target_humid);			
+038	update_+00000014	P: lda ecs _target_temp,g0	13.i.e 240 nS
+042	update_+0000001C	P: lda ec _target_humid,g1	17.i.e 520 nS
+044	update_sy.updat:	write short E800	11.i.e 360 nS
+047	update_+00000024	P: call upda.get_targets	13.i.e 520 nS
#####/usr/hp64000/demo/debug_env/hp64760/update_sys.c - line 54 th			

Notice in the resulting trace (you have to press the <NEXT> key) that the enable and disable states have the "sq adv" string in the line number column. This is because the windowing feature uses the analyzer's sequencer.

## **Modifying the Trace Display**

This section describes the options available when displaying trace lists.

This section describes how to:

- Display the trace about a line number.
- Display the trace, disassembling from a line number.
- Display the trace in absolute format.
- Display the trace in mnemonic format.
- Display the trace with high-level source lines.
- Display the trace with symbol information.
- Change the column widths in the trace display.
- Display time counts in absolute or relative format.
- Display the trace with address information offset by a value.
- Return to the default trace display.
- Display the external analyzer information.

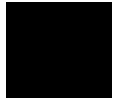

## To display the trace about a line number

- Use the <LINE #> option to the **display trace** command.

The <LINE #> trace display option allows you to specify the line number to be centered in the display.

### Examples

To display the trace about line number 160:

```
set default <RETURN>  
display trace 160 <RETURN>
```

Trace List		Offset=0			
Label:	Address	Opcode or Status		time count	
Base:	hex	mnemonic		relative	
+146	00100CD4	instr		i.X	4.64 uS
+148	00107538	write short	0000	11.i.e	2.3 uS
+149	0010753A	write short	0000	12.i.e	120 nS
+150	00100CF0	P: mov	00,r6	11.i.e	240 nS
+152	00100CF4	P: st	r6,0010765C	13.i.e	240 nS
+156	00100CFC	P: stos	g7,*****	17.i.e	520 nS
+158	00100C08	instr		i.X	1.2 uS
+160	00100D10	P: stos	g7,00108C24	11.i.e	2.4 uS
+164	00100D18	P: mov	00,r3	15.i.e	520 nS
+166	00100D1C	P: lda	00000020,g0	17.i.e	240 nS
+168	00100D20	P: cmpibge	r3,g0,00100D70	11.i.e	360 nS
+170	00100D24	P: mulo	12,r3,g1	13.i.e	240 nS
+172	00100D28	P: lda	00000041,g2	15.i.e	280 nS
+174	00100D2C	P: stis	g2,0011A000(g1)	17.i.e	240 nS
+176	00100CE0	call	to 00100D10	i.X	1.0 uS
+178	00108C24	write short	0000	11.i.e	2.3 uS



## To display the trace in absolute format

- Use the **absolute** option to the **display trace** command.

The **absolute** trace display option allows you to display status information in absolute format (binary, hex, or mnemonic). The **absolute status mnemonic** display is the same as default mnemonic display, except that opcodes are not disassembled.

### Examples

To display the trace in absolute format with the status information as binary values:

*display trace absolute status binary* <RETURN>

Trace List		Offset=0			
Label:	Address	Data	Absolute Status		time count
Base:	hex	hex	binary		relative
+146	00100C04	0010	000000	11100100011111001110000100	4.36 uS
+147	00100C08	0010	000000	10100100011011001100001000	240 nS
+148	00107538	0000	000000	10010110111111001110000001	2.1 uS
+149	0010753A	0000	000000	10010110111111001100010001	120 nS
+150	00100CF0	1E00	000000	10010010111011001110000001	240 nS
+151	00100CF2	5C30	000000	10010010111011001110010001	120 nS
+152	00100CF4	3000	000000	10010010111011001110100001	120 nS
+153	00100CF6	9230	000000	10010010111011001110110001	160 nS
+154	00100CF8	765C	000000	10010010111011001111000001	120 nS
+155	00100CFA	0010	000000	10010010111011001111010001	120 nS
+156	00100CFC	3000	000000	10010010111011001111100001	120 nS
+157	00100CFE	8AB8	000000	10010010111011001101110001	120 nS
+158	00100CD8	0010	000000	11100100011011001110000100	1.1 uS
+159	00100CE0	0010	000000	10100100011011001100001000	240 nS
+160	00100D10	3000	000000	10010010111111001110000001	2.2 uS
+161	00100D12	8AB8	000000	10010010111111001110010001	120 nS

## To display the trace in mnemonic format

- Use the **mnemonic** option to the **display trace** command.

The **mnemonic** trace display option allows you to display the trace information in mnemonic format (that is, opcodes and status). The default trace display is in mnemonic format, with prefetches disassembled and execution messages presented as status.

### Examples

To display the trace in mnemonic format:

```
display trace mnemonic <RETURN>
```

Trace List		Offset=0			
Label:	Address	Opcode or Status		time count	
Base:	hex	mnemonic		relative	
+146	00100CD4	instr		i.X	4.64 uS
+148	00107538	write short	0000	11.i.e	2.3 uS
+149	0010753A	write short	0000	12.i.e	120 nS
+150	00100CF0	P: mov	00,r6	11.i.e	240 nS
+152	00100CF4	P: st	r6,0010765C	13.i.e	240 nS
+156	00100CFC	P: stos	g7,*****	17.i.e	520 nS
+158	00100C08	instr		i.X	1.2 uS
+160	00100D10	P: stos	g7,00108C24	11.i.e	2.4 uS
+164	00100D18	P: mov	00,r3	15.i.e	520 nS
+166	00100D1C	P: lda	00000020,g0	17.i.e	240 nS
+168	00100D20	P: cmpibge	r3,g0,00100D70	11.i.e	360 nS
+170	00100D24	P: mulo	12,r3,g1	13.i.e	240 nS
+172	00100D28	P: lda	00000041,g2	15.i.e	280 nS
+174	00100D2C	P: stis	g2,0011A000(g1)	17.i.e	240 nS
+176	00100CE0	call	to 00100D10	i.X	1.0 uS
+178	00108C24	write short	0000	11.i.e	2.3 uS

To display the trace in mnemonic format with only execution messages disassembled:

```
display trace mnemonic option  
disassemble_execution_messages <RETURN>
```

## Chapter 6: Using the Emulation Analyzer Modifying the Trace Display

Trace List		Offset=0					
Label:	Address	Opcode or Status			time count		
Base:	hex	mnemonic			relative		
+146	00100CD4	E: mov	00,r4	i.X	4.64	uS	
+148	00107538	write short	0000	11.i.e	2.3	uS	
+149	0010753A	write short	0000	12.i.e	120	nS	
+150	00100CF0	read short	1E00	11.i.e	240	nS	
+151	00100CF2	read short	5C30	12.i.e	120	nS	
+152	00100CF4	read short	3000	13.i.e	120	nS	
+153	00100CF6	read short	9230	14.i.e	160	nS	
+154	00100CF8	read short	765C	15.i.e	120	nS	
+155	00100CFA	read short	0010	16.i.e	120	nS	
+156	00100CFC	read short	3000	17.i.e	120	nS	
+157	00100CFE	read short	8AB8	18.i.e	120	nS	
+158	00100CD8	E: st	r4,00107538	i.X	1.1	uS	
+160	00100D10	read short	3000	11.i.e	2.4	uS	
+161	00100D12	read short	8AB8	12.i.e	120	nS	
+162	00100D14	read short	8C24	13.i.e	120	nS	
+163	00100D16	read short	0010	14.i.e	120	nS	

To display the trace in mnemonic format with prefetches and execution messages disassembled:

***display trace mnemonic option disassemble\_both*** <RETURN>

Trace List		Offset=0					
Label:	Address	Opcode or Status			time count		
Base:	hex	mnemonic			relative		
+146	00100CD4	E: mov	00,r4	i.X	4.64	uS	
+148	00107538	write short	0000	11.i.e	2.3	uS	
+149	0010753A	write short	0000	12.i.e	120	nS	
+150	00100CF0	P: mov	00,r6	11.i.e	240	nS	
+152	00100CF4	P: st	r6,0010765C	13.i.e	240	nS	
+156	00100CFC	P: stos	g7,*****	17.i.e	520	nS	
+158	00100CD8	E: st	r4,00107538	i.X	1.2	uS	
+160	00100D10	P: stos	g7,00108C24	11.i.e	2.4	uS	
+164	00100D18	P: mov	00,r3	15.i.e	520	nS	
+166	00100D1C	P: lda	00000020,g0	17.i.e	240	nS	
+168	00100D20	P: cmpibge	r3,g0,00100D70	11.i.e	360	nS	
+170	00100D24	P: mulo	12,r3,g1	13.i.e	240	nS	
+172	00100D28	P: lda	00000041,g2	15.i.e	280	nS	
+174	00100D2C	P: stis	g2,0011A000(g1)	17.i.e	240	nS	
+176	00100CE0	E: call	00100D10	i.X	1.0	uS	
+178	00108C24	write short	0000	11.i.e	2.3	uS	

To display the trace in mnemonic format with neither prefetches nor execution messages disassembled:

***display trace mnemonic option disassemble\_neither***  
<RETURN>

Chapter 6: Using the Emulation Analyzer  
**Modifying the Trace Display**

Trace List		Offset=0					
Label:	Address	Opcode or Status			time count		
Base:	hex	mnemonic			relative		
+146	00100C04	instr		i.X	4.64	uS	
+148	00107538	write short	0000	11.i.e	2.3	uS	
+149	0010753A	write short	0000	12.i.e	120	nS	
+150	00100CF0	read short	1E00	11.i.e	240	nS	
+151	00100CF2	read short	5C30	12.i.e	120	nS	
+152	00100CF4	read short	3000	13.i.e	120	nS	
+153	00100CF6	read short	9230	14.i.e	160	nS	
+154	00100CF8	read short	765C	15.i.e	120	nS	
+155	00100CFA	read short	0010	16.i.e	120	nS	
+156	00100CFC	read short	3000	17.i.e	120	nS	
+157	00100CFE	read short	8AB8	18.i.e	120	nS	
+158	00100C08	instr		i.X	1.1	uS	
+160	00100D10	read short	3000	11.i.e	2.4	uS	
+161	00100D12	read short	8AB8	12.i.e	120	nS	
+162	00100D14	read short	8C24	13.i.e	120	nS	
+163	00100D16	read short	0010	14.i.e	120	nS	

To display the trace in mnemonic format with only prefetches disassembled:

*display trace mnemonic option disassemble\_prefetch*  
 <RETURN>

Trace List		Offset=0					
Label:	Address	Opcode or Status			time count		
Base:	hex	mnemonic			relative		
+146	00100C04	instr		i.X	4.64	uS	
+148	00107538	write short	0000	11.i.e	2.3	uS	
+149	0010753A	write short	0000	12.i.e	120	nS	
+150	00100CF0	P: mov	00,r6	11.i.e	240	nS	
+152	00100CF4	P: st	r6,0010765C	13.i.e	240	nS	
+156	00100CFC	P: stos	g7,*****	17.i.e	520	nS	
+158	00100C08	instr		i.X	1.2	uS	
+160	00100D10	P: stos	g7,00108C24	11.i.e	2.4	uS	
+164	00100D18	P: mov	00,r3	15.i.e	520	nS	
+166	00100D1C	P: lda	00000020,g0	17.i.e	240	nS	
+168	00100D20	P: cmpibge	r3,g0,00100070	11.i.e	360	nS	
+170	00100D24	P: mulo	12,r3,g1	13.i.e	240	nS	
+172	00100D28	P: lda	00000041,g2	15.i.e	280	nS	
+174	00100D2C	P: stis	g2,0011A000(g1)	17.i.e	240	nS	
+176	00100CE0	call	to 00100D10	i.X	1.0	uS	
+178	00108C24	write short	0000	11.i.e	2.3	uS	

## To display the trace with high-level source lines

- Use the **set source** command.

To include high-level source lines in the trace display, you must use the **set** command. The **set** command allows you to include symbolic information in trace, memory, register, and software breakpoint displays. The **set** command affects all displays for the current window.

The **set source on/off/only** command allows you to include source file information in the trace list or memory mnemonic display. The **source only** option specifies that only the source file information will be displayed.

When source lines are included, comments that contain file and line information appear before the source lines.

Also, when source lines are turned on, three additional options are available in the **set** command: **inverse video**, **tabs are**, and **number of source lines**.

The **inverse\_video** option allows you to display source lines in inverse video.

The **tabs\_are** option allows you to specify the number of spaces between tab stops so that the appropriate number of spaces can be inserted for source lines. The default value is eight. Values from two to 15 can be entered.

Typically, there are lines in the source file that are not associated with actual instructions (declarations, comments, etc.). The **number\_of\_source\_lines** option allows you to specify the number of these source lines to be displayed for every source line that is associated with an actual instruction. Only source lines up to the previous source line that corresponds to actual code will be displayed. The default value is five. Values from one to 50 can be entered.

---

### Examples

To display the trace with high-level source lines:

```
set source on <RETURN>  
display trace <RETURN>
```

## Chapter 6: Using the Emulation Analyzer

### Modifying the Trace Display

```

Trace List                               Offset=0
Label:  Address      Opcode or Status w/ Source Lines      time count
Base:  _hex_        _mnemonic_                    _relative_
#####../debug_env/hp64760/init_system.c - line 66 thru 80 ####
* Returns: Nothing.
*****
void
init_val_arr()
{
+160  00100010 P: stos      g7,00108C24              11.i.e  2.4  uS
#####../debug_env/hp64760/init_system.c - line 81 thru 82 ####
      int cur_el;
      for (cur_el = 0; cur_el < NUM_OF_OLD; cur_el++)
+164  00100018 P: mov       00,r3                      15.i.e  520  nS
+166  0010001C P: lda       00000020,g0                 17.i.e  240  nS
+168  00100020 P: cmpibge  r3,g0,00100070            11.i.e  360  nS
#####../debug_env/hp64760/init_system.c - line 83 thru 84 ####
      {
          old_data[cur_el].temp = MIN_TEMP;

```

To set the number of source lines to be displayed at 12:

```

set source on number_of_source_lines 12 <RETURN>
display trace <RETURN>

```

```

Trace List                               Offset=0
Label:  Address      Opcode or Status w/ Source Lines      time count
Base:  _hex_        _mnemonic_                    _relative_
#####../debug_env/hp64760/init_system.c - line 66 thru 80 ####
*
* Description: This code initializes the val_arr data structure.
*
* Parameters: none
*
* References: None.
*
* Returns: Nothing.
*****
void
init_val_arr()
{
+160  00100010 P: stos      g7,00108C24              11.i.e  2.4  uS
#####../debug_env/hp64760/init_system.c - line 81 thru 82 ####
      int cur_el;

```

## To display the trace with symbol information

The **set symbols on/off** command allows you to specify that address information be displayed in terms of program symbols.

### Examples

To display the trace with symbol information:

```
set source off symbols on <RETURN>
display trace <RETURN>
```

Trace List		Offset=0			
Label:	Address		Opcode or Status		time count
Base:	symbols		mnemonic w/symbols	relative	
+160	ini.init_val_arr	P: stos	g7,init_syste.ini:+000	11.i.e	2.4 uS
+164	init_va+00000008	P: mov	00,r3	15.i.e	520 nS
+166	init_va+0000000C	P: lda	00000020,g0	17.i.e	240 nS
+168	init_va+00000010	P: cmpibge	r3,g0,co init_val_arr+	11.i.e	360 nS
+170	init_va+00000014	P: mulo	12,r3,g1	13.i.e	240 nS
+172	init_va+00000018	P: lda	00000041,g2	15.i.e	280 nS
+174	init_va+0000001C	P: stis	g2,0011A000(g1)	17.i.e	240 nS
+176	init_sy+00000000	call	to ini.init_val_arr	i.X	1.0 uS
+178	init_sy+00000004	write short	0000	11.i.e	2.3 uS
+179	ini.init_val_arr	instr		i.X	2.4 uS
+183	init_va+00000024	P: mulo	12,r3,g3	13.i.e	2.7 uS
+185	init_va+00000028	P: lda	00000029,g4	15.i.e	280 nS
+187	init_va+0000002C	P: stis	g4,0011A002(g3)	17.i.e	240 nS
+189	init_va+00000008	instr		i.X	1.4 uS
+191	init_va+0000000C	instr		i.X	4.60 uS
+193	init_va+00000010	instr		i.X	4.84 uS

## To change column widths in the trace display

- Use the **set width** command.

The **set width** command allows you to change the width of the address and mnemonic (or absolute) columns in the trace list. Values from one to 80 can be entered.

When address information is being displayed in terms of symbols (in other words, symbols on), you may wish to increase the width of the address column to display more of the symbol information.

When trace information is displayed in mnemonic format, you can additionally specify the width of symbols in the "Opcode or Status" column.

### Examples

To display the trace with the address column width set to 30 characters:

```
set width label 30 <RETURN>
display trace <RETURN>
```

Trace List	Offset=0	More data off screen
Label:	Address	Opcode or Status
Base:	symbols	mnemonic w/symbols
+160	code init_system.init_val_arr	P: stos g7,init_syste.ini:+000 11.i.
+164	code init_val_arr+00000008	P: mov 00,r3 15.i.
+166	code init_val_arr+0000000C	P: lda 00000020,g0 17.i.
+168	code init_val_arr+00000010	P: cmpibge r3,g0,co init_val_arr+ 11.i.
+170	code init_val_arr+00000014	P: mulo 12,r3,g1 13.i.
+172	code init_val_arr+00000018	P: lda 00000041,g2 15.i.
+174	code init_val_arr+0000001C	P: stis g2,0011A000(g1) 17.i.
+176	code init_system+00000000	call to ini.init_val_arr i.
+178	init_syste.init_syst:+00000004	write short 0000 11.i.
+179	code init_system.init_val_arr	instr i.
+183	code init_val_arr+00000024	P: mulo 12,r3,g3 13.i.
+185	code init_val_arr+00000028	P: lda 00000029,g4 15.i.
+187	code init_val_arr+0000002C	P: stis g4,0011A002(g3) 17.i.
+189	code init_val_arr+00000008	instr i.
+191	code init_val_arr+0000000C	instr i.
+193	code init_val_arr+00000010	instr i.



## To display time counts in absolute or relative format

- Use the **count** option to the **display trace** command.

Count information may be displayed two ways: relative (which is the default), or absolute. When relative is selected, count information is displayed relative to the previous state. When absolute is selected, count information is displayed relative to the trigger condition.

The **count absolute/relative** trace display option is not available when counting is turned off in the trace command.

### Examples

To display the trace with absolute time counts:

```
set default <RETURN>
```

```
display trace count absolute <RETURN>
```

Trace List		Offset=0		time count	
Label:	Address	Opcode or Status			
Base:	hex	mnemonic			absolute
+160	00100010	P: stos	g7,00108C24	11.i.e + 113.	uS
+164	00100018	P: mov	00,r3	15.i.e + 114.	uS
+166	0010001C	P: lda	00000020,g0	17.i.e + 114.	uS
+168	00100020	P: cmpibge	r3,g0,00100070	11.i.e + 114.	uS
+170	00100024	P: mulo	12,r3,g1	13.i.e + 114.	uS
+172	00100028	P: lda	00000041,g2	15.i.e + 115.	uS
+174	0010002C	P: stis	g2,0011A000(g1)	17.i.e + 115.	uS
+176	00100CE0	call	to 00100010	i.X + 116.	uS
+178	00108C24	write short	0000	11.i.e + 118.	uS
+179	00100010	instr		i.X + 121.	uS
+183	00100034	P: mulo	12,r3,g3	13.i.e + 123.	uS
+185	00100038	P: lda	00000029,g4	15.i.e + 124.	uS
+187	0010003C	P: stis	g4,0011A002(g3)	17.i.e + 124.	uS
+189	00100018	instr		i.X + 125.	uS
+191	0010001C	instr		i.X + 130.	uS
+193	00100020	instr		i.X + 135.	uS

## To display the trace with addresses offset

- Use the **offset\_by** option to the **display trace** command.

The **offset\_by** trace display option allows you to cause the address information in the trace display to be offset by the amount specified. The offset value is subtracted from the instruction's physical address to yield the address that is displayed.

If code gets relocated and therefore makes symbolic information obsolete, you can use the **offset\_by** option to change the address information so that it again agrees with the symbolic information.

You can also specify an offset to cause the listed addresses to match the addresses in compiler or assembler listings.

### Examples

To display the trace with addresses offset by 100000H:

```
display trace offset_by 100000h <RETURN>
```

Trace List		Offset=100000		
Label:	Address	Opcode or Status		time count
Base:	hex	mnemonic		absolute
+160	0000010	P: stos	g7,00008C24	11.i.e + 113. uS
+164	0000018	P: mov	00,r3	15.i.e + 114. uS
+166	000001C	P: lda	FFF00020,g0	17.i.e + 114. uS
+168	0000020	P: cmpibge	r3,g0,0000070	11.i.e + 114. uS
+170	0000024	P: mulo	12,r3,g1	13.i.e + 114. uS
+172	0000028	P: lda	FFF00041,g2	15.i.e + 115. uS
+174	000002C	P: stis	g2,0011A000(g1)	17.i.e + 115. uS
+176	00000CE0	call to	0000010	i.X + 116. uS
+178	00008C24	write short	0000	11.i.e + 118. uS
+179	0000010	instr		i.X + 121. uS
+183	0000034	P: mulo	12,r3,g3	13.i.e + 123. uS
+185	0000038	P: lda	FFF00029,g4	15.i.e + 124. uS
+187	000003C	P: stis	g4,0011A002(g3)	17.i.e + 124. uS
+189	0000018	instr		i.X + 125. uS
+191	000001C	instr		i.X + 130. uS
+193	0000020	instr		i.X + 135. uS

## To return to the default trace display

- Use the **set default** command.

The **set default** command allows you to return to the default display.

### Examples

To return to the default trace display:

```
set default <RETURN>
```

Trace List		Offset=0			
Label:	Address	Opcode or Status		time count	
Base:	hex	mnemonic		relative	
+160	00100010	P: stos	g7,00108C24	11.i.e	2.4 uS
+164	00100018	P: mov	00,r3	15.i.e	520 nS
+166	0010001C	P: lda	00000020,g0	17.i.e	240 nS
+168	00100020	P: cmpibge	r3,g0,00100070	11.i.e	360 nS
+170	00100024	P: mulo	12,r3,g1	13.i.e	240 nS
+172	00100028	P: lda	00000041,g2	15.i.e	280 nS
+174	0010002C	P: stis	g2,0011A000(g1)	17.i.e	240 nS
+176	00100CE0	call	to 00100010	i.X	1.0 uS
+178	00108C24	write short	0000	11.i.e	2.3 uS
+179	00100010	instr		i.X	2.4 uS
+183	00100034	P: mulo	12,r3,g3	13.i.e	2.7 uS
+185	00100038	P: lda	00000029,g4	15.i.e	280 nS
+187	0010003C	P: stis	g4,0011A002(g3)	17.i.e	240 nS
+189	00100018	instr		i.X	1.4 uS
+191	0010001C	instr		i.X	4.60 uS
+193	00100020	instr		i.X	4.84 uS

## To display external analyzer information (HP 64705 Only)

- Use the **external** option to the **display trace** command.

The **external** trace display option allows you to include data from the external analyzer in the trace list. External bits are displayed by default. If you do not wish to have the external bits information in the display, you can turn them off.

The bits associated with the external analyzer labels may be displayed in binary or hexadecimal format. Labels must be defined in the external analyzer configuration (and prior to trace command entry) before they appear as softkey selections when displaying the trace. Refer to the "To define labels for the external analyzer signals" description in the "Using the External State Analyzer" chapter.

Note that the **external** option to the **display trace external** is also used to change the number bases of the **bysize**, **memmap**, and **waitcnt** internal trace labels.

### Examples

To display the "xbits" column in binary format:

```
display trace external xbits binary <RETURN>
```

Trace List		Offset=0		More data off screen	
Label:	Opcode or Status		time count		xbits
Base:	mnemonic		relative		binary
+049	perand 00107658	144.c.i.e	120	nS	0000000000000000
+050	te word 00000000	111.c.i.e	260	nS	0000000000000000
+051	te word 00000000	111.c.i.e	240	nS	0000000000000000
+052	00, r6	141.c.i.e	260	nS	0000000000000000
+053	r6, 0010765C	142.c.i.e	120	nS	0000000000000000
+054	perand 0010765C	143.c.i.e	120	nS	0000000000000000
+055	s g7, *****	144.c.i.e	140	nS	0000000000000000
+056	s g7, 00108C24	141.c.i.e	240	nS	0000000000000000
+057	perand 00108C24	142.c.i.e	120	nS	0000000000000000
+058	00, r3	143.c.i.e	140	nS	0000000000000000
+059	00000020, g0	144.c.i.e	120	nS	0000000000000000
+060	te short xxxx0000	111.c.i.e	240	nS	0000000000000000
+061	ibge r3, g0, 00100D70	141.c.i.e	260	nS	0000000000000000
+062	o 12, r3, g1	142.c.i.e	120	nS	0000000000000000
+063	00000041, g2	143.c.i.e	120	nS	0000000000000000
+064	s g2, 0011A000(g1)	144.c.i.e	140	nS	0000000000000000

## Saving and Restoring Traces

The emulator/analyzer interface allow you to save trace commands and trace lists. You can restore trace commands in order to set up the same trace specification. You can restore traces in order to view trace data captured in the stored trace.

This section describes how to:

- Save trace commands.
- Restore trace commands.
- Save traces.
- Restore traces.

---

### To save trace commands

- Choose **File**→**Store**→**Trace Spec**.
- Using the command line, enter the **store trace\_spec** command.

You can save a trace command to a "trace specification" file and reload it at a later time.

The trace command is saved in a file named "tspecfile.TS" in the current directory. The extension ".TS" is appended to trace specification files if no extension is specified in the **store trace\_spec** command.

---

#### Examples

To store the current trace command:

```
store trace_spec tspecfile <RETURN>
```

## To restore trace commands

- Choose **File**→**Load**→**Trace Spec**.
- Using the command line, enter the **load trace\_spec** command.

Trace commands that are restored will always work, even if symbols have been changed; however, once you modify the trace command, it may no longer work.

Loading a trace specification does not start the trace; to do this, you must enter the trace command either by selecting it from the Trace Specification Selection dialog box or by using the **Trace**→**Again** pulldown menu item.

---

### Examples

To bring back the trace command saved in "tspecfile.TS" and perform a trace measurement using it:

```
load trace_spec tspecfile <RETURN>
```

```
trace again <RETURN>
```

## To save traces

- Choose **File**→**Store**→**Trace Data**.
- Using the command line, enter the **store trace** command.

You can save a trace to a trace file and reload it at a later time.

The trace is saved in a file named "trcfile.TR" in the current directory. The extension ".TR" is appended to trace files if it is not specified in the **store trace** command.

---

### Examples

To store the current trace:

```
store trace trcfile <RETURN>
```

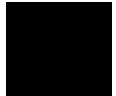

## To restore traces

- Choose **File**→**Load**→**Trace Data**.
- Using the command line, enter the **load trace** command.

The restored trace depth is the depth specified when the trace was stored and cannot be increased. You may want to increase the trace depth before storing traces.

When a trace is loaded, the trace command is not restored. A **trace again** or **trace modify** command will use the last trace command entered, not the command which resulted in the loaded trace. Also, the trace status shown by the **display status** command does not reflect the loaded trace.



---

### Examples

To restore the "trcfile.TR" trace file:

```
load trace trcfile <RETURN>
```

The trace information stored in "trcfile.TR" is restored. You can view the trace as you would any other trace.



---

**7**



---

**Making Software Performance  
Measurements**

---

## Making Software Performance Measurements

The Software Performance Measurement Tool (SPMT) is a feature of the Softkey Interface that allows you to make software performance measurements on your programs.

The SPMT allows you to make some of the measurements that are possible with the HP 64708 Software Performance Analyzer and its Graphical User Interface (HP B1487).

The SPMT post-processes information from the analyzer trace list. When you end a performance measurement, the SPMT dumps the post-processed information to a binary file, which is then read using the **perf32** report generator utility.

Two types of software performance measurements can be made with the SPMT: activity measurements, and duration measurements.

This chapter describes tasks you perform while using the Software Performance Measurement Tool (SPMT). These tasks are grouped into the following sections:

- Activity performance measurements.
- Duration performance measurements.
- Running performance measurements and creating reports.

## Activity Performance Measurements

Activity measurements are measurements of the number of accesses (reads or writes) within an address range. The SPMT shows you the percentage of analyzer trace states that are in the specified address range, as well as the percentage of time taken by those states. Two types of activity are measured: memory activity, and program activity.

Memory activity is all activity that occurs within the address range.

Program activity is the activity caused by instruction execution in the address range. Program activity includes opcode fetches and the cycles that result from the execution of those instructions (reads and writes to memory, stack pushes, etc.).

For example, suppose an address range being measured for activity contains an opcode that causes a stack push, which results in multiple write operations to the stack area (outside the range). The memory activity measurement will count only the stack push opcode cycle. However, the program activity measurement will count the stack push opcode cycle and the write operations to the stack.

By comparing the program activity and the memory activity in an address range, you can get an idea of how much activity in other areas is caused by the code being measured. An activity measurement report of the code (prog), data, and stack sections of a program is shown below.

```
Label
prog
Address Range      ADEH thru      1261H

Memory Activity
  State Percent    Rel =  57.77    Abs =  57.77
                  Mean = 295.80    Sdv =  26.77
  Time  Percent    Rel =  60.97    Abs =  60.97

Program Activity
  State Percent    Rel =  99.82    Abs =  99.82
                  Mean = 511.10    Sdv =   0.88
  Time  Percent    Rel =  99.84    Abs =  99.84

data
Address Range      6007AH thru     603A5H

Memory Activity
  State Percent    Rel =  30.51    Abs =  30.51
                  Mean = 156.20    Sdv =  31.87
  Time  Percent    Rel =  28.09    Abs =  28.09
```

## Chapter 7: Making Software Performance Measurements

### Activity Performance Measurements

```

Program Activity
  State Percent  Rel =   0.18  Abs =   0.18
                  Mean =   0.90  Sdv =   0.88
  Time Percent  Rel =   0.16  Abs =   0.16

stack
Address Range      40000H thru   43FFFH

Memory Activity
  State Percent  Rel =  11.72  Abs =  11.72
                  Mean =  60.00  Sdv =  29.24
  Time Percent  Rel =  10.94  Abs =  10.94

Program Activity
  State Percent  Rel =   0.00  Abs =   0.00
                  Mean =   0.00  Sdv =   0.00
  Time Percent  Rel =   0.00  Abs =   0.00

Graph of Memory Activity relative state percents >= 1
prog      57.77% *****
data     30.51% *****
stack    11.72% *****

Graph of Memory Activity relative time percents >= 1
prog      60.97% *****
data     28.09% *****
stack    10.94% *****

Graph of Program Activity relative state percents >= 1
prog     99.82% *****

Graph of Program Activity relative time percents >= 1
prog     99.84% *****

Summary Information for      10 traces

Memory Activity
State count
  Relative count      5120
  Mean sample        170.67
  Mean Standard Dv   29.30
  95% Confidence 12.28% Error tolerance
Time count
  Relative Time - Us 2221.20

Program Activity
State count
  Relative count      5120
  Mean sample        170.67
  Mean Standard Dv   0.58
  95% Confidence 0.24% Error tolerance
Time count
  Relative Time - Us 2221.20
Absolute Totals

```

## Chapter 7: Making Software Performance Measurements

### Activity Performance Measurements

```
Absolute count - state      5120  
Absolute count - time - Us 2221.20
```

This section describes how to:

- Set up the trace command for activity measurements.
- Initialize activity performance measurements.
- Interpret activity measurement reports.

---

### To set up the trace command for activity measurements

- 1 Turn on instruction execution messages.
- 2 Specify the maximum trace display depth with counting turned on (this is 512 when using the 80960SA/SB emulator with the HP 64704 analyzer or 1024 when using the 80960KA/KB/MC emulator with the HP 64705 analyzer).
- 3 Trace after any state, store all states, and count time.

Before you initialize and run performance measurements, the current trace command (in other words, the last trace command entered) must be properly set up.

In general, you want to give the SPMT as many trace states as possible to post-process, so you should increase the trace depth to the maximum number, as shown in the following command.

If you wish to measure activity as a percentage of all activity, the current trace command should be the default (in other words, **trace <RETURN>**). The default trace command triggers on any state, and all captured states are stored. It is important that time be counted by the analyzer; otherwise, the SPMT measurements will not be correct. Also, since states are stored "after" the trigger state, the maximum number of captured states appears in each trace list.

You can qualify trace commands any way you like to obtain specific information. However, when you qualify the states that get stored in the trace memory, your

## Chapter 7: Making Software Performance Measurements

### Activity Performance Measurements

SPMT results will be biased by your qualifications; the percentages shown will be of only those states stored in the trace list.

---

#### Examples

To turn ON instruction execution messages:

```
modify execution_messages clear <RETURN>  
modify execution_messages set instruction <RETURN>
```

To specify a trace depth of 512:

```
display trace depth 512 <RETURN>
```

To trace after any state, store all states, and count time:

```
trace counting time <RETURN>
```

---

## To initialize activity performance measurements

- Use the `performance_measurement_initialize` command.

After you set up the trace command, you must tell the SPMT the address ranges on which you wish to make activity measurements. This is done by initializing the performance measurement. You can initialize the performance measurement in the following ways:

- Default initialization (using global symbols if the symbols database is loaded).
- Initialize with user-defined files.
- Initialize with global symbols.
- Initialize with local symbols.
- Restore a previous performance measurement (if the emulation system has been exited and reentered).

### Default Initialization

Entering the **performance\_measurement\_initialize** command with no options specifies an activity measurement. If a valid symbolic database has been loaded, the addresses of all global procedures and static symbols will be used; otherwise, a default set of ranges that cover the entire processor address range will be used.

### Initialization with User Defined Ranges

You can specifically give the SPMT address ranges to use by placing the information in a file and entering the file name in the **performance\_measurement\_initialize** command.

Address range files may contain program symbols (procedure name or static), user defined address ranges, and comments. An example address range file is shown below.

```
# Any line which starts with a # is a comment.
# All user's labels must be preceded by a "|".

|users_label 10H 1000H
program_symbol

# A program symbol can be a procedure name or a static. In the case of a pro-
# cedure name the range of that procedure will be used.

|users_label2 program_symbol1 -> program_symbol2

# "->" means thru. The above will define a range which starts with symbol1
# and goes thru symbol2. If both symbols are procedures then the range will
# be defined as the start of symbol1 thru the end of symbol2.

dirl/dir2/source_file.s:local_symbol

# The above defines a range based on the address of local_symbol.
```

### Initialization with Global Symbols

When the **performance\_measurement\_initialize** command is entered with no options or with the **global\_symbols** option, the global symbols in the symbols database become the address ranges for which activity is measured. If the symbols database is not loaded, a default set of ranges that cover the entire processor address range will be used.

The global symbols database contains procedure symbols, which are associated with the address range from the beginning of the procedure to the end, and static symbols, which are associated with the address of the static variable.

### Initialization with Local Symbols

When the **performance\_measurement\_initialize** command is entered with the **local\_symbols\_in** option and a source file name, the symbols associated with that source file become the address ranges for which activity is measured. If the symbols database is not loaded, an error message will occur telling you that the source filename symbol was not found.

You can also use the **local\_symbols\_in** option with procedure symbols; this allows you to measure activity related to the symbols defined in a single function or procedure.

### Restoring the Current Measurement

The **performance\_measurement\_initialize restore** command allows you to restore old performance measurement data from the **perf.out** file in the current directory.

If you have not exited and reentered emulation, you can add traces to a performance measurement simply by entering another **performance\_measurement\_run** command. However, if you exit and reenter the emulation system, you must enter the **performance\_measurement\_initialize restore** command before you can add traces to a performance measurement. When you restore a performance measurement, make sure your current trace command is identical to the command used with the restored measurement.

The **restore** option checks the emulator software version and will only work if the **perf.out** files you are restoring were made with the same software version as is presently running in the emulator. If you ran tests using a former software version and saved **perf.out** files, then updated your software to a new version number, you will not be able to restore old **perf.out** measurement files.



---

**Examples**

Suppose the "addr\_ranges" file contains the names of all the functions in the "ecs" demo program loop:

```
combsort  
do_sort  
gen_ascii_data  
get_targets  
graph_data  
interrupt_sim  
proc_specific  
read_conditions  
save_points  
set_outputs  
strcpy8  
update_system  
write_hwdr
```

Since these labels are program symbols, you do not have to specify the address range associated with each label; the SPMT will search the symbol database for the addresses of each label.

An easy way to create the "addr\_ranges" file is to use the **copy global\_symbols** command to copy the global symbols to a file named "addr\_ranges"; then, fork a shell to UNIX (by entering "! <RETURN>" on the Softkey Interface command line) and edit the file so that it contains the procedure names shown above. Enter a <CTRL>d at the UNIX prompt to return to the Softkey Interface.

To initialize the activity measurement with a user-defined address range file:

```
performance_measurement_initialize addr_ranges <RETURN>
```

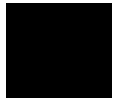

## To interpret activity measurement reports

- View the performance measurement report.

Activity measurements are measurements of the number of accesses (reads or writes) within an address range. The reports generated for activity measurements show you the percentage of analyzer trace states that are in the specified address range, as well as the percentage of time taken by those states. The performance measurement must include four traces before statistics (mean and standard deviation) appear in the activity report. The information you will see in activity measurement reports is described below.

**Memory Activity** All activity found within the address range.

**Program Activity** All activity caused by instruction execution in the address range. Program activity includes opcode fetches and the cycles that result from the execution of those instructions (reads and writes to memory, stack pushes, etc.).

**Relative** With respect to activity in all ranges defined in the performance measurement.

**Absolute** With respect to all activity, not just activity in those ranges defined in the performance measurement.

**Mean** Average number of states in the range per trace. The following equation is used to calculate the mean:

$$mean = \frac{states\ in\ range}{total\ states}$$

**Standard Deviation** Deviation from the mean of state count. The following equation is used to calculate standard deviation:

$$std\ dev = \sqrt{\frac{1}{N-1} \times \sum_{i=1}^N S_{sumq} - N (mean)^2}$$

Where:

- N                                      Number of traces in the measurement.
- mean                                    Average number of states in the range per trace.
- S<sub>sumq</sub>                                    Sum of squares of states in the range per trace.

**Symbols Within Range** Names of other symbols that identify addresses or ranges of addresses within the range of this symbol.

**Additional Symbols for Address** Names of other symbols that also identify this address.

Note that some compilers emit more than one symbol for certain addresses. For example, a compiler may emit "interrupt\_sim" and "\_interrupt\_sim" for the first address in a routine named interrupt\_sim. The analyzer will show the first symbol it finds to represent a range of addresses, or a single address point, and it will show the other symbols under either "Symbols within range" or "Additional symbols for address", as applicable. In the "interrupt\_sim" example, it may show either "interrupt\_sim" or "\_interrupt\_sim" to represent the range, depending on which symbol it finds first. The other symbol will be shown below "Symbols within range" in the report. These conditions appear particularly in default measurements that include all global and local symbols.

**Relative and Absolute Counts** Relative count is the total number of states associated with the address ranges in the performance measurement. Relative time is the total amount of time associated with the address ranges in the performance measurement. The absolute counts are the number of states or amount of time associated with all the states in all the traces.

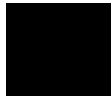

## Chapter 7: Making Software Performance Measurements

### Activity Performance Measurements

**Error Tolerance and Confidence Level** An approximate error may exist in displayed information. Error tolerance for a level of confidence is calculated using the mean of the standard deviations and the mean of the means. Error tolerance gives an indication of the stability of the information. For example, if the error is 5% for a confidence level of 95%, then you can be 95% confident that the information has an error of 5% or less.

The Student's "T" distribution is used in these calculations because it improves the accuracy for small samples. As the size of the sample increases, the Student's "T" distribution approaches the normal distribution.

The following equation is used to calculate error tolerance:

$$\text{error pct.} = \frac{O_m \times t}{N \times P_m} \times 100$$

Where:

$O_m$	Mean of the standard deviations.
$t$	Table entry in Student's "T" table for a given confidence level.
$N$	Number of traces in the measurement.
$P_m$	Mean of the means (i.e., mean sample).

---

### Examples

Consider the following activity measurement report (generated with the commands shown):

```
modify execution_messages clear <RETURN>
modify execution_messages set instruction <RETURN>
display trace depth 512 <RETURN>
trace counting time <RETURN>
performance_measurement_initialize addr_ranges <RETURN>
performance_measurement_run 20 <RETURN>
performance_measurement_end <RETURN>
!perf32 | more
```

## Chapter 7: Making Software Performance Measurements

### Activity Performance Measurements

```
Label
set_outputs
  Address Range    1013C0H thru  1016CFH

  Memory Activity
    State Percent  Rel =  30.05  Abs =  30.00
                    Mean = 153.60  Sdv = 240.72
    Time  Percent  Rel =  28.75  Abs =  28.73

  Program Activity
    State Percent  Rel =  26.22  Abs =  24.38
                    Mean = 124.80  Sdv = 198.84
    Time  Percent  Rel =  24.20  Abs =  22.29

write_hdwr
  Address Range    1016D0H thru  101973H

  Memory Activity
    State Percent  Rel =  30.05  Abs =  30.00
                    Mean = 153.60  Sdv = 240.72
    Time  Percent  Rel =  30.82  Abs =  30.80

  Program Activity
    State Percent  Rel =  25.64  Abs =  23.83
                    Mean = 122.00  Sdv = 195.83
    Time  Percent  Rel =  25.75  Abs =  23.72

proc_specific
  Address Range    102060H thru  10229BH

  Memory Activity
    State Percent  Rel =  24.87  Abs =  24.82
                    Mean = 127.10  Sdv = 225.86
    Time  Percent  Rel =  25.42  Abs =  25.40

  Program Activity
    State Percent  Rel =  19.13  Abs =  17.78
                    Mean =  91.05  Sdv = 164.45
    Time  Percent  Rel =  18.89  Abs =  17.40

do_sort
  Address Range    1009B0H thru  100C57H

  Memory Activity
    State Percent  Rel =  10.02  Abs =  10.00
                    Mean =  51.20  Sdv = 157.59
    Time  Percent  Rel =  10.32  Abs =  10.32

  Program Activity
    State Percent  Rel =   6.56  Abs =   6.09
                    Mean =  31.20  Sdv =  96.17
    Time  Percent  Rel =   6.32  Abs =   5.82

get_targets
```

## Chapter 7: Making Software Performance Measurements

### Activity Performance Measurements

Address Range 100E40H thru 10111FH

#### Memory Activity

State	Percent	Rel =	5.01	Abs =	5.00
		Mean =	25.60	Sdv =	114.49
Time	Percent	Rel =	4.69	Abs =	4.69

#### Program Activity

State	Percent	Rel =	3.97	Abs =	3.69
		Mean =	18.90	Sdv =	84.52
Time	Percent	Rel =	3.46	Abs =	3.19

combsort

Address Range 1006D0H thru 1009ABH

#### Memory Activity

State	Percent	Rel =	0.00	Abs =	0.00
		Mean =	0.00	Sdv =	0.00
Time	Percent	Rel =	0.00	Abs =	0.00

#### Program Activity

State	Percent	Rel =	0.00	Abs =	0.00
		Mean =	0.00	Sdv =	0.00
Time	Percent	Rel =	0.00	Abs =	0.00

gen\_ascii\_data

Address Range 100380H thru 1006C3H

#### Memory Activity

State	Percent	Rel =	0.00	Abs =	0.00
		Mean =	0.00	Sdv =	0.00
Time	Percent	Rel =	0.00	Abs =	0.00

#### Program Activity

State	Percent	Rel =	4.20	Abs =	3.91
		Mean =	20.00	Sdv =	61.78
Time	Percent	Rel =	4.87	Abs =	4.49

graph\_data

Address Range 101D10H thru 101E17H

#### Memory Activity

State	Percent	Rel =	0.00	Abs =	0.00
		Mean =	0.00	Sdv =	0.00
Time	Percent	Rel =	0.00	Abs =	0.00

#### Program Activity

State	Percent	Rel =	1.41	Abs =	1.31
		Mean =	6.70	Sdv =	29.96
Time	Percent	Rel =	1.63	Abs =	1.50

interrupt\_sim

Address Range 100060H thru 100107H

#### Memory Activity

Chapter 7: Making Software Performance Measurements  
Activity Performance Measurements

```
State Percent Rel = 0.00 Abs = 0.00
Mean = 0.00 Sdv = 0.00
Time Percent Rel = 0.00 Abs = 0.00

Program Activity
State Percent Rel = 0.00 Abs = 0.00
Mean = 0.00 Sdv = 0.00
Time Percent Rel = 0.00 Abs = 0.00

read_conditions
Address Range 101120H thru 1013B7H

Memory Activity
State Percent Rel = 0.00 Abs = 0.00
Mean = 0.00 Sdv = 0.00
Time Percent Rel = 0.00 Abs = 0.00

Program Activity
State Percent Rel = 6.82 Abs = 6.34
Mean = 32.45 Sdv = 65.27
Time Percent Rel = 7.90 Abs = 7.28

save_points
Address Range 101980H thru 101D03H

Memory Activity
State Percent Rel = 0.00 Abs = 0.00
Mean = 0.00 Sdv = 0.00
Time Percent Rel = 0.00 Abs = 0.00

Program Activity
State Percent Rel = 0.00 Abs = 0.00
Mean = 0.00 Sdv = 0.00
Time Percent Rel = 0.00 Abs = 0.00

strcpy8
Address Range 100110H thru 10037BH

Memory Activity
State Percent Rel = 0.00 Abs = 0.00
Mean = 0.00 Sdv = 0.00
Time Percent Rel = 0.00 Abs = 0.00

Program Activity
State Percent Rel = 6.05 Abs = 5.62
Mean = 28.80 Sdv = 57.61
Time Percent Rel = 6.98 Abs = 6.43

update_system
Address Range 100D80H thru 100E3FH

Memory Activity
State Percent Rel = 0.00 Abs = 0.00
Mean = 0.00 Sdv = 0.00
Time Percent Rel = 0.00 Abs = 0.00
```

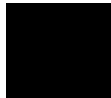

## Chapter 7: Making Software Performance Measurements

### Activity Performance Measurements

```

Program Activity
  State Percent Rel = 0.00 Abs = 0.00
                Mean = 0.00 Sdv = 0.00
  Time Percent Rel = 0.00 Abs = 0.00

```

```

Graph of Memory Activity relative state percents >= 1
set_outputs      30.05% *****
write_hdwr       30.05% *****
proc_specific    24.87% *****
do_sort          10.02% *****
get_targets      5.01% ***

```

```

Graph of Memory Activity relative time percents >= 1
set_outputs      28.75% *****
write_hdwr       30.82% *****
proc_specific    25.42% *****
do_sort          10.32% *****
get_targets      4.69% ***

```

```

Graph of Program Activity relative state percents >= 1
set_outputs      26.22% *****
write_hdwr       25.64% *****
proc_specific    19.13% *****
do_sort          6.56% ****
get_targets      3.97% **
gen_ascii_data   4.20% **
graph_data       1.41% *
read_conditions  6.82% ****
strcpy8          6.05% ***

```

```

Graph of Program Activity relative time percents >= 1
set_outputs      24.20% *****
write_hdwr       25.75% *****
proc_specific    18.89% *****
do_sort          6.32% ***
get_targets      3.46% **
gen_ascii_data   4.87% ***
graph_data       1.63% *
read_conditions  7.90% ****
strcpy8          6.98% ****

```

Summary Information for 20 traces

```

Memory Activity
State count
  Relative count 10222
  Mean sample   39.32
  Mean Standard Dv 75.34
  95% Confidence 89.72% Error tolerance
Time count
  Relative Time - Us 20210.20

```



## Chapter 7: Making Software Performance Measurements

### Activity Performance Measurements

```
Program Activity
State count
  Relative count      9518
  Mean sample        36.61
  Mean Standard Dv  73.42
  95% Confidence 93.91% Error tolerance
Time count
  Relative Time - Us 18632.80
Absolute Totals
  Absolute count - state      10240
  Absolute count - time - Us 20222.60
```

The measurements for each label are printed in descending order according to the amount of activity. You can see that the `set_outputs` function has the most activity. Also, you can see that no activity is recorded for several of the functions. The histogram portion of the report compares the activity in the functions that account for at least 1% of the activity for all labels defined in the measurement.

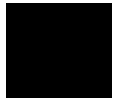

## Duration Performance Measurements

Duration measurements provide a best-case/worst-case characterization of code execution time. These measurements record execution times that fall within a set of specified time ranges. The analyzer trace command is set up to store only the entry and exit states of the module to be measured (for example, a C function or Pascal procedure). The SPMT provides two types of duration measurements: module duration, and module usage.

Module duration measurements record how much time it takes to execute a particular code segment (for example, a function in the source file).

Module usage shows how much of the execution time is spent outside of the module (from exit to entry). This measurement gives an indication of how often the module is being used.

When using the SPMT to perform duration measurements, there should be only two addresses stored in the trace memory: the entry address, and the exit address. Recursion can place several entry addresses before the first exit address, and/or several exit addresses before the first entry address. Duration measurements are made between the last entry address in a series of entry addresses, and the last exit address in a series of exit addresses (see the figure below). All of the entry and exit addresses which precede these last addresses are assumed to be unused prefetches, and are ignored during time measurements.

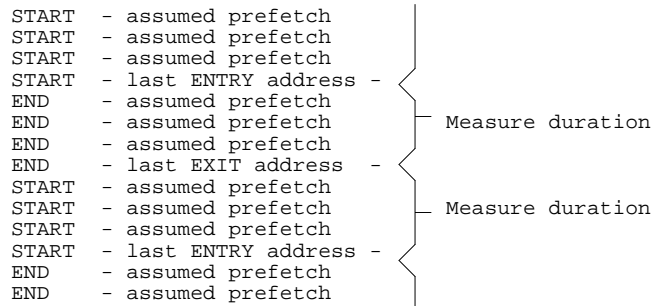

When measuring a recursive function, module duration will be measured between the last recursive call and the true end of the recursive execution. This will affect the accuracy of the measurement.

## Chapter 7: Making Software Performance Measurements

### Duration Performance Measurements

If a module is entered at the normal point, and then exited by a point other than the defined exit point, the entry point will be ignored. It will be judged the same as any other unused prefetch, and no time-duration measurement will be made. Its time will be included in the measure of time spent outside the procedure or function.

If a module is exited from the normal point, and then reentered from some other point, the exit will also be assumed to be an unused prefetch of the exit state.

Note that if you are making duration measurements on a function that is recursive, or one that has multiple entry and/or exit points, you may wind up with invalid information.

This section describes how to:

- Set up the trace command for duration measurements.
- Initialize duration performance measurements.
- Interpret duration measurement reports.

---

### To set up the trace command for duration measurements

- 1 Turn on only call and return execution messages.
- 2 Specify the maximum trace display depth with counting turned on (this is 512 when using the 80960SA/SB emulator with the HP 64704 analyzer or 1024 when using the 80960KA/KB/MC emulator with the HP 64705 analyzer).
- 3 Trace after and store only function start and end addresses.

For duration measurements, the trace command must be set up to store only the entry and exit points of the module of interest. Since the trigger state is always stored, you should trigger on the entry or exit points. For example:

```
trace after symbol_entry or symbol_exit only  
symbol_entry or symbol_exit counting time <RETURN>
```

## Chapter 7: Making Software Performance Measurements

### Duration Performance Measurements

---

#### CAUTION

The previous command depends on the generation of correct exit address symbols by the software development tools.

Or:

```
trace after module_name start or module_name end only  
module_name start or module_name end counting time  
<RETURN>
```

Where "symbol\_entry" and "symbol\_exit" are symbols from the user program. Or, where "module\_name" is the name of a C function or Pascal procedure (and is listed as a procedure symbol in the global symbol display).

---

#### Examples

To turn ON call and return execution messages:

```
modify execution_messages clear <RETURN>  
modify execution_messages set call return <RETURN>
```

To specify a trace display depth of 512:

```
display trace depth 512 <RETURN>
```

To set up the trace command for duration measurements on the interrupt\_sim function:

```
trace after interrupt_sim start status call and exec_to  
or interrupt_sim end status return and exec_at only  
interrupt_sim start status call and exec_to or  
interrupt_sim end status return and exec_at counting  
time <RETURN>
```

The trace specification sets up the analyzer to capture only the states that contain the start address of the interrupt\_sim function or the end address of the interrupt\_sim function. Since the trigger state is also stored, the analyzer is set up to trigger on the entry or exit address of the interrupt\_sim function. With these states in memory, the analyzer will derive two measurements: time from start to end of interrupt\_sim, and time from end to start of interrupt\_sim.

## To initialize duration performance measurements

- Use the **performance\_measurement\_initialize** command with the **duration** option.

After you set up the trace command, you must tell the SPMT the time ranges to be used in the duration measurement. This is done by initializing the performance measurement. You can initialize the performance measurement in the following ways:

- Initialize with user-defined files.
- Restore a previous performance measurement (if the emulation system has been exited and reentered).

### Initialization with User Defined Ranges

You can specifically give the SPMT time ranges to use by placing the information in a file and entering the file name in the **performance\_measurement\_initialize** command.

Time range files may contain comments and time ranges in units of microseconds (us), milliseconds (ms), or seconds (s). An example time range file is shown below.

```
# Any line which starts with a # is a comment.  
  
1 us 20 us  
10.1 ms 100.6 ms  
3.55 s 6.77 s  
  
# us microseconds  
# ms milliseconds  
# s seconds  
#  
# The above are the only abbreviations allowed. The space between the number  
# and the units abbreviation is required.
```

## Chapter 7: Making Software Performance Measurements

### Duration Performance Measurements

When no user defined time range file is specified, the following set of default time ranges are used.

```
1 us 10 us
10.1 us 100 us
100.1 us 500 us
500.1 us 1 ms
1.001 ms 5 ms
5.001 ms 10 ms
10.1 ms 20 ms
20.1 ms 40 ms
40.1 ms 80 ms
80.1 ms 160 ms
160.1 ms 320 ms
320.1 ms 640 ms
640.1 ms 1.2 s
```

### Restoring the Current Measurement

The **performance\_measurement\_initialize restore** command allows you to restore old performance measurement data from the **perf.out** file in the current directory.

If you have not exited and reentered emulation, you can add traces to a performance measurement simply by entering another **performance\_measurement\_run** command. However, if you exit and reenter the emulation system, you must enter the **performance\_measurement\_initialize restore** command before you can add traces to a performance measurement. When you restore a performance measurement, make sure your current trace command is identical to the command used with the restored measurement.

The **restore** option checks the emulator software version and will only work if the **perf.out** files you are restoring were made with the same software version as is presently running in the emulator. If you ran tests using a former software version and saved **perf.out** files, then updated your software to a new version number, you will not be able to restore old **perf.out** measurement files.

---

### Examples

To initialize the duration measurement:

```
performance_measurement_initialize duration <RETURN>
```

## To interpret duration measurement reports

- View the performance measurement report.

Duration measurements provide a best-case/worst-case characterization of code execution time. These measurements record execution times that fall within a set of specified time ranges. The information you will see in duration measurement reports is described below.

**Number of Intervals** Number of "from address" and "to address" pairs (after prefetch correction).

**Maximum Time** The greatest amount of time between the "from address" to the "to address".

**Minimum Time** The shortest amount of time between the "from address" to the "to address".

**Average Time** Average time between the "from address" and the "to address". The following equation is used to calculate the average time:

$$mean = \frac{\text{amount of time for all intervals}}{\text{number of intervals}}$$

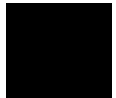

Chapter 7: Making Software Performance Measurements  
**Duration Performance Measurements**

**Standard Deviation** Deviation from the mean of time. The following equation is used to calculate standard deviation:

$$std\ dev = \sqrt{\frac{1}{N-1} \times \sum_{i=1}^N S_{sumq} - N (mean)^2}$$

Where:

- N                                      Number of intervals.
- mean                                    Average time.
- S<sub>sumq</sub>                                Sum of squares of time in the intervals.

**Error Tolerance and Confidence Level** An approximate error may exist in displayed information. Error tolerance for a level of confidence is calculated using the mean of the standard deviations and the mean of the means. Error tolerance gives an indication of the stability of the information. For example, if the error is 5% for a confidence level of 95%, then you can be 95% confident that the information has an error of 5% or less.

The Student's "T" distribution is used in these calculations because it improves the accuracy for small samples. As the size of the sample increases, the Student's "T" distribution approaches the normal distribution.

The following equation is used to calculate error tolerance:

$$error\ pct. = \frac{O_m \times t}{N \times P_m} \times 100$$

Where:

- O<sub>m</sub>                                      Mean of the standard deviations in each time range.
- t                                         Table entry in Student's "T" table for a given confidence level.
- N                                        Number of intervals.



## Chapter 7: Making Software Performance Measurements

### Duration Performance Measurements

$P_m$  Mean of the means (i.e., mean of the average times in each time range).

#### Examples

Consider the following duration measurement report (generated with the commands shown):

```
modify execution_messages clear <RETURN>
modify execution_messages set call return <RETURN>
display trace depth 512 <RETURN>
trace after interrupt_sim start or interrupt_sim end
only interrupt_sim start or interrupt_sim end counting
time <RETURN>
performance_measurement_initialize duration <RETURN>
performance_measurement_run 10 <RETURN>
performance_measurement_end <RETURN>
!perf32 | more
```

Time Interval Profile

```
From Address 100060
      File main(module)."/usr/hp64000/demo/debug_env/hp64760/main.c"
      Symbolic Reference at main.interrupt_sim
To Address 100104
      File main(module)."/usr/hp64000/demo/debug_env/hp64760/main.c"
      Symbolic Reference at interrupt_sim+A4
Number of intervals 2550
Maximum Time 227983.360 us
Minimum Time 23.160 us
Avg Time 31746.513 us
```

```
Statistical summary - for 10 traces
      Stdv 59321.86
      95% Confidence 7.25% Error tolerance
```

```
Graph of relative percents
1 us 10 us 0.00%
10.1 us 100 us 14.98% *****
100.1 us 500 us 15.06% *****
500.1 us 1 ms 15.02% *****
1.001 ms 5 ms 30.08% *****
5.001 ms 10 ms 0.00%
10.1 ms 20 ms 0.00%
20.1 ms 40 ms 0.00%
40.1 ms 80 ms 4.98% ***
80.1 ms 160 ms 14.94% *****
```

## Chapter 7: Making Software Performance Measurements

### Duration Performance Measurements

```
160.1 ms 320 ms          4.94%  ***
320.1 ms 640 ms          0.00%
640.1 ms 1.2 s           0.00%
```

```
From Address  100104
              File main(module)."/usr/hp64000/demo/debug_env/hp64760/main.c"
              Symbolic Reference at interrupt_sim+A4
To Address    100060
              File main(module)."/usr/hp64000/demo/debug_env/hp64760/main.c"
              Symbolic Reference at main.interrupt_sim
Number of intervals  2550
Maximum Time 192102.400 us
Minimum Time 190300.160 us
Avg Time     190741.179 us
```

```
Statistical summary - for      10 traces
                      Stdv 774.96
                      95% Confidence 0.02% Error tolerance
```

Graph of relative percents

```
1 us 10 us          0.00%
10.1 us 100 us      0.00%
100.1 us 500 us     0.00%
500.1 us 1 ms       0.00%
1.001 ms 5 ms       0.00%
5.001 ms 10 ms      0.00%
10.1 ms 20 ms       0.00%
20.1 ms 40 ms       0.00%
40.1 ms 80 ms       0.00%
80.1 ms 160 ms      0.00%
160.1 ms 320 ms     100.00% *****
320.1 ms 640 ms     0.00%
640.1 ms 1.2 s      0.00%
```

Two sets of information are given in the duration measurement report: module duration and module usage.

The first set of information in the duration measurement report is the "module duration" measurement. The module duration report shows that the amount of time it takes for the `interrupt_sim` function to execute varies from 23 microseconds to 228 milliseconds. The average amount of time it takes for the `interrupt_sim` module to execute is roughly 31.7 milliseconds.

The second set is the "module usage" measurement. Module usage measurements show how much time is spent outside the module of interest; they indicate how often the module is used. The information shown in the second part of the duration report above shows that the average amount of time spent outside the `interrupt_sim` function is about 190 milliseconds.

## Running Measurements and Creating Reports

Several performance measurement tasks are the same whether you are making activity or duration measurements.

This section describes how to:

- Run performance measurements.
- End performance measurements.
- Create a performance measurement report.

---

### To run performance measurements

- Use the **performance\_measurement\_run** command.

The **performance\_measurement\_run** command processes analyzer trace data. When you end the performance measurement, this processed data is dumped to the binary "perf.out" file in the current directory. The **perf32** report generator utility is used to read the binary information in the "perf.out" file.

If the **performance\_measurement\_run** command is entered without a count, the current trace data is processed. If a count is specified, the current trace command is executed consecutively the number of times specified. The data that results from each trace command is processed and combined with the existing processed data. The STATUS line will say "Processing trace <NO.>" during the run so you will know how your measurement is progressing. The only way to stop this series of traces is by using <CTRL>c (sig INT).

The more traces you include in your sample, the more accurate will be your results. At least four consecutive traces are required to obtain statistical interpretation of activity measurement results.

**Examples**

To run the performance measurement, enter the following command:

```
performance_measurement_run 20 <RETURN>
```

The command above causes 20 traces to occur. The SPMT processes the trace information after each trace, and the number of the trace being processed is shown on the status line.

---

## To end performance measurements

- Use the **performance\_measurement\_end** command.

The **performance\_measurement\_end** command takes the data generated by the **performance\_measurement\_run** command and places it in a file named **perf.out** in the current directory. If a file named "perf.out" already exists in the current directory, it will be overwritten. Therefore, if you wish to save a performance measurement, you must rename the **perf.out** file before performing another measurement.

The **performance\_measurement\_end** command does not affect the current performance measurement data which exists within the emulation system. In other words, you can add more traces later to the existing performance measurement by entering another **performance\_measurement\_run** command.

Once you have entered the **performance\_measurement\_end** command, you can use the **perf32** report generator to look at the data saved in the **perf.out** file.

Note that the "perf.out" file is a binary file. Do not try to read it with the UNIX **more** or **cat** commands. The **perf32** report generator utility (described in the following section) must be used to read the contents of the "perf.out" file.

---

**Examples**

To cause the processed trace information to be dumped to the "perf.out" file:

```
performance_measurement_end <RETURN>
```

## To create a performance measurement report

- Use the **perf32** command at the UNIX prompt.

The **perf32** report generator utility must be used to read the information in the "perf.out" file and other files dumped by the SPMT (in other words, renamed "perf.out" files). The **perf32** utility is run from the UNIX shell. You can fork a shell while in the Softkey Interface and run **perf32**, or you can exit the Softkey Interface and run **perf32**.

### Options to "perf32"

A default report, containing all performance measurement information, is generated when the **perf32** command is used without any options. The options available with **perf32** allow you to limit the information in the generated report. These options are described below.

<b>-h</b>	Produce outputs limited to histograms.
<b>-s</b>	Produce a summary limited to the statistical data.
<b>-p</b>	Produce a summary limited to the program activity.
<b>-m</b>	Produce a summary limited to the memory activity.
<b>-f&lt;file&gt;</b>	Produce a report based on the information contained in <file> instead of the information contained in perf.out.

For example, the following commands save the current performance measurement information in a file called "perf1.out", and produce a histogram showing only the program activity occupied by the functions and variables.

```
mv perf.out perf1.out <RETURN>
perf32 -hpf perf1.out <RETURN>
```

Options **-h**, **-s**, **-p**, and **-m** affect the contents of reports generated for activity measurements. These options have no effect on the contents of reports generated for duration (time interval) measurements.

## Chapter 7: Making Software Performance Measurements

### Running Measurements and Creating Reports

---

#### Examples

Now, to generate a report from the "perf.out" file, type the following on the command line to fork a shell and run the **perf32** utility:

```
!perf32 | more
```

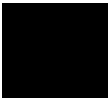

---

**8**



---

**Using the External State Analyzer**

---

## Using the External State Analyzer

The HP 64705A Option 001 analyzer (used with the HP 64760 80960KA/KB/MC emulator) provides an external analyzer with 16 external trace channels. These trace channels allow you to capture activity on signals external to the emulator, typically other target system signals. The external analyzer may be configured as an extension to the emulation analyzer, as an independent state analyzer, or as an independent timing analyzer.

When the external analyzer is configured as an independent state analyzer, the emulator/analyzer interface does not control the external analyzer. However, you can use pod commands to control the independent state analyzer via the terminal interface. Refer to the *80960 Emulator User's Guide for the Terminal Interface* for information on using the external analyzer when it is configured as an independent state analyzer.

When the external analyzer is configured as an independent timing analyzer, you must use a special Timing Analyzer Interface program. Refer to the *Timing Analyzer Interface User's Guide* for information on using the external analyzer when it is configured as an independent timing analyzer.

The tasks you perform with the external analyzer are grouped into the following sections:

- Setting up the external analyzer.
- Configuring the external analyzer.



## Setting Up the External Analyzer

This section assumes you have already connected the external analyzer probe to the HP 64700 Card Cage.

Before you can use the external analyzer, you must:

- Connect the external analyzer probe to the target system.
- Specify threshold voltages of external trace signals.
- Label the external trace signals.
- Select the external analyzer mode.



## To connect the external analyzer probe to the target system

**1** Assemble the Analyzer Probe. The analyzer probe is a two-piece assembly, consisting of ribbon cable and 18 probe wires (16 data channels and the J and K clock inputs) attached to a connector. Either end of the ribbon cable may be connected to the 18 wire connector, and the connectors are keyed so they may only be attached one way. Align the key of the ribbon cable connector with the slot in the 18 wire connector, and firmly press the connectors together.

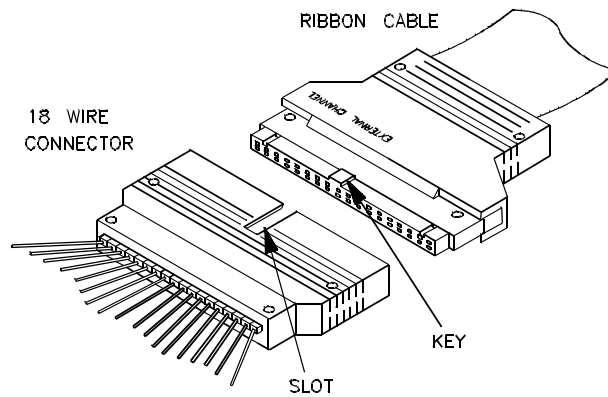

**2** Attach grabbers to probe wires. Each of the 18 probe wires has a signal and a ground connection. Each probe wire is labeled for easy identification. Thirty-six grabbers are provided for the signal and ground connections of each of the 18 probe wires. The signal and ground connections are attached to the pin in the grabber handle.

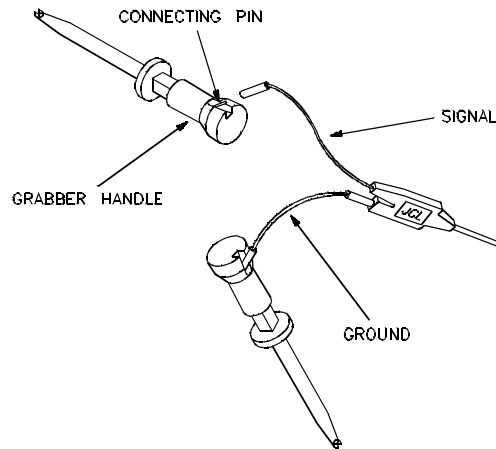

Chapter 8: Using the External State Analyzer  
**Setting Up the External Analyzer**

**CAUTION**

Turn OFF target system power before connecting analyzer probe wires to the target system. The probe grabbers are difficult to handle with precision, and it is extremely easy to short the pins of a chip (or other connectors which are close together) with the probe wire while trying to connect it.

**3** You can connect the grabbers to pins, connectors, wires, etc., in the target system. Pull the hilt of the grabber towards the back of the grabber handle to uncover the wire hook. When the wire hook is around the desired pin or connector, release the hilt to allow the grabber spring tension to hold the connection.

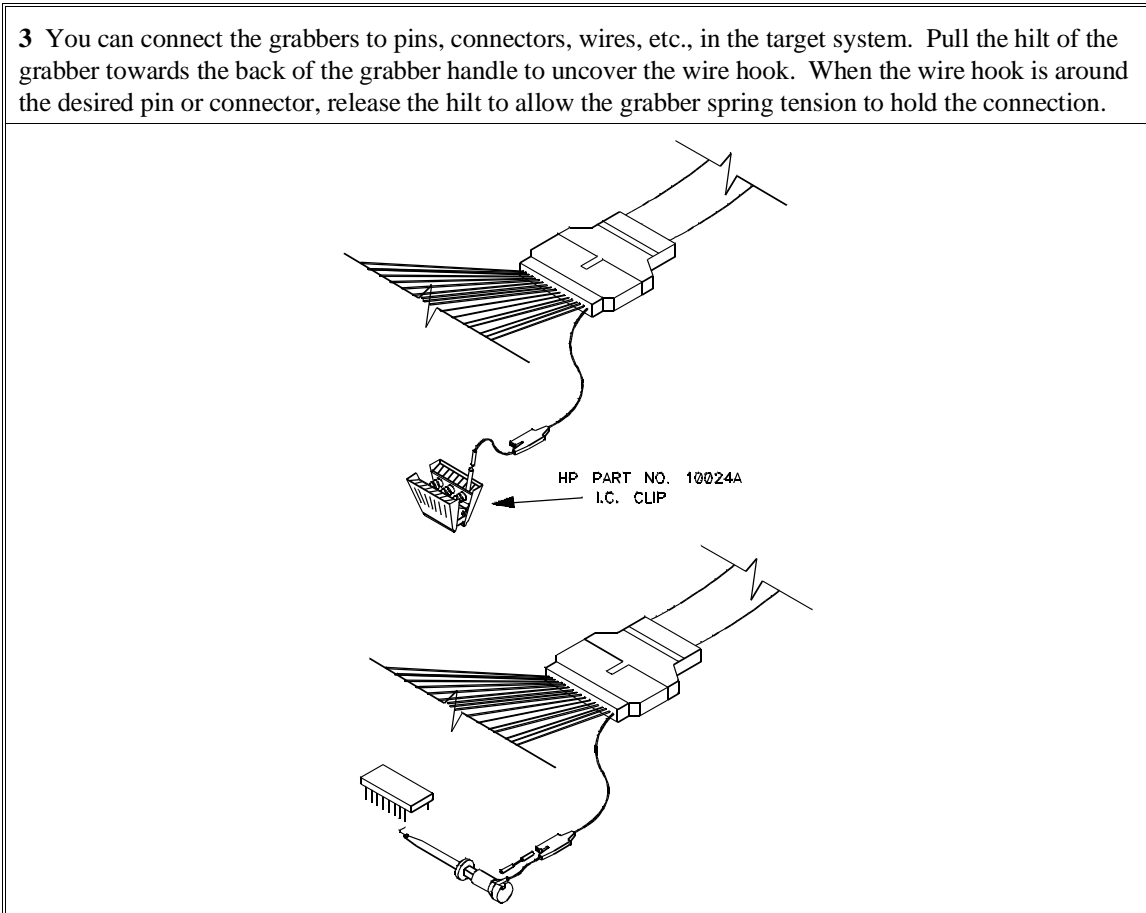

## Configuring the External Analyzer

After you have assembled the external analyzer probe and connected it to the emulator and target system, the next step is to configure the external analyzer.

The external analyzer is a versatile instrument, and you can configure it to suit your needs. For example, you can specify threshold voltage levels on the external analyzer channels, and you can operate the external analyzer in several different modes.

The default configuration specifies that the external analyzer is aligned with the emulation analyzer. TTL level threshold voltages are defined, as well as an external label named "xbits" which contains all 16 channels.

This section describes how to:

- Specify whether the emulation emulator/analyzer interface should control the external analyzer.
- Specify the threshold voltages for the external channels.
- Select the external analyzer mode.
- Specify the slave clock mode when configured as an independent state analyzer.
- Define labels for the external analyzer channels.



## To control the external analyzer with the emulator/analyzer interface

- 1 Enter the **modify configuration** command.
- 2 Answer "yes" to the "Modify external analyzer configuration?" question.
- 3 Answer the "Should emulation control the external bits?" question.

Answer "yes" if the emulation emulator/analyzer interface should control the external analyzer. You must answer "yes" to access the remaining external analyzer configuration questions. At the end of the configuration process the external analyzer mode and threshold voltages will be set; existing labels will be deleted, and only the labels specified in response to the questions below will be defined.

Answer "no" if the emulation emulator/analyzer interface shouldn't control the external analyzer. If emulation does not control the external bits, the external analyzer configuration will not be modified in any way by the emulation interface.

## To specify the threshold voltage

- 1 Enter the **modify configuration** command.
- 2 Answer "yes" to the "Modify external analyzer configuration?" question.
- 3 Answer "yes" to the "Should emulation control the external bits?" question.
- 4 Answer the "Threshold voltage for bits 0-7 and J clock?" question.
- 5 Answer the "Threshold voltage for bits 8-15 and K clock?" question.

The external analyzer probe signals are divided into two groups: the lower byte (channels 0 through 7 and the J clock), and the upper byte (channels 8 through 15 and the K clock). You can specify a threshold voltage for each of these groups.

The default threshold voltages are specified as **TTL** which translates to 1.40 volts.

Voltages may be in the range from -6.40 volts to 6.35 volts (with a 0.05V resolution). You may also specify **CMOS** (which translates to 2.5 volts), or **ECL** (which translates to -1.3 volts).



## To specify the external analyzer mode

- 1 Enter the **modify configuration** command.
- 2 Answer "yes" to the "Modify external analyzer configuration?" question.
- 3 Answer "yes" to the "Should emulation control the external bits?" question.
- 4 Answer the "External analyzer mode?" question.

The default configuration selects the "emulation" external analyzer mode. In this mode, you have 16 external trace signals on which data is captured synchronously with the emulation clock.

The external analyzer may also operate as an independent state analyzer, or it may operate as an independent timing analyzer if a host computer interface program is used.

Answer "emulation" to select the emulation mode. In this mode, the external analyzer becomes an extension of the emulation analyzer. In other words, they operate as one analyzer. The external bits are clocked with the emulation clock. External labels may be used in trace commands to qualify trigger, storage, prestore, or count states. External labels may be viewed in the trace display.

Answer "state" to select the independent state mode of the external analyzer. The external bits are not available for use from the emulation interface. You can, however, use pod commands to control the external state analyzer in its independent mode.

Answer "timing" to select the timing mode of the external analyzer. The external bits are not available for use from the emulation interface. Because the pod commands for the timing analyzer dump information in binary format, you will need to use Timing Analyzer Interface, or other interface program, to capture the timing analyzer data.



## To specify the slave clock mode

- 1 Enter the **modify configuration** command.
- 2 Answer "yes" to the "Modify external analyzer configuration?" question.
- 3 Answer "yes" to the "Should emulation control the external bits?" question.
- 4 Answer "state" to the "External analyzer mode?" question.
- 5 Answer the "Slave clock mode for external bits?" question.

There are two modes of demultiplexing that can be set for the 16 channels of the external analyzer: mixed clocks and true demultiplexing.

Answer "off" to turn slave clocks OFF. If the slave clock is "off", all 16 external bits are clocked with the emulation clock.

Answer "mixed" to specify the mixed clock demultiplexing mode. In this mode, the lower eight external bits (0-7) are latched when the slave clock (as specified by your answers to the next four questions) is received. The upper eight bits and the latched lower eight are then clocked into the analyzer when the emulation clock is received (see the figure below).



Chapter 8: Using the External State Analyzer  
**Configuring the External Analyzer**

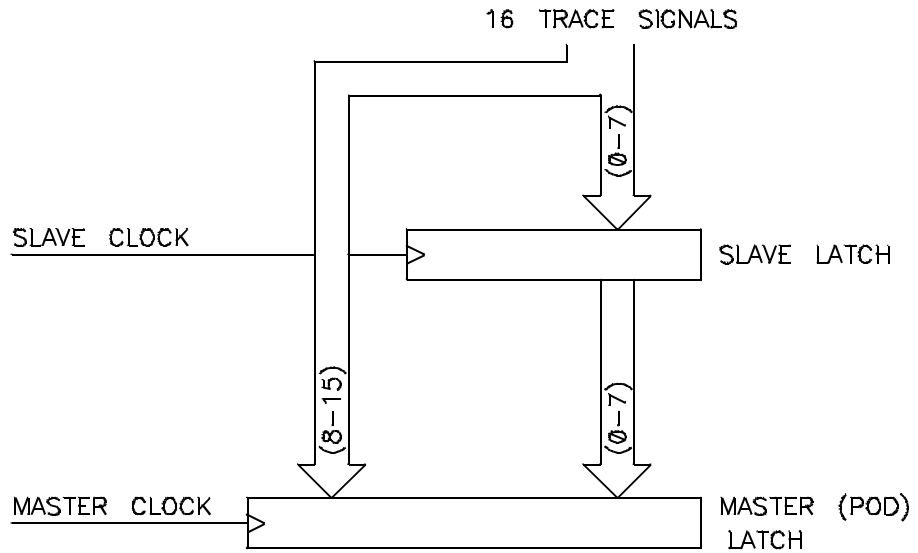

If no slave clock has appeared since the last master clock, the data on the lower 8 bits of the pod will be latched at the same time as the upper 8 bits. If more than one slave clock has appeared since the last master clock, only the first slave data will be available to the analyzer (see the figure below).

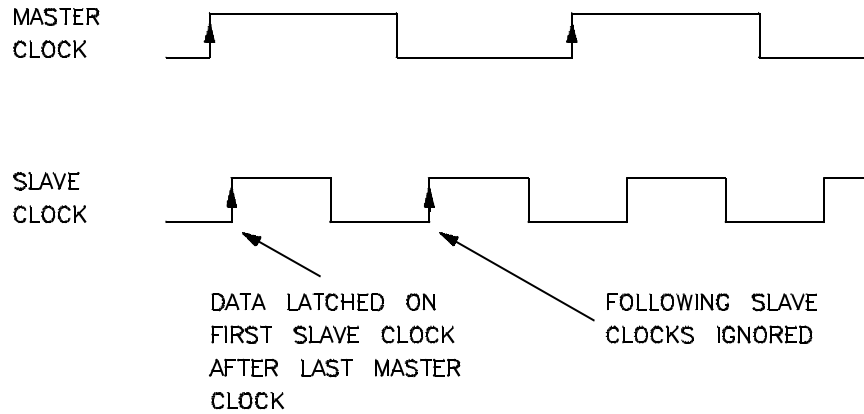

## Chapter 8: Using the External State Analyzer Configuring the External Analyzer

Answer "demux" to specify the true demultiplexing mode. In this mode, only the lower eight external channels (0-7) are used. The slave clock (as specified by your answers to the next four questions) latches these bits and the emulation clock samples the same channels again. The latched bits show up as bits 0-7 in the trace data, and the second sample shows up as bits 8-15 (see the figure below).

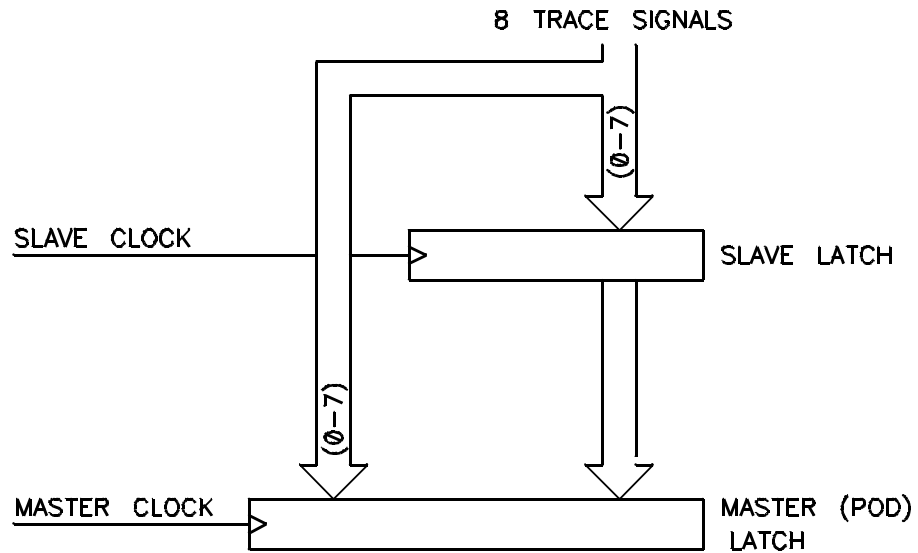

### EXAMPLE TIMING:

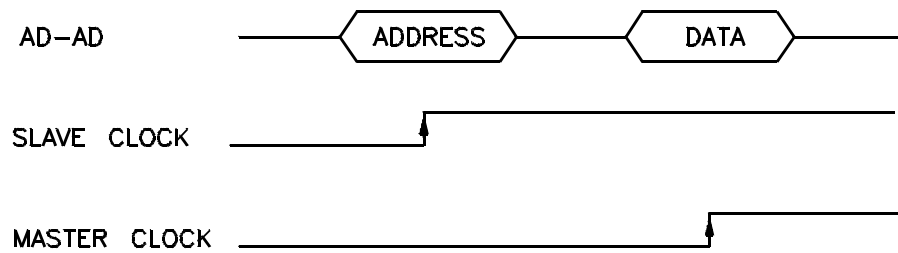

## Chapter 8: Using the External State Analyzer

### Configuring the External Analyzer

If no slave clock has appeared since the last master clock, the data on the lower 8 bits of the pod will be the same as the upper 8 bits. If more than one slave clock has appeared since the last master clock, only the first slave data will be available to the analyzer.

- 6 If the "mixed" or "true demultiplexing" slave clock modes are selected, answer the "Edges of J (K,L,M) clock used for slave clock?" questions.

These four questions are asked when you select either the "mixed" or "demux" slave clock mode. They allow you to define the slave clock. You can specify rising, falling, both, or neither (none) edges of the J, K, L, and M clocks. When several clock edges are specified, any one of the edges clocks the trace.

Clocks J and K are the external clock inputs of the external analyzer probe. The L and M clocks are generated by the emulator. Typically, the L clock is the emulation clock derived by the emulator and the M clock is not used.

---

## To define labels for the external analyzer signals

- 1 Enter the **modify configuration** command.
- 2 Answer "yes" to the "Modify external analyzer configuration?" question.
- 3 Answer "yes" to the "Should emulation control the external bits?" question.
- 4 For each defined external label (there can be up to 8), answer the "name?", "start bit?", "width?", and "polarity?" questions.

You can define up to eight labels for the 16 external data channels in the configuration. These external analyzer labels can be used in trace commands, and the data associated with these labels can be displayed in the trace list. One external analyzer label, "xbits", is defined by the default configuration and is included in the default trace list.

External labels can be defined with bits in the range of 0 through 15. The start bit may be in the range 0 through 15, but the width of the label must not cause the label

## Chapter 8: Using the External State Analyzer

### Configuring the External Analyzer

to extend past bit 15. Thus, the sum of the start bit number plus the width must not exceed 16.

The "polarity?" question allows you to specify positive or negative logic for the external bits. In other words, positive means high=1, low=0. Negative means low=1, high=0.

Once external labels are defined, they may be used in trace commands to qualify events (if the emulation controls the external analyzer). Also, you can modify the trace display to include data for the various trace labels.

Note that the Timing Analyzer Interface does not use the external labels defined in the emulator/analyzer interface. You maintain labels for the timing analyzer within the Timing Analyzer Interface itself.





---

**9**



---

**Making Coordinated Measurements**

---

## Making Coordinated Measurements

When HP 64700 Card Cages are connected together via the Coordinated Measurement Bus (CMB), you can start and stop up to 32 emulators at the same time.

You can use the analyzer in one HP 64700 to arm (that is, activate) the analyzers in other HP 64700 Card Cages or to cause emulator execution in other HP 64700 Card Cages to break into the monitor.

You can use the HP 64700's BNC connector (labeled TRIGGER IN/OUT on the lower left corner of the HP 64700 rear panel) to trigger an external instrument (for example, a logic analyzer or oscilloscope) when the analyzer finds its trigger condition. Also, you can allow an external instrument to arm the analyzer or break emulator execution into the monitor.

The coordinated measurement tasks you can perform are grouped into the following sections:

- Setting up for coordinated measurements.
- Starting and stopping multiple emulators.
- Driving trigger signals to the CMB or BNC.
- Stopping program execution on trigger signals.
- Arming analyzers on trigger signals.



The location of the CMB and BNC connectors on the HP 64700 rear panel is shown in the following figure.

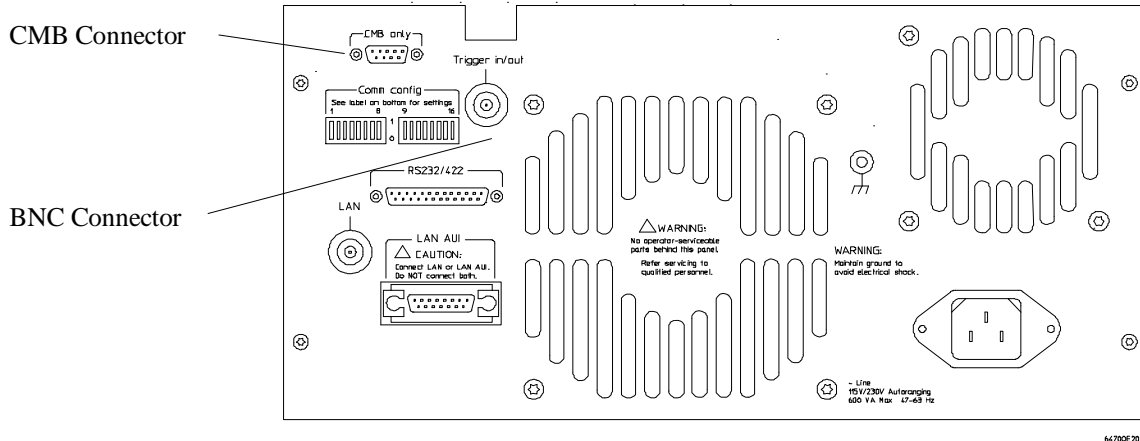

### Signal Lines on the CMB

There are three bi-directional signal lines on the CMB connector on the rear panel of the emulator. These CMB signals are:

**TRIGGER** The CMB TRIGGER line is low true. This signal can be driven or received by any HP 64700 connected to the CMB. This signal can be used to trigger an analyzer. It can be used as a break source for the emulator.

**READY** The CMB READY line is high true. It is an open collector and performs an ANDing of the ready state of enabled emulators on the CMB. Each emulator on the CMB releases this line when it is ready to run. This line goes true when all enabled emulators are ready to run, providing for a synchronized start.

When CMB is enabled, each emulator is required to break to background when CMB READY goes false, and will wait for CMB READY to go true before returning to the run state. When an enabled emulator breaks, it will drive the CMB READY false and will hold it false until it is ready to resume running. When an emulator is reset, it also drives CMB READY false.

**EXECUTE** The CMB EXECUTE line is low true. Any HP 64700 on the CMB can drive this line. It serves as a global interrupt and is processed by both the emulator and the analyzer. This signal causes an emulator to run from a specified address when CMB READY returns true.

### **BNC Trigger Signal**

The BNC trigger signal is a positive rising edge TTL level signal. The BNC trigger line can be used to either drive or receive an analyzer trigger, or receive a break request for the emulator.

**Comparison Between CMB and BNC Triggers** The CMB trigger and BNC trigger lines have the same logical purpose: to provide a means for connecting the internal trigger signals (trig1 and trig2) to external instruments. The CMB and BNC trigger lines are bi-directional. Either signal may be used directly as a break condition.

The CMB trigger is level-sensitive, while the BNC trigger is edge-sensitive. The CMB trigger line puts out a true pulse following receipt of EXECUTE, despite the commands used to configure it. This pulse is internally ignored.

Note that if you use the EXECUTE function, the CMB TRIGGER should not be used to trigger external instruments, because a false trigger will be generated when EXECUTE is activated.

## Setting Up for Coordinated Measurements

This section describes how to:

- Connect the Coordinated Measurement Bus.
- Connect the rear panel BNC.

---

### To connect the Coordinated Measurement Bus (CMB)

---

**Caution**

Be careful not to confuse the 9-pin connector used for CMB with those used by some computer systems for RS-232C communications. Applying RS-232C signals to the CMB connector is likely to result in damage to the HP 64700 Card Cage.

---

To use the CMB, you will need one CMB cable for the first two emulators and one additional cable for every emulator after the first two. The CMB cable is orderable from HP under product number HP 64023A. The cable is four meters long.

You can build your own compatible CMB cables using standard 9-pin D type subminiature connectors and 26 AWG wire.

Note that Hewlett-Packard does not ensure proper CMB operation if you are using a self-built cable!

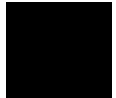

Chapter 9: Making Coordinated Measurements  
**Setting Up for Coordinated Measurements**

**1** Connect the cables to the HP 64700 CMB ports.

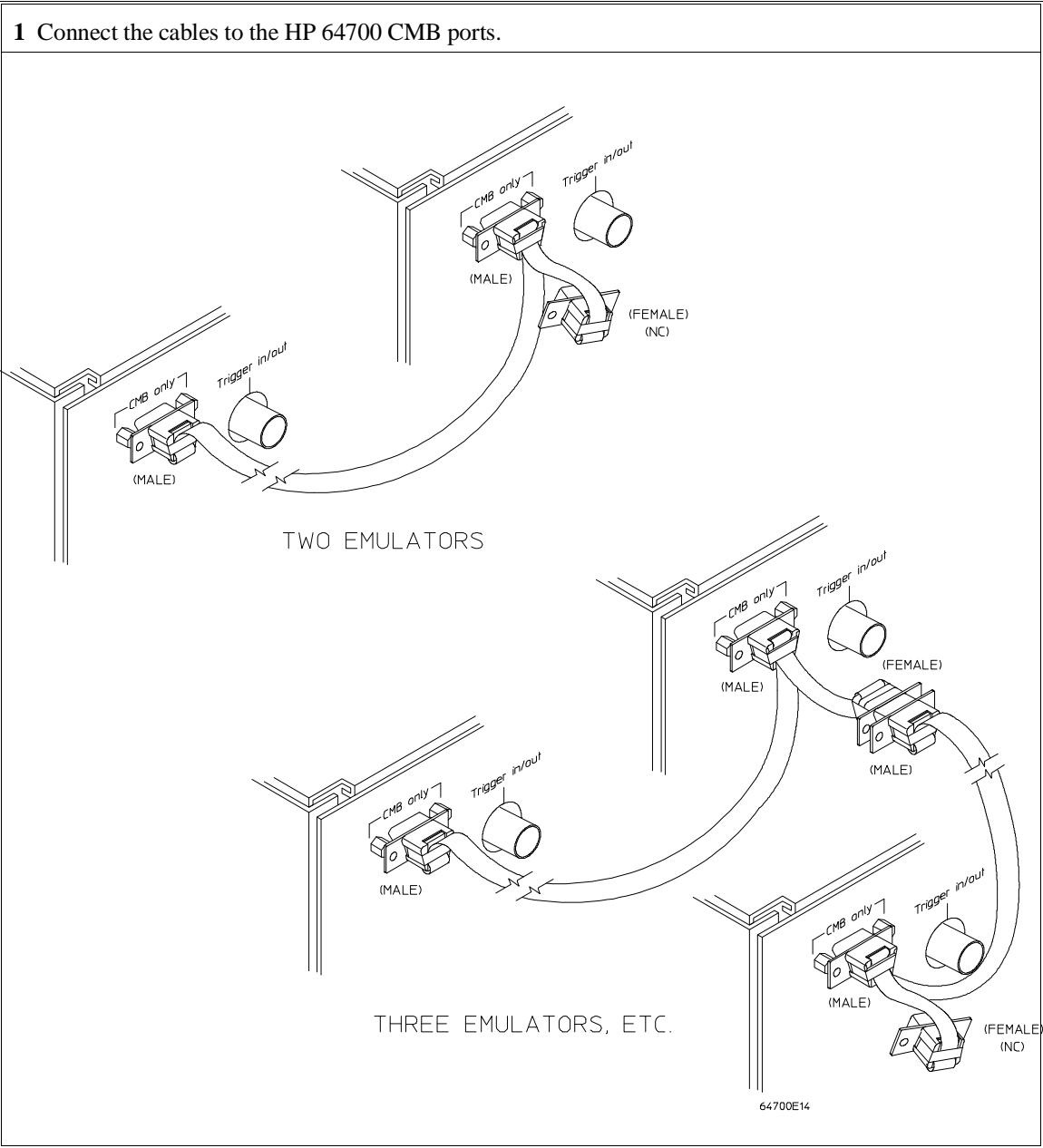

Number of HP 64700 Series Emulators	Maximum Total Length of Cable	Restrictions on the CMB Connection
2 to 8	100 meters	None.
9 to 16	50 meters	None.
9 to 16	100 meters	Only 8 emulators may have rear panel pullups connected. *
17 to 32	50 meters	Only 16 emulators may have rear panel pullups connected. *
<p>* A modification must be performed by your HP Customer Engineer.</p> <p>Emulators using the CMB must use background emulation monitors.</p> <p>At least 3/4 of the HP 64700-Series emulators connected to the CMB must be powered up before proper operation of the entire CMB configuration can be assured.</p>		

---

## To connect to the rear panel BNC

---

### Caution

The BNC line on the HP 64700 accepts input and output of TTL levels only. (TTL levels should not be less than 0 volts or greater than 5 volts.) Failure to observe these specifications may result in damage to the HP 64700 Card Cage.

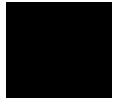

Chapter 9: Making Coordinated Measurements  
**Setting Up for Coordinated Measurements**

- 1 Connect one end of a 50 ohm coaxial cable with male BNC connectors to the HP 64700 BNC receptacle and the other end to the appropriate BNC receptacle on the other measuring instrument.

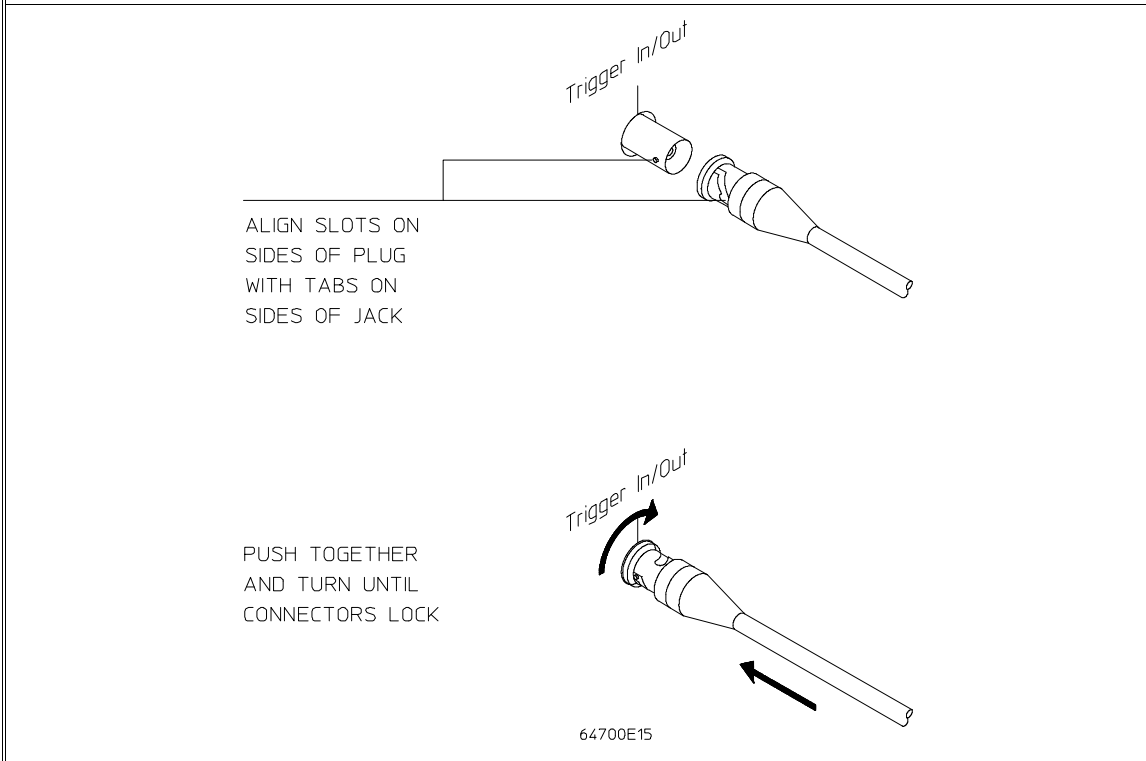

The BNC connector is capable of driving TTL level signals into a 50 ohm load. (A positive rising edge is the trigger signal.) It requires a driver that can supply at least 4 mA at 2 volts when used as a receiver. The BNC connector is configured as an open-emitter structure which allows for multiple drivers to be connected. It can be used for cross-triggering between multiple HP 64700Bs when no other cross-measurements are needed. The output of the BNC connector is short-circuit protected and is protected from TTL level signals when the emulator is powered down.

## Starting/Stopping Multiple Emulators

When HP 64700 Card Cages are connected together via the Coordinated Measurement Bus (CMB), you can start and stop up to 32 emulators at the same time. These are called synchronous measurements.

This section describes how to:

- Enable synchronous measurements.
- Start synchronous measurements.
- Disable synchronous measurements.

---

### To enable synchronous measurements

- Enter the **specify run** command.

You can enable the emulator's interaction with the CMB by using the **specify run** command. When the EXECUTE signal is received, the emulator will run at the current program counter address or the address specified in the **specify run** command.

Note that when the CMB is being actively controlled by another emulator, the **step** command does not work correctly. The emulator may end up running in user code (NOT stepping). Disable CMB interaction (see "To disable synchronous measurements" below) while stepping the processor.

Note that enabling CMB interaction does not affect the operation of analyzer cross-triggering.

You can use the **specify trace** command to specify that an analyzer measurement begin upon reception of the CMB EXECUTE signal.

The trace measurement defined by the **specify trace** command will be started when the EXECUTE signal becomes active. When the trace measurement begins, you will see the message "CMB execute; emulation trace started".

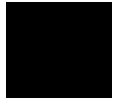

## Chapter 9: Making Coordinated Measurements

### Starting/Stopping Multiple Emulators

When you enter a normal **trace** command, trace at execute is disabled, and the analyzer ignores the CMB EXECUTE signal.

---

#### Examples

To enable synchronous measurements:

```
specify run from 1e8h <RETURN>
```

To trace when synchronous execution begins:

```
specify trace after address main <RETURN>
```

---

### To start synchronous measurements

- Enter the **cmb\_execute** command.

The **cmb\_execute** command will cause the EXECUTE line to be pulsed, thereby initiating a synchronous measurement. CMB interaction does not have to be enabled in order to use either of these commands. (When you enable CMB interaction, you only specify how the emulator will react to the CMB EXECUTE signal.)

All emulators whose CMB interaction is enabled will break into the monitor when any one of those emulators breaks into its monitor.

---

### To disable synchronous measurements

- Enter the **specify run disable** command.

You can disable the emulator's interaction with the CMB by using the **specify run disable** command. When interaction is disabled, the emulator ignores the CMB EXECUTE and READY lines.



## Using Trigger Signals

The HP 64700 contains two internal lines, trig1 and trig2, over which trigger signals can pass from the emulator or analyzer to other HP 64700s on the Coordinated Measurement Bus (CMB) or other instruments connected to the BNC connector.

You can configure the internal lines to make connections between the emulator, analyzer, external analyzer (if its configured as an independent state or timing analyzer), CMB connector, or BNC connector. Measurements that depend on these connections are called *interactive measurements* or *coordinated measurements*.

To configure the internal trig1 and trig2 lines, you must enter the **modify configuration** command and then answer "yes" to the "Modify interactive measurement specification?" question. When you do this, the following display appears.

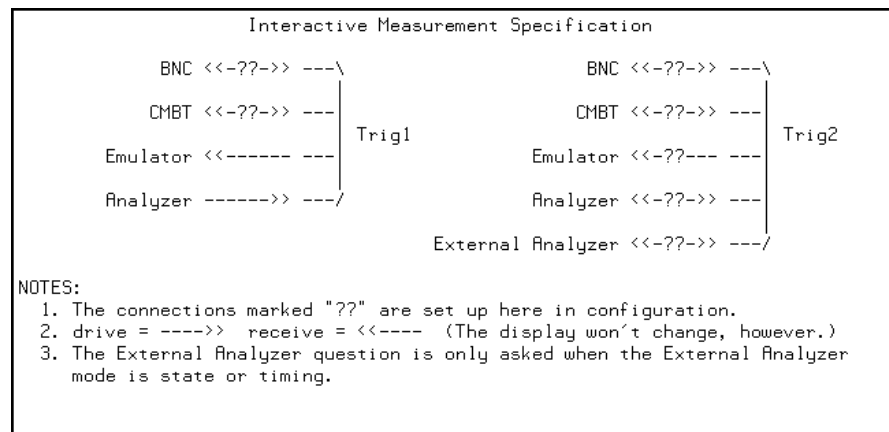

This display illustrates the possible connections between the internal lines (trig1 and trig2) and the emulator, analyzer, and external devices.

Note that the "External Analyzer" option for "Trig2" only appears if you have selected "state" or "timing" for the external analyzer mode.

Notice that the analyzer always drives trig1, and the emulator always receives trig1. This provides for the **break\_on\_trigger** syntax of the **trace** command.

## Chapter 9: Making Coordinated Measurements

### Using Trigger Signals

You can use the trig1 or trig2 line to make a connection between the analyzer and the CMB connector or BNC connector so that, when the analyzer finds its trigger condition, a trigger signal is driven on the HP 64700's Coordinated Measurement Bus (CMB) or BNC connector. This can also be done for the external analyzer when it is configured as an independent state or timing analyzer.

You can use the trig1 or trig2 line to make a connection between the emulator break input and the CMB connector, BNC connector, analyzer, (or external analyzer when configured as an independent state or timing analyzer) so that program execution can break when a trigger signal is received from the CMB, BNC, or analyzer.

You can use the trig2 line to make a connection between the analyzer and the CMB connector or BNC connector so that the analyzer can be armed (that is, enabled) when a trigger signal is received from the CMB or BNC connector. This can also be done for the external analyzer when it is configured as an independent state or timing analyzer.

You can use the trig1 and trig2 lines to make several type of connections at the same time. For example, when the analyzer finds its trigger condition, a signal is driven on the trig1 line. This signal may be used to stop user program execution, but the trigger signal may also be driven on the CMB and BNC connectors.

Also, it's possible for signals to be driven and received on the CMB or BNC connectors. So, for example, while the analyzer's trigger signal can be driven on the CMB and BNC connectors, signals can also be received from the CMB and BNC connectors and used to stop user program execution. In this case, the emulator will break into the monitor on either the analyzer trigger or on the reception of a trigger signal from the CMB or BNC.

You can disable connections made by the internal trig1 and trig2 lines by answering "neither" or "no" to the appropriate interactive measurement configuration question.

This section shows you how to:

- Drive the emulation analyzer trigger signal to the CMB.
- Drive the emulation analyzer trigger signal to the BNC connector.
- Drive the external analyzer trigger signal to the CMB.
- Drive the external analyzer trigger signal to the BNC connector.
- Break emulator execution on signal from CMB.
- Break emulator execution on signal from BNC.
- Break emulator execution on external analyzer trigger.
- Arm the emulation analyzer on signal from CMB.
- Arm the emulation analyzer on signal from BNC.
- Arm the emulation analyzer on external analyzer trigger.
- Arm the external analyzer on signal from CMB.
- Arm the external analyzer on signal from BNC.
- Arm the external analyzer on emulation analyzer trigger.

---

## To drive the emulation analyzer trigger signal to the CMB

- 1 Enter the **modify configuration** command.
- 2 Answer "yes" to the "Modify interactive measurement specification?" question.
- 3 Answer "receive" to the "Should CMBT drive or receive Trig1?" question.

You could also drive the emulation analyzer trigger to the CMB over the trig2 internal line by specifying that the CMBT should receive trig2 and that the emulation analyzer should drive trig2.

## To drive the emulation analyzer trigger signal to the BNC connector

- 1 Enter the **modify configuration** command.
- 2 Answer "yes" to the "Modify interactive measurement specification?" question.
- 3 Answer "receive" to the "Should BNC drive or receive Trig1?" question.

You could also drive the emulation analyzer trigger to the BNC over the trig2 internal line by specifying that the BNC should receive trig2 and that the emulation analyzer should drive trig2.

---

## To drive the external analyzer trigger signal to the CMB

- 1 Enter the **modify configuration** command.
- 2 Answer "yes" to the "Modify interactive measurement specification?" question.
- 3 Answer "receive" to the "Should CMBT drive or receive Trig2?" question.
- 4 Answer "drive" to the "Should External Analyzer drive or receive Trig2?" question.

## To drive the external analyzer trigger signal to the BNC connector

- 1 Enter the **modify configuration** command.
- 2 Answer "yes" to the "Modify interactive measurement specification?" question.
- 3 Answer "receive" to the "Should BNC drive or receive Trig2?" question.
- 4 Answer "drive" to the "Should External Analyzer drive or receive Trig2?" question.

---

## To break emulator execution on signal from CMB

- 1 Enter the **modify configuration** command.
- 2 Answer "yes" to the "Modify interactive measurement specification?" question.
- 3 Answer "drive" to the "Should CMBT drive or receive Trig1?" question.

You could also break emulator execution on a trigger signal from the CMB over the trig2 internal line by specifying that the CMB should drive trig2 and that the emulator break should receive trig2.

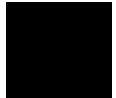

## To break emulator execution on signal from BNC

- 1 Enter the **modify configuration** command.
- 2 Answer "yes" to the "Modify interactive measurement specification?" question.
- 3 Answer "drive" to the "Should BNC drive or receive Trig1?" question.

You could also break emulator execution on a trigger signal from the BNC over the trig2 internal line by specifying that the BNC should drive trig2 and that the emulator break should receive trig2.

---

## To break emulator execution on external analyzer trigger

- 1 Enter the **modify configuration** command.
- 2 Answer "yes" to the "Modify interactive measurement specification?" question.
- 3 Answer "yes" to the "Should Emulator break receive Trig2?" question.
- 4 Answer "drive" to the "Should External Analyzer drive or receive Trig2?" question.

When an emulator break occurs due to the analyzer trigger, the analyzer will stop driving the internal signal that caused the break. Therefore, if trig2 is used both to break and to drive the CMB TRIGGER (for example), TRIGGER will go true when the trigger is found and then will go false after the emulator breaks. However, if trig1 is used to cause the break and trig2 is used to drive the CMB TRIGGER, TRIGGER will stay true until the trace is halted or until the next trace starts.

## To arm the emulation analyzer on signal from CMB

- 1 Enter the **modify configuration** command.
- 2 Answer "yes" to the "Modify interactive measurement specification?" question.
- 3 Answer "drive" to the "Should CMBT drive or receive Trig2?" question.
- 4 Answer "receive" to the "Should Analyzer drive or receive Trig2?" question.
- 5 Use the **arm\_trig2** option to the **trace** command.

---

## To arm the emulation analyzer on signal from BNC

- 1 Enter the **modify configuration** command.
- 2 Answer "yes" to the "Modify interactive measurement specification?" question.
- 3 Answer "drive" to the "Should BNC drive or receive Trig2?" question.
- 4 Answer "receive" to the "Should Analyzer drive or receive Trig2?" question.
- 5 Use the **arm\_trig2** option to the **trace** command.

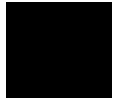

## To arm the emulation analyzer on external analyzer trigger

- 1 Enter the **modify configuration** command.
- 2 Answer "yes" to the "Modify interactive measurement specification?" question.
- 3 Answer "receive" to the "Should Analyzer drive or receive Trig2?" question.
- 4 Answer "drive" to the "Should External Analyzer drive or receive Trig2?" question.
- 5 Use the **arm\_trig2** option to the **trace** command.

---

## To arm the external analyzer on signal from CMB

- 1 Enter the **modify configuration** command.
- 2 Answer "yes" to the "Modify interactive measurement specification?" question.
- 3 Answer "drive" to the "Should CMBT drive or receive Trig2?" question.
- 4 Answer "receive" to the "Should External Analyzer drive or receive Trig2?" question.



## To arm the external analyzer on signal from BNC

- 1 Enter the **modify configuration** command.
- 2 Answer "yes" to the "Modify interactive measurement specification?" question.
- 3 Answer "drive" to the "Should BNC drive or receive Trig2?" question.
- 4 Answer "receive" to the "Should External Analyzer drive or receive Trig2?" question.

---

## To arm the external analyzer on emulation analyzer trigger

- 1 Enter the **modify configuration** command.
- 2 Answer "yes" to the "Modify interactive measurement specification?" question.
- 3 Answer "drive" to the "Should Analyzer drive or receive Trig2?" question.
- 4 Answer "receive" to the "Should External Analyzer drive or receive Trig2?" question.

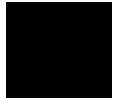



---

**10**



---

**Setting X Resources**

---

## Setting X Resources

The Graphical User Interface is an X Window System application which means it is a *client* in the X Window System client-server model.

The X server is a program that controls all access to input devices (typically a mouse and a keyboard) and all output devices (typically a display screen). It is an interface between application programs you run on your system and the system input and output devices.

An X *resource* controls an element of appearance or behavior in an X application. For example, in the graphical interface, one resource controls the text in action key pushbuttons as well as the action performed when the pushbutton is clicked.

By modifying resource settings, you can change the appearance or behavior of certain elements in the graphical interface.

When the graphical interface starts up, it reads resource specifications from a set of configuration files. Resources specifications in later files override those in earlier files. Files are read in the following order:

- 1 The application defaults file. For example, `/usr/lib/X11/app-defaults/HP64_Softkey` in HP-UX or `/usr/openwin/lib/X11/app-defaults/HP64_Softkey` in SunOS.
- 2 The `$XAPPLRESDIR/HP64_Softkey` file. (The `XAPPLRESDIR` environment variable defines a directory containing system-wide custom application defaults.)
- 3 The server's `RESOURCE_MANAGER` property. (The `xrdb` command loads user-defined resource specifications into the `RESOURCE_MANAGER` property.)

If no `RESOURCE_MANAGER` property exists, user defined resource settings are read from the `$HOME/.Xdefaults` file.

- 4 The file named by the `XENVIRONMENT` environment variable.

If the `XENVIRONMENT` variable is not set, the `$HOME/.Xdefaults-host` file (typically containing resource specifications for a specific remote host) is read.

- 5 Resource specifications included in the command line with the **-xrm** option.
- 6 System scheme files in directory `/usr/hp64000/lib/X11/HP64_schemes`.
- 7 System-wide custom scheme files located in directory `$XAPPLRESDIR/HP64_schemes`.
- 8 User-defined scheme files located in directory `$HOME/.HP64_schemes` (note the dot in the directory name).

*Scheme files* group resource specifications for different displays, computing environments, and languages.

This chapter shows you how to:

- Modify the Graphical User Interface resources.
- Use customized scheme files.
- Set up custom action keys.
- Set initial recall buffer values.
- Set up demos or tutorials.

Refer to the "X Resources and the Graphical Interface" section in the "Concepts" chapter for more detailed information.



## To modify the Graphical User Interface resources

You can customize the appearance of an X Windows application by modifying its X resources. The following tables describe some of the commonly modified application resources.

Application Resources for Schemes		
Resource	Values	Description
HP64_Softkey.platformScheme	HP-UX SunOS (custom)	Names the subdirectory for platform specific schemes. This resource should be set to the platform on which the X server is running (and displaying the Graphical User Interface) if it is different than the platform where the application is running.
HP64_Softkey.colorScheme	BW Color (custom)	Names the color scheme file.
HP64_Softkey.sizeScheme	Small Large (custom)	Names the size scheme file which defines the fonts and the spacing used.
HP64_Softkey.labelScheme	Label \$LANG (custom)	Names to use for labels and button text. The default uses the \$LANG environment variable if it is set and if a scheme file named Softkey.\$LANG exists in one of the directories searched for scheme files; otherwise, the default is Label.
HP64_Softkey.inputScheme	Input (custom)	Specifies mouse and keyboard operation.

Commonly Modified Application Resources		
Resource	Values	Description
HP64_Softkey.lines	24 (min. 18)	Specifies the number of lines in the main display area.
HP64_Softkey.columns	100 (min. 80)	Specifies the number of columns, in characters, in the main display area.
HP64_Softkey.enableCmdline	True False	Specifies whether the command line area is displayed when you initially enter the Graphical User Interface.
*editFile	(example) vi %s	Specifies the command used to edit files.
*editFileLine	(example) vi +%d %s	Specifies the command used to edit a file at a certain line number.
*<proc>*actionKeysSub.keyDefs	(paired list of strings)	Specifies the text that should appear on the action key push buttons and the commands that should be executed in the command line area when the action key is pushed. Refer to the "To set up custom action keys" section for more information.
*<proc>*dirSelectSub.entries	(list of strings)	Specifies the initial values that are placed in the <b>File</b> → <b>Context</b> → <b>Directory</b> popup recall buffer. Refer to the "To set initial recall buffer values" section for more information.
*<proc>*recallSub.entries	(list of strings)	Specifies the initial values that are placed in the entry buffer (labeled "(:)"). Refer to the "To set initial recall buffer values" section for more information.

Chapter 10: Setting X Resources  
**To modify the Graphical User Interface resources**

The following steps show you how to modify the Graphical User Interface's X resources.

- 1 Copy part or all of the HP64\_Softkey application defaults file to a temporary file.

The HP64\_Softkey file contains the default definitions for the graphical interface application's X resources.

For example, on an HP 9000 computer you can use the following command to copy the complete HP64\_Softkey file to HP64\_Softkey.tmp (note that the HP64\_Softkey file is several hundred lines long):

```
cp /usr/lib/X11/app-defaults/HP64_Softkey HP64_Softkey.tmp
```

NOTE: The HP64\_Softkey application defaults file is re-created each time Graphical User Interface software is installed or updated. You can use the UNIX **diff** command to check for differences between the new HP64\_Softkey application defaults file and the old application defaults file that is saved as /usr/hp64000/lib/X11/HP64\_schemes/old/HP64\_Softkey.

- 2 Modify the temporary file.

Modify the resource that defines the behavior or appearance that you wish to change.

For example, to change the number of lines in the main display area to 36:

```
vi HP64_Softkey.tmp
```

Search for the string "HP64\_Softkey.lines". You should see lines similar to the following.

```
!-----  
! The lines and columns set the vertical and horizontal dimensions of the  
! main display area in characters, respectively. Minimum values are 18 lines  
! and 80 columns. These minimums are silently enforced.  
!  
! Note: The application cannot be resized by using the window manager.  
  
!HP64_Softkey.lines:      24  
!HP64_Softkey.columns:   85
```



## Chapter 10: Setting X Resources To modify the Graphical User Interface resources

Edit the line containing "HP64\_Softkey.lines" so that it is uncommented and is set to the new value:

```
!-----  
! The lines and columns set the vertical and horizontal dimensions of the  
! main display area in characters, respectively. Minimum values are 18 lines  
! and 80 columns. These minimums are silently enforced.  
!  
! Note: The application cannot be resized by using the window manager.  
  
HP64_Softkey.lines:      36  
!HP64_Softkey.columns:  85
```

Save your changes and exit the editor.

- 3 If the RESOURCE\_MANAGER property exists (as is the case with HP VUE — if you're not sure, you can check by entering the **xrdb -query** command), use the **xrdb** command to add the resources to the RESOURCE\_MANAGER property. For example:

```
xrdb -merge -nocpp HP64_Softkey.tmp
```

Otherwise, if the RESOURCE\_MANAGER property does not exist, append the temporary file to your \$HOME/.Xdefaults file. For example:

```
cat HP64_Softkey.tmp >> $HOME/.Xdefaults
```

- 4 Remove the temporary file.
- 5 Start or restart the Graphical User Interface.

After you have completed the above steps, you must either start, or restart by exiting and starting again, the Graphical User Interface. Starting and exiting the Graphical User Interface is described in the "Starting and Exiting HP 64700 Interfaces" chapter.



## To use customized scheme files

Scheme files are used to set platform specific resources that deal with color, fonts and sizes, mouse and keyboard operation, and labels and titles. You can create and use customized scheme files by following these steps.

- 1 Create the `$HOME/.HP64_schemes/<platform>` directory.

For example:

```
mkdir $HOME/.HP64_schemes  
mkdir $HOME/.HP64_schemes/HP-UX
```

- 2 Copy the scheme file to be modified to the `$HOME/.HP64_schemes/<platform>` directory.

Label scheme files are not platform specific; therefore, they should be placed in the `$HOME/.HP64_schemes` directory. All other scheme files should be placed in the `$HOME/.HP64_schemes/<platform>` directory.

For example:

```
cp /usr/hp64000/lib/X11/HP64_schemes/HP-UX/Softkey.Color  
$HOME/.HP64_schemes/HP-UX/Softkey.MyColor
```

Note that if your custom scheme file has the same name as the default scheme file, the load order requires resources in the custom file to explicitly override resources in the default file.

- 3 Modify the `$HOME/.HP64_schemes/<platform>/Softkey.<scheme>` file.

For example, you could modify the `"$HOME/.HP64_schemes/HP-UX/Softkey.MyColor"` file to change the defined foreground and background colors. Also, since the scheme file name is different than the default, you could comment out various resource settings to cause general foreground and background color definitions to apply to the Graphical User Interface. At least one resource must be defined in your color scheme file for it to be recognized.

- 4 If your custom scheme file has a different name than the default, you must modify the scheme resource definitions.

The Graphical User Interface application defaults file contains resources that specify which scheme files are used. If your custom scheme files are named differently than the default scheme files, you must modify these resource settings so that your customized scheme files are used instead of the default scheme files.

For example, to use the "\$HOME/.HP64\_schemes/HP-UX/Softkey.MyColor" color scheme file you would set the "HP64\_Softkey.colorScheme" resource to "MyColor":

```
HP64_Softkey.colorScheme: MyColor
```

Refer to the previous "To customize Graphical User Interface resources" section for more detailed information on modifying resources.



## To set up custom action keys

- Modify the "actionKeysSub.keyDefs" resource.

The "actionKeysSub.keyDefs" resource defines a list of paired strings. The first string defines the text that should appear on the action key pushbutton. The second string defines the command that should be sent to the command line area and executed when the action key is pushed.

A pair of parentheses (with no spaces, that is "()") can be used in the command definition to indicate that text from the entry buffer should replace the parentheses when the command is executed.

Action keys that use the entry buffer should always include the entry buffer symbol, "()", in the action key label as a visual cue to remind you to place information in the entry buffer before clicking the action key.

Shell commands can be executed by using an exclamation point prefix. A second exclamation point ends the command string and allows additional options on the command line.

Also, command files can be executed by placing the name of the file in the command definition.

Finally, an empty action ("") means to repeat the previous operation, whether it came from a pulldown, a dialog, a popup, or another action key.

---

### Examples

To set up custom action keys when the graphical interface is used with 80960 emulators, modify the "\*i80960\*actionKeysSub.keyDefs" resource:

```
*i80960*actionKeysSub.keyDefs: \  
"Make"                "cd /users/project2/960; !make! in_browser" \  
"Load Pgm"           "load configuration config.EA; load program2" \  
"Run Pgm"            "run from reset" \  
"Trace after ( )"    "trace after (); display trace" \  
"Step Source"        "set source on; display memory mnemonic; step source" \  
"Again"              ""
```

Refer to the previous "To modify Graphical User Interface resources" section for more detailed information on modifying resources.

## To set initial recall buffer values

- Modify the "entries" resource for the particular recall buffer.

There are six popup recall buffers present in the Graphical User Interface. The resources for these popup recall buffers are listed in the following table.

The window manager resource `*transientDecoration` controls the borders around dialog box windows. The most natural setting for this resource is `"title"`.

<b>Popup Recall Buffer Resources</b>		
<b>Recall Popup</b>	<b>Resources</b>	<b>Description</b>
<b>File→Context→Directory ...</b>	<code>*dirSelect.textColumns</code> <code>*dirSelect.listVisibleItemCount</code> <code>*dirSelectSub.entries</code>	The default number of text columns in the popup is 50.
<b>File→Context→Symbols ...</b>	<code>*symSelect.textColumns</code> <code>*symSelect.listVisibleItemCount</code> <code>*symSelectSub.entries</code>	The default number of visible lines in the popup is 12.
<b>Trace→Trace Spec ...</b>	<code>*modtrace.textColumns</code> <code>*modtrace.listVisibleItemCount</code> <code>*modtraceSub.entries</code>	The "entries" resource is defined as a list of strings (see the following example).
Entry Buffer ():	<code>*recall.textColumns</code> <code>*recall.listVisibleItemCount</code> <code>*recallSub.entries</code>	Up to 40 unique values are saved in each of the recall buffers (as specified by the resource settings
Command Line command recall	<code>*recallCmd.textColumns</code> <code>*recallCmd.listVisibleItemCount</code> <code>*recallCmdSub.entries</code>	<code>"*XcRecall.maxDepth: 40"</code> and <code>"*XcRecall.onlyUnique: True"</code> ).
Command Line pod/simio recall	<code>*recallKbd.textColumns</code> <code>*recallKbd.listVisibleItemCount</code> <code>*recallKbdSub.entries</code>	



## Chapter 10: Setting X Resources

### To set initial recall buffer values

---

#### Examples

To set the initial values for the directory selection dialog box when the Graphical User Interface is used with 80960 emulators, modify the "\*i80960\*dirSelectSub.entries" resource:

```
*i80960*dirSelectSub.entries: \  
    "$HOME" \  
    "." \  
    "/users/project1" \  
    "/users/project2/960"
```

Refer to the previous "To modify the Graphical User Interface resources" section for more detailed information on modifying resources.

---

## To set up demos or tutorials

You can add demos or tutorials to the Graphical User Interface by modifying the resources described in the following tables.

Demo Related Component Resources		
Resource	Value	Description
*enableDemo	False True	Specifies whether <b>Help</b> → <b>Demo</b> appears in the pulldown menu.
*demoPopupSub.indexFile	./Xdemo/Index-topics	Specifies the file containing the list of topic and file pairs.
*demoPopup.textColumns	30	Specifies the width, in characters, of the of the demo topic list popup.
*demoPopup.listVisibleItemCount	10	Specifies the length, in lines, of the demo topic list popup.
*demoTopic	About demos	Specifies the default topic in the demo popup selection buffer.



Chapter 10: Setting X Resources  
To set up demos or tutorials

Tutorial Related Component Resources		
Resource	Value	Description
*enableTutorial	False True	Specifies whether <b>Help</b> → <b>Tutorial</b> appears in the pulldown menu.
*tutorialPopupSub.indexFile	./Xtutorial/Index-topics	Specifies the file containing the list of topic and file pairs.
*tutorialPopup.textColumns	30	Specifies the width, in characters, of the of the tutorial topic list popup.
*tutorialPopup.listVisibleItemCount	10	Specifies the length, in lines, of the tutorial topic list popup.
*tutorialTopic	About tutorials	Specifies the default topic in the tutorial popup selection buffer.

The mechanism for providing demos and tutorials in the graphical interface is identical. The following steps show you how to set up demos or tutorials in the Graphical User Interface.

- 1 Create the demo or tutorial topic files and the associated command files.

Topic files are simply ASCII text files. You can use "\I" to produce inverse video in the text, "\U" to produce underlining in the text, and "\N" to restore normal text.

Command files are executed when the "Press to perform demo (or tutorial)" button (in the topic popup dialog) is pushed. A command file must have the same name as the topic file with ".cmd" appended. Also, a command file must be in the same directory as the associated topic file.



2 Create the demo or tutorial index file.

Each line in the index file contains first a quoted string that is the name of the topic which appears in the index popup and second the name of the file that is raised when the topic is selected. For example:

```
"About demos"      /users/guest/gui_demos/general  
"Loading programs" /users/guest/gui_demos/loadprog  
"Running programs" /users/guest/gui_demos/runprog
```

You can use absolute paths (for example, /users/guest/topic1), paths relative to the directory in which the interface was started (for example, mydir/topic2), or paths relative to the product directory (for example, ./Xdemo/general where the product directory is something like /usr/hp64000/inst/emul/64760A).

3 Set the "\*enableDemo" or "\*enableTutorial" resource to "True".

4 Define the demo index file by setting the "\*demoPopupSub.indexFile" or "\*tutorialPopupSub.indexFile" resource.

For example:

```
*demoPopupSub.indexFile: /users/guest/gui_demos/index
```

You can use absolute paths (for example, /users/guest/Index), paths relative to the directory in which the interface was started (for example, mydir/indexfile), or paths relative to the product directory (for example, ./Xdemo/Index-topics where the product directory is something like /usr/hp64000/inst/emul/64760A).

5 If you wish to define a default topic to be selected, set the "\*demoTopic" or "\*tutorialTopic" resource to the topic string.

For example:

```
*demoTopic: "About demos"
```

Refer to the previous "To customize Graphical User Interface resources" section for more detailed information on modifying resources.

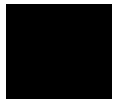



---

## Part 3

---

### Reference

Descriptions of the product in a dictionary or encyclopedia format.

**Part 3**

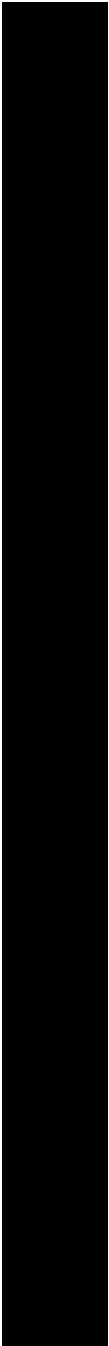

---

**11**

---

**Emulator/Analyzer Interface  
Commands**

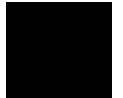

---

## Emulator/Analyzer Interface Commands

This chapter describes the emulator/analyzer interface commands in alphabetical order. First, the syntax conventions are described and the commands are summarized.

### How Pulldown Menus Map to the Command Line

The following table shows the items available in the pulldown menus and the command line commands to which they map.

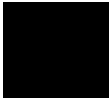

<b>Pulldown</b>	<b>Command Line</b>
<b>File→Context→Directory</b>	cd
<b>File→Context→Symbols</b>	cws
<b>File→Load→Emulator Config</b>	load configuration
<b>File→Load→Executable</b>	load <abs_file>
<b>File→Load→Program Only</b>	load <abs_file> nosymbols
<b>File→Load→Symbols Only</b>	load symbols
<b>File→Store→Trace Data</b>	store trace
<b>File→Store→Trace Spec</b>	store trace_spec
<b>File→Store→BBA Data</b>	bbaunload
<b>File→Copy→Display</b>	copy display to
<b>File→Copy→Memory</b>	copy memory to
<b>File→Copy→Data Values</b>	copy data to
<b>File→Copy→System Table</b>	copy table to
<b>File→Copy→Trace</b>	copy trace to
<b>File→Copy→Registers</b>	copy registers to
<b>File→Copy→Breakpoints</b>	copy software_breakpoints to
<b>File→Copy→Status</b>	copy status to
<b>File→Copy→Global Symbols</b>	copy global_symbols to
<b>File→Copy→Local Symbols ()</b>	copy local_symbols_in --SYMB-- to
<b>File→Copy→Pod Commands</b>	copy pod_command to
<b>File→Copy→Error Log</b>	copy error_log to
<b>File→Copy→Event Log</b>	copy event_log to
<b>File→Log→Playback</b>	<command file>
<b>File→Log→Record</b>	log_commands to
<b>File→Log→Stop</b>	log_commands off
<b>File→Emul700→High-Level Debugger</b>	N/A
<b>File→Emul700→Performance Analyzer</b>	N/A
<b>File→Emul700→Emulator/Analyzer</b>	N/A
<b>File→Emul700→Timing Analyzer</b>	N/A
<b>File→Edit→File</b>	! vi <file> ! no_prompt_before_exit
<b>File→Edit→At () Location</b>	! vi +<line> <file> ! no_prompt_before_exit
<b>File→Edit→At PC Location</b>	! vi +<line> <file> ! no_prompt_before_exit
<b>File→Term</b>	!
<b>File→Exit→Window (save session)</b>	end
<b>File→Exit→Locked (all windows, save session)</b>	end locked
<b>File→Exit→Released (all windows, release emulator)</b>	end release_system

<b>Pulldown</b>	<b>Command Line</b>
<b>Display→Context</b>	pwd, pws
<b>Display→Memory</b>	display memory
<b>Display→Memory→Mnemonic ()</b>	display memory --EXPR-- mnemonic
<b>Display→Memory→Mnemonic at PC</b>	display memory mnemonic at_pc
<b>Display→Memory→Mnemonic Previous</b>	display memory mnemonic previous_display
<b>Display→Memory→Hex ()→bytes</b>	display memory --EXPR-- blocked bytes
<b>Display→Memory→Hex ()→words</b>	display memory --EXPR-- blocked words
<b>Display→Memory→Hex ()→long</b>	display memory --EXPR-- blocked long
<b>Display→Memory→Real ()→short</b>	display memory --EXPR-- real short
<b>Display→Memory→Real ()→long</b>	display memory --EXPR-- real long
<b>Display→Memory→At ()</b>	display memory --EXPR--
<b>Display→Memory→Repetitively</b>	display memory repetitively
<b>Display→Data Values</b>	display data
<b>Display→Data Values→New ()→&lt;type&gt;</b>	display data --EXPR-- <type>
<b>Display→Data Values→Add ()→&lt;type&gt;</b>	display data, --EXPR-- <type>
<b>Display→System Table→Processor Control Block</b>	display table processor_control_block
<b>Display→System Table→System Address</b>	display table system_address
<b>Display→System Table→System Procedure</b>	display table system_procedure
<b>Display→System Table→Trace Procedure</b>	display table trace_procedure
<b>Display→System Table→Fault</b>	display table fault
<b>Display→System Table→Interrupt</b>	display table interrupt
<b>Display→Execution Messages</b>	display execution_messages
<b>Display→Trace</b>	display trace
<b>Display→Registers</b>	display registers
<b>Display→Breakpoints</b>	display software_breakpoints
<b>Display→Status</b>	display status
<b>Display→Simulated IO</b>	display simulated_io
<b>Display→Global Symbols</b>	display global_symbols
<b>Display→Local Symbols ()</b>	display local_symbols_in --SYMB--
<b>Display→Pod Commands</b>	display pod_command
<b>Display→Error Log</b>	display error_log
<b>Display→Event Log</b>	display event_log



<b>Pulldown</b>	<b>Command Line</b>
<b>Modify</b> → <b>Emulator Config</b>	modify configuration
<b>Modify</b> → <b>Memory</b>	modify memory
<b>Modify</b> → <b>Memory at ()</b>	modify memory --EXPR--
<b>Modify</b> → <b>Register</b>	modify register
<b>Modify</b> → <b>Execution Messages</b> → <b>Set All</b>	modify execution_messages set
<b>Modify</b> → <b>Execution Messages</b> → <b>Clear All</b>	modify execution_messages clear
<b>Execution</b> → <b>Run</b> → <b>from PC</b>	run
<b>Execution</b> → <b>Run</b> → <b>from ()</b>	run from --EXPR--
<b>Execution</b> → <b>Run</b> → <b>from Transfer Address</b>	run from transfer_address
<b>Execution</b> → <b>Run</b> → <b>from Reset</b>	run from reset
<b>Execution</b> → <b>Run</b> → <b>until ()</b>	run until --EXPR--
<b>Execution</b> → <b>Step Source</b> → <b>from PC</b>	step source
<b>Execution</b> → <b>Step Source</b> → <b>from ()</b>	step source from --EXPR--
<b>Execution</b> → <b>Step Source</b> → <b>from Transfer Address</b>	step source from transfer_address
<b>Execution</b> → <b>Step Instruction</b> → <b>from PC</b>	step
<b>Execution</b> → <b>Step Instruction</b> → <b>from ()</b>	step from --EXPR--
<b>Execution</b> → <b>Step Instruction</b> → <b>from Transfer Address</b>	step from transfer_address
<b>Execution</b> → <b>Init Processor</b>	init_processor
<b>Execution</b> → <b>Break</b>	break
<b>Execution</b> → <b>Reset</b>	reset
<b>Breakpoints</b> → <b>Display</b>	display software_breakpoints
<b>Breakpoints</b> → <b>Enable</b>	modify software_breakpoints enable/disable
<b>Breakpoints</b> → <b>Permanent ()</b>	modify software_breakpoints set --EXPR-- permanent
<b>Breakpoints</b> → <b>Temporary ()</b>	modify software_breakpoints set --EXPR-- temporary
<b>Breakpoints</b> → <b>Set All</b>	modify software_breakpoints set
<b>Breakpoints</b> → <b>Clear ()</b>	modify software_breakpoints clear --EXPR--
<b>Breakpoints</b> → <b>Clear All</b>	modify software_breakpoints clear

<b>Pulldown</b>	<b>Command Line</b>
<b>Trace→Display</b>	display trace
<b>Trace→Trace Spec</b>	N/A (browses recall buffer for trace commands)
<b>Trace→After ()</b>	trace after STATE
<b>Trace→Before ()</b>	trace before STATE
<b>Trace→About ()</b>	trace about STATE
<b>Trace→Only ()</b>	trace only STATE
<b>Trace→Only () Prestore</b>	trace only STATE prestore anything
<b>Trace→Again</b>	trace again
<b>Trace→Repetitively</b>	<previous trace spec> repetitively
<b>Trace→Everything</b>	trace
<b>Trace→Until ()</b>	trace before STATE break_on_trigger
<b>Trace→Until Stop</b>	trace on_halt
<b>Trace→Stop</b>	stop_trace
<b>Settings→Source/Symbol Modes→Absolute</b>	set source off symbols off
<b>Settings→Source/Symbol Modes→Symbols</b>	set source off symbols on
<b>Settings→Source/Symbol Modes→Source Mixed</b>	set source on inverse_video on symbols on
<b>Settings→Source/Symbol Modes→Source Only</b>	set source only inverse_video off symbols on
<b>Settings→Display Modes→Source Only</b>	set
<b>Settings→Pod Command Keyboard</b>	display pod_command; pod_command keyboard
<b>Settings→Simulated IO Keyboard</b>	display simulated_io; modify keyboard_to_simio
<b>Settings→Command Line</b>	N/A (toggles the command line)

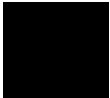

## How Popup Menus Map to the Command Line

The following tables show the items available in the popup menus and the command line commands to which they map.

<b>Mnemonic Memory Display Popup</b>	<b>Command Line</b>
<b>Set/Clear Breakpoint</b>	modify software_breakpoints set/clear --EXPR--
<b>Edit Source</b>	! vi +<line> <file> ! no_prompt_before_exit
<b>Run Until</b>	run until --EXPR--
<b>Trace After</b>	trace after STATE
<b>Trace Before</b>	trace before STATE
<b>Trace About</b>	trace about STATE
<b>Trace Until</b>	trace before STATE break_on_trigger

<b>Breakpoints Display Popup</b>	<b>Command Line</b>
<b>Set/Inactivate Breakpoint</b>	modify software_breakpoints set/deactivate --EXPR--
<b>Clear (delete) Breakpoint</b>	modify software_breakpoints clear --EXPR--
<b>Enable/Disable Software Breakpoints</b>	modify software_breakpoints enable/disable
<b>Set All Breakpoints</b>	modify software_breakpoints set
<b>Clear (delete) All Breakpoints</b>	modify software_breakpoints clear

<b>Symbols Display Popup</b>	<b>Command Line</b>
<b>Display Local Symbols</b>	display local_symbols_in --SYMB--
<b>Display Parent Symbols</b>	display local_symbols_in --SYMB--, display global_symbols
<b>Cut Full Symbol Name</b>	N/A
<b>Edit File Defining Symbol</b>	! vi +<line> <file> ! no_prompt_before_exit

## Chapter 11: Emulator/Analyzer Interface Commands

---

<b>Status Line Popup</b>	<b>Command Line</b>
<b>Remove Temporary Message</b>	N/A
<b>Display Error Log</b>	display error_log
<b>Display Event Log</b>	display event_log
<b>Command Line On/Off</b>	(toggles command line)

---

---

<b>Command Line Popup</b>	<b>Command Line</b>
<b>Position Cursor, Replace Mode</b>	<INSERT CHAR> key (when in insert mode)
<b>Position Cursor, Insert Mode</b>	<INSERT CHAR> key
<b>Execute Command</b>	<RETURN> key
<b>Clear to End of Line</b>	<CTRL>e
<b>Clear Entire Line</b>	<CTRL>u
<b>Command Line Off</b>	(toggles command line)

---

## Syntax Conventions

Conventions used in the command syntax diagrams are defined below.

### Oval-shaped Symbols

Oval-shaped symbols show options available on the softkeys and other commands that are available, but do not appear on softkeys (such as **log\_commands** and **wait**). These appear in the syntax diagrams as:

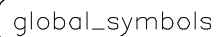

### Rectangular-shaped Symbols

Rectangular-shaped symbols contain prompts or references to other syntax diagrams. Prompts are enclosed with angle brackets (< and >). References to other diagrams are shown in all capital letters. Also, references to expressions are shown in all capital letters, for example --EXPR-- and --SYMB-- (see those syntax diagrams). These appear in the following syntax diagrams as:



### Circles

Circles indicate operators and delimiters used in expressions and on the command line as you enter commands. These appear in the syntax diagrams as:



### The -NORMAL- Key

The softkey labeled **-NORMAL-** allows you exit the --SYMB-- definition, and access softkeys that are not displayed when defining expressions. You can press this key after you have defined an expression to view other available options.

## Commands

Emulator/analyzer interface commands are summarized in the table below and described in the following pages.

!UNIX_COMMAND	display execution_messages <sup>1</sup>	modify keyboard_to_simio <sup>2</sup>
bbaunload	display global_symbols	modify memory <sup>4</sup>
break	display local_symbols_in	modify register <sup>1</sup>
cd (change directory) <sup>3</sup>	display memory <sup>4</sup>	modify software_breakpoints <sup>1</sup>
cmb_execute	display pod_command	name_of_module <sup>3</sup>
<command file> <sup>3</sup>	display registers <sup>1</sup>	performance_measurement_end
copy data <sup>4</sup>	display simulated_io <sup>2</sup>	performance_measurement_init
copy display	display software_breakpoints	performance_measurement_run
copy error_log	display status	pod_command
copy event_log	display table	pwd (print working directory) <sup>3</sup>
copy global_symbols	display trace	pws (print working symbol) <sup>3</sup>
copy help	end	reset
copy local_symbols_in	forward	run
copy memory <sup>4</sup>	help <sup>3</sup>	set
copy pod_command	init_processor	specify
copy registers <sup>1</sup>	load <absolute_file>	step
copy software_breakpoints	load configuration	stop_trace
copy status	load emul_mem	store memory
copy table	load trace	store trace
copy trace	load trace_spec	store trace_spec
cws(change working symbol) <sup>3</sup>	load user_memory	trace
display data <sup>4</sup>	log_commands <sup>3</sup>	wait <sup>3</sup>
display error_log	modify configuration	
display event_log	modify execution_messages <sup>1</sup>	

<sup>1</sup> This option is not available in real-time mode.

<sup>2</sup> This is only available when simulated I/O is defined.

<sup>3</sup> These commands are not displayed on softkeys.

<sup>4</sup> This option is not available in real-time mode if addresses are in user memory.

## break



This command causes the emulator to leave user program execution and begin executing in the monitor.

The behavior of **break** depends on the state of the emulator:

running	Break diverts the processor from execution of your program to the emulation monitor.
reset	Break releases the processor from reset, and diverts execution to the monitor.
running in monitor	The <b>break</b> command does not perform any operation while the emulator is executing in the monitor.

If the emulator is unable to break when execution messages are set, clear the execution messages and look at the "trace-enable" flag in the Process Controls Register. This flag is cleared (disabled) as a part of the processor's initialization procedure, and it should be left this way to avoid taking trace faults in your program. If you find the "trace-enable" flag is set, edit your program and make sure there are no "modpc" instructions that set this flag.

### See Also

The **reset**, **run**, and **step** commands.

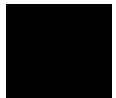

## **bbaunld**

This command is available when the HP Branch Validator product is installed. This basis branch analyzer (BBA) product is used to analyze the testing of your programs, create more complete test suites, and quantify your level of testing.

The HP Branch Validator records branches executed in a program and generates reports that provide information about program execution during testing. It uses a special C preprocessor to add statements that write to a data array when program branches are taken. After running the program in the emulator (using test input), you can use the **bbaunload** command to store the BBA information to a file. Then, you can generate reports based on the stored information.

### **See Also**

Refer to the *HP Branch Validator (BBA) User's Guide* for complete details on the **bbaunload** command syntax.



## **cmb\_execute**



The **cmb\_execute** command causes the emulator to emit an EXECUTE pulse on its rear panel Coordinated Measurement Bus (CMB) connector. All emulators connected to the CMB (including the one sending the CMB EXECUTE pulse) and configured to respond to this signal will take part in the measurement.

### **See Also**

The **specify run** and **specify trace** commands.

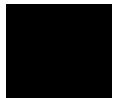

## copy

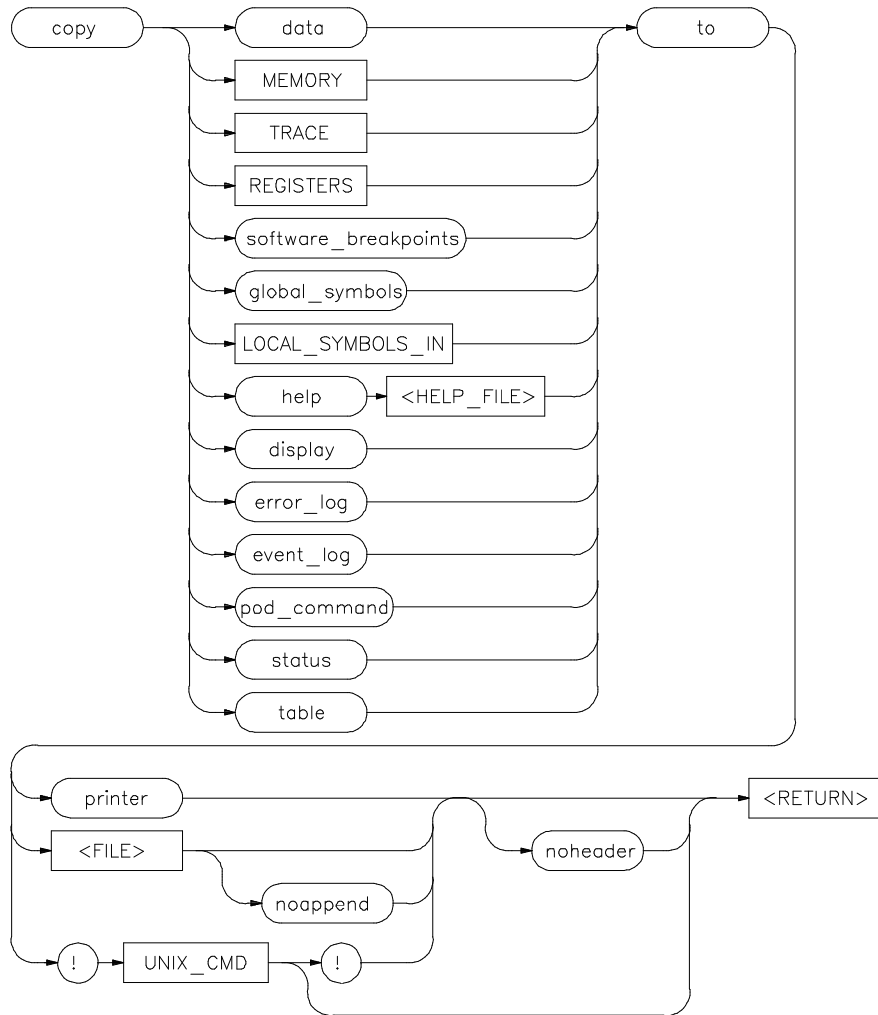

Use this command with various parameters to save or print emulation and analysis information.

The **copy** command copies selected information to your system printer or listing file, or directs it to an UNIX process.

Depending on the information you choose to copy, default values may be options selected for the previous execution of the **display** command. For example, if you display memory locations 10h through 20h, then issue a **copy memory to myfile** command, myfile will list only memory locations 10h through 20h.

The parameters are as follows:

data	This allows you to copy a list of memory contents formatted in various data types (see display data).
display	This allows you to copy the display to a selected destination.
error_log	This allows you to copy the most recent errors that occurred.
event_log	This allows you to copy the most recent events that occurred.
<FILE>	This prompts you for the name of a file where you want the specified information to be copied. If you want to specify a file name that begins with a number, you must precede the file name with a backslash. For example: <b>copy display to \12.10 &lt;RETURN&gt;</b>
global_symbols	This lets you copy a list of global symbols to the selected destination.
help	This allows you to copy the contents of the emulation help files to the selected destination.
<HELP_FILE>	This represents the name of the help file to be copied. Available help file names are displayed on the softkey labels.
UNIX CMD	This represents an UNIX filter or pipe where you want to route the output of the <b>copy</b> command. UNIX commands must be preceded by an exclamation point (!). An exclamation point following the UNIX command continues Softkey Interface command line execution after the UNIX command executes. Emulation is not affected when using an UNIX command that is a shell intrinsic.
local_symbols_in	This lets you copy all the children of a given symbol to the selected destination. See the <b>--SYMB--</b> syntax page and the <i>Symbolic Retrieval Utilities User's Guide</i> for information on symbol hierarchy.
memory	This allows you to copy a list of the contents of memory to the selected destination.
noappend	This causes any copied information to overwrite an existing file with the same name specified by <FILE>. If this option is not selected, the default operation is to



## Chapter 11: Emulator/Analyzer Interface Commands

### copy

append the copied information to the end of an existing file with the same name that you specify.

**noheader** This copies the information into a file without headings.

**pod\_command** This allows you to copy the most recent commands sent to the HP 64700 Series emulator/analyzer.

**printer** This option specifies your system printer as the destination device for the **copy** command. Before you can specify the printer as the destination device, you must define **PRINTER** as a shell variable. For example, you could enter the text shown below after the "\$" symbol:

```
$ PRINTER=lp
$ export PRINTER
```

If you don't want the print message to overwrite the command line, execute:

```
$ set PRINTER = "lp -s"
```

**registers** This allows you to copy a list of the contents of the emulation processor registers to the selected destination.

**software  
\_breakpoints** This option lets you copy a list of the current software breakpoints to a selected destination.

**status** This allows you to copy emulation and analysis status information.

**to** This allows you to specify a destination for the copied information.

**trace** This lets you copy the current trace listing to the selected destination.

**table** Copies the the most recently displayed 80960 table to the destination.

**!** An exclamation point specifies the delimiter for UNIX commands. An exclamation point must precede all UNIX commands. A trailing exclamation point should be used if you want to return to the command line and specify **noheader**. Otherwise, the trailing exclamation point is optional. If an exclamation point is part of the UNIX command, a backslash (\) must precede the exclamation point.

---

**Examples** See the following pages on various **copy** syntax diagrams.

**See Also** See the following pages on various **copy** syntax diagrams.

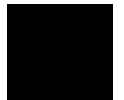

## copy local\_symbols\_in

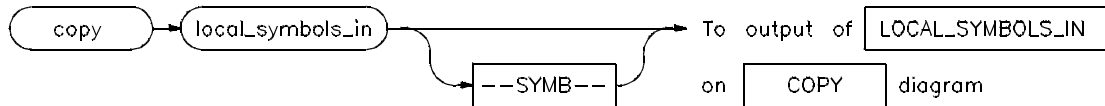

This command lets you copy local symbols contained in a source file and relative segments (program, data, or common) to the selected destination.

Local symbols are symbols that are children of the particular file or symbol defined by **--SYMB--**, that is, they are defined in that file or scope.

For additional information on symbols, refer to the **--SYMB--** syntax pages and the *Symbolic Retrieval Utilities User's Guide*.

**--SYMB--** is the current working symbol.

The parameters are as follows:

**--SYMB--** This option represents the symbol whose children are to be listed. See the **--SYMB--** syntax diagram and the *Symbolic Retrieval Utilities User's Guide* for information on symbol hierarchy.

---

### Examples

```
copy local_symbols_in mod_name to printer <RETURN>
```

```
copy local_symbols_in mod_name: to linenumfile <RETURN>
```

### See Also

The **display local\_symbols\_in** command.

## copy memory

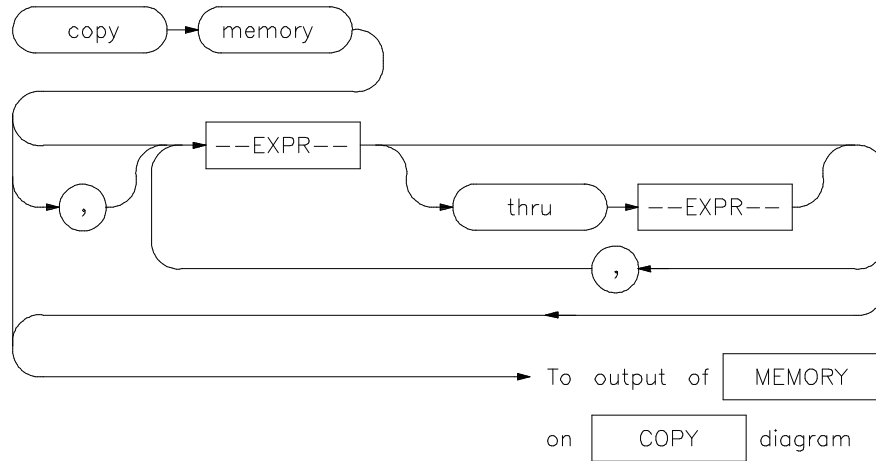

This command copies the contents of a memory location or series of locations to the specified output.

The memory contents are copied in the same format as specified in the last display memory command.

Contents of memory can be displayed if program runs are not restricted to real-time. Memory contents are listed as an asterisk (\*) under the following conditions:

- 1 The address refers to guarded memory.
- 2 Runs are restricted to real-time, the emulator is running a user program, and the address is located in user memory.

Values in emulation memory can always be displayed.

Initial values are the same as those specified by the command **display memory 0 blocked bytes offset\_by 0**.

Defaults are to values specified in the previous **display memory** command.

**copy memory**

The parameters are as follows:

--EXPR--

An expression is a combination of numeric values, symbols, operators, and parentheses, specifying a memory address or offset value. See the EXPR syntax diagram.

,

A comma used immediately after **memory** in the command line appends the current **copy memory** command to the preceding **display memory** command. The data specified in both commands is copied to the destination specified in the current command. Data is formatted as specified in the current command. The comma is also used as a delimiter between values when specifying multiple memory addresses.

---

**Examples**

```
copy memory start to printer <RETURN>
```

```
copy memory 0 thru 100h , start thru +5 , 500H ,  
target2 to memlist <RETURN>
```

```
copy memory 2000h thru 204fh to memlist <RETURN>
```

**See Also**

The **display memory**, **modify memory**, and **store memory** commands.



## copy registers

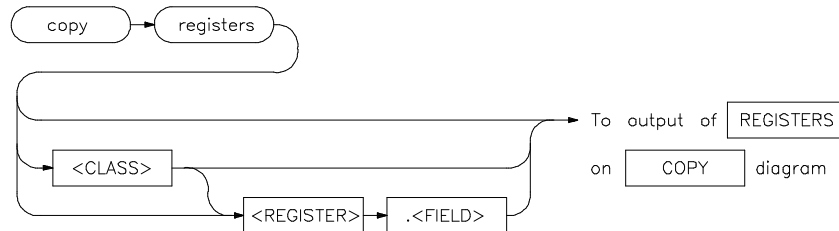

This command copies the contents of the processor registers to a file or printer.

The **copy register** process does not occur in real-time. The emulation system must be configured for nonreal-time operation to list the registers while the processor is running.

Refer to the "Accessing Registers" section in the "Using the Emulator" chapter for a list of the 80960 register classes, names, and control register field names.

With no options specified, the basic register class is copied. This includes the local and global registers.

The parameters are as follows:

- |            |   |
|------------|---|
| <CLASS>    | Specifies a particular class of the emulator registers.                 |
| <REGISTER> | Specifies the name of an individual register or control register field. |
| <FIELD>    | Specifies the name of a field within a control register.                |

---

### Examples

```
copy registers global to printer <RETURN>
```

```
copy registers to reglist <RETURN>
```

### See Also

The **display registers** and **modify registers** commands.

## copy trace

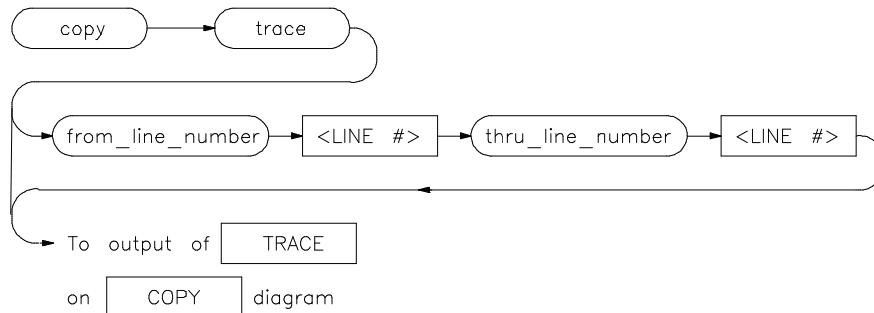

This command copies the contents of the trace buffer to a file or to the printer.

Trace information is copied in the same format as specified in the last display trace command.

Initial values are the same as specified by the last **display trace** command.

The parameters are as follows:

- |                  |   |
|------------------|---|
| from_line_number | This specifies the trace list line number from which copying will begin.  |
| <LINE#>          | Use this with <b>from_line_number</b> and <b>thru_line_number</b> to specify the starting and ending trace list lines to be copied. |
| thru_line_number | Specifies the last line number of the trace list to include in the copied range.  |

---

### Examples

```
copy trace to tlist <RETURN>
```

```
copy trace from_line_number 0 thru_line_number 5  
to longtrac <RETURN>
```

**See Also** The **display trace** and **store trace** commands.

## display

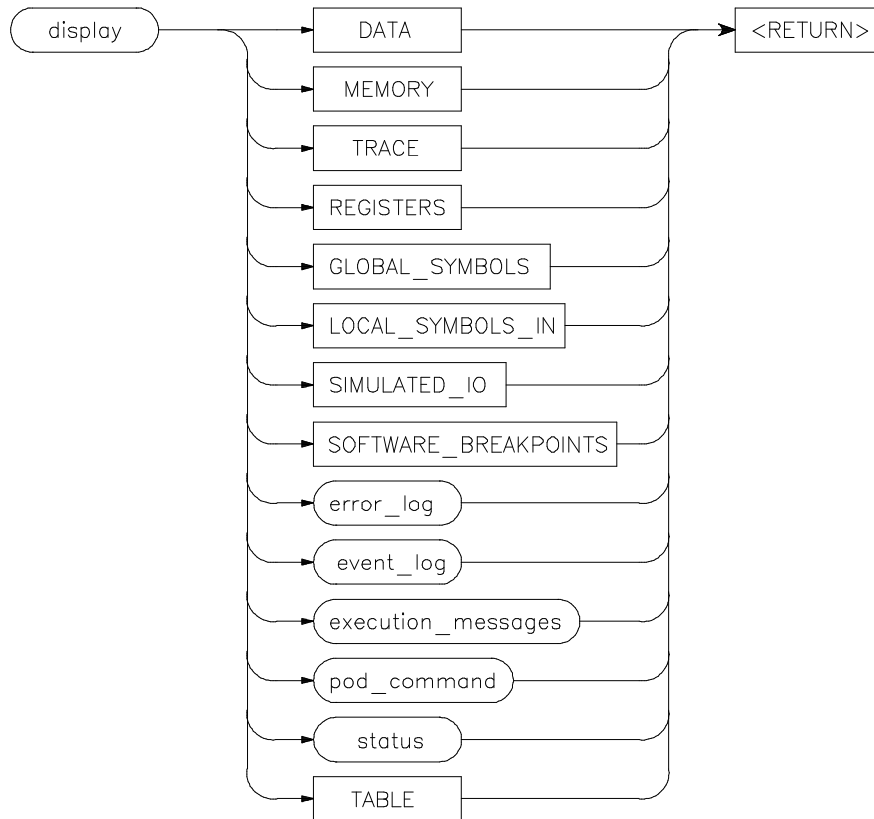

This command displays selected information on your screen.

You can use the <Up arrow>, <Down arrow>, <PREV>, and <NEXT> keys to view the displayed information. For software\_breakpoints, data, memory, and trace displays you can use the <CTRL>g and <CTRL>f keys to scroll left and right if the information goes past the edge of the screen.

Depending on the information you select, defaults may be the options selected for the previous execution of the **display** command.

## Chapter 11: Emulator/Analyzer Interface Commands

### display

The parameters are as follows:

data	This allows you to display a list of memory contents formatted in various data types (see the <b>display data</b> pages for details).
error_log	This option displays the recorded list of error messages that occurred during the emulation session.
event_log	This option displays the recorded list of events.
execution _messages	Displays whether execution messages are enabled or disabled and whether the individual execution messages are set, cleared, or inactivated.
global_symbols	This option lets you display a list of all global symbols in memory.
local_symbols_in	This option lets you display all the children of a given symbol. See the <b>--SYMB--</b> syntax page and the <i>Symbolic Retrieval Utilities User's Guide</i> for details on symbol hierarchy.
memory	This option allows you to display the contents of memory.
pod_command	This option lets you display the output of previously executed emulator pod commands.
registers	This allows you to display the contents of emulation processor registers.
simulated_io	This lets you display data written to the simulated I/O display buffer after you have enabled polling for simulated I/O in the emulation configuration.
software _breakpoints	This option lets you display the current list of software breakpoints.
status	This displays the emulator and trace status.
trace	This displays the current trace list.
table	Displays the contents of the 80960 tables in memory. See the <b>display tables</b> pages for details.

---

### Examples

```
display event_log <RETURN>
```

```
display local_symbols_in mod_name <RETURN>
```

**See Also**

The **copy** command description and the following pages which describe the various **display** commands.

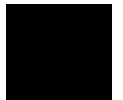

## display data

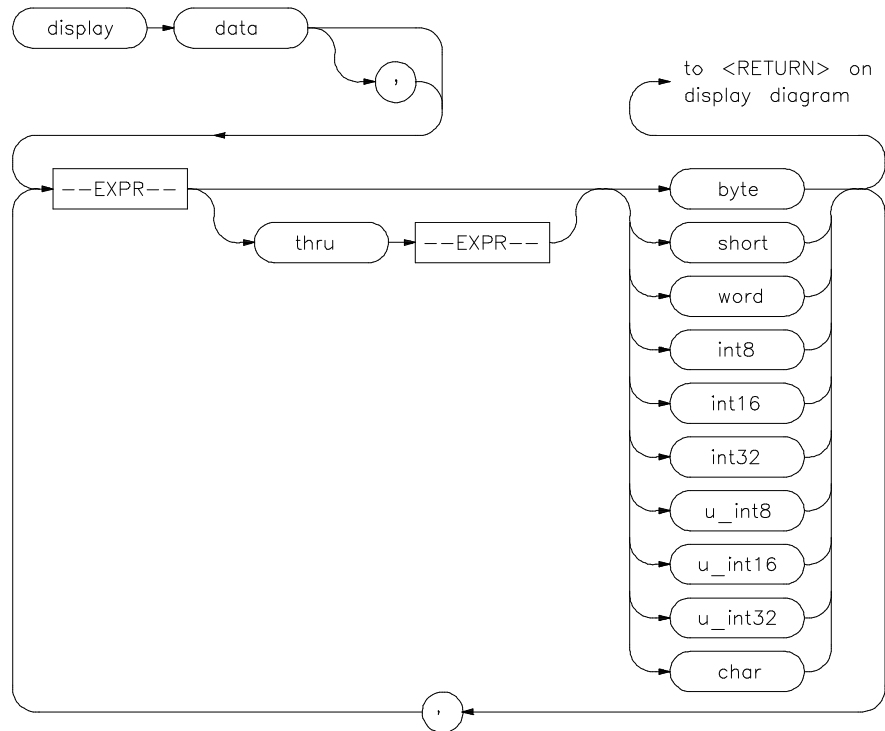

The **display data** command can display the values of simple data types in your program. Using this command can save you time; otherwise, you would need to search through memory displays for the location and value of a particular variable.

The address, identifier, and data value of each symbol may be displayed. You must issue the command **set symbols on** to see the symbol names displayed.

In the first display data command after you begin an emulation session, you must supply at least one expression specifying the data item(s) to display.

Thereafter, the display data command defaults to the expressions specified in the last display data command, unless new expressions are supplied or appended (with a leading comma).

Symbols are normally set off until you give the command **set symbols on**. Otherwise, only the address, data type, and value of the data item will be displayed.

The parameters are as follows:

,	A leading comma allows you to append additional expressions to the previous display data command.
	Commas between expression/data type specifications allow you to specify multiple variables and types for display with the current command.
--EXPR--	Prompts you for an expression specifying the data item to display. The expression can include various math operators and program symbols. See the --EXPR-- and --SYMB-- syntax pages for more information.
thru --EXPR--	Allows you to specify a range of addresses for which you want data display. Typically, you use this to display the contents of an array. You can display both single-dimensioned and multi-dimensioned arrays. Arrays are displayed in the order specified by the language definition, typically row major order for most Algol-like languages.
<TYPE>	Specifies the format in which to display the information. (Data type information is not available from the symbol database, so you must specify.)
byte	Hex display of one 8 bit location.
short	Hex display of one 16 bit location.
word	Hex display of one 32 bit location.
	Note that byte ordering in word and long displays is determined by the conventions of the processor in use.
int8	Display of one 8 bit location as a signed integer using two's complement notation.
int16	Display of two bytes as a signed integer using two's complement notation.
int32	Display of four bytes as a signed integer using two's complement notation.
u_int8	Display of one byte as an unsigned positive integer.
u_int16	Display of two bytes as an unsigned positive integer.
u_int32	Display of four bytes as an unsigned positive integer.
char	Displays one byte as an ASCII character in the range 0 through 127. Control characters and values in the range 128 through 255 are displayed as a period (.).

Chapter 11: Emulator/Analyzer Interface Commands  
**display data**

---

**Examples**

*display data* Msg\_A *thru* +17 *char*, Stack *long* <RETURN>

*set symbols on* <RETURN>

*set width label* 30 <RETURN>

*display data* , Msg\_B *thru* +17 *char*, Msg\_Dest *thru* +17  
*char* <RETURN>

**See Also**

The *copy data* and *set* commands.



## display global\_symbols

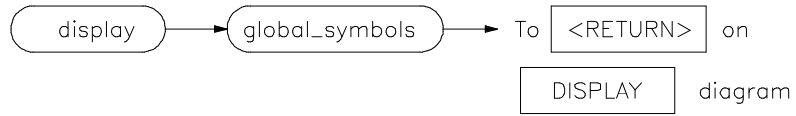

This command displays the global symbols defined for the current absolute file.

Global symbols are symbols declared as global in the source file. They include procedure names, variables, constants, and file names. When the **display global\_symbols** command is used, the listing will include the symbol name and its logical address.

### See Also

The `copy global_symbols` command.

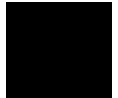

## display local\_symbols\_in

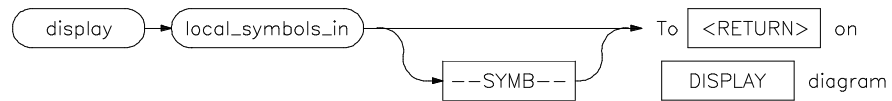

Displays the local symbols in a specified source file and their relative segment (program, data, or common).

Local symbols of **--SYMB--** are the ones which are children of the file and/or scope specified by **--SYMB--**. That is, they are defined in that file or scope.

See the **--SYMB--** syntax pages and the *Symbolic Retrieval Utilities User's Guide* for further explanation of symbols.

Displaying the local symbols sets the current working symbol to the one specified.

The parameters are as follows:

**--SYMB--**

This option represents the symbol whose children are to be listed. See the **--SYMB--** syntax diagram and the *Symbolic Retrieval Utilities User's Guide* for more information on symbol hierarchy and representation.

---

### Examples

```
display local_symbols_in mod_name <RETURN>
```

```
display local_symbols_in mod_name:main <RETURN>
```

### See Also

The **copy local\_symbols\_in** command.

## display memory

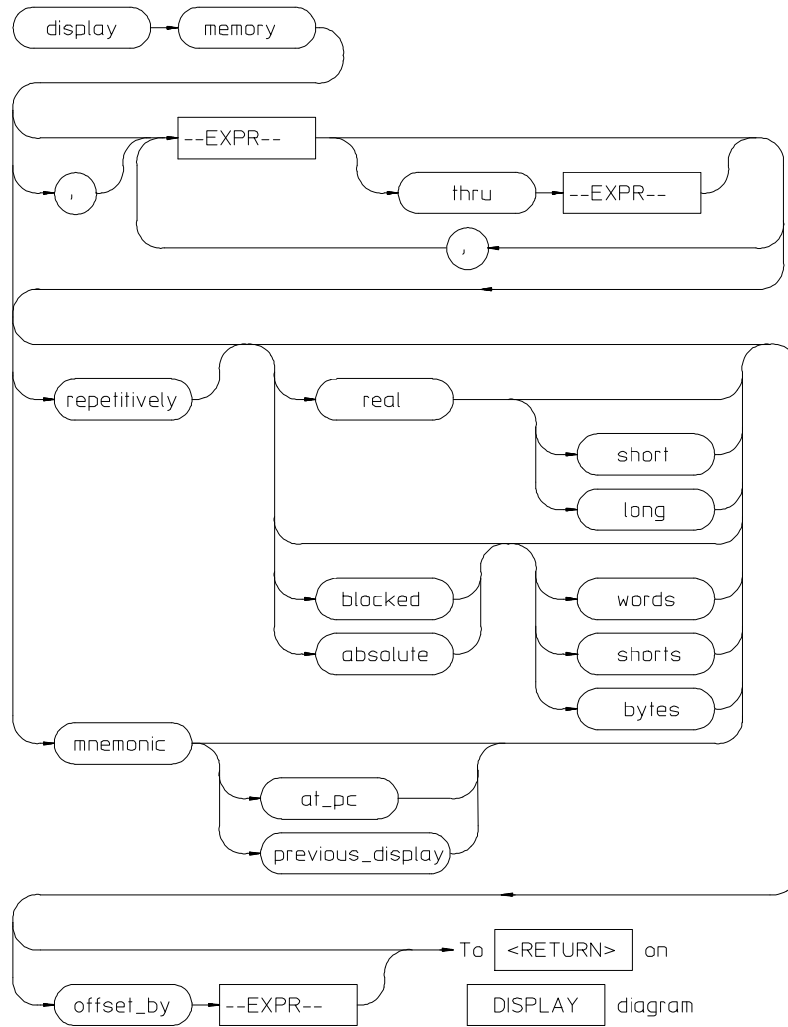

This command displays the contents of the specified memory location or series of locations.

## Chapter 11: Emulator/Analyzer Interface Commands

### display memory

The memory contents can be displayed in mnemonic, hexadecimal, or real number format. In addition, the memory addresses can be listed offset by a value, which allows the information to be easily compared to the program listing.

When displaying memory mnemonic and stepping, the next instruction that will step is highlighted. The memory mnemonic display autopages to the new address if the next PC goes outside the currently displayed address range. This feature works even if stepping is performed in a different emulation window than the one displaying memory mnemonic.

Pending software breakpoints are shown in the memory mnemonic display by an asterisk (\*) in the leftmost column of the assembly instruction or source line that has a pending breakpoint.

A label column (symbols) may be displayed for all memory displays except blocked mode. Memory mnemonic may be displayed with source and assembly code intermixed, or with source code only. Symbols also can be displayed in the memory mnemonic string. (See the set command.)

Initial values are the same as specified by the command:

```
display memory 0 blocked bytes offset_by 0
```

Defaults are values specified in a previous **display memory** command.

The symbols and source defaults are:

```
set source off symbols off
```

The parameters are as follows:

absolute	Formats the memory listing in a single column.
at_pc	Displays the memory at the address pointed to by the current program counter value.
blocked	Formats the memory listing in multiple columns.
bytes	Displays the absolute or blocked memory listing as byte values.
--EXPR--	An expression is a combination of numeric values, symbols, operators, and parentheses, specifying a memory address or memory offset value. See the EXPR syntax diagram.
long	Displays memory in a 64-bit real number format.

<b>mnemonic</b>	This causes the memory listing to be formatted in assembly language instruction mnemonics with associated operands. When specifying mnemonic format, you should include a starting address that corresponds to the first byte of an operand to ensure that the listed mnemonics are correct. If <b>set source only</b> is on, you will see only the high level language statements and corresponding line numbers.
<b>offset_by</b>	<p>This option lets you specify an offset that is subtracted from each of the absolute addresses before the addresses and corresponding memory contents are listed. You might select the offset value so that each module appears to start at address 0000H. The memory contents listing will then appear similar to the assembler or compiler listing.</p> <p>This option is also useful for displaying symbols and source lines in dynamically relocated programs.</p>
<b>previous_display</b>	Returns to display associated with the previous mnemonic memory display command.
<b>real</b>	Formats memory values in the listing as real numbers. (NaN in the display list means "Not a Number.")
<b>repetitively</b>	Updates the memory listing display continuously. You should only use this to monitor memory while running user code, since it is very CPU intensive. To allow updates to the current memory display whenever memory is modified, a file is loaded, software breakpoint is set, etc., use the <b>set update</b> command.
<b>short</b>	Formats the memory list as 32-bit real numbers.
<b>shorts</b>	Displays the absolute or blocked memory listing as 16-bit short values.
<b>thru</b>	This option lets you specify a range of memory locations to be displayed. Use the <Up arrow>, <Down arrow>, <NEXT>, and <PREV> keys to view additional memory locations.
<b>words</b>	Displays the memory listing as 32-bit word values.
<b>,</b>	A comma after <b>memory</b> in the command line appends the current <b>display memory</b> command to the preceding <b>display memory</b> command. The data specified in both commands is displayed. The data will be formatted as specified in the current command. The comma is also a delimiter between values when specifying multiple addresses.



## Chapter 11: Emulator/Analyzer Interface Commands

### display memory

---

#### Examples

Since the 80960 is "little endian", the size determines the ordering of bytes for the memory display when using the absolute or blocked format. For example, consider the following displays with different sizes:

```
display memory 2000h thru 200fh blocked bytes <RETURN>  
00 11 22 33 44 55 66 77 99 AA BB CC DD EE FF
```

```
display memory 2000h thru 200fh blocked shorts <RETURN>  
1100 3322 5544 7766 9988 BBAA DDCC FFEE
```

```
display memory 2000h thru 200fh blocked words <RETURN>  
33221100 77665544 BBAA9988 FFEEDDCC
```

You can also display memory in real number and mnemonic formats:

```
display memory 2000h thru 202fh , 2100h real long  
<RETURN>
```

```
display memory 400h mnemonic <RETURN>
```

```
set symbols on <RETURN>
```

```
set source on <RETURN>
```

```
display memory main mnemonic <RETURN>
```

#### See Also

The `copy memory`, `modify memory`, `set`, and `store memory` commands.

## display registers

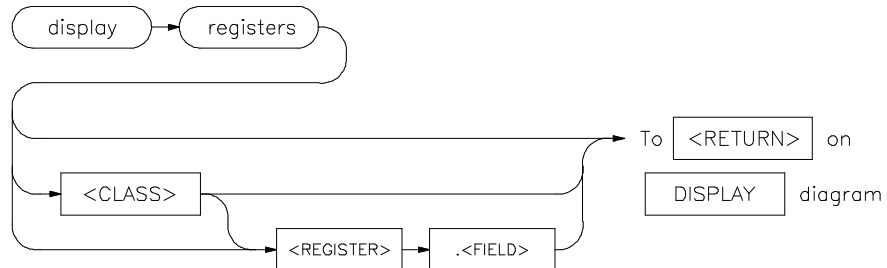

This command displays the current contents of the emulation processor registers.

If a **step** command just executed, the mnemonic representation of the last instruction is also displayed, if the current display is the register display. This process does not occur in real-time. The emulation system must be configured for nonreal-time operation to display registers while the processor is running. Symbols also may be displayed in the register step mnemonic string (see **set symbols**).

Refer to the "Accessing Registers" section in the "Using the Emulator" chapter for a list of the 80960 register classes, names, and control register field names.

With no options specified, the basic register class is displayed as the default. This includes the local and global registers.

The parameters are as follows:

- |            |   |
|------------|---|
| <CLASS>    | This allows you to display a particular class of emulation processor registers. |
| <REGISTER> | This displays an individual register or control register field.                 |
| <FIELD>    | This displays an individual field of a control register.                        |

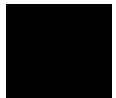

Chapter 11: Emulator/Analyzer Interface Commands  
**display registers**

---

**Examples**

*display registers* <RETURN>

*display registers* control <RETURN>

*display registers* pctl <RETURN>

**See Also**

The **copy registers**, **modify registers**, **set**, and **step** commands.



## display simulated\_io

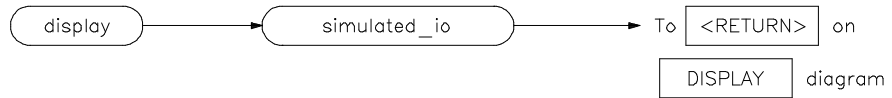

This command displays information written to the simulated I/O display buffer.

After you have enabled polling for simulated I/O during the emulation configuration process, six simulated I/O addresses can be defined. You then define files used for standard input, standard output, and standard error.

For details about setting up simulated I/O, refer to the *Simulated I/O User's Guide*.

---

### Examples

```
display simulated_io <RETURN>
```

### See Also

The **modify configuration** and **modify keyboard\_to\_simio** commands.

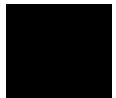

## display software\_breakpoints

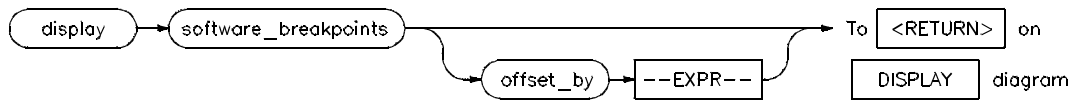

This command displays the currently defined software breakpoints and their status.

If the emulation session is continued from a previous session, the listing will include any previously defined breakpoints. The column marked "status" shows whether the breakpoint is pending, inactivated, or unknown.

A pending breakpoint causes the processor to enter the emulation monitor upon execution of that breakpoint. Executed breakpoints are listed as inactivated. Entries that show an inactive status can be reactivated by executing the **modify software\_breakpoints set** command.

A label column also may be displayed for addresses that correspond to a symbol. See the **set** command for details.

The parameters are as follows:

--EXPR--

An expression is a combination of numeric values, symbols, operators, and parentheses, specifying an offset value for the breakpoint address. See the **--EXPR--** syntax diagram.

offset\_by

This option allows you to offset the listed software breakpoint address value from the actual address of the breakpoint. By subtracting the offset value from the breakpoint address, the system can cause the listed address to match that given in the assembler or compiler listing.

---

### Examples

```
display software_breakpoints <RETURN>
```

```
display software_breakpoints offset_by 1000H <RETURN>
```

### See Also

The **copy software\_breakpoints**, **modify software\_breakpoints**, and **set** commands.

## display table

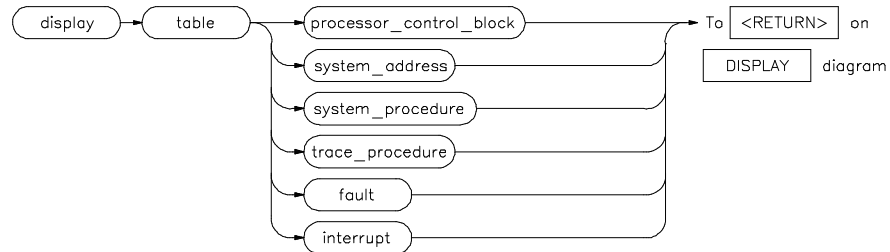

Displays contents of 80960 tables in memory.

The **display table** command gives you a formatted display of the 80960 processor control block, the system tables, and the interrupt and fault tables.

If no table name is specified, the prcb is displayed.

The parameters are as follows:

fault	Displays the fault table.
interrupt	Displays the interrupt table.
processor_control_block	Displays the processor control block.
system_address	Displays the system address table.
system_procedure	Displays the system procedure table.
trace_procedure	Displays the trace procedure table.

### Examples

```
display table <RETURN>
```

```
display table system_address <RETURN>
```

### See Also

The **copy table** command.

## display trace

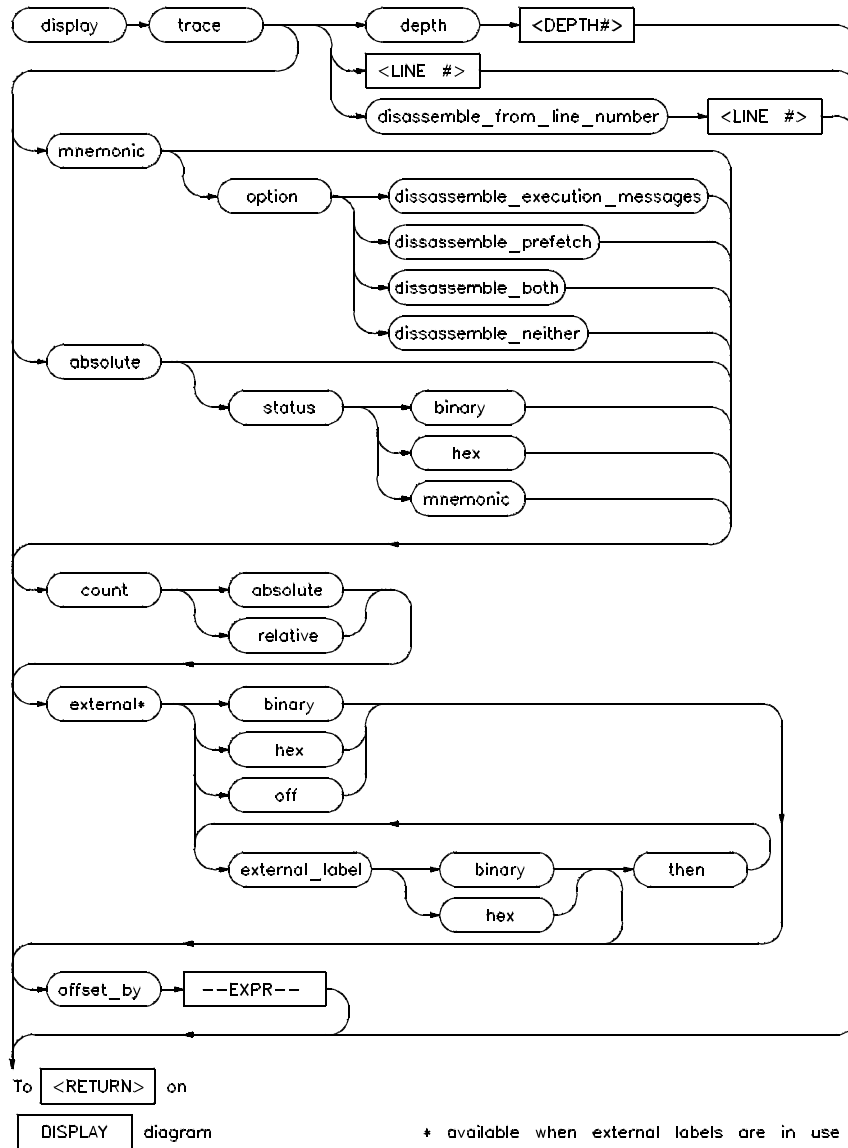

This command displays the contents of the trace buffer.

Captured information can be presented as absolute hexadecimal values or in mnemonic form. The processor status values captured by the analyzer can be listed mnemonically or in hexadecimal or binary form.

Addresses captured by the analyzer are physical addresses.

The **offset\_by** option subtracts the specified offset from the addresses of the executed instructions before listing the trace. With an appropriate entry for **offset**, each instruction in the listed trace will appear as it does in the assembled or compiled program listing.

The **count** parameter lists the time associated with a trace event either relative to the previous event in the trace list or as an absolute count measured from the trigger event.

The **source** parameter allows display of source program lines in the trace listing, enabling you to quickly correlate the trace list with your source program.

Initial values are the same as specified by the command:

```
display trace mnemonic count relative offset_by 0  
<RETURN>
```

The parameters are as follows:

absolute	Lists trace information in hexadecimal format, rather than mnemonic opcodes.
count	
absolute	This lists the time count for each event of the trace as the total time measured from the trigger event.
relative	This lists the time count for each event of the trace as the time measured relative to the previous event.
depth	
<DEPTH#>	This defines the number of states to be uploaded by the Softkey Interface.

Note that after you have changed the trace depth, execute the command **wait measurement\_complete** before displaying the trace. Otherwise the new trace states will not be available.

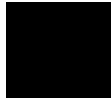

## Chapter 11: Emulator/Analyzer Interface Commands

### display trace

--EXPR-- An expression is a combination of numeric values, symbols, operators, and parentheses, specifying an offset value to be subtracted from the addresses traced by the emulation analyzer. See the EXPR syntax diagram.

#### external

binary Displays the external analyzer trace list in binary format.

<external\_label> This option displays a defined external analyzer label.

hex Displays the external analyzer trace list in hexadecimal format.

off Use this option to turn off the external trace list display.

then This allows you to display multiple external analysis labels. This option appears when more than one external analyzer label is in use.

<LINE#> This prompts you for the trace list line number to be centered in the display. Also, you can use <LINE#> with **disassemble\_from\_line\_number**. <LINE#> prompts you for the line number from which the inverse assembler attempts to disassemble data in the trace list.

mnemonic Lists trace information with opcodes in mnemonic format.

offset\_by This option allows you to offset the listed address value from the address of the instruction. By subtracting the offset value from the physical address of the instruction, the system makes the listed address match that given in the assembler or compiler listing.

This option is also useful for displaying symbols and source lines in dynamically relocated programs.

Note that when using the **set source only** command, the analyzer may operate more slowly than when using the **set source on** command. This is an operating characteristic of the analyzer:

When you use the command **set source on**, and are executing only assembly language code (not high-level language code), no source lines are displayed. The trace list will then fill immediately with the captured assembly language instructions.

When using **set source only**, no inverse assembled code is displayed. Therefore, the emulation software will try to fill the display with high-level source code. This requires the emulation software to search for any captured analysis data generated by a high-level language statement.

In conclusion, you should not set the trace list to **set source only** when tracing assembly code. This will result in optimum analyzer performance.

option

disassemble _execution _messages	Specifies that execution messages should be disassembled in the trace display.
disassemble _prefetch	Specifies that instruction prefetches should be disassembled in the trace display.
disassemble _both	Specifies that both execution messages and instruction prefetches should be disassembled in the trace display.
disassemble _neither	Turns off disassembly and causes only mnemonic status information to be displayed.

status

binary	Lists absolute status information in binary form.
hex	Lists absolute status information in hexadecimal form.
mnemonic	Lists absolute status information in mnemonic form.

---

**Examples**

*display trace count absolute* <RETURN>

*display trace absolute status binary* <RETURN>

*display trace mnemonic* <RETURN>

**See Also**

The **copy trace**, **store trace**, and **set** commands.

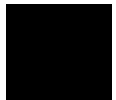

## end

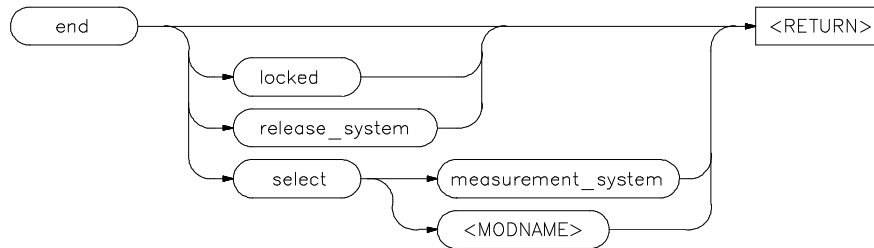

This command terminates the current emulation session.

You can end the emulation session and keep the emulator in a locked state. The current emulation configuration is stored, so that you can continue the emulation session on reentry to the emulator. You can select another measurement system when ending the current session. You also can release the emulation system when ending the session so that others may use the emulator.

Note that pressing **<CTRL>d** performs the same operation as pressing **end <RETURN>**. Pressing **<CTRL>\** or **<CTRL>|** performs the same as **end release\_system <RETURN>**.

When the emulation session ends, control returns to the UNIX shell without releasing the emulator.

The parameters are as follows:

locked

This option allows you to stop all active instances of an emulator Softkey Interface session in one or more windows and/or terminals. This option is not available when operating the emulator in the measurement system.

measurement  
\_system

This is used with the **select** option, and represents another emulation system in the HP 64000-UX measurement system. This option is only available when operating the emulator in the measurement system.

<MODNAME>

Choose this option with **select** to enter another module in the measurement system after ending the current one. <MODNAME> appears when other measurement system modules are defined in the HP 64000-UX measurement system. This option is only available when operating the HP 64700 in the measurement system.



- release\_system** This option stops all instances of the Softkey Interface in one or more windows or terminals. The emulation system is released for other users. If you do not release the emulation system when ending, others cannot access it.
- select** This option lets you choose another defined emulation measurement system when you end the current emulation session. One or more different measurement systems must be active for this option to appear.

---

**Examples**

*end* <RETURN>

*end release\_system* <RETURN>

**See Also**

The "Exiting the Softkey Interface" section in the "Using the Softkey Interface" chapter.

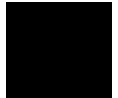

**--EXPR--**

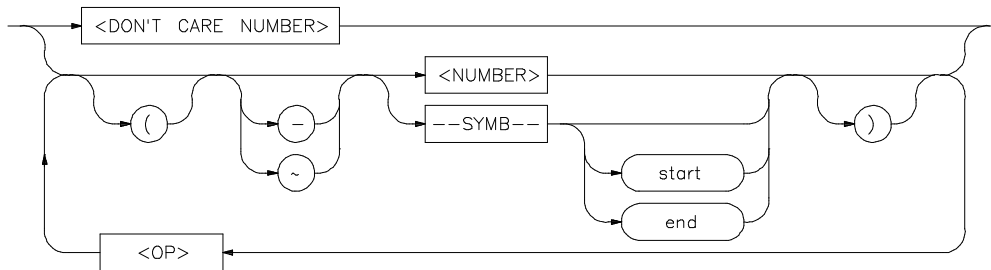

An expression is a combination of numeric values, symbols, operators, and parentheses used to specify address, data, status, executed address, or any other value used in the emulation commands.

The function of an expression (**--EXPR--**) is to let you define the address, data, status, or executed address expression that fits your needs. You can combine multiple values to define the expression.

Certain emulation commands will allow the option of **<+EXPR>** after pressing a thru softkey. This allows you to enter a range without retyping the original base address or symbol. For example, you could specify the address range

```
disp_buf thru disp_buf + 25
```

as

```
disp_buf thru +25
```

The parameters are as follows:

**DON'T CARE NUMBER**

You can include "don't care numbers" in expressions. These are indicated by a number containing an "x." These numbers may be defined as binary, octal, decimal, or hexadecimal. For example: 1fxxh, 17x7o, and 011xxx10b are valid.

Note that "Don't care numbers" are not valid for all commands.

**--NORMAL--**

This appears as a softkey label to enable you to return to the **--EXPR--** key. The **--NORMAL--** label can be accessed whenever defining an expression, but is only

valid when "C" appears on the status line, which indicates a valid expression has been defined.

**<NUMBER>** This can be an integer in any base (binary, octal, decimal, or hexadecimal), or can be a string of characters enclosed with quotation marks.

**<OP>** This represents an algebraic or logical operand and may be any of the following (in order of precedence):

mod	modulo
*	multiplication
/	division
&	logical AND
+	addition
-	subtraction
	logical OR

**--SYMB--** This allows you to define symbolic information for an address, range of addresses, or a file. See the **--SYMB--** syntax pages and the *Symbolic Retrieval Utilities User's Guide* for more information on symbols.

**end** This displays the last location where the symbol information may be located. For example, if a particular symbol is associated with a range of addresses, **end** will represent the last address in that range.

**start** This displays first memory location where the symbol you specify may be located. For example, if a particular symbol is associated with a range of addresses, **start** will represent the first address in that range.

**<UNARY>** This defines either the algebraic negation (minus) sign (-) or the logical negation (NOT) sign (~).

**( )** Parentheses may be used in expressions to enclose numbers. For every opening parenthesis, a closing parenthesis must exist.

Note that when "C" appears on the right side of the status line, a valid expression exists. The **--NORMAL--** key can be accessed at any time, but is only valid when "C" is on the command line.

Note that when a **thru** softkey has been entered, a **<+ EXPR>** prompt appears. This saves you from tedious repeated entry of long symbols and expressions. For example:

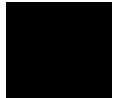

Chapter 11: Emulator/Analyzer Interface Commands  
**--EXPR--**

```
disp_buf thru +25
```

is the same as

```
disp_buf thru disp_buf + 25
```

---

**Examples**

```
05fxh
```

```
0ffffh
```

```
disp_buf + 5
```

```
symb_tbl + (offset / 2)
```

```
start
```

```
mod_name: line 15 end
```

**See Also**

The SYMB syntax description.

## forward

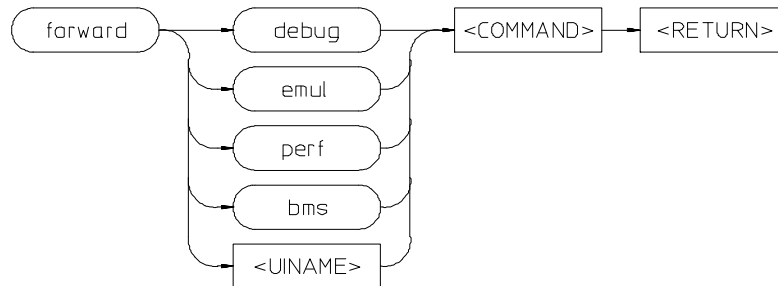

This command lets you forward commands to other HP 64700 interfaces that use the "emul700dmn" daemon process to coordinate actions between the interfaces.

- bms** Sends messages to the Broadcast Message Server or BMS.
- <COMMAND>** An ASCII string, enclosed in quotes, that is the command to be forwarded to the named interface.
- debug** Forwards command to the high-level debugger interface.
- emul** Forwards command to the emulator/analyzer interface.
- perf** Forwards commands to the software performance analyzer interface.
- <UINAME>** Forwards commands to a user interface name other than those available on the softkeys.

---

### Examples

To send the "Program Run" command to the debugger:

```
forward debug "Program Run" <RETURN>
```

To send the "profile" command to the software performance analyzer:

```
forward debug "profile" <RETURN>
```

### See Also

The *User's Guide* for the interface to which you are forwarding commands.

## help



Displays information about system and emulation features during an emulation session.

Typing **help** or **?** displays softkey labels that list the options on which you may receive help. When you select an option, the system will list the information to the screen.

The **help** command is not displayed on the softkeys. You must enter it into the keyboard. You may use a question mark in place of **help** to access the help information.

The parameters are as follows:

<HELP\_FILE>

This represents one of the available options on the softkey labels. You can either press a softkey representing the help file, or type in the help file name. If you are typing in the help file name, make sure you use the complete syntax. Not all of the softkey labels reflect the complete file name.

---

### Examples

```
help system_commands <RETURN>
```

```
? run <RETURN>
```

This is a summary of the commands that appear on the softkey labels when you type **help** or press **?**:

```
system_commands  
run  
trace  
step  
break  
display  
modify  
execution_messages
```

load  
store  
copy  
reset  
stop\_trace  
end  
software\_breakpoints  
registers  
expressions (--EXPR--)  
symbols (--SYMB--)  
specify  
cmb  
cmb\_execute  
map  
set  
wait  
pod\_command  
init\_processor  
bbaunload  
coverage  
performance\_measurement\_initialize  
performance\_measurement\_run  
performance\_measurement\_end

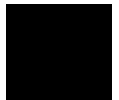

## **init\_processor**



The **init\_processor** command causes the processor to execute a continue initialization IAC message.

If the processor enters the monitor directly out of reset, your program's environment is not yet initialized. Therefore, commands that depend on that environment, such as displaying the processor's registers, are not meaningful. If you enter such a command, the emulator will issue the following error message:

```
ERROR 184: You must do a processor initialization first
```

The **init\_processor** command allows you to initialize your programming environment and re-enter the monitor. First, the eight check-sum words in the program's initial memory image (IMI) are read to verify that they will compute to a valid checksum. Then the PRCB in the IMI is read to determine if it is valid. If the IMI verification passes, the monitor issues a continue initialization IAC message. This causes the processor to carry out the initialization procedure that follows the processor self test, ending just before the first user instruction is executed. The monitor is then re-entered in an initialized state.

If a **run** command is entered before the processor is initialized, the emulator will do the initialization, re-enter the monitor, and then run. If the check-sum words in the IMI are not valid, the processor FAILURE pin will be asserted and the processor will enter the stopped state.

The continue initialization IAC message clears the trace controls register which the emulator uses to establish execution messages and breakpoints. Therefore, the **init\_processor** command forces the monitor to be re-entered in order to restore the previous setting of the trace controls register.

However, a continue initialization IAC message issued by YOUR program does not cause the monitor to be entered. If your program executes a continue initialization IAC message, portions of your debug environment will be disabled until a subsequent break occurs.



## Chapter 11: Emulator/Analyzer Interface Commands

### **init\_processor**

This is similar to the situation that can occur if you run out of reset directly into your program without first entering the monitor. For more information, see the "Enter monitor from reset?" question in the configuration menu.

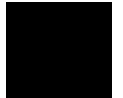

## load

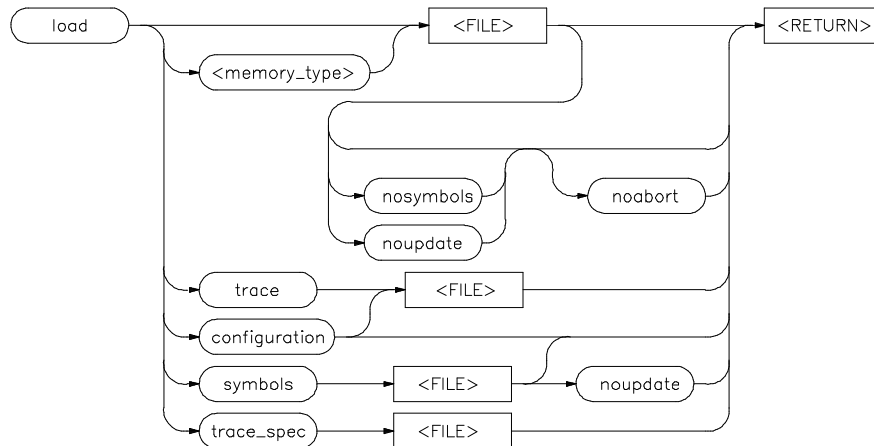

This command transfers absolute files from the host computer into emulation or target system RAM. With other parameters, the load command can load emulator configuration files, trace records, trace specifications, or symbol files.

The absolute file contains information about where the file is stored. The memory map specifies that the locations of the file are in user (target system) memory or emulation memory. This command also allows you to access and display previously stored trace data, load a previously created configuration file, and load absolute files with symbols.

Note that any file specified by <FILE> cannot be named "configuration", "emul\_mem", "user\_mem", "symbols", "trace", or "trace\_spec" because these are reserved words, and are not recognized by the HP 64000-UX system as ordinary file names.

The absolute file is loaded into emulation memory by default.

The parameters are as follows:

### configuration

This option specifies that a previously created emulation configuration file will be loaded into the emulator. You can follow this option with a file name. Otherwise the previously loaded configuration will be reloaded.

<FILE>	This represents the absolute file to be loaded into either target system memory, emulation memory (.X files are assumed), or the trace memory (.TR files are assumed).
<memory_type>	This indicates the type of memory that you choose for the load operation. The memory type can be emulation or user memory. You also can load a background monitor file.
noabort	This option allows you to load a file even if part of the file is located at memory mapped as "guarded" or "target ROM" (trom).
nosymbols	This option causes the file specified to be loaded without symbols.
noupdate	This option suppresses rebuilding of the symbol data base when you load an absolute file. If you load an absolute file, end emulation, then modify the file (and relink it), the symbol database will not be updated upon reentering emulation and reloading the file. The default is to rebuild the database.
symbols	This option causes the file specified to be loaded with symbols.
trace	This option allows you to load a previously generated trace file.
trace_spec	This option allows you to load a previously generated trace specification.

Note that the current trace specification will be modified, but a new trace will not be started. To start a trace with the newly loaded trace specification, enter **trace again** or **specify trace again** (not **trace**). If you specify **trace**, a new trace will begin with the default trace specification, not the one you loaded.

---

### Examples

```
load sort1 <RETURN>

load configuration config3 <RETURN>

load trace trace3 <RETURN>
```

**See Also** The **display trace** command.

## log\_commands

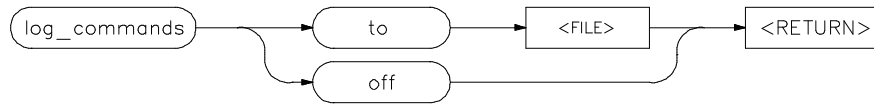

This command allows you to record commands that are executed during an emulation session.

Commands executed during an emulation session are stored in a file until this feature is turned off. This is a handy method for creating command files.

To execute the saved commands after the file is closed, type the filename on the command line.

Commands are not logged (stored) in a file.

The parameters are as follows:

- |        |  |
|--------|--|
| <FILE> | This represents the file where you want to store commands that are executed during an emulation session. |
| off    | This option turns off the capability to log commands.  |
| to     | This allows you to specify a file for the logging of commands.   |

---

### Examples

```
log_commands to logfile <RETURN>
```

```
log_commands off <RETURN>
```

**See Also** The **wait** command.

## **modify**

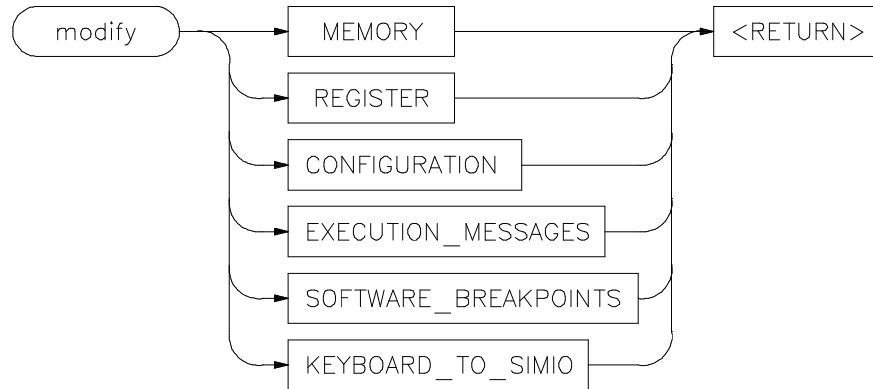

This command allows you to observe or change information specific to the emulator.

The **modify** command is used to:

- Modify contents of memory (as integers, strings, or real numbers).
- Modify the contents of the processor registers.
- View or edit the current emulation configuration.
- Modify the execution message settings.
- Modify the software breakpoints table.

The following pages contain detailed information about the various **modify** syntax diagrams.

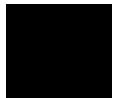

## modify configuration

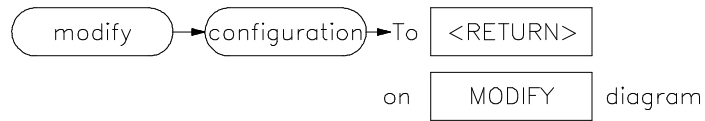

This command allows you to view and edit the current emulation configuration items.

The configuration questions are presented in sequence with either the default response, or the previously entered response. You can select the currently displayed response by pressing <RETURN>. Otherwise, you can modify the response as you desire, then press <RETURN>.

The default responses defined on powerup are displayed.

---

### Examples

*modify configuration* <RETURN>

### See Also

The **load configuration** command.

## modify execution\_messages

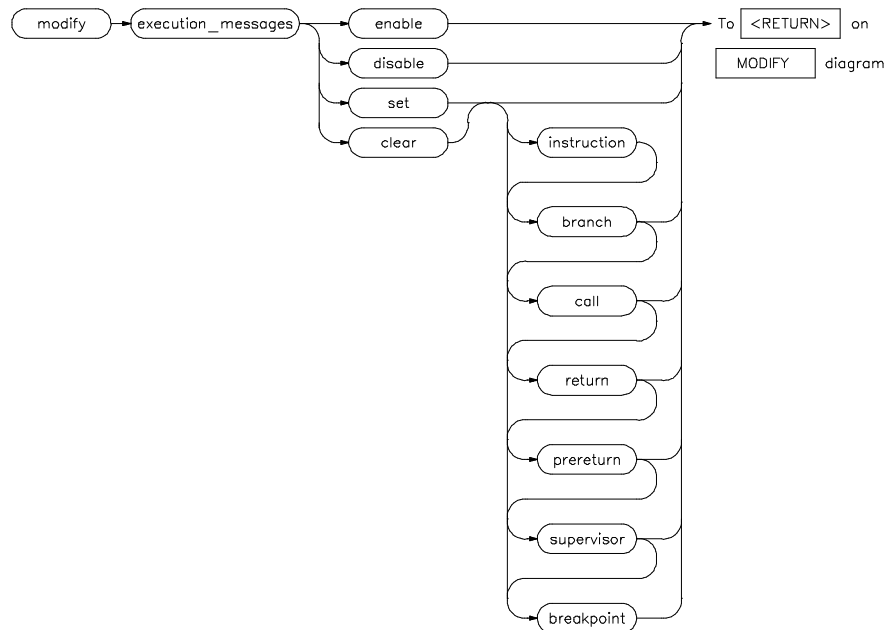

The 80960 executes out of an instruction cache that cannot be disabled. Therefore, it is not possible to determine the execution trace by looking at normal bus activity. An instruction may be prefetched into the cache once and then executed many times. Other instructions may be prefetched but never executed.

The execution message feature provides a way to accurately trace execution activity while the processor is executing instructions contained in the cache. If you "set" execution messages, the emulator will emit a message on the processor bus for specific execution events. This message can then be captured by the analyzer and displayed by the disassembler.

The parameters are as follows:

**enable** Enables the execution message feature.

## Chapter 11: Emulator/Analyzer Interface Commands

### modify execution\_messages

disable	Deactivates any execution messages that have been set, and disables the execution message feature. When you reenables the execution message feature, any execution messages that were deactivated when disabled will be set again.
set	When no options follow, all execution messages except prereturn and breakpoint are set; otherwise, the options that follow turn on specific execution messages. When you set an execution message, the execution messages feature is automatically enabled.
clear	Turns off specific execution messages. When no options follow, all execution messages are turned off; otherwise, the options that follow turn off specific execution messages.
instruction	Turn ON or OFF instruction execution messages.
branch	Turn ON or OFF branch execution messages.
call	Turn ON or OFF call execution messages.
return	Turn ON or OFF return execution messages.
prereturn	Turn ON or OFF pre-return execution messages.
supervisor	Turn ON or OFF supervisor execution messages.
breakpoint	Turn ON or OFF breakpoint execution messages.

---

### Examples

```
modify execution_messages set <RETURN>
```

```
modify execution_messages clear instruction <RETURN>
```

```
modify execution_messages set call return <RETURN>
```

```
modify execution_messages disable <RETURN>
```

---

Setting execution messages will cause a significant performance penalty because the messages take up bus bandwidth. To reduce the performance degradation, you may choose to only set execution messages for a subset of events. For example, you could set execution messages for call events and return events. Note, however,



that this does not allow the inverse assembler to completely recreate the execution history.

When execution messages are enabled, they are included in the trace list. Execution messages in the trace list can be disassembled. To accomplish this, the disassembler may need to access memory to get the instruction's opcode information. Consequently, there may be additional processor cycles due to the execution message.

Note that execution messages cannot be enabled, disabled, or displayed if the emulator is restricted to real-time runs and is executing the user program.

**See Also**

The **display execution\_messages** and **trace** commands.

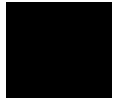

## **modify keyboard\_to\_simio**

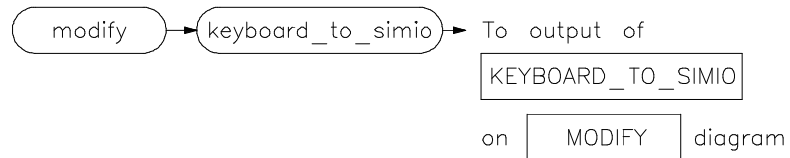

This command allows the keyboard to interact with your program through the simulated I/O software.

When the keyboard is activated for simulated I/O, its normal interaction with emulation is disabled. The emulation softkeys are blank and the softkey labeled "suspend" is displayed on your screen. Pressing **suspend <RETURN>** will deactivate keyboard simulated I/O and return the keyboard to normal emulation mode. For details about setting up simulated I/O, refer to the *Simulated I/O User's Guide*.

**See Also**

The **display simulated\_io** command.

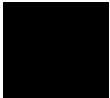

## modify memory

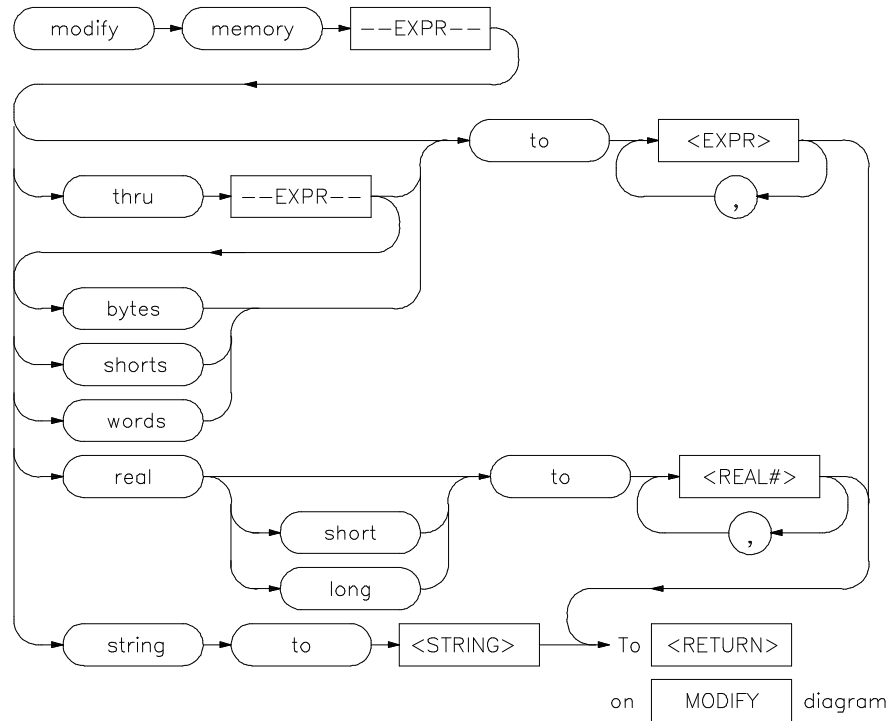

This command lets you modify the contents of selected memory locations.

You can **modify** the contents of individual memory locations to individual values. Or, you can modify a range of memory to a single value or a sequence of values.

Modify a series of memory locations by specifying the address of the first location in the series to be modified, and the values to which the contents of that location and successive locations are to be changed. The first value listed will replace the contents of the first memory location. The second value replaces the contents of the next memory location in the series, and so on, until the list is exhausted. When more than one value is listed, the value representations must be separated by commas. (See the examples for more information.)

## Chapter 11: Emulator/Analyzer Interface Commands

### modify memory

A range of memory can be modified such that the content of each location in the range is changed to the single specified value, or to a single or repeated sequence. This type of memory modification is done by entering the limits of the memory range to be modified (--EXPR-- thru --EXPR--) and the value or list of values (--EXPR--, ... , --EXPR--) to which the contents of all locations in the range are to be changed.

Note that if the specified address range is not large enough to contain the new data, only the specified addresses are modified.

If the address range contains an odd number of bytes and a word operation is being executed, the last word of the address range will be modified. Thus the memory modification will stop one byte after the end of the specified address range.

If an error occurs in writing to memory (to guarded memory or target memory with no monitor) the modification is aborted at the address where the error occurred.

For integer memory modifications, the default is to the current display memory mode, if one is in effect. Otherwise the default is to "byte."

For real memory modifications, the default is to the current display memory mode, if one is in effect. Otherwise the default is "short."

The parameters are as follows:

bytes	Modify memory in byte values.
--EXPR--	An expression is a combination of numeric values, symbols, operators, and parentheses, specifying a memory address. See the EXPR syntax diagram.
long	Modify memory values as 64-bit real values.
real	Modify memory as real number values.
<REAL#>	This prompts you to enter a real number as the value.
short	Modify memory values as 32-bit real numbers.
shorts	Modify memory values as 16-bit values.
string	Modify memory values to the ASCII character string given by <STRING>.
<STRING>	Quoted ASCII string including special characters as follows:
	null                    \ newline                \ 

horizontal tab	\t
backspace	\b
carriage return	\r
form feed	\f
backslash	\\
single quote	\'
bit pattern	\ooo (where ooo is an octal number)

thru	This option lets you specify a range of memory locations to be modified.
to	This lets you specify values to which the selected memory locations will be changed.
words	Modify memory locations as 32-bit values.
,	A comma is used as a delimiter between values when modifying multiple memory addresses.

---

### Examples

```
modify memory data1 bytes to 0E3H , 01H , 08H <RETURN>
```

```
modify memory data1 thru DATA100 to 0FFFFH <RETURN>
```

```
modify memory 0675H real to -1.303 <RETURN>
```

```
modify memory temp real long to 0.5532E-8 <RETURN>
```

```
modify memory buffer string to "This is a test \n\0"  
<RETURN>
```

**See Also** The **copy memory**, **display memory**, and **store memory** commands.

## modify register

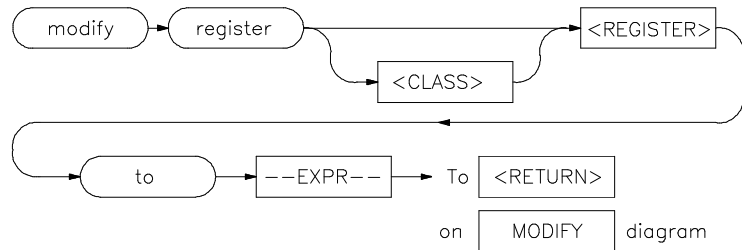

This command allows you to modify the contents of the emulation processor internal registers.

The entry you specify for <REGISTER> determines which register is modified. Individual fields of control registers may be modified.

Register modification cannot be performed during real-time operation of the emulation processor. A **break** command or condition must occur before you can modify the registers.

Refer to the "Accessing Registers" section in the "Using the Emulator" chapter for a list of the 80960 register classes, names, and control register field names.

The parameters are as follows:

--EXPR--

An expression is a combination of numeric values, symbols, operators, and parentheses, specifying a register value. For the floating-point registers, the value is interpreted as a decimal real number. See the **--EXPR--** description.

<REGISTER>

This represents the name of a register.

<FIELD>

This represents the name of a control register field.

to

Allows you to specify the values to which the selected registers will be changed.

---

**Examples**

*modify register* r3 to 41H <RETURN>

*modify register* pct1.pri to 1FH <RETURN>

**See Also**

The **copy registers**, **display registers**, and **modify registers** commands.

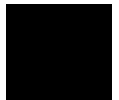

## modify software\_breakpoints

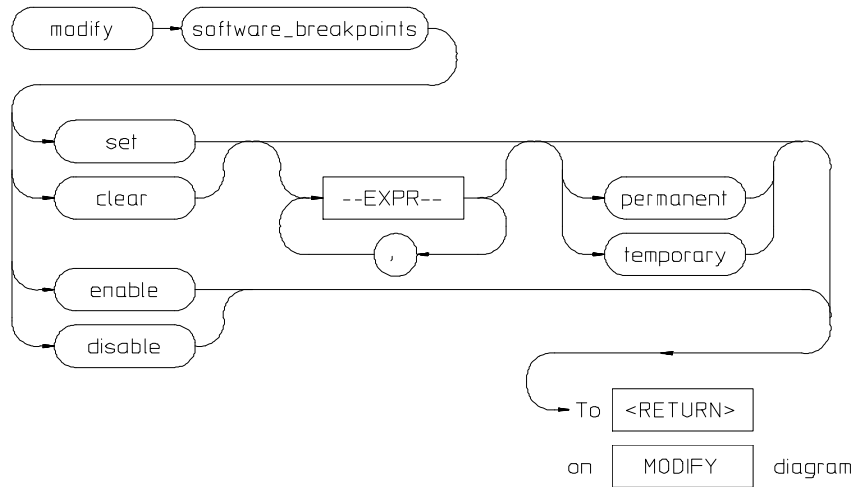

This command changes the specification of software breakpoints.

Software breakpoints provide a way to accurately stop the execution of your program at one or more instruction locations. When a software breakpoint is set, the instruction that is normally at that location is replaced with an "fmark" instruction. When the software breakpoint is executed, control is passed to the emulator's monitor program, and the original instruction is restored in the user program. Thus, execution is interrupted before the instruction at the specified address is executed.

Operation of the program can be resumed after the breakpoint is encountered, by specifying either a **run** or **step** command.

If you modify software breakpoints while the memory mnemonic display is active, the new breakpoints are indicated by a "\*" in the leftmost column of the instruction containing the breakpoint.

The software breakpoint facility may be completely disabled or enabled via the "modify software\_breakpoints" command. The default is "enabled".



The parameters are as follows:

clear	This option erases the specified breakpoint address. If no breakpoints are specified in the command, all currently specified breakpoints are cleared.
disable	This option turns off the software breakpoint capability.
enable	This option allows you to modify the software breakpoint specification.
--EXPR--	An expression is a combination of numeric values, symbols, operators, and parentheses, specifying a software breakpoint address. See the EXPR syntax diagram.
permanent	Sets a permanent breakpoint. The software breakpoint instruction remains in the program until the breakpoint is inactivated or removed.
set	This option allows you to activate software breakpoints in your program. If no breakpoint addresses are specified in the command, all breakpoints that have been inactivated (executed) are reactivated.
temporary	Sets a temporary breakpoint. When the break occurs, the original opcode is replaced in the program.
,	A comma is used as a delimiter between specified breakpoint values.

---

### Examples

```
modify software_breakpoints enable <RETURN>
```

```
modify software_breakpoints set loop1 end , loop2 end ,  
0E40H <RETURN>
```

```
modify software_breakpoints clear <RETURN>
```

```
modify software_breakpoints set <RETURN>
```

The emulator will enter the monitor to set or clear software breakpoints whether the specified address is mapped as emulation or target memory. This is done to assure that the "fmark" instruction is brought into the processor's instruction cache.

In order to successfully set a software breakpoint, the emulator must be able to write to the memory location specified. Therefore software breakpoints can not be set in target ROM. You should use the "run until" command to break on code in

## Chapter 11: Emulator/Analyzer Interface Commands

### **modify software\_breakpoints**

target ROM. Please note that breakpoints set with the "run until" command cause the monitor to be entered AFTER the instruction has executed.

Alternatively, you may use the "break on trigger" feature of the analyzer. Please note, however, that analyzer breakpoints are not precise. There is some delay between the time the trigger event occurs and the time the break occurs.

### **See Also**

The **copy software\_breakpoints**, **display memory mnemonic**, and **display software\_breakpoints** commands.



## **performance\_measurement\_end**

performance\_measurement\_end → <RETURN>

This command stores data previously generated by the **performance\_measurement\_run** command, in a file named "perf.out" in the current working directory.

The file named "perf.out" is overwritten each time this command is executed. Current measurement data existing in the emulation system is not altered by this command.

---

### **Examples**

*performance\_measurement\_end* <RETURN>

### **See Also**

The **performance\_measurement\_initialize** and **performance\_measurement\_run** commands.

Refer to the "Making Software Performance Measurements" chapter for examples of performance measurement specification and use.

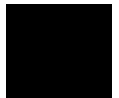

## **performance\_measurement\_initialize**

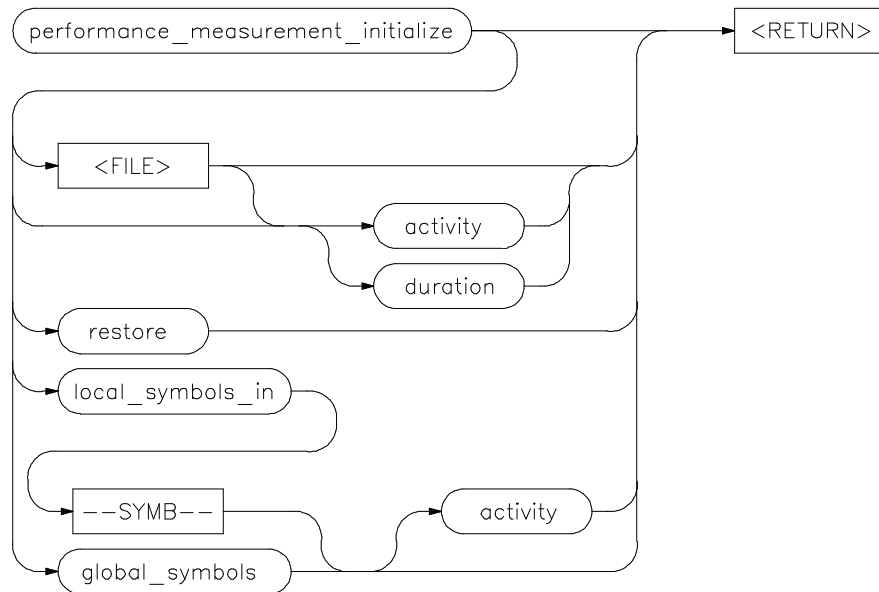

This command sets up performance measurements.

The emulation system will verify whether a symbolic database has been loaded. If a symbolic database has been loaded, the performance measurement is set up with the addresses of all global procedures and static symbols. If a valid database has not been loaded, the system will default to a predetermined set of addresses, which covers the entire emulation processor address range.

The measurement will default to "activity" mode.

Default values will vary, depending on the type of operation selected, and whether symbols have been loaded.

The parameters are as follows:

**activity**

This option causes the performance measurement process to operate as though an option is not specified.

duration	This option sets the measurement mode to "duration." Time ranges will default to a predetermined set (unless a user-defined file of time ranges is specified).
<FILE>	This represents a file you specify to supply user-defined address or time ranges to the emulator.
global_symbols	This option specifies that the performance measurement will be set up with the addresses of all global symbols and procedures in the source program.
local_symbols_in	This causes addresses of the local symbols to be used as the default ranges for the measurement.
restore	This option restores old measurement data so that a measurement can be continued when using the same <b>trace</b> command as previously used.
--SYMB--	This represents the source file that contains the local symbols to be listed. This also can be a program symbol name, in which case all symbols that are local to a function or procedure are used. See the SYMB syntax diagram.

---

### Examples

```
performance_measurement_initialize <RETURN>
```

```
performance_measurement_initialize duration <RETURN>
```

```
performance_measurement_initialize local_symbols_in  
mod_name <RETURN>
```

### See Also

The **performance\_measurement\_run** and **performance\_measurement\_end** commands.

Refer to the "Making Software Performance Measurements" chapter for examples of performance measurement specification and use.

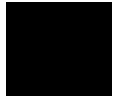

## **performance\_measurement\_run**

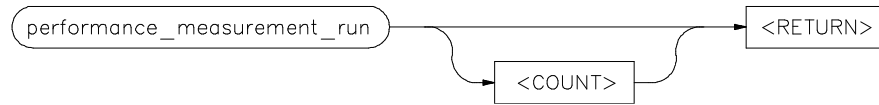

This command begins a performance measurement.

This command causes the emulation system to reduce trace data contained in the emulation analyzer, which will then be used for analysis by the performance measurement software.

The default is to process data presently contained in the analyzer.

The parameters are as follows:

<COUNT>

This represents the number of consecutive traces you specify. The emulation system will execute the trace command, process the resulting data, and combine it with existing data. This sequence will be repeated the number of times specified by the **COUNT** option.

Note that the **trace** command must be set up correctly for the requested measurement. For an activity measurement, you can use the default **trace** command (**trace <RETURN>**).

For a duration measurement, you must set up the trace specification to store only the points of interest. To do this, for example, you could enter:

***trace only*** <symbol\_entry> ***or*** <symbol\_exit>

---

### **Examples**

***performance\_measurement\_run*** 10 <RETURN>

***performance\_measurement\_run*** <RETURN>

### **See Also**

The **performance\_measurement\_end** and **performance\_measurement\_initialize** commands.

Chapter 11: Emulator/Analyzer Interface Commands  
**performance\_measurement\_run**

Refer to the "Making Software Performance Measurements" chapter for examples of performance measurement specification and use.

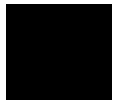

## pod\_command

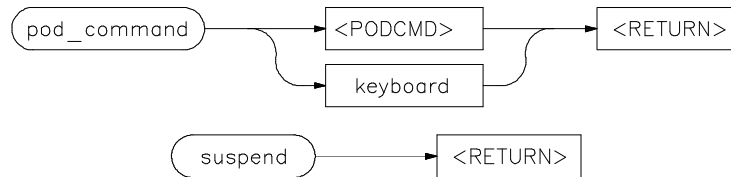

Allows you to control the emulator through the direct HP 64700 Terminal Interface.

The HP 64700 Card Cage contains a low-level Terminal Interface, which allows you to control the emulator's functions directly. You can access this interface using **pod\_command**. The options to **pod\_command** allow you to supply only one command at a time. Or, you can select a keyboard mode which gives you interactive access to the Terminal Interface.

There are certain commands that you should avoid while using the Terminal Interface through **pod\_command**.

<b>stty, po, xp</b>	Do not use. These commands will change the operation of the communications channel, and are likely to hang the Softkey Interface and the channel.
<b>echo, mac</b>	Using these may confuse the communications protocols in use on the channel.
<b>wait</b>	Do not use. The pod will enter a wait state, blocking access by the Softkey Interface.
<b>init, pv</b>	These will reset the emulator pod and force an end release_system command.
<b>t</b>	Do not use. The trace status polling and unload will become confused.

To see the results of a particular **pod\_command** (the information returned by the emulator pod), you use **display pod\_command**.

Refer to the *80960 Emulator User's Guide for the Terminal Interface* for information on using the Terminal Interface to control the emulator.



The parameters are as follows:

keyboard	Enters an interactive mode where you can simply type Terminal Interface commands (unquoted) on the command line. Use <b>display pod_command</b> to see the results returned from the emulator.
<POD_CMD>	Prompts you for a Terminal Interface command as a quoted string. Enter the command in quotes and press <RETURN>.
suspend	This command is displayed once you have entered keyboard mode. Select it to stop interactive access to the Terminal Interface and return to the Softkey Interface.

---

**Examples**

This example shows a simple interactive session with the Terminal Interface.

```
display pod_command <RETURN>
```

```
pod_command keyboard <RETURN>
```

```
cf <RETURN>
```

```
tsq <RETURN>
```

```
tcq <RETURN>
```

Enter **suspend** to return to the Softkey Interface.

**See Also**

The **display pod\_command** command.

Also see the *80960 Emulator User's Guide for the Terminal Interface* and the Terminal Interface on-line help information.

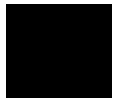

## QUALIFIER

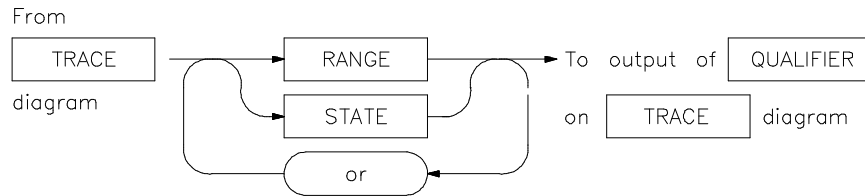

The **QUALIFIER** parameter is used with **trace only**, **trace prestore**, and **TRIGGER** to specify states captured during the trace measurement.

You may specify a range of states (**RANGE**) or specific states (**STATE**) to be captured. You can continue to "or" states until the analyzer resources are depleted. You can use only one **RANGE** statement in the entire **trace** command.

You can include "don't care numbers." These contain an "x" preceded and/or followed by a number. Some examples include 1fxxh, 17x7o, and 011xxx10b. "Don't care numbers" may be entered in binary, octal, or hexadecimal base.

The default is to qualify on all states.

The parameters are as follows:

- |       |  |
|-------|--|
| or    | This option allows you to specify multiple states ( <b>STATE</b> ) to be captured during a trace measurement. See the <b>STATE</b> syntax diagram.   |
| RANGE | This allows you to specify a range of states to be captured during a trace measurement. See the <b>RANGE</b> syntax diagram.                         |
| STATE | This represents a unique state that can be a combination of address, data, status, and executed address values. See the <b>STATE</b> syntax diagram. |

---

### Examples

```
trace only address mod_name:read_input <RETURN>
```

```
trace only address range mod_name:read_input thru  
output <RETURN>
```

*trace only address range* mod\_name:clear *thru* read\_input  
<RETURN>

**See Also**           The **trace** command.

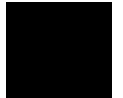

## RANGE

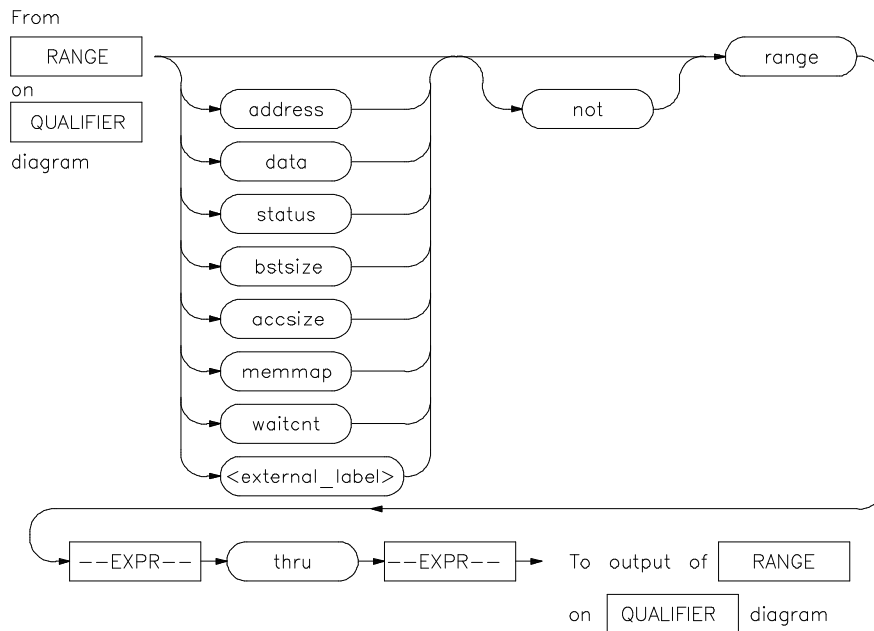

The **RANGE** parameter allows you to specify a condition for the trace measurement, made up of one or more values.

The **range** option can be used for state qualifier labels. **Range** can only be used once in a trace measurement.

Refer to the "Qualifying Trigger and Store Conditions" section in the "Using the Emulation Analyzer" chapter for a list of the predefined values that can be assigned to the accsize, bstsize, memmap, waitcnt, and status state qualifiers.

Expression types are "address" when none is chosen.

The parameters are as follows:

accsize

The value following this softkey is searched for on the lines over which the size of the current access is passed to the analyzer.

address	The value following this softkey is searched for on the lines that monitor the emulation processor's address bus.
bstsize	The value following this softkey is searched for on the lines over which the bus burst size is passed to the analyzer.
data	The value following this softkey is searched for on the lines that monitor the emulation processor's data bus.
--EXPR--	An expression is a combination of numeric values, symbols, operators, and parentheses, specifying an address, data, status, or executed address value. See the EXPR syntax diagram for details.
<external_label>	This represents a defined external analyzer label.
memmap	The value following this softkey is searched for on the lines which monitor the memory map status.
not	This specifies that the analyzer search for the logical "not" of the specified range (this includes any addresses not in the specified range).
range	This indicates a range of addresses to be specified (--EXPR-- thru --EXPR--).
status	The value following this softkey is searched for on the lines that monitor other emulation processor signals.
thru	This indicates that the following address expression is the upper address in a range.
waitcnt	The value following this softkey is searched for on the lines over which the number of wait states that preceded the completion of the bus cycle is passed to the analyzer.

---

**Examples** See the **trace** command examples.

**See Also** The **trace** command and the QUALIFIER syntax description.

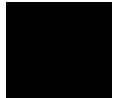

## **reset**

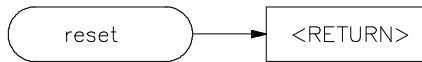

This command suspends target system operation and reestablishes initial emulator operating parameters, such as reloading control registers.

The reset signal is latched when the reset command is executed and released by either the **run** or **break** command.

### **See Also**

The **break** and **run** commands.

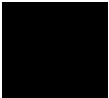

**run**

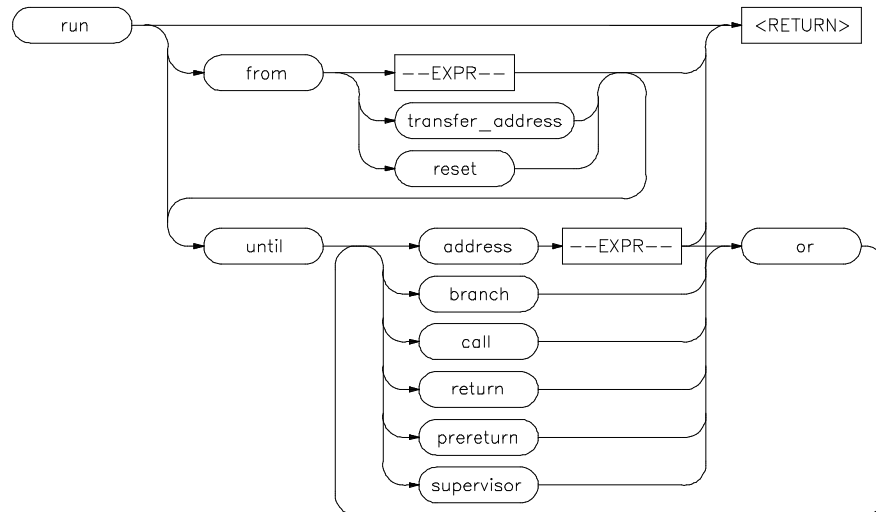

This command causes the emulator to execute a program.

If the processor is in a reset state, **run** will cause the reset to be released. If the emulator is configured to enter the monitor from reset, the monitor will be entered long enough to restore the setting of execution messages and breakpoints before running your program.

If the emulator is configured to run directly into user code out of reset, the monitor will not be entered and part of your debug environment may be temporarily disabled. A subsequent break into the monitor will restore it. See the "Enter monitor from reset?" question in the configuration menu for more information.

If the **from** parameter and an address is specified, the processor will start running your program at that address. Otherwise, the run will occur from the address currently stored in the processor's program counter.

A **run from reset** command will reset the processor and then allow it to run. It is equivalent to entering a **reset** command followed by a **run** command.

## Chapter 11: Emulator/Analyzer Interface Commands

### run

If the emulator is configured to participate in the READY signal on the CMB, then this emulator will release the READY signal so that it will go TRUE if all other HP 64700 emulators participating on that signal are also ready. See the **cmb\_execute** command description.

Qualifying a run command with an **until** parameter allows you to break into the monitor immediately AFTER a particular execution event. These break conditions are implemented by setting bits in the processor's trace control register and by setting the processor's on chip breakpoint registers. Unlike setting a software breakpoint, memory does not have to be modified to set a breakpoint register. This allows you to set a breakpoint in target ROM.

PLEASE NOTE that a software breakpoint occurs immediately before executing the instruction at the specified address, whereas a **run until** break condition occurs after the instruction has executed.

If you omit the address option (--EXPR--), the emulator begins program execution at the current address specified by the emulation processor program counter. If an absolute file containing a transfer address has just been loaded, execution starts at that address.

The parameters are as follows:

address	Specifies an address for a temporary register breakpoint that will be programmed into one of the processor's two breakpoint registers. Up to two addresses may be specified.
branch	Specifies a specialized break condition to the emulator which will halt program execution after any branch instruction.
call	Specifies a specialized break condition to the emulator which will halt program execution after any call instruction.
--EXPR--	An expression is a combination of numeric values, symbols, operators, and parentheses, specifying a memory address. See the EXPR syntax diagram.
from	This specifies the address from which program execution is to begin.
prereturn	Specifies a specialized break condition to the emulator which will halt program execution before any return instruction.
reset	This option resets the processor prior to running.
return	Specifies a specialized break condition to the emulator which will halt program execution after any return instruction.



<b>supervisor</b>	Specifies a specialized break condition to the emulator which will halt program execution after any supervisor call instruction.
<b>transfer_address</b>	This represents the starting address of the program loaded into emulation or target memory. The transfer address is defined in the linker map and is part of the symbol database associated with the absolute file.
<b>until</b>	<p>Specifies execution conditions that will cause the program to stop running and the monitor to be entered.</p> <p>The "run until" command will not cause a break when the address contains certain instructions. For example, if you set a breakpoint register on an IAC instruction or a return from interrupt, the break will not occur.</p> <p>If you run until an instruction that explicitly modifies the fp register (for example, <code>lda 2600,fp</code>), the break will occur; however, all local registers except the rip will be lost.</p>

---

**Examples**

```
run <RETURN>

run from 810H <RETURN>

run from COLD_START <RETURN>

run until return <RETURN>

run from reset until address 910H <RETURN>

run from reset until address 910H or address 920H or
branch or call <RETURN>
```

**See Also**      The `step` command.

## SEQUENCING

From trace  
syntax diagram

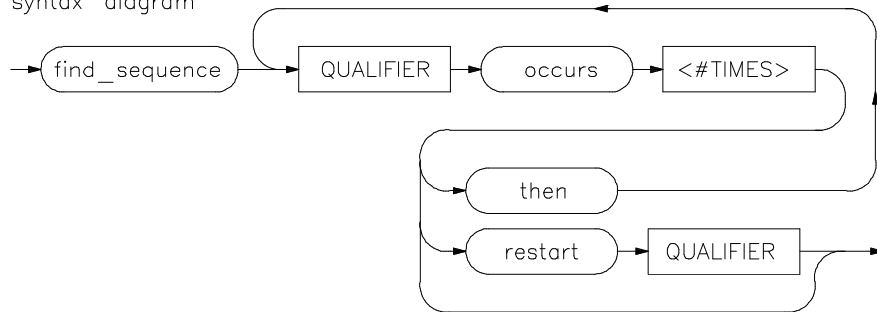

Lets you specify complex branching activity that must be satisfied to trigger the analyzer.

Sequencing provides you with parameters for the **trace** command that let you define branching conditions for the analyzer trigger.

You are limited to a total of seven sequence terms, including the trigger, if no windowing specification is given. If windowing is selected, you are limited to a total of four sequence terms.

The analyzer default is no sequencing terms. If you select the sequencer using the `find_sequence` parameter, you must specify at least one qualifying sequence term.

The parameters are as follows:

**find\_sequence**

Specifies that you want to use the analysis sequencer. You must enter at least one qualifier.

**QUALIFIER**

Specifies the address, data, status, or executed address value or value range that will satisfy this sequence term if looking for a sequence (`find_sequence`), or will restart at the beginning of the sequence (`restart`). See the **QUALIFIER** syntax pages for further information.

occurs	Selects the number of times a particular qualifier must be found before the analyzer proceeds to the next sequence term or the trigger term. This option is not available when trace windowing is in use. See the <b>WINDOW</b> syntax pages.
<#TIMES>	Prompts you for the number of times a qualifier must be found.
then	Allows you to add multiple sequence terms, each with its own qualifier and occurrence count.
restart	Selects global restart. If the analyzer finds the restart qualifier while searching for a sequence term, the sequencer is reset and searching begins for the first sequence term.

---

**Examples**

```
trace find_sequence Caller_3 then Write_Num restart  
"anly.c"."anly.c": line 57 trigger after Results+0c4h  
<RETURN>
```

**See Also** The **trace** command and the QUALIFIER and WINDOW syntax descriptions.

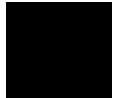

**set**

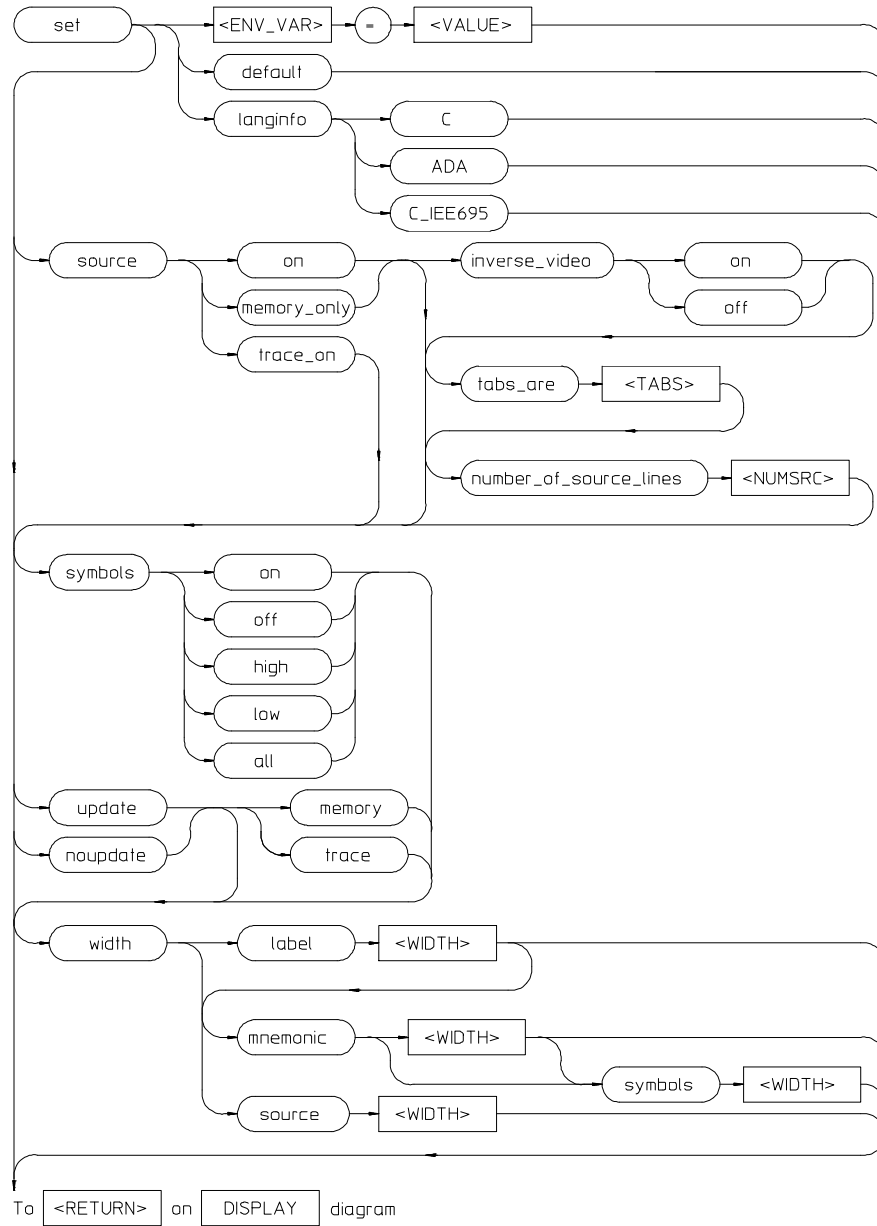

Controls the display format for the data, memory, register, software breakpoint, and trace displays. With the set command, you can adjust the display format results for various measurements, making them easier to read and interpret. Formatting of source lines, symbol display selection and width, and update after measurement can be defined to your needs.

The display command uses the set command specifications to format measurement results for the display window. Another option to the set command, **<ENV\_VAR> = <VALUE>**, allows you to set and export system variables to the UNIX environment.

The default display format parameters are the same as those set by the commands:

***set update***

***set source off symbols off***

You can return the display format to this state by entering:

***set default***

The parameters are as follows:

default	This option restores all the set options to their default settings.
<ENV_VAR>	Specifies the name of a UNIX environment variable to be set.
=	The equals sign is used to equate the <ENV_VAR> parameter to a particular value represented by <VALUE>.
inverse video	
off	This displays source lines in normal video.
on	This highlights the source lines on the screen (dark characters on light background) to differentiate the source lines from other data on the screen.

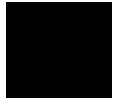

## Chapter 11: Emulator/Analyzer Interface Commands

### set

langinfo	In certain languages, you may have symbols with the same names but different types. For example, in IEEE695, you may have a file named main.c and a procedure named main. SRU would identify these as main(module) and main(procedure). The command <b>display local_symbols_in main</b> would cause an error message to appear (Ambiguous symbol: main(procedure, module)). Users of C tend to think the procedure is important and users of ADA tend to think the module is important. By entering "langinfo" and "C", SRU will interpret the above command to be <b>main(procedure)</b> . With langinfo ADA, SRU will interpret the above command to be <b>main(module)</b> .
C	Identifies ANSI C as the language so SRU can use the C hierarchy to disambiguate symbols.
ADA	Identifies ADA as the language so SRU can use the ADA hierarchy to disambiguate symbols.
C_IEEE695	Identifies C_IEEE-695 as the language so SRU can use the C_IEEE-695 hierarchy to disambiguate symbols.

---

### Note

An alternate method for making the langinfo specification is to use the environment variable, HP64SYMORDER. By making the following entry in your **.profile**, the langinfo setting will always be C, for example.

```
$ HP64SYMORDER=C    # I want to use the C disambiguating
                    # hierarchy
$ export HP64SYMORDER  # let children processes know
                    # about it
```

---

memory	Sets update option for memory displays only.
noupdate	When using multiple windows or terminals, and specifying this option, the display buffer in that window or terminal will not update when a new measurement completes. Displays showing memory contents are not updated when a command executes that could have caused the values in memory to change (modify memory, load, etc.).
number_of_ source_lines	This allows you to specify the number of source lines displayed for the actual processor instructions with which they correlate. Only source lines up to the previous actual source line will be displayed. Using this option, you can specify how many comment lines are displayed preceding the actual source line. The default value is 5.

<NUMSRC>	This prompts you for the number of source lines to be displayed. Values in the range 1 through 50 may be entered.
source	
off	This option prevents inclusion of source lines in the trace and memory mnemonic display lists.
on	This option displays source program lines preceding actual processor instructions with which they correlate. This enables you to correlate processor instructions with your source program code. The option works for both the trace list and memory mnemonic displays.
only	This option displays only source lines. Processor instructions are only displayed in memory mnemonic if no source lines correspond to the instructions. Processor instructions are never displayed in the trace list.
symbols	
off	This prevents symbol display.
on	This displays symbols. This option works for the trace list, memory, software breakpoints, and register step mnemonics.
high	Displays only high level symbols, such as those available from a compiler. See the <i>Symbolic Retrieval Utilities User's Guide</i> for a detailed discussion of symbols.
low	Displays only low level symbols, such as those generated internally by a compiler, or an assembly symbol.
all	Displays all symbols.
tabs_are	This option allows you to define the number of spaces inserted for tab characters in the source listing.
<TABS>	Prompts you for the number of spaces to use in replacing the tab character. Values in the range of 2 through 15 may be entered.
trace	Sets update option for trace displays only.
update	When using multiple windows or terminals, and specifying this option, the display buffer in that window or terminal will be updated when a new measurement completes. This is the default. Note that for displays that show memory contents, the values will be updated when a command executes that changes memory contents (such as modify memory, load, and so on).

## Chapter 11: Emulator/Analyzer Interface Commands

### set

<VALUE> Specifies the logical value to which a particular UNIX environment variable is to be set.

### width

**source** This allows you to specify the width (in columns) of the source lines in the memory mnemonic display. To adjust the width of the source lines in the trace display, increase the widths of the label and/or mnemonic fields.

**label** This lets you specify the address width (in columns) of the address field in the trace list or label (symbols) field in any of the other displays.

**mnemonic** This lets you specify the width (in columns) of the mnemonic field in memory mnemonics, trace list and register step mnemonics displays. It also changes the width of the status field in the trace list.

**symbols** This lets you specify the maximum width of symbols in the mnemonic field of the trace list, memory mnemonic, and register step mnemonic displays.

<WIDTH> This prompts you for the column width of the source, label, mnemonic, or symbols field.

Note that <CTRL>f and <CTRL>g may be used to shift the display left or right to display information which is off the screen.

---

### Examples

```
set source on inverse_video on tabs_are 2 <RETURN>
```

```
set symbols on width label 30 mnemonic 20 <RETURN>
```

```
set PRINTER = "lp -s" <RETURN>
```

```
set HP64KSYMBPATH=".file1:proc1  
.file2:proc2:code_block_1" <RETURN>
```

### See Also

The **display data**, **display memory**, **display software\_breakpoints**, and **display trace** commands.



## specify

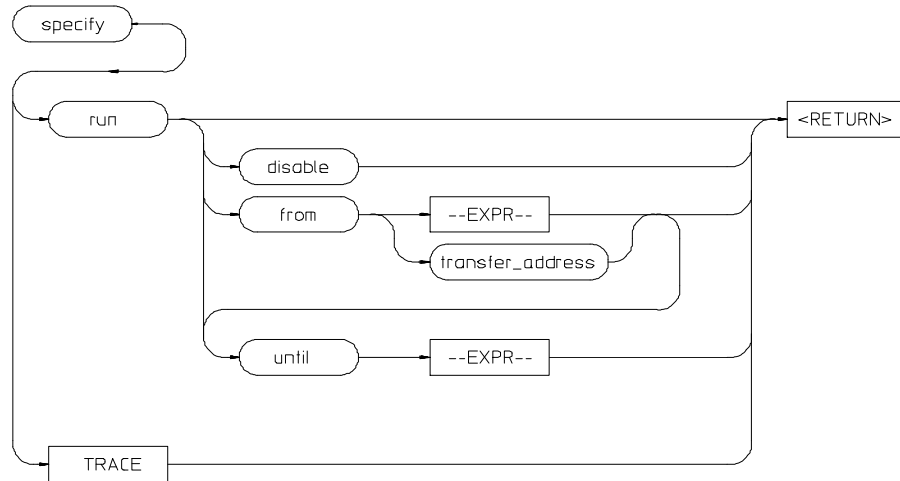

This command prepares a **run** or **trace** command for execution, and is used with the **cmb\_execute** command.

When you precede a **run** or **trace** command with **specify**, the system does not execute your command immediately. Instead, it waits until until an EXECUTE signal is received from the Coordinated Measurement Bus or until you enter a **cmb\_execute** command.

If the processor is reset and no address is specified, a **cmb\_execute** command will run the processor from the "reset" condition.

Note that the **run** specification is active until you enter **specify run disable**. The trace specification is active until you enter another **trace** command without the **specify** prefix.

The emulator will run from the current program counter address if no address is specified in the command.

The parameters are as follows:

**disable**

This option turns off the specify condition of the **run** process.

**specify**

from

--EXPR-- This is used with the **specify run from** command. An expression is a combination of numeric values, symbols, operators, and parentheses, specifying a memory address. See the EXPR syntax diagram.

transfer\_address This is used with the **specify run from** command, and represents the address from which the program will begin running.

run This option specifies that the emulator will run from either an expression or from the transfer address when a CMB EXECUTE signal is received.

TRACE This option specifies that a trace measurement will be taken when a CMB EXECUTE signal is received.

until Specifies an address where program execution is to stop. The emulator will set a software breakpoint at this address and stop execution of your program when it reaches this address and enter the monitor.

---

**Examples**

*specify run from* START <RETURN>

*specify trace after address* 1234H <RETURN>

**See Also**

The **cmb\_execute** command.

## STATE

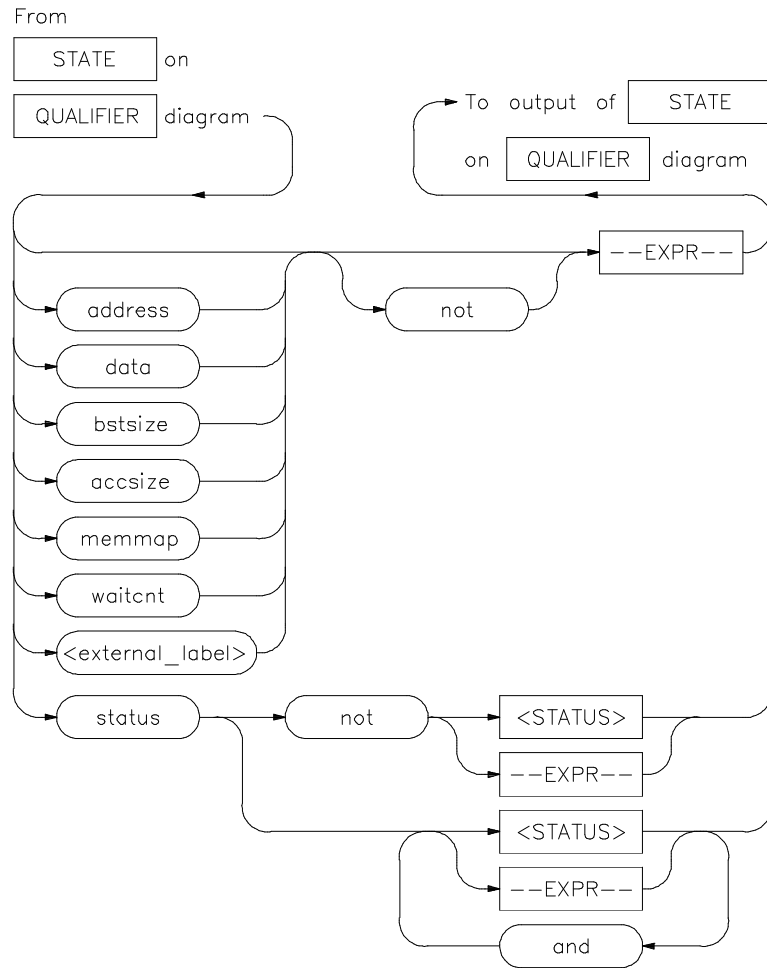

This parameter lets you specify a trigger condition as a unique combination of address, data, status, and executed address values.

The **STATE** option is part of the **QUALIFIER** parameter to the **trace** command, and allows you to specify a condition for the trace measurement.

## Chapter 11: Emulator/Analyzer Interface Commands

### STATE

Refer to the "Qualifying Trigger and Store Conditions" section in the "Using the Emulation Analyzer" chapter for a list of the predefined values that can be assigned to the `accsize`, `bstsize`, `memmap`, `waitcnt`, and `status` state qualifiers.

The default STATE expression type is address.

The parameters are as follows:

<code>accsize</code>	The value following this softkey is searched for on the lines over which the size of the current access is passed to the analyzer.
<code>address</code>	This specifies that the expression following is an address value. This is the default, and is therefore not required on the command line when specifying an address expression.
<code>and</code>	This lets you specify a combination of status and expression values when <b>status</b> is specified in the state specification.
<code>bstsize</code>	The value following this softkey is searched for on the lines over which the bus burst size is passed to the analyzer.
<code>data</code>	The value following this softkey is searched for on the lines that monitor the emulation processor's data bus.
<code>--EXPR--</code>	An expression is a combination of numeric values, symbols, operators, and parentheses, specifying an address, data, status, or executed address value. See the EXPR syntax diagram.
<code>&lt;external_label&gt;</code>	This represents a defined external analyzer label.
<code>memmap</code>	The value following this softkey is searched for on the lines which monitor the memory map status.
<code>not</code>	This specifies that the analyzer will search for the logical "not" of a specified state (this includes any address that is not in the specified state).
<code>status</code>	The value following this softkey is searched for on the lines that monitor other emulation processor signals.
<code>&lt;STATUS&gt;</code>	This prompts you to enter a status value in the command line. Status values can be entered from softkeys or typed into the keyboard. Numeric values may be entered using symbols, operators, and parentheses to specify a status value. See the EXPR syntax diagram.
<code>waitcnt</code>	The value following this softkey is searched for on the lines over which the number of wait states that preceded the completion of the bus cycle is passed to the analyzer.

---

**Examples**

`trace before status write memmap rom <RETURN>`

`trace about address 1000H bstsize quad accsize word  
<RETURN>`

See the **trace** command examples.

**See Also**

The **trace** command and the QUALIFIER syntax description.

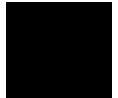

## step

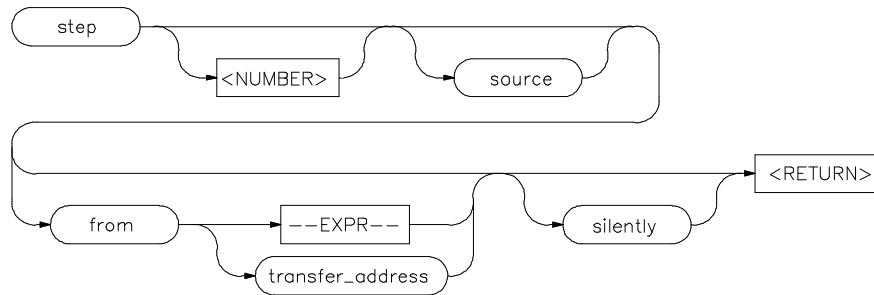

The **step** command allows sequential analysis of program instructions by causing the emulation processor to execute a specified number of assembly instructions or source lines.

You can display the contents of the processor registers, trace memory, and emulation or target memory after each **step** command.

Source line stepping is implemented by single stepping assembly instructions until the next PC is beyond the address range of the current source line. When attempting source line stepping on assembly code (with no associated source line), stepping will complete when a source line is found. Therefore, stepping only assembly code may step forever. To abort stepping, press `<CTRL>c`.

When displaying memory mnemonic and stepping, the next instruction that will step is highlighted. The memory mnemonic display autopages to the new address if the next PC goes outside of the currently displayed address range. This feature works even if stepping is performed in a different emulation window than one displaying memory mnemonic.

If no value is entered for `<NUMBER>` times, only one **step** instruction is executed each time you press `<RETURN>`. Multiple instructions can be executed by holding down the `<RETURN>` key. Also, the default step is for assembly code lines, not source code lines.

If the **from** address option (defined by `--EXPR--` or `transfer_address`) is omitted, stepping begins at the next program counter address.

If you step on an instruction that explicitly modifies the fp register (for example, `lda 2600,fp`), all local registers except the rip will be lost.

The parameters are as follows:

<code>--EXPR--</code>	An expression is a combination of numeric values, symbols, operators, and parentheses specifying a memory address. See the EXPR syntax diagram.
<code>from</code>	Use this option to specify the address from which program stepping begins.
<code>&lt;NUMBER&gt;</code>	This defines the number of instructions that will be executed by the <b>step</b> command. The number of instructions to be executed can be entered in binary (B), octal (O or Q), decimal (D), or hexadecimal (H) notation.
<code>silently</code>	This option updates the register step mnemonic only after stepping is complete. This will speed up stepping of many instructions. The default is to update the register step mnemonic after each assembly instruction (or source line) executes (if stepping is performed in the same window as the register display).
<code>transfer_address</code>	This represents the starting address of the program you loaded into emulation or target memory. The <code>transfer_address</code> is defined in the linker map.
<code>source</code>	This option performs stepping on source lines.

---

### Examples

```
step <RETURN>

step from 810H <RETURN>

step 20 from 0A0H <RETURN>

step 5 source <RETURN>

step 20 silently <RETURN>

step 4 from main <RETURN>
```

**See Also** The **display registers**, **display memory mnemonic**, and **set symbols** commands.

## **stop\_trace**



This command terminates the current trace and stops execution of the current measurement.

The analyzer stops searching for trigger and trace states. If trace memory is empty (no states acquired), nothing will be displayed.

### **See Also**

The **trace** command.



**store**

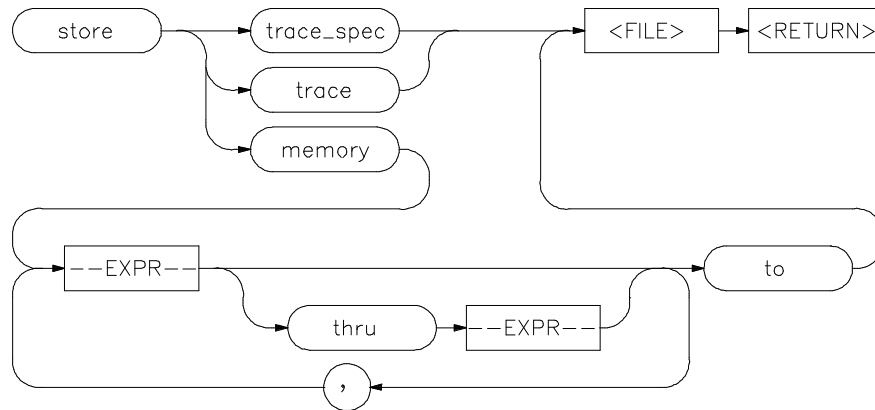

This command lets you save the contents of specific memory locations in an absolute file. You also can save trace memory contents in a trace file.

The **store** command creates a new file with the name you specify, if there is not already an absolute file with the same name. If a file represented by **<FILE>** already exists, you must decide whether to keep or delete the old file. If you respond with **yes** to the prompt, the new file replaces the old one. If you respond with **no**, the **store** command is canceled and no data is stored.

The transfer address of the absolute file is set to zero.

The parameters are as follows:

- EXPR--** This is a combination of numeric values, symbols, operators, and parentheses, specifying a memory address. See the EXPR syntax diagram.
- <FILE>** This represents a file name you specify for the absolute file identifier or trace file where data is to be stored. If you want to name a file beginning with a number, you must precede the file name with a backslash (\) so the system will recognize it as a file name.
- memory** This causes selected memory locations to be stored in the specified file with a **.X** extension.
- thru** This allows you to specify that ranges of memory be stored.

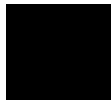

## Chapter 11: Emulator/Analyzer Interface Commands

### **store**

<b>to</b>	Use this in the <b>store memory</b> command to separate memory locations from the file identifier.
<b>trace</b>	This option causes the current trace data to be stored in the specified file with a <b>.TR</b> extension.
<b>trace_spec</b>	This option stores the current trace specification in the specified file with a <b>.TS</b> extension.
<b>,</b>	A comma separates memory expressions in the command line.

---

### **Examples**

```
store memory 800H thru 20FFH to TEMP2 <RETURN>
```

```
store memory EXEC thru DONE to \12.10 <RETURN>
```

```
store trace TRACE <RETURN>
```

```
store trace_spec TRACE <RETURN>
```

### **See Also**

The **display memory**, **display trace**, and **load** commands.

**--SYMB--**

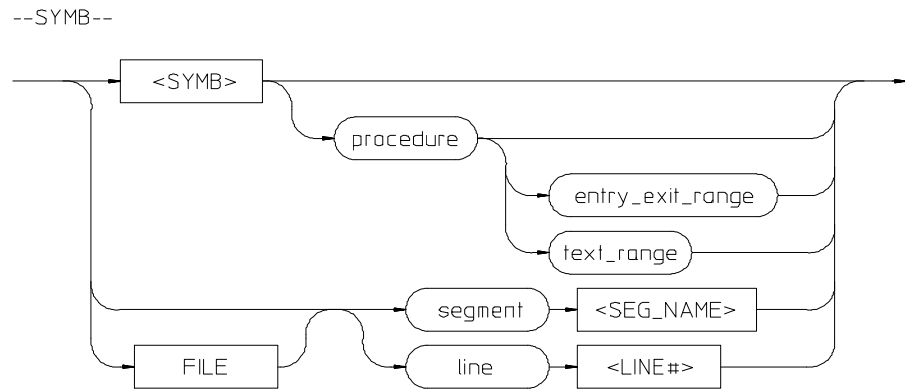

FILE

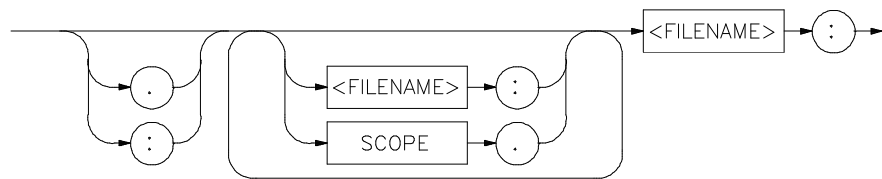

<SYMB>

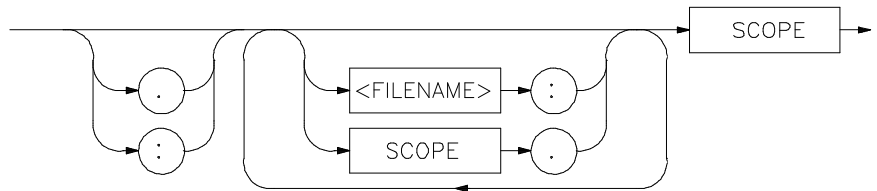

SCOPE

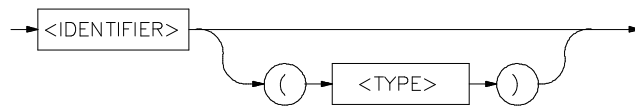

**--SYMB--**

This parameter is a symbolic reference to an address, address range, file, or other value.

Note that if no default file was defined by executing the command **display local\_symbols\_in --SYMB--**, or with the **cws** command, a source file name (<**FILE**>) must be specified with each local symbol in a command line.

Symbols may be:

- Combinations of paths, filenames, and identifiers defining a scope, or referencing a particular identifier or location (including procedure entry and exit points).
- Combinations of paths, filenames, and line numbers referencing a particular source line.
- Combinations of paths, filenames, and segment identifiers identifying a particular PROG, DATA or COMN segment or a user-defined segment.

The Symbolic Retrieval Utilities (SRU) handle symbol scoping and referencing. These utilities build trees to identify unique symbol scopes.

If you use the SRU utilities to build a symbol database before entering the emulation environment, the measurements involving a particular symbol request will occur immediately. If you then change a module and reenter the emulation environment without rebuilding the symbol database, the emulation software rebuilds the changed portions of the database in increments as necessary.

Further information regarding the SRU and symbol handling is available in the *Symbolic Retrieval Utilities User's Guide*. Also refer to that manual for information on the **HP64KSYMBPATH** environment variable.

The last symbol specified in a **display local\_symbols\_in --SYMB--** command, or with the **cws** command, is the default symbol scope. The default is "none" if no current working symbol was set in the current emulation session.

You also can specify the current working symbol by typing the **cws** command on the command line and following it with a symbol name. The **pws** command displays the current working symbol on the status line.

Display memory mnemonic also can modify the current working symbol.

The parameters are as follows:

<FILENAME>	This is an UNIX path specifying a source file. If no file is specified, and the identifier referenced is not a global symbol in the executable file that was loaded, then the default file is assumed (the last absolute file specified by a display local_symbols_in command). A default file is only assumed when other parameters (such as <b>line</b> ) in the <b>--SYMB--</b> specification expect a file.
line	This specifies that the following numeric value references a line number in the specified source file.
<LINE#>	Prompts you for the line number of the source file.
<IDENTIFIER>	Identifier is the name of an identifier as declared in the source file.
SCOPE	Scope is the name of the portion of the program where the specified identifier is defined or active (such as a procedure block).
segment	This indicates that the following string specifies a standard segment (such as PROG, DATA, or COMN) or a user-defined segment in the source file.
<SEG_NAME>	Prompts you for entry of the segment name.
(<TYPE>)	When two identifier names are identical and have the same scope, you can distinguish between them by entering the type (in parentheses). Do not type a space between the identifier name and the type specification. The type will be one of the following:
filename	Specifies that the identifier is a source file.
module	These refer to module symbols. For Ada, they are packages. Other language systems may allow user-defined module names.
procedure	Any procedure or function symbol. For languages that allow a change of scope without explicit naming, SRU assigns an identifier and tags it with type procedure.
static	Static symbols, which includes global variables. The logical address of these symbols will not change.
task	Task symbols, which are specifically defined by the processor and language system in use.
:	A colon is used to specify the UNIX file path from the line, segment, or symbol specifier. When following the file name with a line or segment selection, there must be a space after the colon. For a symbol, there must not be a space after the colon.



**Examples**

The following short C code example should help illustrate how symbols are maintained by SRU and referenced in your emulation commands.

File /users/dave/control.c:

```
int *port_one;
main ()
{
  int port_value;

  port_ptr = port_one;
  port_value = 10;

  process_port (port_ptr, port_value);
} /* end main */
```

File /system/project1/porthand.c:

```
#include "utils.c"

void process_port (int *port_num, int port_data)
{
  static int i;
  static int i2;

  for (i = 0; i <= 64; i++) {
    i2 = i * 2;
    *port_num = port_data + i2;
    delay();
    {
      static int i;
      i = 3;
      port_data = port_data + i;
    }
  }
} /* end of process_port */
```

File /system/project1/utils.c:

```
delay()
{
  int i,j;
  int waste_time;

  for (i = 0; i <= 256000; i++)
    for (j = 0; j <= 256000; j++)
      waste_time = 0;
} /* end delay */
```

The symbol tree as built by SRU might appear as follows, depending on the object module format and compiler used:

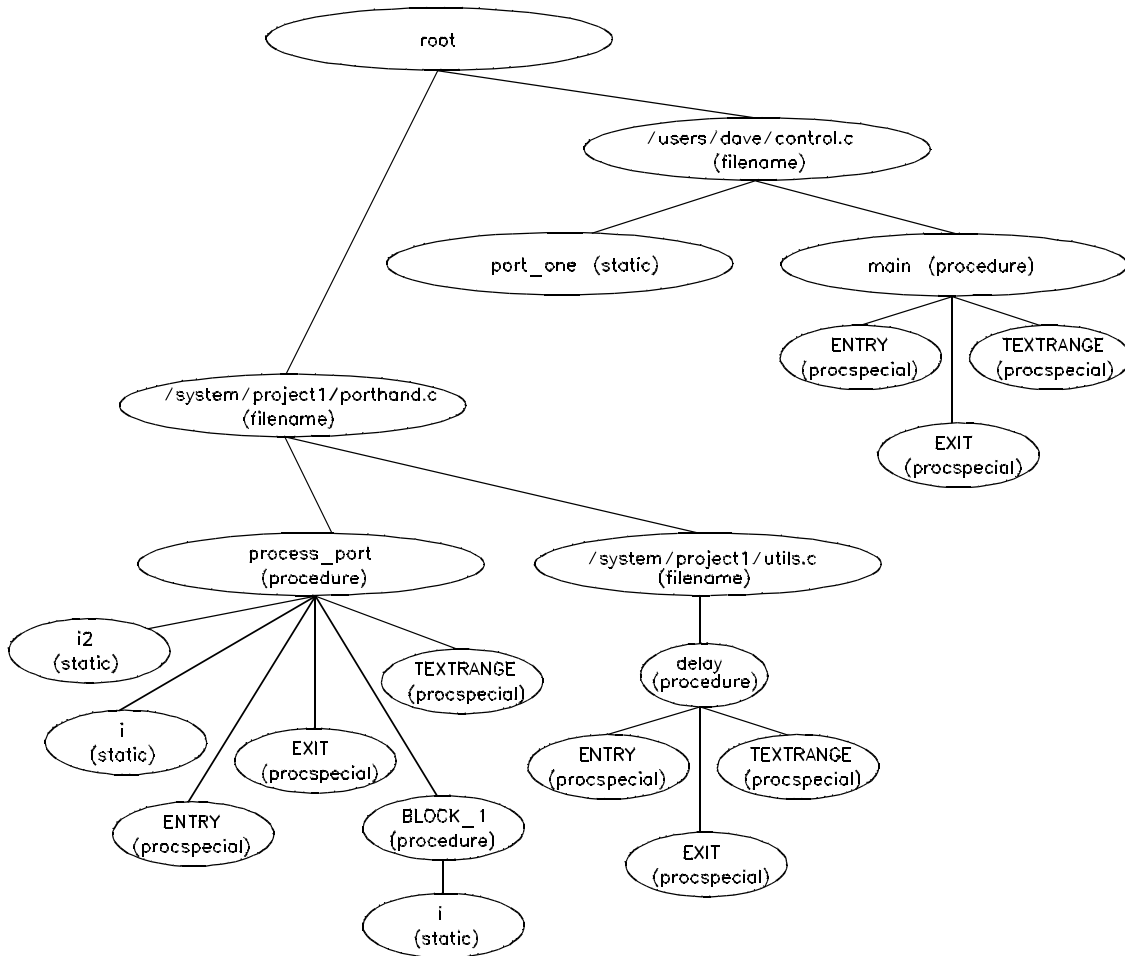

Note that SRU does not build tree nodes for variables that are dynamically allocated on the stack at run-time, such as *i* and *j* within the `delay ()` procedure.

**--SYMB--**

SRU has no way of knowing where these variables will be at run time and therefore cannot build a corresponding symbol tree entry with run time address.

Here are some examples of referencing different symbols in the above programs:

```
control.c:main
```

```
control.c:port_one
```

```
porthand.c:utils.c:delay
```

The last example above only works with IEEE-695 object module format; the HP object module format does not support referencing of include files that generate program code.

```
porthand.c:process_port.i
```

```
porthand.c:process_port.BLOCK_1.i
```

Notice how you can reference different variables with matching identifiers by specifying the complete scope. You also can save typing by specifying a scope with cws. For example, if you are making many measurements involving symbols in the file porthand.c, you could specify:

```
cws porthand.c:process_port
```

Then:

```
i
```

```
BLOCK_1.i
```

are prefixed with porthand.c: process\_port before the database lookup.

If a symbol search with the current working symbol prefix is unsuccessful, the last scope on the current working symbol is stripped. The symbol you specified is then retested with the modified current working symbol. Note that this does not change the actual current working symbol.

For example, if you set the current working symbol as

```
cws porthand.c:process_port.BLOCK_1
```



and made a reference to symbol `i2`, the retrieval utilities attempt to find a symbol called

```
porthand.c:process_port.BLOCK_1.i2
```

which would not be found. The symbol utilities would then strip `BLOCK_1` from the current working symbol, yielding

```
porthand.c:process_port.i2
```

which is a valid symbol.

You also can specify the symbol type if conflicts arise. Although not shown in the tree, assume that a procedure called `port_one` is also defined in `control.c`. This would conflict with the identifier `port_one` which declares an integer pointer. SRU can resolve the difference. You must specify:

```
control.c:port_one(static)
```

to reference the variable, and

```
control.c:port_one(procedure)
```

to reference the procedure address.

**See Also**

The **copy local\_symbols\_in** and **display local\_symbols\_in** commands.

Also refer to the *Symbolic Retrieval Utilities User's Guide* for further information on symbols.

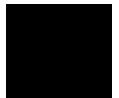

## trace

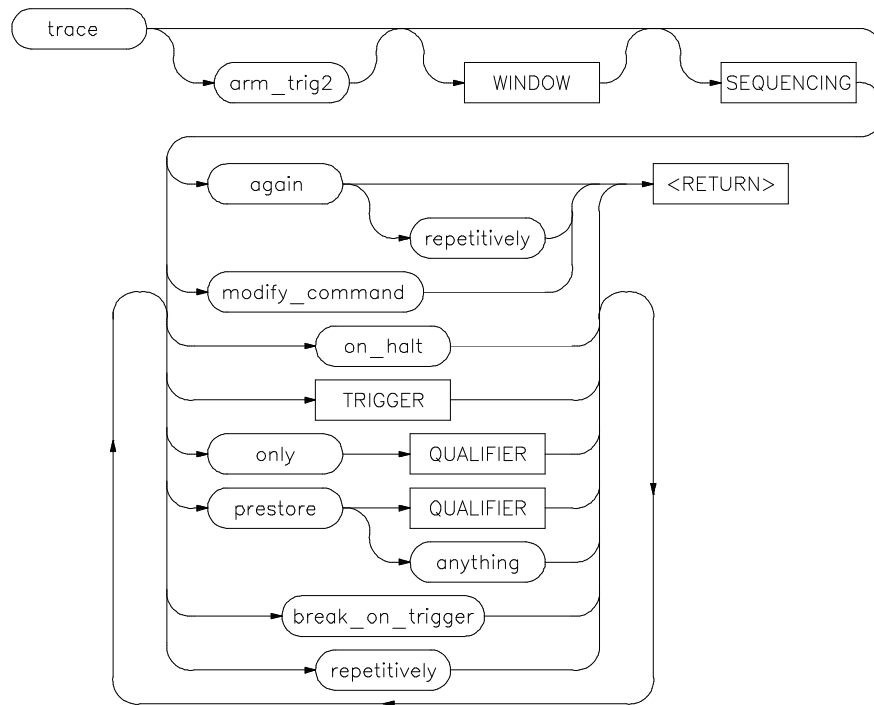

This command allows you to trace program execution using the emulation analyzer.

Note that the options shown can be executed once for each **trace** command. Refer to the TRIGGER and QUALIFIER diagrams for details on setting up a trace.

You can perform analysis tasks either by starting a program run and then specifying the trace parameters, or by specifying the trace parameters first and then initiating the program run. Once a **trace** begins, the analyzer monitors the system busses of the emulation processor to detect the states specified in the **trace** command.

When the trace specification is satisfied and trace memory is filled, a message will appear on the status line indicating the trace is complete. You can then use display trace to display the contents of the trace memory. If a previous trace list is on

screen, the current trace automatically updates the display. If the trace memory contents exceed the page size of the display, the <NEXT>, <PREV>, <Up arrow>, or <Down arrow> keys may be used to display all the trace memory contents. You also can press <CTRL>f and <CTRL>g to move the display left and right.

You can set up trigger and storage qualifications using the **specify trace** command. The analyzers will begin tracing when a **cmb\_execute** command executes, which causes an EXECUTE signal on the Coordinated Measurement Bus.

The analyzer will trace any state by default.

The parameters are as follows:

again	This option repeats the previous trace measurement. It also begins a trace measurement with a newly loaded trace specification. (Using <b>trace</b> without the <b>again</b> parameter will start a trace with the default specification rather than the loaded specification.)
anything	This causes the analyzer to capture any type of information.
arm_trig2	This option allows you to specify the external trigger as a trace qualifier, for coordinating measurements between multiple HP 64700s, or an HP 64700 and another instrument.  Before arm_trig2 can appear as an option, you must modify the emulation configuration interactive measurement specification. When doing this, you must specify that either BNC or CMBT drive trig2, and that the analyzer receive trig2. See the chapter on "Making Coordinated Measurements" for more information.
break_on_trigger	This stops target system program execution when the trigger is found. The emulator begins execution in the emulation monitor. When using this option, the <b>on_halt</b> option cannot be included in the command.
modify_command	This recalls the last trace command that was executed.
on_halt	When using this option, the analyzer will continue to capture states until the emulation processor halts or until a <b>stop_trace</b> command is executed. When this option is used, the <b>break_on_trigger</b> , <b>repetitively</b> , and <b>TRIGGER</b> options cannot be included in the command.
only	This option allows you to qualify the states that are stored, as defined by <b>QUALIFIER</b> .
prestore	This option instructs the analyzer to save specific states that occur prior to states that are stored (as specified with the "only" option).



## Chapter 11: Emulator/Analyzer Interface Commands

### trace

QUALIFIER	This determines which of the traced states will be stored or prestored in the trace memory for display upon completion of the trace. Events can be selectively saved by using <b>trace only</b> to enter the specific events to be saved. When this is used, only the indicated states are stored in the trace memory. See the QUALIFIER syntax.
repetitively	This initiates a new trace after the results of the previous trace are displayed. The trace will continue until a <b>stop_trace</b> or a new <b>trace</b> command is issued. When using this option, you cannot use the <b>on_halt</b> option.
SEQUENCING	Allows you to specify up to seven sequence terms including the trigger. The analyzer must find each of these terms in the given order before searching for the trigger. You are limited to four sequence terms if windowing is enabled. See the SEQUENCING syntax pages for more details.
TRIGGER	This represents the event on the emulation bus to be used as the starting, ending, or centering event for the trace. See the TRIGGER syntax diagram. When using this option, you cannot include the <b>on_halt</b> option.
WINDOW	Selectively enables and disables analyzer operation based upon independent enable and disable terms. This can be used as a simple storage qualifier. Or, you may use it to further qualify complex trigger specifications. See the WINDOW syntax pages for details.

---

### Examples

```
trace after 1000H <RETURN>
```

```
trace only address range 1000H thru 1004H <RETURN>
```

```
trace after address 1000H occurs 2 only address range  
1000H thru 1004H break_on_trigger <RETURN>
```

### See Also

The **copy trace**, **display trace**, **load trace**, **load trace\_spec**, **specify trace**, **store trace**, and **store trace\_spec** commands.

## TRIGGER

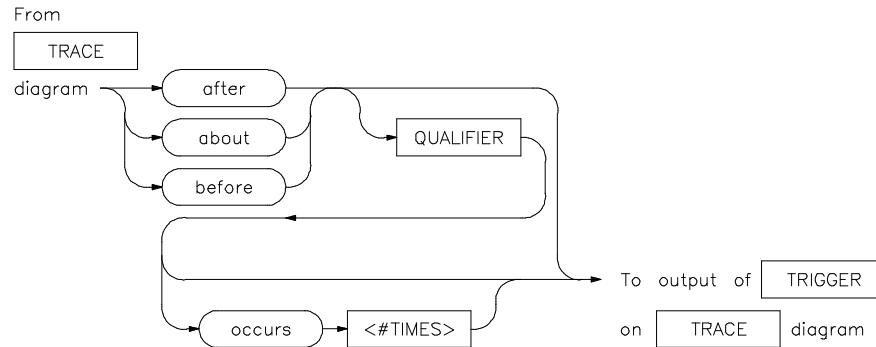

This parameter lets you define where the analyzer will begin tracing program information during a trace measurement.

A trigger is a **QUALIFIER**. When you include the **occurs** option, you can specify the trigger to be a specific number of occurrences of a **QUALIFIER** (see the **QUALIFIER** syntax diagram).

The default is to trace after any state occurs once.

The parameters are as follows:

about	This option captures trace data leading to and following the trigger qualifier. The trigger is centered in the trace listing.
after	Trace data is acquired after the trigger qualifier is found.
before	Trace data is acquired prior to the trigger qualifier.
occurs	This specifies a number of qualifier occurrences of a range or state on which the analyzer is to trigger.
QUALIFIER	This determines which of the traced states will be stored in trace memory.
<#TIMES>	This prompts you to enter a number of qualifier occurrences.



## TRIGGER

---

### Examples

*trace after* MAIN <RETURN>

*trace after* 1000H *then data* 5 <RETURN>

Also see the **trace** command examples.

### See Also

The **trace** command.

Also, refer to the "Making Coordinated Measurements" chapter.

**wait**

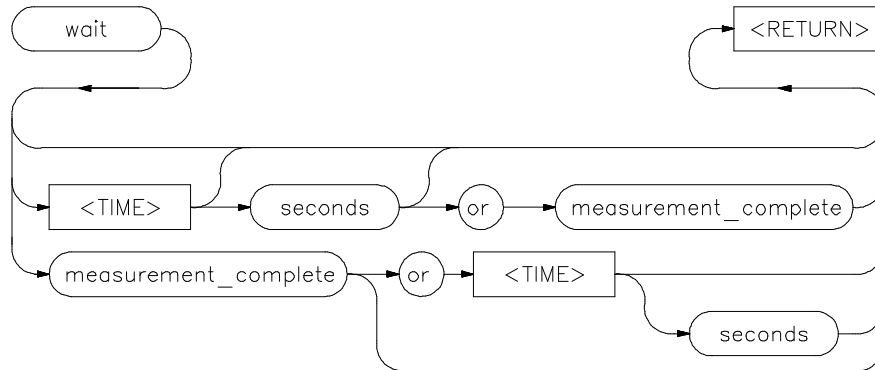

This command allows you to present delays to the system.

The **wait** command can be an enhancement to a command file, or to normal operation at the main emulation level. Delays allow the emulation system and target processor time to reach a certain condition or state before executing the next emulation command.

The **wait** command does not appear on the softkey labels. You must type the **wait** command into the keyboard. After you type **wait**, the command parameters will be accessible through the softkeys.

The system will pause until it receives a <CTRL>c signal.

Note that if **set intr <CTRL>c** was not executed on your system, <CTRL>c normally defaults to the backspace key. See your UNIX system administrator for more details regarding keyboard definitions.

The parameters are as follows:

measurement  
\_complete

This causes the system to pause until a pending measurement completes (a trace data upload process completes), or until a <CTRL>c signal is received. If a measurement is not in progress, the **wait** command will complete immediately.

or

This causes the system to wait for a <CTRL>c signal or for a pending measurement to complete. Whichever occurs first will satisfy the condition.

## Chapter 11: Emulator/Analyzer Interface Commands

### **wait**

seconds                      This causes the system to pause for a specific number of seconds.

<TIME>                      This prompts you for the number of seconds to insert for the delay.

Note that a **wait** command in a command file will cause execution of the command file to pause until a <CTRL>c signal is received, if <CTRL>c is defined as the interrupt signal. Subsequent commands in the command file will not execute while the command file is paused. You can verify whether the interrupt signal is defined as <CTRL>c by typing **set** at the system prompt.

---

### **Examples**

```
wait <RETURN>
```

```
wait 5; wait measurement_complete <RETURN>
```



## WINDOW

From trace  
syntax diagram

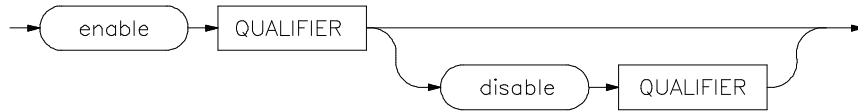

Lets you select which states are stored by the analyzer.

WINDOW allows you to selectively toggle analyzer operation. When enabled, the analyzer will recognize sequence terms, trigger terms, and will store states. When disabled, the analyzer is effectively off, and only looks for a particular enable term.

You specify windowing by selecting an enable qualifier term; the analyzer will trigger or store all states after this term is satisfied. If the disable term occurs after the analyzer is enabled, the analyzer will then stop storing states, and will not recognize trigger or sequence terms. You may specify only one enable term and one disable term.

The analyzer defaults to recognizing all states. If you specify enable, you must supply a qualifier term. If you then specify disable, you must specify a qualifier term.

The parameters are as follows:

disable	Allows you to specify the term which will stop the analyzer from recognizing states once the enable term has been found.
enable	Allows you to specify the term which will enable the analyzer to begin monitoring states.
QUALIFIER	Specifies the actual address, data, status value or range of values that cause the analyzer to enable or disable recognition of states. Note that the enable qualifier can be different from the disable qualifier. Refer to the QUALIFIER syntax pages for further details on analyzer qualifier specification.

### Examples

```
trace enable _rand disable 0ecch <RETURN>
```

Chapter 11: Emulator/Analyzer Interface Commands  
**WINDOW**

**See Also**            The **trace** command and the SEQUENCING and QUALIFIER syntax descriptions.

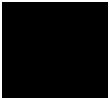

---

**12**

---

**Status and Error Messages**

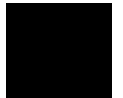

---

## Status and Error Messages

This chapter contains a list of status and error messages that may occur while operating the emulator and analyzer.

The *error log* records error messages received during the emulation session. You may want to display the error log to view the error messages. Sometimes several messages will be displayed for a single error to help you locate a problem quickly. To prevent overrun, the error log purges the oldest messages to make room for the new ones.

To display the error log:

```
display error_log <RETURN>
```

Status and error messages are grouped into the following categories:

- 80960 Emulation Status Messages
- Graphical/Softkey Interface Messages - Unnumbered
- Graphical/Softkey Interface Messages - Numbered
- Terminal Interface Messages

Note that Terminal Interface messages are passed along to the Graphical User Interface (or Softkey Interface) and appear, with numbers, in the error log display.

---

## 80960 Emulation Status Messages

### **960Sx--No target power**

The emulator is unable to detect power in the target system. If you are using the demo target system that comes with the emulator, you must connect the +5 Volt power cable from the front panel of the card cage to the J1 connector on the demo board.

### **960Sx--No processor clock**

The emulator is unable to detect CLK2 in the target system.

### **960Sx--Emulation reset**

The emulator is holding the 80960 processor in reset.

### **960Sx--Awaiting target reset**

The emulator is waiting for a high level at the target system 80960 socket before the emulator hardware will allow the processor out of the reset state. This means that the emulator has been configured to synchronize to the target system reset. For more information, see the "Configuring the Emulator Pod" section in the "Configuring the Emulator" chapter.

### **960Sx--Awaiting target run**

The target system is holding the 80960 processor in reset. This means that the reset pin at the target system 80960 socket is high.

### **960Sx--Processor FAILURE**

The 80960 processor has asserted the FAILURE pin. The most likely cause of this status is that your program has a bad Initial Memory Image that has caused the processor to fail its initialization sequence out of reset. If this is the case, you may want to enter a processor initialization command from the emulator. This will check certain critical parts of your IMI and indicate if they are not valid. If you believe that your program is not being loaded into memory successfully, you may want to check your memory map configuration. See the "Mapping Memory" section in the "Configuring the Emulator" chapter for more information.

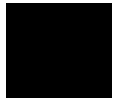

## Chapter 12: Status and Error Messages

### 80960 Emulation Status Messages

#### **960Sx--No READY: <address>**

A memory bus cycle is hung waiting for a READY from the target memory system. A particular instance of this may occur is if you attempt to service an interrupt before establishing a valid interrupt control register. In this case you may get status 960Sx--No READY:0ff000010. This is because the value in the interrupt control register after the processor is initialized is FF000000. For the 80960KA/KB, this configures the INT0 vector for external IAC messages. For the 80960SA/SB, this establishes INT0 as an interrupt with priority 0 which is illegal.

#### **960Sx--Bus Grant**

This indicates that the processor has asserted HLDA to grant control of the bus to an external bus master.

#### **960Sx--No bus cycles**

The bus has not been granted, and there is no ADS strobe on the L-bus. You may see this status if your program is running a loop which is entirely in the cache, and is not accessing memory.

#### **960Sx--Waiting for CMB ready**

This status occurs when you have connected HP 64700 card cages together via the Coordinated Measure Bus (CMB). This allows you to start and stop emulators at the same time. This message means that the emulator is waiting for other emulators on the CMB before starting to run user code. For more information, see the "Making Coordinated Measurements" chapter.

#### **960Sx--Running in monitor**

The emulator is running in the monitor program waiting to execute an emulation command. For more information, see the "Selecting the Emulation Monitor Program" section in the "Configuring the Emulator" chapter.

#### **960Sx--Running user program**

The emulator is running your user program, and your user program is creating some bus activity. If your program is entirely in the cache, and it is not executing any memory loads or stores, you will see the status "No bus cycles" rather than "Running user program".

## Graphical/Softkey Interface Messages - Unnumbered

### **Address range too small for request - request truncated**

Cause: Too small of an address range is specified in a modify memory command.

Action: Specify a larger memory range.

### **Cannot create module file:**

Cause: Insufficient disk space for the module file.

Action: Check disk space under /usr/hp64000.

### **Cannot start. Ending previous session, try again**

Cause: The host system could not start a new emulation session, and is ending the previous session.

Action: After the previous session has ended, try starting a new emulation session. If that fails, try "emul700 -u <logical name>" to unlock the emulator and cycle power, if needed.

### **Cannot start. Pod initialization failed**

Cause: The host system could not start a new emulation session because it could not initialize the emulator.

Action: Cycle power on the emulator; verify that there are no red lights on the front of the emulator. You may need to run the Terminal Interface "pv" command to verify that the emulator is functioning properly before starting a new session.

### **Configuration not valid, restoring previous configuration**

### **Configuration not valid, restoring default configuration**

Cause: The modifications you tried to make to the emulator configuration are not valid, so the host system restored the previous configuration.

Action: See the "Configuring the Emulator" chapter for more information about the emulator configuration items and their settings.

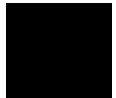

## Chapter 12: Status and Error Messages

### Graphical/Softkey Interface Messages - Unnumbered

#### **Configuration process QUIT**

Cause: The configuration process ended because <CTRL> "\ " (SIGQUIT signal) was encountered. This is an easy way to exit configuration without saving any changes.

Action: Try starting the emulation session again. If the problem persists, you may need to cycle power on the emulator.

#### **Connecting to <LOGICAL NAME>**

Cause: This is a status message. The host system is making a communication connection to the emulator whose logical name is defined in /usr/hp64000/etc/64700tab.net or /usr/hp64000/etc/64700tab.

#### **Continue load failed**

Cause: The host system could not continue the previous emulation session because it could not load the continue file.

Action: Try again. If the failure continues, call your HP Service Representative.

#### **Continuing previous session, continue file loaded**

Cause: This is a status message. An emulation session which was ended earlier with the **end** command has been restarted. The host system reported that the session was continued (using settings from the previous session) and that the continue file loaded properly.

#### **Continuing previous session, user interface defaulted**

Cause: The previous emulation session was continued and the Softkey Interface was set to the default state.

#### **Could not create default configuration**

Cause: The host system could not create a default configuration for the emulation session.

Action: Check disk space under /usr/hp64000 and verify proper software installation.



**Could not create <CONFIGURATION BINARY FILENAME>**

Cause: The system could not create a binary emulation configuration file (file.EB).

Action: Check the file.EB write permission and verify that the specified directory exists and is writeable.

**Could not exec configuration process**

Cause: The host system could not fork the configuration process or could not execute the configuration process.

Action: Make sure that the host system is operating properly, and that all Softkey Interface files were loaded properly during the installation process. Try starting the emulation session again.

**Could not load default configuration**

Cause: The host system could not load the default configuration into the emulator.

Action: Cycle power on the emulator and run the Terminal Interface "pv" (performance verification) command on the emulator to verify that it is functioning properly. Also, verify proper software installation. If loading default configuration still fails, then call your HP 64000 representative.

**<CONFIGURATION FILENAME> does not exist**

Cause: The configuration file you are trying to load does not exist.

Action: Try the **load configuration** command again using a valid configuration file name.

**Don't care number unexpected**

Cause: While defining an expression in your command, you included a don't care number (a binary, octal, decimal, or hexadecimal number containing "x"), which was not expected. Don't care numbers are not valid for all commands. See the EXPR command syntax for more information about expressions.

**Emulation analyzer defaulted to delete label**

Cause: Analyzer trace labels were changed or modified while labels were in use in the trace specification.

Chapter 12: Status and Error Messages  
**Graphical/Softkey Interface Messages - Unnumbered**

Action: Enter the previous trace specification and try again.

**Emul700dmn continuation failed**

Cause: Communication between the emulator and the host system to continue the emulation session failed.

Action: Check the data communication switch settings on the rear panel of the HP 64700 series emulator. If necessary, refer to the *HP 64700 Installation/Service Guide*.

**Emul700dmn executable not found**

Cause: The emulation session could not begin because the host system could not locate the HP 64700 emulator daemon process executable.

Action: Make sure that software installation is correct. Then try starting the emulator again.

**Emul700dmn failed to start**

Cause: The emulation session could not begin because the host system could not start the HP 64700 emulator daemon process.

Action: Make sure there is sufficient disk space under /usr/hp64000. Make sure the host system is operating properly, that all Softkey Interface software has been loaded correctly, and the data communication switch settings on the emulator rear panel match the settings in the /usr/hp64000/etc/64700tab.net (or 64700tab) file.

**Emul700dmn message too large**

**Emul700dmn message too small**

**Emul700dmn queue and/or semaphores missing**

**Emul700dmn queue failure**

**Emul700dmn error in file operation**

**Emul700dmn queue full**

Cause: The HP 64700 emulator daemon process command was too large for the host system to process.

Action: You must press **end\_release\_system** to exit this emulation session completely; then start a new session. Make sure the host system is operating properly, that all Softkey Interface software has been loaded correctly, and the data communication switch settings on the emulator rear panel match the settings in the

Chapter 12: Status and Error Messages  
**Graphical/Softkey Interface Messages - Unnumbered**

/usr/hp64000/etc/64700tab.net (or 64700tab) file. You may have to cycle power and use **emul700 -u ,logical name>** to unlock the system.

**Emul700dmn sem op failed, perhaps kernel limits too low**

Cause: The host system could not start the emulation session; there may be too many processes running on the host system.

Action: Make sure the host system is operating properly, and is not overloaded with currently executing processes. Stop or remove some processes on the system. Also, verify that the semaphore capabilities have been installed in the UNIX kernel. Then try starting the emulation session again.

**Emul700dmn version incompatible with this product**

Cause: The emulation session could not begin because the version of the HP 64700 emulator daemon executable on host system is not compatible with the version of the Softkey Interface you are using.

Action: Make sure the software has been properly installed. Then try starting the emulator again.

**<LOGICAL NAME>: End, continuing**

Cause: This is a status message. The emulation session is being exited with the **end** command. When you restart the emulation session later, it will continue using the same settings as in the session you just ended. The emulator logical name is located in the /usr/hp64000/etc/64700tab.net (or 64700tab) file.

**<LOGICAL NAME>: End, released**

Cause: This is a status message. The emulation session is being exited with the **end release\_system** command. When the session has ended, the emulator is released, meaning that others can access and use it. When you restart the emulation session later, the new session will use all default settings. The emulator logical name is located in the /usr/hp64000/etc/64700tab.net (or 64700tab) file.

**Ending released**

Cause: This is a status message. The emulation session is being exited with the **end release\_system**. The emulator will be released for others to access and use it.

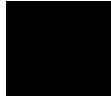

Chapter 12: Status and Error Messages  
**Graphical/Softkey Interface Messages - Unnumbered**

**Error: display size is <LINES> lines by <COLUMNS> columns. It must be at least 24 by 80.**

Cause: You tried to specify an incorrect window size.

Action: Set the window size accordingly, then start the emulation session. The size of the window must be a minimum of 24 lines (rows) by 80 columns to operate an emulation session.

**Error in configuration process  
Error starting configuration process**

Cause: Unexpected configuration error.

Action: Verify proper software installation and call your HP 64000 representative.

**Fatal error from function <ADDRESS OF FUNCTION>**

Cause: This is an unexpected fatal system error.

Action: Cycle power on the emulator and start again. If this is a persistent problem, call your HP 64000 representative.

**File could not be opened**

Cause: You tried to store or load trace data to a file with incorrect permission. Or the analyzer could not find the file you specified, or else there were already too many files open when you entered your command.

Action: Check the directory and file for correct read and write permission. Specify a file that is accessible to the analyzer. Close the other files that are presently open.

**File perf.out does not exist**

Cause: You tried to execute the "restore" command to continue a previous software performance measurement, and the SPMT software found that no "performance\_measurement\_end" command was previously executed to create a file from which "restore" could be performed.

Action: Execute a new SPMT measurement.

**File perf.out not generated by measurement software**

Cause: The file named perf.out exists in the current directory, but it was not created by the "performance\_measurement\_end" command.

Action: Rename the old "perf.out" file, or move it to another directory.

**HP64700 I/O channel semaphore failure: <string>**

Cause: Semaphore (ipc) facility not installed.

Action: Reconfigure the kernel to add ipc facility.

**HP 64700 I/O error; communications timeout**

Cause: This is a communication failure.

Action: Check power to the emulator and check that all cables are connected properly. If you are using LAN and heavy LAN traffic is present, try setting the environment variable to HP64700TIMEOUT="30" (or larger if needed). The value is the number of seconds before timeout occurs. Then try running again.

**HP64700 I/O error; connection timed out**

Cause: A user abort occurred while attempting to connect via LAN.

Action: Possibly connecting to an emulator many miles away, be patient.

**HP 64700 I/O error; power down detected**

Cause: The emulator power was cycled.

Action: Do not do this during a user interface session; this may force the user interface to end immediately.

**HP64700 I/O channel busy; communications timed out**

Cause: The communications channel is in use for an unusually long period of time by another command.

Action: try again later.

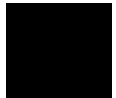

**Illegal status combination**

Cause: You tried to specify combinations of status qualifiers in expressions incorrectly when entering commands.

Action: Refer to the "Emulator/Analyzer Interface Commands" chapter for information about syntax of commands.

**Illegal symbol name**

Cause: You tried to specify incorrect symbol names when entering commands.

Action: Specify correct symbol names. To see global symbol names, use the **display global\_symbols** command. To see local symbol names, use the **display local\_symbols\_in <SYMB>** command.

**Initialization failed**

Cause: The emulator could not be initialized.

Action: Make sure your data communication switch settings are correct, and that all Softkey Interface software has been loaded properly. Cycle power on the emulator, then try starting up the emulation session again.

**Initialization load failed**

Cause: The emulator could not be initialized.

Action: Make sure your data communication switch settings are correct, and that all Softkey Interface software has been loaded properly. Cycle power on the emulator, then try starting up the emulation session again.

**Initializing emulator with default configuration**

Cause: This is a status message. The host system started the emulation session and initialized the emulator using the default configuration. The emulator is probably operating correctly.

**Initializing user interface with default config file**

Cause: This is a status message. The host system started the emulation session and Softkey Interface using the default configuration file. The emulator is probably operating correctly.

**Insufficient emulation memory, memory map may be incomplete**

Cause: You can map only the amount of emulation memory available in your emulator. Trying to map additional unavailable memory may cause information to be missing from your memory map.

Action: Modify your configuration and update the memory map to correctly reflect the amount of emulation memory available.

**Invalid answer in <CONFIGURATION FILENAME> ignored**

Cause: You must provide acceptable responses to questions in the configuration file (file.EA). The emulator ignored the incorrect response. Incorrect responses may appear in configuration files when you have saved the configuration to a file, edited it later, and tried reloading it into the emulator. This may also occur if you have loaded a configuration file that you created while using another emulator, and the response differs from the response required for this emulator.

Action: Examine your configuration file to check for inappropriate responses to configuration file questions.

**Inverse assembly file <INVERSE ASSEMBLER FILENAME> could not be loaded**

**Inverse assembly file <INVERSE ASSEMBLER FILENAME> not found, <filename>**

**Inverse assembly not available**

Cause: The file does not exist.

Action: Reload your interface and/or real-time operating system software.

**Inverse assembly not available**

Cause: The inverse assembler for your emulator is missing.

Action: Verify proper software installation.

**Joining session already in progress, continue file loaded**

Cause: This is a status message. When operating the emulator in multiple windows, a new emulation session is "joined" to a current session. In this case, the new session was able to continue because the continue file loaded properly.

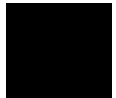

Chapter 12: Status and Error Messages  
**Graphical/Softkey Interface Messages - Unnumbered**

**Joining session already in progress, user interface defaulted**

Cause: When operating the emulator in multiple windows, a new emulation session is "joined" to a current session. In this case, the new session used the user interface default selections.

**Load aborted**

Cause: While loading a file into the emulator, an event occurred that caused the host system to stop the load process.

Action: Use the **display error\_log** command to view any errors. If the problem persists, make sure the host system and emulator are operating properly, and that you are trying to load an acceptable file. See the "Emulator/Analyzer Interface Commands" chapter for information about the **load** command.

**Load completed with errors**

Cause: While loading a file into the emulator, one or more events occurred that caused errors during the load process.

Action: Use the **display error\_log** command to view any errors. You may need to modify the configuration and map memory before you load the file again. If the problem persists, make sure the host system and emulator are operating properly, and that you are trying to load an acceptable file.

**Measurement system not found**

Cause: You tried to end the current emulation session and select another measurement system module which could not be located by the host system.

Action: Either try the **end select measurement\_system** command again or end and release the emulation session.

**Memory allocation failed, ending released**

Cause: This is a fatal system error because the emulation session was unable to allocate memory.

Action: You may need to reconfigure your UNIX kernel to increase the per process maximum memory limit and available swap space. Reboot your UNIX system and try starting a new session again.



**Memory block list unreadable**

**Memory range overflow**

Cause: A modify memory command is attempted that would cross physical 0.

Action: Limit the modify memory command to not overflow physical 0 or break the command into two separate modify commands.

**No address label defined**

Cause: The address trace label was somehow removed in the terminal interface using the **tlb** command.

Action: End session and start again.

**No more processes may be attached to this session**

Cause: You can operate an emulator in four windows. Each time you start the emulator in another window, a new process is attached to the current session.

Action: Do not try to use more than four windows. Once you have started the emulator in four windows, you have reached the maximum number of processes allowed for that emulator.

**Not an absolute file**

**No absolute file: <file>**

**No absolute file, No database: <file>**

Cause: You tried to load a file into the emulator that is not an executable or absolute file, so the host system stopped the load process.

Action: Try your command again, and make sure you specify a valid absolute file name to be loaded.

**No symbols loaded**

Cause: You tried to step through lines in the source file before symbols are loaded.

Action: Load symbols and try again, or use step with the "source" option (i.e. step assembly language program).

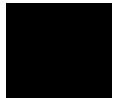

Chapter 12: Status and Error Messages  
**Graphical/Softkey Interface Messages - Unnumbered**

**No valid trace data**

Cause: You tried to store trace data before a trace was completed.

Action: Wait until valid trace data is available before attempting to store a trace.

**Not a valid trace file - load aborted**

Cause: You tried to load a file.TR that was not created by the emulation session.

Action: Only load trace data files that were created by the emulator.

**Not compatible trace file - load aborted**

Cause: You tried to load a file.TR that was created by another type of emulator.

Action: Only load trace data files that were created by the same type of emulator.

**Number of lines not in range: 1 <= valid lines <= 50**

Cause: You tried to enter a number of lines that was outside the range from 1 to 50.

Action: Try entering the command again using a valid number of lines.

**Number of spaces not in range: 2 <= valid spaces <= 15**

Cause: You tried to enter a number of spaces outside the range from 2 to 15.

Action: Try entering the command again using a valid number of spaces.

**opcode extends beyond specified address range**

Cause: Memory disassembly is attempted on an address range that is too small.

Action: Display memory mnemonic using a large address range, or no address range at all.

**Perfinit - Absolute file (database) must be loaded line <LINE NUMBER>**

Cause: No symbolic data base has been opened (or exists) for the target file when you executed the "performance\_measurement\_initialize" command.

Action: Make sure a data base has been loaded for the target file.

**Perfinit - error in input file line <LINE NUMBER> invalid symbol**

You included a "label" file name with your "performance\_measurement\_initialize" command, and that file contains an invalid symbol.

Action: Edit the file and correct the invalid symbol.

**Perfinit - error in input file line <NUMBER>**

Cause: You included an input file name with your "performance\_measurement\_initialize" command, and that file contains a syntax error.

Action: Edit the file and correct the syntax error.

**Perfinit <---EXPR--- ERROR> line <LINE NUMBER>**

**Perfinit - File could not be opened**

Cause: You specified a file as an option to "performance\_measurement\_initialize", and the file you specified could not be found or opened by SPMT software.

Action: Make sure you entered the correct file name.

**Perfinit - No events in file**

Cause: You specified a file along with your "performance\_measurement\_initialize" command that contained no events. Any measurement displayed from this file will have NULL results.

Action: Either edit the file to add events, or use the default setup to start a new measurement.

**perf.out file could not be opened - created**

Cause: The performance analyzer failed to open or create a file named "perf.out" in response to your "performance\_measurement\_end" command.

Action: Free up some file space or correct the write permissions in your current working directory.

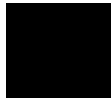

Chapter 12: Status and Error Messages  
**Graphical/Softkey Interface Messages - Unnumbered**

**Performance tool must be initialized**

Cause: You tried to make a performance measurement when the Software Performance Measurement Tool (SPMT) was not initialized.

Action: The Software Performance Measurement Tool (SPMT) must be initialized before making performance measurements on your software. Use the **performance\_measurement\_initialize** command to initialize the SPMT.

**Performance tool not initialized**

Cause: The Software Performance Measurement Tool (SPMT) has not been initialized.

Action: To make accurate activity or duration measurements on current data, use the **performance\_measurement\_initialize** command to initialize the SPMT before running a performance measurement.

**Question file missing or invalid**

Cause: Some of the Softkey User Interface files are missing or are corrupted.

Action: Reinstall the host software and try starting the emulation session again.

**Range crosses segment boundary**

Cause: On a segment offset processor, an address range is specified that would cross different segments.

Action: Break the memory command into multiple commands so that the address ranges start and end in the same segment.

**Read memory failed at <PHYSICAL ADDRESS> - store aborted**

Cause: While storing memory from the emulator to a file, a read memory error occurred.

Action: Use the **display\_error\_log** command to view any errors. You may need to modify the configuration and map memory before storing the file again.

**Session aborted**

Cause: This will only happen when running multiple emulation windows and a fatal system error occurs.

## Chapter 12: Status and Error Messages Graphical/Softkey Interface Messages - Unnumbered

Action: Find the window that caused the error and see the error message that it displayed. All the additional windows will simply state "session aborted". Cycle power on the emulator and enter **emul700 -u <logical name>** to make sure the emulator is unlocked.

### **Session cannot be continued, ending released**

Cause: The emulation session is ending automatically because it could not be continued from the previous session. When the session has ended the emulator will be released, meaning that others can access and use it.

Action: When you restart the emulation session later, the new session will use all default settings.

### **Slave clock requires at least one edge**

Cause: The analyzer has an invalid clock specification.

Action: Modify your configuration and try your command again.

### **Starting address greater than ending address**

Cause: You specified a starting address that is greater than the ending address.

Action: Specify a starting address that is less than or equal to the ending address.

### **Starting new session, continue file loaded**

Cause: This is a status message. The emulator was started using a new emulation session, and the continue file loaded properly.

### **Starting new session, user interface defaulted**

Cause: The emulator was started using a new emulation session, and the user interface was set to default selections.

Action: Call your HP Service Representative.

### **Status unknown, run "emul700 -l <LOGICAL NAME>"**

Cause: The host system cannot determine the status of the emulator.

Action: To verify communication between the emulator and the host system, and display the emulator status, enter the **emul700 -l <logical name>** command. The

## Chapter 12: Status and Error Messages

### Graphical/Softkey Interface Messages - Unnumbered

emulator logical name is located in the /usr/hp64000/etc/64700tab.net (or 64700tab) file.

#### **Stepping aborted; number steps completed: <STEPS TAKEN>**

Cause: Stepping aborted because <CTRL>c or software breakpoint was hit, guarded memory was accessed, or some other kind of error occurred.

Action: See the error log display for any abnormal errors. Correct those errors and then step again.

#### **Stepping complete**

Cause: Stepping was completed successfully.

#### **Step count must be 1 through 999**

Cause: You tried to use a step count greater than 999.

Action: Use a step count less than 1000.

#### **Symbols not accessible, symbol database not loaded**

Cause: You specified a trace list with values expressed using symbols defined in the source code modules, such as source on, and the database file has not been loaded into emulation. Example: display trace symbols on.

#### **Timeout in emul700dmn communication**

Cause: The host system could not start the emulation session because the HP 64700 emulator process ran out of time before the emulator could start.

Action: You must press **end\_release\_system** to exit this emulation session completely; then start a new session. Make sure the host system is operating properly, that all Softkey Interface software has been loaded correctly, and the data communication switch settings on the emulator rear panel match the settings in the /usr/hp64000/etc/64700tab.net (or 64700tab) file.

#### **Trace file not found**

Cause: You tried to load trace data file that does not exist.

Action: Find the correct name and path of the trace data file and try again.

**Unexpected message from emul700dmn**

Cause: The host system could not start the emulation session because of an unexpected message from the HP 64700 emulator process command.

Action: You must press **end\_release\_system** to exit this emulation session completely; then start a new session. Make sure the host system is operating properly, that all Softkey Interface software has been loaded correctly, and the data communication switch settings on the emulator rear panel match the settings in the /usr/hp64000/etc/64700tab.net (or 64700tab) file.

**Unknown expression type**

Cause: While entering your command, you included an unknown expression type.

Action: See the EXPR command syntax for more information about expressions. Then try entering your command again with a known expression type.

**Unload trace data failed**

Cause: An unexpected error occurred while waiting for a trace to be completed.

Action: End and release the session, and then try again.

**Wait time failure, could not determine system time**

Cause: The system call failed.

Action: Verify that 'date' executes correctly from the UNIX prompt.

**Warning: at least one integer truncated to 32 bits**

**Warning: at least one integer truncated to 16 bits**

**Warning: at least one integer truncated to 8 bits**

Cause: The number entered was too large for the currently specified display or access size.

Action: Try entering the command again using the correct size of number.

**Width not in range: 1 <= valid width <= 80**

Cause: You tried to specify the width of the field outside the range from 1 to 80.

Action: Try entering the command again using a valid number for the width.

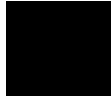

## **Graphical/Softkey Interface Messages - Numbered**

These numbered messages can occur because of various problems with the emulator/analyzer.

- 10315      **Logical emulator name unknown; not found in 64700tab file**
- Cause: This message may occur while trying to start up the emulator. It indicates that the emulator name specified could not be found in the 64700tab.net or /etc/hosts files.
- Action: Specify the name in one of these files.
- 10326      **Emulator locked by another user**
- Cause: This message occurs when you try to start an emulation interface, but your attempt failed because the emulator is being used by someone else.
- Action: The current user must release the emulator.
- 10327      **Cannot lock emulator; failure in obtaining the accessid**  
**Cannot lock emulator; failure in <ERRNO MSG>**
- 10328      **Cannot unlock emulator; emulator not locked**
- Cause: You have issued a command to unlock an emulator that is not locked.
- Action: The emulator is available now. You can start the interface.
- 10328      **Cannot unlock emulator; lock file missing**  
10328      **Cannot unlock emulator; semaphore missing**
- Cause: Lock semaphore missing.
- Action: Verify existence and permissions of /usr/hp64000 directory. Cycle emulator power and use **emul700 -u <logical name>**.
- 10328      **Cannot unlock emulator; emulator in use by user: <USER NAME>**
- Cause: The emulator is already in use by the named user.
- Action: Current user must release the emulator.



- 10329           **Emulator locked by user: <USER NAME>**
- Cause: You tried to start an emulator interface, but your attempt failed because the emulator is already in use by someone else.
- Action: Current user must release the emulator.
- 10330           **Emulator locked by another user interface**
- Cause: You tried to start an emulator interface, but your attempt failed because the emulator is already in use by someone else.
- Action: Current user must release the emulator.
- 10331           **HP64700 I/O channel in use by emulator: <LOGICAL NAME>**
- Cause: You tried to start an emulator interface, but your attempt failed because the emulator is already in use by someone else.
- Action: Current user must release the emulator.
- 10332           **Cannot default emulator; already in use**
- Cause: You tried to start an emulator interface, but your attempt failed because the emulator is already in use by someone else.
- Action: Current user must release the emulator.
- 10350           **Cannot interpret emulator output**
- Cause: There may be characters dropped in the information returned from the emulator.
- Action: Ignore this message unless it becomes frequent. If it becomes frequent, you may have a fatal error; call your HP 64700 representative.
- 10351           **Exceeded maximum 64700 command line length**
- Cause: Your command is longer than 240 characters.
- Action: Shorten the command.
- 10352           **Incompatible with 64700 firmware version**
- Cause: The installed interface firmware combination is incorrect or incompatible.

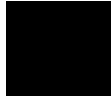

Chapter 12: Status and Error Messages  
**Graphical/Softkey Interface Messages - Numbered**

Action: Upgrade the interface software of product firmware.

10360

**Analyzer limitation; all range resources in use**  
**Analyzer limitation; all pattern resources in use**  
**Analyzer limitation; all expression resources in use**

Cause: Your trace specification would use more than the maximum number of resources available to the analyzer.

Action: Simplify the trace specification.

10371

**64700 command aborted**

Cause: User abort occurred due to emulator being monopolized by another command.

Action Don't issue an abort.

## Terminal Interface Messages

This section contains descriptions of error messages that can occur while using the Terminal Interface. The error messages are listed in numerical order, and each description includes the cause of the error and the action you should take to remedy the situation.

The emulator can return messages to the display only when it is prompted to do so. Situations may occur where an error is generated as the result of some command, but the error message is not displayed until the next command (or a carriage return) is entered.

A maximum number of 8 error messages can be displayed at one time. If more than 8 errors are generated, only the last 8 are displayed.

### Emulator Messages

21

#### **Insufficient emulation memory**

Cause: You have attempted to map more emulation memory than is available.

Action: Reduce the amount of emulation memory that you are trying to map.

40

#### **Restricted to real time runs**

Cause: While the emulator is restricted to real-time execution, you have attempted to use a command that requires a temporary break in execution to the monitor. The emulator does not permit the command and issues this error message.

Action: You must break the emulator's execution into the monitor before you can enter the command.

61

#### **Emulator is in the reset state**

Cause: You have entered a command that requires the emulator to be running in the monitor (for example, displaying registers).

Action: Enter the **break** command to cause the emulator to run in the monitor, and enter the command that caused the error again.

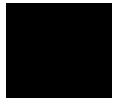

**Terminal Interface Messages**

- 100                    **No response from monitor**
- Cause: The major cause of this error message is when the target system does not assert the ADS signal for target memory accesses.
- Action: Investigate the reason there are no ADS responses on target memory accesses.
- 
- 140                    **Instruction address must be aligned on word boundary**
- Cause: You have attempted to run, step, or set a breakpoint at an address that is not word-aligned.
- Action: Since the addresses specified in these commands are instruction addresses, they must be aligned on word (4-byte) boundaries.
- 
- 141                    **Breakpoint registers are disabled**
- Cause: You have attempted to use the **run until address** command when breakpoints are disabled.
- Action: Enable breakpoints. Note that the breakpoints break condition applies to software breakpoints and breakpoint registers.
- 
- 151                    **Prior emulation memory access pending; request aborted**
- Cause: When emulation memory accesses are synchronized to the target system READY signal, this message occurs when a prior emulation memory access is pending because there is no READY.
- Action: Re-enter the command. If the problem persists, you may need to find out why there is no READY signal for the prior emulation memory access.
- 
- 152                    **Monitor timeout while executing command**
- Cause: The emulation controller gives the monitor up to one second to complete a command. This message occurs, for example, when the bus has been granted to some other device during the execution of a monitor command.
- Action: Re-enter the command.

- 153           **Can not run from <address> out of reset**
- Cause: When the emulator is configured to restrict entry into the monitor from reset, the emulator cannot run from an address out of reset.
- Action: Modify the configuration to allow breaks into the monitor when the emulator is released from reset.
- 154           **Unable to display execution message settings**
- 155           **Unable to modify execution message settings**
- Cause: You have attempted to display or modify execution message settings while the emulator is restricted to real-time runs and is running the user program.
- Action: When the emulator is restricted to real-time runs, you must break execution into the monitor program or reset the emulator before you can display or modify execution message settings.
- 156           **Unable to display processor break conditions**
- 157           **Unable to configure processor break condition**
- Cause: You have attempted to display, enable, or disable the branch, call, return, preret, super, or modtc processor break conditions while the emulator is restricted to real-time runs and is running the user program.
- Action: When the emulator is restricted to real-time runs, you must break execution into the monitor program or reset the emulator before you can display, enable, or disable the branch, call, return, preret, super, or modtc processor break conditions.
- 158           **Unable to display breakpoint registers**
- 159           **Unable to modify breakpoint registers**
- Cause: You have attempted to display or modify breakpoint registers while the emulator is restricted to real-time runs and is running the user program.
- Action: When the emulator is restricted to real-time runs, you must break execution into the monitor program or reset the emulator before you can display or modify breakpoint registers.

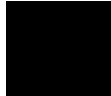

**Terminal Interface Messages**

- 162                    **Unable to initialize processor**
- Cause: This message occurs in response to the **init\_processor** command and usually occurs with other messages.
- Action: Refer to the descriptions for the accompanying error messages.
- 163                    **Processor LPN configured as secondary bus master**
- Cause: This status message occurs when the emulator comes out of reset and indicates that LPN was sampled as 0 which means the emulator should not act as the initializing processor. The emulation processor will not be released from reset if this is the case.
- Action: The emulator should always act as the initializing processor. You may need to investigate why LPN is being sampled as a 0 during initialization instead of a 1.
- 164                    **Unable to display table**
- Cause: You have used the **display table** command to display one of the 80960 tables in memory while the emulator is reset, while the emulator is running in the monitor but before the emulation processor has been initialized, or while the emulator is restricted to real-time runs and is running the user program.
- Action: The emulation processor must be initialized before you can display the 80960 tables in memory. If the emulator is restricted to real-time runs, you must break execution into the monitor program before you can display tables in memory.
- 165                    **Monitor program failure; forcing processor reset**
- Cause: It is possible for target system noise to modify the background memory which contains the emulation monitor program. This may make it impossible for the monitor to continue running. In that case, the emulator will force a processor reset and reload the monitor program.
- Action: Reduce target system noise.
- 166                    **Bus hung: %s; no target READY**
- Cause: This message occurs during a target system memory access when there is no READY response.
- Action: Investigate the reason there is no READY response.

- 167            **Processor FAILURE asserted**
- Cause: This status message indicates that the FAILURE output remains asserted. The emulation prompt status character is "s". FAILURE remains asserted if the emulation processor fails its self test during initialization. This is most likely due to an invalid Initial Memory Image in your program.
- Action: Fix the program's Initial Memory Image.
- 180            **Monitor unable to execute command**
- Cause: This message is displayed if an error was generated by the monitor but none of the other errors from 180 through 189 are appropriate.
- Action: Refer to any error messages that accompany this message. Otherwise, retry the command.
- 181            **BADAC asserted on memory access: %s**
- Cause: A command that causes target system memory accesses results in BADAC being asserted on the access.
- Action: Re-enter the command. If the problem persists, investigate the cause of the BADAC assertion.
- 182            **Invalid command sent to monitor**
- Cause: This message should not occur; if it does, it indicates a problem with the emulator.
- Action: Write down the sequence of commands which caused the error. Cycle power on the emulator and re-enter the commands. If the error repeats, call your local HP Sales and Service office for assistance.
- 183            **Initial Memory Image would fail checksum**
- Cause: This message occurs during an **init\_processor** command and indicates that the sum of the eight checksum words in the Initial Memory Image does not equal 0.
- Action: The problem relates to the processor's reading of the 8 words beginning at address 0.

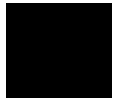

**Terminal Interface Messages**

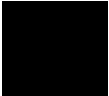
- 184                   **You must do a processor initialization first**
- Cause: You have entered a command that requires the emulation processor to be initialized.
- Action: Enter an **init\_processor** command and then reenter the command.
- 185                   **Fault occurred in monitor: %s**
- Cause: It is possible for target system noise to modify the background memory which contains the emulation monitor program. This may cause a fault to occur in the monitor.
- Action: Reduce target system noise.
- 186                   **Guarded memory access: %s**
- Cause: A command that requires access to target system resources caused the monitor to access a location that is mapped as guarded memory. For example, this message might occur if the Initial Memory Image, Processor Control Block, System Address Table, or interrupt or fault tables are at locations mapped as guarded memory.
- Action: Make sure that the data structures mentioned above are not in locations mapped as guarded memory.
- 187                   **Write to ROM: %s**
- Cause: A command that requires access to target system resources caused the monitor to access a location that is mapped as ROM. For example, this message might occur if the scratch space of the Processor Control Block or the interrupt table are thought to be at locations mapped as ROM.
- Action: Make sure that the data structures mentioned above are not in locations mapped as ROM.
-  188                   **User stack not writeable; fp = %s**
- Cause: If the user stack is not writable, a run command will cause this message to be displayed. The emulator will remain in the monitor.
- Action: Make sure the user stack area is in RAM and is mapped as RAM.



- 189           **Offset %d of PRCB is not valid**
- Cause: This error message may occur in response to a **init\_processor** command which verifies portions of the user's Initial Memory Image before initializing the 80960 processor. This message indicates that a field in the user's Processor Control Block contains an illegal value.
- Action: Investigate the cause of the illegal value in the Processor Control Block.
- 193           **HP64761 i960Sx emulation probe not connected**
- Cause: This status message indicates that the i960Sx emulator probe is not properly connected to the cable coming from the emulator control card in the frame. This renders the emulator completely unuseable.
- 195           **Execution messages temporarily disabled**
- Cause: This message occurs when execution messages are enabled, the emulator is configured to restrict entry into the monitor from reset, and the emulator is run from reset.
- Action: None. This message serves as a reminder that you must break into the monitor before execution messages can be enabled.
- 196           **Breakpoints temporarily disabled**
- Cause: This message occurs when breakpoints are enabled, the emulator is configured to restrict entry into the monitor from reset, and the emulator is run from reset.
- Action: None. This message serves as a reminder that you must break into the monitor before breakpoints can be enabled.
- 197           **Bus hung: %s; forcing READY to enter monitor**
- Cause: This message occurs in response to the break command after the bus is hung due to the lack of a target system READY signal.
- Action: None. This is an informational status message.
- 199           **Range too large - reduced to 0..0ffffffb**
- Cause: You have specified an address range larger than the processor address space.

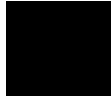

Chapter 12: Status and Error Messages  
**Terminal Interface Messages**

Action: None. The address range is truncated to 0..0ffffffb.

**General Emulator and System Messages**

204 **FATAL SYSTEM SOFTWARE ERROR**

205 **FATAL SYSTEM SOFTWARE ERROR**

208 **FATAL SYSTEM SOFTWARE ERROR**

Cause: The system has encountered an error from which it cannot recover.

Action: Write down the sequence of commands which caused the error. Cycle power on the emulator and reenter the commands. If the error repeats, call your local HP Sales and Service office for assistance.

206 **Incompatible compatibility table entry**

Cause: The emulation firmware (ROM) is not compatible with the analysis or system firmware in your HP 64700 system.

Action: The ROMs in your emulator must be compatible with each other for your emulation system to work correctly. Contact your Hewlett-Packard Representative.

318 **Count out of bounds: %s**

Cause: You specified an occurrence count less than 1 or greater than 65535.

Action: Re-enter the command, specifying a count value from 1 to 65535.

400 **Record checksum failure**

Cause: During a **transfer** operation, the checksum specified in a file did not agree with that calculated by the HP 64700.

Action: Retry the **transfer** operation. If the failure is repeated, make sure that both your host and the HP 64700 data communications parameters are configured correctly.

- 401           **Records expected: %s; records received: %s**
- Cause: The HP 64700 received a different number of records than it expected to receive during a **transfer** operation.
- Action: Retry the **transfer**. If the failure is repeated, make sure that the data communications parameters are set correctly on the host and on the HP 64700. Refer to the "Installation" chapter for details.
- 410           **File transfer aborted**
- Cause: A **transfer** operation was aborted due to a break received, most likely a <CTRL>c from the keyboard.
- Action: If you typed <CTRL>c, you probably did so because you thought the transfer was about to fail. Retry the transfer, making sure to use the correct command options. If you are unsuccessful, make sure that the data communications parameters are set correctly on the host and on the HP 64700, then retry the operation.
- 411           **Severe error detected, file transfer failed**
- Cause: An unrecoverable error occurred during a **transfer** operation.
- Action: Retry the transfer. If it fails again, make sure that the data communications parameters are set correctly on the host and on the HP 64700. Also make sure that you are using the correct command options, both on the HP 64700 and on the host.
- 412           **Retry limit exceeded, transfer failed**
- Cause: The limit for repeated attempts to send a record during a **transfer** operation was exceeded, therefore the transfer was aborted.
- Action: Retry the transfer. Make sure you are using the correct command options for both the host and the HP 64700. The data communications parameters need to be set correctly for both devices. Also, if you are in a remote location from the host, it is possible that line noise may cause the failure.
- 413           **Transfer failed to start**
- Cause: Communication link or transfer protocol incorrect.
- Action: Check link and transfer options.

Chapter 12: Status and Error Messages  
**Terminal Interface Messages**

- 415                    **Timeout, receiver failed to respond**  
Cause: Communication link or transfer protocol incorrect.  
Action: Check link and transfer options.
- 600                    **Adjust PC failed during break**  
Cause: System failure or target condition.  
Action: Run performance verification (Terminal Interface **pv** command), and check target system.
- 602                    **Break failed**  
Cause: The **break** command was unable to break the emulator to the monitor.  
Action: Determine why the break failed, then correct the condition and retry the command. See message 608.
- 603                    **Read PC failed during break**  
Cause: System failure or target condition.  
Action: Try again.
- 604                    **Disable breakpoint failed: %s**  
Cause: System failure or target condition.  
Action: Run performance verification (Terminal Interface **pv** command), and check target system.
- 605                    **Undefined software breakpoint: %s**  
Cause: The emulator has encountered a software breakpoint in your program that was not inserted with the **modify software\_breakpoints set** command.  
Action: Remove the "fmark" instructions in your code before assembly and link.
- 606                    **Unable to run after CMB break**  
Cause: System failure or target condition.

Action: Run performance verification (Terminal Interface **pv** command), and check target system.

608

**Unable to break**

Cause: This message is displayed if the emulator is unable to break to the monitor because the emulation processor is reset, halted, or is otherwise disabled.

This message can occur when the "trace-enable" flag in the Process Controls Register is set. This flag is cleared (disabled) as a part of the processor's initialization procedure, and it should be left this way to avoid taking trace faults in your program.

Action: First, look at the emulation prompt and other status messages displayed to determine why the processor is stopped. If reset by the emulation controller, use the **break** command to break to the monitor. If reset by the emulation system, release that reset. If halted, try **reset** and **break** to get to the monitor. If there is a bus grant, wait for the requesting device to release the bus before retrying the command. If there is no clock input, perhaps your target system is faulty. It's also possible that you have configured the emulator to restrict to real time runs, which will prohibit temporary breaks to the monitor.

If the emulator cannot break because the "trace-enable" flag in the Process Controls Register is set, edit your program and make sure there are no "modpc" instructions that set this flag.

610

**Unable to run**

Cause: System failure or target condition.

Action: Run performance verification (Terminal Interface **pv** command), and check target system.

611

**Break caused by CMB not ready**

Cause: This status message is printed during coordinated measurements if the CMB READY line goes false. The emulator breaks to the monitor. When CMB READY is false, it indicates that one or more of the instruments participating in the measurement is running in the monitor.

Action: None, information only.

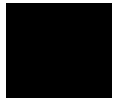

Chapter 12: Status and Error Messages  
**Terminal Interface Messages**

- 612                   **Write to ROM break**
- Cause: This status message will be printed if you have enabled breaks on writes to ROM and the emulation processor attempted a write to a memory location mapped as ROM.
- Action: None (except troubleshooting your program).
- 613                   **Analyzer Break**
- Cause: Status message.
- 614                   **Guarded memory access break**
- Cause: This message is displayed if the emulation processor attempts to read or write memory mapped as guarded.
- Action: Troubleshoot your program; or, you may have mapped memory incorrectly.
- 615                   **Software breakpoint: %s**
- Cause: This status message will be displayed if a software breakpoint is encountered during a program run. The emulator is broken to the monitor. The string %s indicates the address where the breakpoint was encountered.
- 616                   **BNC trigger break**
- Cause: This status message will be displayed if you have configured the emulator to break on a BNC trigger signal and the BNC trigger line is activated during a program run. The emulator is broken to the monitor.
- 617                   **CMB trigger break**
- Cause: This status message will be displayed if you have configured the emulator to break on a CMB trigger signal and the CMB trigger line is activated during a program run. The emulator is broken to the monitor.
- 618                   **trig1 break**
- Cause: This status message will be displayed if you use the **break\_on\_trigger** syntax of the **trace** command and the analyzer has found the trigger condition while tracing a program run. The emulator is broken to the monitor.

- 619            **trig2 break**
- Cause: This status message will be displayed if you have used the internal **trig2** line to connect the analyzer or external analyzer trigger output to the emulator break input and the analyzer has found the trigger condition. The emulator is broken to the monitor.
- 620            **Unexpected software breakpoint**
- Cause: If you have enabled software breakpoints, this message is displayed if a software breakpoint instruction is encountered in your program that was not inserted by a **modify software\_breakpoints set** command and is therefore not in the breakpoint table.
- Action: Remove the "fmark" instructions in your code before assembly and link, and use the **modify software\_breakpoints set** command to reinsert them after the program is loaded into memory.
- 621            **Unexpected step break**
- Cause: System failure.
- Action: Run performance verification (Terminal Interface **pv** command).
- 622            **%s**
- Cause: Monitor specific message.
- 623            **CMB execute break**
- Cause: This message occurs when coordinated measurements are enabled and an EXECUTE pulse causes the emulator to run; the emulator must break before running.
- Action: This is a status message; no action is required.
- 624            **Configuration aborted**
- Cause: Occurs when a <CTRL>c is entered while emulator configuration items are being set.
- 626            **Configuration failed; setting unknown: %s=%s**
- Cause: Target condition or system failure.

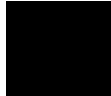

## Chapter 12: Status and Error Messages

### Terminal Interface Messages

Action: Check target system, and run performance verification (Terminal Interface **pv** command).

#### 628 **Processor initialization break**

Cause: This status message occurs when a continue initialization IAC message is executed while the emulator is executing the user program.

Action: None. This message is to inform you of the cause of the break.

#### 628 **modtc break: %s"**

Cause: This status message indicates that the emulator encountered a "modtc" instruction in the user program.

Action: Generally, the trace controls word is used by the emulator to provide debugging capabilities, and user programs should not contain these instructions.

#### 628 **Guarded memory break: %s"**

Cause: A memory access to a location mapped as guarded memory has occurred during execution of the user program.

Action: Investigate the cause of the guarded memory access by the user program.

#### 628 **Write to ROM break: %s"**

Cause: When the emulator is configured to break on writes to ROM, a memory write access to a location mapped as ROM has occurred during execution of the user program.

Action: Investigate the cause of the write to ROM by the user program. You can configure the emulator so that it does not break on writes to ROM.

#### 628 **Branch break: %s"**

Cause: When running until a "branch" trace event, a branch has been taken during execution of the user program.

#### 628 **Call break: %s"**

Cause: When running until a "call" trace event, a call or branch-and-link instruction has been executed in the user program.



- 628           **Return break: %s"**  
Cause: When running until a "return" trace event, a "ret" instruction has been executed in the user program.
- 628           **Prereturn break: %s"**  
Cause: When running until "preret" and "call" trace events and the prereturn-trace flag in r0 is set, a "ret" instruction is about to be executed in the user program.
- 628           **Supervisor break: %s"**  
Cause: When running until a "supervisor" trace event, a call-system instruction or a "ret" from supervisor mode instruction has been executed in the user program.
- 628           **Breakpoint register: %s"**  
Cause: When running until an address, this status message indicates the instruction at the address in the breakpoint register has been executed.
- 628           **Target reset break**  
Cause: This status message indicates the cause of the break into the monitor was a target system reset.
- 630           **Register access aborted**  
Cause: Occurs when a <CTRL>c is entered during register display.
- 631           **Unable to read registers in class: %s**  
Cause: The emulator was unable to read the registers you requested.  
Action: To resolve this, you must look at the other status messages displayed. Most likely, the emulator was unable to break to the monitor to perform the register read. See message 608.
- 632           **Unable to modify register: %s=%s**  
Cause: The emulator was unable to modify the register you requested.

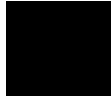

**Terminal Interface Messages**

Action: To resolve this, you must look at the other status messages displayed. It's likely that emulator was unable to break to the monitor to perform the register modification. See message 608.

634            **Display register failed: %s**

Cause: The emulator was unable to display the register you requested.

Action: To resolve this, you must look at the other status messages displayed. It's likely that emulator was unable to break to the monitor to perform the register display. See message 608.

636            **Register not writable: %s**

Cause: This error occurs when you attempt to modify a read only register.

Action: If this error occurs, you cannot modify the contents of the register with the **modify register** command.

637            **Register class cannot be modified: %s**

Cause: You tried to modify a register class instead of an individual register.

Action: You can only modify individual registers. Refer to the **display registers** command description for a list of register names.

640            **Unable to reset**

Cause: Target condition or system failure.

Action: Check target system, and run performance verification (Terminal Interface **pv** command).

650            **Unable to configure break on write to ROM**

Cause: The emulator controller is unable to configure for breaks on writes to ROM, possibly because the emulator was left in an unknown state or because of a hardware failure.

Action: Initialize the emulator or cycle power. Then reenter the command. If the same failure occurs, call your HP sales and service office.

- 651           **Unable to configure break on software breakpoints**
- Cause: The emulator controller cannot enable breakpoints, possibly because the emulator is in an unknown state or because of a hardware failure.
- Action: Initialize the emulator or cycle power, then re-enter the command. If the same failure occurs, call your HP sales and service office.
- 653           **Break condition configuration aborted**
- Cause: Occurs when <CTRL>c is entered during the configuration of break conditions.
- 661           **Software breakpoint break condition is disabled**
- Cause: You have attempted to set or clear a software breakpoint when software breakpoints are disabled.
- Action: You must enable software breakpoints before you can set them.
- 663           **Specified breakpoint not in list: %s**
- Cause: You tried to clear a software breakpoint that was not previously set. The string %s prints the address of the breakpoint you attempted to clear.
- Action: You must first set a software breakpoint before it can be cleared.
- 664           **Breakpoint list full; not added: %s**
- Cause: The software breakpoint table is already reached the maximum of 32 breakpoints. The breakpoint you just requested, with address %s, was not inserted.
- Action: Clear breakpoints that are no longer in use. Then, set the new breakpoint.
- 665           **Enable breakpoint failed: %s**
- Cause: System failure or target condition.
- Action: Check memory mapping and configuration questions.
- 666           **Disable breakpoint failed: %s**
- Cause: System failure or target condition.
- Action: Check memory mapping and configuration questions.



Chapter 12: Status and Error Messages  
**Terminal Interface Messages**

- 667                   **Breakpoint code already exists: %s**
- Cause: You attempted to insert a breakpoint; however, there was already a software breakpoint instruction at that location which was not already in the breakpoint table.
- Action: Your program code is apparently using "fmark" instructions. Remove the "fmark" instructions from your program code and use the **modify software\_breakpoints set** command to insert them.
- 668                   **Breakpoint not added: %s**
- Cause: You tried to insert a breakpoint in a memory location which was not mapped or was mapped as guarded memory.
- Action: Insert breakpoints only within memory ranges mapped to emulation or target RAM or ROM.
- 669                   **Breakpoint remove aborted**
- Cause: Occurs when <CTRL>c is entered when clearing a software breakpoint.
- 670                   **Breakpoint enable aborted**
- Cause: Occurs when <CTRL>c is entered when setting software breakpoints.
- 671                   **Breakpoint disable aborted**
- Cause: Occurs when <CTRL>c is entered when disabling software breakpoints.
- 680                   **Stepping failed**
- Cause: Stepping has failed for some reason.
- Action: Usually, this error message will occur with other error messages. Refer to the descriptions of the accompanying error messages to find out more about why stepping failed.
- 684                   **Failed to disable step mode**
- Cause: System failure.
- Action: Run performance verification (Terminal Interface **pv** command).

- 686           **Stepping aborted; number steps completed: %d**  
Cause: This message is displayed if a break was received during a **step** command with a step count greater than zero. The break could have been due to any of the break conditions or a <CTRL>c break. The number of steps completed is displayed.
- 688           **Step display failed**  
Cause: System failure or target condition.  
Action: Check memory mapping and configuration questions.
- 689           **Break due to cause other than step**  
Cause: An activity other than a **step** command caused the emulator to break. This could include any of the break conditions or a <CTRL>c break.
- 692           **Trace error during CMB execute**  
Cause: System failure.  
Action: Run performance verification (Terminal Interface **pv** command).
- 693           **CMB execute; run started**  
Cause: This status message is displayed when you are making coordinated measurements. The CMB /EXECUTE pulse has been received; the emulation processor started running at the address specified by the **specify run** command.  
Action: None; information only.
- 694           **Run failed during CMB execute**  
Cause: System failure or target condition.  
Action: Run performance verification (Terminal Interface **pv** command), and check target system.
- 700           **Target memory access failed**  
Cause: This message is displayed if the emulator was unable to perform the requested operation on memory mapped to the target system.

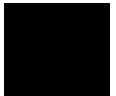

**Terminal Interface Messages**

Action: In most cases, the problem results from the emulator's inability to break to the monitor to perform the operation. See message 608.

702                   **Emulation memory access failed**

Cause: System failure.

Action: Run performance verification (Terminal Interface **pv** command).

707                   **Request access to guarded memory: %s**

Cause: The address or address range specified in the command included addresses within a range mapped as guarded memory. When the emulator attempts to access these during command processing, the above message is printed, along with the specific address or addresses accessed.

Action: Re-enter the command and specify only addresses or address ranges within emulation or target RAM or ROM. Or, you can remap memory so that the desired addresses are no longer mapped as guarded.

710                   **Memory range overflow**

Cause: Accessing a word or short word, for example **display memory 0ffffff blocked word** will cause a rounding error that overflows physical memory.

Action: Reduce memory display request.

725                   **Unable to load new memory map; old map reloaded**

Cause: There is not enough emulation memory left for this request.

Action: Reduce the amount of emulation memory requested.

726                   **Unable to reload old memory map; hardware state unknown**

Cause: System failure.

Action: Run performance verification (Terminal Interface **pv** command).

754                   **Memory modify aborted; next address: %s**

Cause: This message is displayed if a break occurs during processing of a **modify memory** command. The break could result from any of the break conditions (except a software breakpoint) or could have resulted from a <CTRL>c break.

Action: Retry the operation. If breaks are occurring continuously, you may wish to disable some of the break conditions.

901           **Invalid firmware for emulation subsystem**

Cause: This error occurs when the HP 64700 system controller determines that the emulation firmware (ROM) is invalid.

Action: This message is not likely to occur unless you have upgraded the ROMs in your emulator. Be sure that the correct ROM is installed in the emulation controller.

902           **Invalid analysis subsystem; product address: %s**

Cause: This error occurs when the HP 64700 system controller determines that the analysis firmware (ROM) is invalid.

Action: This message is not likely to occur unless you have upgraded the ROMs in your emulator. Be sure that the correct ROMs are installed in the analyzer board.

903           **Invalid ET subsystem; product address: %s**

Cause: Detects an invalid ET. Used only internally.

904           **Invalid auxiliary subsystem; product address: %s**

Cause: For future products.

911           **Lab firmware for emulation subsystem**

Cause: This message should never occur. It shows that you have an unreleased version of emulation firmware.

912           **Lab firmware analysis subsystem; product address: %s**

Cause: This message should never occur. It shows that you have an unreleased version of analysis firmware.

913           **Lab firmware subsystem; product address: %s**

Cause: This message should never occur. It shows that you have an unreleased version of system controller firmware.

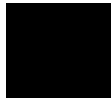

Chapter 12: Status and Error Messages  
**Terminal Interface Messages**

914                   **Lab firmware auxiliary subsystem; product address: %s**

Cause: This message should never occur. It shows that you have an unreleased firmware version of the auxiliary subsystem.

**Analyzer Messages**

1105                   **Unable to delete label; used by emulation analyzer: <label>**

Cause: This error occurs when you attempt to delete an emulation trace label which is currently being used as a qualifier in the emulation trace specification or is currently specified in the emulation trace format.

Action: You stop the trace or must change the trace command before you can delete the label.

1106                   **Unable to delete label; used by external state analyzer: <label>**

Cause: This error occurs when you attempt to delete an external trace label which is currently being used as a qualifier in the external state trace specification or is currently specified in the external trace format.

Action: You stop the trace or must change the trace command before you can delete the label.

1107                   **Unable to delete label; used by external timing analyzer: <label>**

Cause: This error occurs when you attempt to delete an external trace label which is currently being used as a qualifier in the external timing trace specification.

Action: Remove the label from the external timing analyzer specifications, and then delete the label.

1108                   **Unable to redefine label; used by emulation analyzer: <label>**

Cause: This error occurs when you attempt to redefine an emulation trace label which is currently used as a qualifier in the emulation trace specification.

Action: You stop the trace or must change the trace command before you can redefine the label.



- 1109           **Unable to redefine label; used by external state analyzer: <label>**
- Cause: This error occurs when you attempt to redefine an external trace label which is currently used as a qualifier in the external state trace specification.
- Action: You stop the trace or must change the trace command before you can redefine the label.
- 1110           **Unable to redefine label; used by external timing analyzer: <label>**
- Cause: This error occurs when you attempt to redefine an emulation or external trace label which is currently being used as a qualifier in the external timing trace specification.
- Action: Remove the label from the external timing analyzer specifications, and then redefine the label.
- 1301           **External label in use: <label>**
- Cause: This error occurs when you attempt to select the external analyzer's independent state mode while an external trace label is currently used as a qualifier in the emulation analyzer trace specification.
- Action: Remove any external trace label qualifiers from emulation trace specifications before selecting the external analyzer's independent state mode.
- 1304           **Analyzer trace running**
- Cause: This error occurs when you attempt to change the external analyzer mode while a trace is in progress.
- Action: Halt the trace before changing the external analyzer mode.
- 1305           **CMB execute; emulation trace started**
- Cause: This status message informs you that an emulation trace measurement has started as a result of a CMB execute signal (as specified by the **specify trace** command).
- 2021           **Period not in 1/2/5 sequence: <period>**
- Cause: This error message occurs when the external timing sample period is not in a 1/2/5 sequence; for example, 10ns, 20ns, 50ns, 100ns, 200ns, 500ns, 1us, 2us,

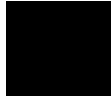

Chapter 12: Status and Error Messages  
**Terminal Interface Messages**

5us, etc. Some examples of invalid sample period specifications are: 12ns, 18ns, 25ns, 60ns, 80ns, etc.

Action: Use a number in the 1/2/5 sequence when specifying the external timing sample period.

2022                   **Sample period out of bounds: <bounds>**

Cause: The external timing sample period must be between 10 ns and 50 ms (in a 1/2/5 sequence).

Action: Re-enter the command with the sample period between the bounds shown.

2030                   **Negated patterns not allowed in timing**

Cause: This error occurs when you attempt to specify a "not equals" expression when defining the external timing trigger. You can only specify labels which equal patterns (of 1's, 0's, or X's).

Action: Do not attempt to specify negated timing patterns.

2031                   **Invalid trigger duration: <duration>**

Cause: This error occurs when you attempt to specify an external timing trigger duration which is in the valid range but is not a multiple of 10 ns.

Action: Re-enter the command with the trigger duration as a multiple of 10 ns.

2032                   **Trigger duration out of bounds: <bounds>**

Cause: This error occurs when you attempt to specify an external timing trigger duration outside the valid range. A "greater than" duration must fall within the range of 30 ns to 10 ms (and must be a multiple of 10 ns). A "less than" duration must fall within the range 40 ns to 10ms (and must be a multiple of 10 ns).

Action: Re-enter the command with the trigger duration within the bounds shown.

2042                   **Trigger delay out of bounds: <bounds>**

Cause: This error occurs when you attempt to specify an external timing trigger delay outside the valid range. The external timing trigger delay must be between 0 and 10 ms (in 10 ns increments).

Action: Re-enter the command with the trigger delay within the bounds shown.

---

# Part 4

---

## Concept Guide

Topics that explain concepts and apply them to advanced tasks.

Part 4

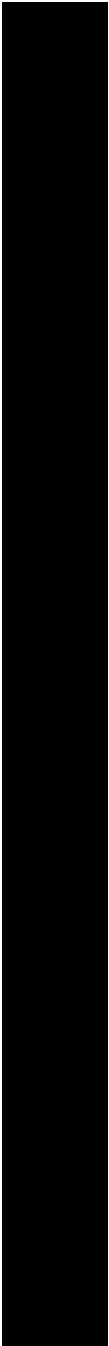

---

**13**

**Concepts**



---

## Concepts

This chapter provides conceptual information on the following topics:

- Target system design considerations.
- The effects of the emulation processor on target system execution.
- X resources and the Graphical User Interface.

## Target System Design Considerations

The emulator requires an external clock signal and power supply in order to run. Therefore, a target system is required in order to use the emulator, and the minimum target system must provide a clock and a power source. The 80960 demo target system that is shipped with the emulator is one such minimum target system.

### Resetting the Target System

When the **reset** command is issued, the emulation processor will enter the reset state. This will not cause the target system to be reset because the 80960 RESET signal is not bi-directional. To allow the target hardware to be reset when the **reset** command is issued, a SYS\_RESET lead is provided. The signal polarity of SYS\_RESET can be selected during configuration. SYS\_RESET is an open collector driver with no pull-up provided by the emulator probe. SYS\_RESET should be synchronized to CLK2 in the target system. For more information, refer to "To synchronize to target system reset" in the "Configuring the Emulator" chapter.

### Access for Emulator Probe

There must be enough clearance in the target system to allow the emulation probe to be plugged in and the cable routed from the target system to the emulator control box. Refer to the "Specifications and Characteristics" chapter in the *80960 Emulator Terminal Interface User's Guide* for probe dimensions and pin orientation.

### Probe Power Requirements and Processor Signal Considerations

Refer to the "Specifications and Characteristics" chapter in the *80960 Emulator Terminal Interface User's Guide* for information on the electrical characteristics of the emulator's active probe.

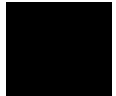

## The Effects of the Emulation Processor on Target Execution

The following emulator features affect target system execution as described below.

- The execution messages feature.
- Debug features that use the emulation processor's trace controls register.
- Background monitor execution.

### Execution Messages

The execution message feature of the 80960 emulator provides a powerful tool for measuring program activity. The 80960 processor has an internal instruction cache that is filled in 16-byte cache line prefetches. The analyzer can only measure bus activity external to the processor. By observing prefetch activity, it is possible to infer where the processor is executing code, but once instructions have been placed in the cache, no further external bus cycles are generated. With data items stored in the large register set of the processor, it is likely that the few external data cycles may not provide enough information to infer what the execution path is.

The execution message feature causes the 80960 bondout emulation processor to generate additional bus cycles that contain information about instruction execution. This information can be selectively emitted for various classes of instructions. The instruction classes correspond directly to the "Trace Modes" of the 80960 processor. Enabling execution messages results in execution performance degradation for the 80960 due to the additional bus cycles generated, as well as the internal bondout execution time caused by the message. Time critical systems may not be able to handle the execution speed penalty.

The execution messages appear on the L-bus using an 80960 bondout strobe signal. To the target system, these cycles appear as Idle (Ti) cycles. Each message is composed of two parts: the address of the executed instruction (AT) along with status describing the type of instruction, and the address of the next instruction to be executed (TO).

The trace status messages are presented to the analyzer as two separate events with a status bit indicating an AT or TO message.

When execution messages are enabled, they are included in the trace list. Execution messages in the trace list can be disassembled to indicate the opcode of



## The Effects of the Emulation Processor on Target Execution

the instruction executed. To accomplish this, the disassembler may need to access memory to get the instruction's opcode information. Consequently, there may be additional processor cycles due to the execution message display.

### Trace Controls

The emulator uses the processor's Trace Controls Register and the on-chip breakpoint registers to establish portions of your debug environment. User programs should not access these registers (that is, your programs should not contain "modtc" instructions, Continue Initialization IAC messages, or Set Breakpoint Register IAC messages).

If your program modifies the trace controls or breakpoint register, your debug environment will temporarily be changed. A subsequent break into the monitor will restore these registers to their previous values.

User programs should not attempt to take a trace fault. The "trace-enable" flag in the Process Controls Register is cleared (disabled) as a part of the processor's initialization procedure. It should be left this way to avoid taking trace faults in your program. Similarly, the "trace-enable" bit in the System Procedure Table should be clear to avoid taking trace faults on system calls.

### Initial Memory Image

In order to execute a program on the 80960 processor, a valid Initial Memory Image (IMI) must be present in memory. If you do not have a valid IMI, your program will not run correctly. In addition, if certain critical fields within the IMI are not valid, this may change the behavior of the bondout processor that the emulator uses to implement some debug features of the product.

If you enter an **init\_processor** command, the emulator will read the critical fields of your IMI and verify that they are valid before initializing the processor. This may be a useful command when you are first trying to run some code in your target system.

### Background Monitor Execution

When the emulator enters the monitor, it appears to the target system that there are no bus cycles running. Actually, the address, data, and W/R signals will be toggling, but ALE, ADS, and DEN will not be asserted unless the monitor accesses the target system.

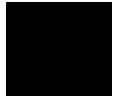

Chapter 13: Concepts

**The Effects of the Emulation Processor on Target Execution**

External interrupts are not recognized while the emulator executes in the monitor.  
Interrupts must be asserted until the monitor returns to the user code.

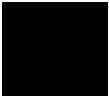

## X Resources and the Graphical User Interface

This section contains more detailed information about X resources and scheme files that control the appearance and operation of the Graphical User Interface. This section:

- Describes the X Window concepts surrounding resource specification.
- Describes the Graphical User Interface's implementation of scheme files.

### X Resource Specifications

An X resource specification is a resource name and a value. The resource name identifies the element whose appearance or behavior is to be defined, and the value specifies how the element should look or behave. For example, consider the following resource specification:

```
Application.form.row.done.background: red
```

The resource name is "Application.form.row.done.background:" and the value is "red".

### Resource Names Follow Widget Hierarchy

A *widget* is an OSF/Motif graphic device from which X applications are built. For example, pushbuttons and menu bars are Motif widgets. Applications are built using a hierarchy of widgets, and the application's X resource names follow this hierarchy. For example:

```
Application.form.row.done.background: red
```

In the resource name above, the top-level widget is named after the application. One of the top-level widget's children is a form widget, one of the form widget's children is a row-column manager widget, and one of the row-column manager widget's children is a pushbutton widget. Resource names show a path in the widget hierarchy.

Each widget in the hierarchy is a member of a widget class, and the particular instance of the widget is named by the application programmer.

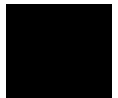

### **Class Names or Instance Names Can Be Used**

When specifying resource names, you can use either instance names or class names. For example, a "Done" pushbutton may have an instance name of "done" and a class name of "XmPushButton". To set the background color for a hypothetical "Done" pushbutton, you can use:

```
Application.form.row.done.background: red
```

Or, you can use:

```
Application.form.row.XmPushButton.background: red
```

Applications also have class and instance names. For example, an application may have an instance name of "applic1" and a class name of "Application". To set the background color for a hypothetical "Done" pushbutton only in the "applic1" application, you can use:

```
applic1.form.row.done.background: red
```

Note that instance names are more specific than class names. That is, class names may apply to many instances of the widget.

The class and instance names for the widgets in the Graphical User Interface can be displayed by choosing **Help**→**X Resource Names** and clicking on the "All names" button.

### **Wildcards Can Be Used**

A wildcard may be used to match a resource specification to many different widgets at once. For example, to set the background color of all pushbuttons, you can use:

```
Application*XmPushButton.background: red
```

Note that resource names with wildcards are more general than those without wildcards.

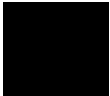

### Specific Names Override General Names

A more specific resource specification will override a more general one when both apply to a particular widget or application.

The names for the application and the main window widget in HP64\_Softkey applications have been chosen so that you may specify custom resource values that apply in particular situations:

- 1 Apply to ALL HP64\_Softkey applications:  
HP64\_Softkey\*<resource>: <value>
- 2 Apply to specific types of HP64\_Softkey applications:  
emul\*<resource>: <value> (for the emulator)  
perf\*<resource>: <value> (for the performance analyzer)
- 3 Apply to all HP64\_Softkey applications, but only when they are connected to a particular type of microprocessor:  
\*i80960\*<resource>: <value> (for the 80960)  
\*m68020\*<resource>: <value> (for the 68020)
- 4 Apply to a specific HP64\_Softkey application connected to a specific processor:  
perf.i80960\*<resource>: <value> (for the 80960 perf. analyzer)  
emul.m68020\*<resource>: <value> (for the 68020 emulator)

If all four examples above are used for a particular resource, #3 will override #2 for all applications connected to a 80960 emulator, and #4 will override #2, but only for the specifically mentioned type of microprocessor.

When modifying resources, your resource paths must either match, or be more specific than, those found in the application defaults file.

### How X Resource Specifications are Loaded

When the Graphical User Interface starts up, it loads resource specifications from a set of configuration files located in system directories as well as user-specific locations.

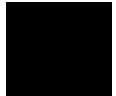

### **Application Default Resource Specifications**

Default resource specifications for an application are placed in a system directory:

HP-UX            /usr/lib/X11/app-defaults

SunOS            /usr/openwin/lib/X11/app-defaults

The name of the Graphical User Interface application defaults file is HP64\_Softkey (same as the application class name). This file is well-commented and contains information about each of the X resources you can modify. You can easily view this file by choosing **Help**→**Topic** and selecting the "X Resources: App Default File" topic. Do not modify the application defaults file; any changes to this file will affect the appearance and behavior of the application for all users.

### **User-Defined Resource Specifications**

User-defined resources (for any X application) are located in the X server's RESOURCE\_MANAGER property or in the user's \$HOME/.Xdefaults file.

### **Load Order**

Resource specifications are loaded from the following places in the following order:

- 5 The application defaults file. For example, /usr/lib/X11/app-defaults/HP64\_Softkey when the operating system is HP-UX or /usr/openwin/lib/X11/app-defaults/HP64\_Softkey when the operating system is SunOS.
- 6 The \$XAPPLRESDIR/HP64\_Softkey file. (The XAPPLRESDIR environment variable defines a directory containing system-wide custom application defaults.)
- 7 The server's RESOURCE\_MANAGER property. (The **xrdb** command loads user-defined resource specifications into the RESOURCE\_MANAGER property.)

If no RESOURCE\_MANAGER property exists, user defined resource settings are read from the \$HOME/.Xdefaults file.

- 8 The file named by the XENVIRONMENT environment variable.

If the XENVIRONMENT variable is not set, the \$HOME/.Xdefaults-*host* file is read (typically contains resource specifications for a specific remote host).

- 9 Resource specifications included in the command line with the **-xrm** option.

When specifications with identical resource names appear in different places, the latter specification overrides the former.

## **Scheme Files**

Several of the Graphical User Interface's X resources identify *scheme files* that contain additional X resource specifications. Scheme files group resource specifications for different displays, computing environments, and languages.

### **Resources for Graphical User Interface Schemes**

There are five X resources that identify scheme files:

HP64\_Softkey.labelScheme:

Names the scheme file to use for labels and button text. Values can be: Label, \$LANG, or a custom scheme file name. The default uses the \$LANG environment variable if it is set and if a scheme file named Softkey.\$LANG exists in one of the directories searched for scheme files; otherwise, the default is Label.

HP64\_Softkey.platformScheme:

Names the subdirectory for the platform specific color, size, and input scheme files. This resource should be set to the platform on which the X server is running (and displaying the Graphical User Interface) if it is different than the platform where the application is running. Values can be: HP-UX, SunOS, pc-xview, or a custom platform scheme directory name.

HP64\_Softkey.colorScheme:

Names the color scheme file. Values can be: Color, BW, or a custom scheme file name.

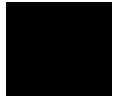

Chapter 13: Concepts  
**X Resources and the Graphical User Interface**

HP64\_Softkey.sizeScheme:

Names the size scheme file which defines the fonts and the spacing used.  
Values can be: Large, Small, or a custom scheme file name.

HP64\_Softkey.inputScheme:

Names the input scheme file which specifies mouse and keyboard operation.  
Values can be: Input, or a custom scheme file name.

The actual scheme file names take the form: "Softkey.<value>".

### **Scheme File Names**

There are six scheme files provided with the Graphical User Interface. Their names and brief descriptions of the resources they contain follow.

Softkey.Label	Defines the labels for the fixed text in the interface. Such things as menu item labels and similar text are in this file. If the \$LANG environment variable is set, the scheme file "Softkey.\$LANG" is loaded if it exists; otherwise, the file "Softkey.Label" is loaded.
Softkey.BW	Defines the <i>color scheme</i> for black and white displays. This file is chosen if the display cannot produce at least 16 colors.
Softkey.Color	Defines the <i>color scheme</i> for color displays. This file is chosen if the display can produce 16 or more colors.
Softkey.Large	Defines the <i>size scheme</i> (that is, the window dimensions and fonts) for high resolution displays (1000 pixels or more vertically).
Softkey.Small	Defines the <i>size scheme</i> (that is, the window dimensions and fonts) for low resolution displays (less than 1000 pixels vertically).
Softkey.Input	Defines the <i>input scheme</i> (that is, the button and key bindings for the mouse and keyboard).



### Load Order for Scheme Files

Scheme files are searched for in the following directories and in the following order:

- 10 System scheme files in directory `/usr/hp64000/lib/X11/HP64_schemes`.
- 11 System-wide custom scheme files located in directory `$XAPPLRESDIR/HP64_schemes`.
- 12 User-defined scheme files located in directory `$HOME/.HP64_schemes` (note the dot in the directory name).

### Custom Scheme Files

You can modify scheme files by copying them to the directory for user-defined schemes and changing the resource specifications in the file. For example, if you wish to modify the color scheme, and your platform is HP-UX, you can copy the `/usr/hp64000/lib/X11/HP64_schemes/HP-UX/Softkey.Color` file to `$HOME/.HP64_schemes/HP-UX/Softkey.Color` and modify its resource specifications.

You can create custom scheme files by modifying the X resource for the particular scheme and by placing the custom scheme file in the directory for user-defined schemes. For example, if the following resource specifications are made:

```
HP64_Softkey.platformScheme:  HP-UX
HP64_Softkey.colorScheme:     MyColor
```

The custom scheme file would be:

```
$HOME/.HP64_schemes/HP-UX/Softkey.MyColor
```

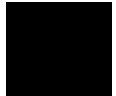

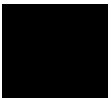

---

# Part 5

---

## Installation Guide

Instructions for installing and configuring the product.

**Part 5**



---

**14**

**Installation**



---

## Installation at a Glance

Before you can use the Graphical User Interface, you may need to install emulator hardware, and you have to install the interface software. You also need to verify the installation of the interface software and understand how to start the Graphical User Interface for the first time.

This chapter is not intended to be a complete installation guide for all of the just-mentioned tasks. This chapter concentrates on information, not found in other places, that is necessary for the installation or operation of the interface.

### Installation Overview for HP 9000 Hosted Systems

Users of HP 9000 hosted systems should follow the instructions in the section titled "Installation for HP 9000 Hosted Systems". Briefly, those instructions tell you to do the following:

- 1 If necessary, install emulator, analyzer, or memory cards in the HP 64700 Series Cardcage according to the instructions found in the *80960 Emulator User's Guide for the Terminal Interface* manual.
- 2 Connect the emulator to your computer system and configure the emulator to communicate via the LAN (or RS-422 or RS-232) with the HP 9000 according to instructions found in the *HP 64700 Series Installation/Service Guide*.
- 3 Install the Graphical User Interface and supporting HP 64700 Series software according to instructions found in this chapter. Alternatively, you may install the Softkey Interface and choose not to install the Graphical User Interface.
- 4 Verify the software installation according to instructions given in the "Installation for HP 9000 Hosted Systems" section of this chapter.
- 5 Start the interface according to instructions given in the "Installation for HP 9000 Hosted Systems" section of this chapter.
- 6 Exit the interface and go on to other chapters in this book.

### Minimum HP 9000 Hardware and System Requirements

The following is a set of minimum hardware and system recommendations for operation of the Graphical User Interface on HP 9000 Series 300/400 and Series 700 workstations.

**HP-UX** For Series 9000/300 and Series 9000/400 workstations, the minimum supported version of the operating system is 7.03 or later. For Series 9000/700 workstations, the minimum supported version of the operating system is version 8.01.

**Motif/OSF** For Series 9000/700 workstations, you must also have the Motif 1.1 dynamic link libraries installed. They are installed by default, so you do not have to install them specifically for this product, but you should consult your HP-UX documentation for confirmation and more information.

**Hardware and Memory** Any workstation used with the Graphical User Interface should have a minimum of 16 megabytes of memory. Series 300 workstations should have a minimum performance equivalent to that of a HP 9000/350. A color display is also highly recommended.

From here, you should proceed to the section titled "Installation for HP 9000 Hosted Systems" for instructions on how to install, verify, and start the Graphical User Interface on HP 9000 systems.

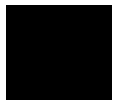

## Installation Overview for Sun SPARCsystems

Users of Sun SPARCsystems should follow the instructions in the section titled "Installation for Sun SPARCsystems". Briefly, those instructions tell you to do the following:

- 7 If necessary, install emulator, analyzer, or memory cards in the HP 64700 Series Cardcage according to the instructions found in the *80960 Emulator User's Guide for the Terminal Interface* manual.
- 8 Connect the emulator to your computer system and configure the emulator to communicate via the LAN with the hosted workstation according to instructions found in the *HP 64700 Series Installation/Service Guide*.
- 9 Install the Graphical User Interface and supporting HP 64700 Series software according to instructions found in this chapter. Alternatively, you may install the Softkey Interface and choose not to install the Graphical User Interface.
- 10 Verify the software installation according to instructions given in the "Installation for Sun SPARCsystems" section of this chapter.
- 11 Start the interface according to instructions given in the "Installation for Sun SPARCsystems" section of this chapter.
- 12 Exit the interface and go on to other chapters in this book.

### Minimum Sun SPARCsystem Hardware and System Requirements

The following is a set of minimum hardware and system recommendations for operation of the Graphical User Interface on Sun SPARCsystem workstations.

**SunOS** The Graphical User Interface software is designed to run on a Sun SPARCsystem with SunOS version 4.1 or 4.1.1 or greater. The tape uses the QIC-24 data format.

**Hardware and Memory** Any workstation used with the Graphical User Interface should have a minimum of 16 megabytes of memory. A color display is also highly recommended.

From here, you should proceed to the section titled "Installation for Sun SPARCsystems" for instructions on how to install, verify, and start the Graphical User Interface on SPARCsystem workstations.



## Installation for HP 9000 Hosted Systems

Follow these instructions to install the Graphical User Interface on HP 9000 workstations. You can also follow these instructions through Step 4 to find out how not to install the Graphical User Interface if you want to use just the Softkey Interface.

---

### Step 1. Install the hardware in the HP 64700 Series Cardcage

Turn to the *80960 Emulator User's Guide for the Terminal Interface* and follow the instructions for installing emulator, memory, or analyzer cards in the HP 64700 Series Cardcage. It may be that you already have installed the cards in the cardcage or your cardcage came with cards already installed.

If you have already installed the hardware and software and connected the emulator to your host system, skip to Step 5 to verify the software installation. Otherwise, continue with Step 2 of these instructions.

---

### Step 2. Configure the emulator for the communication channel

Turn to the *HP 64700 Series Installation/Service Guide* and follow the instructions for configuring the emulator to communicate via LAN, RS-422, or RS-232. (RS-422 and RS-232 are only supported on HP 9000 Series 300/400 machines.)

When you have configured the emulator to communicate via the channel you have chosen, continue with Step 3 of these instructions.

### Step 3. Connect the emulator to your system

Turn to the *HP 64700 Series Installation/Service Guide* and follow the instructions for connecting the emulator to your system. You can connect the emulator via LAN, RS-422, or RS-232.

When you have connected the emulator to your host system, continue with Step 4 of these instructions.

---

### Step 4. Install the software

The tape that contains the Graphical User Interface software may contain several products. Usually, you will want to install all of the products on the tape. However, to save disk space, or for other reasons, you can choose to install selected filesets.

If you plan on using the Softkey Interface instead of the Graphical User Interface, you can save about 3.5 megabytes of disk space by not installing the XUI suffixed filesets in the "64700 Operating Environment" and "<processor-type> Emulation Tools" partitions. (Also, if you choose not to install the Graphical User Interface, you will not have to use a special command line option to start the Softkey Interface.)

Refer to the information on updating HP-UX in your HP-UX documentation for instructions on viewing partitions and filesets and marking filesets that should not be loaded.

The following sub-steps assume that you want to install all products on the tape.

- 1 Become the root user on the system you want to update.
- 2 Make sure the tape's write-protect screw points to SAFE.

- 3 Put the product media into the tape drive that will be the *source device* for the update process.
- 4 Confirm that the tape drive BUSY and PROTECT lights are on. If the PROTECT light is not on, remove the tape and confirm the position of the write-protect screw. If the BUSY light is not on, check that the tape is installed correctly in the drive and that the drive is operating correctly.
- 5 When the BUSY light goes off and stays off, start the update program by entering  
**/etc/update**  
at the HP-UX prompt.
- 6 When the HP-UX update utility main screen appears, confirm that the source and destination devices are correct for your system. Refer to the information on updating HP-UX in your HP-UX documentation if you need to modify these values.
- 7 Select "Load Everything from Source Media" when your source and destination directories are correct.
- 8 To begin the update, press the softkey <Select Item>. At the next menu, press the softkey <Select Item> again. Answer the last prompt with  
**y**  
It takes about 20 minutes to read the tape.
- 9 When the installation is complete, read /tmp/update.log to see the results of the update.

## Step 5. Verify the software installation

A number of new filesets were installed on your system during the software installation process. This and following steps assume that you chose to load the Graphical User Interface filesets.

You can use this step to further verify that the filesets necessary to successfully start the Graphical User Interface have been loaded and that customize scripts have run correctly. Of course, the update process gives you mechanisms for verifying installation, but these checks can help to double-check the installation process.

- 1 Verify the existence of the **HP64\_Softkey** file in the **/usr/lib/X11/app-defaults** subdirectory by entering  
**ls /usr/lib/X11/app-defaults/HP64\_Softkey** at the HP-UX prompt.

Finding this file verifies that you loaded the correct fileset and also verifies that the customize scripts executed because this file is created from other files during the customize process.

- 2 Examine **/usr/lib/X11/app-defaults/HP64\_Softkey** near the end of the file to confirm that there are resources specific to your emulator.

Near the end of the file, there will be resource strings that contain references to specific emulators. For example, if you installed the Graphical User Interface for the 80960 emulator, resource name strings will have **i80960** embedded in them.

After you have verified the software installation, you must start the X server and an X window manager (if you are not currently running an X server). If you plan to run the Motif Window Manager (mwm), or similar window manager, continue with Step 6a of these instructions. If you plan to run HP VUE, skip to Step 6b of these instructions.

## Step 6a. Start the X server and the Motif Window Manager (mwm)

If you are not already running the X server and a window manager, do so now. The X server is required to use the Graphical User Interface because it is an X Windows application. A window manager is not required to execute the interface, but, as a practical matter, you must use some sort of window manager with the X server.

- Start the X server by entering **x11start** at the HP-UX prompt.

Consult the X Window documentation supplied with the HP-UX operating system documentation if you do not know about using X Windows and the X server.

After starting the X server and Motif Window Manager, continue with step 7 of these instructions.

---

## Step 6b. Start HP VUE

If you are running the X server under HP VUE and have not started HP VUE, do so now.

HP VUE is a window manager for the X Window system. The X server is executing underneath HP VUE. Unlike the Motif Window Manager, HP VUE provides a login shell and is your default interface to the HP 9000 workstation.



## Step 7. Set the necessary environment variables

The DISPLAY environment variable must be set before the Graphical User Interface will start. Also, you should modify the PATH environment variable to include the "/usr/hp64000/bin" directory, and, if you have installed software in a directory other than "/", you need to set the HP64000 environment variable.

The following instructions show you how to set these variables at the UNIX prompt. Modify your ".profile" or ".login" file if you wish these environment variables to be set when you log in. The following instructions also assume that you're using "sh" or "ksh"; if you're using "csh", environment variables are set using the "setenv <VARIABLE> <value>" command.

- 1 Set the DISPLAY environment variable by entering

```
DISPLAY=<hostname>:<server_number>.<screen_number>  
export DISPLAY
```

For example:

```
DISPLAY=myhost:0.0; export DISPLAY
```

Consult the X Window documentation supplied with the UNIX system documentation for an explanation of the DISPLAY environment variable.

- 2 Set the HP64000 environment variable.

For example, if you installed the HP 64000 software relative to the root directory, "/", you would enter

```
HP64000=/usr/hp64000; export HP64000
```

If you installed the software relative to a directory other than the root directory, it is strongly recommended that you use a symbolic link to make the software appear to be under /usr/hp64000. For example, if you installed the software relative to directory /users/team, you would enter

```
ln -s /users/team/usr/hp64000 /usr/hp64000
```

If you do not wish to establish a symbolic link, you can set the HP64000 variable to the full path that contains the HP 64000 software. Again, if you installed relative to /users/team, you would enter

```
HP64000=/users/team/usr/hp64000; export HP64000
```

- 3 Set the PATH environment variable to include the **usr/hp64000/bin** directory by entering

```
PATH=$PATH:$HP64000/bin; export PATH
```

Including **usr/hp64000/bin** in your PATH relieves you from prefixing HP 64700 executables with the directory path.

- 4 Set the MANPATH environment variable to include the **usr/hp64000/man** and **usr/hp64000/contrib/man** directories by entering

```
MANPATH=$MANPATH:$HP64000/man:$HP64000/contrib/man  
export MANPATH
```

Including these directories in your MANPATH variable lets you access the on-line "man" page information included with the software.

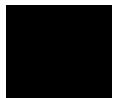

## Step 8. Determine the logical name of your emulator

The *logical name* of an emulator is a label associated with a set of communications parameters in the **\$HP64000/etc/64700tab.net** file. The 64700tab.net file is placed in the directory as part of the installation process.

- 1 Display the 64700tab.net file by entering **more /usr/hp64700/etc/64700tab.net** at the HP-UX prompt.
- 2 Page through the file until you find the emulator you are going to use.

This step will require some matching of information to an emulator, but it should not be difficult to determine which emulator you want to address.

---

### Examples

A typical entry for an 80960 emulator connected to the LAN would appear as follows:

```
#-----  
# Channel | Logical   | Processor | Remainder of Information for the Channel  
# Type   | Name     | Type     | (IP address for LAN connections)  
#-----  
lan:     em80960   i80960    21.17.9.143
```

A typical entry for an 80960 emulator connected to an RS-422 port would appear as follows:

```
#-----  
# Channel | Logical   | Processor | Host   | Physical | Xpar | Parity | Flow | Stop | Char  
# Type   | Name     | Type     | Name  | Device  | Mode |        |      | Bits | Size  
#         |          |          |       |         |     |        | XON |     |     |  
#         |          |          |       |         | OFF | NONE  | RTS | 2   | 8  
#-----  
serial:  em80960   i80960    myhost /dev/emcom23 OFF  NONE  RTS  2   8
```



## Step 9. Start the interface with the **emul700** command

- 1 Apply power to the emulator you wish to access after making sure the emulator is connected to the LAN or to your host system.

On the HP 64700 Series Emulator, the power switch is located on the front panel near the bottom edge. Push the switch in to turn power on to the emulator.

- 2 Wait a few seconds to allow the emulator to complete its startup initialization.
- 3 Choose a terminal window from which to start the Graphical User Interface.
- 4 Start the Graphical User Interface by entering the **emul700** command and giving the logical name of the emulator as an argument to the command, as in

```
$HP64000/bin/emul700 <logical_name> &
```

or

```
emul700 <logical name> &
```

if **\$HP64000/bin** is in you path.

If you are running the X server, if the Graphical User Interface is installed, and if your DISPLAY environment variable is set, the **emul700** command will start the Graphical User Interface. Otherwise, **emul700** starts the Softkey Interface.

You should include an ampersand ("&") with the command to start the Graphical User Interface as a background process. Doing so frees the terminal window where you started the interface so that the window may still be used.

- 5 Optionally start additional Graphical User Interface windows into the same emulation session by repeating the previous step.

You can also choose to use the Softkey Interface under X Windows, but you must include a command line argument to **emul700** to override the default Graphical User Interface. Start the Softkey Interface by entering

Chapter 14: Installation  
Installation for HP 9000 Hosted Systems

**emul700 -u skemul <logical name>**

**Example**

Suppose you have discovered that the logical name for a 80960 emulator connected to the LAN is "em80960". To start the Graphical User Interface and begin communicating with that emulator, enter (assuming your \$PATH includes \$HP64000/bin)

```
emul700 em80960
```

After a few seconds, the Graphical User Interface Emulator/Analyzer window should appear on your screen. The window will be similar to the following:

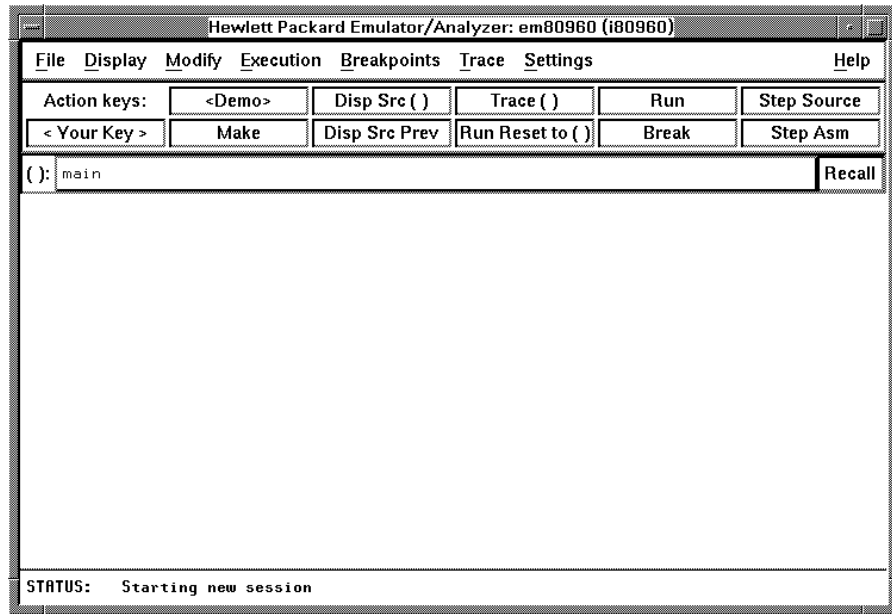

## Step 10. Exit the Graphical User Interface

- 1 Position the mouse pointer over the pulldown menu named "File" on the menu bar at the top of the interface screen.
- 2 Press and hold the *command select* mouse button until the File menu appears.
- 3 While continuing to hold the mouse button down, move the mouse pointer down the menu to the "Exit" menu item.
- 4 Display the Exit cascade menu by moving the mouse pointer to the right edge of the Exit menu choice. There is an arrow on the right edge of the menu item.
- 5 Choose "Released" from the cascade menu.

The interface will terminate and release the emulator for use by others.

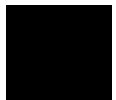

## Installation for Sun SPARCsystems

Follow these instructions to install the Graphical User Interface on Sun SPARCsystem workstations. You can also follow these instructions through Step 4 to find out how to prevent installation of the Graphical User Interface if you only plan to use the Softkey Interface.

---

### Step 1. Install the hardware in the HP 64700 Series Cardcage

Turn to the *80960 Emulator User's Guide for the Terminal Interface* and follow the instructions for installing emulator, memory, or analyzer cards in the HP 64700 Series Cardcage. It may be that you already have installed the cards in the cardcage or your cardcage came with cards already installed.

If you have already installed the hardware and software and connected the emulator to your host system, skip to Step 5 to verify the software installation. Otherwise, continue with Step 2 of these instructions.

---

### Step 2. Configure the emulator for the communication channel

Turn to the *HP 64700 Series Installation/Service Guide* and follow the instructions for configuring the emulator to communicate via LAN. (RS-422 and RS-232 are only supported on HP 9000 Series 300/400 machines.)

When you have configured the emulator to communicate via LAN, continue with Step 3 of these instructions.

### Step 3. Connect the emulator to your system

Turn to the *HP 64700 Series Installation/Service Guide* and follow the instructions for connecting the emulator to your system. You can connect the emulator via LAN.

When you have connected the emulator to your host system, continue with Step 4 of these instructions.

---

### Step 4. Install the software

The tape that contains the Graphical User Interface software may contain several products. Usually, you will want to install all of the products on the tape. However, to save disk space, or for other reasons, you can choose to install selected filesets.

If you plan on using the Softkey Interface instead of the Graphical User Interface, you can save about 3.5 megabytes of disk space by not installing the XUI suffixed filesets. (Also, if you choose not to install the Graphical User Interface, you will not have to use a special command line option to start the Softkey Interface.)

Refer to the *Software Installation Notice* for software installation instructions. After you are done installing the software, return here.

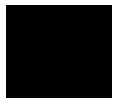

## Step 5. Start the X server and OpenWindows

If you are not already running the X server, do so now. The X server is required to run the Graphical User Interface because it is an X application.

- Start the X server by entering `/usr/openwin/bin/openwin` at the UNIX prompt.

Consult the OpenWindows documentation if you do not know about using OpenWindows and the X server.

---

## Step 6. Set the necessary environment variables

The DISPLAY environment variable must be set before the Graphical User Interface will start. Also, you should modify the PATH environment variable to include the "usr/hp64000/bin" directory, and, if you have installed software in a directory other than "/", you need to set the HP64000 environment variable.

The following instructions show you how to set these variables at the UNIX prompt. Modify your ".profile" or ".login" file if you wish these environment variables to be set when you log in. The following instructions also assume that you're using "csh"; if you're using "sh", environment variables are set in the "<VARIABLE>=<value>; export <VARIABLE>" form.

- 1 The DISPLAY environment variable is usually set by the `openwin` startup script. Check to see that DISPLAY is set by entering

```
echo $DISPLAY
```

If DISPLAY is not set, you can set it by entering

```
setenv DISPLAY=<hostname>:<server_number>.<screen_number>
```

For example:

```
setenv DISPLAY=myhost:0.0
```

Consult the OpenWindows documentation for an explanation of the DISPLAY environment variable.

**2** Set the HP64000 environment variable.

For example, if you installed the HP 64000 software relative to the root directory, "/", you would enter

```
setenv HP64000 /usr/hp64000
```

If you installed the software relative to a directory other than the root directory, it is strongly recommended that you use a symbolic link to make the software appear to be under /usr/hp64000. For example, if you installed the software relative to directory /users/team, you would enter

```
ln -s /users/team/usr/hp64000 /usr/hp64000
```

If you do not wish to establish a symbolic link, you can set the HP64000 variable to the full path that contains the HP 64000 software; also set the LD\_LIBRARY\_PATH variable to the directory containing run-time libraries used by the HP 64000 products. Again, if you installed relative to /users/team, you would enter

```
setenv HP64000 /users/team/usr/hp64000  
setenv LD_LIBRARY_PATH ${LD_LIBRARY_PATH}:${HP64000}/lib
```

**3** Set the PATH environment variable to include the **usr/hp64000/bin** directory by entering

```
setenv PATH ${PATH}:${HP64000}/bin
```

Including **usr/hp64000/bin** in your PATH relieves you from prefixing HP 64700 executables with the directory path.

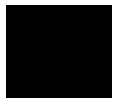

- 4 Set the MANPATH environment variable to include the **usr/hp64000/man** and **usr/hp64000/contrib/man** directories by entering

```
setenv MANPATH ${MANPATH}:${HP64000}/man
setenv MANPATH ${MANPATH}:${HP64000}/contrib/man
```

Including these directories in your MANPATH variable lets you access the on-line "man" page information included with the software.

- 5 If the Graphical User Interface is to run on a SPARCsystem computer that is not running OpenWindows, include the **/usr/openwin/lib** directory in LD\_LIBRARY\_PATH.

```
setenv LD_LIBRARY_PATH ${LD_LIBRARY_PATH}:/usr/openwin/lib
```

---

## Step 7. Verify the software installation

A number of product filesets were installed on your system during the software installation process. Due to the complexity of installing on NFS mounted file systems, a script that verifies and customizes these products was also installed. This stand alone script may be run at any time to verify that all files required by the products are in place in the file system. If required files are not found, this script will attempt to symbolically link them from the \$HP64000 install directory to their proper locations.

- Run the script **\$HP64000/bin/envinstall**.



## Step 8. Map your function keys

If you are using the Softkey Interface, map your function keys by following the steps below.

- 1 Copy the function key definitions by typing:

```
cp $HP64000/etc/ttyswrc ~/.ttyswrc
```

This creates key mappings in the .ttyswrc file in your \$HOME directory.

- 2 Remove or comment out the following line from your .xinitrc file:

```
xmodmap -e 'keysym F1 = Help'
```

If any of the other keys F1-F8 are remapped using xmodmap, comment out those lines also.

- 3 Add the following to your .profile or .login file:

```
stty erase ^H  
setenv KEYMAP sun
```

The erase character needs to be set to backspace so that the Delete key can be used for "delete character."

If you want to continue using the F1 key for HELP, you can use F2-F9 for the Softkey Interface. All you have to do is set the KEYMAP variable. If you use OpenWindows, type:

```
setenv KEYMAP sun.2-9
```

If you use xterm windows (the xterm window program is located in the directory /usr/openwin/demo), type:

```
setenv KEYMAP xterm.2-9
```

Reminder: If you are using OpenWindows, add /usr/openwin/bin to the end of the \$PATH definition, and add the following line to your .profile:

```
setenv OPENWINHOME /usr/openwin
```

After you have mapped your function keys, you must start the X server and an X window manager (if you are not currently running an X server).

## Step 9. Determine the logical name of your emulator

The *logical name* of an emulator is a label associated with a set of communications parameters in the **\$HP64000/etc/64700tab.net** file. The 64700tab.net file is placed in the directory as part of the installation process.

- 1 Display the 64700tab.net file by entering **more \$HP64000/etc/64700tab.net** at the UNIX prompt.
- 2 Page through the file until you find the emulator you are going to use.

This step will require some matching of information to an emulator, but it should not be difficult to determine which emulator you want to address.

---

### Examples

A typical entry for an 80960 emulator connected to the LAN would appear as follows:

```
#-----  
# Channel | Logical   | Processor | Remainder of Information for the Channel  
# Type   | Name     | Type     | (IP address for LAN connections)  
#-----  
lan:    em80960   i80960    21.17.9.143
```

## Step 10. Start the interface with the **emul700** command

- 1 Apply power to the emulator you wish to access after making sure the emulator is connected to the LAN.

On the HP 64700 Series Emulator, the power switch is located on the front panel near the bottom edge. Push the switch in to turn power on to the emulator.

- 2 Wait a few seconds to allow the emulator to complete its startup initialization.
- 3 Choose a terminal window from which to start the Graphical User Interface.
- 4 Start the Graphical User Interface by entering the **emul700** command and giving the logical name of the emulator as an argument to the command, as in

```
$HP64000/bin/emul700 <logical_name> &
```

or

```
emul700 <logical name> &
```

if **\$HP64000/bin** is in your path.

If you are running the X server, if the Graphical User Interface is installed, and if your DISPLAY environment variable is set, the **emul700** command will start the Graphical User Interface. Otherwise, **emul700** starts the Softkey Interface.

You should include an ampersand ("&") with the command to start the Graphical User Interface as a background process. Doing so frees the terminal window where you started the interface so that the window may still be used.

- 5 Optionally start additional Graphical User Interface windows into the same emulation session by repeating the previous step.

You can also choose to use the Softkey Interface in a terminal emulation window, but you must include a command line argument to **emul700** to override the default Graphical User Interface. Start the Softkey Interface by entering

Chapter 14: Installation  
**Installation for Sun SPARCsystems**

```
emul700 -u skemul <logical name>
```

---

**Example**

Suppose you have discovered that the logical name for a 80960 emulator connected to the LAN is "em80960". To start the Graphical User Interface and begin communicating with that emulator, enter (assuming your \$PATH includes \$HP64000/bin)

```
emul700 em80960
```

After a few seconds, the Graphical User Interface Emulator/Analyzer window should appear on your screen.

## Step 11. Exit the Graphical User Interface

- 1 Position the mouse pointer over the pulldown menu named "File" on the menu bar at the top of the interface screen.
- 2 Press and hold the *command select* mouse button until the File menu appears.
- 3 While continuing to hold the mouse button down, move the mouse pointer down the menu to the "Exit" menu item.
- 4 Display the Exit cascade menu by moving the mouse pointer to the right edge of the Exit menu choice. There is an arrow on the right edge of the menu item.
- 5 Choose "Released" from the cascade menu.

The interface will terminate and release the emulator for use by others.

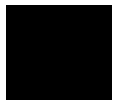

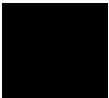



---

**Installing/Updating Emulator  
Firmware**

---

## Installing/Updating Emulator Firmware

If you ordered the HP 64761A 80960SA/SB emulator probe and the HP 64748C emulation control card together, the control card contains the correct firmware for the HP 64761A.

However, if you ordered the HP 64761A and the HP 64748C separately, or if you are using a HP 64748C that has been used previously with a different emulator probe, you must download the correct firmware into the emulation control card.

The 80960SA/SB emulator firmware is included with the emulator/analyzer interface software, and the program that downloads emulator firmware is included with the HP B1471 64700 Operating Environment product.

(The firmware, and the program that downloads it into the control card, are also included with the 80960SA/SB emulator probe on an MS-DOS format floppies. The floppies are for users that do not have hosted interface software.)

Before you can update emulator firmware, you must have already installed the emulator into the HP 64700, connected the HP 64700 to a host computer or LAN, and installed the emulator/analyzer interface and HP B1471 software as described in the "Installation" chapter.

This chapter describes how to:

- Update firmware with the "progflash" command.
- Display current firmware version information.



## To update emulator firmware with "progflash"

- Enter the **progflash -v <emul\_name> <products ...>** command.

The **progflash** command downloads code from files on the host computer into Flash EPROM memory in the HP 64700.

The **-v** option means "verbose". It causes progress status messages to be displayed during operation.

The **<emul\_name>** option is the logical emulator name as specified in the `/usr/hp64000/etc/64700tab.net` file.

The **<products>** option names the products whose firmware is to be updated.

If you enter the **progflash** command without options, it becomes interactive. If you don't include the **<emul\_name>** option, it displays the logical names in the `/usr/hp64000/etc/64700tab.net` file and asks you to choose one. If you don't include the **<products>** option, it displays the products which have firmware update files on the system and asks you to choose one. (In the interactive mode, only one product at a time can be updated.) You can abort the interactive **progflash** command by pressing **<CTRL>c**.

**progflash** will print "Flash programming SUCCEEDED" and return 0 if it is successful; otherwise, it will print "Flash programming FAILED" and return a nonzero (error).

You can verify the update by displaying the firmware version information.

## Chapter 15: Installing/Updating Emulator Firmware

### To update emulator firmware with "progflash"

#### Examples

To update the emulator firmware in the HP 64700 that contains the "em80960" emulator:

```
$ progflash <RETURN>
```

```
HPB1471-19309 A.05.00 03Jan94
64700 SERIES EMULATION COMMON FILES
```

```
A Hewlett-Packard Software Product
Copyright Hewlett-Packard Co. 1988
```

All Rights Reserved. Reproduction, adaptation, or translation without prior written permission is prohibited, except as allowed under copyright laws.

#### RESTRICTED RIGHTS LEGEND

Use, duplication, or disclosure by the Government is subject to restrictions as set forth in subparagraph (c) (1) (II) of the Rights in Technical Data and Computer Software clause at DFARS 52.227-7013. HEWLETT-PACKARD Company, 3000 Hanover St., Palo Alto, CA 94304-1181

Logical Name	Processor
1 em68k	m68000
2 em68340	m68340
3 em80960	i80960

Number of Emulator to Update? (intr (usually cntl C or DEL) to abort)

To update firmware in the HP 64700 that contains the 80960 emulator, enter "3".

```
Product
1 64700
2 64703/64704/64706/64740
3 64744
4 64760
5 64761
```

Number of Product to Update? (intr (usually cntl C or DEL) to abort)

To update the HP 64761A 80960SA/SB emulator firmware, enter "5".

Enable progress messages? [y/n] (y)

To enable status messages, enter "y".

## Chapter 15: Installing/Updating Emulator Firmware To update emulator firmware with "progflash"

```
Checking System firmware revision...
Mainframe is a 64700B

Reading configuration from '/usr/hp64000/inst/update/64761.cfg'
ROM identifier address = 2FFFF0H
Required hardware identifier = 1FF3H
Control ROM start address = 280000H
Control ROM size = 40000H
Control ROM width = 16
Programming voltage control address = 2FFFFEH
Programming voltage control value = FFFFH
Programming voltage control mask = 0H

Rebooting HP64700...
Checking Hardware id code...
Erasing Flash ROM
Downloading ROM code: /usr/hp64000/inst/update/64761.X
  Code start 280000H (should equal control ROM start)
  Code size 3FA4BH (must be less than control ROM size)
Finishing up...

Rebooting HP64700...
Flash programming SUCCEEDED
$
```

You could perform the same update as in the previous example with the following command:

```
$ progflash -v em80960 64761 <RETURN>
```

## To display current firmware version information

- Use the Terminal Interface **ver** command to view the version information for firmware currently in the HP 64700.

When using the Graphical User Interface or Softkey Interface, you can enter Terminal Interface commands with the **pod\_command** command. For example:

```
display pod_command <RETURN>  
pod_command "ver" <RETURN>
```

---

### Examples

The Terminal Interface **ver** command displays information similar to:

```
Copyright (c) Hewlett-Packard Co. 1987  
All Rights Reserved. Reproduction, adaptation, or translation without prior  
written permission is prohibited, except as allowed under copyright laws.
```

```
HP64700B Series Emulation System  
Version: B.01.00 20Dec93  
Location: Flash  
System RAM:1 Mbyte  
  
HP64761A (PPN: 64760A) Intel 80960SA/SB Emulator  
Version: A.00.00 18Aug92  
Control: HP64748C ABG Control Board  
Speed: 16.0 MHz  
Memory: 2048 KBytes  
Bank 0: HP64171B 1 MByte Memory Module  
Bank 1: HP64171B 1 MByte Memory Module  
  
HP64740 Emulation Analyzer  
Version: A.02.02 13Mar91
```

## **If there is a power failure during a firmware update**

If there is a power glitch during a firmware update, some bits may be lost during the download process, possibly resulting in an HP 64700 that will not boot up.

- Repeat the firmware update process.
  
- If the HP 64700 is connected to the LAN in this situation and you are unable to connect to the HP 64700 after the power glitch, try repeating the firmware update with the HP 64700 connected to an RS-232 or RS-422 interface.



---

## Glossary

**access mode** Specifies the types of cycles used to access target system memory locations. For example a "byte" access mode tells the monitor program to use load/store byte instructions to access target memory.

**analyzer** An instrument that captures data on signals of interest at discreet periods.

**background** The emulator mode in which foreground operation is suspended so the emulation processor can be used for communication with the emulation controller. The background monitor does not occupy any processor address space.

**background emulation monitor** An emulation monitor program that does not execute as part of the user program, and therefore, operates in the emulator's background mode.

**background memory** Memory space reserved for the emulation processor when it is operating in the background mode. Background memory does not take up any of the microprocessor's address space.

**display mode** When displaying memory, this mode tells the emulator the size of the memory locations to display. When modifying memory, the display mode tells the emulator the size of the values to be written to memory.

**embedded microprocessor system** The microprocessor system which the emulator plugs into.

**emulation bus analyzer** The internal analyzer that captures emulator bus cycle information synchronously with the processor's clock signal.

**emulation monitor program** A program that is executed by the emulation processor which allows the emulation controller to access target system resources. For example, when you display target system memory locations, the monitor program executes microprocessor instructions that read the target memory locations and send their contents to the emulation controller.



**emulator** An instrument that performs just like the microprocessor it replaces, but at the same time, it gives you information about the operation of the processor. An emulator gives you control over target system execution and allows you to view or modify the contents of processor registers, target system memory, and I/O resources.

**foreground** The mode in which the emulator is executing the user program. In other words, the mode in which the emulator operates as the target microprocessor would.

**foreground emulation monitor** An emulation monitor program that operates in the foreground emulator mode, and therefore, executes as if it were part of the user program.

**global restart** When the same secondary branch condition is used for all terms in the analyzer's sequencer, and secondary branches are always back to the first term.

**prestore** The analyzer feature that allows up to two states to be stored before normally stored states. This feature is useful when you want to find the cause of a particular state. For example, if a variable is accessed from many different places in the program, you can qualify the trace so that only accesses of that variable are stored and turn on prestore to find out where accesses of that variable originate from.

**primary sequencer branch** Occurs when the analyzer finds the primary branch state specified at a certain level and begins searching for the states specified at the primary branch's destination level.

**real-time** Refers to continuous execution of the user program without interference from the emulator. (Such interference occurs when the emulator temporarily breaks into the monitor so that it can access register contents or target system memory or I/O.)

**secondary sequencer branch** Occurs when the analyzer finds the secondary branch state specified at a certain level before it found the primary branch state and begins searching for the states specified at the secondary branch's destination level.

**sequence terms** Individual levels of the sequencer. The HP 64705A analyzer provides 8 sequence terms.



**sequencer** The part of the analyzer that allows it to search for a certain sequence of states before triggering.

**sequencer branch** Occurs when the analyzer finds the primary or secondary branch state specified at a certain level and begins searching for the states specified at another level.

**target system** The microprocessor system which the emulator plugs into.

**trace** A collection of states captured on the emulation bus (in terms of the emulation bus analyzer) or on the analyzer trace signals (in terms of the external analyzer) and stored in trace memory.

**trigger** The captured analyzer state about which other captured states are stored. The trigger state specifies when the trace measurement is taken.

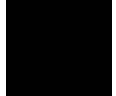



---

## Index

- ! 80960 demo target system, **519**
  - 80960 tables
    - displaying, **180**
  
- A
  - about, trigger position specification, **233**
  - absolute count, in the trace display, **257**
  - absolute files, **402**
    - loading, **133**
    - loading without symbols, **134**
    - storing memory contents into, **134**
  - absolute status, in the trace display, **249**
  - access mode, **126, 567**
  - accsize (analyzer state qualifier softkey), **223, 231, 428, 444**
    - predefined values for, **223, 231**
  - action keys, **28**
    - custom, **340**
    - operation, **75**
    - with command files, **340**
    - with entry buffer, **73, 75**
  - activity measurements (SPMT), **267-281**
    - additional symbols for address, **275**
    - confidence level, **276**
    - error tolerance, **276**
    - interpreting reports, **274**
    - mean, **274**
    - relative and absolute counts, **275**
    - standard deviation, **275**
    - symbols within range, **275**
    - trace command setup, **269**
  - address (analyzer state qualifier softkey), **223, 231, 429, 444**
  - address qualifiers, **223, 231**
  - address range file format (SPMT measurements), **271**
  - ADS signal, on emulation memory accesses, **119, 127**
  - after, trigger position specification, **233**
  - analyzer, **567**
    - arming other HP 64700 Series analyzers, **5**

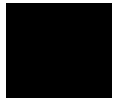

- breaking emulator execution into the monitor, **5**
- breaking execution of other HP 64700 Series emulators, **5**
- count qualifiers, **238**
- definition, **4**
- general description, **4**
- occurrence count, **235**
- prestore qualifiers, **237**
- state qualifiers, **223, 231**
- storage qualifiers, **236**
- trace at EXECUTE, **319**
- trigger condition, **233**
- using the, **198**
- analyzer probe
  - assembling, **298**
  - connecting to the target system, **300**
- analyzer status
  - occurrence left information, **202**
  - sequence term information, **202**
- app-defaults directory
  - HP 9000 computers, **526**
  - Sun SPARCsystem computers, **526**
- application resource
  - See X resource*
- arm information, **201**
- arm\_trig2, in trace command, **459**
- B**
  - background, **112-113, 567**
    - emulation monitor, **567**
    - memory, **567**
  - background monitor, **113-114, 521**
    - selecting, **112-116**
  - bases (number), **214**
  - bbaunload command, syntax, **360**
  - before, trigger position specification, **233**
  - BGND output line, **114**
  - binary numbers, **214**
  - blocks (emulation memory), size of, **118**
  - BNC
    - connector, **5, 312**
    - trigger signal, **314**
  - break command, **151**
    - syntax, **359**

break on guarded memory access, **240**  
breakpoints, **37**  
    screen to file, **192**  
breaks on write to ROM, **128**  
bstsize (analyzer state qualifier softkey), **223, 429, 444**  
    predefined values for, **223**

**C** cables, emulator probe, dimensions, **519**  
cascade menu, **66**  
cautions  
    BNC accepts only TTL voltage levels, **317**  
    CMB 9-pin port is NOT for RS-232C, **315**  
    real-time dependent target system circuitry, **110**  
changing  
    directory context in configuration window, **107**  
    directory context in emulator/analyzer window, **144**  
    symbol context, **145**  
characterization of memory, **119**  
class name, X applications, **524**  
client, X, **332**  
clock source, external, **127, 519**  
clocks  
    *See also* slave clocks  
CMB (coordinated measurement bus), **312**  
    EXECUTE line, **314, 361**  
    HP 64700 connection, **315**  
    READY line, **313**  
    signals, **313**  
    TRIGGER line, **313**  
cmb\_execute command, **320, 361**  
color scheme, **334, 338, 528**  
column width, trace display option, **256**  
columns in main display area, **335**  
command buttons, **29**  
command files, **404**  
    other things to know about, **90**  
    passing parameters, **89**  
command line, **29**  
    Command Recall dialog box, **30**  
    Command Recall dialog box, operation, **84**  
    copy-and-paste to from entry buffer, **74**  
    editing entry area with popup menu, **83**

- editing entry area with pushbuttons, **82**
- entering commands, **81**
- entry area, **29**
- executing commands, **81**
- help, **84**
- keyboard use of, **85-87**
- on-line help, **87**
- recalling commands with dialog box, **84**
- turning on or off, **80, 335**
- command paste mouse button, **31**
- Command Recall dialog box operation, **76**
- command select mouse button, **31**
- commands, **85**
  - combining on a single command line, **85**
  - completion, **85**
  - editing in command line entry area, **82-83**
  - entering in command line, **81**
  - executing in command line, **81**
  - keyboard entry, **85**
  - line erase, **86**
  - recall, **86**
  - recalling with dialog box, **84**
  - summary, **358**
  - word selection, **86**
- comparison of foreground/background monitors, **114**
- configuration context, displaying, **108**
- configuration, emulator
  - exiting the interface, **109**
  - loading from file, **109**
  - modifying a section, **104**
  - monitor selection, **112-116**
  - starting the interface, **102**
  - storing, **106**
- context
  - changing directory in configuration window, **107**
  - changing directory in emulator/analyzer window, **144**
  - changing symbol, **145**
  - displaying directory from configuration window, **108**
  - displaying directory from emulator/analyzer window, **144**
  - displaying symbol, **144**
- coordinated measurements, **321**

- break\_on\_trigger syntax of the trace command, **321**
- definition, **312**
- copy
  - breakpoints screen to file, **192**
  - data values screen to file, **191**
  - display area to file, **191**
  - emulator status screen to file, **192**
  - error log to file, **192**
  - event log to file, **192**
  - global symbols to file, **192**
  - local symbols to file, **192**
  - memory to file, **191**
  - pod commands screen to file, **192**
  - registers to file, **192**
  - system tables screen to file, **191**
  - trace listing to file, **191**
- copy command, **362-365**
  - data, **363**
  - display, **363**
  - error\_log, **363**
  - event\_log, **363**
  - global symbols, **363**
  - help, **363**
  - local\_symbols\_in, **366**
  - memory, **367-368**
  - pod\_command, **364**
  - registers, **369**
  - software breakpoints, **364**
  - status, **364**
  - trace, **370**
- copy-and-paste
  - addresses, **71**
  - from entry buffer, **74**
  - multi-window, **71, 74**
  - symbol width, **71**
  - to entry buffer, **70**
- count absolute/relative, trace display option, **257**
- count information in trace listing, **206**
- count qualifiers, **238**
- count, occurrence, **235**
- cursor buttons, **30**

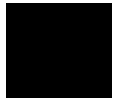

- D**
- data
    - copy command, **363**
    - display command, **374-376**
  - data (analyzer state qualifier softkey), **223, 231, 429, 444**
  - data values, **178-179**
    - adding items to the existing display, **179**
    - clearing the display and adding a new item, **179**
    - copying screen to file, **191**
    - displaying, **41, 178**
  - decimal numbers, **214**
  - default trace command, **200**
  - default trace display, **204**
    - returning to, **259**
  - demo target system, **519**
  - demos, setting up, **343-345**
  - demultiplexing, using slave clocks for, **305**
  - demux, slave clock mode, **307**
  - depth of the trace, **207**
  - design considerations (target system), **519**
  - device table file, **34, 55-56**
  - dialog box, **75**
    - Command Recall, operation, **76, 84**
    - Directory Selection, **144**
    - Directory Selection, operation, **75, 78**
    - Entry Buffer Recall, operation, **73, 76**
    - File Selection, operation, **76-77**
    - Trace Specification Selection, operation, **207**
  - directory context
    - changing in configuration window, **107**
    - changing in emulator/analyzer window, **144**
    - displaying from configuration window, **108**
    - displaying from emulator/analyzer window, **144**
  - Directory Selection dialog box operation, **75, 78**
  - display area, **29**
    - columns, **335**
    - lines, **335-336**
    - screen to file, **191**
  - display command, **371-373**
    - data, **374-376**
    - error\_log, **372**
    - event\_log, **372**



global\_symbols, **377**  
local\_symbols\_in, **378**  
memory, **379-382**  
memory mnemonic, **35, 173**  
pod\_command, **372**  
registers, **166-171, 383-384**  
simulated\_io, **193, 385**  
software\_breakpoints, **386**  
status, **200, 372**  
symbols, **135**  
table, **387**  
trace, **204, 388-391**  
display mode, **567**  
display trace, **247-260**  
  about line number, **248**  
  absolute format, **249**  
  count absolute/relative, **257**  
  default, **259**  
  mnemonic format, **250**  
  offset by, **258**  
  positioning, left/right, **206**  
  positioning, up/down, **206**  
  source line inclusion, **253**  
  symbol information inclusion, **255**  
  width of columns, **256**  
displaying  
  simulated io screen, **195**  
displays, copying, **363**  
don't care digits, **215**  
downloading absolute files, **5, 133**  
dual-port emulation memory, **111**  
duration measurements (SPMT), **282-290**  
  average time, **287**  
  confidence level, **288**  
  error tolerance, **288**  
  interpreting reports, **287**  
  maximum time, **287**  
  minimum time, **287**  
  number of intervals, **287**  
  recursion considerations, **282**  
  selecting, **285**

standard deviation, **288**  
trace command setup, **283**

- E** edit
- command line entry area with popup menu, **83**
  - command line entry area with pushbuttons, **82**
  - file, **188**
  - file at address, **188**
  - file at program counter, **188**
  - file at symbol from symbols screen, **188**
  - file from memory display screen, **188**
- editing
- file, **335**
  - file at address, **335**
- embedded microprocessor system, **567**
- emul700, command to start the emulator/analyzer interface, **55**
- emulation bus analyzer, **567**
- emulation memory, **117**
- block size, **118**
  - dual-port, **111**
  - loading absolute files, **133**
  - size of, **117**
  - target ADS, synchronizing with, **119**
- emulation monitor, **567**
- foreground or background, **112-116**
  - function of, **113**
- emulation session, exiting, **62**
- emulation, external analyzer mode, **304**
- emulator, **568**
- configuring the, **98**
  - device table file, **34, 55-56**
  - error messages, **491**
  - general description, **4**
  - multiple start/stop, **5, 319-320**
  - running from target reset, **149**
  - status lines, predefined values for, **223, 231**
  - using the, **132**
- emulator configuration
- background monitor, **114**
  - break processor on write to ROM, **128**
  - exiting the configuration interface, **109**
  - foreground monitor, **115**

- foreground monitor priority, **115**
- load command, **402**
- loading from file, **109**
- modify command, **406**
- modifying a configuration section, **104**
- monitor entry from reset, **129**
- reset synchronization, **123**
- restrict to real-time runs, **110**
- starting the configuration interface, **102**
- storing, **106**
- synchronize emulation memory accesses to target, **127**
- target memory access size, **126**
- target system clock speed, **127**
- target system reset polarity, **123**
- emulator probe
  - access to target system, **519**
  - dimensions, **519**
  - pin orientation, **519**
  - power requirements, **519**
- emulator status, displaying, **192**
- emulator/analyzer interface
  - exiting, **50, 61-62**
  - running in multiple windows, **55**
  - starting, **55-58**
- end command, **50, 62, 392-393**
- entry
  - pod commands, **94**
  - simulated io, **194**
- entry buffer, **29**
  - address copy-and-paste to, **71**
  - clearing, **70**
  - copy-and-paste from, **74**
  - copy-and-paste to, **70**
  - Entry Buffer Recall dialog box, **29**
  - Entry Buffer Recall dialog box, operation, **73**
  - multi-window copy-and-paste from, **74**
  - multi-window copy-and-paste to, **71**
  - operation, **73**
  - recall button, **29**
  - recalling entries, **73**
  - symbol width and copy-and-paste to, **71**

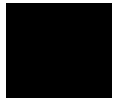

text entry, **70**  
with action keys, **73, 75**  
with pulldown menus, **73**  
Entry Buffer Recall dialog box operation, **76**  
ENTRY/EXIT symbols, **36**  
environment variables (UNIX)  
HP64KPATH, **92**  
HP64KSYMBPATH, **452**  
PATH, **55**  
Softkey Interface, setting while in, **185**  
eram, memory characterization, **119**  
erom, memory characterization, **119**  
error messages, **468**  
analyzer, **512**  
emulator, **491**  
general and system error/status, **498**  
Terminal Interface, **491**  
error\_log  
copy command, **192, 363**  
display command, **372**  
event\_log, **59**  
copy command, **192, 363**  
display command, **372**  
EXECUTE  
CMB signal, **314**  
tracing at, **319**  
execution messages, **208-213, 520**  
modify command, **407-409**  
exit  
emulation session, **62**  
emulator/analyzer windows, **50, 61-62**  
expressions, **214**  
--EXPR-- syntax, **394-396**  
external analyzer  
configuration, **301-309**  
general description, **4**  
labels, **302, 308**  
  
mode, **304**  
should emulation control?, **302**  
using, **296**

- F** file
  - breakpoints screen to, **192**
  - data values screen to, **191**
  - display area to, **191**
  - editing, **188**
  - editing at address, **188**
  - editing at program counter, **188**
  - editing at symbol from symbols screen, **188**
  - editing from memory display screen, **188**
  - emulator configuration, **106**
  - emulator configuration load, **109**
  - emulator status screen to, **192**
  - error log to, **192**
  - event log to, **192**
  - global symbols to, **192**
  - local symbols to, **192**
  - memory to, **191**
  - pod commands screen to, **192**
  - registers to, **192**
  - system table screen to, **191**
  - trace listing to, **191**
- file extensions
  - .EA and .EB, configuration files, **106**
- file formats
  - address ranges for SPMT measurements, **271**
  - time ranges for SPMT measurements, **285**
- File Selection dialog box operation, **76-77**
- firmware updates, **5, 560**
- firmware version, **564**
- foreground, **112-113, 568**
  - emulation monitor, **568**
- foreground monitor, **113, 115**
  - advantages/disadvantages, **114**
  - customizing, **113**
  - emulator modes when using, **113**
  - priority, **115**
  - selecting, **112-116**
- formal parameters (command files), **89**
- forward command, syntax, **397**
- function calling sequence, storing in analyzer trace, **213**
- functions, step over, **173**

- G**
  - global restart qualifier, **244, 568**
  - global symbols, **35, 215, 377**
    - copy command, **363**
    - display command, **136, 377**
    - initializing the SPMT measurement with, **271**
    - to file, **192**
  - grabbers, connecting to analyzer probe, **299**
  - guarded memory accesses, **119, 240**
  
- H**
  - halfbright, **81-82**
  - halt, trace, **203**
  - hand pointer, **29, 69**
  - hardware
    - HP 9000 memory needs, **535**
    - HP 9000 minimum performance, **535**
    - HP 9000 minimums overview, **534**
    - SPARCsystem memory needs, **536**
    - SPARCsystem minimum performance, **536**
    - SPARCsystem minimums overview, **536**
  - help
    - command line, **84**
    - copy command, **363**
    - help index, **79**
    - on-line, **87**
    - softkey driven information, **87**
  - help command, **398-399**
  - help index, displaying, **79**
  - hexadecimal numbers, **215**
  - HP 9000
    - 700 series Motif libraries, **535**
    - HP-UX minimum version, **535**
    - installing software, **537-547**
    - minimum system requirements overview, **534**
  - HP 98659 RS-422 Interface Card, **5**
  - HP-UX, minimum version, **535**
  - HP64KPATH, UNIX environment variable, **92**
  - HP64KSYMBPATH environment variable, **452**
  
- I**
  - IEEE-695 absolute file format, **133**
  - init\_processor command, **400-401**
  - initial memory image, **521**
  - input

- pod commands, **94**
- simulated io, **194**
- input scheme, **334, 528**
- installation
  - at a glance, **534-536**
  - HP 9000 overview, **534**
  - HP 9000 specific instructions, **537-547**
  - SPARCsystem specific instructions, **548-557**
  - SPARCsystems overview, **536**
- instance name, X applications, **523-524**
- interactive measurements, **321**
- interface
  - exiting, **62**
- interface, emulator configuration
  - exiting, **109**
  - modifying a section, **104**
  - starting, **102**
- interrupts, **114**
- inverse video
  - graphical interface demo/tutorial files, **344**
  - source line display option, **253**
- K** keyboard
  - accelerators, **68**
  - choosing menu items, **67**
  - focus policy, **68**
  - pod commands, **94**
  - simulated io, **194**
- keyboard\_to\_simio, modify command, **410**
- L** label scheme, **334, 338, 528**
- labels
  - configuration file, **309**
- LANG environment variable, **528**
- LD\_LIBRARY\_PATH environment variable, **552**
- libraries, Motif for HP 9000/700, **535**
- line numbers (source file), symbol display, **137**
- line numbers (trace), **204**
- line numbers (trace), displaying about, **248**
- lines in main display area, **335-336**
- list, trace, **204**
- load command, **402-403**

- absolute files, **133**
- configuration, **402**
- trace, **263-264, 403**
- trace\_spec, **262, 403**
- local symbols, **215, 378**
  - copy command, **366**
  - display command, **137, 378**
  - initializing the performance measurement with, **272**
  - to file, **192**
- locked, end command option, **62**
- log\_commands command, **404**
- M**
  - mapping memory, **117-122**
  - memmap (analyzer state qualifier softkey), **223, 231, 429, 444**
    - predefined values for, **223, 231**
  - memory, **367-368**
    - activity measurements (SPMT), **267, 274**
    - characterization of, **119**
    - contents listed as asterisk (\*), **367**
    - copy command, **367-368**
    - display command, **379-382**
    - displaying, **172**
    - displaying at an address, **176**
    - displaying repetitively, **177**
    - dual-port emulation, **111**
    - loading programs into, **133**
    - mapping, **117-122**
    - mnemonic format display, **173**
    - modify command, **411-413**
    - modifying, **177**
    - re-assignment of emulation memory blocks in mapper, **122**
    - store command, **449**
    - to file, **191**
  - memory mapper, resolution, **117**
  - memory recommendations
    - HP 9000, **535**
    - SPARCsystem, **536**
  - memory refresh, **99**
  - menus
    - editing command line with popup, **83**
    - hand pointer means popup, **29, 69**
    - pull-down operation with keyboard, **67**





breakpoint locations must contain opcodes, **158, 160**  
CMB EXECUTE and TRIGGER signals, **314**  
external timing analyzer does not use configuration labels, **309**  
measurement errors on recursive/multiple entry routines, **283**  
re-assignment of emulation memory blocks by mapper, **122**  
some compilers emit more than one symbol for an address, **275**  
step command doesn't work when CMB enabled, **319**  
trigger found but trace memory not filled, **206**  
number bases, **214**  
number of source lines, trace display option, **253**  
numerical values, **214**

- O**
  - occurrence counts, **235, 242**
  - octal numbers, **214**
  - offset by, trace display option, **258**
  - on-line help, **87**
  - on\_halt, trace command option, **240**
  - only, trace command storage qualifier, **236**
  - operating system
    - HP-UX minimum version, **535**
    - SunOS minimum version, **536**
  - operators, **215**
  - output line, BGND, **114**
  - overview
    - HP 9000 installation, **534**
    - installation, **534-536**
    - SPARCsystems installation, **536**
- P**
  - parameter passing in command files, **89**
  - parent symbol
    - displaying from symbols screen, **141**
  - paste mouse button, **31**
  - PATH, UNIX environment variable, **55**
  - perf.out, SPMT output file, **272, 286, 291-293, 419**
  - perf32, SPMT report generator utility, **266, 291-292**
    - interpreting reports, **274, 287**
    - options, **293**
    - using the, **293**
  - performance measurements
    - See* software performance measurements
  - performance\_measurement\_end command, **419**
  - performance\_measurement\_initialize command, **420-421**

- performance\_measurement\_run command, **422-423**
  - pin orientation (emulator probe), **519**
  - platform
    - HP 9000 memory needs, **535**
    - HP 9000 minimum performance, **535**
    - SPARCsystem memory needs, **536**
    - SPARCsystem minimum performance, **536**
  - platform scheme, **334, 527**
  - pod commands, **424-425**
    - copy command, **364**
    - display command, **372**
    - display screen, **94**
    - keyboard input, **94**
    - screen to file, **192**
  - popup menus
    - command line editing with, **83**
    - hand pointer indicates presence, **29, 69**
  - positioning the trace display left/right, **206**
  - positioning the trace display up/down, **206**
  - power
    - emulator probe requirements of target system, **519**
    - power failure during firmware update, **565**
    - powered down target, run from reset, **149**
  - prestore qualifiers, **237, 568**
  - primary branches (analyzer sequencer), **568**
  - priority, foreground monitor, **115**
  - processor type, **56**
  - progflash example, **562**
  - program activity measurements (SPMT), **267, 274**
  - program counter
    - mnemonic memory display, **36**
    - running from, **148**
  - pulldown menus
    - choosing with keyboard, **67**
    - choosing with mouse, **66-67**
  - pushbutton select mouse button, **31**
- Q** QUALIFIER, in trace command, **426-427**
- qualifiers, **223, 231**
    - count, **238**
    - prestore, **237**
    - simple trigger, **233**

- slave clock, **305**
- storage, **236**
- R** RAM, mapping emulation or target, **119**
- RANGE, in trace command, **428-429**
- READY (target system) synchronize emulation memory accesses to, **127**
- READY, CMB signal, **313**
- real-time runs, **568**
  - commands not allowed during, **110**
  - restricting the emulator to, **110**
- recall buffer, **29**
  - columns, **341**
  - initial content, **341-342**
  - lines, **341**
  - recalling entries, **73**
- recall command
  - trace specifications dialog box, **207**
- recall, command, **86**
  - dialog box, **84**
- recursion in SPMT measurements, **282**
- registers
  - copy command, **369**
  - display command, **383-384**
  - display/modify, **166-171**
  - displaying, **42, 168**
  - modify command, **171, 414-415**
  - to file, **192**
- relative count, in the trace display, **257**
- relative display of count information, **206**
- release\_system, end command option, **50, 62, 106**
- repetitive display of memory, **177**
- reset
  - target system, **519**
- reset (emulator)
  - commands which cause exit from, **153**
  - monitor entry from, **129**
  - polarity of SYS\_RESET, **123**
  - running from target reset, **149**
  - synchronization, **123**
- reset command, **430**
- resolution, memory mapper, **117**
- resource

- See X resource*
  - RESOURCE\_MANAGER property, **526**
  - restart term, **242, 244**
  - restrict to real-time runs
    - emulator configuration, **110**
    - permissible commands, **110**
    - target system dependency, **110**
  - ROM
    - mapping emulation or target, **119**
    - writes to, **119**
  - RS-422, host computer interface card, **5**
  - run command, **148, 431-433**
    - from reset, **149**
- S**
  - scheme files (for X resources), **333, 527**
    - color scheme, **334, 338, 528**
    - custom, **338-339, 529**
    - input scheme, **334, 528**
    - label scheme, **334, 338, 528**
    - platform scheme, **334, 527**
    - size scheme, **334, 528**
  - scroll bar, **29**
  - secondary branch expression, **568**
  - select mouse button, **31**
  - selecting emulation monitor, **112-116**
  - sequencer (analyzer), **569**
    - branch, **569**
    - terms, **242, 568**
    - using the, **242-246**
  - SEQUENCING, in trace command, **434-435**
  - server, X, **332, 526**
  - set command, **436-440**
  - shell variables, **90**
  - sig INT, **291**
  - signals, CMB, **313**
  - simulated I/O, **98, 410**
    - display command, **385**
    - displaying screen, **193, 195**
    - keyboard input, **194**
  - size scheme, **334, 528**
  - slave clocks, **305**
  - softkey driven help information, **87**

- softkey pushbuttons, **29**
- softkeys, **85**
- software
  - installation for HP 9000, **537-547**
  - installation for SPARCsystems, **548-557**
- software breakpoints, **154-165**
  - clearing, **163**
  - clearing all, **165**
  - copy command, **364**
  - deactivating, **160**
  - display command, **386**
  - enable/disable, **156**
  - modify command, **416-418**
  - opcode locations, **158, 160**
  - permanent, setting, **158**
  - re-activating, **161**
  - setting, **159**
  - setting all, **160**
- software breakpoints list, displaying, **155**
- software performance measurements, **265, 267-294**
  - absolute information, **274**
  - activity measurements, **267-281**
  - adding traces, **272, 286**
  - duration, **282-290**
  - end, **419**
  - ending, **292**
  - how they are made, **266**
  - initialize, **420-421**
  - initializing, **270, 285**
  - initializing, default, **271**
  - initializing, duration measurements, **285**
  - initializing, user defined ranges, **271, 285**
  - initializing, with global symbols, **271**
  - initializing, with local symbols, **272**
  - memory activity, **267, 274**
  - module duration, **282**
  - module usage, **282**
  - program activity, **267, 274**
  - recursion, **282**
  - relative information, **274**
  - restoring the current measurement, **272, 286**

run, **422-423**  
running, **291**  
trace command setup, **269**  
trace display depth, **269**  
source lines  
  set command, **439**  
  symbol display, **137**  
  trace display, **253**  
  trace display, number of, **253**  
source/symbol modes, setting, **182**  
SPARCsystems  
  installing software, **548-557**  
  minimum system requirements overview, **536**  
  SunOS minimum version, **536**  
specify command, **441-442**  
SPMT (Software Performance Measurement Tool)  
  *See* software performance measurements  
sq adv, captured sequence state, **243**  
SRU (Symbolic Retrieval Utilities), **36, 452-453**  
state, external analyzer mode, **304**  
STATE, in trace command, **443-445**  
status  
  copy command, **364**  
  copy screen to file, **192**  
  display command, **200, 372**  
status (analyzer state qualifier softkey), **223, 231, 429, 444**  
  predefined values for, **223, 231**  
status line, **29, 59**  
step command, **38, 151-152, 446-447**  
step over, **173**  
stop\_trace command, **203, 448**  
storage qualifiers, **236**  
store command, **449-450**  
  absolute files, **133-134**  
store trace command, **263-264**  
store trace\_spec command, **261**  
summary of commands, **358**  
SunOS, minimum version, **536**  
switching  
  directory context in configuration window, **107**  
  directory context in emulator/analyzer window, **144**

- symbol context, **145**
  - SYMB-- syntax, **451-457**
  - symbol context
    - changing, **145**
    - displaying, **144**
  - symbol file, loading, **135**
  - symbols, **135, 215**
    - displaying, **135**
    - displaying parent from symbols screen, **141**
    - global to file, **192**
    - local to file, **192**
    - set command, **439**
    - SYMB-- syntax, **451-457**
    - trace display, **255**
  - synchronous measurements, **319**
  - syntax conventions, **357**
  - SYS\_RESET line from emulator probe, **123-124, 519**
    - polarity, **123**
  - system requirements
    - HP 9000 overview, **534**
    - HP-UX minimum version, **535**
    - OSF/Motif HP 9000/700 requirements, **535**
    - SPARCsystem overview, **536**
    - SunOS minimum version, **536**
  - system tables, copy screen to file, **191**
- T**
- t (start trace) command, **200**
  - tables (80960), display command, **180, 387**
  - tabs are, source line display option, **253**
  - target memory
    - access size, **126**
    - loading absolute files, **133**
    - ROM, symbols for, **135**
  - target powered down, run from reset during, **149**
  - target reset, running from, **149**
  - target system, **569**
    - access for emulator probe, **519**
    - clock speed, **127**
    - contents (minimum), **519**
    - dependency on executing code, **110**
    - design considerations, **519**
    - probe power requirements, **519**



- processor signal considerations, **519**
- RAM and ROM, **119**
- READY, synchronize emulation memory accesses to, **127**
- reset polarity, **123**
- terminal emulation window, opening, **192**
- TEXTRANGE symbols, **36**
- threshold voltages, **302-303**
- time range file format (SPMT measurements), **285**
- timing
  - external analyzer mode, **304**
- trace, **569**
  - at EXECUTE, **319**
  - copy command, **370**
  - depth of, **207**
  - display command, **388-391**
  - displaying the, **204**
  - halting the, **203**
  - listing the, **204**
  - listing to file, **191**
  - load command, **403**
  - loading, **263-264**
  - on\_halt, **240**
  - prestore qualifier, **237**
  - recalling trace specifications, **207**
  - starting the, **200**
  - stopping the, **203**
  - storage qualifier, **236**
  - storage qualifier with prestore, **237**
  - store command, **450**
  - storing, **263-264**
  - Trace Specification Selection dialog box, **207**
  - trigger position, **233**
- trace command, **458-460**
  - default, **200**
  - loading and storing, **261-262**
  - setting up for SPMT measurements, **269**
- trace controls, **521**
- trace display, **247-260**
  - about line numbers, **248**
  - absolute format, **249**
  - count absolute/relative, **257**

- default, **259**
- depth, SPMT measurements, **269**
- description of default, **204**
- external data, **260**
- mnemonic format, **250**
- offset by, **258**
- positioning, left/right, **206**
- positioning, up/down, **206**
- source line inclusion, **253**
- source/symbol modes, **182**
- symbol information inclusion, **255**
- width of columns, **256**
- trace signals (emulation analyzer), **216, 226**
- trace status display, **200**
- trace\_spec
  - load command, **403**
  - store command, **450**
- tram, memory characterization, **119**
- transfer address, **148**
- trigger, **569**
  - condition, **233**
  - position, **233**
  - specifying a simple, **233**
  - stop driving on break, **326**
- trigger position, accuracy of, **233**
- TRIGGER, CMB signal, **313**
- TRIGGER, in trace command, **461-462**
- trom, memory characterization, **119**
- TTL (softkey for specifying threshold voltages), **303**
- tutorials, setting up, **343-345**
  
- U** uploading memory, **5**
  - user (target) memory, loading absolute files, **133**
  - user program, **568**
  
- V** values, **214**
  - predefined for analyzer state qualifiers, **223, 231**
  - version, firmware, **564**
  - voltages, threshold, **303**
  
- W** wait command, **463-464**
  - command files, using in, **88**

- waitcnt (analyzer state qualifier softkey), **223, 231, 429, 444**
  - watchdog timer, **99**
  - widget resource
    - See* X resource
  - width of columns, trace display option, **256**
  - WINDOW, in trace command, **465-466**
  - windows
    - exiting emulator/analyzer, **61**
    - opening additional emulator/analyzer, **59**
    - running the emulator/analyzer interface in multiple, **55**
    - terminal emulation, opening, **192**
  - workstation
    - HP 9000 memory needs, **535**
    - HP 9000 minimum performance, **535**
    - SPARCsystem memory needs, **536**
    - SPARCsystem minimum performance, **536**
  - write to ROM break, **128**
- X**
- X client, **332**
  - X resource, **332**
    - \$XAPPLRESDIR directory, **526**
    - \$XENVIRONMENT variable, **527**
    - .Xdefaults file, **526**
    - /usr/hp64000/lib/X11/HP64\_schemes, **529**
    - app-defaults file, **526**
    - class name for applications, **524**
    - class name for widgets, **524**
    - command line options, **527**
    - commonly modified graphical interface resources, **334**
    - defined, **523**
    - general form, **523**
    - instance name for applications, **524**
    - instance name for widgets, **523**
    - loading order, **526**
    - modifying resources, generally, **334-337**
    - RESOURCE\_MANAGER property, **526**
    - scheme file system directory, **529**
    - scheme files, Graphical User Interface, **527**
    - scheme files, named, **528**
    - schemes, forcing interface to use certain, **527**
    - Softkey.BW, **528**
    - Softkey.Color, **528**

## Index

Softkey.Input, **528**  
Softkey.Label, **528**  
Softkey.Large, **528**  
Softkey.Small, **528**  
wildcard character, **524**  
xrdp, **526**  
    xrm command line option, **527**  
X server, **332, 526**  
X Window System, **55**  
xbits, external analyzer label, **308**

---

## Certification and Warranty

---

### Certification

Hewlett-Packard Company certifies that this product met its published specifications at the time of shipment from the factory. Hewlett-Packard further certifies that its calibration measurements are traceable to the United States National Bureau of Standards, to the extent allowed by the Bureau's calibration facility, and to the calibration facilities of other International Standards Organization members.

---

### Warranty

This Hewlett-Packard system product is warranted against defects in materials and workmanship for a period of 90 days from date of installation. During the warranty period, HP will, at its option, either repair or replace products which prove to be defective.

Warranty service of this product will be performed at Buyer's facility at no charge within HP service travel areas. Outside HP service travel areas, warranty service will be performed at Buyer's facility only upon HP's prior agreement and Buyer shall pay HP's round trip travel expenses. In all other cases, products must be returned to a service facility designated by HP.

For products returned to HP for warranty service, Buyer shall prepay shipping charges to HP and HP shall pay shipping charges to return the product to Buyer. However, Buyer shall pay all shipping charges, duties, and taxes for products returned to HP from another country. HP warrants that its software and firmware designated by HP for use with an instrument will execute its programming instructions when properly installed on that instrument. HP does not warrant that the operation of the instrument, or software, or firmware will be uninterrupted or error free.

## **Limitation of Warranty**

The foregoing warranty shall not apply to defects resulting from improper or inadequate maintenance by Buyer, Buyer-supplied software or interfacing, unauthorized modification or misuse, operation outside of the environment specifications for the product, or improper site preparation or maintenance.

**No other warranty is expressed or implied. HP specifically disclaims the implied warranties of merchantability and fitness for a particular purpose.**

## **Exclusive Remedies**

**The remedies provided herein are buyer's sole and exclusive remedies. HP shall not be liable for any direct, indirect, special, incidental, or consequential damages, whether based on contract, tort, or any other legal theory.**

Product maintenance agreements and other customer assistance agreements are available for Hewlett-Packard products.

For any assistance, contact your nearest Hewlett-Packard Sales and Service Office.

---

# Safety

---

## Summary of Safe Procedures

The following general safety precautions must be observed during all phases of operation, service, and repair of this instrument. Failure to comply with these precautions or with specific warnings elsewhere in this manual violates safety standards of design, manufacture, and intended use of the instrument.

Hewlett-Packard Company assumes no liability for the customer's failure to comply with these requirements.

### Ground The Instrument

To minimize shock hazard, the instrument chassis and cabinet must be connected to an electrical ground. The instrument is equipped with a three-conductor ac power cable. The power cable must either be plugged into an approved three-contact electrical outlet or used with a three-contact to two-contact adapter with the grounding wire (green) firmly connected to an electrical ground (safety ground) at the power outlet. The power jack and mating plug of the power cable meet International Electrotechnical Commission (IEC) safety standards.

### Do Not Operate In An Explosive Atmosphere

Do not operate the instrument in the presence of flammable gases or fumes. Operation of any electrical instrument in such an environment constitutes a definite safety hazard.

### Keep Away From Live Circuits

Operating personnel must not remove instrument covers. Component replacement and internal adjustments must be made by qualified maintenance personnel. Do not replace components with the power cable connected. Under certain conditions, dangerous voltages may exist even with the power cable removed. To avoid injuries, always disconnect power and discharge circuits before touching them.

## **Do Not Service Or Adjust Alone**

Do not attempt internal service or adjustment unless another person, capable of rendering first aid and resuscitation, is present.

## **Do Not Substitute Parts Or Modify Instrument**

Because of the danger of introducing additional hazards, do not install substitute parts or perform any unauthorized modification of the instrument. Return the instrument to a Hewlett-Packard Sales and Service Office for service and repair to ensure that safety features are maintained.

## **Dangerous Procedure Warnings**

Warnings, such as the example below, precede potentially dangerous procedures throughout this manual. Instructions contained in the warnings must be followed.

---

**WARNING**

---

Dangerous voltages, capable of causing death, are present in this instrument. Use extreme caution when handling, testing, and adjusting.



## Safety Symbols Used In Manuals

The following is a list of general definitions of safety symbols used on equipment or in manuals:



Instruction manual symbol: the product is marked with this symbol when it is necessary for the user to refer to the instruction manual in order to protect against damage to the instrument.



Indicates dangerous voltage (terminals fed from the interior by voltage exceeding 1000 volts must be marked with this symbol).



OR



Protective conductor terminal. For protection against electrical shock in case of a fault. Used with field wiring terminals to indicate the terminal which must be connected to ground before operating the equipment.



Low-noise or noiseless, clean ground (earth) terminal. Used for a signal common, as well as providing protection against electrical shock in case of a fault. A terminal marked with this symbol must be connected to ground in the manner described in the installation (operating) manual before operating the equipment.



OR



Frame or chassis terminal. A connection to the frame (chassis) of the equipment which normally includes all exposed metal structures.



Alternating current (power line).



Direct current (power line).



Alternating or direct current (power line).

---

**Caution**

---

The Caution sign denotes a hazard. It calls your attention to an operating procedure, practice, condition, or similar situation, which, if not correctly performed or adhered to, could result in damage to or destruction of part or all of the product.

---

**Warning**

---

The Warning sign denotes a hazard. It calls your attention to a procedure, practice, condition or the like, which, if not correctly performed, could result in injury or death to personnel.