

Systems Reference Library

IBM 1403 Printer Component Description

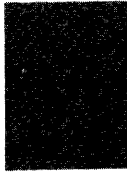

Preface

This reference publication for system planners, programmers, and operators describes the functions and operations of the IBM 1403 Printer. Special features available are described; timing information is presented; and print-quality requirements are set forth. The reader should be familiar, within his field of responsibility, with the system to which this printer is attached. For system and programming information, refer to publications listed in the *Bibliography* for the system.

The manual is sectionalized for convenient access to operating and programming information. Charts throughout the manual provide ready reference for the system planner and programmer.

Ninth Edition (October 1972)

This is a reprint of GA24-3073-7 incorporating changes released in Technical Newsletter GN24-0502, dated September 8, 1972.

Changes are periodically made to the specifications herein; before using this publication in connection with the operation of IBM systems, refer to the latest SRL Newsletter or *Bibliography* for the editions that are applicable and current:

IBM 1130	GN20-1130
IBM 1401/1460	GA24-1495-6
IBM 1410/7010	GA22-6826-5
IBM 1440/1240/1450	GA24-3005-6
IBM 7040/7044	GN20-7040
IBM System/3	GN20-2228
IBM System/360, System/370	GN20-0360
IBM System/360 Model 20	GN20-0361

Requests for copies of IBM publications should be made to your IBM representative or to the IBM branch office serving your locality.

This manual has been prepared by the IBM Systems Development Division, Product Publications, Dept. K10, P.O. Box 6, Endicott, N.Y. 13760. A form for readers' comments is provided at the back of this publication. If the form has been removed, comments may be sent to the above-mentioned address. Comments become the property of IBM.

Contents

IBM 1403 Printer	5
Introduction	5
Printing Method, Models 1, 2, 4, 5, 6, and 7	5
Printing Method, Models 3 and N1	6
Machine Covers and Safety	6
Operating Information	7
Operator Controls	7
Printing Controls	7
Carriage Controls	8
Indicator Panel Lights	9
Manual Controls	10
Forms Carriage Control	12
Control Tape	12
Acoustical Dampener	14
Metering	14
Operator Procedures	14
Print-Quality Requirements	18
Programming Information	22
Printer Timing	22
Restart Procedures for 1403 on System/360 (Models 22 and up) and System/370	23
Special Features	25
Numerical Print	25
Preferred Character Set	25
Interchangeable Chain Cartridge Adapter	26
Universal Character Set	26
Multiple Character Set	39
Auxiliary Ribbon Feeding	40
Selective Tape Listing	40
Appendix	48
Extended Binary-Coded Decimal Interchange Code	48
IBM 1403 A and H Print Arrangement	49
Index	50

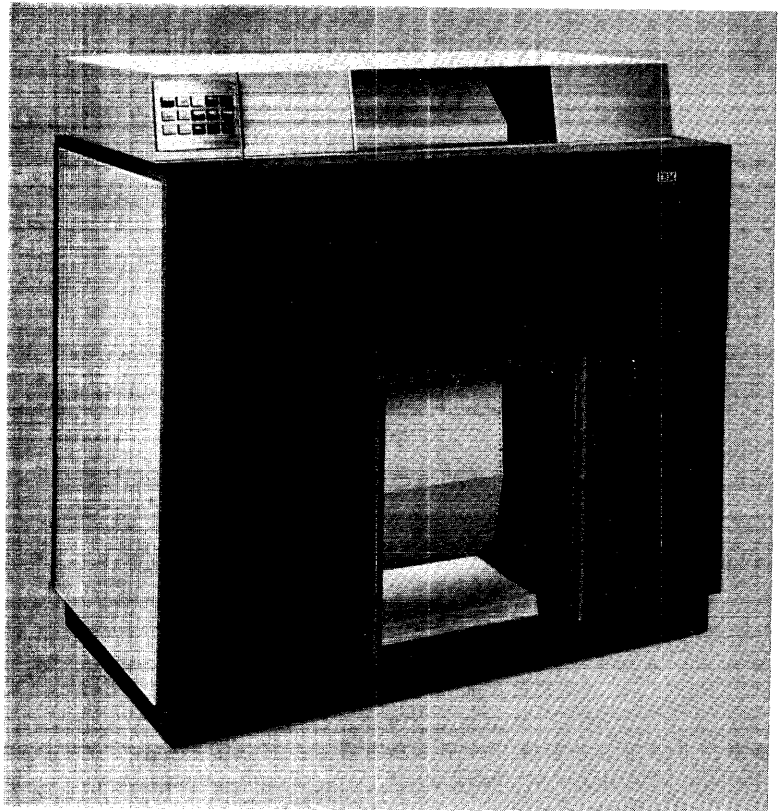
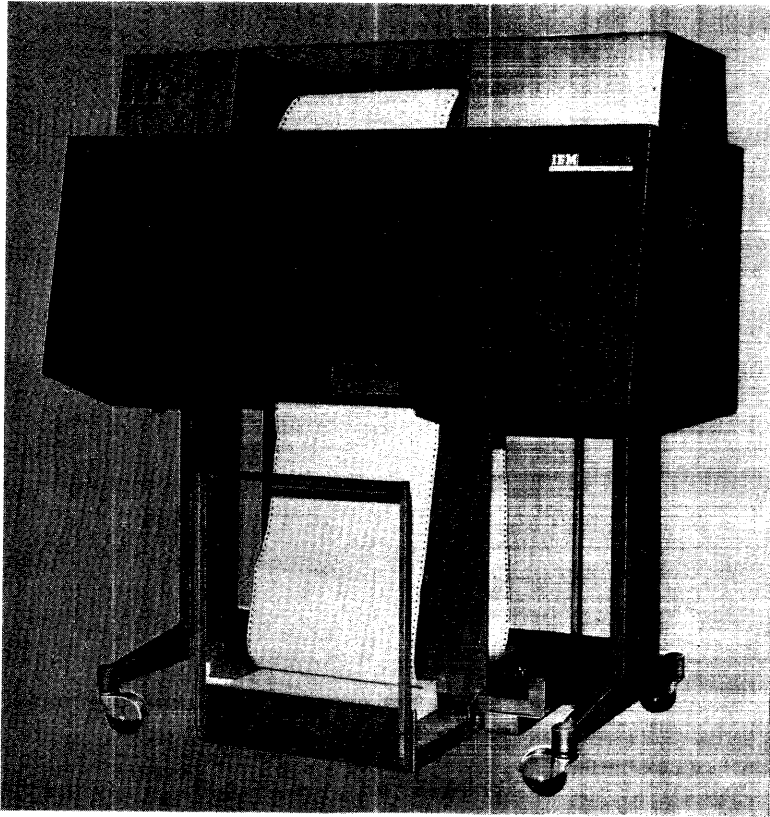

Figure 1. 1403 Printer Models 2 and N1

The IBM 1403 Printer (Figure 1) is an output device attachable to many IBM data processing systems. Fanfold paper, preprinted forms, or adding-machine type paper tape may be used. The 1403 can also be used to generate machine-readable input documents for all IBM optical character readers.

A printer's rated speed (Figure 2) is based upon the number of single-spaced lines that can be printed per minute. Actual printing speed depends also upon the character set used and the time required for processing and for moving paper.

The basic character arrangements for the printers are arrangement A (standard Binary Coded Decimal Interchange Code), or arrangement H (for FORTRAN and COBOL). With either character arrangement, each position can print 48 different characters: 26 alphabetic, 10 numeric, and 12 special characters. A variety of other character sets is available for special applications, predominantly numeric applications, and System/360 installations. See the special

1403 Model	Print Positions	Rated Speed (Lines per minute)
1	100	600 ^θ
2	132	600 ^{θ i}
3z	132	1100 ⁿ
4Δ	100	465
5Δ	132	465
6αΔe	120	340
7αγ	120	600
N1βz	132	1100 ⁿ

α Single-Carriage speed.
 β Appearance significantly different (covers extend to the floor).
 γ Special features limited to: Auxiliary Ribbon and Interchangeable Cartridge.
 Δ Not used to generate input for 1282 Optical Reader Card Punch.
 e Not used to generate input for IBM 1418 and 1428.
 z Uses 1416 Interchangeable Train Cartridge.
 n Maximum speed: 1400 lpm with Preferred (Mod 3) or Universal (Mod 2, 3 and N1) Character Sets.
 θ Maximum speed: 1285 lpm with Numerical Print Special Feature.
 i Maximum speed: 750 lpm with Universal Character Set.

Figure 2. Models of the 1403 Printer

features section: "Preferred Character Set," "Universal Character Set," and "Multiple Character Set." Most character sets are available in two character sizes: 0.095-in. and 0.079-in. heights (2,41 and 2,01 mm).

Horizontal spacing is 10 characters per in. (25,4 mm). Standard vertical spacing is six and eight lines per inch, controlled manually by the operator. Vertical spacing and skipping are initiated by the stored program. Standard skipping rate is about 33 in. (83 cm) per second. The standard carriage on printers (except Models 6 and 7) used with all systems (except 1401 Model A) is dual speed and permits high-speed skipping at about 75 in. (190 cm) per second on skips of more than eight lines.

The production of machine-readable documents requires attention to print quality and format. The specific requirements for each optical reader are described in "Print-Quality Requirements" and in manuals for particular optical character readers (see "References-OCR").

Printing Method, Models 1, 2, 4, 5, 6, and 7

The alphabetic, numeric, and special characters are assembled in a chain (Figure 3). As the chain travels in a horizontal plane, each character is printed as it is positioned opposite a magnet-driven hammer that presses the form against the chain.

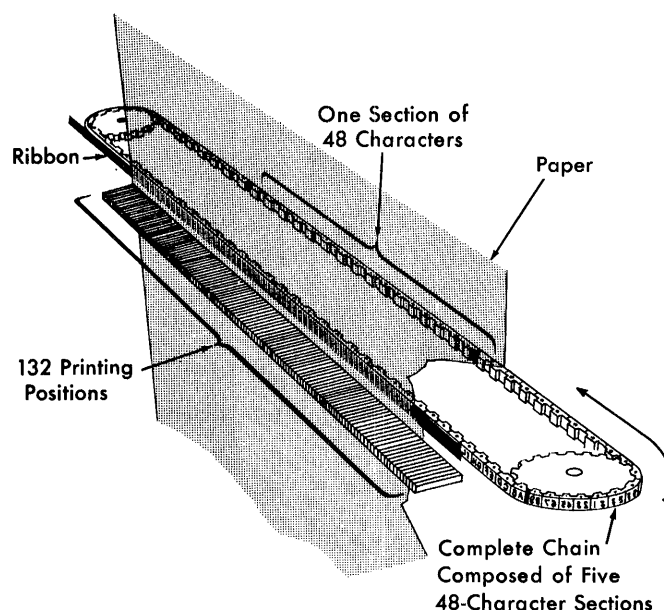

Figure 3. Schematic Chain Printing Mechanism

Information coming from the processing unit is checked for odd parity. Also, the machine checks to ensure that the hammer is energized for the correct print position, that only valid codes are executed, and that overprinting does not occur.

Printing Method, Models 3 and N1

The 1403 Printer Models 3 and N1 use a printing system similar to that of the other 1403 models. The system differs in the design of the print slugs and in the method of transport. Instead of a connecting band (chain) of type, the print slugs are assembled in a train, restrained in a track, and driven by a gear to ensure long life at high speeds (Figure 4).

The printing system in the Models 3 and N1 is different from that of the Models 1, 2, 4, 5, 6, and 7. Therefore, do not assume that paper forms and form sets used on the Models 1, 2, 4, 5, 6, and 7 can be used interchangeably on the Models 3 or N1.

Machine Covers and Safety

The covers of the 1403 are designed to safeguard personnel against possible injury when the machine is in operation.

Some hazards (such as moving mechanical parts) are obvious; others (such as electrical potentials and acoustical noise) are not.

Although IBM maintains rigorous attention to safety on all its machines, the effectiveness of safeguards is decreased by failure to keep the covers closed when the machine is running.

The frames of all IBM equipment have been made electrically safe by standard grounding practices. The covers are acoustically designed to reduce the noise level below any possible hearing damage. Printer operation with the covers open, however, causes needless exposure to these unseen hazards. Because of this, IBM strongly recommends that all personnel associated with the equipment follow the simple *safety first* procedure of keeping the covers closed whenever the machine is operating. In addition to the safety aspects of this procedure, the visual and aural environment of the installation is significantly enhanced.

If necessary to open the side or rear covers of the 1403 Model N1, use a coin or a key to operate the metal tab in the vertical gap between the covers.

Note that the motor-driven cover on the 1403 Model N1 rises when a forms error occurs. Therefore, do not place anything on the printer cover.

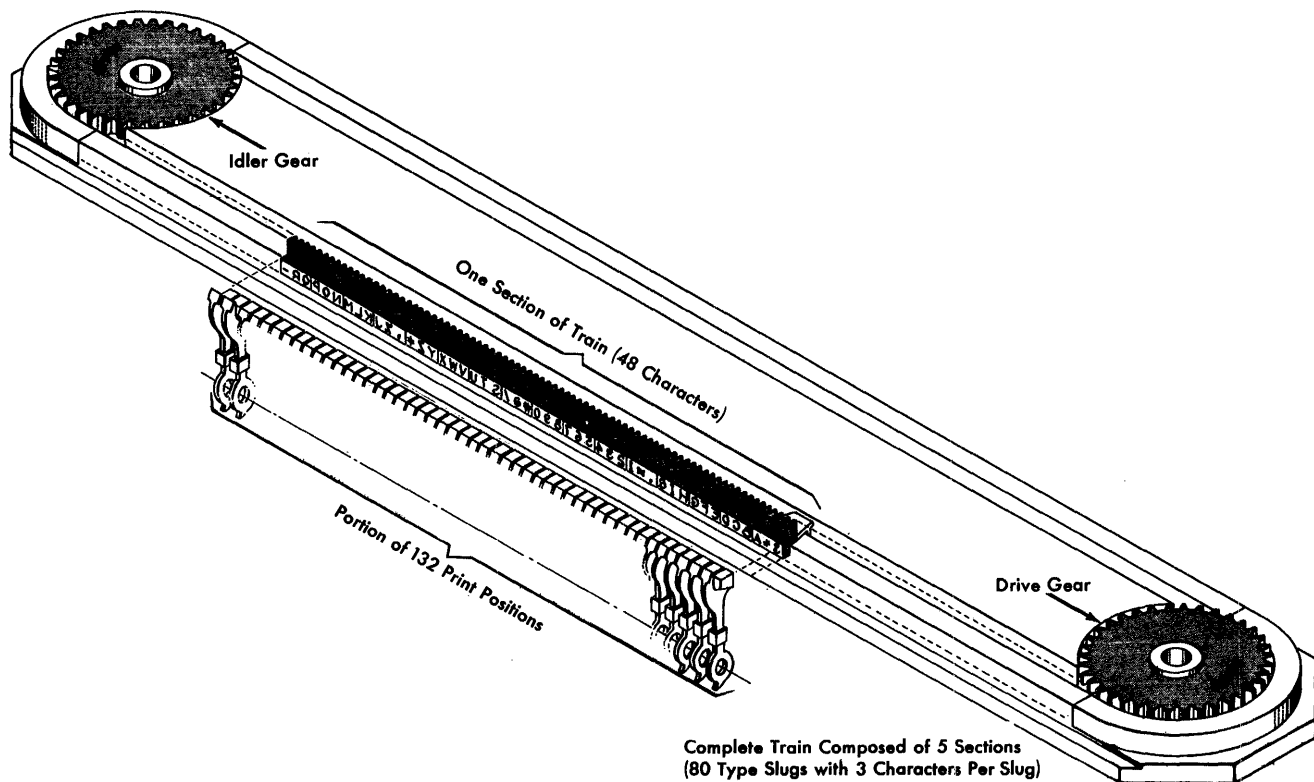

Figure 4. Schematic of Train Printing Mechanism

OPERATOR CONTROLS

The keys and lights (Figures 5 and 6) provide operator control of the printer during setup and programmed interruptions that require operator attention.

Printing Controls

Start

Pressing the start key places the printer in a ready status if the following conditions are met.

- Power on
- Forms guide plates closed
- Feed-clutch control properly positioned
- Carriage-control tape installed
- Carriage-brush assembly closed
- No error conditions, such as print-check, sync-check, form-check, or end-of-form, exist.

The start key on a 1403 attached to some systems permits operating the printer after the end-of-form light is on, until channel 1 of the carriage tape or on buffer-controlled carriages the first line of the next form is sensed.

A duplicate start key (Figure 7) is located at the rear of the printer for operator convenience.

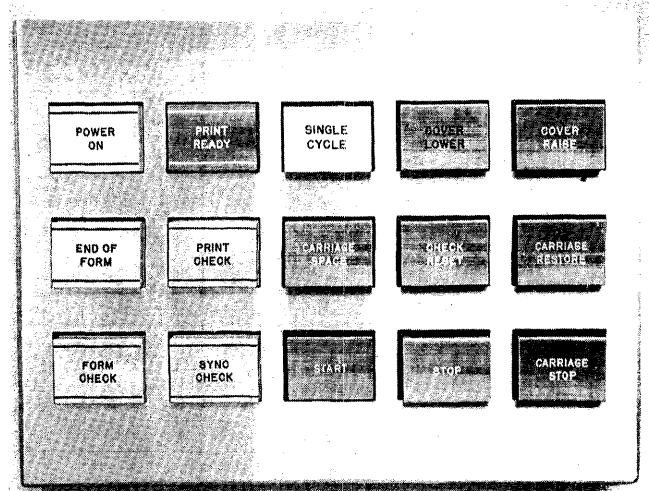

Figure 6. Operating Keys and Lights, Model N1

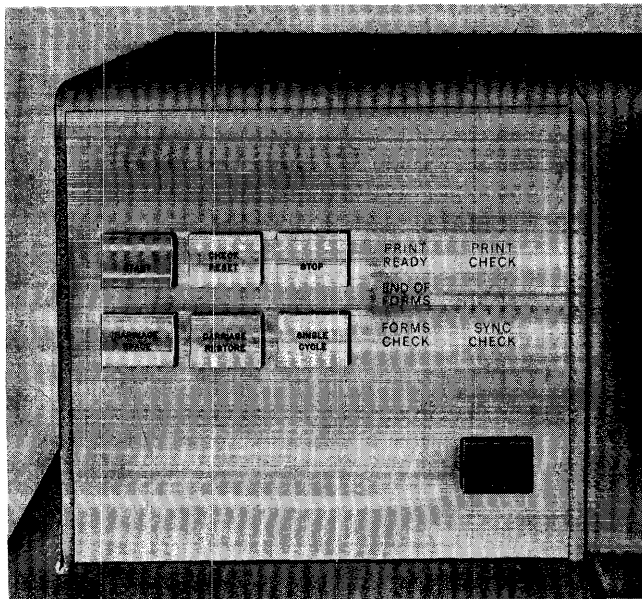

Figure 5. Operating Keys and Lights, Models 1 through 7

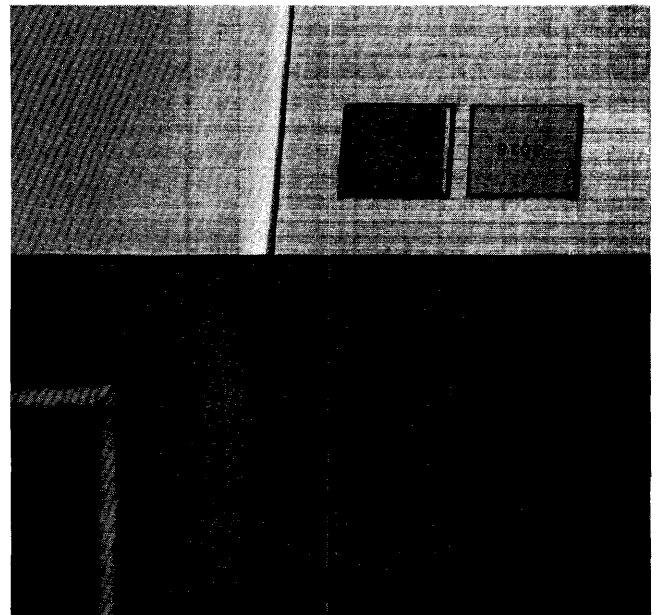

Figure 7. Printer Keys (Rear), Models 1 through 7

Check Reset

The check reset key resets a printer error indication. Pressing the start key restarts the operation.

Stop

The stop key stops the printer at the completion of the current operation. A duplicate stop key (Figure 7) is located at the rear of the machine for operator convenience.

Print Ready

The print ready light indicates that the printer has been conditioned by the operator to accept initial instructions and subsequent commands from the system. This light turns off when:

- The stop key is pressed
- The carriage stop key is pressed
- An end-of-form is indicated
- An error condition (such as form-check, sync-check or print-check) occurs.

Print Check

The print check light indicates a malfunction in the printer circuits. The operation may be retried and, if unsuccessful, service may be required.

End of Form

The end-of-form light turns on and the machine stops when an end-of-form condition occurs.

If an end-of-form occurs during a skip or while spacing within the last form in the printer, the operator should single-cycle print until the next skip to a new form occurs. On some systems, the remainder of the last form is completed automatically without stopping. When the last form is skipped out, follow the procedure described for inserting a new form and determining the first print line (see "Forms Insertion").

Form Check

The form check light is turned on for any of the following conditions.

- Forms not feeding properly through the forms tractors
- Forms guide plates open
- Carriage-control tape not installed
- Carriage-brush assembly open
- Feed-clutch manual control not properly positioned
- Carriage stop key pressed.

Sync Check

The sync check light turns on when the chain or train is not in synchronization with the compare circuits for the

printer. The timing is automatically corrected. Pressing the check reset key turns off this light.

A sync check may result if the forms cart is not in contact with the grounding straps attached to the base of the machine (not applicable to Model N1).

Cover Raise, Cover Lower

These keys operate the covers of the Model N1 (Figure 6). To raise the cover, press the cover raise key. Holding the key in the operating position is not necessary. To lower the cover, press the cover lower key. If the cover raise key is pressed while the cover is descending, the cover returns to a fully raised position.

The cover rises automatically when a form check or end-of-form occurs. Therefore, do not place anything on the printer cover (extra forms, card decks, etc.).

Single Cycle

Pressing the single-cycle key operates the printer for one line. Pressing the start key returns the printer to normal continuous operation. If an end-of-form condition exists, single-cycle operation can occur only until channel 1 of the carriage tape or, on buffer-controlled carriages, until the first line of the next form is sensed.

Note: When the single-cycle key is pressed, control and diagnostic commands are processed (if issued by the processing unit) until a write command is executed. The printer then enters single-cycle mode.

For further details, check the appropriate system publication.

This key is not installed on 1403 printers attached to a System/360 Model 20, except a 2020 submodel 5.

Carriage Controls

Carriage Space

Pressing the carriage space key advances the carriage form one line space if the clutch is engaged. On some systems, this key is operable only when the printer is in a not-ready condition.

Carriage Restore

Pressing the carriage restore key positions the carriage at channel 1 (home position) of the carriage tape, or at line-count 1 of the forms line counter. If the carriage feed clutch is disengaged, the form does not move. Model N1 also has a duplicate carriage restore key located at the rear for operator convenience.

Note: This key must not be pressed when the printer is printing. Printer operation is unpredictable; carriage runaway may occur. On some systems, this key is operable only when the printer is in a not-ready condition.

Carriage Stop

Pressing the carriage stop key stops the carriage operation and turns on the form check light. The form may need to be realigned with the program. Press the check reset key to turn off the form check light.

Indicator Panel Lights

This indicator panel (Figure 8), located below the manual feed clutch control, can enable the operator to easily locate and rectify common trouble sources.

Gate Inlk

The gate interlock light indicates that the print unit is not in position. The print-unit release lever locks this unit in position.

Brush Inlk

The brush interlock light indicates that the carriage tape brushes are not latched in position for operation.

Shift Inlk

The shift interlock light indicates that the manual feed clutch control is not positioned properly.

Thermal Inlk

The thermal interlock light indicates that a fuse has burned out and that service is required.

HS Start

The high-speed start light indicates that a high-speed skip has been initiated. (This light is not operative on Model 6 and models attached to some systems.)

LS Start

The low-speed start light indicates that a low-speed skip or line spacing has been initiated. (This light is not operative on models attached to some systems.)

HS Stop

The high-speed stop light indicates that a high-speed skip stop has been initiated. The light is also on when the carriage is not in motion. (This light is not operative on Model 6 and models attached to some systems.)

LS Stop

The low-speed stop light indicates that a low-speed skip stop has been initiated. The light is also on when the carriage is not in motion. (This light is not operative on models attached to some systems.)

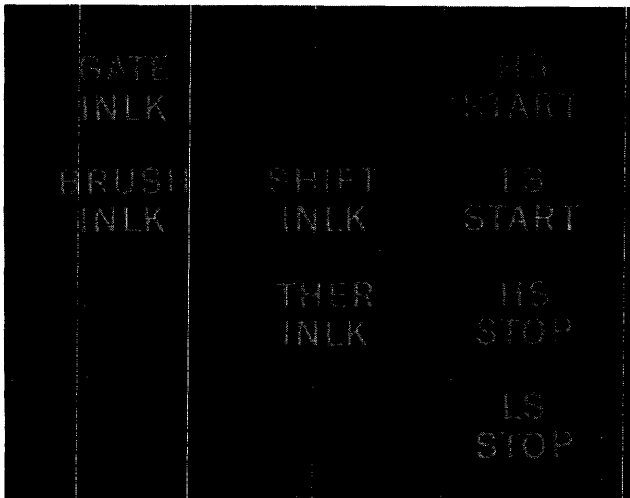

Figure 8. Indicator Panel

Manual Controls

The manual controls are shown in Figures 9 through 13.

Feed Clutch

The feed clutch controls the carriage tape drive and form-feeding mechanism, and selects the 6- or 8-line-per-inch spacing. When the feed clutch is set to neutral, automatic form-feeding cannot occur.

Paper Advance

The paper advance knob positions the form vertically. The feed clutch must be disengaged.

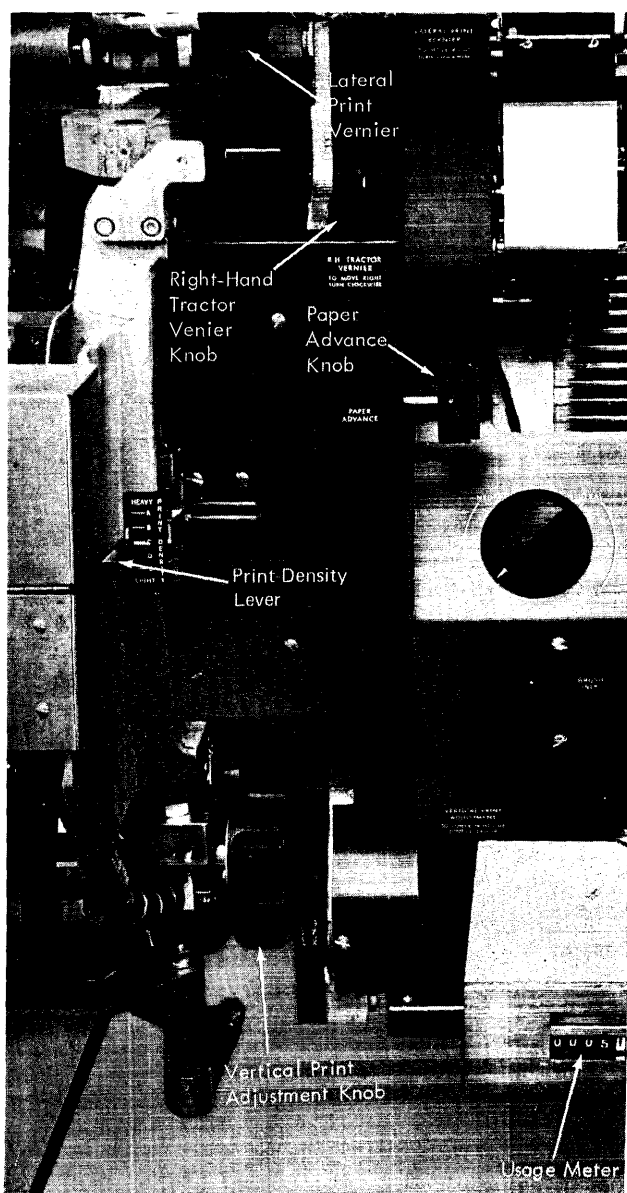

Figure 9. Manual Controls, Models 1, 2, 4, 5, 6, 7

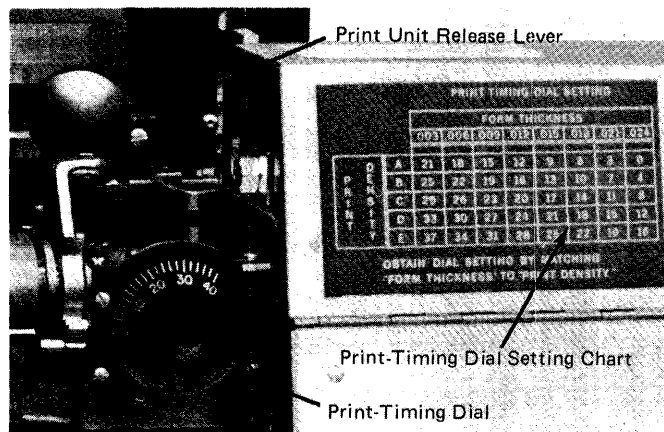

Figure 10. Print-Unit Release Lever (all Models) and Print-Timing Dial, Models 1, 2, 4, 5, 6, 7

Vertical Print Adjustment

The vertical print adjustment knob controls the fine spacing adjustment of forms at the print line. The carriage tape is not affected by this adjustment.

Print-Unit Release

The print-unit release lever unlocks the print unit, allowing it to be swung open to provide access to the form transport area (Figure 10).

Print-Line Indicator and Ribbon Shield

The print-line indicator and ribbon shield (Figure 11) pivot with the ribbon mechanism when the print unit is opened. This assembly may be unlatched from the print unit and pivoted independently.

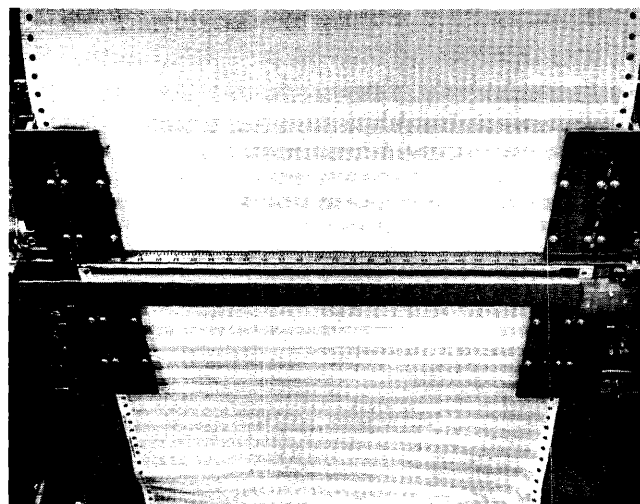

Figure 11. Print-Line Indicator and Ribbon Shield

Lateral Print Adjustment Lever

This lever allows for horizontal positioning of the printing mechanism. When the lever is raised, the print mechanism unlocks and can be positioned horizontally within its 2.4-in. (61 mm) travel limit. (Models 1, 2, 4, 5, 6, and 7 are limited by the positions of the forms tractors.)

Lateral Print Vernier Knob

The lateral print vernier controls the movement of the print mechanism. Movement is up to 1/2 in. (13 mm).

RH Tractor Vernier

The right-hand tractor vernier knob controls fine adjustments in paper tension. Lateral movement is up to 1/2 in. (13 mm).

Tractor Slide-Bars

The forms tractors are mounted on two tractor slide-bars, upper and lower. To facilitate positioning the forms tractors, notches are provided in the tractor slide-bar.

The left tractor is locked in place by a spring-loaded latch in one of the nine notches located 1 in. (25,4 mm) apart on the tractor slide-bar. The third notch from the left end is the normal location for most applications.

The first notch is used for forms from 5-1/2 to 18-3/4 in. (140 to 475 mm) wide. When this notch is used, the lateral movement of the print unit is limited to .4 in. (10 mm). This limitation does not apply to Models 3 and N1.

The second notch is used for forms from 4-1/2 to 17-3/4 in. (115 to 450 mm) in width. When this notch is used, the lateral movement of the print unit is limited to 1.4 in. (35 mm). This limitation does not apply to Models 3 and N1.

The third notch is used for forms from 3-1/2 to 16-3/4 in. (90 to 425 mm) wide. When this notch, or one of the notches 4 through 9 is used, a full lateral print-unit movement of 2.4 in. (61 mm) is possible.

The ninth (last) notch can be used for forms from 3-1/2 to 10-3/4 in. (90 to 273 mm) wide. When this notch is used, the first print position is No. 38.

The right-hand tractor is locked in place by spring-locked pins snapped into any one of 27 holes, located 1/2 in. (13 mm) apart on the tractor slide-bar.

The movement of the tractor slide-bar is controlled by the right-hand tractor vernier.

Print-Density Lever

The print-hammer unit accommodates different thicknesses of forms. The print-density lever (Models 1, 2, 4, 5, 6, and 7) provides a vernier control for print impression. When this lever is set to position E, print impression is lightest.

When this lever is set to position A, print impression is darkest. Between these two settings are intermediate settings. Position C is considered the normal setting. This lever moves the type chain closer to, or farther from, the hammer unit (see Figure 9).

Print-Timing Dial

A movable dial (Models 1, 2, 4, 5, 6, and 7) is set for fine adjustment of print quality (see Figure 10).

The proper dial setting is obtained from the print-timing dial chart (Figure 10) located on the ribbon cover. The setting of the print-density lever, in conjunction with the thickness of the form, gives a nominal setting of the print-timing dial.

The setting from the chart can be adjusted to a finer degree by the operator. For finer setting of the timing dial, turn the timing dial clockwise until the left side of the characters appears to be cut off. Then rotate the dial counterclockwise until the right side of the printing appears to be cut off. The optimum setting of the print-timing dial is halfway between the two readings.

Print-Density Knob

The print-density control on Models 3 and N1 is a knob located on the upper left side of the printer frame (Figure 12). Print density from heavy to light is regulated by settings A to F.

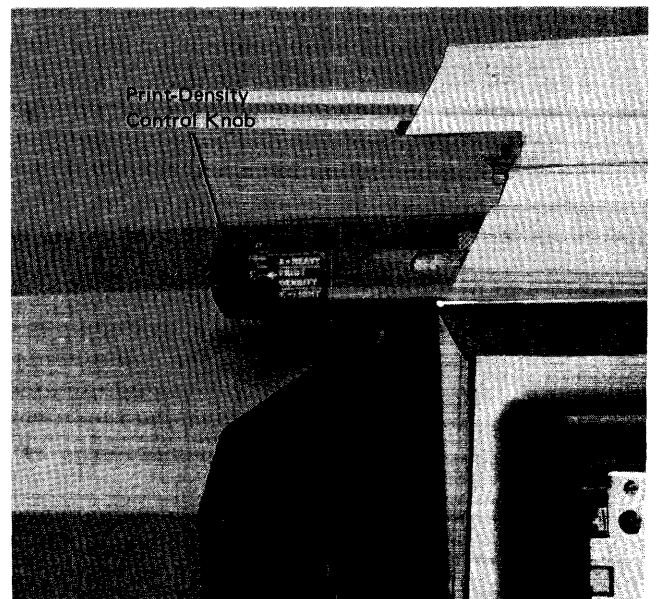

Figure 12. Print-Density Control Knob, Models 3 and N1

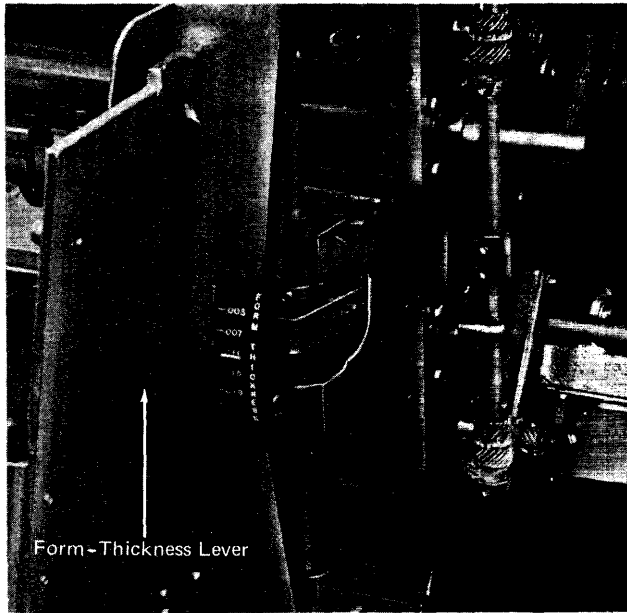

Figure 13. Forms-Thickness Lever, Models 3 and N1

Form-Thickness Lever

The form-thickness lever (Figure 13) on Models 3 and N1 is located at the right-hand end of the ribbon cover (same as the print-density control lever on other models). This lever permits manual adjustment for the various forms (single or multiple copy) thicknesses. The adjustment range is from 0.003 in. (0,08 mm) minimum to 0.019 in. (0,48 mm) maximum graduated in increments of 0.004 in. (0,10 mm).

FORMS CARRIAGE CONTROL

High-speed movement of continuous forms by the carriage is either by tape or by buffer control, depending upon the system to which the 1403 is attached. For tape control, each application has a control tape (Figure 14) corresponding in length to the length of one or more forms. This tape is punched with holes to stop the form when it reaches a predetermined position.

For buffer control, the vertical format for each form is part of the stored program for each application. A standard, prepunched carriage tape, provided with the machine, is used by the program for checking the carriage movement. No operator attention is required other than infrequent inspection for wear of the long-life tape.

With the dual-speed carriage, distances of 8 lines or fewer are skipped at 33 in. (838 mm) per second, and those of more than 8 lines, at 75 in. (1905 mm) per second. The last 8 spaces in a high-speed skip are skipped at 33 in. (838 mm) per second.

With the carriage-control tape, the carriage accommodates continuous forms, up to a maximum of 22 in. (559 mm) in

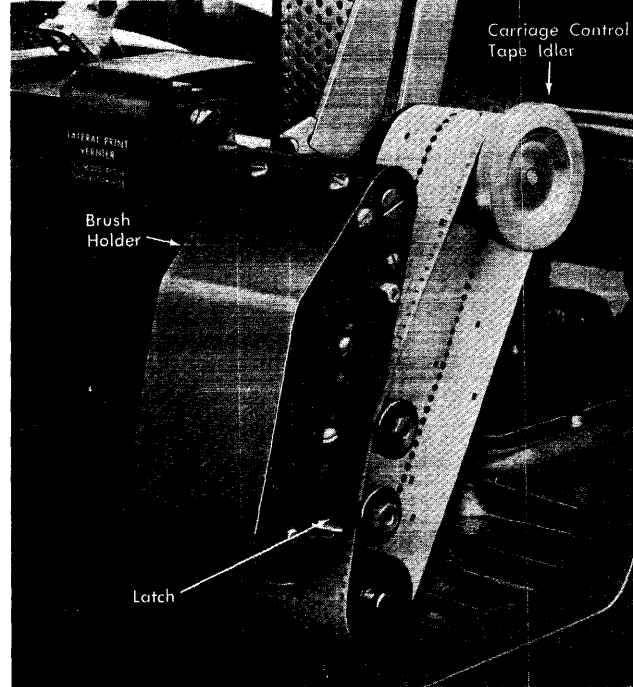

Figure 14. Forms Carriage Control

length (at 6 lines per in.) or 16-1/2 in. (419 mm) in length (at 8 lines per in.). The minimum length is 1 in. (25,4 mm) or 1-1/2 in. (38,1 mm) at 8 or 6 lines per in., respectively.

The buffer-controlled carriage accommodates continuous-forms lengths as defined by the using system. For efficient stacking of forms, the recommended maximum forms length is 17 in. (432 mm). The front door on the Model N1 cannot close if forms are over 17 in. (432 mm). The width of the form can vary from a recommended minimum of 3-1/2 in. (89 mm) to a maximum of 18-3/4 in. (476 mm), including punched margins.

Forms can be designed to permit printing in practically any desired arrangement. Skipping to different sections of the form can be controlled by the program in accordance with either the holes punched in the carriage tape or signals from the forms control buffer.

When the paper moves in the carriage for repetitive skipping (using the same channel in the *control tape*), each skipping operation should be preceded by a command such as WRITE AND SKIP TO CHANNEL X or initiate a spacing operation and then a SKIP TO CHANNEL X. If this is not done, overprinting occurs as the carriage recognizes that it is at channel X or at the defined line count and does not move the carriage.

Control Tape

When the carriage movement is under control of the forms control buffer, a standard prepunched carriage tape is provided with the machine. The number of lines the buffer can accommodate is determined by the using system.

The carriage-control tape (see Figure 14) has 12 columns indicated by vertical lines. These positions are called *channels*. Holes can be punched in each channel throughout the length of the tape. A maximum of 132 lines can be used to control a form, although for convenience the tape blanks are slightly longer. Horizontal lines are spaced six to the in. (25,4 mm) for the entire length of the tape. Round holes in the center of the tape are prepunched for the pin-feed drive that advances the tape in synchronism with the movement of a printed form through the carriage.

Punching the Tape

Six-Lines-per-Inch Spacing: A small, compact punch (Figure 15) is provided for punching the tape. The tape is first marked in the channels in which the holes are to be punched. This can be easily done by laying the tape beside the left edge of the form it is to control, with the top line (immediately under the glue portion) even with the top edge of the form. Then a mark is made in the first channel, on the line that corresponds to the first printing line of the form. Additional marks are made in the appropriate channels for each of the other skip stops, and for the overflow signal required for the flow.

The marking for one form should be repeated as many times as the length of the tape (22 in. or 559 mm) allows. When the tape controls several forms in one revolution through the sensing mechanism, the life of the tape is increased. Finally, the line corresponding to the bottom edge of the last form should be marked for cutting after the tape is punched.

The tape is inserted in the punch by placing the line to be punched over the guide line on the base of the punch

and placing the center feed-holes of the tape over the pins projecting from the base. The indicator slide is then moved until the arrow points to the number of the channel to be punched. Pressing on the top of the punch, toward the back, cuts a rectangular hole at the intersection of a vertical and horizontal line in the required channel of the tape. The tape should *never* be punched in more than one channel on the same line. Holes in the same channel should not be spaced closer than eight lines apart. After the tape is punched, it is cut and looped into a belt. The bottom end is glued to the top section marked *Glue*, with the bottom line coinciding with the first line. Before the tape is glued, the glaze on the tape should be removed with an ink eraser; if this is not done, the tape ends may separate. The center feed-holes should coincide when the two ends of the tape are glued together.

The last hole punched in the tape should be at least four lines from the cut edge, because approximately the last half in. (12,7 mm) of the tape overlaps the glue section when the two ends are spliced. If a hole must be punched lower than four lines from the bottom of the form, place the tape with the top line (immediately under the glue portion) four lines lower than the top edge of the form, before marking the channels. To compensate for the loss, cut the tape four lines lower than the bottom edge of the form.

Eight-Lines-per-Inch Spacing: Each line on the tape always equals one line on the form, regardless whether the form is six to eight lines per in. (25,4 mm). For a document printed eight lines to the in. every 1/8 in. (3,2 mm) on the form represents one line on the tape.

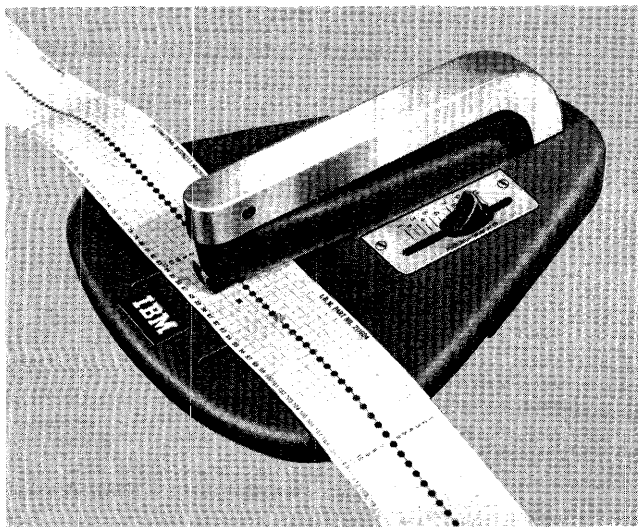

Figure 15. Tape Punch

Carriage-Tape Brushes

Two sets of reading brushes (Figure 16) mounted on the same frame sense holes in the carriage-control tape. A small contact roll is used for each set of brushes. One set is called the *slow brushes*. The other set is called the *stop brushes*. Seven spaces, as measured by the control tape, separate the brush sets. The slow brushes are positioned ahead of the stop brushes.

The slow brushes control high-speed skipping. They regulate the speed of the last eight spaces of a high-speed skip. (Single-speed carriages do not have the slow brushes.)

All carriage stop brushes can function to stop a carriage skip under control of the stored program.

ACOUSTICAL DAMPENER

The acoustical dampener on Models 1, 2, 4, 5, 6, and 7 is a nylon and bronze brush on the print-unit frame. The dampener provides a drag on single-part forms to dampen high-frequency vibration of the paper. The brush is hinged so that it can be rotated out of the way when not needed. To prevent damage to single-part forms, rotate the brush away from the paper when the print unit is moved horizontally for alignment.

On Model 3, the acoustical dampeners consist of electromagnetic plates located below the hammer unit. The plates, energized momentarily during printing, grip the forms and block the passage of an acoustical wave down the paper.

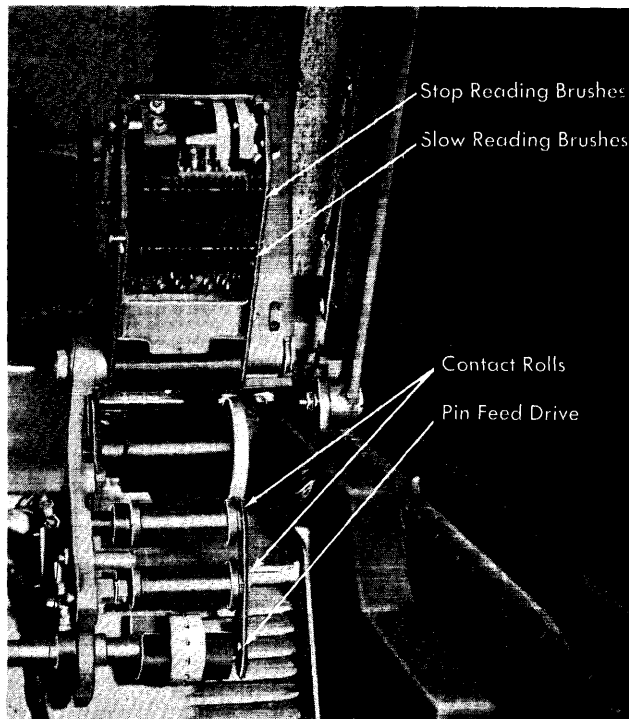

Figure 16. Carriage-Tape Brushes

METERING

The meter on the 1403 is activated when the program first calls upon the printer. The meter stops when the system meter stops. Intermediate starts and stops may occur (for instance, whenever the printer requires operator attention and is not ready), but these depend on the particular system to which the printer is attached. For metering operation on a particular system, refer to the appropriate System Reference Library. See the list of publications under "Programming Information."

OPERATOR PROCEDURES

Carriage-Tape Insertion

1. Raise the printer cover.
2. Turn the feed clutch to neutral.
3. Press the latch on the side of the brush holder, and raise the assembly.
4. With the printing on the outside of the tape loop, place the loop over the pin-feed drive wheel so that the pins engage the holes in the tape. Be certain that the line-position numbers are on the right side of the tape loop, as seen from the front of the printer.
5. Place the other end of the loop around the adjustable carriage-control tape idler.
6. Adjust the idler by loosening the locking knob and moving the idler in its track. No noticeable slack should be in the tape, but the tape should not be under tension. Test the tape by pressing the sides of the loop together. There should be some give. If the tape is too tight, the pin-feed holes will be damaged. Be sure to retighten the locking knob on the idler.
7. Lower the brush assembly. A click can be heard when the latch engages.
8. Press the restore key. When the tape has returned to the home (channel-1 or line-count 1) position, engage the feed clutch.
9. Close the printer cover.

Ribbon Changing

To change the ribbon (Figure 17) on the 1403 Printer:

1. Raise the printer cover.
2. Pull back and unlock the print unit release lever. Swing out the print unit.
3. Open the top ribbon cover.
4. Unlatch the print-line indicator ribbon shield and swing it away from the ribbon, against the forms area.
5. Push the top ribbon roll to the right (hinged side of print unit), lift out the left end of the ribbon roll, and remove the roll from the drive end of the mechanism. (Gloves may be provided with the ribbon.)

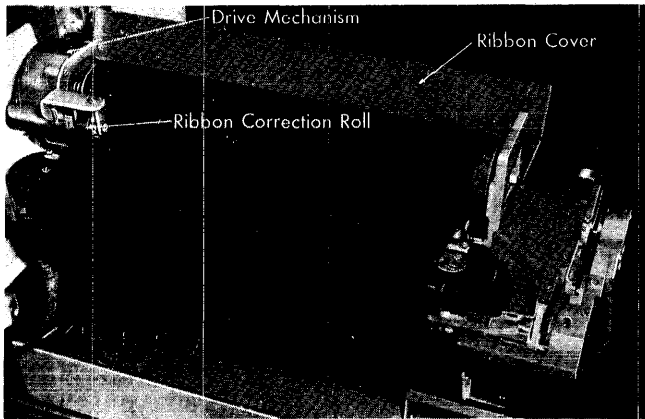

Figure 17. Ribbon Mechanism

6. On printers without the auxiliary ribbon feeding, slip the ribbon from under the ribbon correction roller.
7. To remove the bottom roll, press the ribbon roll to the right, lower the left end of the ribbon roll, and remove it from the mechanism.
8. When replacing the ribbon in the machine, hand-tighten the ribbon to remove slack from in front of the printing mechanism.

Ribbons are available in 11-in. (279,4 mm) widths, in addition to the standard 14-in. (355,6 mm). The ribbon-width lever (Figure 18) can adjust the ribbon-feed mechanism to accommodate the various ribbon widths.

Note: When installing a new ribbon in the printer, always load the full ribbon spool on the bottom spindle to assure proper ribbon skew on the first winding of the ribbon (Figure 19).

Forms Insertion

1. Raise the front cover of the printer to gain access to the print unit and forms area.

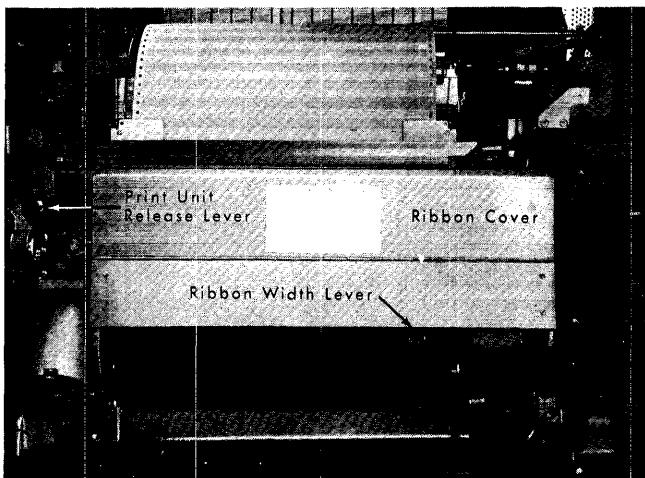

Figure 18. Front of Printer (Cover Raised)

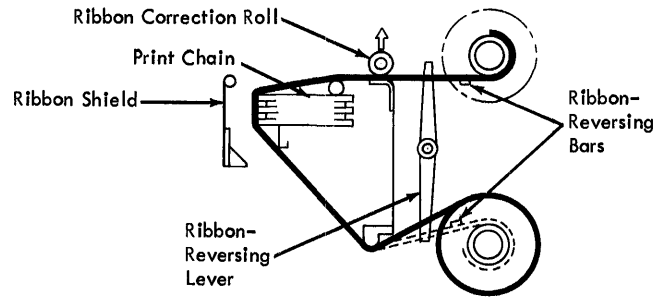

Figure 19. Installing a New Ribbon

2. Turn the feed clutch to **NEUTRAL**.
3. Unlock and swing back the print unit by pulling the print-unit release lever toward you.
4. Set both the left-hand forms tractors slightly to the left of the first printing position. Pull the tractor until it latches in the appropriate notch (Figure 20).
5. Open the left-hand tractor covers and place the forms over the pins. Close the covers.
6. Open both right-hand tractor covers.
7. Move the right-hand tractors to the desired location to line up the right side of the forms. Pull out the tractor pin-latch, and slide the tractor until the pin snaps into the appropriate position (see Figure 11).
8. Place the forms over the tractor feed-pins and close the tractor covers.
9. Tighten the tension on the form, using the right-hand tractor vernier.
10. To position the form, turn the paper advance knob until the block, line, or area on which the first line of print is to occur is just visible above the ribbon guide bar (except Models 3 and N1). Align the desired hammer position to the form with the lateral print-

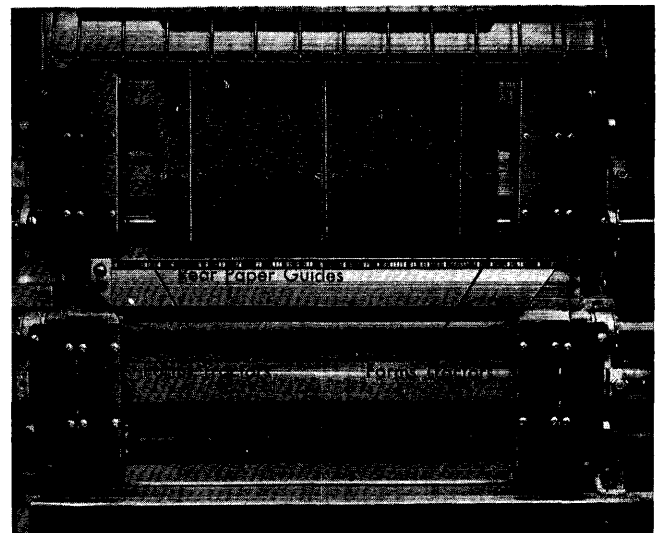

Figure 20. Forms Tractors, Models 1, 2, 4, 5, 6, 7

alignment lever and vernier. Observe the relationship to the form of the markings on the ribbon guide-bar. Now, turn the paper advance knob *backward* three line spaces (if in six-line neutral, or four line spaces if in eight-line neutral). The form is now properly positioned.

Note: If your printer is a Model 3 or N1, turn the paper advance knob backward 4 line spaces for 6-line operation and 5 line spaces for 8-line operation. These models have a plastic ribbon shield that is one line-space higher than the ribbon shields of other models of the 1403 printer. The top surface of the extreme left and right ends of the plastic ribbon shield may still be used for vertical forms alignment when the ribbon shield is unlatched from the print unit and swung against the forms.

11. Close and lock the print unit. Be sure to push the print-unit release lever as far back as it can go.
12. Restore the carriage tape to the first printing position (or the forms-control buffer to line-count 1) by pressing the carriage restore button.
13. Set the feed clutch to DRIVE. Set it for either six or eight lines per in. (25,4 mm), depending on the form to be printed.
14. Close the cover of the printer.
15. Position the paper supply on the input-paper cart so that the forms feed straight up into the machine.
16. When printing begins, operator attention is required behind the printer. The first form must be guided between the forms stacker-guide and the machine. Then, the first forms must be adjusted in the stacker so they fold flatly. See "Forms Stacking."

Interchangeable Cartridge Changing

To change the cartridge (for chain printers used with the Interchangeable Chain Cartridge special feature or any train-cartridge printer):

1. Raise the printer cover.
2. Pull back and unlock the print-unit release lever. Swing out the print unit.
3. Open the top ribbon cover.
4. Unlatch the print-line indicator and swing it against the form.
5. Remove the top ribbon spool as described under "Ribbon Changing," and place it on the tray at the bottom of the print unit.
6. Pivot the two handles on top of the cartridge to their vertical position. The cartridge is unlocked and may be lifted free of the print unit by the handles (Figure 21).

For Models 3 and N1, go to step 10.

7. Lift the chain cartridge with the handles and lower it evenly into position on the aligning pins.
8. If the left end of the cartridge does not seat fully (aligning pins flush with top of cartridge):

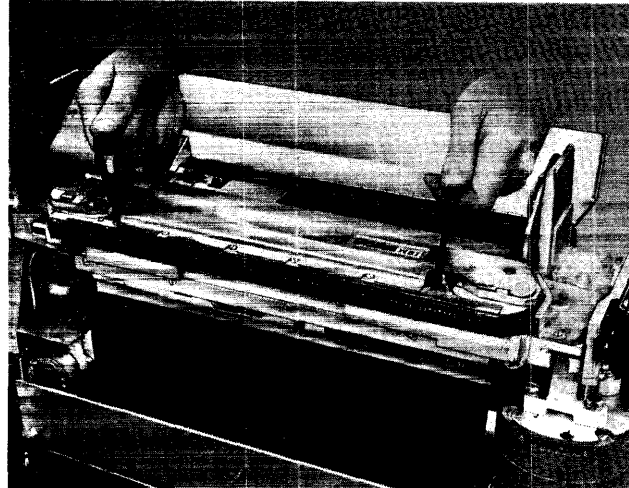

Figure 21. Interchangeable Train Cartridge, Models 3 and N1.

- a. Manually rotate the chain counterclockwise while pressing the idler gear brake button in the chain drive gear cover.
 - b. Align the driving key in the timing disk with the slot in the chain drive sprocket.
9. Press down lightly on the handles to lock the cartridge in position. If the cartridge does not lock, do not force. Repeat step 8.
- For Models 1, 2, 4, 5, and 7, go to step 14.
10. Using the special tool attached to the printer, turn the notched driver on the right side of the print unit until a screw is visible in the nearby open hole in the cover plate. If any further adjustment is required to align the notch in the driver with the notch in the casting, complete this alignment. This final adjustment is minor if the screw is properly positioned.
 11. With the same tool, turn the driven gear in the new cartridge until the appropriate character on the specially marked slug is in line with the arrow engraved on the cartridge base. On standard cartridges, the proper character is the digit 1 on the marked type slug. If the standard cartridge has no marked slug, align any digit 1 with the arrow.
 12. Place the cartridge on its locating pins in the print unit.
 13. Lock the cartridge in place by pivoting the handles down to their horizontal (original) position.
 14. Replace the ribbon spool.
 15. Close and lock the print unit.
 16. Lower the cover.

Forms Stacking

The forms-stacking mechanism of the 1403 printer consists of two major parts: a set of stacker rolls and a paper guide. As the forms are printed, they move upward out of the

print area, over the top of the printer, and downward into the stacker at the back of the machine. Here the forms are refolded into a flat stack.

As the forms enter the stacker, they pass between the powered stacker rolls and a paper-tension device. This device varies in physical appearance and construction according to the printer model. On Models 3 and N1, it consists of a set of idler rolls; on all other models, it consists of a set of circular flat springs. In either case, the operator can disengage the device from the stacker rolls to permit gravity stacking.

The paper-guide arrangement also varies with the printer model. In all cases it is used to help stack the paper evenly. Satisfactory stacking under power depends on the care with which the operator positions or adjusts and supervises the operation of the forms-feeding and stacking mechanisms.

Among the common operator actions recommended for good forms-feeding and stacking are the following.

1. Remove the blank forms from their shipping cartons before installing them in the printer. Air suction produced as the forms are pulled from the carton increases the drag on the paper sufficiently to tear or distort the pin-feed holes at the edges of the forms.

2. Be careful when adjusting the forms tractors. Never adjust the horizontal tractor vernier so that the form is stretched too tightly. This can tear or distort the pin-feed holes in the forms.

In addition, the following operating procedures (according to the printer model) are recommended.

For the 1403 Model N1: position the adjustable stacking guide and the hinged forms guide (Figure 22) to center the stack of printed forms directly beneath the stacker rolls. The adjustable stacking guide can be shifted from front to back by engaging it in the correct holding slots at the top. The hinged forms guide can be adjusted from front to back by sliding the paper tray in or out as required. Of course, this guide must be in the raised position during stacking.

For Models 3 and N1:

1. Starting at each edge of the form and progressing toward the center, engage with the stacker rolls only as many paper-tension idler rolls (Figure 22) as are required to pull the forms smoothly from the printer into the stacker. This applies particularly to multiple-part forms.
2. Initially set the stacker rolls about five in. (127 mm) above the top of the stack. Reposition them whenever



Figure 22. Forms Stacker, Model N1

this distance becomes less than two in. (51 mm). For heavy forms, and for light forms having no skips over five in. (127 mm), this distance may be increased beyond five inches (127 mm).

3. Occasionally dress down the stack, pressing on the paper to squeeze out trapped air and maintain a flat stack.

For all other 1403 models: position the sliding paper guide (Figure 23) up or down as required to obtain the best folding and stacking condition. Use the paper-guide control knob to raise or lower the paper guide. This knob slides along a printed scale graduated from 0 through 6 for convenient operator reference. The lower edge of the paper guide assists in folding the paper; thus, as the pile of stacked forms rises, raise the guide correspondingly.

Gravity stacking is obtained by disengaging the paper-tension device from the powered stacker rolls. In Models 3 and N1, the idler rolls can be individually latched in the disengaged position. In all the other 1403 models, use the stacker spring lift bar (refer to Figure 23) to move the circular tension springs away from the stacker rolls.

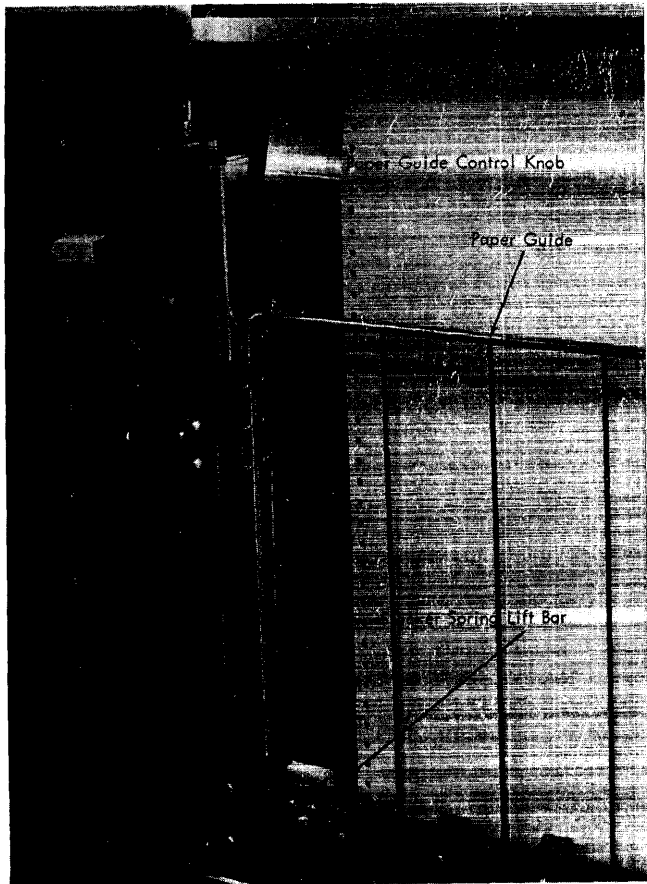

Figure 23. Forms Stacker, Models 1 through 7

Stacking Improvement Device

The 1403 Model N1 is equipped with the stacking improvement device. This device improves forms stacking when repeated long skips occur.

Stacker rolls in the Model N1 turn at a constant speed. The speed is fixed at a rate that gives the best stacking conditions for the majority of printing applications. With the stacker rolls turning at a fixed rate of speed, however, repeated long skips allow the carriage to eject forms faster than the stacker rolls can take them up. This results in an accumulation of forms at the top of the printer. The stacking improvement device prevents this accumulation from becoming excessive by allowing the stacker time to recover from this backlog of forms.

Circuitry in this device calculates the ratio of paper ejected to paper stacked. When this ratio reaches a pre-determined value, the circuitry cuts off the high-speed drive to the carriage for the remainder of the skip being executed. This skip continues, uninterrupted, at low speed.

During the next print operation, some, if not all, of the accumulated forms are stacked. This reduces the forms accumulation sufficiently to ensure that the next skip operation always starts in high speed.

Operation of this device is completely automatic. It depends entirely upon the program being executed and the length of the forms being used. For example:

1. A single line of printing allows enough time to stack the amount of paper accumulated during 12 lines of high-speed skipping.
2. If six or more lines print on any form up to 22 in. (558,8 mm) long, the device remains inoperative.
3. Repeated long skips after printing three or fewer lines represent about the only time this device becomes active.
4. With a pattern of repeated long skips after three or fewer lines of printing, about four forms-lengths are required to activate the device. The device then remains active as long as these conditions exist.
5. In most cases, the net acceptable throughput actually increases due to the reduction in required operator attention.

Figure 24 shows the time lost per form, in milliseconds, when the stacking improvement device is active.

PRINT-QUALITY REQUIREMENTS

When the 1403 printer is used in optical character recognition (OCR) applications, or when the ALA train cartridge is used in particular library applications, correct machine setup is important. The operator must take certain precautions to ensure acceptable print quality. These include:

1. Using recommended ribbon and paper-weight combinations.

Form Length	Lines Printed per Form					
	1	2	3	4	5	6 or More
3-½ inches (88,9mm), (or less)	0	0	0	0	0	0
7 inches (177,8mm)	30	0	0	0	0	0
8-½ inches (215,9mm)	60	5	0	0	0	0
11 inches (279,4mm)	95	45	0	0	0	0
14 inches (355,6mm)	140	90	35	0	0	0
17 inches (431,8mm)	160	110	55	5	0	0
22 inches (558,8mm)	260	205	155	105	50	0

Figures represent approximate time lost in milliseconds per form when Stacking Improvement Device is operating continuously in a steady state.

Figure 24. Stacking Improvement Device Reference Chart

2. Supervising and adjusting the print density as required.
3. Replacing the ribbon as required.
4. Cleaning the type faces.

Ribbons and Paper

For applications in which OCR is used extensively, the IBM OCR ribbon (part 414486) or equivalent, is recommended. For less extensive OCR applications on the 1403 Model 2 only, the IBM general-purpose ribbon (part 419098), or equivalent, may be used, provided a 20- to 24-pound (75- to 90-gram per square meter) bond paper is used. Other weights of paper require the IBM OCR ribbon, or equivalent.

With the ALA train, optimum print quality can be obtained by using the IBM polyester ribbon (part 424325 or 1136917), or equivalent, and single-part, continuous-form, offset master paper or 20- to 24-pound (75- to 90-gram per square meter) bond paper. The quality of the paper, number of parts of the form, and coarseness of the ribbon affect the distinctness of the diacritical marks.

Because of possible overlap of these special symbols, printing eight lines per inch is not recommended. The following items should be tested to assure acceptable results: other ribbons, other paper, continuous card forms, line spacing closer than six lines per inch, and special duplicating applications such as spirit, photo-offset, multilith, diazo, heat transfer, or similar processes.

Ribbon Life

Ribbon life depends upon the amount of ribbon usage. Because new ribbons contain more ink than used ones, the initial print density (darkness of impression) is heavy. The more the ribbon is used, the less ink it contains and the lighter the print density becomes. Therefore, the operator should check the print density at the beginning of the job and periodically throughout the run, and adjust the print-density control as required to maintain the best print quality. See "Print-Density Adjustment."

When printing becomes so light that further adjustment of the print-density control produces no appreciable improvement, replace the ribbon. See "Ribbon Changing." When an OCR ribbon is used, the condition does not occur usually until 250,000 lines have been printed.

Figures 25 and 26 illustrate acceptable and unacceptable OCR printing related to ribbon life. Lines one and two show acceptable printing, and lines three and four show marginal printing. Lines five and six represent unacceptable printing: both inadequate ink coverage and insufficient stroke width.

Character-Stroke Width

Except for the period or decimal, and comma, the character-stroke width for OCR should measure 0.010-0.018 in. (0,25-0,46 mm). The samples of printing shown in this publication can be used for visual comparison. These samples show acceptable as well as unacceptable stroke widths.

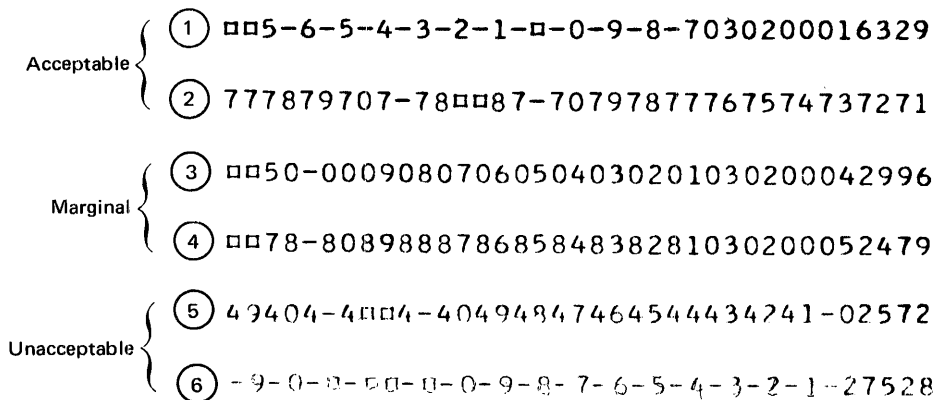

Figure 25. Ribbon Life Related to OCR Print Quality

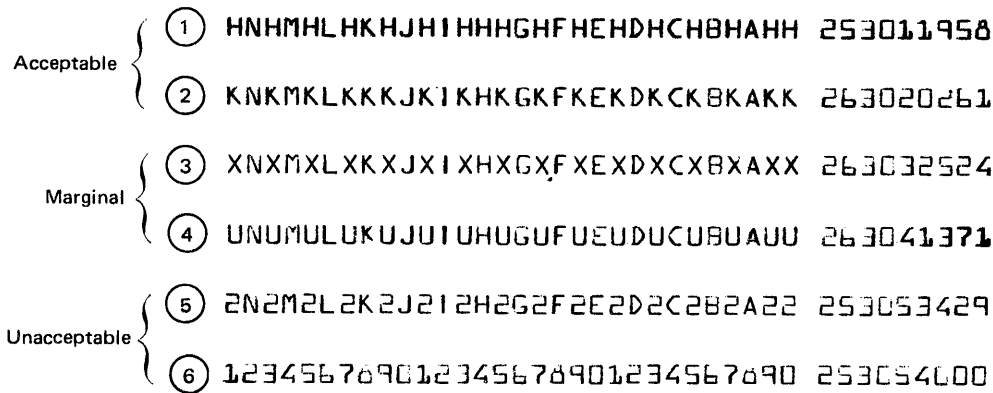

Figure 26. Ribbon Life Related to OCR Print Quality (1428 Font)

Figure 27 shows two samples of ideal OCR printing with stroke widths of 0.013 in. (0,33 mm) and 0.011 in. (0,28 mm). A sample with stroke widths of 0.008 in. (0,20 mm) is included for comparison.

Print-Density and Forms-Thickness Adjustments

In applications in which print quality is critical, correct print-density and forms-thickness adjustments are important. The forms-thickness adjustment must correspond to the thickness of the forms used. If this thickness cannot be measured directly, secure this information from the paper supplier. The thickness of 20- to 24-pound (75- to 90-gram per square meter) paper is about 0.004 in. (0,10 mm), and continuous-forms card stock is about 0.007 in. (0,18 mm). The forms tractors should be adjusted to hold the forms as taut as possible without bursting or tearing the forms.

Because each printing format causes unique ribbon wear, the operator must experiment with a print-density adjustment schedule that provides optimum results for his particular application. A good quality OCR ribbon has a usage expectancy (for OCR printing) of 250,000 lines. As a starting point, the following schedule of print-density settings for the degree of ribbon wear is recommended:

Ribbon Usage	Print-Density Setting
New to 50,000 lines	D
50,000 to 100,000 lines	C
100,000 to 150,000 lines	B
150,000 to 250,000 lines	A

1234567890-□ 0.013 in. (0,32 mm) Stroke Width

1234567890-□ 0.011 in. (0,28mm) Stroke Width

1234567890-□ 0.008. in. (0,20 mm) Stroke Width

Figure 27. Stroke-Width Variations

Figure 28 shows print-density conditions (enlarged) that can be corrected by the 1403 operator. The method of obtaining print-density variations differs between the 1403 chain and train printers.

Chain Printers: On all 1403 models except Models 3 and N1, adjust the print-density control lever (see Figure 9) to get the best impression with the thickness of the forms being used. Then set the print-timing dial (see Figure 10) for that thickness, as prescribed by the chart on the print unit (also in Figure 10). If the left edges of the characters are cut off, turn the print-timing dial counterclockwise until they reappear. If the right edges are cut off, turn the dial clockwise. (Refer to Figure 28A and B.)

Train Printers: On 1403 Models 3 and N1, set the forms-thickness lever to correspond with the thickness of the forms being used. Then set the print-density control knob for the best impression. If the tops of the characters are lighter than the bottoms, increase the setting of the forms-thickness lever. If the bottoms are lighter than the tops,

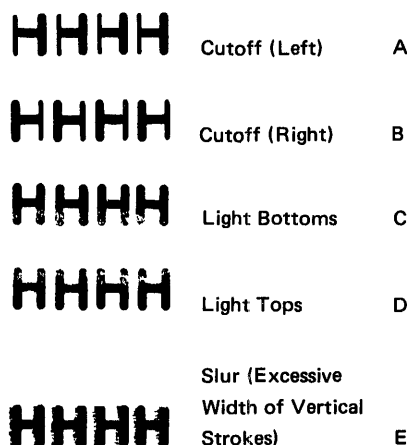

Figure 28. Print Conditions – Operator Adjustable

reduce the forms-thickness setting. (Refer to Figure 28C and D.) Reducing the print density can help eliminate a slur (Figure 28E). This is especially significant during early ribbon life.

If these adjustments do not satisfactorily correct the conditions required for acceptable print quality, notify a service representative.

Print-Quality Test Procedure

To detect a maladjustment that affects print quality and to find the optimum print-density setting, perform the following procedure periodically before actually printing documents to be used for optical character reading.

1. Install ribbon to be used.
2. Insert documents in the forms-feeding mechanism and set the printer controls for the thickness of the document.
3. With the print-density control set at E, print a few lines of H's in all positions to check for fading across the print line (characters blacker on one side of the form than those on the other side). If fading occurs, notify a service representative.
4. With the print-density control set at D, continue printing and look for conditions shown in Figure 28.
5. Vary the print-density control through several positions to determine the optimum setting for the actual printing of documents. At different impression levels, observe the printing for light density, stroke sections, extraneous ink, and excessive stroke widths.

Type-Face Cleaning

For best results, the operator should periodically clean the type faces, first with a vacuum cleaner, then with type-cleaning paper (IBM part 451529, or equivalent). This is a crepe-like paper having a tacky surface. As the hammers drive the cleaning paper against the type (ribbon removed) dirt from the type adheres to its surface. Only one or two sheets are required to clean all the type. Discard the dirty sheets.

Note: Under no circumstances should the operator attempt to clean the chain or train by any method other than the following.

Chain Printers: To clean the 1403 chain printers (all models except 3 and N1):

1. Open the print unit and remove the ribbon.
2. Vacuum-clean the cartridge, type faces, and print area.
3. Install the type-cleaning paper on the tractors, just like any other form. Be sure the crepe side is facing you.

4. Position the paper and tractors so that the entire print line is between the perforated margins.
5. Close and lock the print unit.
6. Set the print-density control lever to C, and the print-timing dial to 17.
7. Put the carriage drive in neutral and press CHECK RESET. (This turns off the forms-check light.)
8. Leave the top cover open and load a suitable program such as OLTEP (On-Line Test Executive Program – available from IBM); press START. The machine starts printing a ripple pattern designed to print every character in every print position many times.
For printers having UCS, use OLTEP program T-1403M; for printers without UCS, use OLTEP program T-1403N. The OLTEP programs are preferred. If these are not available, however, any customer program that exercises the printer may be used.
9. Using the paper advance knob (see Figure 9), manually space the paper every five or six lines while printing until the type faces are clean, as indicated by a light printed line.
Avoid printing more than ten print lines on the same space as this tends to shred the crepe surface of the paper. The shreds that flake off may lodge between the type slugs and damage the chain or train.
10. Remove and discard the dirty cleaning paper. Reinstall the ribbon.

Train Printers: To clean the 1403 train printers (Models 3 and N1), follow the procedures enumerated under “Chain Printers” in this section, except substitute the following for step 6.

6. Set the print-density control knob to C, and the forms-thickness lever to 0.015 inch. (0,38 mm).

References—OCR

For additional information, the operator should refer to the following manuals:

- IBM 1231 and 1232 Optical Mark Page Readers, GA21-9012*
- IBM 1282 Optical Reader Card Punch, GA24-3106*
- IBM 1287 Optical Reader, GA21-9064*
- IBM 1288 Optical Page Reader, GA21-9081*
- IBM 1418 Optical Character Reader, IBM 1428 Alphameric Optical Reader, GA24-1473*
- Print Quality Considerations, IBM 1418 and IBM 1428, GA24-1452*
- OCR Input Preparation Guide, GC20-1686*

Programming Information

For the information required by the programmer about the 1403 Printer, see the publications listed by system below.

System(s)	Publication
1401 (except Model G) and 1460	<i>System Operation Reference Manual, IBM 1401 Data Processing System, IBM 1460 Data Processing System, GA24-3067</i>
1401G	<i>IBM 1401G System Summary, GA24-3165</i>
1410	<i>IBM 1410 Principles of Operation, GA22-0526</i>
1440	<i>System Operation Reference Manual, IBM 1440 Data Processing System, GA24-3116</i>
7010	<i>IBM 7010 Principles of Operation GA22-6726</i>
7040 and 7044	<i>IBM 7040/7044 Principles of Operation, GA22-6649</i>
System/3	<i>Card and Disk System Components Reference Manual, GA21-9103</i>
System/360 Model 20	<i>IBM System/360 Model 20, Functional Characteristics, GA26-5847</i>
System/360 Model 22 and up	<i>IBM System/360 Principles of Operation, GA22-6821 and IBM 2821 Control Unit, GA24-3312</i>
System/370	<i>IBM System/370 Principles of Operation, GA22-7000 and IBM 2821 Control Unit, GA24-3312</i>

PRINTER TIMING

The timing considerations for the 1403 involve these factors:

1. The model of the 1403 used
2. The line spacing required
3. The processing time between print cycles
4. The system using the 1403
5. The special features attached to the 1403 and to the system.

Printer timing depends to some extent on the system to which the printer is attached. For specific timing information, see the system publications listed under "Programming Information." The basic information concerning each model of the printer is given in Figure 29.

Line Spacing and Skipping

The 20 ms required to space one line is included in the basic print cycle given in Figure 29. Spacing two to eight lines

Printer Timing				
Model	Lines Skipped	LPM	Cycle Time	Processing Time
1,2	1	600	100	16 98*
	2	572	105	21 103
	3	545	110	26 108
	4	522	115	31 113
	5	500	120	36 118
	6	480	125	41 123
	7	462	130	46 128
	8	444	135	51 133
Each additional line adds 2.3 ms to the cycle time. *With print storage features.				
3, N1	1	1100	54.5	53.1
	2	1007	59.5	58.1
	3	930	64.5	63.1
	4	863	69.5	68.1
	5	805	74.5	73.1
	6	755	79.5	78.1
	7	710	84.5	83.1
	8	670	89.5	88.1
Each additional line adds 2.3 ms to the cycle time. Note: In the 1403 Model N1 equipped with the stacking improvement device, some lines beyond the first eight skipped may require longer than 2.3 ms for certain unique skipping formats (see "Stacking Improvement Device").				
4,5	1	465	129	
	2	448	134	
	3	432	139	
	4	417	144	
	5	402	149	
	6	389	154	
	7	377	159	
	8	366	164	
Each additional skipped line adds 2.3 ms to the cycle time.				
6	1	340	176	
	2	331	181	
	3	322	186	
	4	314	191	
	5	306	196	
	6	298	201	
	7	291	206	
	8	284	211	
Each additional skipped line adds 5.0 ms to the cycle time.				
7	Same as table for Models 1 and 2 except each skipped line beyond eight, adds five ms to the cycle time.			

Figure 29. Timing for Models of the 1403

adds 5 ms for each line. On 1403 Models 1, 2, 3, 4, 5, and N1, each line after eight lines adds 2.3 ms to the print cycle. The 1403 Models 6 and 7 have a single-speed carriage; therefore, the time required for all additional line skipping is 5 ms per line.

Processing Time

If the program requires more processing time than is available during the print cycle, the additional processing time is added to the print cycle to determine actual printer operating speed.

Special Features

Special features, either those attached to the 1403 or to the system, may affect timing. The numeric print, preferred character set, print storage, synchronizer storage, and universal character set features are examples of central processing unit, control unit, or printer features that may be installed to improve printing speed. See the publications listed under "Programming Information."

Note that the numerical print special feature is not available for the 1403 Printers attached to System/360 and System/370, because the universal character set or multiple character set special features offer greater benefits at equal or lower cost. See "Universal Character Set" or "Multiple Character Set."

RESTART PROCEDURES FOR 1403 ON SYSTEM/360 (MODELS 22 AND UP) AND SYSTEM/370

An I/O error causes an interruption condition. The condition causing the interruption is indicated in the CSW (Channel Status Word). The CSW (a double word) is located in CPU main storage locations 40 through 47 (hexadecimal). Bit 38 of the CSW, when on, indicates a unit-check condition. This bit is bit 6 of the byte at main storage address 44 (hexadecimal).

When unit check is detected by the program, a sense command should be executed for the 1403 that caused the unit check. Sense information sent from the device control unit provides more-detailed information concerning the cause of the unit check. As a result of program analysis of the sense information, an error message should be made available to the operator to indicate the condition. Depending on installation procedures, the error message can be printed out or it can be made available in a main storage location and manually displayed by the operator.

The following information suggests the minimum actions that should be taken when the program detects unit-check status in the CSW. The actions are related to particular sense indications that can occur. These bits are analyzed by the program. The choice of action(s) to be taken by the operator must be established at the installation.

For further information regarding status-byte and sense-byte indications, refer to the *IBM 2821 Control Unit*, GA24-3312.

Command Reject (Sense Bit 0)

The program should provide an operator message and exit from this error-recovery procedure. Command reject occurs because of a programming error and indicates that a command not valid to the 1403 was received at the 2821 for an attached 1403.

Intervention Required (Sense Bit 1)

The printer enters a not-ready condition (ready light off) because one of the following has occurred:

1. The 1403 stop key is pressed. (Possible operator error.)
2. A mechanical interlock, such as the print unit, is open. (Possible operator error.)
3. A form check has occurred. When the form check light is on, paper feed trouble has occurred or the carriage stop key has been pressed. (Also, the ready light is off.) Any jam condition must be corrected and the check reset key must be pressed before the start key is effective. The program should provide an operator message and exit from this error-recovery procedure. The operator should then perform one of the following:
 - a. Correct the not-ready condition, accept the record, and allow the application program to proceed without further retries of the command, or
 - b. Correct the not-ready condition and restart the program from a logical restart point. The logical restart point should be determined at the installation and specified to the operator.
4. An end-of-form has occurred. If an end-of-form has occurred, the end-of-form light is on and the ready light is off. To reset the printer, press the printer start key. The remaining lines of the form are then printed under program control. (Note that the start key is pressed only once.)

When a hole is then sensed in channel 1 of the carriage tape (either space to or skip to or by channel 1), the operation is terminated with both the end-of-form and form check lights on and the ready light off. Printing does not occur for the line at which the channel-1 hole is sensed. Therefore, a carriage tape with a hole punched in channel 1 should be on the carriage. If not, printing continues even if no forms are in the printer (except for selective tape listing operations). If no skip-to-channel-1 command is issued, lines are printed (after the last form) until the channel-1 punch is sensed. (For selective tape listing operation, new tapes should be mounted when the end-of-forms indication occurs.)

The program should provide an operator message and exit from this error-recovery procedure when the end-of-form indication is detected. The operator should then perform a forms runout and satisfy the requirements of the application program.

5. A sync check has occurred. This condition can occur whenever the print chain (or train) is out of synchronism with the print circuitry in the 2821. Depending upon when the sync check occurs, one of the following conditions exists:
 - a. The sync check occurred when no printing was in progress (no line was printed).
 - b. The sync check occurred during a print operation, and one line was printed.
 - c. The sync check occurred during printing, and two lines were printed.

Provide an operator message and exit from this error-recovery procedure. The operator should then:

- a. Correct the not-ready condition (press the check reset key and then the start key) and allow the application program to proceed without further retries of the command, or
- b. Correct the not-ready condition (press the check reset key and then the start key) and restart the program from a logical point.

If the error persists, a call should be made to a service representative.

Bus-Out Check (Sense Bit 2)

If bus-out check occurs at initial selection, retry (via the program) the operation once. If the error occurs during the first retry, provide an operator message to indicate an uncorrectable error and exit from this error-recovery procedure.

If bus-out check occurs on a data transfer for a write command or during data transfer for an STL (selective tape listing) control command, provide an operator message and exit from this error-recovery procedure. The operator should then:

1. Accept the record and indicate that the application program is to proceed without further retries of the command, or
2. Restart the application program at a logical point.
If the error persists, a call should be made to a service representative.

Equipment Check (Sense Bit 3)

Equipment check indicates that a program-resettable malfunction is detected in the printer or control unit. The error indication is reset by the next write or control command accepted by the 2821 for the 1403.

Provide an operator message and exit from this error-recovery procedure. The operator should then:

1. Accept the record and indicate that the application

program is to proceed without further retries of the command or

2. Cause the application program to restart from a logical point.

If the error persists, a call should be made to a service representative.

Data Check (Sense Bit 4)

Data check indicates that a code in a data record sent to the printer does not match a code in the Universal Character Set (UCS) feature storage. Printing does not occur in the print position to which the unmatching code applies. The entire line (except for the data check position) or only a portion of the line may be printed. Therefore, the last printed line may contain erroneous data and/or an incomplete record. Data check usually indicates that the UCS storage was improperly loaded or that a data record code (other than blank or null) does not compare to any code in the UCS storage.

Provide an operator message and exit from this error-recovery procedure. The operator should then:

1. Accept the record and indicate that the application program is to proceed without further retry of the command, or
2. Restart the application program from a logical point.

If the error persists, a call should be made to a service representative.

Parity Check (Sense Bit 5)

This bit indicates that a parity error has been detected in the Universal Character Set (UCS) feature storage. The parity check can be reset only if the UCS storage is reloaded.

If the parity check occurs while the UCS storage is being loaded, retry the operation once. If the error persists, a call should be made to a service representative.

If the parity check occurs during printing, the last print line may contain erroneous data. Provide an operator message and exit from this error-recovery procedure. At this time, the operator should:

1. Accept the record, cause the program to reload the UCS storage, and proceed without further retry of the command, or
2. Cause the program to reload the UCS storage and restart the program at a logical point.

If the error persists, a call should be made to a service representative.

Channel 9 (Sense Bit 7)

The carriage brushes sensed channel 9 during the previous carriage space or skip. Accept the record and indicate that the program is to proceed without further retries of the command. Local installation practices may indicate other action to be taken.

Special features are available for the 1403 Printer that offer customers increased speed or flexibility for certain applications.

NUMERICAL PRINT

The numerical print feature (for Models 1 and 2 only) enables the system user to change from the alphabetic mode of printing to the numeric mode, simply by changing the chain cartridge in the 1403. The numeric chain has 15 character sets, with 16 characters in each set. In the numeric mode, the 1403 can print 1,285 lines per minute.

An operator needs no special tools to remove one chain cartridge and replace it with another. Before locking the new cartridge in place, move the chain only enough to permit the chain drive to engage. When the chain cartridge is placed in the 1403, the corresponding mode is selected automatically. If the printer is in the numeric mode, characters other than the 16 specified for numeric printing cause a print-check error.

Note: The numerical print feature is not available on the 1401 Model A, the System/3, System/360, or System/370.

PREFERRED CHARACTER SET

The preferred character set feature (for Model 3 only) has the standard 48 characters on the train so arranged that the most common characters can be presented to the hammer more frequently to give a maximum speed of 1,400 lines per minute. The preferred character set train contains 8 arrays of 14 numeric and special characters, 4 arrays of 26 alphabetic characters, 4 arrays of four special characters, and 2 arrays of four less-common special characters. Figure 32 shows the sequence of characters on the train.

The actual speed attained depends upon the characters being printed and the number of internal scans required to locate the proper character on the train. For printing exclusively the characters designated by group, the minimum speed is:

Group 1: 0 to 9 . , - *	1,385 lpm
Group 2: A to Z % \$ / &	920 lpm
Group 3: # @ □ ‡	550 lpm

The timing charts in Figure 31 show the print-cycle time associated with the three different character groups, and with the maximum printing speed.

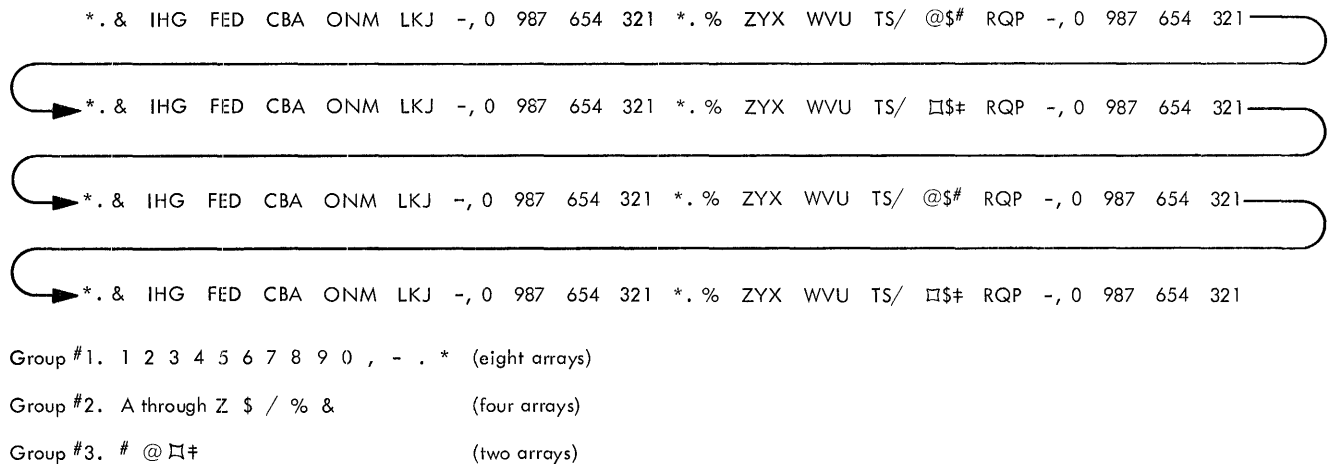

Figure 32. Sequence of Preferred Character Set on Train

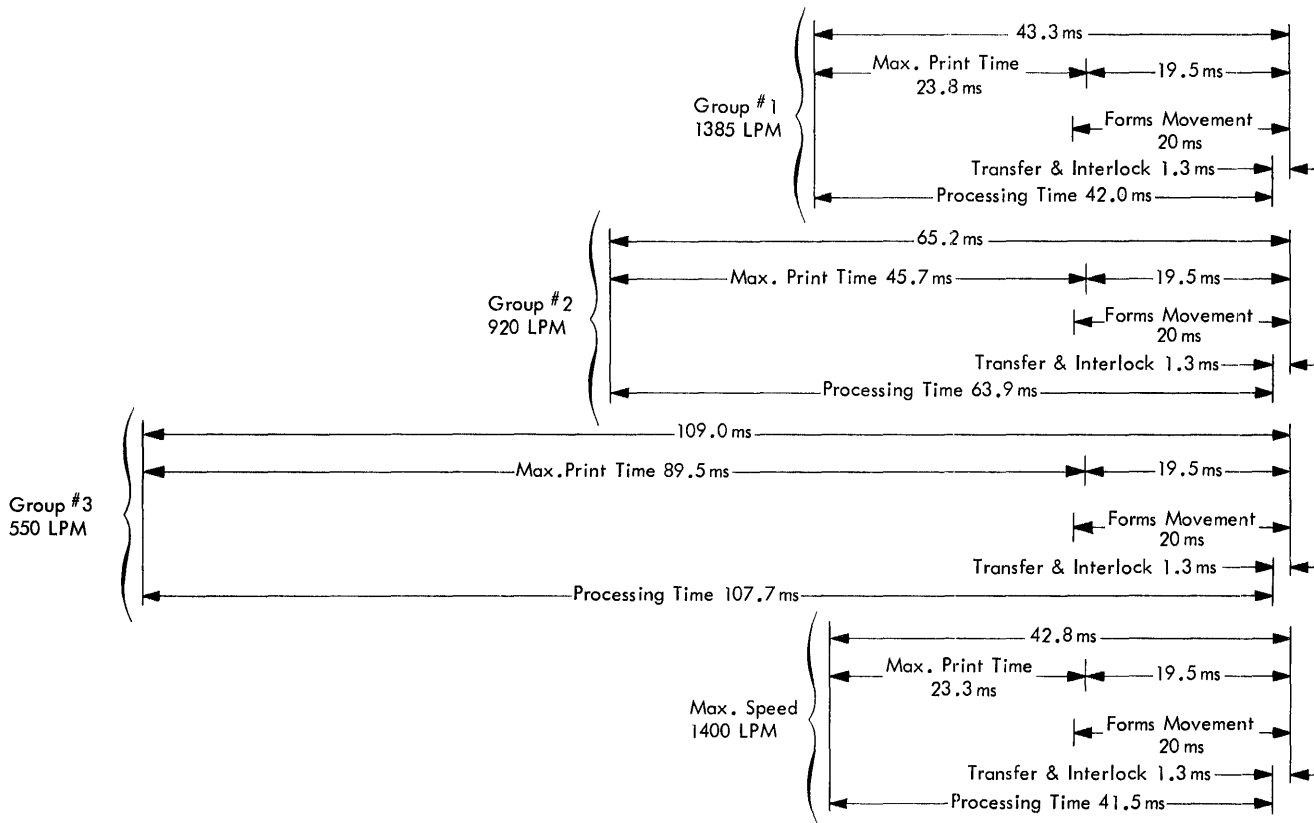

Figure 31. Preferred Character Set Speeds

INTERCHANGEABLE CHAIN CARTRIDGE ADAPTER

This feature (for Models 1, 2, 4, 5, 6, and 7) permits the operator to insert an interchangeable chain cartridge with a different type font, style, or special-character arrangement. This change can be made quickly without the use of special tools, and printer operation is not affected.

When this feature is ordered for a 1403, two interchangeable chain cartridges are supplied: one instead of the standard permanent chain, and one additional.

This interchangeable capability is standard on all Model 3 or N1 printers. The single IBM 1416 Interchangeable Train Cartridge supplied with the Model 3 or N1 printer is interchangeable with others available.

Train cartridges cannot be used on the chain printer; and conversely, the chain cartridges cannot be used on the train printers.

UNIVERSAL CHARACTER SET

The Universal Character Set (UCS) allows using any set of graphics (120 on System/3, 240 on System/360 and System/370) on the 1403. The UCS feature requires the UCS Adapter in the 2020 Processing Unit, or the 2821 Control Unit on other models of System/360 and System/370.

The code corresponding to each graphic is entered into a read/write storage under control of a utility program

available from IBM. Though any graphic desired may be printed, the coding is restricted to the Extended BCD Interchange Code.

On the 1403 Model 2, the type slugs selected or designed by the customer are installed in an interchangeable chain cartridge. With Models 3 and N1, the 1416 Interchangeable Train Cartridge is used. When a different character is desired, the cartridge is changed and new codes are entered into the character storage unit.

The UCS feature offers the following advantages:

1. Chain and train arrangements are provided in addition to the AN, HN, PCS-AN (Preferred Character Set-AN), PCS-HN (Preferred Character Set-HN) and QNC (Figures 32 and 33). These UCS arrangements are for use and optimization of applications requiring:

High-speed alphameric capability
 Programming Language/I (PL/I) Character Set
 Commercial applications of FORTRAN and COBOL
 Commercial and scientific text printing

2. Any previously announced chain or train configurations for 1400-series systems are available for use with the universal character set feature.
3. The customer may design chains or trains, tailored to his own needs, using the guidelines and within the limitations defined in this publication.

Method of Operation

The universal character set utilizes a read/write storage unit. Each position of storage corresponds sequentially to each graphic on the installed print train or chain. This character storage is read out in printing-position sequence as the various graphics are brought into printing position by the movement of the train or chain. Codes read out of character storage are matched to the successive codes of the data record to be printed. Note that the data record is moved to the printer in the normal manner. When a code out of character storage matches a code from the data record, the corresponding print position prints.

The bit patterns in the data record correspond to those selected from the 256 codes of the EBCDI (Extended Binary Coded Decimal Interchange) code. They must also correspond to the codes contained in the character storage unit (each position of which is composed of 8 bits plus a parity bit). The codes for null (00000000) and blank (01000000) must not be loaded into character storage. If a code in the data record (except null, 00000000, or blank, 01000000) does not match any of the codes in character storage, nothing is printed in the print position to which the unmatching data-record code applies.

Dualing of Graphics/Codes with UCS

The four graphics % □ # @ of the AN arrangement are dualled with () = ' of the HN arrangement. *This is accomplished by assigning the 48AN codes from the EBCDI code to both the AN and HN configurations.*

To attain the dualing capability for the 1400-series arrangements (A through K) as used with the UCS feature, the following rules apply:

1. For systems operating with the 1401, 1440, 1460 compatibility feature, assign the codes of the AN arrangement to the load buffer for all arrangements.
2. For systems operating with the 1401, 1440, 1460 compatibility feature, assign the codes of the EBCDI code (Figure 34) for each discrete graphic.

Changing Codes in Character Storage

The contents of character storage are changed through use of either one of two special XIO instructions. Previous contents of the character storage are erased when new codes are loaded. After the desired codes are loaded, they remain unchanged until rewritten by the user.

To load the desired codes and check the contents of character storage after loading, the user enters the coded punched card information into CPU main storage. The procedure is:

1. The new codes are punched in cards and loaded into main storage through a card reader.
2. The new codes are then transferred to the UCS character storage.

3. The printer prints the graphics on the chain or train so that the loading operation of character storage can be checked.

The punched card codes corresponding to the 256 code combination of the EBCDI code are shown in Figure 34.

Printing Speeds

The printing speeds attained with this feature depend upon a number of factors. In general, printing speed for a particular character depends on its frequency of appearance on the print train or chain. Other factors, such as spacing and format, however, affect the printing speed. This section presents a method for determining nominal and absolute-minimum printing speeds for character groups although the actual print speeds are usually greater than the calculated nominal figures.

In order to prevent possible damage to the printer, character groups of fewer than 16 characters should not be entered into character storage. This means that the same code should not be entered into character storage with an interval of *less* than 15 other discrete codes. This restriction does not cause a decrease in printing speed, because the peak print speeds attainable with this feature are achieved with character groups greater than 16.

The following formulas are used to calculate the speed for a given set of characters on the chain or train.

Speed in Lines per Minute

IBM 1403 Model N1

Nominal	Absolute Minimum
60,000	60,000
$\left(\frac{240}{f} - 3 \right) (.729) + 21.2$	$\left(\frac{240}{f} \right) (.729) + 21.2$

IBM 1403 Model 2

Nominal	Absolute Minimum
60,000	60,000
$\left(\frac{240}{f} - 1 \right) (1.665) + 21.7$	$\left(\frac{240}{f} \right) (1.665) + 21.7$

where: f = Number of times the given set of characters appears on the train.

and: $\frac{240}{f}$ must equal a whole number.

Note: In any case, the maximum printing speed for the Model N1 cannot exceed 1,400 lpm. Hence, if a calculated speed exceeds this 1,400 lpm limit, the 1,400 lpm figure is used. In the case of the 1403 Model 2, the maximum printing speed cannot exceed 750 lpm.

Figure 32 (Part 2 of 2). Chain Arrangements (Printout Representation)

	ODA - FIRST ARRAY																																															
Note III	1	2	3	4	5	6	7	8	9	0	#	@	/	S	T	U	V	W	X	Y	Z	&	,	%	J	K	L	M	N	O	P	Q	R	-	\$	*	A	B	C	D	E	F	G	H	I	+	.	▯
	ONA - FIRST ARRAY																																															
Note III	1	2	3	4	5	6	7	8	9	0	#	@	/	S	T	U	V	W	X	Y	Z	&	,	%	J	K	L	M	N	O	P	Q	R	-	\$	*	A	B	C	D	E	F	G	H	I	Y	.	▯
	OAA - FIRST ARRAY																																															
Note III	1	2	3	4	5	6	7	8	9	0	#	@	/	S	T	U	V	W	X	Y	Z	&	,	%	J	K	L	M	N	O	P	Q	R	-	\$	*	A	B	C	D	E	F	G	H	I	+	.	<
	ONB - FIRST ARRAY (WTC Only)																																															
Note III	1	2	3	4	5	6	7	8	9	0	=	'	/	S	T	U	V	W	X	Y	Z	&	,	>	J	K	L	M	N	O	P	Q	R	-	\$	*	A	B	C	D	E	F	G	H	I	+	.	<

Note III Five full sets per cartridge arrangement

		00				01				10				11				Bit Positions 0,1	
		00	01	10	11	00	01	10	11	00	01	10	11	00	01	10	11	Bit Positions 2,3	
Bit Positions 4, 5, 6, 7		0	1	2	3	4	5	6	7	8	9	A	B	C	D	E	F	First Hexadecimal Digit	
Second Hexadecimal Digit		9	9	9	9	9	9	9	9										
Digit Punctures		12				12	12		12	12	12		12	12				Zone Punctures	
			11				11	11	11		11	11			11			Digit Punctures	
			0			0	0	0	0	0	0	0	0	0	0	0	0		
0000	0	8-1	NUL	DLE	DS			SP	&	-								8-1	
0001	1	1	SOH	DC1	SOS						a	j			A	J		1	
0010	2	2	STX	DC2	FS	SYN					b	k	s		B	K	S	2	
0011	3	3	ETX	TM							c	l	t		C	L	T	3	
0100	4	4	PF	RES	BYP	PN					d	m	u		D	M	U	4	
0101	5	5	HT	NL	LF	RS					e	n	v		E	N	V	5	
0110	6	6	LC	BS	EOB	UC					f	o	w		F	O	W	6	
0111	7	7	DEL	IL	PRE	EOT					g	p	x		G	P	X	7	
1000	8	8		CAN							h	q	y		H	Q	Y	8	
1001	9	8-1		EM							i	r	z		I	R	Z	9	
1010	A	8-2	SMM	CC	SM													8-2	
1011	B	8-3	VT	CU1	CU2	CU3												8-3	
1100	C	8-4	FF	IFS		DC4												8-4	
1101	D	8-5	CR	IGS	ENQ	NAK												8-5	
1110	E	8-6	SO	IRS	ACK													8-6	
1111	F	8-7	SI	IUS	BEL	SUB												8-7	
		9	9	9	9										9	9	9	9	
		12				12				12	12		12	12	12		12		
			11				11				11	11	11		11	11	11		
			0				0			0	0	0	0	0	0	0	0		

Card Hole Patterns

- ① 12-0-9-8-1
- ② 12-11-9-8-1
- ③ 11-0-9-8-1
- ④ 12-11-0-9-8-1
- ⑤ No Punctures
- ⑥ 12
- ⑦ 11
- ⑧ 12-11-0
- ⑨ 12-0
- ⑩ 11-0
- ⑪ 0-8-2
- ⑫ 0
- ⑬ 0-1
- ⑭ 11-0-9-1
- ⑮ 12-11

⑮ On some chain configurations, the lozenge (⊠) is printed for this bit pattern, but this is nonstandard.

Control Character Representations

ACK	Acknowledge	EOT	End of Transmission
BEL	Bell	ESC	Escape
BS	Backspace	ETB	End of Transmission Block
BYP	Bypass	ETC	End of Text
CAN	Cancel	FF	Form Feed
CC	Cursor Control	FS	Field Separator
CR	Carriage Return	HT	Horizontal Tab
CU1	Customer Use 1	IFS	Interchange File Separator
CU2	Customer Use 2	IGS	Interchange Group Separator
CU3	Customer Use 3	IL	Idle
DC1	Device Control 1	IRS	Interchange Record Separator
DC2	Device Control 2	IUS	Interchange Unit Separator
DC3	Device Control 3	LC	Lower Case
DC4	Device Control 4	LF	Line Feed
DEL	Delete	NAK	Negative Acknowledge
DLE	Data Link Escape	NL	New Line
DS	Digit Select	NUL	Null
EM	End of Medium	PF	Punch Off
ENQ	Enquiry	PN	Punch On

Special Graphic Characters

¢	Cent Sign	-	Minus Sign, Hyphen	⌋	Hook
.	Period, Decimal Point	/	Slash	⌋	Fork
<	Less-than Sign	,	Comma	⌋	Chair
(Left Parenthesis	%	Percent		
+	Plus Sign	—	Underscore		
	Logical OR, Absolute	>	Greater-than Sign		
&	Ampersand	?	Question Mark		
!	Exclamation Point	:	Colon		
\$	Dollar Sign	#	Number Sign		
*	Asterisk	@	At Sign		
)	Right Parenthesis	'	Prime, Apostrophe		
;	Semicolon	=	Equal Sign		
~	Logical NOT	"	Quotation Mark		
[Left Bracket	\	Backslash		
]	Right Bracket	^	Circumflex		

Note: See "Appendix" for example of chart use.

Figure 34. Extended Binary Coded Decimal Interchange Code

This feature utilizes an end-of-print line concept to permit immediate carriage movement when a printed line is complete. As a result, the printing speed is variable and can be in excess of the calculated nominal speeds.

The two formulas apply for continuous printing with single-line spacing. When skipping or multiple spacing operations are performed, the additional forms-movement time must be added to the denominator of the formulas. Figure 35 shows the forms-movement times to be added to the formula denominator.

Consider, for example, calculation of the speed (by formula) for a 48AN train configuration. The number of times the complete 48AN configuration appears on the train is 5:

$$\frac{240}{48} = 5 \text{ presentation of 48AN set.}$$

Therefore, f (in the nominal formula for the Model N1) equals 5. For continuous printing and single-line spacing with the AN train:

$$\frac{60,000}{\left(\frac{240}{5} - 3\right) (.729) + 21.2} = 1,111 \text{ lpm}$$

Now consider the same 48AN configuration but with spacing of two lines after each line printed. Figure 35 shows that the 21.2 factor, in the denominator of the nominal

Lines Skipped	Time Required (ms) *
2	25
3	30
4	35
5	40
6	45
7	50
8	55

Each space over eight requires an additional 2.3 ms for all models.

* The figure to be substituted in the denominator of the speed calculation formulas for the 21.2 or 21.7 figure.

Additional value to be added to the 8-line figure of 55 is that which results by multiplying the number of spaces (in excess of eight) times 2.3 ms.

Example:
 12 lines skipped
 55 + 4 (2.3)
 or 64.2 ms.

Figure 35. Form-Movement Time

formula for the train printer, is replaced by 25. Nominal speed at which printing occurs (assuming continuous printing and spacing) is then:

$$\frac{60,000}{\left(\frac{240}{5} - 3\right) (.729) + 25} = 1,038 \text{ lpm}$$

IBM System/360 Model 20 UCS Utility Program

This utility program, available from IBM, allows the user to load the 240-character storage (in the 2020) with codes that correspond to the character arrangement of the desired chain or train. The entire contents of the 240-character storage is then checked against the installed chain or train graphics by a printout of all graphics in the sequence in which they occur on the chain (or train). Refer to *IBM System/360 Model 20 Bibliography*, GA26-3565, for publications that describe programs, available from IBM, for use with System/360 Model 20.

Print Chain or Train Selection

Figures 32 and 33 represent an actual printout of the graphics on the appropriate chain or train. For example, if the graphics on the AN chain were to be printed out in the sequence in which they are mounted on the chain, then the printout would be as shown for the AN chain in Figure 32. (Note that this is not the way the graphics appear if the chain itself is observed.)

An order form is used to order a chain or train (S120-1089). This form is laid out in printout sequence (that is, the same as the sequence shown in Figures 32 and 33). The code sequence in character storage also corresponds to the printout sequence. Position "1" of the character storage *always* contains the code that corresponds to the graphic "1" on the chain or train (except possibly when certain non-English graphics are used on the chain or train). The first position is a special marked slug (colored) that designates the beginning of a train cycle (in the Model N1 only). Identical codes for the other "1" graphics are stored in other character storage locations, depending upon the train configuration used.

As an example, consider use of a 48AN train for which the EBCDI code is used to load the character storage. The first three characters on the train and their corresponding character storage codes are:

Graphic	Character Storage Position	EBCDI Code
1 (marked)	1	11110001
2	2	11110010
3	3	11110011

The assigned codes for the graphics of all arrangements are as outlined in the standard EBCDI code (see Figure 34).

For the SN arrangement, which contains one graphic (the long dash) not uniquely defined in the standard EBCDI code, the card code 12-11-0-8-7 has arbitrarily been assigned.

For the TN arrangement, which contains 32 graphics not uniquely defined in the standard EBCDI code, the recommended card codes assigned are shown in Figure 36. These codes *may* be redefined by the customer. Note, however, that if they are redefined, the chain image deck, forwarded with the cartridge, must be similarly amended. The bit patterns that correspond to the card codes defined (in Figure 36) for the TN arrangement are as shown for these same card codes in Figure 34.

Print Chain or Train Design

Customers designing their own chains or trains should consult with their IBM sales representative for order forms and the type-slug catalog prepared to facilitate designing and pricing of new slugs, if required.

In a 48-character set chain or train, the 48-character set is presented identically five times to occupy the 240 type positions of the chain or train. Each time the chain or train moves one character position, a new character is presented to each print position. In order to present each of the 48 different characters to each print position, the chain or train must move one character spacing 48 times. The time interval between the presentation of two successive characters to print position is called a *scan* time. Therefore, 48 scan times are required to present each character of the 48-character set to each print position.

The System/3 chain image buffers contain 120 positions. Character sets for use with this feature should contain 60 or 120 characters. If the character set contains fewer than 60 (or 120) different characters, it must be filled out to 60 (or 120) by repeating characters. For example, if only 48 different characters are desired, the character set must be filled out to 60 by repeating 12 of the 48 characters.

The printing speed (in lines per minute) is directly related to the number of scan times required to present each

character to printing position. For the 60-character-set print train (or chain), 60 scan times are required. For the 80-character set, 80 scan times, etc. The chain or train moves at its same respective rate of speed in all cases. Therefore, the character set with the greatest number of different characters has the slowest line-per-minute print speed.

The 1403 printers not using UCS have their print train or chain characters generally arranged in ascending binary coded order. This is necessary because the electronic control circuitry, used to advance through the character codes, incorporates a binary counter in some systems.

When UCS is used, however, the coded contents of character storage are used to advance through the chain or train. Therefore, chain or train character sequence is related only to the codes loaded into character storage.

Note: Repeated character sets on the chain must be arranged in the *same order* so that the calculated line-per-minute rates can be achieved.

With UCS, preferred arrangements of two or more interlaced sets of graphics can be used. Each set then has its own total number of scan times and related print speed. In the examples, all indicated speeds are nominal (as defined by the nominal formula).

Consider a 60-45 preferred character arrangement with single-line spacing of forms. Instead of showing specific graphics in our example, we are substituting numbers for the characters, because, as already stated, a binary code sequence need not be observed when this feature is used. What we are doing then, is showing the relationship of like characters on the train being designed. For example, if the character designated by the number 15 (in the first set) is an A, then any time the number 15 is used in subsequent sets, the letter A is again designated.

Figure 37 lists suggested graphics and the corresponding EBCDI and card codes. It is essential that the PL/I graphics-code correspondence (shown in Figure 37) be used if the system is used to print Programming Language/I. Also see Figure 34.

Graphic	EBCD		Graphic Name	Graphic	EBCD		Graphic Name
	Hole Patterns	Bit Patterns			Hole Patterns	Bit Patterns	
		Bit Positions 0123 4567				Bit Positions 0123 4567	
0	0	1111 0000	Ligature Ligature	6	12-11-0-6	0110	Superscript Six
1	1	0001		7	12-11-0-7	0111	Superscript Seven
2	2	0010		8	12-11-0-8	1000	Superscript Eight
3	3	0011		9	12-11-0-9	1001	Superscript Nine
4	4	0100		(12-11-0-8-4	1100	Subscript-Open Parens
5	5	0101)	12-11-0-8-5	1101	Closed Bracket
6	6	0110		˘	11-0-8-1	1010 0000	Macron
7	7	0111		˙	11-0-1	0001	Tilde
8	8	1000		s	11-0-2	0010	
9	9	1001		t	11-0-3	0011	
˘	12-11-0-9-8-2	1010	u	11-0-4	0100		
˙	12-11-0-9-8-3	1011	v	11-0-5	0101		
\	0-8-2	1110 0000	w	11-0-6	0110		
S	0-2	0010	x	11-0-7	0111		
T	0-3	0011	y	11-0-8	1000		
U	0-4	0100	z	11-0-9	1001		
V	0-5	0101	α	11-0-8-2	1010	Alpha	
W	0-6	0110	β	11-0-8-3	1011	Beta	
X	0-7	0111	γ	11-0-8-4	1100	Gamma	
Y	0-8	1000	[11-0-8-5	1101	Open Bracket	
Z	0-9	1001	j	12-11-1	1001 0001		
◌	11-0-9-8-2	1010	k	12-11-2	0010		
=	11-0-9-8-3	1011	l	12-11-3	0011		
◌	11-0-9-8-4	1100	m	12-11-4	0100		
◌	11-0-9-8-5	1101	n	12-11-5	0101		
◌	11-0-9-8-6	1110	o	12-11-6	0110		
◌	11-0-9-8-7	1111	p	12-11-7	0111		
J	11-1	1101 0001	q	12-11-8	1000		
K	11-2	0010	r	12-11-9	1001		
L	11-3	0011	‡	12-11-8-2	1010	Double Dagger	
M	11-4	0100)	12-11-8-5	1101	Superscript Close Parens	
N	11-5	0101	±	12-11-8-6	1110	Plus or Minus	
O	11-6	0110	◌	12-0-8-1	1000 0000	Subscript zero	
P	11-7	0111	a	12-0-1	0001	Subscript a	
Q	11-8	1000	b	12-0-2	0010	Subscript b	
R	11-9	1001	c	12-0-3	0011	Subscript c	
£	12-11-9-8-3	1011	d	12-0-4	0100	Subscript d	
◌	12-11-9-8-6	1110	e	12-0-5	0101	Subscript e	
◌	12-11-9-8-7	1111	f	12-0-6	0110	Subscript f	
A	12-1	1100 0001	g	12-0-7	0111	Subscript g	
B	12-2	0010	h	12-0-8	1000	Subscript h	
C	12-3	0011	i	12-0-9	1001	Subscript i	
D	12-4	0100	?	12-0-8-2	1010	Pseudo Question	
E	12-5	0101	(12-0-8-5	1101	Superscript Open Parens	
F	12-6	0110	+	12-0-8-6	1110	Superscript Plus	
G	12-7	0111	-	12-0-8-7	1111	Superscript Minus	
H	12-8	1000	◌	12-11-0	0111 0000	Circle (above)	
I	12-9	1001	ˆ	12-11-0-9-1	0001	Circumflex (ALA)	
+	12-0-9-8-2	1010	¨	12-11-0-9-2	0010	Umlaut	
-	12-0-9-8-3	1011	˘	12-11-0-9-4	0100	Acute	
)	12-0-9-8-4	1100	◌	12-11-0-9-5	0101	Superior Dot	
◌	12-0-9-8-6	1110	◌	12-11-0-9-6	0110	Cedilla	
◌	12-0-9-8-7	1111	◌	12-11-0-9-7	0111	Breve	
◌	12-11-0-8-1	1011 0000	◌	12-11-0-9-8	1000	Hacek	
1	12-11-0-1	0001	◌	8-1	1001	Grave	
2	12-11-0-2	0010	:	8-2	1010	Colon	
3	12-11-0-3	0011	#	8-3	1011	Number Sign, Sharp	
4	12-11-0-4	0100	@	8-4	1100	At Sign	
5	12-11-0-5	0101	'	8-5	1101	Prime, Apostrophe	
			=	8-6	1110	Equal Sign	

Figure 37. Suggested Graphics and Codes for Print Chain or Train Design (Part 1 of 2)

Graphic	EBCD		Graphic Name
		Bit Patterns	
		Bit Positions 0123 4567	
" (†)	8-7	0111 1111	Quotation Mark
-	11	0110 0000	Minus Sign, Hyphen
/	0-1	0001	Slash
ł	11-0-9-2	0010	Polish L (Lower)
ø	11-0-9-3	0011	Scandinavian O (Lower)
đ	11-0-9-4	0100	D with Crossbar (Lower)
þ	11-0-9-5	0101	Thorn (Lower)
æ	11-0-9-6	0110	digraph (Lower)
œ	11-0-9-7	0111	digraph (Lower)
ı	11-0-9-8	1000	Turkish i
ˆ	0-8-1	1001	Double Acute
,	0-8-3	1011	Comma
%	0-8-4	1100	Percent Sign
_	0-8-5	1101	Underscore
>	0-8-6	1110	Greater-Than Sign
?	0-8-7	1111	Question Mark
∓	12	0101 0000	Ampersand
₁	12-11-9-1	0001	Subscript One
₂	12-11-9-2	0010	Subscript Two
₃	12-11-9-3	0011	Subscript Three
₄	12-11-9-4	0100	Subscript Four
₅	12-11-9-5	0101	Subscript Five
₆	12-11-9-6	0110	Subscript Six
₇	12-11-9-7	0111	Subscript Seven
₈	12-11-9-8	1000	Subscript Eight
₉	11-8-1	1001	Subscript Nine
! (†)	11-8-2	1010	Exclam. Point, Right Bracket
\$	11-8-3	1011	Dollar Sign
*	11-8-4	1100	Asterisk
)	11-8-5	1101	Right Parenthesis
;	11-8-6	1110	Semicolon
^	11-8-7	1111	Logical Not, Circumflex
	No Punches	0100 0000	Space
b	12-0-9-1	0001	Musical Flat
Ł	12-0-9-2	0010	Polish L (Upper)
Ø	12-0-9-3	0011	Scandinavian O (Upper)
Đ	12-0-9-4	0100	D with Crossbar (Upper)
Þ	12-0-9-5	0101	Thorn (Upper)
Æ	12-0-9-6	0110	digraph (Upper)
Œ	12-0-9-7	0111	digraph (Upper)
©	12-0-9-8	1000	Subscript Patent
·	12-8-1	1001	Dot in Middle
¢ (†)	12-8-2	1010	Cent Sign, Left Bracket
.	12-8-3	1011	Period, Decimal Point
<	12-8-4	1100	Less-Than Sign
(12-8-5	1101	Left Parenthesis
+	12-8-6	1110	Plus Sign
	12-8-7	1111	Absolute, Logical OR

Note: The lower case alphabetic and those special graphics designated by (†) are not used in the Programming Language/I graphics. If a system is using the Programming Language/I, the PL/I graphics must be used (with corresponding bit patterns as shown above) on the print chain or train.

Figure 37. Suggested Graphics and Codes for Print Chain or Train Design (Part 2 of 2)

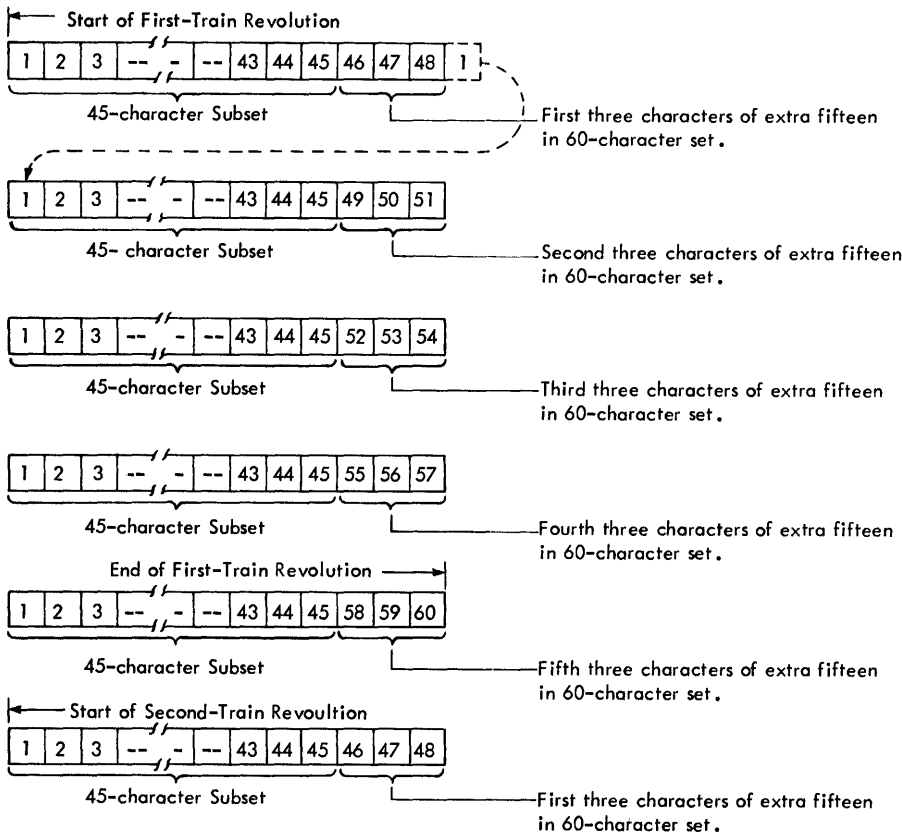

Note that the 45-character set is repeated identically five times in one train revolution. The 15 extra characters of the 60-character set are each presented only once per train revolution.

Figure 38. 45- and 60-Character Preferred Set Print Train

The first 45-character subset and the first three characters of the 60-character subset are shown at the top of Figure 38. Note that the characters of the 60-character set are shown in groups of three because we are considering the design of a print train (Model N1). If we were designing a print chain (Model 2), the characters would be grouped on the chain in groups of *two*. These groupings depend upon the graphics that are on one type slug: three on train type-slugs and two on chain type-slugs.

For the train shown in Figure 38.

1. The 45-character subset has five sets of characters. One additional set of 15 makes up the 60-character subset.

45-character subset presented five times	225
Characters 46 through 60	15
Total type positions	240

2. The 45-character subset is arranged at regular intervals. That is, 48 scans are always between like characters (for example, from character 16 to character 16).
3. The 15 extra characters (46 through 60) are distributed evenly in groups of three.

4. The 240 scans are between the repeat scanning on any one of the 15 extra characters. This results from the fact that a whole chain revolution of 240 characters must occur before the same character is again referenced to any one print position (that is, position 46 to 46).
5. For a 1403 Model N1 printer:
 - a. A line containing any of characters 1 through 45 prints at a nominal speed of 1,110 lpm because 48 scans are required (assuming continuous single-line-printing).
 - b. A line containing *any* of characters 46 through 60 (as well as the full complement of characters 1 through 45) prints at 310 lpm because 240 scans are required.

The most frequently used type slugs in the 45-character and 60-character preferred set train would probably be obtained directly from the type catalog, whereas the five slugs containing characters 46 through 60 would frequently be special slugs.

Note: A straight 60-character set (identical sets of 60 characters presented four times) would print a line containing any or all of the 60 characters at a rate of 955 lpm.

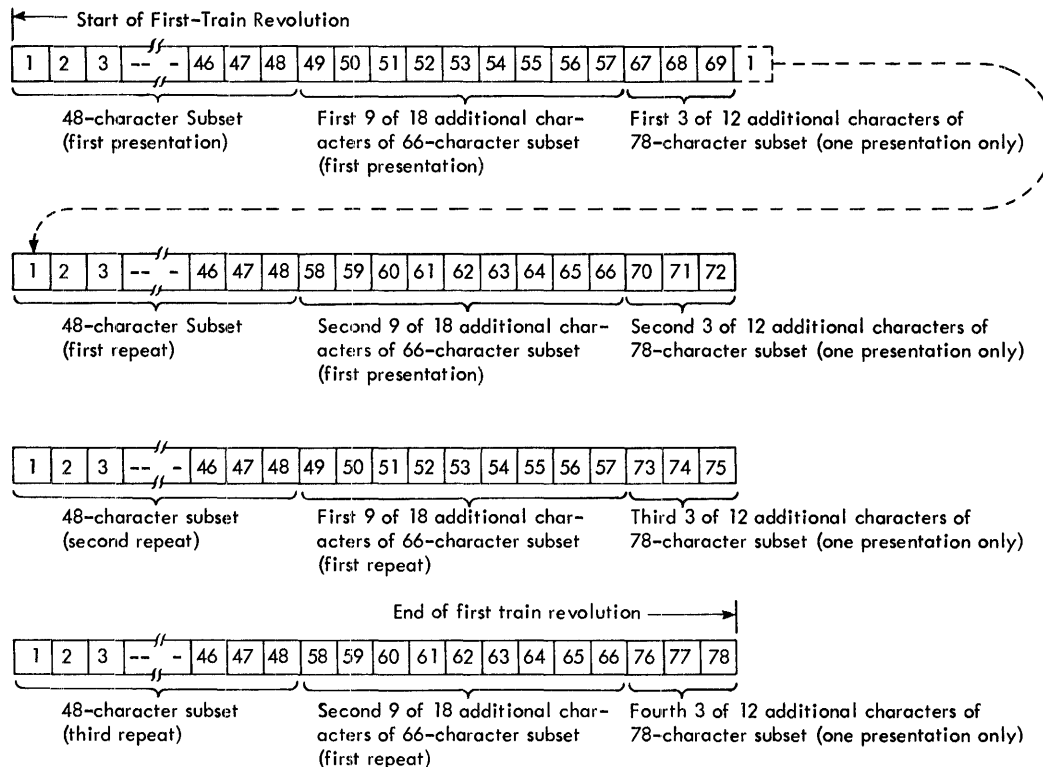

Figure 39. Print Train Composed of Preferred 48-, 66-, and 78-Character Sets

A second example is a three-level preferred arrangement (Figure 39). This train is a 48-66-78 preferred arrangement.

1. This train has four 48-character subsets, two 49-66 character subsets, and one 67-78 character subset.

48-character subset presented four times	192
18-character subset (49-66) presented two times	36
12-character subset (67-78) presented once	12
Total type positions	240

2. The 48-character subset is at regular intervals, 60 scans apart. Print rate for the 48-character subset is 955 lpm.
3. A line containing *any* of characters 49 through 66 (as well as the full complement of characters 1 through 48) that appear at regular intervals of 120 scans (two sets of characters 49 through 66), prints at 560 lpm.
4. The remaining 12 characters (67 through 78) appear at regular intervals within 240 scans, and print at about 310 lpm.

A straight 80-character set (repeated identically three times on the train) prints at the single speed of 775 lpm.

Any line of text, no matter what character set is used, might under optimum conditions reach a maximum rate of 1400 lpm (Model N1) or 750 lpm (Model 2). Calculated rates given for the examples are nominal rates that occur during continuous printing at single-line spacing. Generally the rate is higher than that computed from the formulas.

It is conceivable that a hypothetical condition could reduce the nominal rates slightly.

MULTIPLE CHARACTER SET

The multiple character set (MCS) feature (for System/360 Model 25 only) allows using chains or trains other than the 48-character AN or HN arrangements. Figures 32 and 33 show the available chain and train arrangements. Other chain or train arrangements may be designed by the customer for special applications. The chain or train contains 240 graphic positions. For many of the arrangements, the graphic set appears on the chain or train 2 to 15 times.

In preferred arrangements, some graphics appear several times; others appear only once. The length of these sets is 240 because the full set appears only once on the chain or train.

The MCS feature uses an area of storage called the MCS table. This table is loaded using the Load MCS commands. The 240-byte data records sent by these commands correspond to the 240 graphic positions on the chain. The data byte in a position of the Load MCS data record defines that data byte in a write data record, causing the corresponding chain or train graphic position to print.

When the MCS table is loaded, the data record is analyzed to determine the length of the character set; that is, the number of graphic positions in the set before it is repeated.

Set Name	Number of Graphics	Length of Set	Times on Chain or Train
AN*	48	48	5
HN*	48	48	5
PCS-AN	48	120	2
PCS-HN	48	120	2
PN*	60	60	4
QN	60	240	1
RN	52	240	1
SN	84	240	1
TN*	120	120	2
XN*	40	40	6
QNC	60	240	1
YN	42	120	2

Figure 40. MCS Chain and Train Descriptions

Figure 40 shows the number of graphics, the set length, and the number of times the set appears on the chain or train for the configurations shown in Figures 32 and 33.

The table is then loaded using the 240-byte data field. Because of the manner in which the table is loaded and used, only one chain or train graphic position may be defined for a data code. In preferred arrangements, such as the PCS-AN, some graphics appear several times in the set. Only one of the graphics can be used. Because only one of the preferred graphics can be used, these graphics print at the same speed as those that appear in the character set only once. Preferred arrangements, therefore, offer no speed advantage with the MCS feature. Maximum speed for printing a given number of graphics is attained when the number of graphics and the length of the set are equal. The sets that meet this condition are indicated by an asterisk (*).

For a detailed description of the multiple character set special feature, see *IBM System/360 Model 25 -- Functional Characteristics*, GA24-3510.

AUXILIARY RIBBON FEEDING

This feature is available for the 1403 Models 1, 2, 4, 5, 6, and 7 and is a standard feature on Models 3 and N1. The auxiliary ribbon feeding feature is recommended for use with polyester film ribbon. It can also be used with conventional fabric ribbons. This feature and the polyester film ribbon are recommended when the 1403 is used to prepare paper documents heavier than 24-pound stock for optical character recognition.

SELECTIVE TAPE LISTING

The selective tape listing special feature, attached to a 1403 Printer, provides output printed on adding-machine-style paper tapes. This feature (Figure 41) is used on any 1403

Model 1, 2, 3, or N1, attached to System/360, or to 1401 (except Models A and D), 1440, or 1460 Data Processing System. Used with a System/360 Model 20, this feature requires the printer features control.

When the selective tape listing (STL) feature is installed, a feature mode switch is provided on the 1403. This switch temporarily disconnects the standard carriage-control circuits and activates the tape-feeding circuits when the tape-listing components are latched in operating position.

Tape Specifications

Up to eight 1.5-in.-wide (38 mm) tapes can be accommodated on a 132-position 1403 equipped with this feature. Up to 13 characters can be printed on each tape. One print position on each edge of the tape is allocated as a margin position.

Up to four double-width (3.1-in., 79 mm) tapes can be accommodated on a 132-position 1403 equipped with this feature. Up to 29 characters can be printed on each tape (two 13-character groups, plus two margin positions, and the position that was not used between the two narrow tapes). These double-width tapes must replace specific narrow tape pairs: tapes 1 and 2, 3 and 4, 5 and 6, or 7 and 8. Three print positions are never used between each specific pair of narrow tape positions. Figure 42 shows the print positions used for each tape.

The 1403 Printer Models 1, 2, and 3 are designed to feed 1.5-in. (38 mm) and/or 3.1-in. (79 mm) width roll paper or feed and stack 1.5-in. and/or 3.1-in. width by 8.5-in. (216 mm) length fanfold documents of 20-pound (75 g/m²) paper. The 1403 Printer Model N1 STL feature is designed to feed and stack only the fanfold documents. For satisfactory performance, IBM forms or their equivalent should be used.

Programming Information

Program control of the selective tape listing feature depends on the system to which the 1403 Printer is attached.

STL users should preferably write their STL programs to print a blank line, and space or skip as the first printer operation. This prevents the first line of print from overprinting a line left from a previous program. If a program that is insensitive to the presence of the STL feature is run on a printer with the STL feature active, carriage operations are not performed and overprinting results. Programs that initialize the I/O are especially susceptible (for example, programs to load UCS buffer or to help the operator set up forms). The failure to perform carriage operations is not detected by the channel.

Printer Attached to 1400-Series Systems

A 1403 Printer, attached to a 1401, 1440, or 1460 Data Processing System, continues to operate at regular 1403 speeds with the selective tape listing feature installed. Tapes are individually line-spaced, one line at a time (no skipping

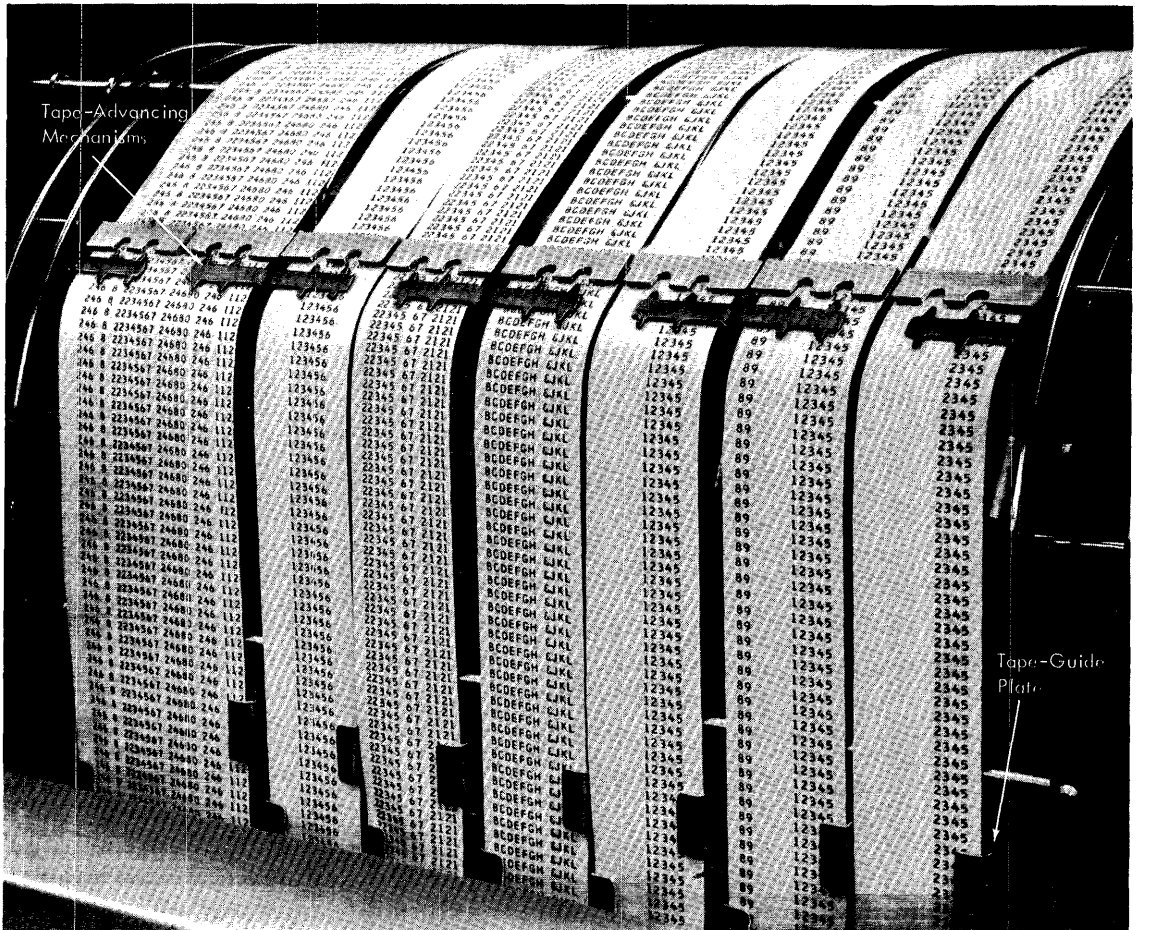

Figure 41. Selective Tape Listing Feature, Models 1, 2, and 3

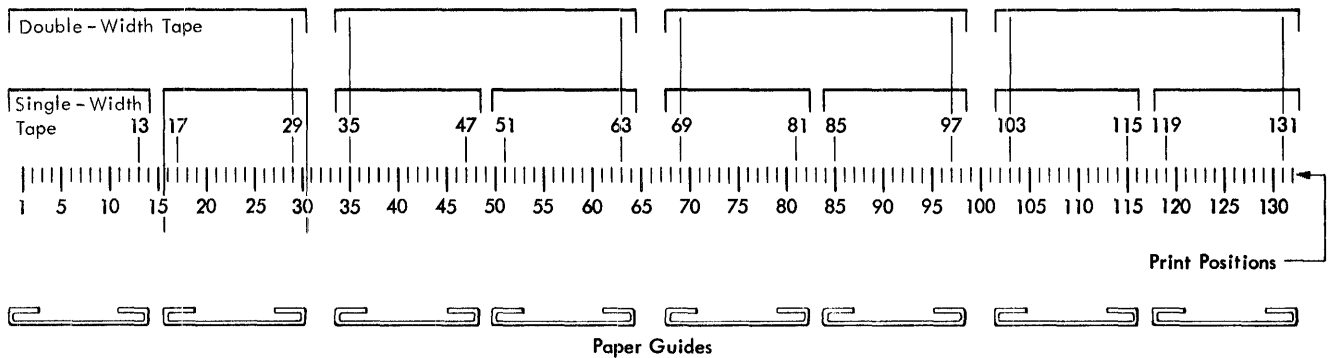

Figure 42. Print-Position Assignment

or ejecting is possible). Tape is spaced by a modified 1403 CONTROL CARRIAGE Op code (F), with a d-character of A through H, which signals a single line space for the corresponding tape. (The space operation takes place after the next print operation.)

The modifier characters and the tapes they control are:

- A – Tape 1
- B – Tape 2
- C – Tape 3
- D – Tape 4
- E – Tape 5
- F – Tape 6
- G – Tape 7
- H – Tape 8

When a double-width tape is used, two tape-line-space instructions are given, using the d-characters corresponding to the positions occupied by the double-width tape. If additional line spacing is desired, a tape-line-space instruction (CONTROL CARRIAGE Op code and the specified d-character), and a PRINT instruction (2) are given. The print operation is a dummy print operation; the print area in core storage should be clear so that nothing is printed. The line-space operation occurs after the print operation. Line spacing is about 6 lines per inch.

To equalize the ribbon wear, the customer can vary the location of the master tape. This is done by using the same width tape in another location and altering the program (changing the d-character to the character that corresponds to the new location). Tapes can be pulled up manually before tearing them against the tear bar of the tape-advancing mechanism.

An end-of-tape condition stops the printing operation and turns on the 1403 end-of-forms light.

Printer Attached to System/360 or System/370

On a System/360 Model 20: When the switch for the STL feature is on, a carriage control I/O instruction has the effect of a delayed single space, regardless of the function specification setting. The function specification, derived from B1-D1 fields, controls the tapes as follows:

Bits	24	25	26	27	28	29	30	31
Tapes	8	7	6	5	4	3	2	1

For example, if bit 24 is a 1-bit, tape 8 is advanced for one space after printing. The double-width tape covers the positions of two narrow tapes and requires that both positions be set to 1-bits to space the double-width tape properly. If more than one carriage-control instruction is interpreted before a print instruction, only the last one is executed.

For System/360 Models 25 and above and System/370, refer to the Systems Reference Manual, *IBM 2821 Control Unit*, GA24-3312.

STL Operator Controls

Feature Mode Switch

The feature mode switch is located below the horizontal adjustment knob and must be moved to the right before STL operations can be performed. Move the feature mode switch to the left for normal page-printing operations. Switching modes is automatic on the Model N1.

Tape Skip Keys

Five tape skip keys (Model N1 only) are located on the front operator control panel (Figure 43). Four keys are used to skip specific tapes in both of two single-width

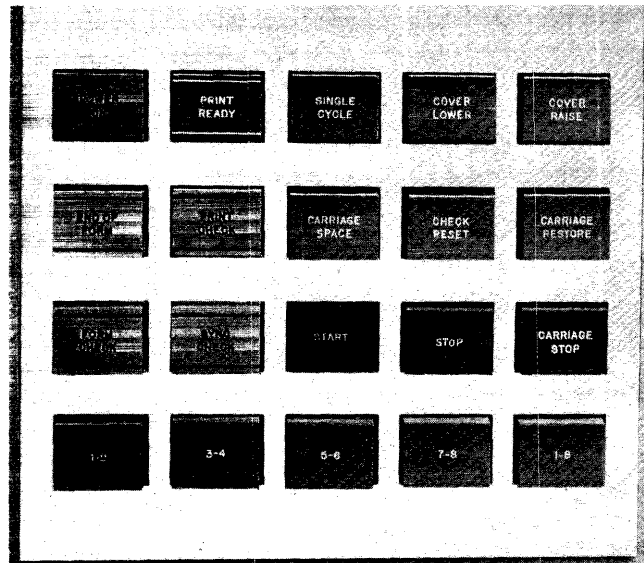

Figure 43. Model N1 Operating Keys and Lights for Selective Tape Listing Feature

positions indicated (see Figure 42). The fifth key skips all tapes.

The distance of the skip can be set to one value in the range 3 to 22 inches (76 to 559 mm). The desired skip distance for the applications involved is specified at installation time. The service representative adjusts the printer for this one specified skip distance for all tapes. The skip distance applies to both manual and program-initiated skips.

When the printer is set up to operate in STL mode, the print unit (T-casting) must be closed and the feature mode switch must be in the STL position (moved to the right) before the skip keys are active. If the skip key is operated accidentally while the printer is printing on-line:

1. Operation continues, but the tape positions selected with the skip key move with line spacing until the skip timer times out whether tape positions are program-selected or not. This may cause inadvertent spacing between lines.
2. A form check occurs. Follow the normal form-check restart procedure.
3. Manually skip previously printed tapes to prevent overprinting.
4. Press printer start key.

Occasionally a form-check signal appears one line before an end-of-form condition because of the location of the end-of-form switch. This can be readily noted when you use the form-check restart procedure. During the procedure, if an end-of-form signal appears, the cover rises when the tapes are skipped or spaced to prevent overprinting.

STL Operating Procedures

End-of-Form and Form-Check Restart

The end-of-form and the form check lights turn on when an out-of-tape condition occurs. The trailing end of the tape is located at the roller on the lower part of the snap-in tape-guide plate.

To provide quick access to the tapes on Model N1, the top cover rises automatically when the end-of-form light turns on. After the out-of-tape condition is corrected, the operator can lower the cover and press the start key to resume operation.

A broken-tape condition or a failure to space turns on the form check light. (The printer cover on Model N1 does not rise automatically for either condition.)

To continue operations:

1. Correct the failure-to-space or broken-tape condition.
2. Press check reset key.

Splicing Tapes

For maximum operating efficiency, tapes should be spliced together (in order to prevent tape runout and a consequent reloading procedure). Use one of the following procedures:

1. If a butt splice is made, splice approximately midway between folds. The folds are normally 8.5 in. (216 mm) apart. Cut the tapes smoothly and perpendicularly to the tape edges so that each section to be joined is 4-1/4 in. (114 mm) from a perforation. Place a thin adhesive tape across the back of the tapes so that printing does not occur on the adhesive tape.

Make sure that the splice is made between perforations of the *opposite* fold so that proper stacking is maintained.

2. If an overlapping splice is made, cut the tapes smoothly, perpendicularly to the tape sides, about 4-1/2 in. (114 mm) from the perforations. This allows for an overlap of 1/4 in. (6 mm). Place an adhesive material between the tapes and join them. Be sure that the first tape through the printer overlaps the second tape so that the second tape is toward the rear of the printer (with respect to the first tape). Make sure that the splice is made midway between perforations of opposite fold so that proper stacking is maintained.

Make sure that no adhesive material is deposited in the paper feed path. Such adhesive may cause jams.

Splice tapes together before the supply of tapes in the printer is exhausted.

1403 Models 1, 2, and 3

Loading Tape: To change from forms printing to tape listing:

1. Press the stop key if the ready light is on and raise the cover.

2. Remove the forms from the forms tractors. Install a blank carriage-control tape.
3. Install the tape-guide plate:
 - a. Unlatch both right-hand forms tractors and move them to the extreme right end of the tractor slide-bars (beyond the last locking position).
 - b. Unlatch the upper left-hand forms tractor and slide it to the extreme left.
 - c. Hang the tape-guide plate on the upper tractor slide-bar by the nylon spools attached to the back of the plate.
 - d. Align the plate laterally so that the tab on the left side of the plate engages the second visible notch to the right of the left-hand forms tractor on the upper tractor slide-bar.
 - e. Using the horizontal adjustment knob, position the printing mechanism so that the hammers are centered behind the large rectangular hole in the tape-guide plate.
 - f. Move the lower left-hand forms tractor as far left as it goes. (It cannot be moved as far left as the upper left-hand forms tractor.)
 - g. Snap the guide plate into place. Nylon fingers behind the bottom section of the plate grip the lower tractor slide-bar.

Note: This final step does not require much force if:

Both right-hand forms tractors and the upper left-hand forms tractor are moved out of the way.

The lower left-hand forms tractor is properly positioned.

The plate is properly aligned with the hammers and the correct notch on the upper tractor slide-bar.

The wires attached to the left-hand forms tractors are not interfering with the nylon fingers.

1403 Model N1

Provided for the selective tape listing feature on the 1403 model N1 are:

1. A tape stacker mounted on the top cover of the printer. The operator can load new tapes, and, using the top stacker, remove processed stacked tapes without leaving the front of the printer. Satisfactory stacking of lister tapes depends upon the quality of paper used. Some documents at low-humidity conditions do not stack to the expected three-inch minimum height because of the type of perforation of the refold, and/or because of paper stiffness. For satisfactory performance, IBM forms, or their equivalent, should be used.
2. Five manually operated tape skip keys. The keys are provided for ease of loading and unloading tapes and for moving the tapes so that printing can be seen readily.

3. Selective spacing and skipping [at 33 in. (838 mm) per second] of tapes under program control.
4. If not in use, move the tape spool tray to the right on its own slide-bar, out of the paper feed path. To position the tray for tape listing, release the spring-lock pin and slide the tray to the left until the pin engages the leftmost hole in the slide-bar. The tray must be properly positioned to close the feature mode switch.
5. Install the stacking device. Two brackets mounted on top of this device engage hanger bolts beneath the printer stacker. The hanger bolts and square washers protrude through the holes in the brackets when the device is properly installed.
6. Plug the stacking-device power cord into the outlet on the right side of the stacking device.
7. Thread the tapes through the tape-sensing switch guides, the paper-tension fingers, the lower paper guides, the upper paper guides, and the tape-advancing fingers and guides. Then, run the tape over the printer to the stacking device (Figure 44).

8. Close the print unit and lower the printer cover.

To return to normal forms printing, remove the tapes, the stacking device, and the paper-guide plate; and slide the tape-spool assembly tray to its storage position on the right. Install the forms and prepare for printing as described under "Forms Insertion."

Paper Stacking Device: An eight-pocket partitioned container is available for the STL feature. The pockets can be arranged to accommodate any combination of tape widths. This device can stack:

1. A maximum of four 3.1-in. (79 mm) tapes on a 132-position printer.
2. A maximum of eight 1.5-in. (38 mm) tapes on a 132-position printer.
3. A combination of 3.1-in. (79 mm) and 1.5-in. paper tapes on the same run.
4. Combinations of fold-pack paper and roll-paper tapes, processed on the same run.

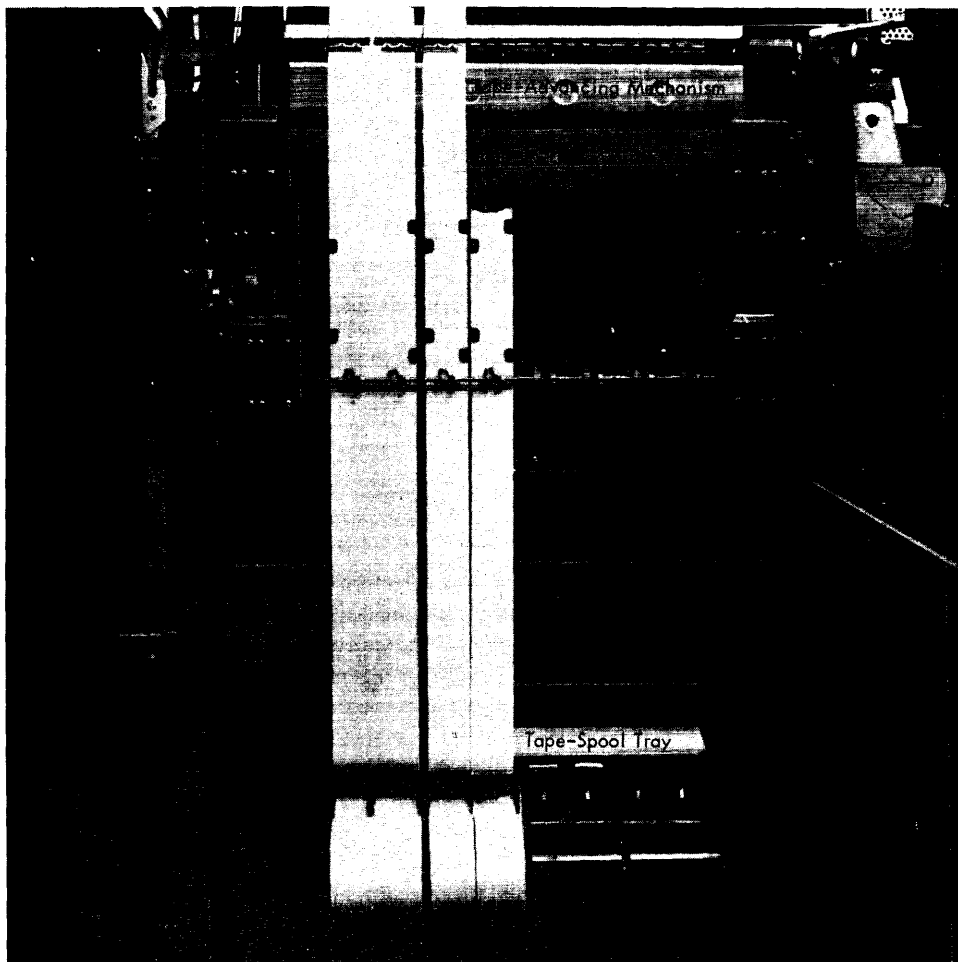

Figure 44. 1403 Model 1, 2, or 3 with Selective Tape Listing Feature

The stacking device is attached directly below the paper-exit port. It can be removed when the STL feature is not in use. The time required to attach or remove the device is less than five minutes.

The fold-pack paper or roll-paper tape leaves the machine through the regular paper-exit port. The paper enters the stacking device through the power take-up roll mechanism, which directs it into the proper pocket. The stacked paper can be removed by lifting one of the four wire retainers that make up the fourth side of the container.

When using fold-pack paper, the pocket holds about 1,000 feet (305 meters) of listing work; when using roll paper, the pocket holds about 20 feet (6 meters) of listing work.

Loading Tape

To change from forms printing to tape listing on the 1403 Model N1:

1. Press the printer stop key if the ready light is on.
2. Press the cover-raise key and wait for the cover to rise.
3. Open the print unit (T-casting).

4. Remove the forms from the forms tractors (see "Forms Insertion") and install a blank carriage tape in the carriage.
5. Move the upper and lower forms tractors to their *extreme* outer positions (that is, both right forms tractors moved to the right, and both left forms tractors moved to the left).
6. Remove the snap-in tape-guide plate from its storage position at the back of the forms tray. Attach connector to the center plate cable. Do not place undue tension on this cable.
 - a. Hang the snap-in tape-guide plate on the upper tractor slide-bar (Figure 45) by the nylon spools attached to the back of the assembly.
 - b. Align the snap-in tape-guide plate so that the metal tab on the left side of this plate engages the second visible notch to the right of the left-hand forms tractor on the upper slide bar.
 - c. Using the horizontal adjustment knob and the vertical print-alignment knob, position the printing mechanism so that the hammer unit is approximately

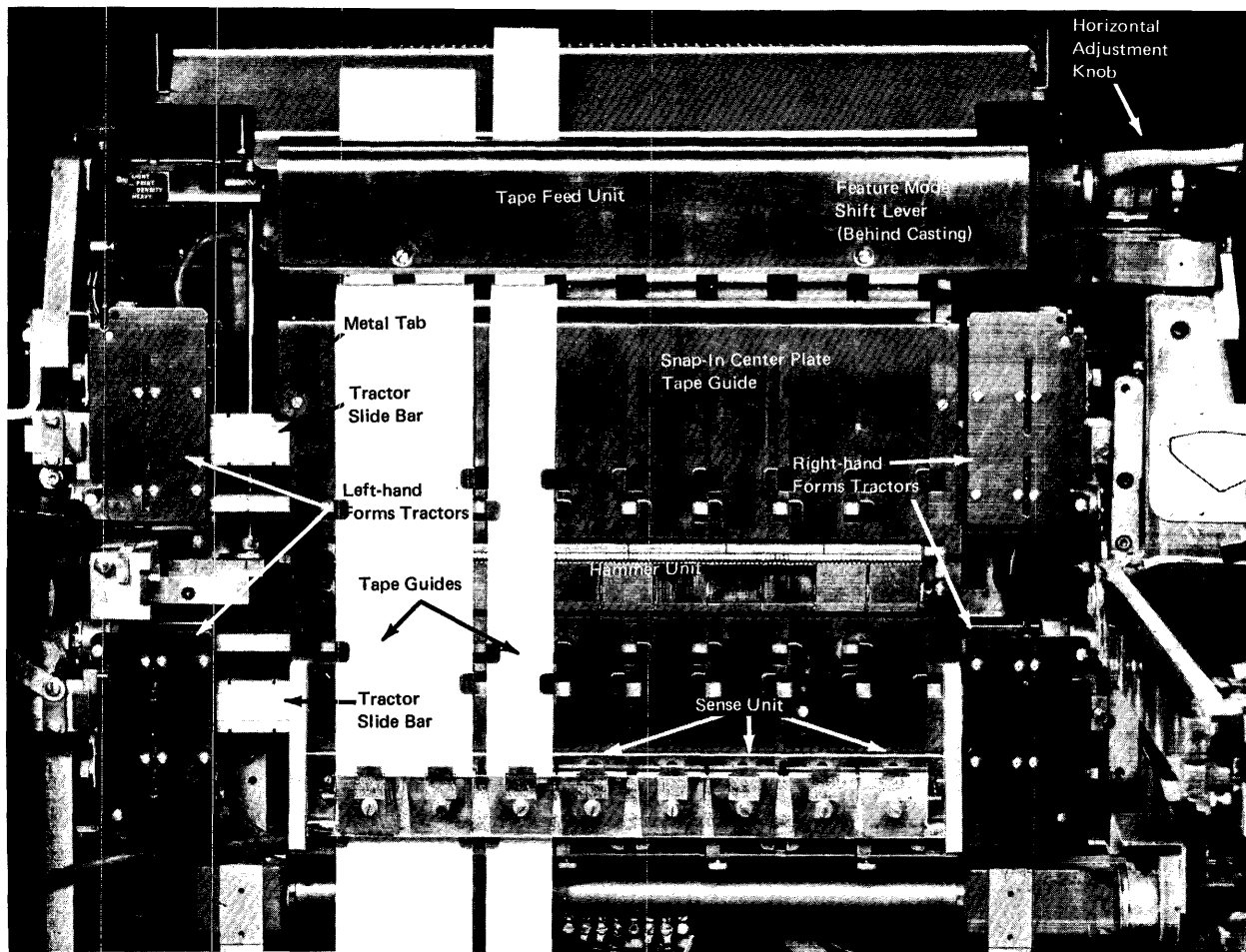

Figure 45. 1403 Model N1 with Selective Tape Listing Feature

centered behind the large rectangular hole in the snap-in tape-guide plate.

- d. Make sure that the cable attached to the lower left-hand forms tractor does not interfere with the snap-in tape-guide plate. If the cable does, reposition the forms tractor.
- e. Snap the snap-in tape-guide plate onto the lower tractor slide-bar. This plate must be positioned properly before the feature mode switch can be placed in the STL position.

Note: This final step does not require much force if:

The forms tractors have been moved out of the way. The snap-in tape-guide plate has been properly aligned with the hammers and with the correct notch on the upper tractor slide-bar.

The cable attached to the lower left-hand forms tractor does not interfere with the nylon fingers on the snap-in tape-guide plate.

7. Place the supply of fanfold tapes in the front of the printer below the snap-in tape-guide plate.
8. Manually position the tapes in the tape-feeding path. To do this:
 - a. Thread the tapes through the tape guides and rollers (on the lower part of the snap-in tape-guide plate).

If double-width tape is used, move the lower center guide to the right and pivot it down out of the paper path.

CAUTION

When positioning the movable guide for single-width-tape operation, take care to ensure correct location in the notch provided.

- b. Slide the tapes partially (about one in. or 25 mm) into the tape-feed unit (Figure 45) so that they are securely gripped.
 - c. Place the feature mode switch in the STL position (that is, to the right).
 - d. Engage the manual clutch and line selector knob in the six-lines-per-inch drive position.
 - e. After all tapes are positioned into the tape advancing mechanism, close the print unit (T-casting) and press the skip key that manually skips all tapes. The feature mode switch must be in the STL position (to the right) and the T-casting must be closed before the skip keys are active.
9. The tapes should now extend through the tape-feed unit.
 10. Close the top printer cover by pressing the cover lower key.
 11. Open the clear access door (Figure 46) located just below the top stacker, and draw tapes to the stacker.

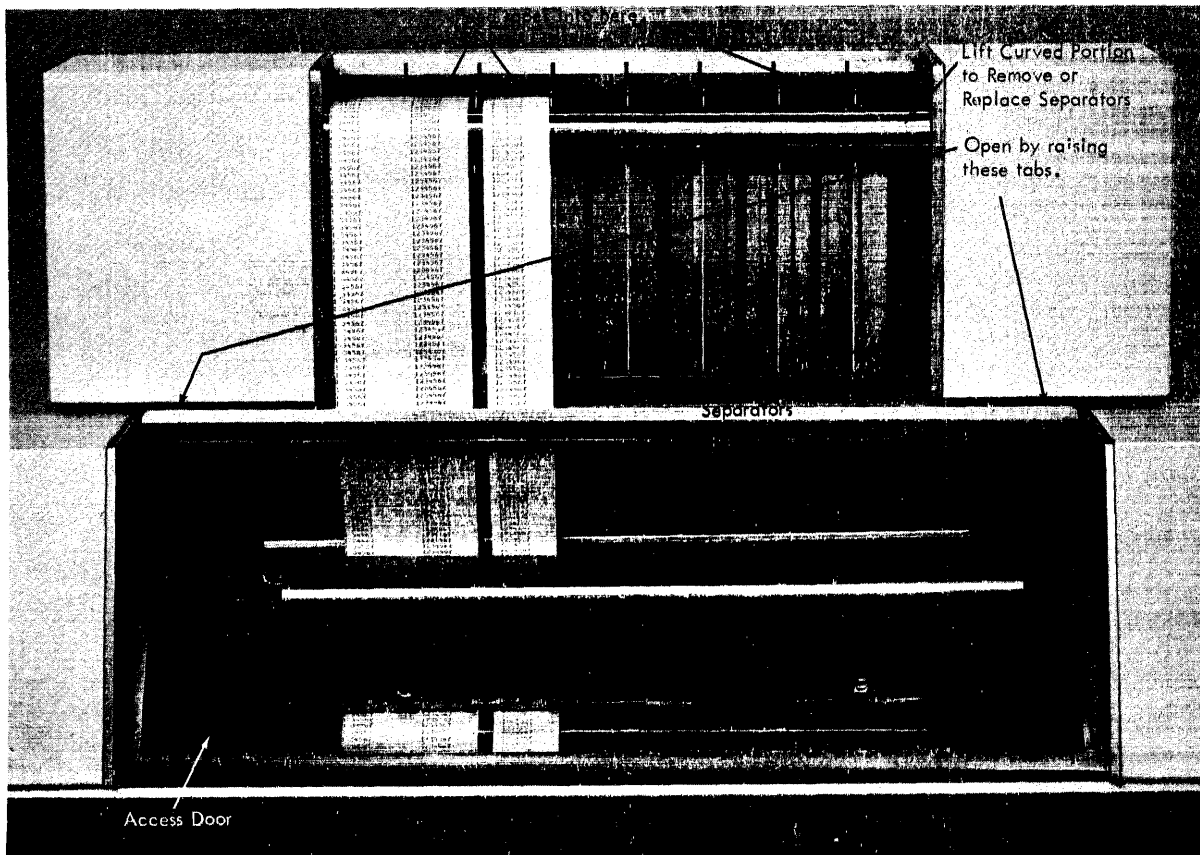

Figure 46. Top Stacker for Selective Tape Listing Feature on Model N1

12. Adjust any of the four removable pocket separators to accommodate double-width tapes. Unused separators can be stored at either end of the stacking device (Figure 46).
13. Feed the tapes into the top openings of the stacker. When you place a tape into the top stacker, the stacker tape-feeding device automatically pulls the tapes into the stacker. Make sure that sufficient tape is fed into the stacker pockets so that proper stacking can be *seen*. The tapes should stack so that the perforated folds fall in their *natural folding direction*. If stacking is attempted with the folds opposite to their normal direction, the tapes do not stack properly.
14. Press the start key to proceed with STL operation.

Unloading Tape

To return to page-printing operation, remove the tapes and the snap-in tape-guide plate and disconnect the cable. Store the snap-in tape-guide plate at the rear of the front forms tray. The nylon spools rest in holes at the top of the cover plate, behind and below the print unit. These spools must be securely engaged in the holes. If the assembly is not properly positioned, the tape sensing switch connector may be damaged if the assembly falls from its storage location.

Replace the normal forms as described under "Forms Insertion."

Appendix

Extended Binary-Coded-Decimal Interchange Code (EBCDIC)

The 256-position table in Figure 34, outlined by the heavy black lines, shows the graphic characters and control character representations for EBCDIC. The bit-position numbers, bit patterns, hexadecimal representations, and card hole patterns for these and other possible EBCDIC characters are also shown.

To find the card hole patterns for most characters, partition the 256-position table into four blocks as follows:

1	3	Block 1: Zone punches at top of table; digit punches at left
2	4	Block 2: Zone punches at bottom of table; digit punches at left
		Block 3: Zone punches at top of table; digit punches at right
		Block 4: Zone punches at bottom of table; digit punches at right

Sixteen positions in the table are exceptions to this arrangement. These positions are indicated by small numbers in the upper right corners of their boxes in the table. The card hole patterns for these positions are given at the bottom of the table. Bit-position numbers, bit patterns, and hexadecimal representations for these positions are found in the usual manner.

Following are some examples of the use of the EBCDIC chart:

Character	Type	Bit Pattern	Hex	Hole Pattern	
				Zone Punches	Digit Punches
PF	Control Character	00 00 0100	04	12 - 9	4
%	Special Graphic	01 10 1100	6C	0	8 - 4
R	Upper Case	11 01 1001	D9	11	9
a	Lower Case	10 00 0001	81	12 - 0	1
	Control Character, function not yet assigned	00 11 0000	30	12 - 11 - 0 - 9	8 - 1

Bit Positions
01 23 4567

IBM 1403 A and H Print Arrangement

PRINT ARRANGEMENT		DEFINED CHARACTER	CARD CODE	BCD CODE	PRINT ARRANGEMENT		DEFINED CHARACTER	CARD CODE	BCD CODE
A	H				A	H			
		Blank		C	G	G	G	12-7	B A 4 2 1
.	.	.	12-3-8	B A 8 2 1	H	H	H	12-8	B A 8
⌘)	⌘	12-4-8	C B A 8 4	I	I	I	12-9	C B A 8 1
		[Left Bracket (Special Character)	12-5-8	B A 8 4 1	-	-	! (Minus Zero)	11-0	B 8 2
		< Less Than (Special Character)	12-6-8	B A 8 4 2	J	J	J	11-1	C B 1
		* Group Mark	12-7-8	C B A 8 4 2 1	K	K	K	11-2	C B 2
&	+	&	12	C B A	L	L	L	11-3	B 2 1
S	S	S	11-3-8	C B 8 2 1	M	M	M	11-4	C B 4
*	*	*	11-4-8	B 8 4	N	N	N	11-5	B 4 1
] Right Bracket (Special Character)	11-5-8	C B 8 4 1	O	O	O	11-6	B 4 2
		; Semicolon (Special Character)	11-6-8	C B 8 4 2	P	P	P	11-7	C B 4 2 1
		Δ Delta (Mode Change)	11-7-8	B 8 4 2 1	Q	Q	Q	11-8	C B 8
-	-	-	11	B	R	R	R	11-9	B 8 1
/	/	/	0-1	C A 1	#	#	* Record Mark	0-2-8	A 8 2
,	,	,	0-3-8	C A 8 2 1	S	S	S	0-2	C A 2
%	(%	0-4-8	A 8 4	T	T	T	0-3	A 2 1
		∨ Word Separator	0-5-8	C A 8 4 1	U	U	U	0-4	C A 4
		\ (Special Character)	0-6-8	C A 8 4 2	V	V	V	0-5	A 4 1
		* Tape Segment Mark	0-7-8	A 8 4 2 1	W	W	W	0-6	A 4 2
#	#	# (Special Character)		A	X	X	X	0-7	C A 4 2 1
#	=	#	3-8	B 8 2 1	Y	Y	Y	0-8	C A 8
⌘	'	⌘	4-8	C 8 4	Z	Z	Z	0-9	A 8 1
		: Colon (Special Character)	5-8	8 4 1	0	0	0	0	C 8 2
		> Greater Than (Special Character)	6-8	8 4 2	1	1	1	1	1
		√ Tape Mark	7-8	C 8 4 2 1	2	2	2	2	2
&	&	? (Plus Zero)	12-0	C B A 8 2	3	3	3	3	C 2 1
A	A	A	12-1	B A 1	4	4	4	4	4
B	B	B	12-2	B A 2	5	5	5	5	C 4 1
C	C	C	12-3	C B A 2 1	6	6	6	6	C 4 2
D	D	D	12-4	B A 4	7	7	7	7	4 2 1
E	E	E	12-5	C B A 4 1	8	8	8	8	8
F	F	F	12-6	C B A 4 2	9	9	9	9	C 8 1

IBM 1403, Models 2 and 7

Print Arrangement	Special Characters
AN	& . ⌘ - S * , % / # ⌘ +
HN	& .) - S * , (/ = ' +

Index

- A**
- A and H print arrangement 49
 - acoustical dampener 14
 - adapter, interchangeable chain cartridge 26
 - adding-machine tape 5
 - ALA train cartridge 18
 - appendix 48
 - arrangement A, H 5
 - arrangements, chain 28
 - arrangements, train 30
 - auxiliary ribbon feeding 40
- B**
- BCDIC 5
 - blank 27
 - brush ink light 9
 - brushes, tape 14
 - buffer carriage control 12
 - bus-out check 23
- C**
- card code-graph chart 35
 - carriage
 - controls 8
 - restore key 8
 - space key 8
 - stop key 9
 - tape 12
 - tape brushes 14
 - tape insertion 14
 - cart, forms 8
 - chain
 - arrangement (UCS) 26
 - arrangements 28
 - design 34
 - MCS 40
 - numeric 25
 - printing 5
 - selection 33
 - changing codes (UCS) 27
 - changing interchangeable cartridge 16
 - changing ribbons 14
 - channel 9 24
 - channels, tape 13
 - channel status word 23
 - character arrangement 5
 - character spacing 5
 - character set
 - COBOL 26
 - FORTTRAN 26
 - multiple 39
 - preferred 25
 - program language/1 26
 - universal 26
 - character storage (UCS) 27
 - character-stroke width 19
 - check reset key 8
 - checking, print 6
 - cleaning type-face 21
 - COBOL 5
 - code
 - card
 - EBCDIC chart 32
 - code (continued)
 - EBCDIC chart use 48
 - EBCDIC (UCS) 27
 - graphic 35-37
 - valid 6
 - code-graphic chart 36
 - codes, UCS 27
 - command reject 23
 - control tape 12
 - controls
 - carriage 8
 - forms carriage 12
 - manual 10
 - operator (STL) 42
 - printing 7
 - cover raise, cover lower keys 8
 - covers, machine 6
 - CSW 23
 - cutoff 20
- D**
- dampener, acoustical 14
 - data check 24
 - design, print chain or train 34
 - dualing (UCS) 27
 - duplicating applications 19
- E**
- EBCDIC chart 32
 - EBCDIC chart description 48
 - eight-lines-per-inch spacing 13
 - end-of-form
 - light 8
 - restart 23
 - restart (STL) 43
 - stop 23
 - ejection 18
 - equipment check 24
 - error, forms 6
 - extended binary coded decimal interchange code chart 32
- F**
- fanfold paper 5
 - feed clutch 10
 - form check
 - light 8
 - restart 23
 - restart (STL) 43
 - form length 12
 - form-movement time (UCS) 33
 - form-thickness lever 12
 - form width 12
 - forms carriage control 12
 - forms cart 8
 - forms error 6
 - forms insertion 15
 - forms stacking 16
 - forms tractors 11
 - forms thickness (OCR) 20
 - FORTTRAN 5

G

gate ink light 9
 graphic-code chart 36
 graphic dualing (UCS) 27

H

H print arrangement 49
 horizontal spacing 5
 HS start light 9
 HS stop light 9

I

impression (OCR) 19
 impression, print 11
 indicator panel 9
 indicator, print line 10
 inserting carriage tape 14
 inserting forms 15
 interchangeable cartridge 16
 interchangeable chain cartridge adapter 26
 intervention required 23
 invalid command 23

K

keys 7
 keys and lights (STL) 42

L

latch, forms tractor 11
 lateral print adjustment lever 11
 lateral print vernier lever 11
 length, form 12
 library applications 18
 lights 7
 lights (STL) 42
 line spacing timing 22
 loading tapes (STL) 43
 lower cover key 8
 LS start light 9
 LS stop light 9

M

machine covers 6
 manual controls 10
 MCS 39
 mechanical interlock 23
 metering 14
 mode, numeric 25
 mode switch, STL 42
 multiple character set 39

N

noise 6
 null 27
 numeric chain 25
 numeric mode 25
 numerical print feature 25

O

OCR applications 18
 OCR references 21
 operating keys and lights 7
 operation, UCS 27
 operator controls (STL) 42

operator procedures
 basic 14-18
 restart 23-24
 STL 43-47
 optical character recognition 18
 overprinting 6

P

panel lights 9
 paper 19
 paper advance knob 10
 paper stacking device (STL) 44
 parity 6
 parity check 24
 PCS 25
 PL/1 26
 preferred character set
 arrangement 38-39
 description 25
 print adjustment lever 11
 print check light 8
 print checking 6
 print conditions 20
 print density
 knob 11
 lever 11
 OCR 20
 print-line indicator 10
 print-position assignment (STL) 40
 print positions 5
 print-quality requirements 18
 print-quality test procedure 21
 print ready light 8
 print slugs 6
 print speed
 basic 5
 PCS 25
 UCS 27
 print-timing
 chart 10
 dial 11
 OCR 20
 operation 11
 print-unit release lever 10
 print vernier knob 11
 printer timing 22
 printing controls 7
 printing method, chain 5
 printing method, train 6
 procedures, operator
 basic 14-18
 restart 23-24
 STL 43-47
 processing timing 23
 program language/1 26
 programming information 22
 programming information (STL) 40
 publications
 OCR 21
 programming 22
 punch, tape 13
 punching the tape 13

R

raise cover key 8
 rate, skipping 5
 rated speed 5
 references
 OCR 21
 programming 22

- restart procedures
 - STL 43
 - System/360 and System/370 23
- RH tractor vernier 11
- ribbon
 - changing 14
 - feeding feature 40
 - installing 14
 - life (OCR) 17
 - OCR 19
 - shield 10
 - width 15
- right-hand tractor vernier 11

S

- safety 6
- schematic chain printing 5
- schematic train printing 6
- selection, chain or train 33
- selective tape listing
 - description 40
 - mode switch 40
 - operating procedures 43
 - operator controls 42
 - programming 35
 - tape commands 41-42
 - tape specifications 35
- sense bits 0-7 24
- shift ink light 9
- single-cycle key 8
- six-lines-per-inch spacing 13
- skip to channel X 12
- skipping
 - carriage tape brushes 14
 - high-speed 9
 - low-speed 9
 - rate 5
 - timing 22
- slide-bars 11
- slow brushes 14
- slugs, print 6
- slur 20
- spacing, character 5
- spacing, line
 - adjustment 10
 - feed clutch 10
 - timing 22
 - vertical 5
- special features 25
- speeds, printing
 - basic 5
 - PCS 25
 - UCS 27
- splicing tapes (STL) 43
- stacking device (STL) 44
- stacking forms 16
- stacking improvement device 18
- start key 7
- status word 23
- STL 40
- stop brushes 14
- stop key 8
- stroke width 19
- sync check 24
- sync check light 8

T

- tape
 - brushes 14
 - channels 13
 - controlled carriage 12-14
 - loading (STL) 43
 - punch 13
 - punching 13
 - skip keys (STL) 42
 - specifications (STL) 40
 - splicing (STL) 43
 - STL 40
 - unloading (STL) 47
- test procedure, print-quality 21
- thermal ink light 9
- timing
 - line spacing 22
 - printer 22
 - processing 23
 - skipping 22
- TN arrangement card codes 35
- tractor latch 11
- tractor slide-bars 11
- tractor vernier 11
- train
 - arrangements 30
 - design 34
 - MCS 40
 - printing 6
 - selection 33
- type-face cleaning 21
- type size 5
- type slugs 6

U

- UCS 26
- universal character set
 - codes 27
 - data check 25
 - description 26
 - design 34
 - operation 27
 - printing speed 27
 - selection, chain or train 33
 - type arrangements 28-31
 - utility program 33
- unloading tape (STL) 47
- utility program (UCS) 33

V

- valid codes 6
- vertical print adjustment 10
- vertical spacing 5

W

- width
 - character stroke 19
 - form 12
 - ribbon 15
 - tape (STL) 40
- write and skip to channel X 12



Technical Newsletter

This Newsletter No.	GN24-0672
Date	April 15, 1974
Base Publication No.	GA24-3073-8
File No.	1403-03
Previous Newsletters	None

IBM 1403 Printer Component Description

This technical newsletter provides replacement pages for subject publication. Pages to be inserted and/or removed are:

25 to 34

A change is indicated by a line to the left.

Summary of Amendment

Update of UCS feature to include 1403 Model 5.

Note: Please file this cover letter at the back of the manual to provide a record of changes.

Special features are available for the 1403 Printer that offer customers increased speed or flexibility for certain applications.

NUMERICAL PRINT

The numerical print feature (for Models 1 and 2 only) enables the system user to change from the alphabetic mode of printing to the numeric mode, simply by changing the chain cartridge in the 1403. The numeric chain has 15 character sets, with 16 characters in each set. In the numeric mode, the 1403 can print 1,285 lines per minute.

An operator needs no special tools to remove one chain cartridge and replace it with another. Before locking the new cartridge in place, move the chain only enough to permit the chain drive to engage. When the chain cartridge is placed in the 1403, the corresponding mode is selected automatically. If the printer is in the numeric mode, characters other than the 16 specified for numeric printing cause a print-check error.

Note: The numerical print feature is not available on the 1401 Model A, the System/3, System/360, or System/370.

PREFERRED CHARACTER SET

The preferred character set feature (for Model 3 only) has the standard 48 characters on the train so arranged that the most common characters can be presented to the hammer more frequently to give a maximum speed of 1,400 lines per minute. The preferred character set train contains 8 arrays of 14 numeric and special characters, 4 arrays of 26 alphabetic characters, 4 arrays of four special characters, and 2 arrays of four less-common special characters. Figure 30 shows the sequence of characters on the train.

The actual speed attained depends upon the characters being printed and the number of internal scans required to locate the proper character on the train. For printing exclusively the characters designated by group, the minimum speed is:

Group 1: 0 to 9 . , - *	1,385 lpm
Group 2: A to Z % \$ / &	920 lpm
Group 3: # @ □ †	550 lpm

The timing charts in Figure 31 show the print-cycle time associated with the three different character groups, and with the maximum printing speed.

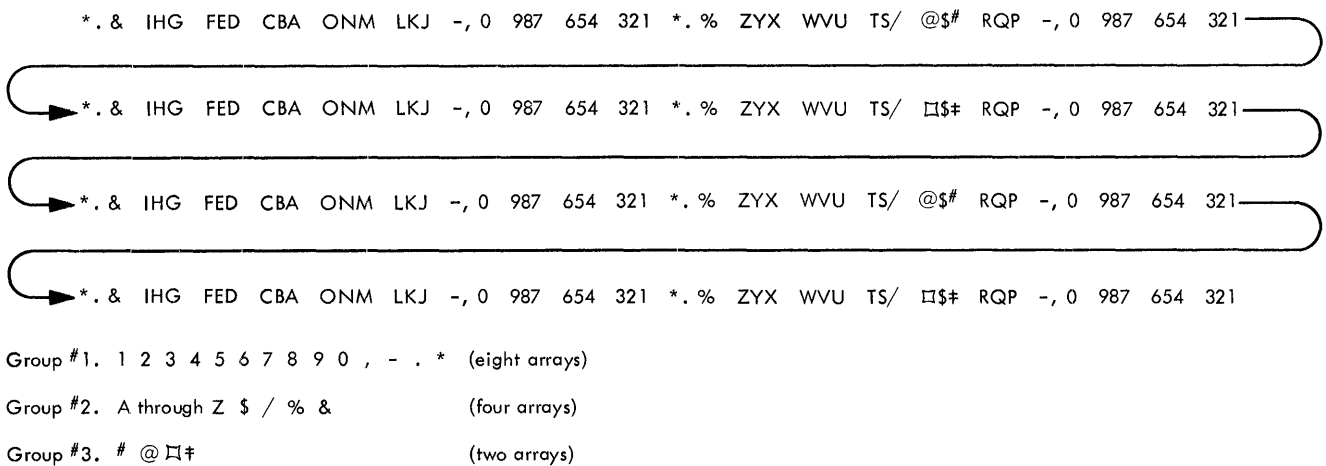

Figure 30. Sequence of Preferred Character Set on Train

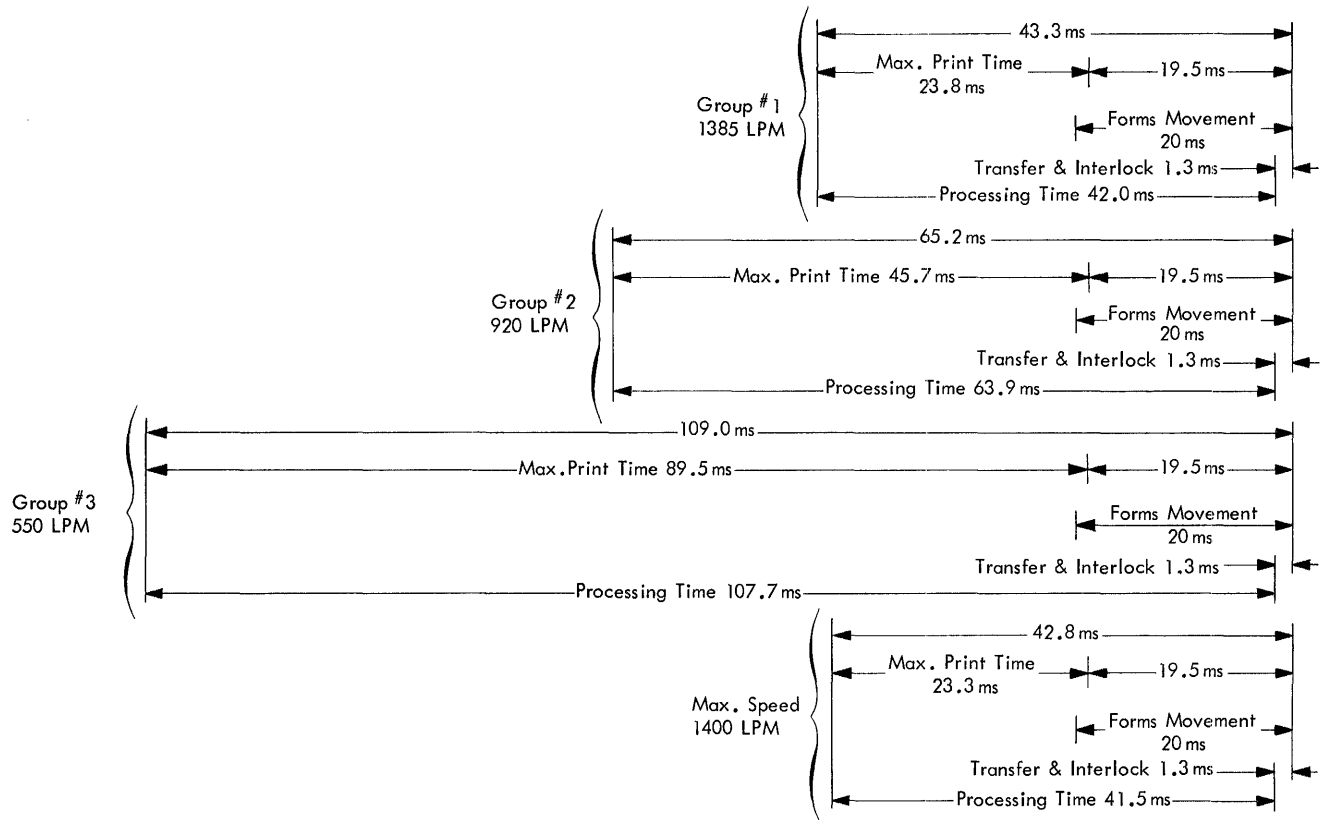

Figure 31. Preferred Character Set Speeds

INTERCHANGEABLE CHAIN CARTRIDGE ADAPTER

This feature (for Models 1, 2, 4, 5, 6, and 7) permits the operator to insert an interchangeable chain cartridge with a different type font, style, or special-character arrangement. This change can be made quickly without the use of special tools, and printer operation is not affected.

When this feature is ordered for a 1403, two interchangeable chain cartridges are supplied: one instead of the standard permanent chain, and one additional.

This interchangeable capability is standard on all Model 3 or N1 printers. The single IBM 1416 Interchangeable Train Cartridge supplied with the Model 3 or N1 printer is interchangeable with others available.

Train cartridges cannot be used on the chain printer; and conversely, the chain cartridges cannot be used on the train printers.

UNIVERSAL CHARACTER SET

The Universal Character Set (UCS) allows using any set of graphics (120 on System/3, 240 on System/360 and System/370) on the 1403. The UCS feature requires the UCS Adapter in the 2020 Processing Unit, or the 2821 Control Unit on other models of System/360 and System/370.

The code corresponding to each graphic is entered into a read/write storage under control of a utility program

available from IBM. Though any graphic desired may be printed, the coding is restricted to the Extended BCD Interchange Code.

On the 1403 Models 2 and 5, the type slugs selected or designed by the customer are installed in an interchangeable chain cartridge. With Models 3 and N1, the 1416 Interchangeable Train Cartridge is used. When a different character is desired, the cartridge is changed and new codes are entered into the character storage unit.

The UCS feature offers the following advantages:

1. Chain and train arrangements are provided in addition to the AN, HN, PCS-AN (Preferred Character Set-AN), PCS-HN (Preferred Character Set-HN) and QNC (Figures 32 and 33). These UCS arrangements are for use and optimization of applications requiring:

High-speed alphanumeric capability
 Programming Language/I (PL/I) Character Set
 Commercial applications of FORTRAN and COBOL
 Commercial and scientific text printing

2. Any previously announced chain or train configurations for 1400-series systems are available for use with the universal character set feature.
3. The customer may design chains or trains, tailored to his own needs, using the guidelines and within the limitations defined in this publication.

Method of Operation

The universal character set utilizes a read/write storage unit. Each position of storage corresponds sequentially to each graphic on the installed print train or chain. This character storage is read out in printing-position sequence as the various graphics are brought into printing position by the movement of the train or chain. Codes read out of character storage are matched to the successive codes of the data record to be printed. Note that the data record is moved to the printer in the normal manner. When a code out of character storage matches a code from the data record, the corresponding print position prints.

The bit patterns in the data record correspond to those selected from the 256 codes of the EBCDI (Extended Binary Coded Decimal Interchange) code. They must also correspond to the codes contained in the character storage unit (each position of which is composed of 8 bits plus a parity bit). The codes for null (00000000) and blank (01000000) must not be loaded into character storage. If a code in the data record (except null, 00000000, or blank, 01000000) does not match any of the codes in character storage, nothing is printed in the print position to which the unmatching data-record code applies.

Dualing of Graphics/Codes with UCS

The four graphics % π # @ of the AN arrangement are dualled with () = ' of the HN arrangement. *This is accomplished by assigning the 48AN codes from the EBCDI code to both the AN and HN configurations.*

To attain the dualing capability for the 1400-series arrangements (A through K) as used with the UCS feature, the following rules apply:

1. For systems operating with the 1401, 1440, 1460 compatibility feature, assign the codes of the AN arrangement to the load buffer for all arrangements.
2. For systems operating with the 1401, 1440, 1460 compatibility feature, assign the codes of the EBCDI code (Figure 34) for each discrete graphic.

Changing Codes in Character Storage

The contents of character storage are changed through use of either one of two special XIO instructions. Previous contents of the character storage are erased when new codes are loaded. After the desired codes are loaded, they remain unchanged until rewritten by the user.

To load the desired codes and check the contents of character storage after loading, the user enters the coded punched card information into CPU main storage. The procedure is:

1. The new codes are punched in cards and loaded into main storage through a card reader.
2. The new codes are then transferred to the UCS character storage.

3. The printer prints the graphics so that the loading operation of character storage can be checked.

The punched card codes corresponding to the 256 code combination of the EBCDI code are shown in Figure 34.

Printing Speeds

The printing speeds attained with this feature depend upon a number of factors. In general, printing speed for a particular character depends on its frequency of appearance on the print train or chain. Other factors, such as spacing and format, however, affect the printing speed. This section presents a method for determining nominal and absolute minimum printing speed for a character group although the actual print speed is usually greater than that calculated.

In order to prevent possible damage to the printer, character groups of fewer than 16 characters should not be entered into character storage. This means that the same code should not be entered into character storage with an interval of *less* than 15 other discrete codes. This restriction does not cause a decrease in printing speed, because the peak print speeds attainable with this feature are achieved with character groups greater than 16.

The following formulas are used to calculate the speed for a given set of characters on the chain or train.

		<i>Speed in Lines per Minute</i>	
		<i>Nominal</i>	<i>Absolute Minimum</i>
IBM 1403 Model N1	60,000	60,000	
	$\left(\frac{240}{f} - 3\right) (.729) + t$	$\left(\frac{240}{f}\right) (.729) + t$	
IBM 1403 Model 2	60,000	60,000	
	$\left(\frac{240}{f} - 1\right) (1.665) + t$	$\left(\frac{240}{f}\right) (1.665) + t$	
IBM 1403 Model 5	60,000	60,000	
	$\left(\frac{240}{f} - \frac{1}{3}\right) (2.222) + t$	$\left(\frac{240}{f}\right) (2.222) + t$	

where: f = Number of times the given set of characters appears on the train
 and: t = forms-movement time. See Figure 35

Note: Each model has a maximum printing speed:

<i>Model</i>	<i>Maximum Speed (lpm)</i>
N1	1400
2	750
5	585

For example, if the calculated speed for a Model N1 exceeds 1400 lpm, use 1400.

Figure 32 (Part 2 of 2). Chain Arrangements (Printout Representation)

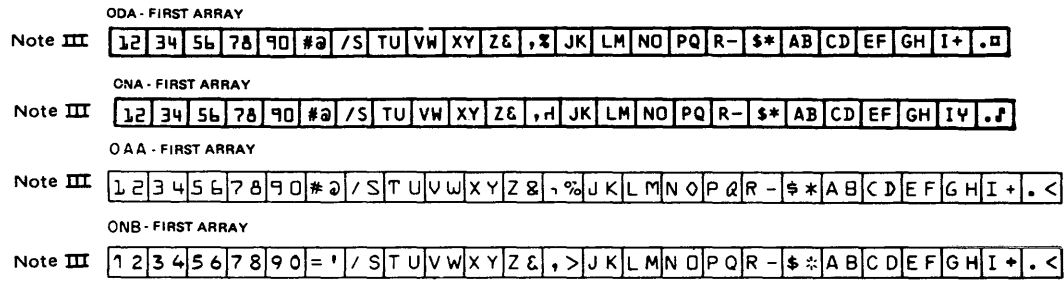

Note III Five full sets per cartridge arrangement

		00				01				10				11				Bit Positions 0,1	
		00	01	10	11	00	01	10	11	00	01	10	11	00	01	10	11	Bit Positions 2,3	
		0	1	2	3	4	5	6	7	8	9	A	B	C	D	E	F	First Hexadecimal Digit	
Bit Positions 4, 5, 6, 7		9	9	9	9	9	9	9	9									Zone Punches	
Second Hexadecimal Digit		12				12	12		12	12	12		12	12				Digit Punches	
Digit Punches			11				11	11	11		11	11	11		11				
			0			0	0	0	0	0	0	0	0		0		0		
0000	0	8-1	① NUL	② DLE	③ DS	④	⑤ SP	⑥ &	⑦ -	⑧			⑨	⑩	⑪	⑫	8-1		
0001	1	1	SOH	DC1	SOS				⑬		a	j		A	J	⑭	1 1		
0010	2	2	STX	DC2	FS	SYN					b	k	s	B	K	S	2 2		
0011	3	3	ETX	TM							c	l	t	C	L	T	3 3		
0100	4	4	PF	RES	BYP	PN					d	m	u	D	M	U	4 4		
0101	5	5	HT	NL	LF	RS					e	n	v	E	N	V	5 5		
0110	6	6	LC	BS	EOB	UC					f	o	w	F	O	W	6 6		
0111	7	7	DEL	IL	PRE	EOT					g	p	x	G	P	X	7 7		
1000	8	8		CAN							h	q	y	H	Q	Y	8 8		
1001	9	8-1		EM							i	r	z	I	R	Z	9 9		
1010	A	8-2	SMM	CC	SM		⋈	⋈	⑮	:							8-2		
1011	B	8-3	VT	CU1	CU2	CU3	.	\$,	#							8-3		
1100	C	8-4	FF	IFS		DC4	⑯	*	%	@				⌘	⌘		8-4		
1101	D	8-5	CR	IGS	ENQ	NAK	()	_	'							8-5		
1110	E	8-6	SO	IRS	ACK		+	;	>	=				⋈			8-6		
1111	F	8-7	SI	IUS	BEL	SUB	⋈	⋈	⋈	?	"						8-7		
		9	9	9	9									9	9	9	9		
		12				12				12	12		12	12	12	12			
			11				11			11	11	11	11	11	11	11			
			0				0			0	0	0	0	0	0	0			

Card Hole Patterns

- | | | | | |
|-----------------|--------------|---------|------------|-----------------------------------------------------------------------------------------------------------|
| ① 12-0-9-8-1 | ⑤ No Punches | ⑨ 12-0 | ⑬ 0-1 | ⑯ On some chain configurations, the lozenge (⋈) is printed for this bit pattern, but this is nonstandard. |
| ② 12-11-9-8-1 | ⑥ 12 | ⑩ 11-0 | ⑭ 11-0-9-1 | |
| ③ 11-0-9-8-1 | ⑦ 11 | ⑪ 0-8-2 | ⑮ 12-11 | |
| ④ 12-11-0-9-8-1 | ⑧ 12-11-0 | ⑫ 0 | | |

Control Character Representations

ACK	Acknowledge	EOT	End of Transmission
BEL	Bell	ESC	Escape
BS	Backspace	ETB	End of Transmission Block
BYP	Bypass	ETC	End of Text
CAN	Cancel	FF	Form Feed
CC	Cursor Control	FS	Field Separator
CR	Carriage Return	HT	Horizontal Tab
CU1	Customer Use 1	IFS	Interchange File Separator
CU2	Customer Use 2	IGS	Interchange Group Separator
CU3	Customer Use 3	IL	Idle
DC1	Device Control 1	IRS	Interchange Record Separator
DC2	Device Control 2	IUS	Interchange Unit Separator
DC3	Device Control 3	LC	Lower Case
DC4	Device Control 4	LF	Line Feed
DEL	Delete	NAK	Negative Acknowledge
DLE	Data Link Escape	NL	New Line
DS	Digit Select	NUL	Null
EM	End of Medium	PF	Punch Off
ENQ	Enquiry	PN	Punch On

Special Graphic Characters

¢	Cent Sign	-	Minus Sign, Hyphen	⌘	Hook
.	Period, Decimal Point	/	Slash	⋈	Fork
<	Less-than Sign	,	Comma	⌘	Chair
(Left Parenthesis	%	Percent		
+	Plus Sign	_	Underscore		
	Logical OR, Absolute	>	Greater-than Sign		
&	Ampersand	?	Question Mark		
!	Exclamation Point	:	Colon		
\$	Dollar Sign	#	Number Sign		
*	Asterisk	@	At Sign		
)	Right Parenthesis	'	Prime, Apostrophe		
;	Semicolon	=	Equal Sign		
⋈	Logical NOT	"	Quotation Mark		
[Left Bracket	\	Backslash		
]	Right Bracket	^	Circumflex		

Note: See "Appendix" for example of chart use.

Figure 34. Extended Binary Coded Decimal Interchange Code

This feature utilizes an end-of-print line concept to permit immediate carriage movement when a printed line is complete. As a result, the printing speed is variable and can be in excess of the calculated nominal speeds.

The three formulas apply for continuous printing with single-line spacing.

Consider, for example, calculation of the speed (by formula) for a 48AN train configuration. The number of times the complete 48AN configuration appears on the train is 5:

$$\frac{240}{48} = 5 \text{ presentation of 48AN set.}$$

Therefore, f (in the nominal formula for the Model N1) equals 5. For continuous printing and single-line spacing with the AN train:

$$\frac{60,000}{\left(\frac{240}{5} - 3\right) (.729 + 21.2)} = 1,111 \text{ lpm}$$

When skipping or multiplespacing operations are performed, the additional forms-movement time (t) must be added to the denominator of the formulas. Figure 35 shows the forms-movement times to be added to the formula denominator.

Now consider the same 48AN configuration but with spacing of two lines after each line printed. Figure 35 shows that the 21.2 factor, in the denominator of the nominal

formula for the train printer, is replaced by 26.2. Nominal speed at which printing occurs (assuming continuous printing and spacing) is then:

$$\frac{60,000}{\left(\frac{240}{5} - 3\right) (.729) + 26.2} = 1,016 \text{ lpm}$$

IBM System/360 Model 20 UCS Utility Program

This utility program, available from IBM, allows the user to load the 240-character storage (in the 2020) with codes that correspond to the character arrangement of the desired chain or train. The entire contents of the 240-character storage is then checked against the installed chain or train graphics by a printout of all graphics in the sequence in which they occur on the chain (or train). Refer to *IBM System/360 Model 20 Bibliography*, GA26-3565, for publications that describe programs, available from IBM, for use with System/360 Model 20.

Print Chain or Train Selection

Figures 32 and 33 represent an actual printout of the graphics on the appropriate chain or train. For example, if the graphics on the AN chain were to be printed out in the sequence in which they are mounted on the chain, then the printout would be as shown for the AN chain in Figure 32. (Note that this is not the way the graphics appear if the chain itself is observed.)

An order form is used to order a chain or train (S120-1089). This form is laid out in printout sequence (that is, the same as the sequence shown in Figures 32 and 33). The code sequence in character storage also corresponds to the print-out sequence. Position "1" of the character storage *always* contains the code that corresponds to the graphic "1" on the chain or train (except possibly when certain non-English graphics are used on the chain or train). The first position is a special marked slug (colored) that designates the beginning of a train cycle (in the Model N1 only). Identical codes for the other "1" graphics are stored in other character storage locations, depending upon the train configuration used.

As an example, consider use of a 48AN train for which the EBCDI code is used to load the character storage. The first three characters on the train and their corresponding character storage codes are:

Graphic	Character Storage Position	EBCDI Code
1 (marked)	1	11110001
2	2	11110010
3	3	11110011

The assigned codes for the graphics of all arrangements are as outlined in the standard EBCDI code (see Figure 34).

Lines Skipped	Forms-Movement Time (t) Required (ms)		
	1403 Models		
	N1	2	5
1	21.2	21.7	23.0
2	26.2	26.7	28.0
3	31.2	31.7	33.0
4	36.2	36.7	38.0
5	41.2	41.7	43.0
6	46.2	46.7	48.0
7	51.2	51.7	53.0
8	56.2	56.7	58.0
over 8	Add 2.3 ms for each line skipped over 8. See Example		
Example:			
Value to be added to the 8-line figure of 56.2 is the result of multiplying the number of spaces (in excess of eight) times 2.3 ms.			
12 lines skipped			
56.2 + 4 (2.3)			
or 65.4 ms.			

Figure 35. Form-Movement Time

For the SN arrangement, which contains one graphic (the long dash) not uniquely defined in the standard EBCDI code, the card code 12-11-0-8-7 has arbitrarily been assigned.

For the TN arrangement, which contains 32 graphics not uniquely defined in the standard EBCDI code, the recommended card codes assigned are shown in Figure 36. These codes *may* be redefined by the customer. Note, however, that if they are redefined, the chain image deck, forwarded with the cartridge, must be similarly amended. The bit patterns that correspond to the card codes defined (in Figure 36) for the TN arrangement are as shown for these same card codes in Figure 34.

Print Chain or Train Design

Customers designing their own chains or trains should consult with their IBM sales representative for order forms and the type-slug catalog prepared to facilitate designing and pricing of new slugs, if required.

In a 48-character set chain or train, the 48-character set is presented identically five times to occupy the 240 type positions of the chain or train. Each time the chain or train moves one character position, a new character is presented to each print position. In order to present each

of the 48 different characters to each print position, the chain or train must move one character spacing 48 times. The time interval between the presentation of two successive characters to print position is called a *scan* time. Therefore, 48 scan times are required to present each character of the 48-character set to each print position.

The System/3 chain image buffers contain 120 positions. Character sets for use with this feature should contain 60 or 120 characters. If the character set contains fewer than 60 (or 120) different characters, it must be filled out to 60 (or 120) by repeating characters. For example, if only 48 different characters are desired, the character set must be filled out to 60 by repeating 12 of the 48 characters.

The printing speed (in lines per minute) is directly related to the number of scan times required to present each

character to printing position. For the 60-character-set print train (or chain), 60 scan times are required. For the 80-character set, 80 scan times, etc. The chain or train moves at its same respective rate of speed in all cases. Therefore, the character set with the greatest number of different characters has the slowest line-per-minute print speed.

The 1403 printers not using UCS have their print train or chain characters generally arranged in ascending binary coded order. This is necessary because the electronic control circuitry, used to advance through the character codes, incorporates a binary counter in some systems.

When UCS is used, however, the coded contents of character storage are used to advance through the chain or train. Therefore, chain or train character sequence is related only to the codes loaded into character storage.

Note: Repeated character sets on the chain must be arranged in the *same order* so that the calculated line-per-minute rates can be achieved.

With UCS, preferred arrangements of two or more interlaced sets of graphics can be used. Each set then has its own total number of scan times and related print speed. In the examples, all indicated speeds are nominal (as defined by the nominal formula).

Consider a 60-45 preferred character arrangement with single-line spacing of forms. Instead of showing specific graphics in our example, we are substituting numbers for the characters, because, as already stated, a binary code sequence need not be observed when this feature is used. What we are doing then, is showing the relationship of like characters on the train being designed. For example, if the character designated by the number 15 (in the first set) is an A, then any time the number 15 is used in subsequent sets, the letter A is again designated.

Figure 37 lists suggested graphics and the corresponding EBCDI and card codes. It is essential that the PL/I graphics-code correspondence (shown in Figure 37) be used if the system is used to print Programming Language/I. Also see Figure 34.

READER'S COMMENT FORM

1403 Printer Component Description

Order No. GA24-3073-8

- Are you able to find information in this publication easily?
- Are the illustrations adequate, clear, and concise?
- Which of the following are included in your occupational responsibilities?
 - System operating.
 - Programming.
 - Supervising.
 - Instructing.
 - Other.
- We would appreciate your comments; please give specific page and line references where appropriate.

Reply Requested?

Yes

No

NAME
STREET
CITY
STATE ZIP CODE

GA24-3073-8

YOUR COMMENTS, PLEASE

Your answers to the questions on the back of this form, together with your comments, will help us produce better publications for your use. Each reply will be carefully reviewed by the persons responsible for writing and publishing this material. All comments and suggestions become the property of IBM.

Please note: Requests for copies of publications and for assistance in utilizing your IBM system should be directed to your IBM representative or to the IBM branch office serving your locality.

Cut Along Line

Fold

Fold

FIRST CLASS
PERMIT NO. 170
ENDICOTT, N.Y.

BUSINESS REPLY MAIL
NO POSTAGE STAMP NECESSARY IF MAILED IN THE UNITED STATES



POSTAGE WILL BE PAID BY

IBM Corporation
Product Publications, K10
P.O. Box 6
Endicott, N. Y. 13760

Fold

Fold

1403 Printer Component Description Printed in U.S.A. GA24-3073-8



International Business Machines Corporation
Data Processing Division
1133 Westchester Avenue, White Plains, New York 10604
(U.S.A. only)

IBM World Trade Corporation
821 United Nations Plaza, New York, New York 10017
(International)



International Business Machines Corporation
Data Processing Division
1133 Westchester Avenue, White Plains, New York 10604
(U.S.A. only)

IBM World Trade Corporation
821 United Nations Plaza, New York, New York 10017
(International)