



**IBM**

General Information Manual  
Introduction to Control Systems

**IBM** **General Information Manual**

**Introduction to Control Systems**



## Contents

	<i>Page</i>		<i>Page</i>
<b>Introduction</b> .....	5	Cascade Control .....	21
Control System .....	5	Analog Computing Elements .....	21
Applications .....	5	Limitations of Analog Control Systems .....	21
Process and Control .....	8		
Basic Definitions .....	8	<b>Digital Computers and Process Control</b> .....	23
		Applications .....	23
<b>Modern-Day Processing</b> .....	10	Data Reduction .....	23
Process Characteristics .....	10	Operator Guide Control .....	24
Multiple Objectives .....	10	Closed-Loop Control .....	24
Many Variables .....	10	Mathematical Model .....	24
Complexity of Process Variables .....	10	Static Model .....	25
Process Control .....	11	Dynamic Model .....	25
Fluid Catalytic Cracking Process .....	11		
		<b>Control System Functions</b> .....	26
<b>Instrumentation</b> .....	15	Evaluation .....	26
Measuring Instruments .....	16	Optimization .....	26
Temperature .....	16	Control .....	27
Pressure .....	17		
Flow .....	17	<b>IBM Control System</b> .....	28
Liquid Level .....	17		
Analytical Instruments .....	18	<b>Advantage of Computer Control</b> .....	28
Automatic Controllers .....	18		
On-Off .....	19	<b>Bibliography</b> .....	29
Floating .....	19		
Proportional .....	19	<b>Glossary</b> .....	31
Proportional plus Reset .....	20		
Proportional plus Reset plus Rate Action .....	20	<b>Index</b> .....	34
Ratio Control .....	20		

## Preface

This manual is intended primarily to provide IBM personnel with the basic concepts of process control and instrumentation and to introduce the IBM Control System. It is intended primarily for IBM personnel who are unfamiliar with industrial processing. Those who have a background in processing may find helpful the sections of the manual devoted to the concepts of computer control.

A glossary and a bibliography covering both processing and computer control are provided at the back of the manual.

Specific applications of the Control System are described in the following publications:

*IBM General Information Manual, 1710 Control System for Petroleum Refining* (Form E26-5572)

*IBM General Information Manual, 1710 Control System for Steam-Electric Generating Units* (Form E26-5573)

The *IBM 1710 Control System Manual* (Form D26-5578) describes a Control System that utilizes the 1620 Data Processing System.

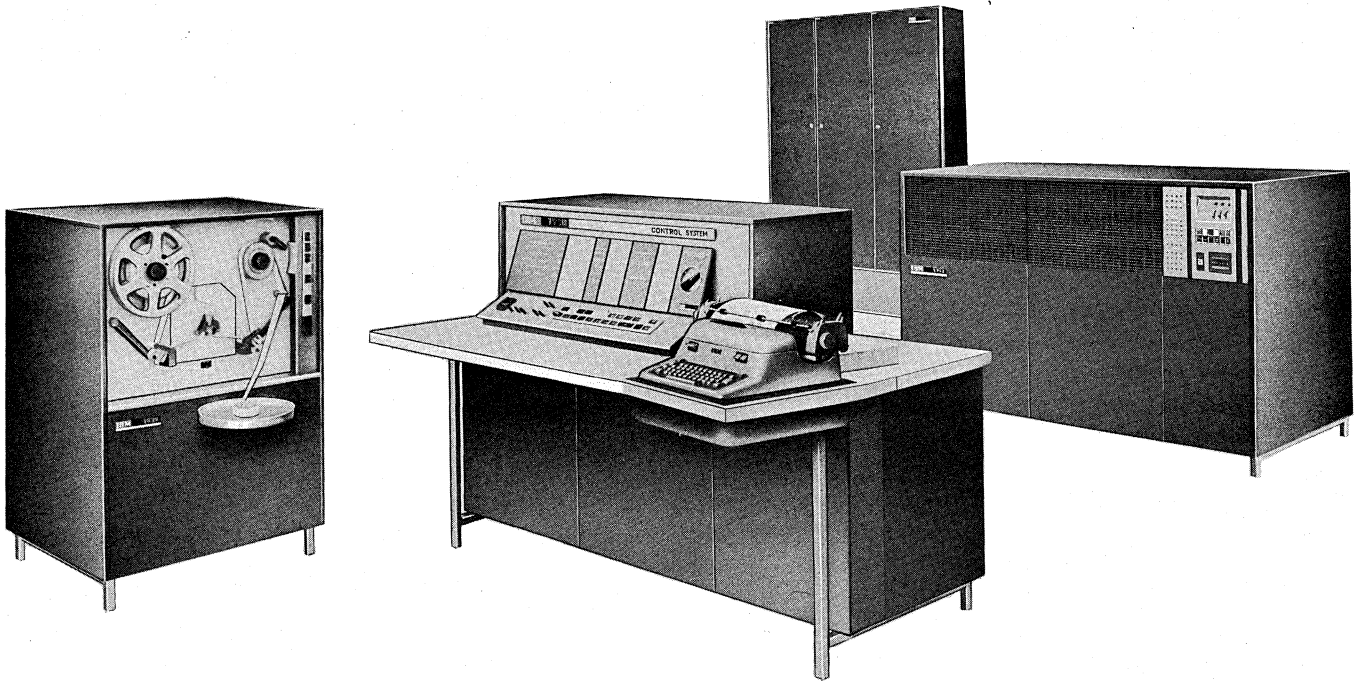

The role of the digital computer in the control of complex continuous, semicontinuous, or batch-type processes, generally found in prime industries, is becoming increasingly more significant as the process industries discover the practical benefits of computer control. To meet this need, the IBM Control System is now available.

### Control System

The Control System is modular in concept, allowing flexibility in the design of individual systems. Special features such as contact sense, interrupt, contact operate, random addressing, analog output, multiplexer and terminal unit(s), and storage units may be added as desired to adapt the system to a particular application. In each case the heart of the system is the digital computer.

Digital computers have long been used in industry to process data pertaining to a company's sales, inventories, marketing and distribution operations, and to compute wages, tax deductions, retirement savings, and similar personnel-record operations.

High-speed digital computers of the scientific type have been used in the research organizations of business

and by the Government in the development of defense tactical systems, weapons, missiles, and satellites, and by the media and local governments in massive civilian computing operations - processing election returns and forecasting election results.

The evolution of the scientific and engineering computer into a Control System, made possible by the addition of conversion and analog input and output devices, is of particular significance to the processing industries and to manufacturers of electrical goods. Areas in which the Control System performs advantageously include quality control, process control, process study, and process optimization.

### Applications

*Quality Control.* In quality control applications, the IBM Control System can be used to inspect, test, and evaluate such items as refrigerators, motors, and transistors, either individually or according to a sampling technique. The sampled data may then be stored within the computer for mathematical evaluation of the performance of individual units or groups of units. The System is able to evaluate and approve or reject units

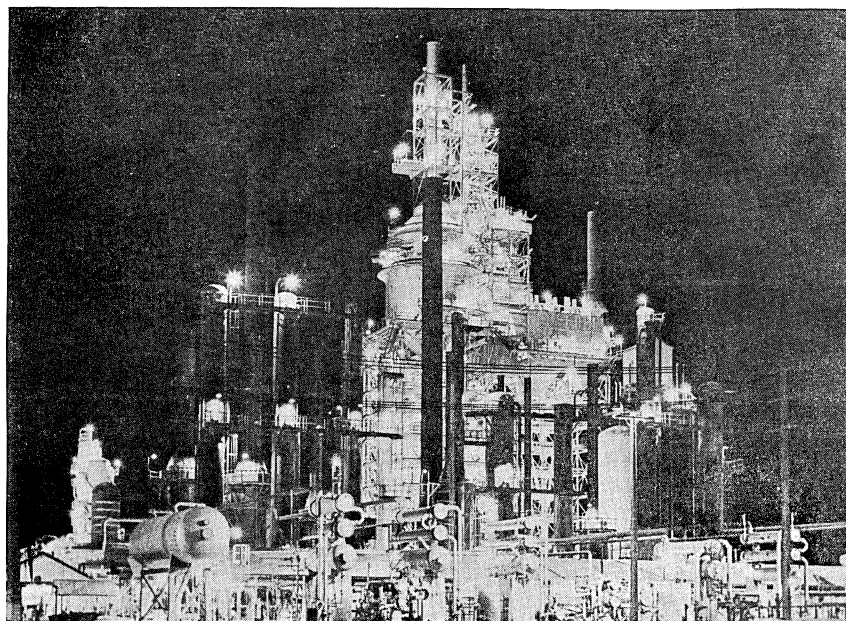

Fluid Catalytic Cracking Plant

under final test. Further, as a result of its evaluation, it may indicate modification of certain steps in the manufacturing process to eliminate flaws and improve product quality.

*Process Study.* The Control System can be used to study a process, to gather and analyze masses of statistical data, and to rapidly perform the complex calculations that will lead to an accurate mathematical model of the process. Such a model is a necessary preliminary step to optimization and closed-loop computer control of a process.

Modern industrial processing is already automated to a degree. Processing plants rely almost wholly on instrumentation for routine control. Manual adjustments of valves are rarely made. Instrumentation costs in these partially automated plants may run from 4% to 8% of total plant investment. The automatic controllers and other instruments enable the operator to control the process to produce a profit and at the same time to maintain the stability and safety of the process.

Yet, for all the efficiency of the instrumentation — and present instruments have undergone considerable refinement, becoming more sensitive, reliable, and accurate — the automatic controllers leave much to be desired. One reason is that generally they control only a single variable.

Cascade control, or metered control as it is sometimes called, couples variables in a single loop, providing control of two, or at most three, variables. The benefits possible from this type of control are not fully realized because of the difficulty of training operators in its use. The control action obtainable with these kinds of instruments falls short of control requirements for a dynamic process in which many factors interact and are interdependent in subtle ways.

The task of integrating the controllers and supervising the process becomes the responsibility of the process supervisor. He is confronted with a dynamic operation; up to 50 or more automatic controllers, each acting independently; and a great number of factors that must be equated, not only those relating to the chemistry or physics of the process but extrinsic economic ones as well. Equating so many factors involves complicated, long-drawn-out calculations requiring several hours or days.

The gap between changes in the process and the time necessary for the engineer to perform the required calculations often makes his answers useless, for conditions in the process are likely to change rapidly. In practice, therefore, the operator relies on his judgment and experience, and since he is not sure where the process is with respect to the true limits, he does not risk exceeding them. He controls at limits well within the safety specifications to avoid disaster, and thus the

yield from the processing operation is less than its potential.

*Process Control.* The IBM Control System is an ideal computer system for automatically controlling processes for maximum performance and profit. In addition to supervising all the controllers it can perform failure check and substitute the controller function, if necessary.

The System provides direct contact with the process, through a multiplexing and terminal unit, and converts process analog signals to digital signals for use by the computer; analog output signals, representing control actions determined by the computer, are accomplished through terminal connections to the devices or controller set points to be operated. Operator control and guidance are possible through typewriter and tape input and output units.

The Control System is a most efficient and versatile process control instrument. Its modular construction permits the installation of a minimum system. When the initial installation has proven the advantages of computer control, that system can be expanded, by the addition of special features and units, to provide closed-loop control for large, continuous or batch processes. Among these are, to name a few, catalytic cracking, catalytic reforming, distillation, and polymerization in the petroleum industry; inorganic, petrochemical, and plastic processes in the chemical industry; natural gas transmission and steam-electric power generating plants in the public utilities industry; rolling mill, blast furnace, and open hearth operations in the steel industry; and pulp and paper processing. The ability of the System to act faster than the process, to scan and relate hundreds of instrument outputs, to retain them along with hundreds of thousands of other items of information locating any one with equal facility, to solve the most involved mathematical problems rapidly, and to effect appropriate control action in time, places at the command of the processing industries a powerful tool for attaining their objectives.

Economic objectives in these industries vary: they may be expressed as improved throughput, reduced unit costs, improved product quality, reduced maintenance and plant costs through fuller utilization of existing facilities, maximum conversion of raw material, or a combination of these. Whichever it is, the IBM Control System can control the process to achieve the desired economic objective.

*Process Optimization.* The importance of the Control System built around the digital computer lies in the ability of the system not only to control the process but also to improve process performance.

The Control System is of great economic advantage to small but highly competitive industries (like the chemical industry) engaged in processing high-cost

products involving expensive raw materials, because it results in more efficient operation and greater dollar return. It benefits the continuous and batch processing industries by increasing their efficiency and economic return through providing integrated control of the process operations. Even in progressive industries now operating almost at optimal levels, the Control System is able to effect a fractional improvement that, because of volume, substantially increases profits.

The research that is conducted by industry to improve products, and to discover ways to process the raw materials of nature to synthetically fill the needs of all, moves in the direction of complexity. Great strides have been made in the development of new processes, but they have been empirically obtained. The state of their art technologically is more advanced than is scientific understanding of the physical phenomena that occur in the processing itself. Processes cited are so complex that neither human engineering skill nor science is cap-

able of controlling them to their best advantage.

A Control System accomplishes process optimization by periodically sampling signals from flow transmitters, pressure transmitters, thermocouples, resistance thermometers, temperature transmitters, and analytical instruments attached to the process. From these it receives information regarding feed composition, temperatures, pressures, flow rates, product qualities, loads, etc., needed to determine optimum conditions of operation. It repeatedly analyzes the information and provides the process or the plant operator, by paper tape, punched card, or typewritten output, with guides to safer and more efficient operation. With the computer making the corrections as in closed-loop direct feedback optimization, decisions are executed faster and human error is avoided. The feedback information is typed out for the operator's reference only, since appropriate action is taken by the Control System directly and immediately.



## Process and Control

### Basic Definitions

*Process.* Industrial processes are broadly defined as a series of operations to produce a given commodity. They are sometimes classified from the process standpoint into (1) discrete, and (2) continuous, semicontinuous, and batch.

Manufacturing operations such as assembling, stamping, cutting, welding, and finishing are discrete. *Discrete* applies to industries whose processing entails steps that can be separated in time. The order of their performance may be dictated to some extent by job schedules or available machinery or personnel. The steps need not follow each other immediately.

Although susceptible to computer control, the discrete processes are not treated in this manual.

Petroleum refining, electric power generating and transmitting, and paper and plastic making are examples of continuous processes. In process industries the term *continuous* connotes the treatment or handling

in bulk form of energy or matter (liquid, solid, or gaseous), and its conversion or modification, by chemical or physical means, to produce the products therefrom at a profit. The process continues to function without interruption for days, months, and, in some instances, for years. This uninterrupted operation is the major basis for naming it a continuous process.

*Control.* Process implies control. Some rudimentary form of control was exercised even in earliest times when raw materials were first batch-processed. Then, for example, the operator in refining copper added fuel when the fire was low and ore when the fire was hot. He varied the rate of adding fuel depending on the temperature in the furnace, and he timed the firing of the ore by the furnace temperature he believed best for maximum purity.

Purity of the ore — pure copper — was his objective only there was no way to test its purity directly. From the way the ore responded to changes in furnace temperature, to pressure changes, and to other varying physical forces or properties, he estimated its purity, for he observed a correlation between these properties and the properties of the metal. He could never be certain that the temperatures and pressures he applied one time would result in copper of equal purity the next because the composition of the ore taken from the earth was never identical.

The variables that determined the purity of the copper included furnace temperature and ore firing. These were subject to his control. The purity of the copper was also determined by the composition of the ore and the ambient (surrounding) temperature. These were uncontrollable.

And certain constraints were imposed during the processing—constraints are limitations within which the process must be conducted owing to product or equipment specifications. The size of the furnace was a constraint. The total amount of fuel to ore that he could add, the proportion of fuel to ore being necessarily limited by the capacity of the furnace, was another constraint.

It is obvious, therefore, that though the variables in the process were few and the process relatively simple, the operator could not always produce copper of uniform quality and quantity. Experience helped him to improve the quality of the copper or to increase the quantity, depending on how he changed the variables in the light of what he thought was happening to the ore



Discrete Process

in the process. But even the experienced operator could not predict with certainty the outcome of his actions or maintain consistency of quality or quantity from one batch to another. The smelted copper was a measure of his skill and judgment in estimating the variables.

The development in the 17th century of elementary, scientific instruments like the thermometer, manometer, and barometer enabled the more precise measurement of such physical properties as heat and pressure, but it was not until the present century that automatic controllers were developed and commonly employed in processing industries.

Automatic controllers are self-regulating because they operate on the feedback principle. This allows them to measure the deviations of the variable from the set point where it is desired that the temperature, pressure, etc., be held, and to correct for the deviations. They are, however, limited to controlling only a small part of the process, a single variable or a single loop.

Over-all supervision of the process requires the interrelation and simultaneous regulation of many variables. Feedback is necessary here, too, and difficult, mathematical problem-solving. Over-all control was made possible in the past decade for the first time with the development and application of high-speed, scientific digital computers to process control.

Computer process control may be considered in terms of (1) management operations and (2) the physical nature and activity of the process. *Operations control* in the petroleum industry, for example, consists in management collecting data on the nature of the crude oil in storage and on the composition of the newly arrived shipments of crude oil, examining the market forecasts of demand for types of products, determining the ratio of one to the other, and setting the day's objectives for its refining operation.

*Process control* which is described in detail under MODERN-DAY PROCESSING consists in regulating the process variables to achieve the desired product separation, conversion, or transformation, while reducing instability and safety hazards during the processing.

Within these types of control, various levels or degrees of use of the computer are possible. Most ele-

mentary is the use of the computer control system to log data, to record without error at microsecond speed the readings from the instruments scanned, and to analyze and reduce this mass of process operating data to a meaningful, statistical account of what the process is doing.

In Operator Guide, where the computer control system is used further to solve complicated mathematical calculations relating the variables of the process and to type out solutions, a higher degree of process control is obtainable. The operator is guided by the typed results in his supervision of the process.

Closed-loop or direct-feedback control provides greater benefit, realizing as it does more of the potential of the computer control system. The computer responds faster and is more sensitive to any sudden changes in the process and being self-regulating initiates proper action as it is needed. The computer is programmed to do this. The program may be said to be a rationalization and organization of the thoughts and decisions the operator would make to such changes. It is one of the elements of the computer that enables it to supervise the whole process automatically.

Optimized computer control results in greater operating efficiency. Optimization is explained in detail in the section devoted to control system functions.

Use of the computer control system to integrate operational and process control is even more beneficial. The raw materials of some industries like the chemical and petroleum industries must undergo several types of processing to produce the end product. What is the economic justification for determining the extent the raw material is processed?

It has been found in the petroleum industry, for example, that paraffin-based crudes generally yield more high-value products at less processing cost than naphthenic-based crudes. Naphthenic crudes can be processed to yield products that are high-priced but they will yield less of them and cost more to process. The computer control system can be used to integrate operational control of the plant with process control for maximum over-all efficiency of the company's operations.

## Modern-Day Processing

Modern processes derive largely from the 17th and 18th century investigations in chemistry and physics. Discovery of physical laws, electricity, chemical elements, the steam engine, and the development on all scientific fronts of new industrial devices were put to good use by men of a practical turn of mind.

Their efforts resulted in the invention of processes on which were founded a number of industries, including

- steam and electric power
- chemicals
- petroleum
- steel
- textiles

All of these processing industries share certain characteristics.

### Process Characteristics

Processes are distinguished by three characteristics: multiple objectives, a large number of variables, and complex interrelationships between the variables. Some are further characterized by frequent disturbances. The petroleum refining industry is used here to illustrate these characteristics.

### Multiple Objectives

The objectives of a process are numerous, often incommensurate, conflicting, and not comparable. If the objective of a particular petroleum process is to increase yield, the attainment of this objective may result in gasoline of a lower octane number. A profitable balance must be reached between yield, quality, operating expense, etc.

Operational objectives such as safety, maximum allowable impurity, and product specification may be treated in two ways: either by considering them as constraints to the process variables or by assigning a cost to violating them and then translating these costs, in terms of other economic objectives, into a single equation. Where objectives conflict, they must be harmonized. This can be done by use of certain mathematical techniques to achieve an over-all balance.

### Many Variables

The variables involved in transforming raw material to some more desirable state, exemplified by the simple process of smelting copper, contrasts sharply with modern processes where each involves a very large number of variables. A variable is any temperature, pressure,

flow, level, or other measurement that determines or indicates the state of the process. Values of the variable correlate with the composition of the product desired. The exact relationship of these variables to each other and to the composition of the product is not always known, being experimentally obtained.

The modern process operator, like the juggler balancing his props, needs to manipulate adroitly the variables under his control so that products of an acceptable level, in the desired quantity, result. To do this efficiently, he should be able to relate all independent variables and constraints whenever there is interplay between them.

This frequently involves advanced mathematical techniques and time-consuming calculations to determine the optimum values. The nonlinear properties of most processes further complicate the mathematical calculations. A human operator may relate intuitively three or possibly four variables. A greater number requires him to use a calculator, and it may take him weeks or months to determine, with the aid of a desk calculator, the optimum values of a set of variables. In the distillation process, for example, as many as 60 simultaneous equations may require a solution every few minutes. The problem is beyond his capability to control so as to produce maximum yield of the highest quality product at the lowest possible cost.

### Complexity of Process Variables

It is the nature of variables that they often are interrelated in complicated, nonlinear ways rather than in a simple additive manner. If the variables in a particular function reacted independently of the whole, the operator's task would be easier.

The independent controllable variables in industrial processes are the temperatures, pressures, flows, and liquid levels that can be directly controlled. The independent uncontrollable variables are composition of the raw material, ambient temperature, power generation load, etc., which vary unpredictably and which create "disturbances" in the process. Control action is necessary to compensate for the disturbances.

Dependent variables cannot be directly controlled. It is impossible to change a dependent variable independently of other variables. Certain internal temperatures, pressures, and flows in a process may be significant dependent variables if there is a reasonable chance

of their approaching their constrained limits. Table 1 summarizes the types of process variables.

Table 1. Process Variables

Independent	Directly Controllable	Temperatures, pressures, air and liquid flow rates, etc., applied to the process.
	Uncontrollable	Composition of raw material, power generation load, ambient temperature, catalyst deterioration, etc.
Dependent	Controllable only by manipulating independent variables.	Temperatures, pressures, concentrations, etc., that result within the process.

Independent variables can be described as variables that cause process behavior; dependent variables as the effects. Independent variables are inputs to the process; dependent variables are in part the results of those inputs.

### Process Control

The complex interrelationships of a process and the problem of controlling it efficiently to obtain maximum profit may be better understood by examining a typical process: Fluid Catalytic Cracking.

### Fluid Catalytic Cracking Process

The purpose of this process is to convert to gasoline some of the valuable products emerging from distillation of the crude oil. Until the conversion to jet craft, fractional distillation separated the constituents of the oil as shown in the left half of Figure 1.

The heavier hydrocarbon constituents totaled more than half, yet their demand and economic value were less than those of gasoline. To make the distillation products more nearly match the products desired, the refiner processed the oil from the distillation tower through the catalytic cracker. After cracking, the proportion of gasoline to other products was as shown in the right half of Figure 1. Most catalytic cracking processes can convert 50% to 75% of the heavier hydrocarbons into gasoline.

A hydrocarbon molecule is a combination of hydrogen and carbon atoms. One petroleum authority estimates that crude oil contains three thousand different hydrocarbon compounds, each a characteristic hydro-

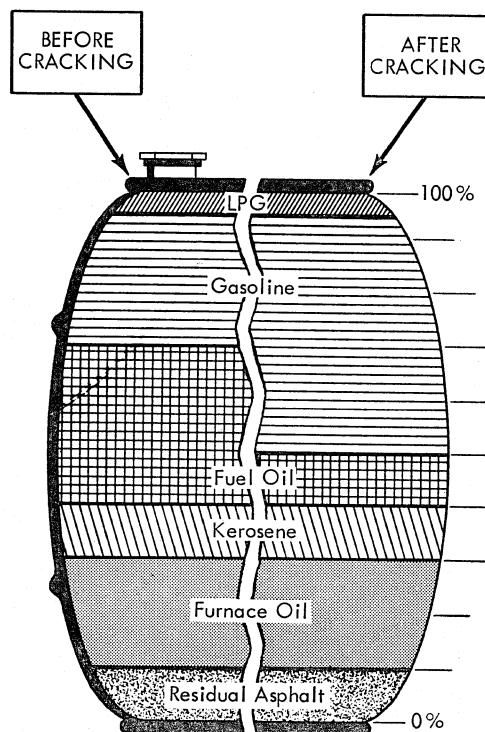

Figure 1. Distribution of Petroleum Constituents

carbon molecule varying in the number and arrangement of hydrogen and carbon atoms. Of these only a few series (a few hundred compounds) have been identified and studied commercially.

The hydrocarbons under high temperatures vaporize and the molecules break up. The fluid catalytic cracking process, using a fine powder as catalyst, speeds up the reaction selectively to produce more gasoline. The catalyst remains chemically unchanged and can be separated easily and reused continually. The heavier hydrocarbon molecules of fuel oil that are cracked result in smaller, lighter, differently arranged molecules, which form some of the constituents of gasoline.

The main elements of the process are two large vessels, a reactor and a regenerator. Streams of heavy oil, recycled from the fractionating tower, and oil from feed storage tanks, are fed into the reactor. At the same time, hot fluid catalyst from the regenerator is fed into the reactor (Figure 2).

As the incoming oil meets the hot catalyst on the way to the reactor, the oil is flashed into vapor. The heavy hydrocarbon vapor molecules are cracked and are rearranged into molecules of gas and gasoline vapor that pass out overhead to a fractionator, leaving the particles of catalyst behind. In the fractionator, the cracked gasoline is separated from the light gases and the heavy fuel oils produced incidentally during cracking.

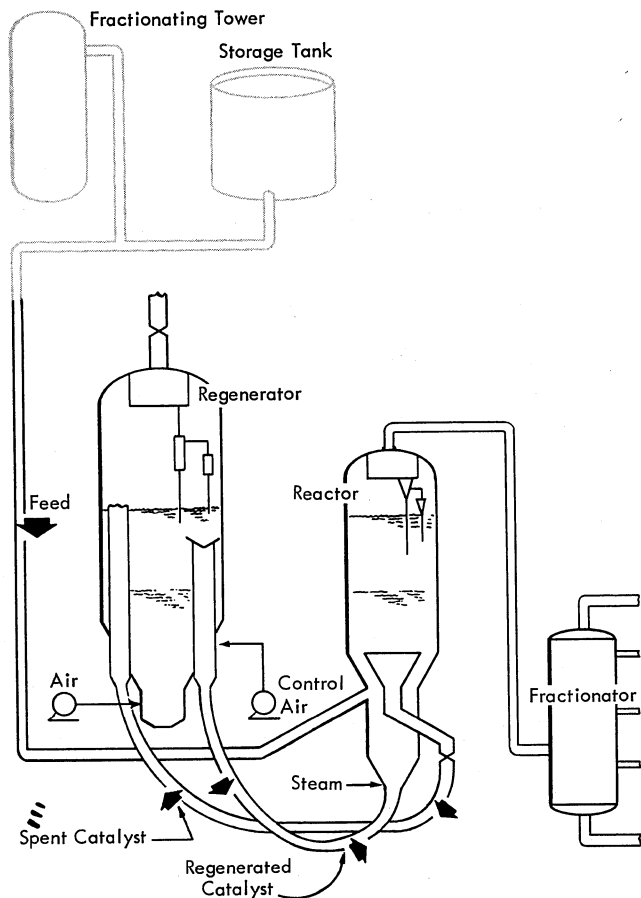

Figure 2. Fluid Catalytic Cracking Process Diagram

Having served its purpose, the spent catalyst returns to the regenerator, where a stream of air is blown through it. Oxygen in the air burns off the film of coke deposited on the catalyst during the reaction. Cyclone separators within the regenerator recover fine particles of catalyst from the flue gas passing out overhead. Farther along the flue gas lines a precipitator recovers most of the remaining particles. The cleansed, regenerated catalyst is ready to resume its work.

Some of the fractions from the fractionating tower are recycled through the catalytic cracker to increase the value of the product. The proportion of light, intermediate, or heavy cuts recycled must be determined by the chemistry of the process as well as by economic considerations.

The catalytic cracking unit is designed for efficient heat balance. Heat is needed in the reactor, along with the catalyst, to bring about the reaction. Heat is generated in the regenerator when the coke is burned off the catalyst. The continuously flowing catalyst acts as the heat transfer medium, maintaining a heat balance between the regenerator and the reactor.

#### SOME VARIABLES IN THE PROCESS

The operator of the cracking process controls many variables: temperature, pressure, flow, etc. The interaction of certain variables together with their effect on other variables in the process is briefly explored here to illustrate the enormously complex ways in which a decision to change any one of these can alter the behavior of the process, favorably or unfavorably. The dependent variable *reactor temperature* is examined.

#### EFFECTS OF A DEPENDENT VARIABLE

*Reactor temperature* must be controlled, directly or indirectly, for it is temperature that chiefly determines the rate of conversion. Reactor temperature depends, in part, on the catalyst circulation rate.

*The catalyst circulation rate* is controlled by the pressure difference between the regenerator and the reactor. Too high a pressure causes the catalyst to circulate too fast and allows insufficient time for it to be regenerated before going to the reactor. Too low a pressure causes the catalyst to circulate too slowly to bring enough heat to the reactor.

*The proper catalyst circulation* involves analysis of the flue gas passing out from the regenerator. Flue gas is of no value; however, like exhaust from an automobile, it does reveal some of the characteristics of combustion. If the oxygen content is low, and the carbon dioxide content is low or the carbon monoxide content high, the operator knows he must increase the amount of air to properly regenerate the catalyst. If the opposite condition exists, he knows the temperature may well exceed the constraints of the equipment and result in damage to the metal cyclone separators in the regenerator.

While reactor temperature is mainly controlled by heat brought over by the catalyst, it can be controlled further by adjusting the rate at which coke is formed, but *coke formation* depends on the nature of the feed.

Feed stocks differ in nature. Some oils give more, some less, gasoline, some more gas and coke, and this is, indeed, another important variable in catalytic cracking. *Feed temperature* is the resultant temperature of the incoming streams of oil from the distillation tower and the cold streams of oil from the storage tanks.

If the temperature of the recycled oil is to be altered, the *proportion of hot to cold feed* must be changed. This creates a disturbance in the *feed characteristics* of the catalytic cracker. The *quality and quantity of the recycled oil* streaming into the catalytic cracker from the distillation tower must be carefully controlled to get the maximum yield of gasoline.

*The recycled oil* used as feed stock complicates the process in other ways because it can create an imbalance, or it can violate some constraint, that is, require more air than is available from the compressor.

Nowhere in the process is there a single valve or switch labeled "reactor temperature." Reactor temperature, regenerator temperature, coke burning rate, flue gas oxygen, and gas production are *responses* to the changes applied to certain independent variables. Calculation of their values, based on the particular feed and the economic objective of the processing, is necessary to achieve the optimum state while staying within the operating limits.

#### FUNCTIONS OF THE VARIABLES

Figure 3 is a block diagram of some over-all process relationships of the catalytic cracker. Figure 4 shows the relationship between two independent variables,  $x_1$  and  $x_2$ , and the dependent variables  $y_1$  and  $y_2$ . Any fixed point in the graph represents a choice of fixed values of variables  $x_1$  and  $x_2$ . The contours represent the yield (objective function) that results for given values of these variables. The object is to optimize the yield. The curves  $y_1$  and  $y_2$  indicate the constraints on  $x_1$  and  $x_2$ , imposed by product specifications or physical limitations of the equipment. The region inside the constraints is the feasible region. Any point within this region corresponds to a choice of values for  $x_1$  and  $x_2$  that keep the process operating without violating any constraints. The optimum is some point, close to these limits, which maximizes the objective function.

The control function, either manual or automatic, consists in regulating the controllable independent variables in a process to compensate for disturbances caused by uncontrollable variables such as composition of the crude oil, so that process objectives are achieved continuously. If the uncontrollable variables did not vary

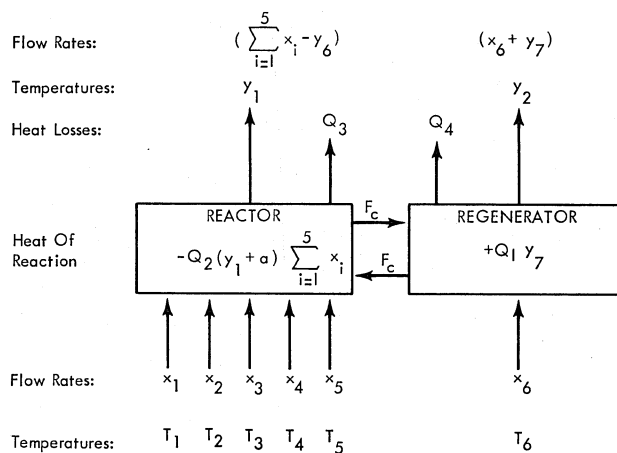

Figure 3. Relationships of Some Variables in the Cracking Unit

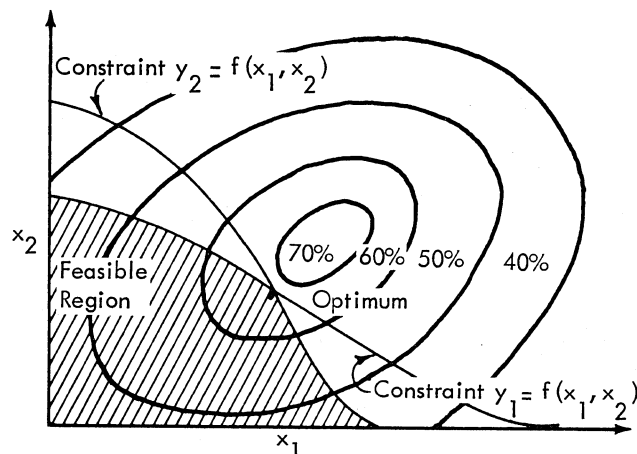

Figure 4. Constrained Optimum

unpredictably, a standard procedure for operating the process to yield maximum profit could be established for use indefinitely and there would be no control problem.

The function of the computer is to rapidly relate the diverse variables and to calculate the most profitable control approach throughout the processing to the industry's best interest.

Processes that are frequently disturbed because of unpredictable variations in composition of the raw materials, feed rates, etc., are good candidates for computer control.

Processes that change infrequently are also good candidates on other grounds. Fluctuations in market demand, seasonal variations, plant wear and tear or catalyst deterioration, which may affect the process gradually, are factors that have a direct bearing on the profit objective. Steady state optimization and control by the digital computer can result in increased profits to these processing industries.

The public utility industry is in a somewhat different class in an operating sense, but stands to benefit as well from computer control. Quality control, in the usual sense, is unnecessary in steam-electric power generating plants since all electrons are the same. Process control by the digital computer is justified for this industry because of random and frequent fluctuations in load, critical demand for immediate power at any moment, interest in making more efficient use of fuel resources and in improving operating efficiency by obtaining the fastest response to the sudden demands for output. The capabilities of the IBM Control System to handle such critical operating problems and to increase efficiency recommend it to the public utility industry.

Figure 5 shows present-day process control with the human operator controlling the process, aided by sensing, indicating and analyzing instruments, and automatic controllers.

Present instrumentation will continue to be used when the process is under computer control. Study preparatory to the building of the mathematical model of the process may indicate the feasibility of instrumenting additional variables; otherwise, it is expected the instruments will remain unchanged.

Inasmuch as the instruments and controllers employed in the process industries form a link in the loop between the computer and the process, the major types are described to acquaint computer personnel with their functions.

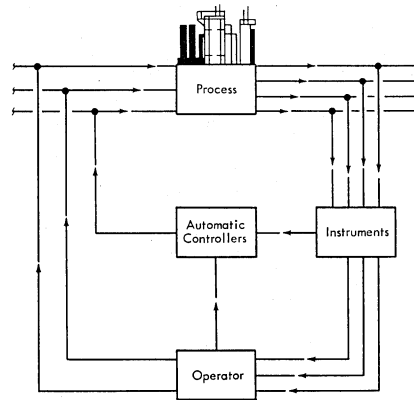

Figure 5. Present-Day Process Control



## Instrumentation

Instruments may be divided into two broad classifications: measuring (analyzing, sensing, indicating, and recording) and control. Instruments in the first class are important to the operator because they are the means by which he reads the status of the process, instruments in the second class because they enable him to control the process.

In modern plants, a central control room houses the important control instruments. Displayed on panels sometimes arranged to represent a schematic of the process, they give the operator an over-all picture and permit him to supervise or control the process remotely (Figure 6). Meters, gages, and indicating and recording instruments indicate to him how important variables are performing.

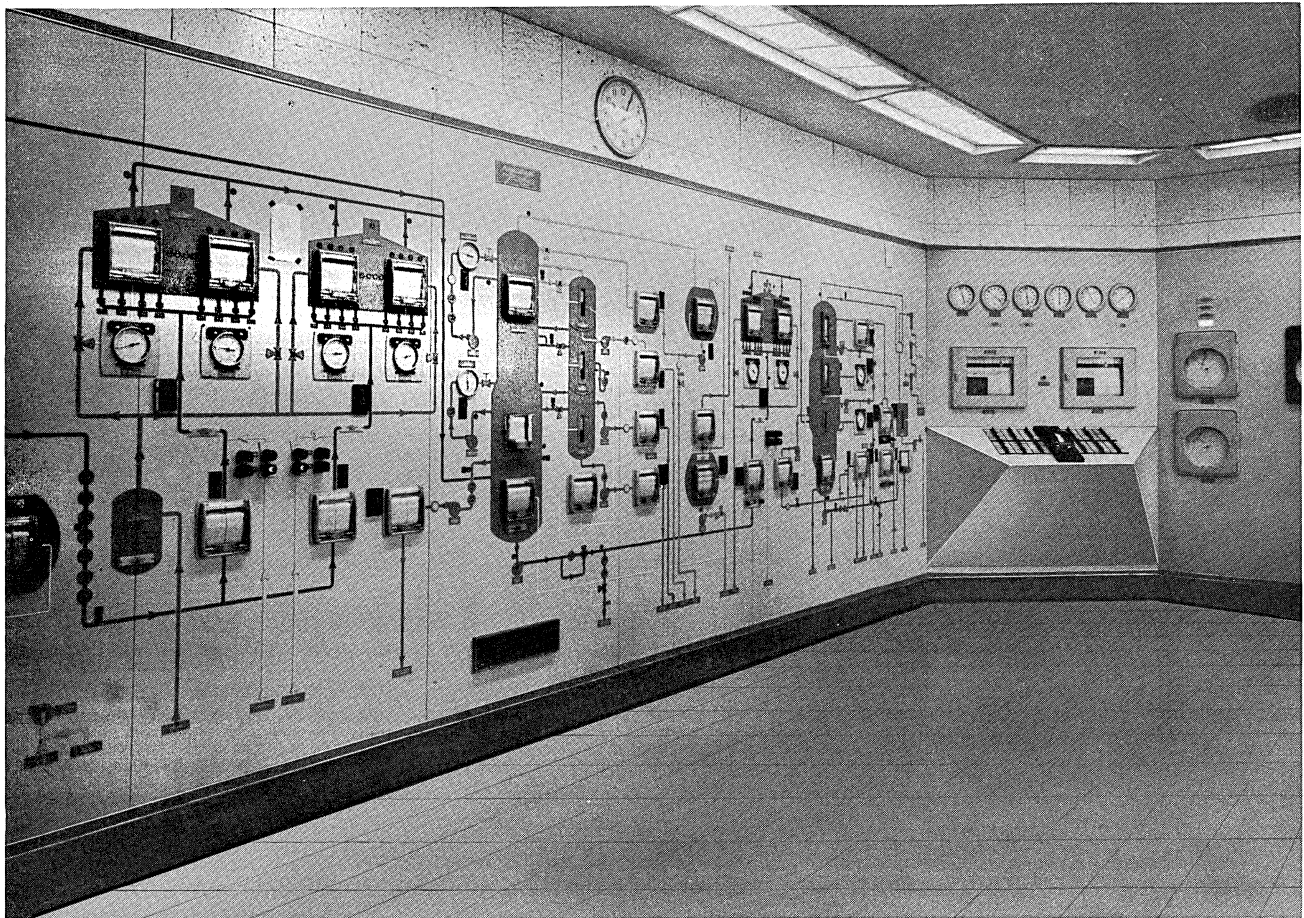

Figure 6. Central Control Room

(Courtesy of American Oil Company)



## Measuring Instruments

Instruments of various types are available to the processing industries for each purpose and each operation. A few of the more commonly used measuring instruments are resistance thermometers, thermocouples, gas-filled and liquid-filled thermometers, pressure gages, flowmeters, and liquid level gages. For analyzing the composition of a stream, there are, among others, mass, infrared, ultraviolet, and nuclear magnetic resonance spectrometers, and gas chromatographs.

Measuring instruments are composed of sensing, indicating, and/or recording elements. The sensing element which is installed on the process may be close to its indicator or recorder or many feet away. Indicators of significant variables are located in the control room where control action is taken.

The method by which the sensing element signals information to the indicator varies; it may be pneumatic or a form of electrical, i.e., analog voltage, analog current, frequency variation, or coded digital. The most common is pneumatic. Recently, analog voltage and current have begun to be used more commonly. Occasionally, pulse duration signals, frequency variation signals and some few coded digital signals are encountered.

Instrument ranges vary, too. In recent years, pneumatic instruments have tended to standardize at 3 to 15 psi. Electronic instruments vary; typical signal ranges include 1 to 5 milliamperes, 4 to 20 milliamperes, 10 to 50 milliamperes, and  $-25$  DC to  $+25$  DC volts.

### Temperature

**Thermocouples.** Thermocouples are the most commonly used temperature-sensing devices. They operate on the principle that when a circuit is formed of two dissimilar metals and heat is applied to one of the two junctions, a voltage or current is developed in the circuit that is proportional to the temperature difference between the two junctions. Several thermocouples employing different combinations of metal are available. Copper-constantan and iron-constantan thermocouples are most frequently used in processing plants. With appropriately chosen thermocouples, temperatures as high as  $9000^{\circ}\text{F}$  and as low as minus  $450^{\circ}\text{F}$  can be measured accurately.

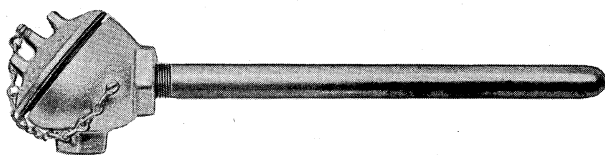

Thermocouple

**Resistance Thermometers.** Resistance thermometers operate on the principle that metals change in electrical resistance with changes in temperature. They are used to measure temperatures from approximately  $-100^{\circ}\text{F}$  to  $1000^{\circ}\text{F}$ . A resistor, wound with platinum or nickel wire generally, sometimes with copper, acts as the detector. The resistance element is usually connected to a Wheatstone bridge and the bridge balanced with a servo system. A change in the shaft position of the balancing slidewire indicates the temperature measurement. Resistance thermometers are used where extra high sensitivity of temperature measurement is required.

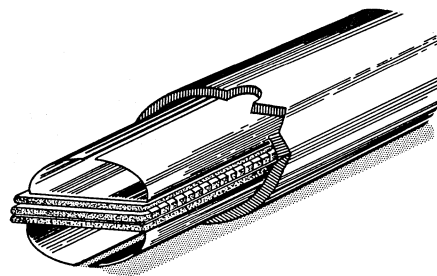

Resistance Thermometer

**Gas-Filled and Liquid-Filled Thermometers.** These thermometers operate on the principle that fluids and gases tend to expand when heated. Expansion of the fluid or gas is transmitted through tubing to a pressure spiral and causes expansion of the spiral, which in turn positions the indicator. Upper limits of temperature measurement are in the order of hundreds of degrees. These measuring devices are used where nonelectrical instruments are desired, where costs of instruments must be minimized, and where instrument sensitivity to small changes in temperature is particularly important.

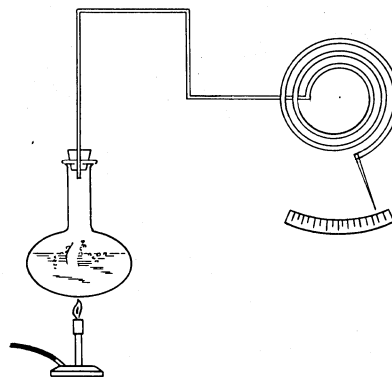

Liquid-Filled Thermometer

## Pressure

**Pressure Gages.** The bourdon tube and spiral are the most commonly used pressure-measuring elements. When pressure is applied to the tube, the tube tends to straighten out, causing the free end to be displaced. Used with a scale, the free end acts as a pointer and indicates changes in pressure. Pneumatic or electrical transmission devices may be coupled to the bourdon tube, or pressure spiral, to transmit the signals to a distance of 1000 feet.

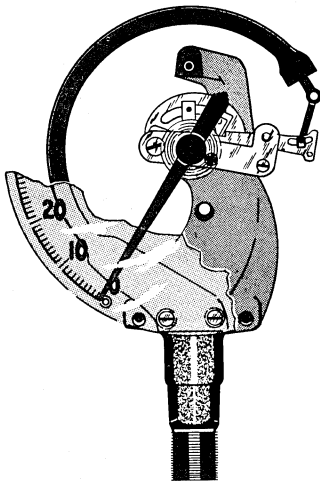

Pressure Gage

## Flow

**Flowmeters.** Many types of flowmeters are available. In the process industries the most commonly used flowmeter is a combination of an orifice plate, or other restriction to flow in the pipe, and a differential pressure meter. By measuring the differential pressure created across the restriction, the flow rate may be inferred. Another commonly used type of flowmeter is the propeller meter. Here a propeller is inserted in the flow line and the number of revolutions it makes per unit time as the fluid flows past is a measure of the flow rate. A magnet on the propeller blade produces pulses that are used to count the revolutions.

A third type of flowmeter is the positive displacement flowmeter. It is similar to the meter found in most residences and is used where precise measurement of flow is necessary. Because of its high cost, its employment in petroleum plants is limited.

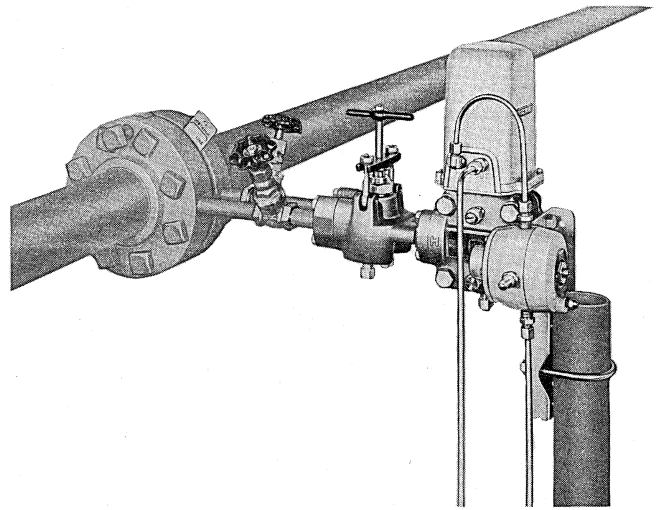

Differential Pressure Flowmeter

## Liquid Level

Liquid level is usually measured by a displacer-type level meter. A float moves up and down as the level changes. This motion is used to indicate, transmit, and/or control the level of liquid in a process vessel.

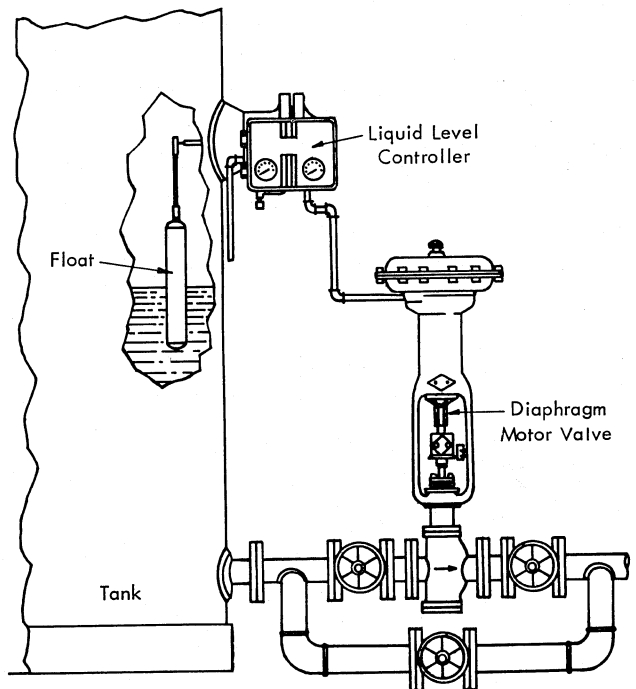

Liquid Level Float

## Analytical Instruments

A number of instruments have been developed to analyze the composition and physical properties of liquids and gases in stream. Among the various methods for accomplishing stream analysis are mass, infrared, ultraviolet, and nuclear magnetic resonance spectrometers, gas chromatographs, and infrared analyzers.

Depending on the sample, one or the other of these instruments is used to obtain the basis for determining the composition of the stream. Each operates a little differently. The infrared analyzer, for example, through a special sensitizing procedure, measures the concentration of certain elements in the process streams.

Analytical measurements such as these, coupled with the temperature, flow, level, and pressure measurements described earlier, are all fed into the computer. The Control System computes values for these variables that will improve process operation, and initiates the proper control action.

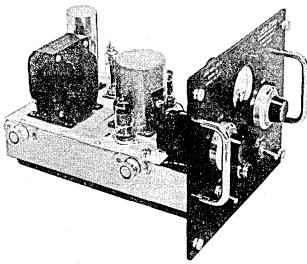

Infrared Gas Analyzer

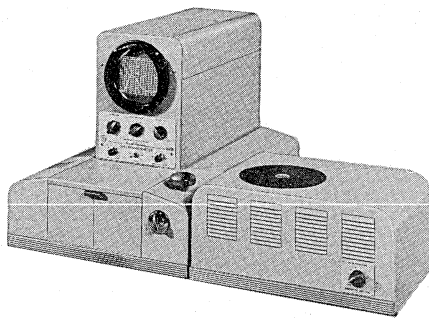

Spectrophotometer

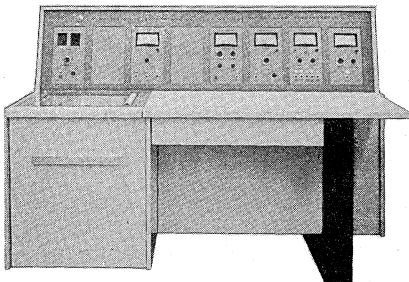

Mass Spectrometer

## PROCESS VAPOR FRACTOMETER

Analyzer Unit

Programmer Unit

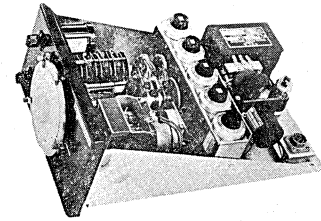
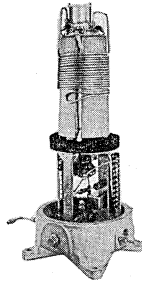

Gas Chromatography

## Automatic Controllers

Automatic controllers were introduced in the process industries in the 1930's and since then have been improved, notably in respect to sensitivity, dependability, and speed. They have become increasingly more sophisticated as industrial processes have grown more complex and their very improvement has contributed to the development of more complicated processes.

Controllers generally control only a single variable. Cascade and ratio control systems, which relate two or more variables, have been designed and are particularly suitable where the variable being controlled is directly affected by one or more other variables in the loop.

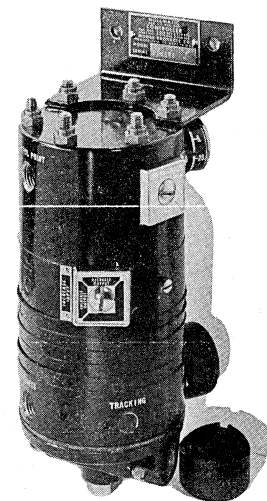

Automatic Controller

Essentially, all controllers maintain a variable at some desired setting by measuring it, comparing it to the set point, detecting the difference, and, based on the error detected, correcting by restoring the variable to the set

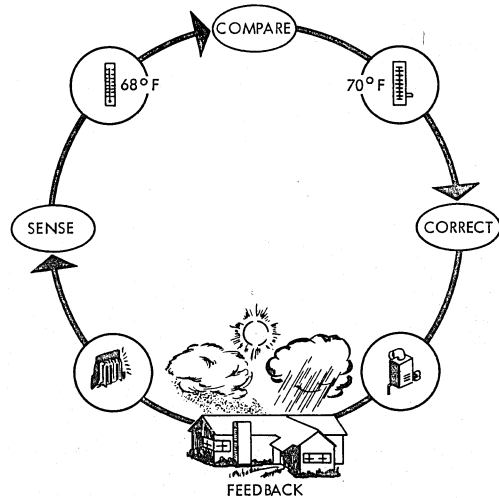

Figure 7. Feedback Control

point (Figure 7). Sensing . . . comparing . . . correcting . . . performed in a closed loop, these functions constitute what is known as feedback control. They are characteristic of any self-regulating system.

Automatic controllers may be hydraulic, pneumatic, electronic, or mechanical in operation, or they may combine one or more of these means. The modes by which they achieve different kinds of control range from simple on-off and floating to the more sophisticated proportional, proportional plus reset, proportional plus reset plus rate action, ratio, and cascade modes. Only the more common modes are described in this manual.

### On-Off

The household thermostat is an example of an on-off controller. When room temperature drops below or rises above the set point of the thermostat, the thermometer acting as a detector registers the deviation, and a signal to correct, either to open or close the fuel valve or final control element to the furnace, is transmitted. If the fuel valve to the furnace is opened, it remains open

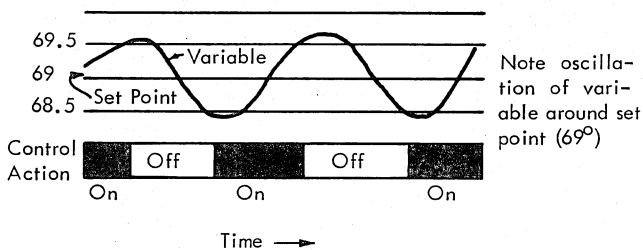

On-Off Control

until room temperature is restored to the set point. If the fuel valve is closed, it continues in that position until room temperature drops below the set point.

On-off action is an all or nothing response to an error signal, consequently it always results in some oscillation or cycling around the set point. Floating control is sometimes preferred because it provides control in an intermediate range and corrects gradually.

### Floating

Floating control, unlike on-off control, offers an infinite number of positions that the final control element can seek. The control is accomplished by a two-directional motor, controlled by an instrument that has a neutral zone in addition to high and low positions.

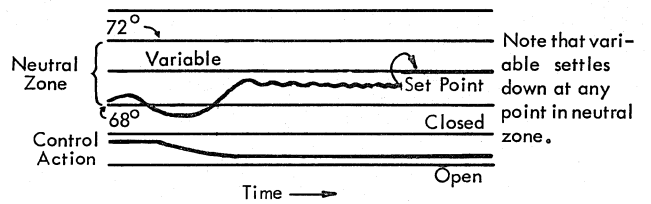

Floating Control

The constant speed motor remains stationary when the instrument is in the neutral zone. When the instrument senses a change in the variable in excess of the neutral zone, either the high or low contact is made, and this causes the motor to move at a constant speed, in the direction that will correct for the change in the variable. When the variable returns within the neutral zone, the motor or final control element stops.

The advantage of floating control is that it reduces oscillation between on and off, because the valve or final control element can assume any number of intermediate positions as required by the load of the system.

### Proportional

In proportional control, as in floating control, the final control element can be positioned in an infinite number of positions between on and off. Proportional control produces a correction that is proportional to the amount the controlled variable deviates from the set point. The controller may or may not return the variable exactly to the set point, because there is only one rate of demand, or load, at which the controller can do this. This deviation of the controlled variable from the set point is called offset or steady state error. Whenever the load varies from this rate, the controller must be manually reset to ensure alignment of the controlled variable with the set point.

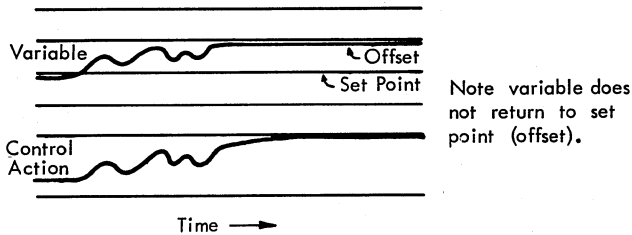

Proportional Control

**Proportional Band.** Proportional band is an expression of the sensitivity of valve movement to a change in the controlled variable. The range through which the valve moves to correct the difference between the controlled variable and the set point is called the proportional band. It is defined as the percentage of instrument span required to move the control valve from full open to full closed.

The width of the band that may be used in a particular process is determined by the characteristics of the process and of the valve or other device in the control loop. A typical wide band may be 200% and a narrow band 10%. The wide band results in smaller corrections, the narrow band in larger corrections and smaller offset. A narrow band ordinarily is used where the process is slow, e.g., temperature measured in a large furnace. A wider band is used on fast processes, e.g., control of flow.

**Proportional plus Reset**

The effect of reset action is proportional to the integral of the deviation with respect to time. Hence, it is also called integral control. A proportional plus reset controller corrects in proportion to the deviation of the controlled variable from the set point and in proportion to the time integral of the deviation.

Proportional action in combination with reset action, commonly referred to as two-mode control, is able to compensate for load changes and maintain the controlled variable at the set point. Offset is thus reduced. Proportional plus reset is preferred when the process is subject to frequent load changes and continual de-

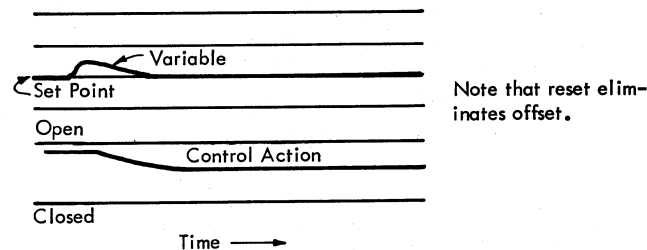

Proportional plus Reset Control

viation or manual reset is undesirable. Fast processes such as control of flow tend to be the most significant applications of two-mode control.

**Proportional plus Reset plus Rate Action**

Proportional plus reset plus rate action control is the sum of three modes of response to a deviation of the controlled variable. Rate action, also called derivative, is control action that is proportional to the speed at which the deviation is changing.

The proportional plus reset plus rate action controller takes into account the amount of deviation of the variable from the set point, the time integral, and the rate at which the variable is changing, and corrects proportionally to all three factors. It is suitable, therefore, for control of process variables that are subject to varying load conditions, both in size and rate.

Temperature processes, because they are inherently slow, require use of three-mode controllers to produce faster control action.

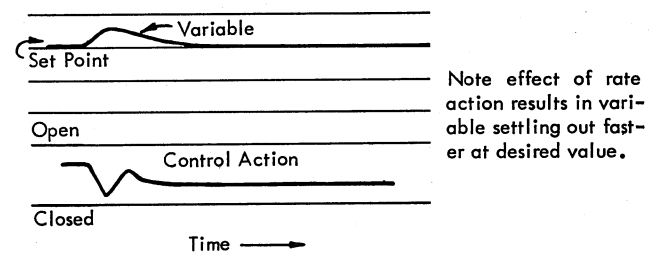

Proportional plus Reset plus Rate Action Control

**Ratio Control**

Control of two or more variables is possible with a ratio controller as long as there is a fixed relationship between the independent variable, often referred to as the primary variable, and a dependent variable, referred to as the secondary variable.

The independent variable may be a variable that is automatically controlled or it may be a free variable, i.e., one that is measured but not controlled.

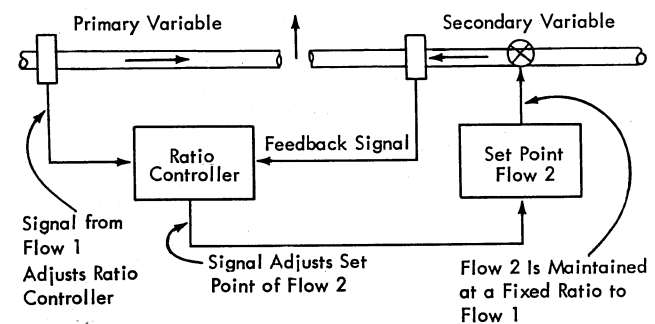

Ratio Control

When there is a fixed ratio between the variables, this type of controller is widely used. It is commonly employed to control flow, but it can be used to control temperature and pressure as well.

### Cascade Control

In cascade control, two or more controllers are connected in series and interlocked to relate two or more controlled variables. There is no fixed ratio between the variables.

It is useful when the lag coefficient is long and correction of the primary variable requires correction of another variable to produce the proper output to the process. Simple feedback control is inadequate here, for an output of the controller that is proportional to the deviation of the primary variable does not correct for the influence of the secondary variable until it has been reflected in the process sometime later.

A temperature controller used to control the fuel line to a process illustrates the problem. The load changes demanded by the process cause the temperature controller to position the fuel valve to correct the flow rate so as to maintain the temperature at the set point. When the flow rate through the fuel valve varies because of pressure changes upstream, the temperature controller cannot correct for resulting changes in heat until these changes are reflected in a temperature change elsewhere in the process.

Cascade control provides the answer by linking the controllers. A flow controller is installed on the line to correct for changes in fuel flow caused by varying line pressures. It is connected to the master (temperature) controller. Based on the temperature measurement, the

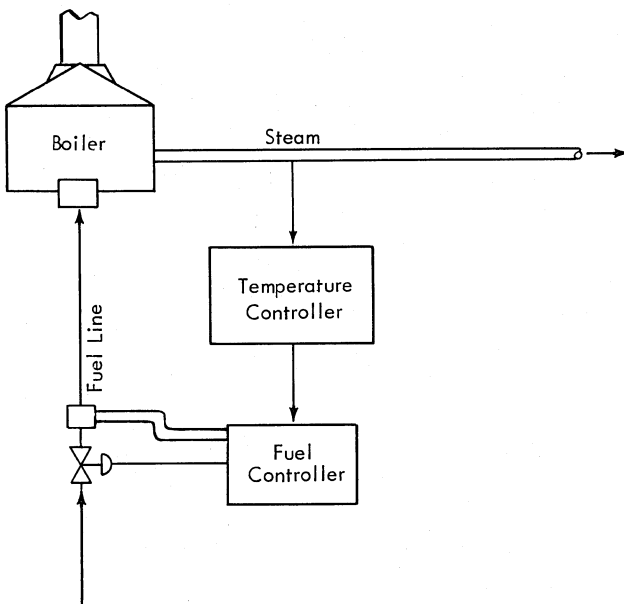

Cascade Control

flow controller's set point is changed so as to change the flow demanded by the process load. Now the set point of the two maintain the temperature within narrow limits as required by the process.

A proportional plus reset action controller is generally used as the master controller. The extent of sophistication available in cascade control is, normally, interaction of three variables.

### Analog Computing Elements

Small pneumatic, electromechanical, mechanical, or electronic computing devices are often used in process control. These allow performance of simple calculations such as multiplying, dividing, or taking the square root. At most they handle only two or three variables.

### Limitations of Analog Control Systems

Automatic controllers are analog controllers. Once their set points have been determined, they efficiently maintain process conditions at the desired values. The operator determines their set points on the basis of his experience, judgment, and various computations made with the help of engineering charts and nomographs that are supplied to him. Since the automatic controllers are not self-determining with respect to their set points, they cannot optimize the process.

A petroleum refinery process supervisor may supervise and control 50 automatic controllers representing temperature, pressure, flow, and similar variables. Sometimes, he is aware that a change in the set point of one of these controllers will improve the yield. If he is unable to estimate the indirect effects of the change on the process, he may make only a partial adjustment or none. If he were to perform the necessary calculations to determine the effects, it is more than likely that his results would be inapplicable, since conditions in the process change continually.

Many plants operate on the theory that it is better to avoid disturbing the process. This maintaining-the-status-quo method of operation yields less than the process is capable of, but it is safe, and it probably was justifiable in the era before digital computer process control.

One other aspect, briefly mentioned, is that the automatic controllers control only a single variable. They do not provide coordinated control action whereas the variables they control are interrelated in highly complicated ways. Even ratio and cascade control, which do relate two or three variables in simple ways, are used by industry to a limited degree because of the complexity of adjustment and application. Integrated control of a large process cannot be achieved practically with present analog control equipment.

What is needed is an overseeing intelligence capable of

- Storing hundreds of thousands of items of information about the process.
- Performing permutations and combinations of solutions for the dependent variables, which cannot be measured directly, by substituting values for the independent variables.

- Performing involved mathematical calculations rapidly and accurately, taking into account a large number of pertinent economic and market statistics, and of almost simultaneously effecting the control action necessary.
- Performing these operations consistently, continually, and repeatedly with no diminution in the speed or accuracy of performance.

## Digital Computers and Process Control

Before examining the applications of IBM control computers to process control, some of the terms frequently used to describe the various computer applications are defined below.

### Basic Definitions

*Off line* refers to a computer that is fed data indirectly by means of punched cards, tape, typewriter, or similar equipment. *On line* refers to a computer that obtains data directly from the process. Degrees between complete off line and complete on line and hybrids are possible.

*Open loop* refers to a computer whose output does not go directly to the process. The system is not, therefore, totally self-correcting. *Closed loop* refers to a computer that is connected directly to the process. Its output completes the loop to make the system self-correcting.

*Operator Guide Control* may be *off line*, *open loop*, involving manual collection and transmission of instrument readings to the computer by means of punched cards, tape, or typewriter, and a visual data output from the computer or *on line*, *open loop*, in which the computer obtains data directly from the process and displays or prints out the output for the operator, to assist him in determining the proper settings for the process controllers.

*Process Control, On Line, Open Loop*, also refers to a computer that is fed data directly from the process and that prints out an output for the operator, but in this instance the computer determines the optimum set points. The operator merely resets the controllers.

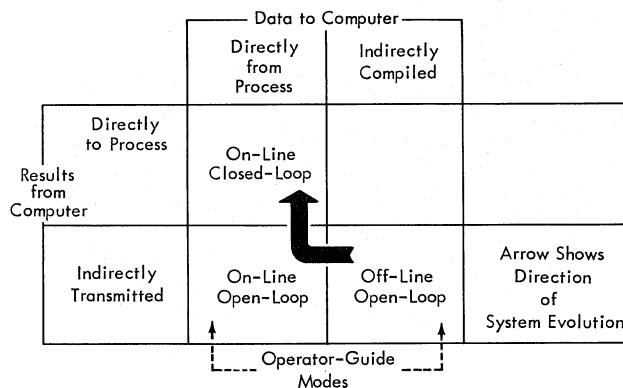

Types of Control

*Process Computer Control, On Line, Closed Loop*, brings the computer directly into the feedback loop by connecting the instrumentation to the computer through an analog-to-digital converter. The computer optimizes and applies control action directly to the process, actuating the valves, setting the controllers, etc., via analog output devices, thereby producing results in real time as changes occur.

### Applications

At least three distinct levels, possibly more, exist for applying digital computers to process control. The first level is data reduction, the second is operator guide control, and the third is on-line, closed-loop, process control.

### Data Reduction

Process data collected automatically without human intervention gives a true and accurate picture of industrial processes. A digital computer integrally tied to the data collection unit (Figure 8) provides a powerful system for analyzing process data by mathematical techniques. Empirical methods, correlation techniques, and/or regression analysis of the process data can give better understanding of the process and lead to the construction of a mathematical model.

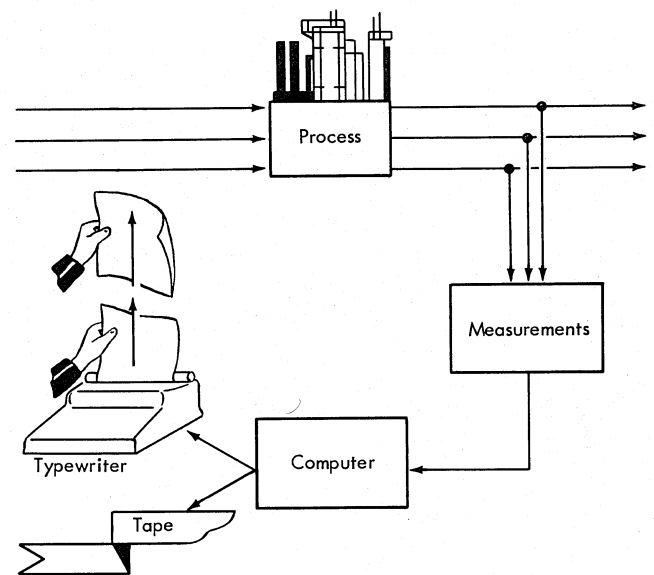

Figure 8. Data Reduction



The IBM Control System provides an ideal system for data reduction applications. It scans analog process signals, converts them to digital form, and enters them into the computer. Reduced data may be printed by the typewriter or punched in paper tape. The system used for data reduction can be expanded by adding special features, as required, to provide complete, closed-loop control.

**Operator Guide Control**

Operator Guide Control includes all aspects of data reduction, as well as the calculation of guides to assist the operator in controlling the process. The principal difference between the two applications is in the use that is made of the computer. Operator guide control requires a greater understanding of the interplay between variables.

Typical calculations associated with operator guide control may be those involved with on-line analyzers such as chromatographs or mass spectrometers . . . calculation of secondary variables which are functionally related to the measured variable . . . calculation of other quantities such as heat and material balances that are of value to the operator in adjusting the process for greater operating efficiency or quality control.

Figure 9 shows an Operator Guide Control type of system. Electrical signals from the process are sampled and entered into the computer. The calculated results are printed by the typewriter. The operator uses the information to better control the process. The IBM Control System is suitable for operator guide control.

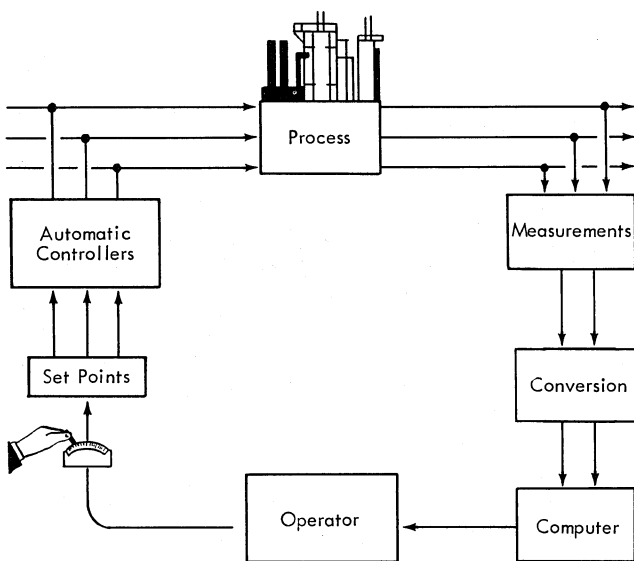

Figure 9. Operator Guide Control

**Closed-Loop Control**

Closed-loop control (Figure 10) allows the process to be monitored and controlled by the digital computer on a real-time basis. Immediate action is taken by the computer to bring the process to its optimum operating point. All elements of Operator Guide Control are encompassed in closed-loop control, and, in addition, electrical outputs to the process from the computer allow the plant to be brought swiftly and safely to its optimum operating point as conditions in the plant change. The IBM Control System is an excellent system for closed-loop control.

**Mathematical Model**

The mathematical model consists of equations that represent the relationships between the variables in a process. As pointed out in the description of the Fluid Catalytic Cracking Process (see MODERN-DAY PROCESSING), those relationships are very complex. The dependent variable, reactor temperature, is shown to be dependent on catalyst circulation rate, coke burning rate, feed stock characteristics, the temperature of the recycled oil, regenerator temperature, and others; the effect of a change in one variable upon the other process variables cited is shown often to be indirect and far-reaching.

To predetermine the effects of changing a variable on other process variables, the computer is provided with a math model of the process. This model includes the physical and chemical equations and the empirically determined relationships of the process, in which the values for the dependent variables are expressed as functions of the independent variables and hence the behavior of the process may be described by this model.

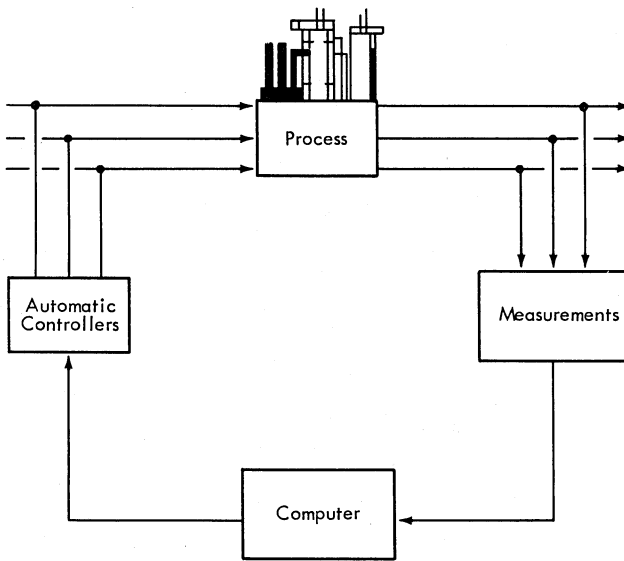

Figure 10. Closed-Loop Control

With this mathematical model, the computer is able to foresee the result of a control action and to determine the best combination of control actions from numerous possible combinations of control moves. It does this without disturbing the process.

The math model is a necessary step in developing the program for the Control System. The mathematical model may be developed analytically or experimentally. The analytical approach is an attempt to write the relationships between the desired variable, e.g., heat and material balances or reaction equations without relying wholly on plant data. This approach presumes an expert knowledge of the process and the fundamental physical and chemical phenomena that govern. Such complete knowledge rarely exists for most continuous processes.

The experimental approach is used when there is insufficient knowledge about the process to develop a model analytically or when the mathematical difficulties are insurmountable. Data obtained from the plant during normal operation or during experimental runs is used to empirically determine, by regression analysis, the parameters of the chosen functions.

It may seem easiest to use data obtained during normal operation of the plant, but, in practice, the use of information resulting from carefully preplanned experimental runs with created disturbances has proved far more effective.

A mathematical model, then, is a mathematical description of the process. Its purpose is to represent the workings of the process so that process performance can be optimized.

### **Static Model**

A process is said to be in steady state when none of its variables are changing with time. The static model, which is necessary for optimization, comprises the mathematical relationships that exist between the process variables when the process is in the steady state. These mathematical relationships or equations are derived from the chemistry and physics of the process, and implicitly relate each of the independent variables to the dependent variables.

Seldom are the independent variables explicitly stated in these equations. If they were, one could sub-

stitute values for the variables and determine the effects of manipulating each input on the output without disturbing the process. The equations themselves are usually nonlinear. This introduces a further problem in that general straightforward techniques such as exist for linear functions are not available for solution of nonlinear equations.

One alternative is to calculate the effects of small changes in the independent variables instead of solving for arbitrary values for them. During normal operations the required changes normally are small.

Besides the equations in the static model, other equations representing the profit objectives and the physical constraints of the plant must be written. For example, if pressure in the reactor is not to exceed 100 psi, the inequation  $P_R < 100$  psi is necessary. The economic objective equation is written in whatever terms management seeks to optimize its operation. It may be in terms of maximum throughput, maximum conversion, maximum yield, minimum unit cost, maximum production of high-value products or a combination of one or more of these.

### **Dynamic Model**

A process is in the dynamic state or transient condition when the process variables are changing with time. Transients are phenomena that occur when the process is proceeding from one steady state to another. A dynamic model of the process is required for dynamic optimization and control. It contains the static model and in addition gives the relationships that are true for the process in all time.

Experimental techniques for building the dynamic model are not so well developed as those for building the static model. Methods exist for determining system dynamics of linear systems by exciting the input with impulse, step, ramp or sine function signals, or random noise, and observing the corresponding output. They can be extended to multi-input, multi-output systems.

Cross-correlation and autocorrelation techniques can be used when normal operating records are all that is available, but, again, as in static optimization, methods based on planned excitation are more effective.

## Control System Functions

The essential functions performed by the IBM Control System are evaluation, optimization, and control.

### Evaluation

In the evaluation function, the computer calculates estimates of the values of those variables that are significant to control of the process yet not directly measurable; quantities like boiler efficiency, catalyst activity, and yield. Some processes have a few variables that cannot be measured directly, others like the distillation process have many. The estimates are necessary to determine the operating state of the process.

Before optimizing a process, it is necessary to know what the process variables are doing at present and to predict what is going to happen to the process if all variables continue in the direction they are going. The computer performs this predictive function by reading instruments attached to the process variables, by extrapolating or interpolating other values calculated or obtained from lookup tables stored within it, and by making further calculations. Table 2 shows the large number of measurements read by the computer in a typical process.

Table 2. Instrument Distribution  
Catalytic Reforming Process

Variable Measured	Functions		
	Logging	Alarming	Integrating
Flow	21	5	16
Pressure	7	6	—
Temperature	87	11	—
Composition	3	3	—
Total	118	25	16

The computer, because of its inherent speed of calculation and facility for handling a tremendous number of factors logically and simultaneously, produces accurate estimates. On the other hand, the estimates of the operator are very rough. These are the best he can hope to make in any reasonable, meaningful period of time.

Quantities like boiler efficiency, catalyst activity, and others, which summarize a considerable amount of information about the state of the plant, are very useful if made available immediately to operators for them to then make appropriate adjustments to the controllers. Providing rapidly computed operating guides

of this kind can improve process performance and may be regarded as an early stage in the logical sequence toward on-line, closed-loop digital computer control.

A further step performed in the evaluation function consists of data editing and correction, checking for consistency to eliminate gross errors, giving an alarm when a variable that is measured directly or is calculated exceeds the upper or lower limits established, and periodically printing out other quantities to satisfy accounting requirements.

### Optimization

The mathematical model of the process is stored in the computer. It is used to determine the adjustments that should be made to the controllable variables to bring the plant to optimum operating performance. The computer determines, in advance, which values for these variables will cause the process to move to the optimum point. It does this by mathematically manipulating values for the independent controllable variables into the equations and by calculating the effects of each change, using some of the information previously developed in the evaluation function to arrive at the optimal values. It should be noted that the optimization calculations in no way affect the plant, for they are done entirely on the model.

Figure 11 presents the principle of optimization graphically. The coordinates represent the independent controllable variables, which can be designated  $x_1$  and  $x_2$ . The constraints on these variables are the curves,  $y_1$  and  $y_2$ , representing physical limitations of the equipment or limits imposed by product specifications. The contours represent the yield (objective function) that results for given values of these variables. The object is to optimize the yield. Figure 12 represents the function in another way. The constraints are not shown.

Many functions are difficult to present graphically, not only because they are nonlinear and behave in an uneven manner but also because they are multidimensional. Figures 11 and 12 show a two-variable function because it is easier to present graphically. If 70% yield is regarded as the mountain top, the other contour lines represent lower levels. Assume that the constraints are fences and that the feasible region is bounded by these constraints. The goal then is to get to the highest point possible within the feasible region. That point represents the constrained optimal values for  $x_1$  and  $x_2$  which, when applied to the process, will bring the plant to the optimum operating state.

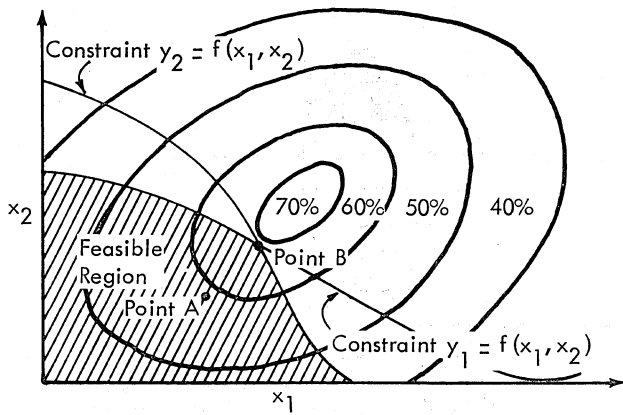

Figure 11. Optimum of a Function

In Figure 11, point A represents the values for these variables before optimization. With these values the yield is between 50% and 60%. Point B which represents the new values established for these variables by the optimization calculations is closer to the true limits. It increases the yield to approximately 70%.

When the objective function and constraints are linear, the optimal values for the variables can be found by using linear programming. The problem is more difficult for nonlinear functions. Special techniques must be employed. One method consists of linearizing about a point, using partial derivatives, and then finding the optimum based on that limited region, using linear programming. As soon as the provisional optimum is found, it is again necessary to linearize about that new point to find a better optimum and to repeat in this way until the true optimum is found. By using successive approximations over linearized segments, the true optimum is established.

Another method is the gradient method in which the direction of steepest ascent is determined at some base starting point and a small step is taken in that direction. At that point the direction of steepest ascent is again evaluated and the procedure is repeated. There are a number of gradient methods that can be used; the difference between them is in the strategy employed after a boundary is encountered.

### Control

After the computer has determined or estimated values for the variables on the basis of the present state (evaluation function) and has computed the dynamic characteristics of the plant, optimizing the variables for, say, a period of 60 minutes in the future, the computer during the control phase of the calculation determines the manner in which the independent variables should be manipulated to bring the plant rapidly to the desired optimum without exceeding operating limits (Figure

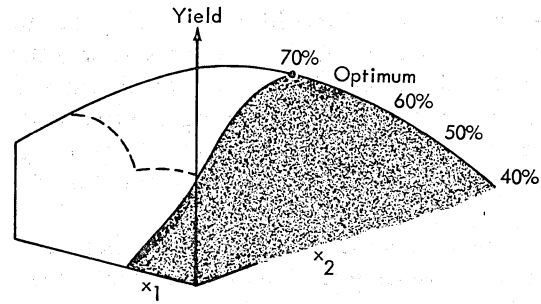

Figure 12. Optimum Determined by Method of Steepest Ascent

13). It applies set point changes to specific controllers. The process moves toward the optimized steady state.

For processes that are sluggish, computer control may be used to compute a certain strategy so that the process will reach a predetermined point in the shortest time. If process response to disturbances is sufficiently slow, practically all available improvement in plant operation can be obtained by steady state optimization. If, however, the plant is subject to transients over most of its operating time, dynamic optimization is required.

As part of the control strategy, the computer estimates the dynamic effects of the calculated change on the process, and applies a large change immediately and rapidly for maximum gain unless this creates instabilities. In this event, the computer makes the change incrementally, in effect smoothing it.

Frequent disturbances or inaccurate predictions as to the composition of the raw material can prevent dynamic processes from reaching the calculated, optimized steady state. The control strategy of the com-

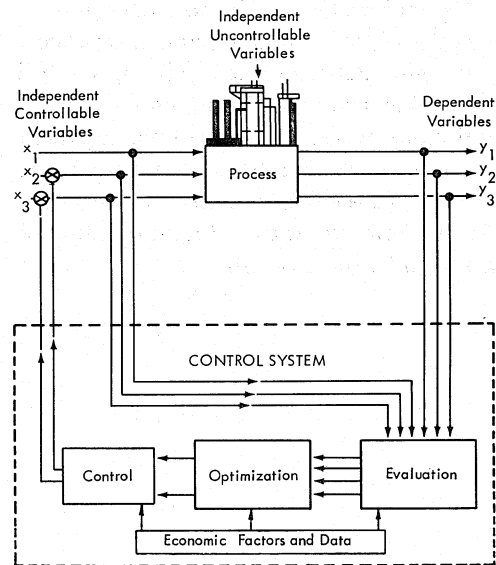

Figure 13. Diagram of Computer Optimization and Control of a Process

puter overcomes these difficulties by looking ahead and by applying the calculated values for, say, only the first 15 minutes of the hour-long projection. At the end of another 15 minutes the computer again projects its calculations on the basis of what the process is doing, to a new optimized steady state 60 minutes in the future.

This technique of looking much farther ahead and of continually reassessing the condition of the process enables the computer to minimize any errors in prediction and to compensate for unanticipated disturbances as they occur. By determining the maximum change that can safely be made in the smallest interval, the computer optimizes process performance rapidly and safely.

The operator's control of a process is admittedly less than optimum; less than he desires. His conservative control action stems from a fear of upsetting the process. Knowing his calculations and estimates are rough, he hesitates to approach the upper limits on the chance they might well exceed operating limits that would be established by more refined calculations. So, he adopts a middle-of-the-road course and controls the temperatures, pressures, flows, etc., well within the safety tolerances.

The computer makes more efficient use of plant facilities and optimizes process performance without jeopardy to the plant by controlling the process in an integrated manner and by operating closer to the actual safety limits.

## IBM Control System

The IBM Control System is modular, flexible in design, expandable, and sufficiently powerful to encompass all types of process control, from data logging and process study, to process optimization and closed-loop control (see Figure 14). The transition from one phase to another is a continuous implementation of management and process requirements, and the end result is the complete correlation of economic incentives with the physical aspects of plant operation — the integration of operations control and process control.

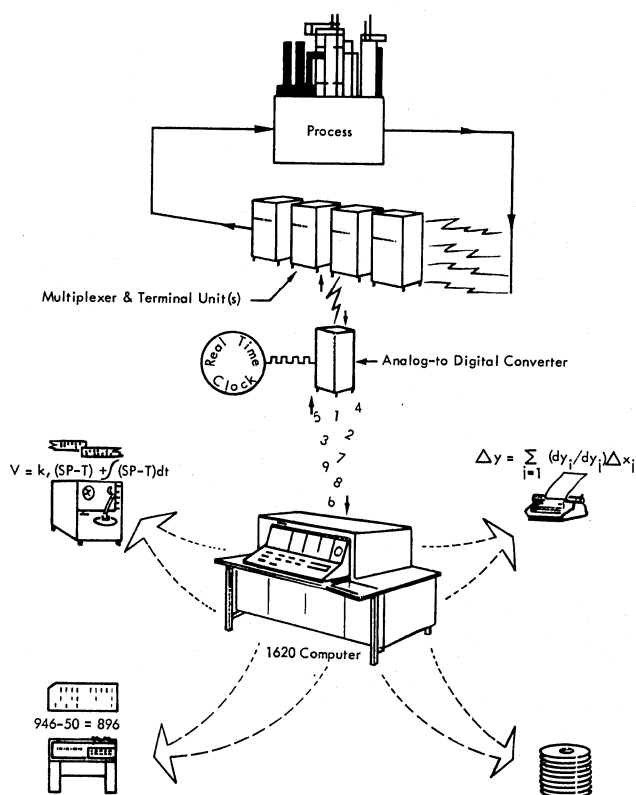

Figure 14. An IBM Control System Configuration

## Advantage of Computer Control

The methods of computer optimization and control just described were applied to a process in a large refinery. Values for the variables in the process were raised or changed only slightly, yet they resulted in an increase of thousands of barrels of gasoline a day, and, because of the volume, a substantial increase in profits. It is significant that this was obtained for a process of petroleum refining, since that industry is known to be progressive and already actively endeavoring to operate close to optimal levels.

## Bibliography

*Automatic Control*, Scientific American reprint. New York: Simon & Schuster, 1955. Paperback.

Excellent nontechnical treatment of feedback, information control theory, and automation in industry.

Bell, H. S., *American Petroleum Refining*, New York: D. Van Nostrand, 1959.

A general description of the various processes in petroleum refining.

Box, G. E. P., *Some General Considerations in Process Optimization*. Stat Tech RES Group, Tech Report 13, April 1958, Princeton University, Princeton, New Jersey.

Theoretical discussion of various considerations in optimizing processes and a description of the method developed by the author.

Ceaglske, Norman H., *Automatic Process Control for Process Engineers*. New York: John Wiley & Sons, 1956.

Mathematical description of various modes of automatic control. Includes graphs of control and of process response characteristics.

Campbell, D. S., *Process Dynamics*. New York: John Wiley & Sons, 1958.

Description of dynamic behavior of industrial processes from viewpoint of control theory.

Considine, D. M., *Process Instruments and Controls Handbook*. New York: McGraw-Hill, 1959.

Basic, comprehensive volume on process instruments. Emphasis is on the mechanics of their operation.

Eckman, Donald P., *Automatic Process Control*. New York: John Wiley & Sons, 1958.

Presents important principles of automatic control. Includes equations, charts, illustrations, and sample problems. Intended for engineering undergraduate. Good basic text.

Eckman, Donald P., *Industrial Instrumentation*. New York: John Wiley & Sons, 1958.

Reviews principles of measurement and measuring instruments. Emphasis is on their method of operation rather than on the mechanics of operation.

Eckman, Donald P., *Industrial Process Control*. New York: John Wiley & Sons, 1956.

Good presentation of instrumentation and automatic controllers in industrial process control. Covers circuitry, response characteristics, reaction curves and other aspects of the transfer function.

Gass, S. I., *Linear Programming*, New York: McGraw-Hill, 1958.

Thorough, mathematical treatment of linear programming.

Grabbe, F., S. Ramo & D. E. Wooldridge, *Handbook of Automation, Computation & Control*. Vol. 1, *Control Fundamentals*; Vol. 2, *Computers and Data Processing*; Vol. 3, *Systems and Components*. New York: John Wiley & Sons, 1958.

These three volumes were compiled to provide an encyclopedia on the subjects of automation, computers, and control.

Grabbe, F. M., *Automation in Business and Industry*. New York: John Wiley & Sons, 1957.

Compilation of lectures by prominent scientists and engineers on all aspects of automation as applied to industrial control systems. Examination of analog and digital computers, data processing, and industrial instrumentation.

Hengstebeck, R. J., *Petroleum Processing, Principles and Applications*. New York: McGraw-Hill, 1959.

Describes petroleum processes and ways of designing the physical plant.

Holzbock, Werner G., *Instruments for Measurement and Control*. New York: D. Reinhold, 1955.

Description of instruments and automatic controllers of every type and manufacturer. Emphasis is on hardware and use. Actual photographs rather than schematic diagrams of instruments are shown. Includes spectrometers and some of the newer stream analyzers.

Nelson, W. L., *Petroleum Refinery Engineering*. New York: McGraw-Hill, 1958.

Basic, comprehensive, authoritative text on petroleum refining processes. Covers chemical and physical properties of petroleum, fluid mechanics, heat transfer, refining processes, etc.

Reid R., and others, *Flow Measurement with Orifice Meters*. New York: Van Nostrand, 1951.

Good reference text on flow measurement.

Salisbury, J. Kenneth, *Steam Turbines and their Cycles*, New York: John Wiley & Sons, 1950.

Study of steam power plants, design and installation of turbines, etc. Basic information on thermodynamics is included.

Savas, E. S., *Bibliography for Industrial Process Control*. New York: IBM Peekskill Laboratory, 1960.

Comprehensive bibliography on all aspects of industrial process control.

Skrotzki, Bernhardt G. A., Editor, *Electric Operation, Steam Stations*. New York: McGraw-Hill, 1956.

Covers steam, steam generators, heaters, instruments, station control, etc. Contributed to by six authors as-

sociated with public utilities or allied companies. Good background information.

Skrotzki, Bernhardt G. A. and William A. Vopat. *Power Station Engineering and Economy*. New York: McGraw-Hill, 1960.

Basic text on steam-electric power generation. Chapter 19 on Station Controls lists variables instrumented and controlled from control room; also their effects on other variables.

Truxal, J., *Automatic Feedback Control Systems Synthesis*. New York: McGraw-Hill, 1955.

Standard, comprehensive text on control theory.

Zerban, Alexander H. and Edwin P. Nye, *Power Plants*. Scranton, Pennsylvania: International Book Company, 1957.

Textbook on steam generators. Sample problems and solutions given. Defines such factors as load, output, operation, etc.

- Analog-to-Digital Converter.** The analog-to-digital converter changes analog signals to digital values for computer use.
- Bottoms:** In petroleum refining, that part of the feed remaining in the vessel or still at the end of the run.
- Bubble Tower:** The most common type of fractionating tower.
- Cascade Control:** Interlocking of two or more controllers to relate two or more variables. The set point of the secondary controller is regulated by the output of the first controller to maintain the primary variable at the set point.
- Catalyst:** A substance which causes or speeds up a chemical reaction without itself undergoing chemical change.
- Constraints:** Limits on process variables set by equipment or product specifications for reasons of safety, acceptability, etc.
- Contact Operate:** Contact operate instructions cause process voltages to be connected to process indicators, pumps, motors, or other devices by means of computer-operated relay points.
- Contact Sense:** Contact sense instructions determine the status, open or closed, of electrical contacts. A closed contact, for example, may represent the status of a process device such as a pump running, a tank overflowing, or a closed valve.
- Control:** The ability to bring a plant or process to any desired state and maintain it there.
- Control Signal:** The signal which energizes the valve or other actuator to take corrective action.
- Control System, On-Line, Closed-Loop:** In which the Control System is connected directly to the instrumentation through an analog-to-digital converter to complete the feedback loop. The computer optimizes, then applies control action directly to the process by actuating the valves, setting the controllers, etc. via analog output devices, and thus produces results in real time as changes occur.
- Controllable Variables:** The independent variables such as temperatures, pressures, air and liquid flow rates, etc., that can be manipulated.
- Cracking Process:** Several types of cracking processes, thermal, flat bed, moving bed, fluid, are used to break up the heavy molecules of oil to produce gasoline with a higher octane value. All except the thermal cracking process use a catalyst in some way.
- Crude:** Short form for crude petroleum, which is an organic, oily liquid found in the upper strata of the earth.
- Cycling:** Oscillation of a variable around the desired value or set point.
- Dependent Variables:** Temperatures, pressures, concentrations, etc., resulting within the process. Effects of the inputs. They cannot be directly controlled.
- Derivative Action:** Also called rate action. Control action that furnishes a correction proportional to the rate of change of the deviation.
- Deviation:** Difference between actual value of a variable or condition and desired value.
- Disturbances:** Effects of uncontrollable variables on process, e.g., composition of oil, which must be compensated for by manipulation of independent variables.
- Dynamic State:** A process is in the dynamic state or transient condition when the process variables are changing with time.
- Dynamics (of a Process):** Those relationships existing between the variables during transition of the process from one condition to another condition.
- Error:** Difference between actual value of a variable or condition and desired value.
- Feedback:** Applied to a system which is continually comparing its output with its input and making corrections. If closed-loop, the feedback system is self-correcting.
- Final Control Element:** Valve or other device which is changed by the controller to correct the value of the variable being manipulated.
- Flash:** To partially or completely vaporize as a result of a sudden change in pressure.
- Flash Point:** The lowest temperature at which the petroleum vapors, passing off and combining with air, produce a flash when ignited.



*Floating Control:* Control in which the final control element moves at a constant rate in response to a signal that the variable has deviated.

*Fractional Distillation:* Uses a bubble tower and progressive distillation to separate feed into its various components according to boiling point: lighter gases at top, heavier liquids at bottom.

*Independent Variables:* Inputs to the process. May be controllable or uncontrollable.

*Integral Control :* Same as Reset Action.

*Interrupt:* A feature of the computer which allows disturbances in the process to interrupt the regular operation and the computer to take proper control action to correct the disturbance.

*Linear Programming:* A mathematical technique for determining the maximum of a linear function subject to linear constraints. In process control it may be used to find the optimum operating point of a process, subject to the process constraints.

*Load:* The demand for the controlled variable, heat, pressure, etc., required by the process as input.

*LPG:* Liquefied petroleum gas, normally the first to be separated in the fractional distillation process.

*Mathematical Model:* A collection of equations that represents mathematically all that goes on in the process, i.e., a mathematical description of the process.

*Multiplexer and Terminal Unit:* The interconnection point for the process equipment and the Control System. Process wires are connected at the terminal blocks in this unit to the Control System. Circuit cards associated with the terminal blocks are used for matching and filtering the incoming signals.

*Neutral Zone (Dead Zone):* A range on either side of the set point in which no control action takes place.

*Nonlinear:* Not a straightline function; a function representing a second or higher degree equation; a function whose variables do not relate proportionally.

*On-Off Control:* Control providing an all or nothing response that results in some oscillation around the control or set point. Example, thermostatic control.

*Operator Guide Control, On-Line, Open-Loop:* The application in which the computer obtains data directly from the process and displays or prints out the output for the operator, to assist him in determining the proper settings for the automatic controllers.

*Process:* The handling in bulk form of matter (liquids, solids, and gases) or energy, and its modification, by chemical or physical means, to produce the products desired therefrom at a profit.

*Proportional Band:* Percentage of instrument span required to move the control valve from full open to full closed. It is an expression of sensitivity of the instrument to a change in the variable.

*Proportional Control:* The final control element is opened or closed in proportion to the amount the controlled variable deviates from the set point.

*Proportional Plus Reset Control:* Control action which corrects in proportion to the deviation of a controlled variable from its set point and the time integral of the deviation. Often referred to as two-mode control.

*Proportional Plus Reset Plus Rate Action:* Three-mode control which causes the valve to move in proportion to the amount of deviation of the variable from the set point, the time integral of the deviation, and the rate at which it is changing.

*Proportional Speed Floating Control:* Also known as Integral or Reset Control.

*Rate Action:* Also called Derivative Action. Control action that furnishes a correction proportional to the rate of change of the deviation.

*Ratio Control:* Maintains fixed ratio between input (primary) variable and controlled (secondary) variable.

*Reactor:* The vessel in which the chemical reaction takes place.

*Real-Time Clock:* A real-time clock furnishes the computer with readable digits for computing elapsed time between unscheduled events, and signals the computer at selected intervals to perform scheduled cycles as specified in the program.

*Reset Action:* Control action in which the correction made is in proportion to the time integral of the deviation of the variable. Also known as Integral Control or Proportional Speed Floating Control.

*Resolution:* The smallest increment which can be observed or detected by the instrument, usually expressed as per cent of full scale of the instrument.

*Sensitivity:* Ability of a measuring instrument to respond to input changes.

*Set Point:* The desired value at which the controller is set to maintain the variable, sometimes distinguished from Control Point, though often used synonymously.

*Steady State:* A process is said to be in steady state when none of the variables are changing with time.

*Still:* Short form for distillation; the process of vaporizing liquid substances through heat and collecting them after they condense. Used for the apparatus of which there are various kinds: packed towers, bubble-cap towers, batch stills, etc.

*Throttling Range:* See Proportional Band.

*Transfer Function:* Relationship of output of a system to its input. It is expressed as the ratio of the Laplace transform of the output to the input with all initial conditions set at zero.

*Transients:* Phenomena that occur when the process is proceeding from one condition to another.

*Uncontrollable Variables:* Independent variables such as composition of raw material, power generation load, ambient temperature, etc., that are beyond direct control and cause disturbances (q.v.) in the process.

*Variable:* A variable is any temperature, pressure, flow, or level that determines or indicates the state of the process.

## Index

	<i>Page</i>		<i>Page</i>
Advantage of Computer Control	28	Flash	31
Analog Computing Elements	21	Flash Point	31
Analog Control Systems, Limitations of	21	Floating Controller	19, 32
Analog-to-Digital Converter (ADC)	31	Flow	17
Analytical Instruments	18	Flowmeters	17
Applications of Control System	5, 23	Fluid Catalytic Cracking Process	11
Automatic Controllers	6, 16, 19	Fractional Distillation	32
		Fractionating Tower	12
Batch Processes	8	Gas Chromatography	18
Bottoms	31	Gas-Filled Thermometer	16
Bubble Tower	31	Gradient Method of Determining Optimum	27
Cascade Control	6, 21, 31	IBM Control System	5, 28
Catalyst	12, 31	Functions	26
Characteristics of a Process	10	Independent Variables	11, 32
Closed-Loop Control	9, 23	Infrared Gas Analyzer	18
Constraints	31	Instrument Distribution	26
Contact Operate	5, 31	Instrumentation	6, 15
Contact Sense	5, 31	Integral Control	32
Continuous Process	10	Interrupt	5, 32
Examples	11		
Definition	8	Linear Programming	27, 32
Control Function, Definition	8, 31	Liquified Petroleum Gas (LPG)	32
Control Function Performed by Computer System	27	Liquid-Filled Thermometer	16
Control Signal	31	Liquid Level Measuring Instruments	17
Control System, On-Line, Closed-Loop	31	Load	32
Control, Types of	23	LPG	32
Controllable Variables	11, 31		
Cracking Process	11, 31	Mass Spectrometer	18
Crude Oil	31	Mathematical Model	24, 32
Cycling	31	Measuring Instruments	16
		Multiplexer and Terminal Unit	5, 32
Data Reduction	23		
Definitions	8, 23, 31-33	Neutral Zone (Dead Zone)	19, 32
Dependent Variables	11, 12, 13, 31	Nonlinear Functions	10, 32
Catalyst Circulation Rate	12	Nuclear Magnetic Resonance Spectrometer	18
Feed Stocks	12		
Reactor Temperature	12	Off-Line, Definition	23
Recycled Oil Temperature	12	Off-Line, Open-Loop, Definition	23
Derivative Action	31	On-Line, Open-Loop, Definition	23
Deviation	31	On-Off Controller	19, 32
Differential Pressure Flowmeters	17	Open-Loop, Definition	20
Digital Computers and Process Control	23	Operations Control	9
Discrete Process	8	Operator Control	28
Disturbances	31	Operator Guide Control	9, 24
Dynamic Model	25	Optimization	9, 26
Dynamic State	31	Optimum, Constrained	13, 27
Dynamics (of a Process)	31	Optimum, Steepest Ascent Method	27
Electronic Instruments, Measurement Range of	16	Petroleum Processing	10
Error	31	Pneumatic Instruments, Measurement Range of	16
Evaluation Function	26	Pressure Gage	17
		Pressure Instruments	17
Feed Temperature	12	Process Computer Control, On-Line, Closed-Loop	23
Feedback Control	9, 19, 31		
Final Control Element	31		

	<i>Page</i>		<i>Page</i>
Process Control .....	9	Resistance Thermometer .....	16
Process, Definition .....	8, 32	Resolution .....	32
Process Industries .....	8	Sensitivity .....	32
Computer Control of .....	13	Set Point .....	32
Process Objectives .....	10	Special Features .....	5
Process Vapor Fractometer .....	18	Spectrophotometer .....	18
Process Variables .....	11	Static Model .....	25
Processing, Modern-Day .....	10	Steady State .....	32
Proportional Band .....	20, 32	Still .....	33
Proportional Controller .....	20, 32	Temperature .....	16
Proportional plus Reset Controller .....	20, 32	Thermocouple .....	16
Proportional plus Reset plus Rate Action Controller .....	20, 32	Throttling Range .....	33
Proportional Speed Floating Control .....	32	Transfer Function .....	33
Random Addressing .....	5	Transients .....	33
Rate Action .....	32	Ultraviolet Spectrometer .....	18
Ratio Control .....	20, 32	Uncontrollable Variables .....	11, 33
Reactor .....	12, 32	Variables .....	10, 11, 33
Reactor Temperature, Effects of .....	12		
Real-Time Clock .....	32		
Regenerator .....	11		
Reset Action .....	32		



International Business Machines Corporation

Data Processing Division

112 East Post Road, White Plains, New York