

VOLUME 048 MACHINE 3705- -0080232 MODEL M81 SYSTEM 0002904 MODE

BOX SHIP 81/12/11

LOGIC TYPE -0- SYSTEMS DIAGRAMS

PAGE NUM	SH	TITLE	PART NUM	EC NUM	FEATURE B/M OR B/MS
AAAA1		BINDER TAB VOL 048	0008496509	322577	.W. 0001762993 .W. 0001862344
RA000		CHANNEL ADAPTOR 1	0005153974	344270	.W. 0001762993
RA001		CHANNEL ADAPTOR 1	0005153975	344270	.W. 0001762993
RA011		CHANNEL ADAPTOR 1	0001986974	344270	.W. 0001762993
RA012		CHANNEL ADAPTOR 1	0001986975	344600	.W. 0001762993
RA013		CHANNEL ADAPTOR 1	0001986976	344600	.W. 0001762993
RA014		CHANNEL ADAPTOR 1	0001785103	309949	.W. 0001762993
RA015		CHANNEL ADAPTOR 1	0001785104	309944	.W. 0001762993
RA016		CHANNEL ADAPTOR 1	0001785105	309949	.W. 0001762993
RA017		CHANNEL ADAPTOR 1	0001785106	309944	.W. 0001762993
RA018		CHANNEL ADAPTOR 1	0001986977	344270	.W. 0001762993
RA020		CHANNEL ADAPTOR 1	0001785109	309545	.W. 0001762993
RA050		CHANNEL ADAPTOR 1	0001785110	309541	.W. 0001762993
RA051		CHANNEL ADAPTOR 1	0001785111	309533	.W. 0001762993
RA052		CHANNEL ADAPTOR 1	0001785112	312926	.W. 0001762993
RA101		CHANNEL ADAPTOR 1	0001986979	344270	.W. 0001762993
RA102		CHANNEL ADAPTOR 1	0001986980	344270	.W. 0001762993
RA103		CHANNEL ADAPTOR 1	0001986981	344600	.W. 0001762993
RA104		CHANNEL ADAPTOR 1	0001986982	344270	.W. 0001762993
RA105		CHANNEL ADAPTOR 1	0001986983	344270	.W. 0001762993
RA106		CHANNEL ADAPTOR 1	0001986984	344270	.W. 0001762993
RA107		CHANNEL ADAPTOR 1	0001986985	344270	.W. 0001762993
RC101		CHANNEL ADAPTOR 1	0001785120	309949	.W. 0001762993
RC102		CHANNEL ADAPTOR 1	0001785121	309545	.W. 0001762993
RC103		CHANNEL ADAPTOR 1	0001986986	344270	.W. 0001762993
RC104		CHANNEL ADAPTOR 1	0001785123	312926	.W. 0001762993
RC105		CHANNEL ADAPTOR 1	0001785124	309548	.W. 0001762993
RC106		CHANNEL ADAPTOR 1	0001785125	309545	.W. 0001762993
RC107		CHANNEL ADAPTOR 1	0001785126	309545	.W. 0001762993
RC201		CHANNEL ADAPTOR 1	0001986978	344600	.W. 0001762993
RC202		CHANNEL ADAPTOR 1	0001986987	344270	.W. 0001762993
RC203		CHANNEL ADAPTOR 1	0001785129	309533	.W. 0001762993
RC204		CHANNEL ADAPTOR 1	0001785130	321750	.W. 0001762993
RC205		CHANNEL ADAPTOR 1	0001986988	344270	.W. 0001762993
RC206		CHANNEL ADAPTOR 1	0001785132	321750	.W. 0001762993
RC301		CHANNEL ADAPTOR 1	0001785133	309545	.W. 0001762993
RC302		CHANNEL ADAPTOR 1	0001785134	309533	.W. 0001762993
RC303		CHANNEL ADAPTOR 1	0001785135	309533	.W. 0001762993
RC304		CHANNEL ADAPTOR 1	0001785136	309533	.W. 0001762993
RC305		CHANNEL ADAPTOR 1	0001785137	309545	.W. 0001762993
RC306		CHANNEL ADAPTOR 1	0001785138	309548	.W. 0001762993
RC307		CHANNEL ADAPTOR 1	0001785139	309548	.W. 0001762993

VOLUME 048 MACHINE 3705--0080232 MODEL M81 SYSTEM 0002904 MODE BOX SHIP 81/12/11

LOGIC TYPE -0- SYSTEMS DIAGRAMS

PAGE NUM	SH	TITLE	PART NUM	EC NUM	FEATURE B/M OR B/MS
RC308		CHANNEL ADAPTOR 1	0001785140	309545	.W. 0001762993
RC309		CHANNEL ADAPTOR 1	0001785141	309548	.W. 0001762993
RC401		CHANNEL ADAPTOR 1	0001785142	309545	.W. 0001762993
RC402		CHANNEL ADAPTOR 1	0001785143	309548	.W. 0001762993
RC403		CHANNEL ADAPTOR 1	0001986989	344270	.W. 0001762993
RC404		CHANNEL ADAPTOR 1	0001785145	309545	.W. 0001762993
RC405		CHANNEL ADAPTOR 1	0001785146	309548	.W. 0001762993
RC406		CHANNEL ADAPTOR 1	0001785147	321750	.W. 0001762993
RC407		CHANNEL ADAPTOR 1	0001785148	309548	.W. 0001762993
RC501		CHANNEL ADAPTOR 1	0001785149	315618	.W. 0001762993
RC502		CHANNEL ADAPTOR 1	0001785150	309548	.W. 0001762993
RC503		CHANNEL ADAPTOR 1	0001986990	344270	.W. 0001762993
RC504		CHANNEL ADAPTOR 1	0001785152	315618	.W. 0001762993
RC505		CHANNEL ADAPTOR 1	0004499503	344600	.W. 0001762993
RC601		CHANNEL ADAPTOR 1	0001986991	344270	.W. 0001762993
RC602		CHANNEL ADAPTOR 1	0001986992	344270	.W. 0001762993
RC701		CHANNEL ADAPTOR 1	0001785156	309533	.W. 0001762993
RC702		CHANNEL ADAPTOR 1	0001785157	309545	.W. 0001762993
RC703		CHANNEL ADAPTOR 1	0001785158	309545	.W. 0001762993
RC704		CHANNEL ADAPTOR 1	0001785159	309545	.W. 0001762993
RC705		CHANNEL ADAPTOR 1	0001785160	309944	.W. 0001762993
RC706		CHANNEL ADAPTOR 1	0004499504	344600	.W. 0001762993
RC707		CHANNEL ADAPTOR 1	0001785162	309949	.W. 0001762993
RC801		CHANNEL ADAPTOR 1	0001785163	309944	.W. 0001762993
RC802		CHANNEL ADAPTOR 1	0001785164	309944	.W. 0001762993
RF101		CHANNEL ADAPTOR 1	0001785165	309548	.W. 0001762993
RF102		CHANNEL ADAPTOR 1	0001785166	309545	.W. 0001762993
RF103		CHANNEL ADAPTOR 1	0001785167	309944	.W. 0001762993
RF104		CHANNEL ADAPTOR 1	0001785168	309545	.W. 0001762993
RF105		CHANNEL ADAPTOR 1	0001986993	344270	.W. 0001762993
RF106		CHANNEL ADAPTOR 1	0001785170	309545	.W. 0001762993
RF201		CHANNEL ADAPTOR 1	0001785171	309533	.W. 0001762993
RF202		CHANNEL ADAPTOR 1	0001785172	309545	.W. 0001762993
RF203		CHANNEL ADAPTOR 1	0001785173	309545	.W. 0001762993
RF204		CHANNEL ADAPTOR 1	0001785174	309545	.W. 0001762993
RF205		CHANNEL ADAPTOR 1	0001785175	309944	.W. 0001762993
RF206		CHANNEL ADAPTOR 1	0004499505	344600	.W. 0001762993
RF207		CHANNEL ADAPTOR 1	0001785177	309533	.W. 0001762993
RS101		CHANNEL ADAPTOR 1	0001986994	344270	.W. 0001762993
RS102		CHANNEL ADAPTOR 1	0001986995	344270	.W. 0001762993
RS103		CHANNEL ADAPTOR 1	0001986996	344270	.W. 0001762993
RS104		CHANNEL ADAPTOR 1	0001986997	344270	.W. 0001762993

VOLUME 048 MACHINE 3705- -0080232 MODEL M81 SYSTEM 0002904 MODE BOX SHIP 81/12/11

LOGIC TYPE -0- SYSTEMS DIAGRAMS

PAGE NUM	SH	TITLE	PART NUM	EC NUM	FEATURE B/M OR B/MS
RS105		CHANNEL ADAPTOR 1	0001986998	344270	.W. 0001762993
RS106		CHANNEL ADAPTOR 1	0001986999	344270	.W. 0001762993
RS107		CHANNEL ADAPTOR 1	0001987000	344270	.W. 0001762993
RS201		CHANNEL ADAPTOR 1	0001987001	344270	.W. 0001762993
RS202		CHANNEL ADAPTOR 1	0001987002	344600	.W. 0001762993
RS203		CHANNEL ADAPTOR 1	0001987003	344600	.W. 0001762993
RS204		CHANNEL ADAPTOR 1	0001987004	344600	.W. 0001762993
RS205		CHANNEL ADAPTOR 1	0001987005	344270	.W. 0001762993
RS206		CHANNEL ADAPTOR 1	0001987006	344270	.W. 0001762993
RS301		CHANNEL ADAPTOR 1	0001987007	344270	.W. 0001762993
RS302		CHANNEL ADAPTOR 1	0001987008	344270	.W. 0001762993
RS303		CHANNEL ADAPTOR 1	0001987009	344270	.W. 0001762993
RS304		CHANNEL ADAPTOR 1	0001987010	344270	.W. 0001762993
RS305		CHANNEL ADAPTOR 1	0001987011	344270	.W. 0001762993
RS306		CHANNEL ADAPTOR 1	0001987012	344270	.W. 0001762993
RS307		CHANNEL ADAPTOR 1	0001987013	344270	.W. 0001762993
RS308		CHANNEL ADAPTOR 1	0001987014	344270	.W. 0001762993
RS401		CHANNEL ADAPTOR 1	0001987015	344270	.W. 0001762993
RS402		CHANNEL ADAPTOR 1	0001987016	344270	.W. 0001762993
RS403		CHANNEL ADAPTOR 1	0001987017	344270	.W. 0001762993
RS404		CHANNEL ADAPTOR 1	0005153913	344270	.W. 0001762993

TOTAL PART NUMBERS THIS MACHINE

846

TOTAL PART NUMBERS THIS VOLUME

105



QC107 38 39 3A 3B 3C 3D  
 RC106 3E 3F 3J  
 RC107 3K 3L 3M 3N 3P 3Q  
 RC108 3R 3S 3T 3U 3V 3W  
 RC109 40 41 42 46 47 48  
 49 4A 4B 4C 4D 4E  
 4F 4G 4H 4J 4K 4L  
 4T 4U 4V 4R 4S  
 RC103 59  
 RC107 60  
 RC104 61  
 RC105 62 63 64 65 66 67

RF102 26 27 28 29 2A  
 RF103 2B 2C 2D 2E  
 RF104 2F 2G 2H 2J 2K  
 RF105 2L 2M  
 RF101 22  
 RF103 34  
 RF106 35 36 37  
 RF101 3A  
 RF106 3B 3C 3D 3E 3F 3G  
 RF105 3H  
 RF106 3I 3J 3K 3L  
 RF102 3M  
 RF106 3N 3P 3Q  
 RF106 3R 3S 3T 3U 3V 3W 3X  
 3Y 3Z 40 41 42 43  
 44 45 46  
 RF103 6A  
 RF105 70 71

U2 B09 RA016DD4  
 B10 RA016DE2  
 B12 RA016DE6  
 D05 RA016DC4  
 D06 RA016DD2  
 D09 RA016DD6  
 D10 RA016DD6  
 D11 RA016DE4

U3 CONNECTOR  
 B02 RF203EL4  
 B05 RF201EC4  
 B08 RF202EC4  
 B09 RF202EC4  
 B10 RF202EL4  
 B12 RF203EC4  
 D05 RF201EC4  
 D06 RF201EL4  
 D09 RF202EC4  
 D10 RF202EC4  
 D11 RF203EC4

U4 CONNECTOR  
 B02 RF204EC4  
 B05 RF204EC4  
 B08 RA017DF2  
 B09 RA017DF2  
 B10 RA017DC2  
 B12 RA017DE2  
 D05 RF205EJ4  
 D06 RF204EL4  
 D09 RC502FA4  
 D10 RA017DF6  
 D11 RA017DC4  
 D13 RA017DC6

U5 CONNECTOR  
 B02 RA017DE6  
 B12 RA017DD4  
 D05 RA017DE4  
 D06 RF205EN4  
 D13 RA017DD2

V2 CONNECTOR  
 B02 RA014DC6  
 B05 RA014DC6  
 B08 RA014DD4  
 B09 RA014DD4  
 B10 RA014DE2  
 B12 RA014DE6  
 D05 RA014DC4  
 D06 RA014DD2  
 D09 RA014DD6  
 D10 RA014DD6  
 D11 RA014DE4

V3 CONNECTOR  
 B02 RC703EL4  
 B05 RC701EG4  
 B08 RC702EC4  
 B09 RC702EC4  
 B10 RC702EL4  
 B12 RC703EG4  
 D05 RC701EC4  
 D06 RC701EL4  
 D09 RC702EG4  
 D10 RC702EG4  
 D11 RC703EC4

V4 CONNECTOR  
 B02 RC704EC4  
 B05 RC704EG4  
 B08 RA015DF2  
 B09 RA015DF2  
 B10 RA015DC2  
 B12 RA015DE2  
 D05 RC705EJ4  
 D06 RC704EL4  
 D09 RC801FA4  
 D10 RA015DF6  
 D11 RA015DC4  
 D13 RA015DC6

V5 CONNECTOR  
 B02 RA015DE6  
 B12 RA015DD4  
 D05 RA015DE4  
 D06 RC705EN4  
 D13 RA015DD2

Q2 QUAD CARD CA1  
 Q3 8235422 6836  
 Q4  
 Q5

S2 QUAD CARD TPS  
 S3 8235422 6836  
 S4  
 S5

RC703 00 01  
 RC702 02 03  
 RC703 04 05  
 RC702 06 07  
 RC701 08  
 RC702 09  
 RC701 0A 0B 0C  
 RC702 0D  
 RC701 0E 0F  
 RC703 0G 0H 0J  
 RC706 0K 0L  
 RC703 0M  
 RC706 0N 0P 0Q 0R 0S 0T  
 RC707 0U 0V 0X 0Y 0Z 10  
 RC704 12  
 RC705 13 14  
 RC703 15 16 17 18  
 RC705 19 1A  
 RC702 1B  
 RC704 1C 1D  
 RC702 1E  
 RC704 1F 1G  
 RC702 1H  
 RC705 1J 1K  
 RC701 1L  
 RC704 1M 1N  
 RC701 1P  
 RC705 1Q 1R  
 RC701 1S  
 RC706 1T 1U  
 RC707 1V 1X  
 RC703 1Z 20  
 RC701 22 30 31  
 RC702 32 33 34  
 RC703 35 36 37  
 RC704 38 39 3A  
 RC705 3B 3C 3D  
 RC706 3E 4H 4J 4K  
 RC707 4L  
 RC706 4M  
 RC704 4N 4P  
 RC706 4R 4S 4T 68  
 RC703 69  
 RC701 70 71 8F

RF203 00 01  
 RF202 02 03  
 RF203 04 05  
 RF202 06 07  
 RF201 08  
 RF202 09  
 RF201 0A 0B 0C  
 RF202 0D  
 RF201 0E 0F  
 RF203 0G 0H 0J  
 RF206 0K 0L  
 RF203 0M  
 RF206 0N 0P 0Q 0R 0S 0T  
 RF207 0V 0W 0X  
 RF203 12  
 RF205 13 14  
 RF203 15 16 17 18  
 RF205 19 1A  
 RF202 1B  
 RF204 1C 1D  
 RF202 1E  
 RF204 1F 1G  
 RF202 1H  
 RF205 1J 1K  
 RF201 1L  
 RF204 1M 1N  
 RF201 1P  
 RF205 1Q 1R  
 RF201 1S  
 RF206 1T 1U  
 RF207 1V 1X 1Y  
 RF203 1Z 20  
 RF201 22 30 31  
 RF202 32 33 34  
 RF203 35 36 37  
 RF204 38 39 3A  
 RF205 3B 3C 3D  
 RF206 3E 4H 4J 4K  
 RF207 4L  
 RF206 4M  
 RF204 4N 4P  
 RF206 4R 4S 4T 68  
 RF203 69  
 RF201 70 71 8F

T2 DOUBLE CARD CA1  
 T3 8251995 2326  
 RC601 00 01 02 03 04 05  
 06 07 08 09 0A 0B  
 0C 0D 0E 0F 0G 0H  
 0J 0K 0L 0M 0N 0P  
 RC602 0Q  
 RC601 0R  
 RC602 0S 0T  
 RC601 0U  
 RC602 0V 0W 0X 0Y  
 RC601 0Z  
 RC602 10 11 12 13 15  
 16 17 18 19 1B 1J  
 RC601 1K  
 RC602 3S 3T 3U

T4 DOUBLE CARD CA1  
 T5 5863413 1869  
 RC801 01 02 03 04 05 06  
 08 09 10 11  
 RC802 12 13 14 15 16 17  
 18 19 20 21 23  
 RC801 24

U2 CONNECTOR  
 B02 RA016DC2  
 B05 RA016DC6  
 B08 RA016DD4

PLUG LIST

PART NO	ACC	TYPE	SOCKETS	TOTAL
5857428	CA1	6828	D2	01
5863413	CA1	1869	T4	01
8231672	TPS	6837	R2	01
8231720	CA1	2325	M2	01
8235422	CA1	6836	Q2	01
8235422	TPS	6836	S2	01
8235431	CA1	7601	P2	01
8235687	CA1	7602	L2	01
8251995	CA1	2326	T2	01
8251996	CA1	7603	K2	01
8254592	CA1	2342	N2	01
CONN				30
A1 A2 A3 A4				
A5 B1 B2 B3				
C3 C4 C5 D1				
E1 F1 G1 H1				
J1 K1 U2 U3				
U4 U5 V2 V3				
V4 V5				

SOCKET LISTING  
 DATE 10-29-80 MACH. 27RNB  
 LOG 854 BOARD 01A-Y4  
 PREV. ENGR. -  
 PRES. ENGR. 10-14-80 344270  
 P-N. 5153974  
 IBM CORP. SED BLK.

00000

00000

TYPE I CHANNEL ADAPTER TERMINATOR CARD SOCKET LISTING

A2	B4 SINGLE CARD 5862885 N885	D2	K2	R2
A3	B5 SINGLE CARD 5862884 N884	E2	L2	S2
A4	C2	F2	M2	T2
A5	C3	G2	N2	U2
B2	C4 SINGLE CARD 5862884 N884	H2	P2	V2
B3	C5	J2	Q2	

PART NO.	ACC	TYPE	SOCKET	TOTAL
5862885	CAI	N885	B4	01
5862884	CAI	N884	B5	01
5862884	CAI	N884	C4	01

NOTE

- THIS PLUG CHART IS TO BE USED ONLY TO INDICATE WHERE THE A4 BOARD TERMINATOR CARDS ARE LOCATED (THERE ARE NO TERMINATOR CARD LOGIC PAGES). THE TERMINATOR CARDS ARE LOCATED IN THE OIA-A4 BOARD.

SOCKET LISTING FOR TYPE I C.A. TERMINATOR CARDS

DATE OCT80 MACH. 3705-80  
BOARD OIA-A4

PREV. ENG. NONE  
PRES. ENG. OCT80 344270

P/N 5153975  
IBM CORP SCD

R  
A  
O  
O  
I

R  
A  
O  
O  
I

+ OUTBUS BIT 0.P AB002DH1- 2-  
 + OUTBUS BIT 0.0 AB002DH3- 4-  
 + OUTBUS BIT 0.1 AB002DH5- 6-  
 + OUTBUS BIT 0.2 AB002DH7- 8-  
 + OUTBUS BIT 0.3 AB002DJ2- 10-  
 + OUTBUS BIT 0.4 AB002DJ4- 12-  
 + OUTBUS BIT 0.5 AB002DJ6- 14-  
 + OUTBUS BIT 0.6 AB002DK1- 16-  
 + OUTBUS BIT 0.7 AB002DK3- 18-  
 + OUTBUS BIT 1.P AB002DK5- 20-  
 + OUTBUS BIT 1.0 AB002DK7- 22-  
 + OUTBUS BIT 1.1 AB002DL2- 24-  
 + OUTBUS BIT 1.2 AB002DL4- 26-  
 + OUTBUS BIT 1.3 AB002DL6- 28-  
 + OUTBUS BIT 1.4 AB002DM1- 30-  
 + OUTBUS BIT 1.5 AB002DM3- 32-  
 + OUTBUS BIT 1.6 AB002DM5- 34-  
 + OUTBUS BIT 1.7 AB002DM7- 36-  
 + INBUS BYTE 0 BIT 0 RA106FB6- 38-  
 + INBUS BYTE 0 BIT 1 RA106FC6- 40-  
 + INBUS BYTE 0 BIT 2 RA106FD6- 42-  
 + INBUS BYTE 0 BIT 3 RA106FE6- 44-  
 + INBUS BYTE 0 BIT 4 RA106FF6- 46-  
 + INBUS BYTE 0 BIT 5 RA106FG6- 48-  
 + INBUS BYTE 0 BIT 6 RA106FH6- 50-  
 + INBUS BYTE 0 BIT 7 RA106FJ6- 52-  
 + INBUS BYTE 0 BIT P RA106FL2- 54-  
 + INBUS BYTE 1 BIT 0 RA107FB6- 56-  
 + INBUS BYTE 1 BIT 1 RA107FC6- 58-  
 + INBUS BYTE 1 BIT 2 RA107FD6- 60-  
 + INBUS BYTE 1 BIT 3 RA107FE6- 62-  
 + INBUS BYTE 1 BIT 4 RA107FF6- 64-  
 + INBUS BYTE 1 BIT 5 RA107FG6- 66-  
 + INBUS BYTE 1 BIT 6 RA107FH6- 68-  
 + INBUS BYTE 1 BIT 7 RA107FJ6- 70-  
 + INBUS BYTE 1 BIT P RA107FL2- 72-

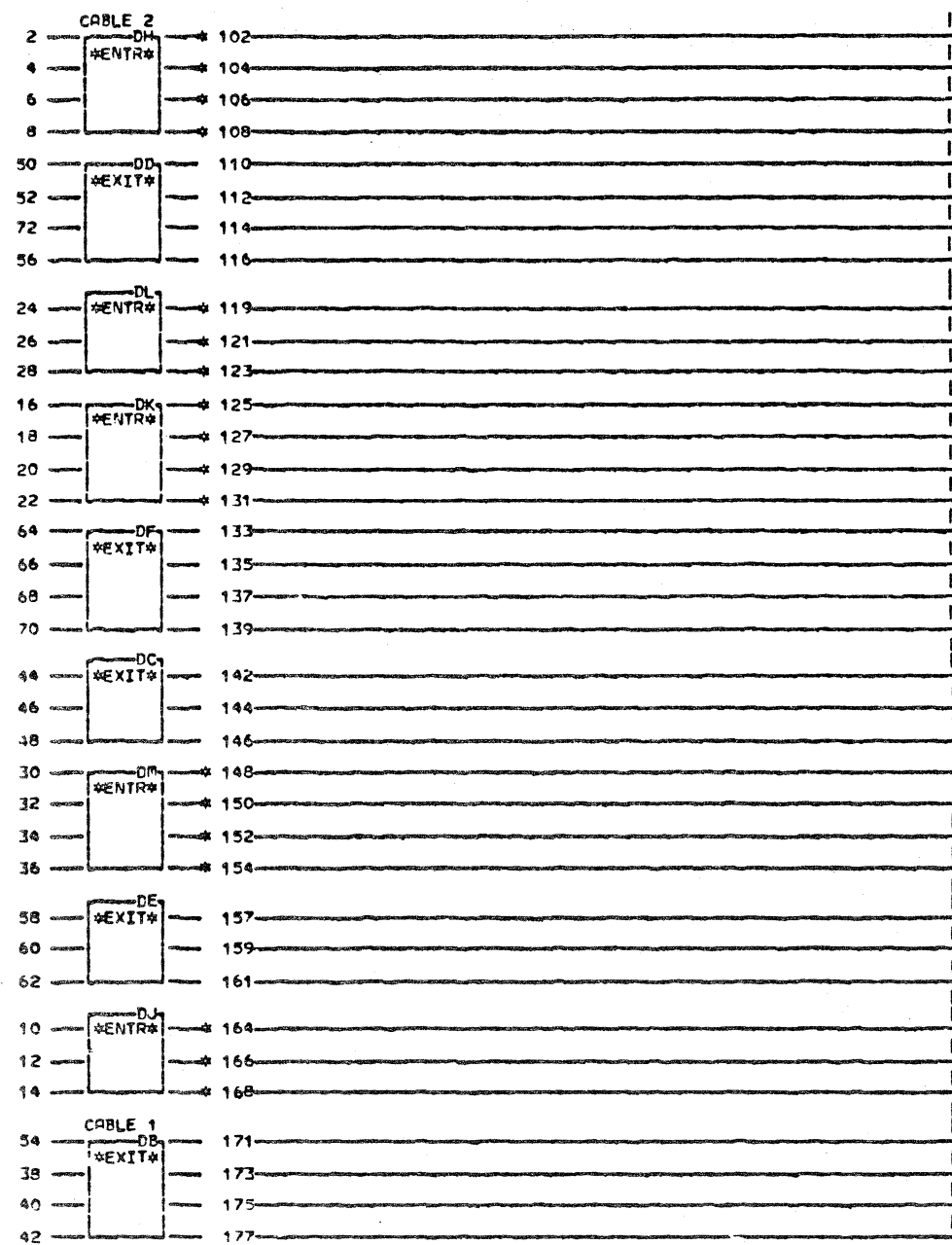

081 RA011  
 171 + INBUS BYTE 0 BIT P AB001-DB1  
 173 + INBUS BYTE 0 BIT 0 AB001-DB3  
 175 + INBUS BYTE 0 BIT 1 AB001-DB5  
 177 + INBUS BYTE 0 BIT 2 AB001-DB7  
 142 + INBUS BYTE 0 BIT 3 AB001-DC2  
 144 + INBUS BYTE 0 BIT 4 AB001-DC4  
 146 + INBUS BYTE 0 BIT 5 AB001-DC6  
 110 + INBUS BYTE 0 BIT 6 AB001-DD1  
 112 + INBUS BYTE 0 BIT 7 AB001-DD3  
 114 + INBUS BYTE 1 BIT P AB001-DD5  
 116 + INBUS BYTE 1 BIT 0 AB001-DD7  
 157 + INBUS BYTE 1 BIT 1 AB001-DE2  
 159 + INBUS BYTE 1 BIT 2 AB001-DE4  
 161 + INBUS BYTE 1 BIT 3 AB001-DE6  
 133 + INBUS BYTE 1 BIT 4 AB001-DF1  
 135 + INBUS BYTE 1 BIT 5 AB001-DF3  
 137 + INBUS BYTE 1 BIT 6 AB001-DF5  
 139 + INBUS BYTE 1 BIT 7 AB001-DF7  
 102 + OUTBUS BIT 0.P DH1  
 LRC105 LRC401 LRS101  
 104 + OUTBUS BIT 0.0 DH3  
 LRC105 LRC401 LRS101  
 106 + OUTBUS BIT 0.1 DH5  
 LRC105 LRC401 LRS101  
 108 + OUTBUS BIT 0.2 DH7  
 LRC105 LRC401 LRS101  
 164 + OUTBUS BIT 0.3 DJ2  
 LRC105 LRC401 LRS101  
 166 + OUTBUS BIT 0.4 DJ4  
 LRC105 LRC401 LRS101  
 168 + OUTBUS BIT 0.5 DJ6  
 LRC105 LRC401 LRS101  
 125 + OUTBUS BIT 0.6 DK1  
 LRC105 LRC401 LRS101  
 127 + OUTBUS BIT 0.7 DK3  
 LRC105 LRC401 LRS101  
 129 + OUTBUS BIT 1.P DK5  
 LRC309 LRS102  
 131 + OUTBUS BIT 1.0 DK7  
 LRC309 LRS102  
 119 + OUTBUS BIT 1.1 DL2  
 LRC309 LRS102  
 121 + OUTBUS BIT 1.2 DL4  
 LRC309 LRS102  
 123 + OUTBUS BIT 1.3 DL6  
 LRC309 LRS102  
 148 + OUTBUS BIT 1.4 DM1  
 LRC309 LRS102  
 150 + OUTBUS BIT 1.5 DM3  
 LRC309 LRS102  
 152 + OUTBUS BIT 1.6 DM5  
 LRC309 LRS102  
 154 + OUTBUS BIT 1.7 DM7  
 LRC309 LRS102

EDGE CONN. 01A-Y4B4D05 01A-Y4B4D02 01A-Y4B4D13  
 102 A-Y4B2B02 121 A-Y4B2D06 131 A-Y4B2D03 164 A-Y4B2B08  
 01A-Y4B4B02 01A-Y4B4D06 01A-Y4B4D03 01A-Y4B4B08  
 104 A-Y4B2B04 123 A-Y4B2D07 148 A-Y4B2D09 166 A-Y4B2B09  
 01A-Y4B4B04 01A-Y4B4D07 01A-Y4B4D09 01A-Y4B4B09  
 106 A-Y4B2B05 125 A-Y4B2B12 150 A-Y4B2D10 168 A-Y4B2B10  
 01A-Y4B4B05 01A-Y4B4B12 01A-Y4B4D10 01A-Y4B4B10  
 108 A-Y4B2B06 127 A-Y4B2B13 152 A-Y4B2D11  
 01A-Y4B4B06 01A-Y4B4B13 01A-Y4B4B11  
 119 A-Y4B2D05 129 A-Y4B2D02 134 A-Y4B2D13

LOC. TYPE

RA011

081 SIM TO PN 1785100 EC 309949

ADAPTER INTERFACE	
E.C. HISTORY	E. RACH. 27RNB
DATE LAST EC	FRAME 01
10-14-80 344270	IBM CORP. SCD RA011
	P. No. 1986974 081

+ I-O REG ADDR BIT 0 AB003DB1- 2  
 + I-O REG ADDR BIT 1 AB003DB3- 4  
 + I-O REG ADDR BIT 2 AB003DB5- 6  
 + I-O REG ADDR BIT 3 AB003DB7- 8  
 + I-O REG ADDR BIT 4 AB003DC2- 10  
 + I-O REG ADDR BIT 5 AB003DC4- 12  
 + I-O REG ADDR BIT 6 AB003DC6- 14  
 + I-O REG ADDR BIT 7 AB003DD1- 16  
 + I-O REG ADDR BIT 8 AB003DD3- 18  
 + SAMPLE OUTPUT DATA ON OUTBUS AB003DD5- 20  
 + GATE INPUT DATA ON INBUS AB003DD7- 22  
 - GATE INPUT 76 AB003DE2- 24  
 - GATE INPUT 77 AB003DE4- 26  
 + RESET AB003DE6- 28  
 + CHANNEL 1 ENABLE INTF A POS AB004DH1- 30  
 + CHANNEL 2 ENABLE INTF A POS AB004DH3- 32  
 + CHANNEL 1 DISABLE INTF A POS AB004DH5- 34  
 + CHANNEL 2 DISABLE INTF A POS AB004DH7- 36  
 + CHANNEL 1 ENABLE INTF B POS AB004DJ2- 38  
 ALWAYS -4V ONE AB004DJ4- 40  
 + CHANNEL 1 DISABLE INTF B POS AB004DJ6- 42  
 ALWAYS -4V TWO AB004DK1- 44  
 + CHANNEL 2 INTF A ENABLED AB004DK3- 46  
 ALWAYS -4V THREE AB004DK5- 48  
 + BID CHANNEL 1 AB004DK7- 50  
 + BID CHANNEL 2 AB004DL2- 52  
 ALWAYS -4V FOUR AB004DM1- 54  
 + ADBUS BIT X.0 AB004DM3- 56  
 + ADBUS BIT X.6 AB004DM5- 58  
 + ADBUS BIT X.7 AB004DM7- 60  
 + BID LVL 1 INTERRUPT RA102CL6- 62  
 + ADAPTER I-O DECODED EXIT RA102ED6- 64  
 + CHANNEL 1 INTF A ENABLED RC103FK2- 66  
 + BID LEVEL 3 INTERRUPT RC407CB6- 68  
 + CHANNEL 1 INTF B ENABLED RF105GD2- 70  
 FOLLOWS BID PROG LEV 2 RS202FF2- 72

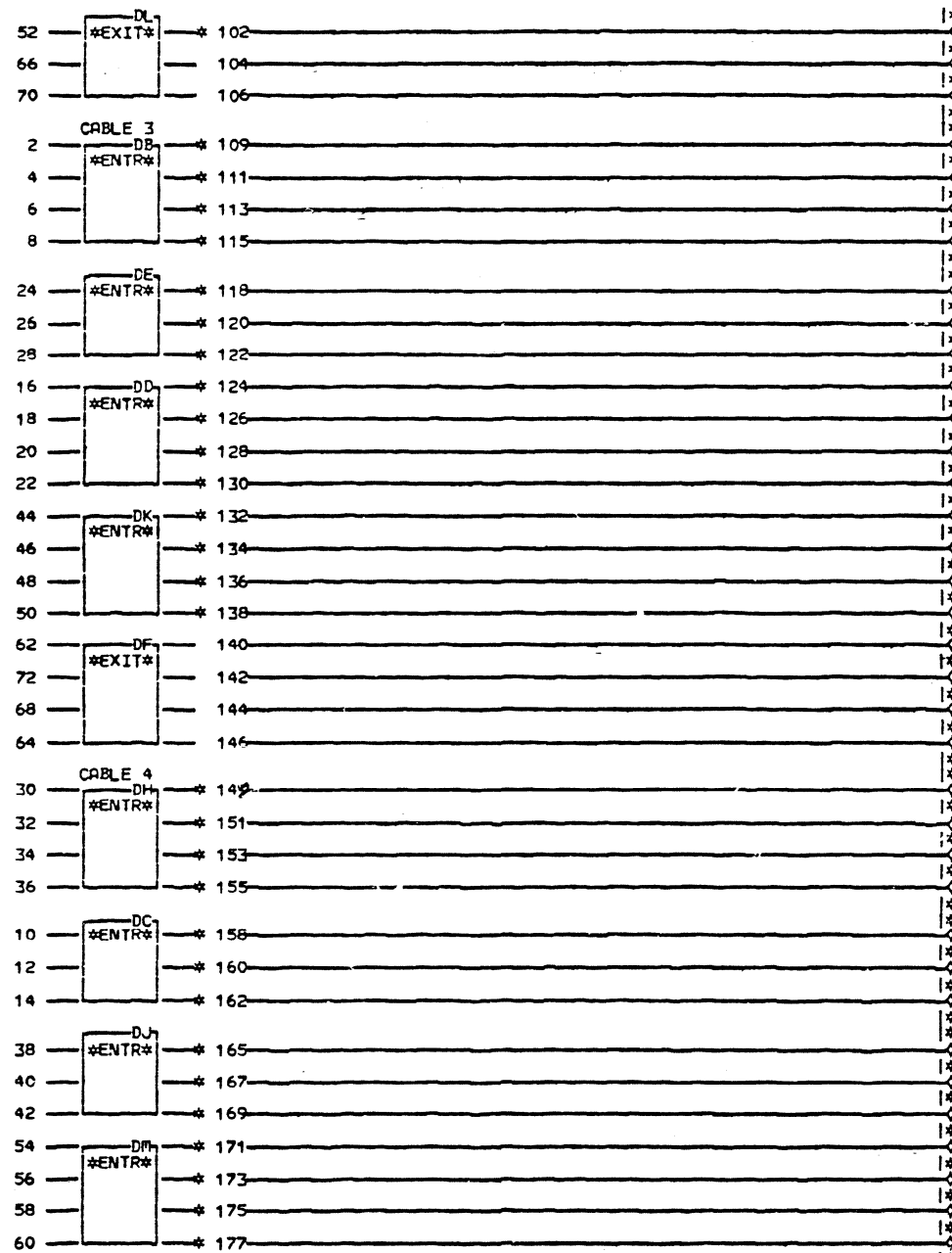

081 RA012

109 + I-O REG ADDR BUS BIT 0- RA101-DB1  
 111 + I-O REG ADDR BUS BIT 1- RA101-DB3  
 113 + I-O REG ADDR BUS BIT 2- RA101-DB5  
 115 + I-O REG ADDR BUS BIT 3- RA101-DB7  
 158 + I-O REG ADDR BUS BIT 4- RA101-DC2  
 160 + I-O REG ADDR BUS BIT 5- RA101-DC4  
 162 + I-O REG ADDR BUS BIT 6- RA101-DC6  
 124 + I-O REG ADDR BUS BIT 7- RA101-DD1  
 126 + I-O REG ADDR BUS BIT 8- RA101-DD3  
 128 + SAMPLE OUTPUT DATA LRC501 LRS103- DD5  
 130 + GATE INPUT DATA ON INBUS LRA103 LRC205 LRC501- DD7  
 118 - GATE 1ST TEST PNTS ON INBUS LRA102- DE2  
 120 - GATE 2ND TEST PNTS ON INBUS LRC407 LRS202- DE4  
 122 + RESET RS105-DE6  
 140 + BID PROGRAM LEV 1 ABC03-DF1  
 142 + BID PROGRAM LEV 2 AB003-DF3  
 144 + BID PROGRAM LEV 3 AB003-DF5  
 146 + ADAPTER I-O ADDRESS DECODED LAB003- DF7  
 149 + CHANNEL 1 ENABLE INTF A POS LRC103- DH1  
 151 + CHANNEL 2 ENABLE INTF A POS LAB004- DH3  
 153 + CHANNEL 1 DISABLE INTF A POS LRC103- DH5  
 155 + CHANNEL 2 DISABLE INTF A POS LAB004- DH7  
 165 + CHANNEL 1 ENABLE INTF B POS LRF105- DJ2  
 167 ALWAYS -4V ONE AB004- DJ4  
 169 + CHANNEL 1 DISABLE INTF B POS LRF105- DJ6  
 132 ALWAYS -4V TWO AB004- DK1  
 134 + CHANNEL 2 INTF A ENABLED LAB004- DK3  
 136 ALWAYS -4V THREE AB004- DK5  
 138 + BID CHANNEL 1 AB004- DK7  
 102 + BID CHANNEL 2 AB004- DL2  
 104 + CHANNEL 1 INTF A ENABLED LAB004- DL4  
 106 + CHANNEL 1 INTF B ENABLED LAB004- DL6  
 171 ALWAYS -4V FOUR AB004- DM1  
 173 + ADBUS BIT X.0 AB004- DM3  
 175 + ADBUS BIT X.6 AB004- DM5  
 177 + ADBUS BIT X.7 AB004- DM7

EDGE CONN.	01A-Y4C4B06	01A-Y4C4B13	01A-Y4C5D03	160 A-Y4C2B09	173 A-Y4C3D10
102 A-Y4C3D07	118 A-Y4C2D05	128 A-Y4C2D02	138 A-Y4C3D06	01A-Y4C4B09	01A-Y4C5D10
01A-Y4C5D06	01A-Y4C4D05	01A-Y4C4D02	149 A-Y4C3B02	162 A-Y4C2B10	175 A-Y4C3D11
109 A-Y4C2B02	120 A-Y4C2D05	130 A-Y4C2D03	151 A-Y4C3B04	01A-Y4C4B10	01A-Y4C5D11
01A-Y4C4B02	01A-Y4C4D06	01A-Y4C4D03	01A-Y4C5B02	165 A-Y4C3B08	177 A-Y4C3D13
111 A-Y4C2B04	122 A-Y4C2D07	132 A-Y4C3B12	153 A-Y4C3B05	167 A-Y4C3B09	01A-Y4C5D13
01A-Y4C4B04	01A-Y4C4D07	01A-Y4C5B10	155 A-Y4C3B06	01A-Y4C5B08	
113 A-Y4C2B05	124 A-Y4C2B12	134 A-Y4C3D02	01A-Y4C5B05	169 A-Y4C3B10	
01A-Y4C4B05	01A-Y4C4B12	01A-Y4C5B13	158 A-Y4C2B08	171 A-Y4C3D09	
115 A-Y4C2B06	126 A-Y4C2B13	136 A-Y4C3D05	01A-Y4C4B08	01A-Y4C5D09	

RA012  
 081 SIM TO PN 1785101 EC 314416

LOC. TYPE

ADAPTER INTERFACE	
E.C. HISTORY 344270	E. MACH. 27RNB
FRAME 01	IBM CORP. SCD RA012
DATE LAST EC 04-14-81 344600	P.N. 1986975 081



+ ADBUS BIT 0.P AB005DB1- 2-  
 + ADBUS BIT 0.0 AB005DB3- 4-  
 + ADBUS BIT 0.1 AB005DB5- 6-  
 + ADBUS BIT 0.2 AB005DB7- 8-  
 + ADBUS BIT 0.3 AB005DC2- 10-  
 + ADBUS BIT 0.4 AB005DC4- 12-  
 + ADBUS BIT 0.5 AB005DC6- 14-  
 + ADBUS BIT 0.6 AB005DD1- 16-  
 + ADBUS BIT 0.7 AB005DD3- 18-  
 + ADBUS BIT 1.P AB005DD5- 20-  
 + ADBUS BIT 1.0 AB005DD7- 22-  
 + ADBUS BIT 1.1 AB005DE2- 24-  
 + ADBUS BIT 1.2 AB005DE4- 26-  
 + ADBUS BIT 1.3 AB005DE6- 28-  
 + ADBUS BIT 1.4 AB005DF1- 30-  
 + ADBUS BIT 1.5 AB005DF3- 32-  
 + ADBUS BIT 1.6 AB005DF5- 34-  
 + ADBUS BIT 1.7 AB005DF7- 36-  
 - ALLOW CHANNELS ON LINE AB006DH1- 38-  
 - NOT INITIALIZED AB006DH3- 40-  
 + POR OR RESET SW AB006DH5- 42-  
 + A TO THRU B TO TIME AB006DH7- 44-  
 + T2 OR T3 TIME TO CA OR RPL AB006DJ2- 46-  
 + T3 OR T0 TIME TO CA OR RPL AB006DJ4- 48-  
 + GO CHANNEL 1 AB006DJ6- 50-  
 + GO CHANNEL 2 AB006DK1- 52-  
 - BAD DATA AB006DK3- 54-  
 - ADDRESS ERROR AB006DK5- 56-  
 + SAR EVEN PARITY AB006DK7- 58-  
 - GATE C.S. DATA ON INBUS AB006DL2- 60-  
 - SAMPLE C.S. DATA ON OUTBUS AB006DL4- 62-  
 + POWER ON RESET AB006DL6- 64-  
 ALWAYS MINUS AB006DM1- 66-  
 + STORE BYTE 0 AB006DM5- 68-  
 + STORE BYTE 1 AB006DM7- 70-  
 + CHAN IPL CMND RC204GH2- 72-

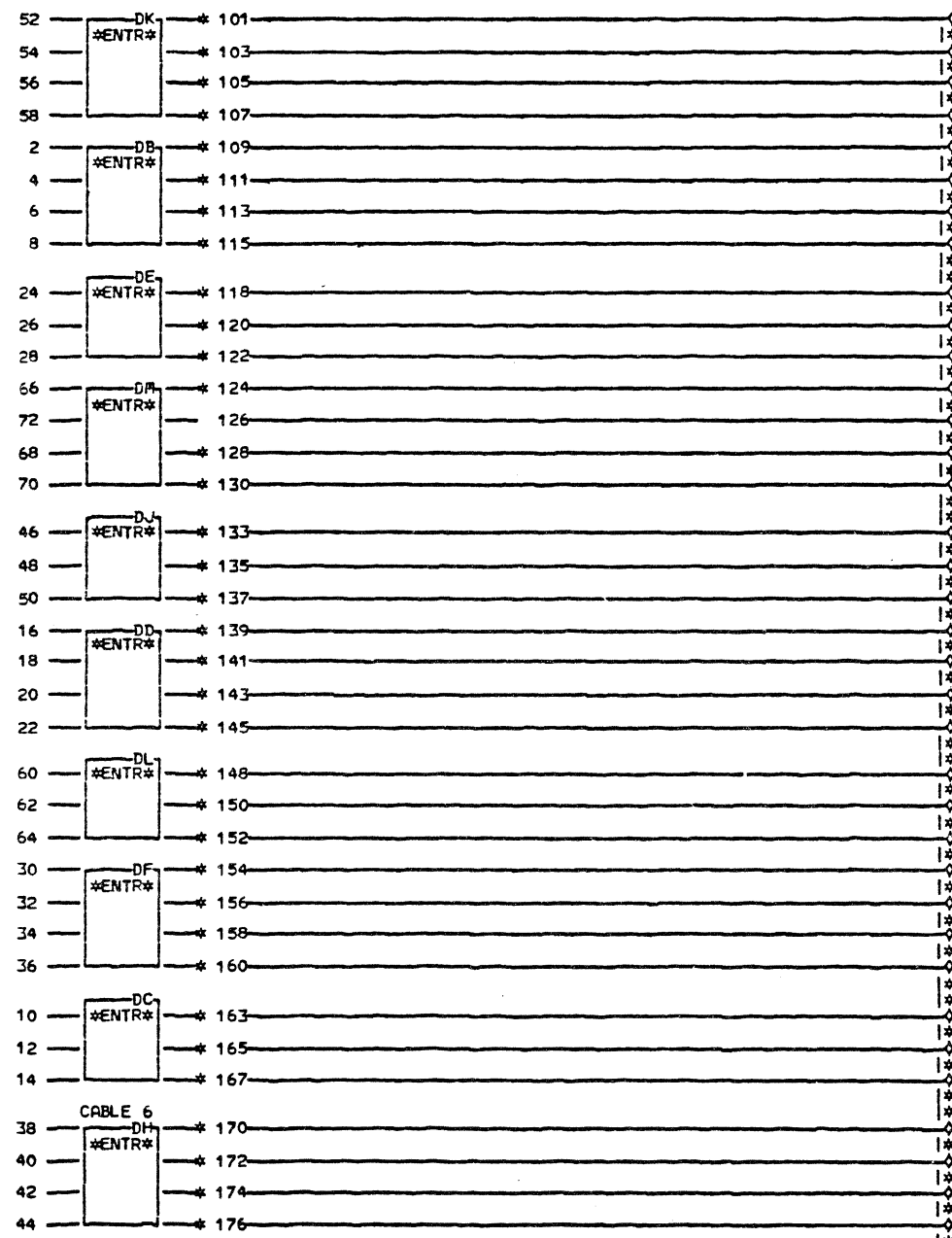

081 RA013

109 + ADBUS BIT 0.P AB005-DB1  
 111 + ADBUS BIT 0.0 AB005-DB3  
 113 + ADBUS BIT 0.1 AB005-DB5  
 115 + ADBUS BIT 0.2 AB005-DB7  
 163 + ADBUS BIT 0.3 AB005-DC2  
 165 + ADBUS BIT 0.4 AB005-DC4  
 167 + ADBUS BIT 0.5 AB005-DC6  
 139 + ADBUS BIT 0.6 AB005-DD1  
 141 + ADBUS BIT 0.7 AB005-DD3  
 143 + ADBUS BIT 1.P AB005-DD5  
 145 + ADBUS BIT 1.0 AB005-DD7  
 118 + ADBUS BIT 1.1 AB005-DE2  
 120 + ADBUS BIT 1.2 AB005-DE4  
 122 + ADBUS BIT 1.3 AB005-DE6  
 154 + ADBUS BIT 1.4 AB005-DF1  
 156 + ADBUS BIT 1.5 AB005-DF3  
 158 + ADBUS BIT 1.6 AB005-DF5  
 160 + ADBUS BIT 1.7 AB005-DF7  
 170 - ALLOW CHANNEL ON LINE DH1  
       RC103 RC205 RC602 RF105  
 172 - NOT INITIALIZED RC602-DH3  
 174 + POR OR RESET SW RC707-DH5  
 176 + A TO THRU B TO TIME AB006-DH7  
 133 + T2 OR T3 TIME A4 BOARD RA103-DJ2  
 135 + T3 OR T0 TIME A4 BOARD RA103-DJ4  
 137 + GO CHANNEL 1 AB006-DJ6  
 101 + GO CHANNEL 2 AB006-DK1  
 103 - BAD DATA AB006-DK3  
 105 - ADDRESS ERROR AB006-DK5  
 107 + SAR EVEN PARITY AB006-DK7  
 148 - GATE C.S. DATA ON INBUS AB006-DL2  
 150 - SAMPLE C.S. DATA ON OUTBUS AB006-DL4  
 152 + POWER ON RESET AB006-DL6  
 124 ALWAYS MINUS AB006-DM1  
 126 + CHAN IPL REQUEST AB006-DM3  
 128 + STORE BYTE 0 AB006-DM5  
 130 + STORE BYTE 1 AB006-DM7

EDGE CONN.	01A-Y4A5B04	01A-Y4B5D09	01A-Y4A5D12	01A-Y4B5D07	01A-Y4A5B09
101 A-Y4B3B12	113 A-Y4A3B05	128 A-Y4B3D11	141 A-Y4A3B13	154 A-Y4A3D09	167 A-Y4A3B10
01A-Y4B5B10	01A-Y4A5B05	01A-Y4B5D11	01A-Y4A5B13	01A-Y4A5D09	01A-Y4A5B10
103 A-Y4B3B13	115 A-Y4A3B06	130 A-Y4B3D13	143 A-Y4A3D02	156 A-Y4A3D10	170 A-Y4B3B02
01A-Y4B5B13	01A-Y4A5B06	01A-Y4B5D13	01A-Y4A5D02	01A-Y4A5D10	01A-Y4B5B02
105 A-Y4B3D02	118 A-Y4A3D05	133 A-Y4B3B08	145 A-Y4A3D03	158 A-Y4A3D11	172 A-Y4B3B04
01A-Y4B5D02	01A-Y4A5D05	01A-Y4B5B08	01A-Y4A5D03	01A-Y4A5D11	01A-Y4B5B04
107 A-Y4B3D03	120 A-Y4A3D06	135 A-Y4B3B09	148 A-Y4B3D05	160 A-Y4A3D13	174 A-Y4B3B05
01A-Y4B5D03	01A-Y4A5D06	01A-Y4B5B09	01A-Y4B5D05	01A-Y4A5D13	01A-Y4B5B05
109 A-Y4A3B02	122 A-Y4A3D07	137 A-Y4B3B10	150 A-Y4B3D06	163 A-Y4A3B08	176 A-Y4B3B06
01A-Y4A5B02	01A-Y4A5D07	01A-Y4B5B12	01A-Y4B5D06	01A-Y4A5B08	01A-Y4B5B06
111 A-Y4A3B04	124 A-Y4B3D09	139 A-Y4A3B12	152 A-Y4B3D07	165 A-Y4A3B09	

RA013  
 081 SIM TO PN 1785102 EC 314416

LOC. TYPE

ADAPTER INTERFACE	
E.C. HISTORY 344270	E. MACH. 27RNB
DATE LAST EC 04-14-81 344600	FRAME 01 IBM CORP. SCD RA013 P.N. 1986976 081

- + BUS OUT P RA014001- 2-1
- + BUS OUT 0 RA014002- 7-1
- + BUS OUT 1 RA014003- 12-1
- + BUS OUT 2 RA014004- 17-1
- + BUS OUT 3 RA014005- 22-1
- + BUS OUT 4 RA014006- 27-1
- + BUS OUT 5 RA014007- 32-1
- + BUS OUT 6 RA014008- 37-1
- + BUS OUT 7 RA014009- 42-1
- + NPL BIT 0 TO INTF A RC701EC4- 47-1
- + NPL BIT 1 TO INTF A RC701EG4- 52-1
- + NPL BIT 2 TO INTF A RC701EL4- 57-1
- + NPL BIT 3 TO INTF A RC702EC4- 62-1
- + NPL BIT 4 TO INTF A RC702EG4- 67-1
- + NPL BIT 5 TO INTF A RC702EL4- 72-1
- + NPL BIT 6 TO INTF A RC703EC4- 77-1
- + NPL BIT 7 TO INTF A RC703EG4- 82-1
- + NPL BIT P TO INTF A RC703EL4- 87-1

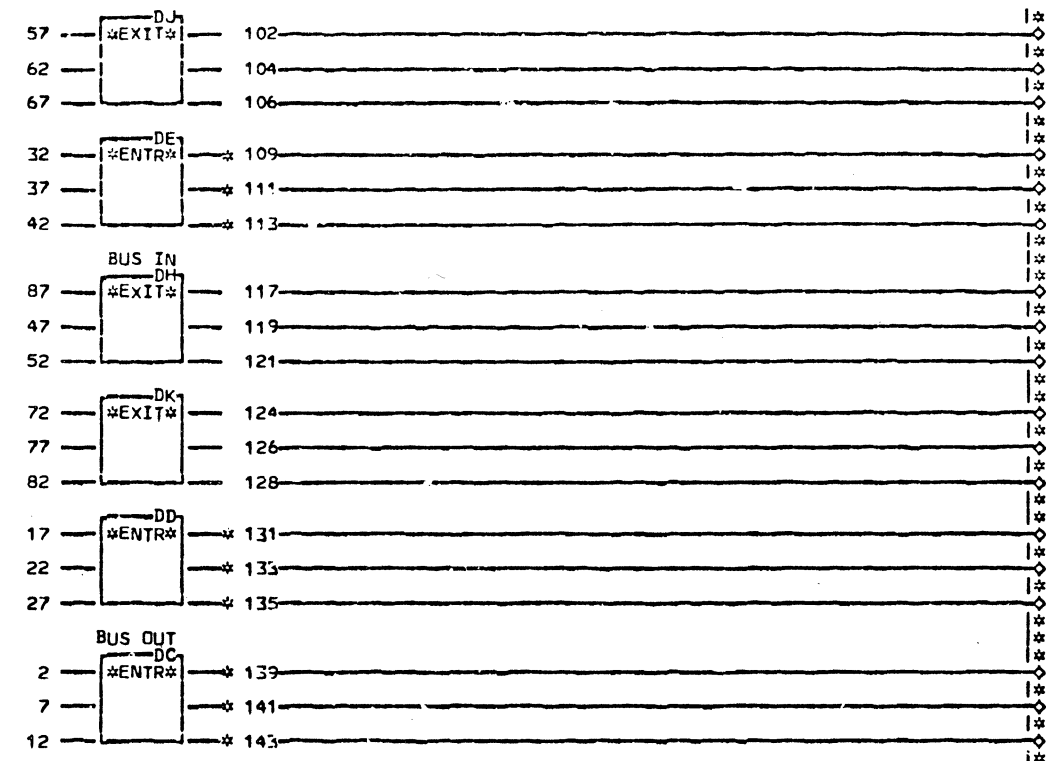

- 139 + INTF A NPL BUS OUT BIT P DC2
- 141 + INTF A NPL BUS OUT BIT 0 DC4
- 143 + INTF A NPL BUS OUT BIT 1 DC6
- 131 + INTF A NPL BUS OUT BIT 2 DD2
- 133 + INTF A NPL BUS OUT BIT 3 DD4
- 135 + INTF A NPL BUS OUT BIT 4 DD6
- 109 + INTF A NPL BUS OUT BIT 5 DE2
- 111 + INTF A NPL BUS OUT BIT 6 DE4
- 113 + INTF A NPL BUS OUT BIT 7 DE6
- 117 + BUS IN P DH2
- 119 + BUS IN 0 DH4
- 121 + BUS IN 1 DH6
- 102 + BUS IN 2 DJ2
- 104 + BUS IN 3 DJ4
- 106 + BUS IN 4 DJ6
- 124 + BUS IN 5 DK2
- 126 + BUS IN 6 DK4
- 128 + BUS IN 7 DK6

NOTE 1 SEE PAGE RA052 FOR A COMPLETE DESCRIPTION OF THE LOGIC BOARD TO TAILGATE FLAT CABLE

NOTE 2 ALL 01T TAILGATE PIN NOMENCLATURE IS THAT OF THE FLAT CABLE END— NOT NECESSARILY WHAT IS PRINTED ON THE TAILGATE CONNECTOR

RA014  
000

EDGE CONN.	131 A-Y4V2D06	01T-A1A1D09
	109 A-Y4V2B10	01T-A1A2B06
	01T-A1A2D10	01T-A1A1D06
	01T-A1A1B10	01T-A1A2D03
	133 A-Y4V2B08	01T-A1A1B03
	111 A-Y4V2D11	01A-Y4V2B09
	01T-A1A2B11	01T-A1A2D08
	01T-A1A1D11	01T-A1A1B08
	113 A-Y4V2B12	135 A-Y4V2D09
	01T-A1A2D12	01A-Y4V2D10
	01T-A1A1B12	01T-A1A2B09
		01T-A1A1B05

LOC. TYPE

TYPE 1 CHANNEL ADAPTER	
CHANNEL INTERFACE A BUS	
E.C. HISTORY	B. MACH. 27RNB
309522C	FRAME 01
309541	
309545	
309548	
DATE	LAST EC
12-27-72	309949
P.N. 1785103	000

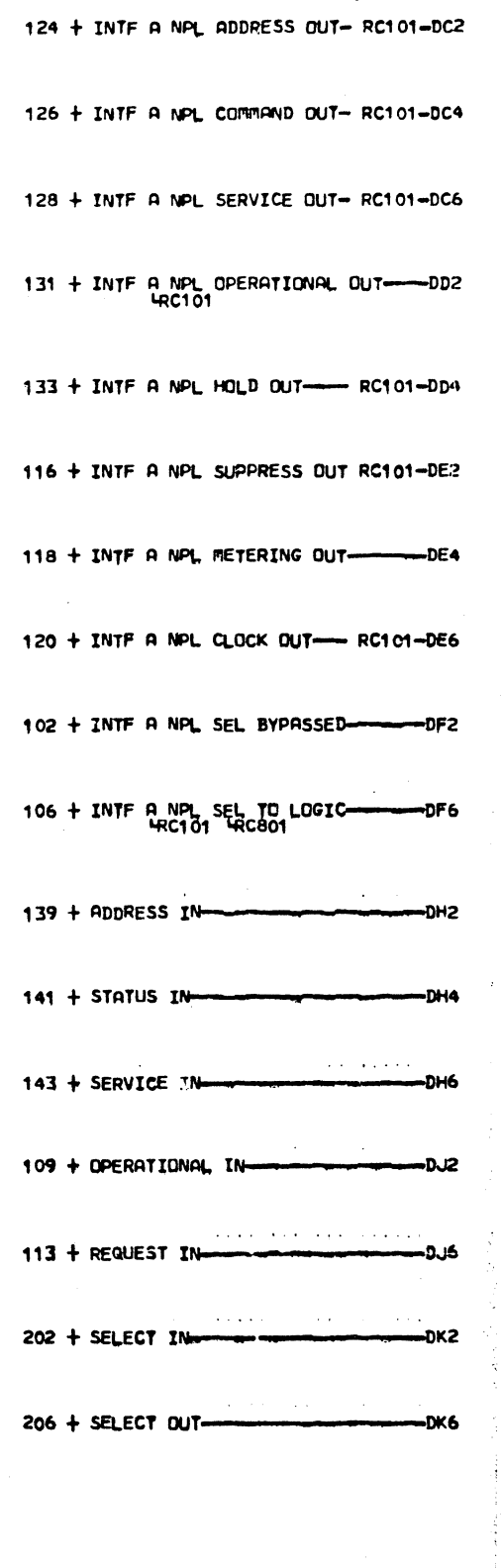
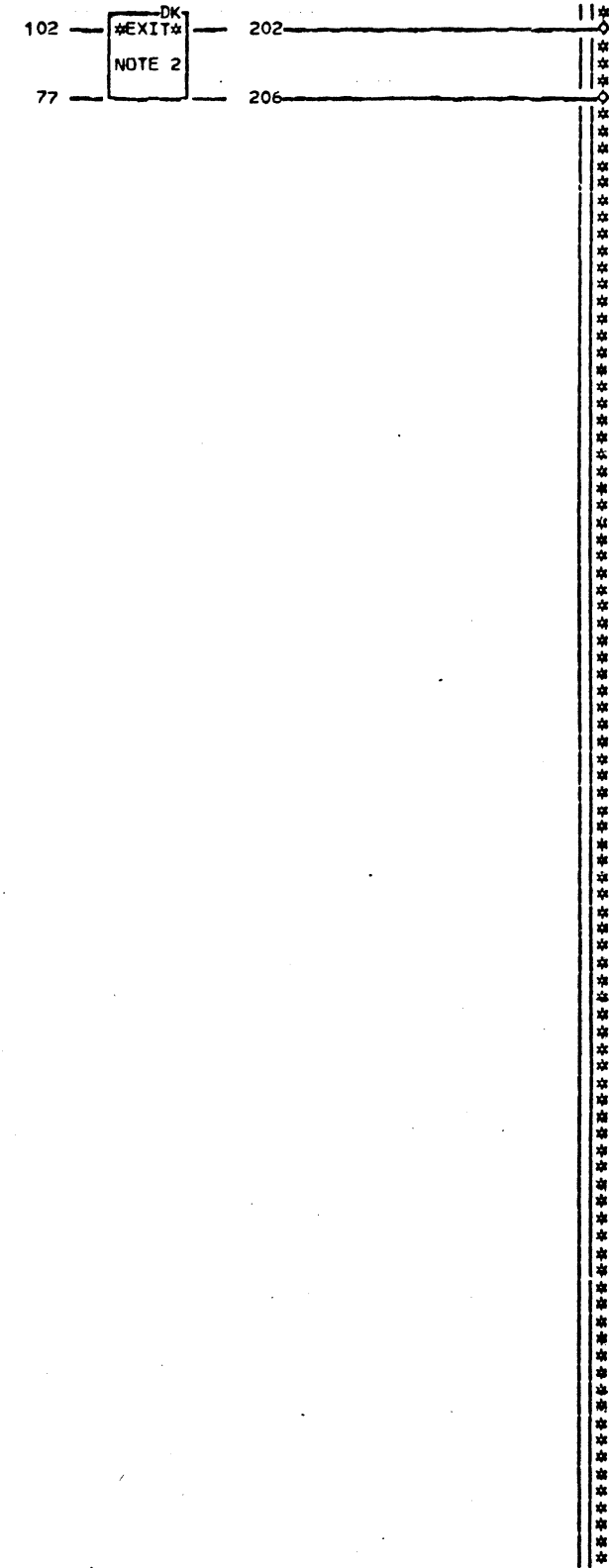
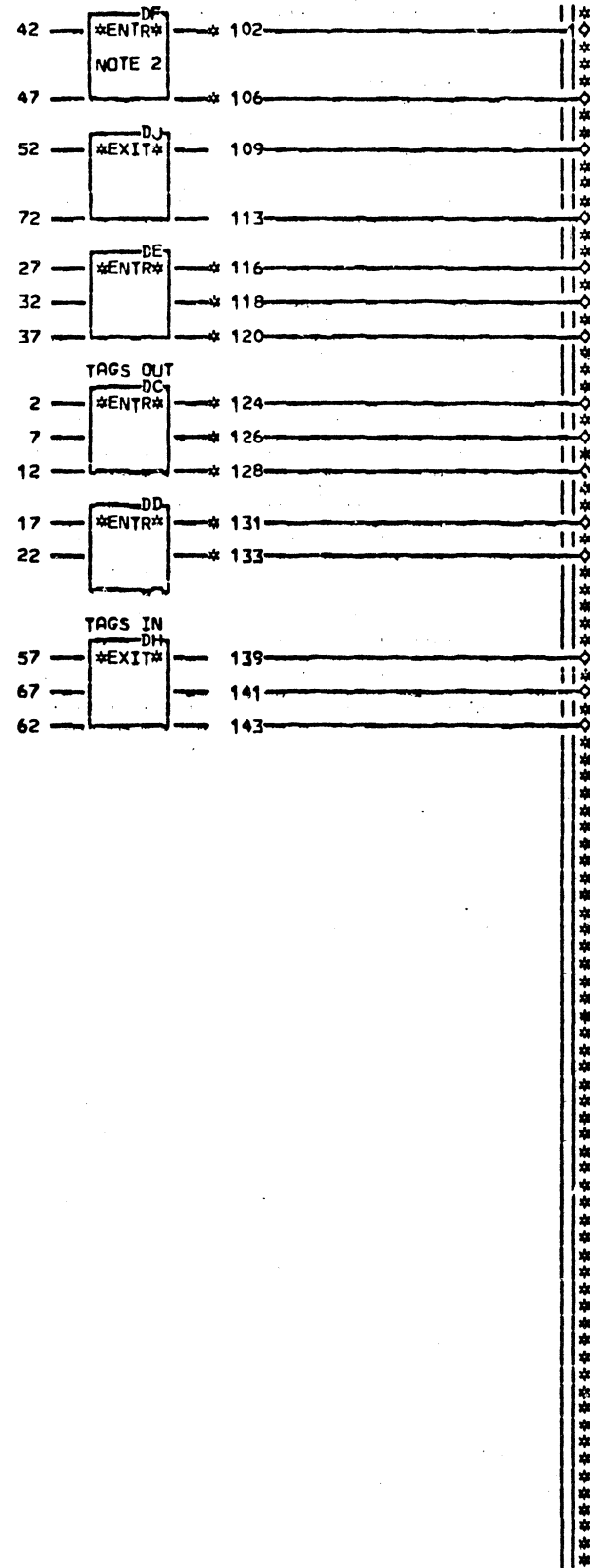
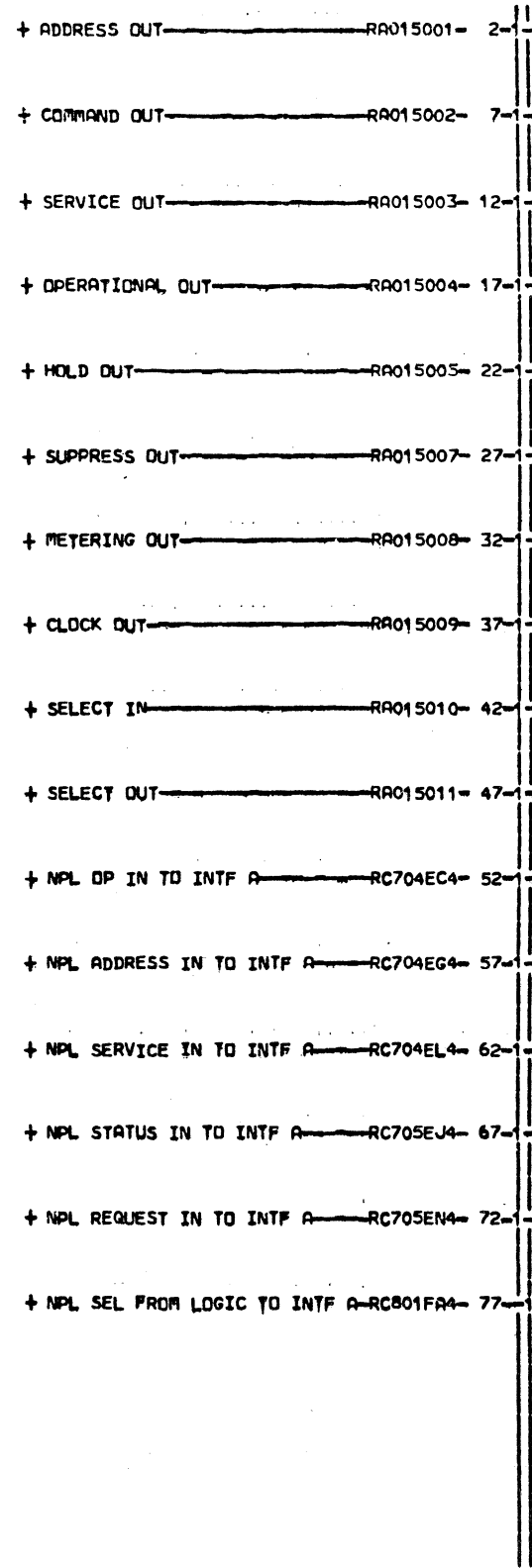

NOTE 1 SEE PAGE RA014 NOTES  
 NOTE 2 FOR TRAPPING ON  
 SELECT OUT THE SIGNALS  
 PROPAGATE DIRECTLY ACROSS  
 THE ENTR AND EXIT BLOCKS.  
 FOR TRAPPING ON SELECT  
 IN THE SIGNALS CROSS  
 IN THE ENTR AND EXIT  
 BLOCKS.

RA015  
000

EDGE CONN.	118 A-Y4V5D05	01T-A1A4B11	01T-A1B3B12
102 A-Y4V4B08	01T-A1B4B04	01T-A1A3D11	
01T-A1A3B08	01T-A1B3D04	128 A-Y4V4D13	
01A-Y4V4B09	120 A-Y4V5B02	01T-A1A4B13	
01T-A1A4D08	01T-A1B4D03	01T-A1A3D13	
106 A-Y4V4D10	01T-A1B3B03	131 A-Y4V5D13	
01T-A1A4B09	124 A-Y4V4B10	01T-A1B4B13	
115 A-Y4V4B12	01T-A1A4D10	01T-A1B3D13	
01T-A1A4D12	01T-A1A3B10	133 A-Y4V5B12	
01T-A1A3B12	126 A-Y4V4D11	01T-A1B4D12	

LOC. TYPE

TYPE 1 CHANNEL ADAPTER			
CHANNEL INTERFACE A TAGS			
E.C.-HISTORY	B. MACH#27RNB		
309522C	309533	FRAME	01
309541			
309545		IBM CORP.SDD	RA015
309548			
DATE	LAST EC		
09-20-72	309944	P.N#	1785104 000

- + BUS OUT P ----- RA016001- 2-
- + BUS OUT 0 ----- RA016002- 7-
- + BUS OUT 1 ----- RA016003- 12-
- + BUS OUT 2 ----- RA016004- 17-
- + BUS OUT 3 ----- RA016005- 22-
- + BUS OUT 4 ----- RA016006- 27-
- + BUS OUT 5 ----- RA016007- 32-
- + BUS OUT 6 ----- RA016008- 37-
- + BUS OUT 7 ----- RA016009- 42-
- + NPL BIT 0 TO INTF B ----- RF201EC4- 47-
- + NPL BIT 1 TO INTF B ----- RF201EG4- 52-
- + NPL BIT 2 TO INTF B ----- RF201EL4- 57-
- + NPL BIT 3 TO INTF B ----- RF202EC4- 62-
- + NPL BIT 4 TO INTF B ----- RF202EG4- 67-
- + NPL BIT 5 TO INTF B ----- RF202EL4- 72-
- + NPL BIT 6 TO INTF B ----- RF203EC4- 77-
- + NPL BIT 7 TO INTF B ----- RF203EG4- 82-
- + NPL BIT P TO INTF B ----- RF203EL4- 87-

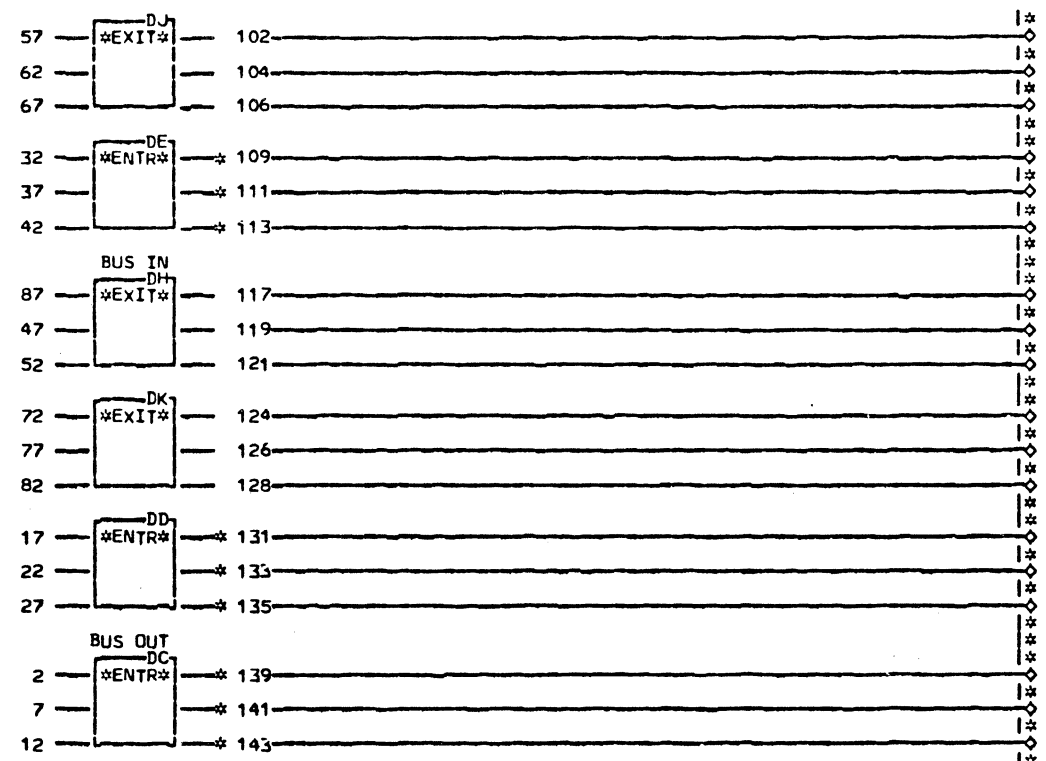

- 139 + INTF B NPL BUS OUT BIT P ----- DC2
- 141 + INTF B NPL BUS OUT BIT 0 ----- DC4
- 1-3 + INTF B NPL BUS OUT BIT 1 ----- DC6
- 131 + INTF B NPL BUS OUT BIT 2 ----- DD2
- 133 + INTF B NPL BUS OUT BIT 3 ----- DD4
- 135 + INTF B NPL BUS OUT BIT 4 ----- DD6
- 109 + INTF B NPL BUS OUT BIT 5 ----- DE2
- 111 + INTF B NPL BUS OUT BIT 6 ----- DE4
- 113 + INTF B NPL BUS OUT BIT 7 ----- DE6
- 117 + BUS IN P ----- DH2
- 119 + BUS IN 0 ----- DH4
- 121 + BUS IN 1 ----- DH6
- 102 + BUS IN 2 ----- DJ2
- 104 + BUS IN 3 ----- DJ4
- 106 + BUS IN 4 ----- DJ6
- 124 + BUS IN 5 ----- DK2
- 126 + BUS IN 6 ----- DK4
- 128 + BUS IN 7 ----- DK6

NOTE 1 SEE PAGE RA052 FOR A COMPLETE DESCRIPTION OF THE LOGIC BOARD TO TAILGATE FLAT CABLE

NOTE 2 ALL 01U TAILGATE PIN NOMENCLATURE IS THAT OF THE FLAT CABLE END— NOT NECESSARILY WHAT IS PRINTED ON THE TAILGATE CONNECTOR

RA016  
000

EDGE CONN#	131 A-Y4U2D06	01U-A1A1D09
109 A-Y4U2B10	01U-A1A2B06	139 A-Y4U2B02
01U-A1A2D10	01U-A1A1D06	01U-A1A2D03
01U-A1A1B10	133 A-Y4U2B08	01U-A1A1B03
111 A-Y4U2D11	01A-Y4U2B09	141 A-Y4U2D05
01U-A1A2B11	01U-A1A2D08	01U-A1A2B04
01U-A1A1D11	01U-A1A1B08	01U-A1A1D04
113 A-Y4U2B12	135 A-Y4U2D09	143 A-Y4U2B05
01U-A1A2D12	01A-Y4U2D10	01U-A1A2D05
01U-A1A1B12	01U-A1A2B09	01U-A1A1B05

LOC. TYPE

TYPE 1 CHANNEL ADAPTER		CHANNEL INTERFACE B BUS	
E.C. HISTORY		MACH#27RNB	
309522C	309533	FRAME	01
309541		IBM CORP.SDD	RA016
309545			
309548			
DATE	LAST EC	P.No	1785105
12-27-72	309949		000

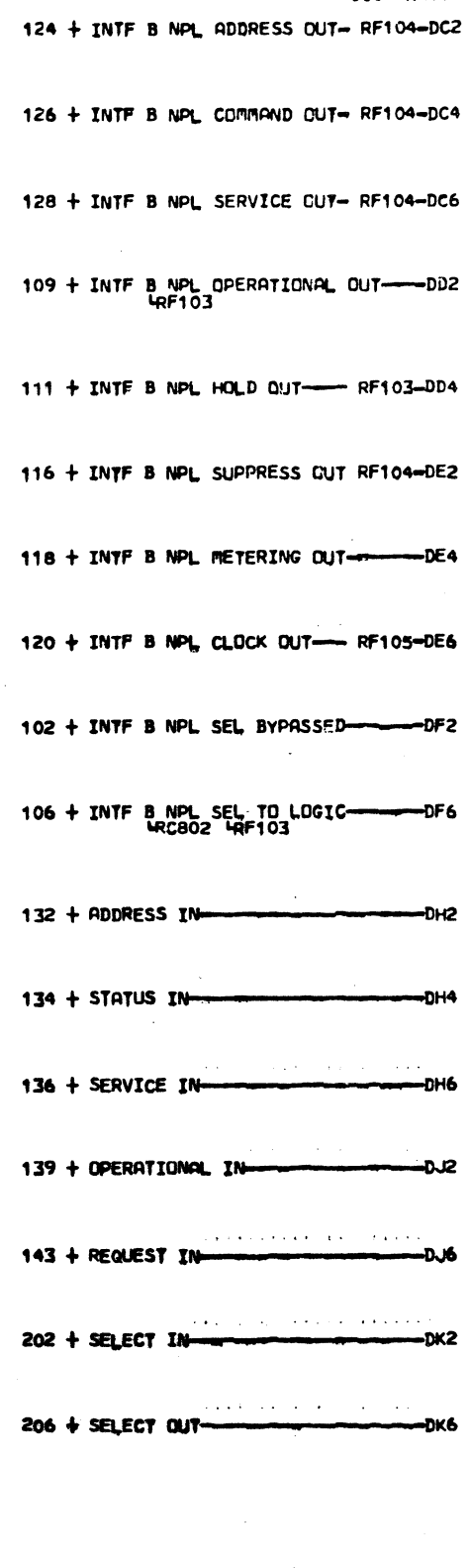
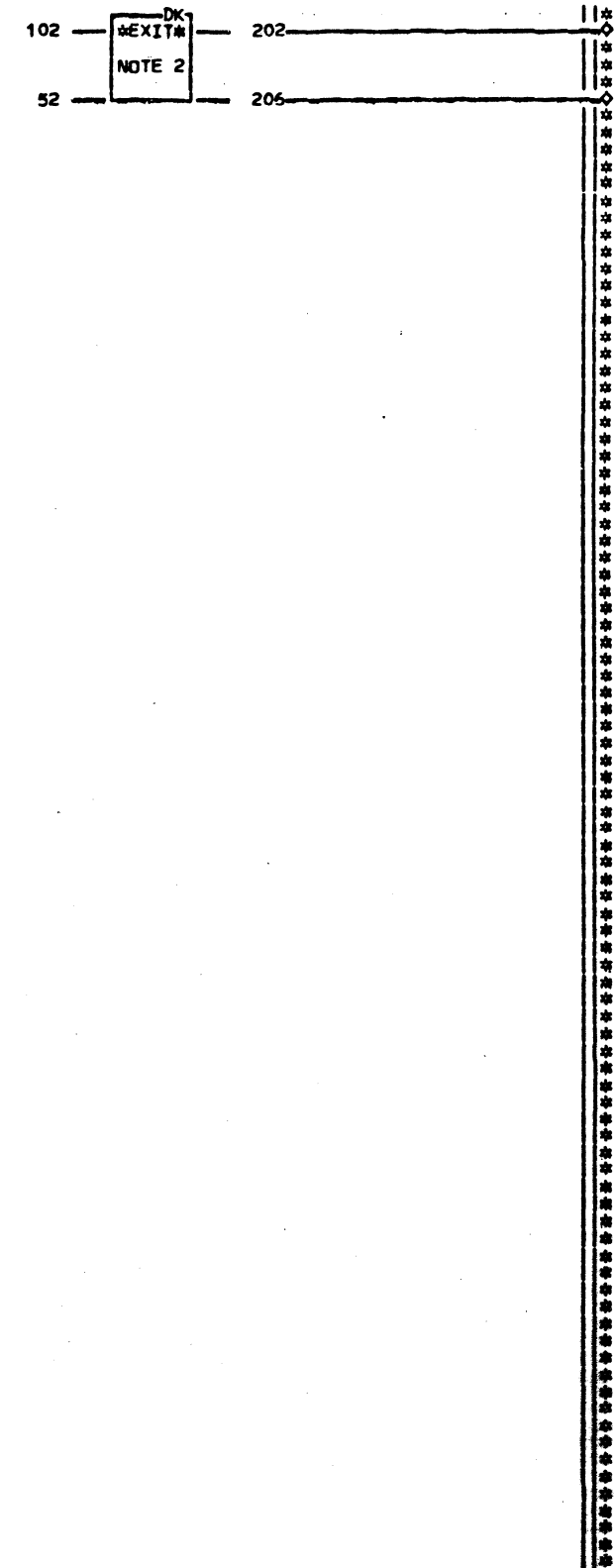
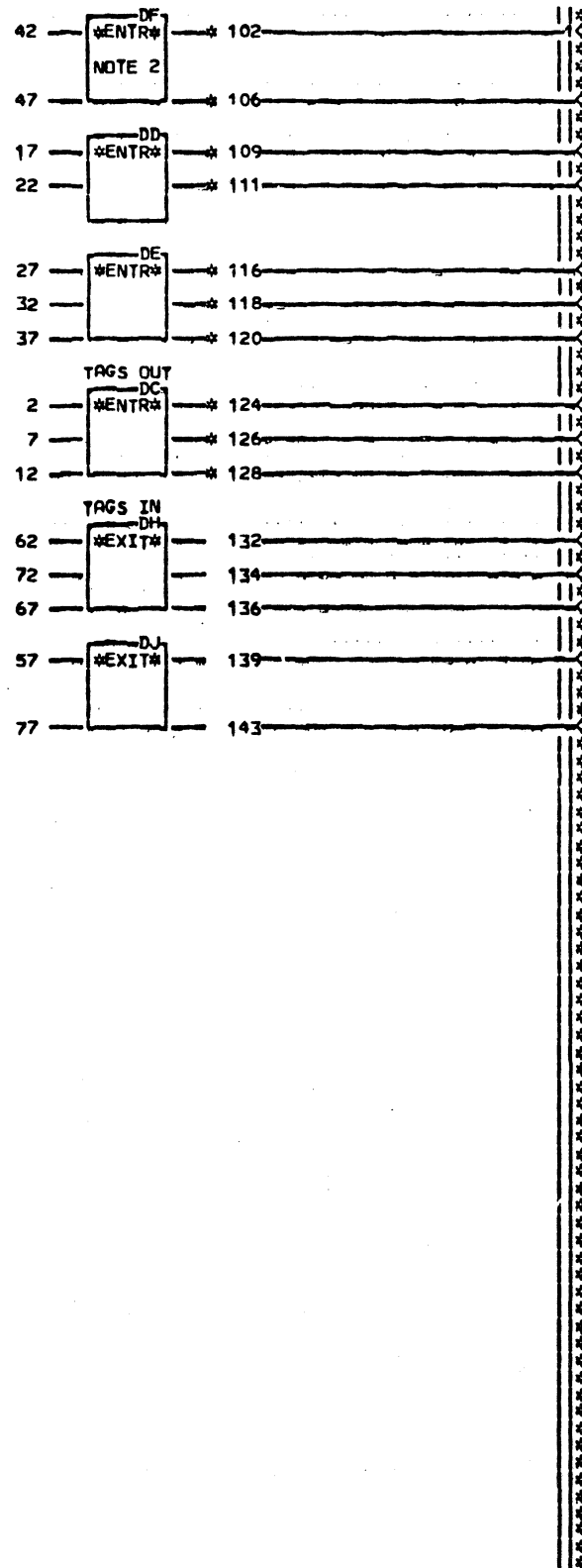
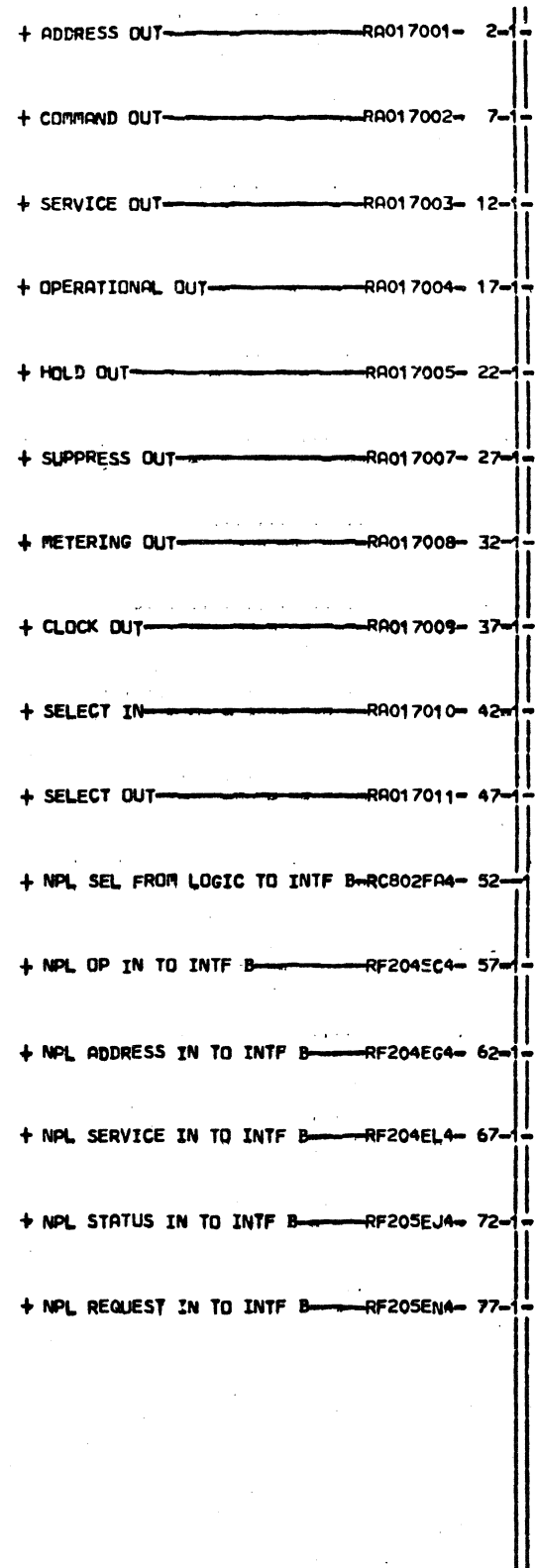

NOTE 1 SEE PAGE RA016 NOTES  
 NOTE 2 FOR TRAPPING ON  
 SELECT OUT THE SIGNALS  
 PROPAGATE DIRECTLY ACROSS  
 THE ENTR AND EXIT BLOCKS.  
 FOR TRAPPING ON SELECT  
 IN THE SIGNALS CROSS  
 IN THE ENTR AND EXIT  
 BLOCKS.

RA017  
000

EDGE CONN.	111 A-Y4U5B12	01U-A1B4D03	01U-A1A3D13
102 A-Y4U4B08	01U-A1B4D12	01U-A1B3B03	
01U-A1A3B08	01U-A1B3B12	124 A-Y4U4B10	
01A-Y4U4B09	116 A-Y4U4B12	01U-A1A4D10	
01U-A1A4D08	01U-A1A4D12	01U-A1A3B10	
106 A-Y4U4D10	01U-A1A3B12	126 A-Y4U4D11	
01U-A1A4R09	118 A-Y4U5D05	01U-A1A4B11	
109 A-Y4U5D13	01U-A1B4B04	01U-A1A3D11	
01U-A1B4B13	01U-A1B3D04	128 A-Y4U4D13	
01U-A1B3D13	120 A-Y4U5B02	01U-A1A4B13	

LOC. TYPE

TYPE 1 CHANNEL ADAPTER		CHANNEL INTERFACE B TAGS	
E-C-HISTORY		B-RACH-27RNB	
309522C	309533	FRAME	01
309541			
309545			
309548		IBM CORP-SDD	RA017
DATE	LAST EC		
09-29-72	309944	P.N. 1785106	000

-BLANK COLUMN-

-BLANK COLUMN-

-BLANK COLUMN-

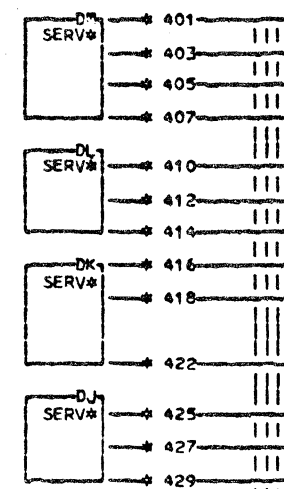

- 081 RA018
- 425 GROUND LEVEL — RS206-DJ2
  - 427 GROUND LEVEL — RS206-DJ4
  - 429 GROUND LEVEL — RS206-DJ6
  - 416 GROUND LEVEL — RS206-DK1
  - 418 GROUND LEVEL — RS206-DK3
  - 422 GROUND LEVEL — RS307-DK7
  - 410 GROUND LEVEL — RS306-DL2
  - 412 GROUND LEVEL — RS306-DL4
  - 414 GROUND LEVEL — RS306-DL6
  - 401 GROUND LEVEL — RS306-DM1
  - 403 GROUND LEVEL — RS306-DM3
  - 405 GROUND LEVEL — RS306-DM5
  - 407 GROUND LEVEL — RS306-DM7

EDGE CONN.	422	A-Y4F1C13
401	A-Y4F1B11	425 A-Y4F1A13
403	A-Y4F1C11	427 A-Y4D1E13
405	A-Y4F1D11	429 A-Y4F1E13
407	A-Y4E1E11	
410	A-Y4E1B13	
412	A-Y4E1C13	
414	A-Y4E1D13	
416	A-Y4G1A13	
418	A-Y4D1E11	

LOC. TYPE

RA018

081 SIM TO PN 1785107 EC 309545

SERV WIRING	
E-C-HISTORY	E-MACH-27RNB
FRAME	01
DATE LAST EC	IBM CORP. SCD RA018
10-14-80 344270	PoN. 1986977 081

+ 6 VOLTS FROM VOLTAGE BUSS—RA020001— 2—3

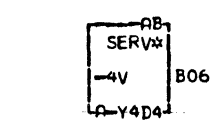
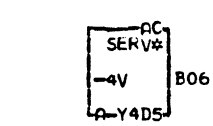
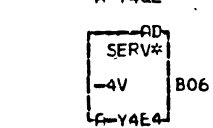
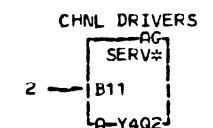
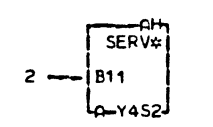
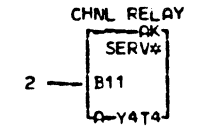
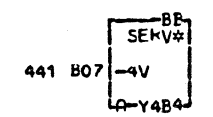
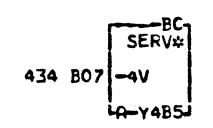
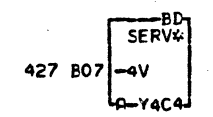
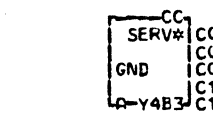
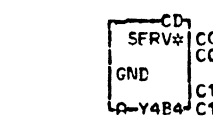
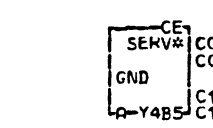
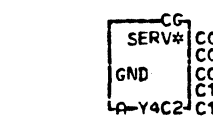
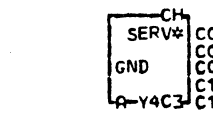
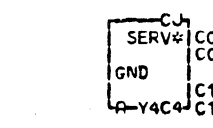
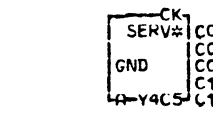
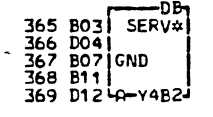
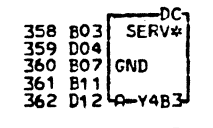
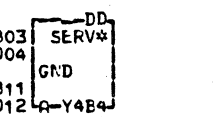
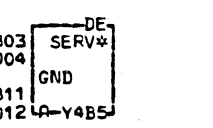
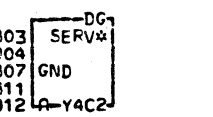
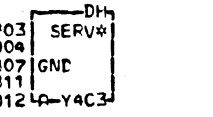
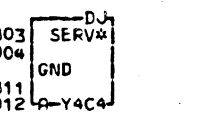
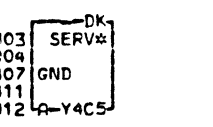
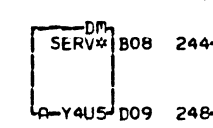
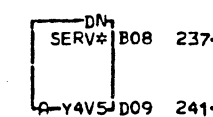
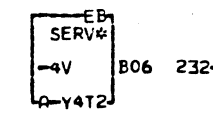
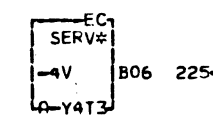
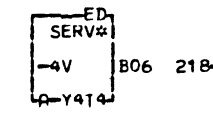
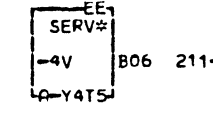
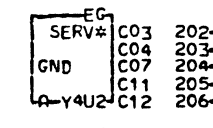
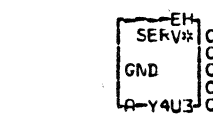
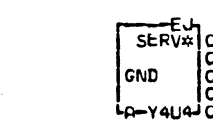
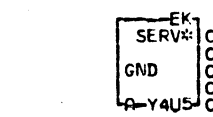
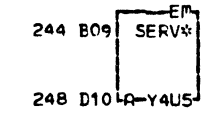
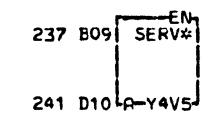
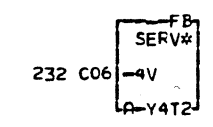
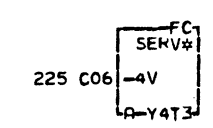
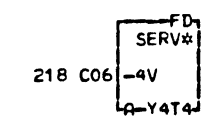
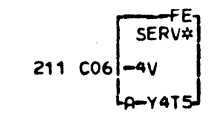
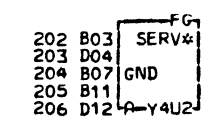
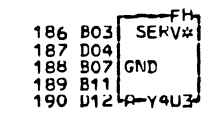
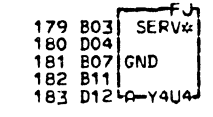
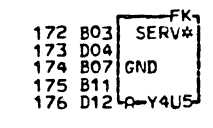

LCC TYPE

SERVICE WIRING

E-C-HISTORY	B-MACH-27FNB
309522C	FRAME 01
309541	IBM CORP. SDD RA020
DATE LAST EC	P.No. 1785109 000
04-19-72 309545	

C  
1785110

PART NO  
1785110

LOGIC PG NO  
RA050

TYPE I CHANNEL ADAPTER CARD JUMPER INFORMATION

1. INTERFACE A NSC CHANNEL ADDRESS

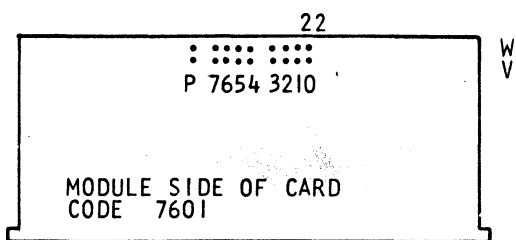

CARD LOCATION: 01A-Y4P2  
INSERT JUMPER FOR 0, REMOVE FOR 1  
LOGIC PAGE - RC104

2. INTERFACE B NSC CHANNEL ADDRESS

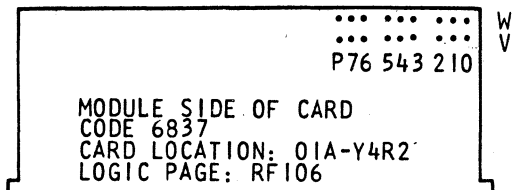

CARD LOCATION: 01A-Y4R2  
LOGIC PAGE: RF106

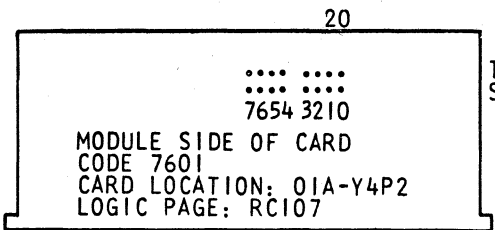

CARD LOCATION: 01A-Y4P2  
LOGIC PAGE: RC107

INSERT JUMPER FOR 0, REMOVE FOR 1

"THIS DOCUMENT IS THE PROPERTY OF IBM. ITS USE IS AUTHORIZED ONLY FOR RESPONDING TO A REQUEST FOR QUOTATION OR FOR THE PERFORMANCE OF WORK FOR IBM. ALL QUESTIONS MUST BE REFERRED TO THE IBM PURCHASING DEPARTMENT."

<b>IBM</b>				DATE	CHANGE NO	DATE	CHANGE NO
NAME	TYPE I CA REFERENCE PAGE			FEB72	309541		
DESIGN	RZ	FEB72	SHT OF				
DETAIL	VR	FEB72					
CHECK			CLASSIFICATION	MUST CONFORM TO ENG SPEC	DEVELOPMENT NO	LOGIC PG NO	
APPRO						RA050	

1785110

C



**C**

LOW VALID ESC ADDRESS

HI VALID ESC ADDRESS

PART NO 1785111 LOGIC PG NO RA051

WRITE IN LOW ADDRESS **40**

WRITE IN HIGH ADDRESS **5F**

FIRST CHANNEL ADDRESS ASSIGNED (MUST BE MULTIPLES OF 16 SUCH AS 0, 16, 32, 48, ETC.)

FIRST ADDRESS PLUG A-Y4M2 (CODE 2325) TO THIS CONFIGURATION

HEX	T29-S29	T28-S28	T27-S27	T26-S26	W20-V20	W19-V19	W16-V16
00	T29-S29	T28-S28	T27-S27	T26-S26	W20-V20	W19-V19	W16-V16
10	T28-S28	T27-S27	T26-S26	W21-V21	W25-V25	W24-V24	W16-V16
20	T29-S29	T27-S27	T26-S26	W26-V26	W25-V25	W24-V24	W16-V16
30	T27-S27	T26-S26	W26-V26	W25-V25	W24-V24	W21-V21	W16-V16
40	W30-V30	W29-V29	T29-S29	T28-S28	T26-S26	W21-V21	W16-V16
50	W30-V30	W29-V29	T28-S28	T26-S26	W21-V21	W19-V19	W16-V16
60	W30-V30	W29-V29	T29-S29	T26-S26	W26-V26	W24-V24	W16-V16
70	W30-V30	W29-V29	T26-S26	W26-V26	W24-V24	W21-V21	W16-V16
80	W31-V31	T29-S29	T28-S28	T27-S27	W19-V19	W16-V16	
90	W31-V31	T28-S28	T27-S27	W20-V20	W19-V19	W16-V16	
AO	W31-V31	T29-S29	T27-S27	W25-V25	W24-V24	W16-V16	
BO	W31-V31	T27-S27	W25-V25	W24-V24	W20-V20	W16-V16	
CO	W31-V31	W29-V29	T29-S29	T28-S28	W19-V19	W16-V16	
DO	W31-V31	W29-V29	T28-S28	W19-V19	W16-V16		
EO	W31-V31	W29-V29	T29-S29	W24-V24			
FO	W31-V31	W29-V29	W24-V24	W16-V16			

PLUG A-Y4M2 (CODE 2325) TO THIS CONFIGURATION

LAST CH ADDRESS		S22-T22	S21-T21	S20-T20	S18-T18	S17-T17	S16-T16
HEX	DEC						
03	3	FLT	JMP	FLT	JMP	FLT	FLT
07	7	FLT	JMP	FLT	JMP	FLT	JMP
0B	11	FLT	JMP	FLT	JMP	JMP	FLT
0F	15	FLT	JMP	FLT	JMP	JMP	JMP
13	19	FLT	JMP	FLT	FLT	FLT	FLT
17	23	FLT	JMP	FLT	FLT	FLT	JMP
1B	27	FLT	JMP	FLT	FLT	JMP	FLT
1F	31	FLT	JMP	FLT	FLT	JMP	JMP
23	35	FLT	JMP	JMP	JMP	FLT	FLT
27	39	FLT	JMP	JMP	JMP	FLT	JMP
2B	43	FLT	JMP	JMP	JMP	JMP	FLT
2F	47	FLT	JMP	JMP	JMP	JMP	FLT
33	51	FLT	JMP	JMP	FLT	FLT	JMP
37	55	FLT	JMP	JMP	FLT	FLT	JMP
3B	59	FLT	JMP	JMP	FLT	JMP	FLT
3F	63	FLT	JMP	JMP	FLT	JMP	JMP
43	67	FLT	FLT	FLT	JMP	FLT	FLT
47	71	FLT	FLT	FLT	JMP	FLT	JMP
4B	75	FLT	FLT	FLT	JMP	JMP	FLT
4F	79	FLT	FLT	FLT	JMP	JMP	JMP
53	83	FLT	FLT	FLT	FLT	FLT	FLT
57	87	FLT	FLT	FLT	FLT	FLT	JMP
5B	91	FLT	FLT	FLT	FLT	JMP	FLT
5F	95	FLT	FLT	FLT	FLT	JMP	JMP
63	99	FLT	FLT	JMP	JMP	FLT	FLT
67	103	FLT	FLT	JMP	JMP	FLT	JMP
6B	107	FLT	FLT	JMP	JMP	JMP	FLT
6F	111	FLT	FLT	JMP	JMP	JMP	JMP
73	115	FLT	FLT	JMP	FLT	FLT	FLT
77	119	FLT	FLT	JMP	FLT	FLT	JMP
7B	123	FLT	FLT	JMP	FLT	JMP	FLT
7F	127	FLT	FLT	JMP	FLT	JMP	JMP
83	131	JMP	JMP	FLT	JMP	FLT	FLT
87	135	JMP	JMP	FLT	JMP	FLT	JMP
8B	139	JMP	JMP	FLT	JMP	JMP	FLT
8F	143	JMP	JMP	FLT	JMP	JMP	JMP
93	147	JMP	JMP	FLT	FLT	FLT	FLT
97	151	JMP	JMP	FLT	FLT	FLT	JMP
9B	155	JMP	JMP	FLT	FLT	JMP	FLT
9F	159	JMP	JMP	FLT	FLT	JMP	JMP
A3	163	JMP	JMP	JMP	JMP	FLT	FLT
A7	167	JMP	JMP	JMP	JMP	FLT	JMP
AB	171	JMP	JMP	JMP	JMP	JMP	FLT
AF	175	JMP	JMP	JMP	JMP	JMP	JMP
B3	179	JMP	JMP	JMP	FLT	FLT	FLT
B7	183	JMP	JMP	JMP	FLT	FLT	JMP
BB	187	JMP	JMP	JMP	FLT	JMP	FLT
BF	191	JMP	JMP	JMP	FLT	JMP	JMP
C3	195	JMP	FLT	FLT	JMP	FLT	FLT
C7	199	JMP	FLT	FLT	JMP	FLT	JMP
CB	203	JMP	FLT	FLT	JMP	JMP	FLT
CF	207	JMP	FLT	FLT	JMP	JMP	JMP
D3	211	JMP	FLT	FLT	FLT	FLT	FLT
D7	215	JMP	FLT	FLT	FLT	FLT	FLT
DB	219	JMP	FLT	FLT	FLT	JMP	JMP
DF	223	JMP	FLT	FLT	FLT	JMP	JMP
E3	227	JMP	FLT	JMP	JMP	FLT	FLT
E7	231	JMP	FLT	JMP	JMP	FLT	JMP
EB	235	JMP	FLT	JMP	JMP	JMP	FLT
EF	239	JMP	FLT	JMP	JMP	JMP	JMP
F3	243	JMP	FLT	JMP	FLT	FLT	FLT
F7	247	JMP	FLT	JMP	FLT	FLT	JMP
FB	251	JMP	FLT	JMP	FLT	JMP	FLT
FF	255	JMP	FLT	JMP	FLT	JMP	JMP

REFER TO LOGIC PAGES RC302 FOR LOW VALID ESC ADDRESSES  
 REFER TO LOGIC PAGES RC304 FOR HIGH VALID ESC ADDRESSES

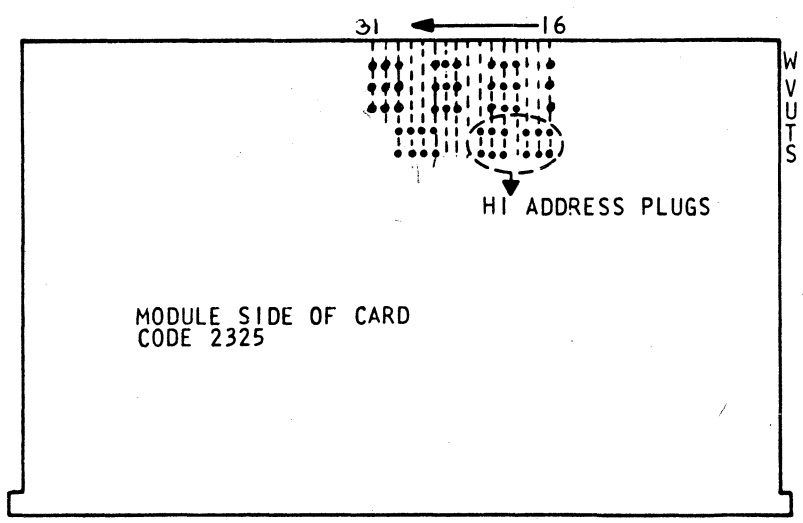

FILL IN ABOVE PLUG CARD ACCORDING TO CHARTS FOR LOW & HIGH VALID ADDRESS. PLUG ONLY THOSE PINS SPECIFIED FOR EACH ADDRESS. WHEN RUNNING IN NSC MODE ONLY, PLUG THIS CARD. LOW VALID ADDRESS = (HEX C0, DECIMAL = 192) AND HIGH VALID ADDRESS = (HEX 53, DECIMAL = 83)

THIS DOCUMENT IS THE PROPERTY OF IBM. ITS USE OR REPRODUCTION IS AUTHORIZED ONLY FOR RESPONDING TO A REQUEST FOR QUOTATION OR FOR THE PERFORMANCE OF WORK FOR IBM. ALL QUESTIONS MUST BE REFERRED TO THE IBM PURCHASING DEPARTMENT.

<b>IBM</b>				DATE	CHANGE NO	DATE	CHANGE NO	1785111
NAME	TYPE I CA REFERENCE PAGE			FEB72	309541			
				JUN 72	309533			
DESIGN	RZ	FEB72	SHT OF					
DETAIL	VR	FEB72						
CHECK			CLASSIFICATION	MUST CONFORM TO ENG SPEC		DEVELOPMENT NO		LOGIC PG NO
APPRO						RA051		<b>C</b>

**SELECT IN - SELECT OUT JUMPERING**

THE 3705 IS FACTORY WIRED TO TRAP ON SELECT-OUT. IN ORDER TO TRAP ON SELECT-IN, THE FOLLOWING BOARD WIRING CHANGES MUST BE MADE TO THE TYPE I CHANNEL ADAPTERS:

TAILGATE "Y CABLE" - P/N 5997539

1785112

DELETE INTERFACE	PINS	IMAGE	NET NUMBER	ADD	TYPE	FROM	TO
A.	V4B08	W	RA015DF2	ADD	YEL	V4D10	V4D09
	V4B09	W	RA015DF6	ADD	YEL	V4B08	T4B07
	V4D10	W					
	T4B07	W					
	P2D02	W					
	V4D09	W	RC801FA4	ADD	YEL	V4B09	T4B02
B.	T4B02	W					
	Q2M12	W					
	U4B08	W	RA017DF2	ADD	YEL	U4D10	U4D09
	U4B09	W	RA017DF6	ADD	YEL	U4B08	T4G09
	U4D10	W					
	T4G09	W					
	R2M04	W					
	U4D09	W	RC802FA4	ADD	YEL	U4B09	T4G03
T4G03	W						
S2M12	P						

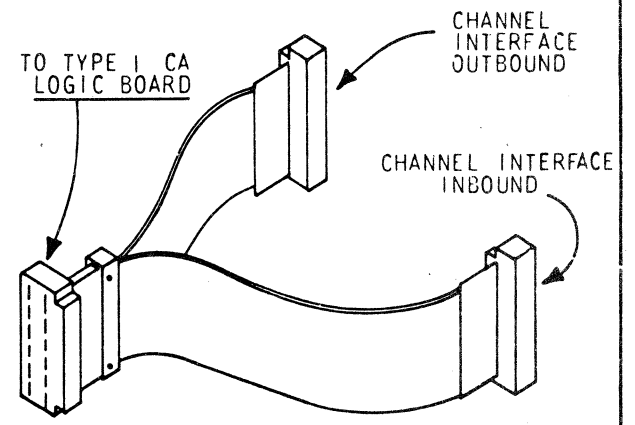

INDICATE CHANGES LISTED ON APPROPRIATE ALD PAGES.

**CHANNEL TAILGATE**

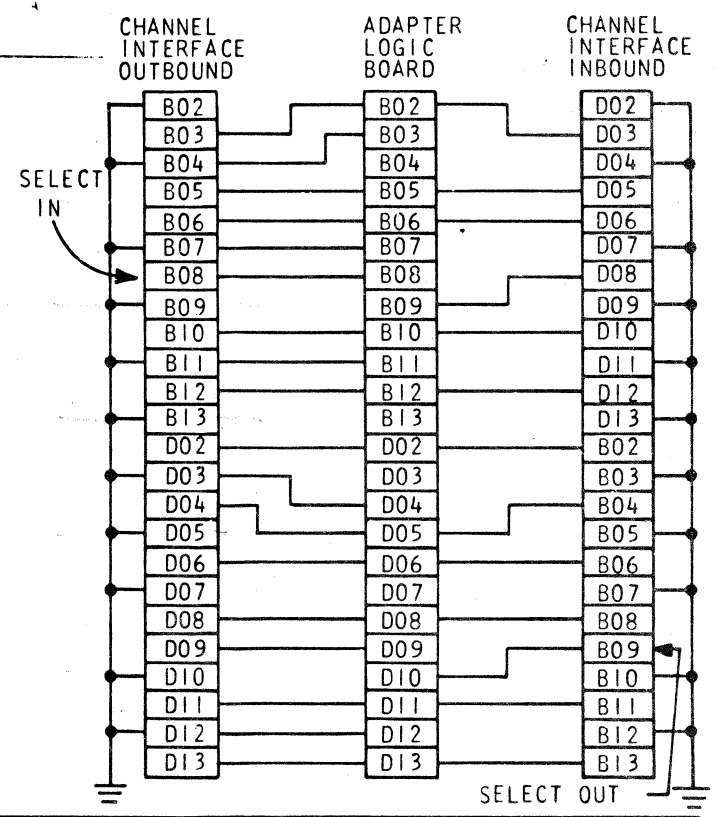
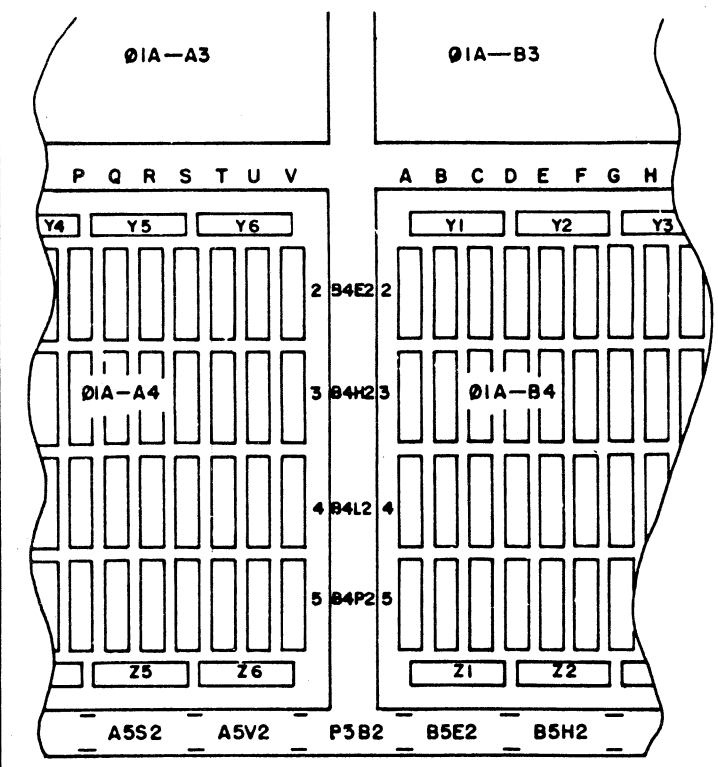

	A	B	1	A	B	LIGHT GY CONN
BUS OUT	TO A4V2	TO A4V3	1	TO A4U2	TO A4U3	
BUS IN	TO A4V2	TO A4V3	2	TO A4U2	TO A4U3	DARK GY CONN
TAG OUT	TO A4V4	TO A4V5	3	TO A4U4	TO A4U5	LIGHT GY CONN
TAG IN	TO A4V4	TO A4V5	4	TO A4U4	TO A4U5	DARK GY CONN

O1U-A1 INTERFACE A      O1U-A1 INTERFACE B(TPS)

CARD SIDE - LOOKING INTO I/O GATE

LIGHT GRAY - 5362304 (A STYLE)  
DARK GRAY - 5362305 (B STYLE)

	FROM O1A-A4 BOARD		TO RACEWAY		TO RACEWAY		TO I/O PANEL SOCKET LOCATION
	SOCKET LOCATION	DIRECTION OF FOLD	LOCATION	DIRECTION OF FOLD	LOCATION	DIRECTION OF FOLD	
FIRST CHANNEL	V2	→	B5B2	←	A5V2	→	O1U-A1A1 A1A2
	V3	→	B5B2	NO FOLD ↓			O1U-A1B1 A1B2
	V4	→	B5B2	←	B5V2	→	O1U-A1A3 A1A4
	V5	→	B5B2	NO FOLD ↓			O1U-A1B3 A1B4
	SECOND CHANNEL (TPS)	U2	→	B5B2	→	B5E2	→
U3		→	B5B2	→	B5H2	→	O1U-A1B1 A1B2
U4		→	B5B2	→	B5E2	→	O1U-A1A3 A1A4
U5		→	B5B2	→	B5H2	→	O1U-A1B3 A1B4

THIS DOCUMENT IS THE PROPERTY OF IBM. ITS USE OR REPRODUCTION IS AUTHORIZED ONLY FOR RESPONDING TO A REQUEST FOR QUOTATION OR FOR THE PERFORMANCE OF WORK FOR IBM. ALL QUESTIONS MUST BE REFERRED TO THE IBM PURCHASING DEPARTMENT.

IBM				DATE	CHANGE NO	DATE	CHANGE NO
NAME	JUMPERING TYPE I CA			FEB72	309541		
REFERENCE PAGE				JUN72	309533		
DESIGN	RZ	FEB72	SHT OF	NOV72	309944		
DETAIL	VR	JUN72		NOV75	312926		
CHECK		CLASSIFICATION	MUST CONFORM TO ENG SPEC		DEVELOPMENT NO		LOGIC PG NO
APPRO							RA052

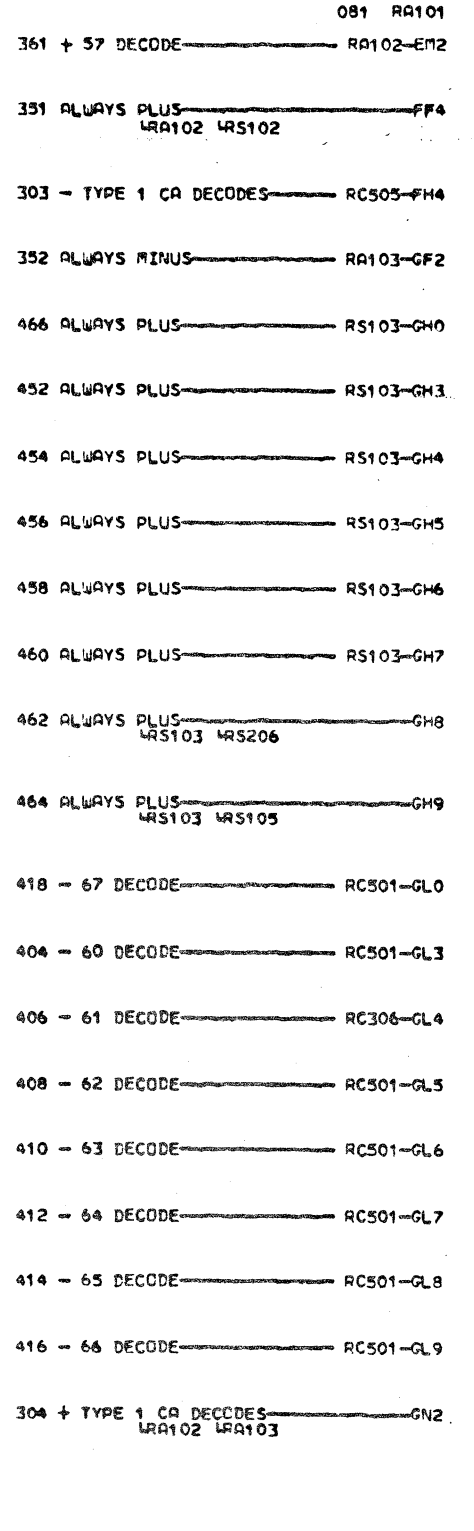
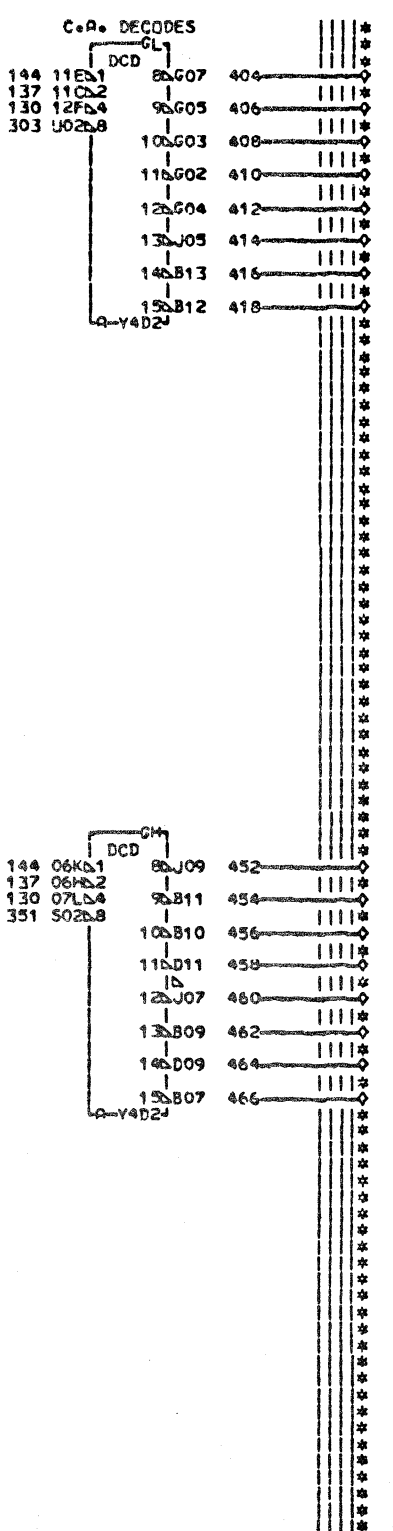
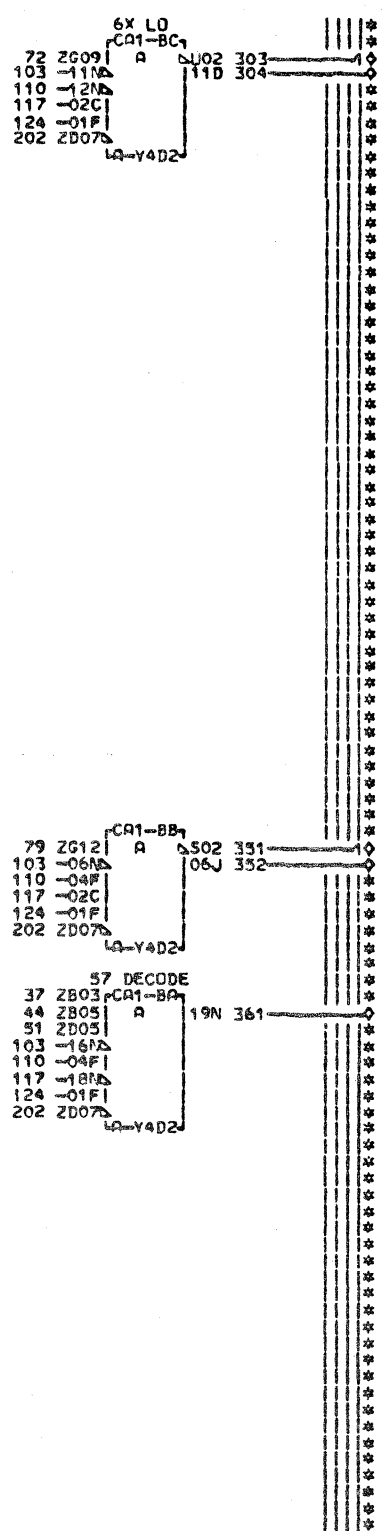
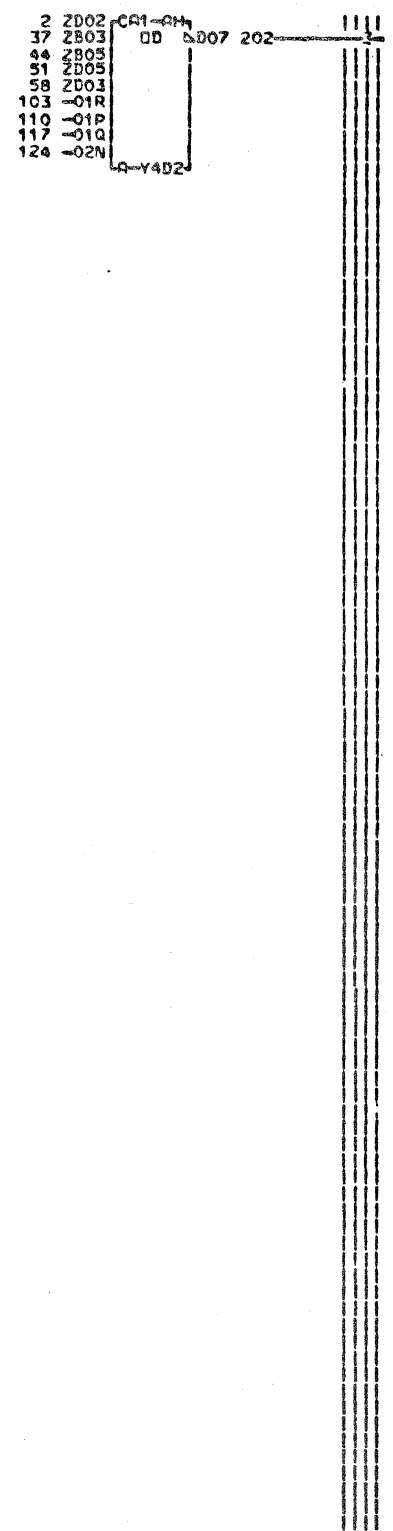
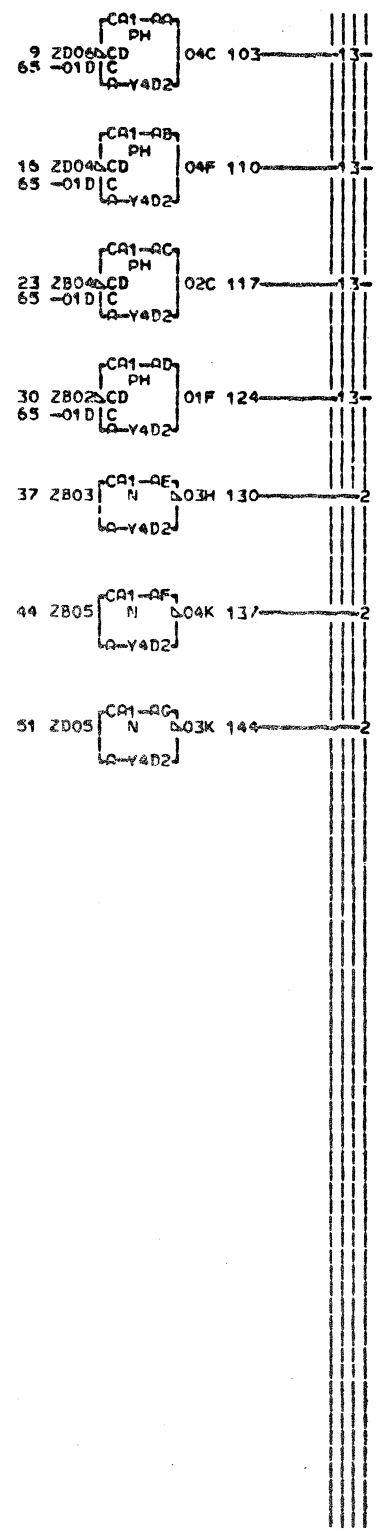
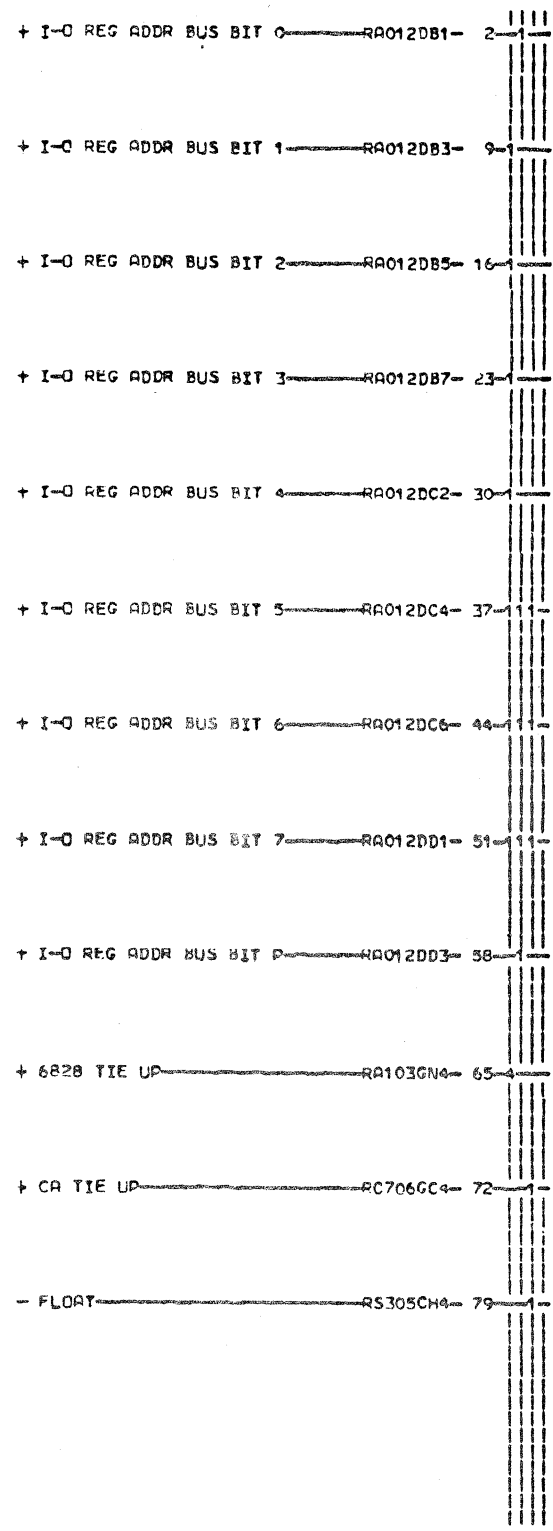

LDC. TYPE  
A-Y4D2 6828

RA101  
081 SIM TO PN 1785113 EC 309548

TYPE 1 CA I-O DECODES	
E-C-HISTORY	E-PACH-27RNB
FRAME	01
DATE LAST EC	IBM CORP-SCD RA101
10-14-80 344270	PN# 1986979 081

- GATE 1ST TEST PNTS ON INBUS—RA012DE2— 2-1

+ 57 DECODE—RA101EM2— 12-1

ALWAYS PLUS—RA101FF4— 22-1

+ TYPE 1 CA DECODES—RA101GN2— 32-1

+ ADAPTER I-O DECODED ENTER—RA102034\*— 42-1

+ CA L1 INTERRUPT REQ—RC505GM6— 52-1

+ CHAL BUS IN ERROR TO EPR DEY—RC707CC2— 62-1

- FLOAT—RS105CM2— 72-1

- FLOAT—RS206GK2— 82-1

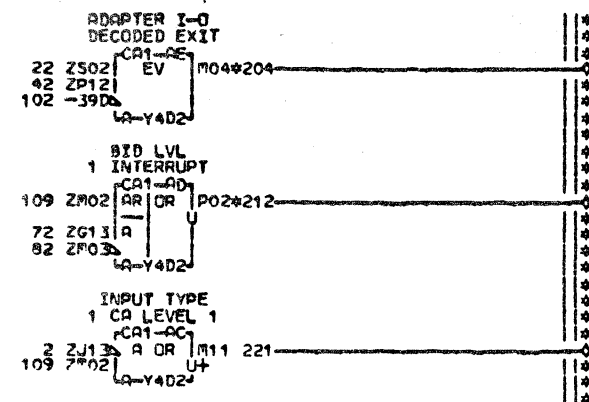
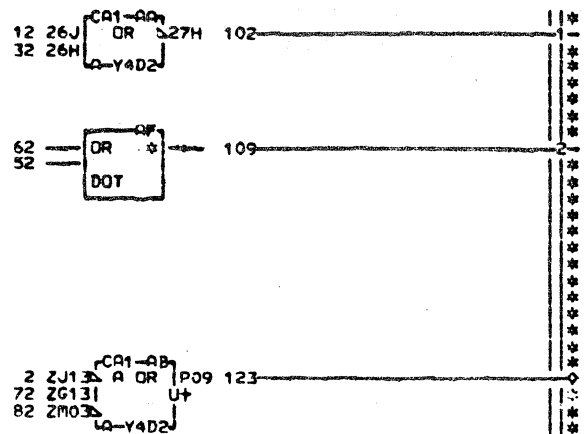

081 RA102

123 FOLLOWS RA104BB4—RA104-CJ2

221 + INPUT TYPE 1 CA LEVEL 1 RA104-CX2

212 + BID LVL 1 INTERRUPT—RA012-CL6

204 + ADAPTER I-O DECODED EXIT—ED6  
RA012

EDGE CONN.  
42 A-Y4C4D09  
204 A-Y4C2D09  
212 A-Y4C2D10  
01A-Y4C4D10

LOC. TYPE  
A-Y4D2 6828

RA102  
081 SIR TO PN 1785114 EC 309545

TYPE 1 CA LEVEL 1 BID		E-C-HISTORY—E-MACH#27RNB	
DATE	LAST EC	FRAME	01
10-14-80	344270	IBM CORP. SCD	RA102
		PN# 1986980	081

+ GATE INPUT DATA ON INBUS — RA012DD7 — 2 — 11

+ T2 OR T3 TIME R4 BOARD — RA013DJ2 — 12 — 22

+ T3 OR T0 TIME R4 BOARD — RA013NJ4 — 22 — 22

ALWAYS MINUS — RA101GF2 — 32 — 1

+ TYPE 1 CA DECODES — RA101GN2 — 42 — 1

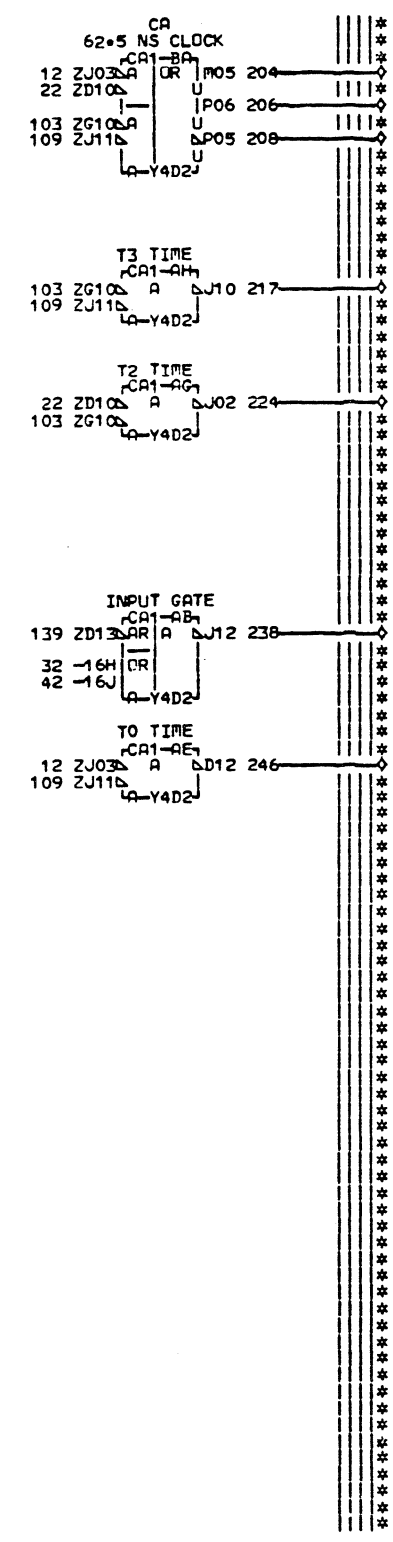
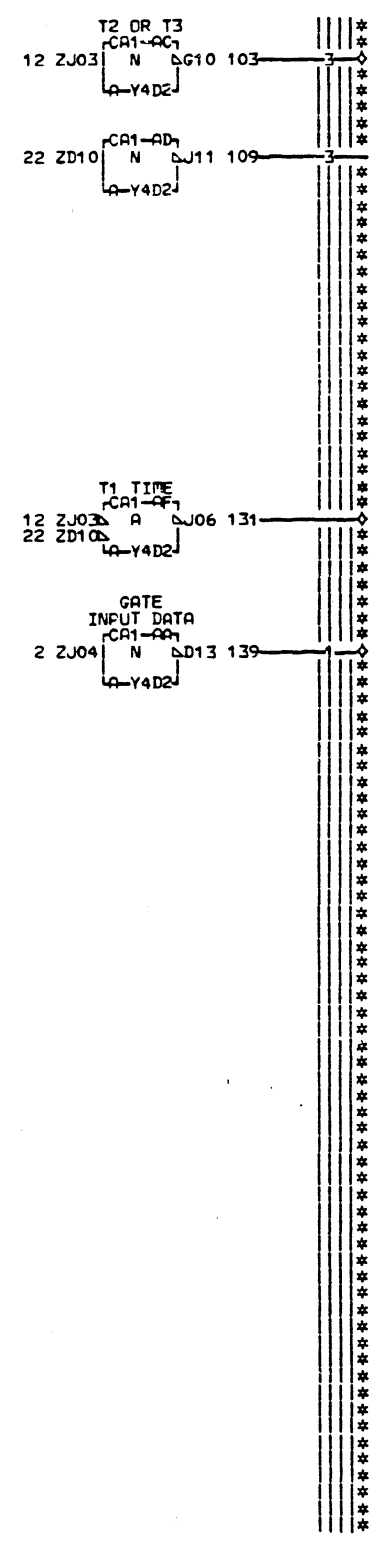

—BLANK COLUMN—

TIE UP  
CA1-BB  
PWR 31D 452  
-75V  
A-Y4D2

081 RA103

139 - GATE INPUT DATA — AP2  
LRC306 LRS103

238 - INPUT GATE — BL6  
LRA106 LRA107

103 - T2 OR T3 — RS102-CC2

246 - T0 TIME — DB6  
LRC403 LRC405 LRC502

131 - T1 TIME — DC6  
LRC202 LRC204

224 - T2 TIME — DD6  
LRC502 LRS202 LRS306

217 - T3 TIME — DE6  
LRC202 LRC404 LRC505 LRS202

204 + CA 62.5 NS CLOCK — FG2  
LRC201 LRC505 LRC706 LRF206

206 + 62.5 NS CLOCK UNUSED — RS203-FH2

208 - 62.5 NS CLOCK UNUSED — RS204-FH6

452 + 6828 TIE UP — RA101-GN4

LOC. TYPE  
A-Y4D2 6828

RA103  
081 SIM TO PN 1785115 EC 321750

TYPE 1 CA BASIC CLOCKING	
E.C. HISTORY 344270	E. PACH. 27RNB
DATE 04-14-81	LAST EC 344600
P.N. 1986981	081
FRAME 01	IBM CORP. SCD RA103

```

FOLLOWS RA104B54-----RA102CJ2- 2-1
+ INPUT TYPE 1 CA LEVEL 1-----RA102CK2- 3-1
+ INTF A ADDR INPUT BIT 0.0-----RC104GB2- 4-1
+ INTF A ADDR INPUT BIT 0.1-----RC104GC2- 5-1
+ INTF A ADDR INPUT BIT 0.2-----RC104GD2- 6-1

+ INTF A ADDR INPUT BIT 0.3-----RC104GE2- 8-1
+ INTF A ADDR INPUT BIT 0.4-----RC104GF2- 9-1
+ INTF A ADDR INPUT BIT 0.5-----RC104GG2- 10-1
+ INTF A ADDR INPUT BIT 0.6-----RC104GH2- 11-1
+ INTF A ADDR INPUT BIT 0.7-----RC104GJ2- 12-1

+ LOCAL STORE BIT 0.0-----RC106GC2- 14-1
+ LOCAL STORE BIT 0.1-----RC106GD2- 15-1
+ LOCAL STORE BIT 0.2-----RC106GE2- 16-1
+ LOCAL STORE BIT 0.3-----RC106GF2- 17-1
+ LOCAL STORE BIT 0.4-----RC106GG2- 18-1

+ LOCAL STORE BIT 0.5-----RC106GH2- 20-1
+ LOCAL STORE BIT 0.6-----RC106GJ2- 21-1
+ LOCAL STORE BIT 0.7-----RC106K2- 22-1
INTF B ADDR INPUT BIT 0.0-----RC107EB2- 23-1
INTF B ADDR INPUT BIT 0.1-----RC107EC2- 24-1

INTF B ADDR INPUT BIT 0.2-----RC107ED2- 26-1
INTF B ADDR INPUT BIT 0.3-----RC107EE2- 27-1
INTF B ADDR INPUT BIT 0.4-----RC107EF2- 28-1
INTF B ADDR INPUT BIT 0.5-----RC107EG2- 29-1
INTF B ADDR INPUT BIT 0.6-----RC107EH2- 30-1

INTF B ADDR INPUT BIT 0.7-----RC107EJ2- 32-1
+ INPUT SEL SYS RESET-----RC205AD2- 33-1
+ INPUT INIT SELTV RST BIT 0.2-----RC205FD2- 34-1
+ INPUT INIT INTF DISC BIT 0.1-----RC205FH2- 35-1
+ INPT SVC STP OR DISC BIT 0.5-----RC205FK2- 36-1

+ SID ADR BIT 0.0-----RC306CC2- 38-1
+ SID ADR BIT 0.1-----RC306CD2- 39-1
+ SID ADR BIT 0.2-----RC306CF2- 40-1
+ SID ADR BIT 0.3-----RC306CG2- 41-1
+ SID ADR BIT 0.4-----RC306CH2- 42-1

+ SID ADR BIT 0.5-----RC306CK2- 44-1
+ SID ADR BIT 0.6-----RC306CL2- 45-1
+ SID ADR BIT 0.7-----RC306CM2- 46-1
+ STAT MOD INPUT 0.1-----RC308DB2- 47-1
+ DEV END INPUT 0.5-----RC308DF2- 48-1

+ ATTN STAT INPUT 0.0-----RC308EA2- 50-1
+ CHAN END INPUT 0.4-----RC308EE2- 51-1
+ INPUT INIT SEL SY 0.0-----RC402GB2- 52-1
+ INPUT STK INITIAL 0.5-----RC402GD2- 53-1
+ INPUT INIT B.0.0.0.3-----RC402GK2- 54-1

+ INPUT OUTSND XFER 0.0-----RC403GC2- 56-1
+ INPUT INBND XFER 0.1-----RC403GD2- 57-1
+ INPUT ESC STAT XFER 0.2-----RC403GE2- 58-1
+ INPUT NSC CE STAT XFER 0.3-----RC403GF2- 59-1
+ INPUT NSC FIN STAT XFER 0.4-----RC403GG2- 60-1

+ INPUT NSC STAT CLRD-----RC503FK2- 62-1
INPUT UNIT CHK STAT 0.6-----RC602FB2- 63-1
INPUT SUPP OUT INT 0.6-----RC602FC2- 64-1
INPUT UNIT EXCPT STAT 0.7-----RC602FE2- 65-1
INPUT PGM INT REQ 0.7-----RC602FF2- 66-1

FOLLOWS RA104AA4-----RS104EB2- 68-1
FOLLOWS RA104AD4-----RS104ED2- 69-1
FOLLOWS RA104AG4-----RS105DG2- 70-1
FOLLOWS RA104BE4-----RS105DL2- 71-1
FOLLOWS RA104BH4-----RS202FC2- 72-1

FOLLOWS RA104BE4-----RS202FE2- 74-1
FOLLOWS RA104BE4-----RS202FJ2- 75-1
FOLLOWS RA104AD4-----RS202FF2- 76-1
FOLLOWS RA104AG4-----RS303DD2- 77-1
FOLLOWS RA104AK4-----RS303DE2- 78-1

FOLLOWS RA104BL4-----RS303DF2- 80-1
+ INPUT MODE BIT 1-----RS304GD2- 81-1
+ INPUT MODE BIT 2-----RS304GF2- 82-1
FOLLOWS RA104AA4-----RS307GJ2- 83-1
FOLLOWS RA104BE4-----RS308FF2- 84-1

+ INPUT C DATA 4-----RS308PG2- 86-1
FOLLOWS RA104BH4-----RS308PH2- 87-1
+ INPUT C DATA 6-----RS308PJ2- 88-1
+ INPUT C DATA 7-----RS308PK2- 89-1

```

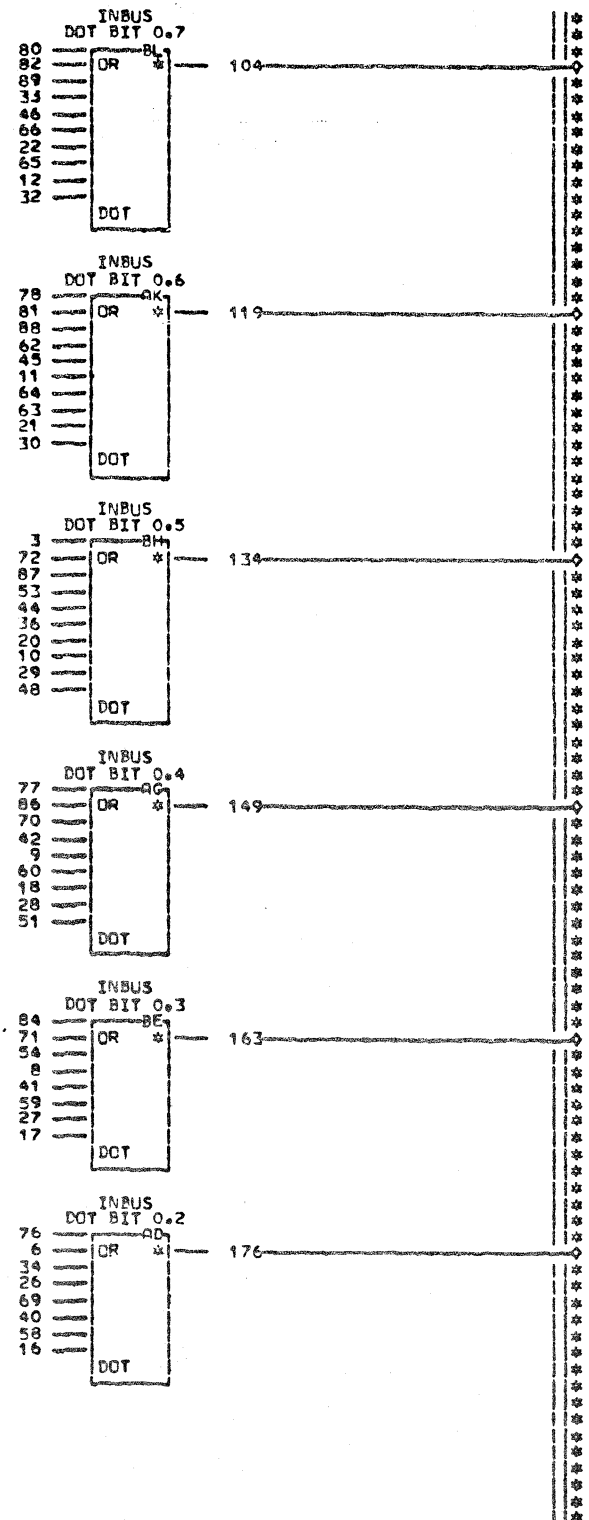

LOC. TYPE

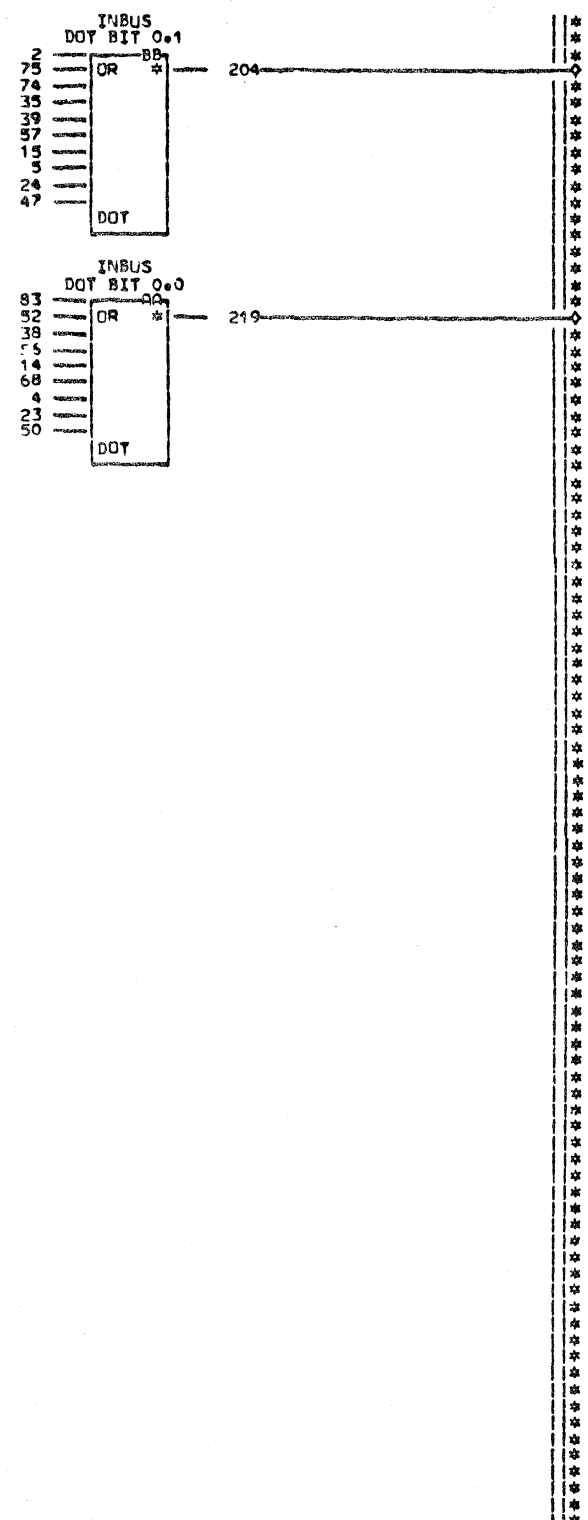

```

081 RA104
219 + INBUS DOT BIT 0.0-----RA106-AA4
176 + INBUS DOT BIT 0.2-----RA106-AD4
149 + INBUS DOT BIT 0.4-----RA106-AG4
119 + INBUS DOT BIT 0.6-----RA106-AK4
204 + INBUS DOT BIT 0.1-----RA106-BB4
163 + INBUS DOT BIT 0.3-----RA106-BE4
134 + INBUS DOT BIT 0.5-----RA106-BH4
104 + INBUS DOT BIT 0.7-----RA106-BL4

```

+ INPUT SUPPRESSIBLE STA STK RC204G2- 2-1  
 + INPUT SVC SELTV RST BIT 1.2 RC205FX2- 3-1  
 + INPUT SID CMD BIT 1.0 RC306GD2- 5-1  
 + INPUT SID CMD BIT 1.1 RC306GE2- 6-1  
 + INPUT SID CMD BIT 1.2 RC306GG2- 8-1  
 + INPUT SID CMD BIT 1.3 RC306GH2- 9-1  
 + INPUT SID CMD BIT 1.4 RC306GJ2- 11-1  
 + INPUT SID CMD BIT 1.5 RC306GL2- 12-1  
 + INPUT SID CMD BIT 1.6 RC306GM2- 14-1  
 + INPUT SID CMD BIT 1.7 RC306GN2- 15-1  
 + LOCAL STORE BIT 1.0 RC307GC2- 17-1  
 + LOCAL STORE BIT 1.1 RC307GD2- 18-1  
 + LOCAL STORE BIT 1.2 RC307GF2- 20-1  
 + LOCAL STORE BIT 1.3 RC307GG2- 21-1  
 + LOCAL STORE BIT 1.4 RC307GH2- 23-1  
 + LOCAL STORE BIT 1.5 RC307GK2- 24-1  
 + LOCAL STORE BIT 1.6 RC307GL2- 26-1  
 + LOCAL STORE BIT 1.7 RC307GM2- 27-1  
 + INPUT HOUR COUNT 1 1.7 RC404GB2- 29-1  
 + INPUT HOUR COUNT 2 1.6 RC404GC2- 30-1  
 + INPUT HOUR COUNT 4 1.5 RC404GD2- 32-1  
 + INPUT SVC CH BD CHK 1.0 RC405GF2- 33-1  
 + INPUT SVC STAT STK 1.3 RC405GH2- 35-1  
 + INIT SEL L3 INT 1.4 RC407CC2- 36-1  
 + SVC L3 INT 1.3 RC407CD2- 38-1  
 + INPUT CA ENABLED 1.4 RC504DC2- 39-1  
 + INPUT RN ACTIVE 1.5 RC504DE2- 41-1  
 + INPUT 1.2 SUPPRESS OUT DN RC504DG2- 42-1  
 + INPUT CMD CHAINING 1.4 RC504FQ2- 44-1  
 + CCU BUS OUT CK BYTF 1.2 RC505GD2- 45-1  
 + LOCAL STORE PAR CK BYTE 1.3 RC505GG2- 47-1  
 + INVALID IO OP BYTE 1.1 RC505GK2- 48-1  
 + CHNL BUS IN ERR TO BIT 1.0 RC707DD2- 50-1  
 + CHNL BUS IN ERR TO BIT 1.0 RF207DD2- 51-1  
 - TPS TIE DOWN TO BIT 1.0 RF207FS2- 53-1  
 FOLLOWS RA105BL4 RS102GG2- 54-1  
 FOLLOWS RA105AD4 RS206GC2- 56-1  
 FOLLOWS RA105BE4 RS206GE2- 57-1  
 FOLLOWS RA105AG4 RS206GG2- 59-1  
 FOLLOWS RA105BH4 RS206GJ2- 60-1  
 FOLLOWS RA105AK4 RS206GM2- 62-1  
 FOLLOWS RA105AR4 RS303DG2- 63-1  
 FOLLOWS RA105BB4 RS303DH2- 65-1  
 FOLLOWS RA105AD4 RS303DJ2- 66-1  
 FOLLOWS RA105BE4 RS303DK2- 68-1  
 + INPUT LOW PRIORITY RS304GH2- 69-1  
 + INPUT A DATA 1 RS306FD2- 71-1  
 + INPUT A DATA 2 RS306FE2- 72-1  
 + INPUT A DATA 3 RS306FF2- 74-1  
 FOLLOWS RA105AG4 RS306FG2- 75-1  
 FOLLOWS RA105BH4 RS306FH2- 77-1  
 FOLLOWS RA105AK4 RS306FJ2- 78-1  
 FOLLOWS RA105BL4 RS306FK2- 80-1  
 + INPUT B NOT DATA 1 RS307GA2- 81-1  
 + INPUT B DATA 2 RS307GC2- 83-1  
 + INPUT B NOT DATA 3 RS307GE2- 84-1  
 + INPUT B DATA 4 RS307GG2- 86-1  
 + INPUT B DATA 6 RS307GL2- 87-1  
 + INPUT B DATA 7 RS307GN2- 89-1  
 + INPUT C DATA 1 RS308FD2- 90-1  
 + INPUT C DATA 2 RS308FE2- 92-1

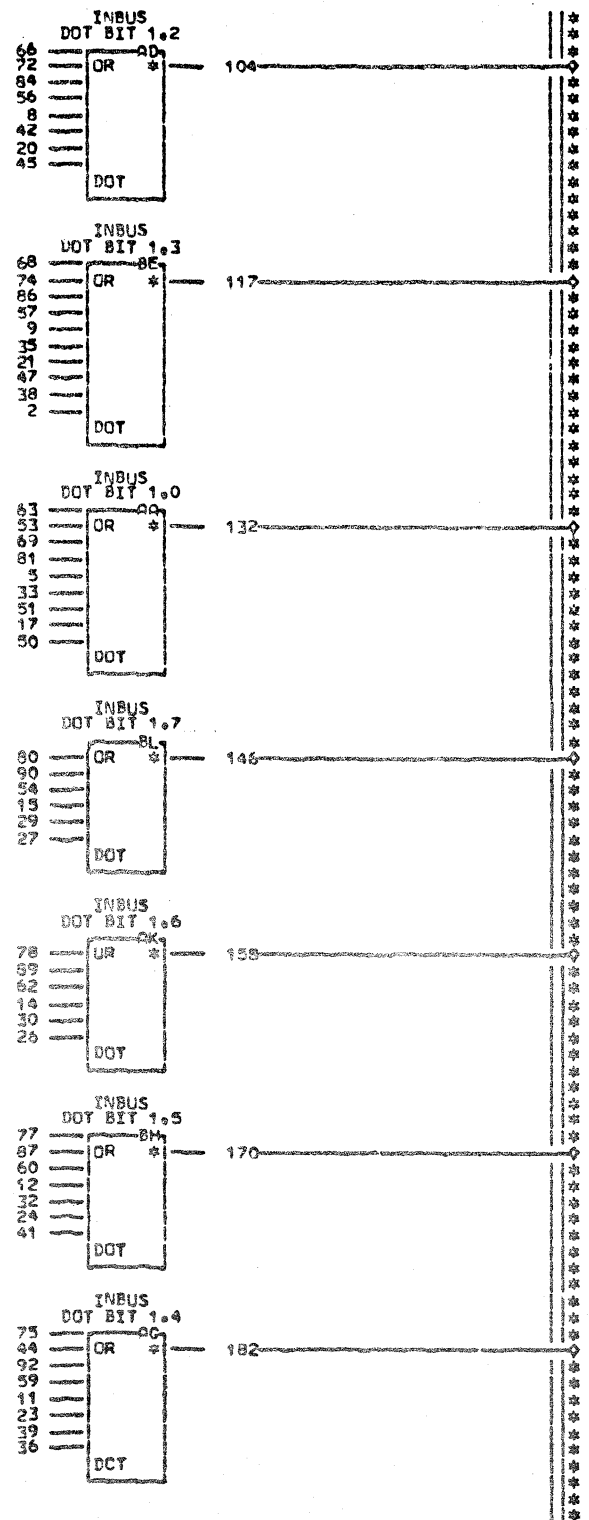

LCC. TYPE

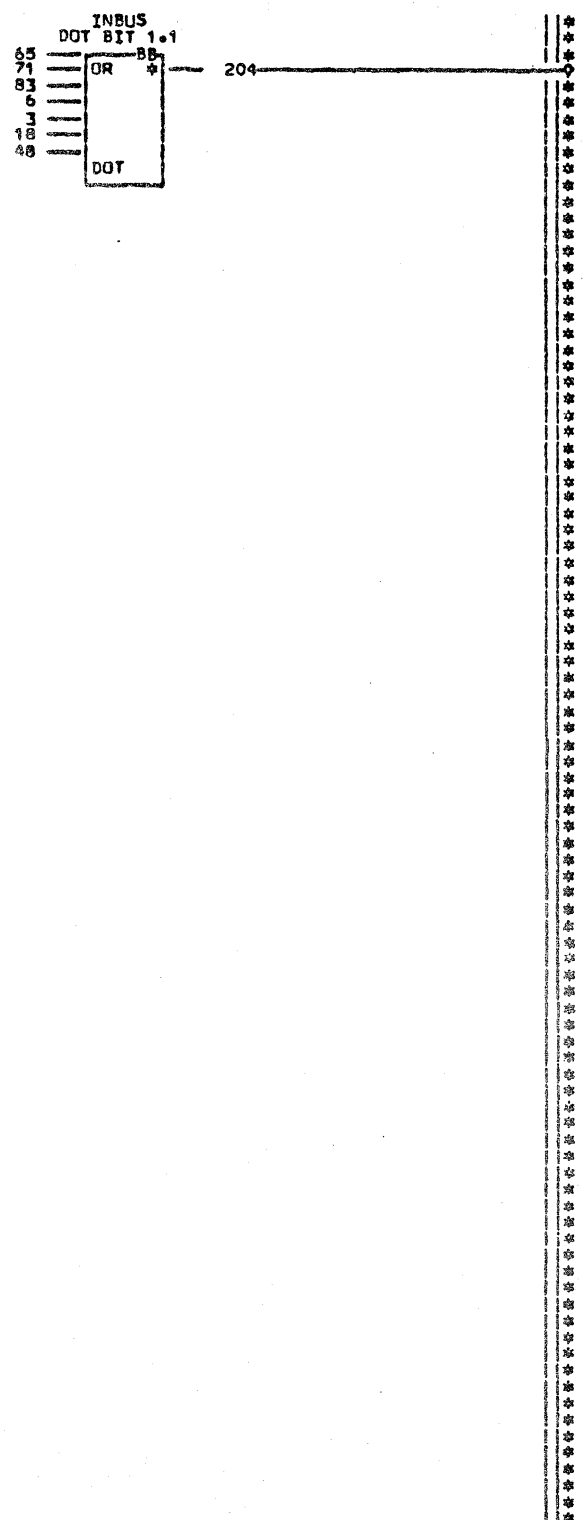

081 RA105  
 132 + INBUS DOT BIT 1.0 RA107-AA4  
 104 + INBUS DOT BIT 1.2 RA107-AD4  
 182 + INBUS DOT BIT 1.4 RA107-AG4  
 158 + INBUS DOT BIT 1.6 RA107-AK4  
 204 + INBUS DOT BIT 1.1 RA107-BB4  
 117 + INBUS DOT BIT 1.3 RA107-BE4  
 170 + INBUS DOT BIT 1.5 RA107-BH4  
 146 + INBUS DOT BIT 1.7 RA107-BL4

RA105  
 081 SIR TO PN 1785117 EC 309533

TYPE 1 CA		MACH#27RNB	
INBUS DOT BYTE 1		FRAP# 01	
E.C. HISTORY		IBR CORP. SCD RA105	
DATE	LAST EC	P.N.	1986983 081
10-14-80	344270		

- INPUT GATE RA103BL6- 2-2  
 + INBUS DOT BIT 0.0 RA104AA4\* 12-2  
 + INBUS DOT BIT 0.2 RA104AD4\* 22-2  
 + INBUS DOT BIT 0.4 RA104AG4\* 32-2  
 + INBUS DOT BIT 0.6 RA104AK4\* 42-2  
 + INBUS DOT BIT 0.1 RA104BB4\* 52-2  
 + INBUS DOT BIT 0.3 RA104BE4\* 62-2  
 + INBUS DOT BIT 0.5 RA104BH4\* 72-2  
 + INBUS DOT BIT 0.7 RA104BL4\* 82-2

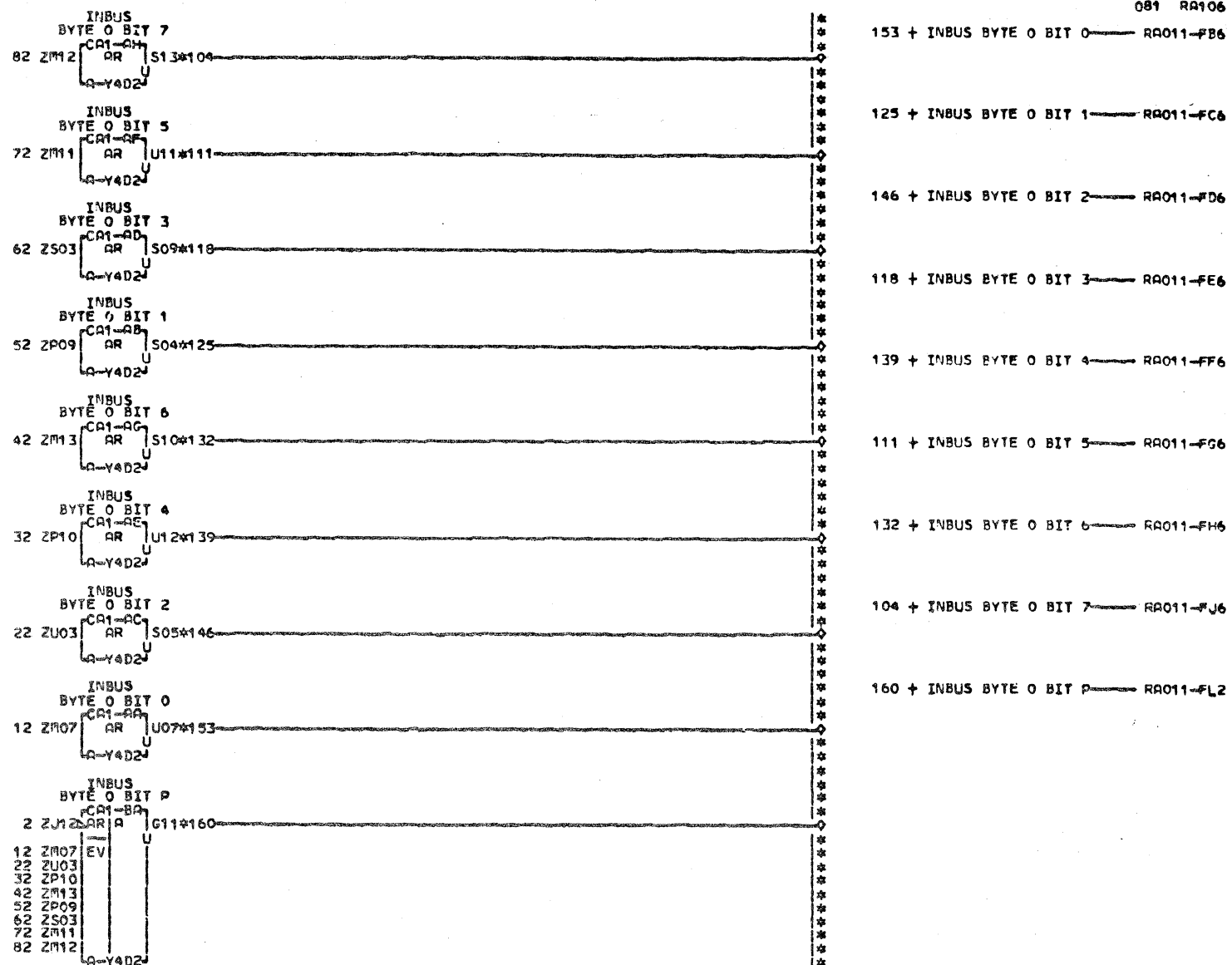

EDGE CONN.	A-Y4D2P09	01A-Y4A4B10	01A-Y4A4B06
12 RESISTOR	62 A-Y4D2M07	118 A-Y4A2B08	153 A-Y4A2B04
22 RESISTOR	72 A-Y4D2U03	125 A-Y4A2B05	160 A-Y4A2B02
32 RESISTOR	82 A-Y4D2P10	132 A-Y4A2B12	
42 RESISTOR	104 A-Y4D2M13	139 A-Y4A2B09	
52 RESISTOR	111 A-Y4A2B10	146 A-Y4A2B06	

LOC. TYPE  
A-Y4D2 6828

RA106  
081 SIA TO PN 1785118 EC 309545

TYPE 1 CA		PACH=27RNB	
INBUS BYTE 0		E	
-E-C-HISTORY-		FRAP	01
DATE	LAST EC	IBM CORP. SCD	RA106
10-14-90	344270	P.No. 1986984	081



- INPUT GATE ----- RA103BL6 2-1  
 + INBUS DOT BIT 1.0 ----- RA105AA4\* 12-2  
 + INBUS DOT BIT 1.2 ----- RA105AD4\* 22-2  
 + INBUS DOT BIT 1.4 ----- RA105AG4\* 32-2  
 + INBUS DOT BIT 1.6 ----- RA105AK4\* 42-2  
 + INBUS DOT BIT 1.1 ----- RA105BB4\* 52-2  
 + INBUS DOT BIT 1.3 ----- RA105BE4\* 62-2  
 + INBUS DOT BIT 1.5 ----- RA105BH4\* 72-2  
 + INBUS DOT BIT 1.7 ----- RA105BL4\* 82-2

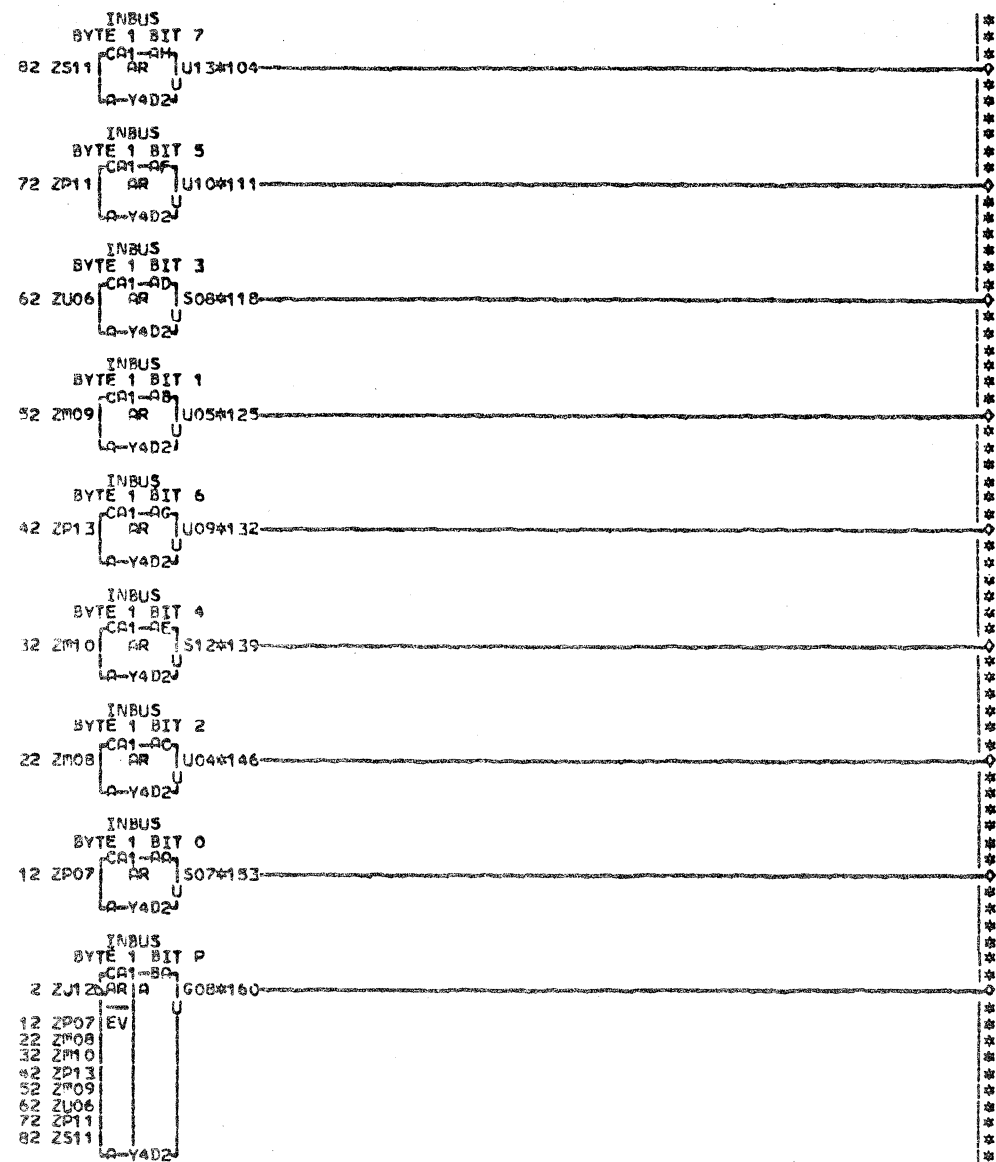

081 RA107  
 153 + INBUS BYTE 1 BIT 0 ----- RA011-FB6  
 125 + INBUS BYTE 1 BIT 1 ----- RA011-FC6  
 146 + INBUS BYTE 1 BIT 2 ----- RA011-FD6  
 118 + INBUS BYTE 1 BIT 3 ----- RA011-FE6  
 139 + INBUS BYTE 1 BIT 4 ----- RA011-FF6  
 111 + INBUS BYTE 1 BIT 5 ----- RA011-FG6  
 132 + INBUS BYTE 1 BIT 6 ----- RA011-FH6  
 104 + INBUS BYTE 1 BIT 7 ----- RA011-FJ6  
 160 + INBUS BYTE 1 BIT P ----- RA011-FL2

EDGE CONN.	Q-Y4D2M09	01Q-Y4A4D10	01Q-Y4A4D06
12 RESISTOR	Q-Y4D2P07	118 Q-Y4A2D07	153 Q-Y4A2D03
22 RESISTOR	Q-Y4D2M08	01Q-Y4A4D07	01Q-Y4A4D03
32 RESISTOR	Q-Y4D2P11	125 Q-Y4A2D05	160 Q-Y4A2D02
42 RESISTOR	Q-Y4D2M10	01Q-Y4A4D05	01Q-Y4A4D02
52 RESISTOR	Q-Y4D2P13	132 Q-Y4A2D11	
62 RESISTOR	Q-Y4D2M09	01Q-Y4A4D11	
72 RESISTOR	Q-Y4D2P10	104 Q-Y4A2D13	139 Q-Y4A2D09
82 RESISTOR	Q-Y4D2M08	01Q-Y4A4D13	01Q-Y4A4D09
		111 Q-Y4A2D10	146 Q-Y4A2D06

LOC. TYPE  
A-Y4D2 6828

RA107  
 081 SIM TO PN 1785119 EC 309545

TYPE 1 CA	
INBUS BYTE 1	
E.C. HISTORY	PACH. 27RNB
	FRAME 01
	IBM CORP. SCD RA107
DATE LAST EC	
10-14-80 344270	P.No. 1986985 081

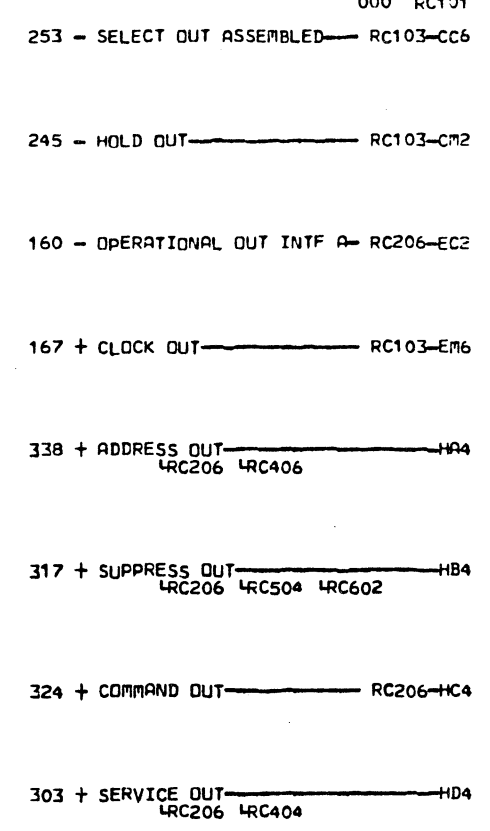
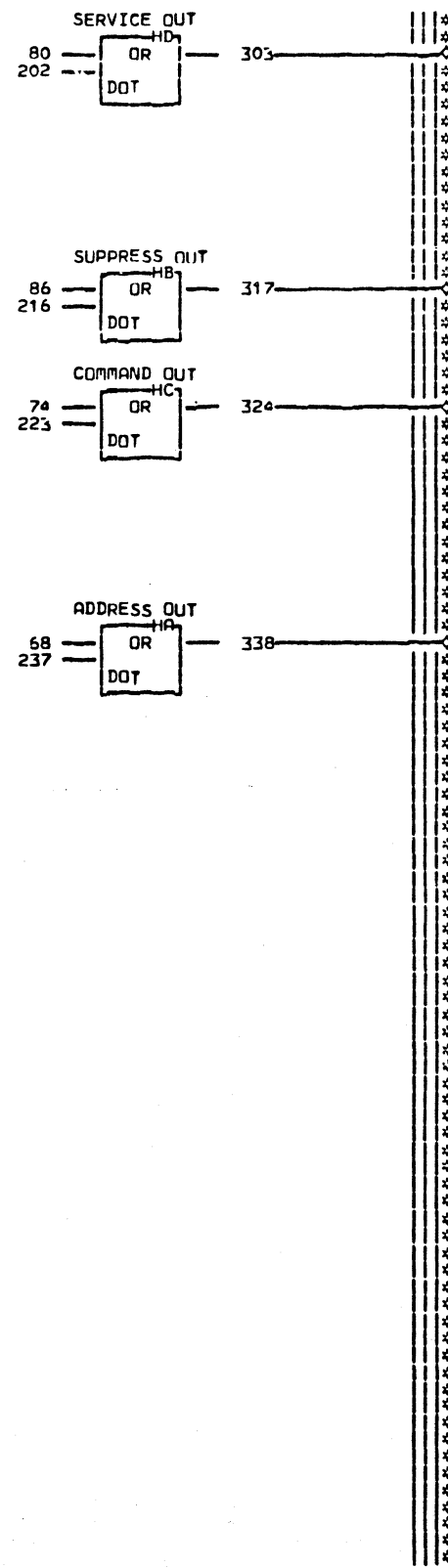
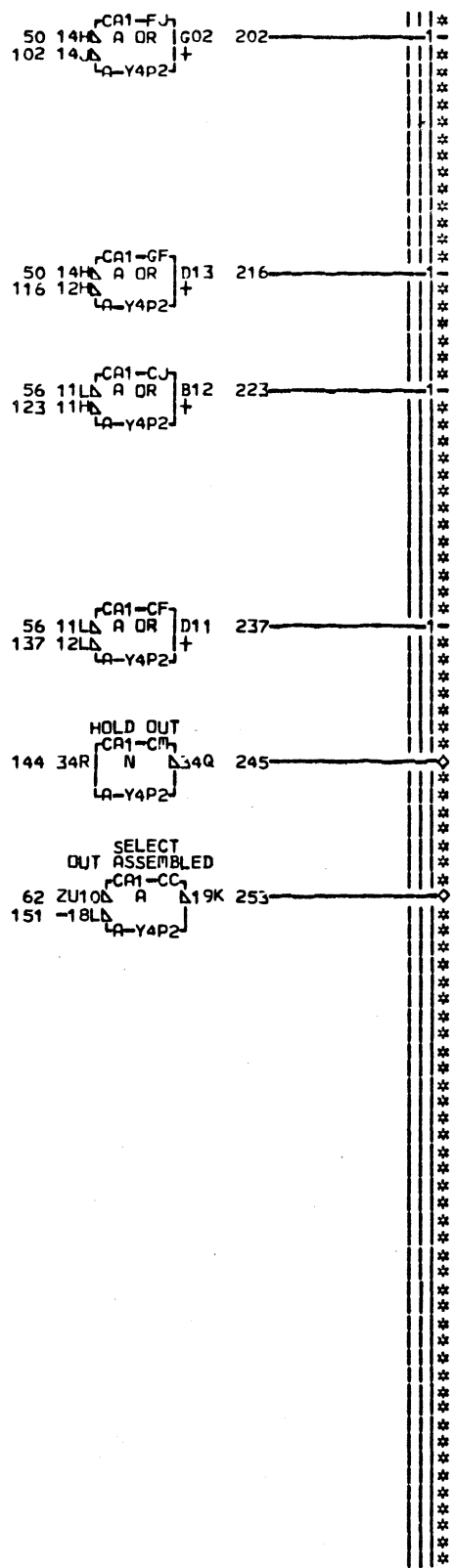
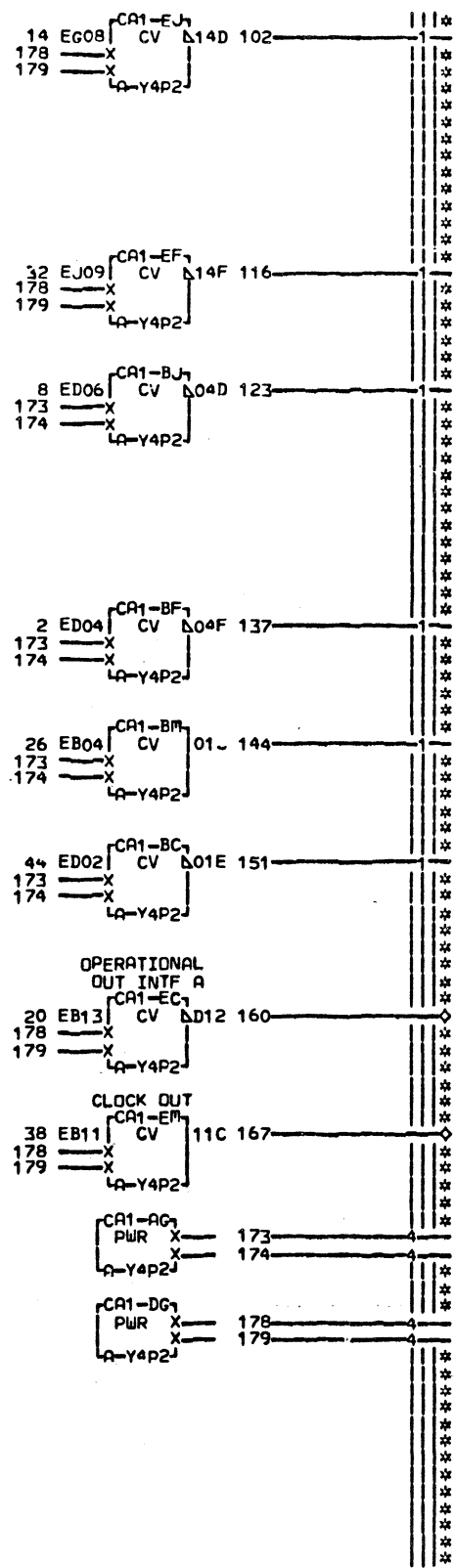
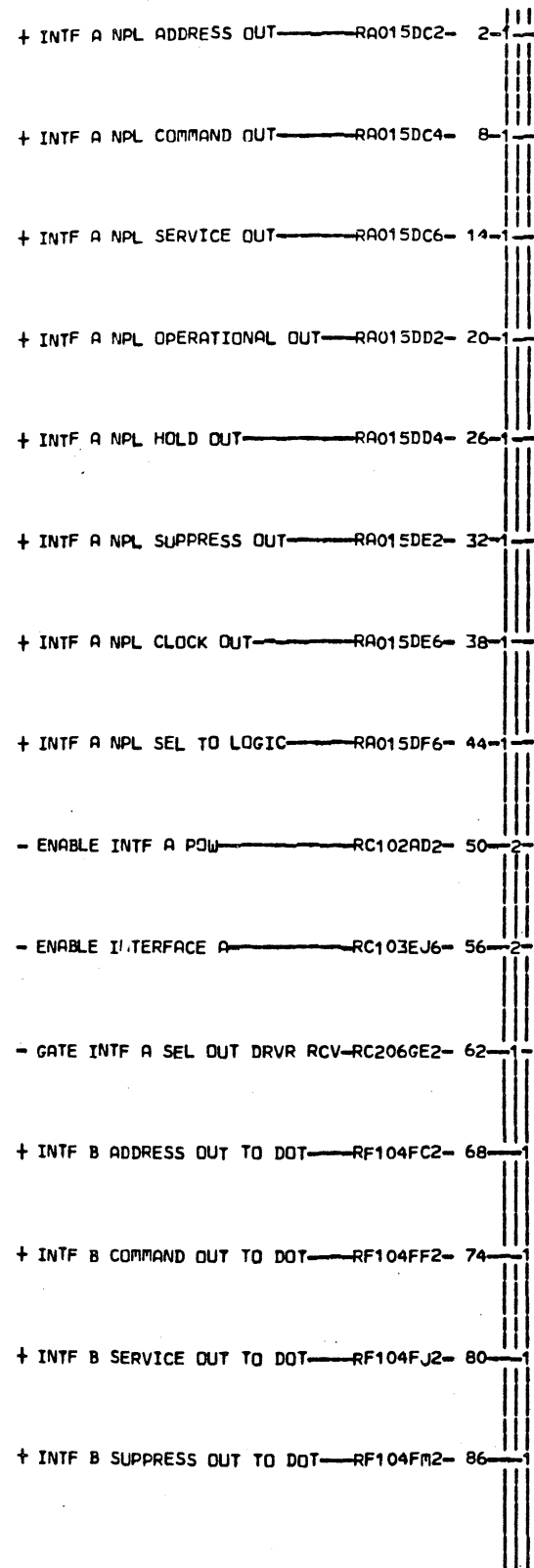

LOC. TYPE  
A-Y4P2 7601

CHANNEL INTF TAGS + CONTROLS			
E.C.—HISTORY—B	MACH—27RNB		
309522C	309944	FRAME	01
309541		IBM CORP.—SDD	RC101
309545		P.N.	1785120
309548			000
DATE	LAST EC		
12-27-72	309949		

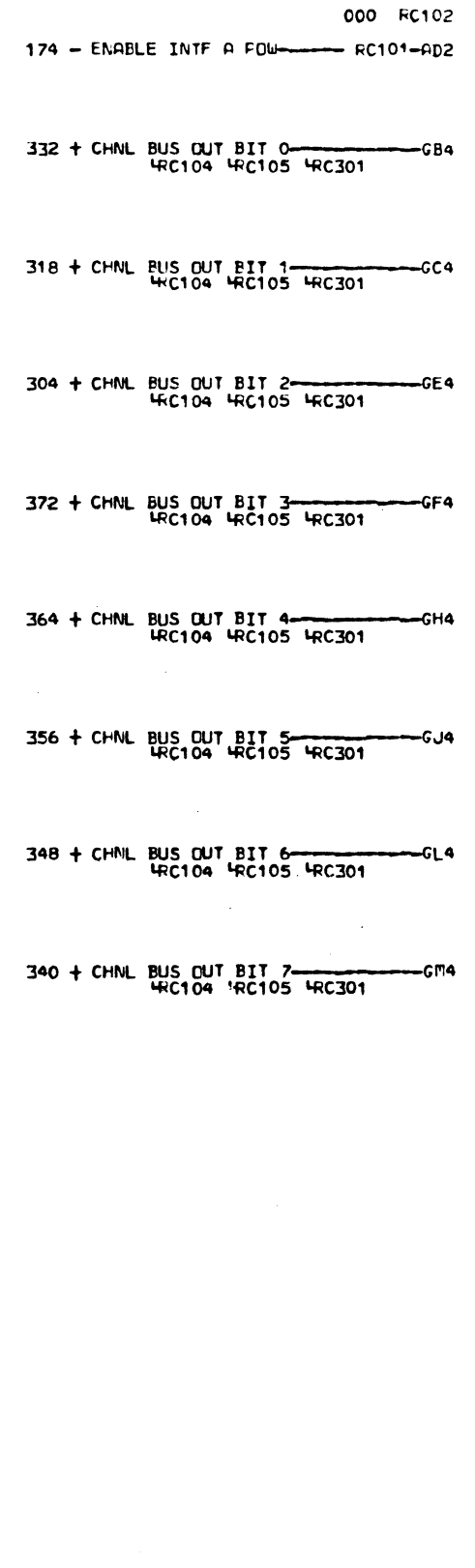
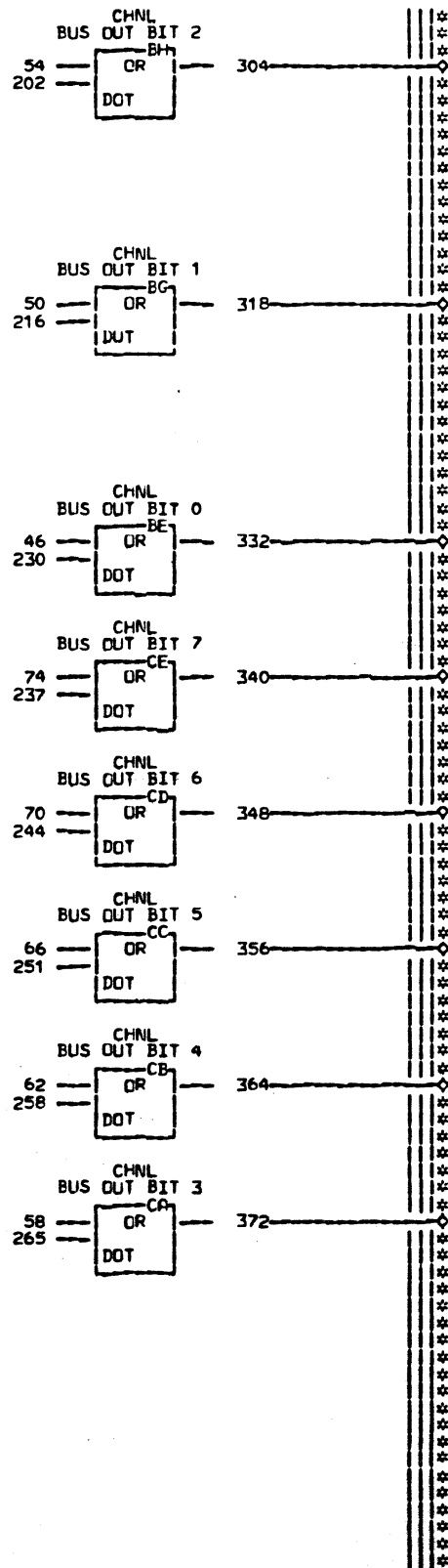
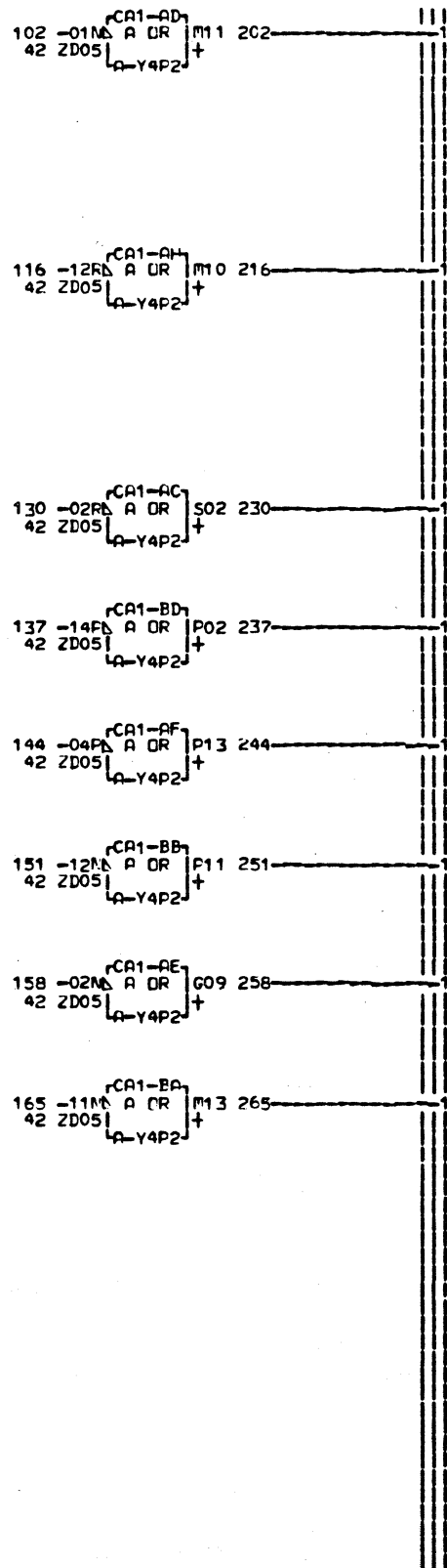
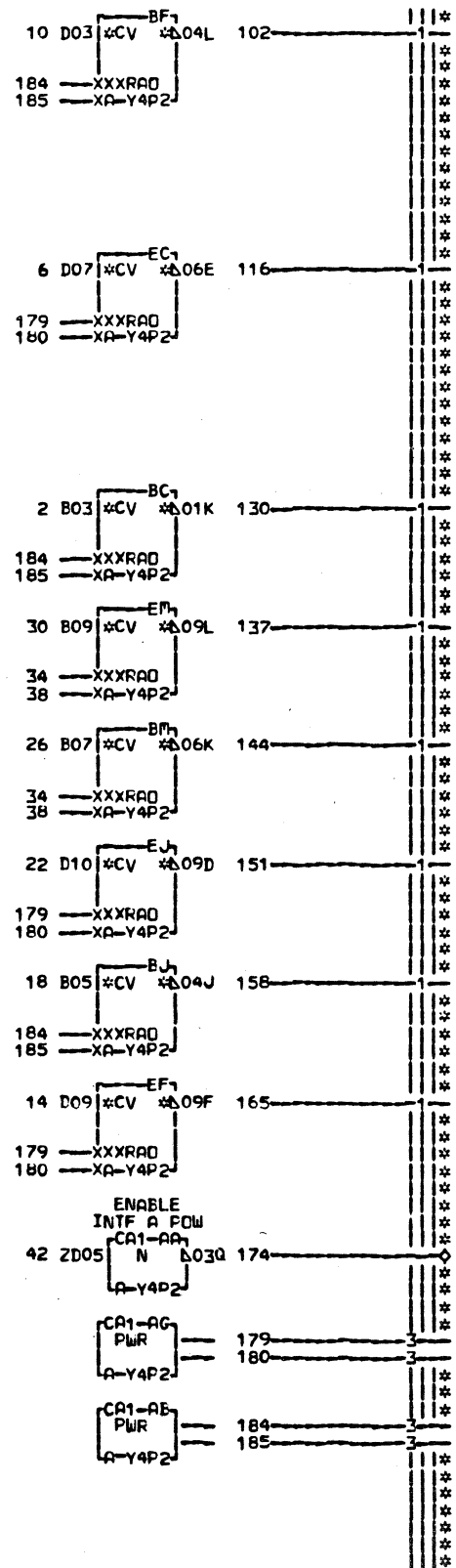
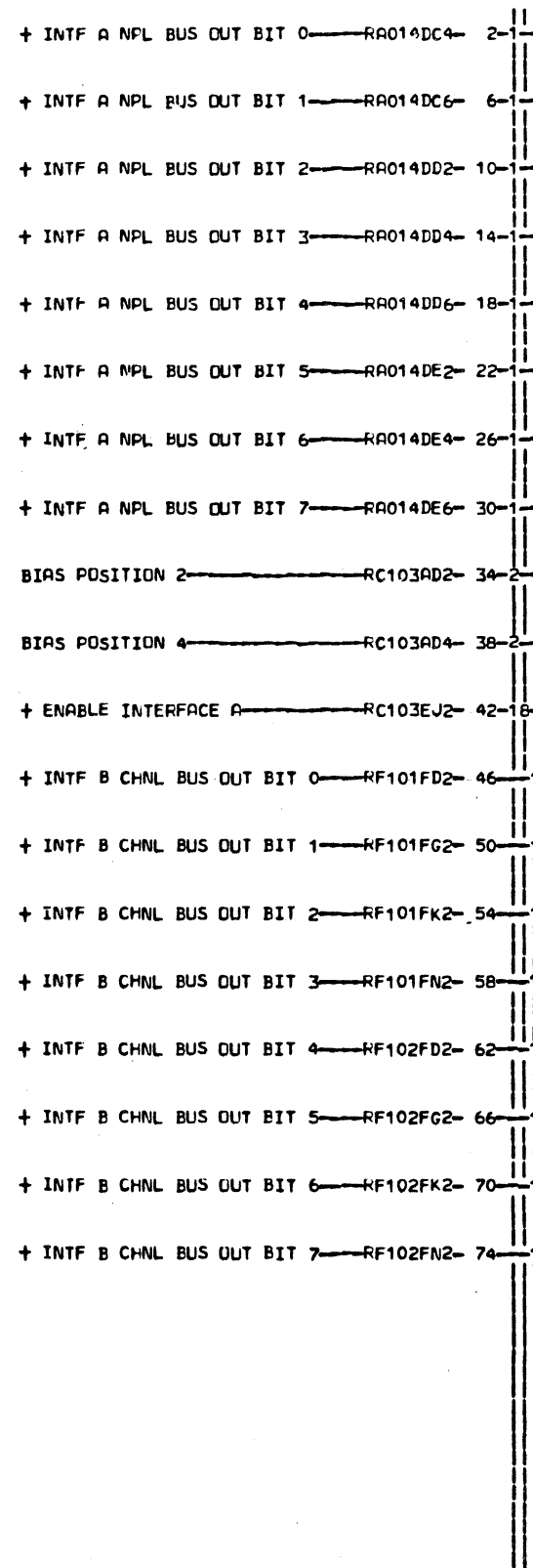

LOC. TYFE  
A-Y4P2 7601

CHANNEL INTF A RCVR	
E.C.—HISTRY 309522C 309541	B-MACH#27RNB FRFPE 01
DATE LAST EC 04-24-72 309545	IRM COFP#SDD RC102 P#N# 1785121 000

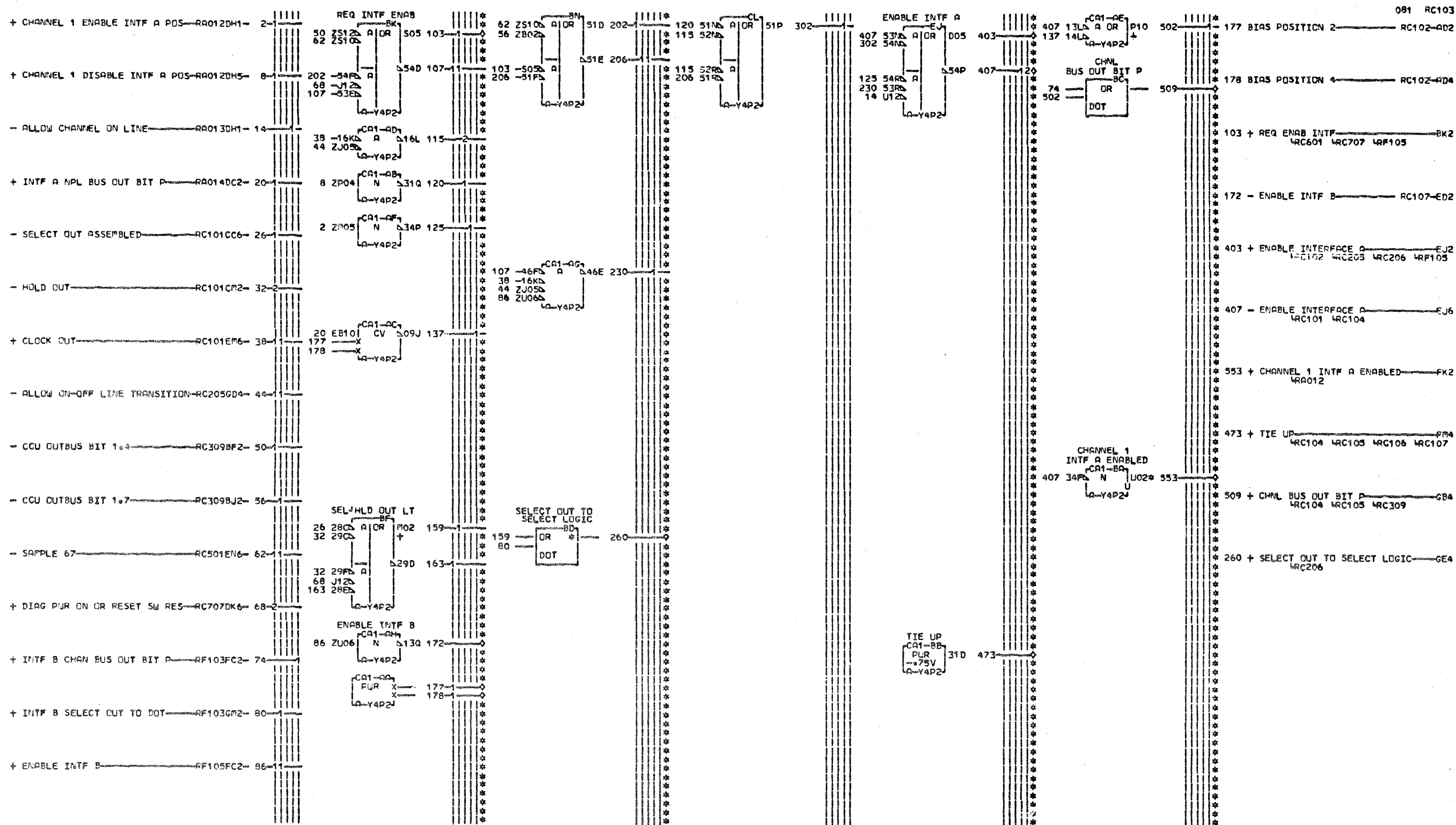

EDGE CONN.  
553 A-Y4C3B13

LOC. TYPE  
A-Y4P2 7601

RC103  
081 SIM TO PN 1785122 EC 309949

INTERFACE A CONTROL			
E.C. HISTORY	E.PACH	27RNB	
	FRAME	01	
DATE	LAST EC	IBM CORP. SCD	RC103
10-14-80	344270	P.N. 1986986	081

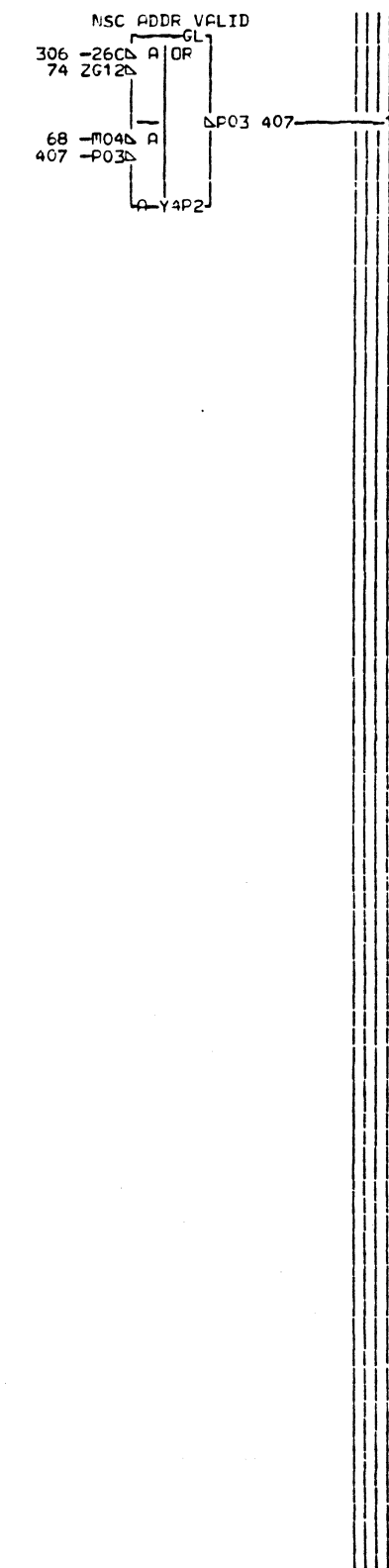
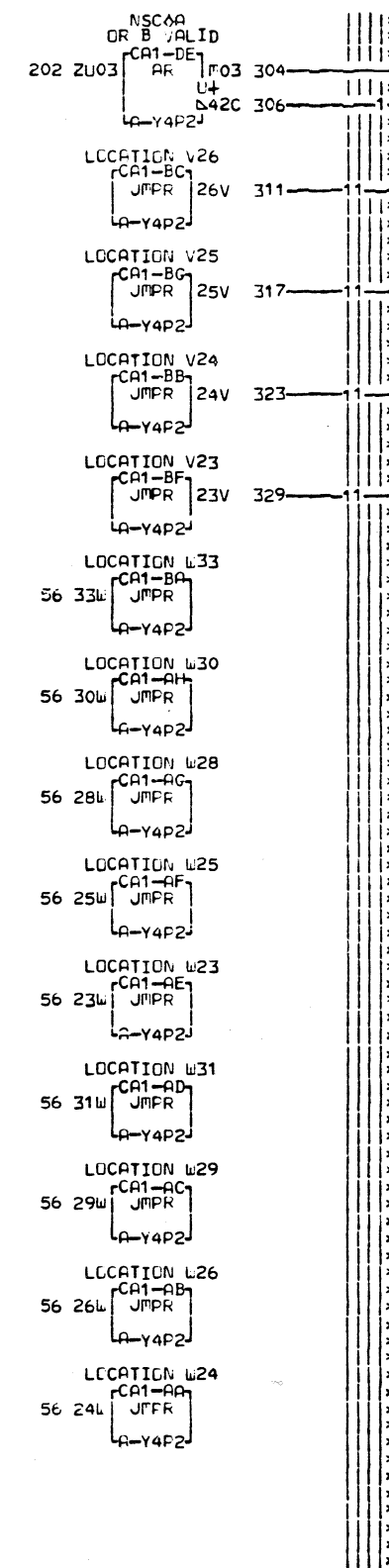
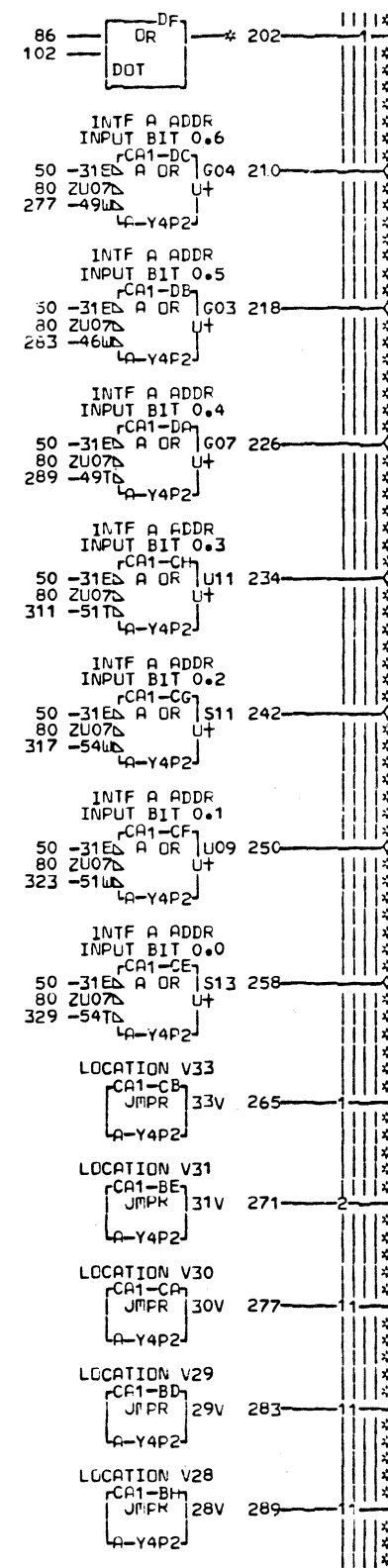
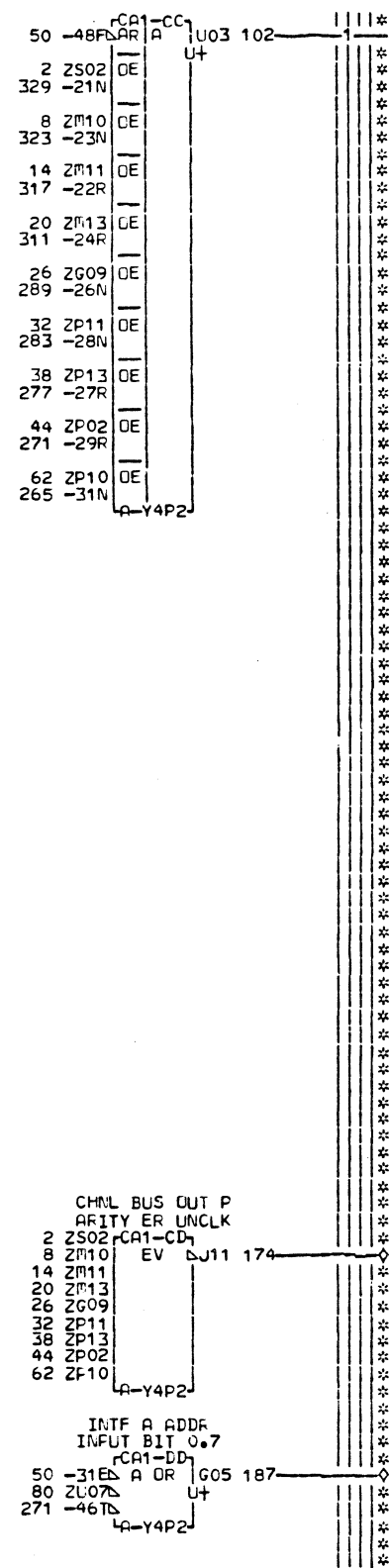
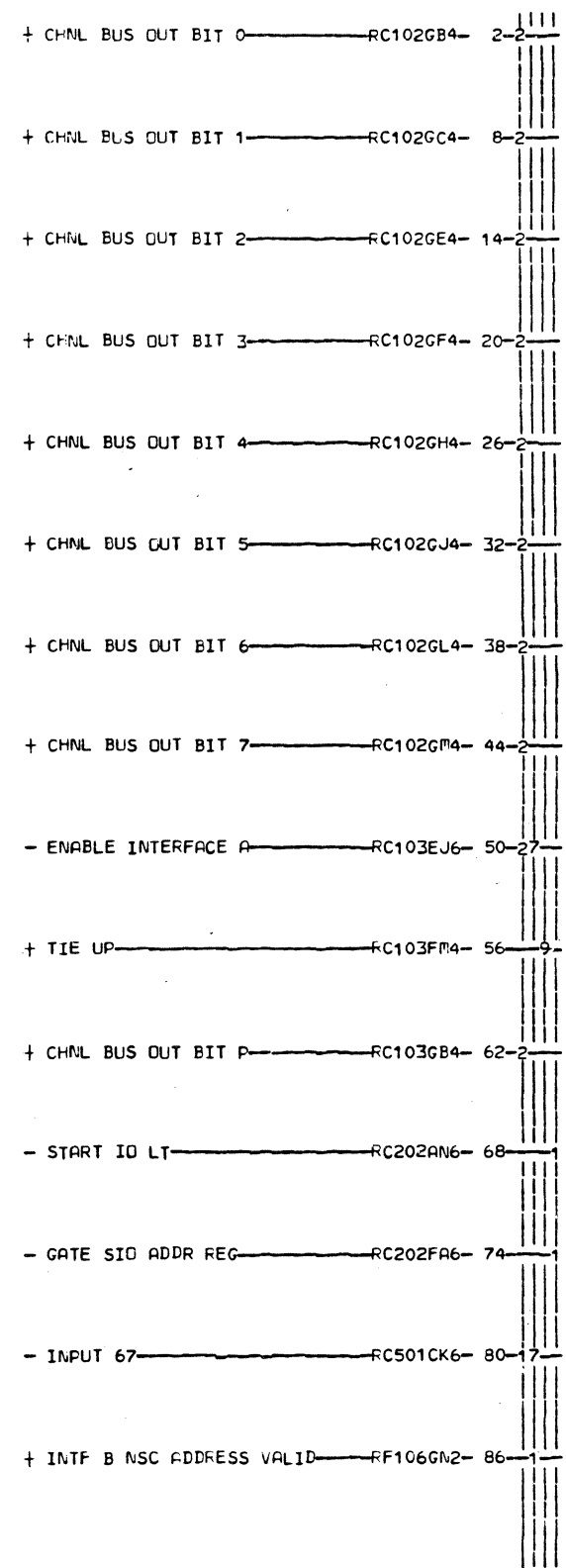

EDGE CONN.  
202 RESISTOR  
A-Y4P2U03

LOC. TYPE  
A-Y4P2 7601

CHANNEL ADDRESS JUMPING		MACH.27RNB	
CHANNEL PARITY CHECK		FRAME 01	
309522C	311279	IBM CORP.SDD RC104	
309541		P.N. 1785123 000	
309545			
309548			
DATE	LAST EC		
06-23-75	312926		

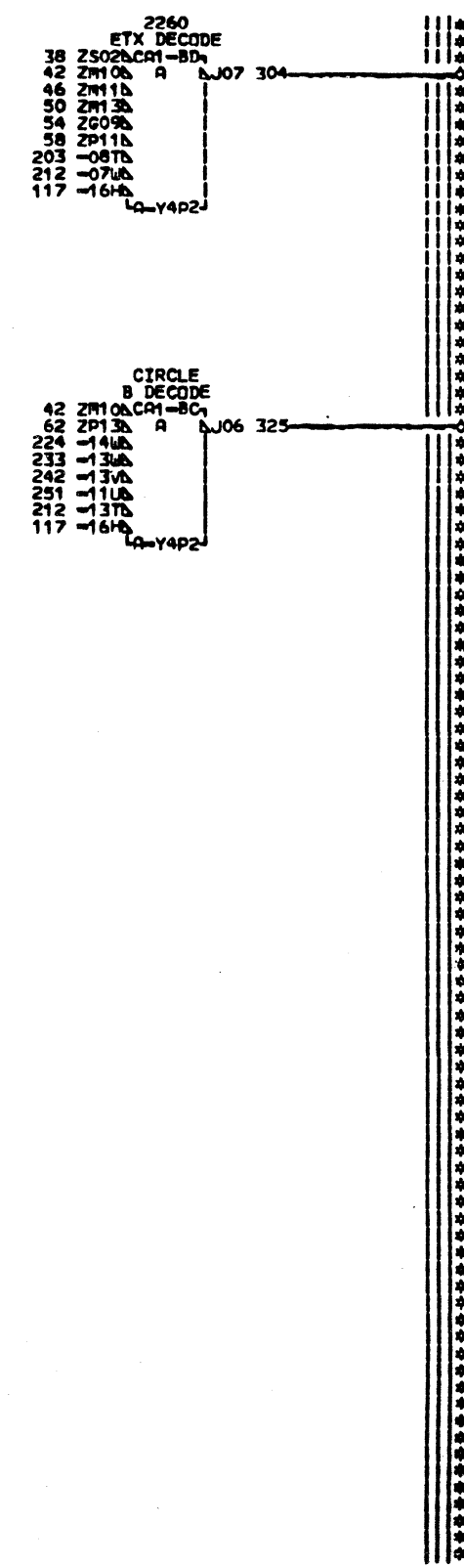
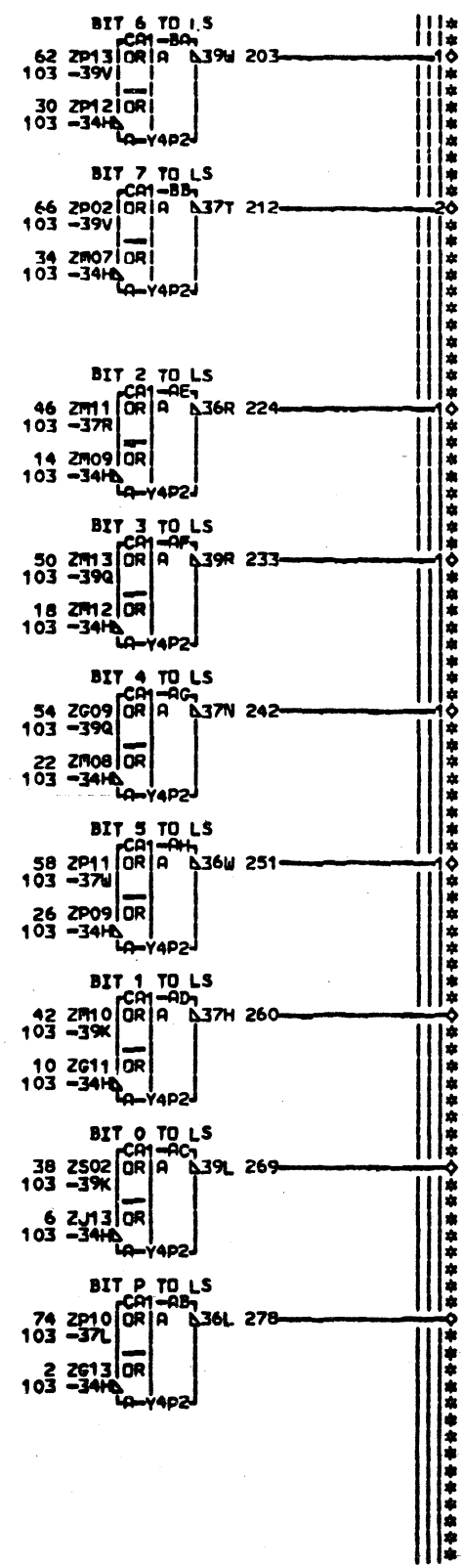
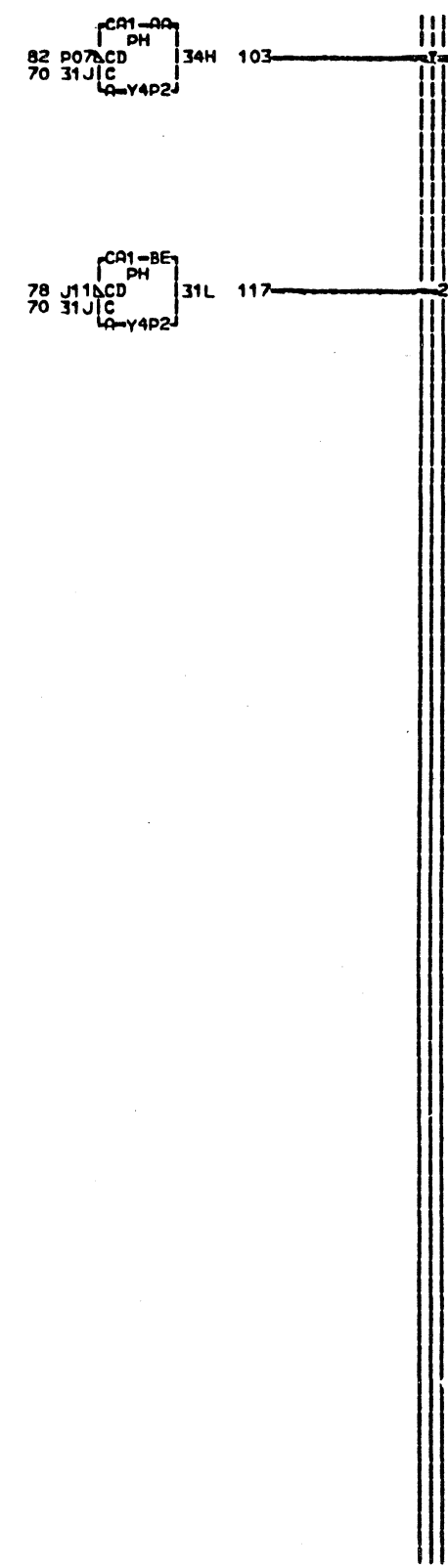
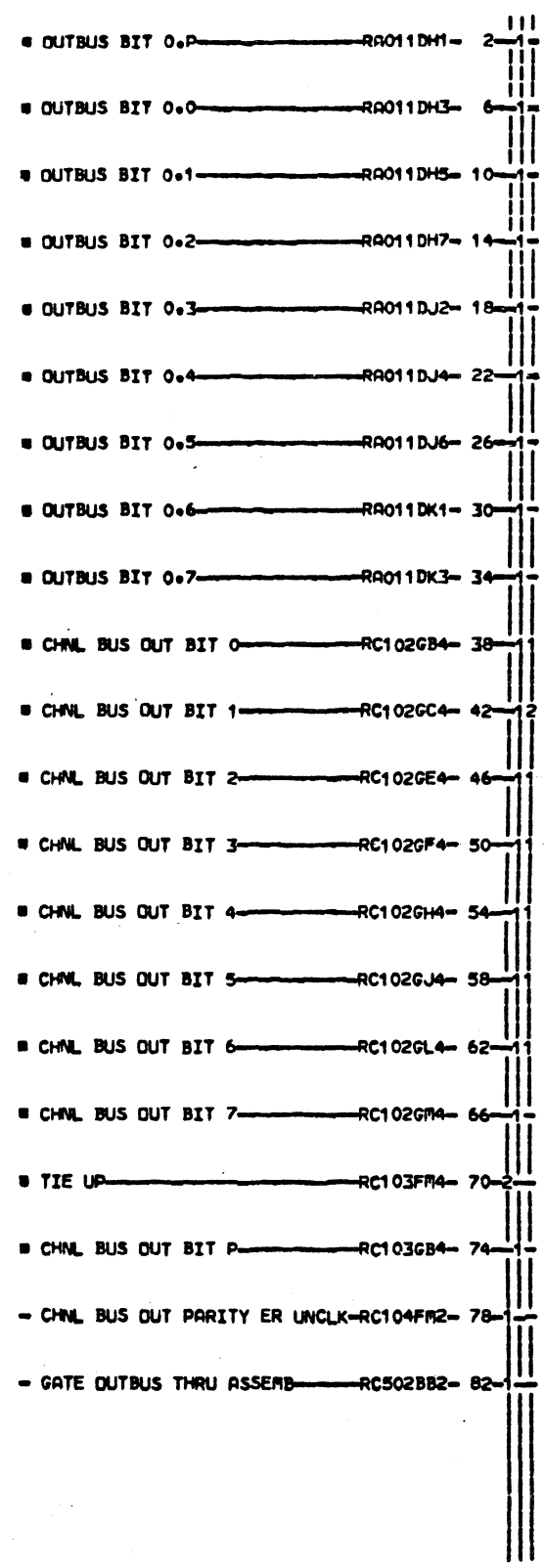

- 000 RC105
- 278 - BIT P TO LS — RC106-FB2
- 269 - BIT 0 TO LS — RC106-FC2
- 260 - BIT 1 TO LS — RC106-FD2
- 224 - BIT 2 TO LS — RC106-FE2
- 233 - BIT 3 TO LS — RC106-FF2
- 242 - BIT 4 TO LS — RC106-FG2
- 251 - BIT 5 TO LS — RC106-FH2
- 203 - BIT 6 TO LS — RC106-FJ2
- 212 - BIT 7 TO LS — RC106-FK2
- 325 - CIRCLE B DECODE — RC504-FM6
- 304 - 2260 ETX DECODE — RC504-FP6

LOC. TYPE  
A-Y4P2 7601

LOCAL STORE BYTE 0 ASSEMBLER	
E.C. HISTORY	B. RACH#27RNB
309522C	
309541	FRAME 01
309545	IBM CORP.SDD RC105
DATE LAST EC	P.N. 1785124 000
05-26-72 309548	

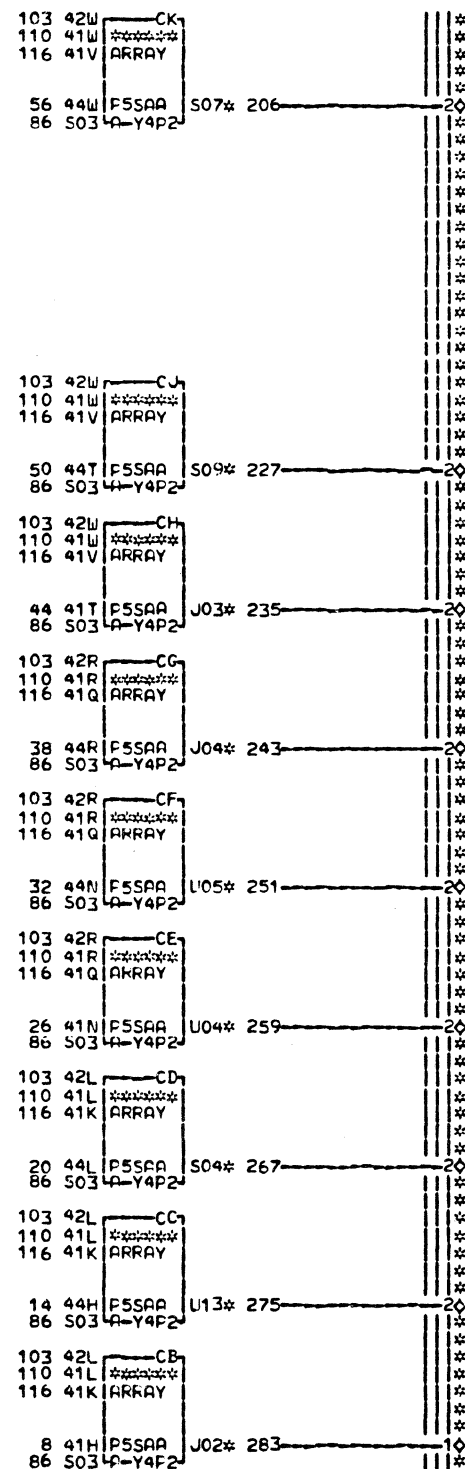
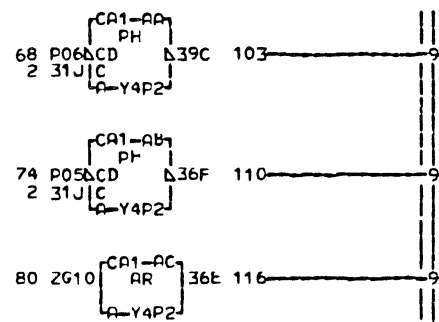
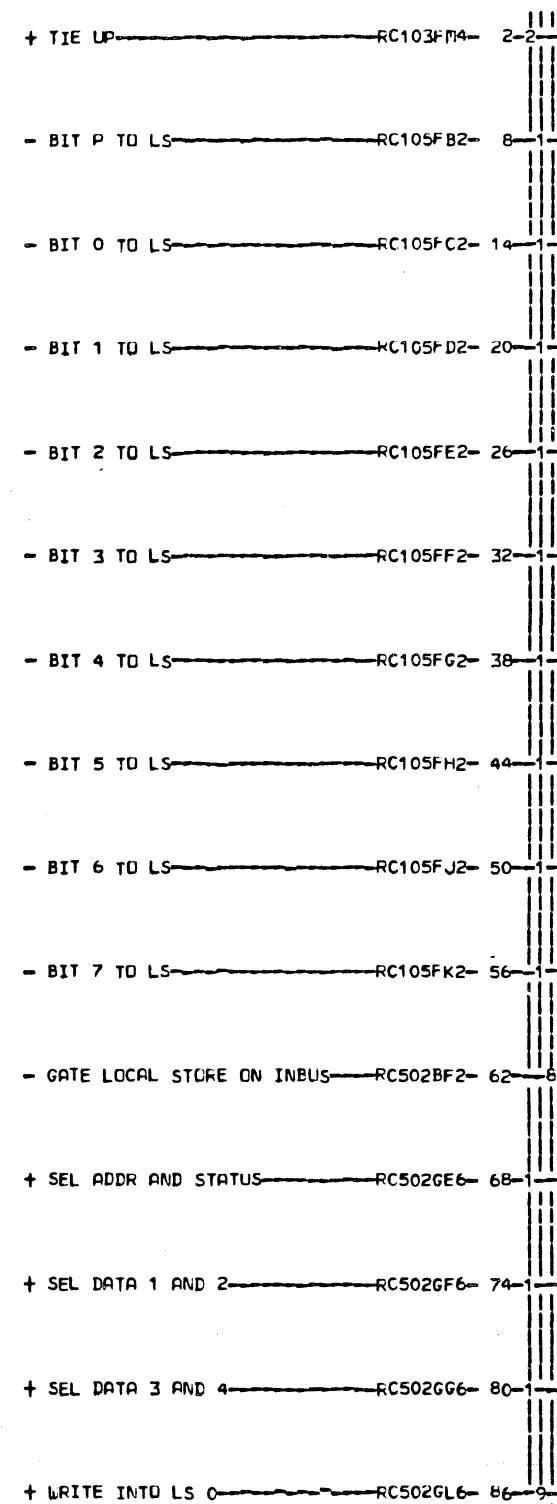

LOC. TYPE  
A-Y4P2 7601

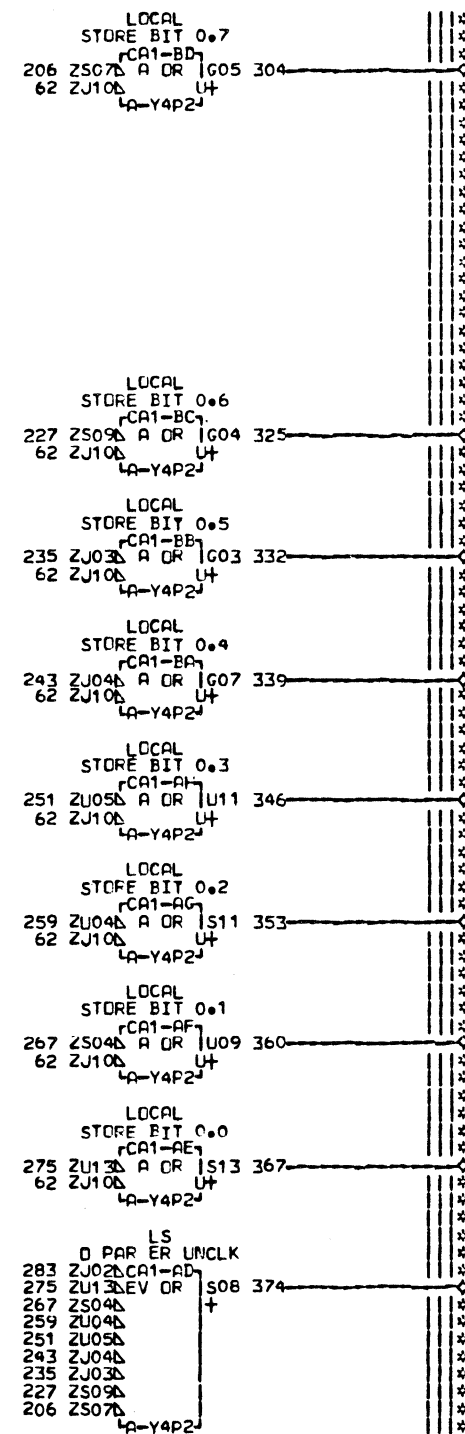

- 000 RC106
- 283 - LOCAL STORE BIT 0.7 TO DRVRCB6
- 275 - LOCAL STORE BIT 0.6 TO DRVRC6
- 267 - LOCAL STORE BIT 0.5 TO DRVRC6
- 259 - LOCAL STORE BIT 0.4 TO DRVRC6
- 251 - LOCAL STORE BIT 0.3 TO DRVRC6
- 243 - LOCAL STORE BIT 0.2 TO DRVRC6
- 235 - LOCAL STORE BIT 0.1 TO DRVRC6
- 227 - LOCAL STORE BIT 0.0 TO DRVRC6
- 206 - LOCAL STORE BIT 0.7 TO DRVRC6
- 374 + LS 0 PAR ER UNCLK RC505-FM2
- 367 + LOCAL STORE BIT 0.0 RA104-GC2
- 360 + LOCAL STORE BIT 0.1 RA104-GD2
- 353 + LOCAL STORE BIT 0.2 RA104-GE2
- 346 + LOCAL STORE BIT 0.3 RA104-GF2
- 339 + LOCAL STORE BIT 0.4 RA104-GG2
- 332 + LOCAL STORE BIT 0.5 RA104-GH2
- 325 + LOCAL STORE BIT 0.6 RA104-GJ2
- 304 + LOCAL STORE BIT 0.7 RA104-GK2

EDGE CONN.	A-Y4P2U05
206 RESISTOR	259 RESISTOR
A-Y4P2S07	A-Y4P2L04
227 RESISTOR	267 RESISTOR
A-Y4P2S09	A-Y4P2S04
235 RESISTOR	275 RESISTOR
A-Y4P2J03	A-Y4P2U13
243 RESISTOR	283 RESISTOR
A-Y4P2J04	A-Y4P2J02
251 RESISTOR	

RC106  
000

LOCAL STORE BYTE 0	
E.C. HISTCRY 309522C 309541	B. MFC#27RMB FRAP# 01
DATE LAST EC 04-24-72 309545	IBM COFF.#SDD FC106 F.No. 1785125 000

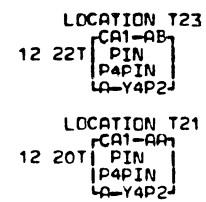
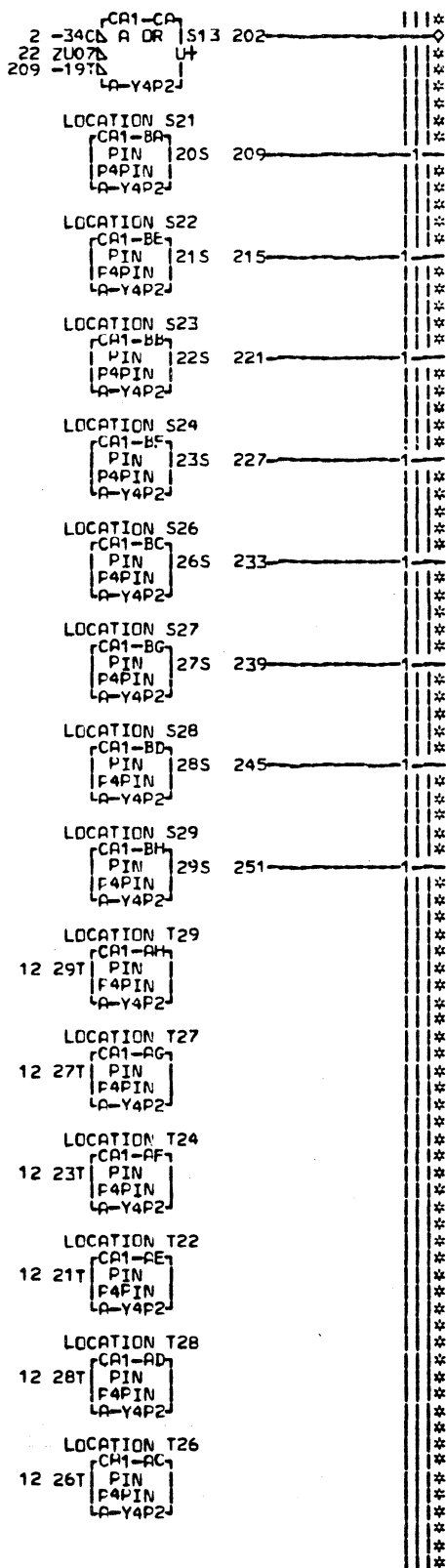
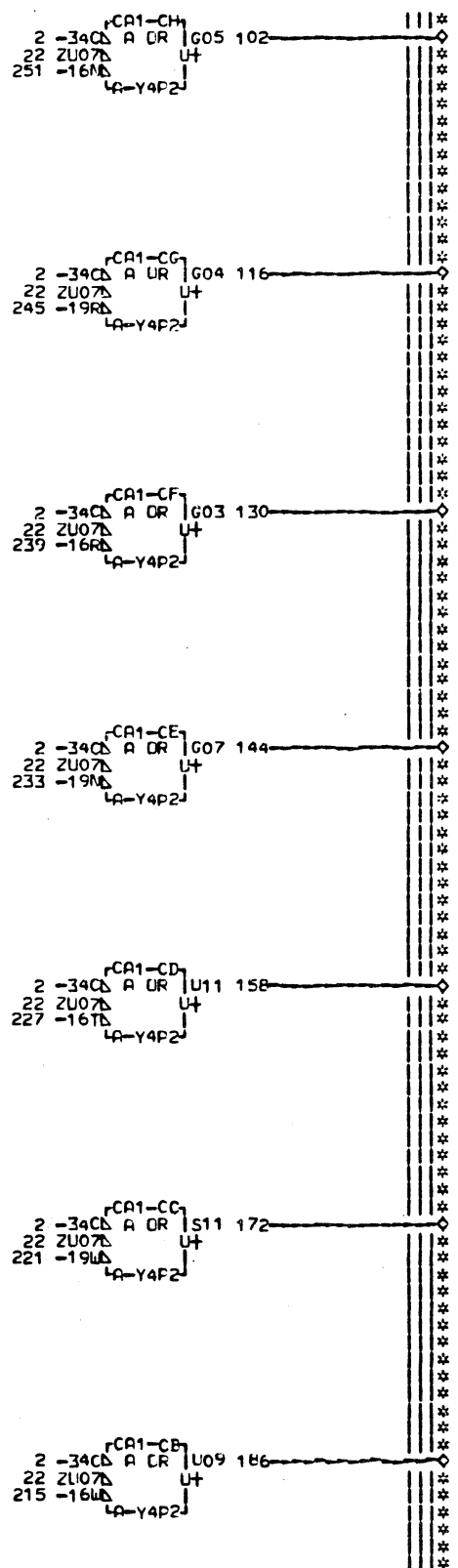
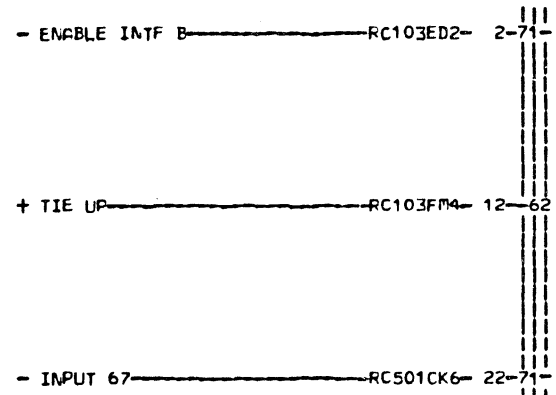

000 RC107

202 INTF B ADDR INPUT BIT 0.0 RA104-EJ2

186 INTF B ADDR INPUT BIT 0.1 RA104-EC2

172 INTF B ADDR INPUT BIT 0.2 RA104-ED2

158 INTF B ADDR INPUT BIT 0.3 RA104-EE2

144 INTF B ADDR INPUT BIT 0.4 RA104-EF2

130 INTF B ADDR INPUT BIT 0.5 RA104-EG2

116 INTF B ADDR INPUT BIT 0.6 RA104-EH2

102 INTF B ADDR INPUT BIT 0.7 RA104-EJ2

LOC. TYPE  
A-Y4P2 7601

INTERFACE B ADDRESS	
E.C. HISTORY	B. FACH. 27RNB
309522C	
309541	FRAME 01
DATE LAST EC	IBM COMP. SDD RC107
04-24-72 309545	P.No. 1785126 000



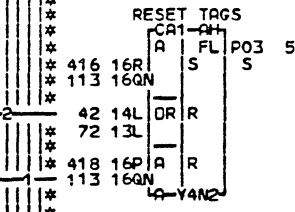
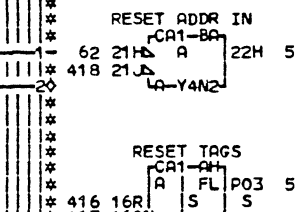
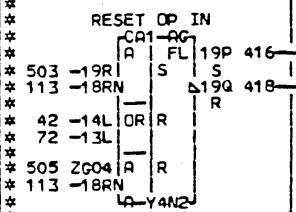
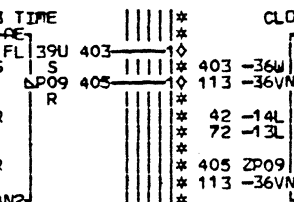
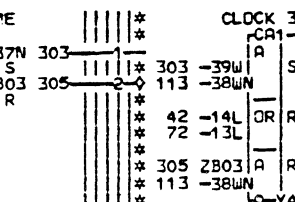
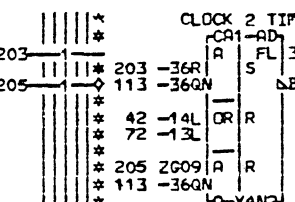
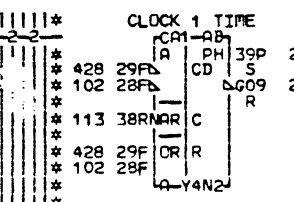
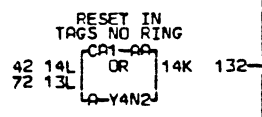
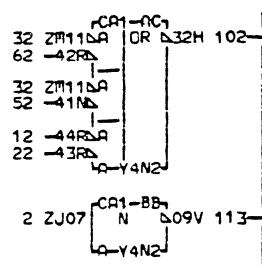
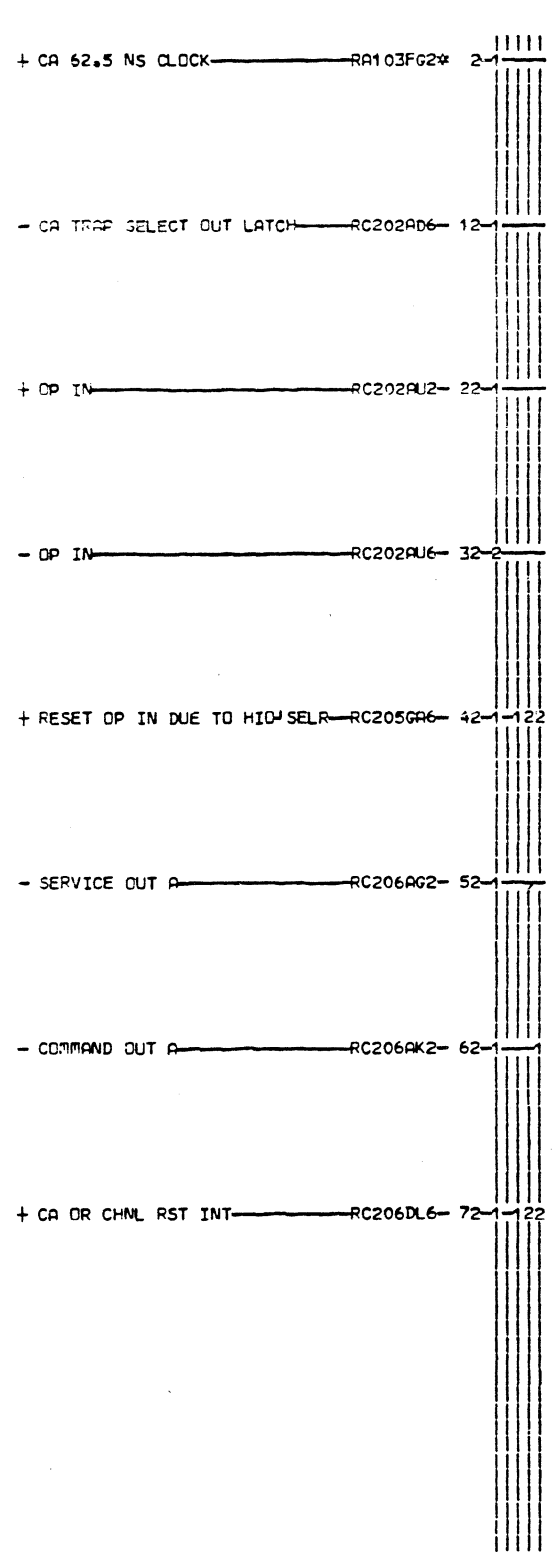

EDGE CONN.  
2 RESISTOR  
A-Y4N2J07

LOC. TYPE  
A-Y4N2 2342

RC201  
081 SIM TO PN 1785127 EC 312926

CHANNEL TAG CONTROL	
TAG CLOCK	E-MACH#27RNB
E-C-HISTORY	344270
FRAME	01
DATE LAST EC	04-14-81 344600
IBM CORP.#SCD	P.#N. 1986978
RC201	081

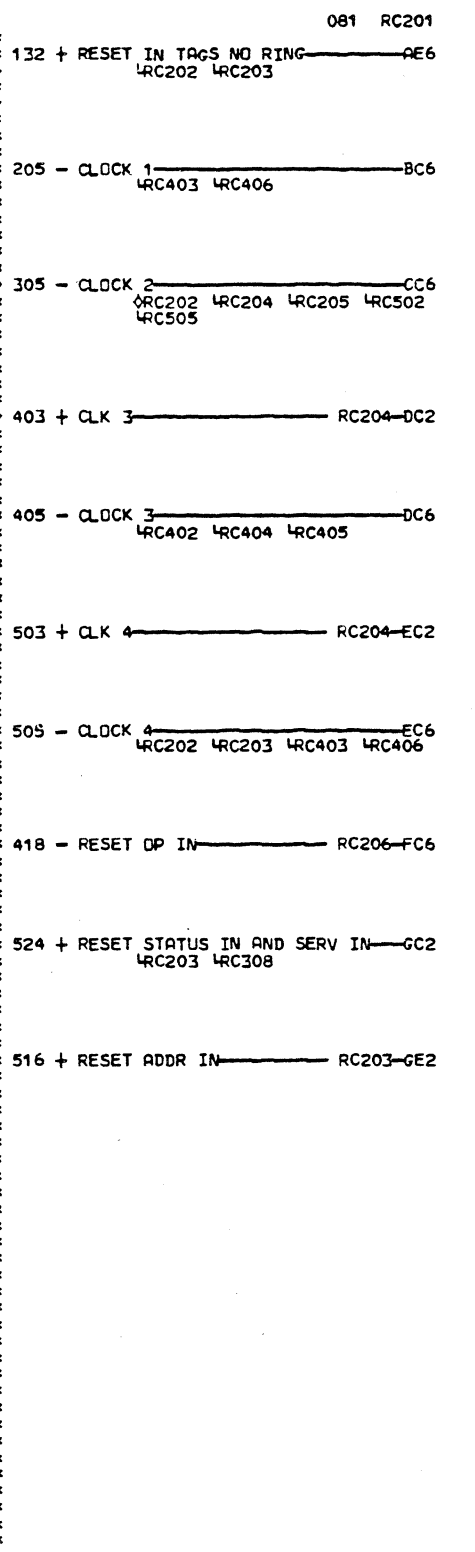

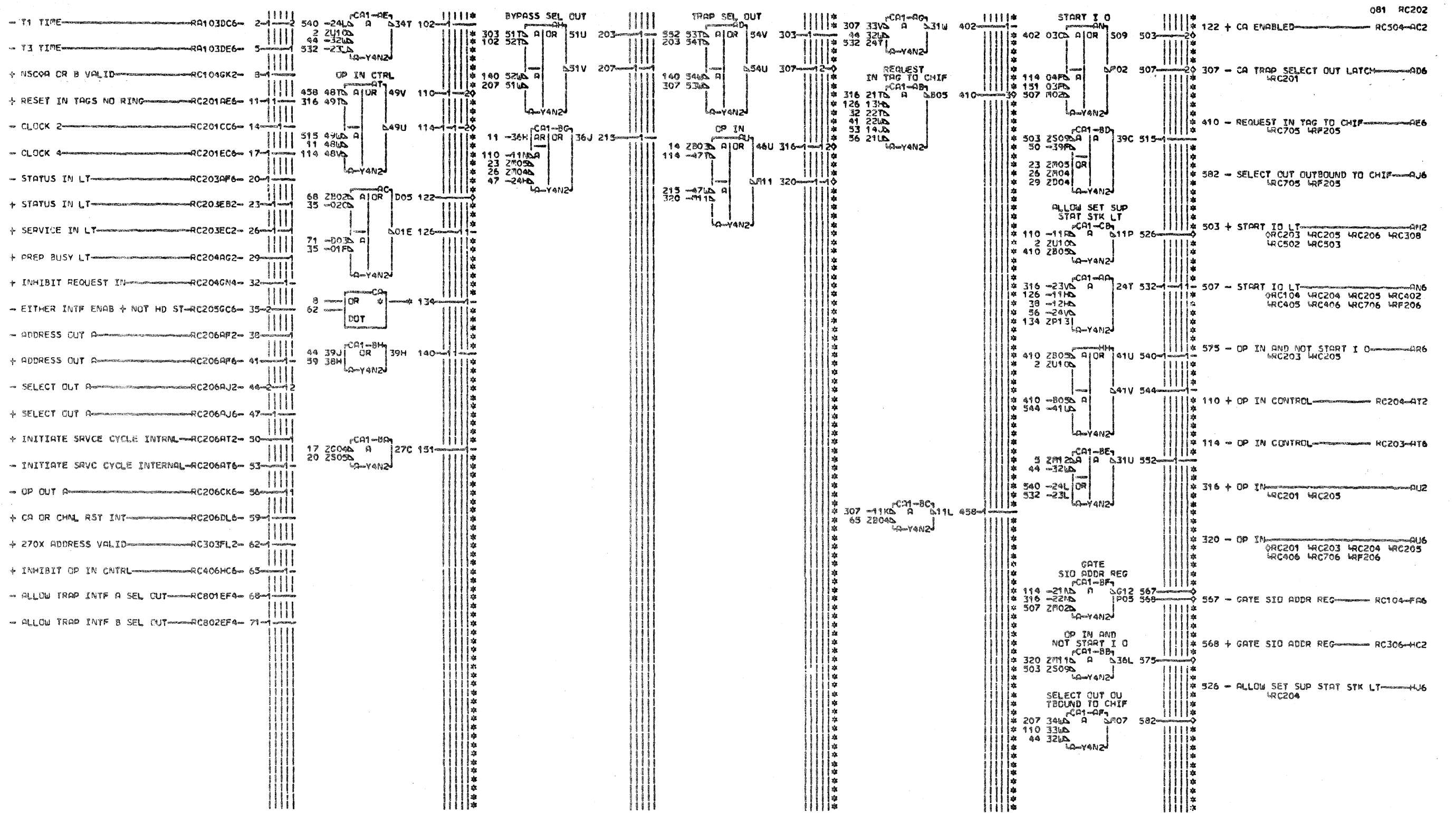

EDGE CONN.  
134 RESISTOR  
A-Y4N2P13

LOC. TYPE  
A-Y4N2 2342

RC202  
081 SIR TO PN 1785128 EC 321750

CHANNEL TAGS CONTROL START I O AND OPERATIONAL IN E.C.-HISTORY E-MACH.27RNB	
FRAME	01
IBR CURP.SCD	RC202
DATE LAST EC	10-14-80 344270
P.No	1986987 081

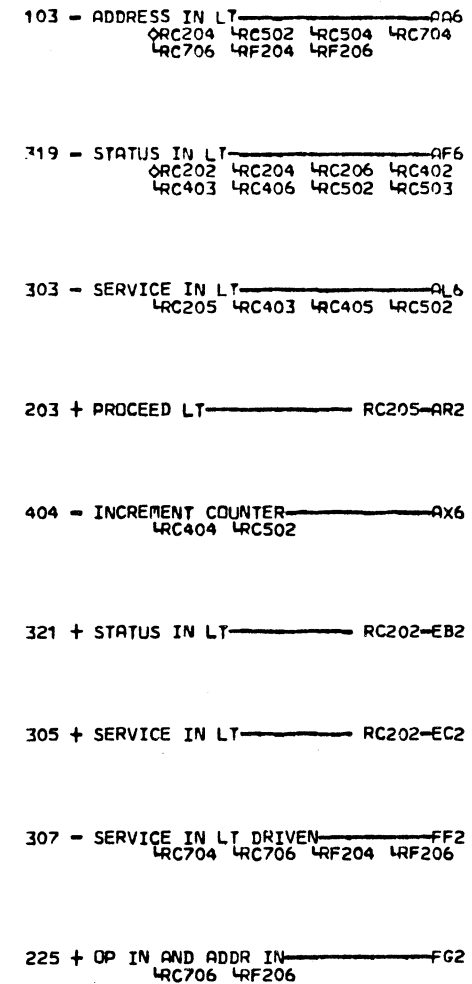
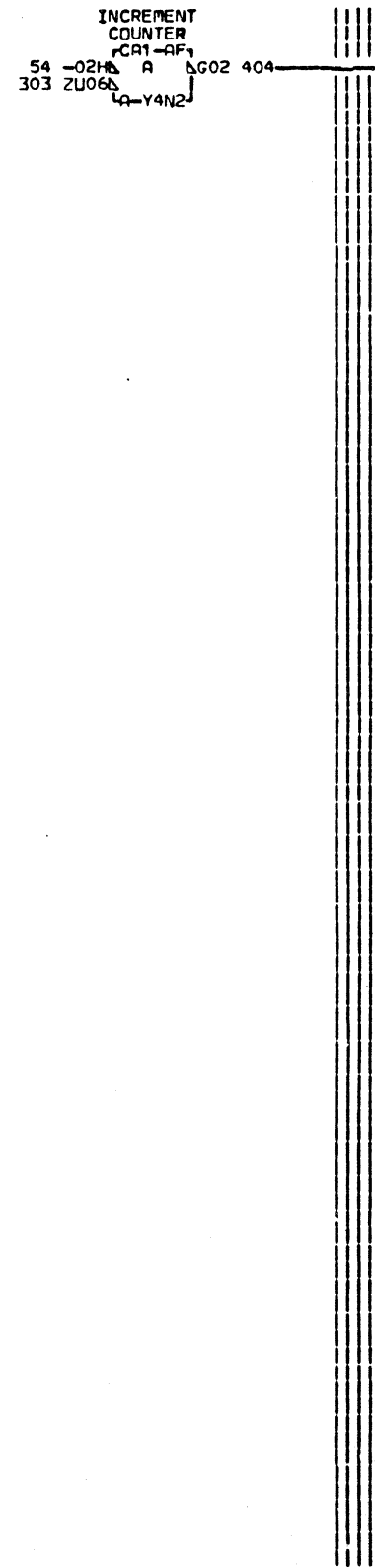
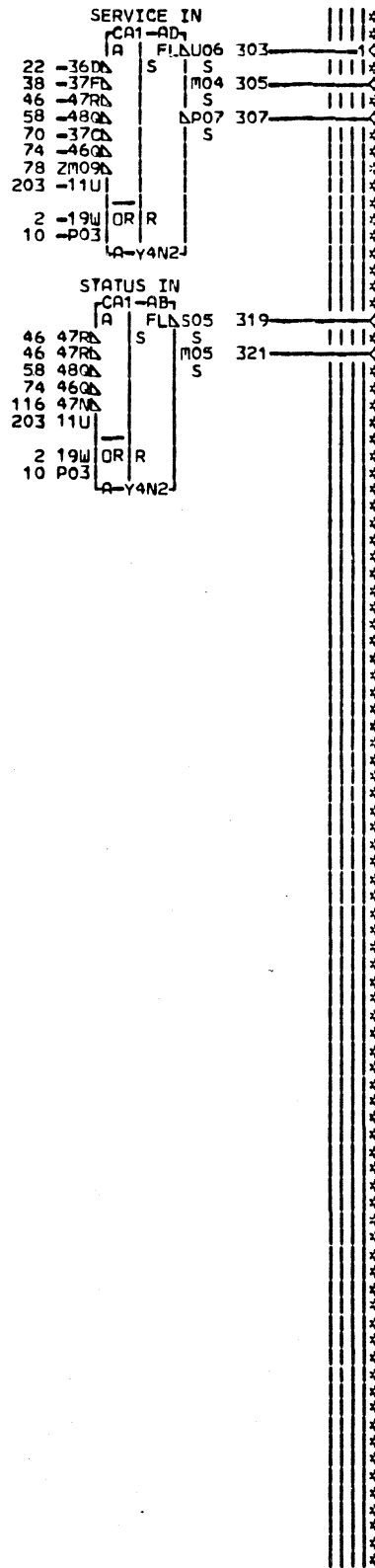
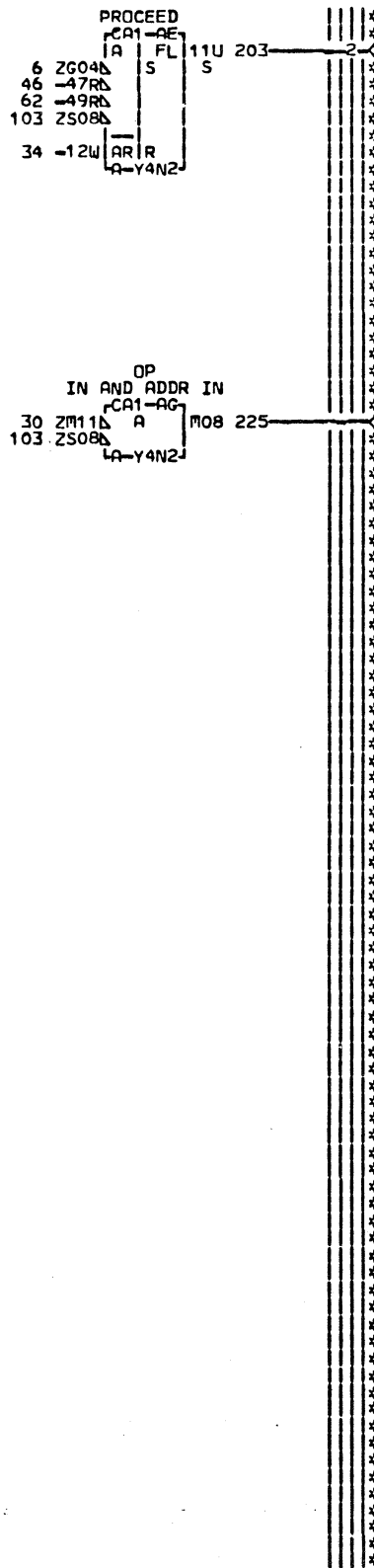
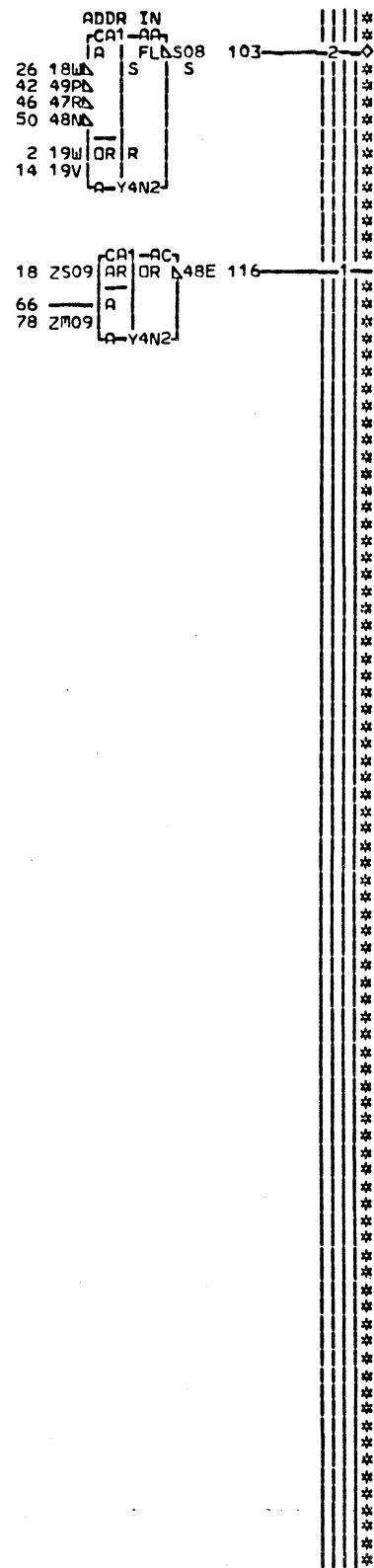
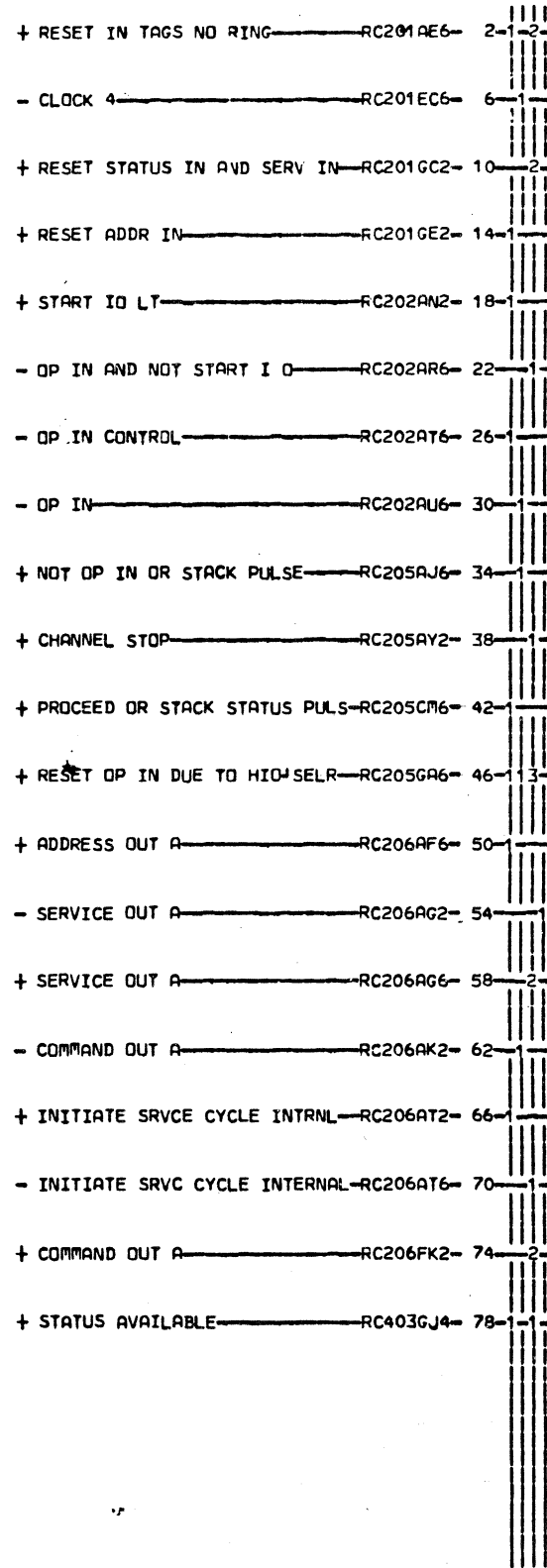

LOC. TYPE  
A-Y4N2 2342

- T1 TIME RC103DC6 2
- NSC ADDRESS VALID RC104GL6 5
- CLOCK 2 RC201CC6 8
- + CLK 3 RC201DC2 11
- + CLK 4 RC201EC2 14
- START ID LT RC202AN6 17-2
- + OP IN CONTROL RC202AT2 20
- OP IN RC202AU6 23
- = ALLOW SET SUP STAT STK LT RC202HJ6 26
- ADDRESS IN LT RC203AA6 29
- STATUS IN LT RC203AF6 32
- + HALT ID RESET RC205BA2 35
- SERVICE OUT A RC206AG2 38
- COMMAND OUT A RC206AK2 41
- = CA ACTIVE A RC206AU6 44
- SUPPR OUT A RC206AV2 47-22
- + SUPPR OUT A RC206AV6 50
- + CA OR CHNL RST INT RC206DL6 53-2
- CCU OUTBUS BIT 1-3 RC309BE2 56
- + NSC CE STATUS RC403FF2 59
- NSC XFER ACPTED RESET RC403GN6 62
- + NSC CE SVC INT RC403GR2 65
- + DATA SVC RESET RC405BK6 68
- ALLOW IPL DEC RC405DM6 71
- INPUT 62 RC501CE6 74
- SAMPLE OUTPUT 62 RC501EC6 77
- + ALLOW PREP BUSY RC503FE2 80
- + ESC MODE ENAB RC602CH2 83
- ALLOW IPL FLAG TO CCU RC602HR2 86

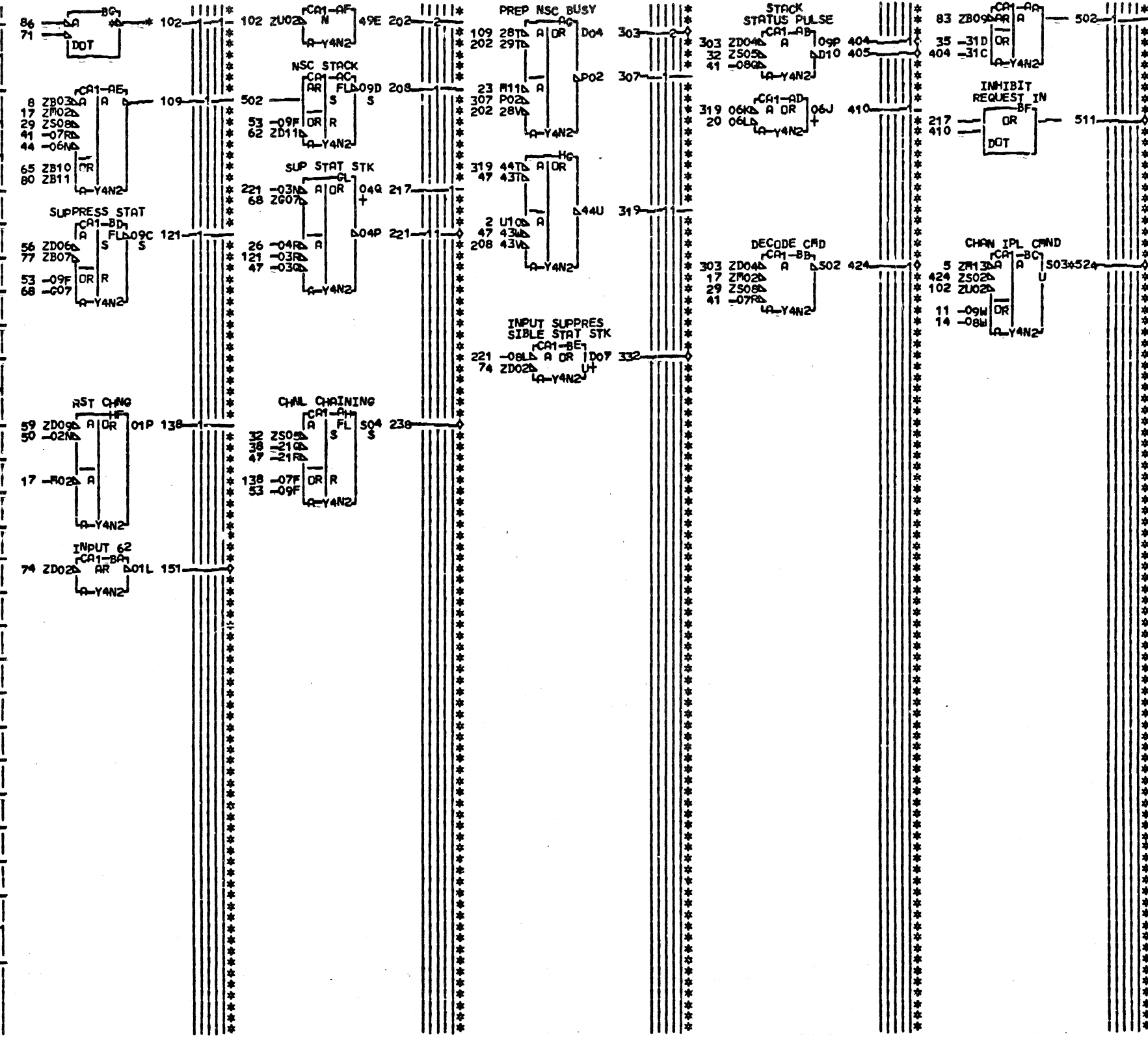

- 404 + STACK STATUS PULSE RC205-AA2
- 405 - STK STATUS PULSE RA6  
LRC402 LRC405 LRC503
- 303 + PREP BUSY LT. RG2  
ORC202 LRC402 LRC403 LRC406  
LRC503 LRC601 LRC707 LRF207
- 151 - INPUT 62 RC205-CL6
- 424 - DECODE CMD FG6  
LRC306 LRC402 LRC406
- 524 + CHAN IPL CMD R3013-CH2
- 221 - SUPPRESSIBLE STAT STK RC205-GL6
- 332 + INPUT SUPPRESSIBLE STAT STK GM2  
LRA105
- 511 + INHIBIT REQUEST IN RC202-GN4
- 238 + CHAINING IND HA2  
LRC205 LRC206 LRC504

EDGE CONN.  
102 RESISTOR  
A-Y4N2U02  
524 A-Y4B3D10  
01A-Y4B5D10

LOC. TYPE  
A-Y4N2 2342

RC204  
000

CHANNEL TAGS CONTROL		STACK CHAINING STOP OR HALT ID	
E.C.	HISTORY	E.	MACH
309522C	309951		
309541	311263	FRAME	01
309548	315618	IBM CORP.	SDD RC204
309548			
DATE	LAST EC	P.N.	1785130 000
08-09-79	321750		

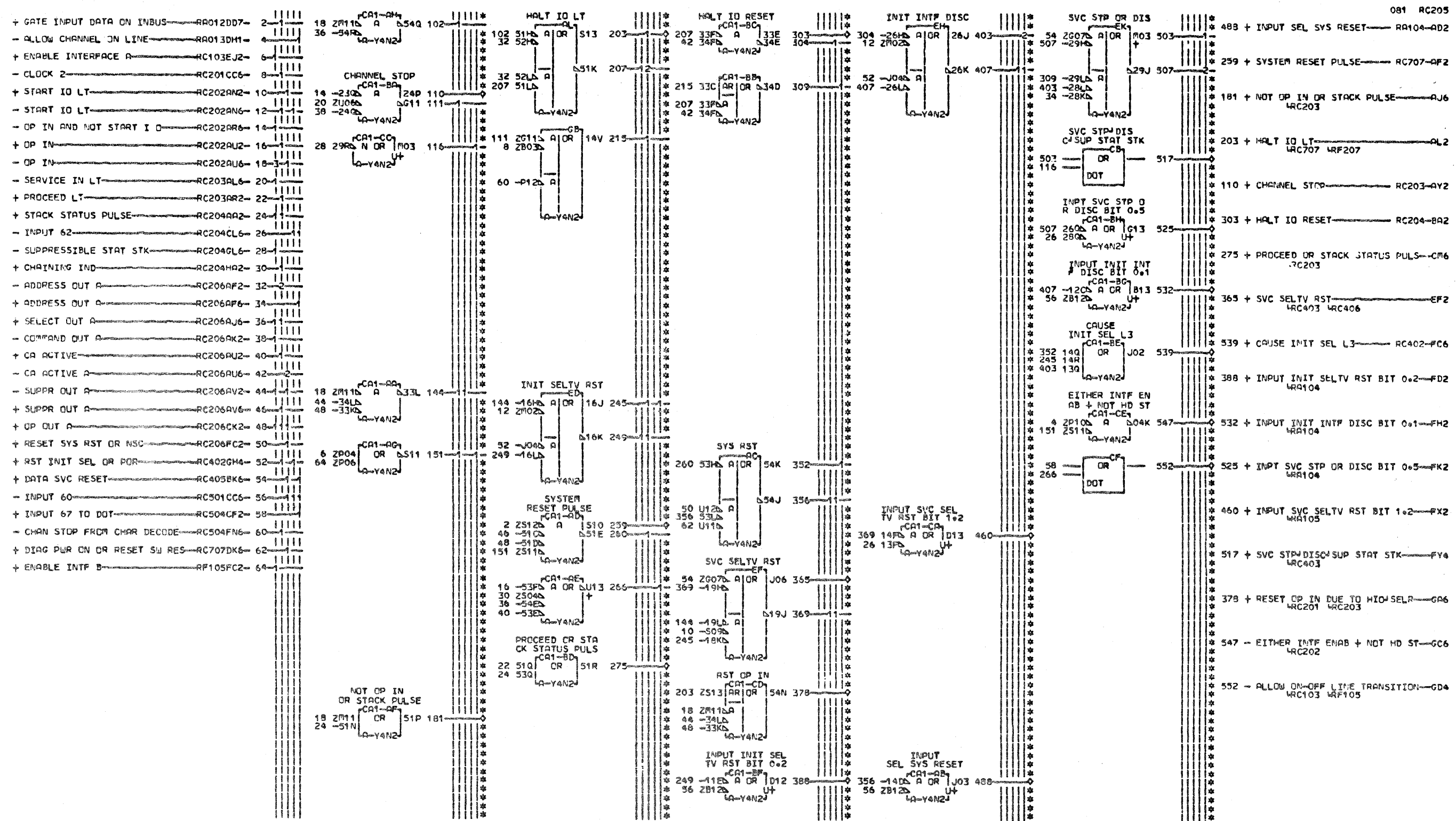

081 RC205

LOC. TYPE  
A-Y4N2 2342

CHANNEL TAGS CONTROL ENABLE AND SEL SYS RESET -EC-HISTORY- E-ROCH-27RNB	
FRAPZ	01
DATE LAST EC	IBR CORP-SCD RC205
10-14-80 344270	P-NO 1986988 081

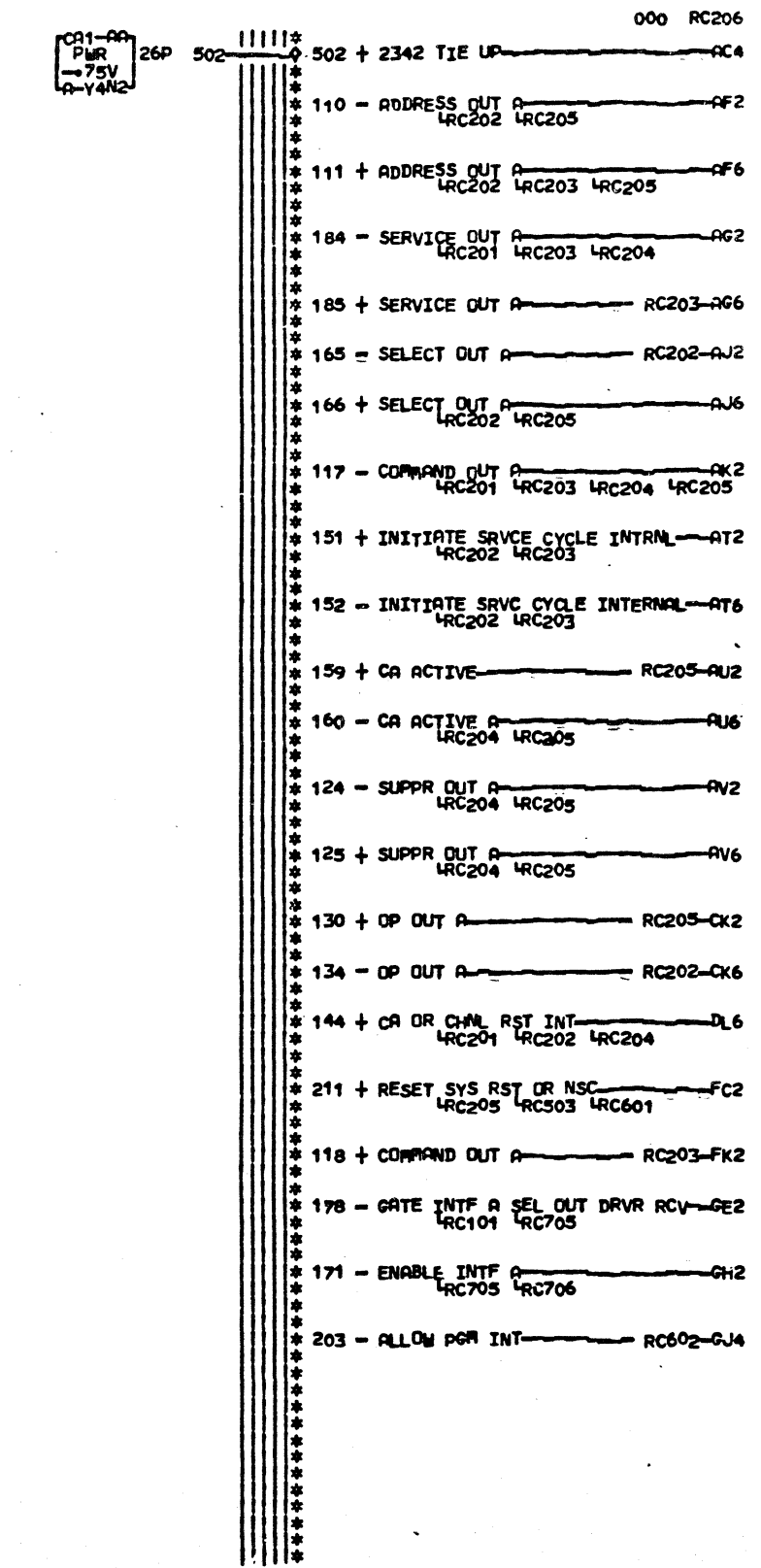
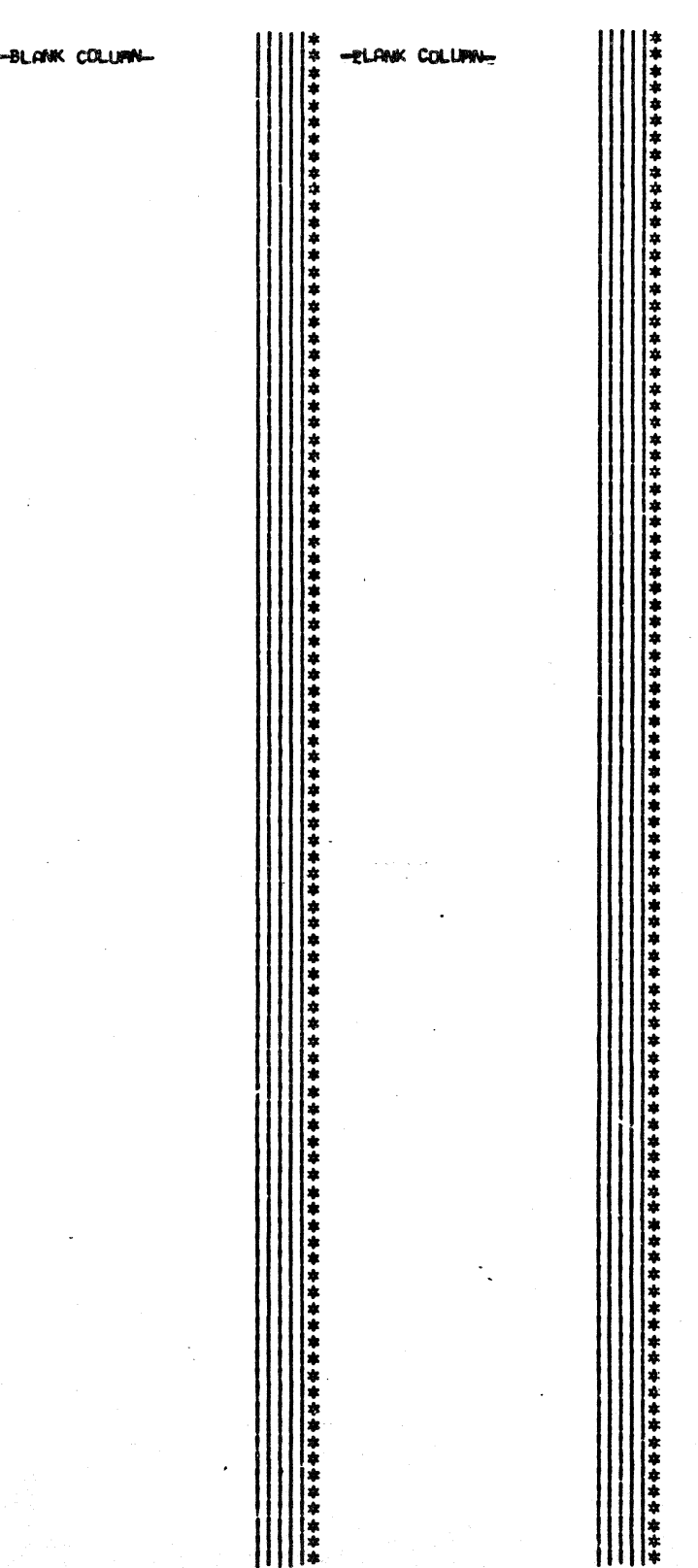
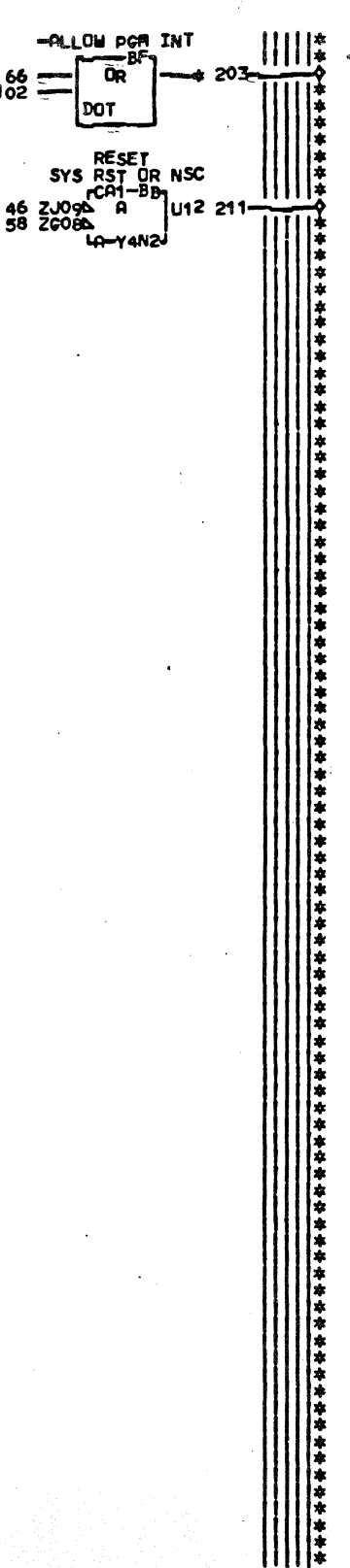
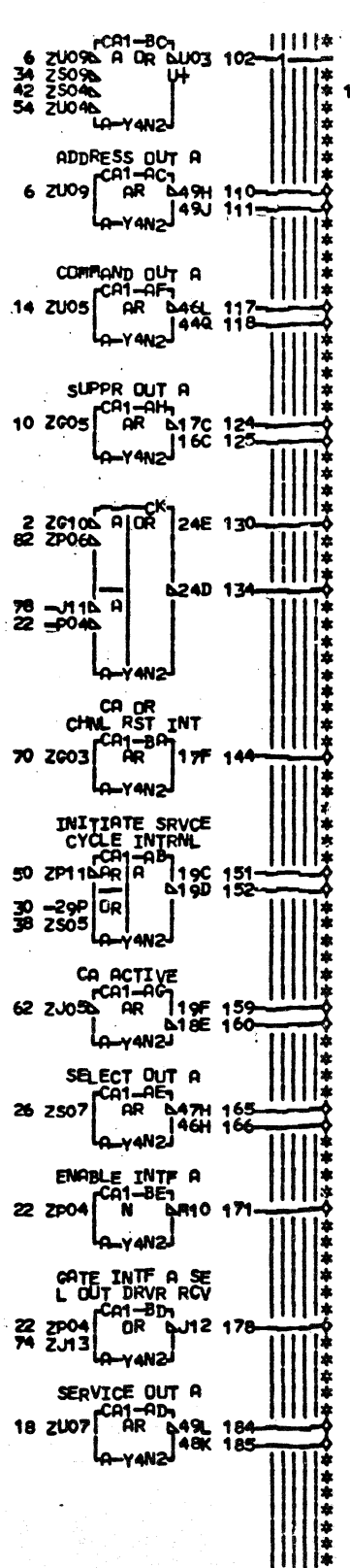
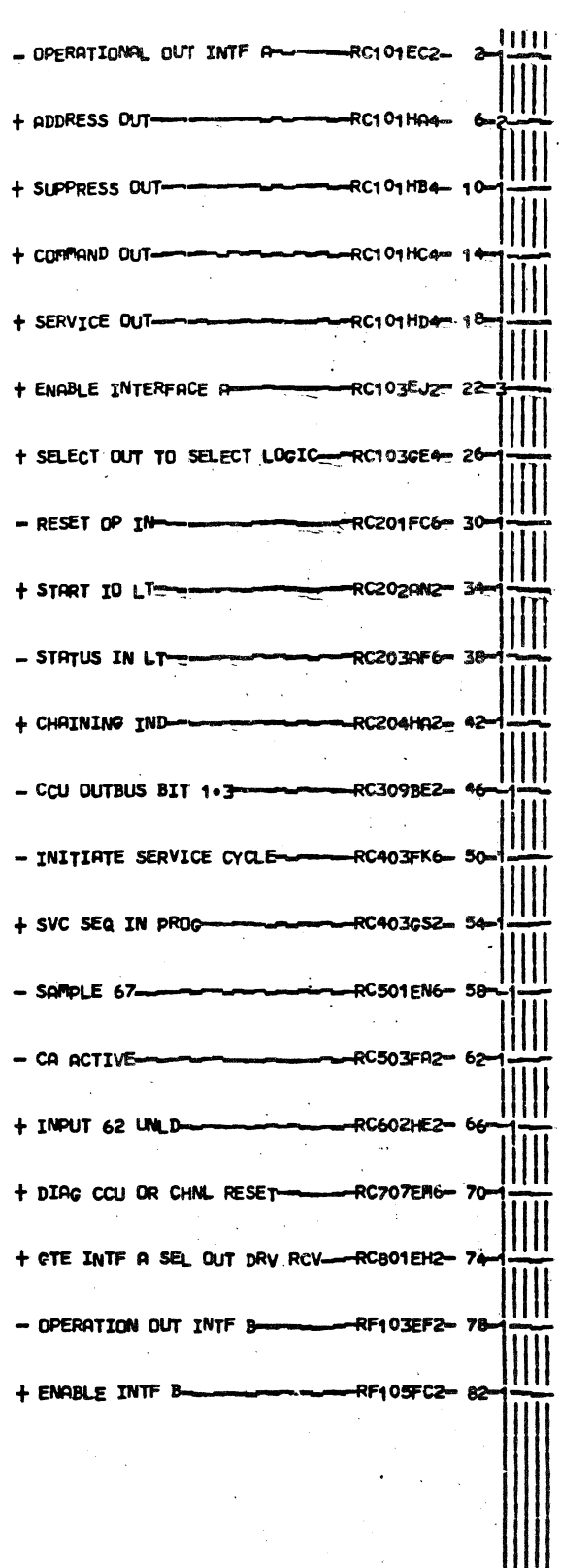

EDGE CONN.  
203 RESISTOR  
A-Y4N2U03

LOC. TYPE  
A-Y4N2 2342

CHANNEL TAG CONTROL			
POWERING			
E.C. HISTORY	E. PACH. 27RNB	FRAME	01
309522C	309533		
309541	309549		
309545	309551		
309548			
DATE	LAST EC	IBM CORP. SDD	RC206
08-09-79	321750	P.N. 1785132	000

RC206  
000

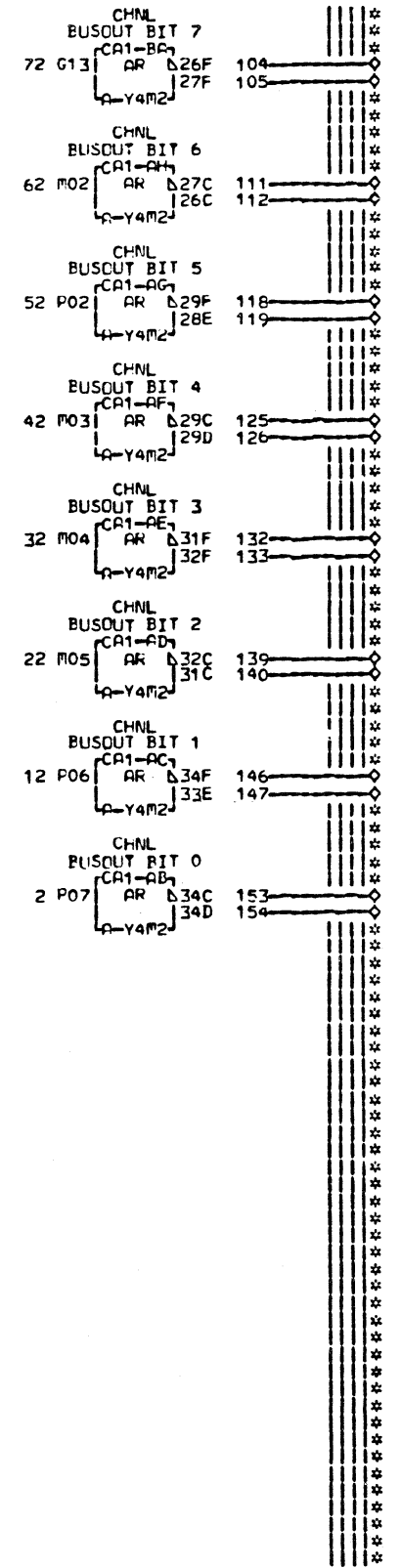
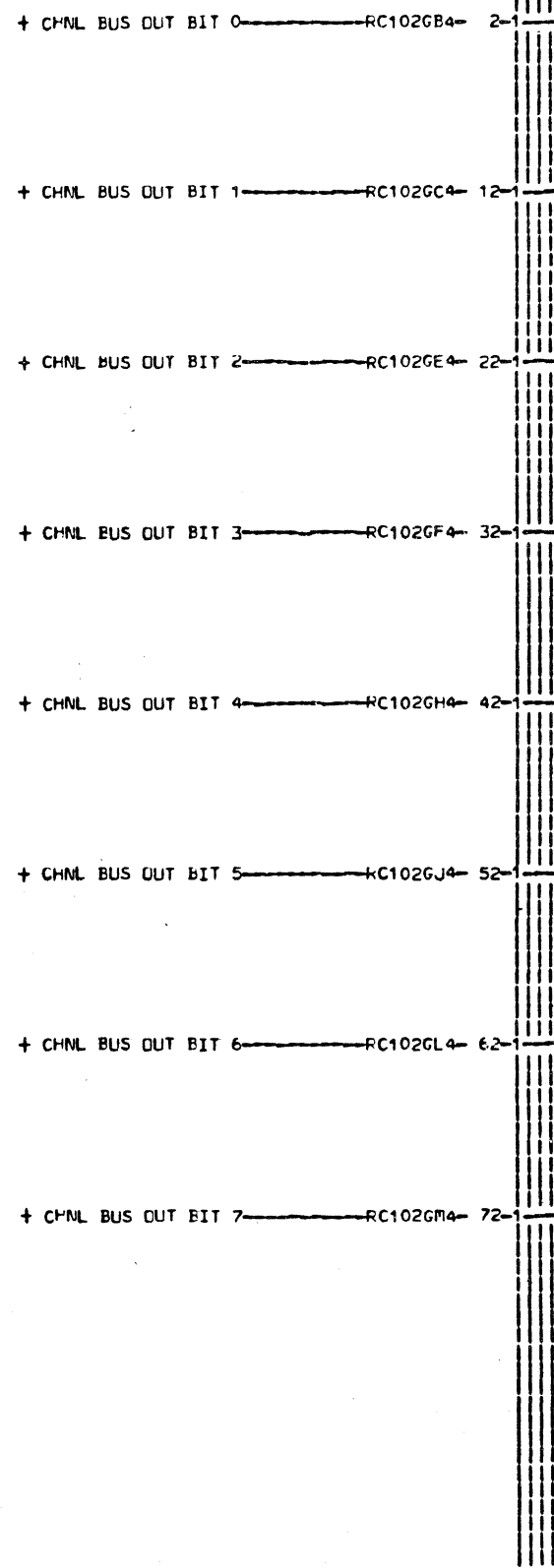

-BLANK COLUMN-

-BLANK COLUMN-

LDC. TYPE  
A-Y4M2 2325

TIE UP  
CA1-BA  
PWR  
XVFLM  
A-Y4M2  
36P 455

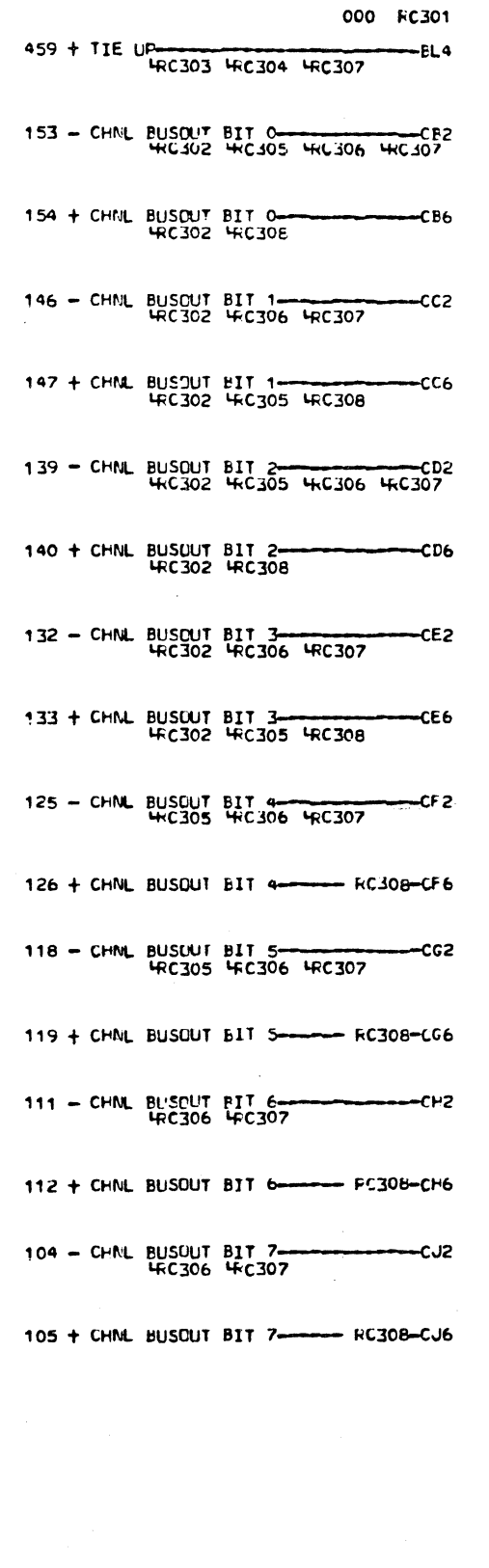

CHNL BUS OUT REPOWER			
E.C.—HISTORY—	309522C	MACH#27RNB	
		FRAME	01
DATE	LAST FC	IBM CORP.SDD	FC301
04-24-72	309545	P.N.	1785133 000

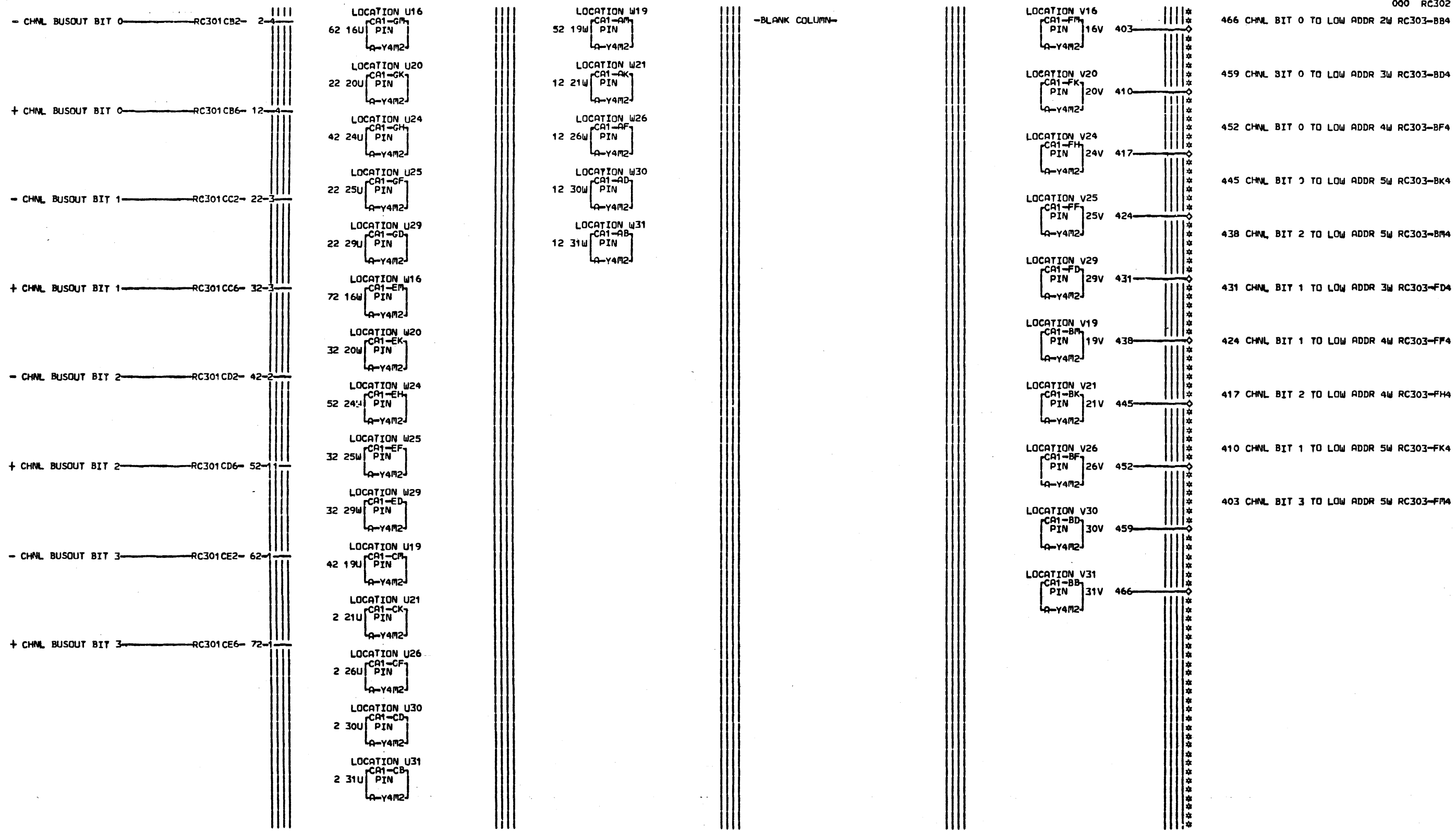

LOC. TYPE  
A-Y4M2 2325

LOW ADDRESS JUMPERS			
E.C. HISTORY		B.MACH. 27RNB	
309522C		FRAME	01
309541		IBN CORP. SDD	RC302
309545		P.N. 1785134	000
DATE	LAST EC		
06-15-72	309533		



+ TIE UP RC301BL4 2-4

CHNL BIT 0 TO LOW ADDR 2W RC302BB4 9-1

CHNL BIT 0 TO LOW ADDR 3W RC302BD4 16-1

CHNL BIT 0 TO LOW ADDR 4W RC302BF4 23-1

CHNL BIT 0 TO LOW ADDR 5W RC302BK4 30-1

CHNL BIT 2 TO LOW ADDR 5W RC302BM4 37-1

CHNL BIT 1 TO LOW ADDR 3W RC302FD4 44-1

CHNL BIT 1 TO LOW ADDR 4W RC302FF4 51-1

CHNL BIT 2 TO LOW ADDR 4W RC302FH4 58-1

CHNL BIT 1 TO LOW ADDR 5W RC302FK4 65-1

CHNL BIT 3 TO LOW ADDR 5W RC302FM4 72-1

- HIGH ADDR VALID RC305FK4 79-1

+ ESC MODE ENAB RC602CH2 86-1

270X ADDRESS VALID

79	-09NA	CA1-BA	B11	104
86	ZG05	UT		
9	-13H	OR		
146	-14H			
16	-08Q	OR		
44	-08R			
140	-07R			
23	-16N	OR		
51	-17N			
58	-18N			
134	-19N			
30	-19P	OR		
37	-18R			
65	-19R			
72	-17R			
128	-18Q			

LOCATION S29  
CA1-AH  
PIN 29S 128  
A-Y4M2

LOCATION S28  
CA1-AG  
PIN 28S 134  
A-Y4M2

LOCATION S27  
CA1-AF  
PIN 27S 140  
A-Y4M2

LOCATION S26  
CA1-AE  
PIN 26S 146  
A-Y4M2

LOCATION T29  
CA1-AD  
PIN 2 29T  
A-Y4M2

LOCATION T28  
CA1-AC  
PIN 2 28T  
A-Y4M2

LOCATION T27  
CA1-AB  
PIN 2 27T  
A-Y4M2

LOCATION T26  
CA1-AA  
PIN 2 26T  
A-Y4M2

LOC. TYPE  
A-Y4M2 2325

LOW ADDRESS LOGIC

-E.C.-HISTORY-B, MACH. 27RNB	
309522C	FRAME 01
309541	
309545	
DATE LAST EC	IBM CORP. SDD RC303
06-15-72 309533	P.N. 1785135 000

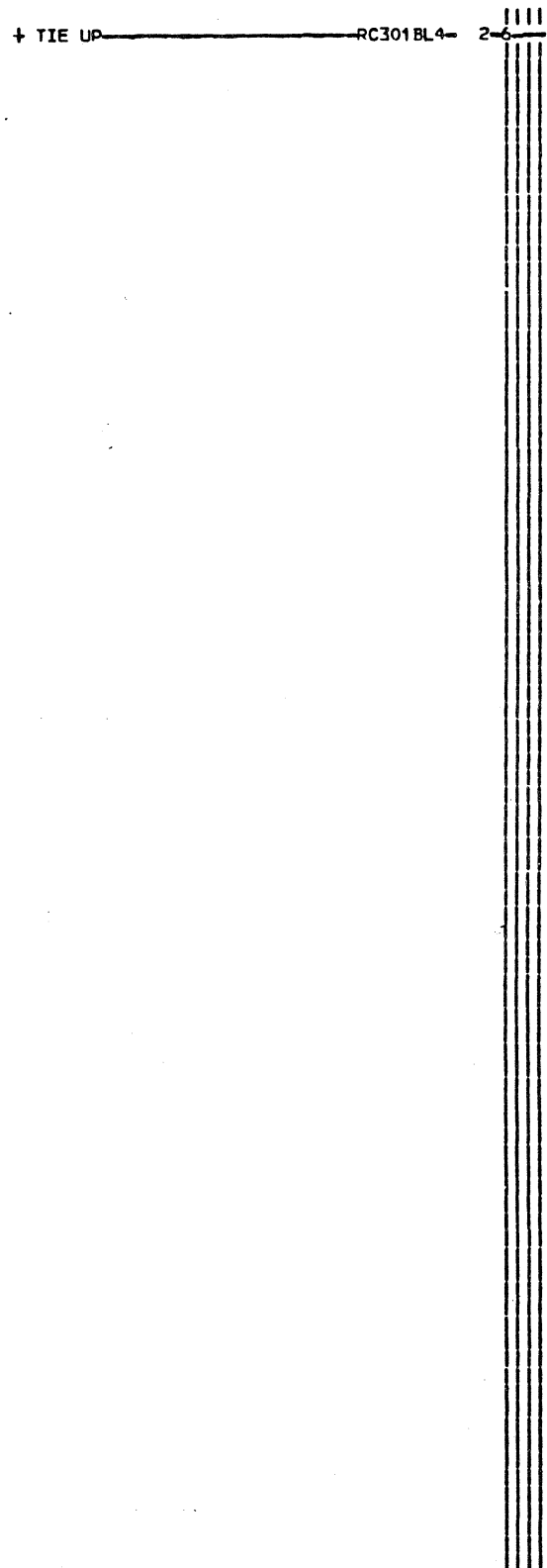

- LOCATION T16  
2 16T CA1-BM  
PIN  
A-Y4M2
- LOCATION T17  
2 17T CA1-BK  
PIN  
A-Y4M2
- LOCATION T18  
2 18T CA1-BH  
PIN  
A-Y4M2
- LOCATION T20  
2 20T CA1-BF  
PIN  
A-Y4M2
- LOCATION T21  
2 21T CA1-BD  
PIN  
A-Y4M2
- LOCATION T22  
2 22T CA1-BB  
PIN  
A-Y4M2

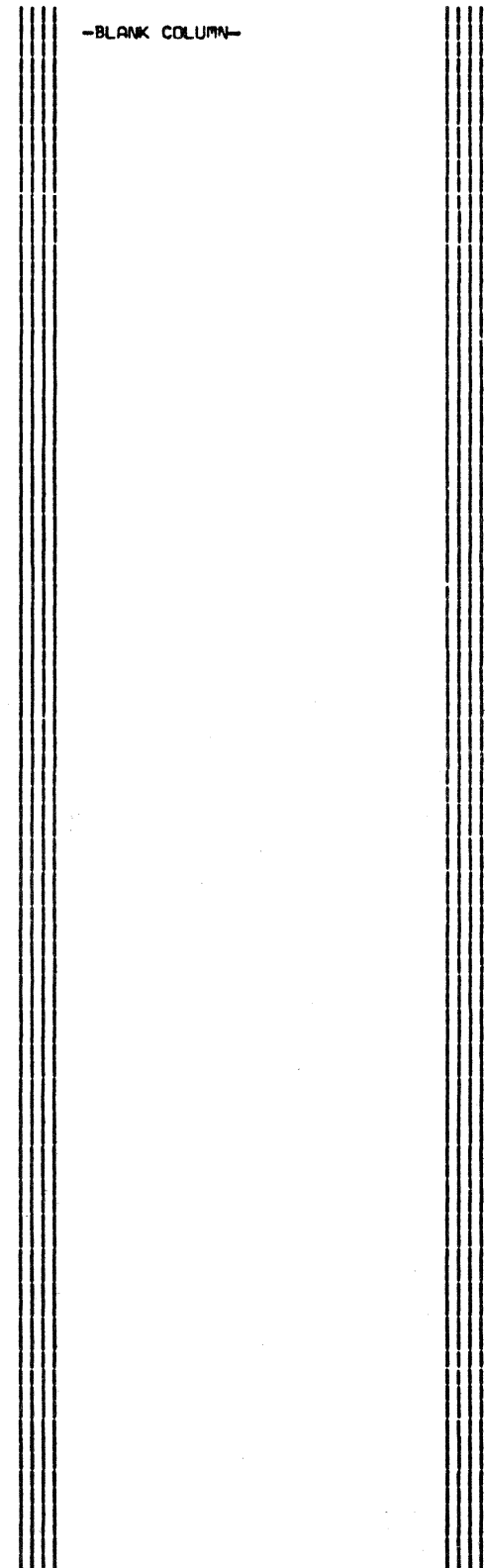
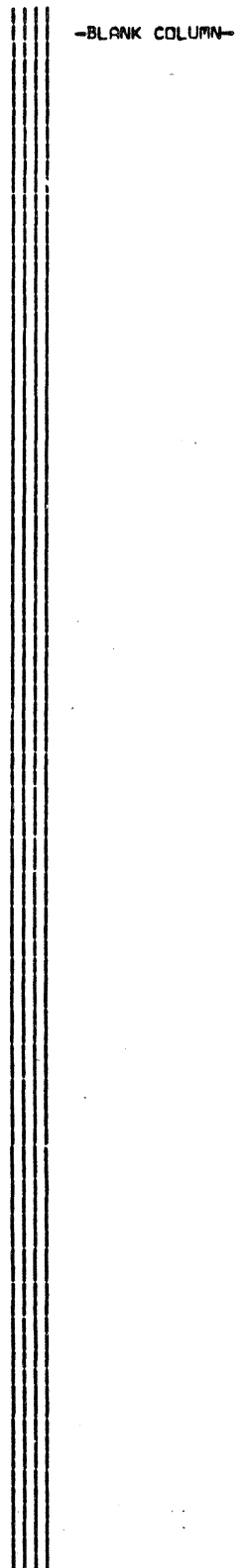

LOC. TYPE  
A-Y4M2 2325

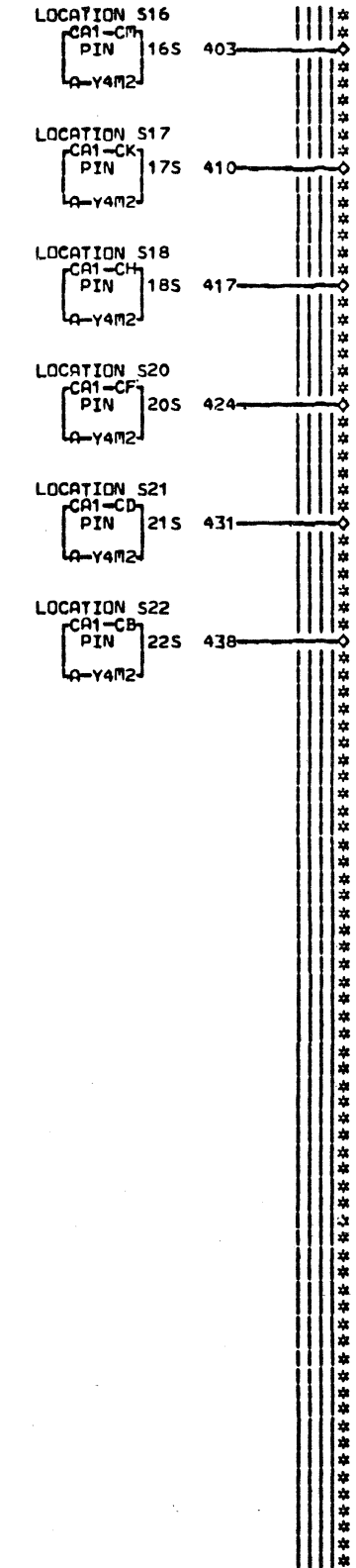

- LOCATION S16  
CA1-CM  
PIN 16S  
A-Y4M2
- LOCATION S17  
CA1-CK  
PIN 17S  
A-Y4M2
- LOCATION S18  
CA1-CH  
PIN 18S  
A-Y4M2
- LOCATION S20  
CA1-CF  
PIN 20S  
A-Y4M2
- LOCATION S21  
CA1-CD  
PIN 21S  
A-Y4M2
- LOCATION S22  
CA1-CB  
PIN 22S  
A-Y4M2

- 438 + HIGH ADDR BIT 0 PLUGGED RC305-CB4
- 431 - HIGH ADDR BIT 1 PLUGGED RC305-CD4
- 424 + HIGH ADDR BIT 2 PLUGGED RC305-CF4
- 417 - HIGH ADDR BIT 3 PLUGGED RC305-CH4
- 410 + HIGH ADDR BIT 4 PLUGGED RC305-CK4
- 403 + HIGH ADDR BIT 5 PLUGGED RC305-CM4

HIGH ADDRESS JUMPERS			
E.C. HISTORY	MACH.27RNB	FRAME	01
309522C		IBM CORP.SCD	RC304
309545		P.No. 1785136	000
DATE	LAST EC		
06-15-72	309533		

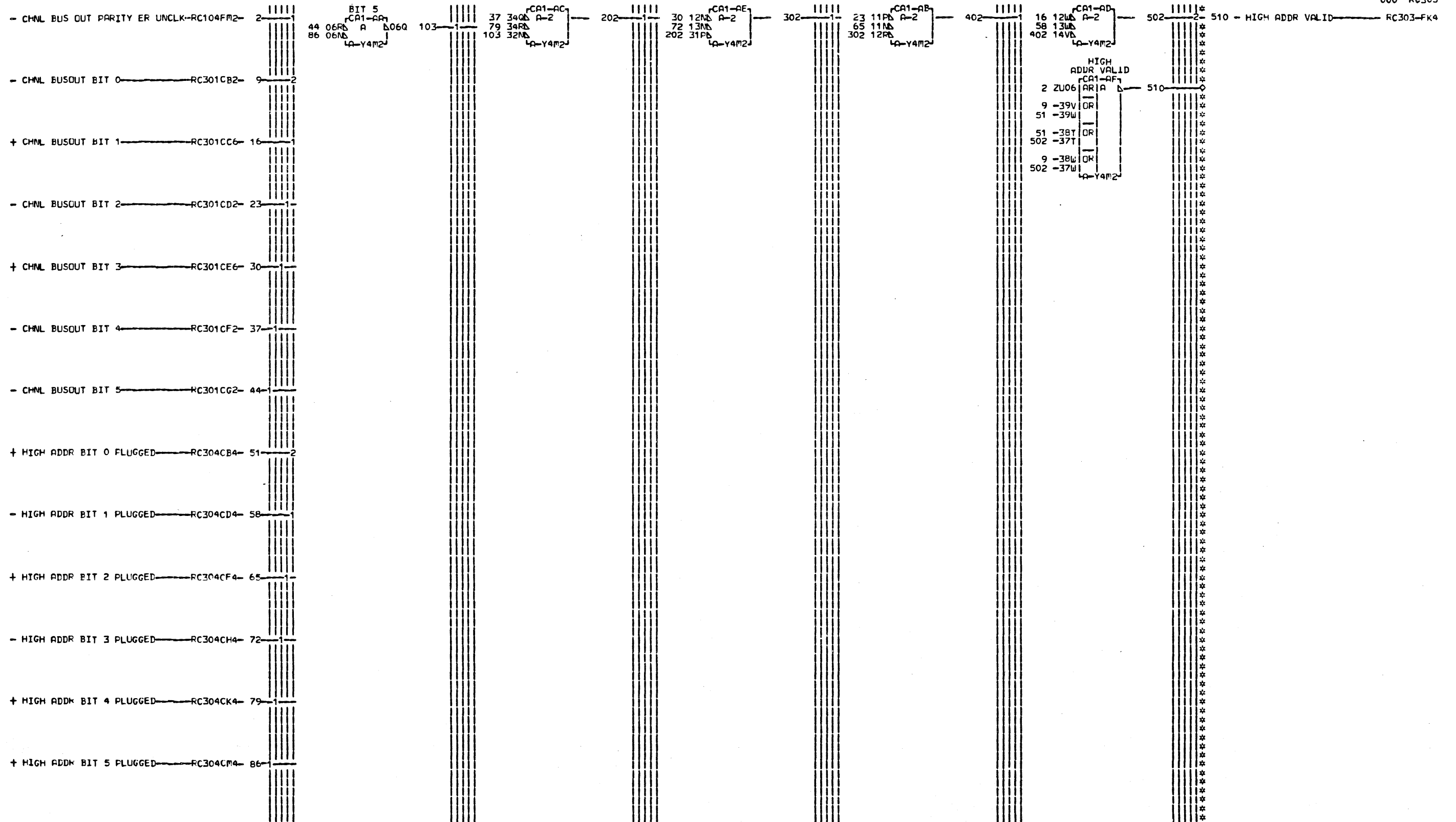

LDC. TYFE  
A-Y4M2 2325

HIGH ADDRESS LOGIC	
E-C-HISTORY 309522C	B-MACH-27FNB
DATE 04-24-72	LAST EC 309545
FRAME 01	IBN CORP-SDD F.No 1785137
	RC305 000

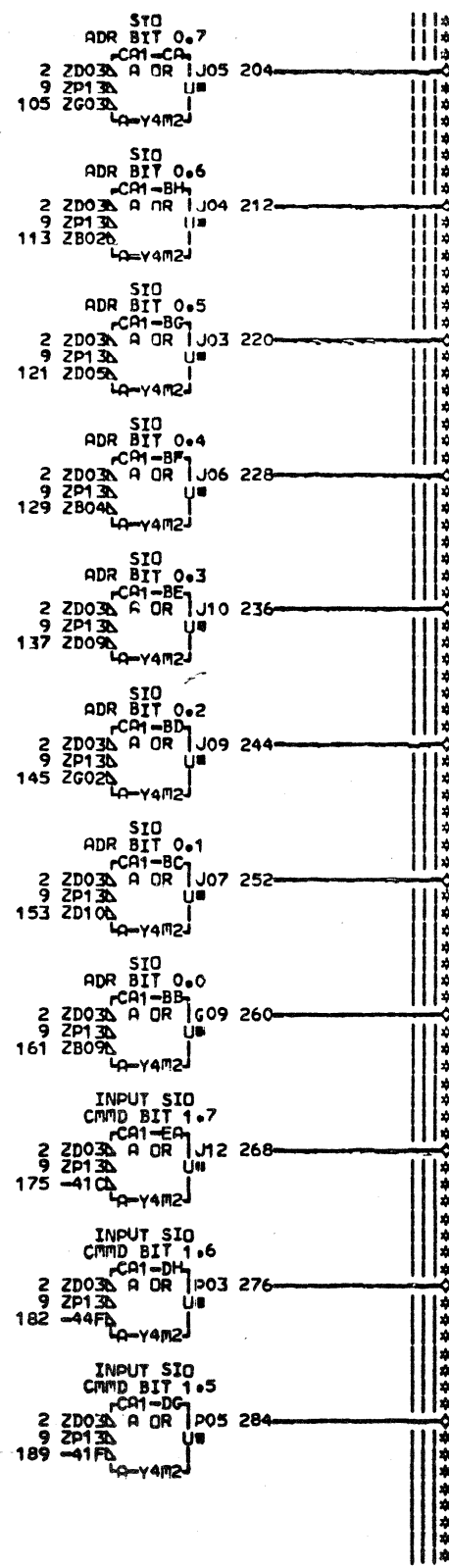
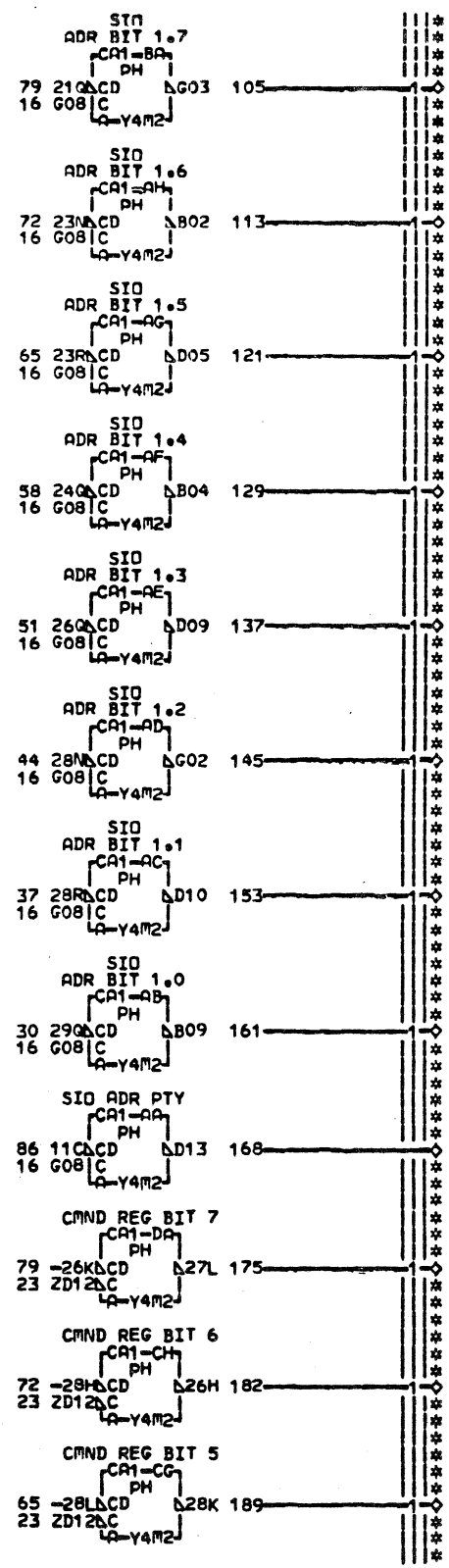
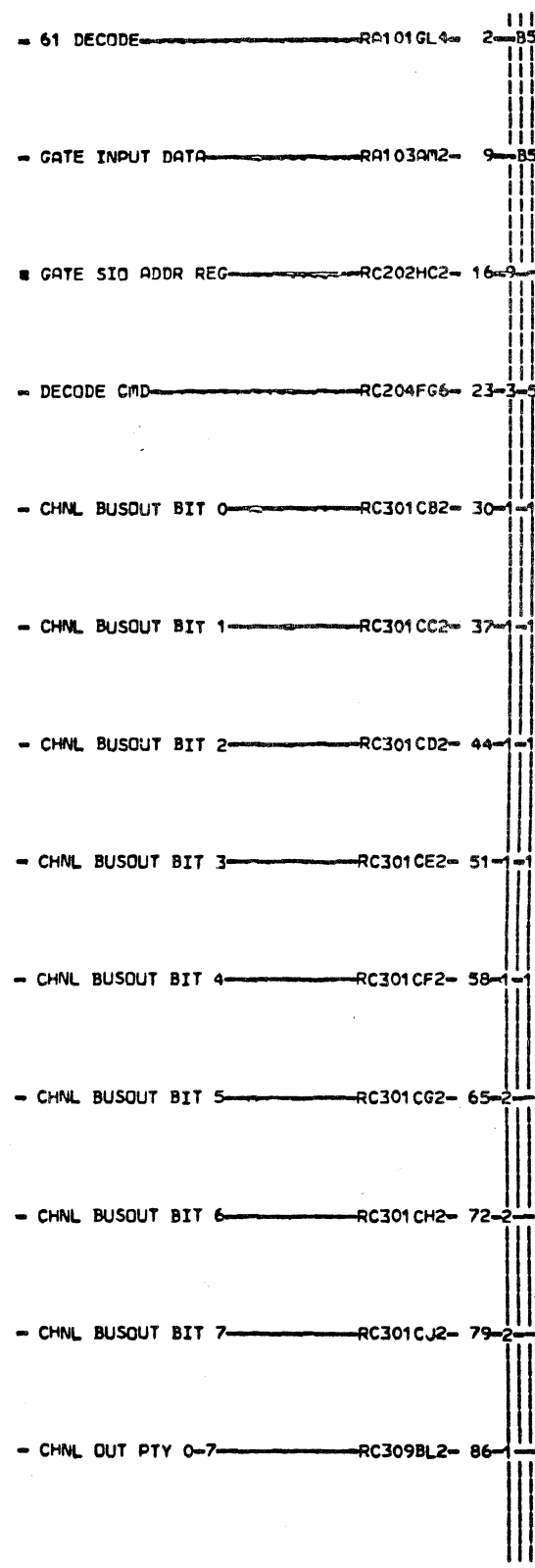

LOC. TYPE  
 A-Y4M2 2325

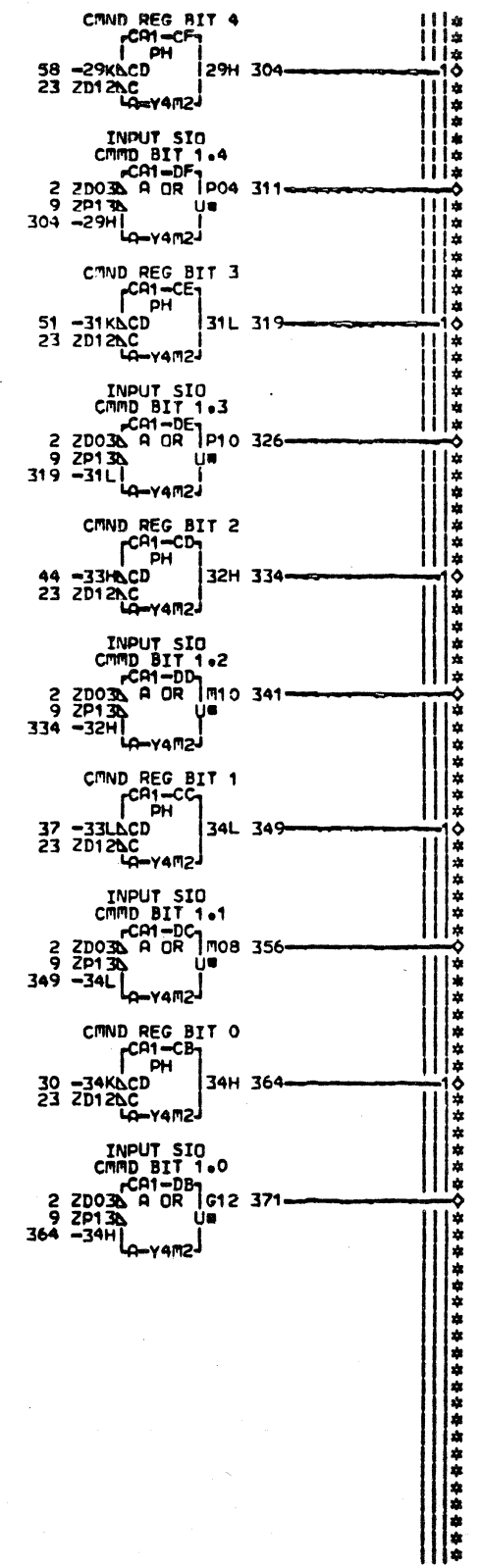

- 000 RC306
- 168 - SID ADR PTY 1.0-1.7 BR6
  - 161 - SID ADR BIT 1.0 BC6
  - 153 - SID ADR BIT 1.1 BD6
  - 145 - SID ADR BIT 1.2 BF6
  - 137 - SID ADR BIT 1.3 BG6
  - 129 - SID ADR BIT 1.4 BH6
  - 121 - SID ADR BIT 1.5 BK6
  - 113 - SID ADR BIT 1.6 BL6
  - 105 - SID ADR BIT 1.7 BM6
  - 260 - SID ADR BIT 0.0 RA104-CC2
  - 252 - SID ADR BIT 0.1 RA104-CD2
  - 244 - SID ADR BIT 0.2 RA104-CF2
  - 236 - SID ADR BIT 0.3 RA104-CG2
  - 228 - SID ADR BIT 0.4 RA104-CH2
  - 220 - SID ADR BIT 0.5 RA104-CK2
  - 212 - SID ADR BIT 0.6 RA104-CL2
  - 204 - SID ADR BIT 0.7 RA104-CM2
  - 364 - CMD REG BIT 0 RC308-FD2
  - 349 - CMD REG BIT 1 RC308-FE2
  - 334 - CMD REG BIT 2 RC308-FG2
  - 319 - CMD REG BIT 3 RC308-FH2
  - 304 - CMD REG BIT 4 RC308-FJ2
  - 189 - CMD REG BIT 5 RC308-FL6
  - 182 - CMD REG BIT 6 RC308-FM6
  - 175 - CMD REG BIT 7 RC308-FN6
  - 371 - INPUT SID CMD BIT 1.0 RA105-GD2
  - 356 - INPUT SID CMD BIT 1.1 RA105-GE2
  - 341 - INPUT SID CMD BIT 1.2 RA105-GG2
  - 326 - INPUT SID CMD BIT 1.3 RA105-GH2
  - 311 - INPUT SID CMD BIT 1.4 RA105-GJ2
  - 284 - INPUT SID CMD BIT 1.5 RA105-GL2
  - 276 - INPUT SID CMD BIT 1.6 RA105-GM2
  - 268 - INPUT SID CMD BIT 1.7 RA105-GN2

START I/O ADR ■ CMD REGS	
E.C. HISTORY	B. MACH. 27RNB
309522C	
309541	FRAME 01
309545	
DATE LAST EC	IBM CORP. SDD RC306
05-23-72 309548	P. N. 1785138 000

- TIE UP RC301BL4 2-2-1
- CHNL BUSOUT BIT 0 RC301CB2 5-1
- CHNL BUSOUT BIT 1 RC301CC2 8-1
- CHNL BUSOUT BIT 2 RC301CD2 11-1
- CHNL BUSOUT BIT 3 RC301CE2 14-1
- CHNL BUSOUT BIT 4 RC301CF2 17-1
- CHNL BUSOUT BIT 5 RC301CG2 20-1
- CHNL BUSOUT BIT 6 RC301CH2 23-1
- CHNL BUSOUT BIT 7 RC301CJ2 26-1
- CCU OUTBUS BIT 1.0 RC309BA2 29-1
- CCU OUTBUS BIT 1.0 RC309BB2 32-1
- CCU OUTBUS BIT 1.1 RC309BC2 35-1
- CCU OUTBUS BIT 1.2 RC309BD2 38-1
- CCU OUTBUS BIT 1.3 RC309BE2 41-1
- CCU OUTBUS BIT 1.4 RC309BF2 44-1
- CCU OUTBUS BIT 1.5 RC309BG2 47-1
- CCU OUTBUS BIT 1.6 RC309BH2 50-1
- CCU OUTBUS BIT 1.7 RC309BJ2 53-1
- CHNL OUT PTY 0-7 RC309BL2 56-1
- GATE OUTBUS THRU ASSEMB RC502BB2 59-2
- GATE LOCAL STORE ON INBUS RC502BF2 62-8
- SEL ADDR AND STATUS RC502GE6 65-1
- SEL DATA 1 AND 2 RC502GF6 68-1
- SEL DATA 3 AND 4 RC502GG6 71-1
- WRITE INTO LS 1 RC502GK6 74-1

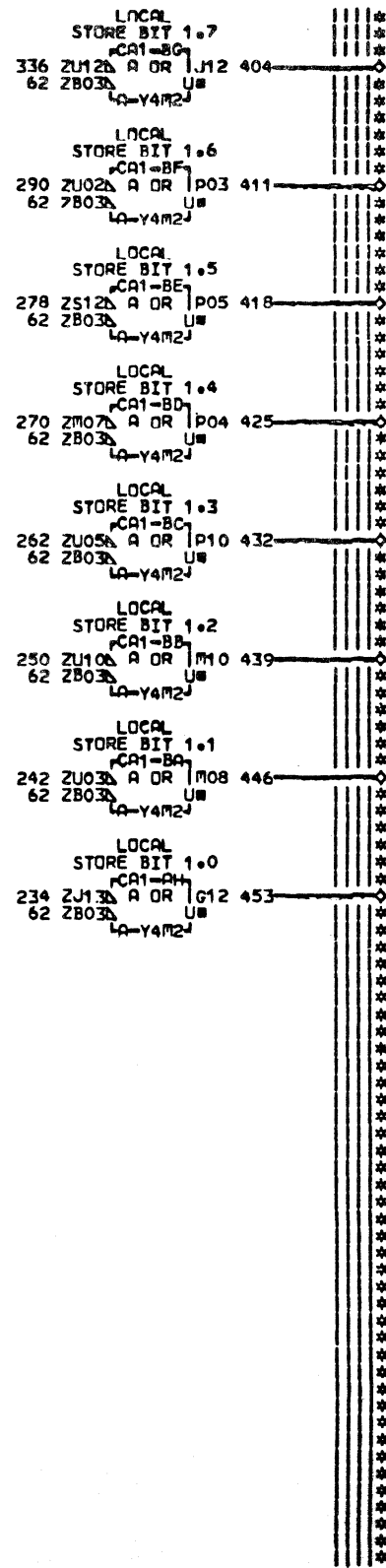
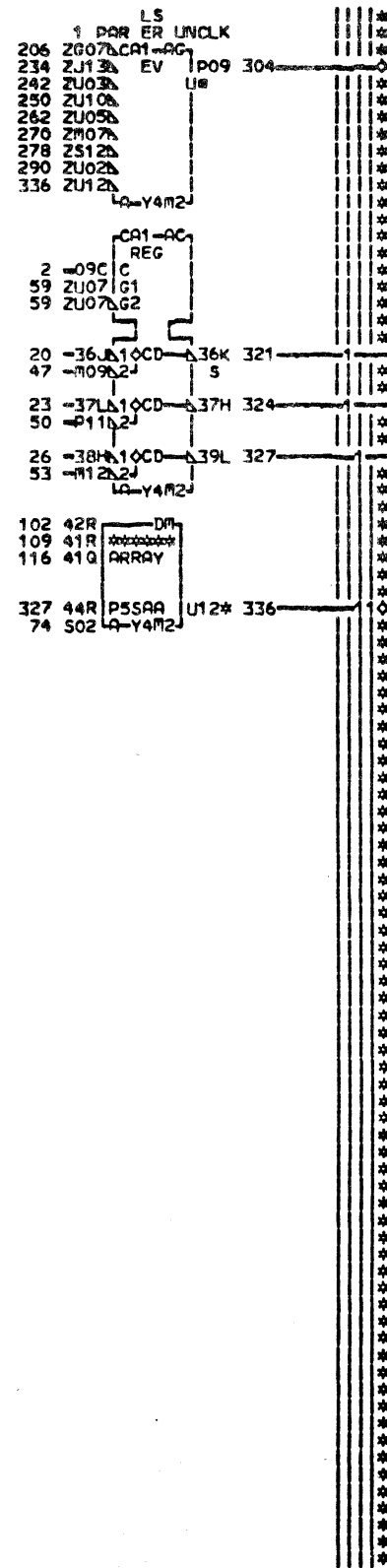
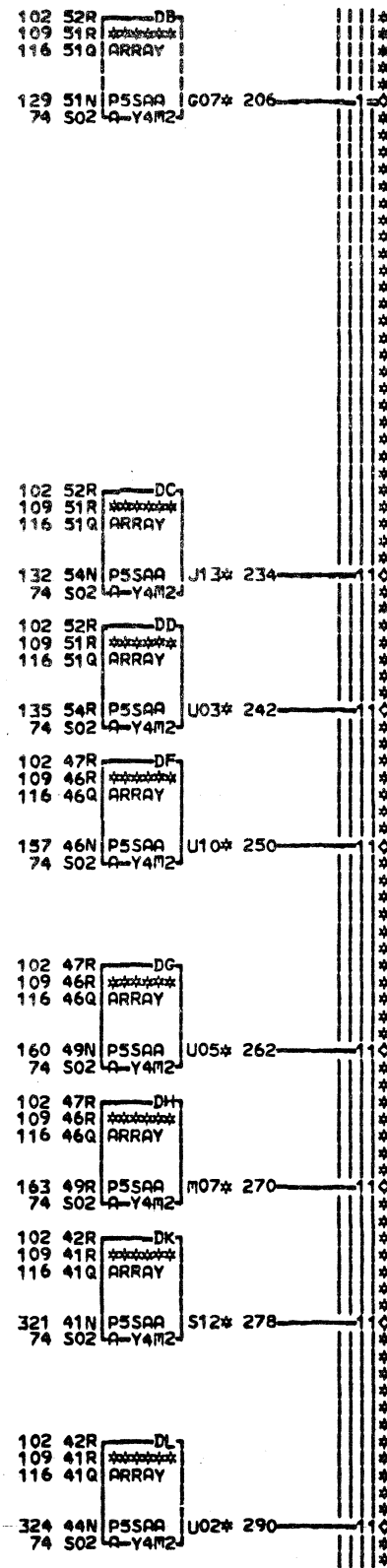
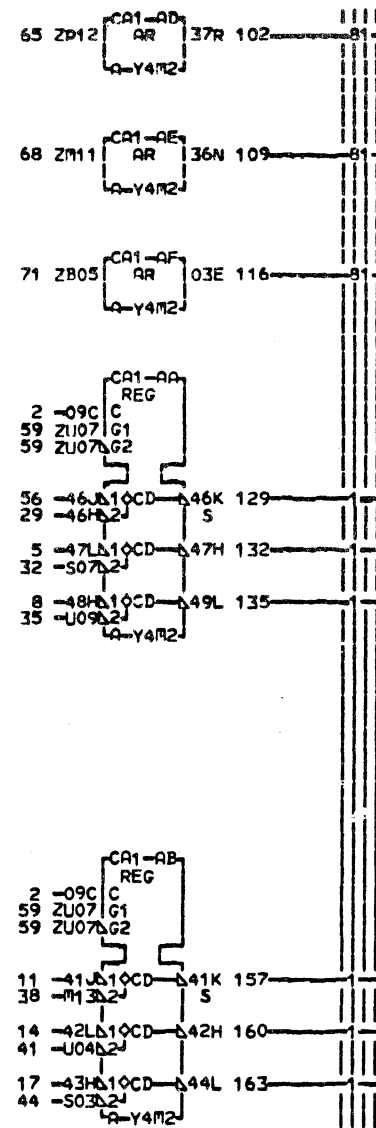

- 000 RC307
- 206 - LOCAL STORE BIT 1.0 TO DRV DB6
- 234 - LOCAL STORE BIT 1.0 TO DRV DC6
- 242 - LOCAL STORE BIT 1.1 TO DRV DD6
- 250 - LOCAL STORE BIT 1.2 TO DRV DF6
- 262 - LOCAL STORE BIT 1.3 TO DRV DG6
- 270 - LOCAL STORE BIT 1.4 TO DRV DH6
- 278 - LOCAL STORE BIT 1.5 TO DRV DK6
- 290 - LOCAL STORE BIT 1.6 TO DRV DL6
- 336 - LOCAL STORE BIT 1.7 TO DRV DM6
- 453 - LOCAL STORE BIT 1.0 RA105-GC2
- 446 - LOCAL STORE BIT 1.1 RA105-GD2
- 439 - LOCAL STORE BIT 1.2 RA105-GF2
- 432 - LOCAL STORE BIT 1.3 RA105-GG2
- 425 - LOCAL STORE BIT 1.4 RA105-GH2
- 418 - LOCAL STORE BIT 1.5 RA105-GK2
- 411 - LOCAL STORE BIT 1.6 RA105-GL2
- 404 - LOCAL STORE BIT 1.7 RA105-GM2
- 304 - LS 1 PAR ER UNCLK RC505-HB2

RC307  
000

- EDGE CONN. A-Y4M2U05
- 206 RESISTOR 270 RESISTOR
- A-Y4M2G07 A-Y4M2M07
- 234 RESISTOR 278 RESISTOR
- A-Y4M2J13 A-Y4M2S12
- 242 RESISTOR 290 RESISTOR
- A-Y4M2U03 A-Y4M2U02
- 250 RESISTOR 336 RESISTOR
- A-Y4M2J10 A-Y4M2U12
- 262 RESISTOR

LOC. TYPE  
A-Y4M2 2325

LOCAL STORE	
E.C. HISTORY	B. MACH. 27RNB
309522C	FRAME 01
309541	IBM CORP. SDD
309545	RC307
DATE LAST EC	P. N. 1785139
05-23-72 309548	000

```

+ RESET STATUS IN AND SERV IN-RC201GC2- 2-1
+ START ID LT-RC202AN2- 4-1
+ CHNL BUSOUT BIT 0-RC301CB6- 6-1
+ CHNL BUSOUT BIT 1-RC301CC6- 8-1
+ CHNL BUSOUT BIT 2-RC301CD6- 10-1
+ CHNL BUSOUT BIT 3-RC301CE6- 12-1
+ CHNL BUSOUT BIT 4-RC301CF6- 14-1
+ CHNL BUSOUT BIT 5-RC301CG6- 16-1
+ CHNL BUSOUT BIT 6-RC301CH6- 18-1
+ CHNL BUSOUT BIT 7-RC301CJ6- 20-1
- SID ADR BIT 1.0-RC306BC6- 22-1
- SID ADR BIT 1.1-RC306BD6- 24-1
- SID ADR BIT 1.2-RC306BF6- 26-1
- SID ADR BIT 1.3-RC306BG6- 28-1
- SID ADR BIT 1.4-RC306BH6- 30-1
- SID ADR BIT 1.5-RC306BK6- 32-1
- SID ADR BIT 1.6-RC306BL6- 34-1
- SID ADR BIT 1.7-RC306BM6- 36-1
+ CMND REG BIT 0-RC306FD2- 38-1
+ CMND REG BIT 1-RC306FE2- 40-1
+ CMND REG BIT 2-RC306FG2- 42-1
+ CMND REG BIT 3-RC306FH2- 44-1
+ CMND REG BIT 4-RC306FJ2- 46-1
- CMND REG BIT 5-RC306FL6- 48-1
- CMND REG BIT 6-RC306FM6- 50-1
- CMND REG BIT 7-RC306FN6- 52-1
- SET UNIT CHECK-RC402EK6- 54-1
+ INPUT 66-RC501CJ2- 56-1
- ATTN STATUS TO DRIVER-RC601FC6- 58-1
- STAT MOD STATUS TO DRIVER-RC601FD6- 60-1
- CHAN END STATUS TO DRIVER-RC601FG6- 62-1
- DEVICE END STATUS TO DRIVER-RC601FH6- 64-1

```

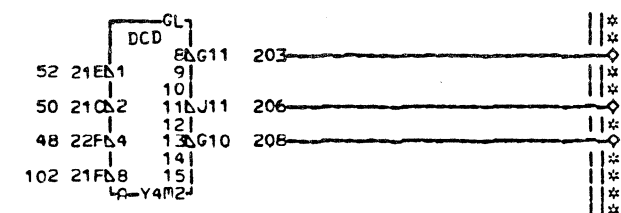
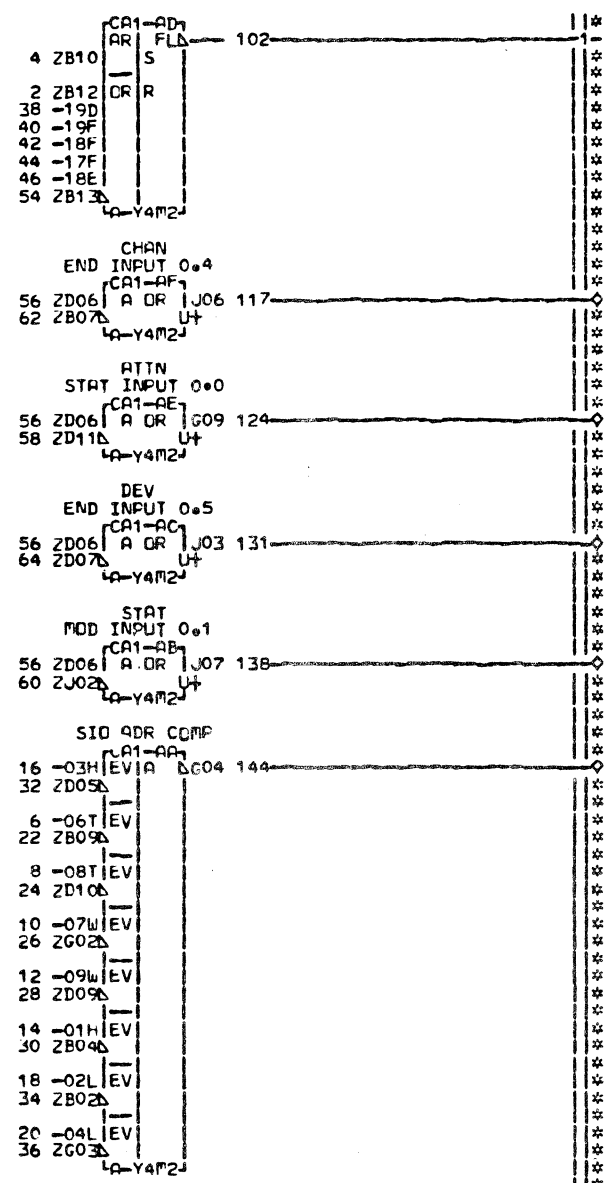

```

000 RC308
144 - SID ADR COMP-----RC406-CD4
138 + STAT MOD INPUT 0.1-----KA104-DB2
131 + DEV END INPUT 0.5-----RA104-DF2
124 + ATTN STAT INPUT 0.0-----KA104-ER2
117 + CHAN END INPUT 0.4-----RA104-EE2
203 - TEST ID DECODE-----GL3
      RC402 RC404 RC406
206 - NO OP DECODE-----GL6
      RC402 RC406
208 - IFL DECODE-----RC405-GL8

```

LCC. TYPE  
F-Y4P2 2325

RC308  
000

CF DGT AND CMFD DECCDE	
E.C. HISTORY 309522C 309541	B. MACH. 27RNB FRAME 01 IBM CORP. SDD RC308 P.N. 1785140 000
DATE LAST EC 04-24-72 309545	

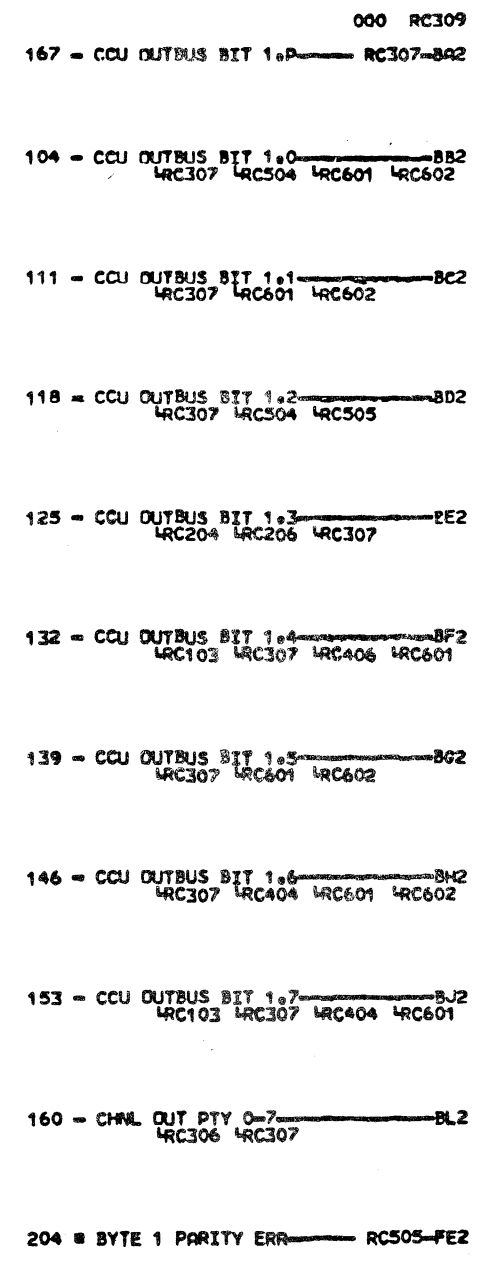
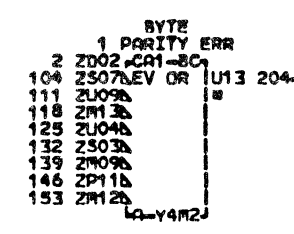
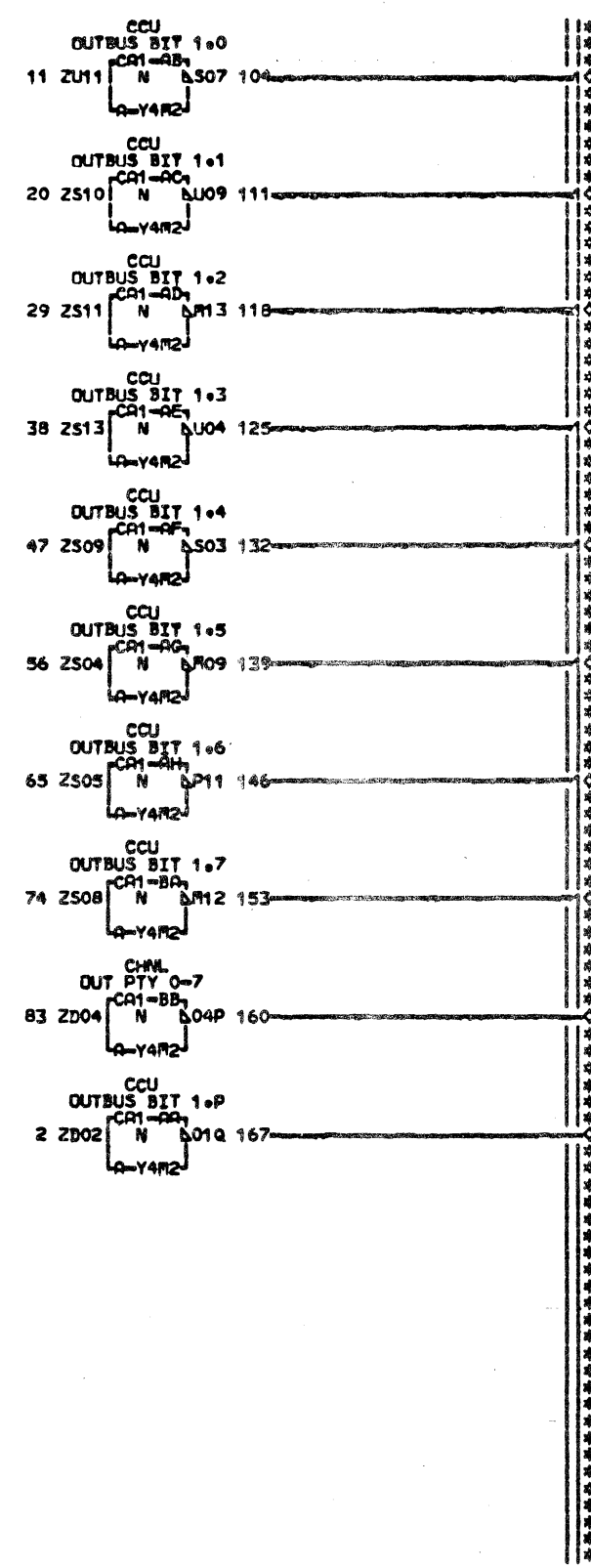
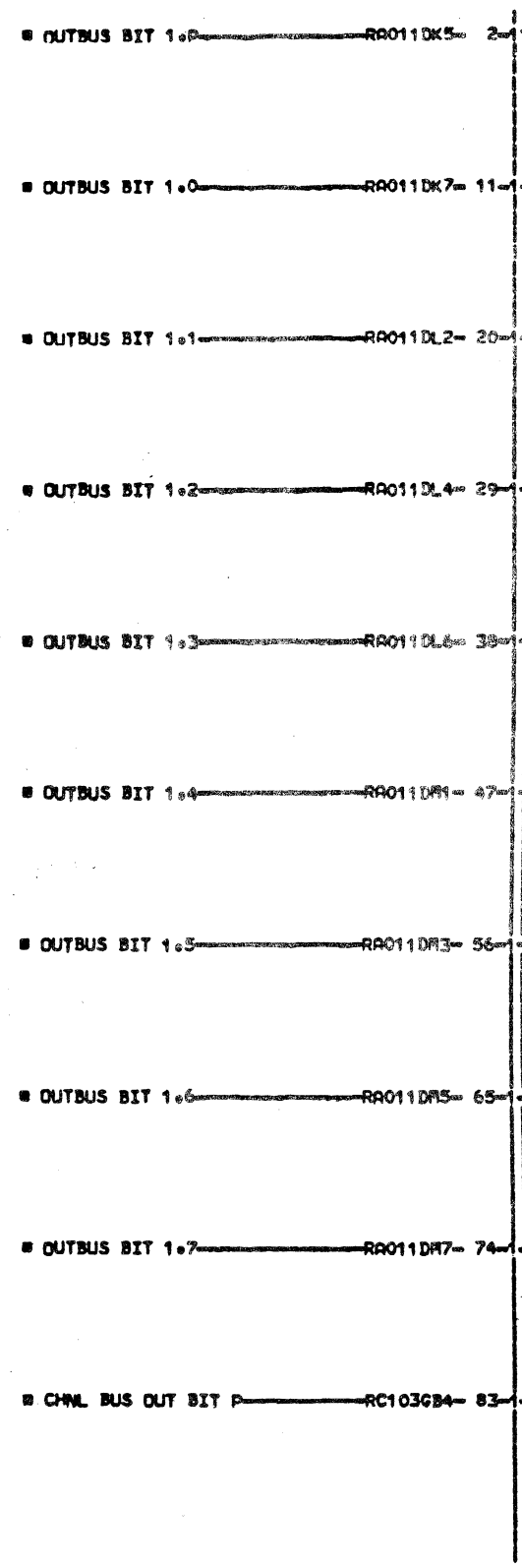

LOC. TYPE  
A-Y4R2 2325

CCU OUTBUS INVERSION			
E.C. HISTORY		B. RACH. 27RNB	
309522C		FRAME	01
309541		IBR CORP. SDD	RC309
309545		P.N. 1785141	000
DATE	LAST EC		
05-23-72	309548		

RC309  
000

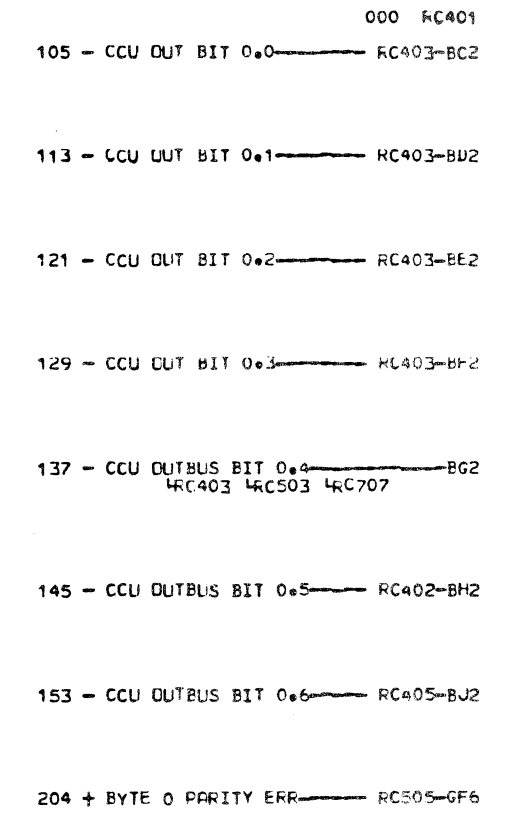
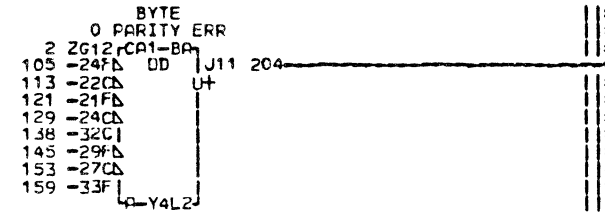
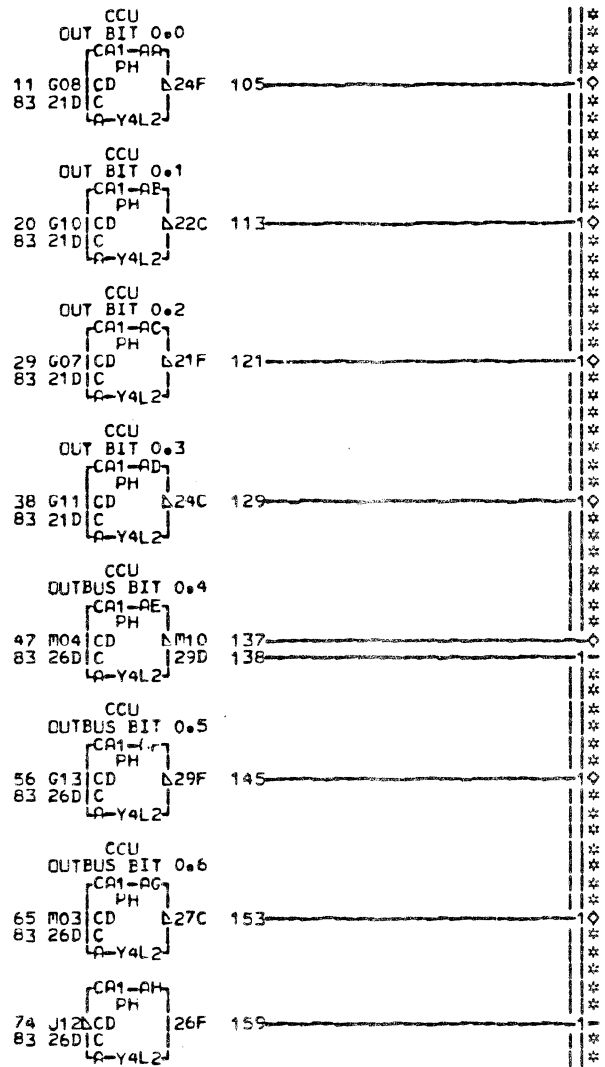
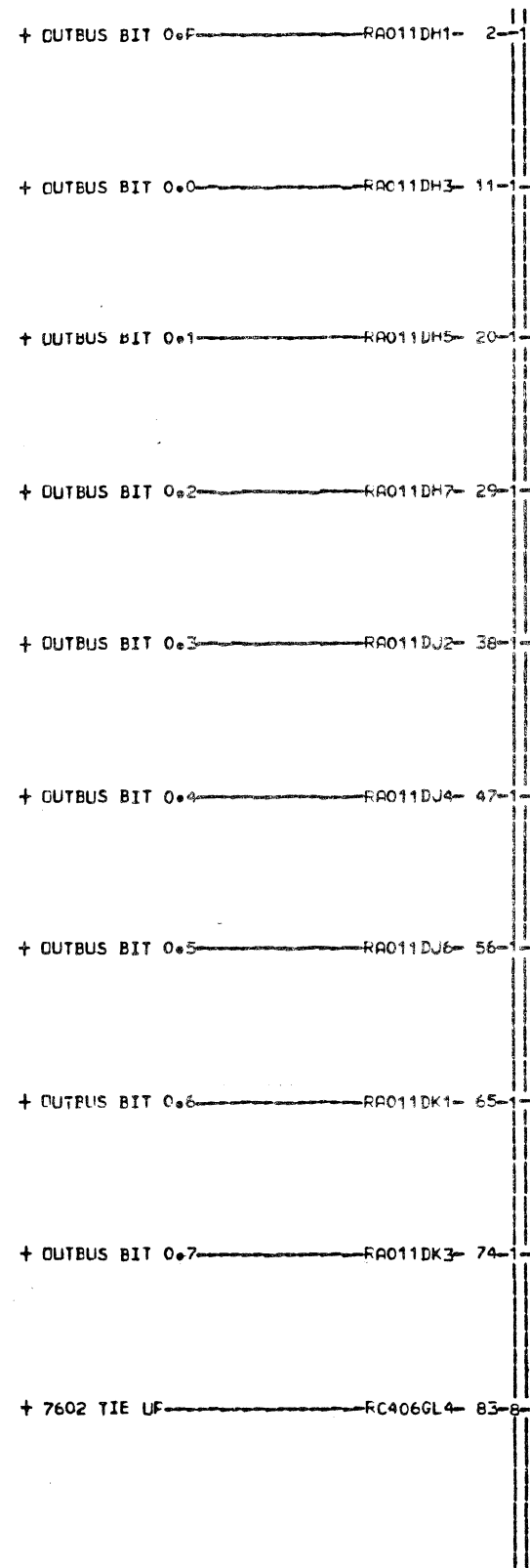

LDC. TYPE  
A-Y4L2 7602

CCU OUTBUS TERMINATION			
E.C. HISTORY	B. MACH. 27RMB	FRAME	01
309522C		IBM CORP. SDD	RC401
309541		P.N. 1785142	000
DATE	LAST EC		
04-24-72	309545		

RC401  
000



- CHNL BUS OUT PARITY ER UNCLK-RC104FM2- 2-1  
 - NSC ADDRESS VALID-RC104GL6- 6-2  
 - CLOCK 3-RC201DC6- 10-1  
 - START IO LT-RC202AN6- 14-1  
 - STATUS IN LT-RC203AF6- 18-1  
 - STK STATUS PULSE-RC204AA6- 22-1  
 - PREP BUSY LT-RC204AG2- 26-1  
 - DECODE CMD-RC204FG6- 30-1  
 - CAUSE INIT SEL L3-RC205FC6- 34-1  
 - TEST IO DECODE-RC308GL3- 38-1  
 - NO OP DECODE-RC308GL6- 42-1  
 - CCU OUTBUS BIT 0.5-RC401BH2- 46-1  
 - SAMPLE 62-RC404DL6- 50-1  
 - OP IN-RC406AD2- 54-1  
 - OX TIO RSPNS RDY-RC406BL2- 58-1  
 - INPUT 60-RC501CC6- 62-2  
 - 60 RST INIT SEL-RC501GH2- 66-1  
 - NSC STATUS CLEARED-RC503EK2- 70-1  
 - DIAG CCU DR CHNL RESET-RC707EM6- 74-1

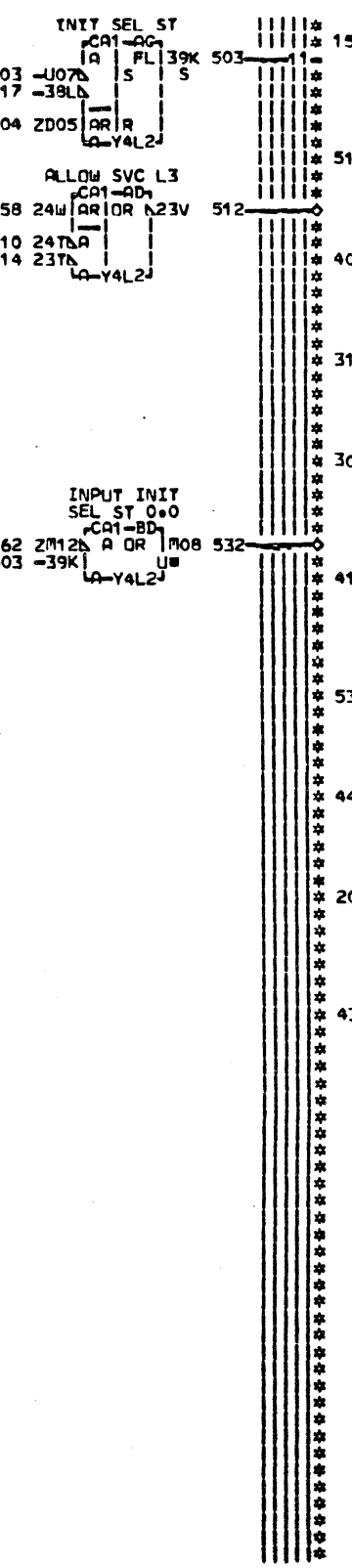
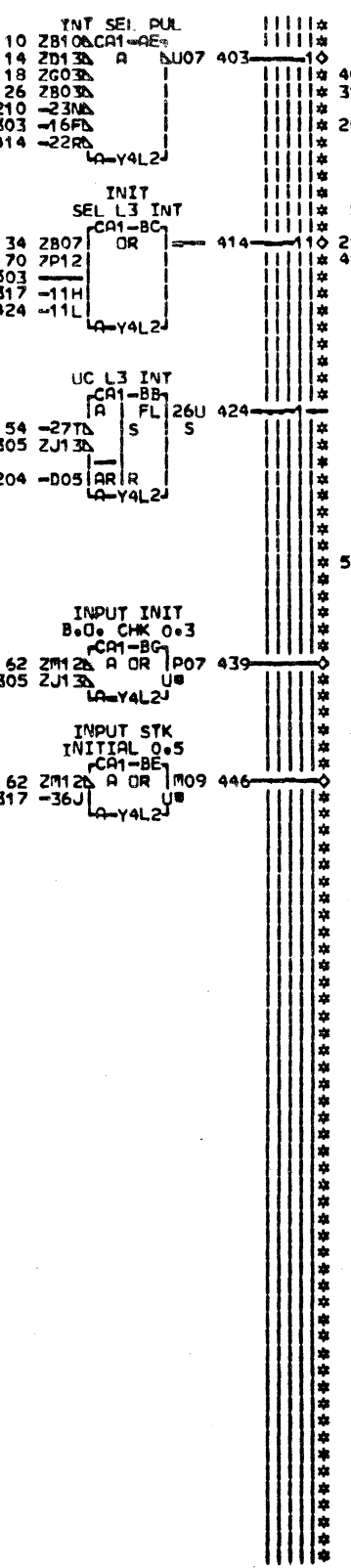
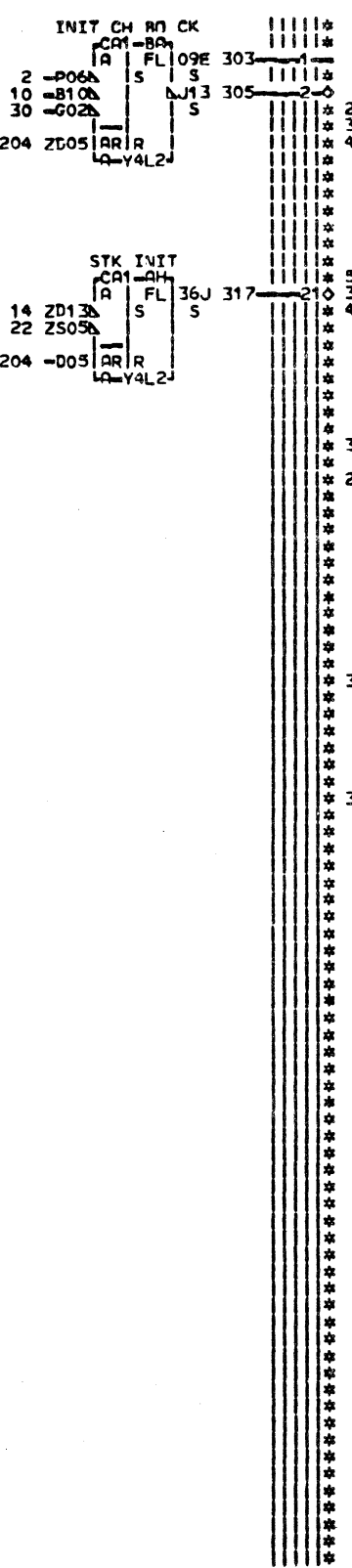
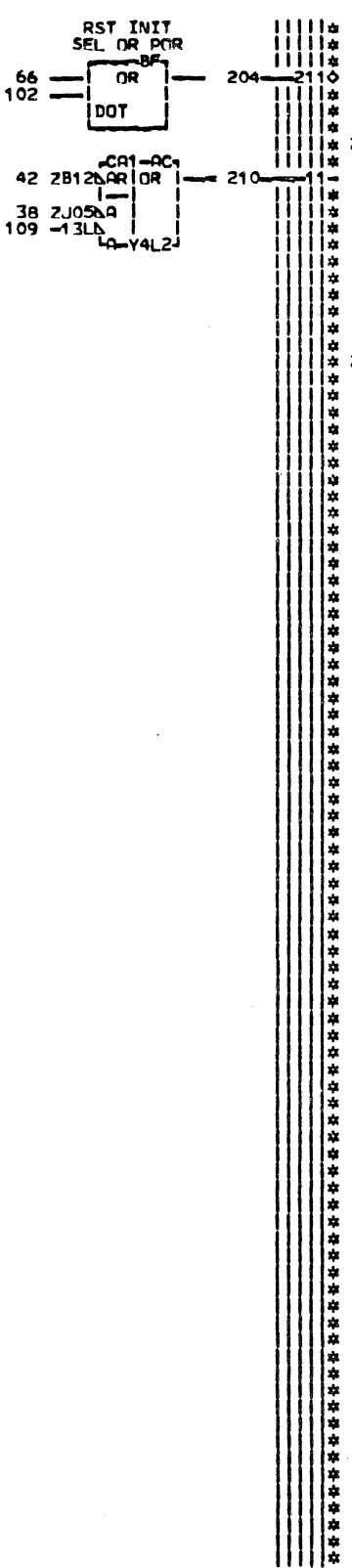
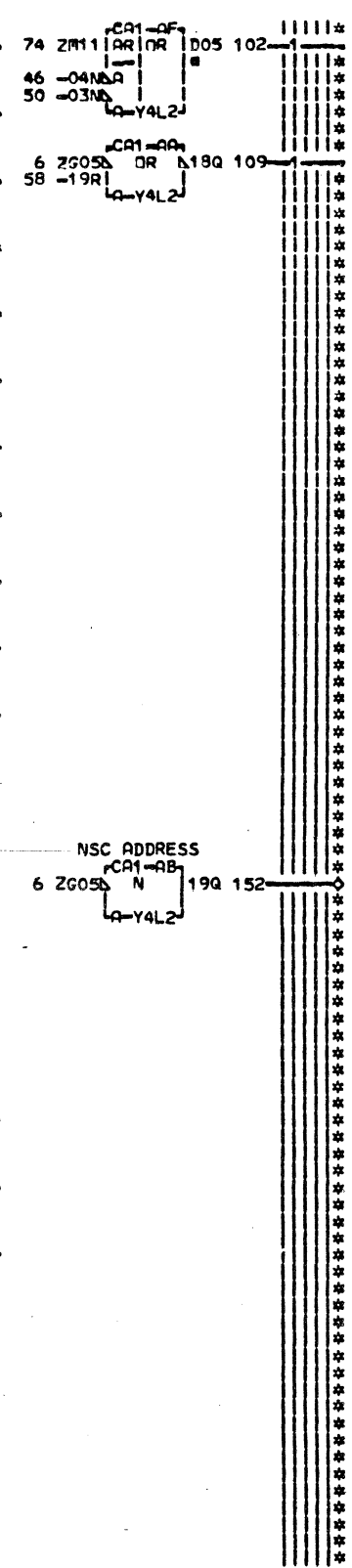

000 RC402  
 152 - NSC ADDRESS-RC403-RC406- AE2  
 512 - ALLOW SVC L3-RC403-CN2  
 403 - INIT SEL PUL SE-RC503-DC6  
 317 - STK INIT LT-RC405-ED2  
 305 - SET UNIT CHECK-RC308-RC406- EK6  
 414 - INIT SEL L3 INT-RC406-RC407- GA4  
 532 - INPUT INIT SEL ST 0.0-RA104-GB2  
 446 - INPUT STK INITIAL 0.5-RA104-GD2  
 204 - RST INIT SEL OR POR-RC205-RC503-RC505- GH4  
 439 - INPUT INIT B.0. CHK 0.3-RA104-GK2

LCC. TYPE  
A-Y4L2 7602

INITIAL SELECTION CONTROL	
E.C. HISTORY	B. MACH. 27RNB
30952C	FRAME 01
309541	IBM CORP. SDD
309545	P.No. 1785143
DATE LAST EC	000
05-23-72 309548	

- TO TIME RC103DB6 2-1  
 - NSC ADDRESS VALID RC104GL6 5-1  
 - CLOCK 1 RC201BC6 8-1  
 - CLOCK 4 RC201EC6 11-2  
 - STATUS IN LT RC203AF6 14-2  
 - SERVICE IN LT RC203AL6 17-1  
 + PREP BUSY LT RC204AG2 20-1  
 + SVC SELTV RST RC205EF2 23-1  
 + SVC STP/DISC/SUP STAT STK RC205FY4 26-1  
 - CCU OUT BIT 0.0 RC401BC2 29-1  
 - CCU OUT BIT 0.1 RC401BD2 32-1  
 - CCU OUT BIT 0.2 RC401BE2 35-1  
 - CCU OUT BIT 0.3 RC401BF2 38-1  
 - CCU OUTBUS BIT 0.4 RC401BG2 41-1  
 + NSC ADDRESS RC402AE2 44-1  
 - ALLOW SVC L3 RC402CN2 47-1  
 - SERVICE OUT TAG RC404DK2 50-1  
 + SAMPLE 62 RC404DL2 53-2  
 - SAMPLE 62 RC404DL6 56-2  
 - COMPARE RC404CP6 59-1  
 + SID LT RC405AA2 62-1  
 + SVC STATUS STK RC405BH2 65-1  
 + OX TIO RSPNS RDY RC406BL2 68-2  
 + INHIBIT REQUEST FOR SVC RC406DF6 71-1  
 + 7602 TIE UP RC406GL4 74-2  
 - INPUT 62 RC501CE6 77-1  
 + CCU BO CK RC505DD2 80-1  
 + DIAG CCU CR CHNL RESET RC707EM6 83-2

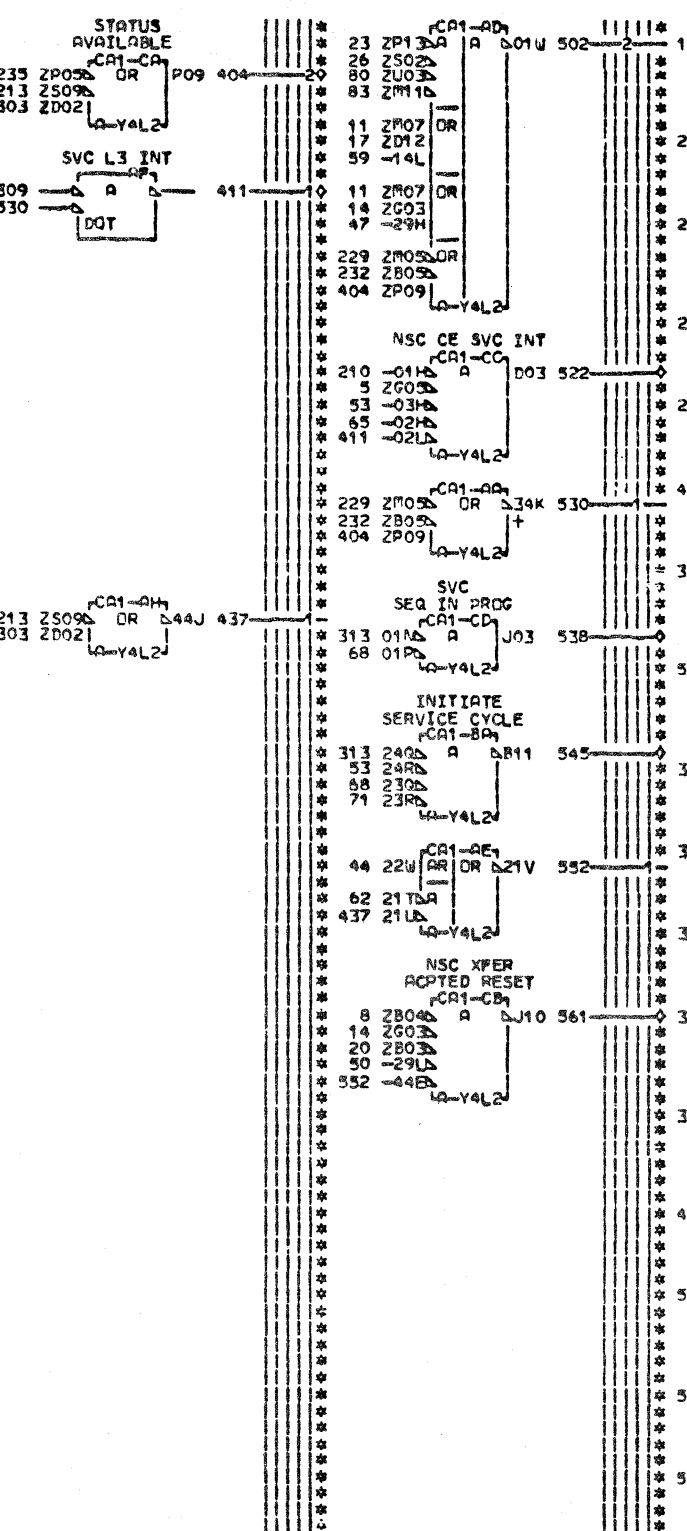
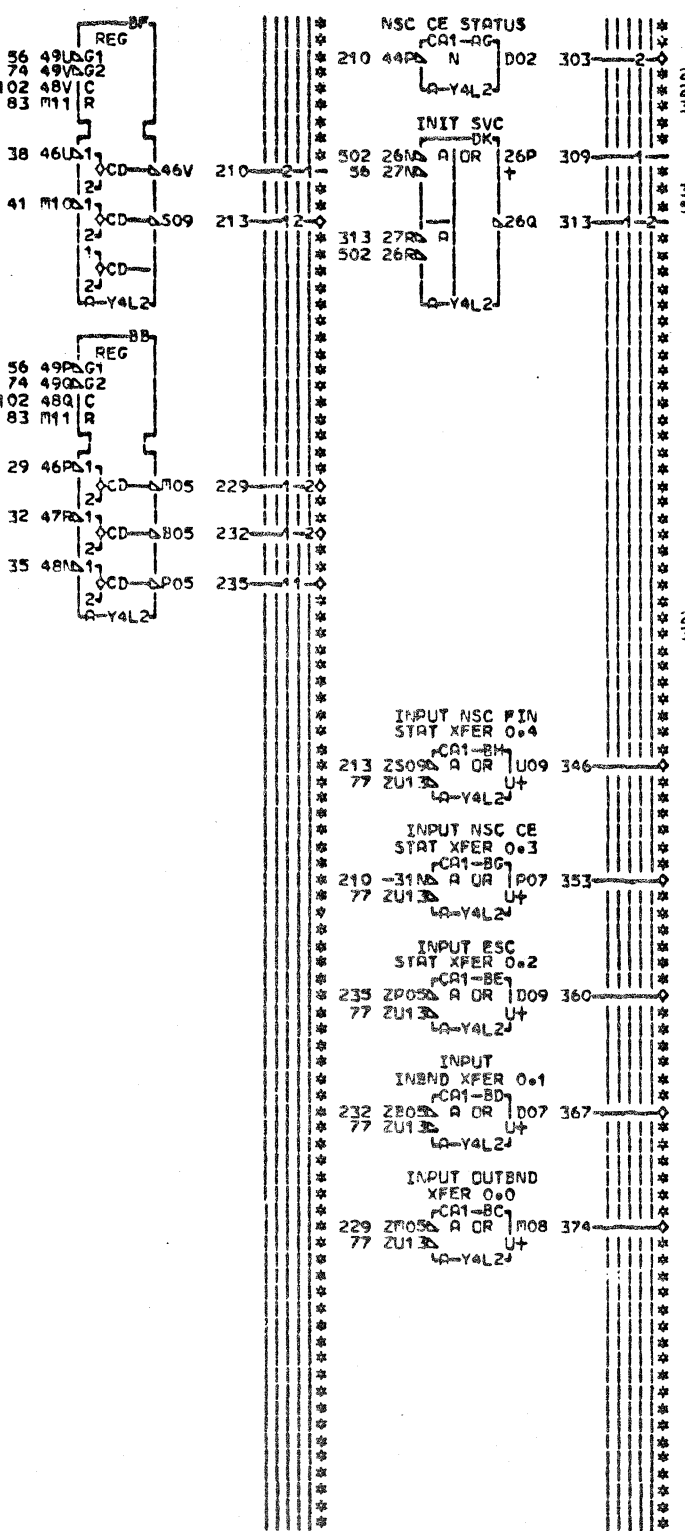
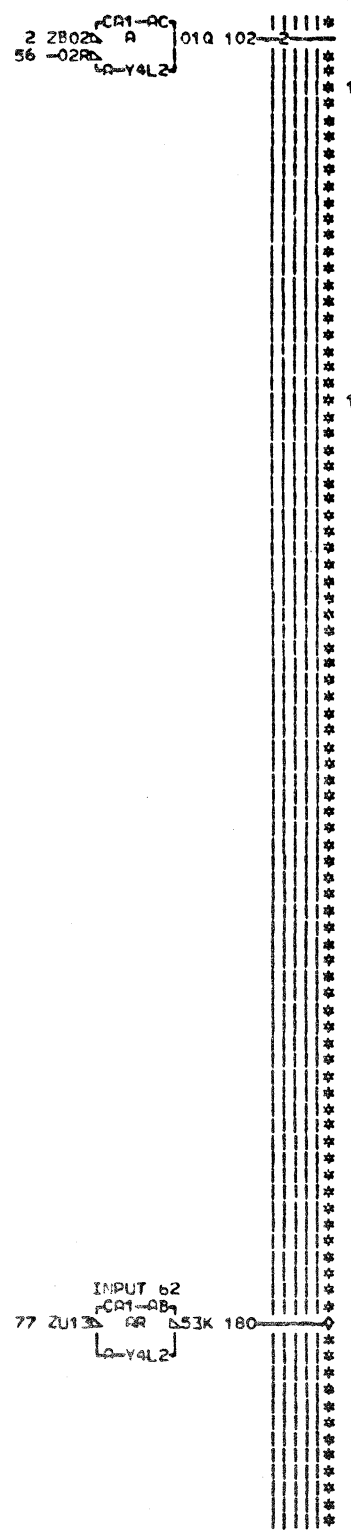

081 RC403  
 130 - INPUT 62 RC404 RC405  
 229 - OUTBOUND XFER RC502-BB2  
 232 - INBND XFER RC405 RC502  
 235 - ESC STATUS XFER RC502-BB8  
 213 - NSC FINAL STATUS XFER RC503-BF5  
 411 - SVC L3 INT RC407-EB4  
 303 + NSC CE STATUS RC204 RC503 RC601  
 545 - INITIATE SERVICE CYCLE RC206 RC505  
 374 + INPUT OUTBND XFER 0.0 RA104-GC2  
 367 + INPUT INBND XFER 0.1 RA104-GD2  
 360 + INPUT ESC STAT XFER 0.2 RA104-GE2  
 353 + INPUT NSC CE STAT XFER 0.3 GP2 RA104  
 346 + INPUT NSC FIN STAT XFER 0.4 GG2 RA104  
 404 + STATUS AVAILABLE RC203-GJ4  
 561 - NSC XFER RCPTD RESET GN6 RC204 RC503 RC601  
 522 + NSC CE SVC INT RC204-GR2  
 538 + SVC SEQ IN PROG RC206-GS2

LOC. TYPE  
 A-Y4L2 7602

SERVICE TRANSFER CONTROL			
E.C. HISTORY	E. PACH 27RNB	FRAME	01
DATE	LAST EC	IBM CORP. SCD	RC403
10-14-80	344270	P.N. 1986989	081

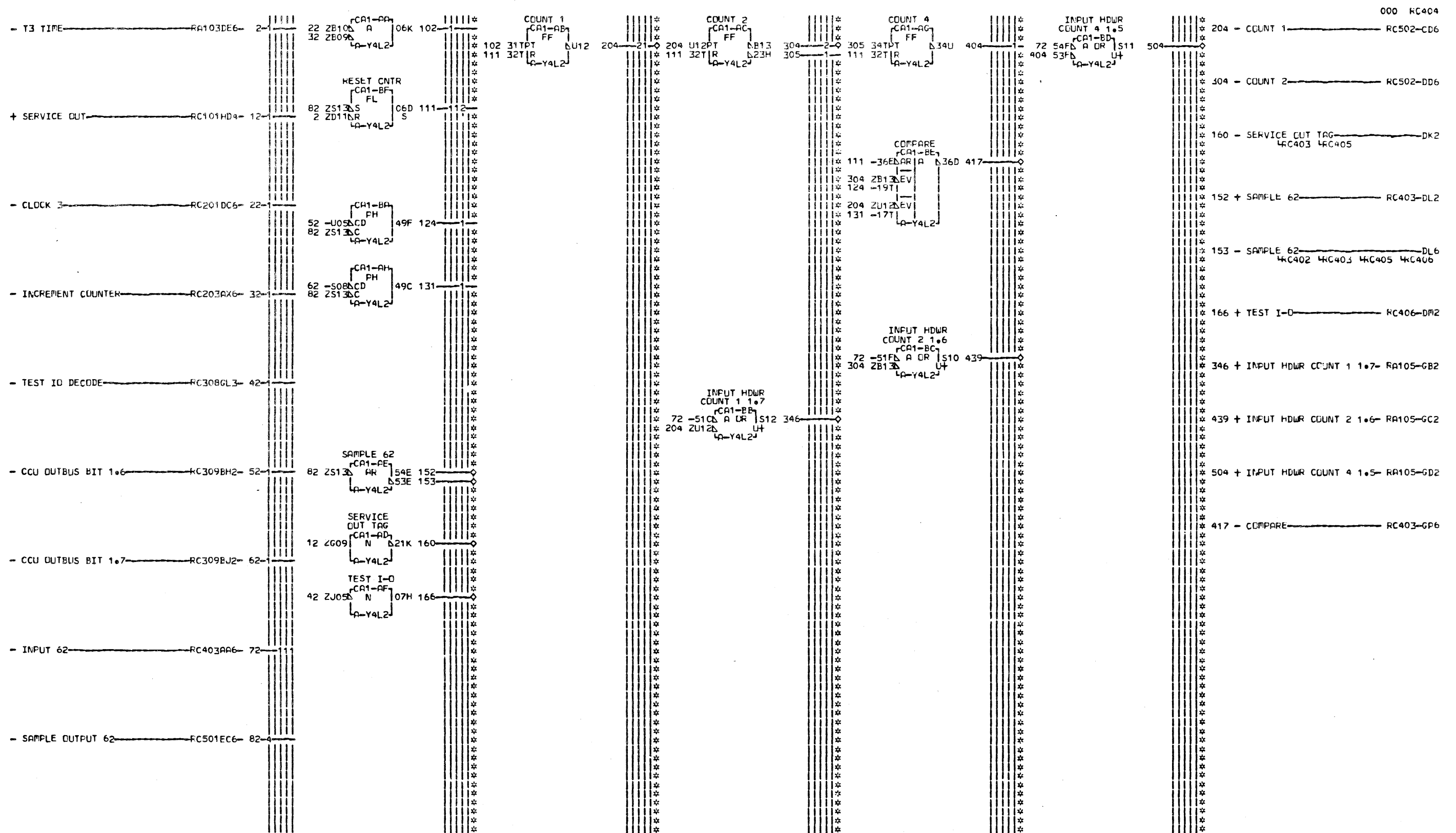

000 RC404

LOC. TYPE  
A-Y4L2 7602

BYTE TRANSFER COUNT			
E.C.	ISTORY	B	MACH. 27RNB
309522C			
309541		FRAME	01
DATE	LAST EC	IBM CORP.	SDD RC404
04-24-72	309545	F.No.	1785145 000

RC404  
000

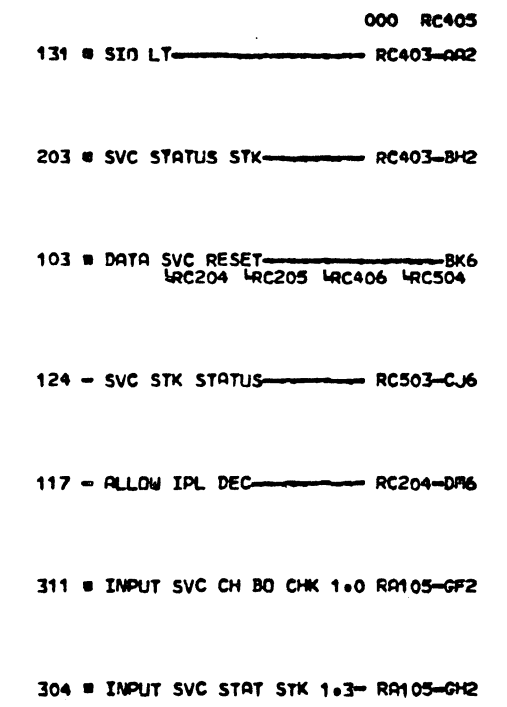
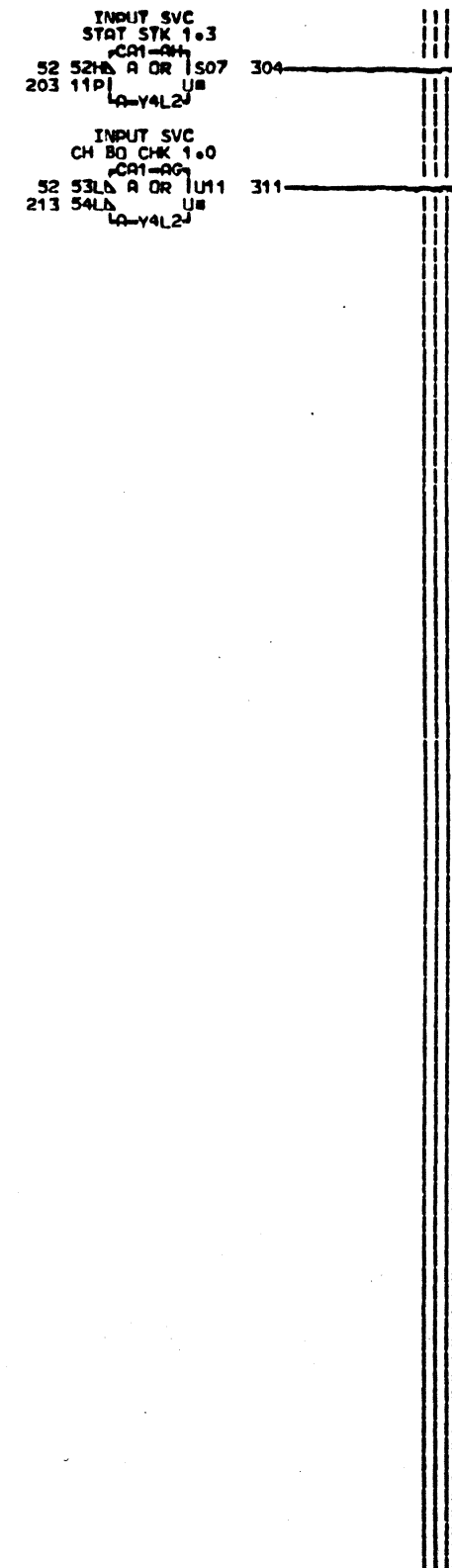
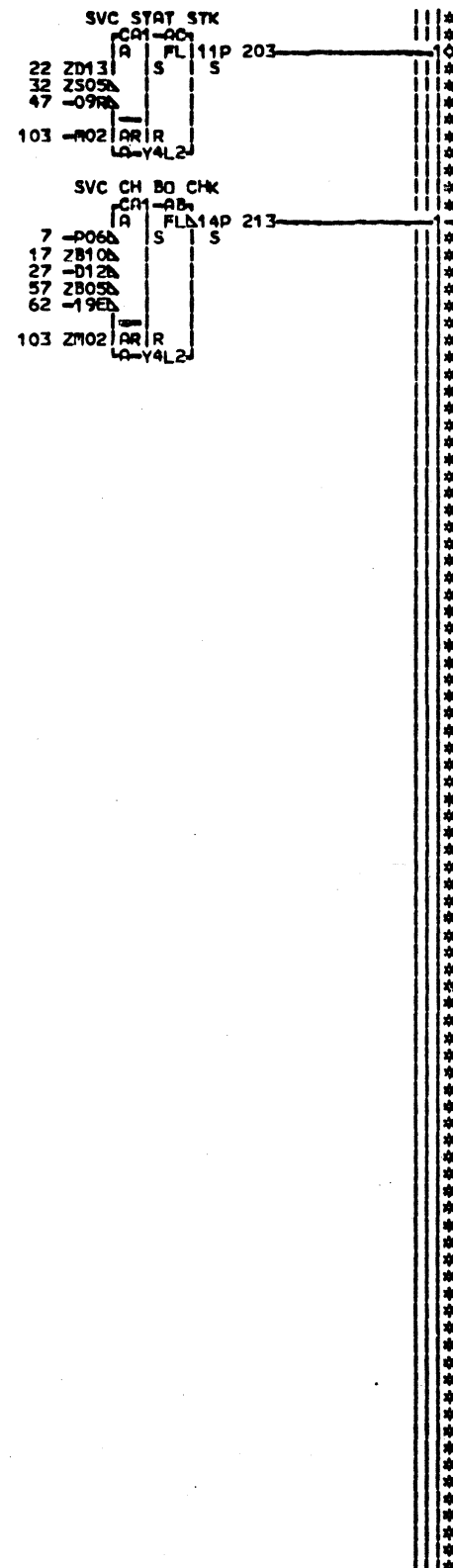
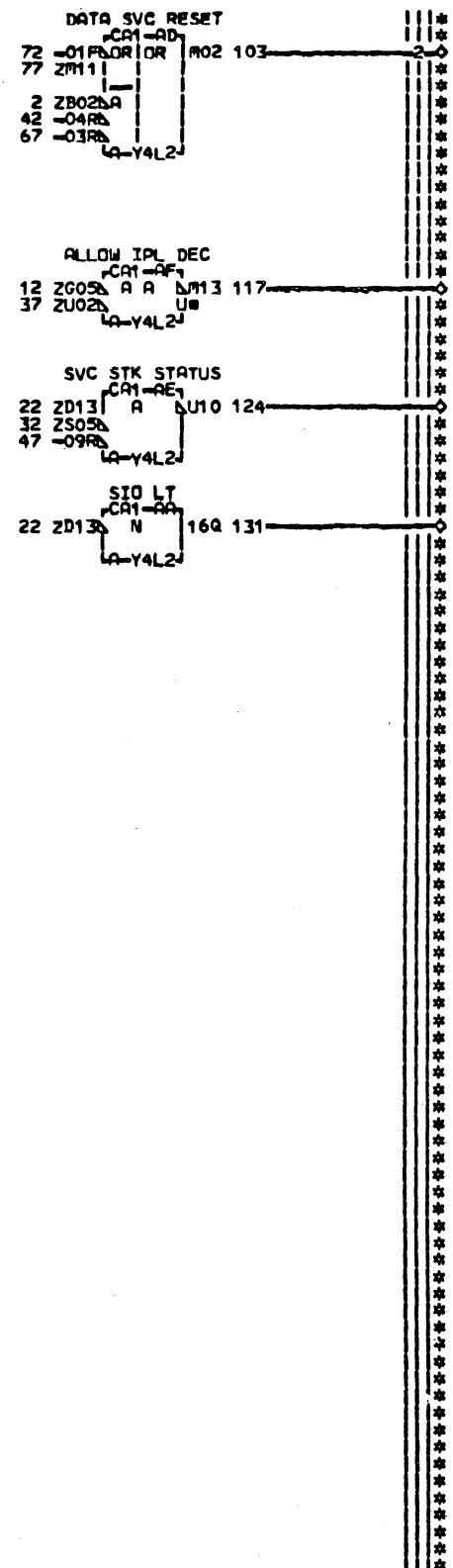
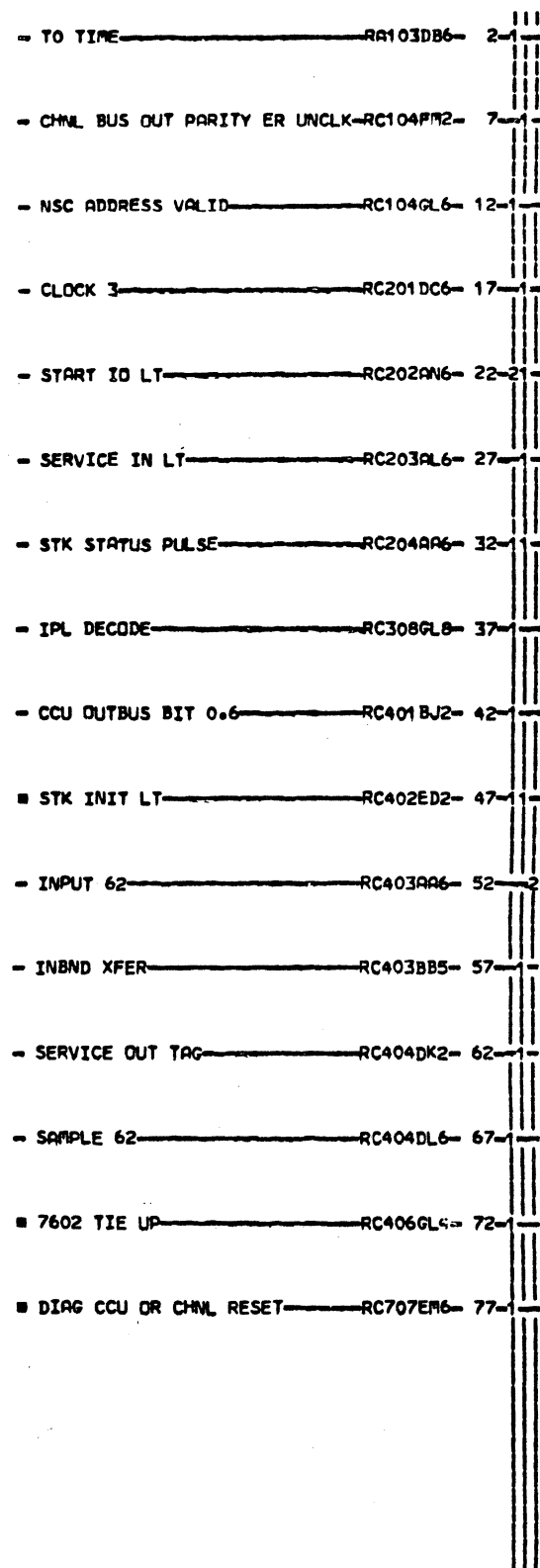

RC405  
000

LOC. TYPE  
A-Y4L2 7602

SERVICE TRANSFER	
E.C. HISTORY	D. RACH. 27RNB
309522C	
309541	FRAME 01
309545	IBM CORP. SDD RC405
DATE LAST EC	P.N. 1785146 000
05-23-72 309548	

- + ADDRESS OUT RC101HA4 2
- CLOCK 1 RC201BC6 6
- CLOCK 4 RC201EC6 10
- START ID LT RC202AK3 14
- OP IN RC202AU6 18-32-2
- STATUS IN LT RC203AF6 22
- + PREP BUSY LT RC204AG2 26
- = DECODE CMD RC204FC6 30
- + SVC SELTV RST RC205EF2 34
- SID ADR COMP RC308CD4 38
- = TEST IO DECODE RC308GL3 42
- = NO OP DECODE RC308GL6 46
- CCU OUTBUS BIT 1.4 RC309BF2 50
- + NSC ADDRESS RC402AE2 54
- SET UNIT CHECK RC402EK6 58
- + INIT SEL L3 INT RC402GA4 62
- SAMPLE 62 RC404DL6 66
- + TEST I-O RC404DR2 70
- + DATA SVC RESET RC405BK6 74
- RN STATUS AVAILABLE RC503BA6 78
- + PGM INT REQ RC602HB2 82
- + DIAG CCU OR CHNL RESET RC707EM6 86

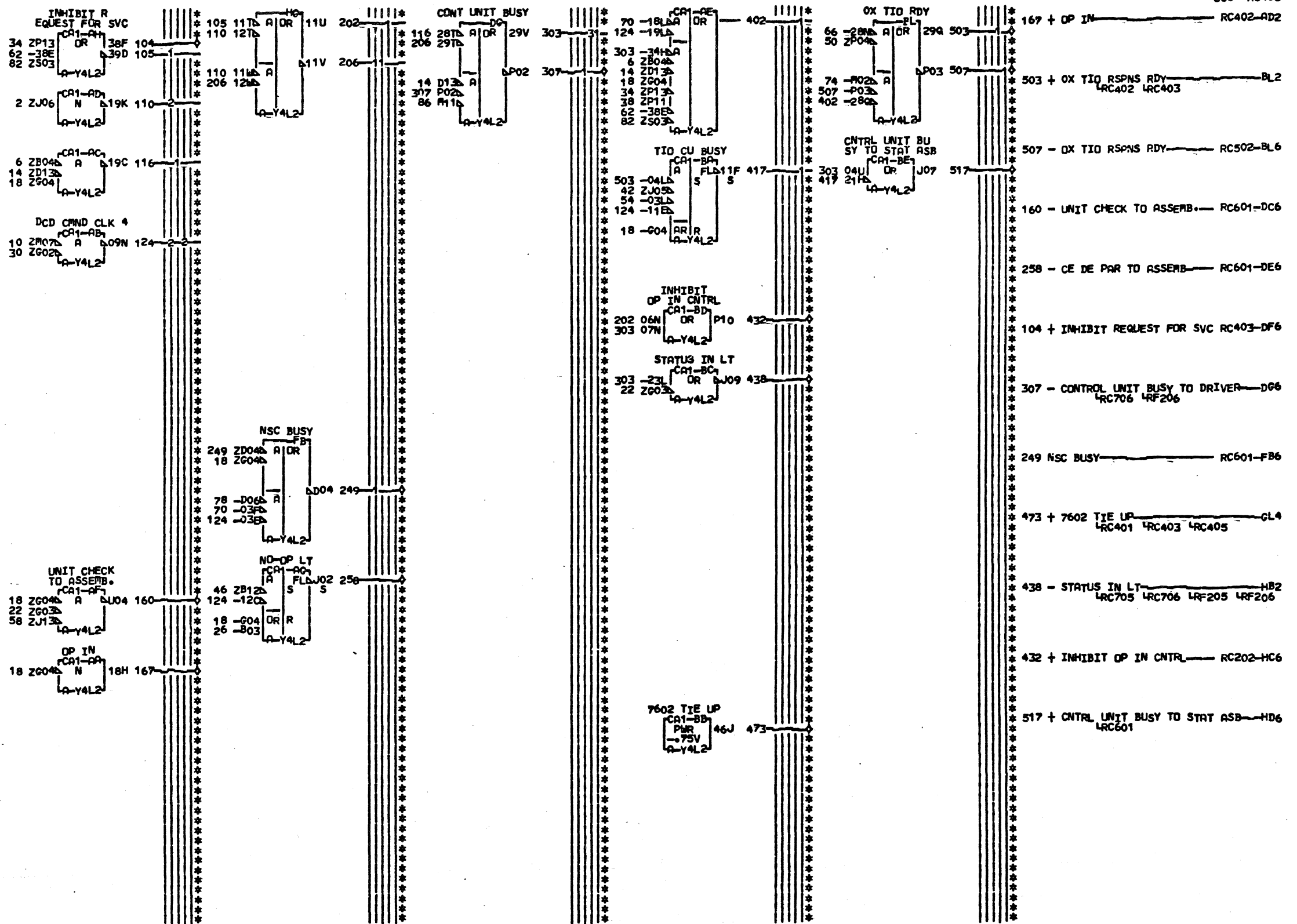

LOC. TYPE  
A-Y4L2 7602

INITIAL STATUS GEN	
E.C. HISTORY	E. MAGH-27KAB
309522C	309949
309541	FRAME 01
309545	IBM CORP. SDD
309548	RC406
DATE	LAST EC
08-09-79	321750
P.No.	1785147
	000

- GATE 2ND TEST PNTS ON INBUS—RA012DE4— 2-2

■ INIT SEL L3 INT—RC402GA4— 12-2

■ SVC L3 INT—RC403EB4— 22-2

■ PGM OR SUPP OUT INT—RC602FH6— 32-2

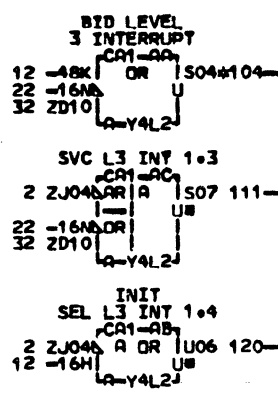

104 ■ BID LEVEL 3 INTERRUPT— RA012-CB6

120 ■ INIT SEL L3 INT 1+4— RA105-CC2

111 ■ SVC L3 INT 1+3— RA105-CD2

EDGE CONN.  
 104 A-Y4C2D13  
 01A-Y4C4D13

LOC. TYPE  
 A-Y4L2 7602

OR DOTS BYTE 0	
E.C. HISTORY	B. RACH#27RNB
309522C	
309541	FRAME 01
309545	
DATE LAST EC	IBM CORP.SDD RC407
05-23-72 309548	P.N. 1785148 000

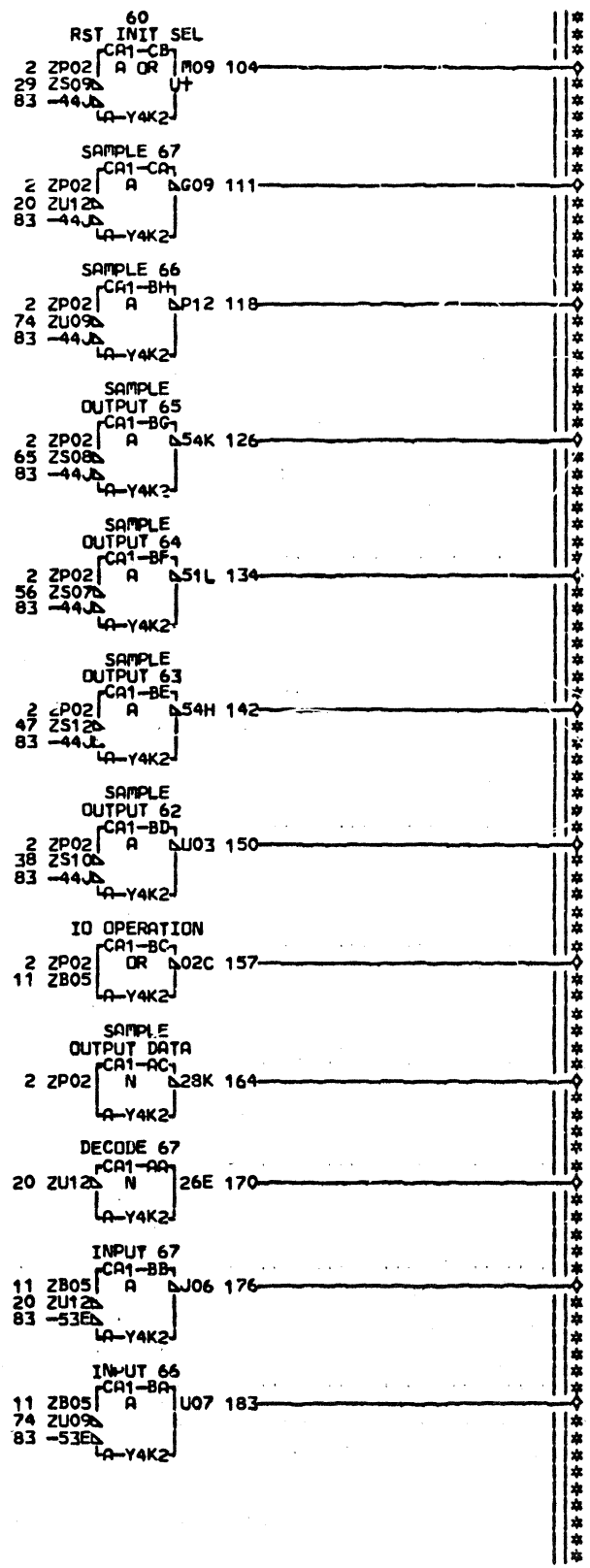
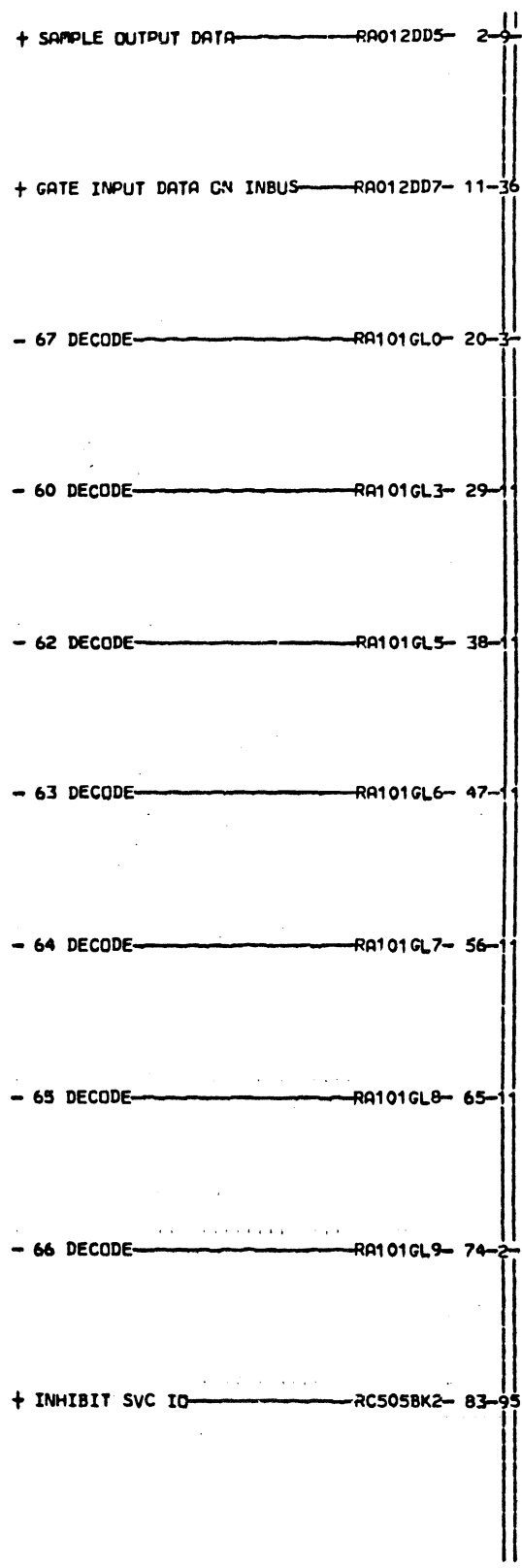

LOC. TYPE  
A-Y4K2 7603

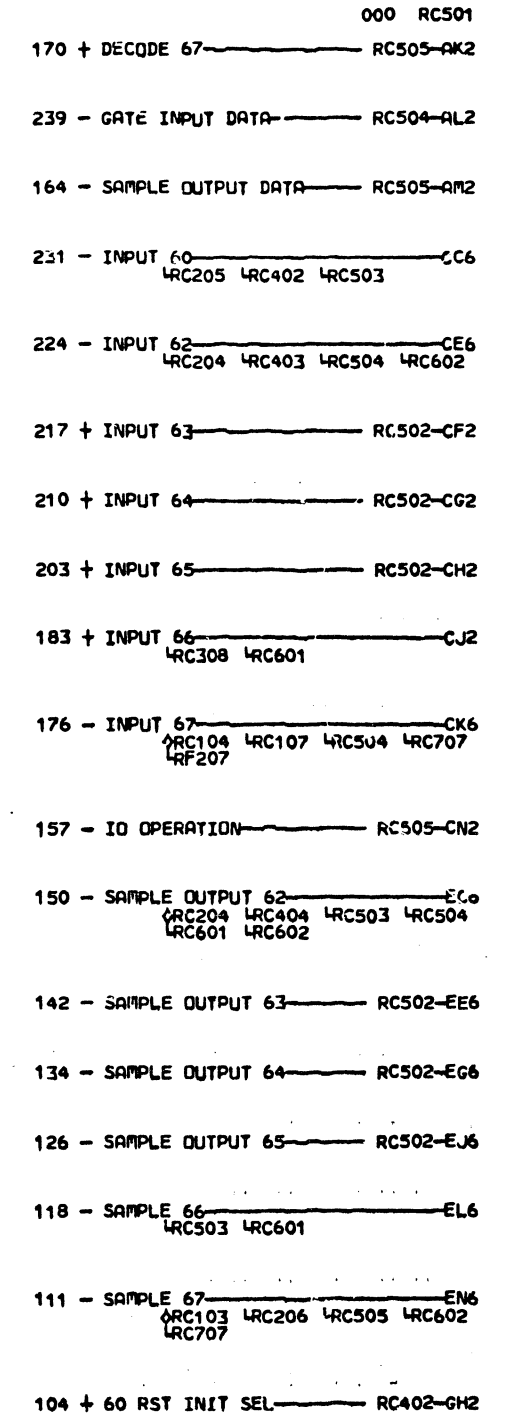
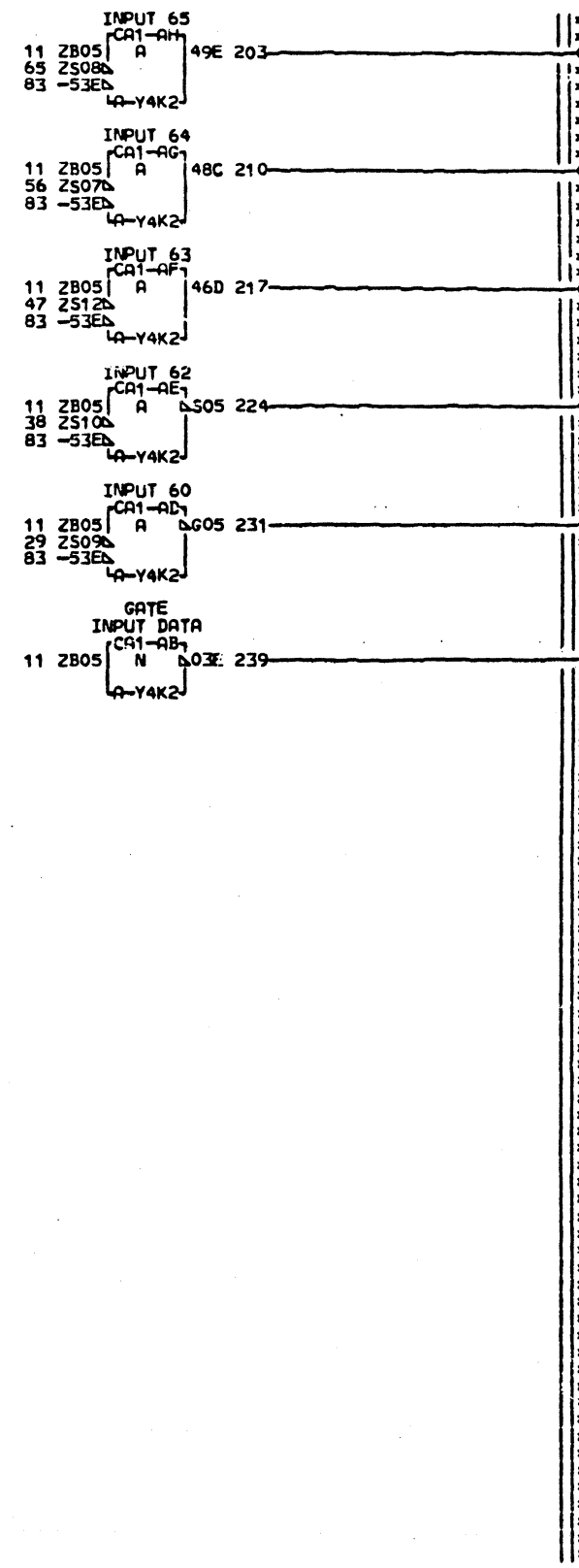

RC501  
000

INPUT-OUTPUT CONTROL			
E.C. HISTORY	D. MACH.	27RNB	
309522C	FRAME	01	
309541	IBN CORP.	SDD RC501	
309545	DATE	LAST EC	
309548	06-07-76	315618	
	P.No.	1785149 000	

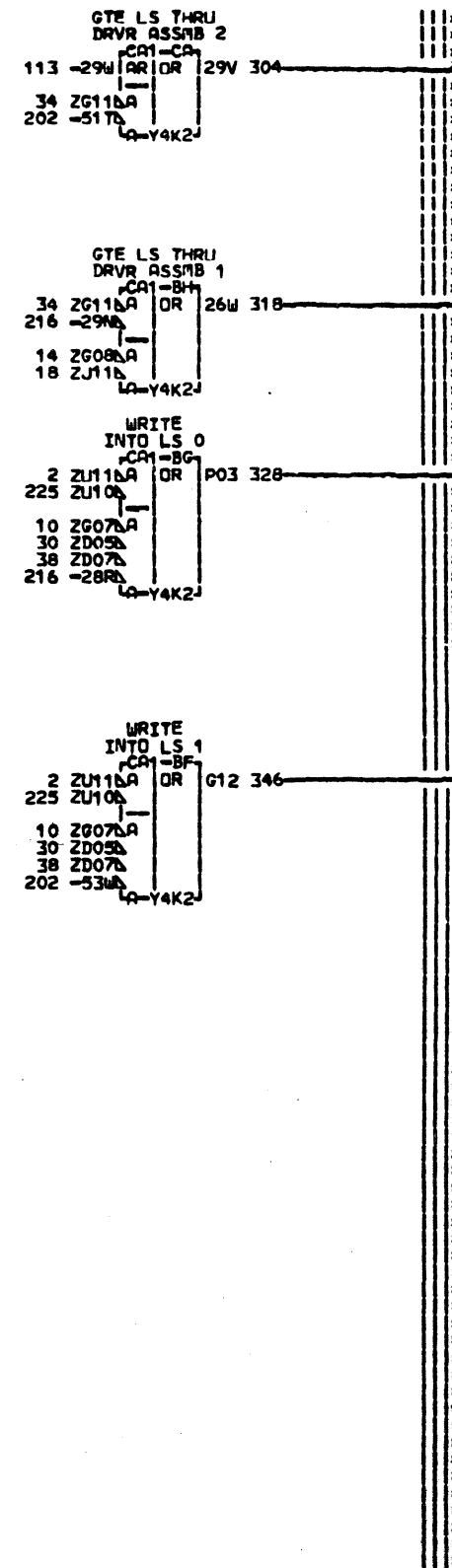
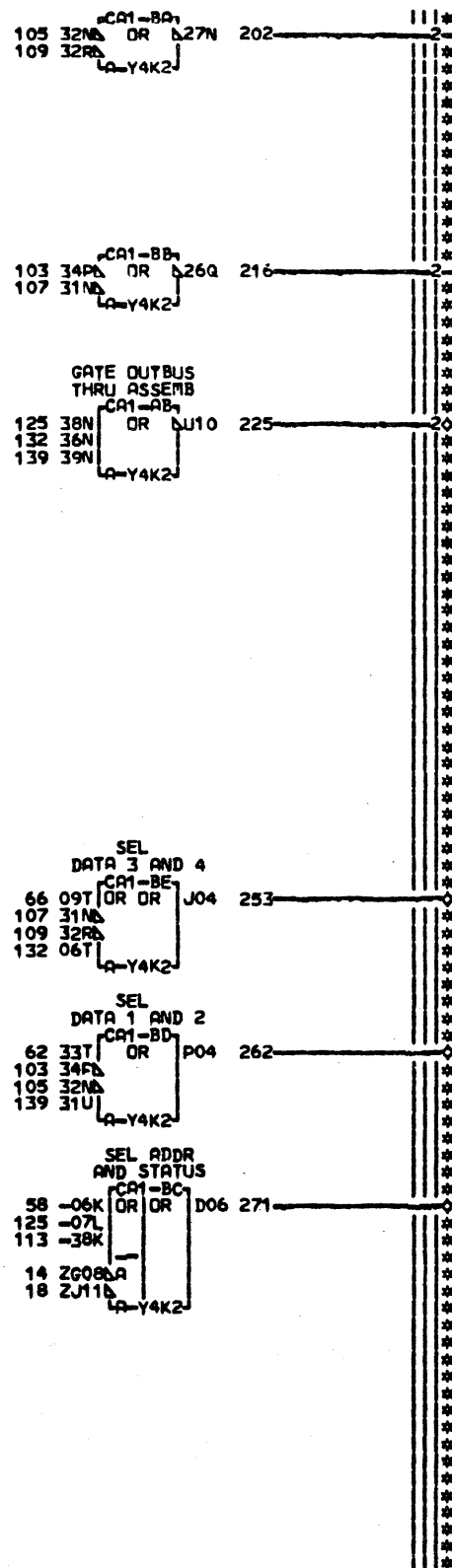
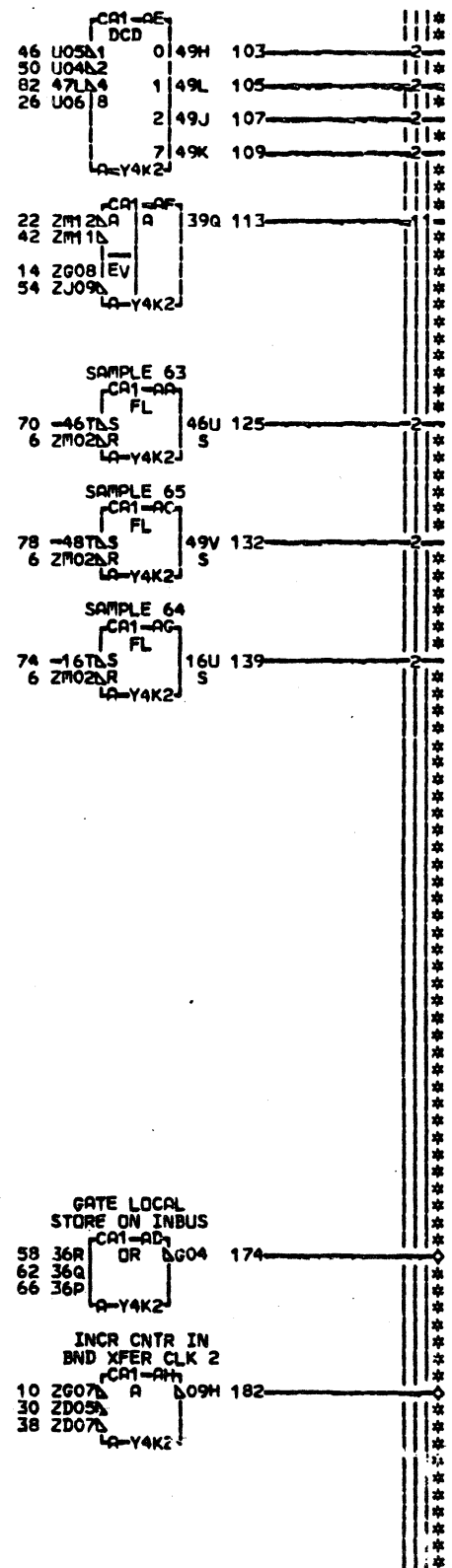
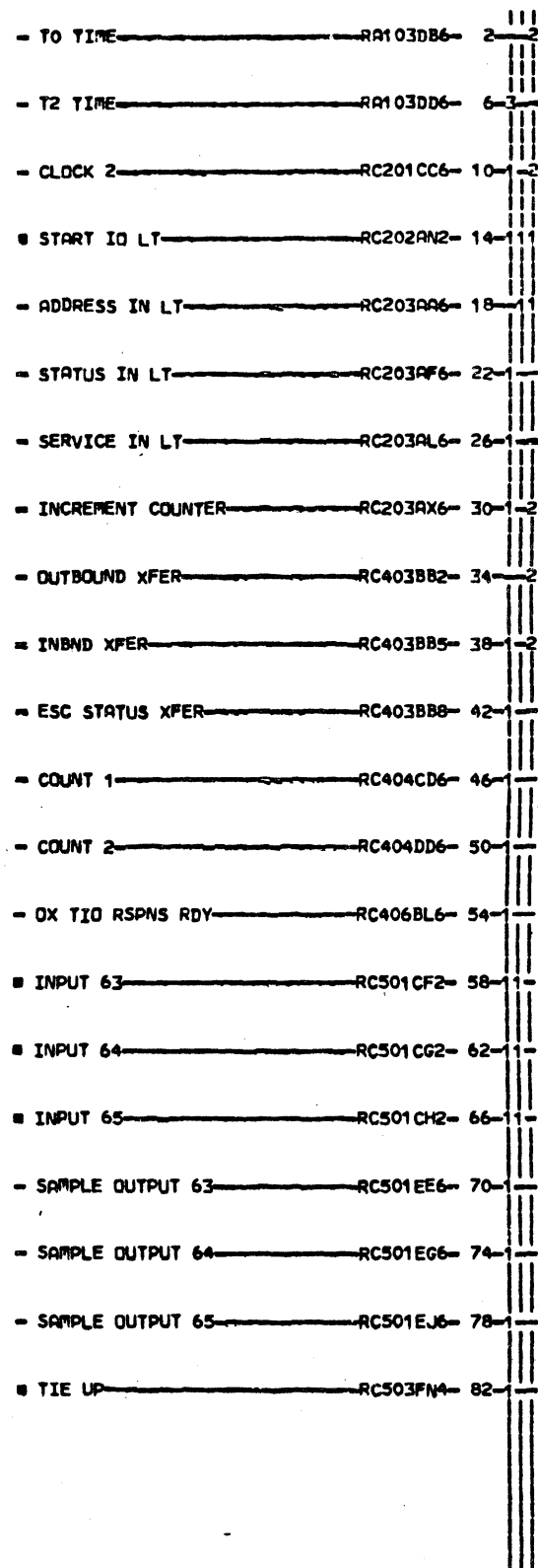

- 000 RC502
- 225 = GATE OUTBUS THRU ASSEMB — BB2  
RC105 RC307
- 174 = GATE LOCAL STORE ON INBUS — BF2  
RC106 RC307 RC505
- 182 = INCR CNTR INBND XFER CLK 2 — DF6  
RC504
- 271 = SEL ADDR AND STATUS — GE6  
RC106 RC307
- 262 = SEL DATA 1 AND 2 — GF6  
RC106 RC307
- 253 = SEL DATA 3 AND 4 — GG6  
RC106 RC307
- 346 = WRITE INTO LS 1 — RC307-GK6
- 328 = WRITE INTO LS 0 — RC106-GL6
- 318 = GTE LS THRU DRVR ASSMB 1 — GM6  
RC504 RC505
- 304 = GTE LS THRU DRVR ASSMB 2 — GN6  
RC504 RC505

LOC. TYPE  
A-Y4K2 7603

ASSEMBLER AND LOCAL STORE CONT	
E.C.—HISTORY	D. PACH. 27RNB
309522C	FRAME 01
309541	IBM CORP. SDD
309545	RC502
DATE LAST EC	P.No. 1785150
05-26-72 309548	000



- NSC ADDRESS VALID RC104GL6 2-2-1 21  
 + START IO LT RC202AN2 7-1 1  
 - STATUS IN LT RC203AF6 12-2 2  
 - STK STATUS PULSE RC204AA6 17-1 1  
 + PREP BUSY LT RC204AG2 22-1 2  
 + RESET SYS RST OR NSC RC206FC2 27-1 1  
 - CCU OUTBUS BIT 0-4 RC401BG2 32-2 2  
 - INIT SEL PULSE RC402DC6 37-1 1  
 + RST INIT SEL OR POR RC402GH4 42-1 1  
 - NSC FINAL STATUS XFER RC403BF5 47-1 1  
 + NSC CE STATUS RC403FF2 52-2 2  
 - NSC XFER ACPTD RESET RC403GN6 57-1 2  
 - SVC STK STATUS RC405CJ6 62-1 1  
 - INPUT 60 RC501CC6 67-1 1  
 - SAMPLE OUTPUT 62 RC501EC6 72-1 1  
 - SAMPLE 66 RC501EL6 77-1 1  
 + RST ESC ACTIVE RC602FM6 82-1 1  
 + DIAG CCU OR CHNL RESET RC707EM6 87-1 1

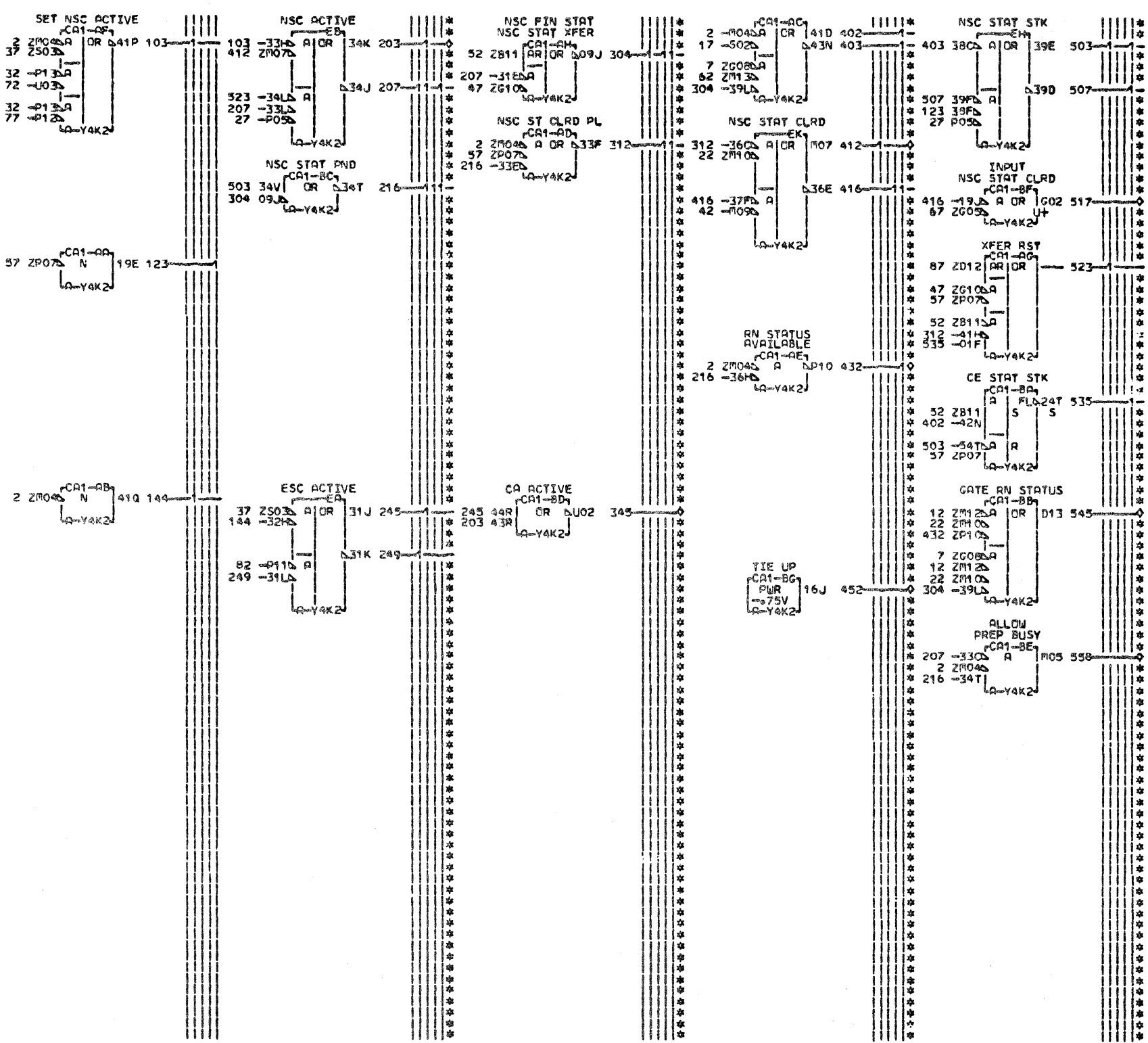

081 RC503  
 \* 432 - RN STATUS AVAILABLE RC406-BM6  
 \* 545 + GATE RN STATUS RC601-DM6  
 \* 203 + NSC ACTIVE RC504-EB2  
 \* 412 + NSC STATUS CLEARED RC402-EK2  
 \* 345 - CA ACTIVE RC206-FR2  
 \* 558 + ALLOW PREP BUSY RC204-FE2  
 \* 517 + INPUT NSC STAT CLRD RA104-FK2  
 \* 452 + TIE UP FN4  
 \* RC502 RC504

LOC. TYPE  
 A-YAK2 7603

NSC CONTROL  
 -E.C.-HISTORY-E, MACH.27RNB  
 FRAME 01  
 IBM CORP. SCD RC503  
 DATE LAST EC  
 10-14-80 344270 P.No. 1986990 081

RC503  
 081 SIM TO PN 1785151 EC 321750

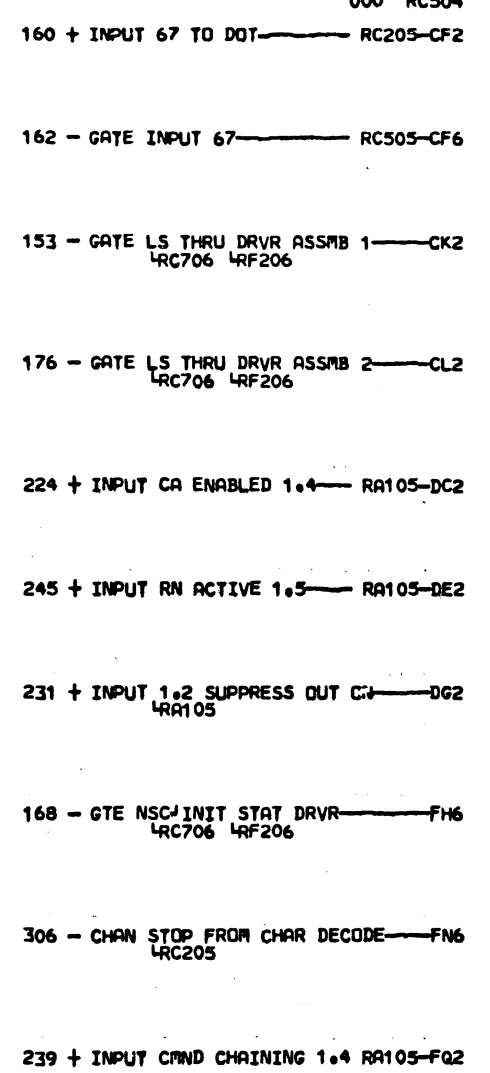
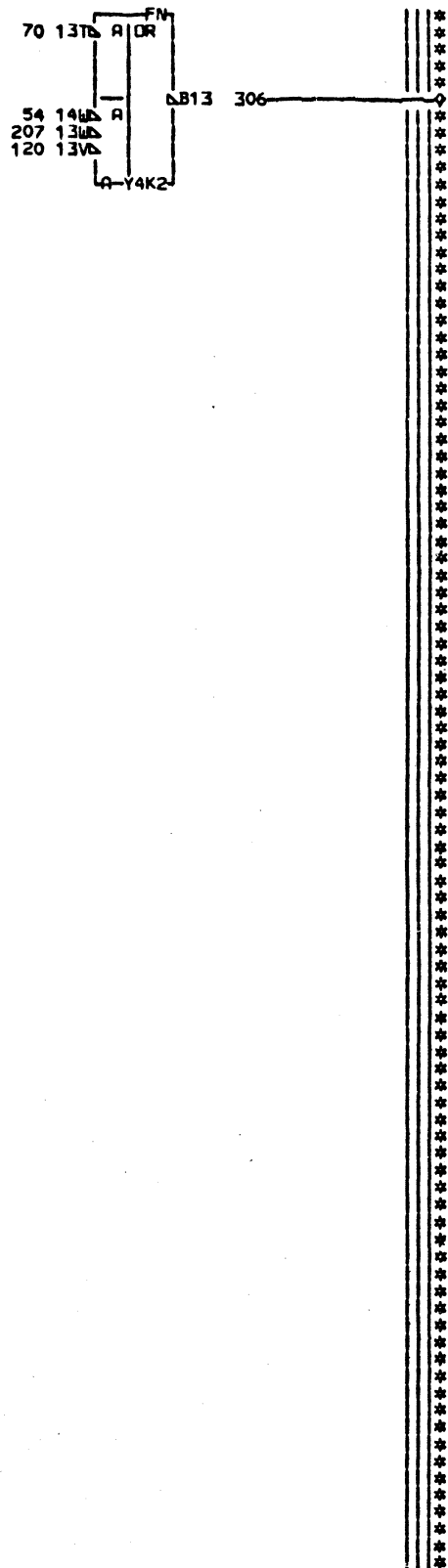
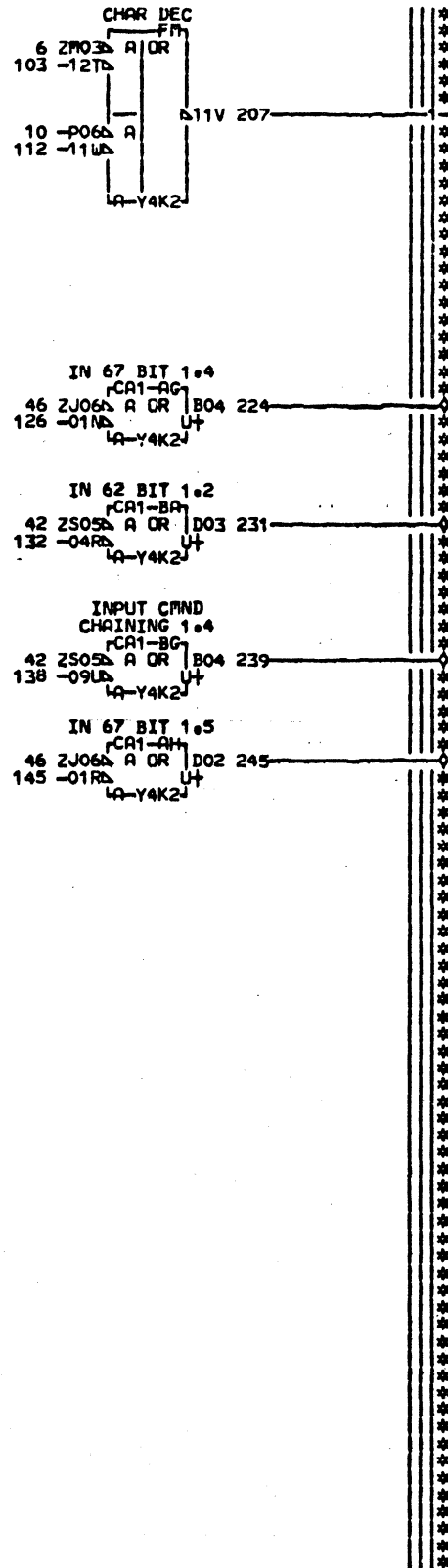
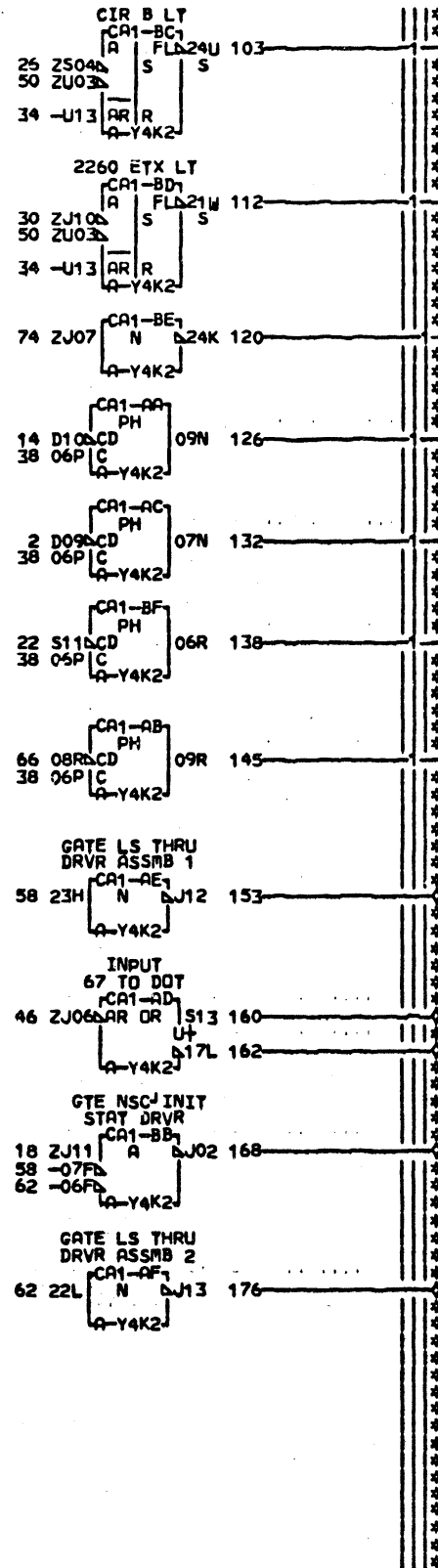
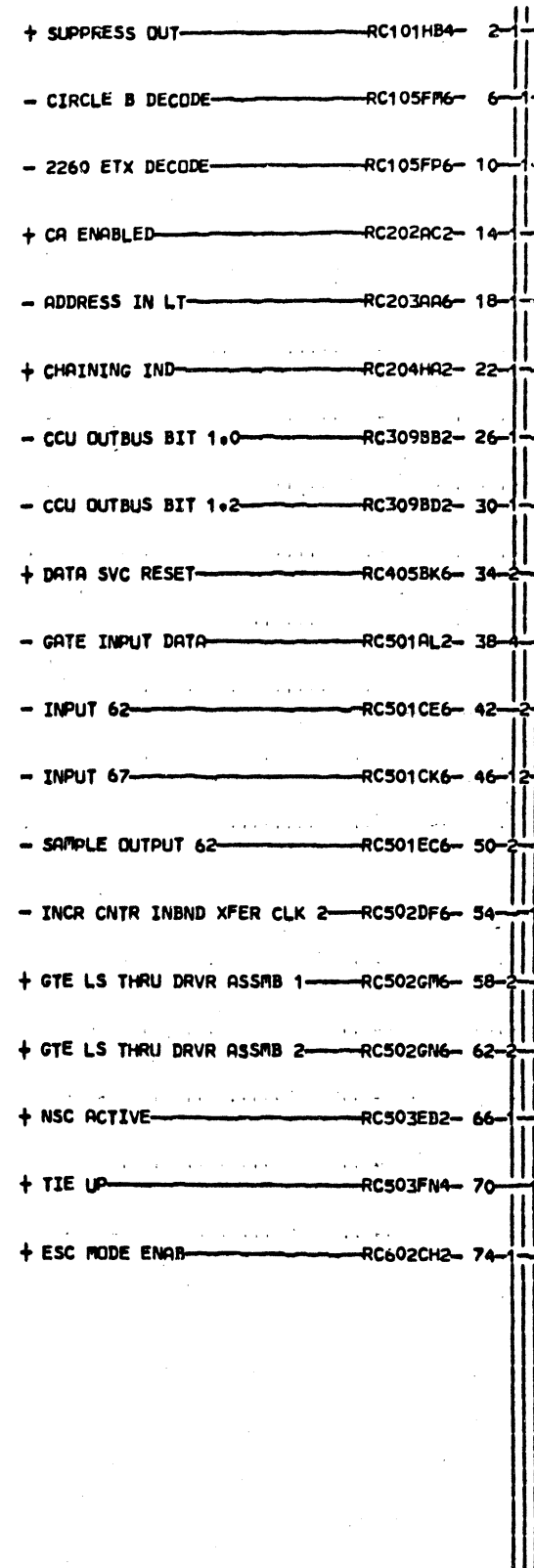

LOC. TYPE  
A-Y4K2 7603

RN ASYNCHRONOUS INFO			
E.C. HISTORY	D	MACH. 27RNB	
309522C	309949		
309541		FRAME	01
309545		IBM CORP. SDD	RC504
309548		DATE	LAST EC
06-07-76	315618	P.No.	1785152 000

- TYPE 1 CA DECODES RA101FH4- 2-2  
 - T3 TIME RA103DE6- 6-1  
 + CA 62.5 NS CLOCK RA103FG2- 10-1  
 + LS 0 PAR ER UNCLK RC106FM2- 14-1  
 - CLOCK 2 RC201CC6- 18-1  
 + LS 1 PAR ER UNCLK RC307HB2- 22-1  
 - CCU OUTBUS BIT 1.2 RC309BD2- 26-1  
 + BYTE 1 PARITY ERR RC309FE2- 30-1  
 + BYTE 0 PARITY ERR RC401GF6- 34-1  
 + RST INIT SEL DR POR RC402GH4- 38-1  
 - INITIATE SERVICE CYCLE RC403FK6- 42-1  
 + DECODE 67 RC501AK2- 46-1  
 - SAMPLE OUTPUT DATA RC501AM2- 50-1  
 - ID OPERATION RC501CN2- 54-1  
 - SAMPLE 67 RC501EN6- 58-1  
 - GATE LOCAL STORE ON INBUS RC502BF2- 62-1  
 + GTE LS THRU DRVR ASSMB 1 RC502GM6- 66-1  
 + GTE LS THRU DRVR ASSMB 2 RC502GN6- 70-1  
 - GATE INPUT 67 RC504CF6- 74-2  
 - REQ ENAB INTF RC601GN2- 78-1  
 + DIAG CCU DR CHNL RESET RC707EM6- 82-1  
 + INTF B CHNL BUS IN ERR RF207CC2- 86-1

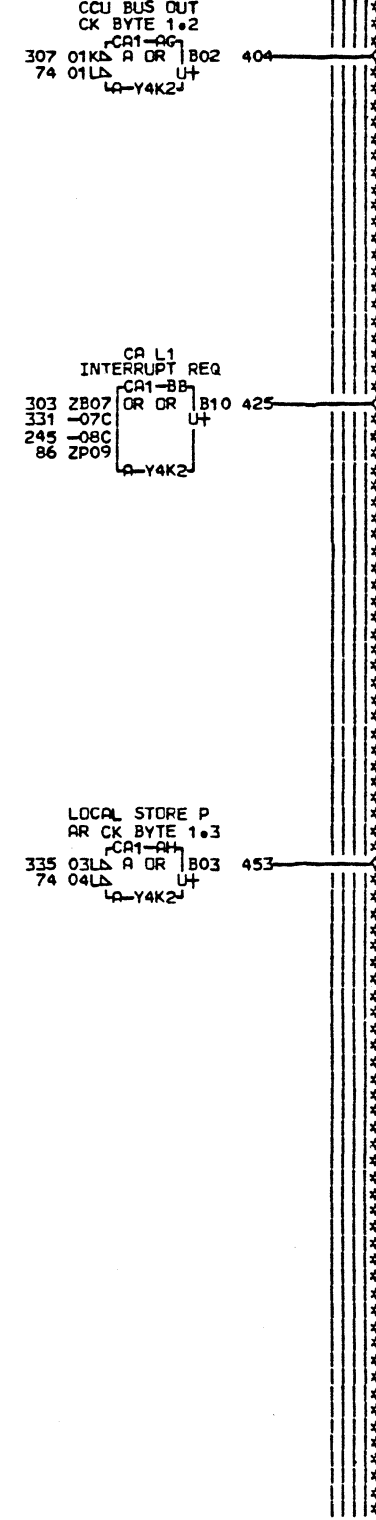
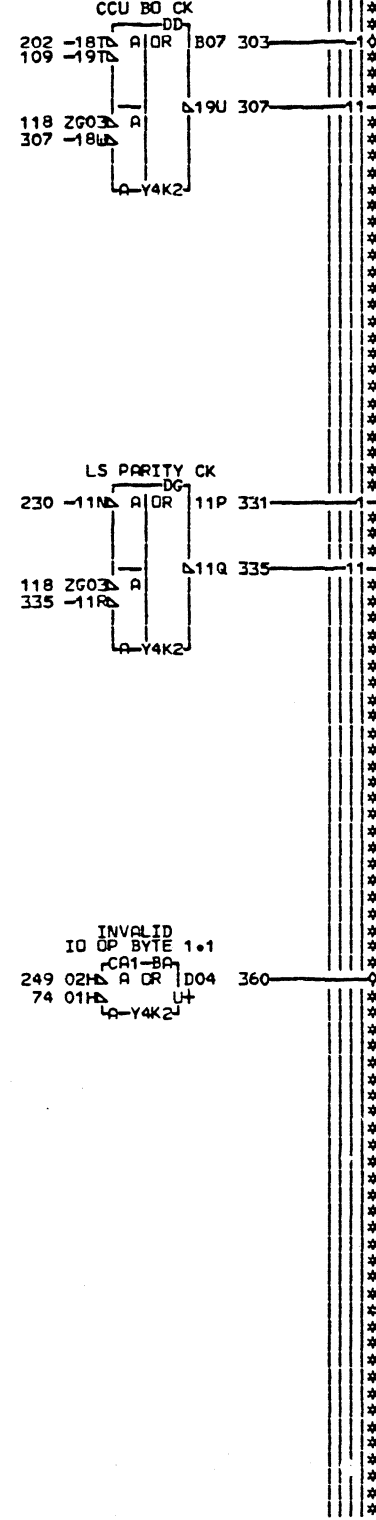
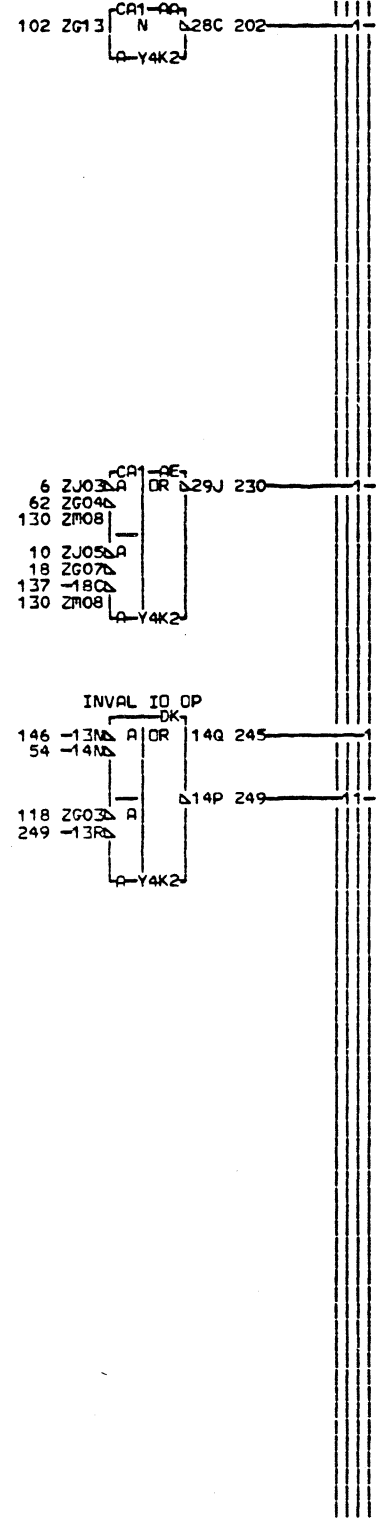
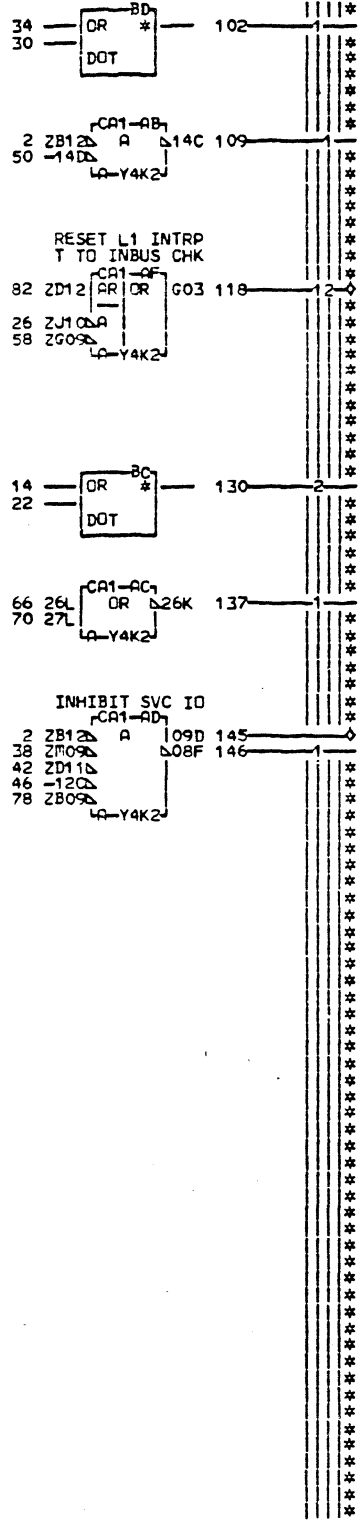

081 RC505  
 145 + INHIBIT SVC ID RC501-BK2  
 118 + RESET L1 INTRPT TO INBUS CHK-CL4  
 RC707 4RF207  
 303 + CCU BO CK RC403-DD2  
 404 + CCU BUS OUT CK BYTE 1.2 RA105-GD2  
 453 + LOCAL STORE PAR CK BYTE 1.3-GG2  
 RA105  
 360 + INVALID ID OP BYTE 1.1- RA105-GK2  
 425 + CA L1 INTERRUPT REQ RA102-GM6

LOC. TYPE  
A-Y4K2 7603

ERROR LATCHES			
E.C.-HISTORY	E-MACH.	27RNB	
	FRAME	01	
DATE	LAST EC	IBM CORP.SDD	RC505
04-14-81	34460C	P.N. 4499503	081

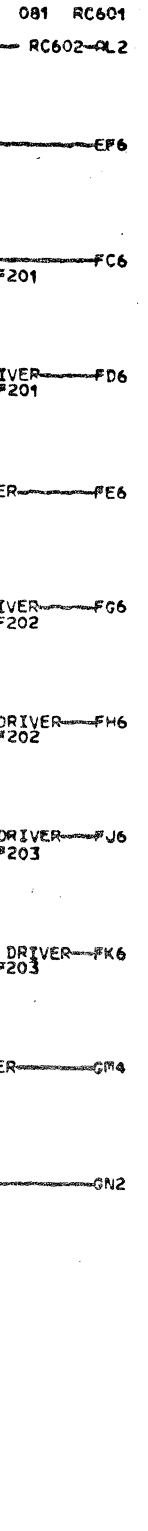
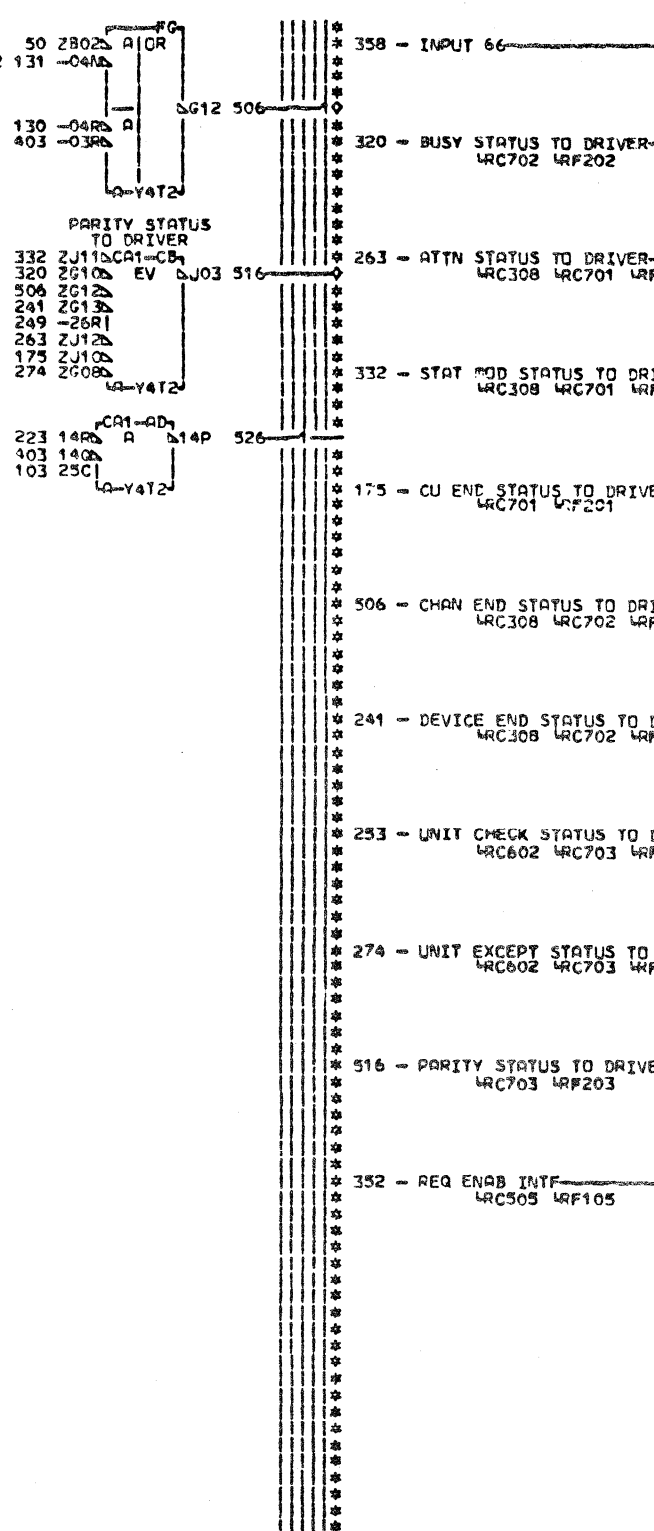
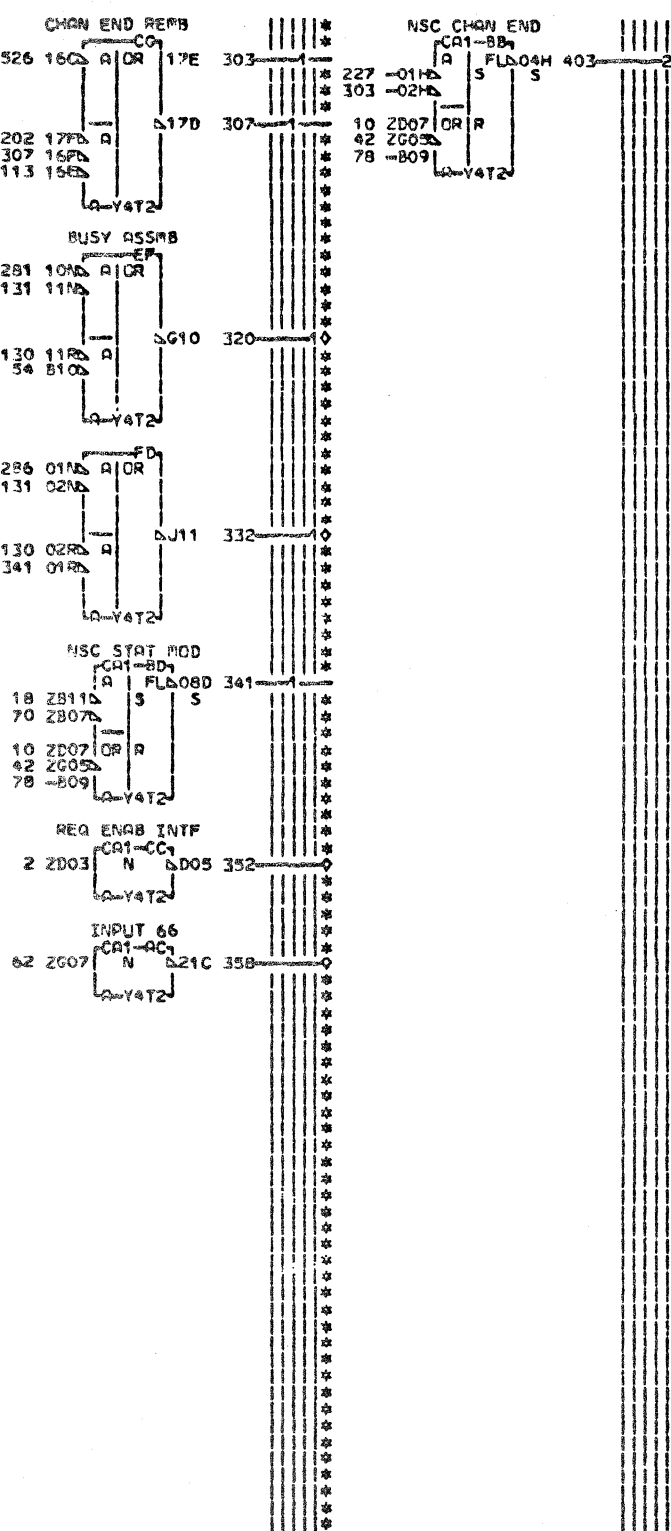
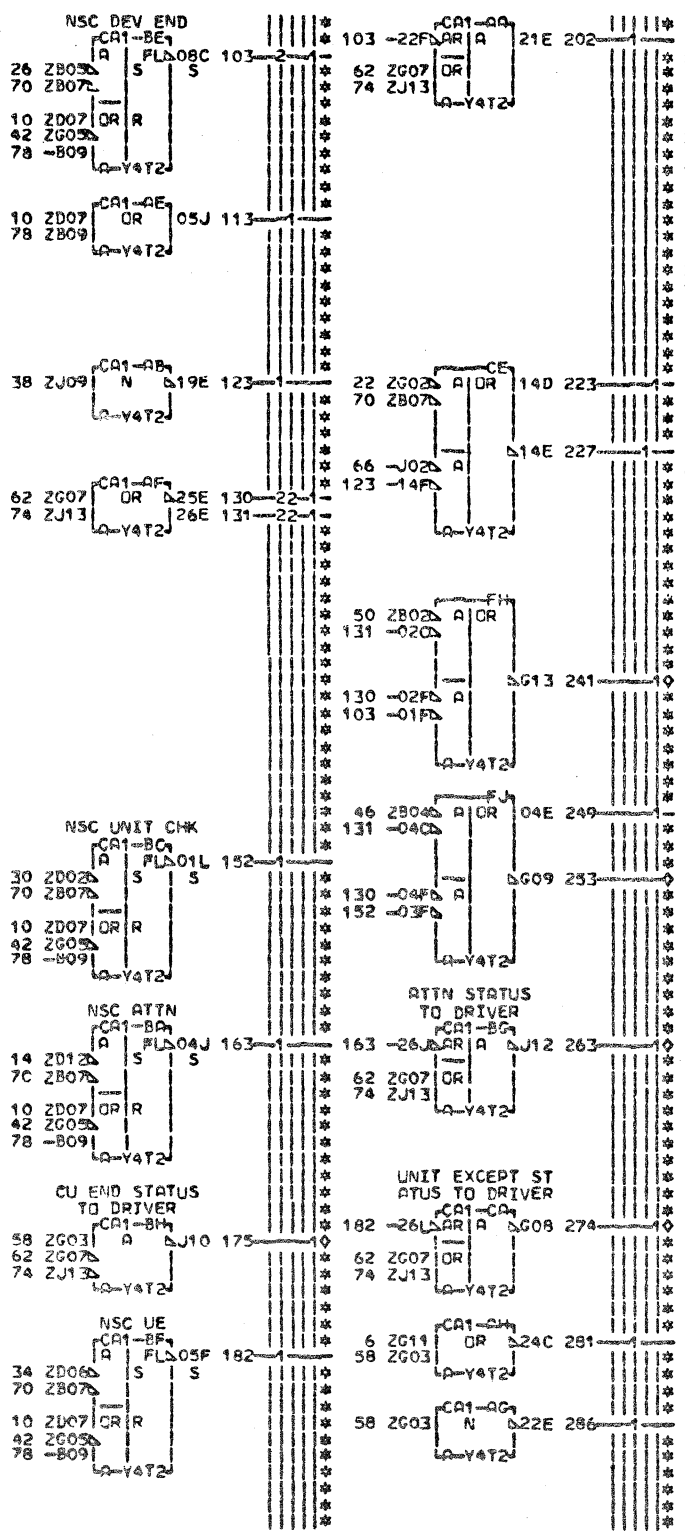
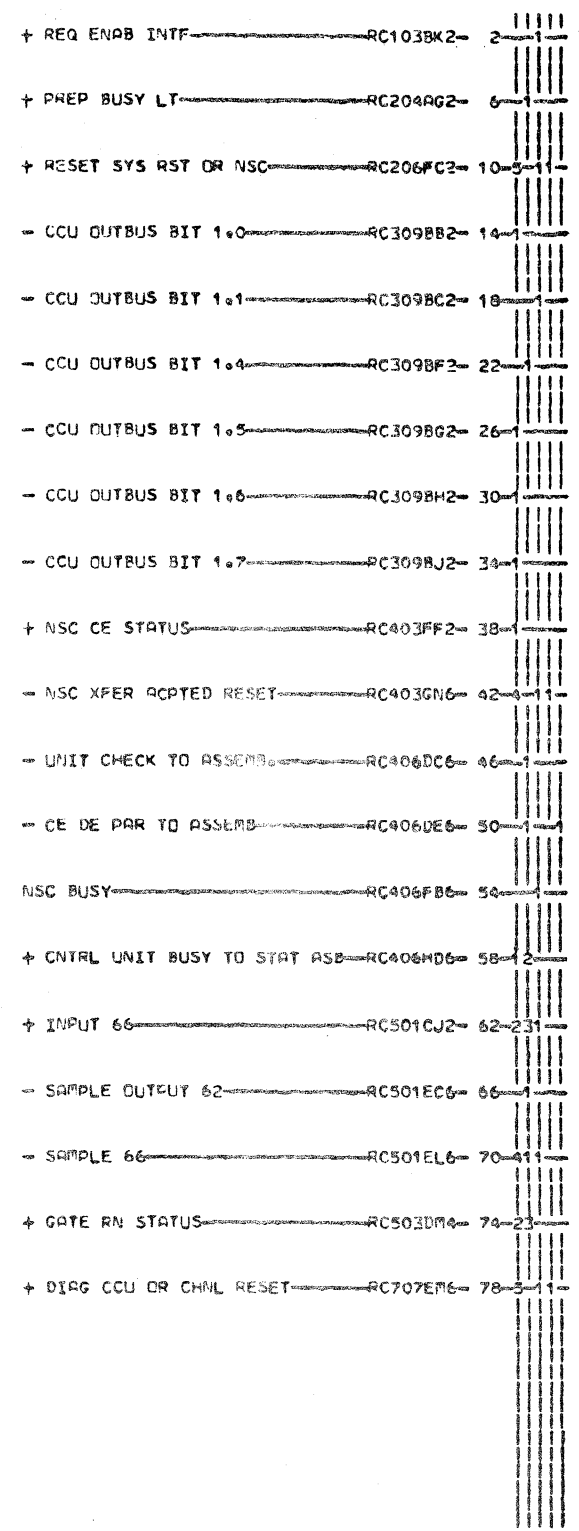

LOC. TYPE  
A-Y4T2 2326

NSC STATUS REG			
E=C-HISTORY	E=MACH#27RNB	FRAME	01
DATE	LAST EC	IBM CORP.SCD	RC601
10-14-80	344270	PeN. 1986991	081

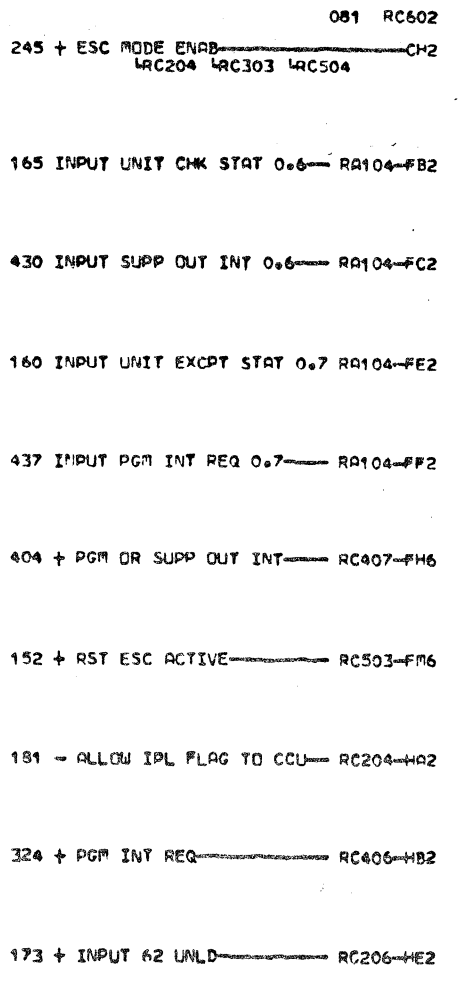
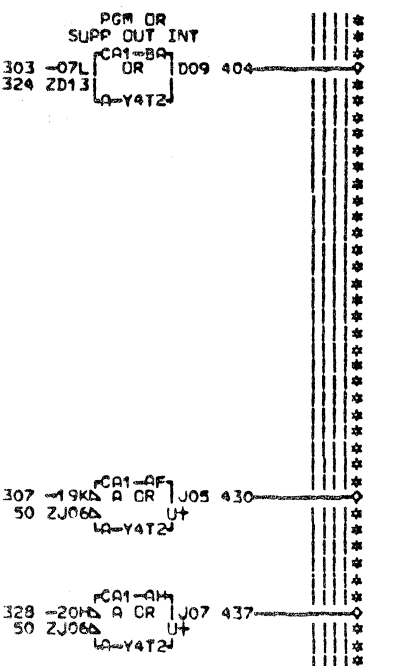
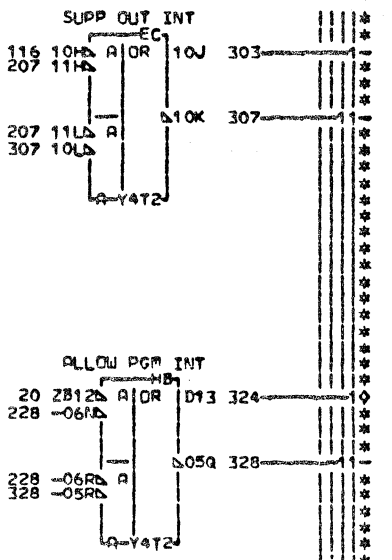
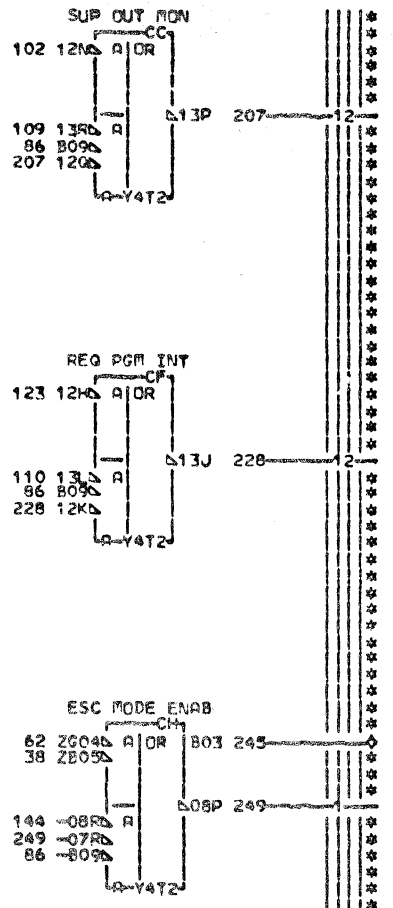
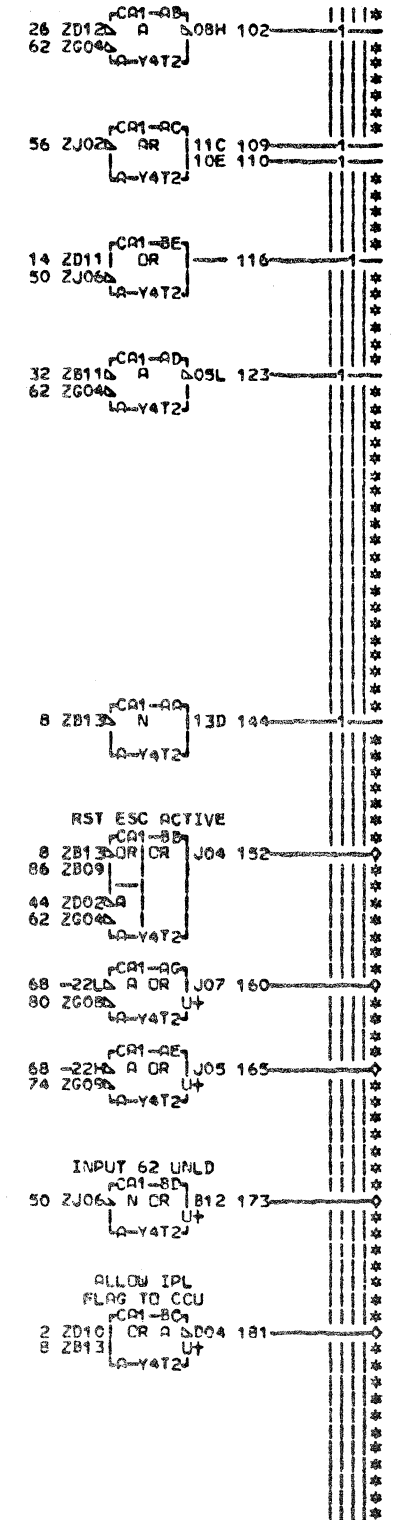
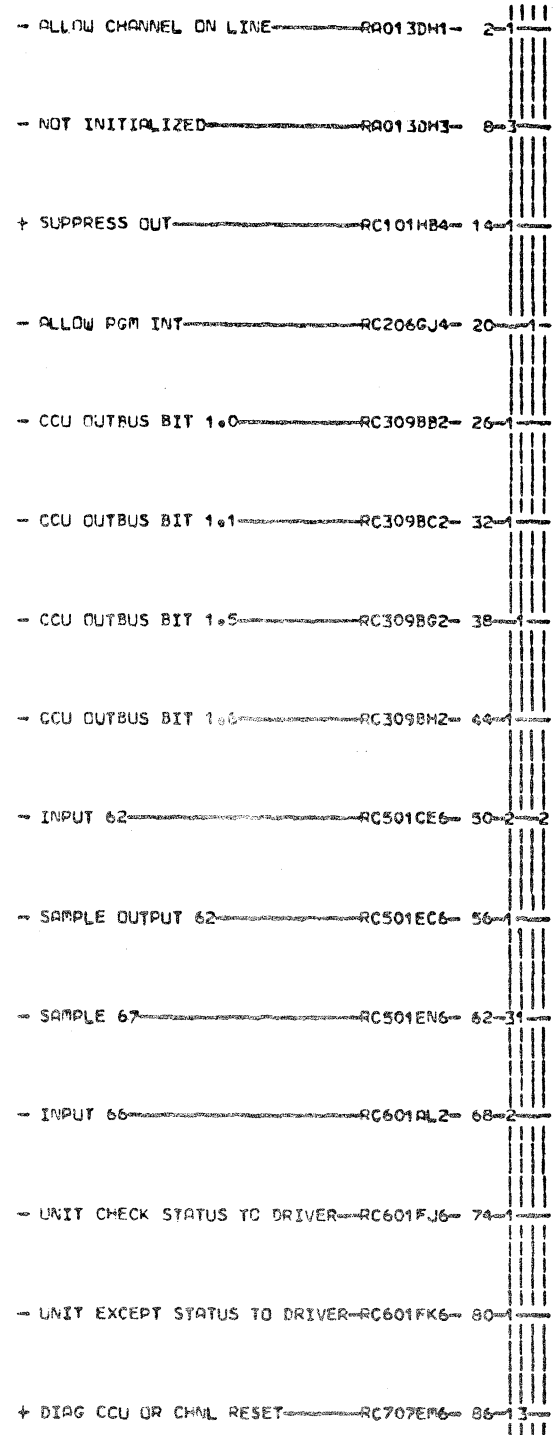

LOC. TYPE  
A-Y4T2 2326

ASYN INTERRUPT CONTROL			
E-C-HISTORY	E-ARCH-27RNB	FRAME	01
DATE	LAST EC	IBM CORP. SCD	RC602
10-14-80	344270	P.N. 1986992	081

- LOCAL STORE BIT 0.0 TO DRVR-RC106CC6- 2-1-1
- LOCAL STORE BIT 0.1 TO DRVR-RC106CD6- 7-1-1
- LOCAL STORE BIT 0.2 TO DRVR-RC106CE6- 12-1-1
- SID ADR BIT 1.0-RC306BC6- 17-1-1
- SID ADR BIT 1.1-RC306BD6- 22-1-1
- SID ADR BIT 1.2-RC306BF6- 27-1-1
- LOCAL STORE BIT 1.0 TO DRVR-RC307DC6- 32-1-1
- LOCAL STORE BIT 1.1 TO DRVR-RC307DD6- 37-1-1
- LOCAL STORE BIT 1.2 TO DRVR-RC307DF6- 42-1-1
- ATTN STATUS TO DRIVER-RC601FC6- 47-1-1
- STAT MOD STATUS TO DRIVER-RC601FD6- 52-1-1
- CU END STATUS TO DRIVER-RC601FE6- 57-1-1
- GATE ADDRESS TO CHANNEL-RC706CF6- 62-3-1
- GATE STATUS TO CHAN-RC706CG6- 67-3-1
- GATE DATA BYTE 1 TO CHANNEL-RC706CH6- 72-3-1
- GATE DATA BYTE 2 TO CHANNEL-RC706CJ6- 77-3-1
- + CA TIE UP-RC706GC4- 82-2-1
- + GEN CTRL UNIT BUSY STATUS-RC706GN2- 87-2-1

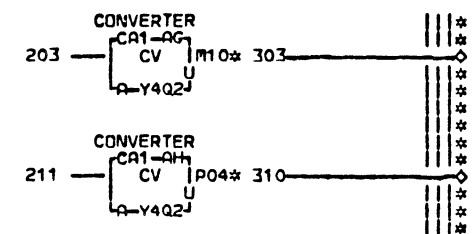
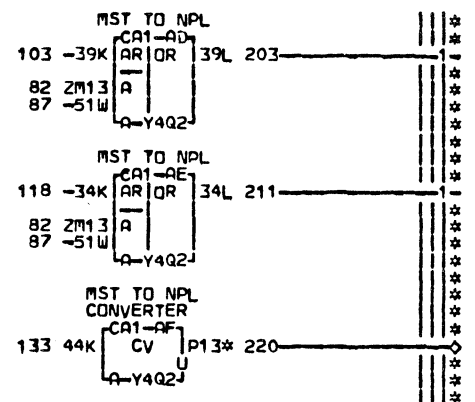
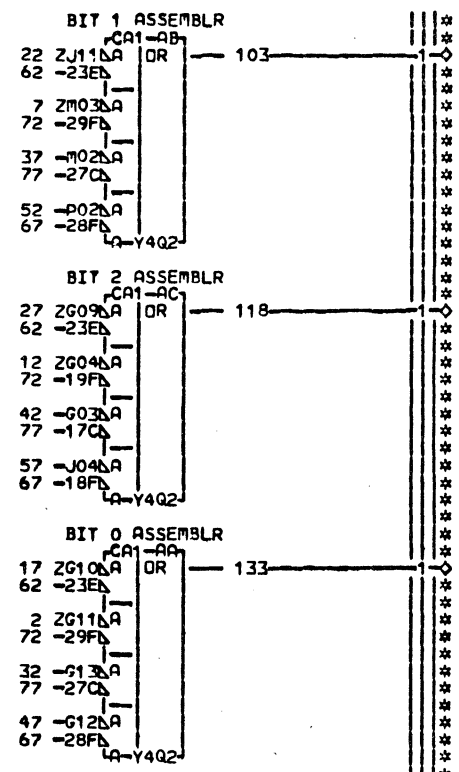

- 133 + BUS IN BIT 0 ASSEMBLED- RC703-BB4
- 103 + BUS IN BIT 1 ASSEMBLED- RC703-BF4
- 118 + BUS IN BIT 2 ASSEMBLED- RC703-BK4
- 220 + NPL BIT 0 TO INTF A- RA014-EC4
- 303 + NPL BIT 1 TO INTF A- RA014-EG4
- 310 + NPL BIT 2 TO INTF A- RA014-EL4

EDGE CONN.  
 220 A-Y4V3D05  
 303 A-Y4V3B05  
 310 A-Y4V3D06

LOC. TYPE  
 A-Y4Q2 6836

CHANNEL DRIVERS BUS IN		
BITS 0 1 2		
E.C. HISTORY	B. MACH. 27RNB	
309522C		
309541	FRAME 01	
309545	IBR CORP. SDD	RC701
DATE LAST EC	P.N. 1785156	000
06-15-72 309533		

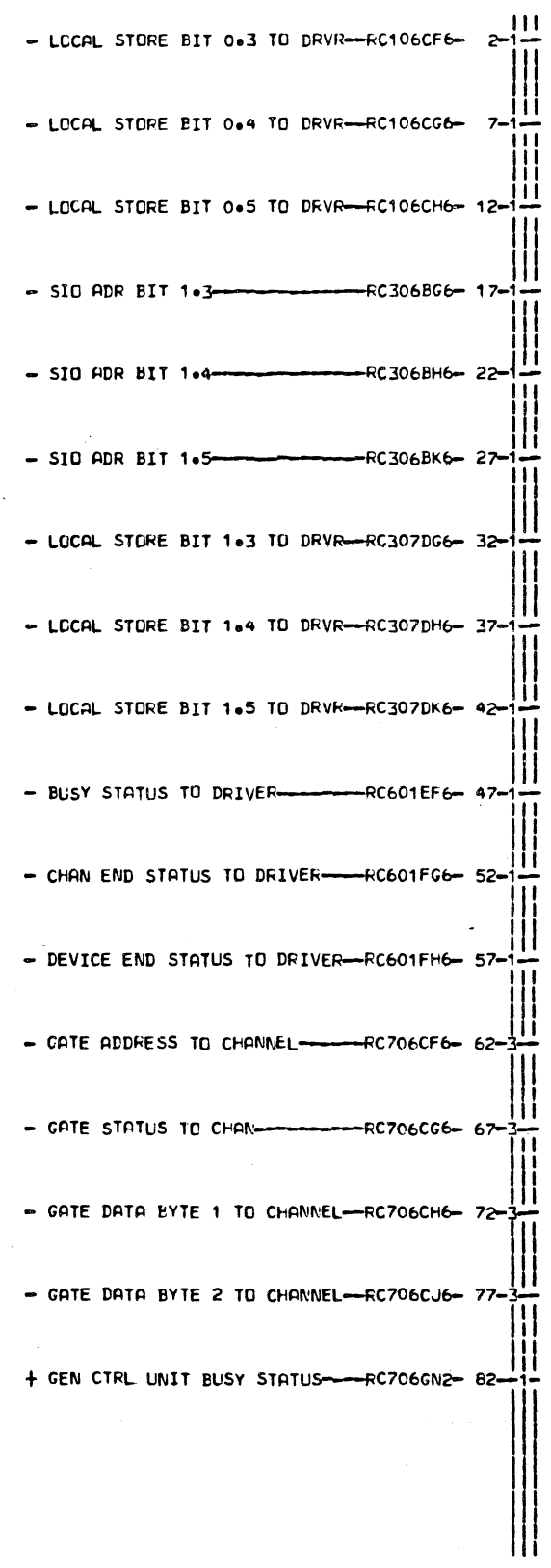

EDGE CONN.  
 211 A-Y4V3B10  
 218 A-Y4V3D09  
 01A-Y4V3D10  
 303 A-Y4V3B08  
 01A-Y4V3B09

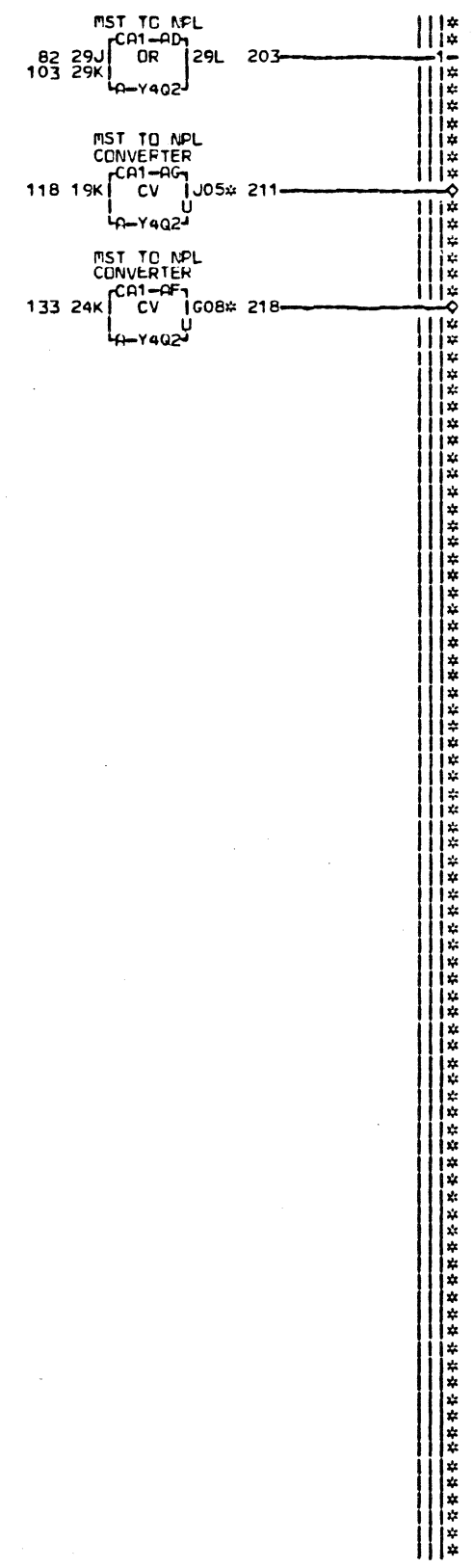
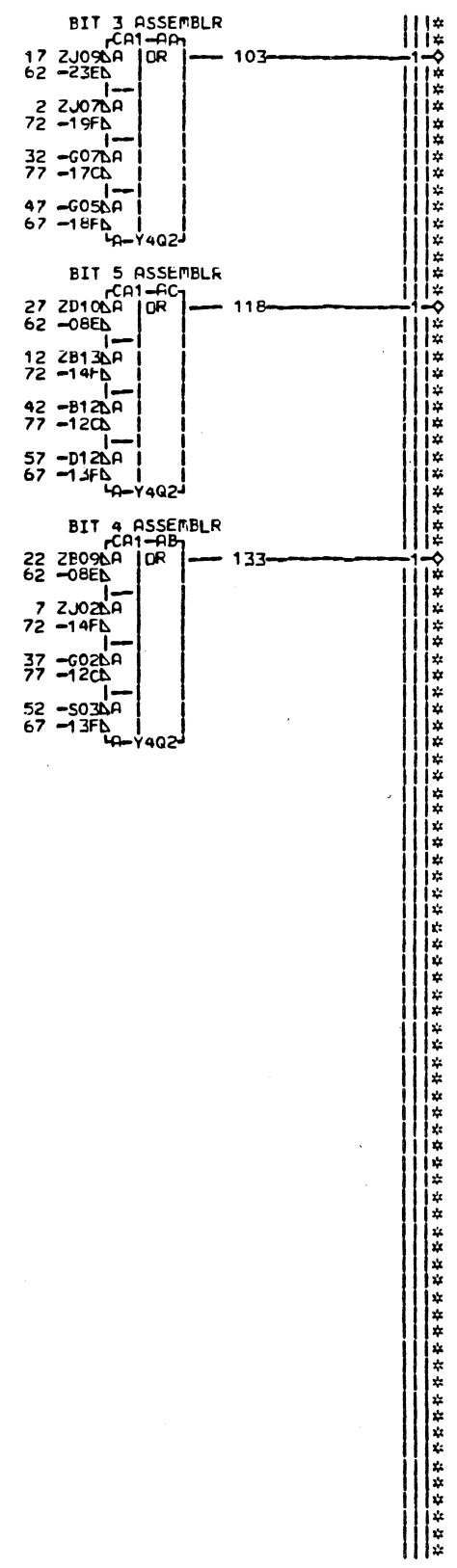

LCC TYPE  
A-Y4Q2 6836

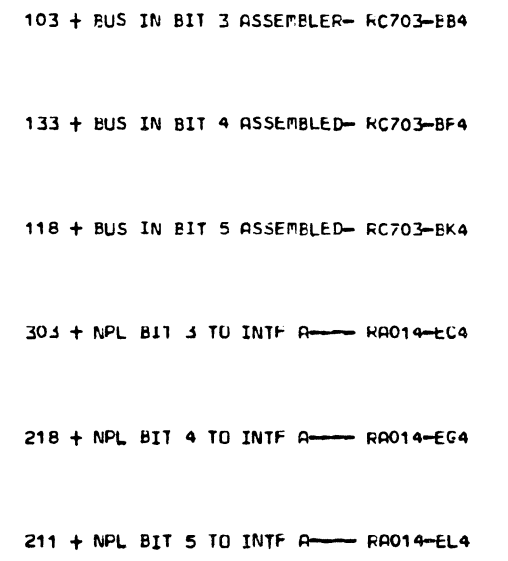
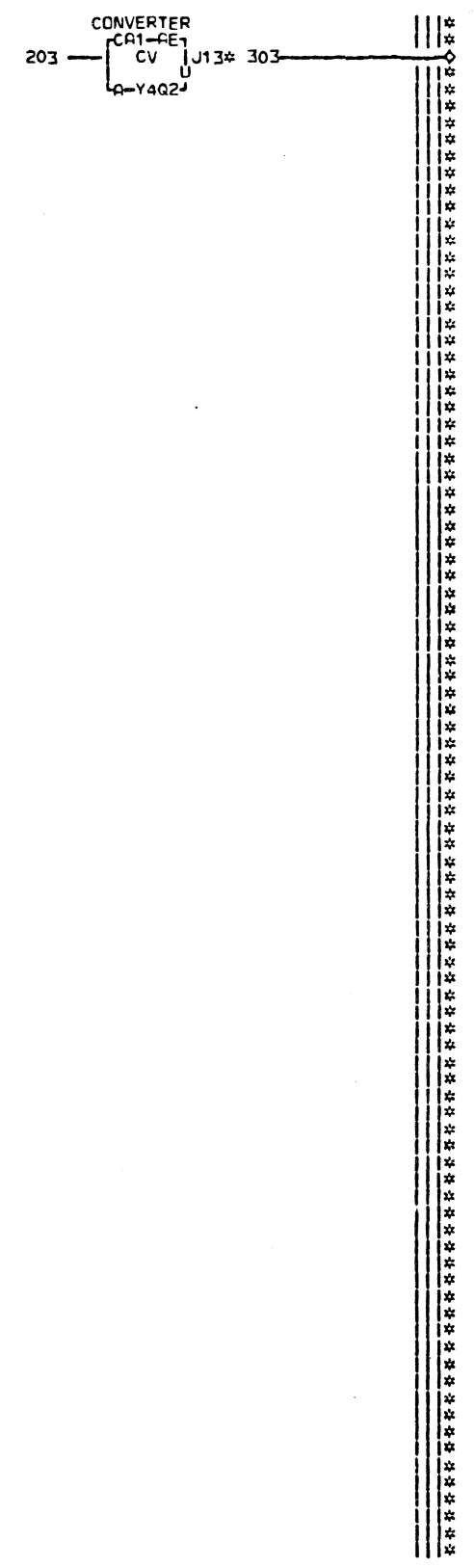

CHANNEL DRIVERS BUS IN	
BITS 3 & 5	
E.C.—HISTORY—	B.FACH#27AMB
309522C	
309541	FRAME 01
DATE LAST EC	IBM CCRP.SDD RC702
04-24-72 309545	P.No. 1785157 000

- LOCAL STORE BIT 0 P TO DRVR—RC106CB6— 2—1—
- LOCAL STORE BIT 0 6 TO DRVR—RC106CJ6— 5—1—
- LOCAL STORE BIT 0 7 TO DRVR—RC106CK6— 8—1—
- SID ADR PTY 1 0-1 7—RC306BB6— 11—1—
- SID ADR BIT 1 6—RC306BL6— 14—1—
- SID ADR BIT 1 7—RC306BM6— 17—1—
- LOCAL STORE BIT 1 P TO DRVR—RC307DB6— 20—1—
- LOCAL STORE BIT 1 6 TO DRVR—RC307DL6— 23—1—
- LOCAL STORE BIT 1 7 TO DRVR—RC307DM6— 26—1—
- UNIT CHECK STATUS TO DRIVER—RC601FJ6— 29—1—
- UNIT EXCEPT STATUS TO DRIVER—RC601FK6— 32—1—
- PARITY STATUS TO DRIVER—RC601GM4— 35—1—
- + BUS IN BIT 0 ASSEMBLED—RC701BB4— 38—1—
- + BUS IN BIT 1 ASSEMBLED—RC701BF4— 41—1—
- + BUS IN BIT 2 ASSEMBLED—RC701BK4— 44—1—
- + BUS IN BIT 3 ASSEMBLER—RC702BB4— 47—1—
- + BUS IN BIT 4 ASSEMBLED—RC702BF4— 50—1—
- + BUS IN BIT 5 ASSEMBLED—RC702BK4— 53—1—
- INTERFACE ENABLED AND OP IN—RC706BK6— 56—1—
- GATE ADDRESS TO CHANNEL—RC706CF6— 59—3—
- GATE STATUS TO CHAN—RC706CG6— 62—3—
- GATE DATA BYTE 1 TO CHANNEL—RC706CH6— 65—3—
- GATE DATA BYTE 2 TO CHANNEL—RC706CJ6— 68—3—
- + GEN CTRL UNIT BUSY STATUS—RC706GN2— 71—1—

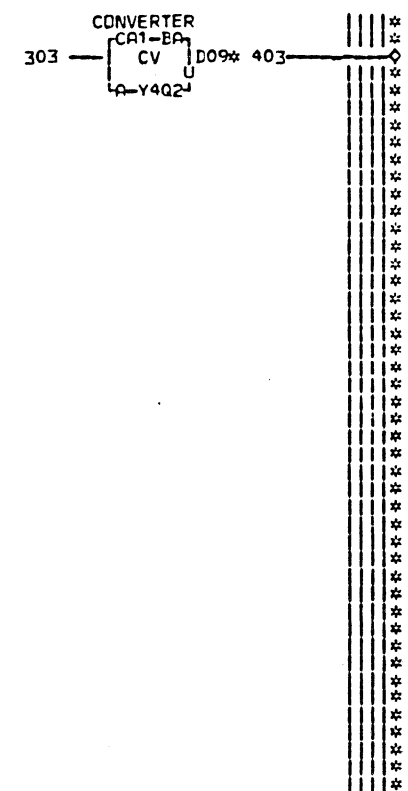
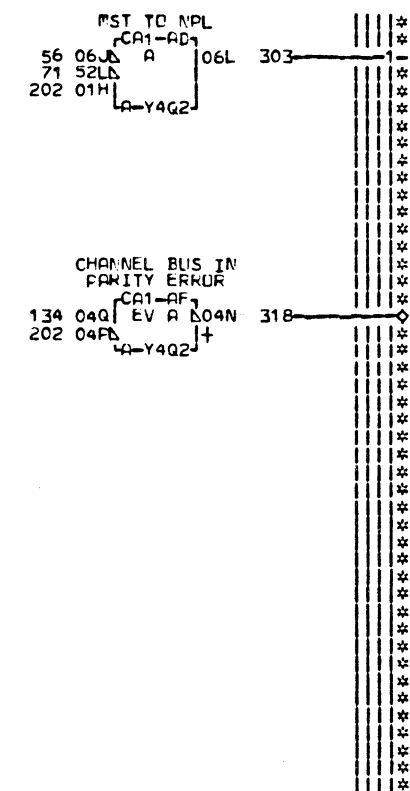
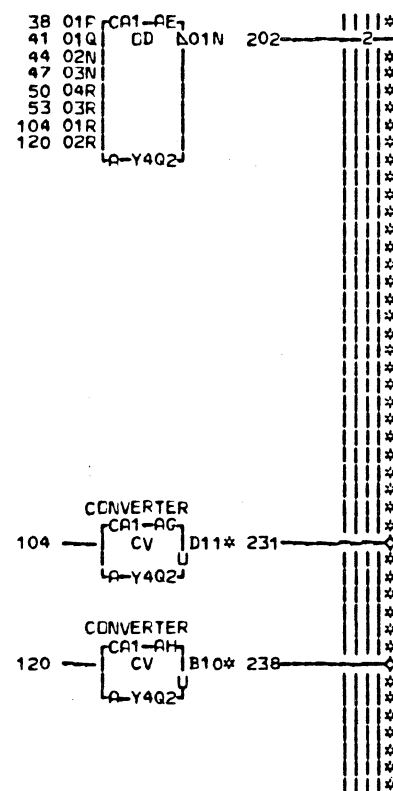
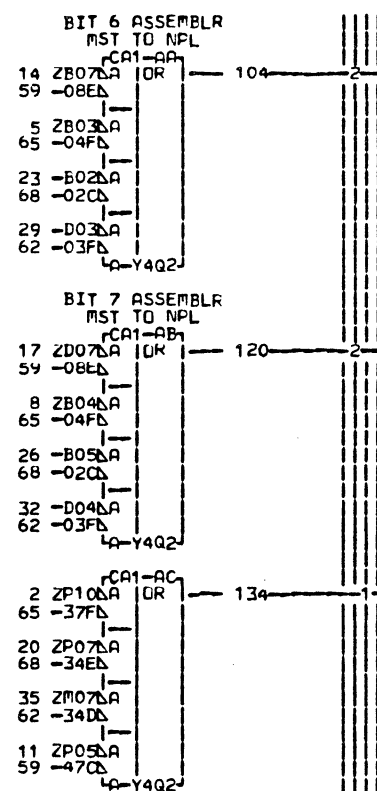

- 318 - CHANNEL BUS IN PARITY ERROR—DH2—RC707
- 231 + NPL BIT 6 TO INTF A—RA014-EC4
- 238 + NPL BIT 7 TO INTF A—RA014-EG4
- 403 + NPL BIT P TO INTF A—RA014-EL4

EDGE CONN.  
231 A-Y4V3D11  
238 A-Y4V3E12  
403 A-Y4V3E02

LOC. TYPE  
A-Y4Q2 6636

CHANNEL DRIVERS BUS IN	
BITS 6 7 P	
E.C.—HISTORY—	B MACH. 27RAB
309522C	FRAME 01
309541	IBM CORP. SDD
DATE LAST EC	P.No. 1785158
04-24-72 309545	000



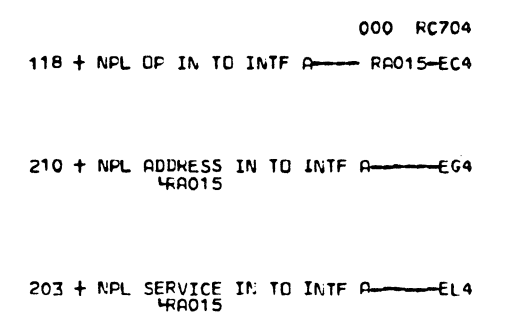
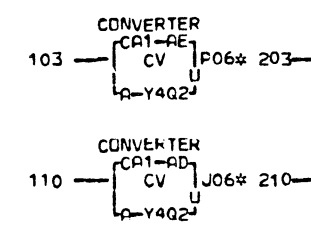
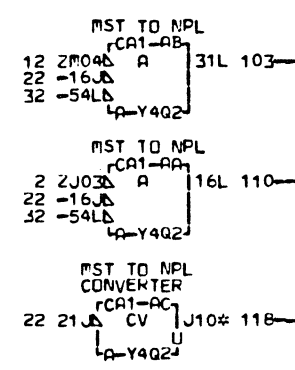
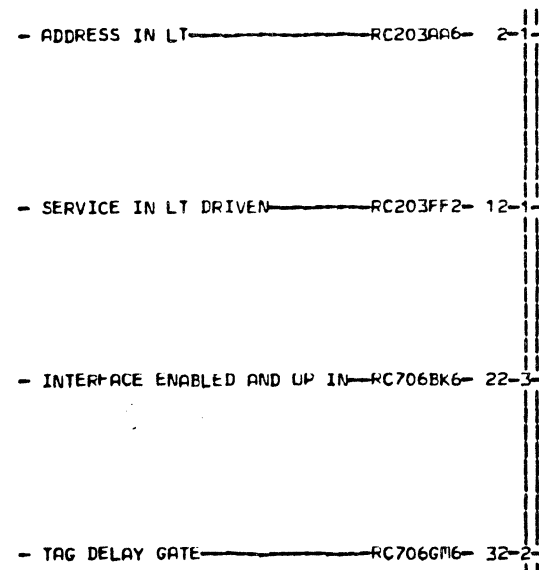

EDGE CONN.  
 118 R-Y4V4E02  
 203 R-Y4V4D06  
 210 R-Y4V4E05

LCC. TYPE  
 R-Y4Q2 6836

CHANNEL DRIVERS	
OP IN ADDR IN AND SERVICE IN	
E.C. HISTORY	B. MACH. 27RMB
309522C	
309541	FRAME 01
DATE LAST EC	IBM CORP. SDD RC704
04-24-72 309545	P.N. 1785159 000

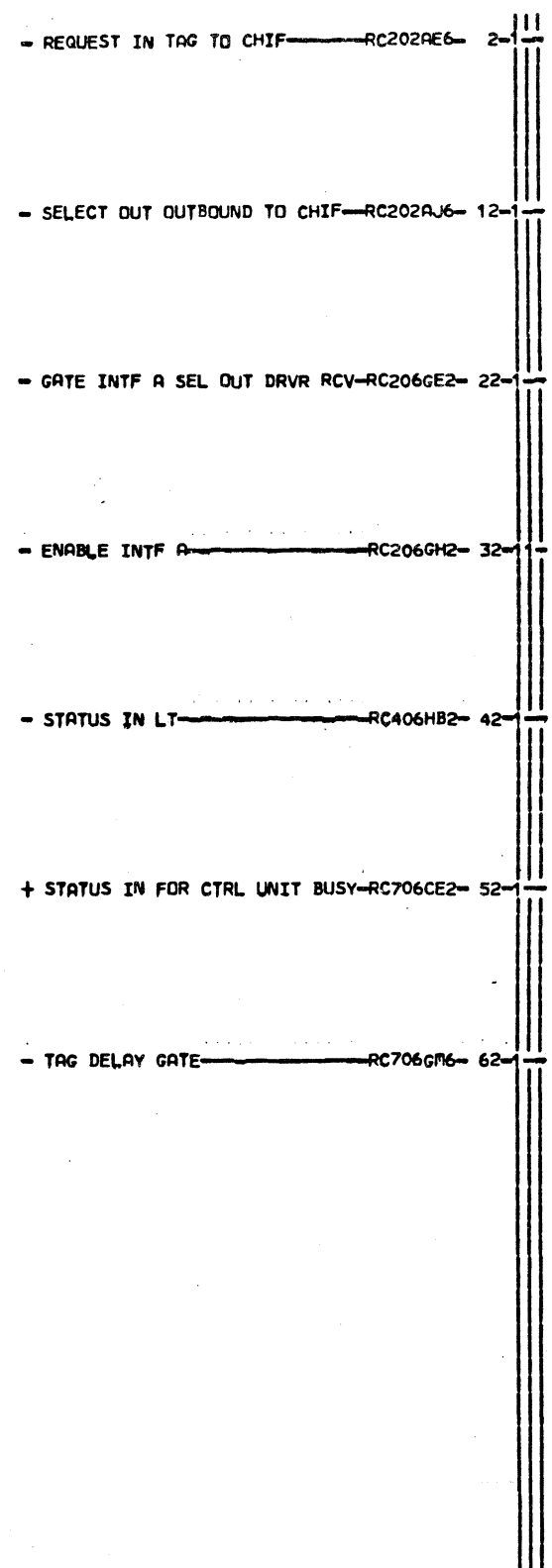

EDGE CONN.  
210 A-Y4V5D06  
303 A-Y4V4D05

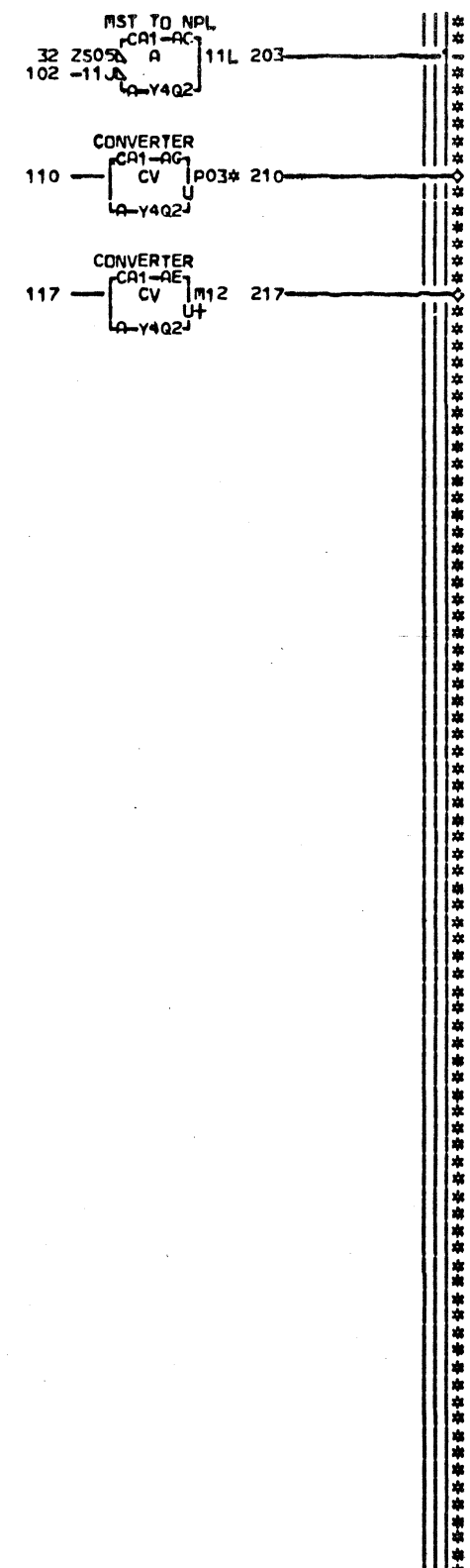
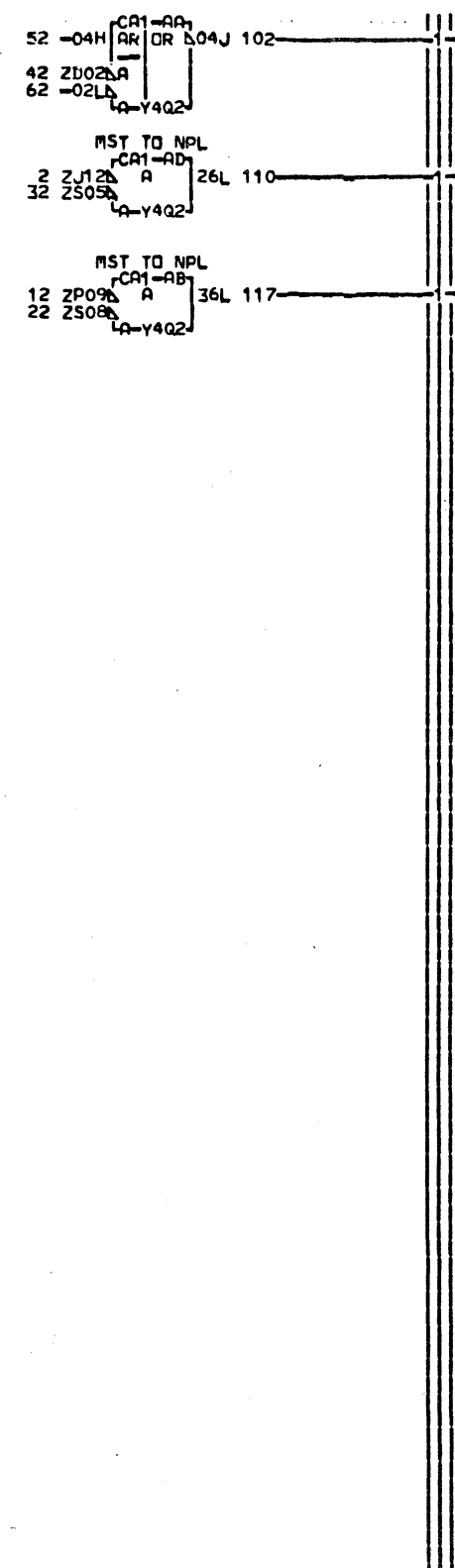

LOC. TYPE  
A-Y4Q2 6836

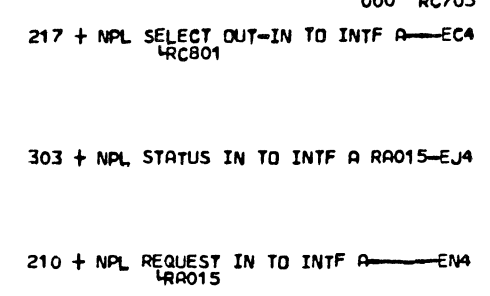
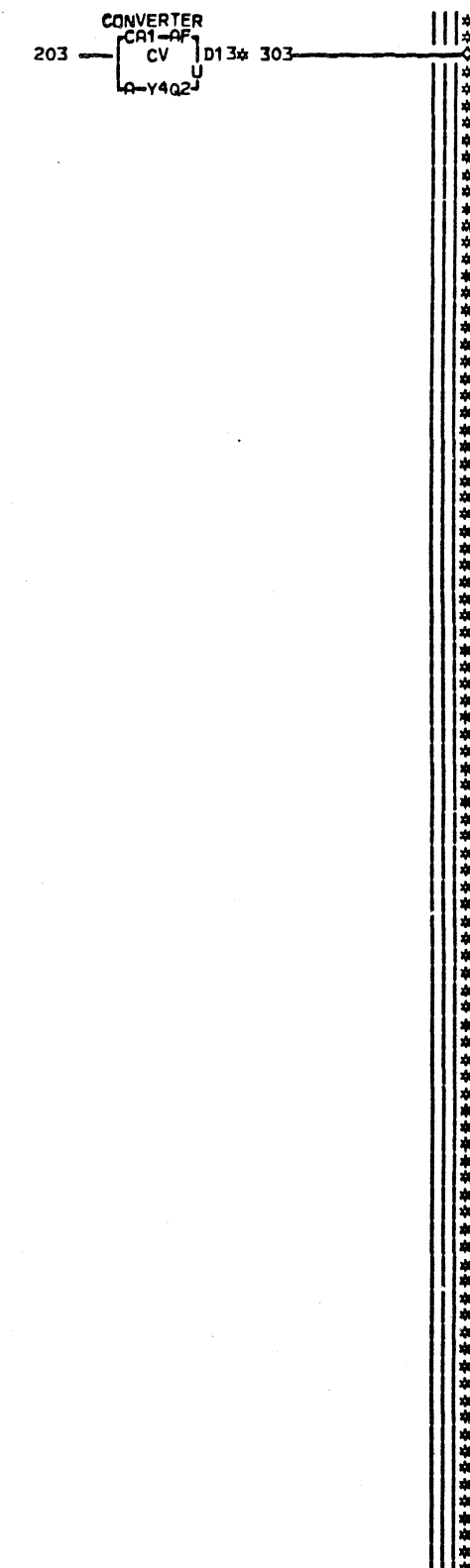

CHANNEL DRIVERS	
SELECT IN REQ IN AND STATUS IN	
E.C.—HISTORY—	B. MACH#27RNB
309522C	FRAME 01
309541	IBM CORP.SDD
309545	P.N. 1785160
DATE LAST EC	000
09-20-72 309944	

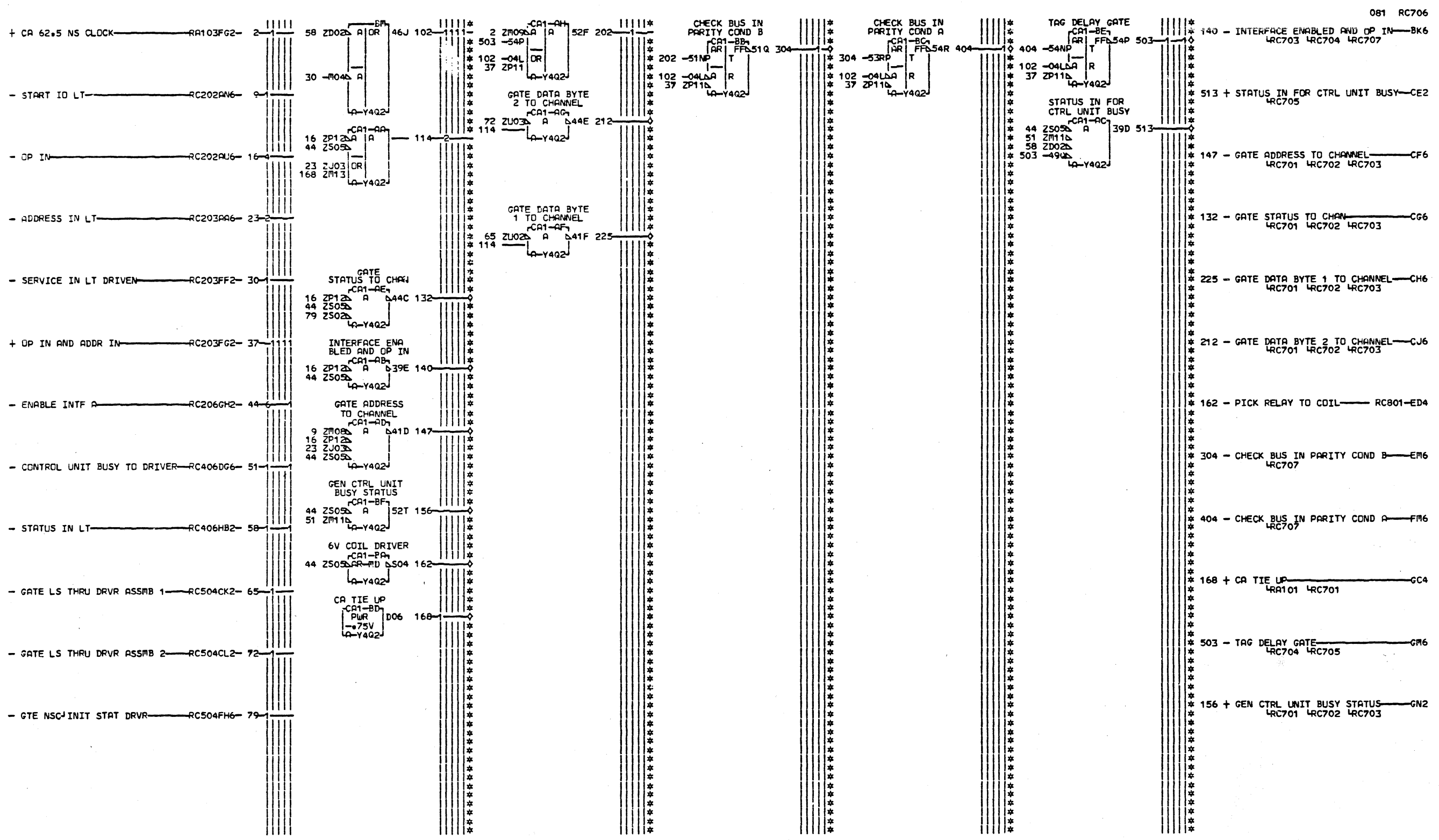

LOC. TYPE  
A-Y4Q2 6836

RC706  
081 SIM TO PN 1785161 EC 309949

CHANNEL SELECT OUT RELAY DRIVER AND CONTROL GATING			
E.C.-HISTORY	E-MACH#27RNB	FRAME	01
DATE LAST EC	IBP CORP.SDD	RC706	
04-14-81 344600	P.N. 4499504	081	

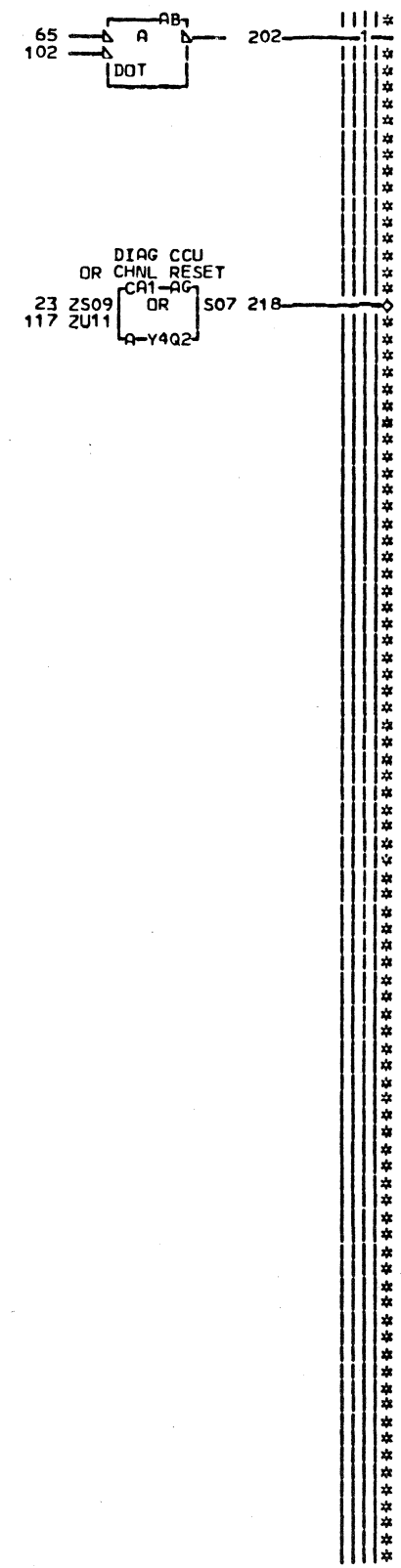
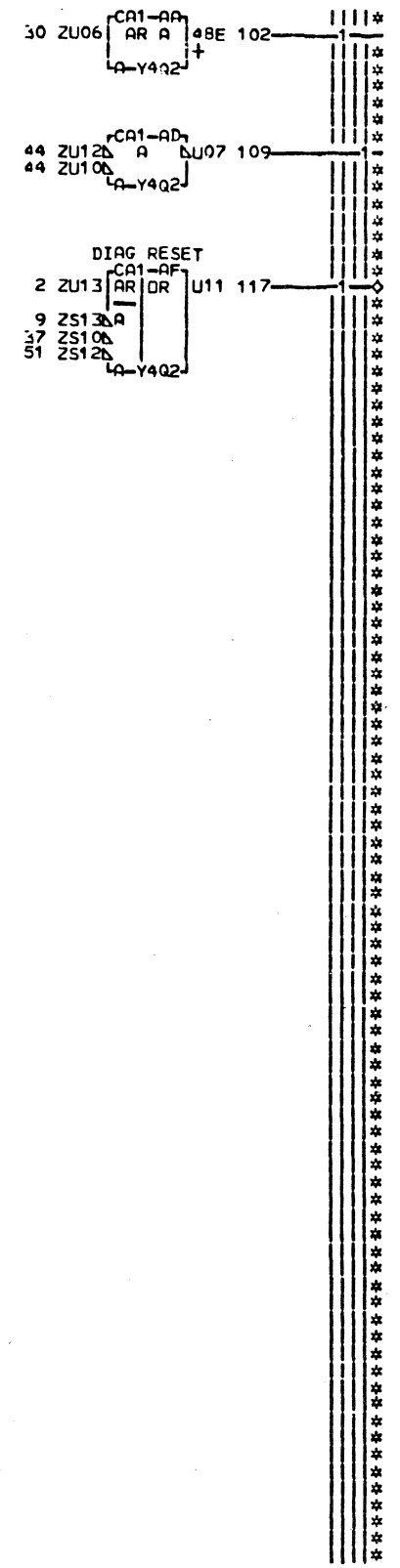
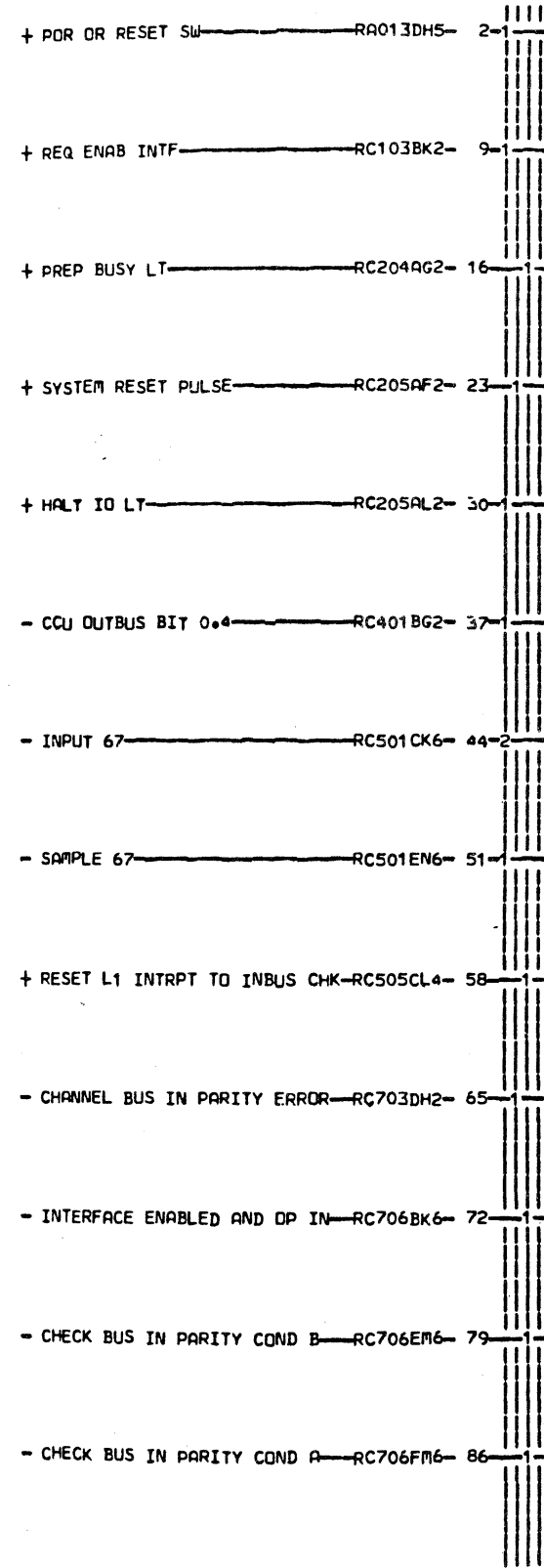

LOC. TYPE  
A-Y4Q2 6836

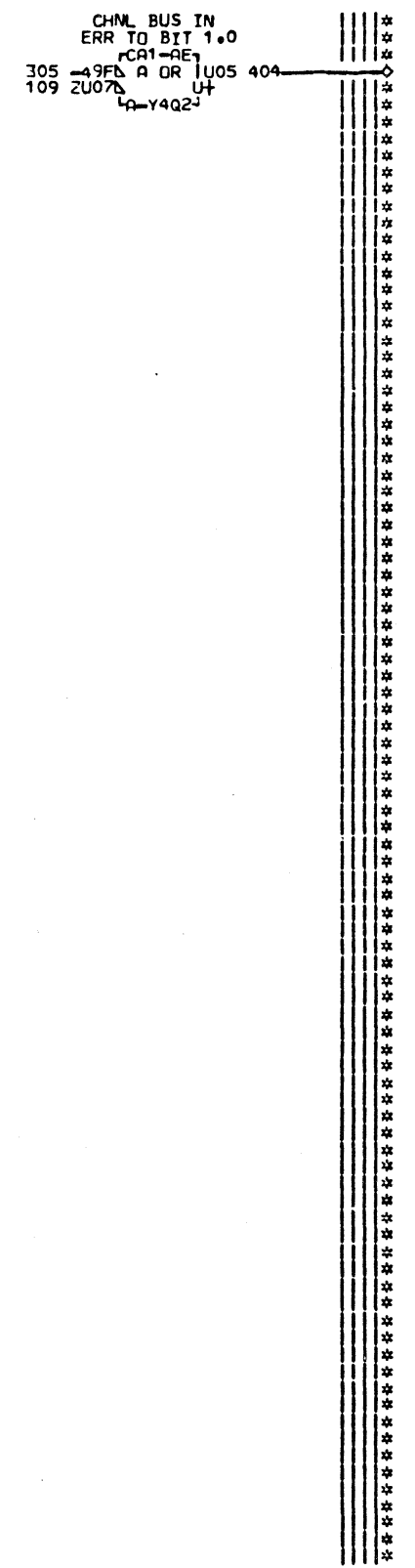
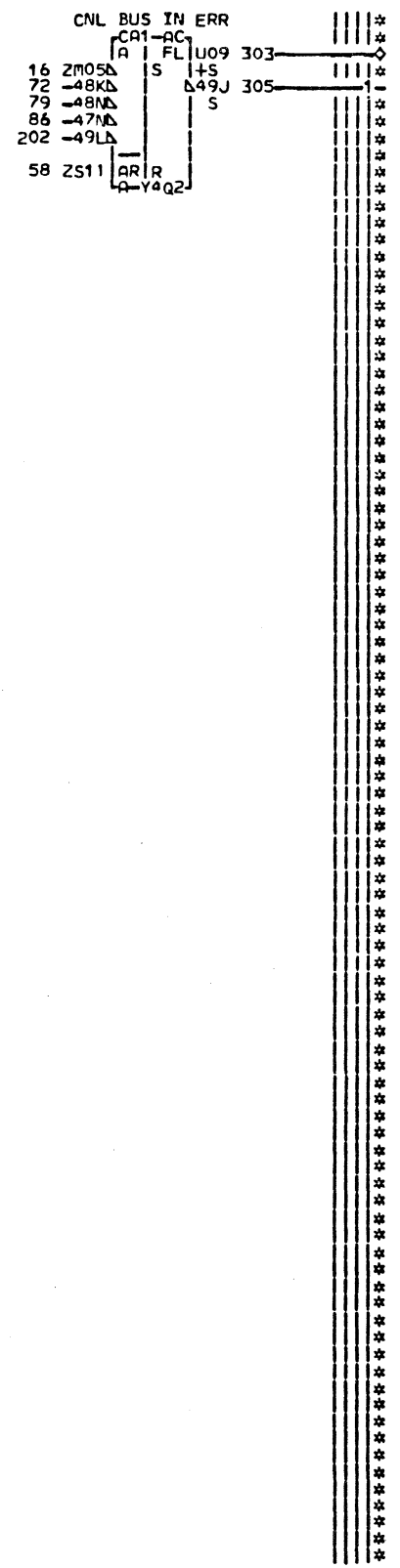

BUS IN ERROR LATCH AND RESET GENERATION	
E.C. HISTORY	MACH. 27RNB
30952C	
309541	FRAME 01
309545	IBM CORP. SDD RC707
DATE 12-27-72	LAST EC 309949
P.No. 1785162	000

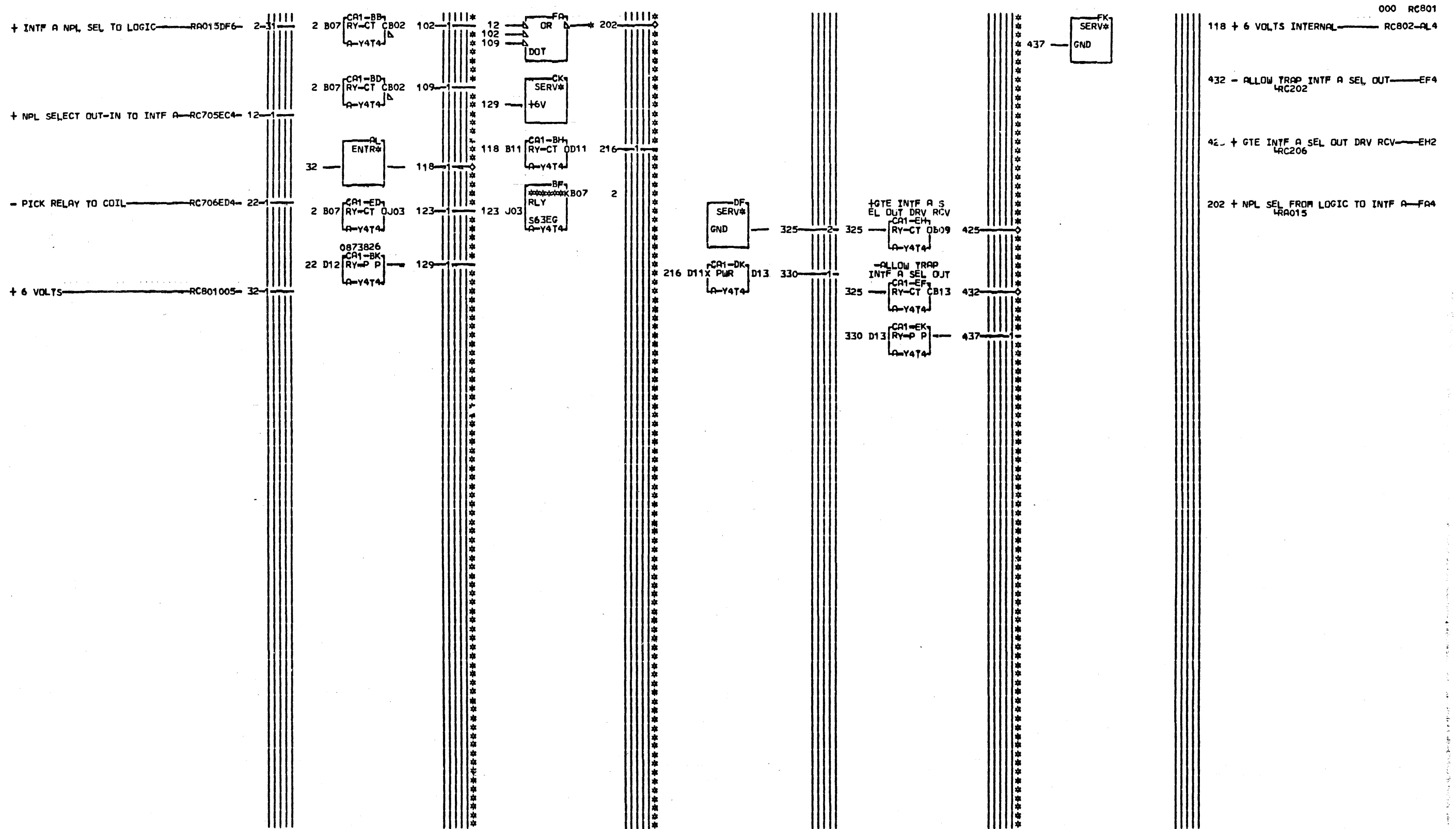

EDGE CONN.  
202 A-Y4V4D09  
01T-A1A3D09

LOC. TYPE  
A-Y4T4 N869

INTF A SELECT OUT RELAYS	
E.C. HISTORY	B. MACH. 27RNB
309522C	
309541	FRAME 01
309545	
309548	IBM CORP. SDD RC801
DATE	LAST EC
09-20-72	309944
	P.N. 1785163 000

RC801  
000

000 RC801

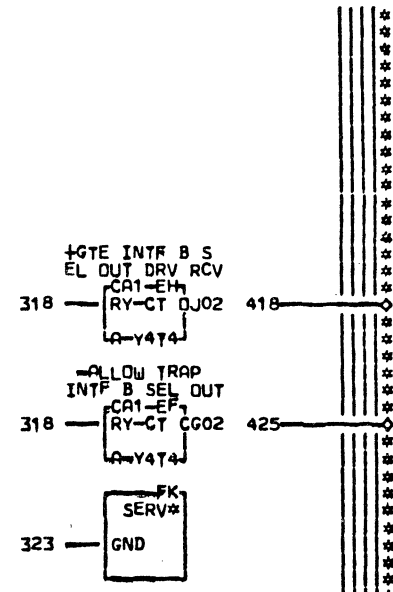
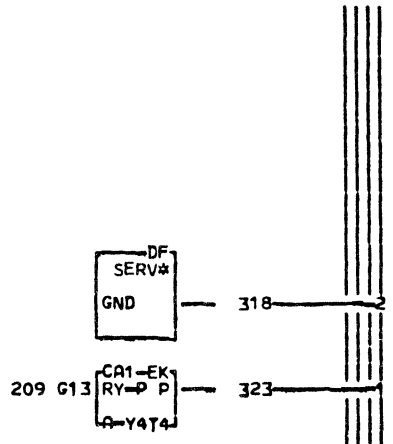
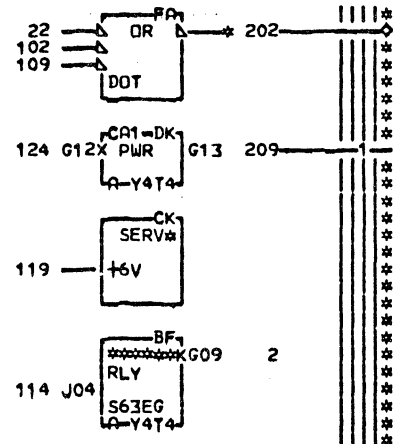
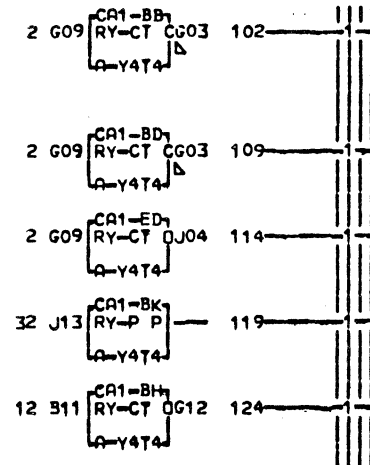
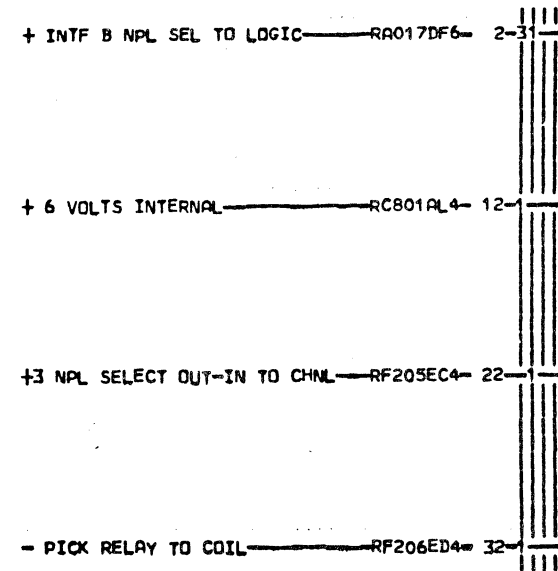

000 RC802

425 - ALLOW TRAP INTF B SEL OUT — EF4  
RC202

418 + GTE INTF B SEL OUT DRV RCV — EH2  
RF105

202 + NPL SEL FROM LOGIC TO INTF B — FA4  
RA017

EDGE CONN.  
202 A-Y4U4D09  
01U-A1A3D09

LOC. TYPE  
A-Y4T4 N869

RC802  
000

INTF B SELECT OUT RELAYS

E-C-HISTORY	B-MACH#27RNB
309522C	
309541	FRAME 01
309545	
309548	IBM CORP.SDD RC802
DATE LAST EC	
09-20-72 309944	P.N. 1785164 000

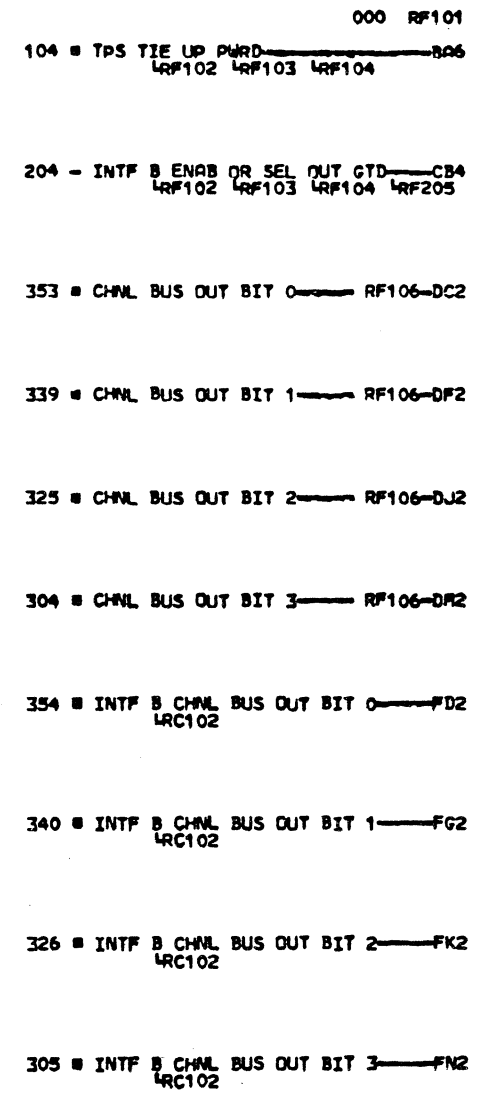
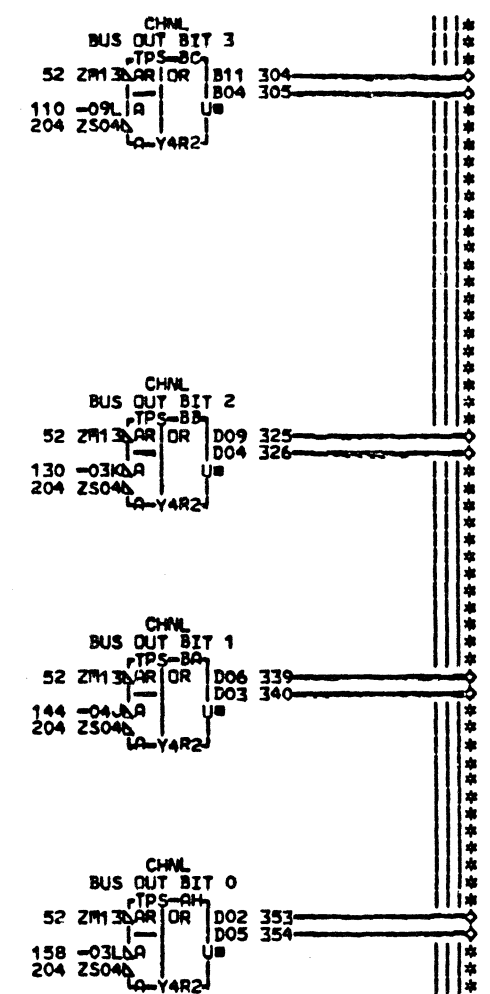
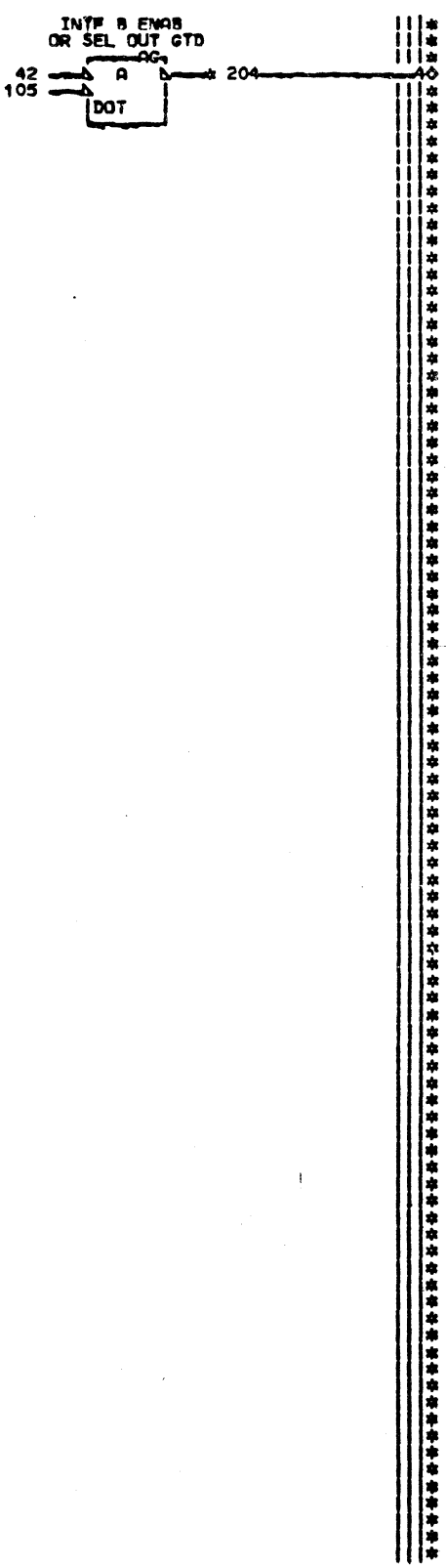
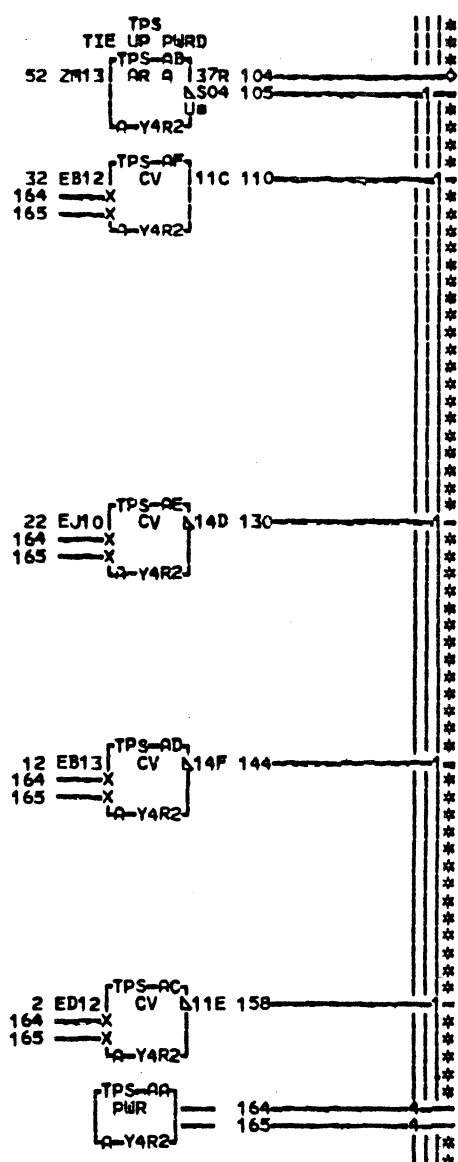
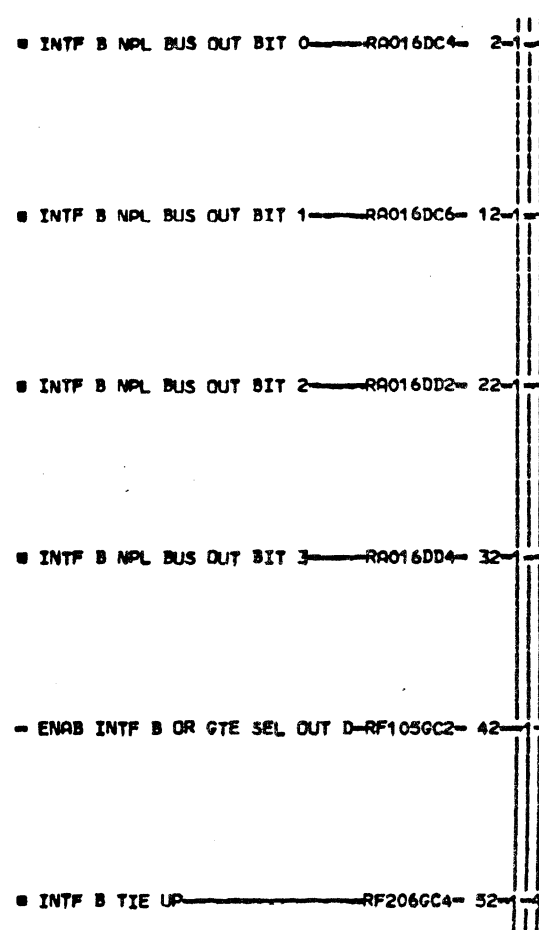

EDGE CONN.  
204 RESISTOR  
A-Y4R2504

LOC. TYPE  
A-Y4R2 6837

CHANNEL RECEIVERS AND DIAGNOSTIC REGISTER		
E.C.—HISTORY	B	FRAC#27RNB
309522C		
309541	FRAME	01
309545		
DATE	LAST EC	IBN CORP. SDD RF101
05-26-72	309548	P. No. 1785165 000

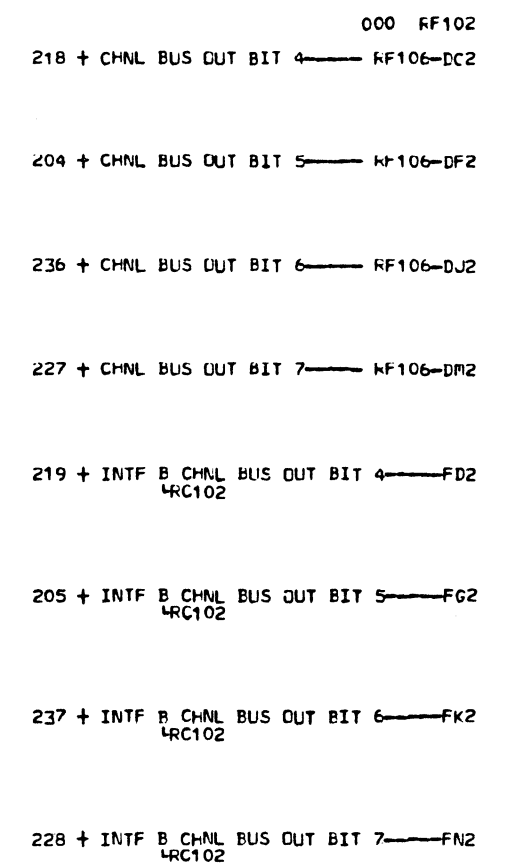
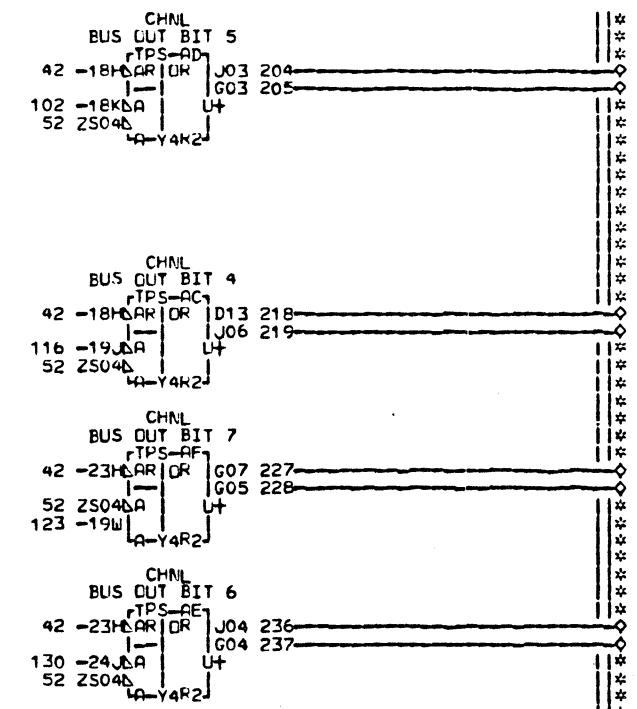
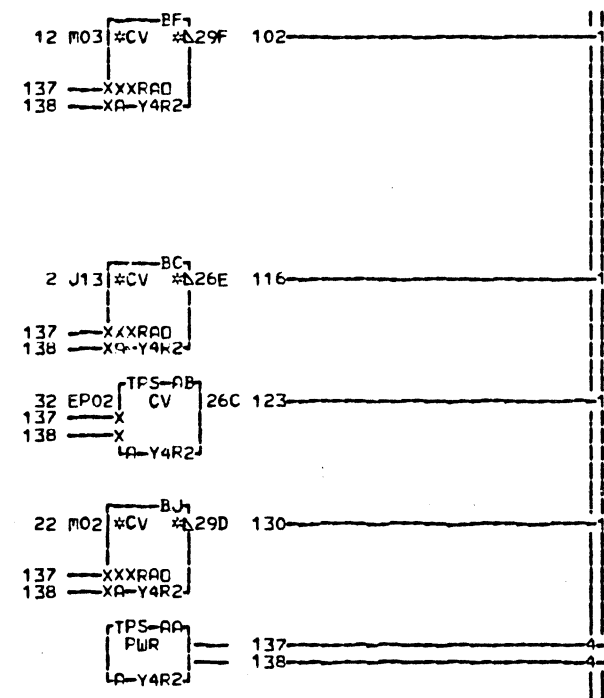
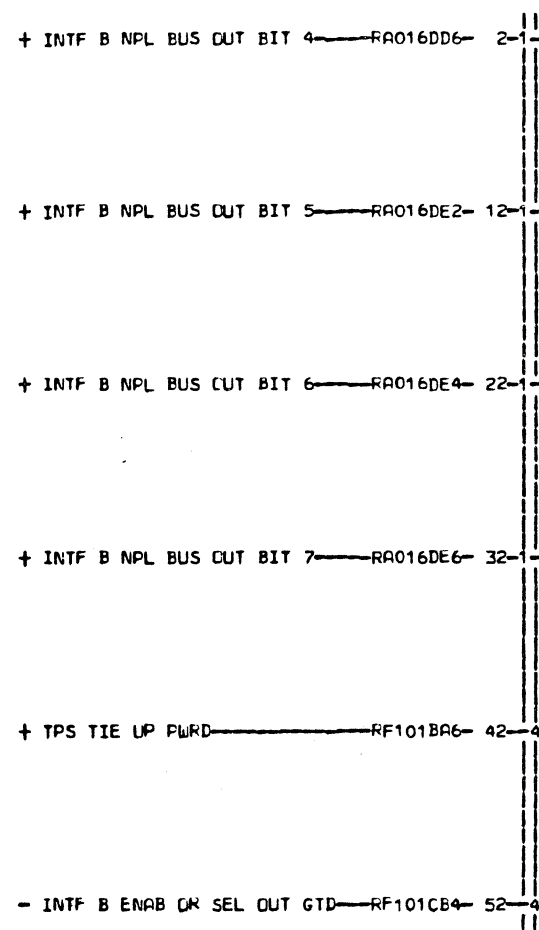

LCC TYPE  
A-Y4R2 6637

CHANNEL RECEIVERS AND DIAGNOSTIC REGISTER	
E.C.—HISTORY—	B. FRAC#27RNB
309522C	FRAP# 01
309541	IBM CORP.SDD
DATE LAST EC	P.No. 1785166
04-24-72 309545	000



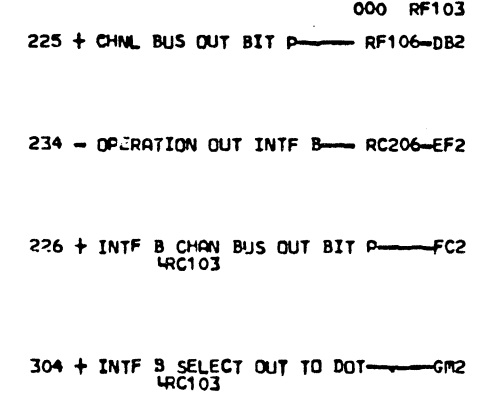
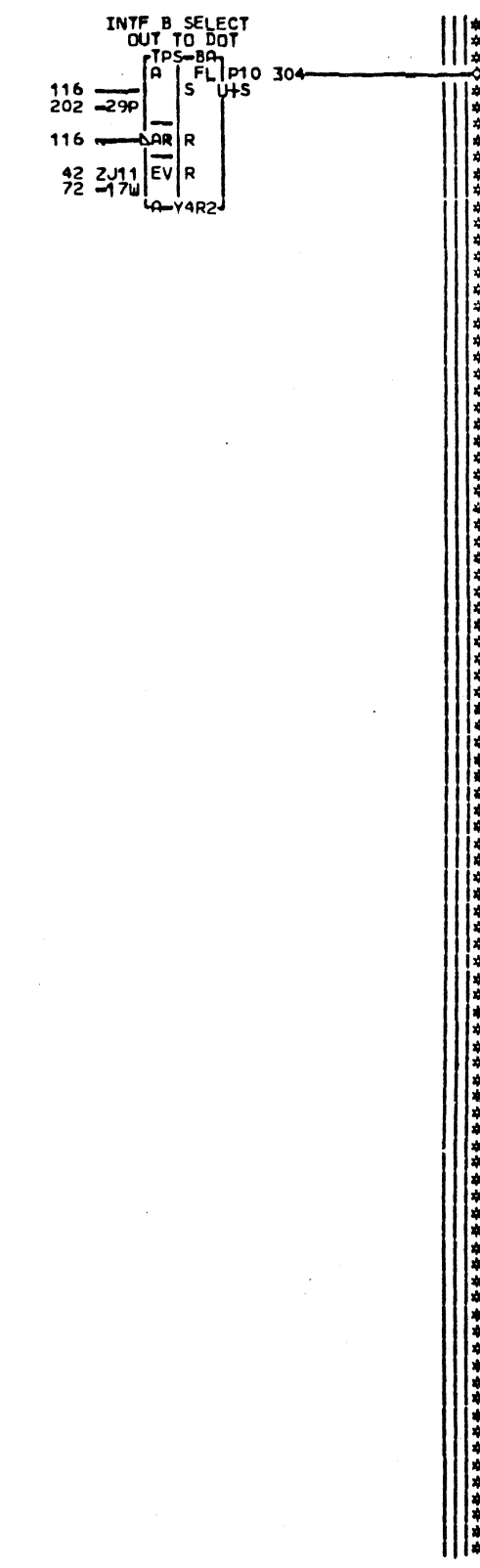
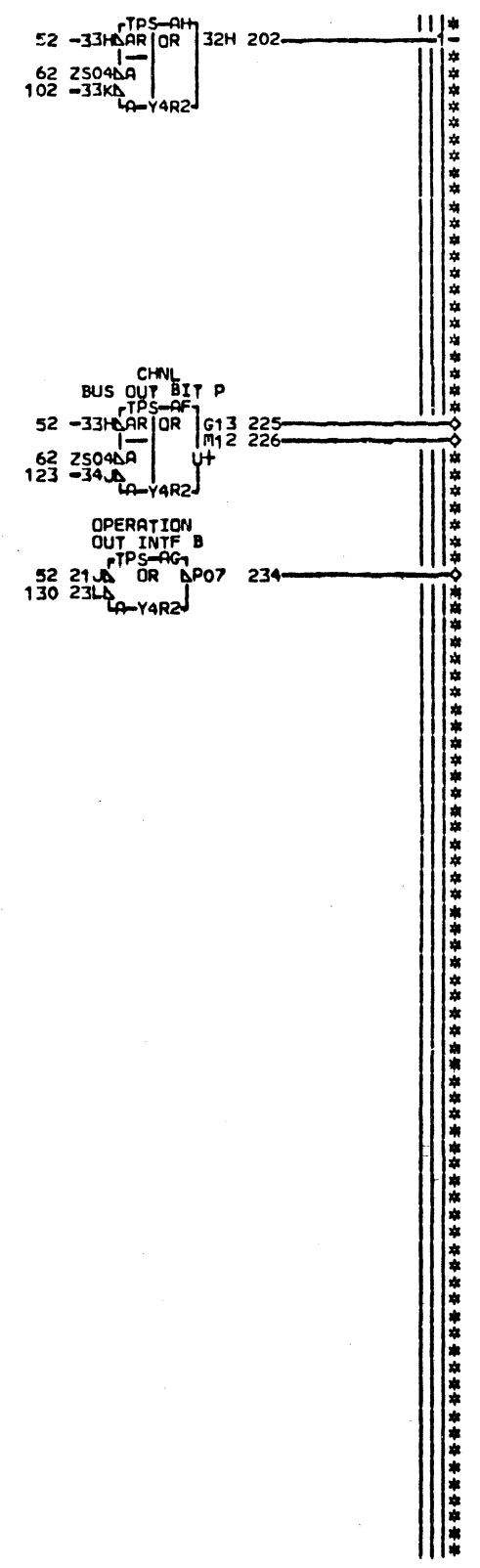
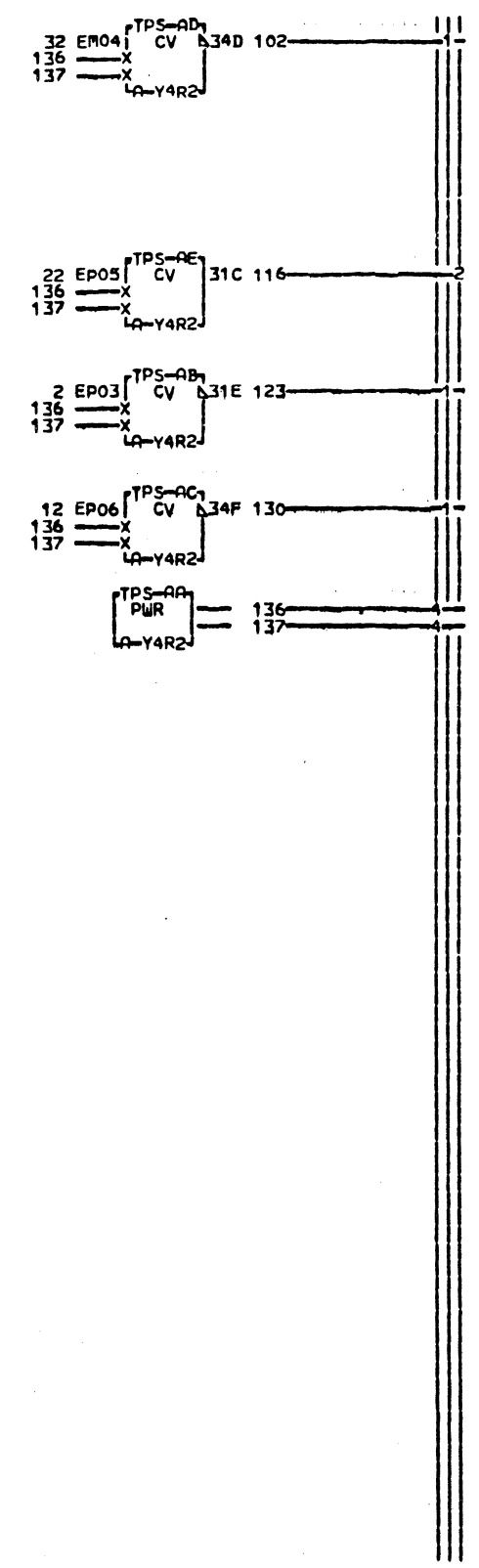
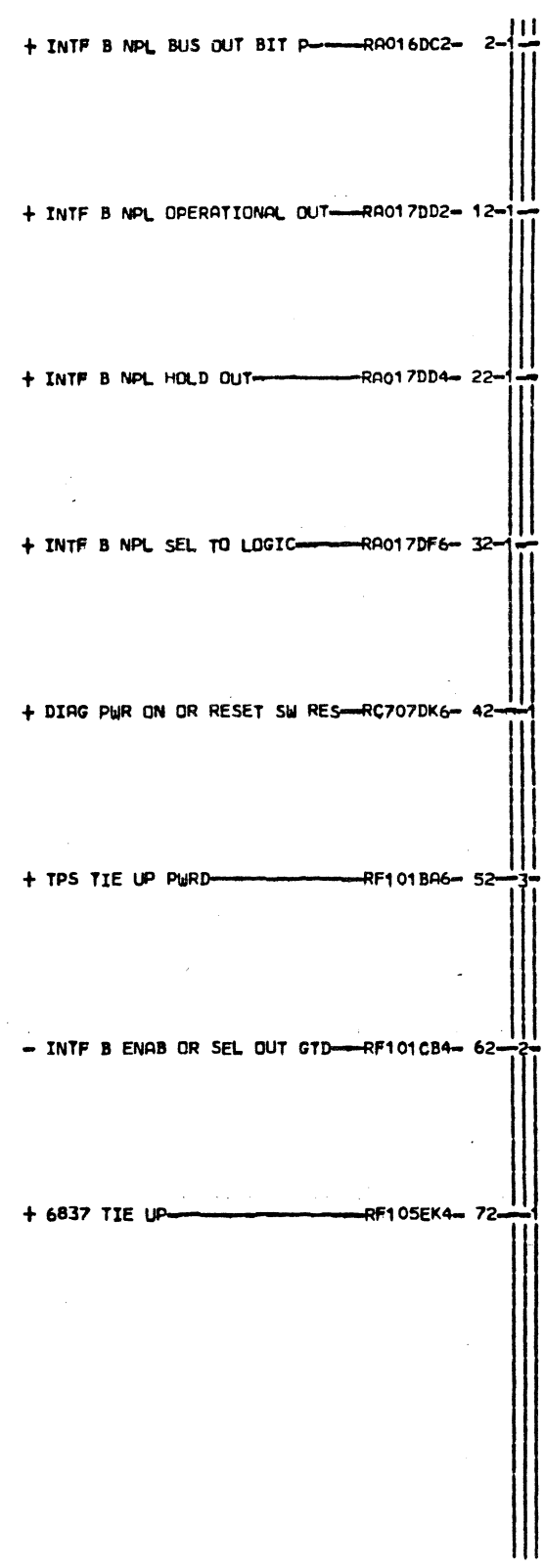

LDC. TYPE A-Y4R2 6837

CHANNEL RECEIVERS AND DIAGNOSTIC REGISTER	
E.C.—HISTORY	MACH. 27RNB
309522C	FRAME 01
309541	
309545	IBM CORP. SDD
309548	RF103
DATE LAST EC	P.No. 1785167
09-20-72 309944	000

+ INTF B MPL ADDRESS OUT—RA017DC2— 2-1

+ INTF B MPL COMMAND OUT—RA017DC4— 12-

+ INTF B MPL SERVICE OUT—RA017DC6— 22-

+ INTF B MPL SUPPRESS OUT—RA017DE2— 32-

+ TPS TIE UP PWRD—RF101BA6— 42-

- INTF B ENAB OR SEL OUT GTD—RF101CB4— 52-

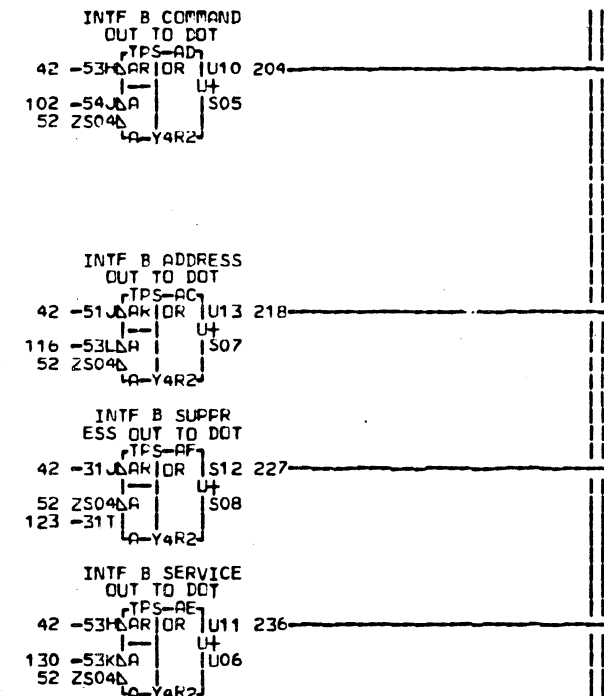
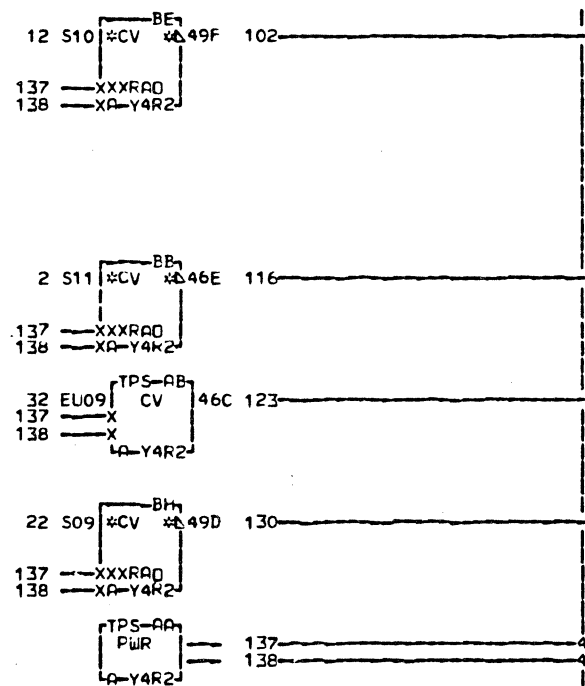

218 + INTF B ADDRESS OUT TO DOT—FC2  
4RC101

204 + INTF B COMMAND OUT TO DOT—FF2  
4RC101

236 + INTF B SERVICE OUT TO DOT—FJ2  
4RC101

227 + INTF B SUPPRESS OUT TO DOT—FM2  
4RC101

LDC TYPE  
A-Y4R2 6837

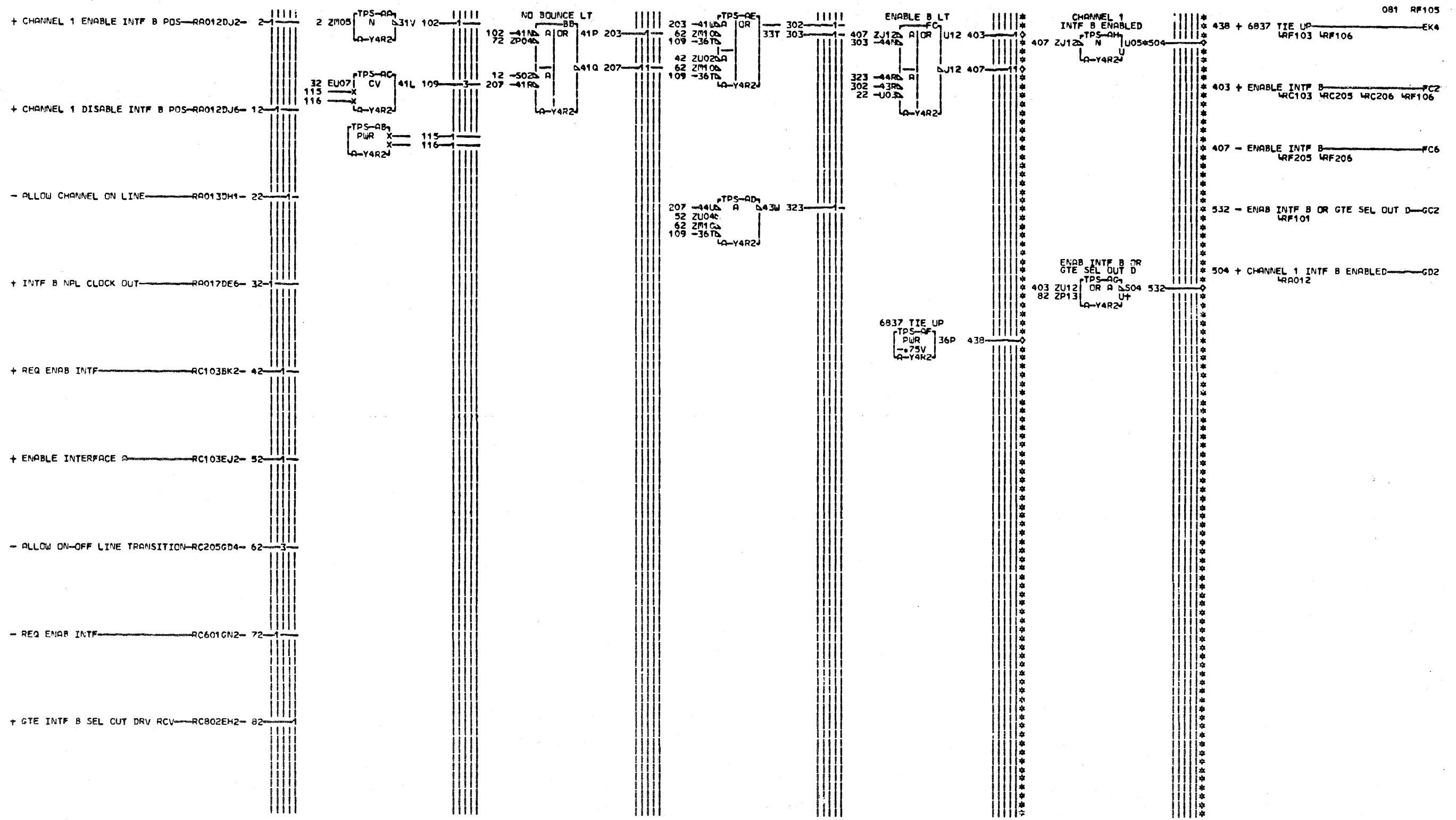

EDGE CONN.  
504 A-Y4C3D03

LDC. TYPE  
A-Y4R2 6837

RF105  
081 SIM TO PN 1785169 EC 309949

CHANNEL RECEIVERS AND DIAGNOSTIC REGISTER	
E.C.—HISTORY	MACH#27RMB
DATE LAST EC	FRAME 01
10-14-80 344270	IBM CORP. SCD RF105
	P.N. 1986993 081

104 + INTF B NSC ADDRESS VALID  
RC104

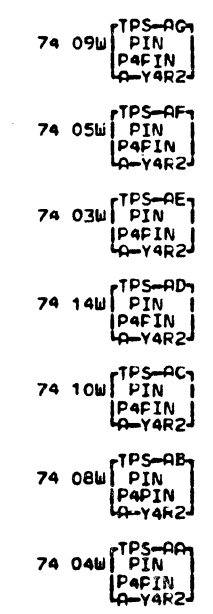
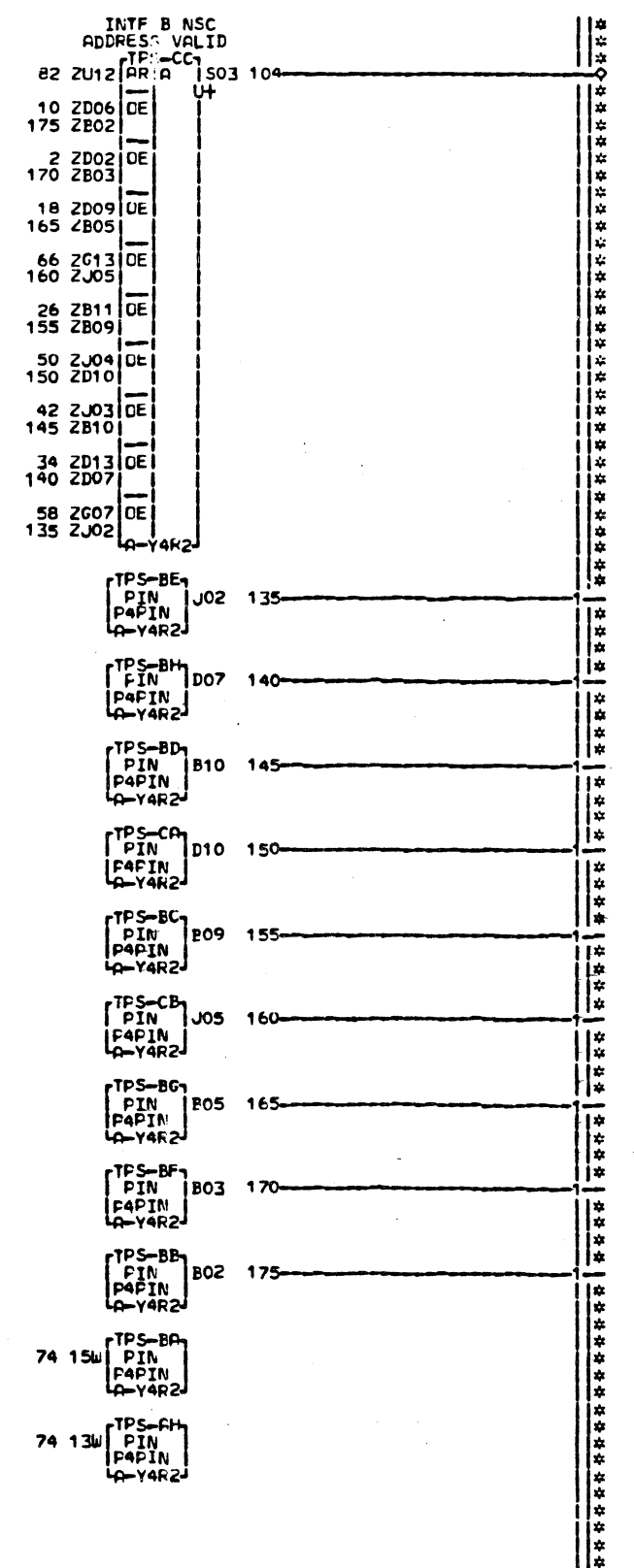
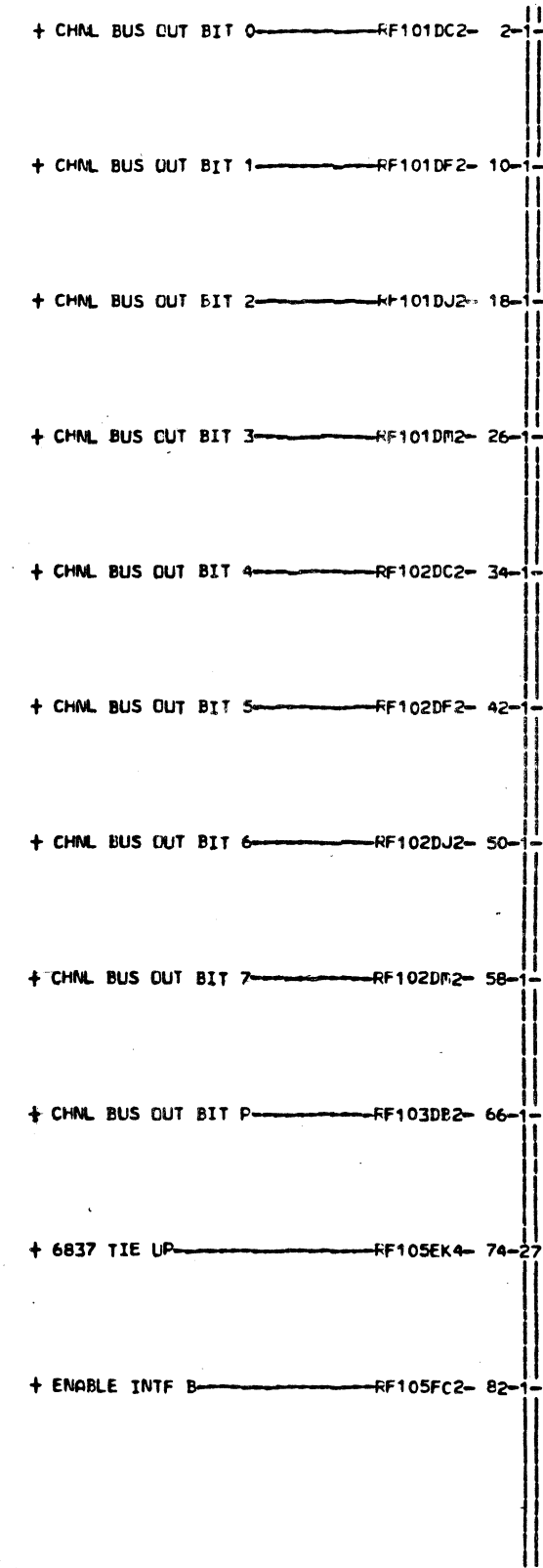

LOC. TYPE  
A-Y4F2 6837

CHANNEL RECEIVERS AND DIAGNOSTIC REG	
E-C-HISTORY	B-PACH-27RNB
309522C	FRAPF 01
309541	IBM CORP-SDD
DATE LAST EC	P.No. 1785170
04-24-72 309545	000

- LOCAL STORE BIT 0.0 TO DRVR—RC106CC6— 2-1
- LOCAL STORE BIT 0.1 TO DRVR—RC106CD6— 7-1
- LOCAL STORE BIT 0.2 TO DRVR—RC106CE6— 12-1
- SID ADR BIT 1.0—RC306BC6— 17-1
- SID ADR BIT 1.1—RC306BD6— 22-1
- SID ADR BIT 1.2—RC306BF6— 27-1
- LOCAL STORE BIT 1.0 TO DRVR—RC307DC6— 32-1
- LOCAL STORE BIT 1.1 TO DRVR—RC307DD6— 37-1
- LOCAL STORE BIT 1.2 TO DRVR—RC307DF6— 42-1
- ATTN STATUS TO DRIVER—RC601FC6— 47-1
- STAT MOD STATUS TO DRIVER—RC601FD6— 52-1
- CU END STATUS TO DRIVER—RC601FE6— 57-1
- GATE ADDRESS TO CHANNEL—RF206CF6— 62-3
- GATE SENSE OR STATUS TO CHAN—RF206CG6— 67-3
- GATE DATA BYTE 1 TO CHANNEL—RF206CH6— 72-3
- GATE DATA BYTE 2 TO CHANNEL—RF206CJ6— 77-3
- + INTF B TIE UP—RF206GC4— 82-2
- + GEN CTRL UNIT BUSY STATUS—RF206GN2— 87-2

EDGE CONN.  
 220 A-Y4U3D05  
 303 A-Y4U3B05  
 310 A-Y4U3D06

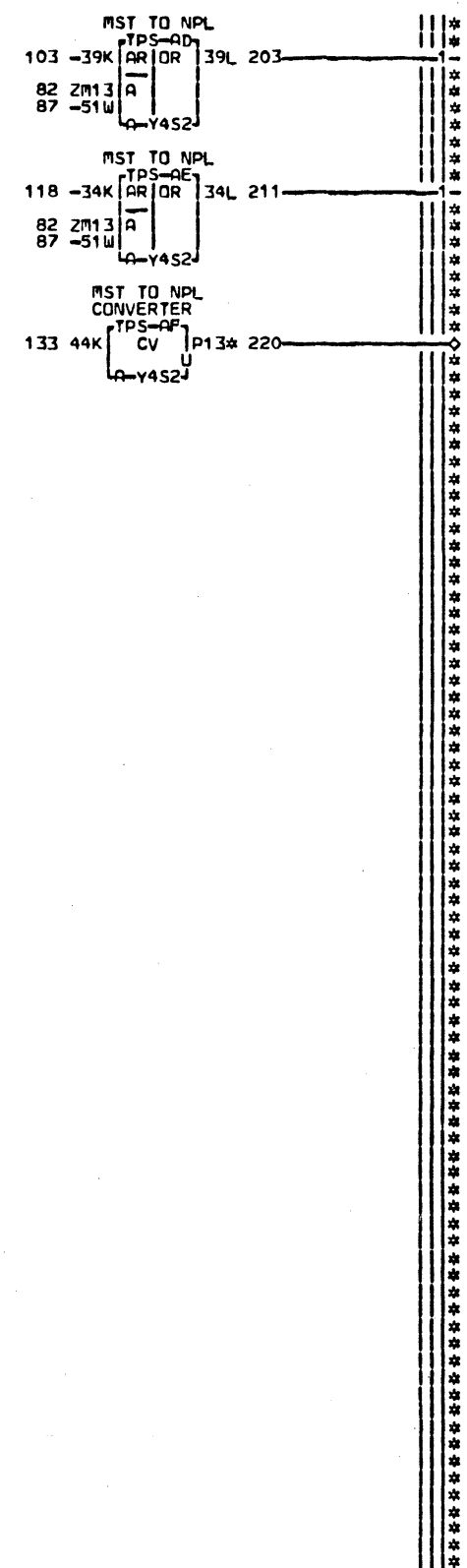
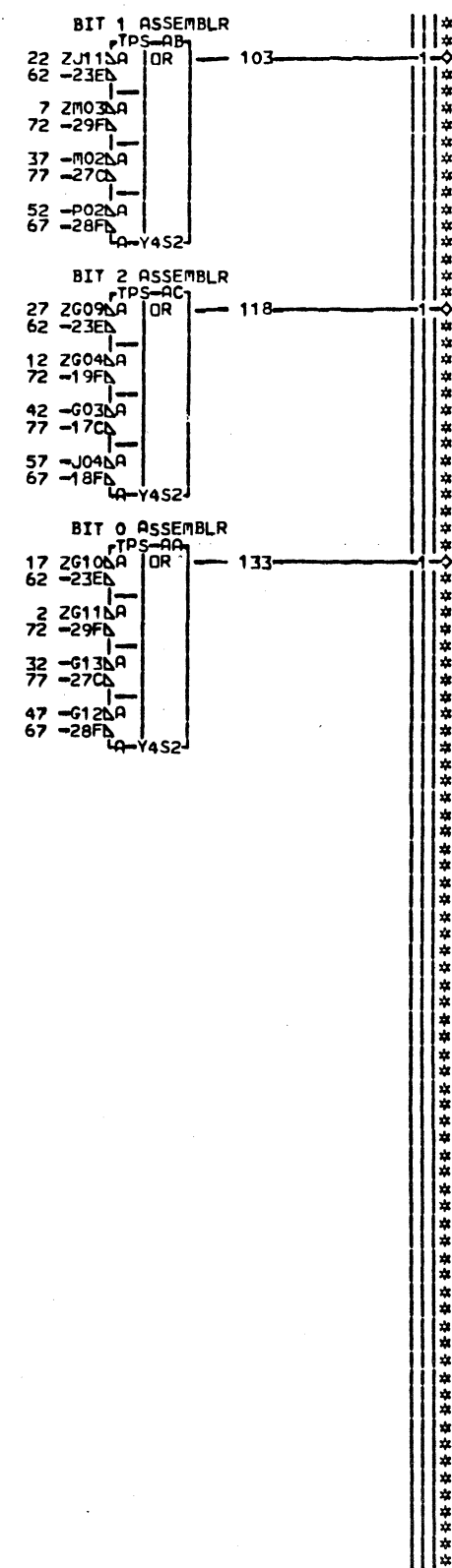

LOC. TYPE  
 A-Y4S2 6836

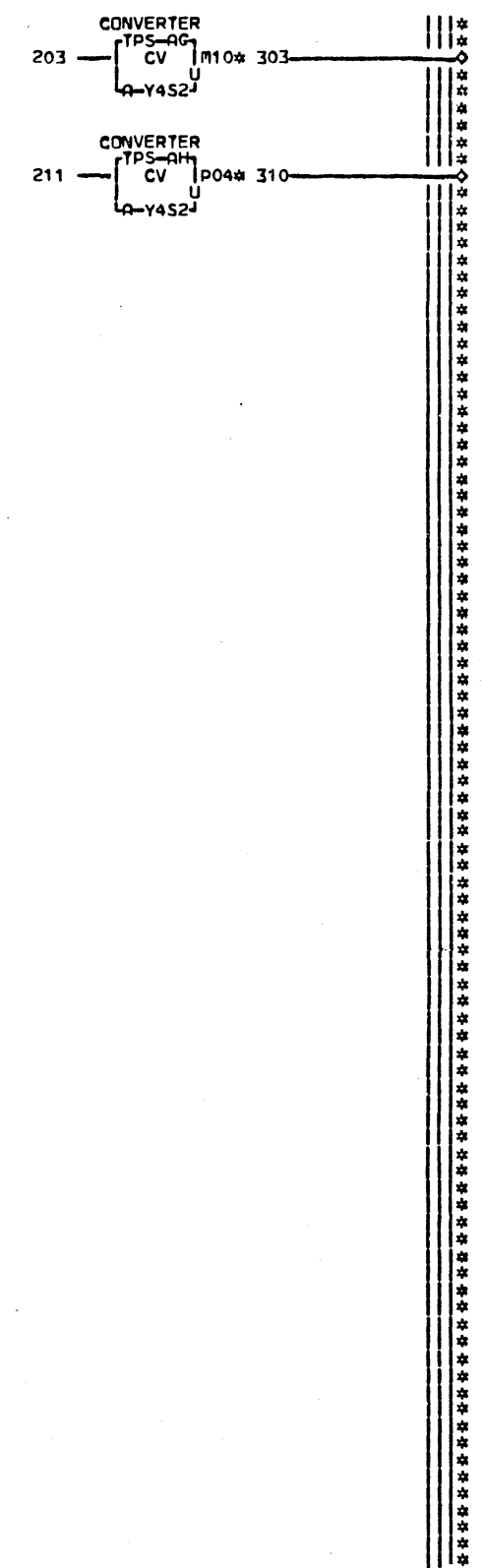

- 133 + BUS IN BIT 0 ASSEMBLED— RF203-BB4
- 103 + BUS IN BIT 1 ASSEMBLED— RF203-BF4
- 118 + BUS IN BIT 2 ASSEMBLED— RF203-BK4
- 220 + NPL BIT 0 TO INTF B— RA016-EC4
- 303 + NPL BIT 1 TO INTF B— RA016-EG4
- 310 + NPL BIT 2 TO INTF B— RA016-EL4

CHANNEL DRIVERS BUS IN	
BITS 0 1 2	
E.C.—HISTORY	B MACH#27RNB
309522C	FRAME 01
309541	IBM CORP.SDD
309545	P.N. 1785171
DATE LAST EC	06-16-72 309533
	RF201 000

- LOCAL STORE BIT 0.3 TO DRVR—RC106CF6— 2-1
- LOCAL STORE BIT 0.4 TO DRVR—RC106CG6— 7-1
- LOCAL STORE BIT 0.5 TO DRVR—RC106CH6— 12-1
- SID ADR BIT 1.3—RC306BG6— 17-1
- SID ADR BIT 1.4—RC306BH6— 22-1
- SID ADR BIT 1.5—RC306BK6— 27-1
- LOCAL STORE BIT 1.3 TO DRVR—RC307DG6— 32-1
- LOCAL STORE BIT 1.4 TO DRVR—RC307DH6— 37-1
- LOCAL STORE BIT 1.5 TO DRVR—RC307DK6— 42-1
- BUSY STATUS TO DRIVER—RC601EF6— 47-1
- CHAN END STATUS TO DRIVER—RC601FG6— 52-1
- DEVICE END STATUS TO DRIVER—RC601FH6— 57-1
- GATE ADDRESS TO CHANNEL—RF206CF6— 62-3
- GATE SENSE DR STATUS TO CHAN—RF206CG6— 67-3
- GATE DATA BYTE 1 TO CHANNEL—RF206CH6— 72-3
- GATE DATA BYTE 2 TO CHANNEL—RF206CJ6— 77-3
- + GEN CTRL UNIT BUSY STATUS—RF206GN2— 82-1

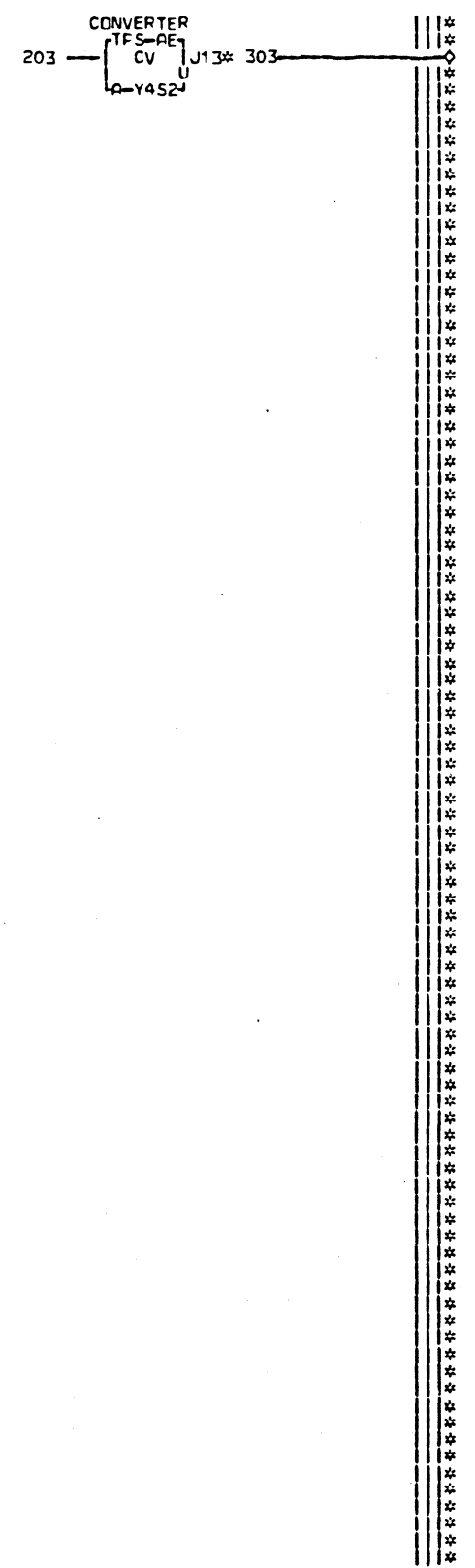
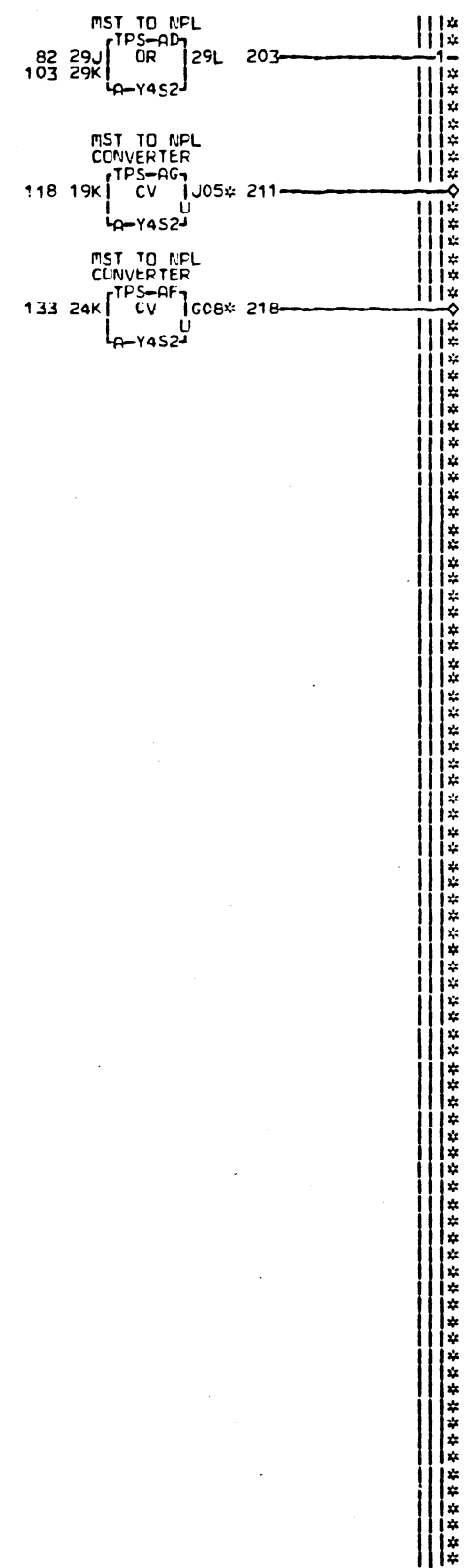
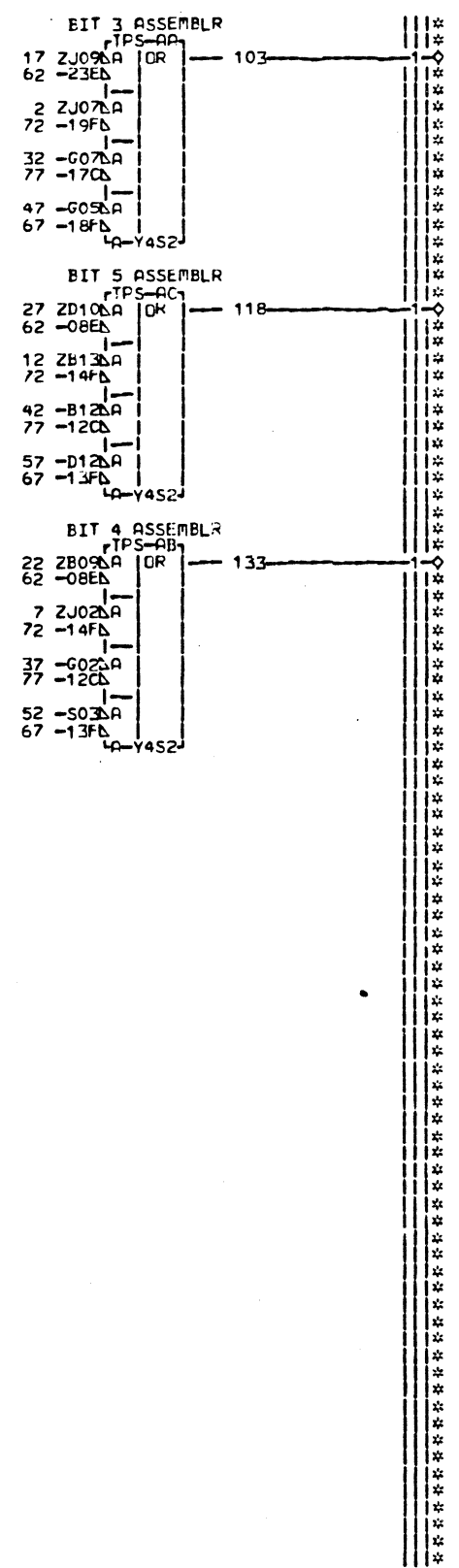

- 000 RF202
- 103 + BUS IN BIT 3 ASSEMBLER— RF203-BB4
- 133 + BUS IN BIT 4 ASSEMBLER— RF203-BF4
- 118 + BUS IN BIT 5 ASSEMBLER— RF203-BK4
- 303 + NPL BIT 3 TO INTF B— RA016-EL4
- 218 + NPL BIT 4 TO INTF B— RA016-EG4
- 211 + NPL BIT 5 TO INTF B— RA016-EL4

EDGE CONN.  
 211 P-Y4L3B10  
 218 P-Y4L3D09  
 01A-Y4L3D10  
 303 P-Y4L3B08  
 01A-Y4L3B09

LOC. TYPE  
 A-Y4S2 6836

CHANNEL DRIVERS BUS IN	
BITS 3 4 5	
E.C.—HISTORY—	B-MACH.—27RMB
309522C	
309541	FRAME 01
DATE LAST EC	IBM CORP.—SDD RF202
04-24-77 309545	File No 1785172 000

- LOCAL STORE BIT 0\*P TO DRV-RC106CB6- 2-1
- LOCAL STORE BIT 0\*6 TO DRV-RC106CJ6- 5-1
- LOCAL STORE BIT 0\*7 TO DRV-RC106CK6- 8-1
- SID ADR PTY 1\*0-1\*7-RC306BB6- 11-1
- SID ADR BIT 1\*6-RC306BL6- 14-1
- SID ADR BIT 1\*7-RC306BM6- 17-1
- LOCAL STORE BIT 1\*P TO DRV-RC307DB6- 20-1
- LOCAL STORE BIT 1\*6 TO DRV-RC307DL6- 23-1
- LOCAL STORE BIT 1\*7 TO DRV-RC307DM6- 26-1
- UNIT CHECK STATUS TO DRIVER-RC601FJ6- 29-1
- UNIT EXCEPT STATUS TO DRIVER-RC601FK6- 32-1
- PARITY STATUS TO DRIVER-RC601GM4- 35-1
- + BUS IN BIT 0 ASSEMBLED-RF201BB4- 38-1
- + BUS IN BIT 1 ASSEMBLED-RF201BF4- 41-1
- + BUS IN BIT 2 ASSEMBLED-RF201BK4- 44-1
- + BUS IN BIT 3 ASSEMBLED-RF202BB4- 47-1
- + BUS IN BIT 4 ASSEMBLED-RF202BF4- 50-1
- + BUS IN BIT 5 ASSEMBLED-RF202BK4- 53-1
- INTERFACE ENABLED AND CP IN-RF206BK6- 56-1
- GATE ADDRESS TO CHANNEL-RF206CF6- 59-3
- GATE SENSE OR STATUS TO CHAN-RF206CG6- 62-3
- GATE DATA BYTE 1 TO CHANNEL-RF206CH6- 65-3
- GATE DATA BYTE 2 TO CHANNEL-RF206CJ6- 68-3
- + GEN CTRL UNIT BUSY STATUS-RF206GN2- 71-1

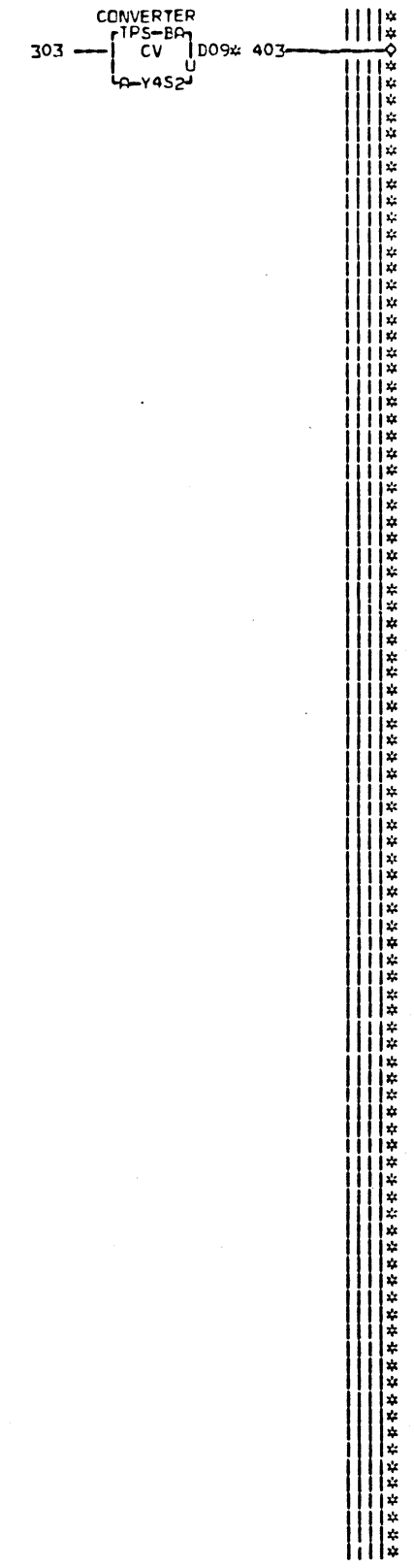
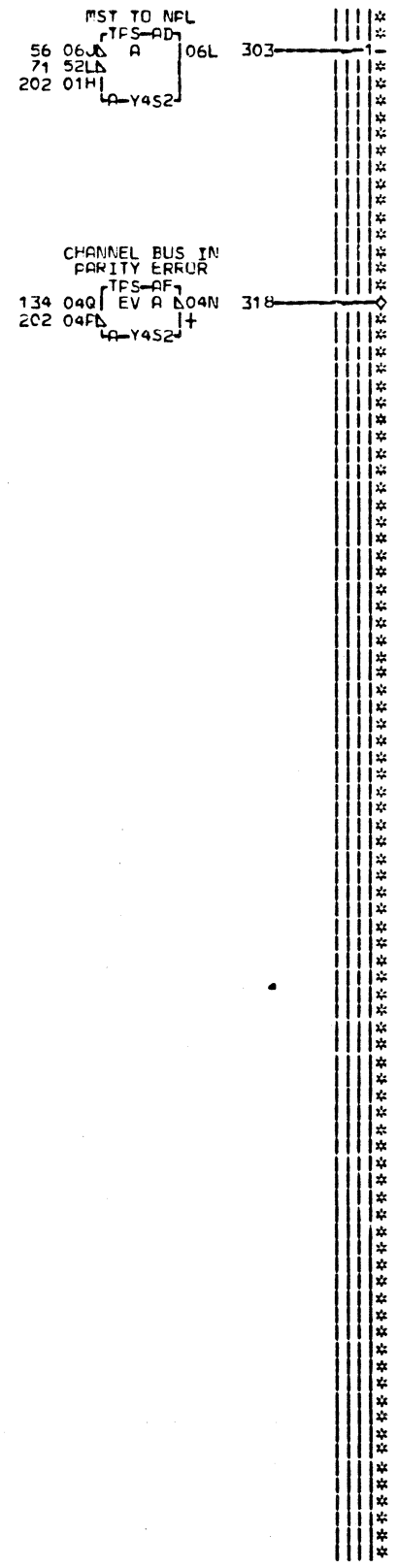
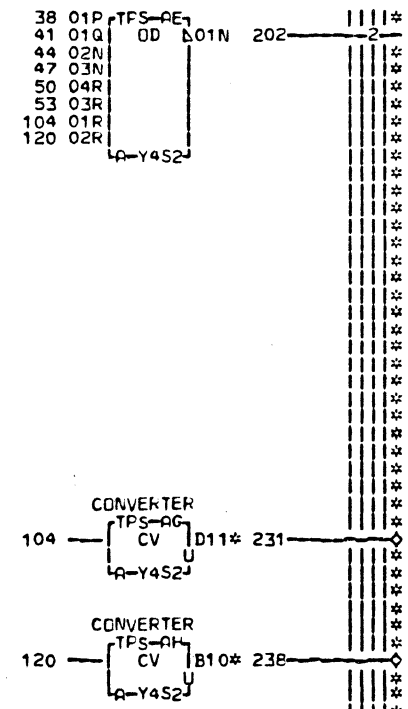
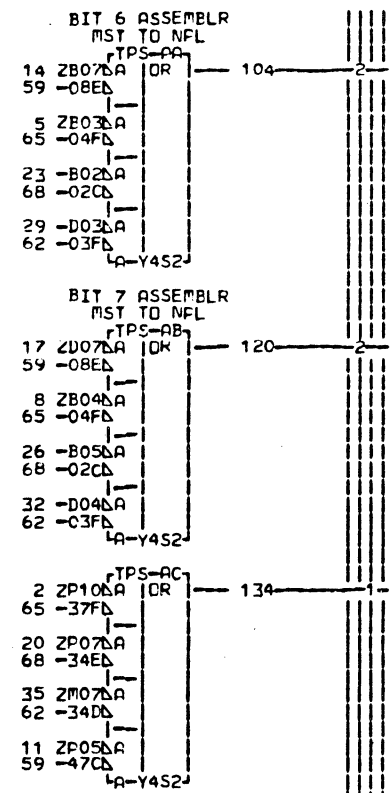

- 318 - CHANNEL BUS IN PARITY ERROR-DH2- RF207
- 231 + MPL BIT 6 TO INTF B- RA016-EC4
- 238 + MPL BIT 7 TO INTF B- RA016-EG4
- 403 + MPL BIT P TO INTF B- RA016-EL4

EDGE CONN.  
231 A-Y4U3D11  
238 A-Y4U3E12  
403 A-Y4U3B02

LCC. TYPE  
A-Y4S2 6F36

CHANNEL DRIVERS BUS IN	
BITS 6 7 P	
E-C-HISTORY	B-PACH-27RAB
309522C	FRAME 01
309541	IBP CORP.SDD RF203
DATE LAST EC	P.No. 1785173 000
04-24-72 309545	

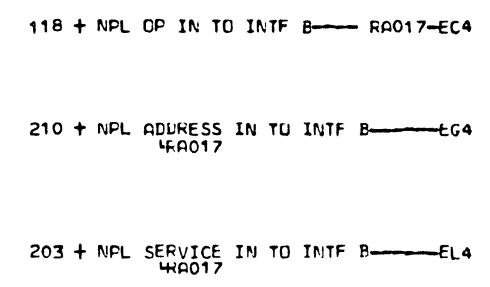
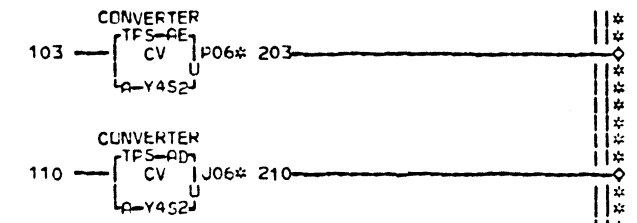
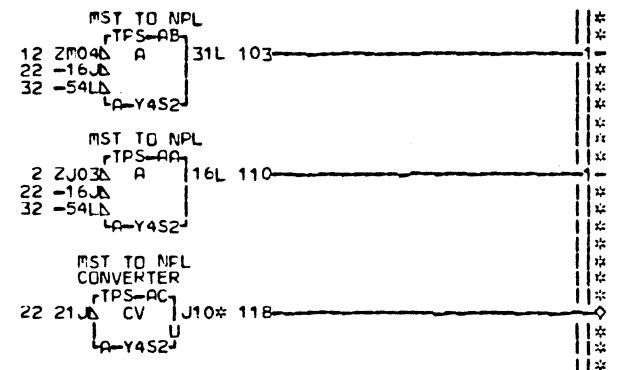
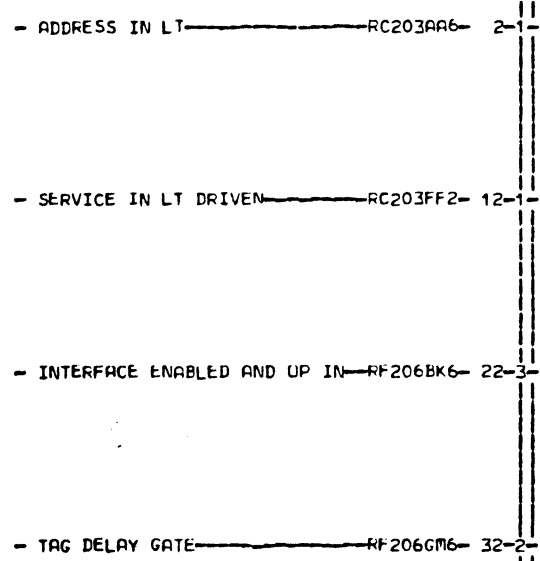

EDGE CONN.  
 118 A-Y4U4B02  
 203 A-Y4U4D06  
 210 A-Y4U4B05

LOC. TYPE  
 A-Y4S2 6836

CHANNEL DRIVERS	
CP IN ADDR IN AND SERVICE IN	
E.C. HISTORY	B1 MACH. 27RAB
309522C	
309541	FRAME 01
DATE LAST EC	IBM CORP. SDD
09-24-72 309545	P.N. 1785174

RF204 000



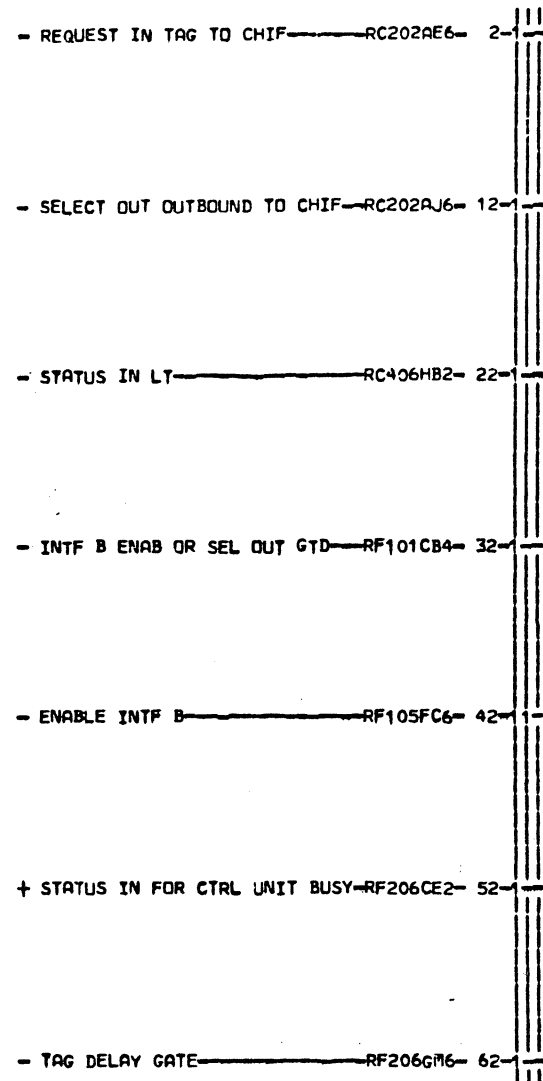

EDGE CONN.  
217 A-Y4U5D06  
303 A-Y4U4D05

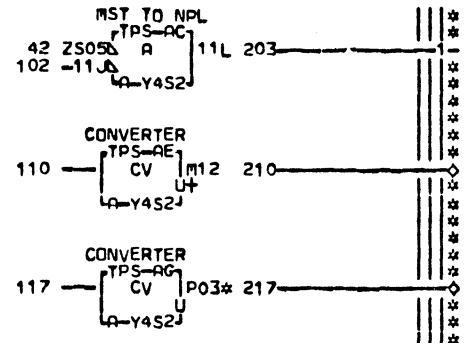
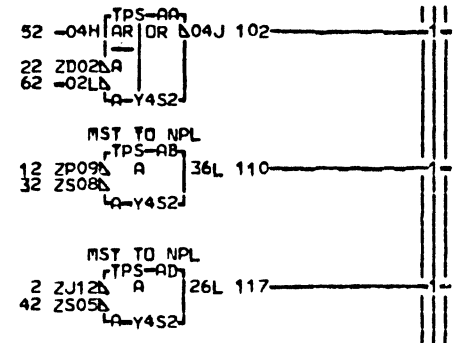

LOC. TYPE  
A-Y4S2 6836

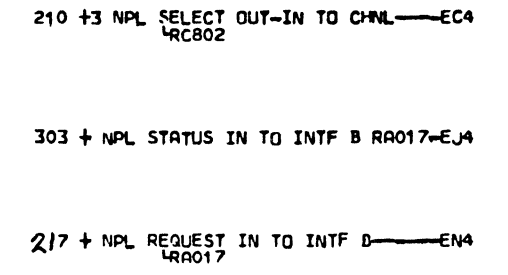
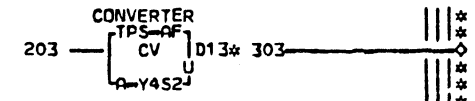

CHANNEL DRIVERS	
SELECT IN REQ IN AND STATUS IN	
E-C-HISTORY	B-MACH-27RNB
30952C	
309541	FRAME 01
309545	
DATE LAST EC	IBM CORP.SDD RF205
09-20-72 309944	P.No. 1785175 000

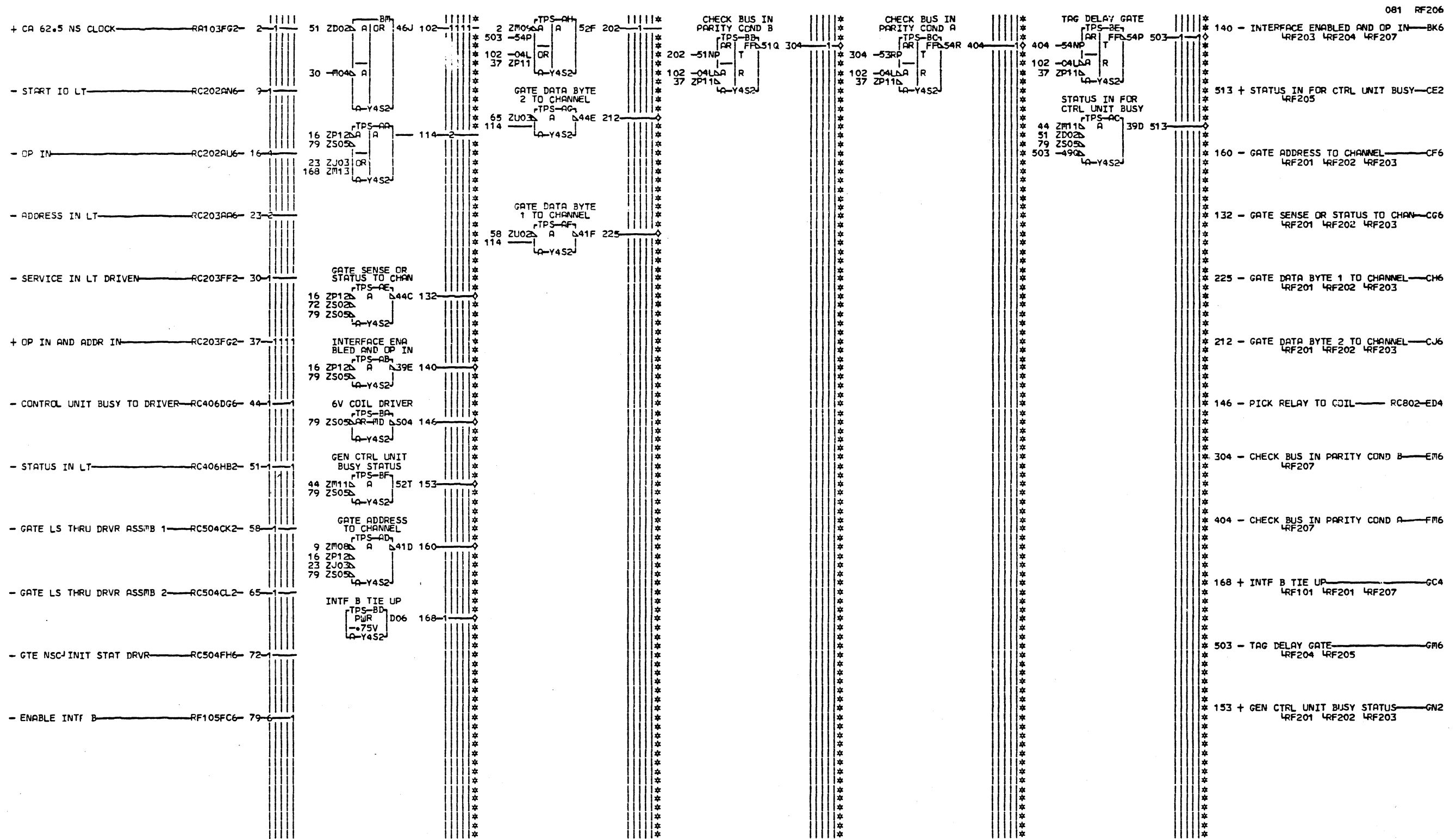

PF206  
 081 SIM TO FN 1785176 EC 309949

LOC. TYPE  
 A-Y4S2 6836

CHANNEL SELECT OUT RELAY DRVR AND CONTROL GATING	
E.C.-HISTORY	E.MACH.#27RNB
FRAME	01
DATE LAST EC	IBM CORP.SDD RF206
04-14-81 344600	P.N. 4499505 081

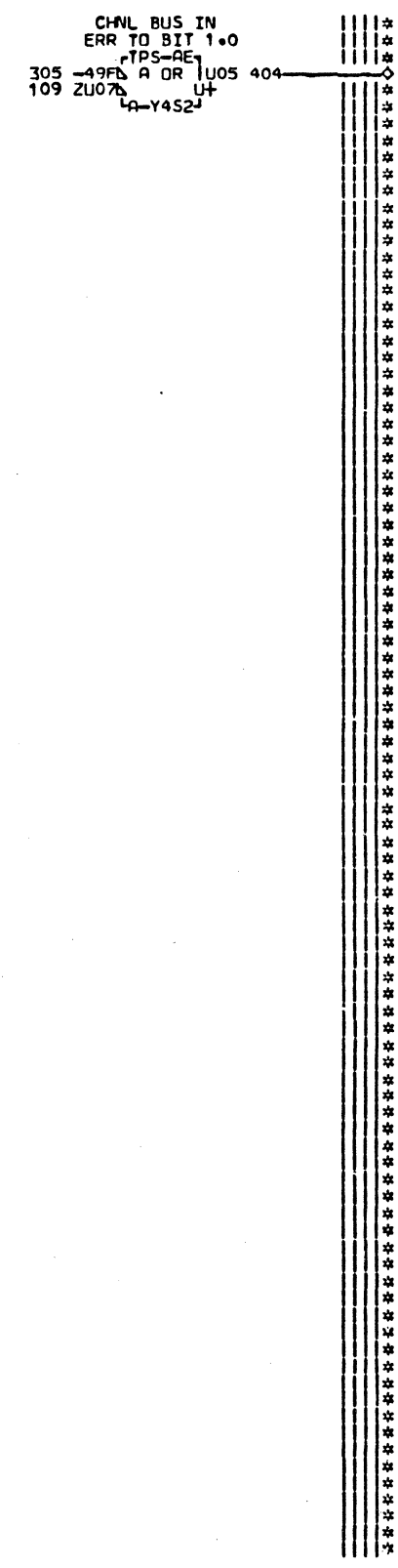
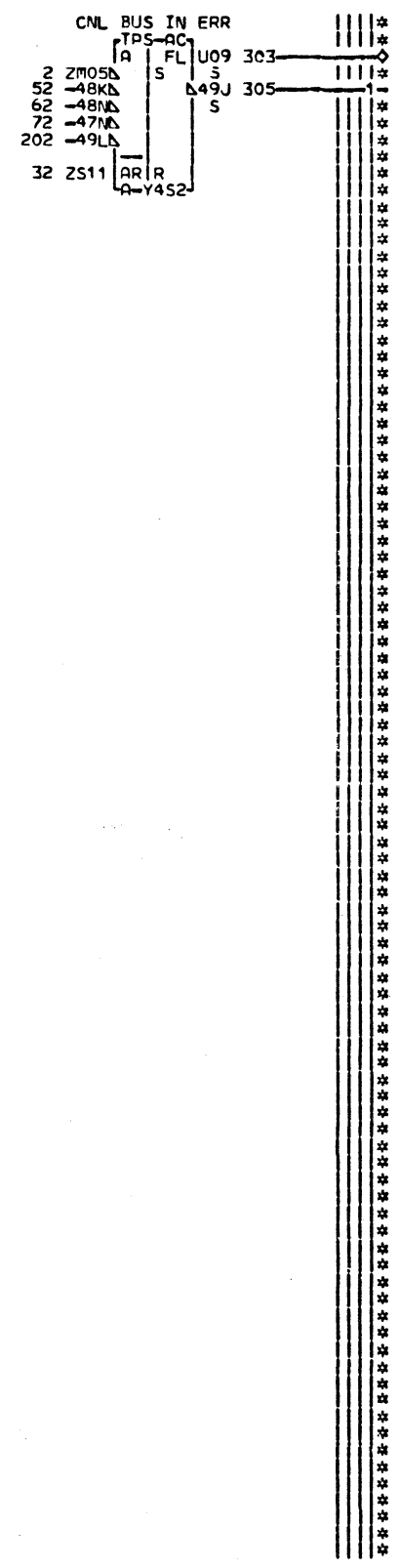
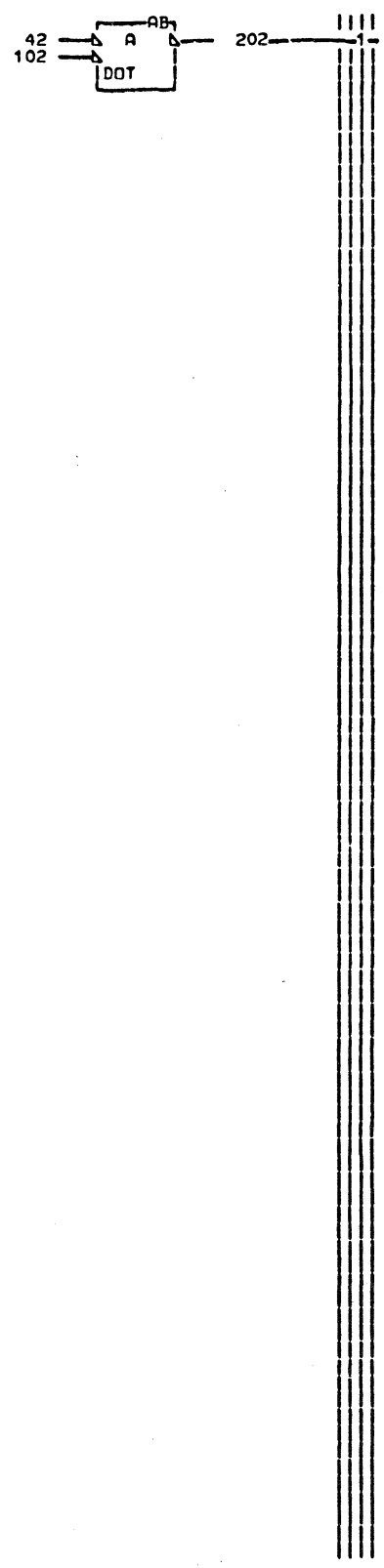
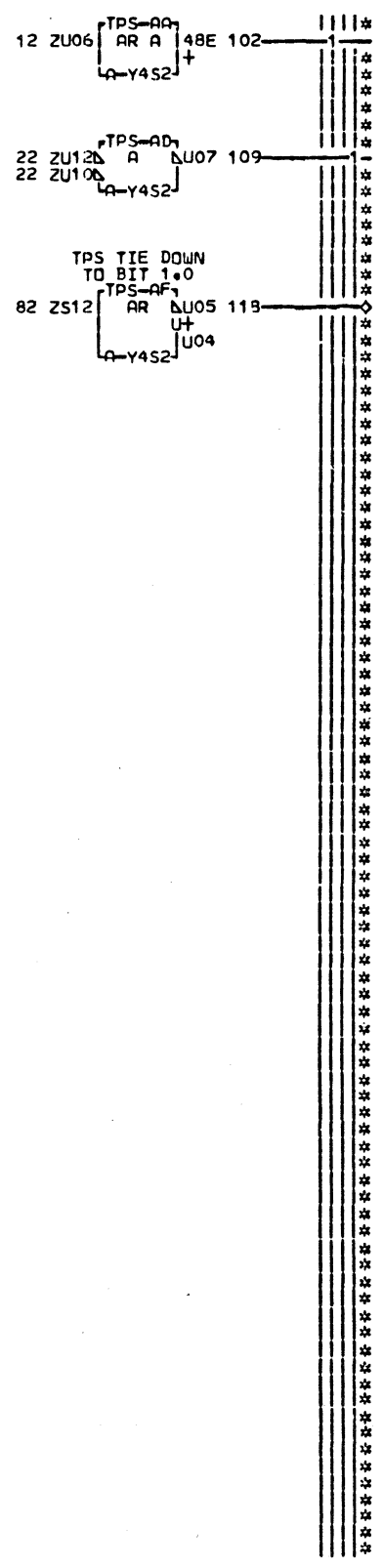
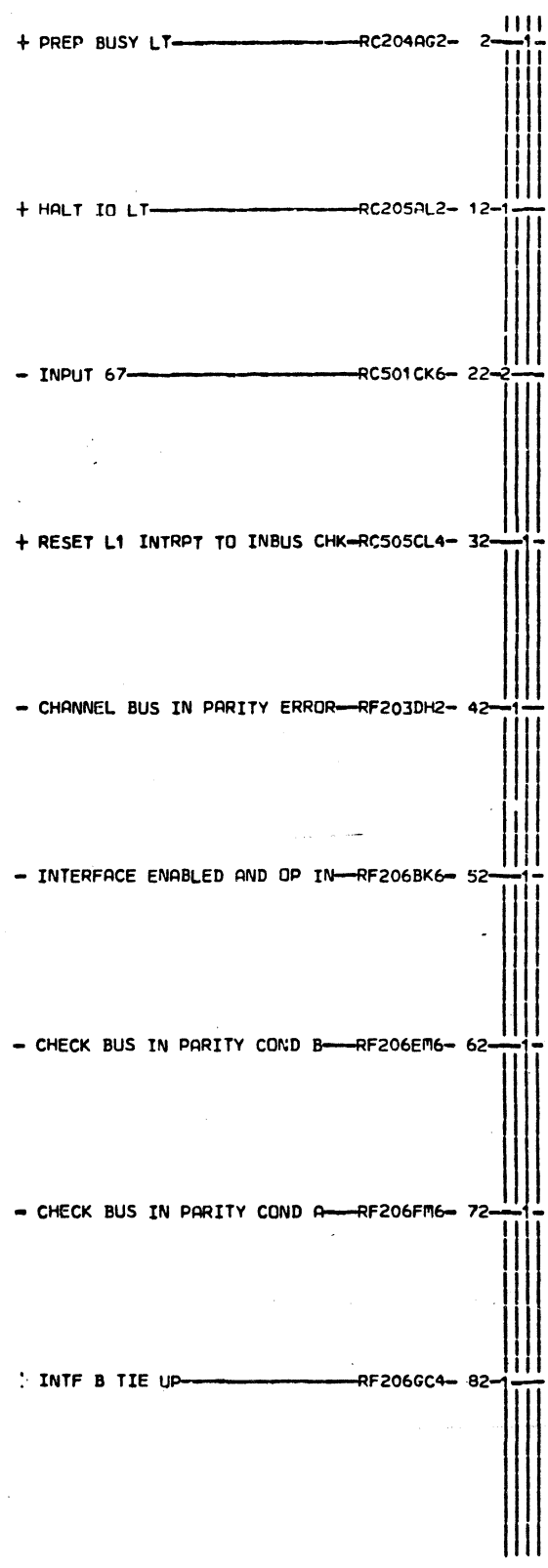

000 RF207

303 + INTF B CHNL BUS IN ERR — RC505-CC2

404 + CHNL BUS IN ERR TO BIT 1.0 — DD2 RA105

118 - TPS TIE DOWN TO BIT 1.0 RA105-F52

LOC. TYPE  
A-Y452 6836

RF207  
000

BUS IN ERROR LATCH AND RESEY GENERATION	
E.C. HISTORY	MACH. 27RNB
309522C	FRAME 01
309541	IBM CORP. SDD
309545	RF207
DATE LAST EC	P.No. 1785177 000
06-19-72 309533	

+ OUTBUS BIT 0.0 — RA011DM1 — 2-1

+ OUTBUS BIT 0.0 — RA011DM3 — 12-1

+ OUTBUS BIT 0.1 — RA011DM5 — 22-1

+ OUTBUS BIT 0.2 — RA011DM7 — 32-1

+ OUTBUS BIT 0.3 — RA011DJ2 — 42-1

+ OUTBUS BIT 0.4 — RA011DJ4 — 52-1

+ OUTBUS BIT 0.5 — RA011DJ6 — 62-1

+ OUTBUS BIT 0.6 — RA011DK1 — 72-1

+ OUTBUS BIT 0.7 — RA011DK3 — 82-1

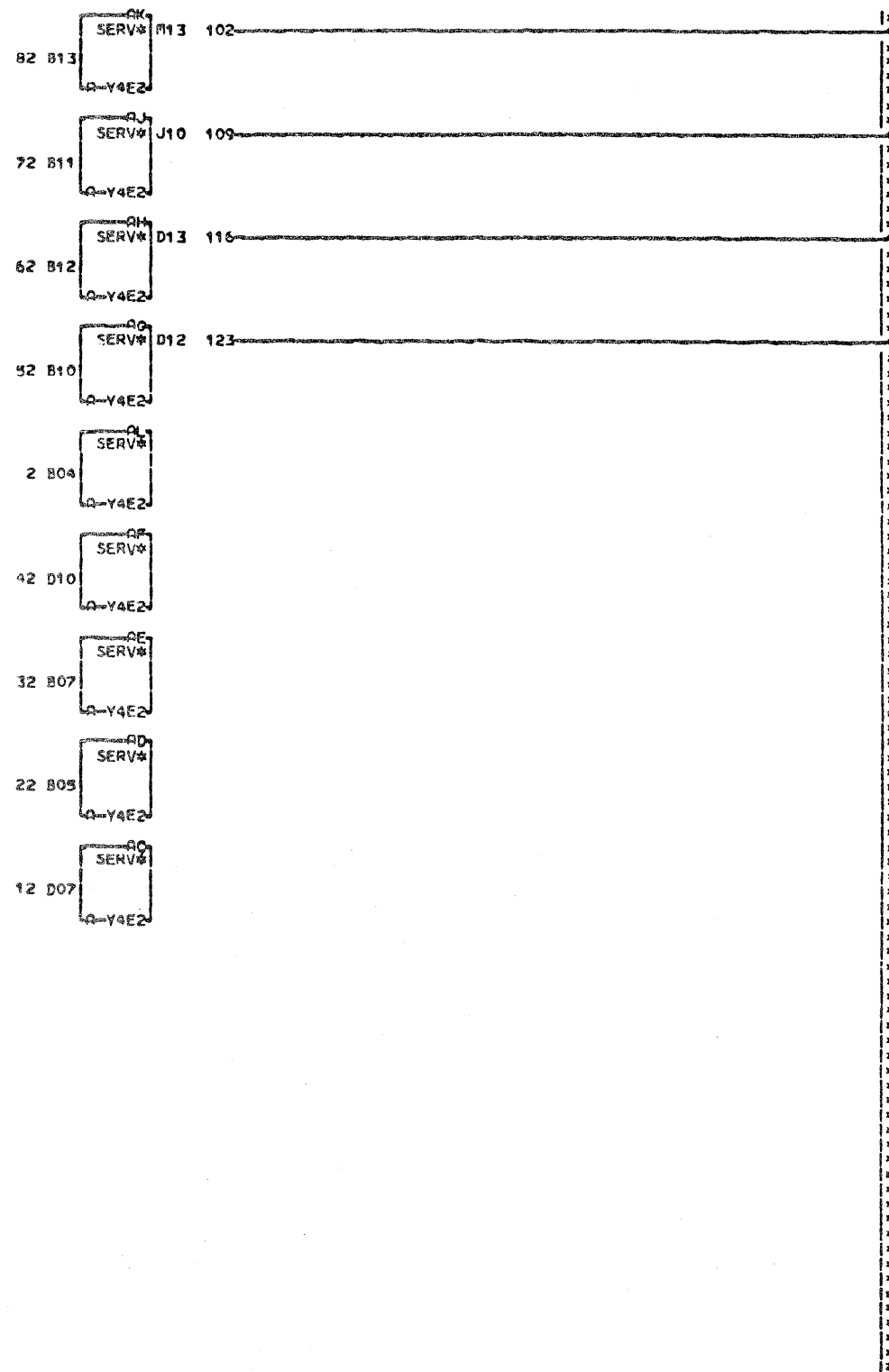

081 RS101

123 GROUND LEVEL — RS206-AG2

116 GROUND LEVEL — RS206-AH2

109 GROUND LEVEL — RS201-AJ2

102 GROUND LEVEL — RS201-AK2

LOC. TYPE

RS101  
081 SIM TO PN 1785178 EC 309545

SERV WIRING	
E.C. HISTORY	FRAC# 27RNB
FRAME	01
DATE LAST EC	IBP CORP. SCD RS101
10-14-80 344270	P.N. 1986994 081

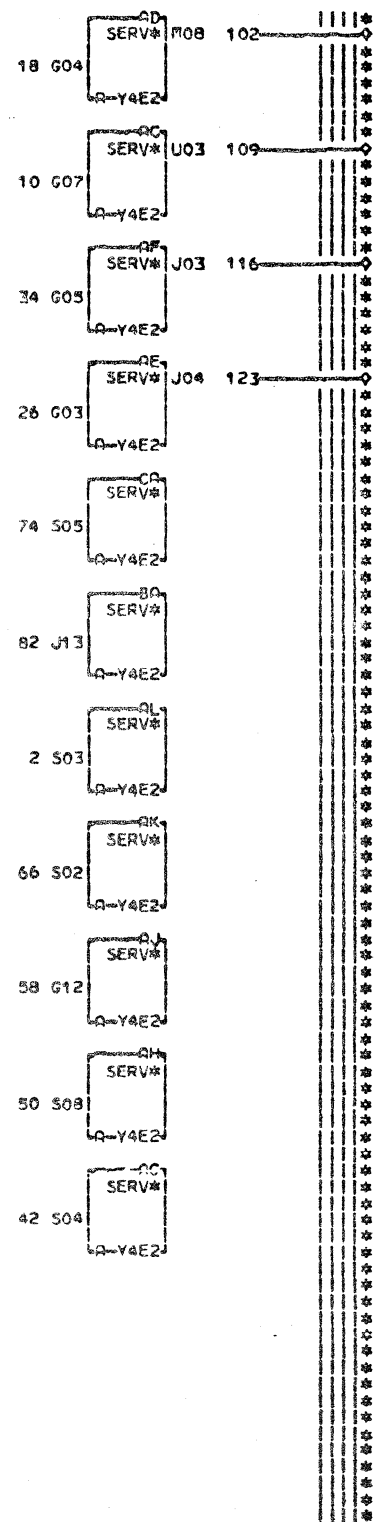
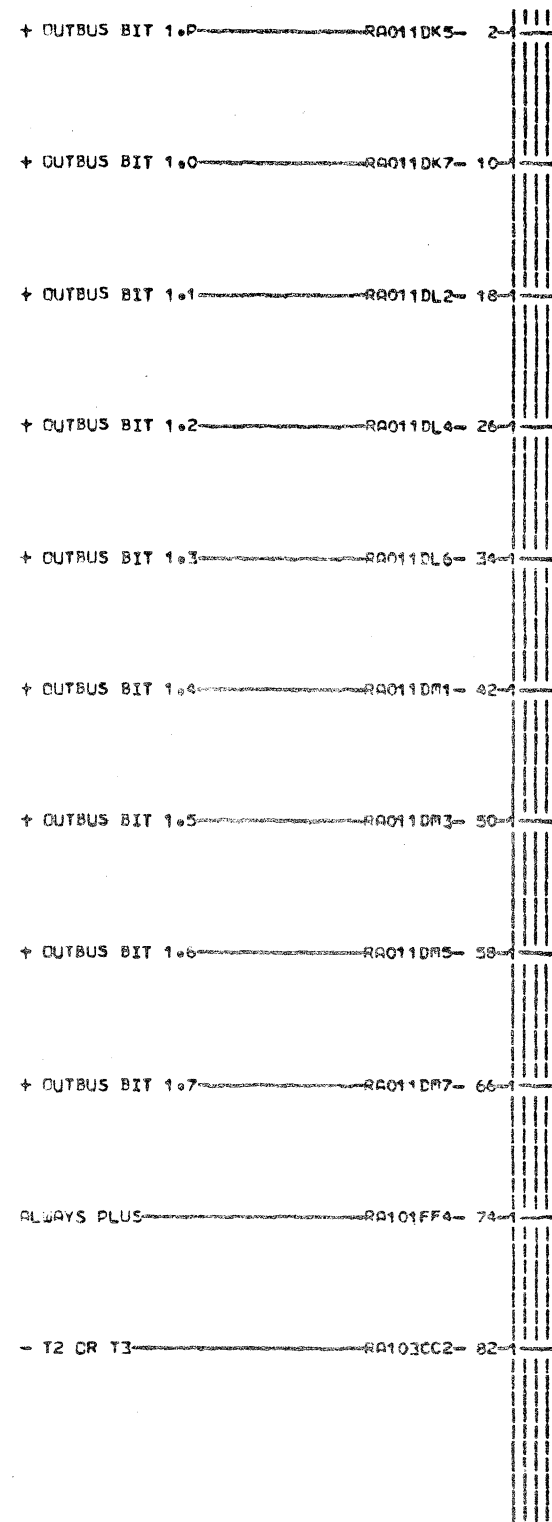

-BLANK COLUMN-

-BLANK COLUMN-

LOC. TYPE

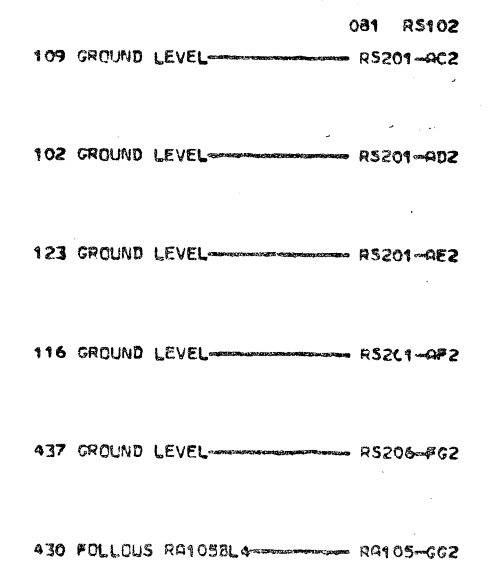
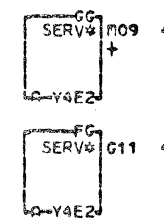

RS102  
 081 SIM TO PN 1785179 EC 309545

SERV WIRING	
E.C. HISTORY	E1 RACH#27RNB
DATE	LAST EC
10-14-60	344270
FRAME	01
IBM CORP. SCD	RS102
P.No. 1986995	081

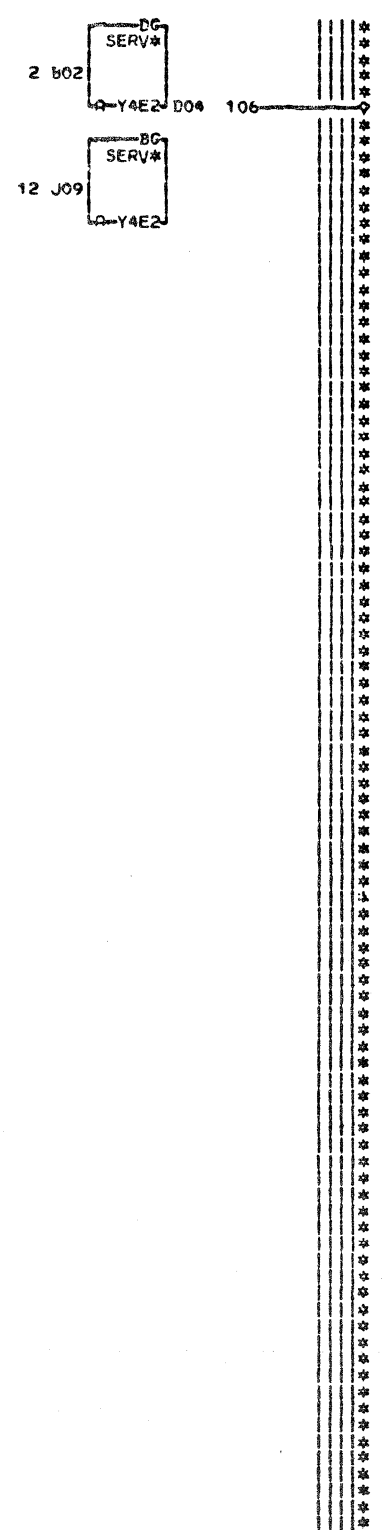
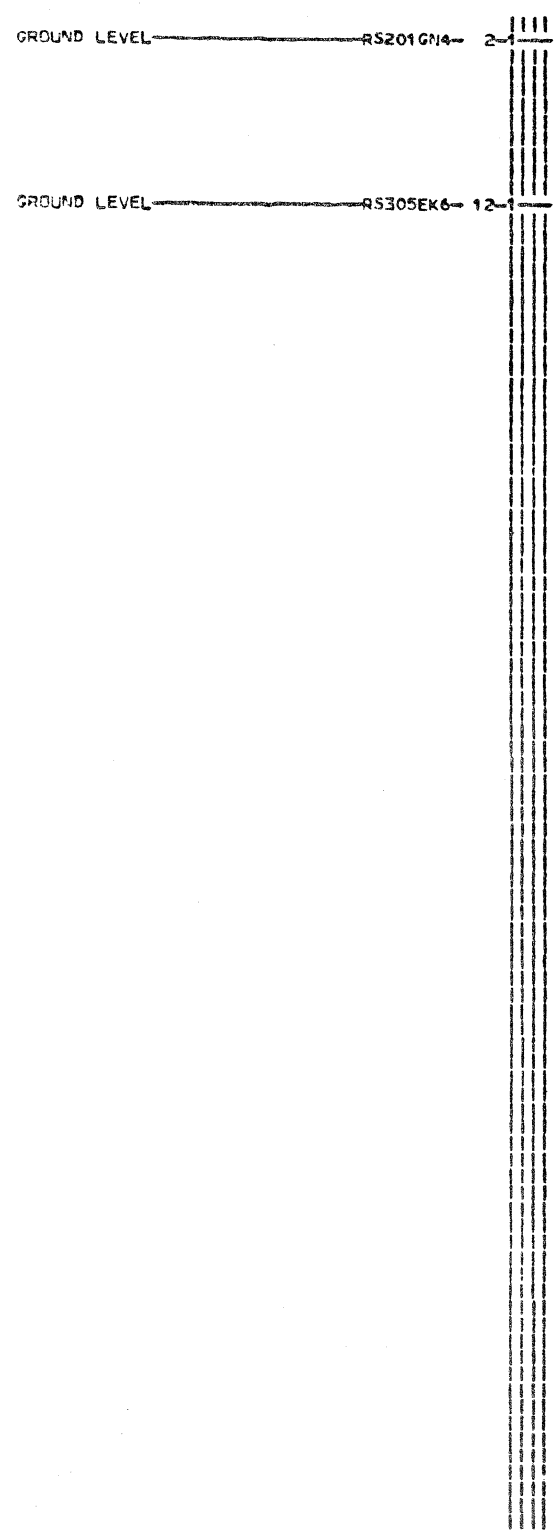

-BLANK COLUMN-

-BLANK COLUMN-

LOC. TYPE

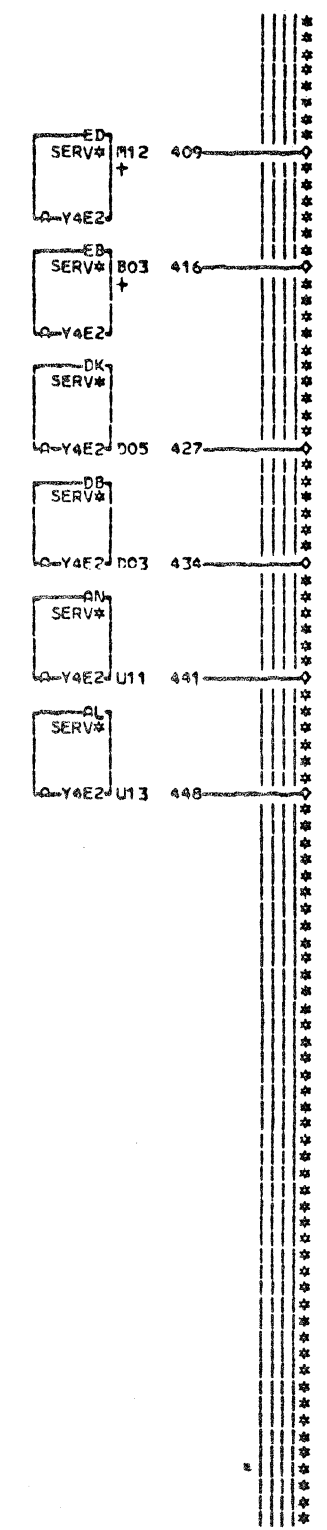

- 081 RS104
- 448 GROUND LEVEL RS202-AL6
- 441 GROUND LEVEL RS202-AN6
- 434 GROUND LEVEL RS304-DB6
- 106 GROUND LEVEL RS202-DG6
- 427 GROUND LEVEL RS202-DK6
- 416 FOLLOWS RA104AA4 RA104-EB2
- 409 FOLLOWS RA104AD4 RA104-ED2

RS104  
081 SIM TO PN 1785181 EC 309545

SERV WIRING	
E.C. HISTORY	MACH. 27RNB
DATE LAST EC	FRAME 01
10-14-60 344270	IBM CORP. SCD
	P.No. 1986997
	RS104 081

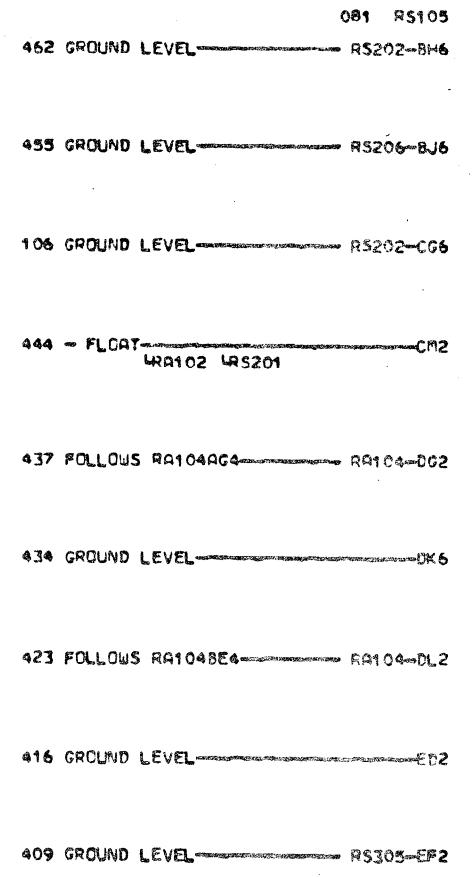
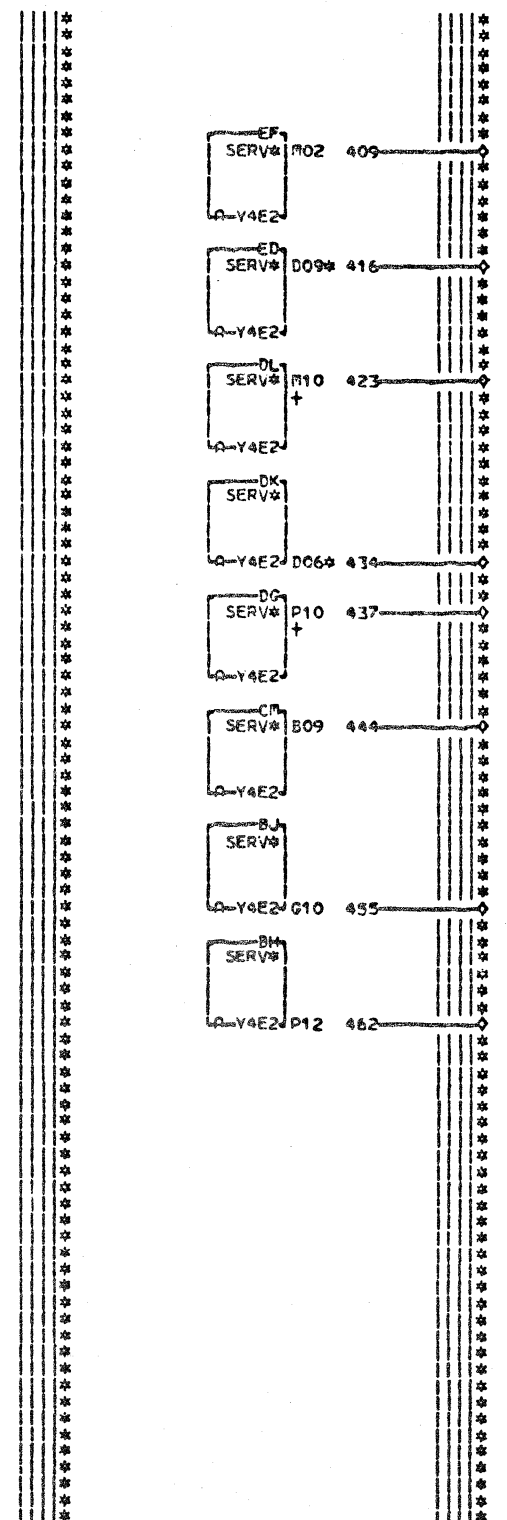
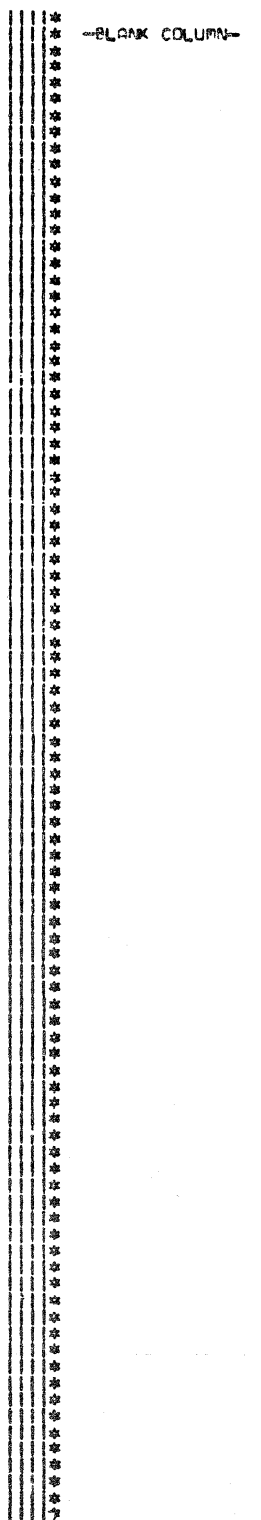
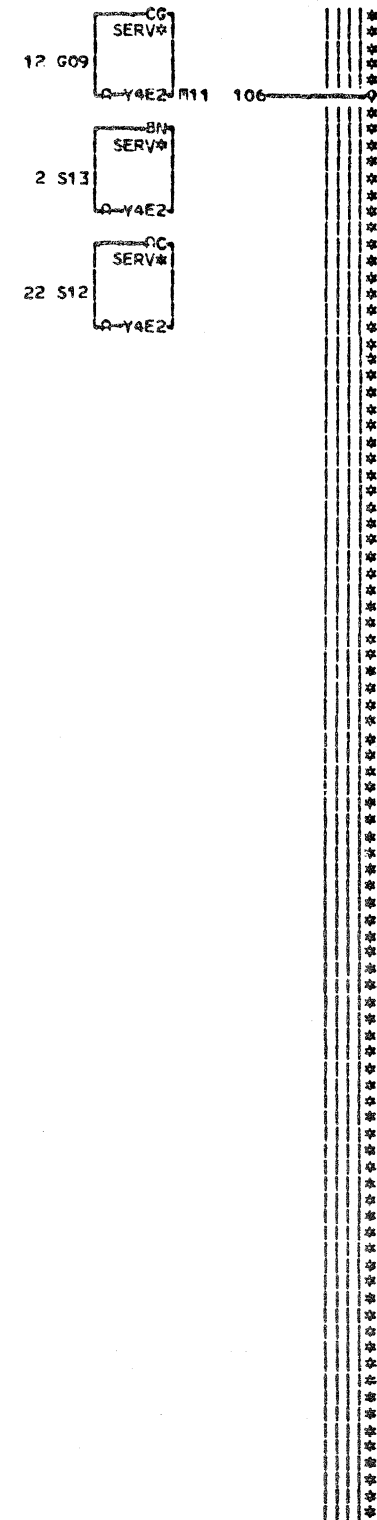
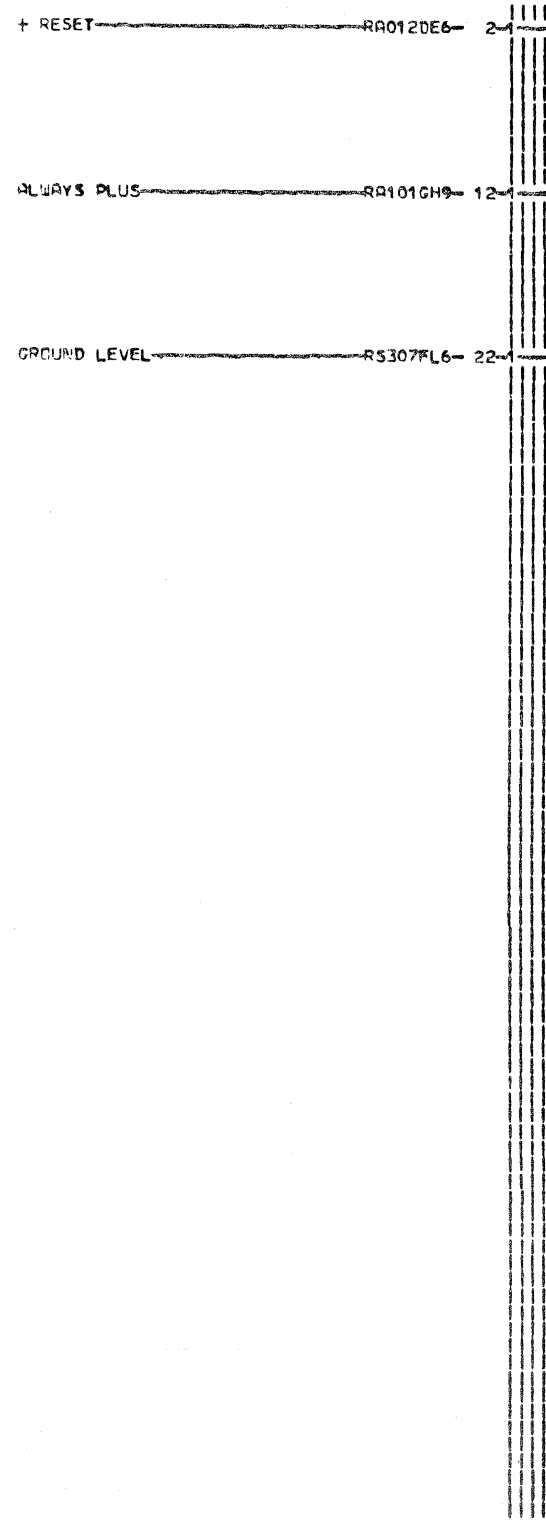

EDGE CONN.  
416 A-Y4C1C11  
434 A-Y4E1C11

LOC. TYPE

RS105  
081 SIM TO PN 1785182 EC 309951

SERV WIRING	
E.C. HISTORY	E. PACH. 27RNB
DATE	FRAME 01
LAST EC	IBM CORP. SCD RS105
10-14-80 344270	P.No. 1986998 081

--BLANK COLUMN--

--BLANK COLUMN--

--BLANK COLUMN--

EDGE CORN.  
 406 R-Y4J1D13  
 413 R-Y4J1C13  
 420 R-Y4J1D13  
 427 R-Y4H1E13  
 434 R-Y4H1D13  
 441 R-Y4H1C13  
 448 R-Y4K1B11

LOC. TYPE

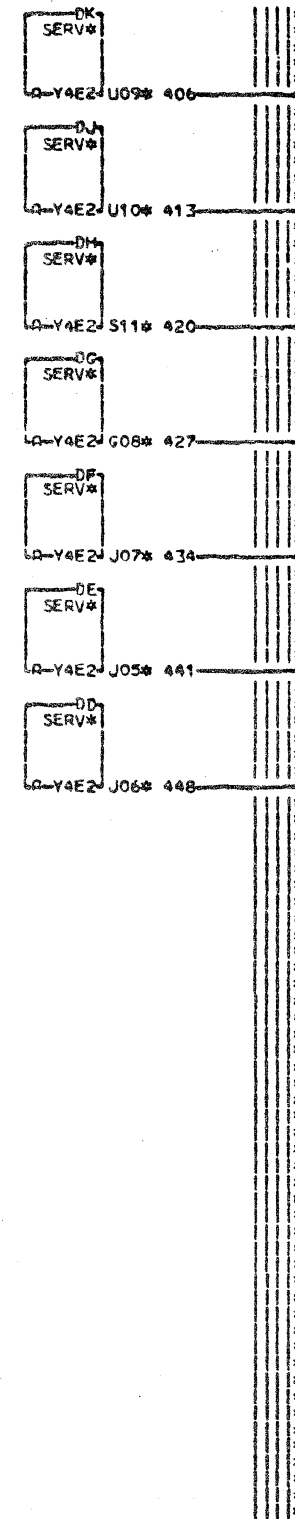

081 RS106

448 GROUND LEVEL DD6

441 GROUND LEVEL DE6

434 GROUND LEVEL DF6

427 GROUND LEVEL DG6

420 GROUND LEVEL DH6

413 GROUND LEVEL DJ6

406 GROUND LEVEL DK6

RS106

081 SIM TO PN 1785183 EC 309545

SERV WIRING			
E.C. HISTORY		E. MACH. 27RNB	
		FRAME	01
DATE LAST EC		IBA CORP. SCD	RS106
10-14-80 344270		P.N. 1986999	081



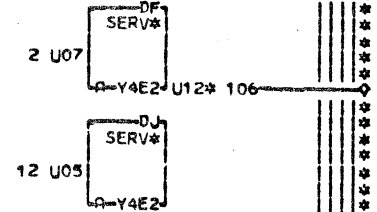
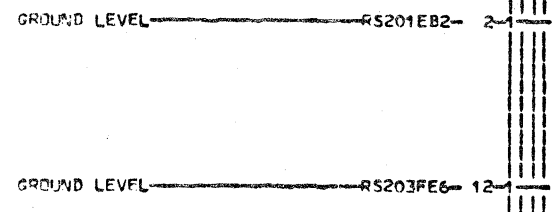

—BLANK COLUMN—

—BLANK COLUMN—

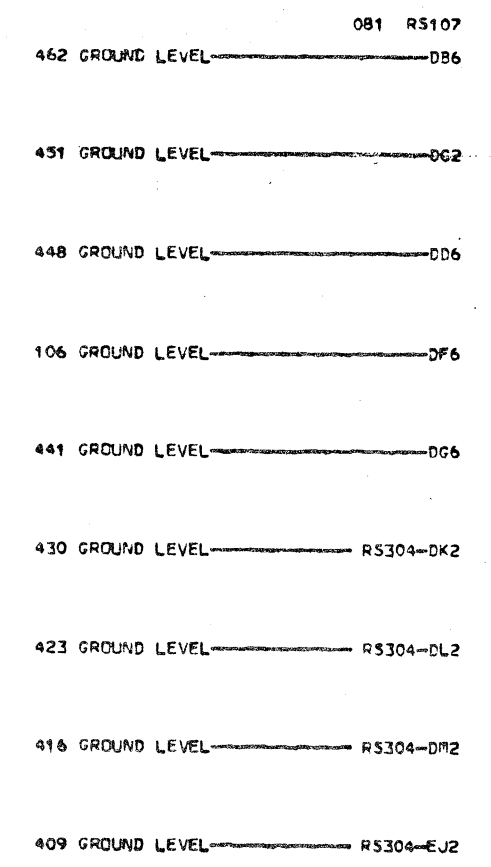
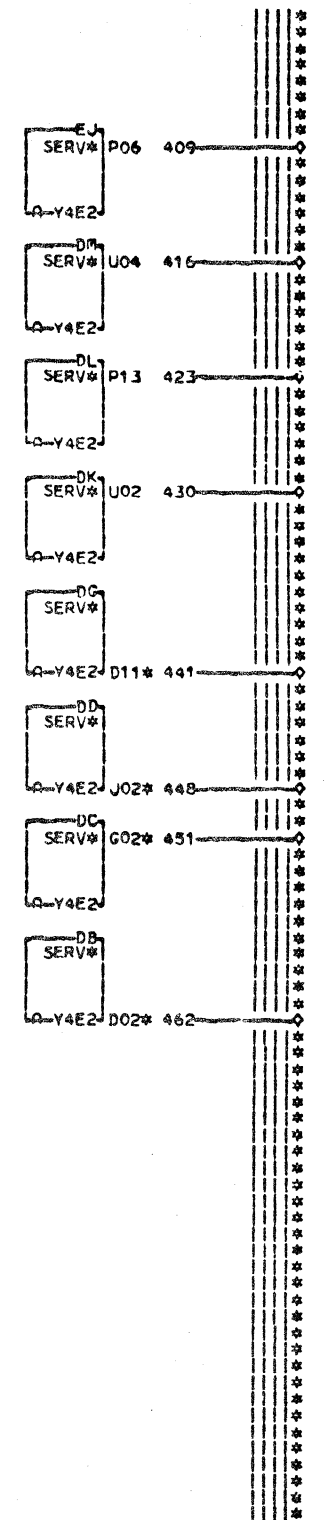

EDGE CONN.  
106 A-Y4C1A11  
441 A-Y4C1B11  
448 A-Y4H1E11  
451 A-Y4H1D11  
462 A-Y4H1B11

LOC. TYPE

RS107  
081 SIM TO PN 1785184 EC 309548

SERV WIRING	
E.C. HISTORY	E. PACH. 27RNB
	FRAME 01
DATE LAST EC	IBR CORP. SCD
10-14-80 344270	P. No. 1987000

RS107 081

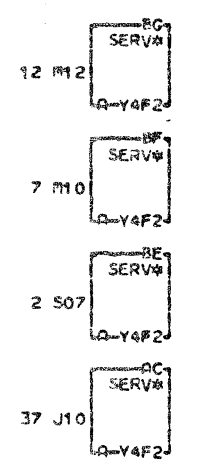
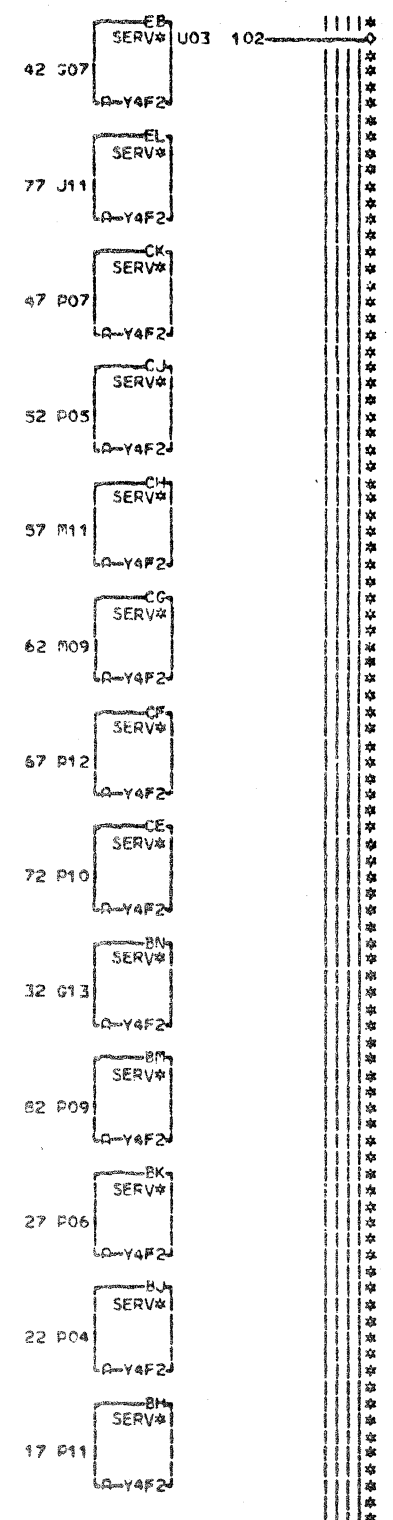
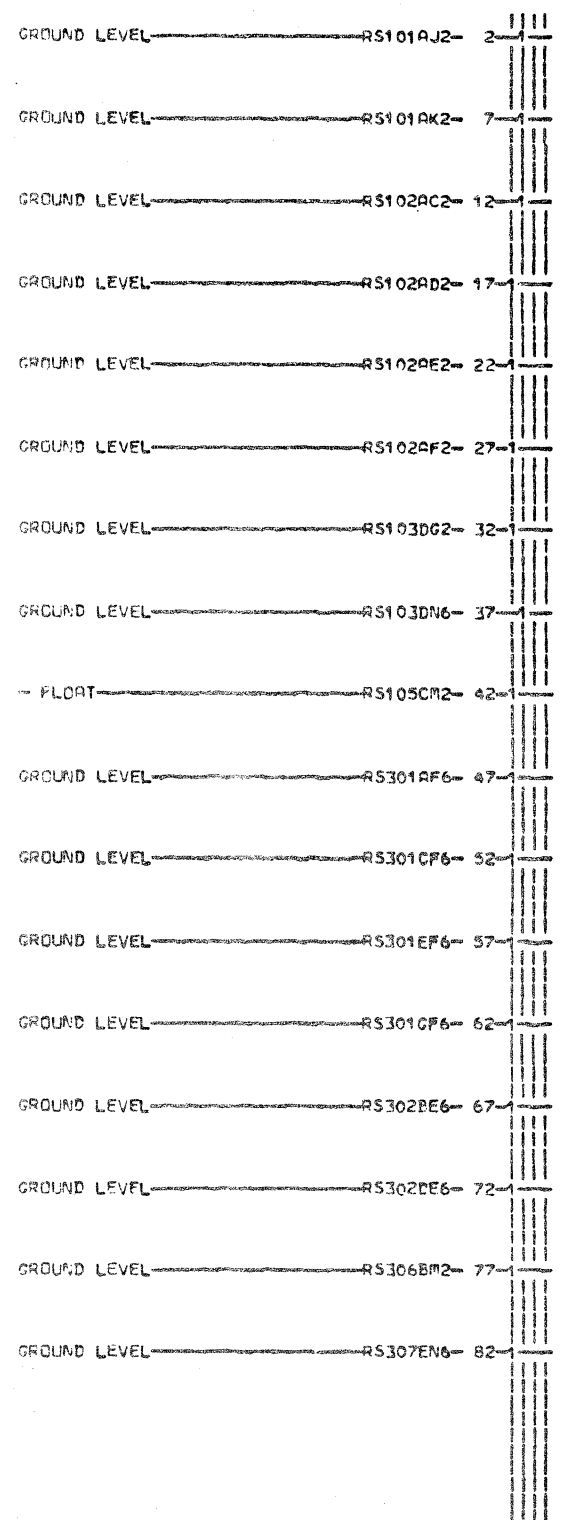

-BLANK COLUMN-

LOC. TYPE

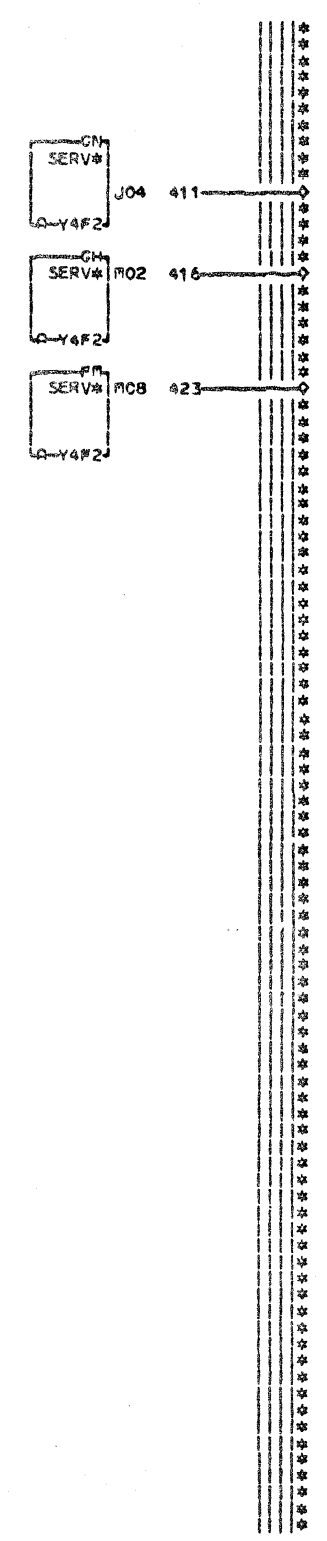

RS201  
081 SIN TO FN 1785185 EC 309545

SERV WIRING	
E-C-HISTORY	MACH#27RNB
DATE LAST EC	FRAME 01
10-14-80 344270	IBM CORP-SCD RS201
	PeNo 1987001 081



+ 62.5 NS CLOCK UNUSED — RA103FH2 — 2-1  
 GROUND LEVEL — RS201GN4 — 12

2 J05 BE  
 SERV\*  
 12 D03 A-Y4F2 G10 106

—BLANK COLUMN—

—BLANK COLUMN—

FE  
 SERV\*  
 A-Y4F2 M13 413  
 EE  
 SERV\* J02 416  
 A-Y4F2  
 DL  
 SERV\*  
 A-Y4F2 U06 427  
 DE  
 SERV\* J06 430  
 A-Y4F2  
 CE  
 SERV\* J12 437  
 A-Y4F2

081 RS203  
 106 GROUND LEVEL — RS301-BE6  
 437 GROUND LEVEL — RS301-CE2  
 430 GROUND LEVEL — RS307-DE2  
 427 GROUND LEVEL — RS103-DL6  
 416 GROUND LEVEL — RS307-EE2  
 413 GROUND LEVEL — FE6  
 RS107 RS305

LOC. TYPE

RS203  
 081 SIM TO PN 1785187 EC 309940

SERV WIRING	
E.C. HISTORY 344270	E-MACH#27RNB FRAME 01
DATE LAST EC 04-14-81 344600	IBM CORP.SCD RS203 P.N. 1987003 081

- 62.5 NS CLOCK UNUSED - RA103FH6 - 2 -

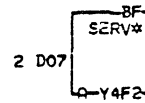

-BLANK COLUMN-

-BLANK COLUMN-

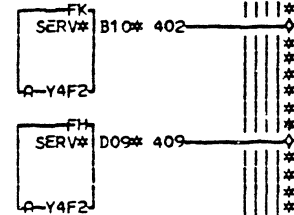

081 RS204  
409 GROUND LEVEL - FH2

402 GROUND LEVEL - FK2

EDGE CONN.  
402 A-Y4B1D11  
409 A-Y4B1C11

LOC. TYPE

RS204  
081 SIM TO PN 1785188 EC 309545

SERV WIRING	
E.C. HISTORY 344270	MACH. 27RNB
DATE LAST EC 04-14-81 344600	FRAME 01 IBM CORP. SCD P.N. 1987004
	RS204 081

-BLANK COLUMN-

-BLANK COLUMN-

-BLANK COLUMN-

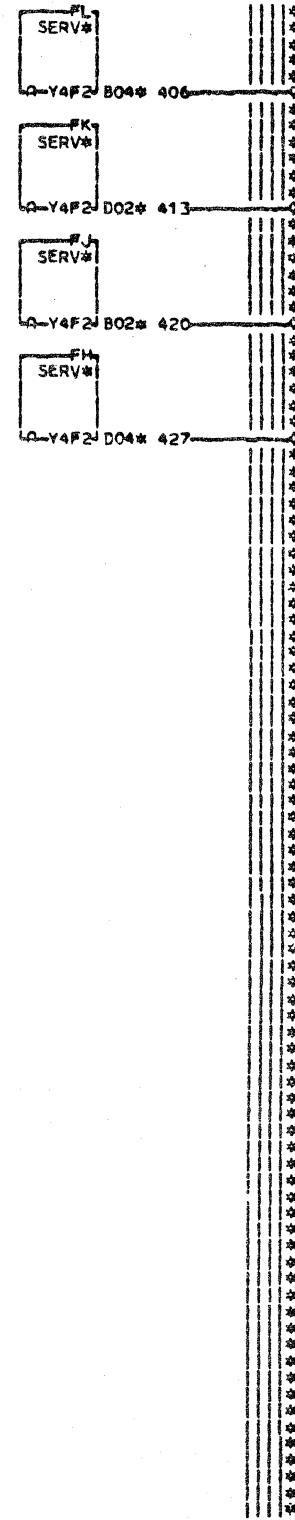

081 RS205

427 GROUND LEVEL FK6

420 GROUND LEVEL FK6

413 GROUND LEVEL FK6

406 GROUND LEVEL FL6

EDGE CONN.  
 406 Q-Y4B1B11  
 413 Q-Y4A1E11  
 420 Q-Y4C1A11  
 427 Q-Y4E1D11

LOC. TYPE

RS205  
 081 SIM TO PN 1785189 EC 309545

SERV WIRING	
E-C-HISTORY	E-MACH-27RNB
FRAM	01
DATE LAST EC	IBM CORP-SCD RS205
10-14-80 344270	PoN. 1987005 081

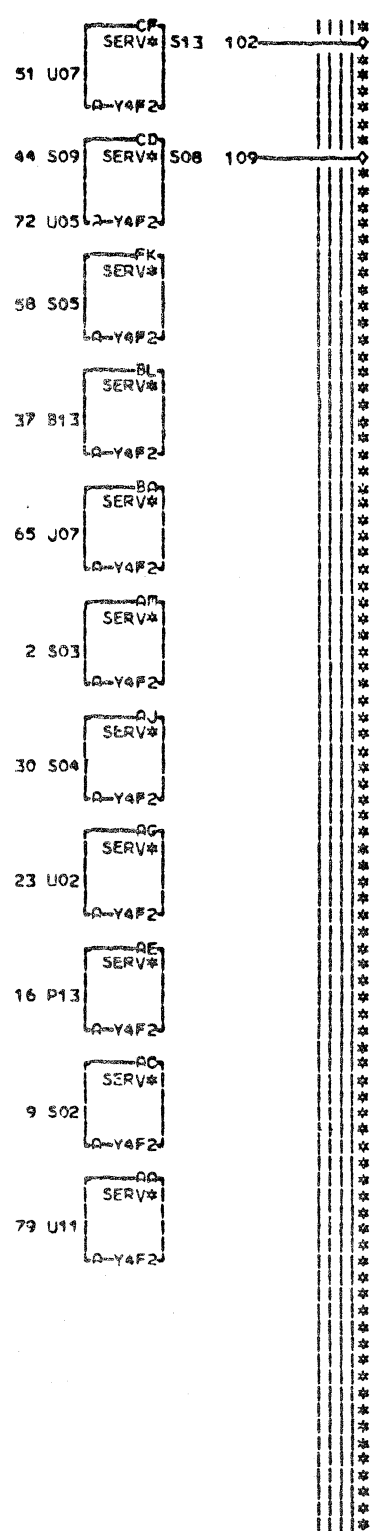
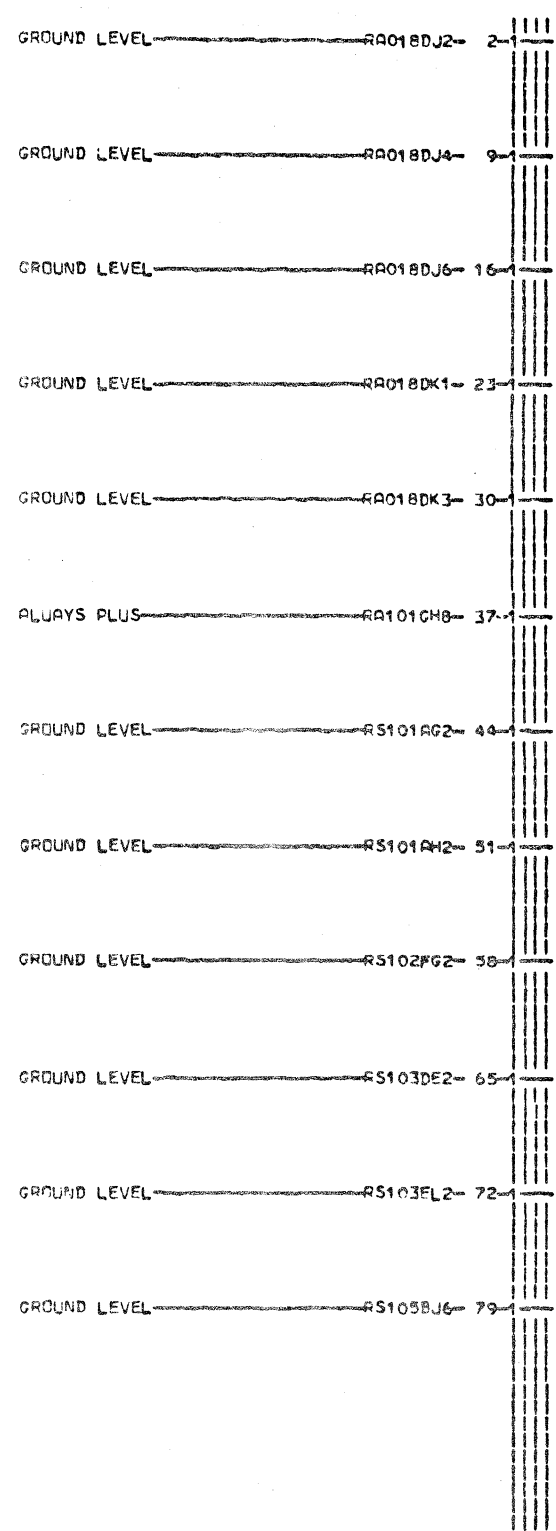

-BLANK COLUMN-

-BLANK COLUMN-

LOC. TYPE

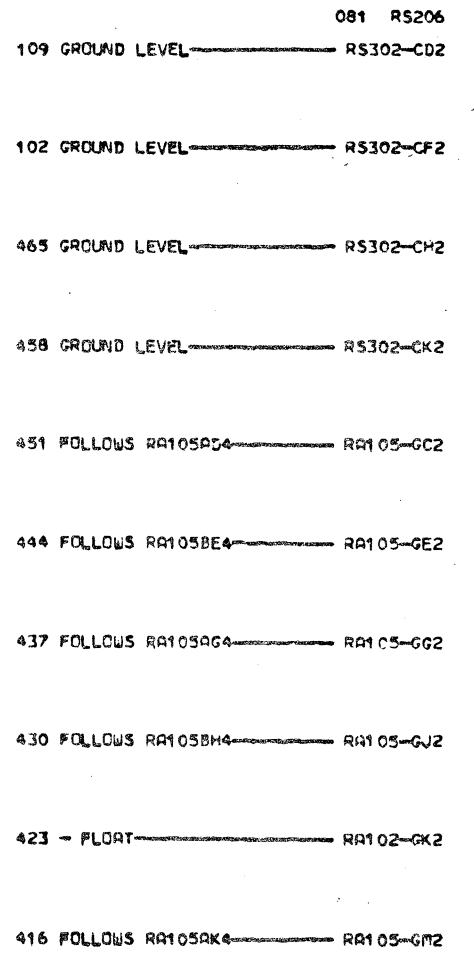
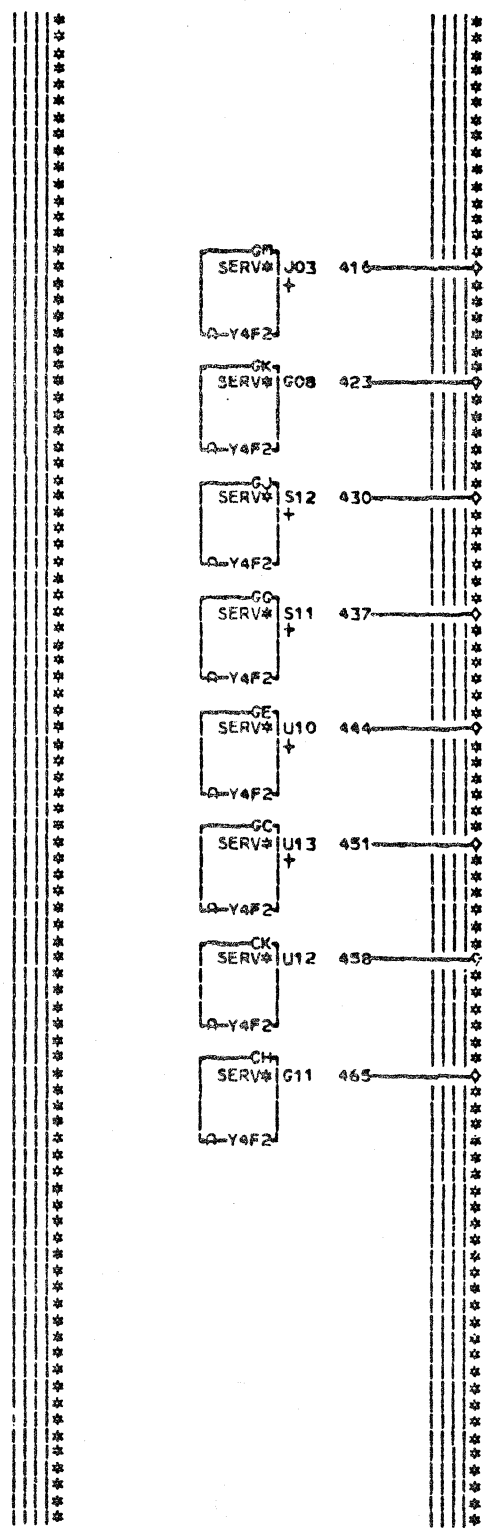

081 RS206

RS206  
081 SIM TO PN 1785190 EC 309545

SERV WIRING  
EoCo-HISTORY E-MACH#27RNB  
FRAME 01  
DATE LAST EC 10-14-80 344270  
IBR CORP#SCD PeNo 1987006 RS206 081

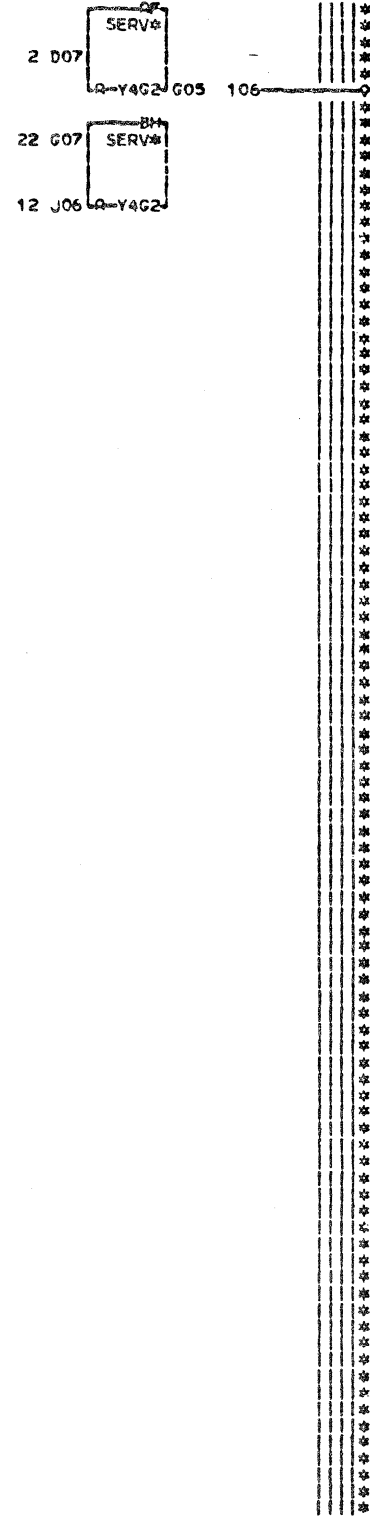
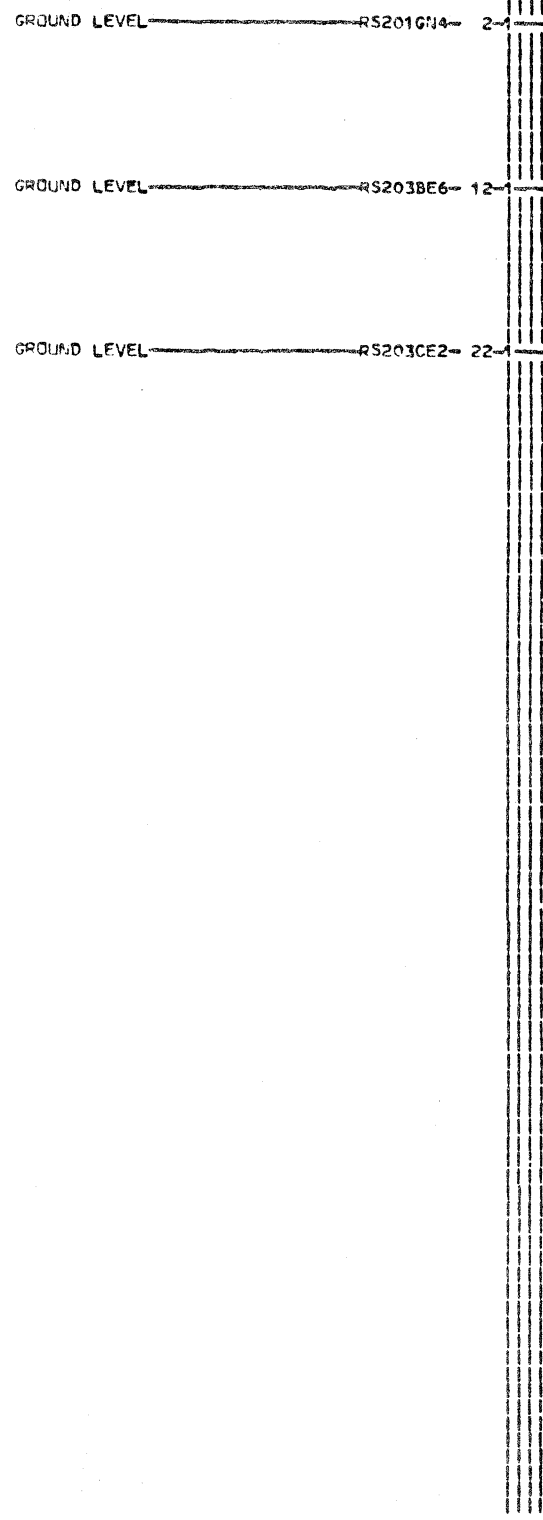

-BLANK COLUMN-

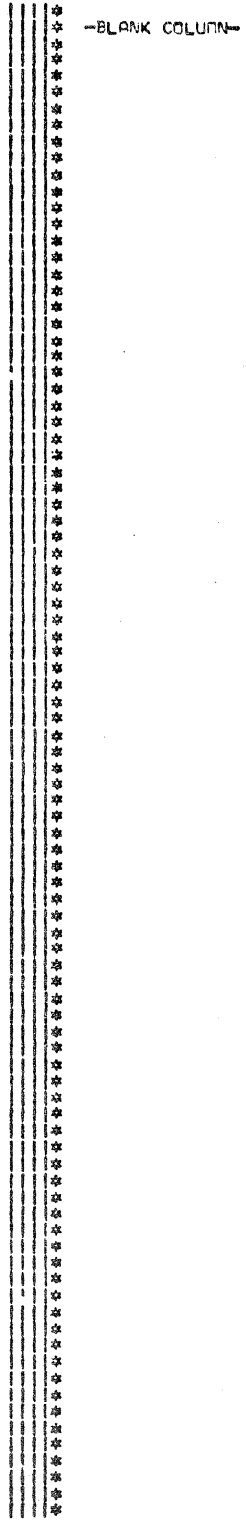

-BLANK COLUMN-

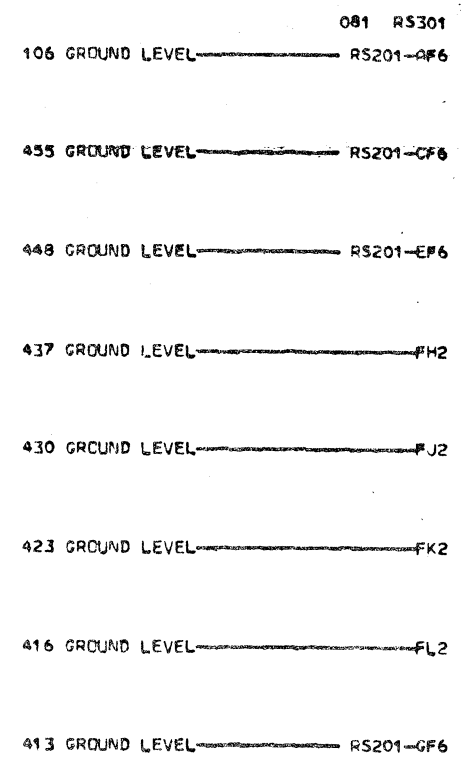
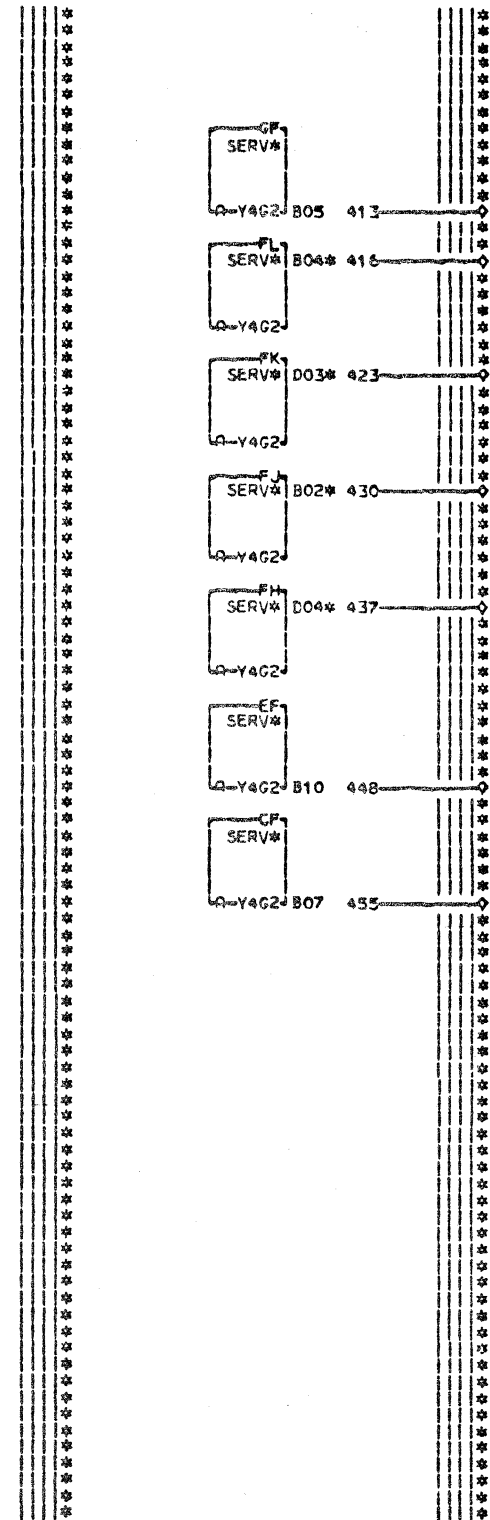

EDGE CONN.  
 416 A-Y4J1C11  
 423 A-Y4J1D11  
 430 A-Y4J1E11  
 437 A-Y4J1A11

LOC. TYPE

RS301  
 081 SIP TO PN 1785191 EC 309545

SERV WIRING	
<del>E.C.</del> HISTORY	E-PACH-27RNB
DATE	LAST EC
10-14-80	344270
FRAP	01
IBM CORP-SCD	RS301
P.No. 1987007	081



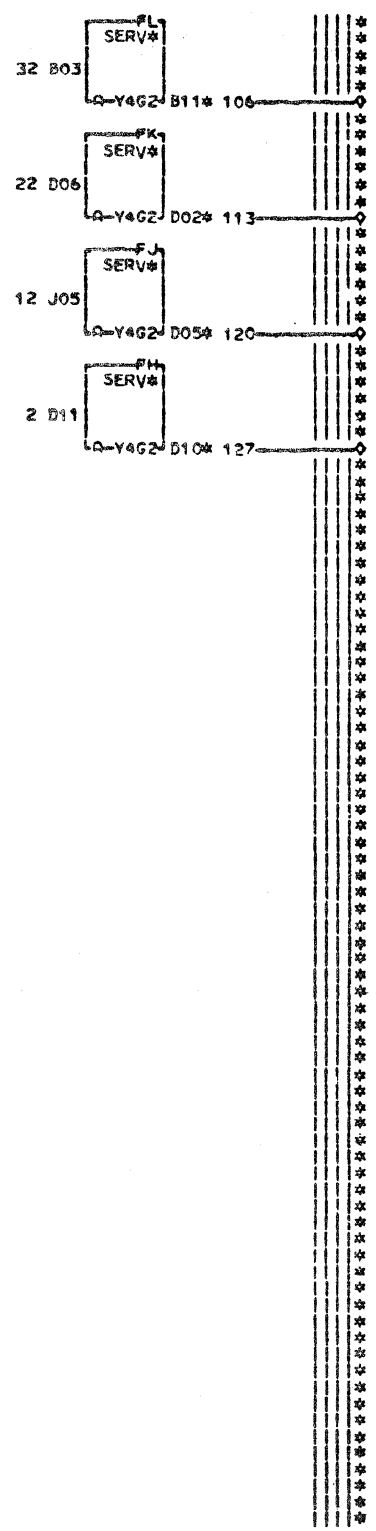
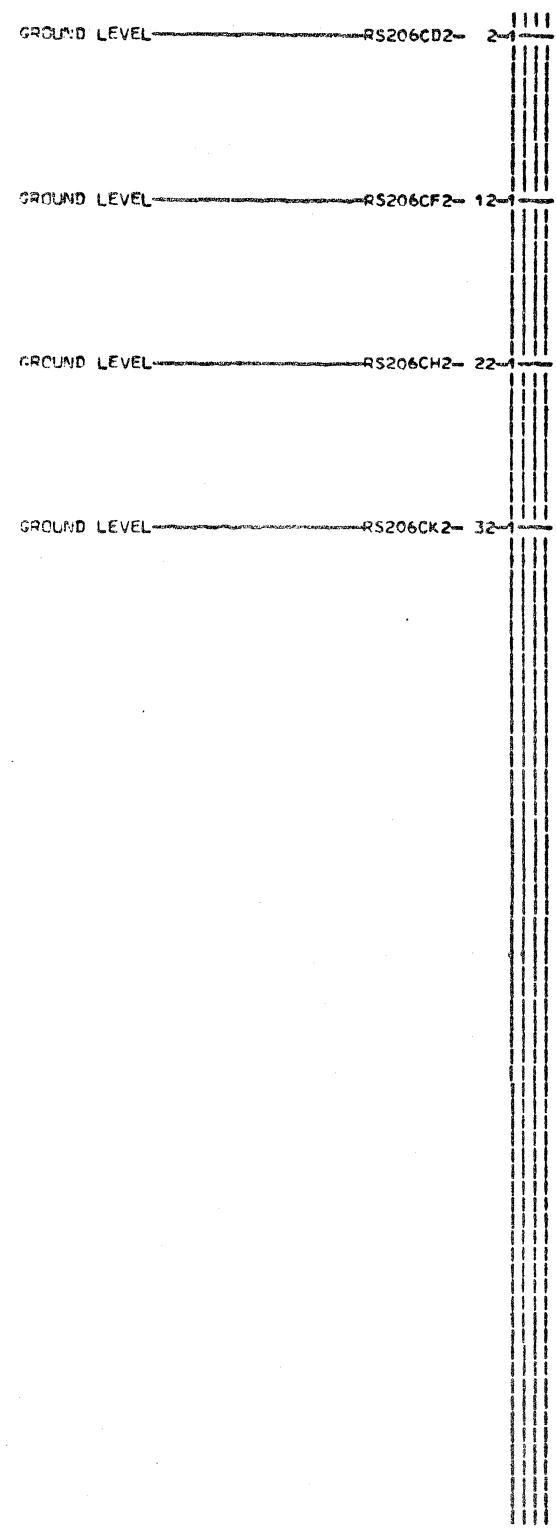

-BLANK COLUMN-

-BLANK COLUMN-

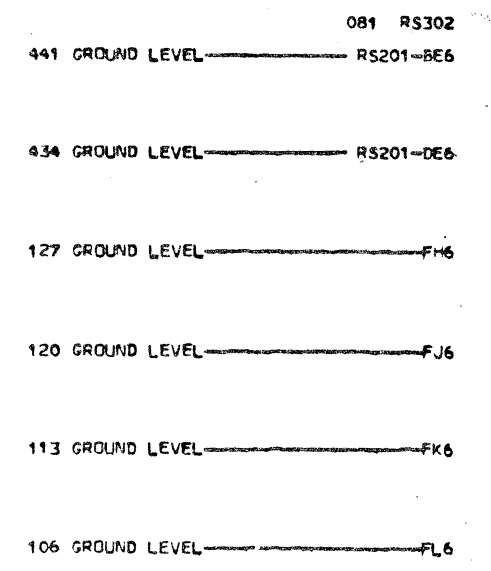
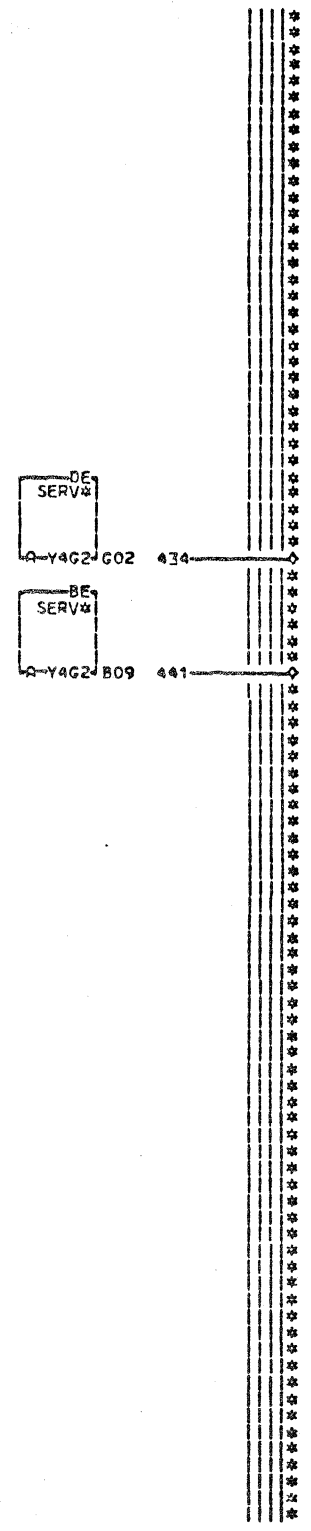

EDGE CONN.  
 106 A-Y4H1A11  
 113 A-Y4K1B13  
 120 A-Y4K1A13  
 127 A-Y4H1A13

LOC. TYPE

RS302  
 081 SIM TO PN 1785192 EC 309545

SERV WIRING	
E.C.-HISTORY	E1 MACH#27RNB
FRAME	01
DATE LAST EC	IBM CORP.SCD RS302
10-14-80 344270	PN# 1987008 081

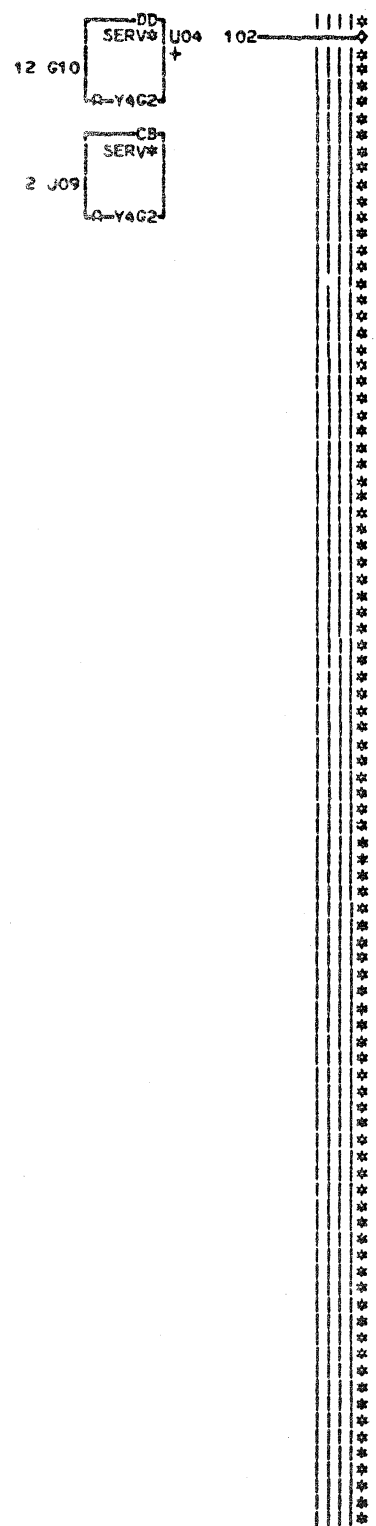
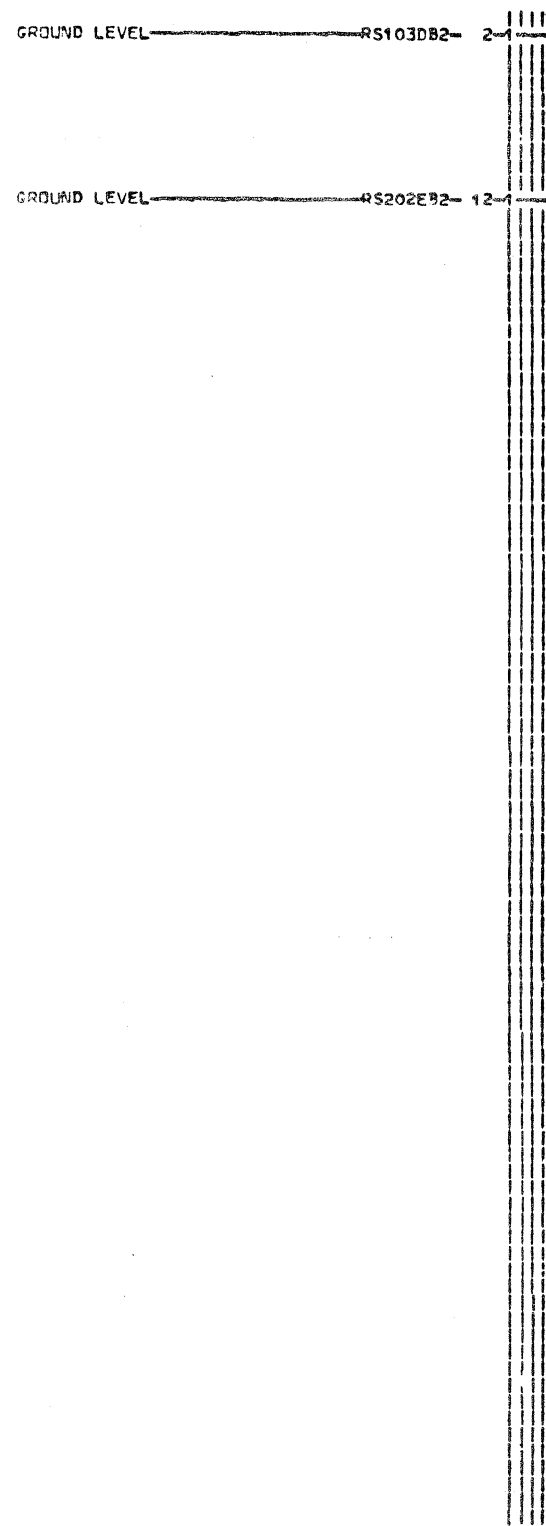

---BLANK COLUMN---

---BLANK COLUMN---

LOC. TYPE

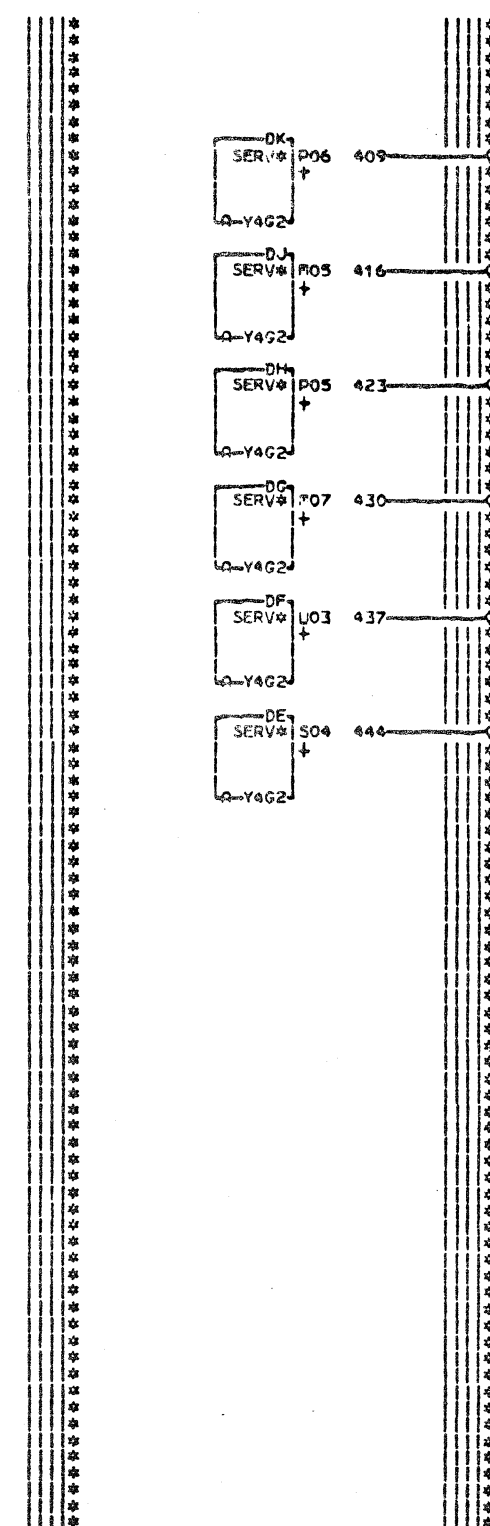

- 081 RS303
- 102 FOLLOWS RA104AG4 — RA104-DD2
  - 444 FOLLOWS RA104AK4 — RA104-DE2
  - 437 FOLLOWS RA104BL4 — RA104-DF2
  - 430 FOLLOWS RA105AA4 — RA105-DG2
  - 423 FOLLOWS RA105BB4 — RA105-DH2
  - 416 FOLLOWS RA105AD4 — RA105-DJ2
  - 409 FOLLOWS RA105BE4 — RA105-DK2

SERV WIRING	
E.C. HISTORY	E. PACH. 27RNB
DATE LAST EC	FRAME 01
10-14-80 344270	IBN CORP. SCD RS303
	P. No. 1987009 081

GROUND LEVEL-----RS103DC2-- 2--

GROUND LEVEL-----RS104DB6-- 12--

GROUND LEVEL-----RS107DK2-- 22--

GROUND LEVEL-----RS107DL2-- 32--

GROUND LEVEL-----RS107DM2-- 42--

GROUND LEVEL-----RS107EJ2-- 52--

12 P10

2 P08

22 J02  
32 D13  
42 DC9  
32 B12

GB  
SERV#  
R-YAG2

FB  
SERV#  
R-YAG2

CD  
SERV#  
R-YAG2

LCC. TYPE

RS304  
081 SIM TO PN 1785194 EC 309545

SERV WIRING	
E.C. HISTORY	E1 MACH#27RNB
	FRAME 01
DATE LAST EC	IBM CORP. SCD RS304
10-18-80 344270	P.N. 1987010 081

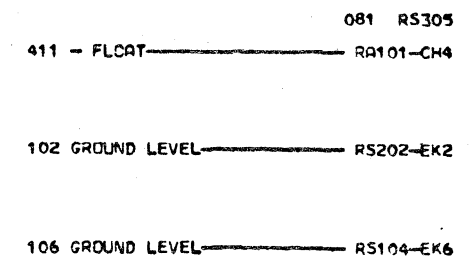
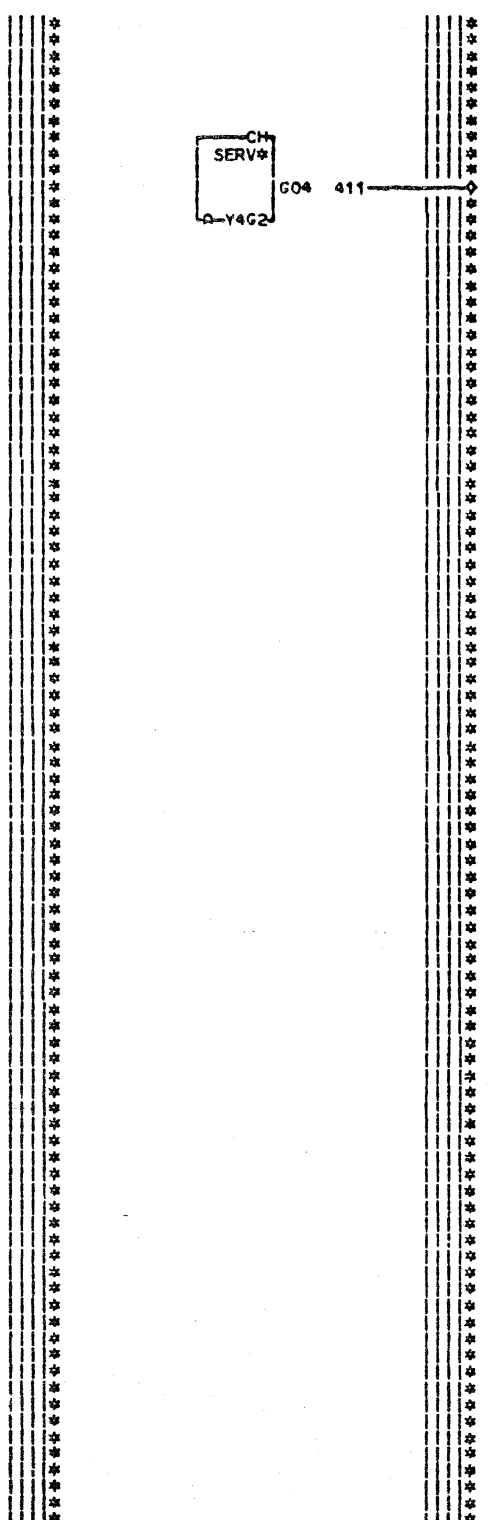
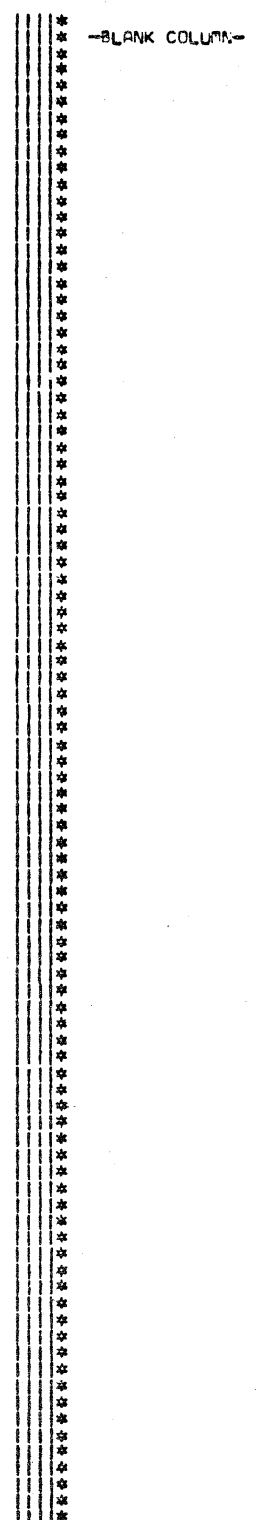
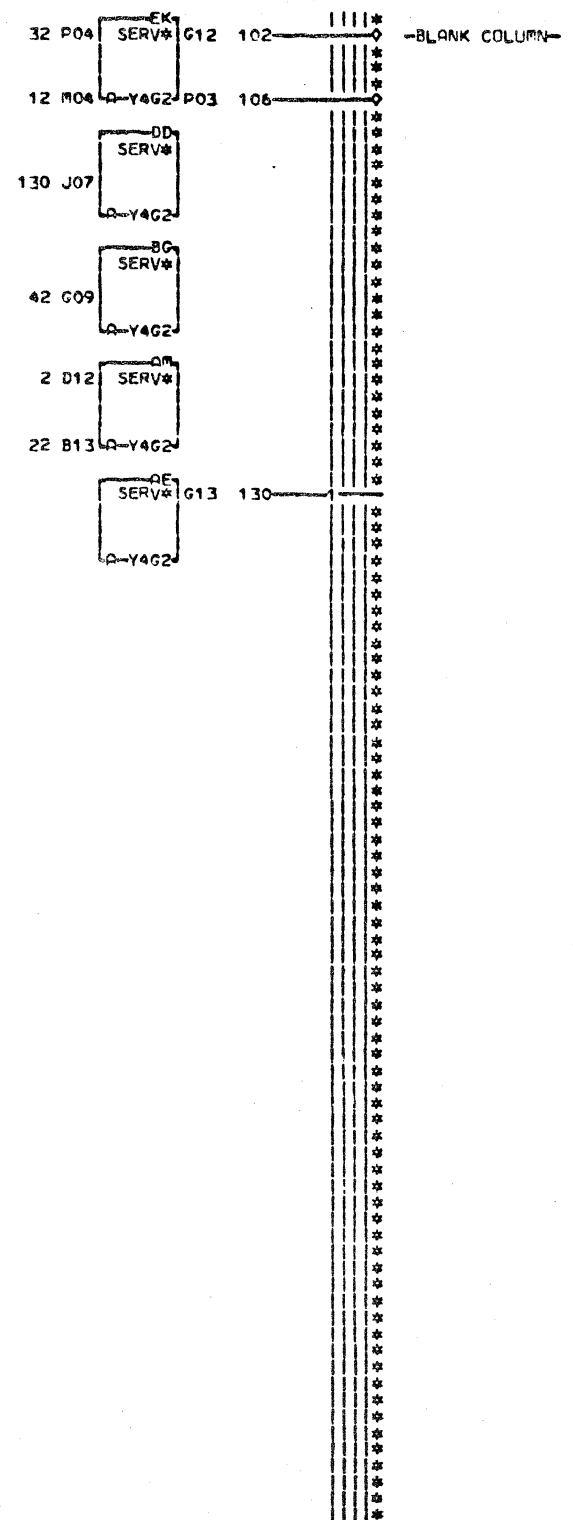
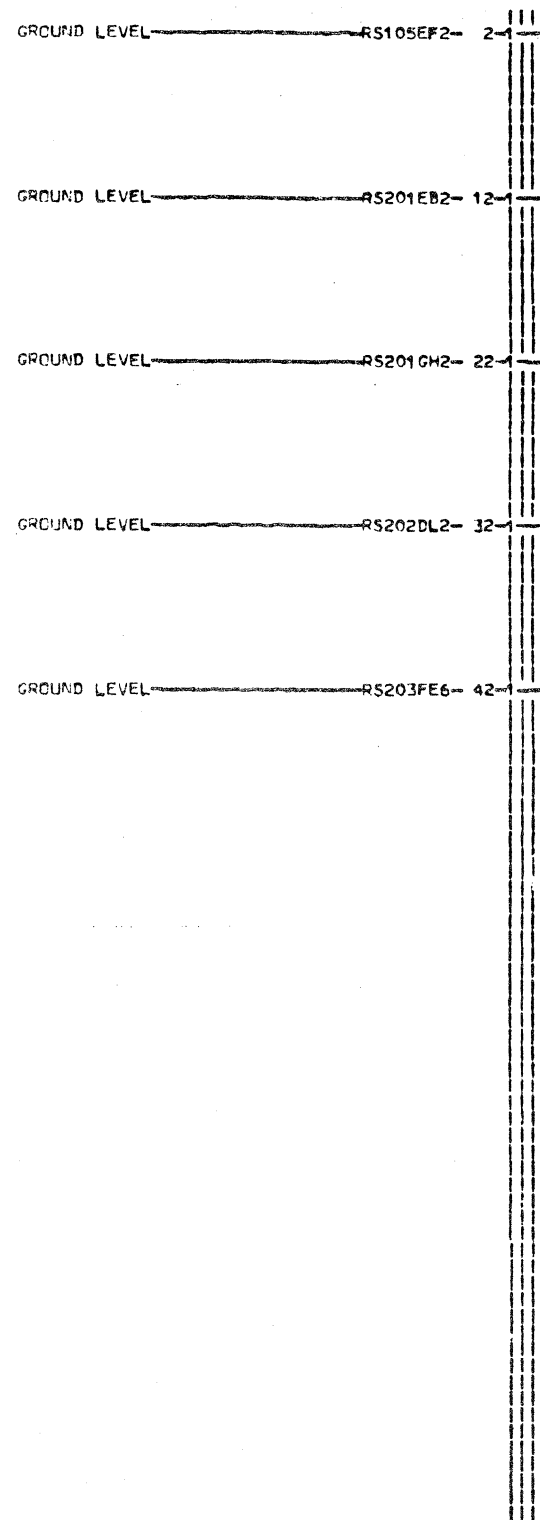

LCC. TYPE

RS305  
081 SIM TO PH 1765195 EC 309940

SERV WIRING	
E.C.—HISTORY	E. MACH. 27RNB
DATE LAST EC	FRAME 01
10-14-80 344270	IBR CORP. SCD RS305
	P.N. 1987011 081

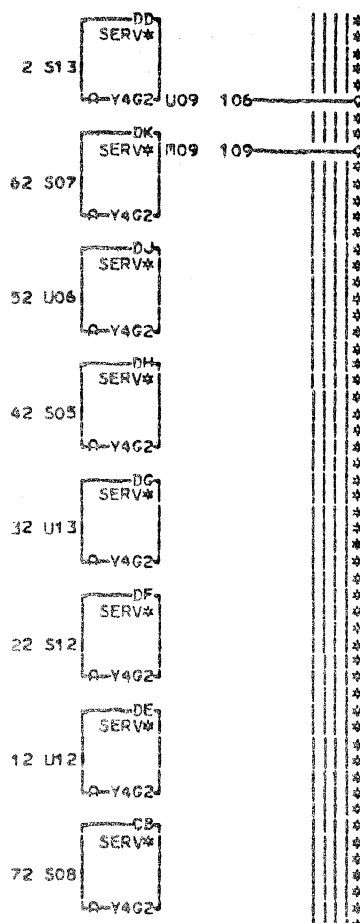
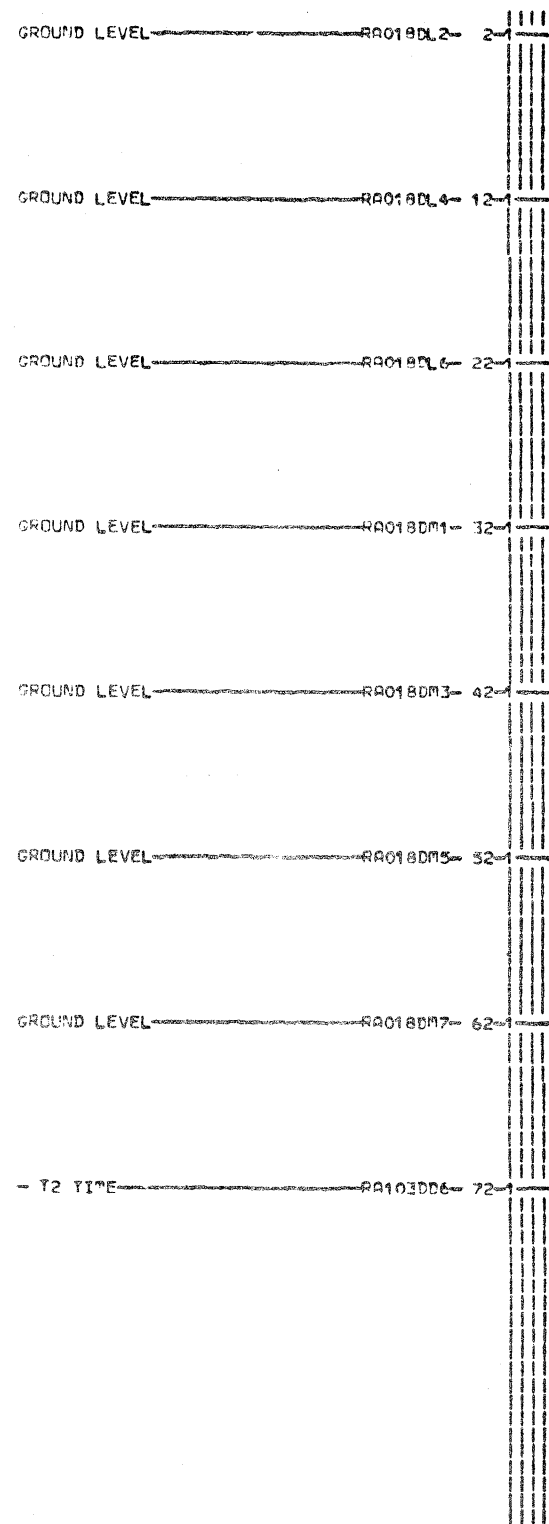

-BLANK COLUMN-

-BLANK COLUMN-

LOC. TYPE

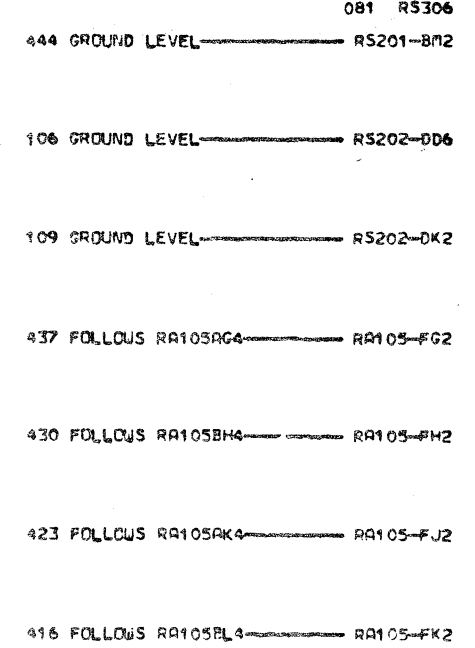
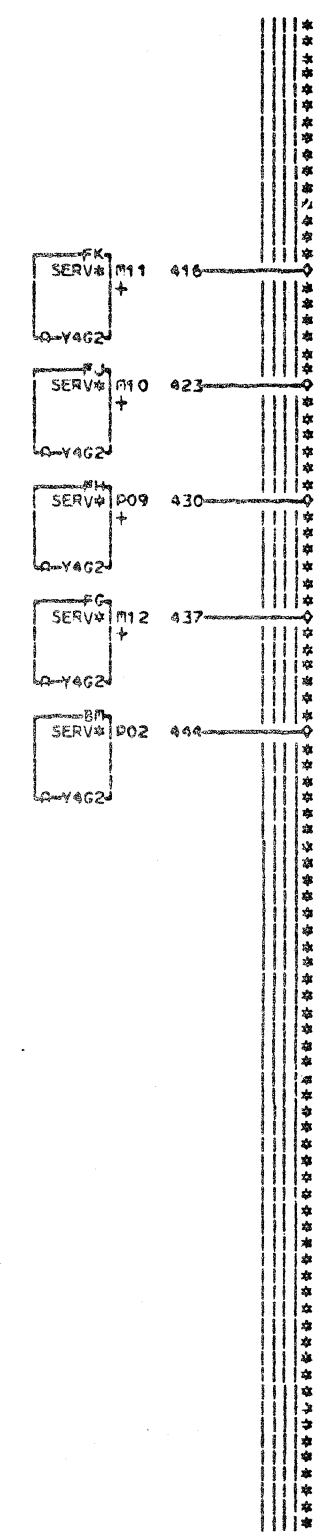

081 RS306

RS306  
081 SIO TO PN 1765196 EC 309545

SERV WIRING	
E-C-HISTORY	PACH-279AB
FRAME	01
DATE LAST EC	IBM CORP. SCD RS306
10-14-80 344270	PN 1987012 081

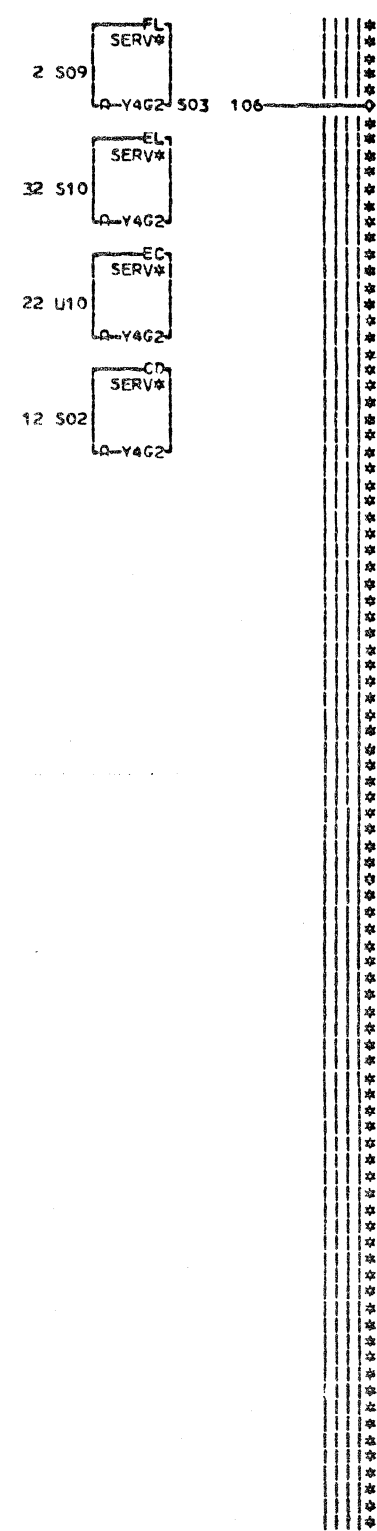
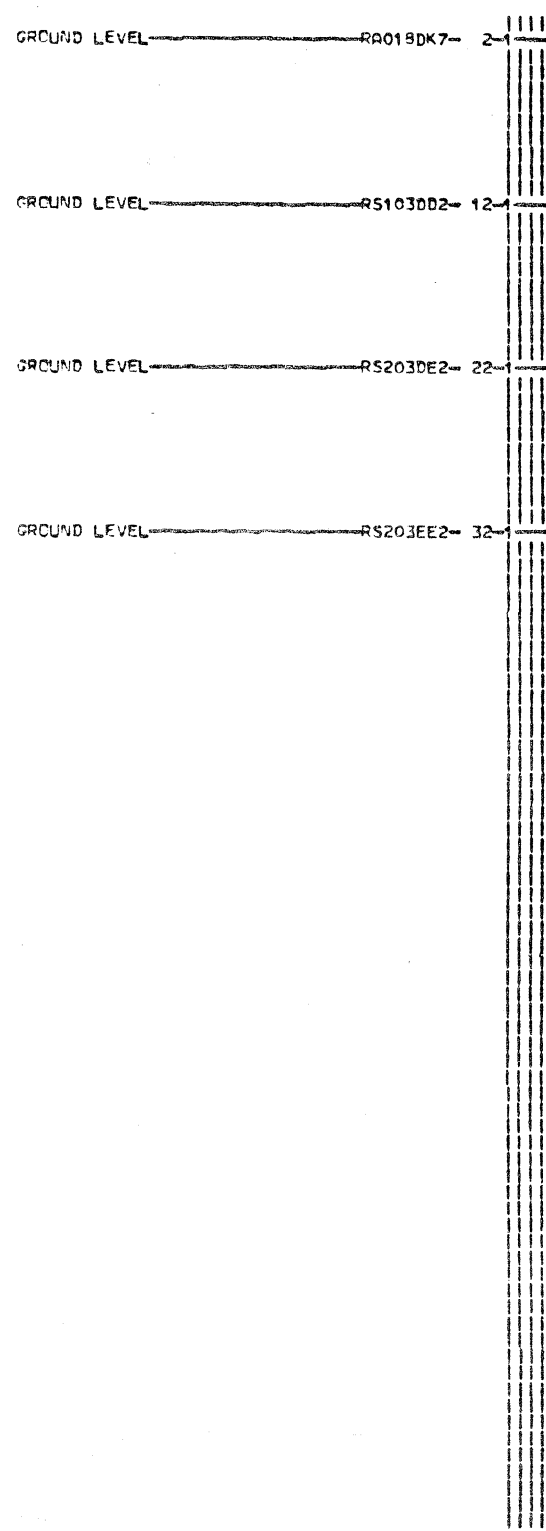

--BLANK COLUMN--

--BLANK COLUMN--

LOC. TYPE

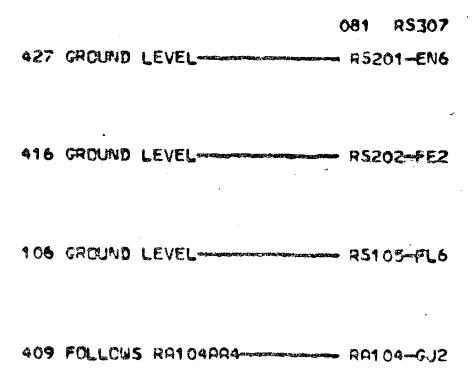
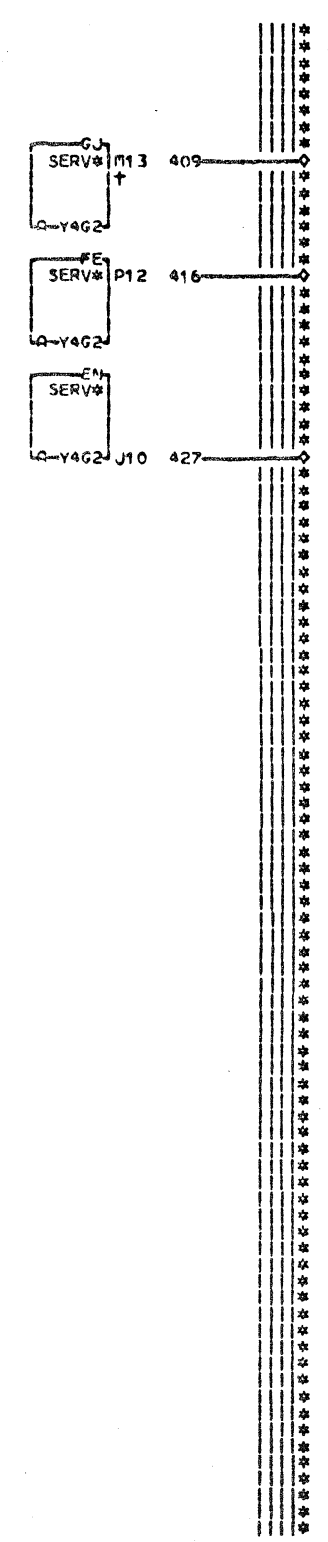

RS307  
081 SIM TO PN 1785197 EC 310284

SERV WIRING	
E.C. HISTORY	FRAME 01
DATE LAST EC	IBM CORP. SCD RS307
10-14-80 344270	P. No. 1987013 081

GROUND LEVEL-----AS201FM2-2

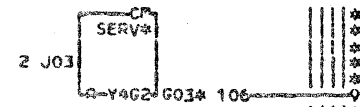

---BLANK COLUMN---

---BLANK COLUMN---

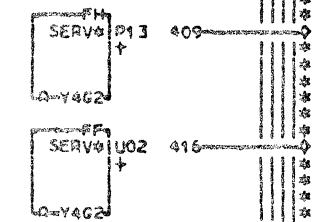

081 RS308  
106 GROUND LEVEL-----C76

416 FOLLOWS RA104BE4-----RA104--FF2

409 FOLLOWS RA104BH4-----RA104--FH2

EDGE CONN.  
106 A-Y4C1E11

LDC. TYPE

SERV WIRING			
---E-C-HISTORY---		E-PACH-27RNB	
DATE	LAST EC	FRAP#	01
10-14-80	344270	IBR CORP-SCD	RS308
		P.N. 1987014	CS1

GROUND LEVEL — RS201 GNA — 2 —



-BLANK COLUMN-

-BLANK COLUMN-

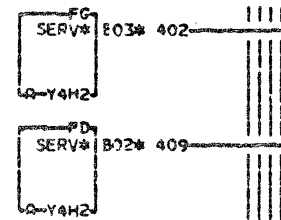

081 RS401  
409 GROUND LEVEL — FD2

402 GROUND LEVEL — FG2

EDGE CONN.  
402 Q-Y4F1B13  
409 Q-Y4B1E13

LOC. TYPE

RS401

081 SIM TO PN 1785199 EC 311272

SERV WIRING	
E.C. HISTORY	PACH. 27RNB
FRAM 01	
DATE LAST EC	IBM CORP. SCD RS401
10-14-80 344270	P.No. 1987015 081



GROUND LEVEL — RS201GN4 — 2 —



—BLANK COLUMN—

—BLANK COLUMN—

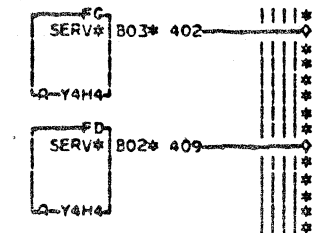

081 RS402  
409 GROUND LEVEL — FD2

402 GROUND LEVEL — FG2

EDGE CONN.  
402 A-Y4B1A13  
409 A-Y4C1A13

LOC. TYPE

SERV WIRING	
—E.C.—HISTORY—	E. PACH. 27RNB
DATE	LAST EC
10-14-80	344270
IBM CORP. SCD	RS402
P.N. 1987016	081

GROUND LEVEL RS201GN4 2

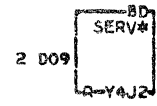

-BLANK COLUMN-

-BLANK COLUMN-

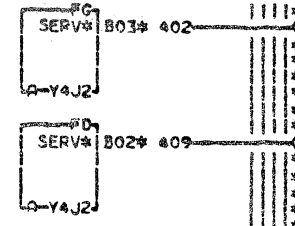

081 RS403  
409 GROUND LEVEL PD2

402 GROUND LEVEL PG2

EDGE CONN.  
402 Q-YAB1B13  
409 Q-YAC1B13

LOC. TYPE

SERV WIRING	
E.C. HISTORY	FRAC# 27RNB
	FRAME 01
DATE LAST EC	IBR CORP. SCD RS403
10-14-80 344270	Per# 1987017 081

RS403  
081 SIR TO PN 1785201 EC 311272

GROUND LEVEL RS201GN4 2

BD  
SERV#  
2 D09  
Q-Y4J4

-BLANK COLUMN-

-BLANK COLUMN-

FG  
SERV# B03# 402  
Q-Y4J4  
FD  
SERV# B02# 409  
Q-Y4J4

081 RS404

409 GROUND LEVEL FD2

402 GROUND LEVEL FG2

EDGE CONN.  
402 A-Y4B1C13  
409 A-Y4E1A11

LOC. TYPE

RS404

081 SIM TO PN 1785202 EC 311272

SERV WIRING	
E.C. HISTORY	E <sub>1</sub> NACH# 27RNB
FRAME	01
DATE LAST EC	IBM CORP. SCD RS404
10-14-80 344270	P. No. 5153913 081