

IBM

*Simulation
of the IBM 650
on the IBM 705*

This manual is the result of work contributed by:

V. J. Groth, Standard Oil Company (Indiana)

J. T. Willette, Standard Oil Company (Indiana)

J. E. Monsma, IBM Corporation

CONTENTS

	Page
Introduction	1
Main Features of the Program:	
705 Components Required	3
705 Memory Area Assignment	3
Simulation of 650 Memory	3
Simulation of the 650 Arithmetic Units.	4
Simulation of the 650 Console	4
Simulation of the 533 Control Panel Functions.	7
Functioning of the Program:	
Housekeeping	9
Main Routines:	
Interpretive Routine	9
Pivot Transfers and 650 Operations Routines.	9
Subroutines:	
Convert 650 Address to 705	11
PAC and UNPAC	11
Convert Alphabetic to Numeric; Convert Numeric to Alphabetic	12
Subroutine Out	12
Other Routines	12
Notes on Programming of Read Mapping and Punch Mapping:	
Available Memory and ASU's.	14
650 Load Cards	15
Simulation of the Standard (80-80) Board	15
Alphanumerical Data	16
Simulation of Storage Entry A-B-C, Punch Card A-B-C, etc..	16
Operating Notes:	
Steps Required to Utilize the Simulation Program.	18
Method of Obtaining a 650 "Drum" Print-Out	20
Listing of the 650 Console Components Versus their 705 Counterparts	21
Program Stops (705)	23
Check Indicator Stops (705).	24
Appendix:	
Flow Charts.	26
Assembly Listing for Housekeeping 1	30
Assembly Listing for Main Simulation Program.	31

INTRODUCTION

The 650 Simulation Program presented in this manual is an interpretive routine for the IBM 705 Electronic Data Processing Machine which in effect transforms the 705 into an IBM 650 Magnetic Drum Data Processing Machine. The program was designed and written primarily as an aid in the transition from a basic 650 system to a 705 system and does not provide for simulation of a 650 with additional features. The logic of this 705 program parallels very closely the internal logic of the 650 itself; persons familiar with 650 operation and with 705 programming will readily understand the functions of the various routines.

It should be clearly understood that the 650 Simulation Program usually will not obviate the necessity of rewriting 650 programs for the 705. For efficient 705 operation, and in order to take full advantage of the greater capacities and speed of the 705, all applications should be completely re-programmed including the re-designing of the basic flow charts, or block diagrams. Nevertheless, the simulation program can be very useful. The necessity of rewriting all 650 programs before the installation of a 705, and release of the 650, is removed; those programs not rewritten before conversion may be treated in an orderly fashion allowing sufficient time for writing efficient 705 programs. In addition, it is possible that at a given installation a few 650 programs are used so infrequently as to make rewriting more expensive than inefficient operation of the 705. For one-time problems or once-a-year jobs, the use of the simulation program might be feasible almost indefinitely. Another possible application of the simulation program is in an installation which includes both a 705 and a 650 when the 650 is not available or is overburdened on occasion.

Certain features of the 650 Simulation Program limit its usefulness and restrict its application. One important factor to be considered is the speed with which a 650 program functions under 705 control. Because of the length and complexity of the simulation program, the 705 will produce 650 output at a slower rate of speed than will the 650. The difference in operating speeds of the 650 as simulated on the 705 compared with an actual 650 will vary depending on the degree of optimizing in the 650 program, the incidence of the various 650 instructions, and sundry other factors. Another feature to be considered is the necessity of programming the mapping routines which perform the functions of the 533 Read-Punch Unit control panel. (See "Simulation of the 533 Control Panel Functions," page 7 and "Notes on Programming of Read Mapping and

Punch Mapping, " page 14.) Because of this feature the 650 Simulation Program is available in the form of a deck of 705 symbolic instruction cards in which symbolic blocks 90-97 are available for programming the mapping routines. After the mapping instructions have been written, card punched, and inserted in the deck, it is necessary, of course, to assemble the complete deck.

The 650 Simulation Program decks (symbolic instruction cards) are available from:

702/705 Program Librarian
Applied Programming Publications
IBM Corporation
590 Madison Avenue
New York 22, New York

MAIN FEATURES OF THE PROGRAM

705 COMPONENTS REQUIRED

To make the 650 Simulation Program as widely applicable as possible it was designed for use with the 20,000 memory position 705. Both 650 memory (2000 words) and the simulation program are contained in the 20,000 memory positions of the 705. If the program is to be used on a 705 with 40,000 memory positions, certain modifications are advisable. Allocation of the first two memory quadrants to the pseudo 650 drum and elimination of the PAC and UNPAC subroutines from the present program will result in a substantial increase in operating speed.

Only a 714 Card Reader and a 722 Card Punch are required in addition to the basic 705. It may be desirable, however, to use tape input instead of card input for the 650 load cards and data cards; this procedure is discussed under "Operating Notes."

705 MEMORY AREA ASSIGNMENT

The 20,000 positions of 705 memory are allocated as follows:

00001 through 14000	- Simulated 650 Drum
14005 through 18019	} Simulation Program
19730 through 19999	
18020 through 19729	- Available for simulation of control panel wiring.

SIMULATION OF 650 MEMORY

The 2000 word 650 drum memory is represented in the first 14,000 positions of 705 memory. This is accomplished by packing each ten-digit 650 word and its sign into seven 705 characters before it is placed in the 705 memory area representing the 650 drum. The sign of the 650 word is placed over the second digit from the left, and the three low order digits are removed, converted into quaternary zone representation, and placed over the third through seventh digits from the left. Thus, the zone portion of each of these five characters represents a factor of zero, one, two, or three times the assigned value of 256, 64, 16, 4, and 1, respectively, according to the position of the quaternary zone digit. In other words, a three-digit decimal number is converted into a five-position quaternary number in binary coding. The figure following shows a

simulated address selection switches (symbolic location 16.19.0 for this operation) and a manual transfer is made to 705 symbolic location 16.77.0 from the 705 console. Both the 650 drum address and the ten-digit word, with its sign, are typed out with appropriate identification, followed by 705 Program Stop 1111. Depression of the start key will cause the next higher drum word to be displayed. The format of the typewriter message is as follows:

650 ADD. XXXX XXXXXXXXXXXX+WORD

To display the contents of the distributor, the accumulator, and the program register, a manual transfer is made to 705 symbolic location 16.25.0. The contents of the three units are typed out with an indication of the signs of the distributor and the accumulator and with appropriate identification for each component, as follows:

DIS XXXXXXXXXXXX+ ACC XXXXXXXXXXXXXXXXXXXXXXXX+
P. R. XX XXXX XXXX

705 Program Stop 2222 follows this message. Depressing the start key will cause a transfer to the beginning of the Interpretive routine and thus effects resumption of operation. (Simulation of the READ-IN STORAGE function of the 650 display switch is obtained by entering the information from the 705 console - see next paragraph.)

The Storage Entry Switches are represented by ten characters in the 705 memory at symbolic location 80.00.0. The sign switch is simulated by the zone portion of the character in the units position. Information may be entered directly from the 705 console or by means of a card in the card reader. The latter method is recommended for initializing the storage entry switches and is discussed more fully under "Operating Notes."

The Operation Lights, Address Lights, and Operating Lights are simulated functionally by typewriter messages. Thus, each instruction executed when the simulated half-cycle mode has been put into effect by the necessary alteration switch setting (see below) is shown by the following message: The words "HALF CYCLE" are typed first and then the contents of the distributor, the accumulator, and the program register are written out with appropriate sign indications before interpretation and execution of the next instruction.

The Address Selection Switches are represented by two groups of four characters each in 705 memory. The four characters at symbolic location

16.24.0 represent the address selection switches with respect to the address stop feature. The other four characters represent the address selection switches with respect to the READ-IN STORAGE and READ-OUT STORAGE functions, and are found at symbolic location 16.19.0.

The Programmed Switch is simulated by means of the 705 alteration switch 0911 in conjunction with appropriate instructions in the simulation program. When 0911 is set to the OFF position a 650 stop code will be executed, and the contents of the distributor, the accumulator, and the program register will be written on the typewriter preceded by the words "650 STOP CODE." Operation may be resumed by depressing the start key. With 0911 set to the ON position a 650 stop code will be executed as a No-Op instruction.

The Half-Cycle Switch is simulated with the 705 alteration switch 0913 and related program instructions. When 0913 is set to the ON position, one 650 instruction is executed each time the start key is depressed. Each instruction executed is written on the typewriter preceded by the words "HALF CYCLE," as well as the contents of the distributor and accumulator with appropriate identification.

Control Switch simulation is effected by means of the 705 alteration switch 0914 and associated program instructions. This switch is turned to the ON position to obtain operation of the address stop feature. The 650 address is stored in symbolic location 16.24.0 representing the setting of the address selection switches. At the time of the address stop, the typewriter writes the words "ADDRESS STOP" followed by the contents of the distributor, the accumulator, and the program register. Depressing the start key causes resumption of operation. Setting 0914 to the OFF position is the equivalent of the 650 control switch in the RUN position; the MANUAL setting is covered by the routine itself.

Overflow Switch simulation is accomplished with the 705 alteration switch 0912 and related instructions. This switch is set to the ON position for overflow SENSE and to the OFF position for overflow STOP. When a stop on overflow occurs, the contents of the distributor, the accumulator, and the program register are written out on the typewriter preceded by the word "OVERFLOW." Operation may be resumed by depressing the start key. When the simulated overflow switch is set to SENSE, i. e., 0912 is set to ON, and an overflow other than quotient overflow occurs, an "A" is placed in the overflow register (at symbolic location 80.47.0) which is interrogated by the Branch on Overflow routine. It is important to note that the 705 overflow check indicator switch (0904) must be set to PROGRAM CONTROL for proper functioning of the simulated 650 overflow switch.

Error Switch simulation is not included in the simulation program. Error sensing is under control of the 705. All check indicator switches other than the 0904 switch are set to the AUTOMATIC position as the simulation program does not include error correction routines for 0902 and 0903 errors. Thus in the event of a 705 read-write error (0902) it is necessary to manually transfer to the appropriate instruction in the simulation program to re-read (symbolic location 7.03.0) or to re-write (symbolic location 7.84.0) the record in error, after restoring the cards as may be required. In the event of an error in card punching (0903) it is advisable to mark the error card for subsequent manual correction and resume operation.

Key Controls simulation is quite apparent. The 650 program start and program stop keys are represented by the 705 start and stop keys. The function of the 650 transfer key is accomplished by entering in the program register, at symbolic location 80.04.1 - 001, a 650 NO-OP instruction with an I-address of the 650 word to which transfer is desired, and manually transferring on the 705 to symbolic location 10.00.0. The function of the remaining keys - program reset, computer reset, accumulator reset, error reset, and error sense reset - may be simulated by entering zeros in the 705 memory positions representing the components concerned.

SIMULATION OF THE 533 CONTROL PANEL FUNCTIONS

The functions performed by the control panel of the 533 Read-Punch Unit and the input-output buffers of the 650 are accomplished in the simulation program by sequences of 705 instructions. It is obvious, therefore, that the portions of the program which simulate the control panel must be programmed to conform with the wiring of the control panel for the 650 program being run. These routines of the program, known as Read Mapping and Punch Mapping, are shown in the listing of the simulation program included in the appendix; they were written specifically for simulation of the control panel wiring for "SOAP" - Symbolic Optimum Assembly Program. Comments and suggestions concerning the programming of Read Mapping and Punch Mapping routines are included under "Notes on Programming of Read Mapping and Punch Mapping."

FUNCTIONING OF THE PROGRAM

As the appendix includes both a flow chart and a complete listing of the 650 Simulation Program, the following explanations are intended merely as a general description of the program. A list of the parts of the program by major symbolic blocks, with a brief description of the functions of each part, is provided below as a basis for discussion.

<u>MAJOR SYMBOLIC BLOCKS</u>	<u>FUNCTIONS</u>
00	Pivot Transfers and 0X Codes Routine *
01	1X Codes Routine
02	2X Codes Routine
03	3X Codes Routine
04	4X Codes Routine
06	6X Codes Routine
07	7X Codes Routine
08	Code 84 - Table Lookup
09	90 BRD Codes and Housekeeping 2
10	Interpretive Routine
11	Convert 650 Address to 705
12	UNPAC (First Part)
13	PAC
14	Convert Numeric to Alphabetic
15	Convert Alphabetic to Numeric
16 & 17	Message Buffer and Routines
19	Exit Routine for Subroutines
20	Final Stop (HLT 7777)
48	Housekeeping 1
50	Unsigned Constants
51	Signed Constants
70	Ten-Word Buffer
71	80 Column Card Buffer
80	650 Components (Storage Entry Switches, Distributor, Accumulator, Program Register, Address Register, and Overflow Register), Alpha Register, Beta Register, and Miscellaneous Constants
90-94	Read Mapping Routine
95-97	Punch Mapping Routine
98	650 Drum Memory Print-Out
99	Continuation of UNPAC

* X indicates a variable digit.

HOUSEKEEPING

Housekeeping operations of the program are accomplished in two stages: Housekeeping 1 (symbolic block 48) is actually a separate 705 program which sets up various ASU's and sets to zero most of the memory positions of the simulated 650 drum. This routine must be assembled apart from the program proper. Housekeeping 1 presumes the use of a special one-card load program supplied with the deck. The final instruction of Housekeeping 1, a transfer to 0004, returns control to this one-card load which brings the balance of the simulation program into 705 memory, thereby displacing Housekeeping 1. The "00" transfer control card of the main simulation deck contains a transfer to Housekeeping 2 which consists of the last few instructions of symbolic block 09. Here, the balance of the "drum" is set to zero, thus wiping out the load program; and entry to the Interpretive routine of the simulation program is effected.

MAIN ROUTINES

Interpretive Routine

Interpretive routine functions are primarily those of executive control and analysis of the specific 650 instructions; they constitute simulation of the internal functions of the 650. Symbolic program block 10 contains the Interpretive routine, and entry is made to its first instruction each time a 650 instruction is executed. The flow chart in the appendix illustrates the functioning of this routine in considerable detail. Instructions are moved into the program register and data into the distributor from 800X locations or from drum locations in the appropriate sequences. When instructions or data are located on the drum, the Interpretive routine utilizes the Convert 650 Address to 705 and UNPAC subroutines to fetch the information and put it in proper form. An α LOD α technique is used to enter and exit these subroutines. In addition, the Interpretive routine provides for validity checking and controls the half-cycle and address stop features. Execution of the specific 650 operation code is carried out in separate routines, transfer to which is effected through a method of digit selection on the tens and units position, in that order, of the operation code. The initial transfer of this digit selection routine using the tens position of the operation code is set up and executed in this Interpretive routine.

Pivot Transfers and 650 Operations Routines

The Interpretive routine and the Pivot Transfers constitute a double digit selection device identifying the operation code. The specific routines

for the various 650 instructions can be located readily in the program listing as the symbolic block numbers correspond to the high order digits of the operation codes.

In the case of the 6X codes, the actual 650 arithmetic operations are performed by the corresponding arithmetic (1X codes) routine in block 01; the function of symbolic block 06 is simply that of resetting the accumulator (upper accumulator only for code 64).

The 2X operations routine makes use of the Convert 650 Address to 705 and PAC subroutines in performing the five 650 Store operations.

The 3X (Shift) and 4X (Branch) functions are straightforward, utilizing only the 03 and 04 symbolic blocks, respectively, without entering any subroutines.

The 7X codes routines are found in program block 07. The Read (70) routine first reads a card into the 80 column card buffer area, and then tests to determine whether it is a 650 load card.* If it is a load card, the entire 80 columns are moved into words 1-8 of the ten-word buffer area. If it is not a load card, transfer is made to the Read Mapping routine where the 80 columns of data are revised and edited by the simulated control panel and placed in the appropriate positions of the ten-word buffer before return to the Read routine. Then by means of the Convert 650 Address to 705 and PAC subroutines, the ten words in the ten-word buffer are placed on the simulated drum one at a time. The Punch (71) routine is essentially the reverse of the above: the Convert 650 Address to 705 and UNPAC subroutines are used in moving the data into the ten-word buffer one word at a time, and the Punch Mapping routine, simulating the control panel, transposes the data into the appropriate arrangement in the 80 column card buffer before the card is written out on the 722 Card Punch or other peripheral equipment.

The Table Lookup operation (Code 84) of the 650 is simulated in program block 08. Here again the subroutines, Convert 650 Address to 705 and

* As the 12 punch which identifies load cards may appear in any card column, it may be necessary to modify the instructions at symbolic locations 07.07.0 and 07.12.0. The listing in this manual assumes the 12 punch to be in the second column as required for the "SOAP" Program. See "Notes on Programming of Read Mapping and Punch Mapping."

UNPAC, are required in performing the operation. Searching for the argument begins with the first word in the designated band of the simulated drum. Since the table arguments must be unpacked one word at a time and compared with the contents of the simulated distributor, the simulation of this 650 operation is relatively more time consuming than that of others.

The 9X operations, Branch on 8 in Distributor Position 1-10, are simulated by a relatively few (the first 13) instructions in symbolic block 09. When a branch is indicated, a portion of block 04 is used to substitute the D-address for the I-address in the program register.

SUBROUTINES

The subroutines discussed below are called for as needed by the main routines described previously. All transfers to subroutines depend on α LOD α sequences carried out in ASU 12.

Convert 650 Address to 705

This subroutine is contained in symbolic block 11 and is utilized by some of the main routines. Before the α LOD α and the transfer to this subroutine, the 650 address is loaded into ASU 04 for conversion. In the subroutine, after the conversion has been made in the manner indicated in the flow chart, the 705 address is loaded into ASU 04, where it will be picked up by the main routine which called for the conversion. Re-entry to that main routine is then effected by returning to the second instruction after the α LOD α instruction through the Subroutine Out.

PAC and UNPAC

These subroutines (PAC in program block 13, UNPAC in blocks 12 and 99) have been illustrated and briefly discussed under "Simulation of 650 Memory."

As mentioned previously, the PAC operation compresses a 650 word and its sign into seven 705 characters by placing the sign over the second digit from the left and by converting the three low-order digits to a quaternary zone representation over the third through the seventh digits. All of the simulated 650 operations which place data on the drum make use of the subroutine. Before the α LOD α and the transfer to PAC, the 650 word (ten digits) to be packed is placed in the Alpha Register. The subroutine, after making the conversion, places the packed (seven character) word in the Beta Register, and returns control to the main routine at the second instruction after the α LOD α instruction.

The function of UNPAC is the reverse of that of the PAC subroutine: UNPAC acts on the contents of the Beta Register, stripping the zones from the six low-order characters and reconvertng them into the sign and the three terminal digits, and places the resulting unpacked (ten digit) word in the Alpha Register.

Convert Alphabetic to Numeric; Convert Numeric to Alphabetic

These subroutines simulate the 650 alphabetic device by converting, respectively, five 705 characters into ten digits corresponding to the 650 alphabetic code, and vice versa. They are available in the 650 Simulation Program (in symbolic blocks 15 and 14) for convenience in programming the Read Mapping and Punch Mapping routines, respectively. Each subroutine converts one word at a time; entry to either is made with an α LOD α each time a word is to be converted.

In the case of Alphabetic to Numeric conversion, the five characters considered alphabetic are placed in the five low-order positions of the Beta Register before entry to the subroutine is made. The converted word is placed in the Alpha Register by the subroutine, and re-entry to Read Mapping is effected.

To convert numeric to alphabetic the process is reversed, i. e., the ten digit numerical word is placed in the Alpha Register before conversion, and the result is found in the Beta Register after conversion. Each of these subroutines is utilized only by the related mapping routine and thus does not figure in the operation of the program unless called for by the programmer writing the mapping routines. Obviously, they are not needed if the input and the output data are entirely numerical.

Subroutine Out

This subroutine (block 19) is actually a secondary subroutine which provides for return to the main routine from all subroutines. As already explained, entering of any subroutine is preceded by an α LOD α in ASU 12. The exit from each subroutine is an automatic transfer to Subroutine Out, which simply sets up and executes the transfer instruction required for re-entry at the appropriate instruction of the main routine concerned.

OTHER ROUTINES

The remaining portions of the program require little or no discussion. A sequence of instructions in symbolic block 16 provides for setting up

and writing out the various typewriter messages. A short routine in symbolic block 98 is available at the user's option for unpacking and printing out, on the 717 printer, the contents of the simulated drum; this routine is designed as an aid in debugging the Read and Punch Mapping routines.

NOTES ON PROGRAMMING OF READ MAPPING AND PUNCH MAPPING

As noted previously, the Read Mapping and Punch Mapping routines perform the functions of control panel wiring in the 533 Read-Punch Unit. Therefore, these routines must be written to conform to the control panel wiring required for the specific 650 application which is to be run on the 705. The program listing in the appendix includes the Read and Punch Mapping routines for "SOAP" which are relatively long and involved inasmuch as the wiring of the "SOAP" control panel is quite extensive. (See 650 Programming Bulletin 1, Symbolic Optimum Assembly Programming - S.O.A.P., Form 22-6285-1, page 34, for wiring diagram) Mapping routines for other applications will usually require considerably fewer instructions.

Familiarity with both the 650 and the 705 is required of the person programming these routines. If the panel wiring to be simulated is complex, it is advisable to make a complete analysis of the control panel functions for that application in the form of a block diagram before attempting to write the routines.

Certain essential information and some suggestions are included in the following paragraphs.

AVAILABLE MEMORY AND ASU's

Approximately 1,700 positions of 705 memory are left free for the Read and Punch Mapping routines: memory positions 18,020 through 19,729. (Symbolic blocks 90-97 are available for coding.) The following list shows the status of the various 705 storage units. Note that ASU's 13, 14, and 15 are available for the mapping routines; ASU's 01 to 05 and 07 may be used also, but if their lengths are altered they must be reset after being used. Caution may have to be exercised if ASU's 01, 02, 04, or 06 are to be used in the Read Mapping or Punch Mapping routines as these ASU's are utilized in Convert Alphabetic to Numeric and Convert Numeric to Alphabetic subroutines.

<u>Storage Unit</u>	<u>Length</u>	<u>Contents</u>	<u>Functions</u>
Accumulator	Various	Various	Miscellaneous
ASU 01	1	X	Miscellaneous
ASU 02	2	XX	Miscellaneous
ASU 03	3	XXX	Miscellaneous

<u>Storage Unit</u>	<u>Length</u>	<u>Contents</u>	<u>Functions</u>
ASU 04	4	XXXX	650 and 705 Addresses
ASU 05	10	XXXXXXXXXX	Unpacked 650 words
ASU 06	2	#0	Executing ADM instructions
ASU 07	7	XXXXXXX	Packed 650 words
ASU 08	1	F	Constant
ASU 09	1	G	Constant
ASU 10	1	H	Constant
ASU 11	1	I	Constant
ASU 12	4	XXXX	α LOD α
ASU 13	-	-	Available
ASU 14	-	-	Available
ASU 15	-	-	Available

650 LOAD CARDS

If the 650 program to be simulated uses only one type of load card, the Read routine (block 07) identifies them as load cards and handles them accordingly, provided the instructions at symbolic locations 7.07.0 and 7.12.0 refer to the card column containing the 12-punch which identifies the load cards. If, however, the program uses two types of load cards, as in the case of "SOAP", it is necessary to test for the secondary load cards in the Read Mapping routine. The first nine instructions of symbolic block 90 constitute the test for secondary load cards in the "SOAP" application; the instructions at symbolic locations 90.00.2 and 90.00.7 might require modification if the sequence were used in another application also requiring two types of load cards.

SIMULATION OF THE STANDARD (80-80) BOARD

The first operation to be programmed in a Read Mapping routine simulating the 80-80 board (or any other board) is the resetting of the 10-word storage area to zeros; conversely, the first step of programming Punch Mapping is the resetting of the 80-column card storage area to blanks. One way to complete the 80-80 board simulation is to provide, in Read Mapping, for the transmission of the first ten positions of card storage to Word 1 of the 10-word storage, the next ten columns to Word 2, etc., until all 80 columns have been moved. Conversely, in Punch Mapping, provide for the transmission of Word 1 to the first 10 positions of card storage, Word 2 to the next 10 positions, etc. This approach might be

thought of as the conventional method as it is similar to the one used in the simulation of complex boards. Of course, the simplest way to accomplish the 80-80 board simulation would be to provide for the transmission of the whole 80-column card storage area at one time to words 1-8 of the 10-word storage, and vice versa. Re-entry to the Read routine from Read Mapping is at symbolic location 07.21.0, and to the Punch routine from Punch Mapping at 07.84.0.

ALPHANUMERICAL DATA

The two subroutines provided for handling alphanumerical data, Convert Alphabetic to Numeric and Convert Numeric to Alphabetic, already have been discussed in some detail. They are used in the following manner:

In Read Mapping, place the five-character alphabetic word to be converted in the Beta Register, α LOD α in ASU 12, and transfer to symbolic location 15.00.0. Upon return from symbolic block 15, the converted word may be loaded into ASU 05 from the Alpha Register and unloaded in the desired word position of the 10-word storage. Conversely, in Punch Mapping, place the 10 digit numerical-coded word in the Alpha Register, α LOD α in ASU 12, and transfer to symbolic location 14.00.0. Upon return from symbolic block 14, the converted word may be loaded into an ASU, set to five positions, from the Beta Register and unloaded in the appropriate five positions of the 80-column card storage area.

SIMULATION OF STORAGE ENTRY A-B-C, PUNCH CARD A-B-C, ETC.

When more than one card format is to be read into the simulated 650, or when more than one card format is to be punched, the programming will be facilitated by writing a separate Read Mapping and/or Punch Mapping routine for each different format, using a different symbolic block number for each routine. Entry to the appropriate routine will be dependent upon an initial test. The setting up of a control word to identify the different card formats in Read Mapping is simply a matter of testing the appropriate columns, i. e., positions of the card record, and placing 8's and 9's in word 10 in accordance with the results of the tests.

When co-selector simulation is necessary, the following technique may prove helpful:

71.00.0 with an increment of 001 is the position of card column 1 in the 80-column card storage area. Depending on whether or not

a predetermined controlling factor, such as an X punch in col. 79, is present, ASU 13 is set to a length of five and ASU 14 is set to a length of zero, or vice versa. Serial transmission is now attempted through both ASU 13 and ASU 14, as follows:

		<u>ASU</u>
RCV	70.01.0 - 009	
TMT	71.00.0 + 001	13
TMT	71.00.0 + 011	14

The ASU which is set to zero will cause the related TMT instruction to function effectively as a NOP instruction, and the other ASU permits the selected five digits to pass.

OPERATING NOTES

The information in this section is intended as a check-list for users of the 650 Simulation Program before assembling the program and as reference material for the operator during the actual running of the program.

STEPS REQUIRED TO UTILIZE THE SIMULATION PROGRAM

- A. Program the Read and Punch Mapping Routines; card punch the symbolic instruction cards and insert them in the proper sequence in the main symbolic deck.
- B. Modify symbolic instructions 07.07.0 and 07.12.0 so that the increment corresponds to the card column containing the 12-punch which identifies the 650 load cards.
- C. It may be desirable to transfer the 650 load cards and data cards to magnetic tape in an auxiliary operation and to use the tape as input for the simulation program. To modify the program for tape input, change the instruction at symbolic location 07.03.0 to "SEL 020X" and insert these three additional housekeeping instructions as class 1 symbolic entries in Housekeeping 2:

09.16.0	SEL	020X
09.17.0	RWD	0002
09.18.0	IOF	0000

These instructions apply to a 705 with a 754 Tape Control Unit. If tape input is desired on a 705 equipped with a 777 Tape Record Coordinator, the instructions should be in the appropriate form, and a BPC instruction should be inserted immediately following the SEL instruction located at symbolic location 07.03.0.

Another procedure which may prove useful if a 650 program is to be simulated frequently is as follows: After the 650 program has been loaded into core storage under control of the simulation program, the entire 705 memory may be written on a tape. Using this tape for subsequent runs of the program will result in a considerable saving of time. To make use of this procedure it is necessary to devise a housekeeping routine which will initialize the various ASU's and, as the final step, read in the tape record containing memory. As the last position of memory will not be present on the tape, the

housekeeping routine must provide for placing the appropriate character, an "H", in memory position 19,999 before the Read instruction addressed to the memory tape is given. Because the housekeeping program will be wiped out when the tape is read in, it is necessary to locate the routine in memory so as to have the last instruction, i. e., the Read instruction, located at 15,334. At the end of the Read command, MAC I will step five positions and thus will be at the appropriate place in the simulation program.

- D. If a 717 printer is available "on-line", it may be desirable to print the output instead of punching it, either while testing the Read and Punch Mapping routines, or for final output if a printed report is needed. To make this modification, simply change symbolic entry 7.84.0 to "SEL 0400". If the 650 card output is to be used for printing reports with rearrangement of the data on, for example, the 402 Accounting Machine, it will save an auxiliary listing operation to print directly on the 717 line printer. It usually will be necessary, then, to incorporate the appropriate instructions in the Punch Mapping routine to provide the desired format.
- E. Assemble Housekeeping 1 and the main program separately. (Note: In assembling the main program the operator may expect three "check operation" messages in addition to the final stop message. These messages will refer to symbolic entries 01.57.0, 01.63.0, and 08.32.0 and may be disregarded; they occur as a result of using the special technique of addressing a LNG instruction to an ASU.)
- F. Prepare 705 program cards to be used to initialize the simulated storage entry switches and simulated program register. The "patch" card for initialization of the storage entry switches should contain, in columns 16-25, the 650 instruction which is set initially in the storage entry switches when operating on an actual 650; the units position of the instruction should be signed plus. The "patch" card for initialization of the simulated program register should be punched with the following 650 instruction as data in columns 16-25: 00 0000 8000; the units position should not be signed. The actual 705 addresses to be punched in the "initial address" columns of these cards may be obtained from the assembly listing. The "number of columns" will be punched "10" in both cases. These two initialization cards must be placed in the main deck of simulation program cards immediately preceding the transfer control card.
- G. Using the assembly listing, translate the symbolic addresses of the various simulated 650 components, etc., into actual addresses so as

to have the information readily available at the console when the program is being run.

H. Arrange the cards in the card reader in the following sequence:

1. Special one-card load program
2. Housekeeping 1 cards
3. Housekeeping 1 "00" transfer control card
4. Simulation deck (main deck)
5. Storage entry switches initialization card
6. Program register initialization card
7. Simulation program "00" transfer control card
8. 650 program load cards
9. 650 program data cards

If tape input is used for the 650 load cards and data cards, the transfer control card of the simulation program will be the last card in the card reader.

METHOD OF OBTAINING A 650 "DRUM" PRINT-OUT

To obtain a print-out of the simulated 650 drum on an "on-line" 717 Printer, the operator may effect a manual transfer (705) to symbolic instruction 98.70.1, actual address, 19734. The end of the drum print will be signaled by HLT 9999. If desired, a 705 memory print-out may thereafter be obtained by placing a memory-print deck in the card reader and depressing the 705 start key, which will transfer control to a connective routine reading in, and transferring to, the memory print-out program.

LISTING OF THE 650 CONSOLE COMPONENTS VERSUS THEIR
705 COUNTERPARTS

650 Console Component

705 Simulation

Display Lights

{ Typewriter messages (See
"Display Switch" below).

Storage Entry Switches

{ Ten characters in 705 memory
(symbolic location 16.21.0)
which may be entered by means
of a card in the card reader or
from the 705 console.

Operation, Address, Operating
Lights

{ Typewriter writes out each
instruction executed when
simulated half-cycle switch
is ON.

Address Selection Switches

{ See ADDRESS STOP and
READ-IN STORAGE

Programmed Switch

{ STOP
RUN

OFF } 705 Alteration Switch 0911
ON }

Half Cycle Switch

{ HALF
RUN

ON } 705 Alteration Switch 0913
OFF }

Control Switch

{ ADDRESS STOP
RUN

ON } 705 Alteration Switch 0914
OFF }
For address stop, store address
at symbolic location 16.24.0.

Display
Switch

{ LOWER ACCUM
UPPER ACCUM
DISTRIBUTOR
PROGRAM REGISTER

{ Contents will be written on
typewriter by transferring to
symbolic location 16.25.0.

READ-OUT STORAGE

{ Contents will be written on type-
writer by storing 650 drum
address at symbolic location
16.19.0 and transferring to
16.77.0.

READ-IN STORAGE

{ Word (signed) to be entered on
drum is stored at symbolic lo-
cation 16.21.0. Drum address
is stored at 16.19.0 and trans-
fer is effected to 16.96.0.

LISTING OF THE 650 CONSOLE COMPONENTS VERSUS THEIR
705 COUNTERPARTS (cont'd.)

<u>650 Console Component</u>		<u>705 Simulation</u>
Overflow Switch	{ STOP SENSE	OFF } 705 Alteration Switch 0912 ON } Note: The 0904 check indicator switch of the 705 must al- ways be set to PROGRAM CONTROL.
Error Switch	{ STOP SENSE	{ Error sensing is under control of the 705. (All check indicator switches except 0904 should be set to AUTOMATIC.)
Transfer Key		{ Enter 00 0000 XXXX in program register (symbolic location 80.04.1) and transfer to symbolic location 10.00.0 (XXXX being the address of the 650 instruction to which a transfer is desired).
Program Start Key		705 Start Key
Program Stop Key		705 Stop Key
Program Reset Key		Enter zeros in simulated pro- gram register.
Computer Reset Key		Enter zeros in simulated pro- gram register, distributor and accumulator.
Accumulator Reset Key		Enter zeros in simulated dis- tributor and accumulator.
Error Sense Reset Key		Not represented

PROGRAM STOPS (705)

Special One-Card Load Program

<u>Stops</u>	<u>Explanation and Action</u>
9531	Card Reader end-of-file stop: "00" card missing. Check program deck, ready "00" card in card reader, RESET, and START.

Simulation Program

<u>Stops</u>	<u>Explanation and Action</u>
0913	650 Half-cycle Stop. Depress START key to continue half-cycling, or place alteration switch 0913 OFF and depress START key to run automatically.
0914	650 Address Stop. Depress START key to resume operation.
1111	End of "Display 650 Word" routine. Depress START key to display word at next higher drum address, or manually transfer to symbolic location 10.00.0 to begin, or resume, operation.
2222	End of typewriter messages. Depress START key to resume operation.
7777	End of job.
9999	End of 650 "drum" print-out. Place 705 memory print program MEPR 70 or MEPR 72 in card reader and depress START key for 705 memory print-out.

CHECK INDICATOR STOPS

<u>Stops</u>	<u>Action</u>
0902 while reading	Remove cards from the hopper and run remaining cards out of the card reader; the error card will be the fourth card from the back. Or if end of file is about to occur, remove cards from both the hopper and the stacker, and run out the remaining cards; the error card will be the second from the front. Correct the error card, ready it and subsequent cards in the card reader, and manually transfer (705) to symbolic location 7.03.0 to re-read the record. Or if input is from tape, RESET, manually back-space the tape from the 705 console, and transfer to symbolic location 7.03.0 to reread the record.
0902 while writing	The card containing the error will be the one entering the stacker. Mark the error card and manually transfer to symbolic location 7.84.0 to rewrite the record.
0903 while writing	The card containing the error will be the top card in the stacker. Mark this card for subsequent manual correction and resume operation by depressing the START key.

APPENDIX

FLOW CHARTS

LISTINGS

FLOW CHART FOR MAIN ROUTINES

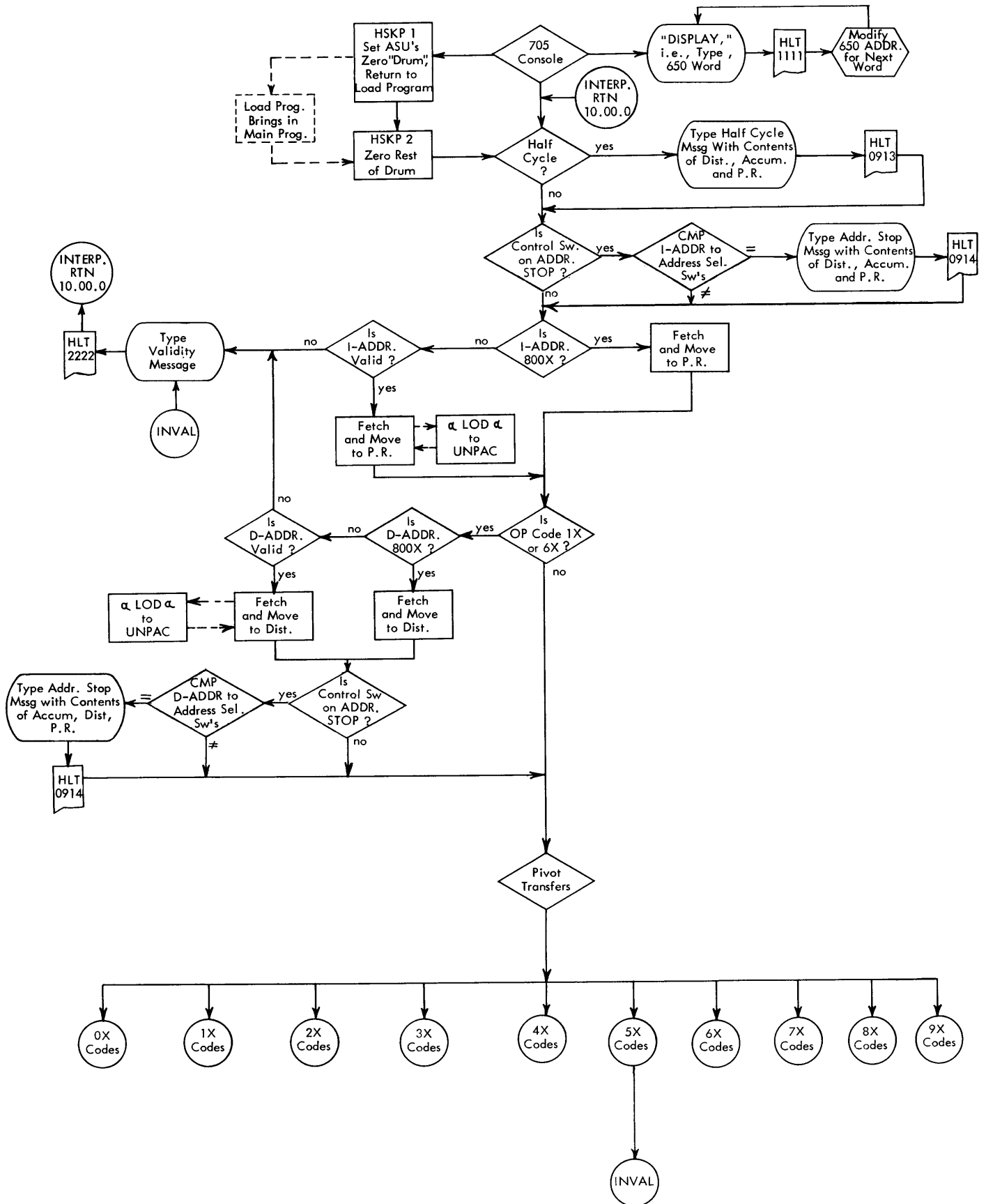

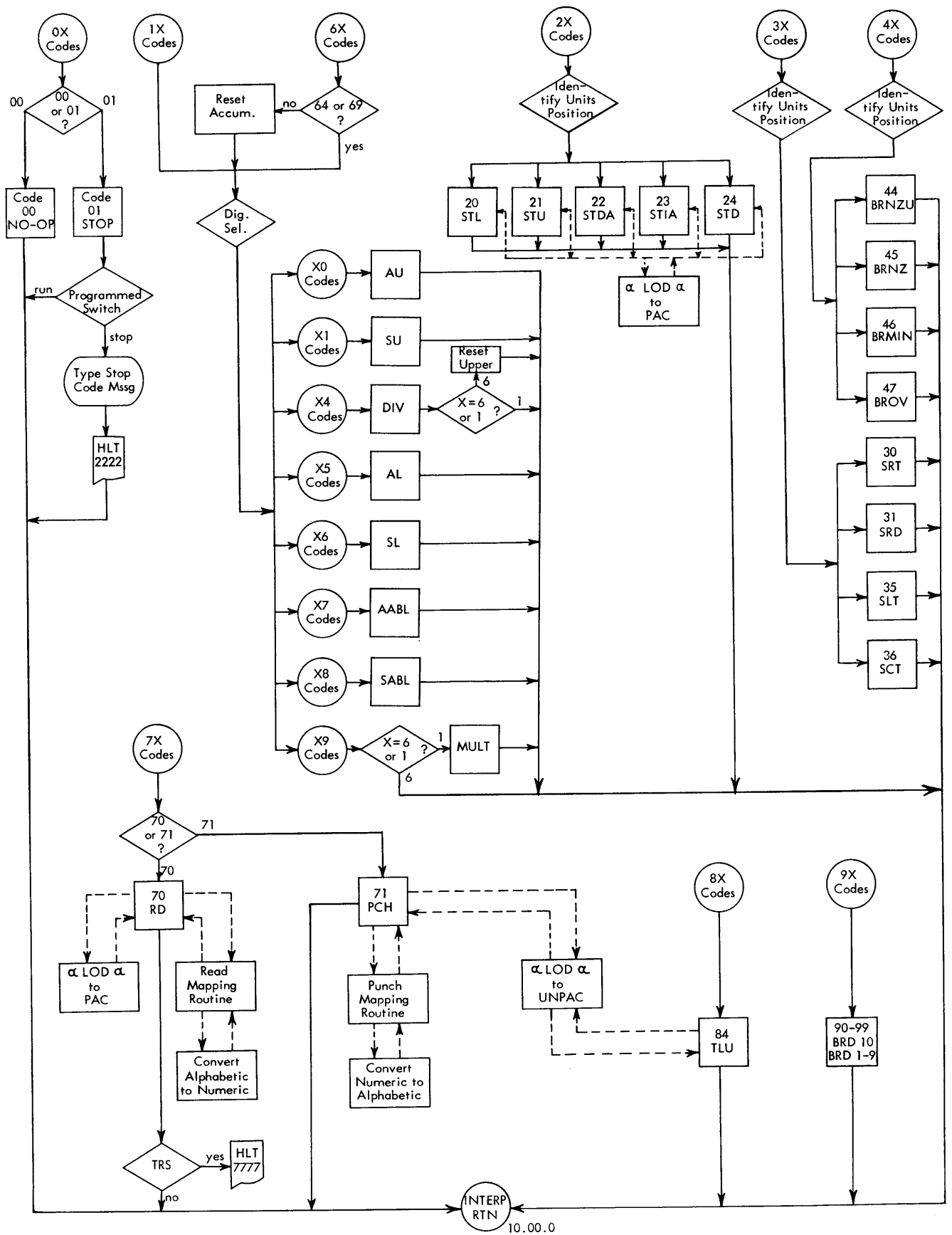

FLOW CHARTS FOR SUBROUTINES

PAC - Symbolic Block 13
(from symbolic blocks 02, 07 or 17)

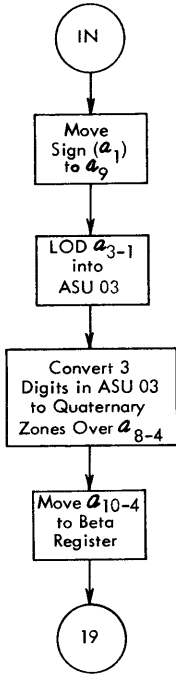

UNPAC - Symbolic Blocks 12 and 99
(from symbolic blocks 07, 08, 10 or 16)

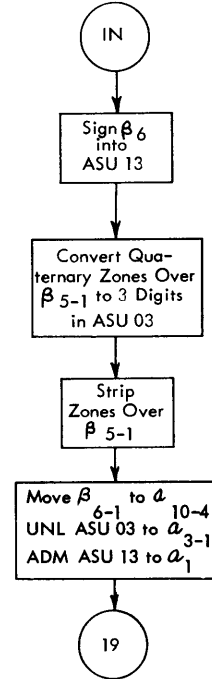

Convert 650 Address to 705
Symbolic Block 11
(from symbolic blocks 02, 07, 08, 10, 16 or 17)

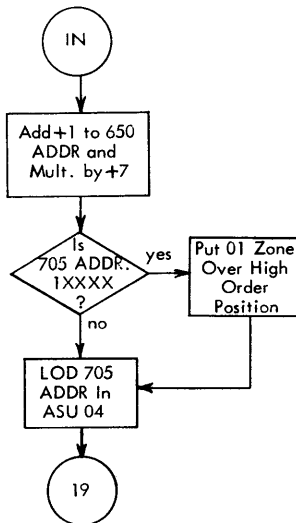

Notation

α_{1-10} = Contents of Alpha Register, Positions 1-10
 β_{1-10} = Contents of Beta Register, Positions 1-10

Convert Numeric to Alphabetic
 Symbolic Block 14
 (from Punch Mapping)

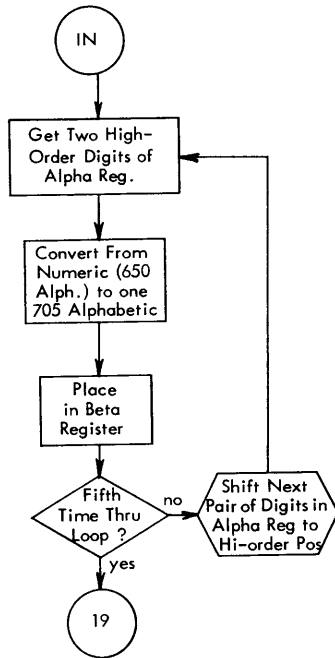

Convert Alphabetic to Numeric
 Symbolic Block 15
 (from Read Mapping)

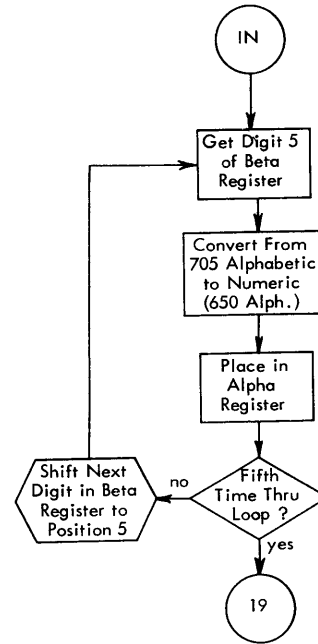

Subroutine Out
 Symbolic Block 19

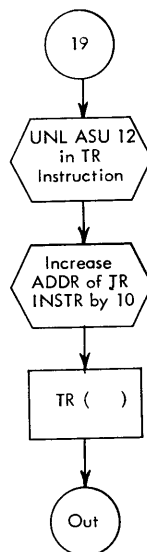

ASSEMBLY LISTING FOR MAIN SIMULATION PROGRAM

C L	LNG	SYMBOLIC			INCR	ACTUAL				S	DATA OR DESCRIPTION	
		LOC	OP	ADDR		ASU	LOC	OP	ADDR			ADDR N
6		.00.0		14005							PIVOT TRANSFERS	BLOCK 00
		.01.0	TR	.81.0	00	14009	1	14204	U204		OX OPER. CODE	
		.02.0	TR	10.43.0	00	14014	1	16324	W324		8000 ADD.	
		.03.0	TR	1.00.0	00	14019	1	14249	U249		1X OPER. CODE	
		.04.0	TR	10.46.0	00	14024	1	16339	W339		8001 ADD.	
		.05.0	TR	2.00.0	00	14029	1	14664	U664		2X OPER. CODE	
		.06.0	TR	10.48.0	00	14034	1	16349	W349		8002 ADD.	
		.07.0	TR	3.00.0	00	14039	1	14834	U834		3X OPER. CODE	
		.08.0	TR	10.50.0	00	14044	1	16359	W359		8003 ADD.	
		.09.0	TR	4.00.0	00	14049	1	15134	V134		4X OPER. CODE	
		.10.0	TR	17.10.0	00	14054	1	17599	X599		INVALID ADD.	
		.11.0	TR	17.10.0	00	14059	1	17599	X599		INVALID CODE	
		.12.0	TR	17.10.0	00	14064	1	17599	X599		INVALID ADD.	
		.13.0	TR	6.00.0	00	14069	1	15269	V269		6X OPER. CODE	
		.14.0	TR	17.10.0	00	14074	1	17599	X599		INVALID ADD	
		.15.0	TR	7.00.0	00	14079	1	15324	V324		7X OPER. CODE	
		.16.0	TR	17.10.0	00	14084	1	17599	X599		INVALID ADD.	
		.17.0	TR	8.00.0	00	14089	1	15754	V754		8X OPER. CODE	
		.18.0	TR	17.10.0	00	14094	1	17599	X599		INVALID ADD.	
		.19.0	TR	9.00.0	00	14099	1	16019	W019		9X OPER.	
7		.21.0									PIVOT TRANS FOR 1X & 6X	
		.22.0	TR	1.04.0	00	14104	1	14274	U274		10 CODE ADD UPPER	
		.23.0	TR	1.03.1	00	14109	1	14269	U269		60 CODE RESET ADD UPPER	
		.24.0	TR	1.27.0	00	14114	1	14404	U404		11 CODE SUB UPPER	
		.25.0	TR	1.26.1	00	14119	1	14399	U399		61 CODE RESET SUB UPPER	
		.26.0	TR	17.10.0	00	14124	1	17599	X599		INVALID	
		.27.0	TR	17.10.0	00	14129	1	17599	X599		INVALID	
		.28.0	TR	17.10.0	00	14134	1	17599	X599		INVALID	
		.29.0	TR	17.10.0	00	14139	1	17599	X599		INVALID	
		.30.0	TR	1.68.0	00	14144	1	14609	U609		14 CODE DIVIDE	
		.31.0	TR	6.04.0	00	14149	1	15289	V289		64 CODE DIVIDE & RESET UPPER	
		.32.0	TR	1.30.0	00	14154	1	14419	U419		15 CODE ADD LOWER	
		.33.0	TR	1.30.0	00	14159	1	14419	U419		65 CODE RESET ADD LOWER	
		.34.0	TR	1.32.0	00	14164	1	14429	U429		16 CODE SUB LOWER	
		.35.0	TR	1.32.0	00	14169	1	14429	U429		66 CODE RESET SUB LOWER	
		.36.0	TR	1.34.0	00	14174	1	14439	U439		17 CODE ADD ABS LOWER	
		.37.0	TR	1.34.0	00	14179	1	14439	U439		67 CODE RESET ADD ABS LOWER	
		.38.0	TR	1.38.0	00	14184	1	14459	U459		18 CODE SUB ABS LOWER	
		.39.0	TR	1.38.0	00	14189	1	14459	U459		68 CODE RESET SUB ABS LOWER	
		.40.0	TR	1.42.0	00	14194	1	14479	U479		19 CODE MULT	
		.41.0	TR	10.00.0	00	14199	1	16099	W099		69 CODE LOAD DISTRIBUTOR	
		.81.0	CMP	50.01.0	01	14204	4	17636	X6T6		OX OP CODE	
		.82.0	TRE	.85.0	00	14209	L	14224	U224			
		.83.0	TRH	17.10.0	00	14214	K	17599	X599			
		.84.0	TR	10.00.0	00	14219	1	16099	W099		00 NOOP	
1		.85.0	SEL	0911	00	14224	2	0911	0911		01 STOP TEST PROGRAM RUN	
		.86.0	TRS	10.00.0	00	14229	0	16099	W099		OR STOP SWITCH	
1		.87.0	SEL	0500	00	14234	2	0500	0500			
		.88.0	WR	16.16.1	00	14239	R	17129	X129			
		.89.0	TR	16.25.0	00	14244	1	17194	X194			
		1.00.0	UNL	1.03.0	-001	01	14249	7	14263	U2W3		BLOCK 01
		1.01.0	SGN	80.02.0	01	14254	T	17926	X9S6		UPPER ACC	
		1.02.0	RAD	80.03.0	00	14259	H	17936	X936		UPPER AND LOWER ACC	
1		1.03.0	TR	14104	00	14264	1	14104	U104		RESET PSEUDO-ACC	
		1.03.1	ST	80.03.0	00	14269	F	17936	X936		10 AU	
1		1.04.0	SHR	0010	00	14274	C	0010	0010			
		1.05.0	ADD	80.01.0	00	14279	G	17916	X916			
1		1.06.0	LNG	0010	00	14284	D	0010	0010			
		1.06.1	UNL	80.02.0	08	14289	7	17926	XR26		DEFINE LENGTH OF LOWER ACCUM	
		1.06.2	ADD	80.03.0	00	14294	G	17936	X936			
1		1.07.0	SEL	0904	00	14299	2	0904	0904		OVERFLOW TEST	
		1.08.0	TRS	1.18.0	00	14304	0	14354	U354			
		1.09.0	ST	80.03.0	00	14309	F	17936	X936			
		1.10.0	SGN	80.03.0	01	14314	T	17936	X9T6		PUT SIGN OF LOWER ACC	
		1.11.0	ADM	80.03.0	01	14319	6	17936	X9T6		ON LOWER ACC	
		1.12.0	ADM	80.02.0	01	14324	6	17926	X9S6		AND UPPER ACC	
		1.13.0	TR	10.00.0	00	14329	1	16099	W099		RETURN TO INTERP ROUTINE	

C	LNG	SYMBOLIC	INCR	ASU	LOC	OP	ADDR	ASU	LOC	OP	ADDR	S	DATA OR DESCRIPTION
L		LOC	OP	ADDR								N	
		1.14.0	SGN	1.13.0	-004	01	14334	T	14325	U3S5			
1		1.15.0	SEL	0500		00	14339	2	0500	0500			
		1.16.0	WR	16.17.5	-007	00	14344	R	17143	X143			
		1.17.0	TR	16.25.0		00	14349	1	17194	X194			
1		1.18.0	SET	0020		00	14354	B	0020	0020			
1		1.19.0	SEL	0912		00	14359	2	0912	0912			
		1.20.0	TRS	1.24.0		00	14364	O	14384	U384			OVERFLOW SWITCH
		1.21.0	RCV	1.13.0	-004	00	14369	U	14325	U325			
		1.22.0	TMT	51.01.0		01	14374	9	17671	X6X1			
		1.23.0	TR	1.09.0		00	14379	1	14309	U309			
		1.24.0	RCV	80.47.0		00	14384	U	17973	X973			
		1.25.0	TMT	51.01.0		01	14389	9	17671	X6X1			
		1.26.0	TR	1.09.0		00	14394	1	14309	U309			
		1.26.1	ST	80.03.0		00	14399	F	17936	X936			RESET PSEUDO-ACC
1		1.27.0	SHR	0010		00	14404	C	0010	0010			61 AND 11 CODE SUB UPPER
		1.28.0	SUB	80.01.0		00	14409	P	17916	X916			
		1.29.0	TR	1.06.0		00	14414	1	14284	U284			
		1.30.0	ADD	80.01.0		00	14419	G	17916	X916			65 AND 15 CODE ADD LOWER
		1.31.0	TR	1.07.0		00	14424	1	14299	U299			
		1.32.0	SUB	80.01.0		00	14429	P	17916	X916			66 AND 16 CODE SUB LOWER
		1.33.0	TR	1.07.0		00	14434	1	14299	U299			
		1.34.0	LOD	80.01.0		01	14439	8	17916	X9/6			67 AND 17 CODE ADD ABS TO LOWER
		1.35.0	CMP	51.09.0		01	14444	4	17679	X6X9			
		1.36.0	TRH	1.32.0		00	14449	K	14429	U429			
		1.37.0	TR	1.30.0		00	14454	1	14419	U419			
		1.38.0	LOD	80.01.0		01	14459	8	17916	X9/6			68 AND 18 CODE SUB ABS TO LOWER
		1.39.0	CMP	51.09.0		01	14464	4	17679	X6X9			
		1.40.0	TRH	1.30.0		00	14469	K	14419	U419			
		1.41.0	TR	1.32.0		00	14474	1	14429	U429			
1		1.42.0	SHR	0010		00	14479	C	0010	0010			19 CODE MULTIPLY
		1.43.0	MPY	80.01.0		00	14484	V	17916	X916			
		1.44.0	LOD	80.03.0		05	14489	8	17936	XZT6			
		1.45.0	TRZ	1.09.0		05	14494	N	14309	UT#9			
1		1.46.0	SHR	0010		00	14499	C	0010	0010			
		1.47.0	SGN	80.01.0		15	14504	T	17916	XIA6			
		1.48.0	SGN	80.03.0		01	14509	T	17936	X9T6			
		1.49.0	TRP	1.60.0		00	14514	M	14569	U569			
		1.50.0	LOD	51.13.0		01	14519	8	17687	X6Y7			
		1.51.0	ADM	80.03.0		01	14524	6	17936	X9T6			
		1.52.0	ADM	80.01.0		01	14529	6	17916	X9/6			
		1.53.0	ADM	80.02.0		01	14534	6	17926	X9S6			
		1.54.0	ADD	80.03.0		00	14539	G	17936	X936			
1		1.55.0	SEL	0904		00	14544	2	0904	0904			
		1.56.0	TRS	1.62.0		00	14549	O	14579	U579			
1		1.57.0	LNG	0010		01	14554	D	0010	00/0			
		1.58.0	ADM	80.01.0		15	14559	6	17916	XIA6			
		1.59.0	TR	1.09.0		00	14564	1	14309	U309			
		1.60.0	LOD	51.00.0		01	14569	8	17670	X6X0			
		1.61.0	TR	1.51.0		00	14574	1	14524	U524			
1		1.62.0	SET	0010		00	14579	B	0010	0010			
1		1.63.0	LNG	0010		01	14584	D	0010	00/0			
		1.64.0	ADD	80.01.0		00	14589	G	17916	X916			
		1.65.0	RCV	80.47.0		00	14594	U	17973	X973			
		1.66.0	TMT	51.01.0		01	14599	9	17671	X6X1			
		1.67.0	TR	1.58.0		00	14604	1	14559	U559			
		1.68.0	DIV	80.01.0		00	14609	W	17916	X916			14 DIV
1		1.69.0	SEL	0904		00	14614	2	0904	0904			STOP ON DIV. OVERFLOW
		1.70.0	TRS	1.15.0		00	14619	O	14339	U339			
		1.71.0	NOP	6.08.0		00	14624	A	15309	V309			
		1.72.0	SGN	80.03.0		15	14629	T	17936	XIC6			
		1.73.0	ST	80.03.0		00	14634	F	17936	X936			
1		1.74.0	SHR	0118		00	14639	C	0118	0118			
1		1.75.0	SET	0010		00	14644	B	0010	0010			
		1.76.0	UNL	80.02.0		00	14649	7	17926	X926			
		1.77.0	ADM	80.02.0		15	14654	6	17926	XIB6			
		1.78.0	TR	10.00.0		00	14659	1	16099	W099			
		2.00.0	RCV	80.10.0	-009	00	14664	U	17962	X962			

BLOCK 02

C	LNG	SYMBOLIC	INCR	ASU	LOC	ACTUAL	S	DATA OR DESCRIPTION
L	LOC	OP	ADDR		LOC	OP	ADDR	N
	2.01.0	CMP	50.02.0		01	14669	4 17637	X6T7
	2.02.0	TRE	2.21.0		00	14674	L 14769	U769
	2.03.0	TRH	2.25.0		00	14679	K 14789	U789
	2.04.0	CMP	50.01.0		01	14684	4 17636	X6T6
	2.05.0	TRE	2.19.0		00	14689	L 14759	U759
	2.06.0	TMT	80.03.0	-009	05	14694	9 17927	XZS7
	2.07.0	RCV	80.01.0	-009	00	14699	U 17907	X907
	2.08.0	TMT	80.10.0	-009	05	14704	9 17962	XZW2
	2.09.0	LOD	2.09.0		12	14709	8 14709	UG09
	2.10.0	TR	13.00.0		00	14714	1 16599	W599
	2.11.0	LOD	80.04.2		04	14719	8 17943	XZ43
	2.12.0	LOD	2.12.0		12	14724	8 14724	UG24
	2.13.0	TR	11.00.0		00	14729	1 16394	W394
	2.14.0	UNL	2.17.0		04	14734	7 14749	UX49
1	2.15.0	SET	0007		00	14739	B 0007	0007
	2.16.0	LOD	80.07.0		00	14744	8 17960	X960
1	2.17.0	UNL	0000		00	14749	7 0000	0000
	2.18.0	TR	10.00.0		00	14754	1 16099	W099
	2.19.0	TMT	80.02.0	-009	05	14759	9 17917	XZ/7
	2.20.0	TR	2.07.0		00	14764	1 14699	U699
	2.21.0	LOD	80.03.0	-004	04	14769	8 17932	XZ32
	2.22.0	UNL	80.01.0	-004	04	14774	7 17912	XZ12
	2.23.0	TMT	80.01.0	-009	05	14779	9 17907	XZ#7
	2.24.0	TR	2.09.0		00	14784	1 14709	U709
	2.25.0	CMP	50.04.0		01	14789	4 17639	X6T9
	2.26.0	TRE	2.23.0		00	14794	L 14779	U779
	2.27.0	TRH	17.10.0		00	14799	K 17599	X599
	2.28.0	SGN	80.01.0		15	14804	T 17916	XIA6
	2.29.0	LOD	80.03.0		04	14809	8 17936	XZ36
	2.30.0	UNL	80.01.0		04	14814	7 17916	XZ16
	2.31.0	SGN	80.01.0		01	14819	T 17916	X9/6
	2.32.0	ADM	80.01.0		15	14824	6 17916	XIA6
	2.33.0	TR	2.23.0		00	14829	1 14779	U779
	3.00.0	SGN	80.02.0		15	14834	T 17926	XIB6
	3.01.0	RAD	80.03.0		00	14839	H 17936	X936
	3.02.0	LOD	80.04.2		15	14844	8 17943	XID3
	3.03.0	CMP	50.05.0		01	14849	4 17640	X6U0
	3.04.0	TRE	3.22.0		00	14854	L 14964	U964
	3.05.0	TRH	3.25.0		00	14859	K 14979	U979
	3.06.0	CMP	50.01.0		01	14864	4 17636	X6T6
	3.07.0	TRE	3.13.0		00	14869	L 14919	U919
	3.08.0	TRH	17.10.0		00	14874	K 17599	X599
	3.09.0	UNL	3.10.0		15	14879	7 14884	UHH4
1	3.10.0	SHR	0000		00	14884	C 0000	0000
1	3.11.0	SET	0020		00	14889	B 0020	0020
	3.12.0	SGN	80.03.0		01	14894	T 17936	X9T6
	3.12.1	UNL	80.03.0		00	14899	7 17936	X936
	3.12.2	ADM	80.03.0		01	14904	6 17936	X9T6
	3.12.3	ADM	80.02.0		01	14909	6 17926	X9S6
	3.12.4	TR	10.00.0		00	14914	1 16099	W099
	3.13.0	CMP	50.10.0	-001	15	14919	4 17647	XFD7
	3.14.0	TRE	3.20.0		00	14924	L 14954	U954
	3.15.0	UNL	3.16.0		15	14929	7 14934	UIC4
1	3.16.0	RND	0000		00	14934	E 0000	0000
1	3.17.0	SEL	0904		00	14939	2 0904	0904
	3.18.0	TRS	3.11.0		00	14944	0 14889	U889
	3.19.0	TR	3.11.0		00	14949	1 14889	U889
	3.20.0	RND	0010		00	14954	E 0010	0010
	3.21.0	TR	3.17.0		00	14959	1 14939	U939
1	3.22.0	UNL	3.23.0		15	14964	7 14969	UIF9
	3.23.0	LNG	0000		00	14969	D 0000	0000
	3.24.0	TR	3.11.0		00	14974	1 14889	U889
	3.25.0	CMP	50.06.0		01	14979	4 17641	X6U1
	3.26.0	TRH	17.10.0		00	14984	K 17599	X599
1	3.27.0	SEL	0904		00	14989	2 0904	0904
	3.28.0	SUB	51.14.0		15	14994	P 17689	XFH9
	3.29.0	LOD	50.00.0		01	14999	8 17635	X6T5

20 STL

21 STU

22 STDA

24 STD
INVALID OP
23 STIA

BLOCK 03

INVALID INSTRUCTION
30 SRT

31 SRD

35 SLT

INVALID INSTRUCTION
36 SCT

C	LNG	SYMBOLIC	INCR	ASU	LOC	ACTUAL	S	DATA OR DESCRIPTION
L	LOC	OP	ADDR		LOC	OP	ADDR	N
1	3.30.0	SET	0001	15	15004	B	0001	0661
	3.30.1	NTR	3.39.0	00	15009	X	15064	V064
	3.30.2	RAD	51.17.0	15	15014	H	17698	XF18
	3.30.3	TR	3.33.0	00	15019	1	15034	V034
1	3.31.0	NTR	3.39.0	00	15024	X	15064	V064
	3.32.0	SET	0002	15	15029	B	0002	0662
	3.33.0	ST	80.03.0	00	15034	F	17936	X936
	3.34.0	SGN	80.03.0	01	15039	T	17936	X9T6
	3.35.0	ADM	80.02.0	01	15044	6	17926	X9S6
	3.36.0	UNL	80.03.0	15	15049	7	17936	X1C6
	3.37.0	ADM	80.03.0	01	15054	6	17936	X9T6
	3.38.0	TR	10.00.0	00	15059	1	16099	W099
1	3.39.0	LNG	0001	00	15064	D	0001	0001
	3.40.0	ADD	51.01.0	15	15069	G	17671	XFG1
	3.42.0	TRS	3.44.0	00	15074	0	15084	V084
	3.43.0	TR	3.31.0	00	15079	1	15024	V024
	3.44.0	NTR	3.46.0	00	15084	X	15094	V094
	3.45.0	TR	3.33.0	00	15089	1	15034	V034
	3.46.0	ST	89.99.0	15	15094	F	18019	Y6A9
1	3.47.0	SHR	0002	00	15099	C	0002	0002
1	3.48.0	LNG	0002	00	15104	D	0002	0002
	3.49.0	TRP	3.52.0	00	15109	M	15124	V124
	3.50.0	SUB	89.99.0	00	15114	P	18019	Y019
	3.51.0	TR	1.18.0	00	15119	1	14354	U354
	3.52.0	ADD	89.99.0	00	15124	G	18019	Y019
	3.53.0	TR	1.18.0	00	15129	1	14354	U354
	4.00.0	CMP	50.06.0	01	15134	4	17641	X6U1
	4.01.0	TRE	4.07.0	00	15139	L	15169	V169
	4.02.0	TRH	4.13.0	00	15144	K	15199	V199
	4.03.0	CMP	50.04.0	01	15149	4	17639	X6T9
	4.04.0	TRE	4.21.0	00	15154	L	15239	V239
	4.05.0	TRH	4.24.0	00	15159	K	15254	V254
	4.06.0	TR	17.10.0	00	15164	1	17599	X599
	4.07.0	SGN	80.03.0	15	15169	T	17936	X1C6
	4.08.0	ADM	80.03.0	15	15174	6	17936	X1C6
	4.09.0	TRP	10.00.0	15	15179	M	16099	W6I9
	4.10.0	RCV	80.04.3	-003 00	15184	U	17944	X944
	4.11.0	TMT	80.04.2	-003 04	15189	9	17940	XZ40
	4.12.0	TR	10.00.0	00	15194	1	16099	W099
	4.13.0	CMP	50.07.0	01	15199	4	17642	X6U2
	4.14.0	TRE	4.16.0	00	15204	L	15214	V214
	4.15.0	TR	17.10.0	00	15209	1	17599	X599
	4.16.0	RAD	80.47.0	00	15214	H	17973	X973
	4.17.0	TRZ	10.00.0	00	15219	N	16099	W099
	4.18.0	RCV	80.47.0	00	15224	U	17973	X973
	4.19.0	TMT	51.00.0	01	15229	9	17670	X6X0
	4.20.0	TR	4.10.0	00	15234	1	15184	V184
	4.21.0	RAD	80.02.0	00	15239	H	17926	X926
	4.22.0	TRZ	10.00.0	00	15244	N	16099	W099
	4.23.0	TR	4.10.0	00	15249	1	15184	V184
	4.24.0	SGN	80.02.0	15	15254	T	17926	X1B6
	4.25.0	RAD	80.03.0	00	15259	H	17936	X936
	4.26.0	TR	4.22.0	00	15264	1	15244	V244
	6.00.0	UNL	6.03.0	-001 01	15269	7	15283	V2Y3
1	6.01.0	SET	0000	00	15274	B	0000	0000
1	6.02.0	SET	0020	00	15279	B	0020	0020
1	6.03.0	TR	14109	00	15284	1	14109	U109
	6.04.0	SGN	80.02.0	15	15289	T	17926	X1B6
	6.05.0	SGN	1.71.0	-004 15	15294	T	14620	UFB0
	6.06.0	RAD	80.03.0	00	15299	H	17936	X936
	6.07.0	TR	1.68.0	00	15304	1	14609	U609
1	6.08.0	SET	0020	00	15309	B	0020	0020
	6.09.0	ADM	1.71.0	-004 15	15314	6	14620	UFB0
	6.10.0	TR	1.09.0	00	15319	1	14309	U309
	7.00.0	CMP	50.01.0	01	15324	4	17636	X6T6
	7.01.0	TRE	7.59.0	00	15329	L	15614	V614
	7.02.0	TRH	17.10.0	00	15334	K	17599	X599

BLOCK 04

INVALID
46 BRMIN

INVALID
47 BROV

44 BRNZU

45 BRNZ

6X CODES

BLOCK 06

RESET ACCUMULATOR

64 DIVRU

7X OP CODE COMPARE FOR READ
OR PUNCH
INVALID OP CODE NOT 70 OR 71

BLOCK 07

C	LNG	SYMBOLIC	INCR	ASU	LOC	ACTUAL	S	DATA OR DESCRIPTION	
L	LOC	OP	ADDR		LOC	OP	ADDR	ADDR N	
1	7.03.0	SEL	0100	00	15339	2	0100	0100	70 READ
	7.04.0	RD	71.00.0	6001	00	15344	Y 17805	X805	
	7.04.1	TRS	20.00.0	00	15349	0	17634	X634	END OF JOB
	7.05.0	RCV	72.00.0	6002	00	15354	U 17888	X888	SET MAC 2
	7.06.0	TMT	72.00.0	6010	01	15359	9 17896	X826	LOC OF J
	7.07.0	TMT	71.00.0	6002	01	15364	9 17806	X8#6	LOC OF LOAD CD IDENT.
	7.08.0	LOD	72.00.0	6009	03	15369	8 17895	X815	
	7.09.0	ADM	72.00.0	6004	03	15374	6 17890	X810	
	7.10.0	RSU	72.00.0	6002	00	15379	Q 17888	X888	
	7.11.0	TRP	90.00.0	00	15384	M 18024	Y024		TO READ MAP - NON LOAD CARD
	7.12.0	SGN	71.00.0	6002	01	15389	T 17806	X8#6	REMOVE PLUS SIGN - LOAD CODE
	7.13.0	LOD	71.01.0	01	15394	8 17884	X8Y4		LOAD COL 80 IN 01
	7.14.0	RCV	71.01.0	00	15399	U 17884	X884		SET RECORD MARK
	7.15.0	TMT	80.56.0	-001	01	15404	9 17997	X927	
	7.16.0	RCV	70.01.0	-005	00	15409	U 17704	X704	MOVE CARD TO 10 WORD BUFFER
	7.17.0	TMT	71.00.0	6005	00	15414	9 17809	X809	USING WORDS 1 TO 8
	7.18.0	UNL	70.08.0	01	15419	7 17779	X7X9		UNLOAD COL 80
	7.19.0	RCV	80.04.3	-003	00	15424	U 17944	X944	
	7.20.0	TMT	80.04.2	-003	04	15429	9 17940	X240	MOVE D ADDRESS TO I ADDRESS
	7.21.0	LOD	80.04.2	02	15434	8 17943	X9M3		FROM READ MAP - LOD UNITS AND TENS OF D ADDR
	7.22.0	CMP	50.12.0	02	15439	4 17655	X6N5		LOC OF 49
	7.23.0	RCV	80.04.2	-001	00	15444	U 17942	X942	SET MAC 2 TO D ADDR TENS POS
	7.24.0	TRH	7.57.0	00	15449	K 15604	V604		
	7.25.0	TMT	50.11.0	-003	02	15454	9 17650	X6N0	LOC OF 00
	7.26.0	LOD	80.04.2	04	15459	8 17943	X243		DATA ADDRESS REGISTER
	7.27.0	LOD	7.27.0	12	15464	8 15464	VD64		A LOD A
	7.28.0	TR	11.00.0	00	15469	1 16394	W394		CONVERT 650 ADDRESS TO 705
	7.29.0	UNL	7.32.0	04	15474	7 15489	VU89		UNL D ADDR. REG. INTO RCV XXXX
	7.30.0	LOD	50.11.0	-001	04	15479	8 17652	XW52	LOD 0001
	7.31.0	ADM	7.32.0	04	15484	6 15489	VU89		INCREASE ADDR BY 0001
1	7.32.0	RCV	0000	00	15489	U 0000	0000		SET MAC 2 TO DRUM ADDRESS
1	7.32.1	SET	0000	13	15494	B 0000	06#0		SET ASU 13 TO OPERATE LOOP 10 TIMES
1	7.33.0	SET	0010	13	15499	B 0010	06/0		TEN ZEROS
	7.34.0	LOD	80.59.0	04	15504	8 18004	Y#04		70.01.0 WITH ASU 05
	7.35.0	UNL	7.40.0	04	15509	7 15519	VV19		SUPPLY 7.40 WITH WORD 1 ADDRESS
	7.36.0	LOD	50.11.0	04	15514	8 17653	XW53		LOC OF 0010
1	7.40.0	LOD	0000	00	15519	8 0000	0000		LOAD WORD FROM 10 WORD BUFFER
	7.41.0	UNL	80.10.0	05	15524	7 17971	XZX1		UNL ASU 05 INTO ALPHA REGISTER
	7.42.0	SGN	80.10.0	15	15529	T 17971	XIG1		REMOVE SIGN
	7.43.0	ADD	80.54.0	05	15534	G 17990	XZZ0		REMOVE ZONES OF WORD IN ASU 05
	7.44.0	CMP	80.10.0	05	15539	4 17971	XZX1		TEST FOR ZONES ON SAME WORD IN MEM
	7.45.0	TRE	7.53.0	00	15544	L 15584	V584		WORD OK NO ZONES OTHER THAN SIGN
	7.46.0	LOD	80.03.1	01	15549	8 17937	X9T7		LOCATION OF BLANK -- FOR ILLEGAL OP CODE
	7.47.0	UNL	80.07.0	-006	01	15554	7 17954	X9V4	UNLOAD INTO BETA REGISTER
	7.48.0	TMT	80.07.0	-006	07	15559	9 17954	XZE4	MOVE CONTENTS OF BETA TO THE DRUM
	7.49.0	NTR	7.51.0	13	15564	X 15574	VEX4		TEST END
	7.50.0	TR	10.00.0	00	15569	1 16099	W099		EXIT TO INTERPRETIVE ROUTINE
	7.51.0	ADM	7.40.0	04	15574	6 15519	VV19		INCR BY 0010 FOR NEXT WORD OF 10 WORD STOR
	7.52.0	TR	7.40.0	00	15579	1 15519	V519		REPEAT
	7.53.0	ADM	80.10.0	15	15584	6 17971	XIG1		RETURN SIGN
	7.54.0	LOD	7.54.0	12	15589	8 15589	VE89		A LOD A
	7.55.0	TR	13.00.0	00	15594	1 16599	W599		TO PAC ROUTINE
	7.56.0	TR	7.48.0	00	15599	1 15559	V559		REPEAT
	7.57.0	TMT	50.14.0	-001	02	15604	9 17660	X600	LOC OF 50
	7.58.0	TR	7.26.0	00	15609	1 15459	V459		REPEAT
	7.59.0	LOD	80.04.2	02	15614	8 17943	X9M3		PUNCH ROUTINE
	7.60.0	CMP	50.12.0	02	15619	4 17655	X6N5		
	7.61.0	RCV	80.04.2	-001	00	15624	U 17942	X942	
	7.62.0	TRH	7.82.0	00	15629	K 15729	V729		
	7.63.0	TMT	50.15.0	-001	02	15634	9 17662	X602	LOC OF 27
	7.64.0	LOD	80.04.2	04	15639	8 17943	XZ43		
	7.65.0	LOD	7.65.0	12	15644	8 15644	VF44		
	7.66.0	TR	11.00.0	00	15649	1 16394	W394		TO CONVERT 650 ADDR TO 705
	7.67.0	UNL	7.74.0	04	15654	7 15689	VW89		
	7.68.0	LOD	80.56.0	02	15659	8 17998	X9R8		
	7.69.0	ADM	7.74.0	-001	02	15664	6 15688	V608	
	7.70.0	LOD	50.13.0	04	15669	8 17659	XW59		LOC OF 0007

C	LNG	SYMBOLIC			INCR	ASU	ACTUAL			S	DATA OR DESCRIPTION
		LOC	OP	ADDR			LOC	OP	ADDR		
1		7.71.0	SET	0000		13	15674	B	0000	06#0	
1		7.72.0	SET	0010		13	15679	B	0010	06/0	
		7.73.0	RCV	70.01.0	-009	00	15684	U	17700	X700	
1		7.74.0	LOD	0000		00	15689	8	0000	0000	
		7.75.0	UNL	80.07.0		07	15694	7	17960	XZFO	
		7.76.0	LOD	7.76.0		12	15699	8	15699	VF99	
		7.77.0	TR	12.00.0		00	15704	1	16454	W454	TO UNPAC
		7.78.0	TMT	80.10.0	-009	05	15709	9	17962	XZW2	
		7.79.0	ADM	7.74.0		04	15714	6	15689	VW89	
		7.80.0	NTR	7.74.0		13	15719	X	15689	VFY9	
		7.81.0	TR	95.00.0		00	15724	1	18779	Y779	TO PUNCH MAPPING
		7.82.0	TMT	50.16.0	-001	02	15729	9	17664	X604	
		7.83.0	TR	7.64.0		00	15734	1	15639	V639	
1		7.84.0	SEL	0300		00	15739	2	0300	0300	RETURN FROM PCH. MAPPING
		7.85.0	WR	71.00.0	8001	00	15744	R	17805	X805	
		7.86.0	TR	10.00.0		00	15749	1	16099	W099	
		8.00.0	CMP	50.04.0		01	15754	4	17639	X6T9	84 TLU
		8.01.0	TRE	8.03.0		00	15759	L	15769	V769	BLOCK 08
		8.02.0	TR	17.10.0		00	15764	1	17599	X599	INVALID
		8.03.0	RAD	80.01.0		05	15769	H	17916	XZ/6	GET CONTENTS OF DISTR.
1		8.03.1	SET	0002		13	15774	B	0002	06#2	
		8.04.0	LOD	80.04.2		13	15779	8	17943	XIU3	UNITS AND TENS POS OF D-ADDR
		8.05.0	CMP	50.12.0		13	15784	4	17655	XFV5	LOC OF 49
1		8.06.0	SET	0002		00	15789	B	0002	0002	
		8.07.0	TRH	8.48.0		00	15794	K	16004	W004	
		8.08.0	LOD	50.11.0	-002	00	15799	8	17651	X651	ZEROS
		8.09.0	UNL	80.04.2		00	15804	7	17943	X943	IN D-ADDR
		8.10.0	LOD	80.04.2		04	15809	8	17943	XZ43	
		8.11.0	LOD	8.11.0		12	15814	8	15814	VH14	A LOD A
		8.12.0	TR	11.00.0		00	15819	1	16394	W394	TO CONVERT 650 ADDR TO 705
		8.13.0	UNL	8.20.0		04	15824	7	15854	VY54	
		8.14.0	LOD	51.16.0		00	15829	8	17695	X695	LOC OF 14
		8.15.0	ADM	8.20.0		00	15834	6	15854	V854	
		8.16.0	LOD	50.13.0		04	15839	8	17659	XW59	LOC OF 0007
		8.18.0	RAD	99.93.0		14	15844	H	19993	ZIR3	LOC OF 648
		8.19.0	RCV	80.07.0	-006	00	15849	U	17954	X954	BETA REG
1		8.20.0	TMT	0000		00	15854	9	0000	0000	
		8.21.0	LOD	8.21.0		12	15859	8	15859	VH59	A LOD A
		8.22.0	TR	12.00.0		00	15864	1	16454	W454	TO UNPAC
		8.23.0	SGN	80.10.0		15	15869	T	17971	XIG1	
		8.24.0	CMP	80.10.0		05	15874	4	17971	XZX1	
		8.25.0	TRH	8.40.0		00	15879	K	15954	V954	
1		8.26.0	SET	0004		00	15884	B	0004	0004	
		8.27.0	LOD	8.20.0		00	15889	8	15854	V854	
1		8.28.0	SHR	0003		00	15894	C	0003	0003	
		8.29.0	CMP	80.52.0		00	15899	4	17984	X984	LOC OF Z
		8.30.0	TRH	8.31.1		00	15904	K	15914	V914	
		8.31.0	ADD	51.14.0		00	15909	G	17689	X689	
1		8.31.1	SET	0002		00	15914	B	0002	0002	
1		8.32.0	LNG	0003		01	15919	D	0003	00#3	
		8.32.1	ADD	51.13.0		00	15924	G	17687	X687	
		8.33.0	DIV	51.07.0		00	15929	W	17677	X677	
		8.35.0	UNL	80.03.0	-004	00	15934	7	17932	X932	
1		8.36.0	SET	0004		13	15939	B	0004	06#4	
		8.37.0	ADM	80.03.0	-004	13	15944	6	17932	XIT2	
		8.39.0	TR	10.00.0		00	15949	1	16099	W099	
		8.40.0	ADM	8.20.0		04	15954	6	15854	VY54	
		8.41.0	SUB	51.01.0		14	15959	P	17671	XFP1	
		8.41.1	TRZ	8.42.0		14	15964	N	15974	VIP4	
		8.41.2	TR	8.19.0		00	15969	1	15849	V849	
		8.42.0	ADM	8.20.0		04	15974	6	15854	VY54	
		8.43.0	ADM	8.20.0		04	15979	6	15854	VY54	
		8.44.0	LOD	8.20.0	-003	01	15984	8	15851	V8V1	
		8.45.0	CMP	16.16.0	-006	01	15989	4	17121	X1S1	LOC OF R
		8.46.0	TRE	17.10.0		00	15994	L	17599	X599	
		8.47.0	TR	8.18.0		00	15999	1	15844	V844	
		8.48.0	LOD	50.14.0		00	16004	8	17661	X661	

C	LNG	SYMBOLIC	INCR	ASU	LOC	ACTUAL	S	DATA OR DESCRIPTION
L	LOC	OP	ADDR			OP	ADDR	N
	8.49.0	SUB	51.15.0	13	16009	P 17691	XFZ1	
	8.50.0	TR	8.09.0	00	16014	1 15804	V804	
	9.00.0	TRZ	9.10.0	01	16019	N 16069	W0W9	90 BRANCH CODES
	9.01.0	UNL	9.04.0	01	16024	7 16039	W0T9	BLOCK 09
	9.02.0	RAD	80.01.0	00	16029	H 17916	X916	
1	9.03.0	LNG	0001	00	16034	D 0001	0001	
1	9.04.0	SHR	0000	00	16039	C 0000	0000	
1	9.05.0	SET	0001	00	16044	B 0001	0001	
	9.06.0	CMP	50.08.0	00	16049	4 17643	X643	LOC OF 8
	9.07.0	TRE	4.10.0	00	16054	L 15184	V184	
	9.08.0	TRH	10.00.0	00	16059	K 16099	W099	
	9.09.0	TR	17.10.0	00	16064	1 17599	X599	INVALID
1	9.10.0	SET	0001	00	16069	B 0001	0001	
	9.11.0	LOD	80.01.0	-009	00	16074	8 17907	X907
	9.12.0	TR	9.06.0	00	16079	1 16049	W049	
1	9.13.0	RCV	0004	00	16084	U 0004	0004	0 START - HSK 2
1	9.14.0	TMT	0204	00	16089	9 0204	0204	START
1	9.15.0	SET	0004	12	16094	B 0004	0604	
1	10.00.0	SEL	0913	00	16099	2 0913	0913	HALF CYCLE SWITCH INTERPRETIVE ROUTINE
	10.01.0	TRS	16.50.0	00	16104	0 17294	X294	
	10.02.0	RCV	80.05.1	-003	00	16109	U 17949	X949
	10.02.1	TMT	80.04.3	-003	04	16114	9 17944	XZ44
	10.02.2	RCV	80.04.1	-001	00	16119	U 17938	X938
1	10.03.0	SEL	0914	00	16124	2 0914	0914	
	10.04.0	TRS	16.57.0	00	16129	0 17329	X329	ADDRESS STOP SWITCH
	10.05.0	LOD	80.05.1	-003	01	16134	8 17949	X9U9
	10.06.0	CMP	50.08.0	01	16139	4 17643	X6U3	LOAD HIGH ORDER OF ADDRESS REGISTER
	10.07.0	TRE	10.39.0	00	16144	L 16304	W304	COMPARE FOR 8XXX ADDRESS
	10.08.0	CMP	50.01.0	01	16149	4 17636	X6T6	800X TO 8000 ADDRESS ROUTINE
	10.09.0	TRH	17.10.0	00	16154	K 17599	X599	LOC OF 1
	10.10.0	LOD	80.05.1	04	16159	8 17952	XZ52	INVALID ADDRESS - GREATER THAN 1999
	10.11.0	LOD	10.11.0	12	16164	8 16164	WA64	LOD ADDR REG IN 04
	10.12.0	TR	11.00.0	00	16169	1 16394	W394	A LOD A
	10.13.0	UNL	10.15.0	04	16174	7 16184	W/84	OUT - CONVERT 650 ADDR. TO 705
1	10.14.0	SET	0007	00	16179	B 0007	0007	RETURN FROM CONVERSION
1	10.15.0	LOD	0000	00	16184	8 0000	0000	SET 00 TO LENGTH OF 7
	10.16.0	UNL	80.07.0	00	16189	7 17960	X960	LOD 650 WORD - IN PAC FORM
	10.17.0	LOD	10.17.0	12	16194	8 16194	WA94	PLACE IN BETA REGISTER
	10.18.0	TR	12.00.0	00	16199	1 16454	W454	A LOD A
	10.19.0	TMT	80.10.0	-009	05	16204	9 17962	XZW2
	10.20.0	NOP	10.52.0	00	16209	A 16369	W369	TO UNPAC
	10.21.0	SGN	80.04.3	01	16214	T 17947	X9U7	PUT UNPAC 650 WORD IN PROG. REGISTER - OR DISTR.
	10.22.0	LOD	80.04.1	-001	01	16219	8 17938	X9T8
	10.23.0	CMP	50.01.0	01	16224	4 17636	X6T6	SWITCH
	10.24.0	TRE	10.33.0	00	16229	L 16274	W274	STRIP SIGN OF 650 WORD
	10.25.0	CMP	50.06.0	01	16234	4 17641	X6U1	LOD 10'S POS OF OP CODE
	10.27.0	TRE	10.33.0	00	16239	L 16274	W274	LOC OF 1
	10.28.0	UNL	10.30.0	-001	01	16244	7 16268	W2W8
	10.29.0	LOD	80.04.1	01	16249	8 17939	X9T9	LOC OF 6
1	10.29.1	SEL	0914	00	16254	2 0914	0914	SET PIVOT TRANSFER
	10.29.2	TRS	16.69.0	00	16259	0 17389	X389	LOD UNITS POS OF OP CODE
	10.29.3	LOD	80.04.1	01	16264	8 17939	X9T9	TEST FOR ADDRESS STOP
1	10.30.0	TR	14009	00	16269	1 14009	U009	ON
	10.33.0	RCV	80.05.1	-003	00	16274	U 17949	X949
	10.34.0	TMT	80.04.2	-003	04	16279	9 17940	XZ40
	10.35.0	SGN	10.20.0	-004	01	16284	T 16205	W2#5
	10.36.0	SGN	10.44.0	-004	01	16289	T 16325	W355
	10.37.0	RCV	80.01.0	-009	00	16294	U 17907	X907
	10.38.0	TR	10.05.0	00	16299	1 16134	W134	SET SWITCH TO TR
	10.39.0	LOD	80.05.1	01	16304	8 17952	X9V2	SET SWITCH TO TR
	10.40.0	ADD	51.01.0	01	16309	G 17671	X6X1	DATA TO DISTRIBUTOR - SET MAC 2
	10.41.0	UNL	10.42.0	-001	01	16314	7 16318	W3/8
1	10.42.0	TR	14004	00	16319	1 14004	U004	UNITS OF ADDR. REGISTER - FOR 800X ADDRESSES
	10.43.0	TMT	80.00.0	-009	05	16324	9 17897	XY27
	10.44.0	NOP	10.52.0	00	16329	A 16369	W369	LOC OF 61
	10.45.0	TR	10.21.0	00	16334	1 16214	W214	SET PIVOT TRANSFER
	10.46.0	TMT	80.01.0	-009	05	16339	9 17907	XZ#7
								PIVOT 800X
								8000 - SEND STOR ENTRY SWITCHES TO P.R.
								8001

C	LNG	SYMBOLIC	INCR	ASU	ACTUAL	S	DATA OR DESCRIPTION
L	LOC	OP ADDR		LOC	OP ADDR ADDR	N	
	10.47.0	TR 10.44.0		00	16344 1 16329 W329		
	10.48.0	TMT 80.03.0	-009	05	16349 9 17927 XZ57		8002
	10.49.0	TR 10.44.0		00	16354 1 16329 W329		
	10.50.0	TMT 80.02.0	-009	05	16359 9 17917 XZ/7		8003
	10.51.0	TR 10.44.0		00	16364 1 16329 W329		
	10.52.0	LOD 51.01.0		01	16369 8 17671 X6X1		
	10.53.0	UNL 10.20.0	-004	01	16374 7 16205 W2#5		
	10.54.0	UNL 10.44.0	-004	01	16379 7 16325 W3S5		RESET NOPS
	10.56.0	LOD 80.04.1	-001	01	16384 8 17938 X9T8		
	10.57.0	TR 10.28.0		00	16389 1 16244 W244		
	11.00.0	ADD 51.01.0		04	16394 G 17671 XW71		CONVERT 650 ADDRESS TO 705 LOC &1
	11.01.0	ST 80.53.0		04	16399 F 17988 XZ88		4 POS BUFFER
	11.02.0	RAD 51.07.0		00	16404 H 17677 X677		LOC OF &7
	11.03.0	MPY 80.53.0		00	16409 V 17988 X988		CALC 705 ADDRESS
	11.04.0	NTR 11.10.0		00	16414 X 16444 W444		TEST FOR 1XXXX ADDRESS
1	11.05.0	SET 0004		00	16419 B 0004 0004		
	11.06.0	UNL 80.53.0		00	16424 7 17988 X988		PLACE 705 ADDRESS IN 80.53.0
	11.07.0	ADM 80.53.0	-002	06	16429 6 17986 XZ06		PUT UPPER MEMORY ZONE ON HIGH ORDER POS.
	11.08.0	LOD 80.53.0		04	16434 8 17988 XZ88		LOD CORRECTED ADDRESS IN ASU 04
	11.09.0	TR 19.00.0		00	16439 1 17614 X614		TO SUB ROUTINE OUT
	11.10.0	UNL 80.53.0		00	16444 7 17988 X988		PUT 705 ADDRESS IN 80.53.0
	11.11.0	TR 11.08.0		00	16449 1 16434 W434		RETURN FOR EXIT
	12.00.0	LOD 80.07.0	-006	01	16454 8 17954 X9V4		UNPAC ROUTINE - COMPARE
	12.01.0	CMP 80.08.0		01	16459 4 17961 X9W1		AGAINST BLANK FOR ILLEGAL OP CODE
	12.02.0	TRE 17.10.0		00	16464 L 17599 X599		
	12.04.0	LOD 80.07.0	-005	02	16469 8 17955 X9N5		PUT OP CODE IN 02 WITH SIGN
	12.05.0	UNL 80.10.0	-008	02	16474 7 17963 X903		PUT OP CODE IN 80.10.0 - ALPHA REG
1	12.06.0	SET 0005		00	16479 B 0005 0005		
	12.07.0	LOD 80.07.0		00	16484 8 17960 X960		LOD REMAINDER OF BETA REGISTER
	12.08.0	UNL 80.65.0	-001	00	16489 7 18010 Y010		
	12.09.0	ADD 80.54.0		00	16494 G 17990 X990		LOC MINUS ZERO - STRIP ZONES
	12.10.0	UNL 80.10.0	-003	00	16499 7 17968 X968		
	12.11.0	SUB 80.55.0		00	16504 P 17996 X996		LOC 111009 TO COMPLEMENT NUMERIC PART
1	12.12.0	LNG 0001		00	16509 D 0001 0001		
	12.13.0	ADM 80.65.0		00	16514 6 18011 Y011		TO UNSIGNED FIELD ADD COMPLEMENT
	12.14.0	LOD 80.65.0	-001	01	16519 8 18010 Y0/0		LEAVING ZONES OVER CONSTANT 11009
	12.15.0	UNL 12.24.0	-001	01	16524 7 16568 W5W8		DUMP ZONES INTO INSTRUCTIONS
	12.16.0	LOD 80.65.0	-002	01	16529 8 18009 Y0#9		TO OBTAIN CORRECT ASU
	12.17.0	UNL 12.25.0	-001	01	16534 7 16573 W5X3		
	12.18.0	LOD 80.65.0	-003	01	16539 8 18008 Y0#8		
	12.19.0	UNL 12.26.0	-001	01	16544 7 16578 W5X8		
	12.20.0	LOD 80.65.0	-004	01	16549 8 18007 Y0#7		
	12.21.0	UNL 12.27.0	-001	01	16554 7 16583 W5Y3		
	12.22.0	LOD 80.65.0	-005	01	16559 8 18006 Y0#6		
	12.23.0	UNL 12.28.0	-001	01	16564 7 16588 W5Y8		
1	12.24.0	UNL 19899		08	16569 7 19899 ZQ99		UNLOAD PROPER ASU S
1	12.25.0	UNL 19903		08	16574 7 19903 ZR03		INTO SPECIFIED ADDRESSES
1	12.26.0	UNL 19908		08	16579 7 19908 ZR08		
1	12.27.0	UNL 19913		08	16584 7 19913 ZR13		
1	12.28.0	UNL 19918		08	16589 7 19918 ZR18		
	12.29.0	TR 99.01.0		00	16594 1 19899 Z899		
	13.00.0	SGN 80.10.0		01	16599 T 17971 X9X1		PAC ROUTINE - REMOVE SIGN
	13.01.0	ADM 80.10.0	-008	01	16604 6 17963 X9W3		STORE SIGN IN D-2
	13.02.0	LOD 80.10.0		03	16609 8 17971 X9G1		LOD 3 TERMINAL DIGITS & CALC ZONES
	13.03.0	SUB 51.10.0		03	16614 P 17682 X6H2		6256
	13.04.0	TRP 13.19.0		03	16619 M 16694 W614		OUT ON PLUS
	13.05.0	ADD 51.10.0		03	16624 G 17682 X6H2		6256
	13.06.0	SUB 51.11.0		03	16629 P 17684 X6H4		664
	13.07.0	TRP 13.21.0		03	16634 M 16704 W764		
	13.08.0	ADD 51.11.0		03	16639 G 17684 X6H4		664
	13.09.0	SUB 51.12.0		03	16644 P 17686 X6H6		616
	13.10.0	TRP 13.23.0		03	16649 M 16714 W7A4		
	13.11.0	ADD 51.12.0		03	16654 G 17686 X6H6		616
	13.12.0	SUB 51.04.0		03	16659 P 17674 X6G4		64
	13.13.0	TRP 13.25.0		03	16664 M 16724 W7B4		
	13.14.0	ADD 51.04.0		03	16669 G 17674 X6G4		64
	13.15.0	TRZ 13.27.0		03	16674 N 16734 W7C4		NO ZONES

C	LNG	SYMBOLIC	INCR	ASU	LOC	ACTUAL	S	DATA OR DESCRIPTION
L	LOC	OP	ADDR			OP	ADDR	ADDR
	13.16.0	SUB	51.01.0	03	16679	P	17671	X6G1
	13.17.0	ADM	80.10.0	-002	06	16684	6	17969 XZ09
	13.18.0	TR	13.15.0	00	16689	1	16674	W674
	13.19.0	ADM	80.10.0	-006	06	16694	6	17965 XZ05
	13.20.0	TR	13.03.0	00	16699	1	16614	W614
	13.21.0	ADM	80.10.0	-005	06	16704	6	17966 XZ06
	13.22.0	TR	13.06.0	00	16709	1	16629	W629
	13.23.0	ADM	80.10.0	-004	06	16714	6	17967 XZ07
	13.24.0	TR	13.09.0	00	16719	1	16644	W644
	13.25.0	ADM	80.10.0	-003	06	16724	6	17968 XZ08
	13.26.0	TR	13.12.0	00	16729	1	16659	W659
	13.27.0	LOD	80.10.0	-003	07	16734	8	17968 XZF8
	13.28.0	UNL	80.07.0	07	16739	7	17960	XZF0
	13.29.0	TR	19.00.0	00	16744	1	17614	X614
1	14.00.0	SEL	0904	00	16749	2	0904	0904
	14.01.0	RCV	80.07.0	-004	00	16754	U	17956 X956
	14.01.1	SGN	80.10.0	01	16759	T	17971	X9X1
	14.02.0	RAD	80.47.0	00	16764	H	17973	X973
1	14.03.0	SET	0005	00	16769	B	0005	0005
	14.04.0	LOD	80.48.0	04	16774	8	17977	XZ77
	14.05.0	UNL	14.15.0	04	16779	7	16834	WY34
	14.05.1	LOD	50.10.0	04	16784	8	17648	XW48
	14.06.0	LOD	80.10.0	-009	01	16789	8	17962 X9W2
	14.07.0	TRZ	14.18.0	01	16794	N	16854	W8V4
	14.08.0	ADD	51.01.0	01	16799	G	17671	X6X1
	14.09.0	TRS	14.12.0	00	16804	0	16819	W819
	14.10.0	ADM	80.10.0	-007	06	16809	6	17964 XZ04
	14.11.0	TR	14.08.0	00	16814	1	16799	W799
1	14.12.0	SET	0001	01	16819	B	0001	00#1
	14.13.0	TMT	80.10.0	-008	01	16824	9	17963 X9W3
	14.14.0	ADM	14.15.0	04	16829	6	16834	WY34
1	14.15.0	LOD	0000	00	16834	8	0000	0000
	14.16.0	UNL	80.10.0	-008	02	16839	7	17963 X903
	14.17.0	NTR	14.06.0	00	16844	X	16789	W789
	14.17.1	TR	19.00.0	00	16849	1	17614	X614
	14.18.0	TMT	80.05.0	01	16854	9	17948	X9U8
	14.19.0	TR	14.14.0	00	16859	1	16829	W829
	15.00.0	RCV	80.10.0	-009	00	16864	U	17962 X962
	15.01.0	LOD	80.49.0	04	16869	8	17981	XZ81
	15.02.0	UNL	15.15.0	04	16874	7	16944	WZ44
	15.02.1	LOD	50.11.0	-001	04	16879	8	17652 XW52
1	15.03.0	RAD	51.01.0	00	16884	H	17671	X671
	15.04.0	SET	0005	00	16889	B	0005	0005
	15.05.0	LOD	80.07.0	-004	01	16894	8	17956 X9V6
	15.06.0	CMP	80.50.0	01	16899	4	17982	X9Y2
	15.07.0	TRH	15.22.0	00	16904	K	16979	W979
	15.08.0	CMP	80.51.0	01	16909	4	17983	X9Y3
	15.09.0	TRH	15.28.0	00	16914	K	17009	X009
	15.10.0	CMP	80.05.0	01	16919	4	17948	X9U8
	15.11.0	TRE	15.30.0	00	16924	L	17019	X019
	15.12.0	TMT	50.06.0	01	16929	9	17641	X6U1
	15.13.0	SGN	80.07.0	-004	01	16934	T	17956 X9V6
1	15.14.0	TMT	80.07.0	-004	01	16939	9	17956 X9V6
	15.15.0	LOD		01	16944	8		
	15.16.0	UNL	80.07.0	-004	01	16949	7	17956 X9V6
	15.17.0	ADM	15.15.0	04	16954	6	16944	WZ44
	15.18.0	NTR	15.05.0	00	16959	X	16894	W894
	15.19.0	LOD	51.00.0	01	16964	8	17670	X6X0
	15.20.0	ADM	80.10.0	01	16969	6	17971	X9X1
	15.21.0	TR	19.00.0	00	16974	1	17614	X614
	15.22.0	CMP	80.52.0	01	16979	4	17984	X9Y4
	15.23.0	TRH	15.26.0	00	16984	K	16999	W999
	15.24.0	TMT	50.08.0	01	16989	9	17643	X6U3
	15.25.0	TR	15.13.0	00	16994	1	16934	W934
	15.26.0	TMT	50.09.0	01	16999	9	17644	X6U4
	15.27.0	TR	15.13.0	00	17004	1	16934	W934
	15.28.0	TMT	50.07.0	01	17009	9	17642	X6U2

LOD NNNNNNNXXX INTO 07 AND
MOVE TO BETA REGISTER
TO SUB-ROUT OUT
NUMERIC TO ALPHA
SET MAC 2 TO BETA REG D5
STRIP SIGN OF NUMERIC WORD

BLOCK 14

TO OPERATE LOOP 5 TIMES
SET UP LOD INSTR AT
14.15.0 WITH ASU 02
LOC OF 0002
LOD DIGIT 10 OF NUMERIC
ZERO EQUALS BLANK
LOC OF &1
OUT ON OVERFLOW
NO OVERFLOW - ADD A-BIT TO D9
REPEAT
RESTORE ASU 01
PUT ALPH. CHAR IN BETA REG
ADD 2 TO LOD INSTR
PICK UP NEXT PAIR FOR CONVERSION AND
DUMP IN HI-ORDER POSITIONS
REPEAT 4 TIMES
EXIT
PUT BLANK IN BETA REG
RETURN

BLOCK 15

ALPHA TO NUMERIC - SET MAC 2
LOC OF 80.07.0 - 003 - BETA REG

LOC OF 0001
LOC OF &1

R

I

BLANK

6

PLACE SIGN ON
NUMERIC WORD

OUT

Z

8

9

7

C	LNG	SYMBOLIC	INCR	ASU	ACTUAL	S	DATA OR DESCRIPTION			
L	LOC	OP	ADDR		LOC	OP	ADDR	ADDR	N	
		15.29.0	TR	15.13.0	00	17014	1	16934	W934	
		15.30.0	TMT	50.11.0	-004	02	17019	9	17649	X6M9
		15.31.0	TR	15.15.0	00	17024	1	16944	W944	
2	004	16.00.0				17028				
2	010	16.01.0				17038				
2	001	16.02.0				17039				
2	005	16.03.0				17044				
2	010	16.04.0				17054				
2	010	16.05.0				17064				
2	001	16.06.0				17065				
2	006	16.07.0				17071				
2	002	16.08.0				17073				
2	001	16.09.0				17074				
2	004	16.10.0				17078				
2	001	16.11.0				17079				
2	004	16.12.0				17083				
2	001	16.13.0				17084				
2	010	16.14.0				17094				
2	001	16.14.1				17095				
2	012	16.15.0				17107				
2	001	16.15.1				17108				
2	019	16.16.0				17127				
2	001	16.16.1				17128				
2	013	16.17.0				17141				
2	001	16.17.1				17142				
2	008	16.17.5				17150				
2	001	16.17.6				17151				
2	009	16.18.0				17160				
2	004	16.19.0				17164				
2	001	16.20.0				17165				
2	010	16.21.0				17175				
2	001	16.22.0				17176				
2	004	16.23.0				17180				
2	001	16.23.1				17181				
5	005	16.24.0			00	17189				
		16.25.0	RCV	16.00.0	6001	00	17194	U	17029	X029
		16.26.0	TMT	80.01.0	-009	05	17199	9	17907	X2#7
		16.27.0	SGN	16.01.0		01	17204	T	17038	X0T8
		16.28.0	UNL	16.02.0		01	17209	7	17039	X0T9
		16.29.0	RCV	16.03.0	6001	00	17214	U	17045	X045
		16.31.0	TMT	80.01.0	6001	05	17219	9	17917	X2/7
		16.32.0	TMT	80.02.0	6001	05	17224	9	17927	X2S7
		16.32.1	SGN	16.05.0		01	17229	T	17064	X0W4
		16.33.0	UNL	16.06.0		01	17234	7	17065	X0W5
		16.34.0	RCV	16.07.0	6001	00	17239	U	17072	X072
		16.35.0	TMT	80.04.1	-001	02	17244	9	17938	X9L8
		16.36.0	RCV	16.09.0	6001	00	17249	U	17075	X075
		16.37.0	TMT	80.04.1	6001	04	17254	9	17940	X240
		16.38.0	RCV	16.11.0	6001	00	17259	U	17080	X080
		16.39.0	TMT	80.04.2	6001	04	17264	9	17944	X244
		16.40.0	WR	16.00.0	-003	00	17269	R	17025	X025
		16.41.0	NOP	16.54.0		00	17274	A	17314	X314
		16.42.0	NOP	16.65.0		00	17279	A	17369	X369
1		16.43.0	HLT	2222		00	17284	J	2222	2222
		16.44.0	TR	10.00.0		00	17289	1	16099	W099
		16.50.0	SGN	16.41.0	-004	14	17294	T	17270	XBPO
1		16.51.0	SEL	0500		00	17299	2	0500	0500
		16.52.0	WR	16.13.0	6001	00	17304	R	17085	X085
		16.53.0	TR	16.25.0		00	17309	1	17194	X194
		16.54.0	ADM	16.41.0	-004	14	17314	6	17270	XBPO
1		16.55.0	HLT	0913		00	17319	J	0913	0913
		16.56.0	TR	10.02.0		00	17324	1	16109	W109
		16.57.0	LOD	80.04.3		04	17329	8	17947	X247
		16.58.0	CMP	16.24.0		04	17334	4	17189	X/89
		16.59.0	TRE	16.61.0		00	17339	L	17349	X349
		16.60.0	TR	10.05.0		00	17344	1	16134	W134
1		16.61.0	SEL	0500		00	17349	2	0500	0500

00

DIS DISTRIBUTOR
0000000000

BLOCK 16

ACC ACCUMULATOR
0000000000
0000000000

P.R. PROGRAM REGISTER
00

0000

0000

□ HALF CYCLE

□ ADDRESS STOP

□ INVALID INSTRUCTION

□ 650 STOP CODE

□ OVERFLOW

□ 650 ADD.

0000

0000000000

WORD

□

ADD. SELECT SWITCH
DISPLAY 800X

HALF CYCLE NOP
ADDRESS STOP

HALF CYCLE

ADDRESS STOP ON I-ADDR.

C	LNG	SYMBOLIC	INCR	ASU	LOC	ACTUAL	S	DATA OR DESCRIPTION
L	LOC	OP	ADDR			OP	ADDR	ADDR N
		16.62.0	WR	16.14.1	6001	00	17354	R 17096 X096
		16.63.0	SGN	16.42.0	-004	14	17359	T 17275 XBP5
		16.64.0	TR	16.25.0		00	17364	1 17194 X194
		16.65.0	ADM	16.42.0	-004	14	17369	6 17275 XBP5
1		16.66.0	HLT	0914		00	17374	J 0914 0914
		16.67.0	NOP	16.75.0		00	17379	A 17419 X419
		16.68.0	TR	10.05.0		00	17384	1 16134 W134
		16.69.0	LOD	80.04.2		04	17389	8 17943 XZ43
		16.70.0	CMP	16.24.0		04	17394	4 17189 X/89
		16.71.0	TRE	16.73.0		00	17399	L 17409 X409
		16.72.0	TR	10.29.3		00	17404	1 16264 W264
		16.73.0	SGN	16.67.0	-004	14	17409	T 17375 XCP5
		16.74.0	TR	16.61.0		00	17414	1 17349 X349
		16.75.0	ADM	16.67.0	-004	14	17419	6 17375 XCP5
		16.76.0	TR	10.29.3		00	17424	1 16264 W264
		16.77.0	LOD	16.19.0		04	17429	8 17164 X/64
		16.78.0	LOD	16.78.0		12	17434	8 17434 XD34
		16.79.0	TR	11.00.0		00	17439	1 16394 W394
		16.80.0	UNL	16.82.0		04	17444	7 17454 XU54
1		16.81.0	SET	0007		00	17449	B 0007 0007
1		16.82.0	LOD	0000		00	17454	8 0000 0000
		16.83.0	UNL	80.07.0		00	17459	7 17960 X960
		16.84.0	LOD	16.84.0		12	17464	8 17464 XD64
		16.85.0	TR	12.00.0		00	17469	1 16454 W454
		16.86.0	SGN	80.10.0		15	17474	T 17971 XI61
		16.87.0	RCV	16.20.0	6001	00	17479	U 17166 X166
		16.88.0	TMT	80.10.0	-009	05	17484	9 17962 XZ22
		16.89.0	UNL	16.22.0		15	17489	7 17176 XAG6
1		16.90.0	SEL	0500		00	17494	2 0500 0500
		16.91.0	WR	16.18.0	-008	00	17499	R 17152 X152
1		16.92.0	HLT	1111		00	17504	J 1111 1111
		16.93.0	LOD	16.19.0		04	17509	8 17164 X/64
		16.94.0	ADD	51.01.0		04	17514	G 17671 XW71
		16.94.1	UNL	16.19.0		04	17519	7 17164 X/64
		16.95.0	TR	16.78.0		00	17524	1 17434 X434
		16.96.0	RCV	80.10.0	-009	00	17529	U 17962 X962
		16.97.0	TMT	16.20.0	6001	05	17534	9 17166 X/W6
		16.98.0	LOD	16.22.0		01	17539	8 17176 X1X6
		16.99.0	ADM	80.10.0		01	17544	6 17971 X9X1
		17.00.0	LOD	17.00.0		12	17549	8 17549 XE49
		17.01.0	TR	13.00.0		00	17554	1 16599 W599
		17.02.0	LOD	16.19.0		04	17559	8 17164 X/64
		17.03.0	LOD	17.03.0		12	17564	8 17564 XE64
		17.04.0	TR	11.00.0		00	17569	1 16394 W394
		17.05.0	UNL	17.08.0		04	17574	7 17589 XV89
1		17.06.0	SET	0007		00	17579	B 0007 0007
		17.07.0	LOD	80.07.0		00	17584	8 17960 X960
1		17.08.0	UNL	0000		00	17589	7 0000 0000
		17.09.0	TR	16.77.0		00	17594	1 17429 X429
1		17.10.0	SEL	0500		00	17599	2 0500 0500
		17.11.0	WR	16.15.1	6001	00	17604	R 17109 X109
		17.12.0	TR	16.25.0		00	17609	1 17194 X194
		19.00.0	UNL	19.03.0		12	17614	7 17629 XF29
		19.01.0	LOD	50.11.0		12	17619	8 17653 XF53
		19.02.0	ADM	19.03.0		12	17624	6 17629 XF29
1		19.03.0	TR	0000		00	17629	1 0000 0000
1		20.00.0	HLT	7777		00	17634	J 7777 7777
2	001	50.00.0					17635	0 UNSIGNED CONSTANTS
2	001	50.01.0					17636	1
2	001	50.02.0					17637	2
2	001	50.03.0					17638	3
2	001	50.04.0					17639	4
2	001	50.05.0					17640	5
2	001	50.06.0					17641	6
2	001	50.07.0					17642	7
2	001	50.08.0					17643	8
2	001	50.09.0					17644	9

ADDRESS STOP ON D-ADDR.

DISPLAY 650 WORD

STORAGE READ IN

INVALID INSPECTION

SUBROUTINE OUT

C	LNG	SYMBOLIC	INCR	ASU	LOC	ACTUAL	S	DATA OR DESCRIPTION
L	LOC	OP	ADDR		LOC	OP	ADDR	ADDR
2	004	50.10.0			17648			0002
2	005	50.11.0			17653			00010
2	002	50.12.0			17655			49
2	004	50.13.0			17659			0007
2	002	50.14.0			17661			50
2	002	50.15.0			17663			27
2	002	50.16.0			17665			77
2	004	50.17.0			17669			0005
2	001	51.00.0			17670		& 0	SIGNED CONSTANTS
2	001	51.01.0			17671		& 1	
2	001	51.02.0			17672		& 2	
2	001	51.03.0			17673		& 3	
2	001	51.04.0			17674		& 4	
2	001	51.05.0			17675		& 5	
2	001	51.06.0			17676		& 6	
2	001	51.07.0			17677		& 7	
2	001	51.08.0			17678		& 8	
2	001	51.09.0			17679		& 9	
2	003	51.10.0			17682		& 256	
2	002	51.11.0			17684		& 64	
2	002	51.12.0			17686		& 16	
2	001	51.13.0			17687		- 0	
2	002	51.14.0			17689		& 10	
2	002	51.15.0			17691		& 50	
2	004	51.16.0			17695		I214	
2	003	51.17.0			17698		& 00	
5	010	70.01.0		00	17709			10 WORD STORAGE
5	010	70.02.0			17719			
5	010	70.03.0			17729			
5	010	70.04.0			17739			
5	010	70.05.0			17749			
5	010	70.06.0			17759			
5	010	70.07.0			17769			
5	010	70.08.0			17779			
5	010	70.09.0			17789			
5	010	70.10.0			17799			
2	005	71.00.0			17804			80 COL CARD STORAGE
5	080	71.01.0			17884			
2	001	71.02.0			17885			
2	001	72.00.0			17886			
2	010	72.01.0			17896			
2	010	80.00.0			17906		& 000000 0J	STOR ENT SW
2	010	80.01.0			17916		& 0000000000	DISTRIBUTOR
2	010	80.02.0			17926		& 0000000000	UPPER ACCUM
2	010	80.03.0			17936		& 0000000000	LOWER ACCUM
2	001	80.03.1			17937			
2	002	80.04.1			17939		& 00	OP REG
2	004	80.04.2			17943		& 0000	DATA ADD REG
2	004	80.04.3			17947		& 0000	INSTR ADD REG
2	001	80.05.0			17948			
2	004	80.05.1			17952			ADDRESS REGISTER
2	001	80.05.2			17953			
2	007	80.07.0			17960		& 0000000	BETA REGIST
2	001	80.08.0			17961			
2	010	80.10.0			17971		& 0000000000	ALPHA REGIS
2	001	80.11.0			17972			
2	001	80.47.0			17973		& 0	OVERFLOW REG.
3		80.48.0	80.10.0	-008 02	17977	17963	X903	
3		80.49.0	80.07.0	-003 01	17981	17957	X9V7	
2	001	80.50.0			17982		R	
2	001	80.51.0			17983		I	
2	001	80.52.0			17984		Z	
5	004	80.53.0			17988			
2	001	80.53.1			17989			
2	001	80.54.0			17990		-	
2	006	80.55.0			17996		& 111009	
2	002	80.56.0			17998		& #0	

C	LNG	SYMBOLIC	INCR	ASU	LOC	ACTUAL	S	DATA OR DESCRIPTION
L	LOC	OP	ADDR			OP	ADDR	ADDR N
2	001	80.57.0			17999			@
2	001	80.58.0			18000			&
3		80.59.0	70.01.0	05	18004	17709	XX#9	
2	007	80.65.0			18011			0000000
5	005	89.99.0			00	18019		
		90.00.0	RCV	72.00.0	6002	00	18024	U 17888 X888
		90.00.1	TMT	72.00.0	6010	01	18029	9 17896 X826
		90.00.2	TMT	71.00.0	6041	01	18034	9 17845 X8U5
		90.00.3	LOD	72.00.0	6009	03	18039	8 17895 X815
		90.00.4	ADM	72.00.0	6004	03	18044	6 17890 X810
		90.00.5	RSU	72.00.0	6002	00	18049	Q 17888 X888
		90.00.6	TRP	90.00.9		00	18054	M 18069 Y069
		90.00.7	SGN	71.00.0	6041	01	18059	T 17845 X8U5
		90.00.8	TR	7.13.0		00	18064	L 15394 V394
1		90.00.9	SET	0000		00	18069	B 0000 0000
1		90.01.0	SET	0100		00	18074	B 0100 0100
		90.02.0	UNL	70.10.0		00	18079	7 17799 X799
1		90.03.0	SET	0001		13	18084	B 0001 06#1
		90.04.0	LOD	80.58.0		13	18089	8 18000 Y6#0
		90.05.0	ADM	91.41.0	-004	13	18094	6 18720 YG50
		90.06.0	RCV	70.10.0	-009	00	18099	U 17790 X790
		90.07.0	LOD	71.00.0	6041	01	18104	8 17845 X8U5
		90.08.0	CMP	50.05.0		01	18109	4 17640 X6U0
		90.09.0	TRE	91.10.0		00	18114	L 18574 Y574
		90.10.0	SGN	91.41.0	-004	13	18119	T 18720 YG50
		90.11.0	CMP	72.01.0	-002	01	18124	4 17894 X824
		90.12.0	TRE	91.01.0		00	18129	L 18534 Y534
		90.14.0	TMT	98.04.0		01	18134	9 19584 Z5Y4
		90.14.1	CMP	98.03.0		01	18139	4 19581 Z5Y1
		90.14.2	TRE	90.15.0		00	18144	L 18159 Y159
		90.14.3	TMT	98.03.0		01	18149	9 19581 Z5Y1
		90.14.4	TR	90.16.0		00	18154	1 18164 Y164
		90.15.0	TMT	98.04.0		01	18159	9 19584 Z5Y4
		90.16.0	SGN	71.00.0	6042	00	18164	T 17846 X846
		90.17.0	TRP	90.20.0		00	18169	M 18184 Y184
		90.18.0	TMT	98.03.0		01	18174	9 19581 Z5Y1
		90.19.0	TR	90.21.0		00	18179	1 18189 Y189
		90.20.0	TMT	98.04.0		01	18184	9 19584 Z5Y4
		90.21.0	TMT	71.00.0	6041	01	18189	9 17845 X8U5
		90.22.0	TR	91.19.0		00	18194	1 18614 Y614
1		90.25.0	SET	0005		14	18199	B 0005 06-5
		90.26.0	LOD	71.00.0	6047	14	18204	8 17851 XHN1
		90.27.0	UNL	80.07.0		14	18209	7 17960 XI00
		90.28.0	LOD	90.28.0		12	18214	8 18214 YB14
		90.29.0	TR	15.00.0		00	18219	1 16864 W864
		90.30.0	LOD	80.10.0		05	18224	8 17971 XZ1
		90.31.0	UNL	70.01.0		05	18229	7 17709 XX#9
		90.32.0	LOD	71.00.0	6050	03	18234	8 17854 X8E4
		90.33.0	UNL	80.07.0	-002	03	18239	7 17958 X9E8
		90.34.0	LOD	71.00.0	6062	02	18244	8 17866 X806
		90.35.0	UNL	80.07.0		02	18249	7 17960 X900
		90.36.0	LOD	90.36.0		12	18254	8 18254 YB54
		90.37.0	TR	15.00.0		00	18259	1 16864 W864
		90.38.0	LOD	80.10.0		05	18264	8 17971 XZ1
		90.39.0	UNL	70.02.0		05	18269	7 17719 XX/9
		90.40.0	LOD	71.00.0	6055	14	18274	8 17859 XHN9
		90.41.0	UNL	80.07.0		14	18279	7 17960 XI00
		90.42.0	LOD	90.42.0		12	18284	8 18284 YB84
		90.43.0	TR	15.00.0		00	18289	1 16864 W864
		90.44.0	LOD	80.10.0		05	18294	8 17971 XZ1
		90.45.0	UNL	70.03.0		05	18299	7 17729 XX59
		90.46.0	LOD	71.00.0	6060	14	18304	8 17864 XH04
		90.47.0	UNL	80.07.0		14	18309	7 17960 XI00
		90.48.0	LOD	90.48.0		12	18314	8 18314 YC14
		90.49.0	TR	15.00.0		00	18319	1 16864 W864
		90.50.0	LOD	80.10.0		05	18324	8 17971 XZ1
		90.51.0	UNL	70.04.0		05	18329	7 17739 XXT9

READ MAP

READ MAP - SET WORDS 1-2-3-4-5-6
7-8-9-10 TO ZERO

LOAD & SIGN IN
ASU 13
SET SW TO NOP

TEST COL 41 FOR 5

TEST COL 41 FOR BLANK
OUT ON BLANK

TEST FOR TYPE 8

NOT TYPE 8 - TMT 8

TYPE 8 - TMT 9
TEST SIGN ON 42
OUT ON &
MINUS

PLUS

CONTINUE CONTROL WORD
WORD I COLS 43 TO 47

CS

WORD 2 COL 48-50

COLS 61-62

CS

WORD 3 COLS 51-55

CS

WORD 4 COLS 56-60

CS

C	LNG	SYMBOLIC	INCR	ASU	ACTUAL	S	DATA OR DESCRIPTION		
L	LOC	OP	ADDR	ASU	LOC	OP	ADDR		
	90.52.0	LOD	71.00.0	6067	14	18334	8 17871	XHP1	WORD 5 COLS 63-67
	90.53.0	UNL	80.07.0		14	18339	7 17960	XI00	
	90.54.0	LOD	90.54.0		12	18344	8 18344	YC44	CS
	90.55.0	TR	15.00.0		00	18349	1 16864	W864	
	90.56.0	LOD	80.10.0		05	18354	8 17971	XZX1	
	90.57.0	UNL	70.05.0		05	18359	7 17749	XXU9	
	90.58.0	LOD	71.00.0	6072	14	18364	8 17876	XHP6	WORD 6 COLS 68-72
	90.59.0	UNL	80.07.0		14	18369	7 17960	XI00	
	90.60.0	LOD	90.60.0		12	18374	8 18374	YC74	CS
	90.61.0	TR	15.00.0		00	18379	1 16864	W864	
	90.62.0	LOD	80.10.0		05	18384	8 17971	XZX1	
	90.63.0	UNL	70.06.0		05	18389	7 17759	XXV9	
	90.63.9	RCV	70.07.0	-007	00	18394	U 17762	X762	SET UP WORDS 7 - 8 - 9
	90.64.0	SGN	98.05.0		00	18399	T 19585	Z585	
	90.65.0	TRP	90.89.0		00	18404	M 18524	Y524	
1	90.66.0	SET	0004		15	18409	B 0004	0664	
	90.67.0	LOD	98.06.0		15	18414	8 19589	ZEH9	
	90.68.0	CMP	71.00.0	6026	15	18419	4 17830	XHC0	
	90.69.0	TRE	90.83.0		00	18424	L 18494	Y494	
	90.70.0	TMT	71.00.0	6023	15	18429	9 17827	XHB7	
	90.71.0	TMT	98.01.0		04	18434	9 19569	ZV69	
	90.72.0	TMT	98.01.0		02	18439	9 19569	Z509	
	90.73.0	CMP	71.00.0	6036	15	18444	4 17840	XHD0	
	90.74.0	TRE	90.85.0		00	18449	L 18504	Y504	
	90.75.0	TMT	71.00.0	6033	15	18454	9 17837	XHC7	
	90.76.0	TMT	98.01.0		04	18459	9 19569	ZV69	
	90.77.0	TMT	98.01.0		02	18464	9 19569	Z509	
	90.78.0	CMP	71.00.0	6040	15	18469	4 17844	XHD4	
	90.79.0	TRE	90.87.0		00	18474	L 18514	Y514	
	90.80.0	TMT	71.00.0	6037	15	18479	9 17841	XHD1	
	90.81.0	TMT	98.01.0		04	18484	9 19569	ZV69	
	90.82.0	TR	7.21.0		00	18489	1 15434	V434	
	90.83.0	TMT	71.00.0	6044	04	18494	9 17848	XY48	
	90.84.0	TR	90.71.0		00	18499	1 18434	Y434	
	90.85.0	TMT	71.00.0	6052	04	18504	9 17856	XY56	
	90.86.0	TR	90.76.0		00	18509	1 18459	Y459	
	90.87.0	TMT	71.00.0	6057	04	18514	9 17861	XY61	
	90.88.0	TR	90.81.0		00	18519	1 18484	Y484	
1	90.89.0	SET	0000		15	18524	B 0000	0660	
7	90.90.0	TR	90.83.0		00	18529	1 18494	Y494	
	91.00.0								SET UP WORD 10 CNTRL INFO
	91.01.0	TMT	98.03.0		02	18534	9 19581	Z5Q1	LOC OF 89 D10 AND D9
	91.02.0	SGN	71.00.0	6042	00	18539	T 17846	X846	
	91.03.0	TRP	91.06.0		00	18544	M 18559	Y559	
	91.04.0	TMT	98.03.0		01	18549	9 19581	Z5Y1	LOC OF 8 D8
	91.05.0	TR	91.07.0		00	18554	1 18564	Y564	
	91.06.0	TMT	98.04.0		01	18559	9 19584	Z5Y4	LOC OF 9 D8
	91.07.0	TMT	98.02.0		01	18564	9 19574	Z5X4	LOC OF 0 D7
	91.08.0	TR	91.19.0		00	18569	1 18614	Y614	
	91.10.0	TMT	98.04.0		01	18574	9 19584	Z5Y4	LOC OF 9 D10
	91.11.0	TMT	98.03.0		01	18579	9 19581	Z5Y1	LOC OF 8 D9
	91.12.0	SGN	71.00.0	6042	00	18584	T 17846	X846	
	91.13.0	TRP	91.16.0		00	18589	M 18604	Y604	
	91.14.0	TMT	98.03.0		01	18594	9 19581	Z5Y1	LOC OF 8 D8
	91.15.0	TR	91.17.0		00	18599	1 18609	Y609	
	91.16.0	TMT	98.04.0		01	18604	9 19584	Z5Y4	LOC OF 9 D8
	91.17.0	TMT	71.00.0	6041	01	18609	9 17845	X8U5	LOC OF COL 41 D7
	91.19.0	SGN	71.00.0	6001	00	18614	T 17805	X805	
	91.20.0	ADM	98.05.0		00	18619	6 19585	Z585	
	91.21.0	TRP	91.39.0		00	18624	M 18714	Y714	
	91.22.0	LOD	98.06.0		01	18629	8 19589	Z5Y9	LOC OF BLANK - X IN COL 1 CARDS
	91.23.0	CMP	71.00.0	6023	01	18634	4 17827	X8S7	PUNCH IN COL 23
	91.24.0	TRE	91.33.0		00	18639	L 18684	Y684	BLANK IN B3
	91.25.0	TMT	98.03.0		01	18644	9 19581	Z5Y1	LOC OF 8 D6
	91.26.0	CMP	71.00.0	6033	01	18649	4 17837	X8T7	PUNCH IN COL 33
	91.27.0	TRE	91.35.0		00	18654	L 18694	Y694	BLANK IN 33
	91.28.0	TMT	98.03.0		01	18659	9 19581	Z5Y1	LOC OF 8 D5

C	LNG	SYMBOLIC	INCR	ASU	LOC	ACTUAL	S	DATA OR DESCRIPTION	
L	LOC	OP	ADDR		LOC	OP	ADDR		
	91.29.0	CMP	71.00.0	ε037	01	18664	4 17841	X8U1	PUNCH IN COL 37
	91.30.0	TRE	91.37.0		00	18669	L 18704	Y704	BLANK IN 37
	91.31.0	TMT	98.03.0		01	18674	9 19581	Z5Y1	LOC OF 8 D4
	91.32.0	TR	91.40.0		00	18679	1 18719	Y719	
	91.33.0	TMT	98.04.0		01	18684	9 19584	Z5Y4	LOC OF 9 D6
	91.34.0	TR	91.26.0		00	18689	1 18649	Y649	
	91.35.0	TMT	98.04.0		01	18694	9 19584	Z5Y4	LOC OF 9 D5
	91.36.0	TR	91.29.0		00	18699	1 18664	Y664	
	91.37.0	TMT	98.04.0		01	18704	9 19584	Z5Y4	LOC OF 9 D5
	91.38.0	TR	91.40.0		00	18709	1 18719	Y719	
	91.39.0	TMT	98.04.0	-002	03	18714	9 19582	Z5H2	LOC OF 999 D6 D5 D4
	91.40.0	TMT	98.02.0		01	18719	9 19574	Z5X4	LOC OF 0 D3
	91.41.0	NOP	91.43.1		00	18724	A 18739	Y739	SWITCH FOR TYPE 5
	91.42.0	TMT	98.02.0		02	18729	9 19574	Z5P4	LOC OF 00 D2 D1
	91.43.0	TR	90.25.0		00	18734	1 18199	Y199	EXIT
	91.43.1	LOD	98.06.0		01	18739	8 19589	Z5Y9	
	91.44.0	CMP	71.00.0	ε048	01	18744	4 17852	X8V2	COMPARE COL 48
	91.45.0	TRE	91.47.0		00	18749	L 18759	Y759	NO PUNCH IN 48
	91.46.0	TR	91.42.0		00	18754	1 18729	Y729	NO PUNCH IN 48
	91.47.0	CMP	71.00.0	ε049	01	18759	4 17853	X8V3	COMPARE COL 49
	91.48.0	TRE	91.42.0		00	18764	L 18729	Y729	NO PUNCH IN 49
	91.49.0	TMT	71.00.0	ε049	02	18769	9 17853	X8N3	NO PUNCH IN 48 PUNCH IN 49 D 2 D1
	91.51.0	TR	90.25.0		00	18774	1 18199	Y199	EXIT
1	95.00.0	SET	0005		14	18779	B 0005	0ε-5	PUNCH MAP
	95.00.1	LOD	98.00.2		01	18784	8 19564	Z5W4	
	95.00.2	RCV	98.00.2		00	18789	U 19564	Z564	
	95.00.3	TMT	80.56.0	-001	01	18794	9 17997	X9Z7	
	95.00.4	RCV	71.00.0	ε005	00	18799	U 17809	X809	
	95.00.5	TMT	98.00.2	-075	00	18804	9 19489	Z489	
	95.00.6	UNL	98.00.2		01	18809	7 19564	Z5W4	
	95.00.7	UNL	71.01.0		01	18814	7 17884	X8Y4	
	95.01.0	SGN	70.10.0		13	18819	T 17799	XGZ9	
	95.02.0	LOD	98.03.0		01	18824	8 19581	Z5Y1	LOAD 8
	95.03.0	CMP	70.10.0	-003	01	18829	4 17796	X7Z6	
	95.04.0	TRE	97.01.0		00	18834	L 19424	Z424	
	95.05.0	LOD	70.01.0		05	18839	8 17709	XX#9	PUNCH CARD A AND C -- ALPHA
	95.06.0	UNL	80.10.0		05	18844	7 17971	XZX1	WORD IN A REGISTER
	95.07.0	LOD	95.07.0		12	18849	8 18849	YH49	
	95.08.0	TR	14.00.0		00	18854	1 16749	W749	
	95.09.0	LOD	80.07.0		14	18859	8 17960	X100	IN B REGISTER
	95.10.0	UNL	71.00.0	ε047	14	18864	7 17851	XHN1	PUT IN CARD
	95.11.0	LOD	70.02.0		05	18869	8 17719	XX/9	WORD 2
	95.12.0	UNL	80.10.0		05	18874	7 17971	XZX1	
	95.13.0	LOD	95.13.0		12	18879	8 18879	YH79	
	95.14.0	TR	14.00.0		00	18884	1 16749	W749	
	95.15.0	LOD	80.07.0	-002	03	18889	8 17958	X9E8	
	95.16.0	UNL	71.00.0	ε050	03	18894	7 17854	X8E4	
	95.17.0	LOD	80.07.0		02	18899	8 17960	X900	
	95.18.0	UNL	71.00.0	ε062	02	18904	7 17866	X806	
	95.19.0	LOD	70.03.0		05	18909	8 17729	XXS9	WORD 3
	95.20.0	UNL	80.10.0		05	18914	7 17971	XZX1	
	95.21.0	LOD	95.21.0		12	18919	8 18919	Y119	
	95.22.0	TR	14.00.0		00	18924	1 16749	W749	
	95.23.0	LOD	80.07.0		14	18929	8 17960	X100	
	95.24.0	UNL	71.00.0	ε055	14	18934	7 17859	XHN9	
	95.25.0	LOD	70.04.0		05	18939	8 17739	XXT9	WORD 4
	95.26.0	UNL	80.10.0		05	18944	7 17971	XZX1	
	95.27.0	LOD	95.27.0		12	18949	8 18949	Y149	
	95.28.0	TR	14.00.0		00	18954	1 16749	W749	
	95.29.0	LOD	80.07.0		14	18959	8 17960	X100	
	95.30.0	UNL	71.00.0	ε060	14	18964	7 17864	XH04	
	95.31.0	LOD	70.05.0		05	18969	8 17749	XXU9	WORD 5
	95.32.0	UNL	80.10.0		05	18974	7 17971	XZX1	
	95.33.0	LOD	95.33.0		12	18979	8 18979	Y179	
	95.34.0	TR	14.00.0		00	18984	1 16749	W749	
	95.35.0	LOD	80.07.0		14	18989	8 17960	X100	
	95.36.0	UNL	71.00.0	ε067	14	18994	7 17871	XHP1	

C	LNG	SYMBOLIC	INCR	ASU	LOC	ACTUAL	S	DATA OR DESCRIPTION		
L	LOC	OP	ADDR			OP	ADDR	N		
	95.37.0	L0D	70.06.0	05	18999	8	17759	XXV9	WORD 6	
	95.38.0	UNL	80.10.0	05	19004	7	17971	XZX1		
	95.39.0	L0D	95.39.0	12	19009	8	19009	Z609		
	95.40.0	TR	14.00.0	00	19014	1	16749	W749		
	95.41.0	L0D	80.07.0	14	19019	8	17960	XI00		
	95.42.0	UNL	71.00.0	6072	14	19024	7	17876	XHP6	
	95.43.0	L0D	70.09.0	-004	04	19029	8	17785	XX85	
	95.43.1	UNL	71.00.0	6020	04	19034	7	17824	XY24	
	95.44.0	L0D	98.03.0	01	19039	8	19581	Z5Y1		
	95.44.1	CMP	70.10.0	-002	01	19044	4	17797	X7Z7	
	95.44.2	TRE	95.45.0	00	19049	L	19074	Z074		
	95.44.3	SGN	70.09.0	01	19054	T	17789	X7Y9	REMOVE SIGN OF	
	95.44.4	L0D	70.09.0	01	19059	8	17789	X7Y9	WORD 9 AND PUT TYPE	
	95.44.5	UNL	71.00.0	6041	01	19064	7	17845	X8U5	CODE IN COL 41
	95.44.6	L0D	98.03.0	01	19069	8	19581	Z5Y1		
	95.45.0	CMP	70.10.0	01	19074	4	17799	X7Z9	TEST SIGN	
	95.46.0	TRE	95.50.0	00	19079	L	19099	Z099	MINUS	
	95.47.0	CMP	70.10.0	-001	01	19084	4	17798	X7Z8	TEST FOR CARD A
	95.48.0	TRE	95.53.0	00	19089	L	19119	Z119	TO PUNCH CARD A	
	95.49.0	TR	96.01.0	00	19094	1	19169	Z169		
	95.50.0	L0D	98.15.0	13	19099	8	19613	ZF/3		
	95.51.0	UNL	71.00.0	6042	13	19104	7	17846	XHU6	COL 42
	95.51.1	L0D	80.58.0	13	19109	8	18000	Y6#0		
	95.52.0	TR	95.47.0	00	19114	1	19084	Z084		
	95.53.0	RCV	71.00.0	6001	00	19119	U	17805	X805	
	95.54.0	CMP	70.10.0	-004	01	19124	4	17795	X7Z5	FOR X IN COL 1
	95.55.0	TRE	95.61.0	00	19129	L	19159	Z159	ON X -- MINUS	
	95.56.0	TMT	98.07.0	01	19134	9	19590	Z5Z0	PLUS COL 1 - LOC OF 60	
	95.57.0	TMT	98.02.0	-003	04	19139	9	19571	ZV71	COL 2-5
	95.58.0	TMT	98.02.1	-003	04	19144	9	19575	ZV75	COL 6-9
	95.59.0	TMT	98.07.0	01	19149	9	19590	Z5Z0	COL 10	
	95.60.0	TR	7.84.0	00	19154	1	15739	V739	RETURN TO BLOCK 7 END OF A	
	95.61.0	TMT	98.08.0	01	19159	9	19591	Z5Z1	COL 1 - MINUS 0	
	95.62.0	TR	95.57.0	00	19164	1	19139	Z139		
7	96.00.0								PUNCH CARD C	
	96.01.0	RCV	71.00.0	6001	00	19169	U	17805	X805	
	96.02.0	CMP	70.10.0	-005	01	19174	4	17794	X7Z4	TEST SEL PJ 5-6-7-8
	96.03.0	TRE	96.17.0	00	19179	L	19249	Z249	TO 800X ROUTINE	
	96.04.0	CMP	70.10.0	-004	01	19184	4	17795	X7Z5	TEST SIGN IN COL 1
	96.05.0	TRE	96.11.0	00	19189	L	19219	Z219	TO MINUS IN COL 1	
	96.06.0	TMT	98.09.0	01	19194	9	19592	Z5Z2	LOC 66	
	96.07.0	TMT	98.11.0	-003	04	19199	9	19594	ZV94	LOC 9195
	96.08.0	TMT	98.12.0	-003	04	19204	9	19598	ZV98	LOC 4195
	96.09.0	TMT	98.13.0	01	19209	9	19602	Z6#2	LOC 63	
	96.10.0	TR	96.13.0	00	19214	1	19229	Z229		
	96.11.0	TMT	98.10.0	01	19219	9	19593	Z5Z3	LOC-6	
	96.12.0	TR	96.07.0	00	19224	1	19199	Z199		
	96.13.0	RCV	71.00.0	6021	00	19229	U	17825	X825	
	96.14.0	TMT	98.14.0	-009	05	19234	9	19603	ZW#3	LOC 24 8000
	96.15.0	ADM	71.00.0	6030	13	19239	6	17834	XHT4	LOC OF 6 SIGN
	96.16.0	TR	96.26.0	00	19244	1	19294	Z294	TO SEL 13-14-15-16	
	96.17.0	CMP	70.10.0	-004	01	19249	4	17795	X7Z5	TEST & OR- IN COL 1
	96.18.0	TRE	96.24.0	00	19254	L	19284	Z284	ON -	
	96.19.0	TMT	98.07.0	01	19259	9	19590	Z5Z0	ON &	
	96.20.0	TMT	98.02.0	-003	04	19264	9	19571	ZV71	
	96.21.0	TMT	98.02.1	-003	04	19269	9	19575	ZV75	
	96.22.0	TMT	98.07.0	01	19274	9	19590	Z5Z0		
	96.23.0	TR	96.26.0	00	19279	1	19294	Z294		
	96.24.0	TMT	98.08.0	01	19284	9	19591	Z5Z1	MINUS COL 1	
	96.25.0	TR	96.20.0	00	19289	1	19264	Z264		
	96.26.0	CMP	70.10.0	-009	01	19294	4	17790	X7Z0	CONTROL INFO 10
	96.27.0	TRE	96.30.0	00	19299	L	19314	Z314		
	96.28.0	L0D	70.08.0	-004	04	19304	8	17775	XX75	
	96.29.0	UNL	71.00.0	6026	04	19309	7	17830	XY30	
	96.30.0	CMP	70.10.0	-008	01	19314	4	17791	X7Z1	CI 9
	96.31.0	TRE	96.34.0	00	19319	L	19339	Z339		
	96.32.0	L0D	70.07.0	-008	02	19324	8	17761	X701	

C	LNG	SYMBOLIC	INCR	ASU	LOC	ACTUAL	S	DATA OR DESCRIPTION
L	LOC	OP	ADDR			OP	ADDR	ADDR N
	96.33.0	UNL	71.00.0	6032	02	19329	7 17836	X8L6
	96.33.1	TR	96.36.0		00	19334	1 19349	Z349
	96.34.0	LOD	80.54.0		13	19339	8 17990	XIZ0
	96.35.0	UNL	71.00.0	6073	13	19344	7 17877	XHX7
	96.36.0	CMP	70.10.0	-007	01	19349	4 17792	X722
	96.37.0	TRE	96.40.0		00	19354	L 19369	Z369
	96.38.0	LOD	70.07.0	-004	04	19359	8 17765	XX65
	96.39.0	UNL	71.00.0	6036	04	19364	7 17840	XY40
	96.40.0	CMP	70.10.0	-006	01	19369	4 17793	X723
	96.41.0	TRE	7.84.0		00	19374	L 15739	V739
	96.42.0	LOD	70.07.0		04	19379	8 17769	XX69
	96.43.0	UNL	71.00.0	6040	04	19384	7 17844	XY44
	96.44.0	CMP	70.10.0		01	19389	4 17799	X729
	96.45.0	TRE	96.49.0		00	19394	L 19404	Z404
	96.48.0	TR	7.84.0		00	19399	1 15739	V739
	96.49.0	LOD	80.54.0		13	19404	8 17990	XIZ0
	96.49.1	SGN	71.00.0	6040	01	19409	T 17844	X8U4
	96.50.0	ADM	71.00.0	6040	13	19414	6 17844	XHU4
	96.51.0	TR	7.84.0		00	19419	1 15739	V739
7	97.00.0							EXIT RETURN TO BLOCK 7 END OF C PUNCH CARD B
	97.01.0	RCV	71.00.0	6001	00	19424	U 17805	X805
	97.02.0	TMT	70.05.0	-009	05	19429	9 17740	XXU0
	97.03.0	TMT	70.06.0	-009	05	19434	9 17750	XXV0
	97.04.0	TMT	70.07.0	-009	05	19439	9 17760	XXW0
	97.05.0	TMT	70.08.0	-009	05	19444	9 17770	XXX0
	97.06.0	TMT	80.58.0		01	19449	9 18000	Y0#0
	97.07.0	LOD	70.09.0	-004	04	19454	8 17785	XX85
	97.08.0	UNL	71.00.0	6046	04	19459	7 17850	XY50
	97.09.0	RCV	71.00.0	6051	00	19464	U 17855	X855
	97.10.0	TMT	70.09.0	-009	02	19469	9 17780	X700
	97.11.0	TMT	70.04.0	-007	04	19474	9 17732	XX32
	97.12.0	TMT	70.09.0	-003	04	19479	9 17786	XX86
	97.13.0	TR	7.84.0		00	19484	1 15739	V739
2	035	98.00.0				19519		
2	035	98.00.1				19554		
2	010	98.00.2				19564		
2	005	98.01.0				19569		00000
2	005	98.02.0				19574		00000
2	004	98.02.1				19578		0800
2	003	98.03.0				19581		888
2	003	98.04.0				19584		999
2	001	98.05.0				19585		
2	004	98.06.0				19589		
2	001	98.07.0				19590		6 0
2	001	98.08.0				19591		- 0
2	001	98.09.0				19592		6 6
2	001	98.10.0				19593		- 6
2	004	98.11.0				19597		9195
2	004	98.12.0				19601		4195
2	001	98.13.0				19602		6 3
2	010	98.14.0				19612		24 8000
2	001	98.15.0				19613		-
6		98.70.0	19730					
	98.70.1	RCV	70.06.0	6006	00	19734	U 17765	X765
	98.71.0	TMT	3.16.0	-003	04	19739	9 14931	UZ31
	98.72.0	TMT	71.00.0	-004	04	19744	9 17800	XY00
	98.72.1	TMT	71.00.0	-004	02	19749	9 17800	X8-0
	98.73.0	LOD	50.11.0		04	19754	8 17653	XW53
1	98.74.0	SET	0004		13	19759	8 0004	06#4
	98.75.0	LOD	50.11.0	-002	13	19764	8 17651	XFV1
1	98.76.0	SET	0004		14	19769	B 0004	06-4
	98.76.1	LOD	98.97.3		14	19774	8 19893	ZHR3
	98.76.2	UNL	98.81.0		14	19779	7 19804	ZH-4
	98.77.0	LOD	50.13.0		14	19784	8 17659	XFN9
1	98.78.0	SET	0000		15	19789	B 0000	0660
1	98.79.0	SET	0010		15	19794	B 0010	06A0
	98.80.0	RCV	70.06.0	6016	00	19799	U 17775	X775

UNPAC 650 DRUM FOR MEM PR

C	LNG	SYMBOLIC	INCR	ASU	LOC	ACTUAL	S	DATA OR DESCRIPTION	
L	LOC	OP	ADDR			OP	ADDR	N	
1	98.81.0	LOD	0007	07	19804	8	0007	0#67	
	98.82.0	UNL	80.07.0	07	19809	7	17960	XZF0	
	98.83.0	LOD	98.83.0	12	19814	8	19814	ZH14	
	98.84.0	TR	12.04.0	00	19819	1	16469	W469	
	98.85.0	TMT	72.01.0	-002	01	19824	9	17894	X824
	98.86.0	TMT	80.10.0	-009	05	19829	9	17962	XZW2
	98.87.0	ADM	98.81.0	14	19834	6	19804	ZH-4	
	98.88.0	NTR	98.81.0	15	19839	X	19804	ZH64	
1	98.89.0	SEL	0400	00	19844	2	0400	0400	
	98.90.0	WR	70.06.0	ε006	00	19849	R	17765	X765
	98.91.0	ADM	70.06.0	ε009	04	19854	6	17768	XX68
	98.92.0	CMP	70.06.0	ε009	13	19859	4	17768	XGW8
	98.93.0	TRE	98.95.0	00	19864	L	19874	Z874	
	98.94.0	TR	98.78.0	00	19869	1	19789	Z789	
1	98.95.0	HLT	9999	00	19874	J	9999	9999	
1	98.96.0	SEL	0100	00	19879	2	0100	0100	
1	98.97.0	RD	0000	00	19884	Y	0000	0000	
1	98.97.1	TR	0004	00	19889	1	0004	0004	
2 001	98.97.2							19890	
2 003	98.97.3							19893	
6	99.00.0		19895						
1	99.01.0	RAD	19950	03	19899	H	19950	Z9E0	
1	99.02.0	ADD	19901	00	19904	G	19901	Z901	
1	99.03.0	ADD	19903	00	19909	G	19903	Z903	
1	99.04.0	ADD	19906	00	19914	G	19906	Z906	
1	99.05.0	ADD	19909	00	19919	G	19909	Z909	
1	99.06.0	SET	0003	03	19924	B	0003	00ε3	
	99.07.0	UNL	80.10.0	03	19929	7	17971	X9G1	
	99.07.1	SGN	80.10.0	-008	01	19934	T	17963	X9W3
	99.08.0	ADM	80.10.0	01	19939	6	17971	X9X1	
1	99.09.0	SEL	0904	00	19944	2	0904	0904	
	99.10.0	TRS	19.00.0	00	19949	0	17614	X614	
	99.11.0	TR	19.00.0	00	19954	1	17614	X614	
6	99.55.0		19956						
2 001	99.56.0				19956			ε 0	
2 001	99.57.0				19957			ε 1	
2 001	99.58.0				19958			ε 2	
2 001	99.59.0				19959			ε 3	
2 002	99.61.0				19961			ε 0	
2 002	99.63.0				19963			ε 0	
2 003	99.66.0				19966			ε 0	
2 003	99.69.0				19969			ε 0	
2 002	99.71.0				19971			ε 4	
2 002	99.73.0				19973			ε 16	
2 003	99.76.0				19976			ε 64	
2 003	99.79.0				19979			ε 256	
2 002	99.81.0				19981			ε 8	
2 002	99.83.0				19983			ε 32	
2 003	99.86.0				19986			ε 128	
2 003	99.89.0				19989			ε 512	
2 002	99.91.0				19991			ε 12	
2 002	99.93.0				19993			ε 48	
2 003	99.96.0				19996			ε 192	
2 003	99.99.0				19999			ε 768	

PRESS 705 START TO
SELECT CARD READER FOR MEPR PROGRAM TO PRINT
INSTRUCTION AND CONSTANT AREA

0
#67

UNPAC CONTINUED
ADD DECIMAL EQUIVALENTS OF ZONES

BLOCK 99

PLACE 3 TERMINAL DIGITS IN ALPHA REG
MOVE SIGN TO
UNITS POSITION

EXIT TO SUBROUTINE OUT



IBM.
*International
Business Machines
Corporation*

590 MADISON AVENUE
NEW YORK 22, N. Y.

32-7763

PRINTED IN U. S. A.