

# Formats

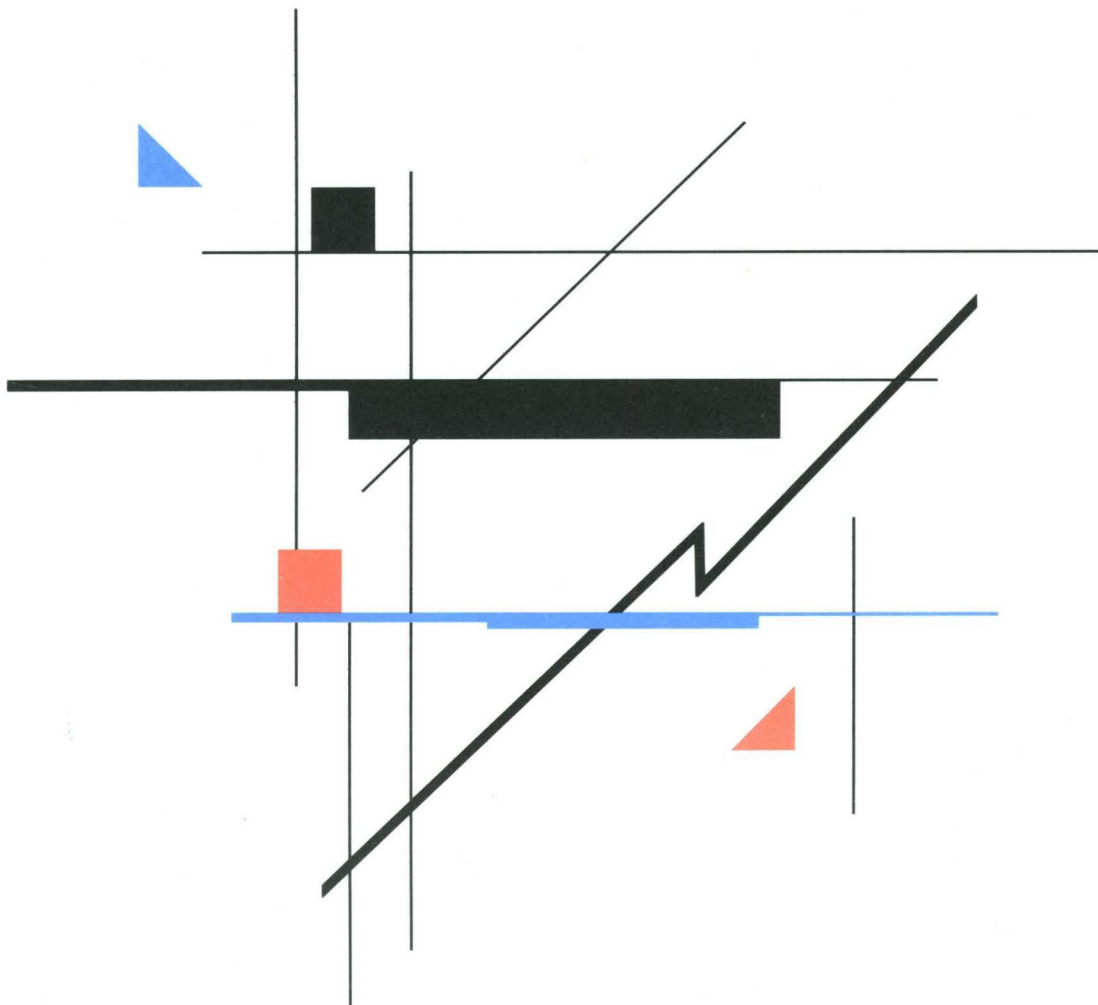

## **Formats**

Ninth Edition (June 1987)

This is a major revision of GA27-3136-7, which is now obsolete.

It is possible that this material may contain reference to, or information about, IBM products (machines and programs) or services that are not announced in your country. Such references or information must not be construed to mean that IBM intends to announce such IBM products or services in your country.

The following paragraph does not apply to the United Kingdom or any country where such provisions are inconsistent with local law: INTERNATIONAL BUSINESS MACHINES CORPORATION PROVIDES THIS PUBLICATION "AS IS" WITHOUT WARRANTY OF ANY KIND, EITHER EXPRESS OR IMPLIED, INCLUDING, BUT NOT LIMITED TO, THE IMPLIED WARRANTIES OF MERCHANTABILITY OR FITNESS FOR A PARTICULAR PURPOSE. Some states do not allow disclaimer of express or implied warranties in certain transactions; therefore, this statement may not apply to you.

Publications are not stocked at the address given below; requests for IBM publications should be made to your IBM representative or to the IBM branch office serving your locality.

A form for reader's comments is provided at the back of this publication. If the form has been removed, comments may be addressed to IBM Corporation, Information and Interface Development Support, Department E01, PO Box 12195, Research Triangle Park, North Carolina U.S.A. 27709. IBM may use or distribute any of the information you supply in any way it believes appropriate without incurring any obligation whatever. You may, of course, continue to use the information you supply.

© Copyright International Business Machines Corporation, 1977, 1987. All rights reserved.

## PREFACE

This book describes the Systems Network Architecture (SNA) formats used between subarea nodes and peripheral nodes, and between type 2.1 nodes using peer-to-peer protocols.

This book is intended for product developers, system programmers, and others who need detailed information about Systems Network Architecture in order to maintain, develop, or adapt a product or program for attachment to an SNA network.

Related publications, providing overview and protocol information, are:

- Systems Network Architecture Concepts and Products (GC30-3072)
- Systems Network Architecture Technical Overview (GC30-3073)
- IBM Synchronous Data Link Control Concepts (GA27-3093)
- Systems Network Architecture Format and Protocol Reference Manual: Architectural Logic (SC30-3112)
- Systems Network Architecture Format and Protocol Reference Manual: Architecture Logic for Type 2.1 Nodes (SC30-3422)
- Systems Network Architecture: Sessions Between Logical Units (GC20-1868)
- Systems Network Architecture Format and Protocol Reference Manual: Architecture Logic for LU Type 6.2 (SC30-3269)
- Systems Network Architecture Format and Protocol Reference Manual: Distribution Services (SC30-3098)
- Systems Network Architecture Format and Protocol Reference Manual: Management Services (SC30-3346)
- Token-Ring Network Architecture Reference (6165877)
- Document Interchange Architecture: Technical Reference (SC23-0781)

## HOW THIS BOOK IS ORGANIZED

This book identifies the formats and meanings of the bytes that a basic link unit (BLU) contains. A BLU is the basic unit of transmission at the data link and link station level. The figure on page v illustrates the organization of this book.



Chapter 1 identifies the formats and meanings of the bytes in a link header and a link trailer.

Chapter 2 identifies the formats and meanings of the bytes in an SDLC station identification command.

Chapter 3 identifies the formats and meanings of the bytes in a transmission header.

Chapter 4 identifies the formats and meanings of the bytes in a request or response header.

Chapter 5.1 identifies the formats and meanings of the bytes in a request unit.

Chapter 5.2 identifies the formats and meanings of the bytes in a response unit.

Chapter 6 explains the transmission services and function management profiles that SNA defines to describe session characteristics.

Chapter 7 identifies the formats and meanings of the bytes in user-structured subfields that appear in a request or response unit.

Chapter 8 identifies the formats and meanings of the control vectors, session keys, and management services vectors that appear in a request or response unit.

Chapter 9 explains the meanings of the SNA-defined sense data that appears in a negative response unit.

Chapter 10 presents the descriptions and formats of the different function management headers.

Chapter 11 identifies the formats and meanings of the bytes in a presentation services header.

Chapter 12 identifies the formats and meanings of the general data stream (GDS) variables that are specific to SNA service transaction programs.

Chapter 13 identifies the formats and meanings of the message units that SNA Distribution Services transaction programs use.

Chapter 14 identifies the general data stream (GDS) variables that are for general use.

Appendix A provides a summary of SNA character sets and symbol-string types.

Appendix B provides a summary of general data stream identifier (GDS ID) value assignments.

Appendix C lists the abbreviations and symbols that are used in this book.

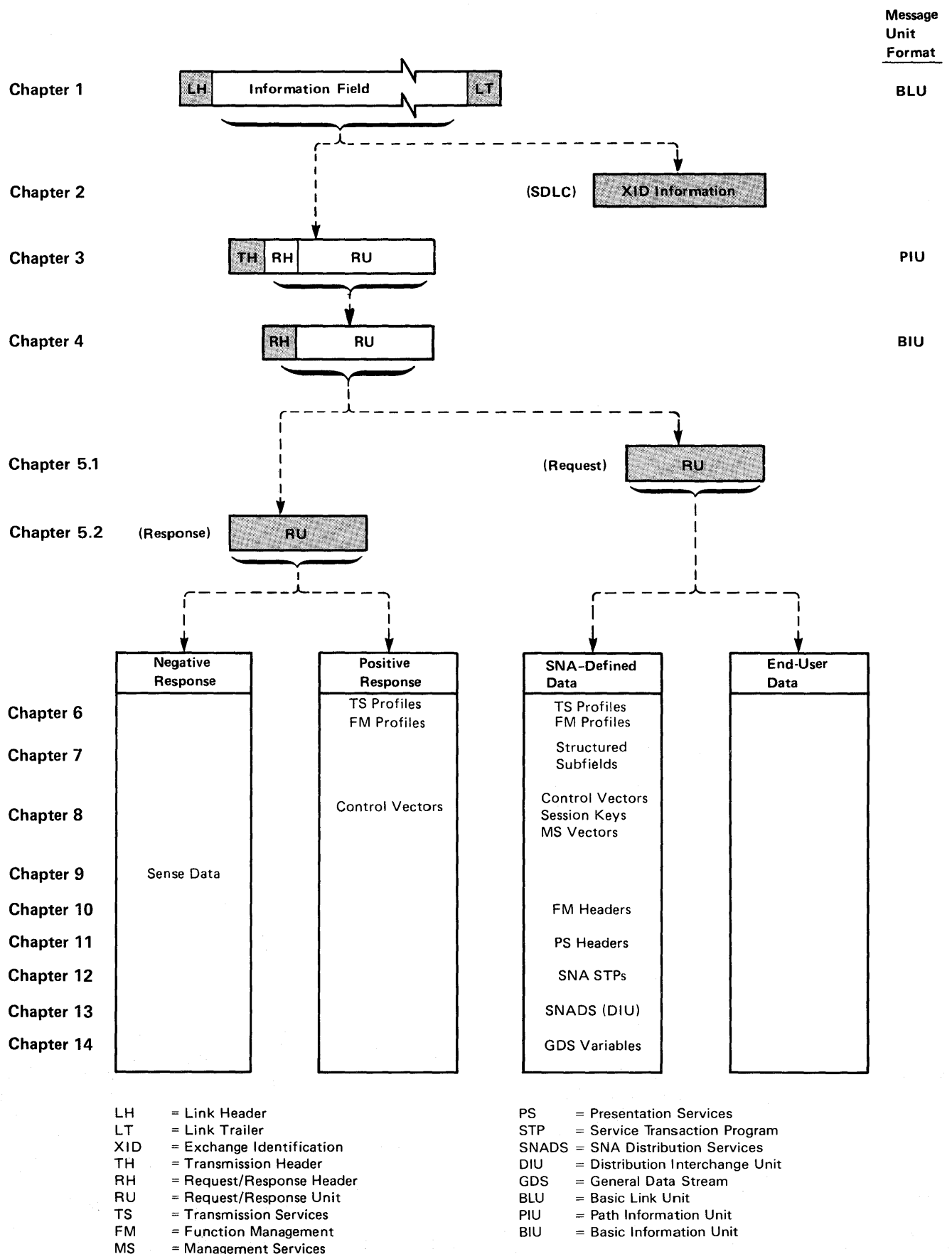



# CONTENTS

Chapter 1. DLC Links . . . . .	1-1
Synchronous Data Link Control (SDLC) . . . . .	1-1
Link Header . . . . .	1-2
Flag . . . . .	1-2
Address . . . . .	1-3
Control . . . . .	1-4
Link Trailer . . . . .	1-10
Frame Check Sequence . . . . .	1-10
Flag . . . . .	1-11
Token-Ring Network DLC . . . . .	1-12
Chapter 2. Exchange Identification (XID) Information Fields . . . . .	2-1
DLC XID Information-Field Formats . . . . .	2-1
Chapter 3. Transmission Headers . . . . .	3-1
Introduction . . . . .	3-1
FID 2 Layout . . . . .	3-2
FID 2 Field Descriptions . . . . .	3-2
Chapter 4. Request/Response Headers . . . . .	4-1
Introduction . . . . .	4-1
RH Formats . . . . .	4-4
IPR and EXR . . . . .	4-10
ISOLATED PACING RESPONSE (IPR) . . . . .	4-10
EXCEPTION REQUEST (EXR) . . . . .	4-10
Chapter 5.1. Request Units . . . . .	5.1-1
Introduction to Request Units . . . . .	5.1-1
Request Unit Summary Information . . . . .	5.1-3
Summary of Request RUs by Category . . . . .	5.1-3
Index of RU's by NS Headers and Request Codes . . . . .	5.1-4
Descriptions of Request Units . . . . .	5.1-5
ACTLU; SSCP-->LU, Exp; SC (ACTIVATE LOGICAL UNIT) . . . . .	5.1-5
ACTPU; SSCP PUCP-->PU, Exp; SC (ACTIVATE PHYSICAL UNIT) . . . . .	5.1-5
BID; LU-->LU, Norm; DFC (BID) . . . . .	5.1-5
BIND; PLU-->SLU, Exp; SC (BIND SESSION) . . . . .	5.1-6
BIS; LU-->LU, Norm; DFC (BRACKET INITIATION STOPPED) . . . . .	5.1-14
CANCEL; LU-->LU, Norm; DFC (CANCEL) . . . . .	5.1-14
CHASE; LU-->LU, Norm; DFC (CHASE) . . . . .	5.1-14
CLEAR; PLU-->SLU, Exp; SC (CLEAR) . . . . .	5.1-14
CRV; PLU-->SLU, Exp; SC (CRYPTOGRAPHY VERIFICATION) . . . . .	5.1-14
DACTLU; SSCP-->LU, Exp; SC (DEACTIVATE LOGICAL UNIT) . . . . .	5.1-15

DACTPU; SSCP PUCP-->PU, PU-->SSCP, Exp; SC (DEACTIVATE PHYSICAL UNIT)	5.1-15
INIT-SELF; ILU-->SSCP, Norm; FMD NS(s) (INITIATE-SELF)	5.1-16
INIT-SELF; ILU-->SSCP, Norm; FMD NS(s) (INITIATE-SELF)	5.1-17
LUSTAT; LU-->LU SSCP, Norm; DFC (LOGICAL UNIT STATUS)	5.1-19
NMVT; SSCP<-->PU T2 Norm; FMD NS(ma) (NETWORK MANAGEMENT VECTOR TRANSPORT)	5.1-20
NOTIFY; LU-->SSCP, Norm; FMD NS(s) (NOTIFY)	5.1-21
LU-LU Session Services Capabilities	5.1-21
QC; LU-->LU, Norm; DFC (QUIESCE COMPLETE)	5.1-22
QEC; LU-->LU, Exp; DFC (QUIESCE AT END OF CHAIN)	5.1-22
RELQ; LU-->LU, Exp; DFC (RELEASE QUIESCE)	5.1-22
RQR; SLU-->PLU, Exp; SC (REQUEST RECOVERY)	5.1-22
RSHUTD; SLU-->PLU, Exp; DFC (REQUEST SHUTDOWN)	5.1-22
RTR; LU-->LU, Norm; DFC (READY TO RECEIVE)	5.1-22
SBI; LU-->LU, Exp; DFC (STOP BRACKET INITIATION)	5.1-23
SDT; PLU-->SLU, SSCP-->PU SSCP, Exp; SC (START DATA TRAFFIC)	5.1-23
SHUTC; SLU-->PLU, Exp; DFC (SHUTDOWN COMPLETE)	5.1-23
SHUTD; PLU-->SLU, Exp; DFC (SHUTDOWN)	5.1-23
SIG; LU-->LU, Exp; DFC (SIGNAL)	5.1-23
STSN; PLU-->SLU, Exp; SC (SET AND TEST SEQUENCE NUMBERS)	5.1-24
TERM-SELF; TLU-->SSCP, Norm; FMD NS(s) (TERMINATE-SELF)	5.1-24
TERM-SELF; TLU-->SSCP, Norm; FMD NS(s) (TERMINATE-SELF)	5.1-25
UNBIND; LU-->LU, Exp; SC (UNBIND SESSION)	5.1-26

Chapter 5.2. Response Units . . . . . 5.2-1

Introduction	5.2-1
Positive Response Units with Extended Formats	5.2-3
RSP(ACTLU); LU-->SSCP, Exp; SC	5.2-3
RSP(ACTPU); PU-->SSCP PUCP, Exp; SC	5.2-3
RSP(BIND); SLU-->PLU, Exp; SC	5.2-4
RSP(STSN); SLU-->PLU, Exp; SC	5.2-5

Chapter 6. Profiles . . . . . 6-1

Introduction	6-1
Transmission Services (TS) Profiles	6-2
TS Profile 1	6-3
TS Profile 2	6-3
TS Profile 3	6-4
TS Profile 4	6-4
TS Profile 7	6-5
Function Management (FM) Profiles	6-6
FM Profile 0	6-7
FM Profile 2	6-7
FM Profile 3	6-8
FM Profile 4	6-9
FM Profile 6	6-10
FM Profile 7	6-11
FM Profile 18	6-12
FM Profile 19	6-13

Chapter 7. User Data Structured Subfields . . . . . 7-1

Introduction	7-1
--------------	-----

Descriptions . . . . .	7-2
Unformatted Data . . . . .	7-2
Session Qualifier . . . . .	7-2
Mode Name . . . . .	7-2
Session Instance Identifier . . . . .	7-2
Network-Qualified PLU Network Name . . . . .	7-3
Network-Qualified SLU Network Name . . . . .	7-3
Random Data . . . . .	7-3
Enciphered Data . . . . .	7-3
 Chapter 8. Common Fields . . . . .	 8-1
Introduction . . . . .	8-1
Subfield Encoding/Parsing Rules . . . . .	8-2
Rules for Common Substructures . . . . .	8-2
Partitioning of Key/Type Values . . . . .	8-2
Architecture-Dependent Keys . . . . .	8-2
Unique Keys . . . . .	8-2
Context-Sensitive Keys . . . . .	8-2
Parsing Rules . . . . .	8-2
Enclosing Rule for Substructures . . . . .	8-3
Control Vectors . . . . .	8-4
Introduction . . . . .	8-4
Control Vector Formats . . . . .	8-4
SSCP-LU Session Capabilities (X'00')	8-4
LU-LU Session Services Capabilities (X'0C')	8-5
Network Name (X'0E')	8-5
Product Set ID (X'10')	8-5
XID Negotiation Error (X'22')	8-6
Session Key . . . . .	8-7
Network or Uninterpreted Name (X'01')	8-7
URC (X'0A')	8-7
MS Major Vectors and Unique Subvectors . . . . .	8-8
Introduction . . . . .	8-8
Alert (X'0000')	8-9
SDLC Link Station Data (X'8C')	8-12
Current N(S)/N(R) Counts (X'01')	8-12
Outstanding Frame Count (X'02')	8-13
Last SDLC Control Field Received (X'03')	8-13
Last SDLC Control Field Sent (X'04')	8-13
Sequence Number Modulus (X'05')	8-13
Link Station State (X'06')	8-13
LLC Reply Timer Expiration Count (X'07')	8-14
Last Received N(R) Count (X'08')	8-14
Basic Alert (X'91')	8-14
Generic Alert Data (X'92')	8-18
Probable Causes (X'93')	8-27
User Causes (X'94')	8-40
User Causes (X'01')	8-40
Install Causes (X'95')	8-46
Install Causes (X'01')	8-46
Failure Causes (X'96')	8-49
Failure Causes (X'01')	8-50
Cause Undetermined (X'97')	8-64

Detailed Data (X'98')	8-65
Qualified Message Data (X'01')	8-65
Detail Qualifier (EBCDIC) (X'A0')	8-67
Detail Qualifier (Hexadecimal) (X'A1')	8-67
Network Alert (X'0000') Common Subfields	8-68
Recommended Actions (X'81')	8-68
Detailed Data (X'82')	8-76
Product Set ID Index (X'83')	8-79
Request Response Time Monitor (X'8080')	8-80
RTM Request (X'92')	8-81
RTM Control (X'94')	8-82
Response Time Monitor (X'0080')	8-83
RTM Status Reply (X'91')	8-85
RTM Data (X'93')	8-86
MS Common Subvectors	8-88
Text Message (X'00')	8-88
Date/Time (X'01')	8-88
Local Date/Time (X'10')	8-88
Greenwich Mean Time Offset (X'20')	8-89
Hierarchy Name List (X'03')	8-89
SNA Address List (X'04')	8-90
Hierarchy/Resource List (X'05')	8-91
Hierarchy Name List (X'10')	8-91
Product Set ID (X'10')	8-93
Product Identifier (X'11')	8-93
Hardware Product Identifier (X'00')	8-95
Emulated Product Identifier (X'01')	8-97
Software Product Serviceable Component Identifier (X'02')	8-97
Software Product Common Level (X'04')	8-97
Software Product Common Name (X'06')	8-98
Software Product Customization Identifier (X'07')	8-98
Software Product Program Number (X'08')	8-98
Software Product Customization Date and Time (X'09')	8-98
Microcode EC Level (X'0B')	8-99
Hardware Product Common Name (X'0E')	8-99
Self-Defining Text Message (X'31')	8-99
Coded Character Set ID (X'01')	8-100
National Language ID (X'11')	8-100
Sender ID (X'21')	8-100
Text Message (X'30')	8-101
Relative Time (X'42')	8-101
Data Reset Flag (X'45')	8-101
LAN Link Connection Subsystem Data (X'51')	8-102
Ring or Bus Identifier (X'02')	8-102
Local Individual MAC Address (X'03')	8-102
Remote Individual MAC Address (X'04')	8-102
LAN Routing Information (X'05')	8-103
Fault Domain Description (X'06')	8-103
Beaconing Data (X'07')	8-103
Single MAC Address (X'08')	8-103
Fault Domain Error Weight Pair (X'09')	8-103
Bridge Identifier (X'0A')	8-104
Local Individual MAC Name (X'23')	8-104
Remote Individual MAC Name (X'24')	8-104

Fault Domain Names (X'26')	8-104
Single MAC Name (X'28')	8-105
Link Connection Subsystem Configuration Data (X'52')	8-105
Port Address (X'01')	8-105
Remote Device Address (X'02')	8-105
Local Device Address (X'04')	8-106
LCS Link Station Attributes (X'06')	8-106
LCS Link Attributes (X'07')	8-106
Sense Data (X'7D')	8-107
 Chapter 9. Sense Data	 9-1
Request Reject (Category Code = X'08')	9-2
Request Error (Category Code = X'10')	9-31
State Error (Category Code = X'20')	9-40
RH Usage Error (Category Code = X'40')	9-43
Path Error (Category Code = X'80')	9-45
 Chapter 10. Function Management Headers	 10-1
FM header 1	10-3
FM header 2	10-6
FM header 3	10-7
FM header 4	10-8
FM header 5: Attach	10-10
Access Security Information Subfields	10-11
PIP Variable	10-11
PIP Subfield	10-11
FM header 5 (Not LU Type 6.2)	10-12
FM header 6	10-13
FM header 7: Error Description	10-14
FM header 7: Error Description (not LU 6.2)	10-15
FM header 8	10-15
FM header 10	10-15
FM header 12: Security	10-16
 Chapter 11. Presentation Services Headers	 11-1
Presentation Services (PS) Headers	11-1
PS header 10: Sync Point Control	11-2
 Chapter 12. General Data Stream (GDS) Variables	 12-1
List of SNA Service Transaction Programs	12-1
Descriptions of GDS Variables for SNA STPs	12-2
CHANGE NUMBER OF SESSIONS (X'1210')	12-2
EXCHANGE LOG NAME (X'1211')	12-3
COMPARE STATES (X'1213')	12-4
 Chapter 13. SNA Distribution Services	 13-1
Introduction	13-1
Interchange Unit Description	13-2
Distribute Interchange Unit	13-2



DISTIU; DSU ---> DSU; (DISTRIBUTE INTERCHANGE UNIT)	13-2
Acknowledge Interchange Unit	13-34
ACKIU; DSU ---> DSU; (ACKNOWLEDGE INTERCHANGE UNIT)	13-34
Names and Code Points	13-41
Specification of the Character-String Fields	13-41
Code Points Used by SNADS	13-42
Status Type Codes	13-44
Transaction Program and Server Names	13-45
 Chapter 14. GDS Variables for General Use	 14-1
Format of Application Data GDS Variable	14-3
Format of Null Data Variable	14-3
Format of User Control Data GDS Variable	14-3
Format of Map Name GDS Variable	14-3
Format of an Error Data GDS variable	14-4
Format of Error Log GDS Variable	14-5
 Appendix A. SNA Character Sets and Symbol-String Types	 A-1
Symbol-String Type	A-1
SNA Character Sets	A-2
 Appendix B. GDS ID Description and Assignments	 B-1
Structured Fields	B-1
Length (LL) Description	B-1
Identifier (ID) Description	B-2
Identifier Registry	B-2
 Appendix C. List of Abbreviations and Symbols	 C-1
 Index	 X-1

# LIST OF ILLUSTRATIONS

## Chapter 1. DLC Links

Figure 1-1. Flag field of link header . . . . .	1-2
Figure 1-2. Shared Trailing/Leading 0 in SDLC Flags . . . . .	1-2
Figure 1-3. Address field of link header . . . . .	1-3
Figure 1-4. Control field of link header . . . . .	1-4
Figure 1-5. Control fields for SDLC Commands and Responses--Modulus 8 . . . . .	1-6
Figure 1-6. Control fields for SDLC Commands and Responses--Modulus 128 . . . . .	1-7
Figure 1-7. Information field of the FRMR Response Frame . . . . .	1-8
Figure 1-8. Frame Check Sequence field of link trailer . . . . .	1-10
Figure 1-9. Flag field of link trailer . . . . .	1-11
Figure 1-10. LLC Commands and Responses . . . . .	1-12

## Chapter 2. Exchange Identification (XID) Information Fields

## Chapter 3. Transmission Headers

Figure 3-1. Transmission Header for FID Type 2 . . . . .	3-2
--	-----

## Chapter 4. Request/Response Headers

Figure 4-1. RH Formats . . . . .	4-2
Figure 4-2. FMD Request/Response Combinations for Sessions between Two LU 6.2s . . . . .	4-6
Figure 4-3. Request/Response Combinations For TS Profile 4 Sync Points . . . . .	4-8

## Chapter 5.1. Request Units

Figure 5.1-1. RU Sizes Corresponding to Values X'ab' in BIND . . . . .	5.1-13
--	--------

## Chapter 5.2. Response Units

## Chapter 6. Profiles

Figure 6-1. TS Profiles and Their Usage . . . . .	6-2
Figure 6-2. FM Profiles and Their Usage . . . . .	6-6

## Chapter 7. User Data Structured Subfields

## Chapter 8. Common Fields

Figure 8-1. Setting of Bits 1 and 3 of Byte 2 of the RTM Request (X'92') Subvector . . . . .	8-82
--	------

## Chapter 9. Sense Data

Figure 9-1. Sense Data Format . . . . .	9-1
Figure 9-2. Usage of X'1008' Sense Code Specific Information by LU Type . . . . .	9-41

## Chapter 10. Function Management Headers

Figure 10-1. FM Header Contained in One RU . . . . .	10-1
Figure 10-2. FM Header Contained in Two Contiguous RUs of a Chain . . . . .	10-1
Figure 10-3. Usage of FM Headers . . . . .	10-2
Figure 10-4. LU Types That Support FM Headers . . . . .	10-2

## Chapter 11. Presentation Services Headers

## Chapter 12. General Data Stream (GDS) Variables

Figure 12-1. SNA-defined Service Transaction Programs . . . . .	12-1
---	------

## Chapter 13. SNA Distribution Services

Figure 13-1. Structure of the Distribute IU . . . . .	13-3
Figure 13-2. Interpretation of the Distribution Flags . . . . .	13-8
Figure 13-3. Priority, Protection, and Capacity Subfield Values . . . . .	13-9
Figure 13-4. Feedback Priority, Protection, and Capacity Subfield Values . . . . .	13-12
Figure 13-5. Structure of the Destination Operands . . . . .	13-14
Figure 13-6. Structure of the REN List . . . . .	13-16
Figure 13-7. Structure of the DGN List . . . . .	13-17
Figure 13-8. Structure of the DEN List . . . . .	13-18
Figure 13-9. Distribution Status Operands Structure . . . . .	13-21
Figure 13-10. SNADS Status Condition Codes . . . . .	13-25
Figure 13-11. Structure of the DGN List of Specific Status . . . . .	13-27
Figure 13-12. Structure of the DEN List of Specific Status . . . . .	13-28
Figure 13-13. Structure of the Acknowledge IU . . . . .	13-35
Figure 13-14. Exception Condition Codes . . . . .	13-37
Figure 13-15. Exception Object Codes . . . . .	13-38
Figure 13-16. Character-String Specification . . . . .	13-41

## Chapter 14. GDS Variables for General Use

Figure 14-1. LU type 6.2 GDS Variable Code Points . . . . .	14-1
---	------

Appendix A. SNA Character Sets and Symbol-String Types

Figure A-1. Character Sets A, AE, 930, and USS . . . . . A-3

Appendix B. GDS ID Description and Assignments

Figure B-1. GDS Structured Field . . . . . B-1

Appendix C. List of Abbreviations and Symbols



## CHAPTER 1. DLC LINKS

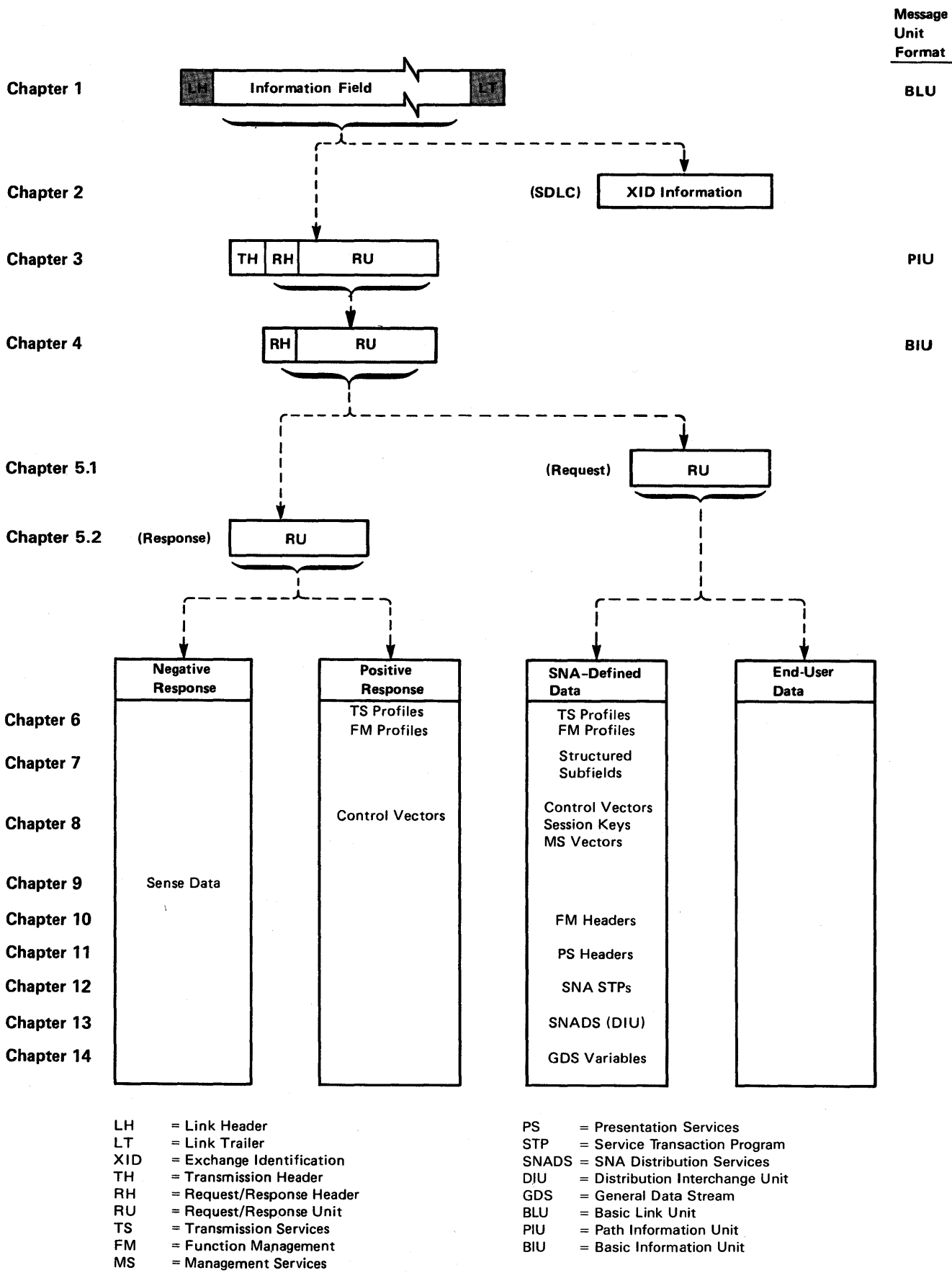

LH = Link Header  
 LT = Link Trailer  
 XID = Exchange Identification  
 TH = Transmission Header  
 RH = Request/Response Header  
 RU = Request/Response Unit  
 TS = Transmission Services  
 FM = Function Management  
 MS = Management Services

PS = Presentation Services  
 STP = Service Transaction Program  
 SNADS = SNA Distribution Services  
 DIU = Distribution Interchange Unit  
 GDS = General Data Stream  
 BLU = Basic Link Unit  
 PIU = Path Information Unit  
 BIU = Basic Information Unit

## CHAPTER 1. DLC LINKS

Two data link controls are described in this chapter: "Synchronous Data Link Control (SDLC)", beginning on this page, and the "Token-Ring Network DLC" on page 1-12.

### SYNCHRONOUS DATA LINK CONTROL (SDLC)

All transmissions on an SDLC link are organized in a specific format called a frame:

Frame = BLU = LH [,I-field], LT

where:           BLU = Basic Link Unit  
                  LH = Link Header  
                  I-field = Information field  
                  LT = Link Trailer

Link headers and link trailers contain data link control information for synchronous data link control (SDLC) links. An SDLC frame begins with the link header (LH), which has three fields: the Flag, Address, and Control fields. The link trailer (LT) follows the Information field and is three bytes long. The first two bytes make up the Frame Check Sequence field; the last byte, the closing Flag field. The following pages identify the formats and meanings of the bytes in a link header and a link trailer.



LINK HEADER  
(FLAG)

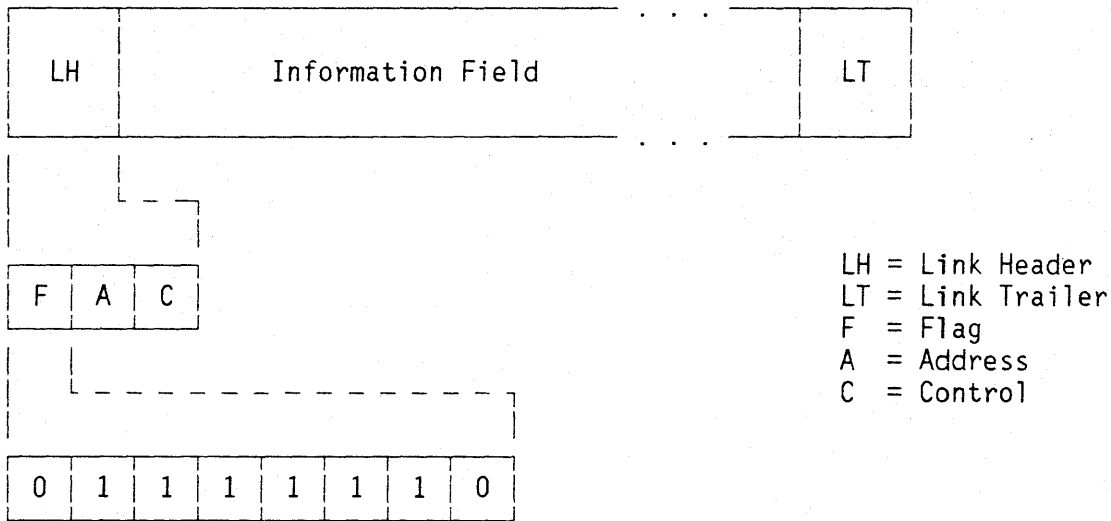

Figure 1-1. Flag field of link header: always X'7E', B'01111110'.

All frames begin with a Flag field. The configuration of the flag is always 01111110 (X'7E'). Because frames also end with flags (see link trailer), the trailing flag of one frame may serve as the leading flag of the next frame. When receiving, the last 0 in the trailing flag may also be the first 0 in the next leading flag, as Figure 1-2 illustrates.

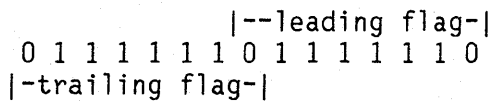

Figure 1-2. Shared Trailing/Leading 0 in SDLC Flags

**Note:** Zero bit insertion between the beginning and ending flags prevents a flag pattern from occurring anywhere else in the frame.

LINK HEADER  
(ADDRESS)

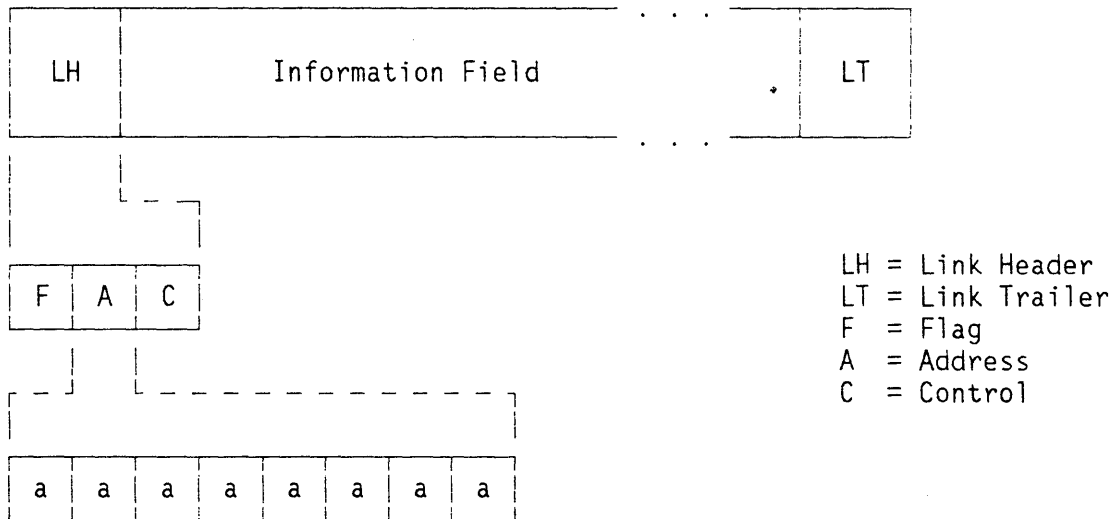

Figure 1-3. Address field of link header: B'aaaaaaaa'

The second byte of the link header is the Address field. This address can be:

- a specific link station address -- to only one link station
- a group address -- to one or more link stations
- a broadcast address (X'FF', B'11111111') -- to all link stations
- a "no stations" address (X'00').

The "no stations" address is reserved and should not be used for any link station or group of link stations.

**Note:** The specific link station address of the secondary is used when the transmission is going from primary to secondary or from secondary to primary.

LINK HEADER  
(CONTROL)

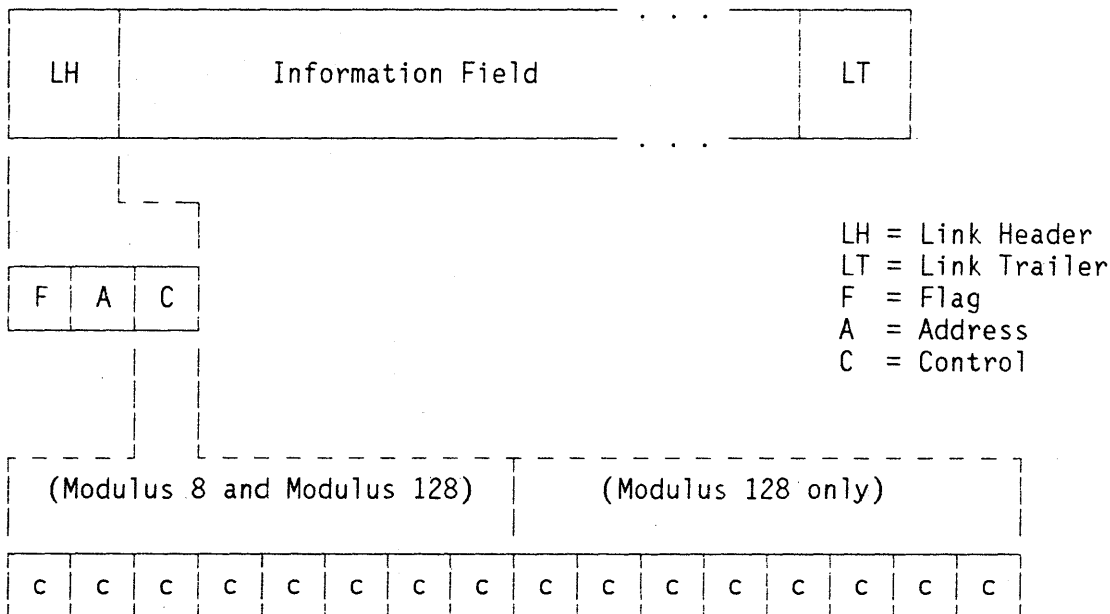

Figure 1-4. Control field of link header: B'cccccccc' for modulus 8; B'cccccccccccccccc' for modulus 128.

The third byte (or third and fourth bytes) of the link header is the Control field. The Control field contains either an SDLC command or a response. All frames transmitted by a primary station are commands, while frames transmitted by a secondary station are responses. There are three categories of SDLC commands and responses:

- Unnumbered Format
- Supervisory Format
- Information Format

**Unnumbered Format:** These commands and responses have a poll/final (P/F) bit that is set to 1 to solicit a response (P bit) or when it is the last SDLC frame of a transmission (F bit). This bit is a poll bit for commands and a final bit for responses. Each of the Unnumbered Format commands and responses have two possible hex values: one value for when the poll/final bit is 0 and another value for when the poll/final bit is 1.

**Supervisory Format:** These commands and responses have a varying number of possible hex values. The number of possible hex values corresponds to the receive sequence numbers assigned to this frame and the setting of the P/F bit. To increase the sequence number modulus from 8 to 128, a two-byte extended Control field is used.

**Information Format:** These commands and responses also vary in the number of possible hex values. The number of possible hex values correspond to the send and receive sequence numbers assigned to this frame and the setting of the P/F bit. To increase the sequence number modulus from 8 to 128, a two-byte extended Control field is used.

The Information Format is identified by a 0 in the low-order bit of the first or only byte of the Control field. In an Information Format SDLC command or response, the Information field contains a PIU (Path Information Unit). The remaining chapters of this book, with the exception of Chapter 2, discuss the contents of the PIU.

Figure 1-5 lists the SDLC commands and responses for modulus 8 (one-byte) Control fields; Figure 1-6 lists them for modulus 128 (two-byte) Control fields.

Figure 1-7 describes the Information field of the Frame Reject (FRMR) response frame, which is one of the unnumbered formats listed in Figure 1-5.

FORMAT	BINARY CONFIGURATION	HEX EQUIVALENT P/F off,P/F on	COMMAND NAME	ACRO- NYM
Unnumbered Format	000 P/F 0011	X'03', X'13'	Unnumbered Information	UI
	000 F 0111	X'07', X'17'	Request Initialization Mode	RIM
	000 P 0111	X'07', X'17'	Set Initialization Mode	SIM
	000 F 1111	X'0F', X'1F'	Disconnect Mode	DM
	001 P 0011	X'23', X'33'	Unnumbered Poll	UP
	010 F 0011	X'43', X'53'	Request Disconnect	RD
	010 P 0011	X'43', X'53'	Disconnect	DISC
	011 F 0011	X'63', X'73'	Unnumbered Acknowledgment	UA
	100 P 0011	X'83', X'93'	Set Normal Response Mode	SNRM
	100 F 0111	X'87', X'97'	Frame Reject	FRMR
	101 P/F 1111	X'AF', X'BF'	Exchange Identification	XID
	110 P/F 0111	X'C7', X'D7'	Configure	CFGR
	110 P 1111	X'CF', X'DF'	Set Normal Response Mode Extended	SNRME
	111 P/F 0011	X'E3', X'F3'	Test	TEST
	111 F 1111	X'EF', X'FF'	Beacon	BCN
Supervisory Format	RRR P/F 0001	X'x1', X'x1'	Receive Ready	RR
	RRR P/F 0101	X'x5', X'x5'	Receive Not Ready	RNR
	RRR P/F 1001	X'x9', X'x9'	Reject	REJ
Information Format	RRR P/F SSS0	X'xx', X'xx'	Numbered Information Present	
Notes: P = Poll bit (sent to secondary station) F = Final bit (sent to primary station) RRR = Nr (receive count) SSS = Ns (send count)				

Figure 1-5. Control fields for SDLC Commands and Responses—Modulus 8

FORMAT	BINARY CONFIGURATION	HEX EQUIVALENT	COMMAND NAME	ACRO- NYM
Unnumbered Format	same as modulus 8 (one-byte), as in Figure 1-5.			
Supervisory Format	0000 0001 RRRR RRR P/F	X'01xx'	Receive Ready	RR
	0000 0101 RRRR RRR P/F	X'05xx'	Receive Not Ready	RNR
	0000 1001 RRRR RRR P/F	X'09xx'	Reject	REJ
Information Format	SSSS SSS0 RRRR RRR P/F	X'xxxx'	Numbered Information Present	
Notes: P = Poll bit (sent to secondary station) F = Final bit (sent to primary station) RRR = Nr (receive count) SSS = Ns (send count)				

Figure 1-6. Control fields for SDLC Commands and Responses—Modulus 128

## Information Field of the FRMR Response Frame

Modulus 8:

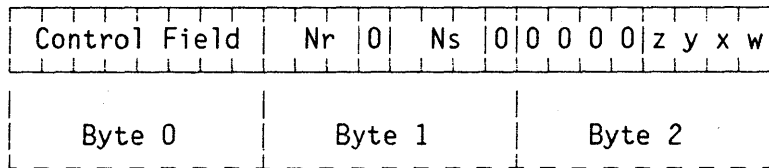

Modulus 128:

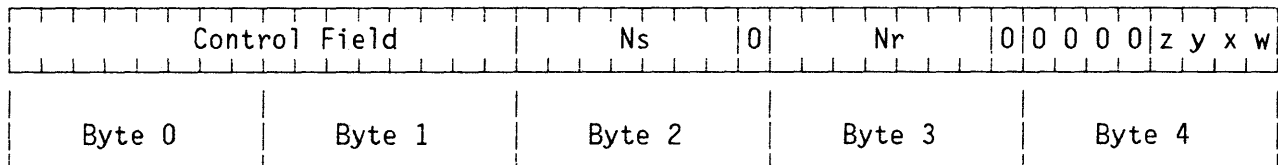

Note: For modulus 128, if control field causing FRMR is an unnumbered format (one-byte), it is placed in byte 0 and byte 1 is set to all 0's.

Field	Description	Explanation/Usage
C	Control Field	Control field of the rejected command, as received
Nr	Receive Count	This station's present receiver frame count (the existing count prior to FRMR)
Ns	Send Count	This station's present transmitter frame count (the existing count prior to FRMR)
Rejection Indicators:		
z	Count	0 = no error 1 = Received Nr disagrees with transmitted Ns
y	Buffer	0 = no error 1 = Buffer overrun (I-field is too long)
x	I-field	0 = no error 1 = Prohibited I-field received
w	Command	0 = no error 1 = Invalid or nonimplemented command received

Figure 1-7. Information field of the FRMR Response Frame: modulus 8 and modulus 128. In each byte, the low-order bit is sent first and the high-order bit is sent last.





LINK TRAILER  
(FRAME CHECK SEQUENCE)

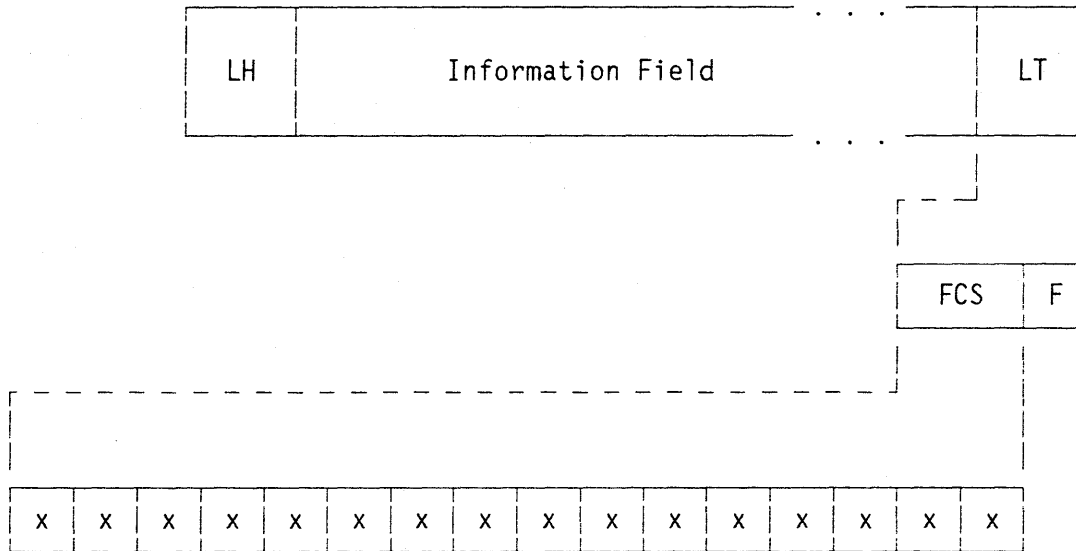

Figure 1-8. Frame Check Sequence field of link trailer

The Frame Check Sequence field carries information that the receiver uses to check the received frame for errors that may have been introduced by the communication channel. This field contains a 16-bit check sequence that is the result of a computation on the contents of both the LH (with the exception of the flag) and the Information field at the transmitter. Cyclic redundancy checking (CRC) is used to perform this calculation.

The receiver performs a similar computation and checks its results.

LINK TRAILER  
(FLAG)

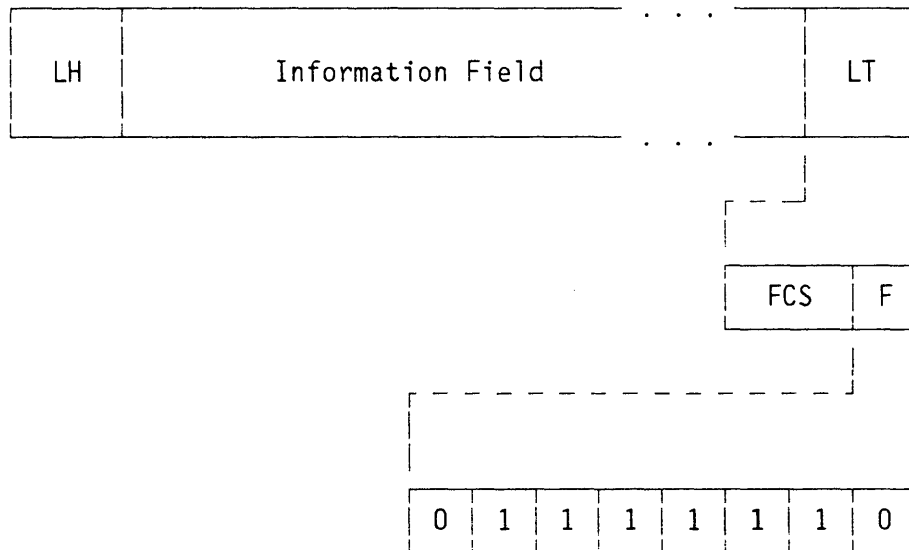

Figure 1-9. Flag field of link trailer: always X'7E', B'01111110'.

All frames end with a Flag field. The configuration of the ending (trailing) flag is the same as that of the beginning (leading) flag that is present in the link header: 01111110 (X'7E').

## TOKEN-RING NETWORK DLC

The token-ring network DLC consists of two sublayers: the medium access control and the logical link control. The medium access control (MAC) sublayer controls the routing of information between the physical layer and the logical link control sublayer. It provides the following functions: address recognition, frame copying, frame delimiting, and 32-bit frame check sequence generation and verification. The logical link control (LLC) sublayer provides sequential, connection-oriented data transfer.

The following commands and responses, a subset of those shown in Figure 1-6, are used by the LLC sublayer in the token-ring network:

Format	Command/Response Name
Unnumbered Format	DM Response
	DISC Command
	UA Response
	SABME Command
	FRMR Response
	XID Command or Response
	Test Command or Response
Supervisory Format	Receive Ready
	Receive Not Ready
	Reject
Information Format	Numbered Information Present

Figure 1-10. LLC Commands and Responses

The code points associated with these commands and responses are the same as those shown in Figure 1-6.

The token-ring network DLC, in contrast to SDLC, transmits the high-order bit first and the low-order bit last within each byte. Also, zero bit insertion is required on the token-ring network, since the differential Manchester encoding technique is used.

Additional information about the token-ring network DLC architecture is contained in the Token-Ring Network Architecture Reference.



## CHAPTER 2. EXCHANGE IDENTIFICATION (XID) INFORMATION FIELDS

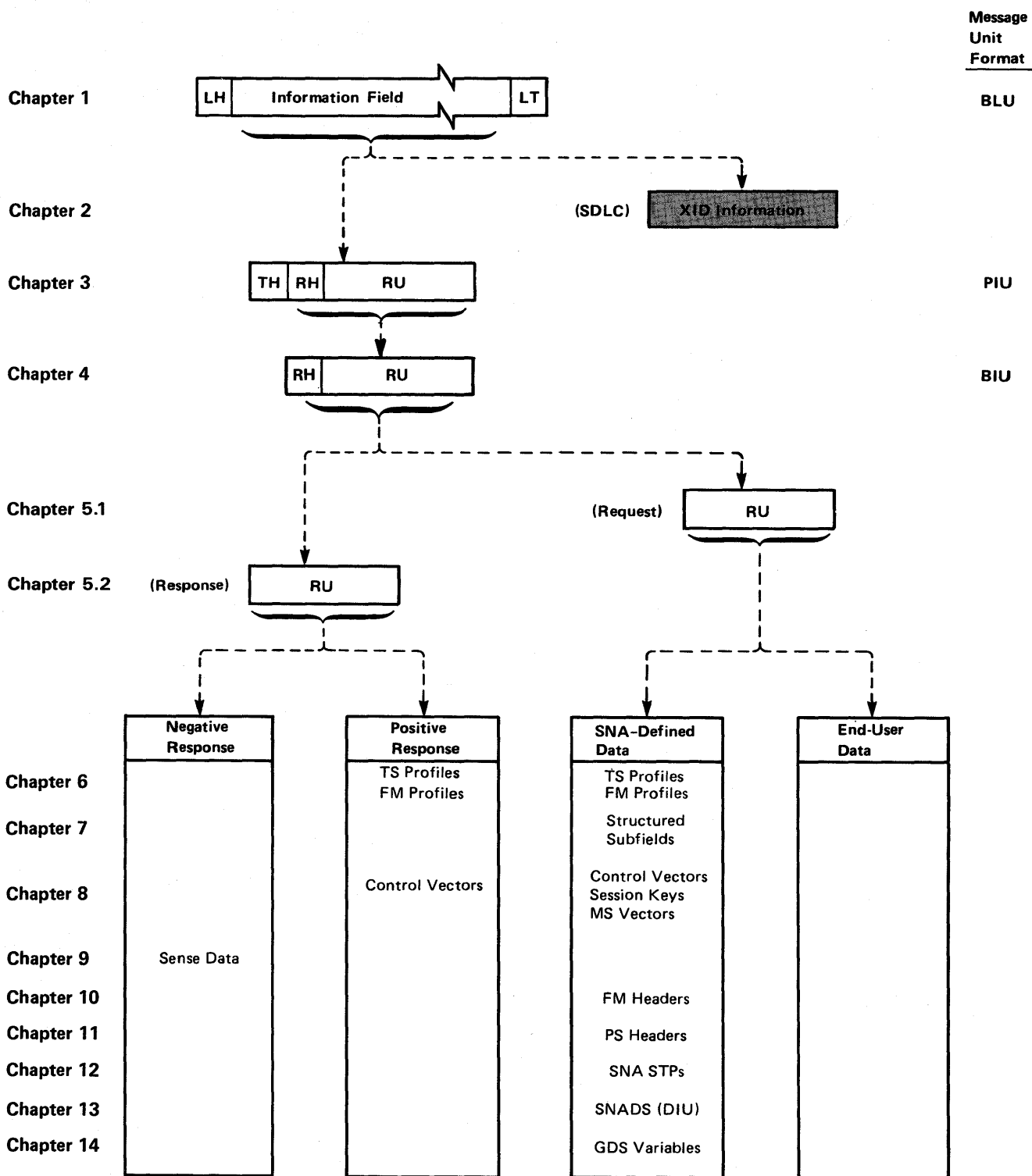

LH = Link Header  
 LT = Link Trailer  
 XID = Exchange Identification  
 TH = Transmission Header  
 RH = Request/Response Header  
 RU = Request/Response Unit  
 TS = Transmission Services  
 FM = Function Management  
 MS = Management Services

PS = Presentation Services  
 STP = Service Transaction Program  
 SNADS = SNA Distribution Services  
 DIU = Distribution Interchange Unit  
 GDS = General Data Stream  
 BLU = Basic Link Unit  
 PIU = Path Information Unit  
 BIU = Basic Information Unit

## CHAPTER 2. EXCHANGE IDENTIFICATION (XID) INFORMATION FIELDS

This chapter describes the formats of the information field of the DLC XID command and response.

### DLC XID INFORMATION-FIELD FORMATS

- 0 bits 0-3, format of XID I-field:  
X'0' fixed format: only bytes 0-5 are included  
X'1' variable format (for T1|2.0 to T4|5 node exchanges):  
bytes 0-p are included  
X'2' reserved  
X'3' variable format (for T2.1 to T2.1 and T2.0 to T4|5  
node exchanges): bytes 0-p are included  
X'8'-X'F' defined for external standards organizations  
bits 4-7, type of the XID-sending node:  
X'1' T1  
X'2' T2  
X'3' reserved  
X'4' subarea node (T4 or T5)
- 1 Length, in binary, of variable-format XID I-field (bytes 0-p); reserved  
for fixed-format XID I-field
- 2-5|7 Node Identification  
2-5 bits 0-11, Block number: an IBM product specific number; see the  
individual product specifications for the specific values used  
Note: The values all 0's and all 1's indicate that bytes 2-5  
do not contain a unique node identifier.  
bits 12-31, ID number: a binary value that, together with the block  
number, identifies a specific station uniquely within a  
customer network installation; the ID number can be assigned  
in various ways, depending on the product; see the individual  
product specifications for details  
Note: When the Block Number field does not contain all 0's or  
all 1's, a value of all 0's in the ID number indicates that no  
ID number has been assigned.  
Note: For XID format 3, the contents of bytes 2-5 of the node  
identification field are used in some instances as a  
role-negotiation-value to resolve contention in protocol roles of nodes,  
e.g., primary/secondary DLC roles or the ODAI value to be appended to the  
(OAF', DAF') values assigned at a node. When a role-negotiation value is  
needed and the node does not supply a unique node identification value, it  
supplies a random value in the ID number field.
- End of Format 0



## XID I-field

- 6-p Format 1 Continuation
- 6-7 Reserved
- 8 Link Station and Connection Protocol Flags
- 8 bits 0-1, reserved
- bit 2, link-station role of XID sender:  
0 sender is a secondary link station (nonnegotiable)  
1 sender is a primary link station (nonnegotiable)
- bit 3, reserved.
- bits 4-7, link-station transmit-receive capability:  
X'0' two-way alternating  
X'1' two-way simultaneous
- 9 Characteristics of the node of the XID sender:
- bits 0-1, reserved
- bits 2-3, segment assembly capability of the path control element of the node:  
00 the Mapping field is ignored and PIUs are forwarded unchanged  
01 segments are assembled on a link-station basis  
10 segments are assembled on a session basis  
11 only whole BIUs are allowed
- bits 4-5, reserved
- bit 6, short-hold status (reserved if byte 9, bit 7 is set to 0):  
0 sender not already engaged in a logical connection using short-hold mode  
1 sender already engaged in a logical connection using short-hold mode
- bit 7, short-hold capability of the XID sender:  
0 short-hold mode not supported  
1 short-hold mode supported
- 10-11 Maximum I-field length that the XID sender can receive:
- bit 0, format flag:  
0 bits 1-15 contain the maximum I-field length (only value defined)
- bits 1-15, maximum I-field length, in binary
- 12 bits 0-3, reserved
- bits 4-7, SDLC command/response profile:  
X'0' SNA link profile (only value defined)
- Note: These profiles refer to the mandatory command/response support on an SDLC link, as follows:
- For an SDLC link in normal response mode (NRM/NRME), having a point-to-point or multipoint configuration (determined from system definition), the support required is:

<u>Commands</u>	<u>Responses</u>
I-frames	I-frames
RR	RR
RNR	RNR
Test	Test
XID	XID
SNRM/SNRME	UA
Disconnect	DM
-	RD
-	Frame Reject
Reject	Reject

Note 1: The RD response is sent by the secondary station if and only if the PU in its node receives a DISCONTACT request from its CP.

Note 2: Reject is required only if both sender and receiver have two-way simultaneous transmit-receive capability.

- For an SDLC link in normal response mode (NRM), having a loop configuration (determined from system definition), the support required is:

<u>Commands</u>	<u>Responses</u>
I-frames	I-frames
RR	RR
RNR	RNR
Test	Test
XID	XID
SNRM	UA
Disconnect	DM
UP	-
-	Frame Reject
Configure	Configure
-	Beacon
-	RD

Note: The RD response is sent by the secondary station if and only if the PU in its node receives a DISCONTACT request from its CP.

- 13 bits 0-1, reserved  
bit 2, SDLC initialization mode options:  
0 SIM and RIM not supported  
1 SIM and RIM supported  
bits 3-7, reserved  
14-15 Reserved

## XID I-field

- 16 bit 0, reserved  
bits 1-7, maximum number of I-frames that can be received by the XID sender before an acknowledgment is sent, with an implied modulus for the send and receive sequence counts—less than 8 implies a modulus of 8, 8 or greater implies a modulus of 128
- 17 Reserved
- For byte 9, bit 7 = 0 (short-hold mode not supported)
- 18-p SDLC Address Assignment Field  
18 Length (p minus 18), in binary, of the SDLC address to be assigned  
19-p Secondary station address to be assigned
- For byte 9, bit 7 = 1 (short-hold mode supported)
- 18-p Short-Hold Mode Dependent Parameters  
18 Reserved  
19-n Dial Digits of XID Sender  
19 Number, in binary, of dial digits  
20-n Dial digits: a string of digits, each having the form X'Fn' ( $0 \leq n \leq 9$ )  
n+1-p Dial digits of an available short-hold mode port  
Note: This field is included only in an XID from a T4 or T5 node and only for an incoming call on an already logically busy (byte 9, bit 6 = 1) short-hold mode port. If this field is not included, then  $p = n$ .  
n+1 Number, in binary, of dial digits of an available short-hold mode port, if one exists  
n+2-p Dial digits of an available short-hold mode port: a string of digits, each having the form X'Fn' ( $0 \leq n \leq 9$ )  
Note: Byte n+1 is set to the value X'00' and the n+2-p field is not included if no free alternate port is found. In this case the station may retry later on the same port used for the current XID.
  - End of Format 1

6-p Format 3 Continuation  
6-7 Reserved  
8-9 Characteristics of the node of the XID sender:  
bit 0, INIT-SELF support:  
0 INIT-SELF may be sent to the XID sender  
Note: If the XID sender does not contain an SSCP, it forwards any INIT-SELF received to the proper node for processing, which returns the response to the originator of the request.  
1 INIT-SELF (and character-coded logon) cannot be sent to the XID sender  
Note: For bits 0-1, the value 11 is reserved.  
bit 1, stand-alone BIND support:  
0 BIND may be sent to the XID sender without a prior INITIATE sequence  
1 BIND may not be sent to the XID sender  
Note: For bits 0-1, the value 11 is reserved.  
bits 2-3, retired, set to 11  
bits 4-7, reserved  
bit 8, retired  
bits 9-11, reserved  
bits 12-13, XID exchange state:  
00 exchange state indicators not supported (set only by implementations not at the current level of SNA)  
01 negotiation proceeding

	10 pre-negotiation exchange
	11 non-activation exchange
	bits 14-15, reserved
10-16	Reserved
17	DLC type: X'01' SDLC (only value defined)
18-n	<u>DLC Dependent Section</u>
18	Length, in binary, of the DLC Dependent Section field (Length field includes itself in the length specified.)
19	<u>Link Station and Connection Protocol Flags</u>
19	bit 0, reserved
	bit 1, ABM support indicator: 0 XID sender cannot be an ABM combined station 1 XID sender can be an ABM combined station
	bits 2-3, link-station role of XID sender: 00 sender is a secondary link station (nonnegotiable) 01 sender is a primary link station (nonnegotiable) 10 reserved 11 negotiable (primary or secondary capability)
	<u>Note:</u> For ABM stations, the value of bits 2-3 is used only for the purposes of OAF'-DAF' assignment and deciding which node sends the Set Mode command.
	bits 4-5, reserved
	bits 6-7, link-station transmit-receive capability: 00 two-way alternating 01 two-way simultaneous
20	Reserved
21-22	Maximum BTU length that the XID sender can receive:
	bit 0, format flag: 0 bits 1-15 contain the maximum BTU length (only value defined)
	bits 1-15, maximum BTU length, in binary
23	bits 0-3, reserved
	bits 4-7, SDLC command/response profile: X'0' SNA link profile (only value defined)
	<u>Note:</u> These profiles refer to the mandatory command/response support on an SDLC link, as follows:
	<ul style="list-style-type: none"> <li>• For an SDLC link in normal response mode (NRM/NRME), having a point-to-point or multipoint configuration (determined from system definition), the support required is:</li> </ul>

## XID I-field

<u>Commands</u>	<u>Responses</u>
I-frames	I-frames
RR	RR
RNR	RNR
Test	Test
XID	XID
SNRM/SNRME	UA
Disconnect	DM
-	RD
-	Frame Reject
Reject	Reject

Note 1: The RD response is sent by the secondary station if and only if the PU in its node receives a DISCONTACT request from its CP.

Note 2: Reject is required only if both sender and receiver have two-way simultaneous transmit-receive capability.

For an SDLC link in normal response mode (NRM), having a loop configuration (determined from system definition), the support required is:

<u>Commands</u>	<u>Responses</u>
I-frames	I-frames
RR	RR
RNR	RNR
Test	Test
XID	XID
SNRM	UA
Disconnect	DM
UP	-
-	Frame Reject
Configure	Configure
-	Beacon
-	RD

Note: The RD response is sent by the secondary station if and only if the PU in its node receives a DISCONTACT request from its CP.

For an SDLC link in asynchronous balanced mode (ABM) (determined from the Link-Station Role of XID Sender field), having a point-to-point configuration, the support required is:

<u>Commands</u>	<u>Responses</u>
I-frames	-
RR	RR
RNR	RNR
Reject	Reject
SABME	UA
Disconnect	DM
Test	Test
XID	XID
-	Frame Reject

Note 1: All commands and responses are transmitted and received in two-octet format (extended control field).

Note 2: Frame Reject is not required to be transmitted; receive capability is required.

24	bits 0-1, reserved bit 2, SDLC initialization mode options: 0 SIM and RIM not supported 1 SIM and RIM supported
25-26	bits 3-7, reserved
27	Reserved bit 0, reserved bits 1-7, maximum number of I-frames that can be received by the XID sender before an acknowledgment is sent, with an implied modulus for the send and receive sequence counts--less than 8 implies a modulus of 8, 8 or greater implies a modulus of 128
28(=n) n+1-p	Reserved Control vectors, as described in "Control Vectors" in Chapter 8 <u>Note:</u> The following control vectors may be included; they are parsed according to subfield parsing rule KL: X'0E' Network Name control vector: type X'F4', network-qualified CP name (always present; the network identifier is always used, i.e., valid lengths of the CP name are 3 to 17 bytes with an imbedded period) X'0E' Network Name control vector: type X'F7', local name of the ALS at the XID sender (always present) X'10' Product Set ID control vector (always present) <u>Note:</u> When included in XID, the product set ID is limited to 60 bytes or less in length. X'22' XID Negotiation Error control vector (conditionally present: present when an error during XID negotiation is detected; more than one may be present)



## CHAPTER 3. TRANSMISSION HEADERS



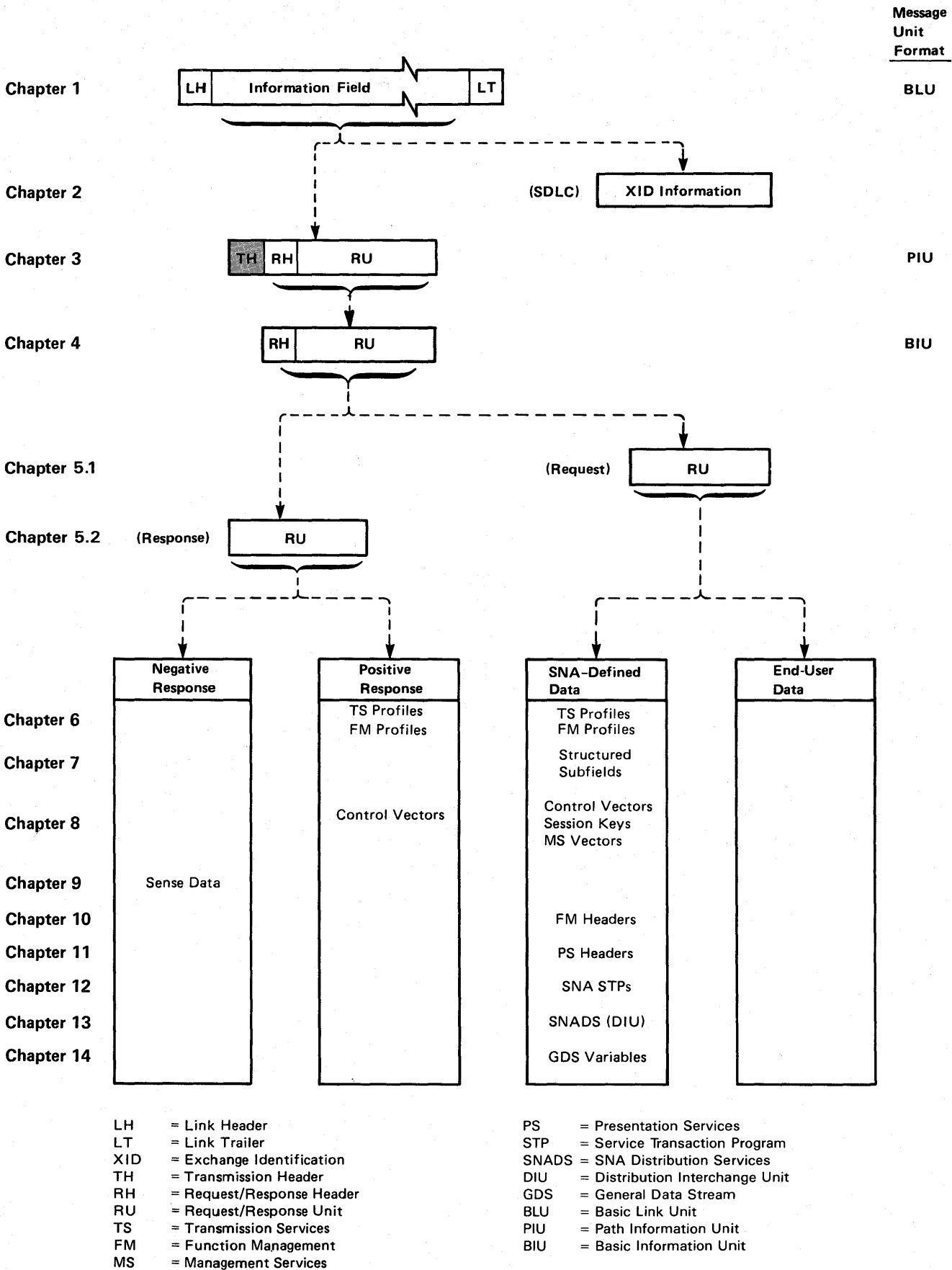

LH = Link Header  
 LT = Link Trailer  
 XID = Exchange Identification  
 TH = Transmission Header  
 RH = Request/Response Header  
 RU = Request/Response Unit  
 TS = Transmission Services  
 FM = Function Management  
 MS = Management Services

PS = Presentation Services  
 STP = Service Transaction Program  
 SNADS = SNA Distribution Services  
 DIU = Distribution Interchange Unit  
 GDS = General Data Stream  
 BLU = Basic Link Unit  
 PIU = Path Information Unit  
 BIU = Basic Information Unit

## CHAPTER 3. TRANSMISSION HEADERS

### INTRODUCTION

A transmission header (TH) is the leading, or only, field of every PIU. The first half-byte of any TH is the Format Identifier (FID) field. FID2 corresponds to hexadecimal value 2 in the FID field. The FID2 TH is described below.

Byte

0	FID2—Format Identification MPF—Mapping Field ODAI—OAF'-DAF' Assignor Indicator EFI—Expedited Flow Ind.	Reserved Byte
2	DAF'—Destination Address	OAF'—Origin Address
4	SNF—Sequence Number Field	

Figure 3-1. Transmission Header for FID Type 2

## FID 2 Field Descriptions

FID2 is the format used between a T4 or T5 node and an adjacent T2 node, or between adjacent T2.1 nodes.

- 0 bits 0-3, FID2--Format Identification: 0010
- bits 4-5, MPF--Mapping Field. The MPF consists of bit 4, the Begin-BIU (BBIU) bit, and bit 5, the End-BIU (EBIU) bit. It specifies whether the information field associated with the TH is a complete or partial BIU, and, if a partial BIU, whether it is the first, a middle, or the last segment.
- 10 first segment of a BIU (BBIU, -EBIU)
  - 00 middle segment of a BIU (-BBIU, -EBIU)
  - 01 last segment of a BIU (-BBIU, EBIU)
  - 11 whole BIU (BBIU, EBIU)
- bit 6, ODAI--OAF'-DAF' Assignor Indicator (used for T2.1 - T2.1 flows; otherwise, reserved). The ODAI indicates which node assigned (at session-activation time) the OAF'-DAF' values carried in the TH (see SNA Format and Protocol Reference Manual: Architecture Logic for Type 2.1 Nodes for details). Together with the DAF' and OAF' values, the ODAI value forms a 17-bit local-form session identifier (LFSID); the DAF' and OAF' values used in the TH in one direction are reversed in the other direction.
- bit 7, EFI--Expedited Flow Indicator. The EFI designates whether the PIU belongs to the normal or expedited flow. Normal-flow PIUs are kept in order on a session basis by PC; so are expedited-flow PIUs. Expedited-flow PIUs can pass normal-flow PIUs flowing in the same direction at queuing points in TC within half-sessions and boundary function session connectors. It has the following meaning:
- 0 normal flow

1 expedited flow

1 Reserved

2 DAF'--Destination Address Field. See discussion above for ODAI.

3 OAF'--Origin Address Field. See discussion above for ODAI.

Note: The PU T2 is always assigned the local address value of 0. Therefore, BIUs to the physical unit always have the associated DAF' = 0; BIUs from the physical unit always have the associated OAF' = 0. The OAF' is also 0 for BIUs from the SSCP, and DAF' is 0 for BIUs to the SSCP. A PU T4|5 adjacent to the T2 node has the local address X'FF'.

4-5 SNF--Sequence Number Field. The Sequence Number Field contains a numerical identifier for the associated BIU; path control, when segmenting, puts the same SNF value in each segment derived from the same BIU. The numerical identifier used depends on a number of factors. If the TS profile indicates sequence numbers are not used, the SNF value is a 16-bit identifier that distinguishes a request being sent or responded to from any other outstanding request on the same flow. If the TS profile indicates sequence numbers are used, the flow is a factor. Expedited-flow requests (other than SIG for LU 6.2) carry 16-bit identifiers; expedited-flow responses echo the SNF values of their corresponding requests. Normal-flow requests, other than between LU 6.2's, carry 16-bit numerical values ranging in value from 1-65,535 (incremented by 1 for each request) and wrapping through 0 thereafter; the corresponding responses echo their SNF values. The table below defines the SIG and normal-flow SNF usage between LU 6.2's.

	Request	Response
	-----	-----
FMD LUSTAT with BB	A	C
FMD LUSTAT with -BB	A	B
BIS	A	D
RTR	A	E
SIG	B	E

- A: A 16-bit number (1-65,535) incremented by 1 for each request and wrapping through 0 thereafter
- B: Low-order 15 bits of the SNF in the request that carried the last successful BB; the high-order bit identifies the half-session that started the bracket (0 = secondary, 1 = primary); in the case of the first bracket of a session, where the BB is implied, not sent, the low-order 15 bits are 0 and the high-order bit is 1.
- C: Low-order 15 bits of the SNF in the BB request being responded to; the high-order bit identifies the sender of the BB request (0 = secondary, 1 = primary).
- D: The half-session does not respond to BIS.
- E: Same value as the corresponding request.

Note: For additional details of LU 6.2 processing, see SNA Format and Protocol Reference Manual: Architecture Logic for LU Type 6.2.



## CHAPTER 4. REQUEST/RESPONSE HEADERS

**Message  
Unit  
Format**

Chapter 1



BLU

Chapter 2



Chapter 3

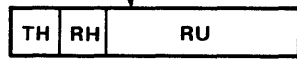

PIU

Chapter 4

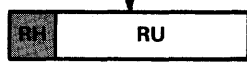

BIU

Chapter 5.1



Chapter 5.2



Chapter 6

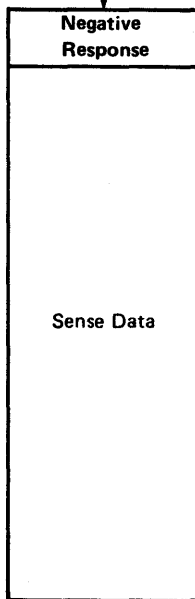

Chapter 7

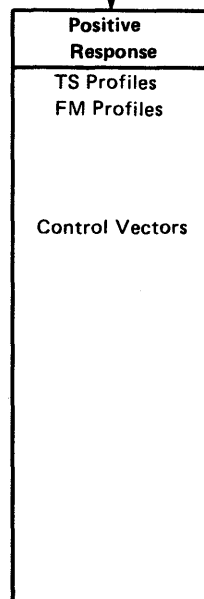

Chapter 8

Chapter 9

Chapter 10

Chapter 11

Chapter 12

Chapter 13

Chapter 14

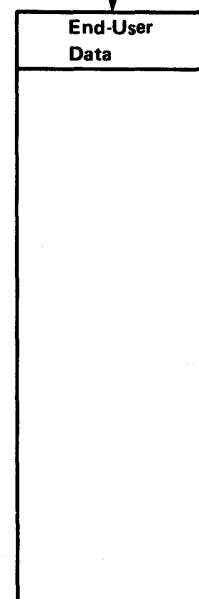
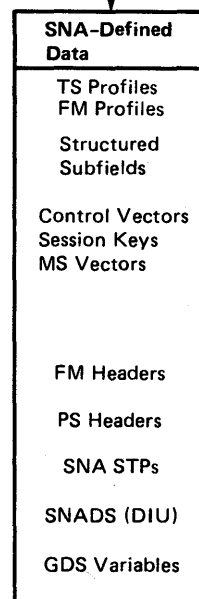

LH = Link Header  
 LT = Link Trailer  
 XID = Exchange Identification  
 TH = Transmission Header  
 RH = Request/Response Header  
 RU = Request/Response Unit  
 TS = Transmission Services  
 FM = Function Management  
 MS = Management Services

PS = Presentation Services  
 STP = Service Transaction Program  
 SNADS = SNA Distribution Services  
 DIU = Distribution Interchange Unit  
 GDS = General Data Stream  
 BLU = Basic Link Unit  
 PIU = Path Information Unit  
 BIU = Basic Information Unit

## CHAPTER 4. REQUEST/RESPONSE HEADERS

## INTRODUCTION

This chapter identifies the formats and meanings of the request and response headers (RH); Chapter 5.1 and Chapter 5.2 describe the request and response units (RU).

To distinguish between a request and a response, examine bit 0 in byte 0 of the RH:

If bit 0 = 0: the RH is a request header and the associated RU is a request unit.

If bit 0 = 1: the RH is a response header and any associated RU is a response unit.

Figure 4-1 on page 4-2 provides a summary of the bytes and field names in the RH.

Two message units, IPR and EXR, which make use of the RH for special purposes, are described at the end of this chapter.



## RH Formats

### Request Header

RRI =0	RU Category	r	FI	SDI	BCI	ECI	Request
-----------	----------------	---	----	-----	-----	-----	---------

: Byte 0 :

RRI =1	RU Category	r	FI	SDI	1	1	Response
-----------	----------------	---	----	-----	---	---	----------

Request	DR1I	r	DR2I	ERI	r	r	QRI	PI
---------	------	---	------	-----	---	---	-----	----

: Byte 1 :

Response	DR1I	r	DR2I	RTI	r	r	QRI	PI
----------	------	---	------	-----	---	---	-----	----

Request	BBI	EBI	CDI	r	CSI	EDI	PDI	CEBI
---------	-----	-----	-----	---	-----	-----	-----	------

: Byte 2 :

Response	r	r	r	r	r	r	r	r
----------	---	---	---	---	---	---	---	---

r = Reserved

Field	Description	Explanation/Usage
RRI	Request/Response indicator	0 = request (RQ); 1 = response (RSP)
RU Category	Request/Response Unit Category	00 = FM data (FMD) 01 = network control (NC) 10 = data flow control (DFC) 11 = session control (SC)
FI	Format indicator	0 = no FM header (-FMH), for LU-LU sessions; or character-coded without an NS header (-NSH), for network services (NS) 1 = FM header (FMH) follows, for LU-LU sessions; or field-formatted with an NS header (NSH), for NS
SDI	Sense Data Included indicator	0 = not included (-SD); 1 = included (SD)
BCI	Begin Chain indicator	0 = not first in chain (-BC); 1 = first in chain (BC)

Figure 4-1. RH Formats (continued next page)

<u>Field</u>	<u>Description</u>	<u>Explanation/Usage</u>
ECI	End Chain indicator	0 = not last in chain (-EC); 1 = last in chain (EC)
DR1I	Definite Response 1 indicator	0 = -DR1; 1 = DR1
DR2I	Definite Response 2 indicator	0 = -DR2; 1 = DR2
ERI	Exception Response indicator	Used in conjunction with DR1I and DR2I to indicate, in a request, the form of response requested. Values and meanings of DR1I, DR2I, ERI are: 000 = no-response requested 100 010 110 = definite-response requested 101 011 111 = exception-response requested
RTI	Response Type indicator	0 = positive (+); 1 = negative (-)
QRI	Queued Response indicator	0 = response bypasses TC queues (-QR); 1 = enqueue response in TC queues (QR)
PI	Pacing indicator	0 = -PAC; 1 = PAC
BBI	Begin Bracket indicator	0 = -BB; 1 = BB
EBI	End Bracket indicator	0 = -EB; 1 = EB (reserved for LU type 6.2)
CDI	Change Direction indicator	0 = do not change direction (-CD); 1 = change direction (CD)
CSI	Code Selection indicator	0 = code 0; 1 = code 1
EDI	Enciphered Data indicator	0 = RU is not enciphered (-ED); 1 = RU is enciphered (ED)
PDI	Padded Data indicator	0 = RU is not padded (-PD); 1 = RU is padded (PD)
CEBI	Conditional End Bracket indicator	0 = not conditional end bracket (-CEB); 1 = conditional end bracket (CEB) (used for LU type 6.2; else, reserved)

Figure 4-1. RH Formats

## RH Formats

### RH FORMATS

The request/response header (RH) is a 3-byte field; it may be a request header or a response header. The RH control fields shown in Figure 4-1 on page 4-2 are described below.

Request/Response Indicator (RRI): Denotes whether this is a request or a response.

RU Category: Denotes that the BIU belongs to one of four categories: session control (SC), network control (NC), data flow control (DFC), or function management data (FMD). (The NC category is not supported by T2.1 nodes.)

Format Indicator: Indicates which of two formats (denoted Format 1 and Format 0) is used within the associated RU (but not including the sense data field, if any; see Sense Data Included indicator, below).

For SC, NC, and DFC RUs, this indicator is always set to Format 1.

On FMD requests for SSCP-SSCP, SSCP-PU, and SSCP-LU sessions, Format 1 indicates that the request RU includes a network services (NS) header and is field-formatted (with various encodings, such as binary data or bit-significant data, in the individual fields). Format 0 indicates that no NS header is contained in the request RU and the RU is character-coded. The Format indicator value on a response is the same as on the corresponding request.

For LU-LU sessions that support FM headers on FMD requests, Format 1 indicates that an FM header is present; Format 0 implies there is no FM header. The Format indicator is always set to 0 on positive responses; negative responses are implementation dependent.

For LU-LU sessions that do not support FM headers, the meaning of this indicator on requests, positive responses, and negative responses is implementation dependent. (A BIND session parameter indicates whether FM headers are supported by the session. For further information, see Chapter 5.1 for details on BIND.)

Sense Data Included Indicator (SDI): Indicates that a 4-byte sense data field is included in the associated RU. The sense data field (when present) always immediately follows the RH and has the format and meaning described in Chapter 9. Any other data contained in the RU follows the sense data field. Sense data is included on negative responses and on EXRs, where it indicates the type of condition causing the exception.

(The Format indicator does not describe or affect the sense data, which is always in the 4-byte format shown in Chapter 9.)

Chaining Control: Indicates that a sequence of contiguous transmitted requests is being grouped in a chain. Two indicators, Begin Chain indicator (BCI) and End Chain indicator (ECI), together denote the relative position of the associated RU within a chain. The 1 values of these indicators (BCI = 1 and ECI = 1) are referred to as BC and EC, respectively.

(BC, -EC) = first RU in chain

(-BC, -EC) = middle RU in chain

(-BC, EC) = last RU in chain

(BC, EC) = only RU in chain

Responses are always marked "only RU in chain."

Form of Response Requested: In a request header, defines the response protocol to be executed by the request receiver.

Three bits in a request header specify the form of response that is desired. They are: Definite Response 1 indicator (DR1I), Definite Response 2 indicator (DR2I), and the Exception Response indicator (ERI). They can be coded to request:

1. No-response, which means that a response will not be issued by the half-session receiving the request. (DR1I, DR2I) = (0,0) = (-DR1, -DR2) and ERI=0 is the only coding possible; the abbreviation RQN refers to a request with this coding. (A special response, ISOLATED PACING RESPONSE [IPR], does set [DR1I, DR2I, ERI] = [0,0,0], but it is used independently of the other responses listed. IPR is sent in connection with session-level pacing; the sequence number in its associated TH does not correlate it to any given request.)
2. Exception response, which means that a negative response will be issued by the half-session receiving the request only in the event of a detected exception (a positive response will not be issued). (DR1I, DR2I) = (1,0)|(0,1)|(1,1) and ERI=1 are the possible codings; RQE1, RQE2, and RQE3 are the abbreviations, respectively; the abbreviation RQE or RQE\* refers to a request with any of these codings.
3. Definite response, which means that a response will always be issued by the half-session receiving the request, whether the response is positive or negative. (DR1I, DR2I) = (1,0)|(0,1)|(1,1) and ERI=0 are the possible codings; RQD1, RQD2, and RQD3 are the abbreviations, respectively; the abbreviation RQD or RQD\* refers to a request with any of these codings.

A request that asks for an exception response or a definite response has one or both of the DR1I and DR2I bits set to 1 (three combinations); a response to a request returns the same (DR1I, DR2I) bit combination (see Figure 4-2 on page 4-6).

The setting of the DR1I, DR2I, and ERI bits varies by RU category. In the case of LU-LU sessions (e.g., LU 6.2), BIND parameters specify the form of response to be requested during the session; Figure 4-2 on page 4-6 shows the values in table form.

For sessions that use sync point protocols with TS profile 4 (LU 6.1), RQD2 or RQE2 asks for the commitment of a unit of work that is to be shared between the session partners; RQD1 is used to request a response when the current unit of work is not to be committed. The table for this set of values is given in Figure 4-3 on page 4-8.

For nonzero, non-LU 6.2, LU types that do not use sync point protocols, the specific meanings of the DR1I and DR2I bits are defined in SNA—Sessions Between Logical Units; for LU type 0, the interpretations of the DR1I and DR2I bits (and distinctions among the three settings) are implementation-dependent.

## RH Formats

The (DR1I, DR2I, ERI) = (0, 0, 1) combination is reserved.

REQUEST	VALID RESPONSE	MEANING OF RESPONSE
RQD1=(1,0,0) (Used by DFC)	+RSP1=(1,0,0) -RSP1=(1,0,1)	positive response negative response
RQE1=(1,0,1)  (Used by DFC and PS)	implied +RSP1 -RSP1=(1,0,1)	reply received with no inter- vening response negative response
RQD2=(0,1,0)  RQE2=(0,1,1) (Used by PS)	+RSP2=(0,1,0) -RSP2=(0,1,1)  implied +RSP2 -RSP2=(0,1,1)	CONFIRMED verb issued SEND_ERROR verb issued  reply received with no inter- vening response no CONFIRMED verb issued
RQD3=(1,1,0)  RQE3=(1,1,1) (Used by PS)	+RSP3=(1,1,0) -RSP3=(1,1,1)  implied +RSP3 -RSP3=(0,1,1)	CONFIRMED verb issued SEND_ERROR verb issued  reply received with no inter- vening response no CONFIRMED verb issued

### Notes:

1. Values displayed in this table are in the order (DR1I,DR2I,ERI) for requests and (DR1I,DR2I,RTI) for responses.
2. All -EC requests are sent as RQE1.
3. RQN=(0,0,0) is not used.

Figure 4-2. FMD Request/Response Combinations for Sessions between Two LU 6.2s

Queued Response Indicator (QRI): In a response header for a normal-flow RU, the Queued Response indicator denotes whether the response is to be enqueued in TC queues (QRI=QR), or whether it is to bypass these queues (QRI=-QR). In a request header for a normal-flow RU, it indicates what the setting of the QRI should be on the response, if any, to this request (i.e., the values on the request and response are the same).

For expedited-flow RUs, this bit is reserved.

The setting of the QRI bit is the same for all RUs in a chain.

Response Type: In a response header, two basic response types can be indicated: positive response or negative response. For negative responses, the RH is always immediately followed by four bytes of sense data in the RU. Thus, RTI=NEG and RTI=POS occur jointly with SDI=SD and SDI=-SD, respectively.

## RH Formats

REQUEST	VALID RESPONSE	MEANING OF RESPONSE
RQD1=(1,0,0)	+RSP1=(1,0,0) -RSP1=(1,0,1)	positive response negative response
RQE1=(1,0,1)	-RSP1=(1,0,1)	negative response
RQD2=(0,1,0)	+RSP2=(0,1,0) -RSP2=(0,1,1)	positive sync point response negative sync point response
RQE2=(0,1,1)	-RSP2=(0,1,1)	negative sync point response
RQD3=(1,1,0)	+RSP3=(1,1,0) -RSP3=(1,1,1)	positive sync point response negative sync point response
RQE3=(1,1,1)	-RSP3=(1,1,1)	negative sync point response

### Notes:

1. Values displayed in this table are in the order (DR1I,DR2I,ERI) for requests and (DR1I,DR2I,RTI) for responses.
2. Each definite- or exception-response chain has the same setting of (DR1I,DR2I)--either (1,0) or (0,1)--on all requests with ECI = -EC. When DR1I = 1 on these requests, the End-Chain request can carry (DR1I,DR2I) = (1,0)|(1,1). When DR2I = 1 on these requests, the End-Chain request can carry only (DR1I,DR2I) = (0,1). ERI is 0 only for definite-response chains and when ECI = EC.
3. RQN=(0,0,0) is not used.

Figure 4-3. Request/Response Combinations For TS Profile 4 Sync Points

Three kinds of positive and negative responses correspond to the three valid (DR1I, DR2I) combinations allowed on requests. The settings of the DR1I and DR2I bits in a response always equal the settings of the DR1I and DR2I bits of the form-of-response-requested field of the corresponding request header.

**Pacing:** In a request header, the Pacing Request indicator denotes that the sender can accept a Pacing Response indicator.

The Pacing Response indicator in a response header is used to indicate to the receiver that additional requests may be sent on the normal flow. The Pacing

Response indicator may be on in an RH that is attached to a response RU on the normal flow; or, if desired, a separate, or isolated, response header may be used, to which no RU is attached. This latter RH signals only the pacing response; it is called an ISOLATED PACING RESPONSE (IPR); isolated and non-isolated pacing responses are functionally equivalent. IPR is discussed further in a later section of this chapter.

Bracket Control: Used to indicate the beginning or end of a group of exchanged requests and responses called a bracket. Bracket protocols are used only on LU-LU sessions. When used, BB appears on the first request in the first chain of a bracket and denotes the beginning of the bracket; the end of the bracket is indicated in one of two ways, depending on LU type.

- For LU 6.2, CEB appears on the last request of the last chain of a bracket. (When bracket usage is specified in BIND, the BIND request carries an implied BB.) The bracket indicators are set only on LUSTAT and FMD requests, and are thus sent normal-flow.
- For other LU types, the end of bracket is delimited by setting EBI to EB in the first request of the last chain in the bracket.

Change Direction Indicator (CDI): Used when there is half-duplex (HDX) control of the normal flows within a session (not to be confused with link-level HDX protocols). It permits a sending half-session to direct the receiving half-session to send. The HDX protocol is useful to half-sessions with limited input/output capabilities that cannot simultaneously send and receive user data. When used, CD appears only on the last request in a chain; it is set only on LUSTAT and FMD requests.

Code Selection Indicator (CSI): Specifies the encoding used for the associated FMD RU. When a session is activated, the half-sessions can choose to allow use of two codes in their FMD RUs (e.g., EBCDIC and ASCII), which they designate as Code 0 and Code 1. FM headers and request and response codes are not affected by the Code Selection indicator.

For SC, NC, and DFC RUs, this bit is reserved.

Enciphered Data Indicator (EDI): Indicates that information in the associated RU is enciphered under session-level cryptography protocols.

Padded Data Indicator (PDI): Indicates that the RU was padded at the end, before encipherment, to the next integral multiple of 8 bytes in length; the last byte of such padding is the count of pad bytes added, the count being a number (1-7 inclusive) in unsigned 8-bit binary representation.



## RH Formats

### IPR AND EXR

Two special message units exist in SNA: ISOLATED PACING RESPONSE (IPR) and EXCEPTION REQUEST (EXR). These are explained below.

#### ISOLATED PACING RESPONSE (IPR)

An IPR is used on a session if BIND specifies session-level pacing is used; it indicates a pacing response, and can be used even when operating under no-response protocols.

The following fields of the TH and RH are set for an IPR:

TH: Either the normal or expedited flow may be indicated. The sequence number is undefined (it may be set to any value, and is not checked by the receiver).

RH: An IPR is coded all 0's except for the Request-Response indicator, the Pacing indicator, and the Chain indicators, which are set to 1's; thus, the IPR RH is coded X'830100' by the sender; the receiver identifies an IPR by detecting that (RRI, DR1I, DR2I, PI) = (1, 0, 0, 1) and ignoring the remaining bits

#### EXCEPTION REQUEST (EXR)

Two EXR types are defined: those replacing requests, and those replacing too-long path information units (PIUs) received by transmission group control (TGC) from an upper layer (e.g., ERC in an intermediate routing node).

EXRs replacing requests are generated by some component between the origin and intended destination of a request found to be in error. The following fields are set in the TH, RH, and RU.

TH: The sequence number remains the same as in the request being replaced. The data count is altered to properly record the new BIU size. The Mapping field is set to (BBIU, EBIU); an EXR replaces a complete BIU, not just one segment of a segmented BIU. All other fields are left as received.

RH: The Sense Data Included bit is set to 1. All other fields are unchanged.

RU: Bytes 0-3 contain sense data defining the last error detected, and in the same format as returned in negative responses. The sense data is followed by the original RU, truncated to no more than three bytes, as described for negative responses.

EXRs replacing too-long PIUs are formatted as follows.

TH: Like EXRs replacing requests, EXRs replacing too-long PIUs change only the Mapping field (to 1's) and the data count (to 7 in this case).

RH: The RH is set to X'07B000', no matter what the replaced RH (if any) was.

RU: Bytes 0-3 contain the sense data X'800A0000'.



CHAPTER 5.1. REQUEST UNITS

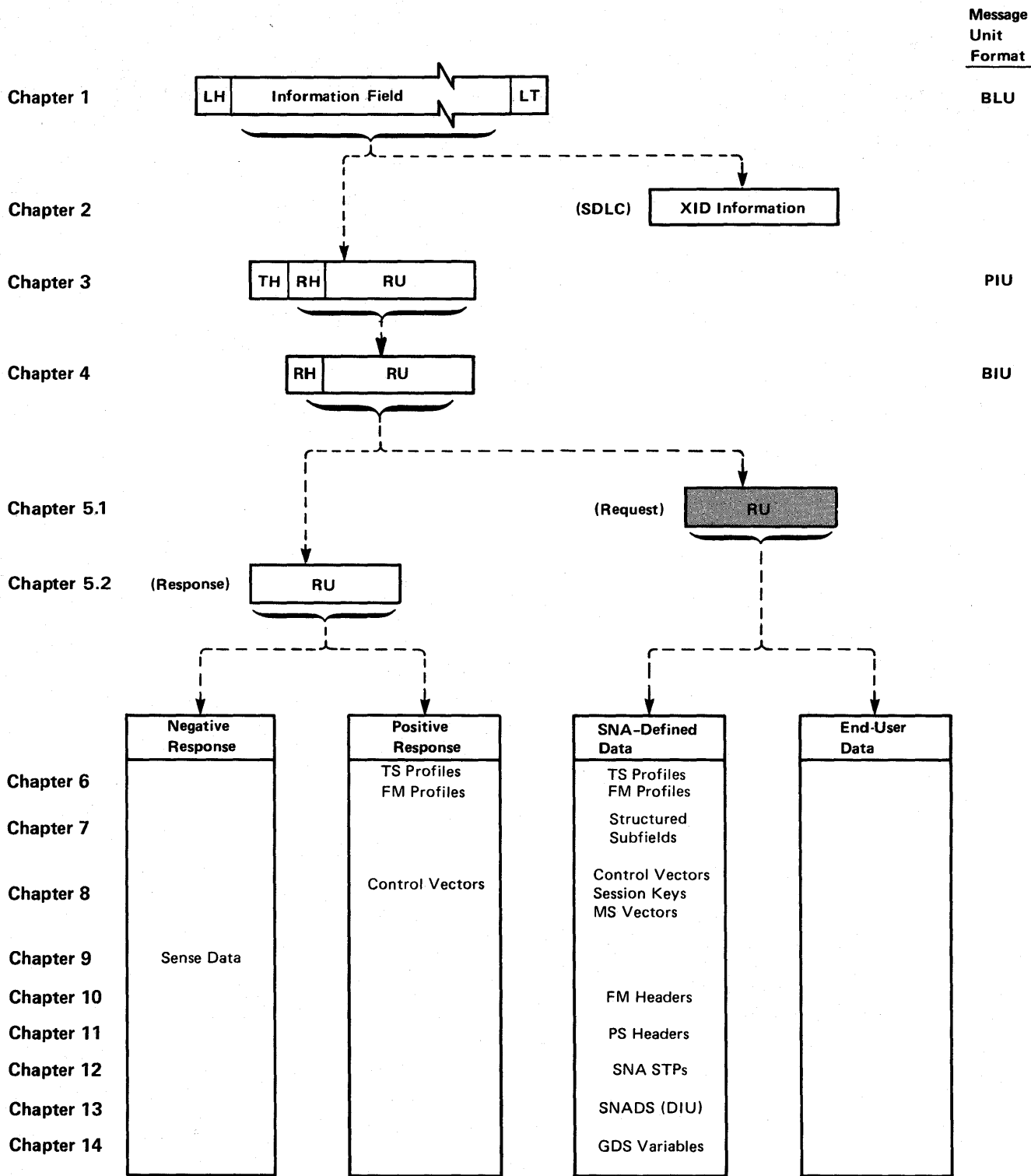

LH = Link Header  
 LT = Link Trailer  
 XID = Exchange Identification  
 TH = Transmission Header  
 RH = Request/Response Header  
 RU = Request/Response Unit  
 TS = Transmission Services  
 FM = Function Management  
 MS = Management Services

PS = Presentation Services  
 STP = Service Transaction Program  
 SNADS = SNA Distribution Services  
 DIU = Distribution Interchange Unit  
 GDS = General Data Stream  
 BLU = Basic Link Unit  
 PIU = Path Information Unit  
 BIU = Basic Information Unit

## CHAPTER 5.1. REQUEST UNITS

## INTRODUCTION TO REQUEST UNITS

This section contains detailed formats of the request units, arranged in alphabetical order. Each format description begins with the following heading:

"ABBREVIATED RU NAME; Origin-NAU-->Destination-NAU, Normal (Norm) or Expedited (Exp) Flow; RU Category (RU NAME)"

Notes:

1. "RU Category" is abbreviated as follows:

DFC            data flow control

SC             session control

NC             network control

FMD NS(ma)   function management data, network services, management services  
(note: formerly maintenance services)

FMD NS(s)    function management data, network services, session services

2. The formats of character-coded FMD NS requests are implementation dependent. LU-->LU FMD requests (e.g., FM headers) are described in Chapter 10 .
3. All values for field-formatted requests that are not defined in this section are reserved.
4. The request-code value X'FF' and the NS-header values X'(3|7|B|F)F\*\*\*\*' and X'\*\*(3|7|B|F)F\*\*' are set aside for implementation internal use, and will not be otherwise defined in SNA.
5. Throughout the format descriptions, reserved is used as follows: reserved bits, or fields, are ones that currently are set to 0's (unless explicitly stated otherwise); reserved values are those that currently are invalid. Correct usage of reserved fields is enforced by the sender; no receive checks are made on these fields.
6. Throughout the format descriptions, retired fields and values are those that were once defined in SNA but are no longer defined. To accommodate implementations of back-level SNA, current implementations of SNA treat retired fields as follows: send checks enforce the setting of retired fields to all 0's except where other unique values are required (described individually); no receive checks are made on these fields, thereby accepting back-level settings

## Request Units

of these fields. Special handling of retired fields, such as echoing or passing on retired fields as received, is discussed where appropriate.

7. User data, control vectors, and session keys referred to in the format descriptions are described in Chapter 7 and Chapter 8.

## REQUEST UNIT SUMMARY INFORMATION

The following is a categorized list of RU abbreviations, followed by a list of RUs indexed by NS headers and request codes.

## SUMMARY OF REQUEST RUS BY CATEGORY

Request RUs prefixed by an asterisk (\*) require response RUs that, if positive, have an extended format containing data in addition to the NS header or request code.

SC Requests

*ACTLU	CRV	SDT
*ACTPU	DACTLU	*STSN
*BIND	DACTPU	UNBIND
CLEAR	RQR	

DFC Requests

BID	QC	SBI
BIS	QEC	SHUTC
CANCEL	RELQ	SHUTD
CHASE	RSHUTD	SIG
LUSTAT	RTR	

FMD NS(ma) Requests

NMVT

FMD NS(s) Requests

INIT-SELF	NOTIFY	TERM-SELF
-----------	--------	-----------



## Request Units

### INDEX OF RU'S BY NS HEADERS AND REQUEST CODES

Within DFC, NC, SC, or any specific FMD NS category, the request code is unique. However, while a request code has only one meaning in a specific category, a given code (e.g., X'05') can represent different requests in separate categories (e.g., DFC, NC, and configuration services).

#### FMD NS Headers (third byte is the request code)

X'010681'	INIT-SELF (Format 0)	X'810620'	NOTIFY
X'010683'	TERM-SELF (Format 0)	X'810681'	INIT-SELF (Format 1)
X'41038D'	NMVT	X'810683'	TERM-SELF (Format 1)

#### DFC, NC, and SC Request Codes

X'04'	LUSTAT (DFC)	X'83'	CANCEL (DFC)
X'05'	RTR (DFC)	X'84'	CHASE (DFC)
X'0D'	ACTLU (SC)	X'A0'	SDT (SC)
X'0E'	DACTLU (SC)	X'A1'	CLEAR (SC)
X'11'	ACTPU (SC)	X'A2'	STSN (SC)
X'12'	DACTPU (SC)	X'A3'	RQR (SC)
X'31'	BIND (SC)	X'CO'	SHUTD (DFC)
X'32'	UNBIND (SC)	X'CO'	CRV (SC)
X'70'	BIS (DFC)	X'C1'	SHUTC (DFC)
X'71'	SBI (DFC)	X'C2'	RSHUTD (DFC)
X'80'	QEC (DFC)	X'C8'	BID (DFC)
X'81'	QC (DFC)	X'C9'	SIG (DFC)
X'82'	RELQ (DFC)		

## DESCRIPTIONS OF REQUEST UNITS

ACTLU; SSCP--&gt;LU, Exp; SC (ACTIVATE LOGICAL UNIT)

ACTLU is sent from an SSCP to an LU to activate a session between the SSCP and the LU and to establish common session parameters.

0 X'0D' request code  
 1 Type activation requested:  
 X'01' cold  
 X'02' ERP  
 2 bits 0-3, FM profile:  
 X'0' FM profile 0  
 X'6' FM profile 6  
 bits 4-7, TS profile:  
 X'1' TS profile 1 (only value defined)

ACTPU; SSCP|PUCP--&gt;PU, Exp; SC (ACTIVATE PHYSICAL UNIT)

ACTPU is sent by the SSCP to activate a session with the PU, and to obtain certain information about the PU.

0 X'11' request code  
 1 bits 0-3, format:  
 X'0' Format 0  
 bits 4-7, type activation requested:  
 X'1' cold  
 X'2' ERP  
 2 bits 0-3, FM profile:  
 X'0' FM profile 0  
 bits 4-7, TS profile:  
 X'1' TS profile 1  
 3-8 A six-byte field that specifies the ID of the SSCP issuing ACTPU; the first four bits specify the format for the remaining bits:  
 bits 0-3, format: 0000 (only value defined)  
 bits 4-7, PU type of the node containing the CP  
 bits 8-47, implementation and installation dependent binary identification

BID; LU--&gt;LU, Norm; DFC (BID)

BID is used by the bidder to request permission to initiate a bracket, and is used only when using brackets. This RU is not used for LU 6.2.

0 X'C8' request code

## BIND

BIND; PLU-->SLU, Exp; SC (BIND SESSION)

BIND is sent from a primary LU to a secondary LU to activate a session between the LUs. The secondary LU uses the BIND parameters to help determine whether it will respond positively or negatively to BIND.

- 0 X'31' request code  
1 bits 0-3, format: 0000 (only value defined)  
bits 4-7, type:  
0000 negotiable (only value defined for LU 6.2)  
0001 nonnegotiable
- 2 FM profile:  
X'02' FM profile 2  
X'03' FM profile 3  
X'04' FM profile 4  
X'07' FM profile 7  
X'12' FM profile 18  
X'13' FM profile 19 (only value defined for LU 6.2)
- 3 TS profile:  
X'02' TS profile 2  
X'03' TS profile 3  
X'04' TS profile 4  
X'07' TS profile 7 (only value defined for LU 6.2)
- FM Usage—Primary LU Protocols for FM Data
- 4 bit 0, chaining use selection:  
0 only single-RU chains allowed from primary LU half-session  
1 multiple-RU chains allowed from primary LU half-session (only value defined for LU 6.2)  
bit 1, request control mode selection:  
0 immediate request mode (only value defined for LU 6.2)  
1 delayed request mode  
bits 2-3, chain response protocol used by primary LU half-session for FMD requests; chains from primary will ask for:  
00 no response  
01 exception response  
10 definite response  
11 definite or exception response (only value defined for LU 6.2)  
bit 4, 2-phase commit for sync point (reserved if any TS profile other than 4):  
0 2-phase commit not supported  
1 2-phase commit supported  
bit 5, reserved  
bit 6, compression indicator (reserved for LU 6.2):  
0 compression will not be used on requests from primary  
1 compression may be used  
bit 7, send End Bracket indicator:  
0 primary will not send EB (only value defined for LU 6.2)  
1 primary may send EB
- FM Usage—Secondary LU Protocols for FM Data
- 5 bit 0, chaining use selection:  
0 only single-RU chains allowed from secondary LU half-session

- 1 multiple-RU chains allowed from secondary LU half-session (only value defined for LU 6.2)
- bit 1, request control mode selection:
  - 0 immediate request mode (only value defined for LU 6.2)
  - 1 delayed request mode
- bits 2-3, chain response protocol used by secondary LU half-session for FMD requests; chains from secondary will ask for:
  - 00 no response
  - 01 exception response
  - 10 definite response
  - 11 definite or exception response (only value defined for LU 6.2)
- bit 4, 2-phase commit for sync point (reserved if any TS profile other than 4):
  - 0 2-phase commit not supported
  - 1 2-phase commit supported
- bit 5, reserved
- bit 6, compression indicator (reserved for LU 6.2):
  - 0 compression will not be used on requests from secondary
  - 1 compression may be used
- bit 7, send End Bracket indicator:
  - 0 secondary will not send EB (only value defined for LU 6.2)
  - 1 secondary may send EB

FM Usage—Common LU Protocols

- 6 bit 0, whole-BIUs required indicator (reserved in non-LU 6.2 BINDs):
- 0 the sending node supports receipt of segments on this session
  - 1 the sending node does not support receipt of segments on this session; the maximum sent-RU size specified in bytes 10 and 11 of BIND and RSP(BIND) are negotiated so that BIUs on this session are not segmented when sent to a node requiring whole BIUs
- bit 1, FM header usage:
- 0 FM headers not allowed
  - 1 FM headers allowed (only value defined for LU 6.2)
- bit 2, brackets usage and reset state:
- 0 brackets not used if neither primary nor secondary will send EB, i.e., if byte 4, bit 7 = 0 and byte 5, bit 7 = 0; brackets are used and bracket state managers' reset states are INB (1) if either primary or secondary, or both, may send EB, i.e., if byte 4, bit 7 = 1 or byte 5, bit 7 = 1; or (2) if FM profile 19 is specified (only value defined for LU 6.2)
  - 0 brackets are used and bracket state managers' reset states are INB
  - 1 brackets are used and bracket state managers' reset states are BETB
- bit 3, bracket termination rule selection (reserved if brackets not used, i.e., if byte 6, bit 2 = 0, byte 4, bit 7 = 0, and byte 5, bit 7 = 0; and if FM profile is not 19):
- 0 Rule 2 (unconditional termination) will be used during this session
  - 1 Rule 1 (conditional termination) will be used during this session (only value defined for LU 6.2)
- bit 4, alternate code set allowed indicator:
- 0 alternate code set will not be used

## BIND

- 1 alternate code set may be used
- bit 5, sequence number availability for sync point resynchronization (reserved if any TS profile other than 4 is used):  
0 sequence numbers not available  
1 sequence numbers available  
Note: Sequence numbers are transaction processing program sequence numbers from the previous activation of the session with the same session name; they are associated with the last acknowledged requests and any pending requests to commit a unit of work. If no previous activation existed, the numbers are 0, and this bit is set to 0.
- bit 6, BIS sent (reserved for TS profiles other than 4):  
0 BIS not sent  
1 BIS sent
- bit 7, BIND queuing indicator:  
0 BIND cannot be queued (held, pending resource availability, thus delaying the BIND response)  
1 BIND sender allows the BIND receiver to queue the BIND for an indefinite period, thus delaying the sending of the BIND response  
Note: BIND sender may provide a timer or operator interface to send UNBIND if session-activation time exceeds BIND sender's implementation-defined limits. BIND queuing is terminated by sending UNBIND to the BIND receiver.
- 7 bits 0-1, normal-flow send/receive mode selection:  
00 full-duplex  
01 half-duplex contention  
10 half-duplex flip-flop (only value defined for LU 6.2)  
11 reserved
- bit 2, recovery responsibility (reserved if normal flow send/receive mode is FDX, i.e., if byte 7, bits 0-1 = 00):  
0 contention loser responsible for recovery (see byte 7, bit 3 for specification of which half-session is the contention loser)  
1 symmetric responsibility for recovery (only value defined for LU 6.2)
- bit 3, contention winner/loser (reserved if normal flow send/receive mode is FDX, i.e., if byte 7, bits 0-1 = 00; or if the normal flow send/receive mode is HDX-FF, brackets are not used, FM profile is not 19, and symmetric responsibility for recovery is used, i.e., if byte 7, bits 0-1 = 10, byte 4, bit 7 = 0, byte 5, bit 7 = 0, byte 6, bit 2 = 0, and byte 7, bit 2 = 1):  
0 secondary is contention winner and primary is contention loser  
1 primary is contention winner and secondary is contention loser  
Note: Contention winner is also brackets first speaker if brackets are used.  
Note: Contention winner is also brackets first speaker.
- bits 4-5, alternate code processing identifier (reserved unless Alternate Code Set Allowed indicator (byte 6, bit 4) is 1):  
00 process alternate code FMD RUs as ASCII-7  
01 process alternate code FMD RUs as ASCII-8 (only value defined for LU 6.2)  
Note: When the Alternate Code Processing Identifier indicator is set to the value 01, the entire FMD request RU is to be

translated using the transforms defined by the ANSI X3.26 Hollerith Card Code.

- bit 6, control vectors included indicator:  
 0 control vectors are not included after the SLU name (bytes r+1-s)  
 1 control vectors are included after the SLU name (bytes r+1-s)
- bit 7, half-duplex flip-flop reset states (reserved unless (1) normal-flow send/receive mode is half-duplex flip-flop (byte 7, bits 0-1 = 10) and (2) brackets are not used or bracket state manager's reset state is INB (byte 6, bit 2 = 0)):  
 0 HDX-FF reset state is RECEIVE for the primary and SEND for the secondary (e.g., the secondary sends normal-flow requests first after session activation)  
 1 HDX-FF reset state is SEND for the primary and RECEIVE for the secondary (e.g., the primary sends normal-flow requests first after session activation) (only value defined for LU 6.2)

#### TS Usage

- 8 bit 0, staging indicator for session-level pacing of the secondary-to-primary normal flow:  
 0 the secondary send window size (byte 8, bits 2-7) and the primary receive window size (byte 13, bits 2-7) are for one-stage pacing (The secondary send window size is always equal to the primary receive window size.)  
 1 the secondary send window size (byte 8, bits 2-7) and the primary receive window size (byte 13, bits 2-7) are for two-stage pacing  
Note: The meanings of 0 and 1 are reversed from the corresponding staging indicator for the primary-to-secondary normal flow.
- bit 1, reserved
- bits 2-7, secondary send window size, in binary, for session-level pacing
- 9 bits 0-1, reserved
- bits 2-7, secondary receive window size, in binary, for session-level pacing
- 10 Maximum RU size sent on the normal flow by the secondary half-session: if bit 0 is set to 0, no maximum is specified and the remaining bits 1-7 are ignored; if bit 0 is set to 1, bit 0 is set to 1, and the byte is interpreted as  $X'ab' = a \cdot 2^{**}b$  (Notice that, by definition,  $a \geq 8$  and therefore  $X'ab'$  is a normalized floating point representation.) See Figure 5.1-1 on page 5.1-13 for all possible values.
- 11 Maximum RU size sent on the normal flow by the primary half-session: identical encoding as described for byte 10
- 12 bit 0, staging indicator for session-level pacing of the primary-to-secondary normal flow:  
 0 the primary send window size (byte 12, bits 2-7) and the secondary receive window size (byte 9, bits 2-7) are for two-stage pacing  
 1 the primary send window size (byte 12, bits 2-7) and the secondary receive window size (byte 9, bits 2-7) are for one-stage pacing (The primary send window size is always equal to the secondary receive window size.)  
Note: The meanings of 0 and 1 are reversed from the corresponding staging indicator for the secondary-to-primary normal flow (byte 8, bit 0).
- bit 1, reserved

BIND

- 13 bits 2-7, primary send window size, in binary, for session-level pacing  
bits 0-1, reserved  
bits 2-7, primary receive window size, in binary, for session-level pacing
- 14 PS Profile  
bit 0, PS Usage field format:
  - 0 basic format (only value defined)bits 1-7, LU type:
  - 0000000 LU type 0
  - 0000001 LU type 1
  - 0000010 LU type 2
  - 0000011 LU type 3
  - 0000100 LU type 4
  - 0000110 LU type 6
  - 0000111 LU type 7PS Usage characteristics  
Note: The following format for bytes 15-25 applies only to LU 6.2; for information on PS usage bytes 15-25 for other than LU 6.2 (indicated by byte 14, bits 1-7 = 0000110 and byte 15 = 00000010), see SNA—Sessions Between Logical Units.
- 15 LU-6 level:  
X'02' Level 2 (i.e., LU 6.2)
- 16-22 Reserved
- 23 bits 0-2, retired  
bit 3, conversation-level security support:
  - 0 Access Security Information field will not be accepted on incoming FMH-5s
  - 1 Access Security Information field will be accepted on incoming FMH-5sbits 4-5, reserved  
bit 6, already-verified function support:
  - 0 Already Verified indicator will not be accepted on incoming FMH-5s
  - 1 Already Verified indicator will be accepted on incoming FMH-5sbit 7, reserved
- 24 bit 0, reserved  
bits 1-2, synchronization level:
  - 01 confirm is supported
  - 10 confirm, sync point, and backout are supportedbit 3, reserved  
bits 4-5, responsibility for session reinitiation (reserved unless bit 6 of this byte is set to 0):
  - 00 operator controlled
  - 01 primary half-session will reinitiate
  - 10 secondary half-session will reinitiate
  - 11 either may reinitiatebit 6, parallel session support for LU-LU pair:
  - 0 not supported
  - 1 supportedbit 7, Change Number of Sessions GDS variable flow support (set to 1 if byte 24, bit 6 = 1):
  - 0 not supported
  - 1 supported
- 25 Reserved  
End of PS Usage Field

- 26-k Cryptography Options  
 26 bits 0-1, private cryptography options (reserved for LU 6.2):  
     00 no private cryptography supported  
     01 private cryptography supported: the session cryptography key and cryptography protocols are privately supplied by the end user  
 bits 2-3, session-level cryptography options:  
     00 no session-level cryptography supported  
     01 session-level selective cryptography supported; all cryptography key management is supported by the SSCP and LU; exchange (via +RSP(BIND)) and verification (via CRV) of the cryptography session-seed value is supported by the LUs for the session; all FMD requests carrying ED are enciphered/deciphered by the TCs  
     10 reserved  
     11 session-level mandatory cryptography supported; all cryptography key management is supported by the SSCP and LU; exchange (via +RSP(BIND)) and verification (via CRV) of the cryptography session-seed value is supported by the LUs for the session; all FMD requests are enciphered/deciphered by TC  
Note: Only values 00 and 11 are defined for LU 6.2.  
 bits 4-7, session-level cryptography options field length:  
     X'0' no session-level cryptography specified; following additional cryptography options fields (bytes 27-k) omitted  
     X'9' session-level cryptography specified; additional options follow in next nine bytes
- 27 bits 0-1, session cryptography key encipherment method:  
     00 session cryptography key enciphered under SLU master cryptography key using a seed value of 0 (only value defined)  
 bits 2-4, reserved  
 bits 5-7, cryptography cipher method:  
     000 block chaining with seed and cipher text feedback, using the Data Encryption Standard (DES) algorithm (only value defined)
- 28-k Session cryptography key enciphered under secondary LU master cryptography key; an eight-byte value that, when deciphered, yields the session cryptography key used for enciphering and deciphering FMD requests
- k+1-m Primary LU Name Field (always present)  
 k+1 Length of primary LU name (values 1 to 17 are valid)  
Note: Value 0 is retired.
- k+2-m Primary LU name or, if the secondary LU issued the INIT-SELF (or INIT-OTHER), INIT-SELF, the uninterpreted name as carried in that RU (and also in CDINIT for a cross-domain session)  
Note: The PLU name is network-qualified (i.e., has a network identifier present) if the SLU name in bytes p+2-r is network-qualified.
- m+1-n User Data Field  
 m+1 Length of user data  
Note: X'00' = no User Data field present; if unstructured user data present, values 1 to 65 are valid.
- m+2-n User data  
 m+2 User data key:  
 X'00' structured subfields follow (only value defined for LU 6.2)  
Note: Individual structured subfields may be omitted entirely. When present, they appear in ascending subfield-number order.



## BIND

- X'00' first byte of unstructured user data
- For unstructured user data:
  - m+3-n Remainder of unstructured user data
- For structured user data:
  - m+3-n Structured subfields (For detailed definitions, see "Chapter 7. User Data Structured Subfields" in Chapter 7.)
  - n+1-p User Request Correlation Field (present only if carried in INIT from SLU, or if Secondary LU name field or control vectors are included)
  - n+1 Length of user request correlation (URC) field (values 0 to 12 are valid)  
Note: X'00' = no URC present.
  - n+2-p URC: LU-defined identifier (present only if carried in INIT from SLU)
  - p+1-r Secondary LU Name Field (present only for negotiable BINDs and for non-negotiable BINDs that include control vectors)
  - p+1 Length of secondary LU name (values 1 to 17 are valid)  
Note: Value 0 is retired.
  - p+2-r Secondary LU name

Note 1: The length of the BIND RU cannot exceed 256.

Note 2: If the last byte of a format 0 request not having control vectors is a length field and that field is 0, that byte may be omitted from the BIND request.

Exponent (b)	Mantissa (a)							
	8	9	A (10)	B (11)	C (12)	D (13)	E (14)	F (15)
0	8	9	10	11	12	13	14	15
1	16	18	20	22	24	26	28	30
2	32	36	40	44	48	52	56	60
3	64	72	80	88	96	104	112	120
4	128	144	160	176	192	208	224	240
5	256	288	320	352	384	416	448	480
6	512	576	640	704	768	832	896	960
7	1024	1152	1280	1408	1536	1664	1792	1920
8	2048	2304	2560	2816	3072	3328	3584	3840
9	4096	4608	5120	5632	6144	6656	7168	7680
A (10)	8192	9216	10240	11264	12288	13312	14336	15360
B (11)	16384	18432	20480	22528	24576	26624	28672	30720
C (12)	32768	36864	40960	45056	49152	53248	57344	61440
D (13)	65536	73728	81920	90112	98304	106496	114688	122880
E (14)	131072	147456	163840	180224	196608	212992	229376	245760
F (15)	262144	294912	327680	360448	393216	425984	458752	491520

Note: A value of X'ab' in byte 10 or byte 11 of BIND represents  $a \cdot 2^{**}b$ . For example, X'C5' represents (in decimal)  $12 \cdot 2^{**}5 = 384$ .

Figure 5.1-1. RU Sizes Corresponding to Values X'ab' in BIND

BIS

BIS; LU-->LU, Norm; DFC (BRACKET INITIATION STOPPED)

BIS is sent by a half-session to indicate that it will not attempt to begin any more brackets.

0 X'70' request code

CANCEL; LU-->LU, Norm; DFC (CANCEL)

CANCEL may be sent by a half-session to terminate a partially sent chain of FMD requests. CANCEL may be sent only when a chain is in process. The sending half-session may send CANCEL to end a partially sent chain if a negative response is received for a request in the chain, or for some other reason. This RU is not used for LU 6.2.

0 X'83' request code

CHASE; LU-->LU, Norm; DFC (CHASE)

CHASE is sent by a half-session to request the receiving half-session to return all outstanding normal-flow responses to requests previously received from the issuer of CHASE. The receiver of CHASE sends the response to CHASE after processing (and sending any necessary responses to) all requests received before the CHASE. This RU is not used for LU 6.2.

0 X'84' request code

CLEAR; PLU-->SLU, Exp; SC (CLEAR)

CLEAR is sent by primary session control to reset the data traffic FSMs and subtrees (for example, brackets, pacing, sequence numbers) in the primary and secondary half-sessions (and boundary function, if any). This RU is not used for LU 6.2.

0 X'A1' request code

CRV; PLU-->SLU, Exp; SC (CRYPTOGRAPHY VERIFICATION)

CRV, a valid request only when session-level cryptography was selected in BIND, is sent by the primary LU session control to verify cryptography security and thereby enable sending and receiving of FMD requests by both half-sessions.

0 X'CO' request code

1-8 A transform of the (deciphered) cryptography session-seed value received (enciphered) in bytes 28-k of +RSP(BIND), re-enciphered under the session cryptography key using a seed value of 0; the transform is the cryptography session-seed value with the first four bytes inverted

Note: The cryptography session-seed is used as the seed for all session-level cryptography encipherment and decipherment provided for FMD RUs.

DACTLU; SSCP-->LU, Exp; SC (DEACTIVATE LOGICAL UNIT)

DACTLU is sent to deactivate the session between the SSCP and the LU.

0 X'0E' request code

Note: End of short (one-byte) request

1 Type of deactivation requested:

X'01' normal deactivation

X'03' session outage notification (SON)

2 Cause (reserved if byte 1 ≠ X'03'):

X'07' virtual route inoperative: the virtual route serving the SSCP-LU session has become inoperative, thus forcing the deactivation of the session

X'08' route extension inoperative: the route extension serving the SSCP-LU session has become inoperative, thus forcing the deactivation of the session

X'09' hierarchical reset: the identified session is being deactivated because of a +RSP(ACTPU, Cold)

X'0B' virtual route deactivated: the SSCP-LU session is being deactivated because of a forced deactivation of the virtual route being used by the session

X'0C' SSCP or LU failure—unrecoverable: the SSCP-LU session had to be reset because of an abnormal termination; recovery from the failure was not possible

X'0D' session override: the SSCP-LU session has to be deactivated because of a more recent session activation request for the SSCP to subarea PU session over a different virtual route

X'0E' SSCP or LU failure—recoverable: the SSCP-LU session had to be deactivated because of an abnormal termination of the SSCP or LU of the session; recovery from the failure may be possible

X'0F' cleanup: the SSCP is resetting its half-session before receiving the response from the LU being deactivated

DACTPU; SSCP|PUCP-->PU, PU-->SSCP, Exp; SC (DEACTIVATE PHYSICAL UNIT)

DACTPU is sent to deactivate the session between the SSCP and the PU.

0 X'12' request code

1 Type deactivation requested:

X'01' final use, physical connection may be broken

X'02' not final use, physical connection should not be broken

X'03' session outage notification (SON)

2 Cause (not present if byte 1 ≠ X'03'):

X'07' virtual route inoperative: the virtual route for the SSCP-PU session has become inoperative, thus forcing the deactivation of the SSCP-PU session

## DACTPU

- X'08' route extension inoperative: the route extension serving the SSCP-PU session has become inoperative, thus forcing the deactivation of the SSCP-PU session
- X'09' hierarchical reset: the identified session is being deactivated because of a +RSP(ACTPU, Cold)
- X'0B' virtual route deactivated: the identified SSCP-PU session is being deactivated because of a forced deactivation of the virtual route being used by the session
- X'0C' SSCP or PU failure—unrecoverable: the identified SSCP-PU session had to be deactivated because of an abnormal termination of the SSCP or PU of the session; recovery from the failure was not possible
- X'0D' session override: the SSCP-PU session has to be deactivated because of a more recent session activation request for the SSCP to subarea PU session over a different virtual route
- X'0E' SSCP or PU failure—recoverable: the identified SSCP-PU session had to be deactivated because of an abnormal termination of the SSCP or PU of the session; recovery from the failure may be possible
- X'0F' cleanup: the SSCP is resetting its half-session before receiving the response from the PU that is being deactivated.

### INIT-SELF Format 0; ILU-->SSCP, Norm; FMD NS(s) (INITIATE-SELF)

INIT-SELF from the ILU requests that the SSCP authorize and assist in the initiation of a session between the LU sending the request (that is, the ILU, which also becomes the OLU) and the LU named in the request (the DLU). This RU is not used for LU 6.2; refer to INIT-SELF Format 1.

- 0-2 X'010681' NS header
- 3 bits 0-3, format:
  - 0000 Format 0: specifies a subset of the parameters shown in Format 1 of INIT-SELF (described separately, because the NS header differs in the first byte), with the receiver supplying default values
- bit 4, reserved
- bits 5-6, 00 DLU is PLU  
01 DLU is SLU
- bit 7, 0 initiate only (I): do not enqueue.  
1 initiate/enqueue (I/Q): enqueue the request if it cannot be satisfied immediately
- 4-11 Mode name: an eight-character symbolic name (implementation and installation dependent) that identifies the set of rules and protocols to be used for the session; used by the SSCP(SLU) to select the BIND image that will be used by the SSCP(PLU) to build the CINIT request
- 12-m Uninterpreted Name of DLU
- 12 Type: X'F3' logical unit
- 13 Length, in binary, of DLU name
- 14-m EBCDIC character string
- m+1-m+2 Retired
- m+3-n User Field
- m+3 Length, in binary, of user data  
Note: X'00' = no user data is present.
- m+4-n User data: user-specific data that is passed to the primary LU on the CINIT request

- m+4 User data key  
 X'00' structured subfields follow  
 -X'00' first byte of unstructured user data  
 Note: Individual structured subfields may be omitted entirely.  
 When present, they appear in ascending field number order.
- For unstructured user data
- m+5-n Remainder of unstructured user data
- For structured user data
- m+5-n Structured subfields (For detailed definitions, see "Chapter 7. User Data Structured Subfields" in Chapter 7.)

Note: The following default values are supplied by the SSCP(ILU) receiving the Format 0 INIT-SELF request:

- Queuing conditions (if queuing is specified):
  - Enqueue if session limit exceeded.
  - Enqueue this request FIFO.
- Initiate origin: network user is the initiator.
- NOTIFY: do not notify

#### INIT-SELF Format 1 and 2; ILU-->SSCP, Norm; FMD NS(s) (INITIATE-SELF)

INIT-SELF from the ILU requests that the SSCP authorize and assist in the initiation of a session between the LU sending the request (that is, the ILU, which also becomes the OLU) and the LU named in the request (the DLU).

- 0-2 X'810681' NS header
- 3 bits 0-3, format:
- 0001 Format 1: specifies queuing, initiate origin, NOTIFY, and URC in addition to the parameters in Format 0 (only value defined for LU 6.2)
  - 0010 Format 2: specifies the COS name field in addition to the parameters in Format 1
- bits 4-7, reserved
- 4 Type:
- bits 0-1, 00 dequeue (DQ) a previously enqueued initiate request (See bits 2-3 for further specification of setup actions.)  
 Note: Value 00 is defined only for Format 1.
- 01 initiate only (I): do not enqueue
  - 10 enqueue only (Q) (See byte 5 for further specification of queuing conditions.)
  - 11 initiate/enqueue (I/Q): enqueue the request if it cannot be satisfied immediately
- Note: Only values 01 and 11 are defined for LU 6.2.
- bits 2-3, (used for DQ; otherwise, reserved)
- 00 leave on queue if setup attempt is unsuccessful
  - 01 remove from queue if setup attempt is unsuccessful
  - 10 remove from queue; do not attempt setup
  - 11 reserved
- bit 4, reserved

## INIT-SELF Format 1 and 2

bits 5-6, PLU/SLU specification:

00 DLU is PLU

01 DLU is SLU

bit 7, reserved

5 Queuing conditions for DLU (reserved when Type = DQ):

bit 0, 0 do not enqueue if session limit exceeded

1 enqueue if session limit exceeded

bit 1, 0 do not enqueue if DLU is not currently able to comply with the PLU/SLU specification (as given in byte 4, bits 5-6)

1 enqueue if DLU is not currently able to comply with the PLU/SLU specification

bit 2, reserved

bit 3, reserved for LU 6.2; otherwise:

0 do not enqueue if no SSCP(DLU)-DLU path

1 enqueue if no SSCP(DLU)-DLU path

bit 4, reserved

bits 5-6, queuing position/service:

00 put this request at the bottom of the queue (the request is put at the bottom of the queue and serviced last)

01 enqueue this request FIFO (only value defined for LU 6.2)

10 enqueue this request LIFO

11 reserved

bit 7, reserved

Note: Since queuing conditions are specified for the DLU only, the following default values are used by SSCP(OLU) for the OLU:

- Enqueue if session limit exceeded.

- Enqueue this request at the foot of the queue (FIFO).

6 Reserved for LU 6.2; otherwise:

bits 0-2, reserved

bit 3, initiator (reserved when Type = DQ):

0 network user is the initiator

1 network manager is the initiator

bits 4-7, reserved

7 NOTIFY specifications (reserved when Type = DQ and for LU 6.2):

bits 0-1, NOTIFY (Resource Requested) conditions:

00 do not notify LUs in session with DLU

01 reserved

10 notify LUs in session with DLU only if request is queued

11 reserved

bits 2-7, reserved

8-15 Mode name: an eight-character symbolic name (implementation and installation dependent) that identifies the set of rules and protocols to be used for the session; used by the SSCP(SLU) to select the BIND image that will be used by the SSCP(PLU) to build the CINIT request (reserved when Type = DQ)

16-n Uninterpreted Name of DLU

16 Type: X'F3' logical unit

17 Length, in binary, of DLU name

18-n DLU name EBCDIC character string

n+1-n+2 Retired

n+3-r User Field (reserved when Type = DQ and for LU 6.2)

n+3 Length, in binary, of user data

Note: X'00' = no user data is present.

- n+4-r User data: user-specific data that is passed to the primary LU on the CINIT request
- n+4 User data key  
X'00' structured subfields follow  
~X'00' first byte of unstructured user data  
Note: Individual structured subfields may be omitted entirely. When present, they appear in ascending field number order.
- For unstructured user data
- n+5-r Remainder of unstructured user data
- For structured user data
- n+5-r Structured subfields (For detailed definitions, see "Chapter 7. User Data Structured Subfields" in Chapter 7.)
- r+1-s User Request Correlation (URC) Field (When Type = DQ, the URC must be the same as in the original INIT-SELF request.)
- r+1 Length, in binary, of URC  
Note: X'00' = no URC. (The length field is always present.)
- r+2-s URC: LU-defined identifier; this value can be returned by the SSCP in a subsequent NOTIFY to correlate a given session to this initiating request
- Note: End of Format 1; Format 2 Continues
- s+1-s+8 COS name: symbolic name of class of service in EBCDIC characters (A value of eight space characters may be specified; in this case, the COS name is derived from the mode name table using the mode name received in bytes 8-15.)

## LUSTAT; LU--&gt;LU|SSCP, Norm; DFC (LOGICAL UNIT STATUS)

LUSTAT is used by one half-session to send up to four bytes of status information to its paired half-session. The RU format allows the sending of either end-user information or LU status information. If the high-order two bytes of the status information are 0, the low-order two bytes carry end-user information and may be set to any value. In general, LUSTAT is used to report about failures and error recovery conditions for a local device of an LU.

- 0 X'04' request code
- 1-4 Status value + status extension field (two bytes each):  
X'0000'+ 'uuuu' user status (no system-defined status) + user-defined field  
X'0001'+ 'ccdd' component now available + component identification (see Note)  
X'0002'+ 'rrrr' sender will have no (more) FMD requests to transmit during the time that this session remains active + reserved field  
X'0003'+ 'ccdd' component entering attended mode of operation + component identification (see Note)  
X'0004'+ 'ccdd' component entering unattended mode of operation + component identification (see Note)  
X'0005'+ 'iiii' prepare to commit all resources required for the unit of work + information field:  
X'0001' request End Bracket be sent on next chain (only value defined)



## LUSTAT

X'0006'+ 'rrrr' no-op (used to allow an RH to be sent when no other request is available or allowed) + reserved field (only value defined for LU 6.2)

X'0007'+ 'rrrr' sender currently has no FMD requests to transmit (but may have later during the time that this session remains active) + reserved field

X'0801'+ 'ccdd' component not available (e.g., not configured) + component identification (see Note)

X'0802'+ 'ccdd' component failure (intervention required) + component identification (see Note)

X'081C'+ 'ccdd' component failure (permanent error) + component identification (see Note)

X'0824'+ 'rrrr' function canceled + reserved field

X'082B'+ 'ccdd' component available, but presentation space integrity lost + component identification (see Note)

X'0831'+ 'ccdd' component disconnected (power off or some other disconnecting condition) + component identification (see Note)

X'0848'+ 'rrrr' cryptography component failure + reserved field

X'400A'+ 'ssss' no-response mode not allowed + sequence number of the request specifying no-response

Note: Values for cc byte are:

X'00' LU itself rather than a specific LU component (For this cc value, dd=X'00'.)

X'FF' The dd byte specifies the LU component medium class and device address. (See SNA—Sessions Between Logical Units for definitions of these terms and usage of the values according to LU type.)

-X'(00|FF)' LU component medium class and device address (For these cc values, dd=X'00'.)

NMVT; SSCP<-->PU\_T2 Norm; FMD NS(ma) (NETWORK MANAGEMENT VECTOR TRANSPORT)

NMVT carries management services (MS) requests and replies between a CP and a PU.

0-2 X'41038D' NS header

3-4 Retired: set to network address by subarea node sender; set to 0, the PU local address, by peripheral node sender; ignored by receivers implementing the current level of SNA

5-6 bits 0-1, reserved  
bits 2-3, retired: set to 01 by subarea PU sender; set to 00 by peripheral node sender; ignored by receivers implementing the current level of SNA  
bits 4-15, procedure related identifier (PRID)  
Note: For unsolicited replies (byte 7, bit 0 = 0), the PRID field contains X'000'. For solicited replies (byte 7, bit 0 = 1), the PRID field echoes the PRID from the NMVT RU request. For requests that need no replies, this field contains X'000'.

7 Flags:  
bit 0, solicitation indicator: used only for PU-to-SSCP|SNCP flow (reserved for SSCP|SNCP-to-PU flow):  
0 unsolicited NMVT  
1 solicited NMVT

bits 1-2, sequence field--used only for PU-to-SSCP|SNCP flow (reserved for SSCP|SNCP-to-PU flow):

- 00 only NMVT for this PRID
- 01 last NMVT for this PRID
- 10 first NMVT for this PRID
- 11 middle NMVT for this PRID

bit 3, SNA Address List subvector indicator:

0 For the SSCP-to-PU flow: MS major vector in this NMVT does not contain an SNA Address List subvector

For the PU-to-SSCP flow: MS major vector in this NMVT does not contain an SNA Address List subvector, or it contains an SNA Address List subvector that does not require address-to-name translation by the SSCP

1 For the SSCP-to-PU flow: MS major vector in this NMVT contains an SNA Address List subvector

For the PU-to-SSCP flow: MS major vector in this NMVT contains an SNA Address List subvector that requires address-to-name translation by the SSCP

bits 4-7, reserved

8-m One MS major vector, as described (using zero-origin indexing) in the table in "MS Major Vectors and Unique Subvectors" in Chapter 8.

NOTIFY; LU-->SSCP, Norm; FMD NS(s) (NOTIFY)

NOTIFY is used to send information from an LU to an SSCP.

0-2 X'810620' NS header

3-p NOTIFY vector X'0C' as described in detail below

X'0C' LU-LU Session Services Capabilities: used to inform the SSCP having an active session with the sending LU of the current LU-LU session services capability of that LU

NOTIFY vectors (described zero-origin)

LU-LU Session Services Capabilities NOTIFY Vector

Note: This NOTIFY vector should not be confused with control vector X'0C' which carries similar information.

0 Key: X'0C'

1 Length of Vector Data field, encoded in binary

2-m Vector Data

2 LU-LU session capability:

bits 0-3, (reserved)

bits 4-7, secondary LU capability:

0000 SLU capability is inhibited, sessions can neither be queued nor started

0001 SLU capability is disabled, sessions can be queued but not started

0010 reserved

0011 SLU capability is enabled, sessions can be queued or started

## NOTIFY

3-4 Retired, (set to X'0001')  
5-7 Retired  
8-15(=m) Retired, (set to X'4040404040404040' or omitted)

QC; LU-->LU, Norm; DFC (QUIESCE COMPLETE)

QC is sent by a half-session after receiving QEC, to indicate that it has quiesced. This RU is not used for LU 6.2

0 X'81' request code

QEC; LU-->LU, Exp; DFC (QUIESCE AT END OF CHAIN)

QEC is sent by a half-session to quiesce its partner half-session after it (the partner) finishes sending the current chain (if any). This RU is not used for LU 6.2.

0 X'80' request code

RELQ; LU-->LU, Exp; DFC (RELEASE QUIESCE)

RELQ is used to release a half-session from a quiesced state. This RU is not used for LU 6.2

0 X'82' request code

RQR; SLU-->PLU, Exp; SC (REQUEST RECOVERY)

RQR is sent by the secondary to request the primary to initiate recovery for the session by sending CLEAR or to deactivate the session. This RU is not used for LU 6.2.

0 X'A3' request code

RSHUTD; SLU-->PLU, Exp; DFC (REQUEST SHUTDOWN)

RSHUTD is sent from the secondary to the primary to indicate that the secondary is ready to have the session deactivated. RSHUTD does not request a shutdown; therefore, SHUTD is not a proper reply; RSHUTD requests an UNBIND. This RU is not used for LU 6.2.

0 X'C2' request code

RTR; LU-->LU, Norm; DFC (READY TO RECEIVE)

RTR indicates to the bidder that it is now allowed to initiate a bracket. RTR is sent only by the first speaker.

0 X'05' request code

SBI; LU-->LU, Exp; DFC (STOP BRACKET INITIATION)

SBI is sent by either half-session to request that the receiving half-session stop initiating brackets by continued sending of BB and the BID request. This RU is not used for LU 6.2.

0 X'71' request code

SDT; PLU-->SLU, SSCP-->PU|SSCP, Exp; SC (START DATA TRAFFIC)

SDT is sent by the primary session control to the secondary session control to enable the sending and receiving of FMD and DFC requests and responses by both half-sessions. This RU is not used for LU 6.2.

0 X'A0' request code

SHUTC; SLU-->PLU, Exp; DFC (SHUTDOWN COMPLETE)

SHUTC is sent by a secondary to indicate that it is in the shutdown (quiesced) state. This RU is not used for LU 6.2.

0 X'C1' request code

SHUTD; PLU-->SLU, Exp; DFC (SHUTDOWN)

SHUTD is sent by the primary to request that the secondary shut down (quiesce) as soon as convenient. This RU is not used for LU 6.2.

0 X'CO' request code

SIG; LU-->LU, Exp; DFC (SIGNAL)

SIG is an expedited request that can be sent between half-sessions, regardless of the status of the normal flows. It carries a four-byte value, of which the first two bytes are the signal code and the last two bytes are the signal extension value.

0 X'C9' request code

1-2

Signal code:

X'0000' no-op (no system-defined code)

X'0001' request to send (only value defined for LU 6.2)

X'0002' assistance requested

X'0003' intervention required (no data loss)

3-4

Signal extension: set by the sending end user or NAU services manager, or set to X'0001' for LU 6.2 by data flow control

## STSN

STSN; PLU-->SLU, Exp; SC (SET AND TEST SEQUENCE NUMBERS)

STSN is sent by the primary half-session sync point manager to resynchronize the values of the half-session sequence numbers, for one or both of the normal flows at both ends of the session. This RU is not used for LU 6.2.

- 0 X'A2' request code  
1 bits 0-1, action code for S-->P flow (related data in bytes 2-3)  
bits 2-3, action code for P-->S flow (related data in bytes 4-5)  
Note: Each action code is set and processed independently. Values for either action code are:
- 00 ignore; this flow not affected by this STSN
  - 01 set; the half-session value is set to the value in bytes 2-3 or 4-5, as appropriate
  - 10 sense; secondary half-session's sync point manager returns the transaction processing program's sequence number for this flow in the response RU
  - 11 set and test; the half-session value is set to the value in appropriate bytes 2-3 or 4-5, and the secondary half-session's sync point manager compares that value against the transaction processing program's number and responds accordingly
- bits 4-7, reserved
- 2-3 Secondary-to-primary sequence number data to support S-->P action code  
4-5 Primary-to-secondary sequence number data to support P-->S action code  
Note: For action codes 01 and 11, the appropriate bytes 2-3 or 4-5 contain the value to which the half-session value is set and against which the secondary half-session's sync point manager tests the transaction processing program's value for the respective flow. For action codes 00 and 10, the appropriate bytes 2-3 or 4-5 are reserved.

TERM-SELF Format 0; TLU-->SSCP, Norm; FMD NS(s) (TERMINATE-SELF)

TERM-SELF from the TLU requests that the SSCP assist in the termination of one or more sessions between the sender of the request (TLU = OLU) and the DLU. This RU is not used for LU 6.2; refer to TERM-SELF Format 1.

- 0-2 X'010683' NS header  
3 Type:
- bits 0-1, 00 the request applies to active and pending-active sessions
  - 01 the request applies to active, pending-active, and queued sessions
  - 10 the request applies to queued only sessions
  - 11 reserved
- bit 2, reserved if byte 3, bit 4 = 1; otherwise:
- 0 forced termination—session to be deactivated immediately and unconditionally
  - 1 orderly termination—permitting an end-of-session procedure to be executed at the PLU before the session is deactivated
- bit 3, 0 do not send DACTLU to OLU; another session initiation request will be sent for OLU

1 send DACTLU to OLU when appropriate; no further session initiation request will be sent (from this sender) for OLU

bit 4, 0 orderly or forced (see byte 3, bit 2)

1 clean up

bits 5-6, 00 select session(s) for which DLU is PLU  
01 select session(s) for which DLU is SLU  
10 select session(s) regardless of whether DLU is SLU or PLU  
11 reserved

bit 7, 0 indicates that the format of the RU is Format 0 and that byte 3 is the Type byte.

4-m Uninterpreted Name of DLU

4 Type: X'F3' logical unit

5 Length, in binary, of DLU name

Note: If the length value of the DLU name is 0, then the TERM-SELF applies to all sessions, as specified in the Type byte, where the TLU is a partner.

6-m EBCDIC character string

Note: The following defaults are supplied by the SSCP receiving a Format 0 TERM-SELF:

- Reason: network user, normal
- Notify: do not notify
- URC is not used in mapping to subsequent requests.

TERM-SELF Format 1; TLU-->SSCP, Norm; FMD NS(s) (TERMINATE-SELF)

TERM-SELF from the TLU requests that the SSCP assist in the termination of one or more sessions between the sender of the request (TLU = OLU) and the DLU.

0-2 X'810683' NS header

3 bits 0-3, format:

0001 Format 1 (only value defined)

bits 4-6, reserved

bit 7, 1 indicates that byte 3, bits 0-3, contain the format value

4 Type:

bits 0-1, 00 the request applies to active and pending-active sessions

01 the request applies to active, pending-active, and queued sessions (only value defined for LU 6.2)

10 the request applies to queued sessions only

11 reserved

bit 2, reserved if byte 4, bit 7 = 1; otherwise:

0 forced termination—session to be deactivated immediately and unconditionally

1 orderly termination—permitting an end-of-session procedure to be executed at the PLU before the session is deactivated

bit 3, 0 do not send DACTLU to OLU; another session initiation request will be sent for OLU

1 send DACTLU to OLU when appropriate; no further session initiation request will be sent (from this sender) for OLU (only value defined for LU 6.2)

bit 4, reserved

bits 5-6, 00 select session(s) for which DLU is PLU

01 select session(s) for which DLU is SLU

TERM-SELF Format 1

- 10 select session(s) regardless of whether DLU is SLU or PLU
- 11 reserved
- bit 7, 0 orderly or forced (see byte 4, bit 2)
- 1 clean up
- 5 Reason:
  - bit 0, 0 network user (only value defined for LU 6.2)
  - 1 network manager
  - bit 1, 0 normal termination
  - 1 abnormal termination
  - bits 2-7, reserved
- 6 NOTIFY specifications (reserved for LU 6.2):
  - bits 0-5, reserved
  - bit 6, 0 do not notify TLU when the session takedown procedure is complete
  - 1 notify the TLU when the session takedown procedure is complete
  - bit 7, reserved
- 7 Reserved
- 8-n Session key, as described in the section "Session Key" in Chapter 8
  - Note: One of the following session keys is used:
    - X'01' uninterpreted name of DLU
      - Note: If the length value is 0, then the TERM-SELF applies to all sessions specified in the Type byte where the TLU is a partner.
    - X'0A' URC
      - Note: This URC is the one carried in the INIT issued previously by the same LU (i.e., ILU = TLU), and differs from the one in bytes n+4 through p.
- n+1-n+2 Retired: set to X'0000'
- n+3-p User Request Correlation (URC) Field
- n+3 Length, in binary, of URC field
  - Note: X'00' = no URC.
- n+4-p URC: LU-defined identifier; this value can be returned by the SSCP in a subsequent NOTIFY to correlate the NOTIFY to this terminating request

UNBIND; LU-->LU, Exp; SC (UNBIND SESSION)

UNBIND is sent to deactivate an active session between the two LUs.

- 0 X'32' request code
- 1 UNBIND type (for UNBIND types X'00' through X'06' and X'80' through X'FF', the session is ended when the response is received; for UNBIND types X'07' through X'7F', the session is ended immediately):
  - X'01' normal end of session
  - X'02' BIND forthcoming; retain the node resources allocated to this session, if possible
  - X'06' invalid session parameters: the BIND negotiation has failed because the primary half-session cannot support parameters specified by the secondary
  - X'07' virtual route inoperative: the virtual route used by the LU-LU session has become inoperative, thus forcing the deactivation of the identified LU-LU session
  - X'08' route extension inoperative: the route extension used by the LU-LU session has become inoperative, thus forcing the deactivation of the identified LU-LU session

- X'09' hierarchical reset: the identified LU-LU session is being deactivated because of a +RSP((ACTPU | ACTLU), Cold)
- X'0A' SSCP gone: the identified LU-LU session had to be deactivated because of a forced deactivation of the SSCP-PU or SSCP-LU session (e.g., DACTPU, DACTLU, or DISCONTACT was received)
- X'0B' virtual route deactivated: the identified LU-LU session had to be deactivated because of a forced deactivation of the virtual route being used by the LU-LU session
- X'0C' LU failure--unrecoverable: the identified LU-LU session had to be deactivated because of an abnormal termination of the PLU or SLU; recovery from the failure was not possible
- X'0E' LU failure--recoverable: the identified LU-LU session had to be deactivated because of an abnormal termination of one of the LUs of the session; recovery from the failure may be possible
- X'0F' cleanup: the node sending UNBIND is resetting its half-session before receiving the response from the partner node
- X'11' gateway node cleanup: a gateway node is cleaning up the session because a gateway SSCP has directed the gateway node (via NOTIFY) to deactivate the session (e.g., a session setup error or session takedown failure has occurred)
- X'FE' session failure: the session has failed for a reason specified by the associated sense data

- For UNBIND Type=X'FE', the Sense Data field is included; otherwise, it is omitted.

2-5        Sense data: same value as generated at the time the error was originally detected (e.g., for a negative response, receive check, or EXR)

Note 1: Extensions to the UNBIND (unrecognized data after byte 5 for UNBIND type=X'FE'; unrecognized data after byte 1 for all other types) are ignored by receivers at the current level of SNA.





## CHAPTER 5.2. RESPONSE UNITS

**Message  
Unit  
Format**

Chapter 1

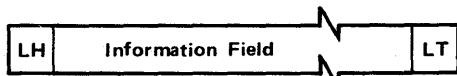

BLU

Chapter 2



Chapter 3

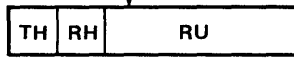

PIU

Chapter 4



BIU

Chapter 5.1



Chapter 5.2



Chapter 6

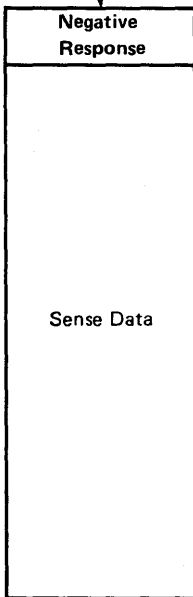

Chapter 7

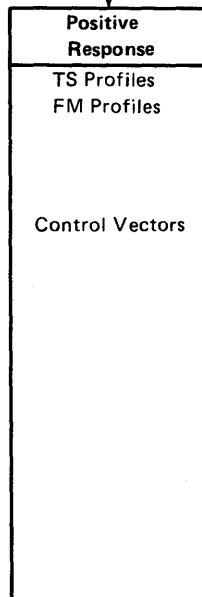

Chapter 8

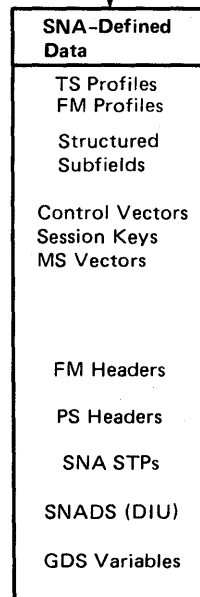

Chapter 9

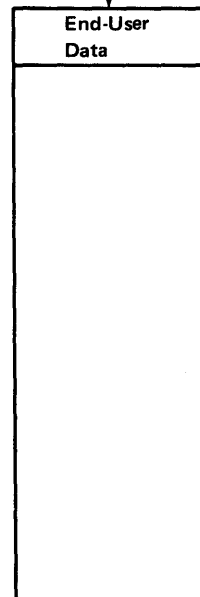

Chapter 10

Chapter 11

Chapter 12

Chapter 13

Chapter 14

LH = Link Header  
 LT = Link Trailer  
 XID = Exchange Identification  
 TH = Transmission Header  
 RH = Request/Response Header  
 RU = Request/Response Unit  
 TS = Transmission Services  
 FM = Function Management  
 MS = Management Services

PS = Presentation Services  
 STP = Service Transaction Program  
 SNADS = SNA Distribution Services  
 DIU = Distribution Interchange Unit  
 GDS = General Data Stream  
 BLU = Basic Link Unit  
 PIU = Path Information Unit  
 BIU = Basic Information Unit

## CHAPTER 5.2. RESPONSE UNITS

## INTRODUCTION

Apart from the exceptions cited below, response units return the number of bytes specified in the following table; only enough of the request unit is returned to include the field-formatted request code or NS header.

<u>RU Category of Response</u>	<u>Number of Bytes</u>
DFC	1
SC	1
NC	1
FMD NS (FI=1) (field-formatted)	3
FMD NS (FI=0) (character-coded)	0
FMD (LU-LU)	0

All negative responses return four bytes of sense data in the RU, followed by either:

1. The number of bytes specified in the table above, or
2. Three bytes (or the entire request unit, if shorter than three bytes).

The second option applies where a sensitivity to SSCP-based sessions versus LU-LU sessions does not necessarily exist and can be chosen for implementation simplicity. Refer to Chapter 9 for sense data values and their corresponding meanings.

Some positive response units return the request code or NS header followed by additional data. "Positive Response Units with Extended Formats" on page 5.2-3 contains detailed formats of these response units, arranged in alphabetical order. Each format description begins with the following heading:

"RSP(ABBREVIATED RU NAME); Origin-NAU-->Destination-NAU, Normal (Norm) or Expedited (Exp) Flow; RU Category"

Notes:

1. "RU Category" is abbreviated as follows:

DFC	data flow control
SC	session control
NC	network control

## Response Units

FMD NS(ma) function management data, network services, management services  
(note: formerly maintenance services)

FMD NS(s) function management data, network services, session services

2. Throughout the format descriptions, reserved is used as follows: reserved bits, or fields, are ones that currently are set to 0's (unless explicitly stated otherwise); reserved values are those that currently are invalid. Correct usage of reserved fields is enforced by the sender; no receive checks are made on these fields.
3. Throughout the format descriptions, retired fields and values are those that were once defined in SNA but are no longer defined. To accommodate implementations of back-level SNA, current implementations of SNA treat retired fields as follows: send checks enforce the setting of retired fields to all 0's except where other unique values are required (described individually); no receive checks are made on these fields, thereby accepting back-level settings of these fields. Special handling of retired fields, such as echoing or passing on retired fields as received, is discussed where appropriate.
4. User data, control vectors, and control lists referred to in the format descriptions are described in Chapter 7 and Chapter 8.

## POSITIVE RESPONSE UNITS WITH EXTENDED FORMATS

RSP(ACTLU); LU--&gt;SSCP, Exp; SC

0 X'0D' request code  
 1 Type of activation selected:  
 X'01' cold  
 X'02' ERP  
 2 bits 0-3, FM profile:  
 X'0' FM Profile 0  
 X'6' FM Profile 6  
 bits 4-7, TS profile: same as the corresponding request

Note: Two versions of this RU are defined.

- A full response can be sent in which bytes 0-m are present.  
 3-m Control vectors as described in the section "Control Vectors" in Chapter 8  
Note: The following control vectors may be included; they are parsed according to subfield parsing rule KL. When present, they appear in the order specified.  
 X'00' SSCP-LU session capabilities (always present, always first)  
 X'0C' LU-LU session services capabilities (always present, always second)
- A two-byte response may be received; it means maximum RU size = 256 bytes, LU-LU session limit = 1, the LU can act as a secondary LU, and all other fields in control vectors X'00' and X'0C' are defaulted to 0's.

RSP(ACTPU); PU--&gt;SSCP|PUCP, Exp; SC

0 X'11' request code  
 1 bits 0-1, reserved  
 bits 2-3, format of response:  
 00 format 0  
 bits 4-7, type activation selected:  
 X'2' ERP  
 2-9 Contents ID: eight-character EBCDIC symbolic name of the load module currently operating in the node; eight space (X'40') characters is the default value

RSP(ACTPU)

RSP(BIND); SLU-->PLU, Exp; SC

A +RSP(BIND) carries the session parameters as indicated by the SLU or by intermediate nodes along the session path.

- A short (1-byte) response may be sent for a nonnegotiable BIND request that specifies no session-level cryptography.
- A cryptography response (bytes 0-k) may be sent for a nonnegotiable BIND request that specifies session-level cryptography.
- A negotiable response (bytes 0-r) may be sent for a negotiable BIND request.

0 X'31' request code  
1 bits 0-3, format: 0000 (only value defined)  
bits 4-7, type:  
    0000 negotiable (only value defined for LU 6.2)  
    0001 nonnegotiable  
2-25 Bytes 2-25 of the BIND request: for a negotiable response, the negotiated values may differ; otherwise, the values are the same as those received in the BIND request  
26-k Cryptography Options (see Note 3)  
26 bits 0-1, private cryptography options: for a nonnegotiable response, same value as received in the request, if present  
bits 2-3, session-level cryptography options: for a nonnegotiable response and an LU 6.2 response, same value returned as received in the request, if present  
bits 4-7, session-level cryptography options field length: same value (Bytes 27-k are omitted if this length field is omitted or set to 0.)  
27 bits 0-1, session cryptography key encipherment method: same value returned as received in the request, if present  
bits 2-4, reserved  
bits 5-7, cryptography cipher method: same value returned as received  
28-k An eight-byte implementation-chosen, nonzero, pseudo random session-seed cryptography value enciphered under the session cryptography key, if session-level cryptography is specified; otherwise, omitted  
k+1(=m) Retired: set to 0 by implementations at the current level of SNA  
m+1 Length of user data  
m+2-n User data: for a negotiable response, the user data may differ from that received on the BIND request  
n+1 Length of URC  
n+2-p URC as received on the BIND request  
p+1(=r) Retired: set to 0 by implementations at the current level of SNA

Note 1: On a response, if the last byte of a response is a length field and that field is 0, that byte may be dropped from the response. This applies also to byte 26 (where the count occupies only bits 4-7) if bits 0-3 are also 0—the entire byte may be dropped if no bytes follow.

Note 2: In negotiable BIND responses, reserved fields in the BIND are set by the SLU to binary 0's in the RSP(BIND); any fields at the end of the BIND (after byte r) that are not recognized by the SLU are discarded and not returned in the RSP(BIND).

Note 3: The first byte of the Cryptography Options field (byte 26) is returned on the response for a nonnegotiable BIND only when session-level cryptography was specified in the BIND. Byte 26 is always present in any negotiable response if not truncated as allowed in Note 1. In all cases, however, the remaining bytes of the Cryptography Options field (bytes 27-k) are present only if session-level cryptography was specified in the BIND.

RSP(STSN); SLU-->PLU, Exp; SC

0 X'A2' request code

1 bits 0-1, result code for S-->P action code in the request (related data in bytes 2-3)

bits 2-3, result code for P-->S action code in the request (related data in bytes 4-5)

Note: Values for either result code are:

- For set or ignore action code:

01 ignore (other values reserved); appropriate bytes 2-3 or 4-5 reserved

- For sense action code:

00 for LU-LU session type 0: user-defined meaning; for all other LU-LU session types: reserved (appropriate bytes 2-3 or 4-5 reserved)

01 reserved

10 secondary half-session's sync point manager does not maintain or cannot return a valid transaction processing program sequence number (appropriate bytes 2-3 or 4-5 reserved)

11 transaction processing program sequence number, as known at the secondary, is returned in bytes 2-3 or 4-5, as appropriate

- For set and test action code:

00 for LU-LU session type 0: user-defined meaning; for all other LU-LU session types: invalid sequence numbers have been detected by the secondary (appropriate bytes 2-3 or 4-5 return the secondary transaction processing program sequence number)

Note: An invalid determination results when the sequence number indicated could not have occurred. For example, the mounting of an incorrect sync point log tape by the operator at one of the LUs would cause this condition.

01 value received in STSN request equals the transaction processing program sequence number value as known at the secondary (appropriate bytes 2-3 or 4-5 return the secondary's value for the transaction processing program sequence number)

10 secondary half-session's sync point manager does not maintain or cannot return a valid transaction processing program sequence number (appropriate bytes 2-3 or 4-5 reserved)

11 value received in STSN request does not equal the transaction processing program sequence number value as known at the secondary (appropriate bytes 2-3 or 4-5 return the



RSP(STSN)

secondary's value for the transaction processing program  
sequence number)

bits 4-7, reserved

2-3 Secondary-to-primary normal-flow sequence number data to support S-->P  
result code, or reserved (see Note 1 above)

4-5 Primary-to-secondary normal-flow sequence number data to support P-->S  
result code or reserved (see Note 1 above)

Note: Where the STSN request specified as action codes two "sets," two "ignores,"  
or a combination of "set" and "ignore," the positive response RU optionally may  
consist of one byte—X'A2' (the STSN request code)—rather than all six bytes.

## CHAPTER 6. PROFILES

**Message  
Unit  
Format**

Chapter 1  
Chapter 2  
Chapter 3  
Chapter 4  
Chapter 5.1  
Chapter 5.2  
Chapter 6  
Chapter 7  
Chapter 8  
Chapter 9  
Chapter 10  
Chapter 11  
Chapter 12  
Chapter 13  
Chapter 14

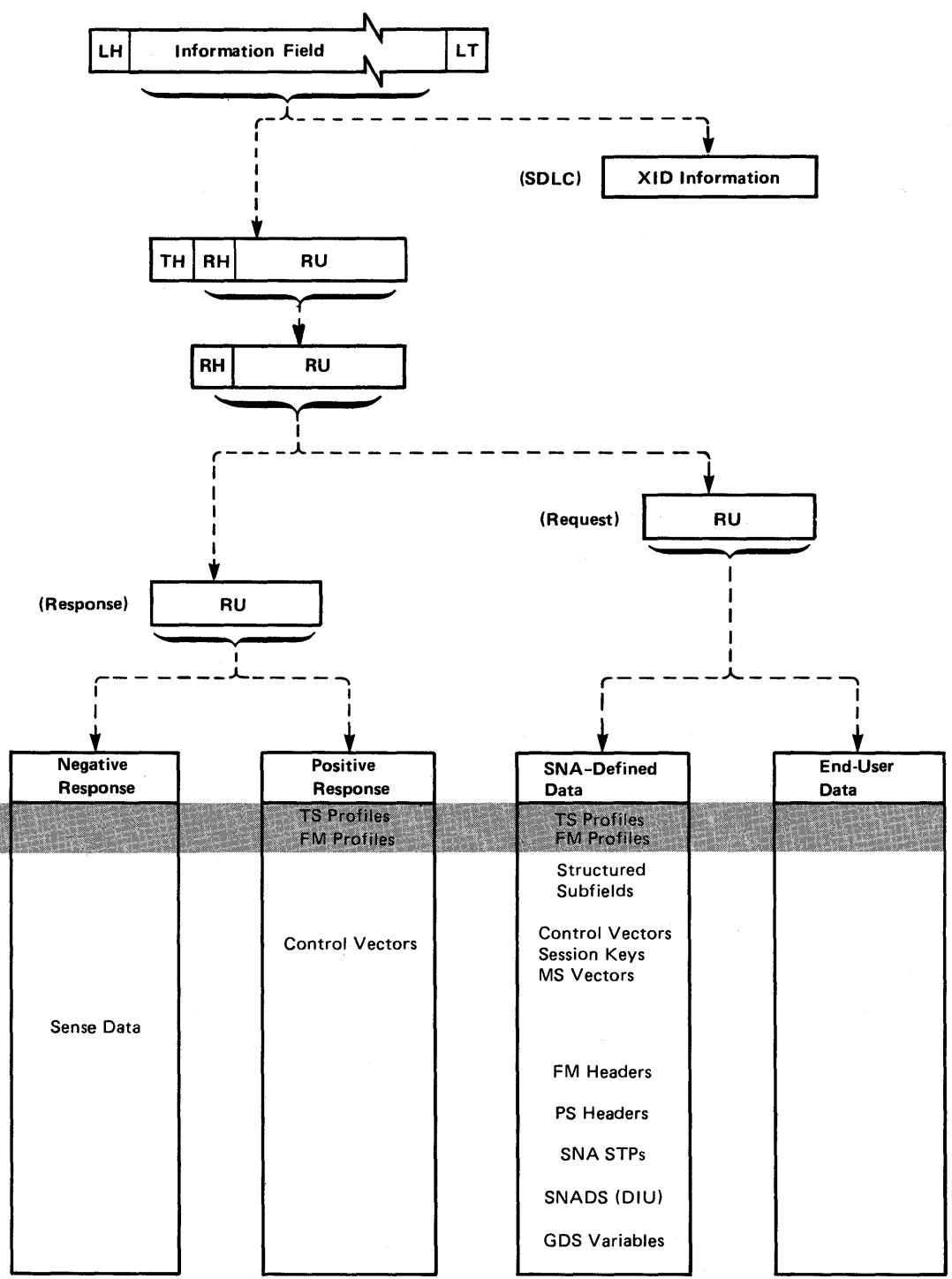

BLU  
  
PIU  
  
BIU

- |     |                           |       |                                 |
|-----|---------------------------|-------|---------------------------------|
| LH  | = Link Header             | PS    | = Presentation Services         |
| LT  | = Link Trailer            | STP   | = Service Transaction Program   |
| XID | = Exchange Identification | SNADS | = SNA Distribution Services     |
| TH  | = Transmission Header     | DIU   | = Distribution Interchange Unit |
| RH  | = Request/Response Header | GDS   | = General Data Stream           |
| RU  | = Request/Response Unit   | BLU   | = Basic Link Unit               |
| TS  | = Transmission Services   | PIU   | = Path Information Unit         |
| FM  | = Function Management     | BIU   | = Basic Information Unit        |
| MS  | = Management Services     |       |                                 |

## CHAPTER 6. PROFILES

### INTRODUCTION

Some of the session protocols (such as for request and response control modes, brackets, and pacing) are selectable at session activation. Specific combinations of these selectable protocol options are known as profiles.

Those profiles that refer to transmission control (TC) options are called transmission services (TS) profiles; those profiles that refer to data flow control (DFC) and function management data services (FMDS) options are called function management (FM) profiles.

The TS and FM profiles to be used in any session are specified at the time of session activation via parameters in the appropriate session activation request and response (see ACTPU, ACTLU, BIND, and their responses in Chapter 5).

## TRANSMISSION SERVICES (TS) PROFILES

This section describes the transmission services (TS) profiles and their use for sessions defined in SNA. Profile numbers not shown are reserved.

Note: If the TS Usage field in BIND specifies a value for a parameter, that value is used unless it conflicts with a value specified by the TS profile. The TS profile overrides the TS Usage field.

Figure 6-1 identifies the different sessions and logical unit (LU) types that use each TS profile.

TS Profile	Session Types	LU Types
1	SSCP-PU(T1 2), <sup>1</sup> SSCP-LU	-
2	LU-LU	0
3	LU-LU	0, 1, 2, 3
4	LU-LU	0, 1, 6.1
7	LU-LU	0, 4, 6.2, 7

<sup>1</sup> The boundary function serves in place of the PU type 1 (e.g., to process ACTPU).

Figure 6-1. TS Profiles and Their Usage

## TS PROFILE 1

Profile 1 (used on SSCP-PU and SSCP-LU sessions) specifies the following session rules:

- No pacing.
- Identifiers rather than sequence numbers are used on the normal flows (whenever the TH format used includes a sequence number field).
- SDT, CLEAR, RQR, STSN, and CRV are not supported.
- Maximum RU size on the normal flow between an SSCP and a peripheral LU is 256, unless a different value is specified in RSP(ACTLU) in control vector X'00'.
- Maximum RU size on the normal flow for an SSCP sending to a peripheral PU is 256; in the reverse direction it is 512.

There is no TS Usage field associated with this profile.

## TS PROFILE 2

Profile 2 (used on LU-LU sessions) specifies the following session rules:

- Primary-to-secondary and secondary-to-primary normal flows are paced.
- Sequence numbers are used on the normal flows (whenever the TH format used includes a sequence number field).
- CLEAR is supported.
- SDT, RQR, STSN, and CRV are not supported.

The TS Usage subfields defining the options for this profile are:

- Pacing window counts
- Maximum RU sizes on the normal flows

### TS PROFILE 3

Profile 3 (used on LU-LU sessions) specifies the following session rules:

- Primary-to-secondary and secondary-to-primary normal flows are paced.
- Sequence numbers are used on the normal flows (whenever the TH format used includes a sequence number field).
- CLEAR and SDT are supported.
- RQR and STSN are not supported.
- CRV is supported when session-level cryptography is selected (via a BIND parameter).

The TS Usage subfields defining the options for this profile are:

- Pacing window counts
- Maximum RU sizes on the normal flows

### TS PROFILE 4

Profile 4 (used on LU-LU sessions) specifies the following session rules:

- Primary-to-secondary and secondary-to-primary normal flows are paced.
- Sequence numbers are used on the normal flows (whenever the TH format used includes a sequence number field).
- SDT, CLEAR, RQR, and STSN are supported.
- CRV is supported when session-level cryptography is selected (via a BIND parameter).

The TS Usage subfields defining the options for this profile are:

- Pacing window counts
- Maximum RU sizes on the normal flows

## TS PROFILE 7

Profile 7 (used on LU-LU sessions) specifies the following session rules:

- Primary-to-secondary and secondary-to-primary normal flows are optionally paced.
- Sequence numbers are used on the normal flows (whenever the TH format used includes a sequence number field).
- SDT, CLEAR, RQR, and STSN are not supported.
- CRV is supported when session-level cryptography is selected (via a BIND parameter).

The TS Usage subfields in BIND defining the options for this profile are:

- Pacing window counts
- Maximum RU sizes on the normal flows



## FUNCTION MANAGEMENT (FM) PROFILES

This section describes the function management (FM) profiles and their use for sessions defined in SNA. Profile numbers not shown are reserved.

Note: If the FM Usage field in BIND specifies a value for a parameter, that value is used unless it conflicts with a value specified by the FM profile. The FM profile overrides the FM Usage field.

Figure 6-2 identifies the different sessions and logical unit (LU) types that use each FM profile.

FM Profile	Session Types	LU Types
0	SSCP-PU(T1 2), <sup>1</sup> SSCP-LU	-
2	LU-LU	0
3	LU-LU	0, 1, 2, 3
4	LU-LU	0, 1
6	SSCP-LU	-
7	LU-LU	0, 4, 7
18	LU-LU	0, 6.1
19	LU-LU	6.2

<sup>1</sup> The boundary function serves in place of the PU type 1 (e.g., to process ACTPU).

Figure 6-2. FM Profiles and Their Usage

## FM PROFILE 0

Profile 0 (used on SSCP-PU and SSCP-LU sessions) specifies the following session rules:

- Primary and secondary half-sessions use immediate request mode and immediate response mode.
- Only single-RU chains allowed.
- Primary and secondary half-session chains indicate definite response. Half-session chains generated by a boundary function on behalf of the LU may indicate no-response or definite response.
- No compression.
- Primary half-session sends no DFC RUs.
- Secondary LU half-session may send LUSTAT.
- No FM headers.
- No brackets.
- No alternate code.
- Normal-flow send/receive mode is full-duplex.

## FM PROFILE 2

Profile 2 (used on LU-LU sessions) specifies the following session rules:

- Secondary LU half-session uses delayed request mode.
- Secondary LU half-session uses immediate response mode.
- Only single-RU chains allowed.
- Secondary LU half-session requests indicate no-response.
- No compression.
- No DFC RUs.
- No FM headers.
- Secondary LU half-session is first speaker if brackets are used.
- Bracket termination rule 2 is used if brackets are used.
- Primary LU half-session will send EB.
- Secondary LU half-session will not send EB.
- Normal-flow send/receive mode is FDX.
- Primary LU half-session is responsible for recovery.

The FM Usage fields defining the options for Profile 2 are:

- Primary request control mode selection
- Primary chain response protocol (no-response may not be used)
- Brackets usage and reset state
- Alternate code

## FM PROFILE 3

Profile 3 (used on LU-LU sessions) specifies the following session rules:

- Primary LU half-session and secondary LU half-session use immediate response mode.
- Primary LU half-session and secondary LU half-session support the following DFC functions:
  - CANCEL
  - SIGNAL
  - LUSTAT (allowed secondary-to-primary only)
  - CHASE
  - SHUTD
  - SHUTC
  - RSHUTD
  - BID and RTR (allowed only if brackets are used)

The FM usage fields defining the options for Profile 3 are:

- Chaining use (primary and secondary)
- Request control mode selection (primary and secondary)
- Chain response protocol (primary and secondary)
- Compression indicator (primary and secondary)
- Send EB indicator (primary and secondary)
- FM header usage
- Brackets usage and reset state
- Bracket termination rule
- Alternate Code Set Allowed indicator
- Normal-flow send/receive mode
- Recovery responsibility
- Contention winner/loser
- Half-duplex flip-flop reset states

## FM PROFILE 4

Profile 4 (used on LU-LU sessions) specifies the following session rules:

- Primary LU half-session and secondary LU half-session use immediate response mode.
- Primary LU half-session and secondary LU half-session support the following DFC functions:
  - CANCEL
  - SIGNAL
  - LUSTAT
  - QEC
  - QC
  - RELQ
  - SHUTD
  - SHUTC
  - RSHUTD
  - CHASE
  - BID and RTR (allowed only if brackets are used)

The FM Usage fields defining the options for Profile 4 are:

- Chaining use (primary and secondary)
- Request control mode selection (primary and secondary)
- Chain response protocol (primary and secondary)
- Compression indicator (primary and secondary)
- Send EB indicator (primary and secondary)
- FM header usage
- Brackets usage and reset state
- Bracket termination rule
- Alternate Code Set Allowed indicator
- Normal-flow send/receive mode
- Recovery responsibility
- Contention winner/loser
- Half-duplex flip-flop reset states

## FM PROFILE 6

Profile 6 (used on SSCP-LU sessions) specifies the following session rules:

- Only single-RU chains allowed.
- Primary and secondary half-sessions use delayed request mode and delayed response mode.
- Primary and secondary half-session chains may indicate definite response, exception response, or no response.
- Primary half-session sends no DFC RUs.
- Secondary half-session may send LUSTAT.
- No FM headers.
- No compression.
- No brackets.
- No alternate code.
- Normal-flow send/receive mode is full-duplex.

## FM PROFILE 7

Profile 7 (used on LU-LU sessions) specifies the following session rules:

- Primary LU half-session and secondary LU half-session use immediate response mode.
- Primary LU half-session and secondary LU half-session support the following DFC functions:
  - CANCEL
  - SIGNAL
  - LUSTAT
  - RSHUTD

The FM Usage fields defining the options for Profile 7 are:

- Chaining use (primary and secondary)
- Request control mode selection (primary and secondary)
- Chain response protocol (primary and secondary)
- Compression indicator (primary and secondary)
- Send EB indicator (primary and secondary)
- FM header usage
- Brackets usage and reset state
- Bracket termination rule
- Alternate Code Set Allowed indicator
- Normal-flow send/receive mode
- Recovery responsibility
- Contention winner/loser
- Half-duplex flip-flop reset states

## FM PROFILE 18

Profile 18 (used on LU-LU sessions) specifies the following session rules:

- Primary LU half-session and secondary LU half-session use immediate response mode.
- Primary LU half-session and secondary LU half-session support the following DFC functions:
  - CANCEL
  - SIGNAL
  - LUSTAT
  - BIS and SBI (allowed only if brackets are used)
  - CHASE
  - BID and RTR (allowed only if brackets are used)

The FM Usage fields defining the options for Profile 18 are:

- Chaining use (primary and secondary)
- Request control mode selection (primary and secondary)
- Chain response protocol (primary and secondary)
- Compression indicator (primary and secondary)
- Send EB indicator (primary and secondary)
- FM header usage
- Brackets usage and reset state
- Bracket termination rule
- Alternate Code Set Allowed indicator
- Normal-flow send/receive mode
- Recovery responsibility
- Contention winner/loser
- Half-duplex flip-flop reset states

## FM PROFILE 19

Profile 19 (used on LU-LU sessions) specifies the following session rules:

- Primary LU half-session and secondary LU half-session use immediate request and immediate response mode.
- Multiple RU chains allowed.
- Primary LU half-session and secondary LU half-session chains indicate definite or exception response.
- No compression.
- Brackets are used.
- FM headers (types 5, 7, and 12 only) are allowed.
- Conditional termination for brackets (specified by CEB) will be used--primary and secondary half-sessions may send CEB.
- Normal-flow send/receive mode is half-duplex flip-flop.
- Half-duplex flip-flop reset state is send for the primary LU half-session and receive for the secondary LU half-session after RSP(BIND).
- Symmetric responsibility for recovery.
- Contention winner/loser polarity is negotiated at BIND time; the contention winner is the first speaker and the contention loser is the bidder.
- Primary and secondary half-sessions support the following DFC functions:
  - SIGNAL
  - LUSTAT
  - BIS
  - RTR
- The following combinations of RQE, RQD, CEB, and CD are allowed on end-chain RUs:
  - RQE\*, CD, -CEB
  - RQD2, CD, -CEB
  - RQD3, CD, -CEB
  - RQE1, -CD, CEB
  - RQD\*, -CD, CEB
  - RQD\*, -CD, -CEB

The only FM Usage field defining options for Profile 19 is Contention Winner/Loser.





## CHAPTER 7. USER DATA STRUCTURED SUBFIELDS

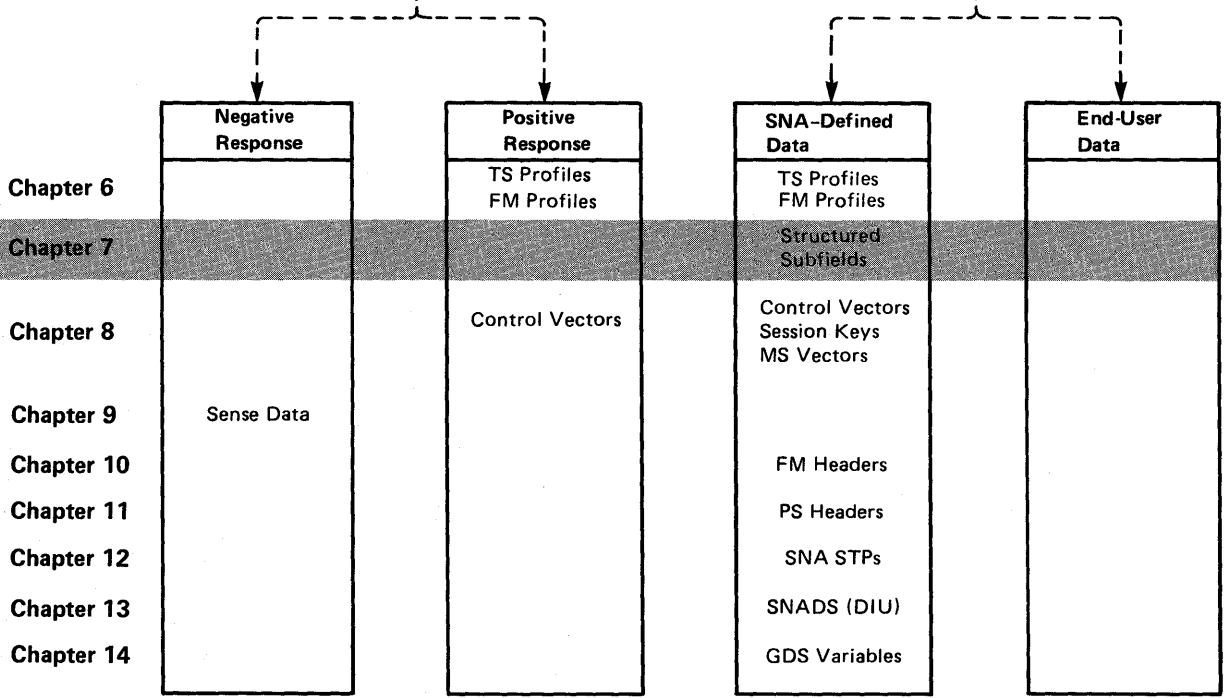
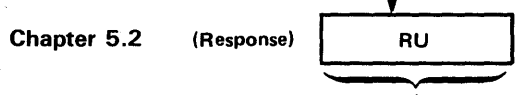
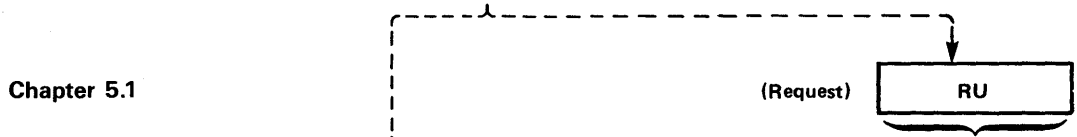
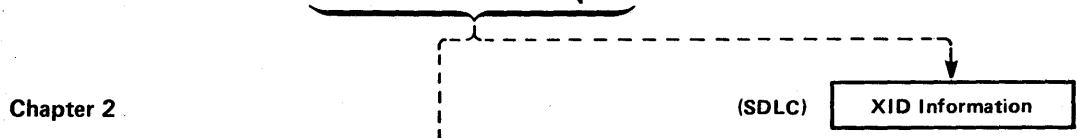
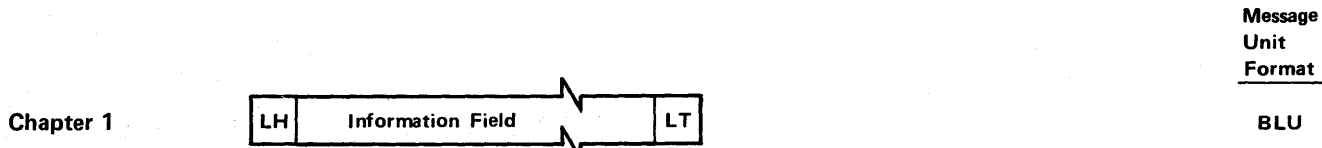

LH = Link Header  
 LT = Link Trailer  
 XID = Exchange Identification  
 TH = Transmission Header  
 RH = Request/Response Header  
 RU = Request/Response Unit  
 TS = Transmission Services  
 FM = Function Management  
 MS = Management Services

PS = Presentation Services  
 STP = Service Transaction Program  
 SNADS = SNA Distribution Services  
 DIU = Distribution Interchange Unit  
 GDS = General Data Stream  
 BLU = Basic Link Unit  
 PIU = Path Information Unit  
 BIU = Basic Information Unit

## CHAPTER 7. USER DATA STRUCTURED SUBFIELDS

## INTRODUCTION

The structured subfields of the User Data field are defined as follows (shown with zero-origin indexing of the subfield bytes—see the individual RU description for the actual displacement within the RU). Each subfield starts with a one-byte binary Length field and is identified by a subfield number in the following byte. The length does not include the Length byte itself. When more than one subfield is included, they appear in ascending order by subfield number.

For LU type 6.2, the Structured User Data field of BIND and RSP(BIND) may contain the Unformatted Data, Mode Name, Network-Qualified PLU Network Name, Network-Qualified SLU Network Name, and Session Instance Identifier subfields. Any subfields received in the Structured User Data field of BIND that are not recognized by the SLU are discarded and not returned as part of the Structured User Data field of the RSP(BIND).

## User Data Subfields

### DESCRIPTIONS

#### Unformatted Data Structured Data Subfield

The Unformatted Data subfield may optionally be sent in BIND, RSP(BIND), or any of the INITIATE RUs. The content is implementation-defined.

- 0 Length of the remainder of the Unformatted Data subfield: values 1 to 17 (X'11') are valid for LU 6.2; otherwise, values 1 to 65 (X'41') are valid
- 1 X'00'
- 2-n Unformatted data: a type-G symbol string

#### Session Qualifier Structured Data Subfield

The Session Qualifier subfield is used for LU 6.1. It may be carried in BIND, RSP(BIND), or any of the INITIATE RUs.

- 0 Length of the remainder of the Session Qualifier subfield (If Session Qualifier subfield is present, values 3 to 19 (X'13') are valid.)
- 1 X'01'
- 2 Length of primary resource qualifier: values 0 to 8 are valid (X'00' means no primary resource qualifier is present)
- 3-m Primary resource qualifier
- m+1 Length of secondary resource qualifier: values 0 to 8 are valid (X'00' means no secondary resource qualifier is present)
- m+2-n Secondary resource qualifier

#### Mode Name Structured Data Subfield

The Mode Name subfield is present in both BIND and RSP(BIND) if the PLU knows the mode name being used by the session.

- 0 Length of the remainder of the Mode Name subfield: values 1 to 9 are valid
- 1 X'02'
- 2-n Mode name: 0 to 8 type-A symbol string characters with optional (but not significant) trailing blanks

#### Session Instance Identifier Structured Data Subfield

The Session Instance Identifier subfield may be present in both BIND and RSP(BIND).

- 0 Length of the remainder of the Session Instance Identifier subfield: values 3 to 9 are valid
- 1 X'03'
- 2-n Session instance identifier: a type-G symbol string  
Note: In BIND, the PLU sets a unique session instance identifier of length 1 to 7 and appends it to X'00'. If known, the SLU compares its network-qualified name with that of the PLU; if the PLU name > SLU name then the SLU changes the first byte of the Session Instance Identifier

subfield in the response from X'00' to X'F0', if the PLU name < SLU name then the subfield is simply echoed.

#### Network-Qualified PLU Network Name Structured Data Subfield

BIND contains the Network-Qualified PLU Network Name subfield (if the name is known by the PLU).

- 0 Length of the remainder of the Network-Qualified PLU Network Name subfield: values 2 to 18 (X'12') are valid
- 1 X'04'
- 2-n Network-Qualified PLU network name  
Note: The network-qualified PLU network name is 1 to 17 bytes in length, consisting of an optional 1- to 8-byte network ID and a 1- to 8-byte LU name, both of which are type-A symbol strings. When present, the network ID is concatenated to the left of the LU name, using a separating period and having the form "NWID.NAME"; when the network ID is omitted, the period is also omitted.

#### Network-Qualified SLU Network Name Structured Data Subfield

The RSP(BIND) contains the Network-Qualified SLU Network Name subfield (if the name is known by the SLU).

- 0 Length of the remainder of the Network-Qualified SLU Network Name subfield: values 2 to 18 (X'12') are valid
- 1 X'05'
- 2-n Network-Qualified SLU network name  
Note: The network-qualified SLU network name is 1 to 17 bytes in length, consisting of an optional 1- to 8-byte network ID and a 1- to 8-byte LU name, both of which are type-A symbol strings. When present, the network ID is concatenated to the left of the LU name, using a separating period and having the form "NWID.NAME"; when the network ID is omitted, the period is also omitted.

#### Random Data Structured Data Subfield

The Random Data subfield contains the random data used in session-level security verification. When session-level security verification is in effect, this subfield is present in both BIND and RSP(BIND).

- 0 Length of the remainder of the Random Data subfield: 10 is the only valid value
- 1 X'11'
- 2 Reserved
- 3-10 Random data: a type-G random value generated for subsequent checking in RSP(BIND) or FMH-12

#### Enciphered Data Structured Data Subfield

The Enciphered Data subfield is present in the RSP(BIND) when session-level security verification is in effect.

## User Data Subfields

This subfield contains the enciphered version of the clear data received in BIND.

- 0 Length of the remainder of the Enciphered Data subfield: 9 is the only valid value
- 1 X'12'
- 2-9 Enciphered version of the Clear Data field carried in BIND (using the DES algorithm and the installation-defined LU-LU password as the cryptographic key)

## CHAPTER 8. COMMON FIELDS



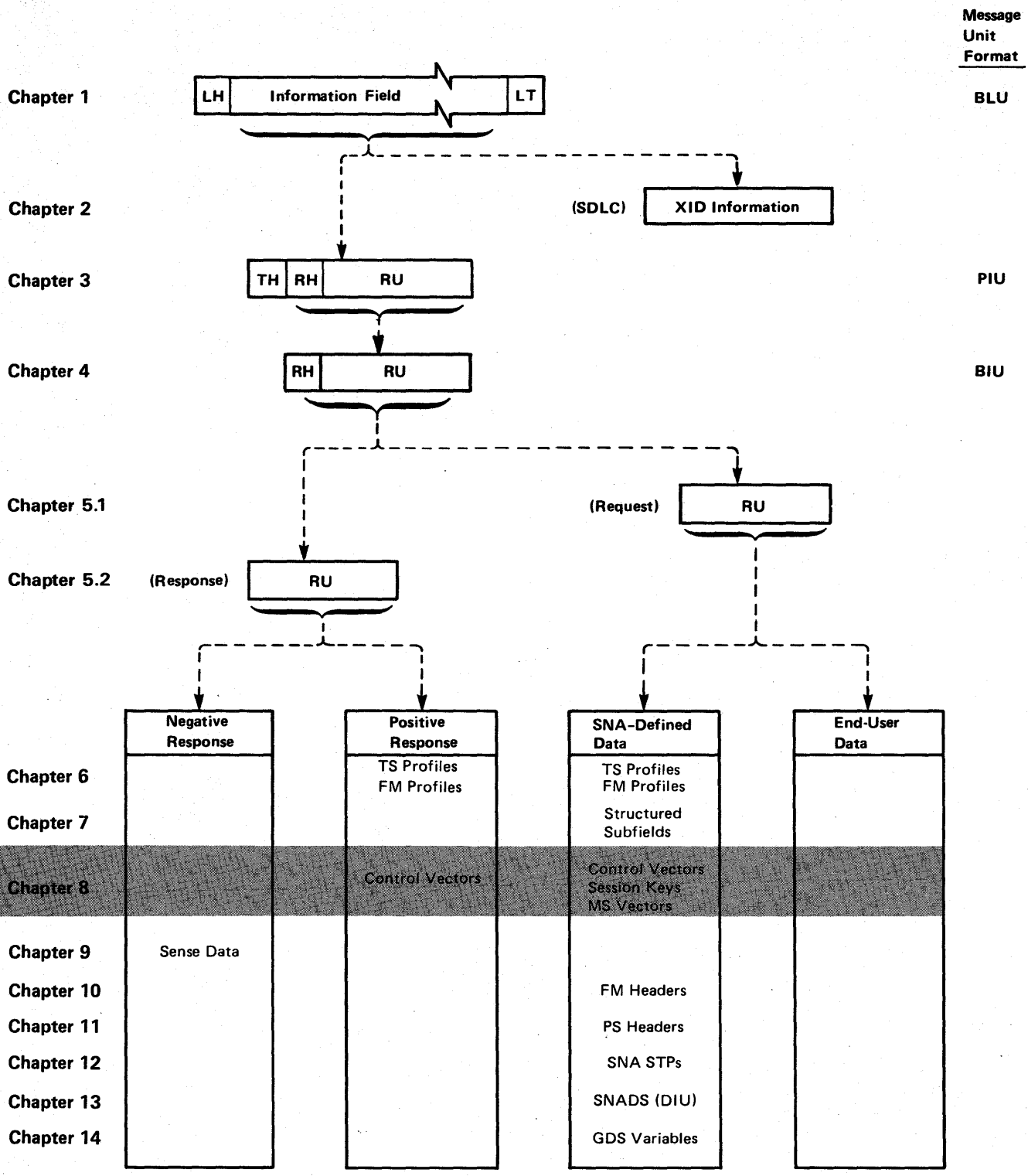

- |  |  |
|--|--|
| <ul style="list-style-type: none"> <li>LH = Link Header</li> <li>LT = Link Trailer</li> <li>XID = Exchange Identification</li> <li>TH = Transmission Header</li> <li>RH = Request/Response Header</li> <li>RU = Request/Response Unit</li> <li>TS = Transmission Services</li> <li>FM = Function Management</li> <li>MS = Management Services</li> </ul> | <ul style="list-style-type: none"> <li>PS = Presentation Services</li> <li>STP = Service Transaction Program</li> <li>SNADS = SNA Distribution Services</li> <li>DIU = Distribution Interchange Unit</li> <li>GDS = General Data Stream</li> <li>BLU = Basic Link Unit</li> <li>PIU = Path Information Unit</li> <li>BIU = Basic Information Unit</li> </ul> |
|--|--|

## CHAPTER 8. COMMON FIELDS

## INTRODUCTION

This chapter contains detailed formats of the following common fields used in message units:

- Control vectors
- Session keys
- Management services major vectors and subvectors

## Encoding/Parsing Rules

### SUBFIELD ENCODING/PARSING RULES

#### RULES FOR COMMON SUBSTRUCTURES

The following rules apply to encodings defined in this chapter; they govern the encoding of SNA-defined RU substructures, i.e., structures that are carried within some enclosing structure and that have one-byte keys identifying the substructures. The terms key and type are used interchangeably here, since both terms are used in the substructures to which the following rules apply.

#### Partitioning of Key/Type Values

The use of one-byte keys means that 256 values are available for defining substructures. The available values are partitioned as follows.

**ARCHITECTURE-DEPENDENT KEYS:** Within the category of control vectors, keys in the range X'00' to X'5F' are unique; within the independent category of management services (MS) subvectors, they are also unique.

**UNIQUE KEYS:** Keys in the range X'60' to X'7D' are unique across the composite grouping of control vectors and MS subvectors, i.e., such a key has the same meaning in both groups.

**CONTEXT-SENSITIVE KEYS:** Keys in the range X'80' to X'FD' are context-sensitive. These are unique only within the enclosing structure (e.g., control vector, GDS variable). Thus a subfield key X'80' may be defined for use within control vector X'30' and also within control vector X'31', and the subfields may be different. The only exception to this rule is found in the management services subfields. Keys in the range X'00' to X'7F' are unique within the enclosing subvector. Keys in the range X'80' to X'FF' are unique within the group of unique subvectors defined for a given management services major vector.

#### Parsing Rules

Common substructures with variable length formats, such as control vectors may be parsed in one of two ways. The parsing rule used is format specific--see the individual format description for the parsing rule used:

KL     The Key field precedes the Length field and the length is the number of bytes, in binary, of the substructure's Data field (e.g., Vector Data field). The Length field value does not include the length of the substructure Header field.

LT The Length field precedes the Key field (also called the "type" field--hence "LT") and the length is the number of bytes, in binary, of the substructure including both the Header field and the Data field.

The general format of a control vector, for example, is:

0-1 Vector header; Key=X'45' (see "Subfield Encoding/Parsing Rules" on page 8-2)  
 2-n Vector Data

When the enclosing structure indicates use of subfield parsing rule KL, the first two bytes are interpreted as:

0 Key  
 1 Length (n-1), in binary, of the Vector Data field (i.e., excluding the length of the Vector Header field)

When the enclosing structure indicates use of subfield parsing rule LT, the first two bytes are interpreted as:

0 Length (n+1), in binary, of the control vector (i.e., including the Vector Header and Vector Data fields)  
 1 Type

### Enclosing Rule for Substructures

All substructures that are enclosed by other than an RU (e.g., another substructure or a GDS variable) are constructed and parsed LT. This is the case even when, for example, an enclosing control vector is parsed KL. This rule holds true for all levels of nesting.

Consider the Product Set ID (X'10') control vector as an example of this rule. Imbedded within this substructure are other substructures, specifically Product Set Identifier (X'11') MS common subvectors.

When the Product Set ID (X'10') is present in XID format 3, it is parsed KL, whereas when it is present in NMVT, it is parsed LT. In both cases the Product Set Identifier (X'11') subvectors are parsed LT.

## Control Vectors

### CONTROL VECTORS

#### INTRODUCTION

The following table shows, by key value, the control vector and the message-unit structures that can carry the control vector.

<u>Key</u>	<u>Control Vector</u>	<u>Applicable Message-Unit Structures</u>
X'00'	SSCP-LU Session Capabilities	RSP(ACTLU)
X'0C'	LU Session Services Capabilities	RSP(ACTLU)
X'0E'	Network Name	XID
X'10'	Product Set ID	XID
X'22'	XID Negotiation Error	XID

#### CONTROL VECTOR FORMATS

The control vectors are defined as follows (with zero-origin indexing of the vector bytes—see the individual RU description for the actual displacement within the RU):

Note: When more than one control vector may appear in an RU, unless otherwise stated, the vectors may appear in any order.

#### SSCP-LU Session Capabilities (X'00') Control Vector

- 0 Key: X'00'
- 1 Maximum RU size sent on the normal flow by either half-session: if bit 0 is set to 0, then no maximum is specified and the remaining bits 1-7 are ignored; if bit 0 is set to 1, then the byte is interpreted as X'ab' =  $a \cdot 2^b$  (Notice that, by definition,  $a \geq 8$  and therefore X'ab' is a normalized floating point representation.) See Figure 5.1-1 on page 5.1-13 for all possible values.
- 2-3 LU Capabilities
  - bit 0, character-coded capability:
    - 0 the SSCP may not send unsolicited character-coded requests; a solicited request is a reply request or a request that carries additional error information to supplement a previously sent negative response or error information after a positive response has already been sent
    - 1 the SSCP may send unsolicited character-coded requests
  - bit 1, field-formatted capability:
    - 0 the SSCP may not send unsolicited field-formatted requests
    - 1 the SSCP may send unsolicited field-formatted requests
  - bits 2-15, reserved
- 4 Reserved

#### LU-LU Session Services Capabilities (X'0C') Control Vector

Note: Do not confuse control vector X'0C' with NOTIFY vector X'0C' which carries similar information.

- 0-1 Vector header; Key=X'0C' (see "Subfield Encoding/Parsing Rules" on page 8-2)
- 2-m Vector Data  
 2 bits 0-3, (reserved)  
 bits 4-7, secondary LU capability:  
     0000 SLU capability is inhibited, sessions can neither be queued nor started  
     0001 SLU capability is disabled, sessions can be queued but not started  
     0010 reserved  
     0011 SLU capability is enabled, sessions can be queued or started
- 3-4 LU-LU session limit: X'0001' session limit of 1 (only value allowed for peripheral LUs)
- 5-6 LU-LU session count: the number of LU-LU sessions that are not reset for this LU, and for which SESSEND will be sent to the SSCP
- 7 (reserved)
- 8-15(=m) Retired, (set to X'4040404040404040' or omitted)

#### Network Name (X'0E') Control Vector

- 0-1 Vector header; Key=X'0E' (see "Subfield Encoding/Parsing Rules" on page 8-2)  
Note: A null X'0E' control vector consists of a vector header with no vector data. The length field is set appropriately.
- 2-n Vector Data  
 2 Network name type:  
 X'F1' PU name  
 X'F3' LU name  
 X'F4' CP name  
 X'F7' link station name (not network-qualified)
- 3-n Network-qualified name: a 1- to 17-byte name consisting of an optional qualifier concatenated to a 1- to 8-byte type-A symbol-string name; when present, the qualifier contains a 1- to 8-byte type-A symbol-string network identifier concatenated with a period (when the qualifier is not present, the period is omitted). The network-qualified name appears, for example, as follows: NETID.NAME, with no imbedded blanks and with optional (but not significant) trailing blanks.

#### Product Set ID (X'10') Control Vector

- 0-1 Vector Header; Key=X'10' (see "Subfield Encoding/Parsing Rules" on page 8-2)
- 2-n Vector Data  
 2 Retired
- 3-n Network product identifier: one or two Product Identifier (X'11') MS common subvectors, as described in "MS Common Subvectors" on page 8-87, one for each hardware product and software product in the implementation of the node

#### XID Negotiation Error (X'22') Control Vector

## Control Vectors

- 0-1 Vector header; Key=X'22' (see "Subfield Encoding/Parsing Rules" on page 8-2).
- 2-n Vector Data
- 2-3 Error byte offset: the binary offset (zero-origin in the XID information field) of the first byte of the field in error
- 4(=n) Error bit offset: the binary offset (zero-origin in the byte pointed at in the Error Byte Offset field) of the first bit of the field in error

## SESSION KEY

The following table shows, by key value, the session key and the message-unit structures that can carry the session key.

<u>Key</u>	<u>Session Key</u>	<u>Applicable Message-Unit Structures</u>
X'01'	Network or Uninterpreted name	TERM-SELF
X'0A'	URC	TERM-SELF

The session keys are defined as follows, with zero-origin indexing of the key bytes—see the individual RU description for the actual displacement within the RU.

**Network or Uninterpreted Name (X'01')**

0	Key: X'01'
1	Type: X'F3' logical unit
2	Length, in binary, of name
3-n	Network or Uninterpreted Name
	<u>Note:</u> For a Network Name session key, the name is a symbolic name; for an Uninterpreted Name session key, the name is any EBCDIC character string.

**URC (X'0A')**

0	Key: X'0A'
1	Length, in binary, of the URC
2-n	URC: LU-defined identifier



## MS Major Vectors

### MS MAJOR VECTORS AND UNIQUE SUBVECTORS

#### INTRODUCTION

The following table shows, by key value, the MS major vectors that NMVT can carry.

<u>Key</u>	<u>MS Major Vector</u>
------------	------------------------

X'0000'	Alert
X'0080'	RTM
X'8080'	Request RTM

The description of each major vector includes a matrix indicating the subvectors that may be included within it.

Subvectors with keys X'80' through X'FE' have a meaning that is unique to the major vector in which they are used. They are defined following each major vector.

Subvectors with keys X'00' through X'7F' are referred to as common subvectors. Their meaning is independent of the major vector in which they are used. They are defined in "MS Common Subvectors" on page 8-87.

Subvectors may appear in any order within a major vector unless otherwise stated.

## MS Major Vector Formats

## Alert (X'0000') MS Major Vector

PU T2-->SSCP

This major vector provides unsolicited notification of a problem or impending problem, type of problem, identification of the cause, and identification of the component that caused the problem.

- 0-1 Length (n+1), in binary, of this MS major vector  
 2-3 Key: X'0000'  
 4-n MS subvectors, as described (using zero-origin indexing) in "MS Common Subvectors" on page 8-87 for subvector keys X'00' - X'7F', and in "Alert MS Subvectors" on page 8-12 for subvector keys X'80' - X'FE'.

Note: The following subvector keys may be used as indicated:

MS Major Vectors

Subvector	Presence in NMVT Alert (X'0000') Major Vector	
	Text Message (X'00')	0
Date/Time (X'01)	CP	Note 2
Hierarchy Name List (X'03')	CP	Note 3
SNA Address List (X'04')	CP	Note 4
Hierarchy/Resource List (X'05')	CP	Note 5
Product Set ID (X'10')	P(n)	Note 6
Self-Defining Text Msg. (X'31')	0	
Relative Time (X'42')	CP	Note 7
LAN Link Connection Subsystem Data (X'51')	CP	Note 8
LCS Configuration Data (X'52')	CP	Note 9
SDLC Link Station Data (X'8C')	CP	Note 10
Basic Alert (X'91')	0	Note 11
Generic Alert Data (X'92')	P	
Probable Causes (X'93')	P	
User Causes (X'94')	CP	Note 12
Install Causes (X'95')	CP	Note 12
Failure Causes (X'96')	CP	Note 12
Cause Undetermined (X'97')	CP	Note 13
Detailed Data (X'98')	0	
Detail Qualifier (X'A0' or X'A1')	O(n)	Note 14

Key:

- P Present one time
- P(n) Present one or more times
- CP Conditionally present one time (See Notes for conditions.)

- 0      Optionally present one time  
 0(n)    Optionally present one or more times

Notes:

1. This subvector may be optionally included by an Alert sender, to transport text in a single Alert major vector that can be processed by both a pre-generic Alert and a generic Alert focal point. If this subvector is present, the X'91' subvector must also be present.
2. If the PU sending the Alert major vector has the capability of providing it, it places this subvector in the NMVT. See Note 7.
3. This subvector may be optionally included in the NMVT by an Alert sender in order to create a single Alert major vector that can be processed by both a pre-generic Alert and a generic Alert focal point. When it is present, this subvector identifies an origin of the Alert condition that is not an SNA network addressable unit. If this subvector is present, the X'91' subvector must also be present.
4. This subvector is present when it is necessary to identify, with an SNA address, the origin of the Alert condition. If the origin of the Alert condition is the PU sending the Alert, this subvector is not present.
5. This subvector is present in the NMVT instead of, or in addition to, the SNA Address List (X'04') subvector if the origin (other than the PU sending the Alert) of the Alert condition cannot be represented in the SNA Address List (X'04') subvector.
6. An instance of this subvector describing the PU sending the Alert is always present. A second instance is present if the origin of the Alert condition is a hardware or software product, and is not the PU sending the Alert. If a second instance is present, it is placed immediately after the first instance of the X'10' subvector.

In an Alert containing two instances of the Product Set ID subvector, the following terms refer, respectively, to these two instances:

- "Alert Sender PSID"--identifies the PU sending the Alert
- "Indicated Resource PSID"--identifies the resource that is being Alerted upon

In an Alert with only one instance of the Product Set ID, this instance is referred to both as the Alert Sender Product Set ID and as the Indicated Resource Product Set ID.

7. If the PU sending the Alert cannot provide a Date/Time (X'01') subvector, it places this subvector in the NMVT instead.
8. This subvector is present when the Alert reports an error on a LAN, and the node sending the Alert is attached to the LAN.

## MS Major Vectors

9. This subvector is present when the Alert reports a problem with a logical link using the SDLC or LAN LLC protocol.
10. This subvector is present when the Alert reports a problem with a logical link using the SDLC or LAN LLC protocol.
11. This subvector may be optionally included by an Alert sender in order to create a single Alert major vector that can be processed by both a pre-generic Alert and a generic Alert focal point.
12. Any or all of these subvectors are present in an Alert, depending on the probable causes of the Alert condition identified by the Alert sender.
13. This subvector is present in an Alert if and only if none of the X'94', X'95', and X'96' subvectors are present.
14. Up to a total of three instances of these subvectors may be optionally included by an Alert sender, in order to create a single Alert major vector that can be processed by both a pre-generic Alert and a generic Alert focal point. If either of these subvectors is present, the X'91' subvector must also be present.

## Alert MS Subvectors

### SDLC Link Station Data (X'8C') Alert MS Subvector

This subvector transports SDLC or LAN LLC link station failure information.

- 0 Length (p+1), in binary, of the SDLC Link Station Data subvector  
1 Key: X'8C'  
2-p Subfields containing SDLC link station data (listed by key value below and described in detail following):

- X'01' Current N(S)/N(R) Counts
- X'02' Outstanding Frame Counts
- X'03' Last SDLC Control Field Received
- X'04' Last SDLC Control Field Sent
- X'05' Sequence Number Modulus
- X'06' Link Station State
- X'07' LLC Reply Timer Expiration Count
- X'08' Last Received N(R) Count

### Current N(S)/N(R) Counts (X'01') SDLC Link Station Data Subfield

This subfield transports the current N(S) and N(R) counts for a link station.

- 0 Length (q+1), in binary, of the Current N(S)/N(R) Counts subfield  
1 Key: X'01'  
2 N(S) count, in binary

3(=q) N(R) count, in binary

#### Outstanding Frame Count (X'02') SDLC Link Station Data Subfield

This subfield transports the outstanding frame count.

0 Length (q+1), in binary, of the Outstanding Frame Count subfield  
 1 Key: X'02'  
 2(=q) Outstanding frame count, in binary

#### Last SDLC Control Field Received (X'03') SDLC Link Station Data Subfield

This subfield transports the last SDLC control field received from the secondary station before the error occurred.

0 Length (q+1), in binary, of the Last SDLC Control Field Received subfield  
 1 Key: X'03'  
 2-3(=q) Last SDLC control field received; if the SDLC control is only one byte long then byte 3 value is X'00'.

#### Last SDLC Control Field Sent (X'04') SDLC Link Station Data Subfield

This subfield transports the last SDLC control field sent to the secondary station before the error occurred.

0 Length (q+1), in binary, of the Last SDLC Control Field Sent subfield  
 1 Key: X'04'  
 2-3(=q) Last SDLC control field sent; if the SDLC control is only one byte long then byte 3 value is X'00'.

#### Sequence Number Modulus (X'05') SDLC Link Station Data Subfield

This subfield transports the modulus of the sequence number for the link station.

0 Length (q+1), in binary, of the Sequence Number Modulus subfield  
 1 Key: X'05'  
 2(=q) Modulus, in binary

#### Link Station State (X'06') SDLC Link Station Data Subfield

This subfield indicates busy conditions at the local or remote link station.

0 Length (q+1), in binary, of the Link Station State subfield  
 1 Key: X'06'  
 2(=q) Link station state  
 bit 0, state of the local link station

## MS Major Vectors

- 0 local link station not busy
- 1 local link station busy (RNR sent)
- bit 1, state of the remote link station
  - 0 remote link station not busy
  - 1 remote link station busy (RNR received)
- bits 2-7, reserved

## LLC Reply Timer Expiration Count (X'07') SDLC Link Station Data Subfield

This subfield transports the number of times the LLC Reply Timer (T1) expired.

- 0 Length (q+1), in binary, of the LLC Reply Timer Expiration Count subfield
- 1 Key: X'07'
- 2-3 Count, in binary, of LLC Reply Timer (T1) expirations

## Last Received N(R) Count (X'08') SDLC Link Station Data Subfield

This subfield transports the most recently received N(R) count.

- 0 Length (q+1), in binary, of the Last Received N(R) Count subfield
- 1 Key: X'08'
- 2(=q) N(R) count, in binary

## Basic Alert (X'91') Alert MS Subvector

This subvector transports Alert information, including an index to predefined screens.

- 0 Length (p+1), in binary, of the Basic Alert subvector
- 1 Key: X'91'
- 2 Flags:
  - bit 0, initiation indicator:
    - 0 Alert was not directly initiated by an operator action
    - 1 Alert was initiated by an operator action
  - bits 1-3, reserved
  - bits 4-7, retired
- 3 Alert type:
  - X'01' permanent loss of availability: a loss of availability to the end user that is not recovered from without intervention external to the reporting product
  - X'02' temporary loss of availability: a momentary loss of availability that will probably be noticed by the end user, yet is recovered from without intervention external to the reporting product
  - X'03' performance: a recognized measurement of response time has exceeded a predetermined threshold
  - X'04' operator intervention required: the intervention of an operator is required to restore proper operational capability to the resource
  - X'05'-X'09' retired

- 4
- X'0A' notification: a loss of availability to the end user is impending but has not yet happened
- X'0B'-X'0E' retired
- X'0F' delayed: the sender is reporting a previously detected alertable condition that prevented reporting when detected
- General cause code: indicates the general classification and cause of the exception condition:
- X'01' hardware or microcode (not distinguished): the Alert condition was caused by either a hardware (machine or equipment) failure, or a microcode failure, but the specific cause cannot be determined.
- X'02' software: the Alert condition was caused by a software (programming) failure or malfunction.
- X'03' retired
- X'04'-X'05' reserved
- X'06' media (e.g., tape, disk, diskette, paper): a failure, imperfection, or defect in the media.  
Note: This code is used for cases where a particular area of a tape, disk or diskette cannot be read or written but other areas are operational. It is also used for torn or jammed forms or paper. It is not used for cases where the medium is not present or the wrong medium, e.g., the wrong size forms, are present; these cases are indicated by X'17' (operator intervention required).
- X'07' hardware or software (not distinguished): the Alert condition was caused by either a hardware (machine or equipment) failure, or a software (programming) failure but the specific cause cannot be determined.
- X'08'-X'09' retired
- X'0A' media or hardware (not distinguished): the Alert condition was caused by either a hardware (machine or equipment) failure, or a failure, imperfection, or defect in the media, but the specific cause cannot be determined.
- X'0B' hardware: the Alert condition was caused by a hardware (machine or equipment) failure or malfunction.
- X'0C' microcode: the Alert condition was caused by a microcode failure or malfunction.  
Note: This code is not used for ROS chips that are packaged in field replaceable units (FRUs) or customer replaceable units (CRUs) and are serviced in the same manner as hardware logic is serviced. X'0B' (hardware) is used in those cases.
- X'0D' protocol above link level: the Alert condition was caused by an SNA protocol error.  
Note: This code point reports protocol errors that are caused by incorrect programming, for example, failure to include a BB bit on the first RU when in BETB state on a session that must use BRACKET protocol.
- X'0E' link-level protocol: the Alert condition was caused by a link level protocol error.  
Note: Errors such as send/receive count errors that can be caused by missing a message due to line hits do not fall into this category; they are indicated by X'0B' (hardware).
- X'0F' undetermined: the cause of the Alert condition cannot be determined.
- X'10' external facilities change or restriction: the number called is temporarily unobtainable



## MS Major Vectors

Note: This code point is used by X.21 networks.

X'11' user: the Alert condition was caused by an incorrect action taken by a user.

Note: Unavailability due to a device being varied offline does not fall into this category; it is indicated by X'13' (component offline).

X'12' system generation, customization, or installation consistency problem: the Alert condition was caused by an invalid system definition or customizing parameter, or by a mismatch between a system definition or customizing parameter and the hardware.

Note: This code is used only in those cases that typically are not corrected by the action of the local operator.

X'13' component offline: the Alert condition was caused by a component being offline.

X'14' component busy: the Alert condition was caused by a component being busy.

X'15' external power failure: the Alert condition was caused by an external power failure.

X'16' thermal problem: the Alert condition was caused by temperature that is not within recommended specifications.

X'17' operator intervention required: the Alert condition was caused because action is required by an operator.

Note: Unattended devices will always Alert when operator intervention is required. Attended devices will not Alert until the local operator has time to perform the required action. After the device-allocated time has expired for attended devices, the device has the option of sending an Alert.

X'18' microcode or software (not distinguished): the Alert condition was caused by either a software (programming) failure or malfunction or a microcode failure but the specific cause cannot be determined.

5-6 Specific component code: indicates the generic type of component, subcomponent, or logical resource that can be most closely related to the exception condition. The component indicated may be the generic type of the "target" or it may be a subcomponent of the target. The terms "local" and "remote" used below, refer to the perspective of the Alert originator.

Defined codes are:

X'0001' base processor

X'0002' service processor

X'0003' reserved

X'0004' main storage

X'0005' disk device

X'0006' printer

X'0007' card reader and/or punch

X'0008' tape device

X'0009' keyboard

X'000A' selector pen

X'000B' magnetic stripe reader

X'000C' display/printer

X'000D' display device

X'000E' remote product: used when a product to which the Alert generator is linked (in any form) has caused an Alert condition and the generic product type cannot be determined

X'000F' power supply internal to this product

X'0010' I/O attached controller

X'0011' communication controller scanner  
 X'0012' communication link adapter  
 X'0013' reserved  
 X'0014' channel adapter  
 X'0015' loop adapter  
 X'0016' adapter for directly attaching devices  
 X'0017' reserved  
 X'0018' channel (direct memory access channel)  
 X'0019' link: used only when common-carrier equipment cannot be distinguished from customer equipment  
 X'001A' link: common-carrier equipment  
 X'001B' link: customer equipment  
 X'001C' loop: used only when common-carrier equipment cannot be distinguished from customer equipment  
 X'001D' loop: common-carrier equipment  
 X'001E' loop: customer equipment  
 X'001F' X.21 link connection external to this product  
 X'0020' X.25 network connection external to this product  
 X'0021' local X.21 interface (DTE-DCE)  
 X'0022' local X.25 interface (DTE-DCE)  
 X'0023' local modem  
 X'0024' remote modem  
 X'0025' local modem interface (DTE-DCE)  
 X'0026' remote modem interface (DTE-DCE)  
 X'0027' local modem link monitor  
 X'0028' remote modem link monitor  
 X'0029' local modem link monitor interface  
 X'002A' remote modem link monitor interface  
 X'002B'-X'0031' reserved  
 X'0032' remote modem or modem interface or remote product  
 X'0033' transmission medium or remote modem  
 X'0034' SDLC data link control component  
 X'0035' BSC data link control component  
 X'0036' start/stop data link control component  
 X'0037'-X'0043' reserved  
 X'0044' cluster controller or device  
 X'0045' local link monitor or modem interface  
 X'0046' reserved  
 X'0047' card reader/punch or display/printer  
 X'0048' controller application program  
 X'0049' keyboard or display  
 X'004A' storage control unit  
 X'004B' storage control unit or storage control unit channel  
 X'004C' storage control unit or controller  
 X'004D' control unit (other than storage control unit)  
 X'004E'-X'0051' reserved  
 X'0052' maintenance device  
 X'0053' maintenance device interface  
 X'0054' reserved  
 X'0055' control program  
 X'0056' application subsystem on top of control program  
 X'0057' telecommunication access method  
 X'0058' application program (other than application subsystem)  
 X'0059' communication controller program

## MS Major Vectors

- X'005A'-X'005F' reserved
  - X'0060' X.25 network interface: DCE to first interface node in X.25 network
  - X'0061' disk device with nonremovable media
  - X'0062' disk device with removable media
  - X'0063' control tailed modem
  - X'0064' reserved
  - X'0065' remote tailed modem
  - X'0066' remote tailed modem interface
  - X'0067' sensor I/O unit
  - X'0068' magnetic stripe reader/encoder
  - X'0069' check (bank) reader
  - X'006A' document feed mechanism
  - X'006B' coin feed mechanism
  - X'006C' envelope depository
  - X'006D' timer adapter
  - X'006E' encryption/decryption adapter
  - X'006F' outboard, user programmable processor
  - X'0070' cable connecting local device to local adapter
  - X'0071'-X'007F' reserved
  - X'0080' Token-ring LAN error
  - X'0081' Carrier Sense Multiple Access (CSMA/CD) LAN error
  - X'0082'-X'00FE' reserved
  - X'00FF' undetermined (the problem cannot be isolated to one of the above generic component types)
- 7-8 Alert description code: a code that provides an index to predefined text that explains the condition that caused the Alert  
Note: This field is product dependent.
- 9-10 User Action Code: a code that provides an index to predefined screens that can include predefined text and variable fields for MS User Action Qualifier subvectors  
Note: This field is product dependent.
- 11-12 Detail text reference code: a code that provides an index to predefined screens that can include predefined text and variable fields for MS Detail Qualifier subvectors  
Note: This field is product dependent.
- 13(=p) Retired

## Generic Alert Data (X'92') Alert MS Subvector

This subvector transports Alert information in the form of code points that correspond to strings of text stored at the Alert receiver. It also transports an Alert ID Number that uniquely identifies a particular Alert.

- 0 Length (p+1), in binary, of the Generic Alert Data subvector
- 1 Key: X'92'
- 2-3 Flags:
  - bit 0, initiation indicator:
    - 0 Alert was not directly initiated by an operator action
    - 1 Alert was initiated by an operator action
  - bit 1, held Alert indicator:
    - 0 Alert was sent when the problem was detected

1 Alert condition was detected earlier, but the Alert was not sent at that time because there was no session available to send it on

bit 2, delayed Alert indicator:

0 Sender is not reporting a previously detected Alert condition that prevented reporting when detected

1 Sender is reporting a previously detected Alert condition that prevented reporting when detected

Note: If the delayed Alert indicator is set to 1, the held Alert indicator must also be set to 1.

bits 3-15, reserved

4 Alert Type: A code point indicating the severity of the Alert condition. Defined codes are:

X'01' permanent loss of availability: A loss of availability to the end user that is not recovered from without intervention external to the reporting product

X'02' temporary loss of availability: A momentary loss of availability that will probably be noticed by the end user, yet is recovered from without intervention external to the reporting product

X'03' performance: Performance is below what is considered an acceptable level

X'11' impending problem: A loss of availability to the end user is impending but has not yet happened

X'12' unknown: It is impossible to assess the severity of the Alert condition

5-6 Alert Description Code: A code point that provides an index to predefined text describing the Alert condition. An Alert receiver has two options for selecting text to display. It can display the English text documented with each code point, or its national language equivalent, or, for a presentation to an operator of a lower skill level, it can choose the following simpler text, or its national language equivalent, based only on the first digit of the code point:

X'1xxx'	HARDWARE
X'2xxx'	SOFTWARE
X'3xxx'	COMMUNICATIONS
X'4xxx'	PERFORMANCE
X'5xxx'	CONGESTION
X'6xxx'	MICROCODE
X'7xxx'	OPERATOR
X'8xxx'	SPECIFICATION
X'9xxx'	INTERVENTION REQUIRED
X'Axix'	PROBLEM RESOLVED
X'Bxxx'	NOTIFICATION
X'Cxxx'	SECURITY
X'Fxxx'	UNDETERMINED

Defined codes are:

X'1000' EQUIPMENT MALFUNCTION: An internal machine error has occurred

X'1001' CONTROL UNIT MALFUNCTION

## MS Major Vectors

X'1002' DEVICE ERROR

Note: This code point is used only if the Alert sender is unable to determine the nature of the affected device.

X'1010' ADAPTER ERROR: A hardware error has occurred in an adapter, making it inoperable

X'1100' INPUT DEVICE ERROR

X'1101' MICR READER/SORTER ERROR: An error has been detected in a magnetic ink character recognition reader/sorter

X'1200' OUTPUT DEVICE ERROR

X'1201' PRINTER ERROR

X'1202' PRINTER CASSETTE ERROR

X'1300' INPUT/OUTPUT DEVICE ERROR

X'1301' LOCAL CONSOLE ERROR

X'1302' REMOTE CONSOLE ERROR

Note: "Local" and "remote" are defined with respect to the system with which the console communicates.

X'1311' DISK FAILURE: A disk unit is no longer usable

X'1312' DISK OPERATION ERROR: A disk operation has failed, but the unit may still be usable

X'1321' DISKETTE DEVICE FAILURE: A diskette unit is no longer usable

X'1322' DISKETTE OPERATION ERROR: A diskette operation has failed, but the unit may still be usable

X'1331' TAPE DRIVE FAILURE: A tape drive is no longer usable

X'1332' TAPE OPERATION ERROR: A tape operation has failed, but the tape drive may still be usable

X'1400' LOSS OF ELECTRICAL POWER: A source of electrical power, internal or external, has been lost

X'1401' LOSS OF CHANNEL ADAPTER ELECTRICAL POWER

X'1402' LOSS OF LINE ADAPTER ELECTRICAL POWER

X'1403' LOSS OF LIC UNIT ELECTRICAL POWER

X'1404' LOSS OF MOSS ELECTRICAL POWER

X'1410' LOSS OF EXTERNAL ELECTRICAL POWER

X'1500' LOSS OF EQUIPMENT COOLING OR HEATING: A loss of equipment cooling or heating has occurred

Note: If loss of power has not been ruled out as a cause for the loss of heating or cooling, then X'1400' (LOSS OF ELECTRICAL POWER) should be sent instead of this code point.

X'1501' LOSS OF EQUIPMENT COOLING

X'1502' LOSS OF MOSS EQUIPMENT COOLING

X'1600' SUBSYSTEM FAILURE: A failure in a set of components that jointly provide a specified function; typically a subsystem includes a

controller, one or more interface adapters, physical connection media, and attached devices

X'1601' STORAGE SUBSYSTEM FAILURE: A failure in a subsystem that supports locally-attached storage devices, such as hard disk (DASD), diskette, and tape

X'1602' WORKSTATION SUBSYSTEM FAILURE: A failure in a subsystem that supports workstations directly attached to a node, i.e., workstations not attached via telecommunications links

X'1603' COMMUNICATIONS SUBSYSTEM FAILURE: A failure in a subsystem that supports communication over telecommunications links; these links may be implemented via leased telephone lines, an X.25 network, a token-ring LAN, or otherwise

X'1611' IMPENDING STORAGE SUBSYSTEM FAILURE

X'1612' IMPENDING WORKSTATION SUBSYSTEM FAILURE

X'1613' IMPENDING COMMUNICATIONS SUBSYST FAILURE

X'2000' SOFTWARE PROGRAM ABNORMALLY TERMINATED: A software program has abnormally terminated due to some unrecoverable error condition  
Note: See also code point X'6000' (MICROCODE PROGRAM ABNORMALLY TERMINATED).

X'2100' SOFTWARE PROGRAM ERROR: An error has occurred within a software program that has caused incorrect results, but the program has not terminated  
Note: See also code point X'6100' (MICROCODE PROGRAM ERROR).

X'3000' COMMUNICATION PROTOCOL ERROR: An architected communication protocol has been violated  
Note: This code point is not used if one that identifies the particular protocol involved is available.

X'3100' SNA PROTOCOL ERROR: An SNA protocol has been violated

X'3110' XID PROTOCOL ERROR: A protocol error related to XID exchange has been detected

X'3111' INVALID XID RECEIVED: An XID has been received which contains either a format error or a value unacceptable to the receiver

X'3200' LAN ERROR: An error has been detected on a local area network

X'3203' LOOP ERROR: An error has been detected on a communications loop

X'3204' LOOP OPEN

X'3205' LOOP ADAPTER INOPERATIVE

X'3210' INITIALIZATION FAILURE: A LAN adapter has detected a problem while being initialized

X'3211' OPEN FAILURE: A LAN adapter has detected a problem during the insertion process; the insertion process did not complete

## MS Major Vectors

X'3212' WIRE FAULT: An error condition caused by a break in the wires or a short between the wires (or shield) in a segment of cable has been detected

Note: The term "wire fault" applies only to failures on the lobes of a token-ring LAN.

X'3213' AUTO REMOVAL: A station's adapter has left a LAN ring or bus as part of an automatic-recovery process. For token rings, this process is known as the beacon automatic-recovery process.

X'3214' REMOVE ADAPTER COMMAND RECEIVED: The reporting station received a Remove Adapter command from a LAN manager and, as a result, left the LAN

X'3215' TOKEN RING INOPERATIVE: After the onset of beaconing, a ring attempted and failed auto recovery; the ring has been beaconing for more than 52 seconds, and is still beaconing

X'3216' TOKEN-RING TEMPORARY ERROR: The ring was in a beaconing state for less than 52 seconds and then recovered; the Alert sender has no knowledge whether a station removed to bypass the fault or the fault was temporary

X'3220' CSMA/CD BUS INOPERATIVE: A CSMA/CD bus is inoperative

X'3221' CSMA/CD LAN COMMUNICATIONS LOST: A station is unable to communicate over a CSMA/CD LAN

Note: The problem may be local to the Alert sender, or it may apply to the entire bus to which the Alert sender is attached

X'3230' LAN MANAGEMENT DATA LOST: A LAN management server has become congested or incapacitated so it cannot handle the data being input to it. As a result, management data from LAN stations has been discarded

X'3300' LINK ERROR: An error has occurred on a network communications link

Note: This default code point covers all of the following: Connections between subarea nodes, connections between subarea nodes and peripheral nodes, connections between peripheral nodes, and connections between peripheral nodes and the devices that are hierarchically below them. If the link is implemented by a local area network, one of the X'32xx' code points should be used instead.

X'3301' REMOTE SUPPORT FACILITY LINK ERROR: An error has occurred on a communications link with the IBM Remote Support Facility

X'3302' UNABLE TO COMMUNICATE WITH DEVICE

X'3303' UNABLE TO COMMUNICATE WITH PRINTER

X'3304' UNABLE TO COMMUNICATE WITH DISPLAY

X'3310' X.21 ERROR: An error has been detected on a communication link operating according to the X.21 protocols.

X'3311' X.21 ERROR--SNA SECONDARY: An error has prevented an SNA secondary link station from establishing an X.21 connection

X'3312' X.21 ERROR--SNA PRIMARY: An error has prevented an SNA primary link station from establishing an X.21 connection

X'3313' X.21 CONNECTION CLEARED

- X'3320' X.25 ERROR: An error has been detected on a communication link operating according to the X.25 protocols
- X'3330' MANAGEMENT SERVER REPORTING LINK ERROR: A LAN manager has detected an error on one of its reporting links with a LAN management server
- X'3400' ISDN ERROR: An error has occurred on an Integrated Services Digital Network (ISDN) connection
- X'3401' D-CHANNEL ISDN ERROR
- X'3402' B-CHANNEL ISDN ERROR
- X'3500' LOCAL CONNECTION ERROR: An error has occurred on a local channel connection
- X'4000' PERFORMANCE DEGRADED: Service or response time exceeds what is considered an acceptable level
- X'4001' EXCESSIVE TOKEN-RING ERRORS: Soft errors are occurring on a token ring at an excessive rate  
Note: The token-ring LAN term "soft error" is defined as follows: an intermittent error on a network that causes data to have to be transmitted more than once to be received. The condition identified by this code point is detected by REM; REM also provides a fault domain to indicate the location of most of the soft errors.
- X'4003' EXCESSIVE CONTROL UNIT ERRORS
- X'4010' ERROR TO TRAFFIC RATIO EXCEEDED: A computed ratio of errors to total traffic has exceeded a specified threshold
- X'4021' EXCESSIVE STORAGE SUBSYSTEM ERRORS
- X'4022' EXCESSIVE WORKSTATION SUBSYSTEM ERRORS
- X'4023' EXCESSIVE COMMUNICATIONS SUBSYST ERRORS
- X'5000' CONGESTION: A system or network component has either reached its capacity or is approaching it
- X'5001' NETWORK CONGESTION: There is excessive traffic in the network
- X'5002' RESOURCE NEARING CAPACITY: A resource is approaching its capacity; it is still usable, but it threatens to become unusable unless corrective action is taken
- X'5003' CAPACITY EXCEEDED: A request has been received by a component which, if granted, would require more resources than the component has available to it
- X'5004' OUT OF RESOURCES: A component has no more resources available; it is no longer able to function
- X'5005' WORKSTATION LIMIT EXCEEDED: More workstations than the workstation subsystem supports being powered on have attempted to power on simultaneously
- X'5010' COMMUNICATIONS UNDERRUN: A link station element is unable to write data to an adapter rapidly enough
- X'5011' COMMUNICATIONS OVERRUN: A MAC service user is unable to read data from an adapter rapidly enough



## MS Major Vectors

- X'5012' RECEIVE QUEUE OVERRUN: A receive queue in a node is unable to receive data from a link station in the node rapidly enough
- X'5013' SLOWDOWN: A device has exhausted its supply of available buffers and has stopped accepting inbound data until it can handle all outbound requests
- X'5020' FILE NEEDS REORGANIZATION A file is approaching its capacity, and will soon be unusable unless it is reorganized
- X'6000' MICROCODE PROGRAM ABNORMALLY TERMINATED: A microcode program has abnormally terminated due to some unrecoverable error condition  
Note: See also code point X'2000' (SOFTWARE PROGRAM ABNORMALLY TERMINATED).
- X'6100' MICROCODE PROGRAM ERROR: An error has occurred within a microcode program that has caused incorrect results, but the program was not terminated  
Note: See also code point X'2100' (SOFTWARE PROGRAM ERROR).
- X'7000' OPERATOR PROCEDURAL ERROR: An operator has attempted to initiate an incorrect procedure, or has initiated a procedure incorrectly
- X'7001' RESOURCES NOT ACTIVE: An operator has deactivated, or failed to activate, resources required for a requested operation
- X'8000' CONFIGURATION OR CUSTOMIZATION ERROR: A system or device generation or customization parameter has been specified incorrectly, or is inconsistent with the actual configuration
- X'9000' OPERATOR INTERVENTION REQUIRED: A condition has occurred indicating that operator intervention is required, and an operator has not responded  
Note: The X'90xx' code points are used only for conditions that (1) require on-site intervention, and (2) can be resolved by personnel that do not possess a high level of technical skill.
- X'9001' PRINTER RIBBON JAM
- X'9002' PAPER JAM
- X'9003' BILL/DOCUMENT JAM
- X'9004' COIN JAM
- X'9005' FILM/VIDEOTAPE NOT MOVING
- X'9010' DEVICE NOT READY: A device has indicated that it is not ready for use, due to an unspecified intervention-required condition
- X'9011' PRINTER NOT READY: A printer has indicated that it is not ready for use, due to an unspecified intervention-required condition
- X'9030' OUT OF FOCUS
- X'9031' SERVICE DOOR OPENED  
Note: Security and/or safety considerations may preclude normal operation until the door is closed.

- X'9100' STOCK LOW: The stock of some required material (e.g., paper, ink, coins) is low, but is not yet exhausted
- X'9101' LOW ON INK
  - X'9102' LOW ON PAPER
  - X'9103' LOW ON BILLS/DOCUMENTS
  - X'9104' LOW ON COINS
  - X'9105' LOW ON FILM/VIDEOTAPE
  - X'9106' LOW ON TONER
  - X'9107' LOW ON FUSER OIL
  - X'9108' LOW ON STAPLES
- X'9200' STOCK EXHAUSTED: The stock of some required material (e.g., paper, ink, coins) has been exhausted
- X'9201' OUT OF INK
  - X'9202' OUT OF PAPER
  - X'9203' OUT OF BILLS/DOCUMENTS
  - X'9204' OUT OF COINS
  - X'9205' OUT OF FILM/VIDEOTAPE
  - X'9206' OUT OF TONER
  - X'9207' OUT OF FUSER OIL
  - X'9208' OUT OF STAPLES
- X'9300' DEPOSITORY FULL: A depository has become full, and thus cannot receive any more deposits
- X'9301' DEPOSITORY APPROACHING CAPACITY: A depository is nearing its capacity; if it is not emptied shortly, it will become completely filled
- X'A000' PROBLEM RESOLVED: A problem has been resolved  
Note: The problem may have been reported earlier by an Alert.
- X'A001' IMPENDING COOLING PROBLEM RESOLVED: An impending cooling problem, reported earlier by an Alert, has been resolved without ever having impacted the availability of any resource
- X'B000' OPERATOR NOTIFICATION: Problem-related information is being conveyed to a network operator  
Note: A X'Bxxx' code point is used only if no more specific one is available.
- X'B001' MAINTENANCE PROCEDURE: A resource has been taken offline for maintenance  
Note: This code point is used to notify a network operator about a disruptive maintenance procedure that was invoked locally; otherwise there would be an unexplained loss of a resource.
- X'B002' OPERATOR TOOK PRINTER OFFLINE
  - X'B003' LAN BRIDGE TAKEN OFFLINE
- X'C000' SECURITY EVENT: An event indicative of a possible security exposure has been detected

## MS Major Vectors

X'CO01' INVALID REPORTING LINK PASSWORD  
X'CO02' UNAUTHORIZED LAN INSERTION ATTEMPTED

X'E000'-X'FFFF' Reserved

Note: This range of code points is reserved for use by non-IBM products, customer written applications, etc. No IBM product will send a code point from within this range.

X'FE00' UNDETERMINED ERROR: An error condition has occurred which cannot be related to a more specific error category

X'FE01' RESOURCE UNAVAILABLE: A resource has become unavailable, but the Alert sender has no indication of why this has happened

Note: This code point should be used only if the Alert sender cannot determine, with any degree of certainty, that another Alert Description is applicable to the event being reported.

7-10(=p) Alert ID Number: A four byte hexadecimal value computed as follows:

Stage 1: Assemble (in order) the following input from the Alert major vector:

- Alert Type
- Alert Description Code
- All Probable Causes code points, in order
- The delimiter X'FFFF'
- All User Causes code points, in order, if any are present
- The delimiter X'FFFF'
- All Install Causes code points, in order, if any are present
- The delimiter X'FFFF'
- All Failure Causes code points, in order, if any are present

Stage 2: Apply to this input the 32 bit CRC algorithm

$$\frac{(X^{**32}) * I(X) + (X^{**k}) * L(X)}{G(X)} = Q(X) + \frac{R(X)}{G(X)}$$

where  $I(X)$  = the polynomial represented by the input (with the convention that the first bit of the input represents the coefficient of this polynomial's highest order term),  $L(X)$  = the polynomial  $X^{**31} + X^{**30} + \dots + X + 1$  (i.e., the polynomial represented by 32 1's),  $k$  = the number of bits in the input, and  $G(X)$  = the generator polynomial  $X^{**32} + X^{**26} + X^{**23} + X^{**22} + X^{**16} + X^{**12} + X^{**11} + X^{**10} + X^{**8} + X^{**7} + X^{**5} + X^{**4} + X^{**2} + X^{**1} + 1$ . The Alert ID Number is defined to be the complement of the number representing the remainder polynomial  $R(X)$ .

## Probable Causes (X'93') Alert MS Subvector

This subvector contains one or more code points denoting probable causes of the Alert condition. The probable causes appear in order of decreasing probability.

- 0 Length (p+1), in binary, of the Probable Causes subvector  
 1 Key: (X'93')  
 2-p One or more two-byte probable cause code points, defined below. Each code point provides an index to predefined text denoting the probable cause. An Alert receiver has the option of displaying, for each code point it receives: either the text associated with that code point, or its national language equivalent; or the text associated with the default code point above it, or its national language equivalent.

Defined code points are:

- X'0000' PROCESSOR: The equipment used to interpret and process programmed instructions. These instructions may be programmed in either software or microcode
- X'0001' MOSS: (Maintenance and Operation Subsystem) A service processor for a communication controller
- X'0003' PROCESSOR SWITCH: A component within a hardware product used to switch buses and the resources attached to them among processors
- X'0004' CONTROL PANEL
- X'0005' SYSTEM I/O BUS
- X'0010' LAN MANAGER: A network component responsible for managing a local area network
- X'0011' PRINTER SERVER: A network component that controls the operation of a printer
- Note: In the current implementation, the printer server is a PC that stands between a printer and the host applications that communicate with it.
- X'0100' STORAGE: The random access memory (RAM) or read only memory (ROM) accessible by a processor and by peripheral devices
- X'0101' MAIN STORAGE: Storage from which instructions and other data can be loaded directly into registers for subsequent execution or processing
- X'0102' AUXILIARY STORAGE: Storage that can not be directly addressed by a processor, such as external or secondary storage
- X'0103' NON-VOLATILE STORAGE
- X'0200' POWER SUBSYSTEM: The subsystem within a hardware product that provides electrical power to the different components within the product that require it
- X'0201' INTERNAL POWER UNIT: An element of the power subsystem providing electrical power to a specific component

## MS Major Vectors

- X'0202' INTERNAL POWER CONTROL UNIT: An element of the power subsystem that controls the internal power units
- X'0203' POWER CABLE
- X'0204' POWER CORD
- X'0205' POWER SUBSYSTEM PROCESSOR: A processor within the power subsystem responsible for its operation
- X'0210' BATTERY
- X'0211' MOSS BATTERY
- X'0220' MAIN AC POWER SUPPLY
- X'0300' COOLING OR HEATING SUBSYSTEM: The subsystems within a hardware product responsible for maintaining a temperature at which the product can operate
- X'0301' COOLING FAN
- X'0310' AIR FLOW DETECTOR
- X'0311' THERMAL DETECTOR
- X'0400' SUBSYSTEM CONTROLLER: A unit within a subsystem that interfaces between a processor and the devices in the subsystem  
Note: See Alert Description X'1600', SUBSYSTEM FAILURE, for descriptions of the particular subsystems mentioned here
- X'0401' STORAGE CONTROLLER  
Note: This code point should be contrasted with X'3131', DASD CONTROL UNIT and X'3132', TAPE CONTROL UNIT. A storage controller is typically a component within a larger node that provides for the node's communication with a variety of storage devices; a DASD or tape control unit is typically a separate device providing communication with storage devices.
- X'0402' WORKSTATION CONTROLLER
- X'0403' COMMUNICATIONS SUBSYSTEM CONTROLLER  
Note: This code point should be contrasted with X'3111', COMMUNICATION CONTROLLER. A communication controller is typically a standalone node within a network, for example, a 3725; a communications subsystem controller is typically a component within a larger node that provides for the node's communication with nodes remote from it.
- X'0421' STORAGE CONTROLLER MICROCODE
- X'0422' WORKSTATION CONTROLLER MICROCODE
- X'0423' COMM SUBSYSTEM CONTROLLER MICROCODE
- X'0441' STORAGE CONTROLLER INTERFACE: The interface between a storage controller and the main processor in its node
- X'0442' WORKSTATION CONTROLLER INTERFACE: The interface between a workstation controller and the main processor in its node
- X'0443' COMM SUBSYSTEM CONTROLLER INTERFACE: The interface between a communications subsystem controller and the main processor in its node
- X'0500' SUBSYSTEM: A set of components that jointly provide a specified function; typically a subsystem includes a controller, one or more interface adapters, physical connection media, and attached devices

Note: See Alert Description X'1600', SUBSYSTEM FAILURE, for descriptions of the particular subsystems mentioned here

X'0501' STORAGE SUBSYSTEM  
 X'0502' WORKSTATION SUBSYSTEM  
 X'0503' COMMUNICATIONS SUBSYSTEM

- X'1000' SOFTWARE PROGRAM: A program implemented in software, as distinguished from one implemented in microcode  
Note: For this code point, and for the replacement code points under it, an Alert receiver has two options: It may display the English text (or its national language equivalent) documented with the code points, or it may display the software product common name from the first software Product Identifier (X'111') subvector within the indicated resource Product Set ID.
- X'1001' APPLICATION PROGRAM: A program written for or by a user that applies to the user's work. A program used to connect and communicate with devices in a network, enabling users to perform application-orientated activities
- X'1010' HOST PROGRAM: A program running in a host processor that is a primary or controlling program in a system
- X'1011' PRINTER SERVER PROGRAM: A program running in a printer server that controls a printer  
Note: See also Probable Cause X'0011' (PRINTER SERVER).
- X'1020' CONTROL PROGRAM: A computer program designed to schedule and supervise the execution of programs in a computer system
- X'1021' COMMUNICATION CONTROLLER CONTROL PROGRAM: A software program designed to schedule and supervise the execution of programs in a communication controller
- X'1022' COMMUNICATIONS PROGRAM: A software program designed to provide direct assistance to a node in communicating with other nodes
- X'1023' COMMUNICATIONS PROGRAM IN REMOTE NODE
- X'1030' LAN MANAGER PROGRAM: The software program in a LAN manager
- X'1031' LAN MANAGEMENT SERVER: A data collection and distribution point for a single LAN segment ring or bus. A LAN management server forwards data received from stations on its ring or bus and possibly results from preliminary analysis performed by the server (on that data) to the LAN manager. LAN management servers also send data to stations on their rings or busses.  
Note: The LAN management servers that are currently defined are: Ring Error Monitor (REM), Configuration Report Server (CRS), Ring Parameter Server (RPS), LAN Bridge Server(LBS), and LAN Reporting Mechanism (LRM).
- X'2000' COMMUNICATIONS: The facility used to permit data flow from one location to another

Note: This code point, and the replacement code points under it, should be used only when a more appropriate probable cause cannot be determined.

- X'2001' START/STOP COMMUNICATIONS: Asynchronous transmission in which a group of signals representing a character is preceded by a start element and is followed by a stop element; for example, ASCII
- X'2002' BINARY SYNCHRONOUS COMMUNICATIONS: Synchronous transmission of binary-coded data between stations, using a standard set of control characters and control character sequences
- X'2003' SNA COMMUNICATIONS: Communication according to the Systems Network Architecture formats, protocols, and operational sequences
- X'2004' SDLC COMMUNICATIONS: (Synchronous Data Link Control)--synchronous, code-transparent, serial-by-bit information transfer over a link connection
- X'2005' X.21 NETWORK: A network implementing the X.21 protocols. These protocols define an interface between Data Terminal Equipment (DTE) and Data Circuit-terminating Equipment (DCE) for synchronous operation on circuit switched public data networks
- X'2006' X.25 NETWORK: A packet switching data network implemented according to the recommendation developed by the CCITT which provides a standard interface for the connection of processing equipment
- X'2007' LAN LLC COMMUNICATIONS: (Logical Link Control)--error-free, in sequence information transfer over a LAN
- X'200A' ISDN NETWORK: A network implementing the Integrated Services Digital Network protocols
- X'2021' BANKING LOOP: A network configuration, specifically designed for the finance industry, in which there is a single path between all devices and the path is a closed circuit terminating in a controller
- X'2022' STORE LOOP: A network configuration, specifically designed for the retail industry, in which there is a single path between all devices and the path is a closed circuit terminating in a controller
- X'2031' LINE: The telephone line or transmission link connecting two or more components in the network
- X'2033' LINE/REMOTE MODEM: A line or the modem on it remote from the Alert sender
- X'2034' LINE/REMOTE LDM: A line or the limited distance modem on it remote from the Alert sender
- X'2035' LINE/REMOTE DIGITAL DATA DEVICE: A line or the digital data device (DDD) on it remote from the Alert sender
- X'2036' LINE/REMOTE DCE A line or the Data Circuit-Terminating Equipment (DCE) on it remote from the Alert sender

Note: This code point should be used only if the Alert sender is unable to determine whether the DCE is a modem or a DDD; see code points X'2033' and X'2035'.

- X'2037' DCE-DSE CONNECTION: The telephone line connecting the calling DCE to its local DSE
- X'2040' INTER-EXCHANGE NETWORK: A network providing services between two local exchange areas
- X'2041' PRIVATE NETWORK REACHED: The private network containing the called DTE
- X'2080' HOST COMMUNICATIONS

Note: If the Alert sender is aware of the protocol being used for communication with the host, it uses a code point identifying that protocol.

- X'2100' COMMUNICATIONS/REMOTE NODE: Either a communications facility denoted by a X'20xx' code point or a remote node denoted by a X'22xx' code point

Note: This code point is used only when a more specific probable cause cannot be determined.

- X'2101' START/STOP COMMUNICATIONS/REMOTE NODE
- X'2102' BSC COMMUNICATIONS/REMOTE NODE
- X'2104' SDLC COMMUNICATIONS/REMOTE NODE
- X'2105' X.21 COMMUNICATIONS/CALLED DTE
- X'2106' X.25 COMMUNICATIONS/REMOTE NODE
- X'2107' LAN LLC COMMUNICATIONS/REMOTE NODE
- X'210A' ISDN COMMUNICATIONS/REMOTE NODE
- X'2130' LINE/REMOTE NODE

- X'2200' REMOTE NODE: The node at the remote end of a link connection
- Note: "Remote" is defined from the point of view of the node detecting the Alert condition.

- X'2201' CALLED DTE: On a switched telephone connection, the data terminal equipment (DTE) to which the telephone call to establish the connection was placed

- X'2300' CONNECTION NOT ESTABLISHED: A telephone connection required for the requested operation has not been established

- X'2301' CALLED NUMBER BUSY: The telephone number dialed for a teleprocessing connection was busy
- X'2302' CALLED NUMBER DID NOT ANSWER: The telephone number dialed for a teleprocessing connection did not answer
- X'2303' CALLED NUMBER OUT OF ORDER: The telephone number dialed for a teleprocessing connection is inoperative
- X'2304' INCORRECT NUMBER CALLED: The telephone number dialed for a teleprocessing connection was incorrect
- X'2305' MANUAL DIAL REQUIRED: The operator must establish a manual dial connection to a remote device before normal operation can continue
- X'2306' CHANGED NUMBER: The called DTE has recently been assigned a new number (unique X.21 status provides this information)
- X'2307' INVALID REQUEST: In the course of attempting to set up a telephone connection, the caller has made an invalid request



## MS Major Vectors

- X'2308' ACCESS BARRED: The calling DTE is not allowed to connect to the called DTE
- X'2600' ELECTRICAL INTERFERENCE: An electrical disturbance in a communications system that interferes with or prevents reception of a signal or of information
- X'3000' CHANNEL: The equipment that is used to direct data to and from input/output devices and locally-attached control units  
Note: This code point applies only to the channel itself. If the channel interface cable is intended, code point X'3411' (CHANNEL INTERFACE CABLE) should be used instead.
- X'3100' CONTROLLER: A communications device that controls other devices and the flow of information to and from them  
Note: For this code point, and for the replacement code points under it, an Alert receiver has two options: It may display the English text (or its national language equivalent) documented with the code points, or it may display the machine type, or, if one is present, the hardware product common name, from the first hardware Product Identifier (X'11') subvector within the indicated resource Product Set ID.
- X'3111' COMMUNICATION CONTROLLER: A communication device that controls the transmission of data over lines in a network  
Note: In SNA a communication controller is a type 4 node.
- X'3121' TERMINAL CONTROL UNIT: A communication device that controls the transmission of data to and from terminals  
Note: In SNA a terminal control unit is a type 2.0 or 2.1 node.
- X'3122' FINANCE CONTROLLER: A terminal control unit specifically designed for the banking industry
- X'3123' STORE CONTROLLER: A terminal control unit specifically designed for the retail industry
- X'3131' DASD CONTROL UNIT: A device that controls the transfer of data to and from a Direct Access Storage Device such as disk or drum
- X'3132' TAPE CONTROL UNIT: A device that controls the transfer of data to and from tape drives
- X'3200' COMMUNICATIONS INTERFACE: The equipment connecting a node to the component in a link connection with which it exchanges physical control signals  
Note: This code point covers (1) the receivers and drivers in the node (2) the cable, and (3) the component in the link connection that responds to the physical control signals from the node (e.g., a modem). This code point should be used only when a more specific probable cause cannot be determined.
- X'3220' LOCAL TOKEN-RING ADAPTER INTERFACE: The programming interface for the local token-ring adapter
- X'3221' CSMA/CD ADAPTER INTERFACE: The programming interface for the local CSMA/CD adapter
- X'3222' ISDN ADAPTER INTERFACE: The programming interface for the local ISDN adapter

- X'3223' TOKEN-RING ADAPTER INTERFACE: The programming interface for a token-ring adapter
- X'32D1' LOCAL DCE COMMUNICATIONS INTERFACE: The communications interface between the Alert sender and the local Data Circuit-Terminating Equipment (DCE)
- X'32D2' REMOTE DCE COMMUNICATIONS INTERFACE: The communications interface between the Data Circuit-Terminating Equipment (DCE) remote from the Alert sender and the remote node
- X'32D3' DCE EMULATION INTERFACE: The communications interface between the Alert sender and the DCE emulation cable that attaches it to a device's DCE interface cable
- X'3300' ADAPTER: The part of a device that interfaces between a processor in the device and one or more attached devices  
Note: The processor referred to here could be either the main processor in the node containing the adapter or a processor in, e.g., a communications subsystem controller.
- X'3301' CHANNEL ADAPTER
- X'3302' COMMUNICATIONS ADAPTER
- X'3309' LINE ADAPTER  
Note: A line adapter in a communication controller is often referred to as a scanner.
- X'330F' HPTSS ADAPTER: A high-speed processor transmission subsystem adapter in a communication controller
- X'3310' LOCAL ISDN ADAPTER: An adapter that attaches the Alert sender to an ISDN network  
Note: See also code point X'3532' LOCAL ISDN TERMINAL ADAPTER. A terminal adapter is distinguished from an ISDN adapter by the presence of a defined interface (e.g., RS-232C) between itself and the node that it serves; an ISDN adapter is typically integrated within its node.
- X'3311' REMOTE ISDN ADAPTER: An adapter that attaches to an ISDN network a node with which the Alert sender has a logical connection utilizing the network  
Note: See also code point X'3533' REMOTE ISDN TERMINAL ADAPTER.
- X'3320' LOCAL TOKEN-RING ADAPTER: An adapter that attaches the Alert sender to a token-ring LAN
- X'3322' LOCAL CSMA/CD ADAPTER: An adapter that attaches the Alert sender to a CSMA/CD LAN
- X'3323' REMOTE CSMA/CD ADAPTER: An adapter that attaches a node other than the Alert sender to a CSMA/CD LAN
- X'3325' CSMA/CD ADAPTER
- X'3330' ADAPTER HARDWARE: The hardware comprising an adapter
- X'3331' ADAPTER MICROCODE: The microcode executing in an adapter
- X'3380' ROTARY GROUP: A number of ports on a device that are all reached via the same telephone number; a rotary group is sometimes referred to as MLSA (multiple lines at same address)
- X'3381' X.21 ROTARY GROUP
- X'33C1' LINE ADAPTER HARDWARE
- X'33C2' LINE ADAPTER MICROCODE
- X'33C3' LINE INTERFACE COUPLER (LIC)

## MS Major Vectors

- X'3400' CABLE: A cable or its connectors used to electrically connect devices together
- X'3401' LOCAL DCE INTERFACE CABLE: The cable, or its connectors, between the Alert sender and the local Data Circuit-Terminating Equipment (DCE)
- X'3403' REMOTE DCE INTERFACE CABLE: The cable, or its connectors, between the Alert sender's remote DCE and the device attached to it. (The device could be another DCE, e.g., the local DCE on a second link segment.)
- X'3404' DCE EMULATION CABLE: The cable, or its connectors, between the Alert sender and a DCE interface cable attached to a device
- Note: The end of the DCE emulation cable remote from the Alert sender plugs directly into the DCE interface cable attached to the device.
- X'3411' CHANNEL INTERFACE CABLE: The cable or cables, or their connectors, between a channel and a locally attached device
- X'3426' CSMA/CD LAN CABLES: The cables of a CSMA/CD LAN. These include the cable attaching the Alert sender to the CSMA/CD bus and the bus itself.
- X'3436' LOCAL CSMA/CD ADAPTER CABLE: The cable attaching the Alert sender to the CSMA/CD bus
- X'3441' LOOP CABLE: A cable connecting the nodes attached to a communications loop
- X'3451' DEVICE CABLE: A cable connecting a device directly to a communications controller or a control unit
- Note: This code point also covers any passive distribution assembly that, externally, is indistinguishable from the cable itself.
- X'3452' STORAGE DEVICE CABLE: A cable directly connecting a local storage device to its adapter/controller
- X'3460' INTERNAL CABLE
- X'3461' CABLE TERMINATOR
- X'3500' COMMUNICATION EQUIPMENT: External equipment used to connect devices or other system components
- Note: If the attaching equipment is known to be a modem, then a modem code point (X'36xx') should be sent instead of this code point.
- Note: LAN components are not reported with X'35xx' code points; see the X'3700' code point for a discussion of how they are reported.
- X'3502' TERMINAL MULTIPLEXER: The equipment used to connect multiple devices to a single cable
- X'3503' LINE SWITCH: A device that on demand allows Data Circuit-terminating Equipment (DCE) to be attached to different Data Terminal Equipment (DTE) ports. The device supports both digital switching for the DCE-DTE interface and also the switching of the analog interface between the DCE and the communication facility (line).

X'3504' TIME DIVISION MULTIPLEXER: A device that combines digital data streams from different tributary channels into one data stream on a common channel; a separate periodic time interval is allocated to each tributary channel in the common channel. It also performs the reverse process of demultiplexing the composite data stream from the common channel into its constituent component data streams for the tributary channels

X'3505' STATISTICAL MULTIPLEXER: A device that combines digital data streams from different tributary channels into one data stream for the common channel; it takes advantage of the bursty nature of information on the tributary channels to interleave information from these channels onto the common channel. It also performs the reverse process of demultiplexing the composite data stream into its constituent component data streams

X'3506' LOCAL DIGITAL DATA DEVICE: The digital data device (DDD) connected to the Alert sender

X'3507' REMOTE DIGITAL DATA DEVICE: The digital data device (DDD) remote from the Alert sender

X'3510' CALLED DCE

Note: See also code point X'3542' REMOTE DCE. X'3510' should be used when reporting a problem encountered during an attempt to establish a switched connection. X'3542' should be used when the problem is not related to the establishment of a switched connection.

X'3530' ISDN NETWORK COMPONENT

X'3531' ISDN NETWORK TERMINATION (NT1): A device, normally residing on the user's premises, that provides conversion, for basic-rate ISDN service, between the 4-wire interface seen by the user and the 2-wire interface seen by the ISDN service provider

X'3532' LOCAL ISDN TERMINAL ADAPTER: The terminal adapter local to the Alert sender

Note: See also code point X'3310' LOCAL ISDN ADAPTER. A terminal adapter is distinguished from an ISDN adapter by the presence of a defined interface (e.g., RS-232C) between itself and the node that it serves; an ISDN adapter is typically integrated within its node.

X'3533' REMOTE ISDN TERMINAL ADAPTER: The terminal adapter that attaches to an ISDN network a node with which the Alert sender has a logical connection utilizing the network

Note: See also code point X'3311' REMOTE ISDN ADAPTER.

X'3541' LOCAL DCE: The Data Circuit-Terminating Equipment (DCE) connected to the Alert sender

Note: This code point should be used only if the Alert sender is unable to determine whether the DCE is a modem or a DDD; see code points X'3506' and X'3601'.

X'3542' REMOTE DCE: The Data Circuit-Terminating Equipment (DCE) remote from the Alert sender

Note: This code point should be used only if the Alert sender is unable to determine whether the DCE is a modem or a DDD; see code points X'3507' and X'3603'. See also code point X'3510' CALLED DCE.

- X'3600' MODEM: A device or functional unit that modulates and demodulates signals transmitted over data communication facilities
- X'3601' LOCAL MODEM: On a particular link segment, the modem nearer to the Alert sender
- X'3602' LOCAL LINK DIAGNOSTIC UNIT: A device that connects to both sides of a local modem and provides Link Problem Determination Aid (LPDA) data for digital and analog links with non-intelligent IBM or non-IBM modems
- X'3603' REMOTE MODEM: On a particular link segment, the modem farther from the Alert sender
- X'3604' REMOTE LINK DIAGNOSTIC UNIT: A device that connects to both sides of a remote modem and provides Link Problem Determination Aid (LPDA) data for digital and analog links with non-intelligent IBM or non-IBM modems
- X'3611' LOCAL LDM: The limited distance modem nearer to the Alert sender
- X'3613' REMOTE LDM: The limited distance modem farther from the Alert sender
- X'3621' LOCAL ENHANCED MODEM: The enhanced modem connected to the Alert sender

Note: An enhanced modem is a modem that can provide functions other than modulation/demodulation, such as establishing switched connections and storing dial digits.

- X'3700' LAN COMPONENT: A component of a local area network. On a token-ring LAN, the LAN components include the adapters, bridges, access units, repeaters, repeater/amplifiers, and the LAN cable. On a CSMA/CD LAN, the LAN components include the adapters, bridges, cables, taps, splitters, amplifiers, and translator units.

Note: This default code point is used to indicate that some unspecified LAN component is a probable cause. Individual LAN components are denoted by replacement code points under X'3700', with the exception of the LAN adapters, which fall under ADAPTER (X'3300'), and the CSMA/CD LAN cables, which fall under CABLE (X'3400').

- X'3701' TOKEN-RING LAN COMPONENT
- X'3702' TOKEN-RING LOBE: An adapter, the lobe cables connecting it to its access unit, and a portion of the access unit
- X'3703' TOKEN-RING FAULT DOMAIN: An adapter, its nearest active upstream neighbor, and the ring media between them; the ring media consists of the lobe cables, portions of one or more access units, and possibly a portion of the LAN cable
- X'3704' TOKEN-RING DUPLICATE STATION ADDRESS
- X'3705' TOKEN-RING REMOVE COMMAND RECEIVED: An adapter received a Remove Ring Station MAC frame
- X'3714' REMOTE TOKEN-RING LOBE: A lobe attaching a node other than the Alert sender to the token ring
- X'3721' CSMA/CD LAN COMPONENT
- X'3724' CSMA/CD DUPLICATE STATION ADDRESS

X'3725' CSMA/CD REMOVE COMMAND RECEIVED

X'3740' LAN BRIDGE: A network component that interconnects, at the medium access sublayer (of the DLC layer, two rings, two busses, or a ring and a bus

Note: The busses involved may use either the CSMA/CD protocol or the token bus protocol

X'5000' MEDIA: A tape, disk, diskette, or paper (or other data medium) that is required to read data from or write data on

X'5001' DASD MEDIA: The media used in a Direct Access Storage Device; it may be either removable or non-removable

X'5002' DISKETTE: A thin, flexible magnetic disk in a semi-rigid protective jacket, in which the disk is permanently enclosed; also termed a floppy diskette

X'5003' TAPE: A recording medium in the form of a ribbon that has one or more tracks along its length; magnetic recordings can be made on either one or both sides

X'5004' OPTICAL DISK: A DASD medium on which data is encoded optically

X'6000' DEVICE: An input, output, or input/output device (e.g., a terminal or disk drive)

Note: An Alert sender may be unable to distinguish a directly-attached device from an attached protocol converter or media conversion unit by which devices are attached to it. Thus this code point covers these additional components as well.

X'6100' INPUT DEVICE: A device that is used to enter data into a system

X'6110' KEYBOARD: An arrangement of alphanumeric, special character and function keys laid out in a specified manner and used to enter information into a terminal, and thereby into a system

X'6111' KEYPAD: A specialized keyboard with an arrangement of a limited number of alphanumeric, special character and/or function keys

X'6112' SELECTOR PEN: A light sensitive pen used in display operations

X'6113' MICR READER/SORTER: A magnetic ink character recognition reader/sorter

X'6114' MAGNETIC STRIPE READER: A device that reads data from, and in some cases writes data to, a card containing a magnetic stripe

X'6200' OUTPUT DEVICE: A device that receives data from a system

X'6210' PRINTER: An output device that produces durable and optically viewable output in the form of characters (and optionally graphics) by a means other than by drawing with one or more pens

Note: Contrast with code point X'6213' PLOTTER.

X'6211' COPIER: An output device that produces one or more copies of an original without affecting the original

## MS Major Vectors

X'6212' CAMERA: An output device that combines electronic data with a visual image on a single visual medium

X'6213' PLOTTER: An output device that produces graphic and/or character output by means of one or more pens that draw on the surface of the output medium

Note: Contrast with code point X'6210' PRINTER.

X'6220' PRINTER CASSETTE: A removable container for inputting paper to a printer

X'6300' INPUT/OUTPUT DEVICE: A device whose parts can be performing an input process and output process at the same time, such as a card reader/punch

X'6301' DISPLAY/PRINTER: A device that has either of the characteristics of a display or printer or both. This code point is used only when the Alert sender cannot determine whether the attached device is a display or printer

X'6302' DISPLAY: A workstation that requires a host connection in order to function; typically a display includes both a monitor and a keyboard

X'6310' DASD DEVICE: A device in which the access time is effectively independent of the location of the data. The device may use either removable or non-removable media

X'6311' DISKETTE DEVICE: A direct access storage device that uses a diskette as the storage medium

X'6312' OPTICAL DISK DEVICE: A direct access storage device that uses an optical disk as the storage medium. The disk may be either removable or non-removable

X'6313' TERMINAL: A device in a system or network at which data can either enter or leave. A terminal is usually equipped with a keyboard and a display device, and is capable of sending and receiving information

X'6314' TAPE DRIVE: An input/output device used for moving magnetic tape and controlling its movement

X'6315' CONSOLE: A terminal used for communication between an operator and a processor

X'6400' DEPOSITORY: A device that receives items into a system

X'6401' ENVELOPE DEPOSITORY: A device that receives into a system items sealed in an envelope. The envelope is not opened, nor are its contents examined by the system; the envelope is stored for human action

X'6402' CHECK DEPOSITORY: A device that receives checks into a system, then reads and retains them. It may also transfer information to a check and return the check to a user

X'6403' CARD DEPOSITORY: A device that retains credit, personal banking, or other cards used to access a PBM

X'6500' DISPENSER: A device that dispenses items to a user of a system

- X'6501' DOCUMENT DISPENSER: A device that dispenses documents, primarily bills
- X'6502' TICKET DISPENSER
- X'6503' KEY DISPENSER
- X'6504' COIN DISPENSER
- X'6600' SELF-SERVICE TERMINAL: A device that allows a customer of a business to perform a transaction that would otherwise require assistance by personnel of the business
- X'6601' PERSONAL BANKING MACHINE: A self-service terminal for financial transactions
- X'6630' TELLER ASSIST UNIT: A terminal that assists a financial teller in transactions
- Note: This device does not fit the strict definition of a self-service terminal, since it is used by personnel of a financial institution; it is included in this range because it is very close in function to other self-service terminals.
- X'7000' PERSONNEL: Action on the part of customer, service, or other personnel
- X'7001' LOCAL SYSTEM OPERATOR: A person (or program) collocated with a system and responsible for the operation of all or part of it, or responsible for performing system orientated procedures
- X'7002' REMOTE SYSTEM OPERATOR: A person (or program) not collocated with a system and responsible for the operation of all or part of it, or responsible for performing system orientated procedures
- X'7003' NETWORK OPERATOR: A person (or program) responsible for the operation of all or part of the network, or responsible for performing network orientated procedures
- X'7004' USER: Anyone who requires the services of a computer system, such as an "end user"
- X'7005' SYSTEM PROGRAMMER
- X'7006' CUSTOMER PERSONNEL
- X'7007' SERVICE REPRESENTATIVE
- X'7010' PRINTER OPERATOR
- X'7011' TERMINAL CONTROL UNIT OPERATOR
- X'7012' LAN BRIDGE OPERATOR
- X'7013' LAN MANAGER OPERATOR
- X'E000'-X'FFFF' Reserved
- Note: This range of code points is reserved for use by non-IBM products, customer written applications, etc. No IBM product will send a code point from within this range.
- X'FE00' UNDETERMINED: No probable cause can be determined for this Alert condition
- X'FFFF' Reserved



## MS Major Vectors

### User Causes (X'94') Alert MS Subvector

This subvector transports code points for stored text detailing the probable user causes for the Alert condition and the recommended actions to be taken in connection with these causes. It may also transport additional detailed data, to be inserted into the text indexed by the user cause and/or recommended action code points.

- 0 Length (p+1), in binary, of the User Causes subvector  
1 Key: X'94'  
2-p Two or more subfields containing user cause data, as described below for keys X'00'-X'7F' and in "Network Alert (X'0000') Common Subfields" on page 8-68 for keys X'80'-X'FE'.  
X'01' User Causes  
X'81' Recommended Actions  
X'82' Detailed Data  
X'83' Product Set ID Index  
Note: Subfields X'01' and X'81' are always present. One or more instances of the X'82' and/or X'83' subfields may be present, depending on the code points present in the X'01' and X'81' subfields.

### User Causes (X'01') User Causes Subfield

This subfield contains one or more code points denoting probable user causes of the Alert condition, listed in order of decreasing probability. A user cause is defined to be a condition that an operator can resolve without contacting any service organization.

- 0 Length (q+1), in binary, of the User Causes subfield  
1 Key: X'01'  
2-q Two-byte user cause code points. Each code point provides an index to predefined text, describing the user cause, that is displayed at the focal point. An Alert receiver has the option of displaying, for each code point it receives: either the text associated with that code point, or its national language equivalent; or the text associated with the default code point above it, or its national language equivalent.

The expression "(sf82 qualifier)" in the English text indicates a variable-length gap, to be filled in with data passed in a Detailed Data (X'82') subfield. The necessary X'82' subfield(s) must follow immediately after this subfield in the X'94' subvector, in the order in which they are to be associated with the gap(s) specified in the X'01' subfield.

The expression "(sf83 product text)" in the English text similarly indicates a variable-length gap, to be filled in with product identification data from the Product Identifier X'11' subvector indicated by a Product Set ID Index (X'83') subfield. The necessary X'83' subfield(s) must follow immediately after the X'01' subfield, in the same subvector, in the order in which they are to be associated with the gap(s) specified in the X'01' subfield. The third digit of each user cause code point indicates the number of succeeding X'82' subfields that are

associated with the code point, and whether there is a X'83' subfield associated with it, as follows:

X'xx0x'-X'xx9x':	No X'82' subfields.
X'xxAx'-X'xxBx':	One X'82' subfield.
X'xxCx':	Two X'82' subfields.
X'xxDx':	Three X'82' subfields.
X'xxEx':	One X'83' subfield.
X'xxFx':	Reserved: code points will not be assigned in this range.

Defined user cause codes are:

X'0100' STORAGE CAPACITY EXCEEDED: A request has been received requiring more storage than is currently available

X'0111' THE PORTION OF MAIN STORAGE MADE AVAILABLE BY THE USER FOR A PARTICULAR OPERATION HAS BEEN EXHAUSTED

X'0112' A USER-SPECIFIED THRESHOLD, INDICATING THAT AVAILABLE AUXILIARY STORAGE IS NEARLY FULL, HAS BEEN REACHED

X'0200' POWER OFF: The equipment is powered off and will require operator action to power on and prepare equipment for use

X'0201' LOCAL DCE POWER OFF

X'0202' REMOTE DCE POWER OFF

X'0203' LOCAL DIGITAL DATA DEVICE POWER OFF

X'0204' REMOTE DIGITAL DATA DEVICE POWER OFF

X'0205' LOCAL MODEM POWER OFF

X'0206' REMOTE MODEM POWER OFF

X'0207' LOCAL LINK DIAGNOSTIC UNIT POWER OFF

X'0208' REMOTE LINK DIAGNOSTIC UNIT POWER OFF

X'0209' REMOTE DEVICE POWER OFF

X'020A' LOCAL TERMINAL ADAPTER (TA) POWER OFF

X'020B' REMOTE TERMINAL ADAPTER (TA) POWER OFF

X'020C' LOCAL CONTROLLER POWER OFF

X'020D' REMOTE CONTROLLER POWER OFF

X'020E' PRINTER POWER OFF

X'020F' COMMUNICATION EQUIPMENT POWER OFF

X'0210' CALLING DCE POWER OFF

X'0211' CALLED DCE POWER OFF

X'0212' CALLED DTE POWER OFF

X'0213' MODEM POWER OFF

X'0214' TERMINAL MULTIPLEXER POWER OFF

X'0220' DEVICE POWER OFF

X'0221' CONSOLE POWER OFF

X'0222' LAN MANAGER POWER OFF

X'2200' REMOTE NODE: The node at the remote end of a link connection

## MS Major Vectors

Note: "Remote" is defined from the point of view of the node detecting the Alert condition.

X'2201' CALLED DTE TAKEN OUT OF SERVICE

X'2300' CONNECTION NOT ESTABLISHED: A telephone connection required for the requested operation has not been established

X'2301' CALLED NUMBER BUSY

X'2304' INCORRECT TELEPHONE NUMBER SPECIFIED

X'2308' CALLING DTE DOES NOT SUBSCRIBE TO THIS FACILITY: The calling DTE has requested a service that it does not subscribe to

X'2310' X.21 CONNECTION INTENTIONALLY CLEARED BY TERMINAL CONTROL UNIT OPERATOR

X'23A0' CONNECTION NOT ESTABLISHED: (sf82 qualifier)

Note: The qualifier indicates the telephone number for the connection that could not be established.

X'2400' BUSY: A requested resource was unavailable because it was in use

X'2401' THE MAXIMUM NUMBER OF WORKSTATIONS SUPPORTABLE BY THE LOCAL WORKSTATION CONTROLLER HAS BEEN EXCEEDED

X'2500' LINE NOT ENABLED: A communications line or link has not been prepared for data transmission

X'2501' PORT DEACTIVATED

X'2510' LINE NOT ENABLED AT CALLED DTE

X'2511' PORT DEACTIVATED AT CALLED DTE

X'3300' ADAPTER NOT READY: An adapter has not been made ready for use

X'3380' AN OPERATOR HAS DEACTIVATED ALL PORTS IN A ROTARY GROUP

X'3381' AN OPERATOR HAS DEACTIVATED ALL PORTS IN A ROTARY GROUP USED BY AN X.21 SHORT HOLD MODE SESSION

X'3400' CABLE NOT CONNECTED: A cable is either loose or disconnected

X'3401' CABLING INSTALLED INCORRECTLY

X'3402' KEYBOARD UNPLUGGED

X'3451' DEVICE CABLE NOT CONNECTED

X'34A0' CABLE NOT CONNECTED: (sf82 qualifier)

Note: The qualifier specifies the disconnected cable, by, for example, specifying the number of the port to which it should be attached.

X'34A1' CABLE NOT INSTALLED: (sf82 qualifier)

Note: The qualifier specifies the cable that was not installed.

X'34A2' CABLE UNPLUGGED: (sf82 qualifier)

Note: The qualifier specifies the cable that is unplugged.

- X'5100' MEDIA DEFECTIVE: The medium (tape, disk, diskette, paper, e.g.) is defective and must be replaced or corrected to continue processing
- X'5101' IMPROPER DISKETTE INSERTED: There is a usable diskette in the diskette drive, but it is not the required one
- X'5102' NO DISKETTE OR DEFECTIVE DISKETTE INSERTED: There is no diskette in the diskette drive, or the diskette in the drive is unusable
- X'5110' NON-DUPLEX PAPER IN CASSETTE
- X'5200' MEDIA JAM: The medium (usually paper, forms, or cards) is jammed in the machine and operator action is required to correct the problem
- X'5201' CARD JAM
- X'5202' FORMS JAM
- X'5203' PAPER JAM
- X'5300' MEDIA SUPPLY EXHAUSTED: The medium (usually paper, forms, or cards) supply has been consumed and operator action is required to replenish the supply and continue operation
- X'5301' OUT OF CARDS
- X'5302' OUT OF FORMS
- X'5303' OUT OF PAPER
- X'5313' CASSETTE OUT OF PAPER
- X'5400' OUT OF SUPPLIES: A device is out of supplies required for it to perform its function
- X'5401' END OF RIBBON ENCOUNTERED: A printer has encountered the end of the print ribbon
- X'5402' OUT OF INK
- X'5403' OUT OF TONER
- X'5404' OUT OF FUSER OIL
- X'5405' OUT OF STAPLES
- X'5500' MEDIA SUPPLY LOW: The medium (usually paper, forms, or cards) supply is low and operator action is required to replenish the supply and continue operation
- X'5501' LOW ON CARDS
- X'5502' LOW ON FORMS
- X'5503' LOW ON PAPER
- X'5600' LOW ON SUPPLIES: A device is low on supplies required for it to perform its function
- X'5602' LOW ON INK
- X'5603' LOW ON TONER
- X'5604' LOW ON FUSER OIL
- X'5605' LOW ON STAPLES

## MS Major Vectors

X'6000' DEVICE NOT READY: A device has not been made ready for operation

X'6001' DEVICE OFFLINE: The device requested has been varied offline by the operator and must be varied online for processing to continue

X'6010' DASD DEVICE NOT READY

X'6011' DISKETTE NOT READY

X'6012' TAPE NOT READY

X'6013' PRINTER NOT READY

X'6014' BIN COVER OPEN

X'6015' PRINTER DOOR OPEN

X'6016' OUTPUT HOPPER FULL

X'7000' OPERATOR INTERVENTION REQUIRED: Operator action is required to return the machine to operational status

X'7001' NO CASSETTE IN PRINTER

X'7100' INCORRECT PROCEDURE: An appropriate procedure was not followed

X'7101' TOKEN-RING REMOVE ADAPTER COMMAND RECEIVED

X'7102' PAPER INSTALLED INCORRECTLY

X'7103' LAN MANAGER OPERATOR ENTERED INCORRECT PASSWORD

X'7104' UNAUTHORIZED ACCESS TO LAN MANAGEMENT SERVER ATTEMPTED

X'7105' UNAUTHORIZED USER ATTEMPTED INSERTION INTO LAN

X'7106' ADAPTER ADDRESS NOT ENTERED IN AUTHORIZATION LIST

X'7107' CSMA/CD REMOVE ADAPTER COMMAND RECEIVED

X'7109' LAN BRIDGE OPERATOR TOOK BRIDGE OFF LINE

Note: When this condition occurs, the bridge can no longer forward frames.

X'710A' LAN MANAGER OPERATOR TOOK BRIDGE OFF LINE

Note: When this condition occurs, the bridge can no longer forward frames.

X'710B' USER INCAPACITATED LAN MANAGEMENT SERVER PROGRAM: A user has caused the LAN management server program to become inactive, but its processor is still able to process interrupts

X'7110' LOCAL X.25 PROCEDURE ERROR: An error has occurred at the side of the X.25 network nearer the Alert sender during an attempt by the Alert sender to establish an X.25 connection

X'7111' REMOTE X.25 PROCEDURE ERROR: An error has occurred at the side of the X.25 network remote from the Alert sender during an attempt by the Alert sender to establish an X.25 connection

X'7200' DUMP REQUESTED: A machine readable copy of processor storage has been obtained at the request of an operator, user, or programmed procedure

X'7201' MICROCODE DUMP REQUESTED

X'7202' SOFTWARE DUMP REQUESTED

X'7300' FILE FULL: A requested operation cannot be performed because the file to be used for the operation does not have space available to contain the data

X'73A0' FILE FULL: (sf82 qualifier): A requested operation cannot be performed because the file to be used for the operation does not have space available to contain the data

Note: The qualifier specifies the name, or other unique identifier, of the file that is full.

X'73A1' FILE NEEDS REORGANIZATION: (sf82 qualifier): A file is approaching its capacity, and will soon be unusable unless it is reorganized

Note: The qualifier specifies the name, or other unique identifier, of the file needing reorganization.

X'7400' CONTAMINATION: Dirt or some other contamination is suspected as the cause of the problem. The operator should perform routine cleaning actions required for this equipment

X'7401' DIRTY READ/WRITE HEAD

X'74A1' BLOCKED AIR FILTER (sf82 qualifier)

Note: The qualifier identifies the air filter number.

X'E000'-X'FFFF' Reserved

Note: This range of code points is reserved for use by non-IBM products, customer written applications, etc. No IBM product will send a code point from within this range.

Note: The following code points specify extended messages, that provide additional information on one or more user causes that have already been specified. An Alert receiver that displays only default text provides no display for these code points.

X'F000' (no display): Additional message data

X'F800' (no display): Additional message data

Note: The X'F8xx' range is used for additional messages that are identical for User, Install, and Failure Causes.

X'F8C0' FAILING COMPONENT IS IDENTIFIED BY (sf82 qualifier) (sf82 qualifier)

Note: The qualifiers identify the failing component by means of its logical location, e.g., its port number and device address.

X'F8D0' PROBLEM IS RELATED TO THE CONTROLLER LOCATED AT (sf82 qualifier) (sf82 qualifier) (sf82 quqlifier)

Note: The qualifiers identify the controller location as follows:

Q1 = RACK

Q2 = UNIT (within a rack)

Q3 = CARD SLOT (within a unit)

X'F8E0' FAILING COMPONENT IS IDENTIFIED BY (sf83 product text)

X'FFFF' Reserved

## MS Major Vectors

### Install Causes (X'95') Alert MS Subvector

This subvector transports code points for stored text detailing the probable install causes for the Alert condition and the recommended actions to be taken in connection with these causes. It may also transport additional detailed data, to be inserted into the text indexed by the install cause and/or recommended action code points.

- 0 Length (p+1), in binary, of the Install Causes subvector  
1 Key: X'95'  
2-p Two or more subfields containing install cause data, as described below for keys X'00'-X'7F' and in "Network Alert (X'0000') Common Subfields" on page 8-68 for keys X'80'-X'FE'.  
X'01' Install Causes  
X'81' Recommended Actions  
X'82' Detailed Data  
X'83' Product Set ID Index  
Note: Subfields X'01' and X'81' are always present. One or more instances of the X'82' and/or X'83' subfields may be present, depending on the code points present in the X'01' and X'81' subfields.

### Install Causes (X'01') Install Causes Subfield

This subfield contains one or more code points denoting probable install causes of the Alert condition, listed in order of decreasing probability. An install cause is defined to be a condition that resulted from the initial installation or set-up of some equipment.

- 0 Length (q+1), in binary, of the Install Causes subfield  
1 Key: X'01'  
2-q Two-byte install cause code points. Each code point provides an index to predefined text, describing the install cause, that is displayed at the Alert receiver. An Alert receiver has the option of displaying, for each code point it receives: either the text associated with that code point, or its national language equivalent; or the text associated with the default code point above it, or its national language equivalent.

The expression "(sf82 qualifier)" in the English text indicates a variable-length gap, to be filled in with data passed in a Detailed Data (X'82') subfield. The necessary X'82' subfield(s) must follow immediately after this subfield in the X'95' subvector, in the order in which they are to be associated with the gap(s) specified in the X'01' subfield.

The expression "(sf83 product text)" in the English text similarly indicates a variable-length gap, to be filled in with product identification data from the Product Identifier X'11' subvector indicated by a Product Set ID Index (X'83') subfield. The necessary X'83' subfield(s) must follow immediately after the X'01' subfield, in the same subvector, in the order in which they are to be associated with the gap(s) specified in the X'01' subfield. The third digit of each install cause

code point indicates the number of succeeding X'82' subfields that are associated with the code point, and whether there is a X'83' subfield associated with it, as follows:

X'xx0x'-X'xx9x': No X'82' subfields.  
 X'xxAx'-X'xxBx': One X'82' subfield.  
 X'xxCx': Two X'82' subfields.  
 X'xxDx': Three X'82' subfields.  
 X'xxEx': One X'83' subfield.  
 X'xxFx': Reserved: code points will not be assigned in this range.

Defined install cause codes are:

X'1200' INCORRECT HARDWARE CONFIGURATION: The hardware has been installed incorrectly and the requested function cannot be performed

X'1202' LOCAL MODEM: The modem connected to the Alert sender

X'1203' REMOTE MODEM: The modem remote from the Alert sender

X'1204' LOCAL DIGITAL DATA DEVICE: The digital data device (DDD) connected to the Alert sender

X'1205' REMOTE DIGITAL DATA DEVICE: The digital data device (DDD) remote from the Alert sender

X'1206' LOCAL DCE: The Data Circuite-Terminating Equipment (DCE) connected to the Alert sender

Note: This code point should be used only if the Alert sender is unable to determine whether the DCE is a modem or a DDD; see code points X'1202' and X'1204'.

X'1207' REMOTE DCE: The Data Circuite-Terminating Equipment (DCE) remote from the Alert sender

Note: This code point should be used only if the Alert sender is unable to determine whether the DCE is a modem or a DDD; see code points X'1203' and X'1205'.

X'1300' INCORRECT SOFTWARE GENERATION: A program has been installed incorrectly and the requested function cannot be performed

X'13E1' INCORRECT SOFTWARE GENERATION: (sf83 product text)

X'1400' MISMATCH BETWEEN HARDWARE AND SOFTWARE: A conflict exists between the hardware configuration and software

X'1401' MISMATCH BETWEEN HARDWARE CONFIGURATION AND SOFTWARE GENERATION

X'1402' MISMATCH BETWEEN HARDWARE AND SOFTWARE CONFIGURATIONS: The hardware configuration represented in a software product does not match the actual hardware configuration



## MS Major Vectors

- X'1500' MISMATCH BETWEEN HARDWARE AND MICROCODE: A conflict exists between the hardware configuration and microcode
- X'1501' INCORRECT CUSTOMIZATION PARAMETERS  
X'1502' INCORRECT MICROCODE FIX
- X'1600' MISMATCH BETWEEN SOFTWARE AND MICROCODE: A conflict exists between a software program and a microcode program
- X'1601' INCORRECT CUSTOMIZATION IMAGE: The software customization image is incompatible with the actual microcode configuration
- X'1602' INCORRECT APPLICATION PROGRAM: An application software program is at the wrong level for the actual microcode configuration, or the wrong application software program is attempting to communicate with the microcode
- X'16A1' INCORRECT SOFTWARE LEVEL  
Note: The qualifier specifies a generation parameter.
- X'1700' INCORRECT VALUE SPECIFIED: An incorrect value has been specified for a system operational parameter
- X'1701' INTERVENTION TIMER VALUE TOO SMALL
- X'2600' SYSTEM OR TRANSMISSION MEDIA INSTALLED NEAR ELECTRICAL INTERFERENCE
- X'3400' CABLE INSTALLED INCORRECTLY: A cable has been incorrectly installed
- X'3401' LOCAL DCE INTERFACE CABLE INSTALLED INCORRECTLY  
X'3402' LINE ADAPTER MULTIPLEXER CABLE INSTALLED INCORRECTLY  
X'3403' REMOTE DCE INTERFACE CABLE INSTALLED INCORRECTLY  
X'3404' DCE EMULATION CABLE INSTALLED INCORRECTLY  
X'3451' DEVICE CABLE INSTALLED INCORRECTLY
- X'3500' COMMUNICATION EQUIPMENT INSTALLED INCORRECTLY: Some communication equipment has been installed incorrectly; the Alert sender cannot determine the precise nature of this equipment
- X'3700' LAN CONFIGURATION ERROR: A configuration parameter for a local area network has been specified incorrectly
- X'3704' TOKEN-RING DUPLICATE STATION ADDRESS ASSIGNED  
X'3724' CSMA/CD DUPLICATE STATION ADDRESS ASSIGNED
- X'E000'-X'FFFF' Reserved  
Note: This range of code points is reserved for use by non-IBM products, customer written applications, etc. No IBM product will send a code point from within this range.

Note: The following code points specify extended messages, that provide additional information on one or more install causes that have already

been specified. An Alert receiver that displays only default text provides no display for these code points.

X'F000' (no display): Additional message data

X'F800' (no display): Additional message data

Note: The X'F8xx' range is used for additional messages that are identical for User, Install, and Failure Causes.

X'F8C0' FAILING COMPONENT IS IDENTIFIED BY (sf82 qualifier) (sf82 qualifier)

Note: The qualifiers identify the failing component by means of its logical location, e.g., its port number and device address.

X'F8D0' PROBLEM IS RELATED TO THE CONTROLLER LOCATED AT (sf82 qualifier) (sf82 qualifier) (sf82 quqlifier)

Note: The qualifiers identify the controller location as follows:

Q1 = RACK

Q2 = UNIT (within a rack)

Q3 = CARD SLOT (within a unit)

X'F8E0' FAILING COMPONENT IS IDENTIFIED BY (sf83 product text)

X'FFFF' Reserved

#### Failure Causes (X'96') Alert MS Subvector

This subvector transports code points for stored text detailing the probable failure causes for the Alert condition and the recommended actions to be taken in connection with these causes. It may also transport additional detailed data, to be inserted into the text indexed by the failure cause and/or recommended action code points.

0 Length (p+1), in binary, of the Failure Causes subvector

1 Key: X'96'

2-p Two or more subfields containing failure cause data, as described below for keys X'00'-X'7F' and in "Network Alert (X'0000') Common Subfields" on page 8-68 for keys X'80'-X'FE'.

X'01' Failure Causes

X'81' Recommended Actions

X'82' Detailed Data

X'83' Product Set ID Index

Note: Subfields X'01' and X'81' are always present. One or more instances of the X'82' and/or X'83' subfields may be present, depending on the code points present in the X'01' and X'81' subfields.

## MS Major Vectors

### Failure Causes (X'01') Failure Causes Subfield

This subfield contains one or more code points denoting probable failure causes of the Alert condition, listed in order of decreasing probability. A failure cause is defined to be a condition resulting from the failure of a resource.

- 0 Length (q+1), in binary, of the Failure Causes subfield  
1 Key: X'01'  
2-q Two-byte failure cause code points. Each code point provides an index to predefined text, describing the failure cause, that is displayed at the Alert receiver. An Alert receiver has the option of displaying, for each code point it receives: either the text associated with that code point, or its national language equivalent; or the text associated with the default code point above it, or its national language equivalent.

The expression "(sf82 qualifier)" in the English text indicates a variable-length gap, to be filled in with data passed in a Detailed Data (X'82') subfield. The necessary X'82' subfield(s) must follow immediately after this subfield in the X'96' subvector, in the order in which they are to be associated with the gap(s) specified in the X'01' subfield.

The expression "(sf83 product text)" in the English text similarly indicates a variable-length gap, to be filled in with product identification data from the Product Identifier X'11' subvector indicated by a Product Set ID Index (X'83') subfield. The necessary X'83' subfield(s) must follow immediately after the X'01' subfield, in the same subvector, in the order in which they are to be associated with the gap(s) specified in the X'01' subfield. The third digit of each failure cause code point indicates the number of succeeding X'82' subfields that are associated with the code point, and whether there is a X'83' subfield associated with it, as follows:

- |                  |   |
|------------------|---|
| X'xx0x'-X'xx9x': | No X'82' subfields.                                       |
| X'xxAx'-X'xxBx': | One X'82' subfield.                                       |
| X'xxCx':         | Two X'82' subfields.                                      |
| X'xxDx':         | Three X'82' subfields.                                    |
| X'xxEx':         | One X'83' subfield.                                       |
| X'xxFx':         | Reserved: code points will not be assigned in this range. |

Defined failure cause codes are:

X'0000' PROCESSOR: The equipment used to interpret and process programmed instructions

- X'0001' MOSS HARDWARE: A hardware failure in MOSS (Maintenance and Operation Subsystem), the service processor for a communication controller
- X'0002' MOSS MICROCODE: A microcode failure in MOSS (Maintenance and Operation Subsystem), the service processor for a communication controller
- X'0003' PROCESSOR SWITCH: A component within a hardware product used to switch buses and the resources attached to them among processors
- X'0004' CONTROL PANEL
- X'0005' SYSTEM I/O BUS
- X'0010' LAN MANAGER PROCESSOR
- X'0011' PRINTER SERVER: A network component that controls the operation of a printer
- Note: In the current implementation, the printer server is a PC that stands between a printer and the host applications that communicate with it.
- X'0020' EXCESSIVE LOAD ON PROCESSOR: The processor is not able to keep up with incoming requests for service. Internal buffers may be filled with queued tasks and not able to accept more requests, which may be asynchronous, and thus, discarded.
- X'00E1' (sf83 product text) PROCESSOR
- X'0100' STORAGE: The random access memory (RAM) or read only memory (ROM) accessible by a processor and by peripheral devices
- X'0101' MAIN STORAGE: Storage from which instructions and other data can be loaded directly into registers for subsequent execution or processing
- X'0102' AUXILIARY STORAGE: Storage that can not be directly addressed by a processor, such as external or secondary storage
- X'0110' STORAGE CONTROL: The component that controls access to storage
- X'0111' NUMBER OF LAN MANAGEMENT FRAMES RECEIVED EXCEEDS BUFFER CAPACITY: Management frames from stations on a local LAN ring or bus are arriving faster than the LAN management server can process them
- X'01E1' (sf83 product text) MAIN STORAGE
- X'0200' POWER SUBSYSTEM: The subsystem within a hardware product that provides electrical power to the different components within the product that require it
- X'0201' INTERNAL POWER UNIT: An element of the power subsystem providing electrical power to a specific component
- X'0202' INTERNAL POWER CONTROL UNIT: An element of the power subsystem that controls the internal power units
- X'0203' POWER CABLE
- X'0204' POWER CORD
- X'0205' POWER SUBSYSTEM PROCESSOR: A processor within the power subsystem responsible for its operation
- X'0210' BATTERY

## MS Major Vectors

X'0211' MOSS BATTERY

X'0220' MAIN AC POWER SUPPLY

X'02C0' INTERNAL POWER UNIT FOR (sf82 qualifier) (sf82 qualifier)

Note: The qualifiers identify the adapter numbers of the adapters served by the failing internal power unit.

X'0300' COOLING OR HEATING SUBSYSTEM: The subsystems within a hardware product responsible for maintaining a temperature at which the product can operate

X'0301' COOLING FAN

X'0310' AIR FLOW DETECTOR

X'0311' THERMAL DETECTOR

X'0400' SUBSYSTEM CONTROLLER: A unit within a subsystem that interfaces between a processor and the devices in the subsystem

Note: See Alert Description X'1600', SUBSYSTEM FAILURE, for descriptions of the particular subsystems mentioned here

X'0401' STORAGE CONTROLLER

X'0402' WORKSTATION CONTROLLER

X'0403' COMMUNICATIONS SUBSYSTEM CONTROLLER

Note: This code point should be contrasted with X'3111', COMMUNICATION CONTROLLER. A communication controller is typically a standalone node within a network, for example, a 3725; a communications subsystem controller is typically a component within a larger node that provides for the node's communication with nodes remote from it.

X'0411' INTERMITTENT STORAGE CONTROLLER ERROR

X'0412' INTERMITTENT WORKSTATION CONTROLLER ERROR

X'0413' INTERMITTENT COMMUNICATIONS SUBSYSTEM CONTROLLER ERROR

X'0421' LOADABLE STORAGE CONTROLLER MICROCODE

X'0422' LOADABLE WORKSTATION CONTROLLER MICROCODE

X'0423' LOADABLE COMMUNICATIONS SUBSYSTEM CONTROLLER MICROCODE

X'0441' STORAGE CONTROLLER INTERFACE: The interface between a storage controller and the main processor in its node

X'0442' WORKSTATION CONTROLLER INTERFACE: The interface between a workstation controller and the main processor in its node

X'0443' COMM SUBSYSTEM CONTROLLER INTERFACE: The interface between a communications subsystem controller and the main processor in its node

X'0500' SUBSYSTEM: A set of components that jointly provide a specified function; typically a subsystem includes a controller, one or more interface adapters, physical connection media, and attached devices

Note: See Alert Description X'1600', SUBSYSTEM FAILURE, for descriptions of the particular subsystems mentioned here

X'0501' STORAGE SUBSYSTEM

X'0502' WORKSTATION SUBSYSTEM

X'0503' COMMUNICATIONS SUBSYSTEM

- X'1000' SOFTWARE PROGRAM: A program implemented in software, as distinguished from one implemented in microcode
- X'1010' HOST PROGRAM: A program running in a host processor that is a primary or controlling program in a system
- X'1011' PRINTER SERVER PROGRAM: A program running in a printer server that controls a printer
- Note: See also Failure Cause X'0011', PRINTER SERVER.
- X'1021' COMMUNICATION CONTROLLER CONTROL PROGRAM: A software program that is designed to schedule and supervise the execution of programs in a communication controller
- X'1022' COMMUNICATIONS PROGRAM: A software program designed to provide direct assistance to a node in communicating with other nodes
- X'1023' COMMUNICATIONS PROGRAM IN REMOTE NODE
- X'1024' COMMUNICATIONS ACCESS METHOD: A software program in a host that provides access to a telecommunications network
- X'1030' LAN MANAGER PROGRAM: The software program in a LAN manager
- X'1031' LAN MANAGEMENT SERVER: A data collection and distribution point for a single LAN ring or bus. A LAN management server forwards data received from stations on its LAN ring or bus and possibly results from preliminary analysis performed by the server (on that data) to the LAN manager. LAN management servers also send data to stations on their LAN rings or busses
- Note: The LAN management servers that are currently defined are: Ring Error Monitor (REM), Configuration Report Server (CRS), Ring Parameter Server (RPS), LAN Bridge Server(LBS), and LAN Reporting Mechanism (LRM).
- X'1032' RING ERROR MONITOR: The LAN management server responsible for receiving and processing error reports from the stations on its token ring
- X'10E1' SOFTWARE PROGRAM (sf83 product text)
- X'2000' COMMUNICATIONS ERROR: An error has occurred on a communication facility
- X'2001' START/STOP COMMUNICATIONS ERROR
- X'2002' BINARY SYNCHRONOUS COMMUNICATIONS ERROR
- X'2003' SNA COMMUNICATIONS ERROR
- X'2004' SDLC COMMUNICATIONS ERROR
- X'2005' X.21 NETWORK
- X'2006' X.25 COMMUNICATIONS ERROR
- X'2007' LAN COMMUNICATIONS ERROR
- X'2008' BANKING LOOP ERROR
- X'2009' STORE LOOP ERROR
- X'200A' ISDN COMMUNICATIONS ERROR
- X'2040' INTER-EXCHANGE NETWORK: A network providing services between two local exchange areas
- X'2041' PRIVATE NETWORK REACHED: The private network containing the called DTE
- X'2050' X.21 NETWORK HAS INITIATED A TEST LOOP

## MS Major Vectors

Note: The different test loops defined for X.21 networks are documented in the CCITT X.150 Recommendation.

X'2051' ISDN NETWORK HAS INITIATED A TEST LOOP

X'2052' X.25 NETWORK HAS INITIATED A TEST LOOP

X'20A0' NO RESPONSE FROM THE X.21 NETWORK -- (sf82 qualifier)  
EXPIRED

Note: The qualifier specifies the X.21 timer that has expired.

X'20A1' NO RESPONSE FROM THE ISDN NETWORK -- (sf82 qualifier)  
EXPIRED

Note: The qualifier specifies the ISDN timer that has expired.

X'20A3' SNA COMMUNICATIONS ERROR (sf82 qualifier)

X'20A4' NO RESPONSE FROM THE X.25 NETWORK -- (sf82 qualifier)  
EXPIRED

Note: The qualifier specifies the X.25 timer that has expired.

X'20A5' NO RESPONSE FROM THE X.25 NETWORK -- (sf82 qualifier)  
RETRY COUNT EXPIRED

Note: The qualifier specifies the X.25 timer for which the retry count has expired.

X'20C1' X.25 COMMUNICATIONS ERROR -- THE FOLLOWING INDICATION  
PACKET WAS RECEIVED FROM THE NETWORK (sf82 qualifier)  
(sf82 qualifier)

Note: The first qualifier specifies the packet type (reset, restart, or clear) and the cause code. The second qualifier specifies the diagnostic code. This code point is sent when an error is detected after end-to-end LLC communication has been established. Contrast with code point X'23C1'.

X'20C2' X.25 COMMUNICATIONS ERROR -- THE DTE SENT THE FOLLOWING  
REQUEST PACKET TO THE NETWORK (sf82 qualifier) (sf82  
qualifier)

Note: The first qualifier specifies the packet type (reset, restart, or clear) and the cause code. The second qualifier specifies the diagnostic code. This code point is sent when an error is detected after end-to-end LLC communication has been established. Contrast with code point X'23C2'.

X'2100' COMMUNICATIONS/REMOTE NODE: Either a communications facility denoted by a X'20xx' code point or a remote node denoted by a X'22xx' code point

Note: This code point is used only when a more specific probable cause cannot be determined.

X'2101' START/STOP COMMUNICATIONS/REMOTE NODE

X'2102' BINARY SYNCHRONOUS COMMUNICATIONS/REMOTE NODE

X'2104' SDLC COMMUNICATIONS/REMOTE NODE

X'2107' LAN LLC COMMUNICATIONS/REMOTE NODE

X'210A' ISDN COMMUNICATIONS/REMOTE NODE

X'2200' REMOTE NODE: The node at the remote end of a link connection

Note: "Remote" is defined from the point of view of the node detecting the Alert condition.

X'2201' CALLED DTE

- X'2202' CALLED DTE SIGNALLING CONTROLLED NOT READY: The called DTE has indicated that it is temporarily unable to accept incoming calls for circuit-switched service  
Note: This condition is unique to X.21.
- X'2203' CALLED DTE SIGNALLING UNCONTROLLED NOT READY: The called DTE has indicated that it is unable to enter an operational state for accepting an incoming call  
Note: This condition is unique to X.21.
- X'22A0' REMOTE NODE (sf82 qualifier)
- X'2300' CONNECTION NOT ESTABLISHED: A telephone connection required for the requested operation has not been established
- X'2306' NEW TELEPHONE NUMBER ASSIGNED TO CALLED DTE
- X'2307' CALLED NUMBER OUTSIDE OF NUMBERING PLAN OR UNKNOWN BY THE NETWORK
- X'2308' ACCESS BARRED: The calling DTE is not allowed to connect to the called DTE
- X'2309' SPEED CLASSES INCOMPATIBLE: The called DTE is operating at a different speed from the calling DTE
- X'230A' USER CLASSES OF SERVICE INCOMPATIBLE: The user class of service of the called DTE is incompatible with that of the calling DTE
- X'23C1' X.25 COMMUNICATIONS NOT ESTABLISHED -- THE FOLLOWING INDICATION PACKET WAS RECEIVED FROM THE NETWORK (sf82 qualifier) (sf82 qualifier)  
Note: The first qualifier specifies the packet type (reset, restart, or clear) and the cause code. The second qualifier specifies the diagnostic code. This code point is sent when an error is detected before end-to-end LLC communication has been established. Contrast with code point X'20C1'.
- X'23C2' X.25 COMMUNICATIONS NOT ESTABLISHED -- THE DTE SENT THE FOLLOWING REQUEST PACKET TO THE NETWORK (sf82 qualifier) (sf82 qualifier)  
Note: The first qualifier specifies the packet type (reset, restart, or clear) and the cause code. The second qualifier specifies the diagnostic code. This code point is sent when an error is detected before end-to-end LLC communication has been established. Contrast with code point X'20C2'.
- X'2600' INTERFERENCE: An electric disturbance in a communications system that interferes with or prevents reception of a signal or of information
- X'3000' CHANNEL FAILURE: The equipment that is used to direct data to and from input/output devices and locally attached control units has experienced a failure
- X'3100' CONTROLLER FAILURE: A communications device that controls other devices and the flow of information to and from them has experienced a failure



## MS Major Vectors

- X'3111' COMMUNICATION CONTROLLER: A communication device that controls the transmission of data over lines in a network  
Note: In SNA a communication controller is a type 4 node.
- X'3121' TERMINAL CONTROL UNIT: A communication device that controls the transmission of data to and from terminals
- X'3200' COMMUNICATIONS INTERFACE: The equipment connecting a node to the component in a link connection with which it exchanges physical control signals
- X'3220' LOCAL TOKEN-RING ADAPTER INTERFACE: The programming interface for the local token-ring adapter
- X'3221' CSMA/CD ADAPTER INTERFACE: The programming interface for the local CSMA/CD adapter
- X'32D1' LOCAL DCE COMMUNICATIONS INTERFACE (sf82 qualifier) (sf82 qualifier) (sf82 qualifier): The communications interface between the Alert sender and the local Data Circuit-Terminating Equipment (DCE)  
Note: The qualifiers identify the standards, protocols, etc. that characterize the interface, e.g., RS-232C, 1200 BPS, V.24.
- X'32D2' REMOTE DCE COMMUNICATIONS INTERFACE (sf82 qualifier) (sf82 qualifier) (sf82 qualifier): The communications interface between the Data Circuit-Terminating Equipment (DCE) remote from the Alert sender and the remote node  
Note: The qualifiers identify the standards, protocols, etc. that characterize the interface, e.g., RS-232C, 1200 BPS, V.24.
- X'32D3' REMOTE DCE COMMUNICATIONS INTERFACE (sf82 qualifier) (sf82 qualifier) (sf82 qualifier): The communications interface between the Alert sender and the DCE emulation cable that attaches it to a device's DCE interface cable  
Note: The qualifiers identify the standards, protocols, etc. that characterize the interface, e.g., RS-232C, 1200 BPS, V.24.
- X'3300' ADAPTER: The part of a device that interfaces between a processor in the device and one or more attached devices  
Note: The processor referred to here could be either the main processor in the node containing the adapter or a processor in, e.g., a communications subsystem controller.
- X'3301' CHANNEL ADAPTER
- X'3302' COMMUNICATIONS ADAPTER
- X'3303' DASD ADAPTER
- X'3304' DISPLAY/PRINTER ADAPTER
- X'3305' DIRECT-ATTACHED ADAPTER
- X'3306' DISKETTE ADAPTER
- X'3307' ENCRYPTION/DECRYPTION ADAPTER
- X'3309' LINE ADAPTER
- X'330A' LOOP ADAPTER
- X'330B' PARALLEL INTERFACE ADAPTER
- X'330C' SERIAL INTERFACE ADAPTER
- X'330D' TAPE ADAPTER
- X'330E' CONSOLE ADAPTER
- X'330F' HPTSS ADAPTER: A high-speed processor transmission subsystem adapter in a communication controller

X'3310' LOCAL ISDN ADAPTER: An adapter that attaches the Alert sender to an ISDN network

Note: See also code point X'3532' LOCAL ISDN TERMINAL ADAPTER. A terminal adapter is distinguished from an ISDN adapter by the presence of a defined interface (e.g., RS-232C) between itself and the node that it serves; an ISDN adapter is typically integrated within its node.

X'3311' REMOTE ISDN ADAPTER: An adapter that attaches to an ISDN network a node with which the Alert sender has a logical connection utilizing the network

Note: See also code point X'3533' REMOTE ISDN TERMINAL ADAPTER.

X'3320' LOCAL TOKEN-RING ADAPTER: An adapter that attaches the Alert sender to a token-ring LAN

X'3321' REMOTE TOKEN-RING ADAPTER: An adapter that attaches a node other than the Alert sender to a token-ring LAN

X'3322' LOCAL CSMA/CD ADAPTER: An adapter that attaches the Alert sender to a CSMA/CD LAN

X'3323' REMOTE CSMA/CD ADAPTER: An adapter that attaches a node other than the Alert sender to a CSMA/CD LAN

X'3324' TOKEN-RING ADAPTER: An adapter that attaches a node to a token-ring LAN

X'3325' CSMA/CD ADAPTER: An adapter that attaches a node to a CSMA/CD LAN

X'33A0' LINE ADAPTER MULTIPLEXER (sf82 qualifier): A line adapter (scanner) multiplexer in a communication controller

Note: The qualifier identifies the line address for the failing multiplexer.

X'33C0' LINE ADAPTER (sf82 qualifier) (sf82 qualifier): A line adapter (scanner) in a communication controller

Note: The qualifiers identify the line adapter number and the line address range for the failing adapter.

X'33C1' LINE ADAPTER HARDWARE (sf82 qualifier) (sf82 qualifier): The hardware comprising a line adapter (scanner) in a communication controller

Note: The qualifiers identify the line adapter number and the line address range for the failing adapter.

X'33C2' LINE ADAPTER MICROCODE (sf82 qualifier) (sf82 qualifier): The microcode executing in a line adapter (scanner) in a communication controller

Note: The qualifiers identify the line adapter number and the line address range for the failing adapter.

X'33C3' LINE INTERFACE COUPLER (LIC) (sf82 qualifier) (sf82 qualifier)

Note: The qualifiers identify the line address and the LIC position for the failing LIC.

X'3400' CABLE LOOSE OR DEFECTIVE: A cable or its connectors used to electrically connect devices together is loose or defective

X'3401' LOCAL DCE INTERFACE CABLE: The cable, or its connectors, between the Alert sender and the local Data Circuit-Terminating Equipment (DCE)

X'3403' REMOTE DCE INTERFACE CABLE: The cable, or its connectors, between the Alert sender's remote DCE and the device

- attached to it. (The device could be another DCE, e.g., the local DCE on a second link segment.)
- X'3404' DCE EMULATION CABLE: The cable, or its connectors, between the Alert sender and a DCE interface cable attached to a device
- Note: The end of the DCE emulation cable remote from the Alert sender plugs directly into the DCE interface cable attached to the device.
- X'3411' CHANNEL INTERFACE CABLE: The cable or cables, or their connectors, between a channel and a locally attached device
- X'3426' CSMA/CD LAN CABLES: The cables in a CSMA/CD LAN. These include the cable attaching the alert sender to the CSMA/CD bus and the bus itself
- X'3434' LOCAL LOBE CABLES: The cables between the reporting node and its access unit on a token-ring LAN
- X'3435' REMOTE LOBE CABLES: The cables between a remote node and its access unit on a token-ring LAN
- X'3436' LOCAL CSMA/CD ADAPTER CABLE: The cable attaching the Alert sender to the CSMA/CD bus
- X'3441' LOOP CABLE: A cable connecting the nodes attached to a communications loop
- X'3451' DEVICE CABLE: A cable connecting a device directly to a communications controller or a control unit
- X'3452' STORAGE DEVICE CABLE: A cable directly connecting a local storage device to its adapter/controller
- X'3460' INTERNAL CABLE
- X'3461' LINE ADAPTER MULTIPLEXER CABLE
- X'3480' TWINAXIAL CABLE DISTRIBUTION ASSEMBLY
- X'3500' COMMUNICATION EQUIPMENT: External equipment used to connect devices or other system components
- Note: If the attaching equipment is known to be a modem, then a modem code point (X'36xx') should be sent instead of this code point.
- X'3502' TERMINAL MULTIPLEXER: The equipment used to connect multiple devices to a single cable
- X'3503' LINE SWITCH: A device that on demand allows Data Circuit-terminating Equipment (DCE) to be attached to different Data Terminal Equipment (DTE) ports. The device supports both digital switching for the DCE-DTE interface and also the switching of the analog interface between the DCE and the communication facility (line).
- X'3506' LOCAL DIGITAL DATA DEVICE: On a particular link segment, the digital data device (DDD) nearer to the Alert sender
- X'3507' REMOTE DIGITAL DATA DEVICE: On a particular link segment, the digital data device (DDD) farther from the Alert sender
- X'3510' CALLED DCE
- X'3511' LINE: The telephone line or transmission link connecting two or more components in the network
- X'3512' THE CONNECTION BETWEEN THE CALLING DCE AND ITS LOCAL DSE
- X'3513' LOCAL LOOP ASSOCIATED WITH THE CALLED DTE

- X'3520' X.21 NETWORK COMPONENT
- X'3521' TEMPORARY LACK OF RESOURCES IN THE X.21 NETWORK
- X'3522' LONG-TERM LACK OF RESOURCES IN THE X.21 NETWORK
- X'3530' ISDN NETWORK COMPONENT
- X'3531' ISDN NETWORK TERMINATION (NT1): A device, normally residing on the user's premises, that provides conversion, for basic-rate ISDN service, between the 4-wire interface seen by the user and the 2-wire interface seen by the ISDN service provider
- X'3532' LOCAL ISDN TERMINAL ADAPTER: The terminal adapter local to the Alert sender
- Note: See also code point X'3310' LOCAL ISDN ADAPTER. A terminal adapter is distinguished from an ISDN adapter by the presence of a defined interface (e.g., RS-232C) between itself and the node that it serves; an ISDN adapter is typically integrated within its node.
- X'3533' REMOTE ISDN TERMINAL ADAPTER: The terminal adapter that attaches to an ISDN network a node with which the Alert sender has a logical connection utilizing the network
- Note: See also code point X'3311' REMOTE ISDN ADAPTER.
- X'3534' TEMPORARY LACK OF RESOURCES IN THE ISDN NETWORK
- X'3535' LONG-TERM LACK OF RESOURCES IN THE ISDN NETWORK
- X'3541' LOCAL DCE: On a particular link segment, the Data Circuit-Terminating Equipment (DCE) nearer to the Alert sender
- Note: This code point should be used only if the Alert sender is unable to determine whether the DCE is a modem or a DDD; see code points X'3506' and X'3601'.
- X'3542' REMOTE DCE: On a particular link segment, the Data Circuit-Terminating Equipment (DCE) farther from the Alert sender
- Note: This code point should be used only if the Alert sender is unable to determine whether the DCE is a modem or a DDD; see code points X'3507' and X'3603'.
- X'3550' X.25 NETWORK COMPONENT
- X'3551' SHORT-TERM CONGESTION IN THE X.25 NETWORK
- X'3552' LONG-TERM CONGESTION IN THE X.25 NETWORK
- X'3600' MODEM: A device or functional unit that modulates and demodulates signals transmitted over data communication facilities
- X'3601' LOCAL MODEM: On a particular link segment, the modem nearer to the Alert sender
- X'3602' LOCAL LINK DIAGNOSTIC UNIT: A device that connects to both sides of a local modem and provides Link Problem Determination Aid (LPDA) data for digital and analog links with non-intelligent IBM or non-IBM modems
- X'3603' REMOTE MODEM: On a particular link segment, the modem farther from the Alert sender
- X'3604' REMOTE LINK DIAGNOSTIC UNIT: A device that connects to both sides of a remote modem and provides Link Problem Determination Aid (LPDA) data for digital and analog links with non-intelligent IBM or non-IBM modems

## MS Major Vectors

X'3621' LOCAL ENHANCED MODEM: The enhanced modem connected to the Alert sender

Note: An enhanced modem is a modem that can provide functions other than modulation/demodulation, such as establishing switched connections and storing dial digits.

X'3700' LAN COMPONENT: A component of a local area network. On a token-ring LAN, the LAN components include the adapters, bridges, access units, repeaters, repeater/amplifiers, and the LAN cable. On a CSMA/CD LAN, the LAN components include the adapters, bridges, LAN cables, taps, splitters, amplifiers, and translator units.

Note: This default code point is used to indicate that some unspecified LAN component is a failure cause. Individual LAN components are denoted by replacement code points under X'3700', with the exception of the LAN cable, which falls under CABLE LOOSE OR DEFECTIVE (X'3400'), and the LAN adapters, which fall under ADAPTER (X'3300').

X'3701' TOKEN-RING LAN COMPONENT

X'3703' TOKEN-RING FAULT DOMAIN: An adapter, its nearest active upstream neighbor, and the ring media between them; the ring media consists of the lobe cables, portions of one or more access units, and possibly a portion of the LAN cable

X'3711' LOCAL ACCESS UNIT: The access unit by which the Alert sender is attached to a token-ring LAN

Note: An access unit is an active or passive wiring concentrator on a token-ring LAN.

X'3712' LOCAL TOKEN-RING LOBE: A token-ring lobe attaching the Alert sender to a token ring

X'3713' REMOTE ACCESS UNIT: An access unit by which a node other than the Alert sender is attached to a token-ring LAN

X'3721' CSMA/CD LAN COMPONENT

X'3722' CSMA/CD LAN TRANSLATOR UNIT: A component at the head end of a CSMA/CD bus, which accepts input at one frequency and transmits the same data at a different frequency

X'3741' CONGESTION IN LAN BRIDGE: Frames are arriving at a bridge faster than they can be forwarded by that bridge and, as a result, some frames are discarded

X'5000' MEDIA: A tape, disk, diskette, or paper (or other data medium) that is required to read data from or write data on

X'5001' DASD MEDIA: The media used in a Direct Access Storage Device; it may be either removable or non-removable

X'5002' DISKETTE: A thin, flexible magnetic disk in a semi-rigid protective jacket, in which the disk is permanently enclosed; also termed a floppy diskette

X'5003' TAPE: A recording medium in the form of a ribbon that has one or more tracks along its length; magnetic recordings can be made on either one or both sides

- X'6000' DEVICE: An input, output, or input/output device (e.g., a terminal or disk drive)
- X'6100' INPUT DEVICE: A device that is used to enter data into a system
- X'6110' KEYBOARD: An arrangement of alphanumeric, special character and function keys laid out in a specified manner and used to enter information into a terminal, and thereby into a system
- X'6111' KEYPAD: A specialized keyboard with an arrangement of a limited number of alphanumeric, special character and/or function keys
- X'6112' SELECTOR PEN: A light sensitive pen used in display operations
- X'6113' MICR READER/SORTER: A magnetic ink character recognition reader/sorter
- X'6114' MAGNETIC STRIPE READER (MSR): A device that reads data from a card containing a magnetic stripe
- X'6200' OUTPUT DEVICE: A device that receives data from a system
- X'6210' PRINTER: An output device that produces durable and optically viewable output in the form of characters (and optionally graphics) by a means other than by drawing with one or more pens
- Note: Contrast with code point X'6213' PLOTTER.
- X'6211' COPIER: An output device that produces one or more copies of an original without affecting the original
- X'6212' CAMERA: An output device that combines electronic data with a visual image on a single visual medium
- X'6213' PLOTTER: An output device that produces graphic and/or character output by means of one or more pens that draw on the surface of the output medium
- Note: Contrast with code point X'6210' PRINTER.
- X'6220' PRINTER CASSETTE: A removable container for inputting paper to a printer
- X'6300' INPUT/OUTPUT DEVICE: A device whose parts can be performing an input process and output process at the same time, such as a card reader/punch
- X'6301' DISPLAY/PRINTER: A device that has either of the characteristics of a display or printer or both. This code point is used only when the Alert sender cannot determine whether the attached device is a display or printer
- X'6302' DISPLAY: A workstation that requires a host connection in order to function; typically a display includes both a monitor and a keyboard
- X'6310' DISK DRIVE: The primarily mechanical component of a DASD device, directly involved with transferring data to and from the media

## MS Major Vectors

- X'6311' DISKETTE DRIVE: The primarily mechanical component of a diskette device, directly involved with transferring data to and from the media
- X'6312' OPTICAL DISK DEVICE: A direct access storage device that uses an optical disk as the storage medium. The disk may be either removable or non-removable
- X'6313' TERMINAL: A device in a system or network at which data can either enter or leave. A terminal is usually equipped with a keyboard and a display device, and is capable of sending and receiving information
- X'6314' TAPE DRIVE: The primarily mechanical component of a tape drive, directly involved with transferring data to and from the media
- X'6315' CONSOLE: A terminal used for communication between an operator and a processor
- X'6317' MAGNETIC STRIPE READER/ENCODER: A device that reads data from, and in some cases writes data to, a card containing a magnetic stripe
- X'6330' DISK DRIVE ELECTRONICS: The electronic components of a DASD device
- X'6350' LOCAL CONSOLE
- X'6351' REMOTE CONSOLE
- Note: "Local" and "remote" are defined with respect to the system with which the console communicates.
- X'6400' DEPOSITORY: A device that receives items into a system
- X'6401' ENVELOPE DEPOSITORY: A device that receives into a system items sealed in an envelope. The envelope is not opened, nor are its contents examined by the system; the envelope is stored for human action
- X'6402' CHECK DEPOSITORY: A device that receives checks into a system, then reads and retains them. It may also transfer information to a check and return the check to a user
- X'6403' CARD DEPOSITORY: A device that retains credit, personal banking, or other cards used to access a PBM
- X'6500' DISPENSER: A device that dispenses items to a user of a system
- X'6501' DOCUMENT DISPENSER: A device that dispenses documents, primarily bills
- X'6502' TICKET DISPENSER
- X'6503' KEY DISPENSER
- X'6504' COIN DISPENSER
- X'6600' SELF-SERVICE TERMINAL: A device that allows a customer of a business to perform a transaction that would otherwise require assistance by personnel of the business
- X'6601' PERSONAL BANKING MACHINE: A self-service terminal for financial transactions
- X'6630' TELLER ASSIST UNIT: A terminal that assists a financial teller in transactions

Note: This device does not fit the strict definition of a self-service terminal, since it is used by personnel of a financial institution; it is included in this range because it is very close in function to other self-service terminals.

X'E000'-X'FFFF' Reserved

Note: This range of code points is reserved for use by non-IBM products, customer written applications, etc. No IBM product will send a code point from within this range.

Note: The following code points specify extended messages, that provide additional information on one or more failure causes that have already been specified. An Alert receiver that displays only default text provides no display for these code points.

X'F000' (no display): Additional message data

X'F010' FRAME REJECT RECEIVED: INVALID/UNSUPPORTED COMMAND OR RESPONSE SENT  
 X'F011' FRAME REJECT RECEIVED: I-FIELD SENT WHEN NOT PERMITTED  
 X'F012' FRAME REJECT RECEIVED: INVALID N(R) SENT  
 X'F013' FRAME REJECT RECEIVED: MAXIMUM I-FIELD LENGTH EXCEEDED  
 X'F014' FRAME REJECT RECEIVED: NO REASON SPECIFIED  
 X'F015' SNRM RECEIVED WHILE IN NRM  
 X'F016' SABME RECEIVED WHILE IN ABME  
 X'F017' POLL COUNT EXHAUSTED  
 X'F018' XID POLL COUNT EXHAUSTED  
 X'F019' INACTIVITY TIMER EXPIRED  
 X'F01A' DM RECEIVED  
 X'F01B' RECEIVE WINDOW SIZE EXCEEDED  
 X'F020' INVALID/UNSUPPORTED COMMAND OR RESPONSE RECEIVED  
 X'F021' I-FIELD RECEIVED WHEN NOT PERMITTED  
 X'F022' INVALID N(R) RECEIVED  
 X'F023' RECEIVED I-FIELD EXCEEDED MAXIMUM LENGTH  
 X'F030' CTS DROPPED  
 X'F031' CTS FAILED TO DROP  
 X'F032' DSR FAILED TO DROP  
 X'F033' RTS NOT RAISED BUT CTS IS ACTIVE  
 X'F034' CTS FAILED TO RISE  
 X'F035' DSR DROPPED  
 X'F036' DSR IS PRESENT BEFORE DTR IS RAISED  
 X'F037' DSR NOT PRESENT AFTER DTR IS RAISED  
 X'F038' CARRIER DETECT LOST  
 X'F040' TRANSMISSION UNDERRUN THRESHOLD REACHED  
 X'F041' EXCESSIVE TRANSMIT PROCEDURE TIMEOUTS  
 X'F042' RECEIVE OVERRUN THRESHOLD REACHED  
 X'F043' EXCESSIVE RECEIVE PROCEDURE TIMEOUTS  
 X'F044' RECEIVE QUEUE OVERRUN  
 X'F050' DCE NOT READY  
 X'F051' DCE CLEAR INDICATION DURING CALL ESTABLISHMENT  
 X'F052' PERSISTENT DCE CLEAR INDICATION DURING CALL ESTABLISHMENT (T6 TIMER EXPIRED)  
 X'F053' DCE CONTROLLED NOT READY DURING CALL ESTABLISHMENT



## MS Major Vectors

X'F054' PERSISTENT DCE CONTROLLED NOT READY DURING CALL ESTABLISHMENT (T6 TIMER EXPIRED)  
X'F055' DCE FAULT CONDITION DURING CALL ESTABLISHMENT  
X'F056' DCE CLEAR INDICATION RECEIVED DURING DATA PHASE  
X'F057' PERSISTENT DCE CLEAR INDICATION RECEIVED DURING DATA PHASE (T6 TIMER EXPIRED)  
X'F058' UNRECOGNIZED CALL PROGRESS SIGNAL RECEIVED FROM THE NETWORK  
X'F059' INVALID CALL PROGRESS SIGNAL RECEIVED FROM THE NETWORK  
X'FOA1' ERROR OCCURRED READING FROM FILE (sf82 qualifier)  
X'FOA2' ERROR OCCURRED WRITING TO FILE (sf82 qualifier)  
X'FOA3' FAILURE OCCURRED ON (sf82 qualifier)  
Note: The qualifier identifies the location of the failure being reported. It may identify the processor on which a failure occurred, e.g., the failing communication control unit in a communication controller.  
X'FOA4' XID NEGOTIATION FAILED WITH (sf82 qualifier)  
Note: The qualifier specifies the SNA Sense Data identifying why the negotiation failed.

X'F800' (no display): Additional message data  
Note: The X'F8xx' range is used for additional messages that are identical for User, Install, and Failure Causes.

X'F8C0' FAILING COMPONENT IS IDENTIFIED BY (sf82 qualifier) (sf82 qualifier)

Note: The qualifiers identify the failing component by means of its logical location, e.g., its port number and device address.

X'F8D0' PROBLEM IS RELATED TO THE CONTROLLER LOCATED AT (sf82 qualifier) (sf82 qualifier) (sf82 quqlifier)

Note: The qualifiers identify the controller location as follows:

Q1 = RACK  
Q2 = UNIT (within a rack)  
Q3 = CARD SLOT (within a unit)

X'F8E0' FAILING COMPONENT IS IDENTIFIED BY (sf83 product text)

X'FFFF' Reserved

### Cause Undetermined (X'97') Alert MS Subvector

This subvector transports code points for stored text detailing the recommended actions to be taken when no probable user, install, or failure causes for the Alert condition can be identified. It may also transport additional detailed data, to be inserted into the text indexed by the recommended action code points.

0 Length (p+1), in binary, of the Cause Undetermined subvector  
1 Key: X'97'  
2-p One or more subfields containing recommended action data, as described in "Network Alert (X'0000') Common Subfields" on page 8-68.  
X'81' Recommended Actions

X'82' Detailed Data

X'83' Product Set ID Index

Note: Subfield X'81' is always present. One or more instances of the X'82' and/or X'83' subfields may be present, depending on the code points present in the X'81' subfield.

#### Detailed Data (X'98') Alert MS Subvector

This subvector transports product specific detailed data.

0 Length (p+1), in binary, of the Detailed Data subvector

1 Key: X'98'

2-p One or more subfields containing detailed data, as described below for keys X'00'-X'7F' and in "Network Alert (X'0000') Common Subfields" on page 8-68 for keys X'80'-X'FE'.

X'01' Qualified Message Data

X'82' Detailed Data

Note: Any number of instances of the X'01' and X'82' subfields may be present. Each X'01' subfield contains a number indicating how many subsequent X'82' subfields are associated with it.

#### Qualified Message Data (X'01') Detailed Data Subfield

This subfield contains an index to a complete message stored at an Alert receiver, as well as an indication of how many qualifiers are to be inserted into the message.

0 Length (q+1), in binary, of the Qualified Message Data subfield

1 Key: X'01'

2 Product ID code: The structure of this field is identical to that present in the Product Set ID Index (X'83') subfield.

bits 0-3, Product ID Subvector Code: A code point that specifies (1) the type of Product ID subvector being indexed (hardware or software), and (2) the particular data to be extracted from this subvector.

Note: See "Product Identifier (X'11') MS Common Subvector" on page 8-93 for the criteria distinguishing hardware and software Product ID subvectors.

X'0'-X'1' Reserved

X'2' (Machine type or hardware product common name) from a hardware Product ID Subvector

Note: The hardware product common name is used if it is present; otherwise the machine type is used.

X'5' (Machine type or hardware product common name) plus model number from a hardware Product ID Subvector

Note: The hardware product common name is used if it is present; otherwise the machine type is used.

X'9' Software product common name from a software Product ID subvector

bit 4, Product Set ID Indicator: An indication of which Product Set ID contains the Product ID subvector being indexed

B'0' Alert sender PSID

## MS Major Vectors

B'1' Indicated resource PSID

bits 5-7, Count: A three-digit binary number that indicates which Product ID subvector, of the type specified by the Product ID Subvector Code, is being indexed within the PSID specified by the Product Set ID Indicator.

Note: This count applies only to Product ID Subvectors of the type specified by the Product ID Subvector Code. If, for example, the code is X'2' (specifying a hardware Product ID) then only hardware X'11's are counted: a count of X'3' would thus index the third hardware Product ID within the PSID indicated by the Product Set ID Indicator.

- 3 Data ID: A code point indicating the type of the message to be constructed from the data carried in the subfield. The English text associated with each code point, or its national language equivalent, must be displayed in conjunction with the message. Defined codes are:

X'01' OPERATOR ERROR MESSAGE

X'E0'-X'EF' Reserved

Note: This range of code points is reserved for use by non-IBM products, customer written applications, etc. No IBM product will send a code point from within this range.

- 4 Message Code Encoding: A code point indicating how the accompanying message code is encoded. This data is included because an Alert receiver has the option of displaying the message code itself in addition to the message that it indexes. Defined code are:

X'00' Hexadecimal: The message code is to be displayed as hexadecimal digits

X'11' Character Set A plus '.', '(', ')', '-', and '/': The data is to be decoded using Character Set A (documented in "Appendix A. SNA Character Sets and Symbol-String Types" in Appendix A) plus five additional code points: X'4B' = '.' (period); X'4D' = '(' (left parenthesis); X'5D' = ')' (right parenthesis); X'60' = '-' (minus sign); X'61' = '/' (slash)

- 5 Qualifier Count: A binary number indicating how many qualifiers are associated with this message

Note: The qualifiers are specified in X'82' subfields following this X'01' subfield, and are substituted into the message in the order in which the X'82' subfields are present.

- 6-q Message code, encoded as specified.

Note: This message code is limited to eight bytes.

## Detail Qualifier (EBCDIC) (X'A0') Alert MS Subvector

This subvector supplies variables for the Alert function in EBCDIC form that can be inserted on the Alert Detail screens. This subvector and the Detail Qualifier (hexadecimal) subvector (X'A1') are identical in function and format except that this subvector contains EBCDIC codes. Note: The detail qualifier (X'A0'-X'A1') subvectors are displayed in the order that they appear in the Alert major vector.

- 0 Length (p+1), in binary, of the Detail Qualifier subvector  
 1 Key: X'A0'  
 2-p Detail qualifier: a type-AE symbol-string that qualifies a reference on the Alert Detail screen  
Note: Each qualifier is p-1 bytes in length, but only one qualifier is used per Detail Qualifier subvector. All qualifiers include only codes, numbers, or internationally recognized terms that do not require translation. The coding is not interpreted by the Alert display mechanism.

## Detail Qualifier (Hexadecimal) (X'A1') Alert MS Subvector

This subvector supplies variables for the Alert function in hexadecimal form that can be inserted on the Alert Detail screens. This subvector and the Detail Qualifier (EBCDIC) subvector (X'A0') are identical in function and format except that this subvector contains codes in hexadecimal. Note: The detail qualifier (X'A0'-X'A1') subvectors are displayed in the order that they appear in the Alert major vector.

- 0 Length (p+1), in binary, of the Detail Qualifier subvector  
 1 Key: X'A1'  
 2-p Detail qualifier: a type-G symbol-string

## MS Major Vectors

### Network Alert (X'0000') Common Subfields

The following table shows, by key value, the subfields common to the Network Alert subvectors, and the subvectors in which each can occur.

<u>Key</u>	<u>Subfield</u>	<u>Applicable Network Alert Subvectors</u>
X'81'	Recommended Actions	User Causes subvector, Install Causes subvector, Failure Causes subvector, Cause Undetermined subvector
X'82'	Detailed Data	User Causes subvector, Install Causes subvector, Failure Causes subvector, Cause Undetermined subvector, Detailed Data subvector
X'83'	Product Set ID Index	User Causes subvector, Install Causes subvector, Failure Causes subvector, Cause Undetermined subvector

### Recommended Actions (X'81') Network Alert Common Subfield

This subfield contains code points for stored text describing recommended actions to be taken to rectify an Alert condition.

- 0 Length (q+1), in binary, of the Recommended Actions subfield
- 1 Key: X'81'
- 2-q Two-byte recommended action code points. Each code point provides an index to predefined text, describing the recommended action, that is displayed at the Alert receiver. An Alert receiver has the option of displaying, for each code point it receives: either the text associated with that code point, or its national language equivalent; or the text associated with the default code point above it, or its national language equivalent.

The expression "(sf82 qualifier)" in the English text indicates a variable-length gap, to be filled in with data passed in a Detailed Data (X'82') subfield. The necessary X'82' subfield(s) must follow immediately after this subfield, in the same subvector, in the order in which they are to be associated with the gap(s) specified in the X'81' subfield.

The expression "(sf83 product text)" in the English text similarly indicates a variable-length gap, to be filled in with product identification data from the Product Identifier X'11' subvector indicated by a Product Set ID Index (X'83') subfield. The necessary X'83' subfield(s) must follow immediately after the X'81' subfield, in the same subvector, in the order in which they are to be associated with the gap(s) specified in the X'81' subfield. The third digit of each recommended action code point indicates the number of succeeding X'82' subfields that are associated with the code point, and whether there is a X'83' subfield associated with it, as follows:

X'xx0x'-X'xx9x':	No X'82' subfields.
X'xxAx'-X'xxBx':	One X'82' subfield.
X'xxCx':	Two X'82' subfields.
X'xxDx':	Three X'82' subfields.
X'xxEx':	One X'83' subfield.
X'xxFx':	Reserved: code points will not be assigned in this range.

Defined codes are:

X'0000' PERFORM PROBLEM DETERMINATION PROCEDURES: Refer to the problem determination documentation provided for this condition and follow the specified procedures

X'0001' RUN ON-LINE PROBLEM DETERMINATION

X'0002' INVOKE INTENSIVE MODE RECORDING

X'0003' DETERMINE THE REASON FOR THE LINE SHUTDOWN

X'0004' DETERMINE THE REASON FOR THE LOOP SHUTDOWN

X'0005' PERFORM SNA DATA STREAM PROBLEM DETERMINATION PROCEDURES

X'0006' USE MICROCODE DUMP AND SYSTEM PROCEDURES TO CREATE AN APAR

X'00A0' PERFORM TRANSMISSION LINE PROBLEM DETERMINATION PROCEDURES ON (sf82 qualifier)

Note: The qualifier identifies the failing transmission line.

X'00B0' PERFORM PROBLEM DETERMINATION PROCEDURE FOR (sf82 qualifier)

Note: The qualifier identifies a value, such as a system reference code, that selects a problem determination procedure to be performed.

X'00B1' PERFORM PROBLEM DETERMINATION PROCEDURE AT THE REPORTING LOCATION FOR (sf82 qualifier)

Note: This code point differs from X'00B0' in that it specifies that the indicated problem determination procedure is one that must be performed locally, at the site of the failure.

X'00E1' PERFORM (sf83 product text) PROBLEM DETERMINATION PROCEDURES

X'0100' VERIFY

X'0101' VERIFY X.25 SUBSCRIPTION NUMBER

X'0102' VERIFY ADAPTER ADDRESS DEFINITION

X'0103' VERIFY TELEPHONE NUMBER

X'0104' CHECK FOR CORRECT MICROCODE FIX

X'0105' REQUEST VERIFICATION OF MANAGEMENT SERVER REPORTING LINKS

X'0200' CHECK POWER: Check the electrical power supply for the device

X'0300' CHECK FOR DAMAGE: Check for damage to the specified resource

X'0301' CHECK CABLE AND ITS CONNECTIONS

## MS Major Vectors

- X'0302' CHECK CABLES AND THEIR CONNECTIONS
- X'0306' CHECK TAPE PATH TO READ/WRITE HEAD FOR OBSTRUCTION
  
- X'0400' RUN APPROPRIATE TEST: Refer to the appropriate documentation for this condition and run the tests specified for this problem
  - X'0401' RUN CONSOLE TEST
    - Note: It is the responsibility of a product sending this code point to insure that the Alert receivers to which it sends it have documentation detailing what this test is.
  - X'0402' RUN CONSOLE LINK TEST
    - Note: It is the responsibility of a product sending this code point to insure that the Alert receivers to which it sends it have documentation detailing what this test is.
  - X'0403' RUN MODEM TESTS
    - Note: It is the customer's responsibility to have documentation detailing the test(s) for the particular modems on this connection.
  
- X'0500' RUN APPROPRIATE TRACE: Refer to the appropriate documentation for this condition and run the traces specified for this problem
  
- X'0600' OBTAIN DUMP: Perform the required operations to obtain a storage dump (copy to external storage of the processor main storage). The dump will be required by support personnel or service personnel in order to resolve the problem
  - X'0601' TRANSFER AND PRINT MOSS DUMP
  - X'0602' TRANSFER AND PRINT CONTROL PROGRAM DUMP
  - X'0603' TRANSFER AND PRINT LINE ADAPTER DUMP
  - X'0610' DUMP CONTROL PROGRAM
  - X'0611' DUMP CHANNEL ADAPTER MICROCODE
  - X'0612' DUMP LINE ADAPTER MICROCODE
  - X'0611' DUMP MOSS MICROCODE
  
- X'1000' PERFORM PROBLEM RECOVERY PROCEDURES: Refer to the problem recovery documentation provided for this condition and follow the specified procedures
  - X'1001' REFER TO OPERATOR'S GUIDE FOR CORRECTIVE ACTION
  - X'1002' FOLLOW LOCAL BACKUP PROCEDURE
  - X'1003' PERFORM LOOP PROBLEM RECOVERY PROCEDURES
  - X'1004' PERFORM LAN PROBLEM RECOVERY PROCEDURES
  - X'1005' PERFORM DISK FILE ERROR RECOVERY PROCEDURES
  - X'1006' FOR SINGLE DRIVE FAILURES, MOVE PACK TO ANOTHER DRIVE AND RERUN SAME JOB
  - X'1007' REQUEST RESET OF RING ERROR MONITOR COMPONENT
  - X'1008' REQUEST REINITIALIZATION OF LAN MANAGER
  - X'1009' ATTEMPT TO REOPEN THE ADAPTER AFTER 30 SECONDS
  - X'100A' REORGANIZE THE FILE
  - X'100B' LEAVE THE ADDITIONAL WORKSTATION POWERED OFF
  - X'100C' POWER OFF ANOTHER WORKSTATION ATTACHED TO THIS CONTROLLER
  - X'100D' TRANSFER THE ADDITIONAL WORKSTATION TO ANOTHER CONTROLLER
  - X'100E' LOCATE AND ELIMINATE THE SOURCE OF ELECTRICAL INTERFERENCE

X'1010' REDUCE AMOUNT OF AUXILIARY STORAGE USED  
 X'1011' INCREASE AMOUNT OF AUXILIARY STORAGE AVAILABLE  
 X'1012' INCREASE AMOUNT OF MAIN STORAGE AVAILABLE  
 X'10A1' PERFORM (sf82 qualifier)

Note: The qualifier specifies a problem recovery procedure to be performed.

X'10A2' FOLLOW PROBLEM RECOVERY PROCEDURE INDICATED AT PRINTER FOR (sf82 qualifier)

Note: The qualifier specifies a value that indexes a local problem recovery procedure.

X'10A3' FOLLOW PROBLEM RECOVERY PROCEDURE INDICATED AT PRINTER SERVER FOR (sf82 qualifier)

Note: The qualifier specifies a value that indexes a local problem recovery procedure.

X'1100' VARY OFFLINE

X'1200' RETRY

X'1201' MOVE THE PAGING DATA SETS TO ANOTHER SUBSYSTEM  
 X'1202' MOVE PACK TO ANOTHER DRIVE AND RERUN THE SAME JOB  
 X'1203' RESTART JOB  
 X'1204' ATTEMPT TO REESTABLISH THE CONNECTION  
 X'1205' RERUN THE APPLICATION PROGRAM  
 X'1206' WAIT THEN RETRY  
 X'12C0' RETRY AFTER (sf82 qualifier) (sf82 qualifier)

Note: The two qualifiers indicate a date and time after which the operation should be retried.

X'1300' CORRECT THEN RETRY: The operator should correct the condition referred to and retry the operation

X'1301' READY THE DEVICE THEN RETRY  
 X'1310' VERIFY THAT AIR VENTS ARE NOT COVERED  
 X'1311' CHECK FOR DIRTY FILTER  
 X'1320' CHECK CABLE CONNECTION AND RETRY  
 X'1330' ACTIVATE PORT THEN RETRY  
 X'1331' ENABLE LINE THEN RETRY  
 X'13A0' ACTIVATE ONE OR MORE PORTS IN THE ROTARY GROUP ASSOCIATED WITH (sf82 qualifier)

Note: The qualifier identifies the telephone number associated with the rotary group.

X'13A1' ACTIVATE RESOURCES ATTACHED TO (sf82 qualifier)  
 X'13A2' DEACTIVATE RESOURCES ATTACHED TO (sf82 qualifier)

X'1400' RESTART: Perform the appropriate restart operation on the indicated resource

X'1401' RE-IML MOSS: Reload the MOSS microcode  
 X'1402' RE-IPL THE COMMUNICATION CONTROLLER: Reload the system software program in the communication controller  
 X'1403' RE-IPL THE SECONDARY FINANCE CONTROLLER  
 X'1404' RE-IML THE CONTROL UNIT  
 X'1405' REACTIVATE LAN MANAGEMENT SERVER PROGRAM



## MS Major Vectors

X'1410' RESUME OPERATION ON BACKUP PU: Automatic problem bypass has been successful, and a backup PU is now available; operation should be resumed using this PU

X'1500' CORRECT INSTALLATION PROBLEM: It will be necessary to correct the installation error before continuing operation

X'1501' CORRECT GENERATION PROBLEM  
X'1502' CORRECT CUSTOMIZATION PARAMETERS  
X'1503' CORRECT CONFIGURATION  
X'1504' APPLY CORRECT SOFTWARE LEVEL  
X'1505' LOAD THE REQUIRED OPTIONAL MODULE  
X'1506' INCREASE INTERVENTION TIMER VALUE

X'1600' REPLACE MEDIA

X'1601' FOR REMOVABLE MEDIA, CHANGE MEDIA AND RETRY  
X'1602' PLACE BACKUP DISKETTE IN DRIVE  
X'1603' CHANGE DISKETTE AND RETRY  
X'1604' PUT CORRECT PAPER IN CASSETTE  
X'1605' PUT CASSETTE IN PRINTER  
X'1606' ADD PAPER

X'1700' REPLENISH SUPPLIES

X'1701' REPLACE RIBBON  
X'1702' ADD INK  
X'1703' ADD TONER  
X'1704' CHANGE ALL AIR FILTERS  
X'1705' ADD FUSER OIL  
X'1706' ADD STAPLES

X'1800' REPLACE DEFECTIVE EQUIPMENT

X'1801' REPLACE KEYBOARD  
X'1802' REPLACE MODULE  
X'1803' REPLACE CARD  
X'1804' REPLACE DEVICE  
X'1805' REPLACE BATTERY  
X'1806' REPLACE PRINTER  
X'1807' REPLACE DISPLAY CONTROL MODULE  
X'1808' REPLACE MSR OR MSRE: Replace the magnetic stripe reader or magnetic stripe reader/encoder

X'1811' REPLACE STORAGE CONTROLLER  
X'1812' REPLACE WORKSTATION CONTROLLER  
X'1813' REPLACE COMMUNICATIONS SUBSYSTEM CONTROLLER  
X'18A0' REPLACE THE CARD IDENTIFIED BY (sf82 qualifier)

Note: The qualifier identifies the card to be replaced, e.g., by its part number.

X'18C0' REPLACE THE BATTERY IDENTIFIED BY (sf82 qualifier) (sf82 qualifier)

Note: The two qualifiers identify the battery to be replaced, e.g., by giving its type and location.

- X'1900' PERFORM PROBLEM BYPASS PROCEDURES: Refer to the problem bypass documentation provided for this condition and follow the specified procedures
- X'19A1' PERFORM MANUAL FALLBACK TO (sf82 qualifier)  
Note: The qualifier identifies the communication control unit (CCU) within the communication controller to which the fallback is to be done.
- X'2000' (Review detailed data): Refer to the detailed data presentation for additional messages and information  
Note: There is no text string defined for this code point; the Alert receiver indicates the action to be taken in terms of its own screen design, command structure, etc.
- X'2001' (Report detailed data): Report the information that was transported in the Detailed Data subvector  
Note: There is no text string defined for this code point; the Alert receiver indicates the action to be taken in terms of its own screen design, command structure, etc.  
Note: An Alert receiver has the option of displaying the data from the Detailed Data (X'82') subvector either in conjunction with this text or in another display that can be reached from the display containing this text.
- X'2010' (Review link detailed data): Review the information that was transported in those of the X'5x' subvectors flowing in this Alert  
Note: There is no text string defined for this code point; the Alert receiver indicates the action to be taken in terms of its own screen design, command structure, etc.
- X'2011' (Review hexadecimal display of the Alert record): Review the screens providing a hexadecimal display of the entire Alert record  
Note: There is no text string defined for this code point; the Alert receiver indicates the action to be taken in terms of its own screen design, command structure, etc.
- X'2100' (review recent Alerts for this resource):  
Note: There is no text string defined for this code point; the Alert receiver indicates the action to be taken in terms of its own screen design, command structure, etc.
- X'2101' (review recent statistical records for this resource):  
Note: There is no text string defined for this code point; the Alert receiver indicates the action to be taken in terms of its own screen design, command structure, etc.
- X'2200' REVIEW DATA LOGS: Review the specified records in one or more data logs
- X'2201' REVIEW REMOTE DEVICE LOGS
- X'3000' CONTACT APPROPRIATE SERVICE REPRESENTATIVE: This Alert condition has been caused by a hardware or software failure. The operator

## MS Major Vectors

is directed to contact the person, organization, or vendor responsible to provide service for this product.

X'30E1' CONTACT SERVICE REPRESENTATIVE FOR (sf83 product text)

X'3100' CONTACT ADMINISTRATIVE PERSONNEL: Contact personnel with administrative responsibility for one or more network resources

- X'3101' CONTACT TOKEN-RING ADMINISTRATOR RESPONSIBLE FOR THIS LAN
- X'3102' CONTACT CSMA/CD ADMINISTRATOR RESPONSIBLE FOR THIS LAN
- X'3103' CONTACT LAN ADMINISTRATOR RESPONSIBLE FOR THIS LAN
- X'3104' CONTACT NETWORK INFORMATION SERVICE FOR PRIVATE NETWORK CALLED
- X'3105' CONTACT X.21 NETWORK INFORMATION SERVICE
- X'3106' CONTACT ISDN NETWORK INFORMATION SERVICE
- X'3107' CONTACT X.25 NETWORK INFORMATION SERVICE
- X'3110' CONTACT COMMUNICATIONS SYSTEMS PROGRAMMER
- X'3120' CONTACT PRINTER OPERATOR
- X'3121' CONTACT TERMINAL CONTROL UNIT OPERATOR
- X'3122' CONTACT CALLED DTE'S OPERATOR

X'3200' REPORT THE FOLLOWING

Note: Since replacement code points for reporting one, two, and three (sf82 qualifiers)'s are all required, the X'32xx' code points violate the usual rule of defining only one replacement code point, in the range indicating three qualifiers. Three separate replacement code points are defined, and should be used by Alert senders, depending on the number of qualifiers to be passed.

- X'32A0' REPORT THE FOLLOWING (sf82 qualifier)
- X'32C0' REPORT THE FOLLOWING (sf82 qualifier) (sf82 qualifier)
- X'32D0' REPORT THE FOLLOWING (sf82 qualifier) (sf82 qualifier) (sf82 qualifier)

X'3300' IF PROBLEM REOCCURS THEN DO THE FOLLOWING: After performing the previous actions, try the operation again. If you experience another problem, then perform the following actions

- X'3301' IF PROBLEM PERSISTS THEN DO THE FOLLOWING
- X'3302' IF PROBLEM CONTINUES TO OCCUR REPEATEDLY THEN DO THE FOLLOWING
- X'3303' IF UNSUCCESSFUL THEN DO THE FOLLOWING

X'3400' WAIT FOR ADDITIONAL MESSAGE BEFORE TAKING ACTION: An additional message will be forthcoming, indicating the action to be taken

X'E000'-X'FFFF' Reserved

Note: This range of code points is reserved for use by non-IBM products, customer written applications, etc. No IBM product will send a code point from within this range.

Note: The following code points specify extended messages. An Alert receiver that displays only default text provides no display for these code points.

X'F000' (no display): Additional message data

X'F001' MULTIPLE FAILURES INDICATE CHANNEL FAILURE  
 X'F002' MULTIPLE FAILURES INDICATE CONTROLLER FAILURE  
 X'F003' MULTIPLE DRIVE FAILURES ON SAME CONTROLLER INDICATE  
 CONTROLLER FAILURE  
 X'F004' MULTIPLE FAILURES INDICATE CONTROL UNIT FAILURE  
 X'F005' MULTIPLE FAILURES INDICATE TERMINAL MULTIPLEXER FAILURE  
 X'F006' REOCCURRENCE OF SAME ERROR INDICATES MEDIA FAILURE  
 X'F007' REOCCURRENCE OF PROBLEM INDICATES DEVICE OR ATTACHMENT  
 ERROR  
 X'F008' REOCCURRENCE INDICATES MEDIA PROBLEM  
 X'F009' NON REOCCURRENCE OF FAILURE INDICATES ORIGINAL DRIVE  
 FAILURE  
 X'F00A' MULTIPLE FAILURES INDICATE LINE ADAPTER MULTIPLEXER  
 FAILURE  
 X'F011' NO FURTHER ACTION REQUIRED UNLESS PROBLEM PERSISTS  
 X'F012' THIS ALERT IDENTIFIES THE CAUSE OF A PREVIOUS ERROR WHICH  
 HAS BEEN RECOVERED  
 X'F013' SERVICE CAN BE SCHEDULED AT A LATER TIME UNLESS REPEATED  
 FAILURES PREVENT NORMAL OPERATION  
 X'F014' RESUME OPERATION  
 X'F050' IPL CAPABILITIES LIMITED  
 X'F051' NO IPL CAPABILITIES  
 X'F052' NORMAL OPERATIONS CAN CONTINUE BUT IF AUXILIARY STORAGE IS  
 EXHAUSTED ONSITE ACTION WILL BE NECESSARY  
 X'F060' TO RECOVER LOST RESOURCE  
 X'FOA0' FOR (sf82 qualifier)  
 X'FOD0' FAILING COMPONENT LOCATION (sf82 qualifier) (sf82  
 qualifier) (sf82 qualifier)

Note: The qualifiers identify the failing component location in one of two ways:

Method 1:

Q1 = RACK  
 Q2 = UNIT (within a rack)  
 Q3 = CARD SLOT (within a unit)

Method 2:

Q1 = RACK/UNIT (with no delimiter between the rack and unit numbers)  
 Q2 = CARD SLOT (within a unit)  
 Q3 = CABLE POSITION (on a card)

Method 2 is used only in those cases where cable position on a card is meaningful.

X'FOE1' PREPARE FOR AUTOMATIC SHUTDOWN OF (sf83 product text)  
 X'FFFF' Reserved

## MS Major Vectors

### Detailed Data (X'82') Network Alert Common Subfield

This subfield contains product specific detailed data to be displayed at an Alert receiver.

- 0 Length (q+1), in binary, of the Detailed Data subfield  
Note: Length = X'02' indicates that the Product ID Code, Data ID, Data Encoding, and Detailed Data fields are not present.
- 1 Key: X'82'
- 2 Product ID code: A code indicating what product identification, if any, must be displayed in conjunction with the data type and data. The structure of this field is identical to that present in the Product Set ID Index (X'83') subfield.

A value of X'00' in this byte indicates that no product identification data is displayed in conjunction with the data type and detailed data.

bits 0-3, Product ID Subvector Code: A code point that specifies (1) the type of Product ID subvector being indexed (hardware or software), and (2) the particular data to be extracted from this subvector.

Note: See "Product Identifier (X'11') MS Common Subvector" on page 8-93 for the criteria distinguishing hardware and software Product ID subvectors.

X'0'-X'1' Reserved

X'2' (Machine type or hardware product common name) from a hardware Product ID Subvector

Note: The hardware product common name is used if it is present; otherwise the machine type is used.

X'5' (Machine type or hardware product common name) plus model number from a hardware Product ID Subvector

Note: The hardware product common name is used if it is present; otherwise the machine type is used.

X'9' Software product common name from a software Product ID subvector

bit 4, Product Set ID Indicator: An indication of which Product Set ID contains the Product ID subvector being indexed

B'0' Alert sender PSID

B'1' Indicated resource PSID

bits 5-7, Count: A three-digit binary number that indicates which Product ID subvector, of the type specified by the Product ID Subvector Code, is being indexed within the PSID specified by the Product Set ID Indicator.

Note: This count applies only to Product ID Subvectors of the type specified by the Product ID Subvector Code. If, for example, the code is X'2' (specifying a hardware Product ID) then only hardware X'11's are counted: a count of X'3' would thus index the third hardware Product ID within the PSID indicated by the Product Set ID Indicator.

- 3 Data ID: A code point indicating the type of data carried in the subfield. The English text associated with each code point, or its national language equivalent, must be displayed in conjunction with the detailed data. Defined codes are:

X'00' (no display)  
 X'01' ABEND CODE  
 X'02' ADAPTER CHECK STATUS  
 X'03' ADAPTER RETURN CODE  
 X'04' BOP CODE  
 X'07' ERROR CODE  
 X'09' EVENT CODE  
 X'0A' LLC ERROR CODE: A logical link control error code  
 X'0B' MACHINE CHECK CODE  
 X'0C' MALFUNCTION CODE  
 X'0D' PROGRAM CHECK CODE  
 X'0E' REASON CODE  
 X'0F' RETURN CODE  
 X'10' SENSE CODE  
 X'11' SENSE DATA  
 X'12' SOFTWARE ERROR CODE  
 X'13' STATUS CODE  
 X'14' SYMPTOM CODE  
 X'15' SNA SENSE DATA  
 X'16' BUS STATUS CODE  
 X'17' RING STATUS CODE  
 X'18' CALL PROGRESS SIGNAL: An notification from an X.21 network to a DTE, indicating why a connection could not be established  
 X'1A' X.25 CLEAR PACKET, CAUSE CODE: A code to or from an X.25 network indicating the reason that a CLEAR request or indication packet was sent  
     Note: This indicates the reason that a network connection was lost or could not be established.  
 X'1B' X.25 RESET PACKET, CAUSE CODE: A code to or from an X.25 network indicating the reason that a RESET request or indication packet was sent  
     Note: This indicates the reason that a network connection was lost or could not be established.  
 X'1C' X.25 RESTART PACKET, CAUSE CODE: A code to or from an X.25 network indicating the reason that a RESTART request or indication packet was sent  
     Note: This indicates the reason that a network connection was lost or could not be established.  
 X'1D' X.25 DIAGNOSTIC CODE: A code to or from an X.25 network providing additional information about why a CLEAR, RESET, or RESTART request or indication packet was sent.  
 X'20' MESSAGE CODE  
 X'21' PANEL ERROR MESSAGE CODE  
 X'22' SYSTEM MESSAGE CODE  
 X'23' MESSAGE SEVERITY  
 X'30' REFERENCE CODE  
 X'31' SYSTEM REFERENCE CODE  
 X'32' REPLACEABLE UNIT CODE  
 X'33' COMPONENT ID  
 X'34' COMMUNICATION CONTROL UNIT  
 X'35' TYPE  
 X'36' LOCATION  
 X'37' PART NUMBER  
 X'3A' RACK/UNIT

## MS Major Vectors

X'3B' RACK  
X'3C' UNIT  
X'3D' CARD SLOT  
X'3E' CABLE POSITION  
X'40' ERROR RECOVERY PROCEDURE  
X'41' PDP CODE  
X'50' CHANNEL UNIT ADDRESS  
X'51' DEVICE ADDRESS  
X'52' LINE ADDRESS  
X'53' LINE ADDRESS RANGE  
X'54' ADAPTER AT ADDRESS  
X'60' PORT NUMBER  
X'61' ADAPTER NUMBER  
X'62' CHANNEL ADAPTER NUMBER  
X'63' LINE ADAPTER NUMBER  
X'64' LINE INTERFACE COUPLER (LIC) POSITION  
X'65' BUS NUMBER  
X'70' GENERATION PARAMETER  
X'80' NODE  
X'81' LINK STATION  
X'82' CP  
X'83' PU  
X'84' LU  
X'85' TRANSACTION PROGRAM  
X'90' YEAR/MONTH/DAY  
X'91' TIME  
X'A0' BYTE OFFSET  
X'A1' BIT OFFSET  
X'A2' DETECTING MODULE  
X'A3' FAILING MODULE  
X'A4' MAINTENANCE LEVEL  
X'A5' COMMAND  
X'A6' PROGRAM  
X'B0' EIA STANDARD  
X'B1' CCITT STANDARD  
X'B8' LINE SPEED (BITS PER SECOND)  
X'B9' LINE SPEED (KILOBITS PER SECOND)  
X'BA' LINE SPEED (MEGABITS PER SECOND)  
X'D0' FILE NAME  
X'D1' LOG RECORD NUMBER  
X'D2' CARTRIDGE: A component that holds items to be dispensed  
X'D3' AIR FILTER NUMBER  
X'D4' TELEPHONE NUMBER  
X'D5' CALLING TELEPHONE NUMBER  
X'D6' TELEPHONE NUMBER CALLED  
X'D7' REPORTING TELEPHONE NUMBER: The telephone number of the Alert sender  
X'D8' TIMER  
X'E0'-X'EF' Reserved  
    Note: This range of code points is reserved for use by non-IBM products, customer written applications, etc. No IBM product will send a code point from within this range.  
X'F0' PRODUCT ALERT REFERENCE CODE: A code that identifies an Alert in a user-friendly way. The product Alert reference code is used to

index documentation provided by the Alert sending product. This documentation can group the Alerts into natural categories and provide extended explanations or diagnostic information.

- 4 Data Encoding: A code point indicating how the accompanying detailed data is encoded, and, thus, how it is to be displayed. Defined code are:
- X'00' Hexadecimal: The data is to be displayed as hexadecimal digits.
  - X'01' Binary: The data is the binary representation of an unsigned integer value (8, 16, 24, or 32 bits in length). The decimal equivalent is to be displayed. For example, the value B'11111111' (X'FF') is to be displayed as 255.
  - X'11' Character Set A plus '.', '(', ')', '-', and '/': The data is to be decoded using Character Set A (documented in "Appendix A. SNA Character Sets and Symbol-String Types" in Appendix A ) plus five additional code points: X'4B' = '.' (period); X'4D' = '(' (left parenthesis); X'5D' = ')' (right parenthesis); X'60' = '-' (minus sign); X'61' = '/' (slash)
- Note: Detailed data encoded in this way is limited to codes, numbers, or internationally recognized terms that do not require translation.
- 5-q Detailed data, encoded as specified.
- Note: Maximum length of the detailed data is 44 bytes.

#### Product Set ID Index (X'83') Network Alert Common Subfield

This subfield contains a code point and a count that jointly specify a particular Product ID (X'11') subvector within a particular Product Set ID (X'10') subvector in the Alert major vector.

- 0 Length (q+1), in binary, of the Product Set ID Index subfield
- 1 Key: X'83'
- 2(=q) Product ID code
- bits 0-3, Product ID Subvector Code: A code point that specifies (1) the type of Product ID subvector being indexed (hardware or software), and (2) the particular data to be extracted from this subvector.
- Note: See "Product Identifier (X'11') MS Common Subvector" on page 8-93 for the criteria distinguishing hardware and software Product ID subvectors.
- X'0'-X'1' Reserved
- X'2' (Machine type or hardware product common name) from a hardware Product ID Subvector
- Note: The hardware product common name is used if it is present; otherwise the machine type is used.
- X'3' Serial number or repair ID number, whichever is present, from a hardware Product ID subvector
- X'4' (Machine type or hardware product common name) plus serial number or repair ID number, whichever is present, from a hardware Product ID subvector
- Note: The hardware product common name is used if it is present; otherwise the machine type is used.
- X'5' (Machine type or hardware product common name) plus model number from a hardware Product ID Subvector



## MS Major Vectors

Note: The hardware product common name is used if it is present; otherwise the machine type is used.

X'6' (Machine type or hardware product common name) plus model number plus serial number or repair ID number, whichever is present, from a hardware Product ID subvector

Note: The hardware product common name is used if it is present; otherwise the machine type is used.

X'9' Software product common name from a software Product ID subvector

bit 4, Product Set ID Indicator: An indication of which Product Set ID contains the Product ID subvector being indexed

B'0' Alert sender PSID

B'1' Indicated resource PSID

bits 5-7, Count: A three-digit binary number that indicates which Product ID subvector, of the type specified by the Product ID Subvector Code, is being indexed within the PSID specified by the Product Set ID Indicator.

Note: This count applies only to Product ID Subvectors of the type specified by the Product ID Subvector Code. If, for example, the code is X'2' (specifying a hardware Product ID) then only hardware X'11's are counted: a count of X'3' would thus index the third hardware Product ID within the PSID indicated by the Product Set ID Indicator.

## Request Response Time Monitor (X'8080') MS Major Vector

SSCP-->PU T2

This major vector enables or disables response time monitoring, transports RTM parameters, and transports a request for RTM data and status from a device.

0-1 Length (n+1), in binary, of this MS major vector

2-3 Key: X'8080'

4-n MS subvectors, as described (using zero-origin indexing) in "MS Common Subvectors" on page 8-87 for subvector keys X'00' - X'7F', and in "Request Response Time Monitor Subvectors" on page 8-81 for subvector keys X'80' - X'FE'

Note: The following subvector keys may be used as indicated:

Subvector	Presence in NMVT Request RTM (X'8080') Major Vector	
	SNA Address List (X'04')	CP
*RTM Request (X'92')	P	
RTM Control (X'94')	CP	Note 2

Key:

- \* Command Subvector (for PU parsing)
- P Present one time
- CP Conditionally present one time (See Notes for conditions.)

Notes:

1. This subvector is present in the NMVT containing an X'8080' major vector when the request is for a specific LU (i.e., identified in the X'04' subvector) associated with the PU processing the request. This subvector is not present when the request is to apply to all LUs associated with the PU processing the request.
2. This subvector is present when RTM parameters are being set. If present, it immediately follows the RTM Request (X'92' subvector).

## Request Response Time Monitor Subvectors

## RTM Request (X'92') Request RTM MS Subvector

This subvector requests RTM data and status or accompanies an RTM control subvector.

- 0 Length (p+1), in binary, of this subvector
- 1 Key: X'92'
- 2 Request indicators (bit is set to 1 to request that the function be performed):
  - bit 0, reset RTM data for the target LU upon reply transmission or immediately if no reply is requested
  - bit 1, Retrieve data and status for all LUs with accumulated RTM data.
  - bit 2, retired
  - bit 3, Retrieve data and status for the LU specified in the SNA Address List (X'04') MS common subvector also included in this major vector
  - bit 4, apply the RTM Control (X'94') MS subvector also included in this major vector to all LUs

## MS Major Vectors

Note: If this bit is set to 1, the RTM Control (X'94') MS subvector will be present. If this bit is set to 0 and the RTM Control (X'94') subvector is present, the SNA Address List (X'04') MS common subvector will be present.

3(=p) bits 5-6, retired  
Reserved

Request Type	Subvectors present in the Request RTM (X'8080') major vector	Bits	
		B1	B3
Retrieve data for all LUs with accumulated data	92	1	0
Retrieve for specified LU	92, 04	0	1
Set parameters for all LUs	92, 94	0	0
Set parameters for specified LU	92, 94, 04	0	0

Figure 8-1. Setting of Bits 1 and 3 of Byte 2 of the RTM Request (X'92') Subvector

## RTM Control (X'94') Request RTM MS Subvector

This subvector controls RTM data accumulation.

- 0 Length (p+1), in binary, of this subvector
- 1 Key: X'94'
- 2-3 RTM status and control change mask (bit is set to 1 if the setting specified by the corresponding RTM status and control indicator in bytes 4-5 should be used):  
bits 0-8, mask bits corresponding respectively to indicator bits 0-8 in bytes 4-5  
bits 9-15, reserved
- 4-5 RTM status and control indicators (bit is set to 1 to activate the function or 0 to deactivate it):  
bit 0, RTM measurement active  
bit 1, return data unsolicited on session deactivation  
bit 2, return data unsolicited on counter overflow  
bit 3, retired  
bit 4, set the RTM measurement definition using byte 8  
bit 5, set the RTM response time measurement boundaries using bytes 9 and 16-m  
bit 6, retired  
bit 7, local display of RTM data  
bit 8, retired  
bits 9-15, reserved
- 6 Reserved

- 7 Retired
- 8 RTM measurement definition--defines when the response-time measurement will begin and end for each exchange between session partners:  
 X'01' measured from the attention or action key depression to the arrival back at the LU of the first character that can alter the presentation space  
 X'02' measured from the attention or action key depression until the LU is ready to accept input from its end user  
 X'03' measured from the attention or action key depression to the receipt and processing back at the LU of Change Direction (CD) or End Bracket (EB)  
 X'04' measured from the attention or action key depression to the receipt of the last character of the last message received prior to the next attention or action key depression.
- 9 Response-time unit of measure:  
 X'00' 100 milliseconds  
 X'01'-X'7F' retired  
 X'90' retired  
 X'A0' retired  
 X'CO' retired  
 X'D0' retired
- 10-15 Reserved
- 16 RTM data collection parameters:  
 bits 0-3, reserved  
 bits 4-7, binary number of 2-byte boundaries in bytes 17-p
- 17-p A set of response-time measurement boundaries, specified in binary (as units of response-time units of measure described by byte 9) and increasing in order of magnitude; thus, response-time data is collected for intervals ( $0 < r1 \leq b1 * u$ ), ( $b1 * u < r2 \leq b2 * u$ ), ... up to ( $b4 < r5$ ), where  $b_i$  is the value of the boundary  $i$ ,  $r_i$  is the response-time being measured for interval  $i$ , and  $u$  is the unit of measure described by byte 9.
- 17-18 Boundary 1
- 19-20 Boundary 2
- 21-p Additional boundaries as required (the total number is defined by byte 16, bits 4-7), up to a maximum of 4

#### Response Time Monitor (X'0080') MS Major Vector

PU T2-->SSCP

This major vector transports RTM data. This data includes the collected response time data and current RTM status.

- 0-1 Length (n+1), in binary, of this MS major vector
- 2-3 Key: X'0080'
- 4-n MS subvectors, as described (using zero-origin indexing) in "MS Common Subvectors" on page 8-87 for subvector keys X'00' - X'7F', and in "Response Time Monitor Subvectors" on page 8-85 for subvector keys X'80' - X'FE'

Note: The following subvector keys may be used as indicated:

## MS Major Vectors

Subvector	Presence in NMVT RTM (X'0080') Major Vector	
Date/Time (X'01)	CP	Note 1
SNA Address List (X'04')	CP	Note 2
Relative Time (X'42')	CP	Note 3
Data Reset Flag (X'45')	CP	Note 4
Sense Data (X'7D')	CP	Note 5
RTM Status Reply (X'91')	CP	Note 6
RTM Data (X'93')	CP	Note 7

### Key:

- P Present one time  
 CP Conditionally present one time (See Notes for conditions.)

### Notes:

1. If the PU sending the X'0080' major vector has the capability of providing it, it places this subvector in the NMVT.
2. This subvector is present when positively replying to a request for RTM data and status if RTM data has been accumulated.
3. If the PU sending the X'0080' cannot provide a Date/Time subvector, it places this subvector in the NMVT instead.
4. This subvector is present in an X'0080' major vector when a set of counters has been reset, either as a result of a request or when sent unsolicited.
5. This subvector is present when a Request RTM major vector cannot be processed, or when requested data cannot be gathered and the PU sending this major vector has elected to send sense data in a reply instead of a negative response.
6. This subvector is present when replying to a request for RTM data and status when data is present or when the reply is for the last LU (sent as a result of a request to retrieve data for all LUs with accumulated data) and no data is present.

7. This subvector is present when positively replying to a request for RTM data and status if RTM data has been accumulated.

### Response Time Monitor Subvectors

#### RTM Status Reply (X'91') RTM MS Subvector

This subvector transports the current status of RTM function for a device.

- 0 Length (p+1), in binary, of this subvector
- 1 Key: X'91'
- 2 Reply indicators (bit is set to 1 to indicate that the assertion is true):  
 bit 0, reserved  
 bit 1, data not included  
 bit 2, an RTM data request has been issued for an LU that has its RTM function disabled  
 bit 3, this is the first RTM reply since session activation (used to initiate a recording of the session partner names and the correlation value in bytes 7-8 of this subvector while there is reasonable assurance that the session is active); on subsequent replies the correlation value will be used to associate data from the same LU-LU session  
 bit 4, an LU-LU session activation or deactivation has occurred at least once while the included RTM data was being accumulated  
 bits 5-7, reserved
- 3 Reason for unsolicited reply, if any (bit is set to 1 to indicate the appropriate reason):  
 bit 0, the session for this resource has ended and is enabled unsolicited-reply-on-session-deactivation  
 bit 1, a counter for this LU has overflowed and unsolicited-reply-on-counter-overflow is enabled  
 bit 2, retired  
 bits 3-5, reserved  
 bit 6, retired  
 bit 7, reserved
- 4 Reason for potential loss of RTM data, if any (bit is set to 1 to indicate the reason):  
 bit 0, reserved  
 bit 1, an overflow has occurred on at least one counter and updating for all of this LU's counters has been stopped to retain the relative significance of the data  
 bit 2, this LU has been reset since the last reply was sent  
 bit 3, a new session was activated before data for the previous session could be transmitted: loss of data for the new session may have occurred; updating for all of this LU's counters has been stopped to retain the relative significance of the data  
 bit 4, the RTM definition or response time measurement boundaries have been changed by a request that did not solicit the RTM data and RTM accumulation was active for this LU: any data collected since the last data request has been lost  
 bits 5-7, reserved
- 5-6 RTM status when this subvector was constructed (a bit set to 1 indicates that the function was active):

## MS Major Vectors

bit 0, RTM measurement active  
bit 1, data to be sent unsolicited on session deactivation  
bit 2, data to be sent unsolicited on counter overflow  
bit 3, retired  
bit 4, RTM definition was set by the control point  
bit 5, RTM boundaries were set by the control point  
bit 6, retired  
bit 7, local display of RTM data  
bit 8, retired  
bits 9-15, reserved

7-8(=p) Correlation value: a unique 2-byte value, generated by the PU, that is retained and used in all RTM replies dealing with the same LU-LU session from session activation through the subsequent session deactivation

## RTM Data (X'93') RTM MS Subvector

This subvector transports solicited or unsolicited RTM data.

0 Length (q+9), in binary, of this subvector  
1 Key: X'93'  
2 RTM measurement definition in effect:  
X'01' measured from the attention or action key depression to the arrival back at the LU of the first character that can alter the presentation space  
X'02' measured from the attention or action key depression until the LU is ready to accept input from its end user  
X'03' measured from the attention or action key depression to the receipt and processing back at the LU of Change Direction (CD) or End Bracket (EB)  
X'04' measured from the attention or action key depression to the receipt of the last character of the last message received prior to the next attention or action key depression.  
3 Response time unit of measure:  
X'00' 100 milliseconds  
X'01'-X'7F' retired  
X'90' retired  
X'A0' retired  
X'CO' retired  
X'D0' retired  
4-5 Reserved  
6-7 Retired  
8 RTM data collection parameters:  
bits 0-3, the number, in binary, of response time measurement boundaries returned; all boundaries that were set previously will be returned in this subvector  
bits 4-7, the number, in binary, of boundary sets for which valid data was collected (overflow data--a count of response times exceeding the maximum boundary--is not included in this number but is always present)  
9-p A set of response-time measurement boundaries as previously set at the LU or by the RTM Control (X'94') MS subvector (specified in binary as units of response-time units of measure described by byte 9) and increasing in order of magnitude; thus, response-time data is collected for intervals

( $0 < r1 \leq b1 \cdot u$ ), ( $b1 \cdot u < r2 \leq b2 \cdot u$ ), ... up to ( $b4 < r5$ ), where  $b_i$  is the value of the boundary  $i$ ,  $r_i$  is the response-time being measured for interval  $i$ , and  $u$  is the unit of measure described by byte 9.

9-10	Boundary 1
11-12	Boundary 2
13-p	Additional boundaries as required to equal the number of boundaries set previously and specified by byte 8, bits 0-3
p+1-q	The number of measured exchanges for each response-time interval: the number of exchanges whose duration was within an interval's boundaries is reported in binary separately for each interval.
p+1-p+2	Number of exchanges in the (0,b1) range
p+3-p+4	Number of exchanges in the (b1+1,b2) range
p+5-q	Additional exchange counts to satisfy the number of boundaries defined , up to a maximum of 4
q+1-q+2	Overflow: the number of exchange durations greater than the maximum boundary specified
q+3-q+6	Total of all individual times for all exchanges measured and reported by this record, including overflow, in the measurement units defined by byte 3
q+7-q+8	Last measured exchange duration in the measurement units defined by byte 3



## MS Common Subvectors

### MS Common Subvectors

The common MS subvectors are defined as follows (using zero-origin indexing):

#### Text Message (X'00') MS Common Subvector

This MS common subvector transports EBCDIC data.

- 0 Length (p+1), in binary, of the Text Message subvector
  - 1 Key: X'00'
  - 2-p Text message in EBCDIC
- Note: The coded character set that may be transported in this field is dependent on the implementation that provided the text or allowed an operator to input the text, as well as the output device used by the Alert processor. The installation management ensures the compatibility of these products.

#### Date/Time (X'01') MS Common Subvector

This MS common subvector is used by the PU for time-stamping the NMVT in which it is carried.

- 0 Length (p+1), in binary, of the Date/Time subvector
- 1 Key: X'01'
- 2-p One or more of the following subfields:

X'10' Local Date/Time (required subfield)  
X'20' Greenwich Mean Time Offset

#### Local Date/Time (X'10') Date/Time Subfield

This subfield transports the local date and time of the creation of the major vector.

- 0 Length (q+1), in binary, of the Local Date/Time subfield
- 1 Key: X'10'
- 2-4 Local date
- 2 Year, in binary, consisting of the last two digits of the year
- 3 Month, in binary (X'01'-X'0C')
- 4 Day, in binary (X'01'-X'1F')
- 5-q Local time
- 5 Hours, in binary (X'00'-X'17')
- 6 Minutes, in binary (X'00'-X'3B')
- 7 Seconds, in binary (X'00'-X'3B')
- 8-q Optional extension of time: a binary value to provide finer granularity than seconds

## Greenwich Mean Time Offset (X'20') Date/Time Subfield

This subfield transports the Greenwich Mean Time (GMT) offset of the node that originated the management services RU (i.e., the origin node). It is optionally included in a major vector by the origin node or by the control point in whose domain the origin node resides.

- 0 Length (q+1), in binary, of the Greenwich Mean Time Offset subfield  
 1 Key: X'20'  
 2-3(=q) Time zone adjustment to Greenwich Mean Time: an interval of time to be added to, or subtracted from, the local time given in the Local Date/Time (X'10') subfield to adjust that time to Greenwich Mean Time  
 bit 0, positive or negative adjustment indicator:  
     0 adjustment to be added to the local time (i.e., all time zones westward, between the Greenwich time zone and the International Date Line)  
     1 adjustment to be subtracted from the local time (i.e., all time zones eastward, between the Greenwich time zone and the International Date Line)  
 bits 1-3, reserved  
 bits 4-7, number of hours of adjustment, in binary (X'0'-X'C')  
 bits 8-15, number of minutes of adjustment, in binary (X'00'-X'3B')

## Hierarchy Name List (X'03') MS Common Subvector

This MS common subvector identifies target resources, other than the reporting PU, that are within the same domain as the origin PU, but cannot be represented in the SNA Address List subvector.

- 0 Length (p+1), in binary, of the Hierarchy Name List subvector  
 1 Key: X'03'  
 2 Reserved  
 3 Number, in binary, of name entries in the hierarchy name list.  
 4-p Hierarchy Name List Entries (1 to 5 entries may be present)

Note: Each entry contains a Name field and a Resource Type field, and has the following form (shown zero-origin):

- 0 Length (q+1), in binary, of the following name plus this Length field  
 1-q Name of resource in upper-case alphanumeric EBCDIC characters  
Note: Resource name never exceeds eight characters.  
 q+1-q+4 Resource type identifier: category in which the resource (named in bytes 1-q) belongs:  
 X'C1C4C1D7' adapter  
 X'C2D9C4C7' LAN bridge  
 X'C3C2E740' computerized branch exchange  
 X'C3C2E4E2' carrier sense multiple access with collision detection (CSMA/CD) bus  
 X'C3C8C1D5' channel  
 X'D3C9D5C5' communication link  
 X'C3E3D9D3' controller

## MS Common Subvectors

X'C4C9E2D2' disk  
X'C4E2D2E3' diskette  
X'D2E8C2C4' keyboard  
X'D3C1D540' local area network (LAN)  
X'D3C3D6D5' link connection

Note: This resource type is used for logical link connections not known to SNA, such as a LAN manager's connection with a management server.

X'D3D6D6D7' loop  
X'D7C2D440' personal banking machine  
X'D7D6E240' point-of-sale unit  
X'D7C2E740' private branch exchange  
X'D7D3E3D9' plotter  
X'D7D9E3D9' printer  
X'D9C9D6C7' token ring  
X'E2D74040' service point  
X'E3F1D9D4' T1 resource manager  
X'E3C1D7C5' tape  
X'E3C1E440' teller assist unit  
X'E3C2E4E2' token bus  
X'E3C5D9D4' terminal  
X'C4C5E540' unspecified device

## SNA Address List (X'04') MS Common Subvector

This MS common subvector is used in both request and data NMVTs. In a request NMVT, it identifies one or more destinations of the MS request when the destination is not the PU addressed in the Transmission Header (TH). In a data NMVT, it identifies the resource associated with the data when the resource is not the PU addressed in the TH.

If present, this subvector is the first subvector within the MS major vector.

- 0 Length (p+1), in binary, of the SNA Address List subvector  
1 Key: X'04'  
2 Address Count: For address entity format types X'00', X'40', X'80', and X'C0', a binary number indicating the number of individual addresses present in the X'04' subvector. This field is set to X'00' for all other address entity format types.  
Note: This field provides a count of individual addresses; thus for format X'40', each pair of addresses counts as two.  
3 Address entity format type:  
X'00' address format is one or more single local addresses  
X'40' address format is one or more pairs of session-partner local addresses, each pair identifying a session  
X'80' address format is one or more single network addresses  
X'A0' address format is one or more network-qualified address pairs, each pair identifying a session  
X'C0' address format is one or more pairs of session partner network addresses, each pair identifying a session  
4-p Address entities: one or more address entities, each having one of the formats defined below (zero-origin):

- For a single local address (byte 3 = X'00'):
  - 0-4 Reserved
  - 5 Local address
- For a pair of session-partner local addresses (byte 3 = X'40'):
  - 0-4 Reserved
  - 5 Local address of SLU
  - 6 Retired
  - 7-11 Reserved
  - 12 Session index (local address of PLU)
- For a single network address (byte 3 = X'80'):
  - 0-5 Network address
- For a network-qualified address pair (byte 3 = X'A0'):
  - 0-5 Network address of NAU1
  - 6-11 Network address of NAU2
  - 12-19 Network ID of the subnetwork in which the above addresses are valid
- For a pair of session-partner network addresses (byte 3 = X'C0'):
  - 0-5 Network address 1
  - 6 X'80'
  - 7-12 Network address 2

#### Hierarchy/Resource List (X'05') MS Common Subvector

This MS common subvector identifies resources, hierarchically below the sending PU, that cannot be represented in the SNA Address List subvector.

- 0 Length (p+1), in binary, of the Hierarchy/Resource List subvector
- 1 Key: X'05'
- 2-p The following subfield containing a hierarchical list of resources (listed by key value below and described in detail following):

X'10' Hierarchy Name List

#### Hierarchy Name List (X'10') Hierarchy/Resource List Subfield

This subfield contains a list specifying the names of resources in a hierarchy. The last name in the list specifies the resource to which the data present in the major vector pertains.

- 0 Length (q+1), in binary, of the Hierarchy Name List subfield
- 1 Key: X'10'
- 2 Always set to X'80'
- 3-q Hierarchy Name List Entries (entries left to right indicate resources down the hierarchy)

**Note:** Each entry contains a Length field, a Name field, a reserved byte and a Resource Type field, and has the following form (shown zero-origin):

## MS Common Subvectors

0 Length (r+1), in binary, of the following name plus this length field  
1-r Name of resource in upper-case alphanumeric EBCDIC characters  
Note: Resource name never exceeds eight characters.

r+1  
bit 0, Reserved  
bit 1, Display resource name indicator.  
0 This name should be displayed if the receiver elects to display a single resource name and type as part of its presentation of the MSU containing this subvector  
1 This name should not be displayed if the receiver elects to display a single resource name and type as part of its presentation of the MSU containing this subvector

bits 2-7, Reserved

r+2 Resource type identifier: category to which the resource (named in bytes 1-r) belongs:

- X'00' unspecified device
- X'11' disk
- X'13' printer
- X'16' tape
- X'17' terminal
- X'21' adapter
- X'25' diskette
- X'27' loop
- X'29' keyboard
- X'2B' plotter
- X'2E' token ring
- X'2F' computerized branch exchange
- X'30' T1 resource manager
- X'31' private branch exchange
- X'32' carrier sense multiple access with collision detection (CSMA/CD) bus
- X'33' token bus
- X'34' printer server
- X'35' personal banking machine
- X'36' teller assist unit
- X'37' point-of-sale unit
- X'38' local controller
- X'39' local area network (LAN)
- X'3A' LAN bridge
- X'3B' logical link connection

Note: See also Resource Type Identifier X'F9' (link). Identifier X'3B' is used for logical link connections not known to SNA, such as a LAN manager's connection with a management server. Identifier X'F9' is used for logical link connections that are known to SNA.

- X'3C' management server
- X'80' controller
- X'81' service point
- X'F0' boundary function physical unit
- X'F1' physical unit
- X'F3' logical unit
- X'F4' control point
- X'F5' network ID
- X'F7' link station
- X'F8' SNA channel

X'F9' link

## Product Set ID (X'10') MS Common Subvector

This MS common subvector identifies one or more products that implement a network component.

- 0 Length (p+1), in binary, of the Product Set ID subvector
- 1 Key: X'10'
- 2 Retired
- 3-p Network product identifier consisting of one or more Product ID (X'11') MS common subvectors, as described below (using zero-origin indexing). Each Product ID (X'11') MS Common Subvector uniquely identifies a product. Products fall into two categories: hardware (with or without microcode) and software.

## Product Identifier (X'11') MS Common Subvector

This MS common subvector uniquely identifies a single product. A product may consist of electronic circuitry (hardware), executable instructions (software), or both (in the case of hardware containing microcode).

- 0 Length (q+1), in binary, of the Product Identifier subvector
- 1 Key: X'11'
- 2 bits 0-3, Reserved
- bits 4-7, Product classification:
  - X'1' IBM hardware
  - X'3' IBM or non-IBM hardware (not distinguished)
  - X'4' IBM software
  - X'9' non-IBM hardware
  - X'C' non-IBM software
  - X'E' IBM or non-IBM software (not distinguished)
- 3-q One or more subfields containing product- and installation-specific information on hardware, microcode, and software.  
 Note: The subfields may be used as indicated in the table on the following page.

MS Common Subvectors

Sub- field	HW or SW X'11' (Note 1)	X'0000' Alert (Note 2)		XID3 (Note 3)	
		Sender	Resource		
X'00'	HW	P	P	P	
X'01'	HW	CP	CP	CP	Note 4
X'0B'	HW	O	O	O	
X'0E'	HW	O	O	O	
X'02'	SW	CP	CP	CP	Note 5
X'04'	SW	CP	CP	CP	Note 6
X'06'	SW	P	P	O	
X'07'	SW	—	CP	O	Note 7
X'08'	SW	CP	CP	CP	Note 6
X'09'	SW	—	CP	O	Note 7

Conditions of Subfield Presence in Product Identifier Subvector

Key:

- Not present
- P Present one time
- CP Conditionally present one time
- O Optionally present one time

Subfield Names:

- X'00' — Hardware Product Identifier
- X'01' — Emulated Product Identifier
- X'02' — Software Product Serviceable Component Identifier
- X'04' — Software Product Common Level
- X'06' — Software Product Common Name
- X'07' — Software Product Customization Identifier
- X'08' — Software Product Program Number
- X'09' — Software Product Customization Date and Time
- X'0B' — Microcode EC Level
- X'0E' — Hardware Product Common Name

Notes:

1. The hardware X'11' Product Identifier subvector is present when the Product classification nibble (byte 2, bits 4-7) is X'1', X'3', or X'9'. The software X'11' Product Identifier subvector is present when this nibble is X'4', X'C', or X'E'.
2. If a PU is sending an Alert for itself, a single Product Set ID (X'10') subvector is present. This is the "Indicated Resource" for purposes of reading this matrix. If the PU is reporting on an Alert for an attached device, two X'10' subvectors are present, in the following order:
  - a. "Alert Sender"--identifies the PU sending the Alert
  - b. "Indicated Resource"--identifies the resource that is being Alerted upon
3. In XID3, the Hardware and Software X'11' subvectors are carried in the X'10' Control Vector rather than the X'10' MS Common subvector.
4. This subfield is present in the hardware X'11' when a product is emulating another hardware product.
5. This subfield is present in the software X'11' for products assigned a component ID by the National Service Division. For products not assigned a component ID, the X'04' and X'08' subfields must be present. (See note 6)
6. The X'04' and X'08' subfields are required in the software X'11' if the X'02' subfield is not present. They are optional when the X'02' is present. (See note 5.) If, however, the software identified is a customer-written application, only the X'08' subfield is present.
7. One of the X'07' and X'09' subfields is required in the software X'11' for software products modifiable by the customer.

#### Hardware Product Identifier (X'00') Product Identifier Subfield

This subfield uniquely identifies an instance of a hardware product.

- 0 Length (r+1), in binary, of the Hardware Product Identifier subfield  
 1 Key: X'00'  
 2 Format type:
- X'10' product instance is identified by a serial number (i.e., IBM plant of manufacture and sequence number) unique by machine type
- X'11' product instance is identified by a serial number (i.e., IBM plant of manufacture and sequence number) unique by machine type and model number
- X'12' product instance is identified by a serial number (i.e., IBM plant of manufacture and sequence number) unique by machine type (as in Format X'10' above). This format provides the model number not to



## MS Common Subvectors

uniquely identify a product instance but, for the purpose of additional information only.

X'13' retired

X'20' product instance is identified by a repair ID number (i.e., IBM plant of manufacture and sequence number) unique by machine type

X'21' product instance is identified by a repair ID number (i.e., IBM plant of manufacture and sequence number) unique by machine type and model number

X'22' product instance is identified by a repair ID number (i.e., IBM plant of manufacture and sequence number) unique by machine type (as in Format X'10' above). This format provides the model number not to uniquely identify a product instance but, for the purpose of additional information only.

X'40' retired

X'41' retired

### 3-r Product identification

Note: The originator of a message unit (e.g., NMVT, XID) reporting for another product that does not supply information required for the Hardware Product Identifier subfield inserts binary 0's into the appropriate fields (except for the Machine Type field where EBCDIC 0's [X'F0'] are inserted) of the Product Identification field to indicate that no identification information is available.

- Format X'10'

3-6 Machine type: four numeric EBCDIC characters

7-8 IBM plant of manufacture: two numeric EBCDIC characters

9-15(=r) Sequence number: seven upper-case alphanumeric EBCDIC characters, right-justified, with EBCDIC 0's (X'F0') fill on the left

- Format X'11'

3-6 Machine type: four numeric EBCDIC characters

7-9 Machine model number: three upper-case alphanumeric EBCDIC characters

10-11 IBM plant of manufacture: two numeric EBCDIC characters

12-18(=r) Sequence number: seven upper-case alphanumeric EBCDIC characters, right-justified, with EBCDIC 0's (X'F0') fill on the left

- Format X'12'

3-6 Machine type: four numeric EBCDIC characters

7-9 Machine model number: three upper-case alphanumeric EBCDIC characters

10-11 IBM plant of manufacture: two numeric EBCDIC characters

12-18(=r) Sequence number: seven upper-case alphanumeric EBCDIC characters, right-justified, with EBCDIC 0's (X'F0') fill on the left

- Format X'20'

3-6 Machine type: four numeric EBCDIC characters

7-8 IBM plant of manufacture: two numeric EBCDIC characters

9-15(=r) Sequence number: seven upper-case alphanumeric EBCDIC characters, right-justified, with EBCDIC 0's (X'F0') fill on the left

- Format X'21'

3-6 Machine type: four numeric EBCDIC characters

7-9 Machine model number: three upper-case alphanumeric EBCDIC characters

10-11 IBM plant of manufacture: two numeric EBCDIC characters

- 12-18(=r) Sequence number: seven upper-case alphanumeric EBCDIC characters, right-justified, with EBCDIC 0's (X'F0') fill on the left
- Format X'22'
- 3-6 Machine type: four numeric EBCDIC characters
- 7-9 Machine model number: three upper-case alphanumeric EBCDIC characters
- 10-11 IBM plant of manufacture: two numeric EBCDIC characters
- 12-18(=r) Sequence number: seven upper-case alphanumeric EBCDIC characters, right-justified, with EBCDIC 0's (X'F0') fill on the left

#### Emulated Product Identifier (X'01') Product Identifier Subfield

This subfield identifies the hardware of the product being emulated in sufficient detail to allow problem determination

- 0 Length (r+1), in binary, of the Emulated Product Identifier subfield
- 1 Key: X'01'
- 2-5 Machine type of product being emulated: four numeric EBCDIC characters
- 6-8(=r) Model number of product being emulated: three upper-case alphanumeric EBCDIC characters

#### Software Product Serviceable Component Identifier (X'02') Product Identifier Subfield

This subfield transports the serviceable component identifier and release level as assigned by service personnel.

- 0 Length (r+1), in binary, of the Software Product Serviceable Component Identifier subfield
- 1 Key: X'02'
- 2-10 Serviceable component identifier: nine upper-case alphanumeric EBCDIC characters
- 11-13(=r) Serviceable component release level: three numeric EBCDIC characters

#### Software Product Common Level (X'04') Product Identifier Subfield

This subfield transports the common version, release, and modification level numbers as given in the product announcement documentation.

- 0 Length (r+1), in binary, of the Software Product Common Level subfield
- 1 Key: X'04'
- 2-3 Common version identifier (numeric EBCDIC characters, right-justified with X'F0' fill on left)
- 4-5 Common release identifier (numeric EBCDIC characters, right-justified with X'F0' fill on left)
- 6-7(=r) Common modification identifier (numeric EBCDIC characters, right-justified with X'F0' fill on left)

## MS Common Subvectors

### Software Product Common Name (X'06') Product Identifier Subfield

This subfield transports the software common name as given in the product announcement documentation.

- 0 Length (r+1), in binary, of the Software Product Common Name subfield
- 1 Key: X'06'
- 2-r Up to thirty upper-case alphanumeric EBCDIC characters identifying the software product common name

### Software Product Customization Identifier (X'07') Product Identifier Subfield

This subfield identifies a set of executable instructions, customized to the user's environment.

- 0 Length (r+1), in binary, of the Software Product Customization Identifier subfield
- 1 Key: X'07'
- 2-r Customization identifier: up to eight alphanumeric EBCDIC characters

### Software Product Program Number (X'08') Product Identifier Subfield

This subfield transports either the program product number as assigned by distribution personnel, or a substitute value supplied by a user-written software program.

- 0 Length (r+1), in binary, of the Software Product Program Number subfield
- 1 Key: X'08'
- 2-8(=r) Program product number: seven upper-case alphanumeric EBCDIC characters  
Note: A user-written application program does not send a program product number in this field. Instead it sends one of 16 substitute values comprised of seven upper-case alphanumeric EBCDIC characters having the following form: characters 1-4 are the letters USER; character 5 is one of the characters 0-9, or A-F; characters 6-7 are space (X'40') characters. Installation managers have the sole responsibility for managing the usage of these substitute values within their networks.

### Software Product Customization Date and Time (X'09') Product Identifier Subfield

This subfield identifies the date and time that a set of executable instructions was customized to the user's environment.

- 0 Length (r+1), in binary, of the Software Product Customization Date and Time subfield.
- 1 Key: X'09'
- 2 Year in unsigned packed decimal
- 3-4 Julian day in unsigned packed decimal, right-justified with 0's as fill
- 5 Hour in unsigned packed decimal (24-hour clock)
- 6(=r) Minute in unsigned packed decimal

## Microcode EC Level (X'0B') Product Identifier Subfield

This subfield identifies the Engineering Change (EC) level of the failing microcode component (e.g., microcode feature EC level or microcode subsystem level such as channel, power, or storage)

- 0 Length (r+1), in binary, of the Microcode EC Level subfield.  
 1 Key: X'0B'  
 2-r Microcode EC Level: up to eight upper-case alphanumeric EBCDIC characters

## Hardware Product Common Name (X'0E') Product Identifier Subfield

This subfield provides the hardware common name as given in the product announcement documentation

- 0 Length (r+1), in binary, of the Hardware Product Common Name subfield  
 1 Key: X'0E'  
 2-r Up to fifteen upper-case alphanumeric EBCDIC characters identifying the hardware product common name

## Self-Defining Text Message (X'31') MS Common Subvector

This MS common subvector transports a text message, additional data identifying the nature of the message sender, the language of the message, and how the message is encoded.

- 0 Length (p+1), in binary, of the Self-Defining Text Message subvector  
 1 Key: X'31'  
 2-p Subfields containing a text message, as well as additional information characterizing the message.  
Note: The following subfield keys are used as indicated:

Subfield	Presence in Self-Defining Text Message (X'31') Common Subvector
Coded Character Set ID (X'01')	Required
National Language ID (X'11')	Required
Sender ID (X'21')	Required
Text Message (X'30')	Required

## MS Common Subvectors

### Coded Character Set ID (X'01') Self-Defining Text Message Subfield

This subfield identifies the coded character set in which the text message is encoded.

- 0 Length (q+1), in binary, of the Coded Character Set ID subfield
- 1 Key: X'01'
- 2-5 Coded Character Set ID: Two 4-digit hexadecimal numbers that specify uniquely the coded character set in which the accompanying user text message is encoded. Bytes 2-3 contain a 4-digit hexadecimal number identifying a code page, while bytes 4-5 contain a 4-digit hexadecimal number identifying a character set. Alert receivers are responsible for documenting the coded character set IDs, as well as the coded character sets themselves, that they support in this subvector.

### National Language ID (X'11') Self-Defining Text Message Subfield

This subfield identifies the national language in which the text message is written. A national language is identified by the conjunction of a generic language code (e.g., English) and a country code (e.g., US, UK, Canada).

- 0 Length (q+1), in binary, of the National Language ID subfield
- 1 Key: X'11'
- 2-3 Country Code: a code point indicating the country component of the national language ID. A value of X'0000' indicates that no country code is specified, i.e., that the sender is specifying only a generic language code. Non-zero values are the hexadecimal equivalents of the three decimal digit country codes specified in the ISO International Standard 3166. For example, the United States would be identified in this field as X'0348', since it is identified in IS 3166 as 840.
- 4-6 Generic Language Code: a code point indicating the generic language component of the national language ID. This code point is based on the representation in the ISO Draft International Standard 639.2. For the purpose of this encoding, the period in DIS 639.2 is treated not as a decimal point, but as a delimiter between two decimal integers. The first two bytes of the Generic Language Code are the hexadecimal equivalent of the decimal integer before the period; the third byte of the Generic Language code is the hexadecimal equivalent of the decimal integer after the period. For example, the Hungarian language would be identified in this field as X'03610B', since it is identified in DIS 639.2 as 945.11. English would be identified as X'001400', since it is identified in DIS 639.2 as 20.

### Sender ID (X'21') Self-Defining Text Message Subfield

This subfield identifies, in generic terms, the nature of the entity that sent the text message. This information will be displayed by the receiver of the message.

- 0 Length (q+1), in binary, of the Sender ID subfield
- 1 Key: X'21'

- 2 Sender ID Code: a code point characterizing the sender of the text message. Defined codes are:
- X'01' Terminal User: A person who, when entering the message, is solely a consumer of system resources, i.e., plays no role in providing them
  - X'02' Operator: A person who, when entering the message, is in some way involved in providing or managing system resources
  - X'11' Application Program: A program written for or by an end user that applies to the end user's work  
Note: This program may be implemented in either software or microcode.
  - X'12' Control Program: A program that controls other system resources.  
Note: This program may be implemented in either software or microcode

## Text Message (X'30') Self-Defining Text Message Subfield

This subfield transports a text message.

- 0 Length (q+1), in binary, of the Text Message subfield
- 1 Key: X'30'
- 2-q Text message

## Relative Time (X'42') MS Common Subvector

This MS common subvector indicates when a record was created relative to other records created by the originating component.

- 0 Length (p+1), in binary, of the Relative Time subvector
- 1 Key: X'42'
- 2 Time increment of measure:
  - X'00' tenths of a second
  - X'01'-X'7F' a number that, when divided into the timer data (in bytes 3-6), converts the value to seconds
  - X'90' microseconds
  - X'A0' milliseconds
  - X'C0' minutes (not used in Alerts)
  - X'D0' hours (not used in Alerts)
  - X'EF' indicates time value is purely a sequence indicator showing relative order only
- 3-6(=p) Time, in binary, having the measure defined by byte 2

## Data Reset Flag (X'45') MS Common Subvector

This MS common subvector acknowledges that the reset function has been performed.

- 0 Length (p+1), in binary, of the Data Reset Flag subvector
- 1(=p) Key: X'45'

## MS Common Subvectors

### LAN Link Connection Subsystem Data (X'51') MS Common Subvector

This MS common subvector transports data on the elements of the LAN link connection.

- 0 Length (p+1), in binary, of the LAN Link Connection Subsystem Data subvector
- 1 Key: X'51'
- 2-p One or more subfields containing data specific to the link connection elements (listed by Key value below and described in detail following):
- X'02' Ring or Bus Identifier
  - X'03' Local Individual MAC Address
  - X'04' Remote Individual MAC Address
  - X'05' LAN Routing Information
  - X'06' Ring Fault Domain Description
  - X'07' Beaconsing Data
  - X'08' Single MAC Address
  - X'09' Fault Domain Error Weight Pair
  - X'0A' Bridge Identifier
  - X'23' Local Individual MAC Name
  - X'24' Remote Individual MAC Name
  - X'26' Fault Domain Names
  - X'28' Single MAC Name

### Ring or Bus Identifier (X'02') LAN Link Connection Subsystem Data Subfield

This subfield transports the ring number (for a token-ring LAN) or the bus number (for a CSMA or token-bus LAN).

- 0 Length (q+1), in binary, of the ring or bus identifier subfield
- 1 Key: X'02'
- 2-3(=q) Ring or bus number, in hexadecimal

### Local Individual MAC Address (X'03') LAN Link Connection Subsystem Data Subfield

This subfield transports the address of the MAC within the node sending the MS major vector.

- 0 Length (q+1), in binary, of the local individual MAC address subfield
- 1 Key: X'03'
- 2-7(=q) Local individual MAC address, in hexadecimal

### Remote Individual MAC Address (X'04') LAN Link Connection Subsystem Data Subfield

This subfield transports the address of the MAC, part of the link connection, within the adjacent node.

- 0 Length (q+1), in binary, of the remote individual MAC address subfield
- 1 Key: X'04'
- 2-7(=q) Remote individual MAC address, in hexadecimal

**LAN Routing Information (X'05')** LAN Link Connection Subsystem Data Subfield

This subfield transports the routing information used by a link.

- 0 Length (q+1), in binary, of the LAN routing information subfield
- 1 Key: X'05'
- 2-q Routing information, not to exceed 18 bytes, in hexadecimal

**Fault Domain Description (X'06')** LAN Link Connection Subsystem Data Subfield

This subfield identifies a pair of LAN ring stations as a fault domain, i.e., the upstream and the downstream LAN ring stations and the cable between them.

- 0 Length (q+1), in binary, of the Ring Fault Domain Description subfield
- 1 Key: X'06'
- 2-7 Individual MAC address of downstream station, in hexadecimal
- 8-13(=q) Individual MAC address of upstream station, in hexadecimal

**Beaconing Data (X'07')** LAN Link Connection Subsystem Data Subfield

This subfield specifies the type of beacon detected by the LAN adapter.

- 0 Length (q+1), in binary, of the Beaconing Data subfield
- 1 Key: X'07'
- 2(=q) Beaconing type:
  - X'01' type 1, recovery mode set
  - X'02' type 2, signal loss
  - X'03' type 3, streaming signal

**Single MAC Address (X'08')** LAN Link Connection Subsystem Data Subfield

This subfield transports the address of the MAC element associated with the failure.

- 0 Length (q+1), in binary, of the Single MAC Address subfield
- 1 Key: X'08'
- 2-7(=q) Single MAC address, in hexadecimal

**Fault Domain Error Weight Pair (X'09')** LAN Link Connection Subsystem Data Subfield

This subfield indicates the severity of the problems reported by two MAC elements (LAN stations) belonging to a fault domain.

- 0 Length (q+1), in binary, of the Fault Domain Error Weight Pair subfield
- 1 Key: X'09'



## MS Common Subvectors

- 2-3 in binary, severity weight for the downstream MAC element (LAN station) problems
- 4-5(=q) in binary, severity weight for the upstream MAC element (LAN station) problems

### Bridge Identifier (X'0A') LAN Link Connection Subsystem Data Subfield

This subfield transports the bridge identifier of a LAN bridge.

- 0 Length (q+1), in binary, of the Bridge Identifier subfield
- 1 Key: X'0A'
- 2-5 Bridge identifier in hexadecimal. The bridge identifier is composed of three parts: a ring or bus number, followed by a bridge number, followed by another ring or bus number. The ring or bus with the lower number is always identified first. The bridge identifier occupies less than 4 bytes, the amount less depending on the partitioning of the LAN routing information field. The bridge identifier is left-justified, with the remaining portion of the subfield B'0'-filled.

**Note:** The partitioning of this field into its three parts is not specified, but is necessarily unique within a LAN, making this information useful in the context of a given bridged LAN.

### Local Individual MAC Name (X'23') LAN Link Connection Subsystem Data Subfield

This subfield transports the name of the MAC element within the sending node.

- 0 Length (q+1), in binary, of the Local Individual MAC Name subfield
- 1 Key: X'23'
- 2-q string of no more than 16 uppercase alphanumeric EBCDIC characters, local individual MAC name

### Remote Individual MAC Name (X'24') LAN Link Connection Subsystem Data Subfield

This subfield transports the name of the MAC element, part of the link connection, within the adjacent node.

- 0 Length (q+1), in binary, of the remote individual MAC Name subfield
- 1 Key: X'24'
- 2-q string of no more than 16 uppercase alphanumeric EBCDIC characters, remote individual MAC name

### Fault Domain Names (X'26') LAN Link Connection Subsystem Data Subfield

This subfield transports the names of the upstream and the downstream LAN ring stations belonging to a fault domain.

- 0 Length (q+1), in binary, of the Ring Fault Domain Names subfield

1 Key: X'26'  
 2-q Pair of Entries

**Note:** Each entry contains a Length field and a Name field, first entry is for the downstream MAC element, second entry is for the upstream MAC element, and has the following form (shown zero-origin)

0 Length (r+1), in binary, of the following name plus this length field  
 1-r string of no more than 16 uppercase alphanumeric EBCDIC characters,  
 individual MAC Name

#### Single MAC Name (X'28') LAN Link Connection Subsystem Data Subfield

This subfield transports the name of the MAC related to the failure.

0 Length (q+1), in binary, of the Single MAC Name subfield  
 1 Key: X'28'  
 2-q string of no more than 16 uppercase alphanumeric EBCDIC characters, Single MAC name

#### Link Connection Subsystem Configuration Data (X'52') MS Common Subvector

This MS common subvector transports data for link connections.

0 Length (p+1), in binary, of the LCS Configuration Data subvector  
 1 Key: X'52'  
 2-p One or more subfields containing LCS configuration data (listed by key value below and described in detail following):

X'01' Port Address  
 X'02' Remote Device Address  
 X'04' Local Device Address  
 X'06' LCS Link Station Attributes  
 X'07' LCS Link Attributes

#### Port Address (X'01') Link Connection Subsystem Configuration Data Subfield

This subfield transports the port address of the link connection.

0 Length (q+1), in binary, of the Port Address subfield  
 1 Key: X'01'  
 2-3(=q) Port address, in binary

#### Remote Device Address (X'02') Link Connection Subsystem Configuration Data Subfield

This subfield transports the DLC address of the remote link station.

## MS Common Subvectors

- 0 Length (q+1), in binary, of the Remote Device Address subfield
- 1 Key: X'02'
- 2(=q) Remote link station DLC address, in hexadecimal; e.g., in LAN specifies the destination link service access point (DSAP) address.

## Local Device Address (X'04') Link Connection Subsystem Configuration Data Subfield

This subfield transports the address of the local link station.

- 0 Length (q+1), in binary, of the Local Device Address subfield
- 1 Key: X'04'
- 2(=q) Local link station DLC address, in hexadecimal; e.g., for LANS is the source service access point (SSAP) address.

## LCS Link Station Attributes (X'06') Link Connection Subsystem Configuration Data Subfield

This subfield identifies link station attributes.

- 0 Length (q+1), in binary, of the LCS Link Station Attributes subfield
- 1 Key: X'06'
- 2 Link Station Role:
  - X'01' primary
  - X'02' secondary
  - X'03' negotiable
- 3(=q) Node type for the remote link station:
  - X'01' Type 1
  - X'02' Type 2
  - X'03' Type 4
  - X'04' Type 2.1
  - X'80' non-SNA, e.g., used for BSC links

## LCS Link Attributes (X'07') Link Connection Subsystem Configuration Data Subfield

This subfield transports LCS link connection attributes.

- 0 Length (q+1), in binary, of the LCS Link Attributes subfield
- 1 Key: X'07'
- 2 link connection type used
  - X'01' non-switched
  - X'02' switched
- 3 Half or full duplex:
  - X'01' half duplex
  - X'02' full duplex
- 4 DLC protocol type:
  - X'01' SDLC
  - X'02' BSC
  - X'02' S/S
- 5(=q) Point-to-point or multipoint:

X'01' Point-to-point  
X'02' Multipoint

### Sense Data (X'7D') MS Common Subvector

This MS common subvector transports error information back to the control point that initiated an MS request. The subvector contains a 4-byte field for sense data.
---

0 Length (p+1), in binary, of the Sense Data subvector  
1 Key: X'7D'  
2-5(=p) Sense data, as defined in "Chapter 9. Sense Data"



## CHAPTER 9. SENSE DATA

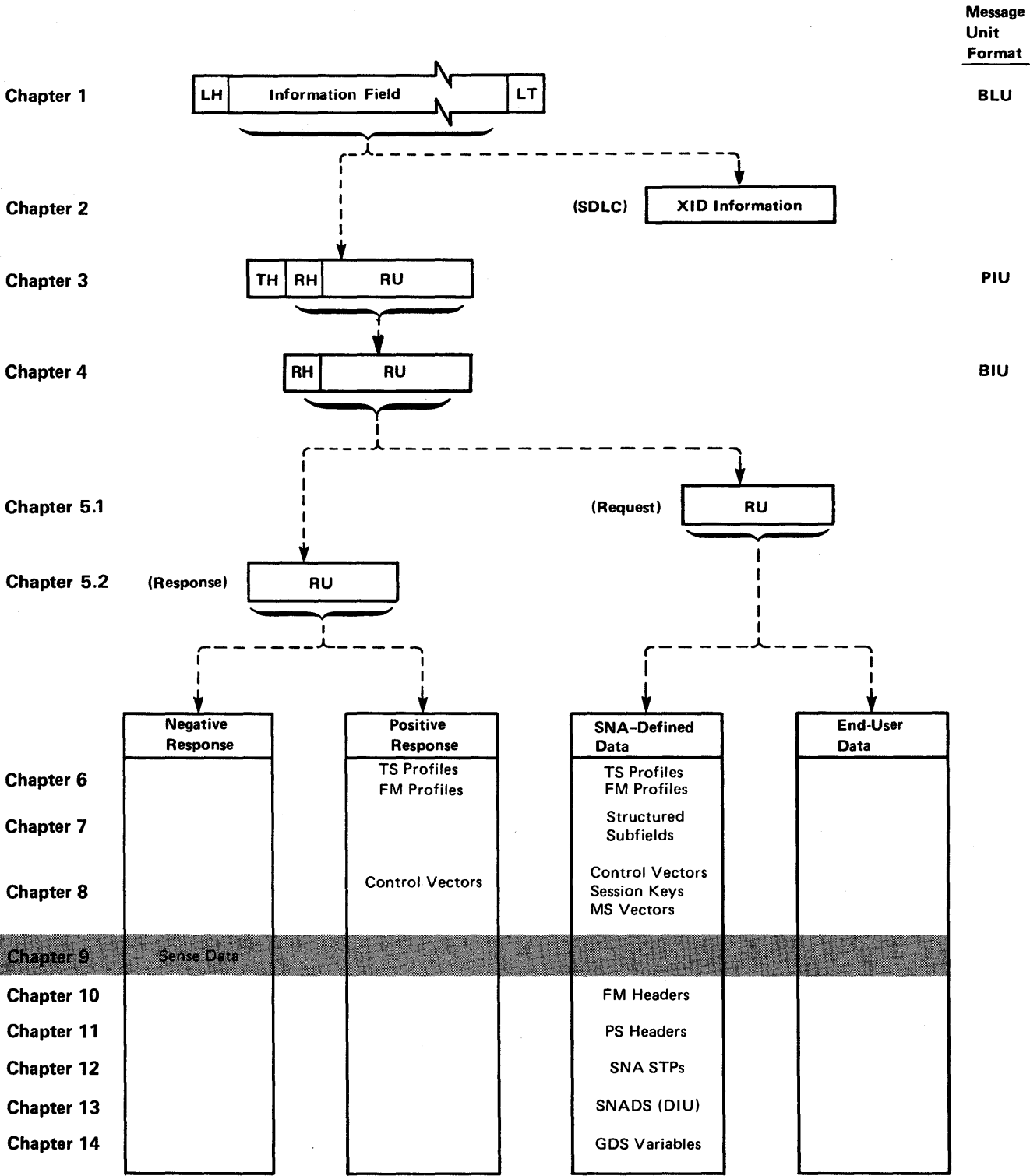

LH = Link Header  
 LT = Link Trailer  
 XID = Exchange Identification  
 TH = Transmission Header  
 RH = Request/Response Header  
 RU = Request/Response Unit  
 TS = Transmission Services  
 FM = Function Management  
 MS = Management Services

PS = Presentation Services  
 STP = Service Transaction Program  
 SNADS = SNA Distribution Services  
 DIU = Distribution Interchange Unit  
 GDS = General Data Stream  
 BLU = Basic Link Unit  
 PIU = Path Information Unit  
 BIU = Basic Information Unit

## CHAPTER 9. SENSE DATA

The sense data included with an EXCEPTION REQUEST (EXR), a negative response, an UNBIND request, a Sense Data (X'7D') MS common subvector, a function management header type 7 (FMH-7), or an extended sense data control vector (X'35') is a four-byte field (see Figure 9-1) that includes a one-byte category value, a one-byte modifier value, and two bytes of sense code specific information, whose format is defined along with the sense code definition, below.

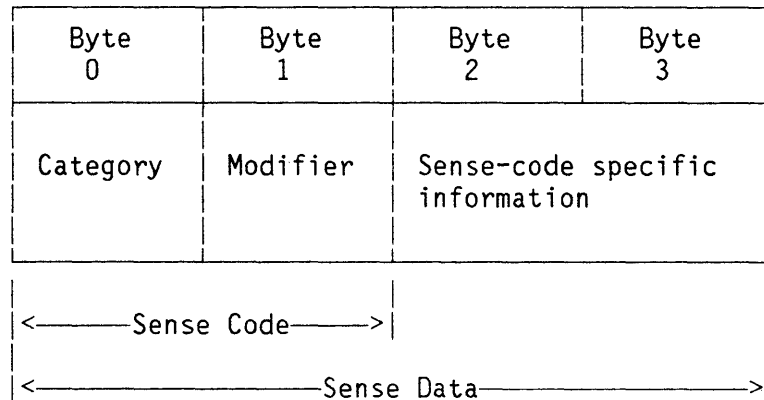

Figure 9-1. Sense Data Format

Together, the category byte 0, the modifier byte 1, and the sense code specific bytes 2 and 3 hold the sense data defined for the exception condition that has occurred.

The following categories are defined; all others are reserved:

VALUE	<u>CATEGORY</u>
X'00'	User Sense Data Only
X'08'	Request Reject
X'10'	Request Error
X'20'	State Error
X'40'	Request Header (RH) Usage Error
X'80'	Path Error



The category User Sense Data Only (X'00') allows the end users to exchange sense data in bytes 2-3 for conditions not defined by SNA within the other categories (and perhaps unique to the end users involved). The modifier value is also X'00'.

In earlier versions of SNA, user data (as well as implementation-specific data) generally could be carried in bytes 2-3 for all categories. This is no longer the case. Bytes 2-3 are used generally only for SNA-defined conditions for nonzero categories; exceptions for implementation-specific use are documented in the appropriate product publications.

The sense codes for the other categories are discussed below.

### REQUEST REJECT (CATEGORY CODE = X'08')

This category indicates that the request was delivered to the intended component and was understood and supported, but not executed.

Category and modifier (in hexadecimal):

0801 Resource Not Available: The LU, PU, link station, or link specified in an RU is not available.

Bytes 2 and 3 following the sense code contain sense code specific information. Settings allowed are:

0000 No specific code applies.

0003 Name aliasing cannot be performed because the name alias function is not available.

0009 The LU is not available because it is not able to comply with the PLU-SLU role specification.

000A The LU is not available because it is being taken down, and is therefore not accepting new sessions. The initiation request should not be retried.

4001-4002 Set aside for implementation-specific use, and will not be otherwise defined in SNA; see implementation documentation for details of usage.

0802 Intervention Required: Forms or cards are required at an output device, or a device is temporarily in local mode, or other conditions require intervention.

0803 Missing Password: The required password was not supplied.

0804 Invalid Password: Password was not valid.

0805 Session Limit Exceeded: The requested session cannot be activated, as one of the NAUs is at its session limit, for example, the LU-LU session limit or the (LU, mode) session limit. This sense code applies to ACTCDRM, INIT, BIND, and CINIT requests.

Bytes 2 and 3 following the sense code contain sense code specific information. Settings allowed are:

0000 No specific code applies.

0001 If accepted, the BIND request would prevent either the receiving LU or the sending LU from activating the number of contention winner sessions to the partner LU that were agreed upon during a change-number-of-sessions procedure.

0002 If accepted, the BIND request would cause the XRF-backup session limit to be exceeded.

0003 If accepted, the BIND request would cause the XRF-active session limit to be exceeded.

Note: The session limit for XRF-active sessions is one. An XRF-active BIND is valid only if there are no XRF-active or XRF-backup sessions with the receiving SLU.

0009 If accepted, the request would cause the PLU session limit to be exceeded.

000A If accepted, the request would cause the SLU session limit to be exceeded.

000B The request was rejected because a session already exists between the same LU pair, and at least one of the LUs does not support parallel sessions.

0806 Resource Unknown: For example, the request contained a name or address not identifying a PU, LU, SSCP, link, or link station known to the receiver or the sender.

Note: In an interconnected network environment, this sense code may be set by an SSCP in whose subnetwork and domain the LU was expected to reside; it is not set by an SSCP that is only an intermediary on the session-setup path. A gateway SSCP examines the Resource Identifier control vector in a session setup request (for example, CDINIT), to determine whether the LU is in the SSCP's subnetwork and domain.

Bytes 2 and 3 following the sense code contain sense code specific information. Settings allowed are:

0000 No specific code applies.

0001 The resources identified in an SNA Address List (X'04') MS common subvector are unknown to the PU receiving the request.

Note: When this sense data flows in a -RSP to an NMVT, the referenced X'04' subvector is the one that was present in the request NMVT to which the -RSP corresponds. When this sense data flows in a Sense Data (X'7D') MS common subvector, the referenced X'04' subvector is present with the X'7D' subvector in the same major vector.

- 0002 Set aside for implementation-specific use, and will not be otherwise defined in SNA; see implementation documentation for details of usage.
- 000A The configuration identifier specified in a management services command is not recognized by the DLC manager at the receiving node.
- 0011 An unknown OLU name was specified in the request.
- 0012 An unknown DLU name was specified in the request.
- 0013 An unknown SLU name was specified in the request.
- 0014 An unknown PLU name was specified in the request.
- 0015 An unknown OLU address was specified in the request.
- 0016 An unknown DLU address was specified in the request.
- 0017 An unknown SLU address was specified in the request.
- 0018 An unknown PLU address was specified in the request.
- 0021 The session-initiation request specified that the receiving SSCP is the SSCP having the DLU in its domain, but the DLU is unknown to the receiving SSCP.
- 0022 The originator of the request is unknown to the receiver.
- 0023 The destination of the request or response is unknown to the sender.
- 0024 An unknown LU1 name was specified in the request.
- 0025 An unknown LU2 name was specified in the request.
- 0026 The SSCP does not have a session with the boundary function PU of an independent LU.
- 0027 The PU associated with a switched SLU is unknown. Session setup processing for the switched SLU cannot proceed.
- 0028 NAU1 network address is unknown.
- 0029 NAU2 network address is unknown.

- 0807 Resource Not Available—LUSTAT Forthcoming: A subsidiary device will be unavailable for an indeterminate period of time. LUSTAT will be sent when the device becomes available.
- 0808 Invalid Contents ID: The contents ID contained on the ACTCDRM request was found to be invalid.
- 0809 Mode Inconsistency: The requested function cannot be performed in the present state of the receiver.

Bytes 2 and 3 following the sense code contain sense code specific information. Settings allowed are:

- 0000 No specific code applies.
- 0001-001B Set aside for implementation-specific use, and will not be otherwise defined in SNA; see implementation documentation for details of usage.
- 001C The RNAA request contains a network ID that is not known to the gateway PU.
- 001D An address pair session key in a Network-Qualified Address Pair control vector (X'15') is not known to the gateway PU.
- 001E A gateway PU received an RNAA request for a cross-network session and all possible address transforms for the named resource are allocated.
- 001F (Retired) An SSCP has detected a specification of gateway responsibility in the CDINIT request that is not consistent with its own definition. For example, an SSCP that has predesignated responsibility to control a gateway node specified in the CDINIT request sends this sense data when it receives the CDINIT from a session partner and the CDINIT indicates that the session partner also has predesignated responsibility for the gateway node; in this situation, a mismatch exists in the responsibilities of the SSCPs, because both cannot simultaneously have predesignated responsibility for the gateway node.
- 0020 The gateway node receiving an RNAA request cannot support another session between the named resource pair.
- 0021-0023 Set aside for implementation-specific use, and will not be otherwise defined in SNA; see implementation documentation for details of usage.
- 0024 A PU received an ACTPU request with the SSCP-PU Session Capabilities control vector (X'0B') indicating that the sending SSCP does not support ENA, but the PU does not know the SSCP's maximum subarea address value.

- 0025-0026 Set aside for implementation-specific use, and will not be otherwise defined in SNA; see implementation documentation for details of usage.
- 0027 A request for a function was received by a component but the function was not enabled or activated.
- 0028 Cleanup termination of an LU-LU session has been converted to a forced termination by the LU. The SSCP must wait for session ended signals before deleting its session awareness records of the session.
- 0031 Set aside for implementation-specific use, and will not be otherwise defined in SNA; see implementation documentation for details of usage.
- 0034 A termination request has been received for a resource that has been taken over by an SSCP. The termination type is not strong enough to apply to the resources. The termination type needs to be Forced or Cleanup.
- 0035 A cross-domain resource, which was expected to be active, is inactive.
- 080A Permission Rejected: The receiver has denied an implicit or explicit request of the sender; when sent in response to BIND, it implies either that the secondary LU will not notify the SSCP when a BIND can be accepted, or that the SSCP does not recognize the NOTIFY vector key X'0C'. (See the X'0845' sense code for a contrasting response.)
- 080B Bracket Race Error: Loss of contention within the bracket protocol. This error can arise when bracket initiation/termination by both NAUs is allowed
- 080C Procedure Not Supported: A procedure (Test, Trace, IPL, REQMS type, MS major vector key) specified in an RU is not supported by the receiver.
- Bytes 2 and 3 following the sense code contain sense code specific information. Settings allowed are:
- 0000 No specific code applies.
- 0001-0003 Set aside for implementation specific use, and will not be otherwise defined in SNA; see implementation documentation for details of usage.
- 0005 The MS major vector key is not supported by the receiver.
- 0006 The MS major vector is identified as one that contains a command, but the receiver does not recognize or support the command subvector. (See the X'086C' sense code for the case in which the command subvector is identified, but an additional required subvector is missing.)

- 0007 A request for a function is supported by the receiver, but the resource identified in the request does not support that function (no function is specifically indicated).
- 0009 A request for session information retrieval for an independent LU was received in an REQMS; such requests are permitted only in an NMVT.
- 000A A request was received containing an address list MS subvector with multiple entries, but the receiver supports only a single entry in such a subvector.
- 4001, 4003 Set aside for implementation-specific use, and will not be otherwise defined in SNA; see implementation documentation for details of usage.
- 080D NAU Contention: A request to activate a session was received while the receiving half-session was awaiting a response to a previously sent activation request for the same session; for example, the SSCP receives an ACTCDRM from the other SSCP before it receives the response for an ACTCDRM that it sent to the other SSCP and the SSCP ID in the received ACTCDRM was less than or equal to the SSCP ID in the ACTCDRM previously sent.
- 080E NAU Not Authorized: The requesting NAU does not have access to the requested resource.
- Bytes 2 and 3 following the sense code contain sense code specific information. Settings allowed are:
- 0000 No specific code applies.
- 0001 The PU, according to its system definition, does not accept an ACTPU from any SSCP having the network ID of the sending SSCP.
- 080F End User Not Authorized: The requesting end user does not have access to the requested resource.
- Bytes 2 and 3 following the sense code contain sense code specific information. Settings allowed are:
- 0000 No specific code applies.
- 6051 Access Security Information Invalid: The request specifies an Access Security Information field that is unacceptable to the receiver; for security reasons, no further detail on the error is provided. This sense data is sent in FMH-7 or UNBIND.
- 0810 Missing Requester ID: The required requester ID was missing.
- 0811 Break: Asks the receiver of this sense code to terminate the present chain with CANCEL or with an FMD request carrying EC. The half-session sending the Break sense code enters chain-purge state when Break is sent; the

half-session receiving the Break sense code discards the terminated chain without ever retransmitting it.

0812 Insufficient Resource: Receiver cannot act on the request because of a temporary lack of resources.

Bytes 2 and 3 may contain the following sense code specific information:

0000 No specific code applies.

0001 More PUs or LUs requested by RNAA than are present in the pool.

0003 Resources are not currently available to support an XRF session.

0004 The RNAA request indicates that the requested address must be pre-ENA compatible, but no pre-ENA compatible address is available.

0007 Insufficient resources are available for LU address allocation.

000D Insufficient buffers exist to activate a session.

0011 There is insufficient storage available to the SNA component to satisfy the request at this time.

0813 Bracket Bid Reject—No RTR Forthcoming: BID (or BB) was received while the first speaker was in the in-bracket state, or while the first speaker was in the between-brackets state and the first speaker denied permission. RTR will not be sent.

Bytes 2 and 3 following the sense code contain sense code specific information. Settings allowed are:

0000 No specific code applies.

0001 Bracket Bid Reject: The component was in the in-bracket state when a bracket request was received.

0002 Bracket Bid Reject: The component was in the between-bracket state when a bracket request was received.

0814 Bracket Bid Reject—RTR Forthcoming: BID (or BB) was received while the first speaker was in the in-bracket state, or while the first speaker was in the between-brackets state and the first speaker denied permission. RTR will be sent.

0815 Function Active: A request to activate a network element or procedure was received, but the element or procedure was already active.

Bytes 2 and 3 following the sense code contain sense code specific information. Settings allowed are:

0000 No specific code applies.

0001 A session activation request was received by a boundary function to activate a session that was already active.

0002 A session activation request was received by a gateway function to activate a cross-network session that was already active.

0003 Processing for another management services request in progress. Sender should retry the request.

Note: This sense data is sent only by a type 2 node, which may lack sufficient queuing space.

0004 A BIND was received from an T2.1 node when the session is already active; i.e., the LFSID is in use. The receiver rejects the BIND.

0816 Function Inactive: A request to deactivate a network element or procedure was received, but the element or procedure was not active.

0817 Link or Link Resource Inactive: A request requires the use of a link or link resource that is not active.

Bytes 2 and 3 following the sense code contain sense code specific information. Settings allowed are:

0000 No specific code applies.

0001 Link inactive.

0002 Link station inactive.

0003 Switched link connection inactive.

4001 Set aside for implementation-specific use, and will not be otherwise defined in SNA; see implementation documentation for details of usage.

0818 Link Procedure in Process: CONTACT, DISCONTACT, IPL, or other link procedure in progress when a conflicting request was received.

Bytes 2 and 3 following the sense code contain sense code specific information. Settings allowed are:

0000 No specific code applies.

0001,0002 Set aside for implementation-specific use, and will not be otherwise defined in SNA; see implementation documentation for details of usage.

0004 Set aside for implementation-specific use, and will not be otherwise defined in SNA; see implementation documentation for details of usage.

0005 Link problem determination test for a modem in progress.



0006 Online terminal test in progress.

0007 SDLC link test, level 2, in progress.

0009 Test initiated from the modem panel is in progress.

0819 RTR Not Required: Receiver of READY TO RECEIVE has nothing to send.

081A Request Sequence Error: Invalid sequence of requests.

Bytes 2 and 3 following the sense code contain sense code specific information. Settings allowed are:

0000 No specific code applies.

0002 An IPL or DUMP RU sequence error has occurred.

0004 An NC\_ER\_TEST was to be sent as a result of receiving a ROUTE\_TEST request. The ROUTE\_TEST was sent in one subnetwork, the NC\_ER\_TEST was to be sent in another. The SSCP sending the ROUTE\_TEST did not have a required alias address within the subnetwork where the NC\_ER\_TEST was to be sent. (Before sending ROUTE\_TEST, the SSCP sends RNAA, or the installation predefines the alias address, so that an origin SSCP address is available within the subnetwork of the route being tested. This address is then specified in the NC\_ER\_TEST RU.)

081B Receiver in Transmit Mode: A race condition: normal-flow request received while the half-duplex contention state was not-receive, (\*S,-R), or while resources (such as buffers) necessary for handling normal-flow data were unavailable. (Contrast this sense code with X'2004', which signals a protocol violation.)

081C Request Not Executable: The requested function cannot be executed, because of a permanent error condition in the receiver.

Bytes 2 and 3 following the sense code contain sense code specific information. Settings allowed are:

0000 No specific code applies.

0001 Set aside for implementation-specific use, and will not be otherwise defined in SNA; see implementation documentation for details of usage.

0002 The receiver has an error resulting from a software problem that prevents execution of the request.

00B1 An SDLC error was detected during link problem determination for a modem.

00B2 A modem error (for example, modem check) was detected during link problem determination.

- 00B3 A timeout threshold was exceeded for a link problem determination aid modem response.
- 00B4 An overrun or underrun occurred in the node using the link connection during link problem determination for a modem.
- 00B5 Data Check was signaled during LPDA-2 test.
- 00B6 Format exception was signaled during LPDA-2 test.
- 00B7 LPDA-2 modem test was attempted and failed because of a communication controller equipment (for example, scanner) error.
- 0n0m An error was detected by the DLC manager of the receiving node during the execution of a management services request. If n=X'A', the link connection status has not changed from the state previous to the execution; if n=X'B', the link connection status was modified from the state existing previous to the execution. The error is specified as follows: m=X'1' for volatile storage error, m=X'2' for non-volatile storage (e.g., file access error), m=X'3' for link connection component (e.g., modem) interface error, and m=X'4' for unspecified software error conditions.

Sense code specific information settings 0004, 0008, 000C, 0010, 0014, 0018, 0020, 0028, 0030, 0034, 0038, 003C, 0040, 0072, 0098, 00AB, 0100-0109, 0120-0125, 0149, 0189-0191, 0200-0209, 0220-0225, 0290, 0291, 07\*\*, and 08\*\* are all set aside for implementation-specific use, and will not be otherwise defined in SNA; see implementation documentation for details of usage.

- 081D Invalid Station/SSCP ID: The station ID or SSCP ID in the request was found to be invalid.
- 081E Session Reference Error: The request contained reference to a half-session that either could not be found or was not in the expected state (generally applies to network services requests).

Bytes 2 and 3 following the sense code contain sense code specific information. Settings allowed are:

- 0000 No specific code applies.
- 0003 No session was found during the processing of a session services request.
- 0004 The appropriate session was found during processing of a session services request, but the session is not in the expected state.

081F Reserved

0820 Control Vector Error: Invalid data for the control vector specified by the target network address and key.

- 0821 Invalid Session Parameters: Session parameters were not valid or not supported by the half-session whose activation was requested.
- Bytes 2 and 3 following the sense code contain sense code specific information. Settings allowed are:
- 0000 No specific code applies.
  - 0003 The primary half-session requires cryptography, but the secondary half-session does not support cryptography.
  - 0004 The secondary half-session requires cryptography, but the primary half-session does not support cryptography.
  - 0005 Selective or required cryptography is specified, but no SLU cryptographic data key is provided.
- 0822 Link Procedure Failure: A link-level procedure has failed due to link equipment failure, loss of contact with a link station, or an invalid response to a link command. (This is not a path error, since the request being rejected was delivered to its destination.)
- 0823 Unknown Control Vector: The control vector specified by a network address and key is not known to the receiver.
- 0824 Logical Unit of Work Aborted: The current unit of work has been aborted; when sync point protocols are in use, both sync point managers are to revert to the previously committed sync point.
- Bytes 2 and 3 following the sense code contain sense code specific information. Settings allowed are:
- 0000 For LU 6.2, Backout Initiated: A transaction program or its LU has initiated backout. The protected resources for the distributed logical unit of work are to be restored to the previously committed sync point. This sense data is sent only in FMH-7.
- For non-LU 6.2, no specific code applies.
- 0825 Component Not Available: The LU component (a device indicated by an FM header) is not available.
- 0826 FM function not supported: A function requested in an FMD RU is not supported by the receiver.
- 0827 Intermittent Error—Retry Requested: An error at the receiver caused an RU to be lost. The error is not permanent, and retry of the RU (or chain) is requested.
- 0828 Reply Not Allowed: A request requires a normal-flow reply, but the outbound data flow for this half-session is quiesced or shut down, and there is no delayed reply capability.

- 0829 Change Direction Required: A request requires a normal-flow reply, but the half-duplex flip-flop state (of the receiver of the request) is not-send, and CD was not set on the request. Therefore, there is no delayed reply capability.
- 082A Presentation Space Alteration: Presentation space altered by the end user while the half-duplex state was not-send, (-S,\*R); request executed.
- 082B Presentation Space Integrity Lost: Presentation space integrity lost (for example, cleared or changed) because of a transient condition—for example, because of a transient hardware error or an end user action such as allowing presentation services to be used by the SSCP. (Note: The end-user action described under X'082A' and X'084A' is excluded here.)
- 082C Resource-Sharing Limit Reached: The request received from an SSCP was to activate a half-session, a link, or a procedure, when that resource was at its share limit.
- 082D LU Busy: The LU resources needed to process the request are being used; for example, the LU resources needed to process the request received from the SSCP are being used for the LU-LU session.
- 082E Intervention Required at LU Subsidiary Device: A condition requiring intervention, such as out of paper, or power-off, or cover interlock open, exists at a subsidiary device.
- 082F Request Not Executable because of LU Subsidiary Device: The requested function cannot be executed, due to a permanent error condition in one or more of the receiver's subsidiary devices.
- 0830 Session-Related Identifier Not Found: The receiver could not find a session-related identifier for a specified session.
- Bytes 2 and 3 following the sense code contain sense code specific information. Settings allowed are:
- 0000 No specific code applies.
  - 0001 PCID not found for the specified resources.
  - 0002 LSID not found for the specified session.
- 0831 LU Component Disconnected: An LU component is not available because of power off or some other disconnecting condition.
- 0832 Invalid Count Field: A count field contained in the request indicates a value too long or too short to be interpreted by the receiver, or the count field is inconsistent with the length of the remaining fields.
- Bytes 2 and 3 following the sense code contain sense code specific information. Settings allowed are:
- nnnn Bytes 2 and 3 contain a binary count that indexes (zero-origin) the first byte of the invalid count field.

Note: This sense code is not used for a BIND error because the displacement of fields within the BIND may not be the same at both ends of a session when the BIND was affected by name transformations—for example, after the BIND has passed through a gateway. Sense code X'0835' is used to specify a displacement for a BIND error.

0833 Invalid Parameter (with Pointer and Complemented Byte): One or more parameters contained in fixed- or variable-length fields of the request are invalid or not supported by the NAU that received the request.

Bytes 2 and 3 following the sense code contain sense code specific information. Settings allowed are:

nmm Byte 2 contains a binary value that indexes (zero-origin) the first byte that contained an invalid parameter.

Byte 3 contains a transform of the first byte that contained an invalid parameter: the bits that constitute the one or more invalid parameters are complemented, and all other bits are copied.

Note: This sense code is not used for a BIND error because the displacement of fields within the BIND may not be the same at both ends of a session when the BIND was affected by name transformations—for example, after the BIND has passed through a gateway. Sense code X'0835' is used to specify a displacement for a BIND error.

0834 RPO Not Initiated: A power-off procedure for the specified node was not initiated because one or more other SSCPs have contacted the node, or because a CONTACT, DUMP, IPL, or DISCONTACT procedure is in progress for that node.

0835 Invalid Parameter (with Pointer Only): The request contained a fixed- or variable-length field whose contents are invalid or not supported by the NAU that received the request.

nnnn Bytes 2 and 3 contain a two-byte binary count that indexes (zero-origin) the first byte of the fixed- or variable-length field having invalid contents.

Note: This sense code is not used to report an invalid value in an MS major vector. If the invalid value occurs in a formatted MS subvector, sense code X'086B' is used. If it occurs in an unformatted subvector, sense code X'0870' is used.

0836 PLU/SLU Specification Mismatch: For a specified LU-LU session, both the origin LU (OLU) and the destination LU (DLU) have only the primary capability or have only the secondary capability.

0837 Queuing Limit Exceeded: For an LU-LU session initiation request (INIT, CDINIT, or INIT-OTHER-CD) specifying (1) Initiate or Queue (if Initiate not possible) or (2) Queue Only, the queuing limit of either the OLU or the DLU, or both, was exceeded.

0838 Reserved

- 0839 LU-LU Session Being Taken Down or LU being Deactivated.
- Bytes 2 and 3 following the sense code contain sense code specific information. Settings allowed are:
- 0000 No specific code applies.
  - 0001 During session-initiation processing, a session-termination request has caused the LU-LU session to be taken down.
- 083A LU Not Enabled: At the time an LU-LU session initiation request is received at the SSCP, at least one of the two LUs, although having an active session with its SSCP, is not ready to accept CINIT or BIND requests.
- Bytes 2 and 3 following the sense code contain sense code specific information. Settings allowed are:
- 0000 No specific code applies.
  - 0001 The PLU is not enabled.
  - 0002 The SLU is not enabled.
- 083B Invalid PCID: the received PCID for a new session duplicated the PCID assigned to another session, or the received PCID intended as an identifier for an existing session could not be associated with such an existing session.
- Bytes 2 and 3 following the sense code contain sense code specific information. Settings allowed are:
- 0000 No specific code applies.
  - 0001 The PCID contained in CDINIT(Initiate or Queue), INIT-OTHER-CD, or CDTAKED duplicates a PCID received previously in one of these requests.
- 083C Domain Takedown Contention: While waiting for a response to a CDTAKED, a CDTAKED request is received by the SSCP containing the SSCP-SSCP primary half-session. Contention is resolved by giving preference to the CDTAKED sent by the primary half-session.
- 083D Dequeue Retry Unsuccessful—Removed from Queue: The SSCP cannot successfully honor a CDINIT(Dequeue) request (which specifies "leave on queue if dequeue-retry is unsuccessful") to dequeue and process a previously queued CDINIT request (for example, because the LU in its domain is still not available for the specified session), and removes the queued CDINIT request from its queue.
- 083E Reserved

083F Terminate Contention: While waiting for a response to a CDTERM, a CDTERM is received by the SSCP of the SLU. Contention is resolved by giving preference to the CDTERM sent by the SSCP of the SLU.

0840 Procedure Invalid for Resource: The named RU is not supported in the receiver for this type of resource (for example, (1) SETCV specifies boundary function support for a type 1 node but the capability is not supported by the receiving node, or (2) the NCP PU receiving an EXEC TEST or TESTMODE is not the primary NCP PU for the target link.)

0841 Duplicate Network Address: In an LU-LU session initiation request, one of the specified LUs has a duplicate network address already in use.

Bytes 2 and 3 following the sense code contain sense code specific information. Settings allowed are:

0000 The SSCP of the DLU determines that the OLU network address specified in the CDINIT request is a duplicate of an LU network address assigned to a different LU name.

0001 A duplicate SLU address is found during session initiation.

0002 A duplicate PLU address is found during session initiation.

0003 An SSCP finds a duplicate network address for the DLU on the OLU side of the gateway.

0004 An SSCP finds a duplicate network address for the DLU on the DLU side of the gateway.

0005 An SSCP finds a duplicate network address for the OLU on the OLU side of the gateway.

0006 An SSCP finds a duplicate network address for the OLU on the DLU side of the gateway.

0842 Session Not Active.

Bytes 2 and 3 following the sense code contain sense code specific information. Settings allowed are:

0000 SSCP-SSCP Session Not Active: The SSCP-SSCP session, which is required for the processing of a network services request, is not active; for example, at the time an LU-LU session initiation or termination request is received, at least one of the following conditions exists:

- The SSCP of the ILU and the SSCP of the OLU do not have an active session with each other, and therefore INIT-OTHER-CD cannot flow.
- The SSCP of the OLU and the SSCP of the DLU do not have an active session with each other, and therefore CDINIT or CDTERM cannot flow.

Note: This value is used if there is not enough data to select one of the more specific codes listed below.

- 0002 For a session-initiation request, an SSCP does not have an SSCP-SSCP session with an SSCP in the direction of the DLU.
  - 0003 For a session-initiation request, an SSCP does not have an SSCP-SSCP session with an SSCP in the direction of the OLU.
  - 0843 Required Synchronization Not Supplied: For example, a secondary LU (LU type 2 or 3) received a request with Write Control Code = Start Print, along with RQE and -CD.
  - 0844 Initiation Dequeue Contention: While waiting for a response to a CDINIT(Dequeue), a CDINIT(Dequeue) is received by the SSCP of the SLU. Contention is resolved by giving preference to the CDINIT(Dequeue) sent by the SSCP of the SLU.
  - 0845 Permission Rejected—SSCP Will Be Notified: The receiver has denied an implicit or explicit request of the sender; when sent in response to BIND, it implies that the secondary LU will notify the SSCP (via NOTIFY vector key X'0C') when a BIND can be accepted, and the SSCP of the SLU supports the notification. (See the X'080A' sense code for a contrasting response.)
  - 0846 ERP Message Forthcoming: The received request was rejected for a reason to be specified in a forthcoming request.
  - 0847 Restart Mismatch: Sent in response to STSN, SDT, or BIND to indicate that the secondary half-session is trying to execute a resynchronizing restart but has received insufficient or incorrect information.
  - 0848 Cryptography Function Inoperative: The receiver of a request was not able to decipher the request because of a malfunction in its cryptography facility.
  - 0849 Reserved
  - 084A Presentation Space Alteration: The presentation space was altered by the end user while the half-duplex state was not-send, (-S,\*R); request not executed.
  - 084B Requested Resources Not Available: Resources named in the request, and required to honor it, are not currently available. It is not known when the resources will be made available.
- Bytes 2 and 3 following the sense code contain sense code specific information. Settings allowed are:
- 0000 No specific code applies.
  - 0003 The application transaction program specified in the request is not available.



- 6002 The resource identified by the destination program name (DPN) is not supported.
- 6003 The resource identified by the primary resource name (PRN) is not supported.
- 6031 Transaction Program Not Available—Retry Allowed: The FMH-5 Attach command specifies a transaction program that the receiver is unable to start. Either the program is not authorized to run or the resources to run it are not available at this time. The condition is temporary. The sender is responsible for subsequent retry. This sense data is sent only in FMH-7.

084C Permanent Insufficient Resource: Receiver cannot act on the request because resources required to honor the request are permanently unavailable. The sender should not retry immediately because the situation is not transient.

Bytes 2 and 3 following the sense code contain sense code specific information. Settings allowed are:

0000 For LU 6.2, Transaction Program Not Available—No Retry: The FMH-5 Attach command specifies a transaction program that the receiver is unable to start. The condition is not temporary. The sender should not retry immediately. This sense data is sent only in FMH-7.

For non-LU 6.2, no additional information is specified.

0001 Set aside for implementation-specific use, and will not be otherwise defined in SNA; see implementation documentation for details of usage.

hnnn where  $h \geq 8$ , i.e., the high-order bit in byte 2 is set to 1. The 15 low-order bits of bytes 2 and 3 contain a binary count that indexes (zero-origin) the first byte of the field found to be in error.

084D Retired

084E Invalid Session Parameters—PRI: A positive response to an activation request (for example, BIND) was received and was changed to a negative response because of invalid session parameters carried in the response. The services manager receiving the response will send a deactivation request for the corresponding session.

084F Reserved

0850 Link-Level Operation Cannot Be Performed: An IPL, dump, or RPO cannot be performed through the addressed link station because the system definition or current state of the hardware configuration does not allow it.

0851 Session Busy: Another session that is needed to complete the function being requested on this session is temporarily unavailable.

- 0852 Duplicative Session Activation Request: Two session activation requests have been received with related identifiers. The relationship of the identifiers and the resultant action varies by request.
- If the RU is an ACTPU or ACTCDRM, it means that a session has already been activated for the subject destination-origin pair by a session activation request that carried a larger activation request identifier than the current request; the current request is refused.
- If the RU is a BIND, it means that the BIND request was received with the same session instance identifier (in the structured subfield X'03' of the User Data field) as an active session's; the current request is refused.
- 0853 TERMINATE(Cleanup) Required: The SSCP cannot process the termination request, as it requires cross-domain SSCP-SSCP services that are not available. (The corresponding SSCP-SSCP session is not active.) TERMINATE(Cleanup) is required.
- 0854 Retired, formerly used for product-specific information.
- 0855 Reserved
- 0856 SSCP-SSCP Session Lost: Carried in the Sense Data field in a NOTIFY (Third-Party Notification vector, X'03') or -RSP(INIT\_OTHER) sent to an ILU to indicate that the activation of the LU-LU session is uncertain because the SSCP(ILU)-SSCP(OLU) session has been lost. (Another sense code, X'0842', is used when it is known that the LU-LU session activation cannot be completed.)
- 0857 SSCP-LU Session Not Active: The SSCP-LU session, required for the processing of a request, is not active; for example, in processing REQECHO, the SSCP did not have an active session with the target LU named in the REQECHO RU.
- Bytes 2 and 3 following the sense code contain sense code specific information. Settings allowed are:
- 0000 No specific code applies.
  - 0001 The SSCP-SLU session is in the process of being reactivated.
  - 0002 The SSCP-PLU session is inactive.
  - 0003 The SSCP-SLU session is inactive.
  - 0004 The SSCP-PLU session is in the process of being reactivated.
- 0858 Reserved
- 0859 REQECHO Data Length Error: The specified length of data to be echoed (in REQECHO) violates the maximum RU size limit for the target LU.

085A  
through Reserved  
085F

0860 Function Not Supported—Continue Session: The function requested is not supported; the function may have been specified by a request code or some other field, control character, or graphic character in an RU.

Bytes 2 and 3 following the sense code contain sense code specific information. Settings allowed are:

nnnn Bytes 2 and 3 contain a two-byte binary count that indexes (zero-origin) the first byte in which an error was detected. This sense code is used to request that the session continue, thereby ignoring the error.

0861 Invalid COS Name: The class of service (COS) name, either specified by the ILU or generated by the SSCP of the SLU from the mode table is not in the "COS name to VR identifier list" table used by the SSCP of the PLU.

Bytes 2 and 3 following the sense code contain sense code specific information. Settings allowed are:

0000 COS name was generated by the SSCP.

0001 COS name was generated by the ILU.

0003 The CDINIT request or response contains a Session Initiation control vector that has Class of Service (COS) Name fields that have not been properly specified.

0862 Medium Presentation Space Recovery: An error has occurred on the current presentation space. Recovery consists of restarting at the top of the current presentation space. The sequence number returned is of the RU in effect at the top of the current presentation space.

nnnn Bytes 2 and 3 following the sense code contain the byte offset from the beginning of the RU to the first byte of the RU that is displayed at the top of the current presentation space.

0863 Referenced Local Character Set Identifier (LCID) Not Found: A referenced character set does not exist.

Bytes 2 and 3 following the sense code contain sense code specific information. Settings allowed are:

0000 No specific code applies.

hnnn where  $h \geq 8$ , i.e., the high-order bit in byte 2 is set to 1. The 15 low-order bits of bytes 2 and 3 contain a binary count that indexes (zero-origin) the first byte of the field found to be in error.

- 0864      Function Abort: The conversation was terminated abnormally. Other terminations may occur after repeated reexecutions; the request sender is responsible to detect such a loop.
- Bytes 2 and 3 following the sense code contain sense code specific information. Settings allowed are:
- 0000      For LU 6.2, Premature Conversation Termination: The conversation is terminated abnormally; for example, the transaction program may have issued a DEALLOCATE\_ABEND verb, or the program may have terminated (normally or abnormally) without explicitly terminating the conversation. This sense data is sent only in FMH-7.
- For non-LU 6.2, no additional information is specified.
- 0001      System Logic Error—No Retry: A system logic error has been detected. No retry of the conversation should be attempted. This sense data is sent only in FMH-7.
- 0002      Excessive Elapsed Time—No Retry: Excessive time has elapsed while waiting for a required action or event. For example, a transaction program has failed to issue a conversation-related protocol boundary verb. No retry of the conversation should be attempted. This sense data is sent in UNBIND when there is no chain to respond to; otherwise, it is sent in FMH-7.
- 0865      Retired
- 0866      Retired
- 0867      Sync Event Response: Indicates a required negative response to an (RQE,CD) synchronizing request.
- 0868      No Panels Loaded: Referenced format not found because no panels are loaded for the display.
- 0869      Panel Not Loaded: The referenced panel is not loaded for the display.
- 086A      Subfield Key Invalid: A subfield key in an MS subvector was not valid in the conditions under which it was processed.
- Bytes 2 and 3 following the sense code contain sense code specific information. Settings allowed are:
- nnmm      Byte 2 following the sense code contains the subvector key (nn) of the subvector containing the unrecognized subfield, and byte 3 contains the unidentified subfield key (mm).
- 086B      Subfield Value Invalid: A value in a subfield within an MS major vector is invalid for the receiver.
- Bytes 2 and 3 following the sense code contain sense code specific information. Settings allowed are:

nnmm Byte 2 following the sense code contains the subvector key (nn) of the subvector containing the subfield with the invalid value, and byte 3 contains the subfield key (mm) of the subfield with the invalid value.

Note: See sense code X'0870' for the case in which the invalid value occurs in an unformatted subvector, that is, one not containing subfields with keys and lengths, or in the unformatted portion of a partially formatted subvector.

086C Required Subvector Missing: One or more MS subvectors that are required by the receiver to perform some function are missing from the received list of subvectors, or are not present in the required position.

Bytes 2 and 3 following the sense code contain sense code specific information. Settings allowed are:

nn00 Byte 2 following the sense code contains the subvector key (nn) of one of the subvectors that is missing, or improperly positioned. Byte 3 is reserved (00).

Note: See the X'080C0006' sense data for the case in which the major vector key is recognized but a subvector representing the function to be performed cannot be identified.

086D Required Subfield Missing: An MS subvector lacks one or more subfield keys that are required by the receiver to perform the function requested.

Bytes 2 and 3 following the sense code contain sense code specific information. Settings allowed are:

nnmm Byte 2 following the sense code contains the subvector key (nn) of the subvector lacking a required subfield, and byte 3 contains the subfield key (mm) of a missing subfield.

086E Invalid Subvector Combination: Two or more subvectors, each permissible by itself, are present in a combination that is not allowed.

Bytes 2 and 3 following the sense code contain sense code specific information. Settings allowed are:

nnmm Bytes 2 and 3 following the sense code contain the subvector keys (nn) and (mm) of two of the subvectors that should not be jointly present.

086F Length Error: A length field within an MS major vector is invalid, or two or more length fields are incompatible.

Bytes 2 and 3 following the sense code contain sense code specific information. Settings allowed are:

0000 No specific code applies.

0001 The MS major vector length is incompatible with the RU length.

- 0002 The sum of the MS subvector lengths is incompatible with the MS major vector length.
- nn03 The sum of the subfield lengths in a MS subvector is incompatible with the subvector length. Byte 2 following the sense code contains the subvector key (nn).
- nn05 MS subvector length invalid. Byte 2 following the sense code contains the relevant subvector key (nn). (This is specified only if the sum of the subvector lengths is compatible with the major vector length.)
- nn06 Subfield length invalid. Byte 2 following the sense code contains the subvector key (nn) of the MS subvector containing the invalid subfield length. (This is specified only if the sum of the subfield lengths is compatible with the subvector length.)
- 0870 Unformatted Subvector Value Invalid: A value in an unformatted MS subvector, or in an unformatted portion of a partially formatted MS subvector, is invalid.
- Bytes 2 and 3 following the sense code contain sense code specific information. Settings allowed are:
- nnxx Byte 2 following the sense code contains the subvector key (nn) of the MS subvector containing the invalid value. Byte 3 contains a one-byte binary count that indexes the first byte in which the invalid value falls. The indexing is zero-origin, from the beginning of the subvector.
- Note: See sense code X'086B' for the case in which the invalid value occurs in a formatted MS subvector, that is, one containing subfields with keys and lengths, or in the formatted portion of a partially formatted subvector.
- 0871 Read Partition State Error: A Read Partition structured field was received while the display was in the retry state.
- 0872 Orderly Deactivation Refused: An NC\_DACTVR(Orderly) request has been received, but sessions are assigned to the VR and it will not be deactivated.
- 0873 Virtual Route Not Defined: No ERN is designated to support this VRN.
- 0874 ER Not in a Valid State: The ER supporting the requested VR is not in a state allowing VR activation.
- 0875 Incorrect or Undefined Explicit Route Requested: The reverse ERNs specified in the NC\_ACTVR do not contain the ERN defined to be used for the VR requested, or the ERN designated to be used for the VR is not defined.

0876 Nonreversible Explicit Route Requested: The ERN used by the NC\_ACTVR does not use the same sequence of transmission groups (in reverse order) as the ERN that should be used for the RSP(NC\_ACTVR).

0877 Resource Mismatch: The receiver of a request has detected a mismatch between two of the following: (1) its definition of an affected resource, (2) the actual configuration, and (3) the definition of the resource as implied in the request.

Bytes 2 and 3 following the sense code contain sense code specific information. Settings allowed are:

0000 No specific code applies.

0001 Link Defined as Switched Is Nonswitched: A link defined to an ACTLINK receiver as being switched was found to be nonswitched during the activation attempt.

0002 Link Defined as SDLC Is Non-SDLC: A link defined to an ACTLINK receiver as being SDLC was found to be non-SDLC during the activation attempt.

0003 Link Defined as Having Automatic Connect-Out Capability Does Not: A link defined to an ACTLINK receiver as having automatic connect-out capability was found to lack it during the activation attempt.

0004 ACTLINK Received for a Resource Other Than a Link: An ACTLINK was received that resolved to a local device address representing a device other than a link.

0005 Link defined as X.21 is not X.21.

0006 Link defined as LPDA-capable is configured in NRZI mode.

0007 A request that is allowed only for a primary link station was received for a link station that is defined to the receiver as secondary.

0008 A request for link problem determination for modems was received for a link that is defined to the receiver as not supporting link problem determination for modems.

0009 A request for link problem determination for modems was received for a link that is defined to the receiver as supporting link problem determination for modems, but no link station supporting link problem determination for modems was found on the link.

000A A request that is allowed only for a nonswitched link was received for a link that is defined to the receiver as switched.

000B A request that is allowed only for a link with a modem not using the multiplexed links feature was received for a link that is defined to the receiver as having a modem using the multiplexed links feature.

- 000C Resource Definition Mismatch for Modems: A request that is allowed only for a link with a non-tailed modem was received for a link that is defined to the receiver as having a tailed modem.
- 0878 Insufficient Storage: The storage resource required for a data format is not available.
- 0879 Storage Medium Error: A permanent error has occurred involving a storage medium.
- Bytes 2 and 3 following the sense code contain sense code specific information. Settings allowed are:
- 0000 No specific code applies.
- 0001 Disk I/O error.
- 087A Format Processing Error: A processing error occurred during data formatting.
- 087B Resource Unknown: The request contains a session key that does not identify a session known to some gateway node; for example, a session activation request arrives at a gateway node after it has released the address transform for the intended session.
- 087C SSCP-PU Session Not Active: A gateway SSCP-PU session that is needed to establish an address transform for the intended cross-network LU-LU session was not active.
- 087D Session Services Path Error: A session services request cannot be rerouted along a path of SSCP-SSCP sessions. This capability is required, for example, to set up a cross-network LU-LU session.
- Bytes 2 and 3 contain sense code specific information that indicates the specific reason for not rerouting the request. Settings allowed are:
- 0000 No specific code applies.
- 0001 An SSCP has attempted unsuccessfully to reroute a session services request to its destination via one or more adjacent SSCPs; this value is sent by a gateway SSCP when it has exhausted trial-and-error rerouting.
- Note: This code is used when SSCP rerouting fails completely. The remaining codes are used for failures to reroute to a particular SSCP. For example, they are associated with specific SSCPs when information about a rerouting failure is displayed in the node that was trying to reroute.
- 0002 An SSCP is unable to reroute a session services request because a necessary routing table is not available, that is, there is no adjacent SSCP table corresponding to the rerouting key in the Resource Identifier control vector. The receiver of this value will, if possible, try rerouting to another SSCP.



- 0003 This SSCP has no predefinition for an LU, but an adjacent SSCP does not support dynamic definition in partner SSCPs. As a result, this SSCP cannot both dynamically define the LU and reroute to that adjacent SSCP.
- 0005 (Retired) An SSCP is unable to use the gateway node specified in CDINIT because that gateway node cannot allocate an address transform for the intended cross-network LU-LU session.
- 0006 (Retired) An SSCP is able to use only a subset of the alternate gateway nodes available to it. However, for the subset that it can use, none can provide the needed alias address pair.
- 0008 The adjacent SSCP does not support the requested CDINIT function (for example, notification of resource availability or XRF).
- 000A An SSCP is unable to reroute a session services request because the request has been routed through the same SSCP twice.
- 000B The DLU specified in the CDINIT is unknown to the receiving SSCP, and the receiving SSCP cannot reroute the CDINIT.

087E SSCP Visit Count Exceeds Limit: The SSCP visit count specified in the session services request—CDINIT, INIT\_OTHER\_CD, or DSRLST—has been decremented to 0. The session services request has been routed through an excessive number of SSCPs. (The SSCPs are not necessarily distinct.)

087F Reserved

0880 Reserved

0881 ACTCDRM Failure—REQACTCDRM Sent: An SSCP-SSCP session-activation request, ACTCDRM, cannot be rerouted to a gateway SSCP because, at some gateway PU, the necessary transform is not complete and the gateway PU has sent REQACTCDRM to the gateway SSCP.

0882 Reserved

0883 Reserved

0884 ACTCDRM Failure—No REQACTCDRM Sent: An SSCP-SSCP session activation request, ACTCDRM, cannot be rerouted to the destination SSCP because, at some gateway node PU, the necessary transform is not complete and REQACTCDRM cannot be sent to the destination SSCP because the gateway SSCP-PU session is not active or the intended SSCP session partner does not provide gateway services.

0885 Reserved

0886 Subnetwork Rerouting Not Supported: An SSCP received a session services request—CDINIT, INIT\_OTHER\_CD, NOTIFY(Vector Key=X'01'), or DSRLST—from an SSCP in its subnetwork that, if rerouted, would not cross a subnetwork boundary. The SSCP does not support rerouting within a subnetwork.

- 0887 Dequeue Retry Unsuccessful—Session Remains Queued: The SSCP cannot successfully honor a CDINIT(Dequeue) request. The request specifies "leave on queue if dequeue-retry is unsuccessful." The SSCP has left the queued session on its queue.
- 0888 Name Conflict: A name specified in an RU is unknown, or is known and does not have the required capabilities, or is a duplicate resource for the specified resource type. When a name conflict is detected, further name checking ceases; multiple name conflicts are not reported or detected.
- Bytes 2 and 3 following the sense code contain sense code specific information. Settings allowed are:
- 0000 No specific code applies.
  - 0001 The specified DLU real network name is known, but identifies a resource that is not LU-LU session capable.
  - 0002 The specified DLU alias network name is known, but identifies a resource that is not LU-LU session capable.
  - 0003 The specified OLU real network name is known, but identifies a resource that is not LU-LU session capable.
  - 0004 The specified OLU alias network name is known, but identifies a resource that is not LU-LU session capable.
  - 0005 Name translation was invalid; that is, a different LU name was returned with the same network ID as the original LU name.
  - 0006 The specified DLU real network name is known, but is a duplicate resource.
  - 0007 The specified DLU alias network name is known, but is a duplicate resource.
  - 0008 The specified OLU real network name is known, but is a duplicate resource.
  - 0009 The specified OLU alias network name is known, but is a duplicate resource.
  - 000A A predefined real resource name and a predefined alias resource name were found for the same resource.
  - 000B A cross-network DLU name is defined as a shadow resource, but shadow resources are not supported for cross-network sessions.
  - 000C Set aside for implementation-specific use, and will not be otherwise defined in SNA; see implementation documentation for details of usage.
- 0889 Transaction Program Error: The transaction program has detected an error.

This sense code is sent only in FMH-7.

Bytes 2 and 3 following the sense code contain sense code specific information. Settings allowed are:

0000 Program Error—No Data Truncation: The transaction program sending data detected an error but did not truncate a logical record.

Program Error—Purging: The transaction program receiving data detected an error. All remaining information, if any, that the receiving program had not yet received, and that the sending program had sent prior to being notified of the error, is discarded.

0001 Program Error—Data Truncation: The transaction program sending data detected an error and truncated the logical record it was sending.

0100 Service Transaction Program Error—No Data Truncation: The service transaction program sending data detected an error and did not truncate a logical record.

Service Transaction Program Error—Purging: The service transaction program receiving data detected an error. All remaining information, if any, that the receiving service transaction program had not yet received, and that the sending service transaction program had sent prior to being notified of the error, is discarded.

0101 Service Transaction Program Error—Data Truncation: The service transaction program sending data detected an error and truncated the logical record it was sending.

088A Resource Unavailable—NOTIFY Forthcoming: The SSCP cannot satisfy the request because a required resource is temporarily unavailable. When the required resource becomes available, NOTIFY NS(s) key X'07' or X'08' will be sent.

Bytes 2 and 3 following the sense code contain sense code specific information. Settings allowed are:

0000 No specific code applies.

0001 SSCP-SSCP Session Not Active: A SSCP-SSCP session required to reroute the cross-network request was not active.

0003 SSCP-LU session not active: The SSCP(DLU) is currently not in session with the DLU.

0004 LU session limit exceeded: The DLU is currently at its session limit and the requested session would cause the limit to be exceeded.

088B BB Not Accepted—BIS Reply Requested: Sent in response to a BB (either an LUSTAT bid or an Attach) to indicate that the receiver has sent a BIS request and wishes to terminate the session without processing any more

conversations, but without sending an UNBIND. A BIS reply is requested so that the negative response sender may send a normal UNBIND. This sense code is sent only by LUs not supporting change-number-of-session protocols.

088C Missing Control Vector: The RU did not contain a control vector that was expected to appear.

Bytes 2 and 3 following the sense code contain sense code specific information. Settings allowed are:

nn00 A required control vector is missing. Byte 2 contains the key (nn) of the required control vector that is missing. If more than one control vector is missing, only the first omission is reported. The second byte of the sense code specific field is set to X'00'.

088D Duplicate Network Name: An SSCP has detected a violation of the requirement that network names used across multiple domains be unique within the multiple-domain network. For example, the SSCP(DLU) has detected that the OLU name received in CDINIT is currently also defined in the domain of the SSCP(DLU).

088E ENA Address Mismatch: An SSCP detected that an ENA LU has an address too large for one of the pre-ENA components (LU or SSCP) involved in the session to support.

Bytes 2 and 3 following the sense code contains sense code specific information. Settings allowed are:

0000 A resource encountered during LU-LU session initiation is not ENA-capable; the session initiation request may be rerouted.

0001 A resource encountered during LU-LU session initiation is not ENA-capable; the session initiation request should not be rerouted.

0002 An SSCP has requested a "pre-ENA compatible" SLU address for an SLU that already has an ENA address.

0003 The gateway node selected by the gateway SSCP from the gateway node list is not ENA-capable when an ENA-capable gateway node is required. Another gateway node may be tried.

088F XRF Procedure Error: A request was received for an XRF-active or XRF-backup session and was not acted on.

Bytes 2 and 3 following the sense code contain sense code specific information. Settings allowed are:

0000 No specific code applies.

0004 A SWITCH request was received that was invalid.

- 0006 An INITIATE request for an XRF-backup session was received that allowed queuing (XRF-backup and session queuing are mutually exclusive functions.)
- 0007 CDINIT was received requesting an XRF-backup session, and the DLU does not support XRF sessions.
- 0008 An XRF-active BIND was received with a session correlation identifier that duplicates a session correlation identifier associated with an existing XRF session.
- 0009 An XRF-backup BIND was received for an LU that currently does not have an XRF session.
- 000A Cryptography Not Supported: An XRF BIND was received indicating cryptography.
- 0010 An XRF-backup BIND was received with a session correlation identifier that does not match the session correlation identifier associated with the existing XRF session with that LU.

0890  
through  
0896 Reserved

0897 System Definition Mismatch: The requested function is not supported by the receiver, or there is a mismatch between the sending and receiving system definitions.

Bytes 2 and 3 following the sense code contain sense code specific information. Settings allowed are:

- 0000 No specific code applies.
- 0006 The SSCP has no predefinition for an LU and does not support dynamic resource definition.
- 0007 The receiving SSCP has a different system-defined name for the SSCP(DLU) than the SSCP(DLU) name in the session initiation request.
- 0008 In a gateway with three gateway SSCPs, a gateway SSCP on the OLU side of the gateway was specified as having predesignated control in the CDINIT. In this configuration, only the middle gateway SSCP may have predesignated control.
- 0009 In a gateway with three gateway SSCPs, none of which is predesignated, the gateway node believes that one is predesignated. As a result, the gateway node receives gateway control RUs such as RNAA from a different SSCP than the one it expects.
- 000B An SSCP has detected a specification of gateway responsibility in the CDINIT request that is not consistent with its own

definition. For example, two gateway SSCPs in the same gateway are both predefined to be predesignated.

- 000C The receiver is unable to interpret the DLU name.
- 0898 Reserved
- 0899 Reserved
- 089A Invalid File or File Not Found: The requested file was not found, or was found to be an invalid file.
- Bytes 2 and 3 following the sense code contain sense code specific information. Settings allowed are:
- 0000 No specific code applies.
- 0001 Requested file not found.
- 089B Reserved
- 089C Reserved
- 089D Gateway Node Error Detected during Cross-Network Session Initiation.
- Bytes 2 and 3 following the sense code contain sense code specific information. Settings allowed are:
- 0000 No specific code applies.
- 0001 The gateway node list used to select a gateway node to cross a network boundary is exhausted.
- 0003 RNAA has failed; another gateway node should be tried.
- 0004 Address conversion based on the subarea/element address split was unsuccessful.
- 0005 The gateway node selected by one gateway SSCP is not known to another gateway SSCP in the same gateway. This can be a system definition error in the gateway SSCP that does not recognize the gateway node.
- 0006 A gateway SSCP has found that a gateway node has assigned duplicate addresses.

#### REQUEST ERROR (CATEGORY CODE = X'10')

This category indicates that the RU was delivered to the intended NAU component, but could not be interpreted or processed. This condition represents a mismatch of NAU capabilities.

Category and modifier (in hexadecimal):

- 1001 RU Data Error: Data in the request RU is not acceptable to the receiving component; for example, a character code is not in the set supported, a formatted data field is not acceptable to presentation services, or a value specified in the length field (LL) of a structured field is invalid.
- Bytes 2 and 3 following the sense code contain sense code specific information. Settings allowed are:
- 0000 No specific code applies.
  - 0001 The request contains a subarea address of 0 or a subarea address greater than the maximum subarea value within the specified or implied network.
  - 0002 The network ID specified in the ACTPU is unknown, or is not valid on the link over which the ACTPU was received.
  - 0008 An invalid character code was found.
  - 0009 The formatted data field is unacceptable to presentation services.
  - 000A An invalid length field for a structured field was found.
  - 000B The value in the name length field is too great.
  - 000C The value in the cryptography key length field is too great.
  - 000D The URC field length is invalid.
  - 000E The control vector length field is inconsistent with the control vector data.
  - 000F A PLU or SLU role specification encoding is invalid.
  - 0020 Too many session keys are present.
  - 0021 A control vector or session key data is invalid.
  - 0022 A BIND image in a session services RU is invalid.
  - 0023 A device characteristics field is invalid.
- hnnn where  $h \geq 8$ , i.e., the high-order bit in byte 2 is set to 1. The 15 low-order bits of bytes 2 and 3 contain a binary count that indexes (zero-origin) the first byte of the field found to be in error.
- 1002 RU Length Error: The request RU was too long or too short.
- 1003 Function Not Supported: The function requested is not supported. The function may have been specified by a formatted request code, a field in an RU, or a control character.

Bytes 2 and 3 following the sense code contain sense code specific information. Settings allowed are:

0000 No specific code applies.

0001 The half-session receiving the request did not perform the function because it is not capable of doing so. The requesting half-session requested a function that the receiver does not support and the receiver did not specify that it was capable of supporting the function at session activation; consequently, there is an apparent mismatch of half-session capabilities.

Note: This is to cover a system error. For example, if the PU receiving a SETCV(Vector Key=X'15') is not a gateway PU, that is, the PU did not indicate in the ACTPU response that it is a gateway PU, the PU reports to the SSCP that sent the SETCV that there is an apparent mismatch of half-session capabilities.

0002 The half-session receiving the request did not perform the function, though it is capable of doing so. The requesting half-session did not specify at session activation that it was capable of supporting the function; consequently, there is an apparent mismatch of half-session capabilities.

Note: This is to cover a system error. For example, if the SSCP sending a SETCV(Vector Key=X'15') is not known to the receiving PU as a gateway SSCP, that is, the SSCP did not indicate in ACTPU that it is a gateway SSCP, the PU reports a mismatch of capabilities.

Note: 0001 and 0002 are also assigned for implementation-specific use; see implementation documentation for details of usage.

0003 The component received an unsupported normal-flow DFC command.

0004 The component received an unsupported expedited-flow DFC command.

0005 The component received a network control command during an LU-SSCP session.

0006 The component received an unsupported session control command during an LU-SSCP session.

0007 The component received an unsupported data flow control command with LU-SSCP session specified.

000D The function identified in the request is not supported by the processing application transaction program.

0010 The RU is not known to session services.

0011 A session key is not supported.

0012 A control vector is not supported.



0014 Cryptography is not supported but a nonzero length was specified for the cryptography key.

0015 Queuing not supported for a controller session.

0020 A session initiation request specified an OLU and DLU that are the same LU. An LU cannot establish a session with itself.

6002 The resource identified by the destination program name (DPN) is not supported.

6003 The resource identified by the primary resource name (PRN) is not supported.

Note: This sense code can also be used instead of sense code X'0826'.

1004 Reserved

1005 Parameter Error: A parameter modifying a control function is invalid, or outside the range allowed by the receiver.

Bytes 2 and 3 following the sense code contain sense code specific information. Settings allowed are:

0000 No specific code applies.

0001 For NMVT, the address type field in an SNA Address List subvector does not match the address type required by the command subvector.

0002 Set aside for implementation-specific use, and will not be otherwise defined in SNA; see implementation documentation for details of usage.

0004 Invalid display type was requested.

0005 Invalid storage length for display type requested.

0006 Invalid storage address; out of specified range.

0008 and 0121-0229 Set aside for implementation-specific use, and will not be otherwise defined in SNA; see implementation documentation for details of usage.

1006 Required field or parameter is missing.

Bytes 2 and 3 following the sense code contain sense code specific information. Settings allowed are:

0000 No specific code applies.

0001 One or more required COS names were omitted.

0002 A required name was omitted.

- 0003 A required network identifier was omitted.
- 0004 A required session key was omitted.
- 0005 A required control vector was omitted.
- 1007 Category Not Supported: DFC, SC, NC, or FMD request was received by a half-session not supporting any requests in that category; or an NS request byte 0 was not set to a defined value, or byte 1 was not set to an NS category supported by the receiver.
- 1008 Invalid FM Header: The FM header was not understood or translatable by the receiver, or an FM header was expected but not present. For LU 6.2, this sense code is sent in FMH-7 or UNBIND.

Bytes 2 and 3 following the sense code contain sense code specific information. Figure 9-2 on page 9-41 shows the usage of the allowed values by LU type. Settings allowed are:

- 0000 No specific code applies.
- 0801 The function code parameters are invalid.
- 0803 The forms functions cannot be performed.
- 0805 The copy function cannot be performed.
- 0806 Compaction table outside the supported set: The number of master characters is not within the valid range.
- 0807 The PDIR (peripheral data information record) identifier is invalid.
- 0808 The printer train function cannot be performed.
- 0809 The FCB (forms control block) load function cannot be performed.
- 080A The FCB (forms control block) load function is not supported.
- 080B The compaction table name is invalid.
- 080C The ACCESS is invalid.
- 080D The RECLLEN is invalid.
- 080E The NUMRECS is invalid.
- 080F The data set is in use.
- 0810 The data set cannot be found.
- 0811 The password is invalid.

0812 The function is not allowed for the destination or for the data set.

0813 The record is too long.

0814 The data set is full.

0815 The RECID is invalid.

0816 Reserved

0817 The VOLID format is invalid.

0818 The maximum number of logical records per chain is exceeded.

0819 The data set exists.

081A No space is available.

081B The VOLID is invalid.

081C The DSACCESS is invalid.

081D The RECTYPE is invalid or the data set cannot be found.

081E The resolution space is insufficient.

081F The key technique is invalid.

0820 The key displacement is invalid.

0821 The key is invalid.

0822 There is an Invalid N (number of records.)

0823 The KEYIND is invalid.

0824 The SERID is invalid.

0825 Disk Error: An error was detected while reading from, or writing on, the disk.

0826 The RECID format is invalid.

0827 The password has not been supplied.

0828 The record ID has not been supplied.

0829 The Volume ID has not been supplied.

082A The PGMNAME is invalid.

1204 Set aside for implementation-specific use, and will not be otherwise defined in SNA; see implementation documentation for details of usage.

2001 The destination (active) is invalid.

2002 The destination (inactive) is invalid.

2003 The destination (suspended) is invalid.

2004 The suspend-resume sequence is invalid.

2005 There has been an interruption level violation.

2006 The resume properties are invalid.

2007 The destination is not available.

2008 The end sequence is invalid.

2009 The FM header length is invalid.

200A Invalid field setting: The reserved field is set to 1 or the setting is not defined.

200B Invalid destination: The destination does not exist.

200C The ERCL is invalid.

200D The DST is invalid.

200E Invalid Concatenation Indicator: The concatenation indicator is on, but concatenation is not allowed.

200F FM data is not allowed for the header.

2010 The FM header set specified in the BIND has been violated.

2011-2013 Reserved

2014 The FM header was not sent concatenated.

2015-2018 Reserved

2019 The stack reference indicator (SRI) is invalid.

201A The CMI modification could not be accepted.

201B The CPI modification could not be accepted.

201C The ECRL modification could not be accepted.

201D FM Header and Associated Data Mismatch: The FM header indicated associated data would or would not follow (for

example, FM header 7 followed by log data, or FM header 5 followed by program initialization parameters), but this indication was in error; or a previously received RU (for example, -RSP(X'0846')) implied that an FM header would follow, but none was received.

- 4001 Invalid FM Header Type for this LU: The type of the FM header is other than 5, 7, or 12.
- 4002 The FMH code is invalid.
- 4003 Compression is not supported.
- 4004 Compaction is not supported.
- 4005 Basic exchange is not supported.
- 4006 Only basic exchange is supported.
- 4007 The medium is not supported.
- 4008 There has been a code selection compression violation.
- 4009 FMHC is not supported.
- 400A Demand select is not supported.
- 400B DSNAME is not supported.
- 400C The media subaddress field is invalid.
- 400D There are insufficient resources to perform the requested function.
- 400E DSP select is not supported.
- 6000 FM Header Length Not Correct: The value in the FM header Length field differs from the sum of the lengths of the subfields of the FM header.
- 6001 The deblocking algorithm (DBA) is invalid.
- 6004 The queue name length is invalid.
- 6005 Access Security Information Length Field Not Correct: The value in the Access Security Information Length field differs from the sum of the lengths of the Access Security Information subfields.
- 6006 The data stream profile (DSP) is invalid.
- 6007 The FMH-7 is not preceded by a negative response carrying the X'0846' sense code.

- 6008 The Attach access code is invalid.
- 6009 Invalid Parameter Length: The field that specifies the length of fixed-length parameters has an invalid setting.
- 600A This is not the first FMH-5, the interchange unit type is not the same as the old, and the interchange unit end indicator is off.
- 600B Unrecognized FM Header Command Code: The partner LU received an FM header command code that it does not recognize. For LU 6.2 this sense data is sent only in FMH-7.
- 600C A null sequence field is required.
- 600D User to user program transition is not allowed.
- 600E User to non-SNA defined program transition is not allowed.
- 600F The FMH-5 reset attached program (RAP) was not sent properly.
- 6010 The FMH-5 reset attached program (RAP) was sent with an inactive Attach register.
- 6011 Invalid Logical Unit of Work (LUW): The LUW Length field (in a Compare States GDS variable or an FMH-5) is incorrect, or the length field is invalid, or a LUW ID is not present but is required by the setting of the synchronization level field.
- 6021 Transaction Program Name Not Recognized: The FMH-5 Attach command specifies a transaction program name that the receiver does not recognize. This sense data is sent only in FMH-7.
- 6031 PIP Not Allowed: The FMH-5 Attach command specifies program initialization parameter (PIP) data is present, but the receiver does not support PIP data for the specified transaction program. This sense data is sent only in FMH-7.
- 6032 PIP Not Specified Correctly: The FMH-5 Attach command specifies a transaction program name that requires program initialization parameter (PIP) data, and either the FMH-5 specifies PIP data is not present or the number of PIP subfields present does not agree with the number required for the program. This sense data is sent only in FMH-7.
- 6034 Conversation Type Mismatch: The FMH-5 Attach command specifies a conversation type that the receiver does not support for the specified transaction program. This sense data is sent only in FMH-7.
- 6040 Invalid Attach Parameter: A parameter in the FMH-5 Attach command conflicts with the statement of LU capability previously provided in the BIND negotiation.

- 6041            Synchronization Level Not Supported: The FMH-5 Attach command specifies a synchronization level that the receiver does not support for the specified transaction program. This sense data is sent only in FMH-7.
- C000            The Header is not supported.
- C001            The header length is invalid.
- C002            There has been a logical message services block-level error.
- C003            There is a version ID mismatch.
  
- 1009            Format Group Not Selected: No format group was selected before issuing a Present Absolute or Present Relative Format structured field to a display.

STATE ERROR (CATEGORY CODE = X'20')

This category indicates a sequence number error, or an RH or RU that is not allowed for the receiver's current session control or data flow control state. These errors prevent delivery of the request to the intended component.

Category and modifier (in hexadecimal):

- 2001            Sequence Number: Sequence number received on normal-flow request was not 1 greater than the last.
  
- 2002            Chaining: Error in the sequence of the chain indicator settings (BCI, ECI), such as first, middle, first.  
  
                  Bytes 2 and 3 following the sense code contain sense code specific information. Settings allowed are:
  - 0000    No specific code applies.
  - 0001    The receiver received a middle or end-chain request when in the in-chain state.
  - 0002    The receiver received a begin-chain request when in the in-chain state.
  
- 2003            Bracket: Error resulting from failure of sender to enforce bracket rules for session. (This error does not apply to contention or race conditions.)  
  
                  Bytes 2 and 3 following the sense code contain sense code specific information. Settings allowed are:
  - 0000    No specific code applies.

Range	LU 1	LU 4	LU 6.1	LU 6.2
0801-0824	X	X		
0825	X			
0826-082A	X	X		
2001-200D	X	X		
200E	X	X	X	
200F-201C	X	X		
201D				X
4001-400E	X	X		
6000				X
6001,6004			X	
6005			X	X
6006-6008			X	
6009			X	X
600A			X	
600B			X	X
600C-6010			X	
6011-6034				X
6040			X	X
6041				X
C000-C003			X	

Figure 9-2. Usage of X'1008' Sense Code Specific Information by LU Type

- 0001 The receiver received a begin-bracket request before receiving a response to its own previously sent begin-bracket request.
- 0002 The receiver received a begin-bracket request not specifying begin-bracket when in the between-bracket state.



- 0003 The receiver received an out-of-sequence LUSTAT command.
- 2004 Direction: Error resulting from a normal-flow request received while the half-duplex flip-flop state was not Receive.
- 2005 Data Traffic Reset: An FMD or normal-flow DFC request received by a half-session whose session activation state was active, but whose data traffic state was not active.
- 2006 Data Traffic Quiesced: An FMD or DFC request received from a half-session that has sent QUIESCE COMPLETE or SHUTDOWN COMPLETE and has not responded to RELEASE QUIESCE.
- 2007 Data Traffic Not Reset: A session control request (for example, STSN), allowed only while the data traffic state is reset, was received while the data traffic state was not reset.
- 2008 No Begin Bracket: An FMD request specifying BBI=BB was received after the receiver had previously received a BRACKET INITIATION STOPPED request.
- 2009 Session Control Protocol Violation: An SC protocol has been violated; a request, allowed only after a successful exchange of an SC request and its associated positive response, has been received before such successful exchange has occurred (for example, an FMD request has preceded a required CRYPTOGRAPHY VERIFICATION request). The request code of the particular SC request or response required, or X'00' if undetermined, appears in the fourth byte of the sense data.
- 200A Immediate Request Mode Error: The immediate request mode protocol has been violated by the request.
- 200B Queued Response Error: The Queued Response protocol has been violated by a request, i.e., QRI=-QR when an outstanding request had QRI=QR.
- 200C ERP Sync Event Error: The ERP sync event protocol in DFC has been violated; for example, after receiving a negative response to a chain, a request other than a request soliciting a synchronization event response was sent to DFC\_SEND and rejected.
- 200D Response Owed Before Sending Request: An attempt has been made in half-duplex (flip-flop or contention) send/receive mode to send a normal-flow request when a response to a previously received request has not yet been sent.
- 200E Response Correlation Error: A response was received that cannot be correlated to a previously sent request.
- 200F Response Protocol Error: A violation has occurred in the response protocol; e.g., a +RSP to an RQE chain was generated.
- 2010 BIS Protocol Error: A BIS protocol error was detected; for example, a BIS request was received after a previous BIS was received and processed.

- 2011 Pacing Error: A normal-flow request is received by a half-session after the pacing count has been reduced to 0 and before a pacing response has been sent.
- 2012 Invalid Sense Code Received: A negative response was received that contains an SNA-defined sense code that cannot be used for the sent request.

#### RH USAGE ERROR (CATEGORY CODE = X'40')

This category indicates that the value of a field or combination of fields in the RH violates architectural rules or previously selected BIND options. These errors prevent delivery of the request to the intended component and are independent of the current states of the session. They may result from the failure of the sender to enforce session rules. Detection by the receiver of each of these errors is optional.

Category and modifier (in hexadecimal):

- 4001 Invalid SC or NC RH: The RH of a session control (SC) or network control (NC) request was invalid. For example, an SC RH with pacing request indicator set to 1 is invalid.
- 4002 Reserved
- 4003 BB Not Allowed: The Begin Bracket indicator (BBI) was specified incorrectly, for example, BBI=BB with BCI=-BC.
- 4004 CEB or EB Not Allowed: The Conditional End Bracket indicator (CEBI) or End Bracket indicator (EBI) was specified incorrectly, for example, CEBI=CEB when ECI=-EC or EBI=EB with BCI=-BC, or by the primary half-session when only the secondary may send EB, or by the secondary when only the primary may send EB.
- 4005 Incomplete RH: Transmission shorter than full TH-RH.
- 4006 Exception Response Not Allowed: Exception response was requested when not permitted.
- 4007 Definite Response Not Allowed: Definite response was requested when not permitted.
- 4008 Pacing Not Supported: The Pacing indicator was set on a request, but the receiving half-session or boundary function half-session does not support pacing for this session.
- 4009 CD Not Allowed: The Change Direction indicator (CDI) was specified incorrectly, for example, CDI=CD with ECI=-EC, or CDI=CD with EBI=EB.
- 400A No-Response Not Allowed: No-response was specified on a request when not permitted. (Used only on EXR.)

- 400B Chaining Not Supported: The chaining indicators (BCI and ECI) were specified incorrectly, for example, chaining bits indicated other than (BC,EC), but multiple-request chains are not supported for the session or for the category specified in the request header.
- 400C Brackets Not Supported: The bracket indicators (BBI, CEBI, and EBI) were specified incorrectly, e.g., a bracket indicator was set (BBI=BB, CEBI=CEB, or EBI=EB), but brackets are not used for the session.
- 400D CD Not Supported: The Change-Direction indicator was set, but is not supported.
- 400E Reserved
- 400F Incorrect Use of Format Indicator: The Format indicator (FI) was specified incorrectly, for example, FI was set with BCI=-BC, or FI was not set on a DFC request.
- 4010 Alternate Code Not Supported: The Code Selection indicator (CSI) was set when not supported for the session.
- 4011 Incorrect Specification of RU Category: The RU Category indicator was specified incorrectly, for example, an expedited-flow request or response was specified with RU Category indicator = FMD.
- 4012 Incorrect Specification of Request Code: The request code on a response does not match the request code on its corresponding request.
- 4013 Incorrect Specification of (SDI, RTI): The Sense Data Included indicator (SDI) and the Response Type indicator (RTI) were not specified properly on a response. The proper value pairs are (SDI=SD, RTI=negative) and (SDI=-SD, RTI=positive).
- 4014 Incorrect Use of (DR1I, DR2I, ERI): The Definite Response 1 indicator (DR1I), Definite Response 2 indicator (DR2I), and Exception Response indicator (ERI) were specified incorrectly, for example, a SIGNAL request was not specified with DR1I=DR1, DR2I=-DR2, and ERI=-ER.
- 4015 Incorrect Use of QRI: The Queued Response indicator (QRI) was specified incorrectly, for example, QRI=QR on an expedited-flow request.
- 4016 Incorrect Use of EDI: The Enciphered Data indicator (EDI) was specified incorrectly, for example, EDI=ED on a DFC request.
- 4017 Incorrect Use of PDI: The Padded Data indicator (PDI) was specified incorrectly, for example, PDI=PD on a DFC request.
- 4018 Incorrect Setting of QRI with Bidder's BB: The first speaker half-session received a BB chain requesting use of a session (via LUSTAT(X'0006')), but the QRI was specified incorrectly, that is, QRI = -QR.
- 4019 Incorrect Indicators with Last-In-Chain Request: A last-in-chain request has specified incompatible RH settings, for example, RQE\*, CEBI=-CEB, and CDI=-CD.

401A  
through Reserved  
4020

4021 QRI Setting in Response Different From That in Request: The QRI setting in the response differs from the QRI setting in the corresponding request.

#### PATH ERROR (CATEGORY CODE = X'80')

This category indicates that the request could not be delivered to the intended receiver, because of a path outage, an invalid sequence of activation requests, or one of the listed path information unit (PIU) errors. Some PIU errors fall into other categories; for example, sequence number errors are sense code category X'20'. A path error received while the session is active generally indicates that the path to the session partner has been lost.

Category and modifier (in hexadecimal):

8001 Intermediate Node Failure: Machine or program check in a node providing intermediate routing function. A response may or may not be possible.

8002 Link Failure: Data link failure.

8003 NAU Inoperative: The NAU is unable to process requests or responses; for example, the NAU has been disrupted by an abnormal termination.

8004 Unrecognized Destination: A node in the path has no routing information for the destination specified either by the SLU name in a BIND request or by the TH.

Bytes 2 and 3 following the sense code contain sense code specific information. Settings allowed are:

0000 No specific code applies.

0001 A request was received by a gateway function that could not be rerouted because of invalid or incomplete routing information.

8005 No Session: No half-session is active in the receiving end node for the indicated origination-destination pair, or no boundary function session connector is active for the origin-destination pair in a node providing the boundary function. A session activation request is needed.

Bytes 2 and 3 following the sense code contain sense code specific information. Settings allowed are:

0000 No specific code applies.

0001 The receiver received a request other than session control request when no LU-LU session was active.

0002 The receiver received a request other than session control request when no LU-SSCP session was active.

0003 The receiver received a session control request other than BIND/UNBIND when no LU-LU session was active.

0004 The receiver received an UNBIND when no LU-LU session was active.

0005 The receiver received a session control request other than ACTLU/DACTLU for the LU-SSCP session when no LU-SSCP session was active.

0006 The receiver received DACTLU when no LU-SSCP session was active.

8006 Invalid FID: Invalid FID for the receiving node. (Note 1)

8007 Segmenting Error: First BIU segment had less than 10 bytes; or mapping field sequencing error, such as first, last, middle; or segmenting not supported and MPF not set to 11. (See note 2.)

Bytes 2 and 3 following the sense code contain sense code specific information. Settings allowed are:

0000 No specific code applies.

0001 The node does not support receipt of segments, and a mapping field value other than OIS was received.

8008 PU Not Active: The SSCP-PU secondary half-session in the receiving node has not been activated and the request was not ACTPU for this half-session; for example, the request was ACTLU from an SSCP that does not have an active SSCP-PU session with the PU associated with the addressed LU.

8009 LU Not Active: The destination address specifies an LU for which the SSCP-LU secondary half-session has not been activated and the request was not ACTLU.

800A Too-Long PIU: Transmission was truncated by a receiving node because the PIU exceeded a maximum length or sufficient buffering was not available.

800B Incomplete TH: Transmission received was shorter than a TH. (see Note 1)

800C DCF Error: Data Count field inconsistent with transmission length.

800D Lost Contact: Contact with the link station for which the transmission was intended has been lost, but the link has not failed. If the difference between link failure and loss of contact is not detectable, link failure (X'8002') is sent.

800E Unrecognized Origin: The origin address specified in the TH was not recognized.

800F The address combination is invalid.

Bytes 2 and 3 following the sense code contain sense code specific information. Settings allowed are:

0000 The (DAF',OAF') (FID2) combination or the LSID (FID3) specified an invalid type of session, for example, a PU-LU combination.

0001 The FID2 ODAI setting in a received BIND is incorrect; the BIND is rejected.

8010 Segmented RU Length Error: An RU was found to exceed a maximum length, or required buffer allocation that might cause future buffer depletion.

8011 ER Inoperative or Undefined: A PIU was received from a subarea node that does not support ER and VR protocols, and the explicit route to the destination is inoperative or undefined.

8012 Subarea PU Not Active or Invalid Virtual Route: A session-activation request for a peripheral PU or LU cannot be satisfied because there is no active SSCP-PU session for the subarea node providing boundary function support, or the virtual route for the specified SSCP-PU (type 1 or type 2 nodes) or SSCP-LU session is not the same as that used for the SSCP-PU session of the type 1 or type 2 node's PU or the LU's subarea PU.

8013 COS Not Available: A session activation request cannot be satisfied because none of the virtual routes requested for the session is available.

Bytes 2 and 3 following the sense code contain sense code specific information. Settings allowed are:

Byte 2 indicates the environment in which the failure was detected:

00 Single network

01 Interconnected network: Failure was detected at a node in a subnetwork other than that of the NAU sending the activation request.

Byte 3 indicates the reason for the session-activation failure:

00 No Specific Code Applies: This means an error occurred, but none of the conditions listed below applies.

01 No Mapping Specified: A session-activation request cannot be satisfied because for each VR in the VR identifier list for the session, no VR to ER mapping is specified.

02 No Explicit Routes Defined: A session-activation request cannot be satisfied because each VR in the VR identifier list for the session maps to a corresponding ER that is not defined.

03 No VR Resource Available: A session-activation request cannot be satisfied because each VR specified in the VR identifier list for the session requires a node resource that is not available.

- 04 No Explicit Routes Operative: A session-activation request cannot be satisfied because no underlying ER is operative for any VR specified in the VR identifier list for the session.
- 05 No Explicit Route Can Be Activated: A session-activation request cannot be satisfied because no VR specified in the VR identifier list for the session mapped to a defined and operative ER that could be activated.
- 06 No Virtual Route Can Be Activated: A session-activation request cannot be satisfied because no VR specified in the VR identifier list for the session can be activated by the PU, though for at least one VR an underlying ER is defined, operative, and activated.
- 07 No Virtual Route Identifier List Available: A session-activation request cannot be satisfied because a VR identifier list is not available.

Note: If none of the virtual routes specified in the VR identifier list for the session is active or can be activated, the reported reason is set based on a hierarchy of failure events. The "highest" of the failures that occurred within the set of virtual routes is returned on the response. For example, if the VR manager receives a negative response to an NC\_ACTVR request for a VR specified in the VR identifier list and for all other VRs in the list no VR to ER mapping is specified, then reason X'06' is reported. The hierarchy of the failure reasons is in ascending numeric order, that is, reason X'02' is higher than reason X'01'.

8014  
through  
8016 Reserved

8017 PIU from Adjacent Pre-ER-VR Subarea Node Rejected: A PIU that requires intermediate path-control routing was received by a subarea node from an adjacent subarea node that does not support ER-VR protocols, but the receiving subarea node does not support intermediate path-control routing for adjacent subarea nodes that do not support ER-VR protocols.

8018 Management Services component is unable to find or recognize the name of the application transaction program specified in the request.

Bytes 2 and 3 following the sense code contain sense code specific information. Settings allowed are:

0000 No specific code applies.

0001 The application transaction program specified in the request is not recognized by PUMS.

Notes:

1. It is generally not possible to send a response for this exception condition, since information (FID, addresses) required to generate a response is not available. It is logged as an error if this capability exists in the receiver.
2. If segmenting is not supported, a negative response is returned for the first segment only, since this contains the RH. Subsequent segments are discarded.





## CHAPTER 10. FUNCTION MANAGEMENT HEADERS

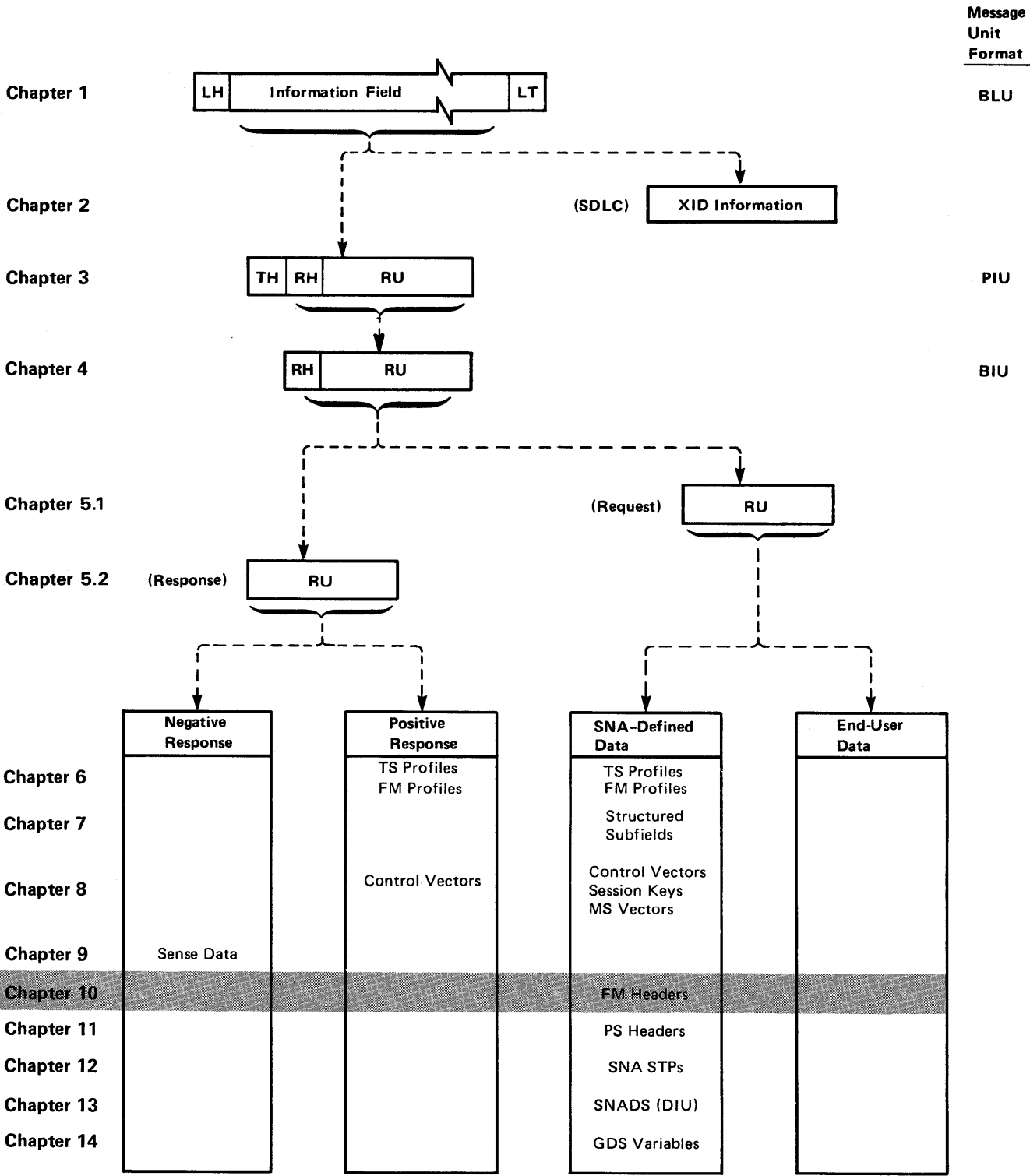

LH = Link Header  
 LT = Link Trailer  
 XID = Exchange Identification  
 TH = Transmission Header  
 RH = Request/Response Header  
 RU = Request/Response Unit  
 TS = Transmission Services  
 FM = Function Management  
 MS = Management Services

PS = Presentation Services  
 STP = Service Transaction Program  
 SNADS = SNA Distribution Services  
 DIU = Distribution Interchange Unit  
 GDS = General Data Stream  
 BLU = Basic Link Unit  
 PIU = Path Information Unit  
 BIU = Basic Information Unit

## CHAPTER 10. FUNCTION MANAGEMENT HEADERS

The request header (RH) contains a format indicator (FI) that, when on, indicates that an FM header is at the beginning of the request unit (RU).

For LU 6.2, FM headers may appear only singly at the beginning of an RU. The RU containing the FM header may appear anywhere within a chain. When the FM header is longer than one RU will hold, the header is continued in as many additional RUs as needed to hold it. Figure 10-1 and Figure 10-2 show the placement of FM headers within an RU:

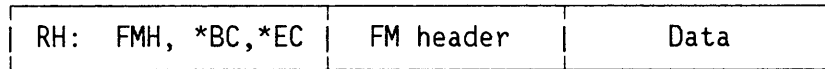

Figure 10-1. FM Header Contained in One RU

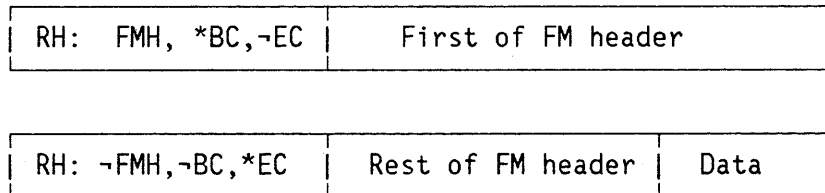
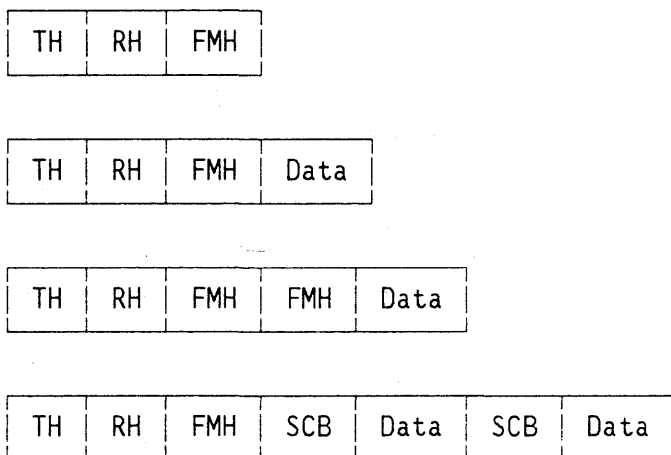

Figure 10-2. FM Header Contained in Two Contiguous RUs of a Chain

Figure 10-3 shows some instances where FM headers are used and Figure 10-4 identifies the logical unit (LU) types that use each FM Header.



FMH -- Function Management (FM) Header  
 SCB -- String Control Byte  
 TH -- Transmission Header  
 RH -- Request/Response Header

Figure 10-3. Usage of FM Headers

LU Type	FM Header Type
0	None required, but may use any header
1	1, 2, and/or 3
2	None
3	None
4	1, 2, and/or 3
6.1	4, 5, 6, 7, 8, and/or 10
6.2	5, 7, 12
7	None

Figure 10-4. LU Types That Support FM Headers

## FM header 1

This header is used to select a destination within a logical unit (LU). A destination may be represented by a device, a data set residing on a device, or merely a data stream. The LU initiates, interrupts, resumes, and concludes data traffic for the half-session using the FMH-1.

- 0 Length, in binary, of FMH-1, including this Length byte
- 1 bit 0, FMH concatenation:
  - 0 no FMH follows this FMH-1
  - 1 another FMH follows this FMH-1
- bits 1-7, type: 0000001
- 2 bits 0-3, select desired medium for data (see notes 1 and 2):
  - 0000 console
  - 0001 exchange
  - 0010 card
  - 0011 document
  - 0100 nonexchange disk
  - 0101 extended document
  - 0110 extended card
  - 0111 data set name select destination (see note 3)
  - 1000 word processing (WP) media 1
  - 1001 WP media 2
  - 1010 WP media 3
  - 1011 reserved
  - 1100 WP media 4
  - 1101 reserved
  - 1110 reserved
  - 1111 reserved
- bits 4-7, logical subaddress (see note 2):
  - 0000-1110 specific device in medium class
  - 1111 any device in medium class (see note 3)
- 3 bit 0, SRI: stack reference indicator:
  - 0 stack to be used is the sender's send stack
  - 1 stack to be used is the receiver's send stack
- bit 1, demand select:
  - 0 receiver may direct data to alternate medium/subaddress
  - 1 receiver must direct data to specified medium/subaddress (spooling is prohibited)
- bits 2-3, reserved
- bits 4-7, DSPs: data stream profiles:
  - 0000 default (the DSP is implied by the Medium Select field)
  - 0001 base
  - 0010 general
  - 0011 job
  - 0100 WP raw-form text
  - 0101 WP exchange diskette
  - 0110 reserved
  - 0111 Office Information Interchange level 2
  - 1000 reserved
  - 1001 reserved
  - 1010 document interchange
  - 1011 structured field
  - 1100 reserved

- 1101 reserved
- 1110 reserved
- 1111 reserved
- 4 FMH-1 properties
  - bits 0-2, DSSEL: destination selection:
    - 000 resume
    - 001 end
    - 010 begin
    - 011 begin/end
    - 100 suspend
    - 101 end-abort
    - 110 continue
    - 111 reserved
  - bit 3, DST: data set transmission (see note 6):
    - 0 transmission exchange format
    - 1 basic exchange format
  - bit 4, reserved
  - bit 5, CMI: compression indicator (see notes 4 and 5):
    - 0 no compression
    - 1 compression (the first byte following FMH(s) is a string control byte)
  - bit 6, CPI: compaction indicator (see notes 4 and 5):
    - 0 no compaction
    - 1 compaction (the first byte following the FMH(s) is a string control byte)
  - bit 7, reserved
- 5 bits 0-7, ECRL: exchange record length if medium select = exchange or card; otherwise reserved. For medium select = card, a hexadecimal value indicates maximum card length:
  - 00000000 80-column length
- 6-7 Reserved (optional)
- 8 DSLEN: length of destination name (optional)
- 9-n DSNAME: destination name (optional; reserved when DSSEL = continue)

Note 1: The data stream profile (DSP) defaults for the Medium Select Field are:

FMH-1 MEDIUM SELECT	DEFAULT DSP
Console, X'0'	Base
Exchange, X'1'	DST field of FMH-1
Card, X'2'	SCS (IRS, TRN)
Document, X'3'	Subset 2 (RJE)
Nonexchange Disk, X'4'	DST field of FMH-1
Extended Document, X'5'	Subset 2 (RJE)
Extended Card, X'6'	SCS (IRS, TRN)
WP Medium 1, X'8'	WP Raw Form
WP Medium 2, X'9'	WP Raw Form
WP Medium 3, X'A'	WP Raw Form
WP Medium 4, X'C'	WP Raw Form

An LU requiring any other DSP value associated with Medium Select must do so by specifying the desired DSP in byte 3, bits 4-7 of the FMH-1. This selection must adhere to those DSPs allowed on the session as specified in the BIND parameters.

Note 2: Medium Select and Logical Subaddress fields are reserved when the Destination Selection (DSSEL) field is set to 110 (continue), 001 (end), 100 (suspend), or 101 (end-abort).

Note 3: Medium Select = X'7' and Logical Subaddress = X'F', the Destination Name (DSNAME) field is used to select destination.

Note 4: CMI, CPI, and ERCL indicators are meaningful and valid only when specified in a Begin, Begin/end, or Continue FMH-1.

Note 5: CMI, CPI, and ERCL information received when DSSEL = Continue overlays the settings of the Begin FMH-1 or the last-received Continue FMH-1.

Note 6: When Medium Select is not equal to Exchange, this field is reserved. Receiver may do spooling and exchange-medium creation locally. When Medium Select = Exchange, specifying 0 preserves chain boundaries while spooling, but nonsequential allocation techniques may be used. Specifying 1 does not preserve chain boundaries, but uses sequential medium allocation.



## FM header 2

Once a destination has been selected using a FMH-1, this header handles the data management tasks for that destination.

- 0 Length, in binary, of FMH-2, including this Length byte
- 1 bit 0, FMH concatenation:
  - 0 no FMH follows this FMH-2
  - 1 another FMH follows this FMH-2
- bits 1-7, type: 0000010
- 2 bit 0, SRI: stack reference indicator (see note below):
  - 0 FMH-2 pertains to the active destination of the sending half-session's send stack and the receiving half-session's receive stack
  - 1 FMH-2 pertains to the active destination of the receiving half-session's send stack and the sending half-session's receive stack
- bits 1-7, FMH-2 function to be performed (see note):
  - nnnnnn identifies the function that this FMH-2 is to perform
- 3-n Parameter fields -- These fields provide the information needed to perform the selected function. They are different for each FMH-2 function, and are described in Sessions Between Logical Units.

Note: Byte 2 of the FMH-2 contains the Stack Reference indicator (SRI) and defines the function to be performed. The valid combinations of SRI and function codes are:

Function Code	Function
X'01'	Peripheral data information record (PDIR)
X'02'	Compaction table
X'04'	Prime compression character
X'07'	Execute program offline
X'20'	Create data set
X'21'	Scratch data set
X'22'	Erase data set
X'23'	Password
X'24'	Add
X'25'	Replace
X'26'	Add replicate
X'27'	Replace replicate
X'28'	Query for data set
X'29'	Note
X'2B'	Record ID
X'2C'	Erase record
X'2D'	Scratch all data sets
X'2E'	Volume ID
X'AA'	Note reply (SRI is always on)

### FM header 3

This header handles data management tasks that are common to all destinations in the LU-LU session.

The FMH-3 format is identical to the FMH-2 format except that an FMH-3 does not have a Stack Reference indicator (SRI) in byte 2. An FMH-3 is used when information is needed or used by all destinations managed by the half-session. By contrast, an FMH-2 is used for a specific destination.

Two functions, the Compaction Table FMH and the Prime Compression Character FMH, can be sent as an FMH-2 or FMH-3. They should be sent as an FMH-2 when they apply to a specific destination at the half-session and as an FMH-3 when they apply to all destinations at the half-session.

The FMH-3 functions are as follows:

Function Code	Function
X'02'	Compaction table
X'03'	Query for compaction table
X'04'	Prime compression character
X'05'	Status
X'06'	Series ID

## FM header 4

This header carries a logical block command and its parameters that, together with information, applies to a logical block within a logical message as defined for Logical Message Service.

- 0 Length, in binary, of FMH-4, including this Length byte  
1 bit 0, FMH concatenation (must be 0)  
bits 1-7, type: 0000100
- 2 FMH4FXCT: Length of fixed length parameters excluding the length of FMH4FXCT. The first nonfixed parameter position is FMH4LBN. The minimum value of FMH4FXCT is 3, the maximum is 4.
- 3 FMH4TT1: block transmission type:  
X'00' inherit code (from MM-TT register)  
X'01'-X'3F' reserved  
X'40' FFR-FNI record  
X'41' FFR-FS record  
X'42' FFR-FS2 record  
X'43'-X'4F' reserved  
X'50'-X'FE' reserved  
X'FF' reserved  
Note: FFR=field formatted record, FNI=fixed fields without field separators, FS=fixed fields with field separators, FS2=fixed fields with or without field separators.
- 4 FMH4TT2: block transmission type qualifier: reserved except for FMH4TT1=X'41' or X'42', in which case it holds the separator value
- 5 FMH4CMD: Command:  
X'00' CRT-NU-BLK  
X'02' CRT-SU-BLK  
X'03' CRT-SN-BLK  
X'10' CONT-NU-BLK  
X'12' CONT-SU-BLK  
X'13' CONT-SN-BLK  
X'23' DEL-SN-BLK  
X'32' UPD-SU-BLK  
X'33' UPD-SN-BLK  
X'42' RPL-SU-BLK  
X'43' RPL-SN-BLK  
Other reserved  
Note: NU=nonshared, unnamed; SU=shared, unnamed; SN=shared, named; NN=nonshared, named
- 6 FMH4FLAG: flags (if omitted, X'00' is assumed):  
bits 0-1, reserved  
bits 2-3, F4RDESCR: record descriptor flag:  
00 no logical record headers (LRHs) in transmission block  
01 LRHs present, with implicit lengths  
10 reserved  
11 reserved  
bits 4-5, reserved  
bit 6, FMH4BDTF: block data transform flag:  
0 FMH4BDT absent  
1 FMH4BDT present  
bit 7, FMH4RDTF: reserved
- m FMH4LBN: Length of FMH4BN (X'00', or omitted, if unnamed block)

m+1	FMH4BN:	Name of block
n	FMH4LBDT:	Length of FMH4BDT (X'00 if FMH4BDTF is 0)
n+1	FMH4BDT:	Block data transform
p	FMH4LVID:	Length of FMH4VID
p+1	FMH4VID:	Version identifier

## FM header 5: Attach

LU type 6.2 uses this header to carry a request for a conversation to be established between two transaction programs. This header identifies the transaction program that is to be put into execution and connected to the receiving half-session.

When a transaction program issues an ALLOCATE verb naming a transaction program to be run at the other end of the conversation, an Attach FMH-5 carries the transaction program name (TPN) to the receiving LU.

0	Length, in binary, of FMH-5, including this Length byte
1	bit 0, reserved
	bits 1-7, type: 0000101
2-3	Command code: X'02FF' (Attach)
4	bit 0, security indicator: 0 user ID is not already verified 1 user ID is already verified
	bits 1-3, reserved
	bit 4, program initialization parameter (PIP) presence: 0 PIP not present following this FMH-5 1 PIP present following this FMH-5 (see "PIP Variable " on page 10-11 for format)
	bits 5-7, reserved
5	Length (j-5), in binary, of Fixed Length Parameters field (currently 3--future expansion possible)
6-j	<u>Fixed Length Parameters</u>
6	Resource type: X'D0' basic conversation X'D1' mapped conversation
7	Reserved
8(=j)	bits 0-1, synchronization level: 00 none 01 confirm 10 confirm, sync point, and backout 11 reserved
	bits 2-7, reserved
j+1-p	<u>Variable Length Parameters</u>
j+1-k	<u>Transaction Program Name Field:</u>
j+1	Length (values 1 to 64 are valid), in binary, of transaction program name
j+2-k	Transaction program name: a symbol string identifying a transaction program name known at the receiver; receivers may constrain such names to be type A, AE, GR, or DB, depending on the implementation
k+1-m	<u>Access Security Information Field:</u>
k+1	Length (0 or m-k-1), in binary, of Access Security Information subfields
k+2-m	Zero or more Access Security Information subfields (see "Access Security Information Subfields " on page 10-11 for format)
m+1-n	<u>Logical-Unit-of-Work Identifier Field:</u>
m+1	Length (values 0 and 10 to 26 are valid), in binary, of Logical-Unit-of-Work Identifier field
m+2-n	<u>Logical-Unit-of-Work Identifier</u>
m+2	Length (values 1 to 17 are valid), in binary, of fully qualified LU network name
m+3-w	Fully qualified LU network name (format described in "User Data Structured Subfield Formats" in "Chapter 7. User Data Structured Subfields")

w+1-w+6 Logical-unit-of-work instance number, in binary  
w+7-  
w+8(=n) Logical-unit-of-work sequence number, in binary  
n+1-p Conversation Correlator Field:  
n+1 Length (values 0 to 8 are valid), in binary, of conversation correlator of sender  
n+2-p Conversation correlator of the sending transaction: a 1- to 8-byte symbol-string type G identifier (unique between partner LUs) of the conversation being allocated via FMH-5 (an example construction of this field would be the composition of a transaction program instance identifier and a resource identifier)

Note: Trailing Length fields (bytes n+1, m+1, and k+1) that have value X'00' can be omitted.

### Access Security Information Subfields

The Access Security Information subfields in FMH-5 have the following formats:

0 Length (valid values are 1 to 11), in binary, of remainder of subfield--does not include this Length byte  
1 Subfield type:  
X'00' profile  
X'01' password  
X'02' user ID  
2-i Data: a symbol string identifying access security information known at the receiver; receivers may constrain such information to be type A, AE, GR, or DB, depending on the implementation.

Note: The Access Security Information subfields may appear in any order in the Access Security Information field of the FMH-5.

### PIP Variable

The PIP variable following FMH-5 Attach has the following format:

0-1 Length (4 or n+1), in binary, of PIP variable, including this Length field  
2-3 GDS indicator: X'12F5'  
4-n Zero or more PIP subfields, each of which has the following format (shown in "PIP Subfield " using zero-origin)

### PIP Subfield

Zero or more of these subfields are contained in a PIP variable (see "PIP Variable").

0-1 Length, in binary, of PIP subfield, including this Length field  
2-3 GDS indicator: X'12E2'  
4-m PIP subfield data: type G symbol string is valid

## FM header 5 (Not LU Type 6.2)

This header flows from the program using the sending half-session to the attach manager of the receiving half-session. This header identifies the program at the receiving LU that it wishes to have attached. An FMH-5 can be followed by other FMHs (for example, FMH-6, FMH-8, and FMH-4), a logical record header (LRH), and FM data. Optionally, it can be sent with CD or EB.

0	Length, in binary, of FMH-5, including this Length byte
1	bit 0, FMH concatenation: 0 no FMH follows this FMH-5 1 another FMH follows this FMH-5
	bits 1-7, type: 0000101
2-3	FMH5CMD: command code: X'0202' attach transaction program X'0204' reset attached process X'0206' data descriptor
4	FMH5MOD: modifier
5	FMH5FXCT: fixed-length parameters: X'00' reset attached process X'02' attach transaction program, data descriptor
6	ATTDSP
7	ATTDBA
8-n	Resource Names

## FM header 6

This header flows from a currently active transaction program using a sending half-session to a currently active transaction program using a receiving half-session.

0	Length, in binary, of FMH-6, including this Length byte
1	bit 0, FMH concatenation: 0 no FMH follows this FMH-6 1 another FMH follows this FMH-6 bits 1-7, type: 0000110
2-3	Command code (CC2): For service transaction programs, the first byte of the command code identifies a transaction program and the second byte identifies a function within a transaction program.
4	FMH6MOD: modifier bit 0, FMH6LNSZ: length of parameter length fields: 0 1-byte field 1 2-byte field bits 1-7, reserved
5-n	Fixed: total length of fixed length parameters (LF): This field contains the sum of the lengths of all fixed length parameters that are mandatory for the particular command code located in bytes 2 and 3. This field is either one byte or two bytes in length based on the setting of FMH6LNSZ (0 = one byte; 1 = two bytes).
n+1-m	Fixed length parameters (FDy): the fixed length parameters are positional by command code
m+1-p	Variable: length field of first, positional variable-length parameter (LV1): This field is either one byte or two bytes in length based on the setting of FMH6LNSZ (0 = one byte; 1 = two bytes). If the Length field (LVx) is equal to 0, then the variable parameter is omitted. The next positional variable-length parameter length (LV2) occurs in byte q+1.
p+1-q	Variable-Length Positional Parameter (VD). The LV and VD fields are replicated to represent x number of variable-length parameters according to command code.



## FM header 7: Error Description

LU type 6.2 uses this header, following negative response (0846), to carry information that relates to an error on the session or conversation. For example, an FMH-7 and additional error information are sent when an FMH-5 (Attach) specifies a nonexistent transaction program name.

0 Length (7), in binary, of FMH-7, including this Length byte  
1 bit 0, reserved  
bits 1-7, type: 00001111  
2-5 SNA-defined sense data (see below)  
6 bit 0, error log variable presence:  
    0 no error log variable follows this FMH-7  
    1 error log GDS variable follows this FMH-7  
bits 1-7, reserved

Note: Only the following sense data (in hexadecimal) can be sent in an LU 6.2 FMH-7. Sense data carried in non-LU 6.2 FMH-7 varies by implementation. See "Chapter 9. Sense Data" for additional details on sense data. The phrases following the sense data are the symbolic return codes provided to the application program in LU 6.2 verbs (see SNA Transaction Programmer's Reference Manual for LU Type 6.2) when the sense data is received.

### Sense Data    Return Code

1008600B	RESOURCE_FAILURE_NO_RETRY
10086021	ALLOCATION_ERROR--TPN_NOT_RECOGNIZED
10086031	ALLOCATION_ERROR--PIP_NOT_ALLOWED
10086032	ALLOCATION_ERROR--PIP_NOT_SPECIFIED_CORRECTLY
10086034	ALLOCATION_ERROR--CONVERSATION_TYPE_MISMATCH
10086041	ALLOCATION_ERROR--SYNC_LEVEL_NOT_SUPPORTED_BY_PGM
080F6051	ALLOCATION_ERROR--SECURITY_NOT_VALID
08240000	BACKED_OUT
084B6031	ALLOCATION_ERROR--TRANS_PGM_NOT_AVAIL_RETRY
084C0000	ALLOCATION_ERROR--TRANS_PGM_NOT_AVAIL_NO_RETRY
08640000	DEALLOCATE_ABEND_PROG
08640001	DEALLOCATE_ABEND_SVC
08640002	DEALLOCATE_ABEND_TIMER
08890000	PROG_ERROR_NO_TRUNC or PROG_ERROR_PURGING
08890001	PROG_ERROR_TRUNC
08890100	SVC_ERROR_NO_TRUNC or SVC_ERROR_PURGING
08890101	SVC_ERROR_TRUNC

## FM header 7: Error Description (not LU 6.2)

This header is sent after a negative response (0846) to provide further information about an error.

0	Length, in binary, of FMH-7, including this Length byte
1	bit 0, FMH concatenation: 0 no FMH follows this FMH-7 1 reserved
	bits 1-7, type: 0000111
2-5	ERPSENSE: SNA-defined sense data, which would appear on error response (see Chapter 9, Sense Data)
6-7	ERPSEQ: sequence number of RU chain in which error was detected

## FM HEADER 8

This header is used only with IMS/VS logical message services that utilize LU type 6.1 protocols. Refer to the IMS publications for the formats and meanings of the bytes in this header.

## FM header 10

This header is sent to prepare the session for a sync point. It may be sent with data. The RU chain must have CD set on so that the receiver may, on the next flow, request a sync point or abort the unit of work.

0	Length, in binary, of FMH-10, including this length byte
1	bit 0, FMH concatenation: 0 no FMH follows this FMH-10 1 another FMH follows this FMH-10
	bits 1-7, type: 0001010
2-3	SPCCMD: sync point command: X'0202' prepare command
4-5	SPCMOD: sync point modifier For a prepare command (FMH-10), the modifier indicates RH settings to be returned on the first RU chain sent by the FMH-10 receiver. X'0000' *CD, *EB. The sender of FMH-10 does not care what RH settings are returned on the reply. X'0001' EB. The sender of FMH-10 requires an EB on the reply. X'0002' CD, -EB. The sender of FMH-10 requires a CD on the reply.

## FM header 12: Security

LU type 6.2 uses this header to carry enciphered data that it received in the clear in +RSP(BIND) for LU-LU session password verification. An FMH-12 is the third flow of LU-LU session password verification information. (BIND and +RSP(BIND) are the other two.)

The function management header 12 (FMH-12) has the following format:

0	Length (10), in binary, of FMH-12, including this Length byte.
1	bit 0, reserved bits 1-7, type: 0001100
2-9	Enciphered version of the random data received in RSP(BIND)

## CHAPTER 11. PRESENTATION SERVICES HEADERS

**Message  
Unit  
Format**

Chapter 1

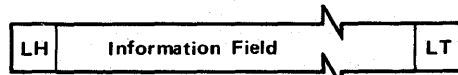

BLU

Chapter 2



Chapter 3

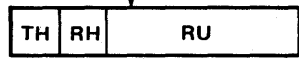

PIU

Chapter 4

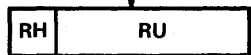

BIU

Chapter 5.1



Chapter 5.2



Chapter 6

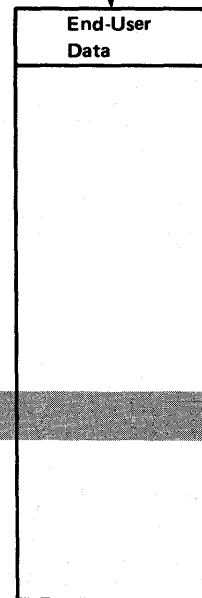
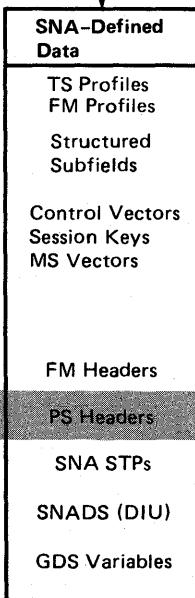
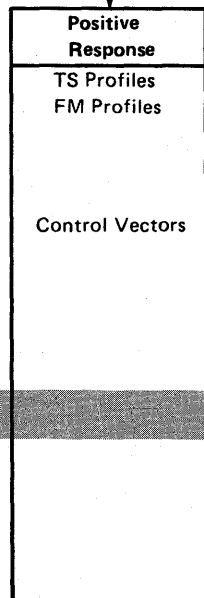
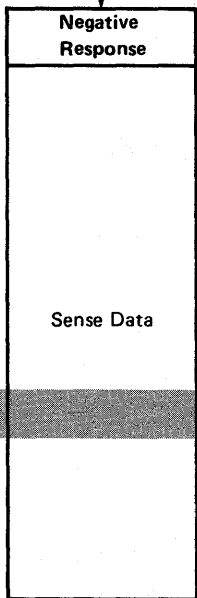

Chapter 7

Chapter 8

Chapter 9

Chapter 10

Chapter 11

Chapter 12

Chapter 13

Chapter 14

- LH = Link Header
- LT = Link Trailer
- XID = Exchange Identification
- TH = Transmission Header
- RH = Request/Response Header
- RU = Request/Response Unit
- TS = Transmission Services
- FM = Function Management
- MS = Management Services

- PS = Presentation Services
- STP = Service Transaction Program
- SNADC = SNA Distribution Services
- DIU = Distribution Interchange Unit
- GDS = General Data Stream
- BLU = Basic Link Unit
- PIU = Path Information Unit
- BIU = Basic Information Unit

## CHAPTER 11. PRESENTATION SERVICES HEADERS

### PRESENTATION SERVICES (PS) HEADERS

Presentation services (PS) headers convey information between PS component sync point managers when the conversation using the session is allocated with the sync-point synchronization level. These headers are only used by LU type 6.2. SNA Format and Protocol Reference Manual: Architecture Logic for LU Type 6.2 describes the use of these PS headers.

Transaction program data is delimited using a 2-byte length field called an LL, containing a value that is the number of bytes contained in the transaction program data plus 2 (the length of the LL field itself).

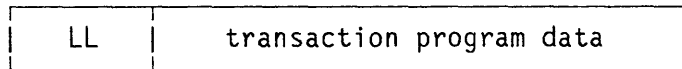

All PS headers are identified by an LL of X'0001' immediately preceding the header. X'0001' is an invalid LL value for use by transaction programs because the LL's value must include the length of itself, which is 2 bytes. Therefore, all LLs indicating a length of less than 2 are reserved for use by the LU. The format of PS headers is shown below.

## PS header 10: Sync Point Control

Presentation services header 10 (Sync Point Control) has the following format:

0	Length, in binary, of PS header, including this length field
1	bit 0, reserved
	bits 1-7, type: 0001010 sync point control (only value defined)
2-3	Sync point command type: X'0005' Prepare X'0006' Request Commit X'0007' Committed X'0008' Forget X'0009' Heuristic Mixed
4-5	Modifier specifying next flow (present only if bytes 2-3 = X'0005' or X'0006'; reserved when bytes 2-3 = X'0006' and 2-phase sync point being used): X'0000' request RECEIVE X'0001' request DEALLOCATE X'0002' request SEND

Note: Bytes 4-5 affect the change direction indicator (CDI) and conditional end bracket indicator (CEBI) settings of the RH for the last PS header in the sync point sequence. For example, Forget command type when Prepare was the first PS header received, and Committed command type when Request Commit was the first PS header received. (See SNA Format and Protocol Reference Manual: Architecture Logic for LU Type 6.2 for details.)

## CHAPTER 12. GENERAL DATA STREAM (GDS) VARIABLES



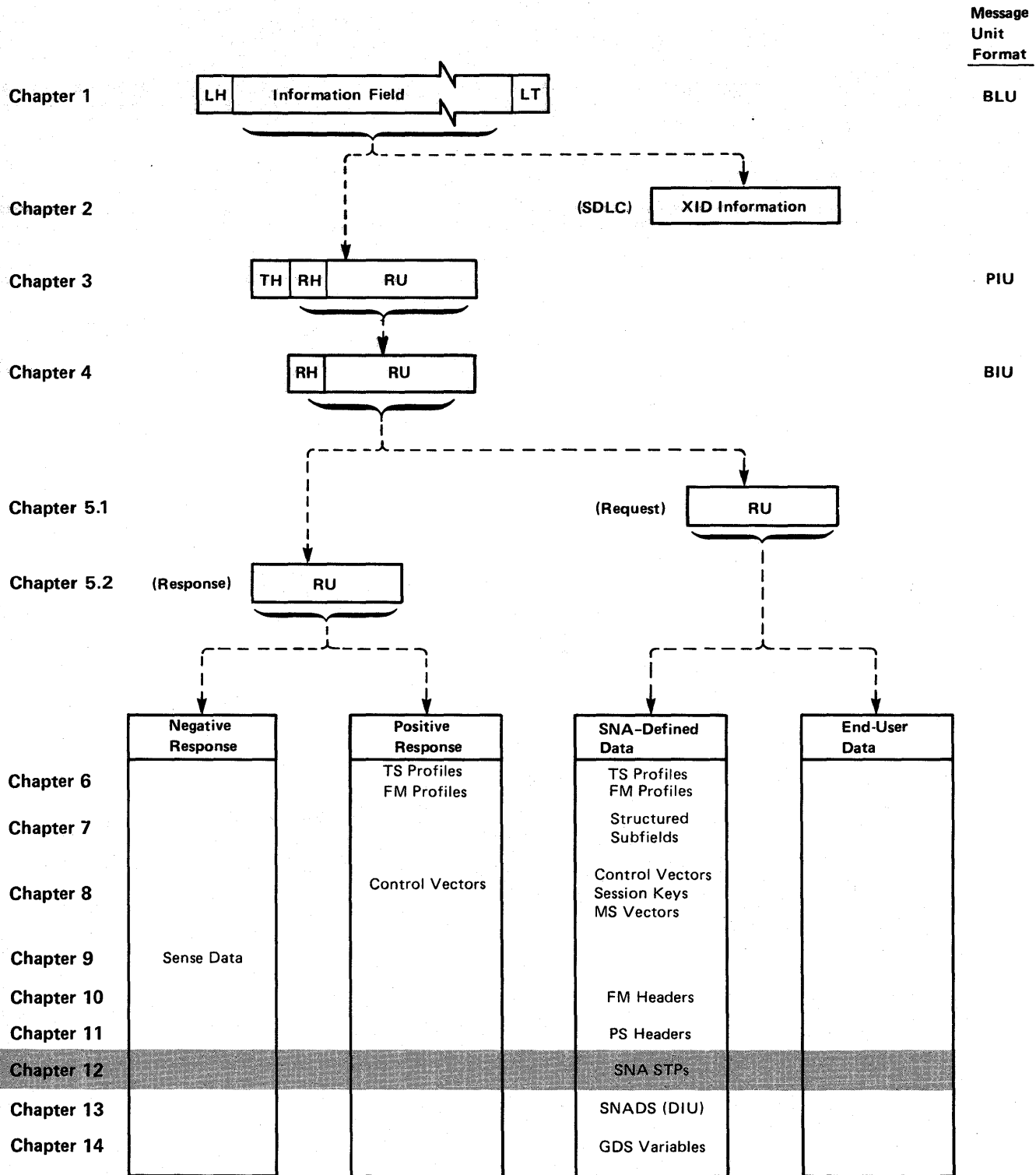

LH = Link Header  
 LT = Link Trailer  
 XID = Exchange Identification  
 TH = Transmission Header  
 RH = Request/Response Header  
 RU = Request/Response Unit  
 TS = Transmission Services  
 FM = Function Management  
 MS = Management Services

PS = Presentation Services  
 STP = Service Transaction Program  
 SNADS = SNA Distribution Services  
 DIU = Distribution Interchange Unit  
 GDS = General Data Stream  
 BLU = Basic Link Unit  
 PIU = Path Information Unit  
 BIU = Basic Information Unit

## CHAPTER 12. GENERAL DATA STREAM (GDS) VARIABLES

### LIST OF SNA SERVICE TRANSACTION PROGRAMS

Logical Unit type 6.2 service transaction programs are identified by a transaction program name (TPN) that begins with a value of X'06'. Other SNA service transaction programs are identified similarly. Figure 12-1 identifies the transaction program names that SNA currently defines. These TPNs are specified in an FM header type 5 (FMH5 Attach).

TP Name	TP Description
X'06F1****'	LU 6.2 Change Number of Sessions
X'06F2****'	LU 6.2 Sync Point Resynchronization
X'07F0F0F1'	DDM Synchronous Conversation
X'20F0F0F0'	DIA PROCESS Destination TP
X'20F0F0F1'	DIA SERVER TP
X'21F0F0F1'	DS SEND TP
X'21F0F0F2'	DS RECEIVE TP
X'21F0F0F3'	DS ROUTER DIRECTOR TP
X'21F0F0F6'	DS General Server TP

\* = any hexadecimal digit

Figure 12-1. SNA-defined Service Transaction Programs

Refer to "Chapter 13. SNA Distribution Services" for additional SNADS information and refer to "Chapter 14. GDS Variables for General Use" for information about GDS variables that are not specific to SNA service transaction programs.

## GDS Variables for SNA STPs

### DESCRIPTIONS OF GDS VARIABLES FOR SNA STPS

#### CHANGE NUMBER OF SESSIONS (X'1210') GDS Variable

- 0-1 Length (17 or n+1), in binary, of Change Number of Sessions GDS variable, including this Length field
- 2-3 GDS ID: X'1210'
- 4 Service flag:  
bits 0-3, reserved  
bits 4-7, request/reply indicator:  
0010 request  
1000 reply, function completed abnormal  
1010 reply, function accepted but not yet completed
- 5 Reply modifier (reserved if byte 4, bits 4-7 = 0010):  
X'00' normal--no negotiation performed  
X'01' abnormal--command race detected  
X'02' abnormal--mode name not recognized  
X'03' reserved  
X'04' normal--negotiated reply  
X'05' abnormal--(LU,mode) session limit is 0
- 6 Action:  
X'00' set (LU,mode) session limits  
X'01' reserved  
X'02' close
- 7 Drain immediacy:  
bits 0-2, reserved  
bit 3, source LU drain (reserved if byte 6 -= 02):  
0 no (send BIS at next opportunity)  
1 yes  
bits 4-6, reserved  
bit 7, target LU drain (reserved if byte 6 -= 02):  
0 no (send BIS at next opportunity)  
1 yes
- 8 Action flags:  
bits 0-6, reserved  
bit 7, session deactivation responsibility:  
0 sender of Change Number of Sessions request (source LU)  
1 receiver of Change Number of Sessions request (target LU)  
Note: Bytes 9-14 are reserved if byte 6 -= 0.
- 9-10 (LU,mode) session limit:  
bit 0, reserved  
bits 1-15, maximum (LU,mode) session count, in binary
- 11-12 Source LU contention winners:  
bit 0, reserved  
bits 1-15, guaranteed minimum number of contention winner sessions at source LU, in binary
- 13-14 Target LU contention winners:  
bit 0, reserved  
bits 1-15, guaranteed minimum number of contention winner sessions at target LU, in binary
- 15 Mode name selection:  
bits 0-6, reserved  
bit 7, mode names affected by this command:

- 0 a single mode name is affected
- 1 all mode names are affected
- 16 Length (values 0 to 8 are valid; reserved if byte 15, bit 7 = 1), in binary, of mode name
- 17-n Mode name (omitted if byte 16 = X'00')

## EXCHANGE LOG NAME (X'1211') GDS Variable

- 0-1 Length (p+1), in binary, of Exchange Log Name GDS variable, including this Length field
- 2-3 GDS ID: X'1211'
- 4 Service flag:
  - bits 0-3, reserved
  - bits 4-7, request/reply indicator:
    - 0010 request
    - 1000 reply, function completed abnormally
    - 1001 reply, function completed normally
- 5 Sync point manager flags:
  - bits 0-6, reserved
  - bit 7, log status:
    - 0 cold
    - 1 warm
- 6 Length (values 1 to 17 are valid), in binary, of fully qualified LU network name
- 7-n Fully qualified LU network name (format described in "Chapter 7. User Data Structured Subfields" )
- n+1 Length (values 1 to 64 are valid), in binary, of log name
- n+2-p Log name (symbol-string type-AE)

## GDS Variables for SNA STPs

### COMPARE STATES (X'1213') GDS Variable

0-1	Length (p+1), in binary, of Compare States GDS variable, including this Length field
2-3	GDS ID: X'1213'
4	Service flag: bits 0-3, reserved bits 4-7, request/reply indicator: 0010 request 1000 reply, function completed abnormally 1001 reply, function completed normally
5	Sync point manager state: X'01' RESET X'02' SYNC_POINT_MANAGER_PENDING X'03' IN DOUBT X'04' COMMITTED X'05' HEURISTIC_RESET X'06' HEURISTIC_COMMITTED X'07' HEURISTIC_MIXED
6	Reserved
7	Length, in binary, of Logical-Unit-of-Work Identifier field (values 10 to 26 are valid)
8-n	<u>Logical-Unit-of-Work Identifier</u>
8	Length, in binary, of fully qualified LU network name (values 1 to 17 are valid)
8-w	Fully qualified LU network name (format described in "Chapter 7. User Data Structured Subfields" )
w+1-w+6	Logical-unit-of-work instance number, in binary
w+7-	
w+8(=n)	Logical-unit-of-work sequence number, in binary
n+1	Length (values 0 to 8 are valid), in binary, of conversation correlator
n+2-q	Conversation correlator of transaction program that allocated the conversation that failed: see FMH-5 for format of this correlator
q+1	Length (values 2 to 8 are valid), of session instance identifier
q+2-p	Session instance identifier of session being used by conversation at time of failure (See "Chapter 7. User Data Structured Subfields" for the format of this identifier.)

## CHAPTER 13. SNA DISTRIBUTION SERVICES

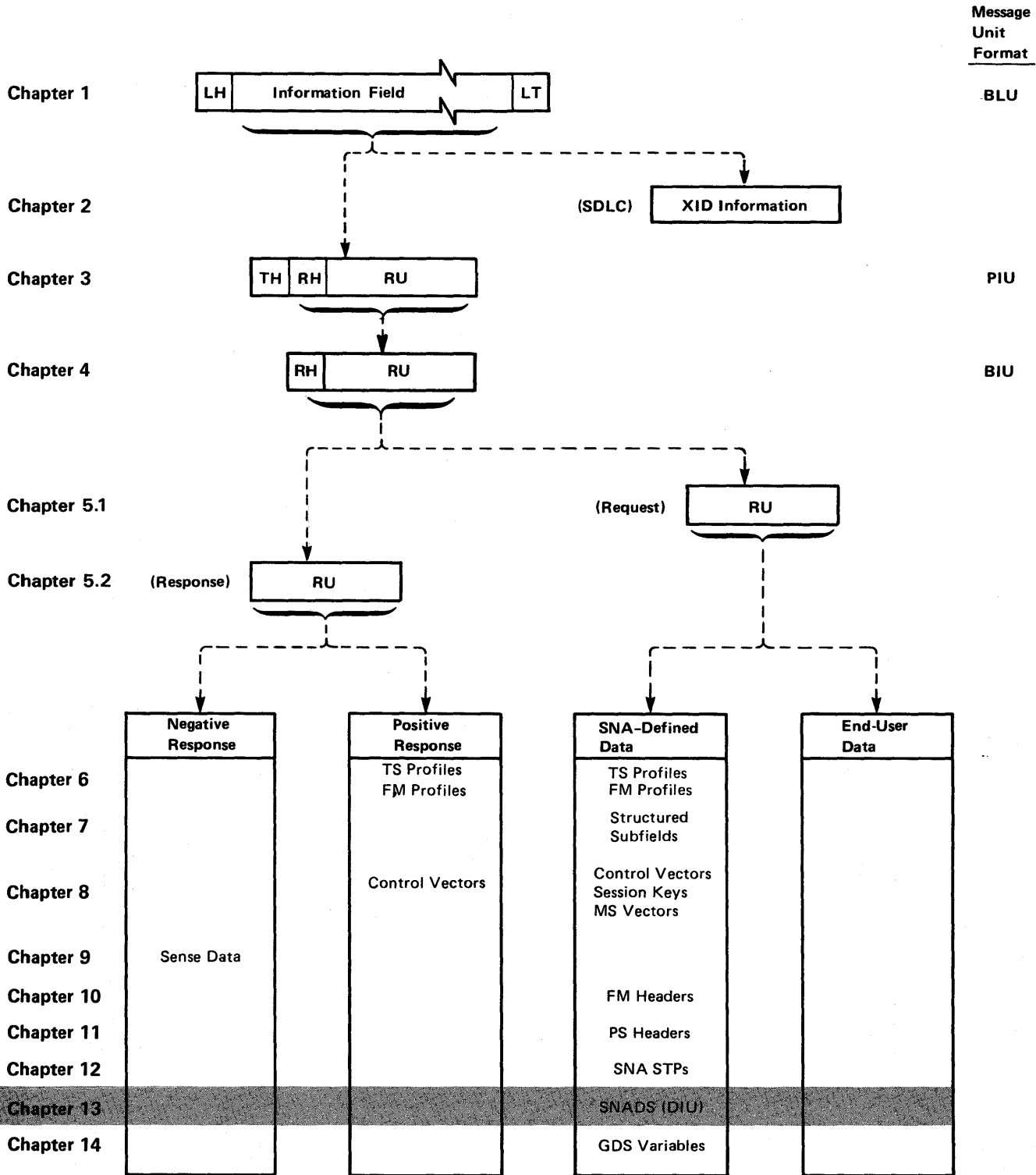

LH = Link Header  
 LT = Link Trailer  
 XID = Exchange Identification  
 TH = Transmission Header  
 RH = Request/Response Header  
 RU = Request/Response Unit  
 TS = Transmission Services  
 FM = Function Management  
 MS = Management Services

PS = Presentation Services  
 STP = Service Transaction Program  
 SNADS = SNA Distribution Services  
 DIU = Distribution Interchange Unit  
 GDS = General Data Stream  
 BLU = Basic Link Unit  
 PIU = Path Information Unit  
 BIU = Basic Information Unit

## CHAPTER 13. SNA DISTRIBUTION SERVICES

### INTRODUCTION

This chapter presents the encodings of the SNA Distribution Services (SNADS) interchange units (IUs) used to transport information and control between the distribution service units (DSUs). It has two parts:

- "Interchange Unit Description" on page 13-2 presents the format and the semantics of the IUs
- "Names and Code Points" on page 13-41 presents all the IU code points, transaction program names, and the server names

The syntax of the IUs follows the Distribution Interchange Architecture: IUs contain a prefix, command, object (optionally), and a suffix. The IUs are sent between DSUs on LU 6.2 conversations. Some of the SNADS IUs may be segmented.



## INTERCHANGE UNIT DESCRIPTION

### DISTRIBUTE INTERCHANGE UNIT

DISTIU; DSU ---> DSU; (DISTRIBUTE INTERCHANGE UNIT)

DISTIU carries data and status for distribution to one or more users.

DISTIU consists of a sequence of GDS variables as follows:

- A prefix
- A command
- A distribution object (optional)
- A suffix

See Figure 13-1 on page 13-3.

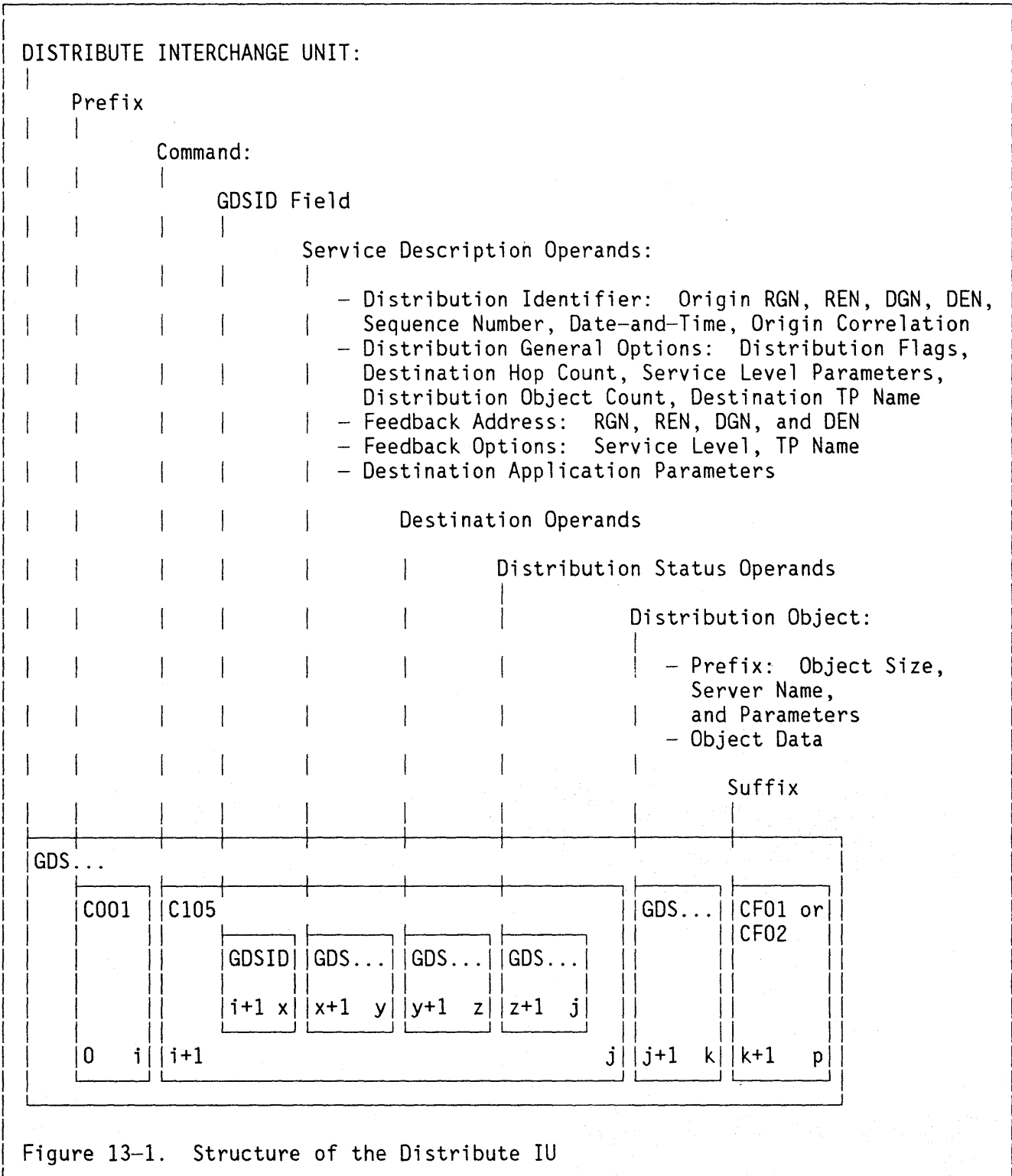

Note: The identifiers (e.g., C001, C105) above are shown to identify portions of the data stream. The two identifier bytes are always preceded by two length bytes in the encoded data stream.

## DISTIU

### 0-i Prefix

Required GDS variable, identifies the beginning of an interchange unit (IU)

0-1 Length (i+1), in binary, of the prefix, including this Length field (values from 5 to 21 are valid)

2-3 Identifier: X'CO01'

4 Format:

X'02' no segmentation descriptor follows

5-i Interchange unit identifier, optional subfield, a 1- to 16-byte correlator of the sending DSU. If an error occurs, the receiving DSU returns this value in an Acknowledge IU, see "Acknowledge Interchange Unit" on page 13-34.

Note: A particular correlator value is optional and is used by a send-receive DSU pair; it has no meaning through the entire SNADS network.

### i+1-j Command

Required sequence of one or more GDS variables that contains:

- A sequence of Service Description operands
- A sequence of Destination operands
- A sequence of Distribution Status operands

See Figure 13-1 on page 13-3.

### i+1-x GDSID field

i+1-i+2 Length (j-i), in binary, of the GDS variable, including this Length field

Note: The maximum length of the command, including all segments, is 32511.

i+3-i+4 Identifier: X'C105'

i+5 Format:

X'02' no segmentation descriptor follows

X'82' segmentation descriptor follows

### i+6-i+8 Segmentation Descriptor

(present only if Format=X'82')

i+6 Position in the command:

X'00' last or only segment (this is the last or only command segment sent)

X'20' not the last segment of the command (at least one more command segment follows contiguously on this conversation<sup>1</sup>)

i+7-i+8 Segment sequence number:

X'0000' segment sequence numbering not used

x=(i+5)|(i+8) for i+5 containing X'02'|X'82', respectively

### x+1-y Service Description Operands

Required set of GDS variables containing:

- Distribution Identifier

<sup>1</sup> SNADS command and distribution object data may be divided into smaller segments to send across the conversation. The last segment is sent before any other different GDS variable is sent.

- Distribution General Options
- Feedback Address (optional)
- Feedback Options (optional)
- Destination Application parameters (optional)

The above components can be in any order. See Figure 13-1 on page 13-3.

Note: Throughout the DISTIU and ACKIU presentation, the offset of the first byte of a subfield is reset to 0 if the subfield can appear in positions (within the field) different from the position shown in the offset-stream field description.

0-n Distribution Identifier

Required GDS variable. It contains the following LT-subfields:

- Origin RGN (optional)
- Origin REN
- Origin DGN
- Origin DEN
- Origin Sequence number
- Origin Date and time
- Origin Correlation (optional)

See Figure 13-1 on page 13-3. The LT-subfields can be in any order.

0-1 Length (n+1), in binary, of the GDS variable, including this Length field (values from 28 to 107 are valid)

Note: The quadruple (origin DGN, origin DEN, Sequence number, Date and time) is the unique distribution identifier (UDI) in the whole SNADS network.

2-3 Identifier: X'C340'

4 Format:  
X'41' no segmentation descriptor follows, contains LT-subfields

0-n1 Origin RGN

Optional LT-subfield

0 Length (n1+1), in binary, of the subfield including this Length field (values from 3 to 10 are valid)

1 Type: X'01'

2-n1 RGN, filled in at the origin DSU, 1- to 8-character string (see "Specification of the Character-String Fields" on page 13-41 for the encoding of the graphic characters used), first part of the name of the DSU where DISTIU originated, obtained from the origin DSU directory

0-n2 Origin REN

Required LT-subfield

0 Length (n2+1), in binary, of this subfield including this Length field (values from 3 to 10 are valid)

1 Type: X'02'

2-n2 REN, 1- to 8-character string (see "Specification of the Character-String Fields" on page 13-41 for the encoding of the graphic characters used),

## DISTIU

second part of the DSU name where DISTIU originated, obtained from the origin DSU directory

### 0-n3 Origin DGN

Required LT-subfield

0 Length (n3+1), in binary, of this subfield including this Length field (values from 2 to 10 are valid)

1 Type: X'03'

2-n3 DGN, 0- to 8-character string (see "Specification of the Character-String Fields" on page 13-41 for the encoding of the graphic characters used), first part of the distribution user name (DUN) that initiated DISTIU, passed by DISTRIBUTE\_DATA or DISTRIBUTE\_STATUS verbs

Note: The name is null (i.e., the length of the LT-subfield is 2) if DISTIU is a status DISTIU generated by a DSU.

### 0-n4 Origin DEN

Required LT-subfield

0 Length (n4+1), in binary, of the subfield including this Length field (values from 2 to 10 are valid)

1 Type: X'04'

2-n4 DEN, 0- to 8-character string, (see "Specification of the Character-String Fields" on page 13-41 for the encoding of the graphic characters used), second part of the, distribution user name (DUN) that initiated DISTIU, passed by DISTRIBUTE\_DATA or DISTRIBUTE\_STATUS verbs

Note: The name is null (i.e., Length of the LT-subfield is 2) if DISTIU is a status DISTIU generated by a DSU.

### 0-5 Origin Sequence Number

Required LT-subfield

0 Length (6), in binary, of the subfield, including this Length field

1 Type: X'05'

2-5 Integer in base 10, 4-numeric EBCDIC encoded character string (values from 'FOFOFOF1' to 'F9F9F9F9' generated by modulo-10000 incrementing counter [with 1, 2, 3, ..., 9999 as states] for DISTIUs of type=DATA, and 'FOFOFOFO' for DISTIUs of type=STATUS), when the distribution verb is invoked or for STATUS DISTIU, when the feedback is generated

### 0-9 Origin Date and Time

Required LT-subfield, contains the date and time generated by SNADS when the distribution verb was issued.

0 Length (10), in binary, of the subfield including this Length field

1 Type: X'06'

2-5 Date:

2-3 Year, in binary (e.g., year 1983 is encoded as X'07BF')

4 Month of the year, in binary (values from 1 to 12 are valid)

5 Day of the month, in binary (values from 1 to 31 are valid)

6-9 Time.

6 Hour of the day, in binary (values from 0 to 23 are valid)

7 Minute of the hour, in binary (values from 0 to 59 are valid)

8 Second of the minute, in binary (values from 0 to 59 are valid)

- 9           Hundredth of the second, in binary (values from 0 to 99 are valid)
- 0-n5       Origin Correlation
- Optional LT-subfield
- 0           Length (n5+1), in binary, of the subfield including this Length field  
(values from 3 to 46 are defined)
- 1           Type: X'07'
- 2-n5       String supplied by application transactions, not used by SNADS
- 0-n        Distribution General Options
- Required GDS variable, describes the processing SNADS performs upon the  
DISTIU. It contains the following LT-subfields:
- Distribution Flags
  - Destination Hop Count
  - Service Level parameters
  - Distribution Object Count
  - Destination TP Name
- See Figure 13-1 on page 13-3. The LT-subfields can be in any order.
- 0-1        Length (n+1), in binary, of the GDS variable, including this Length field  
(values from 30 to 114 are valid)
- 2-3        Identifier: X'C33D'
- 4           Format:  
X'41' no segmentation descriptor follows, contains LT-subfields
- 0-2        Distribution Flags
- Required LT-subfield, services indicated specified by the application  
transaction
- 0           Length (3), in binary, of the LT-subfield, including this Length field
- 1           Type: X'01'
- 2           Flags:
- bit 0, no-feedback request bit:  
                0 SNADS is requested to generate feedback in case of error  
                1 no SNADS feedback for this DISTIU is requested
- bit 1, DISTIU type bit:  
                0 DISTIU is a data distribution  
                1 DISTIU is a status distribution
- bit 2, reserved, DISTIU not rejected whatever its value
- bits 3-7, reserved<sup>2</sup>
- Note: The functions encoded by the Flags field are described in  
Figure 13-2 on page 13-8.

<sup>2</sup> Reserved fields are to be used for later releases; unless specified otherwise, their values are passed unchanged by the intermediate nodes, and, if not 0, rejected by the destination nodes.

## DISTIU

Flag (hex)	Interpretation of the Flag
00	Data distribution with feedback
80	Data distribution with no feedback
C0	Status distribution with no feedback

Figure 13-2. Interpretation of the Distribution Flags

### 0-3 Destination Hop Count

Required LT-subfield

- 0 Length (4), in binary, of the subfield including this Length field
- 1 Type: X'02'
- 2-3 Number, in binary, of hops that may not be exceeded by DISTIU in its way toward its destination DSUs, set by the DSU where DISTIU originated, decremented by one every time the DISTIU is sent to another DSU. When its value is 0 and this DSU is not the final destination of the DISTIU, the DISTIU has a "hop count" error.

### 0-n1 Service Level Parameters

Required LT-subfield, provided by the application transaction to describe the requested functions for the DISTIU

- 0 Length (n1+1), in binary, of Service Level parameters, including this Length field (values 11, 14, 17, ... 32 are valid)
- 1 Type: X'03'
- 2-4 Priority parameter, priority level to be given to the distribution, in decreasing priority order:
  - X'01C0F0' FAST priority
  - X'01C0D0' STATUS priority
  - X'01C080', ..., X'01C0xx', ..., and X'01C008' data priority levels, where 'xx' is the value of the priority level DATA<sub>i</sub>, and 'xx' = [(8 \* i) in hexadecimal]; e.g., 'xx'='80' for i=16, and 'xx'='08' for i=1

Note: If only two data priorities are honored then the high data priority would map to priorities DATA<sub>16</sub> to DATA<sub>9</sub>, and the low data priority to priorities DATA<sub>8</sub> to DATA<sub>1</sub>.

- 5-7 Protection parameter, requirement for minimum protection against distribution losses in the data store:
  - X'02C010' no protection required, distribution object can be stored on volatile storage
  - X'02C030' protection required, distribution object must be stored on non-volatile storage
- 8-10 Capacity parameter, requirement for a route which can provide the storage of distribution data of specified size:
  - X'03C000' NONE capacity, used for DISTIUs without distribution objects
  - X'03C00C' 4K capacity, used for DISTIUs with distribution objects whose sizes are smaller than 4096 bytes
  - X'03E0FF' INDEF capacity, used for DISTIUs with distribution objects whose sizes are relatively large, for example larger than 4096 bytes

Notes:

1. The capacity requirement is for the distribution object, and does not include the capacity needed to store and handle the control subfields of the DISTIU. For example, the 3K required to handle one distribution object of 3K byte size is above the storage needed to store the associated command.
2. The defined values for (priority, protection, capacity) parameters are shown in Figure 13-3.
3. Implementations may accept other service levels as long as they can route IUs responsibly.

Service Level Parameter			Comments
Priority	Protection	Capacity	
01C0F0	02C010	03C000	Data or Status DISTIU with priority=FAST, no protection, and no capacity requested
01C0F0	02C010	03C00C	Data or Status DISTIU with priority=FAST, no protection, and 4K capacity requested
01C0D0	02C030	03C00C	Status DISTIU with priority=STATUS, protected, and 4K capacity requested
01C0D0	02C030	03C000	Status DISTIU with priority=STATUS, protected, and no capacity requested
01C0xx	02C030	03E0FF	Data DISTIU with priority=DATA-i (see Note) protected, and indefinite capacity
Note: 'xx'=[(8*i)], in hexadecimal, is the priority level corresponding to DATA_i, where i=1, 2, ..., 15, 16.			

Figure 13-3. Priority, Protection, and Capacity Subfield Values

11-n1 Optional Service Level Parameters

- An optional stream of up to 7 3-byte fields with the following structure:
- 0-2 Optional parameter
- 0 Parameter identifier: any value larger than X'03'
- 1 Comparison operator:  
X'00'-'0F' optional request, is ignored by a receiving product in the intermediate role that allows the transfer of the DISTIU  
≥ X'10' mandatory request, if not recognized by a product results in the "function not supported" error condition, the DISTIU is rejected
- 2 Parameter value: defined by product, refer to its specifications for the definition of the field



## DISTIU

### 0-3 Distribution Object Count

Required LT-subfield

0 Length (4), in binary, of the Distribution Object Count including this Length field

1 Type: X'04'

2-3 Number, in binary, of distribution objects present in this DISTIU (values 0 and 1 defined)

### 0-n2 Destination TP Name

Required LT-subfield

0 Length (n2+1), in binary, of the subfield including this Length field (values from 3 to 66 are valid)

1 Type: X'05'

2-n2 TP Name, character string, (see "Specification of the Character-String Fields" on page 13-41 for the encoding of the graphic characters used), started by the destination DSU after the DISTIU is enqueued for delivery

### 0-n Feedback Address

Optional GDS variable, valid only if DISTIU type is DATA, contains:

- Feedback RGN (optional)
- Feedback REN
- Feedback DGN
- Feedback DEN

The LT-subfields can be in any order. See Figure 13-1 on page 13-3.

0-1 Length (n+1), in binary, of the GDS variable including this Length field (values 14 to 45 are valid)

2-3 Identifier: X'C360'

4 Format:

X'41' no segmentation descriptor follows, contains LT-subfields

### 0-n1 Feedback RGN

Optional LT-subfield

0 Length, in binary, of the subfield including this Length field (values from 3 to 10 are valid)

1 Type: X'01'

2-n1 Name, character string, first part of the name of the DSU where the feedback is requested to be sent

### 0-n2 Feedback REN

Required LT-subfield

0 Length (n2+1), in binary, of the LT-subfield including this Length field (values from 3 to 10 are valid)

1 Type: X'02'

2-n1 Name, character string, second part of the DSU name where feedback is requested to be sent

### 0-n3 Feedback DGN

## 13-10 SNA Formats

0	Required LT-subfield Length (n3+1), in binary, of the subfield, including this Length (values from 3 to 10 are valid)
1	Type: X'03'
2-n3	Name, character string, first part of the distribution user name (DUN) to which feedback is to be sent
0-n4	<u>Feedback DEN</u>
0	Required LT-subfield Length (n4+1), in binary, of the subfield including this Length (values from 3 to 10 are valid)
1	Type: X'04'
2-n4	Name, character string, second part of the distribution user name (DUN) to which feedback is requested to be sent
0-n	<u>Feedback Options</u>
	Optional GDS variable, valid only if the distribution is of type DATA, defined by the application transaction to specify the functions needed for the feedback DISTIU, containing:
	<ul style="list-style-type: none"> <li>• Feedback Service Level (optional)</li> <li>• Feedback TP Name (optional)</li> </ul>
0-1	See Figure 13-1 on page 13-3. The LT-subfields can be in any order. Length (n+1), in binary, of the GDS variable, including this Length field (values 8 to 103 are valid)
2-3	Identifier: X'C343'
4	Format: X'41' no segmentation descriptor follows, contains LT-subfields
0-n1	<u>Feedback Service Level</u>
	Optional LT-subfield. If omitted, the service level of the feedback DISTIU is calculated as follows: The priority is FAST if this DISTIU has priority FAST, the priority is STATUS for other priorities, the protection is the same as the protection of this DISTIU, and the capacity is 4K or NONE.
0	Length (n1+1), in binary, of Feedback Service Level, including this Length field (values 11, 14, 17, ... 32 are valid)
1	Type: X'01'
2-4	Feedback Priority Parameter, priority level to be given to the feedback DISTIU, in decreasing priority order: X'01COFO' FAST priority X'01COD0' STATUS priority
5-7	Feedback Protection Parameter, requirement for minimum protection against feedback distribution object losses in the data store: X'02C010' no protection required, feedback distribution object can be stored on volatile memory X'02C030' protection required, feedback distribution object must be stored on non-volatile memory
8-10	Feedback Capacity Parameter, requirement for a route which can provide the storage of feedback distribution data of specified size:

DISTIU

- X'03C000' NONE capacity, used for DISTIUs without feedback distribution objects
- X'03C00C' 4K capacity, used for DISTIUs with feedback distribution objects whose sizes are smaller than 4096 bytes

Note: The feedback capacity requirement is for the distribution object and does not include the capacity needed to store and handle the control subfields of the feedback DISTIU.  
The defined values for (feedback priority, feedback protection, feedback capacity) parameters are shown in Figure 13-4.

Feedback Service Level Parameter			Comments
Priority	Protection	Capacity	
01C0F0	02C010	03C000	Feedback with priority=FAST, no protection and no capacity requested
01C0F0	02C010	03C00C	Feedback with priority=FAST, no protection and 4K capacity requested
01C0D0	02C030	03C00C	Feedback with priority=STATUS, protected, and 4K capacity requested
01C0D0	02C030	03C000	Feedback with priority=STATUS, protected, and no capacity requested

Figure 13-4. Feedback Priority, Protection, and Capacity Subfield Values

11-n1 Feedback Optional Service Level Parameter

An optional stream of up to seven 3-byte fields with the following structure:

0-2 Optional parameter

0 Parameter identifier: any value larger than X'03'

1 Comparison operator:

X'00'-'0F' optional request, is ignored by a receiving product in the intermediate role that allows the transfer of the DISTIU  
 ≥ X'10' mandatory request, if not recognized by an implementation, results in the "function not supported" error condition, the DISTIU is rejected

2 Parameter value: defined by product, refer to its specifications for the definition of the field

0-n2 Feedback TP Name

Optional LT-subfield, if omitted the transaction application program to be started after the feedback is queued for delivery is given by the Destination TP Name within Distribution General Options GDS variable  
 Length (n2+1), in binary, of the LT-subfield including this Length field (values from 3 to 66 are valid)

- 1       Type: X'02'  
 2       Name, character string, (see "Specification of the Character-String Fields" on page 13-41 for the encoding of the graphic characters used), name of the transaction application program to be started after the feedback is queued for delivery
- 0-n     Destination Application Parameters (see Figure 13-1 on page 13-3)
- Optional GDS variable
- 0-1     Length (n+1), in binary, of the GDS variable including this Length field (values from 6 to 517 are valid)
- 2-3     Identifier: X'C32D'
- 4       Format:  
 X'01' no segmentation descriptor follows
- 5-n     Parameters, to 512-byte stream, supplied by the application transaction that invoked the distribution verb and passed as a returned parameter when RECEIVE\_DISTRIBUTION is issued.

y+1     replaced by b1

Notes:

1. Offset y+1 will be replaced by b1 in order to simplify the stream description.

2. Offsets bi and ei+1 are used for the first byte of the beginning and the end of a list, as it follows: b1, e1+1 for Destination operands, b2, e2+1 for REN List, b3, e3+1 for DGN List, and b4, e4 for DEN List.

b1-e1+5   Destination Operands

List of destinations of the DISTIU, no larger than 256 destinations if DISTIU is of type DATA and exactly one destination if the DISTIU is of type STATUS, encoded as a list of factored lists of DUNs and DSUNs. The identical RGNs, RENs, and DGNs are factored out of the Destination operands, REN, and DGN lists. The Destination operands list may be fully factored, partially factored, or unfactored (see the following example).

Example: Following is a list of destinations (qualified by RGN.REN.DGN.DEN):

A.K.DA.U1, A.K.DA.U2, A.K.DB.U3, A.K.DB.U4,  
 A.L.DC.U5, A.L.DC.U6, A.L.DD.U7, A.L.DD.U8,  
 B.M.DE.U9, B.M.DE.U10, B.M.DF.U11, B.M.DF.U12,  
 B.N.DG.U13, B.N.DG.U14, B.N.DH.U15, and B.N.DH.U16.

The list may appear factored in Destination operands as follows:

- completely factored:  
 (A(K(DA(U1 U2) DB(U3 U4))  
   L(DC(U5 U6) DD(U7 U8)))  
   B(M(DE(U9 U10) DF(U11 U12))  
   N(DG(U13 U14) DH(U15 U16))))
- partially factored:

```
(A(K(DA(U1) DA(U2) DB(U3 U4))
L(DC(U5 U6)) L(DD(U7 U8)))
B(M(DE(U9 U10) DF(U11 U12))
N(DG(U13)) N(DG(U14)) N(DH(U15 U16))))
```

- not factored, equivalent to the initial list:  
(A(K(DA(U1))) A(K(DA(U2))) A(K(DB(U3))) A(K(DB(U4))) A(L(DC(U5)))  
A(L(DC(U6))) A(L(DD(U7))) A(L(DD(U8))) B(M(DE(U9))) B(M(DE(U10)))  
B(M(DF(U11))) B(M(DF(U12))) B(N(DG(U13))) B(N(DG(U14))) B(N(DH(U15)))  
B(N(DH(U16))))

In the above lists, '(' and ')' represent the beginning and the end of a list respectively. (Inner parentheses have precedence over outer parentheses.)

End of Example

The Destination operands are a required sequence of:

- Beginning of Destination operands field
- Sequence of pairs of RGN and REN List (see Figure 13-6 on page 13-16)
- End of Destination operands field

See Figure 13-1 on page 13-3 and Figure 13-5.

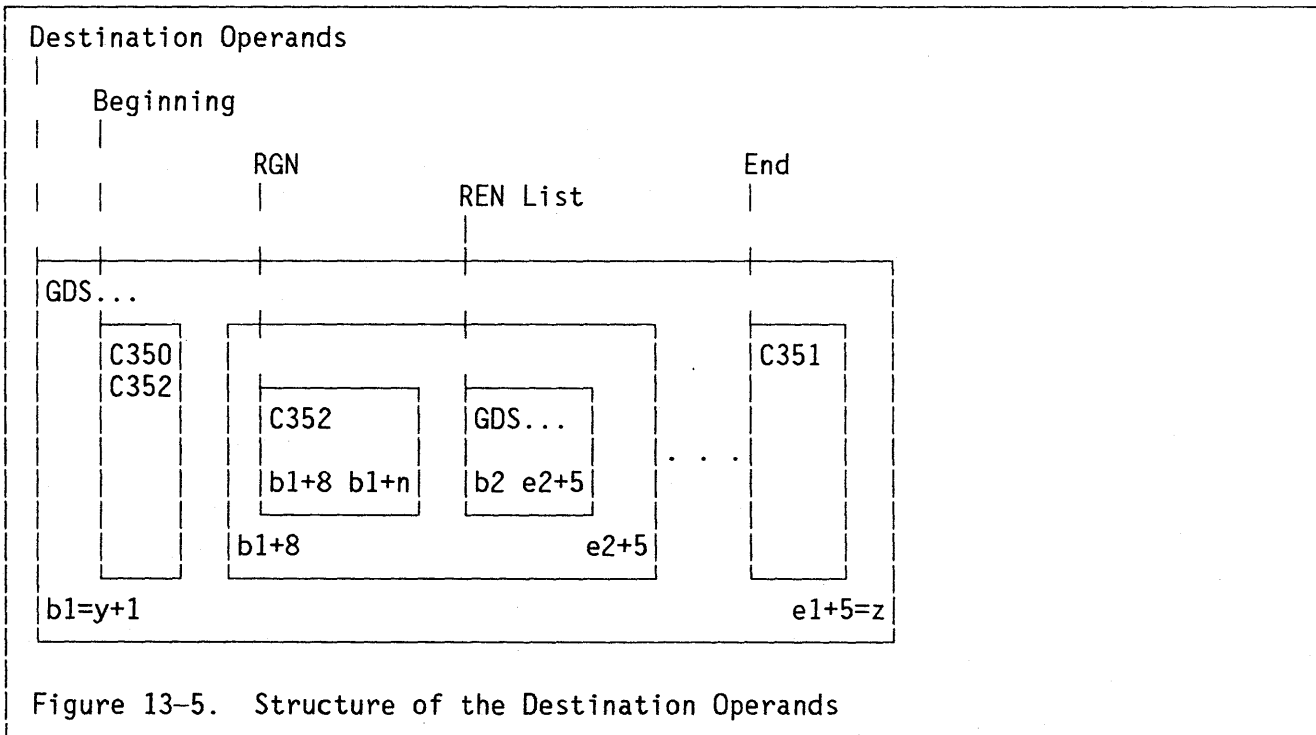

Figure 13-5. Structure of the Destination Operands

b1-b1+7 Beginning of Destination Operands

Required GDS variable

b1-b1+1 Length (8), in binary, of the GDS variable including this Length field

b1+2-b1+3 Beginning of Destination operands identifier: X'C350'

b1+4 Format:  
X'01' no segmentation descriptor follows, does not contain LT-subfields

b1+5-b1+6 RGN identifier: X'C352'

b1+7 Format:  
X'01' no segmentation descriptor follows

Note: RGN and REN List (the stream from offset b1+8 through e2+5) may be repeated.

b1+8-b1+n RGN

Required GDS variable, its content may be null

b1+8-b1+9 Length (n+1), in binary, of the GDS variable including this Length field (values from 5 to 13 are valid)

b1+10-b1+11 Identifier: X'C352'

b1+12 Format:  
X'01' no segmentation descriptor follows, does not contain LT-subfields

b1+13-b1+n Name, 0- to 8-character length string, obtained from the origin DSU directory

b2-e2+5 REN List

Required sequence of:

- Beginning of REN List
- Sequence of pairs of REN and DGN list (see Figure 13-7 on page 13-17)
- End of REN List

See Figure 13-6 on page 13-16 and Figure 13-5 on page 13-14.

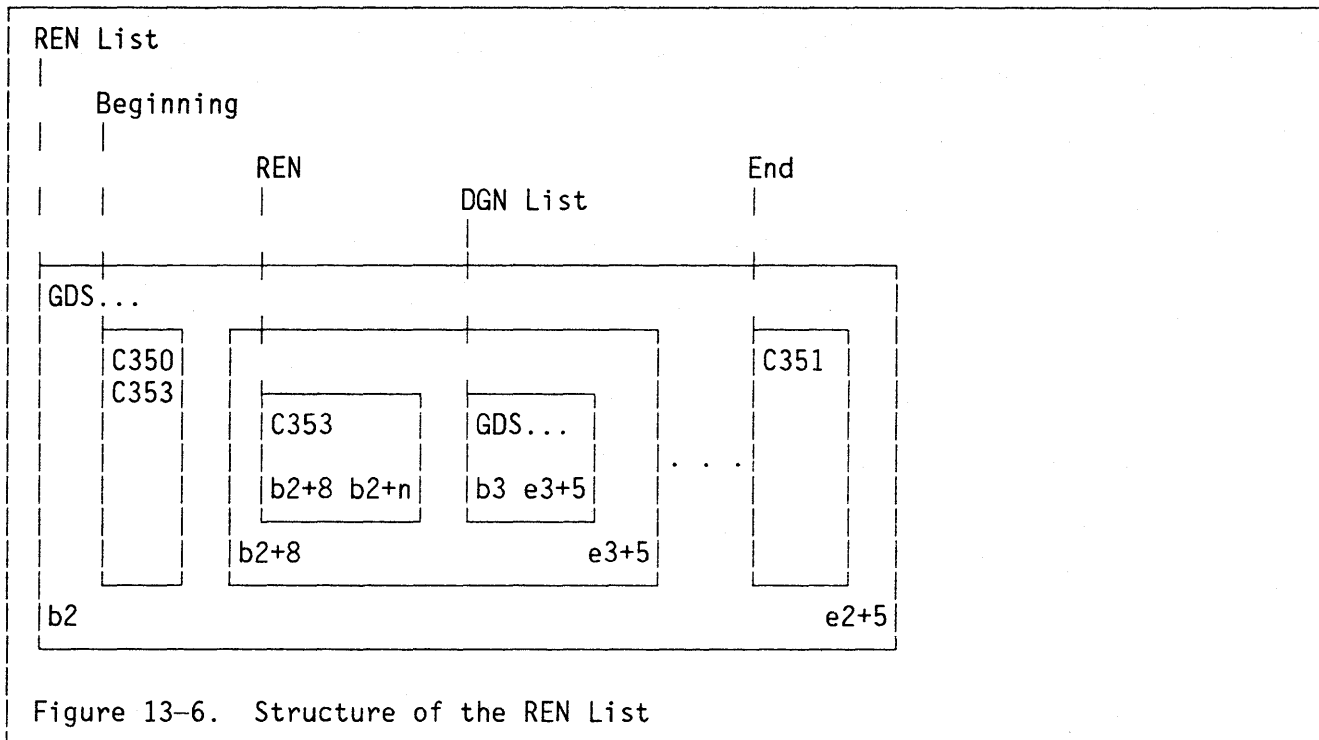

b2-b2+7 Beginning of REN List

Required GDS variable

b2-b2+1 Length (8), in binary, of the GDS variable, including the Length field

b2+2-b2+3 Beginning of a list identifier: X'C350'

b2+4 Format:

X'01' no segmentation descriptor follows, does not contain LT-subfields

b2+5-b2+6 REN identifier: X'C353', with X'C350' represents the identifier of the Beginning of REN List

b2+7 Format:

X'01' no segmentation descriptor follows

Note: REN and DGN List (the stream from offset b2+8 through e3+5) may be repeated.

b2+8-b2+n REN

Required GDS variable

b2+8-b2+9 Length (n+1), in binary, of the GDS variable including this Length field (values from 6 to 13 are valid)

b2+10-b2+11 Identifier: X'C353'

b2+12 Format:

X'01' no segmentation descriptor follows, does not contain LT-subfields

b2+13-b2+n Name, 1- to 8-character string, obtained from the origin DSU directory

b2+n+1

Note: Offset b2+n+1 will be replaced by b3 in order to simplify the stream description

b3-e3+5 DGN List

Required sequence of:

- Beginning of DGN List
- Sequence of pairs of DGN and DEN List (see Figure 13-8 on page 13-18)
- End of DGN List

See Figure 13-6 on page 13-16 and Figure 13-7.

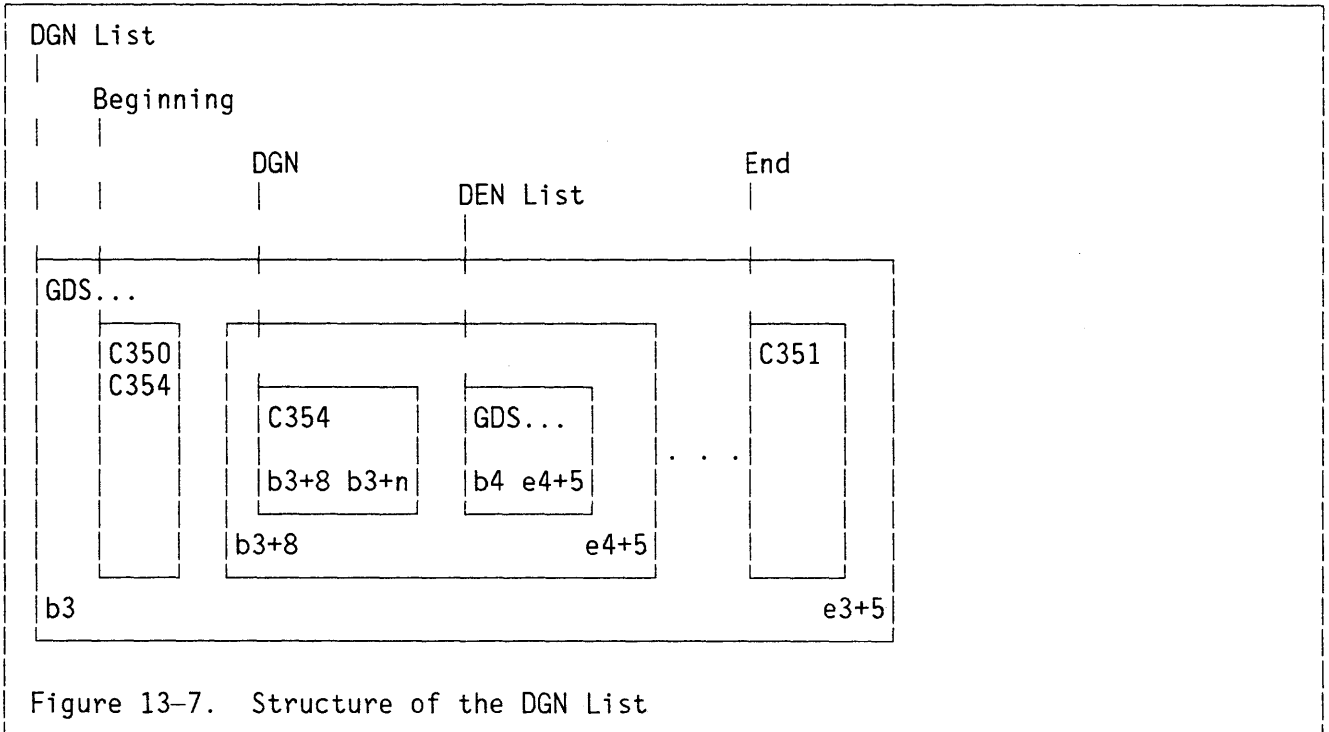

Figure 13-7. Structure of the DGN List

b3-b3+7 Beginning of DGN List

Required GDS variable

b3-b3+1 Length (8), in binary, of the GDS variable including this Length field

b3+2-b3+3 List Beginning Identifier: X'C350'

b3+4 Format:

X'01' no segmentation descriptor follows, does not contain LT-subfields

b3+5-b3+6 DGN identifier: X'C354', with X'C350' represents the identifier of the Beginning of the DGN List

b3+7 Format:

X'01' no segmentation descriptor follows

Note: DGN and DEN list (the stream from offset b3+8 through e4+5) may be repeated

b3+8-b3+n DGN



## DISTIU

Required GDS variable

b3+8-b3+9 Length, in binary, of the GDS variable including this Length field (values from 6 to 13 are valid)

b3+10-b3+11 Identifier: X'C354'

b3+12 Format:

X'01' no segmentation descriptor follows, does not contain LT-subfields

b3+13-b3+n Name, 1- to 8-character length string. It is provided either in the DESTINATION\_DUN parameter of the DISTRIBUTE\_DATA or DISTRIBUTE\_STATUS verb, if DISTIU was generated by the issue of the DISTRIBUTE\_DATA or DISTRIBUTE\_STATUS verb, or in the Feedback\_DGN subfield (or the Origin\_DGN subfield if Feedback Address is missing) of the DISTIU for which the feedback was generated, if this DISTIU is a feedback.

b3+n+1

Note: Offset b3+n+1 will be replaced by b4 in order to simplify the stream description.

b4-e4+5 DEN List

Required sequence of:

- Beginning of DEN List
- Sequence of DENs
- End of DEN List

See Figure 13-7 on page 13-17 and Figure 13-8.

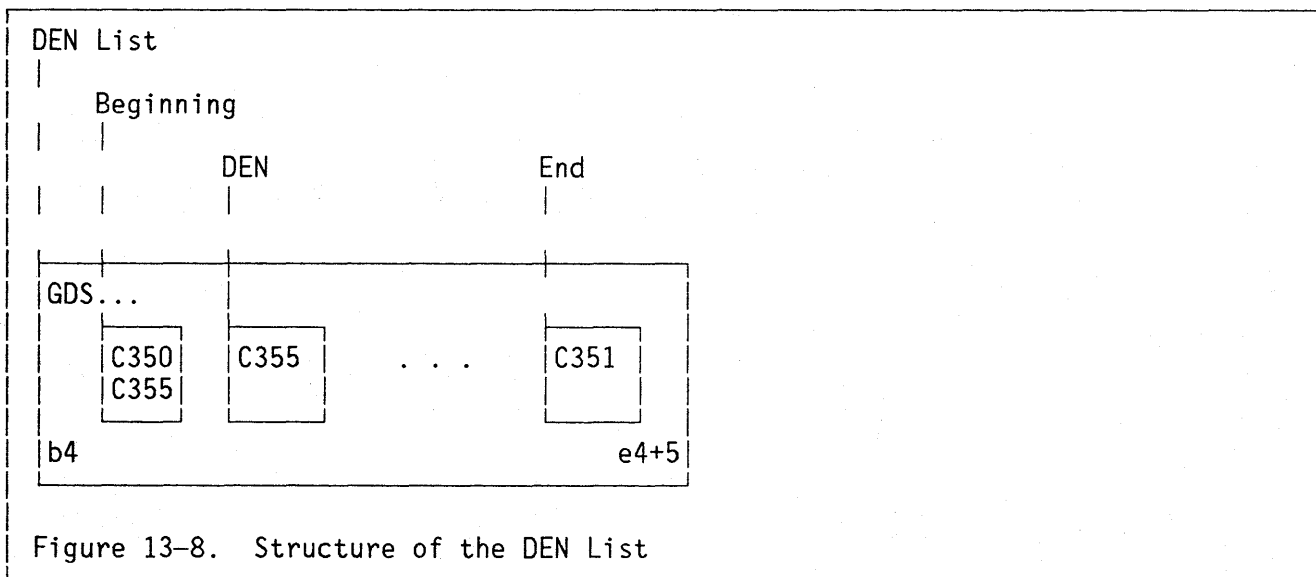

b4-b4+7 Beginning of DEN List

Required GDS variable

b4-b4+1 Length (8), in binary, of the GDS variable including this Length field

b4+2-b4+3 List Beginning code: X'C350'

b4+4       Format:  
           X'01' no segmentation descriptor follows, does not contain LT-subfields  
 b4+5-b4+6 DEN identifier: X'C355', with X'C350' represents the identifier of the  
           beginning of the DEN List  
 b4+7       Format:  
           X'01' no segmentation descriptor follows

Note: DEN GDS variable (the stream from offset b4+8 through e4) may be repeated.

b4+8-b4+n DEN

          Required GDS variable  
 b4+8-b4+9 Length, in binary, of the GDS variable including this Length field (values  
           from 6 to 13 are valid)  
 b4+10-b4+11 Identifier: X'C355'  
 b4+12       Format:  
           X'01' no segmentation descriptor follows, does not contain LT-subfields  
 b4+13-b4+n Name, 1- to 8-character length string. It is provided either in the  
           DESTINATION\_DUN parameter of DISTRIBUTE\_DATA or DISTRIBUTE\_STATUS verb, if  
           DISTIU was generated by the issue of the DISTRIBUTE\_DATA or  
           DISTRIBUTE\_STATUS verb, or in the Feedback DEN subfield (or the Origin DEN  
           subfield if Feedback Address is missing) of the DISTIU for which the  
           feedback was generated, if this DISTIU is a feedback.

e4+1-e4+5 End of DEN List

          Required GDS variable  
 e4+1-e4+2 Length (5), in binary, of the GDS variable including this Length field  
 e4+3-e4+4 Identifier: X'C351'  
 e4+5       Format:  
           X'01' no segmentation descriptor follows, it does not contain LT-subfields

e3+1-e3+5 End of DGN List

          Required GDS variable  
 e3+1-e3+2 Length (5), in binary, of the GDS variable including this Length field  
 e3+3-e3+4 Identifier: X'C351'  
 e3+5       Format:  
           X'01' no segmentation descriptor follows, it does not contain LT-subfields

e2+1-e2+5 End of REN List

          Required GDS variable  
 e2+1-e2+2 Length (5), in binary, of the GDS variable including this Length field  
 e2+3-e2+4 Identifier: X'C351'  
 e2+5       Format:  
           X'01' no segmentation descriptor follows, it does not contain LT-subfields

e1+1-e1+5 End of Destination Operands

          Required GDS variable  
 e1+1-e1+2 Length (5), in binary, of the GDS variable including this Length field  
 e1+3-e1+4 Identifier: X'C351'

## DISTIU

e1+5      Format:  
X'01' no segmentation descriptor follows, it does not contain LT-subfields

z  
Note: Offset z will replace e1+5 in order to simplify the stream description.

### z+1-j      Distribution Status Operands

Required and allowed if and only if DISTIU is of type STATUS ( i.e., the value of bit 1 of Distribution Flags of Distribution General Options is X'1'). It may include SNADS status, application status, or both, along with fields to identify DISTIU for which the status is being reported and transported to the originator or its designate, sequence of:

- Status operands
- General SNADS Status (optional)
- General Application Status (optional)
- Specific Status

See Figure 13-1 on page 13-3 and Figure 13-9 on page 13-21.

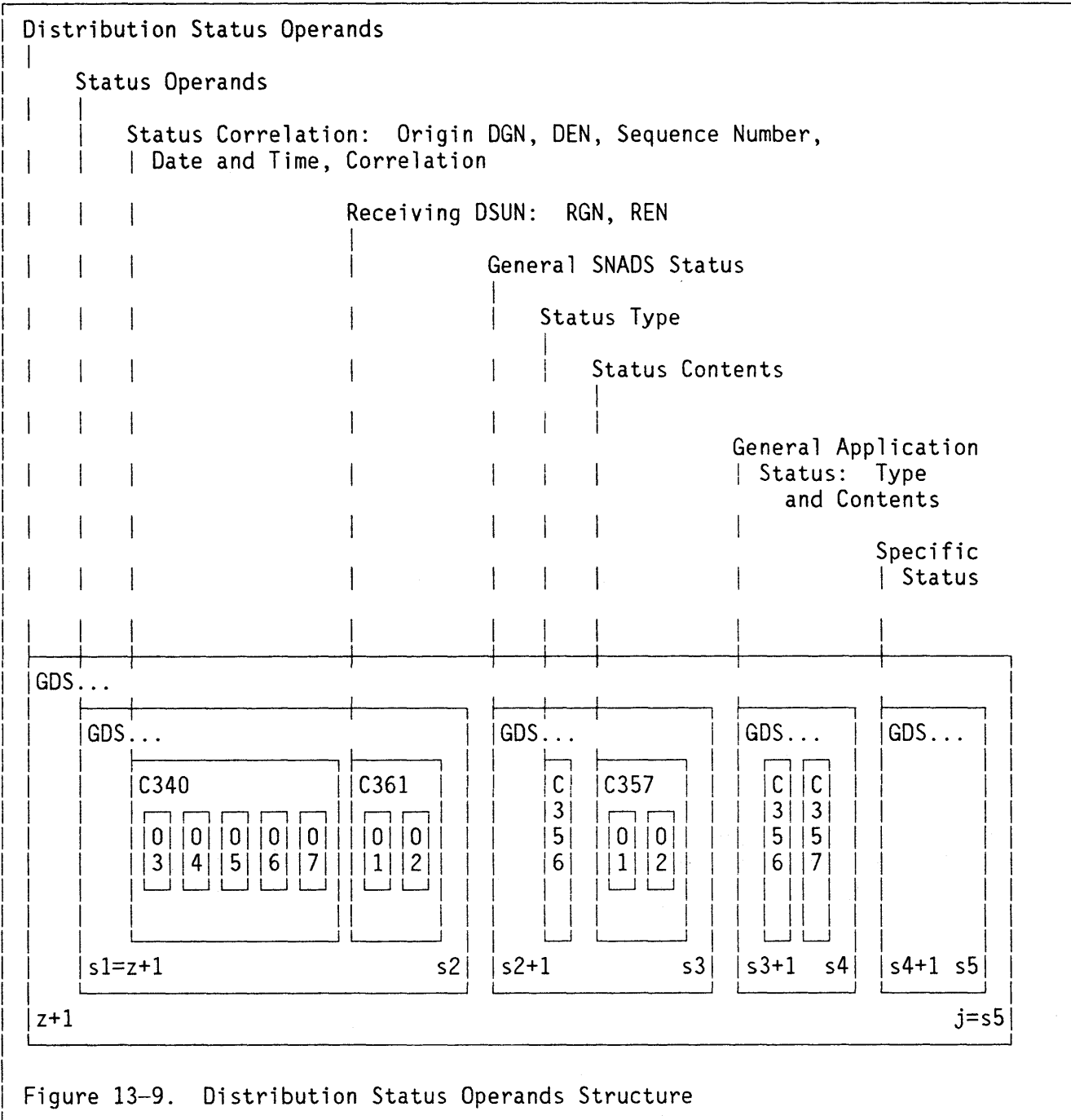

Figure 13-9. Distribution Status Operands Structure

z+1

Note: Offset z+1 will be replaced by s1 in order to simplify the stream description. Offsets s1, s2, s3, s4, and s5 are used to describe the Distribution Status operands stream.

s1-s2 Status Operands

Required set of:

## DISTIU

- Status Correlation
- Receiving DSUN (optional)

The above components can be in any order. See Figure 13-1 on page 13-3 and Figure 13-9 on page 13-21.

### 0-n Status Correlation

Required GDS variable, contains LT-subfields with information to identify the DISTIU for which status information (provided either by SNADS if this DISTIU is generated by SNADS, or by the application transaction if DISTIU is generated through the issue of DISTRIBUTE\_STATUS) is reported:

- Origin DGN
- Origin DEN
- Origin Sequence Number
- Origin Date and Time
- Origin Correlation (optional)

See Figure 13-9 on page 13-21. The LT-subfields can be in any order.

0-1 Length (n+1), in binary, of the GDS variable, including this Length field (values from 27 to 87 are valid)  
2-3 Identifier: X'C340'  
4 Format:  
X'41' no segmentation descriptor follows, contains LT-subfields

### 0-n1 Origin DGN

Required LT-subfield  
0 Length (n1+1), in binary, of the LT-subfield including this Length field (values from 3 to 10 are valid)  
1 Type: X'03'  
2-n1 Name DGN, 1- to 8-character string, equal to the corresponding subfield in the Distribution Identifier of the data-DISTIU for which this status-DISTIU is returned

### 0-n2 Origin DEN

Required LT-subfield  
0 Length (n2+1), in binary, of the LT-subfield including this Length field (values from 3 to 10 are valid)  
1 Type: X'04'  
2-n2 Name, 1- to 8-character string, equal to the corresponding subfield in the Distribution Identifier of the data-DISTIU for which this status-DISTIU is returned

### 0-5 Origin Sequence Number

Required LT-subfield  
0 Length (6), in binary, of the LT subfield including this Length field  
1 Type: X'05'  
2-5 Integer in base 10, 4-numeric EBCDIC encoded character string (values from 'F0F0F0F1' to 'F9F9F9F9'), equal to the corresponding subfield in the

Distribution Identifier of the data distribution for which this DISTIU is returned

0-9 Origin Date and Time

Required LT-subfield, equal to the corresponding subfield in the Distribution Identifier of the data-DISTIU for which this DISTIU is returned (see Figure 13-1 on page 13-3)

- 0 Length (10), in binary, of the subfield including this Length field  
 1 Type: X'06'  
 2-5 Date:  
 2-3 Year, in binary (e.g., year 1983 is encoded as X'07BF')  
 4 Month of the year, in binary (values from 1 to 12 are valid)  
 5 Day of the month, in binary (values from 1 to 31 are valid)  
 6-9 Time:  
 6 Hour of the day, in binary (values from 0 to 23 are valid)  
 7 Minute of the hour, in binary (values from 0 to 59 are valid)  
 8 Second of the minute, in binary (values from 0 to 59 are valid)  
 9 Hundredth of the second, in binary (values from 0 to 99 are valid)

0-n3 Origin Correlation

Optional LT-subfield, equal to the corresponding subfield in the Distribution identifier of the data-DISTIU for which this status-DISTIU is returned.

- 0 Length (n3+1), in binary, of this LT-subfield including this Length field (values from 3 to 46 defined)  
 1 Type: X'07'  
 2-n3 Origin Correlation, byte string, used by application transactions

0-n Receiving DSUN

Optional GDS variable if this status-DISTIU is returned because of receive time errors. It contains the name of the receiving DSU if the transmission error was detected by the receiving DSU.

- Receiving RGN (optional)
- Receiving REN

See Figure 13-9 on page 13-21. The positions of its two LT-subfields are arbitrary.

- 0-1 Length (n+1), in binary, of the GDS variable, including this Length field (values from 8 to 25 are valid)  
 2-3 Identifier: X'C361'  
 4 Format:  
 X'41' no segmentation descriptor follows, contains LT-subfields

0-n1 Receiving RGN

Optional LT-subfield

- 0 Length (n1+1), in binary, of the subfield, including this Length field (values from 3 to 10 are valid)  
 1 Type: X='01'

## DISTIU

2-n1 Name, 1- to 8-character string, first part of the name of the DSU that detected the receive-time error

0-n2 Receiving REN

Required LT-subfield

0 Length (n2+1), in binary, of the subfield, including the Length field (values from 3 to 10 are valid)

1 Type: X='02'

2-n2 Name, 1- to 8-character string, second part of the name of the DSU that detected the receive-time error

s2+1-s4 General Status

Note: New SNADS DSUs will not generate both General SNADS Status and General Application Status in a single IU. However, older SNADS DSUs may generate both SNADS and Application General Status fields in a single IU, and all SNADS DSUs must receive such IUs without error. DSUs may ignore the General Application Status field if General SNADS Status is present.

s2+1-s3 General SNADS Status

Optional pair (elements in required order) of GDS variables, used if Specific SNADS status in Specific Status is missing, describes the SNADS status applicable to all DUNs in the Specific Status when no SNADS status is indicated along with them (i.e., Specific SNADS Status elements [described in the stream from offset s2+1 up to s3 below within Specific Status subfield] are missing):

- Status Type
- Status Contents

See Figure 13-9 on page 13-21.

s2-s2+6 Status Type

Required GDS variable

s2-s2+1 Length (7), in binary, of the GDS variable, including this Length field

s2+2-s2+3 Identifier: X'C356'

s2+4 Format:

X'01' no segmentation descriptor follows, does not contain LT-subfields

s2+5-s2+6 Status Type:

X'0001' for SNADS Status

s2+7-s3 Status Contents

Required GDS variable; it contains the SNADS Condition Code

s2+7-s2+8 Length, in binary, of the GDS variable, including this Length field (value is 9)

s2+9-s2+10 Identifier: X'C357'

s2+11 Format:

X'41' no segmentation descriptor follows, contains LT-subfields

s2+12-s2+15 SNADS Condition Code

Required LT-subfield  
s2+12 Length (4), in binary, of the subfield, including this Length field  
s2+13 Type: X'01'  
s2+14-s2+15 Values are listed in Figure 13-10.

Code (hex)	Description	allowed in DISTIU	allowed in ACKIU
0001	Routing error	yes	yes
0002	Invalid DUN	yes	yes
0003	Hop Count exceeded	yes	yes
0004	Syntax error	yes	yes
0005	Function not supported	yes	yes
0006	Permanent server error	yes	yes
0007	Unknown server name	yes	yes
0008	Invalid server parameters	yes	yes
0009	Invalid Destination TP name	yes	yes
000C	Request purged	yes	no
000D	Lost DUNs	yes	no
000E	Resource not available	yes	yes
000F	System error	yes	yes
0010	Temporary server error	yes	yes
0011	I/O system error	yes	yes
0012	ACKIU error	yes	no
0013	Distribution Object Size incompatible with DSL	yes	yes
0000, 000A, 000B, and 0014 up to FFFF are reserved			

Figure 13-10. SNADS Status Condition Codes

#### s3+1-s4 General Application Status

Optional pair (elements in required order) of GDS variables, describes the application status applicable to all DUNs in the Specific Status (the interpretation of both general and specific application status information is defined by the application):

- Status Type
- Status Contents

#### s3+1-s3+7 Status Type

Required GDS variable

s3+1-s3+2 Length (7), in binary, of the GDS variable, including this Length field

s3+3-s3+4 Identifier: X'C356'

s3+5 Format:

X'01' no segmentation descriptor follows, without LT-subfields

s3+6-s3+7 Status Type:

not equal to X'0001'; see "Status Type Codes" on page 13-44



## DISTIU

### s3+7-s4 Status Contents

Required GDS variable

s3+7-s3+8 Length, in binary, of the GDS variable, including this Length field (values from 7 to 69 are valid)

Note: Older SNADS DSUs may generate IUs with Lengths of up to 517. All SNADS DSUs MUST receive such IUs without error. However, DSUs may modify such IUs to force the Length to be 69 or less.

s3+9-s3+10 Identifier: X'C357'

s3+11 Format:

X'41' no segmentation descriptor follows, contains LT-subfields

s3+12-s4 Status content, application defined bit string

s4+5

Note: The Specific Status has a list structure similar to DGN List of Destination operands; the offset s4+5 and j are replaced by b3 and e3+5 respectively. Offsets b3, e3+1, and b4, e4+1 point to the corresponding DGN and DEN lists beginnings and ends.

### b3-e3+5 Specific Status

Required sequence of GDS variables (see Figure 13-9 on page 13-21 and Figure 13-11 on page 13-27), lists all the names of the recipient users of the distribution for whom the DISTIU reports the status, along with SNADS and/or application status information. It is structured as a DGN List:

- DGN List Beginning
- DGN
- DEN List (see Figure 13-12 on page 13-28)
- End List

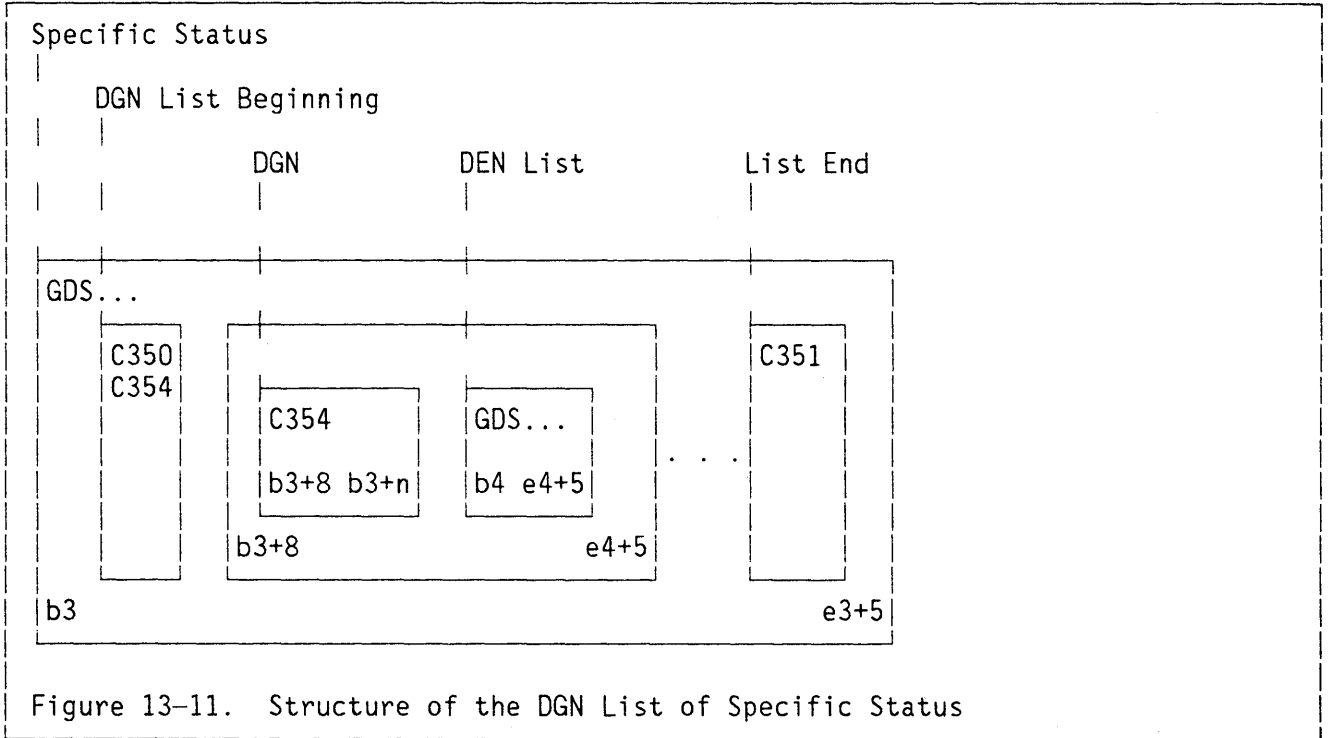

Figure 13-11. Structure of the DGN List of Specific Status

b3-b3+7 DGN List Beginning

Required GDS variable

b3-b3+1 Length (8), in binary, of the GDS variable including this Length field

b3+2-b3+3 List Beginning Identifier: X'C350'

b3+4 Format:

X'01' no segmentation descriptor follows, does not contain LT-subfields

b3+5-b3+6 DGN identifier: X'C354'

b3+7 Format:

X'01' no segmentation descriptor follows

Note: DGN and DEN list (the stream from offset b3+8 through e4+5) can be repeated.

b3+8-b3+n DGN

Required GDS variable

b3+8-b3+9 Length (n+1), in binary, of the GDS variable including this Length field (values from 5 to 13 are valid)

b3+10-b3+11 Identifier: X'C354'

b3+12 Format:

X'01' no segmentation descriptor follows, does not contain LT-subfields

b3+13-b3+n Name, 0- to 8-character length string

b3+n+1

Note: Offset b3+n+1 will be replaced by b4 in order to simplify the stream description.

DISTIU

b4-e4+5 DEN List

Required sequence of:

- DEN List Beginning
- DEN
- Specific SNADS Status (optional)
- Specific Application Status (optional)
- List End

See Figure 13-11 on page 13-27 and Figure 13-12.

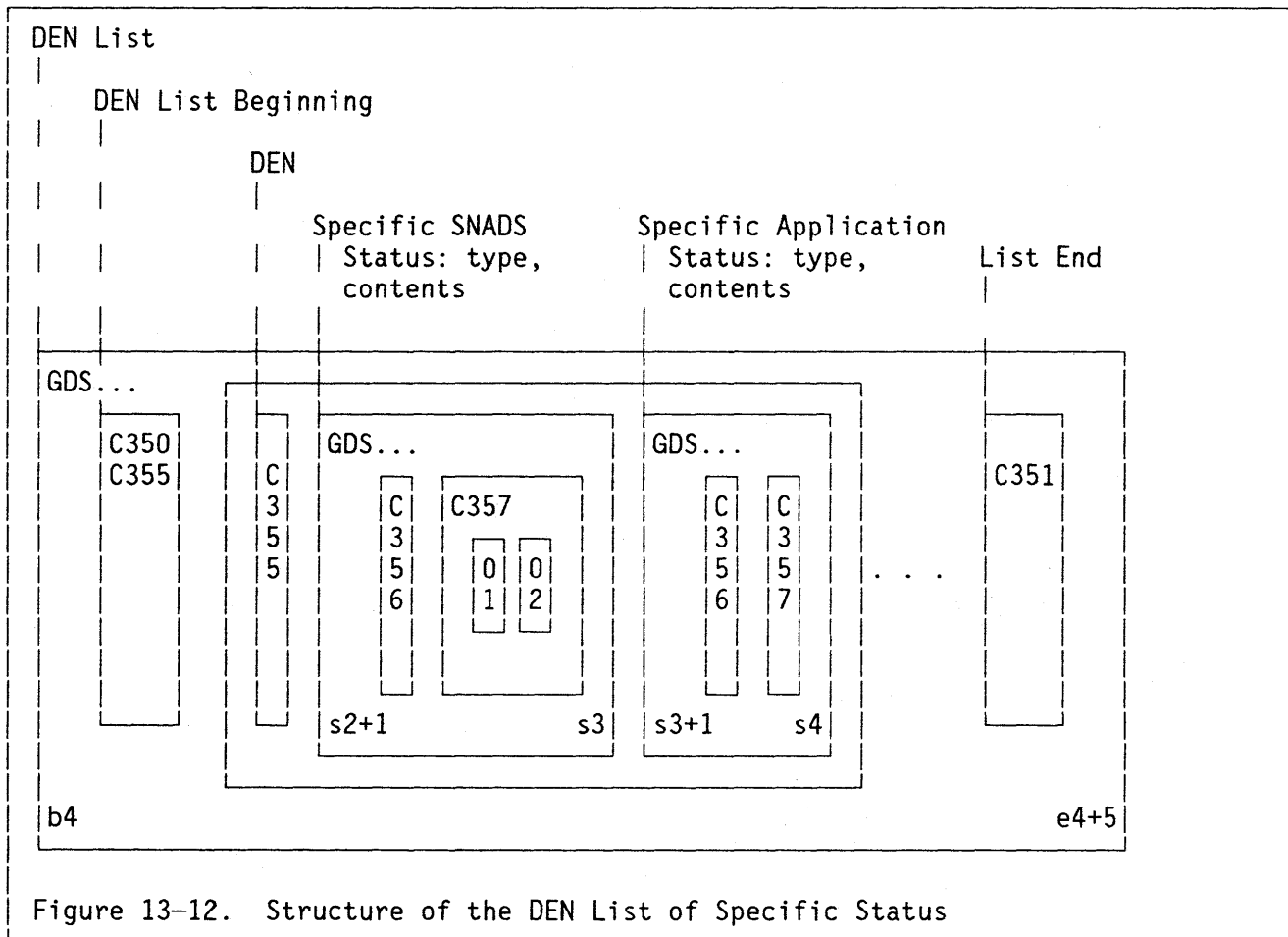

Figure 13-12. Structure of the DEN List of Specific Status

b4-b4+7 DEN List Beginning

Required GDS variable

b4-b4+1 Length (8), in binary, of the GDS variable including this Length field

b4+2-b4+3 List Beginning code: X'C350'

b4+4 Format:

X'01' no segmentation descriptor follows, does not contain LT-subfields

b4+5-b4+6 DEN identifier: X'C355'

b4+7      Format:  
           X'01' no segmentation descriptor follows

Note: DEN GDS variable (the stream from offset b4+8 through e4) may be repeated.

b4+8-b4+n DEN

Required GDS variable

b4+8-b4+9 Length (n+1), in binary, of the GDS variable including this Length field (values from 5 to 13 are valid)

b4+10-b4+11 Identifier: X'C355'

b4+12      Format:

X'01' no segmentation descriptor follows, does not contain LT-subfields

b4+13-b4+n Name, 0- to 8-character length string

Note: DGN is null if and only if DEN is null. In this case, this null addressee (i.e., DGN and DEN null) is the only addressee permitted. DGN and DEN are null if either the General or Specific SNADS Status subfields are present with the SNADS Condition Code X'000D', or if either the General or Specific Application Status of type X'FEFF' are present.

b4+n

Note: Offset b4+n is replaced by s2.

s2+1-s4    Specific Status

Note: New SNADS DSUs will not generate both Specific SNADS Status and Specific Application Status for a single destination. However, older SNADS DSUs may generate both SNADS and Application Specific Status fields for a single destination, and all SNADS DSUs must receive such IUs without error. DSUs may ignore the Specific Application Status field if Specific SNADS Status is present.

s2+1-s3    Specific SNADS Status

Optional pair (elements in required order) of GDS variables, used if General SNADS Status information does not apply to this DUN:

- Status Type
- Status Contents

s2-s2+6    Status Type

Required GDS variable

s2-s2+1    Length (7), in binary, of the GDS variable, including this Length field

s2+2-s2+3 Identifier: X'C356'

s2+4      Format:

X'01' no segmentation descriptor follows, does not contain LT-subfields

s2+5-s2+6 Status Type:

X'0001' for SNADS Status

s2+7-s3    Status Contents

Required GDS variable; it contains the SNADS Condition Code

## DISTIU

s2+7-s2+8 Length, in binary, of the GDS variable, including this Length field (value is 9)

s2+9-s2+10 Identifier: X'C357'

s2+11 Format:  
X'41' no segmentation descriptor follows, contains LT-subfields

s2+12-s2+15 SNADS Condition Code

Required LT-subfield

s2+12 Length (4), in binary, of the subfield, including this Length field

s2+13 Type: X'01'

s2+14-s2+15 Values are listed in Figure 13-10 on page 13-25.

s3+1-s4 Specific Application Status

Optional pair (elements in required order) of GDS variables, (the interpretation of both general and specific application status information is defined by the application):

- Status Type
- Status Contents

s3+1-s3+7 Status Type

Required GDS variable

s3+1-s3+2 Length (7), in binary, of the GDS variable, including this Length field

s3+3-s3+4 Identifier: X'C356'

s3+5 Format:  
X'01' no segmentation descriptor follows, without LT-subfields

s3+6-s3+7 Status Type:  
not equal to X'0001', see "Status Type Codes" on page 13-44

s3+7-s4 Status Contents

Required GDS variable

s3+7-s3+8 Length, in binary, of the GDS variable, including this Length field (values from 7 to 69 are valid)

Note: Older SNADS DSUs may generate IUs with Lengths of up to 517. All SNADS DSUs MUST receive such IUs without error. However, DSUs may modify such IUs to force the Length to be 69 or less.

s3+9-s3+10 Identifier: X'C357'

s3+11 Format:  
X'41' no segmentation descriptor follows, contains LT-subfields

s3+12-s4 Status content, application defined bit string

e4+1-e4+5 DEN List End

Required GDS variable

e4+1-e4+2 Length (5), in binary, of the GDS variable including this Length field

e4+3-e4+4 Identifier: X'C351'

e4+5 Format:  
X'01' no segmentation descriptor follows, it does not contain LT-subfields

e3+1-e3+5 DGN List End

Required GDS variable

e3+1-e3+2 Length (5), in binary, of the GDS variable including this Length field

e3+3-e3+4 Identifier: X'C351'

e3+5 Format:

X'01' no segmentation descriptor follows, it does not contain LT-subfields

j

Note: Offset e3+5 is replaced by j.

j+1-k Distribution Object

Optional sequence of GDS variables (required order), containing:

- Distribution Object Prefix
- Data

See Figure 13-1 on page 13-3.

j+1-j+n Distribution Object Prefix

Required GDS variable containing:

- Object Size (optional)
- Server Name
- Server Parameters (optional)

j+1-j+2 Length (n), in binary, of the subfield, including this Length field  
(values from 8 to 336 are valid)

j+3-j+4 Identifier: X'C90A'

j+5 Format:

X'41' no segmentation descriptor follows, contains LT-subfields

0-9 Object Size

Optional LT-subfield

0 Length (10), in binary, of this LT-subfield including this Length field

1 Type: X'01'

2-9 Unsigned number, in binary, number of bytes of all the segments of the  
distribution object, need not be accurate

0-n1 Server Name

Required LT-subfield

0 Length, in binary, of this LT-subfield, including the Length field (values  
from 3 to 66 are valid)

1 Type: X'02'

2-n1 Name, 1- to 64-character string (see "Specification of the  
Character-String Fields" on page 13-41 for the encoding of the graphic  
characters used), of the server to be used at the destination to store the  
Data GDS variable, supplied as a parameter of the DISTRIBUTE\_DATA or  
DISTRIBUTE\_STATUS verb

## DISTIU

0-n2	<u>Server Parameters</u>
	Optional LT-subfield
0	Length, in binary, of this LT-subfield, including the Length field (values from 3 to 255 are valid)
1	Type: X'03'
2-n2	Stream of bytes, the values of the parameters to be used by the destination server, supplied as a parameter of the DISTRIBUTE_DATA or DISTRIBUTE_STATUS verb
j+n+1	Replaced by b <u>Note:</u> The stream from offset b through e may be repeated.
b-e	<u>Data</u>
	Required sequence of one or more GDS variables
b-b+1	Length, in binary of this GDS variable including this Length field; values from 6 to 32511 are valid if there is no segmentation descriptor. Values from 9 to 32511 are valid if there is a segmentation descriptor and if this is not the last segment, or if this segment is the only segment. Values from 8 to 32511 are valid if there is a segmentation descriptor, and if this is the last and not the only segment.
b+2-b+3	Identifier: X'C908'
b+4	Format: X'01' no segmentation descriptor follows, and no LT-subfields included in the GDS variable X'81' segmentation descriptor follows, and no LT-subfields included in the GDS variable
b+5-b+7	<u>Segmentation Descriptor</u>
b+5	Position of this GDS variable in the Data: X'00' last or only segment (this is the last or only segment sent) X'20' not the last segment of the Data (at least one more segment follows contiguously on this conversation)
b+6-b+7	Segment sequence number: X'0000' segment sequence numbering not used
q	= (b+5) (b+8) for b+4 containing X'01' X'81', respectively
q-e	data stream
e	= k for b+4 and b+5 containing X'81' and X'00', respectively, or b+4 containing X'01'. e < k for b+4 and b+5 containing X'81' and X'20', respectively.
k+1-p	<u>Suffix</u>
	Required GDS variable, either Type 1 or Type 2
k+1-k+2	Length, in binary, of the GDS variable, including this Length field (value 5 is valid if Suffix is Type 1, value 8 valid if Suffix is Type 2)
k+3-k+4	Type identifier: X'CF01' Suffix Type 1: indicates that no exception condition has occurred sending the DISTIU X'CF02' Suffix Type 2: indicates that an exception condition was detected by the sender of the DISTIU (The Suffix type 2 may follow after any subfield within DISTIU after the exception condition occurs.) <u>Note:</u> FMH-7 (see Chapter 10) is sent over the conversation before the Suffix Type 2 is sent. This is the result of issuing the SEND_ERROR verb

(see SNA Transaction Programmer's Reference Manual for LU Type 6.2 ) by the DS\_SEND transaction program of the sending DSU.

- k+5      Format:  
           X'00' no segmentation descriptor follows, for Suffix Type 1  
           X'01' no segmentation descriptor follows, for Suffix Type 2
- k+6-k+8      Exception Code  
               Required subfield for a Type 2 suffix (otherwise, omitted), describing the type of error detected:
- k+6      Exception Class:  
           bits 0-1, severity of error:  
                   11 catastrophic error, request not processed  
           bits 2-7, class of error:  
                   000101 sender error
- k+7      Exception Condition Code, indicating the reason for the exception: values are defined in Figure 13-14 on page 13-37
- k+8      Exception Object, indicating the syntactical entity in error: values are defined in Figure 13-15 on page 13-38
- p         = k+5 or k+8 as the Suffix is Type 1 or Type 2 respectively.



## ACKNOWLEDGE INTERCHANGE UNIT

ACKIU; DSU ---> DSU; (ACKNOWLEDGE INTERCHANGE UNIT)

ACKIU flows between pairs of DSUs, to acknowledge or to notify the DSU that sent a DISTIU that the receiving DSU found errors while processing the DISTIU. It is not forwarded through the SNADS network. It contains:

- Prefix
- Command
- Suffix

See Figure 13-13 on page 13-35.

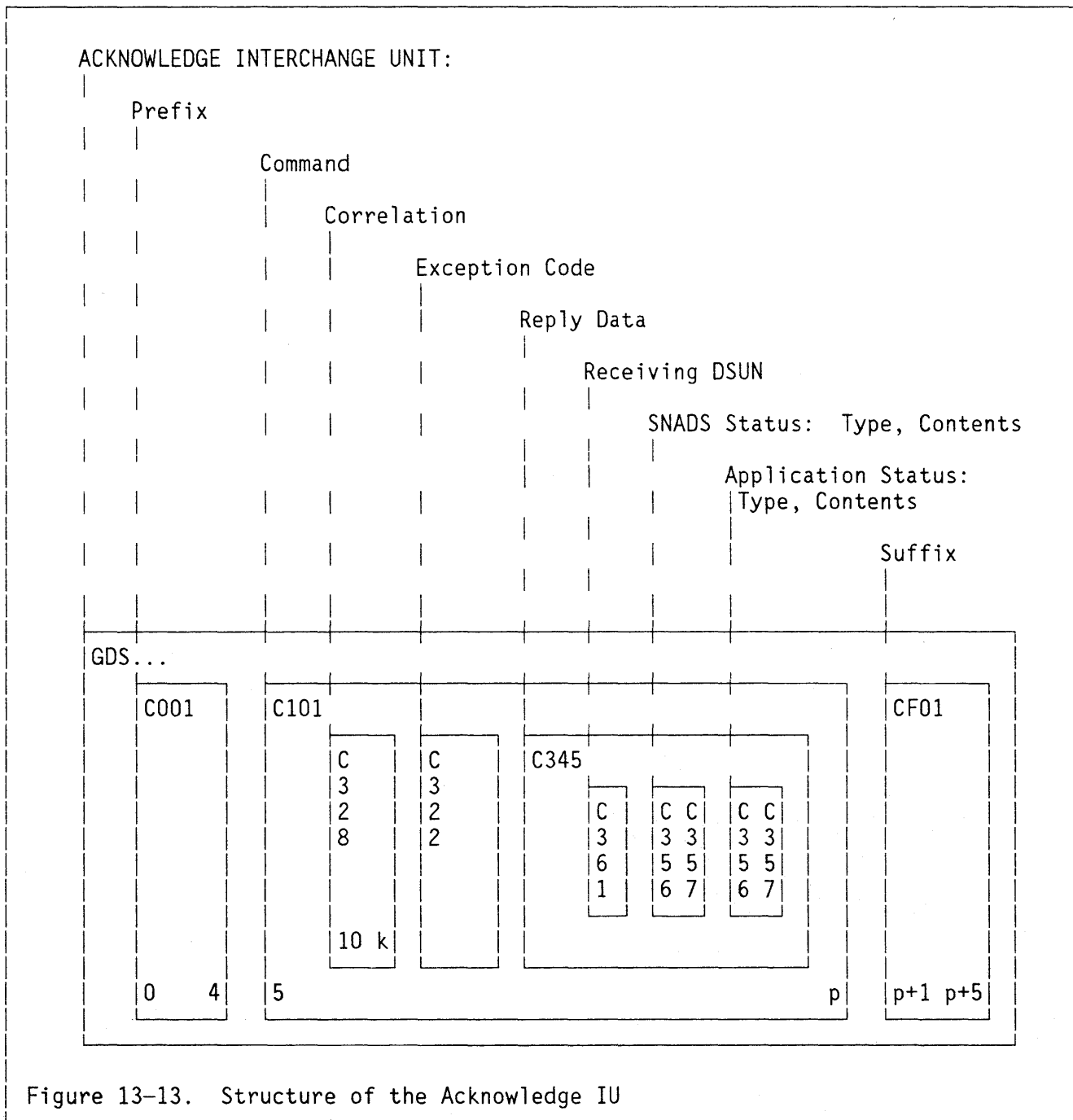

- 0-4 Prefix
- Required GDS variable
- 0-1 Length (5), in binary, of the prefix, including this Length field
- 2-3 Identifier: X'C001'
- 4 Format:
- X'02' no segmentation descriptor follows

## ACKIU

### 5-p Command

Required GDS variable of:

- Correlation
- Exception Code
- Reply Data

See Figure 13-13 on page 13-35. Reply Data may appear after or before the Exception Code.

5-6 Length, in binary, of the GDS variable, including this Length field (values from 49 to 853 are valid)

7-8 Identifier: X'C101', identifies this IU as an ACKIU

9 Format:

X'01' no segmentation descriptor follows

### 10-k Correlation

Required GDS variable (see Figure 13-13 on page 13-35)

10-11 Length, in binary, of the GDS variable, including this Length field (values from 7 to 23 are valid)

12-13 Identifier: X'C328'

14 Format:

X'01' no segmentation descriptor follows

15 Reply indicator:

X'00' ACKIU is the last reply to the referenced DISTIU, see "Distribute Interchange Unit" on page 13-2

16 Command position, in binary, in the IU command sequence:

X'01' for SNADS

17-k Interchange unit identifier, optional field, a 0- to 16-byte identifier provided by the prefix of the DISTIU for which this ACKIU is a notification equal to the IU identifier (see "Distribute Interchange Unit" on page 13-2)

### 0-m Exception Code

Required GDS variable, contains error classification information and, optionally, the DISTIU subfield found in error:

- Exception Class
- Exception Condition Code
- Exception Object
- Exception Data (optional)

0-1 Length (m+1), in binary, of the GDS variable including this Length field (values from 8 to 255 are valid)

2-3 Identifier: X'C322'

4 Format:

X'01' no segmentation descriptor follows, contains no LT-subfields

5 Exception Class

Contains severity and error class:

bits 0-1, severity

'11' catastrophic error, request not processed

bits 2-7, class  
 '000011' semantic error  
 '000010' syntactic error  
 '000100' process error

- 6 Exception Condition Code, indicates reason for exception, values defined in Figure 13-14.

Code (hex)	Description	Allowed in DISTIU Suffix	Allowed in ACKIU
01	Function not supported		yes
02	Data not supported		yes
04	Resource not available		yes
06	Execution terminated	yes	yes
07	Data not found		yes
08	Segmentation		yes
0A	Sequence		yes
0B	I/O error	yes	yes
0C	ID invalid		yes
0E	Format invalid		yes
0F	Length invalid	yes	yes
10	Indicator invalid		yes
11	Range exceeded		yes
15	Subfield length invalid		yes
16	Subfield type invalid		yes
17	Invalid parameters		yes
18	Content error	yes	yes
All other values are reserved			

Figure 13-14. Exception Condition Codes

- 7 Exception Object, indicates the syntactical entity in error. Values are defined in Figure 13-15 on page 13-38.

## ACKIU

Code (hex)	Exception Object	allowed in DISTIU Suffix	allowed in ACKIU
01	IU prefix	yes	yes
02	IU identifier		yes
07	Command	yes	yes
08	Command operand		yes
09	Operand value		yes
0C	Document unit	yes	yes
0D	Document unit identifier		yes
0E	Document profile		yes
0F	Document profile parameter		yes
10	Document content introducer		yes
11	Document content control		yes
12	Document content data		yes
13	IU suffix	yes	yes
14	Segment		yes
16	Unsupported subfield		yes
17	Unknown subfield	yes	yes
1A	Distribution object prefix	yes	yes
1B	Distribution object data	yes	yes
All other values are reserved.			

Figure 13-15. Exception Object Codes

8-m Exception Data, optional, contains the DISTIU subfield in error

0-p Reply Data

Required GDS variable, information to be used by the DSU to create the feedback:

- Receiving DSUN
- SNADS Status
- Application Status (optional)

See Figure 13-13 on page 13-35.

Note: Unless otherwise specified, the receiving DSU is the DSU that receives the DISTIU; likewise, the sending DSU is the DSU that sends the DISTIU.

0-1 Length (p+1), in binary, of the GDS variable including this Length field (values from 29 to 570 are valid)

2-3 Identifier: X'C345'

4 Format:

X'01' no segmentation descriptor follows, contains no LT-subfields

5-n2 Receiving DSUN

Required GDS variable, the name of the receiving the DSU that detected the error, and the name of the sender of the ACKIU, contains:

- Receiving RGN (optional)
- Receiving REN

The above LT-subfields can be in any order.

5-6 Length, in binary, of the GDS variable including this Length field (values from 8 to 25 are valid)

7-8 Identifier: X'C361'

9 Format:

X'41' no segmentation descriptor follows, contains LT-subfields

0-n1 Receiving RGN

Optional LT-subfield

0 Length (n1+1), in binary, of the subfield including this Length field (values from 3 to 10 are valid)

1 Type: X'01'

2-n1 Name, 1- to 8-character length string, first part of the name of the detecting DSU

0-n2 Receiving REN

Required LT-subfield

0 Length (n2+1), in binary, of the subfield including the Length field (values from 3 to 10 are valid)

1 Type: X'02'

2-n2 Name, 1- to 8-character string, second part of the name of the detecting DSU

n2+1-n3 SNADS Status

Required pair of GDS variables:

- Status Type
- Status Contents

See Figure 13-13 on page 13-35:

n2+1-n2+7 Status Type

Required GDS variable

n2+1-n2+2 Length (7), in binary, of the GDS variable including this Length field

n2+3-n2+4 Identifier: X'C356'

n2+5 Format:

X'01' no segmentation descriptor follows, does not contain LT-subfields

n2+6-n2+7 Status Type:

X'0001' for SNADS Status

n2+8-n2+16 Status Contents

Required GDS variable

n2+8-n2+9 Length (9), in binary, of the GDS variable including this Length field

## ACKIU

n2+10-n2+11 Identifier: X'C357'

n2+12 Format:

X'41' no segmentation descriptor follows, contains LT-subfields

n2+13-n2+16 SNADS Condition Code

Required LT-subfield

n2+13 Length (4), in binary, of the subfield including this Length field

n2+14 Type: X'01'

n2+15-n2+16 Values are listed in Figure 13-10 on page 13-25.

n2+17-p Application Status

Optional pair of GDS variables:

- Status Type
- Status Contents

Note: When generating a DIST\_IU with Status information supplied by an ACKIU, the Reporting DSU may ignore Application Status.

n2+17-n2+18 Status Type

Required GDS variable

n2+17-n2+18 Length (7), in binary, of the GDS variable including this Length field

n2+19-n2+20 Identifier: X'C356'

n2+21 Format:

X'01' no segmentation descriptor follows, without LT-subfields

n2+22-n2+23 Status Type:

X'0200'-X'06FF' are valid for applications

n2+24-p Status Contents

Required GDS variable

n2+24-n2+25 Length, in binary, of the GDS variable including this Length field  
(values from 7 up to 517 are valid)

n2+26-n2+27 Identifier: X'C357'

n2+28 Format:

X'41' no segmentation descriptor follows, contains LT-subfields

n2+29-p Status content, application defined bit string

p+1-p+5 Suffix

Required GDS variable

p+1-p+2 Length (5), of the GDS variable, including this field

p+3-p+4 Identifier: X'CF01'

p+5 Format:

X'00' Only valid value

## NAMES AND CODE POINTS

### SPECIFICATION OF THE CHARACTER-STRING FIELDS

Figure 13-16 defines the character sets, string rules, and string lengths used to encode the SNADS interchange units. For more details, see the syntactic and the semantic descriptions.

The character strings are specified for two cases: the base and the enhanced character string (ECS) option subset.

Field Name	Character Set		String Rules		String Length	
	Base	ECS Opt	Base	ECS Opt	Min	Max
DGN	A	930	none	(Note 1)	1 (Note 1)	8
DEN	A	930	none	(Note 1)	1 (Note 1)	8
Origin RGN	A	A	none	none	1	8
Destination RGN	A	930	none	(Note 1)	1	8
Origin REN	A	A	none	none	1	8
Destination REN	A	930	none	(Note 1)	1	8
Destination TP Name, Feedback TP Name, and Server Name	AE (Note 2)		none		1	64
Origin Sequence Number	Numerics of A: (F0, F1, .. F9)		n/a		4	4
Notes: 1. - DGN and DEN minimum length is 0 if the DISTIU is of type STATUS and is generated by SNADS. - Leading space (X'40') characters are not used, trailing space (X'40') characters are not significant, and imbedded space (X'40') characters are significant. 2. The first character of an SNA service transaction program name is a byte ranging in value from X'00' through X'3F'.						

Figure 13-16. Character-String Specification

Note: Appendix A defines the codes of the graphic character sets A, AE, and 930.



## CODE POINTS USED BY SNADS

The values of the ID component of the LLIDF field as used for SNADS GDS variables are shown below:<sup>3</sup>

<u>ID</u>	<u>Subfield Name</u>
C001*	In DIA, IU PREFIX; in SNADS, Prefix for Distribute IU and Acknowledge IU
C101*	in DIA, IU CMD NO REPLY ACKNOWLEDGE; in SNADS, Command of the Acknowledge IU
C105	Command, Distribute IU
C322*	in DIA, IU OPERAND IMM DATA EXCEPTION-CODE; in SNADS, Exception Code, within Acknowledge IU
C328*	in DIA, IU OPERAND IMM DATA DATA CORRELATION; in SNADS, Correlation, within Acknowledge IU
C32D*	in DIA, IU OPERAND IMM DATA USER-DATA; in SNADS, Destination Application Parameters, within Distribute IU
C33D*	in DIA, IU OPERAND IMM DATA STATUS-INFORMATION; in SNADS, Distribution General Options, within Distribute IU
C340*	in DIA, IU OPERAND IMM DATA DISTRIBUTION-IDENTIFIER; in SNADS, Distribution Identifier, within Distribute IU
C343*	in DIA, IU OPERAND IMM DATA GENERAL-ROUTING-DATA; in SNADS, Feedback Options, within Distribute IU
C345*	in DIA, IU OPERAND IMM DATA REPLY DATA; in SNADS, Reply Data, within Acknowledge IU
C350	Beginning of Destination Operand Lists, of the Specific Status Lists, within Distribute IU
C351	End of Destination Operands Lists, of the Specific Status Lists, within Distribute IU
C352	Routing Group Name (RGN) of Destination Operands, within Distribute IU
C353	Routing Element Name (REN) of REN List, within Distribute IU
C354	Distribution Group Name (DGN) of DGN List, within Distribute IU
C355	Distribution Element Name (DEN) of DEN List, within Distribute IU
C356	Status Type, within Distribute IU

---

<sup>3</sup> The asterisk following the ID indicates that that identifier is used by both DIA (Document Interchange Architecture) and SNADS.

- C357 Status Contents, within Distribute IU
- C360 Feedback Address, within Distribute IU
- C361 Receiving Distribution Service Unit Name, within Distribute IU
- C908 Data, Distribution Object, within Distribute IU
- C90A Distribution Object Prefix, Distribute IU
- CF01\* in DIA, IU SUFFIX NORMAL-TERMINATION; in SNADS, Suffix Type 1
- CF02\* in DIA, IU SUFFIX ABNORMAL-TERMINATION; in SNADS, Suffix Type 2

## STATUS TYPE CODES

SNADS uses the following status type code as a subfield of the General and Specific Status subfields of the DISTIUs:

<u>Code</u>	<u>Meaning</u>
X'0000'	Reserved
X'0001'	SNADS errors
X'0002'-X'01FF'	Reserved
X'0200'	DIA application errors
X'0201'-X'FFFF'	Reserved

## TRANSACTION PROGRAM AND SERVER NAMES

Following is a list of all transaction program and server names defined for SNADS, in the FM header 5 (Attach), in the Distribute IU, or used internally in the distribution service unit (DSU).

<u>Code</u>	<u>Meaning</u>
X'20F0F0F0'	DIA PROCESS Destination Transaction Program Name
X'20F0F0F1'	DIA SERVER Name
X'21F0F0F1'	DS_SEND Transaction Program Name
X'21F0F0F2'	DS_RECEIVE Transaction Program Name
X'21F0F0F3'	DS_ROUTER_DIRECTOR Transaction Program Name
X'21F0F0F6'	SNADS General Server Name



**CHAPTER 14. GDS VARIABLES FOR GENERAL USE**

**Message  
Unit  
Format**

Chapter 1

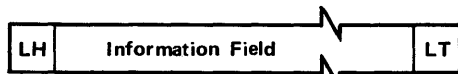

BLU

Chapter 2



Chapter 3

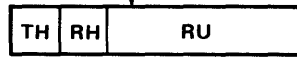

PIU

Chapter 4

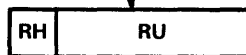

BIU

Chapter 5.1



Chapter 5.2



Chapter 6

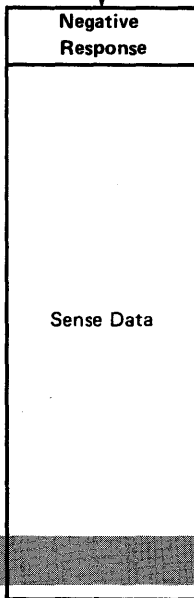

Chapter 7

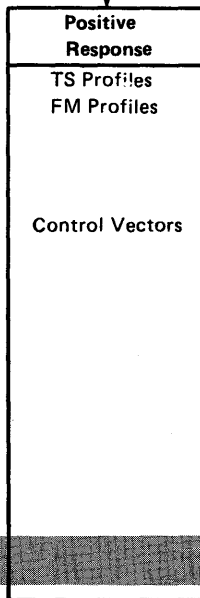

Chapter 8

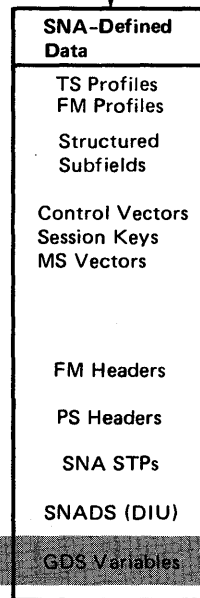

Chapter 9

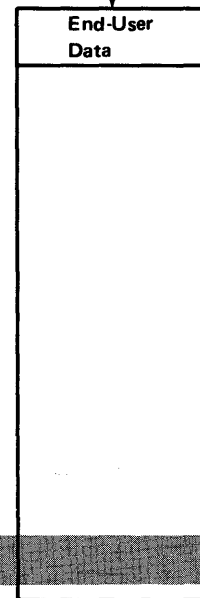

Chapter 10

Chapter 11

Chapter 12

Chapter 13

Chapter 14

- LH = Link Header
- LT = Link Trailer
- XID = Exchange Identification
- TH = Transmission Header
- RH = Request/Response Header
- RU = Request/Response Unit
- TS = Transmission Services
- FM = Function Management
- MS = Management Services

- PS = Presentation Services
- STP = Service Transaction Program
- SNADS = SNA Distribution Services
- DIU = Distribution Interchange Unit
- GDS = General Data Stream
- BLU = Basic Link Unit
- PIU = Path Information Unit
- BIU = Basic Information Unit

CHAPTER 14. GDS VARIABLES FOR GENERAL USE

The following chart indicates (using an "X") each GDS variable code point (with first byte = X'12') used by LU 6.2.

┌ First hexadecimal digit  
└ Second hexadecimal digit

>	0	1	2	3	4	5	6	7	8	9	A	B	C	D	E	F
0																
1	X	X		X												
2																
3																
4																
5																
6																
7																
8																
9																
A	X															
B																
C																
D																
E		X	X													
F		X	X	X	X	X										X

Figure 14-1. LU type 6.2 GDS Variable Code Points



The code points used by LU 6.2 are:

X'1210'	Change Number of Sessions (see note 1)
X'1211'	Exchange Log Name (see note 1)
X'1213'	Compare States (see note 1)
X'12A0'	Workstation Display Passthrough
X'12E1'	Error Log
X'12E2'	PIP Subfield Data (see note 2)
X'12F1'	Null Data
X'12F2'	User Control Data
X'12F3'	Map Name
X'12F4'	Error Data
X'12F5'	PIP Data (see note 2)
X'12FF'	Application Data

**Notes:**

1. See "Chapter 12. GDS Variables for SNA Service Transaction Programs" for the formats and meanings of these GDS variables.
2. See "Chapter 10. Function Management Headers" for the formats and meanings of these GDS variables.

#### FORMAT OF APPLICATION DATA GDS VARIABLE

The Application Data GDS variable, ID X'12FF', contains application data. The application transaction program's data as specified in the MC\_SEND\_DATA verb is (optionally) mapped and then sent as X'12FF' variables.

#### FORMAT OF NULL DATA VARIABLE

The Null Data GDS variable, ID X'12F1', contains no application data. This variable may optionally be generated to carry certain control information (e.g., Confirm) when no application data is available.

#### FORMAT OF USER CONTROL DATA GDS VARIABLE

The User Control Data GDS variable, ID X'12F2', contains user control data. The meaning of this data is known only to the LU Services Component Programs or the transaction programs and their mapping programs. This data can be used, for example, as prefix control information for an Application Data GDS variable that follows it or to carry FM Header Data for a mapped conversation transaction.

#### FORMAT OF MAP NAME GDS VARIABLE

The Map Name GDS variable, ID X'12F3', is followed by a 0- to 64-byte map name.

## Format of an Error Data GDS variable

The Error Data GDS variable, ID X'12F4', is used to convey information about mapping errors. It is sent using the SEND\_DATA verb following a SEND\_ERROR verb. Its format is:

0-1	Length (n+1), in binary, of Error Data GDS variable, including this Length field
2-3	GDS ID: X'12F4'
4-7	Error code: X'00010000' Invalid GDS ID: The mapped conversation verb component encountered a GDS ID that it did not recognize. X'00030001' Map Not Found: The specified map was not available at the target, or access to the referenced map could not be completed. X'00030002' Map Execution Failure: The map program was not able to process the data stream.
8	Length (n-8), in binary, of error parameter
9-n	Error parameter: for a mapping failure, the map name carried in the GDS variable for which the error occurred; for an invalid GDS ID, the 2-byte GDS ID that was not recognized

## Format of Error Log GDS Variable

The Error Log GDS variable, ID X'12E1', following an FMH-7 conveys implementation-specific error information to an LU, where it is added to the system error log for use in debugging and error recovery. It is not used by SNA-defined service transaction programs (other than to log it) since it contains implementation-specific data. The Error Log variable is sent as a consequence of issuing the SEND\_ERROR verb, but is not passed to the receiving transaction program. Its format is:

0-1	Length (n+1), in binary, of Error Log GDS variable, including this Length field
2-3	GDS ID: X'12E1'
4-m	<u>Product Set ID</u>
4-5	Length, in binary, of Product Set ID, including this Length field (values 2 to 32,767 are valid) <u>Note:</u> The Length field is always present; a value of 2 indicates no Product Set ID subvector follows.
6-m	Product Set ID (X'10') subvector (format described in "Chapter 8. Common Fields")
m+1-n	<u>Message Text</u>
m+1-m+2	Length, in binary, of message text, including this Length field (values 2 to 32,767 are valid) <u>Note:</u> The Length field is always present; a value of 2 indicates no message text follows.
m+3-n	Message text data: implementation-specific data



## APPENDIX A. SNA CHARACTER SETS AND SYMBOL-STRING TYPES

This appendix describes the character sets and symbol-string types used for various fields, such as:

- LU name
- Network-qualified LU name
- Mode name
- Transaction program name
- Access security information subfields
- Program initialization parameters (PIP) subfields
- Map name
- SNADS server, user (DGN, DEN), and service unit (RGN, REN) names

The detailed syntax of these and other such strings is described in other chapters where their usage within individual message units is defined.

### SYMBOL-STRING TYPE

The symbol-string type specifies the set of code points and corresponding characters from which the strings listed above are composed, as follows:

- Type A (Assembler oriented): a character string consisting of one or more characters from character set A. The first character of a type A symbol string is not a numeric; i.e., it is different from X'F0', X'F1', ..., or X'F9'.
- Type AE (A extended): a character string consisting of one or more characters from character set AE, with no restriction on the first character.
- Type 930 (distribution services oriented): a character string consisting of one or more characters from character set 930, with the following rules:
  - No leading space (X'40') characters are used, but no other restrictions exist on the first character.
  - Imbedded space (X'40') characters are significant.
  - Trailing space (X'40') characters are not significant.

- Type USS (unformatted system services oriented, used for character-coded requests): a character string consisting of one or more characters from character set USS, with no restriction on the first character.
- Type GR (EBCDIC graphics): a byte string consisting of one or more bytes of value within the range X'41' through X'FE', with no restriction on the first character.
- Type DB (double byte): a byte string consisting of an even number of four or more bytes beginning with a byte of X'0E', followed by bytes in the range X'41' through X'FE', and ending with a byte of X'0F'.
- Symbol-string type G (general): a byte string consisting of one or more bytes of value within the range X'00' through X'FF', with no restriction on the first byte.

## SNA CHARACTER SETS

Figure A-1 defines the character sets A, AE, 930, and USS. The code points that do not belong to any of these sets are not shown.

Hex Code	Graphic	Description	Set			
			A	AE	930	USS
15		Line Feed				X
40		Space			X	X
4B	.	Period		X	X	X
4D	(	Left Parenthesis				X
4E	+	Plus Sign				X
50	&	Ampersand			X	X
59	β	Sharp S			X	
5B	\$	Dollar Sign	X	X	X	X
5C	*	Asterisk				X
5D	)	Right Parenthesis				X
60	-	Minus Sign			X	X
61	/	Slash			X	X
62	Â	A Circumflex, Capital			X	
63	Ä	A Dieresis, Capital			X	
64	À	A Grave, Capital			X	
65	Á	A Acute, Capital			X	
66	Ã	A Tilde, Capital			X	
67	Å	A Overcircle, Capital			X	
68	Ç	C Cedilla, Capital			X	
69	Ñ	N Tilde, Capital			X	
6B	,	Comma			X	X
71	É	E Acute, Capital			X	
72	Ê	E Circumflex, Capital			X	
73	Ë	E Dieresis, Capital			X	
74	È	E Grave, Capital			X	
75	Í	I Acute, Capital			X	
76	Î	I Circumflex, Capital			X	
77	Ï	I Dieresis, Capital			X	
78	Ì	I Grave, Capital			X	
7B	#	Number Sign	X	X	X	X
7C	@	At Sign	X	X	X	X
7D	'	Apostrophe			X	X
7E	=	Equal Sign				X
80	Ø	O Slash, Capital			X	
81	a	a, Small		X		
82	b	b, Small		X		
83	c	c, Small		X		
84	d	d, Small		X		
85	e	e, Small		X		
86	f	f, Small		X		
87	g	g, Small		X		
88	h	h, Small		X		
89	i	i, Small		X		
91	j	j, Small		X		
92	k	k, Small		X		
93	l	l, Small		X		
94	m	m, Small		X		
95	n	n, Small		X		
96	o	o, Small		X		
97	p	p, Small		X		
98	q	q, Small		X		
99	r	r, Small		X		
9A	á	a Underscore, Small			X	
9B	ó	o Underscore, Small			X	
9D	ç	Cedilla			X	
9E	Æ	AE Diphthong, Capital			X	
A0	μ	Micro, Mu			X	

Hex Code	Graphic	Description	Set			
			A	AE	930	USS
A2	s	s, Small		X		
A3	t	t, Small		X		
A4	u	u, Small		X		
A5	v	v, Small		X		
A6	w	w, Small		X		
A7	x	x, Small		X		
A8	y	y, Small		X		
A9	z	z, Small		X		
AC	Ð	D Stroke, Capital				X
AD	Ý	Y Acute, Capital				X
AE	Þ	Thorn, Capital				X
C1	A	A, Capital	X	X	X	X
C2	B	B, Capital	X	X	X	X
C3	C	C, Capital	X	X	X	X
C4	D	D, Capital	X	X	X	X
C5	E	E, Capital	X	X	X	X
C6	F	F, Capital	X	X	X	X
C7	G	G, Capital	X	X	X	X
C8	H	H, Capital	X	X	X	X
C9	I	I, Capital	X	X	X	X
D1	J	J, Capital	X	X	X	X
D2	K	K, Capital	X	X	X	X
D3	L	L, Capital	X	X	X	X
D4	M	M, Capital	X	X	X	X
D5	N	N, Capital	X	X	X	X
D6	O	O, Capital	X	X	X	X
D7	P	P, Capital	X	X	X	X
D8	Q	Q, Capital	X	X	X	X
D9	R	R, Capital	X	X	X	X
DF	ÿ	y, Dieresis, Small				X
E2	S	S, Capital	X	X	X	X
E3	T	T, Capital	X	X	X	X
E4	U	U, Capital	X	X	X	X
E5	V	V, Capital	X	X	X	X
E6	W	W, Capital	X	X	X	X
E7	X	X, Capital	X	X	X	X
E8	Y	Y, Capital	X	X	X	X
E9	Z	Z, Capital	X	X	X	X
EB	Ô	O Circumflex, Capital				X
EC	Ö	O Dieresis, Capital				X
ED	Ò	O Grave, Capital				X
EE	Ó	O Acute, Capital				X
EF	Õ	O Tilde, Capital				X
F0	0	Zero	X	X	X	X
F1	1	One	X	X	X	X
F2	2	Two	X	X	X	X
F3	3	Three	X	X	X	X
F4	4	Four	X	X	X	X
F5	5	Five	X	X	X	X
F6	6	Six	X	X	X	X
F7	7	Seven	X	X	X	X
F8	8	Eight	X	X	X	X
F9	9	Nine	X	X	X	X
FB	U	U Circumflex, Capital				X
FC	Ü	U Dieresis, Capital				X
FD	Ù	U Grave, Capital				X
FE	Ú	U Acute, Capital				X

Figure A-1. Character Sets A, AE, 930, and USS.





## APPENDIX B. GDS ID DESCRIPTION AND ASSIGNMENTS

This appendix defines the general data stream (GDS), which is used in a variety of ways in SNA. For instance, it is used to encode the Document Interchange Architecture (DIA) message units. The basic structural unit in GDS is the structured field, a string of bytes preceded by a length and beginning with a GDS identifier (ID) that defines the structure of the remainder of the field. Some structured fields are used by components of SNA that are defined in this book; these uses are defined in "Chapter 12. GDS Variables for SNA Service Transaction Programs", "Chapter 14. GDS Variables for General Use", "Chapter 5.1. Request Units", "Chapter 5.2. Response Units", and "Chapter 10. Function Management Headers". GDS IDs are assigned, generally in blocks of consecutive values, to different layers and components of SNA and to other interconnection architectures. For a complete listing of these block assignments, see below.

The general data stream applies to data exchanged between nodes over SNA links, over non-SNA links, and to data exchanged via removable storage media or shared storage facilities.

### STRUCTURED FIELDS

Each structured field has the format shown in Figure B-1.

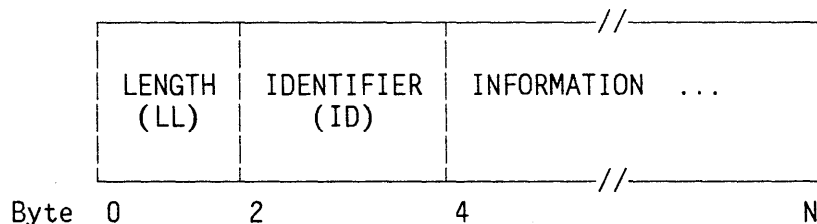

Figure B-1. GDS Structured Field

---

### LENGTH (LL) DESCRIPTION

The LLID is a 4-byte field in which the two LL bytes are used to indicate the length of the LLID field itself (4 bytes) plus the data following the LLID; up to 32,763 bytes of data may follow the LLID. Values 0 and 1 of the LL are reserved for use as escape sequences; values 2 and 3 are not used. For example, a value of X'0001' indicates a presentation services header, which is used for sync point management.

Bit 0 (high-order bit) of byte 0 is used as a length continuation (or not-last segment) indicator. If that bit is set to 1, the logical record is continued by a 2-byte LL; the ID occurs only following the first LL. The continuing LL is located immediately following the information bytes encompassed by the first LL. The continuing LL might itself be continued. In other words, the length specified by the continuing LL might not be the entire remainder of the logical record; it might be followed by yet another LL. The amount of data spanned by each continuing LL can be any size convenient to the sender (including 0). Eventually, the chain of continuing LLs is ended by a final LL, i.e., one with the high-order (not-last) bit set to 0. The final LL may indicate a null information field follows (length = 2).

When an LLID encompasses a string of logical records identified by full LLIDs, the length of the string, determined by summing the (nested) encompassed LLs, equals the length definer of the (outer) encompassing LLID less 4 (this applies at each level of nesting). If the encompassing LLID is continued by segmenting, the length of the string of segments equals the sum of the initial LL and all continuing LLs of the encompassing ID less 4 for the initial LLID and 2 for each continuing LL.

The 2-byte ID values, irrespective of the level of nesting at which they occur, are defined uniquely across all levels of nesting, with the following exception. The ID values X'FF00' through X'FFFF' are used only within an encompassing LLID (which is not necessarily the immediate parent structure); their meaning is defined by the architecture that owns the higher-level ID and it applies only within the context of that ID. In other words, ID values in the X'FF\*\*' range are context dependent. All other ID values are context independent.

## IDENTIFIER (ID) DESCRIPTION

The 2-byte identifier that follows the length field indicates the format and meaning of the data that follows. Sometimes additional values appearing in the information field are needed to completely specify the information field's content. The uniqueness of the identifier (with the exceptions noted above) makes it easy to decode structured fields in line traces, and also to make it easier to create composite data streams by including elements of several architectures. DIA carried by SNADS is an example of such a use.

## IDENTIFIER REGISTRY

The identifiers that have been assigned for specific use are listed below. Identifiers are assigned in blocks; not all identifiers in a block are necessarily currently used by the owner.

<u>GDS ID</u>	<u>Structured Field Owner</u>
00**	3270
01**	3270

03**	3270
06**	3270
09**	3270
0B**	3270
0C**	3270
0D**	3270
0E**	3270
0F00-0FFF	3270
1010-101F	3270
1030-1034	Print Job Restart
1100-1104	SNA Character String
1200-12FF	LU 6.2 (APPC)
1300-13FF	Management Services
1400-140F	3820 Page Printer
1570-157F	SNA Distribution Services
40**	3270
41**	3270
4A**	3270
4B**	3270
4C**	3270
7100-71FF	3250
80**	3270
8100-81FF	3270
C000-C00F	Document Interchange Architecture
C100-C104	Document Interchange Architecture
C105	SNA Distribution Services
C10A-C122	Document Interchange Architecture
C123-C124	SNA Distribution Services
C219	Document Interchange Architecture
C300-C345	Document Interchange Architecture
C350-C359	SNA Distribution Services
C366-C3FF	Document Interchange Architecture

C400-C46F	Document Interchange Architecture
C500-C56F	Document Interchange Architecture
C600-C66F	Document Interchange Architecture
C700-C7FF	Graphical Display Data Manager
C800-C87F	Document Interchange Architecture
C900-C97F	Document Interchange Architecture
C980-C9FF	Document Interchange Architecture
CA00-CA7F	Document Interchange Architecture
CA80-CAFF	Document Interchange Architecture
CB00-CB0F	Document Interchange Architecture
CC00-CC3F	Document Interchange Architecture
CD00-CD3F	Document Interchange Architecture
CF00-CF0F	Document Interchange Architecture
D000-D0FF	Distributed Data Management
D300-D3FF	Document Content Architecture
D600-D6FF	Intelligent Printer Data Stream
D780-D7BF	Facsimile Architecture
E100-E10F	Level-3 Document Content Architecture
E200-E20F	Level-3 Document Content Architecture
E300-E30F	Level-3 Document Content Architecture
E400-E40F	Level-3 Document Content Architecture
E500-E50F	Level-3 Document Content Architecture
E600-E60F	Level-3 Document Content Architecture
E700-E70F	Level-3 Document Content Architecture
E800-E80F	Level-3 Document Content Architecture
E900-E90F	Level-3 Document Content Architecture
EA00-EA0F	Level-3 Document Content Architecture

EEEE	IBM Token Ring Network PC Adapter
F000-FE9F	Non-IBM Reserved Block
FF00-FFFF	Context-Dependent Block



## APPENDIX C. LIST OF ABBREVIATIONS AND SYMBOLS

A	address (SDLC)
ACT	active, activate
B'nnnn'	binary digits
BB	begin bracket
BBI	begin bracket indicator
BC	begin chain
BCI	begin chain indicator
BETB	between brackets
BF	boundary function
BIU	basic information unit
BLU	basic link unit
BSC	Binary Synchronous Communication
BTU	basic transmission unit
(c)	configuration services
C	control (SDLC)
CCA	communication controller adapter
CCITT	International Telegraph and Telephone Consultative Committee
CD	cross-domain, change direction
CDI	change direction indicator
CDRM	cross-domain resource manager
CEB	conditional end bracket
CEBI	conditional end bracket indicator
CICS/VS	Customer Information Control System/Virtual Storage
CMI	compression indicator
CNOS	change number of sessions
CONT	contention
COS	class of service
CP	control point
CPI	compaction indicator
CRC	cyclic redundancy checking
CRV	cryptography verification
CSI	code selection indicator
CSP	control sequence prefix
DAF	destination address field
DCE	data circuit-terminating equipment
DCF	data count field
DD	day of month
ddd	day of year



DEF destination element address field  
 DEN distribution user element name (SNADS)  
 DES Date Encryption Standard  
 DFC data flow control  
 DGN distribution user group name (SNADS)  
 DISC Disconnect (SDLC)  
 DISOSS Distributed Office Support System  
 DISTIU distribution interchange unit (SNADS)  
 DLC data link control  
 DLU destination logic unit  
 DM Disconnected Mode (SDLC)  
 DPN destination program name  
 DQ dequeue  
 DR1I definite response 1 indicator  
 DR2I definite response 2 indicator  
 DSAF Destination Subarea Address Field  
 DSP data stream profile  
 DST data services task or device service task  
 DSU distribution service unit (SNADS)  
 DTE data terminal equipment

EB end bracket  
 EBCDIC extended binary coded decimal interchange code  
 EBI end bracket indicator  
 EC end chain  
 ECI end chain indicator  
 ED enciphered data  
 EDI enciphered data indicator  
 EFI expedited flow indicator  
 ENA extended network addressing  
 ENP Enable Presentation  
 ER explicit route  
 ERP error recovery procedures  
 ERCL exchange record length  
 ERI exception response indicator  
 ERN explicit route number  
 ERP error recovery procedures  
 Exp expedited flow  
 EXR exception request

F flag (SDLC)  
 FCB forms control block  
 FCS frame check sequence (SDLC)  
 FDX full-duplex data flow  
 FF flip-flop direction control  
 FFR field-formatted record  
 FI format indicator  
 FID format identification  
 FIFO first-in, first-out  
 FM function management

FMD function management data  
 FMDS function management data services  
 FMH function management header  
 FMHC function management header concatenation  
 FNI fixed fields without field separators  
 FRMR Frame Reject (SDLC)  
 FS fixed fields with field separators  
 FS2 fixed fields with or without field separators

GDS general data stream

HDX half-duplex data flow  
 hex hexadecimal  
 HH hours  
 HPCA High-Performance Communication Adapter  
 HSID half-session identification

I information (SDLC), initiate only  
 ID identification  
 IERN initial explicit route number  
 ILU initiating logical unit  
 IMS/VS Information Management Systems/Virtual Storage  
 INB in bracket  
 INP Inhibit Presentation  
 IPL initial program load  
 I/Q initiate or queue  
 IRS interchange record separator  
 ISO International Organization for Standardization  
 IU interchange unit (SNADS)

KEYIND key indicator

LAN local-area network  
 LCID local coded graphic character set identifier  
 LH link header  
 LIFO last-in, first-out  
 LL logical record length (prefix)  
 LMS logical messages services  
 LRH logical record header  
 LT link trailer  
 LSID local session identification  
 LU logical unit  
 LVx variable length parameter  
 LV1 variable length parameter, first position

(ma)	maintenance services
MGR	manager
MM	month, minutes
MPC	maximum presentation column
MPF	mapping field (BIU segments)
MPL	maximum presentation line
NA	network address
NAU	network addressable unit
NC	network control
Norm	normal flow
NS	network services
NUMRECS	number of records
OAF	origin address field
OEF	origin element field
OII	office information interchange
OLU	originating logical unit
OSAF	origin subarea field
P	primary
PC	path control
PCID	procedure correlation identifier
PD	padded data
PDI	padded data indicator
PDIR	peripheral data information record
PEND	pending
PGMNAME	program name
PI	pacing indicator
PIP	program initialization parameter
PIU	path information unit
PLU	primary logical unit
PNCP	peripheral node control point
POC	Program Operator Communication
PPU	primary physical unit
PRI	primary
PRID	procedure related identifier
PRN	primary resource name
PRTY	priority
PS	presentation services
PSH	presentation services header
PÜ	physical unit
PUCP	physical unit control point
P/F	poll/final (SDLC)

Q	queue
QC	quiesce complete
QEC	quiesce at end of chain
QR	queued response
QRI	queued response indicator
RCV	receive
RD	Request Disconnect (SDLC)
REC	receive
RECLEN	record length
RECID	record identification
RECTYPE	record type
REJ	Reject (SDLC)
RELQ	release quiesce
REN	routing element name (SNADS)
REQECHO	Request Echo Test
RES	resource
RH	request/response header
RIM	Request Initialization Mode (SDLC)
RJE	remote job entry
RLSD	released
RNR	Receive Not-Ready (SDLC)
RQ	request
RQD	definite-response request
RQE	exception request
RQR	request recovery
RR	Receive Ready (SDLC)
RRI	request/response indicator
RSP	response
RTI	response type indicator (+/-)
RTR	Ready To Receive (SDLC)
RU	request/response unit

S	secondary
(s)	session services
SC	session control
SCB	string control byte
SCS	SNA character string
SDI	sense data included indicator
SDLC	Synchronous Data Link Control
SEC	secondary
SESS	session
SIM	Set Initialization Mode (SDLC)
SLU	secondary logical unit
SNA	Systems Network Architecture
SNC	sense code
SNF	sequence number field

SNI SNA network interconnection  
 SNADS SNA distribution services  
 SNRM Set Normal Response Mode (SDLC)  
 SPC sync point command  
 SPU secondary physical unit  
 SQN sequence number  
 SRI stack reference indicator  
 SS seconds  
 SSCP system services control point  
 STP service transaction program  
 SU shared; unnamed  
 SVC services

T1 type-1 (node)  
 T2.0 type-2.0 (node)  
 T2.1 type-2.1 (node)  
 T4 type-4 (node)  
 T5 type-5 (node)  
 TC transmission control  
 TERM terminate  
 TEST Test (SDLC)  
 TG transmission group  
 TGN transmission group number  
 TH transmission header  
 TLU terminating logical unit  
 TPF transmission priority field  
 TPN transaction program name  
 TRN transparent  
 TS transmission services  
 TWX teletypewriter exchange service

UA Unnumbered Acknowledgment (SDLC)  
 UI Unnumbered Information (SDLC)  
 UNAVL unavailable  
 UP Unnumbered Poll (SDLC)  
 URC user request correlation

VD variable-length positional parameter  
 VOLID volume identification  
 VR virtual route  
 VRID virtual route identifier  
 VRN virtual route number  
 VRPRQ virtual route pacing request  
 VRPRS virtual route pacing response  
 VT vertical tab

WP word processing

XID Exchange Identification (SDLC)  
X'n...n' hexadecimal digits  
XMIT transmit

YY year

| (vertical stroke) exclusive or

\* (asterisk) any value

¬ (not sign) logical not

\*\* exponential operator

\_ (underscore) separates multiple terms, or qualifiers, in a phrase



## INDEX

### A

Access Security Information  
  Subfields 10-11  
  format 10-11

ACK  
  See acknowledge

ACKIU 13-5, 13-34, 13-42  
  See also ACKNOWLEDGE INTERCHANGE UNIT

acknowledge  
  semantics 13-4, 13-34, 13-35  
  syntax 13-42

ACKNOWLEDGE INTERCHANGE UNIT  
  (ACKIU) 13-34

ACTIVATE LOGICAL UNIT (ACTLU) 5.1-5

ACTIVATE PHYSICAL UNIT (ACTPU) 5.1-5

ACTLU 5.1-5  
  See also ACTIVATE LOGICAL UNIT

ACTPU 5.1-5  
  See also ACTIVATE PHYSICAL UNIT

Alert (X'0000') MS Major Vector 8-9

Alert MS Subvector  
  Basic Alert (X'91') 8-14  
  Cause Undetermined (X'97') 8-64  
  Detail Qualifier (EBCDIC)  
    (X'A0') 8-67  
  Detail Qualifier (Hexadecimal)  
    (X'A1') 8-67  
  Detailed Data (X'98') 8-65  
  Failure Causes (X'96') 8-49  
  Generic Alert Data (X'92') 8-18  
  Install Causes (X'95') 8-46  
  Probable Causes (X'93') 8-27  
  SDLC Link Station Data (X'8C') 8-12  
  User Causes (X'94') 8-40

application transaction program (ATP)  
  destination TP name 13-3, 13-7,  
    13-10, 13-12, 13-25

asynchronous  
  feedback  
    See feedback

ATP  
  See application transaction program  
  (ATP)

Attach FM header (FMH-5) 10-10

### B

Basic Alert (X'91') Alert MS  
  Subvector 8-14

BBI  
  See Begin Bracket indicator (BBI)

BCI  
  See Begin Chain indicator (BCI)

Beaconing Data (X'07') LAN Link  
  Connection Subsystem Data  
  Subfield 8-103

Begin Bracket indicator (BBI) 4-3, 4-9

Begin Chain indicator (BCI) 4-2, 4-4

BID 5.1-5

BIND 5.1-6  
  See also BIND SESSION

BIND SESSION (BIND) 5.1-6

BIS 5.1-14  
  See also BRACKET INITIATION STOPPED

BRACKET INITIATION STOPPED (BIS) 5.1-14

Bridge Identifier (X'0A') LAN Link  
  Connection Subsystem Data  
  Subfield 8-104

### C

CANCEL 5.1-14  
  capacity parameter 13-8, 13-9, 13-11,  
    13-12  
  category value, sense code 9-1  
    See also sense data

Cause Undetermined (X'97') Alert MS  
  Subvector 8-64

CDI  
  See Change Direction indicator (CDI)

CEBI  
  See Conditional End Bracket indicator  
  (CEBI)

Change Direction indicator (CDI) 4-3,  
  4-9

Change Number of Sessions (CNOS)  
  command format 12-2



CHANGE NUMBER OF SESSIONS (X'1210') GDS  
   Variable 12-2  
 character-coded request A-2  
 character sets 13-41  
 CHASE 5.1-14  
 CLEAR 5.1-14  
 Code Selection indicator (CSI) 4-3, 4-9  
 Coded Character Set ID (X'01')  
   Self-Defining Text Message  
   Subfield 8-100  
 compare states  
   command format 12-4  
 COMPARE STATES (X'1213') GDS  
   Variable 12-4  
 Conditional End Bracket indicator  
   (CEBI) 4-3, 4-9  
 Control Vector  
   LU-LU Session Services Capabilities  
     (X'0C') 8-4  
   Network Name (X'0E') 8-5  
   Product Set ID (X'10') 8-5  
   SSCP-LU Session Capabilities  
     (X'00') 8-4  
   XID Negotiation Error (X'22') 8-5  
 conversation-level security  
   Access Security Information  
   subfields 10-11  
 CRV 5.1-14  
   See also CRYPTOGRAPHY VERIFICATION  
 CRYPTOGRAPHY VERIFICATION (CRV) 5.1-14  
 CSI  
   See Code Selection indicator (CSI)  
 Current N(S)/N(R) Counts (X'01') SDLC  
   Link Station Data Subfield 8-12

D

DACTLU 5.1-15  
   See also DEACTIVATE LOGICAL UNIT  
 DACTPU 5.1-15  
   See also DEACTIVATE PHYSICAL UNIT  
 data  
   distribution object 13-3, 13-31  
   DIU (DISTIU) type 13-6, 13-7, 13-10,  
     13-11, 13-13  
   priority service level 13-8, 13-9  
 Data Reset Flag (X'45') MS Common  
   Subvector 8-101  
 date and time 13-3, 13-5, 13-6, 13-21,  
   13-22, 13-23

Date/Time (X'01') MS Common  
   Subvector 8-88  
 Date/Time Subfield  
   Greenwich Mean Time Offset  
     (X'20') 8-89  
   Local Date/Time (X'10') 8-88  
 DEACTIVATE LOGICAL UNIT (DACTLU) 5.1-15  
 DEACTIVATE PHYSICAL UNIT  
   (DACTPU) 5.1-15  
 Definite Response 1 indicator  
   (DR1I) 4-3, 4-5  
 Definite Response 2 indicator  
   (DR2I) 4-3, 4-5  
 DEN (distribution user element  
   name) 13-3, 13-5, 13-6, 13-10, 13-11,  
   13-13, 13-17, 13-18, 13-19, 13-21,  
   13-22, 13-26, 13-27, 13-28  
 DEST\_TPN 13-41  
 destination application  
   parameters 13-3, 13-5, 13-13  
 destination hop count 13-7, 13-8  
 destination operands 13-3, 13-4, 13-13,  
   13-14, 13-19, 13-26  
 destination TP name 13-3, 13-7, 13-10,  
   13-12, 13-25, 13-45  
 Detail Qualifier (EBCDIC) (X'A0') Alert  
   MS Subvector 8-67  
 Detail Qualifier (Hexadecimal) (X'A1')  
   Alert MS Subvector 8-67  
 Detailed Data (X'82') Network Alert  
   Common Subfield 8-76  
 Detailed Data (X'98') Alert MS  
   Subvector 8-65  
 Detailed Data Subfield  
   Qualified Message Data (X'01') 8-65  
 DGN (distribution user group  
   name) 13-3, 13-5, 13-6, 13-10, 13-13,  
   13-15, 13-16, 13-17, 13-21, 13-22,  
   13-26, 13-27, 13-29  
 DIA (Document Interchange  
   Architecture) 13-42  
 DISTIU 13-2, 13-5, 13-6, 13-34, 13-41  
   See also DISTRIBUTE INTERCHANGE UNIT  
 DISTRIBUTE INTERCHANGE UNIT  
   (DISTIU) 13-2  
 distribution  
   interchange units (DIUs)  
     See distribution interchange unit  
     (DIU)  
   user element name (DEN) 13-3, 13-5,  
   13-6, 13-10, 13-11, 13-13, 13-17,  
   13-18, 13-19, 13-21, 13-22, 13-26,  
   13-27, 13-28, 13-29, 13-30

- user group name (DGN) 13-3, 13-5, 13-6, 13-10, 13-13, 13-15, 13-16, 13-17, 13-18, 13-21, 13-22, 13-26, 13-27, 13-29
- user name (DUN) 13-6, 13-11
- distribution flags 13-3, 13-7, 13-8, 13-20
- distribution general options 13-3, 13-4, 13-7, 13-20
- distribution identifier 13-3, 13-4, 13-5, 13-22, 13-23
- distribution interchange unit (DIU)
  - data
    - semantic 13-2
  - status
    - semantic 13-2
- distribution object 13-2, 13-3, 13-8, 13-25, 13-31
- distribution object count 13-3, 13-7, 13-10
- DISTRIBUTION\_OBJECT\_PREFIX 13-31
- distribution object prefix (DOP) 13-31, 13-43
- distribution service unit (DSU)
  - name (DSUN) 13-13, 13-22, 13-23, 13-35, 13-38
- DISTRIBUTION\_STATUS\_OPERANDS 13-3, 13-4, 13-21
- DIU
  - See distribution interchange unit (DIU)
- Document Interchange Architecture (DIA) 13-42
- DR1I
  - See Definite Response 1 indicator (DR1I)
- DR2I
  - See Definite Response 2 indicator (DR2I)
- DSL
  - See service level
- DSL FLDS
  - See service level
- DSU
  - See distribution service unit (DSU)
- DSUN (distribution service unit name) 13-13, 13-22
- DUN (distribution user name) 13-6, 13-11, 13-13

E

- EBI
  - See End Bracket indicator (EBI)
- ECI
  - See End Chain indicator (ECI)
- EDI
  - See Enciphered Data indicator (EDI)
- Emulated Product Identifier (X'01')
  - Product Identifier Subfield 8-97
- Enciphered Data indicator (EDI) 4-3, 4-9
- Enciphered Data Structured Data Subfield 7-3
- End Bracket indicator (EBI) 4-3, 4-9
- End Chain indicator (ECI) 4-3, 4-4
- enhanced character string option
  - subset 13-41
- ERI
  - See Exception Response indicator (ERI)
- error category
  - See sense data
- error processing
  - feedback
    - See feedback
- exception class 13-33, 13-36
- exception code 13-33, 13-35, 13-36
- exception condition 13-33, 13-37
- exception condition code 13-37
- exception object code 13-38
- EXCEPTION REQUEST (EXR) 4-10
- Exception Response indicator (ERI) 4-3, 4-5
- Exchange Log Name
  - command format 12-3
- EXCHANGE LOG NAME (X'1211') GDS
  - Variable 12-3
- EXR
  - See EXCEPTION REQUEST (EXR)
- EXR (EXCEPTION REQUEST)
  - sense data included with 9-1
- extended sense data control vector (X'35')
  - sense data included with 9-1

**F**

Failure Causes (X'01') Failure Causes Subfield 8-50  
 Failure Causes (X'96') Alert MS Subvector 8-49  
 Failure Causes Subfield Failure Causes (X'01') 8-50  
 Fault Domain Description (X'06') LAN Link Connection Subsystem Data Subfield 8-103  
 Fault Domain Error Weight Pair (X'09') LAN Link Connection Subsystem Data Subfield 8-103  
 Fault Domain Names (X'26') LAN Link Connection Subsystem Data Subfield 8-104  
 feedback  
   address 13-3, 13-5, 13-10  
   options 13-3, 13-5, 13-11  
   service level 13-3, 13-11, 13-12  
   TP name 13-3, 13-11, 13-12  
 FI  
   See Format indicator (FI)  
 FID (Format Identifier) fields 3-1  
 FID 2 3-2  
 FID 2 Field Descriptions 3-2  
 FM (function management)  
   profiles 6-6  
   Usage field 6-6  
 FM header 1 10-3  
 FM header 10 10-15  
 FM header 12: Security 10-16  
 FM header 2 10-6  
 FM header 3 10-7  
 FM header 4 10-8  
 FM header 5 (Not LU Type 6.2) 10-12  
 FM header 5: Attach 10-10  
 FM header 6 10-13  
 FM header 7: Error Description 10-14  
 FM header 7: Error Description (not LU 6.2) 10-15  
 FM header 8 10-15  
 FM Usage field 6-6  
 Format indicator (FI) 4-2, 4-4  
 Format of an Error Data GDS variable 14-4  
 Format of Error Log GDS Variable 14-5  
 function management (FM) headers 10-1  
   introduction 10-1  
   placement within RU 10-1  
 function management (FM) profiles 6-6

function management header type 7 (FMH-7)  
   sense data included with 9-1  
 function option subsets  
   See subsets of function options

**G**

GDS  
   See general data stream  
 GDS Variable  
   CHANGE NUMBER OF SESSIONS (X'1210') 12-2  
   COMPARE STATES (X'1213') 12-4  
   EXCHANGE LOG NAME (X'1211') 12-3  
 GEN\_SNADS\_STATUS 13-21  
 general application status 13-20, 13-21, 13-25, 13-29, 13-30  
 general data stream B-1  
 general data stream variable B-1  
   Application Data 14-3  
   Error Data 14-4  
   Error Log 14-5  
   Map Name 14-3  
   Null Data 14-3  
   User Control Data 14-3  
 general SNADS status 13-20, 13-21, 13-24, 13-29  
 Generic Alert Data (X'92') Alert MS Subvector 8-18  
 Greenwich Mean Time Offset (X'20')  
   Date/Time Subfield 8-89

**H**

Hardware Product Common Name (X'0E')  
   Product Identifier Subfield 8-99  
 Hardware Product Identifier (X'00')  
   Product Identifier Subfield 8-95  
 Hierarchy Name List (X'03') MS Common Subvector 8-89  
 Hierarchy Name List (X'10')  
   Hierarchy/Resource List Subfield 8-91  
 Hierarchy/Resource List (X'05') MS Common Subvector 8-91  
 Hierarchy/Resource List Subfield  
   Hierarchy Name List (X'10') 8-91  
 hop count 13-3

See also destination hop count

I

I-frames, maximum number of 2-4, 2-7  
INIT-SELF 5.1-16, 5.1-17  
See also INITIATE-SELF  
INIT-SELF Format 0  
See INITIATE-SELF  
INIT-SELF Format 1 and 2  
See INITIATE-SELF  
INITIATE-SELF (INIT-SELF) 5.1-16,  
5.1-17  
Install Causes (X'01') Install Causes  
Subfield 8-46  
Install Causes (X'95') Alert MS  
Subvector 8-46  
Install Causes Subfield  
Install Causes (X'01') 8-46  
IPR  
See ISOLATED PACING RESPONSE (IPR)  
ISOLATED PACING RESPONSE (IPR) 4-10  
IU code points 13-1, 13-42  
IU segmentation 13-4, 13-32, 13-37

L

LAN Link Connection Subsystem Data  
(X'51') MS Common Subvector 8-102  
LAN Link Connection Subsystem Data  
Subfield  
Beaconing Data (X'07') 8-103  
Bridge Identifier (X'0A') 8-104  
Fault Domain Description  
(X'06') 8-103  
Fault Domain Error Weight Pair  
(X'09') 8-103  
Fault Domain Names (X'26') 8-104  
LAN Routing Information  
(X'05') 8-103  
Local Individual MAC Address  
(X'03') 8-102  
Local Individual MAC Name  
(X'23') 8-104  
Remote Individual MAC Address  
(X'04') 8-102  
Remote Individual MAC Name  
(X'24') 8-104

Ring or Bus Identifier (X'02') 8-102  
Single MAC Address (X'08') 8-103  
Single MAC Name (X'28') 8-105  
LAN Routing Information (X'05') LAN Link  
Connection Subsystem Data  
Subfield 8-103  
Last Received N(R) Count (X'08') SDLC  
Link Station Data Subfield 8-14  
Last SDLC Control Field Received (X'03')  
SDLC Link Station Data Subfield 8-13  
Last SDLC Control Field Sent (X'04')  
SDLC Link Station Data Subfield 8-13  
LCS Link Attributes (X'07') Link  
Connection Subsystem Configuration Data  
Subfield 8-106  
LCS Link Station Attributes (X'06') Link  
Connection Subsystem Configuration Data  
Subfield 8-106  
length prefix (LL) B-1  
Link Connection Subsystem Configuration  
Data (X'52') MS Common Subvector 8-105  
Link Connection Subsystem Configuration  
Data Subfield  
LCS Link Attributes (X'07') 8-106  
LCS Link Station Attributes  
(X'06') 8-106  
Local Device Address (X'04') 8-106  
Port Address (X'01') 8-105  
Remote Device Address (X'02') 8-105  
link header 1-1, 1-2, 1-3, 1-4  
Link Station State (X'06') SDLC Link  
Station Data Subfield 8-13  
link trailer 1-1, 1-10, 1-11  
LLC Reply Timer Expiration Count (X'07')  
SDLC Link Station Data Subfield 8-14  
Local Date/Time (X'10') Date/Time  
Subfield 8-88  
Local Device Address (X'04') Link  
Connection Subsystem Configuration Data  
Subfield 8-106  
Local Individual MAC Address (X'03') LAN  
Link Connection Subsystem Data  
Subfield 8-102  
Local Individual MAC Name (X'23') LAN  
Link Connection Subsystem Data  
Subfield 8-104  
LOGICAL UNIT STATUS (LUSTAT) 5.1-19  
LU-LU Session Services Capabilities  
(X'0C') Control Vector 8-4  
LU-LU Session Services Capabilities  
NOTIFY Vector 5.1-21  
LUSTAT 5.1-19  
See also LOGICAL UNIT STATUS

**M**

## Maximum

I-field length 2-2  
 RU size 6-3, 6-4, 6-5  
 Microcode EC Level (X'0B') Product Identifier Subfield 8-99  
 Mode Name Structured Data Subfield 7-2  
 modifier value, sense code 9-1  
 See also sense data  
 MS Common Subvector  
 Data Reset Flag (X'45') 8-101  
 Date/Time (X'01') 8-88  
 Hierarchy Name List (X'03') 8-89  
 Hierarchy/Resource List (X'05') 8-91  
 LAN Link Connection Subsystem Data (X'51') 8-102  
 Link Connection Subsystem  
 Configuration Data (X'52') 8-105  
 Product Identifier (X'11') 8-93  
 Product Set ID (X'10') 8-93  
 Relative Time (X'42') 8-101  
 Self-Defining Text Message (X'31') 8-99  
 Sense Data (X'7D') 8-107  
 SNA Address List (X'04') 8-90  
 Text Message (X'00') 8-88  
 MS Major Vector  
 Alert (X'0000') 8-9  
 Request Response Time Monitor (X'8080') 8-80  
 Response Time Monitor (X'0080') 8-83

**N**

National Language ID (X'11')  
 Self-Defining Text Message Subfield 8-100  
 negative response  
 format 5.2-1  
 sense data included with 9-1  
 Network Alert Common Subfield  
 Detailed Data (X'82') 8-76  
 Product Set ID Index (X'83') 8-79  
 Recommended Actions (X'81') 8-68  
 NETWORK MANAGEMENT VECTOR TRANSPORT (NMVT) 5.1-20  
 Network Name (X'0E') Control Vector 8-5

Network or Uninterpreted Name (X'01') 8-7  
 Network-Qualified PLU Network Name Structured Data Subfield 7-3  
 Network-Qualified SLU Network Name Structured Data Subfield 7-3  
 NMVT 5.1-20  
 See also NETWORK MANAGEMENT VECTOR TRANSPORT  
 NOTIFY 5.1-21  
 NOTIFY Vector  
 LU-LU Session Services Capabilities 5.1-21

**O**

option subsets  
 See subsets of function options  
 ORIG\_DEN 13-21  
 ORIG\_DGN 13-21  
 ORIG\_DTM 13-22  
 ORIG\_REN 13-41  
 ORIG\_RGN 13-41  
 ORIG\_SEQNO 13-6, 13-21, 13-41  
 origin correlation 13-3, 13-5, 13-7, 13-22, 13-23  
 origin DEN 13-3, 13-5, 13-6, 13-19, 13-21, 13-22  
 origin DGN 13-3, 13-5, 13-6, 13-18, 13-21, 13-22  
 origin REN 13-3, 13-5  
 origin RGN 13-3, 13-5  
 Outstanding Frame Count (X'02') SDLC Link Station Data Subfield 8-13

**P**

Pacing indicator (PI) 4-3, 4-8  
 Padded Data indicator (PDI) 4-3, 4-9  
 PDI  
 See Padded Data indicator (PDI)  
 PI  
 See Pacing indicator (PI)  
 PIP Subfield 10-11  
 PIP Variable 10-11  
 PIU (Path Information Unit) 1-5

Port Address (X'01') Link Connection  
   Subsystem Configuration Data  
   Subfield 8-105  
 PREFIX 13-2, 13-3, 13-4, 13-31, 13-34,  
   13-35, 13-36, 13-38, 13-42  
 presentation services (PS) headers  
   definition 11-1  
   format 11-1  
 priority parameter 13-8, 13-9, 13-11,  
   13-12  
 priority service levels  
   data 13-8, 13-9  
   fast 13-8, 13-9, 13-11, 13-12  
   status 13-9, 13-11, 13-12  
 Probable Causes (X'93') Alert MS  
   Subvector 8-27  
 Product Identifier (X'11') MS Common  
   Subvector 8-93  
 Product Identifier Subfield  
   Emulated Product Identifier  
     (X'01') 8-97  
   Hardware Product Common Name  
     (X'0E') 8-99  
   Hardware Product Identifier  
     (X'00') 8-95  
   Microcode EC Level (X'0B') 8-99  
   Software Product Common Level  
     (X'04') 8-97  
   Software Product Common Name  
     (X'06') 8-98  
   Software Product Customization Date  
     and Time (X'09') 8-98  
   Software Product Customization  
     Identifier (X'07') 8-98  
   Software Product Program Number  
     (X'08') 8-98  
   Software Product Serviceable  
     Component Identifier (X'02') 8-97  
 Product Set ID (X'10') Control  
   Vector 8-5  
 Product Set ID (X'10') MS Common  
   Subvector 8-93  
 Product Set ID Index (X'83') Network  
   Alert Common Subfield 8-79  
 profiles  
   FM (function management) 6-6  
   FM profile 0 6-7  
   FM profile 18 6-12  
   FM profile 19 6-13  
   FM profile 2 6-7  
   FM profile 3 6-8  
   FM profile 4 6-9  
   FM profile 6 6-10  
   FM profile 7 6-11

TS (transmission services) 6-2  
 TS profile 1 6-3  
 TS profile 2 6-3  
 TS profile 3 6-4  
 TS profile 4 6-4  
 TS profile 7 6-5  
 protection parameter 13-8, 13-9, 13-11,  
   13-12  
 PS header 10: Sync Point Control 11-2

Q

QC 5.1-22  
   See also QUIESCE COMPLETE  
 QEC 5.1-22  
   See also QUIESCE AT END OF CHAIN  
 QRI  
   See Queued Response indicator (QRI)  
 Qualified Message Data (X'01') Detailed  
   Data Subfield 8-65  
 Queued Response indicator (QRI) 4-3,  
   4-6  
 QUIESCE AT END OF CHAIN (QEC) 5.1-22  
 QUIESCE COMPLETE (QC) 5.1-22

R

Random Data Structured Data  
   Subfield 7-3  
 READY TO RECEIVE (RTR) 5.1-22  
 RECEIVING DSUN 13-21, 13-22, 13-23,  
   13-35, 13-38  
 Recommended Actions (X'81') Network  
   Alert Common Subfield 8-68  
 Relative Time (X'42') MS Common  
   Subvector 8-101  
 RELEASE QUIESCE (RELQ) 5.1-22  
 RELQ 5.1-22  
   See also RELEASE QUIESCE  
 Remote Device Address (X'02') Link  
   Connection Subsystem Configuration Data  
   Subfield 8-105  
 Remote Individual MAC Address (X'04')  
   LAN Link Connection Subsystem Data  
   Subfield 8-102  
 Remote Individual MAC Name (X'24') LAN  
   Link Connection Subsystem Data  
   Subfield 8-104

REPLY\_DATA 13-35, 13-36, 13-38, 13-42  
 request header 4-1  
 request no feedback 13-7  
 REQUEST RECOVERY (RQR) 5.1-22  
 request/response header (RH) 4-2, 4-4  
     discussion of bit usage and values 4-4-4-9  
     format and bit settings 4-2  
 Request/Response Indicator (RRI) 4-2, 4-4  
 Request Response Time Monitor (X'8080') MS Major Vector 8-80  
 Request/Response Unit Category 4-2, 4-4  
 Request RTM MS Subvector  
     RTM Control (X'94') 8-82  
     RTM Request (X'92') 8-81  
 REQUEST SHUTDOWN (RSHUTD) 5.1-22  
 reserved  
     bits and fields 5.1-1  
     values 5.1-1  
 Response Time Monitor (X'0080') MS Major Vector 8-83  
 Response Type indicator (RTI) 4-3, 4-7  
 RGN (routing group name) 13-13  
 RH  
     See request/response header (RH)  
 Ring or Bus Identifier (X'02') LAN Link Connection Subsystem Data Subfield 8-102  
 RQR 5.1-22  
     See also REQUEST RECOVERY  
 RRI  
     See Request/Response Indicator (RRI)  
 RSHUTD 5.1-22  
     See also REQUEST SHUTDOWN  
 RSP(ACTLU) 5.2-3  
 RSP(ACTPU) 5.2-3  
 RSP(BIND) 5.2-4  
 RSP(STSN) 5.2-5  
 RTI  
     See Response Type indicator (RTI)  
 RTM Control (X'94') Request RTM MS Subvector 8-82  
 RTM Data (X'93') RTM MS Subvector 8-86  
 RTM MS Subvector  
     RTM Data (X'93') 8-86  
     RTM Status Reply (X'91') 8-85  
 RTM Request (X'92') Request RTM MS Subvector 8-81  
 RTM Status Reply (X'91') RTM MS Subvector 8-85  
 RTR 5.1-22  
     See also READY TO RECEIVE  
 RU Category

See Request/Response Unit Category  
 RU size, maximum 6-3, 6-4, 6-5

S

SBI 5.1-23  
     See also STOP BRACKET INITIATION  
 SDI  
     See Sense Data Included indicator (SDI)  
 SDLC frames 1-1  
     link header (LH) 1-1  
         address 1-3  
         control field 1-4  
         flag 1-2  
     link trailer (LT) 1-1  
         flag 1-11  
         frame check sequence 1-10  
 SDLC Link Station Data (X'8C') Alert MS Subvector 8-12  
 SDLC Link Station Data Subfield  
     Current N(S)/N(R) Counts (X'01') 8-12  
     Last Received N(R) Count (X'08') 8-14  
     Last SDLC Control Field Received (X'03') 8-13  
     Last SDLC Control Field Sent (X'04') 8-13  
     Link Station State (X'06') 8-13  
     LLC Reply Timer Expiration Count (X'07') 8-14  
     Outstanding Frame Count (X'02') 8-13  
     Sequence Number Modulus (X'05') 8-13  
 SDT 5.1-23  
     See also START DATA TRAFFIC  
 Self-Defining Text Message (X'31') MS Common Subvector 8-99  
 Self-Defining Text Message Subfield  
     Coded Character Set ID (X'01') 8-100  
     National Language ID (X'11') 8-100  
     Sender ID (X'21') 8-100  
     Text Message (X'30') 8-101  
 Sender ID (X'21') Self-Defining Text Message Subfield 8-100  
 sense code  
     See sense data  
 sense data 9-1  
     format of 9-1  
     sense code

category X'00' (user sense data only) 9-1, 9-2  
category X'08' (request reject) 9-2, 9-1  
category X'10' (request error) 9-31, 9-1  
category X'20' (state error) 9-40, 9-1  
category X'40' (RH usage error) 9-43, 9-1  
category X'80' (path error) 9-45, 9-1  
modifier 9-1  
modifier value of X'00' 9-2  
sense-code specific information 9-1  
user-defined data 9-2  
Sense Data (X'7D') MS Common Subvector 8-107  
sense data included with 9-1  
Sense Data Included indicator (SDI) 4-2, 4-4  
sequence number 13-3, 13-5, 13-6, 13-21, 13-22, 13-41  
Sequence Number Modulus (X'05') SDLC Link Station Data Subfield 8-13  
SERVER\_NAME 13-3, 13-25, 13-31, 13-41, 13-45  
SERVER\_PARMS 13-25  
service level  
parameter description  
capacity 13-8, 13-11  
priority 13-8, 13-11  
protection 13-8, 13-11  
Session Instance Identifier Structured Data Subfield 7-2  
Session Keys  
table of 8-7  
session-level security  
FMH-12 10-16  
Session Qualifier Structured Data Subfield 7-2  
SET AND TEST SEQUENCE NUMBERS (STSN) 5.1-24  
SHUTC 5.1-23  
See also SHUTDOWN COMPLETE  
SHUTD 5.1-23  
See also SHUTDOWN  
SHUTDOWN (SHUTD) 5.1-23  
SHUTDOWN COMPLETE (SHUTC) 5.1-23  
SIG 5.1-23  
See also SIGNAL  
SIGNAL (SIG) 5.1-23  
Single MAC Address (X'08') LAN Link Connection Subsystem Data Subfield 8-103  
Single MAC Name (X'28') LAN Link Connection Subsystem Data Subfield 8-105  
SNA Address List (X'04') MS Common Subvector 8-90  
SNF processing 3-3  
Software Product Common Level (X'04') Product Identifier Subfield 8-97  
Software Product Common Name (X'06') Product Identifier Subfield 8-98  
Software Product Customization Date and Time (X'09') Product Identifier Subfield 8-98  
Software Product Customization Identifier (X'07') Product Identifier Subfield 8-98  
Software Product Program Number (X'08') Product Identifier Subfield 8-98  
Software Product Serviceable Component Identifier (X'02') Product Identifier Subfield 8-97  
specific application status 13-25, 13-28, 13-29, 13-30  
specific SNADS status 13-24, 13-28, 13-29  
SSCP-LU Session Capabilities (X'00') Control Vector 8-4  
stack reference indicator (SRI)  
contained in FMH-2  
functions and codes 10-6  
START DATA TRAFFIC (SDT) 5.1-23  
STAT\_CORREL 13-21  
status  
DIU (DISTIU) type 13-6, 13-7, 13-13, 13-20  
priority service level 13-8, 13-9, 13-11, 13-12  
status correlation 13-21, 13-22  
STOP BRACKET INITIATION (SBI) 5.1-23  
Structured Data Subfield  
Enciphered Data 7-3  
Mode Name 7-2  
Network-Qualified PLU Network Name 7-3  
Network-Qualified SLU Network Name 7-3  
Random Data 7-3  
Session Instance Identifier 7-2  
Session Qualifier 7-2  
Unformatted Data 7-2  
structured fields B-1



See also general data stream  
STSN 5.1-24  
See also SET AND TEST SEQUENCE  
NUMBERS  
subsets of function options  
enhanced character string option  
subset 13-41  
SUFFIX 13-2, 13-3, 13-32, 13-34, 13-35,  
13-37, 13-38, 13-40, 13-42  
Suffix type 1 13-32, 13-43  
Suffix type 2 13-32, 13-43  
suffix T2 13-32, 13-33  
Symbol-String Types A-1  
sync point protocols  
RH bit settings 4-6, 4-8  
Synchronous Data Link Control  
See SDLC

T

TERM-SELF 5.1-24, 5.1-25  
See also TERMINATE-SELF  
TERM-SELF Format 0  
See TERMINATE-SELF  
TERM-SELF Format 1  
See TERMINATE-SELF  
TERMINATE-SELF (TERM-SELF) 5.1-24,  
5.1-25  
Text Message (X'00') MS Common  
Subvector 8-88  
Text Message (X'30') Self-Defining Text  
Message Subfield 8-101  
token-ring network DLC 1-1, 1-12

transmission header (TH)  
FID2 3-2  
transmission services (TS) profiles 6-2  
TS (transmission services)  
profiles 6-2  
Usage field 6-2  
TS Usage field 6-2

U

UNBIND 5.1-26  
See also UNBIND SESSION  
sense data included with 9-1  
UNBIND SESSION (UNBIND) 5.1-26  
Unformatted Data Structured Data  
Subfield 7-2  
URC (X'0A') 8-7  
User Causes (X'01') User Causes  
Subfield 8-40  
User Causes (X'94') Alert MS  
Subvector 8-40  
User Causes Subfield  
User Causes (X'01') 8-40  
USS symbol-string type A-2

X

XID Negotiation Error (X'22') Control  
Vector 8-5

---

# Reader's Comment Form

## Systems Network Architecture Formats

### Introducing Publication No. GA27-3136-8

This manual is part of a library that serves as a reference source for systems analysts, programmers, and operators of IBM systems. You may use this form to communicate your comments about this publication, its organization, or subject matter, with the understanding that IBM may use or distribute whatever information you supply in any way it believes appropriate without incurring any obligation to you.

**Note:** Copies of IBM Publications are not stocked at the location to which this form is addressed. Please direct any requests for copies of publications, or for assistance in using your IBM system, to your IBM representative or to the IBM branch office serving your locality.

Possible topics for comment are: clarity, accuracy, completeness, organization, coding, retrieval, and legibility.

**If you wish a reply, give your name, company, mailing address, and date:**

---

---

---

**Comments:**

---

---

---

---

---

---

---

---

**What is your occupation?**

---

**Number of latest Newsletter associated with this publication:**

---

Thank you for your cooperation. No postage stamp necessary if mailed in the U.S.A. (Elsewhere, an IBM office representative will be happy to forward your comments or you may mail directly to the address in the Edition Notice on the back of the title page.)

**Reader's Comment Form**

Fold and tape

Please Do Not Staple

Fold and tape



NO POSTAGE  
NECESSARY  
IF MAILED  
IN THE  
UNITED STATES



**BUSINESS REPLY MAIL**  
FIRST CLASS PERMIT NO. 40 ARMONK, N.Y.

POSTAGE WILL BE PAID BY ADDRESSEE

International Business Machines Corporation  
Dept. E70  
P.O. Box 12195  
Research Triangle Park, N.C. 27709-9990

Fold and tape

Please Do Not Staple

Fold and tape



---

# Reader's Comment Form

**Systems Network Architecture  
Formats**

**Introducing  
Publication No. GA27-3136-8**

This manual is part of a library that serves as a reference source for systems analysts, programmers, and operators of IBM systems. You may use this form to communicate your comments about this publication, its organization, or subject matter, with the understanding that IBM may use or distribute whatever information you supply in any way it believes appropriate without incurring any obligation to you.

**Note:** Copies of IBM Publications are not stocked at the location to which this form is addressed. Please direct any requests for copies of publications, or for assistance in using your IBM system, to your IBM representative or to the IBM branch office serving your locality.

Possible topics for comment are: clarity, accuracy, completeness, organization, coding, retrieval, and legibility.

**If you wish a reply, give your name, company, mailing address, and date:**

---

---

---

**Comments:**

---

---

---

---

---

---

---

---

**What is your occupation?**

---

**Number of latest Newsletter associated with this publication:**

---

Thank you for your cooperation. No postage stamp necessary if mailed in the U.S.A. (Elsewhere, an IBM office representative will be happy to forward your comments or you may mail directly to the address in the Edition Notice on the back of the title page.)

**Reader's Comment Form**

Fold and tape

Please Do Not Staple

Fold and tape



NO POSTAGE  
NECESSARY  
IF MAILED  
IN THE  
UNITED STATES

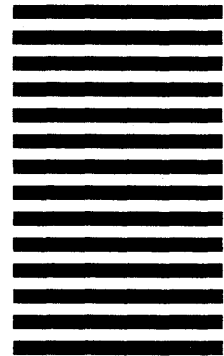

**BUSINESS REPLY MAIL**  
FIRST CLASS PERMIT NO. 40 ARMONK, N.Y.

POSTAGE WILL BE PAID BY ADDRESSEE

International Business Machines Corporation  
Dept. E70  
P.O. Box 12195  
Research Triangle Park, N.C. 27709-9990

Fold and tape

Please Do Not Staple

Fold and tape





Publication Number  
GA27-3136-8

Printed in USA



GA27-3136-08

