

AUG 18 1981

**Canon** LASER BEAM PRINTER  
**LBP-10**  
OPERATION MANUAL

Copyright © By Canon Inc.  
1980

*Printed in Japan*

Prepared by  
NEW ENTERPRISES DIVISION

CANON INC.  
3-11-28 Mita, Minato-ku, Tokyo, Japan

CANON LBP-10 Revision-1 MAR 1980 PRINTED IN JAPAN

## FOREWORD

Before operating the LBP-10, it is recommended that you take time to familiarize yourself with the new machine by reading this operation manual.

## CONTENTS

INTRODUCTION .....	1
FEATURES .....	1
SPECIFICATIONS .....	2
PARTS OF THE LBP-10 .....	3
LASER RADIATION SAFETY INFORMATION .....	4
INSTALLATIONS .....	5
OPERATION PROCEDURE .....	13
OPERATOR PANEL GUIDE .....	13
TROUBLESHOOTING .....	16
SUGGESTIONS FOR DAILY USE .....	24

## INTRODUCTION

The LBP-10 is a non-impact, high-speed, general-purpose printer in which an electrophotographic process, laser optics and electronic control circuits are combined. Because a laser beam is employed, the LBP-10 is capable of printing high quality characters and graphics on plain paper very quietly and very quickly.

The LBP-10 has a wide range of application as an output printer in word processing, in telecommunication and in other fields.

## FEATURES

1. Non-impact, quiet printing
2. High-quality printed images
3. High-speed printing on cut-sheet
4. Compact, low-cost machine
5. Low running cost
6. Variable fonts and font sizes
7. Power saving automatic shut-off

## SPECIFICATIONS

Type:	Desktop type page printer		
Print Method:	NP-Electrophotography + Laser beam scanning		
Print Speed:	10 letter size pages per minute (Time for first page: 13 ~ 96 sec.)		
Development Method:	Liquid-Dry (Canon NP Method, Wet toner with automatic feed to heat fixing)		
Paper Type:	NP standard plain paper (cut sheet)		
Cassette Capacity:	190 sheets (75 g/m <sup>2</sup> ) per cassette (Paper can be piled up to 17 mm.)		
Paper Size Available:	A4	210 x 297 mm	8.3 x 11.7 inch
	Letter	216 x 279 mm	8.5 x 11 inch
	G. Letter	203 x 267 mm	8.0 x 10 inch
	Legal	216 x 356 mm	8.5 x 14 inch
	G. Legal	203 x 330 mm	8.0 x 13 inch
	Foolscap	216 x 330 mm	8.5 x 13 inch
	A. Foolscap	206 x 337 mm	8.1 x 13.3 inch
	Folio	210 x 330 mm	8.3 x 13 inch
	Statement	140 x 216 mm	5.5 x 8.5 inch
Power Requirements:	120 VAC $\pm$ 10%, 60 Hz $\pm$ 1 Hz		
Power Consumption:	0.96 KVA (8 Amps MAX., 120 VAC)		
Aux. Heaters:	Drum heater, Developer heater (Optional)		
Operating Environment:	Temperature:	10 ~ 35°C	
	Humidity:	20 ~ 80% RH	
Warm-Up Time:	14 ~ 75 sec. (depending on environmental conditions)		
Noise Level:	Under 57 dB(A) (Except intermittent impact noise).		
Dimensions:	874 mm (W) x 443 mm (H) x 538 mm (D)		
Weight:	95 kg		

### PARTS OF THE LBP-10

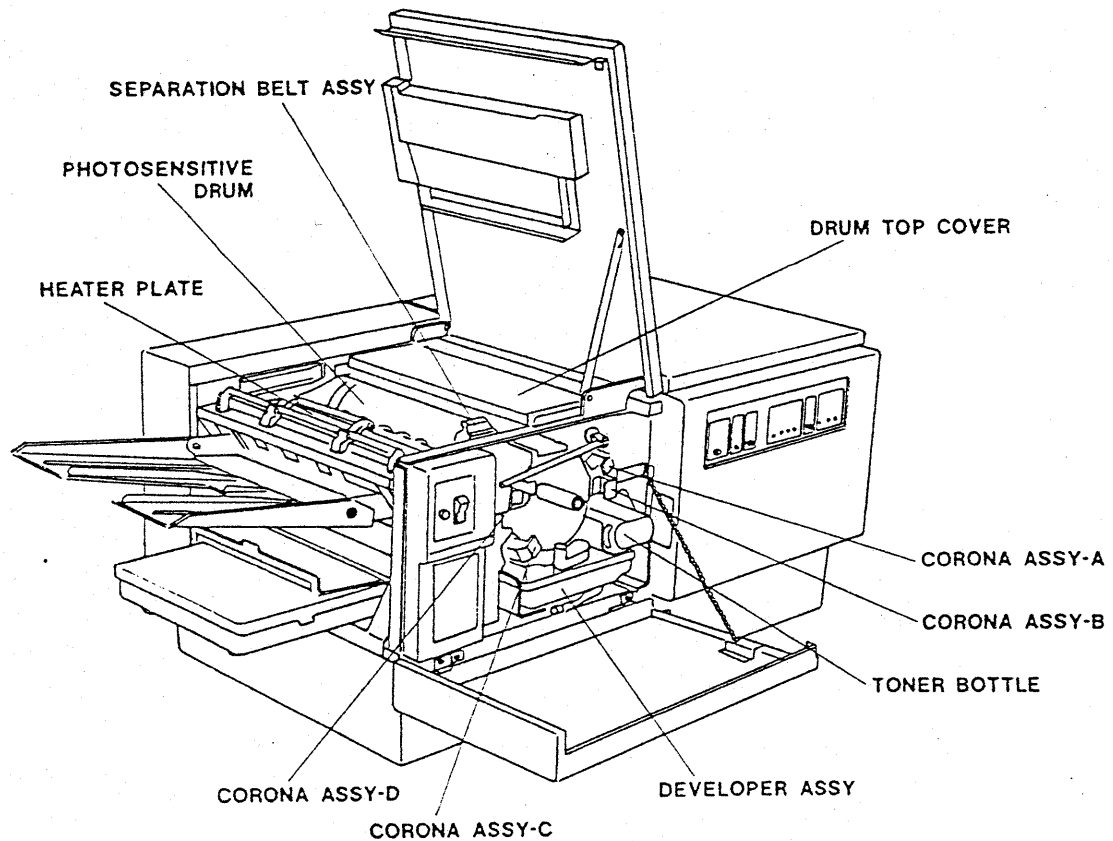
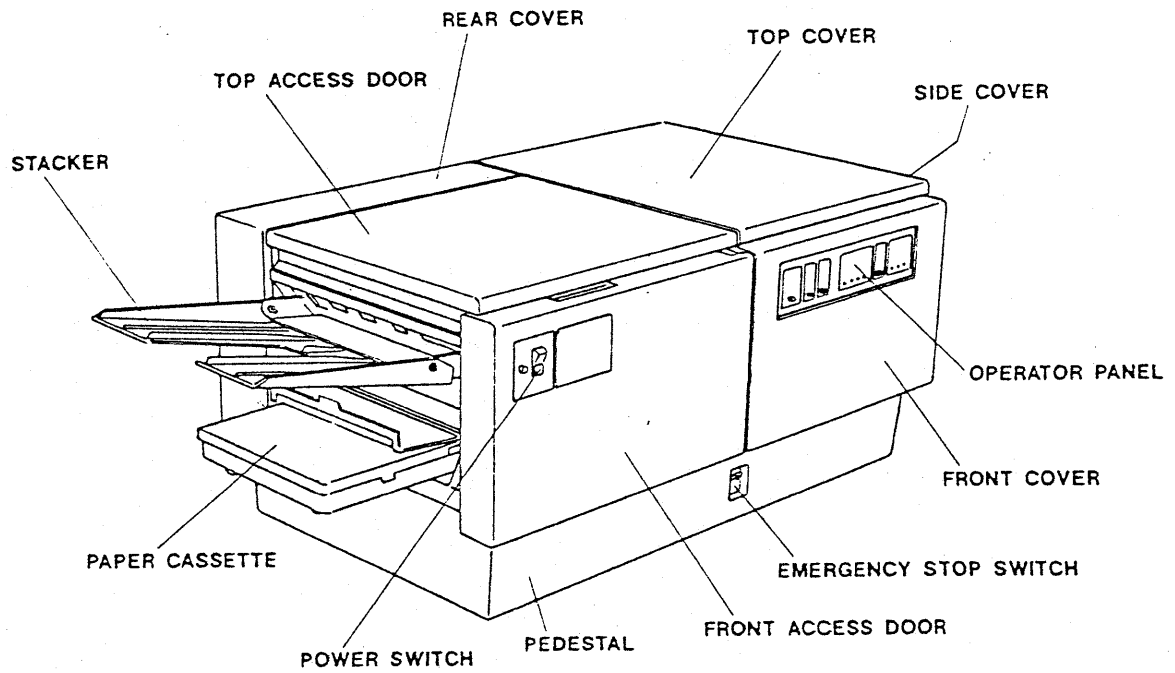

# LASER RADIATION SAFETY INFORMATION

## 1. LASER SAFETY

The LBP-10 is certified to comply with DHEW Radiation Performance Standard under the Radiation Control for Health and Safety Act of 1968 as a Class 1 Laser Product.

This means that the LBP-10 belongs to a class of laser products that does not produce hazardous laser radiation.

Since the radiation emitted inside the LBP-10 is completely confined within protective housings and external covers, the laser beam can not escape from the machine during any phase of user operation.

## 2. BRH REGULATIONS

Effective August 2, 1976, the Bureau of Radiological Health (BRH) of the Food and Drug Administration has established regulations for laser products. The regulations apply to laser products manufactured after August 1, 1976.

The following is the PRODUCT IDENTIFICATION AND CERTIFICATION LABEL required by the BRH regulations.

CANON INC.	AA3-0014
3-30-2 SHIMOMARUKO, OHTA-KU, TOKYO, JAPAN	
CANON U.S.A., INC.	
10 NEVADA DRIVE, LAKE SUCCESS, LONG ISLAND	
N.Y. 11040, U.S.A.	
MANUFACTURED:	
SERIAL NUMBER:	
THIS PRODUCT CONFORMS WITH DHEW RADIATION PERFORMANCE STANDARD 21CFR CHAPTER 1 SUBCHAPTER J	

## 3. ADDITIONAL INFORMATION

### Power Interlock Mechanism

If an access door (top access door or front access door) is opened by the operator, power supplies including that for the laser are shut-off for safety. Furthermore, protective housings are provided inside the access doors. This prevents the operator from being exposed to the laser beam in the event of power interlock failure.

**CAUTION:** Use of controls, adjustments or performance of procedures other than those specified in this manual may result in hazardous radiation exposure.

## INSTALLATIONS

## PAPER LOADING

1. Open and take out about 1/3 of the paper from the 500 sheet pack remembering the side of the paper. The side of the paper relative to the package seam is indicated in the pack label.

**CAUTION:** The top side, indicated in the pack label, must face upward when paper is loaded into the cassette.

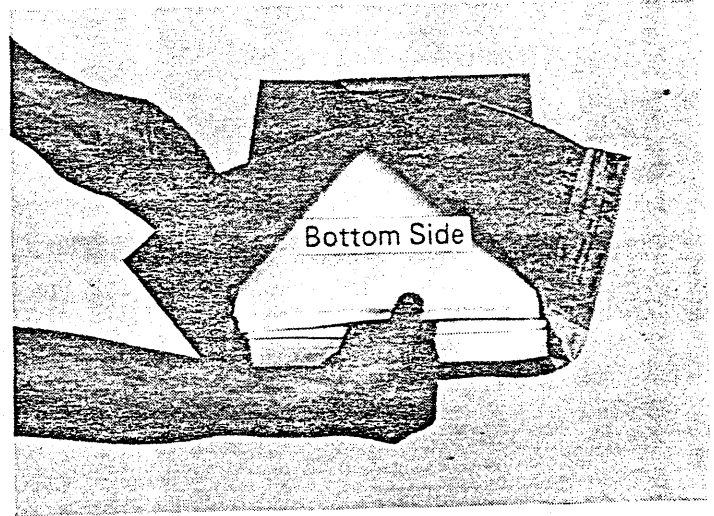

2. Fan the paper as shown.

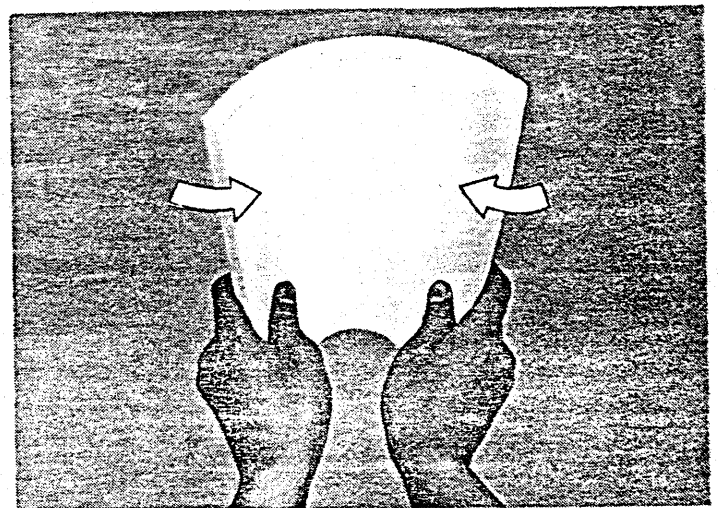
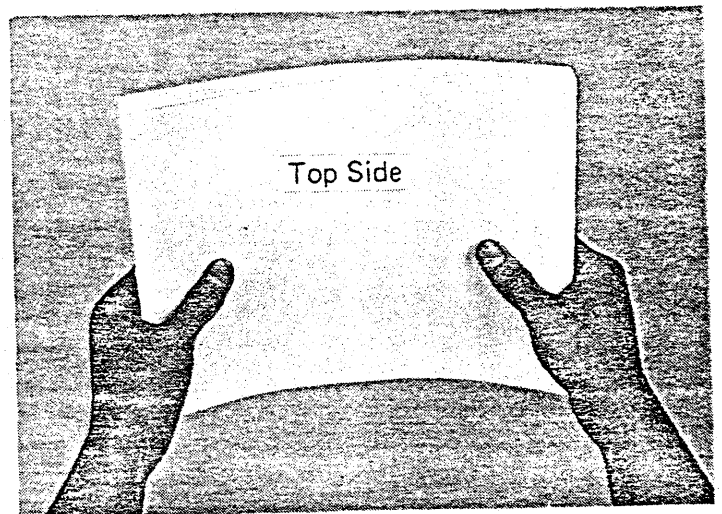

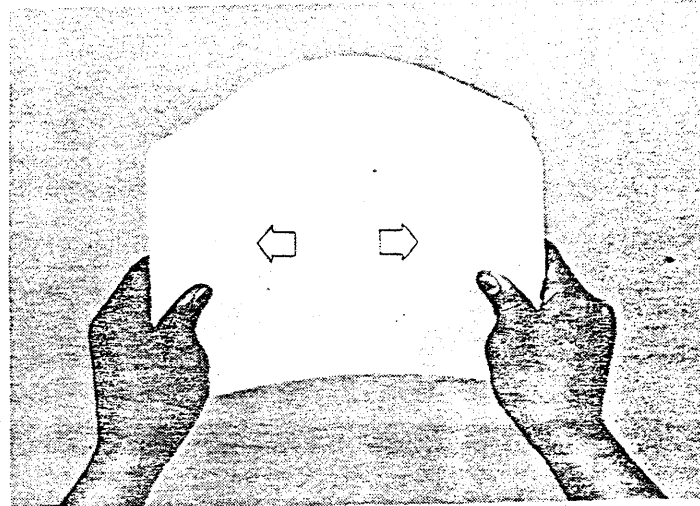

3. Unlock and remove the cassette top cover (slightly push tabs outward).

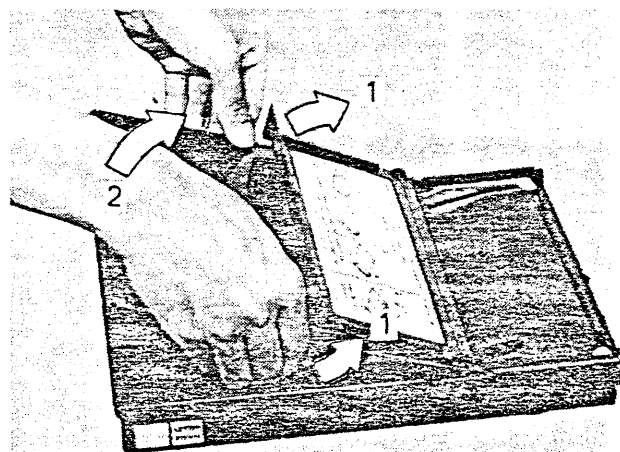

4. Load the stack of paper into the cassette with its rear edge aligned against the cassette end and with the top side facing upward.

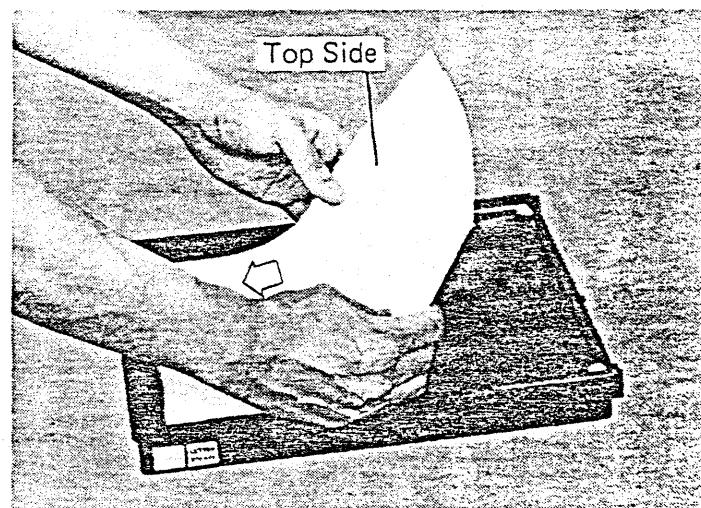



5. Push down the corners of the paper and insert them under both separation tabs.

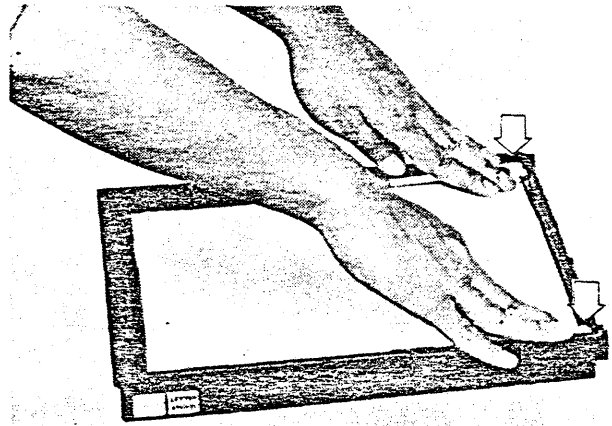

6. Push the contact plate outward and release. Confirm correct stacking.

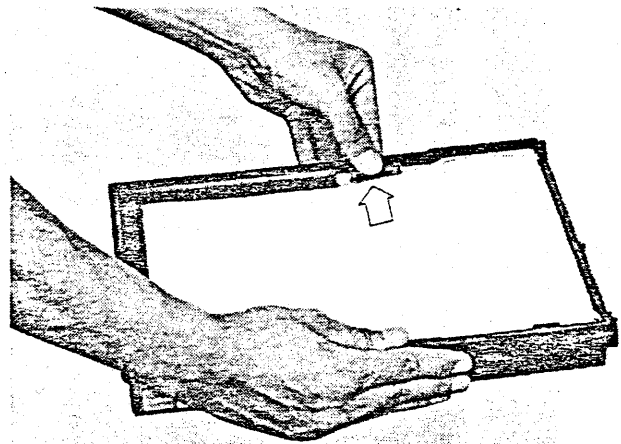

7. Align the front corners of the top cover with the stops provided on the cassette and lock the top cover.

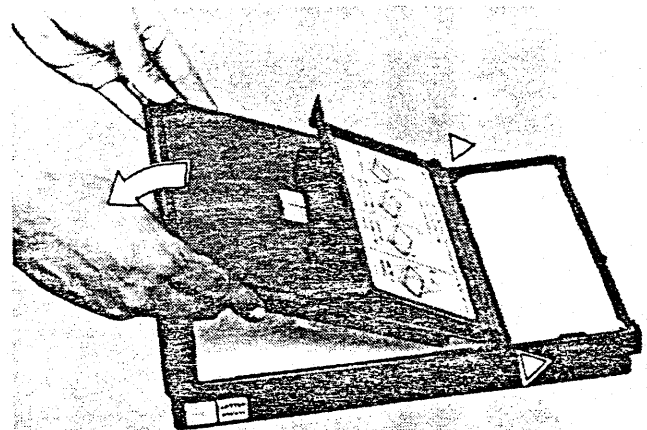

8. Lightly swing the cassette back and forth and ensure alignment of the leading edge.

CAUTION: Use correct paper (Canon paper or the equivalent). Store the remaining sheets in a dry place.

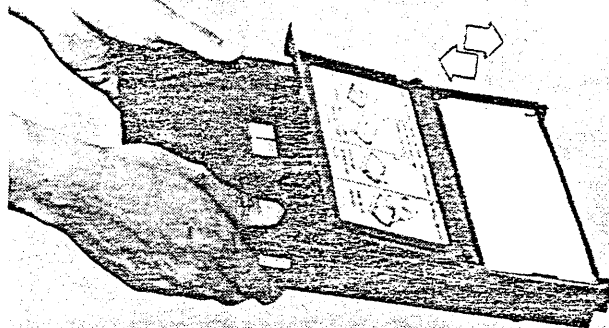

### CASSETTE INSTALLATION

1. Open the cassette top cover.

NOTE: The leading edge should be well aligned, corners should be under the separation tabs and the top cover should be correctly installed.

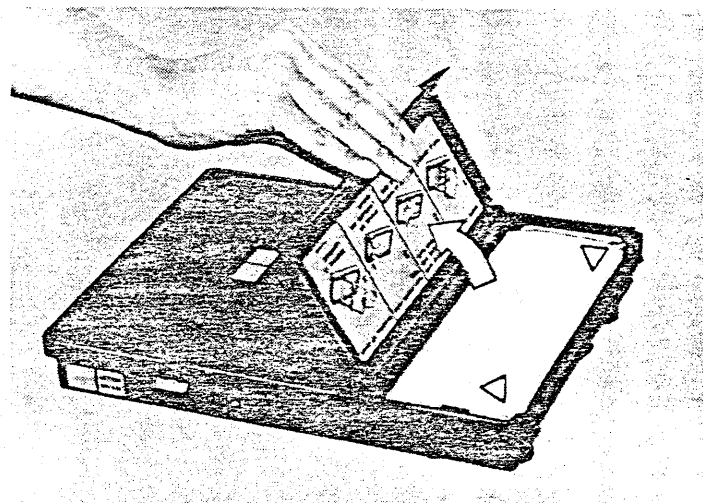

2. Insert the cassette into the LBP-10 until it locks.

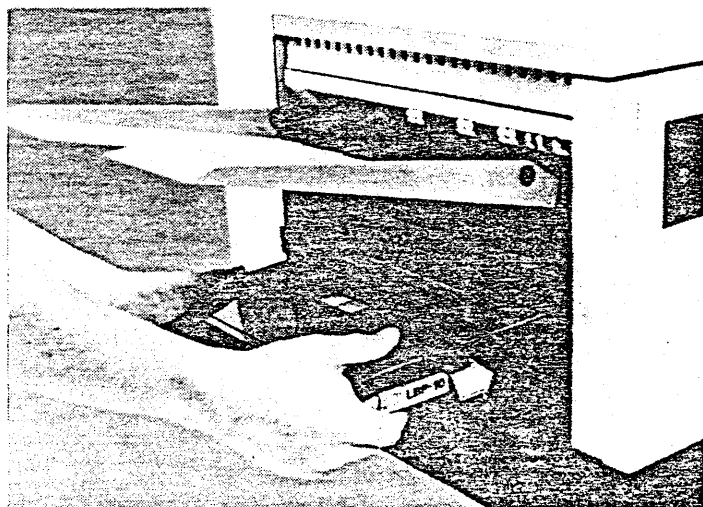

### STACKER INSTALLATION

1. Install the stacker in the sequence shown.

**CAUTION:** Turn off the power before installation.

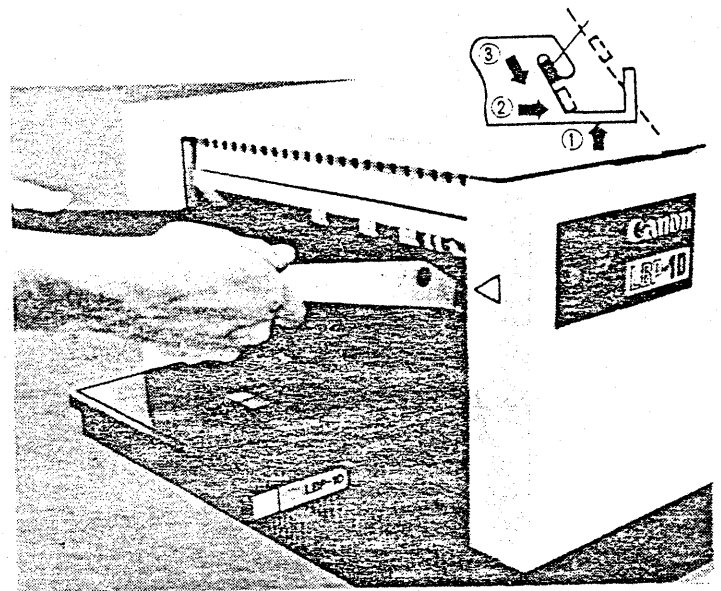

2. When clearing a jam in the cassette area, lift up the stacker.

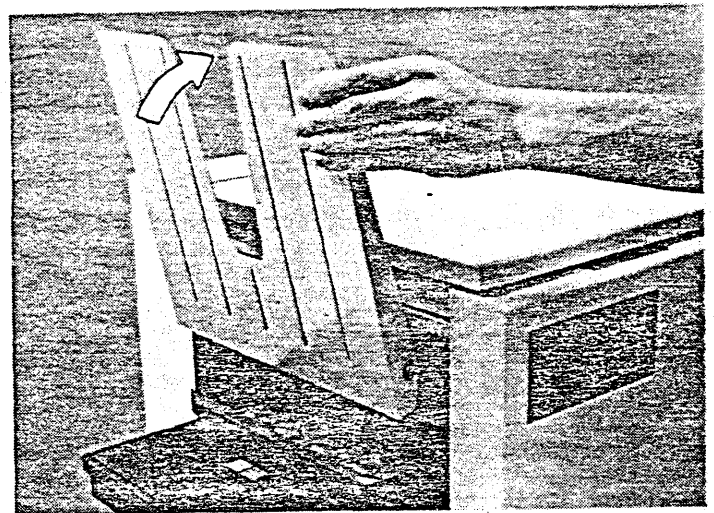

### PREMIX SUPPLY

1. Open the front access door.
2. Shake the bottle well and pour the contents into the tank. On new machine installation: Supply two bottles of premix. After installation: Supply only one bottle of premix when the indicator lamp flashes.

Hook the collar as shown.

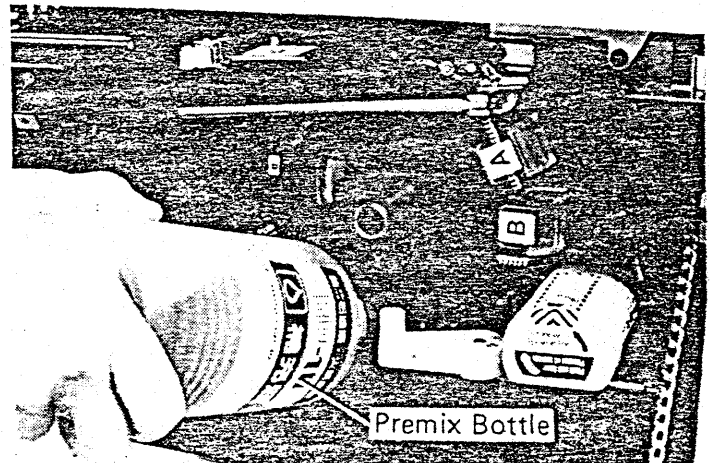
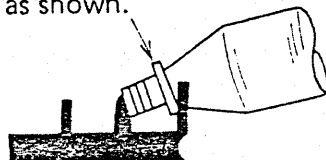

### TONER BOTTLE INSTALLATION

1. Shake the new toner bottle well. Fit the attached black valve.

CAUTION: Do not pour premix into the toner bottle.

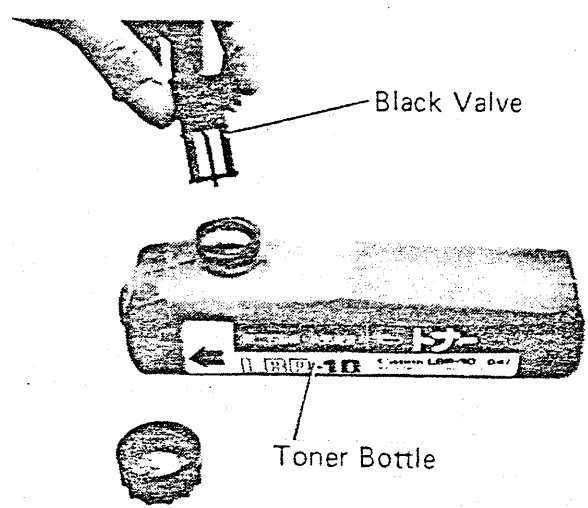

2. Insert the bottle with the valve pointing top-right until it stops (arrow "1").
3. Then, turn the bottle CW until it stops (arrow "2").

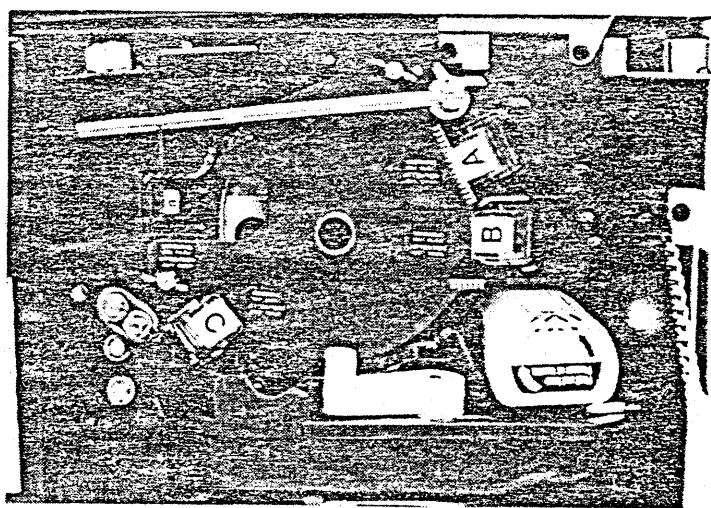
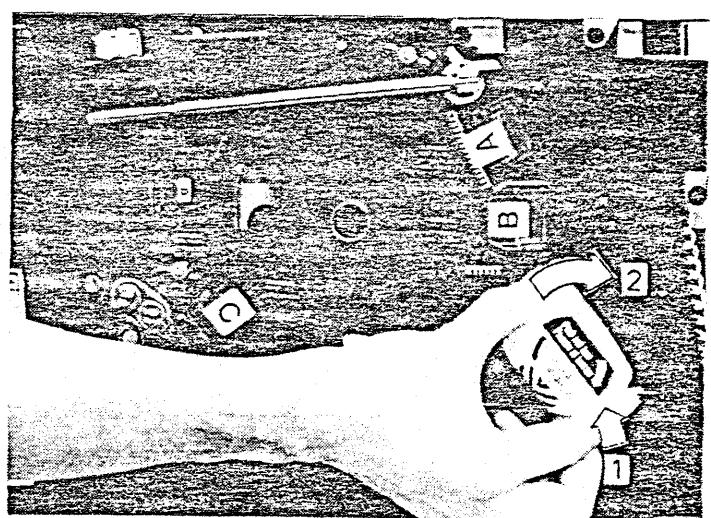

## CONNECTION OF CABLES

## ■ INTERFACE CABLE

Connect the interface cable to the receptacle on the back wall of the LBP-10.

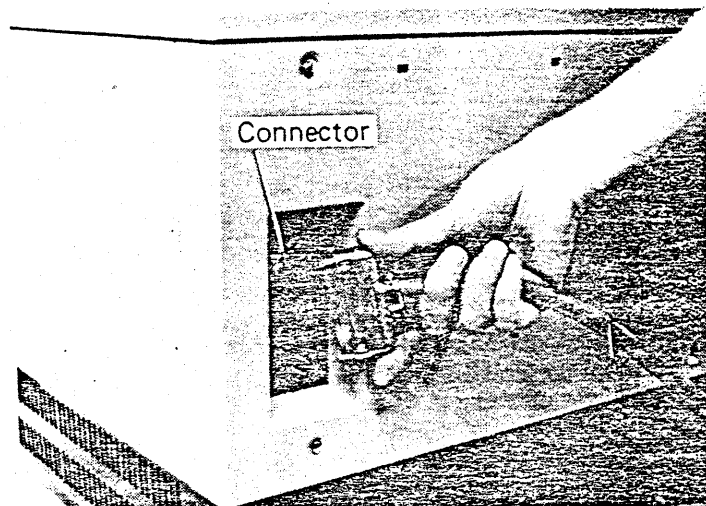

## ■ GROUNDING CABLE

Connect the grounding cable to the grounding terminal on the back of the LBP-10.

NOTE: The following manners are recommended.

If the signal ground (SG) terminal of the external controller is connected with its frame ground (FG) terminal, connect the SG terminal of the LBP-10 with its grounded FG terminal and provide a lead to the FG terminal of the external controller.

If the SG and FG terminals of the external controller are not connected each other, connect the SG terminal of the LBP-10 with its grounded FG terminal and provide separate leads to each corresponding terminal on the external controller.

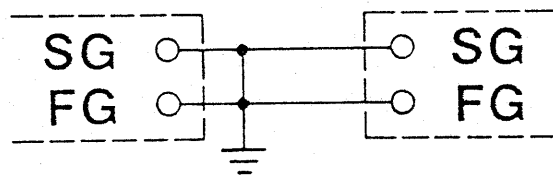
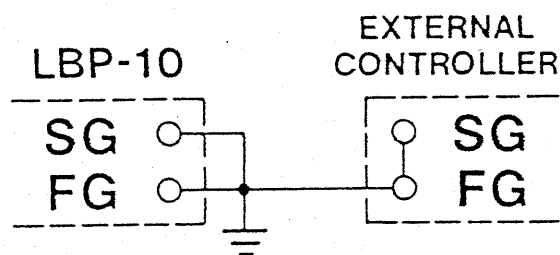

## ■ POWER CORD

Connect the power cord plug to an AC outlet.

CAUTION: Make sure that the power switch is turned off.

## INSTALLATION SUGGESTIONS

To produce the greatest efficiency and prolong the life of the machine, the following items are recommended:

- Machine spacing should be as specified in the figure on the right.
- Floor should be horizontal.
- Room should be well ventilated.
- Grounding should conform to local regulations.
- Avoid a location which is exposed to too high or too low temperature, high humidity, dust, ammonia gas, vibration and direct sunlight. Hang curtains on the windows if necessary.
- In cold and humid areas, so that the auxiliary heaters can keep the key components of the printer in good environment, do not disconnect the power plug. The auxiliary heaters operate as long as AC power is available from the wall. Also built-in developer heater is available as an option for extremely cold areas to ensure quick starting.
- When moving or transporting an LBP-10 which has been used, remove developer so that liquid will not spill out.

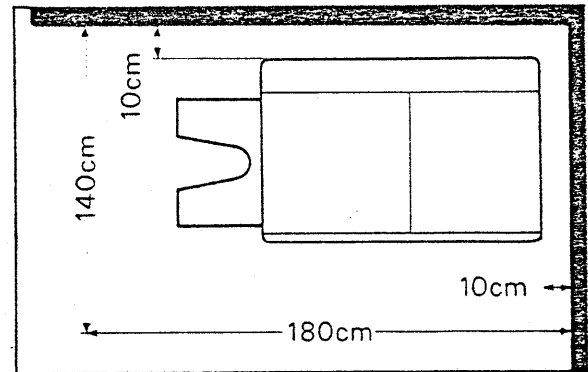

## OPERATION PROCEDURE

Before operating the LBP-10, confirm the following items.

- Power plug is connected to AC outlet.
- Emergency stop switch is turned on.
- Front access door is completely closed.
- Top access door is completely closed.
- Interface cable is connected.

1. Turn on the power switch.

CAUTION: ■ When power switch is once turned off, wait at least 2 seconds before turning on the switch again.

- When the power switch is turned off, it may take sometime for the machine comes to complete stop depending on the machine control sequence.

2. Turn on the select switch.

3. When the READY/WAIT indicator lights continuously, the LBP-10 is ready to use.

## OPERATOR PANEL GUIDE

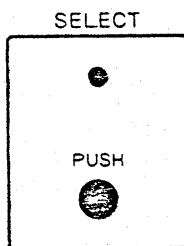
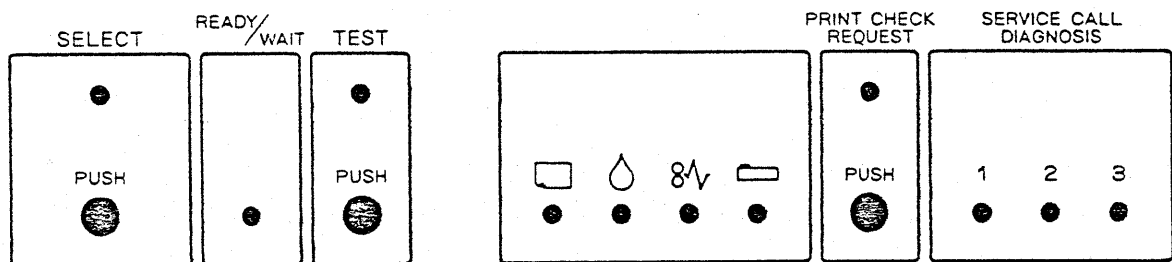

"SELECT" Switch & Indicator: Yellow

- When this switch is pressed, the LBP-10 is ready to operate under the control of the external controller.

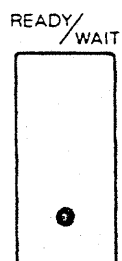

"READY/WAIT" Indicator: Green

- WAIT (flashing): The LBP-10 is warming up.
- READY (Contin.): The LBP-10 is ready to accept a print order and start printing.

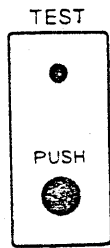

### "TEST" Switch & Indicator: Red

- This switch must be kept off usually, and should be operated only under the supervision of a service engineer.

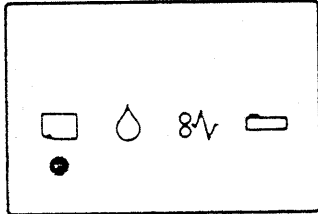

### "CHECK CASSETTE" Indicator: Red, Flashing

- The paper cassette is empty.
  - ↳ Remove the cassette from the LBP-10 and refill paper. (see "Paper Loading")
- No cassette is installed in the LBP-10.
  - ↳ Insert a paper cassette into the LBP-10 (see "Cassette Installation")
- The paper cassette is installed incorrectly.
  - ↳ Reinstall the cassette correctly. (see "Cassette Installation")

CAUTION: Confirm that the cassette top cover is opened before installation of the cassette.

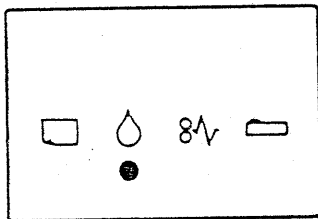

### "ADD PREMIX" Indicator: Red, Flashing

- The tank solution level is low.
  - ↳ Supply one bottle of premix. (see "Premix Supply")

CAUTION: Use Canon premix. Used bottles are collected by a service engineer. Do not throw them away.

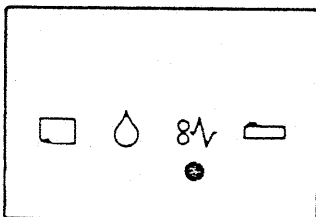

### "CHECK PAPER TRANSPORT" Indicator: Red, Flashing

- A paper jam has occurred.
  - ↳ Locate the jam and clear. (see "Paper Jam")



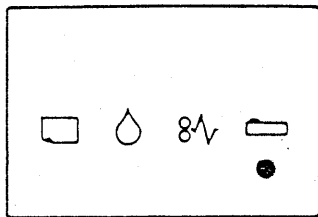

“CHECK TONER BOTTLE” Indicator: Red, Flashing

Open the front access door, then check whether the toner bottle is empty or not.

- The toner bottle is empty.
  - └ Replace it with a new one. (see “Toner Bottle Installation”)
- The toner bottle is not empty (the toner is clogging the valve).
  - └ Turn the bottle CW & CCW several times without taking it out. The bottle can be used until it is empty.

CAUTION: Do not use the old valve. Used bottles are collected by a service engineer. Do not throw them away.

PRINT CHECK REQUEST

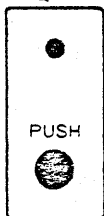

“PRINT CHECK REQUEST” Indicator: Red, Flashing & “RESTART” Switch: Red Push Button

- There are print defects on the last page.
  - └ Take out the printed page from the stacker and examine. Then, push the red switch to restart printing.

SERVICE CALL DIAGNOSIS

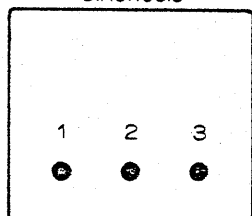

“SERVICE CALL DIAGNOSIS” Indicators: Red, Flashing

- Machine trouble and requires a trained technician.
  - └ Phone and request repair service indicating the number of the flashing LED's.

## TROUBLESHOOTING

## POOR COPY QUALITY

For poor copy quality, perform the following:

- Light copies

Clean corona wires of the corona ass'y-A, -B and -D, (using Canon wire cleaner provided).

- Contaminated copies

Clean corona wires of the corona ass'y-A, and -B.

- Straight blank lines in the copy

Clean corona wire of the corona ass'y-D, and -B.

- Small blank areas in the copy

The paper in the cassette has been exposed to excess humidity. Replace them with well conditioned paper (newly unpacked paper or paper which has been kept in a cassette with top cover closed).

- Totally blank or black copies

Push in the corona ass'y-A and -B fully.

- Moist copies

Push in the corona ass'y-C fully.

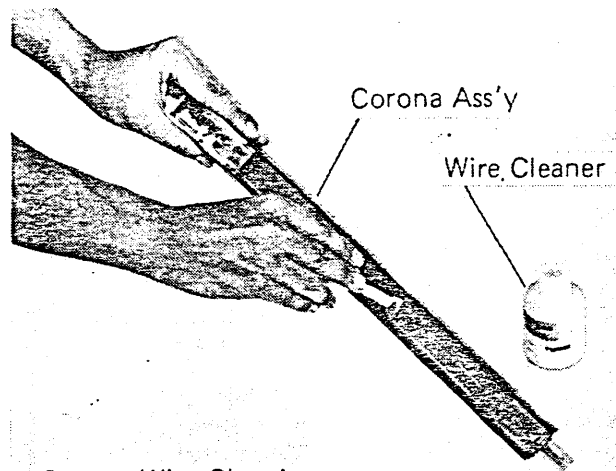

Corona Wire Cleaning

**CAUTION:** Wipe off or vaporize the cleaner solution on the corona wire well before reinstallation.

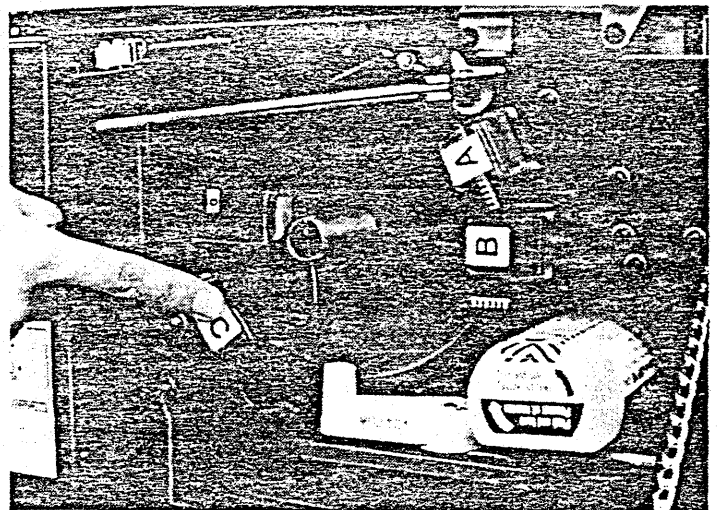

■ Contamination along the left edge

Replace the belt cleaner in the separation belt ass'y according to the following procedure.

- 1) Open the top access door.
- 2) Disengage the feeder (lift up handle and unhook bar).

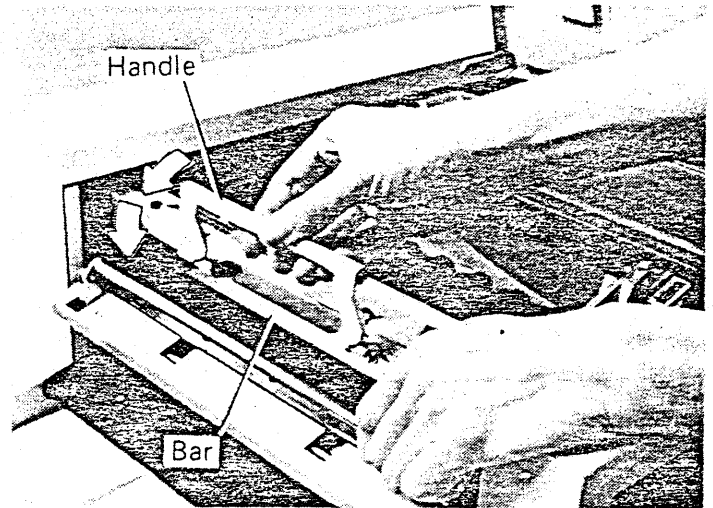

- 3) Turn the cleaner holder in the separation belt ass'y in the direction of the arrow "1" until it stops, then pull off the belt cleaner upward (arrow "2").
- 4) Turn the cleaner holder in The direction of the arrow "1" until it stops, and insert a new belt cleaner.
- 5) Re-engage the feeder (place bar in notches and lower handle).
- 6) Press the reset button and close the top access door.

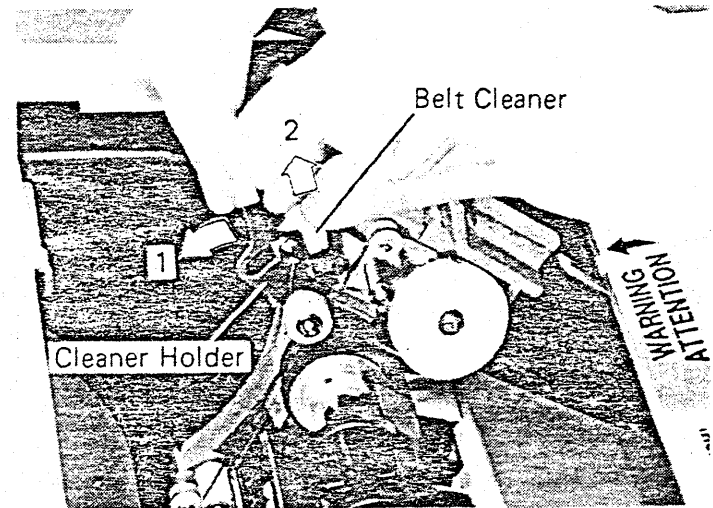

NOTES:

- In cold or humid areas, so that the auxiliary heaters can keep the key components of the printer in good environment, do not disconnect the power plug. When the auxiliary heaters have not been operated, poor quality copies such as a light copy, a contaminated copy and etc. may be produced and also the life of the drum is shortened. In this occasion, before actual printing, auxiliary heaters must be operated for a extended period of time to obtain improved copies. The length of the period depends on the environmental conditions.
- Exposing the print paper to excess humidity may result in a poor quality printout. Try to keep the print paper dry with cassette top cover closed when it is not used.
- In case of no improvement or poor copy quality for reasons other than those listed above, call a service engineer.

## PAPER JAM

1. Turn off the power.
2. Open the top access door.
3. Then, locate the jam referring to the figure on the right.

**CAUTION:** When clearing jam, a small part of jammed paper may be torn off and left inside the machine. Be sure to check paper transport carefully so that even a slip of paper be removed.

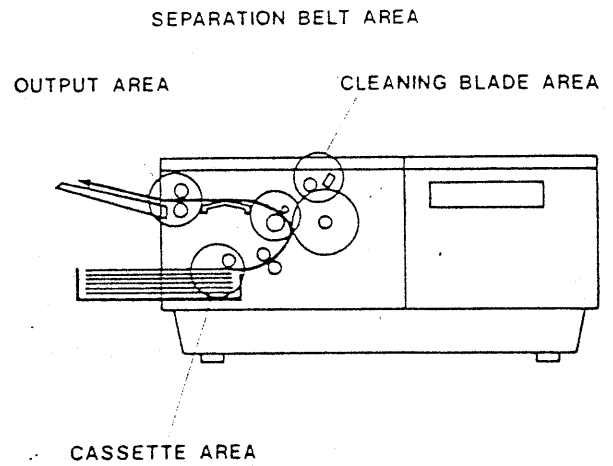

- If the jam is in the [OUTPUT AREA]
  - 1) Disengage the feeder (lift up handle and unhook bar).

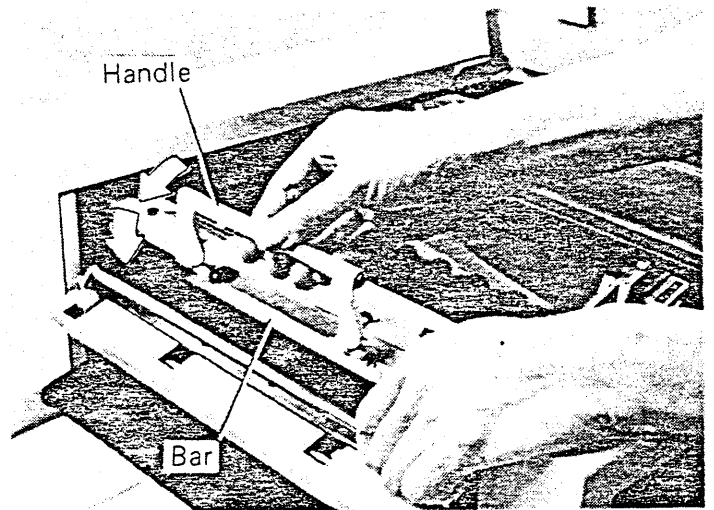

- 2) Remove the jammed paper.

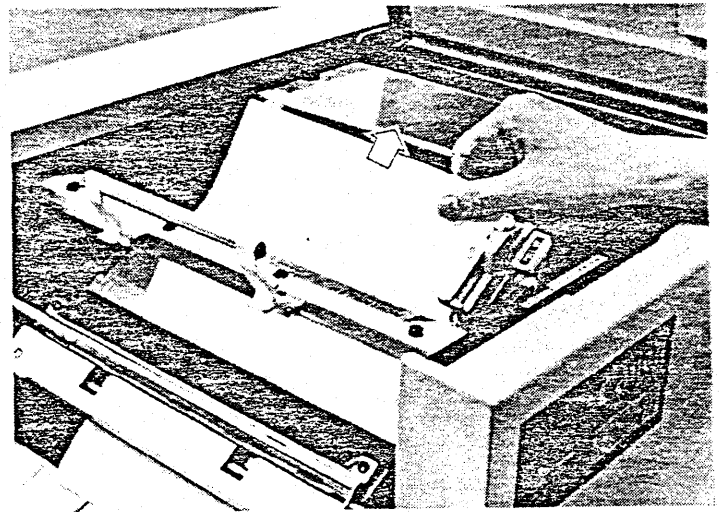

- 3) Re-engage the feeder (place bar in notches and lower handle).
- 4) Press the reset button and close the top access door.

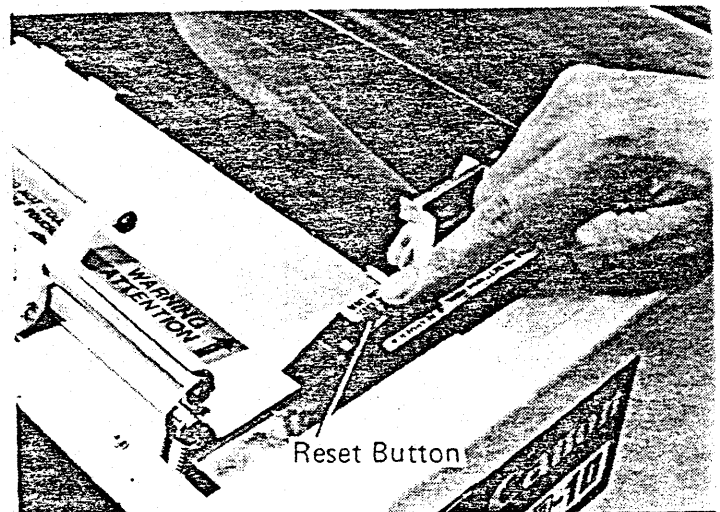

■ If the jam is in the [CLEANING BLADE AREA]

- 1) Open the front access door.
- 2) Unlock the blade lever.
- 3) Open the drum top cover.

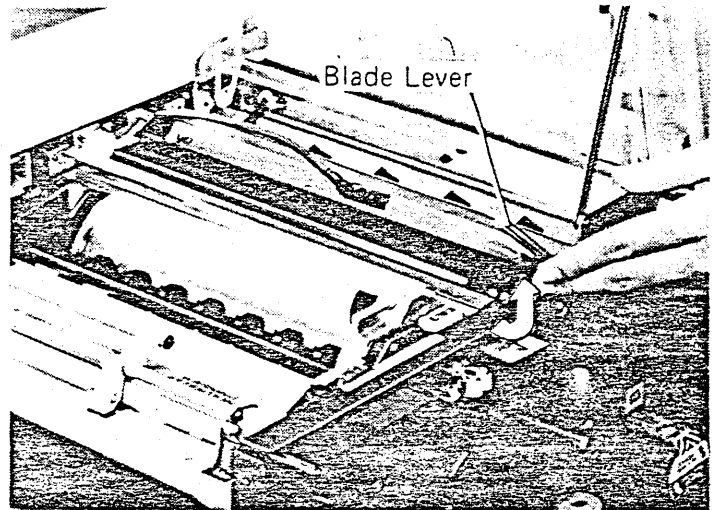

- 4) Remove the jammed paper.

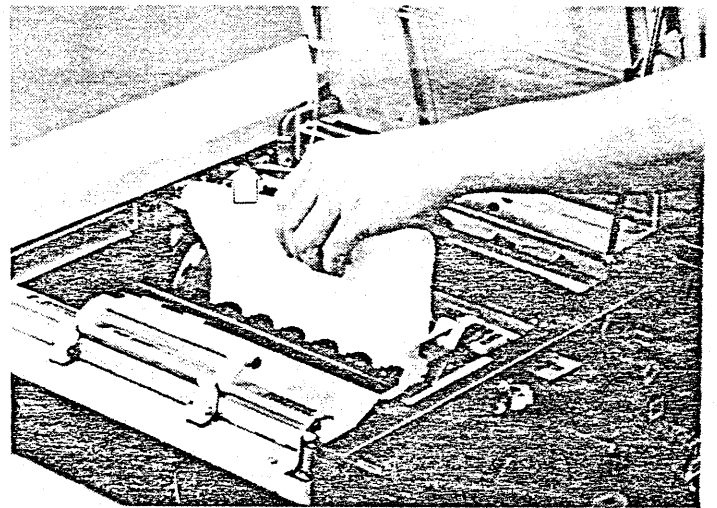

- 5) Disengage the feeder (lift up handle and unhook bar).

Then, check whether the separation belt is broken. If it is broken, replace the entire ass'y referring to the "DAMAGE of The SEPARATION BELT" in this section.

If the belt is not damaged, then

- 6) Re-engage the feeder (place bar in notches and lower handle).
- 7) Lock the blade lever.
- 8) Close the front access door.
- 9) Close the drum top cover.
- 10) Press the reset button and close the top access door.

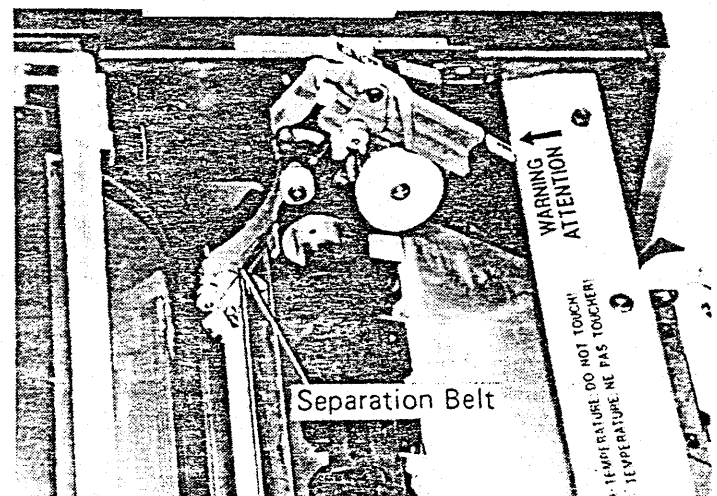

■ If the jam is in the [SEPARATION BELT AREA]

- 1) Disengage the feeder (lift up handle and unhook bar).
- 2) While turning the separation roller gear in the direction shown, remove the jammed paper.
- 3) Re-engage the feeder (place bar in notches and lower handle).

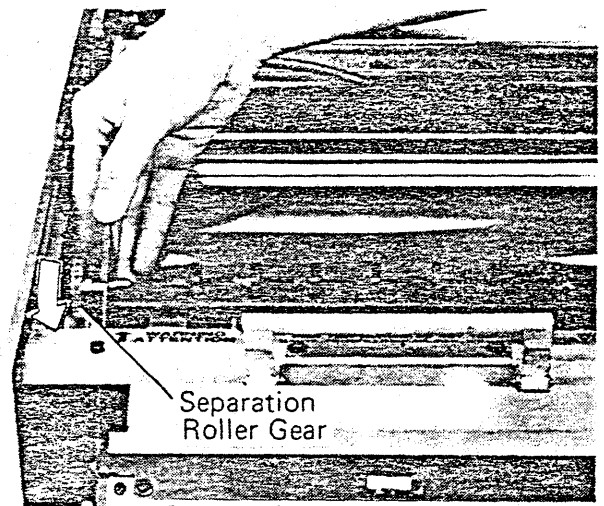

- 4) Press the reset button and close the top access door.

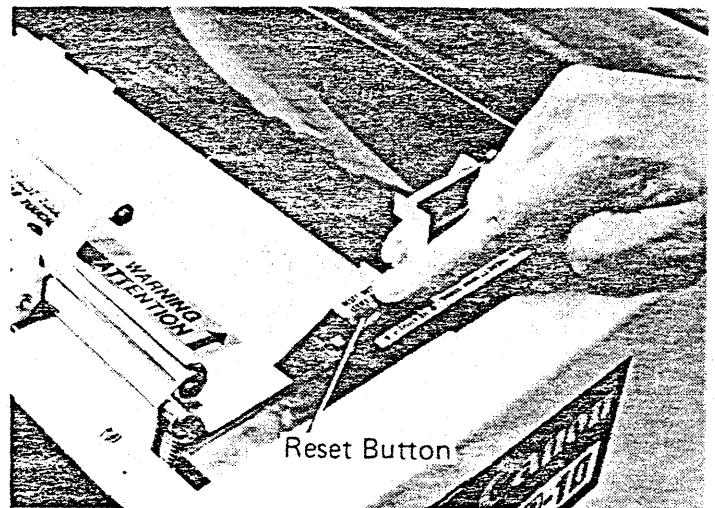

■ If the jam is not in the aforementioned areas, check the [CASSETTE AREA]

- 1) Remove the cassette and clear the jam.
- 2) Press the reset button and close the top access door.

NOTE: For frequent paper jams, reload the paper again following the steps described in the "Paper Loading" section in this manual.

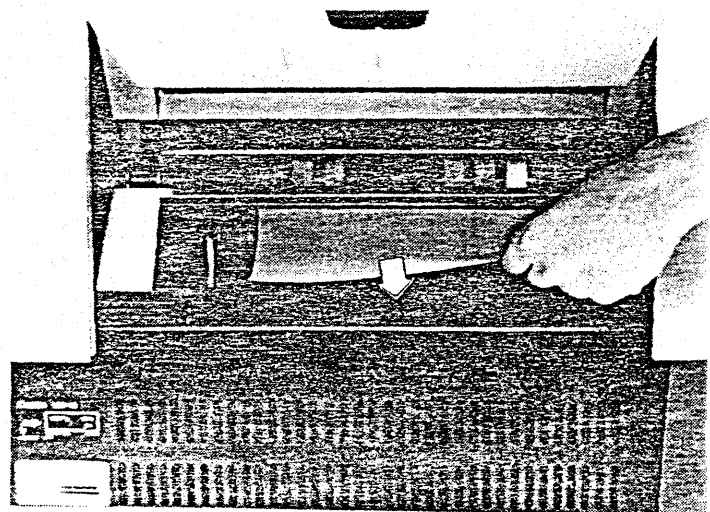

## DAMAGE OF THE SEPARATION BELT

When clearing a jam in the cleaning blade area, check whether the separation belt is broken or not. If broken, replace the entire ass'y according to the following procedure.

1. Lift up the feeder by its bar and remove the cassette from the LBP-10.

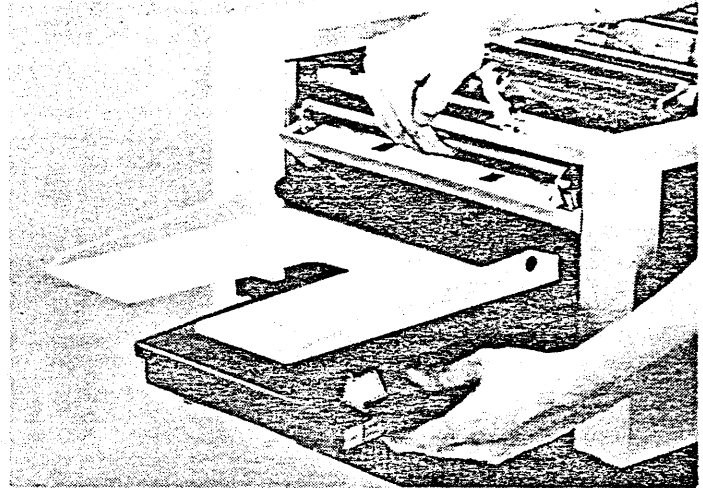

2. Pull the release lever upward.

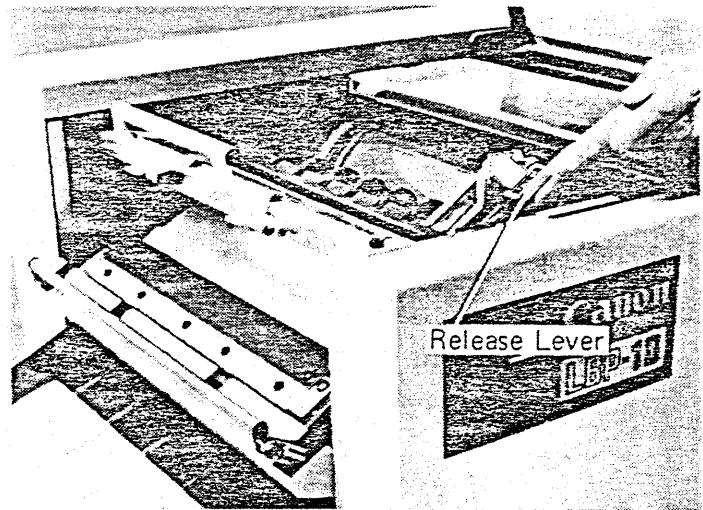

3. Lift up the separation belt ass'y and remove while taking care not to scratch the drum surface.

4. Take out a new separation belt ass'y.

NOTE: Order another spare separation belt ass'y.

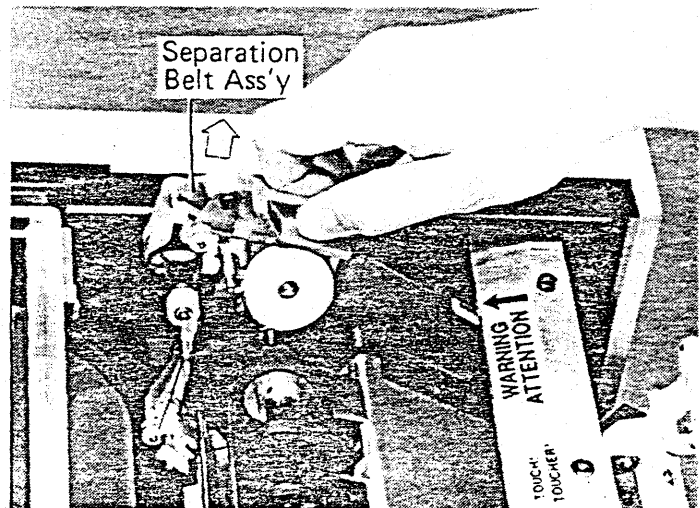



5. Hold the new ass'y with your left hand, insert the ass'y stud into the U-guide of the feeder plate and lower until it stops (taking care not to scratch the drum surface).

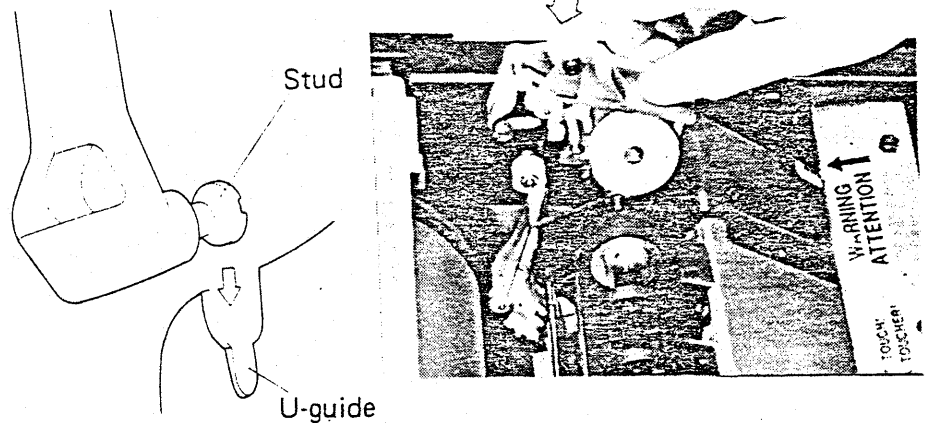

6. Tilt the ass'y in the direction "1" until it stops, press the release lever in the direction "2" with your right hand until it locks.

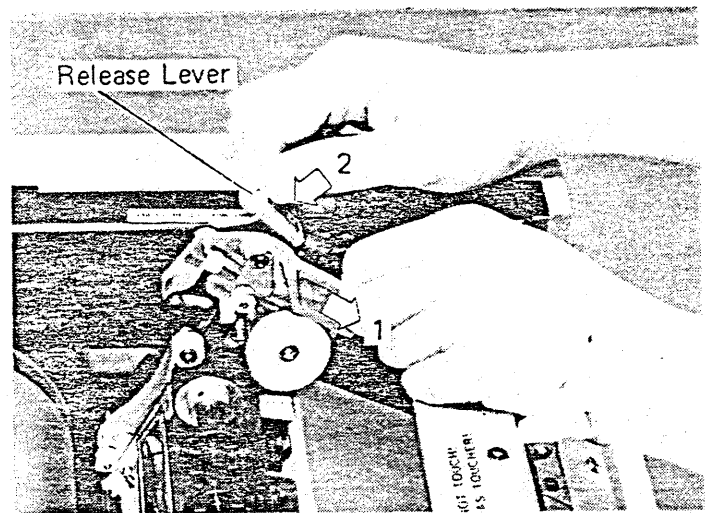

7. Confirm correct movement of the belt by turning the separation roller gear by hand.

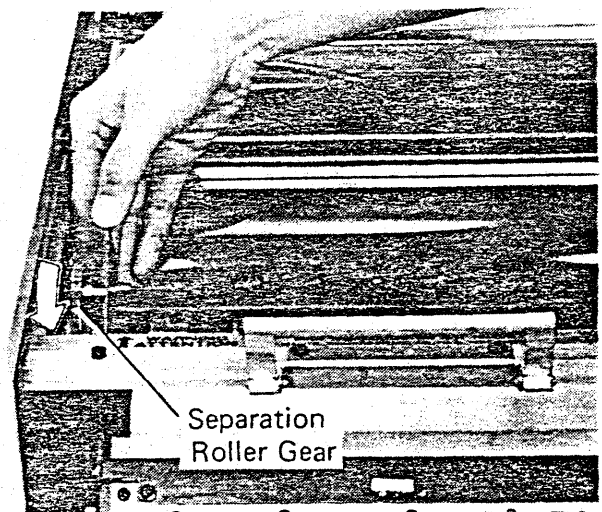

8. Engage the feeder (hook bar and lower handle).
9. Press the reset button and close the top access door.
10. Insert the cassette into the LBP-10.

## SUGGESTIONS FOR DAILY USE

### CORONA WIRE CLEANING

It is recommended that corona wires of the corona ass'y-B and -D be cleaned once every week according to the following procedure.

1. Remove the corona ass'y.
2. Using the applicator, apply the cleaner — after squeezing out excess — to the wire until the black contamination is removed.
3. Push the corona ass'y fully into the LBP-10.

**CAUTION:** Wipe off or vaporize the cleaner solution on the corona wire well before reinstallation.

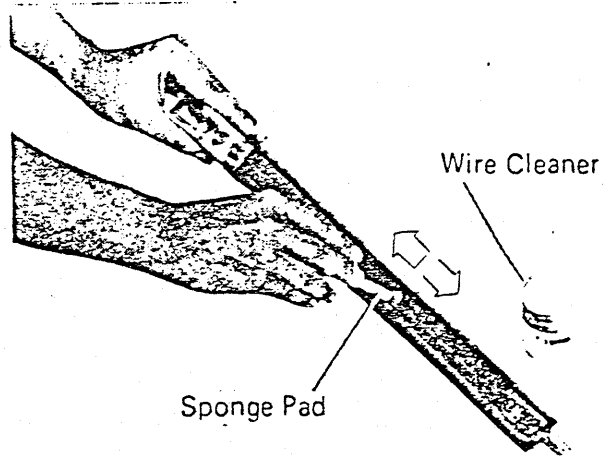

### STORAGE OF CONSUMABLES

- Take care the print paper to keep dry.  
When the paper in the cassette is not used for an extended period of time, close the cassette top cover.
- Store the toner and premix bottles in a dark and cool place.
- Toner and premix are inflammable. Keep them away from open fires.

### EMERGENCY STOP

For the event of unexpected accidents (such as going on fire, emitting smoke, sparking, etc.), EMERGENCY STOP SWITCH is provided on the pedestal.

This switch must be kept normally on, and should be turned off only in an emergency.

