



Interface Systems, Inc.

468

**model 2
operator's guide**



Interface Systems, Inc.

468

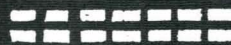

INTERFACE SYSTEMS, INC.

468 Model 2

Revision Date: March 1988

HOW TO USE THIS MANUAL

Congratulations on your choice of the ISI 468 Model 2 printer!

The search for a great printer is over--now the fun part begins. This manual will guide you through all the procedures you'll need to set up and operate the ISI Model 468 printer, also known as the 468. If you are setting up your printer for the first time, be sure to read the sections in order. To help you find the information you need quickly and easily, this manual has been divided into three sections.

Section 1

Getting Started - is a quick version of set up procedures to get you started now and teach you the details later. (4 - 23)

Section 2

How To Operate the 468 - is a detailed version which tells you more about the keys, indicators, and switches on your printer. It also tells you how to use color and programmed symbols as well as what to do if you have any problems with your printer. (24 - 66)

Section 3

Appendix Section - is the section which includes instructions on special programming, programming details on color and programmed symbols, printer options such as the twin-bin and envelope feeder, and the general care and cleaning of your printer. (1 - 124)

Now, let's get started!

Section 1 - GETTING STARTED



...designed to get you set up and printing fast!

Table of Contents

Chapter 1 THE QUICK VERSION	4
1.1 FIRST, UNPACK YOUR PRINTER	4
1.2 NEXT, CHECK FOR DAMAGE	4
1.3 DO YOU HAVE THE RIGHT EQUIPMENT?	5
1.4 INSTALL YOUR PAPER GUIDE RACKS	6
1.5 LOAD THE RIBBON	8
1.6 TURN THE POWER ON AND TEST THE PRINTER	10
1.7 HOW TO ATTACH THE TWIN-BIN AND ENVELOPE FEEDER	11
1.8 LOAD THE PAPER	11
1.8.1 Loading Continuous Forms	12
1.8.2 Loading Cut Sheets	14
1.9 CONNECTING THE 468 TO A CONTROLLER	17
1.10 CONNECTING THE 468 TO A PARALLEL PORT	18
1.11 HOW TO OPERATE YOUR PRINTER	19
1.11.1 The Front Panel	20
1.11.2 The Back Panel	21
1.12 CHECK THESE THINGS BEFORE YOU START PRINTING	22
1.13 WHAT TO DO IF YOU HAVE A PRINTER PROBLEM	23

Section 2 - HOW TO OPERATE THE ISI 468 MODEL 2

...designed to tell you everything you want to know about your ISI 468 printer.

Chapter 2 HOW TO OPERATE THE ISI 468 MODEL 2	26
2.1 SUMMARY OF PRINTER PARTS	26
2.1.1 Standard Features	26
2.2 FEATURES YOU CAN CONTROL	27
2.3 INSTALLING A NEW RIBBON	30
2.4 RELOADING FORMS	31
2.4.1 Reloading Continuous Forms	32
2.4.2 Reloading Cut Sheets	33
2.4.3 Adjusting for Forms Thickness	34
2.5 RELOADING THE TWIN-BIN AND ENVELOPE FEEDER	34
2.6 OPERATIONS YOU CAN CONTROL	34
2.7 DEFAULT SETTINGS	35
2.8 PRIMARY FUNCTION KEYS	36
2.8.1 HOLD PRINT	36
2.8.2 ENABLE PRINT	36
2.8.3 INDEX	36
2.8.4 FORM FEED	36
2.8.5  (Paper Advance Key)	37
2.8.6  (Paper Reverse Key)	37
2.8.7 CHANGE PITCH	37
2.8.8 SETUP	38
2.8.9 BUFFER REPRINT	38
2.8.10 RESET	38
2.8.11 PA1 and PA2 (Program Attention)	39
2.8.12 CANCEL	39
2.8.13 BASE COLOR	39
2.8.14 CHANGE LPI (Lines Per Inch)	39
2.8.15 CHANGE SPACE	40
2.8.16 CHANGE CASE	40
2.8.17 CHANGE MODE	41
2.8.18 CHANGE SPEED	41
2.8.19 SECOND FUNCTION	42
2.9 SECOND FUNCTION KEYS	42
2.9.1 SET FORMS (Forms Length)	42
2.9.2 Forms Length Setting Example	43
2.9.3 SET MPP (Maximum Presentation Position)	44
2.9.4 CONFIGURE	44
2.9.5 100, 10, and 1	45

2.9.6 TEST	45
2.9.7 DIAGNOSE	45
2.9.8 ACCEPT SHEET	46
2.9.9 BIN SELECT	46
2.9.10 F1 (Function)	47
2.9.11 F2 (Function)	47
2.9.12 CHANGE HOST	47
2.10 WHAT THE INDICATOR LIGHTS MEAN	47
2.10.1 READY	48
2.10.2 HOLD PRINT	48
2.10.3 TEST	49
2.10.4 CHECK	49
2.10.5 CU SIGNAL	49
2.10.6 DOUBLE	49
2.10.7 DUAL CASE	50
2.10.8 8 LPI	50
2.10.9 CUT SHEET	50
2.10.10 NLQ	50
2.10.11 ALT (alternate) HOST	50
2.10.12 COMPRESS	50
2.10.13 COLOR	50
2.10.14 SCS MODE	51
2.11 USER SELECTABLE FEATURES	51
2.11.1 The Language Select Switch Settings	51
2.11.2 IBM Model Select Switches	55
2.11.3 Special Function Switch Settings	56
2.11.4 STATUS INDICATOR	58
2.11.5 Audible Alarm	59
2.11.6 CU Indicator	59
2.12 HOW TO USE COLOR AND PROGRAMMED SYMBOLS	59
2.12.1 How to Use Color	59
2.12.2 How to Use Programmed Symbols	62
2.12.3 Combining Color and Programmed Symbols	62
2.12.4 Combining Color and Large Character Printing	62
2.13 WHAT TO DO IF YOU HAVE A PRINTER PROBLEM	63
2.14 Operational Status Codes	63
2.15 Running a Self-Test	65

Section 3 - APPENDIX SECTION

The following appendices contain information that you won't need for everyday use.

Table of Contents

Appendix A CARE AND CLEANING OF YOUR PRINTER	68
Appendix B PROGRAMMING THE ISI 468 FOR SPECIAL PRINTING FUNCTIONS	70
B.1 SELECTING PRINT MODE	71
B.2 PROGRAMMING INSTRUCTIONS FOR THE LARGE CHARACTER OPTION	71
2.0.1 Combining Color and Large Character Printing	74
B.3 INSTRUCTIONS FOR COLOR PRINTING	76
2.0.1 Base Color	76
2.0.2 Extended Color	76
2.0.3 Selecting Color Through the Data Stream	78
B.4 INSTRUCTIONS FOR PROGRAMMED SYMBOLS	79
B.5 Using Color and Programmed Symbols Together	80
2.0.1 Tips on Color Use	80
Appendix C INSTRUCTIONS FOR THE TWIN-BIN AND ENVELOPE FEEDER	82
C.1 Preparing Your Printer for the Twin-Bin and Envelope Feeder	82
C.2 Attaching the twin-bin and envelope feeder	84
C.3 Loading Paper Into the Cartridges	85
C.4 Loading Cartridges Into the Sheet Feeder	90
C.5 Adjusting the Sheet Feeder	91
C.6 How to Adjust the Sheet Feeder	92
C.7 Paper Tray Installation	94
C.8 Bin Selection	95
C.9 Removing/Replacing Fixed Width Cartridge Inserts	96
C.10 Removing/Replacing the "T" Shaped Paper Support	98
C.11 What to Do if You Have Problems With The Sheet Feeder	99
Appendix D PAPER SPECIFICATIONS	102
D.1 CONTINUOUS FORMS DESIGN	102
D.2 CUT SHEET FORMS DESIGN	104
D.3 ENVELOPES	106
D.4 TWIN-BIN AND ENVELOPE FORMS DESIGN	106
D.5 Paper Storage	108
D.6 Continuous Forms Design	109
D.7 Cut Sheet Forms Design	109
D.8 Envelope Design	109
Appendix E CONNECTING AND PROGRAMMING THE IBM PERSONAL COMPUTER FOR USE WITH THE ISI 468 MODEL 2	111
E.1 CONNECTING THE 468 TO A PARALLEL PORT	111
E.2 Control Characters and Escape Sequences	112
E.3 Supported Control Characters	113
E.4 Supported Escape Sequences	114
Appendix F Programming Instructions for the Bar Code Option	119
F.1 Code 3 of 9	122
F.2 Code 2 of 5	123

FEDERAL COMMUNICATIONS COMMISSION

RADIO FREQUENCY INTERFERENCE

STATEMENT

This equipment generates and uses radio frequency energy and if not used properly, i.e., in strict accordance with its operating instructions, may cause harmful interference to radio communications. It has been tested and found to comply with the limits for a Class A computing device pursuant to Subpart J of Part 15 of FCC rules, which are designed to provide reasonable protection against such interference when Class A equipment is operated in a commercial environment.

Operation of this equipment in a residential area is likely to cause interference, in which the user, at his own expense, will be required to correct the interference.

Section 1: The Quick Version

Chapter 1

THE QUICK VERSION

1.1 FIRST, UNPACK YOUR PRINTER

After you have carefully followed the "Unpacking Instructions" attached to your 468:

1. Remove the metal carriage restraint marked with the florescent orange warning tag. NOTE: Some printer's are restrained with plastic tie-wraps instead of the metal carriage restraint. To remove the tie wraps, simply cut with a pair of scissors or clippers.

NOTE

DO NOT try to operate the printer with the restraints on. It may damage the printer.

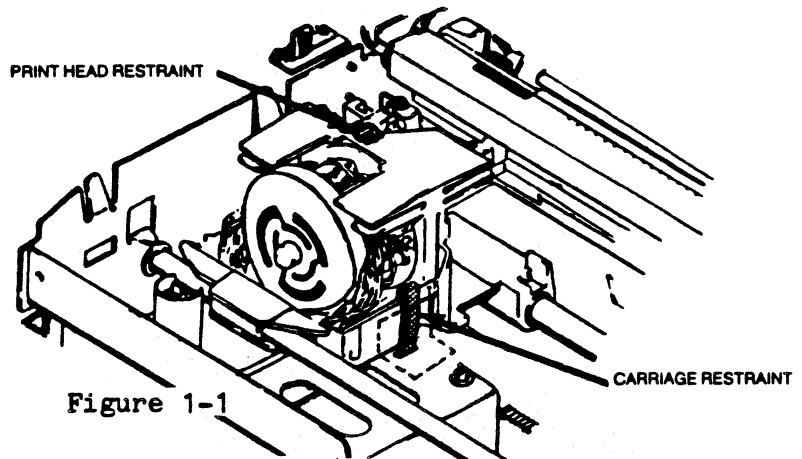

Figure 1-1

1.2 NEXT, CHECK FOR DAMAGE

BEFORE YOU DO ANYTHING ELSE, inspect your printer for shipping damage such as: dents, scratches, cracks, broken switches, and other broken parts. You should also listen for unusual rattling noises. If you find any damage, notify the delivery company immediately!

WARNING

DO NOT operate a damaged printer. It may cause further damage and can void the warranty.

1.3 DO YOU HAVE THE RIGHT EQUIPMENT?

1. One standard three-prong grounded power outlet per printer.
2. One coaxial cable with a BNC coaxial connector, and an IBM 3274 type A Control Unit (CU) or equivalent unit to attach it to. The length should not exceed 1500 meters (4920 feet).
3. If you are connecting to an IBM PC or equivalent unit, you need one standard 36 pin parallel type connector. The maximum length of the connector varies with each system.
4. One table or print stand with enough room around it for ventilation, hookup of the cables, a user work area, and any additional equipment you may want. (See Figure 1-2 below)

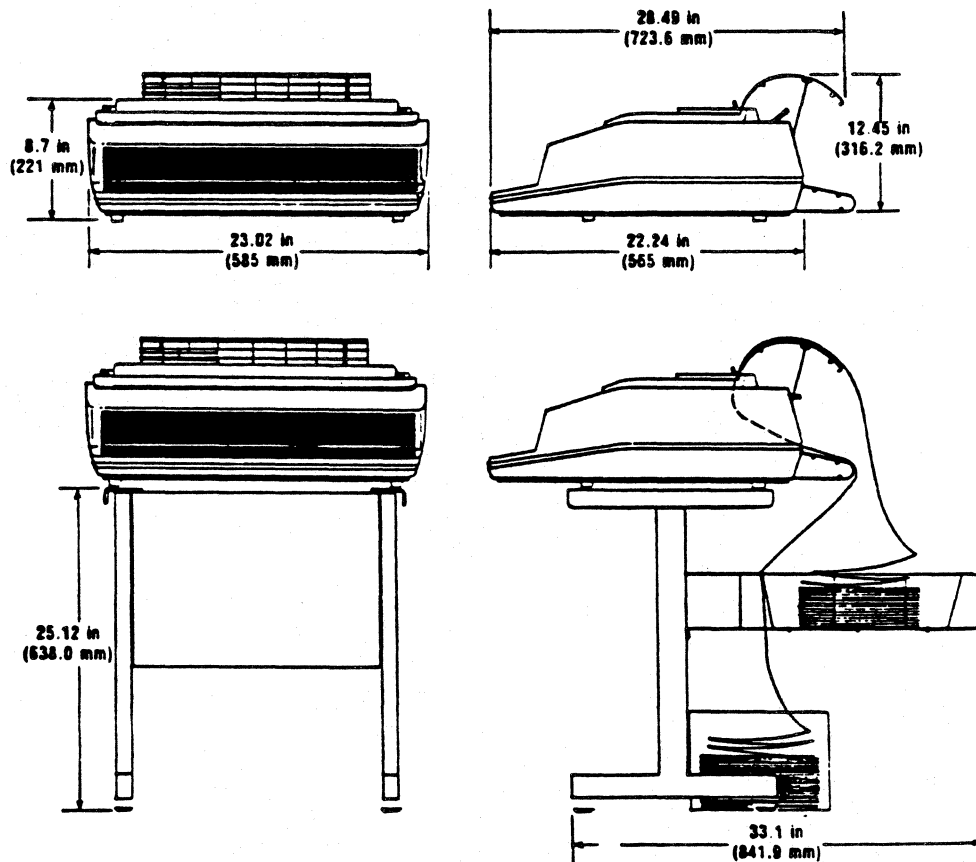

Figure 1-2 Printer Dimensions

1.4 INSTALL YOUR PAPER GUIDE RACKS

To install the input paper rack:

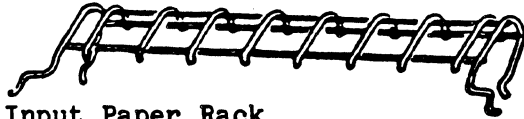

Figure 1-3 Input Paper Rack

1. Face the rear of your printer.
2. Pick up the input paper rack.
3. Insert the prongs into the mounting holes.

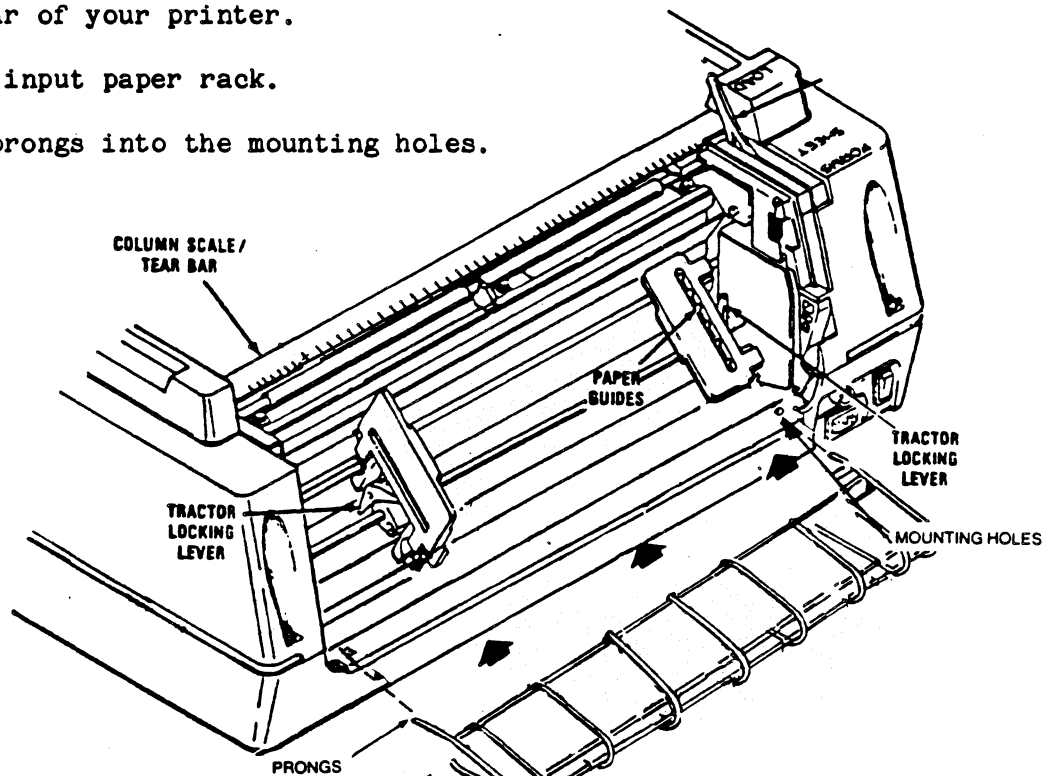

Figure 1-4 Attaching the Input Paper Rack

4. Make sure the input rack is at a 90 degree angle with the rear cover and does not tilt upward.

While you are still facing the back of your printer, install the output paper rack. To install the output paper rack, perform the following directions.

1. Pick up the output paper rack.
2. Remove the two nylon thumbnuts and retain.
3. Insert the two prongs of the output rack into the mounting holes on top of the rear cover.

Figure 1-5 Attaching the Output Rack

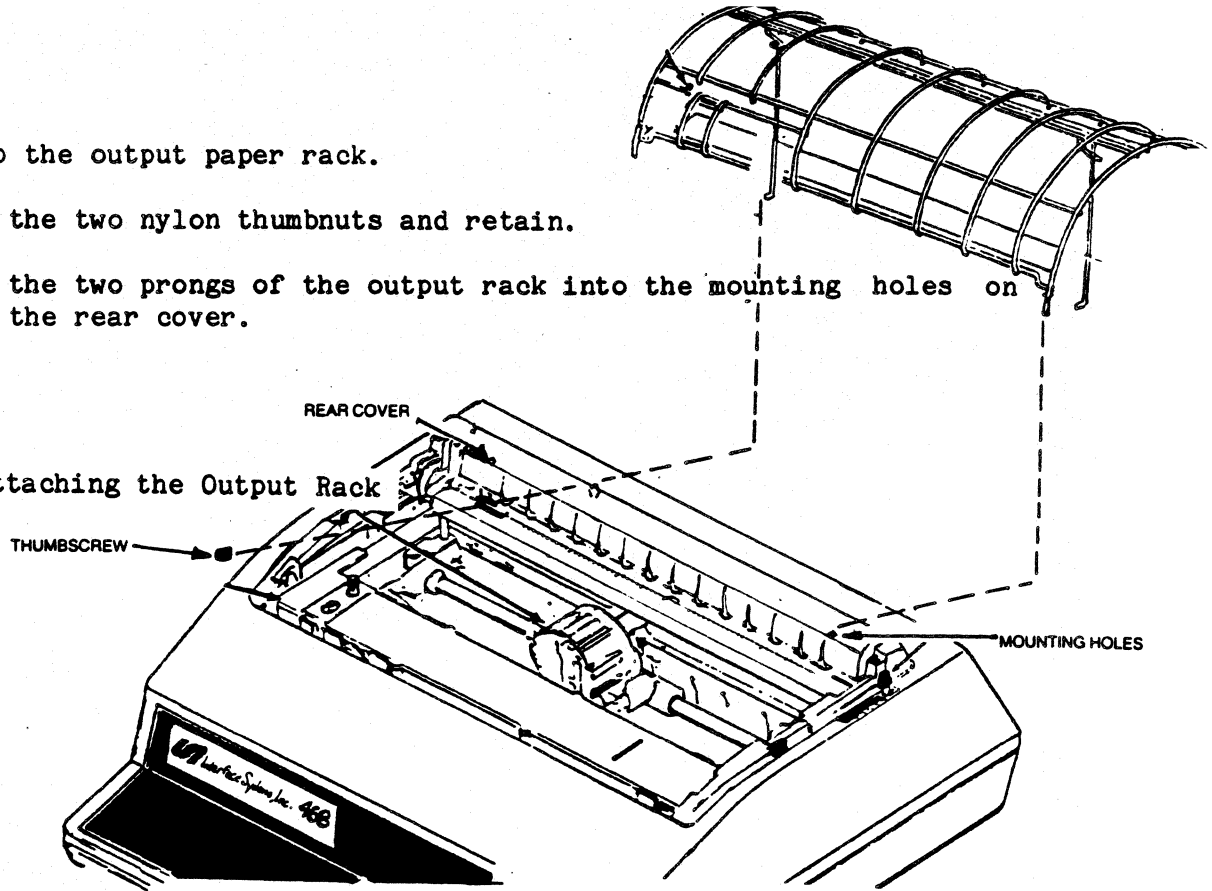

4. Insert the other two threaded mounting prongs into the mounting holes in the middle of the rear cover.

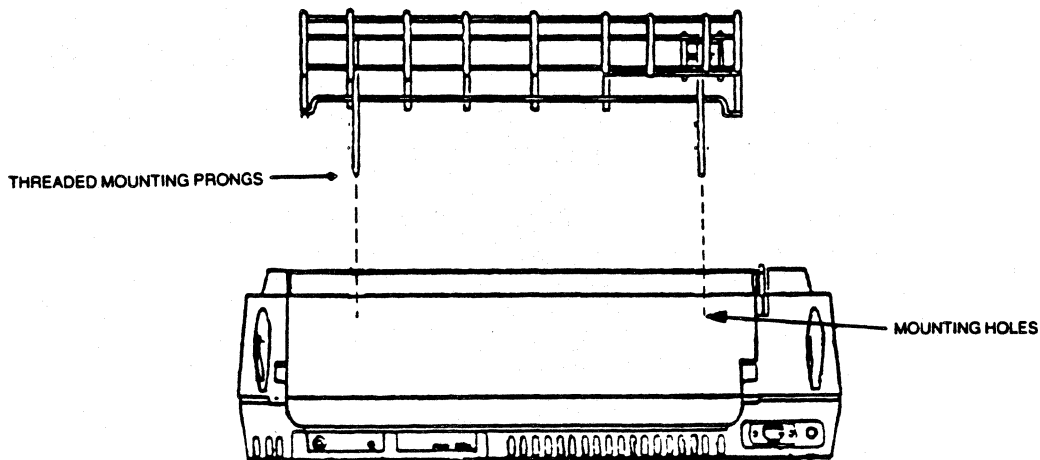

Figure 1-6 Rear View: Attaching the Output Rack

5. Carefully open the rear cover and place the thumbnuts on the threaded part of the mounting arms.
6. Close the rear cover.

NOTE

Failure to properly attach the input and output paper racks will result in static electric buildup and sporadic printer failure.

1.5 LOAD THE RIBBON

Please use the ribbon cassette supplied by Interface Systems, Inc., or you may void the warranty. The Model 2 uses a four color ribbon, (black, blue, green, and red) a seven color ribbon, (yellow, cyan [turquoise], magenta [pink], red, blue, green, and black) as well as an all black ribbon. Please note that ribbon life is determined by the total characters printed in any color, thus it is advisable to use a solid black ribbon for jobs that don't require color. See Section 2.12.1 for printing characteristics of each ribbon.

To install the ribbon, face the front of your 468 and do the following:

1. Turn the printer OFF. (On power up the printer will automatically sense what ribbon has been installed.)
2. Lift the top cover up and off the printer.

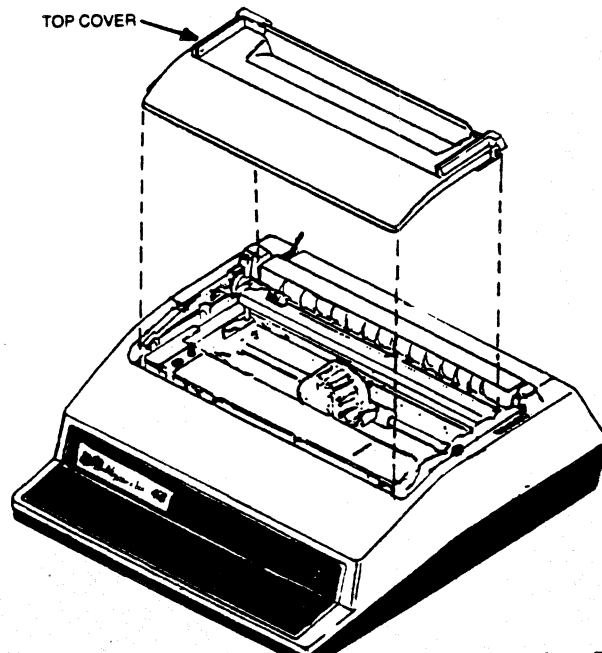

Figure 1-7 Removing the Top Cover

3. Unsnap (by pushing) the top part of the rear cover and let it hang open.

4. Move the forms lever to "LOAD".

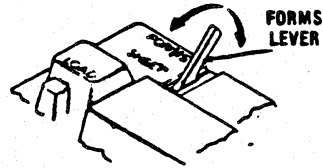
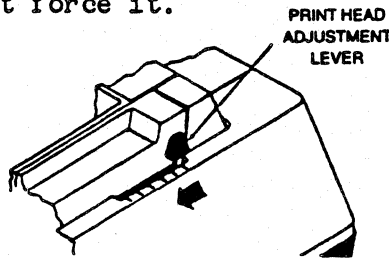

Figure 1-8

5. Pull the head adjustment lever toward the front of the printer as far as it will go, but don't force it.



6. Lift up the silver column scale and move the print head to the middle position. Your printer should not be on at this time, if it is turn it off.

7. Install the new corner guides. To install, simply push the guides onto the guide posts. (See Figure 1-9)

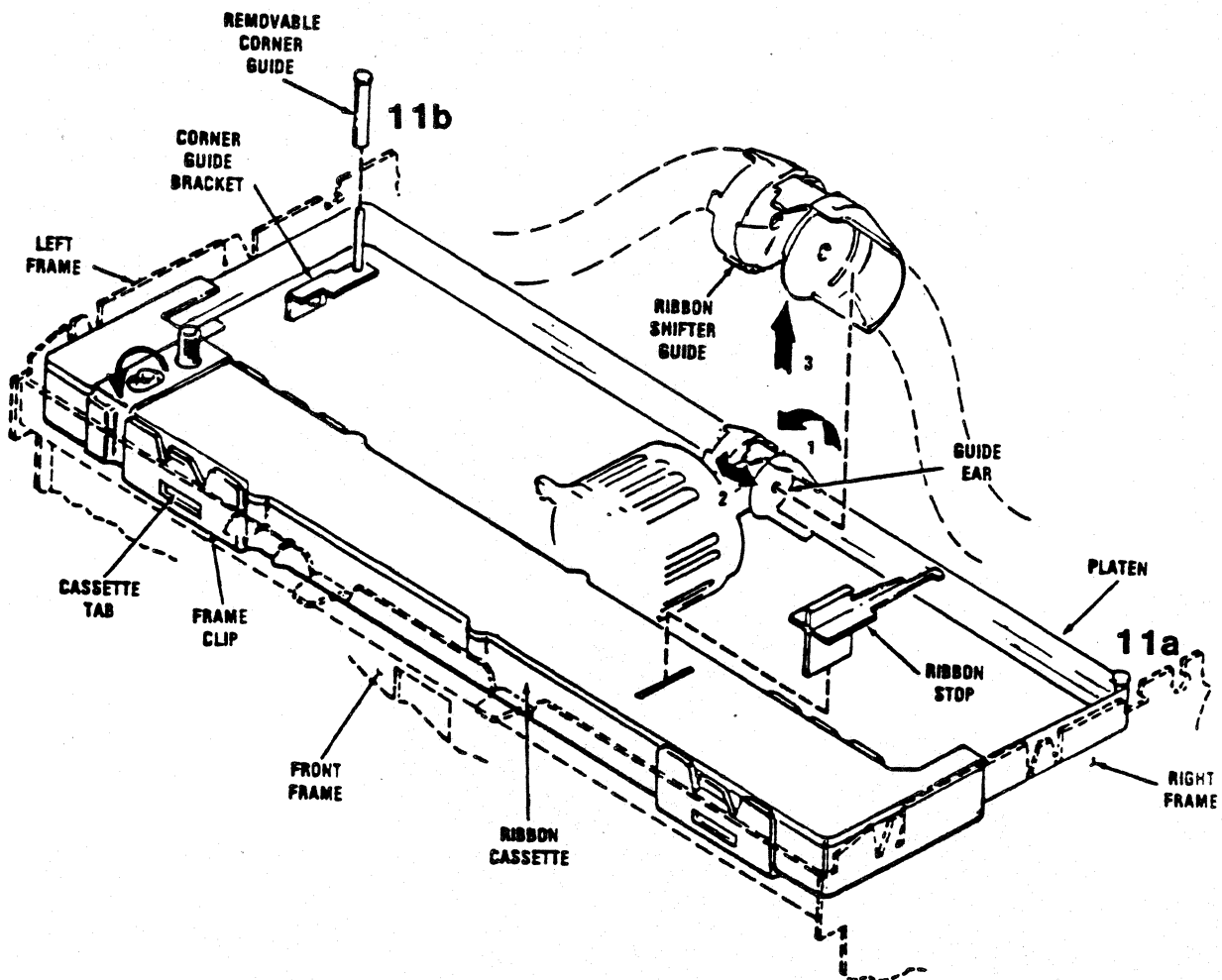

Figure 1-9 Loading the Ribbon Cassette

8. Pull the ribbon stop out of the new cassette and put the stop aside in a safe place.
9. Snap the new cassette into place - tabs on the front and back of the cassette must snap into the clips on the front frame.
10. Install the new ribbon shifter guide. To install: a.) Position the guide above the nose of the print head, then b.) gently spread the guide ears and c.) press down until the shifter guide locks into place. NOTE: The shifter guide must be locked in place to engage the ribbon shifter gear. To check, pivot the shifter toward the front of the printer while checking to see that the white shifter gear directly under it, is also moving. If it is not, the shifter guide is not locked into place. Perform steps a-c until it locks.
11. Route the new ribbon around the right(11a) and left (11b)(in that order) corner guides. Use the tapered end of the ribbon stop to route the ribbon around the guides.
12. Turn the knob on the cartridge counterclockwise to take up slack in the ribbon. (See Figure 1-9)
13. Move the print head to the extreme left.
14. Pull the forms lever to "LOAD" and lower the column scale/tear bar.
15. Move the forms lever to "SHEET" or "FORMS", depending on the paper you are using.
16. Snap the rear cover shut, then insert the front lip of the top cover under the body cover and close the top cover.

NOTE: Wait until the paper is loaded to adjust the print head adjustment lever.

1.6 TURN THE POWER ON AND TEST THE PRINTER

You should power (turn) on your printer before you load your paper. Follow the steps below to power on your printer.

1. Make sure the forms lever is in "FORMS" or "SHEET".
2. Plug the power cord into the power cord connector and into a well grounded three-prong power outlet.

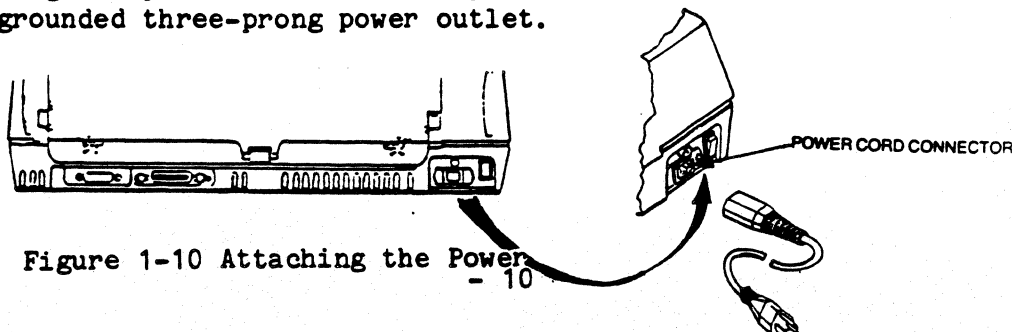

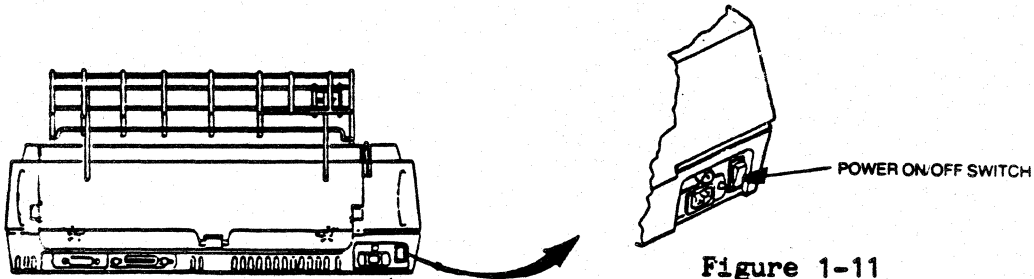

Figure 1-11

3. Locate the power ON/OFF switch and set it to ON.
4. After you power on the 468, it will do an initialization self-test as follows:
 - The status indicator will first read "000".
 - The status indicator will then read "888".
 - All the indicators on the operator control panel will come on and then go off. Only the default status indicators will remain on.
 - The printer performs a self-test of its basic functions. During this test, the print head moves from left to right and back.
 - The alarm will sound and the status indicator will display a "1" to tell you there is no paper loaded. Press HOLD PRINT to silence the alarm. The "1" will remain on. The CU signal will also be on if the control unit has been connected.

If no power goes on at all, check the power outlet you are using. If you are still having problems after you have consulted the detailed section "WHAT TO DO IF YOU HAVE A PRINTER PROBLEM" contact your service representative immediately or call our qualified service personnel at Interface Systems, Inc. The number is (313) 769-5900, 1-800-544-4072, or TWX 810-223-6058.

1.7 HOW TO ATTACH THE TWIN-BIN AND ENVELOPE FEEDER

If you are using the optional twin-bin and envelope sheet feeder, you may attach it at this time. For complete instructions on the sheet feeder refer to Appendix C.

1.8 LOAD THE PAPER

The 468 can handle continuous forms fanfold paper or single cut sheets. For detailed paper specifications and recommendations for attaining best print quality and forms handling, See Appendix D.

1.8.1 Loading Continuous Forms

CAUTION

If you purchased a twin-bin and envelope sheet feeder with your 468, your printer will be configured for use with the sheet feeder. To set your printer for use without the sheet feeder:

1. Turn the 468 OFF.
 2. Place switch number 6 in switch pack E22 in the DOWN position.
 3. Turn your printer back ON. (See Appendix C for details.)
-

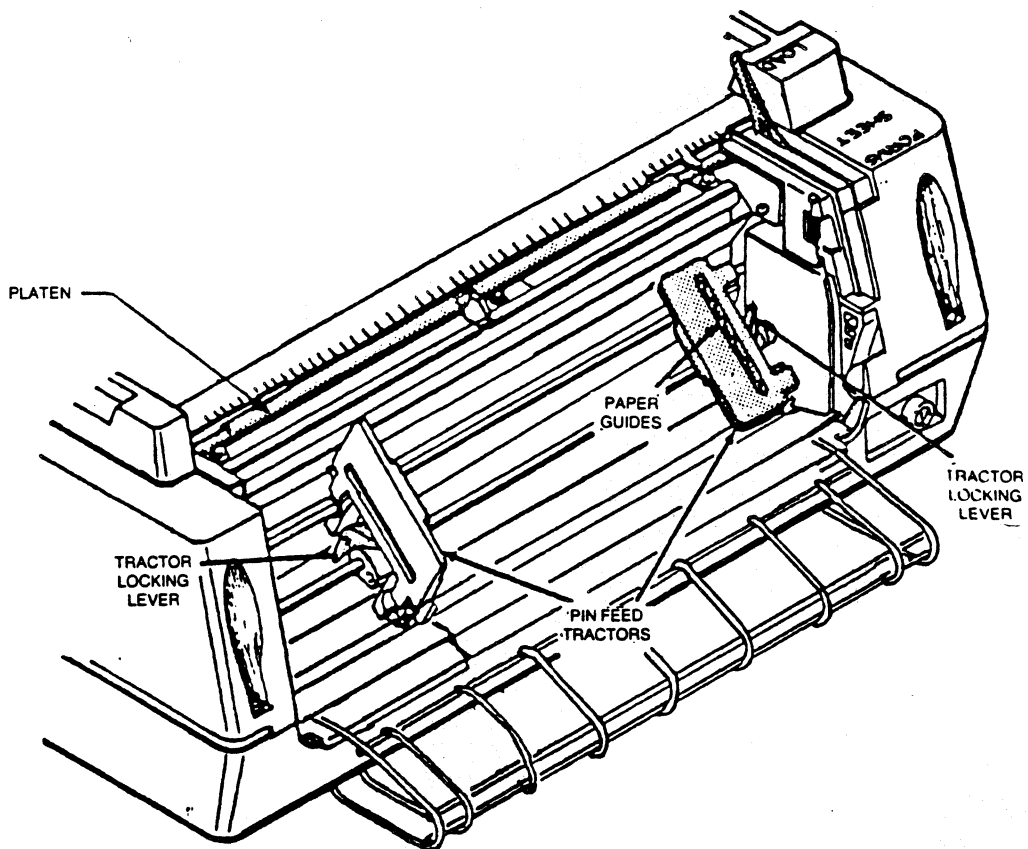

Figure 1-12 Loading Continuous Forms

Listed below are the steps for loading either single part or multi-part continuous forms.

1. Turn the printer OFF.
2. Unsnap and lift the rear cover from the printer. (Refer to Figure 1-13.)
3. Find the left and right pin feed tractors, and open the left and right tractor paper guides.

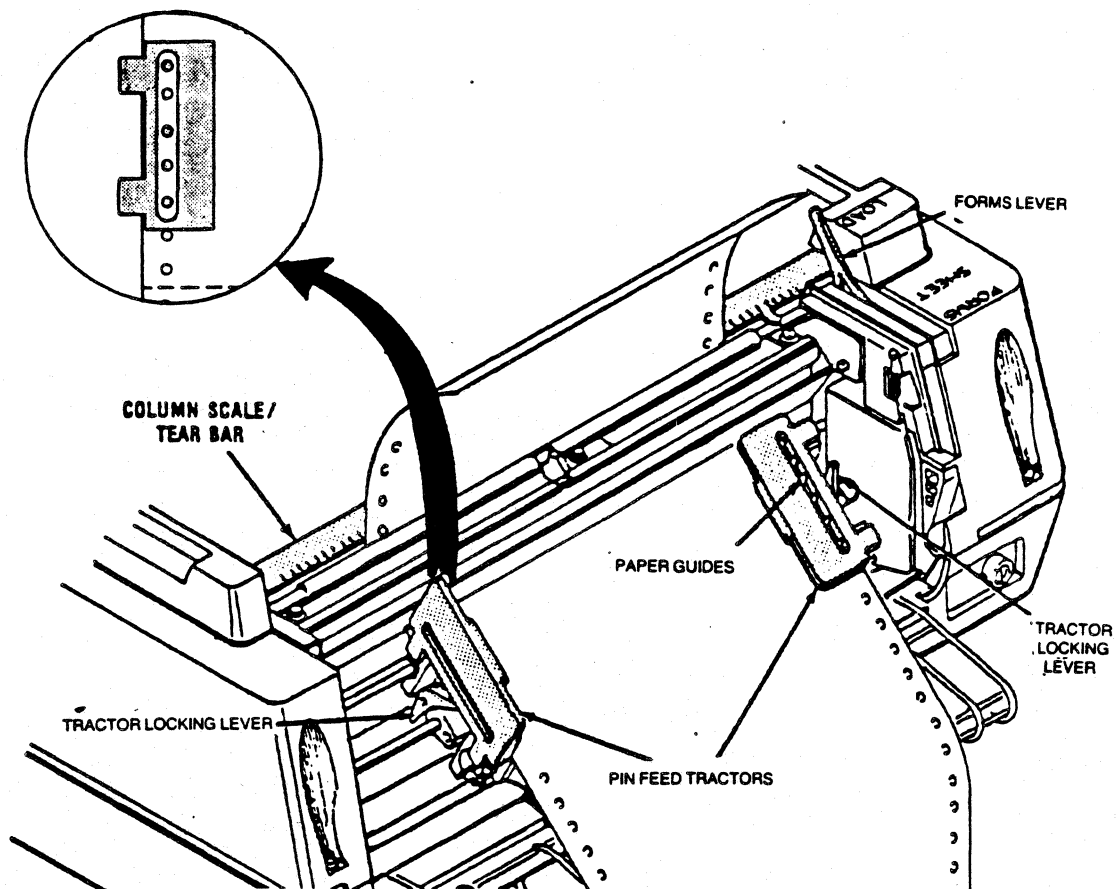





Figure 1-13 Adjusting for Forms Width/Centering Forms on Pins

4. Make sure the tractors are adjusted to the size of your forms. To adjust, lift the left and right pin feed locking levers to loosen, and slide the tractors into place. When adjusted, tighten the locking levers. (The left tractor will only move to the extreme left margin and approximately 1/2 " to the right.)
5. Place your forms on the pin feed tractors. (Make sure the paper is taut and the holes are centered on the pins or your paper may jam.)
6. Replace and close the rear cover.
7. Place the forms lever in "FORMS" position.

8. Make sure the top acrylic cover is closed.
9. Push the ON position of the ON/OFF switch. The printhead will move to the first print position.
10. Wait until the READY indicator is lit and move the lever to "LOAD".
11. Press HOLD PRINT to keep the printing process from starting.
12. Depress the  key for a few seconds to load paper into the printer.
13. Use the  and  key until the edge of the silver column scale/tear bar is directly under where you want the first line printed. Each paper movement is 1/180th of an inch. Holding the key will move the paper continuously.

CAUTION

The first form must be flush with or above the silver column/tear bar before the forms are fed or your paper will jam. Sometimes this requires you to advance to the second form for loading purposes.

14. Press SECOND FUNCTION and FORM FEED. The printer will automatically align the printer to the starting position you have just selected.
15. Move the forms lever back to "FORMS".
16. Press ENABLE and the 468 is ready to print!

NOTE

The forms alignment function is not active in cut sheet mode.

1.8.2 Loading Cut Sheets

CAUTION

If you were using a twin-bin and envelope sheet feeder with your 468, your printer will be configured for use with the sheet feeder. To set your printer for use without the sheet feeder:

1. Turn your printer OFF.
 2. Place switch number 6 in switch pack E22 in the DOWN position.
 3. Turn your printer back ON. (See Appendix C for details.)
-

The following steps tell how to load cut sheets into a 468 that is in continuous forms mode and out of paper when powered on. If there are continuous forms left in the printer remove them before you load the single cut sheets.

1. Press HOLD PRINT to interrupt the printing process.
2. Press CHANGE MODE to enter the cut sheet mode of paper handling. The CUT SHEET indicator will go on.
3. You may want to adjust forms length or maximum presentation position. If you do, look in the detailed section "Primary Function Keys, SET FORMS". When the 468 is in cut sheet mode it begins printing 1" from the top of the sheet and stops 1/2" from the bottom of the sheet. Adjust your parameters accordingly.
4. You may also want to adjust spacing and LPI as required for your printing job if it's different than the default settings listed on page 16. See detailed section "Primary Function Keys, CHANGE LPI and CHANGE SPACE" for instructions.
5. Move the forms lever to "LOAD".
6. Insert a cut sheet into the printer until it rests on the stop. Make sure the left edge of the sheet is aligned with the right edge of the red cut sheet indicator on the silver scale/tear bar.

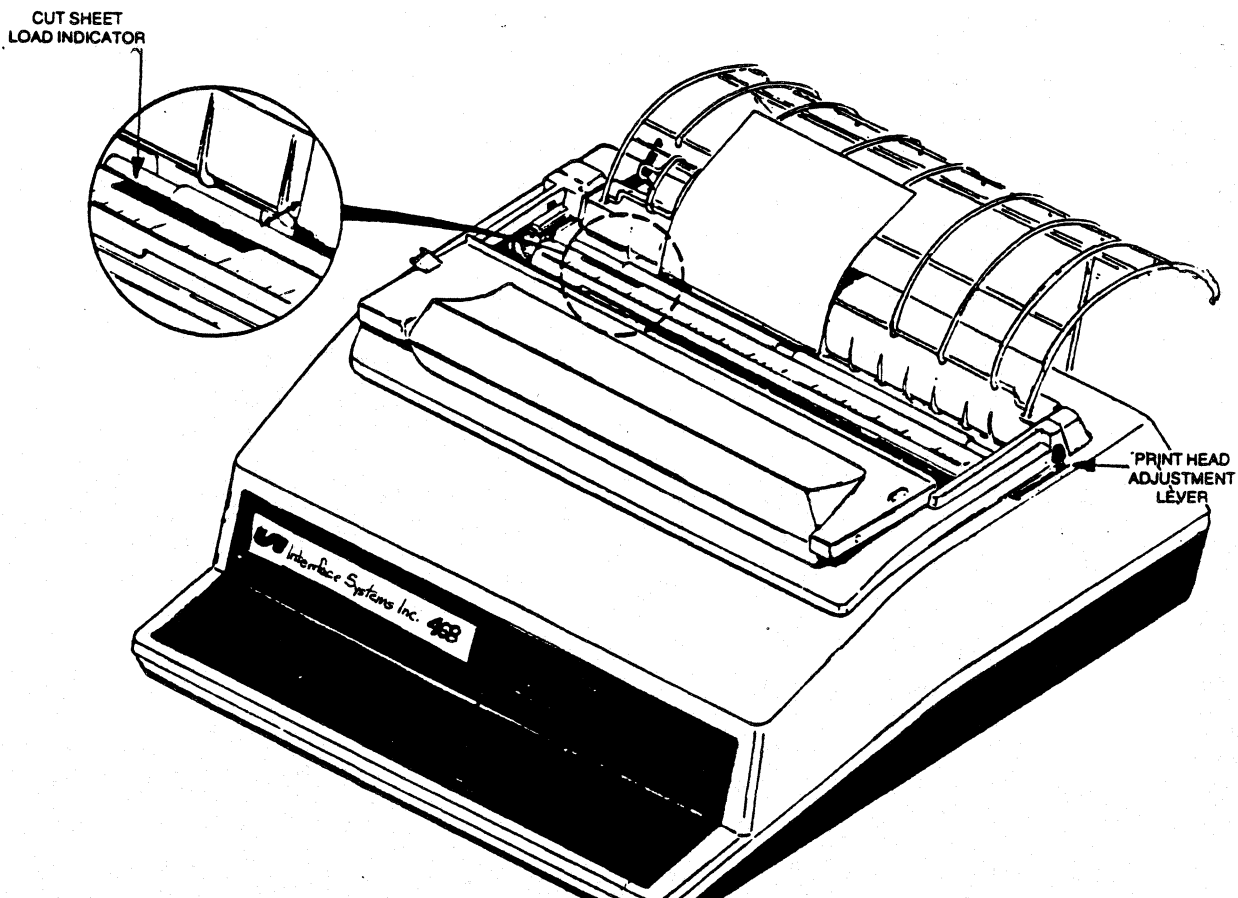

Figure 1-14 Loading Cut Sheet Forms

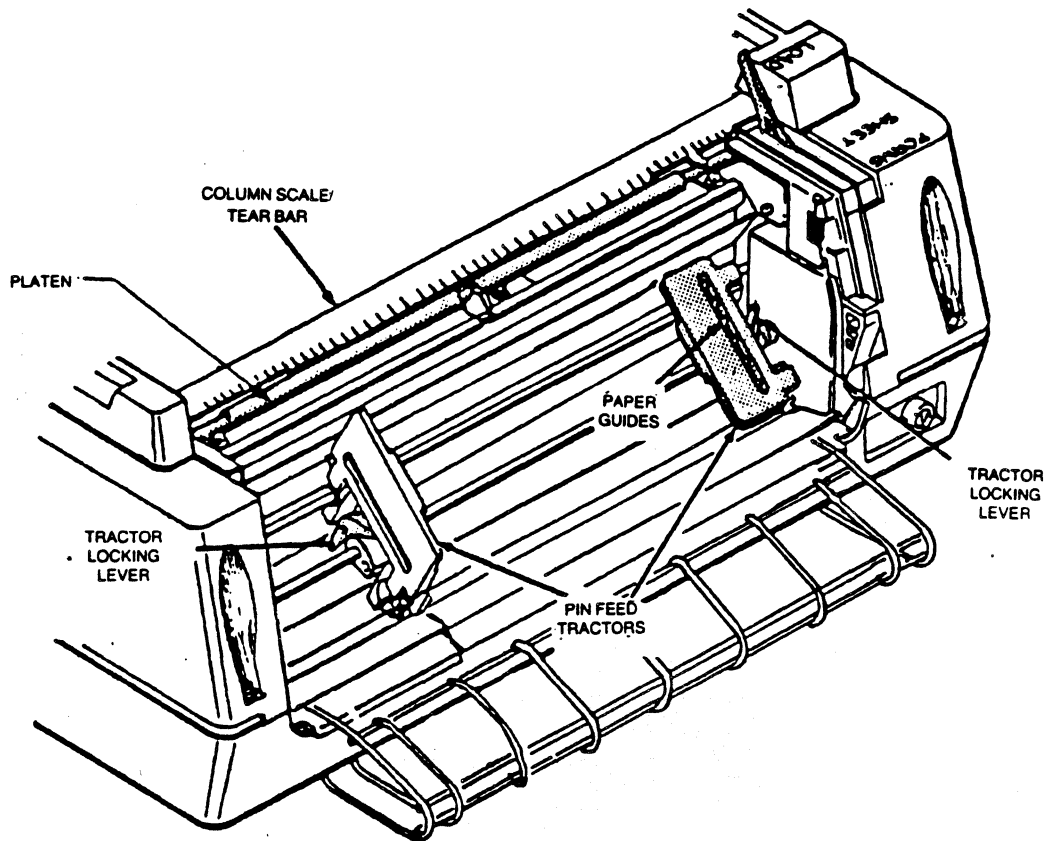

Figure 1-15 Moving Tractors for Cut Sheet Loading

7. Move the forms lever to "SHEET".
8. Move the left tractor to the extreme left, and the right tractor out of the paper path.
9. First press SECOND FUNCTION, then ACCEPT SHEET (printed in orange on the keypad). The printer will automatically load the sheet for printing.
10. Press ENABLE PRINT. Your 468 is ready to print.

1.9 CONNECTING THE 468 TO A TYPE A CONTROLLER

The 468 is only one part of your computer system. In order for your printer to receive data to print, it must be connected to a local or remote control unit. The connection is made by attaching a coaxial cable from the control unit to the printer.

Your ISI 468 emulates the IBM 3287 color printer and can be attached to any of the following equipment:

- IBM 3274 Controller
- IBM 3276 Controller
- IBM 4331 Processor
- Memorex 2076 or 2074
- Telex 274-276
- MDS/Trivex 8074
- MC Data

The control unit port must be configured for an IBM 3287-C printer.

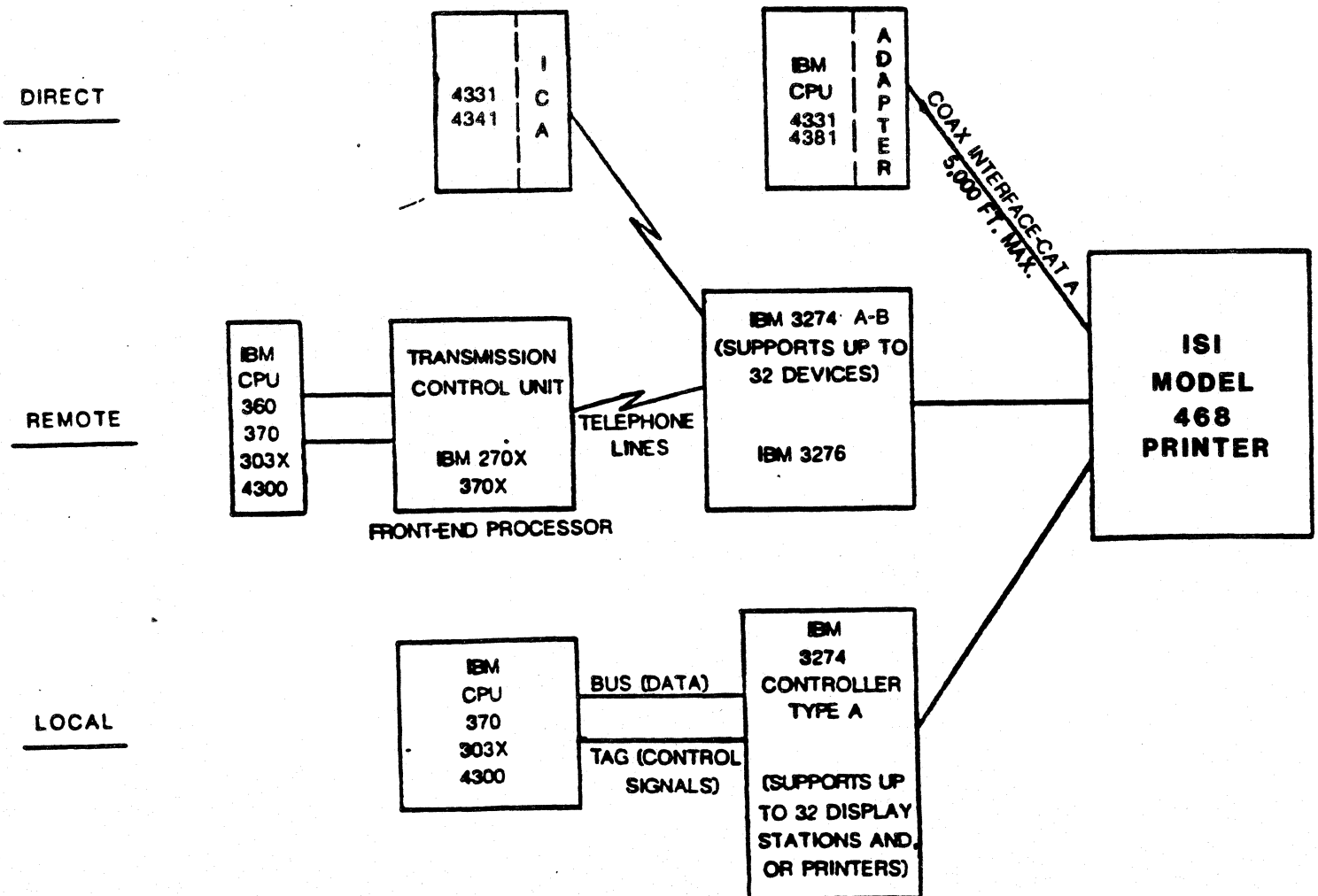

No matter which device you have, the procedure for connecting the coaxial cable is the same. Follow these steps:

1. Turn the printer OFF.
2. Bring the coaxial cable to your printer.

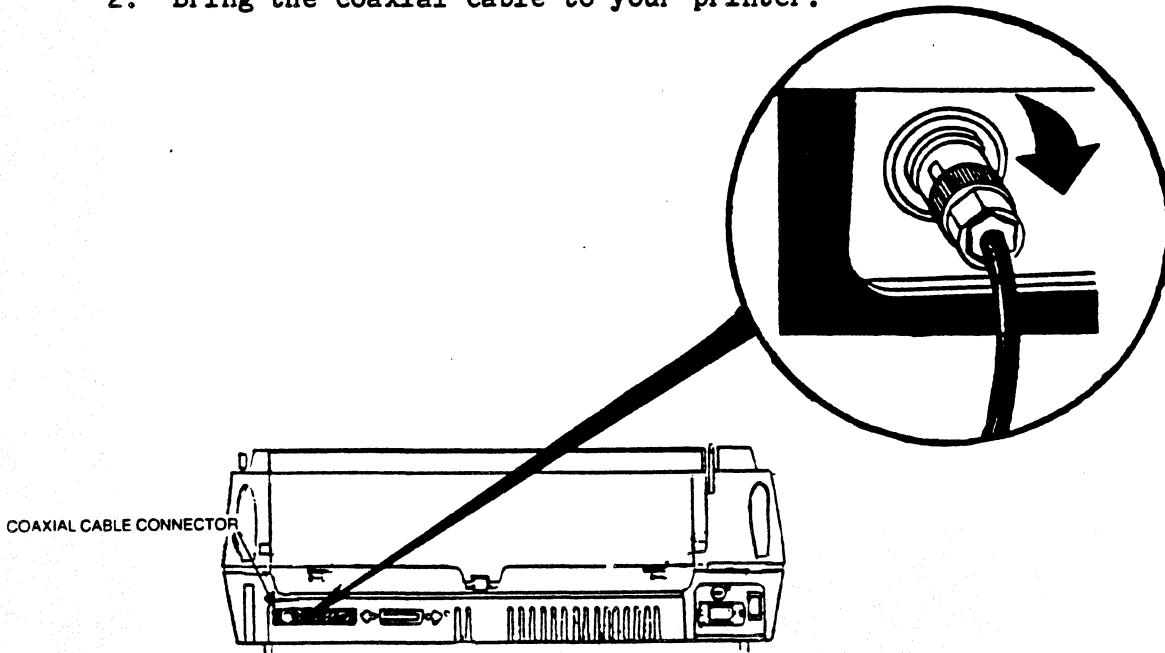

Figure 1-16 Connecting the Coaxial Cable

3. Locate the coaxial connector on the back of the printer as shown.
4. Push and lock (twisting clockwise) the cable connector into the printer.
5. Turn the printer ON and you are ready to go.

1.10 CONNECTING THE 468 TO A PARALLEL PORT

The 468 will emulate an IBM Model 5152 printer when attached to an IBM PC or equivalent unit, via the printer parallel interface. This connection is made by attaching a standard 36 pin parallel connector from the PC to the printer.

NOTE

Graphics and color are not available in this PC mode.

The connection process is easy, just:

1. Turn the printer OFF.
2. Bring the parallel ribbon cable from the PC to the printer.
3. Locate the connector on the back of the printer as shown.

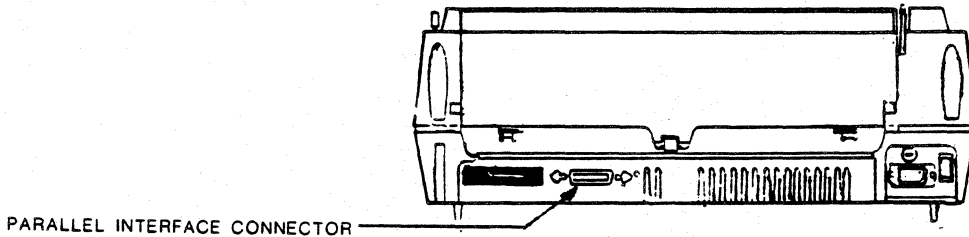

Figure 1-17 Connecting the Parallel Cable

4. Plug the cable connector into the printer making sure it is secure. Then, fasten the retainer clips to the cable connector.
5. Turn the printer ON.
6. Press HOLD PRINT, SECOND FUNCTION, and CHANGE HOST. The printhead will move from left to right and back. The ALT HOST and READY indicators will go on (it may take a few seconds for the indicators to light), and you are ready to print.

1.11 HOW TO OPERATE YOUR PRINTER



There are a number of keys and switches on the back and front panel that allow you to control the printing process. The keys that you'll use to control the operation of the 468 are located on the operator control panel. These keys are arranged for your convenience. You'll find the keys you'll use for everyday operation on the far right. In the middle are the primary and secondary keys (primary in white and secondary in orange). And on the left you will find the status indicators that display the current status of the print functions.

1.11.1 The Front Panel

The keys you will use the most are: HOLD PRINT and ENABLE PRINT.



To stop printing or to access the function keys, press HOLD PRINT.



To start printing again press ENABLE PRINT.

Other keys that are helpful are: FORM FEED,  (advance forms key),  (reverse forms key), and INDEX.

To advance the paper one line press HOLD PRINT and INDEX.

To advance the paper to the top of the forms when using fanfold paper, press HOLD PRINT and FORM FEED. In cut sheet mode, it will eject paper for removal. If you are using the cut sheet feeder option, the FORM FEED key will eject the current page for removal and load the next sheet for printing.

To advance the paper in 1/180 in. increments press HOLD PRINT and . To advance it continuously just hold the  key down.

To move the paper backward in 1/180 in. increments press HOLD PRINT and . To move it continuously backward just hold the  key down.

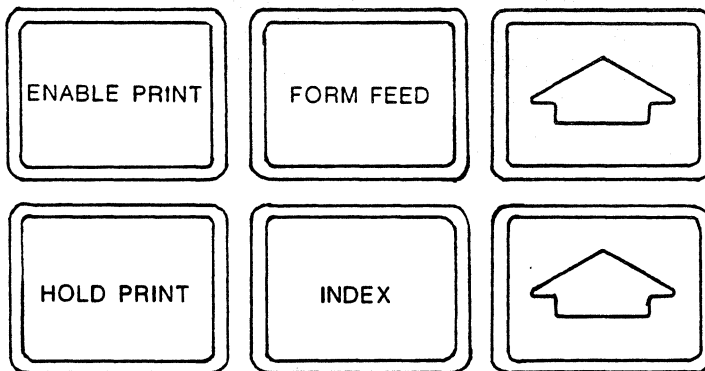

Figure 1-18 Most Used Keys

When your printer is powered on, it is already set to certain default configurations. Default values are functions that your printer will do automatically on power up unless you change them with the CONFIGURE key. See CONFIGURE key description for details.

The default values for the 468 are:

- upper and lower case.
- single spacing between lines.
- six lines per inch.
- 132 characters per line (Maximum Presentation Position).
- 66 lines per page (for standard 11 inch form).*
- continuous forms.
- base color black.

*If you were using a twin-bin and envelope feeder with your 468, it is configured for the feeder. The defaults for the twin-bin and envelope feeder are:

- Bin 1 (envelope bin)- 23 lines per page
- Bin 2 - 66 lines per inch
- Bin 3 - 66 lines per inch

If you want to change any of these power up defaults, or want to learn more about these keys and others, turn to section 2 "OPERATIONS YOU CAN CONTROL". For more details on the twin-bin and envelope feeder, turn to Appendix C.

1.11.2 The Back Panel

There are three switch packs, E1 and E22 located on the rear of your printer, and E74 located on the interface board inside the printer. E1 switches control language and IBM model selection and E22 and E74 switches provide access to special printing functions. These switches, like the front panel keys, are also configured to select certain things at power on.

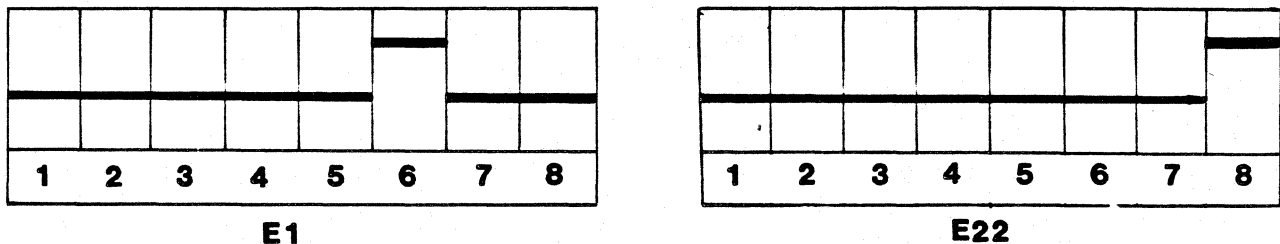

Figure 1-19 Rear Panel Switch Packs

These default settings are:

SWITCH	SETTING	FUNCTION
E1 1-5 6 7,8	Down Up Down	Language - English U.S. 4K Buffer " "
E22 1,2,4-7 3 6 8	Down Down UP Up	Selects "standard" settings (listed in Section 2 "Default Settings") at power up. Will not print null lines.* No automatic line feed. (NOTE: this switch is used along with switch 8 in E74. See the chart on page 57 for details.) If you are using an automatic sheet feeder with your 468 Model 2, this switch should be in the UP position. Otherwise, the printer is configured as listed here. Prints form feed on local copy.**
E74 1,4-7 2-3 8	Reserved Down	Reserved FACTORY DEFAULT (Same as IBM 3287 RPQ S30219 and IBM 3268 Specify Feature 9504.) Controls automatic line feed in parallel mode, ONLY when switch 3 on E22 is set to 1. See chart on page 57 for details.

To change these settings or learn more about them, see Section 2 "USER SELECTABLE FEATURES".

* Null Lines: Will not print null lines - if a print line has no printable characters, a New Line will not be performed. The first print position of the current line is the next print position.

Print null lines - all null lines will be printed as a blank line and a New Line will be performed. The first print position of the next line is the next print position.

**Form Feed On Local Copy - an automatic form feed is performed immediately after a print order. The first print position of the first line on the next form is the next print position.

1.12 CHECK THESE THINGS BEFORE YOU START PRINTING

You are almost ready to start printing, but first go over this list of questions before you start to print to make sure you haven't forgotten to do something.

- | | YES | NO |
|--|-------|-------|
| 1. Is the printer power cord plugged securely into a well grounded power outlet? (pg. 11) | _____ | _____ |
| 2. Is the coaxial cable securely connected to the printer? (applies to control unit hookup) (pg.18) | _____ | _____ |
| 3. Is the parallel cable securely connected to the printer?(applies to parallel port hookup.) (pgs. 18-19) | _____ | _____ |
| 4. Is a good ribbon cassette installed?(pgs. 8-10) | _____ | _____ |
| 5. Is the paper or continuous form loaded properly? (pgs. 12-16) | _____ | _____ |
| 6. Do you have enough paper? | _____ | _____ |
| 7. Is the printer set to desired parameters? (pgs. 21 - 22) | _____ | _____ |
| 8. Are the front, rear, and acrylic covers closed? (pg I) | _____ | _____ |
| 9. Are the CU and READY indicators on? (pgs I , 48) | _____ | _____ |
| 10. Is there an error code displayed? (pg. 23) | _____ | _____ |
| 11. Is the POWER ON/OFF switch ON? (pg. 11) | _____ | _____ |

If you answered no to any one of the questions, go back to the section that has the instructions you need and follow them carefully. If you answered yes to all the questions, you are ready to go, so go ahead and send it a print.

1.13 WHAT TO DO IF YOU HAVE A PRINTER PROBLEM

First, refer to Section 2, "WHAT TO DO IF YOU HAVE A PRINTER PROBLEM" for details. Then, if you are still having problems call our qualified service personnel at Interface Systems, Inc. The number is (313) 769-5900, 1-800-544-4072, or TWX 810-223-6058.

NOTE

This was only a brief description of the basic functions of the 468 Model 2 printer. To use the 468 to its fullest potential, please continue on to Section 2. We don't want you to miss a thing!

Section 2: The Detailed Version

Chapter 2

HOW TO OPERATE THE ISI 468 MODEL 2

2.1 SUMMARY OF PRINTER PARTS

Now that you are familiar with the set up procedures and basic controls you are ready to learn "the other stuff", and do a little experimenting with the other keys and switches. First of all, we would like to tell you a little about your printer.

The ISI 468 is a compact desk-top printer that can be used in place of the IBM 3287 C and is compatible with the 3270 family. It emulates the IBM 5152 printer and can be connected via coaxial "Type A" interface to any of the following control units: IBM 3274 Controller, IBM 3276 Controller, IBM 4331, Memorex 2076 or 2074, Telex 274-276, MC Data, and the MDS/Trivex.

The Model 2 printer can also be connected to an IBM PC or equivalent unit via the printer parallel interface, as well as the control unit. APL character set, programmed symbols, and 7-color printing are also standard features of this model.

2.1.1 Standard Features

The standard features listed below give you an idea of what your printer can do.

Model 2

- 400 characters per second (CPS) dot matrix printing at 10 characters per inch (CPI) and 100 CPS near letter quality (NLQ) printing at 10 CPI.
- 465 CPS dot matrix printing at 16.67 CPI compressed print.
- Continuous forms handling and single cut "letterhead" sheets handling.
- Demand document feature allows printing within 1" of top of form (TOF).

- Operator-programmable memory
- 6 part forms handling capability
- IBM 3287 international character set
- Extended print buffer for local copy support of IBM 3278 Models 3-5.
- Status indicator displays three digit, easy to remember codes for monitoring the current format settings, error codes, and selected test numbers.
- Operational in SCS or non-SCS mode. SCS mode is indicated by the READY indicator flashing while the printer is in HOLD PRINT.
- Plug-compatible with IBM 3287.

Plus:

- 7-color IBM compatible printing
- IBM APL/TEXT support
- IBM Programmed Symbols Support
- 420 CPS printing at 12 CPI
- Dual port 3270/IBM Personal Computer(emulates IBM 5152 model printer;graphics and color are not functional in IBM PC mode).
- Plug-compatible with IBM 3287 2c

2.2 FEATURES YOU CAN CONTROL

This is a description of the standard features that allow you to control the printing process and to set and change various format parameters. Format parameters are the different features which determine the way your documents are printed. Below are the many printer functions you can control through the switch packs in the rear printer cover or the keys on the control panel. Details on how to use all the control features described below are in "OPERATIONS YOU CAN CONTROL".

FORMS LENGTH
(Lines per page)

When you turn the printer on, the default configuration is set to 66 lines per page. This is standard for 11 inch paper at 6 lines per vertical inch. You can select a three digit page length of 001 to 102 lines. Refer to the SET FORMS key description for details.

MAXIMUM PRESENTATION



The line length default is set at 132 character

POSITION(Line Length) positions (including spaces) for 10 CPI. You can select a line length of 001 to 132, or 220 for 16.67 compressed print, and 158 for 12 CPI. Refer to the SET MPP key description for details.

LINES PER INCH The printer default is set at 6 lines per inch (LPI), single spaced. You can choose 6 or 8 as the number of lines to be printed per inch. And, because you can also select single or double spacing, you can vary the number of lines per inch to be 3 (select 6 lines per inch, double spaced) or 4 (select 8 lines per inch double spaced). Refer to the CHANGE LPI and CHANGE SPACE key descriptions for details.

FORM FEED, INDEX, AND ACCEPT SHEET While the printer is in HOLD PRINT, you can advance the paper to the next top of form by using the FORM FEED key for continuous forms, and the ACCEPT SHEET key for cut sheet forms. You can also advance the form by one line, using the INDEX key. See FORM FEED, ACCEPT SHEET and INDEX keys for details.

STOP/START PRINTING You can stop the printing in process with the HOLD PRINT key and restart it with the ENABLE PRINT key. See HOLD PRINT and ENABLE PRINT for details.

FORMS ALIGNMENT While the printer is in HOLD PRINT, you can move the paper up or down using the  (advance forms key or  (reverse forms key). This makes it easy to align preprinted forms, as described in "LOADING FANFOLD FORMS", or "LOADING CUT SHEETS" (See Section 1).

PRINTING SPEED (Print Quality) You can determine the print type of the 468 with the CHANGE SPEED key. The 468 can deliver 400 CPS dot matrix printing, 100 CPS near letter quality printing (NLQ), or 16.67 CPI compressed print. Print type can also be controlled through the data stream, see Appendix B for details.

PRINTING MODE (Type of Forms) You can also select the type of forms the 468 can handle with the CHANGE MODE key. Press the key and the 468 will be ready to handle either single cut sheets or continuous forms. The current setting is for continuous forms. NOTE: If a twin-bin and envelope feeder was purchased with your 468, your printer must be configured for use with the sheet feeder before it can be used with the feeder attached. (See Appendix C).

LANGUAGE SELECT From a variety of international character sets, you can select the language set your printer will print in. (These language sets are functional ONLY if there is both CU and Foreign Keyboard support of the selected language set.) Switch pack E1, located in the

rear of the printer housing makes this selection possible. Refer to the "USER SELECTABLE SWITCHES" section for details on specific settings.

IBM MODEL SELECT

Switch pack E1 also makes possible the selection of various IBM Model numbers (screen sizes), for local copy support by the ISI 468. See "USER SELECTABLE SWITCHES".

NULL LINE PRINT

You can select null line print to print all null lines as a blank line, then perform a New Line. The first print position of the next line is the next print position. Refer to "SPECIAL FUNCTION SWITCH SETTINGS" for details.

16.67 CPI
COMPRESSED PRINT

You can select 16.67 characters per inch printing. Refer to the CHANGE PITCH key description for details. Pitch can also be changed through the data stream, see Appendix B for details.

12 CPI

You can choose 420 CPS 12 CPI printing. See "Second Function Keys, CHANGE PITCH" for details. See Appendix B for details on changing pitch through the data stream.

PROGRAMMED
SYMBOLS

Switch pack E1 lets you select single or triple plane Programmed Symbols(PS) sets. This allows you to print special characters and a variety of shapes, symbols, and patterns. See Section 2 "How to Use Programmed Symbols" for details.

BASE COLOR

You can select base color black or green through a switch on the back panel (See "Special Function Switch Settings") for details. You can also enable or disable color printing. See BASE COLOR key description for details.

CHANGE HOST

You can set the printer to work with your 3270 control unit or with an IBM PC or equivalent unit via the 36 pin parallel type connector. It cannot work with both simultaneously. See Section 2 "Secondary Function Keys, CHANGE HOST" for details. NOTE: The 468 will emulate an IBM Model 5152 printer when attached to the PC. Graphics and color are not available in this PC mode.

2.3 INSTALLING A NEW RIBBON

After the ribbon has been used for approximately 10M characters, you will need a new one. The ISI 468 uses a convenient long-life ribbon cassette. Model 2 uses an all black ribbon as well as one 4-color primary ribbon and one seven color process ribbon. Three of these seven colors are achieved by overstriking. Please note that ribbon life is determined by the most used color, so it is advisable to use an all black ribbon for jobs which don't require color.

Please use only the ribbon cassettes supplied by Interface Systems, Inc. Though other manufacturers offer "similar" ribbons, they are not recommended and may void the warranty. To order ribbon cassettes from Interface Systems, Inc., please refer to the following part numbers:

- Black ribbon - #U21172001,
- Primary Color #U21077001 (black, blue, green, and red)
- Process Color #U21190001 (yellow, cyan [turquoise], magenta [pink] and black).

To remove and install a ribbon cassette, turn the printer OFF and perform the following instructions. The printer will recognize any ribbon changes at power ON.

NOTE

When changing a ribbon, the printer should always be turned OFF. Therefore, the ribbon should never be changed during a print, so PLAN AHEAD.

NOTE

The optional twin-bin and envelope feeder must be tilted back or removed to replace the ribbon cassette.

1. Lift the top cover up and off.
2. Unsnap the top part of the rear cover and let it hang open.
3. Find the print head and move it to the middle position, and place the forms lever in "LOAD."
4. Lift up the silver column scale/tear bar.
5. Place the forms lever in "SHEET" or "FORMS" position.

6. NOTE: Before doing this step, note the position of the head adjustment lever. Once the new ribbon cassette is installed, the lever must be returned to this position. Now, move the head adjustment lever towards the front of the printer as far as it will go, but don't force it.
7. Detach the shifter guide from the print head. To detach: a.) Pivot the guide all the way back so the bottom of the ribbon is in front of the print wires, and b.) gently spread, then lift the guide ears so the ears are no longer locked in place by the small studs on the nose of the print head.
8. Carefully lift the shifter guide up and away from the print head.
9. Pull the cassette out of the mounting clips on the front frame.
10. Pass the cassette over the left corner guide, then the right corner guide to lift the used ribbon up and away from the guides.
11. Discard the used cassette and shifter guide.
12. Remove and discard the used corner guides. To remove, simply lift the guides from the guide posts.
13. Install the new ribbon cassette, corner guides, and shifter guide as instructed in steps 7-16 on pgs. 9-10.
14. Return print head adjustment lever to its original position.
15. Move the forms lever to LOAD and return the column scale/tear bar to its down position.
16. Move the forms lever to the desired setting. Press ENABLE PRINT to resume printing and you are on your way.

2.4 RELOADING FORMS

You are out of paper when:

1. Printing stops.
2. The CHECK indicator lights up.
3. The audible alarm sounds.
4. The status indicator displays a "1".

2.4.1 Reloading Continuous Forms

The 468 prints until the last fanfold form passes through the paper empty switch on the left pin feed tractor. To reload continuous forms, do the following:

1. Press HOLD PRINT.



CAUTION

Whenever the printer runs out of paper while printing, press HOLD PRINT to interrupt printing and ensure that printing does not start while you are loading the paper.

2. Move the forms lever to "LOAD".

NOTE

Before doing the next step, note the position of the head adjustment lever. If loading the same forms as before, you must return the lever to this position once the forms are loaded.

3. Pull the head adjustment lever toward the front of the printer as far as it will go without forcing it.
4. Unsnap and lift the rear cover from the printer.
5. Open the left and right tractor guides and load the forms onto the pins.
6. Close the tractor guides.
7. Replace and close the rear cover.
8. Depress the  key for a few seconds to load paper into the printer.
9. Use the  key and  key until the edge of the silver column scale/tear bar is directly under where you want the first line printed.

CAUTION

The first form must be flush with or above the silver column tear bar before forms are fed or your paper will jam. Position your forms accordingly. Sometimes this requires you to advance forms to the second form for loading.

10. Press SECOND FUNCTION and FORM FEED. The printer will automatically align the printer to the starting position you have just selected.
11. Push the forms lever to "FORMS".
12. Now, return the print head adjustment lever to its original position. If a different forms thickness is needed, follow the print head impression adjustment described in "ADJUSTING FOR FORMS THICKNESS".
13. Press ENABLE PRINT and you may start printing again.

2.4.2 Reloading Cut Sheets

When the last line has been printed on the current sheet, the alarm will sound and the status indicator will display a "1". Follow the procedure below to remove the paper:

1. Press HOLD PRINT.
2. Move the forms lever to "LOAD" and manually remove the sheet from the printer.

If the printing does not reach the bottom of the sheet, follow these steps:

1. Press HOLD PRINT.
2. Press FORM FEED, or  to advance the paper.
3. Move the forms lever to "LOAD" and remove the sheet from the printer.

After removing the previous sheet of cut paper, follow the procedure below to reload the 468:

1. Stay in HOLD PRINT making sure the HOLD PRINT indicator is lit.
2. Move the forms lever to "LOAD".
3. Insert a cut sheet into the printer. Make sure the left edge of the sheet is aligned with the right edge of the red cut sheet indicator on the column scale/tear bar.
4. Move the forms lever to "SHEET".

CAUTION

Left tractor must be set to the extreme left and right tractor must be out of the paper path when using cut sheet forms.

5. First press SECOND FUNCTION, then ACCEPT SHEET. The printer will automatically load the sheet for printing.
6. Press ENABLE PRINT. Your 468 is ready to print.

2.4.3 Adjusting for Forms Thickness

The print head can be adjusted for different form thickness to provide optimum print quality. If your 468 is delivering inferior print quality, it may be the result of a change in forms or printing specifications. To adjust the print head impression accordingly, perform the following steps:

1. Make sure paper is loaded and the forms lever is in the proper setting for the paper loaded.
2. Pull the head adjustment lever toward the front of the printer.
3. Perform self-test #9 while the printer is in HOLD PRINT, see Section 2 "Running a Self Test" for details. While the test is running, push the head adjustment lever toward the back of the printer until smudging occurs.
4. Check the printout to ensure crisp, clear print quality. If the print is too dark move the print head out a notch at a time as needed. If it is too light move the print head in a notch at a time.

When using multi-copy forms, it is essential to adjust the print head correctly or your forms may tear at the perforations and jam in the printer. If your forms are heavy, be sure they don't get caught on the edge of the printer while they are being fed.

2.5 RELOADING THE TWIN-BIN AND ENVELOPE FEEDER

If you are using the optional sheet feeder, refer to Appendix C for details.

2.6 OPERATIONS YOU CAN CONTROL

THE FRONT PANEL

The keys that you'll use to control the operation of the 468 are located on the operator control panel on the front of the printer. You will find the keys which you will use the most at the far right. In the middle you will find the primary function keys (in white), and the secondary function

keys (in orange). These keys let you run different tests, or change things like print quality, forms length and maximum presentation position. On the left you will find the LED status indicator and the indicators that display the current status of the printer functions.

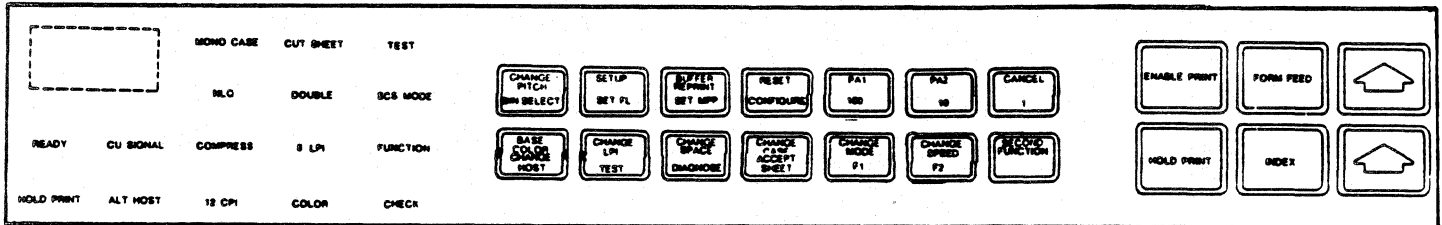

Figure 2-1 ISI 468 Front Panel Layout

2.7 DEFAULT SETTINGS

When the printer is powered on, there are certain format parameters already set and will be used automatically if you don't make any changes. These are called default settings. You can change them temporarily for your specific job by setting the desired keys on the operator panel. You can even change the default settings permanently by using the CONFIGURE key (see the individual description on the CONFIGURE key). If you do not change the default settings, the following settings will be in effect:

DEFAULT SETTINGS	MEANING
Dual Case	Prints in upper and lowercase unless overridden by the host program.
Single Space	Prints with single spacing between lines.
6 LPI	Prints six lines per inch.
Forms Length	Prints 66 lines per page (11 inch forms.)
Maximum Presentation Position	Prints 132 characters per line.
400 CPS, Dot Matrix	Prints 400 CPS, 10 CPI 7x9 dot matrix print quality.
Forms Handling	Handles continuous forms.
Color	Prints base colors.

2.8 PRIMARY FUNCTION KEYS

Most of the time, your printer is in the primary function mode. In primary function mode, the default mode of your printer, you can use the primary function keys. This section describes where each key is, what it does, and how to use it.

NOTE

All of the keys on the control panel (except HOLD PRINT) can only be set when the printer is not printing. This means the HOLD PRINT key must be pressed before using any other key.

2.8.1 HOLD PRINT

Press HOLD PRINT to stop printing.

- The HOLD PRINT indicator comes on.

To resume printing, press ENABLE PRINT.

2.8.2 ENABLE PRINT

Press ENABLE PRINT to continue normal printing.

- The HOLD PRINT indicator goes out.
- The READY indicator is on.

All error conditions must be cleared before this switch can function.

2.8.3 INDEX

While in HOLD PRINT press INDEX to advance the paper one line. Then press ENABLE PRINT to resume printing.

2.8.4 FORM FEED

While in HOLD PRINT press FORM FEED to advance the paper to the next top of form (TOF), when using continuous forms. In cut sheet mode, the FORM FEED key ejects the current sheet of paper. Then press ENABLE PRINT to start printing again. When using the cut sheet feeder option, the FORM

FEED key will eject the current sheet and load the next sheet for printing.

2.8.5 (Paper Advance Key)

Press the  key while in HOLD PRINT to advance the continuous paper in increments of 1/120th of an inch and cut sheet paper in increments of 1/180th of an inch.

To feed paper continuously, press the  key for more than 1/2 second. The paper moves forward until the key is released. To resume printing press ENABLE PRINT.

2.8.6 (Paper Reverse Key)

Press the  key while in HOLD PRINT to move the continuous paper backwards in increments of 1/120th of an inch and cut sheet paper in increments of 1/180th of an inch.

To feed paper continuously, press the  key for more than 1/2 second and paper moves continuously backward until the key is released. Press ENABLE PRINT to start printing again.

NOTE

Pressing the  or  key will change top of forms.

2.8.7 CHANGE PITCH

Press CHANGE PITCH while in HOLD. The printer will change from 10 CPI to 12 CPI to 16.67 CPI. Each time it is pressed the pitch will change to the next in the list. For example, 10 CPI changes to 12 CPI, and 12 CPI changes to 16.67 CPI, and 16.67 CPI changes back to 10 CPI.

If you select 10 CPI.

- No indicator will be on.

If you select 12 CPI.

- The 12 CPI indicator will be on.

If you select 16.67 CPI.

- The COMPRESSED indicator will be on.

Pitch can also be changed through the data stream, see Appendix B "SELECTING PRINT MODE," for details.

2.8.8 SETUP

While in HOLD PRINT press SETUP.

- The printer will print "H's" at 10 CPI between the left margin and the current MPP (maximum presentation position) or right margin. (Only one "H" will be printed at a time; not a whole line.)
- When the MPP is reached, the printer will return to the left margin, but will not advance the form.
- This feature is useful for viewing the current MPP and forms alignment. After you have seen the current MPP, press ENABLE PRINT to resume printing.

2.8.9 BUFFER REPRINT

Press BUFFER REPRINT while in HOLD PRINT to print the contents of the print buffer. This feature is useful if the printer runs out of paper while printing. If the printer has finished the current job, however, the buffer reprint will not work. If the printer can execute the command, the contents of the buffer is printed from the beginning, after ENABLE PRINT is pressed. BUFFER REPRINT must be selected before selecting ENABLE PRINT after printing has been interrupted, otherwise, data in the print buffer may be lost.

NOTE

BUFFER REPRINT is only active in SCS mode if the Host is configured to support it. Check with your system manager if you're not sure.

2.8.10 RESET

Press RESET while in HOLD PRINT to reset the error indication in the numeric display. When the reset is accepted, the form will advance one line. To resume printing, press ENABLE PRINT.



Figure 2-2 Top Row Primary Function Keys

2.8.11 PA1 and PA2 (Program Attention)

These keys are referred to as Program Attention keys. If the SCS (SNA Character String) feature is operational on your printer, these keys can be selected while in SCS mode to transfer printing control to the application program.

2.8.12 CANCEL

You can only use this key if your system supports SNA-SCS (Systems Network Architecture -SNA character strings). This key will be active if the SCS indicator is lit on the front panel. If the printer is in SCS mode, press CANCEL while in HOLD PRINT. Printing will stop and all unprinted data will be lost.

2.8.13 BASE COLOR

The BASE COLOR allows the use of the primary colors with the protect and intensify attributes of your existing program. The BASE COLOR key is used to turn the color printing function on or off. (Base color green or black is selected through switch #5 in switch pack E22. See "Special Function Switch Setting" for Details.) The current status is indicated by the COLOR indicator. The default setting is base color enabled. (See "How to Use Color" for details on color printing.)

Extended color prints in color even if base color is off. Extended color is used primarily for designing a new color system. See Appendix B.3 for details.

2.8.14 CHANGE LPI (Lines Per Inch)

Pressing CHANGE LPI while in HOLD PRINT determines the number of lines per inch to print, 6 or 8. The current status of this key is indicated by the 8 LPI indicator. 6 LPI is the default setting at power up.

Press HOLD PRINT, then press CHANGE LPI.

- The 8 LPI indicator comes on.
- Your ISI 468 will print at 8 LPI.

Press the CHANGE LPI again.

- The 8 LPI indicator will go out.
- The printer will return to 6 LPI.

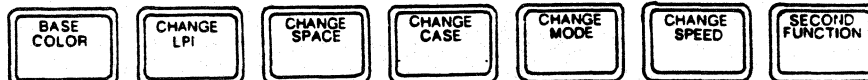

Figure 2-3 Second Row Primary Function Keys

- Press ENABLE PRINT and printing will resume.

NOTE

When changing LPI, it is assumed that you are at TOF. If you specify double spacing along with a setting of 6 LPI (8 LPI), you will actually get 3 lines per inch.

2.8.15 CHANGE SPACE

Pressing CHANGE SPACE while in HOLD PRINT determines whether the spacing between lines will be single or double. The current status of this switch is defined by the DOUBLE indicator. Single spacing is the default setting at power on.

Press HOLD PRINT, then press CHANGE SPACE.

- The DOUBLE indicator is on.
- The printer will print with double spacing.

Press CHANGE SPACE again.

- The DOUBLE indicator goes out.
- The printer will return to single spacing.

Press ENABLE PRINT.

- Printing will resume.

NOTE

When changing SPACE, it is assumed that you are at TOF.

2.8.16 CHANGE CASE

In non-SCS mode while in HOLD PRINT, this key selects which case to print letters in. The current status of this key is defined by the DUAL CASE indicator. Dual case is the default setting at power on: letters are printed in upper and lower case, unless overridden by the host program.

Press HOLD PRINT, then press CHANGE CASE.

- The MONO CASE indicator comes on.
- The printer will print letters in upper case only.

Press CHANGE CASE again.

- The MONO CASE indicator goes out.
- The printer will return to Dual Case printing.

Press ENABLE PRINT.

- Printing will resume.

NOTE

In SCS mode, the printer operates only in Dual Case. Mono Case setting will be overridden. Also, some optional world trade country languages operate correctly only when in DUAL CASE. See "The Language Select Switch Settings" for details.

2.8.17 CHANGE MODE

Pressing this key while in HOLD PRINT determines what type of paper the printer is ready to handle. The current status of this switch is defined by the CUT SHEET indicator. Continuous forms mode is the default setting at power-on.

Press HOLD PRINT, then press CHANGE MODE.

- The CUT SHEET indicator comes on.
- The 468 is now ready to handle single cut sheet paper.

Press the CHANGE MODE key again.

- The CUT SHEET indicator goes out.
- The ISI 468 returns to continuous forms mode.

Press ENABLE PRINT.

- Printing will resume.

2.8.18 CHANGE SPEED

Pressing CHANGE SPEED while in HOLD PRINT determines the print speed of the 468. The current status of this switch is defined by the NLQ (near letter quality) indicator. 400 CPS dot matrix printing is the default setting when the printer is powered on.

Press HOLD PRINT, then press CHANGE SPEED.

- The NLQ indicator will come on.
- The 468 will print 100 CPS in near letter quality.

Press CHANGE SPEED again.

- The NLQ indicator will go out.
- The 468 will return to dot matrix printing.

Press ENABLE PRINT.

- Printing will resume.

Printing speed can also be selected through the data stream. See Appendix B "SELECTING PRINT MODE" for details.

2.8.19 SECOND FUNCTION

Pressing this key while in HOLD PRINT activates the function printed in orange on the keys (lower portion of the keypad), thus placing the printer in Second Function mode. When this switch is pressed, the HOLD PRINT indicator will begin flashing and "ccc" will appear in the Status Indicator. To fully understand how the Second Function keys work, see the following section.

2.9 SECOND FUNCTION KEYS

The Second Functions keys allow you to set and reset a variety of different parameters with temporary or permanent values (see the CONFIGURE key for details). Read the key descriptions below and carefully follow the procedures in the order they are given. The HOLD PRINT indicator will flash on and off to indicate that the keys have assumed their second function.

NOTE

If any key, other than those with designated second functions, is pressed while the printer is in second function mode, the printer will immediately return to primary function.

2.9.1 SET FORMS (Forms Length)

The default setting for forms length is 66 lines. To view the current setting:

- Press HOLD PRINT, then SECOND FUNCTION.
- Then press SET FORMS.



Figure 2-4. Top Row Secondary Function Keys

The LED status indicator displays the current lines per page as a three digit number (066 for 66 lines per page).

Now, you can select a new forms length in the range of 0 to 102.

- Press the 1, 10, and/or 100 keys until the desired forms length is reached.
- Then press SET FORMS to tell the printer to begin using this new forms length. (Or, you may return to primary mode without altering the length, by pressing SECOND FUNCTION.)
- Press ENABLE PRINT to resume printing.

To determine the number of lines to select for your new forms length, you must consider three things:

- The length of the paper form in inches.
- The number of lines you want to have print per inch.
- The line spacing you want: single or double.

2.9.2 Forms Length Setting Example

The default forms length setting at power on is based on a standard form length of 11 inches. The number of lines per inch (LPI) defaults to 6 LPI. Multiply: 11 inches x 6 lines per inch = the total lines per page. This is the default forms length setting. In this example, we'll assume that the paper form length is 11 inches (279.4 mm) and that you want 8 lines per inch, single spaced:

1. First press HOLD PRINT.
2. You want to print 8 LPI, but your printer is in the 6 LPI default setting. To set the printer at 8 LPI simply press CHANGE LPI (the 8 LPI indicator should light) and your printer will print 8 lines per inch.
3. Now, you want single spacing, which is the default setting for the printer. Multiply the paper length by 8 for single spacing (11 x 8 = 88). (For double spacing, set the CHANGE SPACE key and multiply the paper length by 4{11 x 4 = 44}.)
4. Put the printer in second function mode. (You should still be in HOLD PRINT, so just press SECOND FUNCTION.)
5. Then press SET FORMS.
6. Now enter the page length value as a three digit number by using the 1, 10, and 100 keys. Your entry (088) will be displayed in the LED status indicator.

7. Press SET FORMS again.

The printer is back in primary function mode and will select the value you have just set. The display window will be blank. This value is temporary and will not remain once the printer has been powered off. To set your forms length permanently, see "Secondary Function Keys, CONFIGURE". Press ENABLE PRINT to resume printing.

2.9.3 SET MPP (Maximum Presentation Position)

The default setting for maximum presentation position is 132 characters at power on. To view the current setting:

1. Place the printer in second function mode (by pressing HOLD PRINT, then SECOND FUNCTION).
2. Then press SET MPP. The LED status indicator displays the current characters per line as a three digit number.

You may now select a new maximum presentation position setting in the range of 1 to 132 (1 to 220 for 16.67 CPI), or you may exit the second function mode.

1. To select a new MPP use the 1, 10, and 100 keys. You can check your work by viewing the new parameter in the LED status indicator.
2. To exit the second function mode, press SECOND FUNCTION.
3. Press SET MPP again, and your printer is back in primary function mode and will select the value you have just set. This value is temporary and will not remain once the printer has been powered off. To set this value permanently, see the following section. Press ENABLE PRINT to resume printing.

2.9.4 CONFIGURE

While in the second function mode, CONFIGURE allows you to set chosen parameters permanently. Values set permanently will stay in the printer's memory and are ready for use at power on.

NOTE

CONFIGURE is to be used in specialized applications only. It is not recommended for printers used for a variety of printing functions.

Primary function mode parameters such as LPI, print spacing, character case, print type, and paper handling are set temporarily as explained under each key definition. These parameters can also be set permanently by using the CONFIGURE key. To set these features permanently, follow the procedures below:

1. Place the printer in HOLD PRINT.
2. While in primary function mode, select the desired parameters. You may use primary function keys: CHANGE LPI, CHANGE SPACE, CHANGE CASE, CHANGE SPEED, or CHANGE MODE. See the definition of each key you are interested in setting under "Primary Function Keys".
3. Press SECOND FUNCTION. (Notice that the LED display shows "ccc".)
4. Press CONFIGURE.

EXAMPLE

To permanently set the printer at 8 LPI, first press HOLD PRINT, then press SECOND FUNCTION. Next press SET FORMS and increment to desired forms length. Press SET FORMS to register the new forms length in the printer. Then press SECOND FUNCTION, CONFIGURE, and finally ENABLE PRINT to resume printing

2.9.5 100, 10, and 1

The number 100, 10, and 1 keys are used to change page length, line length, and to select a diagnostic test number. If you are using the 3-bin sheet feeder option, the 1 key is used to select specific bins. The number you enter to indicate a new page length, line length, test, or bin number is displayed on the status indicator. For complete instructions on how to use these keys, refer to "SET FORMS", "SET MPP", and "DIAGNOSE".

2.9.6 TEST

While in second function mode, the TEST key is pressed to perform a self-test. The TEST key is not operational in parallel host mode.

- The printer will perform the requested test.
- The TEST indicator comes on.

The ENABLE PRINT key is then pressed to resume printing.

For detailed instructions on the self-tests procedure, see "Running a Self Test" to change the current test number, follow the procedure outlined in the DIAGNOSE key description.

2.9.7 DIAGNOSE

While in second function mode, the DIAGNOSE key allows you to select a test you wish the printer to run when TEST is pressed. The default setting for the test number is 0. To view the current setting:

1. Place the printer in second function mode (by pressing HOLD PRINT, then SECOND FUNCTION).
2. Next, press the DIAGNOSE key. The LED status indicator displays the current test number as a three digit number (003 for test #3).

To select your new test number:

1. Press the "1" key.

See "Running a Self-Test" for a list of the available self-tests and their corresponding numbers. The LED status indicator will display your selection.

To return to primary function mode:

1. Press DIAGNOSE again.
2. The printer is now back in primary function mode and will select the value you have just set. This value is temporary and will not remain once the printer has been powered off. The LED status indicator will be blank. Press ENABLE PRINT to resume printing.

NOTE

The DIAGNOSE setting cannot be set permanently.

2.9.8 ACCEPT SHEET

While in second function mode, ACCEPT SHEET is used to assist the printer in cut sheet paper insertion. After the ACCEPT SHEET key is pressed, the printer will automatically load the sheet currently inserted for printing. ACCEPT SHEET should only be pressed at the point indicated in "Loading Cut Sheets" and "Reloading Cut Sheets" as part of the loading process.

2.9.9 BIN SELECT

The default setting for the twin-bin and envelope feeder is bin 2 at power on. To view the current setting:

1. Place the printer in second function mode (by pressing HOLD PRINT, then SECOND FUNCTION).
2. Then press BIN SELECT. The LED status indicator displays the bin currently selected.
3. To resume printing without altering the bin number simply press SECOND FUNCTION and ENABLE PRINT. If no bin is specified, the printer will select bin 2. To select a different bin or bins refer to Appendix E.



Figure 2-5 Second Row Secondary Function Keys

2.9.10 F1 (Function)

This key is currently undefined.

2.9.11 F2 (Function)

This key is currently undefined.

2.9.12 CHANGE HOST

Press this key while in second function mode to switch printing from IBM 3270 input to an IBM PC or equivalent unit via the parallel port connector. You may switch to this alternate host input any time an IBM print from the CU is not in progress. The current status of this key is indicated by the ALT HOST indicator.

Press HOLD PRINT, SECOND FUNCTION, then CHANGE HOST.

- The ALT HOST indicator comes on.
- The 468 accepts input from an IBM PC or equivalent unit via the parallel connector. The current printer parameters will not change when switching between control unit input and IBM PC input.

To return to 3270 input press HOLD PRINT, SECOND FUNCTION, and CHANGE HOST.

- The ALT HOST indicator goes off.
- The 468 accepts input from the 3270 control unit.

Press ENABLE PRINT and printing will resume.

NOTE

Although both the coax and PC connectors are attached, only one of these devices may communicate to the printer at one time.

2.10 WHAT THE INDICATOR LIGHTS MEAN

The indicators on the operator control panel light to indicate what printer functions are being used. The paragraphs below describe each indicator and Figure 2-6 shows where they are on the panel.

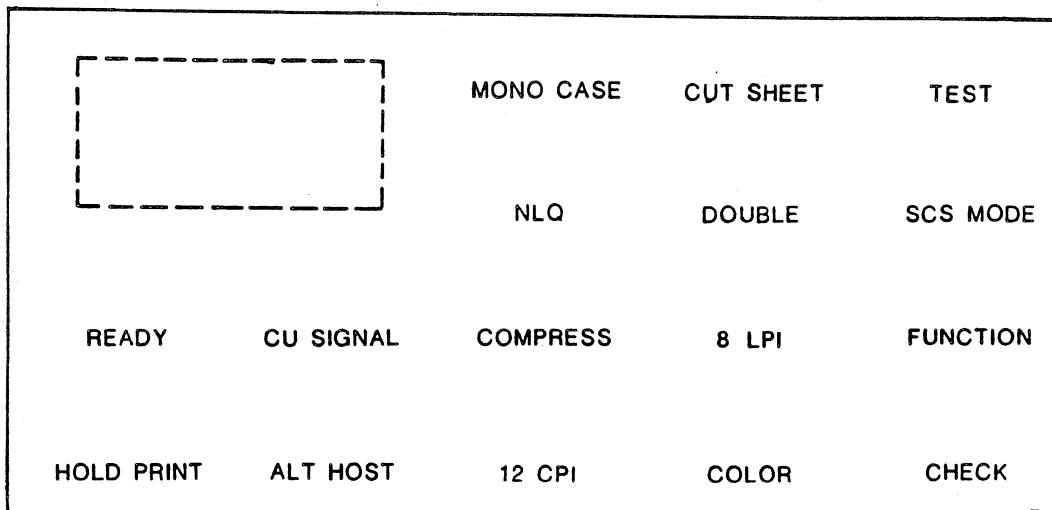

Figure 2-6 Status Indicators and Status Display

2.10.1 READY

READY is on when:

- The printer is ready to receive data from the controller.

READY is off when:

- The printer enters HOLD PRINT.
- The printer enters test mode.
- The check condition occurs (error detected).
- The printer is powered off.
- The printer runs out of paper.

2.10.2 HOLD PRINT

HOLD PRINT is on when:

- The printer is in the hold print mode.

HOLD PRINT flashes when:

- The printer is in second function mode.

2.10.3 TEST

TEST is on when:

- The self-test or a selected diagnostic test is being run.

TEST is off when:

- The printer completes the self-test or a selected diagnostic test.
- The HOLD PRINT key is pressed.

See TEST key description for details.

NOTE

The TEST indicator does not come on during test #8. HOLD PRINT will stop the test, but it will not make the indicator go on.

2.10.4 CHECK

CHECK is on when:

- An error condition occurs.

The printer will stop printing and the status indicator displays an error code (see "WHAT TO DO IF YOU HAVE A PRINTER PROBLEM" to determine the meaning of the error codes).

2.10.5 CU SIGNAL

CU SIGNAL comes on when:

- The printer is in communication with the controller.

CU SIGNAL is off when:

- Signals from the controller are not received approximately every 40 milliseconds.

2.10.6 DOUBLE

DOUBLE is on when:

- The printer is set to print with double spacing.

2.10.7 DUAL CASE

DUAL CASE is on when:

- The printer is set to print in upper and lower case.

2.10.8 8 LPI

8 LPI is on when:

- The printer is set to print 8 lines per vertical inch.

2.10.9 CUT SHEET

CUT SHEET is on when:

- The printer is set to handle single cut sheets of paper.

2.10.10 NLQ

NLQ is on when:

- The printer is set to print 100 CPS near letter quality printing at 10 CPI.

2.10.11 ALT (alternate) HOST

ALT HOST is on when:

- The printer is set to communicate via the parallel connector to a unit such as an IBM PC, instead of to the IBM 3270.

2.10.12 COMPRESS

COMPRESS is on when:

- The printer is set to print 12 CPI.

2.10.13 COLOR

COLOR is on when:

- The printer is configured to print base color.

2.10.14 SCS MODE

SCS MODE is on when:

- The printer is in SCS mode.

2.11 USER SELECTABLE FEATURES

THE BACK PANEL

The switches you can use to control the model selection, language selection, and special functions are located inside the right-hand cut-out window in the rear printer housing. There are two switch packs, E1 and E22. E1 switches control model and language selection and E22 switches provide access to special printing functions. You must change all 468 option switches before the printer is turned on or the printer will not recognize the change. The value of the option switches are read and their values stored only at power on.

When you receive your printer it will already be set at the default values listed in Section 1, "HOW TO OPERATE YOUR PRINTER". If you want to change any of these settings, refer to the sections below for specific switch settings.

When you are using the switch setting charts, the switches to be set are shown in white. The shaded areas are switches which will be set later; ignore the settings of these keys until that time. The UP and DOWN settings are indicated as shown in the following key.

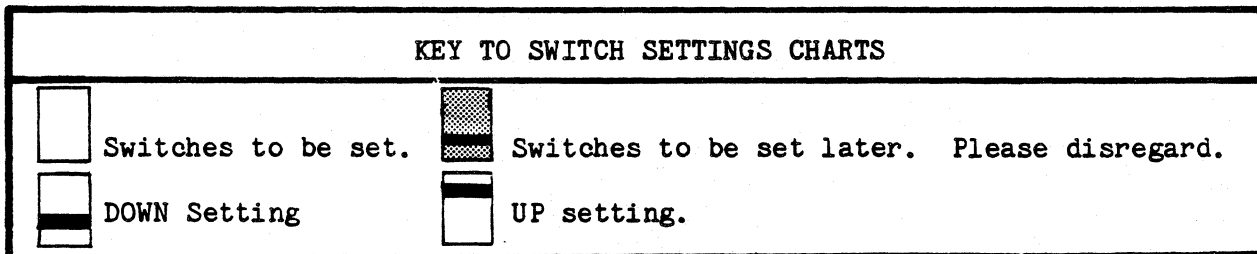

2.11.1 The Language Select Switch Settings

NOTE

These language sets are functional only if there is both CU and Foreign Keyboard support of the selected language.

Switches 1 through 5 on switch pack E1 specify the different language settings. Switches 6 through 8 specify the IBM Model to be used.

The following chart specifies the settings of switches 1 through 5 on E1 for each language supported by the 468. Settings not given default to English, U.S.

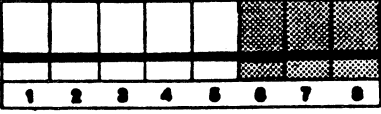
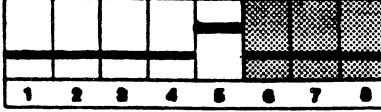
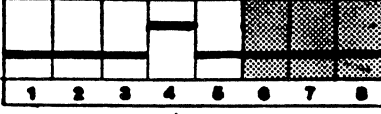
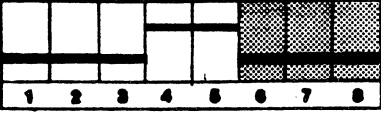
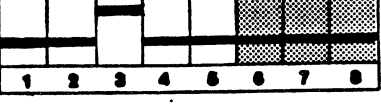
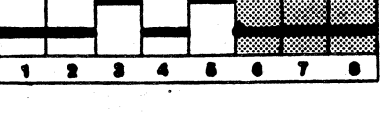
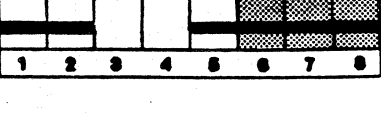
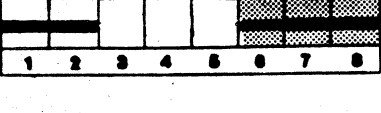
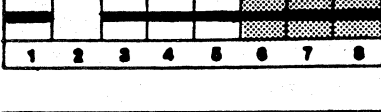
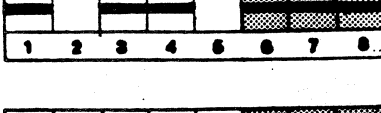
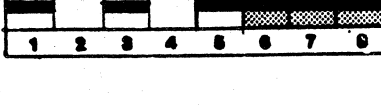
SWITCH E1	LANGUAGE
	English, U.S.
	Austrian/German
	Austrian/German Alt.
	Danish/Norwegian
	Danish/Norwegian Alt.
	Finnish/Swedish
	Finnish/Swedish Alt.
	French
	Italian
	Portugese Alt.
	Spanish

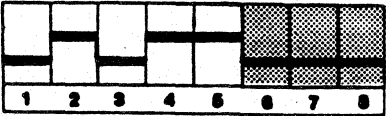
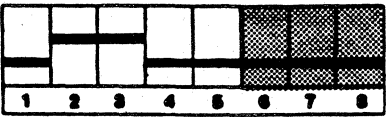
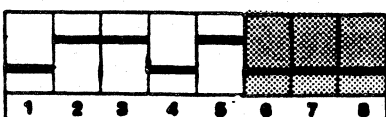
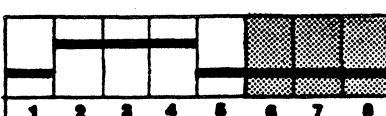
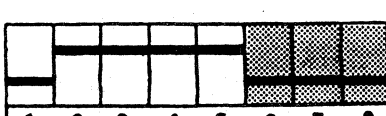
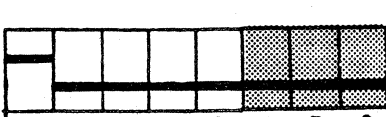
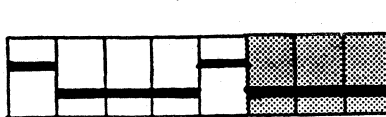
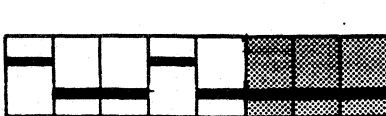
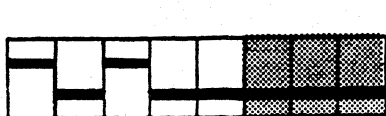
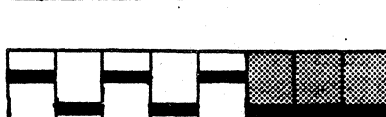
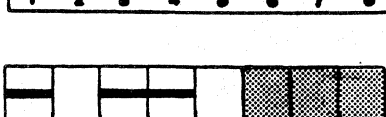
SWITCH E1	LANGUAGE
	English, U.K.
	Belgian
	International
	Japanese/English
	Canadian/French
	Brazilian
	Canadian Bi-lingual
	Katakana*
	Reserved
	Reserved
	Reserved

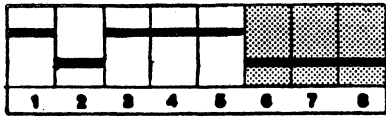
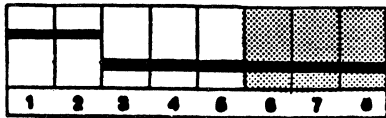
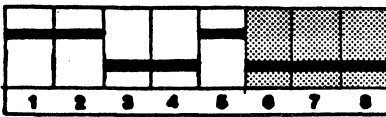
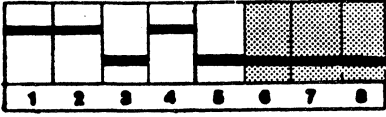
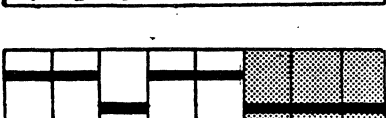
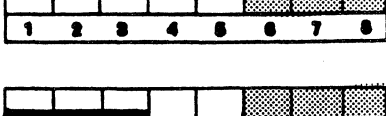
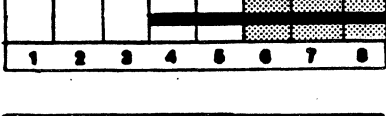
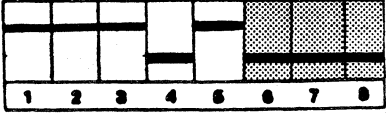
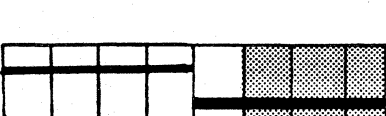
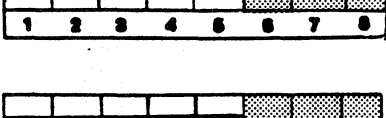
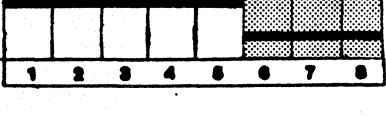
SWITCH E1	LANGUAGE
	Reserved
<p>The following sets enable the right-to-left printing mode:</p>	
	English
	Hebrew, A*
	Hebrew, B*
	Hebrew Bulletin Code
	"
	"
	"
	"
	"
	"





*Full use of these languages requires a different character generator installed in the printer. Contact your ISI representative for details.

IMPORTANT

When a right-to-left language set has been selected, the CHANGE CASE key and its associated indicator, DUAL CASE, control and indicate print direction. Thus, CHANGE CASE must be pressed (and the DUAL CASE indicator lit) to enable right-to-left printing.

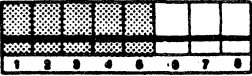
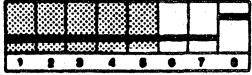
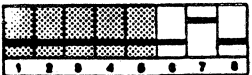
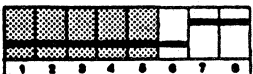
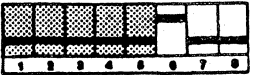
2.11.2 IBM Model Select Switches

It is important that the printer be configured to match the controller. To determine the appropriate screen size count the number of characters per line and the number of lines per screen. For example, if your screen has 24 lines per screen x 80 characters per line you would use = IBM Model 2 with 1920 characters screen size (24 x 80 = 1920).

SWITCH E1	IBM MODEL NO.	SCREEN SIZE	BUFFER SIZE
	2	1920 characters (24 lines x 80 characters)	2K
	1	960 characters (12 lines x 80 characters)	2K
	2	1920 characters (24 lines x 80 characters)	2K
	3	2560 characters (32 lines x 80 characters)	4K
	4	3440 characters (43 lines x 80 characters)	4K
	5	3564 characters (27 lines x 132 characters)	4K
	2	1920 characters (24 lines x 80 characters)	4K
	4	3440 characters (43 lines x 80 characters)	4K





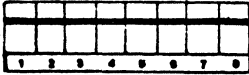

2.11.3 Special Function Switch Settings

Special functions offered by the 468 are selected through switches 1 through 8 on switch pack E22 and switches 2 and 3 on switch pack E74. These functions and their required switch settings are outlined in the following paragraphs:

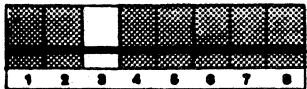
SWITCH E22	FUNCTION (DOWN Setting)
	1 selects settings made permanent by CONFIG 2* alarm enabled 3* disable automatic line feed after carriage return. NOTE: The function of this key is dependent on switch 8 in E74. (See chart below.) 4** single plane PS configuration 5** base color black (same as IBM 3287-2C Specify Feature 9135) 6 twin-bin and envelope feeder not installed 7** do not print null lines 8** do not print form feed on local copy
	(UP Setting) 1 selects "standard default settings at power up 2* alarm disabled 3* automatic line feed after carriage return (See the following chart for details.) 4** triple plane PS configuration 5** base color green (same as IBM Specify Feature 9136) 6 twin-bin and envelope feeder installed 7** print null lines (same as IBM 3287 RPQ ML0042-SC3741 and MK39880-SC3741, and 3268 Specify Feature 9505) 8** print form feed on local copy

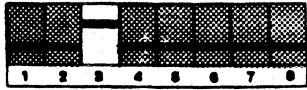
*Used only when ALT HOST (IBM PC Controller) selected.

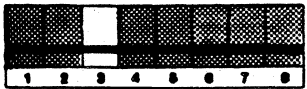
** Used only when Primary Host (3274 Controller) selected.

Switch E22 #3	Switch E74 #8	Function
		Do NOT perform automatic line feed.
		Perform automatic line feed.
		Line feed is externally controlled (pin 14). If there is NO external control, an automatic line feed will NOT be performed. If there IS external control, an automatic line feed WILL be performed.

1 = OPEN

0 = CLOSED

SWITCH PACK E74

Switch pack E74 is located under the body cover. Switch 1 selects IBM printer model, and switches 2, 3, and 7 control special functions. Before you can remove the body cover, the top and rear covers must be removed from

the printer. To remove, see the following directions.

TOP COVER - To remove the top cover simply lift the rear edge of the cover up and off the printer.

REAR COVER -

1. Unsnap the top of the rear cover from the printer.
2. Tilt the rear cover until it is fully open.
3. Lift the rear cover straight up and off the printer.

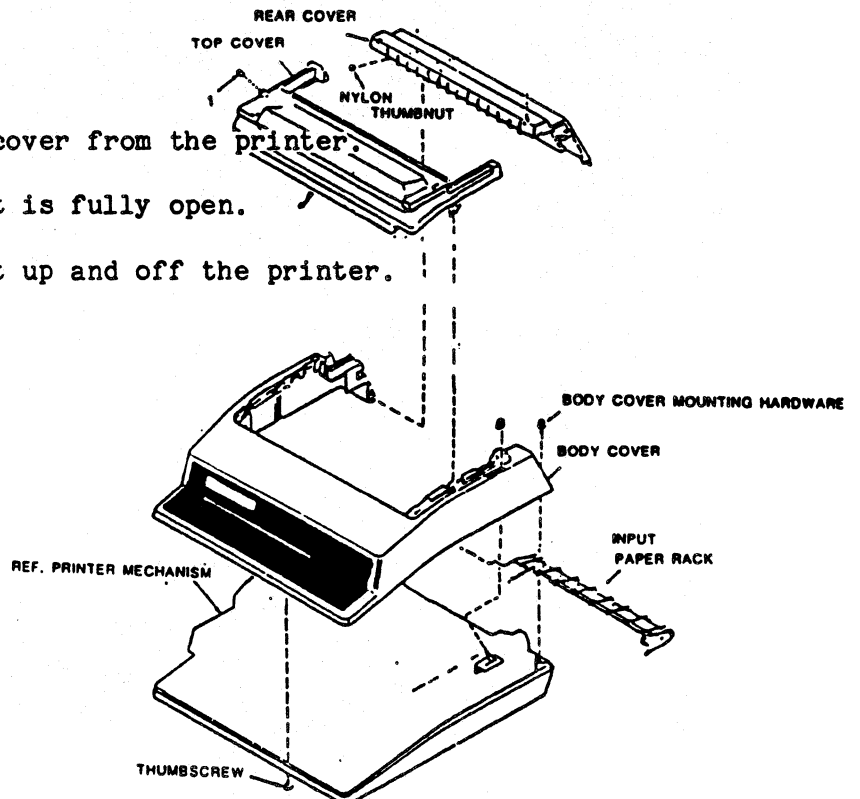
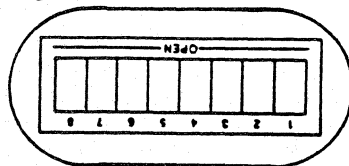

Figure 2-7 Removing the Covers

BODY COVER - After the top and rear covers are removed, remove the body cover.

1. Remove the two Phillips head screws at the rear of the printer mounting the body cover to the printer base.
2. Loosen the thumbscrew which is underneath the front of the printer and is mounting the body cover to the printer base.
3. Place the forms lever in the "LOAD" position.
4. While GENTLY pushing the body cover towards the rear of the printer, lift the cover up and off the printer. NOTE: DO NOT BREAK THE HOOKS! The body cover hooks to the front side of the base, so you must push gently as instructed above.
5. Unplug the operator control panel.

With the cover removed, (the red) Switch pack E74 is found on the front left of the pcb, behind the control panel and right of the power supply as shown.



NOTE: This is exactly how the switch pack appears when looking from the front of the printer.

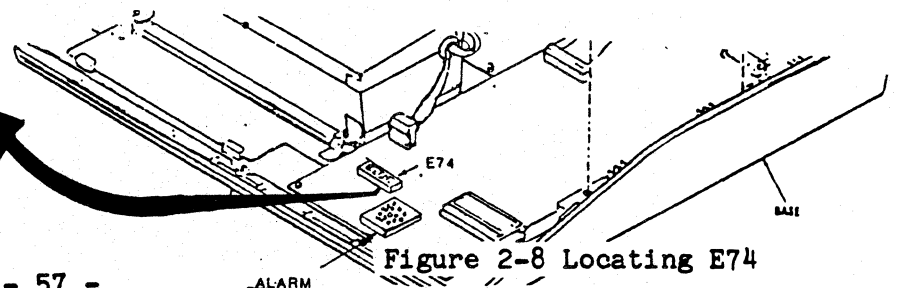
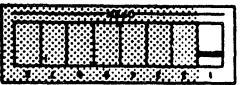
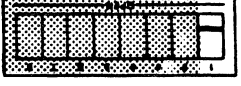
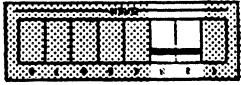
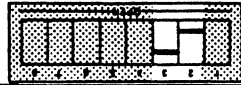

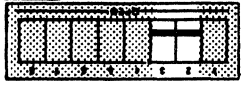
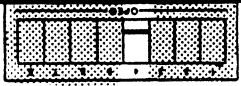
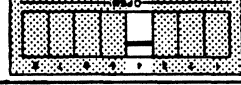



Figure 2-8 Locating E74

SWITCH E74	FUNCTION
	printer is identified as an IBM 3287 2C
	Interface Systems' diagnostics. DO NOT USE!
	FACTORY DEFAULT (same as IBM 3287 RPQ S30219 - 3287 Specify Feature 9504.) A non-SCS form feed at the end of a print will advance the printer to the first print position of the first line on the next form. ALWAYS use this setting with the twin bin and envelope feeder.
	RESERVED (currently the same as the FACTORY DEFAULT)
	SUPPRESS FORM FEEDS. If forms length = 0, the printer will ignore non-SCS form feeds. No paper motion will occur when a form feed is received. Forms length settings other than zero will act the same as FACTORY DEFAULT.
	IBM 3287 STANDARD. A form feed terminating a non-SCS print will advance the printer to the first print position of the second line of the following form.
	CARRIAGE RETURN OR NEW LINE AT MPP+1 (same as IBM 3268 Specify Features 9501 and 9502, and 3287 RPQ S30219). This feature will suppress the printer's automatic New Line at MPP+1.
	NO CARRIAGE RETURN OR NEW LINE At MPP+1. An automatic New Line at MPP+1 will be performed.
	FORM FEED ON END OF JOB (same as IBM 3268 Specify Feature 9507 and 3287 RPQ MK3988-SC3740.) An automatic form feed will be performed at the end of every non SCS print unless the printer is already at Top of Form.
	NO FORM FEED ON END OF JOB (IBM 3287 Standard.) No automatic form feed is performed at the end of a print.

2.11.4 STATUS INDICATOR

You can monitor the operation of your printer by reading the various codes displayed on the status indicator. The status indicator is a three digit LED display located in the upper left corner of the control panel. The information that may be displayed includes:

- A status code when the printer requires operator attention (for example, when the printer runs out of paper). See "Operational Status Codes", for the operational status codes and their meanings.
- The current forms length setting when you press SECOND FUNCTION and then SET MPP.
- The current MPP when you press the SECOND FUNCTION key and then the SET MPP key.

- The current test number selected when you press SECOND FUNCTION and then DIAG.
- The current bin selected for the twin-bin and envelope feeder.

2.11.5 Audible Alarm

When the printer requires your attention, the audible alarm sounds (beeps) a one second tone. It continues to beep at regular intervals until you press HOLD PRINT.

The alarm will sound when:

- The printer is out of paper.
- An error is detected and the CHECK indicator is on.
- The cover is open.
- The printer received a program attention action request.

2.11.6 CU Indicator

The CU indicator comes on when the printer has received, accepted, and is returning a response from the control unit.

2.12 HOW TO USE COLOR AND PROGRAMMED SYMBOLS

The 468 Model 2 can do all the basic printing functions in addition to printing in seven colors and allowing the use of programmed symbols. Your 468 can print with color and programmed symbols without IBM color and programmed symbols software. Just follow the directions below to use these functions.

IMPORTANT

A screen copy from a seven color display to the 468 model 2 printer USUALLY prints in those seven colors, but this is NOT guaranteed. The correct color selects must be present in your system to print seven colors. To determine if your system will support seven color printing, try a sample print before you begin a job.

2.12.1 How to Use Color

To use color you must install the appropriate ribbon and follow the instructions in the specific local operating procedures written for your system. These operating procedures are different for each system. (See Appendix C for details.)

The 468 Model 2 uses three different ribbons: solid black, primary, and process. Listed below are a few general facts to consider when using the different ribbons.

1. Solid Black Ribbon: When a black ribbon is installed only black will print. Using an all black ribbon is the fastest method of printing for the 468.
2. Primary Ribbon: With a primary ribbon installed, the printer acts like a four color printer and may print in red, blue, green, and black. Each color requires one pass of the print head, thus a single line could require up to four passes. For this reason, color printing is slower than solid black printing. For example, a line with red, blue, green, and black print requires four passes of the print head to complete. Base color printing which uses the protect, unprotected, intensified and not intensified attributes allows the use of these four colors. (See Appendix B.3 for details.)
3. Process Ribbon: The process ribbon is cyan, magenta, yellow, and black. With this ribbon installed, the printer can print in seven colors if directed to do so. Three of the seven colors are produced by printing one color over another. These colors require two passes of the print head to complete. See the chart below for a list of single and double pass colors. The maximum amount of passes for any one line is still four as explained for the primary ribbon. Lines requiring all four passes become more frequent when using seven colors, however, thus it is considered the slowest of the three ribbons to use. As a general rule, the more colors you use the longer it will take to complete a job.

SUMMARY OF RIBBON CHARACTERISTICS			
RIBBON NAME	RIBBON COLOR	COLORS PRINTED	SPEED
Solid Black	black	black	Fast
Primary	red, blue, black, green	red, blue, black, green	Medium- each different color requires one pass of the print head
Process	cyan, magenta yellow, black	turquoise, pink, yellow black, red, blue, green	Slow - colors take one or two passes of print head: One pass colors: turquoise, pink, yellow, black Two pass colors: red, blue, green

The instructions given below are for basic functions that you will perform by using the operator control panel on the 468 Model 2 printer. If your instructions tell you to enable or disable color, follow the

instructions below:

1. Press HOLD PRINT. Then check the indicator to see if the COLOR light is on (on means base color is on; off means base color is off).
2. If your printer is at the desired setting, just press ENABLE PRINT to resume printing.
3. If your printer is not at the desired setting press BASE COLOR until you reach the desired setting. Each time the BASE COLOR key is pressed, the COLOR light changes accordingly (on or off). Then, press SECOND FUNCTION and CONFIGURE to tell the printer to use the new setting and ENABLE PRINT to resume printing.

When using the base color option, you have the choice of base color black, or base color green. This is controlled by switch #5 in switch pack E22. If you want most of your text, which is displayed in green on your screen, to print in black use base color black. This maintains ribbon life and allows you to use green, red, and blue with the rest of your program. If you want your text to be printed exactly like it appears on your display screen, use base color green. See the chart below for color displayed - vs - color printed.

COLOR DISPLAYED	COLOR PRINTED*	
	Base Color Black	Base Color Green
Green	Black	Green
Red	Red	Red
Blue	Blue	Blue
White	Green	Black
Turquoise	Turquoise**	Turquoise**
Pink	Pink**	Pink**
Yellow	Yellow**	Yellow**

*The correct ribbon must be installed to print the colors listed.
 **These colors are only available when using a process ribbon and extended color.

To select base color black, place switch # 5 on switch pack E22 in the DOWN position. To select base color green, place the switch in the UP position.

Check these things before you start printing with color:

1. Is a color ribbon installed?(NOTE: When an all black ribbon is installed, the color control codes are ignored, and everything is printed in black.)
2. Can your program control the selection of color on the ribbon?
3. Does your program instruct you to enable or disable base color? If it does, have you done this?

4. Are the switches at the correct settings for the desired base color?
5. Is the correct ribbon installed for the desired colors? (i.e., Seven colors can only be printed when the process ribbon is installed.)

For more specific details on color printing, refer to Appendix C.

2.12.2 How to Use Programmed Symbols

Programmed symbols (PS) printing allows you to define and print a variety of shapes symbols, patterns, and special characters which combine to make almost any picture or graph you may want or need. Without programmed symbols, all the dot patterns for the material to be printed are predefined.

Two types of symbol sets, single plane and triple plane, are available. Single plane sets are used for single color character cells, and triple plane sets are used for multi-color character cells. The single/triple plane switch setting allows you to select whether PS sets 5, 6, and 7 are treated as 3 single plane sets or one triple plane set. To select the triple plane PS configuration, place switch #4, switch pack E22 in the UP position. To select the single plane PS configuration, place switch #4 in the DOWN position.

To use programmed symbols, the programmed symbols characters must be loaded by the application program each time the 468 is powered on or each time the symbols change. Refer to the specific loading instructions written for your system and its programs for details. To define your own symbols refer to Appendix B.3.

2.12.3 Combining Color and Programmed Symbols

Any PS set character can be printed in any one solid color if it is supported by the ribbon installed. Printing one character in two to seven colors requires a triple-plane symbol set. To select the triple-plane symbol set, place switch number 4, Switch Pack E22 in the UP position. (See Appendix C for details.)

2.12.4 Combining Color and Large Character Printing

By using the Large Character escape sequence with a color ribbon installed, the 468 Model 2 will allow you to print one pass colors only. (Please note that ISI does not recommend using a process ribbon for Large Print Characters.) See Appendix B.2 for details.

2.13 WHAT TO DO IF YOU HAVE A PRINTER PROBLEM

First of all stay calm. Most of the problems you encounter during normal operation are called operational problems which you can fix quite easily. When a problem occurs, look at the status indicator to see if a code is displayed. If there is a code, refer to the following section.

2.14 Operational Status Codes

The table below lists the most common operational status codes and their meanings. For example, when the printer runs out of paper the "1" code is displayed on the Status Indicator. A status code is always accompanied by the alarm sounding and the CHECK light coming on.*

To use this chart, locate the code in the left column. Then refer to the middle column for the description of your problem. Finally, look in the right-hand column and follow the suggested corrective action. If the problem can't be corrected by the procedure suggested, contact your service representative or qualified service personnel at Interface Systems, Inc., by calling (313) 769-5900.

OPERATIONAL STATUS CODES		
CODE	PROBLEM DESCRIPTION	CORRECTIVE ACTION
1	paper out	Load in more paper.
2	cover open	Close top and/or acrylic covers
8	operator intervention required(printer has been in HOLD PRINT 10+ minutes, printer electronics failure, or LU1 mode and BUFFER REPRINT has been actuated.)	- Take printer out of service and put back in. -(On Local DOS systems-crash the Host)
4,10,14	head jam	- Make sure forms lever is not in "LOAD". - Remove paper or any other object which may be jamming the print head. - Make sure the restraining clip has been removed.
27	control out of communication	Ask your system manager for instructions on this installation related problem.

*Alarm does not sound for #8 or #27.

63	printer has received action request	Program is requesting a PA switch actuation, if you're not sure why, ask your system manager for instructions.
999	power failure	Turn printer off for 5-10 seconds then power back on.
96X*	print mechanism failure	" " " " " " "
97X*	print controller failure	" " " ". If problem persists contact your service representative.
98X*	format controller failure	Turn printer off for 5-10 seconds then power back on. If problem persists contact your service representative.

* The "X" is currently reserved for future refinement of these error codes.

These next status codes appear when more than one error occurs at once. As you fix them the next appropriate error code will be displayed. For example, if error code 11 (head jam and paper out) shows and you fix the head jam, the code 1 will be displayed until you fix the paper out condition.

3	paper out and cover open	Reload the paper and close the top and/or acrylic covers.
5,11,15	paper out and head jam	- Make sure forms lever is not in "LOAD". - Remove paper or any other object which may be jamming the print head.
6,12,16	cover open and head jam	- Make sure the restraining clip has been removed. - Reload paper as necessary. - Make sure forms lever is not in "LOAD". - Remove paper or any other object which may be jamming the print head.
7,13,17	paper out, cover open and head	- Make sure the restraining clip has been removed. Close the top and/or acrylic covers. - Make sure forms lever is not in "LOAD" - Remove paper or any other object which may be jamming the print head.
999	paper is tearing and/or ink is smearing power failure	- Make sure the restraining clip has been removed. - Reload paper as necessary and close the top and/or acrylic covers. Adjust the print head impression. See "Adjusting For Forms Thickness". Turn the printer off for 5-10 seconds then power on.

2.15 Running a Self-Test

In the event of a printer error the following procedure should be followed to perform a self-test. . This test may not mean much to you, but it will be helpful when talking with ISI service personnel. Please note that while in parallel host mode the only diagnostic available is test #8, hex dump.

1. Place the printer in HOLD.
2. Press the SECOND FUNCTION switch.
3. Press DIAGNOSE to view the current test mode (see Table 2-7).
4. If you wish to change the test mode at this time, press the "1" key until you arrive at the desired number.
5. Push the DIAGNOSE key to store the test in the printer's memory (i.e., you must press DIAGNOSE to achieve the new test, otherwise, the printer will print the original test displayed).
6. Push TEST. The printer will run the test. If you wish to stop a lengthy test (such as 3, 4, 5, and 9) press the TEST key again.
7. When the test is over, the printer returns to the primary condition.
8. To run another test, press SECOND FUNCTION again and repeat steps 2 through 4.
9. To re-run the same test, press TEST.

NOTE: Test #8, auto dump, is run in READY mode. To stop the test push HOLD.

SELF-TEST DIAGNOSTICS

- 0 - version and status
- 1 - version - print version, model, ROM checksum, status
- 2 - print status "Xxyzab"
 - X - identifies the next 6 characters as a status code
- xx
 - 80 - non-SCS Query command received
 - 40 - SCS LPS command received

- 20 - LTT order received
 - 10 - RESET command received
 - 08 - LU3 LPS order received
 - 04 - PRINT order received
 - 02 - ABORT order received
 - 01 - SSA order received
- y F - printer is busy
 0 - printer is not busy
- z F - printer is ENABLED and may alter adapter RAM
 0 - printer is DISABLED
- a 0 - no order received (or an illegal, 0, order was last)
 1 - last received order was ABORT
 2 - last received order was SSA
 3 - last received order was Print
 4 - last received order was Load Programmed Symbols
 5 - last received order was load translate table
 6 - last received order was non-SCS query command
 7-F these last values are illegal at this time
- b 0 - last command received was DISABLE
 1 - last command received was ENABLE
 2 - last command received was RESET
 3 - last command received was SOP
- 3 - dump print buffer and variable RAM (Random Access Memory)
- 4 - dump variable RAM only
- 5 - device dependent test (character dump print)
- 6 - not defined
- 7 - dump programmed symbols RAM
- 8 - Auto dump (as in 3) at the end of print *
- 9 - print test (repeats until stopped). This test prints in color when a color ribbon is installed.
- 10 - print lines of "H's" at 10 CPI
- 11 - print spaces without advancing form
- 12 - color ribbon alignment test

Table 2-7

* This is the only diagnostic available while in parallel host mode.

Section 3: Appendix

Appendix A

CARE AND CLEANING OF YOUR PRINTER

Your printer is clean, new, and operating beautifully and it's easy to keep it that way. Although there are no regularly scheduled preventive maintenance procedures, you should periodically inspect and clean the printer area that is immediately accessible under the top cover.

Occasionally, during paper loading or ribbon replacement, inspect the printer for a build-up of lint or foreign material. If the build up of material is evident, clean the area with a lint free cloth.

Table A-1 below lists the maintenance occasionally required on certain areas of the printer. This maintenance may be required more or less frequently, depending on what you use your printer for and where you use it.

CLEANING AND INSPECTING YOUR 468	
ASSEMBLY	MAINTENANCE
Covers	Clean all cover assemblies using a mild detergent and a lint-free cloth.
Internal Inspection	Remove the top cover and look inside for loose wires, connectors, and hardware, chafing of cables, and worn or damaged parts.
Print Head and Carriage	After removing the ribbon, use a light bristle brush to gently remove the dust and residue from the print head and carriage assembly.
Platen Assembly	Clean the platen assembly with a mild detergent.

Table A-1

There are also some general guidelines you can follow to keep the need for cleaning and maintenance to a minimum. Table A-2 lists a number of common sense tips for the care of your 468.

CARE OF YOUR 468

- Keep the covers closed whenever possible to keep out dust, dirt, fingers, and anything else that may wander in.
- Don't spill liquids (such as your morning coffee) into your printer.
- Don't drop things (paper clips, combs, gum, pencils, etc....) into your 468.
- Keep fingers, ties, and hair out of the printer. It really messes things up, and it doesn't feel too good either.
- Don't let the 468 print past the top, bottom, or side edges of the paper or forms. It will dirty the platen and may damage the printhead.
- Be nice to your printer by following the directions listed in this manual. Do not yank and pull at levers, cassettes, and cables.
- Never kick, pound, or drop your printer; although, situations may arise where you would like to, I have always found the problem is usually minor and not worthy of such abuse.

Table A-2

Appendix B

PROGRAMMING THE ISI 468 FOR SPECIAL PRINTING FUNCTIONS

The 468 can be programmed to perform special printing functions by sending escape sequences through the data stream. The escape sequences available and their functions are listed below. Some of the printing functions are standard, such as the 16.67 CPI Compressed Printing option. Follow the instructions outlined in the following sections under the function you wish to control through programming.

SUMMARY OF AVAILABLE ESCAPE SEQUENCES	
ESCAPE SEQUENCES	FUNCTION SELECTED
& % H 1 & % H 2 & % H 3	Bin 1 of the twin-bin and envelope feeder Bin 2 Bin 3
& % P...	Large Character printing
& % Q 0 & % Q 1 & % Q 2 & % Q 3 & % Q 4 & % O E	400 CPS, 10 CPI dot matrix 100 CPS, 10 CPI near letter quality 16.67 CPI Compressed Print 12 CPI dot matrix 12 CPI near letter quality Prints double width characters on the entire line it is a part of.
& % R 0 & % R 1 & % R 2 & % R 3 & % R 4 & % R 5 & % R 6	Black Blue Red Pink Green Turquoise Yellow

*NOTE: The appropriate ribbon must be installed for color printing. See section 2.12.1 for specific ribbon characteristics.

B.1 SELECTING PRINT MODE

The print mode is controlled from the data stream by means of Interface Systems, Inc.'s defined "escape sequences". The print mode escape sequences are:

ESCAPE SEQUENCES	PRINT MODE SELECTED
& % Q 0	400 CPS, 10 CPI dot matrix
& % Q 1	100 CPS, 10 CPI Near Letter Quality
& % Q 2	16.67 CPI Compressed Print
& % Q 3	12 CPI dot matrix
& % Q 4	12 CPI Near Letter Quality
& % 0 E	Prints double width characters on the entire line it is a part of.

To program the 468, you enter one of the four character escape sequences into the data stream where you want to change the mode. Any characters preceding the escape will be printed using the old mode. Characters following the escape will be printed using the the mode you just selected. The escape is not printed.

There are no restrictions on the use of these escapes. However, when changing mode within a print line, you should be aware that the printer counts characters, not inches, for horizontal positioning. Pad characters may be required when switching to a higher density (i.e., from 10 CPI to 16.67 CPI); some blank space will appear when switching to a lower density unless a CR code is inserted followed by pad characters.

B.2 PROGRAMMING INSTRUCTIONS FOR THE LARGE CHARACTER OPTION

& % P

Large Character Escape Sequence

The following information provides the programming rules for using the Large Character Option of the ISI 468. Large Character Label Printing is an option and can only be performed by an ISI 468 so equipped. The Large Character Option can only be used in variable format print mode (where lines are terminated by new line (NL) or end marker (EM) codes) and in SCS mode subject to the restrictions listed in the addendum. Information does not have to be completed in one line. The plus sign "+", as the only character in the last segment of a line, indicates another sequence is to be added to the current sequence before printing.

A large character print line is distinguished from a normal print line by starting with a large character print "header sequence". This header is &%P and must be the first three characters of any large character print line. (i.e., it should immediately follow a new line (NL) code). Large characters are then programmed by specifying a "segment" or segments (up to 16) in a line. If a print line (defined as data between NL codes) contains a segment, it cannot contain other data to be printed, only other segments (although normal size 0.1 inch characters can be specified in a segment). Segments are delineated from one another by a ";".

A segment is defined as:

(E) (S) (X) (Y) (data) (parenthesis not to be used)

where E is ";" (Hex 5E)

and S is a two digit size code indicating the height of the large characters in tenths of inches.

VALID SIZES	
HEIGHT	WIDTH
S = 01 for 0.1" characters (normal)	0.1"
S = 02 for 0.2" characters	0.1"
S = 04 for 0.4" characters	0.2"
S = 05 for 0.5" characters	0.25"
S = 06 for 0.6" characters	0.3"
S = 07 for 0.7" characters	0.3"

And X is a three digit number, 001 to 132, specifying the starting print line position of the large character.

Y is a two digit number, 00 to 99, specifying the number of tenth inch lines down from the current print position that the top of the large character segment is to be printed.

Data equals the actual character(s) to be printed in large sizes. Except in 0.1 inch high size, the only valid data characters are:

1. space
2. A through Z
3. 0 through 9
4. - + .

In 0.1 inch high size, all valid 3270 EBCDIC characters will be printed except ; _ and —

EXAMPLE: A line consisting of:

&%P;0402103ABC;(NL)

will cause three large character vertical line spaces (01." high), and "ABC" printed 0.4 inches high starting in print position 21.

More than one segment (a sequence) can be programmed between NL codes to specify characters of various sizes and at various positions as follows:

&%P(E) (S) (X) (Y) (data)...(E) (S) (X) (data)

(NL) where "n" is 2, 3, 4...

The only restrictions on defining a sequence are:

1. A sequence can only have a mix of 0.1, 0.2, 0.4, 0.5, 0.6, and 0.7 inch high characters.
2. The last characters printed may not extend below a point 9.9 inches below the starting point. (i.e. ;0702094ABC; is not a legal segment)
3. Each sequence must consist of MPP-1 or fewer characters.

IMPORTANT:

Any invalid sequence will be printed just as it appears in your data when more than one segment within a sequence specifies printing at a particular point on the page, the last segment determines what is printed.

EXAMPLE:

ABC(NL)(NL)&%P;0700100ABC;(NL)(NL)ABC(EM)

There are five lines in this sequence:

Line Number:	1.	"ABC(NL)"
	2.	"(NL)"
	3.	"&%P;0700100ABC;(NL)"
	4.	"(NL)"
	5.	"ABC(EM)"

Line numbers 1,2,4, and 5 -- Height will be normal line spacing of 6 lines per inch (0.166667 inches per line).

Line number 3 -- Height will be large character line spacing of 10 per inch.

The total height of line number 3 will be 0.68400 inches or 6 lines times 0.1" plus 0.084" segment height.

2.0.1 Combining Color and Large Character Printing

By using the Large Character escape sequence and the appropriate color ribbon, you can print any one pass colors. Since Large Character printing always uses only one pass of the print head, a two pass color will only print the first pass. If you are using the Primary ribbon all four colors will print in one pass. When using a process ribbon not all colors will print as expected, thus ISI does not recommend using a process ribbon for Large Print Characters. A Solid Black ribbon, of course, would print only in black.

Print Sample

The following page is an ISI 468 print sample. It shows a number of different print modes that are possible with the 468 such as standard (10 CPI) print, near letter quality print, compressed print, expanded print, expanded NLQ, expanded compressed, and big print. All these print modes and more, can be controlled from the data stream as mentioned above. In addition, NLQ and compressed print can be controlled from the 468's front panel.

COMPRESSED PRINT

EXPANDED COMPRESSED PRINT

NEAR LETTER QUALITY PRINT

EXPANDED NLQ PRINT

EXPANDED PRINT

0.1 INCH PRINT

0.2 INCH PRINT

0.4 INCH PRINT

0.5 INCH PRINT

0.6 INCH PRINT

0.7 INCH PRINT

E.3 INSTRUCTIONS FOR COLOR PRINTING

As explained in "How to use Color", the 468 Model 2 can print in seven colors, and is available for both SCS and non-SCS print modes. There are two types of color available from IBM, Base Color and Extended Color, both of which are supported by the ISI 468 Model 2.

2.0.1 Base Color

Base color printing is available only in the Non-SCS mode. This feature allows printing of color by using existing application programs that use the protect and intensify field attributes. Protect and intensify bits will tell the 468 to print as follows:

	COLOR DISPLAYED 3279-C	COLOR PRINTED*	
		Base Color Black	Base Color Green
U and N	Green	Black	Green
U and I	Red	Red	Red
P and N	Blue	Blue	Blue
P and I	White	Green	Black

U = unprotected
P = protected

N = not intensified
I = intensified

*When base color is enabled by the front panel (and not overridden by extended color) it will print as shown in the chart. When base color is off, all printing defaults to black.

Base color may be turned on or off by using the BASE COLOR key as described in Section 2.15 "HOW TO USE COLOR AND PROGRAMMED SYMBOLS". Base color green or base color black may be selected through the back panel. For base color black place switch #5, Switch Pack E22 in the DOWN position. For base color green, place the switch in the UP position.

2.0.2 Extended Color

This feature allows you to specify color information for each character.

(NOTE: This is the feature you will want to use if you are creating your own color program.) To specify color information:

1. use the Extended Field and Character Attributes for Non-SCS mode (both of which are in the Extended Attribute Buffer[EAB]),
2. and the Set Attribute control codes for SCS mode.

Please note that extended color is used in addition to base color.

SCS Extended Color

The SCS mode uses extended color which is controlled by the Set Attribute control code. A Set attribute control code is a sequence of control codes which allow you to set character attributes such as color, highlighting, and character sets. Once set, these attributes stay in effect (for SCS prints) until modified or reset. If underscoring and color are specified in the same control code, the underscore and the character will be the same color.

Printing more than one color within the same character is also possible. For this you need to be sure to select a triple-plane PS character. See "Combining Color and Programmed Symbols" for details.

NON-SCS Extended Color

Extended color in non-SCS mode is similar to extended color in SCS mode. The difference being, the control information is contained in the EAB, not mixed in with print data in the Base Buffer. This allows color, underscoring, and programmed symbols to be specified by using Character Attributes and Extended Field Attributes.

These extended attributes function as follows:

ATTRIBUTES	DISPLAY FUNCTION	PRINTER FUNCTION
Highlighting	Blinking	No effect
	Reverse video	" "
	Underscore	Underscore
Color	Blue	Blue
	Red	Red
	Green	Green
	Pink	Pink*
	Turquoise	Turquoise*
	Yellow	Yellow *
	Triplane	Defaults to black unless triplane character

Character Set	APL Character set	APL Character Set
	PS 2	Programmed Symbol (PS) Set 2
	PS 3	Programmed Symbol (PS) Set 3
	PS 4	Programmed Symbol (PS) Set 4
	PS 5	Programmed Symbol (PS) Set 5 or Triplane
	PS 6	Programmed Symbol (PS) Set 6
	PS 7	Programmed Symbol (PS) Set 7

*A process ribbon must be installed before you can print these colors.

Color control occurs in the following default order.

1. Character attribute
2. Extended field attribute
3. Field attribute (base color)
4. Black

You can switch from base color to extended color by installing the appropriate programming support for the 3270. Once installed, extended color can be introduced at the desired speed. Extended color still prints in color when base color printing is off.

Color printing can occur in all print positions. Underscoring in color can also occur in all print positions. Defaults occur if your 3270 system is not configured to handle extended field or color attributes.

2.0.3 Selecting Color Through the Data Stream

Color can also be selected through the data stream via Interface Systems, Inc. defined escape sequences. These color escape sequences are:

ESCAPE CODE	COLOR*
& % R 0	Black
& % R 1	Blue
& % R 2	Red
& % R 3	Pink**
& % R 4	Green
& % R 5	Turquoise**
& % R 6	Yellow**

*The appropriate color ribbon must be installed to print in color.

**A process ribbon must be installed before you can print these colors.

NOTE

%R 1-6 remains in effect until it is changed back to black or another color. If you are using a color other than black, please enter the &%R0 as the last command before terminating your color job as a courtesy to the next user.

B.4 INSTRUCTIONS FOR PROGRAMMED SYMBOLS

With programmed symbols you can use your program to alter the character cell size and line spacing, and provide user-defined sets of programmed symbols. Programs refer to each symbol set by using a user-defined two-digit symbol set identifier.

The 468 offers up to eight symbol sets; two are fixed (Base and APL sets), and the other six may be changed as desired. Each of the user defined symbol sets consist of 190 user-defined character cells which may contain all or part of a symbol. The normal alphanumeric character cell is 8 dots high by 7 dots wide. The space between characters is 3 dots. In a programmed symbol this normal cell is altered to include the space above, below, and on both sides of the character cell. This allows you to print a continuous pattern such as that used for bar graphs and pie charts. Programs that use SCS (SNA character string) use structured fields and the set attribute codes. Programs with non-SCS use field, extended field, and character attributes.

To define your own programmed symbols follow the normal alphanumeric printing rules described below:

- No single row of wires can print in successive dot positions.
- Each row of wires can strike the ribbon no more than four times per character cell.
- The horizontal space between characters must equal three dots placed side by side.

These symbols where all points are not available for printing, are 8 dots high by 7 dots wide. Characters where all points are available for printing, are 8 dots high by 10 dots wide. When it is necessary to use these denser programmed symbols, the above rules no longer apply and the 468 can:

- Print all dots (or successive dots) in a character cell.
- Print more than one color within the cell.

WARNING

Excessive use of dense printing is not recommended. (Printing is considered dense when the average number of dots per character is greater than 29.) It may shorten print head life or affect the ribbon life causing the print to vary in darkness.

Two types of symbol sets are available: single-plane and triple-plane. Single-plane sets are used for single colors within a character cell; triple-plane sets are needed whenever multiple colors are printed within a character cell. See section below for details.

B.5 Using Color and Programmed Symbols Together

Printing up to seven colors within a character cell is also possible. This however, requires a triple-plane symbol set. Each plane of a triple-plane set contains the dot representation for the portion of the character using the color associated with that plane. See Figure below.

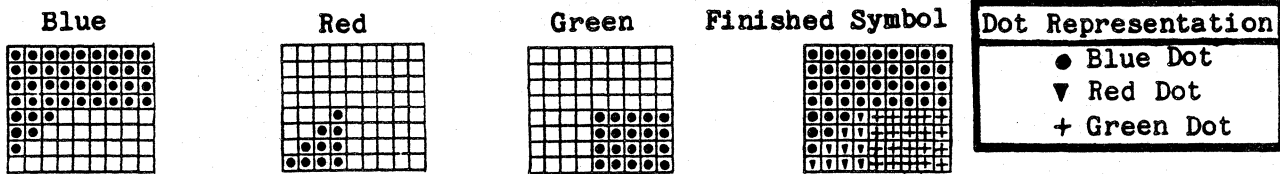

If a character defined in a triple-plane set is printed with a specific color attribute other than multicolor (blue, for example), the entire character prints in that color. Red, green, and blue require their own symbol set plane. The dots in these three planes are combined and print in the specified color. If a dot appears in all three planes of a triple-plane symbol set, in three different colors the symbol set acts like a single-plane symbol set; printing will be in black. See the example below. There are eight ways to put dots in the three planes for each of the 80 points within each cell. Each of these eight ways corresponds to one of the possible colors plus white.

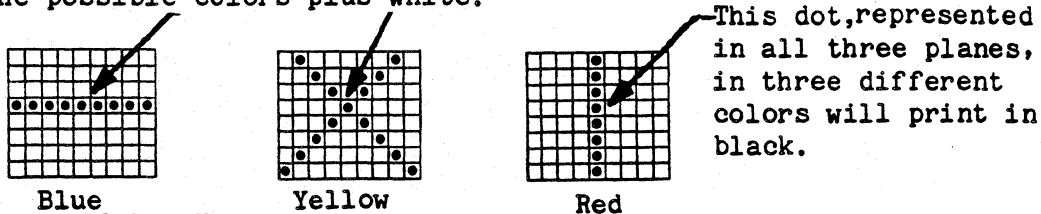

2.0.1 Tips on Color Use

When you are using color, there are a few things you should remember:

- Be consistent. Don't use color randomly, it will confuse your readers. For example, use red throughout text for warning or caution messages.
- Group your colors. It is a lot easier to see large areas of color than it is to see just one or two words. It also increases the speed of printing. The print head must go over the line one time for each color used (if you use 3 colors, it must go over the line three times).
- Don't use too much color. Color printing is fun, but please try to control the urge to print every word or character in a different

color. Use color to make your copy more attractive and readable instead of cluttered and confusing.

- Be careful when assigning colors on a terminal. For example, if you are using all seven colors on a terminal remember a screen copy from a seven color display to the 468 Model 2 printer USUALLY prints in those seven colors, but this is NOT guaranteed. The correct color selects must be present in your system to print seven colors. To determine if your system will support seven color printing, try a sample print before you begin a job. If some colors default to black you may want to use different characters such as the dashes, asterisc, etc. to differentiate between them.
- Be careful when using color on colored forms. Make sure the copy color will contrast with the forms color. (Did you ever try reading dark blue print on dark blue paper?)
- Be careful when assigning colors for a triple plane PS set. If a color dot appears in 2 planes you will get a secondary color. If the dot exists in all 3 planes it will print in black.

Appendix C

INSTRUCTIONS FOR THE TWIN-BIN AND ENVELOPE FEEDER

The following information describes the programming rules for using the twin-bin and envelope feeder which is powered and controlled by the 468 printer. The twin-bin and envelope feeder is an option and can be ordered from Interface Systems, Inc.

The twin-bin and envelope feeder comes ready to be attached to your 468, and needs no electrical connections to install or operate. It has three bins which accept fixed-width, and envelope cartridges. These cartridges are interchangeable and make paper loading fast and easy. The adjustable inserts allow one cartridge to handle different sizes and types of paper. A standard paper tray is also included with the feeder. It mounts on the front of the feeder and collects sheets as they leave the printer in proper collating order.

Bin selection and deselection is controlled through the data stream with ISI's specially designed escape codes or manually through the control panel. Parameters can be set for each bin through the control panel as well.

C.1 Preparing Your Printer for the Twin-Bin and Envelope Feeder

To prepare your printer for the twin-bin and envelope feeder refer to Figure E-2 and do the following. Make sure the printer is on a flat, stable surface and will not fall off during the installation procedure.

1. Push the OFF end of the OFF/ON switch.
2. Move the forms lever to LOAD.
3. Place switch number 6 in rear panel switch pack E22 in the UP position. (See Figure E-1). This will tell the printer to use the twin-bin and envelope feeder. (Remember that a change in these switch positions is only recognized by the printer at power ON. Thus, you must make sure the power is OFF while you are changing the setting.)

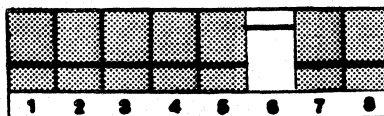

E22

Figure E-1

4. Remove the paper inlet and outlet.
5. Remove the rear cover and put it where it won't get stepped on.
6. Remove any paper left in the printer. (Make sure the paper guides are closed.)
7. Loosen the left tractor locking lever, slide to the extreme left, and then lock it into place.
8. Loosen the right tractor locking lever, slide to the extreme right, and then lock it into place.

NOTE

Tractors must be as close to the printer's side frames as possible or paper jamming may occur.

9. Move the forms lever to SHEET.

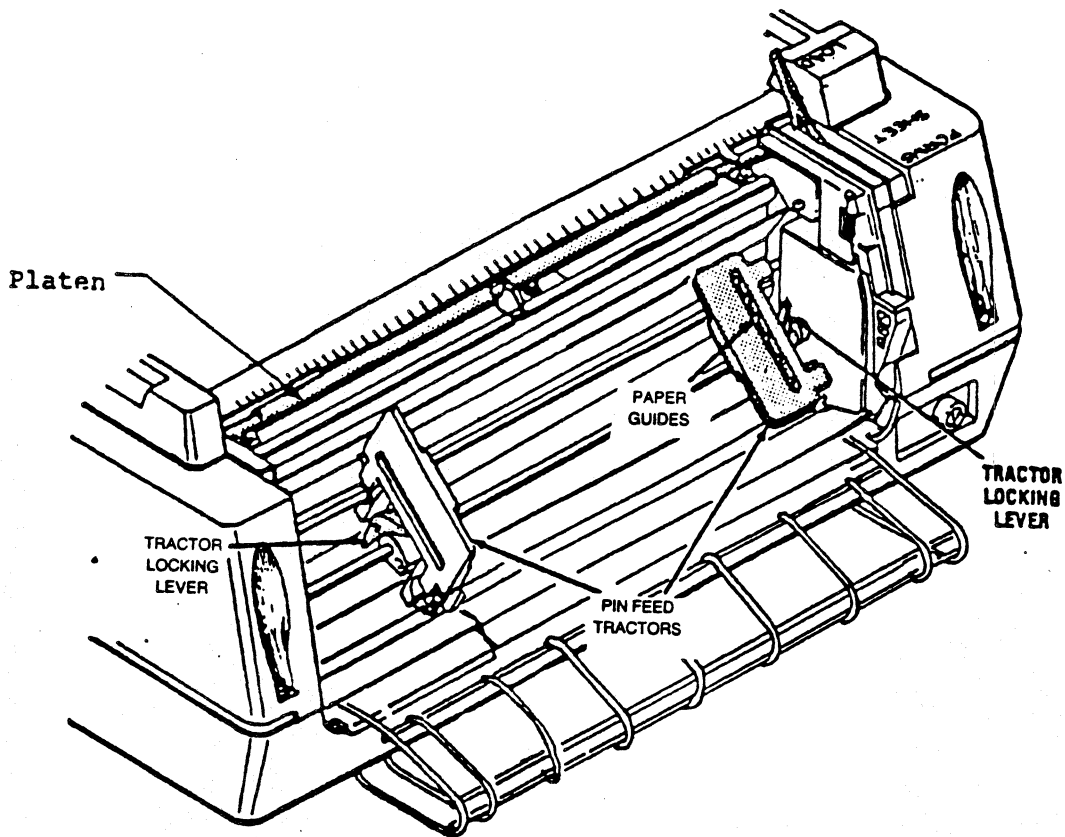

Figure E-2 Preparing the 468 for the Sheet Feeder

10. Remove the acrylic cover attached to the top of the printer. To remove the acrylic cover:
 - a.) Face the front of the printer.
 - b.) Tilt the acrylic cover up.
 - c.) Grasp the ends of the acrylic cover with your thumbs on top and pointing in, and your other fingers underneath.
 - d.) Push up with your thumbs and fingers bowing the cover up in the middle.
 - e.) This should loosen the ends so you can lift the cover off the pegs.
11. Once the standard acrylic cover is removed, replace it with the acrylic cover shipped with your sheet feeder. To attach, follow step 8 above, but in reverse order.

After you have completed these preliminary procedures, you are ready to attach the feeder.

C.2 Attaching the twin-bin and envelope feeder

To attach the twin-bin and envelope feeder refer to Figure E-3 and do the following:

1. Face the front of your printer.
2. Pick up the sheet feeder and carefully guide the right then left ends of the feeder adjustment rod into the mounting slots at the rear body cover.
3. Once the rod is in the slots, grasp the sides of the sheet feeder and lower it. Check to see if the sheet feeder housing contacts either of the printer link shaft holders.
4. If it does contact a shaft holder, turn the sheet feeder adjustment knob to change the lateral position of the sheet feeder. Turn the knob UP to move the feeder to the RIGHT side, and DOWN to move it to the LEFT. Continue adjusting until the housing does not contact the link holder(s).

NOTE

One full turn of the wheel moves the feeder approximately 1/20".

5. Firmly grasp the sheet feeder stay arm, pull the arm forward, and insert the arm hook into the arm bracket as shown.

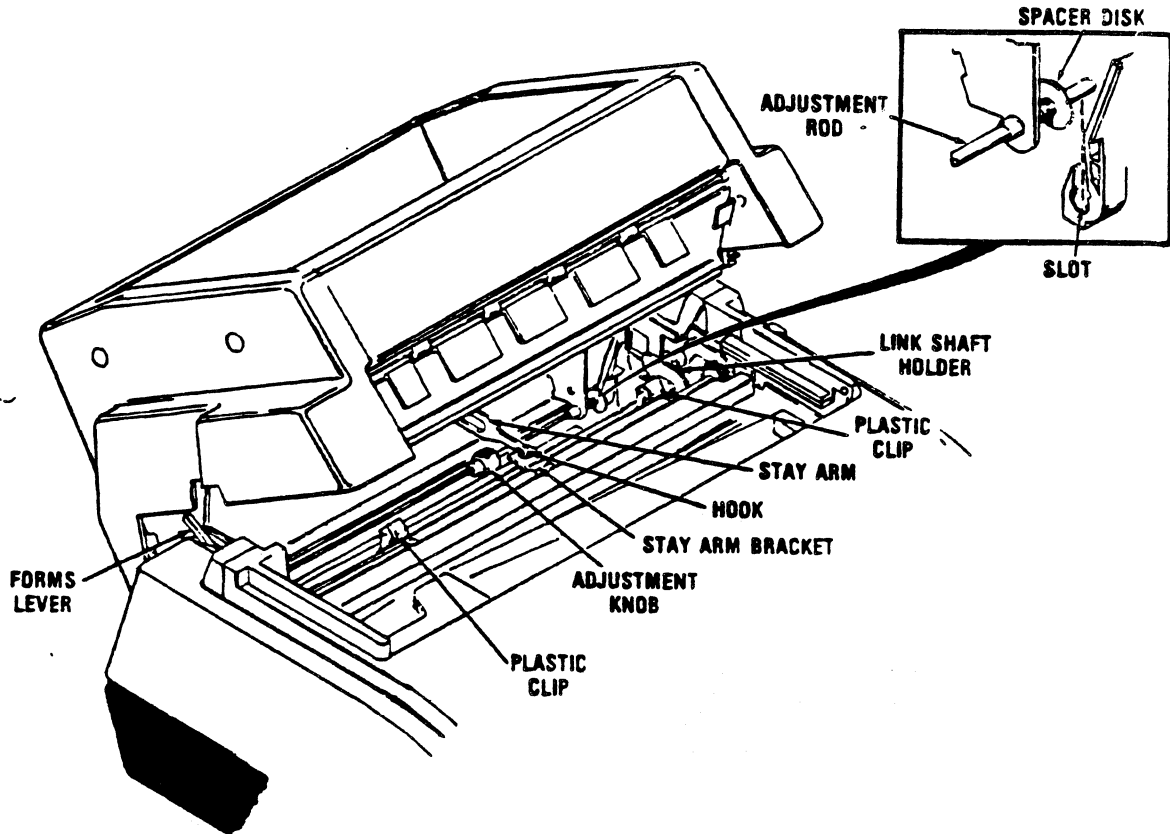

Figure E-3 Attaching the Twin-Bin and Envelope Feeder

6. Tilt the feeder back to lock the hook in place.
7. Lower the sheet feeder until the upper feeder support rod snaps into the plastic mounting clips that are on the printer platen. (You should hear a dull snapping noise when it connects.)

Now your printer is in operating position, but it isn't ready yet. Horizontal adjustment of the sheet feeder is usually required after initial installation. Before you can adjust it, however, you need to know how to load the cartridges and the bins.

C.3 Loading Paper Into the Cartridges

The Paper:

Always use new paper in the feeder. The quality and condition of the paper you use in the sheet feeder is important. If you use suitable paper which is in good condition, the sheet feeder will operate smoothly and efficiently. If you use unsuitable paper you will have problems.

To make sure the paper is suitable for loading, follow these inspection procedures:

1. Choose the package of paper you want to use and inspect the wrapper. If it is torn, dented, or otherwise damaged be sure the enclosed stack of paper is not damaged as well.
2. If the paper looks undamaged, open the wrapper for a closer inspection.
3. Riffle through the stack of paper and remove any torn or wrinkled forms.
4. If you are using letterhead or other printed sheets, make sure they are all positioned the same way. (The side facing the front of the printer is printed.)
5. Square off the sheet edges to make a neat stack.
6. Lay the stack aside, with sheet sides to be printed facing up, until you are instructed to load it into the cartridges.

Basic Paper Loading Procedure:

The basic procedure for loading the paper is the same for all the cartridges. There are some variations for the variable-width envelope cartridge, however. (See "The Envelope Cartridge" section for details on adjusting for different paper sizes.)

Refer to Figure E-4 and do the following to load sheets into the cartridges:

1. First, follow steps 1-6 above.
2. Then, remove the empty cartridge from the packing box.
3. (If you are using the envelope cartridge, refer to the appropriate section for instructions on adjusting for different paper sizes. If you are using a fixed-width cartridge go to step #4.)
4. Grasp the bottom, middle part of the cartridge--keep fingers against the back, palm against the base, and thumb pressing down on the spring-loaded insert plate.

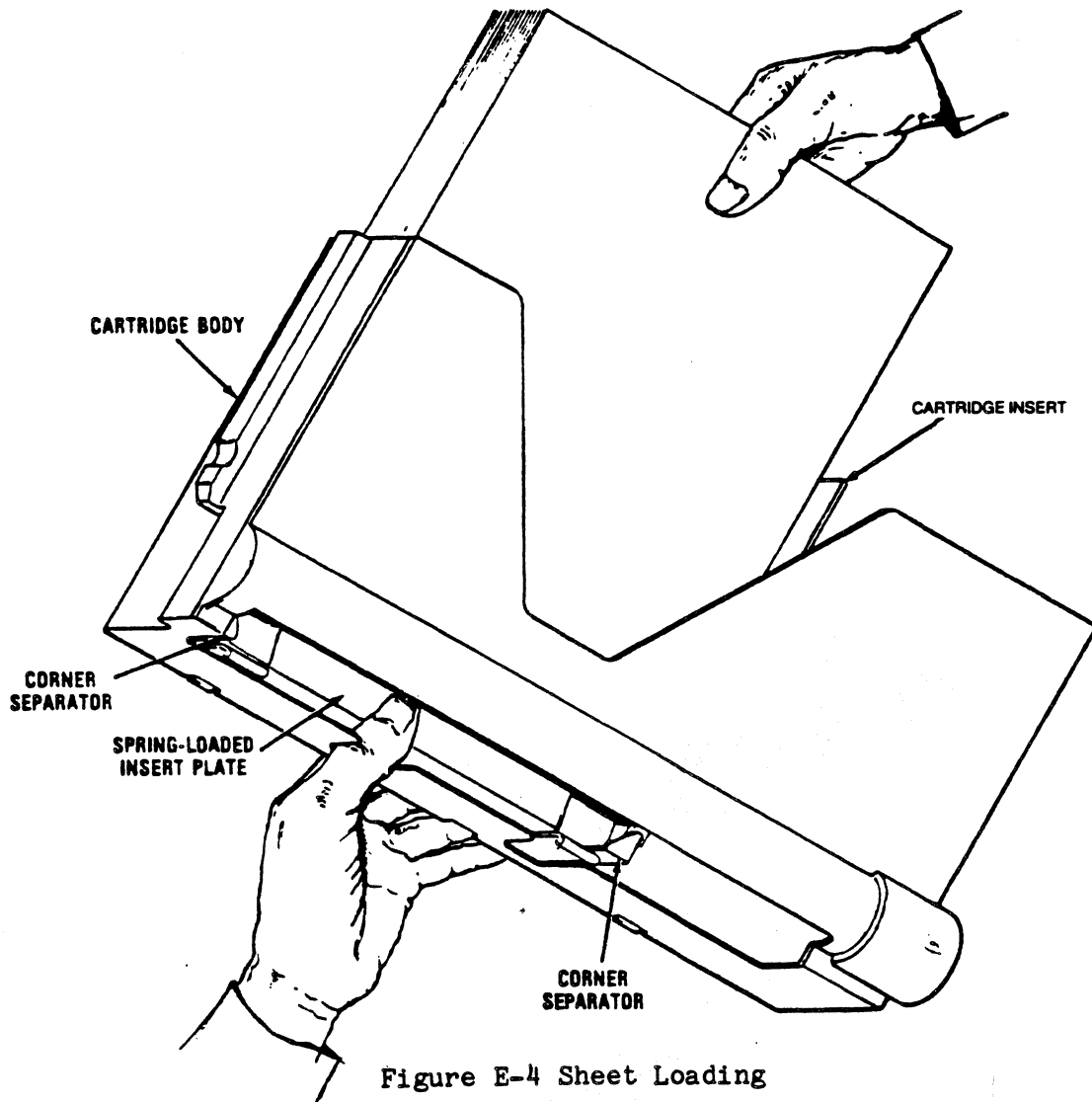

Figure E-4 Sheet Loading

5. Pick up the stack of sheets and place in the cartridge insert.

CAUTION

Overloading the cartridge may result in improper feeding. See Table 1-E for paper capacities.

6. When the bottom of the stack presses against the base of the insert, release the spring-loaded plate. The top sheet will press against the feed rollers.

NOTE

Make sure all sheets are below the corner separators and against the base of the insert or misfeeds may occur.

7. Adjust the "T" shaped paper support (pull up to raise; push down to lower). Ideally, the support should be extended so that the top of the "T" is just below the top of the stack of sheets. Load the cartridge into a bin. (Refer to Section C.4 for details.)
8. Select the feeder and load from bin 1, 2, or 3 using the procedure described in Section C.8.

Table 1-C Cartridge Media	
FIXED-WIDTH CARTRIDGE, U.S. Paper Width Paper Length Paper Weight Capacity	(Can be used in all bins.) 8.5" 6" - 14.0" 16 lb. - 24 lb. (60 - 90 g/m ²) 150 sheets, 20 lb. paper (capacity varies for different types/weights of paper.)
FIXED-WIDTH CARTRIDGE, EUROPEAN Paper Width Paper Length Paper Weight Capacity	(Can be used in all bins.) 21 cm 29.7 cm (maximum) 8 cm (minimum) 16 lb.-24 lb (60-90 g/m ²) 150 sheets, 20 lb paper (capacity varies for different types/weights of paper.)
ADJUSTABLE-WIDTH ENVELOPE CARTRIDGE Envelope Size Paper Weight Capacity	(Can be used in bin 1 only.) #9, 8.875" x 3.875" (225 mm x 96 mm) #10, 9.500" x 4.125 (24 mm x 105 mm) 20-24 lb. (75-90 g/m ²) 50 envelopes

*Not currently available.

The Fixed Width Cartridge:

A spring loaded insert holds paper in place inside the cartridge body. This insert can be positioned at the left or right side of the cartridge to permit special types of printing. Normally, the insert is justified LEFT, i.e., positioned at the left side (facing front) of the cartridge. (See table 1-C for details.)

The Envelope Cartridge:

The envelope cartridge, can be adjusted to hold size #9 or #10 envelopes. You should adjust the insert before you load the envelopes. To adjust for size 9 envelopes do the following:

1. Loosen the adjustment knob at the back of the cartridge(See Figure E-6.
2. Move the adjustment knob to the far right.
3. Tighten the knob to lock the adjustable side plate in position.

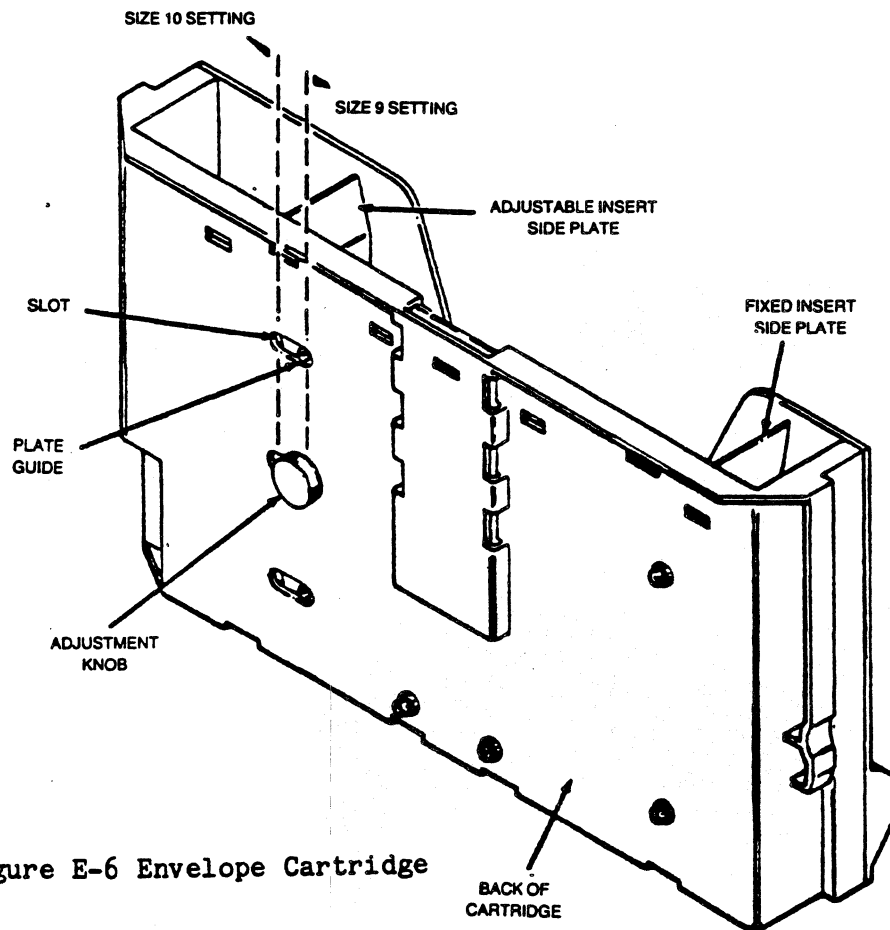

Figure E-6 Envelope Cartridge

To adjust for size 10 envelopes:

1. Loosen the knob.
2. Move the knob to the far left.
3. Tighten the knob to lock the adjustable side plate in place.

Load the cartridge into bin 1.

WARNING

The envelope cartridge can only be loaded into the front bin of the sheet feeder. Never load the cartridge into the middle or the rear bin.

NOTE

Because of design differences between envelope and cut sheet paper cartridges, left edges of paper do not line up with left edges of envelopes. Envelope edges are 1" to the right of cut sheet form edges.

C.4 Loading Cartridges Into the Sheet Feeder

Six slots mounted on the inside left and right side frames of the feeder compose the feeder bins. The front pair of slots compose bin 1, the middle pair bin 2, the rear pair bin 3.

The feeder will operate with one, two, or three bins loaded. You can load three paper cartridges, or one envelope cartridge and two paper cartridges. The envelope cartridge can only be used in bin 1.

To load a cartridge refer to Figure E-7 and perform the following steps:

1. Facing the front of the feeder, position the cartridge above the required bin (pair of slots). The cartridge selector gear should be to your right.
2. Carefully guide either end of the cartridge into the slots on the side frames.
3. Grasp the end of the cartridge and push down until the cartridge locks into place in the bin.

NOTE

Apply equal pressure at both ends while pushing to avoid binding.

To unload a cartridge:

1. Perform steps 1 through 3 above, in reverse order.

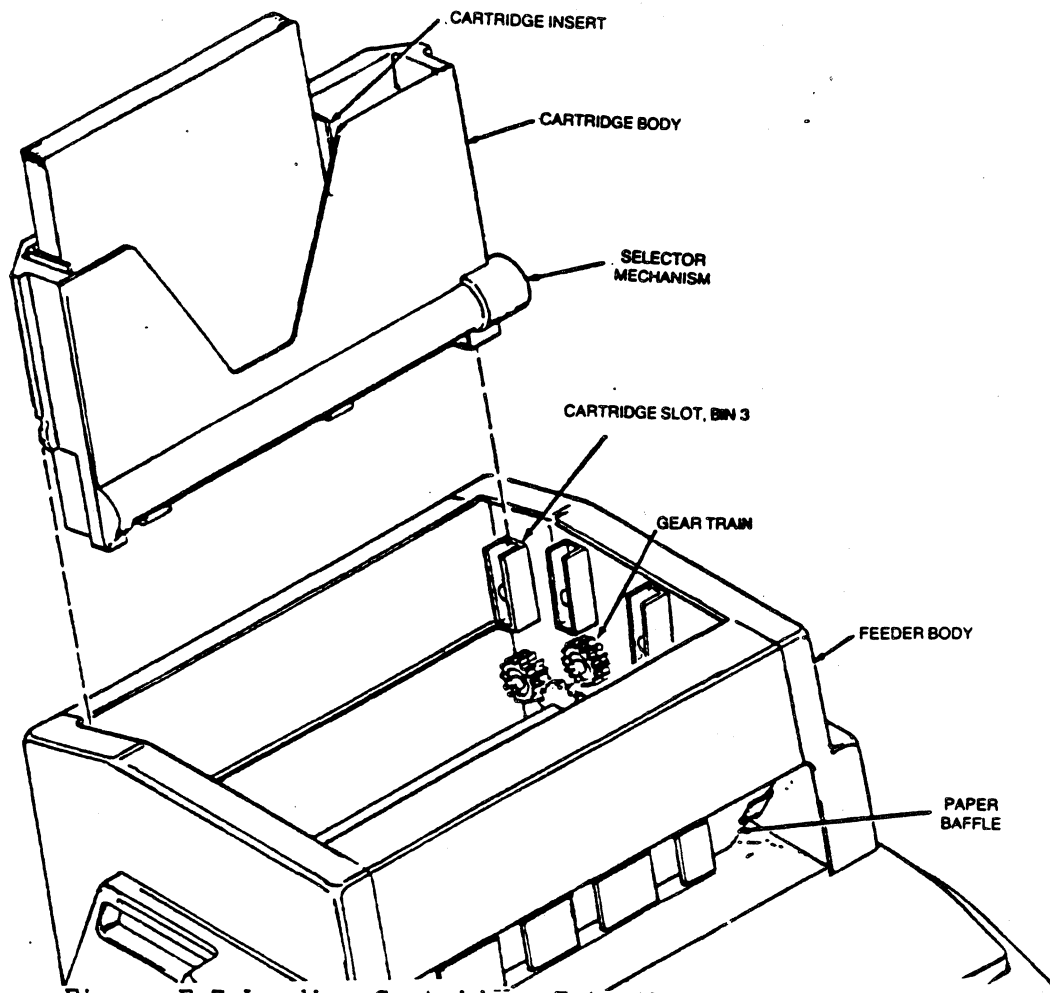

Figure E-7 Loading Cartridges Into the Sheet Feeder

C.5 Adjusting the Sheet Feeder

Now that you know how to load the paper and the cartridges, you may adjust the sheet feeder. To tell if your feeder needs horizontal adjustment, perform the following steps:

1. Load sheets into a cartridge. Be sure the cartridge insert is justified LEFT.
2. Load the cartridge into bin 1 (front bin).
3. Load a sheet into the printer from bin # 1 of the feeder. Refer to Section C.11 for sheet feeder loading instructions.
4. Lift the feeder body up and note how the left edge of the sheet that is in the printer lines up with the right edge of the cut sheet indicator on the silver scale tear bar (see Figure E-8).

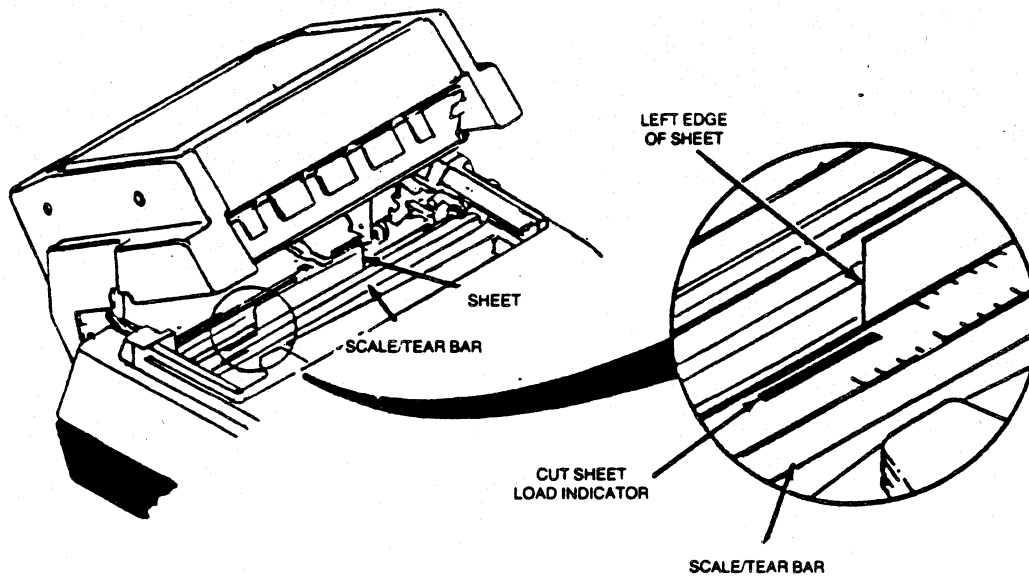

Figure E-8 Adjusting the Sheet Feeder

5. If the edge of the sheet lines up with the edge of the load indicator, the feeder is properly aligned with the printer and no horizontal adjustment is required. Skip the adjustment sections and go to Section C.7, "Installing the Paper Tray".
6. If the sheet does not line up with the edge of the indicator, perform the adjustment described in the following section.

C.6 How to Adjust the Sheet Feeder

This procedure involves turning the feeder adjustment rod to change the lateral position of the feeder on the printer. The adjustment rod in your feeder is turned using either (1) an adjustment wheel, which is at the back of the feeder, or (2) an adjustment knob, which is inside the feeder body.

Look at the back of your feeder to determine if it has an adjustment wheel like that shown in Figure E-6. If the wheel is present, perform steps 1 and 2 below. If your feeder does not have the wheel, skip to steps 3 through 7 below.

The Adjustment Wheel:

1. Turn the adjustment wheel UP (see Figure E-9) to move the feeder closer

to the LEFT (form lever) side of the printer. Turn the wheel DOWN to move the printer toward the RIGHT (control panel) side of the printer.*

2. Eject the loaded sheet (by pressing HOLD and FORM FEED) and load another (by pressing HOLD, 2ND FUNC and F1) to determine if the new sheet lines up with the edge of the indicator. Repeat steps 1 and 2 until alignment is correct.

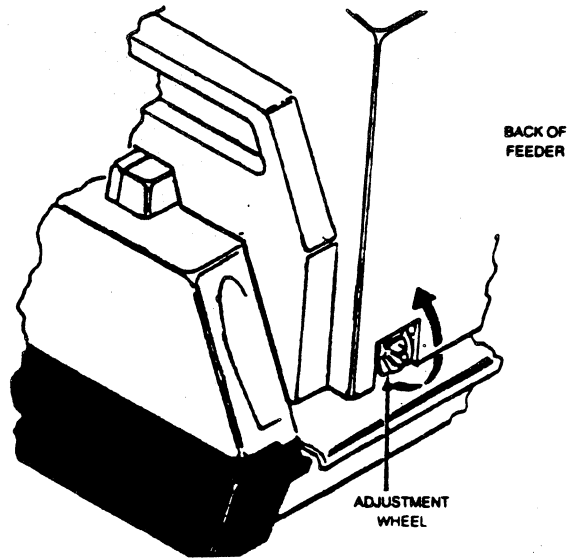

Figure E-9 Horizontal Adjustment; Adjustment Wheel

Adjustment Knob

1. Tilt the feeder body back and locate the horizontal adjustment knob, shown in detail in Figure E-10.
2. Tilt the feeder all the way back to gain access to the adjustment knob.
3. Turn the knob UP (see Figure E-10) to move the feeder toward the RIGHT (control panel) side of the printer. Turn the knob DOWN to move the feeder toward the LEFT (forms lever) side of the printer.*

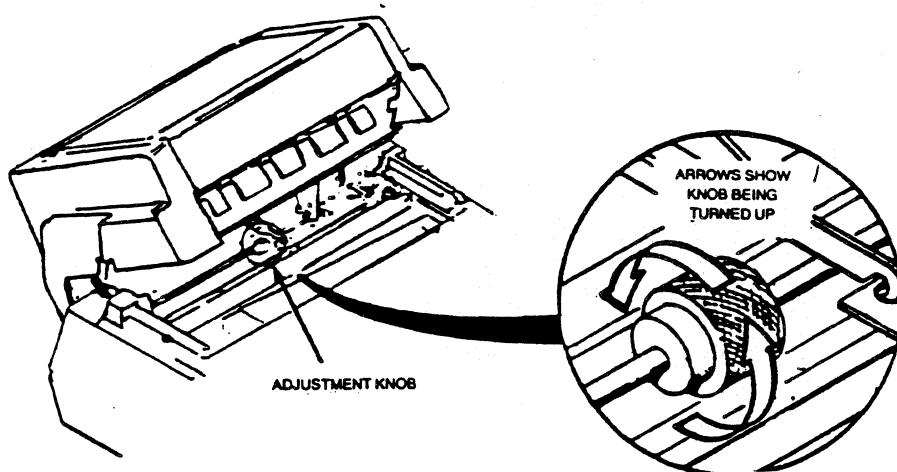

Figure E-10 Horizontal Adjustment; Adjustment Knob

4. Lower the feeder back into operating position. Eject the loaded sheet (by pressing HOLD and FORM FEED) and reload another sheet (by pressing HOLD, 2ND FUNC and F1), then determine if the edge of the new sheet lines up with the edge of the indicator.
5. Repeat steps 4 through 6 until alignment is correct.

*Note: One full turn of the knob or wheel moves the feeder approximately 1/20".

C.7 Paper Tray Installation

The tray attaches to the front of the feeder. To install the tray, refer to Figure E-11 and do the following:

1. Tilt the tray up while pushing down and guide the tray into the feeder body so that the back panel of the tray is just behind the baffle dentations.
2. Lower the front of the tray until the front supports contact the printer top cover.

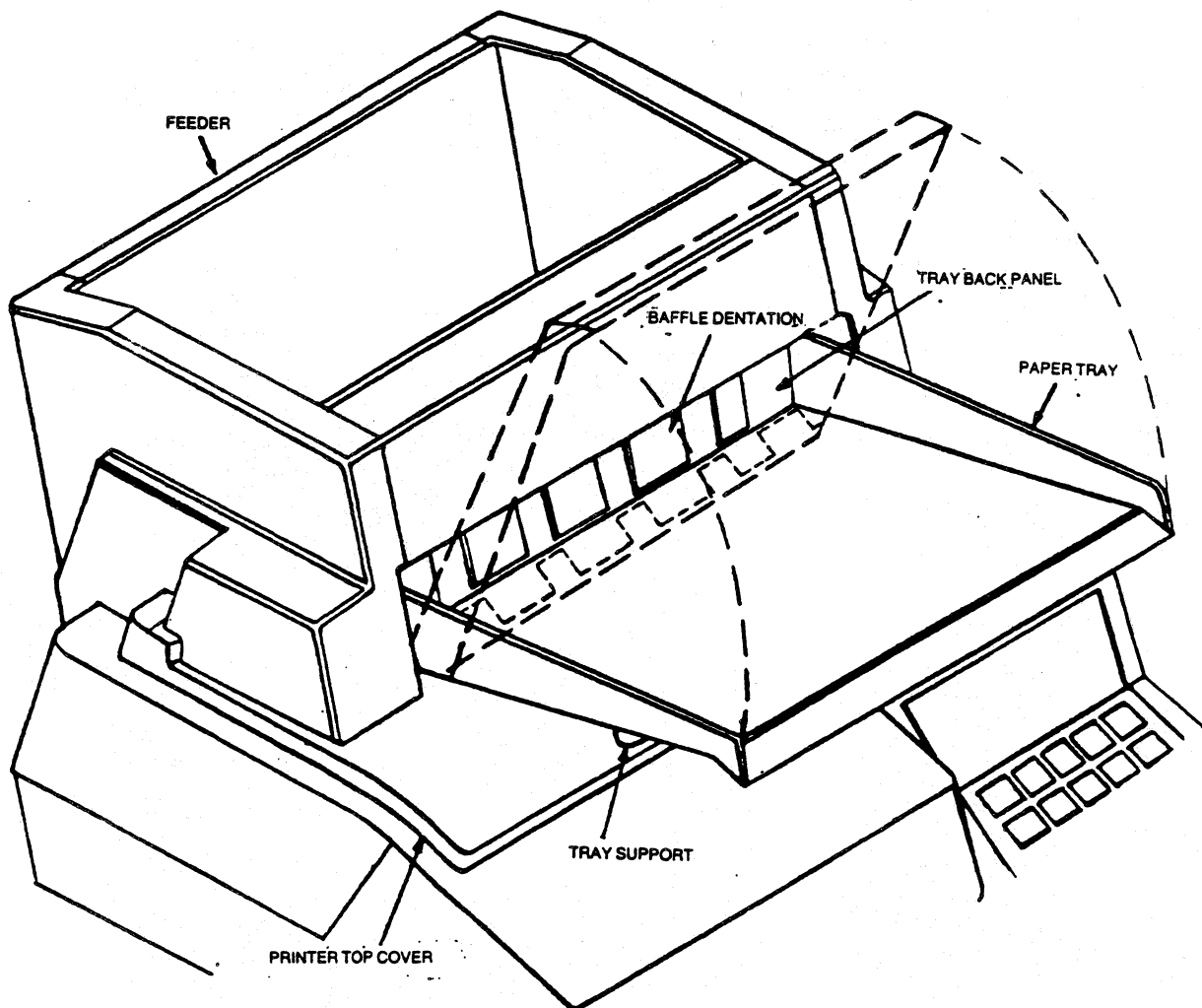

Figure E-11 Paper Tray Installation

3. Pull the tray forward until the tray back panel presses against the feeder baffle dentations.
4. To remove the tray, pivot the tray up while pushing down and pulling forward.

CAUTION

To eliminate the possibility of the paper tray falling to the floor, always REMOVE THE TRAY BEFORE LIFTING THE FEEDER BODY to clear paper jams or to make adjustments.

C.8 Bin Selection

The next thing you should do is choose which bin you want. You can do this two different ways: through the front panel, or through the data stream.

The Front Panel

To choose the bin you want through the front panel press HOLD and 2ND FUNC, then BIN SELECT.

- A bin will be selected. (The front bin is 1, the middle bin is 2, and the back bin is 3.)
- The LED status indicator will display the number of the bin selected.

If the bin you want is selected, press 2ND FUNC. If it is not, press the number 1 key until the desired bin number is reached, then press BIN SELECT and ENABLE PRINT.

- Each time the 1 key is pressed the next bin will be selected. For example, bin 1 changes to bin 2, bin 2 changes to bin 3, and bin 3 changes back to bin 1.
- The next sheet will be fed from the selected bin.

If no bin is specified, the printer will use bin 2. The bins can also be selected through escape codes in the data stream, see below for details.

NOTE

Any selection remains in effect until it is changed through the data or the front panel.

The Data Stream

To select a particular bin during a print under control of the host program you may use the twin-bin and envelope feeder header sequence. This header sequence is `&%H` and must be the first three characters of any twin-bin and envelope feeder line. The automatic sheet feeder bin selection escape codes are:

BIN	ESCAPE CODE
1	<code>&%H1</code>
2	<code>&%H2</code>
3	<code>&%H3</code>

Once the escape is entered, the next sheet fed, will be fed from the selected bin. It is possible to feed sheets from all three bins during one printing job by using the escape codes. For example, by using these codes you may program the 468 to feed from bin one for the first page of a letter, then bin two for the second page, and bin three for the third page. A number of other combinations may be used to fit your particular need. When no automatic sheet feeder is installed, the escape sequences will be accepted, but will not have any effect on printing.

Forms Length

The forms length for all bins will be determined from the normal power on value. (The forms length setting procedure is no different than before. (See pgs. 36,37.) The automatically fed cut sheets will be printed the same way the manually fed cut sheets were. The bottom of the first line available for printing is one inch below the top edge of the paper. The bottom of the last line will be one-half inch above the bottom of the paper. For example, 58 lines can be printed on a form set up as 66 lines at 6 LPI.

C.9 Removing/Replacing Fixed Width Cartridge Inserts

The cartridge inserts may be left or right justified to meet the printing requirements at hand.

TO REMOVE AN INSERT(refer to Figure E-12)

1. Remove the cartridge from the feeder.
2. Remove any sheets loaded in the insert.
3. Raise the paper support to its maximum extended position.
4. Facing the cartridge backplate, unsnap the self-locking insert tabs which secure the top of the insert to the cartridge back plate.

5. Pull the insert up and out of the cartridge.

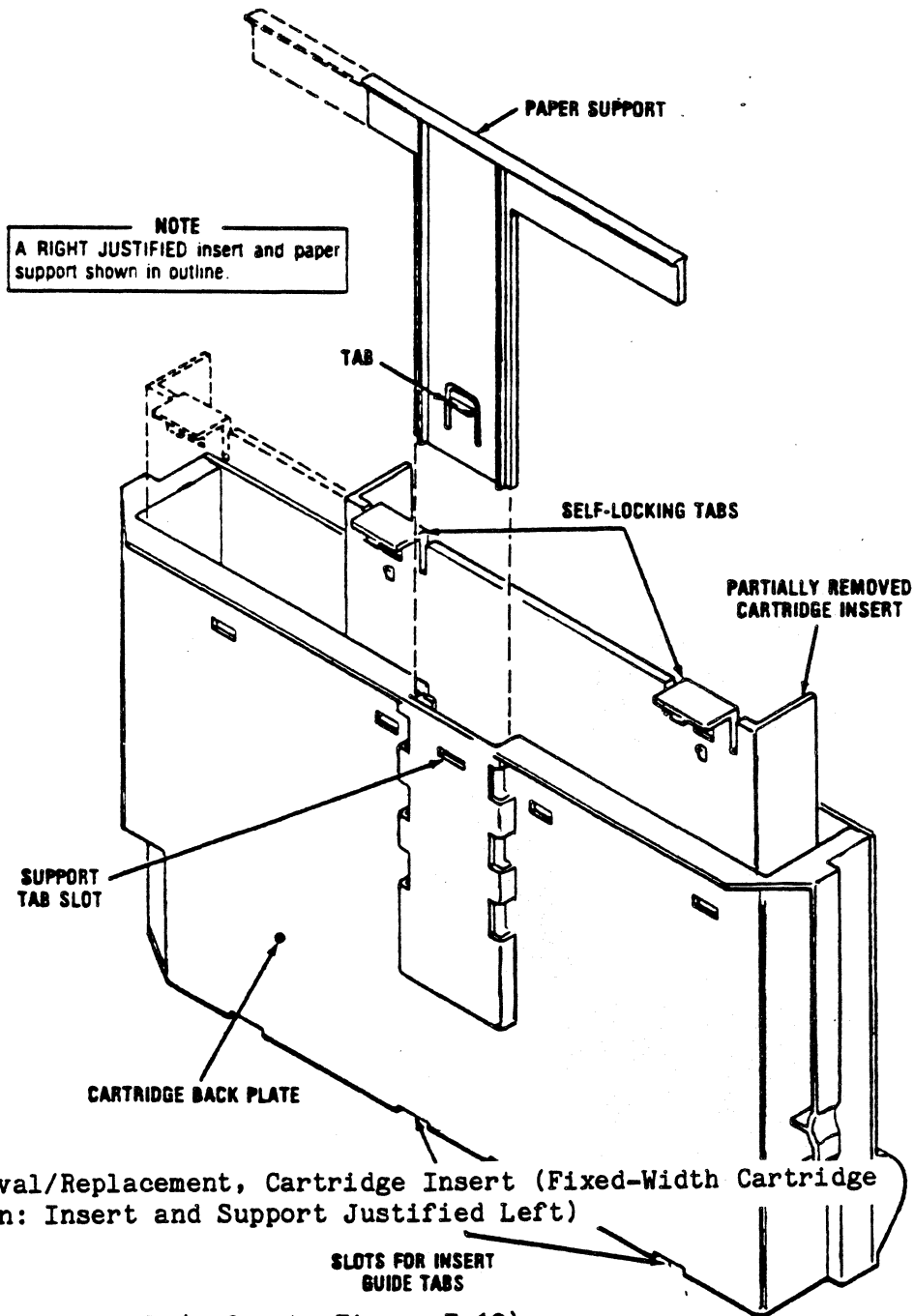

Figure E-12 Removal/Replacement, Cartridge Insert (Fixed-Width Cartridge Shown: Insert and Support Justified Left)

TO REPLACE AN INSERT(refer to Figure E-12)

1. Ensure paper support is in place and properly justified.
2. Guide the insert into the cartridge body.
3. Slide the insert to the extreme left or right to justify as required.

4. Tilt the base of the cartridge up and adjust the insert left/right until the two guide tabs at the bottom of the insert are positioned in the slots in the cartridge base.
5. Snap the two top insert tabs into locked position by pressing the top of the insert against the cartridge back plate.

C.10 Removing/Replacing the "T" Shaped Paper Support

The paper support should always be justified in the same direction as the cartridge insert (see Figure E-13). To reverse justification of the support, perform the removal/replacement procedures described below.

TO REMOVE THE PAPER SUPPORT- Get a flatblade screwdriver and do the following:

1. Remove the cartridge from the insert.
2. Raise the paper support until it locks into maximum-extended position.
3. Insert the edge of the screwdriver into the support tab slot and gently push the tab back while pulling the support up and out of the cartridge.

TO REPLACE THE SUPPORT:

1. Make sure the insert is removed from the cartridge.
2. Insert the support into its guide, making sure the support arm is justified in the proper direction.

You may now install the cartridge insert.

If you have any problems with your sheet feeder refer to the table on page 90. If you still cannot correct the problem after consulting this chart, call our qualified personnel at Interface Systems, Inc. The number is (313)769-5900.

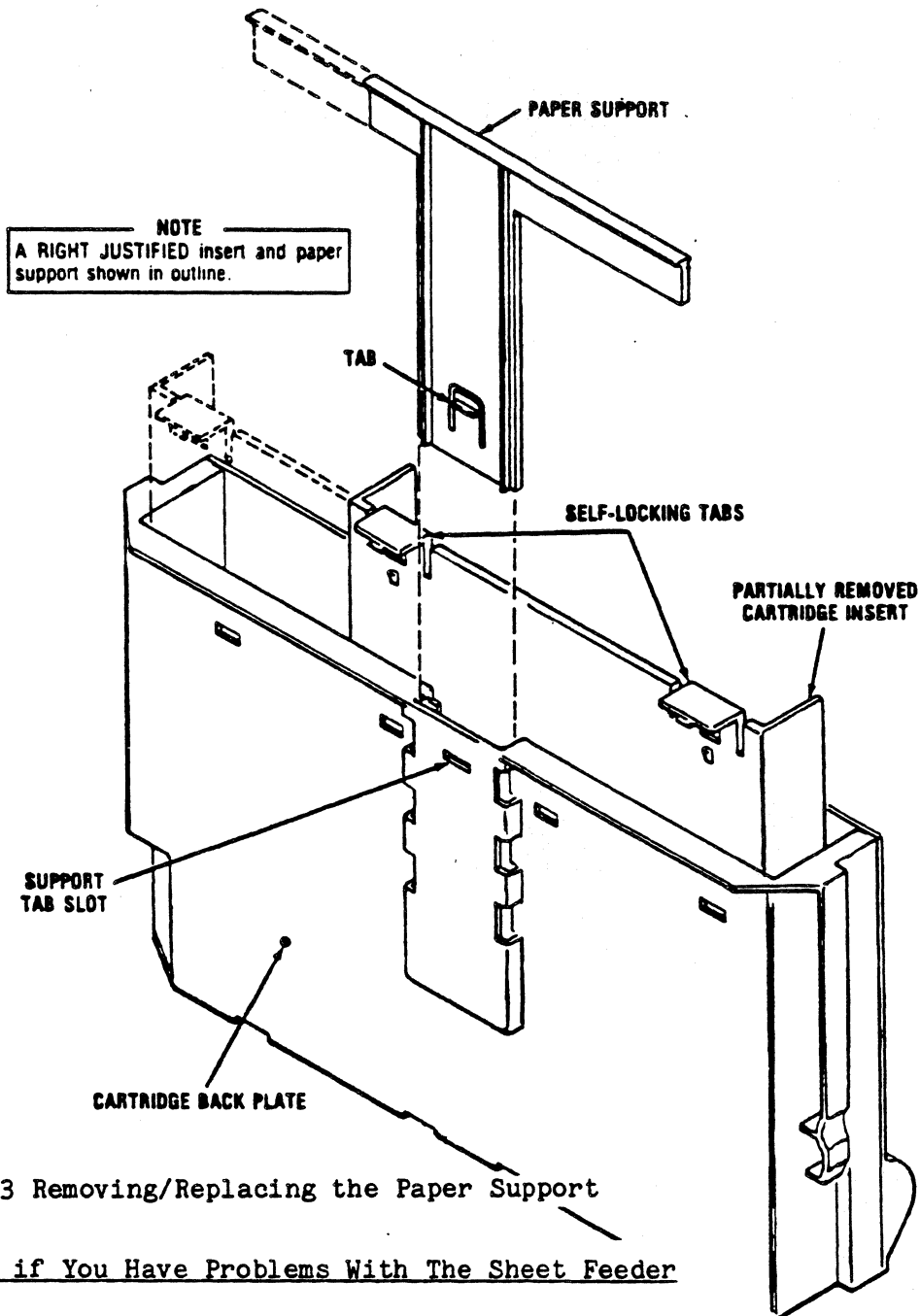

Figure E-13 Removing/Replacing the Paper Support

C.11 What to Do if You Have Problems With The Sheet Feeder

This section provides suggestions for correcting paper handling problems such as misfeeds, jam, etc.

CAUTION

Jam/misfeeds should be corrected immediately to avoid possible damage to a mylar paper guide inside the sheet feeder body.

Most paper handling problems can be corrected quickly and with minimal effort. The following chart lists the more common paper handling problems, lists possible causes, and describes the actions you should perform to correct the problems.

Problem	CAUSE	Corrective Action
Paper will not feed at all.	<p>Cartridge Empty. Cartridge installed incorrectly in bin.</p> <p>Feeder body not engaging printer mounting blocks Paper in cartridge too wide or poorly stacked</p> <p>Paper too heavy.</p> <p>Faulty selector Assembly.</p> <p>Twin-bin and envelope feeder not selected.</p>	<ul style="list-style-type: none"> - Load cartridge - Make sure cartridge is installed squarely and "bottomed" in the bin. - Make sure body engages blocks. - Make sure paper is correct width and is neatly stacked in cartridge. - Make sure paper doesn't exceed maximum paper weight of 24#. - Replace selector assembly. - Select the twin-bin feeder with switch pack E22.
Partial Feed	<p>Paper in cartridge too wide or poorly stacked.</p> <p>Paper too heavy</p> <p>Paper not flat, wrinkled, etc.</p> <p>Paper path obstructed. Printer forms lever not in "SHEET" position.</p>	<ul style="list-style-type: none"> - Make sure paper is of proper width and is neatly stacked within cartridge. - Make sure paper doesn't exceed 24# maximum weight. - Make sure paper is flat and wrinkle-free. - Clear obstruction. - Set forms lever to "SHEET".
Incomplete insertion	<p>Printer forms lever not in "SHEET" position. Forms length/lines per inch ratio too high for length of paper being used.</p>	<ul style="list-style-type: none"> - Set forms lever to "SHEET". - Verify forms length and LPI settings(refer to 2.9.1)and make sure the ratio is correct.
Excessive insertion	<p>Forms length/LPI ratio too low for length of paper being used.</p>	<ul style="list-style-type: none"> - Verify forms length and LPI settings(refer to 2.9.1) and make sure the ratio is correct.
Paper buckles in print cavity during insertion	<p>Paper path in printer is Printer paper tear bar adjusted wrong. Printer paper set plate is damaged.</p>	<ul style="list-style-type: none"> - Remove obstruction. - Adjust tear bar. - Replace the set plate.

<p>No or incomplete paper discharge</p>	<p>Paper/envelope not flat, wrinkled, etc.</p> <p>Forms lever not in SHEET</p> <p>Mylar gate on feeder's upper paper guide assembly is damaged.</p> <p>Feeder adjusted incorrectly</p>	<ul style="list-style-type: none"> - Make sure paper/envelopes are flat and wrinkle-free. - Place forms lever in SHEET - Replace upper paper guide assembly - Perform horizontal adjustment (see pg.26)
---	--	---

Paper Specifications

See Appendix E for details.

Appendix D

PAPER SPECIFICATIONS

The 468 uses tractor-fed single or multi-part forms or single cut sheets of paper. The following sections list the various specifications you should follow when selecting paper for the 468.

The paper you select should:

- fit the specifications listed below.
- be removed from the box before being used.
- be in line with the pin feed tractors (i.e., the paper should not be fed from three feet behind and to the right of the printer.)
- be stored in an area free from both high and low humidity.

D.1 CONTINUOUS FORMS DESIGN

Fanfold forms should fit the specifications listed below.

- Forms may be glued or crimped.
 - Crimps must be spaced a minimum of 2.0 in. (50.8 mm) along both edges of the forms and not within 0.5 in. (12.7 mm).
 - Metal staples cannot be used.
1. Size: See Figure F-1 for size specifications.
 2. Thickness:
 - Single part - 0.010 in. (0.25 mm)
 - Multi-part - 0.0204 in. (0.52 mm) maximum, up to six part with carbon.

3. Weight:

- Single part - 15-20 lb. bond (56 g/m²)
- Multi-part-

PLY	PAPER	CARBON
2	15 lb. (56 g/m ²) bond	#7 (16.5 g/m ²) tissue
3	15 lb. (56 g/m ²) bond	#7 (16.5 g/m ²) tissue
	12 lb. (45 g/m ²) bond	
4-6	12 lb. (45 g/m ²)	#7 (16.5 g/m ²) tissue
	except last copy	
	15 lb. (56 g/m ²)	

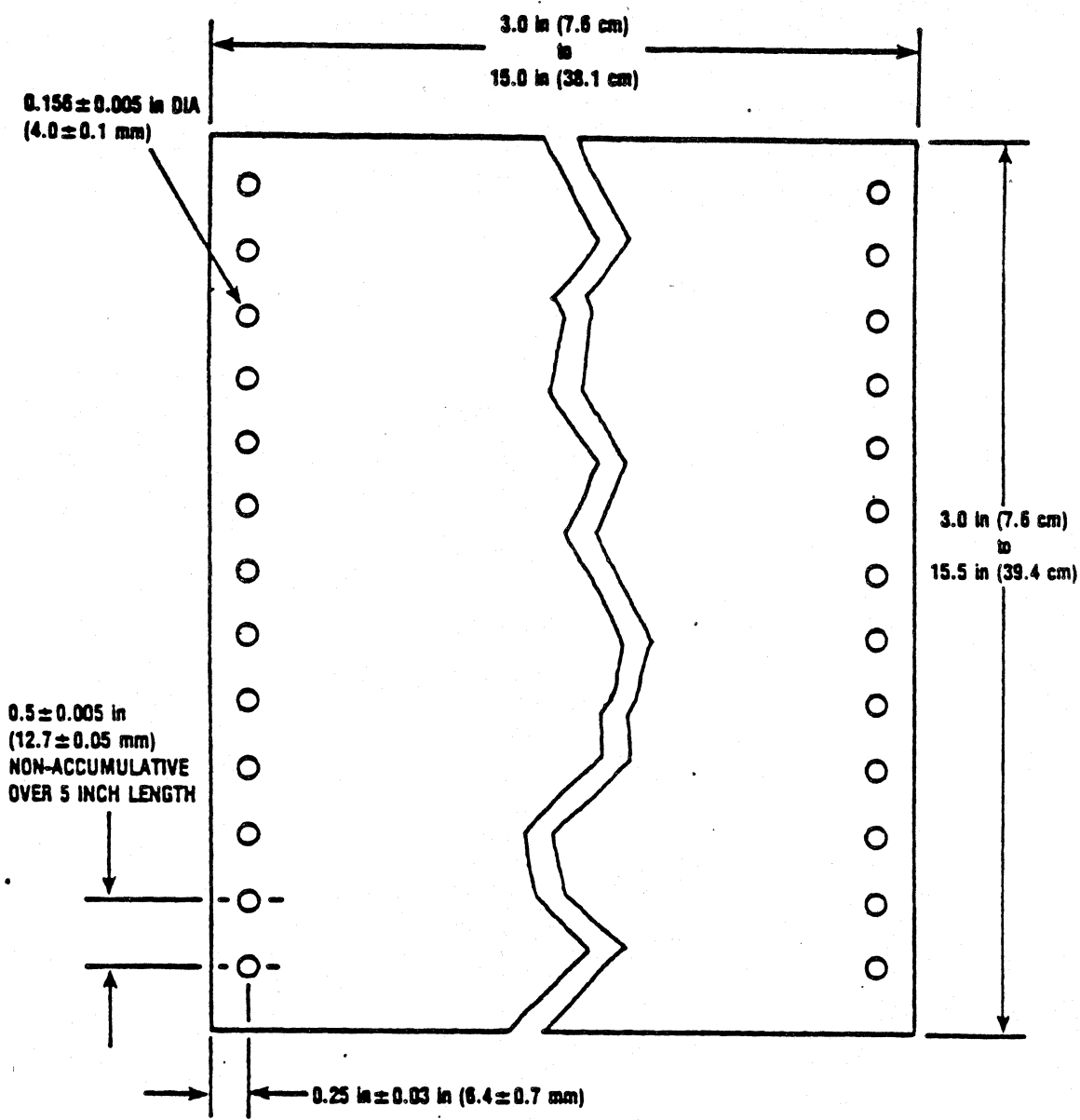

Figure F-1

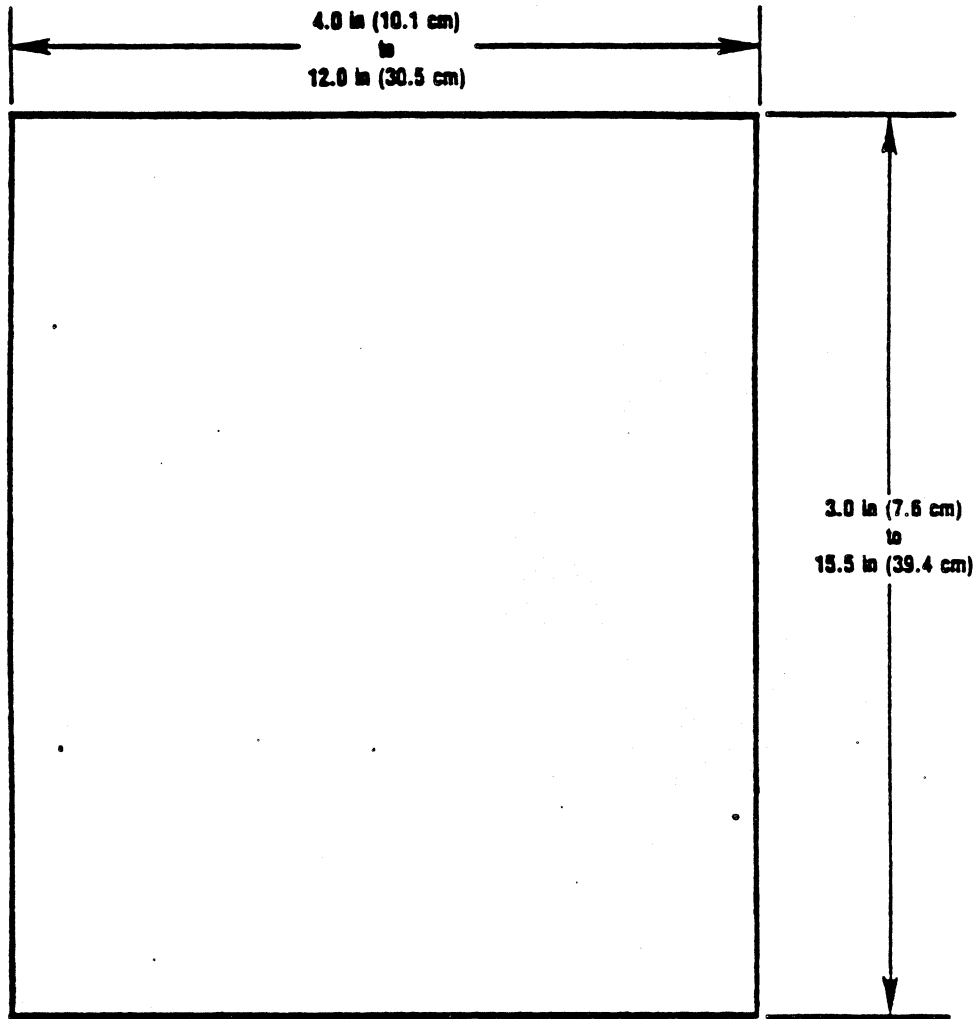

Figure F-2 Cut Sheet Forms Design

D.2 CUT SHEET FORMS DESIGN

Cut sheet forms should fit the specifications listed below.

- Multi-part forms may be glued on the top or bottom.
- Stapled forms may not be used.
- Split forms with each side containing a different thickness or number of sheets are not recommended.
- On multi-part forms, use 12 lb. (45 g/m²) as the first copies with heaviest copies last.

1. Size: See Figure F-2 for specifications.

2. Thickness:

- Single part - 20 lb. paper (70 g/m²) minimum
- Multi-part - 0.024 in. (0.52 mm) maximum

3. Weight:

PLY	PAPER	CARBON
2	15 lb. (56 g/m ²) bond	#7 (16.5 g/m ²) tissue
3	15 lb. (56 g/m ²) bond	#7 (16.5 g/m ²) tissue
	12 lb. (45 g/m ²) bond	
4-6	12 lb. (45 g/m ²) except last copy	#7 (16.5 g/m ²) tissue
	15 lb. (56 g/m ²)	

D.3 ENVELOPES

1. Size:

- Width - 304.8mm (12 in.) 127mm (5 in.) minimum
- Length - 355.6mm (14 in.) 88.9 (3.5 in.) minimum

2. Weight - 16 lb. to 24 lb

D.4 TWIN-BIN AND ENVELOPE FORMS DESIGN

The 468 twin-bin and envelope feeder uses continuous forms or single cut sheets. The following sections list the various specifications you should follow when selecting paper for use in the twin-bin and envelope feeder.

The following things are not permitted:

- hard or metal fasteners
- partial forms separation
- side glued forms
- card stock forms
- printing across any holes , perforations, or edges of the form
- multi-part forms are not recommended, but if used it is recommended that all multi-part forms be:
 1. qualified on an individual basis
 2. bottom glued
 3. of the same length
 4. of "carbonless" construction.

These types of paper are not recommended. Use may cause misfeeds, jams, or other problems which reduce overall reliability.

- coated papers

- Vellum paper
- Coated erasable bond
- Synthetic paper (rice paper, parchment)
- Translucent paper
- Multipart forms
- Forms using peel-off, pressure sensitive labels
- Chemically treated papers (carbonless copy papers)
- Card stock
- Dark colored paper
- Preprinted forms requiring critical registration accuracy

NOTE

When using pre-printed forms, it is recommended that a sample be tested for suitability BEFORE a large quantity is ordered.

- Folded or creased documents
- Highly embossed paper
- A mix of different sizes/types of paper
- Reams of paper with edges or corners folded or bonded
- Paper with poorly cut (rough) edges
- Paper exposed to adverse temperature and/or humidity

D.5 Paper Storage

Do not store paper in areas with high or low humidity and wide variations in temperature. Ideally paper should be stored in an area where the temperature is approximately 72 F(23 C) and the relative humidity is between 40% and 60%.

D.6 Continuous Forms Design

1. Size:

	Maximum	Minimum
Width		
Single-part	377.8mm (14.88 in.)	127mm (5 in.)
Multi-part	377.8mm (14.88 in.)	127mm (5 in.)
Length	355.6mm (14 in.)	76.2mm (3 in.)

D.7 Cut Sheet Forms Design

1. Size:

	Maximum	Minimum
Width		
Single-part	304.8mm (12 in.)	148mm (5.83 in.)
Multi-part	304.8mm (12 in.)	148mm (5.83 in.)
Length	355.6mm (14 in.)	Bin 1 - 152.4mm (6.00 in.) Bin 2 - 152.4mm (6.00 in.) Bin 3 - 203.2mm (8.00 in.)

Weight

Single-part	20 lb to 24 lb
Multi-part (front sheet)	20 lb to 25 lb

2. Thickness .51mm (.020 in.) max.

D.8 Envelope Design

1. Size:

#9	98mm (3.88 in) x 225mm (8.88 in.)
#10	241mm (9.5 in) x 105mm (4.13 in.)

2. Weight:

20 lb to 24 lb (#24 diagonal fold recommended)

Note: When using the twin-bin and envelope feeder, sequentially feeding cut sheet forms and envelopes is not recommended due to varying forms thicknesses. Also, when using the feeder, envelope width tolerances of $\pm 1/16$ inches are required for most reliable feeding.

Appendix E

CONNECTING AND PROGRAMMING THE IBM PERSONAL COMPUTER FOR USE WITH THE ISI 468 MODEL 2

This section contains the information necessary for using the parallel port on your printer. The information includes instructions on connecting to the parallel port and selecting parallel operation. It also includes descriptions of the supported and unsupported control characters and escape sequences for the IBM Epson JX-80 graphic printer emulations for the ISI Printer parallel interface. Other information such as paper and ribbon loading and control panel and switch selectable functions are located in the front of this manual. Please refer to these instructions if necessary.

E.1 CONNECTING THE 468 TO A PARALLEL PORT

The 468 will emulate an IBM Epson JX-80 graphics printer when attached to an IBM PC or equivalent unit, via the printer parallel interface. This connection is made by attaching a standard 36 pin parallel connector from the PC to the printer.

NOTE

Graphics and color are not available in this PC mode.

The connection process is easy, just:

1. Turn the printer OFF.
2. Bring the parallel ribbon cable from the PC to the printer.
3. Locate the connector on the back of the printer as shown.

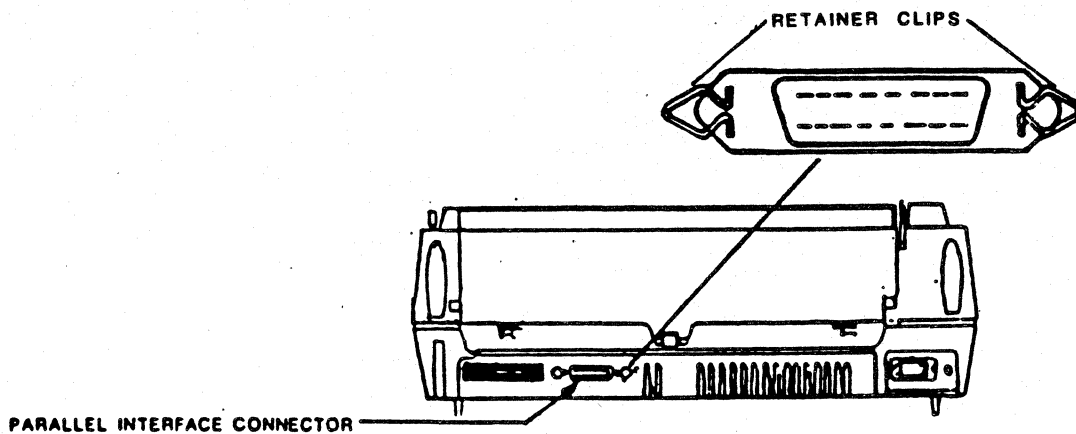

Figure A-1 Attaching the parallel connector.

4. Plug the cable connector into the printer making sure it is secure. Then, fasten the retainer clips to the cable connector.
5. Turn the printer ON.
6. Press HOLD PRINT, SECOND FUNCTION, and CHANGE HOST. The printhead will move from left to right and back. The ALT HOST and READY indicators will go on (it may take a few seconds for the indicators to light), and you are ready to print.

Please note that while you are in parallel host mode the self-test is not operational and #8 is the only available diagnostic.

E.2 Control Characters and Escape Sequences

To access the special features of the parallel interface you will need to enter some printer control codes and escape sequences. These special characters allow your computer to communicate with your printer.

The following charts describe the control codes and escape sequences that are supported and unsupported by the parallel interface. To use these codes properly, you will need to be familiar with BASIC, or know how to put printer control codes into your program. The codes and escape sequences described in the following charts can be used with the LPRINT CHR\$ command in BASIC to enter the desired information.

E.3 Supported Control Characters

SUMMARY OF SUPPORTED CONTROL CHARACTERS

CONTROL CHARACTERS ASCII LOCATION		FUNCTION DESCRIPTION
(Hex)	(Decimal)	
0A	10	LINE FEED: Advances the paper one line based on how many lines per inch have been selected. (6 or 8 LPI may be selected by the appropriate escape sequence. The printer defaults to 6 LPI upon reset, power up, or switch into parallel mode. See Vertical Pitch pg. 95) Line feed causes an automatic carriage return in parallel mode.
0C	12	FORM FEED: Advances the paper to the next Top of Form according to the forms length which has been set by an escape sequence or by the front panel.
0D	13	CARRIAGE RETURN: The printer will perform a carriage return and begin printing the next line of copy at the left margin.
07	07	BELL: Sounds a one second tone
09	09	HORIZONTAL TAB: Moves the print head to the next horizontal tab stop. Tab stops are set with ESC D. The default and power on reset (POR) tabs are set at every 8th column starting in column 9. <u>Expanded Tabs</u> When setting tabs for expanded print, remember that each character position is the equivalent of two normal character positions. A slight positional error (0.1" maximum) will occur if tabs are set at odd positions, such as three, which is 1 1/2 expanded characters.
0B	11	VERTICAL TAB: Not supported. It will generate a line feed.
0E	14	SHIFT OUT (Double wide by line): Expanded characters, which are double the current character width, print on the current line. LF, CR, DC4, and ESC W will cancel this mode. This is Double-Wide Printing
0F	15	SHIFT IN (Compressed): Will begin printing in 16.67 CPI compressed mode. Compressed print (16.67 CPI).

(continued)

(continued)

CONTROL CHARACTERS ASCII LOCATION		FUNCTION DESCRIPTION
(Hex)	(Decimal)	
11	17	DC1: Select printer is not supported.
12	18	DC2 (10 CPI): Stops printing in compressed mode and sets the printer to 10 CPI. This, however, does not cancel expanded printing.
14	20	DC4 (Cancel double wide by line): Stops expanded printing and returns the printer to the previously set printing mode.
18	24	CANCEL: Cancels text in prin
20-7E	32-127	ASCII DATA:
21	2	ESCAPE CODE:

E.5 Supported Escape Sequences

Forms Length (FL), Near Letter Quality (NLQ), Pitch, and Maximum Presentation Position (MPP) can all be set from the front panel. These parameters can also be set by sending the appropriate escape sequences through the data stream. All of the escape sequences are initiated with the ASCII escape (ESC) character hex 1B (decimal 27). Following this will be another ASCII character possibly followed by an 8 bit binary number or list of 8 bit binary numbers.

The syntax must follow the general guidelines listed below:

- characters are in ASCII form
- no intervening spaces are allowed between the characters (spaces below are for clarity only).
- lower case "n" represents an 8 bit binary number.

SUPPORTED ESCAPE SEQUENCES

ESCAPE SEQUENCE	FUNCTION DESCRIPTION
<p>ESC - 1 ESC - 0</p>	<p>CONTINUOUS UNDERLINE: Start underline will underline all data and spaces, with the exception of tabs, that follow the escape. Stop underline code.</p> <p><u> </u> Tabs are not underlined; from here to here.</p>
<p>ESC W 1 ESC W 0</p>	<p>CONTINUOUS EXPANDED (DOUBLE-WIDE) Sets printer to expanded print mode. Stop expanded mode and returns to previously set print mode.</p> <p> T h i s i s e x p a n d e d p r i n t .</p>
<p>ESC A n ESC 0 ESC 1 ESC 2 ESC 3 n ESC J</p>	<p>VERTICAL PITCH: Stores text line spacing at $n/72''$. The value of n can range from 1 to 85. A line spacing of zero is ignored. The new line spacing is activated by ESC 2. Sets printer to 8 LPI. Sets line spacing to $7/72''$. Starts text line spacing at the line spacing value set by ESC A. Any line feeds sent before ESC 2 will space lines at the previously set line space value. If ESC 2 is sent before sending ESC A, the line spacing will default to 6 LPI. Sets graphic line spacing to $n/216''$. The value, n, should be divisible by three to get accurate line spacing. The range of n is 1 to 255. Variable line feed moves the paper up $n/216''$. The value of n must be between 1 and 225. For n, use exact multiples of 9 to move the paper exactly $n/126$ inch. ESC J is reset after the line space takes place and the printer returns to the previously set line spacing.</p>
<p>ESC G ESC H</p>	<p>NEAR LETTER QUALITY (NLQ): Starts NLQ printing. Stops NLQ printing and returns printer to draft mode.</p> <p>10 CPI Near Letter Quality. 12 CPI Near Letter Quality. Expanded Near Letter Quality.</p>

(continued)

CHARACTER SET SELECTION:

These sets show the ASCII locations of the printable characters currently available in the character generator ROM (See Figure A-5). Control characters and unsupported characters are shown as hyphens (-).

ESC 6

Selects character set 2. Character set 2 is defined by the chart in Figure A-5. This set contains multi-lingual characters in locations 80-9F which replace the control characters in set one.

Character set 2H is the Hebrew character set. It will be selected at power up in place of character set 1 when Hebrew is selected on your printer. To select Hebrew, see "Language Select Switch Settings." This character set requires installation of a Hebrew character generator. Contact your ISI representative to order this generator.

ESC 7

Selects character set 1. When reset or powered up, the printer operates with character set 1 until character set 2 is selected. (See Figure A-5.)

Character Set One	Character Set Two	Character Set Two - H
0 1 2 3 4 5 6 7 8 9 A B C D E F	0 1 2 3 4 5 6 7 8 9 A B C D E F	0 1 2 3 4 5 6 7 8 9 A B C D E F
0- - - - -	0- - - - -	0- - - - -
1- - - - -	1- - - - -	1- - - - -
2- ! " # \$ % & ' () * + , - . /	2- ! " # \$ % & ' () * + , - . /	2- ! " # \$ % & ' () * + , - . /
3- 0 1 2 3 4 5 6 7 8 9 ; : < = > ?	3- 0 1 2 3 4 5 6 7 8 9 ; : < = > ?	3- 0 1 2 3 4 5 6 7 8 9 ; : < = > ?
4- @ A B C D E F G H I J K L M N O	4- @ A B C D E F G H I J K L M N O	4- @ A B C D E F G H I J K L M N O
5- P Q R S T U V W X Y Z [\] ^ _	5- P Q R S T U V W X Y Z [\] ^ _	5- P Q R S T U V W X Y Z [\] ^ _
6- ` a b c d e f g h i j k l m n o	6- ` a b c d e f g h i j k l m n o	6- ` a b c d e f g h i j k l m n o
7- p q r s t u v w x y z { } ~	7- p q r s t u v w x y z { } ~	7- p q r s t u v w x y z { } ~
8- - - - -	8- - - - -	8- - - - -
9- - - - -	9- - - - -	9- - - - -
A- - - - -	A- - - - -	A- - - - -
B- - - - -	B- - - - -	B- - - - -
C- - - - -	C- - - - -	C- - - - -
D- - - - -	D- - - - -	D- - - - -
E- - - - -	E- - - - -	E- - - - -
F- - - - -	F- - - - -	F- - - - -

Figure A-5 Character sets.

ESC E

SET EMPHASIZED (Bold):

Sets the printer to print in emphasized mode. The printer will double strike each character (this will slow down the normal print speed.) Any combination of pitch and NLQ is allowed with emphasized printing.

Emphasized (bold) print.

ECS C n

SET FORMS LENGTH:

Set forms length to n lines per page. The maximum forms length is 127 lines (7F Hex). If a number greater than 127 is specified, ESC C will be ignored. Unless otherwise set, the printer defaults to 66 lines per page (n=42 hex) after a reset or power up.

(continued)

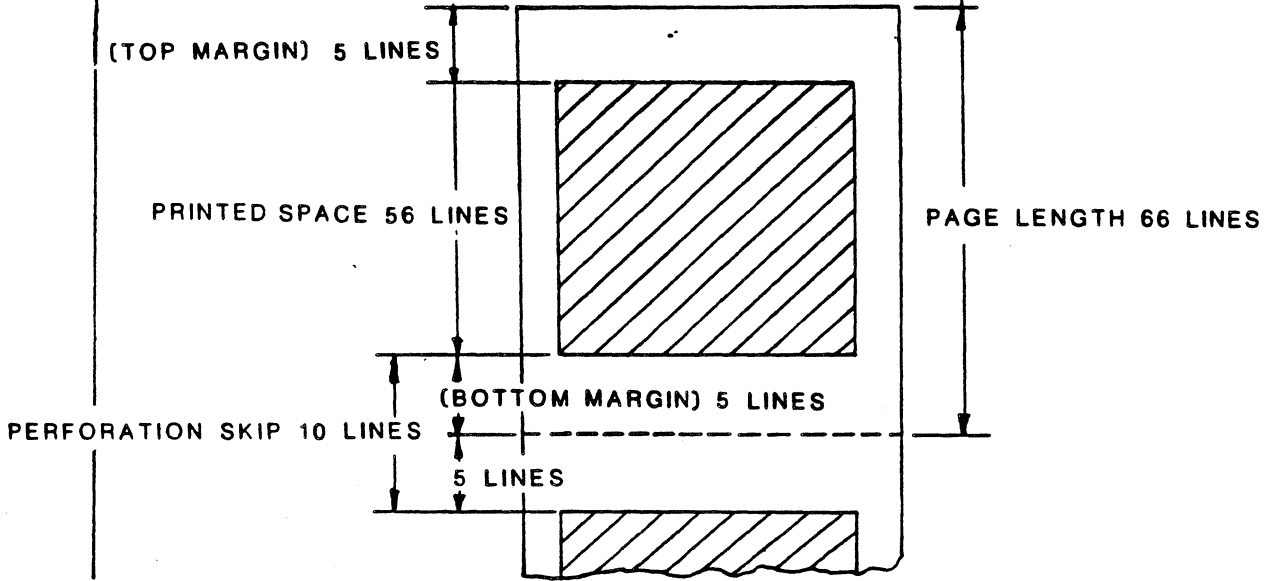
ESC C 0 n	Set forms length to n inches per page. The maximum forms length in inches is 22. If n equals zero or is greater than 22, the ESC is ignored.
ESC N n ESC 0	<p>SKIP PERFORATION: Set skip perforation to n lines. The number n sets the number of lines to advance the paper to get over the perforations after a full page has been printed. (See Figure A-6) If n= 0, the skip perforation function is disabled. ESC N is reset to zero by ESC 0. It is also reset whenever the form length is changed, reset or powered up. Cancel skip perforation.</p>  <p>The diagram illustrates a page layout with the following dimensions and components:</p> <ul style="list-style-type: none">(TOP MARGIN) 5 LINES: Indicated by a vertical arrow at the top left.PRINTED SPACE 56 LINES: A large hatched rectangular area representing the main content.PAGE LENGTH 66 LINES: A vertical arrow on the right side spanning the entire height of the page.(BOTTOM MARGIN) 5 LINES: A vertical arrow at the bottom center.PERFORATION SKIP 10 LINES: A vertical arrow on the left side, starting from the bottom margin and extending upwards.5 LINES: A small vertical arrow at the bottom left, indicating the distance from the bottom margin to the start of the perforation skip.A dashed horizontal line indicates the position of the perforation.A smaller hatched rectangular area is shown at the bottom right, representing the start of the next page. <p>Perforation is set to 10</p>
ESC U 1 ESC U 0	<p>SET PRINT DIRECTION: Unidirectional Print. In this mode the printer prints from left to right only. Upon power up, reset, or switch into parallel mode, the printer defaults to bidirectional mode. Bidirectional print.</p>
ESC S 0 ESC S 1	<p>SET SUPERSCRIP/T/SUBSCRIPT: Set superscript starting with the next printable character. Set subscript. The printer is set to print in subscript mode starting with the next printable character.</p> <p>super^{script} sub_{script} (10 CPI) super^{script} sub_{script} (5 CPI)</p>

(continued)

ESC T	CANCEL SUPERSCRIP/T/SUBSCRIP/T: Printer will stop printing in superscript/subscript mode.																																																																
ESC D n1 n2 n3...00	SET HORIZONTAL TAB STOPS: This escape code is used to set up the horizontal tab stops. Setting up new tab stops cancels all the old ones. The numbers, n, represent the column positions where tab stops are desired. There may be no more than 32 tab stops. A null (00) is used to terminate the string of tabs following the escape. The default and POR tabs are set at every 8th column starting in column 9.																																																																
ESC K n1 n2 m1 m2...mk	60 DOTS PER INCH GRAPHICS MODE: This escape is used to switch from text to graphic mode. n1 and n2 are one byte numbers which allow the specification of the number of graphic data bytes to be transferred. Each graphics data byte represents one column of dots. m1 - mk are the graphic data bytes. The number of graphic data bytes (k) is equal to $n1 + 256n2$ and cannot exceed 792 bytes. If this value exceeds 792, it will be ignored. At every horizontal position each byte can print up to 8 vertical dots. Graphic data may be mixed with Text data on the same line. NOTE: Values should be assigned to n1 and n2 as follows: n1 represents values in the range of 0-255. n2 represents values in the range of 0-3 for ESC K. <table style="margin-left: auto; margin-right: auto;"> <tr> <td colspan="8" style="text-align: center;">n2</td> </tr> <tr> <td style="text-align: center;">MSB</td> <td colspan="6"></td> <td style="text-align: center;">LSB</td> </tr> <tr> <td style="text-align: center;">15</td> <td style="text-align: center;">14</td> <td style="text-align: center;">13</td> <td style="text-align: center;">12</td> <td style="text-align: center;">11</td> <td style="text-align: center;">10</td> <td style="text-align: center;">9</td> <td style="text-align: center;">8</td> </tr> <tr> <td style="text-align: center;">2</td> <td style="text-align: center;">2</td> <td style="text-align: center;">2</td> <td style="text-align: center;">2</td> <td style="text-align: center;">2</td> <td style="text-align: center;">2</td> <td style="text-align: center;">2</td> <td style="text-align: center;">2</td> </tr> </table> <table style="margin-left: auto; margin-right: auto;"> <tr> <td colspan="8" style="text-align: center;">n1</td> </tr> <tr> <td style="text-align: center;">MSB</td> <td colspan="6"></td> <td style="text-align: center;">LSB</td> </tr> <tr> <td style="text-align: center;">7</td> <td style="text-align: center;">6</td> <td style="text-align: center;">5</td> <td style="text-align: center;">4</td> <td style="text-align: center;">3</td> <td style="text-align: center;">2</td> <td style="text-align: center;">1</td> <td style="text-align: center;">0</td> </tr> <tr> <td style="text-align: center;">2</td> <td style="text-align: center;">2</td> <td style="text-align: center;">2</td> <td style="text-align: center;">2</td> <td style="text-align: center;">2</td> <td style="text-align: center;">2</td> <td style="text-align: center;">2</td> <td style="text-align: center;">2</td> </tr> </table> MSB = Most Significant Bit LSB = Least Significant Bit	n2								MSB							LSB	15	14	13	12	11	10	9	8	2	2	2	2	2	2	2	2	n1								MSB							LSB	7	6	5	4	3	2	1	0	2	2	2	2	2	2	2	2
n2																																																																	
MSB							LSB																																																										
15	14	13	12	11	10	9	8																																																										
2	2	2	2	2	2	2	2																																																										
n1																																																																	
MSB							LSB																																																										
7	6	5	4	3	2	1	0																																																										
2	2	2	2	2	2	2	2																																																										
ESC L n1 n2 m1 m2...mk	120 DOTS PER INCH GRAPHICS MODE: This escape is used to switch from text to graphic mode. The input is similar to ESC K, but produces a denser graphic image. The number of bytes of graphic data (k) is $n1 + 256n2$ but cannot exceed 1584. n1 data represents values of 0 to 255.																																																																
ESC Y n1 n2 m1 m2...mk	SAME AS ESC L.																																																																

ESC Z n1 n2 m1 m2...mk	240 DOTS PER INCH GRAPHICS MODE: The input for this escape is similar to the other graphics escapes, but can print in every dot position.
ESC M ESC P	Elite (12 CPI) mode on Elite (12 CPI) mode off
ESC Q	Set right margin
ESC r	Select color
ESC *	Select dot graphics mode: Only 60, 120, and 240 dpi densities are supported; other densities default to 60 DPI.

UNSUPPORTED ESCAPE SEQUENCES

This list consists of escape sequences that may be implemented in the future. For now, these escapes should be ignored.

ESCAPE SEQUENCE	FUNCTION
ESC 4 ESC 5	Set Vertical Pitch
ESC/	Head Home
ESC R ESC X	These codes are not defined by IBM. They should not print.

Any escape sequence which is not listed in this document is considered to be unrecognized. When an unrecognized escape is encountered, the escape code (1B) is suppressed (that is, treated like a null) and everything following it is printed.

Appendix F

Programming Instructions for the Bar Code Option

Any ISI printer equipped for Large Character Label Printing is also able to print Bar Codes. Only the "picket fence" printing of bar codes, where the bars are printed vertically, is supported (see Fig.1). The bar code symbologies currently used are Code 3 of 9 and code 2 of 5 interleaved and non-interleaved. More codes are reserved for a later date.

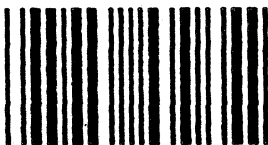

Figure 1 Picket Fence Type Bar Code

A bar code print line is distinguished by using the large print header sequence `&%P`. Bar code symbols are then programmed by specifying a segment or segments (up to 24 in a line). Segments are delineated from one another by a semi-colon `;`.

A segment is defined as:

`(E) (C) (S) (X) (Y) (data) (NOTE: parenthesis not to be used)`

Where E is `;` (Hex 5E) and indicates the end of one segment and the beginning of another.

C is one letter, A to Z, indicating the selections of bar code symbology and density. Density is the number of characters per inch. (See table on the following page for specific codes.)

S is a two digit size code, 01-99, indicating the height of the bar code in tenths of inches (bar code height times 0.1").

X is a three digit number. 001 to 132, specifying the starting print position of the symbol.

Y is a two digit number, 00 to 99, specifying the number of tenth inch lines down from the current print position, the top of the bar code symbol is to be printed (i.e., Code 3 of 9 always begins with a bar, so the

leftmost dot column in the specified print column will be printed.)

Data are the legal characters in the selected symbology such as 3 of 9.

BAR CODE SYMBOLOGY SELECTION CODES

CODE	CPI	W/N RATIO*	SYMBOLOGY	DENSITY
A	4.8	2.9	Code 3 of 9	High
B	reserved			
C	2.9	2.2	Code 3 of 9	Low
D	reserved			
E	7.6	2.9	Code 2 of 5 interleaved	High
F	reserved			
G	5.7	2.2	Code 2 of 5 interleaved	Low
H	reserved			
I	5.5	2.9	Code 2 of 5 non-interleaved	High
J	reserved			
K	3.14	2.2	Code 2 of 5 non-interleaved	Low
.	} reserved for selection of codes and densities to be determined.			
.				
.				
Z				

*W/N RATIO - the ratio of dimensions between wide elements (bars or spaces) and the narrow elements (bars or spaces).

You will specify the size and placement of the human readable character represented by the bar code by means of regular printing or large print segment. This segment may, but will not be required to, accompany the bar code segment.

You will be responsible for maintaining a "quiet zone" (the clear area before and after the start/stop characters).

There are an unlimited number of Large Print-Bar Code printing combinations. Large print and Bar Code can be included in one single line sequence, or they can be used separately.

EXAMPLE:

&%P;C1001005 BAR CODE DATA;0501017LARGE PRINT DATA;nl

(Bar Code and Large Print Sequence)

The only restrictions on defining a sequence are:

1. A sequence can only have 0.1 to 9.9 inch high characters.
2. The last characters printed may not extend below a point 9.9 inches below the starting point.

3. Each sequence must consist of MPP-1 or fewer characters.
4. The semi-colon cannot be included in bar code or large print data.
5. Sequences must be terminated by a new line (nl) code.

ERRORS: Any invalid sequence will be printed just as it is in your data.

When a series is being used, all the previously buffered material is lost and the sequence is treated as a first sequence.

F.1 Code 3 of 9

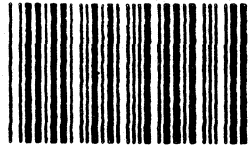

CODE

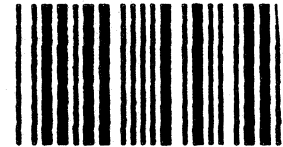

39

Figure 2

Code 3 of 9 is a well defined and widely used code. There are two densities available:

- "A" is high density code at 4.8 CPI and 2.9 wide to narrow bar ratio.
- "C" is low density code at 2.9 CPI and 2.2 wide to narrow bar ratio.

Data are the legal characters defined in the 3 of 9 elements. (See Table 1.)

Code 3 of 9 is characterized by:

- A code structure with three wide elements out of a total of 9 elements. (An element is the area occupied by a bar or space.) The 9 elements consist of five bars and four spaces.
- A full alphanumeric character set.
- A unique start/stop character, plus
- Seven other characters.

(See Figure)

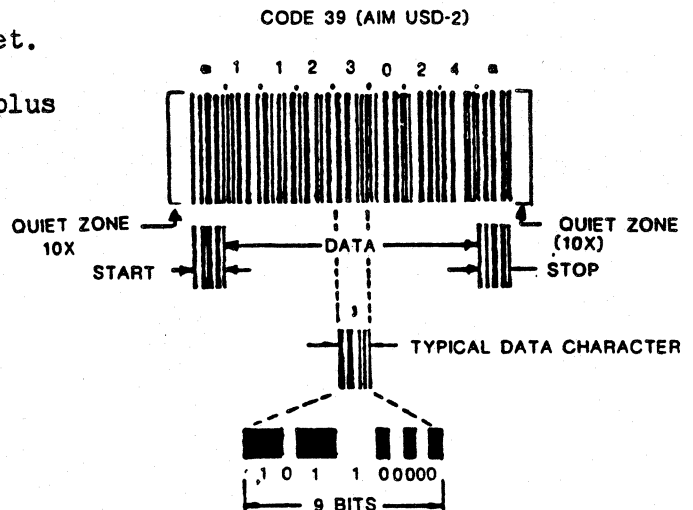

Code 3 of 9 does not include check digits. You are responsible for these, as well as the quiet zone.

The start/stop codes are provided by the printer. They are the same configuration as the asterisc "**". If an "**" is used in the message it will be printed as just another character.

The only restrictions on defining a Large Character/Bar Code sequence in SCS mode are:

1. Combined sequence definitions may not span chains.
2. Sequences cannot include control codes i.e. "TAB."
3. Sequences must be separated from each other and from normal text by new line codes.

Code 3 of 9 Legal Characters

Table 1

Character	Bars	Spaces
1	10001	0100
2	01001	0100
3	11000	0100
4	00101	0100
5	10100	0100
6	01100	0100
7	00011	0100
8	10010	0100
9	01010	0100
0	00110	0100
A	10001	0010
B	01001	0010
C	11000	0010
D	00101	0010
E	10100	0010
F	01100	0010
G	00011	0010
H	10010	0010
I	01010	0010
J	00110	0010
K	10001	0001
L	01001	0001

Character	Bars	Spaces
M	11000	0001
N	00101	0001
O	10100	0001
P	01100	0001
Q	00011	0001
R	10010	0001
S	01010	0001
T	00110	0001
U	10001	1000
V	11001	1000
W	11000	1000
X	00101	1000
Y	10100	1000
Z	01100	1000
-	00011	1000
.	10010	1000
SPACE	01010	1000
*	00110	1000
\$	00000	1110
/	00000	1101
+	00000	1011
%	00000	0111

F.2 Code 2 of 5

There are two types of 2 of 5 bar codes available, interleaved and non-interleaved. Both codes have a code structure with 5 elements. The 5 elements consist of 2 wide bars and 3 narrow. They also have a numeric character set and a unique start/stop character.

Code 2 of 5 interleaved is a bidirectional continuous numeric bar code. It is continuous because there are no intercharacter gaps. Both the bars and the spaces contain information. All interleaved bar codes require an even number of characters. If an odd number of characters are to be

encoded, a leading 0 is automatically added by the printer. For example, number 347 would be represented as 0347. See Figure 3 below.

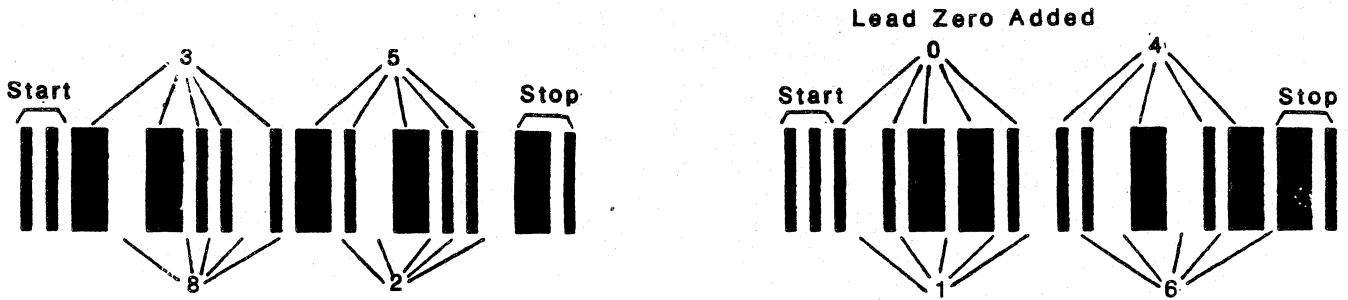

Figure 3

Interleaved Bar Code Symbol
Encoding "3852"

Interleaved Bar Code Symbol
Encoding "146"

Code 2 of 5 non-interleaved differs from interleaved in a number of ways: the spaces do not contain information, all of the spaces are the same width (narrow), intercharacter gaps and an odd number of characters are allowed. See Table 2 for a summary of differences.

Table 2

Interleaved Characteristics	Non-interleaved Characteristics
No intercharacter gaps	Intercharacter gaps
Bars and spaces carry information	Only bars carry information
Start code = 00 Stop code = 10	Start code = 110 Stop code = 101
Requires even number of characters. See Fig. 3.	Doesn't require even number of characters

There are two densities of each code available:

Interleaved

"E" a high density code at 7.6 CPI and 2.9 wide to narrow bar ratio

"G" a low density code at 5.7 CPI and 2.2 wide to narrow bar ratio

Non-interleaved

"I" a high density code at 5.5 CPI and 2.9 wide to narrow bar ratio

"K" a low density code at 3.14 CPI and 2.2 wide to narrow bar ratio

Data are the legal characters defined in the 2 of 5 bar code set listed below.

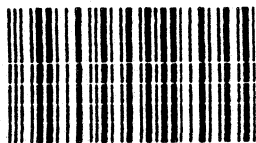

High Density



Low Density

2 of 5 Legal Characters

Table 3

CHARACTER	CODE*
0	00110
1	10001
2	01001
3	11000
4	00101
5	10100
6	01100
7	00011
8	10010
9	01010

*1 = wide elements
0 = narrow elements

REVISIONS

Description	Date
Revised description of error code 08, minor revisions and additions to self-tests.	7/85
Added E74 switch settings, minor revisions of illustrations and copy, addition of appendix G "Programming the IBM PC for Use With the ISI 468 Model 2".	8/85
Changed Portuguese Alt., to Portuguese. Corrected chart on Pg. 55.	9/85
Added 7-color printing information to pages 8, 30, 39, 58-60, 63, 67, 68. Danish/Norwegian/Alt. changed to Danish/Norwegian and vice versa pg.51. Added Hebrew character set 2H pgs. 115, 116. Total reprinting of the manual was required with the addition of this information, thus there will be some page number changes.	10/85
Added bar code information	10/85
Corrected switch settings for E74. Also changed all color printed references from magenta and cyan to pink and turquoise, respectively.	12/85
Revised pages 17 and 18 to include the correct IBM printer emulation.	1/86
Added Self-test 12	1/86
Changed switch #E22 (3), and added #8 on E74 for ALF in parallel mode.	1/86
Added the Buffer Sizes to page 55. There is now a Model 2 with a 4k buffer.	3/86
Added new parallel information	3/86
Added note to &%R section pg.78	4/86
Removed references to variable width bins and added the fixed-width, European bin.	4/86
Added 2 of 5 bar code information. Also added Switch #7, and some general revisions.	7/86
Added graphics escapes K,L,Y,Z. Also added a character set.	9/86
Also added switch 4 for E74 Added parallel diagnostic notes.	1/87

REVISIONS

Description	Date
Added ESC r, ESC *, ESC M, ESC P, and ESC Q. Changed emulation from 5152 to IBM Epson JX-80.	5/87
Added the Hebrew Bulletin Code on page 54.	3/88