

TEKTRONIX®

4012

COMPUTER DISPLAY
TERMINAL

USERS

INSTRUCTION MANUAL

Tektronix, Inc.
P.O. Box 500
Beaverton, Oregon 97005

070-1460-00

Serial Number _____

473



WARRANTY

All Tektronix instruments are warranted against defective materials and workmanship for one year.

Additionally, all Tektronix Computer Display Terminals and related computer peripheral equipment are fully warranted against ANY trouble for the first 90 days. Any equipment trouble occurring to your Tektronix computer terminal or related products during the 90 day period will be repaired by Tektronix personnel at no charge.

Questions regarding warranty should be discussed with your Applications Engineer.

Specifications and price change privileges reserved.

Copyright © 1973 by Tektronix, Inc., Beaverton, Oregon.
Printed in the United States of America. All rights reserved.
Contents of this publication may not be reproduced in any form without permission of Tektronix, Inc.

U.S.A. and foreign Tektronix products covered by U.S. and foreign patents and/or patents pending.

TEKTRONIX is a registered trademark of Tektronix, Inc.

TABLE OF CONTENTS

SECTION 1	INTRODUCTION	Page
	General Description	1-1
	Installation and Care	1-1
	Data Flow	1-2
	Operating Modes	1-2
	Transmitting	1-3
	Receiving	1-4
	Graphic Input (GIN)	1-6
	Local Operation	1-8
	Hard Copy Operation	1-8
	Hold/View	1-9
SECTION 2	CONTROLS	
	Introduction	2-1
	Keyboard Panel	2-2
	Strap Options	2-3
	Control Characters	2-4
SECTION 3	OPERATION	
	Introduction	3-1
	Installation	3-2
	Initialization	3-2
	View/Hold	3-3
	Character Transmission	3-3
	Alpha Mode	3-5
	Graph Mode	3-7
	Gin Mode	3-9
	Hard Copies	3-12
	Operation Summary	3-13
	General Summary	3-14
	Alpha Mode Summary	3-15
	Graph Mode Summary	3-16
	GIN Mode Summary	3-18
APPENDICES	A. Installation	A-1
	B. Code Chart	B-1
	C. Coordinate Conversion Chart	C-1
	D. Interface Design	D-1
	E. Accessories	E-1
	F. Glossary	F-1
INDEX		I

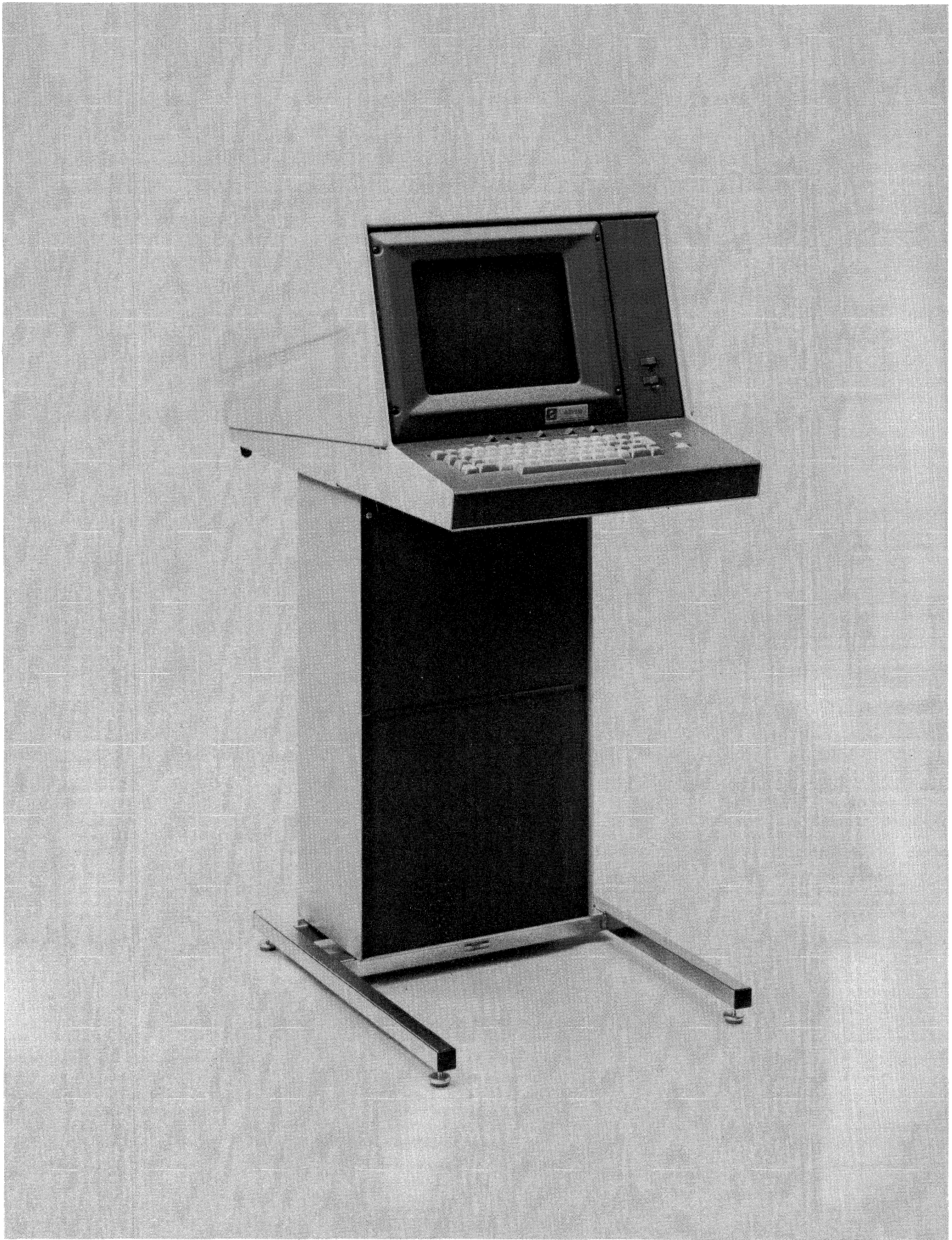

Fig. 1-1. The 4012 Computer Display Terminal

General Description

The Computer Display Terminal is an instrument which enables exchange of information between people and computers. Inputs to the computer are made through the Terminal's keyboard. Data from the computer can be displayed on the face or "screen" of the Terminal's cathode ray storage tube. This tube is similar to that used in television sets, but has the ability to retain or "store" a display.

The Terminal's response to data is not restricted to writing on the screen. It can also perform a variety of functions in response to "control character" commands. These functions include (but are not limited to) controlling the display format, switching modes, ringing the Terminal's bell, and controlling outputs from the Terminal.

When equipped with appropriate interfaces, the Terminal can exchange data with peripheral devices, and can relay data bi-directionally between the peripheral devices and computers. Some of the devices with which the Terminal can interact are Monitors, Audio Recorders, and Tape Reader/Perforator Units.

Reproductions can be made of displays which appear on the Terminal screen, if a Hard Copy Unit is attached to the Terminal. The reproductions are referred to as "hard copies".

The Terminal consists of two principal parts — the Display Unit and the Pedestal Unit. The Display Unit houses the storage tube, keyboard, and their associated circuits. The Pedestal Unit contains the terminal control circuits, the low voltage power supply, and the interfaces.

The Terminal can stand alone, or the Display Unit can be detached from the Pedestal and placed on a separate surface as far as four feet from the Pedestal (Fig. 1-2). Rack-mounted versions of either or both units are also available.

Installation and Care of the Terminal

Details regarding installation are provided in the Appendix. Essentially, installation consists of selecting the proper

line voltage connections and fuse size, selecting strap options, and mounting the Display Unit on the Pedestal or on a table or desk. Care of the Terminal involves keeping it clean, providing proper ventilation, and operating it in a manner which insures a maximum life for the display screen. External surfaces, including the face of the display, can be cleaned with a mild soap and water solution. Proper ventilation can be assured by keeping the air vents free of obstructions and excessively warm air supplies. Maximum life for the screen can be obtained by the following: (1) Keep the Terminal turned off when not in use; (2) Keep the Terminal in Alpha Mode except when actually drawing graphs or utilizing GIN Mode; (3) Do not maintain a stored display for more than 15 minutes in View status, or one hour in Hold status. Maintaining a stored display for longer periods may damage the screen. Details regarding modes and View/Hold status are contained on the following pages.

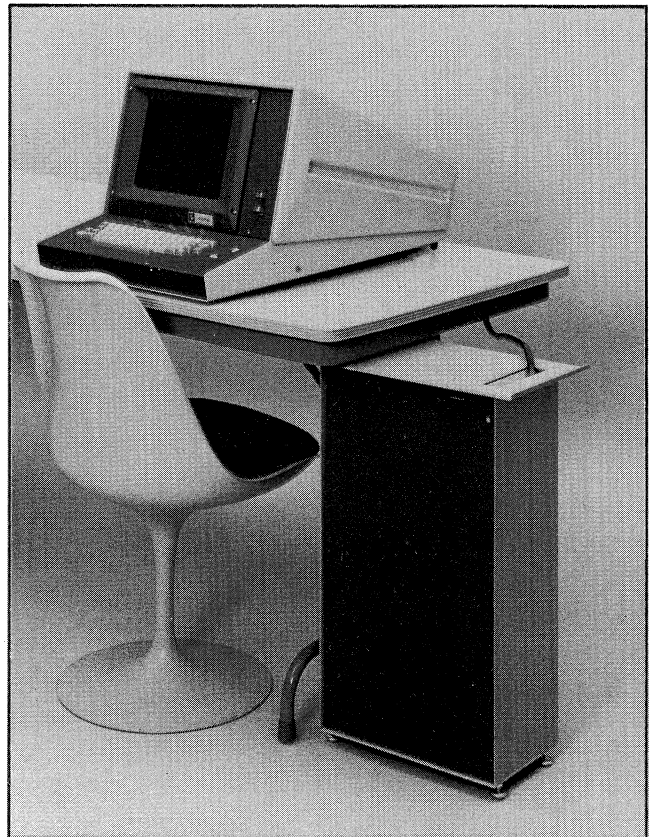

Fig. 1-2. The Display Unit can be desk-mounted or table-mounted.

INTRODUCTION

(cont)

Data Flow

The Terminal's position in the flow of information is shown in Fig. 1-3. Data from a computer is sent to the Terminal circuits via a communication link. This communication link may be a direct connection or may be a modulator/demodulator (modem), a telephone line, and a second modem. The Terminal's interface applies the received data to the terminal control circuits, which cause either display writing or control character execution in accordance with the nature of the incoming signals.

Data entered at the keyboard is routed through the terminal control section, through the interface, and thence to the computer (via a direct connection or through modems and a telephone line). If an echo condition exists (local echo or echoing accomplished by the interface, the modem or the computer), the data is also processed by the terminal control circuits just as though it originated at the computer.

When a Make Copy command is asserted by any source, the Hard Copy Unit takes control of the Terminal and extracts display information from it, reproducing the display on paper. Control of the Terminal from any other source is precluded while the display is being copied.

Operating Modes

The Terminal is normally operated "On Line", as selected by a LOCAL/LINE switch. (The LOCAL position is used for formatting, operator training, troubleshooting, etc.) The basic On Line operations are Transmitting, Receiving, and Graphic Input or "GIN". An introduction to these operations is provided in the remainder of this section, along with a brief description of Local, Hard Copy, and View/Hold operation.

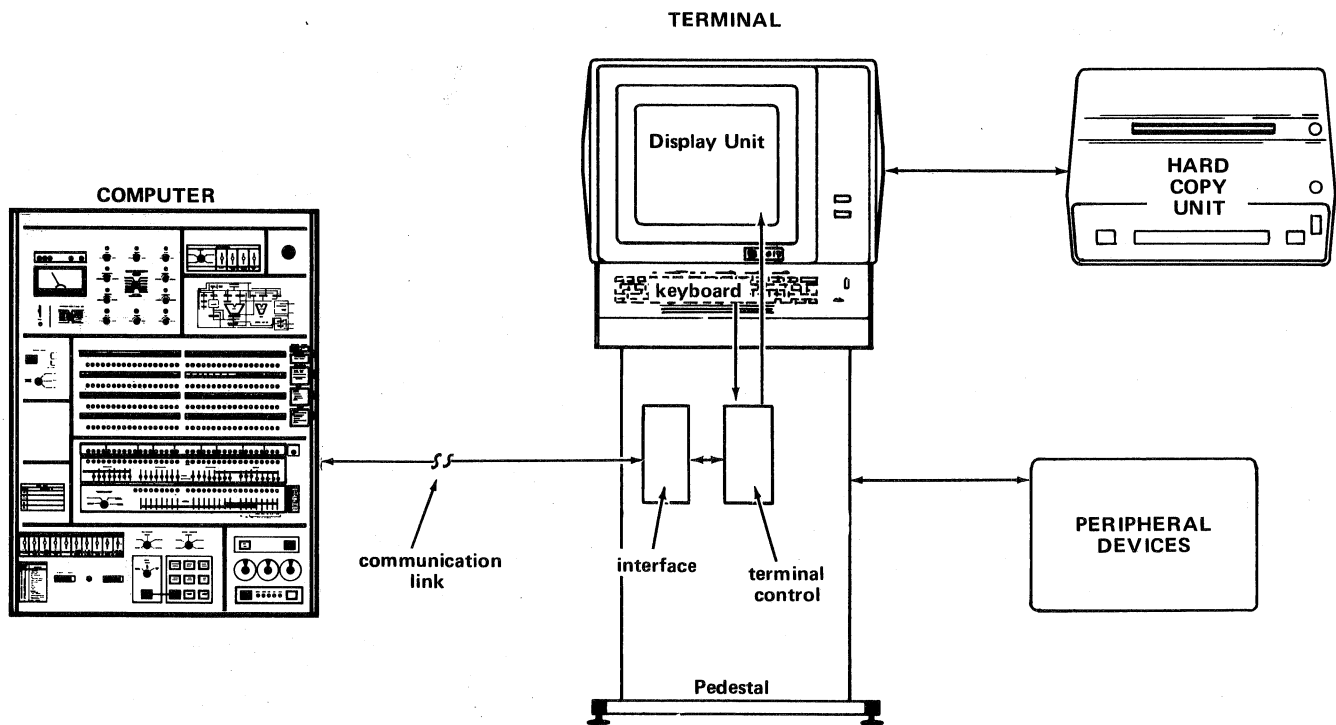

Fig. 1-3. Data flow diagram.

INTRODUCTION TRANSMITTING

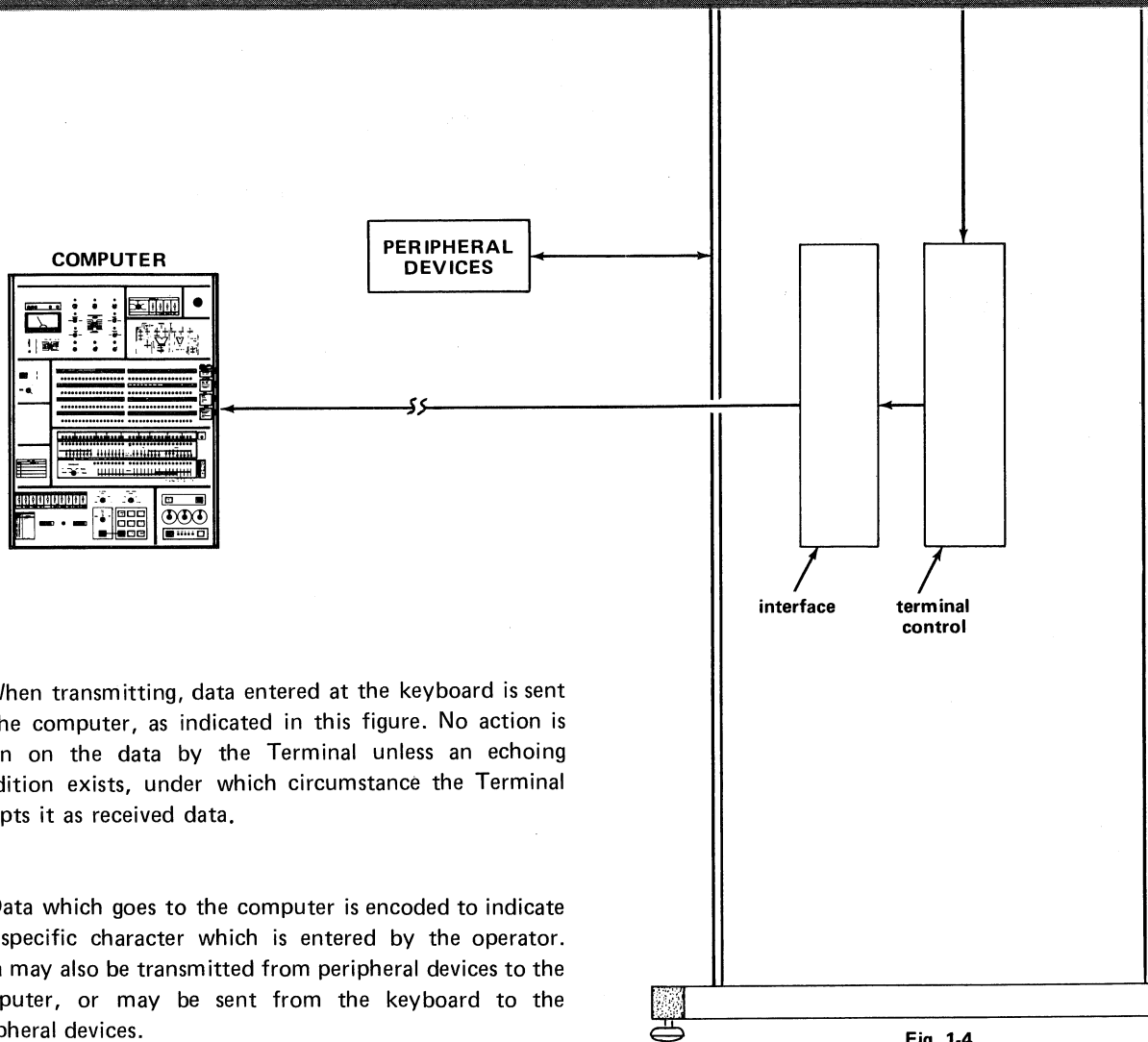

Fig. 1-4

When transmitting, data entered at the keyboard is sent to the computer, as indicated in this figure. No action is taken on the data by the Terminal unless an echoing condition exists, under which circumstance the Terminal accepts it as received data.

Data which goes to the computer is encoded to indicate the specific character which is entered by the operator. Data may also be transmitted from peripheral devices to the computer, or may be sent from the keyboard to the peripheral devices.

INTRODUCTION RECEIVING

The Terminal's receiving operation consists basically of writing characters, drawing lines (vectors), or executing control characters. Characters are written in Alphanumeric (Alpha) Mode; vectors are drawn in Graphic (Graph) Mode; control characters are executed in either mode.

ALPHA MODE

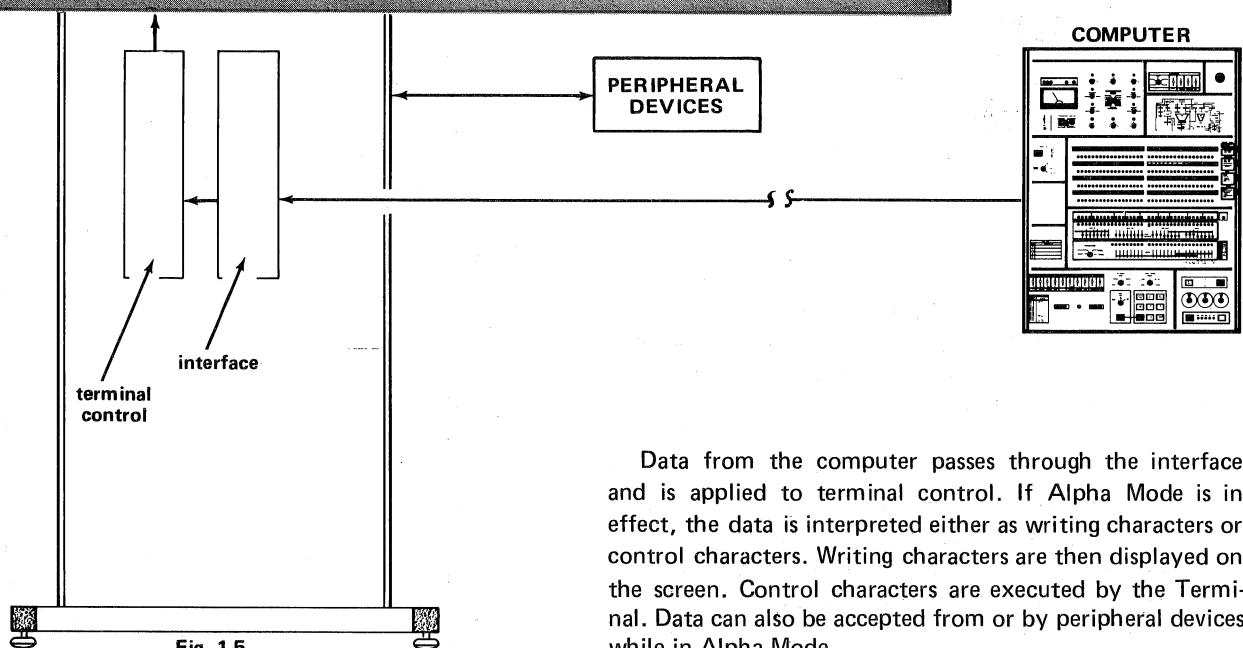
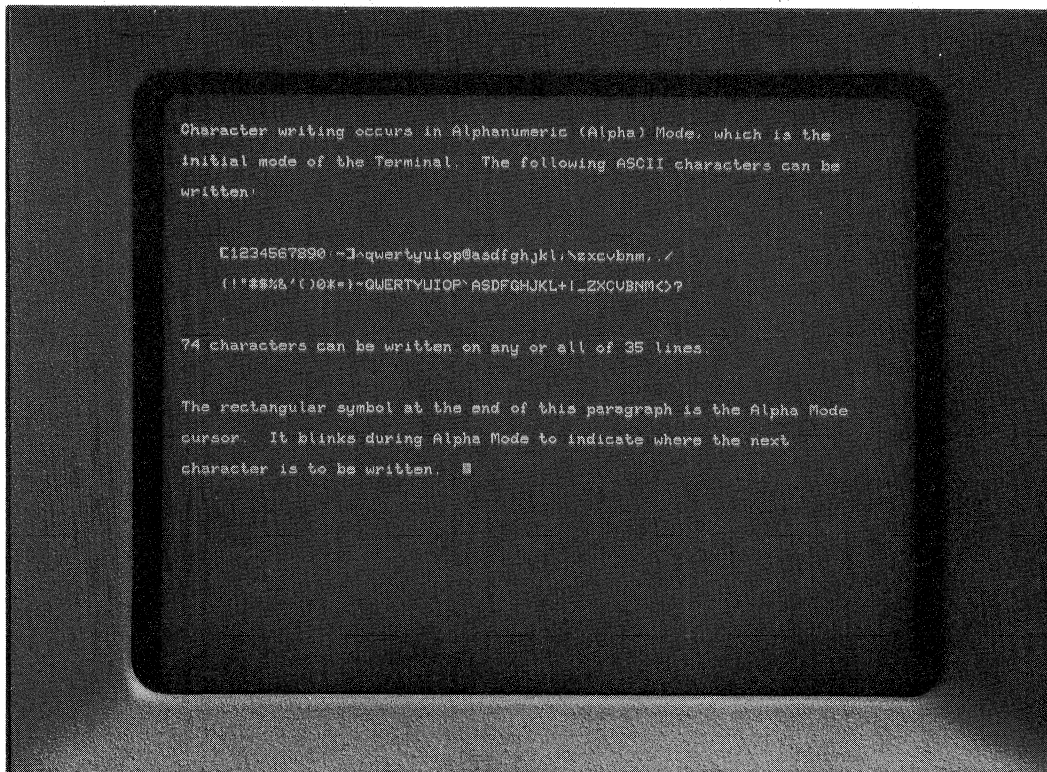

Data from the computer passes through the interface and is applied to terminal control. If Alpha Mode is in effect, the data is interpreted either as writing characters or control characters. Writing characters are then displayed on the screen. Control characters are executed by the Terminal. Data can also be accepted from or by peripheral devices while in Alpha Mode.

GRAPH MODE

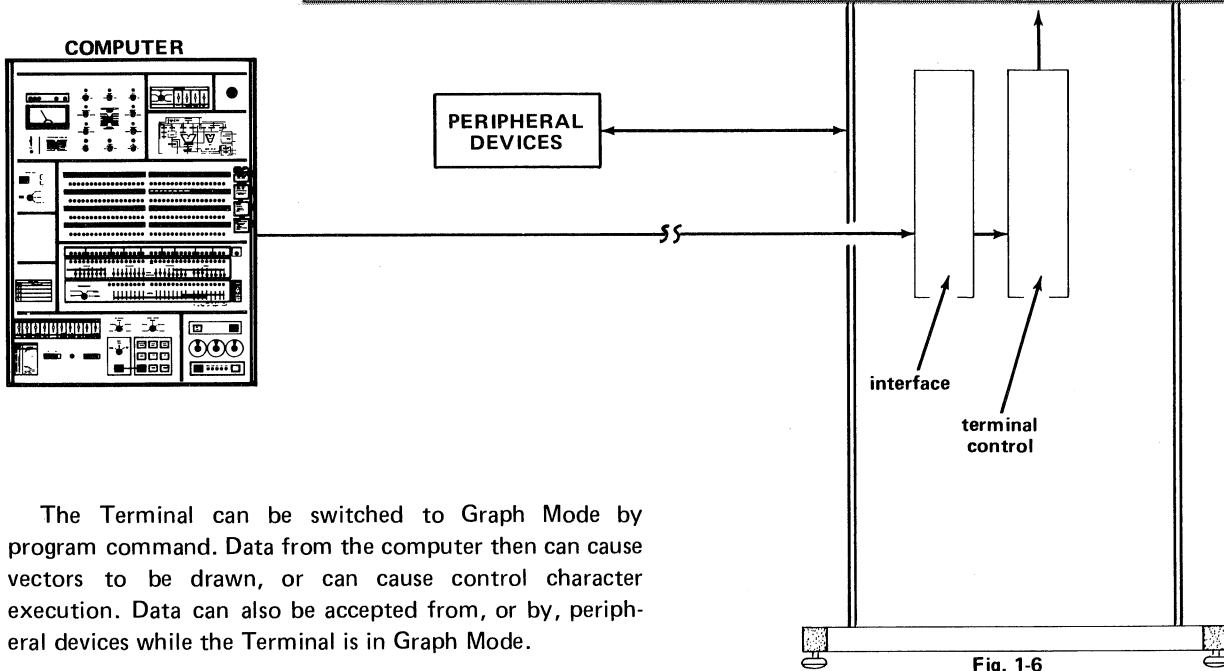
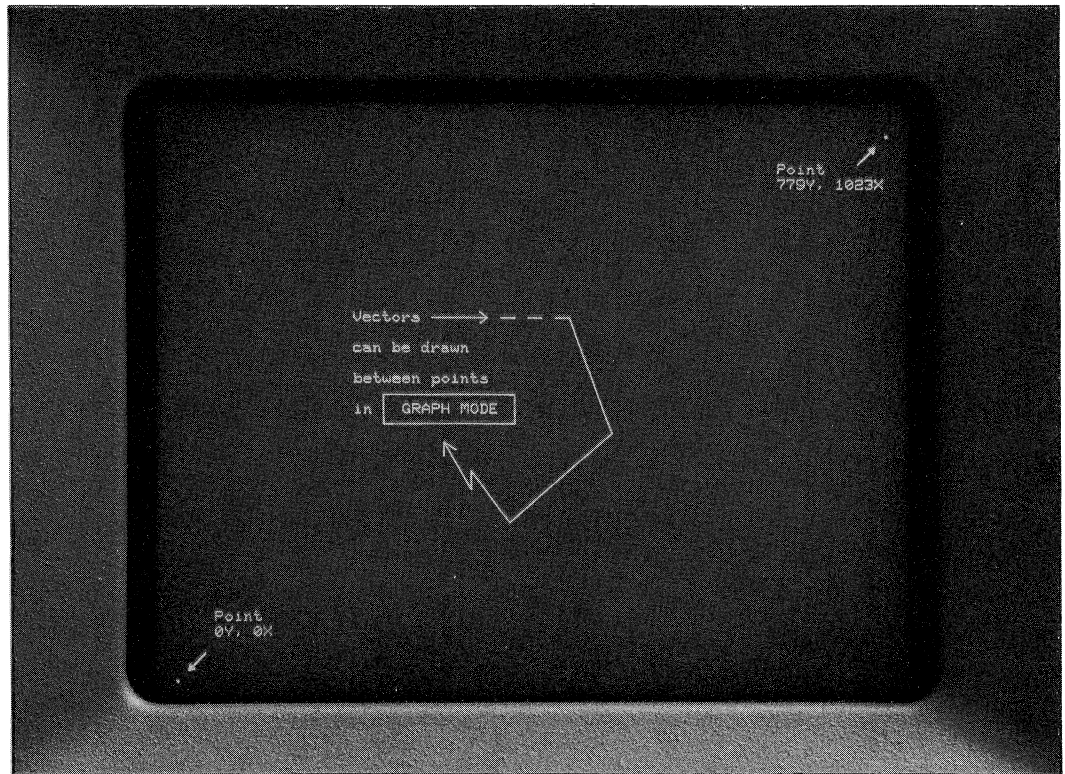

Fig. 1-6

The Terminal can be switched to Graph Mode by program command. Data from the computer then can cause vectors to be drawn, or can cause control character execution. Data can also be accepted from, or by, peripheral devices while the Terminal is in Graph Mode.

GRAPHIC INPUT (GIN)

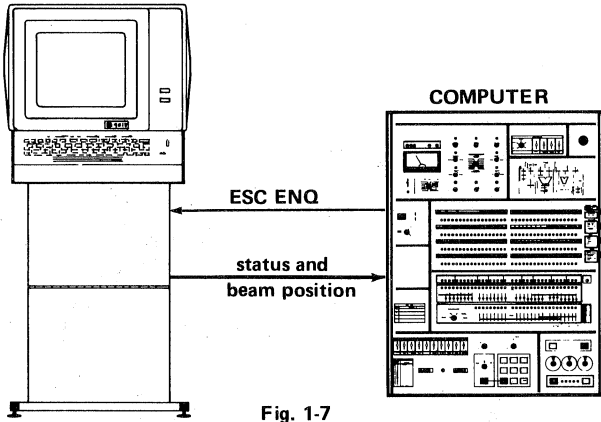

Fig. 1-7

The Graphic Input (GIN) operations are interactive, in that they involve computer requests for information, and the Terminal's response to the requests. The GIN operations are explained in the following paragraphs.

Input of Terminal status and Alpha Mode cursor position. An ESC ENQ request from the computer while the Terminal is in Alpha Mode results in transmission of the Terminal status and the address of the bottom-left corner of the Alpha cursor. The Terminal responds automatically, and the operation is not noticeable to the Terminal user.

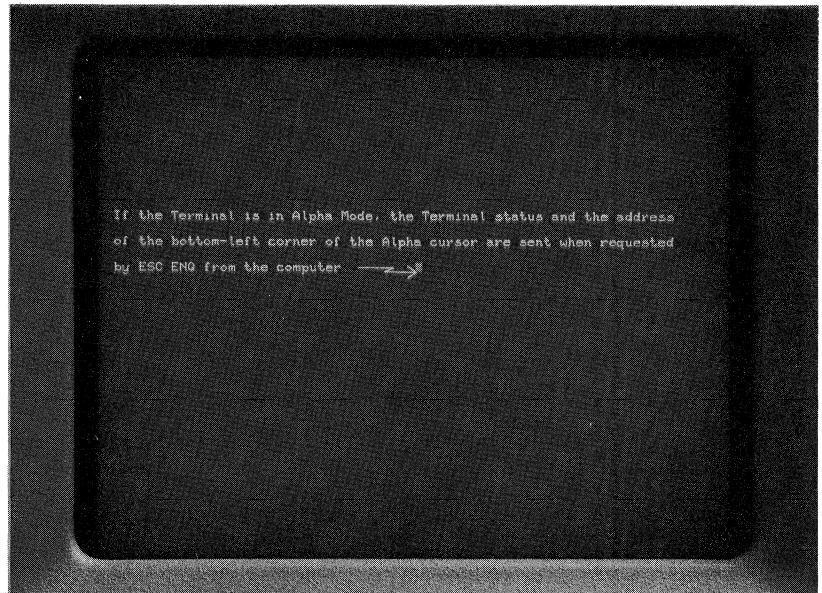

Fig 1-8

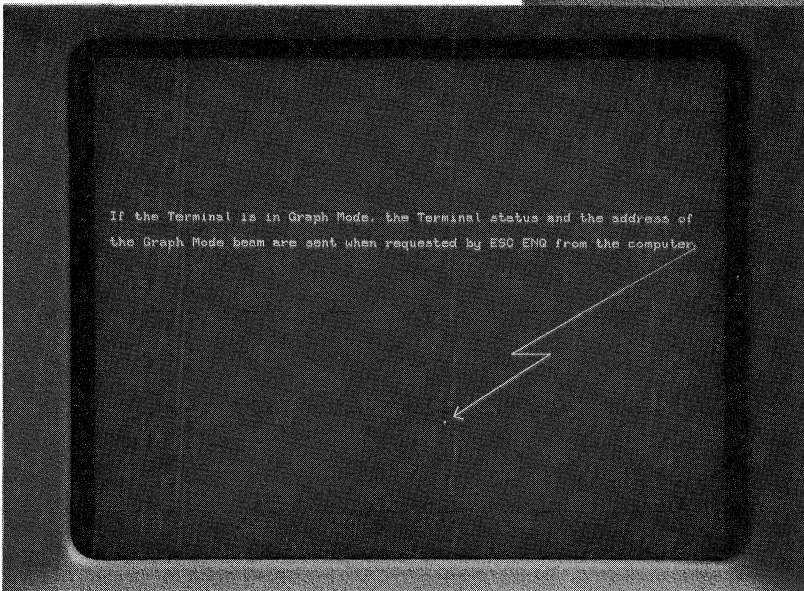

Fig. 1-9

Input of Terminal status and Graph Mode writing beam position. An ESC ENQ request from the computer while the Terminal is in Graph Mode results in automatic transmission of the Terminal status and the address of the writing beam, whether or not a display is present. The operation is not noticeable to the Terminal user.

INTRODUCTION GRAPHIC INPUT (GIN) (cont)

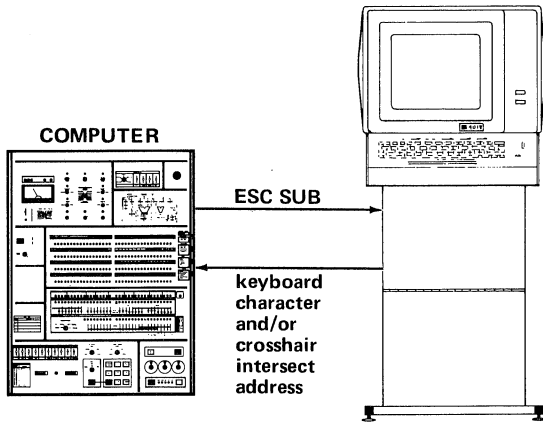

Fig. 1-10

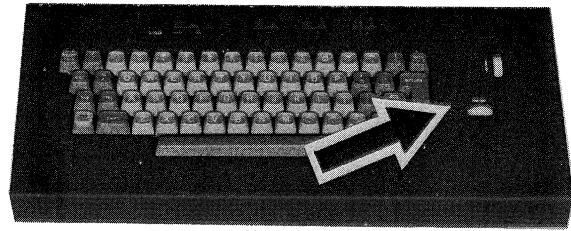

Fig 1-11

Sending the crosshair cursor intersect address in response to computer request. An ESC SUB from the computer causes the Terminal to display a crosshair cursor. A subsequent ESC ENQ from the computer requests the crosshair cursor intersect address. The Terminal responds automatically, and the crosshair cursor disappears.

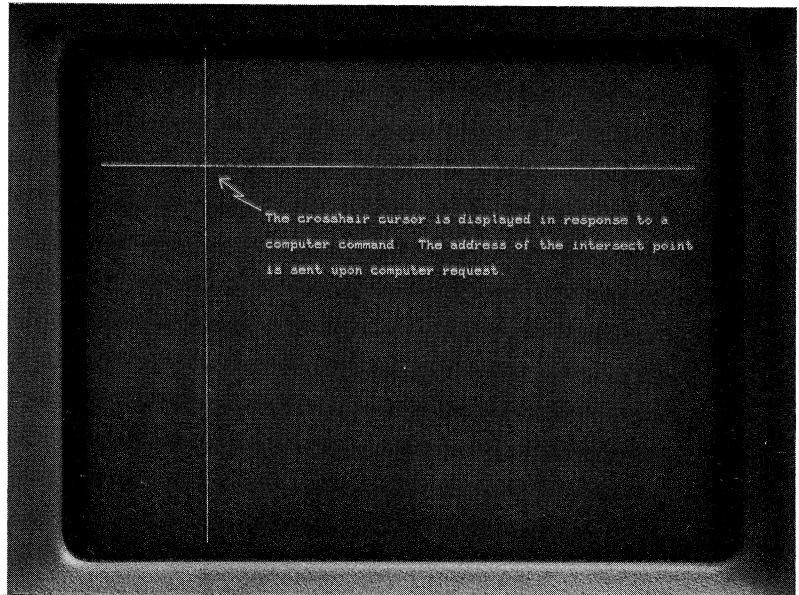

Fig 1-12

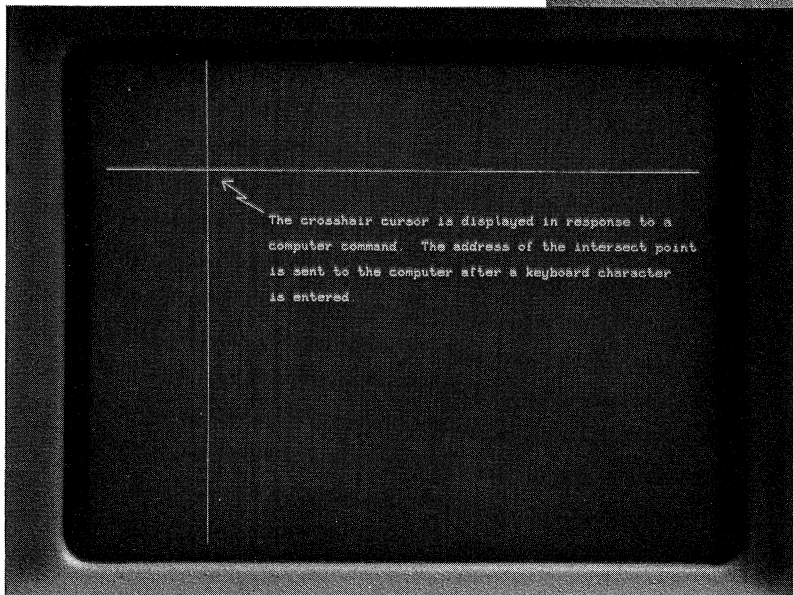

Fig. 1-13

Sending the crosshair cursor intersect address in response to a keyboard input. An ESC SUB from the computer causes the Terminal to display the crosshair cursor. The operator positions the cursor with the keyboard thumbwheels and enters a selected character. The Terminal sends the character, and automatically follows it with the crosshair intersect address. The crosshair cursor disappears.

LOCAL OPERATION

Local Operation. The Terminal is isolated from the computer when the keyboard switch is at LOCAL. Keyboard inputs are displayed or otherwise executed by the Terminal. All modes can be exercised except GIN, where only the display and positioning of the crosshair cursor can occur. The Terminal can interact with peripheral devices while in Local.

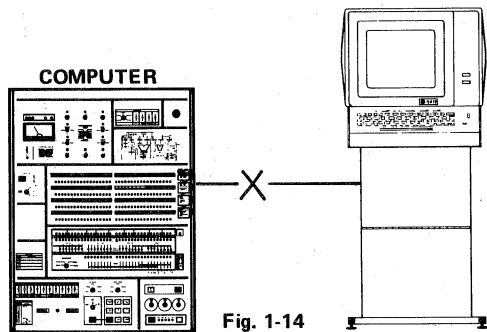

Fig. 1-14

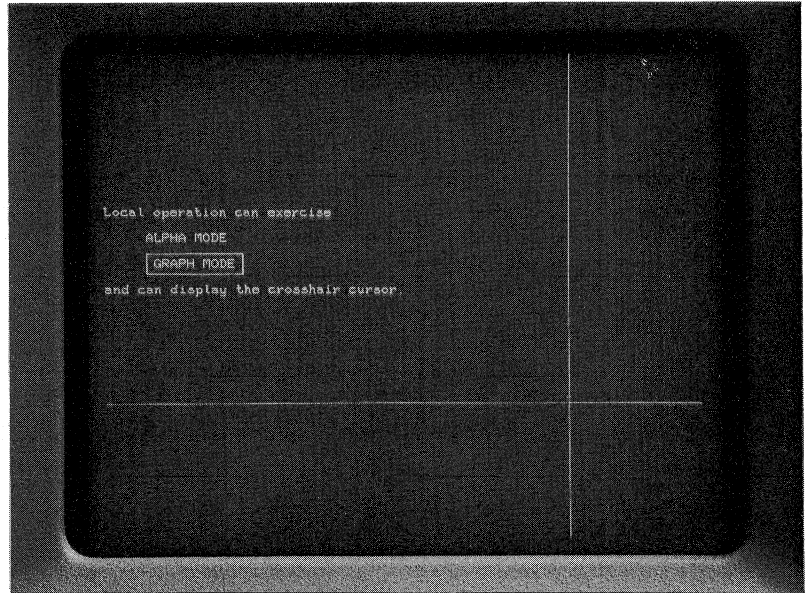

Fig. 1-15

HARD COPY OPERATION

Hard Copy Operation. A Hard Copy Unit can produce a permanent copy of a Terminal display in response to a "Make Copy" signal from the computer, Keyboard, Hard Copy Unit, or from peripheral devices.

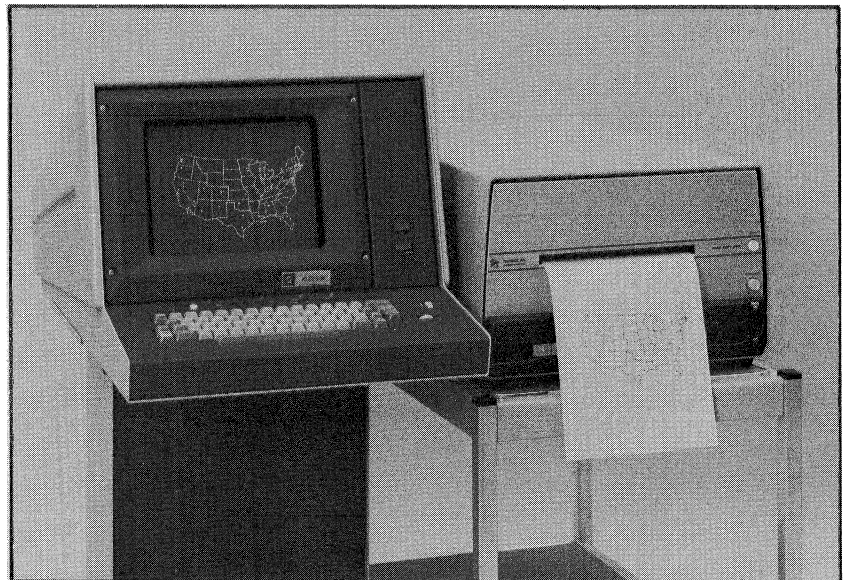

Fig. 1-16

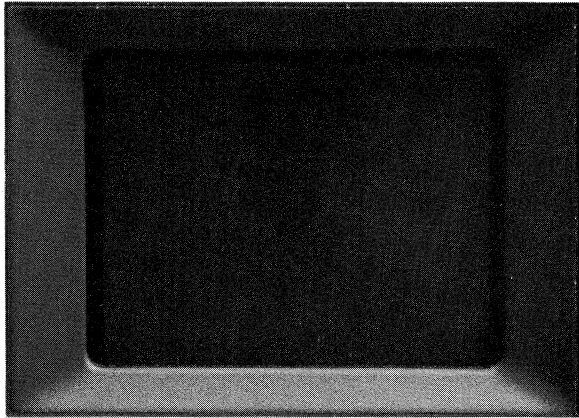

Fig 1-17

Hold is an Alpha Mode reduced-intensity status which occurs after 60 to 120 seconds of Terminal inactivity. Data can be stored in Hold Status for up to one hour without damage to the display screen. The Terminal resets to View Status in response to any Terminal activity. In addition, the SHIFT key resets the Terminal to View Status without otherwise affecting the display.

HOLD STATUS

plus SHIFT or other Terminal activity

equals

VIEW STATUS

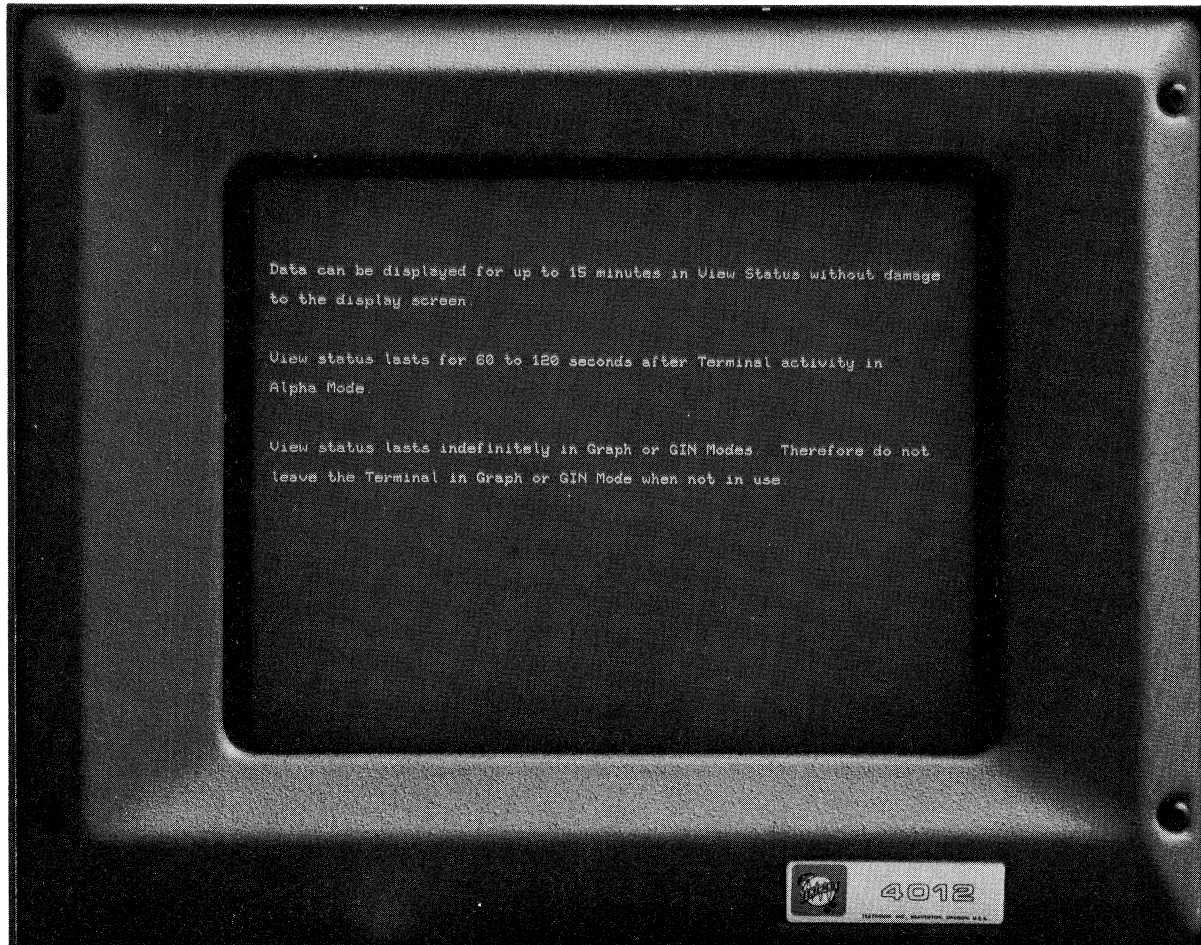

Fig 1-18



CONTROLS

If the Terminal has been installed as explained in the appendix, operation of the Terminal consists of:

- Turning it on
- Selecting keyboard switch positions
- Entering Terminal control commands
- Entering Data
- Controlling the crosshair cursor
- Entering copy-making commands
- Adjusting hard copy intensity
- Selecting strap options

These functions are accomplished by using the following switches, keys, wire strap options, and adjustments.

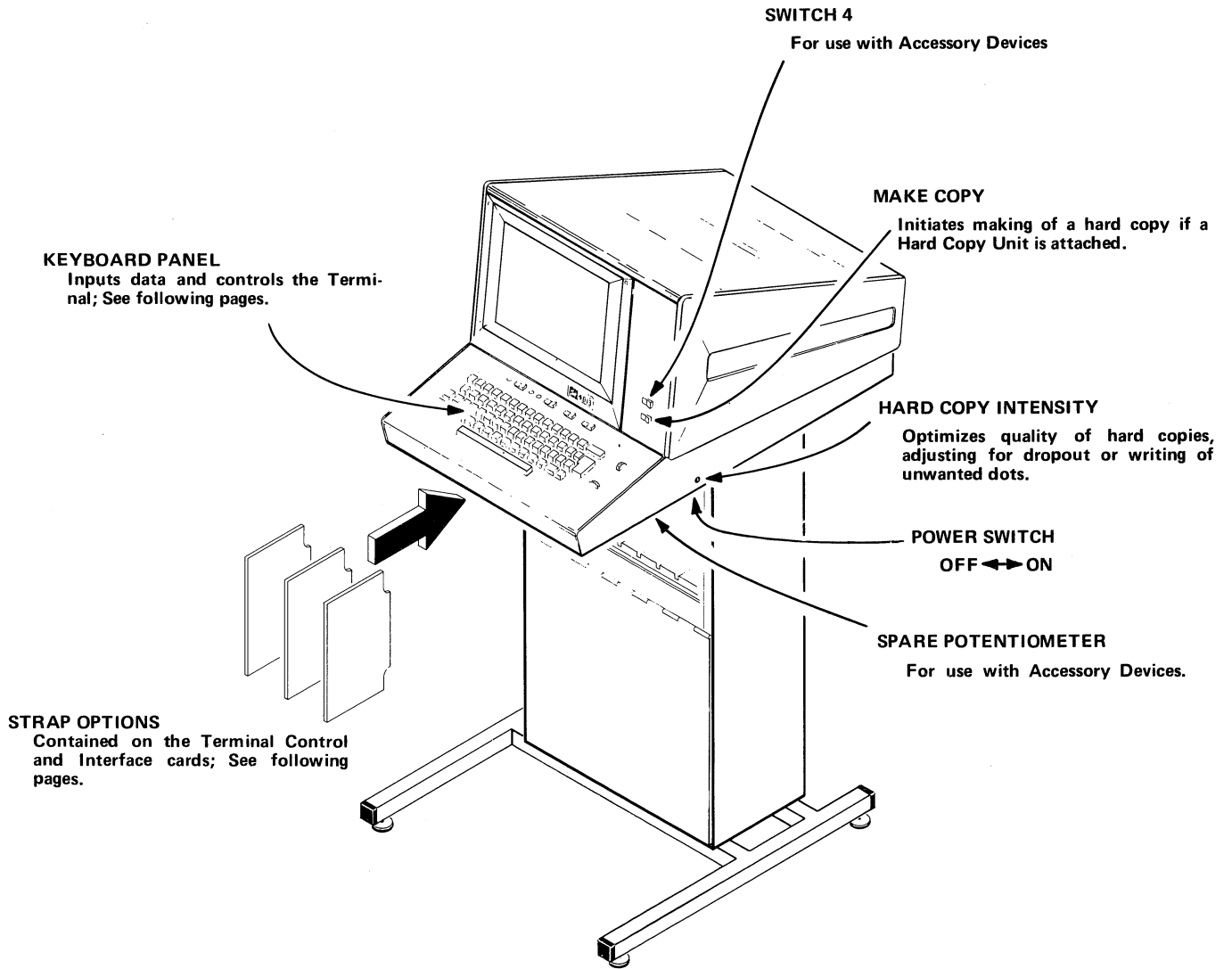

Fig. 2-1

KEYBOARD PANEL

RESET -

Entered with **SHIFT** held down; creates a "home" function, resetting the Terminal to initial status; does not erase

LOCAL -

Isolates the Terminal from the computer and causes the Terminal to execute keyboard inputs

PAGE -

Erases the display, resets to Alpha Mode and home position; resets to Margin 0 and cancels echoplex suppression

LINE -

Permits exchange of data between the Terminal and computer

SPARE INDICATORS and SWITCHES
For use with Accessory Devices

POWER -

Lights when the Terminal is on



CTRL -

Converts key inputs to control characters; also used with **SHIFT** and character keys to enter control characters

CROSSHAIR POSITION THUMBWHEELS -

Control the position of the GIN Mode crosshair cursor.

BREAK -

Generates a break signal. The Terminal Interface may use the break signal to interrupt the computer.

TTY LOCK -

With the lock in effect, transmission is limited to TTY code.

SHIFT -

Used alone, it switches Terminal from Hold to View status; used with character keys, it shifts them to upper case; used with **CTRL** and letter keys, it enters control characters.

Fig. 2-2

CONTROLS STRAP OPTIONS

LF EFFECT

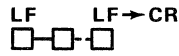

LF position provides line feed in response to LF commands; LF → CR position provides line feed and carriage return in response to LF commands.

CR EFFECT

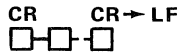

CR position provides carriage return in response to CR commands; CR → LF causes carriage return and line feed in response to CR commands. (This option is not included on all TC-1 cards.)

ROM SELECT

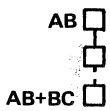

AB + BC position permits switch or program selection of ASCII or alternate writing character set, if installed; AB position limits writing to ASCII.

PF BREAK

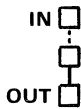

IN position permits a full page to cause a busy signal (T BUSY).

GIN TERMINATORS

Determines which characters follow address transmission in GIN Mode

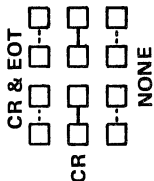

CAUTION

Do not install or remove circuit cards while the terminal is turned on.

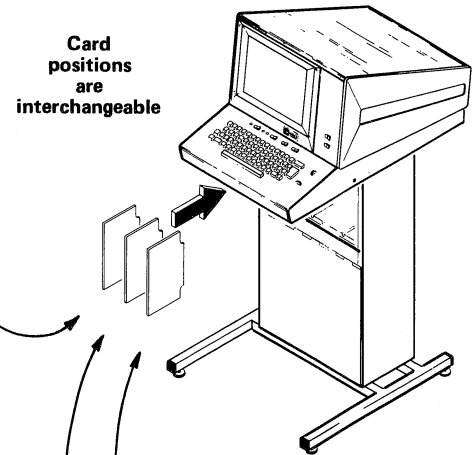
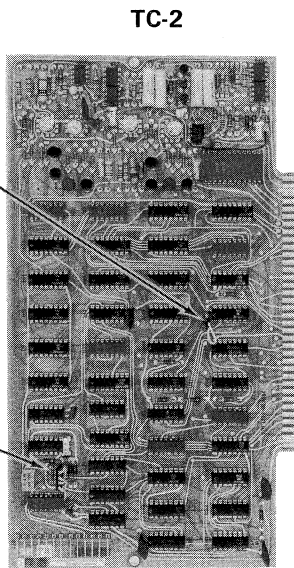
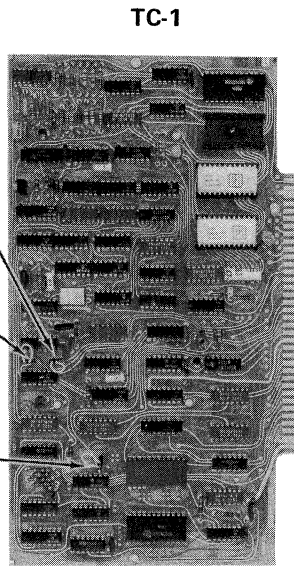

Refer to appropriate manual for strap option information for interfaces and peripheral devices. Also, see the Installation appendix.

INTERFACE CARD

Fig. 2-3.

CONTROL CHARACTERS

Control characters are coded signals which are sent back and forth between the computer, Terminal, and accessory devices to control operation. Their use is relatively standard, but any of them can be used for any purpose, if desired. The control characters, their keyboard equivalent, and their effect upon the basic Terminal are listed here. The transmission and effect is independent of ASCII or TTY selection.

Control Character	Keyboard Equivalent	Effect Upon Basic Terminal
ACK	CTRL F	
BEL	CTRL G	Rings bell; clears echoplex suppression.
BS	BACKSPACE or CTRL H	Backspaces; clears echoplex suppression.
CAN	CTRL X	
CR	RETURN or CTRL M	Carriage return; resets Terminal from Graph to Alpha Mode; cancels crosshair cursor, setting Alpha Mode but leaving the Terminal in an undefined margin (page full) status; clears echoplex suppression. A strap on some TC-1 cards can be set so CR also causes line feed.
DC1	CTRL Q	
DC2	CTRL R	
DC3	CTRL S	
DC4	CTRL T	
DLE	CTRL P	
EM	CTRL Y	
ENQ	CTRL E	As second character in ESC ENQ sequence, it causes echoplex suppression and creates one of the following Gin Mode situations: <ol style="list-style-type: none"> 1) Causes Terminal status and address of lower left corner of the Alpha Cursor to be sent to the computer if received while the Terminal is in Alpha Mode. 2) Causes Terminal Status and address of the display beam to be sent to the computer if received while the Terminal is in Graph Mode. 3) Causes address of crosshair cursor to be sent to the computer if received while the crosshair cursor is being displayed.
EOT	CTRL D	
ESC	ESC or CTRL SHIFT K	Terminal "arming" character which makes the Terminal sensitive to certain control characters received immediately after ESC; see ENQ, ETB, FF, SI, SO, SUB. Other characters may be used in sequence with ESC to control accessory devices.

CONTROLS

CONTROL CHARACTERS

(cont)

Control Character	Keyboard Equivalent	Effect Upon Basic Terminal
ETB	CTRL W	As second character in ESC ETB sequence, it creates a Make Copy signal, which causes a hard copy of the display to be made if an energized Hard Copy Unit is attached. ESC ETB also clears echoplex suppression. Not effective while crosshair cursor is displayed.
ETX	CTRL C	
FF	CTRL L	As second character in ESC FF sequence, it erases the screen, selects Alpha Mode, sets the cursor to home position, sets Margin \emptyset , and clears echoplex suppression.
FS	CTRL SHIFT L	
GS	CTRL SHIFT M	Sets Terminal to Graph Mode; sets circuitry for dark vector. Should not be used while crosshair cursor is displayed.
HT	TAB or CTRL I	Spaces one space to right. Also clears echoplex suppression.
LF	LF or CTRL J	Cursor moves down one line; if cursor moves past the bottom of the display, it "wraps" around and appears at the top of the display, selecting the alternate margin. Also clears echoplex suppression. A strap on TC-1 can be set so LF also causes carriage return.
NAK	CTRL U	
NUL	CTRL SHIFT P	
RS	CTRL SHIFT N	
SI	CTRL O	As second character in ESC SI sequence, it selects the ASCII character set if the left side of keyboard switch 2 is in, and the ROM Select option on TC-1 is at AB+BC position.
SO	CTRL N	As second character in ESC SO sequence, it selects the alternate character set if the right side of the keyboard switch is in and the ROM Select option on TC-1 is at AB+BC position. (Requires installation of alternate character set ROM.)
SOH	CTRL A	
STX	CTRL B	
SUB	CTRL Z	As second character in ESC SUB sequence, it sets GIN Mode and starts the crosshair cursor. Activates echoplex suppression.
SYN	CTRL V	
US	CTRL SHIFT O	Resets Terminal from Graph to Alpha Mode; clears echoplex suppression.
VT	CTRL K	Causes reverse line feed; clears echoplex suppression.

Introduction

This operating procedure can be used in two ways. The entire procedure can be done, taking note of all information; this is beneficial for developing an understanding of the Terminal operation. The second use is to carry out only the left column; this method provides a Terminal check-out procedure for someone familiar with the Terminal operation.

If the Terminal has been installed in accordance with instructions contained in the Appendix, operator use of the Terminal consists of:

- Turning it on;
- Selecting the keyboard switch set-up;
- Entering Terminal control commands;
- Entering data;
- Controlling the crosshair cursor;
- Entering copy making commands;
- Adjusting hard copy intensity;
- Selecting strap options.

In addition, program command operation of the Terminal includes the following:

- Selecting modes;
- Formatting the display;
- Writing characters;
- Drawing vectors;
- Determining Terminal status and/or beam position;
- Controlling other Terminal features (such as the bell) and Terminal accessory devices.

The following procedure demonstrates most of these features.

OPERATION INSTALLATION

4012 Users

1. Select the proper line voltage

Details are given in the Appendix.

2. Select the proper strap options

Instructions for TC-1 and TC-2 are given in the preceding section. Instructions for the interface and accessory devices are given in their respective manuals.



Do not remove or install circuit cards while the terminal is turned on.

3. Connect the Interface to the data communication set (modem) or to the computer

General instructions are given in the Appendix; specific instructions appear in the Interface manual.

4. Connect the Terminal line cord to the power source

The line cord is attached to the Pedestal, at the back, near the bottom.

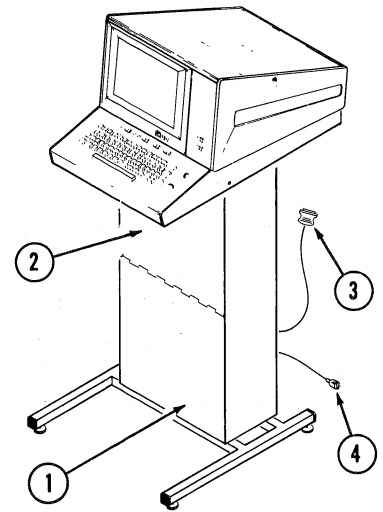

INITIALIZATION

5. Place the LOCAL/LINE switch to LOCAL

LOCAL isolates the Terminal from the computer and causes keyboard inputs to be executed by the Terminal.

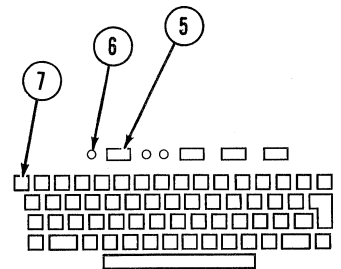

6. Turn the Terminal ON

The Power switch is on the front-top-right of the pedestal. Push in on the right side to turn it on. A green light at the left on the keyboard panel will light, and the display screen will become bright (flood) after a few seconds.

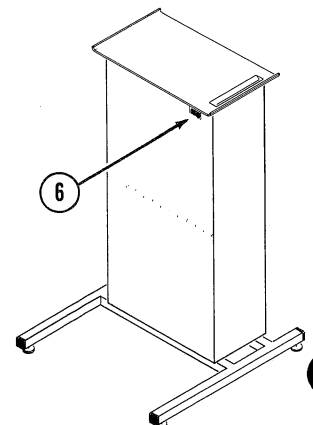

7. Erase the display

Push the PAGE key.

OPERATION VIEW/HOLD

8. Check the Hold Circuit

Wait one to two minutes and note that the display becomes noticeably dimmer and the Alpha cursor disappears. Press the SHIFT key and note that the display brightens and the cursor returns. Again, wait one to two minutes until Hold status occurs; then enter any character key (try the Space bar) and note that View status is regained. Any keyboard character causes View status to return, but SHIFT does it without transmitting or affecting the display.

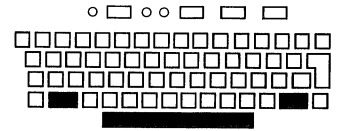

CHARACTER TRANSMISSION

9. Observe the repeat function

Hold down a writing character key. (Try the X.) Note that it causes transmission of the character, a pause of about 1/2 second, and then repeats transmission at approximately 10 characters per second.

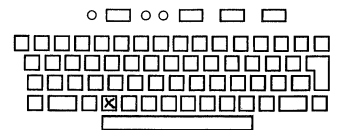

10. Transmit code for unshifted writing characters

Check that the TTY LOCK key is released. Then sequentially press each writing character key, and check transmission of unshifted characters, by comparing the resulting written characters with the characters etched on the lower half of the top surface of the key caps.

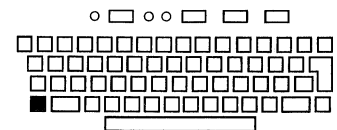

11. Transmit code for shifted writing characters

Hold down the SHIFT key, and sequentially press each writing key. Check transmission of shifted characters by comparing the resulting written characters with the characters etched on the upper half of the top surface of the key caps.

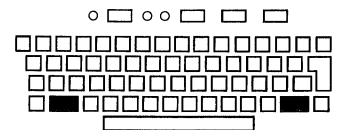

12. Transmit code for control characters

12a Single key

Enter TAB, BACK SPACE, LF and RETURN; check their transmission by observing spacing, backspacing, line feed, and return of the cursor to the left margin, respectively. LF may cause return of the cursor to the left margin, as well as causing line feed, if LF CR has been selected by strap option on TC-1.

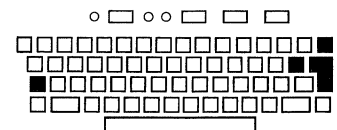

CHARACTER TRANSMISSION

(cont)

12b Dual key

Press letter keys while holding the CTRL key down, to enter the following control characters; note the effect on the receiving circuits:

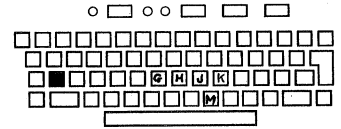

Keys	Control Character	Effect
CTRL G	BEL	Rings bell
CTRL H	BS	Cursor backspaces
CTRL I	HT	Cursor spaces to right
CTRL J	LF	Cursor moves down one line
CTRL K	VT	Cursor moves up one line
CTRL M	CR	Cursor moves to effective margin

The remaining letter keys transmit control characters (as listed in the preceding section), when pressed while the CTRL key is held down. However, they produce no noticeable effect on the basic Terminal.

12c Triple key

Hold down the CTRL and SHIFT keys and press the M. The CTRL SHIFT M will set the receiving circuits to Graph Mode, as indicated by absence of the Alpha Cursor. Hold down the CTRL and SHIFT keys and press the letter O key. CTRL SHIFT O will reset the receiving circuits to Alpha Mode, as indicated by the return of the Alpha cursor.

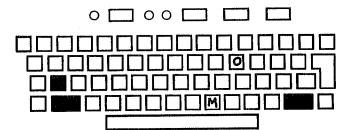

When pressed while the CTRL and SHIFT keys are held down, the letter keys K, L, M, N, O, and P transmit control characters as listed in the preceding section.

12d Command Sequences

The ESC key transmits the control character ESC, which has no observable effect unless used as part of a command sequence. Enter ESC; then hold down the CTRL key and enter an L (to send control character FF). The display will perform a PAGE function, erasing, selecting home position and Alpha Mode.

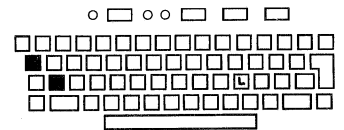

13. Transmit TTY code

Press the H key and note that a lower case h is written. Then, depress the TTY LOCK key, and note that an upper case H is written in response to pressing the H key. TTY LOCK causes all letter keys to transmit the code for upper case ASCII letters,

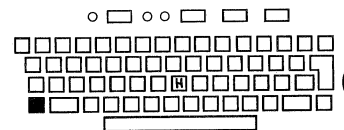

CHARACTER TRANSMISSION (cont)

Cont.

regardless of the position of the SHIFT key. The TTY LOCK key also causes @ [\ and ^ to be transmitted in place of ` { | and ~ respectively. Release the TTY LOCK key.

ALPHA MODE

14. Select Alpha Mode

This mode is automatically selected upon initialization. It is also selected by PAGE or SHIFT RESET from the keyboard, or upon receipt of control characters CR or ESC FF. US resets the Terminal from Graph to Alpha Mode.

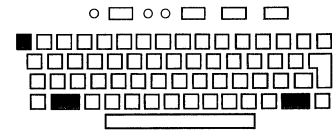

15. Observe automatic line feed and carriage return

Hold down a writing character key and note that the cursor line feeds and returns to the left margin (Margin \emptyset). The line feed and carriage return automatically occur after the last character (74th) in a line is written.

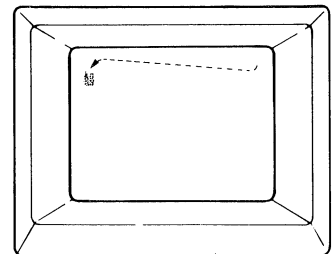

16. Observe selection of Margin 1

Enter PAGE. Then hold down the LF key until the cursor moves down past the last (35th) line. Observe that it reappears at the top-center of the screen, in Margin 1 position. When Margin 1 exists, an accompanying signal (MARG) can cause a $\overline{\text{TBUSY}}$ signal to occur, if selected by strap option on the TC-2 circuit card in the Terminal.

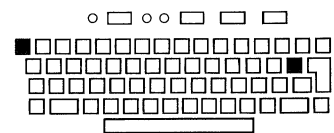

The Margin 1 selection is normally made only by line-feeding past the last (35th) line while Margin \emptyset exists.

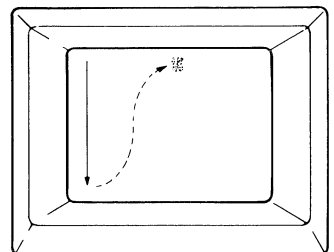

ALPHA MODE (cont)

17. Observe carriage return with Margin 1 selected

Enter several SP (Space bar) commands. Then enter CR (RETURN key); note that the cursor returns to the Margin 1 position. It may also move down to the next line if the CR EFFECT option strap is at CR → LF. Hold down a writing character key until a line is completed. Note that the cursor returns to Margin 1 position on the next line.

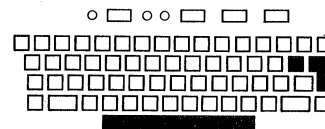

Again, enter LF commands until the cursor line feeds past the 35th line. Note that the cursor returns to Margin 0 position.

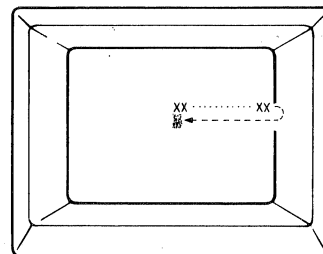

Line-Feeding past the 35th line causes a change in margin selection, whether line-feeding is the result of an LF control character, or is the automatic line feed which occurs after the last character is written, in the last line of the display. The cursor maintains the same position with respect to the new margin as it held with respect to the previous margin, unless Carriage Return accompanies the change in margin selection. For example, assume that the Line Feed option on TC-1 is set so that LF does not cause CR, Margin 0 exists, and the cursor is on the 35th line, in the 10th character position. If a line feed causes Margin 1 to occur, the cursor will move to line 1, in the tenth character position to the right of Margin 1. An exception to this occurs if Margin 0 exists and the cursor is on the right half of the screen; line feeding past the 35th line will change the margin selection, but will not affect the horizontal position of the cursor unless a carriage return is also executed.

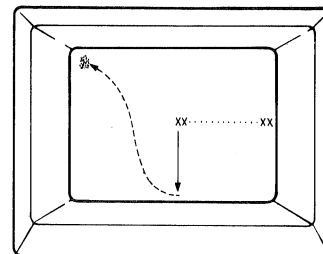

Margin 0 can also be selected by the following: program command ESC FF; executing a Graph Mode vector (written or unwritten); sending the GIN Mode crosshair cursor position to the computer; entering PAGE or SHIFT RESET at the keyboard.

OPERATION GRAPH MODE

18. Select Graph Mode

Program command GS (CTRL SHIFT M from the keyboard) places the Terminal receiving circuits in Graph Mode and permits vector drawing. Written or unwritten vectors of any length (including zero length) can then be executed.

Enter CTRL SHIFT M to achieve Graph Mode. Note that the Alpha cursor disappears.

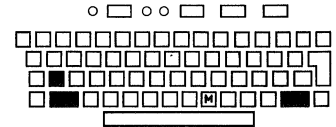

19. Execute an unwritten (dark) vector, establishing a starting point.

An address made up of four characters directs the display writing beam to any point within the 0 - 1023X, 0 - 1023Y grid used by the Terminal. (However, 780Y - 1023Y are outside of the display quality area.)

Set the beam to approximate center of the screen with an address of 390Y, 512X. This can be done by entering the following characters at the keyboard:

, f 0 @

Details regarding addressing the Terminal in Graph Mode are contained in the Graph Mode Summary at the end of this section.

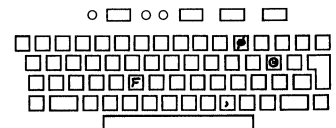

20. Write a point (zero-length vector to disclose the beam position).

Enter @ at the keyboard. Since it is an execution character and is not preceded immediately by a GS command, it will cause writing to occur. Since it is the same as the last character of the preceding address, no beam movement occurs during writing.

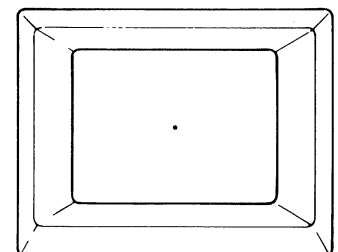
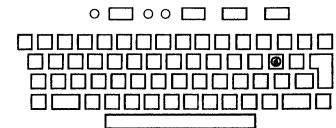

GRAPH MODE (cont)

21. Draw a vector

Any address different from the preceding one causes beam movement, if an execution character is included. The beam will be turned on during movement to cause vector-drawing, unless the command is immediately preceded by a GS. Enter Space 'Space @ and a vector will be drawn to the lower left corner. (Address 0 , 0.)

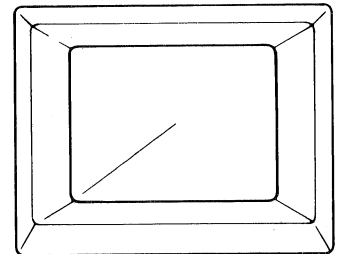
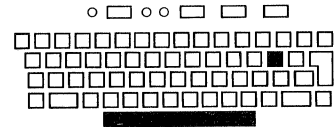

22. Execute an unwritten (dark) vector

Enter a GS (CTRL SHIFT M at the keyboard) to command a dark vector. Then enter , f ? _ to move the beam to right-center of the screen.

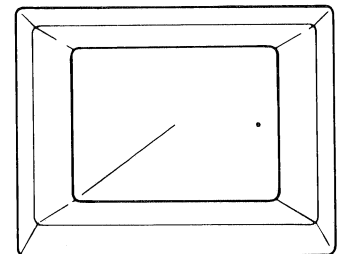
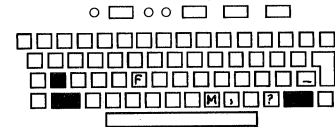

23. Write a point to disclose the beam position

Repeat the _ entry and a written point will show that the beam has moved unseen to the right-center of the screen.

24. Check shortened address transmission and the Graph mode memory circuit

Enter ESC FF (ESC CTRL L) at the keyboard to place the cursor at home in Alpha Mode. Enter GS (CTRL SHIFT M) to return to Graph Mode.

Enter an _ to execute a dark vector. Since the _ is the same final character as in the previous Graph address, the beam will move to its previous address at right-center of the screen. Movement will be dark, since it immediately follows a GS command.

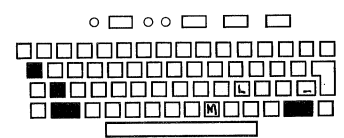

OPERATION GRAPH MODE (cont)

Cont.

Enter another `_` to write a point and confirm this. The Graph Mode memory circuits retain the first 3 bytes of the last-executed address. Shortened address transmission is then possible, as explained in the Graph Mode summary at the end of this section.

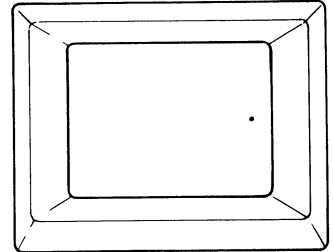

25. Terminate the Graph Mode

Graph Mode can be ended manually by entering PAGE or SHIFT RESET at the keyboard, which returns the Terminal to Alpha Mode. Graph Mode can also be ended by program command US, CR, ESC FF or ESC SUB. US (CTRL SHIFT O) resets the Terminal to Alpha Mode, with the bottom-left corner of the cursor at the position previously occupied by the Graph Mode beam position. CR (CTRL M) sets the Terminal to Alpha Mode and moves the Alpha cursor to the left margin. ESC FF (ESC CTRL L) causes the screen to erase, and homes the Alpha cursor; ESC SUB (ESC CTRL Z) selects GIN Mode and displays the crosshair cursor.

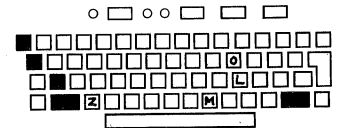

Check the effect of each by alternately selecting Graph Mode (CTRL SHIFT M) and entering one of the reset commands.

26. Computer requests Terminal status and Alpha cursor position

This is automatically sent to the computer in response to ESC ENQ from the computer while in Alpha Mode. (ESC ENQ should not be entered at the keyboard.) The terminal returns to Alpha Mode upon completion of transmission. (However, the receiving circuits must be reset upon completion of transmission before writing can occur.) This operation cannot be demonstrated in Local. See the GIN Mode Summary at the end of this section for transmission details.

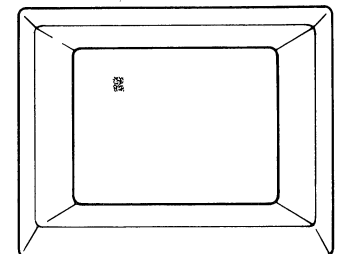

GIN MODE

OPERATION

GIN MODE
(cont)

27. Computer requests Terminal status and Graph Mode beam position

This also is sent automatically in response to ESC ENQ from the computer, received while the Terminal is in Graph Mode. The Terminal returns to Graph Mode upon completion of transmission. This operation cannot be demonstrated in Local. See the GIN Mode Summary at the end of this section for transmission details.

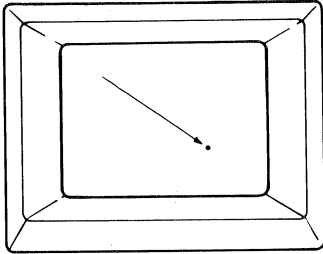

28. Display and position the crosshair cursor

The crosshair cursor is displayed upon receipt of control character sequence ESC SUB (ESC CTRL Z). Enter ESC CTRL Z and note that the crosshair cursor appears. Move the thumbwheels at the right of the keyboard and note the effect. If the horizontal thumbwheel is at either limit, only the horizontal line will appear. If the vertical thumbwheel is at the lower limit, only the vertical line will appear.

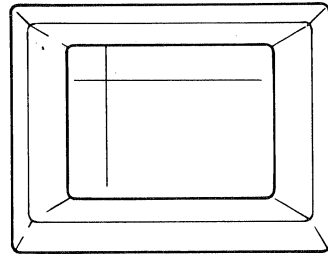
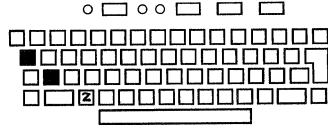

29. Transmitting the address of the crosshair cursor in response to computer request

If the Terminal is On Line and ESC ENQ is received from the computer while the crosshair cursor is being displayed, the address of the intersect point will automatically be sent to the computer. This will be followed by CR or CR and EOT, if selected by strap option in the Terminal. This feature cannot be demonstrated in Local. See the GIN Mode Summary at the end of this section for details.

30. Transmitting the address of the crosshair cursor in response to keyboard entry by the operator

If On Line operation is selected and any keyboard character is entered while the crosshair cursor is being displayed, the entered character will be sent to the computer, and will automatically be followed by the address of the intersect point. This will also be followed by CR or CR and EOT if selected by strap option in the Terminal. See the GIN Mode Summary at the end of this section for details. This feature cannot be demonstrated in Local. The Terminal returns to Alpha Mode upon completion of transmission, but must be reset before character writing can again occur.

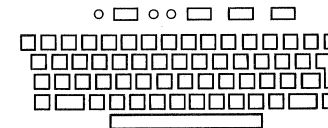
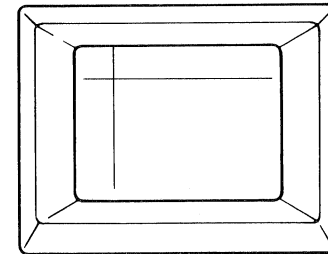

OPERATION

GIN MODE

(cont)

31. Terminate GIN Mode

GIN Mode is automatically terminated whenever the Terminal finishes sending the GIN Mode data. However, the Terminal's character generator must be reset before writing can again occur. If CR is part of the GIN Mode transmission, echoing it will provide the necessary resetting, but will also put the Terminal in Alpha Mode and place the cursor at the left margin. Any of the following program commands reset the character generator: BEL, BS, CR, ESC ETB, ESC FF, HT, LF, US, VT, or executing a written or unwritten vector. However, note that all except BEL, ESC ETB, and US affect the display or position of the cursor. The character generator can also be reset by PAGE or SHIFT RESET from the keyboard, by pressing the MAKE COPY button, or by placing the LOCAL/LINE switch at LOCAL.

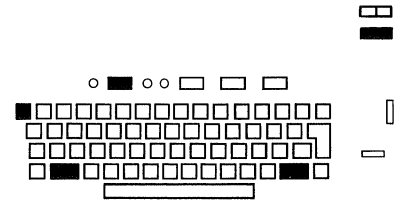

GIN Mode can also be terminated while the crosshair cursor is being displayed, without transmitting to the computer. Program command CR or ESC FF will do it, switching the Terminal to Alpha Mode. However, CR may leave the Terminal in either Margin 0 or Margin 1 status, and ESC FF will erase the display. It may be better to terminate by sending ESC ENQ and ignore the transmission at the computer. The crosshair cursor can also be terminated, and Alpha Mode selected, by entering PAGE or SHIFT RESET at the keyboard.

Press PAGE or SHIFT RESET and note that the crosshair cursor disappears and the Alpha cursor returns to home position.

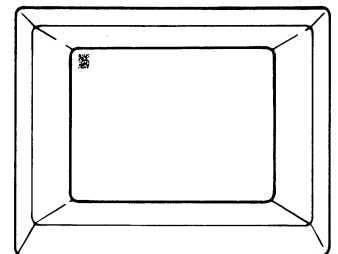

OPERATION

HARD COPIES

32. Check copy making

Connect a Hard Copy Unit to the connector on the back of the Terminal Display Unit. Turn the Hard Copy Unit on. Enter an assortment of characters at the keyboard to provide a display. Press MAKE COPY at the Display Unit. A light bar should scan the display, but should not store. If it does store, adjust the Hard Copy Intensity on the side of the Display Unit and repeat the procedure. When scanning without storing is obtained, a satisfactory hard copy of the display should be provided by the Hard Copy Unit. If excessive "noise" appears on the copy, the Display Unit Hard Copy Intensity adjustment may be set too high. If information loss occurs on the hard copy, the Display Unit Hard Copy Intensity adjustment may be set too low. When the intensity is properly adjusted, the Hard Copy Unit should be able to provide at least five successive hard copies without excessive degradation of the display.

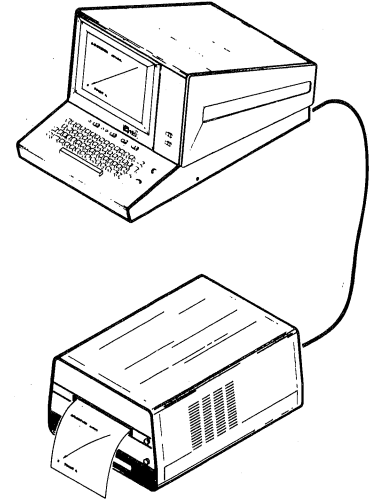

This concludes the operation procedure.

OPERATION SUMMARY

The operating information contained in the foregoing procedure is summarized on the following pages. In addition, specifics are included to support operation and programming of the Terminal. This summary is separated into four sections, as listed here.

The **GENERAL SUMMARY** contains operating information which is not limited to any one specific mode.

The **ALPHA MODE SUMMARY** includes details concerning selection, operation, and programming of the Terminal's Alpha Mode. Specifics about character size, spacing, and writing rate also appear here.

The **GRAPH MODE SUMMARY**, in addition to condensing the Graph Mode operating information, contains the addressing instructions and other details which are needed for drawing vectors and points.

The **GIN MODE SUMMARY** explains in detail how the computer must solicit information from the Terminal. In addition, it defines the status bit and address bytes which the Terminal sends the computer in response to the query.

GENERAL SUMMARY

Interacting With A Computer. The Terminal can interact with a computer when the Terminal is on, the keyboard switch is at LINE, and an appropriate data communication link is in effect.

Initial Status. At turn-on, the Terminal is in Alpha Mode with the cursor at home position. A stored condition may exist on the screen, which can be cleared by pressing the PAGE key.

Keyboard Transmission. This is the result of (1) pressing only a character key; (2) pressing a character key while the SHIFT key is held down; or (3) entering a control character by pressing a letter key while CTRL or CTRL and SHIFT keys are held down.

PAGE, SHIFT, RESET, and BREAK. PAGE erases the display, selects Alpha Mode and homes the cursor. If used alone, SHIFT resets View status without otherwise affecting the display. SHIFT RESET initializes the Terminal, selecting initial conditions for the Terminal circuits; it does not affect the stored display. BREAK generates a break signal, which can be used by the interface to interrupt the computer.

TTY LOCK. When activated, this key permits the keyboard to transmit only TTY code.

Control Character Execution. With minor exceptions, the Terminal can execute control characters or control character sequences while the Terminal is in any mode except Hard Copy. One exception is that GS cannot be executed properly while the crosshair cursor is being displayed in GIN Mode. Another exception is that control characters cannot be executed during GIN Mode transmissions.

Execution of Characters Other Than Control Characters.

Received data other than control characters causes character writing in Alpha Mode and vector drawing in Graph Mode. Alpha and Graph Modes are summarized on the following pages.

GIN Mode. This is an interactive mode in which the Terminal can automatically supply the computer with data in response to a computer request. It is summarized on the following pages.

Hold Status. This is a reduced intensity status of Alpha Mode. The Terminal remains in View status while in Graph or GIN Modes.

Local Operation. When the keyboard switch is at LOCAL, the Terminal is isolated from the computer and will respond to data from the keyboard. Alpha and Graph Modes can be exercised, but GIN Mode operation is limited to the display and positioning of the crosshair cursor. The Terminal can interact with peripheral devices; hard copies can be made.

Hard Copy Operation. Hard copies can be made while the Terminal is in any Mode. Inputs to the Terminal are disabled while copying is occurring. Copy quality is affected by the Terminal's Hard Copy Intensity control. Neither the Alpha nor crosshair cursor can be copied, since they are removed from the display during copying.

Option Straps. Straps on cards in the pedestal permit LF to control carriage return, allow CR to cause line feed, can cause a full page to generate a break signal, and can determine if CR or CR and EOT will be sent as the final bytes of GIN transmission. A character writing option strap permits selection of an alternate character set, if installed.

ALPHA MODE SUMMARY

Mode Selection. Alpha Mode is selected by initialization, program command CR, program command sequence ESC FF, program command US (except when in GIN Mode), keyboard command PAGE, or keyboard command SHIFT RESET.

TTY LOCK. If the TTY LOCK is active, the keyboard can transmit only TTY code.

Display Formatting. Display formatting is controlled by the following:

Program Commands

ESC FF selects home and erases.

CR returns the cursor to the left margin; it may also cause line feed if selected by strap option on TC-1.

LF causes line feed; it may also cause carriage return if selected by strap option on TC-1

HT causes the cursor to move right one space.

BS causes the cursor to move left one space.

Backspacing past the left margin causes the cursor to move to the right side of the screen.

VT causes the cursor to move up one line.

Automatic Commands

Home is selected upon initialization.

Line feed and carriage return occur after entering a writing character or a space in the 74th character position on any line.

A line feed (automatic or program command) past the 35th line causes a change between Margin 0 and Margin 1.

Character Size. A character is approximately .087 inch wide by 0.106 inch high, or approximately 11 by 14 graphic points.

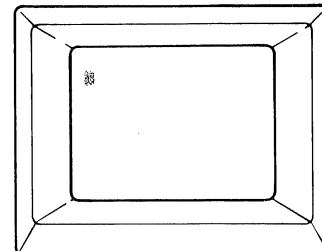

Character Capability. The entire ASCII code can be transmitted and recognized while the TTY LOCK key is released. Activating the TTY LOCK permits transmission of only TTY characters, without affecting receiving.

Character Spaces. A character space is 14 points or approximately 0.11 inch; there are 74 character spaces per line.

Lines. Line spacing is 22 points or approximately 0.17 inch. There are 35 lines per display.

Character Writing. It takes approximately 1 ms to write a character, permitting a 10,000 word per minute writing rate (average of 6 characters per word). The effective writing rate is interface-dependent.

Viewing Time. The display reverts to Hold status after one to two minutes of inactivity, and returns to View status when the SHIFT key is pressed, or when any Terminal activity occurs. A stored display can be retained in View status for 15 minutes, or in Hold status for one hour, without damage to the display screen. Residual images remaining after erasing may sometimes be removed by performing several erase cycles.

GRAPH MODE SUMMARY

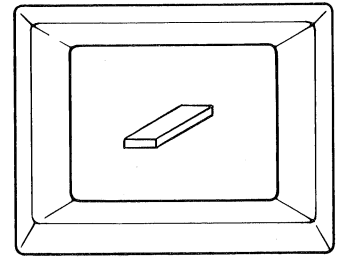

Mode Selection. Graph Mode is selected by program command GS.

Address. An address is any point within the 1024Y by 1024X capability of the Terminal's beam-positioning registers. In the standard Terminal, Y addresses higher than 779 Y fall outside the screen's specified display area.

Complete Address. A complete graphic address consists of four data bytes — Hi Y, Lo Y, Hi X and Lo X, received in that order.

Shortened Address. Addresses may sometimes be reduced to one, two or three bytes, but must always contain a Lo X byte. See the Graph Mode Memory explanation.

Vector Execution. This is accomplished only upon receipt of the Lo X byte.

Dark Vector. A dark vector is an unwritten vector, which always occurs upon execution of the first vector to be received after a GS command.

Written Vector. The second and any subsequent address received after a GS command result in a written vector.

Point Writing. A point can be written by executing a GS and then executing the same address twice. The second address command requires only the Lo X byte.

Point Spacing. There is approximately .0077 inch of horizontal or vertical distance between adjacent point centers.

Graph Mode Termination. Graph Mode can be ended by any one of the following commands:

Program Commands

ESC FF selects Alpha Mode, homes the Alpha cursor, and erases.

CR selects Alpha Mode and sets the Alpha cursor to Margin \emptyset if a vector has been executed while in Graph Mode.

US selects Alpha Mode, leaving the Alpha cursor at the last Graph Mode address.

ESC SUB selects GIN Mode and displays the crosshair cursor.

Keyboard Commands

PAGE selects Alpha Mode, homes the Alpha cursor, and erases the display.

SHIFT RESET selects Alpha Mode, homes the Alpha cursor, and initializes the Terminal circuitry.

Vector Execution Time. The standard Terminal requires approximately 2.6 ms to write a vector.

Viewing Time. The Terminal remains in View status indefinitely while in Graph Mode, since the Hold circuitry is overridden. The Terminal should be returned to Alpha Mode when vectors are not being drawn.

GRAPH MODE SUMMARY

(cont)

Stored Display. A stored display can be retained in View status for 15 minutes without damage to the display screen. The Terminal should be returned to Alpha Mode when vectors are not being drawn, to permit Hold status to occur. (A stored display can be retained in Hold Status for one hour without damage to the display screen.)

Viewable Address. Any point within the 780Y by 1024X grid in the six-inch by eight-inch quality display area can be seen.

Addressing the Display Beam. The beam is addressed to a point by sending to the Terminal the binary equivalent of the Y address and the X address of the point. For example, 205Y 148X translates to 0011001101₂Y and 0010010100₂X.

Each binary equivalent must be separated into two bytes—the 5 most significant bits (MSB) and the 5 least significant bits (LSB). Continuing the example from the preceding paragraph, 0011001101 becomes 00110 Hi Y, 01101 Lo Y, and 0010010100 becomes 00100 Hi X, 10100 Lo X.

Bits 7 and 6 must be affixed to the bytes to identify them. Identification is as follows: Hi Y is 01, Lo Y is 11, Hi X is 01, Lo X is 10. The completed bytes being used as examples become: 0100110 Hi Y, 1101101 Lo Y, 0100100 Hi X, 1010100 Lo X.

If these bytes are sent to the Terminal (in the sequence given) while it is in Graph Mode, the beam will move to 205Y, 148X position. These can be sent to the Terminal receiving circuits via the Terminal keyboard if LOCAL is

selected, or if echoing is in effect. However, the keyboard equivalent must first be determined. This can be obtained from the Coordinate Conversion Chart (in the Appendix), which translates directly from the decimal address to the ASCII equivalents. The address in the example (205Y, 148X) can be represented by the keyboard characters & m \$ T.

Graph Mode Memory. This feature permits shortened addresses to be used. If a byte in an address does not differ from that byte in the preceding address, it may be omitted under certain circumstances. The following table shows which bytes must be sent in response to specific byte changes. For example, if Lo Y changes, Lo Y and Lo X must be sent. As a second example, if the Hi Y and Lo Y bytes change, the Hi Y, Lo Y and Lo X bytes must be sent.

Bytes Which Change	Bytes which must be sent			
	Hi Y	Lo Y	Hi X	Lo X
Hi Y	#			#
Lo Y		#		#
Hi X		#	#	#
Lo X				#

The Graph Mode memory remains in effect even though the Terminal is switched out of Graph Mode, and can be used again after Graph Mode is re-established.

Vector Deviation From a Straight Line. This does not exceed 2%, of which not more than 1.5% is attributable to the vector generator's dynamic geometry error. (Vector generator dynamic geometry error is a measure of the inability of a vector to follow the same path between two points, when drawing in opposite directions. For example, drawing from A to B may follow a slightly different path than drawing from B to A.)

APPENDIX A

INSTALLATION

General

Installation consists of pedestal-mounting or desk-mounting the Terminal display unit, selecting proper operating voltage and fuse size, setting the desired strap options, and connecting the Terminal to the computer. These steps are discussed in the following paragraphs.

Pedestal-Mounting the Display Unit

Mounting of the display unit on the pedestal is best accomplished by two people. It includes the following steps:

1. If the Terminal has previously been used in a desk top configuration, the base (leg assembly) may have been removed from the pedestal and the feet installed directly into the bottom of the pedestal. In that event, put the feet back on the base, and fasten the base to the bottom of the pedestal.

2. Lift the display unit over the pedestal as shown in Fig. A-1.

3. Feed the cable down into the storage bin as far as possible, while lowering the display unit into place. Then double the cable back and forth in the storage bin as lowering of the display unit continues.

4. There is a retaining strip on the bottom of the display unit. Slide it over the back edge of the pedestal top. Install four machine screws up through the pedestal top to fasten the display unit in place.

5. Adjust the four feet to a convenient position, and secure the lock nuts to hold them in position.

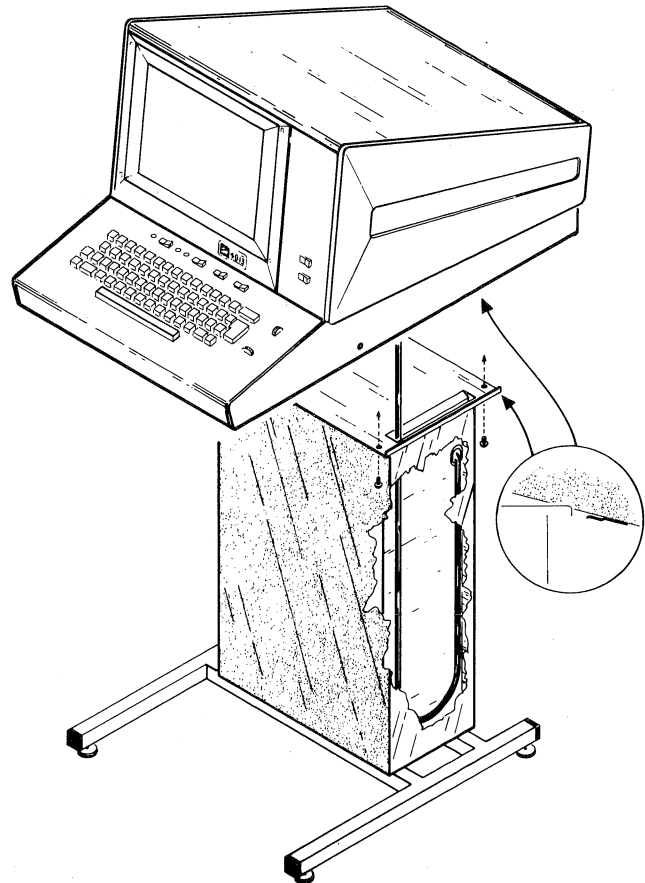

Fig. A-1. Display Mounting.

Desk-Mounting the Display Unit

The display unit and pedestal are connected only by a cable during shipment. Desk-mounting consists of simply setting the display unit on a desk or other surface. The pedestal can be placed as far as four feet away from the display unit. The air vents on the bottom and back should be kept free of obstructions. Note that if the base (leg assembly) is removed from the pedestal, the feet should be unscrewed from the base and inserted into the bottom of the pedestal to permit air flow into the bottom vents. However, make certain that the base is re-installed before the display unit is again placed on the pedestal.

APPENDIX A

INSTALLATION

(cont)

If the display unit has been mounted on the pedestal, desk-mounting consists of reversing the pedestal-mounting procedure and observing the instructions which have just been outlined.

A dimensional drawing is provided in Fig. A-2 as an installation aid.

Selecting Operating Voltage and Fuse Size

The Terminal is intended to be operated from a single-phase power source which has one of its current-carrying conductors (the neutral conductor) at ground (earth) potential. Operation from other power sources where both current-carrying conductors are live with respect to ground (such as phase-to-phase on a multi-phase system, or across the legs of a 117-234 V single-phase three-wire system) is not recommended, as only the line conductor has over-current (fuse) protection within the instrument.

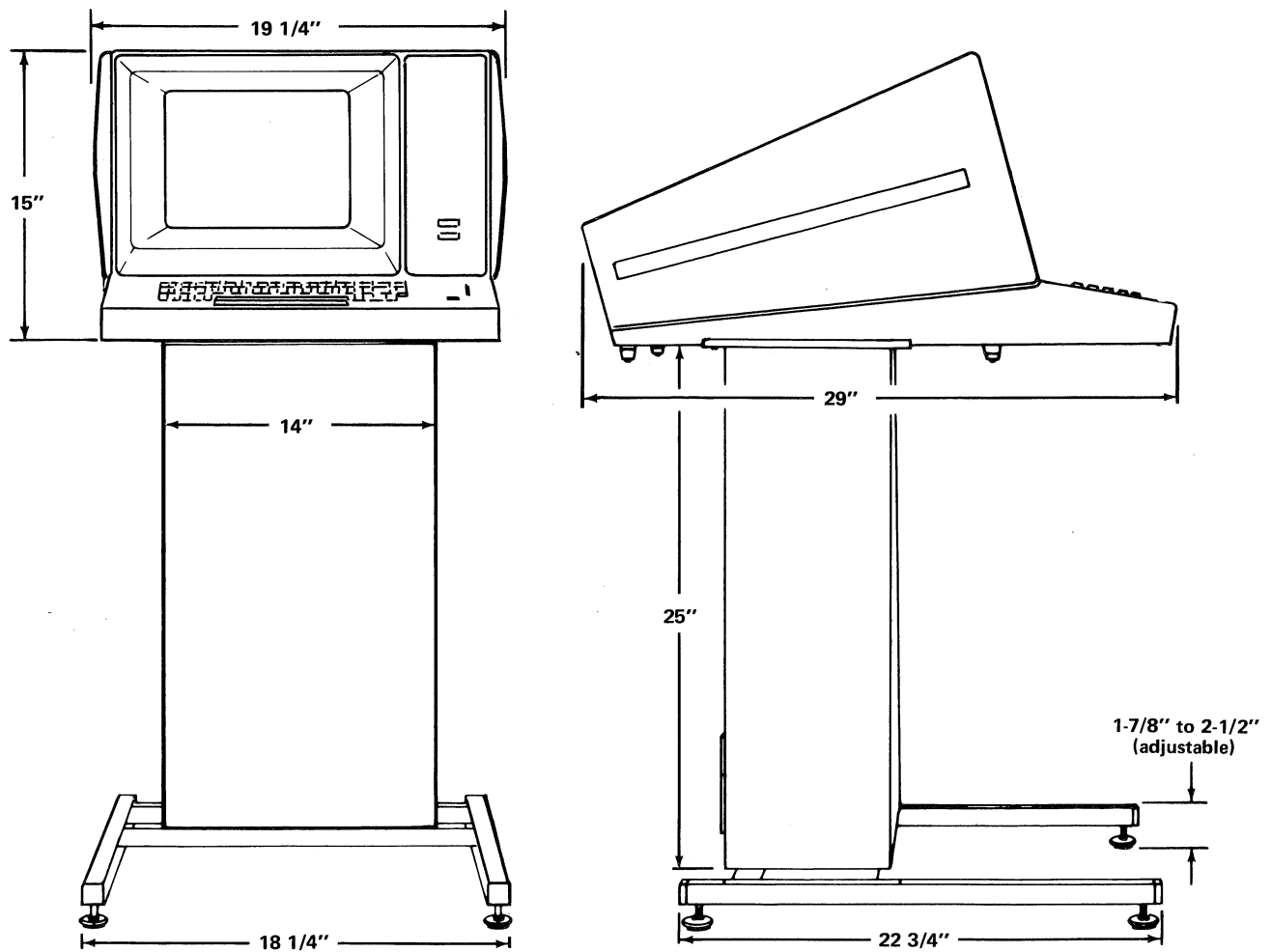

Fig. A-2. Overall Dimensions.

INSTALLATION (cont)

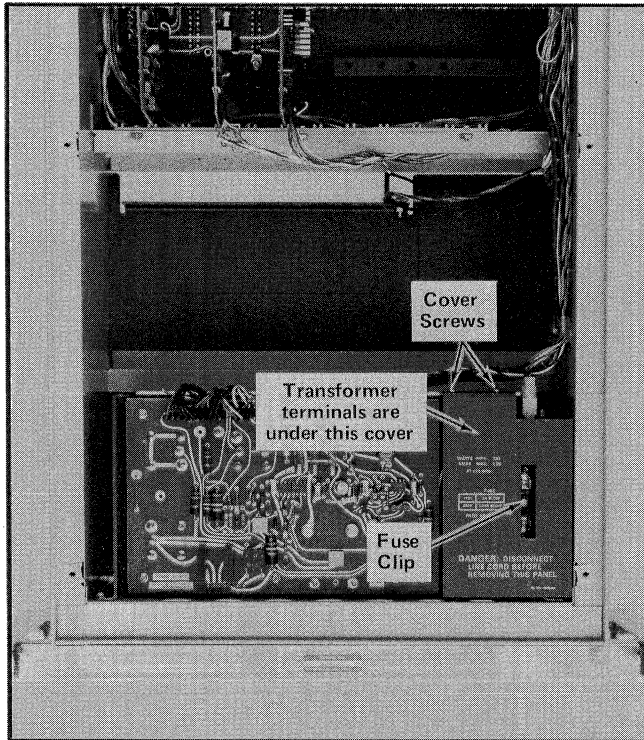

Fig. A-3. Transformer terminals and fuse clip locations. (The fuse is contained on the pedestal front cover.)

The Terminal is provided with a three-wire power cord with a three-terminal polarized plug for connection to the power source. The grounding terminal of the plug is directly connected to the instrument frame as recommended by national and international safety codes. Color coding of cord conductors follows the National Electrical Code (ANSI C1-1968) which specifies Line, Black; Neutral, White; Safety Earth or Ground, Green with a yellow stripe (or solid green).

The Terminal can be operated from either a 110 or 220-volt nominal line voltage source which has a frequency of between 48 and 440 Hz. A clip-in fuse and a jumper arrangement on the transformer permits the Terminal to be modified to suit the supply. The fuse is mounted on the inside of the bottom section of the pedestal front cover, providing a cover interlock. The transformer and fuse clip are located in the bottom-right of the pedestal, as shown in Fig. A-3. Fuse size is indicated on the transformer shield, and the wiring instructions are contained on the inside of the front cover. Wiring instructions are repeated in Fig. A-4 for convenience. Fuse size is 2 A slo-blo for 110-volt operation and 1.25 A slo-blo for 220-volt operation. When changing fuses, the fuse should be pushed (rather than pulled) through the fuse holder.

WARNING

Dangerous potentials exist at several places in the lower section of the pedestal. Disconnect the Terminal from the power source before changing transformer connections.

Selecting Strappable Option Connections

The strappable options are found on circuit cards in the top section of the pedestal. Access to the cards is obtained by loosening the top screws in the front cover and swinging the top of the cover down. The cover should not be entirely removed except during servicing by an authorized technician, since dangerous voltages are contained in the lower section.

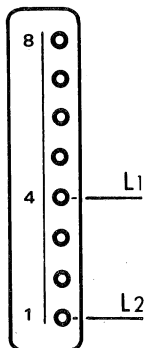

JUMPER ARRANGEMENT

VOLTAGE $\pm 10\%$	100	115	120	200	220	230	240
TERMINAL NO.	1-8 4-5	1-2 3-4	1-7 4-6	5-8	5-7	2-3	6-7
	TWO JUMPERS REQUIRED			ONE JUMPER REQUIRED			

Fig. A-4. Transformer terminals and jumper arrangement.

APPENDIX A INSTALLATION (cont)

The circuit cards are installed in a minibus, and are interchangeable, since identical signal lines are provided at corresponding points of each of the minibus board connectors.

CAUTION

Do not remove or install circuit cards while the Terminal is turned on.

The positions of the straps are dependent upon computer and program requirements, and in some cases upon user preference. Strap locations for the terminal control cards (TC-1 and TC-2) and for the 021-0065-00 Data Communication Interface card are shown in Fig. A-5. Details regarding the strappable options are provided elsewhere, as follows: TC-1 and TC-2 strappable options are explained in the Controls section (section 2) of this manual; 021-0065-00 Data Communication Interface card strappable options are defined in its manual.

Any one of several optional interfaces may be installed in the Terminal in place of the 021-0065-00 Data Communication Interface, and in some cases more than one interface may be installed. Strappable option information for these interfaces is provided in their respective manuals.

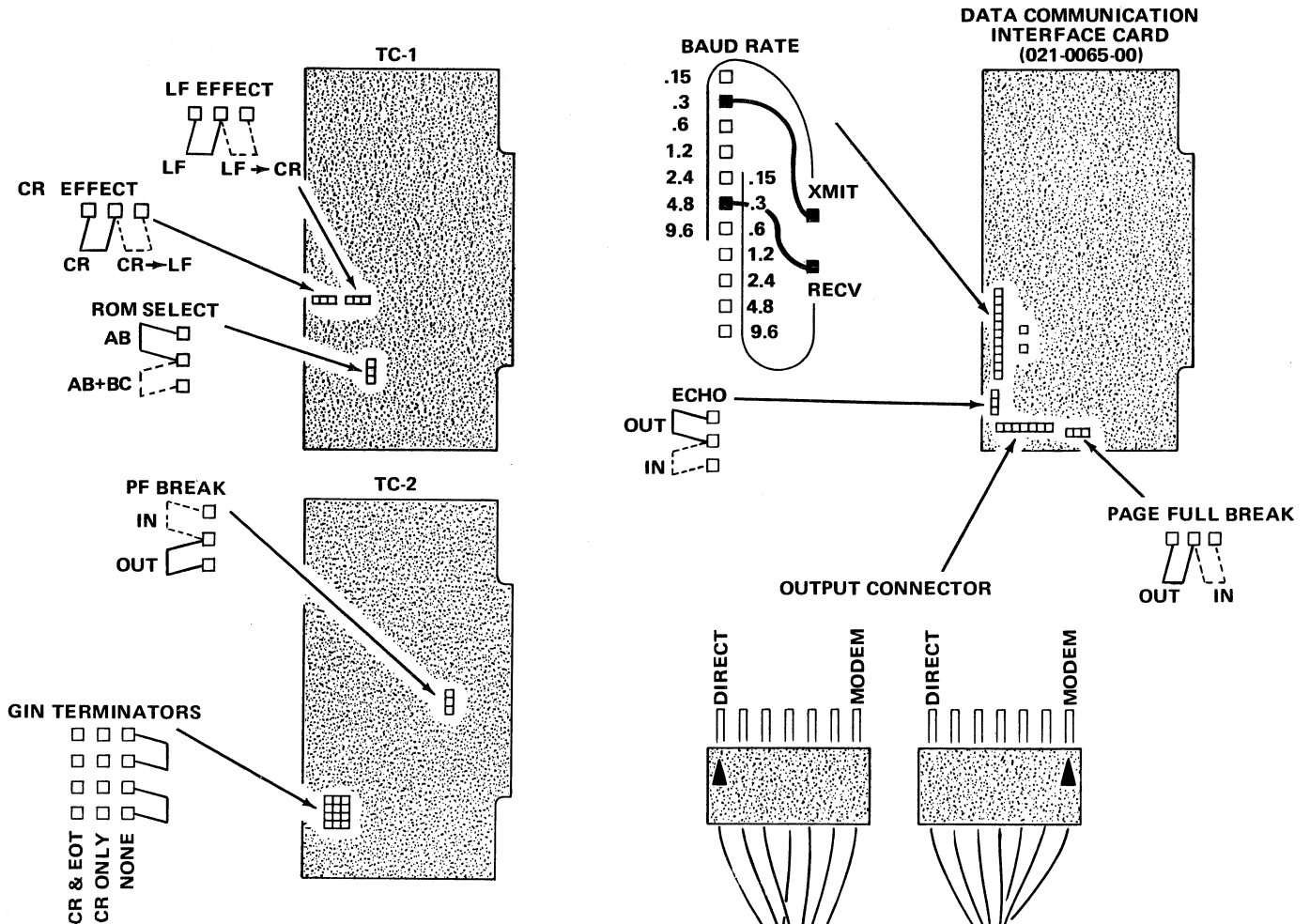

Fig. A-5. Strap option location for TC-1, TC-2, and the Data Communication Interface (021-0065-00) for a standard Terminal. Refer to the appropriate manual for strap information on optional cards.

INSTALLATION (cont)

Soldered Options

In addition to strappable options, there are some options which can be selected by changing soldered wires. These changes should only be made by qualified technicians, to minimize the possibility of damage to the equipment.

Keyboard Bit 8. In standard factory-wired terminals, the keyboard is wired so that a true bit 8 will accompany all characters which are entered at the keyboard. (The final determination of what is sent is made by the interface.) If a false bit 8 transmission is desired instead, the white-brown-blue wire on Pin 5 of plug P80 can be unsoldered and moved to pin 8 of P80. (P80 is the board-edge connector on the keyboard's circuit board.)

Control Characters. In standard factory-wired Terminals, control characters cause effects as listed in the Controls Section of this manual. A network on the TC-1 circuit card in the pedestal permits changes to be made so that any one of the listed results can be obtained in response to any one of the listed control characters. The networks are shown in Fig. A-6.

It is not recommended to have one control character control more than one input line; nor is it recommended to have more than one control character control the same output line. Each of these last two conditions requires special design considerations.

Installing Accessory Cards

Three circuit cards can be contained in the minibus in a standard Terminal. If additional cards are to be used, a Minibus Extender Board must be installed. See the accessory list in Appendix E for the part number.

Spare Switch (SW1, SW2, SW3, SW4) Connections

Connections to SWITCH 1 and SWITCH 2 are provided at pins Z and X, respectively, of the card-edge connector in the Terminal pedestal. Additional details regarding this connector are given in the Interface Design Information appendix.

Wire connections to the Terminal's other two spare switches are available in the pedestal. The wires are coiled under a clamp on the right side in the upper section. The clamp should be loosened prior to extracting the wires. Each wire has a pin-connector attached to it. Wire color is red-yellow-white for SWITCH 3 and orange for SWITCH 4.

Depressing the right side of a switch provides a ground connection for the respective wire; the other position of the switch results in an open circuit.

Spare Indicator Connections

Connections to Indicator 1 and Indicator 2 are provided at pins 25 and N (respectively) of the card-edge connector in the pedestal.

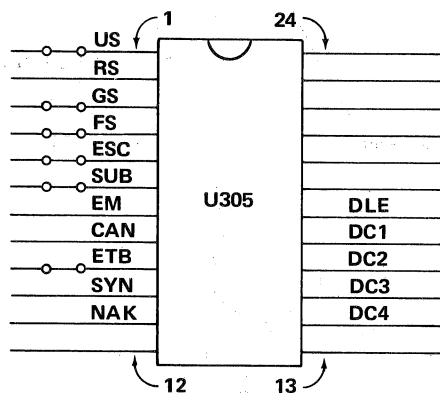

A. Standard factory-wired configuration. Unlabeled lines are inputs, power or ground connections.

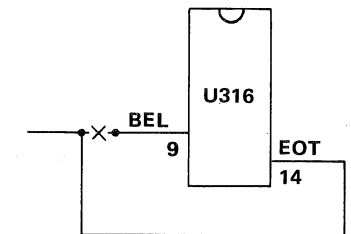
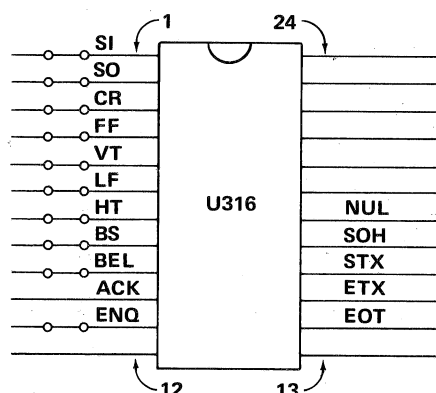

B. An example of rewiring, making EOT control the BEL line rather than having BEL do it.

Fig. A-6. TC-1 Control Character network details.

APPENDIX A

INSTALLATION

(cont)

Spare Potentiometer Connection

Connection to the wiper of the spare potentiometer (bottom surface of display unit) is made through the two-connector plug (P34) at the bottom-left on the minibus in the pedestal. To use it, disconnect it and plug it on the accessory card with which it is to be used. The potentiometer is 50 k Ω , connected between +5 V and +15 V.

Display Multiplexer Bypass Connection

A four-connector plug (P33), at the bottom-left on the minibus board in the pedestal, permits the Terminal's display screen to be controlled by a Display Multiplexer option card, if installed. To use it, remove P33 from J33 and connect P33 to the appropriate connector on the Display Multiplexer card.

Connecting the Terminal to a Computer

The two basic methods of connecting the Terminal to a computer are direct connection and telephone line connection. A direct connection is used when the Terminal and the computer are located close to each other, permitting hook-up without additional equipment. A telephone line connection can be made regardless of the distance which separates the Terminal and the computer.

Direct Connection. When the Terminal has its standard interface (021-0065-00 Data Communication Interface) installed, a direct connection can be made by connecting its plug to the interface card so that the plug index mark is matched with the "DIRECT TO CPU" index mark on the card. This is shown in Fig. A-5. The plug on the other end of the interface cable can then be inserted into the modem jack at the computer. The signal lines available to the computer are shown in Table A-1.

Other direct connections, such as connecting to the computer's teletypewriter port, require a different type of interface, and may require a more extensive connection procedure. Details regarding connection of various interfaces are provided in the manuals which accompany those interfaces.

Telephone Line Connection. A modulator-demodulator (modem) is required to establish telephone line connection. Telephone companies rent these modems (also called data sets or data phones). There are a number of specialized modems available; the type required depends upon the specific needs of the installation.

When a standard interface (021-0065-00 Data Communication Interface) is installed in the Terminal, the plug on the interface card must be connected so that the plug index mark aligns with the "TO MODEM" index mark on the card. Then the other end of the interface cable must be plugged into the modem set. Signal names remain as listed in Table A-1.

TABLE A-1

021-0065-00 Data Communication
Interface Output Connector Signals

Pin No.	RS-232C Circuit	CCITT Equiv.	Description
1	AA	101	Protective Ground
2	BA	103	Transmitted Data
3	BB	104	Received Data
4	CA	105	Request to Send (on while Terminal is on)
5	CB	106	Clear to Send
7	AB	102	Signal Ground (Common Return)
8	CF	109	Received Line Signal Detector
20	CD	108.2	Data Terminal Ready (on while Terminal is on)

Once connected to the modem, computer connection is achieved as follows: 1) Energize the equipment; 2) Dial the number of the computer installation; 3) When the computer responds with an audible tone, place the telephone headset on the cradle provided on the modem; or

INSTALLATION

(cont)

push the button marked DATA, and hang up the headset; or perform such other function as required by the specific modem in use; 4) Perform the sign-on procedure, which varies with the computer installation.

Other interfaces require different considerations which are discussed in detail in the applicable interface manuals. Refer to the Appendix entitled "Interface Design Information" if additional details are required.

CODE CHART

ASCII/TTY CODE CHART
(shaded areas are not included in TTY Code)

BITS				CONTROL				HIGH X & Y GRAPHIC INPUT				LOW X GRAPHIC INPUT				LOW Y GRAPHIC INPUT						
B ₇	B ₆	B ₅	B ₄	B ₃	B ₂	B ₁																
∅	∅	∅	∅	∅	∅	∅	NUL	∅	DLE	16	SP	32	∅	48	@	64	P	8∅	\	96	p	112
∅	∅	∅	1	∅	∅	∅	SOH	1	DC1	17	!	33	1	49	A	65	Q	81	a	97	q	113
∅	∅	1	∅	∅	∅	∅	STX	2	DC2	18	"	34	2	5∅	B	66	R	82	b	98	r	114
∅	∅	1	1	∅	∅	∅	ETX	3	DC3	19	#	35	3	51	C	67	S	83	c	99	s	115
∅	1	∅	∅	∅	∅	∅	EOT	4	DC4	2∅	\$	36	4	52	D	68	T	84	d	1∅∅	t	116
∅	1	∅	1	∅	∅	∅	ENQ	5	NAK	21	%	37	5	53	E	69	U	85	e	1∅1	u	117
∅	1	1	∅	∅	∅	∅	ACK	6	SYN	22	&	38	6	54	F	7∅	V	86	f	1∅2	v	118
∅	1	1	1	∅	∅	∅	BEL	7	ETB	23	,	39	7	55	G	71	W	87	g	1∅3	w	119
1	∅	∅	∅	∅	∅	∅	BS	8	CAN	24	(4∅	8	56	H	72	X	88	h	1∅4	x	12∅
1	∅	∅	1	∅	∅	∅	HT	9	EM	25)	41	9	57	I	73	Y	89	i	1∅5	y	121
1	∅	1	∅	∅	∅	∅	LF	1∅	SUB	26	*	42	:	58	J	74	Z	9∅	j	1∅6	z	122
1	∅	1	1	∅	∅	∅	VT	11	ESC	27	+	43	;	59	K	75	[91	k	1∅7	{	123
1	1	∅	∅	∅	∅	∅	FF	12	FS	28	,	44	<	6∅	L	76	\	92	l	1∅8		124
1	1	∅	1	∅	∅	∅	CR	13	GS	29	-	45	=	61	M	77]	93	m	1∅9	}	125
1	1	1	∅	∅	∅	∅	SO	14	RS	3∅	•	46	>	62	N	78	^	94	n	11∅	~	126
1	1	1	1	∅	∅	∅	SI	15	US	31	/	47	?	63	O	79	_	95	o	111		127 RUBOUT (DEL)

COORDINATE CONVERSION CHART

Low Order X		X or Y Coordinate								Low Order Y	
ASCII	DEC.									DEC.	ASCII
@	64	0	32	64	96	128	160	192	224	96	`
A	65	1	33	65	97	129	161	193	225	97	a
B	66	2	34	66	98	130	162	194	226	98	b
C	67	3	35	67	99	131	163	195	227	99	c
D	68	4	36	68	100	132	164	196	228	100	d
E	69	5	37	69	101	133	165	197	229	101	e
F	70	6	38	70	102	134	166	198	230	102	f
G	71	7	39	71	103	135	167	199	231	103	g
H	72	8	40	72	104	136	168	200	232	104	h
I	73	9	41	73	105	137	169	201	233	105	i
J	74	10	42	74	106	138	170	202	234	106	j
K	75	11	43	75	107	139	171	203	235	107	k
L	76	12	44	76	108	140	172	204	236	108	l
M	77	13	45	77	109	141	173	205	237	109	m
N	78	14	46	78	110	142	174	206	238	110	n
O	79	15	47	79	111	143	175	207	239	111	o
P	80	16	48	80	112	144	176	208	240	112	p
Q	81	17	49	81	113	145	177	209	241	113	q
R	82	18	50	82	114	146	178	210	242	114	r
S	83	19	51	83	115	147	179	211	243	115	s
T	84	20	52	84	116	148	180	212	244	116	t
U	85	21	53	85	117	149	181	213	245	117	u
V	86	22	54	86	118	150	182	214	246	118	v
W	87	23	55	87	119	151	183	215	247	119	w
X	88	24	56	88	120	152	184	216	248	120	x
Y	89	25	57	89	121	153	185	217	249	121	y
Z	90	26	58	90	122	154	186	218	250	122	z
[91	27	59	91	123	155	187	219	251	123	{
\	92	28	60	92	124	156	188	220	252	124	
]	93	29	61	93	125	157	189	221	253	125	}
^	94	30	62	94	126	158	190	222	254	126	~
_	95	31	63	95	127	159	191	223	255	127	RUBOUT (DEL)
DEC. →		32	33	34	35	36	37	38	39		
ASCII →		SP	!	"	#	\$	%	&	'		
High Order X & Y											

Coordinate conversion chart, part 1 of 4. INSTRUCTIONS: Find coordinate value in body of chart; follow that column to bottom of chart to find decimal value or ASCII character which represents the High Y or High X byte; go to the right in the row containing the coordinate value to find the Low Y byte, or go to the left to find the Low X byte. EXAMPLE: 200Y, 48X equals 38 104 33 80 in decimal code, and equals & h ! P in ASCII code.

COORDINATE CONVERSION CHART

(cont)

Low Order X		X or Y Coordinate								Low Order Y	
ASCII	DEC.									DEC.	ASCII
@	64	256	288	320	352	384	416	448	480	96	`
A	65	257	289	321	353	385	417	449	481	97	a
B	66	258	290	322	354	386	418	450	482	98	b
C	67	259	291	323	355	387	419	451	483	99	c
D	68	260	292	324	356	388	420	452	484	100	d
E	69	261	293	325	357	389	421	453	485	101	e
F	70	262	294	326	358	390	422	454	486	102	f
G	71	263	295	327	359	391	423	455	487	103	g
H	72	264	296	328	360	392	424	456	488	104	h
I	73	265	297	329	361	393	425	457	489	105	i
J	74	266	298	330	362	394	426	458	490	106	j
K	75	267	299	331	363	395	427	459	491	107	k
L	76	268	300	332	364	396	428	460	492	108	l
M	77	269	301	333	365	397	429	461	493	109	m
N	78	270	302	334	366	398	430	462	494	110	n
O	79	271	303	335	367	399	431	463	495	111	o
P	80	272	304	336	368	400	432	464	496	112	p
Q	81	273	305	337	369	401	433	465	497	113	q
R	82	274	306	338	370	402	434	466	498	114	r
S	83	275	307	339	371	403	435	467	499	115	s
T	84	276	308	340	372	404	436	468	500	116	t
U	85	277	309	341	373	405	437	469	501	117	u
V	86	278	310	342	374	406	438	470	502	118	v
W	87	279	311	343	375	407	439	471	503	119	w
X	88	280	312	344	376	408	440	472	504	120	x
Y	89	281	313	345	377	409	441	473	505	121	y
Z	90	282	314	346	378	410	442	474	506	122	z
[91	283	315	347	379	411	443	475	507	123	{
\	92	284	316	348	380	412	444	476	508	124	
]	93	285	317	349	381	413	445	477	509	125	}
^	94	286	318	350	382	414	446	478	510	126	~
_	95	287	319	351	383	415	447	479	511	127	RUBOUT (DEL)
DEC. →		40	41	42	43	44	45	46	47		
ASCII →		()	*	+	,	-	.	/		
		High Order X & Y									

Coordinate conversion chart, part 2 of 4. (Refer to part 1 for interpretation instructions.)

COORDINATE CONVERSION CHART

(cont)

Low Order X		X or Y Coordinate								Low Order Y	
ASCII	DEC.									ASCII	DEC.
@	64	512	544	576	608	640	672	704	736	`	96
A	65	513	545	577	609	641	673	705	737	a	97
B	66	514	546	578	610	642	674	706	738	b	98
C	67	515	547	579	611	643	675	707	739	c	99
D	68	516	548	580	612	644	676	708	740	d	100
E	69	517	549	581	613	645	677	709	741	e	101
F	70	518	550	582	614	646	678	710	742	f	102
G	71	519	551	583	615	647	679	711	743	g	103
H	72	520	552	584	616	648	680	712	744	h	104
I	73	521	553	585	617	649	681	713	745	i	105
J	74	522	554	586	618	650	682	714	746	j	106
K	75	523	555	587	619	651	683	715	747	k	107
L	76	524	556	588	620	652	684	716	748	l	108
M	77	525	557	589	621	653	685	717	749	m	109
N	78	526	558	590	622	654	686	718	750	n	110
O	79	527	559	591	623	655	687	719	751	o	111
P	80	528	560	592	624	656	688	720	752	p	112
Q	81	529	561	593	625	657	689	721	753	q	113
R	82	530	562	594	626	658	690	722	754	r	114
S	83	531	563	595	627	659	691	723	755	s	115
T	84	532	564	596	628	660	692	724	756	t	116
U	85	533	565	597	629	661	693	725	757	u	117
V	86	534	566	598	630	662	694	726	758	v	118
W	87	535	567	599	631	663	695	727	759	w	119
X	88	536	568	600	632	664	696	728	760	x	120
Y	89	537	569	601	633	665	697	729	761	y	121
Z	90	538	570	602	634	666	698	730	762	z	122
[91	539	571	603	635	667	699	731	763	{	123
\	92	540	572	604	636	668	700	732	764		124
]	93	541	573	605	637	779	701	733	765	}	125
^	94	542	574	606	638	670	702	734	766	~	126
_	95	543	755	607	639	671	703	735	767	RUBOUT (DEL)	127
DEC →		48	49	50	51	52	53	54	55		
ASCII →		0	1	2	3	4	5	6	7		
High Order X & Y											

Coordinate conversion chart, part 3 of 4. (Refer to part 1 for interpretation instructions.)

COORDINATE CONVERSION CHART

(cont)

Low Order X		X or Y Coordinate								Low Order Y	
ASCII	DEC.									DEC.	ASCII
@	64	768	800	832	864	896	928	960	992	96	`
A	65	769	801	833	865	897	929	961	993	97	a
B	66	770	802	834	866	898	930	962	994	98	b
C	67	771	803	835	867	899	931	963	995	99	c
D	68	772	804	836	868	900	932	964	996	100	d
E	69	773	805	837	869	901	933	965	997	101	e
F	70	774	806	838	870	902	934	966	998	102	f
G	71	775	807	839	871	903	935	967	999	103	g
H	72	776	808	840	872	904	936	968	1000	104	h
I	73	777	809	841	873	905	937	969	1001	105	i
J	74	778	810	842	874	906	938	970	1002	106	j
K	75	779	811	843	875	907	939	971	1003	107	k
L	76	780	812	844	876	908	940	972	1004	108	l
M	77	781	813	845	877	909	941	973	1005	109	m
N	78	782	814	846	878	910	942	974	1006	110	n
O	79	783	815	847	879	911	943	975	1007	111	o
P	80	784	816	848	880	912	944	976	1008	112	p
Q	81	785	817	849	881	913	945	977	1009	113	q
R	82	786	818	850	882	914	946	978	1010	114	r
S	83	787	819	851	883	915	947	979	1011	115	s
T	84	788	820	852	884	916	948	980	1012	116	t
U	85	789	821	853	885	917	949	981	1013	117	u
V	86	790	822	854	886	918	950	982	1014	118	v
W	87	791	823	855	887	919	951	983	1015	119	w
X	88	792	824	856	888	920	952	984	1016	120	x
Y	89	793	825	857	889	921	953	985	1017	121	y
Z	90	794	826	858	890	922	954	986	1018	122	z
[91	795	827	859	891	923	955	987	1019	123	{
\	92	796	828	860	892	924	956	988	1020	124	
]	93	797	829	861	893	925	957	989	1021	125	}
^	94	798	830	862	894	926	958	990	1022	126	~
_	95	799	831	863	895	927	959	991	1023	127	RUBOU (DEL)
DEC →		56	57	58	59	60	61	62	63		
ASCII →		8	9	:	;	<	=	>	?		
High Order X & Y											

Coordinate conversion chart, part 4 of 4. (Refer to part 1 for interpretation instructions.)

INTERFACE DESIGN

General

Communication between the Terminal and a computer falls into two general categories—direct interfacing and data communication interfacing. Direct interfacing simply means that a Terminal and computer are connected together by a wire or wires, without benefit of intervening devices. The data may be transferred back and forth in serial (one bit at a time) or parallel (several bits at a time) fashion. The only requirement is that the Terminal and computer be compatible.

Data Communication Interfacing implies that the Terminal and computer are connected via a data communication link, usually a telephone line with a modulator-demodulator (modem) unit on each end. The modem on the Terminal end of the telephone line accepts serialized digital data from the Terminal and uses it to encode a carrier signal, which is sent to the modem on the computer end. This encoding is referred to as modulation. The modem on the computer end of the telephone line extracts the digital data from the carrier signal in a process called demodulation. The serialized data is then applied to the computer. When the computer sends data to the Terminal, the functions of the two modems are reversed. This use of a telephone line and modems permits communication between Terminals and computers with little concern for the distance between them.

Regardless of whether direct or modem communication is in use, the Terminal must be equipped with an appropriate interface unit. The interface unit provides compatibility between the Terminal and the computer or modem. The jobs performed by the interface usually include parallel-to-serial conversion of outgoing data character bits, serial-to-parallel conversion of incoming data character bits, voltage level conversion, timing, and traffic control.

The parallel-to-serial conversion and serial-to-parallel conversion are required because the Terminal delivers characters to the interface in parallel bit form, while serial form is usually required for transmission to the computer. Fig. D-1 graphically presents these conversions.

Voltage level conversion is necessary because the integrated circuit logic levels in use in the Terminal differ from the levels at which modems operate.

Timing must be considered, since it is necessary that data be sent or received at a rate compatible with all of the devices in use. This is usually accomplished in the Data Communication Interface by appropriate division of the Terminal's master clock. Timing can also be provided by the modem or the computer. Typically, data can be transferred at 110, 300, 600, 1200, 2400, 4800 or 9600 bits per second. (Bits per second is commonly referred to as baud.) However, above 1200 baud, the cost increases significantly for modems and telephone lines.

Traffic control between the computer and Terminal is necessary to insure that data is not lost for any reason. The control signals may be simple or complex, as the occasion requires. Details regarding them can be found in the standards listed in the following paragraph.

Standards concerning data communication aspects are contained in several documents: EIA RS-232-C is generally observed in the United States; CCITT, V24 is used in most of Europe; other specifications exist, but have limited usage and generally follow the same standards as the two documents just mentioned.

Specifics regarding the numerous interfaces which can be used with the Terminal are found in the manuals provided with the interfaces. The manuals can also be ordered separately through Tektronix Field Offices.

TRANSMITTING—PARALLEL TO SERIAL CONVERSION

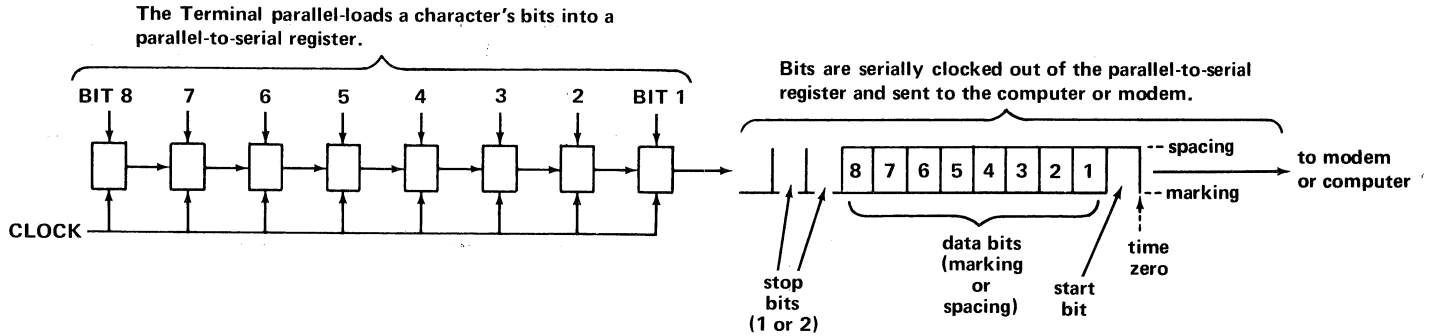

RECEIVING—SERIAL TO PARALLEL CONVERSION

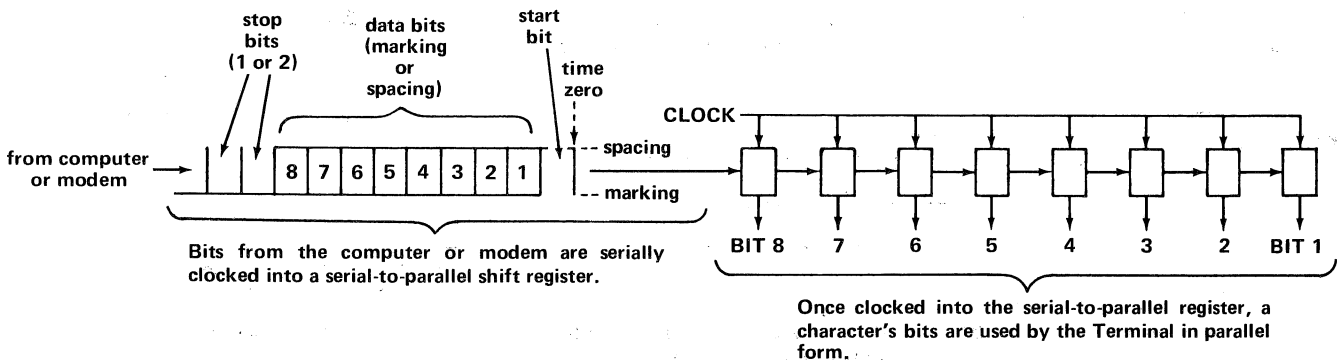

Fig. D-1. Serialization and de-serialization.

Timing Requirements

Certain signal lines are always necessary for interfacing to a modem or computer. These are listed at the end of this paragraph. Timing requirements associated with them appear in Fig. D-2. A variety of additional signals can be used for interfacing, at the discretion of the designer. A complete list of available signal lines is provided in the next topic.

$\overline{\text{TSTROBE}}$ must be asserted to transfer data to the Terminal.

$\overline{\text{CSTROBE}}$ is made available by the Terminal to transfer data to the modem or computer.

$\overline{\text{TBUSY}}$ indicates that the Terminal is busy processing data.

$\overline{\text{CBUSY}}$ can be generated by the interface to indicate that the computer is busy accepting data.

$\overline{\text{CPUNT}}$ is a command from the interface which indicates that data is about to be sent by the computer. $\overline{\text{CPUNT}}$ is used by the Terminal to prevent minibus use until the data is received from the computer.

$\overline{\text{BIT 1}}$ through $\overline{\text{BIT 8}}$ contain the data being transferred. During keyboard inputs, $\overline{\text{BIT 8}}$ will always be either true or false as determined by a keyboard wire connection.

614 kHz and 4.9 MHz are available for clock signals.

INTERFACE DESIGN

(cont)

A. TIMING OF DATA FROM THE TERMINAL TO THE INTERFACE

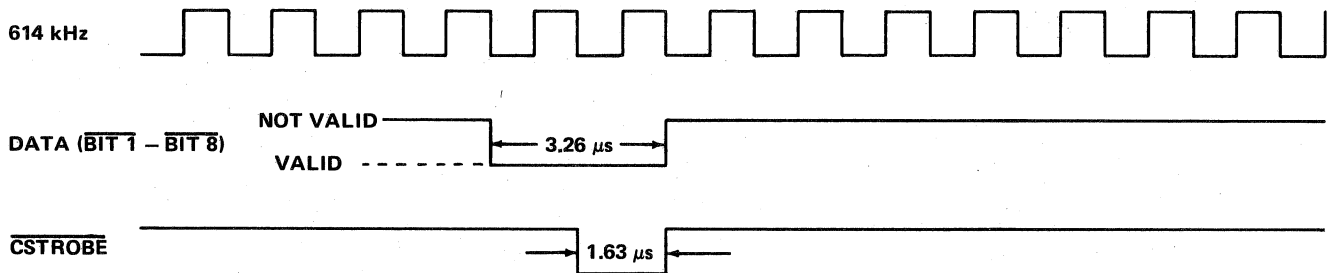

B. TIMING REQUIREMENT FOR TRANSFERRING DATA ON THE MINIBUS

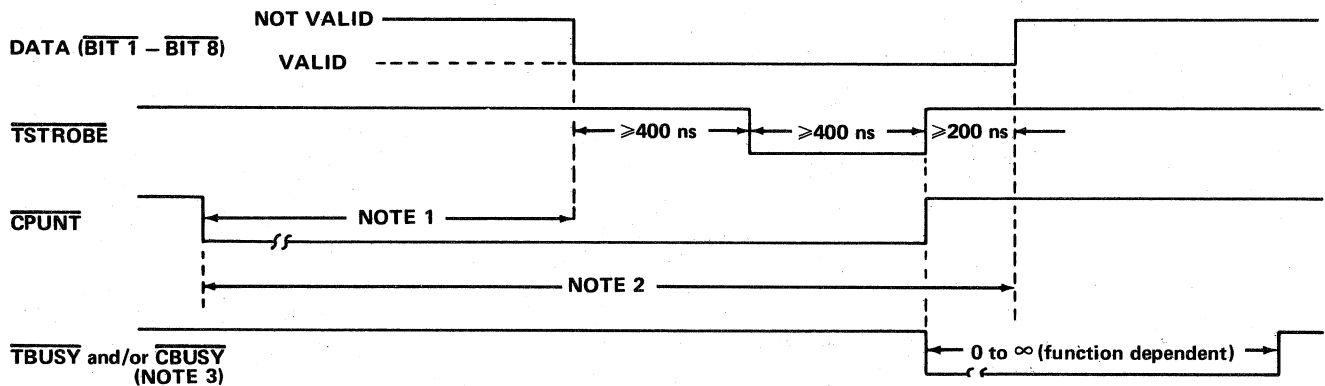

NOTE 1: Between 3.2 and 5 μ s (preferably 5 μ s) for parallel and TTY port interfaces; 10 μ s for data communication interfaces.

NOTE 2: ≤ 3.2 μ s for auxiliary devices; ≤ 7 μ s for parallel and TTY port interfaces.

NOTE 3: TBUSY is asserted by the Terminal if data is being executed by the Terminal. CBUSY should be asserted by the interface if data is being sent to the computer. Both should be asserted if data is being executed by the Terminal and is also being sent to the computer.

Fig. D-2. Timing information applicable to transferring data between the Terminal, interfaces, and auxiliary devices.

Minibus Details

The standard Terminal has a "minibus" board which has three card connectors or "jacks" on it. Corresponding points on each of the jacks are connected together, and are connected to the Terminal's signal lines. These lines or "busses" are thus available for use by any or all installed cards. The minibus board also has a facility for connecting a minibus extender board to it, to permit more than the standard three cards to have access to the signal lines. This board is available under Tektronix Part No. 018-0069-00. Empty circuit cards are also available for use by those who want to design their own interfaces or other circuits.

Fig. D-3 depicts the connector orientation for each jack on the minibus. Note that letters identify signal lines on the component side of an installed circuit card, while numbers identify the signal lines on the "under" side of a card.

The signal lines are defined in the accompanying list. Unless otherwise indicated, sources are totem-pole configured, and loads are 16 mA at 0.4 V. Further details regarding use of these lines are available in the Terminal Maintenance Manual.

INTERFACE DESIGN (cont)

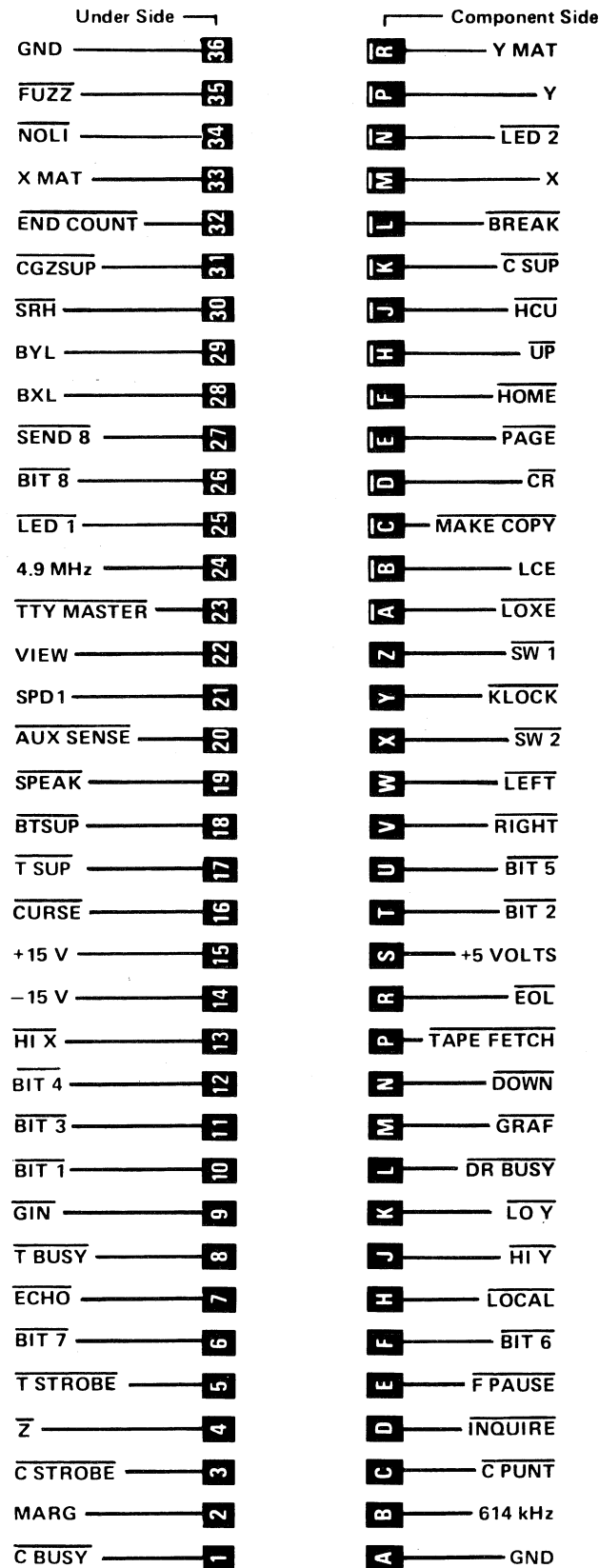

Fig. D-3. Minibus connector wire list.

INTERFACE DESIGN

(cont)

MINIBUS SIGNAL LINE DEFINITIONS

AUXSENSE. Status bit line reserved for auxiliary device(s). Disables graphic lookahead. The HCU bus line may also be used by auxiliary device(s) if no Hard Copy Unit is connected and powered up. Open collector source.

BIT 1–BIT 8. Data to and from the Terminal/CPU. See Fig. D-2 for timing. Open collector source; 48 mA load at 0.4 V.

BREAK. Signal from the keyboard to the interface for computer signaling. Open collector source.

BTSUP. Suppresses Terminal response to **TSTROBE**. Should be asserted in response to **CPUNT** by devices (such as buffers used in error correction schemes) intended to intercept data on behalf of the Terminal. In such cases, the assertion of **BTSUP** should be delayed 2 clock periods if it is desired to avoid interference with copy of locally generated data. Open collector source.

BXL. Buffered output of X digital-to-analog circuits. Does not include effect of vector filters.

BYL. Buffered output of Y digital-to-analog circuits. Does not include effect of vector filters.

CBUSY. Indicates that the CPU (interface) is busy accepting a character. Controls the timing of coordinate data transmitted to the CPU. A low on **CBUSY** will not inhibit the keyboard, allowing keyboard interrupts when **CPUNT** is not asserted. Interfaces which must lock out the keyboard should do so with **KLOCK**. Open collector source; 48 mA load at 0.4 V.

CGZSUP. Suppresses \bar{Z} signal from TC-1. Caused by **END COUNT** into TC-1. Also generated by Fast Vector option.

CPUNT. Means data is about to be asserted by CPU (interface). Must be asserted at least $3.2\mu\text{s}$ before data is placed on **BIT 1–8** and must remain low until after the trailing edge of the strobe(s) associated with the transfer. Open collector source.

CR. CARRIAGE RETURN; high active signal.

CSTROBE. Strokes data to the CPU. Pulse width is $0.5\mu\text{s}$ or more synchronized to the clock. Must not occur more than $2\mu\text{s}$ after **CPUNT** goes low. **TSTROBE** may be asserted simultaneously (from the same source) to provide local copy to the Terminal. Should not occur less than $0.5\mu\text{s}$ after **CBUSY** goes false (+3 V). See Fig. D-2 for timing requirements. Open collector source; 48 mA load at 0.4 V.

CSUP. Inhibits the interface from accepting **CSTROBE**. This signal is used by devices such as line buffers, which need to intercept data destined for the CPU. Open collector source.

CURSE. ESC SUB control character sequence creates this signal, which causes the crosshair cursor to appear.

DOWN. Counting pulse for Y register. Open collector source.

DR BUSY. Asserted by the Hard Copy Unit to set up the display for hard copy readout. **DR BUSY** should be asserted before the trailing edge of **MAKE COPY** in order to hold the Terminal busy during the scan. Also asserted by the display unit for the duration of the erase cycle, during which information may not be written on the screen. Open collector source; 48 mA load at 0.4 V.

ECHO. Directs input sources to assert **TSTROBE** as well as **CSTROBE** when sending data to the CPU to provide a local copy on the screen of data entered into the CPU. Open collector source.

END COUNT. Disables register stepping circuits and suppresses \bar{Z} signal from TC-1.

APPENDIX D

INTERFACE DESIGN

(cont)

MINIBUS SIGNAL LINE DEFINITIONS (cont)

\overline{EOL} . Indicates that the X register is counting past the right margin. Used by the AUTO CR/LF logic. Asserting \overline{EOL} will cause a CR/LF to be generated when in ALPHA. A Display Multiplexer could use this to shorten the right margin for small displays. In such use, EOL should not be asserted after CR is activated to prevent random counting of registers. Open collector source.

\overline{FPAUSE} . Indicates that the X register has folded over in the process of CR, FF, RESET or normal counting (X Right). Used to generate the pause required for proper operation of the Auto Line Feed Circuit when used with a clocked interface. Also used internally on TC-2 for Interactive Graphics.

\overline{FUZZ} . Active state causes a switch from the Character & Vector Focus circuit to the Cursor Focus circuit during Alpha Cursor or Crosshair Cursor writing. Open collector source.

\overline{GIN} . When originated in TC-2, \overline{GIN} indicates that the Crosshair Cursor is on, or that coordinate information is being transmitted to the CPU. Disables the ALPHA Cursor, top of page, and right margin CR/LF circuits. Sets Echoplex Suppression. Asserted by TC-1 or options when entering graphics, in order to insure that the Character Generator is off (reset). Open collector source.

GND. Circuit ground.

\overline{GRAF} . Originates in TC-1 to indicate that Graphic Mode is set. Open collector source; 48 mA load at 0.4 V.

\overline{HCU} . Indicates that the Hard Copy Unit is capable of accepting a $\overline{MAKE COPY}$ request. Open collector source.

\overline{HIX} . Loads the HIGH X graphic byte into the X register. Open collector source.

\overline{HIY} . Loads the HIGH Y graphic byte into the Y register. Open collector source.

\overline{HOME} . Erases the display; selects Alpha Mode and home position. Originated by keyboard HOME key or by TC-1. Open collector source; 48 mA load at 0.4 V.

$\overline{INQUIRE}$. ESC ENQ control character sequence.

\overline{KLOCK} . Inhibits keyboard. Open collector source.

LCE. High active arming signal caused by ESC control character.

$\overline{LED1}$, $\overline{LED2}$. Turns on the light emitting diode (LED) indicators in the keyboard area. Open collector source; 48 mA load.

\overline{LEFT} . Counting pulse for X register. Open collector source.

\overline{LOCAL} . Directs input sources to assert $\overline{TSTROBE}$, providing a screen display in the absence of computer echo. The interface(s) may also use this line. Originates in keyboard switch. Open collector source.

\overline{LOXE} . Loads the LOW X graphic byte into the X register and triggers vector drawing. Open collector source.

\overline{LOY} . Loads the LOW Y graphic byte into the Y register. Open collector source.

$\overline{MAKE COPY}$. Copy request; 866 microseconds wide minimum. Caused by $\overline{MAKE COPY}$ switch or by ESC ETB sequence. Open collector source.

MARG. Indicates that the Terminal is at Margin 1. With a directly connected interface, this corresponds to page full. High active.

INTERFACE DESIGN

(cont)

MINIBUS SIGNAL LINE DEFINITIONS (cont)

NOLI. Suppresses Linear Interpolation vector drawing and timing circuitry on TC-1 and TC-2. Asserted by TC-1 unless in GRAF. Open collector source.

PAGE. Created by ESC FF control character sequence or PAGE key. Causes the display to erase the screen. Open collector source.

RIGHT. Counting pulse for X register. Open collector source.

SEND 8. Directs the interface to accept full 8-BIT binary data instead of providing its own data for the 8th bit. The keyboard provides a fixed 8th bit which is true in standard factory-wired Terminals, but may be rewired false.

SPD 1. Spare.

SPEAK. Audio connection to the loudspeaker. Other terminal of speaker is at +5 volts. Bypassed by a 0.01 microfarad capacitor. Open collector source.

SRH. Contact closure for KEYBOARD SHIFT key. Resets Hold status.

SW 1. Asserted by keyboard switch SW 1. Open collector source.

SW 2. Asserted by keyboard switch SW 2. Open collector source.

TAPEFETCH. A pulse typically provided by some small computer interfaces to cause a paper tape reader or analogous device to read one byte of data. Open collector source.

TBUSY. Indicates that the Terminal is busy executing a function such as writing, ringing the bell, etc. $\overline{\text{TBUSY}}$ controls the timing of data transmitted to the Terminal. Upon receipt of a byte of data, the Terminal will assert

$\overline{\text{TBUSY}}$ by the trailing edge of $\overline{\text{TSTROBE}}$ if that byte is to make the Terminal busy. No condition, with the exception of MARG, will assert $\overline{\text{TBUSY}}$ except momentarily. (MARG can be patched out of $\overline{\text{TBUSY}}$). The Terminal will, however, accept data if $\overline{\text{TBUSY}}$ is high or low, although the results in the low case are not defined. $\overline{\text{TBUSY}}$ does not inhibit transmission of data from the keyboard to the CPU. Open collector source; 48 mA load at 0.4 V.

TOPEN. Disables top of page circuit, allowing an increased number of lines. Not brought out to minibus except by straps. Open collector source.

TSTROBE. Strokes data into the Terminal, for execution by the Terminal. It is a pulse of 0.5 μs or longer, synchronized to the 614 kHz clock. Should not occur less than 0.5 μs after $\overline{\text{TBUSY}}$ goes false (+3 V). See Fig. D-2 for timing requirements. Open collector source; 48 mA load at 0.4 V.

TSUP. Suppresses Terminal response to $\overline{\text{TSTROBE}}$. $\overline{\text{TSUP}}$ should be used by devices which need to blank the Terminal to incoming data, such as a paper tape punch when punching binary data. Open collector source.

TTY MASTER. Used only when a dual communication interface installation exists.

UP. Counting pulse for Y register. Open collector source.

VIEW. Controls the flood guns in the CRT display unit. A high turns the guns on. As long as the Terminal is in GIN or HCU, and for about 90 seconds after the last information sent to the Terminal, TC-1 will allow a steady high on VIEW. Otherwise, TC-1 places the display in Hold status by placing a 1200 hertz signal with 12.5% duty factor on VIEW. An optional device may place the display in non-store by pulling VIEW low. Open collector source.

X. Analog signal from TC-2 to display. -5 to +5 volts covers the screen. Positive signal corresponds to left deflection. Zero volts represents the physical center of the screen.

APPENDIX D
INTERFACE DESIGN
(cont)

MINIBUS SIGNAL LINE DEFINITIONS (cont)

XMAT. Analog signal representing the X location within the character matrix. Originates on TC-1.

YMAT. Analog signal representing the Y location within the character matrix. Originates on TC-1.

Y. Analog signal from TC-2 to display. -5 to +5 volts covers the screen. Positive signal corresponds to down deflection. Zero volts represents the physical center of the screen.

Z. Z-Axis information. Open collector source; 48 mA load at 0.4 V.

4.9 MHz. Clock signal.

614 kHz. Clock signal.

ACCESSORIES

Refer to Tektronix, Inc. advertising information or contact a Tektronix Field Office for up-to-date listing of additional accessory devices.

Standard Accessories

Data Communication Interface	021-0065-00
Data Communication Interface Instruction Manual	070-1458-00
4012 Terminal Users Manual	070-1460-00

Optional Accessories

4012 Service Manual	070-1461-00
---------------------	-------------

Optional Data Communication Interface	021-0074-00
---------------------------------------	-------------

Provides switch-selectable baud rates, switch control of modes (echo, loopback, full duplex, half duplex, half duplex-blanking, half-duplex-supervisory), switch selection of LF control over Terminal carriage return.

TTY Port Interface (Part Number varies with computer)

Permits the Terminal to operate directly into a computer's Teletype port.

Dual Interface Assembly (Uses the Optional Data Communication Interface and a TTY Port Interface in combination)

Permits operation with and between two computers.

Access Cover, Optional	200-1288-01
------------------------	-------------

Required for use with a Dual Interface Assembly

Motherboard Extender	018-0069-00
----------------------	-------------

Needed when accessory devices require more than three circuit cards to be connected into the terminal's minibus.

Audio Recorder Interface	018-0066-01
--------------------------	-------------

Permits tape recording and playback from/to computer, Terminal, and peripheral devices.

Display Multiplexer	018-0067-00
---------------------	-------------

Allows the Terminal to control display devices other than its own display screen.

Logic Extender Card	067-0653-00
---------------------	-------------

A design and maintenance device which can be independently inserted into the minibus to monitor signal lines or to inject signals into them. It can be used as a circuit card extender to perform those same functions, plus a signal interrupt function.

72-pin Extender Card	670-1739-00
----------------------	-------------

Provides access to circuit cards by extending them out of the pedestal. Also equipped with test points for the minibus signal lines.

Copy Holder	016-0291-00
-------------	-------------

Similar to a typewriter copy holder; attaches to the left or right side of the Terminal display unit.

Auxiliary Card	018-0065-00
----------------	-------------

Empty thru-hole plated card for circuit development. Fits into the Terminal minibus.

Terminal Auxiliary Card	018-0068-00
-------------------------	-------------

Similar to 018-0065-00, but contains ground and VCC bus lines. Ideal for use where large quantities of integrated circuits are involved.

This glossary pertains to this manual and is not intended to be a universal reference. It excludes definitions of most control characters and signal lines, which are defined on pages listed in the index.

Accessory—see standard accessory or optional accessory.

Active state—Used with reference to signal lines; it refers to the state indicated by the line name. For example, the MARG line is active when it is high, whereas TSTROBE is active when low, as indicated by the "not line" drawn across the top of the name.

Address—A point within the 1024Y by 1024X coordinate capability of the Terminal's registers. 780Y and 1024X coordinates relate to the viewing area of the Terminal's screen, with 0Y, 0X being in the bottom left corner and 779Y, 1023X being in the top right corner.

Address, Alpha cursor—The position occupied by the lower-left corner of the Alpha cursor. Also the contents of the position registers in Alpha Mode.

Address conversion—Changing an address into a combination of characters which describes that address in ASCII or decimal form; also the reverse operation.

Address, Graphic—The position of the beam in Graph Mode. Also the contents of the position registers in Graph Mode.

Address, shortened—A Graph Mode address of less than four bytes. Can be used when part of a new address is the same as part of the one which immediately precedes it.

Addressable point—Any point within the 0Y to 1023Y, 0X to 1023X capability of the Terminal's registers.

Alpha cursor—A blinking, non-storing rectangular symbol which indicates the next-character writing position. Exists only during view status in Alpha Mode.

Alpha Mode—A Terminal receiving mode which permits writing of a standard set of symbols.

Alphanumeric—Refers to letters and numbers.

Arming—Preparing the Terminal so that the next-received character performs a function other than what it would cause if the Terminal were not "armed". The ESC control character normally is used to "arm" the Terminal.

ASCII character—Any one of 128 characters contained in the character set used by "American Standard Code for Information Interchange". See the ASCII code chart in the appendix.

ASCII Code—Seven-digit binary numbers which express any of the 128 ASCII characters. See the ASCII Code Chart in the appendix.

Auxiliary/Auxiliary Unit—A device which is designed for use with the Terminal, but which is not required for Terminal operation.

Baud—Signalling units per second; an expression of serial data transmission bit rate.

Beam—The element (within the cathode-ray tube) which causes displays to appear on the screen.

Binary—Referring to a number system which uses two as its base. Only the digits 0 and 1 appear in binary expressions.

GLOSSARY

(cont)

Binary equivalent—A number expressed in binary form to represent a number which has a different base or to represent a character from the ASCII code.

Bit—A binary digit.

Blanked—The non-writing status of the display beam.

Board, circuit—See circuit board.

Break—A signal sent from the Terminal to the computer to interrupt computer transmission in some installations. Also the command which initiates the signal.

Bright vector—a line stored on the screen as a result of smoothly changing the beam address while the beam is unblanked.

Bus—A wire which conveys electrical information between two or more points.

Byte—A group of bits operated on as a unit.

Card, circuit—See circuit card.

Carriage return— Movement of the writing beam to the left or center margin. Also the command which causes this movement.

Cathode-ray tube (CRT)—An evacuated glass envelope similar to a television display tube. The CRT face is the Terminal's display screen.

Character generator—An electronic circuit within the Terminal, which provides the positioning and writing information required for displaying characters on the screen.

Character keys—The keys located on the Terminal's keyboard.

Character—A symbol within a set of symbols; also the encoded form of that symbol. Also see control character.

Character set—Characters which make up a defined group, such as ASCII.

Character space—The horizontal area allotted to writing of one character on the screen.

Character writing—Moving the beam through a 7 by 9 dot matrix and unblanking the beam in the positions required for constructing the character.

Circuit board—A bolt-in circuit assembly, as opposed to a plug-in circuit card assembly.

Circuit card—A plug-in circuit assembly, as opposed to a bolt-in circuit board assembly.

Clock—An oscillator or other signal-producing device which provides signals for circuit timing.

Command sequence—A sequence of characters, the first of which arms the Terminal so that the subsequent character(s) produce a result other than what they would produce alone.

Communication link—The connection between the Terminal and computer. It may be a wire cable, or may be a telephone line and modems.

Control character—A character which normally causes a function other than writing to occur, controlling the operation of equipment.

Control character command sequence—See command sequence.

Coordinate—A horizontal or vertical line displayed on the screen; also the horizontal or vertical address of a point on the screen.

Coordinate conversion—See address conversion.

Coordinate conversion chart—A chart which provides address conversion to ASCII and decimal bytes. See the appropriate appendix.

Copy making—Generating a paper reproduction of a display.

CPU—Central processing unit; a term used interchangeably with computer in this manual.

Crosshair cursor—A non-storing image on the screen, created in GIN Mode by alternately cycling the X and the Y position registers and writing each point with a non-storing intensity.

CRT—See cathode-ray tube.

CTRL key—A keyboard key which, when held down, causes letter key entries to result in transmission of control characters.

Cursor, Alpha—See Alpha cursor.

Cursor, crosshair—See crosshair cursor.

Dark vector—Movement of the display beam from one address to another in Graph Mode, without unblanking the beam to cause writing.

Data—Basic elements of information which can be produced or processed by devices such as computers, Terminals, teletypewriters and associated devices.

Data communication interface—A device which provides compatibility between the Terminal and a computer, usually via a modem.

Data communication standards—A statement of particulars regarding interfacing between data terminal equipment and data communication equipment employing serial binary data interchange. Typified by documents such as EIA RS-232-C.

Data lines—Wires which carry data between or within devices.

Direct connection—In computer interfacing, a direct connection infers connecting the Terminal to the computer without benefit of modems.

Display—Information written on the Terminal screen; sometimes also used to denote the screen itself.

Display beam—See beam.

Display Multiplexer—An optional accessory which permits the Terminal to control display devices other than its own display screen.

Display Screen—See screen.

Display Unit—That section of the Terminal which includes the screen, keyboard, and associated circuits.

Dual key entry—Pressing a character key while holding the CTRL or SHIFT key down.

Echoplexing—The return of transmitted data to the transmitting device.

GLOSSARY

(cont)

Echoplex suppression—Disabling the echoplex feature during certain phases of operation.

Erasing—Removing stored data from the screen.

False—A status associated with signal lines which occurs when the line is at the level opposite to that inherent in the line name. For example, in positive logic (such as is used in the Terminal), BIT 8 is false when the line is high (most positive), since a "not line" is part of the signal name. MARG is false when the line is low (least positive).

Flooding—A fully-written screen condition which occurs shortly after turn-on.

Formatting—Arranging the display in the desired manner by using positioning commands between writing commands.

GIN Mode—An interactive mode in which a computer request causes the Terminal to respond with graphic information. Status information and/or control characters may be part of the transmission.

Graph Mode—A terminal mode which permits data to be interpreted as display beam positioning information. Points can be written or lines (vectors) can be drawn (written) between points.

Graph Mode memory—A feature which permits the Terminal to remember three of the four bytes of a graphic address, even if it is switched out of Graph mode.

Graphic address—See address.

Graphic Input—See GIN Mode.

Graphic vector—See vector.

Hard copy—A reproduction (on paper) of a Terminal display.

Hard Copy Intensity—An adjustment on the side of the Terminal. It permits optimization of hard copy writing.

Hard Copy Mode—The operating status achieved by the Terminal during copy making.

Hard Copy Unit—An instrument which generates paper copies of Terminal displays. May also be used in certain other copying situations.

Hardware—The mechanical, magnetic, electrical, and electronic devices and components of data processing equipment.

Hold status—A reduced-intensity status (of the screen) which occurs in Alpha Mode.

Home—The Alpha Mode starting position. Exists at top-left of the screen (767Y, 0X).

Initializing—Turning the Terminal power on, or returning the Terminal to its initial condition.

Interactive graphics—See GIN Mode.

Interface—The unit which permits two devices to interact with each other. Specifically, the unit which makes the Terminal compatible with a computer, modem, or peripheral equipment.

Intersect point—The point where the horizontal and vertical lines of the crosshair cursor meet.

Jack—The least-portable of two mating connectors.

Letter keys—Commonly used to denote the keys which generate the code for Roman (conventional English) letters.

APPENDIX F

GLOSSARY

(cont)

Light vector—See written vector.

Line—A display consisting of 74 horizontally adjacent characters; also the space allocated to such a display.

Line feed—Movement of the writing beam from a line to the next lower line; also the command which causes such movement.

Line voltage—The force of the supply at an electrical outlet. In the United States, it is usually 115 V or 230 V or some slight variation of those values.

Lines, data—See data lines.

Lines, signal—See signal lines.

Local Echo—Simulating echoing within the Terminal, so that the Terminal executes the data it transmits, without having it echoed by the receiving device.

Local operation—An operating status which isolates the Terminal from the computer, and sets up an echoplexing condition.

LSB (least significant bit)—The bit in the position of least magnitude in a binary expression; usually written as the last bit on the right.

Margin 0—A left-margin position at the left side of the screen.

Margin 1—A left-margin position at the center of the screen.

Minibus—A wiring arrangement which makes all signal lines in the Terminal's pedestal available to all installed circuit cards.

Minibus extender—An optional circuit board which extends the minibus capability to permit inclusion of as many as six additional circuit cards.

Modem (Modulator/demodulator)—A device which can convert digital data to a signal (in a process called modulation) which can be conveyed over telephone lines, and can perform the reverse function in a process called demodulation. A modem is required on each end of the telephone line.

Monitor—As associated with the Terminal, monitor refers to a device which provides a copy of the Terminal display, or otherwise displays data which is processed by the Terminal.

MSB (most significant bit)—The bit in the position of greatest magnitude in a binary expression; usually written as the bit on the left.

On Line operation—Communicating with the computer.

Optional accessory—A device which can be purchased from Tektronix for use with the Terminal, but is not supplied as part of the standard Terminal package.

Options—See soldered options or strappable options.

PAGE—A command which erases a display, sets Alpha Mode, and homes the Alpha cursor. Also a completed display.

Page full break—A signal generated when a page full of information has caused the display to line feed past the last (35th) line. Also an option contained on the Data Communication Interface circuit card.

Page full busy—A busy signal which can be generated in response to a page full of information. Also an option found on the TC-2 circuit card.

Parallel transmission—simultaneous transmission of more than one data bit.

Parallelization—The process of converting sequential (serial) data bits to simultaneous (parallel) data bits.

APPENDIX F

GLOSSARY

(cont)

Pedestal—That unit of the Terminal which houses the low voltage power supply, the terminal control circuit cards, and the interface unit(s). The display unit may be mounted on the pedestal.

Peripheral devices—Generally refers to the equipment used in support of, or under control of, the computer. Used in this manual to mean equipment other than the computer or Terminal.

Plug—The most portable of two mating connectors.

Point spacing—The distance between addressable points on the display screen.

Point writing—The result of turning on the display writing beam without changing the beam location.

Poll—To question. Usually the act of electronically asking a device if it is waiting to use the asking device, or the equipment which it represents.

Program—A pre-defined course of action which controls computer or other equipment operation. May be written on paper, punched on tape, stored on magnetic tape, or stored in computer or other equipment memory.

Program command—A command sent from the computer to the Terminal or to peripheral equipment as a result of a program decision.

Quality area—That area of the screen which reliably displays information. It is specified as a six inch by eight inch area which is within one-fourth inch of being centered on the screen.

Register—A device for temporary storage of binary information. May be differentiated between data register and address register.

Reset—Return to initial status; also the command which causes return to initial status.

Residual image—A display which remains after erasing has been completed. Usually caused by storing information for an excessive time. May be permanent or temporary. If temporary, it will disappear after several erase cycles.

Return—See carriage return. Also the keyboard name for control character CR.

Screen—That area of the Terminal's display unit on which data is displayed. The face of the cathode-ray storage tube.

Serialization—The process of converting simultaneously-occurring (parallel) data bits into sequentially-occurring (serial) data bits.

Serial transmission—Sequential transmission of single data bits.

Shift key—A key on the Terminal keyboard whose function is comparable to that of a typewriter shift key.

Shifted character—A character resulting from pressing a symbol key while the Shift key is held down.

Signal lines—Wires which are used to send command signals between or within devices.

Software—Programs, procedures and techniques for directing the hardware (computer, Terminal, etc.) to perform desired functions.

Soldered options—Operating features which are designed to be changed by soldering or unsoldering connections.

Space—The horizontal area allocated to writing a character in Alpha Mode. Also, the movement from a character writing area to the next writing area. Also, the command which causes such movement without causing character writing.

Standard accessory—A device which is supplied with the basic Terminal.

Standards, data communication—See data communication standards.

Status byte—Data bits which indicate the status of the Terminal and certain peripheral devices.

Store—To retain an image on the screen as a result of writing with sufficient beam intensity.

Strappable options—Operating features which can be changed by moving a friction-held wire from one point to another.

TC-1, TC-2 circuit cards—Terminal control circuit cards which are installed in the minibus board in the Terminal pedestal.

Telephone line connection—A communication link between the Terminal and computer. Sometimes generalized to include the associated modems.

Teletypewriter—A device similar in appearance to a typewriter, which produces and responds to binary information. The trade name for such a device produced by AT&T.

Teletype port—The computer connection point for a Teletypewriter cable plug.

Thumbwheels—Adjustment knobs with partially exposed surfaces, a pair of which are used to control the position of the Terminal's crosshair cursor.

Timing—The control of operations between and within devices with respect to time.

Traffic control—Controlling the input and output of data to avoid loss of data.

Transmitting—Sending data to another device.

Triple key entry—Pressing a character key while holding down both the CTRL and SHIFT keys to generate the code for a control character.

True—A status associated with signal lines. This status exists when the line is at the level inherent in the line name. For example, in positive logic (such as is used in the Terminal), $\overline{\text{BIT 8}}$ is true when the line is low (least positive), since a "not line" is part of the signal name. MARG is true when the line is high (most positive).

TTY Code—A code set consisting of all ASCII characters except lower case letters, grave accent, opening brace, vertical line and tilde.

Unblanked—The beam writing condition which produces the display on the screen.

Unshifted character—A character resulting from pressing a symbol key while the SHIFT and CTRL keys are both released.

Unwritten vector—See dark vector.

Vector—Movement in Graph Mode from one address to another. May be accompanied by a blanked or unblanked writing beam. Also, see dark vector or written vector.

View Status—The bright-screen condition (of the Terminal) associated with normal operation.

Viewable address—Those address points which are in the quality display area of the screen. In a standard Terminal, it consists of the 0 to 779 Y area and the 0 to 1023 X area.

GLOSSARY

(cont)

Viewable point—any point in the viewable address area.

Voltage, data transfer—The voltage levels required to denote the status of data being transmitted.

Voltage, operating—See line voltage.

Wrap-around—The condition associated with the position registers incrementing from 1023 to 0 or decrementing from 0 to 1023. The beam position moves from one edge of the screen to the opposite edge without writing.

Writing—Storing information on the screen as a result of unblanking the display beam.

Writing character—Any of the numerous ASCII characters which can be written by the Terminal's character generator.

Written vector—Movement of the display beam from one address to another in Graph Mode while the beam is unblanked. Also the stored effect of such movement.

X—The horizontal axis of the screen.

X coordinate—Any specific value of X. Also a line drawn through every Y value with X held constant.

X register—The register which holds the bits which determine the horizontal position of the display beam.

Y—The vertical axis of the screen.

Y coordinate—Any specific value of Y. Also a line drawn through every X value with Y held constant.

Y register—The register which holds the bits which determine the vertical position of the display beam.

This index contains a listing of the principal subjects contained in this manual. Control characters and minibus line titles are not included individually, but can be found on the page indicated by the general title. For example, control character CR can be found on the page listed for control characters; BTSUP can be found under minibus signals.

- Accessories—E-1, F-1
- Address—1-5 thru 1-7, 3-7 thru 3-10, 3-16 thru 3-19, F-1
- Address, Alpha cursor—1-6, 3-9, 3-18, F-1
- Address, crosshair cursor—1-7, 3-10, 3-18, 3-19
- Address, Graph Mode—1-5, 1-6, 3-7 thru 3-10, 3-16 thru 3-18, F-1
- Address conversion chart—See Coordinate conversion chart
- Addressable point—3-16, F-1
- Alpha cursor—1-4, 1-6, 1-9, 3-3, F-1
- Alpha Mode—1-4, 3-5, 3-6, 3-15, F-1
- Alpha Mode Summary—3-15, F-1
- Arming—2-4, F-1
- ASCII code chart—B-1
- Baud—A-4, D-3, F-1
- Break—2-2, 2-3, 3-14, A-4, F-2
- Care of Terminal—1-1
- Carriage return—2-3, 2-4, 3-6, 3-9 thru 3-11, 3-15, 3-16, 3-18, 3-19, F-2
- Character keys—1-3, 1-7, 2-2, 2-4, 2-5, 3-3, 3-4, 3-14, 3-15, F-2
- Character size—3-15
- Character space—3-15, F-2
- Character writing—3-15, F-2
- Circuit card—2-1, 2-3, 3-14, F-2
- Computer connections—1-2, A-6, D-1
- Control characters—1-4, 1-5, 2-2, 2-3, 2-4, 2-5, 3-3, 3-14, 3-15, 3-16, 3-18, A-4, A-5, F-2
- Control character command sequence—2-4, 2-5, 3-4, F-3
- Controls—Section 2
- Coordinate conversion chart—Appendix C, F-3
- Copy making—1-1, 1-8, 3-12, 3-14, F-3
- Crosshair cursor—1-7, 3-10, 3-18, 3-19, F-3
- CTRL key—2-2, 3-4, 3-14
- Cursor, Alpha—See Alpha cursor
- Cursor, crosshair—See Crosshair cursor
- Dark vector—2-5, 3-7, 3-8, 3-16, F-3
- Data communication Interface—2-3, 3-2, A-6, F-3
- Data communication standards—D-1, F-3
- Dimensions—A-2
- Direct connection—1-2, A-6, D-1, F-3
- Display mounting—1-1, A-1, A-2
- Display Multiplexer—A-5, E-1, F-3
- Display Multiplexer Bypass Strap—3-14, A-5
- Dynamic geometry error—3-17
- Echo—1-2, 3-11, 3-19
- Echoplex suppression—3-18, 3-19, F-4
- Effective writing rate—3-15
- Erasing—3-2, 3-4, 3-14 thru 3-16, F-4
- Formatting—3-6, 3-15, F-4
- Fuse size—A-3
- GIN Mode—1-2, 1-6, 1-7, 1-8, 3-9 thru 3-11, 3-14, 3-18, 3-19, F-4
- GIN Mode selection—3-18
- GIN Mode Summary—3-18
- GIN Mode termination—3-18
- Glossary of Terms—Appendix F
- Graph Mode—1-5, 3-7, 3-16, F-4
- Graph Mode memory—3-8, 3-17, F-4
- Graph Mode summary—3-16
- Graph Mode selection—3-16
- Graph Mode termination—3-16
- Graphic input—See GIN Mode
- Hard Copy intensity—2-1, 3-12, 3-14, F-4
- Hard Copy operation—1-8, 3-12, 3-14
- Hold status—1-9, 3-3, 3-14, 3-15, F-4
- Home—2-2, 3-15, F-4
- Initialization—3-2, 3-14
- Installation—1-1, Appendix A
- Interactive graphics—See GIN Mode
- Interface—2-3, A-4, A-6, D-1, F-4
- Interface Design Information—Appendix D
- Keyboard—1-3, 2-2, 3-3, 3-4, 3-14
- Keyboard panel—2-2
- Line feed—2-3, 3-4 thru 3-6, 3-15, F-5
- Lines, writing—3-15
- Local echo—A-4, F-5
- Local operation—1-8, 3-2, 3-14, F-5
- Margin—3-5, 3-6, 3-15, F-5
- Minibus—Appendix D, F-5
- Minibus extender—E-1, F-5
- Modem—1-2, A-6, F-5
- Modes—1-2, 3-14
- Mounting, display—1-1, A-1, A-2
- On Line operation—1-2, F-5
- Operation—Section 3
- Options, soldered—A-5
- Options, strappable—2-3, 3-14, A-3, A-4
- PAGE—2-2, 3-14, F-5
- Page full break—A-4, F-5
- PF break—2-3, A-4
- Point spacing—3-16, F-6
- Point writing—3-7, 3-8, 3-16, F-6
- Power switch—2-1, 3-2
- Power, operating—A-2, A-3
- Receiving—1-4, 1-5
- Repeat function—3-3
- RESET—2-2, 3-14, F-6
- Residual images—3-15, F-6
- Return—See Carriage Return
- Safety—1-1, 1-9, 3-2, A-3, A-4
- Serialization—D-2, F-6
- SHIFT key—2-2, 3-3, 3-4, 3-14, F-6
- Signal lines—Appendix D, F-6
- Soldered options—A-5, F-6
- Space—3-15, F-6
- Standards, Data Communication—D-1, F-7
- Status byte—3-18, 3-19, F-7
- Stored information—1-1, 1-8, 3-15
- Strappable options—2-1, 2-3, A-3, A-4, F-7
- TC-1 circuit card—2-3, A-4, F-7
- TC-2 circuit card—2-3, A-4, F-7
- Telephone line connection—1-2, A-6, D-1, F-7
- Thumbwheels—1-7, 2-2, 3-10, F-7
- Timing, interface—D-1, D-2
- Traffic control—D-1, D-2, F-7
- Transmitting—1-3, 2-2, 3-3 thru 3-5, 3-14, F-7
- TTY—2-2, 3-4, 3-14, 3-15, F-7
- Vector writing—1-5, 3-7 thru 3-9, 3-16, 3-17
- View—1-9, 2-2, 3-3, 3-14, 3-15, 3-16, 3-17
- Viewable point—3-17, F-8
- Voltage, data transfer—D-1, F-8
- Voltage, operating—A-2, A-3
- Written vector—3-8, 3-16, F-8

MANUAL CHANGE INFORMATION

At Tektronix, we continually strive to keep up with latest electronic developments by adding circuit and component improvements to our instruments as soon as they are developed and tested.

Sometimes, due to printing and shipping requirements, we can't get these changes immediately into printed manuals. Hence, your manual may contain new change information on following pages.

A single change may affect several sections. Sections of the manual are often printed at different times, so some of the information on the change pages may already be in your manual. Since the change information sheets are carried in the manual until ALL changes are permanently entered, some duplication may occur. If no such change pages appear in this section, your manual is correct as printed.



MANUAL CHANGE INFORMATION

PRODUCT 4012 and 4013
Service and Users

CHANGE REFERENCE C2/576
DATE 5-26-76 REV. _____

CHANGE:

DESCRIPTION

TEXT CORRECTION

Page 1-1

ADD the following:

This Computer Display Terminal is listed by UNDERWRITERS' LABORATORIES, INC. in compliance with UL 478, which is the standard for Electronic Data Processing Units and Systems. File No. is E44095. The instrument meets all the TYPE II requirements of the NATIONAL FIRE PROTECTION ASSOCIATION. For continued safety, use replacement parts having the same Tektronix Part Numbers as the original parts.

Page 1-2 (Service manuals)

Page A3 (Users manuals)

ADD following the existing Warning paragraph:

WARNING

For safety, the grounding wire connecting the hinged front cover to the pedestal frame must be in place. Reconnect the wire prior to reinstallation of the cover.



TEKTRONIX®

committed to
technical excellence

MANUAL CHANGE INFORMATION

PRODUCT GENERAL

CHANGE REFERENCE S23351

DATE 4-10-75

CHANGE:

DESCRIPTION

POWER CORD CHANGES

The 1974 National Electrical Code permits the use of IEC (International Electrotechnical Commission) power cord color codes. As production permits, we are changing the entire Tektronix product line to comply with IEC power cord color code requirements. As a result, the power cord on Tektronix instruments may conform to either IEC or the older NEC requirements. The change consists of the following:

Conductor	NEC	IEC
Line	Black	Brown
Neutral	White	Light Blue*
Safety Earth	Green w/Yellow Stripe	Green w/Yellow Stripe

*Tinned copper conductor.