

# Tekniques

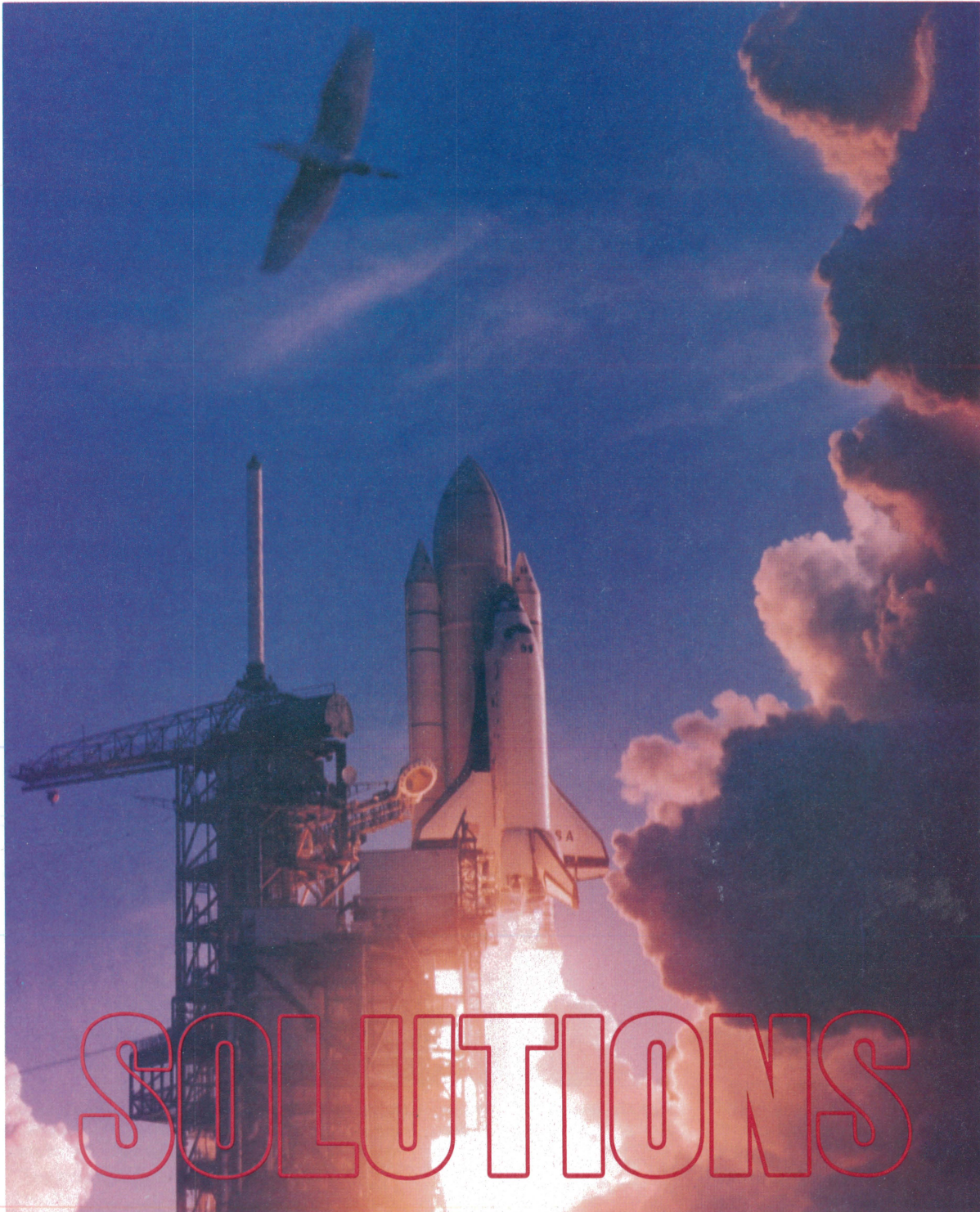

Rockwell International Corporation's New Interactive CAD/CAM System to Support Increasingly Complex Space Shuttle Program.....	2
Tektronix Desktop Computer Indispensable in Fusion Research ....	6
Editor's Note .....	8
Pre- and Post-Processor for Finite Element Modeling Joins Solution Vendor Program: PDA/PATRAN-G.....	9
Solution Vendor Register Outlines Software Solutions for Tektronix Graphics System Users.....	10
4110A Local Programmability: A Closer Look.....	15
TEKniques Update Card .....	19
PLOT 10 — A Lasting Commitment to Excellence .....	23
Software Updates Available Through Software Subscription Services.....	26
Tektronix 4116A Brings Large Display to 4110A Series Family .....	27
Flexible Display Stand, Ergonomic Chair Provide Convenience, Comfort .....	27
Tektronix Presentation Pack Provides the Tools for Overhead Transparencies .....	27
Option to 4052R14 GPIB Enhance- ment ROM Pack Provides Com- patibility with A-Series Systems .....	28
600K Cartridge Tape Supports Extended Memory.....	28
Tektronix 4612 Hard Copier Compatible with DEC VT100 Terminals .....	28
Input/Output .....	29
Graphics Systems Workshops .....	30
Programming Tips .....	31
BASIC Bits.....	36
IDD Program Exchange.....	36
New Abstracts .....	37
Program Exchange Addresses .....	40

*TEKniques*, the IDD Applications News-  
letter, is published in the Information  
Display Division of Tektronix, Inc., Mail  
Stop 63-575, P.O. Box 1000, Wilsonville,  
Oregon 97070. It is distributed to TEK-  
TRONIX computer and terminal users.

Publishing Manager	Ken Cramer
Managing Editor	Patricia Kelley
Technical Editor	Dan Taylor
Graphic Design	John Ellis
Circulation	Rory Mutton
Typesetting	Jean Bunker

Copyright © 1983, Tektronix, Inc.  
All rights reserved.

To submit articles to *TEKniques* or for in-  
formation on reprinting articles, write to  
the above address. Changes of address  
should be sent to the IDD Program Ex-  
change serving your area (see Program Ex-  
change addresses).

# Rockwell International Corporation's New Interactive CAD/CAM System to Support Increasingly Complex Space Shuttle Program

After circling the earth for 54 hours, America's first reusable spacecraft, Columbia, sailed to a smooth landing at Edwards AFB in California. This short, but near-perfect voyage culminated years of engineering, design, analysis and manufacturing, and set the stage for a tremendously complex Space Shuttle program which will involve up to seven vehicles and numerous space-borne experiments.

No one understands the complexity of the Space Shuttle program better than Rockwell International Corporation — the major contractor to the National Aeronautics and Space Administration (NASA). Rockwell will meet the challenges posed by a seven-vehicle and up to 40-mission-per-year program with the help of advanced computer-aided-design and computer-aided-manufacturing (CAD/CAM) techniques.

An important element in Rockwell's CAD/CAM system is a new line of graphics CRT terminals. The new interactive graphics terminals, supported by a dedicated CAD/CAM mainframe computer and various hard-copy

devices, will be used for a wide range of applications. The design, analysis and manufacturing of the Thermal Protection System (heat tiles), hydraulic systems, piping structures, wiring schematics, as well as all structural modifications or additions for subsequent spacecraft will be supported by the CAD/CAM system.

Rockwell International's experience in manned-space flight began in the early 1960s with the Mercury program. Later, the company developed and built the Saturn V Booster, and the Apollo Command and Service Modules which carried men to the moon and back nine times.

Currently, Rockwell's Space Transportation System Development and Production Division is under contract to NASA for two of the four major elements of the Space Shuttle program. Rockwell's Space Division is responsible for design and construction of the shuttle orbiter, and has total responsibility for integration of all elements of the entire reusable space transportation system.

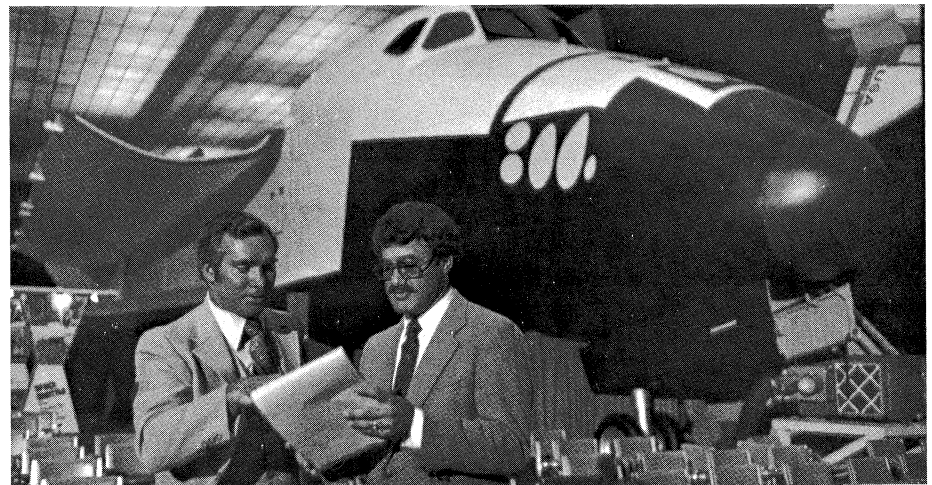

*With the Space Shuttle mock-up in the background, Robert M. Glaysher (left), Director of Technical Management for Rockwell's Space Group, and Larry Manly, Vice President of Operations for Rockwell's Information Center, discuss progress on CAD/CAM installation schedules. (All photos and figures courtesy of Rockwell International Corporation.)*

#### On the Cover

*Wings of fire and feathers provide dramatic contrast as Space Shuttle Columbia and one of the graceful inhabitants of the ecologically rich KSC area both lift free of Earth's restraints. The maiden flight took Astronauts John Young and Robert Crippen into the beginning of an orbital mission scheduled to last for 54 hours, ending with an unpowered landing at Edwards Air Force Base in California. (Courtesy of NASA)*

The integration responsibilities require Rockwell to closely supervise the other two program elements; the solid rocket system is the responsibility of Rockwell International's Rocketdyne Division, while all external elements are the responsibility of other subcontractors.

### Shuttle Complexity Requires CAD/CAM System

"Columbia's first mission was really our 'learning curve' in terms of our understanding the importance of CAD/CAM and computer analysis to the Shuttle program," reflected Robert M. Glaysher, director of technical management for Rockwell's Space Division.

"There was certainly a tremendous amount of computer support for that first flight, but no dedicated CAD/CAM system to aid in the many design, engineering, analysis and manufacturing elements which are essential to a successful flight.

"In addition, Rockwell International is constantly faced with a corporate-wide shortage of skilled engineers. A CAD/CAM system using interactive graphics techniques would improve our productivity by eliminating much of the repetitive manual work which bogs down our staff."

Rockwell will support the growing Space Shuttle program with new CAD/CAM operations at two of its plants in Southern California. Currently undergoing renovation in Downey, California, is a new design and analysis center which will support the work of over 4000 designers and engineers. The design and analysis center will in turn support computer-aided manufacturing operations in Downey and Palmdale, California.

### Interactive Graphics Terminals: Eyes of CAD/CAM

At the heart of Rockwell's expanding CAD/CAM operations is the Tektronix 4114 direct-view storage tube (DVST) graphics display terminal. The 16-bit microprocessor-based 4114 features a high-resolution 19" tube, and the ability to store up to 800 Kbytes locally. The local storage feature speeds redrawing, and minimizes traffic with the host computer. For example, 26,000 short vectors can be redrawn from local memory in less than one-half second.

"From a hardware standpoint, the 4114s have given us tomorrow's technology," Glaysher observed. "The terminal's ability to store information locally speeds our staff's designing and analysis. We no longer have to wait for images to be redrawn from a heavily-used host computer.



Rockwell's Western Computing Center (WCC) in Seal Beach, CA, provides computing services to thousands of Rockwell computer users. This is done via telecommunications to CRTs such as these provided by Tektronix and others. Larry Manly (left) and Robert Glaysher are shown in the Service Control Center which operates the WCC from a central location.

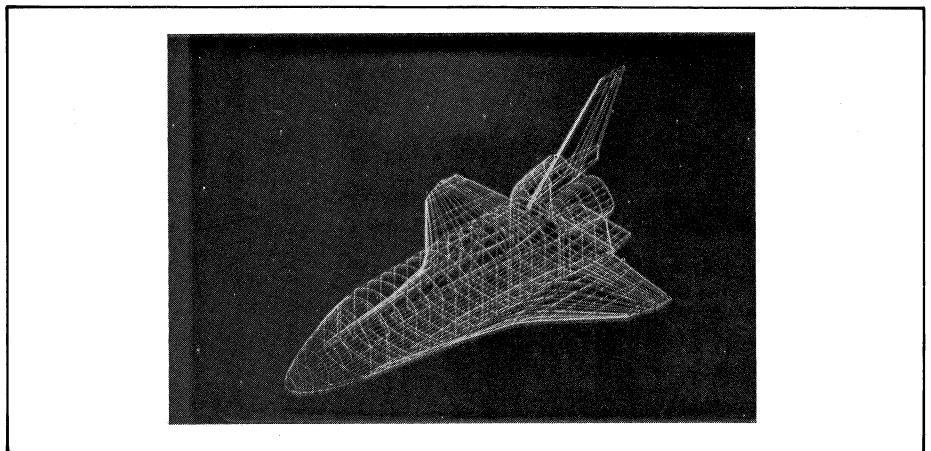

Figure 1. The Space Shuttle is displayed on the face of the Tektronix 4114 graphics screen. Note the three dimensional characteristics of the display. The view can be rotated to various positions to aid the designer's perspective.

"Another feature which impressed us was the color-enhanced refresh option available with the 4114s. Many of our design applications, such as wiring schematics or piping diagrams are extremely dense. The differentiation between the normal green of stored information and the yellow-orange of refreshed graphics ensures a high degree of engineering accuracy - so essential to a safe and successful flight."

State-of-the-art hardware was not Rockwell's only consideration for choosing the Tektronix equipment. The new terminals are also software compatible with the existing Tektronix 4010 series of graphics terminals which are already in wide use at Rockwell.

"On a corporate-wide level, the new equipment fits nicely into our existing system," remarked Larry G. Manly, vice president of Rockwell International's Information Systems Center.

"We have already developed hundreds of years worth of programs using Tektronix

PLOT 10 software. The new terminals will be able to use the existing programs, eliminating almost all reprogramming activity, and most of the re-training for our engineering and design staff," Manly added.

Upon completion of its CAD/CAM facilities, Rockwell will have 34 Tektronix 4114 terminals in use. The graphics terminals will be linked to a large CDC mainframe computer at the Downey-design facility. Rockwell's other computer facilities - Seal Beach, California, Troy, Michigan, Pittsburgh, Pennsylvania, and Richardson, Texas - will also be able to use the design information through a link to the CAD/CAM system.

Most of the 34 terminals will be located at the Downey plant. The remaining terminals will be located at the final assembly plant in Palmdale, California, the launch site at the Kennedy Space Center in Florida, Mission Control at the Johnson Space Center in Houston and at Vandenberg Air Force Base in California.

## CAD/CAM to Speed Design, Analysis of Heat Tiles

One of the first shuttle elements to benefit from Rockwell's new CAD/CAM capabilities will be the thermal protection system (TPS), commonly referred to as the shuttle heat tiles. Of the 31,000 tiles which cover the skin of the shuttle orbiter, no two are identical, differing in material composition, geometry and placement.

"During the initial shuttle orbiter's design and manufacturing stages, most elements of the TPS were maintained manually," Glaysher said.

"Logbooks would detail tile identification number, tile design specifications, placement, materials, as well as all manufacturing parameters. Once designed, individual tiles, or tile arrays could be analyzed for composition, load or stress in a batch mode on our mainframe systems."

According to Glaysher, the shortcomings of a manually-tracked TPS were readily apparent. The volume of information regarding 31,000 tiles was too great to manipulate through logbooks and batch processing.

Furthermore, a faster process was needed because subsequent missions will not have the luxury of lengthy lead times. As NASA schedules flights more frequently, design, analysis or manufacturing modifications must be implemented more quickly.

Currently, Rockwell is completing a CAD/CAM data base containing all the information concerning Columbia's TPS gathered from the initial production. This data base can be accessed via the terminals to perform design revisions and all analysis functions for the production of subsequent spacecraft.

Rockwell is also automating much of its manufacturing operations. The new machinery will run under the control of numeric control (NC) tapes which manufacturing engineers will create with the CAD/CAM system.

### Graphics Terminals Speed Support, Improve Productivity

If a shuttle tile problem arises during any stage of a flight - from final assembly in Palmdale, the launch site in Florida, through the landing in California, the terminals will always be close by to aid with replacement, redesign and manufacturing.

A series of sensors on the underskin of the shuttle vehicle will inform engineers of problem areas during both preparation and flight. If a problem arises, for instance at the launch site, an engineer can call up from the tile base an overall view of the shuttle orbiter (see figure 1).

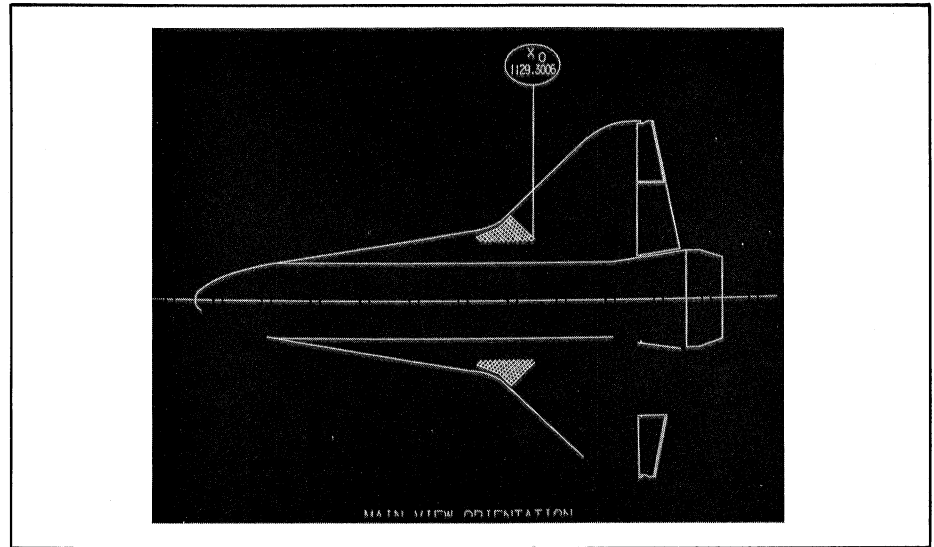

Figure 2a. The graphics display allows engineers and designers to focus on key details, such as tile configurations in this wing section.

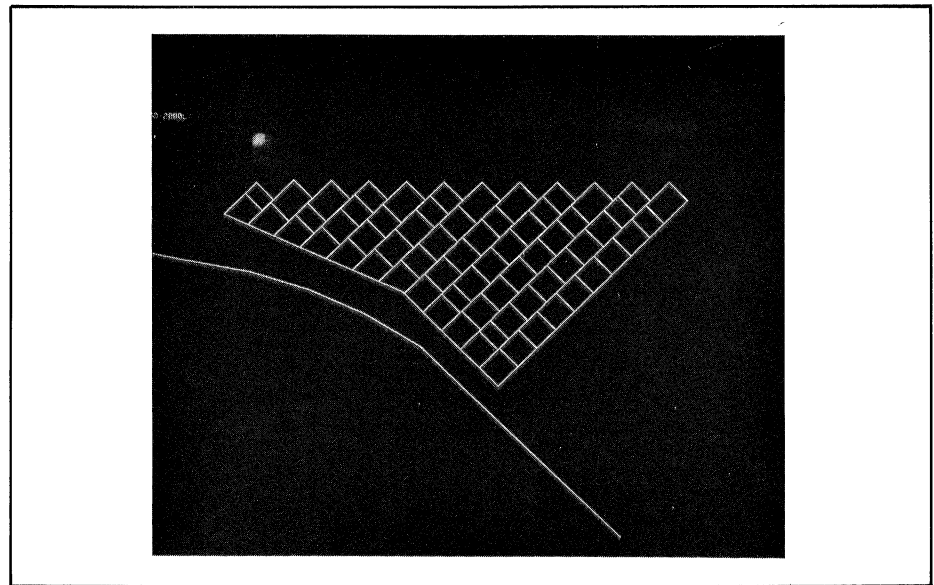

Figure 2b. The engineer can request the terminal to display smaller segments of the tile design.

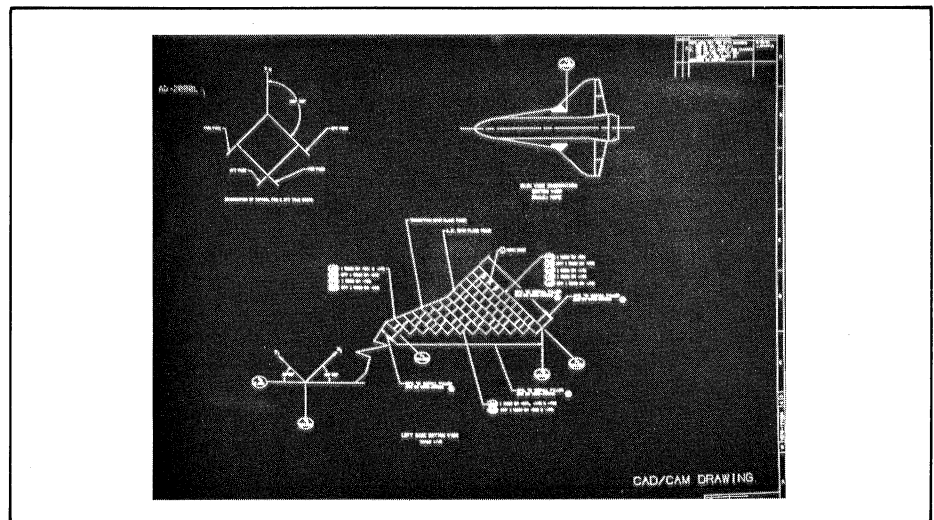

Figure 3. The characteristics of a single tile in an array can be pinpointed.

The engineer will then locate the general area of the tile problem. As the area is determined, the engineer can specify increasingly smaller segments of the tile design to appear on the CRT screen (see figure 2), until the exact problem area – a tile array, or even a single tile – is pin-pointed (see figure 3).

Once a problem is located, such as an ill-fitting, or improperly machined tile or tile array, a design engineer can make numerous design changes on the CRT screen. Tile geometry, composition and placement can be experimented with, altered and then the designs can be re-integrated into the total structure to ensure that modifications are structurally sound.

After design modification, a TPS element is ready for analysis. With the Tektronix 4114 terminals and analysis programs developed by Rockwell, engineers will subject individual tiles, tile arrays or the entire system to as many as 17 different load, stress, temperature and vibration analyses – all in an interactive mode.

“What is most remarkable about these analyses is that they are not ‘standard’ tests,” Glaysher explained. “Because the exact flight elements for each mission are planned well in advance, we can use our interactive graphics system to study the exact forces a particular shuttle vehicle will experience on a particular flight. These analyses are based on the flight route (orbit, distance) and flight procedures (speed, reentry, flight maneuvers).”

Once analysis is complete and any further design modifications have been made, the terminals will aid in the tile manufacturing procedure. Before any materials are used, or before prototype parts are manufactured, engineers can study the machining procedures of the tiles on the CRT screen.

An engineer will watch the path of cutting blades on the tile material, simulating the procedure of the multi-axial automatic equipment used by Rockwell. With the CAD/CAM system an engineer can be certain that elements will be constructed properly, and that the manufacturing procedures will allow the parts to be easily integrated into the entire design. After an engineer is satisfied with the manufacturing procedures, a numerical control tape will be produced from the CAD/CAM system for use by Rockwell or its subcontractors.

Although a subcontractor manufactures most of the heat tiles to Rockwell’s specifications, Rockwell is solely responsible for replacement tiles and critical or closeout tiles. Critical tiles are the highly customized pieces which fit between or “closeout” two sections of the TPS.

“Our CAD/CAM system allows us to modify, analyze and manufacture critical or replacement tiles in a fraction of the time previously required,” said Glaysher.

“The compression of production time will allow us to respond to preflight problems more rapidly. In addition, we will be able to implement modifications more rapidly and have confidence that the modifications will be properly engineered and analyzed.”

#### **CAD/CAM’s Role in Future Missions**

Interactive graphics will be an important element for many of the experiments planned for future shuttle missions. A new tunnel hatchway (see figure 4) was integrated on spacecrafts in 1982.

Located in the Pod Bay section of the spacecraft, the hatchway is used by astronauts moving from the main orbiter to the ancillary experiment stations. The tunnel will link the orbiter to the flying lab planned for missions in 1983 and the remote control telescope planned for missions in 1985.

“The hatchway was designed entirely on the Tektronix 4114,” Glaysher pointed out.

“Original designs were created and modified on-line, and then integrated into existing views of the orbiter to ensure that the new element worked with a proven craft.”

“The time savings afforded by interactive graphics have been remarkable. We went from initial design to a production part in several months; in the past this operation would have taken more than a year to complete.

“Furthermore, we reduced the amount of manual drawing and revision to almost nothing, allowing a smaller staff to handle a large design project. When a design is complete on the terminal it can then be automatically plotted for use by manufacturing personnel or subcontractors.”

According to Glaysher, the Tektronix 4114 terminal will play a larger role as the shuttle program progresses. For the moment it has allowed Rockwell to reduce significantly the design and analysis time required to maintain the growing complexity of the program.

“Most importantly, our CAD/CAM system allows us to perform countless design and analysis iterations in a fraction of the time previously required. Because we can study more design configurations and perform more effective analyses, we can deliver a safer, more productive Space Shuttle.” 

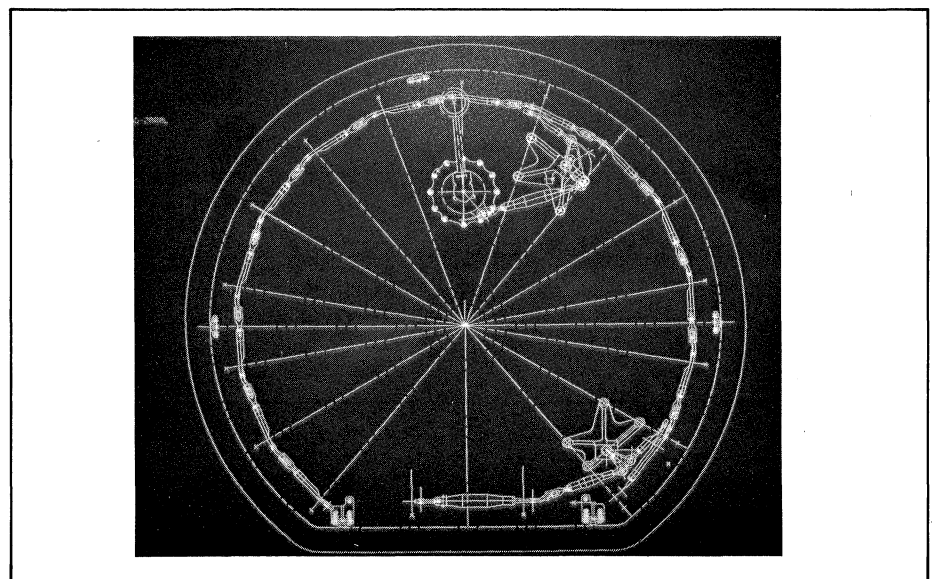
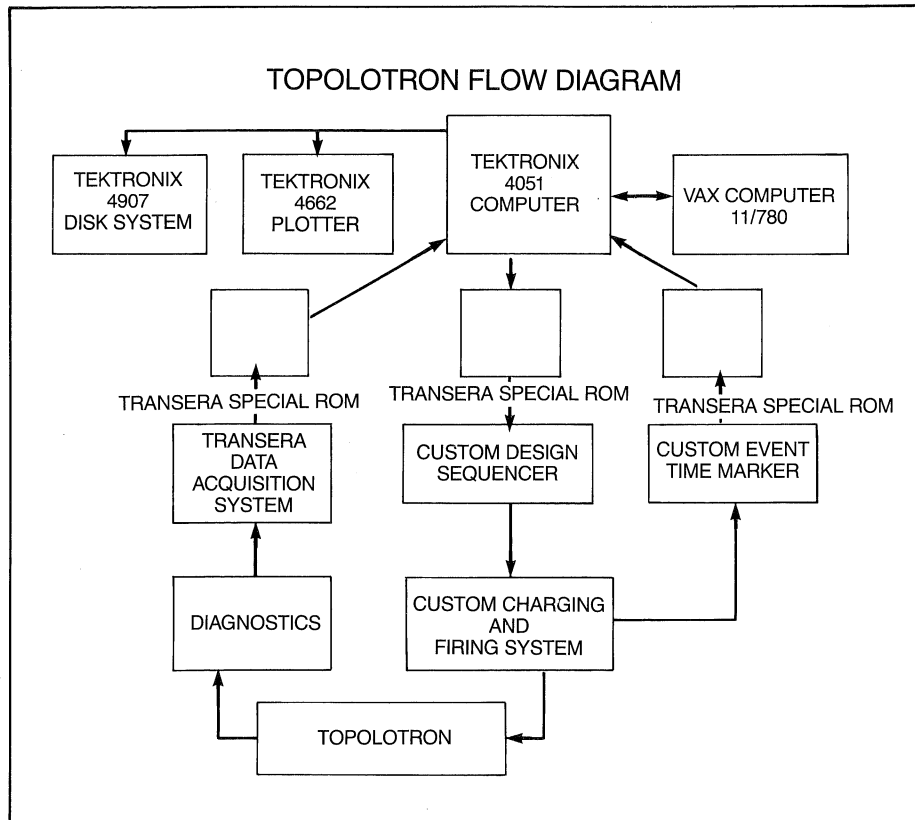

Figure 4. A new tunnel hatchway has been recently incorporated into the Space Shuttles.

# Tektronix Desktop Computer Indispensable in Fusion Research



A data acquisition system comprising a Tektronix 4051 and a TransEra analog-to-digital converter is helping to harness the power of the sun. Positive results from this experiment to duplicate the features of the largest energy source in the solar system could contribute to the establishment of the world's first functioning fusion reactor.

Fusion is the combining of lighter elements into a heavier element with an associated release of energy - which is exactly the way the sun creates its energy. Unlike the sun, however, Man has not been able to "confine" the reaction for a long enough time to control and use the released energy. Therefore, this source of relatively safe atomic energy (as opposed to fission) is currently unavailable except in the experimental state.

Investigating a possible way of confining the reaction is the purpose of "Project" Topolotron, sponsored by the Brigham Young University Plasma Physics Group. Heading up the research is Professor H. Mark Nelson in collaboration with Research Assistants Bryan Peterson, Fred Rock, Ed Gholdston, and others. The experiment is an attempt to research the stability of a magnetically confin-

ed "plasma" (often called the fourth state of matter), in which the fusion reaction is to take place. Understanding a plasma's behavior is critical to exploiting fusion as a source of energy.

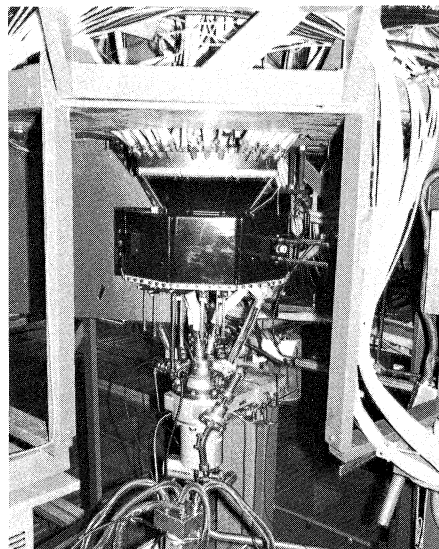

Shown here is Brigham Young University's Topolotron. The fusion reaction occurs inside the enclosure. Fiber-optic cables carry the data to the acquisition system inside the RF-shielded screen room.

Control of the fusion reaction involves simultaneously achieving adequate density, confinement time, and temperature. BYU's research efforts center around the study of magnetic field effects on the confinement of a plasma, and they have chosen the Tektronix 4051 microcomputer plus some TransEra peripheral devices to assist in data acquisition and experiment control.

Researchers believe that the use of magnetic fields is the key to a successful confinement system, even though magnetic fields when combined with the plasmas are generally unstable. BYU feels that its unique coiled magnetic configuration will help confine the plasma by maintaining the magnetic currents as long as possible. "As long as possible" is 50 microseconds or greater. When that field duration is reached, BYU will consider the experiment a success.

The BYU experiment uses a VAX 11/780 for number-crunching and mass storage and the Tektronix 4051 for control of the experiment, data acquisition, and display. The output, usually in the form of two- and three-dimensional diagrams, can be displayed on the 4051 graphics screen or output on a 4662 plotter.

Because of electrical noise emitted during the experiment, the 4051 and its associated data acquisition and interfacing electronics are located inside a screen room shielded from radio frequencies. Most of the experiment control (such as vacuum valve control sig-



Inside the screen room, the data is fed to the Tektronix 4051 and printed on the 4662.

nals, power supplies, etc.) is done via fiber optics with all data signals entering the screen room through coaxial cables.

As mentioned, the experiment has a very short duration (50 microseconds). Therefore, to get enough resolution, BYU uses a series

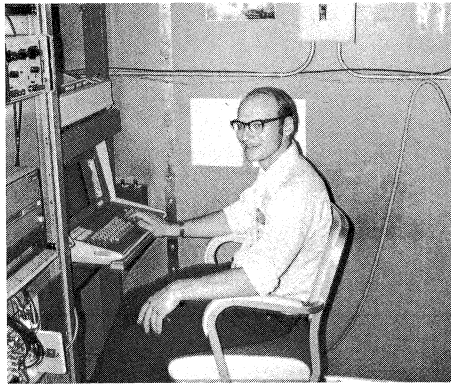

Research Assistant Bryan Peterson, seated at the console of the 4051, monitors the experiment. Notice the wall of the RF-shielded screen room in the background.

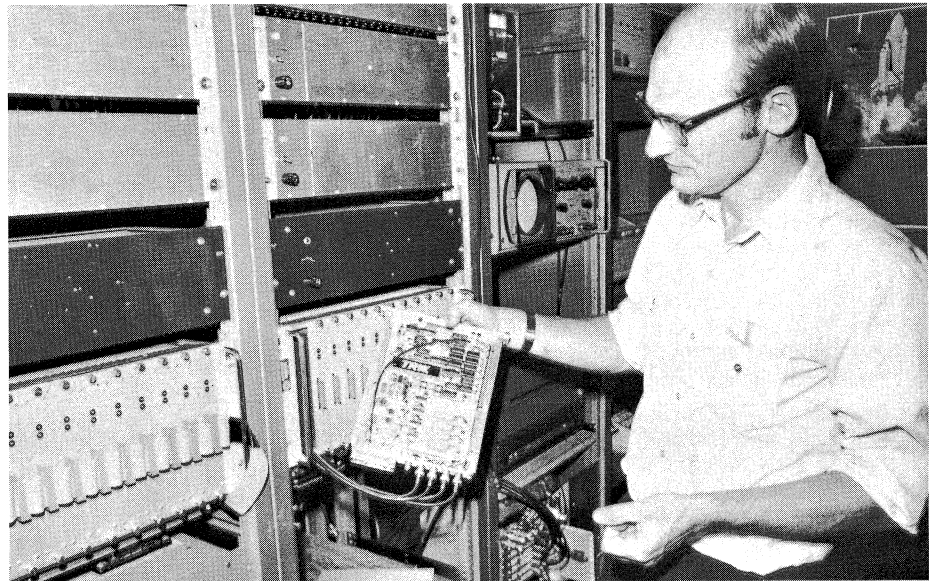

Bryan Peterson holds one of the boards from the specially designed data acquisition system processors which consist of 24 TRW A/D converter boards in a rackmount chassis.

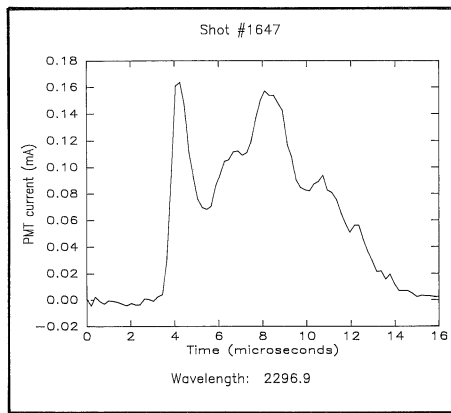

To generate a fusion reaction, the plasma must be bombarded by hydrogen atoms at a high velocity, which causes the associated electrons to be "thrown off." This diagram shows the intensity and duration of the spectral line of ionized Carbon III (two electrons removed) during the experiment.

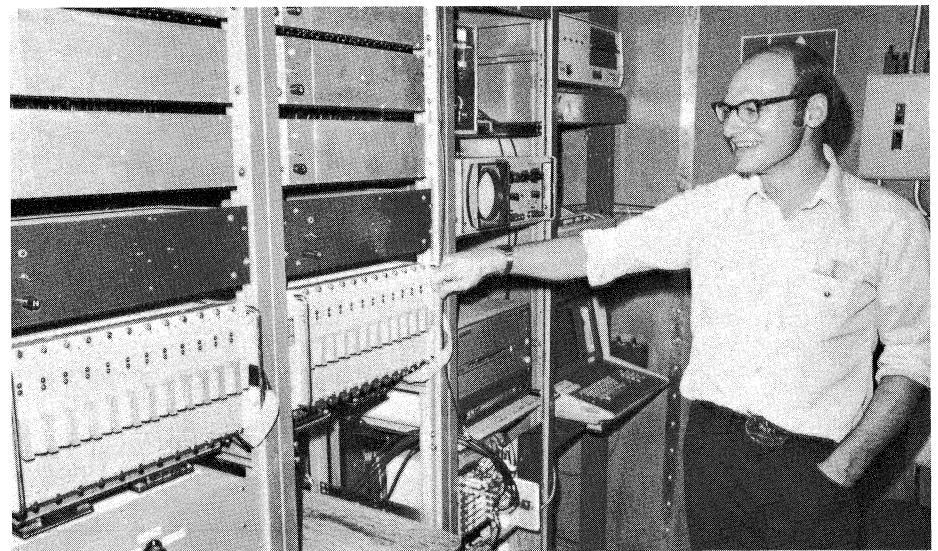

Bryan Peterson displays the 24 TRW data conversion boards which comprise an integral part of the data acquisition system.

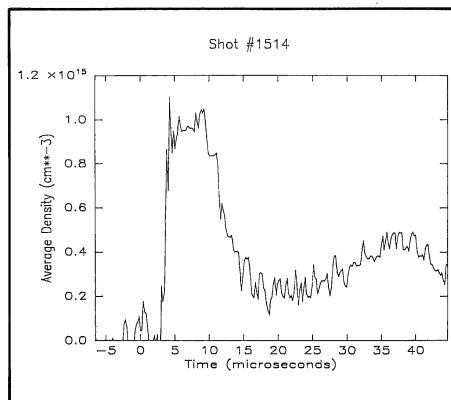

This diagram displays crucial information regarding the density of the plasma. The peaks represent the sustained density. When the peaks can be sustained the full length of the graph, a significant part of the experiment would be considered a success.

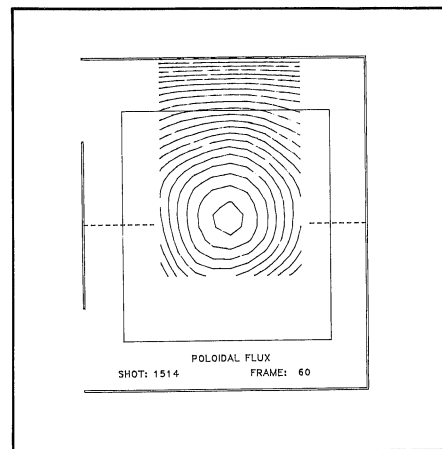

The motion of the plasma within the magnetic fields is important to the success of the experiment. As shown in the diagram, the optimum location is within the inner rectangle.

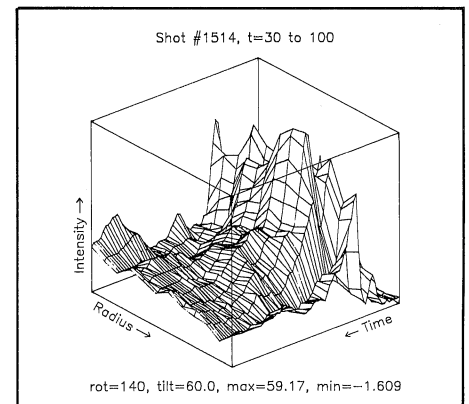

Other important factors in considering the experiment a success are the intensity, duration, and position of the light emitted during the experiment. This three-dimensional graph charts the characteristics of the light, as sampled along 12 vertical, nonoverlapping chords through the plasma.

of high-speed A/D converters designed by Bryan Peterson of BYU and Ron Wilson of TransEra. The system configuration comprises 16 TRW video converters with 4 channels multiplexed into each converter so each channel is sampled 5 times per second.

The system is then interfaced to the 4051 by two custom-designed TransEra interface ROM packs, each of which provides 64 data channels for interface with up to 16 converter boards. With both ROM packs, 24 converter boards are linked to 96 input channels, thus allowing BYU to characterize the magnetic fields, electron density, spectral line intensity, and total light emission intensities on any given experiment. Each experiment generates 24,000 data points that must be read into the 4051 and transferred into the mass storage of the VAX. Bryan Peterson cites the TransEra ROM pack as an important aid in obtaining the speed at which data can be read.

Using the 4051 as a host computer has become indispensable for the continuing success of the Plasma Physics experiment at BYU, because of the high quantities of data acquired during an experiment and the amount of calculation required in reducing the data for display. An interactive system is nearly achieved when the data is read from the diagnostics into the 4051, transferred to the VAX for storage and analysis, and then displayed on the 4051 in terminal mode.

Bryan Peterson commended the Tektronix 4051 and its peripherals. "The amount of time saved through using the 4051 as an interface and control computer," he says, "has been of inestimable help in understanding the characteristics of the plasma generated by the BYU Topolotron."

BYU's experiment is not the only such endeavor to confine the fusion process. Other

institutions are also involved. Aided with equipment like the 4051, scientists are able to penetrate frontiers of understanding and find answers to their problems. Tremendous progress has been made over the last few years. Usable fusion energy is becoming less of a dream and more of a reality. 

## \* Editor's Note:

## It's Time to update *TEKniques*' Mailing List

### Return the form in this issue to continue your subscription.

#### **TEKniques Distribution List Updated**

Several years have passed since we verified *TEKniques*' mailing list, so we are asking that readers who wish to continue receiving *TEKniques* send in the form located in the center of this issue. We would also appreciate your taking time to comment about *TEKniques* in the space provided. Thank you for your cooperation.

#### **IDD Program Exchange Official**

IDD Program Exchange is the name for the Tektronix Information Display Division user library. Although new forms and cards reflect the new name, old forms carrying the 4050 Applications Library name will continue to be accepted for membership and documentation.

#### **IDD Program Exchange Contributions**

Programs for any IDD graphics system are welcome in the IDD Program Exchange. 4050 Series programs, 4010, 4020 and 4110 Series host programs, and 4110A Series Local Programmability programs may be included in the IDD Program Exchange. Documentation instructions and forms are available through the IDD Program Exchange serving your area. (See IDD Program Exchange addresses.)

#### **Keep 4050 Series Catalog**

The 4050 Series Applications Library catalog published in 1981 should be retained. New pages will be added periodically, but the original portion will not be reproduced. Present holders of the catalog should clip the New Abstracts pages from *TEKniques* and insert them in the back of the catalog. Those who do not have a copy of the catalog may order it through Tektronix Central Parts Ordering (see New Abstracts section for information) by part number 062-6343-00, or may call the local Tektronix Field Office. 



# Pre- and Post-Processor for Finite Element Modeling Joins Solution Vendor Program

By making users of Tektronix equipment aware of compatible software available from third party vendors, Tektronix is helping customers find timely solutions to their application problems.

PDA Engineering is a corporation that supplies advanced technology to solve design problems for major defense organizations and commercial enterprises. Their software product, PATRAN<sup>TM</sup>-G, is profiled.

## PDA/PATRAN-G

**WESSCO Engineering  
Software Distributors  
P.O. Box 878  
Elk Grove, CA 95624  
(916) 687-7676**

From its user-friendly interface to its powerful mathematics, PDA Engineering's PATRAN-G software has revolutionized traditional approaches to geometry construction and finite element modeling.

In a radical departure from classical methods, PATRAN-G separates the geometric model from the finite element model. This removes a large burden from the engineer. The geometric model is described as continuous functions allowing PATRAN-G to perform the mathematics, generate the topology and manipulate and maintain the data base. The engineer can concentrate on the model, exploring alternative approaches.

PATRAN-G's geometry-based language and interactive graphics facilitate communication between the engineer and the computer. Functional requests construct the geometric model and their free format and order independence remove a traditional bottleneck in the man-machine communication. Extensive graphics capabilities take advantage of the best features of the graphics display giving the engineer complete control over the content, orientation and presentation of the model. The ability to associate color with the geometry enables the engineer to view and interpret the model in an added dimension.

Once an object is constructed, the applications to which its geometry can be applied are limitless. Without modifying the geometry, the engineer can generate many different analysis models for entirely different response modes of the structure. This flexibility is essential for efficient modeling.

Because the geometric model is continuous, it can be subdivided to any required density

for finite model generation. This operation is highly automated leaving the engineer free to make engineering and design decisions.

Although PATRAN-G provides a large library of element types, it can accommodate special purpose elements. And, by taking advantage of the segregation of the geometric model from the finite element model, PATRAN-G very efficiently performs automated equivalencing.

Throughout the finite element modeling process, the engineer need not be concerned with optimality of the overall model with respect to various criteria. Once the engineer is satisfied with the specifications of the model, PATRAN-G will automatically optimize element connectivity.

The results of PATRAN-G's preprocessing can be submitted to a wide variety of analysis programs including MSC/NASTRAN,

COSMIC/NASTRAN, ANSYS, SAP6, SAP7, ASAS, and SINDA among others. An interactive process translates the finite element model's data base into the specific format of the analysis programs.

PATRAN-G also assists the engineer in the interpretation of results. Its extensive post-processing capabilities enable the engineer to visually and interactively examine any response parameter to focus on problem areas. A particularly powerful option is the ability to color code based upon some aspect of the results.

PATRAN-G fully supports the Tektronix 4010 and 4110 families of graphics display terminals and the DEC VAX family, PRIME family, Harris and CDC Cyber computers.

For more information about PATRAN-G and the Tektronix Graphics Terminals, contact your local Tektronix Sales Engineer.

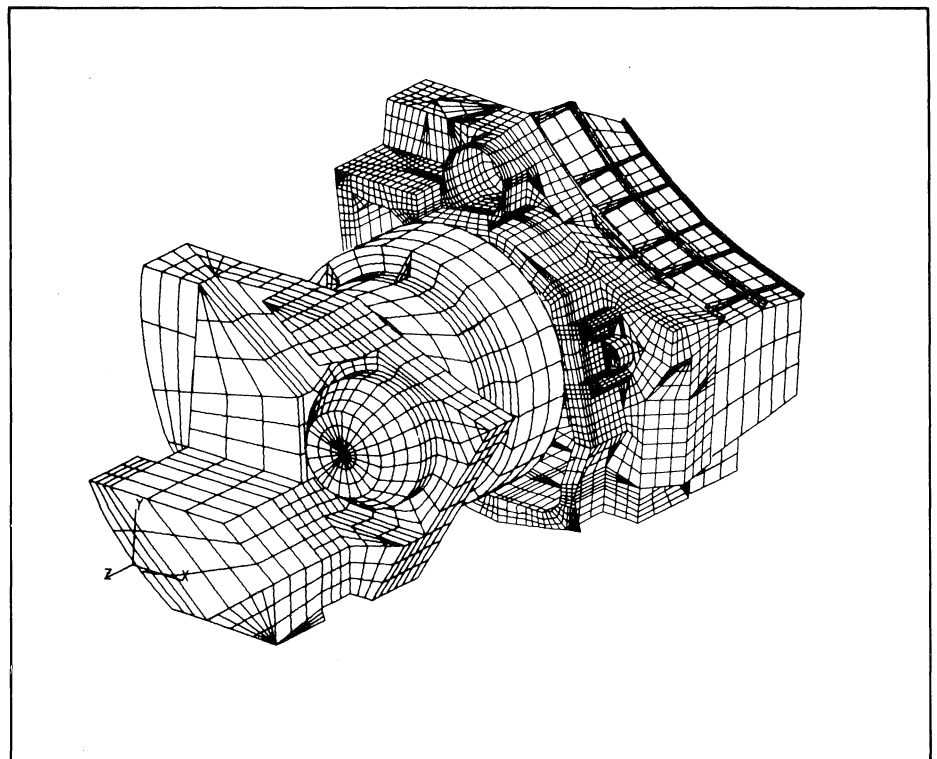

# Solution Vendor Register Outlines Software Solutions for Tektronix Graphics System Users

Solutions for specific applications problems may be as close as the Tektronix *Solution Vendor Register*. A publication of the Solution Vendor Program, the *Register* briefly describes accepted software offerings from outside resources designed for host computers and Tektronix graphics terminals as well as packages for the Tektronix desktop computers.

Currently focusing on engineering and scientific applications, the Solution Vendor Program has identified a number of CAD, CAM, mapping, technical data analysis and application development software packages with a satisfied customer base. A synopsis of these packages follows.

As submittals are accepted into the *Solution Vendor Program*, they will be announced in future issues of *TEKniques*.

For more information on these selected software packages, contact your local Tektronix Sales Engineer.

---

## CAD/CAM

### Computer Aided Design, Drafting and Manufacturing

#### ANVIL-4000

Terminals: 4014, 4100 Series

Computers: DEC VAX, DG 32 bit, IBM HARRIS 24 & 48 bit, PRIME 550, Perkin-Elmer 32 bit

Manufacturing and Consulting Services, Inc.  
17942 Cowan  
Irvine, CA 92714  
(714) 660-1170

ANVIL-4000™ is a comprehensive CAD/CAM package which supports the entire product development and manufacturing process, from concept and design through

production planning and control. The system is adaptable over a broad array of applications including electronic and mechanical design and drafting, finite element modeling, 2-D nesting, comprehensive N/C tape generation, and management information systems.

---

## CAD/Mechanical Engineering

### Finite Element Modeling

#### FASTDRAW/3

Terminals: 4010 Series  
4027  
4050 Series  
4113, 4114

Computers: DEC VAX 11/780

Timesharing: McAuto Timeshare Services

McAuto  
P.O. Box 516  
St. Louis, MO 63166  
(314) 232-6265

FASTDRAW/3 features automatic, interactive mesh generation with solid mesh generation options. Rectangular, cylindrical, and spherical local coordinate systems are also sup-

ported. Interactive post-processing capability includes deflection display, stress display, plot files, and model view enhancements such as shrink, erase, and reorient options.

---

## Structural Analysis and Design

#### GTSTRUDL

Terminals: 4014, 4016  
4114

Computers: DEC VAX, CDC Cyber

Timesharing: Boeing Computer Services  
CDC Cybernet Services

GTICES Systems Laboratory  
Georgia Tech  
Atlanta, GA  
(404) 894-2260 & 2229

GTSTRUDL includes both static and dynamic analysis of structures as well as structural design in steel and reinforced concrete. Used for general finite element analysis and structural analysis of buildings, transmission towers, shell and hydraulic structures, machine components and other structures, the system has integrated pre- and post-processors which minimize the transition between model generation, analysis and design programs, and reviewing results graphically.

## Computer Aided Drafting and Design

### Palette

Terminals: 4014, 4016  
4112, 4114

Computers: DEC VAX and PDP

Structural Programming, Inc.  
83 Boston Post Road  
Sudbury, MA 01776  
(617) 443-5366

A two-dimensional drafting and three-dimensional computer modeling package, Palette is used in electrical, mechanical, civil

and structural engineering, architecture, and both cadastral and topographic mapping. It includes perspective projection and animation features.

---

## Solid Modeling/Finite Element Modeling/Post-Processing

### PATRAN-G

Terminals: 4010 Series  
4100 Series

Computers: DEC, Prime, Harris, CDC

WESSCO Engineering Software Distributors  
P.O. Box 878  
Elk Grove, CA 95624  
(916) 687-7676

PATRAN-G is a general purpose pre- and post-processor for the construction, display and editing of three-dimensional finite element models. An important feature is the ability to create a continuous solid geometric model separate from the analysis model. Generation of multiple analysis models from

this single geometric shape description permits tailoring each analytical model to the analysis type to be performed. PATRAN-G's powerful color capability has an enormous impact in the models and results, and its superior data base management system is virtually transparent to the user. PATRAN-G supports a variety of structural analysis programs.

---

## Finite Element Analysis and Modeling

### MSC/NASTRAN MSC/GRASP

Terminals: 4014, 4016  
4114

Computers: VAX 11/7XX, IBM, CDC,  
CRAY, UNIVAC, FUJITSU,  
APOLLO

The MacNeal-Schwendler Corp.  
815 West Colorado Blvd.  
Los Angeles, CA 90041  
(213) 258-9111

MSC/NASTRAN is a general purpose system that solves a wide variety of engineering analysis problems. Its capabilities include dy-

namic and static structural analysis, heat transfer, material and geometric nonlinearity, electromagnetism, acoustics, aeroelasticity, and any other types of field problems. MSC/GRASP provides MSC/NASTRAN users with friendly, high quality pre- and post-processing tools.

---

## CAD/Architectural Engineering

### Architectural/Interior Design and Drafting

#### TOUCH 'N DRAW

Computer: 4054 Option 24

Arrigoni Computer Graphics  
170 Knowles Ave.  
Los Gatos, CA 95030  
(408) 370-1400

TOUCH 'N DRAW<sup>TM</sup> creates the full range of architectural and consulting engineering drawings using standard pre-stored symbols. Site plans, floor plans, building elevations,

cross sections, and building details can be produced. Detailed engineering overlay drawings for lighting, ceiling, electrical, HVAC and structural elements can be quickly and easily generated. Interior designers and facilities planners can lay out office space, system furniture and other equipment.

---

## Facilities Management

### Spaceman

Computers: 4050 Series

Iconica, Inc.  
5332 College Avenue  
Suite 200  
Oakland, CA 94618  
(415) 428-0963

Spaceman spans a wide range of facilities planning and management tasks including

design, redesign, furniture layout, administration, and space allocation. Perspective drawings can be produced using the system's 3-D capability. Usage and inventory reports can be generated. Space Pro is a companion product for projecting space requirements.

## Mapping/Cartography

### Contour Mapping

#### Contouring System

Terminals: 4010 Series  
4020 Series  
4100 Series

Computers: Major Mainframes and Minis

Precision Visuals, Inc.  
6260 Lookout Road  
Boulder, CO 80301  
(303) 530-9000

The Contouring System is a collection of user-callable routines built on Precision Visuals' DI-3000 system of graphics software

tools. Direct calls to DI-3000 routines may be interspersed with contouring calls to add titling, request graphics input, enable and disable bugging, and generate 3-D views. A scientific calculation in an existing program is easily augmented with Contouring System.

### Statistical Mapping

#### GEOMAP

Terminals: 4027  
4113

Computer: IBM Mainframe

Geographic Systems, Inc.  
100 Main Street  
Reading, MA 01867-3987  
(617) 942-0051

GEOMAP™, a comprehensive package for business mapping, allows interactive definition of a map and immediate viewing of results. Users can select desired data, geographic units, data intervals, colors, patterns, titles,

and legends to produce high quality custom maps. A complete set of GEOFILE cartographic boundary files allows mapping of a geographic area appropriate for the data. GEOBUILD allows users to specify their own unique areas, such as sales territories. GEOMAP software operates as a front-end to ISSCO's TELL-A-GRAF® business graphics.

### Charts, Maps, Illustrations

#### IMAGE

Terminals: 4010 Series  
4020 Series

Computers: PRIME

Alternative View Corporation  
1653 East Main Street  
Rochester, NY 14609  
(716) 654-9030

IMAGE is a core standard computer graphics software system which produces charts,

maps, and illustrations interactively. Reports generated from a customer's data base may be converted automatically into Charts and Graphs.

### Statistical Mapping

#### TRACT-80

Format: EBCDIC or ASCII, 1600 BPI,  
No Label, 9 Track

Geographic Data Technology Inc.  
13 Dartmouth College Highway  
Lyme, NH 03768  
(603) 795-2183

TRACT-80 is a data file containing boundary coordinates for census tracts within 318 Standard Metropolitan Statistical Areas (SMSAs)

defined for the 1980 Census. Similar to the Census Bureau's 1970 Urban Atlas tract boundary coordinate files, TRACT-80 is the only source of 1980 tract geography. It is available in two formats: the DIME format and the Urban or Polygon format.

## Technical Data Analysis and Presentation

### IMAGE

(See Mapping/Cartography section)

### Data Presentation

#### TELL-A-GRAF

Terminals: 4010 Series  
4020 Series  
4100 Series

Computers: Mainframes with FORTRAN

Integrated Software Systems Corporation  
(ISSCO)  
10505 Sorrento Valley Road  
San Diego, CA 92121-1698  
(619) 452-0170

TELL-A-GRAF® is an English language, conversational program that produces a variety of quality graphs for immediate

publication or presentation. TELL-A-GRAF has built-in designs for producing standard graphs and numerous enhancement options for generating intricately tailored charts. Nonprogrammer or programmer will find it a valuable aid.

## Project Planning and Control

### BAI\*PERT

Computers: 4052/4054

**B & A, Inc.**  
225 Santa Monica Blvd.  
Santa Monica, CA 90401  
(213) 451-1743

BAI\*PERT is an interactive, menu-driven project planning, scheduling and control system requiring no knowledge of computer

programming or any programming language; it communicates in English. Using a predecessor/successor format, it builds a project "on the fly," allows alternative exploration, and identifies cost effective procedures.

---

## Data Presentations

### Business Visions

Terminals: 4013, 4015  
4020 Series

Computers: APL Systems

**Digital Visions, Inc.**  
454 West 46th Street  
New York, NY 10036  
(212) 581-7760

Business Visions generates a variety of two and three dimensional chart forms including pie charts, horizontal and vertical bar charts,

bubble charts, scattergrams, net charts, and word charts. Display options include color specifications, grid overlays, definition of viewing position, perspective, and type font selection.

---

## Data Presentation/Business Graphics

### FLEXIGRAF

Terminals: 4010 Series  
4020 Series  
4112

Computer: IBM Mainframe

**Computer Associates**  
4125 North 14th Street  
Phoenix, AZ 85014  
(602) 264-7241

FLEXIGRAF can create virtually any type of chart or graph, company logos, organizational charts, and graphic designs. Text, legends and borders can be added at any angle or po-

sition. It provides automatic data access, conditional statements, arithmetic capabilities, an interactive "sketch-pad" feature, and unlimited color and scaling specifications. FLEXIGRAF is fully integrated with AUTOTAB II, a financial planning system.

---

## Data Presentation

### GRAFMAKER

Terminals: 4010 Series  
4020 Series  
4100 Series

Computers: Major Mainframes and Minis

**Precision Visuals, Inc.**  
6260 Lookout Road  
Boulder, CO 80301  
(303) 530-9000

A system of subroutines callable by application programs, GRAFMAKER tailors graphs from a full range of axes, curves, shadings, grids, legends, and other graphic components

to fit specific data presentation needs. Output may be simple graphs on an interactive display, or publication quality copies on a plotter or other high resolution device. Data structures can be constructed one time and used over and over with new data.

---

## Data Base Management and Presentation

### FOCUS/FOCUS GRAPHICS

Terminals: 4010 Series  
4020 Series

Computers: IBM or Compatible Mainframes  
Under VM/CMS or  
MVS/(TSO,CICS,IMS-DC)

**Information Builders, Inc.**  
1250 Broadway  
New York, NY 10001  
(212) 736-4433

FOCUS is a friendly information control system. Easily understandable, its nonprocedural, English language eliminates unwieldy computer procedures. From simple inquiries to complex problem solving reports, any user, nonprogrammer or programmer, can obtain or store information fast and efficiently. Its comprehensive data base management system, report generator, query language and other features provide easy on-line access to data

and the facilities to develop entire applications. FOCUS may also be used with existing data bases. FOCUS subsystems allow interactive development of graphical presentations of data, financial report models and statistical analysis. FOCUS also has a TELL-A-GRAF® interface.

## Data Presentation

**SPEAKEASY**

(See Application Development section)

---

## Application Development

### General Purpose Plotting

#### DISSPLA

**Terminals:** 4010 Series  
4020 Series  
4100 Series

**Computers:** Mainframes with FORTRAN

**Integrated Software Systems Corporation (ISSCO)**  
10505 Sorrento Valley Road  
San Diego, CA 92121-12698  
(619) 452-0170

DISSPLA® is a high-level subroutine plotting package that provides a production tool

for both business and scientific programmers. DISSPLA can be added to application programs to generate business and management charts, engineering and scientific graphs, reports, maps, contours, and 3-D designs.

---

### Simulation

#### Advanced Continuous Simulation Language (ACSL)

**Terminals:** 4010 Series

**Computers:** Major Mainframes

**Mitchell and Gauthier Associates**  
801 Main Street  
Wayside Square  
Concord, MA 01742  
(617) 369-5115

The Advanced Continuous Simulation Language has been developed to help the engineer or scientist analyze dynamic response, given a

mathematical description of the system. Designed for modeling the behavior of continuous systems described by time-dependent, nonlinear differential equations or transfer functions, an ACSL system helps design engineers express their models for complete solution.

---

### General Purpose Plotting

#### DI-3000

**Terminals:** 4010 Series  
4020 Series  
4100 Series

**Computers:** Major Mainframes and Minis

**Precision Visuals, Inc.**  
6260 Lookout Road  
Boulder, CO 80301  
(303) 530-9000

DI-3000 provides tools for virtually any graphics application, including full color,

2-D or 3-D primitives and viewing, shaded and patterned areas, a graphics data structure, full graphics input, and real-time image manipulation.

---

### Area Fill

#### PANELFILL

**Computers:** 4050 Series

**Computer Mathware**  
P.O. Box 1327  
Princeton, NJ 08540  
(609) 924-6582

PANELFILL is a graphics software utility which will draw, fill, hatch and annotate figures on single and multi-pen plotters.

PANELFILL accepts data from either the user's own software or PANELFILL's digitizing utility. With these capabilities the user can fill, hatch, and annotate maps, diagrams, business charts, graphs, lettering, logos, and a variety of regions quickly and easily.

---

### General Purpose End-User Language

#### SPEAKEASY

**Terminals:** 4010 Series  
4020 Series

**Computers:** IBM and IBM-Compatible Mainframes  
DEC VAX Series

**Speakeasy Computing Corp.**  
222 West Adams Street  
Suite 1425  
Chicago, IL 60606  
(312) 346-2745

Speakeasy creates a user-friendly environment through which the power of a large computer can be used by both the novice and data-processing professional. It provides statisticians, engineers, scientists, and econo-

mists with vector, array, matrix, set and time series oriented statistical, econometric, modeling, graphical and report writing capabilities. Speakeasy includes internal programming capabilities, the ability to link to programs written in the major programming languages, and the ability to interface with other well known commercially available application-specific packages.

# 4110A Local Programmability: A Closer Look

4110A Local Programmability supplies the tools required to develop and run programs locally on the Tektronix 4110A Series of Graphics Terminals. *TEKniques* Vol. 6 No. 4 reviewed the benefits of Local Programmability and briefly described its components. This article takes a closer look at the FORTRAN-86 language, the Low Level Terminal Interface, PLOT 10 Interactive Graphics Library, the operating system and the two assemblers implemented on the 4110A.

## FORTRAN-86

4110A Series Local Programmability's FORTRAN-86 is a high-level language designed for optimal use of Intel's 8086 processor and 8087 numeric coprocessor which form the intelligence of the Tektronix 4110A Graphics Terminals. FORTRAN-86, developed by Intel, conforms to FORTRAN 77 defined by the American National Institute (ANSI) for minicomputers. FORTRAN-86 has been expanded, however, so that it's very close to FORTRAN 77 for large host computers; and it includes additional features helpful in microprocessor software development. This article assumes the reader is familiar with FORTRAN 77 (see accompanying sidebar) and thus focuses mainly on the enhancements provided in FORTRAN-86.

### Data Set Extended

Integer, floating-point, logical and character data types are allowed in FORTRAN-86 with floating-point data encompassing three forms: real, double precision and tempreal.

A storage length of one, two or four bytes for INTEGER data permits values ranging from  $-2,147,483,648$  to  $+2,147,483,647$ . INTEGER constants may be specified in decimal, binary, octal or hex bases.

A choice of data storage lengths provides value ranges for floating-point data of:

REAL	$1.2 \times 10^{-38}$	to	$3.4 \times 10^{38}$
DOUBLE PRECISION	$3.4 \times 10^{-308}$	to	$1.8 \times 10^{308}$
TEMPREAL	$3.4 \times 10^{-4932}$	to	$1.2 \times 10^{4932}$

REAL data is stored in one or two four-byte numeric storage units, DOUBLE PRECISION data in two four-byte numeric storage units, and TEMPREAL data in ten bytes. The internal representation, the precision, and the range of floating-point values conforms to the floating-point conventions established by the IEEE *Proposed Standard for Binary Floating-Point Arithmetic*.

By taking advantage of the 4110A Series 8087 numeric coprocessor, FORTRAN-86 dra-

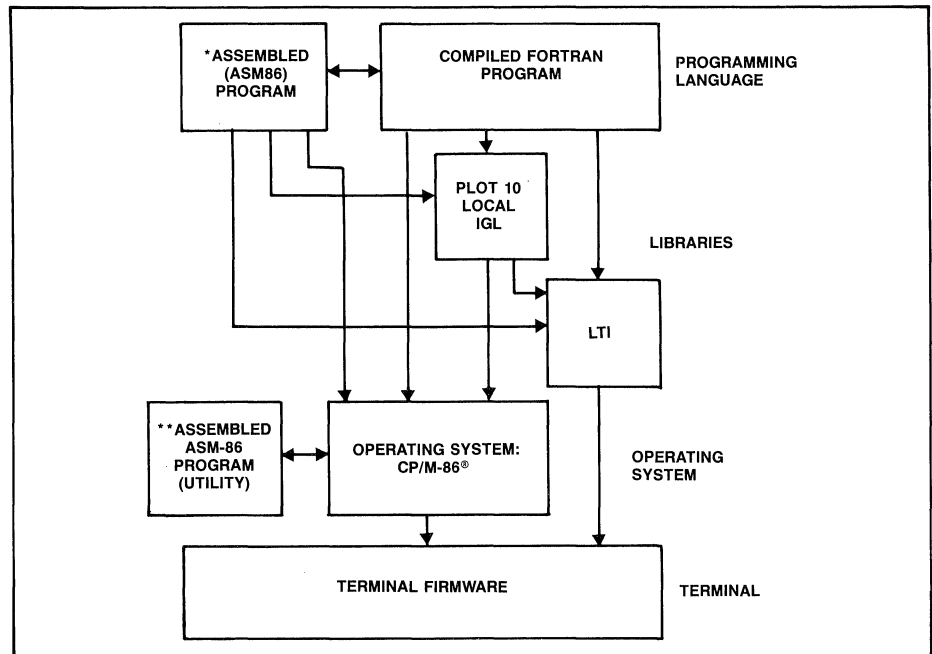

This diagram illustrates the relationships of software modules for a 4110A terminal with Local Programmability.

\*ASM86 is a product of INTEL Corp. ASM86 is available from Tektronix in 4110P02 or 4110P12.

\*\*ASM-86 is a product of Digital Research Inc. ASM-86 is contained in Tektronix version of CP/M-86®. CP/M-86 is a registered trademark of Digital Research, Inc.

matically increases throughput of floating-point operations.

LOGICAL data may have one, two or four-byte numeric storage units.

Augmenting the customary FORTRAN methods for setting data lengths, FORTRAN-86 includes a storage control statement to the compiler which changes the default length specification for INTEGER and LOGICAL data.

FORTRAN-86 supports the CHARACTER data type for better character processing capability, but maintains the HOLLERITH type for compatibility with older FORTRANs.

### Intrinsic Functions Increased

In keeping with the storage lengths possible for FORTRAN-86 data types, arguments supporting these types have been included for the standard FORTRAN *type-conversion functions*. Namely, INTEGER\*1, INTEGER\*2, INTEGER\*4, REAL\*8 and TEMPREAL may be used where appropriate. Four intrinsic functions have been added to support the data types: INT1, INT2, INT4, and TREAL, which perform data type conversion to these respective data types.

FORTRAN 77 *truncation and rounding functions* are expanded to include the new data

types and two functions have been added to round floating-point data types to even whole numbers and even integers.

The customary *MOD remainder function* encompasses the new data types as does the new *RMD function* which uses the whole number rounding in place of truncation to carry out its process.

The rest of the standard FORTRAN 77 intrinsic functions are implemented with provision for the added data types where appropriate.

### % VAL Function Implemented

To enable parameter passing by value for program linkage with non-FORTRAN programs, the % VAL function has been implemented by FORTRAN-86.

### Structured Programming Supported

For easily understood and maintained programs, the improved control structures supported by FORTRAN 77 are adhered to by FORTRAN-86. IF/THEN/ELSE blocks implement decision structures, and IF/THEN/GOTO and DO/CONTINUE statements control looping.

For compatibility with FORTRAN 66, a compiler control specifies whether DO-LOOPS conform to FORTRAN 66 or FORTRAN 77, the former requiring that DO-LOOPS per-

form at least one iteration during execution whereas the latter permits zero iterations.

### Input/Output Broadened

The four standard and three optional physical devices of the 4110A Graphics Terminal, available through the five logical devices provided by the operating system, give the FORTRAN programmer a wide choice for communication.

### Physical Devices

Keyboard (KB)

Terminal's command interpreter (IT)

Direct to Display (DP)  
(bypasses IT)

Host Port (HO)

If Three Port Peripheral Interface is installed:  
Port 0 (PO)

Port 1 (P1)

Port 2 (P2)

### Logical Devices

Console Input (CI)

Console Output (CO)

Auxiliary Input (AXI)

Auxiliary Output (AXO)

List Device (LST)

In addition to assigning physical to logical devices through the operating system directly at the terminal, a library of FORTRAN-callable functions permits dynamic program assignment.

A choice of preconnecting files and logical devices to the input/output UNIT prior to program execution through RUN command controls, or of connecting them through the

OPEN statement during program execution extends input/output flexibility.

The less restrictive list-directed and unformatted data transfers are also supported by FORTRAN-86.

For formatted output, edit descriptors have been extended to include the new data types, and to support interactive input/output from a terminal. B and Z edit descriptors have been added to specify data in binary and hexadecimal notation. The "\$" edit descriptor suppresses "end of line" output during interactive I/O.

### Overlaying Simplified

FORTRAN-86 overlays work very smoothly. Control is passed to a special subroutine in the operating system which loads the overlay and returns control to the "root" program which will call and execute the overlay.

FORTRAN-86, the high-level programming language available for the Tektronix 4110A Series terminals, conforms to FORTRAN 77 for minicomputers, with expansions which bring it close to FOR-

TRAN 77 for host computers. It also has additional features for flexible program design and optimum use of the 4110A's processors. The following table summa-

rizes the advantages of FORTRAN 77 and FORTRAN-86 over older FORTRAN; and the accompanying article profiles FORTRAN-86 enhancements.

	FORTRAN 66	Minicomputer FORTRAN 77	Host FORTRAN-77	FORTRAN-86
<b>Data</b>				
CHARACTER type	No	Yes	Yes	Yes
Hollerith type	Yes	Optional	Optional	Optional
Double Precision	Yes	No	Yes	Yes
Complex	Yes	No	Yes	No
Character Strings	No	No	Yes	Yes
Subscript types	Limited	No array element or function reference	Any integer expression	Any integer expression
Mixed Mode Expressions	No	Yes	Yes	Yes
Number of Dimensions	Unspecified	Three	Seven	Seven
Upper and lower bounds for dimensions	No	Upper	Yes	Yes
Variable dimensions in subprograms	No	Yes	Yes	Yes
IMPLICIT declaration	No	Yes	Yes	Yes
PARAMETER statement	No	No	Yes	Yes
INTRINSIC statement	No	Yes	Yes	Yes
BLOCK DATA subprogram	Yes	No	Yes	Yes
SAVE statement	No	W/List	Yes	Yes
Logical operators for Exclusive OR	No	Yes	Yes	Yes
Concatenation operator	No	No	Yes	Yes
Asterisk specifier for character string length	No	No	Yes	Yes
<b>Structured Control</b>				
Block IF Statement	No	Yes	Yes	Yes
DO Loop				
Index variable parameters	Integer Positive, Integer var.	Integer Pos or Neg, Integer var.	Real or Integer Pos or Neg, Integer exp. or Real expression	Integer Pos or Neg, Integer exp.
comma between statement label & index entered only through DO statement	No	Optional	Optional	Optional
executed if loop count is zero	No	Yes	Yes	Yes
implied allowed in DATA statements	Yes	No	No	Specified
	Yes	No	Yes	Yes



## Compiler Aids

The FORTRAN-86 compiler provides listing output, error messages, and a number of compiler controls to make program development and debugging easier. Controls are provided to copy source code from other files in addition to the main source file, to perform code optimizations, to output debug information and to specify interrupt procedures, as well as to specify other listings and formatting. Most existing FORTRAN programs can be compiled and run with little or no modification.

## Linker Power

LINK86 combines separate object code modules into a single module. It accepts the modules as individual files or extracts them from libraries. Object modules from the FORTRAN-86 compiler, the Low-Level Ter-

минаl Interface Library, the PLOT 10 Local IGL Library, the INTEL ASM86 macro assembler or the user library can be linked and run.

A look at the libraries provided by 4110A Local Programmability will clarify their operation with FORTRAN-86 and one another.

## Low-Level Terminal Interface Library

Graphics applications programmers will find the Low-Level Terminal Interface (LTI) Library supplied by 4110A Local Programmability a valuable resource. To take advantage of the 4110A graphics display features, FORTRAN-86 programs can conveniently access the LTI Library.

This library of over 180 FORTRAN-callable subroutines provides a direct interface to the

terminal's firmware. Each subroutine corresponds directly to one of the terminal's functions. For example, to set the line length of the terminal's dialog area, the FORTRAN program would issue:

```
CALL LLDACH (Ichars)
```

where Ichars is the maximum number of characters permitted on each line of the dialog area.

Designed for efficiency, the LTI library affords a quick path to the terminal's firmware while occupying a minimum of memory.

Since *TEKniques* Vol. 6, No. 3 profiled the features of the 4110 Series Graphics Terminals ("4110 Series: An Evolution in Graphics Display"), only a brief summary of features accessed through the LTI Subroutine Library is covered here.

	FORTRAN 66	Minicomputer FORTRAN 77	Host FORTRAN-77	FORTRAN-86
GOTO statement				
index for computed	Integer var.	Integer var.	Integer exp.	Integer exp.
comma before index	No	Optional	Optional	Optional
Main PROGRAM statement	No	Optional	Optional	Optional
Alternate entry and return points for subroutines	No	No	Yes	No
<b>Functions</b>				
Generic intrinsic function names	No	No	Yes	Yes
Double precision and complex	Yes	No	Yes	Yes
Hyperbolic sine, cosine & tangent	No	No	Yes	Yes
Arcsine & arccosine	No	No	Yes	Yes
Double precision difference & product	No	No	Yes	Yes
Nearest whole number	No	No	Yes	Yes
Nearest integer	Yes	Yes	Yes	Yes
Character conversion	No	No	Yes	Yes
Character string manipulation	No	No	Yes	Yes
<b>Input/Output</b>				
List-Directed	No	No	Yes	Yes
OPEN statement	No	Yes	Yes	Yes
OPEN statement control list	N/A	2 specifiers	9 specifiers	10 specifiers
CLOSE statement	No	No	Yes	Yes
INQUIRE Statement	No	No	Yes	No
Formatted direct-access records	No	No	Yes	Yes
Unit number may be omitted in READ/PRINT statements	No	Yes	Yes	Yes
Error specification may be included in READ statement	No	No	Yes	Yes
UNIT = and FORMAT- may be in READ/WRITE statement	No	Yes	Yes	Yes
Output list may contain expressions	No	No	Yes	Yes
END control item may be in READ statement	No	Yes	Yes	Yes
FORMAT Specification				
apostrophe editing for text	No	Yes	Yes	Yes
Hollerith editors	Yes	Optional	Optional	Optional
T edit descriptors	T only	No	Yes	No
S edit descriptors	No	No	Yes	No
Iw.m edit descriptor	No	No	Yes	No
Ew.dEe & Gw.dEe edit descriptors	No	No	Yes	Yes
Dw.d & Gw.d edit descriptors	Yes	No	Yes	Yes
BN & BZ edit descriptors	No	Yes	Yes	Yes
may be included in I/O statement	No	Yes	Yes	Yes
colon as terminator if no more items in I/O list	No	No	Yes	Yes
may be stored in character variables or array elements	Yes	No	Yes	Yes

*Dialog area commands* setting size, position, surface, writing mode and visibility.

*Graphics commands* directing moves/draws, setting line attributes, marker types, and others.

*Text commands* selecting graph or alpha text and attributes, and displaying it.

*Segment commands* defining a segment and manipulating it.

*GIN commands* for graphics input from various devices, functions enhancing GIN such as inking, rubberbanding, gridding, cursors.

*Macro commands* assigning commands to be invoked by terminal keys or under program control.

*Panel commands* for boundaries, fill patterns, fill mode.

*View commands* selecting views and positioning, setting surfaces, backgrounds, gray levels, color mode and map, and pixel operations.

*Disk commands* for formatting, reading a directory, saving segments, macros and raster data, loading, copying, spooling, deleting, renaming and protecting files.

*Three-port peripheral commands* setting interface parameters, directing output.

*Terminal commands* controlling keyboard, snoopy mode, page full, margins, hard copy.

*Host commands* setting communication parameters.

*Status and report commands.*

## Local IGL

The Local PLOT 10 Interactive Graphics Library (Local IGL) of FORTRAN-callable subroutines may be purchased for use with 4110A Local Programmability. Local IGL provides the user with a rich set of graphics tools. The programmer can concentrate on the application with far less time required to code the necessary higher level graphics routines than would be necessary when using LTI. For example to draw an arc in IGL, the FORTRAN-86 statement would be:

```
CALL ARC (radius, start angle, end angle)
```

Whereas, to draw an arc using LTI routines, the FORTRAN-86 programmer would have to generate a subroutine to determine each intermediate point for the arc and make several calls passing appropriate coordinates each time to the LTI routine

```
CALL LLDRAW (Ix,Iy)
```

while checking for window and viewport edges.

Furthermore, the powerful general routines of Local PLOT 10 IGL are directly compati-

ble with the host version of PLOT 10 IGL. This permits existing host programs using IGL to be run locally. The user simply downloads the program source file, then compiles and links it to Local IGL.

Including Local IGL in the 4110A Local Programmability permits great flexibility in generating graphics: using the graphics routines provided by LTI and/or the routines provided by Local IGL. It also permits flexibility in program execution: on the host, on the terminal, or a combination of the two - without modifying the application program.

## BDOS.LIB

An operating system interface library of FORTRAN-86 and ASM86 callable subroutines is also provided by 4110A Local Programmability. Known as BDOS.LIB, the subroutines therein can be used to access most of the standard CP/M-86 Basic Disk Operating System (BDOS) and Basic I/O System (BIOS) functions, to monitor and control device mapping, to manipulate batch processing, and to check for the presence of input characters at the logical auxiliary input device (AXI). The latter facilitates program communication. A logical function, it permits a program to check for host input and take appropriate action. For example, if input is sensed (axistatus = true), it can be read from the system's buffer; if not (axistatus = false), the program needn't be detained waiting for it.

## User Libraries

A special utility LIB86 creates and modifies specially-formatted files (libraries) which are made up of object code modules and can be

linked to FORTRAN-86 programs. Combining modules in libraries speeds linkage, shortens LINK86 command lines and makes linking easier by letting the user refer to a group of modules by a single file name. LIB86 can manipulate object modules produced by both FORTRAN-86 and ASM86.

## CP/M-86<sup>®</sup> Operating System

Tektronix chose a compact, industry standard operating system to implement Local Programmability. CP/M-86 is a 16-bit version of the popular microprocessor operating system, CP/M. Developed by Digital Research, CP/M-86 supports the advanced features of the Intel 8086 16-bit microprocessor.

The CP/M-86 Operating System allows the user to create and manipulate files, manage resident memory, and control peripherals. The system is friendly and effective; its commands are easy to learn.

Tektronix has heavily enriched CP/M-86 with utilities for greater control of system resources.

There are two levels of interaction with the operating system: at the operator level and at the program level. The latter permits programs to call operating system functions to perform "low-level" tasks briefly reviewed earlier in BDOS.LIB. Operator level functions of the operating system will be the subject here.

## Console Command Processor, BIOS, BDOS

The Console Command Processor (CCP) interprets commands from the keyboard then

Continued on page 21

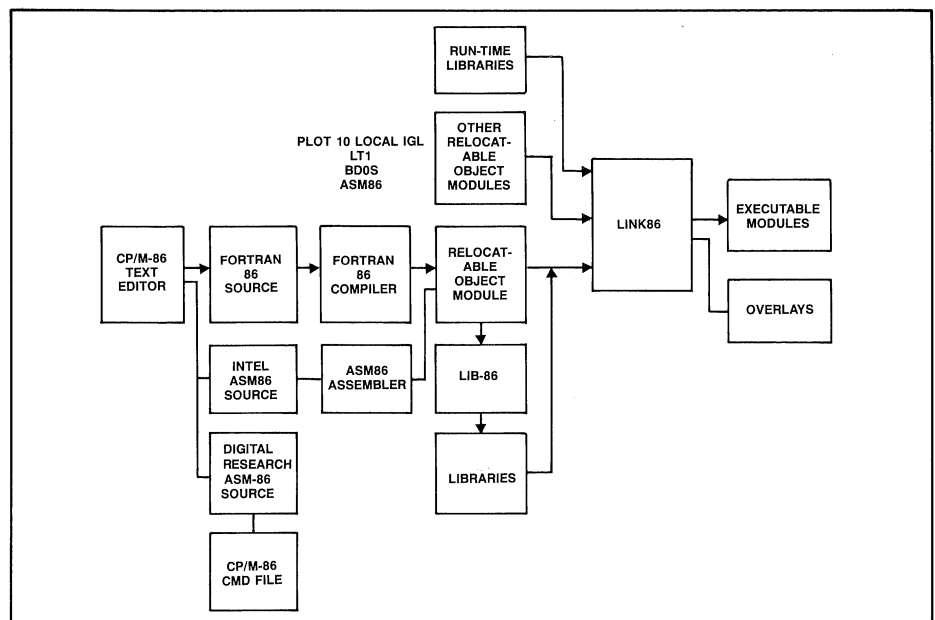

4110A Local Programmability provides the resources for flexible program development.

# TEKniques

*TEKniques* is published by the Information Display Division of Tektronix, Inc. Its application articles and news of new Information Display Division products will be of interest to managers of graphics related projects. Qualified individuals who return the following form may receive *TEKniques*.

Name \_\_\_\_\_ Date \_\_\_\_\_

Job Title \_\_\_\_\_ Tek Sales Engineer \_\_\_\_\_

Company \_\_\_\_\_ Department \_\_\_\_\_

Address \_\_\_\_\_

City \_\_\_\_\_ State \_\_\_\_\_ Zip \_\_\_\_\_

May we phone you for a discussion about your application? Yes, phone \_\_\_\_\_

## Primary Product Interest Area (check one)

- Graphics Terminals
- Intelligent Graphics Terminals
- CAD Workstation
- Desktop Graphics Computers
- Other Graphics Devices \_\_\_\_\_

## Please evaluate *TEKniques*

	Very Useful	Useful	Not Useful
Applications Articles	<input type="checkbox"/>	<input type="checkbox"/>	<input type="checkbox"/>
New Product Information	<input type="checkbox"/>	<input type="checkbox"/>	<input type="checkbox"/>
Programming Tips	<input type="checkbox"/>	<input type="checkbox"/>	<input type="checkbox"/>
New Abstracts	<input type="checkbox"/>	<input type="checkbox"/>	<input type="checkbox"/>
Other _____			
Other features you would like to see included _____			

## Your Relationship with/to Computer Graphics (check all that apply)

- Operator of a Tektronix graphics product
- User of the output of Tektronix graphics products
- Programmer of Tektronix graphics products
- Manager of Tektronix graphics product operators/users
- Manager of graphics programmers
- Specify graphics product purchases
- Approve graphics product purchases

Fold here



NO POSTAGE  
NECESSARY  
IF MAILED  
IN THE  
UNITED STATES

**BUSINESS REPLY MAIL**

FIRST CLASS PERMIT NO. 1 BEAVERTON, OR

POSTAGE WILL BE PAID BY ADDRESSEE

TEKTRONIX, INC.  
Information Display Division  
IDD Program Exchange  
Mail Stop 63-575  
P.O. Box 1000  
Wilsonville, Oregon 97070

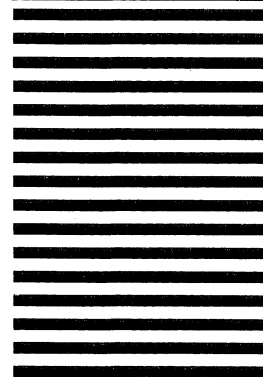

initiates BDOS (Basic Disk Operating System) functions to carry out the commands. The CCP allows multiple programs to reside in memory, providing facilities for background tasks such as spooling or debugging.

Allocating memory for transient programs, tracking program load order and monitoring the keyboard are all CCP tasks.

The BIOS controls, at the lowest level, reading from and writing to the disk drives, the console and other hardware functions. Acting through the BIOS, the BDOS supervises input and output. BIOS and BDOS functions are made available to other programs through special BDOS calls to terminal functions (noted in the section on FORTRAN-86).

### File Management

Source and text files can be created and altered using the CP/M-86 text editor, which is both a line-oriented and context-oriented editor.

The Peripheral Interchange Program copies files, combines files and copies files to and from auxiliary devices, with options to process the source file in special ways.

Files can be copied/backed-up using the archive utility.

An interactive Tektronix HOST utility transfers ASCII files between 4110A Series terminals and a remote host computer system. A menu and several modes of operation provide ease of use and versatility. File transfer can be started or stopped and the user can browse through files on either system. No applications programming is necessary.

The Tektronix SPOOL utility transfers files to serial devices in the "background" allowing operator interaction with the terminal to continue during the transfer.

The directory of files on a disk can be displayed in several formats, and the contents of a file may be displayed on the 4110A graphics screen with one command.

One or more files may be removed from the directory of a disk with verification before deletion.

User numbers and file attributes control file access. The disk directory can be divided into distinct groups through user numbers.

### Batching Commands

A Tektronix batch utility reads commands and command arguments from a file and submits them to the operating system for execution one at a time. Thus, a batch of commands may be executed without further intervention, freeing the operator for other tasks. Batch jobs may be nested to any level.

BATCH replaces the CP/M-86 SUBMIT utility.

### Controlling Disk Drives/Files/Devices

Information about the drives, files and devices associated with the 4110A terminal may be elicited. Attributes of files and drives may be changed and physical devices may be assigned to logical device names. A Tektronix utility extends the physical-to-logical device mapping facility. It also provides access through the operating system to certain unique 4110A terminal features such as the optional 3-Port Peripheral Interface.

### Other Utilities

Other Tektronix utilities controlling the BREAK KEY, disk formatting, memory allocation and terminal operating mode are also contained in the CP/M-86 operating system.

The HELP utility may be invoked to obtain condensed information on all of the operating system's commands and utilities. The user may also add his own entries to the HELP utility.

Although the ability of FORTRAN-86 to perform many operating system level functions by calling the subroutine BDOS.LIB will often obviate the need for assembly language programming, there are cases when assembly language programs may be required. Two assemblers are provided for when this need arises.

## ASM-86 Assembler

Programs developed in Digital Research's ASM-86 assembly language can be used to write new commands for the CP/M-86 operating system. The Digital Research ASM-86 assembler is small and fast, producing a command file from the assembly language source which can be invoked by simply typing in its name on the keyboard. The ASM-86 assembler can also be used to assemble CP/M-86 programs written by other users or vendors.

### Assembly Language Program Development Aids

ASM-86 utility converts 8086 assembly language statements into machine language in hexadecimal format.

Using the hex output of ASM-86 and other language processors, the GENCMD utility produces a command file. Once converted, the program is invoked by typing in its name on the keyboard.

Assembly language programs may be interactively monitored and tested with the DDT-86 utility.

## ASM86 Assembler

Intel's ASM86 is an 8086 macro assembler that produces 8086 object code modules with 8087 instructions that are linkable to object modules produced by FORTRAN-86. It is a macro assembler which can be used to code additional FORTRAN-86 callable routines.

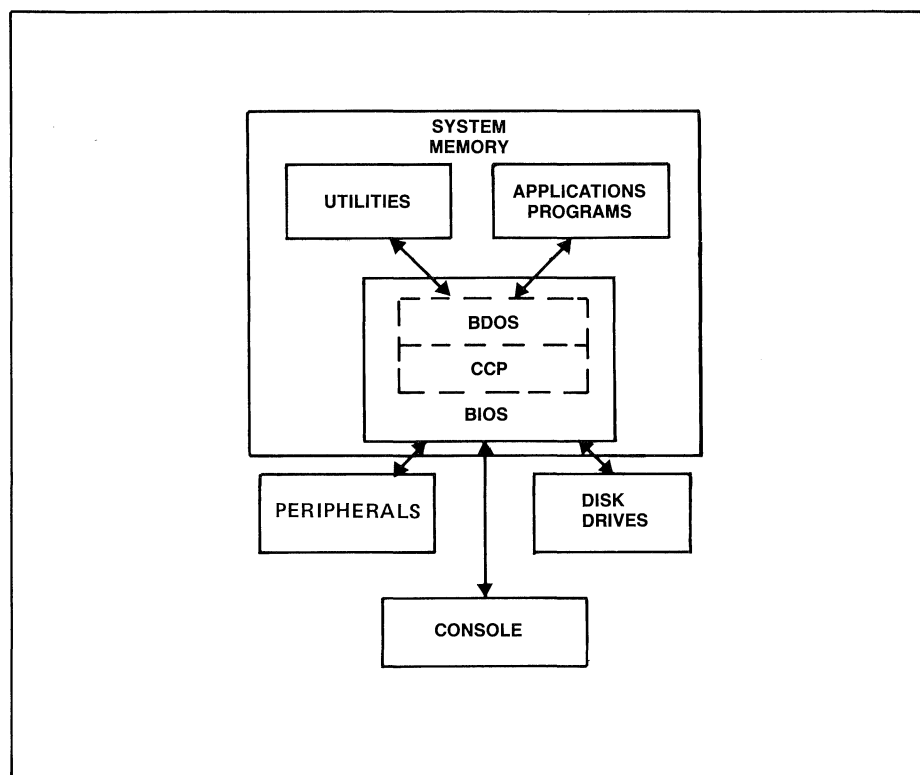

How the operating system functions in programs.

## IDD Program Exchange

Included with Local Programmability is a collection of programs contributed by other users to the IDD Program Exchange. Although these programs are not supported by Tektronix, they contain a number of useful utilities including text editors, CP/M-86 assembler post-processor, programming aids, file copiers, quick batching, date and time, and a special memory pseudo disk drive.

The disk will be updated periodically with additional programs. The current release will be available through the IDD Program Exchange and will be described in the New Abstracts section of *TEKniques*.

## Graphics Terminals Keep Pace

4110A Local Programmability is a natural progression for Tektronix graphics terminals. From the first display in 1968 to the current 4110 Series lies a path of increasing intelligence as dumb terminals became smart and smart terminals became intelligent. Now another large stride has been taken adding mini computing power to intelligence. 4110A Local Programmability combines versatile, friendly software with advanced graphics displays providing the tools to develop:

- Standalone processing for FORTRAN application programming, local mass storage.
- Pre-processors such as program source files for uploading to the host computer, data files for the host, digitizing programs for entering data from the tablet, plotter or screen;
- Post-processors for reformatting host output, performing local statistical analysis, graphing data, fitting curves;
- Programs for distributive processing such as downloading a data base from the host, prompting the 4110A user to edit the data base, and then sending only the final changes to the host to update the master data base;

As Tektronix terminals have evolved, Tektronix has maintained a commitment to compatibility. This commitment also ensures that programs developed today using FORTRAN-86 will run on future 4110A Series Graphics Terminals, preserving the user's investment in software.

## 4110A Component Summary

4110A Local Programmability can be obtained in several different configurations.

**4110P01** contains the CP/M-86 operating

system (and the ASM-86 assembler), FORTRAN compiler, linker and librarian, the LTI library, the BDOS library and the Program Exchange utilities.

**4110P02** contains the CP/M-86 operating system, the Intel ASM86 assembler, the linker, the librarian and the LTI library, for those interested in developing applications in assembly language.

**4110P11** includes the FORTRAN compiler only. This product adds FORTRAN language capabilities to those systems using 4110P02.

**4110P12** adds the ASM86 assembler to 4110P01. Remember that this is the FORTRAN-86 compatible assembler.

**4110P70** is the optional PLOT 10 Local Interactive Graphics Library (IGL). Options are available for Local IGL.

## Documentation

The following list describes the manuals in each binder shipped with 4110A Local Programmability, their publisher, and their Tektronix part number.

### **4110 SERIES CP/M-86® SYSTEM OVERVIEW AND LTI BINDER**

**4110 Series CP/M-86® System Overview (Tektronix) 070-4504-00**

- Provides an overview of 4110A Local Programmability.
- Describes the Tektronix-written utilities.
- Gives an example of a FORTRAN compile and link.
- Gives an example of a FORTRAN overlay.
- Describes the BDOS.LIB routines.

**4110 Series Low-Level Terminal Interface (Tektronix) 070-4534-00**

- Describes the LTI.LIB routines.

**4110 SERIES CP/M-86® O.S. BINDER 062-6739-00**

**CP/M-86 Operating System User's Guide (Digital Research)**

- Describes the standard CP/M-86 commands.

**CP/M-86 Operating System Guide (Digital Research)**

- Describes the system calls.
- Used with the LLBDOS routine in the BDOS.LIB.
- Used with the Digital Research ASM-86 Assembler.

**CP/M-86 Operating System Programmer's Guide (Digital Research)**

- Describes the operation and use of ASM-86 Assembler.

**CP/M-86 Operating System Command Summary (Digital Research)**

- Describes the standard CP/M-86 commands.
- Pocket reference card.

(All four manuals are included in the 062-6739-00 part number.)

The following manuals are shipped with the FORTRAN software configurations.

**4110 SERIES FORTRAN BINDER**

**FORTRAN-86 User's Guide (Intel) 062-6737-00**

- Describes the language.

**FORTRAN-86 Pocket Reference (Intel) 062-6736-00**

- Describes the language syntax.

**iAPX86,88 Family Utilities User's Guide (Intel) 062-6735-00**

- Describes the linker and librarian.

**iAPX86,88 Family Utilities Pocket Reference (Intel) 062-6734-00**

- Summary for the linker and librarian.

The following manuals are shipped with the Intel ASM86 Assembler software configurations.

**4110 SERIES ASSEMBLER (I) BINDER**

**8086/8087/8088 Macro Assembler Operating Instructions (Intel) 062-6748-00**

- Describes Assembler.

**8086/8087/8088 Macro Assembly Language Reference (Intel) 062-6749-00**

- Describes the Macro Assembly language.

**4110 SERIES ASSEMBLER (II) BINDER**

**ASM86 Macro Assembler Pocket Reference (Intel) 062-6746-00**

- Describes the language syntax.

**An Introduction to ASM86 (Intel) 062-6747-00**

- Gives an overview of ASM86.

**ASM86 Language Reference (Intel) 062-6750-00**

- Describes the syntax of each mnemonic.
- Describes register organization.
- Describes memory addressing techniques.



# PLOT 10 — A Lasting Commitment to Excellence

by Will Gallant  
Tektronix, Inc.  
Wilsonville, OR



These are the basics. PLOT 10 TCS includes these and several variations of most, such as relative and absolute line drawing. The simplicity of TCS commands belies their power. Interactive zooming with automatic picture clipping takes only a few lines of FORTRAN. Topological mapping, blueprint review, building layout and finite element model viewing are just a few of the applications developed by programmers using PLOT 10 TCS as a base.

Small size is an attractive feature of PLOT 10 TCS. If the host computer is a DEC PDP-11 with RSX-11M or of equivalent capacity, then PLOT 10 TCS may be the best fit.

TCS is designed and tuned to support the features of Tektronix 4006, 4010, 4012, 4014 and 4016 DVST terminals. Dashed lines, 1024 and 4096 display resolution, multiple character sizes, crosshair cursor, and attached peripheral devices are all accommodated by PLOT 10 TCS. But PLOT 10 TCS is not restricted to these terminals. Graphics display devices emulating the 4010 Series will find PLOT 10 TCS a valuable resource. The Tektronix 4050 Series Desktop Computer and the new 4110 Intelligent Terminals can operate in 4010 emulation mode.

Add-on modules in the "A" Series of software include 4010A02 PLOT 10 Advanced Graphing II (AG-II). With PLOT 10 AG-II

By definition a standard is generally regarded as accepted industry practice and Tektronix PLOT 10 software products have been setting standards in the computer graphics industry for over 10 years. Mention "PLOT 10" and most people would call to mind the PLOT 10 Terminal Control System (TCS). With the large number of copies installed around the world, it is a natural association. Back in 1976, it was revealed that tens of thousands of copies of the PLOT 10 TCS user's manual had been distributed. PLOT 10 TCS was definitely creating a standard.

technology and the details of the graphics terminal operation, PLOT 10 TCS frees the programmer to concentrate on the application. Graphics operations familiar to many are:

- |          |              |
|----------|--------------|
| MOVE     | DASH PATTERN |
| DRAW     | ERASE        |
| ROTATE   | BELL         |
| SCALE    | POINT        |
| WINDOW   | CROSS-HAIR   |
| VIEWPORT | CHAR IN/OUT  |

There is much more to PLOT 10 than just the Terminal Control System. The charter of the Graphics Software Products group at Tektronix is to create tools for graphics application builders. This article briefly describes many of the software tools developed, their intended purpose and physical specifications. PLOT 10 software products are grouped into three families referred to as the "A," "B," and "C" Series.

## The "A" Series

This is the software product family built upon the 4010A01 PLOT 10 Terminal Control System (TCS). PLOT 10 TCS and all members of the "A" Series are written in the ANSI FORTRAN IV language. PLOT 10 TCS provides the FORTRAN programmer with fundamental tools to begin an interactive graphics application project. By managing the intricacies of computer graphics

## Family Members of the PLOT 10 Terminal Control System

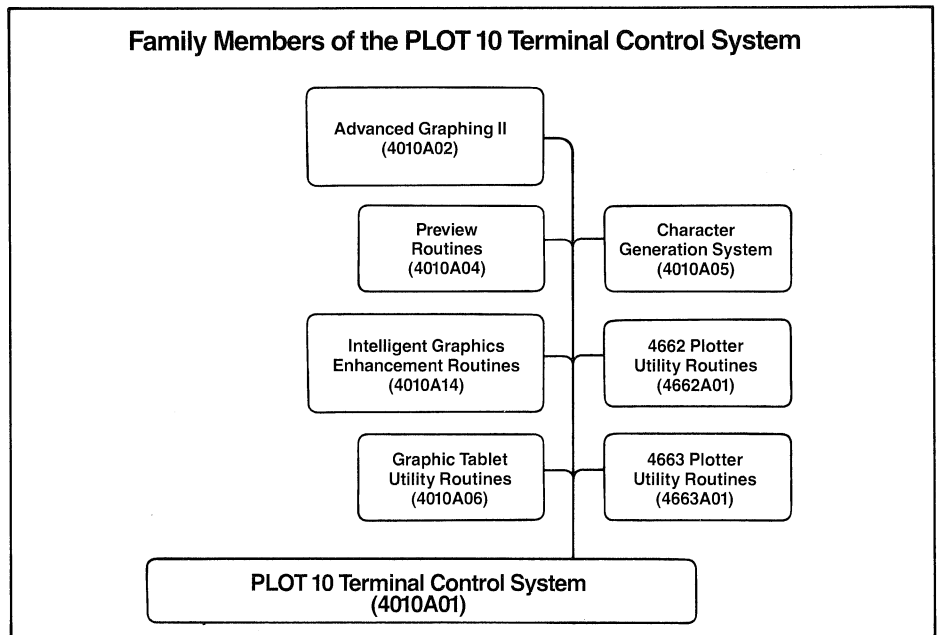

a FORTRAN programmer can produce a graph in as few as five 'call' statements instead of 15 to 500. In two calls PLOT 10 AG-II will test the range of an array of data and automatically generate a full screen graph with properly annotated tick marks. PLOT 10 AG-II commands PLOT 10 TCS to perform the fundamental line drawing. Shaded bar graphs, special symbols, linear, log and log-log displays are as simple as adding another 'call' statement. There is a lot to PLOT 10 AG-II; it is recommended for 32-bit-word computers or virtual systems.

Modules for control of a Tektronix 4953 or 4954 digitizing tablet may be added to the PLOT 10 Terminal Control System for easy digitizing of maps or drawings. For high-resolution color drawings it's just a matter of appending 4662 or 4663 Interactive Digital Plotter support routines. All the fundamental tools for graphics applications development are found in the "A" Series of the PLOT 10 product line.

### The "B" Series

This family member of the PLOT 10 product line is designed specifically for those who want a good looking graph quickly at minimal cost. Today's product, PLOT 10 Easy Graphing II, brings together the most used features of previously offered "B" Series graphing packages, including color in graphing.

PLOT 10 Easy Graphing II is a highly interactive graphing package that nearly anyone can use; FORTRAN programming is not required. The process is simple enough. Once loaded into the computer, Easy Graphing may be commanded to accept data from the terminal's keyboard, or a file. English language commands create titles, select graph styles such as lines, bars, or pie charts. Descriptive paragraphs of text may be interactively positioned using the terminal's cursor controls.

Since graphing is really an art form, Easy Graphing II gives the user full control over the design. Once a basic graphing style is settled upon, the user can elect to mix and match colors for visual effect or call attention to a particular point.

A graph layout may be saved and used again with new or additional data for period reports. The designer is freed from having to remember and key in the commands to recreate the graph. Furthermore, Easy Graphing II provides facilities to update graphs with minimal intervention. The occasional user can be prompted for the new data which is then automatically integrated into the stored graph and previous data to produce the latest report. The same graph may be run off to a 4660 Series Tektronix plotter in the

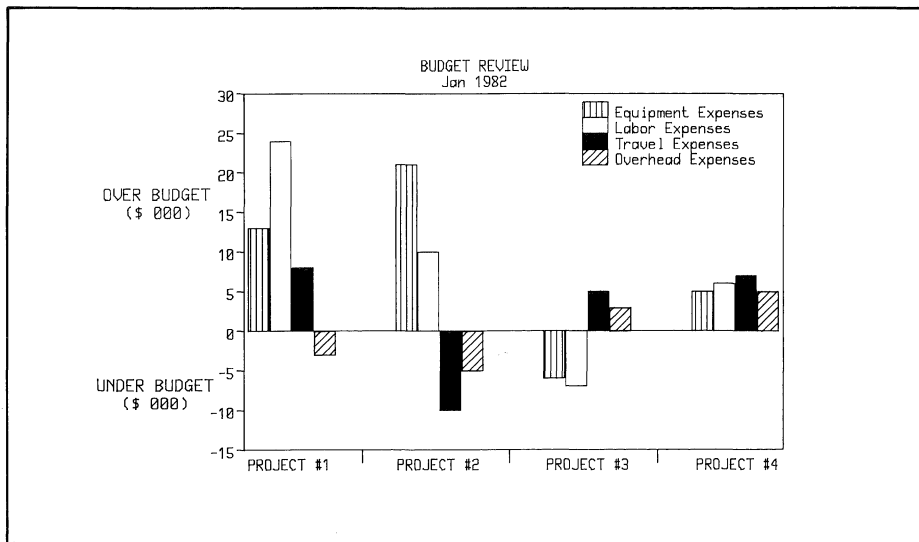
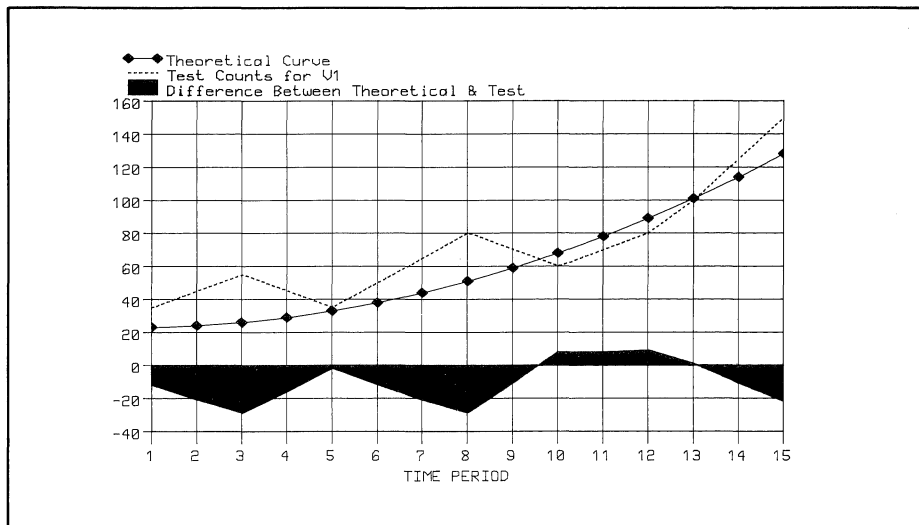
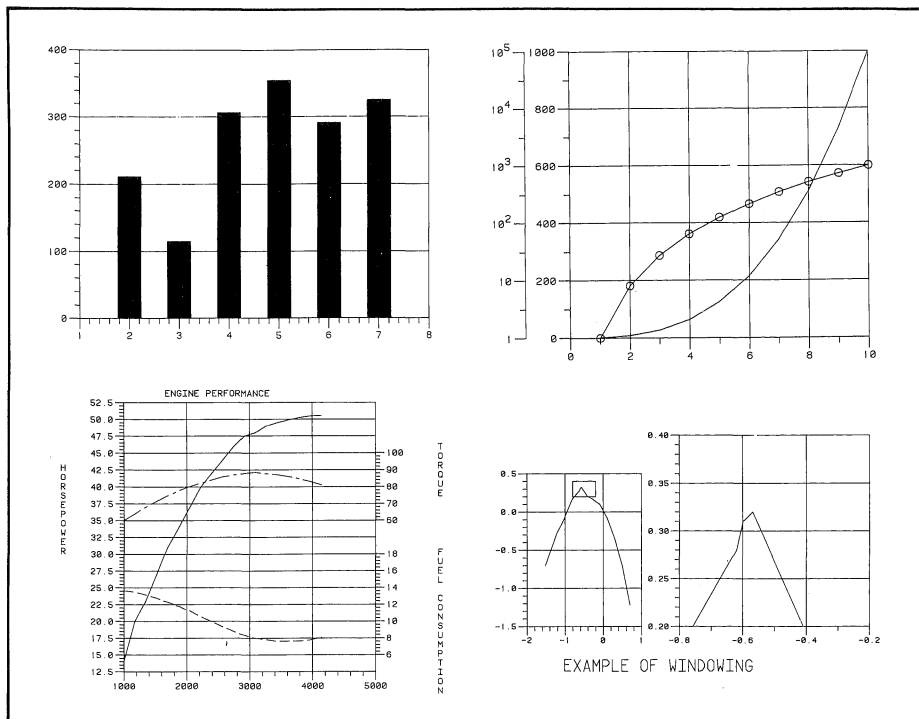



form of an 8½ × 11 color overhead transparency or for handouts to the audience, or even larger format for a flip chart presentation. The scaling is accomplished automatically.

PLOT 10 Easy Graphing II is packaged with a user friendly on-line 'Help' facility. If a command is mistyped and an error message generated, typing 'Help' will display a good explanation or clear example of proper usage.

Easy Graphing II is designed for analysts for whom graphics are a vital part of their day-to-day work. Computer costs are kept low by limiting features to those most often requested by Tektronix terminal users. But quality is not sacrificed. Titles and text from PLOT 10 Easy Graphing II are all displayed in a presentation quality font. It is very similar to the font style used to print this paragraph. Easy Graphing II is the answer for quality graphs, in quantity, at a low cost.

Device drivers are provided so only one version of PLOT 10 Easy Graphing II is required to create graphs on any of Tektronix graphics display products. Alternatively, PLOT 10 Easy Graphing II is available in execution module (object) form to run locally on the Tektronix 4100 Series terminal products, eliminating timesharing costs. Either way, Easy Graphing II is likely to be one of the most used graphics tools in an organization.

### The "C" Series

The use of computer graphics in all sciences has been expanding at a fevered pace. Increased sophistication of graphics display devices has in turn put quite a burden on applications programmers to keep up with the demand to support new displays. Fortunately, there exists a concept which dramatically simplifies the integration of new, more productive display technologies into established applications programs. The Association for Computing Machinery, through its Special Interest Group on Graphics, proposed a standard methodology for approaching graphics applications. It is called the 'Core' proposal. The Tektronix "C" Series supports the objectives of the 'Core' proposal: device independent applications, CPU independent code and a widely supported programming methodology. The Tektronix version is known as the 4010C01 PLOT 10 Interactive Graphics Library, or PLOT 10 IGL for short.

PLOT 10 IGL is a collection of software tools for the graphics applications programmer. The fundamentals are there — FORTRAN-callable routines MOVE, DRAW, ROTATE, SCALE, etc. — just as they have been defined by that prior industry standard PLOT 10 TCS. But with PLOT 10

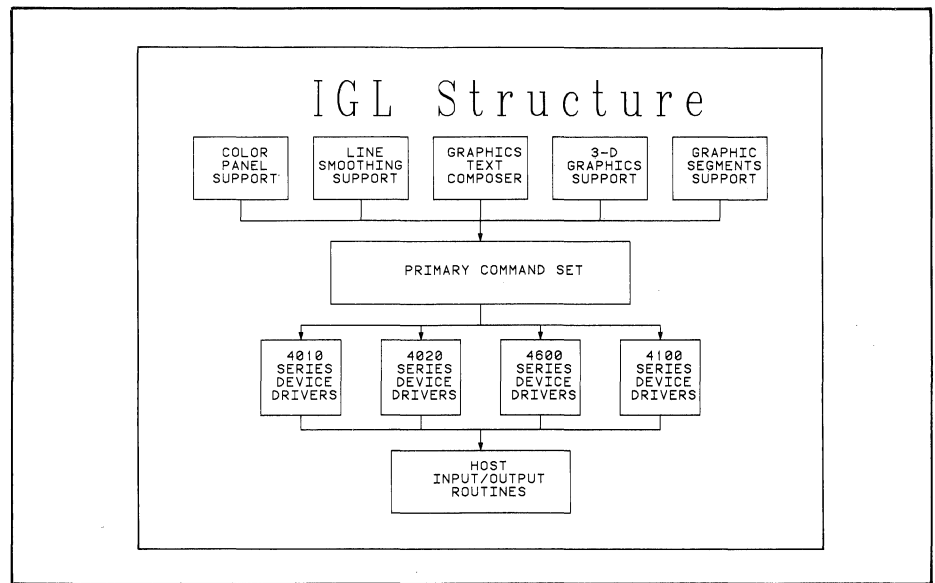
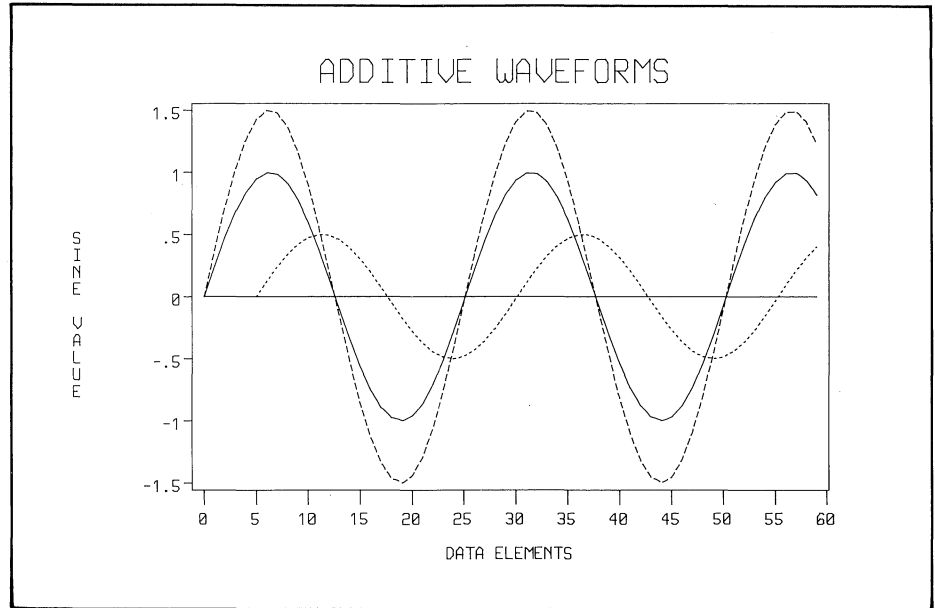

IGL color is inherently a part of every picture. If a terminal can't display color, it will be emulated automatically. A large collection of stroked character fonts is available as well as a rich set of character manipulation commands. Annotation of scaled drawings is easily accomplished with such features as left or right text justification, centering, height and width control, slant, color, underline, tabbing, super- and subscripting plus a collection of special symbols.

Smoothed lines for topo maps, heat transfer diagrams or graphs can be initiated with one command, SMOOTH.

3-D Graphics has advanced from academic exercise to an affordable tool for viewing of structural models, architectural renderings, piping diagrams and even complex data relationships in statistical sciences. PLOT 10 IGL offers 3-D viewing of any picture created by its 2-D commands as well as drawing in X, Y, Z space.

The 'Core' proposal has gone beyond a defined user interface to 2-D and 3-D graphics to include a powerful concept called 'Graphics Segments.' PLOT 10 IGL has incorporated Graphics Segments at its highest level of utility. Graphics Segments may be created then moved about on a terminal screen, highlighted, replicated, "dragged," picked, deleted and so on.

Applications embracing Graphics Segments tools may create drawings, store them away, retrieve a drawing, edit segments in or out and store the drawing under a revision number as needed. Thus, Graphics Segments provides the tools to build an automated drafting board to individual specifications.

All this may sound like it would require quite a powerful terminal. A powerful terminal, such as one of the Tektronix 4110 Series, does yield the highest level of productivity due to its local segment manipulation capability. However, the 'Core' concept employed by PLOT 10 IGL assures that through selectable device drivers, most of the features such as Graphics Segments, 3-D text manipulation and color are emulated on earlier generation Tektronix displays, in other words, upward and downward compatibility. Investment in Tektronix 4010 Family of products is protected.

The powerful routines of PLOT 10 IGL have been included in a PLOT 10 Local IGL package for 4110A Local Programmability users. Since the local version is directly compatible with the host version, many existing host programs using IGL may be run locally.

In summary, PLOT 10 may be a household word when it comes to graphics software, but

the name really should suggest an expanding collection of software tools. PLOT 10 Terminal Control System continues to offer the basics for smaller computer systems. PLOT 10 Easy Graphing II will produce low cost, good looking graphs. Since no programming is necessary to use Easy Graphing II, anyone

who wants to access computer data will appreciate its friendly interface to quick results. And for the latest in state-of-the-art application development tools, the PLOT 10 Interactive Graphics Library is the choice.

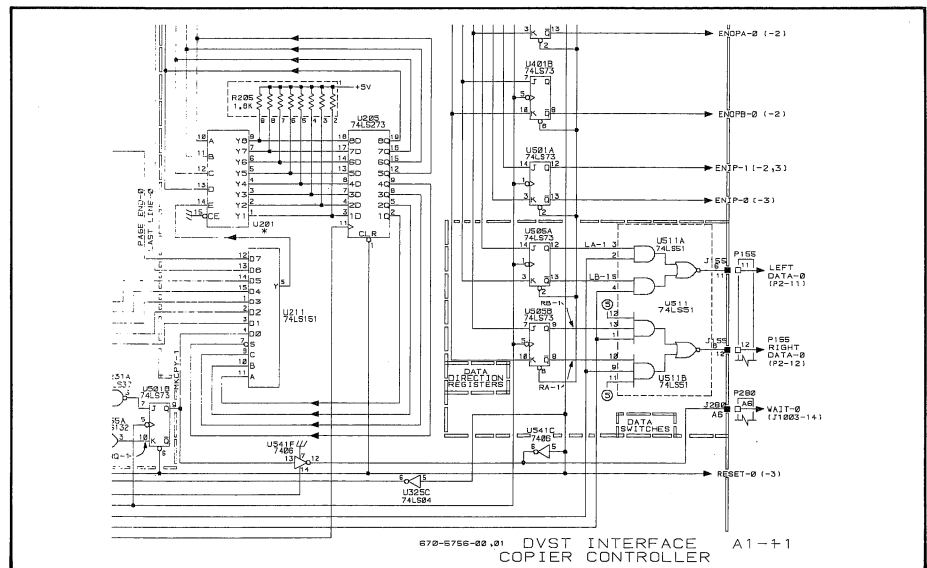
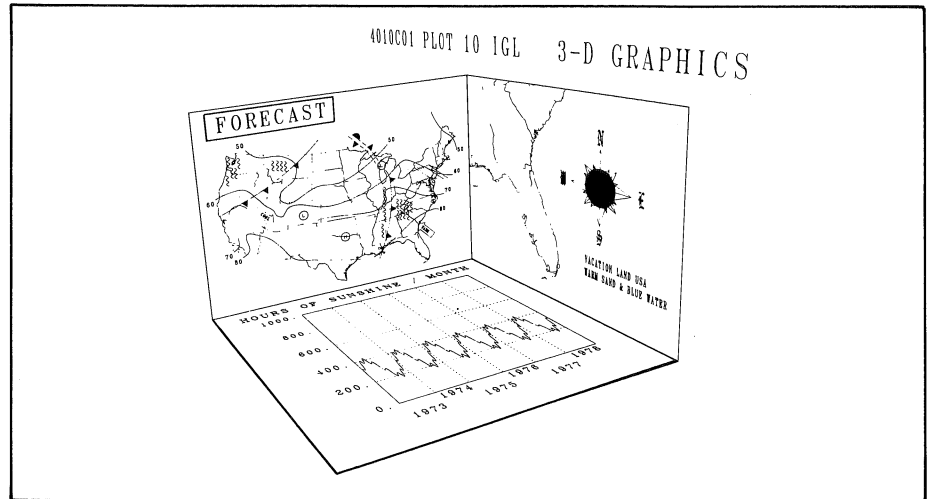

## Software Updates Available Through Software Subscription Services

Tektronix PLOT 10 and PLOT 50 software customers can extend the benefits of their warranty through the Software Subscription Services (SSS). The warranty covers the year following installation of Tektronix licensed software assigned a support category of "A" or "B." During this period Tektronix will provide the source code and any documentation to the customer for released updates to that package.

To continue the advantages of warranty support, PLOT 10 and PLOT 50 customers may purchase SSS at the end of the warranty period and obtain software updates for another year.

For more information on Tektronix software and the Software Subscription Services, contact your local Tektronix Sales Engineer.

# Tektronix 4116A Brings Large Display to 4110A Series Family

Another member of the Tektronix 4110A Series family has recently been introduced. The 4116A Graphics Terminal is an intelligent tool for designers requiring fine resolution and smooth, continuous lines in high density applications. The picture quality of its large 25" direct view storage tube provides easy viewing of the most intricate detail in circuit boards, utility networks, maps, automotive components and similar work.

Containing the advanced intelligent features of its 4114A counterpart\*, the 4116A offers

users an unequalled computer display terminal for complex jobs. Local picture segments, 2-D transforms, refresh support, user-definable fonts, programmed keys - all significantly reduce the delays and costs associated with overdependence on the host computer. And its high data communication rates allow a lot of information to be moved to and from the host in a short time.

Just as its 4112A, 4113A, and 4114A companions, the 4116A Graphics Terminal is compatible with the popular Tektronix 4010 Series

of computer display terminals and PLOT 10 software.

This newest member is available on the standard pedestal or in a desk configuration on a swivel mount (known as the 4116A30). Your local Tektronix Sales Engineer can provide you with more details on how the large screen 4116A can enhance your graphics applications. 

\*The Tektronix 4114A Graphics Terminal was described in *TEKniques* Vol. 6, No. 3.

## Flexible Display Stand, Ergonomic Chair Provide Convenience, Comfort

To enhance 4110 Series Computer Graphics Terminal users' convenience, Tektronix is making available a separate, adjustable display stand for the desk configurations of the 4113, 4114, and 4116 Systems. Removing the graphics display module to this stand leaves the desk surface free for large drawings or tablets. On wheels and with height and swivel adjustments, the stand and module can easily be positioned for convenience. Its design permits the stand to embrace the desk from the rear, suspending the graphics display above the work surface.

The specially designed ergonomic chair has five legs to improve user stability. Multiple chair height and rocking adjustments allow it to be tailored to the individual for ultimate

comfort when working. The chair is available in a dark brown color.

Order these items through your Central Parts Ordering office (map shown in the New Abstracts section of *TEKniques*) or your local Tektronix field office. 

Part numbers are:

4113 or 4116 Display Module Stand  
016-0717-01

4114 Display Module Stand  
016-0717-00

Ergonomic Chair  
016-0698-00

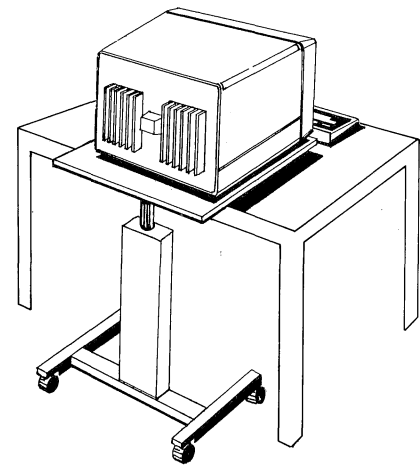

## Tektronix Presentation Pack Provides the Tools for Overhead Transparencies

Those of you who are using the Tektronix 4662 Plotter with Option 31 (eight pens) or the dual pen 4663 or 4663S Plotters, will find the new Tektronix Presentation Pack a vital companion. Designed for environments requiring formal presentation to communicate research and project results, the Pack gives you an organized system of pre-packaged materials to use with the plotter's graphics for effective displays.

Each Presentation Pack contains all the supplies you need to create, present and store the most colorful, quick-drying transparencies:

50 sheets of new "Quick Dry Plotter Film," a new Multicolor nine-pen pack, 25 frames, and a covered pen tray and storage box. The transparency film is a new double polymer coated film which dries to the touch in seconds. Nine colors of plotter pens are specially formulated to complement the new transparency film, resulting in even ink dispersal and excellent solid area fills. Ink is permanently bonded to the film, with virtually no streaking, skipping or smearing. Frames finish your completed visuals.

The covered pen storage box and outer Pre-

sentation Pack box create easy access, protection and convenience for each individual presentation program.

Apply these pre-packaged materials to the power of graphics to succinctly summarize, emphasize and compare ideas.

Order the Tektronix Presentation Pack, part number 020-0888-00 through the Central Parts Ordering office serving your area (see the New Abstract section for the map) or your local Tektronix Sales office. 

# Option to 4052R14 GPIB Enhancement ROM Pack Provides Compatibility with A-Series Systems

by Mark Mehall  
Tektronix, Inc.  
Wilsonville, OR

To operate the 4052R14 GPIB Enhancement ROM Pack with the new 4052A and 4054A Desktop Computers, users will need newly added Option 1A of the 4052R14. Redesignated GPIB hardware on the A-Series necessitated changes to the ROM.

4052R14 Option 1A offers all the functions of the standard GPIB Enhancement ROM\*, plus some new features. Added error handling routines allow programs to intercept error codes generated by the system. For in-

stance, should "MAG TAPE ERROR . . . MESSAGE NUMBER 55" be generated, a program could intercept this message and branch to a routine to aid the user in overcoming the problem.

The ability to determine the write protect status of a cartridge tape and more flexibility when inputting from a tape are provided by tape handling enhancements. A description of all the new features can be obtained from local Tektronix Sales Engineers.

Users who already have the 4052R14 GPIB Enhancement ROM and who have upgraded their 4050 Systems to the A-Series can order a field kit to modify their ROM Pack. Of

course, those who have 4050A-Series systems and are initially ordering the ROM, should be sure to specify 4052R14 Opt. 1A GPIB Enhancement ROM Pack. The standard 4052R14 ROM is still available for standard 4052 and 4054 users. 

\*TEKniques Vol. 6, No. 2 described the features and benefits of the 4052R14 ROM.

---

## 600K Cartridge Tape Supports Extended Memory

A 600-foot long Certified Data Cartridge is now available through Tektronix for the 4050 Series Graphics Systems. The tape is capable of recording 600,000 bytes, providing room for the contents of the Tektronix Extended Memory File Manager recently introduced for the 4052A and 4054A Systems.

The addition of the 600K data cartridge to the two Certified Data Cartridges previous-

ly available provides 4050 Series users a wider choice of media storage to match their application.

In the U.S. the tapes are available through Tektronix Central Parts Ordering (see New Abstracts section). International 4050 Series users should contact the local Tektronix sales office.

Part Numbers

600-foot Certified Data Cartridge  
119-1463-00 (each)

450-foot Certified Data Cartridge  
119-1439-00 (each)

300-foot Certified Data Cartridge  
119-0680-01 (box of five) 

---

## Tektronix 4612 Hard Copier Compatible with DEC VT100 Terminals

Since their introduction,\* the Tektronix 4611 and 4612 Hard Copiers have earned a reputation for superior quality alphanumeric and graphics hard copy at a low cost. A recent option to the 4612, the video signal copier, extends these benefits to users of Digital Equipment Corporation's VT100 family of terminals. Plug-to-plug compatible with the DEC VT100 Series terminals and the new DEC RAINBOW 100 Personal Computer, the 4612 with Option 8 is optimized for use with terminals with aspect ratios at or near 768 x 240, or 768 x 480 pixels. Field kits are available to upgrade existing 4612 Hard Copy Units. For more information, contact your local Tektronix Sales Engineer. 

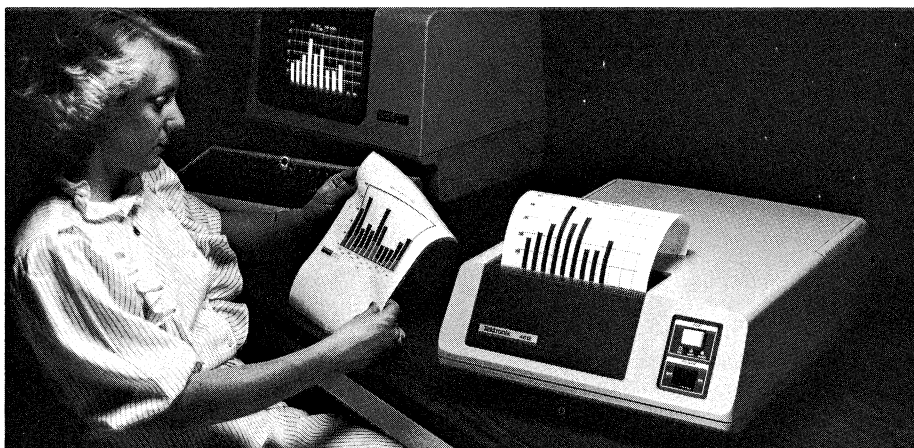

The Tektronix 4612 Video Hard Copy Unit uses electrostatic technology to produce high quality, high contrast black and white copies from raster scan video displays. A new option to the 4612 creates plug-to-plug compatibility with DEC VT100 Series terminals, generating images without distortion from these terminals and others with a horizontal resolution at or near 768 pixels. Hard copies are produced in 28 seconds regardless of image density.

\*See TEKniques Vol. 5, No. 1 for the benefits and features of the 4611 and 4612 Hard Copiers.

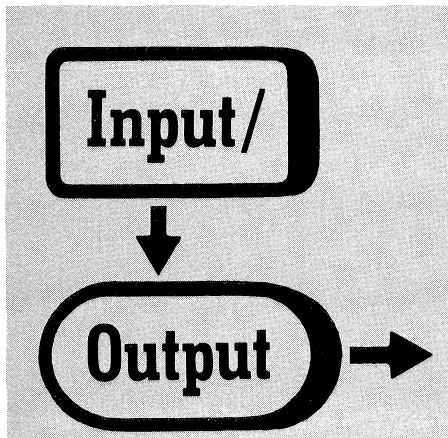

## RS-449 Interface

Several questions have come in regarding the RS-449 Interface Standard, Javad Farjami, Technical Support Specialist at Tektronix, briefly describes its principles.

The RS-449 is the successor to the popular RS-232 interface standard and has two distinct advantages over the RS-232: Speed and Distance.

	Data Rate	Maximum Transmission Distance
RS-232	20k bps	50 feet
RS-449	2M bps	200 feet

In addition, RS-449 supports remote loop-back testing, standby channel selection, and other control functions missing in the RS-232 standard.

The distinguishing features of the RS-449 are:

- 1) New electrical characteristics to allow higher transmission rates and greater distances between equipment. (NOTE: Since the allowable voltage range of RS-232 signals exceeds that of RS-449, an adapter is necessary to provide protection for RS-449 receivers which do not have sufficient tolerance. More information may be obtained from EIA Industrial Electronics Bulletin No. 12, "Application notes on interconnection between interface circuits using RS-449 and RS-232-C.")
- 2) A new 37-pin connector to accommodate the extra lines required by the expanded interface. In addition, the RS-449 standard allows the use of a separate 9-pin connector in applications requiring secondary communications channels.
- 3) Ten new interface functions and deletion of three rarely used ones. The RS-449 standard also establishes a new set of interface circuit function names and mnemonics and makes some changes to circuit function definitions.

Copies of the RS-449 standard along with its companion RS-442 and RS-443 specifying voltage levels for balanced and unbalanced circuits in the RS-449, and Bulletin No. 12 mentioned above may be obtained from the following for a nominal charge:

Electronic Industries Association  
Standards Sales Office  
2001 Eye Street N.W.  
Washington, D.C. 20006

## 4907 File Access Order

John Brophy, Computer Systems Analyst for the Department of Defense, Washington, D.C., seeks a method for determining the order in which files are accessed.

I am designing a data base of moderate size - 1-2 Mbytes of data using the 4907. My approach breaks the data into categories which will fit on one disk, and then into subcategories which are stored in separate files on the disk.

In order to sum an element across subcategories (files), I will perform a group OPEN on the appropriate library. When I want to compute subtotals for groups of subcategories, I need to know the order in which the files will be accessed by the group OPEN.

Although once files are established, the order in which they are opened is invariant, when a new file is created, it may occupy any position within the list of previously-existing files.

Can you provide me with the algorithm which governs the access sequence for group OPENS?

Pat Franz, Tektronix firmware engineer, replies. The order in which files will be opened in a Group OPEN is indeed pseudo-random as a result of a hashing function applied to the directory. While this cuts down the average time to access a particular file, it does mix things up. However, there are several ways of accomplishing what you seek to do which would be much easier than reproducing the effects of the 4907's hashing function on its directory structure.

- 1) Do a CALL "FILE" using the same wildcards used for your desired Group OPEN. The filenames returned in the status messages will be in the same order that the 4907 would access them in a Group OPEN. Pick out the filenames and make a list. Use this list when you need to do subcategory subtotal operations. In some cases, this could take an enormous string.
- 2) A similar, less memory-intensive method is to do a two-pass Group OPEN. The first pass should be for read-only access and

would garner the name sequence; the second pass would do the actual operations.

Either of these methods could be used to generate wildcard subsets. The list of names generated (your desired subtotal set) could be compared to the filename returned from the CALL "NEXT" in the Group OPEN to see if subtotal operations should be done.

Another method would be to create many more files than you need originally and select from among these empty files when another file is needed. You will then always know their order.

## Reading 4907 Binary Programs

W. Budde, National Research Council Canada in Ottawa, queries:

I can OPEN a program-file and read the status message, however, I cannot READ and INPUT the lines of the program. Why not? I encountered this problem when I tried to make backup copies of a series of disk-stored programs on tape under program control.

According to Tektronix Technical Support Specialist, Steve Duncan, binary programs are stored in "host binary" format, and cannot be read using the BASIC READ command. They can be stored in ASCII format, however, which will allow them to be input.

To store a program file in ASCII, simply add a comma and an "A" after the file identifier: SAVE "BUDDE", "A"

to OLD it in:

```
OLD "BUDDE", "A"
```

or to INPUT it, line by line:

```
OPEN "BUDDE";1, "R", A$
INPUT #1: A$
```

(repeating INPUT until all statements brought in) 

# Graphics Systems Workshops

## 4050 Series

Tektronix desktop computers are ideal tools for improving operating effectiveness. Although satisfied with the job the Tektronix graphics system is doing now, the user probably isn't aware of all its capabilities and how they can be used to increase efficiency.

To help the user get the most out of the 4050 Desktop Computer, Tektronix provides workshops combining classroom lecture with extensive supervised laboratory sessions. Each day the students will exercise the problem-solving concepts presented using a complete desktop computing system.

The Winter/Spring 1983 Schedule follows:

<u>Rockville, MD</u>	<u>Santa Clara, CA</u>
February 28-March 4	March 7-March 11
March 21-March 25	May 2-May 6
April 4-April 8	
May 2-May 6	
May 23-May 27	

---

## PLOT 50 2-D Drafting Workshops

A comprehensive workshop gives PLOT 50 2-D Drafting users a jump on productivity. Taught by Tektronix professionals, the one week workshop equips the students with knowledge and skills usually gained only through months of experience. Instruction in optimum use of the PLOT 50 2-D Drafting system combined with "hands-on" training tailored to the user's environment accelerates the individual's effectiveness.

### Course Objectives/Content:

The workshop teaches effective use of PLOT 50 2-D Drafting.

The workshop consists of lectures and laboratories with an emphasis on the development of efficient working habits and a working knowledge of all system functions and capabilities. Specific topics which will be covered in the workshop are:

- Reviewing and using all functions
- Generation of quality ink drawings
- Digitizing drawings
- Geometric operations (lines, arcs, line smoothing)
- Note generation and editing
- Workset usage
- Blanking
- Drawing modifications
- Drawing organization
- Uses and creation of symbols
- Configuring equipment

The workshop is not intended to *introduce* the student to drafting or the PLOT 50 2-D Drafting System.

### Student Profile:

The workshop is designed for a student who has had a minimum of two weeks drafting experience on the PLOT 50 2-D Drafting

System. The student does not require computer experience or a computer programming language.

Enrollment in a workshop is limited to ensure each participant receives the maximum benefit. The following workshops will be taking place in the next few months. Classes may also be scheduled at a customer site.

### Santa Clara, CA

March 28  
May 9

---

## PLOT 10 IGL Workshops

An intensive one week workshop will give FORTRAN programmers or project managers a familiarity with PLOT 10 IGL which will speed them on their way in program development. Instruction in the proper use of IGL routines eliminates the need for experimenting, permitting faster, more effective graphics applications design. Effective training results from keeping class size small and focusing on tasks typical of a user's work. The workshop features hands-on use of the entire Tektronix 4110 Series of graphics terminals, and peripherals such as tablets, plotter and copiers. 

Several spring workshops have been scheduled.

<u>Santa Clara, CA</u>	<u>Boston</u>
March 14	April 4
April 18	May 16
May 23	

For additional information regarding these workshops, or to register, please contact:

Tektronix, Inc.  
ATTN: Customer Training Registrar  
Mail Station 63-574  
P.O. Box 1000  
Wilsonville, OR 97070  
(503) 685-3808

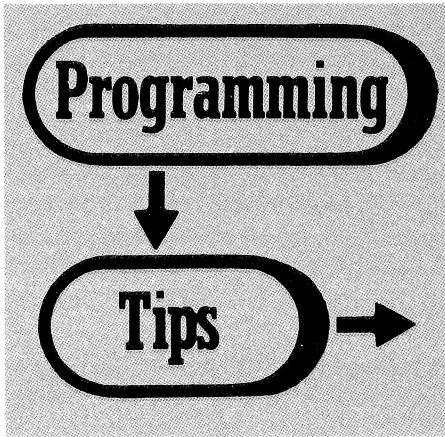

## Simulated Pan and Zoom on the 4114

by Bill Lowery  
Tektronix, Inc.  
Newport News, VA

The 4112 and 4113 have local Pan and Zoom facilities. However, the 4114 requires that any Pan and Zoom operation (windowing) be controlled from the host. This can be done in several ways. The host can perform the transformation and then transmit the picture to the terminal, or the host can create a segment on the terminal with the Pivot Point at the proper location, and then a local terminal transform can be applied. In either case, the whole picture must be retransmitted by the host.

An alternative method takes advantage of the 4100 terminal's local capabilities. The general steps are:

1. Assign each segment as it is created to one or more segment classes.

2. Create a match class from those classes containing segments on which zoom and pan will be performed.
3. Create a new segment (with a pivot point at the proper location) by copying the current match class into the new segment.
4. Apply image transformations as required.

For example:

```

1 <Set-Segment-Class: -2, (0), (1)>
2 (Create as many segments with varying
  pivot points as desired)
3 (Determine XMIN, XMAX, YMIN,
  YMAX, for desired Window)
4 <Set-Current-Matching-Class:
  (1), (0)>
5 <Set-Pivot Point:
  XMIN + (XMAX - XMIN)/2,
  YMIN + (YMAX - YMIN)/2>
6 <Begin-Segment: 500>
7 <Include-Copy-Of-Segment: -3>
8 <End-Segment>
9 <Set-Segment-Image-Transform:
  500, 4096/(XMAX - XMIN),
  3172/(YMAX - YMIN),
  0, (2048, 1586)>

```

Line 1. Assigns all future segments to Segment Class 1.

Line 2. Creates as many segments in memory as desired. These segments may have their pivot points positioned at any valid location.

Line 3. The desired window can be determined by prior knowledge or by use of the GIN operation to define lower left and upper right points.

Line 4. Makes the current matching class consist of all segments which belong to Segment Class 1.

Line 5. Sets the pivot point to the center of the new window.

Line 6. Begins a new Segment. In this case, Segment #500 is assigned.

Line 7. Copies the current matching class into Segment #500. In this case it consists of all segments.

Line 8. Ends Segment #500.

Line 9. Applies the segment image transform to Segment #500. The X and Y scale factors are chosen so that the new window will just fill the screen and the center of the new window is translated to the physical center of the screen.

The Include-Copy-Of-Segment command preserves any Pick ID's assigned within the original segment. Thus, if Pick ID numbers are not duplicated in the original segments created, the segment built using the segment class (step 7) will contain unique Pick ID's. This allows elements within the zoomed picture to be identified using standard Pick techniques.

## 4050 Extended Memory Backup/Restore

by Mark Mehall  
Tektronix, Inc.  
Wilsonville, OR

This short routine will save the contents of the Extended Memory File Manager on tape or restore the contents from tape to memory. It is assumed this routine will reside on file 1 marked for 768 bytes, with file 2 containing the memory contents. For 256K memory (Option 27), use a 300K tape and mark the second file for 300000 bytes; for 512K memory (Option 28), use the new 600K tape and mark the second file for 600000 bytes.

```

100 PRINT "EXTENDED MEMORY BACKUP PROGRAM"
110 PRINT "SAVE OR RESTORE? ";
120 DIM R$(4),A$(300)
130 INPUT R$
140 CALL "DSTAT",4,A$
150 REM S$ IS SIZE OF EXTENDED MEMORY
160 S$=SEG(A$,94,6)
170 S=VAL(S$)
180 FIND 2
190 PRINT "BLOCK:#####";
200 IF R$="REST" THEN 300
210 FOR I=0 TO S/256-1
220 CALL "NUMHEX",I*256,I$
230 I$=SEG(I$,1,4)
240 PRINT "####";I$;
250 CALL "MREAD",I$,256,A$
260 WRITE @33:A$
270 NEXT I
280 PRINT " EXTENDED MEMORY SAVED."
290 END
300 ON EOF (0) THEN 390
310 I=0
320 CALL "NUMHEX",I*256,I$
330 I$=SEG(I$,1,4)
340 PRINT "####";I$;
350 READ @33:A$
360 CALL "MWRITE",I$,A$
370 I=I+1
380 GO TO 320
390 PRINT " RESTORED."

```

# More Hints for the 4052A/4054A

by Lee Rainey  
Tektronix, Inc.  
Dayton, OH

The 4052A and 4054A Graphics Systems introduced in 1982 offer an enhanced BASIC language. *TEKniques* Vol. 6, No. 4 contained some tips for using this upward-compatible superset of traditional BASIC. This issue continues the discussion.

## Memory Management

The addition of subprograms, mnemonic names and local variables place a new emphasis on understanding memory usage in the 4052A and 4054A Graphics Systems. In the A series, memory is consumed by variable names, subprograms and DO loops, as well as by traditional features such as User-Definable Keys.

Whenever flow of control deviates from the normal sequence of line numbers, a return address may need to be added to the dynamic stack. This is cleared when the program construct is exited correctly (RETURN, END SUB, etc.). Stack memory requirements are as follows:

	Bytes
UDK/Return	15
For/Next	26
Do/Loop/Exit If	6
Gosub/Return	6
Call/End Sub	6
If/Then/Else	0

Variable names will take different amounts of memory depending on several factors. When a variable name of any kind is translated by the 4050, it is added to the symbol table. (Translation occurs when a line is olded, appended, or entered in immediate mode.) The space occupied in the symbol table depends on the format of the variable name. When the variable is dimensioned or defined via an assignment statement, additional memory may be required. The details are shown below.

Type	Name	Symbol Space	Used When Defined
Numeric	Traditional (A9)	13	0
Numeric	Extended (Xcent)	13+N chars	0
Array	Traditional (A9)	13	5+(8XrowsXcols)
Array	Extended (Xcent)	13+N chars	5+(8XrowsXcols)
String	Traditional (AS)	13	5+dim length
String	Extended (File\$)	13+N chars	5+dim length

Note: N chars is the length of the variable name including the \$ in strings. Extended names are ones which contain over 2 characters, again counting \$ as a character.

When a variable is deleted, the space in the right-hand column (above) is recovered, plus the overhead associated with any deleted line numbers, etc. In the traditional 4050 System, however, symbol table space could be recovered only by a Delete All. The 4050A pro-

vides a less drastic alternative in the call to SYMREUSE. Variables which are no longer used in existing code, and no longer defined nor dimensioned are dropped. The following example illustrates this feature. The symbol table space recovered can be used for future symbol table entries. This would be a useful feature in a heavily overlaid program with many variables specific to particular overlays.

```
MEM
54378
100 ABCDEFGHIJLMNOPQRSTUVWXYZ=1
MEM
54322
DEL 100
MEM
54339
CALL "SYMREUSE", BYTES
BYTES
39
```

Local variables are added to the symbol table when the LOCAL command is translated. When the LOCAL command executes, additional memory is used at the rate of 15 bytes for the first variable and 12 for each additional local variable regardless of type, name length, or whether the variable is defined outside the routine. And, local variables consume memory at the standard rate when defined or dimensioned inside the subprogram. All memory over and above the symbol table is released when the END SUB is reached.

The 4050A also offers a memory advantage on comments. With the enhanced BASIC, three comment forms are available, as shown below:

Form	Memory
100 REM COMMENT	12 bytes + 1 per character
100 ! COMMENT	11 bytes + 1 per character
100 A=1 ! COMMENT	2 bytes for ! + 1 per character

The third form or comment tail is obviously the most parsimonious, as it saves the overhead associated with a separate line. It also avoids any danger that a target REM line will be deleted with EXCLUDE 2. For these reasons, the comment tail would appear to be the preferred form.

## Enhanced CHR Supports TABLE Function

String enhancement adds the full range of 0 to 255 to the ASC and CHR functions, in support of the new TABLE function. In the illustration lines, 140 through 290 are a lengthy set of DATA statements listing for the 128 ASCII characters (shown in the REMARKS) the corresponding EBCDIC decimal equivalents. Lines 320-360 read these into an array and then, one at a time, pass the EBCDIC decimal equivalent through the CHR function. The result is a string of characters (Alphabet\$) in the range 0-255. This is the translate table. Line 400 then uses it to convert a string of ASCII characters to a string of EBCDIC. Such a string could then be PRINTed to the internal mag tape or to a GPIB device.

```
100 REM ASCII TO EBCDIC TRANSLATION
110 INIT
120 REM - DECIMAL EQUIVALENTS OF EBCDIC COUNTERPARTS OF ASCII CHARS
130 REM - CHARS WITH NO EBCDIC VERSION BECOME COLONS, AS IN TCAM
140 DATA 0,1,2,3,55,45,46,47,22,5,37,11,12,13,14,15
150 REM      ET EQ AK BL BS      LF VT FF CR SO SI
160 DATA 16,17,18,122,60,61,50,38,24,25,63,39,34,122,53,122
170 REM DE D1 D2 D3 D4 NK SY EB CN EM SB ES FS GS RS US
180 DATA 64,0,127,123,91,108,80,125,77,93,92,78,107,96,75,97
190 REM SP ! " # $ % & ' ( ) * + , - . / : ; < = > ?
200 DATA 240,241,242,243,244,245,246,247,248,249,122,94,76,126,110,111
210 REM 0 1 2 3 4 5 6 7 8 9 ; < = > ?
220 DATA 124,193,194,195,196,197,198,199,200,201,209,210,211,212,213,214
230 REM @ A B C D E F G H I J K L M N O
240 DATA 215,216,217,226,227,228,229,230,231,232,233,122,224,122,122,109
250 REM P Q R S T U V W X Y Z [ \ ] ^ _
260 DATA 121,129,130,131,132,133,134,135,136,137,145,146,147,148,149,150
270 REM ` a b c d e f g h i j k l m n o
280 DATA 151,152,153,162,163,164,165,166,167,168,169,192,250,208,161,122
290 REM p q r s t u v w x y z { | } ~ DEL
300 DIM Alphabet(128)
310 DIM Alphabet$(128)
320 READ Alphabet !STORE EBCDIC DECIMAL EQUIVALENTS IN ARRAY
330 Alphabet$=""
340 FOR I=1 TO 128 !CONVERT EBCDIC EQUIVALENTS TO CHARACTERS
350 Alphabet$=Alphabet$+CHR(Alphabet(I))
360 NEXT I !ALPHABET$ NOW IS THE TRANSLATE TABLE
370 PRINT "ENTER AN ASCII STRING TO CONVERT:"
380 INPUT _ascii$
390 EbcDic$=TABLE(_ascii$,Alphabet$) !PERFORM TRANSLATION
410 FOR I=1 TO LEN(EbcDic$)
420 PRINT ASC(EbcDic$,I); " ";
430 NEXT I
440 PRINT
450 PRINT "DO YOU WISH TO TRANSLATE ANOTHER STRING? ";
460 INPUT A$
470 A$=SEG(A$,1,1)
480 IF A$="Y" THEN 370
490 END
```



There are several possible but still hypothetical applications for this capability. In theory, it could be used to communicate with a GPIB device such as a data logger that talks EBCDIC. Another use for TABLE would be data encryption. If you are an amateur code-breaker and want to tackle the ULTRA secret (or a cryptogram in the old *Saturday Review of Literature*), TABLE would be a good starting point.

(A few caveats are necessary on the EBCDIC translate table. This was taken from an IBM document on code translation and matches the ASCII characters to the "standard EBCDIC bit pattern assignments." However, IBM points out that this differs from the print chains on some of their printers. The ASCII control characters were translated to EBCDIC characters with the same mnemonic and the numerous ASCII characters with no EBCDIC counterpart become colons, mimicking TCAM. Double-check that these translations are appropriate before you actually use this routine.)

Ed Note: Also, if A\$ has a hex number, e.g., "3Fa0), then a string ToHex\$ would be useful for converting A\$ to a decimal number.

### ALTER Simplifies Editing

Another useful string enhancement is ALTER, which will greatly simplify editing applications. In fact, it largely removes the need to write a software line editor by making it possible to use the Line Editor Keys on a string under program control, an applica-

tion illustrated in the following code. ALTER can also be a handy debugging tool in programs for file managers, as it gives you a chance to see and revise file names and command strings as the program executes.

```

100 REM - DEMONSTRATION OF ALTER COMMAND
110 A$="LINE TO BE OFFERED FOR POSSIBLE EDITING"
120 REM - EDITING INSTRUCTIONS
130 PRINT "YOU MAY CORRECT THE TEXT USING THE LINE EDITOR KEYS ON THE"
140 PRINT "KEYBOARD. IF YOU WISH TO DISCARD THE ENTIRE LINE AND ENTER"
150 PRINT "A NEW ONE, PRESS 'CLEAR' AND THEN ENTER THE NEW TEXT. PRESS"
160 PRINT "'RETURN' TO SIGNAL THAT YOU ARE DONE EDITING. (THE KEYS"
170 PRINT "'RECALL NEXT LINE' AND 'RECALL LINE' HAVE NO EFFECT."
180 PRINT "TEXT TO EDIT: ";
190 ALTER A$,A$
200 PRINT "TEXT AS EDITED: ";A$
210 PRINT "DO YOU WANT TO DO IT AGAIN? ";
220 INPUT Y$
230 Y$=SEG(Y$,1,1)
240 IF Y$="Y" THEN 180
250 END

```

## Creating Refresh Objects with the 4054 Option 30 Dynamic Graphics

by Steve Duncan  
Tektronix, Inc.  
Wilsonville, OR

If you wish a refresh object to be relocatable on the 4054 display, the Operator's manual (part #070-2289-00) warns that you must use only RMOVE and RDRAW commands. This is because an object created with the absolute commands MOVE and DRAW will be immobile and unaffected by the CURSOR and STPOINT commands.

Objects created using the secondary addresses for move and draw (PRINT @32,21:X,Y and PRINT @32,20:X,Y), however, can be manipulated using CURSOR and STPOINT, just as an object created with the relative commands would be. Obviously, the secondary address format is not modified by the BASIC commands WINDOW and VIEWPORT, but for programmers who prefer or require absolute screen addressing, this format should be welcome.

A possible pitfall is mixing RMOVE and RDRAW commands with the PRINT @ type of commands in the creation of an object. PRINT @ statements do not update the graphic cursor position on the screen,\* and results may not be as expected.

\*Appendix A in the "Introduction to Graphic Programming in BASIC" manual covers the concept of a graphic display point and how its location is affected by commands.

## Symmetric Matrices in One-Dimensional Arrays

by V. Zitko  
Fisheries and Environmental Sciences  
Biological Station  
St. Andrews, N.B.  
Canada

Symmetric matrices ( $a_{ij} = a_{ji}$ ) are common, for example, in parameter estimation and factor analysis. Because of their symmetry across the diagonale, only  $n(n+1)/2$  elements have to be stored as opposed to  $n^2$  elements of the whole matrix. For large matrices this saves considerable amount of memory, as well as operations on such matrices.

When storing the upper "half" ( $i \leq j$ ) of a symmetric matrix  $D(n,n)$  in an array  $M(n(n+1)/2)$ , the element  $D(i,j)$  corresponds to  $M((i-1)(2n-i)/2+j)$  when  $i \leq j$ , and to  $M((j-1)(2n-j)/2+i)$  when  $i > j$ .

The following routine generates a symmetric matrix by left multiplication of a matrix  $C(R,S)$  by its transpose, stores the upper "half" in a one-dimensional array  $M(S*(S+1)/2)$ , and prints the symmetric matrix.

```

50 C1=0
54 REM GENERATE SYMMETRIC MATRIX
55 FOR I=1 TO S
60   FOR J=1 TO S
70     C1=C1+1
75     FOR K=1 TO R
80       M(C1)=M(C1)+C(K,I)*C(K,J)
85     NEXT K
90   NEXT J
95 NEXT I
99 REM AND RETRIEVE IT
100 FOR I=1 TO S
105   FOR J=1 TO S
110     I1=(I-1)*(2*S-1)/2+J
115     IF I>J THEN 130
120     PRINT M(I1)
125     GO TO 140
130     I1=(J-1)*(2*S-J)/2+I
135     PRINT M(I1)
140   NEXT J
145   PRINT
150 NEXT I
155 END

```

## Conditional Branching

by James Love  
and Theodore C. Loder, III  
University of New Hampshire  
Durham, NH

Many programming applications require conditional branches from within a FOR/NEXT loop. This would include branching to an external subroutine (followed by a RETURN statement to transfer execution back to the body of the loop) or simply to a secondary set of instructions further down in the loop itself. Where branching occurs in an ordered pattern, for example as in a simple odd-even conditional, a single statement will usually suffice to direct program execution:

```

1)
100 FOR I=-5 TO 10
110 REM CONTINUE IF ODD
115 REM INTEGER, BRANCH
118 REM IF EVEN
120 IF I/2=INT(I/2) THEN 160
130 REM ... CONTINUE
140 REM
150 REM
160 REM ... INITIATE BRANCH
165 REM EXECUTION

2)
100 FOR I=-5 TO 10
110 REM CONTINUE IF I<0 OR
115 REM ODD INTEGER >0
120 REM BRANCH IF I=0 OR
125 REM EVEN INTEGER >0
130 GO TO I/2=ABS(INT(I/2)) OF 170
140 REM ... CONTINUE
150 REM
160 REM
170 REM INITIATE BRANCH EXECUTION

```

When program execution transfers from the main body of the loop under irregular conditions, it cannot be expressed as a simple function of the loop index variable (I) as in the preceding examples. *TEKniques* Vol. 5, No. 2 described a fast, efficient array search routine by P.L. Hershmann that effectively addresses this problem and eliminates the need for a lengthy string of cumbersome IF.....THEN conditionals. This is particularly significant if the number of iterations is large and a substantial number of non-systematic branches are called for.

Lines 100-250 demonstrate a scheme for conditional branching under the following conditions: If I is other than any of the integers stored in array(A) then continue normal program execution, otherwise branch to line 230 when I is equal to one of these chosen integers. Lines 260-450 illustrate a slightly more sophisticated version of this routine. As in the previous example, program execution proceeds without branching until I is equal to a specific member of array(A). Execution is then sequentially transferred to a unique subroutine dependent on the position of the pointer in A as the loop is completed.

```

100 REM CONDITIONAL BRANCHING: SINGLE TASK
110 DIM A(7),B(7)
120 REM LOAD ARRAY(A) OF USER-SELECTED INTEGERS
130 REM FOR WHICH BRANCHING IS DESIRED
150 READ A
160 DATA 3,7,11,13,19,20,28
180 FOR I=1 TO 30
190 LET B=A-I
200 IF SUM(B)=0 THEN 230
210 PRINT @P:"THIS IS A CHOSEN INTEGER: ";I
220 GO TO 240
230 PRINT @P:"THIS IS NORMAL PROGRAM EXECUTION: ";I
240 NEXT I
250 END

```

```

THIS IS NORMAL PROGRAM EXECUTION: 1
THIS IS NORMAL PROGRAM EXECUTION: 2
THIS IS A CHOSEN INTEGER: 3
THIS IS NORMAL PROGRAM EXECUTION: 4
THIS IS NORMAL PROGRAM EXECUTION: 5
THIS IS NORMAL PROGRAM EXECUTION: 6
THIS IS A CHOSEN INTEGER: 7
THIS IS NORMAL PROGRAM EXECUTION: 8
THIS IS NORMAL PROGRAM EXECUTION: 9
THIS IS NORMAL PROGRAM EXECUTION: 10
THIS IS A CHOSEN INTEGER: 11
THIS IS NORMAL PROGRAM EXECUTION: 12
THIS IS A CHOSEN INTEGER: 13
THIS IS NORMAL PROGRAM EXECUTION: 14
THIS IS NORMAL PROGRAM EXECUTION: 15
THIS IS NORMAL PROGRAM EXECUTION: 16
THIS IS NORMAL PROGRAM EXECUTION: 17
THIS IS NORMAL PROGRAM EXECUTION: 18
THIS IS A CHOSEN INTEGER: 19
THIS IS A CHOSEN INTEGER: 20
THIS IS NORMAL PROGRAM EXECUTION: 21
THIS IS NORMAL PROGRAM EXECUTION: 22
THIS IS NORMAL PROGRAM EXECUTION: 23
THIS IS NORMAL PROGRAM EXECUTION: 24
THIS IS NORMAL PROGRAM EXECUTION: 25
THIS IS NORMAL PROGRAM EXECUTION: 26
THIS IS NORMAL PROGRAM EXECUTION: 27
THIS IS A CHOSEN INTEGER: 28
THIS IS NORMAL PROGRAM EXECUTION: 29
THIS IS NORMAL PROGRAM EXECUTION: 30

```

```

260 REM CONDITIONAL BRANCHING: MULTIPLE TASKS
270 DIM A(3),B(3),C(3)
280 FOR I=1 TO 3
290 READ A(I)
300 C(I)=I
310 DATA 3,7,11
320 NEXT I
330 FOR I=1 TO 15
340 B=A-I
350 B=B*C
360 GO TO SUM(B) OF 390,410,430
370 PRINT @P:"THIS IS NORMAL PROGRAM EXECUTION: ";I
380 GO TO 440
390 PRINT @P:"THIS IS BRANCH OPTION I -- ";I
400 GO TO 440
410 PRINT @P:"THIS IS BRANCH OPTION II -- ";I
420 GO TO 440
430 PRINT @P:"THIS IS BRANCH OPTION III -- ";I
440 NEXT I
450 END

```

```

THIS IS NORMAL PROGRAM EXECUTION: 1
THIS IS NORMAL PROGRAM EXECUTION: 2
THIS IS BRANCH OPTION I -- 3
THIS IS NORMAL PROGRAM EXECUTION: 4
THIS IS NORMAL PROGRAM EXECUTION: 5
THIS IS NORMAL PROGRAM EXECUTION: 6
THIS IS BRANCH OPTION II -- 7
THIS IS NORMAL PROGRAM EXECUTION: 8
THIS IS NORMAL PROGRAM EXECUTION: 9
THIS IS NORMAL PROGRAM EXECUTION: 10
THIS IS BRANCH OPTION III -- 11
THIS IS NORMAL PROGRAM EXECUTION: 12
THIS IS NORMAL PROGRAM EXECUTION: 13
THIS IS NORMAL PROGRAM EXECUTION: 14
THIS IS NORMAL PROGRAM EXECUTION: 15

```

## Group Open on a 4907 File Manager

by W. Budde

National Research Council Canada  
Ottawa, Canada

In my opinion the "Group Open" is a very powerful procedure for the handling of numerous data files but is inadequately treated in the 4907 manual. I thought everything between the Group-Open and Call "Next" commands would be done automatically with all files specified by the File Identifier. However, after experimenting for many hours with various commands, I found that the third, very necessary element in a Group-Open procedure is a "GO TO" statement directing control to the lines describing the action on the files. For example, in a series of lines such as

```
100 OPEN D$ "G";1,...
110 READ #1: A,B,C
|
|
200 CALL "NEXT",1,A$
```

a subsequent line must read:

```
210 GO TO 110
```

Without the GO TO statement, the 4050 will open the second file but then proceed to the subsequent program lines. The Call "Next" will not direct the action back to what was done with the first file of the set.

As an example, the enclosed program prints a Directory at an external peripheral without the intermediate use of a tape file. The essential lines for the Group-Open are 420, 520, and 560. Line 540 provides a tidy exit from the program rather than an exit by means of an error message.

The Directory Program needs some comments. This program prints only the file name (extracted in line 440) and the number

of used bytes (extracted in lines 460 and 480). It could easily be modified between lines 420 and 520 for additional information. A "full" directory lists all files from all libraries by means of the file identifier entered in line 180. In line 440, the LEN(R\$)-189 suppresses a line feed in the string.

Responding with "F" to the first question obtained the following directory.

The @-sign provides access to user libraries and the #-sign calls all files in those libraries. The #-sign by itself calls all files of only the Scratch library.

The directory contains files with data for silicon photodiodes. For a directory of specific libraries, a "P" would be entered first, and the file identifier entered as follows:

- (1) RESP\*  
for a listing of the RESP xxxx files of the Scratch library.
- (2) @MANUF#  
for a listing of all files in the user library "MANUF"
- (3) @MANUF/CEN#  
for a listing of all files in the sub-library "CEN" of the user library "MANUF"

```
100 REM **** DIRECTORY *****
120 PRINT "FULL OR PARTIAL DIRECTORY (F or P): ";
140 INPUT L$
160 IF L$="P" THEN 220
180 D$="@"
200 GO TO 260
220 PRINT "ENTER FILE-IDENTIFIER: ";
240 INPUT D$
260 PRINT "ENTER UNIT NUMBER: ";
280 INPUT U
300 CALL "UNIT",U
320 PRINT "ENTER PERIPHERAL NUMBER FOR TABLE: ";
340 INPUT P3
360 PRINT @P3:"_JFILENAME" LENGTHU
380 DELETE R$
400 DIM R$(300)
420 OPEN D$,"G",9,"R",R$
440 T$=SEG(R$,189,LEN(R$)-189)
460 L$=SEG(R$,83,9)
480 L=VAL(L$)
500 PRINT @P3: USING "30A,8D":T$;L
520 CALL "NEXT",9,R$
540 IF LEN(R$)=0 THEN 580
560 GO TO 440
580 END
```

FILENAME	LENGTH
SCRATCHLIB/RESP6090	846
SCRATCHLIB/RESP5090	846
SCRATCHLIB/RESP6043	846
SCRATCHLIB/RESP6033	846
SCRATCHLIB/RESP6023	846
SCRATCHLIB/RESP6013	846
SCRATCHLIB/RESP6101	846
SCRATCHLIB/RESP6001	846
MANUF/UDT/PIN6DP	875
MANUF/UDT/PIN10UV	875
MANUF/RCA/C30810B	875
MANUF/RCA/NR30842	875
MANUF/HAM/S640B	875
MANUF/HAM/G1117	875
MANUF/CEN/OSD1001	875
MANUF/CEN/OSD1002	875
MANUF/EGG/PV444	875
MANUF/EGG/UV444	875

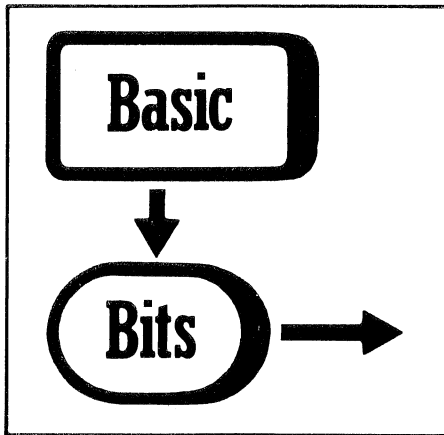

## Save Program on Correct Tape File

by Dr. De Ridder  
R.U.C.A.  
Afdeling Dierkunde  
Antwerpen, Belgium

An easy way to avoid erroneously erasing a tape file by saving a program over it is:

1. Always use a User-Definable Key to save your program on tape.
2. Let the first line of a program always be a REMARK statement containing a special code substring for that program such as "@R3@" (@ is the null character which normally wouldn't occur in a REMARK).

3. Use the following subroutine to save your program:

Comments: The constant I in line 5090 is set to the file number. The POS statement in line 5210 contains the string, with the code for the program. The subroutine first checks file I using the TYP (0) feature. If the file is empty or contains no data (EOF-mark at the beginning), the program is recorded in ASCII code (binary by changing 5260 to 5220 in line 5120). A file containing ASCII data or a binary character string is checked for the occurrence of the program code (@R3@ here).

If the same code is found, the program is recorded in ASCII or binary format, depending on the file type. Otherwise (binary numeric data or wrong code) an error message is sent to the screen and the program terminates without being saved (lines 5160 to 5180).

```

60 GO TO 5090

5090 I=3
5100 Q$=""
5110 FIND I
5120 GO TO TYP(0)+1 OF 5260,5260,5130,5160,5190
5130 INPUT @33:Q$
5140 GO TO 5250
5150 RETURN
5160 PRINT "_WRONG TAPE OR BINARY DATA-FILE :_IPROGRAM NOT RECORDED$$$"
5170 PRINT "_ICHECK YOUR TAPE OR KILL FILE ";I
5180 END
5190 READ @33:Q$
5200 REM === STRING "@...@" = TAPECODE
5210 GO TO (POS(Q$,"@R3@",1)>0)+1 OF 5160,5220
5220 FIND I
5230 CALL "BSAVE"
5240 RETURN
5250 GO TO (POS(Q$,"@R3@",1)>0)+1 OF 5160,5260
5260 FIND I
5270 SAVE
5280 RETURN
  
```

# IDD Program Exchange Is Here!

User Software Source  
for  
Tektronix IDD Graphics Systems  
4010-4020 Terminals  
4050 Desktop Computers  
4110 Terminals  
4110A Local Programmability

New name reflects expanded software collection.  
See details in New Abstracts section.

# IDD Program Exchange

The IDD Program Exchange is a central location of user software for Tektronix Graphics Display Products. As programs are received, they are collected into packages according to the product they support. The packages are available to all uses through exchanges for program contributions or for a nominal charge.

## Program Contributions

Contribute one program to the Applications Library and receive the package of your choice in exchange. To receive documentation instructions and forms, contact the Program Exchange serving your area. In the U.S., you may TWX: 910-467-8708 or TLX: 15-1754.

## U.S. Orders

Order IDD Program Exchange packages through the toll-free number of Tektronix Central Parts Ordering. The following map delineates the geographical regions and the toll-free number serving each region.

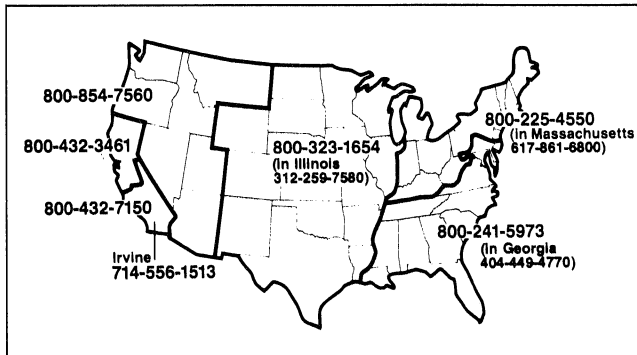

Call the number serving your area and give the customer service representative the nine-digit part number and name of the Program Exchange package you wish. If you have any questions, call your local Tektronix Field Office. The field office has the current prices. (Note: The minimum acceptable Tektronix order is \$25.00.)

## Orders Outside U.S.

To order a copy of the catalog, or to order a package, contact the local Tektronix sales office or the Program Exchange serving your area. See Program Exchange Addresses section of *TEKniques*.

## 4000 Series Graphics Terminals

The 4010, 4020 and 4100 Series programs are packaged and nomenclated with the appropriate prefix and disk number.

Each package includes media with the source code together with the supporting documentation; listings are not included. Documentation may be purchased separately.

A 4000 Series catalog will be published when a sufficient number of packages are collected.

Package Title	Documentation Part #	Package Part #
4110 LP Program Exchange		
Disk 1.....	062-6955-00	..... 062-6955-01

## 4050 Series Desktop Computers

The 4050 Series programs included in the IDD Program Exchange prior to September 1981 are packaged and nomenclated by function. Those programs accepted after September 1981 are packaged and nomenclated with the Volume and Number of the corresponding issue of *TEKniques* in which the package was announced.

Each package includes the source code on tape or disk (T=tape; D=disk) together with the supporting documentation; listings are not included. Documentation may be purchased separately.

The 4050 Series IDD Program Exchange catalog contains the abstracts describing the programs in each package along with representative output in most cases. The catalog part number is 062-6343-00.

Package Title	Documentation Part #	Package Part #
Business Aids T1 .....	062-5987-00	..... 062-5987-01
Business Aids T2 .....	062-5988-00	..... 062-5988-01
CAD T1 .....	062-5976-00	..... 069-5976-01
CAD D1 .....	062-5977-00	..... 062-5977-01
Character Generator T1 .....	062-5951-00	..... 062-5951-01
Education/Research T1 .....	062-5982-00	..... 062-5982-01
Education/Research T2 .....	062-5983-00	..... 062-5983-01
Electrical Engineering T1 .....	062-5978-00	..... 062-5978-01
Graphing T1 .....	062-5964-00	..... 062-5964-01
Graphing T2 .....	062-5965-00	..... 062-5965-01
Graphing T3 .....	062-5966-00	..... 062-5966-01
Graphing D1 .....	062-5967-00	..... 062-5967-01
Graphing D2 .....	062-5968-00	..... 062-5968-01
Interfacing T1 .....	062-5984-00	..... 062-5984-01
Mapping T1 .....	062-5980-00	..... 062-5980-01
Mechanical Engineering T1 .....	062-5979-00	..... 062-5979-01
Programming Aids T1 .....	062-5971-00	..... 062-5971-01
Programming Aids T2 .....	062-5972-00	..... 062-5972-01
Project Aids T1 .....	062-5985-00	..... 062-5985-01
Project Aids D1 .....	062-5986-00	..... 062-5986-01
Recreational Plots T1 .....	062-5989-00	..... 062-5989-01
Slidemaker T1 .....	062-5962-00	..... 062-5962-01
Slidemaker D1 .....	062-5963-00	..... 062-5963-01
Text Processing T1 .....	062-5969-00	..... 062-5969-01
Text Processing D1 .....	062-5970-00	..... 062-5970-01
Utilities T1 .....	062-5974-00	..... 062-5974-01
Utilities D1 .....	062-5975-00	..... 062-5975-01
Tekniques Vol. 5 No. 4 T1 .....	062-5981-00	..... 062-5981-01
Tekniques Vol. 6 No. 1 T1 .....	062-6443-00	..... 062-6443-01
Tekniques Vol. 6 No. 1 D1 .....	062-6442-00	..... 062-6442-01
Tekniques Vol. 6 No. 2 D1 .....	062-6515-00	..... 062-6515-01
Tekniques Vol. 6 No. 3 D1 .....	062-6516-00	..... 062-6516-01
Tekniques Vol. 6 No. 3 T1 .....	062-6514-00	..... 062-6514-01
Tekniques Vol. 6 No. 4 T1 .....	062-6704-00	..... 062-6704-01
Tekniques Vol. 7 No. 1 D1 .....	062-6715-00	..... 062-6715-01

## Software Support Category C

The program material contained herein is supplied without warranty of any kind, and without any representation regarding quality, performance or suitability. TEKTRONIX specifically disclaims any implied warranties of merchantability of fitness for a particular purpose. Software support is TEKTRONIX Category C: Software is provided on an "as is" basis.

## TEKniques Vol. 7 No. 1 D1

### Part #062-6715-01

TEKniques Vol. 7 No. 1 D1 disk consists of six 4050 Series programs: one CAD, one Project Aids, and four Utility. The individual abstracts describe the programs.

#### Program 1

**Title: PICTURE30**

Authors: J.A. Loughran  
A.J. Yerman  
General Electric Company  
Schenectady, NY

Memory Requirement: 4054/Opt. 30  
w/64K

Peripherals: 4052R11 Character Generator  
ROM  
4952 Joystick, Opt. 2  
4907 File Manager  
4663 Plotter\*  
4956 Graphics Tablet  
\*Optional - 4662 Plotter (with  
program changes)

Files: 1 Program  
10 Binary Data (demo pictures)  
Statements: 1891

PICTURE30 is a simple but very capable interactive picture composition program. It uses short, sensible, and easy-to-learn mnemonic keyboard entry commands. The program uses the joystick (or thumbwheels) or optionally, the graphics tablet, to define and manipulate six primitive objects. The combination allows the user to create elementary to complex "pictures": sketches, diagrams, drawings, space layouts, flowcharts, electronic schematics, etc. Stored automatically on the 4907 disk as they are created, most of these pictures can then become additional objects for inclusion in subsequent pictures. The program makes extensive use of the 4054 Dynamic Graphics Option 30. It also uses the 4052R11 Character Generator ROM Pack for enhanced text and refresh graphics capabilities.

The primitive objects generated are lines, labels, crosshatch, arrows, circles, and a particularly versatile one broadly called "polygon." Once created, most pictures can become an additional object available for inclusion into another, new picture. By subdividing an elaborate picture into a group of related, individual overlays reduces access time to the picture elements and provides the opportunity to change plotter pen colors between overlays.

#### Program 2

**Title: EDITPROG**

Author: John Harms  
Tektronix, Inc.  
Wilsonville, OR

Memory Requirement: 8K  
Peripherals: 4907 File Manager  
Files: 2 Program  
Statements: 134

This program will take any number of 4907 host binary files and perform string replacement. For example, a disk with 50 program files can be easily edited. EDITPROG will allow you to change every occurrence of "FOO" to "FUMP", "CAT" to "KITTEN", "A\$" to "B\$", and/or any other combination of strings.

The filenames are specified by a list in DATA statements, and each name may include wildcard characters. The report that lists each change can be optionally directed to a printer.

The user interface has been left unstructured to allow a programmer to easily change the program for other purposes (e.g., listing all occurrences of a string, etc.). Internal program documentation is in SUPERLIST format (see TEKniques Vol. 6, No. 2 D1).

Restriction: Program line numbers must be less than 65000.

#### Program 3

**Title: Production Capacity Forecasting Model**

Authors: Leonard Weitman  
Mark Lyman  
Tektronix, Inc.  
Vancouver, WA

Memory Requirement: 4052/4, 32K  
(see note below)

Peripherals: 4907 File Manager (dual)  
4643 Printer

Files: 8 Program  
6 data & 2 program - examples

Statements: 1661

The Capacity Forecast Model informs production managers and engineers of maximum production capacities within a production area. The mathematical model is based on the interaction of process yields, processing times, and machine use rates with the forecasted market demand for the products manufactured in the area. The results generated by the model answer such questions as:

- Where are possible bottlenecks in the production line?
- What equipment will be needed to meet the forecasted production requirements?
- When will this equipment be needed?
- How much additional space will be required?

The program is an integrated system of modules performing three main functions:

- 1) Data storage - lets the user create a data base containing the information needed for running the model.
- 2) Data file management - aids in the manipulation of data files. Files may be listed, updated, or deleted.
- 3) Calculate/list production capacities - draws information from the data files and calculates the results. The listing routine outputs the results in a clear, meaningful manner.

NOTE: A few statements setting character size won't work on 4052.

#### Program 4

**Title: 4907 Multiple Volume Directory Lister**

Author: Frits Handgraaf  
Tektronix, Inc.  
Europe

Memory Requirement: 32K  
Peripherals: 4907 File Manager (dual)  
Optional - 4641/3 Printer

Files: 5 Program  
1 Data  
Requires pre-MARKed data tape file  
Statements: 841

The program provides a data base of directories of different volumes of disks on one disk. In addition to the 4907 directory output, the program offers the ability to specify parts of the directory information (items) to be output in any order. The first program REMARK statement may be included in the output (as an extra item, provided it was specified with the CREATE function). All items may be sorted in ascending or descending order with the sort-key setting. The following functions are provided:

1. *List created volume directory files*  
Information is stored in two files, one contains the directory of the volume, the second contains the volume label, number of files and a flag indicating whether the first REMARK statement is included. Output may be to a specified output device.
2. *Create volume directory file*  
Stores the volume directories on the system disk, using the internal tape as an interim step, allowing the user to specify the first REMARK statement line to be included.
3. *Sort volume directory file*  
Provides a butterfly sort of the volume directory file using specified key settings in either ascending or descending order. The array and sorted information may be saved on the disk.
4. *Output volume directory file*  
Output of the directory (sorted or not sorted) in a format defined by the user to a specified device address.

## Program 5

### Title: Local Language Translator

Author: Ruud Borstel  
Tektronix, Inc.  
Europe

Memory Requirement: 32K  
Peripherals: 4907 File Manager (dual)  
Optional - 4641/3 Printer

Files: 2 Program  
Statements: 252

Local language translator is an aid in changing the human interface (including screen messages and prompts) from the original language (in most cases English) into a local, other language.

The program offers two modes:

1. Reporting screen messages and prompts of all quoted parts via hard copy or printer.
2. Interactive changing of text strings and reporting the changes made.

NOTE: The original files to be translated must be ASCII files. The documentation contains a utility to convert host binary files to ASCII files.

## Program 6

### Title: DOC1

Author: John McCrory, Jr.  
USDA Forest Service  
Columbia, MO

Memory Requirement: 64K  
Peripherals: 4907 File Manager (dual)  
Optional 4641/3 Printer

Files: 1 Program/1 Data  
5 Data (examples)  
Statements: 193

Based on the five level hierarchy of the 4907 File Manager, DOC1 maintains an inventory of tape/disks, their files, and documentation pertaining thereto.

A Table of Contents file contains all the first two-level libraries under which the Documentation files will be found. Each Documentation file is stored under a user-specified five level name. It contains four sequential strings:

program name (30)

tape or disk volume # and file # (72)

short description of program (72)

location of documentation (72)

The program allows data entry into the Table of Contents file and creation and data entry into the Documentation file, or a listing of any or all.

---

## 4110 LP Program Exchange

### Disk 1

#### Part #062-6955-01

The 4110 LP Program Exchange Disk 1 is the first collection of programs for the 4110A Series Local Programmability. Although the disk is shipped with the Local Programmability product, it is updated periodically with new programs. Thus, the current release is made available in the Program Exchange. As the updates occur, abstracts describing them will be published in *TEKniques*.

## Programs 1-16

### Title: 4110 LP Program Exchange Disk 1, Release 1.1

Authors: GSP Engineering  
Tektronix, Inc.  
Wilsonville, OR

Equipment: 411XA  
Memory Requirement: 256K  
Files: 24  
Files Space: 310K

Program Exchange Disk 1 is a collection of utility type programs which extend the power of CP/M-86<sup>®</sup> as implemented on Tektronix 4110A Series terminals. The programs are either self-documenting in their execution or have a documentation/tutorial file on the disk.

<u>Program</u>	<u>Function</u>
ATR	Set file attributes.
BDOS	Operating System interface library for FORTRAN-86.
*DRIPO	DRI Assembler Post-Processor.
EMACS	Text Editor for refresh terminals.
*EXD	Extracts comments from source code to facilitate documentation.
FILCOM	Line-by-line text file comparison.
FILSPY	Hex dump and byte modify of a file.
GREP	Text string search.
*ITS	Date and time.
MDRIVE	In-memory pseudo disk drive.
OLDFETCH	Converts 4110 file structure to CP/M structure.
PAT	Color pattern program for 4113.
QB	Quick batch.
*SDFC	Single drive file copy.
TECO	Text editor for storage terminals and refresh terminals.
TOD	Date and time.

\*Files included in release 1.1 that weren't in release 1.0.

Note: CP/M-86 is a registered trademark of Digital Research, Inc.

# IDD Program Exchange

## Africa, Europe, Middle East

Contact local sales office

## Australia

IDD Program Exchange  
Tektronix Australia Pty. Limited  
Sydney  
80 Waterloo Road  
North Ryde, N.S.W. 2113

## Canada

IDD Program Exchange  
Tektronix Canada Ltd.  
P.O. Box 6500  
Barrie, Ontario  
Canada L4M 4V3

## Caribbean, Latin America and Far East (excl. Japan)

IDD Group  
Export Marketing  
Tektronix, Inc.  
P.O. Box 500  
Beaverton, Oregon 97077  
U.S.A.

## Japan

IDD Program Exchange  
Sony/Tektronix Corporation  
9-31 Kitashinagawa-5  
Tokyo 141 Japan

## United States

IDD Program Exchange  
Tektronix, Inc.  
Mail Stop 63-575  
P.O. Box 1000  
Wilsonville, Oregon 97070

Address Correction Requestion — Forwarding and Return Postage Guaranteed.

TEKTRONIX, INC.  
Information Display Division  
Tekniques  
Mail Stop 63-575  
P.O. Box 1000  
Wilsonville, Oregon 97070

**Tektronix**  
COMMITTED TO EXCELLENCE

TEKTRONIX, INC.

BULK RATE  
U.S. POSTAGE  
**PAID**